

XH
.0851

vol. 9
1909

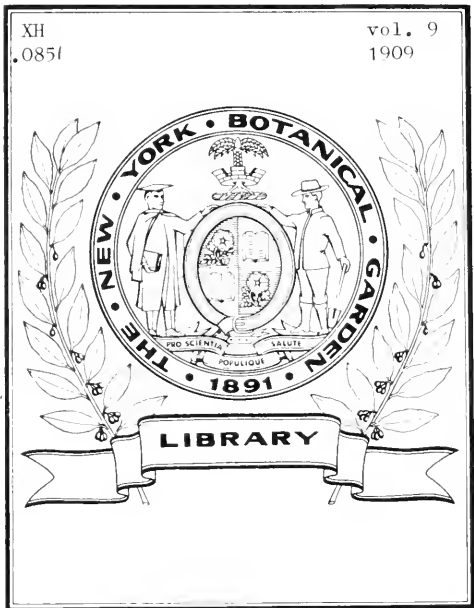

HORTICULTURE

INDEX TO VOL. IX.

Illustrated articles are marked with a *

A	Page		Page		Page
Accidental shooting.....	297	*April herbaceous border.....	689	Campanula:—(Continued)	
Adiantum Farleyense.....	553, 559	*Arabis alba.....	766	—Some novelties of double and semi-double.....	391
After adjournment.....	209, 281, 593	*Arbor-vitae monumentalis.....	631	Canadian Horticultural Association.....	101
Albany:		Arnold Arboretum, Notes from the 761, 739, 829, 863, 895.		*Carnations.....	93
—*Decorations at State Capitol.....	109	Art in the garden.....	527, 589	*Aristocrat.....	139
—Florists' club.....	210, 402c	*Asmus, George.....	68	—At Joliet, Ill.....	698
—Notes.....	643	Asparagus plumosus, Culture of.....	494	—Behavior of Lawson.....	209
—Personals.....	357	Assignment, An.....	71, 505	*Dorothy Gordon; House of Dorothy Gordon.....	141
American Association of Horticultural Inspectors.....	320	A tender appreciation.....	633	—Grower, What the experiment stations are doing for the.....	496
American Association of Nurserymen:				—I have known and their elevating influence.....	174
—*Program.....	800			*In the west.....	139
—*Annual convention; Election of officers.....	832	B		*Lucille.....	364c
—The exhibition.....	852	Baltimore, Gardeners' and Florists' Club of.....	139, 211, 282, 361, 561, 696	*Mrs. Chas. Knopf.....	107
—*At Highland Park.....	857	Bankruptcy, In.....	187, 222, 261, 299, 330	*Mrs. J. C. Vaughan.....	103
—Smoker.....	865	*Barbadoes, An American rival to.....	5	*Niagara.....	142
—*Visiting nurserymen among the rhododendrons.....	865	*Bar Harbor Horticultural Society.....	319	—Pearson's Pink.....	*171, *273
—Nurserymen's Protective Association.....	865	*Bernard, H. A.....	402a	—Selection and cross fertilization of the.....	500
American Association of Park Superintendents.....	402c	*Barron, Leonard.....	395	*Shasta.....	631
American Association of Railroad Gardeners.....	248	*Barry, Wm. C.....	800	—Some interesting.....	78
American Carnation Society.....	39	*Baur, A. F. J.....	101	*Splendor, House of.....	139
—*Program; Officers for 1908-09.....	100	Bedding plant time, Preparing for.....	364d	—Up-to-date.....	498
—Chicago carnation show.....	102	Begonia Gloire de Lorraine.....	*61, 65	*White Enchantress, House of.....	139
—Annual convention; President's address; Treasurer's report; Secretary's report.....	140	Berlin, International Horticultural exhibition in.....	425	*William Taft.....	209
—List of awards.....	141	*Beu, F., Establishment and residence of.....	121	*Catasetum maculatum.....	425
—Election of officers.....	143	*Bisset, Peter.....	154	*Cattleyas in California.....	725
—Banquet.....	*165, 172	Boston:		*Luddemanniana alba.....	389
—Convention report concluded.....	172	—Another market show.....	318	*Mossiae.....	767
—*View in exhibition hall.....	173	—Co-operative Flower Market exhibition.....	*358, 409, *432	Catalogues received.....	12, 44, 76, 116, 148, 216, 220, 256, 292, 404, 457, 492, 536, 615, 636, 668, 670, 738, 774, 806, 837, 902.
—Secretary's office transferred.....	328	—Gardeners' and Florists' Club of.....	70, 104, 212, 247, 364d, 402a, 472, 594, 730, 864.	*Cement bench construction.....	479
Amaryllis, A good.....	241	—Gardener, Seasonable observations by a.....	863	*Central Park, Davenport, Ia., Conservatories at.....	668
*Johnson.....	693	—Market Show.....	103, *246	Chaste, H. B.....	832
American landscape architecture.....	478	*Michell prize.....	247	Chesnut tree fungus.....	772
American Peony Society.....	*902, 906	—List of awards.....	316	Chicago carnation show.....	37
—*Address of President Ward; Secretary's report.....	866	*Views at exhibition.....	317	—Florist Club.....	68, 210, 364a, 529, 696, 834.
American pomological meeting.....	664	—Orchid exhibition in 1910 at.....	393	—Notes.....	562, 629, 684, 704, 741, 772, 809, 841, 873, 904.
American Rose Society.....	40, 144, 899	*Public Garden.....	768	—Plant notes.....	183
—Exhibition at Buffalo.....	211	—Spring Show at.....	393	—Street trees.....	700
—Committee meeting.....	282	—Japanese garden at.....	421, *473, *475	*Chondrychna fimbriata.....	693
—*Program.....	352	—Closing events of the.....	529	Chrysanthemum, The.....	663
*Troquois Hotel.....	352	—What the U. S. census says about.....	284	—Edith de Clausonne.....	107
—Annual meeting; President's address.....	394	Bougainvillea lateritia.....	107	Chrysanthemum Society of America. Report of new chrysanthemums, 1908.....	250
—Secretary's report; Treasurer's report.....	395	*Brasso-cattleya Susannae.....	469	—Announcement by President Smith.....	628, 696
—Election of officers; The exhibition.....	396	*Bretmeyer, Philip.....	354	—Boom the.....	736
—Buffalo's feast.....	429	British horticulture.....	243, 351, 427, 591, 661, 797.	(Cincinnati) and the S. A. F. convention.....	833
—Gold medal fund.....	764	*Brown, Charles J.....	800	—Florists' Society.....	105, 360, 730, 864
American Seed Trade Association.....	148, 806	*Brucker, E. C.....	355	—Cineraria stellata.....	521
—President's address; Officers elected.....	896	Buffalo, McKinley Day in.....	171	Clarkias as spring bedders.....	882
—Aemone species and varieties.....	769	—Florists' Club.....	355, 429	Cleveland Florists' Club.....	42
Anniversary and congratulation, An.....	776	Burbank, A stunt for.....	177	*Cloudsley, J. R.....	355
*Another valuable device.....	42	Business changes.....	25, 47, 78, 123, 146, 187, 223, 258, 299, 330, 358, 417, 457, 505, 541, 575, 607, 641, 673, 706, 777, 808, 852, 870, 897, 914.	Club and Society notes. (See also During Recess).....	9, 42, 70, 105, 146, 177, 212, 254, 283, 322, 364a, 402c, 430, 472, 529, 596, 629, 664, 698, 742, 764, 803, 835, 870, 900.
Anthurium, Leaf cuttings of.....	107	Business troubles.....	706	Concolor, or silver fir of the Rockies.....	471
Apples in New England.....	668	C			
—The Florianer Rose.....	394	Cactus, A modern method of grafting.....	734		
Appliance, A valuable.....	486	*Calceolaria, New hybrid.....	893		
Appraiser's decisions.....	71, 111	Caledonian Horticultural Society.....	177		
*Aquatic pool in a "French Garden".....	620	*Campanula persicifolia Moerhousii.....	885		
		—*Glomerata.....	525		

HORTICULTURE

Connecticut Horticultural Society	Page	Editorials:—(Continued)	Page
68, 176, 249, 322, 402b, 472, 528,		—A Word to the American Carnation Society; Blooming the apple.	98
628, 803, 868.		—Policy versus principle.	99
Comparison, An interesting.	503	—The carnation meeting: Utilizing vacant space; Vilifying an American industry.	138
Comical situation, A.	562	—Window publicity; Hoosier hospitality; Size versus daintiness.	170
*Cowell, J. F.	355	—A great event for 1910: Boston Flower Market exhibition: The safer course.	208
Crassula coccinea, syn. Kalosanthes coccinea.	893	—A fascinating innovation: Florists and the experiment stations; A successful exploring expedition.	214
Curbs: one-buyer to curbstone peddler. From.	393	—Time for a forward movement; Safeguards: Education by precept and practice.	280
Cyanide of sodium, About.	356	—Sizing up a new rose: Impressing the public: Some Dutch bulb observations.	314
*Cyclamen Group of.	309	—The call to Buffalo: The garden rose problem; About the "Formosa" lily.	350
*Cypripedium Ursula.	277	—Owning a home: "Let us reason together": A suggestion for the rose hybridizer.	392
D		—An opportune gift: Still they come: A new feature in horticultural exhibitions.	426
Dahlia Imperialis.	281	—Boston warns up; Easter greeting: A success and its lesson.	479
*Daillouze, Eugene.	38	—Gardening on natural lines: Keep up your advertising: Our cover illustration: Organizations multiplying.	526
Davallias.	590	—"Circumstances alter cases": Time for all to wake up; Looking backward as an aid to looking forward.	558
—"Fijensis."	461	—The call of duty: Boston in 1920, perhaps: The rose and its advancement: The cement greenhouse bench.	632
—Specimen.	801, 882	—The hippocastemum for florists' use; The rose breeders' double chance; After the explosion.	626
Dayton Florist Club.	728	—A society and a duty: What "pure seed" means: Change of policy at the Bussey Institution.	662
*Deitrich, Jacob.	362	—A cloud on the horizon: "Mothers' Day" and the florist: Six long days a week enough.	694
Dendrobium superbum Dearei.	657, 661	—Mr. Rehder returns: Memorial Day possibilities: The salesman's ally; The outlook for the nurserymen.	726
Denison park, Improvements at.	700	—A forecast for June: The congestion problem: Inadequate methods of distribution.	762
Detroit, Carnation show at.	212	—The hail section: Relaxation well earned: A manifest injustice.	798
—Florist Club.	250, 322, 360, 402b, 472.	—A promising innovation: The call to duty; Magnesium as a plant food.	830
—Notes.	740	—The peony at its best: Price cutting and price regulating.	862
—Nursery trade.	709	—Another mile stone: An eminent house: A privilege and a recompense.	894
Dianthus Napoleon III.	870	Albion Horticultural Society.	250, 364c
*Digitalis gloxiniflora.	237	Elm Court Farm club room.	71
—"Lanata."	241	Employers' Association of Landscape Foresters and Commercial Entomologists.	528
Dobbs Ferry Horticultural Association.	364a, 596	Engelmann Botanical Club.	561, 728, 870
*Duke estate, Entrance and lodge.	1	Epsom salts as a fertilizer.	884
*Dumas, J. L.	282	Erenurus, The.	703
During recess.	49, 70, 430, 484, 645, 870.	—"Robustus."	757
—Morris County Gardeners' and Florists' Society; Tarrytown Horticultural Society.	106	Establishment, A new plant.	593
—New York and New Jersey Plant Growers' Association; Nassau County Horticultural Society.	175	European horticulture.	99, 137, 169, 207, 277, 315, 390, 467, 525, 559, 625, 763, 895.
—French Gardeners in London; Newport Horticultural Society.	212	Exchanges, Our.	67
—North Shore Horticultural Society; St. Paul vs. Minneapolis.	213	Experiment stations, Our.	288
—Fun in Prospect at Philadelphia; A good time at Minneapolis; Albany Florists' Club; "Last Call for Dinner."	284	Explosion, Destructive.	652
—New York Florists' Club.	341		
—Greek American Florists' Association.	358		
—Lenox Horticultural Society.	402d		
—Gardeners' and Florists' Club of Boston; Chicago Florists' Club; Bowling Records.	539		
—Gardeners' and Florists' Club of Boston.	583c		
—Florists' Club of Washington; St. Paul vs. Minneapolis.	596		
—Buffalo Florists' Club; New Orleans Horticultural Society.	898		
—Ye Whimsical Sayings of H. A. B.	752		
E			
*East-p, 1909.	461		
—Birds.	562		
—Plants, Notes on.	436		
—Plants in Chicago.	438		
—Trade reports.	568		
Eastern Branch of American Association of Park Superintendents.	321, 590, 900		
Editorials:			
—1909; Seed catalogues; Cereus giganteus no more.	6		
—Useful hints: Worthy of imitation: Christmas trees and the forests.	36		
—Support the S. A. F.; Chrysanthemums from seed: The flower market.	66		
		F	
		*Faronwald, A.	354
		*Farr, B. H.	900
		Feeding the crops.	251, 286
		Fine record.	106, 148, 189, 217, 254, 260, 324, 364c, 407, 457, 714.
		*Fisher, Peter.	101
		Florist robbed, A.	675
		*Floricultural education.	35
		*Florists' Hall Association.	71, 754, 802
		Flower market reports.	10, 15, 17, 24, 49, 51, 81, 83, 121, 123, 153, 155, 189, 191, 225, 227, 261, 263, 267, 299, 333, 335, 373, 375, 409, 411, 447, 449, 507, 509, 541, 543, 606, 609, 643, 645, 675, 677, 707, 719, 743, 745, 749, 781, 786, 811, 813, 843, 845, 875, 907, 909, 914.
		Foxgloves.	241
		French bulbs higher.	852
		French Chrysanthemum Society.	561
		Fruit trees under glass.	146
		Fulfillment of a prophecy, The.	772
		G	
		Gardeners, Movements of.	49, 387, 417, 529, 607, 695, 752, 772.
		Garden Life Yearbook.	700
		Gardenia, Culture of the.	364d
		Gardening World, The.	695
		*Geraniums, Single.	33
		Ghent Horticultural Society.	177
		Giganteums in bloom by March.	29, 1910.
		Glass, Tariff on greenhouse.	562
		—Greenhouse drops in tariff schedule.	889
		Godetia Schamini fl. pl.	468
		*Goodale, Prof., resigns chair at Harvard.	627
		*Greene, Fred C.	633
		Greenhouses building or contemplating.	58, 72, 128, 198, 234, 270, 306, 342, 368, 418, 457, 486, 532, 543, 586d, 615, 651, 665, 715, 738, 751, 819, 850, 886, 915.
		—Heavy snow wrecks.	290
		—Tussar roof in the gale.	665
		*Gude, William F.	106
		H	
		*Hammond, Benjamin.	353
		Handy handle, The.	258
		Hardy perennials and their various uses.	702, 731, *766
		Harrisburg bulbs after blooming.	836
		Care of.	836
		*Harvard Botanical Garden, Spring holding at.	721
		*Herr, A. M.	101, 133
		Hilfinger Bros. flower pot manufactory.	262
		Hill, E. Garney.	354
		*Hollob, C. M.	891
		Holiday mishaps.	47
		Horticultural editors wanted.	293
		Horticulture in the ascendant.	750
		—In the newspapers.	469
		Horbeds, About.	217
		—House of flowers.	695
		*Hukriede, Fred.	102
		Huntington Horticultural and Agricultural Society.	282, 362, 899
		Hybridization, Lonsdale on.	71
		Hydrocyanic acid gas, Fumigating with.	143
		I	
		Illinois State Florist Association.	248, 282, 322
		Incorporated.	45, 76, 119, 121, 222, 290, 328, 373, 418, 457, 509, 536, 573, 607, 673, 709, 745, 772, 806, 837, 870.
		Indiana, State Florists' Association of.	402c
		—"Cup."	103

HORTICULTURE

Indianapolis notes.....	883	News notes.....	39, 47, 51, 72, 83, 106, 117, 119, 151, 155, 180, 187, 191, 223, 268, 292, 294, 297, 328, 342, 364b, 396, 381, 411, 436, 456, 481, 516, 539, 570, 573, 575, 605, 609, 640, 643, 663, 666, 668, 716, 736, 741, 743, 745, 765, 774, 777, 801, 818, 852, 882, 904.
In Memoriam.....	663	New York Christmas report.....	19
Interesting decision. An.....	404	—Easter cut flower market; Plant market.....	508
Ivy, Mexican.....	137	—Florists' Club.....	*69, 145, 211, 283, 341, *369, 430, 569, 664, 666, 867
J		—Horticultural Society of 176, 764, 833	
*Japan, Florists' window decoration in.....	177	—Retail Florists' Protective Association of.....	393
*Junge, H.....	102	—and New Jersey Association of Plant Growers.....	429
K		*Nicholson, William.....	191
Kansas Horticultural Society.....	39	North Shore Horticultural Society.....	*42, 283, *321, 361, 430, 664
*Kasting, W. F.....	353	Northern Westchester County Horticultural and Agricultural Society.....	177, 899
*Kessler, P. F.....	70	Nursery concern, A new.....	531
Kew, Improvements at.....	625	—Inspection in New York.....	627
L		—Notes.....	772
Lawn making.....	45	O	
Lenox Horticultural Society.....	69, 302a, 561, 864.	Obituaries:	
Library Notes.....	110	—Allen, Charles L., *765; Amling, Mrs. G., 663; Andre, J. E., 829; Andross, W. F., 835; Annesley, Lord, 198; Anthony, Jos., 616; Ashley, Fred, 214.	
Lilium formosum.....	391, 471	—Baker, W., 568c; Ball, H. J., 7; Baxter, L. B., 663; Bassett, Mrs. O. P., 695; Baudry, H. W., 402d; Bearn, David, 245; Bennett, G. D., 663; Boland, J. B., 534; Bramley, Chas., Sr., 323; Brenneman, S. S., 79; Burnham, George, 70.	
—More about.....	527	—Card, M. P., 663; Cassidy, John, 765; Chase, W. D., 882; Clark, A. E., 43; Cobb, Mrs. T. D., 914; Cookson, N. C., 829; Cooper, W. F., 49; Cordes, Charles, 49; Corneli, Mrs. M. M., 829; Cragg, Robert, 634; Crane, J. W., 108.	
*Lily lake.....	825	—Dale, Edw., 483; Dallas, John, 685; Daly, E. F., 568c; Debby, W. H., 534; Dickson, G. A., 323; Doyle, Mrs. W. E., 483; Dreyer, H., 634, 663; Dus, J., 245.	
Liriodendron chinensis.....	107	—Earl, G. W., 829; Elton, E. T., Jr., 214.	
Lord & Burnham Company to open a Chicago office.....	615	—Findley, William, *245; Frazer, Dr. Persifor, 568c; Freytag, W., 568c; Friedlander, J., 829; Frost, Adolph, 645.	
Los Angeles Florist Club.....	*177, *362	—Galvin, Mrs. John, 752; Gates, L. A., 402d; Germain, E., 323; Gibbs, T. K., 108; Gill, Edw., 483; Griffin, M., 79; Griffith, John, 214.	
*Lyuch, P. J.....	364	—Hagenmann, William, 534; Hallock, E. V., *233, 364b; Haskins, J. S., 402d; Hauswirth, Mrs. M. C., 433; Hemler, George, 285; Henderson, W. H., 616; Hennessy, Edw., 663; Henry, John, 151; Hersey, Edmund, 829; Hess, H., 151; Hersey, Hexamer, Dr. F. M., 835; Hilton, C. F., 765; Hogg, W. S., 634; Huss, Mrs. J. F., 695.	
M		—Jones, A. S., 151; Jorns, M. J., 765.	
Madison (N. J.) notes.....	335	—Kachert, Chas. Jr., 49; Keneck, P., 178; Kennedy, Thos., 663; Kent, J. J., 616; Klingenberg, Mrs. A., 178; Krick, W. C., 214.	
Maine law affecting nurserymen.....	581	—Lawlor, P., 402d; Lee, Dennis, 7; Lent, John, 568c; Lyons, Mrs. Mary, 178.	
*Maloy, C. J.....	801	—Madison, W. B., 483; Malone, R. A., 364b; Marshall, S. W., 663; McClements, Mrs. Margaret, 49; McBride, Jas., 108; Mellen, Mrs. T. C., 214; Mellor, A., 108; Metz, J., 364b; Mieliez, A., 568c; Montgomery, J. T., 70; Morris, G. F., 178; Munroe, W. A., 214; Myers, H., 214.	
Marchioness orders.....	42	—Newell, Alex., 7.	
Marquette greenhouses sold.....	42	*Nussbaumer, J. J., 882.	
Massachusetts Agricultural College.....	111, 184, 318, 400	—O'Neill, J. B., 364b.	
—Forestry at.....	736	—Paine, L. E., 79; P.	
—*Short course class at.....	481	—Parker, Helen, C., 534.	
Massachusetts Horticultural Society.....	105, 210, 318, 402, 764, 834, 898.	—Raeder, Mary, L., 157; R.	
—Annual meeting; standing committees.....	41	534; Reckhard, A., 49; R.	
—Exhibition notes.....	464	A., 634; Reimels, Mrs. W.	
—Free lectures.....	8	Righter, J. H., 214; Rissel, L. J.	
—Great orchid exhibition.....	212	Rodriguez, B., 568c; Rohn, Mrs. G. A., 402d; Rossow, J. C., 695.	
—Spring show.....	431	—Sanders, Carew, 79; Schnidder, J.	
May.....	698	365; Schroeter, A. C., 695; S.	
*May, Harry O.....	353	John, *416; Shellen, J. A., 663; S.	
Men who win, The.....	171	monito, Benjamin, 634; Smith, Mrs. H. H., 695; Smith, H. C., 534; Smith, Robt., 70; Smith, S. L., 79; Small, J. H., Sr., *245; Sonderman, J., 568c; Stroud, Mrs. J. D., 914.	
*Miller greenhouses, wreck of.....	665	—Terry, H. A., 285; Thompson, Paul, 257; Thorburn, Grant, 695.	
Minneapolis parks, To extend and improve.....	636	—Udell, F., 663.	
Minnesota State Florists' Association.....	39, 144, 318, 428, 595, 764.	—Von Asche, A., 245.	
Monkshood.....	391	—Waldbart, G. T., 829; Weber, E., 483; Weaver, G. A., 151; Wildpret, H. J., 178; Wythis, Mrs. G., 323.	
*Monstera deliciosa.....	7	—Yeuell, Mrs. E. R., 433.	
Morris County Gardeners' and Florists' Society.....	106, 249, 402a, 595, 728, 898.	—Zuber, Chas., 882.	
Moth fight, Harvard takes up.....	683	P	
N		Pacific coast notes.....	339
Nassau County Horticultural Society.....	104, 248, 402b, 594, 728, 868	*Palmer, W. J.....	355
National Chrysanthemum Society.....	37	*Papaver nudicale.....	537
—Dahlia Society.....	729	Park commissioner for Boston, New.....	474
—Horticultural Society of France.....	561, 697	Pasadena Gardeners' and Florists' Association.....	40, 594
—Sweet Pea Society of England.....	253, 736	Patents granted.....	72, 111, 143, 197, 233, 269, 291, 342, 418, 457, 486, 561, 617, 636, 683, 788, 818, 915.
Nebraska Horticultural Society.....	145	*Patten, M. A.....	100
New England Dahlia Society.....	528	Pennsylvania Horticultural Society.....	105, 249, 402b, 595, 728, 803, 834, 864, 900.
New England fruit show, A proposed.....	364b, 668	—State Horticultural Association.....	145
New Haven County Horticultural Society.....	104, 176	Penstemons.....	313
New Jersey Horticultural Society.....	68, 248, 402b, 561, 729, 898	—The Florists'.....	389
New London County Horticultural Society.....	42, 319	Peony day, A.....	916
New Orleans Horticultural Society.....	144, 472, 594, 764	Peonies, The best.....	867
Newport Horticultural Society.....	8, 195, 283, 360, 664, *729, 834, 898.	Pericat, A verdict for Alphonse.....	543
—Weather and its effects on outdoor plants in.....	107	Perpetual Flowering Carnation Society.....	67, 369, 529

HORTICULTURE

	Page	Page	Page
Planting for winter effect in the Northern States.....	480, 636	Seattle, Hawaiian pineapples for.....	209
*Pochlmann, August.....	353	Seed Trade.....	12, 41, 255, 292, 328, 368, 404, 484, 502
*Polites, Frank.....	15	Where reform is needed; The western flower seed trade; Samples of seeds for Department of Agriculture; Notes.....	76
Pots, Making.....	252	About seed Limas; "Johnny-on-the-spot"; Canner prospects; The Ramblers' Club; Notes.....	116
Prevention better than cure.....	178	American Seed Trade Association.....	148
Primula, Method of cultivating.....	214	Unique Window Display; Catalogues wanted; A correction; Notes.....	184
*Kewensis.....	313	—The Cannons' convention; The blue grass question; Watson on the seed trade; Notes.....	220
*Obconica grandiflora.....	229, 335	—The season's record; Bean scarcity; About onion seed.....	440
Project, A commendable.....	37	The free seed answer; Hearing on proposed seed inspection law at Albany; Tariff committee meeting of American seedsmen, florists and nurserymen.....	442
*Providence parks, New head gardener for.....	633	—The free seed distribution; Ad valorem versus specific duties; important action of the Wholesale Seedsmen's League; Notes	536
Pruning peaches.....	97	—Wholesale Seedsmen's League; Legislative doings; A thriving youngster; Beans and cucumbers.....	568d
Publication, A notable.....	850	The Frank S. Platt Company; Crop prospects in California; A letter to the seed trade; Notes.....	602
—Received.....	67, 110, 148, 215, 256, 285, 398, 488, 561, 627, 806	—A questionable policy; Seed stocks running low and values soaring; Notes.....	638
R		—Bush Limas short; Damage in the Norfolk District; New York Seed Co.; Pea prospect; Elly Seed pure seed bill; Notes.....	670
Red spider, A cure for.....	645	—Unfavorable weather conditions; Planting delayed; The coming convention; Notes.....	738
Relationship between producer, wholesaler and retailer, The.....	173	—The backward season; A word for the canners; A banner year; Suit against Blue Grass growers; Notes.....	774
Reminiscence, A.....	568b	—An unwarranted attack upon the canning industry; Crop prospects; The conventions; Personal.....	804
Retail florists, Of interest to.....	14, 46, 118, 370, 406, 414, 501, 538, 570, 604, 640, 672, 704, 740, 776, 808, 840, 872, 904	—American Seed Trade Association, Incorporated; Seed Trade Notes.....	806
Flower stores.....	46, 79, 151, 187, 223, 258, 294, 330, 371, 406, 445, 505, 538, 570, 605, 672, 741, 776, 808, 841, 872	—Canners' convention; American Seed Trade Association; Onion seed crop; Notes.....	838
Rhode Island college lectures.....	358	—Bermuda onion seed-crop prospects; The corn crop; Canning peas; The value of experience.....	902
Florists' and Gardeners' Club of.....	628	*Scelenepidium grande albo-marginata.....	97
—Prepares for New England fruit show.....	474	Shamrock, The real.....	364c
—State Board of Agriculture.....	213	Shaw's garden and Sunday.....	182
*Rhodora canadense L.....	467	*Sherman, E. M.....	832
Rochester Commercial Florists' Association.....	249, 318, 472, 728, 898	Society of American Florists and Ornamental Horticulturists:—	
—Notes.....	897	—New governing board; State vice-presidents; Washington representative.....	38
Rocky mountain rambles.....	*5, *33, *242, *278	—President's greeting.....	71
Root growth in root crops. Promoting.....	67	—National Flower Show committee.....	105, 186, 697
Roses:—		Ladies' S. A. F.....	105, 176, 596
*Baby Dorothy.....	593	—Prizes for travelling men.....	250
—Climbing under glass.....	527	—Legislative and tariff committee meeting.....	319
*Cover design.....	345	—Executive board.....	402b, 428
—Garden, The.....	476	—Advisory committee for trade exhibition.....	594
—Growers' problems, The.....	598	—Window glass and the tariff.....	730
—Growers, Some of our problems as.....	770	—Registration of plants.....	8, 38, 144, 176, 211, 319, 361, 428, 528, 628
—Harry Kirk.....	435		
—Killarney and Beauty.....	180		
—In California, and bungalows.....	477		
—In floral work.....	349		
—My Maryland and its requirements.....	471		
—My Maryland, How to grow it successfully.....	434		
—My Maryland, Regarding.....	315		
—Some new.....	374		
*Trained Rambler.....	591		
*Tausendschon.....	264a		
—Under Glass, 34, 65, 109, 349, 557, 630			
—What to do in March among.....	434		
—White Killarney.....	107		
—A house of.....	*585, 593		
—Displayed at Buffalo meeting.....	430		
—Why so many small growers fail with.....	477		
Royal Horticultural Society.....	214, 264b, 429, 595, 661, 752, 802, 836, 799, 899		
*Rudd, W. N.....	101		
S			
*Sandiford, Charles.....	355		
*Schizanthus Wisetonensis as a basket plant.....	829		
Scott, William memorial.....	355		
—Letter to donors of fund.....	433		
Scranton Florists' Club.....	472		
*Seager, G. C.....	800		
Society of German Landscape Gardeners.....	865		
Sodium cyanide and potassium cyanide.....	427		
Southampton Horticultural Society.....	318, 472		
*Southern grown Beauties.....	730		
Spain, An effective.....	438		
Staying fluids.....	324		
Spring plant trade.....	215		
St. Louis Florists' Club.....	194, 209, 218, 402c, 561, 729, 865		
—Horticultural Society.....	145		
—Spring show.....	474		
—Notes.....	407, 397		
Steamer departures.....	14, 46, 78, 318, 150, 186, 222, 258, 294, 330, 370, 406, 444, 504, 538, 570, 604, 640, 672, 704, 740, 776, 808, 840, 872, 904		
*Stannard, F. H.....	889		
Strawberries.....	870		
—Fruiting under glass.....	7		
*Stuart, J. S.....	172		
Sweet Pea association, A proposed.....	528, 834		
—Society, National.....	864		
—Novelties in England.....	207		
*Sykes, George.....	665		
T			
Tarrytown Horticultural Society.....	42, 177, 362, 898		
Tennessee State Nurserymen's Association.....	212		
Terry, Recollections of Father.....	427		
Trips and their response to light and heat.....	205		
Thrifty French nursery practice.....	829		
Totodo Florists' Club.....	170		
Toronto Gardeners' and Florists' Association.....	320		
—Reflections on the catastrophe.....	632		
Tree agent, The.....	668		
V			
*Vesey, W. J.....	38		
Veterans, The.....	765		
W			
*Ward, C. W.....	866		
Washington Horticultural Association.....	8, *282		
Washington (D. C.) inauguration notes.....	364d		
—Florists' Club of.....	42, 176, 321, 664, 802		
—Notes.....	509		
—Personals.....	411		
*Ward in the garden and home park.....	797		
—Scenery in the garden.....	*831, *861		
*Wedding decoration, A.....	283		
*Welch, P.....	354		
White fly, The.....	716		
*Wiegand & Sons, Vase offered by.....	102		
*Wiegand, H. L.....	102		
Wild flowers.....	179		
Wind and hail.....	715		
*Window, A Lincoln.....	213		
Winnipeg Florists' Association.....	664		
—Trade notes.....	672, 883		
Winter color in the garden.....	727		
*Winzel, Charles.....	362		
Worcester County Horticultural Society.....	177		
Y			
*Yates, Charles L.....	800		

HORTICULTURE

Vol. IX

JANUARY 2, 1909

No. 1



ENTRANCE AND LODGE.

J. B. Duke Estate (west side), Somerville, N. J.

*Devoted to the
FLORIST, PLANTSMAN,
LANDSCAPE GARDENER,
and
Kindred Interests*

*Published
EVERY SATURDAY
At 11 Hamilton Place,
BOSTON, MASS.
Subscription, \$1.00*

JAN 4 - 1909

New Rose **White Killarney**

Come and see White Killarney growing at our Scarborough houses, and you will say at once, as every one does who has seen it, it is

The Best White Rose

they have ever seen. You need it if you want to be up to the times, and it will pay you better than any other white rose that you can plant. You will regret it if you do not plant it this year, and you will not regret it if you do.

Big lots are being booked. Get your order in early. Send us order at once, while you think of it. Get early stock. It will not cost you any more to order to-day, while you think of it, than it will two months from now. Be the early bird that catches the worm.

Strong young plants, 2 1/4-inch pots, own-root, ready for delivery beginning February 15th, 1909. \$30.00 per 100; 250 for \$70.00; 500 for \$125.00; 1000 for \$250.00. Grafted plants, ready for delivery beginning March 1st, 1909, \$5.00 per 100 additional.

MY MARYLAND

This new rose, which was introduced last season in a limited way, has proved to be one of the best roses ever introduced. Every one is enthusiastic in regard to its merits, and it will be planted very largely by the largest, most progressive and most up-to-date growers, who have already placed large orders for it.

It is a strong, healthy, and vigorous grower, producing long stems and long pointed buds, exquisitely fragrant. The color is a soft salmon-pink. This is a rose that we can recommend in the highest terms, as we are sure it will prove very, very satisfactory. It is a welcome addition to our limited list of really first-class varieties for indoor culture; and it is not only a fine midwinter rose, but is also unusually good during the summer months.

Strong plants, 2 1/4-inch pots own-roots, \$10.00 per 100, \$90.00 per 1000
Grafted plants. \$20.00 per 100, \$150.00 per 1,000.

F. R. PIERSON, Tarrytown-on-Hudson, NEW YORK.

New White Carnation

"MARCHIONESS"

Originated by the late Louis E. Marquisee

Of fine form, strong clove fragrance, flowers full 3 to 3 1/2 inches. It is extremely prolific, maturing flowers quickly, early and continuously.

IT IS THE BEST MONEY MAKER EVER PUT ON THE MARKET.
\$10.00 per 100. \$80.00 per 1000.

Orders will be filled strictly in rotation. Come and see it at "Home."

LOUIS E. MARQUISEE ESTATE, Syracuse, N. Y.

BAY STATE

Orders for January Delivery are being rapidly booked.

If you want to get in on the ground floor with this noblest of all the new carnations place your order at once.

Rooted Cuttings, \$12.00 per 100, \$100.00 per 1000

ALBERT ROPER, Tewkesbury, Mass.

NEW RED CARNATION **O. P. BASSETT**

Extra Large Bright Red Free Bloomer

PRICES
Rooted Cuttings, per 1000, \$60.00 | Rooted Cuttings, per 500, \$8.00 | Rooted Cuttings, per 25, \$2.50
per 500, \$5.00 | " " " " per 50, 4.50 | " " " " per 25, 1.50

Ready for delivery Jan. 1st, '09 by the Originators and Growers

BASSETT & WASHBURN, HINSDALE, ILL

CARNATION CUTTINGS

We offer choice varieties for January and later shipments.

	Per 100	Per 1000
Enchantress.....	\$2.50	\$20.00
White do.....	3.50	30.00
Rose Pink do.....	2.50	20.00
White Perfection.....	2.50	20.00
Windsor.....	3.50	30.00
Melody.....	2.50	20.00
Beacon.....	3.50	30.00
Victory.....	3.50	30.00
Aristocrat.....	3.50	30.00
Splendor.....	6.00	50.00
Vesper.....	3.50	30.00
White Lawson.....	2.50	20.00

EAST SUDBURY GREENHOUSES,

Carnation Specialists

P. O. Address South Sudbury, Mass.
Telephone So. Sudbury 20.

NEW CARNATION PINK DELIGHT

Waxy Shell Plak. A Grower's and Shipper's favorite. Has a holding color, keeps well, comes on long stems and is early, very free and continuous flowering. January delivery, \$12.00 per 100; \$100.00 per 1000.

F. Dorner & Sons Co., La Fayette, Ind.

Chicago Carnation Co.

JOLIET, ILL.

CARNATION SPECIALISTS.

IF YOU WOULD ONLY COME

and See, Growing, Our

White Killarney

We Would Be Sure of Your Order

WABAN ROSE CONSERVATORIES

NATICK, MASS.

Newport Fairy

The Rose of the Future For
In and Out Door.

FINE, STRONG, FIELD-GROWN STOCK

3—4 Shoots 3—4 ft. long

50c each, \$30 per 100, \$250 per 1000

JULIUS ROEHRS CO.
RUTHERFORD, N. J.

Hardy Rhododendrons, Azaleas, Conifers, Clematis, H. P. Roses, Shrubs and Herbaceous Plants from our
HOLLAND NURSERIES

Prices Moderate

P. OUWERKERK, 216 Jane St., Weehawken Heights
P. O. No. 1, Hoboken, N. J.

GLEARY'S HORTICULTURAL CO.

Management AMBEROSE T. CLEARY

Wholesale Contracting, Jobbing, Auction
HORTICULTURAL PRODUCTS
of every description.

Consignments Received. Surplus Stock Converted
62 Vesey St., NEW YORK

Box Trees

and other **EVERGREENS** for **Tubs** and **Boxes**
Our Prices are Always Right—Catalog Free
THE NEW ENGLAND NURSERIES, Inc.
BEDFORD, MASS.

THE PRIZE WINNING STRAWBERRY

The Barrymore

Send for Folder at Once.

H. L. GRANE, Originator,
Westwood, Mass.

PEACOCK'S NEW DAHLIAS

SEND FOR LIST

PEACOCK DAHLIA FARMS
Williamstown Junction, N. J.

DAHLIAS. Now is the time to place your order for bulbs which will insure you getting named varieties in any quantity: prompt delivery.

DAVID HERBERT & SON,
Successors to L. K. Peacock, Inc.
ATCO, N. J.

The Northboro Dahlia and
Gladiolus Gardens

Offer for Spring 1909.
300 selected varieties of Dahlias and one and one half million large-flowering Gladiolus in mixtures, in lots to suit. Send list of your wants. Catalogue free.

J. L. MOORE, Northboro, Mass.

BARGAINS in **TREES** and **PLANTS**

Concord Grapes, \$2.00. Peach, \$3.00 per 100.

List Free. D. J. TWOMEY, Dept. H, Geneva, N. Y.

JOHN WATERER & SON, Ltd.

American Nursery Bagshot, England

Are Specialists in the

REALLY HARDY VARIETIES

of Rhododendron Hybrids and in Select Varieties of Hardy Border Plants.

SMITH'S CHRYSANTHEMUMS

We are offering Five new Commercial. Mr. Frey's new Anemones and Singles.
Mr. Livingston's New Singles.

In the Exhibition section, the Wells-Pockett, Sundry English, French and Australian.

The best of the Standard sorts both Commercial and Exhibition, including
POMPONS, ANEMONES, SINGLES and HAIRY VARIETIES

If in need of any kind of Chrysanthemums, write us for prices.

Successors to
ELMER D. SMITH & CO., NATHAN SMITH & SON ADRIAN, MICH.

RHODODENDRONS-RHODODENDRONS

An immense stock of all the **hardest known kinds**, 2 to 3½ ft., fine plants and all home grown, many being on own roots, far better than grafted stock—also **R. Catawbiense seedlings** of all colors and **seedling Hardy Azaleas** not to be obtained elsewhere. This is the nursery in which most of the Rhododendrons that have proved **hardy in America** were raised.

GOLDEN YEWES, KALMIAS, and other **HARDY PLANTS** in great variety and of all sizes.

Catalogues on Application

ANTHONY WATERER Knap Hill Nursery Knap Hill
SURREY, ENGLAND

NO CONNECTION WHATEVER WITH ANY OTHER FIRM.)

TREES, EVERGREENS, SHRUBS, VINES, PERENNIAL PLANTS, FRUITS, TRAINED FRUIT TREES, FOREIGN GRAPE VINES, HARDY RHODODENDRONS and R. MAXIMUM in quantity, per hundred or per thousand, very fine. Complete assortments: Careful grading: Low prices.

AMERICAN NURSERY COMPANY,
Sales Department, - - - 150 BROADWAY, NEW YORK CITY.
BLOODGOOD NURSERIES DEPT., - - - Flushing, Long Island.
F. & F. NURSERIES DEPT., - - - Springfield, New Jersey.

Rocky Mountain Rambles

III.



A beautiful specimen of *Abies concolor* in the Wasatch Mountains, Utah. Elevation 8900 feet.

In two previous numbers I referred to some of the interesting features of the east slope of the Rockies. The west slope contains many interesting physiographic features, besides a great wealth in plants. It was my pleasure during the summer of 1900 for the first time to gaze upon the rugged scenery in the Black Canon of the Gunnison, west of Gunnison.

The railroad making its way through the narrow defile, the steep sides of the gorge with a sparse growth of

spruce, Douglass fir, pines and cedars, and the broken rock piled in all conceivable forms, the water dashing over the rocks and passing swiftly down the canon, was a sight not soon to be forgotten. I have several times since gone over the same region with as much delight last summer as the first time. At Cimarron the gorge becomes so narrow and the rocky cliffs so abrupt that the railway leaves the Gunnison and passes up the Cimarron and over the divide to Montrose. The region over the divide is mostly covered with a scrubby growth. For the first time one meets in these woods a native apple, the *Peraphyllum ramosissimum*, which is a low shrub growing over the hills. Everywhere throughout the region a form of our eastern Lobadium, the *Rhus Canadensis* var. *trilobata* and a form of the dwarf white oak (*Quercus undulata*) is common, and on these hills it forms thickets. The common service berry of the west is also abundant (*Amelanchier alnifolia*). The western Cleome (*Cleome lutea*) is also more plentiful along the roadsides in the Montrose country and in waste places. In these oak woods one finds a great deal of painted cup (*Castilleja miniata*).

Leaving Grand Junction we pass down the valley of the Grand River which here and there opens up into broad expanses where one finds such familiar trees as the Cottonwood (*Populus deltoides*), a few willows like the Sandbar Willow (*Salix interior*), the Buffalo Berry (*Shepherdia argentea*), and the Silver Berry (*Elaeagnus argentea*).

The region beyond is a high undulating plateau with the familiar Western Sagebrush (*Artemisia tridentata*), Greasewood (*Sarcobatus vermiculatus*) in alkali flats and Salt Grass (*Distichlis spicata*). The ascent up the valley from Helper, Utah, is rather abrupt. The dry hillsides contain a great deal of an interesting Wild Foxglove (*Pentstemon barbatus*) with ample racemes of bright scarlet flowers which is worthy of a place in any garden. There are also blue-flowered species which should find a place in our gardens. The ascent up the valley to the summit of the divide is marked by open meadows and dense thickets of willows. This feature is characteristic of all the mountain peaks.

L. A. Samuel

Ames, Ia.

An American Rival to the Barbadoes

Visitors to the Barbadoes are wont to bring home photographs of a certain palm drive leading to the home of the Empress Josephine.

As a matter of fact, away up in north-central California at Sacramento, there is a street, leading toward the capitol, which is almost a duplicate of that one. It is shown in the accompanying picture.

The palms are not quite so tall, but with these on the one side of the walk and the more deciduous shrubbery on the other hand, the effect is even more beautiful.

FELIX J. KOCH.

Cincinnati, O.



A Sacramento Street

HORTICULTURE

VOL. IX JANUARY 2, 1909 NO. 1

PUBLISHED WEEKLY BY
HORTICULTURE PUBLISHING CO.
 11 Hamilton Place, Boston, Mass.

Telephone, Oxford 302
 WM. J. STEWART, Editor and Manager

SUBSCRIPTION PRICE

One Year, in advance, \$1.00; To Foreign Countries, 2.00; To Canada, \$1.50

ADVERTISING RATES

Per Inch, 30 inches to page \$1.00
 Discounts on Contracts for consecutive insertions, as follows:
 One month (4 times) 5 per cent., three months (13 times) 10 per cent.,
 six months (26 times) 20 per cent., one year (52 times) 30 per cent.
 Page and half page spaces, special rates on application.

Entered as second-class matter December 8, 1904, at the Post Office at Boston, Mass., under the Act of Congress of March 3, 1879.

CONTENTS

	Page
COVER ILLUSTRATION—Entrance and Lodge, J. B. Duke Estate.	
ROCKY MOUNTAIN RAMBLES—L. H. Pammel—Illustrated	5
AN AMERICAN RIVAL TO THE BARBADOES—Felix J. Koch—Illustrated	5
MONSTERA DELICIOSA—Illustrated	7
OBITUARY: Dennis Lee—H. J. Ball—Alex. Newett, Sr.	7
NEWS OF THE CLUBS AND SOCIETIES: Washington Horticultural Association—Society of American Florists—Gardeners' and Florists' Club of Baltimore—Massachusetts Horticultural Society—Newport Horticultural Society	9
CLUB and Society Notes	9
FLOWER MARKET REPORTS: Baltimore, Boston, Buffalo, Detroit, Toledo	10
Chicago, Philadelphia	17
New York	19
Indianapolis	24
Washington	25
SEED TRADE	12
OF INTEREST TO RETAIL FLORISTS: Some Chicago Christmas Decorations—Steamer Departures	14
Frank Polites, Illustrated—Albany—Washington	15
MISCELLANEOUS: Plant Breeding	7
Fruiting Strawberries Under Glass—Wilfrid Wheeler	7
Personal	7
Our Exchanges	7
News Notes	9
Catalogues Received	12
Business Changes	25

Happy New Year! Old 1908 with its joys and its sorrows, its hopes and its disappointments, with all it had to bless or to vex, has gone and experience and reminiscence is all it has left with us. And now we look well to the east, to the sunrise of a new and, we all hope, a better year. Wise is he who has watched the indicator on the dial and in his planning for the coming weeks and months, has carefully hoarded the knowledge which comes only to those who are on the alert, and can draw upon it for inspiration in the struggle which now begins anew. Eager to fulfil its legitimate mission, zealous for the

honor and lustre of the name it bears, HORTICULTURE has done its best during the year now gone to live that wisdom which has its birth only in studious investigation, persevering toil and ripe experience and to pass it on in concrete form so that it may open to those who properly apply it, avenues of profitable and happy employment otherwise unattainable. This policy we shall still adhere to and we shall gratefully welcome the assistance and co-operation of all friends of horticulture.

The seed catalogues for 1909 are beginning to arrive. Some are triumphs of art and business sagacity; others are not, but on the average a great advance has been made from the standard of a few years ago when crude illustrations of impossible things on cover and inside pages were the rule. We occasionally see one which recalls the old days, with cover designs showing marvels calculated to make the rural folk gape, autos loaded with onions bigger than the chauffeur's head, ears of corn as long as the wagon seat and other amazing products but these fantastic outbreaks are the exception, nowadays, and the aim of the up-to-date catalogue maker is to show things just as they are. As to the text matter there seems to be a tendency in the direction of more concise and simple descriptions and to refrain from grandiloquent overpraise of varieties but there is still plenty of room for further reform in this respect. Taken all in all, the seed catalogues wield a mighty influence and, as such, they must be classed among the most beneficial agencies in the dissemination of horticultural knowledge and the sharpening of the public appetite for gardening diversions.

"Since the giant cactus, which is by **Cereus** far the most impressive feature of the **giganteus** desert vegetation of the Far Southwest, was studied and named by Dr. George Engelmann, in 1847, it has been known to botanists as **Cereus giganteus**. Now Dr. N. L. Britton and Dr. J. N. Rose of the New York Botanical Garden have found that it is not a **Cereus** at all, but belongs to a separate genus, of which it is the only species. They propose to name the genus **Carnegiea** in honor of Andrew Carnegie."—*New York Sun*.

Undoing one another's work has long been a ruling passion with many of our esteemed friends, the botanists, and genus and species-splitting their ever-besetting sin. The establishment of this monotypic genus in honor of the Laird of Skibo looks questionable. With all due respect to the learned gentlemen mentioned in the above extract we are disposed to credit Dr. Engelmann and our German contemporary Schumann with a better knowledge of the spiny inhabitants of the desert than even our New York and Washington scientists. We know of none who have done more devoted and painstaking work on the Cactaceae and Coniferae and allied classes of plants in America than Dr. Engelmann and it is to be regretted that the name given by him should not be permitted to stand.

PLANT BREEDING.

HORTICULTURE:

I wish to ask for a little information. I am a grower of seed peas and am studying to improve my varieties also to produce new varieties where I think there is a need of them. Can you refer me to books or literature bearing on above subject, and by whom published or could you furnish me with such books as I desire? Darwin I believe wrote books bearing on these matters also Bailey of Cornell University. Can you give me names of these books and where I could obtain same?

Thanking you in advance for any information which you may give, I am
Sincerely yours,

(Signed) J. VERNON SHEAP.

In reply to the above query we would name the following publications:

Bailey's Cyclopaedia of American Horticulture—under the head of Plant-Breeding.

W. S. Harwood. New Creations in Plant Life.

Charles Darwin. Animals and Plants under Domestication.

L. H. Bailey. Plant-Breeding. Cross-Breeding and Hybridizing—with a brief bibliography of the subject. ppH. The Philosophy of the Crossing of Plants considered in reference to their improvement under Cultivation. ppH.

E. L. Sturtevant. Observation on the Hybridization and Cross-Breeding of Plants.

E. Williams. Hybridizing and Cross-Breeding. ppH.

Francis Darwin. Cross and Self-Fertilization.

There are also numerous other publications on the subject, which may be consulted at the library of the Massachusetts Horticultural Society.

FRUITING STRAWBERRIES UNDER GLASS.

Editor of HORTICULTURE:

Dear Sir,—Will strawberries bear in hot houses without bees to carry the pollen?
B. A. R.

Answering your inquiry in regard to strawberries fruiting under glass without bees to carry the pollen, I will say that bees would be an advantage when the operation is to be carried on in a large way, and especially so if some imperfect varieties are to be grown with the perfect ones. Where only a few plants are to be grown bees will not be necessary to carry the pollen and with the perfect flowering varieties artificial pollination will not be necessary, but if the weather is dark and moist at the time the plants bloom it will be necessary to pollinize with a small camel's-hair brush. The main thing is to keep the house dry and airy at the time the plants are blooming, so that the pollen will ripen naturally and spread itself.

WILFRID WHEELER.

CAN'T DO WITHOUT IT.

Enclosed find one dollar to renew my subscription to HORTICULTURE. I am one of your first subscribers and am going to stay by you. Can't do without it. It is getting better and better with every issue.

H. D. SEELE.

Elkhart, Ind.

MONSTERA DELICIOSA.



Some time ago we published a picture of *Monstera deliciosa* in fruit, and it may be of interest to our readers to see how it looks in bloom, as it is somewhat uncommon. When grown in the stove or warm greenhouses it will make luxuriant leaves but seldom

flowers. The plant is always interesting, however, on account of its peculiar perforated foliage. The specimen shown herewith is growing in a corner of the carnation house, in full sun. We are indebted to the grower, M. J. Pope, for the photograph.

PERSONAL.

R. C. Kiel is now with the Hopedale Nurseries, Hopedale, Ill.

William Clubb of Boston has taken a position with L. L. May & Co., St. Paul, Minn.

W. H. King, the Albany florist who fell in front of his home, breaking his leg, is slowly improving.

Miss Dorothea A. Broome is in charge of the Lakeside Floral Co.'s store at Calumet, Mich.

Arthur E. Thatcher has succeeded the late Louis Sander at the Arnold Arboretum, Jamaica Plain, Mass.

George L. Perry of Coldwater has taken a position as manager of the Central Nursery & Floral Co., Kalamazoo, Mich.

Mr. Arthur Brown of Walkerville, Ont., and Miss Grace Young of Amersham, England, were married at St. Matthias Church, Montreal, on December 25.

Wm. R. Smith, of the Botanical Gardens, Washington, who has been seriously ill for the past ten days, is now reported as being much better and is able to sit up for a short while at a time. This will be grateful news for thousands who love the "Grand Old Man of Horticulture." Mr. Smith has been in Providence Hospital for the past two weeks. Owing to his advanced age much solicitude has been felt by his friends.

OBITUARY.

Dennis Lee.

Dennis Lee, gardener for Paul A. Huebener of Yonkers, N. Y., was found in the stable with his skull crushed and suspicion points to the coachman as the perpetrator of the deed.

H. J. Ball.

Henry J. Ball, for the past twenty-five years a successful orchardist of Santa Clara County, died in San Jose, California, on Dec. 16, at the age of 76. A widow, two daughters and a son survive him.

Alexander Newett, Sr.

Alexander Newett died at his home at Lawndale, Chicago, Dec. 18, in his eighty-second year. He was a native of Ireland, came to this country at the age of 22 and started in the florist's business in Chicago about 30 years ago. A daughter and five sons survive him, one son, Alexis, being connected with the Stuppy Floral Co., of St. Joseph, Mo.

OUR EXCHANGES.

Gleanings in Bee Culture for Dec. 15, is full to overflowing with interesting practical information on the fascinating employment of bee keeping. It has also a poultry department. Bee culture comes very close to being a department of horticulture and works well as a side issue with those engaged in any horticultural pursuit. "Gleanings in Bee Culture" is published by the A. I. Root Co., Medina, Ohio, semi-monthly and is well-worth the price—\$1.00 a year.

NEWS OF THE CLUBS AND SOCIETIES

WASHINGTON HORTICULTURAL ASSOCIATION.

The Washington Horticultural Association at its fifth annual convention in Spokane, Dec. 8 to 11, when H. K. Gilbert of North Yakima, president of the organization, presided at the eight sessions, adopted resolutions, recommending the enactment of a law by the Legislature of 1909, prohibiting the liquor traffic, pool-selling and race-track gambling at county, state and inter-state fairs; the repeal of the state horticultural law and the enactment of one which could be enforced; making the National Apple Show an annual affair; the insertion, if possible, in the local option law, if enacted, making the unit no smaller than the county.

The association put itself on record as favoring the immediate improvement of public highways and a practical method of raising funds to bring this about; that industrial training in the public schools be adopted; also encouraging the growing of sufficient nursery stock to supply the demands of orchardists in the state; encouraging the importation and protection of song and insectivorous birds, and requesting the legislature to appropriate \$2,000 for the publication of the annual horticultural report. The Porter apple box bill, submitted to the last Congress, was condemned.

These officers were elected for 1909, President, J. L. Dumas, Dayton; first vice-president, M. O. Tibbitts, Cashmere; second vice-president, F. P. Benson, Prosser; secretary, Levi Grant Montco, Spokane; treasurer, H. W. Greenberg, Spokane. The next annual meeting will take place at Wenatchee the first week in December.

Recommendations by the legislative committee were adopted as follows: That the legislature appoint a state horticultural commissioner and inspectors for 20 or more districts; that adequate provision be made for assistant inspectors during the busy season; that the commissioner and district inspectors be appointed for indefinite terms and be removed only for neglect or inefficiency or that an inspector may be removed by a petition of the majority of the owners of commercial orchards in his particular district; that the inspectors shall be state officials and paid as the other state officers.

It was also urged that the legislature enact a law legalizing the apple and pear boxes at present in use; that the name and address of grower and shipper may be stamped on each package; that infected fruit where found by the inspector may be repacked by the owner or in the case of non-appearance of the owner that the inspector shall pack the same at the expense of the owner; that infected fruit used for by-products may be sold or shipped to the state with proper restrictions, and that all nurseries be fined 10 times the original cost of trees sold not true to name.

SOCIETY OF AMERICAN FLORISTS AND ORNAMENTAL HORTICULTURISTS.

Registration of Plants.

Public notice is hereby given of the application of the Conard & Jones Company, West Grove, Pennsylvania, for the registration of the plants specified below. These applications for registry were filed in this office on Dec. 23, 1908, and any person knowing of any reason why the registration of these names should not be made is requested to communicate with the undersigned.

Canna "Wawa": Parentage, Maidens Blush x a seedling; soft pink flowers, green foliage, 3 to 4 ft. high, nicely rounded flowers.

Canna "Mont Blanc Improved": Mont Blanc improved has the same vigorous constitution and luxuriant green foliage as its antecedent, Mont Blanc. It has large flowers which are almost pure white and produced in great profusion; height about 4 ft. foliage green.

Rose "Climbing Mosella": New climbing rose, a sport from the bush Rose Mostlin and identical in the appearance of blossoms.

W. N. RUDD, Sec'y.

December 23rd, 1908.

GARDENERS' AND FLORISTS' CLUB OF BALTIMORE.

Control of Insect Pests.

The Gardeners' and Florists' Club held the semi-monthly meeting on the 28th, and considering the holiday season the attendance was excellent. Professor A. B. Gahan, assistant horticulturist at Maryland Horticultural College, read a paper on "The Control of Some Insect Pests of the Plant House." He said, in part, that potassium cyanide is recognized as a practicable treatment, when properly handled, for most pests. The amount of the gas which different plants will stand varies widely. He had frequently treated coleus badly infested with mealy bugs with a strength of 3-4 of an ounce per 1000 cubic feet without injury to the plants, but it required several repetitions to kill them all. The eggs were not affected. Roses and chrysanthemums were treated with excellent results. The gas proved more efficient and cheaper than tobacco fumigation. Violets are uninjured by four ounces of cyanide per 1000 cubic feet and a charge of four or five ounces should be used for them. The exposure should not be for less than one hour, and two hours' exposure results in no injury to the plants. It is against white fly, thrips, mealy bug and the aphids that it is especially valuable. Against the scale insects the cyanide treatment is not effective, as the scale covering protects the insect from any strength of gas which would not be fatal to tender growing plants. Plants are less liable to injury when the fumigating is done at night. A long exposure to a mod-rate amount of gas is less likely to cause injury to the plant, and is at the same time more effective against the insects than is a shorter exposure to a heavy charge.

MASSACHUSETTS HORTICULTURAL SOCIETY.

Free Horticultural Lectures.

A notable course of nine lectures on subjects of horticultural interest is announced by the Massachusetts Horticultural Society to be given at Horticultural Hall, Boston, on Saturday mornings at eleven o'clock, beginning Jan. 9.

These lectures are free to all and after the reading of the papers opportunity is given for full discussion of the topics treated.

The inaugural meeting of the society will be held on the first Saturday of the new year at twelve o'clock. At this meeting the president will make an inaugural address, and the annual reports of officers and chairmen of committees will be presented.

The lecture program is as follows:

January 9. The Yeast of the Soil. By Wm. H. Bowker, Boston.

January 16. Garden Insects and How to Control Them. By Prof. E. Dwight Sanders, Durham, N. H.

January 23. Ornamental Gardens and Garden Materials. Stereopticon Illustrations. By Prof. E. A. White, Amherst.

January 29. The Effects of Conditions of Growth in Certain Horticultural Plants Upon Susceptibility to Fungous Diseases. By Prof. B. M. Duggar, Ithaca, N. Y. (The John Lewis Russell Lecture).

February 6. The Etherization of Plants for Forcing Purposes. By Prof. William Stuart, Burlington, Vt.

February 12. Plant Breeding. Stereopticon Illustrations. By Prof. Herbert J. Webber, Ithaca, N. Y.

February 20. American Landscape Architecture. By Prof. F. A. Waugh, Amherst.

February 27. Rural New England. By Mrs. Charlotte R. F. Ladd, Sturbridge.

March 6. The Propagation of Plants by Various Methods. By Jackson Dawson, Jamaica Plain.

W. M. P. RICH, Sec'y.

NEWPORT HORTICULTURAL SOCIETY.

A regular meeting of this society was held on the evening of Dec. 22nd, with a good attendance of members, and President Robertson in the chair. After the routine business had been settled, A. McLellan started a discussion on the dahlia disease which was so prevalent throughout the New England States the past season. Mr. Volquandson gave it as his opinion that this trouble is often caused by a species of aphid, which inhabit and feed on the under side of the foliage, and when left undisturbed in dry, warm weather multiply very rapidly, quickly weakening the constitution of the plant. The speaker said the best remedy he had found was water applied with some force to the little pests with a syringe or hose. Red spider was also admitted by those present to be a powerful agent toward bringing on this disease and the same treatment as for the aphid is good.

Suppose that during 1909 we all try to be fairly decent.

A black man with a white inside is better than a white man with a black inside. An expensive Lily bulb of superior quality is better than a cheap one of inferior quality. We want you to try a case or so of our best quality of Easter Lily Bulbs—the very best produced in Japan.

Write us a postal for prices. Wholesale only.

SEITARO ARAI,
No. 1, Onoecho,
Yokohama, Japan.



RALPH M. WARD & CO.,
12 West Broadway,
New York City.

ORDER NOW FOR FALL DELIVERY.

You can also buy from us first-class French Bulbs, Dutch Bulbs, Azaleas, etc.—a general line at reasonable prices.

CLUB AND SOCIETY NOTES.

The Rose Festival Association of Portland, Ore., will celebrate Feb. 22 as "Rose Planting Day," and will invite the military and fraternal organizations to assist in its celebration.

The National Horticultural Congress in session at Council Bluffs, Ia., elected officers for 1909 as follows: President, W. S. Keeline; vice-president, J. H. Shawhan; secretary-treasurer, G. W. Reye, Council Bluffs.

The Southwestern Iowa Horticultural Society at their meeting at Council Bluffs on Dec. 16 elected officers as follows: President, J. M. Bechtel; vice-president, R. Mackenzie; secretary, W. M. Bomberger.

The State Horticultural Society at its recent meeting in Springfield, Mo., passed a resolution asking the legislature to enact a law making it a misdemeanor to kill quail within a period of five years, as they deem their destruction detrimental to the orchard and farming interests.

The Gardeners' Mutual Protective Association of New Orleans has elected officers as follows: President, V. Zirmmer; vice-president, W. Orth; secretary, John Parr; treasurer, I. Meyer. C. R. Panter, as chairman of the committee on grievances, was instructed to make an effort for better facilities for gardeners at the French market.

At Wilmore, Pa., they are agitating the formation of a horticultural society for Cambria County, and a meeting for organization is to be held at Wilmore on Jan. 16. Great enthusiasm prevails over the project. A correspondent in a Johnstown paper in a communication tells of the great advantages to accrue. He adds:

"And is this to be a gathering of smooth-tongued bachelors and crusty old widowers, such as our State organization appears to be? Not much! The ladies are certainly expected to be in evidence here as elsewhere when anything worth while is to be accomplished. Welcome, three welcome are they—and let them come without money and without price."

The State Horticultural Society will have to take a back seat. Wilmore seems to be all right.

FREEZING ASPARAGUS AND RHO-BARB ROOTS FOR FORCING

It is necessary that these roots be frozen before forcing. There is not the slightest risk in shipping them now. Best roots in country. Big money in forcing them.

WARREN SHINN, Nurseryman, Woodstown, N. J.

FORCING GLADIOLUS

Gladiolus Gandavensis Hybrids
Many florists plant these in boxes, or among their carnations, in the Winter. They are excellent for decorative purposes and realize good prices, either wholesale or retail. Gladiolus are a good catch-crop and take up but little room. The following are the best for this purpose:

America. The flowers, which are of immense size, are of the most beautiful flesh-pink color, \$4.00 per 100; \$35.00 per 1000.

Augusta. The florists' best white Gladiolus. First-size bulbs, 1 3/4 inches and up, \$2.00 per 100; \$18.00 per 1000. Bulbs 1 1/2 to 1 3/4 in. \$1.75 per 100; \$16.00 per 1000.

Shakespeare. White and rose. \$4.75 per 100; \$45.00 per 1000.

May. Pure white, flaked rosy crimson; the best forcer. Selected bulbs. \$1.75 per 100; \$15.00 per 1000.

French-venis (true). Flery scarlet. Selected bulbs, \$1.50 per 100; \$13.00 per 1000. First-size bulbs, \$1.25 per 100; \$10.00 per 1000.

Boddington's White and Light. Extra selected bulbs, 1 3/4 in. and up. \$1.50 per 100; \$14.00 per 1000. Bulbs 1 1/2 to 1 3/4 in. \$1.25 per 100; \$10.00 per 1000.

American Hybrids. A mixture of the choicest varieties of Gladiolus in cultivation. \$1.00 per 100; \$9.00 per 1000.

ARTHUR T. BODDINGTON

SEEDSMAN

342 West 14th Street, NEW YORK CITY

NEWS NOTES.

Salem, Mass.—E. F. Costeller & Co., have given up their retail store on Essex street.

Scranton, Pa.—A fire started in the boiler room of McClintock's greenhouses at Jefferson and Electric Av., but the loss was slight.

Jeffersonville, Ky.—While the family of Edward McCulloch were sleeping on December 19 a greenhouse a few feet from their house was burned to the ground. An overheated furnace is supposed to have been the cause.

Rochester, N. Y.—The widow of the late George Ellwanger has been allowed \$12,632 as reimbursement for the education of her daughter, Julia, nineteen years of age. The Court has also set aside \$5,000 per year until the daughter is 21.

Baltimore, Md.—Edwin A. Seidewitz, who charged from his store on Lexington Street and located on Charles Street, has had a new plate-glass front put in, and having it finished in time for the holidays gained a decidedly fine opportunity for displaying his goods.

Onarga, Ill.—The Mosbaek Greenhouse Co., who recently advertised their plant for sale, have decided to continue in the business and have engaged Charles W. Reimers of Louisville, Ky., as manager. Mr. Reimers is well known to the trade, having been in the business for twenty years.

Chico, Cal.—A total shipment of 1900 young peach and prune trees from an Oregon nursery to F. B. Schell was found to be affected by the peach root borer and condemned. They will either be returned or burned in Chico.

The Massachusetts Railroad Commissioners have been notified by the American Express Company's counsel that a new schedule of rates with a minimum charge of 20 cents on small parcels would go into effect on Jan. 1. This means a rebate of one-half of the advance recently made which was protested against by the Boston Merchants' Association and other commercial bodies.

CYCLAMEN GIGANTEUM

5, 6 and 7 in. pots—50c, 75c, and \$1.00 each.

Extra heavy stock of the very best quality.

Thomas Roland,
Nahant, Mass.

Gladioli

fine named sorts; colors, seedlings and mixtures.
Iris Pallida Dalmatica, German and Japan Iris, Madeira Vines, Cinnamon Vines, Hyacinthus candicans, Spotted Callas.

Send for Price List.

E. S. MILLER,
Wading River, Long Island, N. Y.

Flower Market Reports.

BALTIMORE The rise in price of cut flowers of all sorts and conditions incidental to the holiday season has been about on a par with preceding years. Callas, lilies, carnations, sweet peas, roses, with a few other incidentals of less note, have made up the bulk of the cut flower trade. It must be admitted however, that roses have not measured quite up to the usual standard. Violets have not yet been quite equal to the demand. A few yellow chrysanthemums of excellent quality were seen at the Exchange. In plants the poinsettia easily took the lead. There were also some very well grown plants of *Ardisia crenulata*. Nothing novel was developed worthy of note. Material was pretty well cleaned off. The Exchange did business quite equal to, possibly a little in advance of, the preceding year. Taking the entire year it is more than probable that the flower and plant grower has as little reason for complaint—owing to financial depression—as any business.

Very general satisfaction **BOSTON** is expressed over the trade for Christmas and the succeeding week which now closes. There were some grievous disappointments, to be sure. Those folks who were long on white carnations and short on crops of colored material had just reason to feel a little downcast; for the former was unsalable and the latter brought elegant prices, and the sale far exceeded the supply. The best seller in the entire list was the American Beauty rose, in any grade from two to twelve dollars a dozen, wholesale. Next in value were Richmond and Killarney. Bride and Bridesmaid fell short of last year's record. In all varieties of roses the cheaper grades, say from two to eight dollars a hundred, enjoyed a hungry demand from florists in the country towns, who were glad to get something that they could use at moderate prices. In carnations the bright colors, of course, were far in the lead, but Enchantress also seemed to please the popular fancy and sold well. White carnations, stavia, white narcissi and sweet peas ran far behind, the carnations proving the worst. The demand for violets, callas, gardenias, poinsettias, cattleyas and lilies was very strong. On asparagus, smilax, adiantum and other green goods there was a bad reaction. For ten days previous the call for decorative greens of all kinds was exceptionally strong, but it fell far two days before the holidays. The sales of holly had been very heavy, but there was too big a supply. There was less evidence of the storing up of flowers in advance than ever before. In fact, we have heard not a word of complaint on that score, and the growers are entitled to great credit. Beyond a doubt the flower trade has been permanently strengthened in consequence of their following out this wise policy. As to the plant trade, the story may be told in a few words. Excepting a few azaleas, poinsettias and some straggling odds and ends, everything in the plant line was cleaned up, the demand, not only in the city but far and near, out-of-town, being unprecedentedly active. Azaleas, poinset-

tias, Lorraine begonias and cyclamens held the front line.

BUFFALO Holiday week passed with a good record. While prices were not so good on some lines as previous years it may be said that in other respects results were better. The supply of carnations was excellent and stock excellent, there being a good quantity of red which were in greatest demand and commanded the highest price. Beauties were in good supply and while prices held firm there was no scarcity in this line, the best demand being for Richmond and Killarney. Violets sold exceptionally well. Lily of the valley was in good supply and sold readily as well as mignonette, cattleyas, gardenias and sweet peas. There was an over supply on Harrisii and Giganteum lilies which had little or no demand. Reports from the different florists state that this year's plant trade exceeded previous years, while all Christmas greens trade fell off to a certain extent. The shipping trade was excellent and thanks to the weather man for holding open a few days of mild weather and without snow, causing no late trains or frozen street.

Present reports confirm **DETROIT** the claim of a better Christmas trade than one year ago. Orders began to come in quite freely by Tuesday and somewhat relieved the usual and very embarrassing crush of the last two days. The tendency of purchases seems to indicate a preference for plants and baskets. Violets at \$5.00 per 100 were a poor drawing card, but carnations and roses enjoyed a liberal patronage. Orchids and gardenias were much in demand but short in supply. Wholesale dealers cleaned up very well and report a great increase in the sale of boxwood, leucotoeae and ferns. Extremely fine Richmond, La Detroit and Rhea Reid, were shipped in by Robt. Klage of Mt. Clemens.

A good Christmas business was expected, but it has been very much better than anybody thought it could be. There were many more individual orders but not so many large orders as in former years. Everything sold well. Cut flowers were cleaned up nicely and whatever hore a flower, in the plant line, went off. Poinsettias and Lorraine Begonias took the lead, while azaleas, cyclamens, P. incise, chrysos and oleonica followed in the order named. Of foliage plants, Boston fern with its various spots sold best, the original Boston fern still outstripping its offspring. The weather was ideal especially for delivery as no special care had to be taken in wrapping. Holly did not sell so well and our commission men offered the cases at 5c cents on Thursday morning, but it did not work and many cases are left. The quality was very poor.

ROBERT CRAIG CO.

ROSES, PALMS,

and Novelties in Decorative Plants

MARKET and 49th STREETS., PHILADELPHIA, PA.

Troy's WANT Corner

WANTED

Large Koster's Blue Spruce running from 5 ft. to 8 ft. high. State size and price and how many you can supply.

Write giving full particulars to

J. H. TROY,
Care "The Rosery,"
24 East 34th St., NEW YORK CITY.

ORCHIDS

Largest Importers, Exporters, Growers and Hybridists in the World

Sander, S.I. Albans, England
and 235 Broadway, Room 1
NEW YORK CITY

IMPORTED ORCHIDS

Arrived in Superb Condition

Vanda coerulea, Cattleya Trianae,
Cattleya gigas Sanderiana, Cattleya
Schroederiae, Oncidium varicosum.

JULIUS ROEHRS CO., Rutherford N. J.

ORCHIDS

Orchid Baskets and Peat
Write for Prices

JOSEPH A. MANDA
191 Valley Road - WEST ORANGE, N. J.

ORCHIDS

We have some handsome early *Percivaliana* which we positively guarantee to bloom between now and Christmas, as the buds are visible on the sheath. No less than two new strong growths on each plant. The flowers will more than repay purchase of plant. Plants with 7 to 10 bulbs \$1.00 each; from 10 to 15 bulbs \$1.25

ORDONEZ BROS., Madison, N. J.

ORCHIDS Freshly Imported

We offer a superb lot of *Cattleya gigas Sanderiana* in finest condition; also *C. Bogotensis*, *C. Schroederiae*, *C. labiata*, *C. gigas Hardyana* type and *Miltonia vexillaria*

LAGER & HURRELL, Summit, N. J.

ORCHIDS

Our latest importations have been, *Cattleya Chrysoxoa*, *Cattleya Gaskelliana*, *Cattleya Gigas*, (*Hardyana* district), *Phalaenopsis Amabilis Schilleriana* and others. We will receive in a short time, *Cattleya Dowiana*, *Miltonia Vexillaria* and others.

CARRILLO & BALDWIN
SECAUCUS, N. J.

A. N. PIERSON, Inc.

CROMWELL, CONN.

Wholesale Growers of Cut Flowers, Palms and Ferns

OUR SPECIALTIES. Roses, Lily of the Valley and Carnations. We also grow a general assortment of flowers in their season

Established 40 Years

Rose Hill Nurseries

New and Rare Plants

NEW ROCHELLE, N. Y.

New York Office, Siebert Building, 425 Fifth Avenue

Tobacco Paper IS THE **“NICO-FUME” LIQUID**
STRONGEST,
BEST PACKED,
EASIEST APPLIED.

Furnishes the Most Nicotine for the Money!

By far the **CHEAPEST.**

... Manufactured by ...
 THE KENTUCKY TOBACCO PRODUCT CO., Louisville, Ky.

24 sheets.....	\$ 0.75	Pint.....	\$ 1.50
144 sheets.....	3.50	½ Gallon.....	5.50
288 sheets.....	6.50	Gallon.....	10.50
1728 sheets.....	35.10	5 Gallons.....	47.25

LT NOTE PRICE!

WIZARD
 TRADE BRAND MARK
MANURES

Dried, screened and packed in bags of 100 lbs. each.

PULVERIZED SHEEP MANURE
 PURE — UNIFORM — RELIABLE

A strong and quick acting manure, highly recommended for carnations and chrysanthemums.

SHREDDED CATTLE MANURE
 EASY TO HANDLE AND APPLY

Stronger and better in every way than rough manure. Lasts much longer on the benches. Unequaled for mulching and feeding roses, liquid manuring and mixing with bench and potting soil. Used by all the largest growers.

Ask Your Supply Man or Write Us for Circulars and Prices.

— THE —
Pulverized Manure Co.
 31 Union Stock Yards, CHICAGO

The Lauten Fumigator
 (PATENTED)
 Write for Prices and Particulars.



IT Burns Tobacco Stems, the cheapest and most effective fumigating medium yet found.
 Costs no more than one box Tobacco Paper and will last a lifetime.
 Will not blaze or emit any foreign gases.
 Will not discolor or cripple flowers.
 Is easy to handle and there is no danger of fire in using.
 Will burn 5 or 6 hours without attention.
 Will exterminate aphids absolutely with one operation.

Write for prices of all Supplies for the Grower
WILSON PLANT OIL & FERTILIZER CO. CHATHAM New Jersey

For Trees, Plants, Shrubs and Flowers

USE

THE NIAGARA BRAND LIME SULPHUR SOLUTION

It destroys Scale Lice, Spiders and all forms of Aphides, AT THE SAME TIME Mildew, Blight, Rust and other Fungus difficulties.
 Used in Winter or Summer. — No other remedy has been so universally effective.
 Niagara Brand **ARSENATE OF LEAD** for chewing insects is equal to the best and better than the most. Ask about our Green House sprayer. Address —

NIAGARA SPRAYER CO., - - Middleport, N. Y.

DON'T EXPERIMENT

USE

TO-BAK-INE

and your stock will be free from insects, clean, and the blooms will not be discolored.

Send for full information of

H. E. FISKE SEED CO.
 13 Faneuil Hall Sq., Boston, Mass.

STUMPP & WALTER CO.,
 50 Barclay St., New York.

HENRY F. MICHELL & CO.,
 1018 Market St., Philadelphia.

E. H. HUNT, Gen'l Agent,
 76-78 Wabash Ave., Chicago.

“SCALECIDE”
 PRATT'S
 TRADE MARK REG. U. S. PAT. OFF.

Will positively destroy SAN JOSE SCALE and all soft bodied sucking insects without injury to the tree. Simple, more effective and cheaper than lime sulphur. Not an experiment.
 Write for FREE sample and endorsement of fruit growers and entomologists who have used it for years.
 Prices: 50-gal. bbl., \$25.00; 30-gal. tin, \$15.00; 10-gal. can \$6.00; 5-gal. can, \$3.25; 1-gal. can, \$1.00. f. o. b. New York. One gallon makes 16 to 20 gallons spray by simply adding water.
 Pocket Diary and Spray Calendar for 1909 sent FREE. Mention this paper.
 B. G. PRATT CO., Mfg. Chemists, 50 Church St., Dept. W, NEW YORK CITY.

The Best Bug Killer and Bloom Saver



NICOTINIC BUG KILLER

For PROOF Write to
P. R. Palethorpe Co.
 OWENSBORO, KY.

KILMDEAD TOBACCO DUST
 Free from Sand or Dirt Kind FOR FUMIGATING AND DUSTING
 Dusted on Plants. It covers large surface. Our Quality for Both Uses.

Our Tobacco Dust is the pure tobacco, free from sand and dirt, strong in Nicotine and always of the same strength, making it superior to any dust on the market. Costs you no more than the ordinary product and will do twice the work. 10 lbs. 60c; 25 lbs. \$1.25; 50 lbs. \$2.00; 100 lbs. \$3.50.

STUMPP & WALTER CO.
 50 Barclay St., New York

Prices Quoted in these Columns are for Dealers Only. When Writing to Advertisers Please Mention HORTICULTURE.

Seed Trade

The Canners' Convention which opens at Louisville, Ky., Feb. 1st next, promises to dispense any previous national gathering of the Canners and Allied Industries. As stated the Convention opens on Monday, Feb. 1st, and continues for one week.

Contrary to the usual custom, there will be really no hotel headquarters at this convention. All meetings are to be held at the Armory which has been donated for the purpose. While the canners are in session the machinery is to be stopped, but will be started again immediately after each adjournment and will be kept running at night up to ten o'clock at which time the hall will be closed. It is the purpose of those having the matter in charge to allow the general public to enter in the evening, an admission fee of 25c being charged to all who are not members either of the Canners or Machinery Supply Mena's Association. If the present plans of the officials of the Canners Association are carried out, each member will have to pay \$2.00 for a badge or button showing their membership, and each and every assistant they may bring with them will have to pay the same. The machinery and supply men are expected to pay \$1 each. Assuming that all those who attend the convention are up, it will put into the treasury of the Canners Association from eight to ten thousand dollars, but it is predicted by many that the smaller canners will balk at this tax and especially where they have brought one or more assistants.

Just on what principles the canners propose to tax the machinery and supply men who have to pay the rental of the hall in the way of floor space, and who pay annual dues of \$25.00 each for admission to their own show, has not been explained, nor indeed has any effort been made to offer an explanation. This action on the part of the Canners' Association is very generally resented by the machinery and supply men, not that they mind the \$1 tax, but because they do not see by what right it is imposed on them; however they will no doubt consider it wise to step up and settle rather than challenge the edict of the canners. Already there is much criticism on the inadequate hotel accommodations of Louisville for such a gathering, but, just how well founded this criticism is, will be more definitely known after the convention.

Final estimates on practically all crops have been rendered and deliveries in accordance therewith are being made, and the figures which were furnished "Horticulture" several weeks ago have not been materially changed. It was stated many weeks ago that the Sweet Wrinkled Peas such as Advancers, Hors-fords, Surprise and Admirals, would be very scarce and difficult to secure at any price. The seed has proved this prophecy to have been correct, although several growers of peas have decided to take advantage of the very high prices ruling and have sold considerable quantities of their seed stock, which has greatly relieved the situation; the consequence of this action has resulted in planting stock for another year of the varieties named, being so scarce that

many of the growers have exhausted their supplies and while they are still able to offer Alaskas quite freely, are compelled to limit the quantities which they will book of the varieties above named, or refuse to take orders for them altogether.

Again referring to the matter of spore seed, Alaskas seem to be obtainable at a price which shows a weakening tendency and whereas Alaskas sold readily at \$5.00 per bushel during October and November, it is predicted by many that they will be purchasable before the convention closes at \$4.00 or under. This is borne out by the fact that a few of the growers have already cut their prices on future Alaska seed from 25 to 50c per bushel below the figures at which they started to book orders for future delivery. Just how they are going to square themselves with their early purchasers is not apparent and it looks as if they would be compelled to reduce their prices on this variety on all their early orders to the figures which they are now quoting.

The predictions made in "Horticulture" during the fall as to the abundance of onion seed of the yellow varieties have been amply verified, as well as the further prediction that prices on onion seed for the 1909 crop would be very much lower than the past year. It is understood that some of the California growers are quoting onion seed for next fall's delivery of the yellow varieties from 60 to 70c. The Flat Reds from 75 to 80c; White Globe at \$1.25 and White Portugal at about an even dollar. No doubt most of our California friends have considerable reserves of the yellow varieties which they will carry into next year and many of their orders will be filled next fall from year-old seed.

On the other hand, vine seeds, especially the musk-melons and cucumbers are quoted somewhat above last year's prices, but this has been expected and will not be a surprise to any one; this is largely due to the general crop failures of these lines the past season. The farmers are asking more and as a consequence the grower is compelled to advance his prices, but these advances are comparatively small and are generally accepted philosophically by the trade.

The 1909 retail catalogues are beginning to make their appearance and as a rule are an improvement over those of any previous year, showing much care and labor in their preparation. They are very creditable to the seedsmen who by the way, are quite generally looking for an excellent business the coming season. It is hoped that they will not be disappointed.

Reference was made some time since to the probable shortage in the Burpee's Bush Lima Beans and this has materialized according to schedule. It is very difficult to procure this variety at all and when quoted prices range from \$6.00 to \$7.00 per bushel. Green Pod beans are generally in shorter supply than the wax varieties and are quoted at almost even prices, one or two varieties such as Black Valentine being practically unobtainable at any price. The writer was informed that

one dealer who was fortunate enough to have about fifty bushels of these beans, sold them to a southern seedsmen for \$8.50 per bushel and he stated that he could easily have gotten \$7.00 had he asked it. Seed stock of this variety is very short and prices for the coming year will probably rule high.

The joint action of the Wholesale Seedsmen's League and the American Seed Trade Association in petitioning Congress for specific duties on all seeds, should receive favorable consideration from our Solons as it seems to be a practically unanimous sentiment.

Bloomington, Ill.—The capital stock of Funk Bros. Seed Co., has been increased from \$25,000 to \$50,000.

Chicago, Ill.—The National Seed Co., of 5th avenue, Chicago, have sold their business to the W. W. Barnard Co., who will use it for their retail trade. The location is an excellent one. Mr. Rouse and Mr. Stewart will both be retained for the present at least and the business will be pushed.

CATALOGUES RECEIVED.

California Nursery Co., Niles, Cal.—Price List 1908-1909 of Trees, Palms, Shrubs, etc.

Wood, Stubs & Co., Louisville, Ky.—"The Ribbon Seeds," Spring Catalogue for 1909. Cover in colors, quite attractive.

Forest Nursery & Seed Co., McMinnville, Tenn.—Special List of Seedling Ornamental Trees and Shrubs, Nursery Green Stock, Seeds, etc.

W. E. Marshall & Co., New York, N. Y.—Seed Catalogue for 1909. A very creditable production for this young and progressive house.

Johnson Seed Company, Philadelphia, Pa.—Wholesale Price List for Market Gardeners and Truckers." "Near but not gaudy" cover in green tints.

MICHELL'S

MAMMOTH FANCY VERBENA

Our Mammoth Fancy Strain combines large size, purity of color and free flowering qualities.

	Tr. pkt.	Oz.
BLUE and PURPLE ..	30c	\$1.50
PINK ..	30c	1.50
SCARLET ..	30c	1.50
STRIPED ..	30c	1.50
WHITE ..	30c	1.50
MIXED, all colors ..	30c	1.50

GLADIOLUS BRIDE

PURE WHITE an elegant FORTER

60c per 100; \$5.00 per 1000

Write for our Handy Flower Seed Order Sheet

MICHELL 1018 MARKET ST.
PHILA., PA.

Phoenix Roebeleni Palm Seed

Just arrived from Mr. C. Roebelen, St. M. Write for prices

Ralph M. Ward & Co.
12 W. B'way, New York

SHEEP MANURE

Pulverized Free from Adulteration
In Bag, \$18.00 per Ton. Cash with Order

ROBERT SIMPSON
CLIFTON, N. J.

E. S. Miller, Wading River, N. Y.—Trade Price-List of Bulbs and Hardy Flowers for Spring, 1909. Offers a good selection of gladioli and lilies especially.

Amzi Godden Seed Co., Birmingham, Ala.—Southern Truckers' Guide, 1909. This catalogue, as its name indicates, is devoted mainly to vegetable and forage crops and covers the field fully.

C. S. Harrison, York, Neb.—Price List of Select Nursery Co.'s specialties for Spring, 1909. The Bulletin of the Nebraska Park and Forestry Society which accompanies the catalogue is a very interesting document.

John Lewis Childs, Floral Park, N. Y.—Rare Flowers, Vegetables and Fruits.—Profusely illustrated and replete as usual with wondrous things. Cover page devoted to a new Burbank "creation" said to bear delicious fruit in three months from seed.

Henry Mette, Quedlinburg, Germany.—Trade Catalogue of Vegetable, Flower and Farm Seeds for 1908-1909. Established in 1787 and owning about 2000 acres of ground this firm would naturally be expected to issue a catalogue of more than ordinary scope. Such this catalogue is.

W. Atlee Burpee & Co., Philadelphia, Pa.—Farm Annual for 1909. "The plain truth about the best seeds that grow," is the motto which, in company with a beautiful sweet pea cluster adorns the first cover page of this strictly up-to-date publication. A number of fine colored plates add brilliancy to the contents.

Wm. Elliott & Sons, New York City.—Seed Catalogue for 1909.—The cover of this, the 64th spring edition from this long-established house, is, as usual, elaborate and unique. The title page shows an inviting balcony and lawn scene well depicted in natural colors. The contents—illustrations and all—are of the kind to entuse the buyers.

Mignonette

**FARQUHAR'S
GIANT**

Oz., 75c; 1-4 oz., 25c

R. & J. Farquhar & Co.
6 & 7 South Market Street
BOSTON, MASS.

BRIDGEMAN'S SEED WAREHOUSE
RICKARDS BROS.
Props.
37 East 19th St., - NEW YORK CITY



GROUND BONE
For Potting Purposes
100 lb. \$3, 200 lb. \$4
W. ELLIOTT & SONS
42 Vesey St., New York

48-56 JACKSON ST.,
C. C. MORSE & CO. San Francisco, Cal.
The Largest Seed Growers on the Pacific Coast
ONION, LETTUCE, SWEET PEAS,
ALSO
Carrot, Celery, Leek, Mustard, Parsley, Parsnip, Radish, Salsify

LEONARD SEED CO.
Growers and Wholesalers of Superior Garden Seeds
FLOWER SEEDS—ONION SETS . . . GET OUR PRICES
79 East Kinzie Street
143 West Randolph Street **CHICAGO**

Thorburn's Bulbs

LILY OF THE VALLEY PIPS
Just received our unexcelled pips.
We also offer at reduced prices
Lilium Longiflorum, 6/8 and 7/9
Lilium Multiflorum, 7/9
Double Hyacinths in separate colors.
ASK FOR PRICES.
J. M. THORBURN & CO.
33 BARCLAY ST. through to 38 PARK PLACE
NEW YORK

Burpee's Seeds
PHILADELPHIA
Blue List of Wholesale Prices mailed only to those who plant for profit

C AULIFLOWER S E E D
A B B A G E E D
LILY OF THE VALLEY PIPS.
HJALMAR HARTMANN & CO.
12 Stormgade,
COPENHAGEN, DENMARK.

STOCK SEED
FOR WINTER BLOOMING
Our strain of Double Branching Stocks is exceptionally true. About 90% Double Flowers.
In colors: - 1/2 oz. .60 oz. \$4.00
Pure White 1/2 " .75 " 5.00
H. E. FISKE SEED CO.
Faneuil Hall Square, BOSTON, MASS.

Winter-flowering
SWEET PEA SEED
All Colors Ask for List
A. C. ZVOLANEK
ORIGINATOR. BOUND BROOK, N. J.

NEW CROP SEED
For Early Planting
THOMAS J. GREY CO.
32 SO. MARKET ST., BOSTON, MASS.

READY For Prompt Shipment...
FRENCH and DUTCH BULBS
Catalogues mailed free on application
Joseph Breck & Sons Corp.
47-54 NO. MARKET ST., BOSTON, MASS.

QUALITY SEED BULBS PLANT
SEND FOR CATALOGUE.
ARTHUR T. BODDINGTON
343 West 14th St., New York.

To Florists Everywhere

Orders for Cut Flowers and Floral Decorations to be delivered anywhere in the Greater New York, may be placed with us with the certainty that your customers will be satisfied.

Telegraph, telephone or mail such orders to us and be sure that they will be filled as promptly and as carefully as though you did it yourself.

One third discount will be allowed on all orders thus placed with us by Florists outside of the Greater New York.

THE BLOSSOM

Bond and Livingston Sts.,
BROOKLYN, N. Y.

C. C. TREPEL, Manager

WILLIAM J. SMYTH FLORIST

Cor. Michigan Ave. and 31st St., CHICAGO

We ship to all points in Illinois and Iowa.

Phones: Douglas 744, Douglas 523, Douglas 740

M. C. and J. E. HAUSWIRTH

Out of Town orders for Hospitals
Carefully filled.

232 Michigan Ave.

CHICAGO

AUDITORIUM ANNEX Tel. Harrison 585

SAMUEL MURRAY Florist

Coates House Conservatory

1617 BROADWAY, KANSAS CITY, MO

Both 'Phones 2670 Main

FRED C. WEBER FLORIST

4326-28
OLIVE STREET ST. LOUIS, MO.

Established 1873

Long Distance Phone Bell Lindell 676



WASHINGTON,
D. C.

GUDE'S

The Far-Famed Flowers of TORONTO

Delivered on mail or telegraph order for any occasion, in any part of the Dominion.

JOHN H. DUNLOP,
96 Yonge St., - Toronto, Ont.

The Park Floral Co.

J. A. VALENTINE
Pres.

DENVER, COLORADO

WILLIAM L. ROCK FLOWER CO.

KANSAS CITY, - MO.

will carefully execute orders for Kansas City and any town in Missouri or Kansas.

Of Interest to Retail Florists

SOME CHICAGO CHRISTMAS DECORATIONS.

At Weinhorber's fancy boxes and baskets filled with blooming plants of one, two or even three varieties seemed to be the popular offering. The store was tastily decorated but the palm house was especially beautiful and the arrangement afforded extra sales room which is a valuable adjunct at a holiday time. Two shelves running the entire length of the house just below the glass, three and four feet from the floor, also the walls behind, had been smoothly covered with green moss. The pillars were all closely wound with green wreathing and the glass lightly draped with wild smilax. Against this background and on the green benches the scarlet poinsettias and fancy baskets appeared to best advantage. From the festoons above hung many red immortelle balls and when this place was lighted with electricity it made a tempting picture to show customers.

STEAMER DEPARTURES

American.

St. Louis, N. Y.-S'hampton...Jan. 9
Philadelphia, N. Y.-S'hampt...Jan. 16

Atlantic Transport.

Minnetonka, N. Y.-London...Jan. 9
Mesaba, N. Y.-London...Jan. 19

Cunard.

Lasitana, N. Y.-Liverpool...Jan. 6
Caronia, N. Y.-Med'n ports...Jan. 7
Campania, N. Y.-Liverpool...Jan. 13

French Line.

La Touraine, N. Y.-Havre...Jan. 7
La Bretagne, N. Y.-Havre...Jan. 14

Hamburg-American.

Amerika, N. Y.-Hamburg...Jan. 5
Hamburg, N. Y.-Italian pts...Jan. 5
Batavia, N. Y.-Hamburg...Jan. 9

Leyland.

Bohemian, Boston-Liverpool...Jan. 4
Winifredien, Boston-Liv'pool...Jan. 29

North German Lloyd.

Barbarossa, N. Y.-Gillham...Jan. 4
K. W. der Grosse, N. Y.-B'n...Jan. 5

White Star.

Majestic, N. Y.-S'hampton...Jan. 6
Cedric, N. Y.-Med'n ports...Jan. 9
Cymric, Boston-Liverpool...Jan. 13
Oceanic, N. Y.-S'hampton...Jan. 13

At Paul Blome & Co.'s the small conservatory in the rear was prettily arranged and two days before Christmas most of the plants wore the tag which florists love to adorn their plants with.

A miniature lake in Wittbold's Clark street window was nicely done. It was irregular in outline and the shore relieved with dwarf Japanese trees and araucarias. Another window was entirely in red with the ever popular poinsettia as a centre. Festoons of broad red ribbon and red chenille added brilliancy.

H. R. Hughes had an especially sensational window for Christmas. The large show room was divided into two parts, the one a snow scene with a church vestibule in which lay a tired news boy with his papers. The other represented the dream of the homeless waif—a happy home scene. The picture attracted crowds.

ALEX. McCONNELL

571 FIFTH AVENUE
NEW YORK CITY

Telegraphic orders forwarded to any part of the United States, Canada, and all principal cities of Europe. Orders transferred or intrusted by the trade to our selection for delivery on steamships or elsewhere receive special attention.

Telephone Calls, 487 and 488 36th St.
Cable Address, ALEXCONNELL

New York Deliveries

FLOWERS and PLANTS

by special messenger to Steamer,
Theatre or any address in

NEW YORK or BROOKLYN

THOMAS YOUNG, JR.

500 FIFTH AVE., (near 42nd St.)

NEWMAN FLORAL Co.

(Established 1870)

202 Fifth Ave. and
Madison Square, NEW YORK CITY

FLOWERS FOR STEAMER SAILINGS

M. A. BOWE

In the Heart of New York City

1294 Broadway

Tel. 2270, 38th St. NEW YORK

Our Motto—The Golden Rule

DAVID CLARKE'S SONS

Deliver orders from any part of the country to
New York City

Or OUT-GOING STEAMERS

Write or telegraph

2139-2141 Broadway, New York
Telephone 1552-1553 Columbus

YOUNG & NUGENT

42 West 28 St., NEW YORK

"FLOWERS BY TELEGRAPH"

NEW YORK

MYER, FLORIST

Phone 5297 Plaza. 609-611 MADISON AVE.

ALBANY, N. Y.

EYRES

Flowers or Design Work

DELIVERED IN ALBANY AND VICINITY
ON TELEGRAPHIC ORDER.

11 NORTH PEARL ST., ALBANY, N. Y.

Flower Deliveries

In Brooklyn and other Long Island Points
New York City, New Jersey, etc. At Theatres,
Hotels, Steamers or Residences.

WILSON

Fulton St. and Greene Ave., Brooklyn, N. Y.

**JOHN BREITMEYER'S
SONS**

Cor. Miami and Gratiot Aves.
DETROIT, MICH.

**Artistic Designs . . .
High Grade Cut Blooms**

We cover all Michigan points and good sections of Ohio, Indiana and Canada

**PROMPT DELIVERY IN
BOSTON**

AND ALL NEW ENGLAND POINTS
F. H. HOUGHTON
396 Boylston St., Boston, Mass.

BOSTON'S BEST
In Quality and Design
Can be relied upon when you transfer your retail orders to

EDWARD MACMULKIN
194 Boylston Street, Boston

Send flower orders for delivery in
BOSTON
and all
NEW ENGLAND POINTS
THOS. F. CALVIN
124 Tremont St., Boston

The Original Telegraph Order Florist
WILL DELIVER

Flowers or Designs
to order in Boston and Vicinity. Usual Discount.

J. NEWMAN & SONS, INC.
Est. 1870 24 TREMONT ST., BOSTON

TRANSFER
Your orders for flower or plant delivery in Eastern New England to
JULIUS A. ZINN,
2 Beacon St., Boston.
Fine Design Work a Specialty.

Hoffman
FLORIST
59-61
Massachusetts Ave
for Comm. in South Ave.
BOSTON.

DANKER, Albany, N. Y.

ORDERS FOR
**Choice Flowers and
Floral Emblems**
FILLED PROMPTLY

Palmer's
Buffalo, N. Y.
W. J. PALMER & SON, 30 Main St.

THE NEW IDEA IN PLANT STANDS

**The Moore-Livingston
Graduating or Adjusting**

Saves one-half to two-thirds of cost over ordinary galvanized iron stands.

SEND FOR CIRCULAR GIVING FULL PARTICULARS
SOLD BY SEEDSMEN AND SUPPLY HOUSES

If your seedsman does not carry send us his name and we will promptly send full particulars.

Moore-Livingston Co., Patentees and Mfrs., **Lansdowne, Pa.**

FRANK POLITES.

We present herewith a picture of this enterprising Philadelphia retailer whose attractive flower store is located at 1416 Chestnut street, Philadelphia. A few weeks ago we published the news of the opening of his new branch store at 13th and Chestnut street. Among



foreign born citizens there are few who have borne themselves more bravely or successfully in the warfare of life than Frank Polites. He has built up a fine business and is respected by everybody.

Florists report Christmas business as above the average. Danker, Eyres and Gloeckner are all well in line with reception and inauguration decorations in all of which palms, ferns, poinsettias and bright colored material figure prominently. Killarney roses will have the place of honor on the speaker's desk at the Capitol.

A review of the WASHINGTON market on the 22nd showed an advance of one-third on price of nearly all cut blooms, and on the afternoon of the 23rd prices had advanced to one-half more. Pending the New Year sales are holding their own. One of the prettiest novelties for this market shown by a local florist was an array of imported English holly trees.

THE BEST LETTERS

FOR THOSE
FLORISTS' MADE
USE OF BY THE

Boston Florist Letter Co.
66 PEARL ST., BOSTON
N. F. MCCARTHY, Mgr.

Order direct or buy from your local supply dealer. Insist on having the
BOSTON
Inscriptions, Emblems, etc., Always in Stock

STRING UP
Asparagus and Smilax with
GREEN SILKALINE
There's Nothing So Good.

JOHN C. MEYER & CO., Boston, Mass.

FLORISTS' SUPPLIES
Send for New Catalogue

H. Bayersdorfer & Co.
1129 ARCH ST., PHILADELPHIA

Wired Toothpicks
Manufactured by
W. J. COWEE, BERLIN, N. Y.
10,000....\$1.75; 50,000....\$7.50. Sample free.
For sale by dealers

JACOB SCHULZ, 644 Fourth Ave.,
CUT FLOWERS of BEST QUALITY in season
Delivered promptly to any address.
Write, Telegraph or Telephone.
Cumberland and Home Phones 223 and 984

WELLESLEY COLLEGE
Dana Hall, Walnut Hill and Reckridge Hall
Schools. **TALBY, Wellesley, Mass.**
Tel. Wellesley 441 and 5. Night 443.

ATLANTA FLORAL CO.
41 Peachtree ATLANTA, GEORGIA
Street.

In ordering goods please add "I saw it in HORTICULTURE."

GARDENIAS

WE can supply you with Gardenias and can fill all orders. On short notice we can get them for you special from the greenhouses so as to give perfect satisfaction.

THE LEO NIESSEN CO.

1209 Arch St., Philadelphia, Pa.
Open from 7 a.m. to 8 p.m.



Gypripediums

\$10.00 per 100
In Lots of 100 or over

Smaller Lots at 14c.

QUALITY

S. S. PENNOCK-MEEHAN CO.
1608-1620 Ludlow St., Philadelphia

Special Carnations

Fancy grades from the best growers

W. E. MCKISSICK & BROS.

WHOLESALE FLORISTS
1619-1621 RANSTEAD ST.
PHILADELPHIA

WELCH BROS.

AMERICAN BEAUTY, KILLARNEY, RICHMOND, MARYLAND AND ALL THE SUPERIOR
ROSES, LILY OF THE VALLEY, CARNATIONS, ORCHIDS
BEST PRODUCED

226 Devonshire Street, Boston, Mass.

CUT FLOWER BOXES

EDWARDS FOLDING BOX CO

MANUFACTURERS
PHILADELPHIA, PA.

CHAS. W. MCKELLAR

51 WABASH AVE., CHICAGO

Western Headquarters for Choice Orchids
Valley, Roses and all Cut Flowers

PETER REINBERG

WHOLESALE

CUT FLOWERS

51 Wabash Av., Chicago, Ill

DAILY CONSIGNMENTS

From 40 to 60 Growers

We can care for your cutflower wants to advertise.

E. F. WINTERSON CO.

45-47-49 WABASH AVE., CHICAGO

POEHLMANN BROS. CO.

33-35-37 Randolph St., - CHICAGO

CUT FLOWERS

Greenhouses, - Morton Grove, Ill.

Rice Brothers

115 N. 6th Street, MINNEAPOLIS, MINN.

WHOLESALE FLORISTS and SUPPLIES
CUT FLOWERS received twice daily, and can fill your orders to your satisfaction. A complete line of Hardy Greens - WILD SMILAX, BOXWOOD, HARDY FANCY FERNS, GALAX LEAVES.
Write for quotations on large quantities.

In ordering goods please add "I saw it in HORTICULTURE."

WHOLESALE FLOWER MARKETS—TRADE PRICES—Per 100 TO DEALERS ONLY

	CHICAGO New Year Prices	TWIN CITIES Dec. 28	PHILA. Dec. 28	BOSTON Dec. 31
ROSES				
Am. Beauty, Fancy and Special	55.00 to 65.00	30.00 to 42.00	60.00 to 75.00	60.00 to 75.00
" " Extra	50.00 to 65.00	25.00 to 35.00	40.00 to 50.00	35.00 to 50.00
" " No. 1	35.00 to 50.00	20.00 to 30.00	25.00 to 30.00	10.00 to 15.00
" " Lower grades	20.00 to 25.00	10.00 to 15.00	10.00 to 15.00	6.00 to 8.00
Bride, 'Maid, Fancy & Special	8.00 to 12.00	6.00 to 8.00	12.00 to 15.00	10.00 to 15.00
" " Lower grades	4.00 to 8.00	4.00 to 6.00	6.00 to 8.00	3.00 to 8.00
Killarney, Fan, & Sp.	10.00 to 15.00	8.00 to 12.00	20.00 to 25.00	15.00 to 35.00
" " Lower grades	5.00 to 10.00	4.00 to 8.00	8.00 to 12.00	3.00 to 8.00
Richmond, Fancy & Special	8.00 to 12.00	10.00 to 14.00	20.00 to 25.00	14.00 to 35.00
" " Lower grades	6.00 to 8.00	4.00 to 8.00	6.00 to 8.00	3.00 to 8.00
Chatenay	6.00 to 10.00	4.00 to 8.00	3.00 to 15.00
Golden Gate Ivory, etc.	6.00 to 10.00	4.00 to 8.00	6.00 to 15.00	3.00 to 12.00
My Maryland	6.00 to 25.00
Queen Beattie	3.00 to 12.00
Mrs. Mar. Field	6.00 to 15.00	12.00 to 25.00
CARNATIONS				
Fancy and Rich	6.00 to 8.00	3.00 to 5.00	6.00 to 8.00	3.00 to 6.00
Ordinary and White	4.00 to 6.00	2.00 to 3.00	2.00 to 4.00	1.00 to 2.00
MISCELLANEOUS				
Cattleyas	50.00 to 60.00	50.00 to 60.00	75.00 to 50.00
Lilies	15.00 to 18.00	12.50 to 15.00	12.50 to 15.00	8.00 to 12.00
Lily of the Valley	3.00 to 4.00	3.00 to 4.00	3.00 to 4.00	1.00 to 4.00
Narciss., Paper White	3.00 to 4.00	3.00 to 4.00	3.00 to 4.00	1.00 to 2.00
Roman Hyacinth	3.00 to 4.00	2.00 to 3.00	3.00 to 4.00	1.00 to 2.00
Sweet Peas	.75 to 1.00	1.00 to 2.00	2.00 to 3.00	1.50 to 2.00
Gardenias	40.00 to 50.00	50.00 to 60.00	25.00 to 50.00
Violets	1.00 to 2.00	1.00 to 2.00	1.00 to 2.00	1.50 to 2.00
Adiantum	1.00 to 2.00	1.00 to 2.00	1.50 to 2.00
Smilax	12.00 to 15.00	12.00 to 15.00	12.00 to 15.00	10.00 to 14.50
Asparagus Plumosus, stragg.	35.00 to 50.00	40.00 to 50.00	35.00 to 50.00	85.00 to 90.00
" " & Spreng. (two bchs.)	15.00 to 25.00	15.00 to 25.00	35.00 to 50.00	15.00 to 25.50

J.A. BUDLONG

37-39 Randolph Street, CHICAGO.

ROSES and CARNATIONS
A Speciality.....

WHOLESALE GROWER of CUT FLOWERS

HENRY M. ROBINSON & CO.

15 Province St and 9 Chapman Place - BOSTON, MASS.

WHOLESALE COMMISSION FLORISTS

Hardy Cut Evergreens and Florists' Supplies

We have the stuff and can fill all orders, large or small
WE NEVER DISAPPOINT SATISFACTION GUARANTEED

Prices Quoted in these Columns are for Dealers Only.
When Writing to Advertisers Please Mention
HORTICULTURE.

THE FLORIST SUPPLY HOUSE OF AMERICA

SPECIAL NOTICE

During the month of January **Only**

A SPECIAL DISCOUNT OF 10 PER CENT

on our Celebrated Standard Wheat Sheaves which every one knows are the best. Order now and get this liberal discount only for the month of January.

WE WISH ALL OUR FRIENDS A HAPPY AND PROSPEROUS NEW YEAR

H. BAYERSDORFER & CO., 1129 Arch St., Phila., Pa.

Flower Market Reports.

CHICAGO The Christmas trade with few exceptions was highly satisfactory. Most of the retailers as well as wholesalers sold out everything at their own price. The only fault really to be found was with the quality of the stock, some of it having been kept too long, a condition that comes as regularly as the holidays themselves. Had all the stock been first-class there would probably have been enough for the demand but after taking out the unsaleable there was a shortage and many orders had to be refused. The warm fall had hurried the usual Christmas rose crop through ahead of the season and Beauty, Richmond and Killarney were especially short. Carnations of the best quality would not go around and all other stock was not in excess.

Plants.

Chicago's Christmas plant trade was the heaviest on record and exceeded the most sanguine expectations. This was due in part to the fine quality offered, and in part to the sharp advance in price of flowers. In some of the best retail stores the help worked the entire night making up hampers of plants ranging all the way up to thirty-five dollars.

Azalea Madam C. Petrick made a good impression for Christmas. Its superior keeping qualities as compared with Simon Mardner were particularly noted.

Frank Oechslin, one of Chicago's most successful plant growers is working up stock of the double poinsettia for another year when he will grow it quite extensively.

Christmas Greens.

There was a great deal more Christmas green shipped into the Chicago market than could be disposed of. Ten days before Christmas holly was quoted at four and five dollars per case respectively for southern and eastern stock but the price dropped to one-half that before Christmas day. Saturday in the wholesale district looked every bit "the day after" as the huge loads were hauled away for burning. One hundred boxes of holly were counted in one block to say nothing of the immense lots consigned to the produce commission merchants on South Water St. in car-load lots. In short the green goods business was badly overdone.

Bells.

A deluge of Christmas bells seemed to have descended upon Chicago. What at first seemed to be a valuable acquisition in the way of decorative stock

WHOLESALE FLOWER MARKETS. — PER 100. — TO DEALERS ONLY.

	CINCINNATI Dec. 27		DETROIT Dec. 27		BUFFALO Dec. 28		PITTSBURG Dec. 28	
ROSES								
Am. Beauty, Eco. and Sp.	57.40	70.00	75.00	100.00	65.00	100.00	50.00	70.00
" Extra	35.00	40.00	50.00	75.00	50.00	60.00	35.00	40.00
" No. 1	20.00	25.00	30.00	50.00	15.00	50.00	20.00	25.00
" Lower grades	10.00	15.00	8.00	10.00	15.00	20.00	10.00	15.00
Bride, "Maid, F. & S.	10.00	12.00	10.00	15.00	15.00	20.00	10.00	12.00
" Low gr.	3.00	6.00	8.00	10.00	6.00	10.00	3.00	6.00
Killarney, Fan, & Sp.	12.00	15.00	12.00	18.00	15.00	20.00	12.00	15.00
" Lower grades	6.00	10.00	3.00	12.00	6.00	10.00	6.00	10.00
Richmond, Fancy & Special	10.00	12.00	12.00	18.00	15.00	20.00	15.00	20.00
" Lower grades	6.00	12.00	8.00	12.00	10.00	15.00	6.00	12.00
Catenay	6.00	15.00	8.00	18.00	10.00	15.00	6.00	15.00
Golden Gate, Ivory, etc.	6.00	10.00	6.00	15.00	10.00	15.00	6.00	10.00
My Maryland	12.00	15.00	8.00	18.00	10.00	15.00	12.00	15.00
Queen Beatrice	10.00	15.00	10.00	15.00	10.00	15.00	10.00	15.00
Mrs. Mar. Field	10.00	15.00	10.00	15.00	10.00	15.00	10.00	15.00
CARNATIONS								
Ency and Novelties	4.00	4.00	6.00	8.10	4.00	5.00	4.00	4.00
Ordinary	3.00	3.00	3.00	6.00	3.00	4.00	2.00	3.00
MISCELLANEOUS								
Catleys	75.00	50.00	50.00	75.00	8.00	15.00	75.00	15.00
Lilies	15.00	15.00	12.50	15.00	8.00	15.00	15.00	15.00
Lily of the Valley	3.00	4.00	4.00	4.00	3.00	4.00	3.00	4.00
Narcis, Paper White	2.00	3.00	3.00	4.00	2.50	3.00	2.00	3.00
Roman Hys.	2.00	3.00	3.50	4.00	2.50	3.00	2.00	3.00
Sweet Peas	75.00	1.50	.75	1.50	1.00	1.00	.75	1.50
Gardeolias	50.00	75.00	10.00	15.00	.60	.75	50.00	75.00
Violets	.75	1.25	1.50	2.00	1.50	2.00	.75	1.25
Adiantum	1.25	1.50	1.50	1.50	1.50	1.50	1.25	1.50
Smilax	15.00	15.00	15.00	15.00	12.00	15.00	15.00	15.00
Asparagus Plumosus, strigos.	50.00	50.00	50.00	75.00	25.00	50.00	50.00	50.00
" " & spren (100 bchs.)	50.00	50.00	20.00	30.00	45.00	50.00	50.00	50.00

was sadly overdone. Red bells of every size and of various materials were offered in every store and met with ready sale, but by the middle of the week there began to appear white bells, green bells, purple bells and all sorts of combinations of these colors. The effect was shocking to the point of disgust. How can the taste of the public be cultivated when the trade constantly offends in this way though we are glad to say the worst offenders were the street fakirs.

On the whole the trade is well satisfied with the volume of Christmas business done and the prices received. The clean-up in cut flowers and plants was far better than 1907, and while prices were a trifle lower if anything, other features more than made up for that. The quantity of stock received was about the same as last year, and the quality never better. One leading wholesaler declared that there was no salted stock on the market. We might say, in parenthesis, that the lesson dinned into the grow-

ers' ears for years by HORTICULTURE and others, combined with disastrous returns, seems to have at last borne good fruit, and it looks as if the growers had put that piece of human folly behind them for good and all. Plants, flowers, greens—everything, were in brisk demand, and the volume of business done, according to the writer has interviwed, the largest on record. One leading retail house stated that they ran short of plants by the morning of Wednesday, and were put to extraordinary shifts to replenish. One result of this was a crowding of customers on to cut flowers. Anything presentable in the shape of a flowering plant found a ready market and towards the last even palms were going. There was no special run on any one thing and no striking novelty developed. In cut flowers the scarce items were cattleyas and, in spots, American Beauty roses. Cut poinsettias sold well, especially the smaller ones. A good many of the large, high priced heads hung fire.

(Continued on page 22)

EVERYBODY KNOWS Park, Cemetery and Landscape Gardening cannot be properly done without the aid of an accurate leveling instrument.

Easton's Improved Levels, No. 2 at \$25.00 and No. 3 at \$25.00, are conceded by all who **KNOW** to be the only Levels on the market which meet all the requirements, at the price.

Our guarantee back of every Level we sell, and satisfied users in every State in the Union heartily endorse every claim we make.

Shipping weight 12 lbs. Description on request.

BOSTROM-BRADY MFG CO., 139 Madison Avenue. ATLANTA, GA.

FORD BROTHERS

48 West 28th Street NEW YORK

FINE ROSES FANCY CARNATIONS

A Full Line of ALL CUT FLOWERS

Telephone, 3870 or 3871 Madison Square

H. E. FROMENT

Wholesale Commission Florist,
Choice Cut Flowers,

57 West 28th St. :: NEW YORK

Telephones: 2200, 2201, Madison Square.

Alfred H. Langjahr

All choice cut-flowers in season. Send for quotations. Correspondence with shippers of first-class stock invited.

55 West 28th Street, New York
Telephones 4626-4627 Madison Square

Edward C. Horan

Wholesale Florist

55 WEST 28th ST.

Tel. 1462
1463 Madison Square New York

JOHN YOUNG

WHOLESALE FLORIST

Finest American Beauties and Carnations

51 West 28 St. - NEW YORK

FRANK MILLANG

Wholesale Florist

55-57 West 26th St., NEW YORK

Shipments, any quantity, Wholesale Market Rates.

Consignments Requested

A Good Market and Prompt Returns

GEORGE SALTFOED

43 W. 28th Street, NEW YORK

Telephone, 3393 Madison Sq.

VIOLETS

Finest Grade. Any Quantity

B. S. SLINN

55-57 W. 26 St., New York

Moore, Hentz & Nash

Wholesale Commission Florists

55 and 57 West 26th Street

Telephone No. 756
Madison Square New York

MILLANG BROS.

WHOLESALE COMMISSION FLORISTS

41 West 28th Street

Telephone 3860
3861 Madison NEW YORK

JOHN I. RAYNOR
Wholesale Commission Florist **SELLING AGENT FOR LARGEST GROWERS**
A full line of Choice Cut Flower Stock for all purposes. Comprises every variety grown for New York market, at current prices
TEL. 1998 MADISON SQUARE 49 West 28th St., New York City

Walter F. Sheridan
Wholesale Commission Dealer in
CHOICE CUT FLOWERS
39 West 28th Street, New York
Telephone: 3532-3533 Madison Square

HEADQUARTERS FOR NOVELTIES
ORCHIDS A SPECIALTY
THE HIGHEST GRADE OF **VALLEY** ALWAYS ON HAND
CARNEDIAS, DAISIES, ROSES AND CARNATIONS
JAMES McMANUS, Telephone 769 Mad. Sq. 42 W. 28th St., New York

PHILIP F. KESSLER 55 & 57 W. 26th St., New York City
Commission Dealer, Wholesale Buyer and Seller of
Open from 5 a. m. to 6 p. m. Sunday till 10 a. m. **CUT FLOWERS**
Tel., 5243 and 2921 Madison Sq. Res., 345 J., Newtown.
Finest Lilies in the Market Every Day in the Year.

NEW YORK QUOTATIONS PER 100. To Dealers Only

ROSES	Last Half of Week ending Dec. 26 1908		First Half of Week beginning Dec. 28 1908	
	American Beauty, Fancy and Special.....	75.00	100.00	50.00
" " Extra.....	40.00	60.00	30.00	40.00
" " No. 1.....	15.00	25.00	15.00	20.00
" " Lower Grades.....	8.00	12.00	6.00	8.00
Bride, Field, Fancy and Special.....	12.00	20.00	10.00	15.00
" " Lower Grades.....	4.00	8.00	4.00	8.00
Killarney, Fancy and Special.....	20.00	35.00	10.00	25.00
" " Lower Grades.....	6.00	12.00	6.00	8.00
Richmond, Fancy and Special.....	20.00	35.00	10.00	25.00
" " Lower Grades.....	6.00	12.00	6.00	8.00
Chatenay.....	6.00	25.00	4.00	15.00
Ply Maryland.....	6.00	25.00	8.00	20.00
Golden Gate, Ivory, etc.....	4.00	15.00	4.00	15.00

Alexander J. Guttman
THE WHOLESALE FLORIST OF NEW YORK
34 WEST 28th STREET
PHONES. 1664-1665 MADISON SQUARE
ENOUGH SAID

TRAENDLY & SCHENCK
Wholesale Florists
Furnish best stock at fair prices all the year round.
Send for quotations on Fall Orders.
Tel. 798, 799 Madison Sq. 44 West 28th St., New York City.

GROWERS' CUT FLOWER CO. CUT FLOWERS AT WHOLESALE
VIOLETS, CARNATIONS, ROSES
ORCHIDS, CHRYSANTHEMUMS, LILIES
Consignments Solicited. Shipments to Order, any Distance
Telephone 3333 Madison Square
39 West 28th Street, J. J. O'AN, Manager NEW YORK



HARDY CUT FERNS

1000. BOXWOOD, per bunch 25c, 50 lbs. \$7.50. Sphagnum Moss, Extra Large Bales, per bale, \$1.25. Fancy and Dagger Ferns our specialty. A trial order will convince you that we ship only first-class stock. Headquarters for Florists' supplies and wire work. All cut flowers in season.

MICHIGAN CUT FLOWER EXCHANGE, INC.,

All 'phone connections

38-40 Broadway, Detroit, Mich.

WHOLESALE FLORISTS
54 West 28th St.
NEW YORK
Telephone 3559 Madison Sq.

A. L. YOUNG & CO.

RECEIVERS & SHIP-
PERS OF CUT
FLOWERS.
CONSIGNMENTS SOLICITED.

WILLIAM H. KUEBLER
Brooklyn's Foremost and Best

WHOLESALE COMMISSION HOUSE
A First Class Market for all CUT FLOWERS
28 Willoughby St., Brooklyn, N. Y.
Tel. 4591 Main

Greater New York Florists' Association, Inc.

Now Open for Cut Flower Consignments
162 Livingston Street, BROOKLYN, N. Y.
Geo. W. Crawback Telephone Connection
Manager 3642-43 Main

H. C. BERNING
Wholesale Florist

1402 Pine Street, ST. LOUIS, MO.

REED & KELLER
122 West 25th St., New York

Florists' Supplies
We manufacture all our
Metal Designs Baskets, Wire Work & Novelties
and are dealers in
Glassware Decorative Greens and Florists' Requisites.

THE KERVAN CO.

Wholesale Dealers and Shippers of
Decorative Evergreens
Ferns, Galax, Laurel, Fresh Cycas, Box-
wood, Sphagnum and all Christmas Greens
Send to us for Quotations before Buying
113 West 28 Street, NEW YORK CITY

NEW YORK CHRISTMAS REPORT. Cut Flowers.

Christmas business was good, total results exceeding last year. The stock most in demand ran in about the order as herein mentioned. Gardenias easily had the call with American Beauties, the latter not being in heavy supply; in fact some growers were off crop, and the price held steady at an advance over a year ago, of 20 per cent. Cattleyas of the best grade moved well. The cut of Richmonds and Killarneys was sufficiently large to supply all buyers, and the difference between the lowest and top price was considerable. Killarneys of extra length of stem and fine flowers were no exception in a supply that was larger than ever before for a holiday. There was only a limited supply of the new roses. Bridesmaids were off crop, which helped to sell other pink roses. Brides were not so plentiful as to become a problem as to how to dispose of them. A light crop with some

GEORGE COTSONAS & CO.
Wholesale and Retail Dealers in all kinds of
EVERGREENS

Fancy and Dagger Ferns
Bronze and Green Galax
Main Store 50 W. 28 St.
Phone 1202 Mad. Sq. New York

HENSHAW & FENRICH

WHOLESALE FLORISTS
44 West 28th St., Phones: 325 and 5583 Madison Sq. N. Y.
Night and Sunday Phone 5582 Madison Sq.
Our Specialty is Everything.

Consignments of the best stock solicited.
The square deal guaranteed to all who trade here.



WHOLESALE COMMISSION

J. K. ALLEN 106 W. 28th St. NEW YORK
Tel. 167 Madison Sq.

Open 6 a. m. Daily All Grades of Flowers to Suit All Buyers. Consignments Solicited.

NEW YORK QUOTATIONS PER 100. To Dealers Only

CARNATIONS AND MISCELLANEOUS	Last Half of Week ending Dec. 26 1908		First Half of Week beginning Dec. 28 1908	
	Low	High	Low	High
Carnations, Fancy and Novelties.....	8.00	12.00	6.00	8.00
Ordinary and White.....	1.00	3.00	1.00	3.00
Cyripediums.....	8.00	12.00	8.00	10.00
Cattleyas.....	40.00	75.00	35.00	75.00
Lilies.....	10.00	12.00	10.00	12.00
Lily of the Valley.....	1.00	4.00	1.00	4.00
Nardus, Paper Whites.....	1.00	1.50	1.00	1.50
Roman Hyacinth.....	1.00	1.50	1.00	1.50
Sweet Peas.....	1.00	1.50	1.00	1.50
Gardenias.....	25.00	50.00	15.00	50.00
Violets.....	.75	1.50	.75	1.25
Adiantum.....	.50	1.00	.50	1.00
Crowneanum.....	1.00	1.25	1.00	1.25
Smilax.....	8.00	12.00	8.00	12.00
Asparagus Plumosus, strings.....	15.00	35.00	15.00	35.00
& Spreng. (100 bchs.).....	12.00	25.00	12.00	25.00

growers did not affect the general supply of carnations which were plentiful—too much so to command uniform prices. Reds were in fair demand at lower quotations than usual for Christmas. In some cases averages were below a year ago. As usual, the white carnation was the poorest seller, and many were left or closed out at low figures. Prices ruled from 3 to 12 cents, and at the higher figure but few were sold. Because the supply of violets was not particularly heavy, they were generally cleaned up. The best trade was not clamorous for them but they have not lost all their popularity, as that seems to be measured by the price—75c. to \$1.50. Paper Whites were not so much in evidence as usual; lilies a little more so. Results on poinsettias were not altogether satisfactory, as all of them were not disposed of. Even with a small quantity of mignonette in the market it did not seem to be wanted particularly. Of lily of the valley there was plenty—

some very fine, most of it good and a smaller proportion almost useless. Hyacinths and cyripediums received little notice and the call for green stock was ordinary. Since Christmas business is light, Bridesmaids and Brides appear to be coming along a little faster.

Plants.

The best commentary on the Christmas plant market is the fact that there is nothing left. Everybody cleaned out—growers, wholesalers and retailers alike. Conditions have never been more satisfactory. Practically nothing in the flowering line is left for the New Year's trade but a few azaleas.

SAMUEL A. WOODROW

WHOLESALE PLANTSMAN
Palms, Large and Small Ferns, etc.
53 West 30th Street, NEW YORK
Telephone 2083 Madison

Buyer's Directory and Ready Reference Guide

Advertisements under this head, one cent a word. Initials count as words.

Display advertisers in this issue are also listed under this classification without charge. Reference to List of Advertisers will indicate the respective pages.

Buyers falling to find what they want in this list will confer a favor by writing us and we will try to put them in communication with reliable dealers.

ACCOUNTANT

R. J. Dyarr, 28 State St., Boston.

AQUILEGIAS

Aquilegia. Genuine Coerulea, finest of all. Both plants and seeds from the heart of the Rockies. C. S. Harrison's Select Nursery, York, Neb.

ARAUCARIAS

A. Leuthy & Co., Perkins St. Nurseries, Roslindale, Mass.

For page see List of Advertisers.

Godfrey Aschmann, 1012 West Ontario St., Philadelphia, Pa.

For page see List of Advertisers.

ASPARAGUS

The Geo. Wittbold Co., 1657 Buckingham Palace, Chicago, Ill.

For page see List of Advertisers.

ASTER SEED

Elmer D. Smith & Co., Adrian, Mich. Smith's Peerless.

AUCTION SALES

Oleary's Horticultural Co., 62 Vesey St., New York.

For page see List of Advertisers.

AZALEAS

A. Leuthy & Co., Perkins St. Nurseries, Roslindale, Mass.

For page see List of Advertisers.

Bobblink & Atkins, Rutherford, N. J.

BAMBOO CANES

Yokohama Nursery Co., 31 Barclay Street, New York.

Bamboo Sticks, Colored Green.

For page see List of Advertisers.

BAY TREES

2000 Bay and Box Trees in all sizes, Pyramid and Standards. Write for list. Julius Rehers, Rutherford, N. J.

BOILERS

BOILERS. "Greenham" Boilers made for greenhouse heating. Lord & Burnham, 1133 Broadway, N. Y.

Kroeschell Bros. Co., 35 Erie St., Chicago, Mass.

For page see List of Advertisers.

BOXWOOD TREES

New England Nurseries, Inc., Bedford, Mass.

For page see List of Advertisers.

BUILDING MATERIAL

BUILDING MATERIAL of all description for All Cypress, Steel-Iron, Iron Frame or Truss Houses. Hot Bed Sash and Frames. Lord & Burnham Co., 1133 Broadway, N. Y.

BULBS AND TUBERS

Joseph Breck & Sons, 4754 N. Market St., Boston.

For page see List of Advertisers.

J. M. Thornburn & Co., 33 Barclay St., New York.

For page see List of Advertisers.

A. T. Huntington, 342 W. 14th St., N. Y.

For page see List of Advertisers.

Rickards Bros., 37 East 19th St., New York.

For page see List of Advertisers.

H. F. Michell Co., Philadelphia.

For page see List of Advertisers.

H. E. Fiske Seed Co., Faneuil Hall Sq., Boston.

For page see List of Advertisers.

T. J. Grey & Co., 32 and 33 So. Market St., Boston.

For page see List of Advertisers.

Yokohama Nursery Co., 31 Barclay St., New York.

For page see List of Advertisers.

BULBS AND TUBERS—Continued

Dingee-Conard Co., West Grove, Pa. Narcissus Paper White Graudiflora.

For page see List of Advertisers.

CARNATIONS

F. Dörner & Sons Co., Lafayette, Ind. Carnation, Pink Delight.

For page see List of Advertisers.

Chicago Carnation Co., Joliet, Ill. For page see List of Advertisers.

Albert Roper, Tewksbury, Mass. Carnation Bay State.

For page see List of Advertisers.

Bassett & Washburn, Hudsale, Ill. Carnation O. P. Bassett.

For page see List of Advertisers.

East Sudbury Greenhouses, So. Sudbury, Mass.

Carnation Cuttings.

For page see List of Advertisers.

Wood Bros., Fishkill, N. Y. Carnations, Rooted Cuttings.

For page see List of Advertisers.

L. E. Marquise Estate, Syracuse, N. Y. Carnation Marchioness.

For page see List of Advertisers.

E. G. Hill Co., Richmond, Ind. E. T. Grave, Richmond, Ind.

Carnation May Day.

CHRYSANTHEMUMS

Chas. H. Totty, Madison, N. J. Chrysanthemum Novelties.

For page see List of Advertisers.

E. G. Hill Co., Richmond, Ind. For page see List of Advertisers.

S. J. Goddard, Framingham, Mass. Chrysanthemum Golden Glow.

For page see List of Advertisers.

Elmer D. Smith & Co., Adrian, Mich. For page see List of Advertisers.

Chrysanthemum Golden Glow from 2 1/4 in. pots, for early spring delivery, \$6.00 per 100. Stock plants of Montmort, Oct Frost, Crocus, Matchless, Lucy Devaux, Polly Rose and Halliday, \$1.00 per doz.; \$6.00 per 100. Peirce Bros., Waltham, Mass.

Herrington's book on the Chrysanthemum, mailed to your address for 50c, by Horticulture Publishing Co., 11 Hamilton Place, Boston.

Chrysanthemums, good strong stock plants from solid bed. White—Polly Rose, Ivory, Clementine Tonsset, Alice Roosevelt, Alice Byron, Yellow—Monrovia, Chelton, Mrs. W. Duckham, October Sunshine, Pink—Glory of Pacific, Dr. Enguehard, \$2.50 per 100, assorted as wanted in any quantity. Cash. Chas. Frost, Kenilworth, N. J.

Chrysanthemum Stock Plants, Appleton, Tonsset, Omega, Eatons, Nonin, Robinson, Bassett, Monnford, Halliday, Polly Rose, October Frost, Bonafant, 84 per hundred. Beatrice, Mrs. M. Beach, Mary Mann, Tiger, Salene, Chobanne, Mrs. Duckham, St. Assorted as desired. Henry Trail, Frederick, Md.

CONIFERS

John Waterer & Sons, Ltd., American Nursery, Bascht, Eng.

For page see List of Advertisers.

CUT FLOWER BOXES.

Edwards Folding Box Co., Philadelphia

For page see List of Advertisers.

Folding cut flower boxes, the best made. Write for list. Holton & Hunkel Co., Milwaukee, Wis.

CYCLAMEN.

Thomas Roland, Nahant, Mass. For page see List of Advertisers.

DAHLIAS

David Herbert & Son, Atco, N. J. For page see List of Advertisers.

J. L. Moore, Northboro, Mass. For page see List of Advertisers.

Peacock Dahlia Farms, Williamstown Junction, N. J.

Dahlia Miss Virginia Maule. For page see List of Advertisers.

East Bridgewater Dahlia Gardens want your business. If you are looking for dahlias send to the Eastern Dahlia King, J. K. Alexander, East Bridgewater, Mass.

DAISIES

Daisies, Yellow and White Paris and Queen Alexandra. Rooted Cuttings, \$1.00 per 100, prepaid. Chas. Frost, Kenilworth, N. J.

DECORATIVE PLANTS

A. Leuthy & Co., Perkins St. Nurseries, Roslindale, Mass.

For page see List of Advertisers.

Godfrey Aschmann, 1012 W. Ontario St., Phila., Pa. For page see List of Advertisers.

Joseph Hancock Co., Wyncote, Pa. For page see List of Advertisers.

The Geo. Wittbold Co., 1657 Buckingham Palace, Chicago, Ill. For page see List of Advertisers.

Robert Craig Co., Market and 49th Sts., Philadelphia, Pa. For page see List of Advertisers.

A. Schulteis, College Point, N. Y. For page see List of Advertisers.

A. N. Pierson, Inc., Cromwell, Conn. Palms and Ferns. For page see List of Advertisers.

DRACAENAS

The Geo. Wittbold Co., 1657 Buckingham Place, Chicago, Ill. For page see List of Advertisers.

ECONOMY BRACKET

Baxton & Allard, Nashua, N. H. For page see List of Advertisers.

EVERGREENS

New England Nurseries, Bedford, Mass. For page see List of Advertisers.

American Nursery Co., 150 Broadway, New York, N. Y. For page see List of Advertisers.

Evergreens. Send 25 cents in stamps for complete work on propagating and growing Evergreens. C. S. Harrison's Select Nursery, York, Neb.

FERNS

A. Leuthy & Co., Roslindale, Mass. For page see List of Advertisers.

H. H. Barrows & Son, Whitman, Mass. Nephrolepis Whitmani. For page see List of Advertisers.

John Scott, Brooklyn, N. Y. For page see List of Advertisers.

Frank Oechsli, 2570-2606 W. Adams St., Chicago. Ferns for dishes. For page see List of Advertisers.

The Geo. Wittbold Co., 1657 Buckingham Palace, Chicago, Ill. For page see List of Advertisers.

Godfrey Aschmann, 1012 W. Ontario St., Philadelphia. For page see List of Advertisers.

Henry Weston, Hempstead, N. Y. For page see List of Advertisers.

500 Boston and Scott ferns, 3 and 3 1/2 pots, cheap for cash. Just right for bedding out. Geo. H. Walker, No. Dighton, Mass.

For List of Advertisers See Page 25

FERTILIZERS

Pulverized Manure Co., 31 Union Stock Yards, Chicago, Ill.
 Wizard Brand Sheep and Shredded Cattle Manure.
 For page see List of Advertisers.

Robert Simpson, Clifton, N. J.
 Sheep Manure.
 For page see List of Advertisers.

Wm. Elliott & Sons, 42 Vesey St., New York.
 Ground Bone for Potting.
 For page see List of Advertisers.

FICUS

Ficus elastica; six inch; extra choice; clean stock. \$40.00 per 100. Collingdale Greenhouses, Collingdale, Pa.

FLORAL PHOTOGRAPHS

Floral Photographs, Foley's, 226-228 12 Bowery, New York.

FLORISTS' LETTERS.

Boston Florist Letter Co., 66 Pearl St., Boston, Mass.
 For page see List of Advertisers.

FLORISTS SUPPLIES

N. F. McCarthy & Co., 84 Hawley St., Boston.
 For page see List of Advertisers.
 H. M. Robinson & Co., 15 Province St. and 9 Chapsman Pl., Boston, Mass.
 For page see List of Advertisers.
 Reed & Keller, 122 W. 25th St., New York.
 For page see List of Advertisers.
 H. Bayerdorfer & Co., 1129 Arch St., Philadelphia.
 For page see List of Advertisers.

FLOWERS BY TELEGRAPH

Park Floral Co., Denver, Colo.
 For page see List of Advertisers.
 Gude Bros. Co., 1214 F St., Washington, D. C.
 For page see List of Advertisers.
 Atlanta Floral Co., Atlanta, Ga.
 For page see List of Advertisers.
 M. C. & J. E. Hauswirth, 232 Michigan Ave., Chicago.
 For page see List of Advertisers.
 William J. Smyth, Michigan Ave. and 31st St., Chicago.
 For page see List of Advertisers.
 George Wittbold Co., 1057-59 Buckingham Place, Chicago.
 For page see List of Advertisers.
 Jacob Schulz, 644 1/2 Ave., Louisville, Ky.
 For page see List of Advertisers.
 Thos. F. Galvin, 124 Tremont St., Boston.
 For page see List of Advertisers.
 Julia A. Zinn, 2 Beacon St., Boston.
 For page see List of Advertisers.
 F. H. Houghton, 396 Boylston St., Boston.
 For page see List of Advertisers.

Edward MacMullin, 194 Boylston St., Boston.
 For page see List of Advertisers.
 Hoffman, Florist, 59-61 Massachusetts Ave., Boston.
 For page see List of Advertisers.
 J. Newman & Sons, Inc., 24 Tremont St., Boston.
 For page see List of Advertisers.
 Taillly, Wellesley, Mass.
 For page see List of Advertisers.
 J. Breitmeyer's Sons, Miami and Gratiot Aves., Detroit, Mich.
 For page see List of Advertisers.
 Samuel Murray, 1017 Broadway, Kansas City, Mo.
 For page see List of Advertisers.
 Wm. L. Rook, Flower Co., 116 Walnut St., Kansas City, Mo.
 For page see List of Advertisers.
 Fred C. Welser, 426-28 Olive St., St. Louis, Mo.
 For page see List of Advertisers.
 H. G. Eyles, 11 N. Pearl St., Albany, N. Y.
 For page see List of Advertisers.
 David Clarke's Sons, 2139-2141 Broadway, New York.
 For page see List of Advertisers.

FLOWERS BY TELEGRAPH—Continued

Alex. McConaell, New York.
 For page see List of Advertisers.
 Robert G. Wilson, Fulton St. & Greene Ave., Brooklyn, N. Y.
 For page see List of Advertisers.
 Young & Nugent, 42 W. 28th St., N. Y.
 For page see List of Advertisers.
 M. Bove, 1234 Broadway, New York.
 For page see List of Advertisers.
 Myer, 609-11 Madison Ave., New York.
 For page see List of Advertisers.
 Thos. Young, Jr., 509 Fifth Ave., New York.
 For page see List of Advertisers.
 Newman Floral Co., 202 Fifth Ave., and Madison St., New York.
 For page see List of Advertisers.
 The Hlossom (C. C. Trepel, Mgr.), Bond and Livingston Sts., Brooklyn, N. Y.
 For page see List of Advertisers.
 Calmer's, Buffalo, N. Y.
 For page see List of Advertisers.
 F. A. Danker, Albany, N. Y.
 For page see List of Advertisers.
 J. H. Dunlop, 95 Young St., Toronto, Can.
 For page see List of Advertisers.

FLOWER POTS

W. H. Ernest, 28th and M Sts., Washington, D. C.
 For page see List of Advertisers.
 A. H. Bews & Co., Cambridge, Mass.
 For page see List of Advertisers.
 Hillinger Bros., Ft. Edward, N. Y.
 For page see List of Advertisers.
 Whilliam Pottery Co., Philadelphia.
 Standard Flower Pots.
 For page see List of Advertisers.
 The Peters & Reed Pottery Co., Red pots, seal pans, etc., Zanesville, O.

FOREST SEEDLINGS

To close out quick I offer the following First-class stock for Parks, Cemeteries and Forest Plantings: 100 M. Amorphia Fruticosa, 1 to 3 ft.; 300 M. Albion Rosee Stocks, 100 M. Cal. Privet; 500 M. Cal. Privet Cuttings; 100 M. Black Locust, 4 to 6 ft.; 50 M. Calycanthus, Sweet Shrub, 1 to 3 ft.; 50 M. Cornus Canadensis, Red Bud, 1 to 4 ft.; 60 M. Cornus Stolonifera, Ozier Dogwood, 1 to 2 ft.; 50 M. Diosyros, Am. Persimmon, 6 to 30 inches; 50 M. Elm (white) 1 to 2 ft.; 75 M. Hamamelis, Witch Hazel, 4 in. to 3 ft.; 50 M. Tulip Poplar, 1 to 8 ft.; 20 M. Sweet Gum, 1 to 6 ft.; 50 M. Black Walnut, 1 to 3 ft.; 20 M. Wistaria, 1 to 3 ft.; 20 M. Yucca filamentosa, 1 and 2 year Butternut, Japan Walnut, Ash, Maple, etc. Seed for trade list. I offer my entire stock to close out at low prices; also a large stock of Tree and Shrub Seeds, Black Locust, Sweet Gum, Striped, Ash, Red Bud, Persimmon, Bass Wood, Viburnums, Sugar Maple, Red Cedar and other Seeds. Forest Nursery & Seed Co., J. H. H. Boyd, Prop., R. F. D. No. 2, McMansville, Tenn.

GALAX

Michigan Cut Flower Co., 38 and 40 Broadway, Detroit, Mich.
 For page see List of Advertisers.
 George Cotsonas & Co., 50 W. 28th St., New York.
 For page see List of Advertisers.
 No. Carolina Evergreen Co., Banner Elk, North Carolins.
 The Kerran Co., 113 West 28th St., N. Y.
 For page see List of Advertisers.
 Rice Bros., 115 N. 6th St., Minneapolis, Minn.
 For page see List of Advertisers.
 H. M. Robinson & Co., 15 Province St. and 9 Chapman Place, Boston.
 For page see List of Advertisers.

GARDEN HOSE

Jos. Kopscaj, So. Bend, Ind.

GERANIUMS

R. Vincent Jr. & Sons Co., White Marsh, Md.
 New and Standard Varieties.
 For page see List of Advertisers.

'GLADIOLI

J. L. Moore, Northboro, Mass.
 For page see List of Advertisers.
 E. S. Miller, Wadding River, N. Y.
 For page see List of Advertisers.
 Thomas J. Oberlin, Shikling Spring, Pa.
 Gladiolus America.
 A. T. Boddington, 342 W. 14th St., New York.
 For page see List of Advertisers.

GLASS

Boston Plate & Window Glass Co., Boston
 For page see List of Advertisers.
 Standard Plate Glass Co., 2630 Sudbury St., Boston.
 For page see List of Advertisers.
 Foley Mfg. Co., Western Ave., between 27th & 28th Sts., Chicago.
 Sharp, Partridge & Co., 221 & Lumber St., Chicago.
 For page see List of Advertisers.
 Greenhouse glass, lowest prices, Johnston Glass Co., Hartford City, Ind.
 Glass, High Grade, Double Thick Greenhouse Glass, Lord & Burnham, 1133 Broadway, N. Y.

GLAZING DEVICES

H. A. Dreer, Philadelphia, Pa.
 Peerless Glazing Point.
 For page see List of Advertisers.
 GLAZING POINTS, Lord & Burnham Special Glazing Nails (Points), Lord & Burnham, 1133 Broadway, N. Y.

GREENHOUSE BUILDING MATERIAL

Lord & Burnham Co., 1133 Broadway, New York.
 For page see List of Advertisers.
 Pierson U-Bar Co., 1 Madison Sq., N. Y.
 For page see List of Advertisers.
 A. T. Stearns Lumber Co., Neponset, Boston.
 For page see List of Advertisers.
 King Construction Co., N. Tonawanda, New York.
 For page see List of Advertisers.
 Hitchings & Co., 1170 Broadway, New York.
 For page see List of Advertisers.
 J. C. Moninger Co., 117 East Blackhawk St., Chicago, Ill.
 For page see List of Advertisers.
 Foley Mfg. Co., Western Ave., between 25th & 26th Sts., Chicago.
 For page see List of Advertisers.
 Geo. B. Doane, 18 Midway St., Boston.
 Iron Pipe.
 For page see List of Advertisers.
 Wm. H. Lutton, West Side Avenue Sta., Jersey City, N. J.
 For page see List of Advertisers.

GREENHOUSE CONSTRUCTION

GREENHOUSE CONSTRUCTION, Semi-Iron Greenhouse, New Truss Houses and Iron Frame Houses, Lord & Burnham, 1133 Broadway, N. Y.
 J. A. Payne, 240-274 Culver Ave., Jersey City, N. J.
 For page see List of Advertisers.
 Foley Mfg. Co., Western Ave., between 25th & 26th Sts., Chicago.
 For page see List of Advertisers.
 Wm. H. Lutton, West Side Avenue Sta., Jersey City, N. J.
 Curved Irons, Eaves, etc.
 For page see List of Advertisers.
 Hitchings & Co., 1170 Broadway, New York.
 For page see List of Advertisers.

GREENHOUSE HOSE

Revere Rubber Co., Boston, Mass.
 Revere Hose.
 For page see List of Advertisers.

GUTTERS

GUTTERS, Cast Iron Gutters, L. & B. Improved V. Shaped Gutter with drip gutter attachment, Lord & Burnham, 1133 Broadway, N. Y.

HAIL INSURANCE

Florists' Hail Assn. of America, L. G. Ester, Saddle River, N. J.
 For page see List of Advertisers.

In writing to Advertisers kindly mention Horticulture

HARDY FERNS, MOSS AND GREENS

H. M. Robinson & Co., 15 Province St. and 9 Chapman Pl., Boston, Mass. For page see List of Advertisers.

Michigan Cut Flower Exchange, 38 and 40 Broadway, Detroit, Mich. For page see List of Advertisers.

George Cotoanac & Co., 50 W. 28th St., New York. For page see List of Advertisers.

N. F. McCarthy & Co., 84 Hawley St., Boston. For page see List of Advertisers.

No. Carolina Evergreen Co., Banner Bldg., North Carolina. The Kervan Co., 115 W. 28th St., N. Y. For page see List of Advertisers.

Bliss Bros., 115 N. 6th St., Minneapolis, Minn. For page see List of Advertisers.

HEATING APPARATUS

Lord & Burnham Co., 1133 Broadway, New York. For page see List of Advertisers.

Pierson U-Bar Co., 1 Madison Sq., N. Y. For page see List of Advertisers.

John A. Payne, 250-274 Culver Ave., Jersey City, N. J. For page see List of Advertisers.

Kroeschell Bros. Co., 35 Erie St., Chicago. For page see List of Advertisers.

HELP FURNISHED

Thos. H. Bamblek, 24 S. 7th St., Phila. For page see List of Advertisers.

HERBACEOUS PERENNIALS

P. Ouwerkerk, P. O. No. 41, Hoboken, N. J. For page see List of Advertisers.

New England Nurseries, Bedford, Mass. For page see List of Advertisers.

The Geo. Withold Co., 1657 Buckingham Place, Chicago. For page see List of Advertisers.

HOT-BED SASH

The A. T. Stearns Lumber Co., Neponset, Mass. For page see List of Advertisers.

Pierson U-Bar Co., 1 Madison Sq., N. Y. For page see List of Advertisers.

Lord & Burnham Co., 1133 Broadway, N. Y. For page see List of Advertisers.

Foley Mfg. Co., Western Ave., between 25th & 26th Sts., Chicago.

Sunlight Double Glass Sash Co., Louisville, Ky. For page see List of Advertisers.

INSECTICIDES.

Nicotide kills all greenhouse pests. P. R. Palethorpe Co., Eleventh St., Owensboro, Ky. For page see List of Advertisers.

Stump & Walter Co., 50 Barclay St., New York. Kilmdead Tobacco Dust. For page see List of Advertisers.

Wilson Plant Oil & Fertilizer Co., Chatham, N. J. Laufen Fungicide. For page see List of Advertisers.

Niagara Sprayer Co., Middleport, N. Y. Niagara Brand. For page see List of Advertisers.

E. G. Pratt Co., New York. Scalebyle. For page see List of Advertisers.

"The Fumigating Kind Tobacco Powder" The first on the market and the kind that has so many imitators, has our guarantee tag of satisfaction or money back, \$2.50 per 100 lbs. The H. A. Stouthoff Co., Mount Vernon, N. Y. Makers and sellers.

JAPANESE PLANTS

Yokohama Nursery Co., 31 Barclay St., New York. For page see List of Advertisers.

KENTIAS

Gulfray Aschmann, 1012 W. Ontario St., Phila., Pa. For page see List of Advertisers.

A. Leuthy & Co., Roslindale, Mass. For page see List of Advertisers.

Henry Weston, Hempstead, N. Y. For page see List of Advertisers.

KENTIAS - Continued

Jos. Hancock Co., Wynote, Pa. Single and Made-Up Specimens. For page see List of Advertisers.

KOSTER'S BLUE SPRUCE WANTED
J. H. Troy, 24 E. 34th St., New York. For page see List of Advertisers.

LEVELS FOR LANDSCAPE GARDENING USE.

Bostrom-Brady Mfg. Co., 130 Madison Ave., Atlanta, Ga. For page see List of Advertisers.

LILY OF THE VALLEY PIPS

Hjalmar Hartmann & Co., 12 Stormgade, Copenhagen, Denmark. For page see List of Advertisers.

MUSHROOM SPAWN

Use Anglo-American Mushroom Spawn made "Direct from Spores." Write for pamphlet, Anglo-American Spaw Co., Kennett Square, Pa.

NEW AND RARE PLANTS

Rose Hill Nurseries, New Rochelle, N. Y. For page see List of Advertisers.

NICO-FUME

Kentucky Tobacco Product Co., Louisville, Ky. For page see List of Advertisers.

NURSERY STOCK

John Waterer & Sons, Ltd., American Nursery, Bagshot, England. For page see List of Advertisers.

Clery's Horticultural Co., 62 Vesey St., New York. For page see List of Advertisers.

P. Ouwerkerk, 216 Jane St., Weehawken Heights, N. J. For page see List of Advertisers.

D. J. Twomey, Dept. II, Geneva, N. Y. For page see List of Advertisers.

American Nursery Co., 150 Broadway, New York, N. Y. For page see List of Advertisers.

Manual of the Trees of North America, by C. S. Sargent, mailed to your address for \$6.00, by Horticulture Publishing Co., 11 Hamilton Place, Boston.

TREES, SHRUBS, ROSES, EVERGREENS, PEONIES, HARDY PLANTS, ELLWANGER & BARRY, Rochester, N. Y.

ONION SEED

Federico C. Varela, Teneriffe, Canary Ids. Bermuda Onion Seed.

ORCHID BASKETS

J. A. Manda, 191 Valley Rd., W. Orange, New Jersey. For page see List of Advertisers.

ORCHID PLANTS

Lager & Hurrell, Summit, N. J. For page see List of Advertisers.

Sander, St. Albans, England. Importers, Exporters, Growers, Hybridists. For page see List of Advertisers.

Carrillo & Baldwin, Syracuse, N. Y. For page see List of Advertisers.

Jos. A. Manda, 191 Valley Road, W. Orange, N. J. For page see List of Advertisers.

Ordonez Bros., Madison, N. J., Box 105. For page see List of Advertisers.

Largest stock in the country. Ask for prices. Julius Roehrs, Rutherford, N. J.

PAINT AND PUTTY

PAINT AND PUTTY: Ideal Greenhouse lead; Special Greenhouse Putty. Lord & Burnham, 1133 Broadway, N. Y.

PALMS

A. Leuthy & Co., Perkins St. Nurseries, Roslindale, Mass. For page see List of Advertisers.

Robert Craig Co., Market and 49th Sts., Philadelphia, Pa. For page see List of Advertisers.

Joseph Hancock Co., Wynote, Pa. Home-Grown Palms. For page see List of Advertisers.

PANSY PLANTS.

Pansies, extra fine glauc flowering, strong plants, 30 cents per 100; \$2.50 per 1000. Edw. Wallis, Atco, N. J.

PATENTS

Siggers & Siggers, Washington, D. C. For page see List of Advertisers.

PEAT

J. A. Manda, 191 Valley Rd., W. Orange, New Jersey. For page see List of Advertisers.

Orchid peat, rotted peat, Azalea peat, Leaf-Mould, Live Sphagnum moss, Baled Sphagnum moss, Green Clump moss, etc. Jobbers' list on application. C. W. Brownell & Co., Walden, N. Y.

Orchid Peat and Moss always on hand. Julius Roehrs Co., Rutherford, N. J.

PEONIES

Peonies only, by the wholesale—best 100 varieties. J. F. Rosenfield, Westpoint, Nehr. One of the finest collections in America. Send 25 cents in stamps for new edition of Peony Manual. C. S. Harrison's Select Nursery, York, Neb.

PHLOXES

Send 25 cents in stamps for Phlox Manual. Free list of plants for \$30 per 100. C. S. Harrison's Select Nursery, York, Neb.

PIPE AND FITTINGS

Foley Mfg. Co., between Western Ave. and 26th St., Chicago, Ill. For page see List of Advertisers.

Kroeschell Bros. Co., 35 Erie St., Chicago. For page see List of Advertisers.

PIPE AND FITTINGS. Cast Iron and Wrought Pipe, Valves, Elbows, Pipe Hooks, Automatic Air Headers, etc. Lord & Burnham, 1133 Broadway, N. Y.

PLANT STANDS

Moore-Livingston Co., Landsdowne, Pa. For page see List of Advertisers.

PLANT STAKES

Seale's Telesp Plant Stakes and Trellises. H. D. Seale & Sons, Elkhart, Ind.

POT HANGERS

Pot hangers, Kramer's \$1 doz. by exp. \$1.25 by mail. I. N. Kramer & Son, Cedar Rapids, Ia.

POINSETTIAS (Artificial)

Poinsettias, artificial decorations our specialty. Sample lots of 50 in 3 sizes, \$4.00; 100 lots, \$6, \$8, \$10. J. Stern & Co., 125 N. 10th St., Philadelphia, Pa.

PRUNING SHEARS

Rhodes Mfg. Co., Dept. R., Grand Rapids, Mich. For page see List of Advertisers.

RAFFIA

Raffia colored, 30 beautiful shades. Samples free. R. H. Comey Co., Camden, N. J.; 810 Washburn Ave., Chicago, Ill.

RETAIL FLORISTS

Park Floral Co., Denver, Colo. For page see List of Advertisers.

Guido Bros. Co., 1214 P St., Washington, D. C. For page see List of Advertisers.

Atlanta Floral Co., Atlanta, Ga. For page see List of Advertisers.

M. C. & J. E. Hauswirth, 232 Michigan Ave., Chicago. For page see List of Advertisers.

William J. Smyth, Michigan Ave. and 31st St. For page see List of Advertisers.

George Withold Co., 1657-59 Buckingham Place, Chicago. For page see List of Advertisers.

Jacob Schulz, 644 4th Ave., Louisville, Ky. For page see List of Advertisers.

Thos. F. Galvin, 124 Tremont St., Boston. For page see List of Advertisers.

Julius A. Zinn, 2 Beacon St., Boston. For page see List of Advertisers.

Frank H. Houghton, 296 Boylston St., Boston. For page see List of Advertisers.

Edward MacMillan, 194 Boylston St., Boston. For page see List of Advertisers.

RETAIL FLORISTS — Continued

- Hoffman, Florist**, 59-61 Massachusetts Ave., Boston.
For page see List of Advertisers.
- J. Newman & Sons, Inc.**, 24 Tremont St., Boston.
For page see List of Advertisers.
- Talbly, Wellesley, Mass.**
For page see List of Advertisers.
- J. Breitmeier's Sons**, Detroit, Mich.
For page see List of Advertisers.
- Samuel Murray**, 1017 Broadway, Kansas City, Mo.
For page see List of Advertisers.
- Wm. L. Rock Flower Co.**, 1116 Walnut St., Kansas City, Mo.
For page see List of Advertisers.
- Fred C. Weber**, 426 Olive St., St. Louis, Mo.
For page see List of Advertisers.
- H. G. Eyles**, 11 N. Pearl St., Albany, N. Y.
For page see List of Advertisers.
- David Clarke's Sons**, 2139-2141 Broadway, New York.
For page see List of Advertisers.
- Alex. McConnell**, New York.
For page see List of Advertisers.
- Robert G. Wilson**, Fulton St. and Greene Ave., Brooklyn, N. Y.
For page see List of Advertisers.
- Young & Nugent**, 42 W. 25th St., N. Y.
For page see List of Advertisers.
- M. Bower**, 1294 Broadway, New York.
For page see List of Advertisers.
- Myer**, 609-41 Madison Ave., New York.
For page see List of Advertisers.
- Thos. Young, Jr.**, 500 Fifth Av., New York.
For page see List of Advertisers.
- Newman Floral Co.**, 202 Fifth Av. & Madison Sq., New York.
For page see List of Advertisers.
- The Blossom (C. C. Trepel, Mgr.)**, Bond and Livingston Sts., Brooklyn, N. Y.
For page see List of Advertisers.
- Palmer's Buffalo**, N. Y.
For page see List of Advertisers.
- F. A. Danker**, Albany, N. Y.
For page see List of Advertisers.
- J. H. Dunlop**, 96 Yonge St., Toronto, Can.
For page see List of Advertisers.

RHODODENDRONS

- John Waterer & Sons, Ltd.**, American Nursery, Bagshot, England.
For page see List of Advertisers.
- P. Ouwwerker**, Hoboken, N. J.
For page see List of Advertisers.
- Anthony Waterer**, Knip Hill Nursery, Surrey, Eng.
For page see List of Advertisers.

ROSES

- Robert Craig Co.**, Market and 49th Sts., Philadelphia, Pa.
For page see List of Advertisers.
- P. Ouwwerker**, P. O. No. 2, Hoboken, N. J.
For page see List of Advertisers.
- Julius Roehrs Co.**, Rutherford, N. J., Rose Newport Fair.
For page see List of Advertisers.
- Waban Rose Conservatories**, Natick, Mass., and 3A Somerset St., Boston.
New Forcing Rose White Killarney.
For page see List of Advertisers.
- Thos. F. R. Plerson Co.**, White Killarney and My Maryland, Tarrytown-on-Hudson, N. Y.
For page see List of Advertisers.
- Rosea**, strong, own root, 4 Inch Chateaux, Killarney, Richmond and Mald., \$5 per 100. Sblecht & Son, New Rochelle, N. Y.
- Hand Book of Cultural Notes on Roses Under Glass**, by F. P. Brigham, mailed to your address for 25c. by Horticulture Publishing Co., 11 Hamilton Place, Boston.
- The beautiful new pink rose, **MISS KATE MOUTON** is the queen of all pink roses. It's a springer and you should grow it. Price \$30.00 100; 500 \$125.00; 1000 \$200.00; 5000 and upwards \$175 per 1000. Minneapolis Floral Co., Minneapolis, Minn.

SCALECIDE

- B. G. Pratt Co.**, 50 Church St., New York.
For page see List of Advertisers.

SEED GROWERS

- C. C. Morse & Co.**, 48-56 Jackson St., San Francisco, Cal.
For page see List of Advertisers.
- Hjalmar Hartmann & Co.**, Cauliflower and Cabbage Seed.
12 Stronggade, Copenhagen, Denmark.
For page see List of Advertisers.
- A. J. Pieters Seed Co.**, Hollister, Calif.
Sweet Pea and Onion Seed.
- Federico C. Varela**, Tenerife, Canary Ids.
Bernadina Onion Seed.

SEEDS

- T. J. Gray Co.**, 32 So. Market St., Boston.
For page see List of Advertisers.
- Joseph Breck & Sons**, 51 and 52 N. Market St., Boston, Mass.
For page see List of Advertisers.
- W. Allee Turpece & Co.**, Philadelphia.
For page see List of Advertisers.
- J. M. Thorburn & Co.**, 33 Barclay St., N. Y.
For page see List of Advertisers.
- Arthur T. Rodding**, 392 W. 140th St., New York.
For page see List of Advertisers.
- H. F. Michell Co.**, 1018 Market St., Phila.
For page see List of Advertisers.
- Hjalmar Hartmann & Co.**, 12 Stormgade, Copenhagen, Denmark.
Cauliflower and Cabbage Seed.
For page see List of Advertisers.
- Rickards Inc.**, 37 E. 10th St., New York.
For page see List of Advertisers.
- R. & J. Farquhar & Co.**, 67 So. Market St., Boston.
Mignonette Seed.
For page see List of Advertisers.
- H. E. Fiske Seed Co.**, Paneuil Hall Sq., Boston.
For page see List of Advertisers.
- C. C. Morse & Co.**, 48-56 Jackson St., San Francisco, Calif.
For page see List of Advertisers.
- Leonard Seed Co.**, Chicago, Ill.
For page see List of Advertisers.
- A. J. Pieters Seed Co.**, Hollister, Calif.
Sweet Pea and Onion Seed.

Seeds. Rocky Mountain Evergreen seeds in large or small quantities. C. S. Harralson's Select Nursery, York, Neb.

My own new crop of **SALVIA SPLENDENS VARIETIES** is now ready: **Nana Compacta ZURICH**, finest early flowering pot Salvia in existence, selected seeds. **Compacta Grandiflora FLEEBAL**, best of all for pots and groups, selected seeds. **Grandiflora Ameliorata KING OF THE SCARLETS**, unexcelled for late groups, with extra large deep scarlet spikes, selected seeds. Each of above per Tr. Pkt., 50c.; 6 Tr. Pkt., \$2.50. Larger quantities on special quotation. O. V. ZANGEN, Seedsman, Hoboken, N. J.

SHRUBS

- The Geo. Wittbold Co.**, 1657 Buckingham Palace, Chicago.
For page see List of Advertisers.

SILKALINE

- John C. Meyer & Co.**, Boston, Mass.
For page see List of Advertisers.

SPHAGNUM MOSS

- Live Sphagnum moss, orchid peat and orchid basket always on hand. Lager & Hurrell**, Summit, N. J.
- Fresh, clean, 5 bbl. bale, \$1.25; 2 bales, \$2.25; 5 bales, \$5.00; 10 bales, \$9.50. Cash. H. R. Akers, Chatsworth, N. J.

SPRAYERS

- "SHOWERMAKER," \$1. Jos. Kopschay, So. Bend, Ind.**
- Niagara Sprayer Co.**, Middleport, N. Y.
For page see List of Advertisers.

STEAM TRAP

- E. Hippard**, Youngstown, O.
For page see List of Advertisers.

STRAWBERRY PLANTS

- H. L. Crane**, Westwood, Mass.
Bnrymore Strawberry,
For page see List of Advertisers.

SWEET PEAS

- A. C. Zvolmek**, Round Brook, N. J.
Winter Flowering.
For page see List of Advertisers.

TO-BAK-INE

- E. H. Hunt**, Genl. Agt., 76-78 Wabash Av., Chicago.
For page see List of Advertisers.

VENTILATING APPARATUS

- Pierson (Bar Co.)**, 1 Madison Sq., N. Y.
For page see List of Advertisers.
- Foley Mfg. Co.**, Western Ave., between 25th & 26th Sts., Chicago.
For page see List of Advertisers.
- John A. Payne**, 260-274 Colver Ave., Jersey City, N. J.
For page see List of Advertisers.
- The Advance Co.**, Richmond, Ind.
For page see List of Advertisers.
- Quaker City Machine Co.**, Richmond, Ind., 20th Century Ventilating App.
For page see List of Advertisers.
- VENTILATING MACHINERY**, New Model enclosed, self-acting gear; Standard Model Open Gear. Lord & Burnham, 1133 Broadway, N. Y.

VIOLETS

- Violets, Campbell rooted runners, 75c. per 100. John A. Burris**, 8842 Frankford Ave., Holmesburg, Philadelphia, Pa.

VINCAS

- Vinca variegata, Rooted Cuttings; \$1 per 100; prepaidd. Chas. Frost, Kenilworth, N. J.**

WAX FLOWERS

- We are originators of wax designs and still the standard concern. **J. Stero & Co.**, 125 N. 10th St., Philadelphia, Pa.

WIRED TOOTHPICKS

- W. J. Cowee**, Berlin, N. Y.
For page see List of Advertisers.

WIREWOK

- Reed & Keller**, 122 W. 25th St., N. Y.
For page see List of Advertisers.
- Wirewok**. Write for our catalogue. **Holtz & Hunkel Co.**, Milwaukee, Wis.
- William E. Heilscher's Wire Works**, 38-40 Broadway, Detroit, Mich.
- Headquarters for wire wok. Send for list. **Ball & Betz**, 31 E. 3rd St., Cincinnati, O.
- Wirewok—Compare our prices with others.** **Seranton Florist Supply Co.**, 201 N. 7th St., Scranton, Pa.

WHOLESALE FLORISTS

Boston

- N. F. McCarthy & Co.**, 81 Hawley St., Boston.
For page see List of Advertisers.
- H. M. Robinson & Co.**, 15 Province St. and 9 Chapman Pl., Boston.
For page see List of Advertisers.
- Welch Bros.**, 225 Devonshire St., Boston.
For page see List of Advertisers.
- Talbly, Wellesley, Mass.**
For page see List of Advertisers.

Chicago

- Chas. W. McKellar**, 51 Wabash Av., Chicago.
For page see List of Advertisers.
- Peter Reinberg**, 51 Wabash Av., Chicago.
For page see List of Advertisers.
- E. F. Winsterson Co.**, 45-49 Wabash Av., Chicago.
For page see List of Advertisers.
- J. A. Budding**, 37-39 Randolph St., Chicago.
For page see List of Advertisers.
- Foehlmann Bros.**, 607 Morton Grove, Ill.
For page see List of Advertisers.

Cromwell, Conn.

- A. N. Pierson**, Cromwell, Conn.
For page see List of Advertisers.

In writing to Advertisers kindly mention Horticulture



THE WHILLDIN POTTERY COMPANY

THE LARGEST MANUFACTURERS OF

STANDARD FLOWER POTS

PHILADELPHIA, PA. LONG ISLAND CITY, N. Y. JERSEY CITY, N. J.

WHOLESALE FLORISTS— Continued Detroit

Michigan Cut Flower Exchange, 38 and 40 Broadway, Detroit, Mich.
For page see List of Advertisers.

Minneapolis

Bice Bros., 115 N. 6th St., Minneapolis, Minn.
For page see List of Advertisers.

New York

Ford Bros., 48 W. 28th St., New York.
For page see List of Advertisers.

H. E. Froment, 57 W. 28th St., New York.
For page see List of Advertisers.

Alex. J. Guttman, 34 W. 28th St., New York.
For page see List of Advertisers.

E. C. Horn, 55 W. 28th St., New York.
For page see List of Advertisers.

A. H. Langjahr, 55 W. 28th St., New York.
For page see List of Advertisers.

James McManus, 42 W. 28th St., New York.
For page see List of Advertisers.

John I. Raynor, 49 W. 28th St., New York.
For page see List of Advertisers.

W. F. Sheridan, 39 W. 28th St., New York.
For page see List of Advertisers.

Treadwell & Scheuck, 44 W. 28th St., New York.
For page see List of Advertisers.

Moore, Heitz & Nash, 55 and 57 W. 26th St., New York.
For page see List of Advertisers.

Wm. H. Kuebler, 28 Willoughby St., Brooklyn, N. Y.
For page see List of Advertisers.

Phillip F. Kessler, 55 and 57 W. 26th St., New York.
For page see List of Advertisers.

Milburg Bros., 41 W. 28th St., New York.
For page see List of Advertisers.

John Young, 51 W. 28th St., New York.
For page see List of Advertisers.

Greater New York Florists' Association, 162 Livingston St., Brooklyn, N. Y.
For page see List of Advertisers.

George Saltford, 43 W. 28th St., New York.
For page see List of Advertisers.

Frank Millang, 55-57 W. 26th St., New York.
For page see List of Advertisers.

B. S. Slinn, 55-57 W. 26th St., New York.
For page see List of Advertisers.

A. L. Young & Co., 54 W. 28th St., N. Y.
For page see List of Advertisers.

Growers' Cut Flower Co., 39 W. 28th St., New York.
For page see List of Advertisers.

Hosshaw & Fenrich, 44 W. 28th St., New York.
For page see List of Advertisers.

J. K. Allen, 106 W. 28th St., New York.
For page see List of Advertisers.

Philadelphia

W. E. McKissick & Bros., 1019-1021 Raintstead St., Philadelphia, Pa.
For page see List of Advertisers.

Leo Nissen Co., 120 Arch St., Philadelphia, Pa.
For page see List of Advertisers.

The S. S. Penneck-Meehan Co., 1608-18 Ludlow St., Philadelphia, Pa.
For page see List of Advertisers.

St. Louis

H. G. Berling, 1402 Pine St., St. Louis, Mo.
For page see List of Advertisers.

WHOLESALE PLANTSMAN

Samuel A. Woodrow, 53 W. 30th St., New York.
For page see List of Advertisers.

New Offers in This Issue.

CARNATION CUTTINGS: PRELIMINARY LIST.

The E. G. Hill Co., Richmond, Ind.
For page see List of Advertisers.

DAHLIAS.

R. Vincent Jr. & Sons Co., White Marsh, Md.
For page see List of Advertisers.

FREEZING ASPARAGUS AND RHUBARB ROOTS FOR FORCING.

Warren Shinn, Woodstown, N. J.
For page see List of Advertisers.

GLADIOLUS BRIDE.

H. F. Mitchell Co., 1018 Market St., Phila.
For page see List of Advertisers.

NEW COMMERCIAL CHRYSANTHEMUMS.

Elmer D. Smith & Co., Adrian, Mich.
For page see List of Advertisers.

PHOENIX ROEBELENI PALM SEED.

Ralph M. Ward & Co., 12 W. Broadway, New York.
For page see List of Advertisers.

ROOTED CARNATION CUTTINGS.

Peter Fisher, Ellis, Mass.
For page see List of Advertisers.

STANDARD WHEAT SEEDS.

H. Bayersdorfer & Co., 1129 Arch St., Phila.
For page see List of Advertisers.

FLOWER MARKET REPORTS.

(Continued from page 17)

Lilies were in over supply and demand limited. We heard of but one jobber who dipped a little too deep in hobby. He had two hundred cases left out of one thousand and this was caused mainly by some of his regular customers having misled him as to their probable wants. Holly wreaths, and stock of that kind in the outlying sections—where they usually sell so well—were a great disappointment. The dealers failed in forecasting the business and suffered great loss. *Lyopodium* was also largely overdone and much of this is now being swept to an ignoble resting place. If you ask me what was the most striking feature on the market I would say—Jardine roses at fifty a hundred. They were a revelation to many as to what this rose is capable of. While American Beauty roses were scarce in spots, there was no time during the week that they could not be got by the thousand at two or three of the wholesale places that make a specialty of them and have proper contracts with their growers. And prices held steady too. Killarney was never better. White roses were drabby, as were also all other white flowers. Paper whites were an exception. A whole lot of smilax and plumosus growers seem to think there are more funerals at Christmas than other times. Its red that's wanted—not green. Accessories of plumosus sort are in steady demand the whole season. It is a mistake to think there is a rush for them at any of the holidays. Christmas, nineteen hundred and eight, will go down to

history as the steadiest and best gauged market of any year to date—by grower, wholesaler and retailer. Each department deserves some of the credit. Not forgetting that sanitary balance wheel, the trade press. The schoolmaster has been abroad to some purpose.

INDIANAPOLIS

All the retailers as well as the growers report a big Christmas trade, well ahead of last year. Weather conditions were unusually favorable to the growers. Beauties and select stock of all kinds brought top-notch prices. Stock in general was of excellent quality, each supply about equal to demand. Orchids, sweet peas, violets and Beauties had a tremendous demand. Pot plants had the usual heavy run, but cut flowers were disposed of in great quantities. Nothing especially new in any line was noticeable. The call for pot poinsettia and red carnations was a little ahead of the supply. Holly and evergreens were never more plentiful in this market, and the result was that prices were lower than usual. The buying of evergreen began a week earlier than usual and kept up till Christmas Day. The usual quantity of boxwood balls, red and evergreen wreaths, were in evidence.



STANDARD FLOWER POTS

Packed in small crates, easy to handle.		Price per crate	
1500 2 1/2 in. pots in crate	3.38	120 7 in. pots in crate	\$4.20
1500 2 1/2 " " " "	5.25	60 8 in. " " " "	3.00
1500 2 1/2 " " " "	6.00	HAND MADE	
1000 3 " " " "	5.00	48 9 in. pots in crate	\$3.60
800 3 1/2 " " " "	5.80	48 10 " " " "	4.80
500 4 " " " "	4.50	24 11 " " " "	3.60
250 5 " " " "	4.25	24 12 " " " "	4.80
144 6 " " " "	3.16	12 14 " " " "	4.80

Send pns, same price as pots. Send for price list of Cylinders for Cut flowers, Hanging Baskets, Lawn Vases, etc. Ten percent. off for cash with order. Address HILFINGER BROS., Pottery, Fort Edward, N. Y. August Rolker & Sons, Agts. 31 Barclay St., N. Y. City.

Standard Flower.. POTTS

If your greenhouses are within 500 miles of the Capital, write us, we can save you money

W. H. ERNEST

28th and M Street WASHINGTON D. C.

List of Advertisers

Page	Page
Advance, The Co., 27	McMann Jas., 18
Allen J., 19	Meyer, 14
American Nursery, 4	Meyer J. C. & Co., 15
American Nursery Co., 4	Michell H. F. Co., 12
Aschmann Godfrey, 3	Michigan Cut Flower Exchange, 19
Atlanta Floral Co., 15	Milling Bros., 18
Bambrick Thos., 25	Milling Frank, 18
Barrows H. H. & Son, 3	Miller, E. S., 9
Bassett & Washburn, 2	Moninger J. C., 27
Bayersdorfer H. & Co., 15-17	Moore, L., 18
Berning H. G., 19	Moore, Hunt & Nash, 18
Blossom The, 14	Moore-Livingston Co., 15
Boddington A. T., 13	Morse C. C. & Co., 13
Boston Florist Letter Co., 15	Murray Samuel, 14
Boston Plate and Window Glass Co., 26	New Eng. Nurseries, 4
Bostrom-Brady Mfg. Co., 17	Newman Floral Co., 14
Bowen, M. A., 14	Newman J. & Sons, 15
Brefineyer's J. Sons, 15	Ningara Sprayer Co., 15
Bridgeman's Seed Warehouse, 13	Niessen Leo, Co., 16
Buddle J. A., 15	Oechlin Frank, 30
Burpee W. A. & Co., 13	Ordonez Bros., 30
Burton & Allard, 25	Ouwertek P. Co., 4
Carrillo & Baldwin, 10	Palthehorpe P. R. Co., 10
Clarke's David, Sons, 14	Palmer W. J., 15
Cleary's Horticultural Co., 4	Park Floral Co., 14
Coan J., 18	Payne John A., 26
Cotnam Geo. & Co., 19	Peacock Dahlia Farms, 4
Cowen W. J., 15	Pennock-Meehan Co., 40
Craig, Robt. Co., 10	Perkins St. Nurseries, 3
Crane H. L., 14	Pierson, A. N., 10
Crawback Geo. W., 10	Pierson F. R. Co., 10
Danker F. A., 15	Pierson U. Bar Co., 28
Duges & Conard Co., 27	Poehlmann Bros. Co., 16
Dowd Geo. B. & Sons, 27	Pratt B. G. Co., 11
Dorner F. Sons & Co., 2	Pulverizer Machine Co., 27
Dreer H. A., 25	Quaker City Machine Co., 27
Dunlop John H., 14	Raynor John I., 18
East Sudbury Greenhouses, 2	Reed & Keller, 19
Ewards Folding Box Co., 16	Reuber Peter, 27
Elliott Wm & Sons, 13	Revere Rubber Co., 26
Evel J. G., 27	Rhodes Mfg. Co., 25
Ernest W. H., 24	Rice Bros., 25
Eyres, 14	Rights Bros., 13
Farquhar R. & J. Co., 13	Robinson H. M. & Co., 16
Fisher Peter, 13	Rock Wm. L. Flo. Co., 10
Fiske H. E. Seed Co., 13	Roeber Julius Co., 10
Foley Mfg. Co., 27	Roper Albert, 9
Ford Bros., 18	Roland, Thomas, 3
Fromont H. E., 18	Rolker August & Sons, 24
Galvin Thos. F., 15	Rose Hill Nurseries, 10
Godard S. J., 13	Salford Geo., 18
Greater N. Y. Florists Association, 10	Sandler & Son, 10
Grey T. J. Co., 13	Schlichtes Anton, 3
Growers' Cut Flower Co., 13	Sch Jacob, 3
Gude Bros. Co., 14	Scott, John, 3
Gutman Alex. J., 18	Sharp, Partridge & Co., 26
Hall Asso., 27	Sheridan W. F., 18
Hartmann Hjalmar & Co., 13	Shinn Warren, 9
Hauswirth M. C. & F. B., 13	Siggers & Siggers, 25
Hexcock Jos. & Co., 3	Simpson Robt., 12
Henshaw & Fenrich, 19	Situations & Wants, 25
Herbert David & Son, 4	Sloan B. S., 18
Hews A. H. & Co., 24	Smil, Elmer D. & Co., 4
Hilfinger Bros., 24	Smyth Wm. J., 14
Hill, The E. G. Co., 3	Standard Plate Glass Co., 26
Hippard E., 27	Stearns A. L. Lumber Co., 26
Hitchings & Co., 26	Stimpff & Walter Co., 11
Hoffman, 15	Sunlight Double Glass Co., 26
Horan E. C., 18	Talby, 15
Houghton F. H., 15	Tharbo J. M. & Co., 19
Hout E. H., 11	Totty Chas. H., 3
Kentucky Tobacco Product Co., 4	Traendly & Scheack, 16
Kervan The Co., 10	Trepel C., 10
Kessler, P. F., 18	Troy J. H., 18
King Cons. Co., 26	Twomey, D. J., 14
Knap Hill Nursery, 4	Valentine, J. A., 14
Kreschell Bros. Co., 27	Vincent R. Jr. & Sons, 3
Kuebler Wm H., 19	Waban Rose Confections, 14
Lager & Hurrell, 10	Ward R. M. & Co., 12
Langjahr, Alfred H., 18	Waterer A., 12
Leonard Seed Co., 13	Waterer John & Sons, 4
Leuby A. & Co., 24	Weber F. E., 14
Lord & Burnham Co., 23	Weich Bros., 26
Lutton W. H., 27	Whildin Pottery Co., 24
Manda Jos. A., 15	Weston H., 3
Marquise Louis E., 2	Whitcomb, 3
MacMullen E. A., 15	Whitcomb Plant Oil & Fertilizer Co., 11
McCarthy N. F. & Co., 19	Winterson, E. F. Co., 16
McConnell Alex., 15	Withell Geo. Co., 3
McKellar Charles W., 16	Wood Bros., 3
McKissick, W. E. & Bros., 16	Woodrow Sam'l A., 9

RHODES DOUBLE CUT PRUNING SHEAR

THE only pruner made that cuts from both sides of the limb and does not bruise the bark. Made in all styles and sizes. We pay Express charges on all orders. Write for circular and prices.

Pat'd June 2, 1903.

Dept. R
RHODES MFG. CO., GRAND RAPIDS, MICH.

A twelve inch fall of snow on the afternoon and evening of the 22nd December sent prices of all flowers soaring upward. Not for years has there been such a scarcity of all kinds of flowers, nor has there been a higher standard of prices. Azaleas and Christmas greens were shown in greater quantities than anything else. Carnations brought from \$10 to \$12 per 100. Red carnations commanded \$15 per 100, and before the evening of the 24th could not be bought at any price. The heavy fall of snow so retarded business that more than one retailer did not leave his store the entire night. Every form of delivery was brought into requisition. Violets were about the only thing that did not take a tremendous jump in price. The Virginia violets wholesaled at \$1.00 per 100, while the New York flowers commanded \$3.00.

BUSINESS CHANGES.

Fruitville, Cal.—H. Hayashi & Co. have bought the stock of A. Galloway, florist.
Wilkesbarre, Pa.—The Dewey Park greenhouses have been leased by Ira G. Marvin.
Fairmont, W. Va.—The H. Weber & Sons Co., Oakland, Md., have purchased the business of E. M. Hall, retail flower and seed dealers.

PATENTIS
Trademarks and Copyrights

Send your business direct to Washington. Saves time and insures better service. Personal attention guaranteed. Twenty-five years' active service. SPECIALTY: "Working on the Failure of Others."

SIGGERS & SIGGERS
PATENT LAWYERS
Box 9, National Union Building
Washington, D. C.

USE THE BEST.

Economy Greenhouse Brackets

are used by leading growers everywhere. Send for price list and descriptive circular.

BUXTON & ALLARD, Dept. A, Washua, N. H.

Holds Glass Firmly

See the Point #2

PEERLESS

Glazing Points are the best. No rights of sale. Box of 1,000 points 75 cts. postpaid.

HENRY A. DREER,
734 Chestnut St., Phila., Pa.

WANTS, FOR SALE, ETC.

Advertisements in this column one cent a word. Initials count as words. Cash with order. All correspondence addressed "care HORTICULTURE" should be sent to 11 Hamilton Place, Boston.

HELP WANTED

GOOD MEN

When you need good men, skilled or unskilled, write:

THOS. H. BAMBRICK

34 South 7th Street Philadelphia

Help of all kinds, including that for Florists, Nurserymen, Seedsmen and the Horticultural trade generally.

WANTED

Travelling Salesman to sell Seeds, Plants, Bulbs, etc. Address giving age, experience, also references.

HENRY A. DREER, Inc.
Philadelphia, Pa.

WANTED—A working nursery foreman and salesman, one who understands the value of imported plants. Reply to Salesman, care of this paper. Correspondence considered private.

SITUATIONS WANTED

SITUATION WANTED—By practical landscape gardener and florist; private or commercial; middle aged; married; J. Hodge, 44 West St., Fitzburg, Mass.

FOR SALE

FOR SALE—5000 feet, 2-in., 1000 feet, 4-in., wrought iron pipe; 4000 feet of 4-in. cast iron pipe; clean; 500 boxes 10 x 12, \$1.50; 150 boxes 10 x 15, \$1.20, and 100 boxes of 8 x 10, double-thick and clean glass, at \$1.25 per box. Two S. Olby, 3 glass sections, two S. Olby No. 5, one No. 4, 17 fittings, and one No. 8 Furman boiler. All finds venting apparatus and sash, cast iron fittings, valves, expansion tanks, etc. Everything in first class condition. Cheap. F. O. B. Newark, N. J. Sueserman, 229 Livingston St., Newark, N. J.

FOR SALE—Retail nursery, sixth year, doing good, steady and increasing trade. Stock in excellent condition. Only local supply for community of 50,000. For particulars address R. N., care HORTICULTURE, Boston.

MISCELLANEOUS WANTS

WANTED TO BUY—Complete greenhouse plants and all kinds of greenhouse material, to be taken down and removed at once. Terms cash. Address: L. Sueserman, 229 Livingston St., Newark, N. J.

"REVERO"

Braided Moulded Construction—Seamless Throughout



LIGHT--STRONG--FLEXIBLE

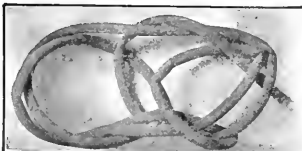

The above cuts represent the non-kinking tendency of Revere as compared with the old style hose of wrapped duck construction

Revere is Furnished on Reels in Continuous Lengths up to 500 feet.

Revere Rubber Company, BOSTON, MASS.

NEW YORK
NEW ORLEANS

PHILADELPHIA
MINNEAPOLIS

PITTSBURG
SAN FRANCISCO

CHICAGO
PORTLAND, ORE.



Sunlight Double-Glass Sash Company
929 East Broadway
LOUISVILLE, KY.

The double layer of glass
does it

Lets in the light always.
Never has to be covered or uncovered; no boards or mats needed.
Retains the heat, excludes the cold.
Makes stronger and earlier plants.
Glass slips in; no putty; cannot work loose; easily repaired.
Ask for catalog W it tells all about Sunlight sash.
Special catalog for greenhouse material.

STANDARD PLATE GLASS CO.

Manufacturers—Importers—Jobbers

NOW IS THE TIME TO BUY

FRENCH OR AMERICAN GREENHOUSE GLASS

LOWEST PRICES ON REQUEST

26-30 Sudbury St. BOSTON, MASS. 61-63 Portland St.

GLASS

Always Write Us Before Buying
SHARP, PARTRIDGE & CO.
22nd and Lumber Streets, CHICAGO
WE HAVE SOME SNAPS

The Payne Steel "T" Bar Greenhouses

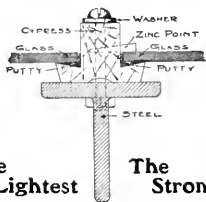

The Lightest The Strongest

Half full Size

HOUSES of this type are constructed with both curved glass eaves and straight glass eaves. Least amount of shadow. Least amount of wood. No drip. Greatest durability.

JOHNA. PAYNE

Greenhouse Designer and Builder
260-274 Culver Avenue

JERSEY CITY, N. J.

CYPRESS SASH BARS 82 feet or longer HOT BED SASH PECKY CYPRESS BENCH LUMBER

GREENHOUSES

ERECTED AND EQUIPPED COMPLETE IF DESIRED

Write for Circular "D" and Prices

The A. T. STEARNS LUMBER CO. NEPONSET, BOSTON, MASS.

EVERYTHING FOR
GREENHOUSE
BUILDING

WRITE FOR
INFORMATION
AND PRICES.

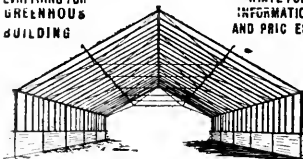

King Greenhouses King Gutters and Eaves
Trussed Roofs Ventilating Machinery.
Trussed Iron Frame Houses.
Tilt Benches and Pipe Hangers.

KING CONSTRUCTION COMPANY NORTH TONAWANDA, N. Y.

In ordering goods please add "I saw it in HORTICULTURE."

BOSTON PLATE & WINDOW GLASS CO.

GREENHOUSE GLASS

German and American

261 to 287 A St., Boston 20-22 Canal St.

In writing to Advertisers kindly mention Horticulture

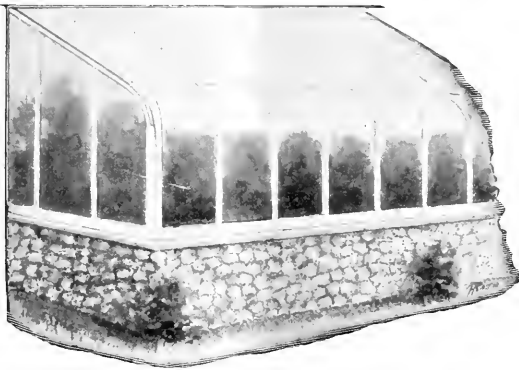

Why My New Curved Iceless Eave is Far Superior to Anything on the Market Today

- 1st. No sash bars incased in iron, thereby eliminating all danger of bars decaying.
- 2nd. Can be used in conjunction with iron frame construction, thereby doing away with that very objectionable feature, "columns."
- 3rd. Roof bars with drip grooves, which act as conductors to carry away the condensation: **Result**, the driest roof ever used for greenhouse purposes.
- 4th. **THE MOST IMPORTANT OF THEM ALL.** The very small increase in cost over the ordinary style of construction which makes it possible to be used for commercial as well as private purposes.

William H. Lutton, Horticultural Architect and Builder
West Side Ave Station (C.R.R. of N.J.) Jersey City, N.J.

KROESCHELL BOILER



MADE OF FIRE BOX FLANGE PLATE
Can not Crack

Water Space in Front, Sides and Back
The Most Popular Boiler Made
SEND FOR CATALOGUE.

KROESCHELL BROS. CO.
35 Erie Street, CHICAGO, ILL.



The Advance Ventilating Apparatus

is a very simple, complete machine that works very easy, is strong, because it is made of the best material in a mechanical manner and so easy to set up. One price to all and that a very moderate one, makes it the machine for all florists. Get our new circular, see the new things we have, scan our prices and give us a trial. You will come again as they all do.

The Advance Co.
RICHMOND, IND.

IRON PIPE

SECOND HAND

WROUGHT IRON PIPE, for Steam, Water, Gas or Oil, Fences or Posts. All Sizes. Price Low.

GEO. B. DOANE & SON
18 Midway Street, BOSTON
Telephone, Main 4419

THE FOLEY MFG. CO.

CHICAGO

Completely equipped with up-to-date machinery for the making of material for

GREENHOUSE CONSTRUCTION

From a Full Supply of Thoroughly Seasoned Lumber

Send your sketches to our draughtsmen for completion and suggestion. Permit us to figure your proposed work, large or small.

We guarantee our prices will save you money

FOLEY VENTILATING APPARATUS IS THE BEST

is Simple in Erecting, is Easiest of Operation. It Will Last a Lifetime. Its Price is the Lowest. Will Ventilate Any Size House. Prices and Circulars on Application.

Our 1908 Catalogue Greenhouse Material Sent Postpaid on Request.

THE FOLEY MFG. CO., WESTERN AVENUE
25th and 26th STS., CHICAGO

THE STANDARD STEAM TRAP

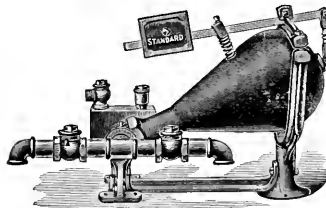

is acknowledged the best for the florist, because it is durable and does its work without trouble and annoyance, saving its cost by the economy in coal bills.

E. HIPPARD

YOUNGSTOWN, OHIO

GREENHOUSE CONSTRUCTION LUMBER

John C. Moninger Co.
117 E. Blackhawk St., CHICAGO.

Look through the Buyers' Directory and Ready Reference Guide. You will find some good offers there also.



Evans 20th Century Arm

Will not twist the shafting pipe. Three times the power of old style elbow arms. Sold only with Evans Challenge Machine.

Write for Free Catalogue to
QUAKER CITY MACHINE CO.
Richmond, Ind.

The FLORISTS' HALL ASSOCIATION OF AMERICA, insurer of 29,000,000 sq. ft. of glass. For particulars address **John C. Esler, Sec'y, Saddle River, N. J.**



A COMPARISON

When you compare the cost of the wooden house with our Iron Frame House, bear in mind that the Iron Frame costs less to erect, less to keep in repair, and gives you greater returns in quantity and quality of flowers, than the best cypress house made. This construction pays for itself many times over.

The next best proposition is our Half Iron Frame House. Send for circular.

Hitchings & Company
1170 Broadway New York

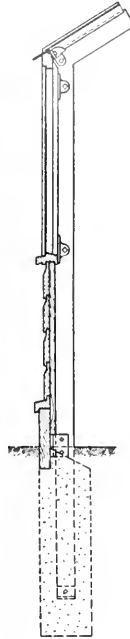

THE POST QUESTION

Along twenty years or so ago we put up a large range of greenhouses at Scarborough, N. Y., and used wrought iron posts—not steel, mind you—but wrought iron. We have recently dug up several of these posts and find they are just as good as ever.

Now we believe it stands to reason that a solid post with no joints from the plate down, has the advantage of increased strength; so in many of our jobs we are now using the solid *Guaranteed Wrought Iron Post*. Not the rolled steel post mind you, which in a few years always rusts entirely off at the ground—but *Guaranteed Wrought Iron*.

This subject is thoroughly gone into on pages four to eight of our *Handy Hand Book*. If you haven't this book—send for it.

Lord & Burnham Co.

Main Sales Office:

1133 BROADWAY, N. Y.

BOSTON: 810 Tremont Building
PHILADELPHIA: 1215 Filbert St.

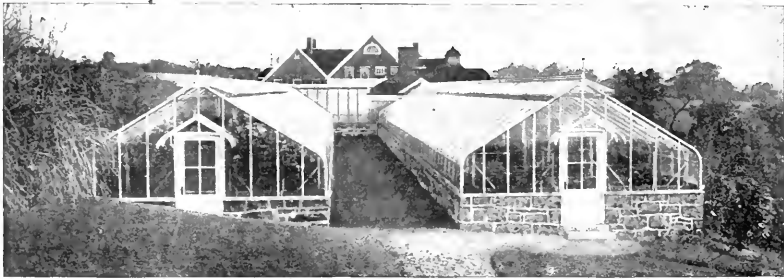

WHY THE U-BAR WINS

If you would just take the time to go and see a U-Bar house and talk with a U-Bar gardener, then you would appreciate how downright truthful we are in saying it is the lightest, most productive house built.

The main structural point of the U-Bar house is the combining of the rafter and roof bar in one, making the U-Bar. This combination is no larger than the single roof bars used in other houses. It does away entirely with the heavy iron supporting members, and makes possible the only successful curved eave.

The glass is spaced 24 inches instead of 16.

The core bar is soaked in a chemical preservative, before putting it in the galvanized steel U-Bar casing.

All iron parts are painted with a special aluminum finish which remains bright for years without attention.

To sum it up then—the U-Bar is indisputably the highest type of greenhouse construction. The ideal construction for private estates, parks, public institutions and florists' show rooms. Send for the catalog.

U-BAR GREENHOUSES

PIERSON

DESIGNERS AND BUILDERS



U-BAR CO.

1 MADISON AVE. NEW YORK

HORTICULTURE

Vol. IX.

JANUARY 9, 1909

No. 2



PRIMULA OBCONICA GRANDIFLORA

Devoted to the
**FLORIST, PLANTSMAN,
LANDSCAPE GARDENER,**
and
Kindred Interests

Published
EVERY SATURDAY
At 11 Hamilton Place,
BOSTON, MASS.
Subscription, \$1.00

JAN 11 1909

CARNATIONS ROOTED CUTTINGS

NEW INTRODUCTIONS

Mrs. Chas. Knopf, light pink } (*Knopf*)
 Ruby, Crimson
 Georgia, white *Cockroff*
 Mrs. J. C. Vaughan, white *Rudd*
 Bay State, variegated *Roper*
 Pink Delight *Dorner*
 Wanoka, crimson } (*Wanoka Greenhouse*)
 Apple Blossom, white light pink marking }
O. P. Bassett, scarlet *Bassett & Washburn*

Per 100	Per 1000
\$12.00	\$100.00
Per 100	Per 1000
\$8.00	\$60.00

Standard Varieties

One Hundred Thousand Cuttings selected strong stock ready to ship

"WHITE"		"PINK"			
per 100	per 1000	per 100	per 1000		
Sarah Hill.....	\$6.00	\$50.00	Splendor.....	\$6.00	\$50.00
Pres. Seelye.....	5.00	40.00	After Glow.....	6.00	50.00
Lloyd.....	5.00	40.00	Winona.....	6.00	50.00
White Enchantress.....	3.50	30.00	Lawson Enchantress.....	5.50	50.00
White Perfection.....	2.50	20.00	Welcome.....	4.00	35.00
			Winsor.....	3.50	30.00
			Aristocrat.....	3.50	30.00
			Rose Pink Enchantress.....	2.50	20.00
			Enchantress.....	2.50	20.00
			Lawson.....	2.50	20.00

CHRYSANTHEMUMS

Golden Glow, 2 1/2 in. pots, ready for shift, \$5.00 per hundred. Rooted Cuttings, selection of forty varieties, the cream of the commercial sorts. Write for list and prices.

NEW ROSE MY MARYLAND

Grafted, 2 1/2 in. pots, \$20.00 per hundred, \$150.00 per thousand; Own Roots, 2 1/2 in. pots, \$10.00 per hundred, \$80.00 per thousand.

ORDERS BOOKED NOW FOR THIS MOST PROMISING VARIETY.

S. J. Reuter & Son, Inc., WESTERLY, R. I.

BAY STATE

Orders for January Delivery are being rapidly booked.

If you want to get in

on the ground floor with this noblest of all the new carnations place your order at once.

Rooted Cuttings, \$12.00 per 100, \$100.00 per 1000

ALBERT ROPER, Tewkesbury, Mass.

NEW RED GARNATION O. P. BASSETT

Extra Large Bright Red Free Bloomer

Rooted Cuttings, per 1000, \$60.00 | Rooted Cuttings, per 100, \$8.00 | Rooted Cuttings, per 25, \$2.50
 per 500, 35 00 | per 50, 4 50 | per 12, 1 50

Ready for delivery Jan. 1st, '09 by the Originators and Growers

BASSETT & WASHBURN, HINSDALE, ILL

Send for our Preliminary List describing and quoting Chrysanthemums and Carnations.

A fine lot of Carnation Cuttings ready now.

THE E. G. HILL CO., RICHMOND, INDIANA

NEW CARNATION PINK DELIGHT

Waxy Shell Pink. A Grower's and Shipper's favorite. Has a holding color, keeps well, comes on long stems and is early, very free and continuous flowering. January delivery, \$12.00 per 100; \$100.00 per 1000.

F. Dorner & Sons Co., La Fayette, Ind.

MARCHIONESS

The Money Making White Carnation \$10.00 per 100; \$80.00 per 1000

Orders Filled Strictly In Rotation

BELLAMY BROS.

Successors to L. E. Maniquette. SYRACUSE, N. Y.

CARNATION CUTTINGS

We offer choice varieties for January and later shipments.

	Per 100	Per 1000
Enchantress.....	\$2.50	\$20.00
White do.....	3.50	30.00
Rose Pink do.....	2.50	20.00
White Perfection.....	2.50	20.00
Winsor.....	3.50	30.00
Melody.....	2.50	20.00
Beacon.....	3.50	30.00
Victory.....	3.50	30.00
Aristocrat.....	3.50	30.00
Splendor.....	6.00	50.00
Vesper.....	3.50	30.00
White Lawson.....	2.50	20.00

EAST SUDBURY GREENHOUSES,

Carnation Specialists

P. O. Address South Sudbury, Mass. Telephone So. Sudbury 20.

Rooted Carnation Cuttings

A Selection from 20 Sorts. (For Early January Delivery, and Later) Every one Reliable

	100	1000
White	W. Perfection	\$3.00 \$25.00
Red	Beacon	4.00 35.00
Light Pink	Enchantress	3.00 25.00
	Winsor	3.00 25.00
Medium Pink	Winona	6.00 50.00
	Rose Enchantress	3.00 25.00
Dark Pink	Melody	3.00 25.00
	Viola Sinclair	6.00 50.00
Variegated	Var. Lawson	3.00 25.00
	Octoroon	3.00 25.00
Crimson		

PETER FISHER, - Ellis, Mass.

ROOTED CARNATION CUTTINGS

Ready for Immediate delivery. Per 100 Per 1000

Andrew Carnegie, scarlet.....	\$6	\$50
Splendor, pink, Scott Shade.....	6	50
Lawson-Enchantress, cerise pink	6	50
Sarah Hill, white.....	6	50
Pres. Seelye.....	6	50
Defiance, scarlet.....	6	50
Aristocrat, beautiful cerise.....	4	35
White Enchantress.....	4	35
Beacon, scarlet.....	4	35
Winsor, pink.....	3	25
Enchantress, light.....	3	25
White Perfection.....	3	25
Rose Pink Enchantress.....	3	25
Daybreak Lawson, light pink.....	3	25
Victory, scarlet.....	3	25
Welcome, pink.....	3	25

Chicago Carnation Co., A. T. Peyer Mgr., Joliet, Ill.

Pillsbury's Carnation Staple

The best, cheapest, quickest, simplest and easiest way to fix your split carnations. No tools required—only 50c per 1000 postpaid.

"They are the best thing yet."—CHAS. J. HEWSON.

I. L. PILLSBURY, FLORIST

Galesburg, Illinois.

CARNATIONS

	Rooted Cuttings, Fine Healthy Stock	
	Per 100	1000
Pres. Seelye	\$6.00	\$50.00
White Enchantress, Beacon	3.50	30.00
Kingston Pet, Winsor, M. lody, Victory	3.00	25.00
Daheim, Enchantress, Lady B untiful, Mrs. Lawson, White Lawson, Red Lawson, Variegated Lawson	2.50	20.00

WOOD BROTHERS, - Fishkill, N. Y.

Dreer's Special Offer of Kentias

The Stock here offered is all of exceptional good value.

Kentia Belmoreana.

	Per doz.	Per 100	Per 1000
2 1/2 in pots, 4 leaves, 8 to 10 inches high	\$1.50	\$10.00	\$90.00
3 " " 5 " " 12 " "	2.00	15.00	140.00
7 " " 6 " " 20 to 24 " "	1.50 each		
6 " " 6 to 7 " " 26 to 28 " "	1.50 "		
11 " " 6 to 7 " " 32 to 34 " "	2.50 "		
6 in tubs, 7 to 8 " " 6 ft. high, very stocky	\$2.00 each.		
11 " " 8 to 9 " " 7 to 8 " "	25.00 "		
11 " " 8 to 9 " " 8 " "	30.00 "		

The three named sizes are exceptionally handsome specimens.

Kentia Forsteriana.

	Per doz.	Per 100	Per 1000
2 1/4 inch pots, 4 leaves, 8 to 10 inches high	\$2.00	\$15.00	\$140.00
3 " " 5 to 6 " " 15 " "	2.50	20.00	175.00
4 " " 5 to 6 " " 15 " "	5.00	40.00	
4 " " 6 " " 28 to 30 " "	1.00 each.		
6 " " 6 " " 34 to 36 " "	1.50 "		
7 " " 6 to 7 " " 36 to 40 " "	2.50 "		
8 " " 6 to 7 " " 36 to 42 " "	3.00 "		
7 " " 7 to 8 " " 42 to 44 " "	4.00 "		
8-inch tubs, 6 to 7 " " 4 1/2 feet	8.00 "		
9 " " 6 to 7 " " 6 " "	10.00 "		
10 " " 6 to 7 " " 8 to 10 " "	10.00 "		
12 " " 6 to 7 " " 8 to 10 " "	17.50 "		
12 " " 7 " " 6 to 7 " "	20.00 "		

Kentia Forsteriana—Made-up Plants.

	High	Each	8-in. tubs, 3 plants in a tub,	High	Each
7 in. tubs, 3 plants in a tub, 34 to 36 in.	34 to 36 in.	\$2.50	42 to 48 in.	6 ft.	\$5.00
8 " " 3 " " 36 to 38 in.	36 to 38 in.	3.00	12 " " 3 " "	8 ft.	15.00
8 " " 3 " " 40 to 42 in.	40 to 42 in.	4.00	12 " " 3 " "	8 ft.	17.00

The two latter sizes are excellent values for decorative purposes.

Kentia Sanderiana.

This is a very graceful hardy Palm of fine decorative appearance which should prove a popular variety. We offer fine bushy made up plants.

4-inch pots, 3 plants in a pot, 15 to 18 inches high	\$0.75 each
5 " " 3 " " 18 to 22 " "	1.00 "

For a full line of DECORATIVE PLANTS and all other seasonal stock, see our new wholesale list issued January 1st.



HENRY A. DREER, - - Philadelphia, Penna.

DECORATIVE PLANTS

Araucaria Excelsa, Pandanus Utilis, Dracaena Indivisa, Kentias, Latanias, Arecas, Etc. Perennials and Shrubs.

4 inch Araucarias.....	50 cents each.	6 inch Araucarias.....	\$1.00 each.
5 " " 3 " ".....	75 " "	7 " " 3 " ".....	\$1.25 and \$1.50 "

FERNS FOR DISHES—\$3.50 per 100, \$30.00 per 1000. SEND FOR OUR PRICE LIST. WE HAVE A COMPLETE STOCK.

The Geo. Wittbold Co.

1657 Buckingham Place, Chicago, Ill.

BARAINS

in KENTIAS and other Decorative Plants, all sizes. Also the following at Lowest Import Prices, 15,000 Azaleas, best commercial varieties, from \$25.00 per 100 to \$2.00 each. A fine lot of Rubbers, Crotons, Araucarias, Pandanus, Asparagus plumosa and Sprengeri.

SMALL FERNS

for table decorative purposes at lowest wholesale rates.

A. LEUTHY & CO.,
Perkins St Nurseries ROSLIND LE, MASS.

FERNS FOR DISHES,

Assorted Varieties

From 2 inch pots, \$3.50 per 100; \$30.00 per 1000

CASH WITH ORDER
2570 to 2606 W. Adams St., Chicago, Ill

FRANK OEGHSLIN

HEADQUARTERS

For Araucarias, Bays, Kentias, Solanums, Lorraine Begonias. Best stock in the country. Write for bargain prices.

GODFREY ASCHMANN

1012 West Ontario St., Phila., Pa.

HEACOCK'S PALMS

Kentia Belmoreana
7-inch pots.....36 to 38 inches high.....\$2.50 each
7-inch pots.....36 to 38 inches high.....3.00 "

Made up **Kentia Forsteriana**
7-inch pots.....34 to 36 inches high.....\$2.50 each
7-inch pots.....36 to 38 inches high.....3.00 "

9-inch tub.....42 to 48 inches high.....5.00 "

Joseph Heacock Co., Wyncote, Pa.

GOLDEN GLOW

THE BEST EARLY CHRYSANTHEMUM

Can be Cut by Aug. 15th

Plants From 2 1-4 in. Pots Now Ready

\$6 00 per 100, \$50.00 per 1000

S. J. GODDARD
FRAMINGHAM, - MASS.

CHAS. H. TOTT
Chrysanthemums
MADISON, N. J.

PALMS AND FERNS

DECORATIVE PLANTS

JOHN SCOTT
Rutland Road and E. 45th St.
Tel. 2890 Bedford **BROOKLYN, N. Y.**

NEP. WHITMANI

2 1/4 in., \$5.00 per 100

NEP. WHITMANI

3 1/2 in., \$25.00 per 100

BOSTON FERNS

2 1/4 in., \$3.00 per 100

H. H. BARROWS & SON, Whitman, Mass.

FERN S'

In fine assortment, good bushy stock, 2 1/4 in. \$3.00 per 100. Kentias for centers, 100 each. Boston, Scottii and Whitmanii ferns, 6 in. 400.; 4 in. 150. Kentia Belmoreana, 5 in. 500.; 250. each.

H. WESTON, HEMPSTEAD, N. Y.

A. N. PIERSON, Inc.

CROMWELL, CONN.

Wholesale Growers of Cut Flowers, Palms and Ferns
OUR SPECIALTIES. Roses, Lily of the Valley and Carnations. We also grow a general assortment of flowers in their season

BE SURE OF THE BEST
STOCK

White Killarney

ORDER NOW

WABAN ROSE CONSERVATORIES
NATICK, MASS.

Newport Fairy

The Rose of the Future For
In and Out Door.

FINE, STRONG, FIELD-GROWN STOCK
3—4 Shoots 3—4 ft. long
50c each, \$30 per 100, \$250 per 1000

JULIUS ROEHRS CO.
RUTHERFORD, N. J.

Hardy Rhododendrons, Azaleas, Conifers, Clematis, H. P. Roses, Shrubs and Herbaceous Plants from our
HOLLAND NURSERIES

Prices Moderate

P. OUWERKERK, 216 Jane St., Weehawken Heights
P. O. No. 1, Hoboken, N. J.

CLEARY'S HORTICULTURAL CO.

Management AMBROSE T. CLEARY

Wholesale Contracting, Jobbing, Auction
HORTICULTURAL PRODUCTS
of every description.

Consignments Received. Surplus Stock Converted
62 Vesoy St., NEW YORK

Box Trees

and other **EVERGREENS** for Tubs and Boxes
Our Prices are Always Right—Catalog Free
THE NEW ENGLAND NURSERIES, Inc.
BEDFORD, MASS.

THE PRIZE WINNING STRAWBERRY

The Barrymore

Send for Folder at Once.

H. L. CRANE, Originator,
Westwood, Mass.

PEACOCK'S NEW DAHLIAS

SEND FOR LIST

PEACOCK DAHLIA FARMS
Williamstown Junction, N. J.

DAHLIAS. Now is the time to
place your order for
bulbs which will insure
you getting named varieties in any quantity; prompt delivery.

DAVID HERBERT & SON,
Successors to L. K. Peacock, Inc.
ATCO, N. J.

The Northboro Dahlia and
Gladiolus Gardens

Offer for Spring 1909
300 selected varieties of Dahlias and one and one half
million large-flowering Gladioli in mixtures, in lots to
suit. Send list of your wants. Catalogue free.

J. L. MOORE, Northboro, Mass.

BARGAINS in TREES and PLANTS

Concord Grapes, \$2.00. Peach, \$3.00 per 100.

List Free. D. J. TWOMEY, Dept. H, Geneva, N. Y.

JOHN WATERER & SON, Ltd.

American Nursery Bagshot, England

Are Specialists in the

REALLY HARDY VARIETIES
of Rhododendron Hybrids and in Select Varieties of Hardy Border Plants.

ROBERT CRAIG CO.

ROSES, PALMS,

and Novelties in Decorative Plants

MARKET and 49th STREETS., PHILADELPHIA, PA.

ROSES

We have a fine stock of large, dormant field-grown plants, on own roots, including Crimson Kamie, Dorothy Perkins, Clio, Alfred Colomb, Francois 1 evet, Jack, Prince, Jamille de Rohan, Magna Charta, Ulrich Br nner, Giant of Battles, and many others at \$45.00 per hundred; \$150.00 per thousand. Send for list. Roses, Dahlias and Cannas a specialty.

THE DINGEE & CONARD CO., W. Grove, Pa.

RHODODENDRONS-RHODODENDRONS

An immense stock of all the **hardest known kinds**, 2 to 3½ ft., fine plants and all home grown, many being on own roots, far better than grafted stock—also **R. Catawbiense seedlings** of all colors and seedling **Hardy Azaleas** not to be obtained elsewhere. This is the nursery in which most of the Rhododendrons that have proved **hardy in America** were raised.
GOLDEN YEWS, KALMIAS, and other **HARDY PLANTS** in great variety and of all sizes.

Catalogues on Application

ANTHONY WATERER **KNAP HILL NURSERY** **KNAP HILL**
SURREY, ENGLAND

(NO CONNECTION WHATEVER WITH ANY OTHER FIRM.)

HORTICULTURE needs a wide-awake representative in every town in the land. Good commission paid on advertising and subscriptions. If you are ambitious, write for terms.

ASTER SEED
AND
CHRYSANTHEMUMS
Elmer D. Smith & Co.
Adrian, Mich.

Buy Your Carnations, Chrysanthemums, Garden Shrubbery, Bulbs and other Seasonable Material from HORTICULTURE'S Advertisers. They represent the Best Element in the Trade. Stick to Them and You Make No Mistake.

Rocky Mountain Rambles

IV.

The Wasatch Mountains are marked by numerous short canons with an abundance of water. Looking west one sees the broad open plain dotted with small farms and fruit orchards. This, the Salt Lake desert, has been largely redeemed with the water coming from the mountains. The Wasatch Mountains contain but few species of forest trees. The *Abies concolor*, always beautiful, is a characteristic conifer at lower altitudes, and with it the Douglass Fir (*Pseudotsuga Douglasii*) which nowhere in this region obtains the magnificent proportions it does in Washington and Oregon. The Lodge Pole Pine and Engelmann Spruce at higher altitudes are magnificent forest trees. The Quaking Aspen (*Populus tremuloides*) is associated with these conifers, covering extensive areas. On some slopes a hard maple much like the eastern species but a smaller tree, *Acer grandidentatum*, is found, also a dwarf bush maple, the *A. glabrum*, and on the dry slopes the *Parshia tridentata*, a small shrub of the rose family and the Mountain Mahogany (*Cercocarpus parvifolius* and *C. ledifolius*) are beautiful, but not generally adapted to dry situations as they grow in very dry soil. The more moist situations along the mountain streams contain a great abundance of the Osier (*Cornus stolonifera*) which is certainly different from the plant of the east of the same name. The Dwarf Birch (*Betula occidentalis*) which I believe now goes by a different name, has the brownish cherry colored bark. Such places may abound with the Salmonberry (*Rubus Nulkanus*), and along the border of the brooks at 9,000 and 10,000 feet a great deal of the *Mertensia Sibirica*, a close relative of the eastern Lungwort (*M. Virginica*), well known in our Iowa woods and in gardens.

I cannot refrain from saying something about the home adornment in the Salt Lake Valley. Trees were planted everywhere in the streets; looking over the valleys from some mountain top one can see dotted every-



Lodge Pole Pine (*Pinus Murrayana*) and Subalpine Fir just below timber line, near Ogden, Utah. Elevation 9200 feet.

where the village with the Lombardy poplar. I have never seen the tree show off to greater advantage than here, the spire-like tree planted in every Mormon village. The Mormons made good use of other trees like the Box Elder, which grows to perfection here making beautiful shade trees. It does not look like our eastern tree; straight and with dense foliage, they are of singular beauty here. Black Locust (*Robinia Pseudacacia*), Honey Locust, English Walnut, and many other trees have been planted here with beautiful effect.

In the gardens one finds the usual eastern plants, sweet peas, nasturtiums, dahlias, verbenas, phlox, and many others. One is astonished at the large number of European weeds that find a congenial home in the streets, the usual plantains, bull thistle, spearmint, lamb's-quarter, horchound, catnip, caraway, and in many places poison hemlock.

Ames, Ia.

L. A. Samuel

Single Geraniums

Amidst an ever increasing taste for furnishing rooms, or simply for show purposes in the conservatory, the single geranium has taken a prominent place, and many of the newer introductions have exhibited such lasting qualities amid unusual and uncongenial surroundings, that in house decoration they are from time to time subjected to, that their value as decorative plants has made rapid strides within the past few years.

The small flowered irregular petalled trusses of a few years ago are giving way to varieties with strong, erect spikes, large well-formed flowers and colors of beautiful harmony and softness, extending from pure white to deepest crimson and including several forms of a rare bluish pink shade. It naturally follows, of course, that a great many of the newer introductions turn out bad:



Mountain Mahogany (*Cercocarpus ledifolius*) growing in the rocks, near Ogden, Utah. Elevation 8500 feet.

in fact many varieties are positively ugly by reason of harsh contrasts of color. "Freak" singles, such as the cactus geranium I also consider highly objectionable and not worth house room.

Double geraniums seem to me to be the most popular geranium in America but why they should be more popular than the English round flower section I could never quite make out. I have always held that if the public were given an opportunity to see a collection of singles in full flower, the popularity of the doubles would suffer a severe relapse. One reason for this is the fact that the singles have a greater variation in color than the doubles, and are much more graceful, and better adapted for decorative effect.

During the last ten or fifteen years so many fine new varieties have been raised as to almost make one wonder when they will reach the limit of perfection; in fact, we can almost see raisers beginning to despair whether improvements can be effected on them. As a rule we look for new varieties in this class, from such growers as Cannell, or Lemoine, but there is at least one well-known American firm who make a specialty of geraniums and who in the future may be depended upon to give us varieties fully as good as the French or English importations.

If one wants a good show of flower during the early winter months or for Christmas week, we must start propagating about the beginning of February. The method which we follow and which I think is about as good as any is to put the cuttings singly into small pots of light sandy soil and place them where they will get a little bottom heat. Give them one good watering and then keep them to the dry side until they are rooted. Geraniums of the round-flower type may be grown to almost any size by keeping the plants well pinched, and growing them in a house moderately warm, as they like a little warmth, but plenty of air should be given when it can be done, and the plants should have plenty of room at all times, else they are apt to become scraggly and drawn. Great attention should be paid to watering. It is better to find a dozen plants too dry than one too wet. There is a remedy for the first evil, but none for the latter, which often causes decay and death. A good compost for geraniums is one made up of fresh fibry loam, well decomposed cow manure, with a little leaf soil and sand. As a rule I think six-inch pots are found

to be the most suitable and serviceable size to flower them in, as a geranium will bloom more freely in a medium sized pot than in a large one.

For any one who wishes to grow a few varieties of real merit I can strongly recommend the following: Paul Crampel, bright scarlet; Jaquerie, crimson; Ian McLaren, salmon; Gertrude Pearson, pink; Duke of Bedford, dark crimson with white eye; Juste Oliver, rosy cerise; Emile Zola, a rich salmon, one of the very best; J. M. Barrie, a peculiar shade of pink, flowers very large; The Scider, red; The Queen, pure white; Reformer, a very compact grower, with large trusses of reddish flowers.

Wm. W. Chas. Brown

North Easton, Mass.

Roses Under Glass

SELECTION OF WOOD FOR CUTTINGS.

It may safely be said that in the selection of wood for cuttings lies a good deal of the future success or failure of the plants, yet, how few of us while engaged in cutting off wood give a thought to this most important point. Among almost all varieties of roses there will be found a percentage of plants which, while very vigorous in growth and with a wealth of foliage, persistently refuse to make buds during the winter and seem, in spite of the best treatment we are capable of giving them, to devote their entire vitality to producing blind wood.

As a plant raised from a cutting is merely a perpetuation of the original stock, in order to avoid perpetuating disease, weakness, or any other undesirable feature, we should be very careful in selecting wood. Those plants which have failed to make buds will, of course, offer an abundant supply of wood, which, producing no revenue, invites one to use it in preference to denuding the plants that show an inclination to produce flowers.

Robust, healthy plants that have proved themselves free bloomers should always be selected, as these characters will undoubtedly under careful cultivation, be maintained and possibly accentuated in the young stock if this system of selection is followed year after year.

Close-jointed, well-ripened wood from this class of stock will produce plants of a more uniform size and habit, and under normal conditions, the productiveness seldom fails to satisfy. By confining as much as possible our selection of wood to short-jointed growths we secure cuttings of a more uniform condition of ripeness than if long stems are taken, as it is quite obvious that only a limited number of eyes on such a stem can be in proper condition for propagating. Particularly does this care in selecting wood apply to Beauty and Richmond. These varieties make none too many flowers at their best, therefore it is to one's interest to exert every influence that can be brought to bear in encouraging the growth and proper development of flowering stems.

J. E. Simpson



HOUSE OF SINGLE GERANIUMS

Grown by W. N. Craig, North Easton, Mass.

FLORICULTURAL EDUCATION.

In a paper by Charles N. Page of Des Moines, read before the Society of Iowa Florists, December 9, 1908, and recently published, the following statement occurs:

"During the past year I have corresponded with most of the agricultural colleges in the United States, but I find that none of them is prepared to train a young man in commercial floriculture. Although the Missouri Botanical Garden and the Illinois Agricultural College have courses which would be of considerable benefit, they are far from complete."

Two years ago the Horticultural Department at Massachusetts Agricultural College was reorganized and a Horticultural Division was formed. This Division is composed of independent departments of pomology, floriculture, landscape gardening and market gardening. The floriculture course aims to give instruction in strictly commercial floriculture. As at present organized there is given in the first three years of the course those subjects upon which the foundations of floriculture are based, namely, botany, bacteriology, entomology, soils, fertilizers, plant propagation, the propagation, care and identification of trees and shrubs, general horticulture and market gardening, together with other subjects such as mathematics, history, English and some of the other languages. In the senior year the course becomes more scientific, practical and technical, and the first half year is largely taken up in the consideration of details of greenhouse design and construction, greenhouse equipment, such as types of benches, beds, ventilators, and the like, also greenhouse heating. In the last half year the time is wholly occupied in the study of cultural methods of commercial florists' crops, methods of marketing, design work and decorating. A student may receive instruction in any of the subjects suggested by Mr. Page. The course is so planned that the student devotes much time to the details of growing plants by practical greenhouse work, in addition to the lectures of the class-room. Observation trips to commercial establishments are taken from time to time, and on each of these trips the student is provided with a written syllabus in which is noted the special features he is to observe. A written report of the trip is required at a later date. This year thirteen seniors are taking the course, six of whom intend to take up commercial floriculture, the remaining seven taking the course in preparation for work in landscape gardening, or in the management of private estates. It is expected that with the new equipment the number of men electing this course will increase rapidly.

The requirements for admission to this course are based upon the studies covered in the high school courses of Massachusetts high schools. In other words, the high schools are the training schools for the agricultural colleges.

To provide for a class of young men who have not had the advantages of a high school education a short course in floriculture has been started this year. This course covers ten weeks beginning January 5, and closing March 10. The only requirements for



New Greenhouses and Instruction Building for Floriculture and Market Gardening at Massachusetts Agricultural College.

entrance to this course are that the individual shall be at least eighteen years of age and of a good moral character. Tuition is free and board and room rent reasonable. Already the registration for this course has reached the capacity of the teaching equipment and a number who wished the course could not be accommodated. The aim of the course is to give as thoroughly as the limited time will permit the principles of greenhouse construction and management essential for success in commercial floriculture. No attempt is made to develop experts in the growth of greenhouse crops. Such expertness comes only after years of practical experience in growing some individual crop. It is hoped, however, that those taking the course may find their lives broadened and their capacity for intelligent work increased by these few weeks of study. The men taking the short course in floriculture are required also to take the lectures given in soils, fertilizers, insects and diseases of greenhouse crops. Aside from the daily lectures of the course, talks will be given each week by experts on special subjects. The men secured for the course this year have been eminently successful in the various subjects on which they are to speak, and the college is to be congratulated on the hearty co-operation these men have given the work.

The facilities for giving instruction along this line will not be surpassed by any institution in the United States when the new range of greenhouses and the new instruction building for the departments of floriculture and market gardening are completed. This will be about March 1, 1909. The Legislature of 1908 made an appropriation of \$34,000 for the erection of a commercial greenhouse range and an attached building. This instruction building is a substantial, two-story, brick structure of pleasing architecture and contains above the basement three class-rooms, a large laboratory, two offices, a coat room, janitor's room and a work-room. In the basement are soil-rooms, a cool room for bulbs, storage rooms and lavatories. Adjoining this building on the east is a palm-house, the dimensions of which are 25 by 12 feet. This house is strictly commercial in type and is intended for the propagation and growth of commercial varieties of palms. Adjoining the palm-house is a small house for orchids and another for ferns. A student's house, 26 by 50 feet, joins the orchid-house on the east, and from the east end of the student's house an alley 12 feet wide and 116 feet long runs directly south. Extending east and west

from this alley there is a violet house, cucumber house, tomato house, rose house and a carnation house, the dimensions of each house being 24 by 50 feet. The alley house will be used for propagation and for growing general plants. The contractors for this range were Lord and Burnham Co. of New York. The range consists of four two-thirds span house and three even-span houses, and with the connecting houses all are built on concrete foundations. Three of these houses are iron frame and the remainder are of the half-iron frame type of construction. The houses are heated by steam from the central heating plant of the college.

In courses of instruction along all lines there is more or less criticism, and in floriculture the chief criticism seems to come from the practical men. It is to the effect that the courses are not up to date. The agricultural colleges need the hearty co-operation and assistance of the practical men in keeping their courses up to date and a closer affiliation will be advantageous to both. Suggestions of methods for strengthening the courses are always welcome and the views of the work from men engaged in it are appreciated. It is the aim of the floriculture department of Massachusetts Agricultural College to keep closely in touch with the practical interests and to offer a course that will train men along all lines of floriculture.

E. A. White,

Amherst, Mass.

PRIMULA OBCONICA GRANDIFLORA.

No florists' plant has shown greater advancement within a few years than has the plant illustrated on our cover page in this issue. In the best strains now offered are to be found full, round flowers with size and substance approaching the finest grade of the chinensis, with a good proportion of bright pink colors and with the advantage that they are as useful for cut flower purposes as for plant use. Plants not sold for the holidays or which have been used for cut flower production may be again brought into full bloom for spring sales either as plants or cut flowers. *P. obconica* seed is late in ripening and is not available until late in January, and as old seed has very poor germinating quality it is always best to depend upon the fresh seed.

HORTICULTURE

VOL. IX

JANUARY 9, 1909

NO. 2

PUBLISHED WEEKLY BY
HORTICULTURE PUBLISHING CO.
 11 Hamilton Place, Boston, Mass.

Telephone, Oxford 392
 WM. J. STEWART, Editor and Manager

SUBSCRIPTION PRICE

One Year, in advance, \$1.00; To Foreign Countries, 2.00; To Canada, \$1.50
 ADVERTISING RATES

Per Inch, 30 inches to page \$1.00
 Discounts on Contracts for consecutive insertions, as follows
 One month (4 times) 5 per cent.; three months (13 times) 10 per cent.;
 six months (26 times) 20 per cent.; one year (52 times) 30 per cent.
 Page and half page spaces, special rates on application

Entered as second-class matter December 8, 1904, at the Post Office at Boston, Mass., under the Act of Congress of March 3, 1879.

CONTENTS

Page

COVER ILLUSTRATION— <i>Primula obconica grandiflora</i>	
ROCKY MOUNTAIN RAMBLES—L. H. Pammel—Illustrated.....	33
SINGLE GERANIUMS—Wm. M. M. Brown—Illustrated.....	33
ROSES UNDER GLASS—J. E. Simpson.....	34
HORTICULTURAL EDUCATION—A. E. White—Illustrated.....	35
PRIMULA OBCONICA GRANDIFLORA.....	35
NEWS OF THE CLUBS AND SOCIETIES:	
National Chrysanthemum Society—Chicago Carnation Show.....	37
Society of American Florists: New Governing Board, Judge W. J. Vesey, Eugene Dailledouze, portraits, State vice-presidents and other appointments.....	38
American Carnation Society—Kansas Horticultural Society—Minnesota State Florists' Association.....	39
Pasadena Gardeners' Association—American Rose Society.....	40
Massachusetts Horticultural Society.....	41
Florists' Club of Washington—Florists' Club of Philadelphia—North Shore Horticultural Society—Tarrytown Horticultural Society—New London County Horticultural Society—Cleveland Florists' Club—Club and Society Notes.....	42
SEED TRADE.....	44
Catalogues Received.....	44
Lawn Making—G. C. Watson.....	45
OF INTEREST TO RETAIL FLORISTS:	
Chicago Holiday Aftermath—Steamer Departures—New Retail Flower Stores.....	46
FLOWER MARKET REPORTS:	
Boston, Buffalo, Chicago, Philadelphia, Washington.....	49
New York.....	51
OBITUARY:	
Margaret McClements Arnold Reckhard—Christopher Cordes—Chas. Kaehfert, Jr.—Arthur E. Clark—W. F. Cooper.....	49
MISCELLANEOUS:	
Personal.....	37
A Commendable Project.....	37
1909. Poetry.....	37
L. E. Marquisee Greenhouses Sold.....	42
Another Valuable Device Illustrated.....	42
Incorporated.....	45
Holiday Mishaps.....	47
News' Notes.....	47-51
Business Changes.....	47
During Recess.....	49
Movements of Gardeners.....	49
Greenhouses Building or Contemplated.....	58

Useful hints For the past few weeks we have devoted considerable space to what florists have been doing in the way of store adornment and window decoration to attract the attention of the passer-by. Such notes are made, not for the purpose of puffing or flattering the individual mentioned but to

serve as useful hints for those of our readers who are engaged in similar lines. The wise and provident merchant will draw suggestions from such paragraphs and jot them down for use when the season comes around again next year, not to be copied but to be used as a stimulant to thought as to how to individualize and amplify them when plans are being made for the season's campaign.

Worthy of Imitation

"You are not right on if your limousine isn't decorated with fresh cut flowers every day. The fashionable florist has standing orders for the favorite blooms that "go with" the furnishings of madame's car, not to mention the dress and furs she wears."—*Boston Herald*.

We don't know the author of the above lines but it bears the impress of some good sensible florist who made wise connection with some equally sensible newspaper correspondent. How much better for the florists' industry and for those engaged in it, how much more refining for the flower-buying public this is than the sensational stories so often poured into the ears of credulous reporters by some charlatan about the scarcity of flowers, the rapacity of growers and inflation of prices, with the result that page after page of newspaper space is devoted by ignorant and silly writers to persuading the public that the florist is a robber, his products undesirable and that artificial flowers are to be preferred to the real article. If the florists in every community would make it their business to supply their local newspaper with some such note as the one above quoted, don't you think it would help the flower trade? Wonder how many florists know that an "auto vase" to hold fresh flowers is one of the novelties of the present season.

Christmas trees and the forests

Protests against the use of evergreens as Christmas trees are again being circulated through the daily papers by well-meaning people who imagine they are doing something practical to stop forest destruction. The argument against the time-honored use of these trees, that they are sources of danger to life and property from fire, is a strong one, as all will admit, but that the practice contributes in any appreciable degree toward the threatened forest famine is not worth serious consideration. Hon. Gifford Pinchot's views, as widely published, and commented upon in these columns last year cover that question fully. Trees suitable for the holiday use are not found in the forests nor in dense young growth, as a rule, but as isolated specimens on cleared land and there is no reason why they should not be as legitimate and profitable a crop for the owners as anything else that might be planted thereon. To those who wish to read up on practical forestry we would recommend *Conservation*, a monthly periodical published by the American Forestry Association, Washington, D. C. The price is \$1.00 per year and this includes annual membership in the Association. Each issue contains from 50 to 60 pages of interesting reading, handsomely illustrated, and every citizen of the United States should be enrolled as a member.

NATIONAL CHRYSANTHEMUM SOCIETY.

Winter Show.

On the 2d and 3d of December the above society held an interesting exhibition of late flowering chrysanthemums and other flowers in the Crystal Palace. The competitive classes were well filled and the keenness of those who entered for the various prizes was a noteworthy feature. Some displays of vases, baskets, etc., filled with chrysanthemum blooms and beautiful autumn foliage helped to raise the general artistic effect. A large number of entries also in the dinner table decorations helped to enliven the show and in the cut bloom classes many of which were for three blooms of each variety in a vase there were grand examples of noble, massive Japanese blooms that would have done honor to a show early in November. It may interest American readers to know that the old painted green show board is not yet abolished and still finds favor with some exhibitors of cut blooms. We cannot go into details over this part of the show which is very extensive and where amateurs and gardeners meet in friendly rivalry for the valuable money prizes and others offered by the society. There were also some fine exhibits in the group of pot plant classes.

In the big trade exhibits a gold medal was awarded to H. J. Jones for a fine collection 42 feet in length. As a piece of floral decoration it was of the highest order of merit. Ferns, palms, dracaenas and other ornamental greenery interspersed with big vases containing large specimen and decorative blooms made a striking appeal to the visitors' attention. Showdritz, a new white incurved, Mme. G. Rivol, J. G. Day, H. J. Jones 1908, Mrs. Leigh, White Victoria, Mrs. Wakefield and others were in fine form. Another gold medal was awarded to Norman Davis. He, too, had a fine lot entirely composed of singles, set up in vases and baskets with maidenhair ferns and autumn foliage. Among his novelties in singles were Pollux, Juno, Aureole Boreale, Vesta, Pegasus, Perseus, Ursa Major, etc.

W. Wells & Co. had a large silver medal. He staged a big collection of singles well arranged and with great taste. Henry Cannell & Son also received a large silver medal. This was a double barreled lot composed on one side of decorative chrysanthemums and on the other of zonal pelargoniums for which the firm is justly famous. Some grand novelties among the latter were staged and as we have personal acquaintance with many of the varieties we have no hesitation in recommending to the lover of the zonal, Carmania, Luceania, Maur-tania, Caronia, Cymric, Arabic, Saxonia and a few of the older ones such as Mentmore, King Vic or, Prince of Orange, Lady Warwick—grand flowers for the greenhouse of any lover of the zonal.

A grand exhibit of fruit came from the government of Nova Scotia. Apples in cases and on plates were highly colored and of the finest quality. A few pears were also shown. The best of the apples were: Bismarck, Emperor, Prince Albert, Smith's Red, Blenheim Blue Pearmain, Maiden's Blush.

The government of British Columbia also sent fruit—a fine lot and most attractively displayed, which, like the preceding, received a large silver medal. The apples of premier merit were: Wagner, Cox's Orange Pippin, Newtown Pippin, Wealthy, Salome, Spitzenberg, Baldwin, Jonathan, Hubbardston's Nonsuch, and a few others.

C. HARMAN PAYNE.

CHICAGO CARNATION SHOW.

The annual Chicago carnation display will be held by the Horticultural Society of Chicago in cooperation with the Chicago Florists' Club at the Art Institute, Chicago, Jan. 14, 1909, from 1:30 p. m. to 5 p. m.

There will be no competitive judging and no prizes will be awarded. Certificates of merit of the Horticultural Society will be given to all new varieties scoring 35 points or over and the grand silver and bronze medals will be available for award either to new varieties of unusual merit or the displays of older varieties which in quantity, variety and quality shall be considered worthy.

All varieties will be staged with the display card of the grower or exhibitor and every effort will be made to secure the best possible advertising returns to the exhibitor. Express charges on all exhibits will be paid by the society. C. W. Johnson of Rockford, Ill., will act as judge and M. P. Miller of Wilmette will superintend the exhibition.

It is believed that in the matter of publicity to the trade and in the number of florists visiting this show it will be only second to the convention of the National Society. Originators of new varieties cannot afford to miss having their productions on exhibition here. It is strongly urged that exhibitors will advise J. H. Burdett, Assistant Secretary 141 First National Bank Building, Chicago, as early as possible as to the number of varieties they will show and the quantity of each so that proper arrangements for vases and staging room may be made. The exhibits should be addressed to M. P. Miller, Art Institute, Chicago, and shipped so as to arrive not earlier than January 13th and preferably on the morning of the 14th.

Do not forget to inclose in the box full directions, labels and display cards. Also advise the Assistant Secretary in advance of the shipment, if possible, by mail.

W. N. RUDD,
Committee, LEONARD KILL,
L. COATSWORTH,
J. H. BURETT, Assistant Secretary.

WORTH MORE THAN ITS PRICE.

Enclosed find \$1 for 1909 for HORTICULTURE, which is worth a deal more than the subscription price to all interested in gardening of all kinds, to all lovers of flowers, trees, shrubs, etc., and all new ideas that tend to improvements in the vegetable world generally. WM. SWAN.

Plymouth, Mass.

Frank C. Emerson of Keene, N. H., salesman for the Chase Nursery Co., has accepted a position as manager of a fruit farm near Orlando, Fla.

PERSONAL.

Visiting Boston this week, Mr. and Mrs. John H. Taylor, Bayside, N. Y.

E. B. Washburn, Chicago, has returned from a holiday trip to Bay City, Michigan.

Mr. Dilloff, representing Schloss Bros., New York, is reported a visitor at Albany.

John J. O'Reilly has taken a position as manager of the C. P. Grimmer Flower Co.'s store on West St., Boston.

Charles Sanders, head gardener for H. G. Eyles, Albany, N. Y., who has been ill with pneumonia, is able to be out again.

David Grillboitzer, of Alevandria, Va., has been seriously sick at his home from an attack of grippe, but he is now on the convalescent list.

Among the very welcome visitors to Boston this week are Mr. and Mrs. Harry Baversdorfer of Philadelphia. It is, as Mr. Bayersdorfer assures us, just a recreation trip, but Mr. B. can no more stay away from the business centres and his friends who congregate there than a fish can live out of water. So we have enjoyed the privilege of a look at him.

A COMMENDABLE PROJECT.

It is proposed to establish a free bed for the use of florists, gardeners, seedsmen and others of the horticultural fraternity who may require medical attendance, at Grace Hospital, Boston. The plan is to collect the amount necessary by subscription, and Mr. W. R. Weston has undertaken the work. Anyone who would like to contribute to this most worthy object or desiring to know more concerning it can address Mr. W. R. Weston at the Hospital, 144 Kingston street, Boston. We hope the response from the craft in and around Boston will be prompt and generous.

1909.

Why speak of the scythe and the hour-glass,

As the birds so long have sung?
Why should we notice how Time may pass,

So long as the soul is young?
Let wrinkles come and the head grow grey—

'Tis never a cause for tears,
For Methuselah hoped and laughed, no doubt,

When he had nine hundred years.

They fail to learn their lesson right
And take the dress for gold.

Who think gray hair, a wrinkle or two,
Are marks of growing old.

Joy's songs may be as gladly sung,
And 'twin in better time.

If the heart keeps time with the proper beat
In December than in June.

So, when it haps in the run of days
That we turn the New Year page,

Why point to Time, with his dentured scythe,
Or other signs of age?

What is it, in truth, that has been brought
By the seasons in their wild,

Where a boy, a light-winged, promising lad,
Gives a good-bye kiss to a girl?

No talk of tombstones on Life's road;
No milestones of the past.

But dreams of Hope and songs of Joy,
Each merrier than the last.

And whether we're eighty, or twenty, or ten,
Let this New Year's praise be sung!

Not Nineteen Hundred and Nine years old,
But that many years still young.

—P. H. Doyle, in Boston Post.

Society of American Florists and Ornamental Horticulturists

New Governing Board.

On Friday, January 1st, 1909, a new line of officers assumed their respective duties in the S. A. F. J. A. Valentine of Denver, Colorado, succeeds Frank H. Trendly of New York City as president; E. G. Gillet of Cincinnati, Ohio, follows George W. McClure of Buffalo, N. Y., as vice-president. The first official act of President Valentine on January 1 was the appointment of Judge William J. Vesey of Fort Wayne, Indiana, and Eugene Dailledeuze of Brooklyn, N. Y., for three-year terms as directors to succeed Theodore Wirth, Minneapolis, Minn. and E. V. Hallock, Queens, N. Y., whose terms have expired. F. H. Trendly replaces W. J. Stewart as a member ex-officio on the Executive Board, on which Mr. Stewart has continuously served in one or



EUGENE DAILLEDOUZE

the other capacity since 1887. The officials who hold over are Secretary W. N. Rudd, Treasurer H. B. Beady and Directors J. K. M. L. Farquhar, Samuel Murray, John Young and George Asmus.

The Executive Board will meet in March at Cincinnati, O., to make preliminary arrangements for the Convention to take place in Cincinnati next August and transact other important business.

Both of the new members of the Board are well known among members of the Society and in the trade generally. Eugene Dailledeuze was for many years in the firm of Dailledeuze Bros., being the elder of the three brothers who succeeded to the business of their father who was a gardener of renown and a pioneer in carnation growing in America. Since the retirement of his brothers recently from the firm, Eugene Dailledeuze has been sole proprietor and the product of this big establishment is among the best shipped to the New York cut flower markets. Mr. Dailledeuze was third president of the American Carnation Society and presided at the

first Boston meeting of that body in 1895.

W. J. Vesey was born April 19, 1857, on a farm in La Grange County, Ind. At the age of 21 he was admitted to the practice of law at Fort Wayne where he has since resided. In 1899 he was appointed Judge of the Superior Court by the Governor to fill an unexpired term, and at its expiration resumed the practice of law. Impelled by his love for flowers he formed a partnership in 1892 with his wife under the name of W. J. & M. S. Vesey and built a small commercial plant which has now increased to an establishment of 150,000 feet of glass devoted largely to wholesale trade and in connection with a handsome retail store in Fort Wayne. Judge Vesey, apart from his law practice, is a director in several banks, trust companies and manufacturing enterprises and his connection with the flower business is largely recreative, the supervision of the business being mainly in the hands of the junior member of the firm.

Other Appointments.

President Valentine has made the following appointments:

STATE VICE-PRESIDENTS.

Alabama—J. L. Parker, Birmingham.
California (Northern)—Samuel Lundy, 1176 Washington street, Oakland.
Colorado—M. A. Benson, Denver.
Connecticut—Frank S. Platt, 376 State street, New Haven.
District of Columbia—Wm. H. Ernest, Washington.
Florida—E. N. Reasoner, Oneco.
Georgia—A. C. Oelschig, Savannah.
Idaho—J. W. C. Deake, Twin Falls.
Illinois (Northern)—H. N. Bruns, 1409 N. Madison street, Chicago.
Illinois (Southern)—H. B. Dörner, Urbana.
Indiana—Irwin C. Bertermann, Indianapolis.
Iowa—Roy F. Wilcox, Council Bluffs.
Louisiana—Chas. Eble, 106 Baronne street, New Orleans.
Maine—Wm. Miller, Mt. Desert Nurseries, Bar Harbor.
Maryland—R. A. Vincent, White Marsh.

Massachusetts (East)—F. E. Palmer, Brookline.
Massachusetts (West)—A. J. Lovells, Lenox.

Michigan (East)—A. Pochehon, Detroit.
Michigan (West)—H. Smith, Grand Rapids.

Minnesota—S. D. Dysinger, 30 W. 5th street, St. Paul.
Mississippi—S. W. Crowell, Rich.

Missouri (South)—Fred H. Meinhart, 7119 Florissant avenue, St. Louis.
Missouri (North)—W. L. Rock, 1116 Walnut street, Kansas City.

Nebraska—Lewis Henderson, 1519 Farnum street, Omaha.
New Hampshire—H. C. Stache, Manchester.

New Jersey—Geo. A. Strohelein, Riverton.
New York (East)—Harry A. Bunnard, 322 W. 14th street, New York.

New York (West)—Wm. L. Keller, Rochester.
North Carolina—W. Rehder, Wilmington.

Oklahoma—Geo. Stiles, 139 W. Main street, Oklahoma City.

Ohio (North)—E. B. George, Painesville.

Ohio (South)—C. E. Critchell, 36 E. 2nd street, Cincinnati.

Pennsylvania (West)—T. P. Langhans, 504 Liberty street, Pittsburg.

Pennsylvania (East)—E. A. Stroud, Philadelphia.

Rhode Island—Peter S. Byrnes, Wickford.

South Carolina—C. A. Moss, Spartanburg.

Tennessee—M. Stauch, Nashville.

Virginia—H. Brown, 5 W. Broad street, Richmond.

Wisconsin (East)—N. Zweifel, 14th street and Groelling avenue, Milwaukee.

Wisconsin (West)—C. E. Schafer, La Crosse.

Washington Representative:—William F. Gude, 1214 F. St., Washington, D. C.



JUDGE WILLIAM J. VESEY

Botanist:—Prof. John F. Cowell, Botanic Garden, Buffalo, N. Y.

Pathologist:—Dr. B. M. Duggar, Ithaca, N. Y.

Entomologist:—Dr. S. A. Forbes, Urbana, Ill.

Tariff and Legislative Committee:—Benj. F. Hammond, Fishkill-on-Hudson, N. Y.; Chairman. F. R. Pierson, Tarrytown-on-Hudson, N. Y.; Patrick O'Mara, Grand Street, Jersey City, N. J.; J. D. Eisdle, Riverton, N. J.; E. A. Meeley, Washington, D. C.; Patrick Welch, Boston, Mass.

National Council of Horticulture:—E. V. Hallock, Queens, N. Y.

Committee on School Gardens:—E. V. Hallock, Chairman, Queens, N. Y.; P. O'Mara, Grand St., Jersey City, N. J.; F. E. Palmer, Brookline, Mass.; F. R. Pierson, Tarrytown, N. Y.; J. F. Cowell, Botanic Garden, Buffalo, N. Y.; Benj. Hammond, Fishkill, N. Y.

Dept. of Plant Registration.

Public notice is hereby given of the application of The Dungee & Conard Company, West Grove, Penna., for the registration of the plant specified below. This application for registry was

THE FLORIST SUPPLY HOUSE OF AMERICA

SPECIAL NOTICE

During the month of January Only

A SPECIAL DISCOUNT of 10 Per Cent

on our Celebrated Standard Wheat Sheaves which every one knows are the best. Order now and get this liberal

DISCOUNT ONLY FOR THE MONTH OF JANUARY

NEW EASTER BASKETS JUST ARRIVING

H. BAYERSDORFER & CO., 1129 Arch Street, Philadelphia, Pa.

filed in this office on December 31st, 1908, and any person knowing of any reason why the registry of this name should not be made is requested to communicate with the undersigned.

Rose—"Charles Dingee"—New Rose originated with us. A cross between White Maman Cochet and Hermosa. Exceedingly strong grower, large heavy foliage resembling Maman Cochet growing ordinarily to a height of two feet; ever-blooming. Large, deep double flowers of good substance produced on long stiff stem. Color delicate rose tints in the center gradually shading off into pale blush and creamy white.

W. N. RUDD, Secretary.
December 31st, 1908.

AMERICAN CARNATION SOCIETY.

The schedule of premiums for the eighteenth annual meeting, to be held at Indianapolis, Ind., has just been received. The meeting will take place on Wednesday and Thursday, January 27 and 28, 1909. All exhibits should be addressed to A. F. J. Baur, "German House," Indianapolis, Ind., whether carnations or other goods. Entries should be made with the secretary, Albert M. Herr, Lancaster, Pa., not later than January 15, otherwise a charge of \$1.00 for each variety entered later will be made. Local arrangements are well perfected and the premiums include several valuable special prizes. We shall refer to these more fully in a later issue, but everyone interested should send at once to Secretary Herr for a copy of the schedule. The headquarters of the Society will be at the New Denison Hotel and the exhibition will be held at the German House.

The Boston delegation will leave the South Station, Boston, by the Big 4 route at 1:45 Monday the 25th, and due to arrive in Indianapolis at 3 p. m. the next day. Going in ample time to secure hotel accommodations.

Through Pullman car. The fare one way is \$29.25; for party of ten or more a slight reduction. Berth \$5.50, making the whole fare one way \$25.80.

Those intending to go please notify at once M. A. Patten, Tewksbury, Mass.

News of the Clubs and Societies.

KANSAS HORTICULTURAL SOCIETY.

The 43rd annual meeting of this society was held in the Supreme Court room of the State House at Topeka. The afternoon of the first day, Dec. 29th, was given to reports of the trustees of the various congressional districts. They were not altogether encouraging; untimely freezes late in the spring were very disastrous. The apple crop was somewhat spotted, some sections producing a fairly good crop and some scarcely any. In short, the year was not a satisfactory one. Small fruits did fairly well. Plums and cherries were light and peaches good in spots.

In the evening an address was given by the president of the Nebraska Park and Forest Society. The subject was "Practical and Ornamental Forestry." He spoke of the millions of acres of waste land in low places which should be put to work raising houses and barns, and emphasized the especial value of Norway poplar, cottonwood and bull pine in various sections.

Dec. 30 was given over to various reports. A. H. Greisa of Lawrence had a paper on originating new fruits for Kansas. In the afternoon, two interesting papers were read, one by Geo. C. Richardson on "Planting and Management of the Orchard," another by J. Treadway on "The Family Orchard." A sharp discussion arose on pedigreed fruit trees, one party insisting that scions should always be cut from the very best bearing trees, the other claiming that it made no difference whatever where you get your scions, so that they were true to nature. Of course, it was a question of thoroughbreds and scrubs. It was hard to make a practical orchardist believe that scions from a perfectly barren tree made trees just as good as those from a prolific and continuous bearer. The evening was given to the "Selection and Preparation of Food" and to the "Food Value of Fruit." The morning of Dec. 31 was given to brief papers on garden topics.

Some way, there was a sort of feel-

ing that the society was not accomplishing all that it might do. The writer was called on to give an outline of the Minnesota plan, which joined together all the affiliated interests of the state—incorporating the rose society, ladies' auxiliary, plant breeders' society and forest society, into one splendid whole—giving place for all. The Kansas and Minnesota societies are of the same age, and yet the latter, in spite of the greatest obstacles, has forged ahead to take first place of all our state societies, with a membership of nearly 2900. Such an example is worth following.

C. S. HARRISON.

Delegate for Minnesota and Nebraska.

MINNESOTA STATE FLORISTS' ASSOCIATION.

The monthly meeting was held at Merriam Park, Dec. 15, with President Wirth in the chair. The exhibits at this meeting were very numerous. Mr. Jorgenson from L. S. Donaldson exhibited some fine roses, carnations and violets. Holm & Olson showed cyclamens and Begonia Gloire de Lorraine, also a seedling from same named Gertrude which looks very promising. Among other exhibitors were Messrs. Nagel & Son, primulas, Lakewood Cemetery, poinsettias and Carl Haugan, violets.

The committee on diplomas, etc., decided to accept the style used by the Connecticut Horticultural Society. The seal will have a cypripedium (Minnesota state flower) in the centre.

Mr. Jorgenson read a very interesting report on the national flower show. Mr. Wirth exhibited plans for the proposed Floricultural Building at the state fair grounds, one main building 150 x 150 x 65 ft. high, glass sides and roof, two show houses one on each side of main building, and two greenhouses which can be used for exhibits or to grow plants for decorating the grounds. After a thorough discussion of the subject, the committee was asked to submit the plans to the board of mana-

New Rose **White Killarney**

Come and see White Killarney growing at our Scarborough houses, and you will say at once, as every one does who has seen it, it is

The Best White Rose

they have ever seen. You need it if you want to be up to the times, and it will pay you better than any other white rose that you can plant. You will regret it if you do not plant it this year, and you will not regret it if you do.

Big lots are being booked. Get your order in early. Send us order at once, while you think of it. Get early stock. It will not cost you any more to order to-day, while you think of it, than it will two months from now. Be the early bird that catches the worm.

Strong young plants, 2 1/4-inch pots, own-root, ready for delivery beginning February 15th, 1909, \$30.00 per 100; 250 for \$70.00; 500 for \$125.00; 1000 for \$250.00. Grafted plants, ready for delivery beginning March 1st, 1909, \$5.00 per 100 additional.

MY MARYLAND

This new rose, which was introduced last season in a limited way, has proved to be one of the best roses ever introduced. Every one is enthusiastic in regard to its merits, and it will be planted very largely by the largest, most progressive and most up-to-date growers, who have already placed large orders for it.

It is a strong, healthy, and vigorous grower, producing long stems and long pointed buds, exquisitely fragrant. The color is a soft salmon-pink. This is a rose that we can recommend in the highest terms, as we are sure it will prove very, very satisfactory. It is a welcome addition to our limited list of really first-class varieties for indoor culture; and it is not only a fine midwinter rose, but is also unusually good during the summer months.

Strong plants, 2 1/4-inch pots, own-roots, \$10.00 per 100, \$90.00 per 1000
Grafted plants, \$5.00 per 100, \$150.00 per 1,000.

F. R. PIERSON, Tarrytown-on-Hudson, NEW YORK.

gers of the state fair and to get busy, working for an appropriation to carry out part of the plans as a beginning.

J. Smith showed a photograph of a *Lilium auratum*, bearing 222 flowers. A. Swanson will read a paper on "What Flowers Do Toward Civilization" at the meeting of the State Agricultural Society on Jan. 12, 1909.

PASADENA GARDENERS' ASSOCIATION.

The Pasadena Gardeners' Association treated their friends, the Los Angeles Florist Club, to a smoker. It is believed to be the first one of its kind ever held in this part of the West, by a florist club. A few weeks ago the Los Angeles Florist Club had gathered in the Pasadena crowd and treated them to the best of everything—in fact, extended "a welcome to all."

The meetings have been held to bring about a more social and friendly intercourse between the two associations and all others interested in horticulture. The meeting was opened by Neil Campbell, who extended a welcome to all. Addresses were also made by Dr. Houghton of Los Angeles; J. J. Reeves of Rodeo Nurseries; J. G. Morley, Los Angeles City Park superintendent, and others. The choir of the Los Angeles and Pasadena German Singing Orchestra was in attendance and rendered some very fine songs, which made it all the more lively. At the conclusion refreshments were served and a most enjoyable time was brought to an end.

H. E. GEORGE.

AMERICAN ROSE SOCIETY.

We have received the preliminary schedule of prizes for the annual exhibition of this Society to be held at Buffalo, N. Y., on March 17 to 20. There are in all 64 regular prizes. The special prizes, of which we understand there is a large and tempting list, will be announced later. Only one special is mentioned in the present list, and it is good enough to make the rose grower "sit up and take notice." First prize

of \$200 is offered by Philip Breitmeyer and second prize of \$100 by Arthur T. Boddington for display of hardy roses in bloom, exhibit to consist of 100 or more plants, in 30 or more varieties, not more than 10 plants of one variety, in pots or tubs, 6 in. or larger.

The Newport Horticultural Society voted to have its annual ball early in February, and a committee was appointed to make the necessary arrangements.

GERANIUMS

Send us \$18.50 and we will send you 1000 Geraniums from 2 in. pots, in 20 good sorts, our selection. We will send you a collection that will please you, and meet the approval of your trade, and we don't care how critical it is. We have been sending out these collections for several years, and are willing to stake our reputation on them.

Our stock is the largest and most complete in the country. We have an immense lot ready for shipment, from 2 in. pots. We do not send out rooted cuttings. We have good Standard sorts at \$2.00 per 100, \$18.50 per 1000 and up to Newer Varieties at 50 cts. each. Send for our Special Geranium catalogue.

LOBELIA

KATHLEEN MALLARD. The new blue double Lobelia, nice stock from 2 inch pots, 50c per doz., \$2.00 per 100, 50c for \$0.25.

WE HAVE READY TO SHIP THE FOLLOWING from 2 in. pots at \$2 per 100

Verbenas, Lemon Verbena, Achyranthes, Black Prince and Minnesota Fuchsias, Coleus, Lobelia Crystal Palace, Hardy English Ivy, Smilax, Salvia, Drier's Superba Single Petunia, Dwarf Double Alyssum, Ageratum, Hardy Chrysanthemums.

R. VINCENT JR. & SONS CO., White Marsh, Md.

MASSACHUSETTS HORTICULTURAL SOCIETY.

Saturday, Jan. 2, was annual meeting day with the Massachusetts Horticultural Society. It was called at noon and President Stephen M. Weld was in the chair.

The president's address first referred to the fact that the society was still spending more money than it got from its income, which he said was not a businesslike proposition. He hoped that the new year would see the present deficit wholly made up. He urged the members to bear in mind how much funds and additional members were needed.

During the year 27 new members were elected, making the present membership 838. There have been 24 deaths in the ranks. There were thirteen exhibitions held, and public interest in these has been well sustained. In regard to the giving of prizes, General Weld said there is an increasing desire on the part of some of the members to have the society give medals in place of money. He believed it was the true ground on which the society shall ultimately have to distribute rewards for merit.

Reports of secretary and librarian and the chairmen of the various standing committees were presented in full.

George McWilliam exhibited a beautiful specimen in flower of a seedling calanthe, a cross between C. Regneri (the straight, bulbous variety) and Sandhurstiana. It is a beautiful flower, white with pink and bright crimson marked lip and is particularly remarkable for the fact that it fills in or "bridges over" the interim between the flowering of the early and late flowering varieties.

Standing Committees for 1909.

Finance—Walter Hunnewell, Chairman; Arthur F. Estabrook, Stephen M. Weld.

Library—C. S. Sargent, Chairman; George B. Dorr, Samuel Henshaw, Charles S. Minot, Henry P. Walcott.

Lectures and Publications—William J. Stewart, Chairman; John A. Pettigrew, William P. Rich, Mary L. Ware, F. A. Waugh.

Prizes and Exhibitions—John K. M. L. Farquhar, chairman; Robert Cameron, William N. Craig, Edward MacMullin, C. S. Sargent, William Sim.

Plants and Flowers—T. D. Hatfield, Chairman; Duncan Flinlayson, Peter Fisher, Thomas Roland, William Thatcher.

Fruits—Wilfrid Wheeler, Chairman; Harry F. Hall, Edward B. Wilder.

Vegetables—Josiah B. Shurtleff, Jr., Chairman; John W. Duncan, George D. Moore.

Gardens—Charles W. Parker, Chairman; William H. Bowker, Arthur H. Fewkes, Thomas J. Grey, T. D. Hatfield, Julius Henrlin, Wm. P. Rich, J. B. Shurtleff, Jr., Thomas H. Westwood, S. M. Weld, Wilfrid Wheeler.

Children's Gardens—Mrs. R. G. Shaw, Chairman; Mrs. E. M. Gill, Mrs. Katharine P. Peabody, Mrs. Dudley L. Pickman, Miss Margaret A. Rand, Mrs. John E. Thayer.

FORCING GLADIOLUS

Gladiolus Gandavensis Hybrids

Many florists plant these in boxes, or among their carnations, in the Winter. They are excellent for decorative purposes and realize good prices, either wholesale or retail. Gladiolus are a good catch-crop and take up but little room. The following are the best for this purpose:

America. The flowers, which are of immense size, are of the most beautiful flesh-pink color, \$4.00 per 100; \$35.00 per 1000.

Augusta. The florists' best white Gladiolus. First-size bulbs, 1 1/2 inches and up, \$2.00 per 100; \$18.00 per 1000. Bulbs 1 1/2 to 1 3/4 in. \$1.75 per 100; \$16.00 per 1000.

Shakespeare. White and rose. \$4.75 per 100; \$45.00 per 1000.

May Pure white, faded rosy crimson; the best forcer. Selected bulbs, \$1.75 per 100; \$15.00 per 1000.

Brecheyevensis (true). Fiery scarlet. Selected bulbs, \$1.50 per 100; \$13.00 per 1000. First-size bulbs, \$1.25 per 100; \$10.00 per 1000.

Boddington's White and Light. Extra selected bulbs, 1 1/2 in. and up, \$1.50 per 100; \$14.00 per 1000.

Bulbs 1 1/2 to 1 3/4 in. \$1.25 per 100; \$10.00 per 1000.

American Hybrids. A mixture of the choicest varieties of Gladiolus in cultivation. \$1.00 per 100; \$9.00 per 1000.

ARTHUR T. BODDINGTON

SEEDSMAN

342 West 14th Street, NEW YORK CITY

JAPAN LILY BULBS

Grown and cultivated with great care to insure the highest standard of merit. Bulbs selected specially for growers who demand the best the market affords. Get the habit of buying the best you can buy. This habit marks the difference between the grower who grows good lilies and the others who have no luck. Write us.

SEITARO ARAI
YOKOHAMA



RALPH M. WARD & CO.
NEW YORK

BULBS, PLANTS, NURSERY STOCK, ETC., OF MERIT

ORDER NOW FOR FALL DELIVERY

Gladioli fine named sorts; colors, seedlings and mixtures.

Iris Pallida Dalmatica, German and Japan Iris, Madeira Vines, Cinnamon Vines, Hyacinthus candicans, Spotted Callas.

Send for Price List.

E. S. MILLER,
Wading River, Long Island, N. Y.

CYCLAMEN GIGANTEUM
5, 6 and 7 in. pots—50c, 75c, and \$1.00 each.

Extra heavy stock of the very best quality.

Thomas Roland,
Nahant, Mass.

Established 40 Years

Rose Hill Nurseries

New and Rare Plants

NEW ROCHELLE, N. Y.

New York Office, Siebrecht Building, 425 Fifth Avenue

ORCHIDS

Our latest importations have been, Cattleya Chryso-ococha, Cattleya Gaskelliana, Cattleya Gigas, (Hardyana district), Phalaenopsis Amabilis schilleriana and others. We will receive in a short time, Cattleya Lowiana, Miltonia Vexillaria and others.

CARRILLO & BALDWIN
SECAUCUS, N. J.

ORCHIDS Freshly Imported

We offer a superb lot of Cattleya gigas Sanderiana in finest condition; also C. Bogotensis, C. Schroderae, C. labiata, C. gigas Hardyana type and Miltonia vexillaria

LAGER & HURRELL, Summit, N.J.

ORCHIDS

Largest Importers, Exporters, Growers and Hybridists in the World

Sander, St. Albans, England
and 235 Broadway, Room 1
NEW YORK CITY

IMPORTED ORCHIDS

Arrived in Superb Condition

Vanda coerulea, Cattleya Trianae, Cattleya gigas Sanderiana, Cattleya Schroderae, Oncidium varicosum.

JULIUS ROEHRS CO., Rutherford, N. J.

ORCHIDS

Orchid Baskets and Peat

Write for Prices

JOSEPH A. MANDA

191 Valley Road - WEST ORANGE, N. J.

We Have A Fine Lot of C. Trianae in bloom at very low prices, and will sell plants in bloom or cut blooms at 15 per cent. less than the market price.

ORDONEZ BROS.

Madison, N. J.

JAPANESE
LILIES
PLANTS
BAMBOO STAKES

THE YOKOHAMA NURSERY CO.
31 BARCLAY STR. NEW YORK

FLORISTS' CLUB OF WASHINGTON.

The regular monthly meeting of the Florists' Club of Washington was held on the evening of Jan. 5. It was known as Ladies' Night, and there was a large attendance of florists with their wives and friends. The business session was unusually short and the formal committees' report from the flower show was held over till next meeting. Gude Bros. showed a very fine vase of My Maryland rose. The Awards Committee, consisting of Peter Bisset, Jno. Robertson and George Cooke, awarded it a first-class certificate. The roses were afterward distributed among the talent of the evening.

There will be the regular yearly nomination of officers at next meeting, the election to take place in March. Willis Serfrass, representative of the firm of Poehlmann Bros., of Chicago, was a visitor of the evening. After the adjournment of the business session, the rest of the evening was given over to a musical hour, which was followed by dancing and refreshments.

FLORISTS' CLUB OF PHILADELPHIA.

Dorothy Gordon, the Joseph Heacock Co.'s new pink carnation, was the center of attraction at the regular monthly meeting of the 5th inst. A special committee had visited the home of this variety the previous Thursday and reported as follows: "Dorothy Gordon resembles Pink Enchantress in color and form but is superior to that variety in being of a more uniform color, also larger and of greater substance, apparently as free a bloomer and of stronger constitution and stiffer in the stem. We find on test the keeping qualities to be good, the flowers kept in an ordinary potting shed being salable four days after being cut." (Signed) Edwin Lonsdale, J. Wm. Colless, Robt. Craig, Alphon. J. Pericat of Collingdale exhibited a superb collection of *Catleya Trianae* of unusual size and fine colors. Robert Kift and others addressed the meeting on the Christmas trade. Among out-of-town visitors were C. Kour, Holland, and P. T. Barnes of Harrisburg.

NORTH SHORE HORTICULTURAL SOCIETY.

At the regular meeting Jan. 1, of the North Shore Horticultural Society at Manchester-by-the-Sea, Mass., the following officers were elected: President, James Salter; vice-president, Dr. W. H. Tyler; secretary, John D. Morrison; financial secretary, Herbert Shaw; treasurer, James McGregor; librarian, George Duncan; executive committee, A. E. Parsons, J. W. Carter, James B. Dow, Joseph Clark, William Swan.

The annual banquet of the Society will be held in the Town Hall, Manchester, Mass., on Wednesday evening, Feb. 10, at 6:30 o'clock, followed by an entertainment and dance. Tickets limited to 165. Members desiring tickets will please notify the secretary of the committee, Robert A. Mitchell. All tickets unsold Feb. 5 will be offered to the public. Last year's banquet was voted the best yet. The committee are bestirring themselves to make this year's affair up to the standard or better.

TARRYTOWN HORTICULTURAL SOCIETY.

At the regular meeting of the Tarrytown Horticultural Society held Thursday evening, Dec. 31st, the following gentlemen were elected to office for this year: President, Abel Weeks; vice-president, John Woodcock; treasurer, Edward W. Berrien; secretary, E. W. Nienbrand; corresponding secretary, Wm. Jamieson. Executive committee: Wm. Scott, J. W. Smith, J. Brunger, Robert Angus, Alex. Mailand, Wm. Jamieson, Robt. Ballantyne, Thos. A. Lee. Directors: F. R. Pierson, Isaac Kegua, Wm. Scott, Dr. R. B. Coutant, J. W. Smith, Hon. I. P. Willard, D. McParlane, Robt. Angus.

The monthly prize was for twelve best carnations, offered by Wm. Jamieson, and was awarded to James Stuart, gardener to Mrs. F. A. Constable, Mamaronock, N. Y.; also special mention for a vase of *Euphorbia Jacquiniaeflora*, which was greatly admired.

The committee appointed to arrange for the annual dinner of the society, have selected the Florence Hotel for Wednesday evening, Jan. 13th, 1909, at 7:45 P. M. An invitation is extended to representatives of florists' and local papers and kindred societies, and we hope to see some of our friends with us on the above date.

L. A. MARTIN.

NEW LONDON COUNTY HORTICULTURAL SOCIETY.

The annual meeting of the New London County Horticultural Society was held at Buckingham Memorial Hall, Norwich, Conn., Jan. 4, 1909. The following officers were elected: President, S. A. Gilbert; vice-presidents T. W. Head, Rev. N. P. Carey; secretary and treasurer, Frank H. Allen; librarian, Chas. T. Beasley; board of directors, T. W. Head, N. P. Carey, Otto Ernst, Alfred Flowers, R. R. Wilcox, H. E. Parker, F. H. Allen, S. A. Gilbert, G. Neumann and O. E. Ryther; show committee, Otto Ernst, R. R. Wilcox, H. E. Parker, N. P. Carey, F. H. Allen, S. A. Gilbert, G. Neumann, Chas. T. Beasley, Oswald Lange, J. Stevens, M. Shea and W. W. Ives.

CLEVELAND FLORISTS' CLUB.

The Cleveland Florists' Club at its last regular meeting, Dec. 25th, decided to hold its Annual Carnation Exhibit in its club rooms, 2610 Detroit avenue, on Feb. 5th. All out-of-town exhibits must be sent to above address, in care of Isaac Kennedy, Secretary, and must be prepaid.

CLUB AND SOCIETY NOTES.

The officers for 1909 in the Kentucky Society of Florists are: Fred L. Schulz, president; Robert Miller, vice-president; H. Kleinstarink, secretary; Joseph Wettle, treasurer.

The first lecture of the season under the auspices of the Massachusetts Horticultural Society will be given by W. H. Bowker of Boston, in Horticultural Hall on January 9, at 11 o'clock. Subject, "The Yeast of the Soil."

The Revere Rubber Co., Boston, has issued an attractive calendar which brings their specialties prominently before the user at just the season they are most needed.

THE L. E. MARQUISEE GREENHOUSES SOLD.

Mrs. Marquisee has sold to Harry and James Bellamy the greenhouses and stock of the late Louis E. Marquisee. The brothers have been associated for many years with the late Mr. Marquisee. They are men of long and large experience in the florist business, and have hosts of friends, both amongst the craft and outside, who wish them success in their undertaking. They are men of the strictest integrity, and anyone doing business with them will have no cause to regret it.

The greenhouses will remain till July 1st. A permanent location has not been selected, but no time will be lost in doing so, and the grounds prepared for an early start. Orders for the new white carnation *Marchioness*, are coming in, and will be filled in rotation.

The firm will be known as Bellamy Bros., successors to L. E. Marquisee.

"MARCHIONESS" ORDERS.

HORTICULTURE:

Gentlemen:—The late Mr. Louis E. Marquisee before he died stated that he had received several orders for his new white seedling carnation "Marchioness." His papers have been searched, but so far no memoranda of same can be found.

Will you kindly allow us to ask those who gave their orders to Mr. Marquisee to communicate with us at once, thereby avoiding disappointment and delay?

Thanking you in advance,

Respectfully yours,

BELLAMY BROS

Syracuse, N. Y.

ANOTHER VALUABLE DEVICE.

The Lauten Fumigator which is being advertised in HORTICULTURE by The Wilson Plant Oil and Fertilizer Company, is highly spoken of by grow-

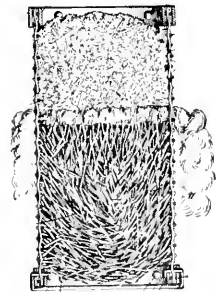

ers who have given it a trial. It is the invention of Fred Lautenschlager, the well-known representative of Kroeschel Bros. Co. The accompanying cut shows how, by its peculiar construction, this device vaporizes the tobacco stems and gives off steam, not smoke, thus obviating any anxiety as to danger from combustion gases. The fumigator is of the simplest construction, will last a lifetime, gives the maximum of efficiency with the minimum of cost, and by its peculiar down-draft system promises to revolutionize the method of insect extermination under glass.

SEEDS OF "THE BURPEE-STANDARD"

PHILADELPHIA, January 1, 1909.

TO MARKET GARDENERS AND FLORISTS—

In this BLUE LIST the same varieties of seeds are offered as in our Retail Catalog, but the prices are lower. It is only fair that those who plant for profit and, consequently, use larger quantities of seeds, should buy at lower prices than does the private planter. The Market Gardener and Florist, however, whose earnings depend upon product of the seeds planted, recognizes more surely even than the amateur the necessity of FIRST-CLASS STRAINS that can be relied upon to come true to type.

The steady increase from year to year in the BURPEE BUSINESS is due to the constantly widening circle of planters who have confidence both in the quality of our seeds and the faithfulness of the service rendered. We owe hearty thanks to many friends who have so kindly recommended BURPEE'S SEEDS to their neighboring gardeners.

We are exclusively a mail-order house and never travel a single mile to solicit an order! Neither do we annoy you by "follow-up" letters. We annually travel many thousands of miles, however, both in America and Europe, to inspect our contract growing crops and conduct on our Pennsylvania and New Jersey farms the largest and most complete trial grounds in America. We thus know the truth of our motto

Burpee's Seeds Grow and are the Best Seeds that Grow

It is not astonishing, therefore, that for years we have had the largest mail-order seed trade in the world.

We are Specialists in Seeds.

Our entire attention is devoted to producing and distributing Seeds. — Seeds only and only Seeds of the Best Quality. Our aim is to do *this one thing well*, — consequently we do not handle Dutch bulbs, small fruits, nursery stock, nor other kindred lines such as fertilizers, implements and poultry supplies.

The small illustration herewith shows the Fifth Street frontage of THE BURPEE BUILDING, our main city warehouse. Here we are pleased to welcome all customers who may have occasion to visit Philadelphia and to give those interested an invitation to inspect our Pennsylvania and New Jersey farms during the growing season. We have nothing to conceal and are always glad to show everything of interest both in the city warehouses and on our trial grounds and seed farms.

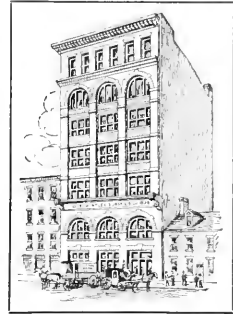

In accordance with our long-established custom when introducing novelties of unusual merit, we offer special cash prizes on the first season's trials of the unique new DWARF-GIANT TOMATO and EARLIEST CATAWBA CORN. Both are well worthy, of thorough trial by market gardeners whose trade demands *quality* in vegetables.

The introduction of sterling Novelties, generally, is not directly a money-making proposition to us. Frequently our entire sales the first year, as with two unique Bush Limas, THE FORDHOOK and THE BURPEE-IMPROVED, introduced in 1907 (when they sold at 12 beans for a quarter), do not suffice to cover the cost of the varieties and expense of introduction. Just like the conduct of our extensive Trial Grounds, however, the introduction of such novelties pays indirectly in helping to extend our trade. Our business is our pleasure. The interests of buyer and seller should be really mutual. We would not seek your trade did we not know that we could give you one hundred cents in value for every dollar expended.

The prices printed have been fixed at actual values as they appear to-day (December 28, 1908). Wherever possible, however, should stocks warrant, we shall be pleased to make quotations by mail or wire to buyers of large quantities of any special varieties. Trusting you will favor us with an order and that you may have a successful and profitable season,

We remain, sincerely yours,

Burpee Building:

475 and 477 North Fifth Street,
476 and 478 York Avenue.

Other Warehouses:

463 North Fifth Street,
168 and 470 York Avenue.

PHILADELPHIA, PA., U. S. A.

Seed Gardens and Trial Grounds at FORDHOOK FARMS, Bucks County, Pa.,
and at our new SUNNYBROOK FARM, in Gloucester County, New Jersey.

ABOVE is repeated *verbatim* the introduction from BURPEE'S BLUE LIST — the most complete Wholesale Seed Catalog for those who plant for profit and which is now ready for mailing. If you as a Florist or Market Gardener appreciate the value of quality in seeds and are willing to pay a fair price for the best it is possible to procure, we shall be pleased to mail you a copy of this catalog. We must ask you in applying, however, to name *this trade paper* as the BLUE LIST is never intentionally sent to any private planter. If you have not already received our Retail Catalog BURPEE'S FARM ANNUAL for 1909, we shall be pleased to send you this also.

SWEET PEAS are a great specialty with us and we have the largest and finest collection in America. Our prices are higher than those of one other house but the care with which the varieties are grown and the quality of the seed in every case warrants the prices charged.

While it is not our custom to advertise "Seasonable Seeds," with prices, from time to time, yet we are always prepared with fresh, new crop seed of the choicest quality and make this prominent announcement that ALL FLORISTS and MARKET GARDENERS who subscribe to the trade papers may apply now and have on hand for reference when occasion may require both our catalogs.

W. ATLEE BURPEE & CO., PHILADELPHIA, PENNA.

Seed Trade

Contrary to general expectations up to a very recent period, Dreer's Bush Limas are proving very short, and growers of these beans have been compelled to reduce the estimates of deliveries on their contract orders. Just why there should be this ever-recurring shortage in these Bush Limas is not apparent. It is not changeable to short crops alone, but doubtless to quite an extent to short acreage. It is well known that the California bean growers do not take kindly to the Bush varieties of Limas, and demand a materially higher price than for the Pole varieties. The men who grow these beans on contract for the seed trade are seeking to keep prices down to the farmers, and often will not pay what is demanded, which may be entirely proper, but sometimes there is too wide a range between what they want to pay the farmer and what they ask the seedsman, and this frequently results in a much smaller acreage than should be planted for the quantities booked; and then with a short crop deliveries are bound to be very light. The writer has learned of specific instances where seed sent to growers was never put out at all, either as the result of negligence or because the grower could not place it at a price satisfactory to him, and this after contracting to have the beans planted at a price named by himself. There seems to be only one solution of this problem, and that is, for those who do enough in this line to make it worth while, to place their own men on duty.

Eastern growers of wax and green pod beans are compelled to pay the growers an average of about 25 cents per bushel over last year's prices, as for several years ordinary white beans have sold readily at from 25 to 50 cents per bushel over the prices which seedsmen have been paying for colored or garden beans, and as the former out-yields the latter from ten to twenty-five per cent, the farmer sees no advantage in growing them. Seedsmen and canners should know these facts and not resist the advance which the grower is absolutely compelled to ask, and the same may be said of peas.

It is reported that market gardeners are not ordering as heavily as last year, particularly of beans. Dealers should note this fact, as it is liable to have a marked influence on demand. It is said that green beans did not sell at remunerative prices last season, and as a result farmers and gardeners allowed part of their plantings to ripen, hence they have raised their own seed in many instances, and will not have to buy of the seedsman.

Prices on cucumber seed show a weakening tendency, which is not surprising excepting to a few who are always chronic bulls on every reported crop shortage, and talk famine prices often with a very imperfect knowledge of actual conditions. The shortage in musk melon seed is genuine, many varieties being scarcely obtainable at any price excepting at retail.

The advance in prices of garden beans, though not sensational, has been from 25 to 50 per cent, and is well maintained, the tendency being toward higher bids. Another such advance

as has been intimated on the trade for the past two years, and something really sensational in the way of prices may be looked for, as reserves are now practically exhausted and we must depend on next season's crops entirely.

Only last month, the Department of Agriculture asked for bids, on a large number of items in seeds for spot delivery. It was generally assumed that the Department had been disappointed in some of its purchases, and was planning to enlarge this year's distribution, but so far as known to the trade the purchases from these bids have been very small, if any. Still more recently bids have been invited on surplus stocks for next year's distribution, the same to be opened on January 15 next. Those who responded to the former invitation will probably not be able to materially increase their offerings, though they may want to change prices, generally downward, which may prove just a trifle embarrassing. It is an interesting situation.

I Rosnosky, representing H. F. Mitchell Co., Philadelphia, has been interviewing the Boston trade during the past week.

The Leonard Seed Co. have added still another retail store. It is at Roseland. This makes four in Chicago.

Des Moines, Ia.—The St. Louis Seed Co. will retain their retail business but have disposed of their mail order business to the Iowa Seed Co.

Portland, Me.—S. C. Allen and F. A. Kendall, formerly with Kendall & Whitney, started in business in the Oxford building on January 1.

Cincinnati, O.—The settling of the foundation under one of the supporting posts of the building at Eggleston avenue and Fifth street, into which the J. Chas. McCullough Co. is moving, caused some excitement last week, but examination results in the report that there is nothing serious the matter with the building.

CATALOGUES RECEIVED.

W. W. Rawson & Co., Boston.—Plant Talk for January.

R. W. Johnson, Northboro, Mass.—Folder of new strawberry, Paul Jones.

Henry Saxton Adams, Wellesley, Mass.—Little Green Book of Choice Seeds, 1909.

Frederick Roemer, Quedlinburg, Germany.—Wholesale Catalogue of Choice German Flower Seeds.

Charles E. Fendall & Son, Towson, Md.—Recent Introductions in Strawberries, especially the sensational "Fendall."

Gillett & Obner, Cincinnati, Ohio.—Illustrated Catalogue of Wire Designs and Supplies for Florists' Use—a model in its way and "all the good."

H. F. Mitchell Co., Philadelphia, Pa.—Wholesale Catalogue for Florists and Market Gardeners, Spring 1909. A business document from cover to cover, well illustrated and full of good suggestions.

Charles H. Totty, Madison, N. J.—Chrysanthemum Novelties and Standard Varieties for 1909. Illustrated. No chrysanthemum grower is up to date without Totty's catalogue. It is indispensable.

Iowa Seed Co., Des Moines, Ia.—Seed and Plant Catalogue for 1909. Cover in colors—roses, pansies, tomatoes, etc., in gorgeous array. Seed corn occupies a space of several pages, including a colored insert of corn varieties.

A. P. Longren, Des Plaines, Ill.—Feeder of carnation novelties, Lucille and O. P. Bassett, both sterling varieties worthy to be universally grown. Lucille is white flushed with soft pink in centre and O. P. Bassett is a bright Christmas red.

Bridgeman's Seed Warehouse, Rickards Bros., Prop's, New York City.—Annual Catalogue of Seeds, Plants and Implements for 1909. This catalogue is very creditable to the popular young men who have succeeded to the Bridgeman business established 85 years ago. A vase of sweet peas in grey tints adorns the front cover page, and lettuce and cauliflowers the back.

R. & J. Farquhar & Co., Boston, Mass.—Garden Annual for 1909. This is the gem of the spring catalogues thus far received. In paper, type, illustrations and make-up it is an example for the seed trade of "how to do it." The cover illustrations—Iris palda Dalmanica on front and Hybrid Delphiniums on back—are among the best pieces of commercial artistic color work we have ever seen. The iris is particularly beautiful. The imprint shows that it was done in Brussels, Belgium.

Henry A. Dreer, Philadelphia, Pa.—Dreer's Garden Book for 1909—71st Annual Edition. This is a big volume of 256 pages, well filled with text and illustrations, with heavy blue cover lettered in gold. Four very fine color plates are presented—one of aquilegias, one of H. T. roses, one of sweet peas and one of vegetables. Every department of gardening art is thoroughly covered in this elaborate production, which is a veritable vade-mecum for the plant and flower lover.

MICHELL'S

MAMMOTH FANCY VERBENA

Our Mammoth Fancy Strain combines large size, purity of color and free flowering qualities.

Tr. pkt.	Oz.
BLUE and PURPLE	30c \$1.50
PINK	30c 1.50
SCARLET	30c 1.50
STRIPED	30c 1.50
WHITE	30c 1.50
MIXED, all colors	30c 1.50

MICHELL 1018 MARKET ST. PHILA., PA.

Phoenix Roebeleni Palm Seed

just arrived from Mr C. Roebelen, Siam
Write for prices

Ralph M. Ward & Co.
12 W. B'way, New York

SHEEP MANURE

Pulverized. Free from Adulteration
In Bag, \$18.00 per Ton. Cash with Order

ROBERT SIMPSON
CLIFTON, N. J.

LAWN MAKING.

Leonard Barron's little volume is a readable compendium of modern thought and practice on lawn making. The author has been particularly happy in reflecting in easily understandable language the best ideas of the men who really know. This is the only book of its kind and will do a vast amount of good in educating the general public in correct methods. The chapters devoted to seeding are worthy of an expert. The only contribution the writer can think of, to add to its value, would be in the line of recommending a greater variety of species in the lawn mixtures; Crested Dogstail for instance. This is a deep rooting grass, and will do well even in dry situations, so it is a mistake to class it among the kinds that only do well in shady situations. In America we have to depend on Kentucky Blue as a basis for our lawn mixtures, instead of the Lolium perenne of European practice. Crested Dogstail, in addition to its other good qualities, is exactly the same shade as Kentucky Blue, and blends finely with that variety. Every first-class seed house uses it in making up their finest mixtures. Mr. Barron has done a great injustice to this variety in placing it in a subordinate position. Red Fescue is another good species for some purposes, and is not mentioned at all. Sweet Vernal and Hard Fescue are also deserving of higher consideration. Supplemented with "Barenbrug on Grasses" any student of the theory and practice of lawn making will be well equipped if all the points are well digested.

G. C. WATSON.

These books can be got from the publication department of HORTICULTURE at the advertised price of \$1.00, and it will be money well spent for every sensibler, florist, nurseryman, landscape gardener, cemetery superintendent and others in responsible positions—to procure these up-to-date "vade mecum's".

INCORPORATED.

Ft. Worth, Tex.—The Southern Seed Co.; C. W. Young, J. S. McCauley, F. A. Martin; capital, \$1,000.

Mignonette

FARQUHAR'S GIANT

Oz., 75c; 1-4 oz., 25c

R. & J. Farquhar & Co.
6 & 7 South Market Street
BOSTON, MASS.

BRIDGEMAN'S SEED WAREHOUSE
RICKARDS BROS.
Props.
37 East 19th St., - NEW YORK CITY



GROUND BONE
For Potting Purposes
100 lb. \$3, 200 lb. \$4
W. ELLIOTT & SONS
42 Vesey St., New York

C. C. MORSE & CO. 48-56 JACKSON ST., San Francisco, Cal.
The Largest Seed Growers on the Pacific Coast

ONION, LETTUCE, SWEET PEAS,
ALSO
Carrot, Celery, Leek, Mustard, Parsley, Parsnip, Radish, Salsify

LEONARD SEED CO.
CONTRACT GROWERS AND WHOLESALE DEALERS
BEANS, PEAS, SWEET CORN, ONION, GARDEN SEEDS
ONION SETS 79 and 81
FLOWER SEEDS Get Our Prices E. KINZIE STREET, CHICAGO

Thorburn's Seeds

New wholesale catalogue for Market Gardeners and Florists now ready. SEND FOR A COPY.

LILY OF THE VALLEY PIPS
Our unexcelled quality.
A Few Double Hyacinths in Separate Colors at Much Reduced Prices.
J. M. THORBURN & CO.
33 BARCLAY ST. through to 38 PARK PLACE
NEW YORK

Burpee's Seeds
PHILADELPHIA
Blue List of Wholesale Prices mailed only to those who plant for profit

C AULIFLOWERS S E E D
A B B A G E E D
LILY OF THE VALLEY PIPS.
HJALMAR HARTMANN & CO.
12 Stormgade,
COPENHAGEN, DENMARK.

STOCK SEED
FOR WINTER BLOOMING
Our strain of Double Branching Stocks is exceptionally true. About 90% Double Flowers.
In colors: .75 oz. .60 oz. \$4.00
Pure White 1/2 " .75 " 5.00
H. E. FISKE SEED CO.
Faneuil Hall Square, BOSTON, MASS.

Winter-flowering
SWEET PEA SEED
All Colors Ask for List
A. C. ZVOLANEK
ORIGINATOR. BOUND BROOK, N. J.

NEW CROP SEED
For Early Planting
THOMAS J. GREY CO.
32 SO. MARKET ST., BOSTON, MASS.

BRECK'S SEEDS for FLORISTS
Fresh, Reliable. Prompt Delivery.
Catalogues mailed free on application
Joseph Breck & Sons Corp.
47-54 NO. MARKET ST., BOSTON, MASS.

QUALITY SEED BULBS PLANTS
SEND FOR CATALOGUE.
ARTHUR T. BODDINGTON
342 West 14th St., New York.

To Florists Everywhere

Orders for Cut Flowers and Floral Decorations to be delivered anywhere in the Greater New York, may be placed with us with the certainty that your customers will be satisfied.

Telegraph, telephone or mail such orders to us and be sure that they will be filled as promptly and as carefully as though you did it yourself.

One third discount will be allowed on all orders thus placed with us by Florists outside of the Greater New York.

THE BLOSSOM

Bond and Livingston Sts.,
BROOKLYN, N. Y.

C. C. TREPEL, Manager

**WILLIAM J. SMYTH
FLORIST**

Cor. Michigan Ave. and 31st St., CHICAGO

We ship to all points in Illinois and Iowa.

Phones: Douglas 744, Douglas 523, Douglas 740

M. C. and J. E. HAUSWIRTH

Out of Town orders for Hospitals
Carefully filled.

**232 Michigan Ave.
CHICAGO**

AUDITORIUM ANNEX Tel. Harrison 585

**SAMUEL MURRAY
Florist**

Coates House Conservatory
1017 BROADWAY, KANSAS CITY, MO
Both 'Phones 2670 Main

**FRED C. WEBER
FLORIST**

4326-28 ST. LOUIS, MO.
Established 1873
Long Distance Phone Bell Lindell 676



WASHINGTON,
D. C.

GUDE'S

The Far-Famed Flowers of
TORONTO

Delivered on mail or telegraph order for any occasion, in any part of the Dominion.

JOHN H. DUNLOP,
96 Yonge St., - Toronto, Ont.

The Park Floral Co.

J. A. VALENTINE
Pres.

DENVER, COLORADO

**WILLIAM L. ROCK
FLOWER CO.**

KANSAS CITY, - MO.

will carefully execute orders for Kansas City and any town in Missouri or Kansas.

**Of Interest to Retail
Florists**

CHICAGO HOLIDAY AFTERMATH.

As a result of the remarkable demand for plants during the recent holidays, Chicago plant growers are making special preparations to turn out a much larger Easter product than ever attempted heretofore. Some retailers who thought they were buying liberally in advance duplicated their orders twice over for plants at Christmas. It would be hard to find better azaleas for the time of year than were offered in Chicago this year. Cyclamens and poinsettias sold well, and when placed in hampers brought in some stores the highest prices ever reached. Green plants also sold with surprising readiness at a time when color is so much in demand.

Most of the cut flowers offered were good. The unusual call for plants did not seem to cut down the sale of cut flowers, but supply increased the volume of business done. One store is said to have handled at retail one thousand orchids and one hundred thousand violets, which gives an idea of what a good holiday trade means

STEAMER DEPARTURES

American.	
Philadelphia, N. Y. S'hampton, Jan. 16	
St. Paul, N. Y. S'hampton, Jan. 25	
Atlantic Transport.	
Miscula, N. Y. London, Jan. 19	
Minnehaha, N. Y. London, Jan. 23	
Cunard.	
Campania, N. Y. Liverpool, Jan. 13	
Carmania, N. Y. Med'n P'ts, Jan. 21	
French Line.	
La Bretagne, N. Y. Havre, Jan. 4	
La Savoie, N. Y. Havre, Jan. 21	
Hamburg-American.	
Moltke, N. Y. Italian Ports, Jan. 28	
Pennsylvania, N. Y. Hamburg, Jan. 20	
Leyland.	
Winifreda, Boston-Liverpl., Jan. 20	
North German Lloyd.	
K. Lohse, N. Y. Med'n P'ts, Jan. 16	
P. Friedrich Wil., N. Y. Bra'd, Jan. 19	
White Star.	
Cymric, Boston-Liverpl., Jan. 13	
Oceanic, N. Y. S'hampton, Jan. 13	
Celtic, N. Y. Liverpool, Jan. 16	
Cette, Boston Med'n P'ts, Jan. 16	
Teutonic, N. Y. S'hampton, Jan. 20	

in Chicago. All are agreed that prices held up well, showing some drop after Christmas Day, and nearly reaching normal after New Year's Day. At the beginning of this week trade was below the average owing, no doubt, largely to the warm weather and partly to the aftermath.

- NEW RETAIL FLOWER STORES.**
- Erie, Pa.—Roman Olzewski.
 - Northampton, Mass.—Harry Sinclair, State Street.
 - Cairo, Ill.—Metcalf, the Florist, 410 Commercial avenue.
 - Sand Point, Idaho.—Misses Wells, post-office building.
 - Beaumont, Texas.—Max Scheink, Pearlstein building.
 - Providence, R. I.—T. F. Keller Co., 220 Weybosset street.
 - New York, N. Y.—Hunter & McAlister, 11 Fifth avenue.
 - Detroit, Mich.—Lorraine. Flower Shop, Majestic Building.

ALEX. McCONNELL

571 FIFTH AVENUE
NEW YORK CITY

Telegraphic orders forwarded to any part of the United States, Canada, and all principal cities of Europe. Orders transferred or entrusted by the trade to our selection for delivery on steamships or elsewhere receive special attention.

Telephone Calls, 487 and 488 38th St.
Cable Address, ALEXCONNELL

New York Deliveries

FLOWERS and PLANTS

by special messenger to Steamer,
Theatre or any address in

NEW YORK or BROOKLYN

THOMAS YOUNG, JR.

500 FIFTH AVE., (near 42nd St.)

NEWMAN FLORAL Co.

(Established 1870)

202 Fifth Ave. and Madison Square, NEW YORK CITY

FLOWERS FOR STEAMER SAILINGS

M. A. BOWE

In the Heart of New York City

1294 Broadway

Tel. 2270, 38th St. NEW YORK

Our Motto—The Golden Rule

DAVID CLARKE'S SONS

Deliver orders from any part of the country to

New York City

Or OUT-GOING STEAMERS

Write or telegraph

2139-2141 Broadway, New York

Telephone 1592-1553 Columbus

YOUNG & NUGENT

42 West 28 St., NEW YORK

"FLOWERS BY TELEGRAPH"

NEW YORK

MYER, FLORIST

Phone 5297 Plaza. 609-611 MADISON AVE.

ALBANY, N. Y.

EYRES

Flowers or Design Work

DELIVERED IN ALBANY AND VICINITY ON TELEGRAPHIC ORDER.

11 NORTH PEARL ST., ALBANY, N. Y.

Flower Deliveries

in Brooklyn and other Long Island Points New York City, New Jersey, etc. At Theatres, Hotels, Steamers or Residences.

WILSON

Fulton St. and Greene Ave., Brooklyn, N. Y.

JOHN BREITMEYER'S SONS

Cor. Miami and Gratiot Aves.
DETROIT, MICH.

Artistic Designs . . .
High Grade Cut Blooms

We cover all Michigan points and good sections of Ohio, Indiana and Canada

PROMPT DELIVERY IN BOSTON

AND ALL NEW ENGLAND POINTS
F. H. HOUGHTON
396 Boylston St., Boston, Mass.
BOSTON'S BEST

In Quality and Design
Can be relied upon when you transfer your retail orders to

EDWARD MACMULKIN
194 Boylston Street, Boston

Send flower orders for delivery in
BOSTON

and all
NEW ENGLAND POINTS
THOS. F. GALVIN
124 Tremont St., Boston

The Original Telegraph Order Florist
WILL DELIVER

Flowers or Designs
to order in Boston and Vicinity. Usual Discount.

J. NEWMAN & SONS, Inc.
Est. 1870 24 TREMONT ST., BOSTON

TRANSFER
Your orders for flower or plant delivery in Eastern New England to

JULIUS A. ZINN,
2 Beacon St., Boston.
Fine Design Work a Specialty.



DANKER, Albany, N. Y.
ORDERS FOR
Choice Flowers and Floral Emblems
FILLED PROMPTLY

Palmer's
Buffalo, N. Y.
W. J. PALMER & SON, 30 Main St.

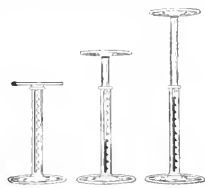

THE NEW IDEA IN PLANT STANDS

The Moore-Livingston Graduating or Adjusting

Saves one-half to two-thirds of cost over ordinary galvanized iron stands.

SEND FOR CIRCULAR GIVING FULL PARTICULARS
SOLD BY SEEDSMEN AND SUPPLY HOUSES

If your seedsman does not carry send us his name and we will promptly send full particulars.

Patentees
Moore-Livingston Co., and Mfrs., Lansdowne, Pa.

HOLIDAY MISHAPS.

Cleveland, O.—A lantern used for heating purposes exploded in the delivery wagon of the J. M. Gasser Co., partially destroying the plants and flowers with which it was filled.

Cleveland, O.—The delivery wagon of Albrecht & Smith was hit by an automobile on Christmas eve, and a general shaking up of the orders was the result with consequent damage to the stock.

Racine, Wis.—A horse attached to the delivery van of the North Side Greenhouses in turning the corner of State street hit a post, and demolished the rear wheels of the wagon, but the flowers were saved.

NEWS NOTES.

Washington, D. C.—G. C. Shaffer, florist, has increased his floor space by the addition of three rooms in the rear.

The annual meeting of stockholders and election of officers of the Chicago Flower Growers' Market, took place Jan. 5.

Ed Eisner, S. Halstead St., Chicago, experienced his first Christmas in his own store and it was a good beginning. Mr. Eisner was for many years with Samuelson.

The Kensington Flower Shop, Boston, has a big electric sign which may be seen afar off and shows that the proprietor appreciates the value of effective advertising.

Graniteville, N. Y.—Robert Thompson, florist, has been acquitted of the charge of arson recently brought against him and his complete innocence established by the court.

Chicago, Ill.—A. Magnuson on the North side had the finest cut chrysanthemums the writer saw during Christmas week. The varieties were Jeanie Nonin and White and Yellow Chadwick.

Mrs. C. Lundberg, whose husband was struck and killed by the street car last June, has bravely gone on with the business and the trade are glad to know she has been able to meet with success.

BUSINESS CHANGES.

Harbor Springs, Mich.—T. J. Fetters of the Fetters Floral Co., has disposed of his interest to Henry Babcock, who will carry on the business.

THE BEST LETTERS

FOR THOSE
FLORISTS' MADE
USE OF BY THE



Boston Florist Letter Co.
66 PEARL ST., BOSTON
N. F. McCARTHY, Mgr.

Order direct or buy from your local supply dealer. Insist on having the

BOSTON
Inscriptions, Emblems, etc., Always in Stock

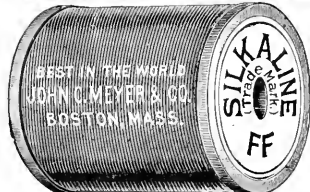

FLORISTS' SUPPLIES

Send for New Catalogue
H. Bayersdorfer & Co.
1129 ARCH ST., PHILADELPHIA

JACOB SCHULZ, 644 Fourth Ave., LOUISVILLE, KY.
Cut Flowers of BEST QUALITY in season delivered promptly to any address.
Write, Telegraph or Telephone.
Cumberland and Home Phones 223 and 984

WELLESLEY COLLEGE
Dana Hall, Walnut Hill and Rockridge Hall Schools. TALBY, Wellesley, Mass.
Tel. Wellesley 44-1 and 2. Night 44-3.

ATLANTA FLORAL CO.
41 Peachtree Street, ATLANTA, GEORGIA

ROBERT J. DYSART,
Public Accountant and Auditor
Simple methods of correct accounting especially adapted for florists' use.
Books Balanced and Adjusted
Merchants Bank Building
28 STATE ST., BOSTON
Telephone, Main 58.

GARDENIAS

WE can supply you with Gardenias and can fill all orders. On short notice we can get them for you special from the greenhouses so as to give perfect satisfaction.

THE LEO NIESSEN CO.

1209 Arch St., Philadelphia, Pa.

Open from 7 a.m. to 8 p.m.

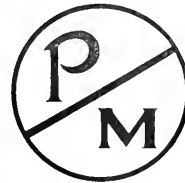

CHOICE Cattleyas

\$9.00 per doz.
\$60.00 per 100

QUALITY

S. S. PENNOCK - MEEHAN CO.
1608-1620 Ludlow St., Philadelphia

Special Carnations

Fancy grades from the best growers

W. E. McKISSICK & BROS.

WHOLESALE FLORISTS

1619-1621 RANSTAD ST. PHILADELPHIA



CHAS. W. McKELLAR

51 WABASH AVE., CHICAGO

Western Headquarters for Choice Orchids
Valley, Roses and all Cut Flowers

PETER REINBERG

WHOLESALE

CUT FLOWERS

51 Wabash Av., Chicago, Ill.

DAILY CONSIGNMENTS

From 40 to 60 Growers

We can care for your cutflower wants to advantage.

E. F. WINTERSON CO.

45-47-49 WABASH AVE., CHICAGO

POEHLMANN BROS. CO.

33-35-37 Randolph St., - CHICAGO

CUT FLOWERS

Greenhouses, - Morton Grove, Ill.

Rice Brothers

115 N. 6th Street, MINNEAPOLIS, MINN.

WHOLESALE FLORISTS and SUPPLIES

CUT FLOWERS received twice daily, and can fill your orders to your satisfaction. A complete line of Hardy Greens - WILD SMILAX, BOXWOOD, HARDY FANCY FERNS, GALAX PLANTS. Write for quotations on large quantities.

In ordering goods please add "I saw it in HORTICULTURE."

WELCH BROS.

AMERICAN BEAUTY, KILLARNEY, RICHMOND, MARYLAND AND ALL THE SUPERIOR ROSES, LILY OF THE VALLEY, CARNATIONS, ORCHIDS
BEST PRODUCED

226 Devonshire Street,

Boston, Mass.

WHOLESALE FLOWER MARKETS—TRADE PRICES—Per 100 TO DEALERS ONLY

	CHICAGO Jan. 4		TWIN CITIES Jan. 4		PHILA. Jan. 4		BOSTON Jan 8	
ROSES								
Am Beauty, Fancy and Special	30.00	to 40.00	50.00	to 65.00	50.00	to 60.00	60.00	to 75.00
" " Extra	20.00	to 30.00	40.00	to 50.00	40.00	to 50.00	35.00	to 50.00
" " No. 1	15.00	to 20.00	32.00	to 40.00	35.00	to 35.00	10.00	to 15.00
" " Lower grades	10.00	to 15.00	25.00	to 30.00	5.00	to 12.00	6.00	to 8.00
Bride, "Maid, Fancy & Special	8.00	to 10.00	0.00	to 8.00	15.00	to 10.00	10.00	to 15.00
" " Lower grades	6.00	to 8.00	4.00	to 6.00	3.00	to 10.00	3.00	to 8.00
Killarney, "Fao, & Sp.	6.00	to 10.00	8.00	to 12.00	20.00	to 30.00	15.00	to 35.00
" " Lower grades	3.00	to 6.00	6.00	to 8.00	4.00	to 10.00	3.00	to 8.00
Richmond, Fancy & Special	10.00	to 15.00	10.00	to 14.00	20.00	to 25.00	15.00	to 35.00
" " Lower grades	4.00	to 8.00	6.00	to 8.00	4.00	to 10.00	3.00	to 8.00
Chareny	8.00	to 10.00	6.00	to 8.00	4.00	to 10.00	3.00	to 15.00
Golden Gate, Ivory, etc.	6.00	to 8.00	6.00	to 8.00	6.00	to 15.00	3.00	to 12.00
My Maryland	6.00	to 25.00
Queen Beatrice	3.00	to 12.00
Mrs. Mar. Field	6.00	to 15.00
CARNATIONS								
Fancy and Red	3.00	to 6.00	5.00	to 6.00	5.00	to 6.00	3.00	to 6.00
Ordinary and White	1.50	to 2.00	4.00	to 5.00	2.00	to 4.00	1.00	to 2.00
MISCELLANEOUS								
Cattleyas	40.00	to 60.00	50.00	to 75.00	60.00	to 75.00	50.00	to 75.00
Lilies	16.00	to 20.00	12.50	to 15.00	10.00	to 12.00	8.00	to 12.00
Lily of the Valley	3.00	to 4.00	3.00	to 4.00	2.00	to 4.00	1.00	to 4.00
Narciss, Paper White	3.00	to 4.00	3.00	to 4.00	2.00	to 3.00	1.00	to 2.00
Roman Hyac.	3.00	to 4.00	2.50	to 3.00	2.00	to 3.00	1.00	to 2.00
Sweet Peas	.50	to 1.50	.75	to 1.00	.50	to 1.00	.75	to 1.00
Gardenias	40.00	to 50.00	40.00	to 50.00	25.00	to 50.00
Violets	1.00	to 1.50	1.50	to 2.00	1.00	to 1.50	.75	to 1.00
Adiantum	1.00	to 1.50	1.00	to 2.00	1.00	to 1.50	.75	to 1.00
Smilax	12.00	to 15.00	12.00	to 15.00	to 15.00	10.00	to 12.00
Asparagus Plumosus, strigosa	35.00	to 60.00	40.00	to 50.00	35.00	to 50.00	25.00	to 50.00
" " & Spree. (roc bcha)	20.00	to 45.00	15.00	to 35.00	35.00	to 50.00	15.00	to 35.00

J.A. BUDLONG

37-39 Randolph Street, CHICAGO.

Roses and Carnations A Specialty..... WHOLESALE GROWER of CUT FLOWERS



HENRY M. ROBINSON & CO.

15 Province St and 9 Chapman Place - BOSTON, MASS.

WHOLESALE COMMISSION FLORISTS

Hardy Cut Evergreens and Florists' Supplies

We have the stuff and can fill all orders, large or small
WE NEVER DISAPPOINT SATISFACTION GUARANTEED



Prices Quoted in these Columns are for Dealers Only.
When Writing to Advertisers Please Mention HORTICULTURE.

Flower Market Reports.

BOSTON The week following New Years opened auspiciously, but the hot weather crippled business badly, increasing the product, impairing the quality and reducing the quality generally so that everything has been weak and brilliancy is lacking while present weather conditions exist. Prospects appear good, however, and the general sentiment is that the season opened very encouraging and promises a good year for the cut flower interests. A tour of the rose houses shows that high quality blooms are a certainty for the coming weeks.

BUFFALO The closing week of the old year ended very satisfactory to the trade. A fairly good cleaning up was had on everything. Roses, carnations and other stock were not overplentiful and prices held firm, the demand being heavy in the rose line especially for Killarney, Richmond, Reid and Bridesmaid. Carnations were in good supply and moved rapidly. Lily of the valley, violets, narcissi and other stock sold well. There is an abundance of stevia and other greens.

CHICAGO Warm, moist weather prevails in Chicago with the usual depressing result on business and on growing stock. The week opens with very light trade. There is nothing in the way of local affairs to cause a sharp demand for flowers and the market is feeling the reaction after a good holiday trade. There is plenty of good stock, though such may not be the case by the time this reaches its readers if the unseasonable weather continues. Most of the unsold holly and other Christmas green has been hauled away, leaving the market a little bare in consequence.

PHILADELPHIA While prices did not rule so high during New Year's week as around Christmas, trade kept up well and there was a satisfactory demand. The demand for cacteyas slackened up and there is now enough of these to fill all wants. Crops of American Beauty roses have dropped off a little. Liberty and Richmond are of good quality and prices steady but moderate. Killarney and Jardine bring fine prices. Carnations are a trifle less plentiful. Lily of the valley is in better demand and cleans up well. Gardenias are being offered freely much below Christmas rates. Violets are rather on the scarce side. Early French daffodils are arriving.

WASHINGTON The week succeeding Christmas proved to be as good for the florist as the week previous had been. It was characterized by a loosening up on most everything that had been scarce at Christmas except red carnations, which still continue scarce. Prices held their own. Some fine panises from near-by growers are being sent in now, and sweet peas are shown in quantities and of very fine quality.

Detroit reports that business in that city is keeping up satisfactorily since the Holidays. The supply is short on some things, especially roses. Violets are picking up in quality and quantity and sell well.

WHOLESALE FLOWER MARKETS.—TO DEALERS ONLY.

ROSES	CINCINNATI Jan. 5		DETROIT Jan. 3		BUFFALO Jan. 4		PITTSBURG Jan. 7	
	Per 100	Per 50	Per 100	Per 50	Per 100	Per 50	Per 100	Per 50
Am. Beauty, Fan. and Sp.	4.00	5.00	7.00	7.00	40.00	30.00	40.00	30.00
" Extra	25.00	30.00	50.00	60.00	25.00	35.00	25.00	30.00
" No. 1	10.00	15.00	30.00	40.00	8.00	10.00	10.00	15.00
" Lower grades	5.00	6.00	10.00	12.00	4.00	5.00	5.00	6.00
Bride, 'Maid, F. & S.	10.00	12.00	10.00	12.00	10.00	12.00	10.00	12.00
" Low gr.	3.00	4.00	5.00	6.00	5.00	6.00	5.00	6.00
Killarney, Fan. & Sp.	10.00	12.00	8.00	10.00	12.00	15.00	10.00	12.00
" Lower grades	6.00	8.00	3.00	5.00	6.00	10.00	6.00	8.00
Richmond, Fancy & Special	8.00	10.00	8.00	10.00	10.00	12.00	10.00	12.00
" Lower grades	8.00	10.00	6.00	8.00	4.00	6.00	6.00	8.00
Chateaux	4.00	5.00	4.00	5.00	4.00	5.00	4.00	5.00
Golden Gate, Ivory, etc.	10.00	12.00	10.00	12.00	10.00	12.00	10.00	12.00
My Maryland	10.00	12.00	10.00	12.00	10.00	12.00	10.00	12.00
Queen Beatrice	10.00	12.00	10.00	12.00	10.00	12.00	10.00	12.00
Mrs. Mar, Field	10.00	12.00	10.00	12.00	10.00	12.00	10.00	12.00
CARNATIONS								
Fancy and Novelties	3.00	4.00	3.00	4.00	3.00	4.00	3.00	4.00
Ordinary	1.50	2.00	2.00	3.00	2.00	3.00	2.00	3.00
MISCELLANEOUS								
Cattleyas	75.00	75.00	75.00	75.00	75.00	75.00	75.00	75.00
Lilies	15.00	15.00	15.00	15.00	15.00	15.00	15.00	15.00
Lily of the Valley	3.00	4.00	3.00	4.00	3.00	4.00	3.00	4.00
Narciss, Paper White	3.00	3.00	3.00	3.00	3.00	3.00	3.00	3.00
Roman Hyacinth	3.00	3.00	3.00	3.00	3.00	3.00	3.00	3.00
Sweet Peas	75	1.25	1.00	1.50	1.00	1.50	1.00	1.50
Gardenias	50.00	50.00	50.00	50.00	50.00	50.00	50.00	50.00
Violets	1.00	1.25	1.50	1.75	1.00	1.50	1.00	1.25
Adiantum	1.00	1.50	1.50	2.00	1.50	2.00	1.50	2.00
Smilax	15.00	15.00	15.00	15.00	15.00	15.00	15.00	15.00
Asperagus Plumosus, strings	30.00	50.00	30.00	50.00	25.00	50.00	30.00	50.00
" & "green (100 bchs.)	30.00	50.00	30.00	50.00	25.00	50.00	30.00	50.00

OBITUARY.

Charles Kaehlert, Jr.

Charles Kaehlert, Jr., born June 2, 1832, died on Dec. 21. His father is proprietor of the South Side Greenhouses, Joliet, Ill. He leaves a widow.

Margaret McClements.

Miss Margaret, sister of Samuel McClements of Pittsburg, Pa., passed away on Christmas eve.

Christopher Cordes.

Christopher Cordes, one of the old-time gardeners of Chicago, died on Dec. 27, at the age of 65. A widow and four sons survive him.

Arnold Reckhard.

Arnold Reckhard, landscape gardener of Poughkeepsie, N. Y., died at his home on Dec. 22, aged 51.

Arthur E. Clark.

Arthur E. Clark of East Weymouth, Mass., well known to the trade in the vicinity of Boston, succumbed to an attack of pneumonia on Dec. 24. He was 30 years of age and leaves a widow and two children.

W. F. Cooper.

W. F. Cooper, of Medway, Mass., for many years engaged in the greenhouse business, dropped dead at his home on Jan. 4. He was 76 years of age. A widow and two sons survive him.

The sympathy of the trade is extended to U. J. Virgin of New Orleans, whose little son, Irby Joseph, passed away on Christmas Day.

DURING RECESS.

The Astoria Florists' Bowling Club of Long Island City, N. Y., had a Ladies' Night on Tuesday, Dec. 29. As this date happened to be the 50th birthday of W. H. Siebrecht, that estimable gentleman provided a splendid supper which, needless to say, was thoroughly enjoyed. Speeches of appropriate character for the occasion were made by several of the guests. It was arranged that on Thursday, Jan. 7, the club would visit the Flatbush Bowling Club and try conclusions with them on their alleys. Mr. Siebrecht's touring car being placed at the disposal of the club for transportation. Scores were made as follows:

Siebrecht, Sr.	168	150	147
Donaldson	133	190	182
Kessler	211	155	124
Miesem	190	198	117
Siebrecht, Jr.	119	85	130
H. Siebrecht	104	107	104
Douffer	172	181	—
Lawrence	97	116	127
Shaw	153	110	127
Jacobson	139	111	115
Pleckween	125	109	88

MOVEMENTS OF GARDENERS.

Hollywood, Cal.—J. R. Hills, formerly with J. W. Wolfskill, has taken a position on the estate of William Haerle.

William Fisher, formerly assistant gardener to H. Gould, has been appointed gardener to Commodore Lutgen, Villa Linta, Redding, Conn.

William B. Jones, who has been greenhouse foreman the past four years for Mr. Griffin at the E. T. Gorry estate, Newport, R. I., has taken a position as gardener for T. J. Manson at East Hampton, L. I.

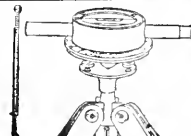

EVERYBODY KNOWS Park, Cemetery and Landscape Gardening cannot be properly done without the aid of an accurate leveling instrument.

Bostrom's Improved Levels, No. 2 at \$15.00 and No. 3 at \$20.00, are conceded by all who **KNOW** to be the only Levels on the market which meet all the requirements, at the price.

Our guarantee book of every Level we sell, and satisfied users in every State in the Union heartily endorse every claim we make.

Shipping weight 12 lbs. Description on request.

BOSTROM-BRADY MFG. CO., 139 Madison Avenue, ATLANTA, GA.

FORD BROTHERS
 48 West 28th Street - NEW YORK
FINE ROSES FANCY CARNATIONS
 A Full Line of All CUT FLOWERS
 Telephone, 3870 or 3871 Madison Square

H. E. FROMENT
 Wholesale Commission Florist,
 Choice Cut Flowers,
 57 West 28th St. :: NEW YORK
 Telephones: 2200, 2201, Madison Square.

Alfred H. Langjahr
 All choice cut-flowers in season. Send for quotations. Correspondence with shippers of first-class stock invited.
 55 West 28th Street, New York
 Telephones 4626-4627 Madison Square

Edward C. Horan
 Wholesale Florist
 55 WEST 28th ST.
 Tel. 1462 Madison Square New York
 1463

JOHN YOUNG
WHOLESALE FLORIST
 Finest American Beauties and Carnations
 51 West 28 St. - NEW YORK

FRANK MILLANG
Wholesale Florist
 55-57 West 26th St., NEW YORK
 Shipments, any quantity, Wholesale Market Rates.

Consignments Requested
 A Good Market and Prompt Returns

GEORGE SALTFOED
 43 W. 28th Street, NEW YORK
 Telephone, 3303 Madison Sq.

VIOLETS
 Finest Grade. Any Quantity
B. S. SLINN
 55-57 W. 26 St., New York

Moore, Hentz & Nash
 Wholesale Commission Florists
 55 and 57 West 26th Street
 Telephone No. 756 New York
 Madison Square

MILLANG BROS.
 WHOLESALE COMMISSION FLORISTS
 41 West 28th Street
 Telephone 3660 Madison
 3661 NEW YORK

JOHN I. RAYNOR
Wholesale Commission Florist SELLING AGENT FOR LARGEST GROWERS
 A full line of Choice Cut Flower Stock for all purposes. Comprises every variety grown for New York market, at current prices
 TEL. 1998 MADISON SQUARE 49 West 28th St., New York City

Walter F. Sheridan
 Wholesale Commission Dealer in
CHOICE CUT FLOWERS
 39 West 28th Street, New York
 Telephone: 3532-3533 Madison Square

HEADQUARTERS FOR NOVELTIES
ORCHIDS A SPECIALTY
 THE HIGHEST GRADE OF **VALLEY** ALWAYS ON HAND
 GARDENIAS, DAISIES, ROSES AND CARNATIONS
JAMES McMANUS, Telephone 765 Mad. Sq. 42 W. 28th St., New York

PHILIP F. KESSLER 55 & 57 W. 26th St., New York City
 Commission Dealer, Wholesale Buyer and Seller of
CUT FLOWERS
 Open from 5 a. m. to 6 p. m. Sunday till 10 a. m.
 Tel., 5243 and 2921 Madison Sq. Res., 345 J., Newtown.
Finest Lilies in the Market Every Day in the Year.

NEW YORK QUOTATIONS PER 100. To Dealers Only

	Last Half of Week ending Jan. 2 1909		First Half of Week beginning Jan. 4 1909	
ROSES				
American Beauty, Fancy and Special.....	40.00	75.00	40.00	60.00
" " Extra.....	20.00	30.00	20.00	25.00
" " No. 1.....	10.00	15.00	10.00	15.00
" " Lower Grades.....	3.10	6.00	3.00	5.00
Bride, 'Taid, Fancy and Special.....	12.00	20.00	10.00	15.00
" " Lower Grades.....	4.00	8.00	3.50	6.00
Killarney, Fancy and Special.....	12.00	20.00	10.00	20.00
" " Lower Grades.....	4.00	8.00	3.00	6.00
Richmond, Fancy and Special.....	12.00	20.00	10.00	20.00
" " Lower Grades.....	4.00	8.00	3.00	6.00
Chatenay.....	4.00	20.00	3.00	20.00
Ly Maryland.....	4.00	20.00	4.00	20.00
Golden Gate, Ivory, etc.....	3.00	12.00	3.00	12.00

Alexander J. Gutman
THE WHOLESALE FLORIST OF NEW YORK
 34 WEST 28th STREET
 PHONES. 1664--1665 MADISON SQUARE
ENOUGH SAID

TRAENDLY & SCHENCK
 Wholesale Florists
Furnish best stock at fair prices all the year round.
 Send for quotations on Fall Orders.
 Tel. 798, 799 Madison Sq. 44 West 28th St., New York City.

GROWERS' CUT FLOWER CO. CUT FLOWERS AT WHOLESALE
VIOLETS, CARNATIONS, ROSES
ORCHIDS, CHRYSANTHEMUMS, LILIES
 Consignments Solicited. Shipments to Order, any Distance
 Telephone 6237 Madison Square
39 West 28th Street, J. J. COAN, Manager NEW YORK



HARDY CUT FERNS

1000. BOXWOOD, per bunch 35c., 50 lbs., \$7.50. Sphagnum Moss, Fancy and Dagger Ferns our speciality. A trial order will convince you that we ship only first-class stock. Headquarters for Florists' supplies and wire work. All cut flowers in season.

MICHIGAN CUT FLOWER EXCHANGE, INC.,

All 'phone connections

38-40 Broadway, Detroit, Mich.

FANCY and DAGGER
Extrafine, \$1.50 per 1000. Bronze and Green Galax, \$1.25 per 1000, \$7.50 case of 10,000. Leucothoe Sprays, \$1.00 per 100, \$7.50 per 1000. Extra Large Bales, per bale, \$1.25.

WHOLESALE FLORISTS
54 West 28th St.
NEW YORK
Telephone 3659 Madison Sq.

A. L. YOUNG & CO.

RECEIVERS & SHIPPERS OF CUT FLOWERS.
CONSIGNMENTS SOLICITED.

WILLIAM H. KUEBLER

Brooklyn's Foremost and Best

WHOLESALE COMMISSION HOUSE

A First Class Market for all CUT FLOWERS

28 Willoughby St., Brooklyn, N. Y.
Tel. 4591 Main

Greater New York Florists' Association, Inc.

Now Open for Cut Flower Consignments

162 Livingston Street, BROOKLYN, N. Y.
Geo. W. Crawbuck Telephone Connection
Manager 3642-43 Main

H. G. BERNING

Wholesale Florist

1402 Pine Street, ST. LOUIS, MO.

REED & KELLER
122 West 25th St., New York

Florists' Supplies

We manufacture all our

Metals Designs, Baskets, Wire Work & Novelties
and are dealers in
Glassware Decorative Bronzes and Florists' Requisites

THE KERVAN CO.

Wholesale Dealers and Shippers of
Decorative Evergreens

Ferns, Galax, Laurel, Fresh Cycas, Boxwood, Sphagnum and all Christmas Greens
Seed to us for Quotations being Buying.

113 West 28 Street, NEW YORK CITY

GEORGE GOTSONAS & CO.

Wholesale and Retail Dealers in all kinds of
EVERGREENS

Fancy and Dagger Ferns
Bronze and Green Galax

Main Store 50 W. 28 St.
Phone 1202 Madison Sq. New York

HENSHAW & FENRICH

WHOLESALE FLORISTS

Phone: 325 and
44 West 28th St., 5583 Madison Sq. N. Y.

Night and Sunday Phone 5582 Madison Sq.

Our Specialty is Everything.

Consignments of the best stock solicited.
The square deal guaranteed to all who trade here.

WHOLESALE COMMISSION

Open 6 a. m. Daily

J. K. ALLEN

106 W. 28th St.
NEW YORK

Tel. 167 Madison Sq.

All Grades of Flowers to Suit All Buyers. Consignments Solicited.

NEW YORK QUOTATIONS PER 100. To Dealers Only

CARNATIONS AND MISCELLANEOUS	Last Half of Week ending Jan. 2 1909	First Half of Week beginning Jan. 4 1909
	Carnations, Fancy and Novelties.....	4.00 to 6.00
" Ordinary and White.....	2.00 to 3.00	1.50 to 2.00
Cyripediums.....	8.00 to 12.00	8.00 to 10.00
Cattleyas.....	20.00 to 50.00	25.00 to 50.00
Lilies.....	3.00 to 10.00	3.00 to 10.00
Lily of the Valley.....	1.00 to 3.00	1.00 to 3.00
Narciss., Paper White.....	1.00 to 2.00	1.00 to 2.00
Roman Hyacinth.....	1.00 to 2.00	1.00 to 2.00
Sweet Peas.....	1.00 to 1.50	1.00 to 1.50
Gardenias.....	20.00 to 50.00	25.00 to 50.00
Violets.....	.75 to 1.25	.50 to 1.00
Adiantum.....	.75 to 1.00	.50 to 1.00
" Crownatum.....	1.00 to 1.25	1.00 to 1.25
Smilax.....	8.00 to 10.00	8.00 to 10.00
Asparagus Plumosus, strigs.....	15.00 to 35.00	15.00 to 35.00
" " & Spreo. (too bchs.).....	15.00 to 25.00	15.00 to 25.00

NEW YORK MARKET.

After a generally satisfactory holiday trade which was maintained with greater steadiness after it got under way than in some past years the usual reaction has set in and since New Year's day trade has been rapidly weakening. The result is a steady decline in values from day to day which is hastened by the increasing supplies of carnations and roses, due in part to the very warm weather of the past few days. Predictions are for a very cold wave to follow and doubtless by the time these notes get into print there will be "something doing" in the wintry line, which may stop for a while at least the downward tendency of the market. We hope to see good paying values prevail for the next few weeks. It will be better for all interests.

In ordering goods please add "I saw it in HORTICULTURE."

NEWS NOTES.

Grand Rapids, Mich.—At a meeting of the directors of the Grand Rapids Greenhouse Co., Charles W. Garfield was elected a director and later president of the company in place of F. M. Strong, deceased.

Winchendon, Mass.—The boiler house connected with the greenhouses of W. H. Rhuland was destroyed by fire on Jan. 1, but fortunately the plants were not injured. The loss is estimated at \$4500.

An observant and always-alert grower asserts that much of the "diseased" Easter lily plants which some forcers complain of are the direct result of injudicious treatment while growing. He gives as an infallible rule in successful lily forcing: "Get a temperature and stick right to it; fluctuations are fatal."

The compromise rate of 20 cents an-

nounced by the American Express Company as a minimum charge on small parcels locally, which was accepted by the Boston merchants, is not satisfactory to the New Hampshire people, who assert that the old rate of 15 cents was sufficiently profitable and should be restored.

Wired Toothpicks

Manufactured by

W. J. COWEE, BERLIN, N. Y.

10,000....\$1.75; 50,000....\$7.50. Sample free.
For sale by dealers

SAMUEL A. WOODROW

WHOLESALE PLANTSMAN

Palms, Large and Small Ferns, etc.
53 West 30th Street, NEW YORK

Telephone 2083 Madison

Buyer's Directory and Ready Reference Guide

Advertisements under this head, one cent a word. Initials count as words.

Display advertisers in this issue are also listed under this classification without charge. Reference to List of Advertisers will indicate the respective pages.

Buyers failing to find what they want in this list will confer a favor by writing us and we will try to put them in communication with reliable dealers.

ACCOUNTANT

R. J. Dyanrt, 28 State St., Boston.
For page see List of Advertisers.

AQUILEGIAS

Aquilegas. Genuine Coerulea, finest of all. Both plants and seeds from the heart of the Rockies. C. S. Harrison's Select Nursery, York, Neb.

ARAUCARIAS

A. Leuthy & Co., Perkins St. Nurseries, Roslindale, Mass.

For page see List of Advertisers.

Godfrey Aschmann, 1012 West Ontario St., Philadelphia, Pa.
For page see List of Advertisers.

ASPARAGUS

The Geo. Wittbold Co., 1657 Buckingham Palace, Chicago, Ill.
For page see List of Advertisers.

ASPARAGUS AND RHUBARB ROOTS FOR FORCING

Warren Shinn, Woodstown, N. J.

AUCTION SALES

Oleary's Horticultural Co., 62 Vesey St., New York.
For page see List of Advertisers.

AZALEAS

A. Leuthy & Co., Perkins St. Nurseries, Roslindale, Mass.
For page see List of Advertisers.

BAMBOO CANES

Yokohama Nursery Co., 31 Barclay Street, New York.
Bamboo Sticks, Colored Green.
For page see List of Advertisers.

BAY TREES.

2000 Bay and Box Trees in all sizes, Pyramid and Standards. Write for list. Julius Roehrs, Rutherford, N. J.

BOILERS

"Burnham" Boilers made for greenhouse heating. Lord & Burnham, 1133 Broadway, N. Y.

Kroeschell Bros. Co., 35 Erie St., Chicago.
For page see List of Advertisers.

BOXWOOD TREES

New England Nurseries, Inc., Bedford, Mass.
For page see List of Advertisers.

BUILDING MATERIAL

BUILDING MATERIAL of all description for All Cypress, Semi-Iron, Iron Frame or Truss Houses. Hot Bed Sash and Frames. Lord & Burnham Co., 1133 Broadway, N. Y.

BULBS AND TUBERS

Joseph Breck & Sons, 47-54 N. Market St., Boston.
For page see List of Advertisers.

J. M. Thornburn & Co., 33 Barclay St., New York.
For page see List of Advertisers.

A. T. Boddington, 242 W. 14th St., N. Y.
For page see List of Advertisers.

Rickards Bros., 37 East 19th St., New York.
For page see List of Advertisers.

H. F. Michell Co., Philadelphia.
For page see List of Advertisers.

H. E. Fiske Seed Co., Faneuil Hall Sq., Boston.
For page see List of Advertisers.

T. J. Grey & Co., 32 and 33 So. Market St., Boston.
For page see List of Advertisers.

Yokohama Nursery Co., 31 Barclay St., New York.
For page see List of Advertisers.

BULBS AND TUBERS—Continued

Dlgee-Conard Co., West Grove, Pa.
Narcissus Paper White Grandiflora.
For page see List of Advertisers.

CARNATIONS

F. Dorner & Sons Co., Lafayette, Ind.
Carnation, Pink Delight.
For page see List of Advertisers.

Chicago Carnation Co., Joliet, Ill.
For page see List of Advertisers.

Albert Roper, Tewksbury, Mass.
Carnation Bay State.
For page see List of Advertisers.

Bassett & Washburn, Hinsdale, Ill.
Carnation O. P. Bassett.
For page see List of Advertisers.

East Sudbury Greenhouses, So. Sudbury, Mass.
Carnation Cuttings.
For page see List of Advertisers.

Wood Bros., Fishkill, N. Y.
Carnations, Rooted Cuttings.
For page see List of Advertisers.

The E. G. Hill Co., Richmond, Ind.
Carnation Cuttings.
For page see List of Advertisers.

Peter Fisher, Ellis, Mass.
Rooted Cuttings.
For page see List of Advertisers.

L. E. Marquisee Estate, Syracuse, N. Y.
Carnation Marchioness.

CHRYSANTHEMUMS

Chas. H. Tutty, Madison, N. J.
Chrysanthemum Novelties.
For page see List of Advertisers.

E. G. Hill Co., Richmond, Ind.
For page see List of Advertisers.

S. J. Goddard, Framingham, Mass.
Chrysanthemum Golden Glow.
For page see List of Advertisers.

Elmer D. Smith & Co., Adrian, Mich.
For page see List of Advertisers.

Chrysanthemum Golden Glow from 2-14 in. pots, for early spring delivery, \$6.00 per 100. Stock plants of Montmort, Oct. Frost, Crocus, Matchless, Lucy Devaux, Peppy Rose and Huddley, \$1.00 per doz.; \$6.00 per 100. Peirce Bros., Waltham, Mass.

Herrington's hook on the Chrysanthemum, mailed to your address for 50c., by Horticulture Publishing Co., 11 Hamilton Place, Boston.

CONIFERS

John Waterer & Sons, Ltd., American Nursery, Bagshot, Eng.
For page see List of Advertisers.

CUT FLOWER BOXES.

Edwards Folding Box Co., Philadelphia.
For page see List of Advertisers.

Folding out flower boxes, the best made. Write for list. Holton & Hunkel Co., Milwaukee, Wis.

CYCLAMEN.

Thomas Roland, Nahant, Mass.
For page see List of Advertisers.

DAHLIAS

David Herbert & Son, Atco, N. J.
For page see List of Advertisers.

J. L. Moore, Northboro, Mass.
For page see List of Advertisers.

Peacock Dahlia Farms, Williamstown Junction, N. J.
Dahlia Miss Virginia Maule.
For page see List of Advertisers.

R. Vincent Jr. & Sons Co., White Marsh, Md.
East Bridgewater Dahlia Gardens wants your business. If you are looking for dahlias send to the Eastern Dahlia King, J. K. Alexander, East Bridgewater, Mass.

DAISIES

Daisies, Yellow and White Paris and Queen Alexandra. Rooted Cuttings, \$1.00 per 100, prepaid. Chas. Frost, Kenilworth, N. J.

DECORATIVE PLANTS

A. Leuthy & Co., Perkins St. Nurseries, Roslindale, Mass.
For page see List of Advertisers.

Godfrey Aschmann, 1012 W. Ontario St., Phila., Pa.
For page see List of Advertisers.

Joseph Hancock Co., Wyncote, Pa.
For page see List of Advertisers.

The Geo. Wittbold Co., 1657 Buckingham Palace, Chicago, Ill.
For page see List of Advertisers.

Robert Craig Co., Market and 49th Sts., Philadelphia, Pa.
For page see List of Advertisers.

A. N. Pierson, Inc., Cromwell, Conn.
Palms and Ferns.
For page see List of Advertisers.

DRAECAENAS

The Geo. Wittbold Co., 1657 Buckingham Place, Chicago, Ill.
For page see List of Advertisers.

ECONOMY BRACKET

Buxton & Allard, Nashua, N. H.

EVERGREENS

New England Nurseries, Bedford, Mass.
For page see List of Advertisers.

American Nursery Co., 150 Broadway, New York, N. Y.
For page see List of Advertisers.

Evergreens. Send 25 cents in stamps for complete work on propagating and growing Evergreens. C. S. Harrison's Select Nursery, York, Neb.

FERNS

A. Leuthy & Co., Roslindale, Mass.
For page see List of Advertisers.

H. H. Barrows & Son, Whitman, Mass.
Nephrolepis Whitmani.
For page see List of Advertisers.

John Scott, Brooklyn, N. Y.
For page see List of Advertisers.

Frank Oechslin, 2570-2606 W. Adams St., Chicago.
Ferns for Dishes.
For page see List of Advertisers.

The Geo. Wittbold Co., 1657 Buckingham Palace, Chicago, Ill.
For page see List of Advertisers.

Godfrey Aschmann, 1012 W. Ontario St., Philadelphia.
For page see List of Advertisers.

Henry Weston, Hempstead, N. Y.
For page see List of Advertisers.

500 Boston and Scott's ferns, 3 and 3½ pots, cheap for cash. Just right for bedding out. Geo. H. Walker, No. Dighton, Mass.

FERTILIZERS

Pulverized Manure Co., 21 Union Stock Yards, Chicago, Ill.
Wizard Brand Sheep and Shredded Cattle Manure.

Robert Simpson, Clifton, N. J.
Sheep Manure.
For page see List of Advertisers.

Wm. Elliott & Sons, 42 Vesey St., New York.
Ground Bone for Potting.
For page see List of Advertisers.

For List of Advertisers See Page 57

FIGUS

Ficus elastica, six inch extra choice; clean stock, \$4.00 per Do. Collingdale Greenhouses, Collingdale, Pa.

FLORAL PHOTOGRAPHS

Flora: Photographs, Foley's, 226-228 1-2 Bowery, New York.

FLORISTS' LETTERS.

Boston Florist Letter Co., 66 Pearl St., Boston, Mass.
For page see List of Advertisers.

FLORISTS SUPPLIES

N. F. McCarthy & Co., 84 Hawley St., Boston.
For page see List of Advertisers.
H. M. Robinson & Co., 15 Province St. and 9 Chapman Pl., Boston, Mass.
For page see List of Advertisers.
Reed & Keller, 122 W. 25th St., New York.
For page see List of Advertisers.
H. Bayerdorfer & Co., 1129 Arch St., Philadelphia.
For page see List of Advertisers.

FLOWERS BY TELEGRAPH

Park Floral Co., Denver, Colo.
For page see List of Advertisers.
Gude Bros. Co., 1214 F St., Washington, D. C.
For page see List of Advertisers.
Atlanta Floral Co., Atlanta, Ga.
For page see List of Advertisers.
M. C. & J. E. Hanswrth, 232 Michigan Ave., Chicago.
For page see List of Advertisers.
William J. Smyth, Michigan Ave. and 31st St., Chicago.
For page see List of Advertisers.
George Withold Co., 1657-59 Buckingham Place, Chicago.
For page see List of Advertisers.
Jacob Schinz, 644 4th Ave., Louisville, Ky.
For page see List of Advertisers.
Thos. F. Galvin, 124 Tremont St., Boston.
For page see List of Advertisers.
Julius A. Zinn, 2 Beacon St., Boston.
For page see List of Advertisers.
F. H. Houghton, 596 Boylston St., Boston.
For page see List of Advertisers.
Edward MacMulklin, 194 Boylston St., Boston.
For page see List of Advertisers.

Hoffman, Florist, 59-61 Massachusetts Ave., Boston.
For page see List of Advertisers.
J. Newman & Sons, Inc., 24 Tremont St., Boston.
For page see List of Advertisers.
Talby, Wellesley, Mass.
For page see List of Advertisers.

J. Breitmeyer's Sons, Miami and Gratiot Aves., Detroit, Mich.
For page see List of Advertisers.
Samuel Murray, 1017 Broadway, Kansas City, Mo.
For page see List of Advertisers.
Wm. L. Rock Flower Co., 1116 Walnut St., Kansas City, Mo.
For page see List of Advertisers.

Fred C. Weber, 452 1/2 Olive St., St. Louis, Mo.
For page see List of Advertisers.
H. G. Eyles, 11 N. Pearl St., Albany, N. Y.
For page see List of Advertisers.
David Clarke's Sons, 2139-2141 Broadway, New York.
For page see List of Advertisers.

Alex. McConnell, New York.
For page see List of Advertisers.
Robert G. Wilson, Fulton St. & Greene Ave., Brooklyn, N. Y.
For page see List of Advertisers.

Young & Nugent, 42 W. 28th St., N. Y.
For page see List of Advertisers.
M. Bowe, 1294 Broadway, New York.
For page see List of Advertisers.
Meyer, 609-11 Madison Ave., New York.
For page see List of Advertisers.

Thos. Young, Jr., 509 Fifth Ave., New York.
For page see List of Advertisers.
Newman Floral Co., 202 Fifth Ave., and Madison St., New York.
For page see List of Advertisers.

FLOWERS BY TELEGRAPH—

Continued

The Blossom (C. C. Trepel, Mgr.), Bond and Livingston Sts., Brooklyn, N. Y.
For page see List of Advertisers.
Palmer's, Buffalo, N. Y.
For page see List of Advertisers.
F. A. Danker, Albany, N. Y.
For page see List of Advertisers.
J. H. Dunlop, 96 Yonge St., Toronto, Can.
For page see List of Advertisers.

FLOWER POTS

W. H. Ernest, 28th and M Sts., Washington, D. C.
For page see List of Advertisers.
A. H. Hewes & Co., Cambridge, Mass.
For page see List of Advertisers.
Hilfinger Bros., Ft. Edward, N. Y.
For page see List of Advertisers.
Willidin Pottery Co., Philadelphia.
Standard Flower Pots.
For page see List of Advertisers.
The Peters & Reed Pottery Co., Red pots, seed pans, etc. Co., Zanesville, O.

FOREST SEEDLINGS

To close out quick I offer the following first-class stock for Parks, Cemeteries and Forest Plantings: 100 M. Amorpha Fruticosa, 1 to 3 ft.; 300 M. Althea Rosea Stock, 100 M. Cal. Privet; 500 M. Cal. Privet cuttings; 100 M. Black Locust, 4 to 6 ft.; 50 M. Calycanthus, Sweet Shrub, 1 to 3 ft.; 150 M. Cercis Canadensis, Red Bud, 1 to 4 ft.; 40 M. Cornus Stolonifera, Ozier Dogwood, 1 to 2 ft.; 50 M. Diosyros, Am. Persimmon, 6 to 30 inches; 50 M. Elm (white) 1 to 2 ft.; 75 M. Hamamelis, Witch Hazel, 6 in. to 3 ft.; 50 M. Tulip Poplar, 1 to 8 ft.; 20 M. Sweet Gum, 1 to 2 ft.; 20 M. Black Walnut, 1 to 3 ft.; 20 M. Vistaria, 1 to 3 ft.; 20 M. Yucca Flammula, 1 and 2 year Butternut, Japan Walnut, Ash, Maple, etc. Send for trade list. I offer my entire stock to close out at low prices; also a large stock of Tree and Shrub Seeds, Black Locust, Sweet Gum, Sycamore, Ash, Red Bud, Persimmon, Bass Wood, Viburnums, Sugar Maple, Red Cedar and other Seeds. Forest Nursery & Seed Co., J. H. H. Boyd, Prop., R. F. D. No. 2, McMinnville, Tenn.

GALAX

Michigan Cut Flower Co., 38 and 40 Broadway, Detroit, Mich.
For page see List of Advertisers.

George Cotoonaa & Co., 50 W. 28th St., New York.
For page see List of Advertisers.

The Kervan Co., 113 West 28th St., N. Y.
For page see List of Advertisers.

Rice Bros., 115 N. 6th St., Minneapolis, Minn.
For page see List of Advertisers.

H. M. Robinson & Co., 15 Province St. and 9 Chapman Place, Boston.
For page see List of Advertisers.

GERANIUMS

R. Vincent Jr. & Sons Co., White Marsh, Md.
New and Standard Varieties.
For page see List of Advertisers.

GLADIOLI

J. L. Moore, Northboro, Mass.
For page see List of Advertisers.
E. S. Miller, Wading River, N. Y.
For page see List of Advertisers.
A. T. Boddington, 312 W. 14th St., New York.
For page see List of Advertisers.

GLASS

Boston Plate & Window Glass Co., Boston
For page see List of Advertisers.
Standard Plate Glass Co., 26-30 Sudbury St., Boston.
For page see List of Advertisers.
Foley Mfg. Co., Western Ave., between 25th & 26th Sts., Chicago.
Sharp, Partridge & Co., 221 & Lumber St., Chicago.
For page see List of Advertisers.

GLASS—Continued

Greenhouse glass, lowest prices, Johnston Glass Co., Hartford City, Ind.
Glass, High Grade, Double Thick Greenhouse Glass. Lord & Burnham, 1133 Broadway, N. Y.

GLAZING DEVICES

H. A. Dreer, Philadelphia, Pa.
Peerless Glazing Point.
For page see List of Advertisers.
GLAZING POINTS, Lord & Burnham Special Glazing Nails (Points), Lord & Burnham, 1133 Broadway, N. Y.

GREENHOUSE BUILDING MATERIAL

Lord & Burnham Co., 1133 Broadway, New York.
For page see List of Advertisers.
Pierson U-Bar Co., 1 Madison Sq., N. Y.
For page see List of Advertisers.
A. T. Stearns Lumber Co., Neposcut, Boston.
For page see List of Advertisers.
King Construction Co., N. Tonawanda, New York.
For page see List of Advertisers.
Hitchings & Co., 1170 Broadway, New York.
For page see List of Advertisers.
J. C. Moninger Co., 117 East Blackhawk St., Chicago, Ill.
For page see List of Advertisers.
Foley Mfg. Co., Western Ave., between 25th & 26th Sts., Chicago.
For page see List of Advertisers.
Geo. B. Doane, 18 Midway St., Boston.
Iron Pipe.
For page see List of Advertisers.
Wm. H. Lutton, West Side Avenue Sta., Jersey City, N. J.
For page see List of Advertisers.

GREENHOUSE CONSTRUCTION

GREENHOUSE CONSTRUCTION, Semi-Iron Greenhouse, New Truss, Houses and Iron Frame Houses, Lord & Burnham, 1133 Broadway, N. Y.
J. A. Payne, 250-274 Culver Ave., Jersey City, N. J.
For page see List of Advertisers.
Foley Mfg. Co., Western Ave., between 25th & 26th Sts., Chicago.
For page see List of Advertisers.
Wm. H. Lutton, West Side Avenue Sta., Jersey City, N. J.
Curved Iceless Eave.
For page see List of Advertisers.
Hitchings & Co., 1170 Broadway, New York.
For page see List of Advertisers.

GREENHOUSE HOSE

Revere Rubber Co., Boston, Mass.
Revere Hose.
For page see List of Advertisers.

GUTTERS

GUTTERS, Cast Iron Gutters, L. & B. Improved V Shaped Gutter with drip gutter attachment. Lord & Burnham, 1133 Broadway, N. Y.

HAIL INSURANCE

Florists' Hall Asso. of America, J. G. Ester, Saddle River, N. J.
For page see List of Advertisers.

HARDY FERNS, MOSS AND GREENS

H. M. Robinson & Co., 15 Province St. and 9 Chapman Pl., Boston, Mass.
For page see List of Advertisers.
Michigan Cut Flower Exchange, 38 and 40 Broadway, Detroit, Mich.
For page see List of Advertisers.
George Cotoonaa & Co., 50 W. 28th St., New York.
For page see List of Advertisers.
N. F. McCarthy & Co., 84 Hawley St., Boston.
For page see List of Advertisers.
The Kervan Co., 113 W. 28th St., N. Y.
For page see List of Advertisers.
Rice Bros., 115 N. 6th St., Minneapolis, Minn.
For page see List of Advertisers.

In writing to Advertisers kindly mention Horticulture

HEATING APPARATUS

- Lord & Burnham Co.,
1133 Broadway, New York.
For page see List of Advertisers.
- Pierson U-Bar Co., 1 Madison Sq., N. Y.
For page see List of Advertisers.
- John A. Payne, 260-274 Culver Ave., Jersey
City, N. J.
For page see List of Advertisers.
- Kroeschell Bros. Co., 35 Erie St., Chicago.
For page see List of Advertisers.

HELP FURNISHED

- Chos. H. Bambrick, 34 S. 7th St., Phila.
For page see List of Advertisers.

HERBACEOUS PERENNIALS

- P. Ouwerkerk, P. O. No. 1, Hoboken, N. J.
For page see List of Advertisers.
- New England Nurseries, Bedford, Mass.
For page see List of Advertisers.
- The Geo. Withhold Co., 1657 Buckingham
Place, Chicago.
For page see List of Advertisers.

HOT-BED SASH

- The A. T. Stearns Lumber Co., Neponset,
Mass.
For page see List of Advertisers.
- Pierson U-Bar Co., 1 Madison Sq., N. Y.
For page see List of Advertisers.
- Lord & Burnham Co., 1133 Broadway, N. Y.
For page see List of Advertisers.
- Foley Mfg. Co., Western Ave., between
25th & 26th Sts., Chicago.
- Sunlight Double Glass Sash Co.,
Louisville, Ky.
For page see List of Advertisers.

INSECTICIDES.

- Nicotinole kills all greenhouse pests.
P. R. Palethorpe Co.,
Eleventh St., Owensboro, Ky.
For page see List of Advertisers.
- Stompp & Walter Co., 50 Barclay St.,
New York.
Kilnhead Tobacco Dust.
For page see List of Advertisers.
- Wilson Plant Oil & Fertilizer Co., Chat-
ham, N. J.
Lauten Fumigator.
For page see List of Advertisers.
- Nagara Sprayer Co., Middleport, N. Y.
Nizara Brand.
For page see List of Advertisers.
- R. G. Pratt Co., New York.
Scleide.
For page see List of Advertisers.
- "The Fumigating Kind Tobacco Pow-
der"—The first on the market and the kind
that has so many imitators, has our guar-
antee tag of satisfaction or money back,
and "The Moon Trade Mark" on every bag,
\$3.00 per 100 lbs. The H. A. Stoothoff Co.,
Mount Vernon, N. Y. Makers and sellers.

JAPANESE PLANTS

- Yokohama Nursery Co., 31 Barclay St.,
New York.
For page see List of Advertisers.

KENTIAS

- Godfrey Aschmann,
1012 W. Ontario St., Phila., Pa.
For page see List of Advertisers.
- A. Leuthy & Co., Roslindale, Mass.
For page see List of Advertisers.
- Henry Weston, Hempstead, N. Y.
For page see List of Advertisers.
- Joe Hencock Co., Wynote, Pa.
Single and Made-Up Specimens.
For page see List of Advertisers.

**LEVELS FOR LANDSCAPE GAR-
DENING USE.**

- Boatrom-Frady Mfg. Co., 139 Madison Ave.,
Atlanta, Ga.
For page see List of Advertisers.

LILLY OF THE VALLEY PIPS

- Hjalmar Hartmann & Co., 12 Stormgade,
Copenhagen, Denmark
For page see List of Advertisers.

MUSHROOM SPAWN

- Use Anglo-American Mushroom Spawn
made "Direct from Spores." Write for
pamphlet. Anglo-American Spawn Co.,
Kennett Square, Pa.

NEW AND RARE PLANTS

- Rose Hill Nurseries, New Rochelle, N. Y.
For page see List of Advertisers.

NICO-FUME

- Kentucky Tobacco Product Co.,
Louisville, Ky.

NURSERY STOCK

- John Waterer & Sons, Ltd.,
American Nursery, Bagshot, England.
For page see List of Advertisers.
- Clary's Horticultural Co., 62 Vesey St.,
New York.
For page see List of Advertisers.
- P. Ouwerkerk, 216 June St., Weehawken
Heights, N. J.
For page see List of Advertisers.
- D. J. Twomey, Dept. II, Geneva, N. Y.
For page see List of Advertisers.
- American Nursery Co., 150 Broadway, New
York, N. Y.
For page see List of Advertisers.
- Manual of the Trees of North America,
by C. S. Sargent, mailed to your address
for \$6.00, by Horticulture Publishing Co.,
11 Hamilton Place, Boston.

TREES, SHRUBS, ROSES, EVER-
GREENS, PEONIES, HARDY PLANTS,
ELLWANGER & BARRY, Rochester, N. Y.

ONION SEED

- Federico C. Varela, Teneriffe, Canary Is.,
Bermuda Onion Seed.

ORCHID BASKETS

- J. A. Manda, 191 Valley Rd., W. Orange,
New Jersey.
For page see List of Advertisers.

ORCHID PLANTS

- Lager & Harrell, Summit, N. J.
For page see List of Advertisers.
- Sander, St. Albans, England,
Importers, Exporters, Growers, Hybridists.
For page see List of Advertisers.
- Carillo & Baldwin, Syracuse, N. Y.
For page see List of Advertisers.
- Jos. A. Manda, 191 Valley Road, W.
Orange, N. J.
For page see List of Advertisers.
- Ordonez Bros., Madison, N. J., Box 105.
For page see List of Advertisers.
- Largest stock in the country. Ask for
prices. Julius Roehrs, Rutherford, N. J.

PAINT AND PUTTY

- PAINT AND PUTTY: Ideal Greenhouse
lead; Special Greenhouse Putty. Lord &
Burnham, 1133 Broadway, N. Y.

PALMS

- A. Leuthy & Co., Perkins St. Nurseries,
Roslindale, Mass.
For page see List of Advertisers.
- Robert Craig Co., Market and 40th Sts.,
Philadelphia, Pa.
For page see List of Advertisers.
- Joseph Hencock Co., Wynote, Pa.
Home-Grown Palms.
For page see List of Advertisers.

PANSY PLANTS.

- Pansies, extra fine giant flowering, strong
plants, 30 cents per 100; \$2.50 per 1000
Edw. Wallis, Atco, N. J.

PATENTS

- Siggers & Siggers, Washington, D. C.
For page see List of Advertisers.

PEAT

- J. A. Manda, 191 Valley Rd., W. Orange,
New Jersey
For page see List of Advertisers.
- Orchid peat, Rotted peat, Azalea peat,
Leaf-Mould, Live Sphagnum moss, Baled
Sphagnum moss, Green Clump moss, etc.
Jobbers' list on application. C. W. Brown-
ell & Co., Walden, N. Y.
- Orchid Peat and Moss always on hand
Julius Roehrs Co., Rutherford, N. J.

PEONIES

- Peonies only, by the wholesale—best 100
varieties. J. F. Rosenfeld, Westpoint, Nebr.
One of the finest collections in America.
Send 25 cts. in stamps for new edition of
Peony Manual. C. S. Harrison's Select
Nursery, York, Neb.

PHOXES

- Send 25 cts in stamps for Phlox Manual.
Fine mixed phloxes \$2.00 per 100. C. S.
Harrison's Select Nursery, York, Neb.

**PHOENIX ROEBELENI PALM
SEED**

- Ralph M. Ward & Co., 12 W. Broadway,
New York
For page see List of Advertisers.

PIPE AND FITTINGS

- Foley Mfg. Co., between Western Ave. and
26th St., Chicago, Ill.
For page see List of Advertisers.
- Kroeschell Bros. Co., 35 Erie St., Chicago.
For page see List of Advertisers.
- PIPE AND FITTINGS: Cast Iron and
Wrought Pipe, Valves, Elbows, Pipe Hooks,
Automatic Air Headers, etc. Lord &
Burnham, 1133 Broadway, N. Y.

PLANT STANDS

- Moore-Livingston Co., Landowave, Pa.
For page see List of Advertisers.

PLANT STAKES

- Scle's Heedless Plant Stakes and Trell-
ises. H. D. Scle & Sons, Elkhart, Ind.

POT HANGERS

- Pot hangers, Kramer's \$1 doz. by exp.,
\$1.25 by mail. I. N. Kramer & Son, Cedar
Rapids, Ia.

POINSETTIAS (Artificial)

- Poinsettias, artificial decorations our
specialty. Sample lots of 50 in 3 sizes,
\$1.00; 100 lots, \$5, \$10. J. Stern & Co.,
125 N. 10th St., Philadelphia, Pa.

PRUNING SHEARS

- Rhodes Mfg. Co., Dept. R., Grand Rapids,
Mich.

RAFFIA

- Raffia (colored), 20 beautiful shades.
Samples free. R. H. Conroy Co., Camden,
N. J.; 810 Washburn Ave., Chicago, Ill.

RETAIL FLORISTS

- Park Floral Co., Denver, Colo.
For page see List of Advertisers.
- Gude Bros. Co., 1214 F St.,
Washington, D. C.
For page see List of Advertisers.
- Atlanta Floral Co., Atlanta, Ga.
For page see List of Advertisers.
- M. C. & J. E. Hanswirth, 252 Michigan Ave.,
Chicago.
For page see List of Advertisers.
- William J. Smyth, Michigan Ave. and 31st
St., Chicago.
For page see List of Advertisers.
- George Withhold Co., 1657-59 Buckingham
Place, Chicago.
For page see List of Advertisers.
- Jacob Schulz, 644 4th Ave., Louisville, Ky.
For page see List of Advertisers.
- Thos. F. Galvin, 124 Tremont St., Boston.
For page see List of Advertisers.
- Julius A. Zinn, 2 Beacon St., Boston.
For page see List of Advertisers.
- Frank H. Houghton, 396 Boylston St.,
Boston.
For page see List of Advertisers.
- Edward MacMullin, 104 Boylston St.,
Boston.
For page see List of Advertisers.
- Hoffman, Florist, 59-61 Massachusetts Ave.,
Boston.
For page see List of Advertisers.
- J. Newman & Sons, Inc., 24 Tremont St.,
Boston.
For page see List of Advertisers.
- Talby, Wellesley, Mass.
For page see List of Advertisers.

RETAIL FLORISTS - Continued

- J. Breitmever's Sons, Detroit, Mich.
For page see List of Advertisers.
- Samuel Murray, 1017 Broadway,
Kansas City, Mo.
For page see List of Advertisers.
- Wm. L. Rock Flower Co., 1116 Walnut St.,
Kansas City, Mo.
For page see List of Advertisers.
- Fred C. Weber, 4326 Olive St., St. Louis,
Mo.
For page see List of Advertisers.
- H. G. Eyre, 11 N. Pearl St., Albany, N. Y.
For page see List of Advertisers.
- David Clarke's Sons, 2139-2141 Broadway,
New York.
For page see List of Advertisers.
- Alex. McConnell, New York.
For page see List of Advertisers.
- Robert G. Wilson, Fulton St. and Greene
Ave., Brooklyn, N. Y.
For page see List of Advertisers.
- Young & Nugent, 42 W. 25th St., N. Y.
For page see List of Advertisers.
- M. Rowe, 1294 Broadway, New York.
For page see List of Advertisers.
- Myer, 609-11 Madison Ave., New York.
For page see List of Advertisers.
- Thos. Young, Jr., 500 Fifth Ave., New York.
For page see List of Advertisers.
- Newman Floral Co., 292 Fifth Ave. & Mad-
ison Sq., New York.
For page see List of Advertisers.
- The Blossom (C. C. Trepel, Mgr.),
Bond and Livingston Sts., Brooklyn, N. Y.
For page see List of Advertisers.
- Palmer's Buffalo, N. Y.
For page see List of Advertisers.
- F. A. Danker, Albany, N. Y.
For page see List of Advertisers.
- J. H. Dunlop, 96 Yonge St., Toronto, Can.
For page see List of Advertisers.

RHODODENDRONS

- John Waterer & Sons, Ltd.,
American Nursery, Bagshot, England.
For page see List of Advertisers.
- P. Onwerkerk, Hoboken, N. J.
For page see List of Advertisers.
- Anthony Waterer, Knap Hill Nursery,
Surrey, Eng.
For page see List of Advertisers.

ROSES

- Robert Craig Co., Market and 49th Sts.,
Philadelphia, Pa.
For page see List of Advertisers.
- P. Onwerkerk, P. O. No. 2, Hoboken, N. J.
For page see List of Advertisers.
- Julius Roehrs Co., Rutherford, N. J.
Rose Newport Fairy.
For page see List of Advertisers.
- Wabau Rose Conservatories, Natlek, Maana,
and 3A Somerset St., Boston.
New Porching Rose White Killarney.
For page see List of Advertisers.
- The F. R. Pierson Co.,
White Killarney and My Maryland,
Tarrytown, Hudson, N. Y.
For page see List of Advertisers.
- Roses, strong, own root, 4 inch Chatsenay,
Killarney, Richmond and Mald, \$8 per 100.
Stebrecht & Son, New Rochelle, N. Y.

Hand Book of Cultural Notes on Roses
Under Glass, by F. P. Brigham, mailed to
your address for 25c., by Horticulture Pub-
lishing Co., 11 Hamilton Place, Boston.

SCALECIDAE

- B. G. Pratt Co., 50 Church St., New York.
For page see List of Advertisers.

SEED GROWERS

- C. C. Morse & Co., 48-56 Jackson St.,
San Francisco, Cal.
For page see List of Advertisers.
- Hjalmar Hartmann & Co.,
Cauliflower and Cabbage Seed.
12 Stromgade, Copenhagen, Denmark.
For page see List of Advertisers.
- Federico C. Varela, Tenerife, Canary Ids.
Bernat da Onion Seed.

SEEDS

- T. J. Gray Co., 32 So. Market St., Boston.
For page see List of Advertisers.
- Joseph Breck & Sons,
51 and 52 N. Market St., Boston, Mass.
For page see List of Advertisers.
- W. Atlee Burpee & Co., Philadelphia.
For page see List of Advertisers.
- J. M. Thorburn & Co., 23 Barclay St., N. Y.
For page see List of Advertisers.
- Arthur T. Boddington, 342 W. 14th St.,
New York.
For page see List of Advertisers.
- H. F. Mitchell Co., 1018 Market St., Phila.
For page see List of Advertisers.
- Hjalmar Hartmann & Co.,
12 Stromgade, Copenhagen, Denmark.
Cauliflower and Cabbage Seed.
For page see List of Advertisers.
- Rickards Bros., 37 E. 19th St., New York.
For page see List of Advertisers.
- R. & J. Farquhar & Co., 6-7 So. Market
St., Boston.
Mignonette Seed.
For page see List of Advertisers.
- H. E. Fiske Seed Co., Faneuil Hall Sq.,
Boston.
For page see List of Advertisers.
- C. C. Morse & Co., 48-56 Jackson St.,
San Francisco, Calif.
For page see List of Advertisers.
- Leonard Seed Co., Chicago, Ill.
For page see List of Advertisers.
- Seeds. Rocky Mountain Evergreen seeds
in large or small quantities. C. S. Harri-
son's Select Nursery, York, Neb.

My own new crop of SALVIA SPLEN-
DENS VARIETIES is now ready: Nana
Compacta ZURICH, finest early flowering
pot Salvia in existence, selected seeds
Compacta Grandiflora FIREBALL, best of
all for pots and groups, selected seeds,
Grandiflora Amellorata KING OF THE
SCARLETS, unexcelled for late groups,
with extra large deep scarlet spikes, se-
lected seeds. Each of above per Tr. Pkt.,
50c.; 6 Tr. Pkt., \$2.50. Larger quantities
on special quotation. O. V. ZANGEN,
Seedsman, Hoboken, N. J.

SHRUBS

- The Geo. Wittbold Co., 1657 Buckingham
Palace, Chicago.
For page see List of Advertisers.

SILKALINE

- John C. Meyer & Co., Boston, Mass.
For page see List of Advertisers.

SPHAGNUM MOSS

- Live Sphagnum moss, orchid peat and
orchid baskets always on hand. Lager &
Hurrell, Summit, N. J.

SPRAYERS

- "SIOWERMAKER," \$1. Jos. Kopcsay,
So. Bend, Ind.
- Niagara Sprayer Co., Middleport, N. Y.
For page see List of Advertisers.

STEAM TRAP

- E. Hippard, Youngstown, O.

STRAWBERRY PLANTS

- H. L. Crane, Westwood, Mass.
Barrymore Strawberry.
For page see List of Advertisers.

SWEET PEAS

- A. C. Zvolnek, Romd Brook, N. J.
Winter Flowering.
For page see List of Advertisers.

TO-BAK-INE

- E. H. Hunt, Genl. Agt., 76-78 Wabash Av.,
Chicago.
For page see List of Advertisers.

TOMATO PLANTS.

10,000 tomato plants for forcing. Cassini,
Florence and Mayflower, ready January 23.
Good plants from 25c. each; pods, \$1 per
1000. Locust Street Greenhouses, J. H. A.
Hutchinson, Prop., Oxford, Pa.

VENTILATING APPARATUS

- Pierson U-Bar Co., 1 Madison Sq., N. Y.
For page see List of Advertisers.
- Foley Mfg. Co., Western Ave., between
25th & 26th Sts., Chicago.
For page see List of Advertisers.
- John A. Payne, 20-274 Cuyler Ave., Jersey
City, N. J.
For page see List of Advertisers.
- The Advance Co., Richmond, Ind.
For page see List of Advertisers.
- Quaker City Machine Co., Richmond, Ind.,
20th Century Ventilating App.
For page see List of Advertisers.
- VENTILATING MACHINERY, New
Model enclosed, self-oiling gear, Standard
Model Open Gear. Lord & Burnham, 1133
Broadway, N. Y.

VIOLETS

Violets, Campbell rooted runners, 75c.
per 100. John A. Burns, 8542 Frankford
Ave., Holmesburg, Philadelphia, Pa.

VINCAS

Vinca variegated, Rooted Cuttings, 75c.
per 100; prepaid. Chas. Frost, Kenilworth,
N. J.

WAX FLOWERS

We are originators of wax designs and
still the standard concern. J. Stern & Co.,
125 N. 10th St., Philadelphia, Pa.

WHEAT SHEAVES

- H. Bayersdorfer & Co., 1129 Arch St.,
Phila.
For page see List of Advertisers.

WIRED TOOTHPICKS

- W. J. Cowee, Berlin, N. Y.
For page see List of Advertisers.

WIREWORK

- Reed & Keller, 122 W. 25th St., N. Y.
For page see List of Advertisers.
- Wirework. Write for our catalogue.
Hilton & Hunkel Co., Milwaukee, Wis.
- William E. Heilscher's Wire Works, 28-40
Broadway, Detroit, Mich.
- Headquarters for wire work. Send for
list. Ball & Betz, 31 E. 3rd St., Cin-
cinnati, O.
- Wirework—Compare our prices with
others. Scranton Florist Supply Co., 201
N. 7th St., Scranton, Pa.

WHOLESALE FLORISTS

Boston

- N. F. McCarthy & Co., 84 Hawley St.,
Boston.
For page see List of Advertisers.
- H. M. Robinson & Co., 15 Province St.
and 9 Chapman Pl., Boston.
For page see List of Advertisers.
- Welch Bros., 226 Devonshire St., Boston.
For page see List of Advertisers.
- Talbot, Wellesley, Mass.
For page see List of Advertisers.

Chicago

- Chas. W. McKellar, 51 Wabash Ave.,
Chicago.
For page see List of Advertisers.
- Peter Reinberg, 51 Wabash Ave., Chicago.
For page see List of Advertisers.
- E. F. Winterson Co., 43-49 Wabash Ave.,
Chicago.
For page see List of Advertisers.
- J. A. Bondlog, 37-53 Randolph St., Chicago.
For page see List of Advertisers.
- Poehlmann Bros. Co., Morton Grove, Ill.
For page see List of Advertisers.

Cromwell, Conn.

- A. N. Pierson, Cromwell, Conn.
For page see List of Advertisers.

In writing to Advertisers kindly mention Horticulture



THE WHILLDIN POTTERY COMPANY

THE LARGEST MANUFACTURERS OF

STANDARD FLOWER POTS

PHILADELPHIA, PA. LONG ISLAND CITY, N. Y. JERSEY CITY, N. J.

WHOLESALE FLORISTS—

Continued

Detroit

Michigan Cut Flower Exchange, 38 and 40 Broadway, Detroit, Mich.
For page see List of Advertisers.

Minneapolis

Rice Bros., 115 N. 6th St., Minneapolis, Minn.
For page see List of Advertisers.

New York

- Ford Bros., 48 W. 28th St., New York.
For page see List of Advertisers.
- H. E. Froment, 37 W. 28th St., New York.
For page see List of Advertisers.
- Alex. J. Gutman, 34 W. 28th St., New York.
For page see List of Advertisers.
- E. C. Horan, 55 W. 28th St., New York.
For page see List of Advertisers.
- A. H. Langjahr, 55 W. 28th St., New York.
For page see List of Advertisers.
- James McManus, 42 W. 28th St., New York.
For page see List of Advertisers.
- John I. Raynor, 49 W. 28th St., New York.
For page see List of Advertisers.
- W. F. Sheridan, 39 W. 28th St., New York.
For page see List of Advertisers.
- Traendly & Schenck, 44 W. 28th St., New York.
For page see List of Advertisers.
- Moore, Heutz & Nash, 55 and 57 W. 26th St., New York.
For page see List of Advertisers.
- Wm. H. Kuebler, 28 Willoughby St., Brooklyn, N. Y.
For page see List of Advertisers.
- Phillip F. Kessler, 55 and 57 W. 26th St., New York.
For page see List of Advertisers.
- Millang Bros., 41 W. 28th St., New York.
For page see List of Advertisers.
- John Young, 51 W. 28th St., New York.
For page see List of Advertisers.
- Greater New York Florists' Association, 162 Livingston St., Brooklyn, N. Y.
For page see List of Advertisers.
- George Saltford, 43 W. 28th St., New York.
For page see List of Advertisers.
- Frank Millang, 55-57 W. 26th St., New York.
For page see List of Advertisers.
- B. S. Slinn, 55-57 W. 26th St., New York.
For page see List of Advertisers.
- A. L. Young & Co., 54 W. 28th St., N. Y.
For page see List of Advertisers.
- Growers' Cut Flower Co., 39 W. 28th St., New York.
For page see List of Advertisers.
- Henshaw & Fenrich, 44 W. 28th St., New York.
For page see List of Advertisers.
- J. K. Allen, 106 W. 28th St., New York.
For page see List of Advertisers.

Philadelphia

- W. E. McKieslek & Bros., 1619-1621 Rancstead St., Philadelphia, Pa.
For page see List of Advertisers.
- Leo Nissen Co., 1209 Arch St., Philadelphia, Pa.
For page see List of Advertisers.
- The S. S. Pennock-Meehan Co., 1608-18 Ludlow St., Philadelphia, Pa.
For page see List of Advertisers.

St. Louis

H. G. Berning, 1402 Pine St., St. Louis, Mo.
For page see List of Advertisers.

WHOLESALE PLANTSMAN

Samuel A. Woodrow, 53 W. 30th St., New York.
For page see List of Advertisers.

New Offers in This Issue.

ASTER SEED.

Elmer D. Smith & Co., Adrian, Mich.
For page see List of Advertisers.

CARNATION MARCHIONESS.

Bellamy Bros., Suc. to L. E. Marquisee, Syracuse, N. Y.
For page see List of Advertisers.

CARNATIONS, ROOTED CUTTINGS: CHRYSANTHEMUMS: ROSE MY MARYLAND.

S. J. Reuter & Son, Westery, R. I.
For page see List of Advertisers.

CARNATION STAPLE.

J. L. Pillsbury, Galesburg, Ill.
For page see List of Advertisers.

EASTER BASKETS.

H. Bayersdorfer & Co., 1129 Arch St., Philadelphia, Pa.
For page see List of Advertisers.

JAPAN LILY BULBS.

Ralph M. Ward & Co., 12 W. Broadway, New York.
For page see List of Advertisers.

KENTIAS.

Henry A. Dreer, 714 Chestnut St., Phila.
For page see List of Advertisers.

ROSES: DAHLIAS: CANNAS.

Dinger & Conard Co., West Grove, Pa.
For page see List of Advertisers.

ROOTED CARNATION CUTTINGS.

Chicago Carnation Co., Joliet, Ill.
For page see List of Advertisers.

SEEDS.

Joseph Breck & Sons, Boston.
For page see List of Advertisers.

SEEDS OF THE BURPEE STANDARD.

W. Atlee Burpee & Co., Philadelphia, Pa.
For page see List of Advertisers.



STANDARD FLOWER POTS

Packed in small crates, easy to handle.

	Price per crate	Price per crate	
1500 2 in. pots in crate	\$4.88	1207 in. pots in crate \$4.20	
1500 2 1/2 " " " "	5.25	60 8 in. " " " " 3.00	
1500 3 " " " "	5.00	HAND MADE	
1000 3 " " " "	5.00	48 9 in. pots in crate	\$3.60
800 3 1/2 " " " "	5.80	48 10 " " " " "	4.80
500 4 " " " "	4.50	24 11 " " " " "	3.60
320 5 " " " "	4.51	24 12 " " " " "	4.80
144 6 " " " "	3.16	12 14 " " " " "	4.80
		6 16 " " " " "	4.50

Send names, same price as pots. Send for price list of Cylinders for Cut flowers, Hanging Baskets, Lawn Vases, etc. Ten per cent. off for cash with order. Address Hillinger Bros., Pottery, Fort Edward, N. Y. August Folker & Sons, Agts. 31 Barclay St., N. Y. City.

HELP WANTED

GOOD MEN

When you need good men, skilled or unskilled, Write:

THOS. H. BAMBRICK

34 South 7th Street Philadelphia

Help of all kinds, including that for Florists, Nurserymen, Seedsmen and the Horticultural trade generally.

SITUATIONS WANTED

SITUATION WANTED by a German, 40, small family. Private or commercial life. Experienced; good grower of carnations, chrysanthemums, ferns, palms, roses, lilies, bulbs and general pot plants. Good worker; sober; over five years in one place as foreman. State wages and particulars in first letter. Neighborhood of Boston or New York preferred. Address B. S., 11 Hamilton Place, Boston.

GARDENER, professional, desires situation on private place; 18 years' experience in all branches; first-class references. Address William Kane, 714 Kent St., Rome, N. Y.

SITUATION WANTED—By practical landscape gardener and florist; private or commercial; middle aged; married. J. Hodge, 44 West St., Fitchburg, Mass.

FOR SALE

FOR SALE—5000 feet, 2-in., 1000 feet, 4-in., wrought iron pipe; 4000 feet of 4-in. cast iron pipe; clean 500 boxes 10 x 12, \$1.50; 150 boxes 10 x 15, \$1.70; and 100 boxes of 8 x 10, double-thick and clean glass, at \$1.25 per box. Two Scollay, 3 sections, two Scollay No. 5, one No. 17 fittings, and one No. 8 Furman boilers. All kinds ventilating apparatus and sash, cast iron fittings, valves, expansion tanks, etc. Everything in first class condition. Cheap. F. O. B. Newark car. I. Sueserman, 229 Livingston St., Newark, N. J.

SEEK BUSINESS FOR SALE—An A No. 1 well-established seed business, wholesale and retail, doing business of \$100,000 per annum. Owner desires to retire from business. Clifford L. Newman, Counselor at Law, United Bank Bldg., Paterson, N. J.

FOR SALE—Retail nursery, sixth year, doing good, steady and increasing trade. Stock in excellent condition. Only local supply for community of 50,000. For particulars address R. N., care HORTICULTURE, Boston.

MISCELLANEOUS WANTS

WANTED TO BUY—Complete greenhouse plants and all kinds of greenhouse material, to be taken down and removed at once. Terms cash. Address I. Sueserman, 229 Livingston St., Newark, N. J.

WANTED TO LEASE, with privilege of buying, greenhouses in good repair, unstocked; retail trade; state full particulars; no fancy rent. Address Retailer, 180 Grand St., Jersey City, N. J.

Standard Flower POTS

If your greenhouses are within 500 miles of the Capitol, write us, we can save you money

W. H. ERNEST

28th and M Street WASHINGTON D. C.

List of Advertisers

Page	Page
Advance, The Co.....	59
Allen J. K.....	31
American Nursery.....	52
Achmann Godfrey.....	31
Atlanta Floral Co.....	47
Brambick Thos. H.....	56
Barrows H. H. & Son.....	31
Bassett & Washburn.....	30
Bayersdorfer H. & Co.....	46
Bellamy Bros.....	39-47
Berning H. G.....	51
Blossom T.....	46
Boddington A. T.....	45
Boston Florist Letter Co.....	47
Boston Plate and Window Glass Co.....	38
Bostrum-Brady Mfg. Co.....	49
Bowe, M. A.....	49
Breck, Joseph & Sons.....	47
Breitheyer, J. Sons.....	47
Bridgeman's Seed Warehouse.....	45
Badlon, J. A.....	48
Burpee W. A. & Co.....	43
Carrillo & Baldwin.....	41
California Carnation Co.....	30
Clarke's David, Sons.....	46
Clary's Horticultural Co.....	32
Coan J. J.....	32
Cotsonas G. & Co.....	51
Cowse W. J.....	51
Craig, Robt. Co.....	32
Crane H. L.....	32
Crawback Geo. W.....	51
Danker F. A.....	47
Dingee & Conard Co.....	42
Dixon Geo. E. & Son.....	50
Dornet F. Sons & Co.....	50
Dreer H. A.....	31-58
Dualop John H.....	46
Dysart R. J.....	47
East Sudbury Greenhouses.....	30
E. Lewis Folding Box Co.....	48
Elrott Wm & Sons.....	45
Elder J. G.....	59
East W. H.....	58
Eyes.....	46
Farruhar R. & J. Co.....	45
Fisher Peter.....	47
Fiske H. E. Seed Co.....	45-57
Foley Mfg. Co.....	59
Ford Bros.....	50
Froment H. E.....	50
Galvin Thos. F.....	47
Goldard S. J.....	47
Greater N. Y. Florists' Association.....	54
Grey T. J. Co.....	45
Growers' Cut Flower Co.....	50
Gude Bros. Co.....	46
Guttman Alex. J.....	50
Hall Assn.....	50
Hartmann Hjalmar & Co.....	45
Hauswirth M.C. & J. E.....	46
Heacock Jos. & Co.....	51
Heushaw & Fenrich.....	51
Herbert David & Son.....	31
Hews A. H. & Co.....	56
Hilfinger Bros.....	56
Hill, The E. G. Co.....	30
Hillings & Co.....	60
Hoffman.....	47
Horan E. C.....	50
Houghton F. H.....	47
Hunt E. H.....	57
Kervan The Co.....	51
Kessler, P. F.....	50
King Cons. Co.....	59
Knap Hill Nursery.....	32
Kresschell Bros. Co.....	59
Kuebler Wm H.....	51
Lager & Hurrell.....	41
Langer, Alfred H.....	50
Leonard Seed Co.....	45
Leuthy A. & Co.....	31
Lord & Burnham Co.....	60
Lutton W. H.....	59
Maeda Jos. A.....	41
McKalkin E. A.....	47
McCarthy N. F. & Co.....	47
McConnell Alex.....	46
McKellar Charles W.....	46
McKissick, W. E. & Bros.....	48
McManus Jas.....	50
Meyer.....	46
Meyer J. C. & Co.....	47
Michell H. F. Co.....	48-57
Michigan Cut Flower Exchange.....	51
Mihlang Bros.....	50
Mihlang Frank.....	50
Miller, E. S.....	41
Montager J. C.....	19
Moore, J. L.....	32
Moore, Hentz & Nash.....	47
Moore-Livingston Co.....	47
Morse C. C. & Co.....	45
Murray Samuel.....	46
New Eng. Nurseries.....	32
Newman Floral Co.....	46
Newman J. & Sons.....	47
Niagara Sprayer Co.....	57
Niessen Leo. Co.....	48
Oechslin Fraank.....	31
Ordoñez Bros.....	32
Ouwertkerk P.....	32
Palethorpe P. R. Co.....	57
Palmer W. J.....	47
Park Flora Co.....	46
Payne John A.....	58
Pescok Dahlia Farms.....	32
Pescok-Meehan Co.....	48
Perkins St. Nurseries.....	31
Piersou, A. N.....	31
Pierson F. R. Co.....	40
Pierson, Bar Co.....	47
Pillbury L.....	30
Poehlmanu Bros. Co.....	48
Pratt B. G. Co.....	57
Quaker City Machine Co.....	59
Kaynor John I.....	50
Reed & Keller.....	50
Reinberg Peter.....	48
Reuter S. J. & Son Inc.....	30
Revere Rubber Co.....	58
Rice Bros.....	48
Richards Bros.....	48
Robinson H. M. & Co.....	48
Rock Wm. L. Flo. Co.....	46
Roehrs Julius Co.....	37-41
Roper Albert.....	48
Roland, Thomas.....	41
Rolker August & Sons.....	56
Rose Hill Nurseries.....	41
Saltford Geo.....	50
Sander & Son.....	41
Schulz Jacob.....	47
Scott, John.....	31
Sharp, Partridge & Co.....	58
Sheridan W. F.....	50
Siggers & Siggers.....	50
Simpson Robt.....	49
Situations & Wants.....	56
Slian B. S.....	50
Smith Elmer D. & Co.....	31
Smyth Wm J.....	46
Standard Plate Glass Co.....	58
Stearns A. T. Lumber Co.....	50
Stump & Walter Co.....	57
Sunlight Double Glass Sash Co.....	58
Tailby.....	47
Thorburn J. M. & Co.....	45
Tony Chas.....	31
Tracandy & Schenck.....	50
Trepel C. C.....	46
Twomey D. J.....	52
Valentine, J. A.....	40
Vincent R. Jr. & Sons.....	30
Waban Rose Coaservatories.....	32
Ward R. M. & Co.....	41-44
Waterer John & Sons.....	32
Weber E. C.....	46
Webb Bros.....	48
Whitely Footery Co.....	56
Weston H.....	31
Wilson.....	46
Wilson Plant Oil & Fertilizer Co.....	57
Winterson, E. F. Co.....	48
Witthold Geo. Co.....	31
Wood Bros.....	30
Woodrow Sam'l A.....	51
Yokohama Nursery Co.....	41
Young A. L.....	51
Young John.....	59
Young, Thos. Jr.....	46
Young & Nugent.....	46
Zinn Julius A.....	47
Zvolnack A. C.....	45

The Lauten Fumigator

(PATENTED)
Write for Prices and Particulars.

TOBACCO STEMS, 75¢ PER CWT.



Burns Tobacco Stems, the cheapest and most effective fumigating medium yet found.

Costs no more than one box Tobacco Paper and will last a lifetime.

Will not blaze or emit any foreign gases.

Will not discolor or cripple flowers.

Is easy to handle and there is no danger of fire in using.

Will burn 5 or 6 hours without attention.

Will exterminate aphids absolutely with one operation.

Write for prices of all Supplies for the Grower

WILSON PLANT OIL & FERTILIZER CO. CHATHAM
New Jersey

For Trees, Plants, Shrubs and Flowers

— USE —

THE NIAGARA BRAND LIME SULPHUR SOLUTION

It destroys Scale Lice, Spiders and all forms of Aphids, AT THE SAME TIME Mildew, Blight, Rust and other Fungus difficulties.

Used in Winter or Summer — No other remedy has been so universally effective.

Niagara Brand ARSENATE OF LEAD for chewing insects is equal to the best and better than the most.

Ask about our Green House strayer. Address —

NIAGARA SPRAYER CO., - - Middleport, N. Y.

"SCALECIDE"

TRADE MARK REG. U. S. PAT. OFF.

Will positively destroy SAN JOE SCALE and all soft bodied sucking insects without injury to the tree. Simple, more effective — and cheaper than lime sulphur. Not an experiment.

Write for FREE sample and endorsement of fruit growers and entomologists who have used it for years.

Prices: 5-gal. bbl., \$25.00; 3-gal. tin, \$15.00; 10-gal. can \$6.00; 5-gal. can, \$3.25; 1-gal. can, \$1.00, f. o. b. New York. One gallon makes 16 to 21 gallons spray by simply adding water.

* Pocket Diary and Spray Calendar for 1909 sent FREE. Mention this paper.*

B. G. PRATT CO., Mfg. Chemists, 50 Church St., Dept. W, NEW YORK CITY.



The Best Bug Killer and Bloom Saver

For PROOF Write to

P. R. Palethorpe Co.
OWENSBORO, KY.

DON'T EXPERIMENT

USE

TO-BAK-INE

and your stock will be free from insects, clean, and the blooms will not be discolored.

Send for full information of

H. E. FISKE SEED CO.
13 Faneuil Hall Sq., Boston, Mass.

STUMPP & WALTER CO.,
50 Barclay St., New York.

HENRY F. MICHELL & CO.,
1018 Market St., Philadelphia.

E. H. HUNT, Gen'l Agent,
76-78 Wabash Ave., Chicago.

KILMDEAD TOBACCO DUST

Free from Sand or Dirt Kind FOR FUMIGATING AND DUSTING

Dusted on Plants it covers large surface. One Quality for Both Uses.

Our Tobacco Dust is the pure tobacco, free from sand and dirt strong in Nicotidene and always of the same strength, making it superior to any dust on the market. Costs you no more than the ordinary product and will do twice the work. 10 lbs. 60¢; 25 lbs. \$1.25; 50 lbs. \$2.00; 100 lbs. \$3.50.

STUMPP & WALTER CO.
50 Barclay St., New York

Prices Quoted in these Columns are for Dealers Only. When Writing to Advertisers Please Mention HORTICULTURE.

IS YOUR NAME IN THE ABOVE LIST? IF NOT, WHY NOT?

"REVERO"

Braided Moulded Construction—Seamless Throughout

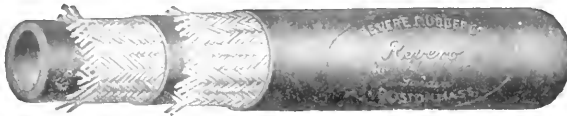

LIGHT -- STRONG -- FLEXIBLE

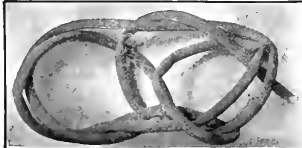

The above cuts represent the non-kinking tendency of Revere as compared with the old style hose of wrapped duck construction.

Revere is Furnished on Reels in Continuous Lengths up to 500 feet.

Revere Rubber Company, BOSTON, MASS.

NEW YORK PHILADELPHIA PITTSBURG CHICAGO
NEW ORLEANS MINNEAPOLIS SAN FRANCISCO PORTLAND, ORE.

SUNLIGHT
DOUBLE-GLASS
SASH PATENTED

FOR
HOT-BEDS
AND COLD FRAMES

ADDRESS:
Sunlight Double-Glass Sash Company
325 East Broadway LOUISVILLE, KY.

The double layer of glass does it

Lets in the light always. Never has to be covered or uncovered; no boards or mats needed. Retains the heat, excludes the cold. Makes stronger and earlier plants. Glass slips in; no putty; cannot work loose; easily repaired. Ask for catalog W. It tells all about Sunlight sash. Special catalog for greenhouse material.

STANDARD PLATE GLASS CO.

Manufacturers—Importers—Jobbers

NOW IS THE TIME TO BUY

FRENCH OR AMERICAN GREENHOUSE GLASS

LOWEST PRICES ON REQUEST

26-30 Sudbury St. BOSTON, MASS. 61-63 Portland St.

GLASS Always Write Us Before Buying
SHARP, PARTRIDGE & CO.
22nd and Lumber Streets, CHICAGO
WE HAVE SOME SNAPS

TO BUYERS

Patronize our advertisers. they will treat you right

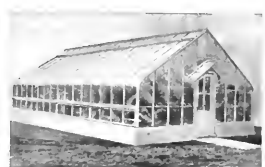

The "T" Bar Curved Eave Greenhouse

Is absolutely Dripless, glass rests on Wood, reducing breakage and condensation, less wood than any other construction, wood all exposed— all steel inside, all wood outside.

Greenhouses of Every Type

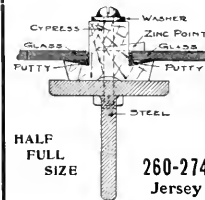

JOHN A. PAYNE

Greenhouse Designer and Builder

260-274 Culver Ave. Jersey City, N. J.

CYPRESS SASH BARS 82 feet or longer

HOT BED SASH
PECKY CYPRESS BENCH LUMBER

GREENHOUSES

ERECTED AND EQUIPPED COMPLETE IF DESIRED

Write for Circular "D" and Prices

The A. T. STEARNS LUMBER CO. NEPONSET, BOSTON, MASS.

Holds Glass Firmly See the Point **PEERLESS** FULL SIZE N° 2

Glazing Points are the best. No rights or lefts. Box of 1,000 points 75 cents, postpaid.
HENRY A. DREER,
114 Chestnut St., Phila., Pa.

BOSTON PLATE & WINDOW GLASS CO.

GREENHOUSE GLASS

German and American

261 to 287 A St. Poston 20-22 Canal St.

GREENHOUSES BUILDING OR CONTEMPLATED.

Warrensburg, Mo.—E. Markey, one house.

Mantua, N. J.—W. P. Carre, range of houses.

St. Louis, Mo.—Board of Education, two houses.

Ashtabula, O.—Knapp & Fisher, range of houses.

Winchester, Ky.—J. W. Shearer, two houses, 32 x 200.

Grand Rapids, Mich.—W. C. Cukerski, range of houses.

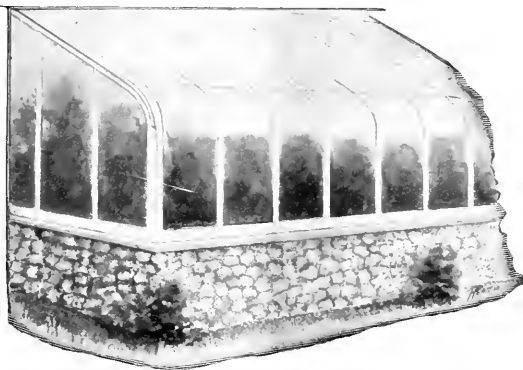

Why My New Curved Iceless Eave is Far Superior to Anything on the Market Today

- 1st. No sash bars incased in iron, thereby eliminating all danger of bars decaying.
- 2nd. Can be used in conjunction with iron frame construction, thereby doing away with that very objectionable feature, "columns."
- 3rd. Roof bars with drip grooves, which act as conductors to carry away the condensation: Result, the driest roof ever used for greenhouse purposes.
- 4th. **THE MOST IMPORTANT OF THEM ALL.** The very small increase in cost over the ordinary style of construction which makes it possible to be used for commercial as well as private purposes.

William H. Lutton, Horticultural Architect and Builder
West Side Ave Station (C.R.R. of N.J.) Jersey City, N.J.

KROESCHELL BOILER



MADE OF FIRE BOX FLANGE PLATE
Can not Crack

Water Space in Front, Sides and Back
The Most Popular Boiler Made
SEND FOR CATALOGUE.

KROESCHELL BROS. CO.
35 Erie Street, CHICAGO, ILL.

THE FOLEY MFG. CO.

CHICAGO

Completely equipped with up-to-date machinery for the making of material for

GREENHOUSE CONSTRUCTION

From a Full Supply of Thoroughly Seasoned Lumber

Send your sketches to our draughtsmen for completion and suggestion. Permit us to figure your proposed work, large or small.

We guarantee our prices will save you money
FOLEY VENTILATING APPARATUS IS THE BEST
Is Simple in Erecting. Is Easiest of Operation. It Will Last a Lifetime. Its Price is the Lowest. Will Ventilate Any Size House. Prices and Circulars on Application.
Our 1908 Catalogue Greenhouse Material Sent Postpaid on Request.

THE FOLEY MFG. CO., WESTERN AVENUE
25th and 26th STS., CHICAGO



The Advance Ventilating Apparatus

You run no risk in buying our machines as we guarantee satisfaction or no sale. Get our new circular, take note of the many good and practical things we have for the florists, scan our net prices and compare same with others and remember that we dare any other line to give you as good, as long and as easy service as we will.

The Advance Co.
RICHMOND, IND.

IRON PIPE

SECOND HAND

WROUGHT IRON PIPE, for Steam, Water, Gas or Oil, Fences or Posts.
All Sizes. Price Low.

GEO. B. DOANE & SON
18 Midway Street, BOSTON
Telephone, Main 4419

PATENTS

Trademarks and Copyrights

Send your business direct to Washington. Saves time and insures better service. Personal attention guaranteed. Twenty-five years' active service. SPECIALTY: "Working on the Failure of Others."

SIGGERS & SIGGERS

PATENT LAWYERS

Box 9, National Union Building
Washington, D. C.

GREENHOUSE CONSTRUCTION LUMBER

John C. Moninger Co.

117 E. Blackhawk St., CHICAGO.

Look through the Buyers' Directory and Ready Reference Guide. You will find some good offers there also.

EVERYTHING FOR GREENHOUSE BUILDING

WRITE FOR INFORMATION AND PRICES

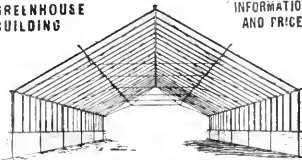

King Greenhouses. King Gutters and Eave. Trussed Roofs. Ventilating Machinery. Trussed Iron Frame Hones. Tile Benche and Pipe Hangers.

KING CONSTRUCTION COMPANY
NORTH TONAWANDA, N. Y.

Evans 20th Century Arm
Will not twist the shafting pipe. Three times the power of old style elbow arms. Sold only with Evans Challenge Machine.
Write for free Catalogue to
QUAKER CITY MACHINE CO.
Richmond, Ind.

The FLORISTS' HALL ASSOCIATION OF AMERICA, insurer of 29,000,000 sq. ft. of glass. For particulars address
John C. Esler, Sec'y, Saddle River, N. J.



THE TEST PRACTICAL

The practical part is this: to manufacture materials only, is one thing, but to prove their defects by erecting them ALSO, is quite another. We both manufacture and erect our own materials, which gives us every chance to see defects and make improvements. The question is do you or do you not want the up-to-date enduring construction? If you do, then get into communication with us.

Send at once for Half Iron Frame Circular.

Hitchings & Company
1170 Broadway New York



We Intended That Every One of You Should have a Handy Hand-Book

— we printed enough for every grower in the United States and Canada

Those who have it write that "it is invaluable to them as a reference book."

If you haven't one, it looks as if it were up to you to send for it. It is free

Lord & Burnham Co.

Main Sales Office: 1133 BROADWAY, N.Y.

BOSTON: 819 Tremont Building. PHILADELPHIA: 1215 Filbert St.



WHY THE U-BAR WAS CHOSEN HERE

The owner lives in a large city where space is both valuable and limited. He wanted a house that would fit attractively in this limited space. The many nearby buildings shutting off the light made it absolutely imperative that it should be the lightest possible construction in order to secure best growing results. For these reasons he chose the U-Bar. Is he satisfied? Well, his neighbor recently built one too, and you know neighbors talk things over. You better send for our catalog.

U-BAR GREENHOUSES

PIERSON



U-BAR CO.

DESIGNERS AND BUILDERS

1 MADISON AVE., NEW YORK

HORTICULTURE

Vol. IX.

JANUARY 16, 1909

No. 3



BEGONIA GLOIRE DE LORRAINE
As Grown in England.

*Devoted to the
FLORIST, PLANTSMAN,
LANDSCAPE GARDENER,
and
Kindred Interests*

*Published
EVERY SATURDAY
At 11 Hamilton Place,
BOSTON, MASS.
Subscription, \$1.00*

CARNATIONS ROOTED CUTTINGS

NEW INTRODUCTIONS

Mrs. Chas. Knopf, light pink } <i>Knopf</i>	Per 100	Per 1000
Ruby, Crimson		
Georgia, white } <i>Cockcroft</i>		
Mrs. J. C. Vaughan, white } <i>Rudd</i>	\$12.00	\$100.00
Bay State, variegated } <i>Roper</i>		
Pink Delight } <i>Dorner</i>		
Wanoka, crimson } <i>Wanoka Greenhouses</i>		
Apple Blossom, white light pink marking } <i>Wanoka Greenhouses</i>		
O. P. Bassett, scarlet } <i>Bassett & Washburn</i>	Per 100	Per 1000
	\$8.00	\$60.00

Standard Varieties

One Hundred Thousand Cuttings selected strong stock ready to ship

"WHITE"		"PINK"			
	per 100	per 1000			
Sarah Hill.....	\$6.00	\$50.00	Splendor.....	\$6.00	\$50.00
Pres. Seelye.....	6.00	50.00	After Glow.....	6.00	50.00
Lloyd.....	5.00	40.00	Winona.....	6.00	50.00
White Enchantress.....	3.50	30.00	Lawson Enchantress.....	5.50	50.00
White Perflection.....	2.50	20.00	".....	4.00	35.00
			".....	3.50	30.00
			".....	3.50	30.00
			".....	2.50	20.00
			".....	2.50	20.00
			".....	2.50	20.00
			".....	2.50	20.00
			".....	2.50	20.00
			".....	2.50	20.00

CHRYSANTHEMUMS

Golden Glow, 2 1/2 in. pots, ready for shift, \$6.00 per hundred. Rooted Cuttings, selection of forty varieties, the cream of the commercial sorts. Write for list and prices.

NEW ROSE MY MARYLAND

Grafted, 2 1/2 in. pots, \$20.00 per hundred, \$150.00 per thousand; Own Roots, 2 1/2 in. pots, \$10.00 per hundred, \$90.00 per thousand.
ORDERS BOOKED NOW FOR THIS MOST PROMISING VARIETY.

S. J. Reuter & Son, Inc., WESTERLY, R. I.

The two novelties, Mrs. Chas. Knopf and Ruby give great promises as commercial varieties. Both are free producers. We have them both growing side by side with the standard sorts and they have demonstrated now that they are here to stay. Mrs. Chas. Knopf is at this time especially good being larger and of better form and color than Enchantress. Ruby is a very large, perfectly formed flower with excellent stem and it has a good crimson shade not too dark.

BAY STATE

Orders for January Delivery are being rapidly booked. If you want to get in on the ground floor with this noblest of all the new carnations place your order at once.

Rooted Cuttings, \$12.00 per 100, \$100.00 per 1000

ALBERT ROPER, Tewkesbury, Mass.

NEW RED CARNATION O. P. BASSETT

Extra Large Bright Red Free Bloomer

Rooted Cuttings, per 1000, \$60.00 | Rooted Cuttings, per 100, \$8.00 | Rooted Cuttings, per 25, \$2.50
per 500, \$35.00 | " " per 50, 4.50 | " " per 12, 1.50

Ready for delivery Jan. 1st, '09 by the Originators and Growers

BASSETT & WASHBURN, HINSDALE, ILL

Send for our Preliminary List describing and quoting Chrysanthemums and Carnations.
A fine lot of Carnation Cuttings ready now.

THE E. G. HILL CO., RICHMOND, INDIANA

CARNATION CUTTINGS

We offer choice varieties for January and later shipments.

	Per 100	Per 1000
Enchantress.....	\$2.50	\$20.00
White do.....	3.50	30.00
Rose Pink do.....	2.50	20.00
White Perflection.....	2.50	20.00
Winsor.....	3.50	30.00
Melody.....	2.50	20.00
Beacon.....	3.50	30.00
Victory.....	3.50	30.00
Aristocrat.....	3.50	30.00
Splendor.....	6.00	50.00
Vesper.....	3.50	30.00
White Lawson.....	2.50	20.00

EAST SUDBURY GREENHOUSES, Carnation Specialists

P. O. Address South Sudbury, Mass. Telephone So. Sudbury 20.

Rooted Carnation Cuttings

A Selection from 20 Sorts.
(For Early January Delivery, and Later) Every one Reliable.

		100	1000
White	W. Perflection	\$3.00	\$25.00
Red	Beacon	4.00	35.00
Light Pink	Enchantress	3.00	25.00
	Melody	3.00	25.00
Medium Pink	Winsor	3.00	25.00
	Winona	6.00	50.00
Dark Pink	Rose Enchantress	3.00	25.00
	Splendor	6.00	50.00
Variegated	Viola Sinclair	6.00	50.00
	Var. Lawson	3.00	25.00
Crimson	Octorson	3.00	25.00

PETER FISHER, - Ellis, Mass.

ROOTED CARNATION CUTTINGS

Ready for Immediate delivery. Per 100 Per 1000

Andrew Carnegie, scarlet.....	\$6	\$60
Splendor, pink, Scott Shade.....	6	50
Lawson-Enchantress, cerise pink.....	6	50
Sarah Hill, white.....	6	50
Pres. Seelye.....	6	50
Defiance, scarlet.....	6	50
Aristocrat, beautiful cerise.....	4	35
White Enchantress.....	4	35
Beacon, scarlet.....	3	25
Winsor, pink.....	3	25
Enchantress, light.....	3	25
White Perflection.....	3	25
Rose Pink Enchantress.....	3	25
Daybreak Lawson, light pink.....	3	25
Victory, scarlet.....	3	25
Welcome, pink.....	3	25

Chicago Carnation Co. A. T. Pyper, Mgr., Joliet, Ill.

CARNATIONS Rooted Cuttings Fine Healthy Stock

	Per 100	Per 1000
Pres. Seelye	\$6.00	\$50.00
White Enchantress, Beacon	3.50	30.00
Victory, Winsor, Melody, Kingston Pet	3.00	25.00
Daheim, Enchantress, Lady Houghton, Tris Lawson, White Lawson, Red Lawson, Variegated Lawson	2.50	20.00

WOOD BROTHERS FISHKILL, N. Y.

MARCHIONESS

The Money Making White Carnation \$10.00 per 100; \$80.00 per 1000

Orders Filled Strictly in Rotation
BELLAMY BROS.

Successors to L. E. Marchioness SYRACUSE N. Y.

In writing to Advertisers kindly mention Horticulture

Dreer's Special Offer of Kentias

The Stock here offered is all of exceptional good value.

Kentia Belmoreana.

	Per doz.	Per 100	Per 1000
2 1/2 in. pots, 4 leaves, 8 to 10 inches high	\$1.50	\$10.00	\$90.00
3 " " 5 " 12 " " " " " "	2.00	15.00	140.00
6 " " 6 " " 20 to 24 " " " " " "	1.00 each.		
6 " " 6 to 7 " " 25 to 28 " " " " " "	1.50 "		
6 " " 6 to 7 " " 32 to 34 " " " " " "	2.50 "		
11-in. tubs, 7 to 8 " " 6 ft. high, very stocky	\$20.00 each.		
11 " " 8 to 9 " " 7 to 8 " " " " " "	35.00 "		
11 " " 8 to 9 " " 8 " " " " " "	50.00 "		

The three named sizes are exceptionally handsome specimens.

Kentia Forsteriana.

	Per doz.	Per 100	Per 1000
2 1/2 inch pots, 4 leaves, 8 to 10 inches high	\$2.00	\$15 00	\$140 00
3 " " 5 to 6 " " 15 " " " " " "	2.50	20.00	175.00
4 " " 5 to 6 " " 15 " " " " " "	3.00	20.00	175.00
6 " " 6 " " 28 to 30 " " " " " "	1.00 each.		
6 " " 6 " " 34 to 36 " " " " " "	1.50 "		
7 " " 6 to 7 " " 36 to 40 " " " " " "	2.50 "		
7 " " 7 " " 38 to 40 " " " " " "	3.00 "		
8-inch tubs, 6 to 7 " " 42 to 44 " " " " " "	4.00 "		
9 " " 6 to 7 " " 5 1/2 feet " " " " " "	8.00 "		
10 " " 6 to 7 " " 6 " " " " " "	10.00 "		
12 " " 6 to 7 " " 8 to 9 " " " " " "	19.50 "		
12 " " 7 " " 6 to 7 " " " " " "	20.00 "		

Kentia Forsteriana— Made-up Plants.

	High	Each	High	Each
7-in. tubs, 3 plants in a tub	34 to 36-in.	\$2.50	8-in. tubs, 3 plants in a tub	42 to 48-in.
7 " " 3 " " "	36 to 38-in.	3.00	6-ft.	15.00
8 " " 3 " " "	42 to 48-in.	4.00	8-ft.	17.50

The two latter sizes are excellent values for decorative purposes.

Kentia Sanderiana.

This is a very graceful hardy Palm of fine decorative appearance which should prove a popular variety. We offer fine bushy made up plants.
4-inch pots, 3 plants in a pot, 12 to 18 inches high\$0.75 each.
5 " " 3 " " " 18 to 20 " " " " " " 1.00 "



For a full line of DECORATIVE PLANTS and all other seasonable stock, see our new wholesale list issued January 1st.

HENRY A. DREER, - - **Philadelphia, Penna.**

DECORATIVE PLANTS

Araucaria Excelsa, Pandanus Utilis, Dracaena Indivisa, Kentias, Latanias, Arecas, Etc. Perennials and Shrubs.

4 inch Araucarias.....50 cents each. 6 inch Araucarias.....\$1.00 each.
5 " " " " 75 " " " " 7 " " " " \$1.25 and \$1.50

FERNS FOR DISHES—\$3.50 per 100, \$30.00 per 1000.
SEND FOR OUR PRICE LIST. WE HAVE A COMPLETE STOCK.

The Geo. Witthold Co.

1657 Buckingham Place, Chicago, Ill.

BARAINS

in KENTIAS and other Decorative Plants, all sizes. Also the following at Lowest Import Prices. 15,000 Azaleas, best commercial varieties, from \$25.00 per 100 to \$2.00 each. A fine lot of Rubbers, Crotons, Araucarias, Pandanus, Asparagus plumosus and Sprengerii.

SMALL FERNS for table decorative purposes at lowest wholesale rates.

A. LEUTHY & CO.,
Perkins St Nurseries ROSLIND LE, MASS.

FERNS FOR DISHES,

Assorted Varieties
From 2 inch pots, \$3.50 per 100; \$30.00 per 1000

CASH WITH ORDER
2570 to 2606 W. Adams St., Chicago, Ill.

FRANK OECHSLIN

GOLDEN GLOW

THE BEST EARLY CHRYSANTHEMUM
Can be Cut by Aug. 15th
Plants From 2 1-4 in. Pots Now Ready
\$6.00 per 100, \$50.00 per 1000

S. J. GODDARD
FRAMINGHAM, - MASS.

NEW CARNATION PINK DELIGHT

Waxy Shell Pink. A Grower's and Shipper's favorite. Has a holding color, keeps well, comes on long stems and is early, very free and continuous flowering.
January delivery, \$12.00 per 100; \$100.00 per 1000.
F. Dorner & Sons Co., La Fayette, Ind.

HEACOCK'S PALMS
Kentia Belmoreana
7-inch pots.....32 to 34 inches high.....\$2.50 each
7-inch pots.....36 to 38 inches high.....3.00 " "
9-inch tubs.....42 to 48 inches high.....5.00 "
Made up Kentia Forsteriana
7-inch pots.....34 to 36 inches high.....\$2.50 each
7-inch pots.....36 to 38 inches high.....3.00 "
9-inch tub.....42 to 48 inches high.....5.00 "
Joseph Heacock Co., Wyncote, Pa.

PALMS AND FERNS
DECORATIVE PLANTS
JOHN SCOTT
Rutland Road and E. 45th St.
Tel. 2890 Bedford **BROOKLYN, N. Y.**

CHAS. H. TOTT
Chrysanthemums
MADISON, N. J.

NEP. WHITMANI
2 1/4 in., \$5.00 per 100
NEP. WHITMANI
3 1/2 in., \$25.00 per 100
BOSTON FERNS
2 1/4 in., \$3.00 per 100

H. H. BARROWS & SON, Whitman, Mass.

FERNS

In fine assortment, good bushy stock, 2 1/4 in. \$3.00 per 100. Kentias for centers, 10c. each. Boston, Scottii and Whitmanii ferns, 6 in 40c.; 4 in 15c. Kentia Belmoreana, 5 in. 50c., 7 1/2c. each.
H. WESTON, HEMPSTEAD, N. Y.

A. N. PIERSON, Inc.
CROMWELL, CONN.
Wholesale Growers of Cut Flowers, Palms and Ferns
OUR SPECIALTIES. Roses, Lily of the Valley and Carnations. We also grow a general assortment of flowers in their season

IF YOU GROW ROSES

You Must Have

White Killarney

Also OUR Stock

WABAN ROSE CONSERVATORIES

NATICK, MASS.

Newport Fairy

The Rose of the Future For
In and Out Door.

FINE, STRONG, FIELD-GROWN STOCK

3-4 Shoots 3-4 ft. long

50c each, \$30 per 100, \$250 per 1000

JULIUS ROEHRS CO.

RUTHERFORD, N. J.

Hardy Rhododendrons, Azaleas, Conifers, Clematis, H. P. Roses, Shrubs and Herbaceous Plants from our **HOLLAND NURSERIES**

Prices Moderate

P. OUWERKERK, 216 Jane St., Weehawken Heights
P. O. No. 1, Hoboken, N. J.

GLEARY'S HORTICULTURAL CO.

Management **AMBROSE T. GLEARY**

Wholesale Contracting, Jobbing, Auction
HORTICULTURAL PRODUCTS

of every description.

Consignments Received. Surplus Stock Converted
62 Vesey St., NEW YORK

Box Trees

and other **EVERGREENS** for **Tubs** and **Boxes**
Our Prices are Always Right—Catalog Free
THE NEW ENGLAND NURSERIES, Inc.
BEDFORD, MASS.

THE PRIZE WINNING STRAWBERRY

The Barrymore

Send for Folder at Once.

H. L. CRANE, Originator,
Westwood, Mass.

**PEACOCK'S
NEW DAHLIAS**

SEND FOR LIST

PEACOCK DAHLIA FARMS
Williamstown Junction, N. J.

DAHLIAS. Now is the time to place your order for bulbs which will insure you getting named varieties in any quantity: prompt delivery.

DAVID HERBERT & SON,
Successors to L. K. Peacock, Inc.
ATCO, N. J.

The Northboro Dahlia and Gladiolus Gardens

Offer for Spring 1909

300 selected varieties of Dahlias and one and one half million large-flowering Gladioli in mixtures, in lots to suit. Send list of your wants. Catalogue free.

J. L. MOORE, Northboro, Mass.

BARGAINS in **TREES** and **PLANTS**

Concord Grapes, \$2.00. Peach, \$3.00 per 100.

List Free. **D. J. TWOMEY, Dept. H, Geneva, N. Y.**

**RHODODENDRONS, ANDROMEDAS, KALMIAS
AND SPECIMEN EVERGREENS**

JOHN WATERER & SONS, LD.

AMERICAN NURSERY

BAGSHOT, - - - ENGLAND

CHRYSANTHEMUMS

We have mailed our Catalogue for 1909 to our customers. If not received promptly please notify.

Every Chrysanthemum grower should have a copy. It is the most complete issued in this Country, either as to Novelties or Standard varieties.

Also a very Complete list of the best **ASTER SEEDS** for Florists use.

Free on Application.

ELMER D. SMITH & CO., - - Adrian, Mich.

TREES, EVERGREENS, SHRUBS, VINES, PERENNIAL PLANTS, FRUITS, TRAINED FRUIT TREES, FOREIGN GRAPE VINES, HARDY RHODODENDRONS and R. MAXIMUM in quantity, per hundred or per thousand, very fine. Complete assortments: Careful grading: Low prices.

AMERICAN NURSERY COMPANY,
Sales Department, - - - 150 BROADWAY, NEW YORK CITY.
BLOODGOOD NURSERIES DEPT., - - - Flushing, Long Island.
F. & F. NURSERIES DEPT., - - - Springfield, New Jersey.

ROBERT CRAIG CO.

ROSES, PALMS,

and Novelties in Decorative Plants

MARKET and 49th STREETS., PHILADELPHIA, PA.

Established 40 Years

Rose Hill Nurseries

New and Rare Plants

NEW ROCHELLE, N. Y.

New York Office, Siebrecht Building, 425 Fifth Avenue

In ordering goods please add "I saw it in HORTICULTURE."

ROSES

We have a fine stock of large, dormant field-grown plants, on own roots, including **Crimson Rambler**, **Borothy Perkins**, **Cllo**, **Alfred Colomb**, **Francis Levet**, **Jack**, **Prince Camille de Rohan**, **Magnus Charta**, **Ulrich Bruner**, **Giant of Battles**, and many others at \$16.00 per hundred; \$150.00 per thousand. Send for list. - **Roses, Dahlias and Camas a specialty.**

THE DINGEE & CONARD CO., W. Gr. ve. Pa.

HEADQUARTERS FOR

Araucaria Excelsa, 6 in pots, 5 6 tiers, 75c, \$1, \$1.25;
Robusta Compacta and **glauca**, 30 to 30 in. high, \$1.50, \$2.00. **Ficus elastica**, 5 1/2 in., 25c, 35c, 50c.
Kentia Belmoreana, 4 to 5 1/2 in., 35c, 50c, 60c.
Forsteriana, 5 to 6 in., 50c, 60c, 75c, \$1.00, \$1.25, \$1.50.
Boston, **Scottland** and **Whitmanii Ferns**, 6 to 7 in. pots, 50c, 75c, \$1.00, \$1.50. **Amerpobill**, 5 1/2 in., 35c, 50c.
Azalea Apollo in bloom, 75c, \$1.00.
Cineraria Hybrida for Easter, 3 in., 5c, 6 in., 25c.

GODFREY ASCHMANN

1012 W. Ontario St., PHILADELPHIA, PA.

Roses Under Glass

PROPAGATION

Before filling in the sand, the propagating bench should be thoroughly overhauled and repaired. Spaces between the boards and places where the sand is likely to run through should be covered with thin strips of wool—laths, for instance, or caulked firmly with sphagnum. See that the pipes underneath the bench are in good condition as it is of utmost importance that a uniform temperature be maintained during the entire period of root formation.

Sand for roses should be clean and sharp, not too gritty, and free from any decomposing matter. Some growers prefer to sterilize their sand, but with proper care good results are obtainable from the ordinary material. When the bench is filled moisten the sand well and pound it down firm leaving a depth of about four inches.

CUTTINGS

About the style of cuttings so much has been said that there remains very little to be added. A good sized cutting with three or four eyes seems to have become generally adopted, and as, in these push-and-go-ahead days the desire is for a large plant in the shortest possible time, the medium is perhaps the best that could be employed.

In making the cutting use a sharp knife and cut clean and short, almost straight across, as the smaller the wound the quicker will be the healing process and more uniform the arrangement of the young roots. Keep the wood and cuttings well moistened until the cuttings are placed in the sand.

About 1 inch apart in the row and from two to three inches—as size of cuttings suggests—between the rows will be close enough to place the cuttings. Overcrowding is often the cause of many of the cuttings decaying in the sand, and should by all means be avoided. As soon as a batch is inserted in the sand they should be given a thorough watering and, if necessary, shaded.

TEMPERATURE

The temperature at which to maintain the sand is rather an open question as some of the new varieties of roses do not take kindly to the treatment bestowed on Chateauy or Richmond, for instance. Most of the older varieties strike well in a sand temperature of 62 degrees with the house at 52 to 54 degrees, but until we have learned a little more about the habits of the new roses we cannot say with any degree of certainty that this temperature is suited to them.

SPRAYING AND WATERING

Spray the cuttings frequently during bright weather, as the moisture on the foliage is a great factor in helping to produce a good and uniform strike. The cuttings are very sensitive to erratic watering, therefore a careful examination of the sand previous to the performance of this duty becomes absolutely necessary. Leaves which may fall from the cuttings should be re-

moved as soon as they are noticed. If allowed to remain, a fungus growth quickly forms on them which, spreading itself to the cuttings depletes their number in an incredibly short time. Constant care and proper treatment alone are contributable to the propagator's success in bringing out a goodly percentage of well-rooted cuttings.

J. E. Simpson

Lorraine Begonias

The illustration shown on the cover page will give readers of HORTICULTURE a fair idea as to how the society ladies of England like their greenhouse arranged. In the house illustrated there were somewhere over a thousand large plants used, besides hundreds of hanging baskets. Nothing but the pink Lorraine was used, and needless for me to say the effect was simply bewildering to those who saw it for the first time. This style of showhouse within recent years has become remarkably popular in England. I am not quite sure but I think that it was the late Baron Rothschilds who first started the craze of devoting long ranges of glass to one particular kind of flower. At Waddeson Manor, Buckinghamshire, one of the most up-to-date private establishments in Britain, many original ideas of this kind were carried out, and here it was where the all one color idea got its start.

I remember visiting a large establishment in the south of England a few years ago, where over three thousand Lorraines were grown for show purposes alone. A long range of five houses were entirely given up to them and as usual the roof was completely hidden with hanging baskets. It was there where I first saw the mirror arrangement done to perfection. All the doors and partitions of the houses were made so that they could be removed when the begonias were brought indoors, and at the extreme end of the range a clever arrangement of mirrors gave one the impression of an endless house of begonias. So cleverly were the mirrors arranged and so perfect the deception that the visitor's reflection did not appear on the glass until he was within two or three yards from it.

A show house of this description might to some appear to be too much of one thing to be appreciated, but somehow I think that a range of glass in a public garden or park arranged in this fashion would draw more people in a week and interest them more than the choicest collection of plants would draw in a year. The idea is worth the consideration of some of our philanthropists.

Wm. W. Brown

North Easton, Mass.

HORTICULTURE

VOL. IX

JANUARY 16, 1909

NO. 3

PUBLISHED WEEKLY BY

HORTICULTURE PUBLISHING CO.
 11 Hamilton Place, Boston, Mass.

Telephone, Oxford 392

WM. J. STEWART, Editor and Manager

SUBSCRIPTION PRICE

One Year, in advance, \$1.00; To Foreign Countries, 1.00; To Canada, \$1.50

ADVERTISING RATES

 Per Inch, 30 inches to page \$1.00.
 Discounts on Contracts for consecutive insertions, as follows:
 One month (4 times) 5 per cent.; three months (12 times) 10 per cent.;
 six months (16 times) 20 per cent.; one year (52 times) 30 per cent.
 Page and half page spaces, special rates on application.

 Entered as second-class matter December 8, 1904, at the Post Office at Boston, Mass.,
 under the Act of Congress of March 3, 1879.

CONTENTS

	Page
COVER ILLUSTRATION—Begonia Gloire de Lorraine in England.....	65
ROSES UNDER GLASS—J. E. Simpson.....	65
LORRAINE BEGONIAS—Wm. McM. Brown.....	67
PERPETUAL FLOWERING CARNATION SOCIETY—C. Harman Payne.....	67
PROMOTING ROOT GROWTH IN ROOT CROPS.....	67
NEWS OF THE CLUBS AND SOCIETIES:	
Pittsburgh Florists' and Gardeners' Club—Chicago Florists' Club; George Asmus, Portrait—American Cannaion Society—New Jersey Floricultural Society—Connecticut Horticultural Society.....	68
New York Florists' Club; President Hallock's Beef-steak Dinner, Illustrated—Lenox Horticultural Society.....	69
Gardeners' and Florists' Club of Boston—Club and Society Notes.....	70
Florists' Hail Association.....	71
A WORD FROM THE PRESIDENT OF THE S. A. F.	71
OBITUARY:	
J. T. Montgomery—George Burnham—S. S. Breneman—S. L. Smith—Lewis B. Paine—Robert Smith—Martin Griffin—Carew Sanders.....	70
SEED TRADE:	
Where Reform Is Needed—Thomas L. Brown.....	76
The Western Flower Seed Trade—Samples of Seeds for Department of Agriculture—Notes—Catalogues Received.....	76
SOME INTERESTING CARNATIONS.....	78
FLOWER MARKET REPORTS:	
Boston, Buffalo, Chicago, Indianapolis, Philadelphia, Washington.....	81
New York Market.....	83
MISCELLANEOUS:	
Publications Received.....	67
Our Exchanges.....	67
During Recess: P. F. Kessler, Portrait.....	70
Lonsdale on Hybridization.....	71
An Assignment.....	71
Appraisers' Decisions.....	71
Elm Court Farm Club Room.....	71
News Notes.....	72-83
Patents Granted.....	72
Greenhouses Building or Contemplated.....	72
Incorporated.....	77
Steamer Departures.....	78
Business Changes.....	78
Personal.....	79
New Retail Flower Stores.....	79
Philadelphia Notes.....	81

entire and to all those officially associated with him in the good work to which the national society is committed that his words be given respectful and thoughtful consideration. Furthermore, every individual dependent upon any department of the floricultural industry owes it to himself—even from the most selfish standpoint—to give such aid as he can in the struggle to secure for him relief from burdens which are costing him dearly. "God helps those who help themselves."

Chrysanthemums from seed

We shall not be surprised if within a year or two the offering of carefully fertilized seeds of at least one class of chrysanthemums—the single earlies—should be taken up as a specialty by firms in this country and abroad who have heretofore dealt only in young plants under name. These varieties produce seed in abundance and the raising of plants from seed is simple enough. Chrysanthemum growers are well aware of the fact that plenty of varieties equal in all respects to the named parents can be found in any batch of seedlings from these sorts. This was plainly demonstrated in the chrysanthemum show at Boston last fall when an extensive array of seedlings from W. N. Craig suffered nothing in comparison with the exhibits of the best imported named varieties. As small pot plants to be sold at popular prices, as are Chinese primroses and cinerarias, for instance, the general florist ought to do a big and profitable trade in season with these easily grown subjects.

The flower market

Reports received from the important flower centres indicate the usual reaction and shrinkage of values generally from holiday standard to the scale of prices which were in effect previous to the Christmas activity. An assurance that even these rates would run along without material change until Easter would undoubtedly be hailed with joy by the growers but there is no reason to doubt that the customary slump may be looked for about the time Lent comes in and the plants begin to respond to the warm sun of early spring and consequently much anxiety is now felt over the situation for it is much easier to break prices than to restore them, and it is only natural that solicitude should be expressed as to the duration of the present inactivity and its influence upon the standard of values for the few critical weeks in which lies any hope of reimbursement for the year's labor. Extreme fluctuations are always to be deplored but nobody has yet perfected any practical way to prevent their recurrence in the course of a business dealing with a product not only perishable but uncertain as to supply and demand. While this remains true there will be periods in which the product must be sold below cost and therefore we must also have compensating periods when the goods must return more than a reasonable profit, otherwise disaster is inevitable among the producers.

In his little address to the florists of America which appears in this issue, President Valentine makes a reasonable and well-grounded appeal to the sense and good judgment of the trade. It is due to Mr. Val-

Support
the S. A. F.

PERPETUAL FLOWERING CARNATION SOCIETY.

The fifth show of the above society was held on December 9 in the Royal Horticultural Hall, London, Eng., and a very brilliant display was made. Secretary E. F. Hawes and the officers are to be congratulated on the result. The schedule provided for 28 classes of collections, groups, vases, bouquets and table decorations, most of which were well filled. Section C, open to members, included several prizes presented by American growers, viz.: E. G. Hill, Fred Dornier and the F. R. Pierson Co. New varieties were judged by the Floral Committee on the following scale: Color 20 points, size 20, fragrance 10, substance 10, calyx 5, habit of plant 20, form 15—100. To obtain a first-class certificate, a novelty must obtain 85 points, and 75 for an award of merit.

A gold medal was awarded to Mr. Leopold de Rothschild for a finely flowered collection in pots. The blooms were superb and consisted among many others of Jessica, Eclipse, Beacon, Winsor, Melody, Flamingo, Enchantress, Lady Bountiful, Mrs. M. A. Patten, etc.

Bell & Sheldon had a fine lot—carnations and winter flowering sweet peas. They, too, received a gold medal, having a fine display of unnamed seedlings and beautiful bouquets of Aristocrat, Britania, Beacon, Mrs. H. Burnett, White Perfection and others.

Hugh Low & Co. made a grand display in the middle of the hall with a large circular stand having shelves all around it. Ornamental greenery was interspersed with vases of cut blooms of the best and most up-to-date carnations. Unnamed seedlings were in quantity. Helen Gould, Winsor, Victory, Beacon, Rose Enchantress, Britannia and many more besides.

A gold medal, the first prize in Class 1, was awarded to W. E. Wallace, a fine collection of cut blooms on a table 10 feet by 3 feet.

An imposing lot of Rose Doree was made by Mr. Lancashire, and was awarded a silver medal. There were ten large vases of it, besides several smaller ones. A big bloom and a soft delicate color.

H. Burnett had a large silver medal for a group in great variety. Fortuna, Snowball, Winona, Rose Pink Enchantress and others previously named were shown in large numbers.

A similar award went to Cutbush & Son, whose flowers were staged in tall stands. Jas. Yeitch & Son had a good lot of American sorts. Winona, Melody, Afterglow, Mrs. T. W. Lawson, Winsor were only a few of the most meritorious. They also showed a long group of winter flowering begonias that made a fine array of color.

C. Engelmann also had a large silver medal for carnations. Seedlings in quantity, also My Maryland, Red Lawson, Winona, Andrew Carnegie, Beacon, etc.

Heath & Son showed Yellow Queen and Golden Glory.

A silver medal went to the American Carnation Nursery at Sawbridgeworth for an imposing display of well-grown flowers staged in good form, and including Victory, Boston Market, The Belle, Imperial, Afterglow and all the better known standard kinds.

G. Lange showed a fine lot in vases

and received a large silver medal, as also did John Peed & Son, and C. E. Waters. There were several other exhibitors of rock plants, foliage plants and other things of interest.

C. HARMAN PAYNE.

PUBLICATIONS RECEIVED.

Chrysanthemums. A practical treatise on their propagation, cultivation, training, raising for market, exclusively out of doors in the garden or field. By Dr. J. H. Thomas. Price, 25c.

Bulletin 213 of the New Jersey Agricultural Experiment Stations, by John B. Smith, Sc. D., is a very valuable treatise on Insecticide Materials and Their Application, with Suggestions for Practice. Spraying machinery, nozzles, the various poisons used in the work, analyses of certain proprietary compounds, mineral oils, etc., with directions for their mixture and use for different purposes and kindred topics are well covered, and the pamphlet is a good thing to have handy for reference. We are pleased to see that it has a good word to say for B. G. Pratt Company's Scaicide, a preparation continuously advertised in HORTICULTURE.

The Nineteenth Annual Report of the Missouri Botanical Garden has been received. It is a volume of nearly 300 pages and there are 35 full page plates. Among the valuable botanical contributions is a paper by Prof. C. S. Sargent, describing and classifying one hundred and three species of Crataegus indigenous to Missouri. Nearly one half of the book is devoted to an Ecological Cross Section of the Mississippi River in the Region of St. Louis, a very elaborate production of much scientific interest by Henri Huss. In the report of the Director, Professor William Trelease shows that the institution is being conducted on a high plane of usefulness, and its affairs are prosperous in all departments.

Bulletin 259 of the Department of Horticulture, Cornell University, is devoted to the peony. The author is J. Eliot Coit. The bulletin will be found very valuable as a reference book by peony fanciers. It comprises 80 pages, illustrated with numerous portraits of varieties, giving much information on the history, culture, classification and description of varieties which appear to be fairly authentic as to nomenclature and description. In an introductory note Prof. John Craig intimates that this bulletin is only a beginning of the work contemplated and will be followed by others as fast as definite results are reached. A bibliography of peony literature is included in this number.

The twenty-fourth annual convention report of the Society of American Florists and Ornamental Horticulturists has been received from Secretary Rudd. It is a publication of 276 pages, similar in make-up to the preceding annual reports and containing the proceedings in full of the convention at Niagara Falls last August, reports of State Vice-presidents, Entomologist, Botanist, Pathologist, details of the trade exhibition, bowling contests, etc., with a list of the officers, committees and members, and statistics of mem-

bership. Brief reports of the transactions of the American Carnation Society, American Rose Society, Ladies' Society of American Florists and Florists' Hall Association are also included.

We miss two familiar features of the preceding annual reports—the frontispiece portrait of the president-elect and the list of plant introductions for the year. The reports of entomologist, botanist and pathologist are new and useful features but we believe the list of plant introductions would add value to the volume. The list of members, life and annual, totals 899.

PROMOTING ROOT GROWTH IN ROOT CROPS.

What means have we growers and cultivators by which we can induce or further root-growth in such forms as carrots, parsnips, turnips, beets, ginseng and similar commercial roots?

In a case like any of the above our aim is to get large roots, not taps. What can we do, presuming the crop is worth the effort?

The best means to promote root growth in the crops referred to is to give each plant space enough for the proper development of its root. Given sufficient light and air the nitrogenous food which under crowded conditions produces excessive leaf growth, will be stored up in the roots. In this country we are apt to neglect the thinning of the root crops. In Europe turnips are usually sown in drills two and a half feet apart and the plants thinned to eight inches distant in the drill, by means of a sharp hoe the blade of which is the correct width for the purpose. The result is that the turnip roots usually fill the eight-inch spaces. The same care is bestowed in thinning other root crops such as carrots, parsnips, beets and mangels, giving each sufficient space according to its growth, for full development of the root.

Occasionally an insufficient root-growth may result from acidity of the soil; this may be corrected by a liberal application of air-slacked lime. In most cases, however, it is the result of crowding the plants.

OUR EXCHANGES.

The Long Island Agronomist is sending out as a 1908 year-end supplement a reprint of "Agricultural Enquiries" from Judge Richard Peters' Book, published in 1796.

The Fern Bulletin, quarterly issue for October, 1908, has been received, and we add it with pleasure to our treasury of valuable literature. It is as usual, carefully compiled, and contains a number of interesting scientific contributions from eminent fern students, illustrated with original drawings. It is the official organ of the American Fern Society. Published by Willard N. Crote & Co., Joliet, Ill.

A serviceable little desk tray, for ashes or pins or other odds and ends comes to us with the compliments of W. Atlee Burpee & Co. A medalion in the center shows an ideal musk melon and tells us where to buy "seeds that grow." Burpee has such winning ways.

NEWS OF THE CLUBS AND SOCIETIES

PITTSBURGH FLORISTS' AND GARDENERS' CLUB.

At the regular meeting of the Club on the evening of Jan. 5th about fifty members were in attendance. There was one election to membership, and five nominations. E. Blind and W. A. Clark were appointed to audit the accounts.

The president called attention to the fact that at the Washington convention of the Carnation Society in January, 1908, an invitation had been extended to the Society to hold their next convention in Pittsburgh, in January, 1909, and asked the sentiment of the Club as to inviting the convention for 1910. The sentiment seemed to be wholly favorable, and the secretary was instructed to prepare a letter of invitation.

The nomination of officers for 1909 resulted in the following names being presented: President, F. Barki; vice-president, P. S. Randolph; treasurer, H. L. Blind; secretary, H. P. Joslin; assistant secretary, C. S. Crall; Executive Committee: E. C. Reineman, Jno. L. Wyman and Jno. Badler.

It was Rose Night, with a competitive display by the private gardeners on primulas, cyclamens and roses. R. Pierson Co., sent a large vase of White Killarney, staged by their Mr. Gotheringham, and the S. S. Pennock-Meehan Co., sent roses Mrs. Jardine and My Maryland. The Waban Rose Conservatories sent some magnificent blooms of White Killarney which arrived too late for the meeting but were exhibited next day at the rooms of the Pittsburg Cut Flower Co.

White Killarney was for the first time before our Club and there was universal appreciation of its fine blooms. My Maryland was also new to us, and though Mrs. Jardine is grown here to some extent it had not before been exhibited. Letters from the exhibitors were read in which, for Mrs. Jardine, they claimed that many growers did not handle it properly; that it was as fine as any pink rose they were receiving, but was not a summer rose. My Maryland, on the contrary, is a good summer rose, a strong feature about it being that it does not fade out when hot weather comes.

The judges, Jas. Hutchinson, D. Fraser and Harry Bunyard, awarded first class certificates to F. R. Pierson Co., for White Killarney and S. S. Pennock-Meehan Co., for Mrs. Jardine and My Maryland. Cultural certificate to Pittsburg Rose and Carnation Co., for roses Bride, Bridesmaid, Richmond, Madame Cousin and Bon Silene buds. Favorable comment was made on carnation seedlings from the Finlayville Floral Co., and on primulas from North Side Park Conservatories.

In the private gardeners' competition the committee awarded first prize for *Primula sinensis* and *Thimula stellata* to N. C. Madsen, gardener for R. H. Boggs, Sewickly, and for 12 Tea roses to W. J. Wiseman, gardener for D. M. Clenson, Pittsburg.

CHICAGO FLORISTS' CLUB.

The Chicago Florists' Club held their annual election Thursday, January 7th,

with the following result: President, Geo. Asmus; vice-president, T. E. Waters; recording secretary, J. H. Pepper; corresponding secretary, F. J. Johnson; treasurer, E. F. Winterson; trustees, Leonard Kill, J. F. Klimmer, H. N. Bruns, C. H. Fisk and August Pohlmann.

In the absence of President Leonard Kill and Vice-president Geo. Asmus, Mr. Bentley was elected chairman. As Mr. Bentley was also chairman of the Nominating Committee he called Harry Phillips to the chair. After the report of the Nominating Committee had been read, nominations were made from the floor. After considerable discussion of the by-laws pertaining to elections the voting took place.

Mr. Bentley reported for the Transportation Committee that no reduction would be made in the rates to the Carnation Convention. The Chicago

NEW JERSEY FLORICULTURAL SOCIETY.

The monthly meeting and annual installation exercises took place on January 8, conducted by Rev. H. Lightfoot, an honorary member, and President Malcolm MacRorie, Vice-President Edwin Thomas and Treasurer William Reid were duly installed. Secretary-elect John Deryan finding it impossible to give the necessary time as secretary resigned and a new election was ordered at which Joseph B. Davis was elected unanimously and entered upon his duties. The policy of the society was outlined among which the holding of special Carnation, Dahlia and Chrysanthemum nights was determined on and closer social relations with sister societies. An invitation was given by Joseph A. Mauda on the part of the Morris County gardeners and representation promised at their smoker this week. The treasurer's report gave a cheerful balance and the secretary's showed an increase of members, while it noted with regret the deaths of David A. Rose and William Barr. Among the committees appointed by President MacRorie are eight of younger and more energetic men to attend to much of the outside work of the society and select the attractions for the monthly meetings.

The floral display for the evening consisted of *Cattleyas maximum* and *Trianae alba* from Thomas Jones of Short Hills, carnation Georgia from James D. Cockerot, hybrid *Cypripediums* from Edwin Thomas, gardener for George Graves; carnations Lady Bountiful, Enchantress and Winsor from William Reid, gardener for S. & A. Colgate, carnations from John Hayes, gardener for Charles Munn, freesias, violet Governor Herrick and carnation Rob Roy from Max Schneider, gardener for Charles Hathaway.

JOSEPH B. DAVIS.

CONNECTICUT HORTICULTURAL SOCIETY.

The annual meeting of this society was held in the County Building, Hartford, Jan. 8, President Huss in the chair. Officers for the ensuing year were elected as follows: President, J. F. Huss; vice-president, J. Gerard; treasurer, W. W. Hunt; secretary, A. Cummings, Jr.; botanist, Geo. W. Smith; pomologist, C. H. Sieman; librarian, C. S. Comstock; executive committee, C. H. Sieman, Amos Reynolds, J. M. Adams, J. Gerard, C. S. Comstock. A summary of the treasurer's and secretary's reports shows the society to be in a most active and prosperous condition. During the season twenty-two meetings have been held; at nine of these meetings exhibits of plants and cut flowers in season have been tabled. The annual dahlia and chrysanthemum shows both proved very successful and should do much to encourage the committees in their future efforts. The following cultural awards were made during the season: Diplomas 29, certificates of merit 23, honorable mention 4. The membership roll shows a substantial increase of forty-seven new members. A pleasing incident of this meeting



GEORGE ASMUS

President-elect Chicago Florists' Club.

florists will leave for Indianapolis via the Panhandle route at midnight, Jan. 26th and reach Indianapolis at 6 A. M. the 27th. Sleepers can be occupied till 7.30. It is expected that Chicago will be well represented. Fare each way \$3.70, sleeper extra.

AMERICAN CARNATION SOCIETY. Carnations Registered.

By John S. Pfeuffer, Irvington, N. Y.—Mrs. Pfeuffer, parentage, Prosperity and Floriana; color, white splashed with deep pink; size, 3 1/2 inches; habit, strong, healthy grower, stiff long stems, heavy bloomer (Dec. and Jan.), never bursts calyx, very fragrant and an excellent keeper.

By Henry Eicholz, Waynesboro, Pa.—Washington, a dark pink sport of Enchantress; in color a dark glowing pink; size of flower four inches, habit identical with Enchantress.

Registered provisionally, subject to cancellation by the Society.

Alvina. Parentage, Lawson and a pink seedling; color, clear cerise pink; size, 3 to 3 1/2 inches; habit, ideal; calyx burst proof, floriferousness phenomenal, stem up to thirty inches.

ALBERT M. HERR, Sec'y.
Lancaster, Pa.

was the presentation of a handsome china closet to President Huss. Geo. W. Smith made an able and appropriate presentation address, which well conveyed the esteem and sentiment of the members. In concluding his address Mr. Smith complimented the society on having as its president a man who, in addition to his equine personality, is a noted worker in the interests of horticulture and the welfare of the society.

NEW YORK FLORISTS' CLUB.

The January meeting of the New York Florists' Club was a sort of inaugural session and the attendance was large and representative. The retiring president, C. B. Weathered addressed the meeting in a few felicitous words, thanking the members for the assistance in maintaining the prestige

of the country would prosper in proportion as we have more love and less fashion in floral matters.

The other incoming officers were then severally introduced and responded briefly and the retiring official presented their reports. Retiring treasurer Allen's report showed the treasury to be in excellent shape and same was confirmed by Mr. Marshall for the Board of Trustees, a balance of \$3150.81 being duly accounted for. The various committees for the coming year: legislative, essays, awards, exhibition, house, outing, bowling, etc., were then appointed by the president. It was voted to donate to the Chrysanthemum Society of America one silver and one bronze medal of the New York Florists' Club for award at their next fall exhibition.

Harry Turner reported for the com-

LENOX HORTICULTURAL SOCIETY.

Saturday, Jan. 2, being Monday night, the members of the Lenox Horticultural Society turned out in good force to support the newly-elected officers, which argues well for the new year. The meeting was full of interest from start to finish. President Allan Jenkins occupied the chair. Messrs. Arthur Koscause and James Kinnie were elected active members of the society. Percy Ellinas was unanimously elected assistant secretary. It was voted to hold the society's annual ball, which is always looked forward to with much interest in Lenox and vicinity, also dinner, the committee for the former being Messrs. J. Clifford, H. P. Wookey and W. Jack; for the latter Messrs. E. Jenkins, A. H.



NEW YORK FLORISTS' CLUB OFFICIALS.

President Hallock Gives a Beefsteak Dinner to the Retiring and Newly Elected Officers and the Trade Press.

of the organization through the year of his incumbency and then introduced his successor E. V. Hallock who, after courteously putting a motion of thanks to the retiring officers proceeded to express his views on the duty and work of the club for the coming year. He said that a president counts for naught without the support of loyal members and while fraternal fellowship is all right in its way yet the club stands for much more than that. "A germ of thought is often worth a pound of advice" and every member would be expected to devote some of his best thought to the interests of the club during the coming year. He referred to the movement for horticultural education and its influence on the future happiness of the people and declared that the horticultural interests

committee on awards that they had journeyed to Scarborough and examined the new rose White Killarney as growing there and had awarded \$0 points and a certificate. Awards for the evening were a cultural certificate to Harry Turner, for some superb blooms of hybrid amaryllises, certificate of merit to J. A. Peterson for new Begonia "President Tatt," vote of thanks to F. W. Fletcher for Violet "Baronne Rothschild." On a fern shown by G. Glutras the committee reported that it would defer judgment until it could have an opportunity to compare same with other existing sports of Nephrolepis.

The next meeting will be Carnation Night and three prizes are offered by A. H. Langjahr for 25 blooms of a variety not yet disseminated. The club has now eight life members.

Wingett, A. J. Loveless, S. Carlquist and P. Heeremans, the dates to be decided by the committees.

The following questions were asked and created lively discussion: What is the proper depth to lay drain tiles? The proper depth recommended by those present for average soils was from three to four feet, from thirty to forty feet apart, though instances were quoted where drains laid to the depth of four feet in heavy clay soils had failed to bring about the desired results, and from two and a half to three feet in heavy tenacious soils had been found more satisfactory. It must be taken for granted that the shallower the drains are laid the closer they should be together; for instance, drains laid at the depth of four feet should be effective for a distance of

twenty feet on either side, consequently 40 feet apart is considered the proper distance, while drains laid at three feet or less should be correspondingly closer together.

Is bleeding injurious to vines or trees? The general opinion was that bleeding as it is understood horticulturally was not necessarily dangerous to vines or trees in a thoroughly healthy condition, and while it is not recommended to wilfully prune vines or trees when they are apt to bleed, numerous instances were cited where maple and birch trees had bled profusely and yet showed no signs of material injury.

Why is it that standard fruit trees are planted in preference to pyramid or bush? The consensus of opinion was that pyramid or bush trees were preferable to standards in many ways. First, that nearly three times as many could be planted per acre, they were much easier to prune and keep clean and could be got into full bearing in lesser time, and better fruit could be produced, but they were not so long-lived as standards.

Visitors: J. Beaton, of R. & J. Farquhar & Co.; T. J. Grey, Boston, and Jas. B. McArdle, New York.

G. H. INSTONE, Secretary.

GARDENERS' AND FLORISTS' CLUB OF BOSTON.

The next regular monthly meeting of the Gardeners' and Florists' Club of Boston will be held at Horticultural Hall, Boston, on Tuesday evening, Jan. 19. This being the first meeting of the year the officers elected at the December meeting will be installed. Following the custom adopted for several years past, ladies are cordially invited to be present on this occasion. An appropriate entertainment will be furnished and the exhibition table will be, as usual, an attractive feature.

CLUB AND SOCIETY NOTES.

The fifth annual meeting of the Alabama State Horticultural Society will be held in Mobile, January 26th and 27th.

A. E. Chilman, gardener for Mrs. Bowen, lectured upon Gladioli before the M. Desert Horticultural Society, Bar Harbor, Me., on January 14.

At the annual meeting of the Cumberland County (Me.) Horticultural Society on January 6, J. L. Robinson was chosen president and Dr. C. H. Leighton of Westbrook, secretary.

"Small fruit culture" is the subject of the conference, scheduled by the Worcester County Horticultural Society, Worcester, Mass., for Jan. 21, and Wilfrid Wheeler of Concord, Mass., is the chief speaker.

The next lecture before the Massachusetts Horticultural Society will be given by Prof. E. Dwight Sanderson, Durham, N. H., on January 16, at 11 o'clock, in Horticultural Hall, Boston. Subject, Garden Insects and how to control them.

The Albany Florist Club held its annual meeting on January 7 and elected the following officers: President, F. Goldring; vice-president, F. Henkes; treasurer, F. A. Danker; secretary, J. Butts; trustees, W. C. King, A. E. Whittle, P. Hyde, E. Meany, F. Snare, W. Kurth. After the meeting a spread was enjoyed at German Hall.

The Southampton (N. Y.) Horticultural

Society met on Jan. 7 and elected officers for 1909 as follows: President, W. F. Halsoy; vice-president, U. G. Ager; secretary, B. C. Palmer; treasurer, Julius King. During the winter a course of lectures will be carried on, the first one to be given on Jan. 21, by H. B. Fullerton; subject, "The lure of the land."

The Virginia State Horticultural Society met at Lynchburg on Jan. 7 and had a profitable session. Dr. J. B. Emmerson advocated the growing of chestnuts, and Hon. A. McNeill of Ottawa, Canada, urged co-operation in selling fruit. The Emmerson cup went to Dr. Parsons's Mills for best collection of apples. Officers were elected as follows: President, W. W. Sproule; treasurer, Walter Whately; secretary, H. L. Price, Blacksburg.

DURING RECESS.

The Astoria Florists' Bowling Club on Thursday journeyed to Flatbush in



PHILIP F. KESSLER.

Wm. H. Siebrecht's large touring car. After visiting the different greenhouses and enjoying a good supper, they proceeded to the bowling alleys and took up the business of the evening. Mr. Kessler of the Astorias offered three valuable prizes for the three highest scores in the second game. Although Mr. Kessler made the highest score, he of course did not compete. The result is shown below:

FLATBUSH.		ASTORIA.	
Zeller	124	Finsmann	135
P. Daillebonze	137	Donaldson	178
H. Daillebonze	177	Mieson	174
Weeker	145	W. H. Siebrecht	115
Redly	124	Jacobson	167
Schnutz	136	H. Siebrecht	92
Schnutz, Jr.	106	Lewinson	142
O. H.	132	Kosler	183
Eiggren	112	Siebrecht, Jr.	96

The prize winners were J. Donaldson, H. Daillebonze and P. Jacobson. The Astorias visited the Flatbush Club to come to their alleys some time in February.

OBITUARY.

J. T. Montgomery.

J. T. Montgomery, a carnation specialist of Toughkenamon, Pa., died on January 1, after a brief illness.

S. S. Brenneman.

S. S. Brenneman of Webb City, Mo., died December 26, aged 62. He was born at Harrisonburg, Va., and had conducted a florist business in Webb City since 1896.

George Burnham.

George Burnham, who was early identified with the corn packing industry of the country, and is well known among the seedsmen, died at his home in Portland, Me., on January 1.

S. L. Smith.

Samuel L. Smith, at one time employed in the greenhouses of H. L. Crawford at North Easton, Mass., died in Brockton on January 4, at the age of 46. A widow, three sons and a daughter survive him.

Lewis B. Paine.

Lewis B. Paine, who with his two sons has been engaged in the florist business in Randolph, Mass., for several years, passed away on January 1, at the age of 63. A widow, three daughters and three sons survive him.

Robert Smith.

Robert Smith, for many years a gardener at Wellesley College, died at his home in Dorchester, Mass., on December 5. It is thought that grief over the sudden death on Sunday previous of his wife, to whom he had been married over a half-century, was the cause. He was born in Scotland in 1836 and came to this country in 1854. Four children survive him.

Martin Griffin.

Martin Griffin, who came to this country almost 55 years ago from Ireland and who has been for the past 50 years florist to the Treasury Department at Washington, died at his home in that city, January 9th. Two years ago, in trying to save his wife, who was burned to death, he was badly burned, and within the past year has had to give up all business. He is survived by five sons and three daughters.

Carew Sanders.

The shock caused by the burning of his residence at 5738 Vernon avenue, St. Louis, Sunday, from which, a helpless invalid, he was rescued by his nurse, Mrs. Enis Halton, hastened the death of Carew Sanders, 82 years old. He died Wednesday evening, Jan. 6, at St. Luke's Hospital.

Mr. Sanders was a well-known florist and writer on horticulture. He conducted the Sanders nurseries at 5600 Delmar avenue until 20 years ago, when he retired and turned the business over to his son, C. C. Sanders. For many years Mr. Sanders contributed to horticultural magazines and journals, and was interested in the "city beautiful" movement.

He was born in Sussex, Eng. He

followed the occupation of florist in England up to the age of 21 years, when he came to America and secured employment in Cincinnati, where he remained for a time, later going to New York, where he was married to Miss Susan E. Samson. After his marriage, Mr. Sanders again returned to Cincinnati, and was engaged as florist for Joseph Longworth, grandfather of Congressman Nicholas Longworth. In 1857 Mr. Sanders removed to St. Louis.

Many beautiful floral designs were sent to the funeral by the local trade and friends. The St. Louis Florist Club, of which Mr. Sanders was a member for 22 years, sent a handsome wreath. The pall bearers were Fred C. Weber, Theo. Miller, J. J. Bencke, C. A. Kuehn, Fred Ammann, Frank Fillmore, E. H. Michel and F. H. Meinhardt. Many other members of the fraternity attended.

LONGDALE ON HYBRIDIZATION.

On Friday evening, Jan. 8th, Edwin Longdale was to have read a paper on hybridization and cross-fertilization to the students of the National Farm School, Bucks Co., Pa. At the last moment Mr. Longdale found it impossible to be present and the paper was sent to Mr. Fancourt, who read it in his stead. The students were intensely interested. Mr. Longdale took them back to the time of Theophrastus, who first saw the necessity of impregnating the date palm. He gave a history of the evolution of the carnation from the time of William the Conqueror to the present world-wide recognized American perpetual flowering varieties. He told of the earlier work of the European rosarians and of the later systematic efforts of Henry Bennett. His history of the pansy was a lesson in itself. Phloxes and other annuals were treated in a masterful manner. He spoke of the latest achievement in systematic hybridization in the results obtained in the Wichuraiana roses and Meehan's Mallow Marvels. At the close of the reading the students gave a hearty vote of thanks to the author.

FLORISTS' HAIL ASSOCIATION.

Secretary Esler of the Florists' Hail Association, calls the writer's attention to the fact that in condensing the report of that association for publication, certain important statistics were left out, and he wishes that members will correct the records as published in the annual report of the S. A. F. & O. B. by adding the following:

Extra half and extra whole insurance upon 7,354,293 square feet of glass, making a total risk upon 29,092,566 square feet of glass.

W. N. Rudd, Secretary, S. A. F.

AN ASSIGNMENT.

J. F. & D. J. Quinn, florists, of Harvard street, Brookline, Mass., have made an assignment. It is understood that the amount of liabilities is quite large. The firm have been heavy buyers at the Boston Flower Market and several prominent growers are hard hit.

A WORD FROM THE PRESIDENT OF THE S. A. F.

To each member of the S. A. F. and O. H. I send greeting and best wishes for the New Year.

This is to be an important year for the florists—the tariff is to be revised and you are all interested in the result. In addition to that it is necessary to follow up the work which has previously been inaugurated in the way of securing equitable rates from express and railroad companies, and the recognition of just claims presented against them. It is evident that a society that is strong numerically and financially can do more for its members than a weak one can, and I appeal to both your loyalty and to your self-interest when I ask you to at once assist in securing additional members. There are about nine thousand florist establishments of all kinds in this country and our society has a total membership of nine hundred, so that each member might find it possible to secure nine new members.

Of course we do not expect such results but it is not too much to expect that each member will get at least one new member, and thus quickly double our membership. No florist can consistently say you "Nay", for there is not one of them whose business importance has not been increased by the fact that for over twenty years our society has been consistently working to promote the calling in which he is engaged. If any men can afford to stay out of the society it would be the big concerns whose financial strength and whose volume of business would entitle them to a respectful hearing from any corporations with which they do business. But these very concerns are the ones you are certain to find enrolled on the books of our society. May it not be that some portion of their success is due to having associated with other bright men at our conventions and to the added enthusiasm bound to come from contact with successful men in the same line of work?

To my mind the annual report which is mailed to each member is of great value. It contains a complete list of the members with their addresses, and to those who do not have a regular directory of the florists of the country, it furnishes names of florists in nearly all the states. This list contains the live progressive men with whom it pays to do business.

If you had to send an order to be filled in a town where there were two florists and you knew nothing of either except that one belonged to the S. A. F. and O. H. and the other did not, would it take you long to decide as to which one you would take a chance on? Is not that point alone enough to bring the retailers into the fold?

We hope that the Tariff and Transportation Committee will be such diplomats that they will secure just what they want from Congress and that the Express Companies will concede all the things that can reasonably be asked of them.

But if a strong navy is a guarantee of peace to a nation, we may well assume that a strong membership and a full treasury will be our best reliance in securing the remedies we seek.

When the next annual report is published it will show how many new

membership fees have been sent in by each old member. Let your name be prominent among these active workers for the good of the society.

So I urge upon you to at once go to work and secure new members (not next month, but now) and thus render to the society the loyal service she has a right to expect from you; at the same time making your membership more valuable to yourself.

Yours for a larger and more powerful society. J. A. VALENTINE,
President.

APPRAISERS' DECISION.

Before Board 3, December 10, 1908.

No. 20684.—Evergreen Seedlings—Norway Spruce—Protest 167628 of Wells, Fargo & Co. (New York).

Norway spruce, classified as evergreen seedlings under paragraph 252, tariff act of 1897, was claimed to be dutiable under the provision in the same paragraph for ornamental trees. Protest overruled.

Waite, General Appraiser: * * * The importers have offered no evidence in support of their contention. The appraiser makes a special report, which reads, in part, as follows:

Norway spruce is one of the commonest of the evergreens. It is never referred to or classified in commercial catalogues as anything other than evergreen, nor is it ever placed in the same group with what are called ornamentals—i. e., maples, chestnuts, elms, etc. The particular stock under consideration was a seedling, not grafted.

(The appraisers' conceptions concerning evergreens and "ornamentals" seem to be badly mixed. The decision itself may be a proper construction of the law but the ignorance displayed in the last four lines is awful.—Ed.)

ELM COURT FARM CLUB ROOM.

A striking example of the way a keen business man may care for the well-being of his employees is furnished by Mr. Wm. Douglas Sloan at his large estate in Lenox, Mass., where he has recently erected for the various employes a comfortable club room well heated and ventilated, and lighted by electricity. Installed therein is a pool table of the finest make, and a phonograph of the latest design furnishes musical-entertainment. Chess, checkers, dominoes, cards and a well stocked library make the club attractive to the young men, keeping them interested and amused and away from the more or less harmful and expensive attractions of the adjacent city of Pittsfield. Mr. Sloan has not only earned the gratitude of his employes but has made a splendid investment that will bear continuous interest in more efficient work and in the mental, moral and physical well-being of his employes.

The Illinois Heater & Mfg. Co., 40th street and Wentworth avenue, Chicago, have now three acres of ground and a brick factory, 50x100 ft., at Downer's Grove. This will give them room for their rapidly increasing business in the manufacture of self-watering window and porch boxes, hanging baskets, lawn and cemetery boxes, jardinières, etc. This company will open an office in the down-town district of Chicago in a short time, probably on Lake street, and will be prepared to push their business better than ever before.

THE FLORIST SUPPLY HOUSE OF AMERICA

SPECIAL NOTICE

During the month of January **Only**

A SPECIAL DISCOUNT of 10 Per Cent

on our Celebrated Standard Wheat Sheaves which every one knows are the best. Order now and get this liberal

DISCOUNT ONLY FOR THE MONTH OF JANUARY

NEW EASTER BASKETS JUST ARRIVING

H. BAYERSDORFER & CO., 1129 Arch Street, Philadelphia, Pa.

NEWS NOTES.

J. A. Peterson of Cincinnati, O., has named a new begonia for President-elect Taft.

Oakland, Cal.—The Bay Tree Nursery Co., has recently started a sales yard on Telegraph Avenue.

Lockview, Pa.—A. T. Linn, of Finleyville, has bought the greenhouses of T. J. Allen and will continue the business.

Woonsocket, R. I.—S. Colitz, doing business under the name of the Rustic Flower Store, has moved to 206 Main St.

Miss Kate Furbish, a well-known botanist of New England, has recently given her entire collection of drawings to Bowdoin College.

Dran Hunt of the State School of Agriculture and Experiment Station, State College, Pa., in his annual message urged the need of a greenhouse and horticultural building.

Winchendon, Mass.—H. J. Whittemore, owner of the greenhouses occupied by W. H. Rhuland that were destroyed by fire January 1, has started plans for rebuilding on a more extensive scale.

Brooklyn, N. Y.—An overheated stove caused a fire in the greenhouse of Frank Albrecht, florist of Evergreen, on January 7, which destroyed about \$4000 worth of plants. The damage to the house is placed at \$2000.

Somersworth, N. H.—G. S. Ramsburg has nearly completed the rebuilding of his greenhouses that were destroyed by fire some two months ago and is rushing the work along in order to get his stock under way for Memorial Day.

Pasadena, Cal.—The Tournament of Roses was held for the twentieth time on January 1 and witnessed by fully one hundred thousand people. The day was perfect as to weather and the beautifully decked procession was two hours in passing.

A conference between the State Commissioner of Agriculture and leading horticulturists of the State at Albany,

N. Y., on Jan. 8, resulted in a decision to send to each nurseryman a warning against the brown tail moth which had been found in some importations of nursery seedlings recently arrived from France.

The nurseries of Salt Lake County, Utah, suffered considerably in December on account of the heavy snowstorms and frosts which caught the orchardists with their fall work about half completed, but by close observance of the weather practically every tree was saved, says Inspector J. P. Sorenson in his report.

The report of the fruit committee of the New Jersey Horticultural Society in session at Taunton on Jan. 7, reflects great credit on the products of the state. J. H. Barclay of Cranbury carried off the highest honors with some magnificent specimens of apples; Lemuel Black, Hightstown, C. B. Horner, Mt. Holly, and N. H. Conover, Riverton, had good exhibits. Chas. Black of Hightstown spoke on "Dwarf Apples—Are They Practical for Fillers." President Black urged legislation to prevent the manufacture and sale of adulterated fungicides and insecticides, and warned farmers and fruit growers to watch the railroads lest they be discriminated against in the proposed advance of freight rates. Howard G. Taylor of Reiverton was elected secretary.

PATENTS GRANTED.

- 906,626 Fruit Harvester. George G. Schreiber, Hammond, Ind.
 906,641 Grate. Eli L. Long, Cheektowaga, N. Y.
 906,652 Boiler Cleaner. William D. Nicholson and William H. Smith, Clymers, Ind.
 906,806 Pipe Hanger. John C. Kortich and George Eberhard, San Francisco, Cal.
 907,064 Hand Pruner. Thaddens J. Litzelman, Williamsport, Pa.
 907,065 Pruner. Thaddens J. Litzelman, Williamsport, Pa.
 907,136 Packing for Pipe Joints. William L. Farrington and Almeron H. Van Denburg, Syracuse, N. Y.

GREENHOUSES BUILDING OR CONTEMPLATED.

- Topeka, Kan.—C. E. Hubbard, one house.
 Kalispell, Mont.—J. W. Schauer, one house.
 Elysburg, Pa.—W. H. Carl, house, 20 x 60.
 Tewksbury, Mass.—John Gale, additions.
 Rockford, Ill.—J. W. Ingalls, range of houses.
 Cromwell, Conn.—A. N. Pierson, rose house.
 Monmouth, Ill.—Charles Hewitt, two houses.
 Hagerstown, Md.—C. C. Hoover, house, 28x31.
 Fairbury, Ill.—Mrs. J. A. Sheaff, house 20 x 70.
 Auburndale, Mass.—J. G. Forbes, improvements.
 Decatur, Ill.—M. Z. Kellogg, three houses, 20 x 80.
 Baltimore, Md.—W. Halliday, house, 20 x 100.
 Ft. Worth, Texas.—W. L. McCart, range of houses.
 Pride's Crossing, Mass.—A. P. Loring, conservatory.

- Mount Pleasant, Ia.—J. W. Thompson, house 27 x 70.
 Independence, Kan.—Kishpaugh & Olesen, one house.
 Winchendon, Mass.—H. J. Whittemore, range of houses.
 Harrisburg, Pa.—Berry Hill Nursery Co., house, 24x40.
 Dorothy, N. J.—Henry K. Lewis, two houses, 21 x 100, 11 x 100.
 Bound Brook, N. J.—Thos. Young, Jr., two truss houses 500 ft. in length.
 Woodbury, N. J.—J. Reeves Merritt, three houses, 18x75; two mushroom houses, 18x75.

WANTED A few Plants* or Seed each of

CHORIZEMA HYBRIDS and LIBONIA PENRHOSIENSIS

ED. HERRMANN
 North and Hillton Avenues Baltimore, Md.

Your Source of Supply is Important

All who are well informed know the world-wide reputation of these growers for high quality. It is a pleasure to buy their goods.

FRENCH BULBS
MARTIAL BREMOND
 Ollioules, France



JAPAN BULBS
SEITARO ARAI
 Yokohama, Japan

WRITE FOR PRICES

RALPH M. WARD & CO.,

12 WEST BROADWAY
 NEW YORK

ORCHIDS

Our latest importations have been, *Cattleya Chrysozona*, *Cattleya Gaskelliana*, *Cattleya Gigas*, (*Hardyana* district), *Phalaenopsis Amabilis* Schilleriana and others. We will receive in a short time, *Cattleya Dowiana*, *Miltonia Vexillaria* and others.

CARRILLO & BALDWIN
 SECAUCUS, N. J.

ORCHIDS Freshly Imported

We offer a superb lot of *Cattleya gigas Sanderiana* in finest condition; also *C. Bogotensis*, *C. Schroederiae*, *C. labiata*, *C. gigas Hardyana* type and *Miltonia vexillaria*

LAGER & HURRELL, Summit, N.J.

ORCHIDS

Largest Importers, Exporters, Growers and Hybridists in the World

Sander, St. Albans, England
 and 235 Broadway, Room 1
 NEW YORK CITY

IMPORTED ORCHIDS

Arrived in Superb Condition

Vanda coerulea, *Cattleya Trianae*, *Cattleya gigas Sanderiana*, *Cattleya Schroederiae*, *Oncidium varicosum*.

JULIUS ROEHRS CO., Rutherford, N. J.

ORCHIDS

Orchid Baskets and Peat

Write for Prices

JOSEPH A. MANDA

191 Valley Road - WEST ORANGE, N. J.

We Have A Fine Lot of *C. Trianae* in bloom at very low prices, and will sell plants in bloom or cut blooms at 15 per cent. less than the market price.

ORDONEZ BROS.

Madison, N. J.

In ordering goods please add "I saw it in HORTICULTURE."

GERANIUMS

\$2.00 per 100 and up, 300 varieties described in our Special Geranium catalogue.

HARDY POMPON CHRYSANTHEMUMS

We are headquarters, 80 varieties, \$2.00 per 100.

DAHLIAS

We are booking orders for Plants next Spring, or Roots for next Fall.

LOBELIA

KATHLEEN MALLARD. The new double Blue Lobelia, nice stock from 2 inch pots, 50c per doz., \$2.00 per 100, 50c for \$9.25.

WE HAVE READY TO SHIP THE FOLLOWING from 2 in. pots at \$2 per 100

Verbenas, Lemon Verbenas, *Achyranthus*, Black Prince and Minnesota Fuchsias, *Coleus*, *Lobelia Crystal Palace*, Hardy English Ivy, *Smilax*, *Salvia*, *Drer's Superb* Single *Petunias*, Dwarf Double *Alyssum*, *Ageratum*, Hardy *Chrysanthemums*.

R. VINCENT JR. & SONS CO., White Marsh, Md.

FORCING GLADIOLUS

Gladiolus Gandavensis Hybrids

Many florists plant these in boxes, or among their carnations, in the winter. They are excellent for decorative purposes and realize good prices, either wholesale or retail. *Gladiolus* are a good catch-crop and take up but little room. The following are the best for this purpose:

America. The flowers, which are of immense size, are of the most beautiful fresh-pink color, \$4.00 per 100; \$35.00 per 1000.

Augusta. The florists' best white *Gladiolus*. First-size bulbs, 1 1/2 inches and up, \$2.00 per 100; \$18.00 per 1000. Bulbs 1 1/4 to 1 1/2 in. \$1.75 per 100; \$16.00 per 1000.

Shakespeare. White and rose. \$4.75 per 100; \$45.00 per 1000.

May. Pure white, flaked rosy crimson; the best forcer. Selected bulbs. \$1.75 per 100; \$15.00 per 1000.

Brenchleyensis (true). Flery scarlet. Selected bulbs, \$1.50 per 100; \$13.00 per 1000. First-size bulbs, \$1.25 per 100; \$10.00 per 1000.

Boddington's White and Light. Extra selected bulbs, 1 1/2 in. and up, \$1.50 per 100; \$14.00 per 1000.

Bulbs 1 1/2 to 1 3/4 in. \$1.25 per 100; \$10.00 per 1000.

American Hybrids. A mixture of the choicest varieties of *Gladiolus* in cultivation. \$1.00 per 100; \$9.00 per 1000.

ARTHUR T. BODDINGTON

SEEDSMAN

342 West 14th Street,

NEW YORK CITY

CYCLAMEN GIGANTEUM

5, 6 and 7 in. pots—50c, 75c, and \$1.00 each.

Extra heavy stock of the very best quality.

Thomas Roland,
 Nahant, Mass.

Gladioli fine named sorts; colors, seedlings and mixtures.

Iris Pallida Dalmatica, German and Japan *Iris*, Madeira Vines, Cinnamon Vines, *Hyacinthus candicans*, Spotted *Callas*.

Send for Price List.

E. S. MILLER,
 Wading River, Long Island, N. Y.

JAPANESE
 THE YOKOHAMA NURSERY CO. NEW YORK.
 31 BARCLAY STR. NEW YORK.
 LILIES
 PLANTS
 BAMBOO STAKES

Boddington's Quality Flower Seeds for Florists

Seed You Need for January

REMEMBER YOU MAY DEDUCT 5 PER CENT IF CASH ACCOMPANIES ORDER

ASTERS

BODDINGTON'S Asters are famous. Write for catalogue of varieties and prices.

AGERATUM

	Tr. pkt.	Oz.
Mexicoann album.....	\$0.10	\$0.20
Blue Perfection.....	.15	.50
Imperial Dwarf Blue.....	.10	.25
Imperial Dwarf White.....	.10	.25
Little Dwarf.....	.15	.50
Stanley Blue.....	.10	.25
Little Blue Star, trade pkt. 25c, 5 pkts for \$1.00		
Boddington's Mauve Beauty, large flowers; dwarf, compact, very free-flowering Trade pkt. 10c, oz. 50c.		

GIANT ANTIRRHINUM

Coral-red, Carmine, Daybreak, Light pink; Brill ot, Scarlet, gold and white; Crescia, Dark scarlet; Lut-ann, Yellow; Firefly, Scarlet; Romeo, Deep rose; Lilacinn, Beautiful lilac; Striatum, Finest striped, Trade pkt., 20c, oz, 60c.	Trade pkt. Oz.
Queen Victoria, Pure white.....	\$0.25 \$1.00
Fire King, Scarlet, with orange.....	.25 .75
Mixed.....	.20 .50

BEGONIA

	Tr. pkt.
Erford II, Carmine, 1 1/2 oz., \$1.00.....	\$0.25
Semperflorens.....	.75
Verion grandiflora 1/2 ft. A fine leading sort, with rich red flowers and glossy bronze-red foliage.....	.75

BELLIS

(Double Daisy). One of the most charming of spring flowers, for edgings or pot culture.

	Tr. pkt.	Oz.
The Bride. The finest double pure white.....	\$0.50	
Boddington's Crimson King (New, Extra large crimson.....	.50	
Longfellow Double Rose.....	\$2.50	
Snowball, Double White.....	2.50	
Delicata II, pl. Rose white, with purplish red center.....	.30	2.50

CINERARIA

Cineraria maritima, 1 1/2 ft. Trade pkt, 10c, oz, 15c.
Cineraria maritima "Diamond" A vast improvement over the above. Foliage very white, leaves much serrated Trade pkt, 50c., \$2.00 per oz.

CENTAUREA

	Oz.
Candilissima, 1000 seeds, 25c.....	\$1.00
Gymnocarpa, 1000 seeds is, 15c.....	.75

GREVILLEA ROBUSTA

	Tr. pkt.	Oz.
(Silk Oak).....	\$0.10	\$0.50

COBAEA

	Tr. pkt.	Oz.
Scandens, H. P. Blue.....	\$0.10	\$0.30
Alba, White.....	.20	.75

LOBELIA

	Tr. pkt.	Oz.
Erinus gracilis, Light Blue.....	\$0.15	\$0.45
Erinus speciosa, Deep Blue.....	.15	.50
Crystal Palace compacta.....	.20	1.25
Emperor William compacta.....	.25	1.00

MIGNONETTE

Boddington's Majesty. The finest fancy Mignonette for under glass or pot culture. Seeds saved from select spikes under glass. 1/2 trade pkt., 60c; trade pkt., \$1.00.

MYOSOTIS

	Tr. pkt.	Oz.
Eliza Fanrobert, excellent for pots		
Blue.....	\$0.15	\$0.60
Palustris Semperflorens, ever blooming.....	.25	1.50

PETUNIAS

Boddington's Century Prize

Gigantic single flowers having the edges deeply ruffled or fluted; fine substance, with deep white throats. Colors vary from pure white to dark purple-violet, many being beautifully striped or veined. 1/2 trade pkt., about 1000 seeds, 60c; trade pkt., about 2000 seeds, \$1.00.

Boddington's Quality Double Fringed Our double Petunias have reached the highest standard of excellence, and may be confidently relied on to produce a large proportion of double flowers of exquisite beauty and great size. 1/2 trade pkt., about 1000 seeds, 60c; trade pkt., about 2000 seeds, \$1.00.

Boddington's Snowball, Double. The finest double; pure white, 1/2 trade pkt., 60c; trade pkt., \$1.00.

Boddington's Bar Harbor Beauty, Single. Color a beautiful rose,..... \$0.25

Boddington's Rattle Giants. A grand selection of single fringed..... .50

Boddington's Unimitable Dwarf Compact Hybrids, Single. Flowers blotched and striped..... .25

Canary Bird, Medium size, finely fringed and curled, yellow, which deepens in the throat, 5 pkts., \$1.00..... .25

Empress, Single. Large blossoms. The solid colors are particularly rich and velvety, some of the crimson blossoms have pink stars, some pure white, while others are distinctly striped..... .50

Howard's Star, Rich crimson, with a distinct white star in center, oz, \$2.00..... .25

1853 Worm, Soft, carmine-pink..... .25

Snow Storm, Pure single white..... .25

Hybrida, Single Mixed, oz., 5c..... .15

PYRETHRUM

	Tr. pkt.	Oz.
Aureum (Golden Feather).....	\$0.10	\$0.25
selaginoides Foliage serrated.....	.15	.50

SALVIA

	Tr. pkt.	Oz.
Clara Bedman (Bonfire) 1/2 ft.....	\$0.25	\$2.00
Splendens (Scarlet Sage).....	.25	1.00
Splendens, Ball of Fire. Very dwarf and early.....	.25	3.50
Splendens, Little Lord Fauntleroy. Neat and compact, upright and free-flowering.....	.50	4.00
Splendens, Boddington's Miniature. Early, dwarf, 12 in. and very free-flowering; covered the whole summer with large spikes of rich scarlet.....	.50	
Splendens, Zurich.....	.50	

STOCKS

Boddington's Quality Large-Flowering German Ten-Weeks Stocks

Brilliant Rose, Canary-Yellow, Crimson, Dark Blood-Red, Dark Violet-Blue, Dark Purple, Flesh Color, Light Blue, Scarlet, Snow-White, Fine Mixed, Trade pkt., 25c, 1/2 oz., 35c, 1/2 oz., 60c, oz., \$1.00.

Boddington's Quality Cut-and-Come-Again

These splendid Stocks will flower continuously through the summer if sown early. Princess Alice, White; Apple Blossom, Light pink; Peach Blossom, Soft pink; Chamois; Bridesmaid, Rose; Canary, Yellow; Flamingo, Blood-red; Blue Jay, Light blue; Violet, Dark blue; Carmine, Crimson, Trade pkt., 25c, 1/2 oz., 40c, oz., \$2.50.

BODDINGTON'S QUALITY VERBENAS

Boddington's Mammoth Hybrids. A strain of very vigorous growth, producing trusses of large flowers of brilliant and varied colors; Mammoth Auricula-flowered, large flowers with white eye; Mammoth Blue; Mammoth Pink; Mammoth Scarlet De finance, the finest scarlet sort; White (Candidissima), pure white; Striped, many colors; Lemon (Aloysia citrodora); Trade pkt., 25c, oz., \$1.00.

VINCA

	Tr. pkt.	Oz.
Alba, White.....	\$0.15	\$0.50
Rosea, Rose.....	.15	.50
Rosea alba, Rose and white.....	.15	.50
Mixed.....	.10	.40

ROSES

Hybrid Perpetual: Alfred Colomb, Anna de Diesbach, Ball of Snow, Baron Bonstetten, Baroness Rothschild, Duke of Edinburgh, Frau Karl Druschki, Jacqueminot, Gen. Washington, John Hopper, La France, Magna Charta, Mme. G. Luise, Mme. Planzier, Mrs. John Lang, Prof. Neyron, Fr. Camille de Rohan, Ulrich Brunner. Price immediate delivery, 25c for 5, one variety; \$12.00 per 100; \$100.00 per 1000.

Ramblers: Crimson, Dorothy Perkins, Wedding Bells, Lady Gay, Gloire de Lyon, Baby Rambler, Catherine Zemann, Heavy Flawn in several sizes, all American crown stock. Don't try to force any others.

Wholesale Catalogue of Quality seeds and bulbs, contains 52 pages of seeds and bulbs you need. A post card will fetch it. Write to-day.

ARTHUR T. BODDINGTON, Seedsman, 324 W. 14TH STREET, NEW YORK CITY.

**The New Crested
SCOTTII FERN...**

NEPHROLEPIS SCHOLZELI



NEPHROLEPIS SCHOLZELI

This crested sport of Scottii will hold the same position to all the crested forms of Nephrolepis that Scottii now holds to the Boston. It is entirely distinct from all others and will become even more popular than its parent, with which it is identical in every way except that the pinnae are subdivided, giving it a beautiful crested appearance.

We have shown the plant at the exhibitions noted below and have been awarded the following honors:

- SHAW GOLD MEDAL**, St. Louis Horticultural Society, Nov. 3rd, 1908, for "Best plant, of decided merit for cultivation, not previously an article of North American commerce"
- SILVER MEDAL**, offered by the Society of American Florists, through the St. Louis Horticultural Society, Nov. 3rd, 1908, for "The most meritorious plant, or flower of American origin."
- CERTIFICATE OF MERIT** of the Horticultural Society of St. Louis, Nov. 3rd, 1908.
- SILVER MEDAL**, Pennsylvania Horticultural Society, Philadelphia, Nov. 3rd, 1908, for the best new plant.
- CERTIFICATE OF MERIT**, Massachusetts Horticultural Society, Boston, Nov. 6th, 1908.
- CERTIFICATE OF MERIT**, Dutchess County Horticultural Society, Poughkeepsie, N. Y., Oct. 30th, 1908.
- CERTIFICATE OF MERIT**, Morris County Gardeners and Florists' Society, Madison, N. J., Oct. 30th, 1908.
- CERTIFICATE OF MERIT**, Chestnut Hill Horticultural Society, Philadelphia, Pa., Nov. 4th, 1908.

We are booking orders now which will be filled in strict rotation June 1st, 1909.

Price per doz., \$3.50; per 100, \$25.00; per 1000, \$200.00. Twenty-five supplied at hundred rate and five hundred at thousand rate.

HENRY A. DREER, 714 CHESTNUT STREET, PHILADELPHIA, PA.

New Rose White Killarney

Come and see White Killarney growing at our Scarborough houses, and you will say at once, as every one does who has seen it, it is

The Best White Rose

they have ever seen. You need it if you want to be up to the times, and it will pay you better than any other white rose that you can plant. You will regret it if you do not plant it this year, and you will not regret it if you do.

Big lots are being booked. Get your order in early. Send us order at once, while you think of it. Get early stock. It will not cost you any more to order to-day, while you think of it, than it will two months from now. Be the early bird that catches the worm.

Strong young plants, 2 1/4-inch pots, own-root, ready for delivery beginning February 15th. 1909 \$30.00 per 100; 250 for \$70.00; 500 for \$125.00; 1000 for \$250.00. Grafted plants, ready for delivery beginning March 1st, 1909, \$5.00 per 100 additional.

MY MARYLAND

This new rose, which was introduced last season in a limited way, has proved to be one of the best roses ever introduced. Every one is enthusiastic in regard to its merits, and it will be planted very largely by the largest, most progressive and most up-to-date growers, who have already placed large orders for it.

It is a strong, healthy, and vigorous grower, producing long stems and long pointed buds, exquisitely fragrant. The color is a soft salmon-pink. This is a rose that we can recommend in the highest terms, as we are sure it will prove very, very satisfactory. It is a welcome addition to our limited list of really first-class varieties for indoor culture; and it is not only a fine midwinter rose, but is also unusually good during the summer months.

Strong plants, 2 1/4-inch pots, own-roots, \$10.00 per 100, \$90.00 per 1000.
Grafted plants, \$2.00 per 100, \$150.00 per 1,000.

F. R. PIERSON CO., Tarrytown-on-Hudson NEW YORK.



THE WHILLDIN POTTERY COMPANY

THE LARGEST MANUFACTURERS OF

STANDARD FLOWER POTS

PHILADELPHIA, PA. LONG ISLAND CITY, N. Y. JERSEY CITY, N. J.

Seed Trade

WHERE REFORM IS NEEDED.

From the first number of HORTICULTURE this worthy publication has upheld the seed business. A great deal has been said lately about the deterioration of seeds and in all reason our trade papers may keep at it until there is such an awakening that some of the growers who are forever contracting at cut prices will sit up and take notice. When wholesale seed growers expect to place growing contracts with farmers for less than the farmer can afford to properly care for the crop for, then turn about and slash the prices to the seed houses for the sake of business, it means a tendency toward degenerate stock.

The leading market gardeners from one end of the country to the other would gladly give a higher price for seed if they were sure of increasing quality. There are two classes of grabbers in the seed business; the wholesale grower that grinds down the grower to a neglectful basis, and the seed buyer that buys his stock on a price basis. These are fellows to fight. We are glad to see that HORTICULTURE stands for a square deal in this

most important branch, and it is to be hoped that this publication will continue its energies and do what it can to hammer out of business the rascals who cause failure when all other conditions are perfect for a successful crop.

THOMAS L. BROWN.

So. Manchester, Conn.

THE WESTERN FLOWER SEED TRADE.

One of the best known seed houses in the middle west states that they are getting without trouble all the flower seeds they have ordered. Apparently, there is no lack of stock except in sweet peas. This shortage is in old-standard varieties, principally in lavender, Dorothy Tennant is one of the scarce varieties in this color. There is an over-abundance of white peas and a good supply of Blanche Ferry. In *Salvia splendens*, seed of the large-petioled strain seems scarce, while the common is plentiful. There is no shortage of pansies, asters or verbenas. Most of the flower seeds are imported, though some important items are produced in the United States. California strains of all seeds are scarce this year. The seed industry is growing in the western part of the United States, but so far it has not been able to supply more than a small proportion of what is needed.

of popped corn ready for planting, with the price per pint attached. It ought to sell the goods.

The La Grange Floral & Seed Co. will open for business as soon as the store they are to occupy is completed. They have a fine location on 5th avenue. La Grange is fifteen miles west of Chicago. The firm is composed of Mrs. Walter Scott, president; W. F. Baker, secretary, and Walter Scott, business manager. Mr. Scott came to La Grange from England sixteen years ago, and is well known as a successful landscape gardener, which business he will also continue.

CATALOGUES RECEIVED.

Peacock Dahlia Farms, Williamstown, N. J.—Folder of Peacock's "Peerless Cut Flower Dahlias."

Dingee & Conard Co., West Grove, Pa.—Dingee Guide to Rose Culture. "Sixty Years Among the Roses" is the inscription on the cover of this catalogue, which is lavishly adorned with roses in colors and a portrait of Charles Dingee, founder of the Dingee & Conard Co. The book is profusely illustrated with handsome rose portraits.

Elmer D. Smith & Co., Adrian, Mich.—Chrysanthemums and Asters, 1909. As might be expected of anything emanating from the headquarters of this widely-known chrysanthemum authority, the present catalogue is quite up to date and very complete in its lists of new and desirable sorts in all classes. The illustrations are excellent for comparison of varieties.

Joseph Breck & Sons Corp., Boston, Mass.—Seed and Implement Catalogue for 1909.—It's a beauty throughout and fully up to the tradition of this long-established house. A heavy cover in pale grey tint with the name vignettted into a big cluster of double blue corn

"SOW NOW"

Irish Shamrock Seed

To have good plants for St. Patrick's Day. Always a good demand and profitable for the Florist.

Trade Pkt. 25c
Per Oz. 75c

Write for Our Handy Flower Seed Order Sheet.

MICHELL 1018 MARKET ST.
PHILA., PA.

SHEEP MANURE

Pulverized. Free from Adulteration
In Bag, \$18.00 per Ton. Cash with Order

ROBERT SIMPSON
CLIFTON, N. J.



STANDARD FLOWER POTS

Packed in small crates, easy to handle.

Price per crate	Price per crate	
1500 2 1/2 in. pots in crate \$3.85	1207 in. pots in crate \$4.20	
1500 2 1/4 " " " 5.25	60 5 in. " " " 3.00	
1000 3 " " " 6.00	HAND MADE	
800 3 1/2 " " " 5.00	48 6 in. pots in crate \$3.60	
800 3 3/4 " " " 5.80	48 10 in. " " " 4.80	
500 4 " " " 4.50	24 11 " " " 3.60	
320 5 " " " 4.51	12 12 " " " 4.80	
144 6 " " " 3.15	6 15 " " " 4.80	

Seed pans, same price as pots. Send for price list of Cylinders for Cut Flowers, Hanging Baskets, Lawn Vases, etc. Ten per cent. off for cash with order. Address Hilfinger Bros., Pottery, Fort Edward, N. Y. August Folker & Sons, Agts. 31 Barclay St. N. Y. City.

Standard Flower .. POTTS

If your greenhouses are within 500 miles of the Capital, write us, we can save you money

W. H. ERNEST

28th and M Street WASHINGTON, D. C.

NOTES.

Charleroi, Pa.—Earl Lutes has purchased the seed business of Theo. J. Allen.

President Watson S. Woodruff has called a meeting of the Executive Committee of the American Seed Trade Association for Friday, January 22, at the Hotel Astor, New York City.

The Pennsylvania Seed Improvement Association at its meeting on January 4, elected A. S. Haines, Westtown, president; W. M. Evans, Bloomsburg, vice-president; Prof. F. D. Gardner, State College, secretary and treasurer.

The Holmes Seed Co., Harrisburg, Pa., have a good window display of popcorn just at present. A big basketful of popcorn, all popped ready to eat, stands alongside another big basket

flowers, gives richness and simplicity at the same time, and there are some unique features in the make-up which give special distinction to the contents.

A. T. Boddington, New York. Boddington's Seeds and Bulbs, Spring 1909. A unique cover design of sweet peas conventionally treated, in crimson, green and gold, gives especial distinction to this volume and lures one to want to look inside, which is the main purpose of cover adornment. The reader who follows the impulse and does look inside will undoubtedly be heard from, for it is full of temptations for the flower lover.

Peter Henderson & Co., New York. "Everything for the Garden," as big and handsome as ever—even more so—has come to hand for 1909. In its external appearance it is refined and beautiful and the contents fully bear out the inscription, "Everything for the Garden." There are three full page colored plates of tomatoes, sweet peas and roses, respectively. In general make up the book is a model for the catalogue maker and also for the dealer who seeks to present his goods to best advantage when the buyer begins to contract the garden fever.

INCORPORATED.

Mykawa, Texas.—Waverley Gardens Nursery Co.; C. F. Smith; C. F. Carson, I. M. Taylor; capital, \$10,000.

Boston, Mass.—F. B. Shattuck Co., landscape gardening; president, S. J. George, Winthrop; treasurer, W. J. Patten, Boston capital, \$50,000.

Beverly, N. J.—Davison Cranberry Co., E. A. Miller, F. McVaine, G. D. McVaine; capital, \$15,000; to grow cranberries, fruit seeds, etc.

Barenbrug On Grasses. By Joseph T. Barenbrug, \$1.00, postpaid. Horticulture Publishing Co., 11 Hamilton Place, Boston.

Mignonette

**FARQUHAR'S
GIANT**

Oz., 75c; 1-4 oz., 25c

R. & J. Farquhar & Co.
6 & 7 South Market Street
BOSTON, MASS.

BRIDGEMAN'S SEED WAREHOUSE
RICKARDS BROS.
Props.
37 East 19th St., - NEW YORK CITY

NEW SEED OF

<p>Ageratum</p> <p>Dwf. Blue..... Tr. Pk. Oz. \$0.10 \$0.25</p> <p>Asters</p> <p>Queen Market White..... 0.20 0.50 Rose..... 0.20 0.50 Victoria Mixed..... 0.25 1.50 Comet..... 0.25 2.50</p> <p>Salvia</p> <p>Splendens..... 0.25 2.50 Bon Fire..... 0.25 2.50 Zurich..... 1 oz. 75c</p>	<p>Alyssum</p> <p>Carpet of Snow..... Tr. Pk. Oz. \$0.10 0.35</p> <p>Begonia</p> <p>Vernon..... 0.25 2.50 Erlford..... 0.25 1.00</p> <p>Pansy</p> <p>Blended..... 1.00 8.00 Large French Stained..... 0.50 3.00</p>
--	--

WM. ELLIOTT & SONS, 42 Vesey St., NEW YORK

48-56 JACKSON ST.,
C. C. MORSE & CO. San Francisco, Cal.
The Largest Seed Growers on the Pacific Coast

ONION, LETTUCE, SWEET PEAS,

— ALSO —

Carrot, Celery, Leek, Mustard, Parsley, Parsnip, Radish, Salsify

LEONARD SEED CO.

CONTRACT GROWERS AND WHOLESALE DEALERS

BEANS, PEAS, SWEET CORN, ONION, GARDEN SEEDS

ONION SETS **Get Our Prices** 79 and 81
FLOWER SEEDS **E. KINZIE STREET, CHICAGO**

Thorburn's Seeds

LILY OF THE VALLEY PIPS
Unexcelled Hamburg or Berlin

TUBEROUS ROOTED BEGONIAS
GLOXINIAS

ROSA MULTIFLORA NANA SEED
and all other flower seeds for Florists
SEND FOR CATALOGUE

J. M. THORBURN & CO.
33 BARCLAY ST. through to 38 PLACE
NEW YORK

Burpee's Seeds
PHILADELPHIA

Blue List of Wholesale Prices mailed only to those who plant for profit.

CAULIFLOWERS SEED
CABBAGE

LILY OF THE VALLEY PIPS.

HJALMAR HARTMANN & CO.
12 Stormgade,
COPENHAGEN, DENMARK.

STOCK SEED
FOR WINTER BLOOMING

Our strain of Double Branching Stocks is exceptionally true. About 90% Double Flowers.

In colors: 1/2 oz. 50c or..... \$4.00
Pure White 3/4 " 25 "..... 5.00

H. E. FISKE SEED CO.
Faneuil Hall Square, BOSTON, MASS.

Winter-flowering
SWEET PEA SEED

All Colors Ask for List
A. C. ZVOLANEK

ORIGINATOR. BOUND BROOK, N. J.

NEW CROP SEED

For Early Planting
THOMAS J. GREY CO.
32 SO. MARKET ST., BOSTON, MASS.

BRECK'S SEEDS for FLORISTS

Fresh, Reliable. Prompt Delivery.
Catalogues mailed free on application

Joseph Breck & Sons Corp.
47-54 NO. MARKET ST., BOSTON, MASS.

QUALITY SEED BULBS

SEND FOR CATALOGUE.

ARTHUR T. BODDINGTON
349 West 14th St., New York.

To Florists Everywhere

Orders for Cut Flowers and Floral Decorations to be delivered anywhere in the Greater New York, may be placed with us with the certainty that your customers will be satisfied.

Telegraph, telephone or mail such orders to us and be sure that they will be filled as promptly and as carefully as though you did it yourself.

One third discount will be allowed on all orders thus placed with us by Florists outside of the Greater New York.

THE BLOSSOM

Bond and Livingston Sts.,
BROOKLYN, N. Y.

C. C. TREPPEL, Manager

WILLIAM J. SMYTH FLORIST

Cor. Michigan Ave. and 31st St., CHICAGO

We ship to all points in Illinois and Iowa.

Phones: Douglas 744, Douglas 523, Douglas 740

M. C. and J. E. HAUSWIRTH

Out of Town orders for Hospitals
Carefully filled.

232 Michigan Ave.
CHICAGO

AUDITORIUM ANNEX Tel. Harrison 585

SAMUEL MURRAY Florist

Coates House Conservatory
1017 BROADWAY, KANSAS CITY, MO
Both 'Phones 2670 Main



WASHINGTON,
D. C.

GUDE'S

The Far-Famed Flowers of TORONTO

Delivered on mail or telegraph order for any occasion, in any part of the Dominion.

JOHN H. DUNLOP, Jr
96 Yonge St., - Toronto, Ont.

The Park Floral Co.

J. A. VALENTINE
Pres.

DENVER, COLORADO

**WILLIAM L. ROCK
FLOWER CO.**

KANSAS CITY, - MO.

will carefully execute orders for Kansas City and any town in Missouri or Kansas.

Palmer's

Buffalo, N. Y.
W. J. PALMER & SON, 30 Main St.

SOME INTERESTING CARNATIONS

The award committee of the New York Florists' Club with representatives of the trade press visited on invitation the greenhouses of the F. R. Pierson Company at Scarborough, N. Y., on Saturday, January 9. The visit was primarily for the purpose of inspecting the rose White Killarney, on which the award committee was to make report, but opportunity was taken by Mr. Pierson to show the visitors through the carnation houses and, later on, to extend lavish hospitality on the return to New York City.

There are three carnation sports besides a number of seedlings that will be found very interesting by those who will take the trouble to visit Scarborough. The Lawson Winsor is, as its name indicates, a Lawson colored sport from Winsor. The color is fully equal to, if not even brighter than, that of Lawson, and in form of flower, length of stem and floriferousness it appears to far excel that famous variety. The Daybreak Winsor is a beauty which will be hard to beat. It has every good quality of Winsor with

STEAMER DEPARTURES

American.	
St. Paul, N. Y.-S'hampton.....	Jan. 23
New York, N. Y.-S'hampton.....	Jan. 30
Atlantic Transport.	
Mesaba, N. Y.-London.....	Jan. 19
Minnehaha, N. Y.-London.....	Jan. 23
Minneapolis, N. Y.-London.....	Jan. 30
Cunard.	
Carmack, N. Y.-Med'N Ports.....	Jan. 21
Saxonia, Boston Liverpool.....	Jan. 25
Lincoln, N. Y.-Liverpool.....	Jan. 27
French Line.	
La Savoie, N. Y.-Havre.....	Jan. 21
La Lorraine, N. Y.-Havre.....	Jan. 28
Hamburg-American.	
Moltke, N. Y.-Italian Ports.....	Jan. 28
Pennsylvania, N. Y.-Hamburg.....	Jan. 30
Leyland.	
Winifredian, Boston-Liv'pool.....	Jan. 20
Canadian, Boston-Liv'pool.....	Jan. 27
North German Lloyd.	
P. Friedrich Wil., N. Y.-Br'n.....	Jan. 19
Cheamitz, N. Y.-Hamburg.....	Jan. 28
Koenig Albert, N. Y.-Med. Ports.....	Jan. 30
White Star.	
Tontone, N. Y.-S'hampton.....	Jan. 20
Republic, N. Y.-Med. Ports.....	Jan. 22
Baltic, N. Y.-Liverpool.....	Jan. 30

a glowing soft pink color which the name Daybreak does not do full justice to. Prosperity Lawson is another sensational flower, a sport from White Lawson mottled with pink after the style of Prosperity. It has been admired greatly by those who have seen it. Among the seedlings is one which is to be named Pierson. The best description of it is to say that it is a mammoth Wm. Scott. In color, form of flower and habit generally it is closely reminiscent of the famous old variety, but in size of bloom and length of stem it is several times magnified. It is, in fact, one of the largest flowers produced as yet.

BUSINESS CHANGES.

Sharon, Pa.—Charles Heins succeeds to the business of Fred Heinz.

New York, N. Y. Kessler Bros. succeed Schumacher & Kessler, wholesale plantsmen, and will be located at 50 West 28th St.

Akron, O. L. C. McFarland has been given an interest in his father's business, and hereafter the firm name will be McFarlands, Florists.

ALEX. McCONNELL

571 FIFTH AVENUE
NEW YORK CITY

Telegraphic orders forwarded to any part of the United States, Canada, and all principal cities of Europe. Orders transferred or intrusted by the trade to our selection for delivery on steamships or elsewhere receive special attention.

Telephone Calls, 487 and 488 38th St.
Cable Address, ALEXCONNELL

New York Deliveries

FLOWERS and PLANTS

by special messenger to Steamer,
Theatre or any address in

NEW YORK or BROOKLYN

THOMAS YOUNG, JR.
500 FIFTH AVE., (near 42nd St.)

NEWMAN FLORAL Co.

(Established 1870)

202 Fifth Ave. and
Madison Square, NEW YORK CITY

FLOWERS FOR STEAMER SAILINGS

M. A. BOWE

In the Heart of New York City
1294 Broadway

Tel. 2270, 38th St. NEW YORK
Our Motto—The Golden Rule

DAVID CLARKE'S SONS

Deliver orders from any part of the country to
New York City

Or OUT-GOING STEAMERS

Write or telegraph

2139-2141 Broadway, New York
Telephone 1552-1553 Columbus

YOUNG & NUGENT

42 West 28 St., NEW YORK
"FLOWERS BY TELEGRAPH"

NEW YORK
MYER, FLORIST
Phone 5297 Plaza. 609 611 MADISON AVE.

ALBANY, N. Y.
EYRES
Flowers or Design Work

DELIVERED IN ALBANY AND VICINITY
ON TELEGRAPHIC ORDER.

11 NORTH PEARL ST., ALBANY, N. Y.

Flower Deliveries

In Brooklyn and other Long Island Points
New York City, New Jersey, etc. At Theatres,
Hotels, Steamers or Residences.

WILSON

Fulton St. and Greene Ave., Brooklyn, N. Y.

JOHN BREITMEYER'S SONS

Cor. Miami and Gratiot Aves.
DETROIT, MICH.

Artistic Designs . . .
High Grade Cut Blooms

We cover all Michigan points and good sections of Ohio, Indiana and Canada

PROMPT DELIVERY IN BOSTON

AND ALL NEW ENGLAND POINTS
F. H. HOUGHTON
396 Boylston St., Boston, Mass.
BOSTON'S BEST
In Quality and Design

Can be relied upon when you transfer your retail orders to

EDWARD MACMULKIN
194 Boylston Street, Boston

Send flower orders for delivery in

BOSTON

and all
NEW ENGLAND POINTS
THOS. F. GALVIN
124 Tremont St., Boston

The Original Telegraph Order Florist

WILL DELIVER

Flowers or Designs
to order in Boston and Vicinity. Usual Discount.

J. NEWMAN & SONS, Inc.
Est. 1870 24 TREMONT ST., BOSTON

TRANSFER

Your orders for flower or plant delivery in Eastern New England to

JULIUS A. ZINN,
2 Beacon St., Boston.

Fine Design Work a Specialty



DANKER, Albany, N. Y.

ORDERS FOR
Choice Flowers and
Floral Emblems

FILLED PROMPTLY

JACOB SCHULZ, 644 Fourth Ave., LOUISVILLE, KY.
Cut Flowers of BEST QUALITY in season delivered promptly to any address.
Write, Telegraph or Telephone.
Cumberland and Home Phones 223 and 984

WELLESLEY COLLEGE

Dana Hall, Walnut Hill and Rockledge Hall Schools. **TALLEY, Wellesley, Mass.**
Tel. Wellesley 44-1 and 2. Night 44-3.

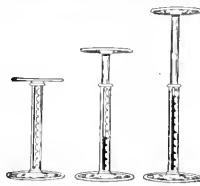

THE NEW IDEA IN PLANT STANDS

The Moore-Livingston Graduating or Adjusting

Saves one-half to two-thirds of cost over ordinary galvanized iron stands.

SEND FOR CIRCULAR GIVING FULL PARTICULARS
SOLD BY SEEDSMEN AND SUPPLY HOUSES

If your seedsman does not carry send us his name and we will promptly send full particulars.

Moore-Livingston Co., Patentees and Mfrs., Lansdowne, Pa.

PERSONAL.

E. S. Blauvelt of Coeyman's, N. Y., is issuing a very handsome calendar to his patrons.

Joseph Stillwell of Westerly, R. I., has taken a position with G. S. Ramsburg, Somersworth, N. H.

Chicago visitors: A. J. Peters, seed grower, Hollister, Cal.; W. E. Dwight, of Dwight Floral Co., Janesville, Wis.

Visitors in Boston: A. C. Zvolanek, Bound Brook, N. J.; Al. Rickards, New York City; H. S. DeForest, New York City.

Miss Mabel Hayes of the E. J. Harmon store, Portland, Me., has gone on a vacation south and will spend three weeks in Georgia.

J. Mergen, florist, 12th and Robey streets, Chicago, fell on the icy steps at the elevated station last Wednesday, fracturing his right wrist.

P. L. Carbone, florist, of Boston, who has relatives in Messina, sailed for Italy on January 5 to assist in relieving the sufferers from the recent earthquake.

T. Mellstrom, American representative of Sander & Sons, St. Albans, Eng., sailed from New York on Wednesday, January 13. He will return in March.

Philip Recht, representative of the Hinoe Nursery Co., Whitestone, N. Y., has been called suddenly to sail for Europe on account of the serious illness of his father.

Visitors in Albany, N. Y.—John Tegelaar, of Van Meenwen & Tegelaar, bulb-growers, Lisse, Holland; Henry Shrader, carnation grower of Saratoga, N. Y., accompanied by Mrs. Shrader; S. P. Dennison, New York.

Wm. Wallace Burnham was presented by the employees of the horticultural department of Bloomingdale's, New York, with a handsome silver loving cup last Monday when leaving his position of manager to assume his new duties elsewhere. The entire plant and flower trade of New York extends best wishes to Mr. Burnham.

A letter received from A. H. Goodwin, vice-president of the W. W. Barnard Co., Chicago, dated Palermo, Sicily, Dec. 24, and announcing his arrival and saying he expected to remain there, is causing much apprehension on the part of Mr. Goodwin's friends as to his safety. It is hoped

that he left Palermo and the vicinity of the terrible earthquake before the disaster occurred. Word of his safety is anxiously looked for.

NEW RETAIL FLOWER STORES.
Oakland, Cal.—O. Roller, 12th St., near Chanier of Commerce.

Cairo, Ill.—T. L. Metcalfe, 410 Commercial Ave.

Indianapolis, Ind.—M. Williams & Co., West End.

THE BEST LETTERS

FOR THOSE
FLORISTS' MADE
USE OF BY THE



Boston Florist Letter Co.

66 PEARL ST., BOSTON

Wm. F. McCARTHY, Mgr.

Order direct or buy from your local supply dealer. Insist on having the

BOSTON

Inscriptions, Emblems, etc. Always in Stock

TIE UP

Your Chrysanthemum Plants with
GREEN SILKALINE
Made Especially for that Purpose.

JOHN C. MEYER & CO., Boston, Mass.

FLORISTS' SUPPLIES

Send for New Catalogue

H. Bayersdorfer & Co.

1129 ARCH ST., PHILADELPHIA

ATLANTA FLORAL CO.

41 Peachtree Street, ATLANTA, GEORGIA

ROBERT J. DYSART,

Public Accountant and Auditor
Simple methods of correct accounting especially adapted for florists' use.

Books Balanced and Adjusted

Merchants Bank Building

28 STATE ST., BOSTON
Telephone, Main 58.

GARDENIAS \$6.00 per doz.
DOUBLE VIOLETS \$1.00 per 100
WHITE ORCHIDS \$6.00 per doz.

We will have a good supply of the above stock and can give you good value.

THE LEO NIESSEN CO.
 1209 Arch St., Philadelphia, Pa.
 Open from 7 a.m. to 8 p.m.

CHOICE Cattleyas
 \$6.00 per doz.
 \$40.00 per 100

QUALITY

S. S. PENNOCK-MEEHAN CO.
 1608-1620 Ludlow St., Philadelphia

Special Carnations
 Fancy grades from the best growers

W. E. McKISSICK & BROS.
 WHOLESALE FLORISTS
 1619-1621 RANSTEAD ST.
 PHILADELPHIA

WELCH BROS.
 AMERICAN BEAUTY, KILLARNEY, RICHMOND, MARYLAND AND ALL THE SUPERIOR
 ROSES, LILY OF THE VALLEY, CARNATIONS, ORCHIDS
BEST PRODUCED
 226 Devonshire Street, Boston, Mass.

CUT FLOWER BOXES
EDWARDS FOLDING BOX CO
 MANUFACTURERS
 PHILADELPHIA, PA.

CHAS. W. McKELLAR
 51 WABASH AVE., CHICAGO

Western Headquarters for Choice Orchids
 Valley, Roses and all Cut Flowers

PETER REINBERG
 WHOLESALE
CUT FLOWERS
 51 Wabash Av., Chicago, Ill.

DAILY CONSIGNMENTS
 From 40 to 60 Growers
 We can care for your outflow wants to advantage.

E. F. WINTERSON CO.
 45-47-49 WABASH AVE., CHICAGO

POEHLMANN BROS. CO.
 33-35-37 Randolph St., - CHICAGO

CUT FLOWERS
 Greenhouses, - Morton Grove, Ill.

Rice Brothers
 115 N. 6th Street, MINNEAPOLIS, MINN.
 WHOLESALE FLORISTS and SUPPLIES
 CUT FLOWERS received twice daily, and can fill your orders to your satisfaction. A complete line of Hardy Greens - WILD SMILAX, BOXWOOD, HARDY FANCY FERNS, GALAX LEAVES.
 Write for quotations on large quantities.

In ordering goods please add "I saw it in HORTICULTURE."

WHOLESALE FLOWER MARKETS—TRADE PRICES—Per 100 TO DEALERS ONLY

	CHICAGO Jan. 12	TWIN CITIES Jan. 11	PHILA. Jan. 11	BOSTON Jan. 14
ROSES				
Am. Beauty, Fancy and Special.....	30.00 to 40.00	30.00 to 40.00	60.00 to 75.00	40.00 to 60.00
" Extra.....	20.00 to 30.00	25.00 to 30.00	40.00 to 50.00	20.00 to 30.00
" No. 1.....	15.00 to 20.00	15.00 to 20.00	35.00 to 40.00	10.00 to 15.00
" Lower grades.....	10.00 to 15.00	10.00 to 15.00	8.00 to 12.00	4.00 to 8.00
Bevic, "Mad, Fancy & Special.....	10.00 to 12.00	8.00 to 10.00	12.00 to 15.00	10.00 to 15.00
" Lower grades.....	6.00 to 8.00	6.00 to 8.00	4.00 to 8.00	3.00 to 8.00
Killarney, Fan, & Sp.....	6.00 to 10.00	8.00 to 12.00	25.00 to 25.00	15.00 to 25.00
" Lower grades.....	3.00 to 6.00	5.00 to 7.00	6.00 to 12.00	3.00 to 8.00
Richmond, Fancy & Special.....	10.00 to 12.00	10.00 to 12.00	20.00 to 25.00	15.00 to 20.00
" Lower grades.....	6.00 to 8.00	6.00 to 8.00	4.00 to 12.00	3.00 to 8.00
Chatenay.....	8.00 to 10.00	6.00 to 8.00 to	3.00 to 12.00
Golden Gate, Ivory, etc.....	6.00 to 8.00	6.00 to 8.00	4.00 to 12.00	3.00 to 12.00
My Maryland..... to to to	6.00 to 25.00
Queen Beatrice..... to to to	3.00 to 12.00
Mrs. Mar. Field.....	6.00 to 15.00 to to to
CARNATIONS				
Fancy and Red.....	3.00 to 6.00	3.00 to 5.00	4.00 to 5.00	2.00 to 3.00
Ordinary and White.....	1.50 to 2.00	1.50 to 3.00	2.00 to 3.00	1.00 to 1.50
MISCELLANEOUS				
Cattleyas.....	40.00 to 60.00	50.00 to 60.00 to 60.00	40.00 to 50.00
Cypripediums..... to	10.00 to 14.00	12.00 to 15.00 to
Lily.....	12.00 to 15.00	10.00 to 12.00	10.00 to 12.00	8.00 to 10.00
Lily of the Valley.....	3.00 to 4.00	3.00 to 4.00	2.00 to 4.00	1.00 to 4.00
Narcis, Paper White.....	3.00 to 4.00	3.00 to 4.00	2.00 to 3.00	1.00 to 2.00
Roman Hyacinth.....	3.00 to 4.00	2.50 to 3.00	2.00 to 3.00	1.00 to 2.00
Tritepis.....	3.00 to 4.00 to to to
Freesia..... to to to to
Sweet Peas.....	.50 to 1.50	.75 to 1.25	.75 to 1.00	.75 to 1.00
Gardenias..... to	40.00 to 50.00 to 50.00	25.00 to 50.00
Violets.....	.50 to 1.50	1.50 to 2.00	.75 to 1.00	.35 to .75
Adiantum.....	1.00 to 1.00	1.00 to 1.50	1.00 to 1.50	.75 to 1.00
Smilax.....	12.00 to 15.00	12.00 to 14.00	12.00 to 15.00	10.00 to 15.00
Asparagus Plumosus, strings.....	35.00 to 50.00	40.00 to 50.00	35.00 to 50.00	25.00 to 50.00
" " Sera. (100 behs.).....	20.00 to 40.00	15.00 to 25.00	15.00 to 50.00	15.00 to 25.00

J.A. BUDLONG
 37-39 Randolph Street, CHICAGO.

Roses and Carnations
 A Specialty.....
 WHOLESALE GROWER of **CUT FLOWERS**

HENRY M. ROBINSON & CO.
 15 Province St. and 9 Chapman Place - BOSTON, MASS.
 WHOLESALE COMMISSION FLORISTS
 Hardy Cut Evergreens and Florists' Supplies
 We have the stuff and can fill all orders, large or small
 WE NEVER DISAPPOINT SATISFACTION GUARANTEED

Prices Quoted in these Columns are for Dealers Only.
 When Writing to Advertisers Please Mention
HORTICULTURE.

Flower Market Reports.

BOSTON Snow is falling rapidly as we jot down these notes, and the conditions do not promise any immediate change from the listless character which has distinguished the flower trade as a whole since the early part of January. While prices have changed but little, demand is exasperatingly weak on most lines, although the quality of the stock is extra good on the average and it cannot be said that the product is or has been thus far noticeably heavy. The shortening up of the cut which is caused by inclement weather is no longer any advantage to the market, as now-a-days so large a proportion of the aggregate production finds its outlet through small distributors whose sales are disastrously affected by stormy weather that the advantage at one end is more than offset by the loss at the other. Out of town demand is no better than the home demand at present, and the shippers find things unpleasantly dull.

The week ending January 9 was a rather dull one. Roses, especially the short grade, have been rather scarce, while select Killarney, Richmond and Beauty have been in good supply and demand light. The first part of the week found carnations in only fair supply, but nearing Friday shipments came in heavy with light demand. A sprinkling of floral work moved a good portion of the light colors together with lilies of the valley and sweet peas. There has been little or no demand for violets since the holidays. The Charity Ball and other social functions are booked for the coming week and will keep the market awake.

CHICAGO Chicago market has been up and down during the past week. Like the thermometer, it has had its rise and fall. On the 6th, Chicago experienced the coldest weather in three years, and shipping trade was light when the thermometer was registering ten degrees below. The market is well filled with flowers and while there is not a glut or even a very near approach to one, there are more flowers of some varieties than can be used to good advantage. Killarney is not so good as earlier in the season, while Bridesmaid is at its best and preferred by many customers. Budlong has exceptionally fine Brides and Bridesmaids, with heavy stems thirty or more inches long, and the writer thinks them the finest seen here this season. Beauties in short and medium move well, but the very long ones are going rather slowly. There is an abundance of paper whites, dafodils, and some tulips, but they do not move very rapidly. The coming carnation convention at Indianapolis is an interesting topic of conversation, and it is expected that the attendance from Chicago will be good.

INDIANAPOLIS The cut flower market continues to be on a good basis with supply and demand fairly proportionate. A little cold snap curtailed the supply of roses and carnations to some extent. There has been quite a weakening of prices in general since New Year. Beauties and Teas

WHOLESALE FLOWER MARKETS.— PER 100. TO DEALERS ONLY.

	CINCINNATI		DETROIT		BUFFALO		PITTSBURG	
	Jan. 11	Jan. 12	Jan. 11	Jan. 12	Jan. 11	Jan. 12	Jan. 11	Jan. 12
ROSES								
Am. Beauty, Fan, and Sp.	36.00	to 45.00	35.00	to 40.00	40.00	to 50.00	40.00	to 50.00
" Extra	20.00	to 25.00	21.00	to 25.00	25.00	to 40.00	25.00	to 40.00
" No. 1	10.00	to 20.00	18.00	to 25.00	15.00	to 20.00	10.00	to 15.00
" Lower grades	2.00	to 6.00	8.00	to 15.00	6.00	to 10.00	to 8.00
Bride, 'Maid, F. & S.	4.00	to 8.00	16.00	to 8.00	10.00	to 15.00	19.00	to 12.00
" Lower grades	2.00	to 6.00	3.00	to 5.00	5.00	to 6.00	3.00	to 8.00
Killarney, Fan, & Sp.	5.00	to 8.00	6.00	to 8.00	12.00	to 15.00	10.00	to 12.00
" Lower grades	3.00	to 4.00	3.00	to 5.00	6.00	to 13.00	6.00	to 8.00
Richmond, Fancy & Special	6.00	to 8.00	7.00	to 10.00	12.00	to 15.00	to 12.00
" Lower grades	2.00	to 4.00	4.00	to 7.00	4.00	to 10.00	8.00	to 10.00
Chatenay	6.00	to 8.00	3.00	to 8.00	4.00	to 10.00	4.00	to 10.00
Golden Gate, Ivory, etc.	4.00	to 6.00	to 10.00	to 10.00	to 10.00
My Maryland	3.00	to 5.00	to 10.00	to 10.00	to 10.00
Queen Beatrice	6.00	to 8.00	to 10.00	to 10.00	to 10.00
Mrs. Mar. Field	to 10.00	to 10.00	to 10.00	to 10.00
CARNATIONS								
Fancy and Novelties	3.00	to 5.00	2.00	to 3.00	2.50	to 3.00	2.00	to 4.00
Ordinary	2.00	to 3.00	1.50	to 2.00	2.00	to 2.50	to 1.50
MISCELLANEOUS								
Cattleyas	to 10.00	to 10.00	to 10.00	to 75.00
Oxyrpediums	to 10.00	to 10.00	to 10.00	to 10.00
Lilies	12.00	to 16.00	15.00	to 20.00	8.00	to 15.00	to 15.00
Lily of the Valley	2.00	to 5.00	3.00	to 4.00	3.00	to 4.00	3.00	to 4.00
Narciss, Paper White	2.00	to 3.00	3.00	to 4.00	2.00	to 3.00	to 3.00
Roman Hyacinth	2.00	to 3.00	2.00	to 3.00	2.00	to 3.00	to 3.00
Dafodils	2.10	to 3.00	to 10.00	to 10.00	to 10.00
Freesia	to 2.00	to 10.00	to 10.00	to 10.00
Sweet Peas	to 2.00	1.00	to 1.50	.50	to 1.00	.75	to 1.50
Gardenias	to 1.00	to 1.00	to 1.00	to 50.00
Violets	25	to 1.50	.50	to 1.25	.75	to 1.25	1.00	to 1.25
Adiantum	to 1.00	to 1.50	.50	to 1.50	1.00	to 1.50
Smilax	to 12.00	to 15.00	12.00	to 15.00	12.50	to 15.00
Asparagus Plumosus, string	to 50.00	to 50.00	25.00	to 50.00	30.00	to 50.00
" & Syren (too heavy)	25.00	to 35.00	30.00	to 50.00	25.00	to 50.00	30.00	to 50.00

continue to sell well, the quality being a bit off. Good violets seem to be a little on the scarce side. Bulbous stock is coming in more freely, paper whites and Roman hyacinths predominating. Lilies are not over plentiful but sufficient to meet the demand. Orchids, lily of the valley, sweet peas and mignonette are in good supply and move well. Plant trade is holding up well, quantities being moved daily.

Last week was **PHILADELPHIA.** not so good; stock more plentiful and trading rather dull so that average conditions receded a little. American Beauty roses were a redeeming feature, the crop of these being well cut out for the time being—not nearly so many good ones as around Christmas and the quality on the whole only fair. Liberty and Richmond roses sold well but all varieties of pink roses were almost a bugaboo, and white roses also dropped back a notch. Carnations very plentiful and of fine quality. Violets more plentiful and prices lower. Lily of the valley in good demand. Receipts of Roman hyacinths and paper whites largely diminished and cleaning up at rather better prices. Easter lilies too many; mignonette accumulating; sweet pea market has improved. Greens selling up better and now in fairly healthy condition. Out-of-town trade has dropped off. Supply business brisk—especially in ribbons.

WASHINGTON There is not much change to report in the Washington floral world. Of course, the holiday rush has quieted down some but there are so many social functions on the tapis that there is a steady de-

mand for good flowers of nearly all kinds. There is no overplus for the greater part of the time since the New Year opened has been very dark and cloudy. There is an unusual demand just now for Killarney roses and pink carnations, also paper white narcissus and lily of the valley, caused by a succession of debutantes.

PHILADELPHIA NOTES.

J. Horace McFarland, of Harrisburg, Pa., gave an interesting lecture before the Civic Improvement Association, Lansdowne, January eighth.

Arthur Niessen, of the Leo Niessen Co., stole a march on his many friends January sixth when he slipped quietly off to Baltimore and got married. His well known modesty should have taken a back seat to our keen desire to dance at the wedding, and thus testify in a small way how much we think of him.

James Walsh, late decorator for Graham, has been located in Camden, since September first. He makes and sells his own flags and does quite a business in co-operation with other florists as well as on his own account.

Henry F. Michell Co., have now got their two stores at 1018 and 518 Market street running, both fully equipped. A large consignment of tuberous rooted begonias and gloxinias was being opened up in excellent condition at date of our last call.

Montreal, Que.—White & Co. lost several hundred dollars' worth of plants on Jan. 7 through a fire which started in the basement in the rear of the store from an overheated furnace.

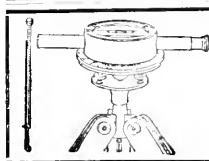

EVERYBODY KNOWS Park, Cemetery and Landscape Gardening cannot be properly done without the aid of an accurate leveling instrument. Bostrom's Improved Levels, No. 2 at \$15.00 and No. 3 at \$35.00, are conceded by all who KNOW to be the only Levels on the market which meet all the requirements, at the price. Our guarantee back of every Level we sell, and satisfied users in every State in the Union heartily endorse every claim we make. Shipping weight 12 lbs. Description on request.

BOSTROM-BRADY MFG. CO., 139 Madison Avenue, ATLANTA, GA.

FORD BROTHERS

48 West 28th Street NEW YORK
FINE ROSES FANCY CARNATIONS
 A Full Line of All CUT FLOWERS

Telephone, 3870 or 3871 Madison Square

H. E. FROMENT

Wholesale Commission Florist,
 Choice Cut Flowers,

57 West 28th St. :: NEW YORK
 Telephones: 2200, 2201, Madison Square.

Alfred H. Langjahr

All choice cut-flowers in season. Send for quotations. Correspondence with shippers of first-class stock invited.

55 West 28th Street, New York
 Telephones 4826-4827 Madison Square

Edward C. Horan
 Wholesale Florist

55 WEST 28th ST.

Tel. 1462 Madison Square New York

JOHN YOUNG

WHOLESALE FLORIST

Finest American Beauties and Carnations

51 West 28 St. - NEW YORK

FRANK MILLANG

Wholesale Florist

55-57 West 26th St., NEW YORK
 Shipments, any quantity, Wholesale Market Rates.

Consignments Requested

A Good Market and Prompt Returns

GEORGE SALT FORD

43 W. 28th Street, NEW YORK
 Telephone, 2202 Madison Sq

VIOLETS

Finest Grade. Any Quantity

B. S. SLINN

55-57 W. 26 St., New York

Moore, Hentz & Nash

Wholesale Commission Florists

55 and 57 West 26th Street

Telephone No. 756 Madison Square New York

MILLANG BROS.

WHOLESALE COMMISSION FLORISTS

41 West 28th Street

Telephone 3860 Madison NEW YORK

JOHN I. RAYNOR

Wholesale Commission Florist SELLING AGENT FOR LARGEST GROWERS

A full line of Choice Cut Flower Stock for all purposes. Complies every variety grown for New York market, at current prices

TEL. 1998 MADISON SQUARE 49 West 28th St., New York City

Walter F. Sheridan
 Wholesale Commission Dealer in

CHOICE CUT FLOWERS

39 West 28th Street, New York
 Telephone: 3532-3533 Madison Square

HEADQUARTERS FOR NOVELTIES
ORCHIDS A SPECIALTY

THE HIGHEST GRADE OF VALLEY ALWAYS ON HAND

GARDENIAS, DAISIES, ROSES AND CARNATIONS

JAMES McMANUS, Telephone 763 Mad. Sq. 42 W. 28th St., New York

PHILIP F. KESSLER 55 & 57 W. 26th St., New York City
 Commission Dealer, Wholesale Buyer and Seller of

Open from 5 a. m. to 6 p. m. Sunday till 10 a. m.

Tel., 5243 and 2921 Madison Sq. Res., 345 J., Newtown.

CUT FLOWERS

Finest Lilies in the Market Every Day in the Year.

NEW YORK QUOTATIONS PER 100. To Dealers Only

ROSES AND CARNATIONS	Last Half of Week ending Jan. 9 1909		First Half of Week beginning Jan. 11 1909	
American Beauty, Fancy and Special.....	40.00	to 60.00	40.00	to 60.00
" " Extra.....	20.00	to 30.00	20.00	to 25.00
" " No. 1.....	10.00	to 15.00	10.00	to 15.00
" " Lower Grades.....	3.00	to 6.00	3.00	to 5.00
Bride, "Taid, Fancy and Special.....	8.00	to 12.00	8.00	to 12.00
" " Lower Grades.....	2.00	to 8.00	2.00	to 6.00
Killarney, Fancy and Special.....	12.00	to 15.00	10.00	to 15.00
" " Lower Grades.....	3.00	to 8.00	3.00	to 6.00
Richmond, Fancy and Special.....	12.00	to 15.00	10.00	to 15.00
" " Lower Grades.....	4.00	to 8.00	3.00	to 6.00
Chatenay.....	3.00	to 12.00	3.00	to 12.00
Ty Maryland.....	4.00	to 20.00	4.00	to 20.00
Golden Gate, Ivory, etc.....	2.00	to 12.00	2.00	to 12.00
Queen Beatrice.....	to	to
Mrs. Mar. Field.....	to	to
Carnations, Fancy and Novelties.....	4.00	to 5.00	3.00	to 5.00
" " Ordinary and White.....	2.00	to 3.00	1.50	to 2.00

Alexander J. Guttman

THE WHOLESALE FLORIST OF NEW YORK

34 WEST 28th STREET

PHONES: 1664-1665 MADISON SQUARE

ENOUGH SAID

TRAENDLY & SCHENCK

Wholesale Florists

Furnish best stock at fair prices all the year round.

Send for quotations on Fall Orders.

Tel. 798, 799 Madison Sq.

44 West 28th St., New York City.

GROWERS' CUT FLOWER CO.

CUT FLOWERS AT WHOLESALE

VIOLETS, CARNATIONS ROSES ORCHIDS, CHRYSANTHEMUMS, LILIES

Consignments Solicited. Shipments to Order, any Distance

39 West 28th Street,

Telephone 3537 Madison Square

J. J. OJAN, Manager NEW YORK

WHOLESALE FLORISTS
54 West 28th St.
NEW YORK
Telephone 3659 Madison Sq.

A. L. YOUNG & CO.

RECEIVERS & SHIP-
PERS OF CUT
FLOWERS.
CONSIGNMENTS SOLICITED.

WILLIAM H. KUEBLER
Brooklyn's Foremost and Best

WHOLESALE COMMISSION HOUSE
A First Class Market for all CUT FLOWERS
28 Willoughby St., Brooklyn, N. Y.
Tel. 4591 Main

Greater New York Florists' Association, Inc.
Now Open for Cut Flower Consignments
162 Livingston Street, BROOKLYN, N. Y.
Geo. W. Crawbuck Telephone Connection
Manager 3642-43 Main

H. C. BERNING
Wholesale Florist

1402 Pine Street, ST. LOUIS, MO.
REED & KELLER
122 West 25th St., New York

Florists' Supplies
We manufacture all our
Metal Designs, Baskets, Wire Work & Novelties
and are dealers in
Glassware, Decorative Greens and Florists' Requisites

THE KERVAN CO.
Wholesale Dealers and Shippers of
Decorative Evergreens
Ferns, Galax, Laurel, Fresh Cycas, Box-
wood, Sphagnum and all Christmas Greens
Send to us for Quotations before Buying.
113 West 28 Street, NEW YORK CITY

MICHIGAN CUT FLOWER EXCHANGE, Inc.
WHOLESALE COMMISSION FLORISTS
Consignments Solicited.
Hardy Fancy Fern Our Specialty.

38-40 BROADWAY, DETROIT, MICH.
BRONZE GALAX
I will offer during the next 60 days first class
Bronze Galax at \$3.00 per case of 10,000,
size 2 3/4 to 3 1/2 in. f. o. b. Mt. Airy, N. C.
Cash with order. Sample Order Solicited.
G. A. HOLDER, Round Peak, N. C.

In ordering goods please add "I saw
it in HORTICULTURE."

Wired Toothpicks
Manufactured by
W. J. COWEE, BERLIN, N. Y.
20,000.....\$1.75; 50,000.....\$7.50. Sample free.
For sale by dealers

SAMUEL A. WOODROW
WHOLESALE PLANTSMAN
Palms, Large and Small Ferns, etc.
53 West 30th Street, NEW YORK
Telephone 2083 Madison

GEORGE COTSONAS & CO.
Wholesale and Retail Dealers in all kinds of
EVERGREENS
Fancy and Digger Ferns
Bronze and Green Galax
Main Store 50 W. 28 St.
Phone 3302 Mad. Sq. New York

Henshaw & Fenrich
WHOLESALE FLORISTS
44 West 28th St., NEW YORK
Phones Mad. Sq. 325, 558-2, 558-3.

WHOLESALE COMMISSION J. K. ALLEN 106 W. 28th St.
NEW YORK
Open 6 a. m. Daily Tel. 167 Madison Sq.
All Grades of Flowers to Suit All Buyers. Consignments Solicited.

NEW YORK QUOTATIONS PER 100. To Dealers Only

MISCELLANEOUS	Last Half of Week ending Jan. 9 1909		First Half of Week beginning Jan. 11 1909	
	Cyrtipediums.....	8.00	12.00	8.00
Cattleyas.....	20.00	10.00	25.00	60.00
Lilies.....	4.00	10.00	4.00	10.00
Lily of the Valley.....	1.00	3.00	1.00	3.00
Narcis., Paper White.....	1.00	2.00	1.00	2.00
Roman Hyacinth.....	1.00	2.00	1.00	2.00
Tulips.....	2.00	4.00	2.00	4.00
Daffodils.....	2.00	4.00	2.00	4.00
Freesia.....
Sweet Peas.....	1.00	1.50	1.00	1.50
Gardenias.....	20.00	50.00	20.00	50.00
Violets.....	.30	.75	.30	.75
Adiantum.....	.75	1.50	.50	1.00
Crowanum.....	1.00	1.25	1.00	1.25
Smilax.....	8.00	10.50	8.00	10.00
Asparagus Plumosus, strings.....	15.00	35.00	15.00	35.00
" & Sprea. (too bchs).....	15.00	25.00	15.00	25.00

NEW YORK MARKET.
This market has been very sluggish for the past two weeks. There is an abundance of very choice material daily on the tables in the wholesale marts—fit in quantity and quality to supply a heavy and exacting demand, but much of it must find its outlet through bargain channels. The street corners seem to be the main distributing centres for the once patrician violet, and high grade material of all kinds makes its appeal for appreciation from many places where its beauty is strongly in contrast with its surroundings. With every recurrence of such a period as this the problem of the disposal of the common run of stock which must at all times preponderate becomes more and more difficult. The prices quoted in our tabulated reports must not be taken as arbitrary but rather as a guide—and a very elastic one at that—in estimating comparative values. Cattleya Trianae are coming in freely and can be bought in quantity at minimum rates this week. In quality they have never been finer. Some florists' windows display them in plant form—beautiful specimens with abundant bloom. Well flowered camellias as small pot plants are a prime window attraction. Julius Roehrs of Rutherford, N. J., makes a specialty of these. Lilacs, white and



pale-tinted, are among the handsomest things shown. Double flowered peaches are also exquisite.

NEWS NOTES.
It is said that Thorley's new establishment at the corner of Fifth avenue and Forty-sixth street, New York, which he is to occupy next fall, is to be modelled after the Pavillon d'Armenonville, the famous Parisian restaurant in the Bois de Boulogne. It will be known as "The House of Flowers."

Chicago, Ill.—The annual meeting of the Flower Growers' Co. of Chicago, was held on January 5 and officers were elected as follows: President, W. L. Tonner; vice-president, A. Henderson; recording secretary, John Sinner; financial secretary and manager, Percy Jones; treasurer, M. R. Hills.

We will allow on all orders of
Sheaves and Wire Work
15 per cent discount. Orders of \$30.00 up 20 per cent. This for the month of January only.
J. STERN & CO.
125 N. 10th St., Philadelphia, Pa.

Buyer's Directory and Ready Reference Guide

Advertisements under this head, one cent a word. Initials count as words.

Display advertisers in this issue are also listed under this classification without charge. Reference to List of Advertisers will indicate the respective pages.

Buyers failing to find what they want in this list will confer a favor by writing us and we will try to put them in communication with reliable dealers.

ACCOUNTANT

R. J. Dyaart, 28 State St., Boston.
For page see List of Advertisers.

AQUILEGIAS

Aquilegas. Genuine Coerulea, Sweet of all. Both plants and seeds from the heart of the Rockies. C. S. Harrison's Select Nursery, York, Neb.

ARAUCARIAS

A. Leuthy & Co., Perkins St. Nurseries, Roslindale, Mass.

For page see List of Advertisers.

Godfrey Aschmann, 1012 West Ontario St., Philadelphia, Pa.

For page see List of Advertisers.

ASPARAGUS

The Geo. Wittbold Co., 1657 Buckingham Palace, Chicago, Ill.

For page see List of Advertisers.

AUCTION SALES

Clery's Horticultural Co., 62 Vesey St., New York.

For page see List of Advertisers.

AZALEAS

A. Leuthy & Co., Perkins St. Nurseries, Roslindale, Mass.

For page see List of Advertisers.

BAMBOO CANES

Yokohama Nursery Co., 31 Barclay Street, New York.

Bamboo Sticks, Colored Green.

For page see List of Advertisers.

BAV TREES.

2000 Bay and Box Trees in all sizes, Pyramid and Standards. Write for list. Julia Roehrs, Rutherford, N. J.

BOILERS

BOILERS. "Burnham" Boilers made for greenhouse heating. Lord & Burnham, 113 Broadway, N. Y.

Kroeschell Bros. Co., 35 Erie St., Chicago. For page see List of Advertisers.

BOXWOOD TREES

New England Nurseries, Inc., Bedford, Mass.

For page see List of Advertisers.

BUILDING MATERIAL

BUILDING MATERIAL of all description for All Cypress, Semi-Iron, Iron Frame or Truss Houses. Hot Bed Sash and Frames. Lord & Burnham Co., 113 Broadway, N. Y.

BULBS AND TUBERS

Joseph Breck & Sons, 47-54 N. Market St., Boston.

For page see List of Advertisers.

J. M. Thornburn & Co., 33 Barclay St., New York.

For page see List of Advertisers.

A. T. Boddington, 342 W. 14th St., N. Y.

For page see List of Advertisers.

Rickards Bros., 37 East 19th St., New York.

For page see List of Advertisers.

H. F. Mitchell Co., Philadelphia.

For page see List of Advertisers.

H. E. Fiske Seed Co., Faneuil Hall Sq., Boston.

For page see List of Advertisers.

T. J. Grey & Co., 32 and 33 So. Market St., Boston.

For page see List of Advertisers.

Yokohama Nursery Co., 31 Barclay St., New York.

For page see List of Advertisers.

Ralph M. Ward & Co., 12 W. Broadway, New York.

Japan Lily Bulbs.

For page see List of Advertisers.

CANNAS

Dingee & Conard Co., West Grove, Pa.
For page see List of Advertisers.

CARNATIONS

F. Dornier & Sons Co., Lafayette, Ind.

Carnation, Pink Delight.

For page see List of Advertisers.

Chicago Carnation Co., Joliet, Ill.

For page see List of Advertisers.

Albert Roper, Tewksbury, Mass.

Carnation Day State.

For page see List of Advertisers.

Bassett & Waanburn, Hinsdale, Ill.

Carnation O. P. Bassett.

For page see List of Advertisers.

East Sudbury Greenhouses, So. Sudbury, Mass.

Carnation Cuttings.

For page see List of Advertisers.

Wood Bros., Fishkill, N. Y.

Carnations, Rooted Cuttings.

For page see List of Advertisers.

The E. G. Hill Co., Richmond, Ind.

Carnation Cuttings.

For page see List of Advertisers.

Peter Fisher, Ellis, Mass.

Rooted Cuttings.

For page see List of Advertisers.

S. J. Renter & Son, Westery, K. I.

For page see List of Advertisers.

Bellamy Bros., Suc. to L. E. Marquisee, Syracuse, N. Y.

Carnation March-ones.

For page see List of Advertisers.

I. L. Pillsbury, Galesburg, Ill.

CHRYSANTHEMUMS

Chas. H. Totty, Madison, N. J.

Chrysanthemum Novelties.

For page see List of Advertisers.

E. G. Hill Co., Richmond, Ind.

For page see List of Advertisers.

S. J. Goddard, Framingham, Mass.

Chrysanthemum Golden Glow.

For page see List of Advertisers.

S. J. Renter & Son, Westery, R. I.

For page see List of Advertisers.

Elmer D. Smith & Co., Adrian, Mich.

For page see List of Advertisers.

Chrysanthemum Golden Glow from 2 1/4 in. pots, for early spring delivery, \$1.00 per doz., \$3.00 per 100, \$75.00 per 1000. Stock plants of Mountfort, Oct. Frost, Crocena, Matchless, Lucey Devaux, Polly Rose and Halliday, \$1.00 per doz.; \$5.00 per 100. Poiree Bros., Waltham, Mass.

Herrington's book on the Chrysanthemum, mailed to your address for 50c., by Horticulture Publishing Co., 11 Hamilton Place, Boston.

CONIFERS

John Waterer & Sons, Ltd., American Nursery, Bagshot, Eng.

For page see List of Advertisers.

CUT FLOWER BOXES.

Edwards Folding Box Co., Philadelphia.

For page see List of Advertisers.

Folding cut flower boxes, the best made. Write for list. Holton & Hunkel Co., Milwaukee, Wis.

CYCLAMEN.

Thomas Roland, Nahant, Mass.

For page see List of Advertisers.

DAHLIAS

David Herbert & Son, Atco, N. J.

For page see List of Advertisers.

J. L. Moore, Northboro, Mass.

For page see List of Advertisers.

DAHLIAS - Continued

Peacock Dahlia Farms, Williamstown Junction, Miss. Virginia Maule.

For page see List of Advertisers.

R. Vincent Jr. & Sons Co., White Marsh, Md.

For page see List of Advertisers.

Dingee & Conard Co., West Grove, Pa.

For page see List of Advertisers.

East Bridgewater Dahlia Gardens wants your business. If you are looking for dahlias send to the Eastern Dahlia King, J. K. Alexander, East Bridgewater, Mass.

DAISIES

Daisies, Yellow and White Paris and Queen Alexandra. Rooted Cuttings, \$1.00 per 100, prepaid. Chas. Frost, Kenilworth, N. J.

DECORATIVE PLANTS

A. Leuthy & Co., Perkins St. Nurseries, Roslindale, Mass.

For page see List of Advertisers.

Godfrey Aschmann,

1012 W. Ontario St., Phila., Pa.

For page see List of Advertisers.

Joseph Peacock Co., Wyncote, Pa.

For page see List of Advertisers.

The Geo. Wittbold Co., 1657 Buckingham Palace, Chicago, Ill.

For page see List of Advertisers.

Robert Craig Co., Market and 49th St., Philadelphia, Pa.

For page see List of Advertisers.

A. N. Pierson, Inc., Cromwell, Conn.

Palms and Ferns.

For page see List of Advertisers.

DRAECAENS

The Geo. Wittbold Co.,

1657 Buckingham Place, Chicago, Ill.

For page see List of Advertisers.

ECONOMY BRACKET

Burton & Allard, Nashua, N. H.

For page see List of Advertisers.

EVERGREENS

New England Nurseries, Bedford, Mass.

For page see List of Advertisers.

American Nursery Co., 150 Broadway, New York, N. Y.

For page see List of Advertisers.

Evergreens. Send 25 cents in stamps for complete work on propagating and growing Evergreens. C. S. Harrison's Select Nursery, York, Neb.

FERNS

A. Leuthy & Co., Roslindale, Mass.

For page see List of Advertisers.

H. H. Barrows & Son, Whitman, Mass.

Nephrolepis Whitmaul.

For page see List of Advertisers.

John Scott, Brookly, N. Y.

For page see List of Advertisers.

Frank Oechslein, 2570-2605 W. Adams St., Chicago.

Ferns for Dishea.

For page see List of Advertisers.

The Geo. Wittbold Co., 1657 Buckingham Palace, Chicago, Ill.

For page see List of Advertisers.

Godfrey Aschmann, 1012 W. Ontario St., Philadelphia.

For page see List of Advertisers.

Henry Weston, Hempstead, N. Y.

For page see List of Advertisers.

500 Boston and Scott's ferns, 3 and 3 1/2

pots, cheap for cash. Just right for bedding out. Geo. H. Walker, No. Dighton, Mass.

For List of Advertisers See Page 89

FERTILIZERS

Pulverized Manure Co., 31 Union Stock Yards, Chicago, Ill.
Wizard Brand Sheep and Shredded Cattle Manure.
 For page see List of Advertisers.

Robert Simpson, Clifton, N. J. Sheep Manure.
 For page see List of Advertisers.

Wm. Elliott & Sons, 42 Vesey St., New York.
 Ground Bone for Potting.
 For page see List of Advertisers.

FICUS

Ficus elastica; six inch; extra choice; clean stock, \$4.00 per 100. Collingdale Greenhouses, Collingdale, Pa.

FLORAL PHOTOGRAPHS

Flora! Photographs, Foley's, 226-228 1-2 Bowery, New York.

FLORISTS' LETTERS.

Boston Florist Letter Co., 66 Pearl St., Boston, Mass.
 For page see List of Advertisers.

FLORISTS' PRINTING

Letter-heads, bill-heads, tags, etc., \$1.25 per thousand. Samples free. Write now. Distance no hindrance. Fink & Sotter, Pottstown, Pa.

FLORISTS SUPPLIES

N. F. McCarthy & Co., 84 Hawley St., Boston.
 For page see List of Advertisers.

H. M. Robinson & Co., 15 Province St. and 9 Chapman Pl., Boston, Mass.
 For page see List of Advertisers.

Reed & Keller, 122 W. 25th St., New York.
 For page see List of Advertisers.

H. Bayersdorfer & Co., 1129 Arch St., Philadelphia.
 Easter Baskets.
 For page see List of Advertisers.

FLOWERS BY TELEGRAPH

Park Floral Co., Denver, Colo.
 For page see List of Advertisers.

Gude Bros. Co., 1214 F St., Washington, D. C.
 For page see List of Advertisers.

Atlanta Floral Co., Atlanta, Ga.
 For page see List of Advertisers.

M. C. & J. E. Hauewirth, 232 Michigan Ave., Chicago.
 For page see List of Advertisers.

William J. Smyth, Michigan Ave. and 31st St., Chicago.
 For page see List of Advertisers.

George Wittbold Co., 1657-59 Buckingham Place, Chicago.
 For page see List of Advertisers.

Jacob Schulz, 644 4th Ave., Louisville, Ky.
 For page see List of Advertisers.

Thos. F. Galvin, 124 Tremont St., Boston.
 For page see List of Advertisers.

Julius A. Zinn, 2 Beacon St., Boston.
 For page see List of Advertisers.

F. H. Houghton, 396 Boylston St., Boston.
 For page see List of Advertisers.

Edward MacMikin, 194 Boylston St., Boston.
 For page see List of Advertisers.

Hoffman, Florist, 59-61 Massachusetts Ave., Boston.
 For page see List of Advertisers.

J. Newman & Sons, Inc., 24 Tremont St., Boston.
 For page see List of Advertisers.

Tally, Wellesley, Mass.
 For page see List of Advertisers.

J. Breitmeyer's Sons, Miami and Gratiot Aves., Detroit, Mich.
 For page see List of Advertisers.

Samuel Murray, 1017 Broadway, Kansas City, Mo.
 For page see List of Advertisers.

Wm. L. Rock Flower Co., 1116 Walnut St., Kansas City, Mo.
 For page see List of Advertisers.

Fred C. Weber, 4326-28 Olive St., St. Louis, Mo.

FLOWERS BY TELEGRAPH—

Continued

H. G. Eyres, 11 N. Pearl St., Albany, N. Y.
 For page see List of Advertisers.

David Clarke's Sons, 2139-2141 Broadway, New York.
 For page see List of Advertisers.

Alex. McConaell, New York.
 For page see List of Advertisers.

Robert G. Wilson, Fulton St. & Greene Ave., Brooklyn, N. Y.
 For page see List of Advertisers.

Young & Nugeet, 42 W. 28th St., N. Y.
 For page see List of Advertisers.

M. Bowe, 1294 Broadway, New York.
 For page see List of Advertisers.

Myer, 600-11 Madison Ave., New York.
 For page see List of Advertisers.

Thos. Young, Jr., 509 Fifth Av., New York.
 For page see List of Advertisers.

Newman Floral Co., 202 Fifth Ave., and Madison Sq., New York.
 For page see List of Advertisers.

The Blossom (C. C. Trepel, Mgr.), Bond and Irvington Sts., Brooklyn, N. Y.
 For page see List of Advertisers.

Palmer's, Buffalo, N. Y.
 For page see List of Advertisers.

E. A. Danker, Albany, N. Y.
 For page see List of Advertisers.

J. H. Dunlop, 96 Yonge St., Toronto, Can.
 For page see List of Advertisers.

FLOWER POTS

W. H. Ernest, 28th and M Sts., Washington, D. C.
 For page see List of Advertisers.

A. H. Hews & Co., Cambridge, Mass.
 For page see List of Advertisers.

Hilfinger Bros., Ft. Edward, N. Y.
 For page see List of Advertisers.

Willidin Pottery Co., Philadelphia.
 Standard Flower Pots.
 For page see List of Advertisers.

The Peters & Reed Pottery Co., Red pots, seed pans, etc. Zanesville, O.

FOREST SEEDLINGS

To close out quick I offer the following first-class stock for Parks, Cemeteries and Forest Plantings: 100 M. Amorpha Fruticosa, 1 to 3 ft.; 306 M. Althea Rosa Stocks; 100 M. Cal Privet; 500 M. Cal Privet Cuttings; 100 M. Black Locust, 1 to 6 ft.; 50 M. Calycanthus, Sweet Shrub, 1 to 3 ft.; 150 M. Cercis Canadensis, Red Bud, 1 to 4 ft.; 60 M. Cornus Stolonifera, Ozler Dogwood, 1 to 2 ft.; 50 M. Diosyros, Am. Persimmon, 6 to 30 inches; 50 M. Elm (white) 1 to 2 ft.; 75 M. Hamamelis, Witch Hazel, 6 in. to 3 ft.; 50 M. Tulip Poplar, 1 to 8 ft.; 20 M. Sweet Gum, 1 to 6 ft.; 50 M. Black Walnut, 1 to 3 ft.; 20 M. Wistaria, 1 to 3 ft.; 20 M. Yucca Flammulosa, 1 and 2 year Butternut, Japan Walnut, Ash, Maple, etc. Send for trade list. I offer my entire stock to close out at low prices; also a large stock of Tree and Shrub Seeds, Black Locust, Sweet Gum, Sycamore, Ash, Red Bud, Persimmon, Bass Wood, Viburnums, Sugar Maple, Red Cedar and other Seeds. Forest Nursery & Seed Co., J. H. H. Boyd, Prop., R. F. D. No. 2, McClunville, Tenn.

GALAX

Michigan Cut Flower Co., 38 and 40 Broadway, Detroit, Mich.
 For page see List of Advertisers.

George Colsonas & Co., 50 W. 28th St., New York.
 For page see List of Advertisers.

The Kervan Co., 113 West 28th St., N. Y.
 For page see List of Advertisers.

Rice Bros., 115 N. 6th St., Minneapolis, Minn.
 For page see List of Advertisers.

H. M. Robinson & Co., 15 Province St. and 9 Chapman Place, Boston.
 For page see List of Advertisers.

GERANIUMS

R. Vincent Jr. & Sons Co., White Marsh, Md.
 New and Standard Varieties.
 For page see List of Advertisers.

GLADIOLI

J. L. Moore, Northboro, Mass.
 For page see List of Advertisers.

E. S. Miller, Wading River, N. Y.
 For page see List of Advertisers.

A. T. Boddington, 312 W. 14th St., New York.
 For page see List of Advertisers.

GLASS

Boston Plate & Window Glass Co., Boston.
 For page see List of Advertisers.

Standard Plate Glass Co., 26-30 Sudbury St., Boston.
 For page see List of Advertisers.

Foley Mfg. Co., Western Ave., between 25th & 26th Sts., Chicago.
Sharp, Partridge & Co., 221 & Lumber St., Chicago.
 For page see List of Advertisers.

Greenhouse glass, lowest prices. Johnston Glass Co., Hartford City, Ind.
Glass, High Grade, Double Thick Greenhouse Glass. Lord & Burnham, 1133 Broadway, N. Y.

GLAZING DEVICES

H. A. Dreer, Philadelphia, Pa.
 Peerless Glazing Point.
 For page see List of Advertisers.

GLAZING POINTS, Lord & Burnham Special Glazing Nails (Points). Lord & Burnham, 1133 Broadway, N. Y.

GREENHOUSE BUILDING MATERIAL

Lord & Burnham Co., 1133 Broadway, New York.
 For page see List of Advertisers.

Pierson U-Bar Co., 1 Madison Sq., N. Y.
 For page see List of Advertisers.

A. T. Stearns Lumber Co., Neponset, Boston.
 For page see List of Advertisers.

Kling Construction Co., N. Tonawanda, New York.
 For page see List of Advertisers.

Hitchings & Co., 1170 Broadway, New York.
 For page see List of Advertisers.

J. C. Moninger Co., 117 East Blackhawk St., Chicago, Ill.
 For page see List of Advertisers.

Foley Mfg. Co., Western Ave., between 25th & 26th Sts., Chicago.
 For page see List of Advertisers.

Geo. B. Doane, 18 Midway St., Boston, Iron.
 For page see List of Advertisers.

Wm. H. Lutton, West Side Avenue Sta., Jersey City, N. J.
 For page see List of Advertisers.

GREENHOUSE CONSTRUCTION

GREENHOUSE CONSTRUCTION, Semi-Iron Greenhouse, New Truss Houses and Iron Frame Houses. Lord & Burnham, 1133 Broadway, N. Y.

J. A. Payne, 290-274 Culver Ave., Jersey City, N. J.
 For page see List of Advertisers.

Foley Mfg. Co., Western Ave., between 25th & 26th Sts., Chicago.
 For page see List of Advertisers.

Wm. H. Lutton, West Side Avenue Sta., Jersey City, N. J.
 Curved Iceless Eave.
 For page see List of Advertisers.

Hitchings & Co., 1170 Broadway, New York.
 For page see List of Advertisers.

GREENHOUSE HOSE

Revere Rubber Co., Boston, Mass.
 Revere Hose.
 For page see List of Advertisers.

GUTTERS

GUTTERS, Cast Iron Gutters, L. & B. Improved V Shaped Gutter with drip gutter attachment. Lord & Burnham, 1133 Broadway, N. Y.

HAIL INSURANCE

Florist's Hail Assn. of America. J. G. Esler, Saddle River, N. J.
 For page see List of Advertisers.

In writing to Advertisers kindly mention Horticulture

HARDY FERNS, MOSS AND GREENS

H. M. Robinson & Co., 15 Province St. and 9 Chapman Pl., Boston, Mass.
For page see List of Advertisers.

Michigan Cut Flower Exchange, 38 and 40 Broadway, Detroit, Mich.
For page see List of Advertisers.

George Cotsanos & Co., 50 W. 23rd St., New York.
For page see List of Advertisers.

N. F. McCarthy & Co., 84 Hawley St., Boston.
For page see List of Advertisers.

The Kervan Co., 113 W. 25th St., N. Y.
For page see List of Advertisers.

Bice Bros., 115 N. 6th St., Minneapolis, Minn.
For page see List of Advertisers.

HEATING APPARATUS

Lord & Burham Co.,
1133 Broadway, New York.
For page see List of Advertisers.

Pierson U-Bar Co., 1 Madison Sq., N. Y.
For page see List of Advertisers.

John A. Payne, 260-274 Culver Ave., Jersey City, N. J.
For page see List of Advertisers.

Kroschell Bros. Co., 35 Erie St., Chicago.
For page see List of Advertisers.

HELP FURNISHED

Thos. H. Bambrick, 34 S. 7th St., Phila.
For page see List of Advertisers.

HERBACEOUS PERENNIALS

P. Ouwerkerk, P. O. No. 1, Hoboken, N. J.
For page see List of Advertisers.

New England Nurseries, Bedford, Mass.
For page see List of Advertisers.

The Geo. Witthold Co., 1637 Buckingham Place, Chicago.
For page see List of Advertisers.

HOT-BED SASH

The A. T. Stearns Lumber Co., Neponset, Mass.
For page see List of Advertisers.

Pierson U-Bar Co., 1 Madison Sq., N. Y.
For page see List of Advertisers.

Lord & Burham Co., 1133 Broadway, N. Y.
For page see List of Advertisers.

Foley Mfg. Co., Western Ave., between 25th & 26th Sts., Chicago.

Sunlight Double Glass Sash Co.,
Louisville, Ky.
For page see List of Advertisers.

INSECTICIDES.

Nicotide kills all greenhouse pests.
P. R. Palethorpe Co.,
Eleventh St., Owensboro, Ky.
For page see List of Advertisers.

Stump & Walter Co., 50 Barclay St., New York.

Kilmind Tobacco Dust.

Wilson Plant Oil & Fertilizer Co., Chatham, N. J.

Lauteu Fumigator.

Nigara Sprayer Co., Middleport, N. Y.
Nigara Brand.

For page see List of Advertisers.

R. G. Pratt Co., New York.

Scabicide.

"The Fumigating Kind Tobacco Powder"—The first on the market and the kind that has so many imitators, has our guarantee of satisfaction or money back, and "The Moon Trade Mark" on every bag, \$3.60 per 100 lbs. The H. A. Stothoff Co., Mount Vernon, N. Y., Makers and sellers.

JAPANESE PLANTS

Yokohama Nursery Co., 31 Barclay St., New York.
For page see List of Advertisers.

KENTIAS

Godfrey Aschmann,
1012 W. Ontario St., Phila., Pa.
For page see List of Advertisers.

KENTIAS—Continued

A. Leuthy & Co., Roslindale, Mass.

For page see List of Advertisers.

Henry Weston, Hempstead, N. Y.

For page see List of Advertisers.

Jos. Hencock Co., Wyncoke, Pa.

Single and Multi-Top Specimens.

For page see List of Advertisers.

Henry A. Ureter, 714 Chestnut St., Phila.

For page see List of Advertisers.

LEVELS FOR LANDSCAPE GARDENING USE.

Bostrom-Brady Mfg. Co., 139 Madison Ave., Atlanta, Ga.
For page see List of Advertisers.

LILY OF THE VALLEY PIPS

Hjalmar Hartmann & Co., 12 Storgade, Copenhagen, Denmark.
For page see List of Advertisers.

NEW AND RARE PLANTS

Rose Hill Nurseries, New Rochelle, N. Y.
For page see List of Advertisers.

NICO-FUME

Kentucky Tobacco Product Co.,
Louisville, Ky.
For page see List of Advertisers.

NURSERY STOCK

John Waterer & Sons, Ltd.,
American Nursery, Bagshot, England.
For page see List of Advertisers.

Clary's Horticultural Co., 62 Vesey St., New York.
For page see List of Advertisers.

P. Ouwerkerk, 216 Jane St., Weebawken Heights, N. J.
For page see List of Advertisers.

D. J. Twomey, Dept. H, Geneva, N. Y.
For page see List of Advertisers.

American Nursery Co., 150 Broadway, New York, N. Y.
For page see List of Advertisers.

Manual of the Trees of North America, by C. S. Sargent, mailed to your address for \$5.00, by Horticulture Publishing Co., 11 Hamilton Place, Boston.

TREES, SHRUBS, ROSES, EVERGREENS, PEONIES, HARDY PLANTS, ELLWANGER & BARRY, Rochester, N. Y.

ONION SEED

Federico C. Varela, Teneriffe, Canary Is.
Bernuda Onion Seed.

ORCHID BASKETS

J. A. Manda, 191 Valley Rd., W. Orange, New Jersey.
For page see List of Advertisers.

ORCHID PLANTS

Lager & Hurrell, Summit, N. J.
For page see List of Advertisers.

Sander, St. Albans, England.
Importers, Exporters, Growers, Hybridists.
For page see List of Advertisers.

Carrillo & Baldwin, Syracuse, N. Y.
For page see List of Advertisers.

Jos. A. Manda, 191 Valley Road, W. Orange, N. J.
For page see List of Advertisers.

Ordonez Bros., Madison, N. J., Box 105.
For page see List of Advertisers.

Largest stock in the country. Ask for prices. Julius Roehrs, Rutherford, N. J.

PAINT AND PUTTY

PAINT AND PUTTY: Ideal Greenhouse lend; Special Greenhouse Putty. Lord & Burnham, 1133 Broadway, N. Y.

PALMS

A. Leuthy & Co., Perkins St. Nurseries, Roslindale, Mass.
For page see List of Advertisers.

Robert Craig Co., Market and 40th Sts Philadelphia, Pa.
For page see List of Advertisers.

Joseph Hencock Co., Wyncoke, Pa.
Home-Grown Palms.
For page see List of Advertisers.

PANSY PLANTS.

Pansies, extra fine plant flowering, strong plants, 20 cents per 100; \$2.50 per 1000 Edw. Wallis, Atco, N. J.

PATENTS

Siggers & Siggers, Washington, D. C.

PEAT

J. A. Manda, 191 Valley Rd., W. Orange, New Jersey
For page see List of Advertisers.

Orchid peat, Rotted peat, Azalea peat, Leaf-Mould, Live Sphagnum moss, Baled Sphagnum moss, Green Clump moss, etc. Jobbers' list on application. C. W. Brownell & Co., Walden, N. Y.

Orchid Peat and Moss always on hand. Julius Roehrs Co., Rutherford, N. J.

PEONIES

Peonies only, by the wholesale—best 100 varieties. J. F. Rosenfield, Westpoint, Nebr.

One of the finest collections in America. Send 25 cts. in stamps for new edition of Peony Manual. C. S. Harrison's Select Nursery, York, Neb.

PHLOXES

Send 25 cts in stamps for Phlox Manual. Fine mixed phloxes \$2.00 per 100. C. S. Harrison's Select Nursery, York, Neb.

PHOENIX ROEBLENI PALM SEED

Ralph M. Ward & Co., 12 W. Broadway, New York.

PIPE AND FITTINGS

Foley Mfg. Co., between Western Ave. and 26th St., Chicago, Ill.
For page see List of Advertisers.

Kroschell Bros. Co., 35 Erie St., Chicago.
For page see List of Advertisers.

PIPE AND FITTINGS—Cast Iron and Wrought Pipe, Valves, Elbows, Pipe Hooks, Automatic Air Headers, etc. Lord & Burnham, 1133 Broadway, N. Y.

PLANT STANDS

Moore-Livingston Co., Landsdowne, Pa.
For page see List of Advertisers.

PLANT STAKES

Seale's Telescopic Plant Stakes and Trelises. H. D. Seale & Sons, Elkhart, Ind.

POT HANGERS

Pot hangers, Kramer's \$1 doz. by exp. \$1.25 by mail. I. N. Kramer & Son, Cedar Rapids, Ia.

POINSETTIAS (Artificial)

Polynettins, artificial decorations our specialty. Sample lots of 50 in 3 sizes, \$4.00; 100 lots, \$6, \$8, \$10. J. Stern & Co., 125 N. 10th St., Philadelphia, Pa.

PRUNING SHEARS

Rhodes Mfg. Co., Dept. R., Grand Rapids, Mich.

RAFFIA

Raffia (colored), 20 beautiful shades. Samples free. R. H. Coney Co., Camden, N. J.; 810 Washburn Ave., Chicago, Ill.

RETAIL FLORISTS

Park Floral Co., Denver, Colo.
For page see List of Advertisers.

Guide Bros. Co., 1214 F St., Washington, D. C.
For page see List of Advertisers.

Atlanta Floral Co., Atlanta, Ga.
For page see List of Advertisers.

M. C. & J. E. Hauswirth, 232 Michigan Ave., Chicago.
For page see List of Advertisers.

William J. Smyth, Michigan Ave. and 31st St., Chicago.
For page see List of Advertisers.

George Witthold Co., 1637-59 Buckingham Place, Chicago.
For page see List of Advertisers.

Jacob Schulz, 644 4th Ave., Louisville, Ky.
For page see List of Advertisers.

Thos. F. Galvin, 124 Tremont St., Boston.
For page see List of Advertisers.

Julius A. Zinn, 2 Beacon St., Boston.
For page see List of Advertisers.

For List of Advertisers See Page 89

RETAIL FLORISTS—Continued

- Frank H. Houghton, 296 Boylston St., Boston.
For page see List of Advertisers.
- Edward MacMinkin, 194 Boylston St., Boston.
For page see List of Advertisers.
- Hoffman, Florist, 59-61 Massachusetts Ave., Boston.
For page see List of Advertisers.
- J. Newman & Sons, Inc., 24 Tremont St., Boston.
For page see List of Advertisers.
- Talby, Wellesley, Mass.
For page see List of Advertisers.
- J. Breimeyer's Sons, Detroit, Mich.
For page see List of Advertisers.
- Sauuel Murray, 1017 Broadway, Kansas City, Mo.
For page see List of Advertisers.
- Wm. L. Rock Flower Co., 1116 Walnut St., Kansas City, Mo.
For page see List of Advertisers.
- Fred C. Weber, 4326 Olive St., St. Louis, Mo.
- H. G. Eyres, 11 N. Pearl St., Albany, N. Y.
For page see List of Advertisers.
- David Clarke's Sons, 2139-2141 Broadway, New York.
For page see List of Advertisers.
- Alex. McCConnell, New York.
For page see List of Advertisers.
- Robert G. Wilson, Fulton St. and Greene Ave., Brooklyn, N. Y.
For page see List of Advertisers.
- Young & Nugent, 42 W. 25th St., N. Y.
For page see List of Advertisers.
- M. Bowe, 1294 Broadway, New York.
For page see List of Advertisers.
- Myer, 609-11 Madison Ave., New York.
For page see List of Advertisers.
- Thos. Young, Jr., 500 Fifth Ave., New York.
For page see List of Advertisers.
- Newman Floral Co., 202 Fifth Ave. & Madison St., New York.
For page see List of Advertisers.
- The Blossom (C. C. Trepel, Mgr.), Bond and Livingston Sts., Brooklyn, N. Y.
For page see List of Advertisers.
- Palmer's Buffalo, N. Y.
For page see List of Advertisers.
- F. A. Danker, Albany, N. Y.
For page see List of Advertisers.
- J. H. Dunlop, 96 Yonge St., Toronto, Can.
For page see List of Advertisers.

RHODODENDRONS

- John Waterer & Sons, Ltd., American Nursery, Bagshot, England.
For page see List of Advertisers.
- P. Onwkerk, Hoboken, N. J.
For page see List of Advertisers.
- Anthony Waterer, Knop Hill Nursery, Surrey, Eng.

ROSES

- Robert Craig Co., Market and 49th Sts., Philadelphia, Pa.
For page see List of Advertisers.
- P. Onwkerk, P. O. No. 2, Hoboken, N. J.
For page see List of Advertisers.
- Julius Roehrs Co., Rutherford, N. J. Rose Newport Fair.
For page see List of Advertisers.
- Washon Rose Conservatories, Natick, Mass., and 3A Somerset St., Boston.
New Porching Rose White Killarney.
For page see List of Advertisers.
- The P. R. Plerson Co., White Killarney and My Maryland, Tarrytown-on-Hudson, N. Y.
For page see List of Advertisers.
- S. J. Reuter & Son, Westerlo, R. I. My Maryland.
For page see List of Advertisers.
- Dinger & Conard Co., West Grove, Pa.
For page see List of Advertisers.
- Roses, strong, own root, 4 inch Chataenay Killarney, Richmond and Mald, \$8 per 100. Sletbrecht & Son, New Rochelle, N. Y.
- Hand Book of Cultural Notes on Roses Under Glass, by F. P. Brigham, mailed to your address for 25c by Horticulture Publishing Co., 11 Hamilton Place, Boston.

SCALECIDE

- B. G. Pratt Co., 50 Church St., New York.

SEED GROWERS

- C. C. Morse & Co., 48-56 Jackson St., San Francisco, Cal.
For page see List of Advertisers.
- Hjalmar Hartmann & Co., Calliflower and Cabbage Seed.
12 Stormgade, Copenhagen, Denmark.
For page see List of Advertisers.
- Federico C. Varcla, Tenerife, Canary Ids. Bermuda Onion Seed.

SEEDS

- T. J. Gray Co., 32 So. Market St., Boston.
For page see List of Advertisers.
- Joseph Breck & Sons, 51 and 52 N. Market St., Boston, Mass.
For page see List of Advertisers.
- W. Atlee Burpee & Co., Philadelphia.
For page see List of Advertisers.
- J. M. Thorburn & Co., 33 Barclay St., N. Y.
For page see List of Advertisers.
- Arthur T. Boddington, 342 W. 14th St., New York.
For page see List of Advertisers.
- H. E. Mitchell Co., 1018 Market St., Phila.
For page see List of Advertisers.
- Hjalmar Hartmann & Co., 12 Stormgade, Copenhagen, Denmark. Cauliflower and Cabbage Seed.
For page see List of Advertisers.
- Rickards Bros., 37 E. 19th St., New York.
For page see List of Advertisers.
- R. & J. Farquhar & Co., 67 So. Market St., Boston.
Mignonette Seed.
For page see List of Advertisers.
- H. E. Fiske Seed Co., Faneuil Hall Sq., Boston.
For page see List of Advertisers.
- C. C. Morse & Co., 48-56 Jackson St., San Francisco, Calif.
For page see List of Advertisers.
- Leonard Seed Co., Chicago, Ill.
For page see List of Advertisers.
- Elmer D. Smith & Co., Adrian, Mich.
Acier Seed.

Seeds, Rocky Mountain Evergreen seeds in large or small quantities. C. S. Harrison's Select Nursery, York, Neb.

My own new crop of SALVIA SPLENDENS VARIETIES is now ready: Nana Compacta ZURICH, finest early flowering pot Salvia in existence, selected seeds. Compacta Grandiflora FIREBALL, best of all for pots and groups, selected seeds. Grandiflora Amellorata KING OF THE SCARLETS, unequalled for late groups, with extra large deep scarlet spikes, selected seeds. Each of above per Tr. Pkt., 50c; 6 Tr. Pkt., \$2.50. Larger quantities on special quotation. O. V. ZANGEN, Seedsman, Hoboken, N. J.

SHRUBS

- The Geo. Wittbold Co., 1657 Buckingham Palace, Chicago.
For page see List of Advertisers.

SILKALINE

- John C. Meyer & Co., Boston, Mass.
For page see List of Advertisers.

SPHAGNUM MOSS

Live Sphagnum moss, orchid peat and orchid basket always on hand. Lager & Hurrell, Summit, N. J.

Fresh, clean, 5 hbl. bale, \$1.25; 2 hales, \$2.25; 5 bales, \$5.00; 10 bales, \$9.50. Cash. H. R. Akers, Chatsworth, N. J.

SPRAYERS

- "SHOWERMAKER." \$1. Jos. Kopschay, So. Bend, Ind.
Niagara Sprayer Co., Middleport, N. Y.
For page see List of Advertisers.

STEAM TRAP

- E. Hippard, Youngstown, O.
For page see List of Advertisers.

STRAWBERRY PLANTS

- H. L. Crane, Westwood, Mass.
Barrmore Strawberry.
For page see List of Advertisers.

SWEET PEAS

- A. C. Zvalanek, Pound Brook, N. J. Winter Flowering.
For page see List of Advertisers.

TO-BAK-INE

- E. H. Hunt, Genl. Agt., 79-78 Wabash Av., Chicago.
For page see List of Advertisers.

TOMATO PLANTS.

10,000 tomato plants for forcing. Comet Breeze and Mayflower, ready January 20. Good plants from 2 1/2 inch pots, 81c per 1000. Lowest Street Greenhouses, J. H. A. Hutchison, Prop., Oxford, Pa.

VENTILATING APPARATUS

- Person U-Bar Co., 1 Madison St., N. Y.
For page see List of Advertisers.
- Foley Mfg. Co., Western Ave., between 25th & 26th Sts., Chicago.
For page see List of Advertisers.
- John A. Payne, 260-274 Culver Ave., Jersey City, N. J.
For page see List of Advertisers.
- The Advance Co., Richmond, Ind.
For page see List of Advertisers.
- Quaker City Machine Co., Richmond, Ind. 20th Century Ventilating Arm.
For page see List of Advertisers.
- VENTILATING MACHINERY, New Model enclosed, self-acting gear, Standard Model Open Gear, Lord & Burnham, 1133 Broadway, N. Y.

VIOLETS

Violets, Campbell rooted runners, 75c. per 100. John A. Burns, 8342 Frankford Ave., Holmesburg, Philadelphia, Pa.

VINCAS

Vinca variegated, Frost Cuttings; 75c. per 100; prepped. Chas. Frost, Kenilworth, N. J.

WAX FLOWERS

We are originators of wax designs and still the standard concern. J. Stern & Co., 125 N. 10th St., Philadelphia, Pa.

WHEAT SHEAVES

H. Bayersdorfer & Co., 1129 Arch St., Phila.
For page see List of Advertisers.

WIRED TOOTHPICKS

W. J. Cowee, Berlin, N. Y.
For page see List of Advertisers.

WIREWOK

- Reed & Keller, 122 W. 25th St., N. Y.
For page see List of Advertisers.
- Wirework. Write for our catalogue. Holton & Hunkel Co., Milwaukee, Wis.
- William E. Heidecker, Wire Works, 38-40 Broadway, Detroit, Mich.
- Headquarters for wire work. Send for list. Ball & Betz, 31 E. 3rd St., Cincinnati, O.
- Wirework—Compare our prices with others. Scranton Florist Supply Co., 201 N. 7th St., Scranton, Pa.

WHOLESALE FLORISTS

Boston

- N. F. McCarthy & Co., 84 Hawley St., Boston.
For page see List of Advertisers.
- H. M. Robinson & Co., 15 Province St. and 9 Chapman Pl., Boston.
For page see List of Advertisers.
- Welch Bros., 226 Devonshire St., Boston.
For page see List of Advertisers.
- Talby, Wellesley, Mass.
For page see List of Advertisers.

Chicago

- Chas. W. McKellar, 51 Wabash Ave., Chicago.
For page see List of Advertisers.
- Peter Reinberg, 51 Wabash Ave., Chicago.
For page see List of Advertisers.
- E. F. Winterson Co., 45-49 Wabash Ave., Chicago.
For page see List of Advertisers.
- J. A. Badlong, 37-39 Randolph St., Chicago.
For page see List of Advertisers.
- Foehlmann Bros. Co., Morton Grove, Ill.
For page see List of Advertisers.
- Cromwell, Conn.
A. N. Plerson, Cromwell, Conn.
For page see List of Advertisers.

In writing to Advertisers kindly mention Horticulture

Tobacco Paper

IS THE
STRONGEST,
BEST PACKED,
EASIEST APPLIED.

24 sheets.....	\$ 0.75
144 sheets.....	3.50
288 sheets.....	6.50
1728 sheets.....	35.10

"NICO-FUME" LIQUID

OVER 40% NICOTINE

By far the
CHEAPEST.

Furnishes the
Most Nicotine for the Money!

J LT NOTE PRICE!

Pint.....	\$ 1.50
½ Gallon.....	5.50
Gallon.....	10.50
5 Gallons.....	47.25

... Manufactured by ...

THE KENTUCKY TOBACCO PRODUCT CO., Louisville, Ky.

WHOLESALE FLORISTS— Continued

Detroit

Michigan Cut Flower Exchange, 38 and 40
Broadway, Detroit, Mich.
For page see List of Advertisers.

Minneapolis

Rice Bros., 115 N. 6th St., Minneapolis,
Minn.
For page see List of Advertisers.

New York

Ford Bros., 48 W. 28th St., New York.
For page see List of Advertisers.
H. E. Froment, 57 W. 28th St., New York.
For page see List of Advertisers.
Alex. J. Guttman, 34 W. 28th St., New
York.
For page see List of Advertisers.

E. C. Horan, 55 W. 28th St., New York.
For page see List of Advertisers.

A. H. Langjahr, 55 W. 28th St., New York.
For page see List of Advertisers.

James McManus, 42 W. 28th St., New York.
For page see List of Advertisers.

John I. Raynor, 49 W. 28th St., New York.
For page see List of Advertisers.

W. F. Sheridan, 39 W. 28th St., New York.
For page see List of Advertisers.

Treadly & Schenck, 44 W. 28th St., New
York.
For page see List of Advertisers.

Moore, Hentz & Nash, 55 and 57 W. 26th
St., New York.
For page see List of Advertisers.

Wm. H. Kuehler, 28 Willoughby St.,
Brooklyn, N. Y.
For page see List of Advertisers

Philip F. Kessler, 55 and 57 W. 26th St.,
New York.
For page see List of Advertisers.

Millang Bros., 41 W. 28th St., New York.
For page see List of Advertisers.

John Young, 51 W. 28th St., New York.
For page see List of Advertisers.

Greater New York Florists' Association,
162 Livingston St., Brooklyn, N. Y.
For page see List of Advertisers.

George Salford, 43 W. 28th St., New York.
For page see List of Advertisers.

Frank Millang, 55-57 W. 26th St., New
York.
For page see List of Advertisers.

B. S. Silin, 55-57 W. 26th St., New York.
For page see List of Advertisers.

A. L. Young & Co., 54 W. 28th St., N. Y.
For page see List of Advertisers.

Growers' Cut Flower Co., 39 W. 28th St.,
New York.
For page see List of Advertisers.

Henshaw & Fenrich, 44 W. 28th St.,
New York.
For page see List of Advertisers.

J. K. Allen, 106 W. 28th St., New York.
For page see List of Advertisers.

Philadelphia

W. E. McKlesiek & Bros., 1619-1621 Ran-
stead St., Philadelphia, Pa.
For page see List of Advertisers.

Leo Niessen Co., 1269 Arch St., Philadel-
phia, Pa.
For page see List of Advertisers.

The S. S. Pennock-Meehan Co., 1608-18
Lindlow St., Philadelphia, Pa.
For page see List of Advertisers.

WHOLESALE FLORISTS— Continued St. Louis

H. G. Berning, 1402 Pine St., St. Louis, Mo.
For page see List of Advertisers.

WHOLESALE PLANTSMAN
Samuel A. Woodrow, 53 W. 30th St.,
New York.
For page see List of Advertisers.

New Offers in This Issue.

AZALEA APOLLO IN BLOOM.
Godfrey Aschmann, 1042 W. Ontario St.,
Philadelphia.
For page see List of Advertisers.
**BASKETS; CRATES; LADDERS;
VENEERS; BOXES.**

Bacon & Co., Appleton, N. Y.
For page see List of Advertisers.
BRONZE GALAX.

G. A. Holder, Round Peak, N. C.
For page see List of Advertisers.
**CHORIZEMAS AND LIBONIA
WANTED.**

Ed. Herrmann, North & Milton Aves.,
Baltimore, Md.
For page see List of Advertisers.

IRISH SHAMROCK SEED.
H. F. Michell Co., 1018 Market St., Phila.
For page see List of Advertisers.

NEPHROLEPIS SCHOLZELI.
Henry A. Dreer, 714 Chestnut St., Phila.
For page see List of Advertisers.

SEED YOU NEED FOR JANUARY.
A. T. Boddington, 342 W. 14th St.,
New York.
For page see List of Advertisers.

SULFOCID.
The B. G. Pratt Co., 50 Church St., Dept.
W., New York City.
For page see List of Advertisers.

**TUBEROUS BEGONIAS; GLOXI-
NIAS; ROSA MULTIFLORA.**

J. M. Thorburn & Co., 33 Barclay St.,
New York.
For page see List of Advertisers.

**WHEAT SHEAVES; FLORISTS'
SUPPLIES.**

J. Stern & Co., 125 N. 10th St., Phila.
For page see List of Advertisers.



The Best
Bug Killer and
Bloom Saver

For PROOF

Write to

P. R. Paethorpe Co.
OWENSBORO, KY.

HELP WANTED

GOOD MEN

When you need good men,
skilled or unskilled, Write:

**THOS. H.
BAMBRICK**

34 South 7th Street Philadelphia

Help of all kinds, including that for
Florists, Nurserymen, Seedsmen and the
Horticultural trade generally.

WANTED—At once, a thoroughly com-
petent man to take entire charge of our
retail and wholesale shipping department of
cut flowers. Must be a first-class des-
igner and competent to handle a general
retail trade. Reply with references. S. J.
Kenter & Son, Inc., Westbury, L. I.

WANTED, NURSERYMEN—Man cap-
able of taking full charge and competent to
handle men. Best of references required as
to honesty, ability and practical experi-
ence. Also good assistant wanted. Rose-
dale Nurseries, Tarrytown, N. Y.

SITUATIONS WANTED

SITUATION WANTED—By practical
landscape gardener and florist; private or
commercial; middle aged; married. J.
Hodge, 44 West St., Fitchburg, Mass.

FOR SALE

FOR SALE—5000 feet, 2-in., 1000 feet,
4-in., wrought iron pipe; 4000 feet of 4-in.
cast iron pipe, clean; 500 boxes 10 x 12,
\$1.50; 150 boxes 10 x 15, \$1.70; and 100
boxes of 8 x 10, double-thick and clean
glass, at \$1.25 per box. Two Scollay, 8
sections, two Scollay No. 5, one No. 17
Hitchings, and one No. 8 Furman boilers.
All kinds venting apparatus and sash,
cast iron fittings, valves, expansion tanks,
etc. Everything in first class condition.
Cheap. F. O. B. Newark arc. I. Sues-
serman, 229 Livingston St., Newark, N. J.

SELD BUSINESS FOR SALE—An A.
No. 1 well-established seed business, whole-
sale and retail, doing business of \$100,000
per annum. Owner desires to retire from
business. Clifford L. Newman, Counsellor-
at-Law, United Bank Bldg., Paterson, N. J.

FOR SALE—Retail nursery, sixth year,
doing good, steady and increasing trade.
Stock in excellent condition. Only local
apply for community of 50,000. For
particulars address R. N. care HORTI-
CULTURE, Boston.

FOR SALE—A greenhouse plant of about
25,000 square feet of glass, ten acres of
land, house, stable, ice house, etc. For
particulars apply to Pinecroft Green-
houses, East Brookfield, Mass.

MISCELLANEOUS WANTS

WANTED TO BUY—Complete green-
house plants and all kinds of greenhouse
material, to be taken down and removed
at once. Terms cash. Address I. Sues-
serman, 229 Livingston St., Newark, N. J.

List of Advertisers

Advance, The Co.	91	McKissick, W. E. & Bros.	80
Allen J. K.	83	McManus Jas.	82
American Nursery Co.	64	Meyer J. C. & Co.	79
American Nursery Co.	64	Meyer J. C. & Co.	79
Achmann Godfrey.	64	Michell H. F. Co.	76-89
Atlanta Floral Co.	79	Michigan Cut Flower Exchange.	83
Bambrick Thos. H.	88	Millang Bros.	82
Barrows H. H. & Sons.	63	Millang Frank.	82
Bassett & Washburn.	63	Miller, E. S.	41
Bayersdorfer H. & Co.	72-79	Moninger J. C.	90
Bellamy Bros.	72-79	Moore, J. L.	64
Berning H. G.	84	Moore, Hentz & Nash.	82
Blossom The.	78	Moore-Livingston Co.	79
Boddington A. T.	73-74-77	Morse C. C. & Co.	77
Boston Florist Letter Co.	79	Murray Samuel.	78
Boston Plate and Window Glass Co.	90	New Eng. Nurseries.	64
Boström-Brady Mfg. Co.	81	Newman Floral Co.	78
Bowen H.	75	Newman J. & Sons.	79
Breck Joseph & Sons.	77	Niagara Sprayer Co.	89
Breimeyer's J. Sons.	79	Nielsen Land. Co.	80
Brüggeman's Seed Warehouse.	77	Oebelin Frank.	63
Budlong J. A.	80	Ordover Bros.	73
Burpee W. A. & Co.	77	Ouwkerk P.	64
Buxton & Allard.	90	Paletborpe P. R. Co.	88
Carrillo & Baldwin.	73	Palmer W. J.	78
Chicago Carnation Co.	63	Park Floral Co.	78
Clarke's David, Sons.	78	Payne John A.	90
Cleary's Horticultural Co.	64	Peacock L.	80
Coca J. J.	83	Pennock-Meehan Co.	80
Cosmanos Geo. & Co.	83	Perkins St. Nurseries.	63
Covey W. J.	83	Pierson A. N.	63
Craig, Robt. Co.	64	Pierson F. R. Co.	73
Crane H. L.	64	Pierson U Bar Co.	92
Crawback Geo. W.	83	Poehlmann Bros. Co.	80
Danker F. A.	79	Pratt B. G. Co.	89
Dingee & Conard Co.	64	Pulverized Manure Co.	89
Dodge Geo. B. & Son.	91	Quaker City Machine Co.	90
Dorff F. Sons & Co.	81	Raylor John I.	82
Dreer H. A.	63-75-90	Reed & Keller.	83
Dunlop John H.	78	Reinberg Peter.	80
Dysart R. J.	79	Reuter S. J. & Son Inc.	62
East Sudbury Greenhouses.	63	Revere Rubber Co.	90
Edwards Folding Box Co.	80	Rice Bros.	80
Elliott Wm & Sons.	77	Rickards Bros.	77
Ellis J. G.	90	Robinson H. M. & Co.	80
Ernest W. H.	76	Rock Wm. L. Flo. Co.	78
Eyres.	78	Rochrs Julius Co.	84-73
Farquhar R. & J. Co.	77	Roper Albert.	62
Fisher Peter.	62	Roland, Thomas.	73
Fiske H. E. Seed Co.	77-89	Rolker August & Sons.	76
Foley Mfg. Co.	91	Rose Hill Nurseries.	64
Ford Bros.	82	Salford Geo.	82
Froment H. E.	82	Sander & Sons.	73
Galvin Thos. F.	79	Schulz Jacob.	69
Goddard S. J.	63	Scott, John.	63
Greater N. Y. Florists' Association.	83	Sharp, Partridge & Co.	90
Grey T. J. Co.	77	Sherman W.	76
Growers' Cut Flower Co.	82	Simpson Robt.	76
Gude Bros. Co.	78	Situations & Wants.	88
Guttman Alex. J.	82	Slinn B. S.	82
Hall Asso.	90	Smith Elmer D. & Co.	78
Hartmann Hjalmar & Co.	77	Smyth Wm. J.	78
Hauwirth M. C. R. E.	77	Standard Plate Glass Co.	91
Heacock Jos. & Co.	63	Stern J. & Co.	83
Henshaw & Fenrich.	83	Sterns A. T. Lumber Co.	90
Herbert David & Son.	64	Stump & Walter Co.	89
Herrman E.	73	Sunlight Double Glass Sash Co.	76
Hewes A. H. & Co.	76	Tailly.	79
Hilfinger Bros.	76	Thorburn J. M. & Co.	77
Hill, The E. G. Co.	62	Totty Chas. H.	83
Hippel E.	91	Treandly & Schenck.	82
Hitchings & Co.	92	Treat C. C. Co.	68
Hoffman.	79	Truway D. J.	64
Holder G. A.	83	Valentine J. A.	78
Hors E. C.	83	Vincent R. Tr. & Sons.	73
Houghton F. H.	79	Waban Rose Conservatory.	64
Hunt E. H.	89	Ward R. M. & Co.	73
Kentucky Tobacco Product Co.	88	Waterer John & Sons.	64
Kerr The Co.	63	Welch Bros.	86
Kessler, P. F.	82	Whitlin Pottery Co.	86
King Cons. Co.	90	Weston H.	67
Kroeschell Bro. Co.	91	Wilson.	78
Kueller Wm. H.	83	Wilson Plant Oil & Fertilizer Co.	89
Lager & Hurrell.	73	Witthold Geo. Co.	63
Langjahr, Alired H.	77	Wood Bros.	82
Leonard Seed Co.	77	Woodrow Sam'l A.	83
Leuty A. & Co.	63	Yokohama Nursery Co.	73
Lord & Burnham Co.	92	Young A. L.	83
Luttwon W. H.	91	Young John.	82
Manda Jos. A.	73	Young, Thos. Jr.	78
MacMulklin E. A.	79	Young & Nugent.	78
McCarrny N. F. & Co.	81	Zinn Julius A.	79
McConnell Alex.	78	Zvolnack A. C.	77
McKellar Charles W.	80		

The Lauten Fumigator

(PATENTED)
Write for Prices and Particulars.

Burns Tobacco Stems, the cheapest and most effective fumigating medium yet found.

Costs no more than one box Tobacco Paper and will last a lifetime.

Will not blaze or emit any foreign gases.

Will not discolor or cripple flowers.

Is easy to handle and there is no danger of fire in using.

Will burn 5 or 6 hours without attention.

Will exterminate aphids absolutely with one operation.



TOBACCO STEMS, 75¢ PER CWT.

IT

Write for prices of all Supplies for the Grower

WILSON PLANT OIL & FERTILIZER CO. CHATHAM New Jersey

For Trees, Plants, Shrubs and Flowers

— USE —

THE NIAGARA BRAND LIME SULPHUR SOLUTION

It destroys Scale Lice, Spiders and all forms of Aphides, AT THE SAME TIME Mildew, Blight, Rust and other Fungus difficulties.

Used in Winter or Summer. — No other remedy has been so universally effective.

Niagara Brand ARSENATE OF LEAD for chewing insects is equal to the best and better than the most. Ask about our Green House sprayer. Address —

NIAGARA SPRAYER CO. Middleport, N. Y.

WIZARD BRAND MANURES

Dried, screened and packed in bags of 100 lbs. each.

PULVERIZED SHEEP MANURE
PURE — UNIFORM — RELIABLE

A strong and quick acting manure, highly recommended for carnations and chrysanthemums.

SHREDDED CATTLE MANURE
EASY TO HANDLE AND APPLY

Stronger and better in every way than rough manure. Lasts much longer on the benches. Unequalled for mulching and feeding roses, liquid manuring and mixing with bench and potting soil. Used by all the largest growers.

Ask Your Supply Man or Write Us for Circulars and Prices.

— THE —

Pulverized Manure Co.

31 Union Stock Yards, CHICAGO

DON'T EXPERIMENT

— USE —

TO-BAK-INE

and your stock will be free from insects, clean, and the blooms will not be discolored.

Send for full information of

H. E. FISKE SEED CO.
13 Faneuil Hall Sq., Boston, Mass.

STUMPP & WALTER CO.,
50 Barclay St., New York.

HENRY F. MICHELL & CO.,
1018 Market St., Philadelphia.

E. H. HUNT, Gen'l Agent,
76-78 Wabash Ave., Chicago.

SOMETHING NEW FOR GREENHOUSES

"SULFOCIDE"

PRATT'S

SOLUBLE SULPHUR SUMMER SPRAY

Non-caustic and non-irritating

A FUNGICIDE and INSECTICIDE

FOR FRUIT TREES, VEGETABLES and GREENHOUSES

A promising substitute for Bordeaux mixture. For 10 cts. to cover postage will send sample sufficient for one gallon of spray.

Use 1 part to 75 or 100 parts of water.

B. G. PRATT CO., 50 Church St., New York, U. S. A.

KILMDEAD TOBACCO DUST

Free from Sand or Dirt Kind FOR FUMIGATING AND DUSTING

Dusted on Plants it covers large surface. One Quality for Both Uses.

Our Tobacco Dust is the pure tobacco, free from sand and dirt, strong in Nicotine and all ways of the same strength, making it superior to any dust on the market. Costs you no more than the ordinary product and will do twice the work. 10 lbs. 60c.; 25 lbs. \$1.25; 50 lbs. \$2.00; 100 lbs. \$3.50.

STUMPP & WALTER CO.
50 Barclay St., New York

IS YOUR NAME IN THE ABOVE LIST? IF NOT, WHY NOT?

“REVERO”

Braided Moulded Construction—Seamless Throughout



LIGHT -- STRONG -- FLEXIBLE

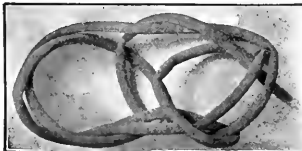

The above cuts represent the non-kinking tendency of Revere as compared with the old style hose of wrapped duck construction.

Revere is furnished on Reels in Continuous Lengths up to 500 feet.

Revere Rubber Company,
BOSTON, MASS.

NEW YORK
NEW ORLEANS

PHILADELPHIA
MINNEAPOLIS

PITTSBURG
SAN FRANCISCO

CHICAGO
PORTLAND, ORE.



Sunlight Double-Glass Sash Company
929 East Broadway
LOUISVILLE, KY.

The double layer of glass
does it

Lets in the light always.
Never has to be covered or uncovered; no boards or mats needed.
Retains the heat, excludes the cold.
Makes stronger and earlier plants.
Glass slips in; no putty; cannot work loose; easily repaired.
Ask for catalog W. It tells all about Sunlight sash.
Special catalog for greenhouse material.

GLASS

Always Write Us Before Buying
SHARP, PARTRIDGE & CO.
22nd and Lumber Streets, CHICAGO
WE HAVE SOME SNAPS

GREENHOUSE CONSTRUCTION LUMBER

John C. Moninger Co.
117 E. Blackhawk St., CHICAGO.

Evans 20th Century Arm

Will not twist the shafting pipe. Three times the power of old style elbow arms. Sold only with Evans Challenge Machine.

Write for free catalogue to
QUAKER CITY MACHINE CO.
Richmond, Ind.



EVERYTHING FOR
GREENHOUSE
BUILDING

WRITE FOR
INFORMATION
AND PRICES

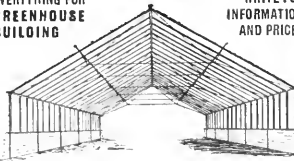

King Greenhouses. King Gutters and Eaves.
Trussed Roofs. Ventilating Machinery.
Trussed Iron Frame Houses.
Tile Benches and Pipe Hangers.

KING CONSTRUCTION COMPANY
NORTH TONAWANDA, N. Y.

The Payne Steel "T" Bar Greenhouses

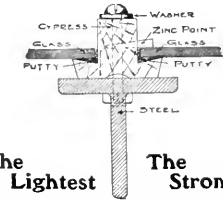

The Lightest The Strongest

Half full size

HOUSES of this type are constructed with both curved glass eaves and straight glass eaves. Least amount of shadow. Least amount of wood. No drip. Greatest durability.

JOHNA. PAYNE

Greenhouse Designer and Builder
260-274 Culver Avenue

JERSEY CITY, N. J.

CYPRESS SASH BARS
82 feet or longer
HOT BED SASH
PECKY CYPRESS BENCH LUMBER

GREENHOUSES

EREGED AND EQUIPPED COMPLETE IF DESIRED

Write for Circular "D" and Prices

The A. T. STEARNS LUMBER CO.
NEPONSET, BOSTON, MASS.

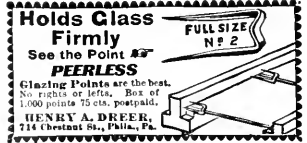

BOSTON PLATE & WINDOW GLASS CO.

GREENHOUSE GLASS

German and American

261 to 287 A St., Boston 20-22 Canal St.

USE THE BEST.
Economy Greenhouse Brackets
are used by leading growers everywhere. Send for price list and descriptive circular.
BUXTON & ALLARD, Dept. A, Nashua, N. H.

The **FLORISTS' HALL ASSOCIATION OF AMERICA**, insurer of 29,000,000 sq. ft. of glass. For particulars address **John C. Ester, Secy, Saddle River, N. J.**

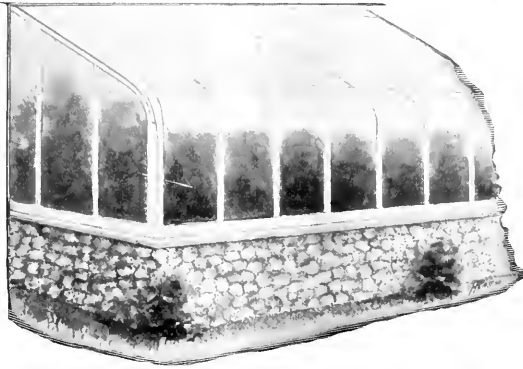

Why My New Curved Iceless Eave is Far Superior to Anything on the Market Today

- 1st. No sash bars incased in iron, thereby eliminating all danger of bars decaying.
- 2nd. Can be used in conjunction with iron frame construction, thereby doing away with that very objectionable feature, "columns."
- 3rd. Roof bars with drip grooves, which act as conductors to carry away the condensation: Result, the driest roof ever used for greenhouse purposes.
- 4th. **THE MOST IMPORTANT OF THEM ALL.** The very small increase in cost over the ordinary style of construction which makes it possible to be used for commercial as well as private purposes.

William H. Lutton, Horticultural Architect and Builder
West Side Ave Station (C.R.R. of N.J.) Jersey City, N.J.

KROESCHELL BOILER



MADE OF FIRE BOX FLANGE PLATE
Can not Crack

Water Space in Front, Sides and Back
The Most Popular Boiler Made
SEND FOR CATALOGUE.

KROESCHELL BROS. CO.
35 Erie Street, CHICAGO, ILL.

THE FOLEY MFG. CO.

CHICAGO

Completely equipped with up-to-date machinery for the making of material for

GREENHOUSE CONSTRUCTION

From a Full Supply of Thoroughly Seasoned Lumber

Send your sketches to our draughtsmen for completion and suggestion. Permit us to figure your proposed work, large or small.

We guarantee our prices will save you money
FOLEY VENTILATING APPARATUS IS THE BEST

is Simple in Erecting. Is Easiest of Operation. It Will Last a Lifetime. Its Price is the Lowest. Will Ventilate Any Size House. Prices and Circulars on Application.

Our 1908 Catalogue Greenhouse Material Sent Postpaid on Request.

THE FOLEY MFG. CO., WESTERN AVENUE
25th and 26th STS., CHICAGO



The Advance Ventilating Apparatus

You run no risk in buying our machines as we guarantee satisfaction or no sale. Get our new circular, take note of the many good and practical things we have for the florists, scan our net prices and compare same with others and remember that we dare any other line to give you as good, as long and as easy service as we will

The Advance Co.
RICHMOND, IND.

THE STANDARD STEAM TRAP

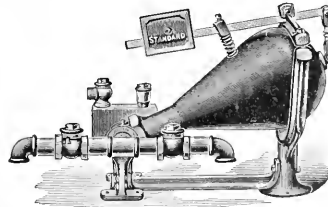

is acknowledged the best for the florist, because it is durable and does its work without trouble and annoyance, saving its cost by the economy in coal bills

E. HIPPARD
YOUNGSTOWN, OHIO

IRON PIPE

SECOND HAND

WROUGHT IRON PIPE, for Steam, Water, Gas or Oil, Fences or Posts. All Sizes. Price Low.

GEO. B. DOANE & SON
18 Midway Street, BOSTON
Telephone, Main 4419

STANDARD PLATE GLASS CO.

Manufacturers—Importers—Jobbers

NOW IS THE TIME TO BUY

FRENCH OR AMERICAN GREENHOUSE GLASS

LOWEST PRICES ON REQUEST

26-30 Sudbury St. BOSTON, MASS. 61-63 Portland St.

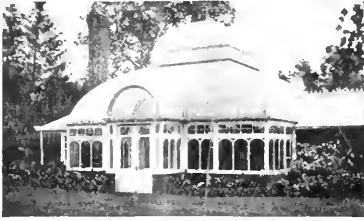

PALM HOUSES

Square ones like this, with curvilinear roof and dome are decidedly ornamental and give an attractiveness to the entire range; but a straight gable, curvilinear house is less expensive.

Of less cost still, is one with the straight roof and high sides, but you don't get quite as much head room. Send for illustrated circular, it shows our several kinds.

Hitchings & Company
1170 Broadway New York

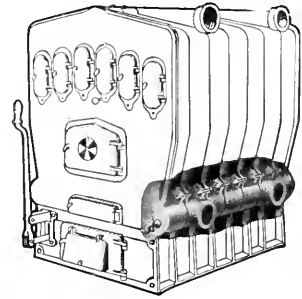

EACH SECTION HAS SEPARATE TIE BOLTS

As A Case Of Insurance

Why not have a boiler you can absolutely depend on? One that if anything should happen to a section, it can be taken out and replaced in shortest possible time, and your house won't freeze up. This is one of the things we mean by INSURANCE. Send for catalog.

Lord & Burnham Co.

Main Sales Office: 1133 BROADWAY, N.Y.

BOSTON: 829 Tremont Building. PHILADELPHIA: 1215 Filbert St.



And This Is The House His Neighbor Built

Last week you recall we showed you a snug little U-Bar proposition that was so satisfactory to the owner that he said as much to his neighbor — and his neighbor built one. It, too was a case of limited space, and is located between the drive and dwelling, in fact, the vestibule faces one of the main entrances.

The usual greenhouse construction, with its heavy members would have been impractical here, because the dwelling shades the greenhouse a part of the day — a light, the absolutely lightest house was necessary — the U-Bar "filled the bill."

And did you send for the catalog?

U-BAR GREENHOUSES

PIERSON

DESIGNERS AND BUILDERS



U-BAR CO.

1 MADISON AVE. NEW YORK

HORTICULTURE

Vol. IX.

JANUARY 23, 1909

No. 4

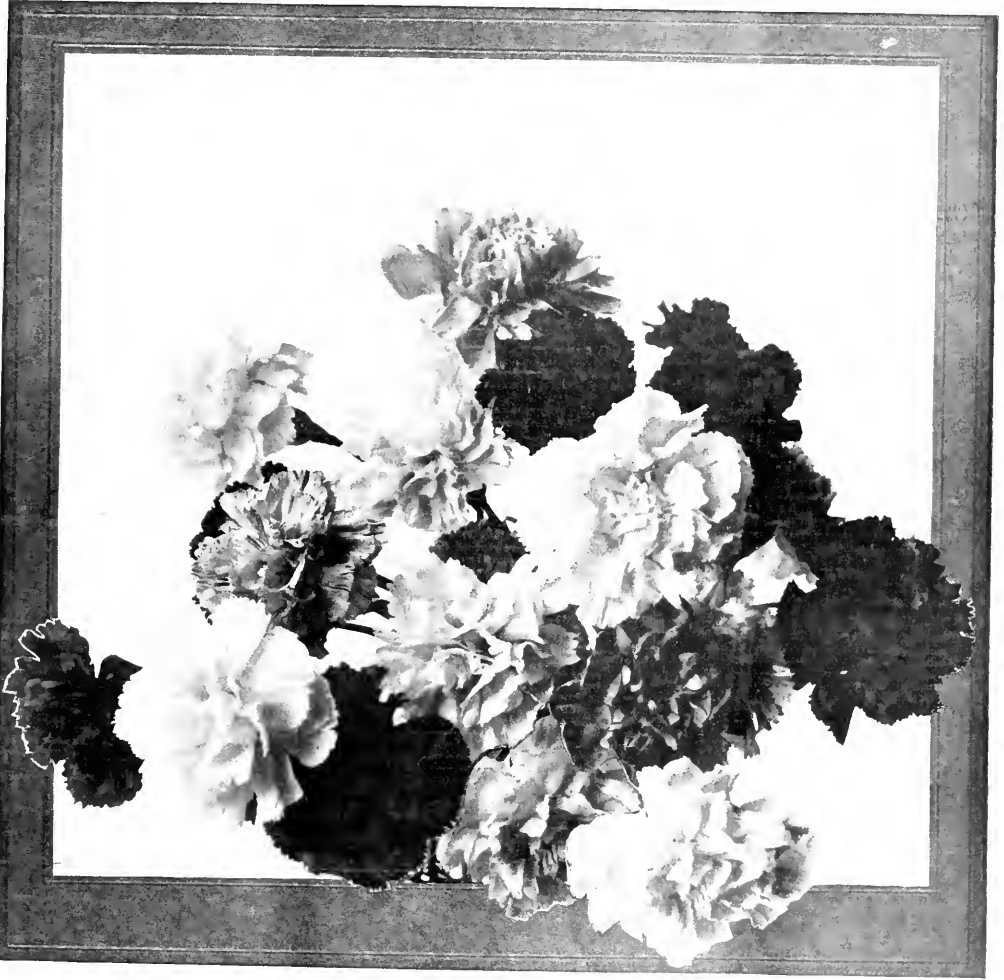

DEVOTED TO THE
FLORIST, PLANTSMAN, LANDSCAPE GARDENER AND KINDRED INTERESTS

PUBLISHED EVERY SATURDAY AT 11 HAMILTON PLACE, BOSTON, MASS.

SUBSCRIPTION, \$1 00 PER YEAR



Boddington's Quality Flower Seeds for Florists

Seed You Need for January

REMEMBER YOU MAY DEDUCT 5 PER CENT IF CASH ACCOMPANIES ORDER

ASTERS

BODDINGTON'S Asters are famous.
Write for catalogue of varieties and prices.

AGERATUM

	Tr. pkt.	Oz.
Mexicanum album.....	\$0.10	\$0.50
Blue Perfection.....	.15	.50
Imperial Dwarf Blue.....	.10	.25
Imperial Dwarf White.....	.10	.25
Little Dorrit.....	.15	.50
Stanley Blue.....	.10	.25
Little Blue Star, trade pkt. 25c. 5 pkts. for \$1.00		
Boddington's Mauve Beauty , large flowers; dwarf, compact, very free-flowering. Trade pkt. 10c. oz. 50c.		

GIANT ANTIRRHINUM

Coral-red, Carmine, Daybreak, Light pink; Brill. Bl., Scarlet, Gold and white; Crescia, Darks carlet; Lutetum, Yellow; Firefly, Scarlet; Romeo, Deep rose; Lilacum, Beautiful lilac; Striatum, Fiest striped, Trade pkt., 20c., oz., 60c.

	Trade pkt.	Oz.
Queen Victoria, Pure white.....	\$0.25	\$1.00
Fire King, Scarlet, with orange.....	.25	.75
Mixed.....	.20	.50

BEGONIA

	Tr. pkt.
Erfordii, Carmine, 1 oz. \$1.....	\$0.25
Semperflorens.....	.25
Vernon grandiflora, ½ ft. A fine bedding sort, with rich red flowers and glossy bronze red foliage.....	.25

BELLIS

(Double Daisy). One of the most charming of spring flowers, for edgings or pot culture.

	Tr. pkt.	Oz.
The Bride, The finest double pure white.....	\$0.50	
Boddington's Crimson King (New), Extra large crimson.....	.50	
Longfellow, Double Rose.....	\$2.50	
Snowball, Double White.....	.20	2.50
Delicata fl. pl. Rose white, with purplish red center.....	.30	2.50

CINERARIA

Cineraria maritima, 1½ ft. Trade pkt., 10c., oz., 25c.
Cineraria maritima "Diamond" A vast improvement over the above. Foliage very white, leaves much serrated Trade pkt., 50c., \$2.00 per oz.

CENTAUREA

	Oz.
Candidissima, 1000 seeds, 25c.....	\$1.00
Gymnocarpa, 1000 seeds, 15c.....	.35

GREVILLEA ROBUSTA

	Tr. pkt.	Oz.
(SDB.....)	\$0.70	\$3.50

COBAEA

	Tr. pkt.	Oz.
Scandens, H. P. Blue.....	\$0.20	\$0.75
Alba, White.....	.10	.30

LOBELIA

	Tr. pkt.	Oz.
Erinus gracilis, Light Blue.....	\$0.15	\$0.40
Erinus speciosa, Deep Blue.....	.15	.50
Crystal Palace compacta.....	.30	1.25
Emperor William compacta.....	.25	1.00

MIGNONETTE

Boddington's Majesty, The finest fancy Mignonette for under glass or pot culture. Seeds saved from select spikes under glass, ½ trade pkt., 60c; trade pkt., \$1.00.

MYOSOTIS

	Tr. pkt.	Oz.
Eliza Fanrobert, excellent for pots		
Blue.....	\$0.15	\$0.50
Palustris Semperflorens, ever-blooming.....	.25	1.00

PETUNIAS

Boddington's Century Prize

Gigantic single flowers having the edges deeply ruffled or fluted, fine substance, with deep white throats. Colors vary from pure white to dark purple-violet, many being beautifully striped or veined. ½ trade pkt., about 1000 seeds, 60c; trade pkt., about 2000 seeds, \$1.00.

Boddington's Quality Double Fringed Our double Petunias have reached the highest standard of excellence, and may be confidently relied on to produce a large proportion of double flowers of exquisite beauty and great size. ½ trade pkt., about 1000 seeds, 60c; trade pkt., about 2000 seeds, \$1.00.

Boddington's Snowball, Double, The finest double; pure white, ½ trade pkt., 60c; trade pkt., \$1.00.

Boddington's Bar Harbor Beauty, Single, Color a beautiful rose..... \$0.25

Boddington's Bullied Giants, A grand selection of single fringed..... .50

Boddington's Inimitable Dwarf Compact Hybrids, Single, Flowers blotched and striped..... .25

Canary Bird, Medium size, finely fringed and curled, yellow, which deepens in the throat, 4 pkts., \$1.00..... .25

Emperor, Single, Large blossoms. The solid colors are particularly rich and velvet, some of the crimson blossoms have pink stars, some pure white, while others are distinctly striped..... .10

Howard's Star, Rich crimson, with a distinct white star in center, oz., \$1.00..... .25

Rosy Morn, Soft carmine-pink..... .25

Snowstorm, Pure single white..... .15

Hybrida, Single Mixed, oz., 50c..... .15

PYRETHRUM

	Tr. pkt.	Oz.
Aureum Golden Feather.....	\$0.10	\$0.25
Selaginoides Foliage serrated.....	.15	.50

SALVIA

	Tr. pkt.	Oz.
Clara Bedman (Bonifre) 1½ ft.....	\$0.25	\$2.00
Splendens (Scarlet Sage).....	.25	1.00
Splendens, Ball of Fire, Very dwarf and early.....	.25	3.50
Splendens, Little Lord Fauntleroy, Neat and compact, upright and free-flowering.....	.50	4.00
Splendens, Boddington's Mixture, Early, dwarf, 12 in. and very free-flowering; covered the whole summer with large spikes of rich scarlet.....	.50	
Splendens, Zurich.....	.50	

STOCKS

Boddington's Quality Large-Flowering German Ten-Weeks Stocks

Brilliant Rose, Canary-Yellow, Crimson, Dark Blood-Red, Dark Violet-Blue, Dark Purple, Flesh Color, Light Blue, Scarlet, Snow-White, Fine Mixed, Trade pkt., 25c., ½ oz., 35c., ¼ oz., 60c., oz., \$2.00.

Boddington's Quality Cut-and-Come-Again

These splendid Stocks will flower continuously through the summer if sown early. Princess Alice, White; Apple Blossom, Light pink; Peach Blossom, Soft pink; Chamoise; Bride-maid, Rose, Canary, Yellow; Flamingo, Blood-red; Blue Jay, Light blue; Violet, Dark blue; Carmine, Crimson, Trade pkt., 25c., ½ oz., 40c., oz., \$2.50.

BODDINGTON'S QUALITY VERBENAS

Boddington's Mammoth Hybrids, A strain of very vigorous growth, producing trusses of large flowers of brilliant and varied colors; **Mammoth Auricular-flowered**, large flowers with white eye; **Mammoth Blue**; **Mammoth Pink**; **Mammoth Scarlet Delance**, the finest scarlet sort; **White** (Candidissima), pure white; **Striped**, many colors; **Lemon** (Alysia citriodora), Trade pkt., 25c., oz., \$1.00.

VINCA

	Tr. pkt.	Oz.
Alba, White.....	\$0.15	\$0.50
Rosea, Rose.....	.15	.50
Rosea alba, Rose and white.....	.15	.50
Mixed.....	.10	.40

ROSES

Hybrid Perpetual, Alfred Colomb, Anna de Diesbach, Ball of Snow, Baro Bonstetten, Baroress Rothschild, Duke of Edinburgh, Frau Karl Druschki, Jacquemont, Gen. Washington, John Hopper, La France, Macka Charta, Mme. G. Luisset, Mme. Planter, Mrs. John Laing, Paul Neyron, Fr. Camille de Rohan, Ulrich Brunner. Free immediate delivery, 75c. for 5, one variety; \$12.00 per 100; \$10.00 per 100.

Ramblers, Crimson, Dorothy Perkins, Wedding Bells, Lady Godiva, Rose de Bignon, Fairy Rambler, Catharine Zimeh. Heavy Plants in several sizes, all American grown stock. Don't try to force any others.

Wholesale Catalogue of Quality seeds and bulbs, contains 82 pages of seeds and bulbs you need. A post card will fetch it. Write to-day.

ARTHUR T. BODDINGTON, Seedsman, 324 W. 14TH STREET, NEW YORK CITY.

The New Crested
SCOTTII FERN...

NEPHROLEPIS SCHOLZELI

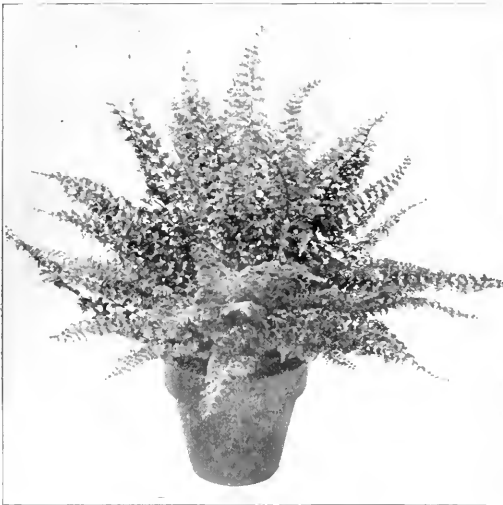

NEPHROLEPIS SCHOLZELI

This crested sport of Scottii will hold the same position to all the crested forms of Nephrolepis that Scottii now holds to the Boston. It is entirely distinct from all others and will become even more popular than its parent, with which it is identical in every way except that the pinnae are subdivided, giving it a beautiful crested appearance.

We have shown the plant at the exhibitions noted below and have been awarded the following honors:

- SHAW GOLD MEDAL**, St. Louis Horticultural Society, Nov. 3rd, 1908, for "Best plant, of decided merit for cultivation, not previously an article of North American commerce"
- SILVER MEDAL**, offered by the Society of American Florists, through the St. Louis Horticultural Society, Nov. 3rd, 1908, for "The most meritorious plant, or flower of American origin."
- CERTIFICATE OF MERIT** of the Horticultural Society of St. Louis, Nov. 3rd, 1908.
- SILVER MEDAL**, Pennsylvania Horticultural Society, Philadelphia, Nov. 3rd, 1908, for the best new plant.
- CERTIFICATE OF MERIT**, Massachusetts Horticultural Society, Boston, Nov. 6th, 1908.
- CERTIFICATE OF MERIT**, Dutchess County Horticultural Society, Poughkeepsie, N. Y., Oct. 30th, 1908.
- CERTIFICATE OF MERIT**, Morris County Gardeners and Florists' Society, Madison, N. J., Oct. 30th, 1908.
- CERTIFICATE OF MERIT**, Chestnut Hill Horticultural Society, Philadelphia, Pa., Nov. 4th, 1908.

We are booking orders now which will be filled in strict rotation June 1st, 19.9.

Price per doz., \$3.50; per 100, \$25.00; per 1000, \$200.00. Twenty-five supplied at hundred rate and five hundred at thousand rate.

HENRY A. DREER, 714 CHESTNUT STREET, PHILADELPHIA, PA.

DECORATIVE PLANTS
 Araucaria Excelsa, Pandanus Utilis, Dracaena Indivisa, Kentias, Latanias, Arecas, Etc. Perennials and Shrubs.

4 inch Araucarias.....	50 cents each.	6 inch Araucarias.....	\$1.00 each.
5 " " " " " " " " " "	75 " " " "	7 " " " " " " " " " "	\$1.25 and \$1.50 "

FERNS FOR DISHES — \$3.50 per 100, \$30.00 per 1000.
 SEND FOR OUR PRICE LIST. WE HAVE A COMPLETE STOCK.

The Geo. Wittbold Co.
 1657 Buckingham Place, Chicago, Ill.

BARGAINS
 in KENTIAS and other Decorative Plants, all sizes. Also the following at Lowest Import Prices. 15,000 Azaleas, best commercial varieties, from \$25.00 per 100 to \$2.00 each. A fine lot of Rubbers, Crotons, Araucarias, Pandanus, Asparagus plumosa and Sprengerii.

SMALL FERNS
 for table decorative purposes at lowest wholesale rates.

A. LEUTHY & CO.,
 Perkins St. Nurseries, ROSLINDALE, MASS.

FERNS FOR DISHES, Assorted Varieties
 From 2 inch pots, \$3.50 per 100; \$30.00 per 1000

FRANK OECHSLIN

HEACOCK'S PALMS
 Kentia Belmoreana
 7-inch pots.....32 to 34 inches high.....\$2.50 each
 7-inch pots.....36 to 38 inches high..... 3.00 "
 9-inch tub.....42 to 48 inches high..... 5.00 "

Made up Kentia Forsteriana
 7-inch pots.....34 to 36 inches high.....\$2.50 each
 7-inch pots.....36 to 38 inches high..... 3.00 "
 9-inch tub.....42 to 48 inches high..... 5.00 "

Joseph Heacock Co., Wyncote, Pa

CYCLAMEN GIGANTEUM
 5, 6 and 7 in. pots — 50c, 75c, and \$1.00 each.

Extra heavy stock of the very best quality.

Thomas Roland,
 Nahant, Mass.

Established 40 Years

PALMS AND FERNS
DECORATIVE PLANTS
JOHN SCOTT
 Rutland Road and E. 45th St.
 Tel. 2800 Bedford BROOKLYN, N. Y.

NEP. WHITMANI
 2 1/4 in., \$5.00 per 100

NEP. WHITMANI
 3 1/2 in., \$25.00 per 100

BOSTON FERNS
 2 1/4 in., \$3.00 per 100

H. H. BARROWS & SON, Whitman, Mass.

Rose Hill Nurseries
 New and Rare Plants
NEW ROCHELLE, N. Y.
 New York Office, Siebrecht Building, 425 Fifth Avenue

SHAMROCK
 IRISH. THE REAL THING! GREEN.
 Best to order early and grow on for strong plants for St. Patrick's Day. Our stock is very fine. \$1.00 per 100, or postpaid 60c per dozen.

JOHN F. RUPP, Shiremanstown, Pa.
RUPPTON: The Home of Primroses.

HEADQUARTERS FOR

Araucaria Excelsa, 7 in. pots, 6 tiers, 75c, \$1.25; Robusta Compacta and glauca, 20 to 30 in. high, \$1.00, \$2.00. Ficus elastica, 5 1/2 in., 25c, 35c, 50c. Kentia Belmoreana, 4 to 5 1/2 in., 35c, 50c, 90c. Forsteriana, 5 to 6 in., 50c, 75c, \$1.00, \$1.25, \$1.50. Boston, Scottii and Whitmanii Ferns—10 to 10 in. pots 50c, 75c, \$1.00, \$1.50; Amerophill, 5 1/2 in., 35c, 50c. Azalea Apollo in bloom, 7 1/2 to \$1.00. Cineraria Hybrida for Easter, 3 in., 5c, 6 in., 25c.

GODFREY ASCHMANN
 and Ferns
 1012 W. Ontario St., PHILADELPHIA, PA.

A. N. PIERSON, Inc.
CROMWELL, CONN.
 Wholesale Growers of Cut Flowers, Palms and Ferns

OUR SPECIALTIES. Roses, Lily of the Valley and Carnations. We also grow a general assortment of flowers in their season

Look through the Buyers' Directory and Ready Reference Guide. You will find some good offers there also.

WE BEGIN SHIPPING
White Killarney
 OWN ROOTS
 February 15, 1909
HAVE YOU ORDERED?
WABAN ROSE CONSERVATORIES
NATICK, MASS.

Newport Fairy
 The Rose of the Future For
 In and Out Door.
 FINE, STRONG, FIELD-GROWN STOCK
 3—4 Shoots 3—4 ft. long
 50c each, \$30 per 100, \$250 per 1000
JULIUS ROEHRS CO.
 RUTHERFORD, N. J.

Hardy Rhododendrons, Azaleas, Conifers, Clematis, H. P. Roses, Shrubs and Herbaceous Plants from our **HOLLAND NURSERIES**

Prices Moderate
P. OUWERKERK, 216 Jane St., Weehawken Heights, P. O. No. 1, Hoboken, N. J.

CLEARY'S HORTICULTURAL CO.
 Management AMBROSE T. CLEARY
 Wholesale Contracting, Jobbing, Auction
HORTICULTURAL PRODUCTS
 of every description.
 Consignments Received. Surplus Stock Converted
62 Vesey St., NEW YORK

Box Trees
 and other **EVERGREENS** for Tubs and Boxes
 Our Prices are Always Right—Catalog Free
THE NEW ENGLAND NURSERIES, Inc.
BEDFORD, MASS.

THE PRIZE WINNING STRAWBERRY
The Barrymore
 Send for Folder at Once.
H. L. CRANE, Originator,
 Westwood, Mass.

PEACOCK'S NEW DAHLIAS
 SEND FOR LIST
PEACOCK DAHLIA FARMS
 Williamstown Junction, N. J.

DAHLIAS. Now is the time to place your order for bulbs which will insure you getting named varieties in any quantity; prompt delivery.
DAVID HERBERT & SON,
 Successors to L. K. Peacock, Inc.
ATCO, N. J.

The Northboro Dahlia and Gladiolus Gardens
 Offer for Spring 1909
 300 selected varieties of Dahlias and one and one half million large-flowering Gladioli in mixtures, in lots to suit. Send list of your wants. Catalogue free.
J. L. MOORE, Northboro, Mass.

BARGAINS in TREES and PLANTS
 Concord Grapes, \$2.00. Peach, \$3.00 per 100.
 List Free. D. J. TWOMEY, Dept. H, Geneva, N. Y.

JOHN WATERER & SON, Ltd.
American Nursery Bagshot, England
 Are Specialists in the
REALLY HARDY VARIETIES
 of Rhododendron Hybrids and in Select Varieties of Hardy Border Plants.

To PRIVATE GARDENERS
 The following Chrysanthemums are looked upon with favor by English growers, and are considered among the best.

CHAS. WEEKS	NORFOLK BLUSH	KITTY HARDY
THE DUCHESS	TABLE FANNER	FREDA BEDFORD
Mrs. R. O'BURTER	TOPEYMAKER	MME. P. RADAELLI
RICHNES	Mrs. R. CADBURY	BEATRICE
MAGNIFICENT	DONALD McLEOD	MARY GODFREY
JUMBO	LILY BAKER	Mrs. CURIE
Mrs. R. LAXTON	VICTORIA & ALBERT	W. LUXFORD

 While these varieties do not appear in our Catalogue we can supply to all desiring same.
 Remember this is only a partial list of varieties not Catalogued.
 If you don't find what you want write us.
ELMER D. SMITH & CO. ADRIAN, MICH.

RHODODENDRONS-RHODODENDRONS
 An immense stock of all the **hardest known kinds**, 2 to 3½ ft., fine plants and all home grown, many being on own roots, far better than grafted stock—also **R. Catawbiense** seedlings of all colors and seedling **Hardy Azaleas** not to be obtained elsewhere. This is the nursery in which most of the Rhododendrons that have proved **hardy in America** were raised.
GOLDEN YEWES, KALMIAS, and other **HARDY PLANTS** in great variety and of all sizes.
 Catalogues on Application
ANTHONY WATERER **KNAP HILL NURSERY** **KNAP HILL**
SURREY, ENGLAND
 (NO CONNECTION WHATEVER WITH ANY OTHER FIRM.)

ROSES
ROBERT CRAIG CO.
ROSES, PALMS,
 and Novelties in Decorative Plants
 MARKET and 49th STREETS., PHILADELPHIA, PA.

ROSES
 We have a fine stock of large, dormant field-grown plants, on own roots, including **Crimson Rambler**, **Dorothy Perkins**, **Clio**, **Alfred Colomb**, **Francois Levet**, **Jack**, **Princesse de Rohan**, **Magna Charta**, **Ulrich Brunner**, **Giant of Battles**, and many others at \$16.00 per hundred; \$150.00 per thousand. Send for list. **Roses, Dahlias and Cannas** a specialty.
THE DINGEE & CONARD CO. W. Grove, Pa.

Selenepedium grande albo-marginata



The subject of the illustration is a fine variety of *Selenepedium grande*, differing from the type in being of a lighter shade of color and by the white margin of the dorsal sepal and the petals. Among the many varieties and hybrids of *Selenepediums*, *S. grande* is one of the best if not the best, and one can't help but admire it when seen in bloom. Some of the *Selenepediums* have the habit of dropping one flower as soon as the next one on the scape is opening, but in this variety the individual flowers remain on the scape much longer and frequently three or four flowers will be open at one time on the same scape which makes the plant more desirable.

Selenepediums like to grow in a house where the temperature does not go below 60 deg. at night in winter with a rise of 10 to 20 deg. through the day, according to the weather. I like to grow them in the warmest corner of the house; there they will always be on the move, either growing or flowering and for that reason will at all times require plenty of moisture at the root and a spraying overhead in bright weather will do no harm to most varieties, except *S. caudatum*, *S. longifolium* and their hybrids. These latter seem to like a dryer and somewhat cooler atmosphere.

Osmunda fibre is evidently the best compost to grow them in on account of its open nature and lasting quality. Plenty of drainage must be provided and the pots should be so placed that the air can freely circulate among the roots. About once a week the plants are

watered with weak liquid manure (one quart of undiluted manure water to three gallons of clear water).

Somebody might ask how strong the undiluted manure water is. In a barrel (60 gallon gasoline) I put two pailfull of cow manure and a 6-inch pot full of Clay's Fertilizer; then fill up with water obtained from a catch-basin into which the drainage from the horse stables runs. This water seems to be very rich in ammonia. What ever there is in it, the plants like it and soon pay for the extra trouble taken. I have used this manure water on all my orchids for the last six years with good results and if time permitted me should use it still more extensively.

M. J. Ope

Naugatuck, Conn.

Pruning Peaches

In the peach house, pruning is one of the most important operations. To have the proper fruiting wood for this year's crop depends upon whether the trees were properly cared for the past year when disbudding was done and the proper training depends upon how the new wood was tied in. A perfectly trained tree can only be secured by great care in the first training and pruning. All of the strong and rank growth must be taken off unless it is needed to form the shape desired. Cut off the wood that fruited last year when possible and leave the bottom new wood to take its place.

When peaches are in flower all the air possible should be given; keep the atmosphere dry. To ensure fertilization some gardeners put a hive of bees into the house when the trees are in flower, with great success. If this is done it is well to have an opening on the outside of the house so they can get back to their hive if they should get out of the ventilator, which they will naturally do if the day is warm. When the peaches are in full bloom the outside entrance could be closed up for a few hours and make them all come out into the house. Others use a camel's hair brush to distribute the pollen. I prefer tapping the trees with my hand, to dislodge the pollen, three or four times a day; this must be done when the house has ventilation on, or dried up with fire heat.

When the fruit is set and the growth starting give them a good syringing every bright morning and in the afternoon on bright days when closing the house up. This should be done early, so they can dry up before sunset. A good watering should be given as soon as the fruit is set for now root action has started. This should be done with the chill taken off. The best and easiest way I have found is to have a faucet attached to the hot water pipe and run the water into a barrel, then use a Kinney pump to syphon the hot water from the can and water through the hose. This should be done early in the morning while the water is good and hot.

James Wheeler

HORTICULTURE

VOL. IX JANUARY 23, 1909 NO. 4

PUBLISHED WEEKLY BY
HORTICULTURE PUBLISHING CO.
 11 Hamilton Place, Boston, Mass.

Telephone, Oxford 922
 WM. J. STEWART, Editor and Manager

SUBSCRIPTION PRICE

One Year, in advance, \$1.00: To Foreign Countries, 2.00: To Canada, \$1.50

ADVERTISING RATES

Per Inch, 30 inches to page \$1.00.
 Discounts on Contracts for consecutive insertions, as follows:
 One month (4 times) 5 per cent.; three months (13 times) 10 per cent.;
 six months (26 times) 20 per cent.; one year (52 times) 30 per cent.
 Page and half page spaces, special rates on application.

Entered as second-class matter December 8, 1904, at the Post Office at Boston, Mass. under the Act of Congress of March 3, 1879.

CONTENTS

Page

COVER ILLUSTRATION—Carnations.	
SELENIPEDIUM GRANDE ALBO-MARGINATA— M. J. Pope—Illustrated.....	97
PRUNING PEACHES—James Wheeler.....	97
EUROPEAN HORTICULTURE—Frederick Moore.....	99
AMERICAN CARNATION SOCIETY: Program and Exhibition Schedule for Eighteenth Convention—Portraits of Officers and Judges.....	100-101
Portraits of Chairmen of Local Committees— Illustration, Wiegand Trophy.....	102
Illustration, State Florists Asso. of Indiana Trophy	103
CHICAGO CARNATION SHOW.....	102
PROSPECTS FOR BOSTON MARKET SHOW.....	103
NEWS OF THE CLUBS AND SOCIETIES: Gardeners' and Florists' Club of Boston—St. Louis Florist Club—Nassau County Horticultural Society—Canadian Horticultural Society—New Haven County Horticultural Society.....	104
Massachusetts Horticultural Society—Newport Horticultural Society—Society of American Flor- ists—Ladies' Society of American Florists—Penn- sylvania Horticultural Society—Cincinnati Flor- ists' Society—Club and Society Notes.....	105
DURING RECESS: Morris County Gardeners' and Florists' Society— Tarrytown Horticultural Society.....	106
TWO CARNATIONS Illustrated.....	107
OBITUARY Theodore K. Gibbs—Arthur McIlroy— Lord Amisley—James McPride—J. W. Crane.....	108
ROSES UNDER GLASS—Richard J. Hayden.....	109
LIBRARY NOTES—C. Harman Payne.....	110
AN IMPORTANT APPRAISER'S DECISION.....	111
MASSACHUSETTS AGRICULTURAL COLLEGE— Prof. E. A. White.....	111
SEED TRADE: About Seed Limas—"Johnny on the Spot"—Can- ner Prospects—The Ramblers' Club—Notes—Cat- alogues Received.....	116
OF INTEREST TO RETAIL FLORISTS: Nature as a Guide, W. H. Long—Steamer De- partures.....	118
FLOWER MARKET REPORTS: Boston, Chicago, Indianapolis, Philadelphia, Washington.....	121
New York.....	123
MISCELLANEOUS: Carnation Mrs. J. C. Vaughan, Illustration.....	103
Fire Record.....	106
Personal W. F. Gude, Portrait.....	106
White Killarney Bougainvillea lateritia.....	107
Newport Weather Notes.....	107
Leaf Cuttings of Anthurium.....	107
Chrysanthemum Edith de Clausonne.....	107
Liriodendron Chinense.....	107
Decorations at State Capitol, Albany—Illustration Publication Received.....	109
Patents Granted.....	110
Philadelphia Notes.....	112
News Notes.....	117-119
Incorporated.....	119-121
Establishment of Frank Bell.....	121
Business Changes.....	123
Greenhouses Building or Contemplated.....	128

A Word
to the
American Carnation
Society

A few days more and all eyes and ears will be trained on Indianapolis. The American Carnation Society occupies a position of peculiar responsibility in its relation to the floral industry and to the great flower-loving public which lies beyond. At last year's meeting of the Society the subject of the obligations of the introducer to the grower and what the latter has a right to expect from the former was freely discussed. The claims of the grower and dealer on the Society itself are no less paramount. Such advancement as the carnation has made in recent years in popularity and in commercial importance is credited, and justly so, to the well-directed work of the American Carnation Society in a large degree. Naturally the trade look to the Society to still exercise a salutary maternal influence and to so foster the lusty child whose protection it has assumed that it will continue to grow strong and healthy not only as a brilliant demonstration of the hybridizer's art and the grower's skill but as a commercial product indispensable to all classes of the public. As we have before urged, nothing will more effectively accomplish this much-to-be-desired result than to show to the people at every opportunity the possibilities of the carnation as a decorative flower for all occasions. The carnation is worthy to be elevated away from the lowly position it has occupied too long in so many florists' hands, as a mere ground work for pillows, anchors and other funeral design work. The society, by encouraging artistic displays of the use of the carnation in other ways, can do much to widen its sphere, increase the demand and stay the sagging of values which is so discouraging to the grower who, having done his part so well, yet finds himself helpless when it comes to realizing a fair return for his investment and labor.

The apple is coming to its own. World-renowned and first of all fruits in history the apple from the Garden of Eden down through legend and mythology and, as Downing asserts, succeeding better in the United States than in any other part of the world, it is only now that a large section of our country is beginning to realize its pre-eminent value as a commercial crop. Even in New England, whence apples were exported in considerable abundance to the West Indies in 1741, and to England as long ago as 1773, it has been deemed necessary at a recent convention of governors and other dignitaries, to urge upon the people the great possibilities that lie in commercial apple-culture on their own abandoned lands. We are inclined to look upon the development of the apple industry in the northwest as something of very recent birth, yet it is true that forty years ago a collection of twenty-five varieties sent from Nebraska to the exhibition of the Massachusetts Horticultural Society, at Boston, created a sensation by their fine appearance. We have given space, of late, to some interesting matter and impressive pictures, from time to time, illustrating the apple craze which has stirred the horticulturists of the west to unprecedented activity and which prompted President James J. Hill of the Great Northern Railroad in his speech at the opening of the Spokane Apple Show,

to predict that in a quarter of a century, the value of the apple crop of the northwest would exceed the combined value of the wheat, ore and timber production. Perhaps some of our readers may look upon this topic as rather outside the legitimate sphere of HORTICULTURE, but it is well to remember that the history of horticulture shows that in all cases the useful came before the beautiful. The tree valued first for its timber and fruit, soon becomes appreciated for its shade and its beauty, and the garden devoted to ornamental plants and flowers follows close upon that intended for food production only. So we propose to be on friendly terms with the apple men.

The fact of enlightened, reputable business men feeling themselves coerced into the payment of considerable sums of money which they have neither legal nor moral obligation to pay—and that to the United States government—seems incomprehensible. Nevertheless, un-American as it may seem, not a few of our leading importers of seeds and bulbs have felt themselves so coerced; believing that it was good policy to forestall the over-zealous appraiser by voluntarily adding sums in excess of the actual foreign prices to their import invoices and paying additional duty thereon. This they have done to facilitate delivery of the goods and also to avoid the possibility of any addition by the appraiser to meet his notions of foreign market values and which might be large enough to involve a penalty. The decision of the Board of United States General Appraisers sustaining in full the appeal of R. & J. Farquhar & Co. of Boston against such advances and penalty—an account of which appears elsewhere in this issue—will do much to clear the situation. In this instance a large importation of bulbs was advanced in value and held by the appraiser for over four weeks and was not released until the importing firm had called the attention of the Treasury Department to their grievance. The local officials learning from the importers of their complaint to Washington lost no time in clearing the goods. Then followed a hearing in Boston at which the importers' appeal was sustained in part; a further appeal and subsequent hearing in New York at which the importers were fully upheld. Reflected for a moment on the trouble and expense the importers have been put to in obtaining vindication in this instance and then note that there is no redress against the loss due to the action of the incompetent appraiser who first examines the goods and as in this case wrongfully causes the importer to bear it. We have known of several recent instances where live plants have been held ten and eleven days after entry was made and duty paid. In one lot there was an almost total loss, yet here again the importer was the victim of the delinquency of the examiner, and without redress. Messrs. Farquhar's persistent fight for prompt service and against the imposition of unfair charges will, we believe have a most salutary effect and should stimulate importers in other cities to demand from the government prompt and efficient service. Horticultural importations are now of sufficient magnitude to fully justify importers in demanding on the part of the government the employment of examiners who have practical knowledge of the goods they pass upon—even if they may not be broad enough in experience to know that the Hollander will never be found guilty of selling anything at less than its market value.

European Horticulture

ANDROPOGON FORMOSUS

Pretty, elegant, decorative grasses are almost acceptable in the formation of plant groups in the flower garden and as solitary specimens on the lawn; and the subject of this note is one of these. It will reach a height of 3-1/2 feet to 6 feet; the leafage is narrow, 1/3 to 1/2 an inch, slender and readily moved with the least breath of wind. The plant is of vigorous growth and requires the simplest cultivation.

The life of the plant extends over several years, but it is better treated as an annual. Seeds can now be obtained from most of the larger seedhouses, and sowings should be made, as a rule at the end of January and throughout February, and early in March. A warmth of 65 degree Fahr. hastens the vegetation of the seeds; usually the germ becomes visible in 5 to 6 days. When the plants are 1-1/2 to 2 inches high they should be pricked off into pans, and placed on a warm bed, and in a month they must be potted, and kept in a warm frame, rather close at the first, air being afforded daily in fine weather. If to be planted out in May and June the plants should be repotted into 1-1/2 inch pots and kept for a time in warmth till established in the new soil, accustoming the plants gradually to the open air when well rooted.

PRIMULA MALACOIDES

This promising introduction of Mr. Bulley's by means of seeds was sent to him by his collector, Mr. George Forrest, from Yunnan. In Yunnan the plant is sparsely distributed, and is only found in the Tali valley, where Father Delavay discovered it and sent material to Paris. The plant was described by Franchet in 1886. Forrest found the plant in large numbers in the Tali valley, in moist sunny places. *Primula malacoides* belongs to Franchet's section monocarpicæ of the genus. To this section belong three other Chinese species: *P. Forbesi*, *P. androsæra*, both in cultivation; this last named likewise introduced by Forrest; and *P. gemmifera*, not yet introduced to gardens. Franchet adopted the name *malacoides* from the similarity of the leaves to those of *Erodium malacoides*. In general *P. malacoides* reminds one of *P. Forbesi*, but the novelty is larger, and considerably freer in flowering which on the other hand contradicts its affinity to the monocarpicæ section. *P. malacoides* bears seed abundantly and is easy to increase by division.

For open air cultivation this apparently hardy primula has scarcely any importance, but as a pot plant for decorative purposes it may be valuable, especially by reason of its long season of flowering. The pale red or lilac red color of the blooms and the flower-stalks of a nearly gray tint are not sufficiently taking for the taste of today; but time and cultivation will alter these properties. As *P. malacoides* can be grown with but little trouble and is easy of propagation, it will probably become a general favorite.

Frederick Moore

AMERICAN CARNATION SOCIETY

Eighteenth Annual Meeting to be held in Indianapolis, Ind., Wednesday, and Thursday, January 27 and 28, 1909

OFFICERS FOR 1908-1909.

President—M. A. Patten, Tewksbury, Mass.

Vice-President—A. F. J. Baur, Indianapolis, Ind.

Secretary—Albert M. Herr, Lancaster, Pa.

Treasurer—Fred. Dornier, Jr., Lafayette, Ind.

Directors.

M. A. Patten, A. F. J. Baur, Albert M. Herr, Fred Dornier, Jr., Eugene Dailledouze, Wm. Weber, Wm. Gammage, J. S. Wilson, J. F. Wilcox.

Judges.

W. N. Rudd, Morgan Park, Ill.; Wm. Nicholson, Framingham, Mass.; Peter Fisher, Ellis, Mass.

Officers of State Florists Asso. of Indiana.

President, J. S. Stuart, Anderson, Ind.; **1st V. President**, H. Junge, Indianapolis, Ind.; **2d V. President**, Chas. Knopf, Richmond, Ind.; **Secretary**, A. F. J. Baur, Indianapolis, Ind.; **Treasurer**, H. L. Wiegand, Indianapolis, Ind.

Finance.

Chas. Knopf, J. S. Stuart, W. W. Coles, Geo. Wiegand, Peter Wieland.

Entertainment.

H. L. Wiegand, F. S. Smith, F. H. Lemon, F. B. Alley, J. A. E. Haugh.

Exhibition.

F. Huckreide, E. A. Nelson, R. F. Harritt, J. A. Evans, H. Schilling.

Reception.

A. F. J. Baur, F. E. Dornier, J. Heidenrich, Ernest Reiman, E. M. Hyatt.

Press.

H. Junge, J. A. Keiman, H. Heller.

Meetings and Exhibition.

The meetings and exhibition will be held in the German House. There will be sessions, morning and afternoon on Wednesday and Thursday for the annual reports of officers and committees, election of officers and other business of the Society and papers and discussions on topics of timely interest are promised. The Question Box

is expected to bring forward some fruitful themes for consideration.

Entertainment.

The State Florists' Association of Indiana has completed all preparations for the comfort and entertainment of

Baur, "German House," Indianapolis, Indiana.

Express charges on all exhibits must be prepaid.

Special tables will be provided for exhibits not intended for competition.

The Society provides vases of uniform size for exhibitor's use, respectively for 100, 50 and 25 blooms. It is obligatory upon exhibitors to use these vases for Classes A and B and for entries for Certificate of Merit.

In all other classes exhibitors have the option of using either the Society's vases, or providing their own.

Rules and Regulations.

1st. A charge of \$1.00 for each variety, entry of which has not been made with the secretary on or before January 15.

2nd. All entries not staged before 1 p. m., January 27th, will be disqualified from any and all competition excepting for "Certificate of Merit."

3rd. None but members of the Society are eligible to compete for any prizes, medals or certificates.

4th. All exhibits for competition must have the variety correctly labeled, if a named sort, or numbered if an unnamed seedling. The Society will furnish a uniform card for this purpose, and varieties not labeled or numbered with this card

will not be judged in any of the classes. The secretary will typewrite these cards for exhibitors who get their entries in early enough for him to do it, and furnish them to the exhibitor in Indianapolis any time during the morning of January 27.

5th. The same vase is not allowed to compete for more than one prize, excepting those entered for Certificates and where otherwise stated.

Judges' Scale of Points.

This scale shall be employed in judging all seedlings for Certificate of Merit, or for any special prize, and in all classes where competition is



MARCELLUS A. PATTEN

President American Carnation Society

the visitors. Much good natured rivalry for the honor of extending hospitality has developed between the delegations from various Indiana centres and Indianapolis, as the head centre of activity, is full of enthusiasm.

A theatre party has been arranged for the enjoyment of the ladies on Wednesday evening and a smoker on the same evening for the gentlemen. On Thursday there will be a banquet for ladies and gentlemen at which it is expected the Governor of the State will be present to extend a formal welcome.

THE EXHIBITION.

Address all Exhibits to A. F. J.



W. N. RUDD
Judge

close, it shall be used to arrive at a decision:

Color	25	Substance	10
Size	20	Form	15
Calyx	5	Fragrance	5
Stem	20		
		Total	100

Rules Governing the Award of Certificates of Merit.

A variety must have been bloomed not less than three years; not less than fifty blooms must be shown, and an entrance fee of \$5.00 is charged for each variety. The variety must be properly labeled with the Society's Card. (See Rules and Regulations.)

Preliminary Certificate.

This can be competed for by two-year-old seedlings, twelve blooms or more to be shown, and an entrance fee of \$2.00 paid for each variety. The variety must be properly labeled with the Society's Card. (See Rules and Regulations.)

General Premiums.

Class A—Open to all varieties, Seedlings or Standard Sorts, 100 blooms to a vase. First prize, \$10.00; second prize, for each number.

No. 1, White; 2, Flesh pink being

those shades of pink of a flesh or salmon color; 3, Light pink being those lighter shades of pink, verging on the true pink and lighter than Lawson; 4, Dark pink being as dark or darker than Lawson, including all so-called crise not dark enough to be classed as red; 5, Red or carmine, including all shades of red that can not be classed as scarlet or cardinal; 6, Scarlet or cardinal, to include those bright shades now commonly known in the trade as scarlet; 7, Maroon, to cover those shades now known as crimson; 8, Yellow or yellow variegated; 9, White variegated; 10, Any other color; to include any color decidedly distinct from other colors specified.

Class B—Open to all varieties disseminated prior to July 1st, 1903, 50 blooms to a vase. First prize, \$5.00; second prize, \$3.00, for each number.

No. 11, White Enchantress; 12, White Perfection; 13, Any other white; 14, Enchantress; 15, Any other flesh pink; 16, Winsor; 17, Welcome; 18,



A. F. J. BAUR
Vice-President

varieties, arrangement and general effect to be considered.

Bertermann Bros. Co., Indianapolis, a Sweepstake Prize as follows: \$40 for first; \$30 for second; \$20 for third; and \$10 for fourth. Prize to be awarded to the best four vases in the 100 Class (A). The winner of each of these prizes is to duplicate the vase of carnations within ten days after the close of the show to whomsoever the prize giver specifies.

Indiana Floral Festival Association, \$25 in gold for the best vase of 100 carnations, one variety, grown in the state of Indiana. (Separate from Class A.)

H. W. Field, Northampton, Mass., \$10 for the best vase of 50 blooms of President Seelye.

American Carnation Society Medals.

Class C—A Gold Medal will be given for the best vase of 100 blooms, any variety, any color. A Silver Medal will be given for the second best vase of 100 blooms any variety, any color. A Bronze Medal will be given for the



PETER FISHER
Judge

Rose Pink Enchantress; 19, Afterglow; 20, Any other light pink; 21, Lawson; 22, Aristocrat; 23, Any other dark pink; 24, Red Chief; 25, Victory; 26, Beacon; 27, Any other scarlet; 28, Harlowarden; 29, Octoroon; 30, Any other crimson; 31, M. A. Patten; 32, Variegated Lawson; 33, Any other white variegated; 34, Any yellow variegated; 35, Any other color (same as No. 10 in Class A). Three prizes may be awarded under No. 36.

Special Prizes.

Special prizes are offered as follows: By Baur & Smith, Indianapolis, Ind., \$10.00 in gold for the best 50 blooms of carnation "May".

A. Wiegand & Son, Indianapolis, Ind., \$25 Silver Cup to the best vase of 100 blooms, one or more varieties, quality arrangement and general effect to be equally considered. (Separate from Class A.)

The State Florists' Association of Indiana, a \$50 Silver Cup for the best vase of 200 blooms, in five or more



A. M. HERR
Secretary



WM. NICHOLSON
Judge



H. JUNGE
Chairman Press Committee.



FRED. R. HUKRIEDE.
Chairman Reception Committee.



H. L. WIEGAND
Chairman Entertainment Committee.

third best vase of 100 blooms, any variety, any color.

Special Medals of the Society of American Florists.

Class D—A Silver Medal will be awarded for the best vase of 50 blooms of carnations not yet disseminated. A Bronze Medal will be given for the second best vase of 50 blooms of carnation not yet disseminated.

The variety to be in all cases of American origin.

Judges are to reserve awards in this class if in their opinion the exhibits are not worthy of the medals.

Hotel Accommodations.

Following hotels are recommended to members of the American Carnation Society during their meeting in Indianapolis, January 27-28, 1909:

	American	European
New DeLison Hotel	\$82.50 up	\$1.00 up
Claypool Hotel	2.50 "	2.00 "
Hotel English	2.00 "	1.00 "
Grand Hotel	2.50 "	2.00 "
Hubbs Hotel	2.50 "	2.00 "
Imperial Hotel	2.50 "	2.00 "
Lorraine Hotel	2.50 "	2.00 "

The New DeLison Hotel will be headquarters for this meeting. It is conveniently located so that meeting and exhibition hall and banquet hall can all be easily reached from it. The reception committee wishes to announce that it will meet all trains at the Union Station and escort all visiting delegates to which ever hotel they may designate, so look for them; they will be there.

FRED. R. HUKRIEDE,

Chairman of Reception Committee.

Boston to Indianapolis.

President Patten and his party will leave Boston for Indianapolis by the Lake Shore Limited from South Station at 1.15 p. m., Monday, January 25, due to arrive in Indianapolis at 3 p. m., Tuesday.

Chicago to Indianapolis.

The Chicago delegation will leave the Union Station over the Pennsylvania R. R. at 12.01 o'clock Tuesday night, January 26, arriving in Indianapolis, January 27 at 6 a. m. The

special car (or cars) will be at the disposal of delegates as early as 10.10 in the evening and will be left at Indianapolis and occupants may remain aboard until 7.30 a. m. F. F. Benthey is chairman of the transportation committee.

AMERICAN CARNATION SOCIETY.

Carnation Registered.

By A. C. Brown, Springfield, Ill.—Governor Deneen, Parentage, Enchantress and President Roosevelt; color, royal purple; size of flower, 3 to 4 inches; habit, similar to Enchantress, somewhat less grass, leaves broader and Pelvier, blue green in color.

By S. Knudsen, Boulder, Col.—Arapahoe Glacier, Parentage, White Lawson and Lady Bountiful; color white; size of flower, 3½ to 4 inches; habit, etc., growth resembles Lawson but much stronger, early and continuous.

ALBERT M. HERR

Lancaster, Pa.

CHICAGO CARNATION SHOW.

Twenty-eight cases of new and standard varieties of carnations made a very creditable show at the Art Institute on Jan. 14th. The flowers were slow in arriving and at noon the outlook was not very encouraging, but by two o'clock everything was in shape, with Uncle John Thorpe the presiding genius. The sight of M. R. Miller, of Willmette, quietly superintending everything, brought back the big show of a few weeks ago. C. W. Johnson, of Rockford, Ill., arrived and assumed his duties as judge.

While the attendance cannot be said to have been large, it was fair and a good beginning. The rival red carnations, O. P. Bassett and Pres. Taft occupied opposite ends of a long table, while Bay State, Lucile and Seedling 500—three varieties about which there was a great difference of opinion—with Sarah Hill and White Enchantress, filled to excellent advantage the space between them. The other tables contained a fine showing of other varieties and seedlings. Pöehmann Bros. had vases of Victory, Winsor, Beacon, White Lawson, Lawson, White Perfection, Enchantress and Winona an admirable collection.

About Greenwood Cemetery Association showed Defiance and four vases of seedlings; #294 A, light pink,



Silver Vase Ordered by A. Wiegand & Sons.

"Greenwood", a still lighter pink No. 1700; C, and a vase of mixed seedlings.

F. Dörner & Sons Co. sent a collection including Pink Delight, a delicate shell pink introduced this year.

Wanoka Greenhouses exhibited a deep maroon and a white tinted pink in center, unnamed. They stood their trip well. Chicago Carnation Co. exhibited a magnificent vase of White Enchantress. Much attention was given to their No. 500, a light pink regularly overlaid with deep pink. It is one of the last seedlings raised by the late James Hartshorne. This firm also showed the new white Sarah Hill.

Lucille, introduced by A. F. Longren and grown by Fred Bahr, of Highland Park, Ill., is after the type of Prosperity. Bay State is the famous new variegated. It was exhibited by Albert Roper, of Tewksbury, Mass., and showed no indications of its long trip. The F. R. Pierson Co. sent a vase of White Killarney roses which arrived in perfect condition. Bassett & Washburn sent specimen plants of Formosa lilies fully 5 ft. high, and Peter Reinberg sent a vase of American Beauties.

The report of the judges awarded points as follows to the new carnations entered.

	Points.	Points./	
O. P. Bassett	86	Mary Tolman	82
Bay State	85	Pink Delight	84
Lucille	81	No. 175-96, Dörner	85
Sarah Hill	82	No. 68-06, Dörner	81
No. 500, Chi. Car. Co.	79	No. 6204A, Mt. Gr. Co.	81
Wm. Taft	75	Cen. Asso.	81
Wanoka	75	Greenwood	88
Apple Blossom	87	11004, Mt. Gr. Cem. Asso.	80

NEW CARNATION MRS. J. C. VAUGHAN.



STATE FLORISTS' ASSOCIATION OF INDIANA SILVER CUP
To be competed for at Indianapolis.

THE BOSTON MARKET SHOW.

The preliminary premium list of the Boston Co-operative Flower Growers' Association's annual flower show to be held at Horticultural Hall, February 27-28, 1909, has been issued. The complete schedule will be issued about the first of February. Copies of this preliminary list may be had on application to George Cartwright, 1 Park street, Boston, or E. Allan Peirce, Waltham, Mass. There are 62 peculiar and special premiums listed. Committees are constituted as follows:

Wm. H. Elliott, chairman, Brighton; E. Allan Peirce, secretary and treasurer, Waltham, Mass.; Geo. Cartwright, Park St., Boston; S. J. Goddard, Framingham; Wm. Sim, Clintondale; Wm. R. Nicholson, Framingham. Carnations—E. Allan Peirce, Waltham, Mass.; S. J. Goddard, Framingham, Mass.; Wm. Nicholson, Framingham, Mass.; M. A. Patten, Tewksbury, Mass.; Peter Fisher, Ellis, Mass. Roses—W. H. Elliott, Brighton, Mass.; Alex. Montgomery, Natick, Mass.; Eben Holmes, Montrose, Mass.; Harry Badlong, Providence, R. I. Violets, Sweet Peas and Miscellaneous—Wm. Sim, Clintondale, Mass.; Wm. Spilsbury, Woburn, Mass.; Thomas Pegler, Park St., Boston, Mass.; Herman Ulrich, Waverly, Plants and Bulbs—L. W. Mann, Randolph, Mass.; E. Sutermeister, Rendville, Mass.; Thomas Roland, Nahant, Mass.; Geo. Butterworth, So. Framingham; F. J. Dolansky, Lynn. Judges—S. J. Reuter, Waverly, R. I.; Thos. Roland, Nahant, Mass.; A. H. Fawkes, Newton Highlands, Mass.; E. A. Wood, West Newton, Mass.; A. H. Lange, Jr., Worcester.

NEWS OF THE CLUBS AND SOCIETIES

GARDENERS' AND FLORISTS' CLUB OF BOSTON.

That this organization has grown to be a very strong factor in the horticultural life of Boston was plainly evidenced in the great throng of members and ladies that filled the lecture hall of the Massachusetts Horticultural Society on Tuesday evening, 19th inst. It was the inaugural meeting for the new officers and, according to custom, ladies night and the gathering was worthy of the occasion. The retiring president Mr. Westwood opened the meeting with a brief appreciative address thanking the members, officers and committees for their faithful work and co-operation and bespeaking the same support for his successor Mr. Downs, whom he introduced in well-chosen words amid much applause.

President Downs' speech of acceptance was graceful and pertinent. He made many thoughtful suggestions as to the activities of the club for the year to come. He advocated the establishment of a hospital bed for florists and gardeners overtaken by sickness or injury, the offering of a club trophy to be competed for at the coming florists' market exhibition in Horticultural Hall, a closer affiliation and exchange of visits with sister organizations, an employment bureau for members, the enlargement of the scope of the exhibition department and redoubled efforts to draw into the ranks every gardener and florist within the club's jurisdiction. These sentiments were all generously applauded and at a later hour Mr. W. R. Weston was given an opportunity to explain the hospital project the result of which was the appointment of a committee of five members to look into the matter fully and report later.

Secretary W. N. Craig's report for the year showed an average attendance of 170 at the meetings of the past year, the largest being 325 on ladies' night and the smallest 112, in May. 46 new members added during the year. The secretary seconded the president's suggestion of an employment bureau and favored the establishment of life memberships in the club at \$25.00. Twelve new members were duly proposed and elected.

The treasurer's report was presented by assistant treasurer Peter Miller and showed a gain of \$205 in the cash on hand for the year after paying all obligations. The report from the landscape study class was also satisfactory. The exhibition judges for 1909 were appointed as follows: Eber Holmes, chairman, Geo. M. Anderson, Jas. Wheeler, M. A. Patten, C. Holloway, Robt. McGorum, Kenneth Finlayson and J. F. Flood. Refreshment committee: J. P. A. Guerin, chairman, G. W. Butterworth, W. Nicholson, Jr., P. J. Turley, Messrs. Lindsey, Murray and Barry.

Alternating with the above recorded business transactions were costume dancing by the Stewart Sisters Quartette, tenor solos by the famous Scotch tenor, Stuart Moncur and songs by Miss Hannigan the latter already well-

known to the members of the club. The entertainment was of a high order and the artists were repeatedly recalled.

The exhibits of the evening and awards to same by the judges were as follows: Wm. Sim, violets Baronne Rothschild, Boston, Kaiser Wilhelm and Princess of Wales; honorable mention for Kaiser Wilhelm, which Mr. Sim predicts will shortly supersede Princess of Wales. Violets Baronne Rothschild from F. W. Fletcher, Princess of Wales from H. T. Woods and G. Bleicken, Lady Campbell from H. F. Woods. A handsome crimson seedling carnation from Lewis Small, Tewksbury; honorable mention, Carnations Bay State and fine scarlet seedling from A. Roper; honorable mention to the latter. Yellow seedling carnation Kanarieblud, from Henry Schrade, Saratoga Springs, N. Y., (a cross between a pink seedling and Lawson). Improved *Primula Kewensis* from T. Coles. Mushrooms from John F. Flood. All not otherwise specified received a vote of thanks.

President Patten of the American Carnation Society extended a cordial invitation to all who could do so to go to the meeting of that society at Indianapolis next week.

Ice cream, cake and coffee was served later in the evening.

ST. LOUIS FLORIST CLUB.

This club held its regular monthly meeting on last Thursday afternoon. The meeting was an important one and the attendance quite large, with a few from the suburban towns, this being the first meeting since the holidays.

The trustees reported that they had not yet found a new meeting hall, but hoped to report on one by the next meeting. The Smoker Committee reported that they would hold the Smoker on the evening of the next club meeting, February 11th. A very important letter was read from President Valentine of the S. A. F., which will receive proper attention from the president in due time. The chair appointed Messrs. Ammann, Beneke and Augenmuller to draft resolutions on the death of Carew Sanders, which read as follows:

Whereas, Our beloved friend and fellow members, Carew Sanders has been called to his eternal rest; and

Whereas, In our association with him for many years we found him a loyal friend to the interest of this club and possessed of that noble spirit which endears a man to his fellowmen; therefore, be it

Resolved, That we briefly record our sense of the inexpressible loss which this club and all branches of our profession have sustained in the removal of Carew Sanders from the scenes of his earthly labors and our grateful recognition of his useful services in the cause of horticulture.

The club voted to hold its annual carnation meeting February 11th, and the Smoker will take place the same evening in another hall close by. A general discussion then ensued as to the holiday trade in plants and flowers which it appears, was about 25 per cent. better than any previous Christmas.

The meeting then adjourned to a nearby cafe where a general good time was had and refreshments served.

NASSAU COUNTY HORTICULTURAL SOCIETY.

The regular monthly meeting of the Nassau County Horticultural Society was held in Pembroke Hall, Glen Cove, N. Y., on Wednesday, January 15, the new president, Mr. John Everett occupying the chair. There was an unusually large attendance, nearly sixty members being present. The result of the monthly points competition was as follows: Mr. Knight, poinsettias, 95 2-3; Trepress, mignonette, 77 2-3; Reul, Enchantress carnations, 75; Gale, do., 81 2-3; Cleres, Winsor carnation, 84; Elmslie, Beacon carnations, 83 1-3; Wilson, Princess of Wales violets, 80 1-3; Gaut, moschosa, 89 1-3.

There was also a fine display of flowers and plants for exhibition, the most conspicuous of which was a magnificent plant of *Eucharis Amazonica* shown by Mr. Knight who received a cultural certificate. Mr. Trepress showed a carnation seedling which was much admired. The president appointed Messrs. Jaenicke, Matz, Holloway, Ashworth, Garrett and Duthie to do duty as judges at the monthly exhibition during the ensuing year. Three new members were elected and two proposed.

Messrs. Matz, Meyer and Jaenicke were appointed as committee to ascertain if a suitable lot could be acquired upon which a horticultural hall could be built. The N. C. H. Society is nothing if not ambitious. On behalf of Thorburn & Co., New York, Mr. McTaggart offered a prize of \$10 for twelve dishes of vegetables grown from Thorburn's seeds, the prize to be competed for at the fall show.

The society's annual dinner takes place this month. With "Jed" Everett as chairman of the entertainment committee a good time is assured.

WM. H. MacKENZIE, Cor. Sec.

CANADIAN HORTICULTURAL ASSOCIATION.

Harry Philpot gives us the following report. The Executive Board of the Canadian Horticultural Association met at Toronto, January 12. All of the officers and all but two of the Executive Committee were present. The chief business transacted was the completing of arrangements for the annual meeting of the society which will be in Toronto in November, at the time of the Chrysanthemum Show in the same place. They are perfecting arrangements to invite and entertain the S. A. F. at Montreal in 1910, if that society can be induced to accept. They expect to send a strong delegation to Cincinnati.

NEW HAVEN COUNTY HORTICULTURAL SOCIETY.

At the last meeting of this society the following officers were elected for the current year: President, John H. Murray; vice-president, Walter Koella; treasurer, David Kydd; secretary, F. H. Wirtz; board of managers, Ernest Carol, Thomas Pettit, Wm. Beattie, R. Bell, Wm. Symons. At the next meeting John H. Slocombe will give a talk, the subject to be announced later.

F. H. Wirtz, Sec'y.

MASSACHUSETTS HORTICULTURAL SOCIETY.

The "January Exhibition," held in Horticultural Hall, Boston, on Saturday, Jan. 16, was very large—probably the most extensive ever held at this season, although the weather was very cold. The carnation display by Patten & Co. and others, was most creditable. Among Patten's novelties were Hattie Starritt yellow variegated, Sara Nicholson crimson and Genevieve white. Mrs. J. Montgomery Sears, gardener W. C. Ritchie, was represented in many classes including *Primula Kewensis*, *obconica grandiflora* and *chinesis*, *Celsia arcturus*, *Clerodendron Fallax*, *Lorraine begonia*, *cyclamens*, *camellias* and an *amaryllis*, 18 months from seed, of singular beauty—a very dark crimson maroon. The finest Chinese primroses ever shown here came from Wm. Whitman, gardener Martin Sullivan, who also showed *P. stellata* and *obconica* in excellent shape. E. J. Mitton, gardener J. Lawson, was also represented by grand *P. chinensis*. From Mrs. J. L. Gardner, gardener Wm. Thatcher, the primroses in all classes were fine. Altogether a distinct advance in type was apparent in the primroses, as a whole. Bellevue Greenhouses showed some handsome mushrooms.

Awards were as follows:

Primula Kewensis—Six plants in not less than five-inch pots: First, Mrs. Frederick Ayer; second, Mrs. J. M. Sears; third, Mrs. J. L. Gardner.

Primula Sinensis—Six plants in not less than six-inch pots: First, Wm. Whitman; second, E. J. Mitton; third, Mrs. J. M. Sears.

Primula Stellata—Six plants in not less than six-inch pots: First, Wm. Whitman; second, Mrs. J. L. Gardner.

Primula Obconica Varieties—Six plants in not less than six-inch pots: First, Mrs. J. L. Gardner; second, Mrs. J. M. Sears; third, Mrs. Frederic Ayer.

Begonia Glorie de Lorraine—Six plants: The second prize to Mrs. J. M. Sears.

Cyclamens—Six plants in not over seven-inch pots: First, Mrs. J. M. Sears; second Mrs. A. W. Blake.

Carnations—Fifty blooms of any named variety not disseminated: First, M. A. Patten, Sara Nicholson. Four vases, distinct varieties, twenty-five blooms each: First, Chas. S. Strout; second, M. A. Patten; third, S. J. Goddard.

Gratuities—Wm. Whitman, display of *Primulas*; Mrs. J. L. Gardner, display of *Primulas*; Chas. S. Strout, vase of *Carnation Winsor*; Miss E. Jackson Clark, violets; S. J. Goddard, *Freezia Purity*; Mrs. J. M. Sears, display.

Silver Medal—M. A. Patten, *Carnation Sara Nicholson*.

First Class Certificate of Merit—Mrs. J. M. Sears, *Seedling Amaryllis*.

Honorable Mention—H. F. Woods, *Violet Comet*; M. A. Patten, *Carnation No. 595*.

Mushrooms—Twenty-four specimens: Bellevue Greenhouses.

Forced Vegetables—Rane & Hall.

NEWPORT HORTICULTURAL SOCIETY.

This society held a regular meeting on the evening of Jan. 12 with an at-

tendance of members that was very encouraging to its officers. The regular business being quickly disposed of some time was then devoted to the exchange of ideas about the holding of exhibitions for the year. Some objections were raised to holding the usual two shows on account of the heavy expenses involved, but as the society has already accepted offers of several handsome premiums to be competed for at two seasons of the year it is safe to expect that the two shows will be voted for and that keener competition than usual will be the rule, as it is evident that there is a desire by a majority of the members that the premiums should be more equally distributed than they have been the past few years, and this condition of affairs will no doubt tend to make the coming exhibitions excel the high standard of excellence which they have been reported for in the past.

SOCIETY OF AMERICAN FLORISTS.

National Flower Show Committee.

Chairman W. F. Kasting directs me to call a meeting of the Committee of Fifty to take place at Indianapolis, January 28th, at 10.00 a. m.

The Executive Committee will meet the same day at 2.00 p. m.

The business of the Committee will be wound up finally.

J. H. BURDETT, Secretary.

Chicago, January 15th, 1909.

Ladies' Society of American Florists.

A meeting of all members of the Ladies' Society of American Florists attending the *Carnation Convention* at Indianapolis, Ind., is called for Wednesday morning, Jan. 27, 1909, at 10 a. m., in Exhibition Hall.

MRS. J. C. VAUGHAN, Pres.

MRS. CHAS. H. MAYNARD, Sec.

PENNSYLVANIA HORTICULTURAL SOCIETY.

The regular monthly meeting was held on the 19th inst. Dr. Henry Skinner, professor of entomology, gave an illustrated lecture on diseases caused by insects, and the remedies. His lecture was along the lines of civic improvement, the abatement of swamps, mosquitoes, malaria, yellow fever, etc., and was very interesting and instructive. The first prize for *Primula Chinensis* went to Wm. Fowler, gardener for Mrs. Geo. B. Wilson, for vase of *Laelia anceps alba*; and to Jas. Goodier, gardener to C. G. Roebing, for *Cypripedium aureum Roebingiana* and *Cattleya Trianae alba*. The annual spring show will take place March 23rd, 24th and 25th.

CINCINNATI FLORISTS' SOCIETY.

A meeting was held on the evening of January 9, at the office of William Murphy, for the purpose of arranging local details for the convention of the Society of American Florists to be held in Cincinnati next August. An executive committee was appointed, consisting of President J. A. Peterson, Vice-President C. E. Critchell, Secretary A. Sunterbruch, Treasurer D. Rusconi, G. Adrian, E. A. Forder, William Murphy, J. W. Rogers, Richard Witterstaetter and E. G. Gillett.

CLUB AND SOCIETY NOTES.

The State Florists' Association of Indiana, met at Indianapolis, on January 12. The officers were re-elected for the coming year.

January 28, E. W. Breed, of Clinton, will speak on the Value of Trees, before the Worcester County Horticultural Society, Worcester, Mass.

The Detroit Florists' Club will hold a carnation show, February 18, and possessors of novelties are invited to send exhibits to the Michigan Cut Flower Exchange.

The new entertainment committee of the Milwaukee Florists' Club, Gus Roesch, Will Zimmerman and Eugene Oestreicher, appointed on January 7, already have plans on foot for a dance early in February.

The Sedgwick County Horticultural Society of Kansas, at their last meeting endorsed the bill of Representative Matson, providing for the punishment of dealers selling fruit trees under false labels.

The Rhode Island Horticultural Society's annual meeting was held at Providence on January 20. Secretary Rich and Wilfrid Wheeler were present as guests, representing the Massachusetts Horticultural Society.

At a meeting of the executive board of the American Civic Association, held December 4, Richard B. Watrous, of Milwaukee, was elected to the position of secretary made vacant by the resignation of Clinton R. Woodruff.

The next lecture in Horticultural Hall in the course by the Massachusetts Horticultural Society will be given on January 23, at 11 o'clock, by Prof. E. A. White; subject, *Ornamental Gardens and Garden Materials*; with stereopticon illustrations.

The American Association of Park Superintendents are arranging a series of photographs of park views and construction work to be exhibited at the Alaska Yukon Pacific Exposition. The park superintendents hold their next meeting in Seattle and the opportunity for emphasizing the work they are accomplishing seems opportune.

The State Florists' Association will meet at Springfield, Ill., on February 16 and 17, in Arion Hall. The Florists' Club has appointed a committee to take charge of the exhibition and issued a circular regarding space. W. T. Homburg, 829 South Second Street is secretary of the club and will give further information to all interested.

Conservation of our national resources was the topic under consideration at the first meeting of the year, January 13, of the Worcester County (Mass.) Horticultural Society. Arthur J. Marble was the principal speaker. His address was vigorous and his denunciation of certain people in public life and their unpatriotic course on

public questions was refreshingly frank and timely.

How to Control Insects was the title of a lecture by Prof. E. Dwight Sanderson, of the New Hampshire Agricultural Experiment Station, before the Massachusetts Horticultural Society on Jan. 16. Prof. Sanderson had the largest audience which has been seen at a lecture for a very long time, and the many questions that he was called upon to answer indicated how deeply the public is interested in this subject.

At the twenty-second annual meeting of the State Florists' Association of Indiana, held at Indianapolis on January 12, carnations exhibited were recognized as follows: New carnation, by Charles Knopf, of the Charles Knopf Floral Company, Richmond, "Admiration," 85 points out of a possible 100, "Mrs. Charles Knopf," 78 points; "Ruby," 81 points; new carnation, "Shasta," by Baur & Smith, Indianapolis, 85 points. Honorable mention to B. F. Hensley, Anderson, and Stuart & Haugh, Anderson.

FIRE RECORD.

Westwood, Mass. The greenhouses of Charles S. Danrell were damaged by fire on January 6.

Ashland, Neb. In the recent fire that destroyed the greenhouse of Dr. A. S. Mansfeld, many rare plants were lost.

New Brunswick, N. J. A fire which started in the boiler house on the morning of January 13 destroyed the rose and carnation houses of R. W. Johnson, Belleview Farm. The valuable orchid collection was saved. The loss is estimated at \$15,000; no insurance.

Chicago, Ill. Four houses belonging to the plant of the Guardian Angel Orphan Asylum, Ridge avenue, were completely destroyed by a fire which started in the boiler room on January 7. The larger range of houses was saved but the contents were frozen. The loss will aggregate about \$6000.

Alex. Weizeroski lost his greenhouses by fire on the morning of January 12.

NEWS NOTES.

The estate of August Dressel, a former florist of Chicago who went into bankruptcy eight years ago, has paid the creditors 100 cents on the dollar and left a balance for the bankrupt.

Newport, R. I.—Mrs. Goelet, widow of the late Robert Goelet, has ordered two of her Newport greenhouses put out of commission for the purposes of economy, it is said.

Mrs. Goelet is a sister to George Henry Warren, and her fortune is rated at \$20,000,000.

The Nurseryman and Seedsman, our well-known English contemporary, has been purchased and will be published henceforth by W. J. Bruce & Co., 35 Surrey street, Strand, London. W. C. Mr. Bruce is highly spoken of by acquaintances on this side of the Atlantic and we wish him success.

PERSONAL.

Harry E. Klunder has gone out of business in Chicago and has returned to New York City.

Chicago Visitors: F. A. Bentley, Jr., New Castle, Ind.; Mr. Kalisch, of Kalisch Bros. Co., St. Louis, Mo.

Visitors in Boston—E. J. Faucourt representing S. S. Pennock-Meehan Company, Phila.; Ernst Bitterhoff, Berlin, Germany.

Visitors in Albany: R. E. Hall, representing J. Stern & Co., Philadelphia; Morris Cohn, of Weathermet Bros., New York; R. Greenlaw, representing N. F. McCarthy & Co., Boston.

Mr. D. J. Conghlin, Newport, R. I., who was dangerously ill for several weeks, is now able to attend to his usual duties as gardener for E. Rollins Morse and his many friends are very pleased to see him about again.

Chicago visitors—C. E. Heite, vice-president of the W. L. Rock Flower Co., Kansas City, Mo.; Geo. Bancroft, Cedar Falls, Iowa; A. T. Pyfer, manager Chicago Carnation Co., Joliet, Ill.; H. E. Philpot, Winipeg, Man.; G. W. Johnson, Rockford, Ill.; Harry Bock, Burlington, Iowa.

The Washington florists are very much elated over the fact that one of their number, Wm. F. Gude, has been elected to the highest office in the Chamber of Commerce. Mr. Gude has for a long time been closely associated



WM. F. GUDE

with the business interests of Washington, and it is a subject for congratulation to the Washington public that so representative a man should have been chosen to the presidency of this influential organization.

The Ionia Pottery Company are sending out a calendar for 1909. The attraction which gives special value to it is "Julia." Julia is appropriately garlanded with roses, and deserves a place in every florist's office.

During Recess

MORRIS COUNTY GARDENERS' AND FLORISTS' SOCIETY.

Seldom, indeed, does one breathe an atmosphere as full of good nature and fun as there was in Madison on the occasion of the thirteenth annual smoker of the society. The entertainment part was preceded by a short business meeting. The secretary reported for the year ten monthly meetings, two special meetings, nine monthly exhibitions, one annual flower show, twenty-eight cultural certificates and eleven certificates of merit were awarded. Sixty-eight members in good standing, ten new members. During the year six resigned, five to locate in distant places. He further reported that all within the club was harmonious and the public begins to look on the society as a permanent institution, which we hope will prove true. The treasurer reported a cash balance on hand after all bills are paid of \$179.01.

Mr. Herrington, our past president, went through the ceremony of installing H. B. Vyse as president. Mr. Vyse began by welcoming the guests in the name of the society, in a neat speech. About one hundred and thirty members and guests partook of the viands and enjoyed the talent, which was very good. Cigars, coffee, sandwiches and "Totty's celebrated punch" were served with a free hand. The inclemency of the weather prevented the attendance of many members, as well as guests from a distance. But we all had a good time. The "Mayor of the Bowery" and Billy Carter were good and, as heretofore, we had lots of local talent in song and recitation, among whom were the Goebel Brothers, John R. Mitchell, Percy Herbert, A. Herrington, Samuel Wyatt, Richard Carey, "Al" and "Billy" Rickards we can't do without, and they made lots of fun for us. Wm. Sperling, from Stump & Walter, Arthur T. Boddington, Wm. Turner, N. Butterback, Harry Turner and a delegation of our Orange friends helped us to make merry. The singing of Auld Lang Syne and a loud three cheers for the Morris County Society ended an enjoyable time.

E. REAGAN, Sec'y.

TARRYTOWN HORTICULTURAL SOCIETY.

The tenth annual dinner of this flourishing society was held at the Florence Hotel, Tarrytown, N. Y., on Wednesday, January 13. It was in all reports a splendid affair and everyone present was delighted. It was pronounced the best the society has ever had. The menu was a corker.

Mr. A. H. Brown acted as toastmaster, and speeches were made by J. Austin Shaw, M. D. Raymond and Wallace Odell of the local press. Surgeon Frank V. Millard, F. R. Pierson, Robt. E. Patterson of the local bank, Messrs. Dunbar of Dobbs Ferry, Wilson of Chatham, N. J., Lee of White Plains, and several others. The tables were prettily decorated with Glorie de Lorraine begonias and carnations from the different private estates and vases of a variegated sport from carnation Mrs. M. A. Patien and White Killarney from F. R. Pierson Co.

CARNATIONS, RUBY AND MRS. CHAS. KNOPF.



MRS. CHAS. KNOPF

Mrs. Chas. Knopf is showing up well this year and gives promise of being a valuable commercial variety. It resembles Enchantress in color but is of a more lively, bright shade without

the salmon cast and does not fade out on the edges of the petals. The blooms are very large, beating Enchantress at its best and the calyx does not spit as much as in that variety.

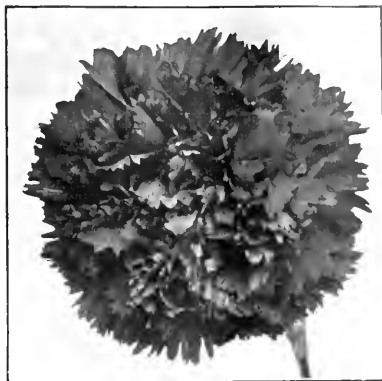

RUBY

Blooms sent into the wholesale markets have brought \$1.00 per hundred more than Enchantress and it is well liked by critical buyers.

Ruby is a very large, strong-growing crimson, with excellent form, stem and color. The flower stands high above the calyx, giving it a fine finish. Wherever this variety has been tested it has demonstrated its pre-eminence in this color.

WHITE KILLARNEY.

Waban Rose Conservatories, always the Mecca of visiting rose growers, is at present especially so on account of the widespread interest in that most beautiful of all rose introductions, White Killarney. Seeing this rose as grown here one is disposed to agree with the assertion of one visitor that it would turn out to be a white running mate for American Beauty. This Waban variety is a much heavier flower than the parent Killarney, carrying never less than twenty-three petals to the flower and sometimes up to forty, while the maximum number in Killarney proper is twenty-three. In modeling it is a picture, and the 324 ft. house filled with it in full bloom is an inspiring sight. Grafting young stock is progressing rapidly, 25,000 being now in the cases. Mr. Montgomery is greatly pleased with direct results from advertising in HORTICULTURE, which has brought him orders from Germany, Bermuda and Canada in addition to those from domestic sources.

LEAF CUTTINGS OF ANTHURIUM.

The Gardeners' Chronicle records that at the meeting of the Scientific Committee of the Royal Horticultural Society (England), on December 8, Mr. Chittenden, secretary, showed a plant illustrating a method of reproduction in Anthurium Decharidii. Mr. Blakey, of Wisley Surrey, had inserted a leaf taken off the plant with its base intact but without any part of the stem, in a propagating pit. Four buds had been produced on the inner surface of the basal part of the leaf and numerous roots had developed. Two of the shoots had grown out into rhizomes 10-12 inches in length bearing at their tips well developed plants, and the other two shoots had grown

out for a short distance. This fact may point out a useful hint to gardeners who may wish to propagate anthuriums in quantity.

NOTES ON WEATHER AND ITS EFFECT ON OUTDOOR PLANTS IN NEWPORT, R. I.

- 1908, Dec. 13—First snow of season, depth $\frac{1}{2}$ inch.
 Dec. 18—Second snow of season, depth 1 inch.
 1909, Jan. 5—Temperature 46 degrees at 7 a. m.; unprotected parsley, brussels sprouts and kale still good for use and pansies, dandelions and honeysuckle *Halliana* in flower.
 Jan. 8—Temperature 14 degrees at 7 a. m.
 Jan. 14—Third snow fall, average depth $2\frac{1}{2}$ inches.
 Jan. 15—Large patches of private hedges and honeysuckle vines in sheltered positions with leaves still green.
 Jan. 17—Fourth snow storm, average depth 3 inches.
 Jan. 19—Temperature 7 degrees at 6 a. m.; coldest to date.

LIRIODENDRON CHINENSE.

This introduction from China by Messrs. J. Veitch & Son, in rapidity of growth and hardness is the equal of the North American *L. tulipifera*. The flowers are smaller than those of that species and the petals are less broad. It was at first thought to be merely a geographical form of *L. tulipifera*, but both Sargent and Hemsley consider the plant distinct enough to be classed as a species. In its native habitat it is, according to Hortus Veitchii usually found growing to a height of 15-20 feet. The tree is illustrated on p. 429 of The Gardeners' Chronicle for December 19, 1908, from

a specimen growing at Kew, which at 8 years of age is 10 feet in height; and as the leading growth made during the past summer is 4 feet in length, the tree promises to grow to greater dimensions than in its native country; and to make an interesting addition to the arborescent Magnoliaceae.

CHRYSANTHEMUM EDITH DE CLAUSSONNE.

A valuable addition to any collection of chrysanthemums is without doubt Edith de Claussonne, an introduction of the chrysanthemum specialist, H. Hermann Strauss, of Zurich, who also some few years ago introduced *Mlle. Marguerite Desjonis* to commerce. In regard to the size of the flower Edith de Claussonne is much larger than *Mlle. Marguerite Desjonis*, with extra good cultivation twice as large; and well adapted as an exhibition flower. One capital property of E. de Claussonne is its freedom in flowering, every bud-crown and terminal developing good blooms; so that cultural failures are entirely averted. The color is pure white with a green centre; and in the full meaning of the phrase it is a florists' flower in the highest grade.—*Chas. Torbeck, in No. 50, 1908, Mollers Deutsche Gartner Zeitung.*

BOUGAINVILLEA LATERITA.

This rare and beautiful species of *Bougainvillea* with its peculiar shade of red has been claimed by some to be useless as a pot plant. As soon growing at the Newbold conservatories at Jenkintown, Pa., the magnificent form and wealth of blossoms under pot culture would seem to raise some doubt as to that dictum. Samuel Battelot, the gardener at Newbold's, is very successful with it.

VICK QUALITY ASTERS

THE STANDARD OF EXCELLENCE

INTRODUCED BY US
GROWN EVERYWHERE

VICK'S LATE BRANCHING
(8 colors)

VICK'S SNOWDRIFT
VICK'S LAVENDER GEM
VICK'S DAYBREAK
VICK'S PURITY
VICK'S VIOLET KING

and many other money-making varieties.

SEND FOR OUR ILLUSTRATED ASTER BOOK for Florists. It incorporates our experience for more than twenty years of Aster growing, during which time we have introduced more high grade varieties than all other American Seedsmen combined.

IT'S FREE.

HOW TO GROW ASTERS

A little hand-book for practical uses of Aster growers. PRICE 10 CENTS, or free with an order of Aster seed.

JAMES VICK'S SONS

ROCHESTER, N. Y.

The Leading Specialists and Largest Growers of
High Grade Asters in the World

OUR BEST NOVELTY

VICK'S MIKADO PINK, PREMIER OF SHELL PINK ASTERS. For years we have seen the necessity of a good mid-season Comet type shell pink Aster. Now we have it, and it's a beauty. Every wholesale florist who has seen it praises it extravagantly. Just the thing to grow between the extra early and the late flowering varieties. Habit similar to non-lateral Branchings. Stems straight, long and strong. Plant vigorous, flowers very large and yet very dainty. Petals long and narrow and gracefully reflexed. Crown completely covered. Color a charming sea shell pink. Sold this year by packet only. Each 25c.

Vick's Mikado White and Rose

Every grower ought to have both of these colors to go with Vick's Mikado Pink. Although we have catalogued these two colors before, we have never heretofore had enough stock to fill orders. We have a splendid stock this year, and prices are lower than ever before.

Mikado White and Rose: 1-64 oz., 20c.; 1-32 oz., 35c.; 1-16 oz., 50c.; 1-8 oz., 75c.; 1-4 oz., \$1.50; 1-2 oz., \$2.75; 1 oz., \$5.00.

TWO MORE NEW ASTERS

VICK'S IMPERIAL LAVENDER. Vick's Imperials, Daybreak and Purity, are known wherever good Asters are grown. VICK'S IMPERIAL LAVENDER possesses all of the splendid qualities of Daybreak. Color a

pure lavender. Will sell well in any market. 1-64 oz., 40c.; 1-32 oz., 60c.; 1-16 oz., \$1.00; 1-8 oz., \$1.50; 1-4 oz., \$2.50; 1-2 oz., \$4.50; 1 oz., \$8.00.

VICK'S NON-LATERAL BRANCHING. For several years we have been working to produce a "branching" plant with fewer, stronger, longer stems, without being sapped by side buds and shoots. We now have a strain in which the whole strength of the plant goes into from nine to fifteen stems, all of which produce exhibition flowers. Two colors only, white and rose. 1-32 oz., 25c.; 1-16 oz., 40c.; 1-8 oz., 60c.; 1-4 oz., \$1.00; 1-2 oz., \$1.75; 1 oz., \$3.00.

OTHER RECENT VICK INTRODUCTIONS.

VICK'S EARLY BRANCHING. Similar to the well-known Standard Late Branching. Season about a week or ten days earlier. Two colors, white and rose. 1-16 oz., 25c.; 1-8 oz., 40c.; 1-4 oz., 70c.; 1-2 oz., \$1.30; 1 oz., \$2.50.

VICK'S ROYAL PURPLE. Flowers similar to Branching. Stems start close to the ground. Very lateral stems. Season medium early. Goes well with Early Branching. 1-16 oz., 25c.; 1-8 oz., 40c.; 1-4 oz., 70c.; 1-2 oz., \$1.30; 1 oz., \$2.50.

VICK'S UPRIGHT WHITE. There is a heavy demand for this variety. Flowers similar to Branching, but stems grow directly upwards, leaving more room for cultivation. Splendid shipper. Last year we could not furnish seed enough. 1-16 oz., 30c.; 1-8 oz., 50c.; 1-4 oz., 75c.; 1-2 oz., \$1.25; 1 oz., \$2.00.

VICK'S CARMINAL. For brilliancy in color and profusion of bloom this Aster surpasses all others. Especially adapted for bedding, where it makes as gorgeous a showing as Scarlet Salvia. Each plant resembles a large bonquet. 1-32 oz., 25c.; 1-16 oz., 40c.; 1-8 oz., 60c.; 1-4 oz., \$1.00; 1-2 oz., \$1.75; 1 oz., \$3.00.

Obituary

Theodore K. Gibbs.

We regret to announce the loss of Theodore K. Gibbs, of Newport, R. I., who died in Pasadena, Cal., Jan. 16th, where he went in the autumn for the benefit of his health. He was a native of Newport and was in his 69th year. During the civil war he was appointed an officer of the army from Rhode Island, and by his gallant conduct was quickly promoted to the rank of major. Latter in life he returned to Newport and spent much of his time and wealth in improving his estate, which is now from a horticultural point of view, one of the most interesting places in the city, as it probably contains a larger variety of plants than any place in Newport. Major Gibbs also took an active interest in many public institutions which received much benefit from his wise counsel and generous gifts. He was a member of the Newport Horticultural Society, a frequent contributor to its exhibitions and much of the past success of this society was due to his generous help. His loss is indeed severely felt by all.

JAMES ROBERTSON.

Lord Annesley.

Those of our readers who are interested in beautiful shrubs and trees

from the subtropical, and more temperate parts of the world, will learn with regret that the Earl of Annesley died on December 15, at the age of 77 years, at his residence, Castlewellan, in the County Down, Ireland. The climate of this part of the country is particularly favorable to the growth of trees, shrubs and plants in general, from South Africa, China, Japan and New Zealand, of which Lord Annesley had the finest collection growing in the open air that is found in Greater Britain. A very interesting book illustrated by 70 photographs taken by his Lordship, was published by him in 1902, entitled, "Beautiful and Rare Shrubs."

Arthur Mellor.

Arthur Mellor formerly well known in Lowell, Mass., and in flower trade circles in Boston, died at Phoenix, Arizona, on Saturday, January 16, Mr. Mellor, when quite young was employed by Dudley Hartford in a flower store in Lowell after which he worked for Edwin Sheppard and later for George Patten. He then started in partnership with George Saunders as Mellor & Saunders but after two years was forced to give up and go to Arizona on account of ill health. He was a young man of agreeable manners and genial personality and his demise will be regretted by many friends in the trade. He leaves a wife, besides father and mother and four sisters.

James McBride.

James McBride, the veteran florist of Weymouth, Mass., died on January 10, at an advanced age. Funeral services were held on January 13, and the floral offerings included remembrances from Joseph Breck & Sons, Patrons of Husbandry, and others.

J. W. Crane.

John W. Crane, a florist of Bathany, O., died on January 13, in his seventy-third year. He is survived by a widow.

Chicago.—Negotiations are under way pending a settlement with the United States Express Co. for the loss of \$500 by J. P. Brooks, at Morton Grove, Ill. Mr. Brooks had ordered a new pump to replace a defective one in his greenhouse plant and it was brought out by the Express Co. Though Mr. Brooks, with three men and a team, met the train to take the pump, the express messenger refused to deliver it because the local agent was not at the station. It was carried on and returned the following day, but the stock in the greenhouses received a serious set back. Mr. Brooks has the sympathy of the other florists, and the Express Co. is severely criticized.

Fairmont, Minn.—The Fairmont Nurseries have recently acquired forty acres of land adjoining their present nursery.

S. S. PENNOCK-MEEHAN COMPANY

The Wholesale Florists of Philadelphia, 1608 to 1620 Ludlow Street



Headquarters for Rooted Cuttings of any Carnation
Novelties Worth Growing

ALL STOCK GUARANTEED

<p>GEORGIA</p> <p>The Glorious White. It Has No Rival.</p>	<p>PRICE</p> <p>Per 100 Per 1000</p> <p>\$12.00 \$100.00</p>	<p>BAY STATE</p> <p>The Perfection of Quality in Variegated.</p>
---	--	---

Mrs. Chas. Knopf, Knopf's Sensational Light Pink, and Ruby, The Crimson Masterpiece,
Per 100, \$12.00. Per 1000, \$100.00

STANDARD VARIETIES

WHITE.	RED.	PINK
Sarah Hill 100 1000 \$6.00 \$50.00	Beacon 100 1000 3.50 30.00	Afterglow 6.00 50.00
Pres. Seelye 6.00 50.00	VARIEGATED.	Welcome 4.00 35.00
Lloyd 5.00 40.00	Mrs. Patten 100 1000 2.50 20.00	Winsor 3.00 25.00
White Enchantress 3.50 30.00	PINK.	Aristocrat 3.00 30.00
White Perfection 2.50 20.00	Splendor \$6.00 \$50.00	R. P. Enchantress 2.50 20.00
	Winona 6.00 50.00	Enchantress 2.50 20.00
		Lawson 2.50 20.00
		Victoria 50.00

THE THREE WINNING ROSES

White Killarney, My Maryland, Mrs. Jardine. Grafted or Own Root Stock at Introducing Prices. We Stand Behind the Shipments.

S. S. PENNOCK-MEEHAN COMPANY

ROSES UNDER GLASS.

Rose Grafting.

From experience and observation it has been demonstrated that grafted stock has proven itself to be more vigorous and better able to stand the sudden changes, which have been so often injurious to roses. For grafting, Manetti stocks are held in high esteem. The Manetti stock should be potted into as small a pot as possible, usually 2 1/2 or 2 3/4 inch, and placed in a house where the temperature is about 45 or 50 degrees. Never allow them to become dry, neither should they be kept soggy. When the eyes begin to swell, they should be grafted and directly put into propagating case.

When selecting the scions take only healthy and well-ripened stock, which shows an eye not yet started. In order that you may have a plentiful supply, it is a good plan to leave two or three eyes on the plant when cutting flowers. In performing the work, use a sharp knife to ensure a clean cut, and as the scions must not be allowed to become dry or shriveled, it is best to place them in a dish of water until used.

There are many methods of grafting, varying according to size of stock or scion. The method most in practice is as follows: Cut back Manetti stock to about two inches above the pot, making an oblique cut about three quarters of an inch long; cut the scion in the same way so that the two will match as nearly as possible; of course it is not possible to have them always match, but it is essential to have one side perfect. The funda-

mental principle of grafting is the direct communication between the layers of inner bark in each of the parts to be united. Raffia is the best tying material to hold the scion in place.

When the work is completed and the plants are placed in the case, they should be watered thoroughly and kept damp, holding the temperature

as near to 75 degrees as possible, taking care to avoid draughts. The scion should adhere in about fourteen days. When the uniting parts are forming a callus, a little air must be given each day, for the first few days gradually increasing until the plants are hardened. Watch out for the Manetti each morning and see that it throws no shoots. RICHARD J. HAYDEN.

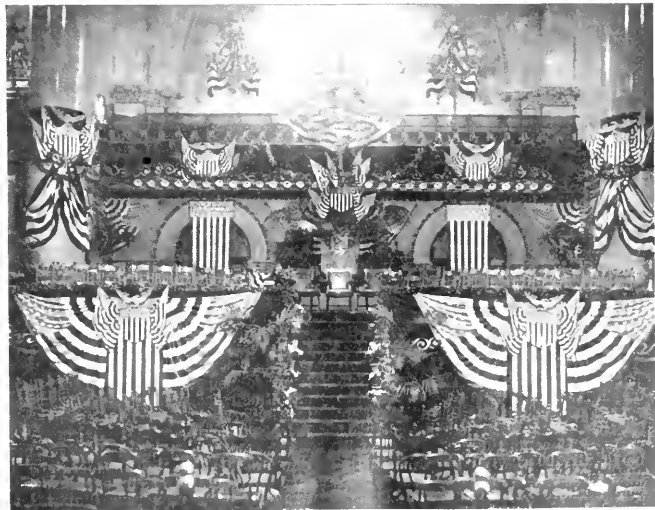

DECORATIONS AT STATE CAPITOL, ALBANY, FOR GOVERNOR HUGHES' INAUGURATION
By Wm. C. Gloeckner.

THE FLORIST SUPPLY HOUSE OF AMERICA

SPECIAL NOTICE

During the month of January Only

A SPECIAL DISCOUNT of 10 Per Cent

on our Celebrated Standard Wheat Sheaves which every one knows are the best. Order now and get this liberal

DISCOUNT ONLY FOR THE MONTH OF JANUARY

NEW EASTER BASKETS JUST ARRIVING

H. BAYERSDORFER & CO., 1129 Arch Street, Philadelphia, Pa.

LIBRARY NOTES.

Since our last communication to the readers of HORTICULTURE, under the above heading, quite an unusually large pile of new gardening books, English and foreign has accumulated on our table and we hasten to dispose of some of them by a few short notes.

The Book of the Pansy, Viola and Violet, by Howard H. Crane. This is one of the John Lane series of Handbooks of Practical Gardening, of which there are now no fewer than 33 volumes. The author is a young man, well known as a practical cultivator and his book is the most complete and up-to-date one on the subject. Price, 75 cents.

The Book of Fern Culture, by Alfred Hensley. Another book in the same series as the preceding, and got up in identical style. There are 25 nicely executed process engravings; and the author is well known as a practical gardener and journalist, well qualified for the task he has set himself. He has an experience of over 40 years, during which time he has been largely associated with fern culture, therefore, he speaks as one with authority. Price, 75 cents.

The Journal of the Royal Horticultural Society of London.—Part I, Vol. XXXIV.—has recently been issued. We notice too that the Society has obtained a supply of the Repertoire de Couleurs, published not long since by the French Chrysanthemum Society. Members of the R. H. S. can purchase it at a reduced price, but why not use its proper title instead of calling it "Color Chart"? There is another French work in colors which might be easily mistaken for the Repertoire if the title is not correctly given.

Beautiful Flowers and How to Grow Them, by Horace J. Wright and Walter P. Wright. This is a work, the nature of which is fully indicated by its title. It is being published in 17 parts, at 25 cents the part. There will be in all 100 colored plates with figures in the text in black and white. The authors are well known experienced horticultural writers and the book will no doubt serve a useful pur-

CARNATION AND ROSE SHOW

UNDER AUSPICES OF

Boston Co-operative Flower Growers Association

The Park Street Market

SEND FOR PREMIUM LIST

ALL the old and THE BEST of the new varieties. SEE BEFORE BUYING

NEW ENGLAND'S LEADING COMMERCIAL SHOW

FEBRUARY 27TH AND 28TH, 1909

HORTICULTURAL HALL, BOSTON

For information write **E. ALLAN PEIRCE, Waltham, Mass.**

pose. The first number is devoted to the Rose. The plan adopted is a selection of the best, most popular and most beautiful flowers for adorning gardens, greenhouses and windows to the number of 100.

The Country Home. This is a new monthly magazine, published by A. Constable & Co. Those who reside or get their living in the country will find many articles of interest in it. The garden, rural industries, bee-keeping, poultry, pretty country homes and other kindred subjects are more or less fully treated by experienced writers. It is well illustrated with photo-blocks and there are 48 pages of text in each number. Price, 12 cents, monthly.

Little Gardens and How to Make the Most of Them, by H. H. Thomas. A capital little volume of real practical utility to the dweller in town or suburb. The text numbers 150 pages and is freely illustrated. Price, 40 cents.

Garden Rockery—How to Make, Plant and Manage It, by Francis George Heath. A nicely printed little handbook on a popular subject, liberally illustrated with neat photoengravings executed in fairly good style. Price, 60 cents.

Les Nymphéas dans l'Ornementation des Jardins, by J. Guernier. A nice little booklet of 10 pages in paper wrappers with numerous illustrations dealing with water lilies for the garden. The botanical characteristics,

description of types, the use of hybrids, the selection of appropriate positions, the soil, propagation and planting, together with a list of varieties are given in a brief manner. Price, 15 cents.

C. HARMAN PAYNE.

PUBLICATION RECEIVED.

Progressive Poultry Culture, by Dr. A. A. Brigham. Published by The Torch Press, Cedar Rapids, Ia. Poultry keeping for profit or for pleasure is a fascinating pursuit in which many of our horticultural friends find recreation and ever-increasing charm. To such enthusiasts whether veterans or beginners Dr. Brigham's text-book will prove a "companion, guide and own familiar friend." It comprises 294 pages of the principles and practice of breeding, brooding, feeding, marketing, exhibiting and general management and is illustrated with many excellent cuts.



**Baskets, Crates,
Ladders, Veneers
and Boxes.**

BACON & CO.
Appleton, N. Y.

For Early or Late Forcing



HARDY AZALEA, MOLLIS—This hardy Azalea is becoming more popular every season to force as a pot plant; it is a profitable plant to handle, as it can be grown at a minimum cost; when in bloom it is useful for decorative purposes, and also appeals to the retail buyer as a house plant. We have an exceptionally fine lot of well budded plants, 15 to 18 inches high, \$4.50 per doz; \$35.00 per 100.

RHODODENDRON, PINK PEARL,—As an ideal pot plant, nothing can equal this beautiful variety. The individual flowers as well as the trusses are of gigantic size, while its color, a beautiful pearly pink, cannot be improved upon. We believe this is one of the coming pot plants, and when it becomes more plentiful and lower in price it will be very popular. You should try a few plants and become acquainted with it. A limited stock of good plants, about 15 inches high, with 5 or more trusses, \$1.50 each.

DEUTZIAs, Extra strong field grown plants for forcing.

GRACILIS.....	\$1.25 per dozen;	\$8.00 per 100;	\$70.00 per 1000
" Rosea.....	1.25 per dozen;	8.00 per 100;	70.00 per 1000
LEMOINEI.....	1.50 per dozen;	10.00 per 100;	90.00 per 1000

For a full line of seasonable stock see our wholesale list, issued January 1st

HENRY A. DREER, Philadelphia, Pa.

AN IMPORTANT APPRAISERS' DECISION.

The Board of U. S. General Appraisers in New York have just made a decision which will be of great benefit to importers of bulbs, inasmuch as it sets aside the arbitrary foreign market values of Dutch bulbs established by the New York appraisers.

The case involved is Re-appraisal No. 4957 on 64 cases of bulbs imported by R. & J. Farquhar & Co. of Boston, in the S. S. Statendam, from Rotterdam, and invoiced August 13th, 1908. The appraiser at Boston advanced the invoice prices of tulips, hyacinths, and polyanthus narcissus, after having forwarded the invoice to New York for the opinion of the appraisers there; the advance carrying with it a large penalty. In taking this action the Boston appraiser states that he believed the invoice to be an honest one but that the bulbs had been bought at less than market value.

Messrs. Farquhar appealed from the appraisers' advances, claiming that the invoice represented a true value of the bulbs at time and place of shipment. They showed that the prices of hyacinths given in the Holland catalogues printed and distributed to the American trade did not represent their market value in Holland, where they were freely offered to other countries at prices much lower. Foreign catalogues giving such prices were put in evidence. The appraiser's values had been based largely on the prices quoted in such catalogues and, therefore, did not represent the true market values in Holland. General Appraiser Waite at the first hearing in Boston sustained Messrs. Farquhar's appeal as to hyacinths, and also as to polyanthus narcissus which they claimed and showed to be freely offered in Holland at the prices invoiced. He also allowed the importers' contention on invoices of certain varieties of tulips, but denied it in respect to certain other tulips. It was on these last that the case came before the full Board. Here again the importers maintained that their invoice prices and not those of the appraiser represented the correct foreign market value of the tulips. They stated that tulips were offered to the different countries by the Holland growers at prices more nearly uniform than hya-

cinths were. They contended that the government was in error in fixing a standard of value on any variety of tulip without reference to size and quality of the bulbs, even although they might be imported as first size. They exhibited samples in support of their contention, including samples of so-called first size tulips from certain growers, some of which were fifty to seventy-five per centum larger than the first size of the same variety from other growers. It was also shown that there was little uniformity in the bulb prices in Holland—that the exporters sold their bulbs at all sorts of prices—and that there were no regularly established export prices.

The task of Messrs. Farquhar was rendered more difficult by the course taken by many importers who, when making their entries, voluntarily add to their invoice prices, not because of undervaluation, but as the easiest way of securing prompt delivery of the examination packages and of avoiding penalties as they have seen it. In the light of this decision it would seem that such humiliating compromising methods should now be unnecessary if the importer only insists upon his rights and demands prompt service and justice.

PATENTS GRANTED.

- 907,198 Lawn Mower. Daniel G. Treat, Reading, Pa., assignor to Reading Hardware Company, Reading, Pa.
- 907,208 Fruit Harvester. Augustus Wettengel, Fulton, N. Y.
- 907,245 Sharpening Device for Lawn Mowers. Daniel R. Kenney, Huntington, W. Va.
- 907,371 Lawn Mower. Oscar M. Keith and Ernest L. Early, Newton, Iowa.
- 907,381 Sash Holder. Frank Lenkey, and Joseph Szalay, New York, N. Y.
- 907,386 Tile Press. William P. Meeker, Maplewood, N. J.
- 907,493 Sash Holder. Oscar Gunther, Kellogg, Idaho.
- 907,570 Electric Insect Destroyer. Thomas C. Cheney and John S. Bosson, Chickasha, Okla.
- 907,572 Smoke Consuming Forced Draft Steam Boiler Furnace. Alfred Cotton, Newark, N. J.

MASSACHUSETTS AGRICULTURAL COLLEGE.

Eber Holmes of Montrose, Mass., gave a very instructive talk before the classes in floriculture last Wednesday. Mr. Holmes spoke on methods followed in the propagation and culture of roses, and he treated the subject in a practical, comprehensive manner. Nineteen are taking the short course in floriculture. These are:—J. B. Allen, Haverhill, Mass.; L. E. Avery, Plymouth, Mass.; R. A. Badger, Tolman's, Randolph, Vt.; H. T. Barstow, South Hadley, Mass.; Harry Badger, New York City; E. F. Belcher, South Framingham, Mass.; J. C. Bibber, Freeport, Me.; P. A. Derr, Williamsport, Pa.; G. A. Felch, Felch's Greenhouses, Ayer, Mass.; N. J. Fennelly, Galvin's, Boston, Mass.; R. M. Forbes, Worcester Conservatories, Worcester, Mass.; W. S. Finlay, E. G. Hill Co., (Richmond, Ind.) Zanesville, O.; Esther M. Johnson, Cambridge, Mass.; F. L. Midgeley, Worcester Conservatories, Worcester, Mass.; E. M. F. Perrin, Potsdam, N. Y.; A. A. Phelps, Southboro, Mass.; E. A. R. Schmitz, Danvers, Mass.; A. L. Galerneau, Totman's, Randolph, Vt.; Harlow Welch, Boston. Many of these young men will return to their former positions, but few desire positions after March 15th.

The observation trip last Saturday was to the commercial establishment of H. W. Field, Northampton. This range is strictly up-to-date in every respect, and is one of the very best in central Massachusetts. All of Mr. Field's crops were in excellent condition and the trip was an excellent object lesson of how a range of greenhouses should be run. Detailed written reports of the trip, including a sketch to show the location of all the houses, have been prepared by each short-course student. This week the trip will be to Mt. Holyoke College Conservatories. E. A. WHITE, Amherst, Mass.

California Privet.

We have 20 acres to offer for sale this Spring. All 2 years old, 2 to 2½ ft. high, 8 to 12 branches and well graded. We are looking orders daily now. \$2.75 per 100; \$22.50 per 1000. 500 at 1000 rates. Packing Free. Cash with Order.

JOHN BENNETT, Atlantic Highlands, N. J.

PHILADELPHIA NOTES.

Henry P. Mitchell left on the 19th inst. for a short vacation at Pinehurst, N. C.

Alexander Forbes, of Peter Henderson & Co., N. Y., was the guest of W. Albee Burpee at the monthly dinner of the Poor Richard Club on the 18th inst.

John Westcott and Robert Craig leave on the 30th inst. for a combined business and pleasure trip to Cuba and the Isle of Pines.

Samuel S. Pennock received his first consignment of oranges last week from his grove in Florida. If there is a florist in this neighborhood who has not got a box he is a wonder. S. S. P. is like John Wanamaker he can sell anything from hams to hairpins.

Mr. Thomas, late chief assistant for Mr. Lonsdale at Girard College has been appointed to an important position in the horticultural department of the University of Illinois. Reward of merit.

Geo. Walther, of 63rd street and Eggleston avenue, Chicago, completed his conservatory just in time for the Christmas trade. He now has the largest retail store in the South Side. Mr. Walther has a good idea for the front corner. It is separated from the rest of the windows by glass partitions and has a glass door opening into the store. This gives him a fine corner show window, cool enough to keep flowers without ice, and warm enough to prevent freezing. The main entrance is just at the side of this corner.

EXPERIENCE

keeps a dear school, but fools will learn in no other, and scarce in that.

Five or ten dollars a thousand more for lily bulbs is a difference of only one half to one cent a bulb. If only one bulb in ten produce one more flower, it pays.

Still some haggle over price, trusting to luck instead of common sense for quality.

A shrewd buyer of bulb's buys from a reliable source, pays for quality and insists on getting it.

We will appreciate your inquiry for prices on reliable bulbs.



RALPH M. WARD & CO.

12 W. B'way, New York.

WANTED A few Plants for Seed each of

CHORIZEMA HYBRIDS and LIBONIA PENRHOSIENSIS

ED. HERRMANN
North and Tilton Avenues
Baltimore, Md.

JAPANESE
THE YOKOHAMA NURSERY CO. NEW YORK.
31 BARCLAY STR. NEW YORK.
LILIES
PLANTS
BAMBOO STAKES

GERANIUMS

\$2.00 per 100 and up, 300 varieties described in our Special Geranium catalogue.

HARDY POMPON CHRYSANTHEMUMS

We are headquarters, 80 varieties, \$2.00 per 100.

DAHLIAS

We are booking orders for Plants next Spring, or Roots for next Fall.

LOBELIA

KATHLEEN MALLARD. The new double Blue Lobelia, nice stock from 2 inch pots, 50c per doz., \$2.00 per 100, 50c lot \$9.25.

WE HAVE READY TO SHIP THE FOLLOWING from 2 in. pots at \$2 per 100

Verbenas, Lemon Verbenas, Achyranthus, Black Prince and Minnesota Fuchsias, Coleus, Lobelia Crystal Palace, Hardy English Ivy, Smilax, Salvia, Dreer's Superb Single Petunias, Dwarf Double Alyssum, Ageratum, Hardy Chrysanthemums.

R. VINCENT JR. & SONS CO., White Marsh, Md.

FORCING GLADIOLUS

Gladiolus Gandavensis Hybrids

Many florists plant these in boxes, or among their carnations, in the Winter. They are excellent for decorative purposes and realize good prices, either wholesale or retail. Gladiolus are a good catch-crop and take up but little room. The following are the best for this purpose:

America. The flowers, which are of immense size, are of the most beautiful flesh-pink color, \$4.00 per 100; \$25.00 per 1000.

Augusta. The florists' best white Gladiolus. First-size bulbs, 1 1/2 inches and up. \$2.00 per 100; \$18.00 per 1000. Bulbs 1 1/2 to 1 3/4 in. \$1.75 per 100; \$16.00 per 1000.

Shakespeare. White and rose. \$4.75 per 100; \$45.00 per 1000.

May. Pure white, flaked rosy crimson; the best forcer. Selected bulb. \$1.75 per 100; \$15.00 per 1000.

Breconthelyensis (true). Flery scarlet. Selected bulbs, \$1.50 per 100; \$13.00 per 1000. First-size; bulbs, \$1.25 per 100; \$10.00 per 1000.

Boddington's White and Light. Extra selected bulbs, 1 1/2 in. and up. \$1.50 per 100; \$14.00 per 1000. Bulbs 1 1/2 to 1 3/4 in. \$1.25 per 100; \$10.00 per 1000.

American Hybrids. A mixture of the choicest varieties of Gladiolus in cultivation. \$1.00 per 100; \$9.00 per 1000.

ARTHUR T. BODDINGTON

SEEDSMAN

342 West 14th Street, NEW YORK CITY

IMPORTED ORCHIDS

Arrived in Superb Condition

Vanda coerulea, Cattleya Trianae, Cattleya gigas Sanderiana, Cattleya Schroederiae, Oncidium varicosum.

JULIUS ROEHRS CO., Rutherford, N. J.

ORCHIDS

Orchid Baskets and Peat

Write for Prices

JOSEPH A. MANDA

191 Valley Road - WEST ORANGE, N. J.

We Have A Fine Lot of C. Trianae in bloom at very low prices, and will sell plants in bloom or cut blooms at 15 per cent. less than the market price.

ORDONEZ BROS.

Madison, N. J.

ORCHIDS

Our latest importations have been, Cattleya Chrysoxoa, Cattleya Gaskelliana, Cattleya Gigas, (Hardyana district), Phalaenopsis Amabilis Schilleriana and others. We will receive in a short time, Cattleya Dowiana, Miltonia Vexillaria and others.

CARRILLO & BALDWIN
SECAUCUS, N. J.

ORCHIDS Freshly Imported

We offer a superb lot of Cattleya gigas Sanderiana in finest condition; also C. Bogotenais, C. Schroederiae, C. labiata, C. gigas Hardyana type and Miltonia vexillaria

LAGER & HURRELL, Summit, N.J.

ORCHIDS

Largest Importers, Exporters, Growers and Hybridists in the World

Sander, St. Albans, England
and 235 Broadway, Room 1
NEW YORK CITY

T O B U Y E R S

Patronize our advertisers. they will treat you right

MRS.

J. C. Vaughan

Early, Free, Continuous

High Score for Certificate at Wash-
ington after 54 hours in Box.

Won Sweepstakes and prize for best
white seedling at Chicago, 1907.

Certificated Nov., 1907, Horticultural
Society, Chicago; Jan., 1908, American
Carnation Society; Nov., 1908, St.
Louis Horticultural Society, and Nov.,
1908, Society American Florists.

Generally Recognized as the
Best White Carnation in Existence.

\$12.00 per 100;
\$100.00 per 1000.



JENSEN & DEKEMA, 67 W. Foster Ave., **W. N. RUDD,** Morgan Park,
CHICAGO, ILL. ILL.

New Rose White Killarney

Come and see White Killarney growing at our Scarborough houses, and you will say at once, as every one does who has seen it, it is

The Best White Rose

they have ever seen. You need it if you want to be up to the times, and it will pay you better than any other white rose that you can plant. You will regret it if you do not plant it this year, and you will not regret it if you do.

Big lots are being booked. Get your order in early. Send us order at once, while you think of it. Get early stock. It will not cost you any more to order to-day, while you think of it, than it will two months from now. Be the early bird that catches the worm.

Strong young plants, 2 1/2-inch pots, own-root, ready for delivery beginning February 15th, 1909. \$30.00 per 100; 250 for \$70.00; 500 for \$125.00; 1000 for \$250.00. Grafted plants, ready for delivery beginning March 1st, 1909, \$5.00 per 100 additional.

MY MARYLAND

This new rose, which was introduced last season in a limited way, has proved to be one of the best roses ever introduced. Every one is enthusiastic in regard to its merits, and it will be planted very largely by the largest, most progressive and most up-to-date growers, who have already placed large orders for it.

It is a strong, healthy, and vigorous grower, producing long stems and long pointed buds, exquisitely fragrant. The color is a soft salmon-pink. This is a rose that we can recommend in the highest terms, as we are sure it will prove very, very satisfactory. It is a welcome addition to our limited list of really first-class varieties for indoor culture; and it is not only a fine midwinter rose, but is also unusually good during the summer months.

Strong plants, 2 1/4-inch pots own-roots, \$10.00 per 100, \$90.00 per 1000
Grafted plants, \$20.00 per 100, \$150.00 per 1,000.

F. R. PIERSON CO., Tarrytown-on-Hudson NEW YORK.

The Great **WM. H. TAFT** Worthy of
 Red its
WINNER Namesake

We have grown it for four years. Christmas week 4000 blooms were cut from three beds 150 ft. long. Flowering continuously since October 1. Plants still full of buds and bloom.
STRONG AND THRIFTY.

ROOTED CUTTINGS NOW READY
 Prices:—25, \$4.00; 50, \$7.00; 100, \$12.00; 500, \$50.00; 1000, \$90.00.
 Send for Illustrated Circular.

The Taft is grown at Evanston, corner of Oakton and Ashbury Ave., Chicago. Visitors to the Carnation Convention are invited to call and see it. Rooted and Unrooted Cuttings of all Standard Carnations Ready for Shipment.

SCHEIDEN & SCHOOS, 58-60 Wabash Ave.,
CHICAGO

150,000 ROOTED GARNATION CUTTINGS READY

We have won more prizes on carnations this season than any other carnation grower, which goes to show that our stock is in the very best condition and grown to the highest standard of perfection. No sign of disease on our place.

White Enchantress We have the largest and best stock of the pure White Enchantress, winning first wherever we show it, \$4.00 per 100, \$35.00 per 1000	Beacon scarlet. Extra fine stock. \$4.00 per 100, \$35.00 per 1000
Splendor a true pink, is an excellent commercial variety, resembling the old favorite variety, Wm. Scott. \$6.00 per 100, \$50.00 per 1000	Aristocrat beautiful cerise. Very best in this color. \$4.00 per 100, \$35.00 per 1000
Lawson-Enchantress is all we could desire in a cerise. Does very well with us, \$6.00 per 100, \$50.00 per 1000	
Andrew Carnegie one of our best paying scarlets. An early and continuous bloomer. \$6.00 per 100, \$50.00 per 1000	
White Perfection Our stock of this variety won the Highest Honor at the National Flower Show, \$3.00 per 100, \$25.00 per 1000	

Also the following varieties.

Defiance, Afterglow, Lloyd. \$6.00 per 100, \$50.00 per 1000	
Winsor, Enchantress, Rose Pink Enchantress, Melody, pink, Victory, red. \$3.00 per 100, \$25.00 per 1000	

CHICAGO CARNATION CO., A. T. PYFER, Mgr. JOLIET, ILL.

MY COMPLETE LIST OF MUMS, GARNATIONS AND ROSES

has been mailed you. If not yet received send me a postcard. I carry over 300 varieties of **The Finest Chrysanthemums in Commerce** and offer you just the cream of the world's novelties, discarding the poor ones. **Saves You Money and Me Trouble!** New Carnations ready for immediate delivery **Bay State, Georgia, Mrs. J. C. Vaughan, \$12.00 per 100; \$100.00 per 1000. Mrs. O. P. Bassett, \$8.00 per 100.**

CHARLES H. TOTTY, - Madison, N. J.

GOLDEN GLOW

THE BEST EARLY CHRYSANTHEMUM

Can be Cut by Aug. 15th

Plants From 2 1-4 In. Pots Now Ready
\$6.00 per 100, \$50.00 per 1000

S. J. GODDARD
FRAMINGHAM, - MASS.

NEW CARNATION
PINK DELIGHT

Waxy Shell Pink. A Grower's and Shipper's favorite. Has a holding color, keeps well, comes on long stems and is early, very free and continuous flowering.
 January delivery, \$12.00 per 100; \$100.00 per 1000.
F. Dorner & Sons Co., La Fayette, Ind.

NEPTUNE

is the only yellow Carnation on the market that is worth growing. Very strong. Free and easy grower. Hasn't burst 1/2 of 1 per cent in 4 years. Well rooted cuttings now ready, \$8.00 per 100. Other commercial varieties at reasonable prices.

PAUL THOMSON, Grower
West Hartford, Ct.

Pillsbury's Carnation Staple

The best, cheapest, quickest, simplest and easiest way to fix your split carnations. No tools required—only **50c per 1000** postpaid.

"They are the best thing yet."—CHAS. J. HEWSON.

I. L. PILLSBURY,
 FLORIST
Galesburg, - - Illinois.

Gladioli fine named sorts; colors, seedlings and mixtures.

Iris Pallida Dalmatica, German and Japan Iris, Madeira Vines, Cinnamon Vines, Hyacinthus candicans, Spotted Callas.

Send for Price List.

E. S. MILLER,
Wading River, Long Island, N. Y.

CANNAS

We are the largest Canna growers in the world and can make attractive prices on 200 kinds. Let us quote on your entire list for immediate or spring delivery or contract 1910 dormant roots. Also Catadiums, Gladiolus, Dahlia's, Tuberoses, etc.

SHELLROAD CANNA FARMS,
Grange P. O. Baltimore, Md.

CARNATIONS ROOTED CUTTINGS

NEW INTRODUCTIONS

Mrs. Chas. Knopf, light pink } (<i>Knopf</i>)		
Ruby, Crimson		
Georgia, white (<i>Cockerhoff</i>)	Per 100	Per 1000
Mrs. J. C. Vaughan, white (<i>Rudd</i>)	\$12.00	\$100.00
Bay State, variegated (<i>Roper</i>)		
Pink Delight (<i>Dorner</i>)		
Wanoka, crimson } (<i>Wanoka Greenhouses</i>)		
Apple Blossom, white light pink marking }	Per 100	Per 1000
O. P. Bassett, scarlet (<i>Bassett & Washburn</i>)	\$8.00	\$60.00

Standard Varieties

One Hundred Thousand Cuttings selected strong stock ready to ship

"WHITE"		"PINK"			
	per 100	per 1000			
Sarah Hill.....	6.00	\$50.00	Splendor.....	6.00	\$50.00
Pres. Seelye.....	5.00	40.00	After Glow.....	6.00	50.00
Lloyd.....	5.00	40.00	Winnona.....	6.00	50.00
White Enchantress.....	3.50	30.00	Lawson Enchantress.....	5.50	50.00
White Perfection.....	2.50	20.00	Welcome.....	4.00	35.00
"RED"		"VARIEGATED"			
Beacon.....	\$3.50	\$30.00	Winnona.....	3.50	30.00
Mrs. Patten.....	\$2.50	\$20.00	Aristocrat.....	3.50	30.00
			Rose Pink Enchantress.....	2.50	20.00
			Enchantress.....	2.50	20.00
			Lawson.....	2.50	20.00

CHRYSANTHEMUMS

Golden Glow, 2 1/2 in. pots, ready for shift, \$6.00 per hundred. Rooted Cuttings, selection of forty varieties, the cream of the commercial sorts. Write for list and prices.

NEW ROSE MY MARYLAND

Grafted, 2 1/2 in. pots, \$20.00 per hundred, \$150.00 per thousand; Own Roots, 2 1/2 in. pots, \$10.00 per hundred, \$90.00 per thousand.

ORDERS BOOKED NOW FOR THIS MOST PROMISING VARIETY.

S. J. Reuter & Son, Inc., WESTERLY, R. I.

The two novelties, Mrs. Chas. Knopf and Ruby give great promises as commercial varieties. Both are free producers. We have them both growing side by side with the standard sorts and they have demonstrated now that they are here to stay. Mrs. Chas. Knopf is at this time especially good being larger and of better form and color than Enchantress. Ruby is a very large, perfectly formed flower with excellent stem and it has a good crimson shade not too dark.

BAY STATE

Orders for January Delivery are being rapidly booked.

If you want to get in

on the ground floor with this noblest of all the new carnations place your order at once.

Rooted Cuttings, \$12.00 per 100, \$100.00 per 1000

ALBERT ROPER, Tewkesbury, Mass.

NEW RED CARNATION O. P. BASSETT

Extra Large Bright Red Free Bloomer

Rooted Cuttings, per 1000, \$60.00 | Rooted Cuttings, per 100, \$8.00 | Rooted Cuttings, per 25, \$2.50
 per 500, \$5.00 | per 50, 4.50 | per 12, 1.50

Ready for delivery Jan. 1st, '09 by the Originators and Growers

BASSETT & WASHBURN, HINSDALE, ILL.

Send for our Preliminary List describing and quoting Chrysanthemums and Carnations.

A fine lot of Carnation Cuttings ready now.

THE E. G. HILL CO., RICHMOND INDIANA

CARNATION CUTTINGS

We offer choice varieties for January and later shipments.

	Per 100	Per 1000
Enchantress.....	\$2.50	\$20.00
White do.....	3.50	30.00
Rose Pink do.....	2.30	20.00
White Perfection.....	2.50	20.00
Winsor.....	3.50	30.00
Melody.....	2.50	20.00
Beacon.....	3.50	30.00
Victory.....	3.50	30.00
Aristocrat.....	3.50	30.00
Splendor.....	6.00	50.00
Vesper.....	3.50	30.00
White Lawson.....	2.50	20.00

EAST SUDBURY GREENHOUSES,

Carnation Specialists

P. O. Address South Sudbury, Mass.
 Telephone So. Sudbury 20.

Rooted Carnation Cuttings

A Selection from 20 Sorts.
 (For Early January Delivery, and Later)
 Every one Reliable

White	W. Perfection	100	1000
Red	Beacon	4.00	35.00
Light Pink	Enchantress	3.00	25.00
	Melody	3.00	25.00
Medium Pink	Winsor	3.00	25.00
	Winnona	6.00	50.00
Dark Pink	Rose Enchantress	3.00	25.00
	Splendor	6.00	50.00
Variegated	Viola Sinclair	6.00	50.00
	Var. Lawson	3.00	25.00
Crimson	Outdoor	3.00	25.00

PETER FISHER, - Ellis, Mass.

CARNATIONS Rooted Cuttings

Pres. Seelye	Per 100	Per 1000
White Enchantress, Beacon	\$6.00	\$50.00
Victory, Winsor, Melody, Kingston Pet	3.00	25.00
Dahheim, Enchantress, Lady Bountiful, Mrs Lawson, White Lawson, Red Lawson, Variegated Lawson	2.50	20.00

WOOD BROTHERS
 FISHKILL, N. Y.

JUST AS A REMINDER TO OUR PATRONS

We have rooted cuttings of the best CARNATIONS
 PATTEN & COMPANY, Tewksbury, Mass.

CARNATIONS ROOTED CUTTINGS

Afterglow	Sarah Hill	Winsor
Beacon	Victory	Enchantress
Mrs Patten	O. P. Bassett	Ruby
Georgia	Pink Delight	Wa-No-ka
Apple Blossom	Mrs. Chas. Knopf	
Mrs J. C. Vaughan	White Perfection	

Send for complete list of all standard varieties and prices.
 W.M. SWAYNE, Box 220, Kennett Square, Pa.

MARCHIONESS

The Money Making White Carnation
 \$10.00 per 100; \$80.00 per 1000
 Orders Filled Strictly In Rotation
 BELLAMY BROS.

Successors to L. E. Marquise, SYRACUSE N. Y.

In writing to Advertisers kindly mention Horticulture

Seed Trade

AMERICAN SEED TRADE ASSOCIATION.

Watson S. Woodruff, Orange, Conn., Pres.; J. C. Robinson, Waterloo, N.Y., First Vice-Pres.; C. F. Kowalski, Cleveland, O., Secy and Treas. Twenty-seventh annual convention, June, 1969.

WHOLESALE SEEDSMEN'S LEAGUE.

F. W. Braggendorf, Pres.; Burnett Land reb, Sec'y.

About Seed Limas.

In a recent issue of HORTICULTURE the annual shortage in the crop of seed Lima beans, particularly of the dwarf varieties, was discussed and a large share of the responsibility was placed on the California growers. Recently the writer met the most extensive grower of seed Limas in California, and discussed this matter with him, and it is only fair to give his side of the question.

He says in effect what is generally conceded, that the farmers or ranchers have been reluctant to grow seed beans because they have been getting almost as much for commercial beans which yielded nearly double per acre. For the last two years they have received from four to four and a half cents per lb., while the growers could not afford to pay over four and a half cents, hence they have not been able to get their beans on the best land nor with the best ranchers, thus they have been handicapped with their crops, and the small yields, though not a fair test of the relative merits of the seed and commercial beans, have been used as an argument against them. Owing to the decline in the price of commercial beans—they are now selling at three and three-quarter cents—the better class of ranchers are willing to grow the seed Limas at four and a half to five cents, and the gentleman referred to thinks there will be no complaint of short crops this year, and samples will also be better. Amen! So mote it be.

"Johnny-on-the-Spot."

January 15th was the date set by the Department of Agriculture for the opening of the bids for supplies of seeds for next year's distribution. Our buoyant friend, Major Braslan, who is always in the fore-front of the battle, had pitched his tent in Washington ready for the fray. He is always Johnny-on-the-spot on such occasions, and with his three energetic assistants is combing the country over, keenly alert to every noise that sounds like an order. They will return to the coast richly laden with the spoils of the east.

Canner Prospects.

There is not much activity in canned goods at present, and packers are viewing the future with some anxiety, especially in the lines of peas, beans, corn and tomatoes, but with the steady revival of business all over the country consumption will increase, and the present surplus stocks are likely to disappear before another season's pack is placed on the market. Unless both the output

of canned goods and seeds are exceptionally large, there is likely to be a brisk demand for canners' seeds next autumn, and the growers of such seeds need not begin to lie awake of nights worrying about a market for their goods.

The Ramblers' Club.

The annual dinner of the "Ramblers' Club," which always takes place during the week of the Canners' Convention, promises to be a "hummer" this year. It costs \$25.00 to belong to this select organization, and the membership is limited to fifty. Each member may have one guest, but there are always a number of "specially invited" guests, so that the number present this year will not be less than one hundred, and may considerably exceed that number. It is stating an obvious fact to say that invitations to this dinner are never declined. The membership is confined exclusively to the Machinery and Supplies Association. Canners are not eligible.

Notes.

The mail order houses having sent out their catalogues are now awaiting with confidence the response. Let us hope it will be most gratifying.

Rocky Ford, Colo. The stock of the Elbert Seed Co. was sold at public auction on January 11 and bought in by W. B. Mandeville, cashier of the National Bank, for \$800.

The seedsmen of California are reported to be much encouraged over the prospects for the coming season. The timely rains, though light, have been sufficient for plowing for seeds, and the ground is in much better condition than for many years.

CATALOGUES RECEIVED.

Good & Reese Co., Springfield, O.—Spring Trade List, 1969, for florists, nurserymen and dealers only.

S. L. Allen & Co., Philadelphia, Pa.—List of "Planet Jr." Farm and Garden Implements. New edition.

Johnson Seed Company, Philadelphia, Pa.—Wholesale Price List, Season of 1969. For Market Gardeners and Truckers.

W. Atlee Burpee & Co., Philadelphia, Pa.—Wholesale Catalog "for Seedsmen and Dealers only who buy to sell again." "Red List." Send for one.

G. Edward Schultz, Washington, D. C.—Seed Annual for 1969. A neat publication. New Lettuce "All Heart" has the post of honor on the cover.

H. F. Mitchell Co., Philadelphia, Pa.—Spring 1969 Wholesale Catalogue for Florists and Market Gardeners. This catalogue is for the trade only.

Leonard Seed Co., Chicago, Ill.—Market Gardeners' Catalogue. Well printed and handsomely illustrated. Gives the market gardener an extensive choice of good things.

D. McNallie Plant and Fruit Co., Sarcoxie, Mo., and Durant, Okla.—1969 Catalog and Price List of Strawberry Plants. This concern has 350 acres of strawberries—75 varieties.

W. W. Wilmore, Denver, Colo.—Trade List, Spring of 1969 Dahlias,

Gladioli, Peonies and Hardy Plants. Also regular list for general circulation, on heavy paper and handsomely illustrated.

Leonard Seed Co., Chicago, Ill.—General Catalogue of Garden, Vegetable and Flower Seeds. Covers brightly adorned with flowers and vegetables in colors on a richly paneled background.

Pape & Bergmann, Quedlinburg, Germany.—This comprehensive catalogue has a very attractive cover illustration in colors, of a dainty miss with watering pot, sprinkling a cluster of 4-leaved clover foliage.

James Smalley & Co., McPherson, Kansas.—Garden and Field Seed Annual, 1969. The covers of this catalogue are embellished, one with a chrysanthemum the other with ears of corn, on a background of oak leaves done in dark purple ink.

Dobbie & Co., Rothsay, Scotland.—Spring Catalog, 1969. Compares favorably with the best American catalogues, which is saying a good deal. The cover is pearl enamel, gold lettered on front and adorned with a beautiful group of new sweet peas in colors.

Conard & Jones Co., West Grove, Pa.—New Floral Guide for 1969. New Rose Barbarossa, bright crimson, adorns the front cover page and on the back is a collection of five other handsome roses in colors. The catalogue is well gotten up and ought to bring in the orders.

Weeber & Don, New York.—Garden, Farm and Flower Seeds for 1969. An attractive catalog, well printed and with a particularly interesting list of novelties and specialties in seeds. Seth Low Musk Melon occupies the front cover page and on the back appears a fine lawn picture.

H. F. Mitchell Co., Philadelphia, Pa.—1969 Book of Seeds. A large catalog, with copious illustrations and bristling with the enterprising character of this hustling house. Lawn views and giant cosmos embellish the covers, paneled in dark green with white embossed lettering. There is one plate in colors—subject, gladioli.

R. Vincent Jr. & Sons Co., White Marsh, Md.—1969 Wholesale Trade

"SOW NOW"

Irish Shamrock Seed

To have good plants for St. Patrick's Day. Always a good demand and profitable for the Florist.

Trade Pkt. 25c
Per Oz. 75c

Write for Our Handy Flower Seed Order Sheet.

MICHELL 1018 MARKET ST. PHILA. PA.

SHEEP MANURE

Pulverized. Free from Adulteration
In Bag, \$18.00 per Ton. Cash with Order

ROBERT SIMPSON
CLIFTON, N. J.

List of Vegetable, Greenhouse and Bedding Plants. The Messrs Vincent have a very extensive establishment and their business in these specialties is among the largest in the country. On dahlias, geraniums and pompon chrysanthemums particularly their preeminence is generally recognized.

J. M. Thorburn & Co., New York, N. Y.—Seeds, 1909. Here is front-rank example of seed catalog art. An embossed medallion with garlands of cosmos in colors outlined with gold makes a cover ornament decidedly unique. Illustrations, arrangement and typographical work are of the highest order. The lists are very complete in flower, vegetable, grass and tree seeds.

NEWS NOTES.

Echo, Ore.—Frank Skinner of Grant County has purchased five acres of land and will establish a market gardening business.

Worcester, Mass.—Daniel F. Kavanagh has purchased three of the greenhouses of the late Stephen Salisbury and started in the florist business.

Chicago, Ill.—The Setterberg Landscape and Nursery Co. are located in the Monadnock building, room 1305, with a sales office at 4488 Perry Ave.

San Francisco, Cal.—L. O. Beery has started in business at 101 Valencia street with ornamentals and general nursery stock.

M. Sievers has taken a ten years' lease of the store at corner of Powell and O'Farrell streets, at a rental of \$72,000.

Mignonette
FARQUHAR'S
GIANT
 Oz., 75c; 1-4 oz., 25c
R. & J. Farquhar & Co.
 6. & 7 South Market Street
BOSTON, MASS.

BRIDGEMAN'S SEED WAREHOUSE
RICKARDS BROS.
 Props.
 37 East 19th St., - NEW YORK CITY

GEO. E. DOW
 Designing and Illustrating
 178 Washington St., Boston, Mass.
 OUR SPECIALTY
 Machine, Booklet, Advertising and Flower
PHOTOGRAPHS

NEW SEED OF

Ageratum			Alyssum		
Dwf. Blue	Tr. Pk.	Oz.	Carpet of Snow	Tr. Pk.	Oz.
.....
.....
Asters			Begonia		
Queen Market White	0 20 0 50	Vernon	0 25 2 50
Rose	0 20 0 50	Erlford	0 25 1 00
Victoria Mixed	0 25 1 50
Comet	0 25 2 50
Salvia			Pansy		
Splendens	0 25 2 50	Blended	1 00 8 00
Bon Fire	0 25 2 50	Large French Stained	0 50 3 00
Zurich	1/2 oz. 75c

WM. ELLIOTT & SONS, 42 Vesey St., NEW YORK

C. C. MORSE & CO. 48-56 JACKSON ST., San Francisco, Cal.
 The Largest Seed Growers on the Pacific Coast
ONION, LETTUCE, SWEET PEAS,
 ALSO
 Carrot, Celery, Leek, Mustard, Parsley, Parsnip, Radish, Salsify
LEONARD SEED CO.
 CONTRACT GROWERS AND WHOLESALE DEALERS
BEANS, PEAS, SWEET CORN, ONION, GARDEN SEEDS
 ONION SETS FLOWER SEEDS Get Our Prices 79 and 81 E. KINZIE STREET, CHICAGO

Thorburn's
Seeds
LILY OF THE VALLEY PIPS
 Unexcelled Hamburg or Berlin
TUBEROUS ROOTED BEGONIAS
GLOXINIAS
ROSA MULTIFLORA NANA SEED
 and all other flower seeds for Florists
 SEND FOR CATALOGUE
J. M. THORBURN & CO.
 33 BARCLAY ST. through to 38 PARK PLACE
NEW YORK

Burpee's Seeds
 PHILADELPHIA
 Blue List of Wholesale Prices mailed only to those who plant for profit

C **AULIFLOWERS** **S**
A **B** **B** **A** **G** **E** **E** **D**
 LILY OF THE VALLEY PIPS.
HJALMAR HARTMANN & CO.
 12 Stormgade,
COPENHAGEN, DENMARK.

STOCK SEED
 FOR WINTER BLOOMING
 Our strain of Double Branching Stocks is exceptionally true. About 90% Double Flowers.
 In colors: 1/4 oz. .60 oz. \$4.00
 Pure White 1/2 " .75 " 5.00
H. E. FISKE SEED CO.
 Faneuil Hall Square, BOSTON, MASS.

Winter-flowering
SWEET PEA SEED
 All Colors Ask for List
A. C. ZVOLANEK
 ORIGINATOR. BOUND BROOK, N. J.

NEW CROP SEED
 For Early Planting
THOMAS J. GREY CO.
 32 SO. MARKET ST., BOSTON, MASS.

BRECK'S SEEDS for FLORISTS
 Fresh, Reliable. Prompt Delivery.
 Catalogues mailed free on application
Joseph Breck & Sons Corp.
 47-54 NO. MARKET ST., BOSTON, MASS.

QUALITY **SEED**
BULBS
PLANT
 SEND FOR CATALOGUE
ARTHUR T. BODDINGTON
 342 West 14th St., New York.

To Florists Everywhere

Orders for Cut Flowers and Floral Decorations to be delivered anywhere in the Greater New York, may be placed with us with the certainty that your customers will be satisfied.

Telegraph, telephone or mail such orders to us and be sure that they will be filled as promptly and as carefully as though you did it yourself.

One third discount will be allowed on all orders thus placed with us by Florists outside of the Greater New York.

THE BLOSSOM

Bond and Livingston Sts.,
BROOKLYN, N. Y.

C. C. TREPPEL, Manager

**WILLIAM J. SMYTH
FLORIST**

Cor. Michigan Ave. and 31st St., CHICAGO

We ship to all points in Illinois and Iowa.

Phones: Douglas 744, Douglas 523, Douglas 740

M. C. and J. E. HAUSWIRTH

Out of Town orders for Hospitals
Carefully filled.

**232 Michigan Ave.
CHICAGO**

AUDITORIUM ANNEX Tel. Harrison 585

**SAMUEL MURRAY
Florist**

Coates House Conservatory

1017 BROADWAY, KANSAS CITY, MO.

Both 'Phones 2670 Main.



WASHINGTON,
D. C.

GUDE'S

**The Far-Famed Flowers of
TORONTO**

Delivered on mail or telegraph order for any occasion, in any part of the Dominion.

JOHN H. DUNLOP,
96 Yonge St., Toronto, Ont.

The Park Floral Co.

J. A. VALENTINE
Pres.

DENVER, COLORADO

**WILLIAM L. ROCK
FLOWER CO.**

KANSAS CITY, MO.

will carefully execute orders for Kansas City and any town in Missouri or Kansas.



Buffalo, N. Y.

W. J. PALMER & SON, 30 Main St.

**Of Interest to Retail
Florists**

NATURE AS A GUIDE.

On more than one occasion have I been asked if a knowledge of art was necessary for one desirous of arranging flowers tastefully, the blending of colors being the first consideration. One must not of necessity be an artist in the strictest sense in order to accomplish such an end, as the means are at the disposal of any who will become the simplest student of nature. The fields, the forests and streams, the mountainside, beautiful landscapes, glorious sunsets, all gorgeous in bewilderingly beautiful tints are but few of the examples furnished by nature for man's study. He who will but observe and copy them is not apt to go astray, as there is naught in nature but what is abundant in harmony. What is most desired is an avoidance of those hideous combinations of color too often handed out as

STEAMER DEPARTURES

D

American.

New York, N. Y. - Southampton, Jan. 30
St. Louis, N. Y. - Southampton, Feb. 6

Atlantic Transport.

Minneapolis, N. Y. - London, Jan. 30
Montetoka, N. Y. - London, Feb. 13

Guard.

Saxonia, Boston Liv'pl., Jan. 23
Lancania, N. Y. - Liverpool, Jan. 27
Mauretania, N. Y. - Liverpool, Feb. 3

French Line.

La Touraine, N. Y. - Havre, Jan. 28
La Touraine, N. Y. - Havre, Feb. 4

Hamburg-American.

Moltke, N. Y. - Italian Ports, Jan. 25
Pennsylvania, N. Y. - Hamburg, Jan. 30

Leyland.

Canadian, Boston Liv'pl., Jan. 27
Devonian, Boston Liv'pl., Feb. 3

North German Lloyd.

Chonitz, N. Y. - Bremen, Jan. 28
K. Von der Grosse, N. Y. - Bremen, Jan. 28
Bremen, N. Y. - Bremen, Feb. 2
Koenig Albert, N. Y. - Mod., Feb. 2

White Star.

Rattic, N. Y. - Liverpool, Jan. 30
Romanic, Boston-Med. Ports, Jan. 30
Adriatic, N. Y. - Southampton, Feb. 3

art parcels and which are expected to be accepted as such.

No more striking illustration of the pernicious practice of color abuse can be found than that furnished by the fashionable milliner whose product of the present day must, in many instances, offend one's sight, but is accepted because it is purely Parisian. Imagine a bonnet or hat trimmed with black, blue and green roses, red lily of the valley and white foliage together with equally frightful matter fashioned into a heterogeneous mass, and you may be sure of such a production adorning the head of a metropolitan belle. As is well known to all, the sense of seeing being more delicate than either of the others, is most easily and lastingly offended. Another instance has just come to my mind, and in order to show how deeply an impression may be made by things unpleasant, will tell of a dinner party given by one of Boston's most prominent men about town and practical joker, to a number of female friends at a fashionable hotel. A noted florist

ALEX. McCONNELL

571 FIFTH AVENUE
NEW YORK CITY

Telegraphic orders forwarded to any part of the United States, Canada, and all principal cities of Europe. Orders transferred or entrusted by the trade to our selection for delivery on steamships or elsewhere receive special attention.

Telephone Calls, 487 and 488 36th St.
Cable Address, ALEXCONNELL

New York Deliveries

FLOWERS and PLANTS
by special messenger to Steamer,
Theatre or any address in
NEW YORK or BROOKLYN

THOMAS YOUNG, JR.
500 FIFTH AVE., (near 42nd St.)

NEWMAN FLORAL CO.

Established 1870

202 Fifth Ave. and
Madison Square, NEW YORK CITY
FLOWERS FOR STEAMER SAILINGS

M. A. BOWE

In the Heart of New York City
1294 Broadway
NEW YORK
Tel. 2270, 38th St.
Our Motto—The Golden Rule

DAVID CLARKE'S SONS

Deliver orders from any part of the country to
New York City
Or OUT-GOING STEAMERS
Write or telegraph
2139-2141 Broadway, New York
Telephone 1552-1553 Columbus

YOUNG & NUGENT

42 West 28 St., NEW YORK
"FLOWERS BY TELEGRAPH"

**NEW YORK
MYER, FLORIST**

Phone 5297 Plaza. 609-611 MADISON AVE.
ALBANY, N. Y.

EYRES

Flowers or Design Work
DELIVERED IN ALBANY AND VICINITY
ON TELEGRAPHIC ORDER.
11 NORTH PEARL ST., ALBANY, N. Y.

Flower Deliveries

In Brooklyn and other Long Island Points
New York City, New Jersey, etc. At Theatres,
Hotels, Steamers or Residences.

WILSON
Fulton St. and Greene Ave., Brooklyn, N. Y.

JOHN BREITMEYER'S SONS

Cor. Miami and Gratiot Aves.
DETROIT, MICH.

Artistic Designs . . .
High Grade Cut Blooms

We cover all Michigan points and good sections of Ohio, Indiana and Canada

PROMPT DELIVERY IN BOSTON

AND ALL NEW ENGLAND POINTS
F. H. HOUGHTON
396 Boylston St., Boston, Mass.

BOSTON'S BEST In Quality and Design

Can be relied upon when you transfer your retail orders to

EDWARD MACMULKIN
194 Boylston Street, Boston

Send flower orders for delivery in

BOSTON

and all

NEW ENGLAND POINTS
THOS. F. GALVIN
124 Tremont St., Boston

The Original Telegraph Order Florist

WILL DELIVER

Flowers or Designs
to order in Boston and Vicinity. Usual Discount.

J. NEWMAN & SONS, Inc.
Est. 1870 24 TREMONT ST., BOSTON

TRANSFER

Your orders for flower or plant delivery in Eastern New England to

JULIUS A. ZINN,
2 Beacon St., Boston.

Fine Design Work a Specialty



DANKER, Albany, N. Y.

ORDERS FOR

Choice Flowers and
Floral Emblems

FILLED PROMPTLY

LOUISVILLE, KY.
JACOB SCHULZ,
550 South Fourth Ave.

WELLESLEY COLLEGE

Dana Hall, Walnut Hill and Rockridge Hall
Schools. TAILBY, Wellesley, Mass.
Tel. Wellesley 44-1 and 2. Night 44-3.



THE NEW IDEA IN PLANT STANDS

The Moore-Livingston Graduating or Adjusting

Saves one-half to two-thirds of cost over ordinary galvanized iron stands.

SEND FOR CIRCULAR GIVING FULL PARTICULARS
SOLD BY SEEDSMEN AND SUPPLY HOUSES

If your seedsman does not carry send us his name and we will promptly send full particulars.

Moore-Livingston Co., Patentees and Mfrs., Lansdowne, Pa.

of the Hub and the manager of the hotel were enlisted in a secret with the following program to be carried out.

The dinner table was covered with damp and musty linen, napkins to match, and furnished with rusty knives and forks, chipped china of many and ancient patterns, mouldy confections and partly decomposed fruit, etc., etc.

A wire frame in the form of a mound, the convex side being covered with the most dismal of dark tulips and other overripe flowers of equal darkness, with no light colored blossoms to brighten the object, operated as a cover for a centerpiece. The whole thing was violently hurtful to the sight, but it answered the purpose.

In due time the ladies were ushered into the dining room where they were confronted with this wondrous piece of work and welcomed by their host, who, by the way, attempted an apology, the ladies in the meantime showing signs of having been humiliated, in fact were about to retire from the apartment when at a given signal from the host a number of attendants who had been concealed behind screens, and drilled for the work, sprang to the table and in the twinkling of an eye had every piece of offensive matter removed and their places filled with the establishment's choicest china and silver. The mournful centerpiece remained in position, however, until the finish of the repast, when it was quietly lifted, revealing most exquisite corsage bouquets for the women. As a surprise the affair was a success and referred to frequently in after years, but most particularly on account of the impression made at the start by an offensive display.

It must be apparent to all that in order to get before us an object offensive to our sight it is necessary that we purposely depart from nature's offerings and adopt its antithesis. Follow nature and its colorings will not carry us away from the harmony it so readily bestows. W. H. LONG.

NEWS NOTES.

New York, N. Y.—The branch store of A. LeMoult recently established in the Bronx, is proving a decided attraction. Mr. LeMoult has recently moved his main store to larger quarters at 202 Bowery.

Detroit.—The inauguration of Mayor Philip Breitmeyer on January 12 was one of the most brilliant spectacles seen in this city in a long time. The floral display was unprecedented for such an occasion. The new Mayor's address has the right ring to it and

the popular florists' candidate is plainly starting in to make a record creditable to himself and gratifying to his myriad of friends.

INCORPORATED.

New York, N. Y.—Julius Cohen & Son, botanist and horticulturist; Julius Cohen, Eugene Cohen, F. Cohen; capital, \$25,000.

The New York Fleischman Stores; Ferdinand Fleischman, Jacob Ausbacher, Stella Offenbach; capital, \$25,000.

THE BEST LETTERS

FOR THOSE
FLORISTS' MADE
USE BY THE



Boston Florist Letter Co.

66 PEARL ST., BOSTON

N. F. MCCARTHY, Mgr.

Order direct or buy from your local supply dealer. Insist on having the

BOSTON

Inscriptions, Emblems, etc., Always in Stock

STRING UP

Asparagus and Smilax with

GREEN SILKALINE

There's Nothing So Good.

JOHN C. MEYER & CO., Boston, Mass.

FLORISTS' SUPPLIES

Send for New Catalogue

H. Bayersdorfer & Co.

1129 ARCH ST., PHILADELPHIA

ATLANTA FLORAL CO.

41 Peachtree Street, ATLANTA, GEORGIA

ROBERT J. DYSART,

Public Accountant and Auditor

Simple methods of correct accounting especially adapted for florists' use.

Books Balanced and Adjusted

Merchants Bank Building

28 STATE ST., BOSTON
Telephone, Main 54.

Rooted Carnation Cuttings

SATISFACTION GUARANTEED.

PINK		WHITE	
Atterglow.....	100 1000 \$6.00 \$50.00	Sarah Hill.....	100 1000 \$6.00 \$50.00
Winona.....	6.00 50.00	White Enchantress.....	3.00 25.00
Winsor.....	3.00 25.00	White Perfection.....	3.00 25.00
R. P. Enchantress.....	3.00 25.00	White Lawson.....	2.50 20.00
Enchantress.....	2.50 20.00		
Lawson.....	2.50 20.00		
RED		MISCELLANEOUS	
Beacon.....	3.50 30.00	Patten.....	2.50 20.00
Victory.....	3.00 25.00	Harlowarden.....	2.50 20.00
		H. Fenn.....	2.50 20.00

And all the Standard Varieties. Send for Complete Price List.

DOUBLE VIOLETS \$1.00 per 100

DAFFODILS, Single \$4.00 per 100

CATTELYAS \$6.00 per doz. \$40.00 per 100

GARDENIAS \$6.00 per doz.

THE LEO NIESSEN CO.

1209 Arch St., Philadelphia, Pa.

Open from 7 a.m. to 8 p.m.

Special Carnations

Fancy grades from the best growers

W. E. McKISSICK & BROS.

WHOLESALE FLORISTS

1619-1621 RANSTEAD ST. PHILADELPHIA

CUT FLOWER BOXES
EDWARDS FOLDING BOX CO
 MANUFACTURERS
 PHILADELPHIA, PA.

CHAS. W. McKELLAR

51 WABASH AVE., CHICAGO

Western Headquarters for Choice Orchids
 Valleys, Roses and all Cut Flowers

PETER REINBERG
 WHOLESALE

CUT FLOWERS

51 Wabash Av., Chicago, Ill

DAILY CONSIGNMENTS

From 40 to 60 Growers

We can care for your cutflower wants to advantage.

E. F. WINTERSON CO.

45-47-49 WABASH AVE., CHICAGO

POEHLMANN BROS. CO.
 33-35-37 Randolph St., - CHICAGO

CUT FLOWERS

Greenhouses, - Morton Grove, Ill.

Rice Brothers
 118 N. 6th Street, MINNEAPOLIS, MINN.

WHOLESALE FLORISTS and SUPPLIES
 CUT FLOWERS received twice daily, and can fill your orders to your satisfaction. A complete line of Hardy Greens - WILD SMILAX, BOXWOOD, HARDY FANCY FERNS, GALAX LEAVES. Write for quotations on large quantities.

In ordering goods please add "I saw it in HORTICULTURE."

WELCH BROS.

AMERICAN BEAUTY, KILLARNEY, RICHMOND, MARYLAND AND ALL THE SUPERIOR ROSES, LILY OF THE VALLEY, CARNATIONS, ORCHIDS

BEST PRODUCED

226 Devonshire Street,

Boston, Mass.

WHOLESALE FLOWER MARKETS—TRADE PRICES—Per 100 TO DEALERS ONLY

	CHICAGO Jan. 19	TWIN CITIES Jan. 18	PHILA. Jan. 19	BOSTON Jan. 21
ROSES				
Am. Beauty, Fancy and Special.....	30.00	40.00	35.00	45.00
" " Extra.....	20.00	30.00	25.00	35.00
" " No. 1.....	15.00	20.00	15.00	25.00
" " Lower grades.....	6.00	10.00	8.00	15.00
Bride, "Maid, Fancy & Special.....	10.00	12.00	8.00	10.00
" " Lower grades.....	6.00	10.00	8.00	10.00
Killarney, Fan. & Sp.....	10.00	15.00	8.00	10.00
" " Lower grades.....	5.00	10.00	8.00	10.00
Richmond, Fancy & Special.....	10.00	15.00	10.00	12.00
" " Lower grades.....	8.00	10.00	8.00	10.00
Chateaux.....	8.00	10.00	8.00	10.00
Golden Gate, Ivory, etc.....	6.00	8.00	6.00	8.00
My Maryland.....
Queen Beatrice.....
Mrs. Mar. Field.....
CARNATIONS				
Ordinary and White.....	2.00	4.00	3.00	4.00
" " Fancy and White.....	1.50	2.00	1.50	2.00
MISCELLANEOUS				
Cattleyas.....	40.00	50.00	50.00	60.00
Cypripediums.....
Lilies.....	15.00	20.00	10.00	12.50
Lily of the Valley.....	3.00	4.00	3.00	4.00
Narciss, Paper White.....	3.00	4.00	2.00	3.50
Roman Hyacinth.....	3.00	4.00	2.50	3.00
Daffodils.....
Freesias.....
Sweet Peas.....	.75	1.50	.75	1.25
Gardenias.....
Violets.....	.50	1.50	1.00	1.50
Adonis.....	3.00	4.00	3.00	4.00
Smilax.....	12.00	15.00	12.00	14.00
Asparagus Plumosus, string.....	35.00	50.00	40.00	50.00
" " & Soren (tree beha.).....	20.00	40.00	15.00	25.00

J.A. BUDLONG

37-39 Randolph Street, CHICAGO.

Roses and Carnations
A Specialty..... WHOLESALE GROWER OF **CUT FLOWERS**

HENRY M. ROBINSON & CO.

15 Province St and 9 Chapman Place - BOSTON, MASS.

WHOLESALE COMMISSION FLORISTS

Hardy Cut Evergreens and Florists' Supplies

We have the stuff and can fill all orders, large or small
 WE NEVER DISAPPOINT SATISFACTION GUARANTEED

Prices Quoted in these Columns are for Dealers Only.
 When Writing to Advertisers Please Mention
HORTICULTURE.

Flower Market Reports.

WHOLESALE FLOWER MARKETS.—PER 100. TO DEALERS ONLY.

	CINCINNATI		DETROIT		BUFFALO		PITTSBURG	
	Jan. 18	Jan. 19	Jan. 18	Jan. 19	Jan. 18	Jan. 19	Jan. 18	Jan. 19
ROSES								
Am. Beauty, Fan, and Sp.	45.00	50.00	35.00	40.00	40.00	30.00	40.00	50.00
" Extra	20.00	30.00	25.00	30.00	25.00	40.00	20.00	30.00
" No. 1	10.00	15.00	18.00	25.00	6.00	30.00	10.00	15.00
" Lower grades	3.00	6.00	8.00	15.00	4.00	10.00	3.00	6.00
Bride, Maid, F. & S.	10.00	10.00	7.00	10.00	10.00	12.00	10.00	12.00
" Low gr.	3.00	6.00	3.00	5.00	4.00	6.00	3.00	6.00
Killarney, Fan & Sp.	12.00	16.00	6.00	8.00	10.00	12.00	12.00	16.00
" Lower grades	4.00	8.00	3.00	5.00	4.00	6.00	4.00	8.00
Richmond, Fancy & Special	15.00	15.00	10.00	10.00	10.00	10.00	10.00	10.00
" Lower grades	6.00	12.00	4.00	7.00	4.00	6.00	6.00	12.00
Chateau	4.00	12.00	3.00	8.00	4.00	12.00
Golden Gate, Ivory, etc.
My Maryland
Queen Beatrice
Mrs. Mar. Field
CARNATIONS								
Fancy and Novelties	3.00	4.00	2.00	3.00	2.50	3.00	3.00	4.00
Ordinary	1.00	2.00	1.50	2.00	2.00	2.50	1.00	2.00
MISCELLANEOUS								
Cattleyas	50.00	75.00	50.00	75.00
Oypripediums	15.00	15.00
Lilies	12.50	15.00	20.00	8.00	15.00	12.50
Lily of the Valley	3.00	4.00	3.00	4.00	3.00	4.00	3.00	4.00
Sweet Peas	5.00	1.25	3.00	4.00	2.00	3.00	3.00	4.00
Roman Hyac.	2.00	3.00	2.00	3.00	2.00	3.00	2.00	3.00
Daffodils	3.00	5.00	3.00	5.00
Freesia	3.00	5.00	3.00	5.00
Violas	5.00	1.00	1.00	1.50	1.00	1.50	1.00	1.50
Gardenias
Adiantum	1.00	1.50	1.50	50	1.50	1.00	1.50
Asparagus Plumosus, strings	35.00	50.00	30.00	50.00	25.00	50.00	35.00	50.00
" " & Sprea (100 bchs.)	35.00	50.00	30.00	50.00	25.00	50.00	35.00	50.00

BOSTON Business is slow, very slow. A decided falling off from last week and not quite explicable. In roses, Bridesmaid and Bride are the worst sufferers from the cave-in; Richmond, Beauty and Killarney are holding their own pretty well. Quality is good generally, so the growers have done their part, all right. Last week's business here was quite satisfactory on all lines. At present carnations are on the toboggan and violets are at the foot of the toboggan and in distress. Lily of the valley is a companion in misfortune, and sweet peas are getting there entirely too fast. Yellow narcissi find a receptive market and are thus an exception to the general rule. Improvement is hoped for as the best part of the season is yet to come.

CHICAGO There has been an unusual market for white flowers during the past week. White roses have been in such demand that the supply, particularly in short and medium, was sometimes hard to fill. Brides being off crop with most growers. White carnations also were in good demand. There are some nice tulips in the market, some especially fine in pink and yellow but they do not sell very readily. Jonquills have sold well during the past week. The market for home grown violets has been affected by the quantity shipped here from the East, the price varying with conditions favorable or otherwise to shipping, but on the whole the market for the week has been satisfactory.

INDIANAPOLIS The usual after holiday depression is in evidence.

The unsettled weather has been rather unsatisfactory for rose growers. There is a scarcity of good Beauties while good supplies of other roses are to be had. Killarney is increasing in favor and promises to be a good rival to the old favorite Bridesmaid. There is a good supply of fancy carnations, also longflorums; the demand for the latter is a little slow. The demand for bulbous stock is not as good as it might be. Daffodils, sweet peas, frezias, paper whites, lilacs, lily of the valley and violets are seen in quantities. Tulips are in fair supply, but not eagerly sought for on account of short stem. A good supply of all kinds of greens finds a ready demand. There is quite a good variety of flowering plants on the market but the demand is unusually light for this season.

PHILADELPHIA Neutral conditions prevailed during the past week prices being kept on a stable footing by the shortening up of supplies. Stock generally has been on the short side and business far from brisk; but these two factors taken together keep the situation on an even keel. In American Beauty roses the only good ones were the specials. Neither Richmond nor Liberty are very plentiful. Bridesmaids have improved wonderfully and are now giving the new pink varieties a good run. White roses are rather draggy as to demand. A few very choice Marylands have been seen

around. The supply of carnations has slackened up, and with quality up to high water mark, prices remain firm. Violet market is in fair shape. Cattleyas plentiful and fine. Cypripediums enough for the demand. Sweet peas moving a little better. Lilies slow. Mignonne excellent and going well. Freesia just commencing to arrive. Daffodils scarce. Paper White and Roman hyacinths shortened up.

WASHINGTON The effect of the inclement weather upon the market is a scarcity of almost everything, and consequent stiff prices. Violets are higher than the same quality was at Christmas. Richmonds are easily taking up the lead in the rose line, Killarneys running second in demand and bringing about the same figure. White lilac is quite scarce. Gude Bros. are supplying the entire Washington market and even shipping to Philadelphia. It eagerly responds to the call at \$2.00 per dozen. Everything is brisk; Washington is primarily a city of social activities, which is something for the florist to be thankful for.

INCORPORATED.

Texarkana, Tex.—The Texarkana Seed and Implement Co.; K. H. Leonard, C. C. Rarcliff, R. P. Dorrough; capital, \$2,500.

Troy, N. Y.—Northern Orchard Company of Peru; F. L. Porter, W. L. Brown, John McL. Stevens, F. E. Foote; capital, \$15,000; dealers in fruit and produce.

Elgin, Ill.—Batavia Greenhouse Co., capital, \$8,000.

ESTABLISHMENT AND RESIDENCE OF FRANK BEU, CHICAGO.

The little picture herewith reproduced, furnishes a very good illustration of a type of moderate-sized, prosperous florist establishment to be found in almost any community of



sufficient size. Ten years ago Mr. Beu bought four small greenhouses and by industry and careful attention to business and the assistance of his capable wife has now twelve houses, 25 x 125 ft., all new and up-to-date in equipment, with over two acres of land. The Chicago wholesale market furnishes an outlet for a large portion of the product.

The U-N-I-T Sprayer, advertised in another column, is highly recommended by Poehlmann Bros., Fred Burki and other equally reliable florists and gardeners, and fills the bill for the purpose intended. Send to the manufacturers for full particulars. You will not regret it.

Detroit.—The Woodmere Floral Co. is erecting a new brick store with all modern equipments.

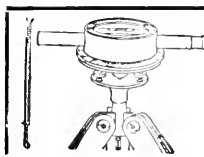

EVERYBODY KNOWS

Gardening cannot be properly done without the aid of an accurate leveling instrument.

Bostrom's Improved Levels, No. 2 at \$15.00 and No. 3 at \$25.00, are conceded by all who KNOW to be the only levels on the market which meet all the requirements, at the price.

Our guarantee back of every Level we sell, and satisfied users in every State in the Union heartily endorse every one we make.

Shipping weight 12 lbs. Description on request.

BOSTROM-BRADY MFG. CO., 139 Madison Avenue, ATLANTA, GA.

FORD BROTHERS
 48 West 28th Street NEW YORK
FINE ROSES FANCY CARNATIONS
 A Full Line of ALL CUT FLOWERS
 Telephone, 3870 or 3871 Madison Square

H. E. FROMENT
 Wholesale Commission Florist,
 Choice Cut Flowers,
 57 West 28th St. :: NEW YORK
 Telephones: 2200, 2201, Madison Square.

Alfred H. Langjahr
 All choice cut-flowers in season. Serv.
 for quotations. Correspondence with
 shippers of first-class stock invited.
 55 West 28th Street, New York
 Telephone 4626 4627 Madison Square

Edward C. Horan
 Wholesale Florist
 55 WEST 28th ST.
 tel. 1462 Madison Square NEW YORK
 1463

JOHN YOUNG
WHOLESALE FLORIST
 Finest American Beauties and
 Carnations
 51 West 28 St. - NEW YORK

FRANK MILLANG
Wholesale Florist
 55-57 West 26th St., NEW YORK
 Shipments, any quantity, Whole-
 sale Market Rates.

Consignments Requested
 A Good Market and Prompt Returns
GEORGE SALT FORD
 43 W. 28th Street, NEW YORK
 Telephone, 3101 Madison Sq

VIOLETS
 Finest Grade. Any Quantity
B. S. SLINN
 55-57 W. 26 St., New York

Moore, Hentz & Nash
 Wholesale Commission Florists
 55 and 57 West 26th Street
 Telephone No. 756
 Madison Square New York

MILLANG BROS.
 WHOLESALE COMMISSION FLORISTS
 41 West 28th Street
 Telephone 3860 Madison
 3861 NEW YORK

JOHN I. RAYNOR
Wholesale Commission Florist SELLING AGENT FOR
 LARGEST GROWERS
 A full line of Choice Cut Flower Stock for all purposes. Comprises every variety
 grown for New York market, at current prices
 TEL. 1998 MADISON SQUARE 49 West 28th St., New York City

Walter F. Sheridan
 Wholesale Commission Dealer in
CHOICE CUT FLOWERS
 39 West 28th Street, New York
 Telephone: 3332-35-3 Madison Square

HEADQUARTERS FOR NOVELTIES
ORCHIDS A SPECIALTY
 THE HIGHEST GRADE OF VALLEY ALWAYS ON HAND
 GARDENIAS, DAISIES, ROSES AND CARNATIONS
 Telephone
JAMES McMANUS, 753 Mac St. 42 W. 28th St. New York

PHILIP F. KESSLER 55 & 57 W. 26th St., New York City
 Commission Dealer, Wholesale Buyer
 and Seller of
CUT FLOWERS
 Open from 5 a. m. to 6 p. m. Sunday
 till 10 a. m.
 Tel., 5243 and 2021 Madison Sq. Res., 345 J., Newtown.
Finest Lilies in the Market Every Day in the Year.

NEW YORK QUOTATIONS PER 100. To Dealers Only

ROSES AND CARNATIONS	Last Half of Week ending Jan. 16 1959		First Half of Week beginning Jan. 12 1959	
American Beauty, Fancy and Special	30.00	to 40.00	30.00	to 42.00
" " Extra	20.00	to 25.00	20.00	to 25.00
" " No. 1	10.00	to 15.00	10.00	to 15.00
" " Lower Grades	3.00	to 6.00	3.00	to 5.00
Bride, 'Field, Fancy and Special	8.00	to 10.00	8.00	to 10.00
" " Lower Grades	2.00	to 6.00	2.00	to 6.00
Killarney, Fancy and Special	10.00	to 15.00	10.00	to 15.00
" " Lower Grades	3.00	to 6.00	3.00	to 6.00
Richmond, Fancy and Sp. cal.	12.00	to 15.00	10.00	to 15.00
" " Lower Grades	3.00	to 6.00	3.00	to 6.00
Chatenay	3.00	to 10.00	3.00	to 10.00
Ty Maryland	4.00	to 15.00	4.00	to 15.00
Golden Gate, Ivory, etc.	2.00	to 10.00	1.00	to 10.00
Queen Beatrix	to	to
Mrs. Har. Field	to	to
Carnations, Fancy and Novelties	3.00	to 5.00	3.00	to 5.00
" " Ordinary and White	1.50	to 2.00	1.50	to 2.00

Alexander J. Guttman
THE WHOLESALE FLORIST OF NEW YORK
 34 WEST 28th STREET
 PHONES. 1664--1665 MADISON SQUARE
ENOUGH SAID

TRAENDLY & SCHENCK
 Wholesale Florists
Furnish best Stock at fair prices all the year round.
 Send for quotations on any variety and quantity
 Tel. 798, 799 Madison Sq. 44 West 28th St., New York City.

GROWERS' CUT FLOWER CO. CUT FLOWERS AT WHOLESALE
VIOLETS, CARNATIONS, ROSES
ORCHIDS, CHRYSANTHEMUMS, LILIES
 Consignments Solicited. Shipments to Order, any Distance
 Telephone 697 Madison Square
39 West 28th Street, J. J. OLAN, Manager NEW YORK

WHOLESALE FLORISTS
54 West 28th St.
NEW YORK
Telephone 3659 Madison Sq.

A. L. YOUNG & CO.

RECEIVERS & SHIP-
PERS OF CUT
FLOWERS.
CONSIGNMENTS SOLICITED.

WILLIAM H. KUEBLER
Brooklyn's Foremost and Best
WHOLESALE COMMISSION HOUSE
A First Class Market for all CUT FLOWERS
28 Willoughby St., Brooklyn, N. Y.
Tel. 4591 Main

GEORGE COTSONAS & CO.
Wholesale and Retail Dealers in all kinds of
EVERGREENS
Fancy and Dagger Ferns
Bronze and Green Galax
Main Store 50 W. 28 St.
Phone 2202 Mad. Sq. New York



Greater New York Florists' Association, Inc.
Now Open for Cut Flower Consignments
162 Livingston Street, BROOKLYN, N. Y.
Geo. W. Crawback Telephone Connection
Manager 3642-43 Main

Henshaw & Fenrich
WHOLESALE FLORISTS
44 West 28th St., NEW YORK
Phones Mad. Sq. 325, 558-2, 558-3.

H. C. BERNING
Wholesale Florist

1402 Pine Street, ST. LOUIS, MO.
REED & KELLER
122 West 25th St., New York
Florists' Supplies
We manufacture all our
Hotel Designs, Baskets, Wire Work & Novelties
and are dealers in
Glassware Decorative Greens and Florists' Requisites

WHOLESALE COMMISSION J. K. ALLEN 106 W. 28th St. NEW YORK
Open 6 a.m. Daily Tel. 167 Madison Sq.
All Grades of Flowers to Suit All Buyers. Consignments Solicited.

NEW YORK QUOTATIONS PER 100. To Dealers Only

MISCELLANEOUS

	Last Half of Week ending Jan. 16 1909	First Half of Week beginning Jan. 18 1909
Cyripediums.....	8.00 to 10.00	8.00 to 10.00
Cattleyas.....	20.00 to 40.00	25.00 to 40.00
Lilies.....	4.00 to 10.00	4.00 to 10.00
Lily of the Valley.....	1.00 to 3.10	1.00 to 3.00
Narcis., Paper White.....	1.00 to 3.00	1.00 to 2.00
Roman Hya.....	1.00 to 2.00	1.00 to 2.00
Tulips.....	2.00 to 4.00	2.00 to 4.00
Daffodils.....	2.00 to 3.10	2.00 to 3.00
Freezia.....	2.00 to 3.00	2.00 to 3.00
Sweet Peas.....	1.00 to 1.50	1.00 to 1.50
Gardenias.....	20.00 to 35.00	20.00 to 35.00
Violets.....	30 to 75	25 to 75
Adiantum.....	75 to 1.00	.50 to 1.00
Crownam.....	1.00 to 1.25	1.00 to 1.25
Smilax.....	8.00 to 10.00	8.00 to 10.00
Asparagus Plumosus, strings.....	15.00 to 35.00	15.00 to 35.00
" & Soren (two brs).....	13.00 to 25.00	15.00 to 25.00

THE KERVAN CO.
Wholesale Dealers and Shippers of
Decorative Evergreens
Ferns, Galax, Laurel, Fresh Cycas, Box-
wood, Sphagnum and all Christmas Greens
Send to us for Quotations before Buying.
113 West 28 Street, NEW YORK CITY

MICHIGAN CUT FLOWER EXCHANGE, Inc.
WHOLESALE COMMISSION FLORISTS
Consignments Solicited.
Hardy Fancy Fern Our Specialty.

38 40 BROADWAY, DETROIT, MICH.
BRONZE GALAX
I will offer during the next 60 days first class
Bronze Galax at \$3.00 per case of 10,000,
size 2 3/4 to 3 1/2 in. f.o.b. Mt. Airy N. C.
Cash with order. Sample Order Solicited.
G. A. HOLDER, Round Peak, N. C.

In ordering goods please add "I saw
it in HORTICULTURE."

Wired Toothpicks
Manufactured by
W. J. COWEE, BERLIN, N. Y.
50,000....\$1.75; 50,000....\$7.50. Sample free.
For sale by dealers

SAMUEL A. WOODROW
WHOLESALE PLANTSMAN
Palms, Large and Small Ferns, etc.
53 West 30th Street, NEW YORK
Telephone 2083 Madison

NEW YORK MARKET.

While conditions may fairly be said to maintain an unchanging attitude for the past week, yet it is very evident that the product, as a whole, is steadily on the increase and unless a better tide of cut-flow soon begins to move the inevitable results will be a diminishing of values all along the line which will be as unseasonable as it will be unfortunate for the producer. Quantities are good, generally, and it is now full time for the mid-season rush to commence if there is to be any. Carnations are abundant and inclined to accumulate in wholesalers' hands and certainly need whatever impetus the Carnation Society's meeting next week may give to the divine flower. Cattleyas are very plentiful, also the gardenias, which share with them the honor of ultra-fashionable favor. Violets are still finding their best comfort on the "curbstone" market. Bulbous stock of all kinds is on the increase.

BUSINESS CHANGES.

Baltimore, Md.—W. O. Stran has sold his florist store on Monument St. to Guy Strickland.
Brandon, Man.—H. L. Patmore has branched the greenhouse business of the A. E. McKenzie Co.
Columbus, O.—The Fifth Avenue Floral Co. has moved into more spacious quarters at 44 North High St.
Bristol, Va.—The Bristol Floral Co. is the new name chosen by the purchasers of the D. S. Simpson Floral Co.
St. Louis, Mo.—J. H. Kahrs, formerly with Grimm & Gorley, has bought the florist business of John Burke at 605 Locust St.
Sewickley, Pa.—A. C. Robens, formerly with J. M. Gasser Co., Cleveland, has purchased the florist business of H. C. Bucheler.

We will allow on all orders of
Sheaves and Wire Work
15 per cent discount. Orders of \$30.00 up 20 per cent. This for the month of January only.

J. STERN & CO.
125 N. 10th St., Philadelphia, Pa

HORTICULTURE:
Enclosed check for my subscription to HORTICULTURE to January first, 1910. My kind regards and best wishes and may HORTICULTURE continue to flourish and prosper.
Very truly yours,
T. D. S.

Buyer's Directory and Ready Reference Guide

Advertisements under this head, one cent a word. Initials count as words.

Display advertisers in this issue are also listed under this classification without charge. Reference to List of Advertisers will indicate the respective pages.

Buyers failing to find what they want in this list will confer a favor by writing us and we will try to put them in communication with reliable dealers.

ACCOUNTANT

R. J. Dyrant, 28 State St., Boston.
For page see List of Advertisers.

AQUILEGIAS

Aquilegas. Genuine Coerulea, finest of all. Both plants and seeds from the heart of the Rockies. C. S. Harrison's Select Nursery, York, Neb.

ARAUCARIAS

A. Leuthy & Co., Perkins St. Nurseries, Roslindale, Mass.
For page see List of Advertisers.

Godfrey Aschmann, 1012 West Ontario St., Philadelphia, Pa.
For page see List of Advertisers.

ASPARAGUS

The Geo. Wittbold Co., 1657 Buckingham Palace, Chicago, Ill.
For page see List of Advertisers.

AUCTION SALES

Cleary's Horticultural Co., 62 Vesey St., New York.
For page see List of Advertisers.

AZALEAS

A. Leuthy & Co., Perkins St. Nurseries, Roslindale, Mass.
For page see List of Advertisers.

Godfrey Aschmann, 1012 W. Ontario St., Philadelphia, Pa.
For page see List of Advertisers.

BAMBOO CANES

Yokohama Nursery Co., 31 Barclay Street, New York.
Bamboo Sticks, Colored Green.
For page see List of Advertisers.

BAY TREES.

2000 Bay and Box Trees in all sizes, Pyramid and Standards. Write for list. Julius Roehrs, Rutherford, N. J.

BOILERS

BOILERS. "Buruhum" Boilers made for greenhouse heating. Lord & Buruhum, 1133 Broadway, N. Y.

Kroeschell Bros. Co., 35 Erie St., Chicago.
For page see List of Advertisers.

BOXWOOD TREES

New England Nurseries, Inc., Bedford, Mass.
For page see List of Advertisers.

BUILDING MATERIAL

BUILDING MATERIAL of all description for All Cypress, Semi-Iron, Iron Frame or Truss Houses. Hot Bed Sash and Frames. Lord & Buruhum Co., 1133 Broadway, N. Y.

BULBS AND TUBERS

Joseph Breck & Sons, 47-54 N. Market St., Boston.
For page see List of Advertisers.

J. M. Thorburn & Co., 33 Barclay St., New York.
For page see List of Advertisers.

A. T. Roddington, 342 W. 14th St., N. Y.
For page see List of Advertisers.

Rickards Bros., 37 East 19th St., New York.
For page see List of Advertisers.

H. F. Michell Co., Philadelphia.
For page see List of Advertisers.

H. E. Fiske Seed Co., Faneuil Hall Sq., Boston.
For page see List of Advertisers.

T. J. Grey & Co., 32 and 33 So. Market St., Boston.
For page see List of Advertisers.

BULBS AND TUBERS—Continued

Yokohama Nursery Co., 31 Barclay St., New York.
For page see List of Advertisers.

Ralph M. Ward & Co., 12 W. Broadway, New York.
Japan Lily Bulbs.

For page see List of Advertisers.

CANNAS

Dingee & Conard Co., West Grove, Pa.
For page see List of Advertisers.

CARNATIONS

F. Dorrer & Sons Co., Lafayette, Ind.
Carnation, Pink Delight.
For page see List of Advertisers.

Chicago Carnation Co., Joliet, Ill.
For page see List of Advertisers.

Albert Roper, Tewksbury, Mass.
Carnation Bay State.
For page see List of Advertisers.

Bassett & Waahburn, Hinsdale, Ill.
Carnation O. F. Bassett.
For page see List of Advertisers.

East Sudbury Greenhouse, So. Sudbury, Mass.
Carnation Cuttings.

For page see List of Advertisers.

Wood Bros., Fishkill, N. Y.
Carnations, Rooted Cuttings.
For page see List of Advertisers.

The E. G. Hill Co., Richmond, Ind.
Carnation Cuttings.
For page see List of Advertisers.

Peter Fisher, Ellis, Mass.
Rooted Cuttings.
For page see List of Advertisers.

S. J. Renter & Son, Westery, R. I.
For page see List of Advertisers.

Bellamy Bros., Suc. to L. E. Marquisse, Syracuse, N. Y.
Carnation Marchioness.
For page see List of Advertisers.

CARNATION STAPLE

J. L. Pillsbury, Galesburg, Ill.
For page see List of Advertisers.

CHORIZEMAS AND LIBONIA

WANTED

Ed. Herrmann, North & Milton Aves., Baltimore, Md.
For page see List of Advertisers.

CHRYSANTHEMUMS

Chas. H. Totty, Madison, N. J.
Chrysanthemum Novelties.
For page see List of Advertisers.

E. G. Hill Co., Richmond, Ind.
For page see List of Advertisers.

S. J. Goddard, Framingham, Mass.
Chrysanthemum Golden Glow.

For page see List of Advertisers.

S. J. Renter & Son, Westery, R. I.
For page see List of Advertisers.

Elmer D. Smith & Co., Adrian, Mich.
For page see List of Advertisers.

Chrysanthemum Golden Glow from 2 1/4 in. pots, for early spring delivery, \$1.00 per doz., \$6.00 per 100, \$50.00 per 1000. Stock plants of Montpelier, Oct. Frost, Crocus, Matchless, Lucy Devaux, Polly Rose and Halliday, \$1.00 per doz.; \$6.00 per 100. Peirce Bros., Waltham, Mass.

Herrington's book on the Chrysanthemum, mailed to your address for 50c, by Horticulture Publishing Co., 11 Hamilton Place, Boston.

Chrysanthemums, rooted cuttings, Bonaparte, Pacific, Oriental Glory, pink, Raynor, late white, \$1.00 per 100, \$8.00 per 1000. Sargent's Greenhouses, 94 Holden St., Worcester, Mass.

CONIFERS

John Waterer & Sons, Ltd., American Nursery, Bagshot, Eng.
For page see List of Advertisers.

CUT FLOWER BOXES.

Edwards Folding Box Co., Philadelphia.
For page see List of Advertisers.

Folding cut flower boxes, the best made, Write for list. Holton & Hunkel Co., Milwaukee, Wis.

CYCLAMEN.

Thomas Roland, Nahant, Mass.
For page see List of Advertisers.

DAHLIAS

David Herbert & Son, Atco, N. J.
For page see List of Advertisers.

J. L. Moore, Northboro, Mass.
For page see List of Advertisers.

Peacock Dahlia Farms, Williamstown June 10th, N. J.

Dahlia Miss Virginia Maule.
For page see List of Advertisers.

R. Vincent Jr. & Sons Co., White Marsh, Md.
For page see List of Advertisers.

Dingee & Conard Co., West Grove, Pa.
For page see List of Advertisers.

East Bridgewater Dahlia Gardens want your business. If you are looking for dahlias send to the Eastern Dahlia King, J. K. Alexander, East Bridgewater, Mass.

DAISIES

Chas. Yellow and white Paris R. Co., 75c. Queen Alexandra, \$1 per 100, prepaid. (Dais. Prost, Kenilworth, N. J.)

DECORATIVE PLANTS

A. Leuthy & Co., Perkins St. Nurseries, Roslindale, Mass.
For page see List of Advertisers.

Godfrey Aschmann, 1012 W. Ontario St., Phila., Pa.
For page see List of Advertisers.

Joseph Heacock Co., Wyncote, Pa.
For page see List of Advertisers.

The Geo. Wittbold Co., 1657 Buckingham Palace, Chicago, Ill.
For page see List of Advertisers.

Robert Craig Co., Market and 49th Sts., Philadelphia, Pa.
For page see List of Advertisers.

A. N. Pierson, Inc., Cromwell, Conn.
Palms and Ferns.
For page see List of Advertisers.

DRACAENAS

The Geo. Wittbold Co., 1657 Buckingham Place, Chicago, Ill.
For page see List of Advertisers.

ECONOMY BRACKET

Burton & Allard, Nashua, N. H.

EVERGREENS

New England Nurseries, Bedford, Mass.
For page see List of Advertisers.

American Nursery Co., 150 Broadway, New York, N. Y.
For page see List of Advertisers.

Evergreens. Send 25 cents in stamps for complete work on propagating and growing Evergreens. C. S. Harrison's Select Nursery, York, Neb.

FERNS

A. Leuthy & Co., Roslindale, Mass.
For page see List of Advertisers.

H. H. Barrows & Son, Whitman, Mass.
Nephrolepis Whitman.
For page see List of Advertisers.

For List of Advertisers See Page 129

FERNS - Continued

John Scott, Brooklyn, N. Y.
For page see List of Advertisers.

Frank Oechlin, 2570-2606 W. Adams St., Chicago.
Ferns for Dishes.
For page see List of Advertisers.

The Geo. Wittbold Co., 1657 Buckingham Palace, Chicago, Ill.
For page see List of Advertisers.

Godfrey Aschmann, 1012 W. Ontario St., Philadelphia.
For page see List of Advertisers.

Henry A. Dreer, 714 Chestnut St., Phila.
Nephrolepis Scholzei.
For page see List of Advertisers.

Henry Weston, Hempstead, N. Y.
500 Boston and Scottt Ferns, 3 and 3 1/2 doz., cheap for cash. Just right for bedding out. Geo. H. Walker, No. Dighton, Mass.

FERTILIZERS

Pulverized Manure Co., 31 Union Stock Yards, Chicago, Ill.
Wizard Brand Sheep and Shredded Cattle Manure.

Robert Simpson, Clifton, N. J.
Sheep Manure.
For page see List of Advertisers.

FIGUS

Ficus elastica; six inch; extra choice; clean stock, \$40.00 per 100. Collingdale Greenhouses, Collingdale, Pa.

FLORAL PHOTOGRAPHS

Floral Photographs, Foley's, 226-228 12 Bowery, New York.

FLORISTS' LETTERS.

Boston Florist Letter Co., 66 Pearl St., Boston, Mass.
For page see List of Advertisers.

FLORISTS' PRINTING

Letter-heads, bill-heads, tags, etc., \$1.25 per thousand. Samples free. Write now. Distance no hindrance. Plink & Sotter, Pottstown, Pa.

FLORISTS SUPPLIES

N. F. McCarthy & Co., 84 Hawley St., Boston.
For page see List of Advertisers.

H. M. Robinson & Co., 15 Province St. and 9 Chapman Pl., Boston, Mass.
For page see List of Advertisers.

Reed & Keller, 122 W. 25th St., New York.
For page see List of Advertisers.

M. Bayeradorfer & Co., 1129 Arch St., Philadelphia.
Enster Baskets.
For page see List of Advertisers.

J. Stern & Co., 125 N. 10th St., Phila.
For page see List of Advertisers.

FLOWERS BY TELEGRAPH

Park Floral Co., Denver, Colo.
For page see List of Advertisers.

Gude Bros. Co., 1214 F St., Washington, D. C.
For page see List of Advertisers.

Atlanta Floral Co., Atlanta, Ga.
For page see List of Advertisers.

M. C. & J. E. Hauswirth, 232 Michigan Ave., Chicago.
For page see List of Advertisers.

William J. Smyth, Michigan Ave. and 31st St., Chicago.
For page see List of Advertisers.

George Wittbold Co., 1657-59 Buckingham Place, Chicago.
For page see List of Advertisers.

Jacob Schulz, 644 14th Ave., Louisville, Ky.
For page see List of Advertisers.

Thos. F. Galvin, 124 Tremont St., Boston.
For page see List of Advertisers.

Julius A. Zinn, 2 Beacon St., Boston.
For page see List of Advertisers.

F. H. Houghton, 396 Boylston St., Boston.
For page see List of Advertisers.

Edward MacMuirn, 194 Boylston St., Boston.
For page see List of Advertisers.

FLOWERS BY TELEGRAPH - Continued

Hoffman, Florist, 59-61 Massachusetts Ave., Boston.
For page see List of Advertisers.

J. Newman & Sons, Inc., 24 Tremont St., Boston.
For page see List of Advertisers.

Taillly, Wilesley, Mass.
For page see List of Advertisers.

J. Breilmeier's Sons, Miami and Gratiot Aves., Detroit, Mich.
For page see List of Advertisers.

Samuel Murray, 1017 Broadway, Kansas City, Mo.
For page see List of Advertisers.

Wm. L. Rock Flower Co., 1116 Walnut St., Kansas City, Mo.
For page see List of Advertisers.

H. G. Eyrres, 11 N. Pearl St., Albany, N. Y.
For page see List of Advertisers.

David Clarke's Sons, 2139-2141 Broadway, New York.
For page see List of Advertisers.

Alex. McConnell, New York.
For page see List of Advertisers.

Robert G. Wilson, Fulton St. & Greene Ave., Brooklyn, N. Y.
For page see List of Advertisers.

Young & Nugent, 42 W. 28th St., N. Y.
For page see List of Advertisers.

M. Bowe, 1204 Broadway, New York.
For page see List of Advertisers.

Myer, 608-11 Madison Ave., New York.
For page see List of Advertisers.

Thos. Young, Jr., 599 Fifth Ave., New York.
For page see List of Advertisers.

Newman Floral Co., 202 Fifth Ave., and Madison Sq., New York.
For page see List of Advertisers.

The Blossom (C. C. Trepel, Mgr.), Bond and Livingston Sts., Brooklyn, N. Y.
For page see List of Advertisers.

Palmer's, Buffalo, N. Y.
For page see List of Advertisers.

F. A. Danker, Albany, N. Y.
For page see List of Advertisers.

J. H. Dunlop, 96 Yonge St., Toronto, Can.
For page see List of Advertisers.

FOREST POTS

W. H. Ernest, 28th and M Sts., Washington, D. C.
For page see List of Advertisers.

A. H. Hews & Co., Cambridge, Mass.
For page see List of Advertisers.

Hilfinger Bros., Ft. Edward, N. Y.
For page see List of Advertisers.

Whilldin Pottery Co., Philadelphia.
Standard Flower Pots.

The Peters & Reed Pottery Co., Red pots, seed pans, etc., Zanesville, O.

FOREST SEEDLINGS

To close out quick I offer the following first-class stock for Parks, Cemeteries and Forest Plantings: 100 M. Amorpha Fruticosa, 1 to 3 ft.; 300 M. Althea Rosa Stocks, 100 M. Cal. Privet; 500 M. Cal. Privet Cuttings; 100 M. Black Locust, 4 to 6 ft.; 50 M. Calycanthus, Sweet Shrub, 1 to 3 ft.; 150 M. Cercis Canadensis, Red Bud, 1 to 4 ft.; 60 M. Cornus Stolonifera, Ozler Dogwood, 1 to 2 ft.; 50 M. Diosyros, Am. Persimmon, 6 to 10 inches; 50 M. Elm (white) 1 to 2 ft.; 75 M. Hamamelis, Witch Hazel, 6 in. to 3 ft.; 50 M. Tulip Poplar, 1 to 8 ft.; 20 M. Sweet Gum, 1 to 6 ft.; 50 M. Black Walnut, 1 to 3 ft.; 20 M. Wistaria, 1 to 3 ft.; 20 M. Yucca Flammulosa, 1 and 2 year Butternut, Japan Walnut, Ash, Maple, etc. Send for trade list. I offer my entire stock to close out at low prices; also a large stock of Tree and Shrub Seeds, Black Locust, Sweet Gum, Sycamore, Ash, Red Bud, Persimmon, Bass Wood, Viburnums, Sugar Maple, Red Cedar and other seeds. Forest Nursery & Seed Co., J. H. H. Boyd, Prop., R. F. D. No. 2, McMinnville, Tenn.

GALAX

Michigan Cut Flower Co., 28 and 40 Broadway, Detroit, Mich.
For page see List of Advertisers.

George Cotsonas & Co., 50 W. 28th St., New York.
For page see List of Advertisers.

The Kerran Co., 113 West 28th St., N. Y.
For page see List of Advertisers.

GALAX - Continued

Rice Bros., 115 N. 6th St., Minneapolis, Minn.
For page see List of Advertisers.

H. M. Robinson & Co., 15 Province St. and 9 Chapman Place, Boston.
For page see List of Advertisers.

G. A. Holder, Round Peak, N. C.
Brazos Galax.
For page see List of Advertisers.

GERANIUMS

R. Vincent Jr. & Sons Co., White Marsh, Md.
New and Standard Varieties.
For page see List of Advertisers.

GLADIOLI

J. L. Moore, Northboro, Mass.
For page see List of Advertisers.

E. S. Miller, Wading River, N. Y.
For page see List of Advertisers.

A. T. Boddington, 342 W. 14th St., New York.
For page see List of Advertisers.

Gladioli. As good as any and better than many. Send for trade list. E. E. Stewart, River Junction, Mich.

GLASS

Boston Plate & Window Glass Co., Boston.
For page see List of Advertisers.

Standard Plate Glass Co., 26-30 Sudbury St., Boston.
For page see List of Advertisers.

Foley Mfg. Co., Western Ave., between 25th & 26th Sts., Chicago.
Sharp, Partridge & Co., 22d & Lumber St., Chicago.
For page see List of Advertisers.

Greenhouse glass, lowest prices. Johnston Glass Co., Hartford City, Ind.
Glass, High Grade, Double Thick Greenhouse Glass. Lord & Burnham, 1133 Broadway, N. Y.

GLAZING DEVICES

H. A. Dreer, Philadelphia, Pa.
Peerless Glazing Point.
For page see List of Advertisers.

GLAZING POINTS, Lord & Burnham Special Glazing Nails (Points). Lord & Burnham, 1133 Broadway, N. Y.

GREENHOUSE BUILDING MATERIAL

Lord & Burnham Co., 1133 Broadway, New York.
For page see List of Advertisers.

Pierson U-Bar Co., 1 Madison Sq., N. Y.
For page see List of Advertisers.

A. T. Stearns Lumber Co., Neponset, Boston.
For page see List of Advertisers.

King Construction Co., N. Tonawanda, New York.
For page see List of Advertisers.

Hitchings & Co., 1170 Broadway, New York.
For page see List of Advertisers.

J. C. Moulger Co., 117 East Blackhawk St., Chicago, Ill.
For page see List of Advertisers.

Foley Mfg. Co., Western Ave., between 25th & 26th Sts., Chicago.
For page see List of Advertisers.

Geo. B. Doane, 18 Midway St., Boston.
Iron Pipe.
For page see List of Advertisers.

Wm. H. Lutton, West Side Avenue Sta., Jersey City, N. J.
For page see List of Advertisers.

GREENHOUSE CONSTRUCTION

GREENHOUSE CONSTRUCTION, Semi-Iron Greenhouse, New Truss Houses and Iron Frame Houses. Lord & Burnham, 1133 Broadway, N. Y.

J. A. Payne, 260-274 Culver Ave., Jersey City, N. J.
For page see List of Advertisers.

Foley Mfg. Co., Western Ave., between 25th & 26th Sts., Chicago.
For page see List of Advertisers.

Wm. H. Lutton, West Side Avenue Sta., Jersey City, N. J.
Curved Iron Pipe.
For page see List of Advertisers.

Hitchings & Co., 1170 Broadway, New York.
For page see List of Advertisers.

In writing to Advertisers kindly mention Horticulture

GREENHOUSE HOSE

Revere Rubber Co., Boston, Mass.
Revere Hose.
For page see List of Advertisers.

GUTTERS

GUTTERS, Cast Iron Gutters, L. & B. Improved V Shaped Gutter with drip gutter attachment. Lord & Burham, 1133 Broadway, N. Y.

HAIL INSURANCE

Florists' Hall Assn. of America.
J. G. Esler, Saddle River, N. J.
For page see List of Advertisers.

HARDY FERNS, MOSS AND GREENS

H. M. Robinson & Co., 15 Province St. and 9 Chapman Pl., Boston, Mass.
For page see List of Advertisers.

Michigan Cut Flower Exchange,
38 and 40 Broadway, Detroit, Mich.
For page see List of Advertisers.

George Cotsonas & Co., 50 W. 28th St., New York.
For page see List of Advertisers.

N. F. McCarthy & Co., 84 Hawley St., Boston.
For page see List of Advertisers.

The Kervan Co., 113 W. 28th St., N. Y.
For page see List of Advertisers.

Rice Bros., 115 N. 6th St., Minneapolis, Minn.
For page see List of Advertisers.

HEATING APPARATUS

Lord & Burham Co.,
1133 Broadway, New York.
For page see List of Advertisers.

Pierson U-Bar Co., 1 Madison Sq., N. Y.
For page see List of Advertisers.

John A. Payne, 260-274 Culver Ave., Jersey City, N. J.
For page see List of Advertisers.

Kroeschel Bros. Co., 35 Erie St., Chicago.
For page see List of Advertisers.

HELP FURNISHED

Thos. H. Bambrick, 31 S. 7th St., Phila.
For page see List of Advertisers.

HERBACEOUS PERENNIALS

P. Ouwkerk, P. O. No. 1, Hoboken, N. J.
For page see List of Advertisers.
New England Nurseries, Bedford, Mass.
For page see List of Advertisers.

The Geo. Wittbold Co., 1657 Buckingham Place, Chicago.
For page see List of Advertisers.

HOT-BED SASH

The A. T. Stearns Lumber Co., Neponset, Mass.
For page see List of Advertisers.

Pierson U-Bar Co., 1 Madison Sq., N. Y.
For page see List of Advertisers.

Lord & Burham Co., 1133 Broadway, N. Y.
For page see List of Advertisers.

Foley Mfg. Co., Western Ave., between 25th & 26th Sts., Chicago.
Sunlight Double Glass Sash Co.,
Louisville, Ky.

INSECTICIDES.

Nicotine kills all greenhouse pests. P. R. Palethorpe Co.,
Eleventh St., Greencastle, Ky.
For page see List of Advertisers.

Stump & Walter Co., 50 Barclay St., New York.
Kiln-dried Tobacco Dust.
For page see List of Advertisers.

Wilson Plant Oil & Fertilizer Co., Chatham, N. J.
Lauten Fumigator.
For page see List of Advertisers.

Niagara Sprayer Co., Middleport, N. Y.
Niagara Brand.
For page see List of Advertisers.

B. G. Pratt Co., New York.
Suffolk, N. J.
For page see List of Advertisers.

"The Fumigating Kind Tobacco Powder"—The first on the market and the kind that has so many imitators, has our guarantee tag of satisfaction or money back, and "The Moon Trade Mark" on every bag, \$2.00 per 100 lbs. The H. A. Stothoff Co., Mount Vernon, N. Y., Makers and sellers.

IRISH SHAMROCK SEED

H. P. Mitchell Co., 1015 Market St., Phila.
For page see List of Advertisers.

JAPANESE PLANTS

Yokohama Nursery Co., 31 Barclay St., New York.
For page see List of Advertisers.

KENTIAS

Godfrey Aschmann,
1012 W. Ontario St., Phila., Pa.
For page see List of Advertisers.

A. Leuthy & Co., Roslindale, Mass.
For page see List of Advertisers.

Henry Weston, Hempstead, N. Y.
Jos. Hancock Co., Wyncote, Pa.
Single and Made-Up Speeches.
For page see List of Advertisers.

Henry A. Dreer, 714 Chestnut St., Phila.

LEVELS FOR LANDSCAPE GARDENING USE.

Boström-Brady Mfg. Co., 139 Madison Ave., Atlanta, Ga.
For page see List of Advertisers.

LILY OF THE VALLEY PIPS

Hjalmar Hartmann & Co., 12 Storgade, Copenhagen, Denmark.
For page see List of Advertisers.

NEW AND RARE PLANTS

Rose Hill Nurseries, New Rochelle, N. Y.
For page see List of Advertisers.

NICO-FUME

Kentucky Tobacco Product Co.,
Louisville, Ky.

NURSERY STOCK

John Waterer & Sons, Ltd.,
American Nursery, Bagshot, England.
For page see List of Advertisers.

Clery's Horticultural Co., 62 Vesey St., New York.
For page see List of Advertisers.

P. Ouwkerk, 216 Jane St., Weehawken Heights, N. J.
For page see List of Advertisers.

D. J. Twomey, Dept. II, Geneva, N. Y.
For page see List of Advertisers.

American Nursery Co., 150 Broadway, New York, N. Y.
Manual of the Trees of North America,
by C. S. Sargent, mailed to your address
for \$5.00, by Horticulture Publishing Co.,
11 Hamilton Place, Boston.

TREES, SHRUBS, ROSES, EVERGREENS, PEONIES, HARDY PLANTS, ELLWANGER & BARRY, Rochester, N. Y.

ONION SEED

Federico C. Varella, Tenerife, Canary Ids.
Bermuda Onion Seed.

ORCHID BASKETS

J. A. Manda, 191 Valley Rd., W. Orange, New Jersey.
For page see List of Advertisers.

ORCHID PLANTS

Lager & Hurrell, Summit, N. J.
For page see List of Advertisers.

Sander, St. Albans, England.
Importers, Exporters, Growers, Hybridata.
For page see List of Advertisers.

Carroll & Baldwin, Syracuse, N. Y.
For page see List of Advertisers.

Jos. A. Manda, 191 Valley Road, W. Orange, N. J.
For page see List of Advertisers.

Ordenez Bros., Madison, N. J., Box 105
For page see List of Advertisers.

Largest stock in the country. Ask for prices. Julius Roehrs, Rutherford, N. J.

PAINT AND PUTTY

PAINT AND PUTTY: Ideal Greenhouse lead; Special Greenhouse Putty. Lord & Burham, 1133 Broadway, N. Y.

PALMS

A. Leuthy & Co., Perkins St. Nurseries, Roslindale, Mass.
For page see List of Advertisers.

Robert Craig Co., Market and 49th Sts., Philadelphia, Pa.
For page see List of Advertisers.

Joseph Hancock Co., Wyncote, Pa.
Home-Grown Palms.
For page see List of Advertisers.

PANSY PLANTS.

Pansies, extra fine glaucous flowering, strong plants, 30 cents per 100; \$2.50 per 1000. Edw. Wallis, Atco, N. J.

PATENTS

Siggers & Siggers, Washington, D. C.
For page see List of Advertisers.

PEAT

J. A. Manda, 191 Valley Rd., W. Orange, New Jersey.
For page see List of Advertisers.

Orchid peat, rotted peat, Azalea peat, Leaf-Mould, Live Sphagnum moss, Baled Sphagnum moss, Green Clump moss, etc. Jobbers' list on application. C. W. Brownell & Co., Walden, N. Y.

Orchid Peat and Moss always on hand. Julius Roehrs Co., Rutherford, N. J.

PEONIES

Peonies only, by the wholesale—best 100 varieties. J. F. Rosenfield, Westpoint, Nebr.
One of the finest collections in America. Send 25 cts. in stamps for new edition of Peony Manual. C. S. Harrison's Select Nursery, York, Neb.

Send 25 cts in stamps for Phlox Manual. Fine mixed phloxes \$2.00 per 100. C. S. Harrison's Select Nursery, York, Neb.

PHLOXES

Send 25 cts in stamps for Phlox Manual. Fine mixed phloxes \$2.00 per 100. C. S. Harrison's Select Nursery, York, Neb.

PIPE AND FITTINGS

Foley Mfg. Co., between Western Ave. and 26th St., Chicago, Ill.
For page see List of Advertisers.

Kroeschel Bros. Co., 35 Erie St., Chicago.
For page see List of Advertisers.

PIPE AND FITTINGS. Cast Iron and Wrought Pipe, Valves, Elbows, Pipe Hooks, Automatic Air Headers, etc. Lord & Burham, 1133 Broadway, N. Y.

PLANT STANDS

Moore-Livington Co., Landsdowne, Pa.
For page see List of Advertisers.

PLANT STAKES

Steele's Tiesee Plant Stakes and Trellises. H. D. Steele & Sons, Elkhart, Ind.

POT HANGERS

Pot hangers, Kramer's \$1 doz. by exp., \$1.25 by mail. I. N. Kramer & Son, Cedar Rapids, Ia.

POINSETTIAS (Artificial)

Poinsettias, artificial decorations our specialty. Sample lots of 50 in 3 sizes, \$4.00; 100 lots, \$6, \$8, \$10. J. Stern & Co., 125 N. 10th St., Philadelphia, Pa.

PRUNING SHEARS

Rhodes Mfg. Co., Dept. R., Grand Rapids, Mich.

RAFFIA

Raffia (colored), 20 beautiful shades. Samples free. R. H. Comey Co., Camden, N. J.; 810 Washburn Ave., Chicago, Ill.

RETAIL FLORISTS

Park Floral Co., Denver, Colo.
For page see List of Advertisers.

Gude Bros. Co., 1214 F St., Washington, D. C.
For page see List of Advertisers.

Atlanta Floral Co., Atlanta, Ga.
For page see List of Advertisers.

M. C. & J. E. Hauswirth, 232 Michigan Ave., Chicago.
For page see List of Advertisers.

William J. Smyth, Michigan Ave. and 31st St., Chicago.
For page see List of Advertisers.

George Wittbold Co., 1657-59 Buckingham Place, Chicago.
For page see List of Advertisers.

Jacob Schulz, 644 4th Ave., Louisville, Ky.
For page see List of Advertisers.

Thos. E. Galvin, 124 Tremont St., Boston.
For page see List of Advertisers.

For List of Advertisers See Page 129

RETAIL FLORISTS—Continued

- Julius A. Zinn, 2 Beacon St., Boston.
For page see List of Advertisers.
- Frank H. Houghton, 306 Boylston St., Boston.
For page see List of Advertisers.
- Edward MacMulkin, 194 Boylston St., Boston.
For page see List of Advertisers.
- Hoffman, Florist, 59-61 Massachusetts Ave., Boston.
For page see List of Advertisers.
- J. Newman & Sons, Inc., 24 Tremont St., Boston.
For page see List of Advertisers.
- Talby, Wellesley, Mass.
For page see List of Advertisers.
- J. Breitmeier's Sons, Detroit, Mich.
For page see List of Advertisers.
- Samuel Murray, 1017 Broadway, Kansas City, Mo.
For page see List of Advertisers.
- Wm. L. Rock Flower Co., 1116 Walnut St., Kansas City, Mo.
For page see List of Advertisers.
- H. G. Eyres, 11 N. Pearl St., Albany, N. Y.
For page see List of Advertisers.
- David Clarke's Sons, 2139-2141 Broadway, New York.
For page see List of Advertisers.
- Alex. McConnell, New York.
For page see List of Advertisers.
- Robert G. Wilson, Fulton St. and Greene Ave., Brooklyn, N. Y.
For page see List of Advertisers.
- Young & Nugent, 42 W. 28th St., N. Y.
For page see List of Advertisers.
- M. Bove, 1234 Broadway, New York.
For page see List of Advertisers.
- Myer, 606-11 Madison Ave., New York.
For page see List of Advertisers.
- Thos. Young, Jr., 500 Fifth Ave., New York.
For page see List of Advertisers.
- Newman Floral Co., 202 Fifth Ave. & Madison Sq., New York.
For page see List of Advertisers.
- The Blossom (C. C. Trepel, Mgr.), Bond and Livingston Sts., Brooklyn, N. Y.
For page see List of Advertisers.
- Palmer's Buffalo, N. Y.
For page see List of Advertisers.
- F. A. Danker, Albany, N. Y.
For page see List of Advertisers.
- J. H. Dunlop, 96 Yonge St., Toronto, Can.
For page see List of Advertisers.

RHODODENDRONS

- John Waterer & Sons, Ltd., American Nursery, Engleot, England.
For page see List of Advertisers.
- P. Ouwkerk, Hoboken, N. J.
For page see List of Advertisers.
- Anthony Waterer, Knap Hill Nursery, Surrey, Eng.
For page see List of Advertisers.

ROSES

- Robert Craig Co., Market and 49th Sts., Philadelphia, Pa.
For page see List of Advertisers.
- P. Ouwkerk, P. O. No. 2, Hoboken, N. J.
For page see List of Advertisers.
- Julius Roehrs Co., Rutherford, N. J.
Rose Newport Fairy.
For page see List of Advertisers.
- Waban Rose Conservatories, Natick, Mass., and 3A Somerset St., Boston.
New Forcing Rose, White Killarney.
For page see List of Advertisers.
- The E. R. Plerson Co., White Killarney and My Maryland, Tarrytown-on-Hudson, N. Y.
For page see List of Advertisers.
- S. J. Reuter & Son, Westervly, R. I., My Maryland.
For page see List of Advertisers.
- Dirgee & Conard Co., West Grove, Pa.
For page see List of Advertisers.
- Roses, strong, own root, 4 inch Chateaux Killarney, Richmond and Mald., \$8 per 100. Siebrecht & Snn, New Rochelle, N. Y.
- Hand Book of Cultural Notes on Roses Under Glass, by F. P. Brigham, mailed to your address for 25c., by Horticulture Publishing Co., 11 Hamilton Place, Boston.

SEED GROWERS

- C. C. Morse & Co., 48-56 Jackson St., San Francisco, Cal.
For page see List of Advertisers.
- Hjalmar Hartmann & Co., Cauliflower and Cabbage Seed, 12 Stromgade, Copenhagen, Denmark.
For page see List of Advertisers.
- Federico C. Varda, Teneriffe, Canary Ids. Bermuda Onion Seed.

SEEDS

- T. J. Grey Co., 22 So. Market St., Boston.
For page see List of Advertisers.
- Joseph Breck & Sons, 51 and 52 N. Market St., Boston, Mass.
For page see List of Advertisers.
- W. Atlee Burpee & Co., Philadelphia.
For page see List of Advertisers.
- J. M. Thorburn & Co., 33 Barclay St., N. Y.
For page see List of Advertisers.
- Arthur T. Boddington, 342 W. 14th St., New York.
For page see List of Advertisers.
- H. F. Michell Co., 1018 Market St., Phila.
For page see List of Advertisers.
- Hjalmar Hartmann & Co., 12 Stromgade, Copenhagen, Denmark, Cauliflower and Cabbage Seed.
For page see List of Advertisers.
- Rickards Bros., 37 E. 19th St., New York.
For page see List of Advertisers.
- R. & J. Farquhar & Co., 67 So. Market St., Boston.
Mignonette Seed.
For page see List of Advertisers.
- H. E. Fiske Seed Co., Faneuil Hall Sq., Boston.
For page see List of Advertisers.
- C. C. Morse & Co., 48-56 Jackson St., San Francisco, Calif.
For page see List of Advertisers.
- Leonard Seed Co., Chicago, Ill.
For page see List of Advertisers.
- Wm. Elliott & Sons, 42 Vesey St., N. Y. New Seed.
For page see List of Advertisers.

Seeds, Rocky Mountain Evergreen seeds in large or small quantities. C. S. Harrison's Select Nursery, York, Neb.

My own new crop of SALVIA SPLENDENS VARIETIES is now ready: Nana Compacta ZURICHI, finest early flowering pot Salvia in existence, selected seeds. Compacta Grandiflora FIREBALL, best of all for pots and groups, selected seeds. Grandiflora Amellorsta KING OF THE SCARLETS, unexcelled for late groups, with extra large deep scarlet spikes, selected seeds. Each of above per Tr. Pkt., 50c.; 6 Tr. Pkt., \$2.50. Larger quantities on special quotation. O. V. ZANGEN, Seedsman, Hoboken, N. J.

SHRUBS

- The Geo. Withold Co., 1657 Buckingham Palace, Chicago.
For page see List of Advertisers.

SILKALINE

- John C. Meyer & Co., Boston, Mass.
For page see List of Advertisers.

SPHAGNUM MOSS

- Live Sphagnum moss, orchid peat and orchid baskets always on hand. Lager & Hurrell, Summit, N. J.

SPRAYERS

- "SHOWERMAKER," \$1. Jos. Kopcsay, So. Fend, Ind.
Niagara Sprayer Co., Middleport, N. Y.
For page see List of Advertisers.

STEAM TRAP

- E. Hippard, Youngstown, O

STRAWBERRY PLANTS

- H. L. Crane, Westwood, Mass.
Barrimore Strawberry.
For page see List of Advertisers.

SULFOCID

- The E. G. Pratt Co., 50 Church St., Dept. W., New York City.
For page see List of Advertisers.

SWEET PEAS

- A. C. Zvalanek, Bonad Brook, N. J. Winter Flowerlog.
For page see List of Advertisers.

TO-BAK-INE

- E. H. Hunt, Genl. Agt., 76-78 Wabash Av., Chicago.
For page see List of Advertisers.

TOMATO PLANTS.

- 10,000 tomato plants for forcing. Comet, Picote and Mayflower, ready January 20. Good plants from 2 1/2 inch pots, \$15 per 1000. Louest Street Greenhouses, J. H. A. Hutchinson, Prop., Oxford, Eng.

VENTILATING APPARATUS

- Pierson U-Bar Co., 1 Madison Sq., N. Y.
For page see List of Advertisers.
- Foley Mfg. Co., Western Ave., between 25th & 26th Sts., Chicago.
For page see List of Advertisers.
- John A. Payne, 230-274 Culver Ave., Jersey City, N. J.
For page see List of Advertisers.
- The Advance Co., Richmond, Ind.
For page see List of Advertisers.
- Quaker City Machine Co., Richmond, Ind., 20th Century Ventilating Arm.
For page see List of Advertisers.
- VENTILATING MACHINERY, New Model encased, self-acting gear; Standard Model Open Gear. Lord & Burnham, 1133 Broadway, N. Y.

WAX FLOWERS

- We are originators of wax designs and still the standard concern. J. Stern & Co., 125 N. 10th St., Philadelphia, Pa.

WHEAT SHEAVES

- H. Bayersdorfer & Co., 1129 Arch St., Philadelphia.
For page see List of Advertisers.
- J. Stern & Co., 125 N. 10th St., Phila.
For page see List of Advertisers.

WIRED TOOTHPICKS

- W. J. Cowee, Berlin, N. Y.
For page see List of Advertisers.

WIREWORE

- Reed & Keller, 122 W. 25th St., N. Y.
For page see List of Advertisers.
- Wirework—Write for our catalogue. Holton & Hunkel Co., Milwaukee, Wis.
- William E. Heibacher's Wire Works, 35-40 Broadway, Detroit, Mich.
- Headquarters for wire work. Send for list. Ball & Betz, 31 E. 3rd St., Cincinnati, O.
- Wirework—Compare our prices with others. Scranton Florist Supply Co., 201 N. 7th St., Scranton, Pa.

WHOLESALE FLORISTS

Boston

- N. E. McCarthy & Co., 84 Hawley St., Boston.
For page see List of Advertisers.
- H. M. Robinson & Co., 15 Province St. and 9 Chapman Pl., Boston.
For page see List of Advertisers.
- Welch Bros., 226 Devonshire St., Boston.
For page see List of Advertisers.
- Talby, Wellesley, Mass.
For page see List of Advertisers.

Chicago

- Chas. W. McKellar, 51 Wabash Ave., Chicago.
For page see List of Advertisers.
- Peter Reinberg, 51 Wabash Ave., Chicago.
For page see List of Advertisers.
- E. F. Winterson Co., 45-49 Wabash Ave., Chicago.
For page see List of Advertisers.
- J. A. Endlog, 37-39 Randolph St., Chicago.
For page see List of Advertisers.
- Poehlmann Bros. Co., Morton Grove, Ill.
For page see List of Advertisers.

Cromwell, Conn.

- A. N. Plerson, Cromwell, Conn.
For page see List of Advertisers.

In writing to Advertisers kindly mention Horticulture

WHOLESALE FLORISTS—

Continued

Detroit

Michigan Cut Flower Exchange, 38 and 40 Broadway, Detroit, Mich.
For page see List of Advertisers.

Minneapolis

Rice Bros., 115 N. 6th St., Minneapolis, Minn.
For page see List of Advertisers.

New York

Ford Bros., 48 W. 28th St., New York.
For page see List of Advertisers.

H. E. Froment, 57 W. 28th St., New York.
For page see List of Advertisers.

Alex. J. Guttman, 34 W. 28th St., New York.
For page see List of Advertisers.

E. C. Horan, 55 W. 28th St., New York.
For page see List of Advertisers.

A. H. Langjahr, 55 W. 28th St., New York.
For page see List of Advertisers.

James McManua, 42 W. 28th St., New York.
For page see List of Advertisers.

John J. Raynor, 49 W. 28th St., New York.
For page see List of Advertisers.

W. F. Sheridan, 39 W. 28th St., New York.
For page see List of Advertisers.

Trendly & Schenck, 44 W. 28th St., New York.
For page see List of Advertisers.

Moore, Hentz & Nash, 55 and 57 W. 26th St., New York.
For page see List of Advertisers.

Wm. H. Kuehler, 28 Willoughby St., Brooklyn, N. Y.
For page see List of Advertisers.

Phillip F. Kessler, 55 and 57 W. 26th St., New York.
For page see List of Advertisers.

Milling Bros., 41 W. 28th St., New York.
For page see List of Advertisers.

John Young, 51 W. 28th St., New York.
For page see List of Advertisers.

Greater New York Florists' Association, 162 Livingston St., Brooklyn, N. Y.,
For page see List of Advertisers.

George Saltford, 43 W. 28th St., New York.
For page see List of Advertisers.

Frank Millang, 55-57 W. 26th St., New York.
For page see List of Advertisers.

B. B. Blinn, 55-57 W. 26th St., New York.
For page see List of Advertisers.

A. L. Young & Co., 54 W. 28th St., N. Y.
For page see List of Advertisers.

Growers' Cut Flower Co., 39 W. 28th St., New York.
For page see List of Advertisers.

Henshaw & Fenrich, 44 W. 28th St., New York.
For page see List of Advertisers.

J. K. Allen, 106 W. 28th St., New York.
For page see List of Advertisers.

Philadelphia

W. E. McKislick & Bros., 1619-1621 Rantstead St., Philadelphia, Pa.
For page see List of Advertisers.

Leo Niessen Co., 1209 Arch St., Philadelphia, Pa.
For page see List of Advertisers.

The S. S. Pennock-Meehan Co., 1608-13 Ludlow St., Philadelphia, Pa.
For page see List of Advertisers.

St. Louis

H. G. Berning, 1402 Pine St., St. Louis, Mo.
For page see List of Advertisers.

WHOLESALE PLANTSMAN

Samuel A. Woodrow, 53 W. 30th St., New York.
For page see List of Advertisers.

New Offers in This Issue.

AZALEA MOLLISS: RHODODEN-DRON PINK PEARL.

Henry A. Dreer, Philadelphia
For page see List of Advertisers.

BASKETS: CRATES: LADDERS: BOXES.

Racon & Co., Appleton, N. Y.
For page see List of Advertisers.

CALIFORNIA PRIVET.

John Bennett, Atlantic Highlands, N. J.
For page see List of Advertisers.

CANNAS: CALADIUMS: DAHLIAS: GLADIOLUS.

Shellroad Canna Farms, Grange P. O., Baltimore, Md.
For page see List of Advertisers.

CARNATIONS, ROOTED CUTTINGS.

Chicago Carnation Co., Joliet, Ill.
For page see List of Advertisers.

CARNATION MRS. J. C. VAUGHAN.

Jensen & DeKema, Chicago; W. N. Ridd, Morgan Park, Ill.
For page see List of Advertisers.

CARNATIONS: ROSES.

Charles H. Totty, Madison, N. J.
For page see List of Advertisers.

CARNATIONS, ROOTED CUTTINGS.

Patten & Co., Tewksbury, Mass.
For page see List of Advertisers.

CARNATIONS, ROOTED CUTTINGS.

Wm. Swayne, Kennett Square, Pa.
For page see List of Advertisers.

CARNATION NEPTUNE.

Paul Thomson, W. Hartford, Conn.
For page see List of Advertisers.

CARNATION AND ROSE SHOW.

Boston Co-operative Flower Growers' Assn., Boston.
For page see List of Advertisers.

CARNATION WM. H. TAFT.

Scheiden & Schoos, Chicago
For page see List of Advertisers.

CARNATION NOVELTIES AND NEW ROSES.

Pennock-Meehan Co., Philadelphia, Pa.
For page see List of Advertisers.

PHOTOGRAPHS: DESIGNING: ILLUSTRATING.

Geo. E. Dew, 178 Washington St., Boston.
For page see List of Advertisers.

SHAMROCK.

John F. Rupp, Shrewstown, Pa.
For page see List of Advertisers.

U-N-I-T GLOBE SPRAYER.

J. F. Cass Mfg. Co., Dept. H., Detroit, Mich.
For page see List of Advertisers.

VICK QUALITY ASTERS.

James V. V. S. Sons, Rochester, N. Y.
For page see List of Advertisers.

GREENHOUSES BUILDING OR CONTEMPLATED.

Denver, Col.—Mrs. Mary Lehman, one house.

Hastings, Neb.—C. B. Tanner & Co., three houses.

Woburn, Mass.—William Simpson, house, 21x100.

Shelbyville, Ind.—Charles Hammond, one house.

New Britain, Conn.—Andrew Bromley, house, 20x40.

Baltimore, Md.—Charles Hamilton, packing shed, 25x250.

Hammonton, N. J.—Wm. Colwell, range of vegetable houses.

WANTS, FOR SALE, ETC.

Advertisements in this column one cent a word. Initials count as words. Cash with order. All correspondence addressed "care HORTICULTURE" should be sent to 11 Hamilton Place, Boston.

HELP WANTED

GOOD MEN

When you need good men, skilled or unskilled, Write:

THOS. H. BAMBRICK

34 South 7th Street Philadelphia

Help of all kinds, including that for Florists, Nurserymen, Seedsmen and the Horticultural trade generally.

HORTICULTURE needs a wide-awake representative in every town in the land. Good commission paid on advertising and subscriptions. If you are ambitious, write for terms.

WANTED—At once, a thoroughly competent man to take entire charge of our retail and wholesale shipping department of cut flowers. Must be a first-class designer and competent to handle a general retail trade. Reply with references. S. J. Reuter & Son, Inc., Westery, R. I.

WANTED—Good reliable man to work in greenhouses and help with bedding out. Private place. In first letter state age, experience and references. John Thatcher, Chester, W. Va.

FOR SALE

FOR SALE—6000 feet, 2-in., 1000 feet, 4-in., wrought iron pipe; 4000 feet of 4-in. cast iron pipe; cheap; 500 boxes 10 x 12, \$1.50; 150 boxes 10 x 15, \$1.70; and 100 boxes of 8 x 10, double-thick and clean glass, at \$1.25 per box. Two Scollay, 3 sections, two Scollay No. 5, one No. 7 Hiltchings, and one No. 8 Furman boilers. All kinds ventilating apparatus and sash, cast iron fittings, valves, expansion tanks, etc. Everything in first class condition. Cheap. F. O. B. Newark care. I. Sueserman, 229 Livingston St., Newark, N. J.

FOR SALE—Retail nursery, with year, doing good, steady and increasing trade. Stock in excellent condition. Only local supply for community of 50,000. For particulars address B. N., care HORTICULTURE, Boston.

FOR SALE—A greenhouse plant of about 25,000 square feet of glass, ten acres of land, house, stable, ice house, etc. For particulars apply to Pine-Croft Greenhouses, East Brookfield, Mass.

FOR SALE—Second-hand mixed glass, 8x10 and 10x12, about 20 boxes, \$1.00 box; sash bars 6 and 12 feet lengths, cheap. Glass, 67 Van Cleaf St., Jersey City, N. J.

BUSINESS CHANCES

WANTED—To unite in partnership in Massachusetts with man needing more capital or assistance in horticultural business warranting expansion; or to join with man thoroughly qualified in horticulture in establishment of new enterprise. Address K., care Horticulture.

MISCELLANEOUS WANTS

WANTED TO BUY—Complete greenhouse plants and all kinds of greenhouse material, to be taken down and removed at once. Terms cash. Address I. Sueserman, 229 Livingston St., Newark, N. J.

List of Advertisers

Page	Page
Advance, The Co. 131	McConnell Alex. 118
Allen J. K. 123	Mckellar Charles W. 120
American Nursery .. 96	McKlaskic, W. E. & Bros. 120
Achmann Godfrey .. 95	McManus Jas. 122
Atlanta Floral Co. 119	Meyer 118
Bacon & Co. 110	Meyer J. C. & Co. 119
Banbrick Thos. H. 118	Michell H. F. Co. 120
Barrows H. H. & Son. 95	Michigan Cut Flower Exchange. 123
Bassett & Washburn. 115	Millang Bros. 122
Bayersdorfer H. & Co. 110-19	Millang Frank. 122
Bellamy Bros. 115	Miller, E. S. 122
Bennett J. 111	Mininger J. C. 121
Berning H. G. 123	Moore, J. 96
Blossom Thos. 118	Moore, Hentz & Nash 122
Boddington A. T. 94-112-117	Moore-Livingston Co. 119
Boston Co-operative Flower Growers' Assn. 110	Morse C. C. & Co. 117
Boston Florist Letter Co. 119	Murray Samuel 118
Boston Plate and Window Glass Co. 120	New Eng. Nurseries. 96
Bostrom-Brady Mfg. Co. 121	Newman Floral Co. 118
Bowe, M. A. 118	Newman J. & Soos. 119
Breck Joseph & Sons 117	Niagara Sprayer Co. 120
Bridgeman's Seed Warehouse. 117	Niessen Leo Co. 120
Budlong J. A. 118	Oechslin Frank. 95
Barpee W. A. & Co. 117	Ordonez Bros. 112
Carrillo & Baldwin 113	Overkerk P. R. Co. 120
Cass J. F. Mfg. Co. 120	Palmer W. J. 118
Chicago Carnation Co. 122	Park Floral Co. 114
Clarke's David, Sons. 118	Fatten & Co. 114
Cleary's Horticultural Co. 96	Payne John A. 120
Cook J. 122	Peacock Dahlieterns 96
Cotsons Geo. & Co. 123	Peck & Mehan Co. 120
Cowee W. J. 123	Perkins St. Nurseries. 95
Craig, Robt. Co. 96	Pierston, A. N. 95
Crane H. L. 123	Pierston F. R. Co. 113
Crackel Geo. W. 123	Pittsford W. H. Co. 120
Danker F. A. 119	Pill-bury L. L. 114
Diagee & Conard Co. 96	Poehlmann Bros. Co. 120
Doane Geo. B. & Son. 113	Pratt B. G. Co. 120
Dow Gen. E. 117	Quaker City Machine Co. 121
Dreer H. A. 113-120	Raynor John I. 120
Dunlop John H. 118	Reed & Keller. 123
Dysart K. J. 119	Reinberg Peter. 120
Edw. Stubbard Greenhouses. 115	Reuter S. J. & Son. Inc. 125
Edwards Folding Box Co. 120	Revere Rubber Co. 120
Edwards & S. Sons. 117	Rice Bros. 120
Elder J. G. 120	Rickards Bros. 120
Eroest W. H. 120	Robinson F. M. & Co. 120
Eyres. 118	Rock Wm. L. Flo. Co. 120
Farquhar R. J. & Co. 117	Roesch Julius Co. 96-122
Fisher Peter. 115	Reper Albert. 115
Fiske H. E. Seed Co. 117-120	Reiland, Thomas. 95
Foley Mfg. Co. 121	Rolker August & Sons 120
Ford Bros. 122	Rose Hill Nurseries. 95
Fronten H. E. 122	Rupp J. F. 95
Galvin Thos. F. 119	Salford Geo. 122
Goddard S. J. 114	Sander & D. & Co. 96
Greater N. V. Florists' Association. 123	Scheidt & Schoss. 114
Grey T. J. Co. 117	Schulz Jacob. 119
Growers' Cut Flower Co. 122	Scott, John. 95
Gude Bros. Co. 118	Sharp, Fardig & Co. 120
Gutman Alex. J. 122	Shelton & Cannon Farms. 112
Hall Assn. 121	Sheridan W. F. 122
Hartmann Hjalmar & Co. 117	Siggers & Siggers. 112
Hauswirth M. C. & J. E. 118	Sington Robt. 116
Hancock Jos. & Co. 95	Situations & Wants. 122
Henshaw & Fenrich. 123	Slinn B. S. 122
Herbert David & Son. 96	Smith Elmer D. & Co. 96
Herrmann E. 112	Smyth Wm. J. 128
Hewe A. H. & Co. 120	Standard Plate Glass Co. 120
Hilfinger Bros. 120	Stern J. & Co. 120
Hill, The E. G. Co. 125	Stewart A. T. Lumber Co. 121
Hitchings & Co. 124	Stumpff & Walter Co. 120
Hoffman. 119	Swayne Wm. 114
Holder G. A. 123	Taahy. 119
Horan E. C. 122	Thomson Paul. 123
Houghton F. H. 119	Thorburn J. M. & Co. 117
Hunt E. H. 123	Totty Chas. H. 114
Jensen & Dekema. 123	Traendly & Scheeck. 122
Kervan The Co. 123	Trepp G. C. 118
Kessler, P. F. 122	Tweeney D. J. 96
King Cons. Co. 121	Valentee, J. A. 118
Knapp Hill Nursery. 96	Vincent R. Jr. & Sons. 122
Knechtell Bros. Co. 121	Vick's Jas. Sons. 128
Knebler Wm. H. 123	Waban Rose Conser. varieties. 96
Lager & Hurrell. 112	Ward R. M. & Co. 112
Langjahr, Alfred H. 122	Waterer A. 96
Leonard Seed Co. 120	Waterer John & Sons. 96
Leuthy A. & Co. 95	Welch Bros. 120
Lord & Burnham Co. 123	Wilson. 128
Lutton W. H. 121	Wilson Plant Oil & Fertilizer Co. 120
Manda Jos. A. 112	Winterman F. F. Co. 120
MacMulklin E. A. 119	Withold Geo. Co. 95
McCarthy N. F. & Co. 123	Wood Bros. 115

The Lauten Fumigator

(PATENTED)
Write for Prices and Particulars.

Burns Tobacco Stems, the cheapest and most effective fumigating medium yet found.

Costs no more than one box Tobacco Paper and will last a lifetime.

Will not blaze or emit any foreign gases. Will not discolor or cripple flowers. Is easy to handle and there is no danger of fire in using.

Will burn 5 or 6 hours without attention. Will exterminate aphids absolutely with one operation.

Write for prices of all Supplies for the Grower

WILSON PLANT OIL & FERTILIZER CO. CHATHAM New Jersey



For Trees, Plants, Shrubs and Flowers

USE

THE NIAGARA BRAND LIME SULPHUR SOLUTION

It destroys Scale Lice, Spiders and all forms of Aphides, AT THE SAME TIME Mildew, Blight, Rust and other Fungus difficulties.

Used in Winter or Summer. — No other remedy has been so universally effective.

Niagara Brand ARSENATE OF LEAD for chewing insects is equal to the best and better than the most.

Ask about our Green House strayer. Address —

NIAGARA SPRAYER CO., - - Middleport, N. Y.

SOMETHING NEW for GREENHOUSES

"SULFOCIDE"

PRATT'S

SOLUBLE SULPHUR SUMMER SPRAY

Non-caustic and non-irritating

A FUNGICIDE AND INSECTICIDE

FOR FRUIT TREES, VEGETABLES and GREENHOUSES

A promising substitute for Bordeaux mixture. For 10 cts. to cover postage will send sample sufficient for one gallon of spray.

Use 1 part to 75 or 100 parts of water.

B. G. PRATT CO., 50 Church St., New York, U. S. A.

DON'T EXPERIMENT

USE

To-Bak-INE

and your stock will be free from insects, clean, and the blooms will not be discolored.

Send for full information of

H. E. FISKE SEED CO.
13 Faneuil Hall Sq., Boston, Mass.

STUMPP & WALTER CO.,
50 Barclay St., New York.

HENRY F. MICHELL & CO.,
1018 Market St., Philadelphia.

E. H. HUNT, Gen'l Agent,
76-78 Wabash Ave., Chicago.

The Best Bug Killer and Bloom Saver



NICOTIDENE BUG KILLER

For PROOF Write to

P. R. Palethorpe Co.
OWENSBORO, KY.

Mr. Carnation Grower:—

To raise the most thrifty plants use Salt, Potash or Soda in the

U-N-IT Globe Sprayer.

Application, easy, reliable, effective; price, reasonable.

References.

Any Grower who has used it or any trade publication or supply house. Write for circulars or better still order one now from your dealer or sent prepaid on receipt of \$3.50.

—ADDRESS—

Dept. H, J. F. CASS MFG. CO, Detroit, Mich.



KILMDEAD TOBACCO DUST

Free from Sand or Dirt Kind FOR FUMIGATING AND DUSTING

Dusted on Plants It covers large surface. One Quality for Both Uses.

Our Tobacco Dust is the pure tobacco, free from sand and dirt, strong in Nicotine and all ways of the same strength, making it superior to any dust on the market. Costs you no more than the ordinary product and will do twice the work. 10 lbs. 60c; 25 lbs. \$1.25; 50 lbs. \$2.00; 100 lbs. \$3.50.

STUMPP & WALTER CO.
50 Barclay St., New York

"REVERO"

Braided Moulded Construction—Seamless Throughout



LIGHT -- STRONG -- FLEXIBLE

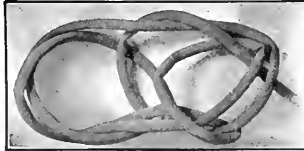

The above cuts represent the non-kinking tendency of Revere as compared with the old style hose of wrapped duck construction.

Revere is Furnished on Reels in Continuous Lengths up to 500 feet.

Revere Rubber Company,

BOSTON, MASS.

NEW YORK
NEW ORLEANS

PHILADELPHIA
MINNEAPOLIS

PITTSBURG
SAN FRANCISCO

CHICAGO
PORTLAND, ORE.

STANDARD PLATE GLASS CO.

Manufacturers—Importers—Jobbers

NOW IS THE TIME TO BUY

FRENCH OR AMERICAN GREENHOUSE GLASS

LOWEST PRICES ON REQUEST

26-30 Sudbury St. BOSTON, MASS. 61-63 Portland St.

GLASS

Always Write Us Before Buying
SHARP, PARTRIDGE & CO.
22nd and Lumber Streets, CHICAGO
WE HAVE SOME SNAPS

BOSTON PLATE & WINDOW GLASS CO.

GREENHOUSE GLASS

German and American

261 to 287 A St., Boston 20-22 Canal St.

Holds Glass Firmly
See the Point  FULL SIZE No. 2
PEERLESS
Glazing Points are the best. No ricks or leaks. Box of 1,000 joints 25c. prepaid.
HENRY A. DREER,
714 Chestnut St., Phila., Pa.

PATENTS

Trademarks and Copyrights

Send your business direct to Washington. Saves time and insures better service. Personal attention guaranteed. Twenty-five years' active service. SPECIALTY: "Working on the Failure of Others."

SIGGERS & SIGGERS

PATENT LAWYERS

Box 9, National Union Building
Washington, D. C.



The "T" Bar Curved Eave Greenhouse

Is absolutely dripless, glass rests on Wood, reducing breakage and condensation, less wood than any other construction, wood all exposed—all steel inside, all wood outside.

Greenhouses of Every Type

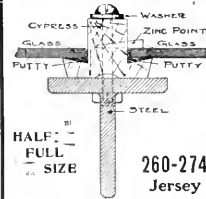

JOHN A. PAYNE

Greenhouse Designer and Builder

260-274 Culver Ave.
Jersey City, N. J.



STANDARD FLOWER POTS

Packed in small crates, easy to handle.

Price per crate		Price per crate	
1500 2 in. pots	in crate \$4.88	144 6 in. pots	in crate \$3.16
1500 2 1/4 "	" " 5.95	120 7 "	" " 4.00
1500 3 "	" " 6.00	60 8 "	" " 3.00
1000 3 "	" " 5.00	HAND MADE	
800 3 1/2 "	" " 5.80	48 10 in. pots	in crate \$3.60
500 4 "	" " 4.50	24 11 "	" " 4.80
450 4 1/2 "	" " 5.24	24 12 "	" " 4.80
300 5 "	" " 4.51	12 14 "	" " 4.80
210 5 1/2 "	" " 3.28	1 16 "	" " 4.50

Seed pans, same price as pots. Send for price list of Cylinders for Cut Flowers, Hanging Baskets, Lawn Vases, etc. Ten per cent off for cash with order. Address Hilfinger Bros., Pottery, Fort Edward, N.Y. August Bolker & Sons, Agts. 31 Barclay St., N. Y. City.

Standard Flower .. POTTS

If your greenhouses are within 500 miles of the Capital, write us, we can save you money

W. H. ERNEST

28th and M Street WASHINGTON D. C.

In ordering goods please add "I saw it in HORTICULTURE."

In writing to Advertisers kindly mention Horticulture

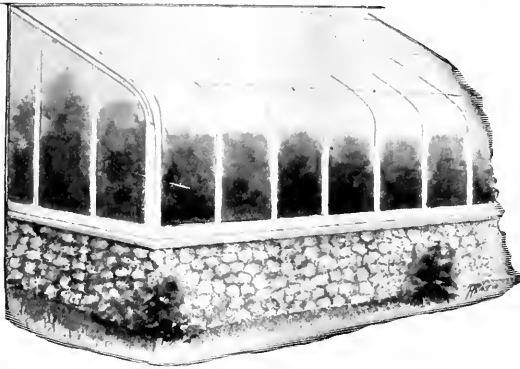

Why My New Curved Iceless Eave is Far Superior to Anything on the Market Today

- 1st. No sash bars incased in iron, thereby eliminating all danger of bars decaying.
- 2nd. Can be used in conjunction with iron frame construction, thereby doing away with that very objectionable feature, "columns."
- 3rd. Roof bars with drip grooves, which act as conductors to carry away the condensation: Result, the driest roof ever used for greenhouse purposes.
- 4th. **THE MOST IMPORTANT OF THEM ALL.** The very small increase in cost over the ordinary style of construction which makes it possible to be used for commercial as well as private purposes.

William H. Lutton, Horticultural Architect and Builder
West Side Ave Station (C.R.R. of N.J.) Jersey City, N.J.

KROESCHELL BOILER



MADE OF FIRE BOX FLANGE PLATE
Can not Crack

Water Space in Front, Sides and Back
The Most Popular Boiler Made
SEND FOR CATALOGUE.

KROESCHELL BROS. CO.
35 Erie Street, CHICAGO, ILL.

THE FOLEY MFG. CO.

CHICAGO

Completely equipped with up-to-date machinery for the making of material for

GREENHOUSE CONSTRUCTION

From a Full Supply of Thoroughly Seasoned Lumber

Send your sketches to our draughtsmen for completion and suggestion. Permit us to figure your proposed work, large or small.

We guarantee our prices will save you money

FOLEY VENTILATING APPARATUS IS THE BEST

Is Simple in Erecting, is Easiest of Operation. It Will Last a Lifetime. Its Price is the Lowest. Will Ventilate Any Size House. Prices and Circulars on Application.

Our 1908 Catalogue Greenhouse Material Sent Postpaid on Request.

THE FOLEY MFG. CO., WESTERN AVENUE
25th and 26th STS., CHICAGO



The Advance Ventilating Apparatus

You run no risk in buying our machines as we guarantee satisfaction or no sale. Get our new circular, take note of the many good and practical things we have for the florists, scan our net prices and compare same with others and remember that we dare any other line to give you as good, as long and as easy service as we will.

The Advance Co.
RICHMOND, IND.

IRON PIPE

SECOND HAND

WROUGHT IRON PIPE, for Steam, Water, Gas or Oil, Fences or Posts. All Sizes. Price Low.

GO. B. DOANE & SON
18 Midway Street, BOSTON
Telephone, Main 4419

CYPRESS SASH BARS
32 feet or longer
HOT BED SASH
PECKY CYPRESS BENCH LUMBER

GREENHOUSES

ERECTED AND EQUIPPED COMPLETE IF DESIRED

Write for Circular "D" and Prices

The A. T. STEARNS LUMBER CO.
NEPONSET, BOSTON, MASS.



Evans 20th Century Arm
Will not twist the shafting pipe. Three times the power of old style elbow arms. Sold only with Evans Challenge Machine. Write for free catalogue to **QUAKER CITY MACHINE CO.** Richmond, Ind.

In ordering goods please add "I saw it in HORTICULTURE."

EVERYTHING FOR GREENHOUSE BUILDING

WRITE FOR INFORMATION AND PRICES

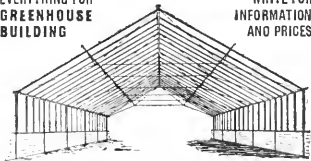

King Greenhouses. King Gutters and Eaves. Trussed Roofs. Ventilating Machinery. Trussed Iron Frame Houses. * Tile Benches and Pipe Hangers.

KING CONSTRUCTION COMPANY
NORTH TONAWANDA, N. Y.

GREENHOUSE CONSTRUCTION LUMBER

John C. Moninger Co.
117 E. Blackhawk St., CHICAGO.

The FLORISTS' HALL ASSOCIATION OF AMERICA, insurer of 29,000,000 sq. ft. of glass. For particulars address **John C. Ester, Sec'y, Saddle River, N. J.**

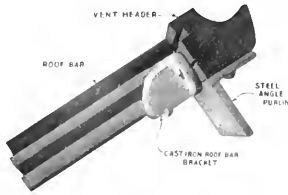

HEADER FACTS

You know that it is not safe construction to depend on a couple of nails, toed into the header, to hold the bars.

The same roof bar brackets that are such stiffeners on our eaves, we also use at the header.

An angle purlin stiffens the cypress header, which is grooved for the glass, and milled with a drip gutter.

Other construction facts shown in new circular — send for it.

Hitchings & Company
1170 Broadway New York

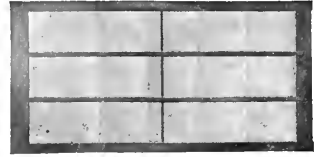

What Are You Doing About Sash This Year?

Going to keep on spending your money for the open mortise kind that are a few cents cheaper, and which in a short time go all to pieces — or will you invest in the L & B kind, made with blind mortises, snug, weather-proof joints and round iron tie rod — the Sash That Last? Saw some of these L & B sash at Stamford, Conn. last week, that are thirty-three years old, and apparently good for years yet. How is that for lasting? Send for our Sash Circular and prices.

Lord & Burnham Co.

Main Sales Office: 1133 BROADWAY, N.Y.

BOSTON: 819 Tremont Building. PHILADELPHIA: 1215 Filbert St.



LAST WEEK AND WEEK BEFORE

We talked with you about two propositions where ground space was limited and the very lightest possible greenhouse was necessary, because the nearby buildings would somewhat shade them — and so just because it is the lightest house, the U-Bar was chosen.

Now here is another case in the same City, where space was not a question — there was plenty — but attractiveness was decidedly important.

You see the greenhouses are one of the most prominent features of the layout and are connected direct to the dwelling by a loggia, that is glass enclosed during the coldest months. And so once more the U-Bar construction was chosen.

Seems to us you never sent for that catalog — did you?

U-BAR GREENHOUSES

PIERSON

DESIGNERS AND BUILDERS



U-BAR CO.

1 MADISON AVE., NEW YORK

HORTICULTURE

Vol. IX.

JANUARY 30, 1909

No. 5



A. M. HERR

President-elect American Carnation Society.

Library
NEW YORK
BOTANICAL
GARDEN

*Devoted to the
FLORIST, PLANTSMAN,
LANDSCAPE GARDENER,
and
Kindred Interests*

*Published
EVERY SATURDAY
At 11 Hamilton Place,
BOSTON, MASS.
Subscription, \$1.00*

FEB 1 - 1909

CARNATIONS ROOTED CUTTINGS

NEW INTRODUCTIONS

Mrs. Chas. Knopf, light pink } (Knopf)	Per 100	Per 1000
Ruby, Crimson		
Georgia, white Cockcroft	\$12.00	\$100.00
Mrs. J. C. Vaughan, white (Rudd)		
Bay State, variegated (Roper)		
Pink Delight (Dorner)		
Wanoka, crimson		
Apple Blossom, white light pink marking } (Wanoka Greenhouses)	Per 100	Per 1000
O. P. Bassett, scarlet (Bassett & Washburn)	\$8.00	\$60.00

Standard Varieties

One Hundred Thousand Cuttings selected strong stock ready to ship

"WHITE"		"PINK"			
per 100	per 1000	per 100	per 1000		
Sarah Hill.....	\$6.00	\$50.00	Splendor.....	\$6.00	\$50.00
Pres. Seelye.....	6.00	50.00	After Glow.....	6.00	50.00
Lloyd.....	5.00	40.00	Winnona.....	6.00	50.00
White Enchantress.....	3.50	30.00	Lawson Enchantress.....	5.50	50.00
White Perfection.....	2.50	20.00	Welcome.....	4.00	35.00
			Winsor.....	3.50	30.00
			Atstocrat.....	3.50	30.00
			Rose Pink Enchantress.....	2.50	20.00
			Enchantress.....	2.50	20.00
			Lawson.....	2.50	20.00

CHRYSANTHEMUMS

Golden Glow, 2½ in. pots, ready for shift, \$8.00 per hundred. Rooted Cuttings, selection of forty varieties, the cream of the commercial sorts. Write for list and prices.

NEW ROSE MY MARYLAND

Grafted, 2½ in. pots, \$20.00 per hundred, \$150.00 per thousand; Own Roots, 2½ in. pots, \$10.00 per hundred, \$90.00 per thousand.

ORDERS BOOKED NOW FOR THIS MOST PROMISING VARIETY.

S. J. Reuter & Son, Inc., WESTERLY, R. I.

The two novelties, Mrs. Chas. Knopf and Ruby give great promises as commercial varieties. Both are free producers. We have them both growing side by side with the standard sorts and they have demonstrated now that they are here to stay. Mrs. Chas. Knopf is at this time especially good being larger and of better form and color than Enchantress Ruby is a very large, perfectly formed flower with excellent stem and it has a good crimson shade not too dark.

BAY STATE

Orders for January Delivery are being rapidly booked.

If you want to get in on the ground floor with this noblest of all the new carnations place your order at once.

Rooted Cuttings, \$12.00 per 100, \$100.00 per 1000

ALBERT ROPER, Tewkesbury, Mass.

NEW RED CARNATION O. P. BASSETT

Extra Large Bright Red Free Bloomer

PRICES
Rooted Cuttings, per 1000, \$60.00 | Rooted Cuttings, per 100, \$8.00 | Rooted Cuttings, per 25, \$2.50
per 500, \$5.00 | " " " " per 50, 4.50 | " " " " per 12, 1.50

Ready for delivery Jan. 1st, '09 by the Originators and Growers

BASSETT & WASHBURN, HINSDALE, ILL

Send for our Preliminary List describing and quoting Chrysanthemums and Carnations.

A fine lot of Carnation Cuttings ready now.

THE E. G. HILL CO., RICHMOND INDIANA

Rooted Carnation Cuttings

	per 100	per 1000
WHITE		
Mrs. J. C. Vaughan,	\$12.00	\$100.00
Sarah Hill,	6.00	50.00
Pres. Seelye,	6.00	50.00
Lloyd,	5.00	40.00
White Enchantress,	4.00	35.00
White Perfection,	3.00	25.00
Lady Bountiful,	3.00	25.00
White Lawson,	3.00	25.00

	per 100	per 1000
LIGHT PINK		
Mrs. Chas. Knopf,	12.00	100.00
Enchantress,	3.00	25.00
Melody,	3.00	25.00

	per 100	per 1000
PINK		
Splendor,	6.00	50.00
Winsor,	3.00	25.00
Rose Pink Enchantress,	3.00	25.00
Welcome,	3.00	25.00

	per 100	per 1000
CERISE PINK		
Lawson-Enchantress,	6.00	50.00
Afterglow,	6.00	50.00
Aristocrat,	4.00	35.00

	per 100	per 1000
SCARLET		
O. P. Bassett,	8.00	60.00
Andrew Carnegie,	6.00	50.00
Defiance,	6.00	50.00
Beacon,	4.00	35.00
Victory,	3.00	25.00

	per 100	per 1000
VARIEGATED		
Lucille, white overlaid with pink,	12.00	100.00

	per 100	per 1000
CRIMSON		
Ruby,	12.00	100.00

Chicago Carnation Co., JOLIET, ILL.

A. T. PYFER, Mgr.

CARNATIONS Rooted Cuttings Fine Healthy Stock

	per 100	per 1000
Pres. Seelye	6.00	\$50.00
White Enchantress, Beacon	3.50	30.00
Victory, Winsor, Melody,		
Kingston Pet	3.00	25.00
Daheim, Enchantress, Lady Bountiful, Mrs. Lawson, White Lawson, Red Lawson, Variegated Lawson	2.50	20.00

WOOD BROTHERS FISHKILL, N. Y.

JUST AS A REMINDER TO OUR PATRONS

We have rooted cuttings of the best

CARNATIONS

PATTEN & COMPANY, Tewksbury, Mass.

MARCHIONESS

The Money Making White Carnation \$10 00 per 100; \$80.00 per 1000

Orders Filled Strictly in Rotation BELLAMY BROS.

Successors to L. E. Marquisee, SYRACUSE, N. Y.

In writing to Advertisers kindly mention Horticulture

For Early or Late Forcing

HARDY AZALEA, MOLLIS—This hardy Azalea is becoming more popular every season to force as a pot plant; it is a profitable plant to handle, as it can be grown at a minimum cost; when in bloom it is useful for decorative purposes, and also appeals to the retail buyer as a house plant. We have an exceptionally fine lot of well bedded plants, 15 to 18 inches high, **\$4.50 per doz.; \$35.00 per 100.**

RHODODENDRON, PINK PEARL,—As an ideal pot plant, nothing can equal this beautiful variety. The individual flowers as well as the trusses are of gigantic size, while its color, a beautiful pearly pink, cannot be improved upon. We believe this is one of the coming pot plants, and when it becomes more plentiful and lower in price it will be very popular. You should try a few plants and become acquainted with it. A limited stock of good plants, about 15 inches high, with 5 or more trusses, **\$1.50 each**

DEUTZIAS, Extra strong field grown plants for forcing.

GRACILIS.....	\$1.25 per dozen;	\$8.00 per 100;	\$70.00 per 1000
" Rosea.....	1.25 per dozen;	8.00 per 100;	70.00 per 1000
LEMOINEI.....	1.50 per dozen;	10.00 per 100;	90.00 per 1000

For a full line of reasonable stock see our wholesale list, issued January 1st

HENRY A. DREER, Philadelphia, Pa.



CARNATION CUTTINGS

We offer choice varieties for January and later shipments.

	Per 100	Per 1000
Enchantress.....	\$2.50	\$20.00
White do.....	3.50	30.00
Rose Pink do.....	2.50	20.00
White Perfection.....	2.50	20.00
Winsor.....	3.50	30.00
Melody.....	2.50	20.00
Beacon.....	3.50	30.00
Victory.....	3.50	30.00
Aristocrat.....	3.50	30.00
Splendor.....	6.00	50.00
Vesper.....	3.50	30.00
White Lawson.....	2.50	20.00

EAST SUDBURY GREENHOUSES,
Carnation Specialists

P. O. Address South Sudbury, Mass.
Telephone 50, Sudbury 20.

The Great Red Winner **WM. H. TAFT** Worthy of its Namesake

Christmas week 4000 blooms were cut from three beds 150 feet long. Flowering continuously since October 1

ROOTED CUTTINGS NOW READY

Prices:—25, \$4.00; 50, \$7.00; 100, \$12.00; 500, \$50.00; 1000, \$90.00

SEND FOR ILLUSTRATED CIRCULAR

The Taft is grown at Evanston, corner of Oakton and Ashbury Ave., Chicago.

FOLLOWING ARE OTHER VARIETIES ALSO READY FOR IMMEDIATE SHIPMENT:

Enchantress.....	100, \$1.75; 1000, \$15.00	White Lawson.....	100, \$2.00; 1000, \$18.00
Pink Lawson.....	100, 1.50; 1000, 12.50	Variiegated Lawson.....	100, 2.75; 1000, 25.00
Victory.....	100, \$2.50; 1000, \$20.00		

UNROOTED CUTTINGS

Mrs. E. A. Nelson.....	100, \$0.60; 1000, \$5.00	Variiegated Lawson.....	100, \$1.50; 1000, \$12.50
Boston Market.....	100, 0.50; 1000, 5.00	Crosser.....	100, 1.00; 1000, 5.00
Pink Lawson.....	100, 0.75; 1000, 6.25	White Lawson.....	100, 1.00; 1000, 9.00

SCHEIDEN & SCHOOS, 58-60 Wabash Ave. CHICAGO

MY COMPLETE LIST OF MUMS, CARNATIONS AND ROSES

has been mailed you. If not yet received send me a postcard. I carry over 300 varieties of **The Finest Chrysanthemums in Commerce** and offer you just the cream of the world's novelties, discarding the poor ones. **Saves You Money and Ms Trouble!** New Carnations ready for immediate delivery **Bay State, Georgia, Mrs. J. C. Vaughan,** \$12.00 per 100; \$100.00 per 1000. **Mrs. O. P. Bassett, \$8.00 per 100.**

CHARLES H. TOTTY, - Madison, N. J.

Rooted Carnation Cuttings

A Selection from 20 Sorts.
(For Early January Delivery, and Later)
Every one Reliable.

White	W. Perfection	100	1000
Red	Beacon	\$4.00	\$25.00
	Enchantress	3.00	25.00
Light Pink	Melody	3.00	25.00
	Winsor	3.00	25.00
Piedum Pink	Winooa	6.00	50.00
	Rose Enchantress	3.00	25.00
Dark Pink	Splendor	6.00	50.00
	Viola Sinclair	6.00	50.00
Variiegated	Var. Lawson	3.00	25.00
Crimson	Octoroon	3.00	25.00

PETER FISHER, - Ellis, Mass.

NEW CARNATION PINK DELIGHT

Waxy Shell Pink. A Grower's and Shipper's favorite. Has a holding color, keeps well, comes on long stems and is early, very free and continuous flowering.

January delivery, \$12.00 per 100; \$100.00 per 1000.
F. Dornier & Sons Co., La Fayette, Ind.

NEPTUNE

is the only yellow Carnation on the market that is growing. Very strong. Free and easy growth. Hasn't burst 1/2 of 1 per cent in 4 years. Well rooted cuttings now ready, \$8.00 per 100. Other commercial varieties at reasonable prices.

PAUL THOMSON, Grower
West Hartford, Ct.

GOLDEN GLOW

THE BEST EARLY CHRYSANTHEMUM

Can be Cut by Aug. 15th

Plants From 2 1-4 In. Pots Now Ready
\$6.00 per 100, \$50.00 per 1000

S. J. GODDARD
FRAMINGHAM, - MASS.

A. N. PIERSON, Inc.
CROMWELL, CONN.

Wholesale Growers of Cut Flowers, Palms and Ferns

OUR SPECIALTIES. Roses, Lily of the Valley and Carnations. We also grow a general assortment of flowers in their season

Gladioli fine named sorts; colors, seedlings and mixtures.

Iris Pallida Dalmatica, German and Japan Iris, Madeira Vines, Cinnamon Vines, Hyacinthus candicans, Spotted Callas.

Send for Price List.
E. S. MILLER,
Wading River. Long Island, N. Y.

CANNAS

We are the largest Canna growers in the world and can make attractive prices on 200 kinds. Let us quote on your entire list for immediate or spring delivery or contract 15th dormant roots. Also Caladiums, Gladiols, Dahlias, Tuberoses, etc.

SHELLROAD CANA FARMS,
Grange P. O. Baltimore, Md.

CYCLAMEN GIGANTEUM
5, 6 and 7 in. pots—50c, 75c, and \$1.00 each.

Extra heavy stock of the very best quality.
Thomas Roland,
Nahant, Mass.

White Killarney "WABAN CONSERVATORIES VARIETY"

OUR SPORT is known as above or "Waban Variety."

You must have OUR SPORT.

Be sure of the best stock—order from us.

WABAN ROSE CONSERVATORIES, Natick, Mass.

Newport Fairy
 The Rose of the Future For In and Out Door.
 FINE, STRONG FIELD-GROWN STOCK
 3-4 Shoots 3-4 ft. long
 50c each, \$30 per 100, \$250 per 1000
JULIUS ROEHR'S CO.,
 RUTHERFORD, N. J.

Hardy Rhododendrons, Azaleas, Conifers, Clematis, H. P. Roses, Shrubs and Herbaceous Plants from our
HOLLAND NURSERIES
 Prices Moderate
P. OUWERKERK, 216 Jane St., Woburn Heights
 P. O. No. 1, Woburn, N. J.

CLEARY'S HORTICULTURAL CO.
 Management **AMBROSE T. CLEARY**
 Wholesale Contracting, Jobbing, Auction
HORTICULTURAL PRODUCTS
 or every description.
 Consignments Received. Surplus Stock Converted
62 Vesey St., NEW YORK

Box Trees
 and other **EVERGREENS** for Tubs and Boxes
 Our Prices are Always Right—Catalog Free
THE NEW ENGLAND NURSERIES, Inc.
BEDFORD, MASS.

ROSES
 We have a fine stock of large, dormant field-grown plants, on own roots, including Crimson Rambler, Dorothy Perkins, Cleo, Alfred Colomb, Francois Levet, Jack, Prince Camille de Rohan, Magna Charta, Ulrich Brunner, Giant of Battles, and many others at \$4.00 per hundred; \$5.000 per thousand. Send for list. Roses, Dahlias and Cannas a specialty.
THE DINGEE & CONARD CO. W. Gr. ve. Pa.

ROBERT CRAIG CO.
ROSES, PALMS,
 and Novelties in Decorative Plants
MARKET and 49th STREETS., PHILADELPHIA, PA.

BARGAINS in TREES and PLANTS
 Concord Grapes, \$2.00. Peach, \$5.00 per 100.
 List Free. D. J. TWOMEY, Dept. H, Geneva, N. Y.

RHODODENDRONS, ANDROMEDES, KALMIAS AND SPECIMEN EVERGREENS
JOHN WATERER & SONS, Ltd.
 AMERICAN NURSERY
BAGSHOT - - - ENGLAND

CHRYSANTHEMUMS
 Those that make the big ones. Also all the little ones.
 All the best ready now.
 We also make a specialty of Aster Seeds and grow our own.
 None better than those we offer. A sample order will convince you as it has many others.
ELMER D. SMITH & CO., Adrian, Mich.

RHODODENDRONS-RHODODENDRONS
 An immense stock of all the **hardest known kinds**, 2 to 3 1/2 ft., fine plants and all home grown, many being on own roots, far better than grafted stock—also **R. Catawbiense** seedlings of all colors and seedling **Hardy Azaleas** not to be obtained elsewhere. This is the nursery in which most of the Rhododendrons that have proved **hardy in America** were raised.
GOLDEN YEW'S, KALMIAS, and other HARDY PLANTS in great variety and of all sizes.
 Catalogues on Application
ANTHONY WATERER Knap Hill Nursery Knap Hill
SURREY, ENGLAND
 (NO CONNECTION WHATEVER WITH ANY OTHER FIRM.)

TREES, EVERGREENS, SHRUBS, VINES, PERENNIAL PLANTS, FRUIT'S, TRAINED FRUIT TREES, FOREIGN GRAPE VINES, HARDY RHODODENDRONS and R. MAXIMUM in quantity, per hundred or per thousand, very fine. Complete assortments: Careful grading: Low prices.
AMERICAN NURSERY COMPANY,
 Sales Department, - - - 150 BROADWAY, NEW YORK CITY.
BLOODGOOD NURSERIES DEPT., - - - Flushing, Long Island.
F. & F. NURSERIES DEPT., - - - Springfield, New Jersey.
 In ordering goods please add, "I saw it in HORTICULTURE"

European Horticulture

SPECIAL SOCIETIES IN ENGLAND

Under this denomination may be counted such as are devoted to the Sweet Pea, the National Auricula, the National Chrysanthemum, Perpetual Flowering Carnation, National Dahlia, with which last the London Dahlia Society is now amalgamated; and the National Rose Society. Most, if not all these societies, can look backwards on a year of successful effort and of prosperity. The National Rose Society, which for several years was in a languishing condition, has received increased support from the gardening public, and has increased its membership. At the end of 1907 the members numbered 2,181, and new members have since joined to the number of 666. At the recent annual meeting Mr. Edward Mawley was the recipient of one hundred pounds in recognition of his valuable services as honorary secretary.

The cultivation of the newer varieties of sweet peas is extending rapidly in England, and also on the continent, and the membership of the National Sweet Pea Society has increased from 692 to 779. So beautiful are the varieties now in commerce, and so great is the admiration of the public that we may hope in a few years to see the last of the old inferior varieties banished from our gardens. The dwarf "præcox" varieties are only awaiting the attention of the cross-breeder ere taking their deserved place as forcing plants for late winter and spring, and as objects for general decorative purposes in the summer months.

The National Carnation and Picotee Society has recently sustained a great loss in the death of its president, Martin R. Smith, who was the most successful raiser of carnations and picotees this country has ever known. This society, as also the National Auricula and Picotee, and the Perpetual Flowering Carnation Societies have all had their special exhibitions in the past year. All are doing useful work in their special spheres. The National Dahlia Society and the London Union have joined hands—a fact that will most probably tend to increase the usefulness and prestige of the newly instituted body.

The National Chrysanthemum Society maintains its hold on the public, and is well supported. The show held at the Crystal Palace on December 2 and 3 was of average merit, but the entries were slightly fewer than on some former occasions. Fourteen new varieties were presented to the floral committee, but only two were awarded a certificate of merit, viz., *Aurora Boreale*, a

single flowered variety of large size with reddish bronze colored florets that run into yellow at the base; and *Kathleen May*, a decorative variety of a deep crimson tint and having an "anemone" centre. The following fine varieties were observed, viz., *Kitty Gullivan*, cerise red; *Mrs. Wynne*, an incurved flower; *Helen Williams*, a yellow sport from *Madame R. Oberthur*; *Snowdrift*, *True Gold*, *Mrs. Wakefield* (terra cotta color). *Pollox* and *Juno* were fine yellow varieties shown by Mr. Norman Davis.

HELIOTROPE FRAU G. VON POSCHINGER

This new variety of heliotrope is but little, if at all, known to English gardeners; yet it is an ideal plant for the greenhouse, brings large corymbs of blooms of a beautiful blue tint, the corymbs supported on strong stalks; and is not at all tender in constitution. It possesses all the good properties a heliotrope should have. Well grown examples of the plant in smallish pots have been disposed of in Germany for 12s. a plant—a high price for such subjects. A plant of this variety was figured in "Möller's Deutsche Gärtner-Zeitung," Nov. 11, 1908.

DRACEANA BROOMFIELDI

This species was imported for the first time by John Broomfield from the South Sea Islands in the year 1878, but the plants were found to be dead on arrival. An importation made in 1897 was more successful, and the plant was shown at Ghent in 1898. Apparently the plant is not readily propagated, and although ten years have flown since that year it has remained scarce, which is remarkable for so fine a species. A variety of the plant, *D. B. superba*, appeared in 1903 for the first time, and a specimen of it was exhibited at Ghent last year. The leaves are edged in a lively manner in the variety.

Fredrick Moore

Mexican Ivy

Epimedium alpinum is the proper name of the plant, the leaves of which have been sold extensively this season in Chicago for florists' use, under the name of "Mexican Ivy." This plant is a native of Japan. We have a nearly allied native plant of our own, *Vancouveria hexandra*, which is found abundantly in the northwest section of the U. S. and in western Canada. The foliage is very much like that of *Epimedium* and could be used in the same manner.

HORTICULTURE

VOL. IX JANUARY 30, 1909 NO. 5

PUBLISHED WEEKLY BY HORTICULTURE PUBLISHING CO. 11 Hamilton Place, Boston, Mass.

Telephone, Oxford 292 WM. J. STEWART, Editor and Manager

SUBSCRIPTION PRICE

One Year, in advance, \$1.00; To Foreign Countries, 2.00; To Canada, \$1.50

ADVERTISING RATES

Per Inch, 30 inches to page \$1.00. Discounts on Contracts for consecutive insertions, as follows: One month (4 times) 5 per cent.; three months (13 times) 10 per cent.; six months (26 times) 20 per cent.; one year (52 times) 30 per cent. Page and half page spaces, special rates on application.

Entered as second-class matter December 8, 1904, at the Post Office at Boston, Mass. under the Act of Congress of March 3, 1879.

CONTENTS

Table listing contents with page numbers: COVER ILLUSTRATION—A. M. Herr, President-elect American Carnation Society. EUROPEAN HORTICULTURE—Frederick Moore. 137 MEXICAN IVY 137 CARNATIONS IN THE WEST—Illustrated. 139 NEWS OF THE CLUBS AND SOCIETIES: Gardeners' and Florists' Club of Baltimore. 139 New Orleans Horticultural Society—Minnesota State Florists' Association—American Rose Society—Society of American Florists. 141 State Horticultural Association of Pennsylvania—Nebraska Horticultural Society—St. Louis Horticultural Society—New York Florists' Club. 145 CLUB AND SOCIETY NOTES. 146 AMERICAN CARNATION SOCIETY: Eighteenth Annual Convention at Indianapolis—Address of President—Treasurer's Report—Secretary's Report. 149 List of Awards. 141 Thursday's Session—Election of Officers. 142 CARNATION DOROTHY GORDON—Illustrated. 141 NIAGARA—Illustrated. 142 FEMIGATING WITH HYDRO-CYANIC ACID GAS—Alfred J. Loveless. 143 FIGURT TREES UNDER GLASS—P. T. Barnes. 146 SEED TRADE: American Seed Trade Association. 148 OBITUARY—Mrs. Walter Reimels—John Henry—Alfred S. Jones—Mary L. Raeder—G. A. Weaver. 151 FLOWER MARKET REPORTS: Baltimore, Boston, Buffalo, Chicago, Philadelphia, Washington, New York. 153 MISCELLANEOUS: Patents Granted. 143 Business Changes. 146 Catalogues Received. 148 Publications Received. 148 Fire Record. 148 Personal. 150 Steamer Departures. 150 New Retail Flower Stores. 151 News Notes. 151, 153 Philadelphia Notes. 153

sending of any part of it by mail in time for publication on our regular day and we do not think it would be fair to our readers as a whole to send out the paper one day late. Such detailed reports as might suffer in precision or clearness by telegraphic transmission we have preferred to hold back until our issue of next week when we shall be able to give them in fuller and more interesting and intelligible form, in connection with the closing proceedings and the story of the banquet on Thursday evening.

Utilizing vacant space Visitors to the F. R. Pierson Company's carnation houses at Scarborough, N. Y., all notice and comment approvingly on the graceful effect of the sweet peas which are trained on the numerous upright supports throughout the houses. Mr. Pierson says that the returns from these peas amount to a sum not to be despised and their effect in slightly tempering the bright sunlight is good so it is just so much added to the aggregate income from the house. It is easy to detect the thrifty grower by the way in which the odd corners in a greenhouse are utilized. We often wonder why so many growers tolerate so much unoccupied and wasted space in their establishments, forgetting apparently that every square foot of bench surface under glass costs just so much in cash for maintenance. These men would not think of harboring an idle employe on the place yet they thoughtlessly maintain idle space which in many instances costs more than a man would.

Vilifying an American industry A certain European dealer in tree and grass seeds has seen fit in a recent communication to one of our contemporaries to reflect upon the reliability and business integrity of the American dealers in Kentucky Blue Grass (Poa pratensis). We do not like to see such statements as the one in question which we have good reason to believe is an unfounded vilification of an important industry conducted by honorable merchants. We are assured by those in a position to know that there are some of the most reliable firms in the seed business in central Kentucky that can be found on the globe. No doubt there is a quantity of old Blue grass in existence but we are quite sure that nine men out of every ten in the seed business know the location of same. There is also plenty of guaranteed high-class new crop seed in stock and any buyer wanting to purchase same from responsible people will get just what is represented. Perfection does not exist, of course, in the seed trade any more than in any other line of business and, as Mr. Brown intimated in his contribution on this topic to HORTICULTURE under date of January 16th, if there should be as much competition for quality as there is for price there would be a material improvement in the results obtained from the seed sown but this does not justify a general condemnation of an industry in which unreliability is certainly the exception, not the rule.

The carnation meeting still in session at Indianapolis as we go to press. Such news of the meeting up to the present moment as we have been able to give in this issue is transmitted entirely by telegraph, the great distance precluding the

Carnations in the West



HOUSE OF SELENDOR
Chicago Carnation Co.



HOUSE OF WHITE ENCHANTRESS
Chicago Carnation Co.

No one should go to Chicago without taking the trip to Joliet and visiting the houses of the Chicago Carnation Company. Their motto is "Not the largest but the best" carnation establishment, and they are fast making a record to this effect. During a recent visit we noted White Enchantress, the strain that won the \$100 cup at the National Show, and Splendor, which they will grow extensively another year; it blooms two weeks ahead of any others. Defiance is not proving satisfactory with them, as it splits badly. Aristocrat is a favorite by reason of its length of stem and productiveness. Carnatic on account of its upright habit, admits of nearly double the number of plants being grown in the same space.

But the pride of the place is Seedling 509, one of James Hartshorne's last productions. Three-fourths of the petal is a pure rose pink, the other fourth is a border of a light flesh pink. The effect is decidedly striking.

Four thousand blooms daily is the output of this company to the retail stores. The numerous prizes won and the success attained by them show what can be done by careful selection and thorough cultivation. A. T. Pyter is the present able manager.

GARDENERS' AND FLORISTS' CLUB OF BALTIMORE.

The semi-monthly meeting of the Gardeners' and Florists' Club was held on Jan. 25. Attendance good and meeting interesting. The question box revealed the fact that some of our rose growers are experiencing difficulty with My Maryland. One reported having visited Mr. Cook's establishment quite recently and that at the home of this rose no trouble of any kind existed; on the contrary the conditions both in the flowering bed and in the propagating bench are such as to leave nothing to be desired. Mr. Cook will be invited to the next meeting to give full information as to cultural necessities, etc.

The next meeting will be Carnation Night. Consideration was given to the idea of offering premiums for the new-

er varieties and inviting exhibits from all over the country. This was finally abandoned and just Carnation Night, without frills, was the final conclusion. A letter was read from the Sports Committee of the Philadelphia Club,

suggesting a tri-city bowling contest between Philadelphia, Washington and Baltimore, three games at each city. This was referred to the bowling team, and the contest will take place in the near future.



ARISTOCRAT
As Grown by Chicago Carnation Co.

AMERICAN CARNATION SOCIETY

Eighteenth Annual Convention at Indianapolis — A Magnificent Exhibition—Splendid Attendance.

The convention opened under the most favorable auspices, with a magnificent exhibition, splendid attendance and weather like May. A short session was held at noon, when Fred Burki, Eugene Dailledouze and S. S. Pennock were appointed as extra judges. The regular session opened at 7:30 p. m. with an eloquent address of welcome by City Attorney Bowen, which was loudly applauded. This was responded to by E. G. Gillett, who rose to the occasion in his appreciative remarks on the hospitality extended and the splendid facilities provided for the meeting and exhibition. President M. A. Patten was then introduced and after an enthusiastic welcome read his address, as follows:

ADDRESS OF THE PRESIDENT.

Ladies and Gentlemen of the American Carnation Society: We have been already in Indianapolis long enough to learn that we are among indulgent friends. As eighteenth president I also extend you a welcome and wish you all a prosperous and happy New Year, and a successful convention on this our third visit to Indianapolis.

The past year has been a trying one to the florists. The depression in business has laid a heavy hand on many, but the future looks bright. Let us be alert and ready to take advantage of the improvement in business.

Many new varieties of carnations have been introduced the past season; time will tell how many will prove worthy of perpetuation. Anyone sending out a new variety should exercise due care to have the stock healthy, cuttings good and well rooted.

The carnation is still the popular flower, and as our Society stands for the advancement of the carnation, continue it so. The raisers of new varieties have made marked improvement, but have not reached perfection yet.

I think it generally understood that this Society does not necessarily endorse a variety as a profitable kind to grow commercially, because it has been successful in obtaining a prize.

At the National Flower Show at Chicago, last November, under the auspices of the Society of American Florists, the interest in carnations was indeed manifested by the enthusiasm of the many visitors. This was probably the largest exhibition of carnations at a fall show ever held in the country, and was a credit to the exhibitors.

As our conventions are held in different parts of the country, some members lose interest when the conventions are held at a distance and drop out. As our society creates an interest in

the carnation and the proceedings at our meetings are quoted over the entire country, every florist receives the benefit to a certain extent and ought in justice to the society to become a member, even if unable to attend.

Some florists have been growing their carnations on concrete benches; it would be interesting if they would relate their experiences. It probably is economy to build or concrete if the plants do equally as well as on the wooden benches. Many growers have dispensed with the use of bone, and claim that their plants do just as well, if not better.

Last year the Experiment Station at Washington devoted a lot of work to carnations, which was appreciated by all who had the privilege of visiting the greenhouses and listening to Dr. B. T. Galloway, Chief of the Bureau of Plant Industry. We might get more good from this Bureau if we would try, for the officers are ready to work with us.

What about having pot grown carnations at our exhibitions? This has been called to your attention by former presidents, but we don't seem to make any headway in the matter. I think it would be a good thing for the introducers of a new variety to have a well grown pot plant in a pot to show with the cut flowers. It certainly would be of interest to intending purchasers.

Would it not be well to offer prizes for collections of three or more pot grown carnations, say \$10.00, \$6.00, \$4.00. It would give more material to make an exhibition and tend to create more interest in the divine flower. Pot carnations years ago were quite a source of revenue to the florists.

At the convention of the S. A. F. at Niagara Falls, last August, the Carnation Society voted the sum of \$25.00 to be sent as a premium to the Perpetual Flowering Carnation Society of England.

I would suggest that the salary of the secretary be increased if possible.

I hope all our members will wear a carnation in memory of the lamented President McKinley, on January 29th.

I wish to thank you for the loyal support given me, especially the secretary, Mr. Albert M. Herr, and Vice-President A. E. J. Baur, also the directors.

The press, which has been so friendly to us, is entitled to all the thanks we can give it.

To the members of the local society for the arrangement and details of the exhibition, we are under obligations and grateful to each and every one.

Treasurer Fred Dörner, Jr., followed with the financial report:

TREASURER'S REPORT.

Expenditures.

Paid orders on Treas.,	\$1104.54	
Cash on hand, Jan. 24,		
1909	227.58	
		\$1332.12

Receipts.

Cash from Sec'y Herr,	\$81.00	
Cash from interest...	113.07	
Balance Jan. 24, 1908,	338.05	
		\$1332.12

Permanent Fund.

Reported Jan. 21, 1908,	\$2375.31
-------------------------------	-----------

F. E. DÖRNER, Treas.

Secretary A. M. Herr then read his report for the year:

SECRETARY'S REPORT.

Mr. President and Fellow Members of The American Carnation Society.

Your Secretary begs leave to report having issued the Report of our Annual Meeting in due time and having mailed the same to all members in good standing.

January 4th the Premium List was issued and mailed to all members on our books; this list was made up as per instructions from your Board of Directors at a meeting held in Washington last January. The usual effort was made to secure advertisements for this list by your Secretary. A circular letter was sent to every member on our books and about 200 possible advertisers who were not members of this Society. This was followed up by a personal letter to a hundred or more whom your Secretary thought should advertise with us. The result is \$195 worth of advertising, not one fifth enough for the work of solicitation necessary to get it, and I again recommend that this part of our Premium List be abolished.

An innovation this year was a request made to every member of this Society to add to our Class B. of named varieties any variety they might want to see inserted, providing they would pay the premiums, if any were awarded. This was followed up by an appeal made through the trade papers and the result was one addition, that of Afterglow, by R. Witterstaetter, Cincinnati, Ohio. This manager response may have been due to this feature not being properly understood and partly owing to financial depression. At least it is to be hoped that we as individuals will have pride enough in our Society to see

that this part of our Premium List is well filled for another year.

In membership we have 32 who have not paid their dues for 1908 and 11 new members so that we are gradually gaining in membership as the new list will no doubt be increased considerably at this meeting. There were several deaths during the year, but no notice being received by your Secretary, no official announcement can be made.

I want to thank the President and Vice-President for their assistance during the past year and beg pardon for the few errors that have occurred during the same period. I also want to thank every member of this Society for their hearty co-operation during the fourteen years I have served them as Secretary, and bespeak for my successor the same helpful spirit from them.

This Society has advanced the carnation and its methods of culture somewhat near perfection. To continue its mission it must take up the work of popularizing the flower with the buying public, and as far as possible correct the evils and make improvements in the buying and selling end of the business.

We need a Secretary who either has ample time of his own to devote to its affairs or sufficient clerical force to have them attend to all of the details between meetings and one to whom the salary is no object for the amount of work done. With me it has been a labor of love for fourteen years, years which I can look back over with many pleasant memories and for which I feel amply repaid by the acquaintance of the men I have been working with, and that is all of you, for we have all worked together or we would not be where we are.

But a few years ago, as some of you know, I was bumped pretty hard financially, and as the hardest part of the work of this Society extends from November 1st, with the solicitation of advertisements, until some time in March with the sending out of the Annual Report without any intermission, right in my own busy season, it makes too much work for me (work that I could not possibly have given the attention I did had it not been for the kindly assistance of Mrs. Herr) and feeling that I can not give this work the attention it should have I hereby tender my resignation to take effect at the end of our official year (April 1st).

ALBERT M. HERR, Secretary.

This was received with a vote of thanks

A letter of thanks was read from the Perpetual Flowering Carnation Society of England for the trophy sent by the American Carnation Society.

Invitations for the next meeting were then presented from Pittsburg and Milwaukee, Mr. Clark speaking for Pittsburg, and Mr. Zwifel for Milwaukee.

The judges' report was then presented as follows :

List of Awards.

Class A, 100 blooms to a case. White—Steadford Flower Farms first, with Lady Bonifant; The E. G. Hill Co. second, with White Enchantress. Flesh Pink—F. Dorner & Sons Co. first, Pink Delight; second, Chicago Carnation Co. Enchantress. Light Pink—F. Dorner & Sons Co. first, Winona; second, A. C. Brown. Dark Pink—The E.

(Continued on page 112)

Carnation Dorothy Gordon

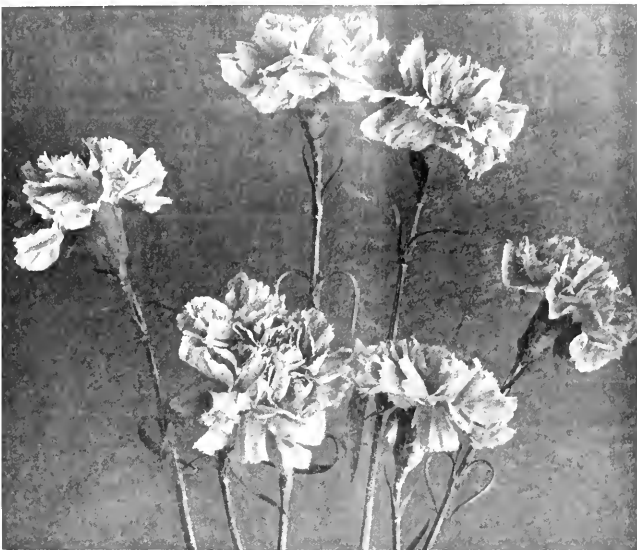

DOROTHY GORDON

Seedling by Jos. Heacock Co. (Lawson Enchantress.)

We present herewith illustrations of Joseph Heacock's sterling novelty, Dorothy Gordon, showing individual flowers and also plants as they appear growing in Mr. Heacock's houses the first week in November after having been planted three months. This

variety is a cross between Lawson and Enchantress and the color is similar to that of Rose Pink Enchantress. It was awarded a certificate at the Washington meeting of the American Carnation Society scoring 86 points. Its strong points are its constitution, size and productiveness.



HOUSE OF DOROTHY GORDON

Jos. Heacock Co.

St. Valentine's Day

Weddings

Easter

We Call Your Attention

to the approaching floral festivities of the season. You never make any mistake when you follow our tip. You'll get more customers and better prices for your flowers if you provide the right accessories to set them off.

The Florists Supply House of America

Has the Goods. No other establishment can touch us for

Originality, Novelty, Variety, Adaptability and Price.

Violet Hampers, Violet Boxes, Heart Boxes and Fancy Baskets are now in the height of their season. Tone Ware Vases are always in season. We have them in new styles. Send for illustrated list of our Wedding furnishings and requisites for Easter Trade. Every page will help you in selecting the right goods.

H. BAYERSDORFER & CO., 1129 Arch St. Philadelphia, Pa.

G. Hill Co. first, R. Witterstatter second, both with Afterglow. Red or Carmine—Bassett & Washburn, O. P. Bassett, first; Chicago Carnation Co. second, Beacon. Scarlet or Cardinal—E. G. Hill Co. with Victory, first; E. G. Hill Co. second, with Beauty. Maroon—F. R. Pierson Co. first; W. W. Coles second, with Mrs. W. W. Coles. Yellow—Bertermann Bros. with Whitecomb Ribby. Any other color—H. Weber & Sons Co. first, with Treador. Bertermann Bros. Sweepstake prize—H. Weber & Sons Co., first; A. C. Brown, second; Chicago Carnation Co., third.

Class II, 50 blooms to a vase. White Enchantress—Chicago Carnation Co., first; E. G. Hill Co., second. White Perfection—Baur & Smith, first; Chicago Carnation Co., second. Any other white—E. G. Hill Co., first; H. Weber & Sons Co., second. Enchantress—Manke Bros., first; Chicago Carnation Co., second. Any other flesh pink—Chicago Carnation Co., first; W. J. & M. S. Vesey, second. Winner—Chicago Carnation Co., first; Pittsburg Rose & Carnation Co., second. Welcome—Chicago Carnation Co., Rose Pink Enchantress—F. Dornier & Sons Co., first; Wieland & Olinger, second. Afterglow—E. G. Hill Co., first; Chicago Carnation Co., second. Any other light pink—E. G. Hill Co., first; F. Dornier & Sons Co., second, both with Winona. Lawson—Manke Bros., first; W. J. & M. S. Vesey, second. Aristocrat—F. Dornier & Sons Co., first; Chicago Carnation Co., second. Any other dark pink—Baur & Smith with Pink Imperial, first; Chicago Carnation Co. with Enchantress, second. Red Chief—F. Dornier & Sons Co., Victory—Wieland & Olinger, first; W. J. & M. S. Vesey, second. Beacon—Chicago Carnation Co., first; E. G. Hill Co., second. Any other scarlet—Chicago Carnation Co. with Carnegie. M. A. Patten—A. C. Brown, first; Wieland & Olinger, second.

Class C. The Gold Medal for best vase of 100 blooms, any variety, any color, was won by A. Roper with Ray State. The Silver Medal went to Baillodonne Bros. for Scodling 402, and the Bronze Medal to Bassett & Washburn for O. P. Bassett. The silver S. A. F. medal went to F. Dornier & Sons Co. for Scodling, the bronze to A. C. Brown for Superba.

Special Prizes.

The Wiegand Silver Cup was won by Bertermann Bros.; the State Florists' Association cup by E. G. Hill Co.; Indiana Floral Festival Association prize by E. G. Hill Co. with Afterglow; H. W. Field, cash, to F. R. Pierson Co.

Preliminary Certificates.

Preliminary certificates were awarded to W. W. Coles, for Mrs. W. W. Coles; Chas. Knopf Floral Co., for Adm. Plan, one each to A. C. Brown and Nio. Zwickel, and three to E. G. Hill Co., for varieties under name, but certificates of merit were awarded to several fine productions on which a full report will be made next week.

The report was laid on the table on Thursday. The next business was the nomination of officers.

Fred Burki and A. M. Herr were nominated for president. Mr. Burki declined the honor, but allowed his name to stand for vice-president; Louis Reuter, secretary; A. E. J. Baur, treasurer; Fred Forner, director for three years. The meeting then adjourned and the evening was spent enjoyably at the smoker and in bowling.

Thursday's Session.

The session on Thursday morning opened at eleven o'clock. The judges reported a complete list of sweepstakes awards; first to E. G. Hill Co. for Afterglow; second, Bassett & Washburn for O. P. Bassett; third, to F. R. Pierson Co. for Victory; fourth, to Strafford Flower Farm for Lady Beautiful.

Election of Officers.

The election of officers was the next

NIAGARA.



E. G. HILL CO.'S NIAGARA (No. 142) WHITE

The variety illustrated is one of a number of very handsome and promising seedlings by the E. G. Hill Company. Good whites with the per-

fection of form and finish shown in the accompanying illustration are not over-abundant, and Mr. Hill has undoubtedly secured a "trotter" in Niagara.

WARD'S BULBS

are from the most reliable sources in the world.
Sole representatives for

MARTIAL BREMOND, Ollioules, France

РУССАН HYACINTHS, PAPER WHITES, Etc.

SEITARO ARAI, Yokohama, Japan

МУЛТИФЛОРУМ, ГИГАНТЕУМ, Etc.

Strictly Wholesale

RALPH M. WARD & CO.
12 W. B'way, New York



ADVERTISE

There is a good Customer somewhere for every good thing you have to offer. *Horticulture* can help you to find him * * *

ADVERTISE

business, and the result was as follows: Albert M. Herr, president; Fred Burki, vice-president; Fred Dorner, Jr., treasurer; Richard Witterstaetter, judge. The ballot for secretary resulted in the election of A. F. J. Bauer. W. J. Stewart then read his paper on "The Relationship between Producer, Wholesaler and Retailer." F. R. Pierson, J. C. Vaughan and August Poehlmann were appointed a committee to prepare resolutions on the death of L. E. Marquisee.

A vote was passed after considerable discussion that ninety points must be received on any variety before it can receive the society's gold medal, eighty-eight points for the silver medal and eighty-six for the bronze. H. B. Dorner then proceeded to read his paper on "What the Experiment Stations Are Doing for the Carnation Grower."

Notes.

J. A. Peterson made a fine display of decorative foliage and flowering plants.

F. Dorner & Sons Co. had some choice seedling carnations, H. W. Riemans flowering and foliage plants.

A. Wiegand & Sons a large variety of flowering plants and artistic floral arrangements.

The exhibits of The F. R. Pierson Co. of Nephrolepis superbissima and White Killarney rose, of Waban Rose Conservatories of White Killarney, and of Weiland & Olinger of roses and tulips will have more extended attention next week.

FUMIGATING WITH HYDRO-CYANIC ACID GAS.

So much has been said regarding this matter that it seems almost unnecessary to write further on the subject, but in answer to many queries I take this opportunity of giving my experience, for the general good, hoping that it may result in the prevention of, at least some of the difficulties which apparently do much to prevent its general use among florists and gardeners.

We have used it successfully for the past two years, in preference to any other fumigating agent, with most notably during the chrysanthemum season during the chrysanthemum season, from the time the plants are boxed, until the flowers are cut, we use it on violets with good results, on tomatoes and melons. For killing

white fly it has no equal. In peach houses after the fruit is set, in rose houses, in houses of miscellaneous plants and flowers, calceolarias, cinerarias, cyclamens, schizanthus, callas, Lillium longiflorum, Harrisii, speciosum and candidum, and in carnation houses we have employed it constantly and have never hurt a plant by its use. Many dislike to use it because it is known to be deadly in its action on all insect life, and also to indiscreet or careless operators, but there is absolutely no need to run any risk what ever in its application, the only precaution necessary being to get out of the house quickly, and keep out until next morning.

We always fumigate at night and proceed as follows, for a house 50 x 20 feet: The house is closed, and the floors dampened. An earthen bowl is used, and 2 ounces sulphuric acid and 6 ounces of water are put together in the bowl, which is then carried into the house and placed on the floor near the center. Be sure that everything is all right at this time, and that the door is left open, for a hasty retreat is necessary. Then add quickly 1 ounce cyanide of sodium, and get out of the house quickly, close and lock the door and leave it so until next morning. I usually put the cyanide in the corner of a small box, as it can be readily turned out of this. It is very important that none of the cyanide be allowed to get into the mixture of acid and water until the final moment, as this forms the gas which is so destructive and the greatest care must be taken not to breathe any of it while placing the cyanide at the last moment or any other time. It is also advisable not to stand long over the cyanide itself while preparing it, and for this reason the granulated kind is preferable as it needs less handling.

In the summer time when it is not advisable to keep a house closed all right, an outside door can be thrown open, after the gas has been in the house about four hours, and allowed to remain open an hour before entering; by this time there will be no danger.

An important matter which is often overlooked, and one of the principal cause of injury to plants is that the foliage on the plants themselves must be dry at the time of fumigating, or trouble will surely follow neglect of this precaution. Used in this way we

have found it safe and efficient, and if any are in doubt about the quantity required, I advise such to go slow, using it by degrees until the desired effect is accomplished. I experimented for myself until I found out the necessary quantity for each of my houses, and have discarded everything else for fumigating purposes.

ALFRED J. LOVELESS.

LIST OF PATENTS.

- 907,721 Field and Garden Market. Robert G. Hoak, Thompsonville, Mich.
- Arthur W. Metcalfe and John S. D. Shanks, Belfast, Ireland.
- 907,863 Heater. William Norris, Toronto, Ontario, Canada, assignor of one-half to Murray Hamilton Williams, Oakville, Canada.
- 907,954 Boiler Compound. Max Becker, Mannheim, Germany.
- 908,046 Sash Center. Clinton D. Tabor, New Dorp, N. Y., assignor to Tador Sash Company, Newark, N. J.
- 908,565 Nozzle for Boiler Tube Cleaners. Richard W. Hamann, St. Louis, Mo., assignor to Eugene J. Feiner, St. Louis, Mo.
- 908,645 Celery Cultivator. Walter L. Bonney, Batavia, N. Y.
- 908,939 Superheater-Boiler. John E. Bell, New York, N. Y., assignor to The Babcock & Wilcox Company, New York, N. Y.
- 909,361 Sash for Hotbeds and other purposes. William S. Bodley, Louisville, Ky., assignor to Sunlight Double Glass Sash Co., Incorporated, Louisville, Ky.
- 909,463 Sash Operating Mechanism. William Sefton, Elizabeth, N. J., assignor to Hitchings & Company, Elizabeth, N. J., a Corporation of New Jersey.

JAPANESE

LILIES

PLANTS

BAMBOO STAKES

THE YOKOHAMA NURSERY CO.
31 BARCLAY STR. NEW YORK.

New Rose **White Killarney**

Come and see White Killarney growing at our Scarborough houses, and you will say at once, as every one does who has seen it, it is

The Best White Rose

they have ever seen. You need it if you want to be up to the times, and it will pay you better than any other white rose that you can plant. You will regret it if you do not plant it this year, and you will not regret it if you do.

Big lots are being booked. Get your order in early. Send us order at once, while you think of it. Get early stock. It will not cost you any more to order to-day, while you think of it, than it will two months from now. Be the early bird that catches the worm.

Strong young plants, 2½-inch pots, own-root, ready for delivery beginning February 15th, 1909, \$30.00 per 100; 250 for \$70.00; 500 for \$125.00; 1000 for \$250.00. Grafted plants, ready for delivery beginning March 1st, 1909, \$5.00 per 100 additional.

F. R. PIERSON CO., Tarrytown-on-Hudson NEW YORK.

NEWS OF THE CLUBS AND SOCIETIES

NEW ORLEANS HORTICULTURAL SOCIETY.

The regular meeting of this society was held January 21. In the absence of President Steckler, Vice-President Scheuermann presided, with Chas. R. Panter, secretary. A large number of members was present. After interesting talks on plants and flowers, the results of the November Flower Show were considered and plans laid for another exhibition in the spring of 1910. The reports of secretary and treasurer showed that a loss of \$326 had been sustained on the flower show. The original loss was \$600, but the members who won prizes donated the amounts to the Association. A letter was read from Prof. W. Newall, of the State Crop Pest Commission, warning the horticulturists to look out for the fish-tailed moth. This destructive moth had been found on plants and flowers imported from France to New York. R. Eichling read an interesting and instructive paper entitled "The Forcing and Growing of Bulbous Stock for Cut Flowers in the Southern States." Mr. Eichling showed some rare specimens of lilies, callas, hyacinths, etc., which he had grown under the methods he advocated.

The members paid their yearly dues in advance, so that the nucleus of a fund could be established for a flower show in the spring of 1910. If the public show interest and responsiveness this exhibition will be given on grander lines than ever before attempted.

J. A. Newsham exhibited beautiful *Oncidium splendendum* gathered by him while in Central America. Mr. Panter showed some substantial looking cork that he had taken from a tree on the State Farm at Avondale.

CHAS. R. PANTER, Sec'y.

MINNESOTA STATE FLORISTS' ASSOCIATION.

The meeting of the association was held at Merriam Park on January 19 with President Wirth in the chair. The society will hold its first social in the U. C. T. Hall in St. Paul on Feb-

ruary 15. The State Fair committee reported favorably on the meeting they had with the managers of the State Fair Association. The premium list for the State Fair exhibits was submitted by the committee and approved. O. J. Olson read a very interesting paper on "The Retailer's Profit." A committee was appointed to consider the advisability of a fall flower show.

There was a fine exhibit of plants and flowers. Certificates of merit were awarded to Carl Haugen for double cyclamen; A. Swanson for Marle Lesray lilac; H. Nagel & Son for Winsor carnations; Minneapolis Park Greenhouses for *Primula chinensis* and *Kewensis*. Honorable mention to Nagel & Son for sweet peas.

Jas. M. Jansen, with C. Keur & Sons, Billigom, Holland, A. Henderson and Arnold Ringier, Chicago, were present.

AMERICAN ROSE SOCIETY.

The preliminary schedule of prizes for the exhibition which is to take place in Buffalo, March 17, 18 and 19, under the auspices of the American Rose Society in connection with the spring exhibition of the Buffalo Florists' Club, has been issued. A gold medal for the best new rose not yet disseminated, 95 points being required to win, a silver medal for any novelty in this competition scoring 85 points, a certificate of merit under same conditions to any novelty scoring 80 points, the Breitmeyer prize \$200, and the Boddington prize \$100 for best and second best display of hardy roses in bloom, the Dorrance Challenge Prize, the Michell Prize for 50 Kate Monton, the Kroeschell Prize for 12 H. P. roses in pots, the Valentine Prize for best arrangement of one dozen rose blooms, and the prizes unassigned as yet, offered by J. A. Budlong, Waban Rose Conservatories, W. H. Elliott, Welch Bros., Ellwanger & Barry, and several others are among the special inducements which should contribute to bring out a record exhibition from far and near. Copies of the schedule as completed up to date can be procured from the Secretary, Benj. Hammond, Fishkill, N. Y.

SOCIETY OF AMERICAN FLORISTS AND ORNAMENTAL HORTICULTURISTS.

Registration of *Cypripedium*.

Public notice is hereby given that Alfred J. Loveless, of Lenox, Mass., offered for registration the plant described below. Any person objecting to the registration of this plant or to the use of the proposed name is requested to communicate with the undersigned at once. Failing to receive objection to the registration the same will be made three weeks from this date.

Date—January 25, 1909.

Name—*"Tusula."*

Kind of plant—*Cypripedium*.

Parentage—*Leanum Clinkaberry* X *Nolo Shortleuse*.

Description—Upper dorsal, round-pointed at the apex 2¼ inches wide and the same in depth, upper half pure white, base yellowish green with numerous dark spots; a bright reddish purple line ¼ inch wide runs through center to apex, and the dorsal is also flushed with the same color, on each side of central line radiating from the base, until lost in the white above. Lower dorsal, pale green, keeping well forward, giving the flower a round full effect. Petals, deeply corrugated, brownish on upper half with a margin of pale green, terminating with numerous minute spots at base; dark brown line runs through center; lower half light yellowish green splashed with chocolate. Pouch 1½ inches wide at top, differing from either parent by almost touching the petals on either side and being of a bright glossy reddish brown in front shading back to yellowish green. Foliage, similar to *Leanum*.

W. N. RUDD, Secretary.

THE PRIZE WINNING STRAWBERRY **The Barrymore**

Send for Folder at Once.

H. L. CRANE, Originator,
Westwood, Mass.

California Privet.

We have 10 acres to offer for sale this Spring. All 2 years old, 2 to 2½ ft. high, 8 to 12 branches and well graded. We are booking orders daily now. \$2.75 per 100; \$22.50 per 1000. 500 at 1000 rates.

Packing Free. Cash with Order.

JOHN BENNETT, Atlantic Highlands, N. J.

STATE HORTICULTURAL ASSOCIATION OF PENNSYLVANIA.

The 50th annual meeting of the State Horticultural Association was held at Harrisburg on the 19th and 20th inst., President Gabriel Hiester presiding. The president's address reviewed the work of the association and indicated lines along which the society might develop.

J. H. Hale of South Glastonbury, Conn., made two addresses during the two days' session. In these he gave his experience in planting and cultivating peaches on rough and stony Connecticut hillsides as well as in Georgia, and he discussed "Things we are up against." Both were full of suggestions for the Pennsylvania fruit growers.

Mr. L. G. Young of North East, Pa., told how grapes were grown in his section. Few people realize that the best portion—the west end—of the Chatanqua grape belt lays in Pennsylvania. Grapes grown here are better and bring higher prices than those grown across the line in New York State. North East is the shipping point, and more grapes are shipped from there than from any other place in the country.

Prof. S. B. Heiges gave an extremely interesting reminiscent talk about the association and its members.

Among the reports that of Prof. H. A. Snrface, that told of the work of the orchard inspection and demonstration work in the state was of great interest.

The attendance was very large and enthusiastic.

THE NEBRASKA HORTICULTURAL SOCIETY.

This society, which met in Lincoln, Jan. 15th, had probably the best and largest meeting which they have ever held. The gathering was at the state farm. On this farm are some splendid new buildings. We were glad to welcome twenty-five young men who had organized themselves into a Horticultural Society of their own among the students. They were promptly made honorary members. The usual topics were discussed. Prof. Emerson gave a very hopeful address on commercial orcharding. Mr. Hadkinson, who was landscape gardener at the St. Louis Exposition, had a paper on ornamental shrubs. This society with others in the West is getting out of the old ruts to take a wider view, and there is now a turning from forests to ornamentation. The merits of the Bull pine were discussed, and it was the general opinion that it was the tree for the semi-arid regions. There was a fine exhibit both of fruits and flowers. A veteran orchardist from the northwest part of the state was there. He had fought great difficulties for years, but was now a victor. Orchards are being extended into the dry farming regions, where the fruit pests have not yet made their appearance. Altogether it was a good profitable meeting.

C. S. HARRISON.

ST. LOUIS HORTICULTURAL SOCIETY.

This society held an important meeting on Jan. 19 in the hall of the Central Young Men's Christian Association. It was decided to hold two flower shows this year one in the spring and

GARNATION AND ROSE SHOW

UNDER AUSPICES OF

Boston Co-Operative Flower Growers Association

The Park Street Market

SEND FOR PREMIUM LIST

ALL the old and THE BEST of the new varieties. SEE BEFORE BUYING

NEW ENGLAND'S LEADING COMMERCIAL SHOW
FEBRUARY 27th AND 28th, 1909

HORTICULTURAL HALL, BOSTON

For information write **E. ALLAN PEIRCE**, Waltham, Mass.

Any of the florists throughout New England or elsewhere wishing to attend the annual flower show of the Boston Flower Growers' Association, Feb. 27th and 28th can get free tickets to the same by applying to N. F. McCarthy & Co., 84 Hawley St., Boston, Mass.

one in the fall. It was also voted to offer \$50 in prizes for the best kept gardens and home surroundings this summer. The following officers were elected: Edward Mallinckrodt, president; J. B. Gazzan, D. S. Brown, Leonard Matthews and J. F. Gundlach, vice-presidents; C. Weber, treasurer; Otto G. Koenig, secretary. The society is in good financial condition and has added a number of well-to-do society folks to its membership during the past year. Their last show was a success and the fall show should be a money maker.

NEW YORK FLORISTS' CLUB.
Carnation Night February 8th, 1909.

Carnation night is a special feature of the club, and we would like to have an exhibit of standard varieties, also any new ones you may have. It will be a good advertisement for your firm and the Cultural Certificate of the club will be given to all deserving exhibits.

Kindly notify us to the amount of flowers you will exhibit.

Exhibits coming from a distance must be express prepaid and addressed to John Young, Sec'y, 51 West 28th St., New York City.

If you cannot be present at the meeting, we will see that your exhibit is staged in an attractive manner.

EXHIBITION COMMITTEE,
Harry O. May, Sec'y.

SPLIT GARNATIONS

quickly repaired with

Pillsbury's Carnation Staples

"I think they are the finest thing there is for mending carnations and I shall use nothing else."

CHAS. KNOFF FLORAL CO.

"We are very much pleased with them."

ADGATE & SON

2000 for One Dollar

J. L. PILLSBURY, Florist
GALESBURG, ILL.

IMPORTED ORCHIDS

Arrived in Superb Condition

Vanda coerulea, Cattleya Trianae, Cattleya gigas Sanderiana, Cattleya Schroederae, Oncidium varicosum.

JULIUS ROEHR'S CO., Rutherford, N. J.

ORCHIDS

Fresh Imported for Spring Delivery
Cattleyas, Laelias, Oncidiums, etc.

Write for Prices

My new Catalogue is now ready; if you have not received one, send for it.

JOSEPH A. MANDA, West Orange, N. J.

We Have A Fine Lot of **C. Trianae** in bloom at very low prices, and will sell plants in bloom or cut blooms at 15 per cent. less than the market price.

ORDONEZ BROS.
Madison, N. J.

ORCHIDS

Our latest importations have been, **Cattleya Chrysooxa, Cattleya Gaskelliana, Cattleya Gigas, (Hardyana district), Phalaenopsis Amabilis Schilleriana** and others. We will receive in a short time, **Cattleya Dowiana, Miltonia Vexillaria** and others.

CARRILLO & BALDWIN
SECAUCUS, N. J.

ORCHIDS Freshly Imported

We offer a superb lot of **Cattleya gigas Sanderiana** in finest condition; also **C. Bogotensis, C. Schroederae, C. labiata, C. gigas Hardyana** type and **Miltonia vexillaria**

LAGER & HURRELL, Summit, N. J.

ORCHIDS

Largest Importers, Exporters, Growers and Hybridists in the World

Sander, St. Albans, England
and 235 Broadway, Room 1
NEW YORK CITY

FOR "POT LUCK" TRY US...

HEWS STANDARD POTS

POT MAKERS FOR 140 YEARS
WORLD'S LARGEST MANUFACTURERS

Pearson Street,
LONG ISLAND CITY, N. Y.

WRITE FOR CATALOGUE AND DISCOUNTS

A. H. HEWS & CO., Inc.
CAMBRIDGE, MASS.

452-460 No. Branch St.,
CHICAGO, ILL.

CLUB AND SOCIETY NOTES.

The National Association of Gardeners will hold their annual show on March 17 and 18, at Shetler Hall, 3rd avenue and 17th street, New York.

The Florists' Club of Utica, N. Y., will hold their annual flower show and banquet on February 18 at Arcanum hall, to which ladies will be invited.

The Colorado State Horticultural Society met on January 19-21 at Denver. The program shows interesting fruit and orchard topics.

A joint annual meeting of the State Horticultural Society and the State Nurserymen's Association was scheduled for January 26, 27, at Nashville, Tenn.

Hon. Harold Parker of Lancaster, will speak Feb. 4 on "The Development of the Roads of Massachusetts," before the Worcester County Horticultural Society, Worcester, Mass.

Officers of the Salt Lake County Horticultural Society, Utah, were elected on Jan. 16 as follows: President, J. W. Fisher; vice-president, John Woodbury; secretary, J. C. Stay.

The reception of the president of the New Jersey Floricultural Society and the annual smoker will be held on February 12 at 8 o'clock, at the rooms of the society, Orange, N. J.

At the meeting of the Horticultural Club of Burlington, Vt., at the home of William Stuart on January 21, T. L. Kinney of So. Hero spoke on horticultural conditions in the state.

The Florists' Club of Cleveland, O., will hold their annual carnation show on February 10 at the club rooms, 2610 Detroit Ave. Out-of-town exhibits should be prepaid and sent in care of Isaac Kennedy, secretary.

The lecture before the Massachusetts Horticultural Society on Jan. 30, at eleven o'clock, will be on "The Effects of Conditions of Growth in Certain Horticultural Plants Upon Susceptibility to Fungous Diseases," by Prof. B. M. Duggar, Ithaca, N. Y.

At the regular meeting of the Pasadena Gardeners' Association held on Jan. 15th, the following officers were elected: President, Otto Heutschy; vice-president J. McGillvray; secretary, R. McKenzie; treasurer, John Blake; trustee, Robert Pegg; sergeant-at-arms, R. Krohl.

The Cambria County Horticultural Society was organized at Wilmore, Pa., on January 17 with 100 charter members. The following officers were elected: Abram Hostetler, Johnstown, president; Frank Westrick, Patton,

vice-president; George W. Settlemyer, Wilmore, secretary.

One important matter under consideration at the recent meeting of the horticulturists and nurserymen at Brownsville, Texas, was the amendment and improvement of the state inspection law. Closer relations between the railroads and the producers was urged by B. F. Yoakum.

At the meeting of the Peninsula Horticultural Society held on January 13, 14, at Wilmington, Del., interesting addresses were made by Richard Vincent, Jr., on Floriculture, and by Antonio Wintzer on Cannas and Roses. W. Irving Walker of Chestertown, Md., was elected president, and Prof. Wesley Webb of Dover, Del., secretary.

The meeting of the Engelmann Botanical Club, St. Louis, postponed from Jan. 11 was held on Jan. 23, when the one hundredth anniversary of the birth of Dr. George Engelmann was observed. The subject of the evening was "Twigs of Woody Plants in Winter" and C. H. Thompson of the Botanical Garden was the speaker.

The Florists' and Gardeners' Club of Rhode Island enjoyed their annual banquet on January 18. After a short business session President C. S. Macnair presented the retiring president, Alex. Macrae, with a gavel. C. Hartstra, gardener at the Rhode Island Hospital, presented the club with two volumes on "Medicinal Plants." An enjoyable musical program closed the evening's festivities.

The meeting of the Detroit Florist Club on January 18 was rendered very interesting through the reminiscences of the old times vividly pictured by Robert Flowerday. He began with his apprentice days in England and traced the progress of the florist industry up to the present time. Among other items of local interest he stated that the first flower store in Detroit was opened in 1878, on Woodward avenue.

BUSINESS CHANGES.

Louisiana, Mo.—T. L. Culp is now manager of the Foreman greenhouses.

Clarinda, Ia.—J. F. Pfander has taken a partner and the firm name is now Pfander & Crosthwait.

Washington, D. C.—Robert Bowdler has purchased the stand of George A. Conley at the Centre Market.

Dorchester, Mass.—Francis W. Wilson has purchased the Dickerman greenhouses at 21 Mill street.

Red Wing, Minn.—Decker & Fritze have bought the Humphrey greenhouses and will carry on the business.

Detroit, Mich.—The consolidation of the American Flower Co. of this city and the Sirocco Engineering Co. of New York is reported.

FRUIT TREES UNDER GLASS.

Up to the present time there has been only one authoritative work on dwarf fruit trees, in the English language, "The Miniature Fruit Garden" by Thomas Rivers. "The Miniature Fruit Garden" went through some twenty editions but for some years has been out of print, and from some correspondence I had a year ago with the publishers, Longmans, Green & Co., it is not likely to be republished. Therefore, the present importation of "The Culture of Fruit Trees in Pots," by Josh Brace, is exceedingly timely.

Mr. Brace has been employed for twenty-two years by Thomas Rivers & Son, of Sawbridgeworth, as foreman of the orchard house, a fact sufficient to convince anyone that the author is well grounded in the subject of fruits under glass.

In the 108 pages of this book, Mr. Brace thoroughly discusses the kind of house, its location, ventilation, and furnishing, as well as cultural details, varieties best adapted for growing in cool houses and for forcing, and insects and other pests.

There is also a calendar of operations that gives the gardener an idea of what should be done each month. Of course the dates and conditions in this country differ from those of the Old World but the book contains so much valuable information regarding fruit trees in pots, that it should be owned by every person in this country interested in their culture.

P. T. BARNES.

W. Marche, Washington, D. C., has created a sensation by a wreath that he has just completed to ship to Paris to a French opera singer. The wreath is about 5 ft. in diameter and is made of imported laurel. On one side are the French and American flags and on the other light blue streamers bearing the inscription in raised gold letters.

STANDARD FLOWER POTS

Packed in small crates, easy to handle.

Price per crate		Price per crate	
1500 2 1/2 in. pots in crate \$3.80	144 6 in. pots in crate \$3.10		
1500 2 1/4 " " " 5.25	120 7 " " " 4.20		
1500 2 1/2 " " " 6.00	60 8 " " " 3.00		
		HAND MADE	
1000 3 " " " 5.00	48 8 in. pots in crate \$3.60		
300 3 1/2 " " " 5.80	48 10 " " " 4.80		
500 4 " " " 4.50	24 11 " " " 3.60		
450 4 1/2 " " " 5.74	24 12 " " " 4.80		
120 5 " " " 4.51	12 14 " " " 4.80		
210 5 1/2 " " " 3.78	10 16 " " " 4.50		

Send pails, same price as pots. Send for price list of Cylinders for Cut flowers, Hanging Baskets, Lawn Vases, etc. Ten per cent off for cash with order. Address: Hillinger Bros., Pottery, Fort Edward, N.Y. *August Rolker & Sons, Artls. 31 Barclay St., N. Y. City

Standard Flower . . . POTS

If your greenhouses are within 500 miles of the Capital, write us, we can save you money

W. H. ERNEST

28th and M Street WASHINGTON D. C.

Seed Trade

AMERICAN SEED TRADE ASSOCIATION.

Watson S. Woodruff, Orange, Conn., Pres.; J. C. Robinson, Waterloo, Neb., First Vice-Pres.; C. E. Kendel, Cleveland, O., Sec'y and Treas. Twenty-seventh annual convention, June, 1909.

WHOLESALE SEEDSMEN'S LEAGUE.

F. W. Bruegnerhof, Pres.; Burnet Landreth, Sec'y.

AMERICAN SEED TRADE ASSOCIATION.

A meeting of the executive committee of the American Seed Trade Association was held at the Hotel Astor, New York, Jan. 22, with the following in attendance: Watson S. Woodruff, president; M. H. Duryea, 2nd vice-president; C. E. Kendel, secretary; Charles Dickinson, George S. Green, Howard M. Earl, S. F. Willard, members of the committee, and A. L. Don and W. Atlee Burpee by invitation. It was decided to hold the convention June 22-24 at Niagara Falls and the Clifton House on the Canadian side was chosen for headquarters. Details of rates, program, etc., will be announced later. C. E. KENDEL, Sec'y.

CATALOGUES RECEIVED.

Theodosta B. Shepherd Co., Ventura, Cal.—Specialties in seeds and plants.

T. R. Watson, Old Colony Nurseries, Plymouth, Mass.—List of choice ornamental nursery stock.

D. B. Long, Buffalo, N. Y.—Folder of florists' specialties in floral photographs, cards and other trade adjuncts.

Daniel A. Clarke, Red Oak Nurseries, Fiskeville, R. I.—Hardy Garden Flowers, Spring, 1909. A very dainty little affair.

L. L. Olds Seed Company, Madison, Wis.—Twenty-second Annual Catalogue of Seeds for the Farm and Garden. Agricultural and vegetable seeds fill a prominent place in this excellent catalogue.

Griffith & Turner Co., Baltimore, Md.—Catalogue of Farm and Garden Supplies. Implement department very extensive and profusely illustrated. This well-known house will celebrate its 50th anniversary next year.

W. Atlee Burpee & Co., Philadelphia, Pa.—Wholesale Prices for Market Gardeners and Florists. Printed and illustrated with the same careful attention bestowed on regular catalogues; something not often done. Ask for the "Blue List."

Northrup King & Co., Minneapolis, Minn.—"Quarter Century Offering of Sterling Seeds." This is a big fellow in all respects, well printed, handsomely illustrated and covering the whole domain of the popular seedsman. Cover in colors and two colored inserts.

S. J. Reuter & Son, Westerly, R. I.—Price List, 1909, of Chrysanthemums,

MICHELL Headquarters for Bulbs

Lilium Giganteum—Cold Storage
6-8" (500 Bulbs in Case).....\$60.00 per 1000 | 7-9" (250 Bulbs in Case).....\$85.00 per 1000
8-10" (500 Bulbs in Case).....\$100.00 per 1000

We have an exceptionally fine lot of

FORCING GLADIOLUS—Extra Large Bulbs

Profitable for the Florist

AMERICA AUGUSTA MAY BRENCHLEYENSIS
MICHELL'S WHITE and LIGHT GROFF'S HYBRIDS

Write for quotations on the above sorts—also all other varieties of Gladiolus, Cannas, Begonias and Gloxinias.

Our New 1909 Wholesale Catalog Now Ready

HENRY F. MICHELL CO., 1018 and 518 Market St., PHILADELPHIA

Carnations, Roses. This is a wholesale list issued by a good grower and covers the best of the novelties in the various florists' classes. An excellent illustration of Rose My Maryland adorns the title page.

PUBLICATIONS RECEIVED.

Bulletin 134, Agricultural Experiment Station, Colorado Agricultural College. This bulletin treats on Orchard Plant Lice and Their Remedies, by C. P. Gillette and E. P. Taylor. It contains good practical information on the subject of these destructive orchard pests and the means of exterminating them.

The Physical Properties of Soils. By Arthur G. McCall, Professor of Agronomy at Ohio State University, Published by Orange Judd Company, New York. This work is designed especially for the use of students and alternate pages are left blank for students' notes and reports of laboratory practice. It is printed on very heavy paper and has many illustrations of apparatus used in experimenting and analysis. Instructions are given in the successive chapters for the determination of the various properties and constituents of soils and complete data as to the processes to be followed in each test.

The American Apple Orchard. By F. A. Waugh, Massachusetts Agricultural College, Amherst. Published by Orange Judd Company, New York. This is a book which no fruit grower can afford to be without. It covers every step in the practice of apple growing as now carried on by the most progressive culturists, from the selection of the soil to the packing of the fruit for market. Its 215 pages are rich in good, common-sense instruction given in concise, easily understood form. It is a subject on which Professor Waugh is well qualified to teach and the book under consideration ranks among his best efforts.

The Horticultural Directory and Year Book for 1909 comes to us from the publishers of the "Journal of Horticulture" and "Poultry", office, Fleet Street, London. This useful publication is now in its fiftieth year. It comprises nearly six hundred pages

teeming with information and representing a vast amount of labor in its compilation. Besides complete lists of all the nurserymen, seedsmen and florists, alphabetically and by counties, in Great Britain, Scotland, Ireland, etc., there are included complete lists of all the estates with name and address of gardeners, lists of landscape gardeners, commission dealers, horticultural builders and allied industries, and many other tables and indexes covering a wide field of useful information.

Roses and Rose Growing, by Rose G. Kingsley. Published by the MacMillan Company, New York, and Whitaker & Co., London. In the preface to this interesting book the author tells the reader that the contents are mainly the record of the practical experience of an amateur in her own English garden. Her chapters on the various processes of planting, propagating and general care are good evidence that she thoroughly understands her subject. The lists and descriptions of roses in all classes are very complete and strictly up-to-date and will prove of greatest value for any one interested in rose culture, either commercially or as an amateur. The closing chapter is by Rev. F. Page-Roberts, Vice-President of the National Rose Society, on "How to Grow Roses for Exhibition." There are numerous illustrations, including 28 in colors. The price of the book is \$2.00 net.

FIRE RECORD.

The Thos. Martin Seed & Flower Co. at Riverside, 12 miles west of Chicago, suffered a loss by fire Jan. 21, which is estimated at about \$5,000.

Rochester, N. Y.—Fire in the florist store of Paul Thorman, 3 Clinton avenue, South, on Jan. 12, did about \$500 damage.

The fifth annual convention of the Canadian Seed Growers' Association will be held in Ottawa, Ont., on Feb. 4, 5. An interesting program is presented.

Barenbrug On Grasses. By Joseph T. Barenbrug, \$1.00, postpaid. Horticulture Publishing Co., 11 Hamilton Place, Boston.

NEW SEED OF

<p>Ageratum</p> <p>Dwf. Blue Tr. Pk. Oz. \$0.10 \$0.25</p> <p>Asters</p> <p>Queen Parquet White 0.20 0.50</p> <p>Rose 0.20 0.50</p> <p>Victoria Mixed 0.25 1.50</p> <p>Comet 0.25 2.50</p> <p>Salvia</p> <p>Splendens 0.25 2.50</p> <p>Bon Fire 0.25 2.50</p> <p>Zürich 1/2 oz. 75c</p>	<p>Alyssum</p> <p>Carpet of Snow Tr. Pk. Oz. \$0.10 0.35</p> <p>Begonia</p> <p>Vernon 0.25 2.50</p> <p>Erfordl. 0.25 1.00</p> <p>Pansy</p> <p>Blended 1.00 8.00</p> <p>Large French Stained 0.50 3.00</p>
--	---

WM. ELLIOTT & SONS, 42 Vesey St., NEW YORK

C. C. MORSE & CO. 48-56 JACKSON ST., San Francisco, Cal.

The Largest Seed Growers on the Pacific Coast

ONION, LETTUCE, SWEET PEAS,

ALSO

Carrot, Celery, Leek, Mustard, Parsley, Parsnip, Radish, Salsify

LEONARD SEED CO.

CONTRACT GROWERS AND WHOLESALE DEALERS

BEANS, PEAS, SWEET CORN, ONION, GARDEN SEEDS

ONION SETS FLOWER SEEDS Get Our Prices E. 79 and 81 KINZIE STREET, CHICAGO

Thorburn's Seeds

LILY OF THE VALLEY PIPS
Unexcelled Hamburg or Berlin

TUBEROUS ROOTED BEGONIAS
GLOXINIAS

ROSA MULTIFLORA NANA SEED
and all other flower seeds for Florists

SEND FOR CATALOGUE

J. M. THORBURN & CO.
33 BARCLAY ST. through to 38 PARK PLACE
NEW YORK

Burpee's Seeds
PHILADELPHIA

Blue List of Wholesale Prices mailed only to those who plant for profit

CAULIFLOWERS CABBAGE SEED
LILY OF THE VALLEY PIPS.

HJALMAR HARTMANN & CO.
12 Stormgade, COPENHAGEN, DENMARK.

STOCK SEED
FOR WINTER BLOOMING

Our strain of Double Branching Stocks is exceptionally true. About 604 Double Flowers.

In colors: - 3/4 oz. .60 oz. \$4.00
Pure White 1/2 " .75 " 5.00

H. E. FISKE SEED CO.
Faneuil Hall Square, BOSTON, MASS.

Winter-flowering
SWEET PEA SEED
All Colors Ask for List
A. C. ZVOLANEK
ORIGINATOR. BOUND BROOK, N. J.

NEW CROP SEED
For Early Planting
THOMAS J. GREY CO.
32 SO. MARKET ST., BOSTON, MASS.

BRECK'S SEEDS FOR FLORISTS
Fresh, Reliable. Prompt Delivery.
Catalogues mailed free on application

Joseph Breck & Sons Corp.
47-54 NO. MARKET ST., BOSTON, MASS.

SHEEP MANURE
Pulverized. Free from Adulteration
In Bag, \$18.00 per Ton. Cash with Order

ROBERT SIMPSON
CLIFTON, N. J.

Mignonette

FARQUHAR'S GIANT

Oz., 75c; 1-4 oz., 25c

R. & J. Farquhar & Co.
6 & 7 South Market Street
BOSTON, MASS.

PURE RELIABLE
Bermuda Onion Seeds
F. C. VARELA
- Teneriffe -
CANARY ISLANDS
Improved Stock's
TRUE TO NAME

NO COMPLAINTS AND -
NO TROUBLE WITH MY SEEDS

BRIDGEMAN'S SEED WAREHOUSE
RICKARDS BROS.
Props.
37 East 19th St., - NEW YORK CITY

GEO. E. DOW
Designing and Illustrating
178 Washington St., Boston, Mass.
OUR SPECIALTY
Machine, Booklet, Advertising and Flower
PHOTOGRAPHS

JAPANESE BULBS, Etc.
R. TANOI, Yokohama, Japan.

Send for catalog and write to Representative
K. TAKEUCHI,
478a Boylston St., Boston, Mass.

In ordering goods please add "I saw it in HORTICULTURE."

QUALITY SEED BULBS PLANTS
SEND FOR CATALOGUE
ARTHUR T. BODDINGTON
345 West 14th St., New York.

To Florists Everywhere

Orders for Cut Flowers and Floral Decorations to be delivered anywhere in the Greater New York, may be placed with us with the certainty that your customers will be satisfied.

Telegraph, telephone or mail such orders to us and be sure that they will be filled as promptly and as carefully as though you had it yourself.

One third discount will be allowed on all orders thus placed with us by Florists outside of the Greater New York.

THE BLOSSOM

Bond and Livingston Sts.,
BROOKLYN, N. Y.

C. C. TREPEL, Manager

**WILLIAM J. SMYTH
FLORIST**

Cor. Michigan Ave. and 31st St., CHICAGO

We ship to all points in Illinois and Iowa.

Phones: Douglas 744, Douglas 523, Douglas 740

M. C. and J. E. HAUSWIRTH

Out of Town orders for Hospitals
Carefully filled.

**232 Michigan Ave.
CHICAGO**

AUDITORIUM ANNEX Tel. Harrison 585

**SAMUEL MURRAY
Florist**

Coates House Conservatory
1017 BROADWAY, KANSAS CITY, MO.

Both 'Phones 2670 Main.



WASHINGTON,
D. C.

GUDE'S

**The Far-Famed Flowers of
TORONTO**

Delivered on mail or telegraph order for any occasion, in any part of the Dominion.

JOHN H. DUNLOP,
96 Yonge St., Toronto, Ont.

The Park Floral Co.

J. A. VALENTINE
Pres.

DENVER, COLORADO

**WILLIAM L. ROCK
FLOWER CO.**

KANSAS CITY, MO.

will carefully execute orders for Kansas City and any town in Missouri or Kansas.



Buffalo, N. Y.

W. J. PALMER & SON, 30 Main St.

PERSONAL.

Adolph Arn of Davenport, Ia., has been elected superintendent of parks at Meridian, Miss.

Paul Shaeffer has taken a position as head gardener on the estate of Charles Klein at Rowayton, Conn.

D. D. England of Winnipeg, Man., has taken a position with the Park Department of Victoria, B. C.

Chicago visitors: Geo. Heint, Toledo, O.; Andrew Bather, Clinton, Iowa; Emil Glauber, Denver, Colo.

Charles Edgar, of Pittsburg, Pa., is now employed in Elmira, N. Y., as shipper for the U. S. Cut Flower Co.

Louisa M. Halstead, daughter of A. S. Halstead of Belleville, Ill., was married to John W. Cornell of Detroit on January 19.

Daniel MacRorie, of South Orange, N. J., has started in business in San Francisco, Calif., at 721 Crocker Building, with seeds and general greenhouse stock.

Henry Cliffe has resigned his position as superintendent on the estate of

STEAMER DEPARTURES

American.

St. Louis, N. Y. - Hampton...	Feb. 6
Philadelphia, N. Y. - Hampton...	Feb. 13
Atlantic Transport.	
Minnetonka, N. Y. - London...	Feb. 13
Cunard.	
Manreanta, N. Y. - Liverpool...	Feb. 3
Ivernia, Boston - Liverpool...	Feb. 9
Campania, N. Y. - Liverpool...	Feb. 10
French Line.	
La Touraine, N. Y. - Havre...	Feb. 4
La Bretagne, N. Y. - Havre...	Feb. 11
Hamburg-American.	
Deutschland, N. Y. - Itzehouze...	Feb. 6
Leyland.	
Devonian, Boston - Liverpool...	Feb. 3
Belgian, Boston - Liverpool...	Feb. 10
North German Lloyd.	
K. Wihl, der Grosse, N. Y. - Bremen...	Feb. 2
Breslau, N. Y. - Bremen...	Feb. 4
Neckar, N. Y. - Med. Ports...	Feb. 6
Barbarossa, N. Y. - Med. Ports...	Feb. 13
White Star.	
Adriatic, N. Y. - Southampton...	Feb. 3
Majestic, N. Y. - Southampton...	Feb. 10
Celtic, N. Y. - Liverpool...	Feb. 13
Canopic, Boston - Med. Ports...	Feb. 13

O. B. Jennings, Fairfield, Conn., and sails on Jan. 20 for a short vacation in England and Scotland.

Henry Kallen, formerly with H. F. Darrow of New York, has formed a partnership with two wholesale growers of nursery stock in Boskoop, Holland, under the firm name of Kallen & Lunnemann.

Orange B. Burrill of So. Haven, Mich., a graduate of Massachusetts Agricultural College, has been appointed agricultural inspector for the Philippine Islands, and will sail from Seattle on Feb. 2.

Peter Reinberg, of Chicago, has been ill for a couple of weeks and on the 21st inst. submitted to an operation for tumor. At this writing he was doing as well as could be expected. His many friends wish him a speedy recovery.

Visitors in Boston: E. J. Harmon, Portland, Me.; J. C. Hatcher, Amsterdam, N. Y. Mr. Hatcher had with him a sample of a remarkable variety of Asparagus plumosa, originating in his greenhouses, which he will place on the market.

ALEX. McCONNELL

571 FIFTH AVENUE
NEW YORK CITY

Telegraphic orders forwarded to any part of the United States, Canada, and all principal cities of Europe. Orders transferred or intrusted by the trade to our selection for delivery on steamships or elsewhere receive special attention.

Telephone Calls, 487 and 488 38th St.
Cable Address, ALEXCONNELL

New York Deliveries

FLOWERS and PLANTS

by special messenger to Steamer,
Theatre or any address in

NEW YORK or BROOKLYN

THOMAS YOUNG, JR.

500 FIFTH AVE., (near 42nd St.)

NEWMAN FLORAL Co.

(Established 1870)

202 Fifth Ave. and
Madison Square, NEW YORK CITY

FLOWERS FOR STEAMER SAILINGS

M. A. BOWE

In the Heart of New York City

1294 Broadway

Tel. 2270, 38th St. NEW YORK

Our Motto—The Golden Rule

DAVID CLARKE'S SONS

Deliver orders from any part of the country to
New York City

Or OUT-GOING STEAMERS

Write or telegraph

2139-2141 Broadway, New York
Telephone 1552-1553 Columbus

YOUNG & NUGENT

42 West 28 St., NEW YORK

"FLOWERS BY TELEGRAPH"

NEW YORK

MYER, FLORIST

Phone 5297 Plaza. 609-611 MADISON AVE.

ALBANY, N. Y.

EYRES

Flowers or Design Work

DELIVERED IN ALBANY AND VICINITY
ON TELEGRAPHIC ORDER.

11 NORTH PEARL ST., ALBANY, N. Y.

Flower Deliveries

In Brooklyn and other Long Island Points
New York City, New Jersey, etc. At Theatres,
Hotels, Steamers or Residences.

WILSON

Fulton St. and Greene Ave., Brooklyn, N. Y.

JOHN BREITMEYER'S SONS

Cor. Miami and Gratiot Aves.
DETROIT, MICH.

Artistic Designs . . .
High Grade Cut Blooms

We cover all Michigan points and good sections of Ohio, Indiana and Canada

PROMPT DELIVERY IN BOSTON

AND ALL NEW ENGLAND POINTS

F. H. HOUGHTON
396 Boylston St., Boston, Mass.
BOSTON'S BEST

In Quality and Design
Can be relied upon when you transfer your retail orders to

EDWARD MACMULKIN
194 Boylston Street, Boston

Send flower orders for delivery in
BOSTON

and all
NEW ENGLAND POINTS

THOS. F. CALVIN
124 Tremont St., Boston

The Original Telegraph Order Florist
WILL DELIVER

Flowers or Designs
to order in Boston and Vicinity. Usual Discount.

J. NEWMAN & SONS, Inc.
EST. 1870 24 TREMONT ST., BOSTON

TRANSFER

Your orders for flower or plant delivery in Eastern New England to

JULIUS A. ZINN,
2 Beacon St., Boston.
Fine Design Work a Specialty



DANKER, Albany, N. Y.

ORDERS FOR
Choice Flowers and
Floral Emblems

FILLED PROMPTLY

LOUISVILLE, KY.

JACOB SCHULZ,
550 South Fourth Ave.

WELLESLEY COLLEGE
Dana Hall, Walnut Hill and Rockbridge Hall
Schools. T. L. E. Y. Wellesley, Mass.

Tel. Wellesley 44-1 and 2. Night 44-3.



THE NEW IDEA IN PLANT STANDS The Moore-Livingston Graduating or Adjusting

Saves one-half to two-thirds of cost over ordinary galvanized iron stands.

SEND FOR CIRCULAR GIVING FULL PARTICULARS
SOLD BY SEEDSMEN AND SUPPLY HOUSES

If your seedsman does not carry send us his name and we will promptly send full particulars.

Moore-Livingston Co., Patentees
and **Mrs., Lansdowne, Pa.**

C. L. Reynolds, assistant superintendent of Botanical Gardens, Washington, D. C., was driving with his wife and niece a few days since when the horse took fright at an engine, bolted and overturned the carriage. Mr. Reynolds was thrown out and it is feared quite seriously injured; the ladies escaped almost unhurt.

OBITUARY.

Mrs. Walter Reimels.

Mrs. Walter Reimels died suddenly at her home in Woodhaven, New York, on January 20.

John Henry.

John Henry, well known in the wholesale flower district of New York, died at his home in Richmond, Staten Island, on January 16.

Mary L. Raeder.

Miss Mary L. Raeder, of Raeder & Co., Hyde Park, Mass., who had been in attendance at Park Street flower market on January 9, passed away on January 13, with pneumonia.

Alfred S. Jones.

Alfred S. Jones, who for fifteen years was gardener on the estate of H. B. Hyde, Bay Shore, died on January 21, at his home in Brooklyn, N. Y. He was eighty-five years of age.

G. A. Weaver.

George A. Weaver of Newport, R. I., died at his home on Bull street, January 26. Mr. Weaver was the head of the well-known firm of that name which conducts the most extensive horticultural and agricultural supply business in that city.

NEW RETAIL FLOWER STORES.

Berkeley, Cal.—Miss L. B. Penniman.
Newark, O.—Kent Bros., 20 West Church street.

Hudson, Mass.—F. A. Morse, agent for Mrs. A. A. Smith.

NEWS NOTES.

Akron, N. Y.—J. J. Bates has resumed the management of the Newman greenhouses.

Williston, N. D.—The Williston Fruit & Nursery Co. has recently been organized to carry on a general nursery business.

Marlboro, Mass.—The Lewis Conservatories (W. L. Lewis, prop.) are

reported as having made an assignment.

Schedules of prizes to be given at the spring show of the Massachusetts Horticultural Society have been sent out. In addition to the cash prizes which will aggregate \$1,628, there will be the usual medals. The exhibition will be held on March 24-28.

THE BEST LETTERS

FOR THOSE
FLORISTS' MADE
USE BY THE



Boston Florist Letter Co.

66 PEARL ST., BOSTON

N. F. MCCARTHY, Mgr.

Order direct or buy from your local supply dealer. Insist on having the

BOSTON

Inscriptions, Emblems, etc., Always in Stock

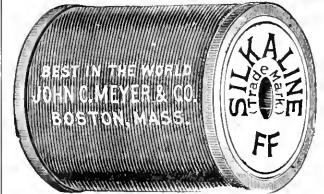

FLORISTS' SUPPLIES

Send for New Catalogue

H. Bayersdorfer & Co.

1129 ARCH ST., PHILADELPHIA

ATLANTA FLORAL CO.

41 Peachtree Street, ATLANTA, GEORGIA

ROBERT J. DYSART
Public Accountant and Auditor

Simple methods of correct accounting especially adapted for florists' use.

Books Balanced and Adjusted
Merchants Bank Building
28 STATE STREET, BOSTON

Telephone, Main 58.

CARNATIONS

We would be glad to quote you special prices on Carnations in large quantities — we can make the prices very interesting. The quality has never been better at this season of the year. We exercise the utmost care in selecting stock for shipping orders and guarantee the freshness of the same.

THE LEO NIESSEN CO.

1209 Arch St., Philadelphia, Pa.
Open from 7 a. m. to 8 p. m.

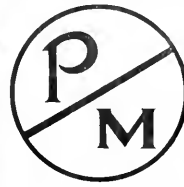

Cattleyas

\$6.00 per doz.
\$40.00 per 100

CUT FARLEYENSE

Choicest Quality
\$12.00 and \$15.00 per 100.

S. S. PENNOCK - MEEHAN CO.
1608-1620 Ludlow St., Philadelphia

Daffodils, Tulips and Spring Flowers

W. E. McKISSICK & BROS.

WHOLESALE FLORISTS
1619-1621 RANSTEAD ST.
PHILADELPHIA



CHAS. W. MCKELLAR

51 WABASH AVE., CHICAGO

Western Headquarters for Choice Orchids
Valley, Roses and all Cut Flowers

PETER REINBERG WHOLESALE

CUT FLOWERS

51 Wabash Av., Chicago, Ill.

DAILY CONSIGNMENTS

From 40 to 60 Growers

We can care for your cutflower wants to advantage.

E. F. WINTERSON CO.

45-47-49 WABASH AVE., CHICAGO

POEHLMANN BROS. CO.

33-35-37 Randolph St., - CHICAGO

CUT FLOWERS

Greenhouses, - Morton Grove, Ill.

Rice Brothers

118 N. 6th Street, MINNEAPOLIS, MINN.

WHOLESALE FLORISTS and SUPPLIES

CUT FLOWERS received twice daily, and can fill your orders to your satisfaction. A complete line of Hardy Greens — WILD SMILAX, BOXWOOD, HARDY FANCY FERNS, GALAX LEAVES. Write for quotations on large quantities.

In ordering goods please add "I saw it in HORTICULTURE."

WELCH BROS.

AMERICAN BEAUTY, KILLARNEY, RICHMOND, MARYLAND AND ALL THE SUPERIOR ROSES, LILY OF THE VALLEY, CARNATIONS, ORCHIDS

BEST PRODUCED

226 Devonshire Street,

Boston, Mass.

WHOLESALE FLOWER MARKETS—TRADE PRICES—Per 100 TO DEALERS ONLY

	CHICAGO		TWIN CITIES		PHILA.		BOSTON	
	Jan. 25	Jan. 26	Jan. 25	Jan. 26	Jan. 25	Jan. 26	Jan. 25	Jan. 26
ROSES								
Am. Beauty, Fancy and Special	30.00	40.00	30.00	40.00	50.00	60.00	40.00	60.00
" Extra	20.00	30.00	25.00	30.00	30.00	40.00	20.00	30.00
" No. 1	10.00	20.00	15.00	20.00	12.00	25.00	13.00	18.00
" Lower grades	6.00	10.00	10.00	15.00	8.00	10.00	4.00	8.00
Bride, 'Maid, Fancy & Special	10.00	15.00	8.00	10.00	8.00	12.00	8.00	12.00
" Lower grades	6.00	10.00	6.00	8.00	4.00	6.00	2.00	6.00
Killarney, Pac. & Sp.	10.00	12.00	8.00	12.00	20.00	25.00	12.00	25.00
" Lower grades	6.00	10.00	5.00	7.00	5.00	12.00	4.00	8.00
Richmond, Fancy & Special	10.00	12.00	10.00	12.00	20.00	25.00	12.00	25.00
" Lower grades	5.00	10.00	6.00	8.00	6.00	10.00	4.00	8.00
Chatenay	5.00	8.00	5.00	10.00	4.00	8.00
Golden Gate Ivory, etc.	6.00	10.00	4.00	10.00	4.00	8.00
My Maryland	10.00	15.00
Queen Beatrice	3.00	12.00
Mrs. Mar. Field
CARNATIONS								
Fancy and Red	3.00	4.00	3.00	6.00	3.00	5.00	2.00	3.00
Ordinary and White	2.00	3.00	1.50	3.00	2.00	2.50	1.00	1.50
MISCELLANEOUS								
Cattleyas	40.00	50.00	50.00	60.00	40.00	50.00	40.00	50.00
Cypripediums	10.00	14.00	15.00
Lilies	15.00	20.00	10.00	14.00	12.00	15.00	8.00	10.00
Lily of the Valley	3.00	4.00	3.00	4.00	3.00	4.00	1.00	4.00
Narciss, Paper White	3.00	4.00	3.00	4.00	2.00	4.00	1.00	2.00
Roman Hyacinth	3.00	4.00	2.50	3.00	2.00	4.00	1.00	2.00
Daffodils	4.00	5.00	3.00	4.00	4.00
Freesia	4.00	5.00	3.00	5.00
Sweet Peas	5.00	1.50	5.00	1.00	5.00	1.00	7.50	1.00
Gardenias	30.00	40.00	40.00	50.00	40.00	25.00	30.00
Violets	15.00	7.50	7.50	1.00	7.50	1.00	3.50	7.50
Adiantum	1.00	1.50	1.00	1.50	1.00	1.50	7.50	1.00
Smilax	12.00	15.00	12.00	14.00	15.00	10.00	18.00
Asparagus Plumosus, strings	35.00	50.00	40.00	50.00	35.00	50.00	25.00	50.00
" " & Sprea. (100 bchs.)	20.00	4.00	15.00	25.00	15.00	20.00	10.00	25.00

J.A. BUDLONG

37-39 Randolph Street, CHICAGO.

Roses and Carnations
A Speciality.....

WHOLESALE GROWER of CUT FLOWERS



HENRY M. ROBINSON & CO.

15 Province St and 9 Chapman Place - BOSTON, MASS.

WHOLESALE COMMISSION FLORISTS

Hardy Cut Evergreens and Florists' Supplies

We have the stuff and can fill all orders, large or small
WE NEVER DISAPPOINT SATISFACTION GUARANTEED



Prices Quoted in these Columns are for Dealers Only.
When Writing to Advertisers Please Mention
HORTICULTURE.

Flower Market Reports.

BALTIMORE The weather has of late not been of the kind which our flower growers would have made to order. Prices on the whole have been quite normal, the supply has been just about equal to the demand, and the quality generally good. Things are moving along very nicely. More social events would be welcomed by the decorators but there is little to complain of.

BOSTON Crops are increasing steadily on all lines, but this fact does not seem to bear any relationship to the market, which has been erratic all through this unusual season, and is still keeping fully up to its reputation. Following a dispiritingly dull week the situation has now changed and the present week starts in with a vim as refreshing as it is inexplicable. How long it will last is a guess. Quality is excellent all through. Bulbous stock is greatly improved. Killarney still holds the lead among roses in popularity and quantity sold. White carnations are doing much better.

Trade has been fairly good on almost everything along the line. Lilies and white material have been in demand, especially roses of short quality, for floral work. American Beauty, Killarney and Richmond have not been too plentiful and prices have held firm. In violets the supply and light demand sent prices on the decline. Bulbous stock, lily of the valley, mignonette, sweet peas have been none too plentiful. Carnations have been in excellent supply and with the quality good; select stock moved at fairly good prices. Preparations have been made for large supplies of carnations on McKinley Day, as the outlook is for the heaviest day yet recorded for the sale of carnations.

CHICAGO As might be expected, the summer weather has been quite a factor in trade conditions, the thermometer registering 65 deg. before the close of the week. All stock felt the unreasonable heat, and in roses Killarney was the most affected. Trade held up well throughout the week though there was no special demand. Floral work made a scarcity of white flowers but white tulips helped out. The second batch of daffodils was not in, so supply was short while demand was a little extra. There are plenty of tulips to be seen and in all colors. Some fine Keizerkroon were noted at Poehlmann Bros. The warm weather caused violets to sell readily. At Charles McKellar's were seen fine gardenias. Carnations are in good supply and there is no trouble in selling good ones at fair prices.

PHILADELPHIA Increasing receipts and business almost stationary has had its effect on the market here. An easier tone prevails—in favor of the buyer as a general thing—except on a few items where the demand has been rather brisk. There were very few large functions that called for many flowers. American Beauty roses are a little more plentiful but there is no improvement yet as to quality among the shorts. Richmonds are much better than Liberties. Both these

WHOLESALE FLOWER MARKETS.—PER 100 TO DEALERS ONLY.

	CINCINNATI Jan. 26	DETROIT Jan. 26	BUFFALO Jan. 26	PITTSBURG Jan. 27
ROSES				
Am. Beauty, Fao. and Sp.	35.00 to 40.00	35.00 to 40.00	40.00 to 50.00	40.00 to 50.00
" Extra	25.00 to 30.00	25.00 to 30.00	30.00 to 40.00	30.00 to 40.00
" No. 1	15.00 to 20.00	15.00 to 20.00	20.00 to 30.00	20.00 to 30.00
" Lower grades	5.00 to 10.00	5.00 to 10.00	10.00 to 15.00	10.00 to 15.00
Bride, "Maid, F. & S.	6.00 to 8.00	6.00 to 8.00	10.00 to 12.00	10.00 to 12.00
" Lower grades	3.00 to 5.00	3.00 to 5.00	5.00 to 7.00	5.00 to 7.00
Killarney, Fao. & Sp.	6.00 to 8.00	6.00 to 8.00	10.00 to 12.00	10.00 to 12.00
" Lower grades	3.00 to 5.00	3.00 to 5.00	5.00 to 7.00	5.00 to 7.00
Richmond, Fancy & Special	6.00 to 8.00	6.00 to 8.00	10.00 to 12.00	10.00 to 12.00
" Lower grades	3.00 to 5.00	3.00 to 5.00	5.00 to 7.00	5.00 to 7.00
Chatenay	5.00 to 7.00	5.00 to 7.00	8.00 to 10.00	8.00 to 10.00
Golden Gate, Ivory, etc.	4.00 to 6.00	4.00 to 6.00	5.00 to 7.00	5.00 to 7.00
My Maryland	5.00 to 7.00	5.00 to 7.00	8.00 to 10.00	8.00 to 10.00
Queco Beatrice	5.00 to 7.00	5.00 to 7.00	8.00 to 10.00	8.00 to 10.00
Mrs. Moe, Field	5.00 to 7.00	5.00 to 7.00	8.00 to 10.00	8.00 to 10.00
CARNATIONS				
Fancy and Novelties	4.00 to 5.00	3.00 to 4.00	2.50 to 3.00	2.00 to 3.00
Ordinary	3.00 to 4.00	2.00 to 3.00	2.00 to 2.50	1.00 to 2.00
MISCELLANEOUS				
Cattleyas	50.00 to 75.00	50.00 to 75.00	50.00 to 75.00	50.00 to 75.00
Oxyperidiums	10.00 to 15.00	10.00 to 15.00	10.00 to 15.00	10.00 to 15.00
Lilies	10.00 to 15.00	10.00 to 15.00	10.00 to 15.00	10.00 to 15.00
Lily of the Valley	10.00 to 15.00	10.00 to 15.00	10.00 to 15.00	10.00 to 15.00
Narcis, Paper White	2.00 to 3.00	2.00 to 3.00	2.00 to 3.00	2.00 to 3.00
Roman Hyacinth	2.00 to 3.00	2.00 to 3.00	2.00 to 3.00	2.00 to 3.00
Buffalo	3.00 to 4.00	3.00 to 4.00	3.00 to 4.00	3.00 to 4.00
Freesia	3.00 to 4.00	3.00 to 4.00	3.00 to 4.00	3.00 to 4.00
Sweet Peas	5.00 to 7.00	5.00 to 7.00	5.00 to 7.00	5.00 to 7.00
Gardenias	5.00 to 7.00	5.00 to 7.00	5.00 to 7.00	5.00 to 7.00
Violets	5.00 to 7.00	5.00 to 7.00	5.00 to 7.00	5.00 to 7.00
Adiantum	5.00 to 7.00	5.00 to 7.00	5.00 to 7.00	5.00 to 7.00
Smilax	5.00 to 7.00	5.00 to 7.00	5.00 to 7.00	5.00 to 7.00
Asparagus Plumosus, strigosa	5.00 to 7.00	5.00 to 7.00	5.00 to 7.00	5.00 to 7.00
" & Spreng (two bchs.)	5.00 to 7.00	5.00 to 7.00	5.00 to 7.00	5.00 to 7.00

rod roses are among the scarcest things on the market. Bridesmaid, Killarney and Jarline are excellent and cleaning up well. There are plenty of orchids of excellent quality and they are in good demand. Carnations generally are of very good quality and prices are holding firm. Sweet peas are more plentiful with demand keeping pace. Violets are a little too plentiful and prices have sagged a little. Callas are of excellent quality and meet with ready sale. Prices on Easter lilies rule low, there being rather more coming in than the market will readily absorb. The daffodil market is still in healthy condition. Paper Whites and Romans are in medium supply and bring fair prices. Freesia, mignonette, tulips and lilac are excellent and in good demand. Greens plentiful.

WASHINGTON Carnations have taken somewhat of a drop owing to the fact that Pennsylvania is shipping them here in quantities for \$2.00 per 100. First class, near by carnations are holding their own in price, bringing \$1.00 and \$1.50 per dozen and there is a steady demand for flowers of that quality. The first tulips, in any quantity, were shown last week and find ready sale at 75 cents and \$1.00 per dozen. A solid week of dark cloudy weather has retarded bloom on everything; the effect is particularly noticeable with callas, instead of big open flowers, the majority of them are small and crumpled, but they go at 10 cents apiece quite readily. Richmonds seem to be taking the lead in the rose line. At all of the principal functions of the past week they were a conspicuous part of the decoration.

PHILADELPHIA NOTES.

Bro. Stephenson's Sons, the Oak Lane florists, have been particularly successful with Jardine this winter, sending in probably the finest specials seen on the Philadelphia market. The plants show extraordinary health and vigor; stems five feet long and shooting from the bottom like rhubarb.

Joseph Heacock, William Swayne and Chas. E. Meehan are among those whom we hear reported as going from this vicinity to the carnation convention.

Alexander E. Scott left on the Florida special for Summerville, S. C., on the 25th inst., to be gone about a month.

W. Atlee Burpee and his son have gone on a pleasure voyage to southern seas, Bermuda, Cuba, Venezuela and other points are on the itinerary.

The next meeting of the Florists' Club will be devoted to the carnation, a discussion of the convention and an exhibit of the latest new varieties. A. M. Herr and Joseph Heacock will be the principal speakers.

J. Liddon Pennock and Mrs. Pennock are among the guests registered at the Royal Poinciana, Palm Beach, Fla.

William Graham will start as chief of the Habermehl decorating department Monday, Feb. 1st.

Edward Reid has been handling cattleyas of exceptional quality recently. Those he showed us were magnificent as to size and coloring.

Detroit reports a decided lull in business almost equal to that of mid-summer. The heavy calls from out of town have helped the wholesalers in reducing their stock. There is an especial demand for roses.

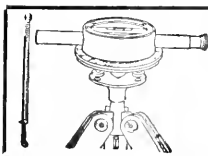

EVERYBODY KNOWS

Park, Cemetery and Landscape Gardening cannot be properly done without the aid of an accurate leveling instrument. Bostrom's Improved Levels, No. 2 at \$15.00 and No. 3 at \$25.00, are conceded by all who KNOW to be the only Levels on the market which meet all the requirements, at the price.

Our guarantee back of every Level we sell, and satisfied users in every State in the Union heartily endorse every claim we make.

Shipping weight 12 lbs. Description on request. BOSTROM-BRADY MFG. CO., 139 Madison Avenue., ATLANTA, GA.

FORD BROTHERS
 48 West 28th Street NEW YORK
FINE ROSES FANCY CARNATIONS
 A Full Line of All CUT FLOWERS
 Telephone, 3870 or 3871 Madison Square

H. E. FROMENT
 Wholesale Commission Florist,
 Choice Cut Flowers,
 57 West 28th St. :: NEW YORK
 Telephones: 2200, 2201, Madison Square.

Alfred H. Langjahr
 All choice cut-flowers in season. Send for quotations. Correspondence with shippers of first-class stock invited.
 55 West 28th Street, New York
 Telephone 4628-4627 Madison Square

Edward C. Horan
 Wholesale Florist
 55 WEST 28th ST.
 Tel. 1462 Madison Square New York
 1463

JOHN YOUNG
WHOLESALE FLORIST
 Finest American Beauties and Carnations

51 West 28 St. - NEW YORK
FRANK MILLANG
 Wholesale Florist
 55-57 West 26th St., NEW YORK
 Shipments, any quantity, Wholesale Market Rates.

Consignments Requested
 A Good Market and Prompt Returns

GEORGE SALT FORD
 43 W. 28th Street, NEW YORK
 Telephone, 3301 Madison Sq.

VIOLETS
 Finest Grade. Any Quantity
B. S. SLINN
 55-57 W. 26 St., New York

Moore, Hentz & Nash
 Wholesale Commission Florists
 55 and 57 West 26th Street
 Telephone No. 756 Madison Square New York

MILLANG BROS.
 WHOLESALE COMMISSION FLORISTS
 41 West 28th Street
 Telephone 3860 Madison 3861 NEW YORK

JOHN I. RAYNOR
Wholesale Commission Florist SELLING AGENT FOR LARGEST GROWERS
 A full line of Choice Cut Flower Stock for all purposes. Completes every variety grown for New York market, at current prices
 TEL. 1998 MADISON SQUARE 49 West 28th St., New York City

Walter F. Sheridan
 Wholesale Commission Dealer in
CHOICE CUT FLOWERS
 39 West 28th Street, New York
 Telephone: 3532-3573 Madison Square

HEADQUARTERS FOR NOVELTIES
ORCHIDS A SPECIALTY
 THE HIGHEST GRADE OF VALLEY ALWAYS
 GARDENIAS, DAISIES, ROSES AND CARNATIONS
JAMES McMANUS, Telephone 799 Mad. Sq. 42 W. 28th St., New York

PHILIP F. KESSLER 55 & 57 W. 26th St., New York City
 Commission Dealer, Wholesale Buyer and Seller of
CUT FLOWERS
 Open from 5 a.m. to 6 p.m. Sunday till 10 a.m.
 Tel., 5243 and 2921 Madison Sq. Res., 345 J., Newtown.
Finest Lilies in the Market Every Day in the Year.

NEW YORK QUOTATIONS PER 100. To Dealers Only

ROSES AND CARNATIONS	Last Half of Week ending Jan. 23 1909		First Half of Week beginning Jan. 25 1909	
American Beauty, Fancy and Special.....	30.00	to 40.00	30.00	to 50.00
" " EXTRA.....	20.00	to 25.00	15.00	to 20.00
" " No. 1.....	10.00	to 15.00	10.00	to 14.00
" " Lower Grades.....	3.00	to 5.00	3.00	to 6.00
Bride, Field, Fancy and Special.....	8.00	to 10.00	8.00	to 10.00
" " Lower Grades.....	2.00	to 6.00	2.00	to 5.00
Killbuck, Fancy and Special.....	10.00	to 20.00	10.00	to 20.00
" " Lower Grades.....	3.00	to 6.00	3.00	to 6.00
Richmond, Fancy and Special.....	10.00	to 25.00	10.00	to 20.00
" " Lower Grades.....	3.00	to 6.00	3.00	to 5.00
Chatenay.....	3.00	to 10.00	3.00	to 15.00
" Maryland.....	4.00	to 15.00	4.00	to 15.00
Golden Gate, Ivory, etc.....	2.00	to 10.00	2.00	to 10.00
Queen Beatrice.....	3.00	to 6.00	3.00	to 5.00
Mrs. Par. Field.....	to.....	to.....
Carnations, Fancy and Novelties.....	3.00	to 5.00	3.00	to 5.00
" Ordinary and White.....	1.50	to 2.00	1.50	to 2.00

Alexander J. Guttman
THE WHOLESALE FLORIST OF NEW YORK
 34 WEST 28th STREET
 PHONES. 1664-1665 MADISON SQUARE
ENOUGH SAID

TRAENDLY & SCHENCK
 Wholesale Florists
 Furnish best Stock at fair Prices all the year round
 Send for Quotations on Any Variety and Quantity
 Tel. 798, 799 Madison Sq. 44 West 28th St., New York City

GROWERS' CUT FLOWER CO. CUT FLOWERS AT WHOLESALE
VIOLETS, CARNATIONS, ROSES ORCHIDS, CHRYSANTHEMUMS, LILIES
 Consignments Solicited. Shipments to Order, any Distance
 Telephone 839 Madison Square J. J. COAN, Manager
39 West 28th Street, NEW YORK

WHOLESALE FLORISTS
54 West 28th St.
NEW YORK
Telephone 3559 Madison Sq.

A. L. YOUNG & CO.

RECEIVERS & SHIP-
PERS OF CUT
FLOWERS.
CONSIGNMENTS SOLICITED.

WILLIAM H. KUEBLER
Brooklyn's Foremost and Best
WHOLESALE COMMISSION HOUSE
A First Class Market for all CUT FLOWERS
28 Willoughby St., Brooklyn, N. Y.
Tel. 4691 Main

GEORGE COTSONAS & CO.
Wholesale and Retail Dealers in all kinds of
EVERGREENS
Fancy and Dagger Ferns
Bronze and Green Galax
Main Store 50 W. 28 St.
Phone 1802 Mad. Sq. New York



Greater New York Florists' Association, Inc.
Now Open for Cut Flower Consignments
162 Livingston Street, BROOKLYN, N. Y.
Geo. W. Crawback Telephone Connection
Manager 3642-43 Main

Henshaw & Fenrich
WHOLESALE FLORISTS
44 West 28th St., NEW YORK
Phones Mad. Sq. 325, 558-2, 558-3.

H. G. BERNING
Wholesale Florist

1402 Pine Street, ST. LOUIS, MO.
REED & KELLER
122 West 25th St., New York

Florists' Supplies
We manufacture all our
Hotel Designs, Baskets, Wire Work & Novelties
and are dealers in
Glassware Decorative Greens and Florists' Requisites

THE KERVAN CO.
Wholesale Dealers and Shippers of
Decorative Evergreens
Ferns, Galax, Laurel, Fresh Cycas, Box-
wood, Sphagnum and all Christmas Greens
Send to us for Quotations before Buying.
113 West 28 Street, NEW YORK CITY

MICHIGAN CUT FLOWER EXCHANGE, Inc.
WHOLESALE COMMISSION FLORISTS
Consignments Solicited.
Hardy Fancy Fern Our Specialty.

38-40 BROADWAY, DETROIT, MICH.
BRONZE GALAX
I will offer during the next 60 days first class
Bronze Galax at \$3.00 per case of 10,000,
size 2 3/4 to 3 1/2 in. f.o.b. Mt. Airy N. C.
Cash with order. Sample Order Solicited.
G. A. HOLDER, Round Peak, N. C.

In ordering goods please add "I saw
it in HORTICULTURE."

Wired Toothpicks
Manufactured by
W. J. COWEE, BERLIN, N. Y.
50,000.....\$1.75; 50,000.....\$7.50. Sample free.
For sale by dealers

SAMUEL A. WOODROW
WHOLESALE PLANTSMAN
Palms, Large and Small Ferns, etc.
53 West 30th Street, NEW YORK
Telephone 2083 Madison

WHOLESALE COMMISSION J. K. ALLEN 106 W. 28th St. NEW YORK
Open 6 a.m. Daily Tel. 167 Madison Sq.
All Grades of Flowers to Suit All Buyers. Consignments Solicited.

NEW YORK QUOTATIONS PER 100. To Dealers Only

MISCELLANEOUS	Last Half of Week ending Jan. 23 1909		First Half of Week beginning Jan. 25 1909	
	100	1000	100	1000
Cyripediums.....	8.00	10.00	8.00	10.00
Cattleyas.....	30.00	40.00	15.00	35.00
Lilies.....	4.00	10.00	5.00	10.00
Lily of the Valley.....	1.00	3.00	1.50	3.00
Narcis., Paper White.....	1.00	1.00	1.50	2.00
Roman Hyas.....	1.00	2.00	1.00	2.00
Tulips.....	2.00	4.00	2.00	4.00
Daffodils.....	2.00	3.00	4.00	5.00
Freesia.....	2.00	3.00	1.00	2.00
Sweet Peas.....	1.00	1.50	1.00	1.50
Gardenias.....	20.00	35.00	20.00	35.00
Violets.....	35	75	75	1.00
Adiantum.....	.75	1.00	.75	1.00
Croweanum.....	1.00	1.25	1.00	1.25
Smilax.....	8.00	10.00	8.00	10.00
Asparagus Plumosus, string.....	15.00	35.00	15.00	35.00
& Spre. (100 bchs).....	15.00	25.00	15.00	25.00

NEW YORK MARKET.

The market remains very tame, with little indication of a change for the better. Roses are being received in increasingly heavy shipments, American Beauty being the only exception. The best demand is enjoyed by Killarney, which practically monopolizes the situation as to pink roses. Carnations are very plentiful and prices tending downward. Violets are no longer a factor of any importance in the wholesale flower market; they fluctuate up and down with the weather, but the bulk of them go at curbstone figures anyway. Lily of the valley and cattleyas are very abundant. Tulips, daffodils, etc., of fine quality, also lilacs, are offered in abundance.

NEWS NOTES.

Traudly & Schenck, the New York wholesalers, after suffering from petty stealing of flowers for some time past, caught a young man in the act on Tuesday of this week and handed him over to the police.

One of the most beautiful calendars of the season is that being sent out by the American Colorotype Company, Chicago, New York and Boston. The subject is a reproduction of Jonicieres'

work of art, "A Honey-moon in Venice." The color work is very fine.

On Saturday, Jan. 23, Prof. E. A. White of Amherst, Mass., delivered a lecture before the Massachusetts Horticultural Society at Boston on Ornamental Gardens and Garden Materials. The lecture was illustrated by a series of stereopticon views in colors, showing garden scenes in England, Italy, Japan and America, and was enjoyed by a very large audience.

Entries are already coming in freely for the annual flower show of the Market Growers at Horticultural Hall, Boston, February 27 and 28. Liberal prizes are offered for carnations, roses, violets, sweet peas, plants and bulbs, etc., and all interested should write to E. Allan Peirce, secretary and treasurer, Waltham, Mass., for a copy of the premium list. This is distinctly the great commercial exhibition of the year.

We will allow on all orders of
Sheaves and Wire Work
15 per cent discount. Orders of \$30.00 up 20 per cent. This for the month of January only.

J. STERN & CO.
125 N. 10th St., Philadelphia, Pa.

Buyer's Directory and Ready Reference Guide

Advertisements under this head, one cent a word. Initials count as words.

Display advertisers in this issue are also listed under this classification without charge. Reference to List of Advertisers will indicate the respective pages.

Buyers failing to find what they want in this list will confer a favor by writing us and we will try to put them in communication with reliable dealers.

ACCOUNTANT

R. J. Dysart, 28 State St., Boston.
For page see List of Advertisers.

AQUILEGIAS

Aquilegia. Genuine Coerulea, finest of all. Both plants and seeds from the heart of the Rockies. C. S. Harrison's Select Nursery, York, Neb.

ARAUCARIAS

A. Leuthy & Co., Perkins St. Nurseries, Roslindale, Mass.
For page see List of Advertisers.
Godfrey Aschmann, 1012 West Ontario St., Philadelphia, Pa.
For page see List of Advertisers.

ASPARAGUS

The Geo. Wittbold Co., 1657 Buckingham Palace, Chicago, Ill.
For page see List of Advertisers.

ASTERS.

James Vick's Sons, Rochester, N. Y.
Vick Quality.
For page see List of Advertisers.

AUCTION SALES

Cleary's Horticultural Co., 62 Vesey St., New York.
For page see List of Advertisers.

AZALEAS

A. Leuthy & Co., Perkins St. Nurseries, Roslindale, Mass.
For page see List of Advertisers.
Godfrey Aschmann, 1012 W. Ontario St., Philadelphia, Pa.
Apollo in Bloom.
Henry A. Troer, Philadelphia.
Azalea Mollis.
For page see List of Advertisers.

BAMBOO CANES

Yokohama Nursery Co., 31 Barclay Street, New York.
Bamboo Sticks, Colored Green.
For page see List of Advertisers.

BAY TREES.

2000 Bay and Box Trees in all sizes, Pyramid and Standards. Write for list. Julius Roehrs, Rutherford, N. J.

BOILERS

BOILERS. "Burnham" Boilers made for greenhouse heating. Lord & Burnham, 1133 Broadway, N. Y.
Kroeschell Bros. Co., 35 Erie St., Chicago.
For page see List of Advertisers.

BOXWOOD TREES

New England Nurseries, Inc., Bedford, Mass.
For page see List of Advertisers.

BUILDING MATERIAL

BUILDING MATERIAL of all description for All Cypress, Semi-Iron, Iron Frame or Truss Houses, Hot Bed Sash and Frames. Lord & Burnham Co., 1133 Broadway, N. Y.

BULBS AND TUBERS

Joseph Breck & Sons, 47-54 N. Market St., Boston.
For page see List of Advertisers.
J. M. Thornburn & Co., 35 Barclay St., New York.
For page see List of Advertisers.
A. T. Boddington, 342 W. 14th St., N. Y.
For page see List of Advertisers.
Rickards Bros., 37 East 19th St., New York.
For page see List of Advertisers.

BULBS AND TUBERS—Continued

H. F. Mitchell Co., Philadelphia.
For page see List of Advertisers.
H. E. Fiske Seed Co., Faneuil Hall Sq., Boston.
For page see List of Advertisers.
T. J. Grey & Co., 32 and 33 So. Market St., Boston.
For page see List of Advertisers.
Yokohama Nursery Co., 31 Barclay St., New York.
For page see List of Advertisers.
Ralph M. Ward & Co., 12 W. Broadway, New York.
Japan Lily Bulbs.
For page see List of Advertisers.

CALADIUMS

Shellroad Canna Farms, Grange, P. O., Baltimore, Md.
For page see List of Advertisers.

CANNAS

Dingee & Conard Co., West Grove, Pa.
For page see List of Advertisers.
Shellroad Canna Farms, Grange P. O., Baltimore, Md.
For page see List of Advertisers.

CARNATIONS

F. Dörner & Sons Co., Lafayette, Ind.
Carnation, Pink Delight.
For page see List of Advertisers.
Chicago Carnation Co., Joliet, Ill.
For page see List of Advertisers.
Albert Roper, Tewksbury, Mass.
Carnation Bay State.
For page see List of Advertisers.
Bassett & Washburn, Hinsdale, Ill.
Carnation O. P. Bassett.
For page see List of Advertisers.
East Sudbury Greenhouses, So. Sudbury, Mass.

Carnation Cuttings.
For page see List of Advertisers.

Wood Bros., Fishkill, N. Y.
Carnations, Rooted Cuttings.
For page see List of Advertisers.

The E. G. Hill Co., Richmond, Ind.
Carnation Cuttings.
For page see List of Advertisers.

Peter Fisher, Eliz., Mass.

Rooted Cuttings.
For page see List of Advertisers.

S. J. Reuter & Son, Westery, R. I.
For page see List of Advertisers.
Bellary Bros., Suc. to L. E. Marquisee, Syracuse, N. Y.

Carnation Marchioness.
For page see List of Advertisers.
Jensen & DeKena, Chicago, W. N. Rudd,
Carnation Mrs. J. C. Vaughan,
Morgan Park, Ill.

Charles H. Totty, Madison, N. J.
For page see List of Advertisers.
Boston Co-operative Flower Growers' Assoc., Boston.

Carnation and Rose Show.
For page see List of Advertisers.

Scheibler & Schoos, Chicago

Carnation Wm. H. Taft.
For page see List of Advertisers.

Patten & Co., Tewksbury, Mass.

Carnations, Rooted Cuttings.
For page see List of Advertisers.

Paul Thompson, W. Hartford, Conn.

Carnation Noptum.
For page see List of Advertisers.

Wm. Swanve, Kennett Square, Pa.

Carnations, Rooted Cuttings.

CARNATION STAPLE

I. L. Pillsbury, Galesburg, Ill.
For page see List of Advertisers.

CHRYSANTHEMUMS

Chas. H. Totty, Madison, N. J.
Chrysanthemum Novelites.
For page see List of Advertisers.
E. G. Hill Co., Richmond, Ind.
For page see List of Advertisers.
S. J. Goddard, Framingham, Mass.
Chrysanthemum Golden Glow.
For page see List of Advertisers.
S. J. Reuter & Son, Westery, R. I.
For page see List of Advertisers.
Elmer D. Smith & Co., Adrina, Mich.
For page see List of Advertisers.
Chrysanthemum Golden Glow from 2-14 in. pots, for early spring delivery, \$1.00 per doz., \$6.00 per 100, \$50.00 per 1000. Stock plants of Montmort, Oct. Frost, Crocus, Matchless, Lucy Devaux, Polly Rose and Halliday, \$1.00 per doz., \$6.00 per 100, Peirce Bros., Waltham, Mass.
Herrington's book on the Chrysanthemum, mailed to your address for 50c, by Horticulture Publishing Co., 11 Hamilton Place, Boston.
Chrysanthemums, rooted cuttings, Bonafont, Pacific, Oriental Glory, pink, Rayner. Late white, \$1.00 per 100, \$5.00 per 1000. Sargent's Greenhouses, 94 Holden St., Worcester, Mass.

CONFITERS

John Waterer & Sons, Ltd., American Nursery, Bagshot, Eng.
For page see List of Advertisers.

CUT FLOWER BOXES.

Edwards Folding Box Co., Philadelphia.
For page see List of Advertisers.
Folding cut flower boxes, the best made. Write for list. Holton & Hunkel Co., Milwaukee, Wis.

CYCLAMEN.

Thomas Roland, Nahant, Mass.
For page see List of Advertisers.

DAHLIAS

David Herbert & Son, Atco, N. J.
For page see List of Advertisers.
J. L. Moore, Northboro, Mass.
For page see List of Advertisers.
Peacock Dahlia Farms, Williamstown Junction, N. J.
Dahlia Miss Virginia Maule.
For page see List of Advertisers.
R. Vincent Jr. & Sons Co., White Marsh, Md.
For page see List of Advertisers.
Dingee & Conard Co., West Grove, Pa.
For page see List of Advertisers.
Shellroad Canna Farms, Grange, P. O., Baltimore, Md.
For page see List of Advertisers.

East Bridgewater Dahlia Garden wants your business. If you are looking for dahlias send to the Eastern Dahlia Kieg, J. K. Alexander, East Bridgewater, Mass.

DAISIES

Daisies, yellow and white Paris R. C., 75c. Queen Alexandra, \$1 per 100, prepaid. Chas. Frost, Kenilworth, N. J.

DECORATIVE PLANTS

A. Leuthy & Co., Perkins St. Nurseries, Roslindale, Mass.
For page see List of Advertisers.
Godfrey Aschmann,
1012 W. Ontario St., Phila., Pa.
For page see List of Advertisers.
Joseph Heacock Co., Wyncote, Pa.
For page see List of Advertisers.
The Geo. Wittbold Co., 1657 Buckingham Palace, Chicago, Ill.
For page see List of Advertisers.

For List of Advertisers See Page 161

DECORATIVE PLANTS Continued

Robert Craig Co., Market and 49th Sts. Philadelphia, Pa.
 For page see List of Advertisers.
 A. N. Pierson, Inc., Cromwell, Conn.
 Palms and Ferns.
 For page see List of Advertisers.

DRACAENAS

The Geo. Witthold Co.,
 1657 Buckingham Place, Chicago, Ill.
 For page see List of Advertisers.

ECONOMY BRACKET

Buxton & Allard, Nashua, N. H.
 For page see List of Advertisers.

EVERGREENS

New England Nurseries, Bedford, Mass.
 For page see List of Advertisers.
 American Nursery Co., 160 Broadway, New York, N. Y.
 For page see List of Advertisers.
 Evergreens. Send 25 cents in stamp for complete work on propagating and growing Evergreens. C. S. Harrison's Select Nursery, York, Neb.

FERNS

A. Leuthy & Co., Roslindale, Mass.
 For page see List of Advertisers.
 H. H. Barrows & Son, Whitman, Mass.
 Nephrolepis Wiltonii.
 For page see List of Advertisers.
 John Scott, Brooklyn, N. Y.
 For page see List of Advertisers.
 Frank Oechslin, 2570-2606 W. Adams St., Chicago.
 Ferns for Dishes.
 For page see List of Advertisers.

The Geo. Witthold Co., 1657 Buckingham Palace, Chicago, Ill.
 For page see List of Advertisers.

Godfrey Aschmann, 1012 W. Ontario St., Philadelphia.
 For page see List of Advertisers.
 Henry A. Dreer, 714 Chestnut St., Phila. Nephrolepis Scholzei.

500 Boston and Seattle ferns, 3 and 3 1/2 pots, cheap for cash. Just right for bedding out. Geo. H. Walker, No. Dighton, Mass.

FERTILIZERS

Pulverized Manure Co., 31 Union Street Yards, Chicago, Ill.
 Wizard Brand Sheep and Shredded Cattle Manure.
 For page see List of Advertisers.
 Robert Simpson, Clifton, N. J. Sheep Manure.
 For page see List of Advertisers.

FEVERFEW

Double Feverfew, 2 1/2 in., \$2.50 per 100. B. P. Welch, Framingham, Mass.
 Feverfew 1 1/2 in. dia., 50c per 100; \$7.00 per 1000. S. W. Fike, St. Charles, Ill.

FLORAL PHOTOGRAPHS

Flora Photographs, Foley's, 226-228 1-2 Bowery, New York.

FLORISTS' LETTERS.

Boston Florist Letter Co., 66 Pearl St., Boston, Mass.
 For page see List of Advertisers.

FLORISTS SUPPLIES

N. F. McCarthy & Co., 84 Hawley St., Boston.
 For page see List of Advertisers.
 H. M. Robinson & Co., 15 Province St. and 9 Chapman Pl., Boston, Mass.
 For page see List of Advertisers.

Reed & Keller, 122 W. 25th St., New York.
 For page see List of Advertisers.

H. Bayerdorfer & Co., 1129 Arch St., Philadelphia.
 Easter Baskets.

For page see List of Advertisers.
 J. Stern & Co., 125 N. 10th St., Phila.
 For page see List of Advertisers.

Baron & Co., Appleton, N. Y. Baskets; Crates; Ladders; Boxes.
 For page see List of Advertisers.

FLORISTS SUPPLIES—Continued

Make your own paper pots, easy, quick and cheap. Roy can make them. Thoroughly tested. Instructions and samples are directed to the stamps. Geo. R. Rohe, Gardener, Bowling Green, Ohio.

FLOWERS BY TELEGRAPH

Park Floral Co., Denver, Colo.
 For page see List of Advertisers.
 Gude Bros. Co., 1214 F St., Washington, D. C.
 For page see List of Advertisers.

Atlanta Floral Co., Atlanta, Ga.
 For page see List of Advertisers.
 M. C. & J. E. Hanzwirth, 232 Michigan Ave., Chicago.

For page see List of Advertisers.
 William J. Smyth, Michigan Ave. and 31st St., Chicago.

For page see List of Advertisers.
 George Witthold Co., 1657-59 Buckingham Palace, Chicago.

For page see List of Advertisers.
 Jacob Schulz, 644 4th Ave., Louisville, Ky.
 For page see List of Advertisers.

Thos. F. Galvin, 124 Tremont St., Boston.
 For page see List of Advertisers.
 Julius A. Zinn, 2 Beacon St., Boston.

For page see List of Advertisers.
 F. H. Houghton, 336 Boylston St., Boston.

For page see List of Advertisers.
 Edward MacMakin, 194 Boylston St., Boston.

For page see List of Advertisers.
 Hoffman, Florist, 59-61 Massachusetts Ave., Boston.

For page see List of Advertisers.
 J. Newman & Sons, Inc., 24 Tremont St., Boston.

For page see List of Advertisers.
 Taitly, Wellesley, Mass.
 For page see List of Advertisers.

J. Bretmeyer's Sons, Miami and Gratiot Aves., Detroit, Mich.
 For page see List of Advertisers.

Samuel Murray, 1017 Broadway, Kansas City, Mo.
 For page see List of Advertisers.

Wm. L. Rock Flower Co., 1116 Walnut St., Kansas City, Mo.
 For page see List of Advertisers.

H. G. Eyles, 11 N. Pearl St., Albany, N. Y.
 For page see List of Advertisers.

David Clarke's Sons, 2139-2141 Broadway, New York.
 For page see List of Advertisers.

Alex. McConnell, New York.
 For page see List of Advertisers.

Robert G. Wilson, Fulton St. & Greene Ave., Brooklyn, N. Y.
 For page see List of Advertisers.

Young & Ngeut, 42 W. 28th St., N. Y.
 For page see List of Advertisers.

M. Bove, 1294 Broadway, New York.
 For page see List of Advertisers.

Myer, 600-11 Madison Ave., New York.
 For page see List of Advertisers.

Thos. Young, Jr., 500 Fifth Ave., New York.
 For page see List of Advertisers.

Newman Floral Co., 202 Fifth Ave., and Madison Sq., New York.
 For page see List of Advertisers.

The Blossom (C. C. Trepel, Mgr.), Bond and Livingston Sts., Brooklyn, N. Y.
 For page see List of Advertisers.

Palmer's, Buffalo, N. Y.
 For page see List of Advertisers.

F. A. Danker, Albany, N. Y.
 For page see List of Advertisers.

J. H. Dunlop, 96 Yonge St., Toronto, Can.
 For page see List of Advertisers.

FLOWER POTS

W. H. Ernest, 28th and M Sts., Washington, D. C.
 For page see List of Advertisers.

A. H. Hews & Co., Cambridge, Mass.
 For page see List of Advertisers.

Hilfinger Bros., Ft. Edward, N. Y.
 For page see List of Advertisers.

The Peters & Reed Pottery Co., Red pots, seed pans, etc. Zanesville, O.

FOREST SEEDLINGS

To close out quick I offer the following first-class stock for Parks, Cemeteries and Forest Plantings: 100 M. Amorpha Fruticosa, 1 to 3 ft.; 300 M. Albion Rosea Stocks, 100 M. Call. Privet; 200 M. Call. River Cuttings; 100 M. Black Locust, 4 to 6 ft.; 50 M. Calycanthus, Sweet Shrub, 1 to 3 ft.; 150 M. Cercis Canadensis, Red Bud, 1 to 4 ft.; 50 M. Cornus Stolonifera, Oshler Dogwood, 1 to 2 ft.; 50 M. Eriogonon, Am. Pershoo, 6 to 30 inches; 50 M. Elm (white) 1 to 2 ft.; 75 M. Hamamelis, Witch Hazel, 6 in. to 3 ft.; 50 M. Tullip Poplar, 1 to 8 ft.; 20 M. Sweet Gum, 1 to 9 ft.; 50 M. Black Walnut, 1 to 3 ft.; 20 M. Wistaria, 1 to 3 ft.; 20 M. Yucca Flamentosa, 1 and 2 year Buttumit, Japan Walnut, Ash, Maple, etc. Send for Price List. I offer my entire stock to close out at low prices; also a large stock of Tree and Shrub Seeds, Black Locust, Sweet Gum, Sycamore, Ash, Red Bud, Persimmon, Bass Wood, Viburnum, Sugar Maple, Red Cedar and other Seeds. Forest Nursery & Seed Co., J. H. H. Boyd, Prop., R. F. D. No. 2, McMinnville, Tenn.

GALAX

Michigan Cut Flower Co., 28 and 40 Broadway, Detroit, Mich.
 For page see List of Advertisers.

George Coatsoun & Co., 50 W. 28th St., New York.
 For page see List of Advertisers.

The Kerran Co., 113 West 28th St., N. Y.
 For page see List of Advertisers.

Rice Bros., 115 N. 6th St., Minneapolis, Minn.
 For page see List of Advertisers.

H. M. Robinson & Co., 15 Province St. and 9 Chapman Pl., Boston.
 For page see List of Advertisers.

G. A. Holter, Round Peak, N. C.
 For page see List of Advertisers.

GERANIUMS

R. Vincent Jr. & Sons Co., White Marsh, Md.
 New and Standard Varieties.
 For page see List of Advertisers.

A few hundred fine mixed stock geraniums, all kinds, \$10.00 per 100. Fine geraniums, 2 1/2 in., \$2.50 per 100. Cash. H. J. Blanchard, Ashburnham, Mass.

GLADIOLI

J. L. Moore, Northboro, Mass.
 For page see List of Advertisers.

E. S. Miller, Wading River, N. Y.
 For page see List of Advertisers.

A. T. Roddington, 312 W. 14th St., New York.
 For page see List of Advertisers.

Shredford Gamma Farms, Grange, P. O., Baltimore, Md.
 For page see List of Advertisers.

Gladioli. As good as any and better than many. Send for trade list. E. E. Stewart, Rives Junction, Mich.

Trenchellis Gladioli, \$8.00 per 1000. Cash with order, please. Estate of Louis Siebrucht, Floral Park, N. Y.

GLASS

Boston Plate & Window Glass Co., Boston.
 For page see List of Advertisers.

Standard Plate Glass Co., 26-30 Sudbury St., Boston.
 For page see List of Advertisers.

Foley Mfg. Co., Western Ave., between 25th & 26th Sts., Chicago.

Sharp, Partridge & Co., 221 & Lumber St., Chicago.
 For page see List of Advertisers.

Greenhouse glass, lowest prices. Johnston Glass Co., Hartford City, Ind.

Glass, High Grade, Double Thick Greenhouse Glass. Lord & Burnham, 1133 Broadway, N. Y.

GLAZING DEVICES

H. A. Dreer, Philadelphia, Pa.
 Peerless Glazing Point.
 For page see List of Advertisers.

GLAZING POINTS, Lord & Burnham Special Glazing Nails (Points). Lord & Burnham, 1133 Broadway, N. Y.

In writing to Advertisers kindly mention Horticulture

GREENHOUSE BUILDING MATERIAL

Lord & Burnham Co.,
1133 Broadway, New York.
For page see List of Advertisers.

Pierson U-Bar Co., 1 Madison Sq., N. Y.
For page see List of Advertisers.

A. T. Stearns Lumber Co., Neponset,
Boston.
For page see List of Advertisers.

King Construction Co., N. Tonawanda,
New York.
For page see List of Advertisers.

Hitchings & Co., 1170 Broadway, New York
For page see List of Advertisers.

J. C. Moninger Co., 117 East Blackhawk St.,
Chicago, Ill.
For page see List of Advertisers.

Foley Mfg. Co., Western Ave., between
25th & 26th Sts., Chicago.
For page see List of Advertisers.

Geo. B. Doane, 18 Midway St., Boston.
Iron Pipe.

Wm. H. Lutton, West Side Avenue Sta.,
Jersey City, N. J.
For page see List of Advertisers.

GREENHOUSE CONSTRUCTION

GREENHOUSE CONSTRUCTION, Semi-Iron
Greenhouse, New Truss Houses and
Iron Frame Houses. Lord & Burnham,
1133 Broadway, N. Y.

J. A. Payne, 290-274 Culver Ave., Jersey
City, N. J.
For page see List of Advertisers.

Foley Mfg. Co., Western Ave., between
25th & 26th Sts., Chicago.
For page see List of Advertisers.

Wm. H. Lutton, West Side Avenue Sta.,
Jersey City, N. J.
Curved Iceless Eave.
For page see List of Advertisers.

Hitchings & Co., 1170 Broadway, New York
For page see List of Advertisers.

GREENHOUSE HOSE

Revere Rubber Co., Boston, Mass.
Revere Hose.
For page see List of Advertisers.

GUTTERS

GUTTERS, Cast Iron Gutters, L. & B.
Improved V Shaped Gutter with drip
gutter attachment. Lord & Burnham, 1133
Broadway, N. Y.

HAIL INSURANCE

Florists' Hall Asso. of America.
J. G. Esler, Saddle River, N. J.
For page see List of Advertisers.

HARDY FERNS, MOSS AND GREENS

H. M. Robinson & Co., 15 Province St.
and 9 Chapman Pl., Boston, Mass.
For page see List of Advertisers.

Michigan Cut Flower Exchange,
38 and 40 Broadway, Detroit, Mich.
For page see List of Advertisers.

George Cotsouas & Co., 50 W. 28th St.,
New York.
For page see List of Advertisers.

N. F. McCarthy & Co., 84 Hawley St.,
Boston.
For page see List of Advertisers.

The Kervan Co., 113 W. 28th St., N. Y.
For page see List of Advertisers.

Wico Bros., 115 N. 6th St., Minneapolis,
Minn.
For page see List of Advertisers.

HEATING APPARATUS

Lord & Burnham Co.,
1133 Broadway, New York.
For page see List of Advertisers.

Pierson U-Bar Co., 1 Madison Sq., N. Y.
For page see List of Advertisers.

John A. Payne, 290-274 Culver Ave., Jersey
City, N. J.
For page see List of Advertisers.

Kroeschell Bros. Co., 35 Erie St., Chicago.
For page see List of Advertisers.

HELP FURNISHED

Thos. H. Bambrick, 24 S. 7th St., Phila.
For page see List of Advertisers.

HERBACEOUS PERENNIALS

P. Ouwerkerk, P. O. No. 1, Hoboken, N. J.
For page see List of Advertisers.

New England Nurseries, Bedford, Mass.
For page see List of Advertisers.

The Geo. Willbold Co., 1557 Buckingham
Place, Chicago.
For page see List of Advertisers.

HOT-BED SASH

The A. T. Stearns Lumber Co., Neponset,
Mass.
For page see List of Advertisers.

Pierson U-Bar Co., 1 Madison Sq., N. Y.
For page see List of Advertisers.

Lord & Burnham Co., 1133 Broadway, N. Y.
For page see List of Advertisers.

Foley Mfg. Co., Western Ave., between
25th & 26th Sts., Chicago.

INSECTICIDES.

Nicotinide kills all greenhouse pests.
P. R. Paletthorpe Co.,
Eleventh St. Owensboro, Ky.
For page see List of Advertisers.

Stumpff & Walter Co., 50 Barclay St.,
New York.
Kiln-dried Tobacco Dust.
For page see List of Advertisers.

Wilson Plant Oil & Fertilizer Co., Chat-
ham, N. J.
Lauten Fumigator.

Niagara Sprayer Co., Middleport, N. Y.
Niagara Brand.
For page see List of Advertisers.

B. G. Pratt Co., New York.
Sulfuride.
For page see List of Advertisers.

Tobacco dust and stems, dust in bbls.,
150 to 200 lbs., \$1.00; stems in bales from
550 to 400 lbs., \$2.00. Cash with order;
money back if you say so. I lead them all
in quality and price. S. R. Levy, Bingham-
ton, N. Y.

"The Fumigating Kind Tobacco Pow-
der"—The first on the market and the kind
that has so many imitators. Has our guar-
antee tag of satisfaction or money back,
and "The Moon Trade Mark" on every bag,
\$3.00 per 100 lbs. The H. A. Stothoff Co.,
Mount Vernon, N. Y., Makers and sellers.

JAPANESE PLANTS

Yokohama Nursery Co., 31 Barclay St.,
New York.
For page see List of Advertisers.

KENTIAS

Godfrey Schumann,
1012 W. Ontario St., Phila., Pa.
For page see List of Advertisers.

A. Leuthy & Co., Roslindale, Mass.
For page see List of Advertisers.

Jos. Hancock Co., Wyncote, Pa.
Single and Made-Up Specimens.
For page see List of Advertisers.

**LEVELS FOR LANDSCAPE GAR-
DENING USE.**

Bostrom-Brady Mfg. Co., 139 Madison Ave.,
Atlanta, Ga.
For page see List of Advertisers.

LILY OF THE VALLEY PIPS

Hjalmar Hartmann & Co., 12 Stormgade,
Copenhagen, Denmark.
For page see List of Advertisers.

MARGUERITES

Marguerites, Queen Alexandra, \$1.25 per
100, prepaid. S. W. Pike, St. Charles, Ill.

NEW AND RARE PLANTS

Rose Hill Nurseries, New Rochelle, N. Y.
For page see List of Advertisers.

NICO-FUME

Kentucky Tobacco Product Co.,
Louisville, Ky.
For page see List of Advertisers.

NURSERY STOCK

John Waterer & Sons, Ltd.,
American Nursery, Bagshot, England.
For page see List of Advertisers.

Cleary's Horticultural Co., 62 Vesey St.,
New York.
For page see List of Advertisers.

P. Ouwerkerk, 216 Jane St., Weehawken
Heights, N. J.
For page see List of Advertisers.

NURSERY STOCK Continued

D. J. Twomey, Dept. H, Geneva, N. Y.
For page see List of Advertisers.

American Nursery Co., 150 Broadway, New
York, N. Y.
For page see List of Advertisers.

Manual of the Trees of North America,
by C. S. Sargent, mailed to your address
for \$5.00, by Horticulture Publishing Co.,
11 Hamilton Place, Boston.

TREES, SHRUBS, ROSES, EVER-
GREENS, FERNIES, HARRY PLANTS,
ELLWANGER & BARRY, Rochester, N. Y.

ONION SEED

Federico C. Varela, Tenerife, Canary Ida.
Bermuda Onion Seed.
For page see List of Advertisers.

ORCHID BASKETS

J. A. Manda, 191 Valley Rd., W. Orange,
New Jersey.
For page see List of Advertisers.

ORCHID PLANTS

Lager & Harrell, Summit, N. J.
For page see List of Advertisers.

Saunders, St. Albans, England.
Importers, Exporters, Growers, Hybridists.
For page see List of Advertisers.

Carrillo & Baldwin, Syracuse, N. Y.
For page see List of Advertisers.

Jos. A. Manda, 191 Valley Road, W.
Orange, N. J.
For page see List of Advertisers.

Ordonez Bros., Madison, N. J., Box 105.
For page see List of Advertisers.

Largest stock in the country. Ask for
prices. Julius Roehrs, Rutherford, N. J.

PAINT AND PUTTY

PAINT AND PUTTY: Ideal Greenhouse
lead; Special Greenhouse Putty. Lord &
Burnham, 1133 Broadway, N. Y.

PALMS

A. Leuthy & Co., Perkins St. Nurseries,
Roslindale, Mass.
For page see List of Advertisers.

Robert Craig Co., Market and 49th St.,
Philadelphia, Pa.
For page see List of Advertisers.

Joseph Hancock Co., Wyncote, Pa.
Home-Grown Palms.
For page see List of Advertisers.

PANSY PLANTS.

Pansies, extra fine giant flowering, strong
plants, 30 cents per 100; \$2.50 per 1000
Edw. Wallis, Atco, N. J.

PATENTS

Siggers & Siggers, Washington, D. C.
For page see List of Advertisers.

PEAT

J. A. Manda, 191 Valley Rd., W. Orange,
New Jersey
For page see List of Advertisers.

Orchid peat, Rotted peat, Azalea peat,
Leaf-Mould, Live Sphagnum moss, Baled
Sphagnum moss, Green Clump moss, etc.
Jobbers' list on application. C. W. Brown-
ell & Co., Walden, N. Y.

Orchid Peat and Moss always on hand.
Julius Roehrs Co., Rutherford, N. J.

PEONIES

Peonies only, by the wholesale—best 100
varieties. J. F. Rosenfield, Westpoint, Nebr.
One of the finest collections in America.
Send 25 cts. in stamps for new edition of
Peony Manual. C. S. Harrison's Select
Nursery, York, Neb.

PHLOXES

Send 25 cts in stamps for Phlox Manual.
Fine mixed phloxes \$2.00 per 100. C. S.
Harrison's Select Nursery, York, Neb.

**PHOTOGRAPHS; DESIGNING; IL-
LUMSTRATING**

Geo. E. Dow, 178 Washington St., Boston.
For page see List of Advertisers.

For List of Advertisers See Page 161

PIPE AND FITTINGS

Foley Mfg. Co., between Western Ave. and 26th St., Chicago, Ill.
For page see List of Advertisers.

Krosschell Bros. Co., 35 Erie St., Chicago.
For page see List of Advertisers.
THE AND FITTINGS. Cast Iron and Wrought Pipe, Valves, Elbows, Pipe Hooks, Automatic Air Headers, etc. Lord & Burnham, 1133 Broadway, N. Y.

PLANT STANDS

Moore-Livingson Co., Landdowne, Pa.
For page see List of Advertisers.

PLANT STAKES

Seale's Treeless Plant Stakes and Trellises. H. D. Seale & Sons, Elkhart, Ind.

POT HANGERS

Pot hangers, Kramer's \$1 doz. by exp., \$1.25 by mail. I. N. Kramer & Son, Cedar Rapids, Ia.

POINSETTIAS (Artificial)

Poinsettias, artificial decorations our specialty. Sample lots of 50 to 30 dozens, \$3.00; 100 lots, \$2.50. J. Stern & Co., 125 N. 10th St., Philadelphia, Pa.

PRIVET

John Bennett, Atlantic Highlands, N. J.
For page see List of Advertisers.

PRUNING SHEARS

Rhodes Mfg. Co., Dept. R., Grand Rapids, Mich.

RAFFIA

Raffia colored, 20 beautiful shades. Samples free. The Coney Co., Camden, N. J.; 810 Washburn Ave., Chicago, Ill.

RETAIL FLORISTS

Park Floral Co., Denver, Colo.
For page see List of Advertisers.
Gude Bros. Co., 1214 F St., Washington, D. C.
For page see List of Advertisers.

Athlanta Floral Co., Atlanta, Ga.
For page see List of Advertisers.
M. C. & J. E. Hauswirth, 232 Michigan Ave., Chicago.

For page see List of Advertisers.
William J. Smyth, Michigan Ave. and 31st St., Chicago.

For page see List of Advertisers.
George Wittbold Co., 1657-59 Buckingham Place, Chicago.

For page see List of Advertisers.
Jacob Schulz, 644 4th Ave., Louisville, Ky.
For page see List of Advertisers.

Thos. F. Galvin, 124 Tremont St., Boston.
For page see List of Advertisers.

Julius A. Zinn, 2 Beacon St., Boston.
For page see List of Advertisers.
Frank H. Houghton, 396 Boylston St., Boston.

For page see List of Advertisers.
Edward MacMullin, 104 Boylston St., Boston.

For page see List of Advertisers.
Hoffman, Florist, 59-61 Massachusetts Ave., Boston.

For page see List of Advertisers.
J. Newman & Sons, Inc., 24 Tremont St., Boston.

For page see List of Advertisers.
Talby, Wellesley, Mass.
For page see List of Advertisers.

J. Brettmeyer's Sons, Detroit, Mich.
For page see List of Advertisers.

Samuel Murray, 1017 Broadway, Kansas City, Mo.
For page see List of Advertisers.

Wm. L. Rock Flower Co., 1116 Walnut St., Kansas City, Mo.
For page see List of Advertisers.

H. G. Erves, 11 N. Pearl St., Albany, N. Y.
For page see List of Advertisers.

David Clarke's Sons, 2139-2141 Broadway, New York.
For page see List of Advertisers.
Alex. McConnell, New York.
For page see List of Advertisers.

RETAIL FLORISTS - Continued

Robert G. Wilson, Fulton St. and Greene Ave., Brooklyn, N. Y.
For page see List of Advertisers.

Young & Nugent, 42 W. 26th St., N. Y.
For page see List of Advertisers.
M. Bove, 1294 Broadway, New York.
For page see List of Advertisers.

Myer, 600-11 Madison Ave., New York.
For page see List of Advertisers.
Thos. Young, Jr., 500 Fifth Ave., New York.
For page see List of Advertisers.

Newman Floral Co., 202 Fifth Ave. & Madison Sq., New York.
For page see List of Advertisers.

The Blossom (C. C. Tremp, Mgr.), Bond and Livingston Sts., Brooklyn, N. Y.
For page see List of Advertisers.

Palmer's Buffalo, N. Y.
For page see List of Advertisers.

F. A. Danker, Albany, N. Y.
For page see List of Advertisers.
J. H. Dunlop, 36 Yonge St., Toronto, Can.
For page see List of Advertisers.

RHODODENDRONS

John Waterer & Sons, Ltd., American Nursery, Bagshot, England.
For page see List of Advertisers.

P. Ouwwerker, Hoboken, N. J.
For page see List of Advertisers.

Anthony Waterer, Knapp Hill Nursery, Surrey, Eng.
For page see List of Advertisers.

Henry A. Dreer, Philadelphia.
For page see List of Advertisers.

ROSES

Robert Craig Co., Market and 49th Sts., Philadelphia, Pa.
For page see List of Advertisers.

P. Ouwwerker, P. O. No. 2, Hoboken, N. J.
For page see List of Advertisers.

Julius Roehrs Co., Rutherford, N. J.
Rose Newport Fairy.
For page see List of Advertisers.

Waban Rose Conservatories, Natick, Mass., and 3A Somerset St., Boston.
New Forcing Rose White Killarney.
For page see List of Advertisers.

The F. R. Pierson Co., White Killarney.
Tarrytown-Hudson, N. Y.
For page see List of Advertisers.

S. J. Reuter & Son, Westery, R. I., My Maryland.
For page see List of Advertisers.

Dhizee & Conard Co., West Grove, Pa.
For page see List of Advertisers.

Charles H. Totty, Madison, N. J.
For page see List of Advertisers.

Roses, strong, own root, 4 inch Chateaux Killarney, Richmond and Mald., \$8 per 100. Stehrecht & Son, New Rochelle, N. Y.

Hand Book of Cultural Notes on Roses Under Glass, by F. P. Brigham, mailed to your address for 25c. by Horticulture Publishing Co., 11 Hamilton Place, Boston.

SEED GROWERS

C. C. Morse & Co., 48-56 Jackson St., San Francisco, Cal.
For page see List of Advertisers.

Hjalmar Hartmann & Co., Cauliflower and Cabbage Seed.
12 Stormgade, Copenhagen, Denmark.
For page see List of Advertisers.

Federico C. Varla, Tenerife, Canary Ids. Bernuda Onion Seed.
For page see List of Advertisers.

SEEDS

T. J. Grey Co., 22 So. Market St., Boston.
For page see List of Advertisers.

Joseph Breck & Sons, 51 and 52 N. Market St., Boston, Mass.
For page see List of Advertisers.

W. Atlee Burpee & Co., Philadelphia.
For page see List of Advertisers.

C. C. Morse & Co., 48-56 Jackson St., San Francisco, Calif.
For page see List of Advertisers.

Arthur T. Bodington, 342 W. 14th St., New York.
For page see List of Advertisers.
H. E. Flske Seed Co., Faneuil Hall Sq., Boston.
For page see List of Advertisers.

SEEDS - Continued

Hjalmar Hartmann & Co., 12 Stormgade, Copenhagen, Denmark. Cauliflower and Cabbage Seed.
For page see List of Advertisers.

Rickards Bros., 37 E. 30th St., New York.
For page see List of Advertisers.

R. & J. Farquhar & Co., 67 So. Market St., Boston.
Mignonette Seed.
For page see List of Advertisers.

H. F. Michell Co., 1018 Market St., Phila.
For page see List of Advertisers.

J. M. Thorburn & Co., 33 Barclay St., N. Y.
For page see List of Advertisers.

Leonard Seed Co., Chicago, Ill.
For page see List of Advertisers.
Wm. Elliott & Sons, 42 Vesey St., N. Y.
New Seed.
For page see List of Advertisers.

Seeds. Rocky Mountain Evergreen seeds in large or small quantities. C. S. Harri son's Select Nursery, York, Neb.

My own new crop of SALVIA SPLENDENS VARIETIES is now ready. Nama compacta ZIRICH, finest early flowering pot Salvia in existence, selected seeds, compacta Grandiflora FIREBALL, best of all for pots and groups, selected seeds, all for Grandiflora Ameliora KING OF THE STARLETS, unexcelled for late groups, with extra large deep scarlet spikes, selected seeds. Each of above per Tr. Pkt., 50c; 4 Tr. Pkt., \$2.50. Larger quantities on special quotation. O. V. ZANGEN, Seedsman, Hoboken, N. J.

SHAMROCKS

John F. Rupp, Shilohmestown, Pa.
For page see List of Advertisers.

SHRUBS

The Geo. Wittbold Co., 1657 Buckingham Palace, Chicago.
For page see List of Advertisers.

SILKALINE

John C. Meyer & Co., Boston, Mass.
For page see List of Advertisers.

SPHAGNUM MOSS

Live Sphagnum moss, orchid peat and orchid baskets always on hand. Lager & Hurrell, Summit, N. J.

Fresh, clean, 5 lb. bale, \$1.25; 2 bales, \$2.25; 5 bales, \$5.00; 10 bales, \$9.50. Cash. H. R. Akers, Chatsworth, N. J.

Sphagnum moss and mountain laurel in bags, bales or car lots. Prices low. Spruce and hemlock in bales. James Day, Box 660, Milford, N. H.

SPRAYERS

"SHOWERMAKER" St. Jos Kopsca, So. Bend, Ind.

Niagara Sprayer Co., Middleport, N. Y.
For page see List of Advertisers.

J. F. Cass Mfg. Co., Dept. H., Detroit, Mich.
U-N-I-T Globe Sprayer.
For page see List of Advertisers.

STEAM TRAP

E. Hppard, Youngstown, O.
For page see List of Advertisers.

STRAWBERRY PLANTS

H. L. Crane, Westwood, Mass.
Barrimore Strawberry.
For page see List of Advertisers.

SULFOCID

The B. G. Pratt Co., 50 Church St., Dept. W., New York City.
For page see List of Advertisers.

SWEET PEAS

A. C. Zvolnack, Bound Brook, N. J.
Winter Flowering.
For page see List of Advertisers.

TO-BAK-INE

E. H. Hunt, Genl. Agt., 76-78 Wabash Av., Chicago.
For page see List of Advertisers.

TOMATO PLANTS.

10,000 tomato plants for forcing. Comet, Pierce and Maxima ready January 20. Good plants from 2 1/2 inch pots, \$15 per 1000. Loentz Street Greenhouses, J. H. A. Hitchison, Prop., Oxford, Pa.

20,000 Forcing Tomatoes, 2 1/2 in., \$2.00 per 100. Roney Bros., West Grove, Pa.

In writing to Advertisers kindly mention Horticulture

Tobacco Paper

IS THE

**STRONGEST,
BEST PACKED,
EASIEST APPLIED.**

24 sheets.....	\$ 0.75
144 sheets.....	3.50
288 sheets.....	6.50
1728 sheets.....	35.10

"NICO-FUME" LIQUID

OVER 40% NICOTINE

By far the

CHEAPEST.

**Furnishes the
Most Nicotine for the Money!**

JUST NOTE PRICE!

Pint.....	\$ 1.50
1/2 Gallon.....	5.50
Gallon.....	10.50
5 Gallons.....	47.25

... Manufactured by ...
THE KENTUCKY TOBACCO PRODUCT CO., Louisville, Ky.

VENTILATING APPARATUS
Person U-Bar Co., 1 Madison Sq., N. Y.
For page see List of Advertisers.
Foley Mfg. Co., Western Ave., between 25th & 26th Sts., Chicago.
For page see List of Advertisers.
John A. Payne, 240-274 Culver Ave., Jersey City, N. J.
For page see List of Advertisers.
The Advance Co., Richmond, Ind.
For page see List of Advertisers.
Quaker City Machine Co., Richmond, Ind.
20th Century Ventilating Arm
For page see List of Advertisers.
VENTILATING MACHINERY. New Model enclosed, self-rolling gear; Standard Model Open Gear. Lord & Burham, 1133 Broadway, N. Y.

WAX FLOWERS

We are originators of wax designs and still the standard concern. J. Stern & Co., 125 N. 10th St., Philadelphia, Pa.

WHEAT SHEAVES

H. Bayersdorfer & Co., 1129 Arch St., Phila.
J. Stern & Co., 125 N. 10th St., Phila.
For page see List of Advertisers.

WIRED TOOTHPICKS

W. J. Cowee, Berlin, N. Y.
For page see List of Advertisers.

WIREWOK

Reed & Keller, 122 W. 25th St., N. Y.
For page see List of Advertisers.
Wiwework. Write for our catalogue. Holton & Hunkel Co., Milwaukee, Wis.
William E. Heilscher's Wire Works, 38-40 Broadway, Detroit, Mich.
Headquarters for wire work. Send for list. Hall & Betz, 31 E. 3rd St., Cincinnati, O.
Wiwework—Compare our prices with others. Scranton Florist Supply Co., 201 N. 7th St., Scranton, Pa.

WHOLESALE FLORISTS

Boston

N. F. McCarthy & Co., 84 Hawley St., Boston.
For page see List of Advertisers.
H. M. Robinson & Co., 15 Province St. and 9 Chapman Pl., Boston.
For page see List of Advertisers.
Welch Bros., 226 Devonshire St., Boston.
For page see List of Advertisers.
Tallhy, Wellesley, Mass.
For page see List of Advertisers.

Chicago

Chas. W. McKellar, 51 Wabash Ave., Chicago.
For page see List of Advertisers.
Peter Reinberg, 51 Wabash Ave., Chicago.
For page see List of Advertisers.
E. F. Winterson Co., 45-49 Wabash Ave., Chicago.
For page see List of Advertisers.
J. A. Budlong, 37-39 Randolph St., Chicago.
For page see List of Advertisers.
Poehlmann Bros. Co., Morton Grove, Ill.
For page see List of Advertisers.

Cromwell, Conn.

A. N. Pierson, Cromwell, Conn.
For page see List of Advertisers.

Detroit

Mehlgan Cut Flower Exchange, 38 and 40 Broadway, Detroit, Mich.
For page see List of Advertisers.

**WHOLESALE FLORISTS—
Continued**

Minneapolis

Rice Bros., 115 N. 6th St., Minneapolis, Minn.
For page see List of Advertisers.

New York

Ford Bros., 48 W. 28th St., New York.
For page see List of Advertisers.
H. E. Froment, 57 W. 28th St., New York.
For page see List of Advertisers.
Alex. J. Guttman, 34 W. 28th St., New York.
For page see List of Advertisers.
E. C. Horan, 55 W. 28th St., New York.
For page see List of Advertisers.
A. H. Langjahr, 55 W. 28th St., New York.
For page see List of Advertisers.
James McManus, 42 W. 28th St., New York.
For page see List of Advertisers.
John L. Raynor, 49 W. 28th St., New York.
For page see List of Advertisers.
W. F. Sheridan, 39 W. 28th St., New York.
For page see List of Advertisers.
Trendly & Schenck, 44 W. 28th St., New York.
For page see List of Advertisers.
Moore, Heutz & Nash, 55 and 57 W. 26th St., New York.
For page see List of Advertisers.
Wm. H. Kuehler, 28 Willoughby St., Brooklyn, N. Y.
For page see List of Advertisers.
Philip E. Kessler, 55 and 57 W. 26th St., New York.
For page see List of Advertisers.

Willang Bros., 41 W. 28th St., New York.
For page see List of Advertisers.
John Young, 51 W. 28th St., New York.
For page see List of Advertisers.
Greater New York Florists' Association, 162 Livingston St., Brooklyn, N. Y.,
For page see List of Advertisers.
George Saltford, 43 W. 28th St., New York.
For page see List of Advertisers.
Frank Millang, 55-57 W. 26th St., New York.
For page see List of Advertisers.

B. B. Slinn, 55-57 W. 26th St., New York.
For page see List of Advertisers.
A. L. Young & Co., 54 W. 28th St., N. Y.
For page see List of Advertisers.
Growers' Cut Flower Co., 39 W. 28th St., New York.
For page see List of Advertisers.
Henshaw & Fenrich, 44 W. 28th St., New York.
For page see List of Advertisers.
J. K. Allen, 100 W. 28th St., New York.
For page see List of Advertisers.

Philadelphia

W. E. McKissick & Bros., 1619-1621 Broad St., Philadelphia, Pa.
For page see List of Advertisers.
Leo Nissen Co., 1209 Arch St., Philadelphia, Pa.
For page see List of Advertisers.
The S. S. Pennock-Meehan Co., 1608-18 Ludlow St., Philadelphia, Pa.
For page see List of Advertisers.

St. Louis

H. G. Berning, 1402 Pine St., St. Louis, Mo.
For page see List of Advertisers.

WHOLESALE PLANTSMAN

Sammel A. Woodrow, 53 W. 30th St., New York.
For page see List of Advertisers.

New Offers in This Issue.

**FREE TICKETS TO SHOW OF BOS-
TON FLOWER GROWERS' ASSO.**
N. E. McCarthy & Co., 84 Hawley St., Boston.
For page see List of Advertisers.

JAPANESE BULBS.

K. Takahashi, 47N Baylston St., Boston.
For page see List of Advertisers.

**NOVELTIES FOR ST. VALENTINE'S
DAY.**

H. Bayersdorfer & Co., Philadelphia.
For page see List of Advertisers.

HELP WANTED

GOOD MEN

When you need good men,
skilled or unskilled, Write:

**THOS. H.
BAMBRICK**

34 South 7th Street Philadelphia

Help of all kinds, including that for Florists, Nurserymen, Seedsmen and the Horticultural trade generally.

WANTED—A young man for designing in store or one willing to travel for a florist. Address Florist, care Horticulture.

FOR SALE

FOR SALE—5000 feet, 2-in., 1000 feet, 4-in., wrought iron pipe; 4000 feet of 4-in. cast iron pipe, clean; 500 boxes 10 x 12, \$1.50; 150 boxes 10 x 15, \$1.70; and 100 boxes of 8 x 10, double-thick and clean glass, at \$1.25 per box. Two Scollay, 3 sections, two Scollay No. 5, one No. 17 Hiltchings, and one No. 8 Furman boilers. All kinds ventilating apparatus and sash, cast iron fittings, valves, expansion tanks, etc. Everything in first class condition. Cheap. F. O. B. Newark car. I. Susselman, 229 Livingston St., Newark, N. J.

FOR SALE—5000 feet, 2-in., 1000 feet, 4-in., wrought iron pipe; 4000 feet of 4-in. cast iron pipe, clean; 500 boxes 10x12, \$1.50; and 100 boxes of 8x10, double thick and clean glass, at \$1.25 per box. One No. 17 Hiltchings. All kinds ventilating apparatus and sash, cast iron fittings, valves, expansion tanks, etc. Everything in first-class condition. Cheap. F. O. B. Newark car. I. Susselman, 229 Livingston St., Newark, N. J.

FOR SALE—One complete greenhouse, 24 feet by 22 1/2 feet; all double thick 16x24 inch glass; heated by Furman boiler and about 3000 feet of 1 1/2 inch and 1 1/4 inch wrought iron pipe, drip bars and all up-to-date supports and ventilating apparatus. Cheap. Inspect at West street, South Norwalk, Conn. (Franklin A Smith Greenhouses), or inquire of I. Susselman, 229 Livingston street, Newark, N. J.

FOR SALE—Retail nursery, sixth year. Stock in excellent condition. Only local supply for community of 50,000. For particulars address B. N., care HORTICULTURE, Boston.

List of Advertisers

Advance, The Co. 163	Page	McCarthy N. F. Co.	Page
Allen J. K. 155		McConnell Alex. & Co. 145-155	
American Nursery Co. (Eug.) 136		McKellar Charles W. 152	
American Nursery Co. 136		McKissick, W. E. & Bros. 152	
Aschmann, Thos. 147		McManus Jas. 152	
Atlanta Floral Co. 151		Meyer 150	
Hambrick Thos. H. 160		Meyer J. C. & Co. 151	
Barrows H.H. & Son. 147		Michell H. F. Co. 148-161	
Bassett & Washburn. 134		Michigan Cut Flower Exchange. 155	
Bayersdorfer H. & Co. 149-151		Millang Bros. 154	
Bellamy Bros. 134		Millang Frank. 154	
Bennett J. 144		Miller, E. S. 135	
Bernig H. G. 155		Moninger J. C. 163	
Blossom The 150		Moore, J. L. 147	
Boddington A. T. 147-149		Moore, Hente & Nash. 154	
Boston Co-operative Flower Growers' Assn. 145		Moore-Livingston Co. 151	
B. Seton Florist Letter Co. 151		Morse C. C. & Co. 149	
B. Ston Plate and Window Glass Co. 162		Murray Samuel 150	
Bstrom-Brady Mfg. Co. 153		New Eng. Nurseries. 136	
Bowk, M. A. 150		Newman Floral Co. 150	
Beck, Joseph & Son. 149		Newman J. & Sons. 151	
Bred Meyer's J. Sons. 151		Niagara Sprayer Co. 161	
Budgeman's Seed Warehouse 149		Nielsen Leo. Co. 152	
Burdell J. A. & Co. 159		Oechslin Frank. 147	
Burke W. A. & Co. 159		Ordonez Bros. 145	
Buxton & Allard. 162		Quwerker P. 146	
Carrillo & Baldwin. 145		Paltheorpe P. R. Co. 161	
Cass J. F. Mfg. Co. 162		Palmer W. J. 150	
Chicago Carnation Co. 134		Park Floral Co. 150	
Clarke's David, Sons, 150		Patten & Co. 134	
Cleary's Horticultural Co. 139		Payson Geo. A. 169	
Coan J. J. 154		Peacock Dublin Farms. 147	
Corsosan Geo. & Co. 155		Pennock-Meehan Co. 152	
Cowee W. J. 155		Berkins St. Nurseries. 147	
Craig, Robt. Co. 130		Pierson A. N. 145	
Crawford H. L. 151		Pierson F. R. Co. 145	
Crawford Geo. W. 151		Pierson U. Bar. Co. 164	
Danker F. A. 151		Pill-buy I. L. 145	
Diagee & Conard Co. 136		Pochman Bros. Co. 154	
Dorner F. Sons & Co. 135		Pohlman G. Co. 161	
Dow Geo. E. 149		Pulverized Manure Co. 161	
Oreer H. A. 135-162		Quaker City Mach. Co. 163	
Dunlop John H. 150		Kaynor John I. 154	
Dysart R. J. 151		Reed & Keller. 155	
East Sudbury Greenhouse. 135		Reimberg Peter. 154	
Edwards Folding Box Co. 152		Reuters, J. & Son, Inc. 134	
Elliott Wm & Sons. 149		Revere Rubber Co. 162	
Eler J. G. 165		Rice Bros. 152	
Ernest W. H. 146		Richards Bros. 149	
Eyres 150		Robinson H.M. & Co. 152	
Farquhar K. & J. Co. 149		Rock Wm. L. Flo. Co. 150	
Fisher Peter. 135		Rochrs Julius Co. 145	
Fiske H. E. Seed Co. 149-161		Roper Albert. 134	
Foley Mfg. Co. 163		Roland, Thomas 155	
Forst Bros. 154		Rolker August & Sons. 146	
Ford H. E. 154		Rose Hill Nurseries. 147	
Galvin Thos. F. 151		Rupp J. P. 147	
Goddard S. J. 135		Salford Geo. 154	
Greater N.Y. Florists' Association. 155		Sander & Son. 145	
Grey T. J. Co. 149		Scheiden & Schoss. 135	
Growers' Cut Flower Co. 154		Schulz Jacob. 151	
Gude Bros. Co. 150		Scott, John. 162	
Guttman Alex. J. 154		Shurr, Partridge & Co. 167	
Hall Asso. 163		Sherrard Cannn Farms. 135	
Hartmann Hjalmar & Co. 149		Sheridan W. F. 154	
Hausewirth M. C. & J. E. 150		Shick & Siggers. 149	
Heacock Jos. & Co. 147		Simpson Robt. 149	
Henshaw & Fentich. 155		Situations & Wants. 160	
Herbert David & Son. 147		Siln B. S. 154	
Hews A. H. & Co. 146		Smith Elmer D. & Co. 156	
Hilfinger Bros. 146		Smyth Wm. J. 150	
HJ. The E. G. Co. 145		Standard Plate Glass Co. 162	
Hippard E. 162		Stern J. & Co. 155	
Hitchings & Co. 164		Stearns A.T. Lumber Co. 163	
Hoffman 151		Stump & Walter Co. 161	
Hogter G. 145		Tailly 151	
Horan E. C. 154		Takeuch K. K. 149	
Houghton F. H. 151		Tani R. 149	
Hunt E. H. 161		Thomson Paul. 125	
Kentucky Tobacco Product Co. 160		Thorburn J. M. & Co. 149	
Kervan The Co. 150		Young A. L. 155	
Kessler, P. F. 154		Vicent R. Jr. & Sons. 147	
King Cons. Co. 163		Waban Rose Conservatories. 136	
Knap Hill Nurseries. 145		Ward R. M. & Co. 143	
Kraeschel Bros. Co. 163		Water J. 136	
Kuebler Wm H. 155		Waterer John & Sons. 136	
Lager & Hurrell. 145		Welch Bros. 150	
Lanjahar, Alfred H. 154		Wilson. 159	
Leonard Seed Co. 149		Winters, E. L. 150	
Leuthy A. & Co. 142		Withold Geo. Co. 147	
Lord & Burnham Co. 164		Wood Bros. 134	
Lutton W. H. 163		Woodrow Sam'l A. 145	
Manda Jos. A. 143		Yokohama Nursery Co. 143	
MacMulkin E. A. 151		Young A. L. 155	
		Young John. 154	
		Young, Thos. Jr. 150	
		Young & Nugent. 150	
		Zinn Julius A. 151	
		Zvolanek A. C. 149	

For Trees, Plants, Shrubs and Flowers

USE

THE NIAGARA BRAND LIME SULPHUR SOLUTION

It destroys Scale Lice, Spiders and all forms of Aphides, AT THE SAME TIME Mildew, Blight, Rust and other Fungus Diseases.
 Used in Winter or Summer — No other remedy has been so universally effective.
 Niagara Brand ARSENATE OF LEAD for chewing insects is equal to the best and better than the most.
 Ask about our Green House sprayer. Address —

NIAGARA SPRAYER CO., - - Middleport, N. Y.

WIZARD
 TRADE BRAND MARK
MANURES

Dried, screened and packed in bags of 100 lbs. each.

PULVERIZED SHEEP MANURE
 PURE — UNIFORM — RELIABLE

A strong and quick acting manure, highly recommended for carnations and chrysanthemums.

SHREDDED CATTLE MANURE
 EASY TO HANDLE AND APPLY

Stronger and better in every way than rough manure. Lasts much longer on the benches. Un-qualld for mulching and feeding roses, liquid manuring and mixing with bench and potting soil. Used by all the largest growers.

Ask Your Supply Man or Write Us for Circulars and Prices.

THE

Pulverized Manure Co.
 31 Union Stock Yards, CHICAGO

DON'T EXPERIMENT

USE

To-Bak-Ine

and your stock will be free from insects, clean, and the blooms will not be discolored.

Send for full information of

H. E. FISKE SEED CO.
 13 Faneuil Hall Sq., Boston, Mass.

STUMPP & WALTER CO.
 50 Barclay St., New York.

HENRY F. MICHELL & CO.,
 1018 Market St., Philadelphia.

E. H. HUNT, Gen'l Agent,
 76-78 Wabash Ave., Chicago.

KILMDEAD TOBACCO DUST
 Free from Sand or Dirt Kin
 FOR FUMIGATING AND DUSTING
 Dusted on plants it covers their surface.
 One Quality for Both Uses.
 Our Tobacco Dust is the pure tobacco, free from sand and dirt, strong in Nicotine and always of the same strength, making it superior in any dust on the market. Costs you no more than the ordinary product and will do twice the work. 10 lbs. 60c; 25 lbs. \$1.25; 50 lbs. \$2.00; 100 lbs. \$3.50.
STUMPP & WALTER CO.
 50 Barclay St., New York



The Best Bug Killer and Bloom Saver

For PROOF Write to

P. R. Paltheorpe Co.
 OWENSBORO, KY.

BUSINESS CHANCES

WANTED—To unite in partnership in Massachusetts with man needing more capital or assistance in horticultural business wanting expansion; or to join with man thoroughly qualified in horticulture in establishment of new enterprise. Address K., care Horticulture.

MISCELLANEOUS WANTS

WANTED TO BUY Complete green house plants and all kinds of greenhouse material, to be taken down and removed at once. Terms cash. Address L. Strosserman, 229 Livingston St., Newark, N. J.

HORTICULTURE needs a wide-awake representative in every town in the land. Good commission paid on advertising and subscriptions. If you are ambitious, write for terms.

SOMETHING NEW for GREENHOUSES

"SULFOCID" PRATT'S SOLUBLE SULPHUR SUMMER SPRAY

Non-caustic and non-irritating
 A FUNGICIDE AND INSECTICIDE
 FOR FRUIT TREES, VEGETABLES and GREENHOUSES

A promising substitute for Bordeaux mixture. For 10 cts. to cover postage will send sample sufficient for one gallon of spray. Use 1 part to 75 or 100 parts of water. B. G. PRATT CO., 50 Church St., New York, U. S. A.

In ordering goods please add "I saw it in HORTICULTURE."

"REVERO"

Braided Moulded Construction—Seamless Throughout



LIGHT--STRONG-- FLEXIBLE



The above cuts represent the non-kinking tendency of Revero as compared with the old style hose of wrapped duck construction

Revero is Furnished on Reels in Continuous Lengths up to 500 feet.

Revere Rubber Company,

BOSTON, MASS.

NEW YORK
NEW ORLEANS
PHILADELPHIA
MINNEAPOLIS
PITTSBURG
SAN FRANCISCO
CHICAGO
PORTLAND, ORE.

THE STANDARD STEAM TRAP

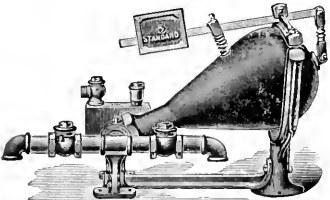

is acknowledged the best for the florist, because it is durable and does its work without trouble and annoyance, saving its cost by the economy in coal bills

E. HIPPARD

YOUNGSTOWN, OHIO

STANDARD PLATE GLASS CO.

Manufacturers—Importers—Jobbers

NOW IS THE TIME TO BUY

FRENCH OR AMERICAN GREENHOUSE GLASS

LOWEST PRICES ON REQUEST

26-30 Sudbury St. BOSTON, MASS. 61-63 Portland St.

GLASS

Always Write Us Before Buying

SHARP, PARTRIDGE & CO.

22nd and Lumber Streets, CHICAGO

WE HAVE SOME SNAPS

The Payne Steel "T" Bar Greenhouses

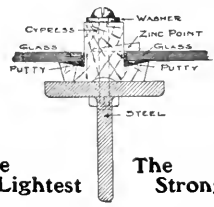

The Lightest

The Strongest

Half full Size

HOUSES of this type are constructed with both curved glass eaves and straight glass eaves. Least amount of shadow. Least amount of wood. No drip. Greatest durability.

JOHNA. PAYNE

Greenhouse Designer and Builder
260-274 Culver Avenue
JERSEY CITY, N. J.

Mr. Carnation Grower:—

To raise the most

thirty plants use Salt, Potash or Soda in the

U-N IT Globe Sprayer.



Application, easy; results, effective; price, reasonable.

References.

Any Grower who has used or supply house. Write for circulars or letter still order one now from your dealer or sent prepaid on receipt of \$3.50.

ADDRESS

Dept. H, J. F. GASS MFG. CO, Detroit, Mich.

USE THE BEST.

Economy Greenhouse Brackets

are used by leading growers everywhere. Send for price list and descriptive circular.

BUXTON & ALLARD, Dept. A, Nashua, N. H.

BOSTON PLATE & WINDOW GLASS CO.

GREENHOUSE GLASS

German and American

261 to 287 A St., Boston 20-22 Canal St.

Holds Glass Firmly

See the Point  FULL SIZE N° 2

PEERLESS

Glazing Points are the best. No rights or lefts. Box of 1,000 points 75 cts. postpaid.

HENRY A. DREER,
214 Chestnut St., Phila., Pa.

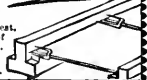

In writing to Advertisers kindly mention Horticulture

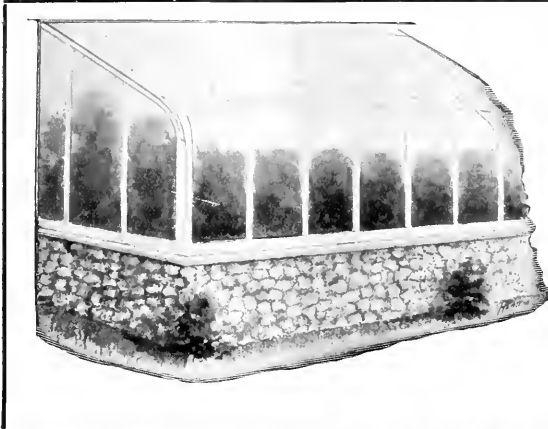

Why My New Curved Iceless Eave is Far Superior to Anything on the Market Today

- 1st No sash bars incased in iron, thereby eliminating all danger of bars decaying.
- 2nd Can be used in conjunction with iron frame construction, thereby doing away with that very objectionable feature, "columns."
- 3rd. Roof bars with drip grooves, which act as conductors to carry away the condensation: Result, the driest roof ever used for greenhouse purposes.
- 4th. **THE MOST IMPORTANT OF THEM ALL.** The very small increase in cost over the ordinary style of construction which makes it possible to be used for commercial as well as private purposes.

William H. Lutton, Horticultural Architect and Builder
West Side Ave Station (C.R.R. of N.J.) Jersey City, N.J.

KROESCHELL BOILER

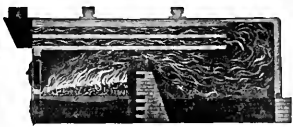

MADE OF FIRE BOX FLANGE PLATE
Can not Crack

Water Space In Front, Sides and Back
The Most Popular Boiler Made
SEND FOR CATALOGUE.

KROESCHELL BROS. CO.
35 Erie Street, CHICAGO, ILL.

THE FOLEY MFG. CO.
CHICAGO

Completely equipped with up-to-date machinery for the making of material for

GREENHOUSE CONSTRUCTION

From a Full Supply of Thoroughly Seasoned Lumber

Send your sketches to our draughtsmen for completion and suggestion. Permit us to figure your proposed work, large or small.

We guarantee our prices will save you money FOLEY VENTILATING APPARATUS IS THE BEST

is Simple in Erecting, is Easiest of Operation, it Will Last a Lifetime, its Price is the Lowest, Will Ventilate Any Size House. Prices and Circulars on Application.

Our 1908 Catalogue Greenhouse Material Sent Postpaid on Request.

THE FOLEY MFG. CO., WESTERN AVENUE
25th and 26th STS., CHICAGO

The Advance Ventilating Apparatus



If we did not have a better line than others, we could not have thousands of our machines at work in 40 states in less than 5 ye is time from the placing of the first machine on the market. It sells best and easiest where best known because it tells its own merits better than we can. **SELF BRACKETS** t n cents each, just what you need now. Other articles at fair prices and fair profits. Get our estimate, try and see why we please.

The Advance Co.
RICHMOND, IND.

CYPRESS SASH BARS
22 feet or longer
HOT BED SASH

PECKY CYPRESS BENCH LUMBER

GREENHOUSES

ERECTED AND EQUIPPED COMPLETE IF DESIRED

Write for Circular "D" and Prices

The A. T. STEARNS LUMBER CO.
NEPONSET, BOSTON, MASS.



Evans 20th Century Arm
Will not twist the shunting pipe. Three times the power of old style elbow arms. Sold only with Evans Challenge Machine. Write for Free Catalogue to **QUAKER CITY MACHINE CO.** Richmond, Ind.

In ordering goods please add "I saw it in HORTICULTURE."

EVERYTHING FOR GREENHOUSE BUILDING

WRITE FOR INFORMATION AND PRICES

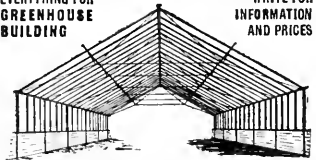

King Greenhouses. King Gutters and Eaves. Trussed Roofs. Ventilating Machinery. Trussed Iron Frame Houses. Tile Benches and Pipe Hangers.

KING CONSTRUCTION COMPANY
NORTH TONAWANDA, N. Y.

GREENHOUSE CONSTRUCTION LUMBER

John C. Moninger Co.
117 E. Blackhawk St., CHICAGO.

The FLORISTS' HALL ASSOCIATION OF AMERICA, insurer of 29,000,000 sq. ft. of glass. For particulars address **John C. Esler,** Sec'y, Saddle River, N. J.

PATENTS

Trademarks and Copyrights

Send your business direct to Washington. Saves time and insures better service. Personal attention guaranteed. Twenty-five years' active service. SPECIALTY: "Working on the Failure of Others."

SIGGERS & SIGGERS

PATENT LAWYERS

Box 9, National Union Building
Washington, D. C.

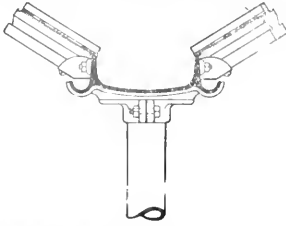

OUR CAST IRON CENTRE GUTTERS

Not cast of brittle stove plate iron — but high grade, tough iron. Are not crooked — are cast smooth and straight.

Lengths of 8 feet 4 inches, making it necessary to use only half the posts required with the shorter gutters that are on the market.

Every gutter of ours is equipped with root bar brackets which stiffen the roof and prevent bar end rot.

Write for prices.

Hitchings & Company
1170 Broadway New York

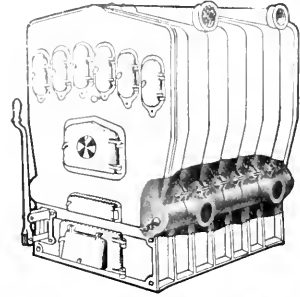

The Advantages of *The* Burnham Short Tie Bolts

- Much time saved in erecting.
- No blocking up of sections to tighten them.
- Each pair of sections have their own tie bolts.
- You can tighten each section perfectly as you go along.
- When you increase size of boiler by adding sections, you don't have to buy new long tie bolts. We furnish the short bolts and washers with each section.

Send for Catalog

Lord & Burnham Co.

Main Sales Office: 1133 BROADWAY, N.Y.

BOSTON: 819 Tremont Building. PHILADELPHIA: 1215 Filbert St.



ANOTHER VIEW OF LAST WEEK'S SUBJECT

This photo was taken directly from the residence terrace as you look towards the rose garden. Here is an instance of an eminently successful linking of greenhouse and residence — it's the kind of thing no one cares to do with the ordinary greenhouse — it's too heavy — too unattractive. But the U-Bar with its extreme lightness and graceful lines, is a beautifying addition to any grounds. Because: they are lighter, they grow more and better flowers. Their endurance is unequalled. You intended to send for our catalog last week — do it this time.

U-BAR GREENHOUSES

PIERSON

DESIGNERS AND BUILDERS



U-BAR CO.

1 MADISON AVE., NEW YORK

HORTICULTURE

Vol. IX.

FEBRUARY 6, 1909

No. 6



BANQUET TO AMERICAN CARNATION SOCIETY

By the State Florists' Association of Indiana

*Devoted to the
FLORIST, PLANTSMAN,
LANDSCAPE GARDENER,
and
Kindred Interests*

*Published
EVERY SATURDAY
At 11 Hamilton Place,
BOSTON, MASS.
Subscription, \$1.00*

CARNATIONS ROOTED CUTTINGS

NEW INTRODUCTIONS

Mrs. Chas. Knopf, light pink } <i>Knopf</i>		
Ruby, crimson		
Georgia, white } <i>Cockcroft</i>		
Mrs. J. C. Vaughan, white } <i>Rudd</i>	Per 100	Per 1000
Bay State, variegated } <i>Roper</i>	\$12.00	\$100.00
Pink Delight } <i>Dermer</i>		
Wanoka, crimson		
Apple Blossom, white light pink marking } <i>(Wanoka Greenhouses)</i>		
	Per 100	Per 1000
O. P. Bassett, scarlet } <i>Bassett & Washburn</i>	\$8.00	\$60.00

Standard Varieties

One Hundred Thousand Cuttings selected strong stock ready to ship

"WHITE"		"PINK"			
	per 100	per 1000			
Sarah Hill.....	\$6.00	\$50.00	Splendor.....	\$5.00	\$50.00
Pres. Seelye.....	6.00	50.00	After Glow.....	6.00	50.00
Lloyd.....	5.00	40.00	Winona.....	6.00	50.00
White Enchantress.....	3.50	35.00	Lawson Enchantress.....	5.50	50.00
White Perfection.....	2.50	20.00	Walsome.....	4.00	35.00
			Winsor.....	3.50	30.00
"RED"					
Beacon.....	\$3.50	\$30.00	Aristocrat.....	3.50	30.00
"VARIEGATED"					
Mrs. Patten.....	\$2.50	\$20.00	Rose Pink Enchantress.....	2.50	20.00
			Enchantress.....	2.50	20.00
			Lawson.....	2.50	20.00

CHRYSANTHEMUMS

Golden Glow, 2 1/2 in. pots, ready for shift, \$6.00 per hundred. Rooted Cuttings, selection of forty varieties, the cream of the commercial sorts. Write for list and prices.

NEW ROSE MY MARYLAND

Grafted, 2 1/2 in. pots, \$20.00 per hundred, \$150.00 per thousand; Own Roots, 2 1/2 in. pots, \$10.00 per hundred, \$90.00 per thousand

ORDERS BOOKED NOW FOR THIS MOST PROMISING VARIETY.

S. J. Reuter & Son, Inc., WESTERLY, R. I.

The two novelties, Mrs. Chas. Knopf and Ruby give great promises as commercial varieties. Both are free producers. We have them both growing side by side with the standard sorts and they have demonstrated now that they are here to stay. Mrs. Chas. Knopf is at this time especially good being larger and of better form and color than Enchantress. Ruby is a very large, perfectly formed flower with excellent stem and it has a good crimson shade not too dark.

The Great Red Winner WM. H. TAFT Worthy of its Namesake

Christmas week 4000 blooms were cut from three beds 150 feet long, Flowering continuously since October :

ROOTED CUTTINGS NOW READY

Prices:—25, \$4.00; 50, \$7.00; 100, \$12.00; 500, \$50.00; 1000, \$90.00

SEND FOR ILLUSTRATED CIRCULAR

The Taft is grown at Evanston, corner of Oakton and Ashbury Ave., Chicago. Carnation Growers are invited to come and see it

FOLLOWING ARE OTHER VARIETIES ALSO READY FOR IMMEDIATE SHIPMENT:

Enchantress.....100, \$1.75; 1000, \$15.00	White Lawson.....100, \$2.00; 1000, \$18.00
Pink Lawson.....100, 1.50; 1000, 12.50	Variegated Lawson.....100, 2.75; 1000, 25.00
Victory.....100, \$3.00; 1000, \$30.00	

UNROOTED CUTTINGS

Mrs. E. A. Nelson.....100, \$0.60; 1000, \$5.00	Variegated Lawson.....100, \$1.50; 1000, \$12.50
Boston Market.....100, 0.50; 1000, 5.00	Crusader.....100, 0.00; 1000, 5.00
Pink Lawson.....100, 0.75; 1000, 6.25	White Lawson.....100, 1.00; 1000, 9.00

SCHEIDEN & SCHOOS, 58-60 Washab Ave. CHICAGO

NEW RED CARNATION O. P. BASSETT

Extra Large Bright Red Free Bloomer

Rooted Cuttings, per 1000, \$60.00	Rooted Cuttings, per 100, \$8.00	Rooted Cuttings, per 25, \$2.50
per 500, 35.00	per 50, 4.50	per 12, 1.50

Ready for delivery Jan. 1st, '09 by the Originators and Growers

BASSETT & WASHBURN, HINSDALE, ILL

Rooted Carnation Cuttings

WHITE

Mrs. J. C. Vaughan.....	per 100	per 1000
Sarah Hill.....	\$12.00	\$100.00
Pres. Seelye.....	6.00	50.00
Lloyd.....	5.00	40.00
White Enchantress.....	4.00	35.00
White Perfection.....	3.00	25.00
Lady Bountiful.....	2.00	20.00
White Lawson.....	2.00	25.00

LIGHT PINK

Mrs. Chas. Knopf.....	12.00	100.00
Enchantress.....	3.00	25.00
Melody.....	3.00	25.00

PINK

Splendor.....	6.00	50.00
Winsor.....	2.00	25.00
Rose Pink Enchantress.....	3.00	25.00
Welcome.....	2.00	25.00

CERISE PINK

Lawson Enchantress.....	6.00	50.00
Afterglow.....	6.00	50.00
Aristocrat.....	4.00	35.00

SCARLET

O. P. Bassett.....	8.00	60.00
Andrew Carnegie.....	6.00	50.00
Defiance.....	6.00	50.00
Proctor.....	4.00	25.00
Victory.....	2.00	25.00

VARIEGATED

Lucille, white overlaid with pink.....	12.00	100.00
--	-------	--------

CRIMSON

Ruby.....	12.00	100.00
-----------	-------	--------

Chicago Carnation Co., Joliet, Ill.
A. T. PYFER, Mgr.

Rooted Carnation Cuttings

A Selection from 20 Sorts. (For Immediate Delivery and Later) Every one Reliable

White	W. Perfection	\$3.00	\$25.00
Red	Beacon	4.00	35.00
Light Pink	Enchantress	3.00	25.00
	Melody	3.00	25.00
Medium Pink	Winsor	4.00	35.00
	Winona	6.00	50.00
Dark Pink	Rose Enchantress	3.00	25.00
	Splendor	6.00	50.00
Variegated	Viola Sinclair	6.00	50.00
	Var. Lawson	3.00	25.00
Crimson	Octoroon	3.00	25.00

PETER FISHER, - Ellis, Mass.

CARNATIONS Rooted Cuttings Fine Healthy Stock

Pres. Seelye.....	per 100	per 1000
White Enchantress, Beacon	\$6.00	\$50.00
Victory, Winsor, Melody, Kingston Pet.....	3.50	30.00
Dahlem, Enchantress, Lady Bountiful, Mrs Lawson, White Lawson, Red Lawson, Variegated Lawson.....	3.00	25.00

WOOD BROTHERS FISHKILL, N. Y.

JUST AS A REMINDER TO OUR PATRONS

We have rooted cuttings of the best CARNATIONS
PATTEN & COMPANY, Tewksbury, Mass.

NEW CARNATION PINK DELIGHT

Waxy Shell Pink. A Grower's and Shipper's favorite. Has a holding color, keeps well, comes on long stems and is early, very free and continuous flowering. January delivery, \$12.00 per 100; \$100.00 per 1000.

F. Dörner & Sons Co., La Fayette, Ind.

In writing to Advertisers kindly mention Horticulture

A WIRELESS WINNER

HAS WON ABSOLUTELY ON ITS OWN MERITS. CERTIFICATES INNUMERABLE, EVERYWHERE.

MASSACHUSETTS HORTICULTURAL SOCIETY'S

AMERICAN CARNATION SOCIETY'S

SILVER MEDAL LAST YEAR

COLD MEDAL THIS YEAR

At Indianapolis.

That's the Record of

It Is Invincible. **BAY STATE** *Buy it and Grow it*

The noblest carnation ever introduced. White with carmine penciling

ROOTED CUTTINGS, - \$12 00 per 100, \$100.00 per 1000.

ALBERT ROPER, - - - **TEWKSBURY, MASS.**

CARNATION CUTTINGS

We offer choice varieties for January and later shipments.

	Per 100	Per 1000
Enchantress.....	\$2.50	\$20.00
White do.....	3.50	30.00
Rose Pink do.....	2.50	20.00
White Perfection.....	2.50	20.00
Winsor.....	3.50	30.00
Melody.....	2.50	20.00
Beacon.....	3.50	30.00
Victory.....	3.50	30.00
Aristocrat.....	3.50	30.00
Splendor.....	6.00	50.00
Vesper.....	3.50	30.00
White Lawson.....	2.50	20.00

EAST SUDBURY GREENHOUSES,
Carnation Specialists

P. O. Address South Sudbury, Mass.
Telephone So. Sudbury 20.

Send for our Preliminary List describing and quoting

Chrysanthemums
and
Carnations.

A fine lot of
Carnation Cuttings
ready now.

THE E. G. HILL CO.,
Richmond, Indiana.

NEPTUNE

is the only yellow Carnation on the market that is worth growing. Very strong. Free and easy grower. Hasn't burst 1/2 of 1 per cent in 4 years. Well rooted cuttings now ready, \$5.00 per 100. Other commercial varieties at reasonable prices.

PAUL THOMSON, Grower
West Hartford, Ct.

A. N. PIERSON, Inc.
CROMWELL, CONN.

Wholesale Growers of Cut Flowers, Palms and Ferns

OUR SPECIALTIES: Roses, Lily of the Valley and Carnations. We also grow a general assortment of flowers in their season.

In ordering goods please add "I saw it in HORTICULTURE."

New White Carnation

Best for Quality **GEORGIA** Best for Quantity

THE BEST WHITE

Has been awarded a certificate wherever shown

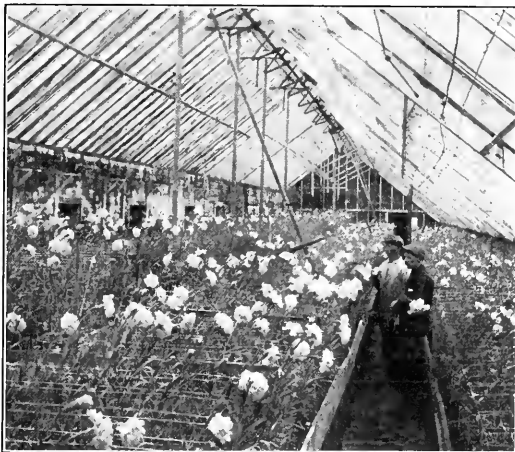

CHRISTMAS CROP

ROSE

This variety is a free and continuous bloomer. We have 20,000 cuttings in the sand for January delivery. Rooted cuttings, \$2.00 per dozen, \$12.00 per 100, \$100 per 1000.

SATISFACTION GUARANTEED. Write for price list of Standard Varieties.

J. D. COCKCROFT, Northport, Long Island, N. Y.

CARNATION AND ROSE SHOW

UNDER AUSPICES OF

Boston Co-Operative Flower Growers Association

The Park Street Market

SEND FOR PREMIUM LIST

ALL the old and THE BEST of the new varieties. SEE BEFORE BUYING

NEW ENGLAND'S LEADING COMMERCIAL SHOW

FEBRUARY 27H AND 28TH, 1909

HORTICULTURAL HALL, BOSTON

For Information write **E. ALLAN PEIRCE, Waltham, Mass.**

ORCHIDS-ORCHIDS-ORCHIDS

BURMESE DENDROBES

Just to hand in fine condition :

Dendrobium Thyrsiflorum	each \$2.00
" Brymerianum	" 5.00
" Victory, small plants. A new Dendrobium like Nobile, but darker and larger,	" 3.00
Dendrobium Falconerii	each 1.25

To arrive in a few days :

Dendrobium Nobile	Dendrobium Cretaceum
" Chryso toxum	" Bensonii
" Heterocarpum	" Crystallinum
" Densiliorum	" Parishii
" Farmerii	" Capellier
" Luteolum	

Established plants of Cypripedium Insigne, 5 and 6 in. pots, \$50 per 100

JULIUS ROEHRS CO., - - RUTHERFORD, N. J.

ORCHIDS

We beg to offer the following EAST INDIAN ORCHIDS just arrived in fine condition.

DENDROBIUM WARDIANUM, fine plant # at \$18.00 to \$30.00 per dozen
DENDROBIUM CRASSINODE, fine plant # at \$3.00 per dozen
DENDROBIUM PRIULINUM, fine plant # at \$3.00 per dozen.

Other shipments to follow. Write us for prices on any orchids you may require.

LAGER & HURRELL Summit, N.J.

ORCHIDS

Fresh Imported for Spring Delivery Cattleyas, Laelias, Oncidiums, etc.

Write for Prices

My new Catalogue is now ready: if you have not received one, send for it.

JOSEPH A. MANDA, West Orange, N.J.

We Have A Fine Lot of C. Trianae in bloom at very low prices, and will sell plants in bloom or cut blooms at 15 per cent. less than the market price.

ORDONEZ BROS. N. J. Madison.

ORCHIDS

We are booking orders now for delivery early in the Spring on all commercial CATTLEYS and SOUVENIRS. Our prices are right and our guarantee perfect. We sell only first-class goods

CARRILLO & BALDWIN, Secaucus, N. J.

ORCHIDS

Largest Importers, Exporters, Growers and Hybridists in the World

Sander, St. Albans, England and 235 Broadway, Room 1 NEW YORK CITY

HEACOCK'S PALMS

7-inch pots.....29 to 34 inches high.....	\$2.50 each
7-inch pots.....36 to 38 inches high.....	3.00 "
9-inch tub.....42 to 48 inches high.....	5.00 "
Made up Kentia Forsteriana	
7-inch pots.....34 to 36 inches high.....	\$2.50 each
7-inch pots.....36 to 38 inches high.....	3.00 "
9-inch tub.....42 to 48 inches high.....	5.00 "

Joseph Heacock Co., Wyncote, Pa.

DECORATIVE PLANTS

Araucaria Excelsa, Pandanus Utilis, Dracaena Indivisa, Kentias, Latanias, Arecas, Etc. Perennials and Shrubs.

4 inch Araucarias.....	50 cents each.	6 inch Araucarias.....	\$1.00 each.
5 ".....	75 "	7 ".....	\$1.25 and \$1.50 "

FERNS FOR DISHES—\$3.50 per 100, \$30.00 per 1000. SEND FOR OUR PRICE LIST. WE HAVE A COMPLETE STOCK.

The Geo. Wittbold Co.

1657 Buckingham Place, Chicago, Ill.

FERNS FOR DISHES,

CASH WITH ORDER
2570 to 2606 W. Adams St., Chicago, Ill.

Assorted Varieties
From a 2 inch pots, \$3.50 per 100; \$30.00 per 1000
FRANK OEGHSLIN

BARAINS

in KENTIAS and other Decorative Plants, all sizes. Also the following at Lowest Import Prices. 15,000 Azaleas, best commercial varieties, from \$25.00 per 100 to \$2.00 each. A fine lot of Rubbers, Crotons, Araucarias, Pandanus, Asparagus plumosa and Sprengeri.

SMALL FERNS

for table decorative purposes at lowest wholesale rates.

A. LEUTHY & CO.,
Perkins St. Nurseries, ROSLIN DALE, MASS.

HEADQUARTERS FOR

Araucaria Excelsa, 6 in pots, 5-6 tiers, 75c, \$1, \$1.25; Robusta Compacta and glauca, 20 to 30 in. high, \$1.00, \$2.00; Ficus elastica, 5 1/2 in., 35c, 50c, 50c; Kentia Belmoreana, 4 to 5 1/2 in., 35c, 50c, 60c; Forsteriana, 5 to 6 in., 50c, 60c, 75c, \$1.00, \$1.25, \$1.50; Boston, Scottell and Whitmanii Ferns, 6 to 7 in. pots 50c, 75c, \$1.00, \$1.50; Amerpophyll, 5 1/2 in., 35c, 50c; Azalea Apollo in bloom, 75c, \$1.00; Cineraria Hybrida for Easter, 3 in. 5c, 6 in. 25c.

GODFREY ASCHMANN
1012 W. Ontario St., PHILADELPHIA, PA.

Established 40 Years

Rose Hill Nurseries

New and Rare Plants

NEW ROCHELLE, N. Y.

New York Office, Siebrecht Building, 425 Fifth Avenue

PALMS AND FERNS

DECORATIVE PLANTS

JOHN SCOTT
Rutland Road and E. 45th St.
Tel. 2690 Bedford
BROOKLYN, N. Y.

NEP. WHITMANI

2 1/4 in., \$5.00 per 100

NEP. WHITMANI

3 1/2 in., \$25.00 per 100

BOSTON FERNS

2 1/4 in., \$3.00 per 100

H. H. BARROWS & SON, Whitman, Mass.

PEACOCK'S NEW DAHLIAS

SEND FOR LIST

PEACOCK DAHLIA FARMS
Williamstown Junction, N. J.

DAHLIAS. Now is the time to place your order for bulbs which will insure you getting named varieties in any quantity; prompt delivery.

DAVID HERBERT & SON,
Successors to L. K. Peacock, Inc.
ATCO, N. J.

The Northboro Dahlia and Gladiolus Gardens

Offer for Spring 1909
300 selected varieties of Dahlias and one and one half million large-flowering Gladioli in mixtures, in lots to suit. Send list of your wants. Catalogue free.

J. L. MOORE, Northboro, Mass.

Prices Quoted in these Columns are for Dealers Only.

When Writing to Advertisers Please Mention

HORTICULTURE.

European Horticulture

THE MASTERS MEMORIAL LECTURES

The Royal Horticultural Society has arranged with Professor Hugo de Vries to deliver two lectures during 1909 in connection with the fund raised as a memorial to the late Dr. Maxwell Tylden Masters. The first lecture will be delivered on June 22, the subject being "Masters' Vegetable Teratology." The second lecture on "The Production of Varieties" will be given by Prof. de Vries on September 28. The lectures will be delivered in the lecture room of the Hall, St. Vincent Square, Westminster, at 3 P. M.

GLOXINIA HYBRIDA GRANDIFLORA CIRCE

Contrariwise to the modern gloxinia varieties the novelty Circe carries its flowers horizontally. Moreover the markings in the throat of the flower show themselves by this position in their full beauty. The variety comes fairly true from seed, and its leafage is of the true crassifolia type of the present day. The flowers are borne on stiff strong stalks, possess a diameter of 10 c. m. and they are slightly waved at the edges. They are white with an azure blue tinge, and with throat marking of a purple tint running into blue, and reddish dots at base.

A NEW DISEASE OF THE ROSE

Mr. H. T. Gusson gives in the Royal Horticultural Society's Journal an account of a new disease of roses, that the gardener will have to contend with. The new disease which Mr. Gusson shows to be due to a fungus, *Coniothyrium Fuckelii*, begins its attack on the one-year old shoots, and is not readily recognized till it is well advanced. The first signs consist in purplish or red brown spots on the rind. He thinks it is a wound parasite, and he recommends the cutting out or removal of the affected shoot and dressing the wound with creosoted wood pitch.

JUBILEE FLOWER SHOW AT HAARLEM IN 1910

It has now been definitely fixed that the opening of this great show will take place on March 23, 1910. The show will consist of a permanent exhibition in the open air, and three temporary ones in buildings. It is expected to afford a good idea of the commercial horticulture of Holland. Of the temporary shows the first will be held at Eastertide; the second in the middle of April—that is in the height of the bulb season; and the third in the early days of May. Queen Wilhelmina and the Queen mother are patronesses of the Society; and the show will celebrate the 50th year of its existence.

CONTINENTAL HORTICULTURAL ITEMS

In 1908 a State Department for Horticulture was established in Belgium and this fact was received with pleasure in Great Britain, where it is felt that the gardeners and horticulturists may likewise look forward to further recognition by the state of the importance of the science and business of horticulture. A chair of Forestry was established last year at Oxford, and there are aspirations amongst gardeners that a chair for Horticulture may also be instituted at one or more of the universities. The French system of intensive market gardening has "caught on" in England, and a few public companies have already been formed and large

sums of money laid out in establishing such market gardens.

MUSHROOM CULTURE BY THE LATEST METHODS

The production of mushroom spawn has until recent years been of a clumsy, uncertain character, and more or less uncertain in results, since the mycelium of other fungi than *Agaricus campestris*, the common mushroom, has occasionally been mistaken for it to the chagrin and loss of the cultivator. A method of manufacturing virgin mushroom spawn by artificially germinating the spores was discovered in 1897 and the mycelium obtained was sold in test tubes by the makers. This was a forward step, and mushroom cultivators were enabled for the first time to be fairly certain that the spawn they bought would produce the variety of mushroom they desired. This method, however, had its disadvantages, and hopes were expressed that a better one might be discovered. Some years later, the process by which Messrs. Sutton & Sons manufacture their "20th Century Mushroom Spawn" was adopted. This method is now known as "tissue culture" and originated in the discovery that mycelium could be engendered from a portion of the mushroom itself. The possibility of this is the underlying principle of the new culture. By this method it is stated that not only can the growers be quite certain that the spawn they buy is true to name, but also that the improvement of varieties by selection is for the first time made possible, and it is a fact that the yield has already been greatly increased.

A REMARKABLE PLANT HYBRID

An illustration appeared in the "Gardeners' Chronicle" on January 23, last, of a hybrid raised by Mr. C. G. van Tubergen, Jr., Haarlem, by crossing *Brunsrigia Josephinae* and *Amaryllis Belladonna*. Mr. van Tubergen states that principally with a view of ascertaining the parentage of the Kew variety of *Amaryllis Belladonna*, in the autumn of 1892 he artificially impregnated the above named *Brunsrigia* with the pollen of *Amaryllis Belladonna*, and as the two genera are very closely related, seeds were formed freely. As could be foreseen with the slow growing *Brunsrigia Josephinae* for the seed parent, a long time had to elapse before the seedling plants would be strong enough to flower. After an interval of sixteen years two of the strongest bulbs produced flowering spikes in September of last year. When the hybrid plants had been cultivated for several years, it became evident they differed in habit from the Kew variety of *Amaryllis Belladonna*, which produces a leaf-stem of about four inches in height; whereas, the van Tubergen hybrids all bear the character of *Brunsrigia Josephinae* in the foliage, leaves being formed directly above the neck of the bulbs. The bulbs show the infusion of the *Amaryllis* blood and have a resemblance to *A. Belladonna*, and produce offsets freely, which *Brunsrigia* never does. A comparison of the supplementary illustration in the *Gardeners' Chronicle* for January 23, drawn from an inflorescence sent from Mr. van Tubergen's garden with the engraving in the "Garden," November 19, 1898, leads to the conclusion that the Kew plant can no longer be regarded as a hybrid between these species, unless it was a cross effected in the reverse way, taking *A. Belladonna* as the seed-bearer. In that case the variety *Claudia* must have been used, it being the only variety of *A. Belladonna* known, that produces a leaf stem. The color of the flowers of the hybrid was a clear deep rose suffused with carmine. A single spike bore twenty-two flowers.

André van Tubergen

HORTICULTURE

VOL. IX FEBRUARY 6, 1909 NO. 6

PUBLISHED WEEKLY BY

HORTICULTURE PUBLISHING CO.
11 Hamilton Place, Boston, Mass.

Telephone, Oxford 292

WM. J. STEWART, Editor and Manager

SUBSCRIPTION PRICE

One Year, in advance, \$1.00; To Foreign Countries, 2.00; To Canada, \$1.50

ADVERTISING RATES

Per Inch, 30 Inches to page \$1.00.

Discounts on Contracts for consecutive insertions, as follows:

One month (4 times) 5 per cent.; three months (12 times) 10 per cent.;

six months (12 times) 20 per cent.; one year (12 times) 30 per cent.

Page and half page spaces, special rates on application.

Entered as second-class matter December 8, 1904, at the Post Office at Boston, Mass. under the Act of Congress of March 3, 1879.

CONTENTS

COVER ILLUSTRATION—Banquet to the American Carnation Society.....	Page
EUROPEAN HORTICULTURE—Frederick Moore.....	169
THE MEN WHO WIN—C. S. Harrison.....	171
AMERICAN CARNATION SOCIETY: The Banquet—J. S. Stuart, Portrait—Final Resolutions—Certificates—Trade Exhibits—Friday's Outing.....	172
Miscellaneous Notes and Comments—View in Exhibition Hall, Illustration.....	173
RELATIONSHIP BETWEEN PRODUCER, WHOLESALEMAN AND RETAILER—Wm. J. Stewart.....	173
CARNATIONS I HAVE KNOWN—Sarah A. Hill.....	174
DURING RECESSION: New York and New Jersey Plant Growers' Association—Nassau County Horticultural Society.....	175
NEWS OF THE CLUBS AND SOCIETIES: Florists' Club of Washington—Connecticut Horticultural Society—New Haven Horticultural Society—Society of American Florists—Ladies' Society of American Florists—Horticultural Society of New York—Florists' Club of Philadelphia—Toledo Florists' Club.....	176
Tarrytown Horticultural Society—Worcester County Horticultural Society—Ghent Horticultural Society—Northern Westchester County Horticultural and Agricultural Society—Caledonian Horticultural Society—Los Angeles Florists' Club—Club and Society Notes.....	177
OBITUARY: George Field Morris—Heiman Josef Wildpret—Mrs. Mary Lyons—Patrick Kenelick—Leander Remington Peck—Mrs. Anna Klingenberg.....	178
WILD FLOWERS—O. C. Simonds.....	179
KILLARNEY AND BEAUTY—A. L. Squire.....	180
SEED TRADE: Unique Window Display—Catalogues Wanted—A Correction—Notes.....	184
FLOWER MARKET REPORTS: Boston, Buffalo, Chicago, Philadelphia, Twin Cities, Washington, New York.....	189
MISCELLANEOUS: Pierson's Pink, Illustrated.....	171
McKinley Day in Buffalo.....	171
A Stunt for Burbank.....	177
Florists' Window in Japan, Illustration.....	177
Prevention Better Than Cure, David Miller.....	178
News Notes.....	180, 187,
Philadelphia Notes.....	182
Shaw's Garden and Sunday.....	182
Plant Imports.....	183
Chicago Plant Notes.....	183
Massachusetts Agricultural College.....	184
Personal.....	186
Steamer Departures.....	186
New Retail Flower Stores.....	187
Business Changes.....	187
In Bankruptcy.....	187
Fire Legend.....	189
Incorporated.....	191
Patents Granted.....	197
Greenhouses Building or Contemplated.....	198

Window publicity

In the seed trade columns of a recent number we took occasion to refer approvingly to a seedsmen's clever window display in which pop corn figured particularly. We have since learned that the direct business induced by that display was almost incredible. In this issue will be found a description of another example of ingenious window advertising, also by a seedsmen. One can imagine the crowds that such a display would attract. The old-fashioned plan of merely arranging a lot of samples of seeds, bulbs, tools, etc., in the store window makes a very poor showing as compared with modern methods of publicity. Show windows are an expensive investment and it is good business to make the most possible of them.

On the occasion of its first visit to Indianapolis, in 1894, the American Carnation Society was told by the mayor in his address of welcome that "the Hoosier loves his friends." The measure of hospitality meted out to the visitors last week for the third time was conclusive proof of the sincerity of this sentiment and the warm friendship still existing towards the Carnation Society. It would be hard indeed to suggest any way in which the comfort and pleasure of the visitors could have been added to or the local arrangements for the exhibition and meetings and the convenience of those interested therein improved. Nothing but the highest praise was heard as to the thoroughness with which the various committee chairmen carried out their work and in the election of one of the most active of them to the office of secretary the Society only bestowed an honor well-earned.

Size versus daintiness

A valued correspondent, whose communication will be found elsewhere in this issue, in testifying to the high qualities which mark the new rose, White Killarney, dissents from our views as expressed in a previous issue concerning this splendid acquisition, in which we referred to it as a possible "running mate for American Beauty." In response we would explain to our critic and to our other readers that in thus commenting on White Killarney we had in mind, not the chaste loveliness or artistic elegance which this variety undoubtedly possesses, but, speaking from the standpoint of the commercial florist solely, its qualifications of proportionate size of bloom, strength of stem, wealth of massive foliage and contrast of color, all of which are indispensable in any rose used in association with American Beauty in that class of decorative work for which the Beauty is preeminently fitted. In the Hybrid Perpetual section there are plenty of varieties so provided but every florist knows that no ever-blooming rose has hitherto appeared which could be introduced in combination with American Beauty without in some degree straining the impressiveness and dignity of the composition. Perhaps we are too optimistic in regard to White Killarney's qualifications in this respect but that a pure white ever-blooming rose adapted to such use has possibly appeared should be cause for congratulation. If in addition to this it surpasses its red companion in other respects, so much the better.

THE MEN WHO WIN.

Many able men are narrow because they use but a small part of themselves, or of their capital. A college professor is too often tethered to his chair, and knows little of the world around him, too much like the dying professor of Greek, who said the mistake of his life was, that instead of trying to compass the whole of the Greek language, he should have confined his whole life to the single particle "en"—poor man! what a splendid residence he could have built on the point of a needle. Many a man does a rank injustice to his age, and to himself, by using but a small portion of his power.

W. A. Harshbarger is professor of mathematics in Washburn College, Topeka, Kans. I have known him intimately for years, was associated with him for some time in educational work, have spent many joyful days with him and his wife in the mountains. He is a blend of Scotch and German ancestry—combining the sterling qualities of both races.

Born in Virginia at the close of the war, in one of those battle scarred valleys, the family knew what extreme poverty was. By the hardest struggle he secured his education, not content with an ordinary equipment, he must have the best, regardless of the cost or sacrifice. A man of splendid health, of a strenuous nature, he has a large overflow of soul which reaches out beyond his profession. I have just had a splendid visit with him and was surprised at his knowledge of horticulture. Lately he has taken up the study of the rose, and probably no man in America has a better grasp of the subject. Conversant with French and German he sends across the sea and ransacks the world for the best literature on the subject. He has above one hundred varieties in his garden which he is studying. He is so thorough in all his researches that he could fill any vacant chair of horticulture now waiting for the best of talent with a good salary. Kansas is very fortunate in owning such a man.

A man of education has a great advantage over the ordinary nurseryman. He is good in his wide sphere of usefulness. The age is greatly indebted to him. He has transformed the dreary prairie land into orchards, groves and beautiful landscapes. But the man of scientific training has the advantage. We are glad the "professor" is leading the way, throwing wide open the doors of nature so that people can go in and aid her in working her miracles. There is a vast room in the upper story of horticulture, and we need able men to fill it.

We are on the borders of a transfigured earth. A world to be adorned with new creations that our eyes have not yet seen. Hundreds of men are at work evolving new and glorious forms of beauty, and we are gloriously to get a view of our possibilities. Soon the curtain will be lifted and we will see a section of paradise let down to earth. Farm houses, no longer pictures of neglect, will be adorned with trees and flowers which will vie with the famous estates of Eastern millionaires. Instead of a dreary farm being a good place to run away from, it will have attractions which will keep the children at home, and allure others to the country. Mother earth is kind and

PEARSON'S PINK—ACTUAL SIZE.

E. R. Pearson Company Seedling.

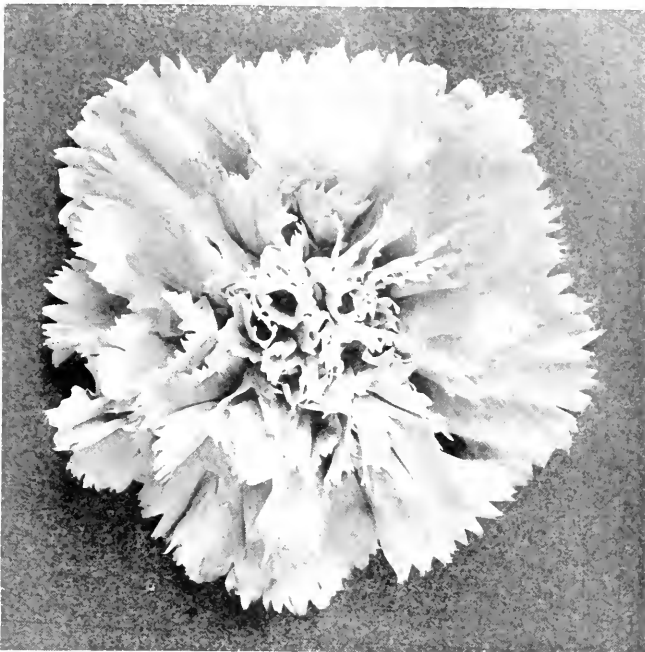

This is the sensational seedling mentioned in our notes, on page 78, issue of Jan. 16. As therein stated, the flower is in effect a very much magnified Wm. Scott. This applies to size of flower and strength and length

of stem. It is a "whopper" and stands out distinctly from and above all other varieties growing in the benches, so that it is noticed from any part of the house. The color follows very closely that of Scott.

faithful, and loves her children and never discharges them because of a panic. We need all possible aid to make the sombre old world more beautiful. God never has had a chance to show how good He is; the horticulturist and the florist introduce Him to men.

MCKINLEY DAY IN BUFFALO.

Professor Saunders, of the Chemical Department of Hamilton College is another man who finds vast fields of enjoyment outside of his profession. He is an expert among peonies and perennials, and he can enlarge his world of beauty at his will. How much of unused talent there is which might be used to make this a delightful world. How much of unused capital there is from which we might draw; myriads of bushels of luscious fruits are held in solution in earth, and air, in shower, and sunbeam. We need to plant the tree, the shrub, and vine, so that they can materialize and reveal the Divine bounty. All around us in the unseen are vast fields of flowers of wondrous beauty waiting our invitation to enter our gates and adorn our homes. And in the great unknown beside us are things of loveliness no eye has yet seen, which we may call forth, so the "beauty of the Lord may be upon us."

The people of Buffalo paid tribute to McKinley's memory on Jan. 29. The martyred president's favorite flower was worn by everyone and large sums were realized for the Rescue Mission. Fresh as the carnation so generously and patriotically displayed in his honor on Friday, the 29th, by all classes of people, is the memory of Wm. McKinley. Scarcely a man, woman or child could be seen on the streets that did not have a carnation conspicuously displayed on coat or corsage.

Spanish-American War Veterans honored the martyred president's memory by placing a wreath on the bronze tablet on the main floor of the City Hall, where the body of the dead president lay in state nearly eight years ago. Flags at half-mast, pictures of the dead president and tokens of all kinds commemorating the 66th birthday of the statesman were in evidence everywhere. The five hundred women and girls who volunteered their services to sell carnations for the benefit of the Rescue Mission met with generous support from all quarters. Every public building and office building, as well as street cars and railroad stations, were besieged by a boy of pretty bandits whose persuasive eloquence made every man capitulate.

We need hosts of high priests of nature to discover to us the unknown God, who never yet has been fully revealed to man. C. S. HARRISON.

AMERICAN CARNATION SOCIETY

Convention Report Completed

THE BANQUET.

The spacious banquet hall of the Columbian Club was well filled with guests and a beautiful sight in its floral decorations on Thursday evening, Jan. 28. The banqueters were seated in groups of six at the tables, each of which was adorned with a centerpiece of plants and flowers. During the evening music was supplied in abundance by a band. Interspersed among the speeches that followed there were songs by a male quartette and by Miss Maude Langstaff.

After the excellent menu had been traversed to the end, a brief address of welcome was made by Dr. Haugh, in the absence of President J. S. Stuart. He introduced E. G. Hill as toastmaster. Mr. Hill was in his best vein, witty and humorous, and very pleasing in his introductions. He spoke with pride of the Carnation Society's exhibition, which he pronounced the best ever, and extended an especially enthusiastic welcome to the ladies.

The first toast was "Indiana—a good place to stay." This was responded to by Mayor C. A. Bookwalter, who spoke eloquently of the contributions to literature and the aesthetic and beautiful in art by Indiana, which he declared was supplanting Massachusetts in that respect, and humorously paid his respects to the Indiana florists who, while heartlessly making him pay Broadway prices, yet gave good value for the money. The training of beautiful surroundings he declared to be conducive to elevation of character. He urged the visitors to come again and often.

Dr. Haugh then proposed the toast of "Our Guests." Referring to the fact that this was the society's third appearance in Indianapolis he made a bid for a fourth visit not more than six years hence. He spoke feelingly of the death of such valuable members as William Scott, L. E. Marquisee and Alexander Wallace during the past year as an irreparable loss to the Society. J. F. Ammann responded.

Miss Sarah Hill then read a paper in response to the toast, "Some Carnations I Have Met," which brought down the house repeatedly by its witty satire and allusions to the career of many carnations which had failed to live up to their promise. It was one of the best things of the kind we have ever listened to.

W. N. Ridd responded in characteristic style to "The Exhibition; after all, that's the reason we're here." A meaty subject handled by a very wise man. He gave the Society the credit for all the advancement made by the carnation in recent years, and expressed appreciation of the high honor he carried in being selected as a judge at the Society exhibitions, and the responsibility which the judges carry in shaping the destiny of new varieties.

J. C. Vaughan, being called upon, spoke in terms of high appreciation of the many manly traits of the late L. E. Marquisee. Mrs. Vesey followed with a plea for the carnation as the

"national flower," and called attention to the coming of McKinley Day on the morrow.

President Patten then responded to the toast of "The American Carnation Society." He advocated making the carnation more and more popular and warmly thanked the members for their good work during the year. He called for a standing toast to the deceased members of the Society. He next proceeded to present to the winners the various medals, cups and special prizes in gold awarded in the exhibition and the recipients severally responded as the trophies were handed over. Mr. Roper on receiving his gold medal for the best vase of 100 blooms any variety any color, incidentally remarked that he proposed to try to get another. J. A. Valentine was the last speaker,

the hospitable welcome extended to our Society;

That we record with deep appreciation our gratitude to the State Florists' Association of Indiana, and the members of our profession who have been allied with them in perfecting the admirable arrangements that have contributed so greatly to the success of this meeting;

And that our thanks are further due to the press of the City of Indianapolis for the accurate reports they have made of our meetings.

And to the horticultural press especially for the interest they have taken in advancing everything pertaining to the welfare of our society.

F. R. PIERSON,
PETER FISHER,
WILLIAM WEBER,

Committee on Final Resolutions.

CERTIFICATES.

Certificates of merit were awarded to the following varieties, which scored as indicated: No. 175-06, by F. Dörner & Sons Co.; dark red, deeply fringed flower; 90 points. Shasta, by Eaur & Smith; a glistening white; 89 points. Superba, by A. C. Brown; pink; 88 points. No. 30, by F. R. Pierson Co.; white; 86 points. No. 228, by Nic Zweifel; cerise pink; 86 points. Sangamo, by A. C. Brown; pink; 85 points. Dark Winsor, by F. R. Pierson Co.; 85 points. No. 60, by F. R. Pierson Co.; crimson; 85 points. James Whitcomb Riley, by Bertermann Bros.; yellow; 86 points.

All the above named, as well as the medal winners, were simply grand. Among the other gems of the show, some of which have been already certificated and others have not yet been entered therefor, were Hill and Graves' May Day, soft pink; Longren's Lucille, pale, almost white, flushed deeper pink; Wanoka Co.'s Apple Blossom, white with pink mottling in centre; Witterstatter's 1400 E, mellow light pink; Jensen & Dekema's Mrs. J. C. Vaughan, white; Dörner's Pink Delight, pink, and No. 51-06, Victory red; Dailedouze Bros.' No. 401 white, and Chicago Carnation Company's Conquest, variegated, formerly No. 500.

TRADE EXHIBITS.

Among the exhibits, outside of carnations, which we did not mention in last week's telegraphic report were the following: The Morehead Mfg. Co., who exhibited their useful steam trap; Kroeschell Bros., Chicago, who were well represented by Fred Lautenschlager in charge of an exhibit of their heating specialties; The Pulverized Manure Company of Chicago, with a good display of their different brands of natural fertilizers; The Advance Co., Richmond, Ind., with their greenhouse ventilating apparatus, and A. L. Randall, florists' supplies.

FRIDAY'S OUTING.

On Friday, starting on special car at the early hour of 6.30 a. m., a large



J. S. STUART

President Indiana State Florists' Association.

his toast being "The Parent Society." His speech was full of stories and wit. He assured the members of the Carnation Society that the mother heart of the S. A. F. is filled with joy at the success they had achieved.

FINAL RESOLUTIONS.

Whereas, The American Carnation Society has been for the past two days the guest of the State Florists' Association of Indiana, and of allied professions in Indianapolis and its vicinity; and,

Whereas, The exhibition hall and facilities for staging displays have been the most convenient and best adapted ever placed at our disposal; and,

Whereas, The kindness, courtesy and ever-ready assistance extended by our fellow members of Indianapolis have deeply impressed us; therefore, be it

Resolved, That we tender to Mayor Bookwalter and the city officials of Indianapolis, our sincere thanks for

party visited the establishment of the E. G. Hill Company at Richmond, and several other places en route. They were hospitably entertained and, despite the blizzard weather which interposed, enjoyed themselves thoroughly and were well repaid for the journey in what they saw, especially the sensational seedling roses and carnations which are in training for future triumphs.

MISCELLANEOUS NOTES AND COMMENTS.

The ladies were out in good force. Thirty-three were present at their society meeting on Wednesday evening.

It was generally agreed that Nic Zwiefel's vase of 100 Eucharist was the finest exhibit of this variety ever made.

Daille-douze Bros.' seedling 404, which secured the society's silver medal, is a superb white flower of high exhibition quality.

The menu and program for the banquet given by the State Florists' Association of Indiana in honor of the American Carnation Society was a gem in its way.

Fred Burki was elected a director for five years, but by virtue of his election as vice-president he would become a director for one year, and consequently the directors' board will be one member short during the coming year.

Victory has always been highly esteemed by F. K. Pierson, and is grown by him as his leading scarlet. Its wonderful keeping qualities were well shown at Indianapolis, the flowers exhibited having been 48 hours in a box en route.

E. G. Hill Company's vase of 200 blooms in variety was one of the most striking features in the hall. It won the \$50.00 silver cup, offered by the State Florists' Association, as everybody knew it would as soon as they saw it staged.

One of the most enjoyable incidents of the convention was the entertainment given by Judge Vesey on Wednesday evening at the Columbian Club to a party of the visitors. It was said, by those who knew, to be a virtual re-carnation of the old-time Ananias Club. Some time-honored stories were told, also some that were accepted as new.

There was some misunderstanding of the conditions attaching to the award of the Sweepstakes prizes, which was settled by vote of the society after considerable discussion, the decision being that this class required no regular entries but that all winners of prizes in Class A should participate. The S. A. B. silver medal awarded to F. Dorner & Sons for seedling under number 18 is to be withheld until Mr. Doran has selected a permanent name for the variety.

The selection of Pittsburg as the place for the next meeting will, we believe, meet with general approval, for Pittsburg was very magnanimous one year ago in giving way to Indianapolis. Many of those who were present and active in the Pittsburg meeting in 1892 have already joined the great majority, but those who are still left will recall with pleasure that enjoyable occasion and no doubt make a strenuous

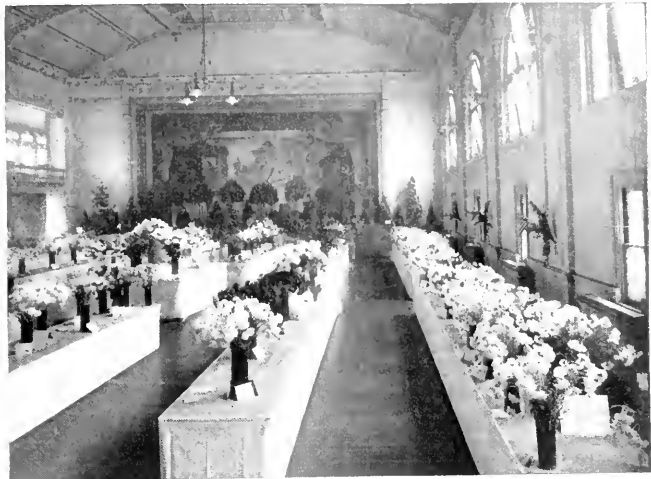

VIEW IN EXHIBITION HALL.

effort to revisit that hospitable city next year.

A Roper has good cause for joy over the winning of the gold medal by his pet variety, Bay State. The splendid qualifications of this sensational flower have been generally recognized, but that it should make the trip of over one thousand miles from Massachusetts to Indiana, and right in the carnation growers' stronghold capture the premier prize, was hardly to be hoped for. It was a courageous move on Mr. Roper's part, and we congratulate him on the result.

THE RELATIONSHIP BETWEEN PRODUCER, WHOLESALE AND RETAILER.

A Paper read before the American Carnation Society at Indianapolis by William J. Stewart.

The topic on which I have been asked to say a few words might easily furnish food for profitable discussion for the time of an entire convention. Briefly stated, I think all will agree that a closer accord and mutual understanding between the representatives of these three interests would greatly conduce to the advantage of the industry as a whole and every individual connected with commercial horticulture. We need not confine our consideration to the carnation industry alone; what we shall deduce applies equally to all.

At the start we might ask ourselves, first—whether our industry is enjoying a reasonable prosperity; is or is not returning to those who labor in its various departments a fair recompense for the effort expended. If not, where shall we look for the cause and what can we apply as a remedy?

The business which is under consideration is one of recent development rapidly increasing in importance and influence and now involving many direct and allied interests. It is not surprising that new phases hitherto unforeseen are constantly intruding themselves. We find in the ranks

many who started when its problems were simple, its operations somewhat primitive and its profits large in proportion to the investment. It is only natural that we should here encounter a sentiment reluctant to acknowledge that former conditions can never be restored and well-intrenched convictions with resultant prejudices as to the supposed causes contributing to present grievances. All this is inimical to the conciliatory, co-operative spirit which the interdependence of the different interests makes so desirable.

On the other hand the inherent principle of progress demands, that as our business assumes a magnitude which makes modern mercantile methods essential to its best success we should fit ourselves to so conduct it, regardless of any pre-conceived views and cherished prejudices which may stand in the way. According as we are willing to so fit ourselves and encourage the same in our auxiliaries will the foundations of our industry be strengthened, its dignity upheld and its permanency assured as an avocation universally respected and honored.

Looking at the commercial horticultural industry as comprising the three distinct divisions mentioned in the title of this paper we may state as a self-evident proposition that any interruption of the prosperity of one department must eventually react directly or indirectly on all the others, and the misfortune of one should therefore be the concern of all.

Following out this thought a first requisite for the movement towards a better understanding and the benefits which may be expected to follow is the recognition by each department of the indispensability of the other.

"I care for nobody, no, not I. It nobody cares for me," is not the sort of sentiment that will bring either emolument or credit to either.

With the wholesale growers' first and greatest obligation—that of producing good and acceptable material—

this paper does not concern itself. We shall assume that the grower is doing his part well and as-ent also to the proposition that, under conditions as they now exist, he has all he can attack to. It, however, the product is not well-sold and the money well-collected it matters little how well it may have been grown and so here we come to the problem which presses most urgently upon us today. When the production outstrips the demand then are the highest qualifications of the marketing forces put to the test. You, growers, who make up the bulk of the membership of this organization, know something of the bitterness of disappointment, as you have seen your product, under the slightest provocation of sunlight and crop, piled up unsold in the wholesale markets or condemned to the alternative of being proclaimed by a "hole-in-the-wall" shouter at "ten for a nickel," while perhaps you read in the trade papers of a scarcity and unsupplied demand a couple of hundred miles away. You are justified in asking "Can't this be helped? What is it that stands between the flower and the public?" But instead of asking of the wind or of your brother grower, would it not be well to call in the other members of the family—the wholesaler and the retailer—and reason together? The subject is one which will tax the combined capabilities of all.

In the meeting for the organization of this society at Philadelphia 18 years ago, among the objects of the organization as set forth by the committee on resolutions were the following: "To increase general interest in the cultivation and consumption of the carnation; to improve the methods of cultivation and the methods of placing it on the market; to increase its use as a decorative flower." Do the records of the society show that these two propositions have been followed up as of equal importance or that one has been allowed to overshadow the other?

Our worthy president in asking me to prepare this paper, writes: "You have been through the mill, so I think you might give us a few suggestions." Consulting the dictionary, I find the word "mill" defined as "a machine in which substances are ground"; "a prize fight." The president evidently had in mind my connection with the flower commission business in the long, long ago. From my observation I should say that the commission method of marketing flowers was still holding its own all right, although proof is not wanting to indicate that the sentiment among some of the best informed commission dealers seems to favor a system of direct outright purchases from the wholesale grower. In any event the vital interests of grower and wholesaler demand that the wholesale dealer should at all times have exact information from the grower as to crops present and prospective, and a strict compliance with his wishes as to time and manner of shipment. It is the wholesaler's privilege and duty to concern himself in the matters which affect the welfare of his grower, advise him as to ways and means whereby he may increase his income, post him as to the movements and tendencies of the market as discerned by the man at the front, keep the scouts busy and do something more than sell. If he is incapable of all this, he may be "in the

right church," but is certainly "in the wrong pew."

The grower should have from his wholesaler unquestioned assurance of financial responsibility. I sometimes think the growers as a class have been remarkably trusting and generous in this latter respect to salesmen of all kinds, but whether it is good business is a different question and, as before intimated, hardly in harmony with accepted commercial practice which demands that the money from the sale of flowers should pass promptly from the consumer through the medium of retailer and wholesaler to the grower, and with equal celerity from the latter, to those who supply and serve him. In no respect are the various departments of the trade more closely interdependent and in none is reform more urgently needed than in this matter of credits and accountability.

As to the retailer he should never forget that the producer of the stock which he must have, if he is to continue in business, is entitled to a fair return and the means of placing his business in a position of honor and good repute. It is natural to want to buy as cheap as possible but the disposition to beat down wholesale values regardless of the possibilities of ruin and discouragement that may follow should be looked upon with disapproval by all well-wishers of the floral industry.

In conclusion, let none of us be "content with knowledge sufficient for the present need." The business with which our fortunes are linked is only in course of development, and to keep pace with its growth and its emergencies requires the best combined thought you can give to it. Mutual respect and mutual toleration are good qualities to cultivate. Our peace of mind, our business future and, last but not least, our pocketbooks, will all share in the prosperity following upon a wise discernment of the close relationship between producer, wholesaler and retailer.

CARNATIONS I HAVE KNOWN AND THEIR ELEVATING INFLUENCE.

Paper read by Miss Sarah A. Hill at the Carnation Society Lunquet, Indianapolis.

Brother Toastmaster and Dear Friends: I have taken my pen in hand to write you a few lines because I can express what I have in mind much better than in attempting an after dinner speech, for unlike the majority of my sex, I happen not to be eloquent of tongue.

I recognize many faces present as those of old and tried friends, but if I could for a moment see your signatures I should know many more of you intimately, for the written name at once brings up a picture of your letters, and I can say without boasting that few women, the country over, have as many delightful gentlemen correspondents as yours truly.

Now that the machine has taken the place of the steel pen I am seldom at a loss to arrive at the meaning of my correspondents, but there have been times in the past when I hardly knew whether I was deciphering an ardent declaration, or only a very warm cancellation of an order for a belated lot of the reigning novelty in carnations.

It is never safe for an unmarried woman to let her memory reach too far back into the past, but I can re-

member when old La Purite was our mainstay; I remember when Mlle. Carle threw up its first snow white flower and we held our breath over its purity of color and its clear cut form, but even the most daring catalog liar could not claim freedom of bloom for either of these beautiful old pathfinders, nor for Buttercup or Chester Pride, Portia or Grace Wilder, which were added as the years went by, and if there had been only carnations on our benches I doubt if we should have butter on our bread, for the Bread-and-Butter carnation had as yet no existence.

In '88 with Tidal Wave the tide began to turn, and Father Dornier soon after gave us a delightful set of seedlings, and these, with Lizzie McGowan and Daybreak, set an entirely new pace, and a carnation, from being a spoiled beauty for admiration only, began to be questioned as to its right to occupy space and as to its returns in hard dollars and cents per square foot; the heavy boot of sordid commercialism had kicked aside the old-time beauties, and the husky varieties with sleeves rolled up, stems like steel, calyxes like gutta percha, petals like leather, and a noise like money, came rustling on the stage and many a song and dance they have given us.

Visitors who go about a greenhouse with the proprietor seldom fail to remark upon the elevating influence of flowers: I have never known a florist yet who failed to acquiesce; he will stretch his neck in his collar, elevate his shoulders, and really feel higher up both mentally and morally as the suggestion is once more made to him. But I have seen the most enthusiastic visitor put to flight from the most magnificent carnation range by a very depressed looking section hand who might be scattering bone meal or other dainty tidbit for Lady Carnation's mid-week meal—and further, I have known carnations that have dragged their owners down very near to the bottomless pit, and even the best of varieties at times have tried the souls of their grower till no modern tongue contained sufficiently lurid language to express his feelings.

I once made the acquaintance of a glorious red carnation, sweet as winds from Araby, a stem like whalebone, 8 and 10 blooms to the plant, a blaze of color, and every florist wanted it by the 500 or 1000, but the rust "swept down like the wolf on the fold" and devoured every green leaf, and I still have the vision of our good German grower with wildly waving arms over his grassless benches, exclaiming: "That Jubilly, he was the very dyufel," and what else he may have said when no ladies were present I never dared inquire. A prominent firm in Massachusetts, who had a nice order for "Jubilly" placed with us, were extremely curious to know why they were failing to receive their cuttings, and made inquiry quite forcibly weekly, and faintly each week we replied. I am glad that I am addressing a company of florists every one of whom has disseminated or been upon the point of disseminating a new carnation, for you know exactly what I am talking about, and how often you went into a perspiration before the season closed, and neither did you need a rose temperature to make your pores open.

Well, some four years after Jubilee

this same prominent Massachusetts firm sent out a seedling, Mrs. Thomas W. L., I believe. We gave it a good write-up in our catalogue—"Size enormous, stems stiff, free in growth, profuse in bloom, of healthy constitution, never bursts its calyx, everything has been claimed for it and our opinion is that it will justify the claim"; and it did very nearly, but I believe it was late in May before our orders were filled, and so despicable is feminine human nature that I confess to pure enjoyment in going to our file and copying verbatim several letters addressed to us four years previously, only substituting the name Mrs. Thomas W. Lawson for Jubilee, asking why we were not receiving those cuttings promised us with such absolute certainty for early delivery in the January past, and I think that the secretary of the disseminating company must have duplicated our replies of even date, for I recognized the same tone of chastened humility that had characterized our own.

I never felt my sympathies more deeply stirred than in the case of a certain magnificent pink variety grown not a thousand miles away from this city, which seemed to have every necessary qualification for success, but it later developed that the cuttings would not root. Now a perfect carnation, like the great American mortgage lifter, must "root, hog or die." We waited and waited for those cuttings, so did the rest of you; each time we were told that the last batch had failed to root. One grower was sure the plants were grown too warm; another that it was too much bottom heat in the propagating house; a third that they needed a Bordeaux spray. A happy thought struck our firm; we would ask for unrooted cuttings, take them over to Richmond, under our perfect conditions we would root them in three weeks and complete our orders.

Our disseminating friend was very accommodating and sent us baskets of the loveliest tips imaginable, but with every appliance known to modern carnation culture, we failed to root over ten per cent.

It would not have been safe for you to talk to the owner of Mrs. Nelson that year on the elevating influence of flowers. Nothing short of diabolism itself could have been more tantalizing than the antics of that magnificent beauty.

Our firm has at different times tested for their owners a number of aspirants for favor with varying success; it's a risky thing to do; if they fail to make good, the owner will always have a doubt in his mind as to whether all the conditions were just right to bring out their good points, and the gentleman who does the testing, and his grower, will have arguments about wasted space—and the nice discrimination needed in endorsing a novelty. Less than a decade ago, your Toastmaster went down into the East to take a last look at a fine white seedling which we were to test, and, if satisfactory, to help disseminate; it showed up so fine down in its eastern home that he could hardly wait to get the stock planted on his own place; in the meantime, our Mr. Lemon had gone up into the Northwest on a similar errand with regard to a gorgeous pink. On his return he gave the usual wheat-field description, buds and blooms knocking their heads together—and

such heads—on such stems! E. G. H. wanted a south bench to test his White Beauty and F. H. L. insisted on a southern exposure for his glorified pink; they each had a 200 foot bench facing south in the best 400 ft. house. When the date of the annual meeting of this society came around, where the White Beauty and the Glorified Pink were to take your breath away, E. G. H.'s south bench was covered with a dense growth of pale green carnation grass which would have required a scythe to cut it and not a flower in sight; F. H. L.'s south bench looked like a patch of seedling onions in very early Spring, with an occasional petal of pink thrown in for cheer. The two gentlemen never went together to inspect the two benches; the senior member might be seen gazing with a pained expression at Lemon's choice, but carefully avoiding a glance at his own Eastern Beauty. An hour later, "Ibber" Lemon could be found, arms folded, an unholly smile upon his face, gazing at 200 ft. of Hill's Hopes, but without a glance at the onion patch, and to this day their only comment has been, "Check," but the check never went through the treasurer's hands.

Then there was Adonis and here words fail me for the present—but—some day, when Richard W. and Robert C. and the secretary of the E. G. H. Co. have all reached the age limit, and have leisure to take up literature, we are going to collaborate a biography and romance of the Young Adonis, the most ravishing scarlet carnation ever shown to human gaze; behold a bench of it in full bloom, heads erect, a color far beyond words to describe—you can see the ecstasy in the faces of Messrs. Craig, Hill and Witterstaetter as they devoured its dazzling beauty. This is not yet a matter of ancient history, and still it was before the days when the florist had grown sadly wise and had learned to balance a carnation stem on his index finger as the juggler does his pole to test its stiffness; before he had learned to draw the flower slowly through his closed hand and watch the petals spring back to the horizontal—before he had learned to slap the bloom upon the table and watch the resisting power of the texture. Adonis helped to teach the trade this last trick, and so was not wholly lost in the economy of carnation culture.

Since Adonis there have been others; they are current history and still in mind. Father Dorner and Mr. Peter Fisher have been the means of giving us the most popular carnations and the best wage earners in the family; we can gaze long and fondly upon White Perfection and Enchantress as a father does upon a good child and say: "They have never given me an anxious moment." Oh! but the waste of it all, the squandering of hard-earned dollars, you may say; but progress always costs in any line of trade or life, and the expenditure of money is the smallest item; the thing that really counts is endeavor and patient perseverance, and absolute honesty, and this is as true in commerce as in manufacturing or in carnation culture, and flowers do have an elevating influence on their growers, if the soil is mixed with good will for one's fellows and faith in a kindly Providence that sends the needed rain and sunshine and finally gives the increase.

During Recess

New York and New Jersey Plant Growers' Association.

In the ability to provide and the capacity to get away with a princely feast, the plant growers can give the mere florists all the trumps and then bear them out. The "New York and New Jersey" is one of the youngest of the special organizations, yet its past performances in the picnic and banquet have brought it prominently into the lime light and when announcement was made that on the evening of January 28 the annual dinner would be held at the St. Denis, a wave of anticipatory agitation swept over the old town and now the Indianapolis fraternity can easily see what happened to keep the New Yorkers away from the Carnation convention. President Julius Roehrs, Jr.'s willowy form occupied the seat of honor and in front of him and on the small tables around which were grouped the seventy members and guests were flowers in profusion, each lady having a favor of orchids in a little Japanese receptacle, all donated by enthusiastic members of the association. The orating was done by E. V. Hallock, Robert Craig and Patrick O'Mara—names which at once settle the fact of its adequateness and quality and to put a characteristic finish on the performance, J. Austin Shaw presented an original poem—a sort of dreamy oriental idyl crossed with a Borough Park pastoral—which delighted the ladies and thrilled the sterner sex to the limit.

If one can't be a plant grower surely the next best thing is to have the honor of the plant growers' acquaintance. They are the people.

Nassau Co. Horticultural Society.

This society held its fourth annual dinner in the Oriental Hotel, Glen Cove, N. Y., on Wednesday evening, January 29th. President Everett presided over a well attended dinner, about forty members being present. Quite a number of invited guests also joined us in the feast. J. Austin Shaw acted as toastmaster. On rising, Mr. Shaw called upon the president to present H. F. Meyer with a cup which he had won in the points competition in 1908. The cup, a massive silver one, was the gift of Rickards Brothers, of New York City. Ex-President Jaenicke and ex-Corresponding Secretary Kesson were presented by the society with a pearl and diamond pin and fountain pen, respectively, in recognition of services performed in 1908. An interesting talk on Society Organization was given by Mr. Maynard of the Gardeners' Chronicle.

The singing was first-rate. Rickards Brothers, C. Russel and W. Armstrong each gave of their best. As a violinist R. Angus of Tarrytown proved himself an able exponent of old Scotch airs. Andrew Wilson of Summit, N. J., also did his part towards the entertainment of an appreciative audience with some of his clever tricks and witty stories.

One of the most successful dinners ever given by the society was brought to a close by singing Auld Lang Syne. The society enters upon its fifth year with brighter hopes than ever before.

WM. H. MacKENZIE, Cor. Sec.

NEWS OF THE CLUBS AND SOCIETIES

FLORISTS' CLUB OF WASHINGTON.

The regular monthly meeting of the Florists' Club of Washington, was held at Eagles Hall on the night of Feb. 2nd, with President Kramer in the chair. The most important business was the nomination of officers. It is the custom of the club to nominate the officers at the February meeting, elect them at the March meeting and at the April meeting they take their seats. The nomination of President Kramer to succeed himself was made unanimous, also of John Robertson for vice-president. Geo. Shaffer absolutely declined to be re-nominated for the office of secretary, and O. A. C. Ochler and Jas. L. Carbery were nominated. Wm. F. Gude was nominated for treasurer. In the awards committee, Geo. H. Cooke was nominated to fill the vacancy made by the departure of Mr. McCauley. In the board of directors, two out of five of the terms had expired and Jas. L. Carbery of Washington, and Theo. Deitrich of Anacostia, were nominated to fill the vacancies. A most gratifying report of the financial end of the last show was made by the secretary. There will be the usual annual banquet given in April when the newly elected members take their seats.

Wm. F. Gude was warmly congratulated by the club on his election to the presidency of the Chamber of Commerce, and in a few well chosen words he thanked the club for their unwavering loyalty to him and reiterated his interest in and love for the club in particular and the trade in general. Thanks are due Elmer D. Smith of Adrian, Michigan, for a number of pleasing catalogues which were distributed at the meeting. It was moved and seconded that the Baltimore Bowling Team be invited over on Feb. 11th to play the Washingtons.

CONNECTICUT HORTICULTURAL SOCIETY.

At the meeting of the society on January 22, President Huss announced a gift from William B. May, a life member of the society, of his valuable collection of books on horticulture to the society. Mr. May is to make his home in Jacksonville, Florida, in future. A prize of \$25 in cash from A. T. Baldwin for the best collection of vegetables at the fall show was announced. A whist and smoker will be the program for the next meeting, and on February 26 there will be an exhibition of carnations.

NEW HAVEN HORTICULTURAL SOCIETY.

The regular meeting of the New Haven Co. Horticultural Society was held on Tuesday, Feb. 2nd, at which one of our members, John H. Slocumbe of East Haven, Conn., a well-known florist, read a very interesting and instructive paper on "Viola's," tracing it as far back as 1830. Our amateur garden competition, which proved very successful last year, will be repeated this year, it being the unanimous vote of the society.

SOCIETY OF AMERICAN FLORISTS AND ORNAMENTAL HORTICULTURISTS.

The executive committee of the National Flower Show Committee of Fifty had a meeting in Indianapolis on Thursday, January 28 and later made report to the committee of Fifty that they had received full reports from the chairmen of all sub-committees. The auditing committee's report showed an unexpended balance of \$1,083.75 and it was voted to distribute 10 per cent. dividend to each guarantor for money actually paid in, the balance of nearly \$500.00 to go to the S. A. F. It was decided that all records should be collated and filed with the secretary of the S. A. F., including samples of all printed matter and other material that might prove of value for future shows and help the management to steer clear of any snags that had been encountered in the last. Records in class 77 were reported missing and E. G. Hill was appointed a committee of one to communicate with the exhibitors and see that awards are duly made. Owing to a misunderstanding by the judges, no awards had been made in class 347. It was voted to refer this back to the judges for adjudication and award of the medals if possible.

Registration of Rose.

A protest having been filed against the registration of a rose offered by the Dungee & Conard Company under the name "Charles Dungee," the registration of the rose is held in suspense.

Under the rules of this Society the original matter of the registration and the protest against it have been placed in the hands of Mr. Robert Simpson, certified to the undersigned by the secretary of the Rose Society as the chairman of their committee in charge of such matters, and no further action will be taken by this Society pending the result of the investigation to be made by the committee of the Rose Society. W. N. RUTD, Secretary.

LADIES' SOCIETY OF AMERICAN FLORISTS.

The members of the Ladies' Society of American Florists return thanks to Indiana florists for the royal entertainment given them at Indianapolis during the Carnation meeting.

MRS. CHAS. H. MAYNARD, Sec'y.

HORTICULTURAL SOCIETY OF NEW YORK.

The meeting of the Horticultural Society of New York, in the American Museum of Natural History on Wednesday Feb. 10, will be devoted to carnations. Possessors and introducers of novelties are invited to send blooms for exhibition in competition for the society's awards, to be judged purely on the individual merits.

Messrs Eugene Balleudoux and John Ernie have consented to act as judges, and to take part in the discussion on modern carnations at the formal meeting at four o'clock on that day.

Specimens for exhibition should be staged, ready for the judges, at one o'clock. L. BARRON, Secretary.

FLORISTS' CLUB OF PHILADELPHIA.

An exhibit of carnations and Albert M. Herr were the star attractions at the monthly meeting held on the 2nd inst. Edward A. Stroud exhibited Lady Bonififul, Winsor, White Perfection, Enchantress, Beacon, and Mrs. W. H. Barnett, the latter being an English variety which Mr. Stroud thinks highly of and which looks better now than when received two years ago. Campbell Bros., Pennington, sent three very fine vases of Enchantress, White Perfection, and Pink Imperial. Wm. Kleinheinz staged a vase of Pink Imperial, and White Perfection, the latter containing three varieties, but the committee did not observe the joke; also a vase of light pink stock, "Beauty of Nice." Samuel Batchelor exhibited a vase of Cineraria stellata—clear yellow in color and very free flowering—a sport originating on the Newbold place from seed received from Sutton's two years ago. W. T. Le Croix, Buena, N. J., sent a fine lot of Marly lilac, with spikes a foot and more in length, and exceptionally well done. A vase of White Killarney rose from the Waban Conservatories was staged by the Pennock-Meehan Co. This exhibit had been on show for eight days previously, and the flowers were still in good condition.

Mr. Herr's address was very interesting and the after-discussion quite animated. Mr. Fahrnerwald called attention to the coming meeting of the Rose Society on the "17th of Ireland," and urged all members to be present. Parker Thayer Barnes, of Suburban Life, Harrisburg, was nominated for active membership. A discussion took place on boiler insurance. The general opinion seems to be that the state law does not apply to greenhouse boilers. The subject for next meeting will be "Gardenias" by William Kleinheinz.

TOLEDO FLORISTS' CLUB.

The last meeting of our club was a special one for the introduction of novelties to the members, and was largely attended. Invitations were sent out early in January to the introducers of new varieties to favor us with a dozen flowers of their novelties for this meeting. As judges the chair appointed Messrs. Thos. Magee, Harry Heint and George Bayer, and asked them to use the scale of the American Carnation Society. Bassett & Washburn sent O. P. Bassett, which proved to be the best red we had ever seen, and scored 85 points. There will surely be orders for this variety, as we are in need of a good red one.

The Highland Park Floral Co. sent us Lucille, a very large white flower, pencilled with rose. This variety will also be grown here. The flower has a good substance and is one of the largest we have ever seen, and the stem carries the flower fairly well. W. H. Shumway's Edward arrived in a poor condition, which did not permit judging it.

A prize was awarded to Emil Kuhuke for the twelve best red carnations, own seedlings. The color was good of what Kuhuke staged, size rather small

and stem a little weak. J. L. Schiller exhibited a few *Primula oboconica* Arendsi (*gigantea*), one of his specialties, in 4 in. pots. The plants were very well grown and remarkable for size of flower. If the improvements in *obconica* keep on, then goodbye to *Chinensis* varieties. The Arendsi shown were grown from the originator's strain, and when better known will be found indispensable as cut flowers or pot plants.

TARRYTOWN HORTICULTURAL SOCIETY.

The regular monthly meeting of this society was held on the evening of Jan. 29. Owing to weather conditions the attendance was rather small. Mr. Abel Weeks, our new president, occupied the chair for the first time and made a promising start. The secretary's report on the annual dinner was very favorable and a vote of thanks was extended to Mrs. Driscoll, proprietor of the Florence Hotel for her hospitality. The prize for this meeting offered by James Stuart was for two primulas, any variety, and was awarded to Thomas Aitchison, gardener to Mrs. H. Seigel, Mamaroneck, who exhibited two fine specimens which also received a cultural certificate. A superb vase of White Killarley rose exhibited by F. R. Pierson Co. attracted much attention and was awarded a certificate of merit. Discussion of exhibits brought the meeting to a close.
W. JAMIESON.

WORCESTER COUNTY HORTICULTURAL SOCIETY.

Program of meetings:

Thursday, February 11—Conference on Vegetable Growing, Herbert R. Kinney.

Saturday, February 13—Children's Day—Children and Music, Adin A. Hixon.

Thursday, February 18—Worcester County Bee Keepers Institute, 10.45 a. m. Speaker to be announced. 2.30 P. M., Insects in Everyday Life, Burton L. Gates.

Thursday, February 25—Ladies' Day—Music, Floriculture. Speakers to be announced.

Thursday, March 4—Rambles in the West, Charles W. Wood.

Wednesday, March 10—Annual Reunion.

Wednesday and Thursday, March 10 and 11—Massachusetts Fruit Growers' Convention.

Thursday, March 11—Speaker to be announced.

GHEENT HORTICULTURAL SOCIETY.

At the monthly meeting held under the auspices of the *Chambre Syndicate des Horticulteurs Belges*, which took place Jan. 2nd, certificates of merit were awarded to the following orchids exhibited by M. F. Lambeau: *Cypripedium insigne* Labette, *C. Leumann Lakense*, *C. i. Lambeauianum*, and *C. aureum* Cyrus; also to *Cypripedium* var. (*Orphanum* x *Boadicea*) shown by M. J. Van Schots, to *Laelia anceps alba* var. *Stella*, and *Cattleya Trianae superba* shown by M. Verdone.

FLORISTS' WINDOW DECORATION IN JAPAN.



In Celebration of Visit of U. S. Fleet.

NORTHERN WESTCHESTER COUNTY HORTICULTURAL AND AGRICULTURAL SOCIETY.

The Northern Westchester Horticultural Society held its annual dinner and installation of officers on January 21, at Mount Kisco, N. Y. The visitors and guests were Mr. Howard E. Bailey, who has done much for the society at previous shows, and who has promised a special for the coming fall show; David MacFarland, of White Plains; Dr. E. W. Brown and J. E. Gorbam, of Mount Kisco. M. J. O'Brien, gardener for J. Borden Harriman, was toast-master. The table was decorated with carnations.

A. L. Marshall, superintendent for Col. Wm. Jay, Katonah, was installed president; M. J. O'Brien, vice-president; Wm. Bauley, treasurer; and H. A. Spavins, secretary.

THE CALEDONIAN HORTICULTURAL SOCIETY.

The annual general meeting of the above society was held on Jan. 13, which is also the occasion of the centenary of its existence. Financially, the society is prospering, and the treasurer's statement showed a satisfactory balance. The centenary will be celebrated by a show in September next, and great efforts will be made to insure a full success.

LOS ANGELES FLORIST CLUB.

At the regular meeting of the Los Angeles Florist Club held on January 23, Vice-President Houghton in the chair, officers for the ensuing year were elected: President J. Dietrich; vice-president, Dr. Houghton; secretary, Jno. I. Reeves; financial secretary, Chas. Wimsel; treasurer, W. Wern; sergeant-at-arms, G. Peterson.
H. E. GEORGE.

CLUB AND SOCIETY NOTES.

The lecture before the Massachusetts Horticultural Society on Feb. 6, at 11 o'clock, will be on "The Etherization

of Plants for Forcing Purposes," by Prof. William Stuart, Burlington, Vt.

The annual ball and concert by the Lenox Horticultural Society was held in the Town Hall, Lenox, Mass., on January 29. The best in music, an elaborate supper and finely decorated hall were attractions that the large and brilliant company did not fail to appreciate.

The Arkansas State Horticultural Society at their annual meeting on Jan. 21, passed a resolution asking the legislature to pass a compulsory spraying bill to protect the orchardist from San Jose scale. H. H. Shibley, of Van Buren, was elected president and J. W. Vestal, of Little Rock, treasurer.

The annual dinner of the New York Florists' Club will be held at Shanley's, 42nd street and Broadway, in the "Roman Banquet Hall," on Saturday night, February 27. Fine decorations are promised by the committee in charge, and it is said that the menu will surpass any in the past. The ladies will be present for the first time on record.

Among the matters under consideration by the State Horticultural Society of Colorado which convened at Denver Jan. 20, that of orchard looters was prominent. The early loots that have appeared for the past two years have been the means of losing some two million dollars to the fruit growers. After an address on the subject by James I. Hamilton, the society took a special car for the Parfet orchards where six different looters were put in operation. The result will be known later. Officers were elected as follows: President, George E. Richardson; vice-president, O. D. Strick; secretary, Clinton Oliver; pauper, treasurer, Mrs. Lute Wilcox, Denver.

A STUNT FOR BUREBANK.

Scientists say the white ant lays 50,000 eggs a month. Would it, we desire to ask, would it be possible to cross the white ant with the Plymouth Rock hen?—Topeka Capital.

Obituary

George Field Morris.

Many will learn with regret of the death of George Field Morris, which took place at his residence, Cambridge Park, Waukegan, on Jan. 2. The deceased, who was born in 1831, may be said to have been the founder of the widely known firm of Messrs. Protheroe & Morris, of 67 and 68 Cheapside, London, on its present lines, for he, in conjunction with Mr. W. H. Morris about the year 1874, opened the City Branch, then at Gracechurch street, and later removed to Cheapside. The firm was started about 1830 as a nursery business at Highbury by Mr. Thos. Morris (father of G. F. Morris) and Mr. Alex Protheroe.

After Mr. G. F. Morris retired in 1903, the firm was carried on by the present partners, H. C. Morris, F. A. Morris, A. E. Protheroe and J. B. Slade; and there will be no change in the management of the business.

Hermann Josef Wildpret.

We regret to announce the death of this earlier director of the Botanic Garden at Orotava in Tenerife, which took place on December 19, 1908. The deceased during his 35 years of service in the Garden constantly endeavored to add to his collection of plants and bring it to perfection, but his endeavors met with small encouragement from the Spanish government. When Wildpret went to Orotava there existed but one solitary species of Phoenix canariensis, and today there are over a hundred.

Mrs. Anna Klingenberg.

Mrs. Anna Klingenberg, who opened a retail flower store at 920 N. Halsted St., Chicago, last spring, died January 22, leaving a husband and infant daughter. Mrs. Klingenberg had had many years' experience with others and had built up a nice little business for herself. Mr. Klingenberg will dispose of the business, as he is not a florist.

Mrs. Mary Lyons.

Mary, wife of William Lyons, of Bernardsville, N. J., who died on January 23, was a daughter of James Hart, the veteran flower wholesaler, of New York, and was highly esteemed by all who knew her.

Patrick Kenefick.

Patrick Kenefick, for the past seven years manager of the Fenwick Nurseries, Halifax, N. S., died on January 20, in his seventy-second year. He is survived by a widow, three sons and five daughters.

Leander Remington Peck.

L. R. Peck, Barrington, R. I., owner of one of the finest collections of orchids in America, died suddenly from appendicitis on Jan. 28.

L. B. Coddington is mourning the death of his mother who died on Sunday, January 31, at his home in New Providence, N. J. She had been in poor health for some time past, having suffered a series of strokes of paralysis.

GERANIUMS

Our Geranium Catalogue describes one of the largest and best collections in this country, including the best standard and novelties, 2 in. pot plants, \$2.00 per 100 and up.

HARDY POMPON CHRYSANTHEMUMS

Every grower of Chrysanthemums will want to grow the Pompoms next fall. We have the best collection to select from, and are acknowledged to be head quarters, \$2.00 per 100. Special prices on large lots.

LOBELIA

KATHLEEN MALLARD. The new double Blue Lobelia.

We shall continue his week to offer this Novelty of exceptional Merit at the Special Price of \$2.00 per 100.

DAHLIAS

We have a splendid collection in plants for next spring or roots next fall. Ask for list and prices.

We also offer a general Collection of Bedding Stock.

R. VINCENT JR. & SONS CO., White Marsh, Md

PREVENTION BETTER THAN CURE.

The advocating of a hospital bed for the members of the Boston Florists' Club by the president, is a thoughtful suggestion providing the members are willing to make use of it, which would be very doubtful.

It seems to me, that there are far more important questions which ought to have consideration. The questions which I have reference to are to try and secure the half holiday on Saturday, and also to try to secure better remuneration for labor, and the reduction of the assistant's outlays.

Why should greenhouse men who are using water more or less all the time, be required to provide themselves with rubber boots, when all professionals such as coachmen and washers of all kinds, secure them free? These are far more important questions which every member ought to consider, and if taken up in some practical form would do far more good and at the same time, make the assistants whose average pay, when all the hours of labor are counted, is less than \$2.00 a day, feel far more independent and make them more able financially to provide a bed for themselves.

An interesting subject for debate would be. Do the best growers hold the best positions? If not, why not? Why trouble ourselves about the education of a young gardener? Make it worth while and the modern assistant will take care of his own education.

Should the Boston Florists' Club take up these questions, the attendance would be greatly increased by those who are really interested in the welfare of horticulture.

If you take a look at the horticultural barometer you will find the mercury standing about 20 or 30 degrees above and still falling every year, and then look at these large rose factories,

violet factories and cyclamen factories being built, and in a few years time the mercury will be down to about 5 or 6 above and only a few horticultural experts required. How are these Horticultural Clubs going to look after their members' interests? Why not organize and build one of these large factories and allow every member to have equal shares in it, then we could have a bed in the hospital should our manager take sick. So that it would not reduce our dividends, we could have bowling alleys and all kinds of amusement for the young members, then we could with confidence say, that we were members of one of the most practical horticultural organizations in the world.

DAVID MILLER.

Anything of Value
to the profession
CAN BE SOLD
through advertising in
Horticulture

CHOICE AMARYLLIS

We make a specialty of the finest strain in the world. A limited supply of 1, 2 and 3 year old bulbs will arrive in a few days. Prices by mail.

KNIGHT & STRUCK

1 Madison Ave., - NEW YORK

SHAMROCK

IRISH. THE REAL THING! GREEN.

Best to order early and grow on for strong plants for St. Patrick's Day. Our stock is very fine. \$4.00 per 100, or post-paid 60c. per dozen.

JOHN F. RUPP, Shiremanstown, Pa.
RUPPTON: The Home of Primroses.

WILD FLOWERS.

A paper read before the Illinois Horticultural Society by O. C. Simonds.

In August, 1892, I visited, in company with its owner, the country home of Mr. William Robinson. As we approached his house, I noticed, some distance ahead, quite large areas of delicate color, mostly light blue. On coming nearer, these areas were found to be large beds of native American asters. "Oh, you have some of our flowers!" I exclaimed. "Yes," said Mr. Robinson, "you Americans do not appreciate your wild flowers. We have to bring them over to England and cultivate them awhile before you will notice them." This has been to some extent true. We have valued our flowers as little as we have our forest, our birds, our wild game, and other products of nature which cost us nothing. To be sure, as children, we have all taken delight in going to the woods and picking wild flowers, and then we have taken them home in a wilted condition and thrown them away. I know areas near cities where this has been done to such an extent that where trilliums, hepaticas, erythroniums and blood-roots were formerly abundant, they can no longer be found. Some people who missed the wild flowers in their vicinity secured some wild phlox and trilliums from another place, and planted them in their own yard. These grew well, and were left undisturbed so that they would increase in numbers, but one day they were discovered by some passers-by, who entered the grounds, and commenced picking the blue and white blossoms. When remonstrated with, instead of realizing that they had been intruding and had done something wrong, they simply said, "Why we thought these were wild."

Let us take for granted the fact that our native flowers are beautiful, and that they may be used to advantage in home grounds, parks, and other areas which we try to make pleasing with planting, and then let us study how to secure the most satisfactory results. The place for such study is wherever wild flowers are growing. One can often see such places from a car window. Every spring I notice along railways low places which are covered with marsh marigolds; other places covered with wild phlox, often a bit of woodland where trilliums show their white heads in profusion. Sometimes the ground is almost completely covered with shooting stars. Again, a sandy ridge will be colored blue and purple with the flowers of the lupine. Asters, goldenrods, daisies, and buttercups are abundant in certain localities at various times of the year. Still other flowers which I remember hav-

ing seen with pleasure from a car window are our native lilies, bunch-bells, painted-cup, butterfly-weed, spilanthes, and puccoon. These are by no means all. I merely mention a few neighbors. There are now firms that that I happen to think of as I write—I remember a roadside where some wide-spreading thorns grew. Underneath these the conditions were not favorable for grass, but the ground was hidden in May with our native anemones. Another area was carpeted with dog-tooth violets, both the yellow and white, but each in a colony by itself. Many of the flowers mentioned are so fragile and delicate that they cannot be used for cut-flowers, or for house decoration with satisfaction, but that is no reason why they should not be allowed to grow and beautify the land in places where they will be happy, and give us pleasure.

The examples mentioned, and many others which you will undoubtedly recall, should furnish hints for the treatment of unusual spaces in parks. Advantage might be taken of a place that is naturally wet. Instead of draining it or filling the area and covering it with a lawn, we might have a succession of flowers throughout the season, beginning with marsh-marigolds, skunk cabbage and wild violets, which could be followed later with some of the saxifrages, meadow rue, lady-slippers, blue lobelias, cardinal flowers, grass of Parnassus, and finally with the closed and the tinged gentians. All of these plants like moist situations, and are most attractive in appearance. A group of shrubs on higher land might furnish protected places for hepaticas, dutchman's breeches and blood-roots. A sandy knoll, where it is difficult to have a good lawn, might be beautifully covered with puccoons, lupines, butterfly weeds and other flowers that like such a location. Instead of trying to have beds of wild flowers with definite geometrical shapes, let them spread as freely and carelessly as they would grow in any of the places where we usually look for them. "What do you suppose I study," said Mr. Robinson, "when I wish to select a good shape for a flower area?" I was fortunate enough to give the right answer the first time, but it was accidental. "Clouds," I said hesitatingly. Mr. Robinson said, "Yes, clouds always have good shapes."

If we could only appreciate our native flowers as they deserve, we might have them in profusion. They would greet us from among the trees and shrubs of our parks, from every roadside, from our own home grounds, and would be waiting for us along fences and in our forests. Many wild flowers can be moved at almost any time of the year by taking out the plants in blocks of earth so that their roots will be very little disturbed. Others can be moved when dormant by simply transplanting their roots, and still others can be raised from seed. Many of them can be collected from some locality within reach, but in making such collections one should avoid taking the plants from places where they may be seen and enjoyed by many passers-by, and from neighbor's yards,

FROM GROWER TO PLANTER

**Ellwanger
& Barry's**

TREES
Shrubs, Roses
Evergreens
 and
Hardy Plants
Are Famous
The World Over

Best stock at reasonable prices. No agents. Commissions saved. Collections unequalled. Beautiful illustrated catalogue mailed free on request.

MOUNT HOPE NURSERIES
 ESTABLISHED 1840 Box T, Rochester, N. Y.

CANNAS

We are the largest Canna growers in the world and can make attractive prices on 200 kinds. Let us quote on your entire list for immediate or spring delivery or contract 1910 dormant roots. Also Caladulms, Gladiolus, Dahlias, Tuberoses, etc.

SHELLROD CANNA FARMS,
 Charge P. O. Baltimore, Md.

CYCLAMEN GIGANTEUM

5, 6 and 7 in. pots—50c, 75c, and \$1.00 each.

Extra heavy stock of the very best quality.

Thomas Roland,
 Nahant, Mass.

THE PRIZE WINNING STRAWBERRY

The Barrymore

Send for Folder at Once.

H. L. CRANE, Originator,
 Westwood, Mass.

—at least without the consent of such make a business of collecting wild plants and selling them at reasonable prices.

When I think of a large sugar maple forest in northern Michigan whose floor was covered with ground hemlock, above which appeared the enormous white flowers of the trillium grandiflorum; when I think of wooded hillsides covered with masses of pink, white and blue flowers of the hepaticas; of sandy fields almost entirely covered with lupine; of areas in open woodlands covered with wild asters and goldenrods; of groups of moor-ash flowers seen against green banks, of marshy land sprinkled with fringed gentians; of the banks of streams bordered with cardinal flowers and jewelweed, I wish that we might reproduce these effects near where we live. To me they seem more beautiful than beds of tulips, of hyacinths or geraniums.

New Rose **White Killarney**

Come and see White Killarney growing at our Scarborough houses, and you will say at once, as every one does who has seen it, it is

The Best White Rose

they have ever seen. You need it if you want to be up to the times, and it will pay you better than any other white rose that you can plant. You will regret it if you do not plant it this year, and you will not regret it if you do.

Big lots are being booked. Get your order in early. Send us order at once, while you think of it. Get early stock. It will not cost you any more to order to-day, while you think of it, than it will two months from now. Be the early bird that catches the worm.

Strong young plants, 2½-inch pots, own-root, ready for delivery beginning February 15th, 1909. \$30.00 per 100; 250 for \$70.00; 500 for \$125.00; 1000 for \$250.00. Grafted plants, ready for delivery beginning March 1st, 1909, \$5.00 per 100 additional.

F. R. PIERSON CO., Tarrytown-on-Hudson NEW YORK.

White Killarney

"Waban Conservatories Variety"

**FOR STRONG, HEALTHY
STOCK**

ORDER FROM US

**WABAN ROSE CONSERVATORIES
NATICK, MASS.**

KILLARNEY AND BEAUTY.

The Editor of HORTICULTURE:

Dear Sir,—Referring to the note on White Killarney, page 107, in your issue of Jan. 23, I would like to endorse all you there said in its favor and to add that, judging from those I saw growing at F. R. Pierson's nurseries at Scarborough, N. Y., beside having a heavier flower than Killarney proper, this white sport seems to be a stronger grower than the original.

But why insult this beautiful rose by saying "it would turn out to be a white running mate to American Beauty?"

While wishing to make all allowance for difference in taste, I think it would be difficult to find any rosarian who would place American Beauty in the first rank of beautiful roses.

Lacking as this variety is in both form and color to the extent of coarseness, it has only size, scent and length of stem to recommend it, qualities which, though desirable, are hardly sufficient for the making of a beautiful rose, though they ought to go a great way if we were considering peonies or chrysanthemums.

I grant you that American Beauty is of use in decorating a large room where general effect is the chief consideration, just as rinsed and painted faces may please on the stage, but the charm of both is quickly lost on closer scrutiny.

Perhaps all this is rather hard on a flower so many seem to fancy, but for

the life of me I cannot understand why certain growers will insist upon comparing a rose with American Beauty when they wish to praise it—for instance, one grower calls Frau Karl Druschki, White American Beauty—unless it is that they are wise in their generation and know that the larger and more gaudy a flower is the better chance it will have with the tasteful and discriminating public, and the more that same public will think they are getting for their money.

Oh, for the time when we Americans will learn to love the beautiful because of its beauty, and not for the price it will bring or because it is the fashion. Very truly yours,

A. L. SQUIRE.

The Boston Globe for Sunday, January 31, devoted a large space to an illustrated article on the growth from humble beginnings of the flower business of Mann Bros. of Randolph, Mass., and their Easter lily specialty.

Newport Fairy

The Rose of the Future For
In and Out Door.

FINE, STRONG, FIELD-GROWN STOCK

3—4 Shoots 3—4 ft. long

50c each, \$30 per 100, \$250 per 1000

**JULIUS ROEHR'S CO.
RUTHERFORD, N. J.**

NEWS NOTES.

The bill to do away with the office of State Entomologist in Indiana is meeting with considerable opposition. One feature of the bill is that the sale of apples that are infected with any kind of disease shall be prohibited. It is said that it is impossible to store apples away for several weeks and have them remain free from scab or bitter rust.

A bill giving the Secretary of Agriculture authority to regulate the importation and interstate transportation of nursery stock, including seed, was presented January 30 by Chairman Scott, of the House Committee on Agriculture. An appropriation of \$100,000 is provided for the appointment of skilled inspectors. It is provided that there can be no entry of nursery stock without a certificate from an expert satisfactory to the Secretary.

MY COMPLETE LIST OF MUMS, CARNATIONS AND ROSES

has been mailed you. If not yet received send me a postcard. I carry over 300 varieties of **The Finest Chrysanthemums in Commerce** and offer you just the cream of the world's novelties, discarding the poor ones. **Saves You Money and Me Trouble.** New Carnations ready for immediate delivery **Bay State, Georgia, Mrs. J. C. Vaughan, \$12.00 per 100; \$100.00 per 1000. Mrs. O. P. Bassett, \$8.00 per 100.**

CHARLES H. TOTTY, - Madison, N. J.



For Early or Late Forcing

HARDY AZALEA, MOLLIS—This hardy Azalea is becoming more popular every season to force as a pot plant; it is a profitable plant to handle, as it can be grown at a minimum cost; when in bloom it is useful for decorative purposes, and also appeals to the retail buyer as a house plant. We have an exceptionally fine lot of well-budded plants, 15 to 18 inches high, \$4.50 per doz.; \$35.00 per 100.

RHODODENDRON, PINK PEARL.—As an ideal pot plant, nothing can equal this beautiful variety. The individual flowers as well as the trusses are of gigantic size, while its color, a beautiful pearly pink, cannot be improved upon. We believe this is one of the coming pot plants, and when it becomes more plentiful and lower in price it will be very popular. You should try a few plants and become acquainted with it. A limited stock of good plants, about 15 inches high, with 5 or more trusses, \$1.50 each.

DEUTZIAS, Extra strong field grown plants for forcing.

GRACILIS.....	\$1.25 per dozen;	\$8.00 per 100;	\$70.00 per 1000
" Rosea.....	1.25 per dozen;	8.00 per 100;	70.00 per 1000
LEMOINEI.....	1.50 per dozen;	10.00 per 100;	90.00 per 1000

For a full line of seasonable stock see our wholesale list, issued January 1st

HENRY A. DREER, Philadelphia, Pa.

Hardy Rhododendrons, Azaleas, Conifers, Clematis, H. P. Roses, Shrubs and Herbaceous Plants from our **HOLLAND NURSERIES**

Prices Moderate

P. OUWERKERK, 216 Jane St., Weehawken Heights, N. J.

CLEARY'S HORTICULTURAL CO.

Management AMBROSE T. CLEARY

Wholesale Contracting, Jobbing, Auction **HORTICULTURAL PRODUCTS** or every description.

Consignments Received. Surplus Stock Obtained
62 Vesey St., NEW YORK

Box Trees

and other **EVERGREENS** for Tubs and Boxes
Our Prices are Always Right—Catalog Free
THE NEW ENGLAND NURSERIES, Inc.
BEDFORD, MASS.

California Privet.

We have 10 acres to offer for sale this Spring. All 2 years old, 2 to 2½ ft. high, 8 to 12 branches and well graded. We are booking orders daily now. \$2.75 per 100; \$22.50 per 1000. 500 at 1000 rates. Packing Free. Cash with Order.

JOHN BENNETT, Atlantic Highlands, N. J.

ROSES

We have a fine stock of large, dormant field-grown plants, on own roots, including **Crimson Rambler**, **Dorothy Perkins**, **Clie**, **Alfred Colomb**, **Francois Levet**, **Jack**, **Prince Camille de Rohan**, **Magna Charta**, **Ulrich Brunner**, **Giant of Battles**, and many others at \$16.00 per hundred; \$150.00 per thousand. Send for list. **Roses, Bibulas and Canas** a specialty.

THE DINGEE & CONARD CO., W. Grove, Pa.

ROBERT CRAIG CO.

ROSES, PALMS,

and Novelties in Decorative Plants

MARKET and 49th STREETS., PHILADELPHIA, PA.

BARGAINS in TREES and PLANTS

Concord Grapes, \$2.00. Peach, \$3.00 per 100. List Free. D. J. TWOMEY, Dept. H, Geneva, N. Y.

JOHN WATERER & SON, Ltd.

American Nursery Bagshot, England

Are Specialists in the

REALLY HARDY VARIETIES

of Rhododendron Hybrids and in Select Varieties of Hardy Border Plants

Florists' Asters.

FOR MAIN CROP there is nothing better than the Branching type. They are known as **Semple's**, **Vick's**, **Carlson's** and **Henderson's** Invincible.

From last year's records we deduct the following conclusion.

Invincible Blue, while offered as a branching Aster, seems to be distinct from other Invincibles both in habit and form of flower. We should think it an improved Victoria Aster. Although slightly different it is a grand variety. All the strains mentioned above are very similar in style of growth and form of flowers.

Invincible Rose Pink is the same color as **Vick's** Pink and **Carlson's** Shell Pink, the latter coming a few days earlier.

Invincible Crimson is nearly same shade as **Vick's** Rose.

Owing to this similarity the merits of the several strains are governed by selection and much depends upon the thoroughness of the Seed Producer. From last years tests we believe **Henderson's** Invincible gives a larger percentage of perfect flowers.

We Have All The Best Kinds. Send for List and Prices. Early, Midseason and Late.
ELMER D. SMITH & CO., Adrian, Mich.

RHODODENDRONS-RHODODENDRONS

An immense stock of all the **hardest known kinds**, 2 to 3½ ft., fine plants and all home grown, many being on own roots, far better than grafted stock—also **R. Catawbiense** seedlings of all colors and **seedling Hardy Azaleas** not to be obtained elsewhere. This is the nursery in which most of the Rhododendrons that have proved **hardy in America** were raised.

GOLDEN YEW'S, KALMIAS, and other **HARDY PLANTS** in great variety and of all sizes.

Catalogues on Application

ANTHONY WATERER Knap Hill Nursery Knap Hill Surrey, England

(NO CONNECTION WHATEVER WITH ANY OTHER FIRM.)

In writing to Advertisers kindly mention Horticulture

THE QUALITY YOU CAN MAKE MONEY ON

CANNAS

SOUND PIECES TRUE TO NAME BED ROCK PRICES

Red-Flowering, Green Foliage

	Per doz.	100	1000
A. Bouvier. 4 ft. Dark crimson.....	\$3.25	\$2.25	\$23.00
Alice Roosevelt. Deep crimson, 4 ft.....	4.50	3.50	20.00
Beattie Polkville. 3 1/2 ft. Dark crimson.....	4.50	2.00	20.00
Black Prince. Velvety maroon, 3 to 4 ft. Green foliage.....	5.00	2.75	25.00
Charles Henderson. 4 ft. Bright crimson.....	3.50	2.25	20.00
Crimson Redder. 3 1/2 ft. Intense scarlet.....	3.00	2.00	17.50
Duke of Marlborough. 4 1/2 ft. Dark crimson.....	3.50	2.25	20.00
J. D. Kische. Brilliant vermilion-scarlet, 4 ft.....	3.50	2.25	20.00
Explorateur Crampel. Deep rich crimson, 5 1/2 ft. Express. Crimson foliage green. Dwarf habit, 2 to 2 1/2 ft.....	6.00	4.50	40.00
Flamingo. 4 1/2 ft. Intense crimson.....	3.00	2.00	17.50
Pres. McKinley. Brilliant crimson 2 1/2 to 3 ft.....	3.50	2.25	20.00

Pink-Flowering

L. Patry. Delicate rosy pink, 4 1/2 ft.....	\$3.35	\$2.25	\$20.00
Luray. Attractive rosy pink, 3 ft.....	3.50	2.25	20.00
Louise. Grand old full Martha Washington. Rose. Height, 2 1/2 to 3 ft. No. each.....	7.50	5.00	
Miss Berrall. 4 1/2 ft. Rose-carmine.....	3.50	2.25	20.00
Tennyson. Rosy pink; green foliage; 3 1/2 ft.....	5.00	3.00	

Orange-Flowered

	Per doz.	100	1000
President Cleveland. Bright, distinct orange-scarlet; 4 ft.....	\$4.50	\$2.25	\$20.00

Red, Gold-Edged and Spotted

Gladiator. Bright yellow, spotted crimson, 2 1/2 ft. foliage; 4 ft.....	\$5.00	\$2.00	\$25.00
Cinnabar. Cinnabar-red, edged with distinct golden bands; 3 1/2 ft.....	4.00	2.00	17.50
Queen Charlotte. Scarlet gold edge.....	3.00	2.00	17.50
Miss Crozy. 5 1/2 ft. Vermillion, gold border.....	3.00	2.25	20.00
Premier. Deep crimson, bordered yellow, 2 1/2 ft.....	3.00	2.00	17.50
S. W. d'Al Crozy. 4 ft. Crimson, gold border.....	5.00	4.00	35.00

Yellow Shades

Buttercup. 3 1/2 ft. Clear golden yellow.....	\$3.40	\$2.75	\$25.00
Comte de Bonchard. Yellow, spotted red, 4 1/2 ft.....	3.00	2.00	17.50
Florence Vaughan. 5 ft. Yellow, spotted crimson.....	5.00	2.75	25.00
L. E. Bailey. Rich yellow, dotted with red; 4 1/2 ft.....	3.00	2.00	17.50

White and Cream Shades

Alsace. 3 1/2 ft. Creamy white.....	\$3.50	\$2.75	\$15.00
--	--------	--------	---------

Bronze-Leaved, Red-Flowering

Brandywine. 4 to 5 ft. Dark bronze foliage.....	\$5.50	\$4.00	\$10.00
Black Beauty. True, 5 ft. Grand foliage.....	.60	4.50	40.00

David Harum. 3 1/2 ft. Vermilion-scarlet.....	\$4.00	\$2.75	\$25.00
Egadore. 4 ft. Currant-red.....	4.50	2.25	20.00
King Humbert. Fine Bronze foliage, orange-scarlet with bright red markings, 4 ft.....	1.00	5.00	75.00
Leonard Vaughan. 4 1/2 ft. Bright scarlet.....	4.50	2.25	20.00
Musafolia. The finest foliage Cannas, with enormous musa-like leaves, 3 by 5 ft., of a dark green bronze tinged color.....	3.50	2.25	20.00
Philadelphia. A bright glowing red. Height 5 ft.....	.75	4.00	30.00
Papa Nardy. Large, rich carmine-red, 4 1/2 ft.....	3.00	2.00	17.50
Pillar of Fire. 4 to 5 ft. High; flowers bright crimson-scarlet.....	7.50	4.50	40.00
Robusta. Height 6 to 8 ft., with immense foliage.....	1.70	1.75	15.00
Strenuous. Large Salmon flowers, 6 ft.....	1.70	1.75	15.00

Orchid-Flowering

Allemania. 4 to 5 ft. Scarlet and yellow. Green foliage.....	\$3.50	\$2.25	\$20.00
Austria. Pure canary yellow; an orchid-flowering type; 4 ft.....	3.00	1.75	15.00
Italia. 4 1/2 ft. Green foliage. Red bord red yellow.....	3.00	2.00	17.50
Kronus. Rich golden yellow, with patches of bright red, 5 ft.....	3.00	1.75	15.00
Mrs. Kate Gray. 6 ft. Green foliage. Scarlet and yellow.....	3.00	2.00	17.50
Pennsylvania. 5 ft. Green foliage. Deep scarlet.....	3.50	2.25	20.00

CATALOGUE FREE.

We go through the block from 14th Street to 13th Street, but our address is still

ARTHUR T. BODDINGTON, Seedsman, 342 West 14th St., NEW YORK CITY.

PHILADELPHIA NOTES.

Visitors this week: Frank Henry Chas. Loechner, New York; W. H. Vance, Wilmington, Del.; P. T. Barnes, Harrisburg, Pa.

A silver tray engraved with Easter lilies and Asparagus plumosus is among the special prizes offered by the H. F. Michell Co. for the forthcoming exhibition of the Boston Flower Growers, Feb. 27th, for the best 12 pots of Easter lilies.

J. Stern & Co., the enterprising supply house of this city, report largely increased business over January last year. They have three men now on the road.

Samuel S. Pennock thinks Mr. Stewart's address at the Indianapolis convention full of wit and wisdom and should be framed and hung up in the office of every retailer and wholesaler the world over.

W. Kleinheinz of the Widener Conservatories does not subscribe to the general notion that Lady Bountiful is a less desirable commercial white carnation than White Perfection.

Edward A. Stroud, of the Stratford Flower Farms, is receiving the congratulations of his many friends on his success at Indianapolis with his exhibit of white carnations.

W. Paul Binder has resigned his position as manager of the Shellem greenhouses. It is understood that J. Shellem, Jr., will be manager during his father's illness. Mr. Shellem, Sr., being now at St. Agnes' Hospital seriously ill with heart trouble.

The local mail order trade has felt

the effect of the western blizzard the past few days. Notwithstanding, all agree that January business breaks the record. Dingee & Conard Co. report that both enquiries and orders exceed last year, which was their high water mark.

Some very fine Georgia carnations were seen here recently. They showed up fine and their keeping quality proves exceptional. This new variety promises to be one of our best commercial whites. The experts are very much interested in it.

SHAW'S GARDEN AND SUNDAY.

The trustees of Shaw's Garden have decided to omit the annual banquet provided for in the will of Henry Shaw founding the Missouri Botanical Garden, and the \$1000 thus saved will be added to the endowment fund, a sum that yielded \$210,814.31 last year. This decision is announced in the annual report of the trustees which also contains the information that 118,465 persons visited the garden during 1908. Of the total attendance it is stated that 33,971 passed through the gates on the only two Sundays in the year that the garden is open, leaving only 84,494 as the number of visitors on the other 316 days that the institution was open.

The income of the garden, all but about \$47,000 of which was spent last year, is about \$2.50 for each visitor on a week day, an enormous sum. If the garden had been open every Sunday and the attendance had been what it was on the Sundays it was open, the

total attendance would have reached nearly a million and the cost per visitor would have been less than 25 cents.

In providing by will that the garden should be opened only on the first Sunday in June and September each year, Mr. Shaw was actuated by a Sabbatarian influence that was stronger a quarter of a century ago than it is now. The trustees have seen fit to disregard his wishes concerning the annual banquet. They might profitably decide that in closing the garden on the days that the largest attendance is possible the intention of the founder is not realized.

William Fischer formerly assistant on the Helen Gould place at Irvington, N. Y., has taken position as head gardener with Walter Luttgen, Bethel, Conn.

BULBS FOR FLORISTS

If you will permit, we would like to mail you our Wholesale Price List for 1909. Drop us a postal.



RALPH M. WARD & CO.

12 W. B'way, N. York

HORSESHOE BRAND.

PLANT IMPORTS.

Entered at New York during January, 1909:

From Rotterdam: A. T. Boddington, 3 es. bulbs, 51 lbs. grass seed; Peter Henderson & Co., 1 es. plants, 165 sks. grass seed; Maltus & Ware, 6 cs. trees, 16 es. bulbs, 2 pgs. seed; McHutchison & Co., 1 es. plants, 3 es. shrubs; J. M. Thorburn & Co., 53 bgs. seed; Vaughan's Seed Store, 18 es. trees, 4 lbs. seed; Sundry Forwarders, 11 es. plants, 9 es. bulbs.

From Germany: A. T. Boddington, 3 bgs. seed; H. F. Darrow, 5 es. lily of the valley pips, 9 bgs. seed; Wm Elliott & Sons, 1 bbl. seeds; Wm. Hagemann & Co., 70 es. lily of the valley pips; Peter Henderson & Co., 11 es. seed; Maltus & Ware, 40 es. lily of the valley pips, 30 es. flower bulbs; Thos. Meehan & Co., 1 es. seeds; August Rolker & Sons, 25 es. lily of the valley pips; Stump & Walter Co., 1 cask seeds; J. M. Thorburn & Co., 10 pgs. seeds; Vaughan's Seed Store, 84 es. lily of the valley pips, 16 bgs. seeds, 20 pgs. vegetable fibre; Sundry Forwarders, 64 es. lily of the valley pips, 92 pgs. seeds, 26 bgs. seeds; To Order, 26 es. lily of the valley pips.

Via Southampton: C. C. Abel & Co., 25 es. plants; A. T. Boddington, 5 sks. seeds; H. F. Darrow, 49 es. plants; L. Dupuy, 12 es. do.; Peter Henderson & Co., 6 pgs. seeds; McHutchison & Co., 208 es. plants, 1 es. trees; Maltus & Ware, 14 es. plants; August Rolker & Sons, 27 es. plants; Sundry Forwarders, 119 es. plants; 2 es. trees, 7 bgs. seeds. Via Havre: H. F. Darrow, 70 pgs. plants, 215 pgs. seeds; Peter Henderson & Co., 112 pgs. seeds; Stump & Walter Co., 22 es. seeds; Vaughan's Seed Store, 6 pgs. seeds; Sundry Forwarders, 149 pgs. seeds, 221 pgs. plants.

Via Glasgow: H. F. Darrow, 1 es. trees; Peter Henderson & Co., 23 bgs. roots.

Via Copenhagen: Peter Henderson & Co., 2 es. seeds; Maltus & Ware, 25 es. lily of the valley pips; Forwarders, 27 es. grass seed.

By Peter Henderson & Co., 3 es. plant wash from London; Vaughan's Seed Store, 4 bags seed from London, 16 bags seed from Marsville.

CHICAGO PLANT NOTES.

The Chicago market is well supplied with bedding plants at present. There are the Dutch bulbous stock consisting of pans of Montrose, Proserpine, Keiserkroon and La Reine tulips, hyacinths Dutch and "miniature," Narcissus Von Zion, etc. Dutch bulbs are not in quite as heavy supply as last year and are doing much better as to price. There is also a good supply of azaleas, cyclamens and Primula obconica. Rhododendrons are beginning to make their appearance. Boston ferns of good size are rather short in supply.

OFFERS ENOUGH.

Horticulture Publishing Company: Gentlemen:—You may stop want ad. in your paper. I got offers and information enough.

Yours respectfully,

(Signed) ED. HERRMANN.

Baltimore, Md., Jan. 25, 1909.

Gladiolus Bulbs

GLADIOLUS AMERICA
A few points of merit

Color: A beautiful, soft, flesh pink, very light and much like Enchantress. Crimson, exact slightly tinged with lavender, which gives it the delicate coloring of the most beautiful Laetia. Words fail to do justice in describing this grand and glorious color; it must be seen to be appreciated. Fineness: For florists' use, its color makes it everything to be desired; delicate, attractive and absolutely new; no other color in Gladiolus like it or one-half so beautiful. It has created a sensation in the cut flower markets, selling for more than five times the price of other varieties.

America. The best commercial pink in existence. 1st size bulbs, \$4.00 per 100; \$5.00 per 1000; \$175.00 per 5000.

Augusta. Lovely, pure white with blue centers, 1 1/2 to 2 1/2 in., \$3.00 per 100; \$45.00 per 1000; \$70.00 per 5000.

Blue Jay (Baron Hulot). Finest blue Gladiolus yet seen. It is a rich, deep color of indigo shade. The only real blue Gladiolus on the market. \$40.00 per 100; \$50.00 per 1000.

Brenchleyensis. Extra fine red variety. 1 1/4 to 2 1/2 in., \$3.50 per 100; \$42.00 per 1000; \$50.50 per 5000.

May. A lovely, pure white flower, finely flaked, bright rosy crimson. 1 1/2 to 2 1/2 in., \$3.00 \$15.00 \$70.00

Princes. Rich crimson with very deep shadings in the throat and broad blotches on lower petals. 1 1/2 to 2 1/2 in., \$10.00

Salem. Fine salmon-pink, maroon blotches. 1 1/2 to 2 1/2 in., \$6.00 \$50.00

Gladiolus in Mixture
Trial Grounds Mixture, 1.50 10.00 45.00
Groff's Hybrids Mixture, 1.50 12.00 58.00

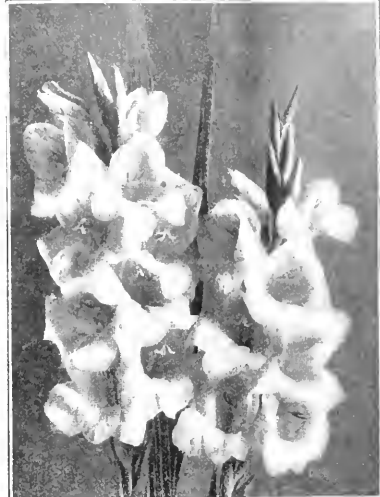

For forcing, and planting during the Spring, by ordering bulbs now, you receive not only the best selection, but the advantage of the following low prices:

Gladiolus in Mixture	100	1000	5000
WHITE AND LIGHT MIXTURE	\$1.50	\$12.00	\$58.00
Pink and Rose Mixture	1.50	12.00	58.00
Red and Scarlet Mixture	1.50	12.00	58.00
Lennox's Extra Fine Mixture	1.00	10.00	45.00
AMERICAN HYBRIDS MIXTURE	1.00	8.00	35.00
CHILDISH MIXTURE	1.50	12.00	58.00

STUMPP & WALTER CO., 50 Barclay Street, NEW YORK

FORCING GLADIOLUS

Gladiolus Gandavensis Hybrids

Many florists plant these in boxes, or among their carnations, in the Winter. They are excellent for decorative purposes and realize good prices, either wholesale or retail. Gladiolus are a good catch-crop and take up but little room. The following are the best for this purpose:

America. The flowers, which are of immense size, are of the most beautiful flesh-pink color, \$4.00 per 100; \$35.00 per 1000.

Augusta. The florists' best white Gladiolus. First-size bulbs, 1 1/2 inches and up, \$2.00 per 100; \$18.00 per 1000. Bulbs 1 1/2 to 1 3/4 in. \$1.75 per 100; \$16.00 per 1000.

Shakespeare. White and rose, \$4.75 per 100; \$45.00 per 1000.

May. Pure white, flaked rosy crimson; the best forcer. Selected bulbs, \$1.75 per 100; \$15.00 per 1000.

Brenchleyensis (true). Flery scarlet. Selected bulbs, \$1.50 per 100; \$13.00 per 1000. First-size bulbs, \$1.25 per 100; \$10.00 per 1000.

Hoddington's White and Light. Extra selected bulbs, 1 1/2 in. and up, \$1.50 per 100; \$14.00 per 1000. Bulbs 1 1/2 to 1 3/4 in. \$1.25 per 100; \$10.00 per 1000.

American Hybrids. A mixture of the choicest varieties of Gladiolus in cultivation. \$1.00 per 100; \$9.00 per 1000.

ARTHUR T. BODDINGTON

SEEDSMAN

342 West 14th Street, NEW YORK CITY

Gladioli fine named sorts; colors, seedlings and mixtures.

Iris Pallida Dalmatica, German and Japan Iris, Madeira Vines, Cinnamon Vines, Hyacinthus candicans, Spotted Callas.

Send for Price List.

E. S. MILLER, Wading River, Long Island, N. Y.

Gladiolus Brenchleyensis

Extra fine Healthy Imported Stock

1,000 \$10.00 10,000 \$80.00

O. V. ZANGEN, HOBOKEN, N. J.

TO BUYERS

Patronize our advertisers. they will treat you right

Seed Trade

AMERICAN SEED TRADE ASSOCIATION.

Watson S. Woodruff, Orange, Conn., Pres.; J. C. Robinson, Watertown, N.H., First Vice-Pres.; C. E. Kandel, Cleveland, O., Sec'y and Treas. Twenty-seventh annual convention June 22-24, 1909, at Clifton House, Niagara Falls, Ont.

WHOLESALE SEEDSMEN'S LEAGUE.

F. W. Bruggenhorf, Pres.; Burnet Landreth, Sec'y.

UNIQUE WINDOW DISPLAY.

The Germain Seed and Plant Company of Los Angeles, California, have two large show windows, each 20 x 14, in which the display is changed every two weeks. During the week when Home Products were advertised, one window was dressed to represent a country home. A small farm house was shown, the actual cost of which was \$35.00. The interior could be seen by looking through the windows. Inside, a family was seated at the dinner table. Miniature furniture was used. The house had a large porch; in front, an automobile with lighted electric head-lights. Lawn in front grown from Germain's Kentucky Blue Grass; duck-pond with ducks swimming in the pond. In the distance could be seen windmill in operation, and a stream of water flowing from same to the duck-pond. At the side and rear of the house could be seen growing vegetables, such as peas, beans, corn, wheat, radishes, etc. Large trees made a background for the scene, and were swayed back and forth by means of an electric fan. Along the front and side of the farm ran a graded street. An automobile filled with people could be seen coming up the road and a two-horse delivery wagon, marked "Germain Seed and Plant Co." and filled with bags of seeds, could be seen turning the corner. At corner was suspended an arc light. Electricity was conveyed to it by means of a small copper wire which was suspended from telephone poles. Across from the side of the farm was a large empty lot sown to wheat, and in this lot was a signboard on which was printed "Home Products can be obtained by planting Germain's Seeds. Try them."

CATALOGUES WANTED.

HORTICULTURE.

Would you kindly through the columns of your journal inform interested parties that I shall be glad to receive their Seed Catalogues with a view to establishing some trade with these Islands?

Wishing you all prosperity in 1909.

Very truly yours,

FEDERICO C. VARELA.

Tenerife, Canary Islands.

December 30, 1908.

Lawns and How to Make Them, Leonard Barron. Price \$1.10, postpaid from the office of HORTICULTURE, 11 Hamilton Place, Boston.

MICHELL

Headquarters for Bulbs

Lilium Giganteum—Gold Storage

6-8" (300 Bulbs in Case).....\$60.00 per 1000 | 7-9" (200 Bulbs in Case).....\$85.00 per 1000
 8-10" (1000 Bulbs in Case).....\$100.00 per 1000

We have an exceptionally fine lot of

FORCING GLADIOLUS—Extra Large Bulbs

Profitable for the Florist

AMERICA AUGUSTA MAY BRENCHLEYENSIS
MICHELL'S WHITE and LIGHT GROFF'S HYBRIDS

Write for quotations on the above sorts—also all other varieties of *Gladiolus*, *Cannas*, *Begonias* and *Gloxinias*.

Our New 1909 Wholesale Catalog Now Ready

HENRY F. MICHELL CO., 1018 and 518 Market St., PHILADELPHIA

A CORRECTION.

January 27, 1909.

Publishers of HORTICULTURE.

Boston Mass.

Dear Sirs:—A few weeks ago, the stock of The Gobin-Ebbert Seed Co. was taken charge of by a receiver and sold. As a news item, you published a report that the stock of The Ebbert Seed Company had been sold.

This is not a fact, and the statement has done us an injury. The Gobin-Ebbert Seed Co. has never in any way been connected with The Ebbert Seed Co., but on the contrary was a rival concern, organized by a former member of The Ebbert Seed Co.

We have a better stock and a better trade than ever before. We don't owe a dollar, and we are the strongest seed house in the Arkansas valley. See our rating.

We ask you to publish this, and as far as possible, correct the misapprehension.

Very truly yours,

THE EBBERT SEED CO.

John Wisda, Mgr.

Rocky Ford, Colo.

NOTES.

A cable from Kingston, Jamaica, Feb. 2nd, reports W. Atlee Burpee and junior all well and enjoying the balmy breezes of the West Indies.

The Johnson Seed Co., Philadelphia, are now through with the mailing of their annual catalogue and Mr. Sherry reports that the advance orders are already away beyond expectations and much ahead of same date last year.

Toledo, O.—Business has been good of late. No one complains but the Dutch bulb men, who do not seem to get the same amount of orders as formerly, and many would like to dispense with all of them if they could do so, but a certain amount must be handled to have the variety on hand when needed. Little glass will be added this year. Schiller will erect two propagating houses 9x125 each, one to be used during part of the year for cyclamens. This one will be so arranged as to admit circulation directly below the gutters as well as along the house. There are some other growers talking about building, but nothing has been decided so far.

MASSACHUSETTS AGRICULTURAL COLLEGE.

Mr. E. O. Orpet of South Lancaster gave a most instructive talk before the Horticultural classes at Massachusetts Agricultural College Wednesday P. M., January 27. Mr. Orpet spoke of the history of orchids, with special reference to the rapid increase in their production by American growers during the last ten years. He also covered the cultural problems in a very clear, concise manner, and showed the blooms of many specimens which gave the students a splendid idea of differences in genera and species. The hour proved too short a time for the consideration of the subject and Mr. Orpet met the students informally in the evening and answered many questions regarding orchid culture. Feb. 3rd George Sinclair of Holyoke will speak on "Chrysanthemum Culture." The observation trip on Saturday will be to the extensive commercial range of A. N. Pierson at Cromwell, Conn. On the trip down it is expected there will be time for a visit to the noted rose garden at Elizabeth Park, Hartford.

USEFUL BOOKS.

We can supply the following books, postpaid, at the prices listed:—
 Roses and How to Grow Them. By Many Experts. Price, \$1.10.

The New Cyclopedia of American Horticulture. L. H. Bailey. Four volumes; \$20.00.

How to Make School Gardens. H. D. Hemenway. Price, \$1.10.

How to Make A Fruit Garden. S. W. Fletcher. Price, \$2.20.

How to Plan the Home Grounds. S. Parsons, Jr. Price, \$1.10.

How to Make a Vegetable Garden. Edith L. Fullerton. Price, \$2.20.

The Art of Landscape Gardening. By Humphrey Repton. Price, \$3.22.

Manual of the Trees of North America. C. S. Sargent. Price, \$6.00.

Soils: How to Handle and Improve Them. S. W. Fletcher. Price, \$2.20.

The Art of Landscape Gardening, by H. Repton. Price \$3.20, postpaid.

A Plea for Hardy Plants. J. Wilkinson Elliot. Price, \$1.76.

Barenbrug On Grasses. By Joseph T. Barenbrug, \$1.00 postpaid. Horticulture Publishing Co., 11 Hamilton Place, Boston.



Ageratum

	Tr. Pk.	Oz.
Dwl. Blue	\$0.10	\$0.25

Asters

Queen Market White	0.20	0.50
Rose	0.20	0.50
Victoria Mixed	0.25	1.50
Comet	0.25	2.50

Alyssum

	Tr. Pk.	Oz.
Carpet of Snow	\$0.10	0.35

Begonia

Vernon	0.25	2.50
Erfordt	0.25	1.00

Pansy

Blended	1.00	8.00
Large French Stained	0.50	3.00

Salvia

Splendens	0.25	2.50
Bon Fle.	0.25	2.50
Zurich	1 oz.	75c

Wm. Elliott & Sons,
42 Vesey St., NEW YORK.

Mignonette

**FARQUHAR'S
GIANT**

Oz., 75c; 1-4 oz., 25c

R. & J. Farquhar & Co.
6 & 7 South Market Street
BOSTON, MASS.

BRIDGEMAN'S SEED WAREHOUSE
RICKARDS BROS.
Props.
37 East 19th St., - NEW YORK CITY

JAPANESE CO.
THE YOKOHAMA NURSERY
31 BARCLAY STR. NEW YORK.
LILIES
PLANTS
BAMBOO STAKES

C. C. MORSE & CO. 48-56 JACKSON ST.,
San Francisco, Cal.
The Largest Seed Growers on the Pacific Coast
ONION, LETTUCE, SWEET PEAS,
ALSO
Carrot, Celery, Leek, Mustard, Parsley, Parsnip, Radish, Salsify

LEONARD SEED CO.

CONTRACT GROWERS AND WHOLESALE DEALERS
BEANS, PEAS, SWEET CORN, ONION, GARDEN SEEDS
ONION SETS Get Our Prices 79 and 81
FLOWER SEEDS E. KINZIE STREET, CHICAGO



LILY OF THE VALLEY PIPS

Unexcelled Hamburg or Berlin
**TUBEROUS ROOTED BEGONIAS
GLOXINIAS**

ROSA MULTIFLORA NANA SEED
and all other flower seeds for Florists
SEND FOR CATALOGUE

J. M. THORBURN & CO.
33 BARCLAY ST. through to 38 PARK PLACE
NEW YORK

C **AULIFLOWERS** **S**
E **C** **A** **B** **A** **G** **E** **E** **D**
LILY OF THE VALLEY PIPS.

HJALMAR HARTMANN & CO.
12 Stormgade,
COPENHAGEN, DENMARK.

Burpee's Seeds
PHILADELPHIA

Blue List of Wholesale Prices mailed only to those who plant for profit

Vegetable and Flower **SEEDS**
Reliable and Tested. Catalogue Mailed Free
WEEBER & DON
Seed Merchants 114 CHAMBERS STREET
NEW YORK

SHEEP MANURE
Pulverized. Free from Adulteration
In Bag, \$18.00 per Ton. Cash with Order
ROBERT SIMPSON
CLIFTON, N. J.

STOCK SEED
FOR WINTER BLOOMING
Our strain of Double Branching Stocks is exceptionally true. About 90% Double Flowers.
In colors: 3/4 oz. .50 oz. \$4.00
Pure White 3/4 " .75 " 5.00
H. E. FISKE SEED CO.
Faneuil Hall Square, BOSTON, MASS.

Winter-flowering
SWEET PEA SEED
All Colors Ask for List
A. C. ZVOLANEK
ORIGINATOR. BOUND BROOK, N. J.

NEW CROP SEED
For Early Planting
THOMAS J. GREY CO.
32 SO. MARKET ST., BOSTON, MASS.

BRECK'S SEEDS for FLORISTS
Fresh, Reliable. Prompt Delivery.
Catalogues mailed free on application
Joseph Breck & Sons Corp.
47-54 NO. MARKET ST., BOSTON, MASS.

GEO. E. DOW
Designing and Illustrating
178 Washington St., Boston, Mass.
OUR SPECIALTY
Machine, Booklet, Advertising and Flower
PHOTOGRAPHS

Japanese Bulbs, Etc.
R. TANOI, Yokohama, Japan.
Send for catalog and write to Representative
K. TAKEUCHI,
478a Boylston St., Boston, Mass.

QUALITY SEEDS
BULBS
PLANTS
SEND FOR CATALOGUE.
ARTHUR T. BODDINGTON
349 West 14th St., New York.

To Florists Everywhere

Orders for Cut Flowers and Floral Decorations to be delivered anywhere in the Greater New York, may be placed with us with the certainty that your customers will be satisfied.

Telegraph, telephone or mail such orders to us and be sure that they will be filled as promptly and as carefully as though you did it yourself.

One third discount will be allowed on all orders thus placed with us by Florists outside of the Greater New York.

THE BLOSSOM

Bond and Livingston Sts.,
BROOKLYN, N. Y.

C. C. TREPEL, Manager

WILLIAM J. SMYTH FLORIST

Cor. Michigan Ave. and 31st St., CHICAGO

We ship to all points in Illinois and Iowa.

Phones: Douglas 744, Douglas 523, Douglas 740

M. C. and J. E. HAUSWIRTH

Out of Town orders for Hospitals
Carefully filled.

232 Michigan Ave. CHICAGO

AUDITORIUM ANNEX Tel. Harrison 585

SAMUEL MURRAY Florist

Coates House Conservatory

1017 BROADWAY, KANSAS CITY, MO.

Both 'Phones 2670 Main.



WASHINGTON,
D. C.

GUDE'S

The Far-Famed Flowers of TORONTO

Delivered on mail or telegraph order for any occasion, in any part of the Dominion.

JOHN H. DUNLOP,
96 Yonge St., Toronto, Ont.

The Park Floral Co.

J. A. VALENTINE
Pres.

DENVER, COLORADO

WILLIAM L. ROCK FLOWER CO.

KANSAS CITY, MO.

will carefully execute orders for Kansas City and any town in Missouri or Kansas.

Palmer's

Buffalo, N. Y.

W. I. PALMER & SON, 30 Main St.

PERSONAL.

W. P. Jackson of Manchester, Mass., sailed for Cuba last week.

R. L. Ledy, of Toledo, has taken a position as manager of the Roethke Floral Co., at Bay City, Mich.

Vernon L. Sherwood has taken a position as assistant gardener at Mrs. J. L. Gardner's, Brookline, Mass.

Visitors in New York: Ben Elliott, Pittsburg, Pa.; C. A. Johansen, representing I. Van Houtte, Pere, Gand, Belgium.

Mr. A. Rice, of Rice Bros., Minneapolis, who was in the hospital for several weeks, is at home now and improving nicely.

C. Norton has closed his retail store in Mt. Pleasant, D. C. Vernon Ley, of 14th St., Washington, D. C., has also closed his store.

Julius Roehrs, of Rutherford N. J., and Robert Craig and John Westcott, Philadelphia, sailed on January 30 on the Havana for Cuba and Isle of Pines.

STEAMER DEPARTURES

American.

Philadelphia, N. Y.-Shampton, Feb. 13

St. Paul, N. Y.-Shampton, Feb. 20

Atlantic Transport.

Minnetonka, N. Y.-London, Feb. 13

Cunard.

Ivonia, Boston-Liverpool, Feb. 9

Campania, N. Y.-Liverpool, Feb. 10

Lusitania, N. Y.-Liverpool, Feb. 17

French Line.

La Bretagne, N. Y.-Havre, Feb. 11

La Provence, N. Y.-Havre, Feb. 18

Leyland.

Bohemian, Boston-Liverpool, Feb. 10

North German Lloyd.

Barharossa, N. Y.-Med. Pts., Feb. 13

Kronpr. Coelbe, N. Y.-Bremen, Feb. 16

White Star.

Majestic, N. Y.-Shampton, Feb. 10

Celtic, N. Y.-Liverpool, Feb. 13

Campic, Boston-Med. Pts., Feb. 13

Cynric, Boston-Liverpool, Feb. 17

Cedic, N. Y.-Med. Ports, Feb. 20

J. L. Senlberger of Oakland, Calif., will retain the position of horticultural commissioner for the county, much opposition to his removal having been expressed.

Miss Emma Barnd who was in charge of the retail store of E. J. Foster & Son at Findlay, O., has been transferred to the greenhouses since the store was closed.

Chicago visitors: Martin Reukauf, of H. Bayersdorfer & Co., Philadelphia; Frey & Frey, Lincoln, Neb.; W. E. Dwight, of Dwight Greenhouses, Janesville, Wis.; Jas. Melkdejohn, representing H. Frank Darrow, New York; C. B. Knickman, representing McHutchison & Co., New York; A. C. Rott or Joliet, Ill., and a full dozen Dutch bulb travellers.

Mr. and Mrs. Jno. M. Hodson, Manayunk, Phila., announce the marriage of their daughter, Elsie K. Hodson, to Edwin J. Fancourt, Wednesday, January 27th. Mr. Fancourt is a member of the Pennock-Meehan Co. and is well known to the trade, both locally and outside. May the two adventurers live long and prosper. Salams and salutations.

ALEX. McCONNELL

571 FIFTH AVENUE
NEW YORK CITY

Telegraphic orders forwarded to any part of the United States, Canada, and all principal cities of Europe. Orders transferred or intrusted by the trade to our selection for delivery on steamships or elsewhere receive special attention.

Telephone Calls, 487 and 488 38th St.
Cable Address, ALEXCONNELL

New York Deliveries

FLOWERS and PLANTS

by special messenger to Steamer,
Theatre or any address in

NEW YORK or BROOKLYN

THOMAS YOUNG, JR.

500 FIFTH AVE., (near 42nd St.)

NEWMAN FLORAL Co.

(Established 1870)

202 Fifth Ave. and
Madison Square, NEW YORK CITY

FLOWERS FOR STEAMER SAILINGS

M. A. BOWE

In the Heart of New York City

1294 Broadway

Tel. 2270, 38th St. NEW YORK

Our Motto—The Golden Rule

DAVID CLARKE'S SONS

Deliver orders from any part of the country to
New York City

Or OUT-GOING STEAMERS

Write or telegraph

2139-2141 Broadway, New York

Telephone 1552-1553 Columbus

YOUNG & NUGENT

42 West 28 St., NEW YORK

"FLOWERS BY TELEGRAPH"

NEW YORK MYER, FLORIST

Phone 5297 Plaza. 609-611 MADISON AVE.

ALBANY, N. Y.

EYRES

Flowers or Design Work

DELIVERED IN ALBANY AND VICINITY
ON TELEGRAPHIC ORDER.

11 NORTH PEARL ST., ALBANY, N. Y.

Flower Deliveries

In Brooklyn and other Long Island Points
New York City, New Jersey, etc. At Theatres,
Hotels, Steamers or Residences.

WILSON

Fulton St. and Greene Ave., Brooklyn, N. Y.

JOHN BREITMEYER'S SONS

Cor. Miami and Gratiot Aves.
DETROIT, MICH.

Artistic Designs . . .
High Grade Cut Blooms

We cover all Michigan points and good sections of Ohio, Indiana and Canada

PROMPT DELIVERY IN BOSTON

AND ALL NEW ENGLAND POINTS
F. H. HOUGHTON
396 Boylston St., Boston, Mass.

BOSTON'S BEST In Quality and Design

Can be relied upon when you transfer your retail orders to

EDWARD MACMULKIN
194 Boylston Street, Boston

Send flower orders for delivery in
BOSTON

and all
NEW ENGLAND POINTS
THOS. F. GALVIN
124 Tremont St., Boston

The Original Telegraph Order Florist
WILL DELIVER

Flowers or Designs
to order in Boston and Vicinity. Usual Discount.

J. NEWMAN & SONS, Inc.
EST. 1870 24 TREMONT ST., BOSTON



DANKER, Albany, N. Y.

ORDERS FOR
Choice Flowers and
Floral Emblems
FILLED PROMPTLY

LOUISVILLE, KY.
JACOB SCHULZ,
550 South Fourth Ave.

WELLESLEY COLLEGE
Dana Hall, Walnut Hill and Rockridge Hall
Schools. TAILBY, Wellesley, Mass.
Tel. Wellesley 44-1 and 2. Night 44-3.

ATLANTA FLORAL CO.
41 Peachtree Street, ATLANTA, GEORGIA

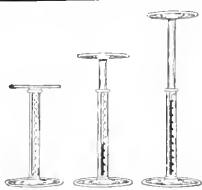

THE NEW IDEA IN PLANT STANDS

The Moore-Livingston Graduating or Adjusting

Saves one-half to two-thirds of cost over ordinary galvanized iron stands.

SEND FOR CIRCULAR GIVING FULL PARTICULARS
SOLD BY SEEDSMEN AND SUPPLY HOUSES

If your seedsman does not carry send us his name and we will promptly send full particulars.

Moore-Livingston Co., Patentees, and Mrs. Lansdowne, Pa.

NEW RETAIL FLOWER STORES.

Hamilton, Ont.—Vossen Co., 269 King St.

Clinton, Ia.—Andrew Bather, 235 Fifth Ave.

New Milford, Conn.—Cornell, the florist, Kirsch block.

Mason City, Ia.—Mason City Floral Co.; Edward Curtis, manager.

BUSINESS CHANGES.

Philadelphia, Pa.—The business of Julius Wolff, Jr., has been purchased by Victor Redinour.

Erie, Pa.—The firm of Offerle & Schaal has dissolved and the business will be continued by Mr. Offerle.

Milwaukee, Wis.—E. Schmitz & Sons have purchased and are improving the Wolff greenhouses for business purposes. Wm. Schmitz, who is in charge, was with the C. C. Pollworth Co. formerly.

IN BANKRUPTCY.

Los Gatos, Cal.—George G. Payne, florist, has filed a voluntary petition in bankruptcy.

Boston, Mass.—Arthur C. Seitz, gardener, has filed a petition in bankruptcy; liabilities, \$1,978; assets, \$88.

NEWS NOTES.

Mr. and Mrs. Chas. H. Fiske, 118 Ogden Ave., are operating one of the finest retail stores on the west side of Chicago, and have built up an excellent business.

Peter Reinburg of Chicago, who recently underwent an operation at Elizabeth Hospital, is recovering nicely and was removed to his home Wednesday, February 3.

Washington, D. C.—John M. Hammer & Sons, who have been engaged in the florist business at 64 Florida Ave. N. E., have made an assignment to John M. Gittenman. The assignee says that prospects are favorable for the creditors, with good management for the coming year.

The order of the board of police of Lowell, Mass., prohibiting Sunday selling, allows a florist to make up and deliver on Sunday an order that he received on Saturday. An effort will be made to permit florists to deliver flowers for funerals, churches, etc., on Sunday mornings up to eleven o'clock.

THE BEST LETTERS

FOR THOSE
FLORISTS' MADE
USE OF BY THE



Boston Florist Letter Co.

66 PEARL ST., BOSTON
N. F. MCCARTHY, Mgr.

Order direct or buy from your local supply dealer. Insist on having the

BOSTON

Inscriptions, Emblems, etc., Always in Stock



Baskets, Crates,
Ladders, Veneers
and Boxes.

BACON & CO.
Appleton, N. Y.

TIE UP

Your Pot Plants with
GREEN SILKALINE
Made Especially for that Purpose.

JOHN C. MEYER & CO., Boston, Mass.

FLORISTS' SUPPLIES

Send for New Catalogue

H. Bayersdorfer & Co.

1129 ARCH ST., PHILADELPHIA

In ordering goods please add "I saw it in HORTICULTURE."

ROBERT J. DYSART
Public Accountant and Auditor

Simple methods of correct accounting especially adapted for florists' use.

Books Balanced and Adjusted

Merchants Bank Building

28 STATE STREET, BOSTON

Telephone, Main 58.

CARNATIONS

We would be glad to quote you special prices on Carnations in large quantities — we can make the prices very interesting. The quality has never been better at this season of the year. We exercise the utmost care in selecting stock for shipping orders and guarantee the freshness of the same.

THE LEO NIESSEN CO.

1209 Arch St., Philadelphia, Pa.
Open from 7 a. m. to 8 p. m.

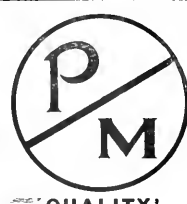

Choice Single
DAFFODILS
\$40.00 per 1000
CUT FARLEYENSE
Choicest Quality
\$12.00 and \$15.00 per 100.

S. S. PENNOCK - MEEHAN CO.
1608-1620 Ludlow St., Philadelphia

Daffodils, Tulips and Spring Flowers

W. E. McKISSICK & BROS.
WHOLESALE FLORISTS
1619-1621 RANSTEAD ST.
PHILADELPHIA



CHAS. W. MCKELLAR

51 WABASH AVE., CHICAGO

Western Headquarters for Choice Orchids
Valley, Roses and all Cut Flowers

PETER REINBERG

WHOLESALE

CUT FLOWERS

51 Wabash Av., Chicago, Ill.

DAILY CONSIGNMENTS

From 40 to 60 Growers

We can care for your cutflower wants to advantage.

E. F. WINTERSON CO.

45-47-49 WABASH AVE., CHICAGO

POEHLMANN BROS. CO.

33-35-37 Randolph St., - CHICAGO

CUT FLOWERS

Greenhouses, - Morton Grove, Ill.

Rice Brothers

115 N. 6th Street, MINNEAPOLIS, MINN.

WHOLESALE FLORISTS and SUPPLIES

CUT FLOWERS received twice daily, and can fill your orders to your satisfaction. A complete line of Hardy Greens — WILD SMILAX, BOXWOOD, HARDY FANCY FERNS, GALAX LEAVES.

Write for quotations on large quantities.

In ordering goods please add "I saw it in HORTICULTURE."

WELCH BROS.

AMERICAN BEAUTY, KILLARNEY, RICHMOND, MARYLAND AND ALL THE SUPERIOR ROSES, LILY OF THE VALLEY, CARNATIONS, ORCHIDS
BEST PRODUCED
226 Devonshire Street, Boston, Mass.

WHOLESALE FLOWER MARKETS—TRADE PRICES—Per 100 TO DEALERS ONLY

	CHICAGO Feb. 1	TWIN CITIES Feb. 1	PHILA. Feb. 1	BOSTON Feb. 4
ROSES				
Am. Beauty, Fancy and Special.....	30.00	to 40.00	35.00	to 45.00
" Extra.....	20.00	to 30.00	30.00	to 35.00
" No. 1.....	10.00	to 20.00	20.00	to 30.00
" Lower grades.....	6.00	to 10.00	8.00	to 20.00
Bride, 'Maid, Fancy & Special.....	8.00	to 12.00	10.00	to 12.00
" Lower grades.....	5.00	to 8.00	6.00	to 8.00
Killarney, Fan & Sp.....	12.00	to 15.00	10.00	to 14.00
" Lower grades.....	5.00	to 12.00	8.00	to 10.00
Richmond, Fancy & Special.....	12.00	to 15.00	8.00	to 12.00
" Lower grades.....	5.00	to 12.00	6.00	to 8.00
Chatenay.....	6.00	to 8.00	6.00	to 8.00
Golden Gate, Ivory, etc.....	6.00	to 8.00	6.00	to 8.00
My Maryland.....
Queen Beatrice.....
Mrs. Mar. Field.....	8.00	to 15.00
CARNATIONS				
Fancy and Red.....	2.00	to 4.00	4.00	to 5.00
Ordinary and White.....	1.50	to 2.00	2.50	to 3.00
MISCELLANEOUS				
Carleys.....	40.00	to 50.00	40.00	to 45.00
Cypripedium.....	8.00	to 10.00
Lilies.....	12.00	to 20.00	10.00	to 12.00
Lily of the Valley.....	3.00	to 4.00	2.50	to 3.00
Narciss., Paper White.....	3.00	to 4.00	2.00	to 3.00
Roman Hyacinth.....	3.00	to 4.00	2.00	to 3.00
Daffodils.....	3.00	to 4.00	2.00	to 3.00
Freesia.....	2.00	to 3.00	4.50	to 5.00
Sweet Peas.....	.75	to 1.50	.75	to 1.00
Gardeas.....	30.00	to 40.00	50.00	to 55.00
Violets.....	.50	to 1.00	.50	to 1.00
Adiantum.....	1.00	to 1.50	1.50	to 2.00
Smilax.....	14.00	to 15.00	10.00	to 15.00
Asparagus Plumosus, strigis.....	15.00	to 50.00	15.00	to 50.00
" " & Spreng. (100 bchs.).....	20.00	to 40.00	15.00	to 25.00

J.A. BUDLONG

37-39 Randolph Street, CHICAGO.

Roses and Carnations
A Specialty.....
WHOLESALE GROWER of CUT FLOWERS

HENRY M. ROBINSON & CO.

15 Province St. and 9 Chapman Place - BOSTON, MASS.

WHOLESALE COMMISSION FLORISTS

Hardy Cut Evergreens and Florists' Supplies

We have the stuff and can fill all orders, large or small
WE NEVER DISAPPOINT SATISFACTION GUARANTEED

Prices Quoted in these Columns are for Dealers Only.
When Writing to Advertisers Please Mention
HORTICULTURE.

Flower Market Reports.

BOSTON A favorable report can be made this week, we are happy to say, and the prospects are good for a steady run of satisfactory business for the few weeks, at least, which intervene between now and Ash Wednesday. Roses are off crop just at present and more could be sold than this market is able to supply, so prices are firm and will probably continue on present plane for some time. All crops are on the advance, however, and the scarcity will not be so pronounced after a few days. Business assumed an improved tone early last week, and the steadiness displayed in the face of a rapidly increasing supply of bulbous material is very justifying. Of the bulbous stock there is no such overstock as in former years. Light buying last fall is responsible for the healthier tone of this class of material and a similarly prudent course by the forcers this year will be the part of wisdom.

Trade the past week has been quite satisfactory as a good demand for flowers was had throughout. Beauties and other roses were rather scarce, especially of the short grades, and prices held firm. Narcissi, Roman hyacinths, lily of the valley, etc., are in good supply. Sweet peas have been in better demand than heretofore, but violets have had to be urged somewhat to make them sell. Carnations in fair supply and cleaning up well. Green goods in good supply and demand normal.

CHICAGO The warm, cloudy weather which prevailed during the week ending Jan. 23 gave way to a cold wave and the thermometer fell from 65 deg. to zero. But the sunshine helped both the quantity and quality of the flowers. The carnations had opened up so fast during the warm spell that the supply was considerably ahead of the demand, while the quality was decidedly poor. Roses had fared differently, and while the quality had remained unimpaired, the quantity diminished—according to some of the growers, one-half. The first week in February opens up a little quiet in some localities, but with clear cold weather and a uniformly good quality of stock. Sales are slow in all bulbous stock tulips and daffodils particularly.

PHILADELPHIA General market conditions continue on a satisfactory basis. The demand is good with stock far from plentiful. All kinds of flowers cleared up fairly well, the liveliest item on the list being carnations. American Beauty roses were rather drabby for a few days but towards end of week they got scarcer and are now moving off all right. The long stems are the only up-to-standard in quality, the shorts still continuing very poor. Richmond is in good demand, selling right up. In pink, Jardino and Killarney have the call. Bridesmaid, although fine, being rather neglected by the buyers. Shorts in

WHOLESALE FLOWER MARKETS.—TO DEALERS ONLY.

	CINCINNATI		DETROIT		BUFFALO		PITTSBURG	
	Feb. 2	Feb. 2	Feb. 2	Feb. 2	Feb. 1	Feb. 1	Feb. 1	Feb. 1
ROSES								
Am. Beauty, Fan, and Sp.	35.00	40.00	35.00	40.00	40.00	50.00	40.00	50.00
" Extra	25.00	30.00	25.00	30.00	25.00	30.00	20.00	25.00
" No. 1	15.00	20.00	15.00	20.00	15.00	20.00	10.00	15.00
" Lower grades	8.00	10.00	8.00	10.00	4.00	10.00	3.00	6.00
Eride, "Maid, F. & S.	6.00	8.00	6.00	8.00	10.00	12.00	8.00	10.00
" Large	3.00	5.00	3.00	5.00	4.00	6.00	3.00	5.00
Killarney, Fan, & Sp.	8.00	10.00	8.00	10.00	10.00	12.00	10.00	12.00
" Lower grades	3.00	5.00	3.00	5.00	4.00	6.00	3.00	5.00
Richmond, Fancy & Special	6.00	8.00	7.00	10.00	10.00	12.00	10.00	15.00
" Lower grades	3.00	5.00	4.00	7.00	4.00	6.00	6.00	8.00
Chatenay	8.00	10.00	8.00	10.00	10.00	12.00	10.00	12.00
Golden Gate, Ivory, etc.	4.00	6.00	4.00	6.00	4.00	6.00	4.00	6.00
My Maryland	4.00	6.00	4.00	6.00	4.00	6.00	4.00	6.00
Mrs. Mar. Field	4.00	6.00	4.00	6.00	4.00	6.00	4.00	6.00
CARNATIONS								
Fancy and Novelties	2.00	4.00	1.50	3.00	2.50	3.00	1.00	3.00
Ordinary	2.00	3.00	1.50	2.00	2.00	2.50	1.00	2.00
MISCELLANEOUS								
Cattleyas	50.00	75.00
Oxyripediums	70.00	120.00
Lilies	10.00	12.00	10.00	12.00
Lily of the Valley	4.00	3.00	4.00	3.00	4.00	3.00	4.00
Narciss, Paper White	3.00	3.00	4.00	2.00	3.00	3.00
Roman Hyac.	2.00	3.00	2.00	3.00	2.00	3.00	2.00
Daffodils	3.00	4.00	3.00	4.00
Freesia	3.00	4.00
Sweet Peas50	1.00	1.00	.50	1.00	.50	1.00
Gardenias	10.00	15.00
Violets	50	1.00	.50	.75	1.00	.85	1.00
Adiantum	1.00	1.50	.50	1.50	1.00
Smilax	12.50	15.00	13.00	15.00	10.00	15.00
Asparagus Plumous, strings	40.00	50.00	30.00	50.00	25.00	50.00	25.00
" & Spruce (100 lbs.)	25.00	30.00	50.00	25.00	50.00	25.00	50.00

whites clean out well but the fancies bang fire. Carnations are in brisk demand and clean right up. As intimated above, they are about the scarest item on the market. Violets and lily of the valley are both rather drabby. Sweet peas fine and in good demand, especially in the dark colors. Easter lilies do not receive much attention but callas are rather lively. Daffodils are now in their hey day; receipts just about right; more, and prices would go to pieces. Freesia is coming in freely—rather more than the market will stand. Cattleyas are redundant and prices easier. Gardenias if good find ready market and there are lots of fancy arriving. Tulips in quantity are confined mostly to white. Pinks and yellows are in limited supply; no scarlets as yet. There are enough Paper Whites and Roman hyacinths to go around, and these continue in healthy condition as to price.

TWIN-CITIES Business in the Twin Cities has been quite dull this last week. McKinley day hardly differed from any other day. The day was too cold and stormy for anybody to be outside, and but very few carnations were seen even in offices. It seems McKinley day is not quite as popular out here as it is in the east. The market about holds its own, and prices are about normal, without much variation. Supply and demand are about equal.

WASHINGTON For the first two days of the week Washington was in the grasp of one of the most bitter cold spells of the winter, a furious "nor'wester" blowing steadily all the while. In consequence the cut on

everything has shortened up; especially is this true of roses. Prices still hold their own. As there are only three short weeks allowed to the world-minded before the penitential season sets in, receptions and dinners and social gatherings of every kind are being squeezed in which makes a more than busy time for the retailers. Several report very large decorations for the coming week. All bulbous stock is being shown in greater quantity and there is a brisk demand for freesias, paper white narcissus and tulips. Green has been scarce, but seems to be coming in a little better.

FIRE RECORD.

Minot, N. D.—The entire stock in the greenhouse of George Walker was destroyed by a fire on January 21.

Toledo, O.—C. W. Conner met with a loss of about \$600 on stock and building through a fire which started from an overheated smoke-stack.

Dubuque, Ia.—What threatened to be a serious fire at Harkett's Floral Nursery on January 11 was extinguished by the quick work of the fire department with but slight loss.

Beaver Dam, Wis.—A fire which started in the rear of the store of Joseph Wagner on January 16 swept through the entire side of his greenhouse. His loss is estimated to be about \$2,000; no insurance.

Grand Junction, Colo.—The Grand Valley Floral Co. were the victims of a fire on January 6 which completely destroyed the inside of their building and ruined the stock. An overheated furnace is supposed to be the cause. The building was partially insured.

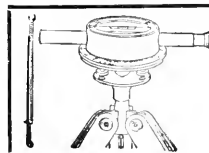

EVERYBODY KNOWS

Park, Cemetery and Landscape Gardening cannot be properly done without the aid of an accurate leveling instrument. Bostrom's Improved Levels, No. 2 at \$15.00 and No. 3 at \$25.00, are conceded by all who KNOW to be the only Levels on the market which meet all the requirements, at the price. Our guarantee back of every Level we sell, and satisfied users in every State in the Union heartily endorse every claim we make. Shipping weight 10 lbs. Description on request. BOSTROM-BRADY MFG. CO., 139 Madison Avenue, ATLANTA, GA.

FORD BROTHERS

48 West 28th Street NEW YORK
FINE ROSES FANCY CARNATIONS
 A Full Line of All CUT FLOWERS
 Telephone, 3870 or 3871 Madison Square

H. E. FROMENT

Wholesale Commission Florist,
 Choice Cut Flowers,
 57 West 28th St. :: NEW YORK
 Telephones: 2200, 2201, Madison Square.

Alfred H. Langjahr

All choice cut-flowers in season. Send for quotations. Correspondence with shippers of first-class stock invited.
 55 West 28th Street, New York
 Telephones 4626-4627 Madison Square

Edward C. Horan

Wholesale Florist
 55 WEST 28th ST.
 Tel. 1462 Madison Square New York
 1463

JOHN YOUNG

WHOLESALE FLORIST
 Finest American Beauties and Carnations

51 West 28 St. - NEW YORK

FRANK MILLANG

Wholesale Florist
 55-57 West 26th St., NEW YORK
 Shipments, any quantity, Wholesale Market Rates.

Consignments Requested

A Good Market and Prompt Returns

GEORGE SALTFOED

43 W. 28th Street, NEW YORK
 Telephone, 3393 Madison Sq.

VIOLETS

Finest Grade. Any Quantity

B. S. SLINN

55-57 W. 26 St., New York

Moore, Hentz & Nash

Wholesale Commission Florists

55 and 57 West 26th Street
 Telephone No. 756
 Madison Square New York

MILLANG BRUS.

WHOLESALE COMMISSION FLORISTS

41 West 28th Street

Telephone 3880
 3881 Madison NEW YORK

JOHN I. RAYNOR

Wholesale Commission Florist **SELLING AGENT FOR LARGEST GROWERS**
 A full line of Choice Cut Flower Stock for all purposes. Comprises every variety grown in New York market, at current prices
 TEL. 1998 MADISON SQUARE 49 West 28th St., New York City

Walter F. Sheridan

Wholesale Commission Dealer in
CHOICE CUT FLOWERS
 39 West 28th Street, New York
 Telephone: 3532-3533 Madison Square

HEADQUARTERS FOR NOVELTIES ORCHIDS A SPECIALTY

THE HIGHEST GRADE OF **VALLEY** ALWAYS ON HAND
 CARNEDIAS, DAISIES, ROSES AND CARNATIONS
 Telephone
JAMES McMANUS, 753 Mad. Sq. 42 W. 28th St., New York

PHILIP F. KESSLER 55 & 57 W. 26th St., New York City
 Commission Dealer, Wholesale Buyer and Seller of

Open from 5 a. m. to 6 p. m. Sunday till 10 a. m. **CUT FLOWERS**
 Tel., 5243 and 2921 Madison Sq. Res., 345 J., Newtown.
 Finest Lilies in the Market Every Day in the Year.

NEW YORK QUOTATIONS PER 100. To Dealers Only

ROSES AND CARNATIONS

	Last Half of Week ending Jan. 30 1909	First Half of Week beginning Feb. 1 1909
American Beauty, Fancy and Special.....	30.00 to 50.00	40.00 to 75.00
" " Extra.....	20.00 to 25.00	20.00 to 30.00
" " No. 1.....	10.00 to 15.00	10.00 to 15.00
" " Lower Grades.....	3.00 to 6.00	3.00 to 6.00
Bride, 'Toid, Fancy and Special.....	8.00 to 10.00	10.00 to 12.00
" " Lower Grades.....	2.00 to 6.00	3.00 to 6.00
Kilmarney, Fancy and Special.....	10.00 to 20.00	10.00 to 20.00
" " Lower Grades.....	3.00 to 6.00	3.00 to 8.00
Richmond, Fancy and Special.....	15.00 to 25.00	12.00 to 20.00
" " Lower Grades.....	3.00 to 6.00	3.00 to 8.00
Chatenay.....	3.00 to 10.00	3.00 to 12.00
By Maryland.....	4.00 to 15.00	3.00 to 15.00
Golden Gate, Ivory, etc.....	2.00 to 10.00	3.00 to 12.00
Queen Beatrice..... to to
Mrs. Har. Field..... to to
Carnations, Fancy and Novelties.....	3.00 to 5.00	4.00 to 5.00
" " Ordinary and White.....	1.50 to 2.00	2.00 to 3.00

Alexander J. Guttman

THE WHOLESALE FLORIST OF NEW YORK
 34 WEST 28th STREET
 PHONES. 1664--1665 MADISON SQUARE
ENOUGH SAID

TRAENDLY & SCHENCK
 Wholesale Florists

Furnish best Stock at fair Prices all the year round
 Send for Quotations on Any Variety and Quantity
 Tel. 798, 799 Madison Sq. 44 West 28th St., New York City

GROWERS' CUT FLOWER CO. CUT FLOWERS AT WHOLESALE

VIOLETS, CARNATIONS, ROSES ORCHIDS, CHRYSANTHEMUMS, LILIES

Consignments Solicited. Shipments to Order, any Distance

39 West 28th Street, NEW YORK
 Telephone 5377 Madison Square J. J. COAN, Manager

WHOLESALE FLORISTS
54 West 28th St.
NEW YORK
Telephone 3559 Madison Sq.

A. L. YOUNG & CO.

RECEIVERS & SHIP-
PERS OF CUT
FLOWERS.
CONSIGNMENTS SOLICITED.

WILLIAM H. KUEBLER
Brooklyn's Foremost and Best
WHOLESALE COMMISSION HOUSE
A First Class Market for all CUT FLOWERS
28 Willoughby St., Brooklyn, N. Y.
Tel. 4591 Main

GEORGE COTSONAS & CO.
Wholesale and Retail Dealers In all kinds of
EVERGREENS
Fancy and Dagger Ferns
Bronze and Green Galax
Main Store 50 W. 28 St.
Phone 1202 Mad. Sq. New York



**Greater New York
Florists' Association,**
Inc.
Now Open for Cut Flower Consignments
162 Livingston Street, BROOKLYN, N. Y.
Geo. W. Crawback Telephone Connection
Manager 3642-43 Main

Henshaw & Fenrich
WHOLESALE FLORISTS
44 West 28th Street, NEW YORK
Phones Mad. Sq. 325, 558-2, 558-3

H. C. BERNING
Wholesale Florist

1402 Pine Street, ST. LOUIS, MO.
REED & KELLER
122 West 25th St., New York

Florists' Supplies

We manufacture all our
Hotel Designs, Baskets, Wire Work & Novelties
and are dealers in
Glassware Decorative Greens and Florists' Requisites

THE KERVAN CO.

Wholesale Dealers and Shippers of
Decorative Evergreens
Ferns, Galax, Laurel, Fresh Cycas, Box-
wood, Sphagnum and all Christmas Greens
send to us for Quotations before Buying.
113 West 28 Street, NEW YORK CITY

**MICHIGAN CUT FLOWER
EXCHANGE, Inc.**

WHOLESALE COMMISSION FLORISTS
Consignments Solicited
Hardy Fancy Fern Our Specialty
38-40 BROADWAY, DETROIT, MICH.

BRONZE GALAX
I will offer during the next 60 days first case
Bronze Galax at \$3.00 per case of 10,000,
size 2 3/4 to 3 1/2 in. f.o.b. Mt. Airy N. C.
Cash with order. Sample Order Solicited.
G. A. HOLDER, Round Peak, N. C.

In ordering goods please add "I saw
it in HORTICULTURE."

Wired Toothpicks

Manufactured by
W. J. COWEE, BERLIN, N. Y.
50,000....\$1.75; 50,000....\$7.50. Sample free.
For sale by dealers

SAMUEL A. WOODROW
WHOLESALE PLANTSMAN
Palms, Large and Small Ferns, etc.
53 West 30th Street, NEW YORK
Telephone 2083 Madison

WHOLESALE COMMISSION **J. K. ALLEN** 106 W. 28th St.
NEW YORK
Open 6 a. m. Daily Tel. 167 Madison Sq.
All Grades of Flowers to Suit All Buyers. Consignments Solicited.

NEW YORK QUOTATIONS PER 100. To Dealers Only

MISCELLANEOUS	Last Half of Week ending Jan. 30 1939		First Half of Week beginning Feb. 1 1939	
	100	100	100	100
Cypripediums	8.00	10.00	8.00	10.00
Cattleyas	20.00	40.00	15.00	40.00
Lilies	8.00	10.00	8.00	12.00
Lily of the Valley	1.00	3.00	1.50	3.00
Nerds., Paper White	1.50	2.00	1.50	2.00
Roman Hydrangea	1.50	2.00	1.50	2.00
Tulips	2.00	4.00	3.00	4.00
Daffodils	4.00	5.00	4.00	6.00
Adiantum	2.00	3.00	2.00	3.00
Sweet Peas	1.00	1.50	1.00	1.50
Gardenias	20.00	35.00	20.00	35.00
Violets30	.75	.30	.75
Adiantum75	1.00	.75	1.00
Crowanum	1.00	1.25	1.00	1.25
Smilax	10.00	12.00	10.00	12.00
Asparagus Plumosus, strings	15.00	35.00	15.00	35.00
& Spreng. (100 bchs)	15.00	25.00	15.00	25.00

NEW YORK FLOWER MARKET
The early part of the present week was marked by a famine in roses and carnations which must have recalled old times to many dealers. Other material was not scarce but responded in sympathy and prices were firmer than for a long time. It could not be said that business was particularly good or the aggregate of sales unusual. The conditions were plainly resultant from the two or three days of severe weather only, and could not be regarded as indicating any permanent strength in the flower market. Complaints by buyers for retail stores were frequent in the wholesale district over the unusual experience of being unable to get everything they asked for on the moment, and they felt aggrieved, but those who had ordered ahead had to be first served and the rest had to be content with whatever was left.

NEWS NOTES.
Raleigh, N. C.—The J. Van Lindley Nursery Co., of Pomona, has opened a branch office in the Masonic Temple Pharmacy.
Beatrice, Neb.—A. E. Hetherington, has purchased the Gage nursery farm, a few miles west of Beatrice, and will enter extensively into market gardening.
Riverside, Cal.—The name of the Jurupa Nursery has been changed to the Riverside Nursery. C. E. Watkins is manager.

Boston.—Leonard W. Ross, who was at one time connected prominently with the cemetery department, has been elected superintendent of the cemetery department, to succeed James H. Morton, resigned. It is said the action of the cemetery trustees was not unanimous, owing to the fact that there were a number of candidates, all of whom had fine political backing. For some years Mr. Ross has been in charge of Knollwood Cemetery.

If you want to do business Advertise in Horticulture.

Buyer's Directory and Ready Reference Guide

Advertisements under this head, one cent a word. Initials count as words.

Display advertisers in this issue are also listed under this classification without charge. Reference to List of Advertisers will indicate the respective pages.

Buyers failing to find what they want in this list will confer a favor by writing us and we will try to put them in communication with reliable dealers.

ACCOUNTANT

R. J. Dysart, 28 State St., Boston.
For page see List of Advertisers.

AQUILEGIAS

Aquilegia. Genuine Coerulea, finest of all. Both plants and seeds from the heart of the Rockies. C. S. Harrison's Select Nursery York, N. C.

ARAUCARIAS

A. Leuthy & Co., Perkins St. Nurseries, Roslindale, Mass.
For page see List of Advertisers.
Godfrey Aschmann, 1012 West Ontario St., Philadelphia, Pa.
For page see List of Advertisers.

ASPARAGUS

The Geo. Witthold Co., 1657 Buckingham Palace, Chicago, Ill.
For page see List of Advertisers.

AUCTION SALES

Cleary's Horticultural Co., 62 Vesey St., New York.
For page see List of Advertisers.

AZALEAS

A. Leuthy & Co., Perkins St. Nurseries, Roslindale, Mass.
For page see List of Advertisers.
Godfrey Aschmann, 1012 W. Ontario St., Philadelphia.
Apello in Bloom.
For page see List of Advertisers.
Henry A. Dorer, Philadelphia.
Azalea Mollis.
For page see List of Advertisers.

BAMBOO CANES

Yokohama Nursery Co., 31 Barclay Street, New York.
Bamboo Sticks, Colored Green.
For page see List of Advertisers.

BAY TREES

2000 Bay and Box Trees in all sizes. Pyramid and Standard. Write for list. Julius Rehers, Rutherford, N. J.

BOILERS

BOILERS. "Brenham" Boilers made for greenhouse heating. Lord & Burnham, 1133 Broadway, N. Y.
Kroeschell Bros. Co., 35 Erie St., Chicago.
For page see List of Advertisers.

BOXWOOD TREES

New England Nurseries, Inc., Bedford, Mass.
For page see List of Advertisers.

BUILDING MATERIAL

BUILDING MATERIAL of all description for All Cypress, Semi-Iron, Iron Frame or Truss Houses, Hot Bed Sash and Frames. Lord & Burnham Co., 1133 Broadway, N. Y.

BULBS AND TUBERS

Joseph Breck & Sons, 47-54 N. Market St., Boston.
For page see List of Advertisers.
J. M. Thornburn & Co., 33 Barclay St., New York.
For page see List of Advertisers.
A. T. Boddington, 342 W. 14th St., N. Y.
For page see List of Advertisers.
Rickards Bros., 37 East 10th St., New York.
For page see List of Advertisers.
H. F. Michel Co., Philadelphia.
For page see List of Advertisers.
H. E. Fiske Seed Co., Faneuil Hall Sq., Boston.
For page see List of Advertisers.

BULBS AND TUBERS - Continued

T. J. Grey & Co., 32 and 33 So. Market St., Boston.
For page see List of Advertisers.
Yokohama Nursery Co., 31 Barclay St., New York.
For page see List of Advertisers.
Ralph M. Ward & Co., 12 W. Broadway, New York.
Japan Lily Bulbs.
For page see List of Advertisers.
K. Takeuchi, 478A Boylston St., Boston.
Japanese Bulbs.
For page see List of Advertisers.

CALADIUMS

Shellroad Cannas Farms, Grange, P. O., Baltimore, Md.
For page see List of Advertisers.

CANNAS

Dingee & Conrad Co., West Grove, Pa.
For page see List of Advertisers.
Shellroad Cannas Farms, Grange P. O., Baltimore, Md.
For page see List of Advertisers.

CARNATIONS

F. Dörner & Sons Co., Lafayette, Ind.
Carnation, Pink Delight.
For page see List of Advertisers.
Chicago Carnation Co., Joliet, Ill.
For page see List of Advertisers.
Albert Roper, Tewksbury, Mass.
Carnation Bay State.
For page see List of Advertisers.
Bassett & Washburn, Hilsdale, Ill.
Carnation O. P. Bassett.
For page see List of Advertisers.
East Sudbury Greenhouses, So. Sudbury, Mass.
Carnation Cuttings.
For page see List of Advertisers.
Wood Bros., Fishkill, N. Y.
Carnations, Rooted Cuttings.
For page see List of Advertisers.
The E. G. Hill Co., Richmond, Ind.
Carnation Cuttings.
For page see List of Advertisers.
Peter Fisher, Ellis, Mass.
Rooted Cuttings.
For page see List of Advertisers.
S. J. Reuter & Son, Westery, R. I.
For page see List of Advertisers.
Bellary Bros., Syc. to L. E. Marquisee, Syracuse, N. Y.
Carnation Marchions.
Charles H. Totty, Madison, N. J.
For page see List of Advertisers.
Boston Co-operative Flower Growers' Assn., Boston.
Carnation and Rose Show.
For page see List of Advertisers.
Scheiden & Schone, Chicago
Carnation Wm. H. Taft.
For page see List of Advertisers.
Patten & Co., Tewksbury, Mass.
Carnations, Rooted Cuttings.
For page see List of Advertisers.
Paul Thomson, W. Hartford, Conn.
Carnation Neptune.
For page see List of Advertisers.
Andrew Carnegie cuttings from soil, \$5.00 per 100. The carpet carnation you ought to grow; average 3 1/2 in. stems W. S. Hall, Osage, Iowa.

CARNATION CUTTINGS

For page see List of Advertisers.

CARNATION STAPLE

J. L. Pillsbury, Galesburg, Ill.

CHRYSANTHEMUMS

Chas. H. Totty, Madison, N. J.
Chrysanthemum Novelties.
For page see List of Advertisers.

CHRYSANTHEMUMS - Continued

E. G. Hill Co., Richmond, Ind.
For page see List of Advertisers.
S. J. Goddard, Framingham, Mass.
Chrysanthemum Golden Glow.
S. J. Reuter & Son, Westery, R. I.
For page see List of Advertisers.
Elmer D. Smith & Co., Adrian, Mich.
For page see List of Advertisers.
Chrysanthemum Golden Glow from 2 1/4 in. pots, for early spring delivery, \$1.00 per doz., \$6.00 per 100, \$50.00 per 1000. Stock plants of Montmore, Oct. Frost, Crocus, Matchless, Lucy Devaux, Polly Rose and Halley, \$1.00 per doz.; \$6.00 per 100. Peirce Bros., Waltham, Mass.
Herrington's book on the Chrysanthemum, mailed to your address for 50c., by Horticulture Publishing Co., 11 Hamilton Place, Boston.
Chrysanthemums, rooted cuttings, Bonfont, Pacific, Oriental Glory, pink, Raynor, late white, \$1.00 per 100, \$5.00 per 1000. Sargent's Greenhouses, 94 Holden St., Worcester, Mass.

CONIFERS

John Waterer & Sons, Ltd., American Nursery, Bagshot, Eng.
For page see List of Advertisers.

CUT FLOWER BOXES.

Edwards Folding Box Co., Philadelphia
For page see List of Advertisers.
Folding cut flower boxes, the best made. Write for list. Holton & Hunkel Co., Milwaukee, Wis.

CYCLAMEN.

Thomas Roland, Nahant, Mass.
For page see List of Advertisers.

DAHLIAS

David Herbert & Son, Atco, N. J.
For page see List of Advertisers.
J. L. Moore, Northboro, Mass.
For page see List of Advertisers.
Peacock Dahlia Farms, Williamstown June 10th, N. J.
Dahlia Miss Virginia Maule.
For page see List of Advertisers.
R. Vincent Jr. & Sons Co., White Marsh, Md.
For page see List of Advertisers.
Dingee & Conrad Co., West Grove, Pa.
For page see List of Advertisers.
Shellroad Cannas Farms, Grange, P. O., Baltimore, Md.
For page see List of Advertisers.

DAHLIAS.

Geo. H. Walker, New Brighton, Mass.
Wholesale and Retail.
Send your name for my 1909 Catalog and Pocket Guide, ready to mail about Feb. 25th.

East Bridgewater Dahlia Gardens want your business. If you are looking for dahlias send to the Eastern Dahlia King, J. K. Alexander, East Bridgewater, Mass.

DAISIES

Daisies, yellow and white Paris R. C., 70c. Queen Alexandra, \$1 per 100, prepaid. Chas. Frost, Kenilworth, N. J.

DECORATIVE PLANTS

A. Leuthy & Co., Perkins St. Nurseries, Roslindale, Mass.
For page see List of Advertisers.
Godfrey Aschmann, 1012 W. Ontario St., Phila., Pa.
For page see List of Advertisers.
Joseph Heacock Co., Wyncote, Pa.
For page see List of Advertisers.

For List of Advertisers See Page 197

DECORATIVE PLANTS—Continued

The Geo. Wittbold Co., 1657 Buckingham Palace, Chicago, Ill.
For page see List of Advertisers.

Robert Craig Co., Market and 49th Sts., Philadelphia, Pa.
For page see List of Advertisers.

A. N. Pierson, Inc., Cromwell, Conn.
Palms and Ferns.
For page see List of Advertisers.

DRAECAENAS

The Geo. Wittbold Co., 1657 Buckingham Place, Chicago, Ill.
For page see List of Advertisers.

ECONOMY BRACKET

Buxton & Allard, Nashua, N. H.

EVERGREENS

New England Nurseries, Bedford, Mass.
For page see List of Advertisers.

American Nursery Co., 150 Broadway, New York, N. Y.
For page see List of Advertisers.

Evergreens. Send 25 cents in stamps for complete work on propagating and growing Evergreens. C. S. Harrison's Select Nursery, York, Neb.

FERNS

A. Leuthy & Co., Roslindale, Mass.
For page see List of Advertisers.

H. H. Barrows & Son, Whitman, Mass.
Nephrolepis Whitman.
For page see List of Advertisers.

John Scott, Brooklyn, N. Y.
For page see List of Advertisers.

Frank Oechslin, 2570-2606 W. Adams St., Chicago.
Ferns for Dishes.
For page see List of Advertisers.

The Geo. Wittbold Co., 1657 Buckingham Palace, Chicago, Ill.
For page see List of Advertisers.

Godfrey Aechmann, 1012 W. Ontario St., Philadelphia.
For page see List of Advertisers.

FERTILIZERS

Pulverized Manure Co., 31 Union Stock Yards, Chicago, Ill.

Wizard Brand Sheep and Shredded Cattle Manure.

Robert Simpson, Clifton, N. J.
Sheep Manure.
For page see List of Advertisers.

FEVERFEW

Double Feverfew, 2 1/2 in., \$2.50 pr 100. B. P. Winch, Framingham, Mass.

Feverfew Little Gem, 50c. per 100; \$7.00 per 1000. S. W. Pike, St. Charles, Ill.

FLORAL PHOTOGRAPHS

Flora: Photographs. Fotey's, 226-228 1 1/2 Bowery, New York.

FLORISTS' LETTERS.

Boston Florist Letter Co., 66 Pearl St., Boston, Mass.
For page see List of Advertisers.

FLORISTS SUPPLIES

N. F. McCarthy & Co., 84 Hawley St., Boston.
For page see List of Advertisers.

H. M. Robinson & Co., 15 Province St. and 9 Chapman Pl., Boston, Mass.
For page see List of Advertisers.

Reed & Keller, 122 W. 25th St., New York.
For page see List of Advertisers.

H. Bayersdorfer & Co., 1129 Arch St., Philadelphia.
For page see List of Advertisers.

J. Stern & Co., 125 N. 10th St., Phila.
Baron & Co., Appleton, N. Y.
Baskets: Crates: Ladders: Boxes.
For page see List of Advertisers.

FLOWERS BY TELEGRAPH

Park Floral Co., Denver, Colo.
For page see List of Advertisers.

Gude Bros. Co., 1214 F St., Washington, D. C.
For page see List of Advertisers.

Atlanta Floral Co., Atlanta, Ga.
For page see List of Advertisers.

M. C. & J. E. Hauswirth, 232 Michigan Ave., Chicago.
For page see List of Advertisers.

William J. Smyth, Michigan Ave. and 31st St., Chicago.
For page see List of Advertisers.

George Wittbold Co., 1657-59 Buckingham Place, Chicago.
For page see List of Advertisers.

Jacob Schulz, 644 4th Ave., Louisville, Ky.
For page see List of Advertisers.

Thos. F. Galvin, 124 Tremont St., Boston.
For page see List of Advertisers.

Julius A. Zinn, 2 Beacon St., Boston.
For page see List of Advertisers.

F. H. Houghton, 396 Boylston St., Boston.
For page see List of Advertisers.

Edward MacMullin, 194 Boylston St., Boston.
For page see List of Advertisers.

Hoffman, Florist, 59-61 Massachusetts Ave., Boston.
For page see List of Advertisers.

J. Newman & Sons, Inc., 24 Tremont St., Boston.
For page see List of Advertisers.

Tailly, Wellesley, Mass.
For page see List of Advertisers.

J. Breitmeyer's Sons, Miami and Gratiot Aves., Detroit, Mich.
For page see List of Advertisers.

Samuel Murray, 1017 Broadway, Kansas City, Mo.
For page see List of Advertisers.

Wm. L. Rock Flower Co., 1116 Walnut St., Kansas City, Mo.
For page see List of Advertisers.

H. G. Eyres, 11 N. Pearl St., Albany, N. Y.
For page see List of Advertisers.

David Clarke's Sons, 2139-2141 Broadway, New York.
For page see List of Advertisers.

Alex. McConnell, New York.
For page see List of Advertisers.

Robert G. Wilson, Fulton St. & Greene Ave., Brooklyn, N. Y.
For page see List of Advertisers.

Young & Nugent, 42 W. 28th St., N. Y.
For page see List of Advertisers.

M. Bowe, 1234 Broadway, New York.
For page see List of Advertisers.

Myer, 609-11 Madison Ave., New York.
For page see List of Advertisers.

Thos. Young, Jr., 509 Fifth Ave., New York.
For page see List of Advertisers.

Newman Floral Co., 202 Fifth Ave. and Madison Sq., New York.
For page see List of Advertisers.

The Blossom (C. C. Trepel, Mgr.), Bond and Livingston Sts., Brooklyn, N. Y.
For page see List of Advertisers.

Palmer's, Buffalo, N. Y.
For page see List of Advertisers.

F. A. Danker, Albany, N. Y.
For page see List of Advertisers.

J. H. Dunlop, 96 Yonge St., Toronto, Can.
For page see List of Advertisers.

FLOWER POTS

W. H. Ernest, 28th and M Sts., Washington, D. C.
For page see List of Advertisers.

A. H. Hewa & Co., Cambridge, Mass.
For page see List of Advertisers.

Hilfinger Bros., Ft. Edward, N. Y.
For page see List of Advertisers.

The Peters & Reed Pottery Co., Red pots, seed pans, etc. Zanesville, O.

FOREST SEEDLINGS

To close out quick I offer the following first class stock for Parks, Cemeteries and Forest Plantings: 100 M. Amorphia Fruticosa, 1 to 3 ft.; 300 M. Althea Rosea Stocks; 100 M. Cal. Privet; 500 M. Cal. Privet Cuttings; 100 M. Black Locust, 4 to 6 ft.; 30 M. Calycanthus, Sweet Shrub, 1 to 3 ft.; 150 M. Cercis Canadensis, Red Bud, 1 to 4 ft.; 60 M. Cornus Stolonifera, Ozel Dogwood, 1 to 2 ft.; 50 M. Diosyros, Am. Persimmon, 6 to 30 inches; 50 M. Elm (white) 1 to 2 ft.; 75 M. Hamamelis, Witch Hazel, 6 in. to 3 ft.; 50 M. Tullip Poplar, 1 to 8 ft.; 20 M. Sweet Gum, 1 to 6 ft.; 50 M. Black Walnut, 1 to 3 ft.; 20 M. Whitebark, 1 to 3 ft.; 20 M. Yucca filamentosa, 1 and 2 year Butternut, Japan Walnut, Ash, Maple, etc. Send for trade list. I offer my entire stock to close out at low prices; also a large stock of Tree and Shrub Seeds, Black Locust, Sweet Gum, Sycamore, Ash, Red Bud, Persimmon, Bass Wood, Viburnums, Sugar Maple, Red Cedar and other Seeds. Forest Nursery & Seed Co., J. H. Boyd, Prop., R. F. D. No. 2, McMinnville, Tenn.

GALAX

Michigan Cut Flower Co., 38 and 40 Broadway, Detroit, Mich.
For page see List of Advertisers.

George Cotoos & Co., 50 W. 25th St., New York.
For page see List of Advertisers.

The Kervan Co., 113 West 28th St., N. Y.
For page see List of Advertisers.

Rice Bros., 115 N. 6th St., Minneapolis, Minn.
For page see List of Advertisers.

H. M. Robinson & Co., 15 Province St. and 9 Chapman Place, Boston.
For page see List of Advertisers.

G. A. Holder, Round Peak, N. C.
Bronze Galax.
For page see List of Advertisers.

GERANIUMS

R. Vincent Jr. & Sons Co., White Marsh, N. J.
New and Standard Varieties.
For page see List of Advertisers.

A few hundred fine mixed stock geraniums, all double, \$10.00 per 100. Fine geraniums, 2 1/2 in., \$2.50 per 100. Cash. H. J. Blanchard, Ashburnham, Mass.

GLADIOLI

J. L. Moore, Northboro, Mass.
For page see List of Advertisers.

E. S. Miller, Wading River, N. Y.
For page see List of Advertisers.

A. T. Boddington, 342 W. 14th St., New York.
For page see List of Advertisers.

Shellread Canna Farms, Grange, P. O., Baltimore, Md.
For page see List of Advertisers.

Gladiol. As good as any and better than any I send for trade list. E. E. Stewart, Rives Junction, Mich.

Bronchylepis Gladiol., \$8.00 per 1000. Cash with order, please. Estate of Louis Siebrecht, Floral Park, N. Y.

GLASS

Boston Plate & Window Glass Co., Boston
For page see List of Advertisers.

Standard Plate Glass Co., 25-30 Sudbury St., Boston.
For page see List of Advertisers.

Foley Mfg. Co., Western Ave., between 25th & 26th Sts., Chicago.

Sharp, Partridge & Co., 22d & Lumber St., Chicago.
For page see List of Advertisers.

Greenhouse Glass, lowest prices. Johnson Glass Co., Hartford City, Ind.

Glass, High Grade, Double Thick Greenhouse Glass. Lord & Burnham, 1133 Broadway, N. Y.

GLAZING DEVICES

H. A. Dreer, Philadelphia, Pa.
Peerless Glazing Point.
For page see List of Advertisers.

GLAZING POINTS, Lord & Burnham Special Glazing Nails (Points). Lord & Burnham, 1133 Broadway, N. Y.

In writing to Advertisers kindly mention Horticulture

GREENHOUSE BUILDING MATERIAL

Lord & Burnham Co.,
1133 Broadway, New York.
For page see List of Advertisers.

Pierson U-Bar Co., 1 Madison Sq., N. Y.
For page see List of Advertisers.

A. T. Stearns Lumber Co., Neponset,
Boston.
For page see List of Advertisers.

King Construction Co., N. Tonawanda,
New York.
For page see List of Advertisers.

Hitchings & Co., 1170 Broadway, New York.
For page see List of Advertisers.

J. C. Moulger Co., 117 East Blackhawk St.,
Chicago, Ill.
For page see List of Advertisers.

Foley Mfg. Co., Western Ave., between
25th & 26th Sts., Chicago.
For page see List of Advertisers.

Wm. H. Lutton, West Side Avenue Sta.,
Jersey City, N. J.

GREENHOUSE CONSTRUCTION

GREENHOUSE CONSTRUCTION, Semi-Iron
Greenhouse, New Crusa Houses and
Iron Frame Houses. Lord & Burnham,
1133 Broadway, N. Y.

J. A. Payne, 260-274 Culver Ave., Jersey
City, N. J.
For page see List of Advertisers.

Foley Mfg. Co., Western Ave., between
25th & 26th Sts., Chicago.
For page see List of Advertisers.

Wm. H. Lutton, West Side Avenue Sta.,
Jersey City, N. J.
Curved Iceless Eave.

Hitchings & Co., 1170 Broadway, New York.
For page see List of Advertisers.

GREENHOUSE HOSE

Revere Rubber Co., Boston, Mass.
Revere Hose.
For page see List of Advertisers.

GUTTERS

GUTTERS, Cast Iron Gutters, L. & B.
Improved V Shaped Gutter with drip
gutter attachment. Lord & Burnham, 1133
Broadway, N. Y.

HAIL INSURANCE

Florista' Hall Asso. of America.
J. G. Esler, Saddle River, N. J.
For page see List of Advertisers.

HARDY FERNS, MOSS AND GREENS

H. M. Robinson & Co., 15 Province St.
and 9 Chapman Pl., Boston, Mass.
For page see List of Advertisers.

Michigan Cut Flower Exchange,
38 and 40 Broadway, Detroit, Mich.
For page see List of Advertisers.

George Colsonas & Co., 50 W. 28th St.,
New York.
For page see List of Advertisers.

N. F. McCarthy & Co., 84 Hawley St.,
Boston.
For page see List of Advertisers.

The Kervan Co., 113 W. 28th St., N. Y.
For page see List of Advertisers.

Wice Bros., 115 N. 6th St., Minneapolis,
Minn.
For page see List of Advertisers.

HEATING APPARATUS

Lord & Burnham Co.,
1133 Broadway, New York.
For page see List of Advertisers.

Pierson U-Bar Co., 1 Madison Sq., N. Y.
For page see List of Advertisers.

John A. Payne, 260-274 Culver Ave., Jersey
City, N. J.
For page see List of Advertisers.

Kroeschel Bros. Co., 35 Erie St., Chicago.
For page see List of Advertisers.

HELP FURNISHED

Thos. H. Bambrick, 34 S. 7th St., Phila.
For page see List of Advertisers.

HERBACEOUS PERENNIALS

P. Ouwerkerk, P. O. No. 1, Hoboken, N. J.
For page see List of Advertisers.
New England Nurseries, Bedford, Mass.
For page see List of Advertisers.

The Geo. Wirthold Co., 1637 Buckingham
Place, Chicago.
For page see List of Advertisers.

HOT-BED SASH

The A. T. Stearns Lumber Co., Neponset,
Mass.
For page see List of Advertisers.

Pierson U-Bar Co., 1 Madison Sq., N. Y.
For page see List of Advertisers.

Lord & Burnham Co., 1133 Broadway, N. Y.
For page see List of Advertisers.

Foley Mfg. Co., Western Ave., between
25th & 26th Sts., Chicago.

INSECTICIDES.

Nicotidie kills all greenhouse pests.
P. R. Palethorpe Co.,
Eleventh St., Owensboro, Ky.
For page see List of Advertisers.

Stump & Walter Co., 50 Barclay St.,
New York.
Kiln-dried Tobacco Dust.
For page see List of Advertisers.

Niagara Sprayer Co., Middleport, N. Y.
Niagara Brand.
For page see List of Advertisers.

B. G. Pratt Co., New York.

For page see List of Advertisers.

Tobacco dust and stems, dust in bbls,
150 to 200 lbs., \$1.00; stems in bales from
350 to 400 lbs., \$2.00. Cash with order;
money back if you say so. I lead them all
in quality and price. S. R. Levy, Hingham-
ton, N. Y.

"The Fumigating Kind Tobacco Powder"
—The first on the market and the kind
that has so many imitators, has our guaran-
tee tag of satisfaction or money back,
and "The Moon Trade Mark" on every bag,
\$3.00 per 100 lbs. The H. A. Stouthoff Co.,
Mount Vernon, N. Y., Makers and sellers.

JAPANESE PLANTS

Yokohama Nursery Co., 31 Barclay St.,
New York.
For page see List of Advertisers.

KENTIAS

Godfrey Aschmann,
1012 W. Ontario St., Phila., Pa.
For page see List of Advertisers.

A. Leuthy & Co., Rosindale, Mass.
For page see List of Advertisers.

Jos. Heacock Co., Wyncote, Pa.
Single and Made-Up Specimens.
For page see List of Advertisers.

LEVELS FOR LANDSCAPE GAR-**DENING USE.**

Bostrom-Brady Mfg. Co., 139 Madison Ave.,
Atlanta, Ga.
For page see List of Advertisers.

LILLY OF THE VALLEY PIPS

Hjalmar Hartmann & Co., 12 Stormgade,
Copenhagen, Denmark.
For page see List of Advertisers.

MARGUERITES

Marguerites, Queen Alexandra, \$1.25 per
100, prepaid. S. W. Pike, St. Charles, Ill.

NEW AND RARE PLANTS

Rose Hill Nurseries, New Rochelle, N. Y.
For page see List of Advertisers.

NICO-FUME

Kentucky Tobacco Product Co.,
Louisville, Ky.

NURSERY STOCK

John Waterer & Sons, Ltd.,
American Nursery, Bagshot, England.
For page see List of Advertisers.

Cleary's Horticultural Co., 62 Vesey St.,
New York.
For page see List of Advertisers.

P. Ouwerkerk, 216 June St., Weehawken
Hights, N. J.
For page see List of Advertisers.

D. J. Twomey, Dept. H, Geneva, N. Y.
For page see List of Advertisers.
American Nursery Co., 150 Broadway, New
York, N. Y.

NURSERY STOCK Continued

Manual of the Trees of North America,
by C. S. Sargent, mailed to your address
for \$5.00, by Horticulture Publishing Co.,
11 Hamilton Place, Boston.

TREES, SHRUBS, ROSES, EVER-
GREENS, PEONIES, HARDY PLANTS.
ELLIWANGER & BARRY, Rochester, N. Y.

ONION SEED

Federico C. Varela, Tenerife, Canary Ids.
Beranda, Boston Seed.
For page see List of Advertisers.

ORCHID PLANTS

Lager & Hurrell, Summit, N. J.
For page see List of Advertisers.

Sander, St. Albans, England.
Importers, Exporters, Growers, Hybridists.
For page see List of Advertisers.

Carrillo & Baldwin, Syracuse, N. Y.
For page see List of Advertisers.

Joa. A. Manda, 191 Valley Road, W.
Orange, N. J.
For page see List of Advertisers.

Ordonez Bros., Madison, N. J., Box 105.
For page see List of Advertisers.
Largest stock in the country. Ask for
prices. Julia Roehrs, Rutherford, N. J.

PAINT AND PUTTY

PAINT AND PUTTY: Ideal Greenhouse
lead; Special Greenhouse Putty. Lord &
Burnham, 1133 Broadway, N. Y.

PALMS

A. Leuthy & Co., Perkasie St. Nurseries,
Rosindale, Mass.
For page see List of Advertisers.

Robert Craig Co., Market and 40th Sts.,
Philadelphia, Pa.
For page see List of Advertisers.

Joseph Heacock Co., Wyncote, Pa.
Home-Grown Palms.
For page see List of Advertisers.

PANSY PLANTS.

Pansies, extra fine giant flowering, strong
plants, 30 cents per 100; \$2.50 per 1000
Edw. Wallis, Ato., N. J.

PATENTS

Siggers & Siggers, Washington, D. C.
For page see List of Advertisers.

PEAT

Orchid peat, Rotted peat, Azalea peat,
Leaf-Mould, Live Sphagnum moss, Baled
Sphagnum moss, Green Clump moss, etc.
Jobbers' list on application. C. W. Brown-
ell & Co., Walden, N. Y.

Orchid Peat and Moss always on hand.
Julius Roehrs Co., Rutherford, N. J.

PEONIES

Peonies only, by the wholesale—best 100
varieties. J. F. Rosenfield, Westpoint, Neb.

One of the finest collections in America.
Send 25 cts. in stamps for new edition of
Peony Manual. C. S. Harrison's Select
Nursery, York, Neb.

PHLOXES

Send 25 cts in stamps for Phlox Manual.
Fine mixed phloxes \$2.00 per 100, C. S.
Harrison's Select Nurseries, York, Neb.

**PHOTOGRAPHS; DESIGNING; IL-
LUSTRATING**

Geo. E. Dow, 178 Washington St., Boston.
For page see List of Advertisers.

PIPE AND FITTINGS

Foley Mfg. Co., between Western Ave. and
26th St., Chicago, Ill.
For page see List of Advertisers.

Kroeschel Bros. Co., 35 Erie St., Chicago.
For page see List of Advertisers.

PIPE AND FITTINGS. Cast Iron and
Wrought Pipe, Valves, Elbows, Pipe Hooks,
Automatic Air Reducers, etc. Lord &
Burnham, 1133 Broadway, N. Y.

PLANT STANDS

Moore-Livington Co., Landsdowne, Pa.
For page see List of Advertisers.

PLANT STAKES

Seale's Tieless Plant Stakes and Trellises.
H. D. Seale & Sons, Elkhart, Ind.

POT HANGERS

Pot hangers, Kramer's \$1 doz. by exp. \$1.25 by mail. I. N. Kramer & Son, Cedar Rapids, Ia.

POINSETTIAS (Artificial)

Poinsettias, artificial decorations our specialty. Sample lots of 50 in 3 sizes, \$4.00; 100 lots, \$6, \$8, \$10. J. Stern & Co., 125 N. 10th St., Philadelphia, Pa.

PRIVET

John Bennett, Atlantic Highlands, N. J. For page see List of Advertisers.

PRUNING SHEARS

Rhodes Mfg. Co., Dept. R., Grand Rapids, Mich. For page see List of Advertisers.

RAFFIA

Raffia (colored), 20 beautiful shades. Samples free. R. H. Comey Co., Camden, N. J. 810 Washburn Ave., Chicago, Ill.

RETAIL FLORISTS

Park Floral Co., Denver, Colo. For page see List of Advertisers.

Gude Bros. Co., 1214 F St., Washington, D. C. For page see List of Advertisers.

Atlanta Floral Co., Atlanta, Ga. For page see List of Advertisers.

M. C. & J. E. Hanswirth, 232 Michigan Ave., Chicago. For page see List of Advertisers.

William J. Smyth, Michigan Ave. and 31st St., Chicago. For page see List of Advertisers.

George Wittbold Co., 1657-59 Buckingham Place, Chicago. For page see List of Advertisers.

Jacob Schulz, 644 4th Ave., Louisville, Ky. For page see List of Advertisers.

Thos. F. Galvin, 124 Tremont St., Boston. For page see List of Advertisers.

Julius A. Zinn, 2 Beacon St., Boston. For page see List of Advertisers.

Frank H. Houghton, 396 Boylston St., Boston. For page see List of Advertisers.

Edward MacMulkin, 194 Boylston St., Boston. For page see List of Advertisers.

Hoffman, Florist, 50-61 Massachusetts Ave., Boston. For page see List of Advertisers.

J. Newman & Sons, Inc., 24 Tremont St., Boston. For page see List of Advertisers.

Tailby, Wellesley, Mass. For page see List of Advertisers.

J. Brehmever's Sons, Detroit, Mich. For page see List of Advertisers.

Samuel Murray, 1017 Broadway, Kansas City, Mo. For page see List of Advertisers.

Wm. L. Rock Flower Co., 1116 Walnut St., Kansas City, Mo. For page see List of Advertisers.

H. G. Eyles, 11 N. Penn St., Albany, N. Y. For page see List of Advertisers.

David Clarke's Sons, 2139 21st Broadway, New York. For page see List of Advertisers.

Alex. McConnell, New York. For page see List of Advertisers.

Robert G. Wilson, Fulton St. and Greene Ave., Brooklyn, N. Y. For page see List of Advertisers.

Young & Nugent, 42 W. 28th St., N. Y. For page see List of Advertisers.

M. Bowe, 1294 Broadway, New York. For page see List of Advertisers.

Myer, 609-11 Madison Ave., New York. For page see List of Advertisers.

Thos. Young, Jr., 500 Fifth Av., New York. For page see List of Advertisers.

Newmann Floral Co., 202 Fifth Av. & Madison Sq., New York. For page see List of Advertisers.

The Blossom (C. C. Trepel, Mgr.), Wood & Livingston Sts., Brooklyn, N. Y. For page see List of Advertisers.

Palmer's Buffalo, N. Y. For page see List of Advertisers.

F. A. Danker, Albany, N. Y. For page see List of Advertisers.

RETAIL FLORISTS—Continued

I. H. Dunlop, 96 Young St., Toronto, Can. For page see List of Advertisers.

RHODODENDRONS

John Waterer & Sons, Ltd., American Nursery, Bagshot, England. For page see List of Advertisers.

P. Onwerkerk, Hoboken, N. J. For page see List of Advertisers.

Anthony Waterer, Knap Hill Nursery, Surrey, Eng. For page see List of Advertisers.

Henry A. Dreor, Philadelphia. For page see List of Advertisers.

ROSES

Robert Craig Co., Market and 49th Sts., Philadelphia, Pa. For page see List of Advertisers.

J. Onwerkerk, P. O. No. 2, Hoboken, N. J. For page see List of Advertisers.

Julius Roehrs Co., Rutherford, N. J. Rose Newport Fairy. For page see List of Advertisers.

Waban Rose Conservatories, Natick, Mass., and 34 Somerset St., Boston. New Forcing Rose White Killarney. For page see List of Advertisers.

The F. R. Pierson Co., White Killarney, Tarrytown-on-Hudson, N. Y. For page see List of Advertisers.

S. J. Route & Son, Western, R. I. My Maryland. For page see List of Advertisers.

Dilgee & Conard Co., West Grove, Pa. For page see List of Advertisers.

Charles H. Totty, Madison, N. J. For page see List of Advertisers.

Roses, strong, own root, 4 inch Chateaux, Killarney, Richmond and Mald, \$8 per 100. Stretsch & Son, New Rochelle, N. Y.

Hand Book of Cultural Notes on Roses Under Glass, by F. P. Bigham, mailed to your address for 25c, by Horticulture Publishing Co., 11 Hamilton Place, Boston.

The beautiful new pink rose, MISS KATE MOULTON is the queen of all pink roses. It is a winner and you should grow it. Price \$30.00 100; \$50.00 200; \$100.00 500 and upwards \$175 per 1000. Minneapolis Floral Co., Minneapolis, Minn.

SEED GROWERS

C. C. Morse & Co., 48-56 Jackson St., San Francisco, Cal. For page see List of Advertisers.

Hjalmar Hartmann & Co., Cauliflower and Cabbage Seed. 12 Stormgade, Copenhagen, Denmark. For page see List of Advertisers.

Federico C. Varcla, Tenerife, Canary Ids. Bermuda Onion Seed.

SEEDS

T. J. Grey Co., 32 So. Market St., Boston. For page see List of Advertisers.

Joseph Breeck & Sons, Boston, Mass. 51 and 52 N. Market St., Boston, Mass. For page see List of Advertisers.

W. Albee Burpee & Co., Philadelphia. For page see List of Advertisers.

C. C. Morse & Co., 48-56 Jackson St., San Francisco, Calif. For page see List of Advertisers.

Arthur T. Boddington, 342 W. 14th St., New York. For page see List of Advertisers.

H. E. Flske Seed Co., Faneuil Hall Sq., Boston. For page see List of Advertisers.

Hjalmar Hartmann & Co., 12 Stormgade, Copenhagen, Denmark. Cauliflower and Cabbage Seed. For page see List of Advertisers.

Rickards Bros., 37 E. 19th St., New York. For page see List of Advertisers.

R. & J. Parquhar & Co., 67 So. Market St., Boston. Monette Seed. For page see List of Advertisers.

H. F. Michell Co., 1018 Market St., Phila. For page see List of Advertisers.

J. M. Thorburn & Co., 33 Barelay St., N. Y. For page see List of Advertisers.

Leonard Seed Co., Chicago, Ill. For page see List of Advertisers.

SEEDS—Continued

Wm. Elliott & Sons, 42 Vesey St., N. Y. New Seed. For page see List of Advertisers.

Seeds. Rocky Mountain Evergreen seeds in large or small quantities. C. S. Harrison's Select Nursery, York, Neb.

Our own Seed—Bos Crop; truly dependable seed; yellow, red and white Globe. Write for prices. Laughlin Seed Co., Keaton, O.

My own new crop of SALVIA SPLEN-DENS VARIETIES is now ready; Nana Compacta ZUCCH, first early flowering pot Salvia in existence, selected seeds Compacta Grandiflora FIREBALL, best of all for pots and groups, selected seeds. Grandiflora Amellorata KING OF THE SCARLETS, unequalled for late groups, with extra large deep scarlet spikes, selected seeds. Each of above per Tr. Pkt., 50c; 6 Tr. Pkt., \$2.50. Larger quantities on special quotation. O. V. ZANGEN, Seedsman, Hoboken, N. J.

John P. Rupp, Shippensburg, Pa. For page see List of Advertisers.

SHAMROCKS

The Geo. Wittbold Co., 1657 Buckingham Palace, Chicago. For page see List of Advertisers.

SILKALINE

John C. Meyer & Co., Boston, Mass. For page see List of Advertisers.

SPHAGNUM MOSS

Live Sphagnum moss, orchid peat and orchid baskets always on hand. Lager & Horrell, Summit, N. J.

Sphagnum moss and mountain laurel in bags, bales or car lots. Prices low. Spruce and hemlock in bales. James Day, Box 660, Milford, N. H.

SPRAYERS

"SHOWERMAKER," \$1. Jos. Kopceas, So. Bend, Ind. Nigam Spray Co., Middleport, N. Y. For page see List of Advertisers.

J. F. Cass Mfg. Co., Dept. H., Detroit, Mich. U-N-T Globe Sprayer. For page see List of Advertisers.

STEAM TRAP

E. Hppard, Youngstown, O.

STRAWBERRY PLANTS

H. L. Crane, Westwood, Mass. Barrymore Strawberry. For page see List of Advertisers.

SULFOCIDE

The B. G. Pratt Co., 50 Church St., Dept. W., New York City. For page see List of Advertisers.

SWEET PEAS

A. C. Zvolanek, Round Brook, N. J. Winter Flowering. For page see List of Advertisers.

TO-BAK-INE

E. H. Hunt, Genl. Agt., 76-78 Wabash Av., Chicago. For page see List of Advertisers.

TOMATO PLANTS.

10,000 tomato plants for forcing. Comet, Pierce and Majflower, ready January 20. Good plants from 2 1/2 inch pots, \$15 per 1000. Locust Street Greenhouses, J. H. A. Hutchison, Prop., Oxford, Pa.

20,000 Forcing Tomatoes, 2 1/2-in., \$2.00 per 100. Roney Bros., West Grove, Pa.

VENTILATING APPARATUS

Pierson U-Bar Co., 1 Madison Sq., N. Y. For page see List of Advertisers.

Foley Mfg. Co., Western Ave., between 25th & 26th Sts., Chicago. For page see List of Advertisers.

John A. Payne, 200-274 Culver Ave., Jersey City, N. J. For page see List of Advertisers.

The Advance Co., Richmond, Ind. For page see List of Advertisers.

Quaker City Machine Co., Richmond, Ind. 20th Century Ventilating Arm. For page see List of Advertisers.

In writing to Advertisers kindly mention Horticulture

VENTILATING APPARATUS —

Continued

VENTILATING MACHINERY. New Model enclosed, self-feeding gear; Standard Model Open Gear. Lord & Burnham, 1133 Broadway, N. Y.

WAX FLOWERS

We are originators of wax designs and still the standard concern. J. Stern & Co., 125 N. 10th St., Philadelphia, Pa.

WIRED TOOTHPICKS

W. J. Cowee, Berlin, N. Y.
For page see List of Advertisers.

WIREWOK

Reed & Keller, 122 W. 25th St., N. Y.
For page see List of Advertisers.
Wlrewok. Write for our catalogue. Holton & Haubel Co., Milwaukee, Wis.
William E. Heilscher's Wire Works, 38-40 Broadway, Detroit, Mich.

Headquarters for wire work. Send for list. Ball & Betz, 31 E. 3rd St., Cincinnati, O.

Wlrewok—Compare our prices with others. Scranton Florist Supply Co., 201 N. 7th St., Scranton, Pa.

WHOLESALE FLORISTS

Boston

N. F. McCarthy & Co., 81 Hawley St., Boston.
For page see List of Advertisers.
H. M. Robinson & Co., 15 Province St. and 9 Chapman Pl., Boston.
For page see List of Advertisers.
Welch Bros., 226 Devonshire St., Boston.
For page see List of Advertisers.
Tailby, Wellesley, Mass.
For page see List of Advertisers.

Chicago

Chas. W. McKellar, 51 Wabash Ave., Chicago.
For page see List of Advertisers.
Peter Reinberg, 51 Wabash Ave., Chicago.
For page see List of Advertisers.
E. F. Winterson Co., 45-49 Wabash Ave., Chicago.
For page see List of Advertisers.
J. A. Rudolph, 37-39 Randolph St., Chicago.
For page see List of Advertisers.
Poehmann Bros. Co., Morton Grove, Ill.
For page see List of Advertisers.

Cromwell, Conn.

A. N. Pierson, Cromwell, Conn.
For page see List of Advertisers.

Detroit

Mehlgan Cut Flower Exchange, 38 and 40 Broadway, Detroit, Mich.
For page see List of Advertisers.

Minneapolis

Rice Bros., 115 N. 6th St., Minneapolis, Minn.
For page see List of Advertisers.

New York

Ford Bros., 48 W. 28th St., New York.
For page see List of Advertisers.
H. E. Froment, 57 W. 28th St., New York.
For page see List of Advertisers.
Alex. J. Gutman, 34 W. 25th St., New York.
For page see List of Advertisers.
E. C. Horan, 55 W. 28th St., New York.
For page see List of Advertisers.
A. H. Langjahr, 55 W. 28th St., New York.
For page see List of Advertisers.
James McManus, 42 W. 28th St., New York.
For page see List of Advertisers.
John I. Raynor, 49 W. 28th St., New York.
For page see List of Advertisers.
W. F. Sheridan, 39 W. 28th St., New York.
For page see List of Advertisers.
Frandly & Schenck, 44 W. 28th St., New York.
For page see List of Advertisers.
Moore, Hentz & Nash, 55 and 57 W. 26th St., New York.
For page see List of Advertisers.
Wm. H. Knobler, 28 Willoughby St., Brooklyn, N. Y.
For page see List of Advertisers.
Philip F. Kessler, 55 and 57 W. 26th St., New York.
For page see List of Advertisers.
Millang Bros., 41 W. 28th St., New York.
For page see List of Advertisers.

WHOLESALE FLORISTS—

New York—Continued

John Young, 51 W. 28th St., New York.
For page see List of Advertisers.
Greater New York Florists' Association, 162 Livingston St., Brooklyn, N. Y.
For page see List of Advertisers.
George Smitford, 43 W. 28th St., New York.
For page see List of Advertisers.
Frank Millang, 55-57 W. 26th St., New York.
For page see List of Advertisers.
B. S. Silna, 55-57 W. 26th St., New York.
For page see List of Advertisers.
A. L. Young & Co., 54 W. 28th St., N. Y.
For page see List of Advertisers.
Growers' Cut Flower Co., 39 W. 28th St., New York.
For page see List of Advertisers.
Heinshaw & Feinlich, 44 W. 28th St., New York.
For page see List of Advertisers.
J. K. Allen, 106 W. 28th St., New York.
For page see List of Advertisers.

Philadelphia

W. E. McKisick & Bros., 1619-1621 Ransstead St., Philadelphia, Pa.
For page see List of Advertisers.
Leo Niessen Co., 1209 Arch St., Philadelphia, Pa.
For page see List of Advertisers.
The S. S. Pennock-Meehan Co., 1608-18 Ludlow St., Philadelphia, Pa.
For page see List of Advertisers.

St. Louis

H. G. Berling, 1402 Pine St., St. Louis, Mo.
For page see List of Advertisers.

WHOLESALE PLANTSMAN

Sammel A. Woodrow, 53 W. 30th St., New York.
For page see List of Advertisers.

New Offers in This Issue.

BURMESE DENDROBES.

Julius Roehrs Co., Rutherford, N. J.
For page see List of Advertisers.

CANNAS.

A. T. Boddington, 342 W. 14th St., New York.
For page see List of Advertisers.

CARNATION GEORGIA.

J. O. Cockcroft, Northport, L. I., N. Y.
For page see List of Advertisers.

CHOICE AMARYLLIS BULBS.

Knight & Struck, New York City.
For page see List of Advertisers.

DEMING SPRAY PUMP.

Chas. J. Jager Co., Boston.
For page see List of Advertisers.

EAST INDIAN ORCHIDS.

Lager & Harrell, Summit, N. J.
For page see List of Advertisers.

FLORISTS' ASTERS.

Elmer D. Smith & Co., Adrian, Mich.
For page see List of Advertisers.

GLADIOLUS BRENCHLENIUS.

G. V. Zanghe, Hoboken, N. J.
For page see List of Advertisers.

GLADIOLUS BULBS.

Stump & Walter Co., 50 Barclay St., New York.
For page see List of Advertisers.

SEEDS.

Wheeler & Don, 114 Chambers St., New York.
For page see List of Advertisers.

TREES, SHRUBS, ROSES, EVER-GREENS, HARDY PLANTS.

Ellwanger & Barry, Rochester, N. Y.
For page see List of Advertisers.

MISCELLANEOUS WANTS

WANTED TO BUY—Greenhouses and all kinds of greenhouse material; dismantled and removed at once. Best prices. Terms cash. Address, Max Tomback, 24 Avon

WANTED TO BUY—Complete-to-grow house plants and all kinds of greenhouse material to be taken down and removed at once. Terms cash. Address I. Snesserman, 229 Livingston St., Newark, N. J.

HELP WANTED

GOOD MEN

When you need good men, skilled or unskilled, Write:

THOS. H. BAMBRICK

34 South 7th Street Philadelphia

Help of all kinds, including that for Florists, Nurserymen, Seedsmen and the Horticultural trade generally.

WANTED MARCH 15

An experienced, energetic gardener thoroughly acquainted with hardy stock, garden making, grading, trimming, etc. Permanent position to right party. State references and salary.

The Elm City Nursery Co. NEW HAVEN, CONN.

SALESMAN—Wholesale cut flower trade; must be experienced; good position for the right man. Apply with references and full particulars to W. E. McKisick & Bros., 1619-21 Ransstead St., Philadelphia.

SITUATIONS WANTED

SITUATION WANTED—Young man, aged 24, single, wishes position as assistant gardener; experienced in hardy shrubs, trees, bedding stock; also furnace management and all outside work in general. Can give best references as to honesty, sobriety and good work. Address J. L. M., 555 2d Ave., N. Y. City.

FOR SALE

FOR SALE—5600 feet, 2 in., 1000 feet, 4 in., wrought iron pipe; 4000 feet of 4 in. cast iron pipe, clean; 500 boxes 10x12, 8x10, and 10 boxes of 8x10, double-thick and clean glass, at \$1.25 per box. One No. 17 Hitchings. All kinds ventilating apparatus and sash, cast iron fittings, valves, expansion tanks, etc. Everything in first-class condition. Cheap. F. O. B. Newark, N. J. Snesserman, 229 Livingston St., Newark, N. J.

FOR SALE—One complete greenhouse, 24 feet by 22 1/2 feet; all double thick 16x24 inch glass; heated by Furman boiler and about 3000 feet of 1 1/2 inch and 3/4 inch wrought iron pipe; drip bars and all up-to-date supports and ventilating apparatus. Cheap. Inspect at West street, South Norwalk, Conn. (Franklin A. Smith Greenhouses), or inquire of I. Snesserman, 229 Livingston street, Newark, N. J.

FOR SALE—An up-to-date greenhouse; property in good repair; situated in the State of Massachusetts; 12,000 feet glass, stocked for cut flowers and pot plants; large nine-room house, one six-room house, large barn, 6 acres good land; established for 35 years. Doing good business, \$5000 net. Cash. Reason for selling, own going out of business. Address P. M. 100, care Horticulture.

FOR SALE—Retail nursery, sixth year, doing good, steady and increasing trade. Stock in excellent condition. Only local supply for community of 50,000. For particulars address R. N., care HORTICULTURE, Boston.

BUSINESS CHANCES

WANTED—To unite in partnership in Massachusetts with man needing more capital or assistance in horticultural business warranting expansion; or to join with man thoroughly qualified in horticulture in establishment of new enterprise. Address K., care Horticulture.

List of Advertisers

Table listing various horticultural businesses and their locations, including Advance, The Co., Allen J. K., American Nurseries, Aschmann Godfrey, Adams Floral Co., Bambrick Thos., Barrows H. H. & Son, Bassett & Washburn, Beversdorfer H. & Co., Bacon & Co., Bennett J., Berns H. G., Blossom The, Boddington A. T., Boston Co-operative Flower Growers Assn, Boston Florist Letter, Boston Plate and Window Glass Co., Bystrom-Brady Mfg. Co., C. G., C. J., C. K., C. L., C. M., C. N., C. O., C. P., C. Q., C. R., C. S., C. T., C. U., C. V., C. W., C. X., C. Y., C. Z., C. AA, C. AB, C. AC, C. AD, C. AE, C. AF, C. AG, C. AH, C. AI, C. AJ, C. AK, C. AL, C. AM, C. AN, C. AO, C. AP, C. AQ, C. AR, C. AS, C. AT, C. AU, C. AV, C. AW, C. AX, C. AY, C. AZ, C. BA, C. BB, C. BC, C. BD, C. BE, C. BF, C. BG, C. BH, C. BI, C. BJ, C. BK, C. BL, C. BM, C. BN, C. BO, C. BP, C. BQ, C. BR, C. BS, C. BT, C. BU, C. BV, C. BW, C. BX, C. BY, C. BZ, C. CA, C. CB, C. CC, C. CD, C. CE, C. CF, C. CG, C. CH, C. CI, C. CJ, C. CK, C. CL, C. CM, C. CN, C. CO, C. CP, C. CQ, C. CR, C. CS, C. CT, C. CU, C. CV, C. CW, C. CX, C. CY, C. CZ, C. DA, C. DB, C. DC, C. DD, C. DE, C. DF, C. DG, C. DH, C. DI, C. DJ, C. DK, C. DL, C. DM, C. DN, C. DO, C. DP, C. DQ, C. DR, C. DS, C. DT, C. DU, C. DV, C. DW, C. DX, C. DY, C. DZ, C. EA, C. EB, C. EC, C. ED, C. EE, C. EF, C. EG, C. EH, C. EI, C. EJ, C. EK, C. EL, C. EM, C. EN, C. EO, C. EP, C. EQ, C. ER, C. ES, C. ET, C. EU, C. EV, C. EW, C. EX, C. EY, C. EZ, C. FA, C. FB, C. FC, C. FD, C. FE, C. FF, C. FG, C. FH, C. FI, C. FJ, C. FK, C. FL, C. FM, C. FN, C. FO, C. FP, C. FQ, C. FR, C. FS, C. FT, C. FU, C. FV, C. FW, C. FX, C. FY, C. FZ, C. GA, C. GB, C. GC, C. GD, C. GE, C. GF, C. GG, C. GH, C. GI, C. GJ, C. GK, C. GL, C. GM, C. GN, C. GO, C. GP, C. GQ, C. GR, C. GS, C. GT, C. GU, C. GV, C. GW, C. GX, C. GY, C. GZ, C. HA, C. HB, C. HC, C. HD, C. HE, C. HF, C. HG, C. HH, C. HI, C. HJ, C. HK, C. HL, C. HM, C. HN, C. HO, C. HP, C. HQ, C. HR, C. HS, C. HT, C. HU, C. HV, C. HW, C. HX, C. HY, C. HZ, C. IA, C. IB, C. IC, C. ID, C. IE, C. IF, C. IG, C. IH, C. II, C. IJ, C. IK, C. IL, C. IM, C. IN, C. IO, C. IP, C. IQ, C. IR, C. IS, C. IT, C. IU, C. IV, C. IW, C. IX, C. IY, C. IZ, C. JA, C. JB, C. JC, C. JD, C. JE, C. JF, C. JG, C. JH, C. JI, C. JJ, C. JK, C. JL, C. JM, C. JN, C. JO, C. JP, C. JQ, C. JR, C. JS, C. JT, C. JU, C. JV, C. JW, C. JX, C. JY, C. JZ, C. KA, C. KB, C. KC, C. KD, C. KE, C. KF, C. KG, C. KH, C. KI, C. KJ, C. KK, C. KL, C. KM, C. KN, C. KO, C. KP, C. KQ, C. KR, C. KS, C. KT, C. KU, C. KV, C. KW, C. KX, C. KY, C. KZ, C. LA, C. LB, C. LC, C. LD, C. LE, C. LF, C. LG, C. LH, C. LI, C. LJ, C. LK, C. LL, C. LM, C. LN, C. LO, C. LP, C. LQ, C. LR, C. LS, C. LT, C. LU, C. LV, C. LW, C. LX, C. LY, C. LZ, C. MA, C. MB, C. MC, C. MD, C. ME, C. MF, C. MG, C. MH, C. MI, C. MJ, C. MK, C. ML, C. MN, C. MO, C. MP, C. MQ, C. MR, C. MS, C. MT, C. MU, C. MV, C. MW, C. MX, C. MY, C. MZ, C. NA, C. NB, C. NC, C. ND, C. NE, C. NF, C. NG, C. NH, C. NI, C. NJ, C. NK, C. NL, C. NM, C. NO, C. NP, C. NQ, C. NR, C. NS, C. NT, C. NU, C. NV, C. NW, C. NX, C. NY, C. NZ, C. OA, C. OB, C. OC, C. OD, C. OE, C. OF, C. OG, C. OH, C. OI, C. OJ, C. OK, C. OL, C. OM, C. ON, C. OO, C. OP, C. OQ, C. OR, C. OS, C. OT, C. OU, C. OV, C. OW, C. OX, C. OY, C. OZ, C. PA, C. PB, C. PC, C. PD, C. PE, C. PF, C. PG, C. PH, C. PI, C. PJ, C. PK, C. PL, C. PM, C. PN, C. PO, C. PP, C. PQ, C. PR, C. PS, C. PT, C. PU, C. PV, C. PW, C. PX, C. PY, C. PZ, C. QA, C. QB, C. QC, C. QD, C. QE, C. QF, C. QG, C. QH, C. QI, C. QJ, C. QK, C. QL, C. QM, C. QN, C. QO, C. QP, C. QQ, C. QR, C. QS, C. QT, C. QU, C. QV, C. QW, C. QX, C. QY, C. QZ, C. RA, C. RB, C. RC, C. RD, C. RE, C. RF, C. RG, C. RH, C. RI, C. RJ, C. RK, C. RL, C. RM, C. RN, C. RO, C. RP, C. RQ, C. RR, C. RS, C. RT, C. RU, C. RV, C. RW, C. RX, C. RY, C. RZ, C. SA, C. SB, C. SC, C. SD, C. SE, C. SF, C. SG, C. SH, C. SI, C. SJ, C. SK, C. SL, C. SM, C. SN, C. SO, C. SP, C. SQ, C. SR, C. SS, C. ST, C. SU, C. SV, C. SW, C. SX, C. SY, C. SZ, C. TA, C. TB, C. TC, C. TD, C. TE, C. TF, C. TG, C. TH, C. TI, C. TJ, C. TK, C. TL, C. TM, C. TN, C. TO, C. TP, C. TQ, C. TR, C. TS, C. TT, C. TU, C. TV, C. TW, C. TX, C. TY, C. TZ, C. UA, C. UB, C. UC, C. UD, C. UE, C. UF, C. UG, C. UH, C. UI, C. UJ, C. UK, C. UL, C. UM, C. UN, C. UO, C. UP, C. UQ, C. UR, C. US, C. UT, C. UY, C. UZ, C. VA, C. VB, C. VC, C. VD, C. VE, C. VF, C. VG, C. VH, C. VI, C. VJ, C. VK, C. VL, C. VM, C. VN, C. VO, C. VP, C. VQ, C. VR, C. VS, C. VT, C. VU, C. VV, C. VW, C. VX, C. VY, C. VZ, C. WA, C. WB, C. WC, C. WD, C. WE, C. WF, C. WG, C. WH, C. WI, C. WJ, C. WK, C. WL, C. WM, C. WN, C. WO, C. WP, C. WQ, C. WR, C. WS, C. WT, C. WU, C. WV, C. WW, C. WX, C. WY, C. WZ, C. XA, C. XB, C. XC, C. XD, C. XE, C. XF, C. XG, C. XH, C. XI, C. XJ, C. XK, C. XL, C. XM, C. XN, C. XO, C. XP, C. XQ, C. XR, C. XS, C. XT, C. XU, C. XV, C. XW, C. XX, C. XY, C. XZ, C. YA, C. YB, C. YC, C. YD, C. YE, C. YF, C. YG, C. YH, C. YI, C. YJ, C. YK, C. YL, C. YM, C. YN, C. YO, C. YP, C. YQ, C. YR, C. YS, C. YT, C. YU, C. YV, C. YW, C. YX, C. YY, C. YZ, C. ZA, C. ZB, C. ZC, C. ZD, C. ZE, C. ZF, C. ZG, C. ZH, C. ZI, C. ZJ, C. ZK, C. ZL, C. ZM, C. ZN, C. ZO, C. ZP, C. ZQ, C. ZR, C. ZS, C. ZT, C. ZU, C. ZV, C. ZW, C. ZX, C. ZY, C. ZZ.

For Trees, Plants, Shrubs and Flowers

THE NIAGARA BRAND LIME SULPHUR SOLUTION

It destroys Scale, Lice, Spiders and all forms of Aphides, AT THE SAME TIME Mildew, Blight, Rust and other Fungus difficulties. Use in Winter or Summer. No other remedy has been so universally effective. Ask about our GREENHOUSE ARSENATE OF LEAD, the best and latest means to combat them. Address - NIAGARA SPRAYER CO., Middleport, N. Y.

Mr. Carnation Grower: - To raise the most thrifty plants use Salt Potash or Soda in the U-N-I-T Globe Sprayer.

Application, easy; results, effective; price, reasonable. References: Any Grower who has used it or any trade publication or supply house. Write for circulars or better still order one now from your dealer or sent prepaid on receipt of \$2.50.

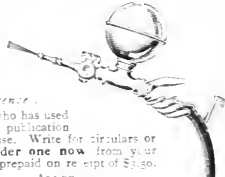

Dept. H, J. F. CASS MFG. CO, Detroit, Mich.

SOMETHING NEW FOR GREENHOUSES "SULFOCID" PRATT'S SOLUBLE SULPHUR SUMMER SPRAY

A non-caustic and non-irritating FUNGICIDE AND INSECTICIDE FOR FRUIT TREES, VEGETABLES and GREENHOUSES. A promising substitute for Bordeaux mixture. For 10 cts. to cover postage will send sample sufficient for one gallon of spray. Use 1 part to 75 or 100 parts of water. B. G. PRATT CO., 50 Church St., New York, U. S. A.

Which Spray Pump?

What shall you buy? Buy the Spray Pump that fully meets the demands of the Government Agricultural Scientists and all practical Fruit Growers. These pumps are widely known. DEMING SPRAYERS are made in 22 styles for use in small gardens or immense orchards. Write for our 199 catalog with Spraying Chart. Add 4 cents postage and receive "Spraying for Profit" a useful guide book. CHARLES J. JAGER CO., 251-255 Franklin St., Boston



- PATENTS GRANTED. 909,576. Manure Pulverizer and Loader. John N. Frost, Ailington, Mass. 909,600. Process of Preserving Fruits or Vegetables. Arthur Hugh, Brunswick, Germany. 909,843. Flower Pot. Ernest Bade, New York, N. Y., assignor of one-half to Albert Pulvermacher, New York, N. Y. 909,857. Water Intake Valve and Safety Device for Hot Water Heating Systems. George C. Andrews, Minneapolis, Minn. 910,111. Lawn Edger. Homer L. Carter, Traverse City, Mich. 910,133. Boiler. Julius Kindervaten, Richmond, Va. 910,400. Plant Sprinkling Apparatus. John W. Lischer, Syracuse, N. Y.

DON'T EXPERIMENT

USE TO-BAK-INE

and your stock will be free from insects, clean, and the blooms will not be discolored.

Send for full information of H. E. FISKE SEED CO. 13 Faneuil Hall Sq., Boston, Mass. STUMPP & WALTER CO., 50 Barclay St., New York. HENRY F. MICHELL & CO., 1018 Market St., Philadelphia. E. H. HUNT, Gen'l Agent, 76-78 Wabash Ave., Chicago.



The Best Bug Killer and Bloom Saver

For PROOF Write to P. R. Palethorpe Co. OWENSON, KY.

KILMDEAD TOBACCO DUST Free from Sand or Dirt Kind FOR FUMIGATING AND DUSTING Dusted on Plants it covers large surface. One Quality for Both Uses. Our Tobacco Dust is the pure tobacco, free from sand and dirt, strong in Nicotine and always of the same strength, making it superior to any dust on the market. Costs you no more than the ordinary product and will do twice the work. 10 lbs. face \$2.50. 25 lbs. \$4.25. 50 lbs. \$7.00. 100 lbs. \$13.50. STUMPP & WALTER CO. 50 Barclay St., New York

In ordering goods please add "I saw it in HORTICULTURE."

**GREENHOUSES BUILDING OR CON-
TEMPLATED.**

- Lexington, Ky.—L. Knight, house 350 ft.
- Oskaloosa, Ia. Theo. Grove, one house.
- Ft. Morgan, Colo.—L. J. Reid, one house.
- Summit, N. J.—John N. May, range of houses.
- Springfield, O.—H. C. Reeser, range of houses.
- Shelbyville, Ind.—Chas. Hammond, one house.
- South Ridge, N. Y. Arthur Beach, one house.
- Waldena, Minn.—C. E. Robinson, one house.
- Rochester, N. H.—Frank Varney, house 50 ft.
- Moorestown, N. J.—W. P. Stokes, two houses.
- Charleston, W. Va.—Rosedale Greenhouse, additions
- Green Bay, Wis.—Chas. De Clerc, range of houses.
- Carthage, Mo.—Stephen Hyde, Jr., range of houses.
- Clarinda, Ia.—Pfander & Crosthwait, range of houses.
- Shawnee, Okla.—Brenner Floral Co., range of houses.
- Uxbridge, Mass.—Miss A. Goldthwaite, one house.
- Mitchell, S. D.—The Newburys, four houses, each 14x120.
- Rugby, N. D.—N. P. Lindberg, three houses, each 25 x 90.
- Manchester, Mass.—Magnuson & Hylen, storage shed.
- Wyndmore, Pa.—Alfred Burton, two houses, each 25x250.
- Cold Spring, N. Y. J. W. Cunningham, house, 20 x 100.
- Lansdowne, Pa.—A. Doemling, two houses, each 21 x 200.
- Springville, N. Y.—M. L. Hampton & Co., range of houses.
- Milton, Mass.—A. S. Ferry, two houses, each 200 ft. long.
- Newport, R. I.—R. L. Beekman, chrysanthemum house, 16 x 50.
- Tewksbury, Mass.—H. S. Chandler & Son, violet house, 30 x 200.
- Milwaukee, Wis.—Mueller & Schroeder Co., carnation house, 150 ft.
- Petersburg, Va.—A. W. Bryan, house, 30 x 50; boiler shed, 10 x 30.

BOSTON PLATE & WINDOW GLASS CO.

GREENHOUSE GLASS
German and American

261 to 287 A St., Boston 20-22 Canal St.

“REVERO”

Braided Moulded Construction—Seamless Throughout



LIGHT -- STRONG -- FLEXIBLE



The above cuts represent the non-kinking tendency of Revero as compared with the old style hose of wrapped duck construction.

Revero is Furnished on Reels in Continuous Lengths up to 500 feet.

**Revere Rubber Company,
BOSTON, MASS.**

NEW YORK
NEW ORLEANS

PHILADELPHIA
MINNEAPOLIS

PITTSBURG
SAN FRANCISCO

CHICAGO
PORTLAND, ORE.

RHODES DOUBLE CUT PRUNING SHEAR

THE only pruner made that cuts from both sides of the limb and does not bruise the bark. Made in all styles and sizes. We pay Express charges on all orders. Write for circular and prices.

Pat'd June 2, 1903.

Dept. R RHODES MFG. CO., GRAND RAPIDS, MICH.

STANDARD FLOWER POTS

Packed in small crates, easy to handle.

Price per crate	Price per crate	
1500 2 in. pots in crate \$4.88	144 6 in. pots in crate \$3.16	
1500 2 1/2 " " " 5.25	120 7 " " " 4.20	
1500 2 3/4 " " " 6.00	60 8 " " " 3.00	
1000 3 " " " 5.00	HAND MADE	
800 3 1/2 " " " 5.80	48 9 in. pots in crate \$3.60	
500 4 " " " 4.50	48 10 " " " 4.80	
400 4 1/2 " " " 5.25	24 11 " " " 3.60	
320 5 " " " 4.51	24 12 " " " 4.80	
210 5 1/2 " " " 3.78	6 16 " " " 4.50	

Send pans, same price as pots. Send for price list of cylinders for Cut flowers, Hanging Baskets, Lawn Vases, etc. Ten percent off for cash with order. Address Hilfinger Bros., Pottery, Fort Edward, N.Y. August Rolker & Sons, Agts. 31 Barclay St. N. Y. City.

In ordering goods please add "I saw it in HORTICULTURE."

Standard Flower . . POTS

If your greenhouses are within 500 miles of the Capital, write us, we can save you money

W. H. ERNEST

28th and M Street WASHINGTON D. C.

Holds Glass Firmly
See the Point at **PEERLESS**

Glazing Points are the best. No rickety or flimsy. Box of 1,000 points 75 cts. postpaid.

HENRY A. DREER,
715 Chestnut St., Phila., Pa.

FOR "POT LUCK" TRY US...

HEWS STANDARD POTS

POT MAKERS FOR 140 YEARS

WORLD'S LARGEST MANUFACTURERS

WRITE FOR CATALOGUE AND DISCOUNTS

A. H. HEWS & CO., Inc.
CAMBRIDGE, MASS.

Pearson Street,
LONG ISLAND CITY, N. Y.

452-460 No. Branch St.
CHICAGO, ILL.



The "T" Bar Curved Eave Greenhouse

Is absolutely dripless, glass rests on wood, reducing breakage and condensation, less wood than any other construction, wood all exposed—all steel inside, all wood outside.

Greenhouses of Every Type

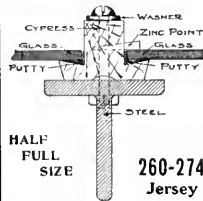

JOHN A. PAYNE

Greenhouse Designer and Builder

260-274 Culver Ave. Jersey City, N. J.

KROESCHELL BOILER



MADE OF FIRE BOX FLANGE PLATE Can not Crack

Water Space in Front, Sides and Back The Most Popular Boiler Made

SEND FOR CATALOGUE.

KROESCHELL BROS. CO.
35 Erie Street, CHICAGO, ILL.



The Advance Ventilating Apparatus

will take care of the ventilation in a 20 ft. house. We have one machine in a 30 ft. house taking care of the ventilation. It is strong, easily operated and lasting. See our SHELF BRACKETS with steel arms at 10c, all complete. Nothing better, give size of post or column in ordering. We have other good things.

The Advance Co.
RICHMOND, IND.

GREENHOUSE CONSTRUCTION LUMBER

John C. Moninger Co.
117 E. Blackhawk St., CHICAGO.

THE FOLEY MFG. CO.

CHICAGO

Completely equipped with up-to-date machinery for the making of material for

GREENHOUSE CONSTRUCTION

From a Full Supply of Thoroughly Seasoned Lumber

Send your sketches to our draughtsmen for completion and suggestion. Permit us to figure your proposed work, large or small.

We guarantee our prices will save you money

FOLEY VENTILATING APPARATUS IS THE BEST

Is Simple In Erecting. Is Easiest of Operation. It Will Last a Lifetime. Its Price is the Lowest. Will Ventilate Any Size House. Prices and Circulars on Application.

Our 1908 Catalogue Greenhouse Material Sent Postpaid on Request.

THE FOLEY MFG. CO., WESTERN AVENUE
25th and 26th STS., CHICAGO

STANDARD PLATE GLASS CO.

Manufacturers—Importers—Jobbers

NOW IS THE TIME TO BUY

FRENCH OR AMERICAN GREENHOUSE GLASS

LOWEST PRICES ON REQUEST

26-30 Sudbury St. BOSTON, MASS. 61-63 Portland St.

GLASS Always Write Us Before Buying
SHARP, PARTRIDGE & CO.
22nd and Lumber Streets, CHICAGO
WE HAVE SOME SNAPS

CYPRESS SASH BARS 82 feet or longer
HOT BED SASH
PECKY CYPRESS BENCH LUMBER

GREENHOUSES

ERECTED AND EQUIPPED COMPLETE IF DESIRED

Write for Circular "D" and Prices

The A. T. STEARNS LUMBER CO.
NEPONSET, BOSTON, MASS.

Evans 20th Century Arm
Will not twist the shafting pipe. Three times the power of old style elbow arms. Sold only with Evans Challenge Machine.
Write for free Catalogue to
QUAKER CITY MACHINE CO.
Richmond, Ind.

The **FLORISTS' HALL ASSOCIATION OF AMERICA**, insurer of 29,000,000 sq. ft. of glass. For particulars address **John G. Esler, Sec'y, Saddle River, N. J.**

EVERYTHING FOR GREENHOUSE BUILDING

WRITE FOR INFORMATION AND PRICES

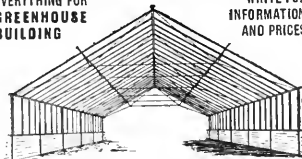

King Greenhouses. King Gutters and Eaves. Trussed Roofs. Ventilating Machinery. Trussed Iron Frame Houses. Tile Benches and Pipe Hangers.

KING CONSTRUCTION COMPANY
NORTH TONAWANDA, N. Y.

PATENTS
Trademarks and Copyrights

Send your business direct to Washington. Saves time and insures better service. Personal attention guaranteed. Twenty-five years' active service. SPECIALTY: "Working on the Failure of Others."

SIGGERS & SIGGERS

PATENT LAWYERS
Box 9, National Union Building
Washington, D. C.



EAVE FACTS

Decreased shade and increased strength are what you are looking for at the eaves — Our way is to use a Galvanized Steel Eave with Roof Bar Brackets — this cut shows you how light it is. Bar End rot is prevented. Ice at the eave line is overcome.

Send for circular which explains it and all about our Half Iron Frame House.

Hitchings & Company
1170 Broadway New York

Sometimes You Forget

that we make every part of a greenhouse but the glass — that we sell any part.

You remember us on the bigger things, but often it never enters your head to think of sending to us for a tub of putty or a few fittings.

But you ought to — and here's why: Our sole business is manufacturing every part of a greenhouse. We give it, and it only, our undivided attention.

Everything we make is made with an exact knowledge of just what conditions it must meet, and that is why an ever increasing number from all over the country are continually sending us their orders for just the smaller things.

You know how well we do the big things, and if you only stop to think, it is just because of well done little things that it is possible for us to do so thoroughly and enduringly the big things. So whether white lead, glazing nails, bench fittings, it matters not what, first write to

Lord & Burnham Co.

Main Sales Office: 1133 BROADWAY, N.Y.

BOSTON: 819 Tremont Building. PHILADELPHIA: 1215 Filbert St.



OVERCOMING THE UNUSUAL

A steep grade, running from east to west is not a very promising outlook for a greenhouse location, still here is a case where it was that or nothing, so we built these U-Bar houses, "stepped up fashion," and put the last house on the lower end, on a wall ten or twelve feet high, and used the space below for potting room and boiler celler — and it makes a fine one too.

Any place where we can make a firm foundation we can build our greenhouses. Their extreme lightness and graceful lines make them attractive whatever the location. Send for our catalog and study it over.

U-BAR GREENHOUSES

PIERSON
DESIGNERS AND BUILDERS



U-BAR CO.
1 MADISON AVE. NEW YORK

HORTICULTURE

Vol. IX.

FEBRUARY 13, 1909

No. 7

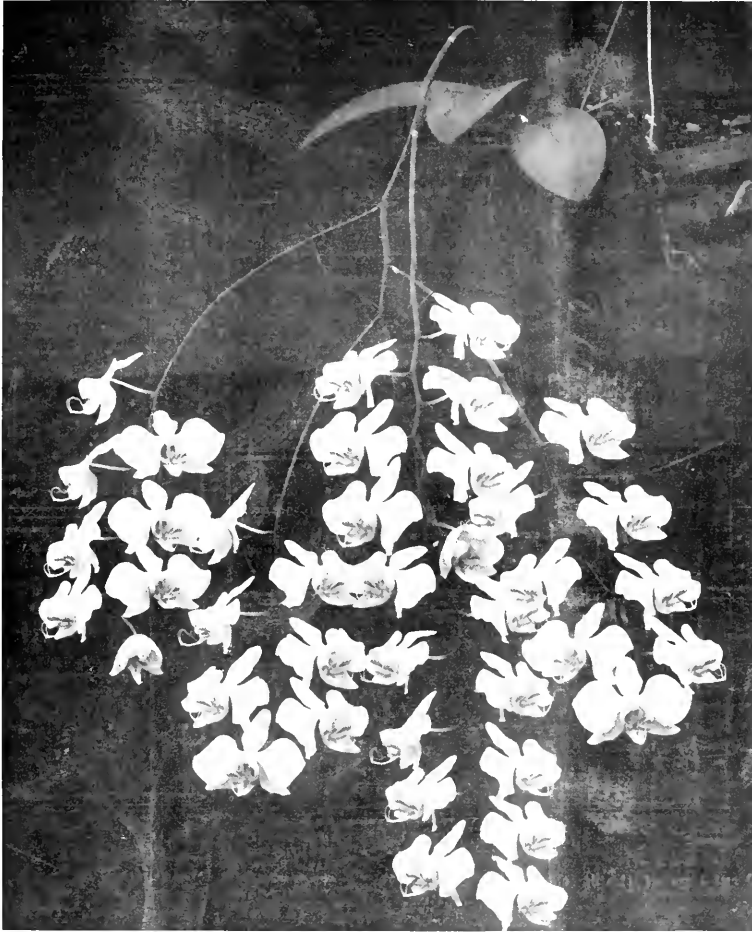

PHALAENOPSIS APEROLEII

DEVOTED TO THE
FLORIST, PLANTSMAN, LANDSCAPE GARDENER AND KINDRED INTERESTS

PUBLISHED EVERY SATURDAY AT 11 HAMILTON PLACE, BOSTON, MASS.

SUBSCRIPTION, \$1 00 PER YEAR



The Great Red WINNER **WM. H. TAFT** Worthy of It's Namesake

Christmas week 4000 blooms were cut from three beds 150 feet long, Flowering continuously since October 1

ROOTED CUTTINGS NOW READY

Prices:—25, \$4.00; 50, \$7.00; 100, \$12.00; 500, \$50.00; 1000, \$90.00

SEND FOR ILLUSTRATED CIRCULAR

The Taft is grown at Evanston, corner of Oakton and Ashbury Ave., Chicago.
Carnation Growers are invited to come and see it

FOLLOWING ARE OTHER VARIETIES ALSO READY FOR IMMEDIATE SHIPMENT:

Enchantress,.....100, \$4 75; 1000, \$15.00	White Lawson,.....100, \$2 04; 1000, \$14 00
Pink Lawson,.....100, 1 50; 1000, 12 50	Variiegated Lawson,.....100, 2 75; 1000, 25 00
Victory,.....100, \$2 50; 1000, \$20 00	

UNROOTED CUTTINGS

Mrs. E. A. Nelson,.....100, \$0.60; 1000, \$5 00	Variiegated Lawson,.....100, 1 50; 1000, \$12 50
Boston Market,.....100, 0.60; 1000, 5 00	Crusader,.....100, 0 0; 1000, 5 00
Pink Lawson,.....100, 0 75; 1000, 6 25	White Lawson,.....100, 1 00; 1000, 9 00

SCHEIDEN & SCHOOS, 58-60 Wabash Ave. CHICAGO

A WIRELESS WINNER

Has Won Absolutely on Its Own Merits. Certificates Innumerable Everywhere
MASSACHUSETTS HORTICULTURAL SOCIETY'S SILVER MEDAL LAST YEAR
AMERICAN CARNATION SOCIETY'S GOLD MEDAL THIS YEAR

THAT'S THE RECORD OF

It is Invincible. **BAY STATE** Buy it and Grow it.

The noblest carnation ever introduced. White with carmine pencillings.

ROOTED CUTTINGS, - \$12.00 per 100, \$0.00 per 1000.

ALBERT ROPER, - - - - - TEWKSBURY, MASS.

NEW RED CARNATION **O. P. BASSETT**

Extra Large Bright Red Free Bloomer

Rooted Cuttings, per 1000, \$60.00 | Rooted Cuttings, per 500, \$30.00 | Rooted Cuttings, per 25, \$25.00
per 500, 35.00 | per 50, 4.50 | per 25, 1.50

Ready for delivery Jan. 1st, '09 by the Originators and Growers

BASSETT & WASHBURN, HINSDALE, ILL

GARNATIONS **ROSE MY MARYLAND**

Standard sorts and all the novelties of merit.

Orders booked now for this most promising variety.

CHRYSANTHEMUMS The cream of the commercial sorts. Send for our price-list. We can quote you right and supply first class stock.

S. J. REUTER & SON, WESTERLY, R. I.

MY COMPLETE LIST OF MUMS, GARNATIONS AND ROSES

has been mailed you. If not yet received send me a postcard. I carry over 300 varieties of **The Finest Chrysanthemums in Commerce** and offer you just the cream of the world's novelties, discarding the poor ones. **Saves You Money and Me Trouble.** New Carnations ready for immediate delivery **Bay State, Georgia, Mrs. J. C. Vaughan, \$12.00 per 100; \$100.00 per 1000. Mrs. O. P. Bassett, \$8.00 per 100.**

CHARLES H. TOTTY, - Madison, N. J.

JUST AS A REMINDER TO OUR PATRONS

We have rooted cuttings of the best
CARNATIONS
PATTEN & COMPANY, Tewksbury, Mass.

NEW CARNATION PINK DELIGHT

Waxy Shell Pink. A Grower's and Shipper's favorite. Has a bolding color, keeps well, comes on long stems and is early, very free and continuous flowering.
March 20th delivery, \$12 per 100, \$100 per 1000.

F. Dorner & Sons Co., La Fayette, Ind.

GARNATIONS Rooted Cuttings Fine Healthy Stock

Pres Seelye - - - - -	Per 100	Per 1000
White Enchantress, Beacon	3 50	30 00
Victory, Winsor, Melody, Kingston Pet - - - - -	3 00	25 00
Dahrim, Enchantress, Lady Bountiful, Mrs Lawson, White Lawson, Red Lawson, Variegated Lawson	2 50	20 00

WOOD BROTHERS FISHKILL, N. Y.

In ordering goods please add "I saw it in HORTICULTURE."

Rooted Carnation Cuttings

WHITE,	per 100	per 1000
Sarah Hill,	\$6 00	\$50 00
Pres. Seelye,	6 00	50 00
Lloyd,	5 00	40 00
White Enchantress,	3 00	25 00
White Perfection,	3 00	25 00
Lady Bountiful,	3 00	25 00
White Lawson,	3 00	25 00
LIGHT PINK,		
Pink Delight,	12 00	100 00
Play Day,	3 00	25 00
Enchantress,	3 00	25 00
Melody,	3 00	25 00
PINK,		
Splendor,	6 00	50 00
Winsor,	3 00	25 00
Rose Pink Enchantress,	3 00	25 00
Welcome,	3 00	25 00
CERISE PINK,		
Lawson-Enchantress,	6 00	50 00
Afterglow,	6 00	50 00
Aristocrat,	4 00	35 00
SCARLET,		
Andrew Carnegie,	6 00	50 00
Defiance,	6 00	50 00
Beacon,	4 00	35 00
Victory,	3 00	25 00

Chicago Carnation Co. A.T.Pyfer, Joliet Ill, Mgr.

GARNATION CUTTINGS

We offer choice varieties for January and later shipments.

	Per 100	Per 1000
Enchantress.....	\$2.50	\$20.00
White do.....	3.50	30.00
Rose Pink do.....	2.50	20.00
White Perfection.....	2.50	20.00
Wiosor.....	3.50	30.00
Melody.....	2.50	20.00
Beacon.....	3.50	30.00
Victory.....	3.50	30.00
Aristocrat.....	3.50	30.00
Splendor.....	6 00	50 00
Vesper.....	3.50	30.00
White Lawson.....	2.50	20.00

EAST SUDBURY GREENHOUSES, Carnation Specialists

P. O. Address South Sudbury, Mass.
Telephone No. Sudbury 20.

Send for our Preliminary List describing and quoting

Chrysanthemums and Carnations.

A fine lot of

Carnation Cuttings
ready now.

THE E. G. HILL CO.,
Richmond, Indiana.

PETER FISHER ELLIS, MASS.

Send for Price List of Carnations

NEPTUNE

is the only yellow Carnation on the market that is worth growing. Very strong. Free and easy grower. Hasn't burst 1/2 of 1 per cent in 4 years. Well rooted cuttings now ready, \$8.00 per 100. Other commercial varieties at reasonable prices.

PAUL THOMSON, Grower
West Hartford, Ct.

New Rose **White Killarney**

Come and see White Killarney growing at our Scarborough houses, and you will say at once, as every one does who has seen it, it is

The Best White Rose

they have ever seen. You need it if you want to be up to the times, and it will pay you better than any other white rose that you can plant. You will regret it if you do not plant it this year, and you will not regret it if you do.

Big lots are being booked. Get your order in early. Send us order at once, while you think of it. Get early stock. It will not cost you any more to order to-day, while you think of it, than it will two months from now. Be the early bird that catches the worm.

Strong young plants, 2 1/4-inch pots, own-root, ready for delivery beginning February 15th, 1909, \$30.00 per 100; 250 for \$70.00; 500 for \$125 00; 1000 for \$250.00. Grafted plants, ready for delivery beginning March 1st, 1909, \$5 00 per 100 additional.

F. R. PIERSON CO., Tarrytown-on-Hudson NEW YORK.

Newport Fairy

The Rose of the Future For
In and Out Door.

FINE, STRONG FIELD-GROWN STOCK

3-4 Shoots 3-4 ft. long

50c each, \$30 per 100, \$250 per 1000

JULIUS ROEHR'S CO.,
RUTHERFORD, N. J.

Hardy Rhododendrons, Azaleas, Conifers, Clematis, H. P. Roses, Shrubs and Herbaceous Plants from our HOLLAND NURSERIES

Prices Moderate

P. OUWERKERK, 210 Jane St., Weehawken Heights
P. O. No. 1, Hoboken, N. J.

CLEARY'S HORTICULTURAL CO.

Management AMBROSE T. CLEARY

Wholesale Contracting, Jobbing, Auction
HORTICULTURAL PRODUCTS
of every description.

Consignments Received. Surplus Stock Converted
62 Vesey St., NEW YORK

Box Trees

and other EVERGREENS for Tubs and Boxes
Our Prices are Always Right—Catalog Free
THE NEW ENGLAND NURSERIES, Inc.
BEDFORD, MASS.

California Privet.

We have 10 acres to offer for sale this Spring. All 2 years old, 2 to 2 1/2 ft. high, 8 to 12 branches and well graded. We are booking orders daily now. \$2.75 per 100; \$22.50 per 1000. 500 at 1000 rates.
Packing Free. Cash with Order.

JOHN BENNETT, Atlantic Highlands, N. J.

ROSES

We have a fine stock of large, dormant field-grown plants, on own roots, including Crimson Rambler, Dorothy Perkins, Clim, Alfred Colomb, Francois Levay, Jack, Prince Camille de Rohan, Magos Charta, Ulrich Brunner, Giant of Battles, and many others at \$26.00 per hundred; \$150.00 per thousand. Send for list. Roses, Dahlias and Cannas a specialty.

THE DINGEE & CONARD CO. W. Grove, Pa.

RHODODENDRONS, ANDROMEDES, KALMIAS AND SPECIMEN EVERGREENS

JOHN WATERER & SONS, Ltd.

AMERICAN NURSERY

BAGSHOT - - - ENGLAND

TREES, EVERGREENS, SHRUBS, VINES, PERENNIAL PLANTS, FRUITS, TRAINED FRUIT TREES, FOREIGN GRAPE VINES, HARDY RHODODENDRONS and R. MAXIMUM in quantity, per hundred or per thousand, very fine. Complete assortments: Careful grading: Low prices.

AMERICAN NURSERY COMPANY,

Sales Department, - - - 150 BROADWAY, NEW YORK CITY.
BLOODGOOD NURSERIES DEPT., - - - Flushing, Long Island.
F. & F. NURSERIES DEPT., - - - Springfield, New Jersey.

RHODODENDRONS-RHODODENDRONS

An immense stock of all the **hardest known kinds**, 2 to 3 1/2 ft., fine plants and all home grown, many being on own roots, far better than grafted stock—also **R. Catawbiense seedlings** of all colors and **seedling Hardy Azaleas** not to be obtained elsewhere. ~~BT~~ This is the nursery in which most of the Rhododendrons that have proved **hardy in America** were raised.

GOLDEN YEW'S, KALMIAS, and other **HARDY PLANTS** in great variety and of all sizes.

Catalogues on Application

ANTHONY WATERER **KNAP HILL NURSERY** **KNAP HILL**
SURREY, ENGLAND

(NO CONNECTION WHATEVER WITH ANY OTHER FIRM.)

THE PRIZE WINNING STRAWBERRY

The Barrymore

Send for Folder at Once.

H. L. CRANE, Originator,
Westmore, Mass.

If you want to do business
Advertise in Horticulture.

ROBERT CRAIG CO.

ROSES, PALMS,

and Novelties in Decorative Plants

MARKET and 49th STREETS, PHILADELPHIA, PA.

BARGAINS in TREES and PLANTS

Concord Grapes, \$2.00. Peach, \$3.00 per 100.
List Free. D. J. TWOMEY, Dept. H, Geneva, N. Y.

ORCHIDS-ORCHIDS-ORCHIDS

BURMESE DENDROBES

Just to hand in fine condition :

Dendrobium Thysiflorum..... each \$2.00	Dendrobium Nobile.....	Dendrobium Gretaceum.....
" Brymerianum..... " 5.00	" Chrysoctenax.....	" Bensonii.....
" Victory, small plants. A new Dendrobium like Nobile, but darker and larger,..... " 3.00	" Heterocarpum.....	" Crystallinum.....
Dendrobium Falconerii..... each 1.25	" Densilorum.....	" Parishii.....
	" Farmerii.....	" Capellieri.....
	" Luteolum.....	

To arrive in a few days :

Established plants of Cypripedium Insigne, 5 and 6 in. pots, \$50 per 100

JULIUS ROEHRS CO., - - RUTHERFORD, N. J.

ORCHIDS

We beg to offer the following **EAST INDIAN ORCHIDS** just arrived in fine condition.

DENDROBIUM WARDIANUM, fine plants at \$18.00 to \$30.00 per dozen

DENDROBIUM CRASSINODE, fine plants at \$24.00 per dozen

DENDROBIUM PRIMULINUM, fine plants at \$30.00 per dozen.

Other shipments to follow. Write us for prices on any orchids you may require.

LAGER & HURRELL Summit, N.J.

ORCHIDS

Fresh Imported for Spring Delivery
Cattleyas, Laelias, Oncidiums, etc.

Write for Prices

My new Catalogue is now ready; if you have not received one, send for it.

JOSEPH A. MANDA, West Orange, N.J.

We Have A Fine Lot of C. Trianæ in bloom at very low prices, and will sell plants in bloom or cut blooms at 15 per cent. less than the market price.

ORDONEZ BROS. Madison, N. J.

ORCHIDS

We are booking orders now for delivery early in the Spring on all commercial **CATLEYSAS** and **NOVELTIES**. Our prices are right and our guarantee perfect. We sell only first class goods.

CARRILLO & BALDWIN, Secaucus, N. J.

ORCHIDS

Largest Importers, Exporters, Growers and Hybridists in the World

Sander, St. Albans, England
and 235 Broadway, Room 1
NEW YORK CITY

HEACOCK'S PALMS

Kentia Belmoreana	
7-inch pots.....32 to 34 inches high.....	\$2.50 each
7-inch pots.....36 to 38 inches high.....	3.00 "
9-inch tub.....42 to 48 inches high.....	5.00 "
<i>Made up Kentia Forsteriana</i>	
7-inch pots.....34 to 36 inches high.....	\$2.50 each
7-inch pots.....36 to 38 inches high.....	3.00 "
9-inch tub.....42 to 48 inches high.....	5.00 "

Joseph Heacock Co., Wyncote, Pa.

Prices Quoted in these Columns are for Dealers Only.
When Writing to Advertisers Please Mention
HORTICULTURE.

DECORATIVE PLANTS

Araucaria Excelsa, Pandanus Utilis, Dracaena Indivisa, Kentias, Latanias, Arecas, etc. Perennials and Shrubs.

4 inch Araucarias.....50 cents each.	6 inch Araucarias.....\$1.00 each.
5 " ".....75 " "	7 " ".....\$1.25 and \$1.50 "

FERNS FOR DISHES—\$3.50 per 100, \$30.00 per 1000.
SEND FOR OUR PRICE LIST. WE HAVE A COMPLETE STOCK.

The Geo. Wittbold Co.

1657 Buckingham Place, Chicago, Ill.

FERNS FOR DISHES,

Assorted Varieties
From 2 inch pots, \$3.50 per 100; \$30.00 per 1000

CASH WITH ORDER
2570 to 2606 W. Adams St., Chicago, Ill.

FRANK OEGHSLIN

BARGAINS

in **KENTIAS** and other Decorative Plants, all sizes. Also the following at Lowest Import Prices: 15,000 Azaleas, best commercial varieties, from \$25.00 per 100 to \$2.00 each. A fine lot of Rubbers, Crotons, Araucarias, Pandanus, Asparagus plumosa and Sprengeri.

SMALL FERNS

for table decorative purposes at lowest wholesale rates.

A. LEUTHY & CO.,

Perkins St. Nurseries, ROSLINDALE, MASS.

HEADQUARTERS FOR

Araucaria Excelsa, 6 in. pots, 5-6 tiers, 75c.	\$1.125;
Robusia Compacta and glauca, 20 to 30 in. high,	\$1.00, \$2.00.
Ficus elastica, 5 1/2 in. 25c, 35c, 50c.	
Kentia Belmoreana, 4 to 5 1/2 in., 35c, 50c, 60c.	
Forsteriana, 5 to 6 in., 50c, 60c, 75c.	\$1.00, \$1.25, \$1.50.
Boston, Scottii and Whitmanii Ferns, 8 to 7 in. pots	50c, 75c, \$1.00, \$1.50.
American Hill, 5 1/2 in., 35c, 50c.	
Azalea Apollo in bloom, 75c.	\$1.00.
Cineraria Hybrida for Easter, 3 in. sc, 6 in. 25c.	

GODFREY ASCHMANN

1012 W. Ontario St., PHILADELPHIA, PA

CYCLAMEN GIGANTEUM

5, 6 and 7 in. pots—50c, 75c, and \$1.00 each.

Extra heavy stock of the very best quality.

Thomas Roland,

Nahant, Mass.

PALMS AND FERNS

DECORATIVE PLANTS

JOHN SCOTT
Rutland Road and E. 45th St.
Tel. 2890 Bedford BROOKLYN, N. Y.

NEP. WHITMANI

2 1/4 in., \$5.00 per 100

NEP. WHITMANI

3 1/2 in., \$25.00 per 100

BOSTON FERNS

2 1/4 in., \$3.00 per 100

H. H. BARROWS & SON, Whitman, Mass.

PEACOCK'S NEW DAHLIAS

SEND FOR LIST

PEACOCK DAHLIA FARM

Williamstown Junction, N. J.

DAHLIAS.

Now is the time to place your order for bulbs which will insure you getting named varieties in any quantity; prompt delivery.

DAVID HERBERT & SON,

Successors to L. K. Peacock, Inc.
ATCO, N. J.

The Northboro Dahlia and Gladiolus Gardens

Offer for Spring 1909

300 selected varieties of Dahlias and one and one-half million large-flowering Gladioli in mixtures, in lots to suit. Send list of your wants. Catalogue free.

J. L. MOORE, Northboro, Mass.

Thrips and Their Response to Light and Heat

THE GENERAL DESCRIPTION OF THIRPS

Thrips are very small insects. The females of the species considered in this article are from one twenty-fifth to one-twentieth of an inch in length while the males are smaller, those of *E. tritici* being about one thirty-second of an inch long. Some species of thrips infesting other plants are larger and some are smaller than those described here. All the species known to infest greenhouse plants are winged species, though at certain seasons many or even all the individuals may be wingless or else have only short wing pads. The wings are four in number, long and membranous. They are never folded. The hind margin is always and the fore margin generally, fringed with long slender hairs, in length greatly exceeding the breadth of the membranous part of the wing. The name of the order, Thysanoptera to which these insects belong, is derived from two Greek words meaning tassel-wing and one of the common names, Fringe Wings, is based on this peculiar wing structure.

The antennae are very slender, six to eight jointed structures. Besides the faceted eyes, two or three ocelli are present on the winged forms, even though the individual may not at the time possess wings. These ocelli are not present in the larval stage.

The feet are not terminated by a claw, but the tip is fitted with a protrusible bladder-like organ. This gives rise to the name Blasenfusse or Bladder-feet and the scientific name Physopoda.

The mouth parts are intermediate in form between those of chewing and sucking insects but are believed to be used for sucking. Some of the parts which form a peculiar cone far back beneath the head are modified to a piercing organ with which the insect pierces the tender parts of plants and withdraws the sap. It is therefore impossible to kill thrips by spraying or dusting poisons on the plant, notwithstanding the opinion of some growers. Any benefit, if such there be, is due to other action of the material applied.

REPRODUCTION

Reproduction is oviparous, that is, multiplication by means of eggs. Reproduction is either bisexual or parthenogenetic. The latter method, i. e., reproduction without fertilization by the male, is thought by Dr. Hinds to be the usual means of reproduction in at least ten species and that it occurs in many others. He states further that the females almost always outnumber the males and that in some species males are found at certain seasons, in others the males are rare and in others unknown. The eggs of thrips, so far as they have been observed, are bean-shaped and when fresh, clear white in color. In size they are very minute, those of wheat thrips being .009 x .003 of an inch.

The female thrip lays her eggs in the green parts of plants, first cutting a slit with her saw-like ovipositor,

after which the egg is pushed down into the tissue below the epidermis. The operation has rarely been observed but so far as known requires only a minute and a half. The short time required for this operation, together with the fact that the insect, when possible, remains concealed, makes it difficult to discover where the insect lays its eggs. Again, it is impossible to know when the egg laying is about to begin. Sometimes the tissue is too hard and the insect is unable to withdraw the ovipositor, and the insect is kept a prisoner until relieved by death.

In the pupal stage the insect is quite inactive, changes color and usually retires to a quiet spot where it does not feed. During this stage the wings, the ovipositor and the genital organs develop. The insect emerges a fully developed adult. It is a noteworthy fact that the young thrips resemble the adult insects in general form, in structure of the mouth parts, and in food habits. They differ in lacking wings, in color, which is lighter than the mature insect, and in some of their activities.

Prof. Quantance says that the life cycle of *Thrips tritici* is twelve days under summer conditions in Florida. The egg state lasts approximately three days, the larval stage five days, the nymph state four days. In the north, especially in the high spring and autumn temperatures in greenhouses, no doubt the life cycle approaches or equals this. The same writer finds the life cycle of Onion thrips is approximately sixteen days, divided as follows: egg state three and a half days, larval stage seven to nine days, and pupal stage three days.

HIBERNATION

The studies thus far made upon thrips indicate that they pass the winter in the same place they have fed. Those feeding on leaves and flowers hibernate under the dead foliage and in the dried flowers. The grass-inhabiting species, among which are those doing the most damage to cut flowers, pass the winter in the turf. In such situations they can endure very low temperatures without suffering injury as shown by the fact that they revive quickly when brought into warm quarters. They emerge very early in the spring and begin their activities as soon as the growth of their food plants starts.

Hibernating thrips can be destroyed by burning all dead grass, weeds, flowers, remains of vegetables, leaves, etc., in the vicinity of the greenhouses but to be effective this should be done before April 1st.

THE EFFECT OF TEMPERATURE AND LIGHT ON THIRPS

From the results of many observations it appears that thrips are not very active at temperatures below about 65 degrees F. On cloudy and rainy days when the temperature in carnation houses is more nearly that maintained at night (50-52 degrees) it has been found that thrips are rarely seen outside the buds. When the temperature rises above 60 F. thrips become more active and if the sunlight is not very intense they may be seen outside the buds in the majority of cases in the morning.

The effect of temperature on thrips activity is shown by the well known fact that, like red spider, they cause most damage in the warmer parts of the house. A case in point was the result obtained from two benches of

Mrs. T. W. Lawson. One bench was near the wall with a narrow walk separating them and in this walk at about the height of the bench a return steam pipe from the rose houses. The other was a center bench with only the usual heating pipe below. On the first described bench 9 per cent. of the buds were injured by thrips while on the center bench there were 5 per cent. injured buds during the season from November to June. The difference decreased as the season advanced for in April there was a difference of one per cent. in favor of the center bench but in May the results were the same. The conditions were unlike because of the radiation from this return pipe but as the sun heat increased and the artificial heat was less used, the conditions on the two benches were more nearly equal and the thrips' injury became proportionately equal as we would expect. These results are based on an examination of 27,038 buds and flowers during each week from Nov. 1, 1907, to June 1, 1908.

The foregoing indicates what takes place under small variations of temperature when other conditions are similar. These warmer parts should be remedied when possible but in all cases the plants growing therein should be carefully watched for thrips and red spider.

In cucumber houses, where the temperature is kept above 60 F. at night, Thrips tabaci often increases when unchecked to such an extent as to destroy the crops. On the other hand so far as we have had opportunity to study thrips in lettuce houses they are only abundant in October and November and decrease as the season advances. In spring the crop in these houses is changed so that there was no opportunity to learn if there was a spring invasion.

During April and May there were opportunities to get more information on the effect of temperature on thrips, since the difference between the day and night temperatures was greater than in winter. The results of the earlier observations were confirmed. Thrips tritici on roses retire within the unfolding petals of the flower as night approaches, where they feed along the edges of the petals and especially in the point of the bud. This night feeding in the point of the bud results in the disfiguring of all the petals and renders the flower worthless. In the morning as the temperature rises the thrips of this species move out to more exposed positions on the petals that have unrolled. Here they feed further from the edges of the petals. It is a noteworthy fact that if the sun is shining they place themselves so that the petal is between themselves and the sun. In this position they have all the advantage of the temperature with the least light.

The thrips on carnations were less often seen outside the buds as the days became longer. This species is more responsive to heat and light for on cucumbers the adults could be seen late in the afternoon crawling over the edge of the leaves to the upper surface where they fed during the night. In the morning if the day was cloudy they remained where they were but when the sun came out they retired to the lower surface. On a sunny morning it was interesting to observe the relative numbers of thrips on the upper surface of leaves in sunny and shaded parts of the house or even on the same plant in sun-shine and shadow.

Thrips femoralis on the calla feeds on the lower side of the leaves whether the day is cloudy or otherwise, but it does feed to a certain extent on the upper side at night as shown by the fact that the leaves show injury there. The preference is for the lower surface. On the amaryllis from observations on a limited number of plants

this species prefers the upper surface where the result of its feeding is seen in bright red spots which later become brown and dead.

In every case in which I have observed the development of thrips in greenhouses on callas, carnations, cucumbers and roses they made their appearance first and caused greatest injury in the warmest part of the house. Further than this the leaf infesting thrips in the immature stages are found on the under sides of the leaves where they have hatched and are least exposed. On roses the immature thrips were never observed feeding exposed. Even the adult insect when feeding in carnation buds and shoots remains almost wholly concealed.

Mr. J. A. Davis, my assistant in certain phases of the life history of this insect, made the following laboratory experiments to determine the reactions of the thrips towards heat and light. Adult *Heliothrips femoralis* were placed on carnation buds, twenty-five on each bud. The buds were then placed in lamp chimneys, covered with gauze to prevent the escape of the insects, and the cages placed under the following conditions. Two cages were placed side by side so the temperature was the same, one of them being exposed to light and the other covered so as to exclude all light. The other two were placed one in the insectary room and the last in the office, the light intensity being apparently equal but the temperature of the rooms unequal. In general the experiments to determine the effect of light showed that more thrips were out on the bud where light was totally excluded but if the temperature became unequal the results were changed very noticeably. When the thrips were out on the bud in the lighted cage they were on the shaded side as far as possible, this being less marked early in the morning than at mid-day. Temperatures 60 and 70 F. showed the greatest difference in activities of thrips compared with any other equal difference of temperature. In these cages also thrips avoided intense light when possible. Mr. Davis concludes from the results of these tests that thrips activities are largely or almost entirely occasioned by the temperature and that light is only a secondary consideration.

It appears that thrips do not thrive where the night temperature is low with only a moderate rise in the day temperature but where this rise is great or when the lowest temperature is above 60 they find conditions suited to their welfare. In the first case thrips are less active feeding but they respond quickly to the rise in temperature in the morning due to the sun heat. In cucumber houses the thrips are not hindered by any unfavorable temperature.

To secure the greatest results from the use of an insecticide for the destruction of thrips we must know its habits for it is apparent to any one that they are difficult to kill when they have pushed their way down into a carnation bud. Since it has been shown by observation and experiment that thrips are more active in the morning and if they are outside the buds it is at this time a comparison of the results of using insecticides in the evening and in the morning is of interest. It was found that when fumigating was done at five o'clock in the morning during May the efficiency of Nicotinic, Tobacco, and Nikoten was respectively increased 18, 21 and 20 per cent. over those obtained from using the same insecticides in the evening. The same reasoning applies to spraying but as it is the general practice to spray in the morning no tests were made on this particular point.

European Horticulture

NOVELTIES IN ORCHIDS IN 1908 IN ENGLAND.

As regards orchids of great splendor the hybridists appear to lead the way, for not many new species have been imported. It is gratifying to note the recognition enjoyed by the so-called botanical species, and which is their due. Sir Trevor Lawrence, President of the Royal Horticultural Society, gardener W. H. White, exhibited at the society's meetings and showed a good number of showy novelties. Among them Cattleya Mossiae Goossensiana and Odontoglossum Wigamianum superbum obtained first-class certificates; and Cattleya Maronii aurea, Catasetum Russellianum, Cirrhopetalum Wendlandianum, Angracum angustum, A. Germinyanum, Dendrobium, Jerdonianum, Odontoglossum platycheilum superbum, and Epidendrum virens obtained awards of merit.

Sir J. Colman of Gatton Park, gardener Mr. Collier, received awards for a number of hybrids raised at that place. Of these mention may be made: Cymbidium Gattonense (C. Tracyanum x C. Lowianum), C. Lady Colman (C. eburneo-Lowianum x C. Tracyanum), both graceful hybrids; the white Diacattleya Colmanae, Dendrobium Cybele Gatton Park variety, D. Thwaitesia Bound's variety; the Gatton Park variety of D. Chessingtonense; the yellow D. Brymerianum, and the singular looking Bulbophyllum nimum. Mr. Collier succeeded in flowering for the first time the interesting B. lemniscatoides.

Lieut.-Col. G. L. Holford, of Westonbirt, Gloucestershire, gardener Mr. Alexander, had as in former years the larger number of hybrids, all of which were raised in his garden. The Royal Horticultural Society first class certificates were awarded to Cypripedium Sultan, C. Helen H. and C. Acteus Bianca, all of them fine flowers; to Brasso-Cattleya Heatonensis, Laelio-Cattleya Elva, L. C. Clive magnifica and the fine Cattleya Schroderae "The Baron," a splendid variety of F. Sander & Son's importation. Lieut.-Col. Holford received awards of merit for numerous Laelio-Cattleyas and Cattleyas, C. Enid magnifica being an extremely fine variety; Cypripedium Rossettii a very beautiful yellow; Sophro-Laelio-Cattleya Dana and S. L. C. medea vinicolor; Cypripedium Antinons, a handsome flower.

Mr. J. Gurney Fowler obtained a first class certificate for the scarlet colored Sophro-Cattleya Doris one of the brightest colored novelties of the year. Other fine novelties exhibited by him were Odontoglossum percutum J. R. Roberts, Od. Ossulstonii Glebeland's variety, Cypripedium Ernest Read and Catasetum maculatum.

The finest Cattleya Mendelii, His Majesty The King, shown by Mr. Francis Wellesley, of Westfield, Woking, received a first class certificate. The smaller exhibits of new orchids, and those of nurserymen will be given in a subsequent issue.

A NEW HYBRID NEPENTHES

Under the name of N. Dr. John MacFarlane, a hybrid Nepenthes was shown by Messrs. J. Veitch & Sons on September 29 last, which had been raised by them from a cross of N. Curtisii and N. sanguinea. The pitcher is 7-8 inches in depth, and is of a brownish-red tint splashed with a deeper tint, and in the upper part of the interior, just beneath the operculum or lid curious markings of dark purple color stand out strikingly from the bright green walls. The keel is furnished with two rows of stiff bristles. The operculum barely

suffices to cover the entrance to the pitcher. The leaves measure 5 to 6 inches in breadth. The plant when shown bore five large pitchers and several smaller ones. It was awarded a first-class certificate.

Frederick Moore

Sweet Pea Novelties in England

There is apparently no wane of the sweet pea "boom" which has now stood the test of several seasons. The supply of new varieties is well maintained; the difficulty is that nurserymen's catalogues are getting overcrowded with varieties, and this causes a good deal of perplexity to the amateur in making a selection. There is evidently a weeding out process needed, with the view of getting rid of some of the obsolete kinds which have been superseded by more attractive forms of a similar tint. The following are among the chief novelties now being offered: Mrs. Henry Bell, soft pink, on an apricot ground; St. George, fiery orange; Mid Blue, deep blue; Memie Christie, purple mauve standard, with wings of a lighter tint; Queen Victoria flushed with rose, on a background of deep primrose; Apple Blossom of a tint the name indicates; Mrs. Charles Masters, rosy salmon standard with pure cream wings; Dodwell F. Browne, bright crimson; Mrs. Wilcox, striped; Sunrise orange pink; Miss Frills, pale blush. The National Sweet Pea Society, which has done so much to further popularise the flower, will continue their trials this season at the University College, Reading, where the best conditions are obtainable for securing reliable results. In addition to the show and trials the society also are rendering a useful service in issuing a "Year Book," which gives the novice the fullest guide in selecting the best varieties, and in attaining the highest cultural efficiency.

W. H. Adsett.

London, Eng.

Phalaenopsis Aphrodite

Our cover page picture represents a good specimen of Phalaenopsis Aphrodite in the collection of Mrs. B. B. Tuttle of Naugatuck, Conn. It shows what the species is capable of under cultivation. This panicle produced forty-five flowers, five of them having dropped off when the picture was taken. However one does not get such grand spikes on all plants, from eighteen to twenty-five being considered a good crop. Some plants will invariably throw up branched panicles with many flowers, while others will produce less, but much better and larger flowers.

This plant, like many others in the collection has been growing in osmunda fibre for the past three years and they evidently seem to like to grow in this material. An occasional feeding with weak liquid manure helps to build up good strong leaves and flower spikes. The plants must be well ripened off in the fall by keeping the house a little cooler and dryer and by giving the plants plenty of fresh air and all the light available without scorching the leaves. Keep a sharp lookout for thrips and other in-sect pests.

M. J. Pope

Naugatuck, Conn.

HORTICULTURE

VOL. IX

FEBRUARY 13, 1909

NO. 7

PUBLISHED WEEKLY BY

HORTICULTURE PUBLISHING CO.
11 Hamilton Place, Boston, Mass.

Telephone, Oxford 323
WM. J. STEWART, Editor and Manager

SUBSCRIPTION PRICE

One Year, in advance, \$1.00. To Foreign Countries, 2.00. To Canada, \$1.50

ADVERTISING RATES

Per Inch, 30 lines to page \$1.00
Discounts on Contracts for consecutive insertions, as follows:
One month (4 times) 5 per cent.; three months (12 times) 10 per cent.;
six months (26 times) 20 per cent.; one year (52 times) 30 per cent.
Page and half page spaces, special rates on application

Entered as second-class matter December 8, 1904, at the Post Office at Boston, Mass under the Act of Congress of March 3, 1879.

CONTENTS

COVER ILLUSTRATION Phalaenopsis Aphrodite....	Page
THRIPS AND THEIR RESPONSE TO LIGHT AND HEAT Prof. A. C. Beal.....	205
EUROPEAN HORTICULTURE—Frederick Moore....	207
SWEET PEA NOVELTIES IN ENGLAND—W. H. Adsett.....	207
PHALAENOPSIS APHRODITE M. J. Pope.....	207
AFTER ADJOURNMENT.....	209
CARNATION WILLIAM TAFT Illustrated.....	209
NEWS OF THE CLUBS AND SOCIETIES:	
Pittsburgh Florists' and Gardeners' Club—Chicago Florists' Club—Albany Florists' Club—Massachusetts Horticultural Society.....	210
Gardeners' and Florists' Club of Baltimore—New York Florists' Club—Society of American Florists American Rose Society.....	211
Tennessee State Nurserymen's Association—Carnation Show at Detroit—Gardeners' and Florists' Club of Boston—Club and Society Notes.....	212
Royal Horticultural Society, Fred'k Moore.....	214
A GREAT ORCHID EXHIBITION.....	212
DURING RECESS:	
French Gardens at London—Newport Horticultural Society.....	212
North Shore Horticultural Society—St. Paul versus Minneapolis.....	213
OBITUARY:	
W. C. Krick—Fred. Ashley—John Griffith—Mrs. T. C. Mellen—Hiram Myers—Edward T. Elton, Jr.—John H. Righter Wm. A. Munroe.....	214
A METHOD OF CULTIVATING PRIMULA OBCONICA—Fred'k Moore.....	214
SEED TRADE:	
The Cammers' Convention.....	219
The Blue Grass Question, Albert McCullough—Watson on the Seed Trade—Notes—Catalogues Received.....	220
FLOWER MARKET REPORTS:	
Baltimore, Boston, Buffalo, Chicago, Detroit, Indianapolis, Philadelphia, Twin Cities, Washington, New York.....	225
MISCELLANEOUS:	
Behavior of Lawson Carnation.....	209
A Pressing Call.....	209
Hawaiian Pineapples for Seattle.....	209
A Lincoln Window, Illustrated.....	213
Rhode Island State Board of Agriculture.....	213
Spring Plant Trade.....	215
Publications Received.....	215
Catalogues Received.....	216
Philadelphia Notes.....	217
About Hot Beds.....	217
Fire Record.....	217
Personal.....	222
Steamer Departures.....	222
Incorporated.....	222
In Bankruptcy.....	222
New Retail Flower Stores.....	223
Business Changes.....	223
News Notes.....	223
Patents Granted.....	223
Greenhouses Building or Contemplated.....	224

We give space in our reading columns to the announcement and preliminary schedule of prizes for the notable orchid exhibition which is to be held in Boston in May, 1910. The prizes offered by the Massachusetts Horticultural Society are unprecedented in this country and, with the special premiums which may be added from other sources, will undoubtedly bring out an exhibition of great extent and rare beauty. It is expected that this exhibition will stir the blood of the expert plant growers and incite to old-time rivalry the giants of horticulture under glass. All the accomplishments and accessories will be of a character commensurate to the occasion.

As the time approaches for this important event it becomes more and more apparent that it is to be a much more pretentious affair than any of its annual predecessors and the claim that it will take rank as the most notable exhibition of the year from the standpoint of direct benefit to the commercial florist would seem to be well founded. Naturally carnations will, as heretofore, hold the lead in quantity and interest and in this particular the enterprise will invite comparison with the recent effort of the American Carnation Society at Indianapolis, but other departments of commercial floriculture will also be strongly in evidence. This exhibition differs from all other prominent shows in this country because of its spontaneous origin and growth. On this account no one can say to what extent it may yet develop. Up to the present time it has made lusty progress without any of the expedients usually resorted to in such enterprises. In fact, like Topsy, it "just grewed," and it gives every promise of still greater expansion in the future.

We should be sorry to appear disposed to assume anything like a censorious attitude toward the worthy secretary of the S. A. F., but we feel impelled to record our grave doubts of the wisdom of publishing unnamed, indefinite protests such as that which was given publicly last week over the signature of the Secretary in regard to the registration of a rose by a member of the Society. Anonymous criticisms when circulated are often prolific of mischief and have been responsible for many heart-burnings and shattered friendships among the fraternity in the past. We know nothing of the merits of the case nor even the identity of the protestants in this particular instance but if the name of the accused must be brought into the open then let the name of the accuser be coupled with it in the publicity given. Otherwise the publication of such a protest bears an aspect of unfairness, as a reflection not yet justified, which in the minds of some, at least, will have the effect of an aspersion. For these reasons the course seems a dangerous one for the S. A. F. to follow.

After Adjournment

It is fair to assume that the horticultural industry of tomorrow will excel that of today, as much as today's outstrips that of yesterday. The man who thinks the limit has been reached is booked for a surprise party before he is many years older.

We found among last week's issue a number of copies where the sheets had been misplaced in binding, thus bringing several pages in the wrong place. If any such have been received by subscribers we will thank them to notify us, when we shall be glad to replace them with perfect copies.

The newspapers have grabbed up another horticultural marvel—the only rose absolutely without thorns and with flowers of unusual beauty," produced by a lady "now of Seattle," who was for several years "a neighbor of Luther Burbank in California, where she studied his methods." These rivals of Luther are cropping up here and there continually. Hope he'll not feel jealous.

How elated those New Yorkers are over that "Roman" banquet hall which is to be the scene of festivity on the night of February 27! From the "Cave" where the last symposium was held to Roman luxury, and from beef-steak aprons to togas is surely quite a jump. Hallock, "the noblest Roman of them all," will look quite fetchy in a toga.

"Nor rough, nor barren, are the winding ways
Of her antiquity, but strewn with flowers."

By the way, we learn from the press reports that our friend Hallock in his speech at the N. Y. and N. J. Plant Growers' blow-out took his hearers "back to the time of the Roman Empire," and told them about Homer and Cicero. In another place, we read of an excursion into the dim past by Philadelphia's shining light, Lonsdaie. He took his audience back to the time of Theophrastus and gave the history of the carnation from the time of William the Conqueror! What's up?

BEHAVIOR OF LAWSON CARNATION.

Some of the growers in and about Chicago are having their troubles with the Lawson carnation this year. Stems are weak, blooms off color and too often sleepy. These conditions are not usually all found in the same place. Some growers think this variety is running out. Others declare it was never better. The most likely solution of this problem seems to be found in the field conditions last summer. Where a grower had a low, moist piece of ground for his Lawsons he has now first-class blooms. When his field plants were obliged to suffer from the long drought they are unable now to produce strong perfect flowers.

CARNATION WM. TAFT.

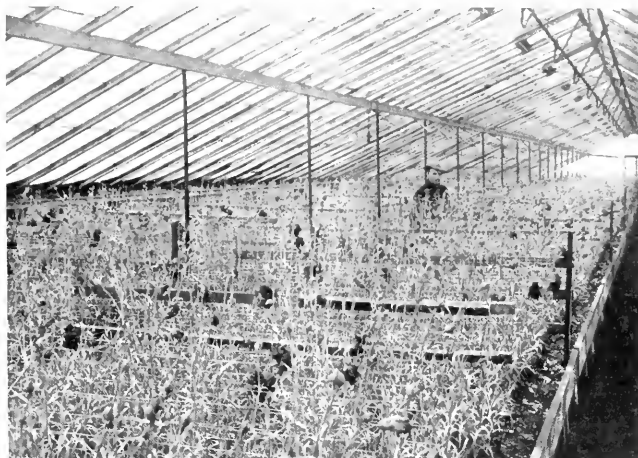

To properly estimate the commercial value of the Wm. Taft carnation, one of the new reds, one should visit the greenhouses of Scheiden & Schoos, Oakton and Asbury avenues, Chicago, and see it growing. The Taft is not a "show" flower and its owners will tell you that the stem is not as stiff as

they could wish, but they expect by proper feeding to improve this. They offer it as a commercial variety and back it up with a record for productiveness hard to beat. In color and shape it is all that can be desired, is easily propagated and a constant bloomer.

A PRESSING CALL.

The attendance at a club or society meeting depends, in no small degree, upon the way announcement is made by the secretary or other official in charge. We have seen many unique and ingenious announcements intended to make the recipient "sit up and take notice." For brevity, point and persuasiveness we think the following is one of the best we have seen. It was printed on an orange colored full-size letter sheet, in bold black type.

**Hang This on Your Business File of
Thursday, Feb. 11th.**

FIRST CALL

2 O'Clock.

The St. Louis Florist Club will on Thursday afternoon, February 11th, at 2 o'clock P. M., hold its regular monthly meeting on Third floor in the Bowman Building, 1023 Locust Street. All members are requested to attend this meeting without fail.

Respectfully,

W. C. YOUNG, President.
A. J. BENTZEN, Secretary.

SECOND CALL

3 O'clock.

At 3 o'clock the same date, the Club will hold its regular Yearly Carnation Show, to which all florists in the city are invited. It will be of advantage to Carnation growers to attend and see the new varieties on exhibition. This exhibition promises to be a large one.

Don't fail to invite non-members to come and view the exhibition.

LAST CALL.

5 O'Clock.

At 5 o'clock you will place yourself in the hands of the undersigned committee, who have arranged for an Entertainment and Smoker at a nearby cafe. You can also inform your folks that you will not be home for supper, as you will be the guest of the Club for the evening. If you fail to attend you will miss the time of your life.

Respectfully,

HENRY OSTERTAG,
CHAS. SCHOENLE,
W. C. SMITH,
GEORGE ANGERMULLER,
J. J. BENEKE.

Committee.

HAWAIIAN PINEAPPLES FOR SEATTLE.

The Hawaiian Pineapple Growers' Association will feature their products at the Alaska-Yukon-Pacific Exposition to be held in Seattle next summer, and the display to be made at the coming fair will be beyond question the most elaborate and complete that has ever been attempted.

At a meeting of the Association held last month in Honolulu, at which all pineapple growers and packers of the islands were represented, the sum of twenty thousand dollars was subscribed to be used in placing a magnificent display in the coming exposition. In addition to this sum, the individual planters will expend an amount considerably in excess in exhibiting and distributing their own products.

NEWS OF THE CLUBS AND SOCIETIES

PITTSBURG FLORISTS' AND GARDENERS' CLUB.

The meeting of the club on the 2nd inst. was well attended by members who were desirous of hearing the news from the Carnation Convention at Indianapolis, and of seeing our own display, as it was Carnation Night with us. After electing five new members and hearing the auditing committee report that the books of the club had been found correct, the election of officers for 1909 came in order, and the secretary was instructed to cast the unanimous ballot of the club for the following officers:

F. Burki, president; P. S. Randolph, vice-president; H. L. Blind, treasurer; H. P. Joslin, secretary; C. S. Crall, assistant secretary; E. C. Reineman, Jno. L. Wyland and Jno. Badler, executive committee.

As these officers serve until the next election in February, 1910, they will be the officers of the club not only prior to, but during, the time the Carnation Convention is held with us in January, 1910, and the election was therefore of unusual importance. There was discussion of a suitable place for holding the convention, and of the committees that should be appointed, but the President announced he would not appoint the heads of the committees before the March meeting.

Never have I known our delegates to any convention to be so unanimous in favorable comment as they were in regard to the carnation convention in Indianapolis last month. One delegate said that he had not a criticism to make on the arrangements, and the general opinion seemed to be that we would have to "go some" to equal, and that to excel would require careful thought and hard work.

There was much praise for the hall in which the blooms were shown at Indianapolis, very few blooms going to sleep during the continuance of the exhibition. As far as novelties were concerned, while the average was high, there were very few to attract attention by decided pre-eminence. The most striking were thought to be Bertermann Bros.' 1. Whitcomb, Riley, Baur & Smith's Shasta, Dornier's red seedling and A. C. Brown's Superba.

It was Carnation Night with us. The only entry from the private gardeners in their competition display was N. C. Madsen of Sawtckley with a bunch of 25. He also displayed three rarely shown Primulas in pots, floribunda, verticillata and Kewensis. The Finleyville Floral Co. showed Afterglow, Lady Bountiful and Winona, S. J. Hatch of De Haven showed Winsor, Rose Pink Enchantress, Enchantress and White Perfection. Pittsburg Rose and Carnation Co. showed Beacon, Pres. Seelye, Winona, White Perfection, Afterglow, White Lawson and others. Frank Crook, gardener for J. P. Park, Pittsburg, showed a number of pots of freesia.

The judges, P. S. Randolph, J. W. Jones and C. S. Crall, awarded cultural certificates to N. C. Madsen, Frank Crook, Pittsburg Rose and Carnation Co., Finleyville Floral Co. and commendation to S. J. Hatch. Mr. Hatch spoke of the bud-keeping qual-

ties of Rose Pink Enchantress, and will not grow it another year on that account.

The club, on motion of Mr. Falkoner, awarded a gratuity to N. C. Madsen of \$5.00 for his primulas, as showing much cultural skill, varieties seldom grown and of a high order of merit.

Subject for next meeting, "Bulbous Plants and Blooms."

H. P. JOSLIN, Secretary.

CHICAGO FLORISTS' CLUB.

At the regular meeting of the Chicago Florists' Club, Feb. 4, the newly-elected officers were installed. The following committees were appointed: For revising by-laws, Albert T. Hay, chairman, L. Coatsworth, H. B. Howard; transportation, F. J. Foley, chairman, August Pochmann, A. T. Pyter; finance, H. N. Bruns, Jos. Kilmier, Walter Scott; sports and pastimes, David Erickson; seed of the club, Edward Enders, Frank Pasternick, A. Longren. Thirteen new names were proposed for membership.

An important feature of the evening was the discussion of the bill appropriating \$3500 for the Experiment Station at Urbana, Ill. This was regarded as a most worthy object and methods for fostering it were discussed. Among other things it was decided to place a bouquet of carnations on the desks of the speakers at the meeting of the Legislature, which happens to be at the same time that the Illinois State Florists' Association meets at Springfield. It is expected that quite a number of Chicago florists will attend, among them Geo. Asmus, the new Club President.

To show their appreciation of his faithful work the Club presented Retiring President Leonard Kil with a handsome watch charm in the form of a Maltese cross set with a diamond.

The important topic for discussion at the next regular meeting will be the advisability of holding a flower show next fall.

ALBANY FLORISTS' CLUB.

At the meeting on Thursday evening, Feb. 4, Charles Sanders, gardener for H. G. Eyres, had on exhibition a sample bloom of a new seedling geranium. The flower is a handsome red, and the members agreed that it was the largest geranium they had ever seen and some were so enthusiastic as to declare that there is none like it known. The flower had been on the plant for six weeks when it was cut yesterday by the show before the club. Mr. Sanders has selected the name "Goliah" tentatively for the new variety.

The members discussed the subject of best methods of fumigating greenhouses. James H. Snyder of Rhinebeck gave the experience of the violet growers in that section of the state with potassium cyanide gas. The growers of Rhinebeck have used the gas for some time and have become experts in its use.

The entertainment committee reported that arrangements are under way for a banquet which will be held within the next two or three weeks.

MASSACHUSETTS HORTICULTURAL SOCIETY.

Professor E. M. Duggar of Ithaca, N. Y., gave the John Lewis Russell lecture before this society on Saturday morning, Jan. 30, 1909, his topic being "The Effects of Conditions of Growth in Certain Horticultural Plants upon Susceptibility to Fungous Diseases." There was a large attendance of members. Professor Duggar said that great advances have been made in our knowledge of fungi. He outlined the relation between the weather and parasitic diseases of plants, and said that ten days of continued damp and rainy weather has often destroyed crops of fruit and vegetables, although some other crops thrive on such weather. Fungous diseases in many cases depend on the wounds caused by previous fungous attacks. In studying the action of fungi upon growing plants we are met with a remarkable diversity. Certain fungi appear to be able to attack the healthiest parts of growing plants, such as rusts, white mildew, etc. These, however, do not kill the tissues of the growing plant, but themselves die as the tissues of the plant die. Contrasted with these are such fungi as leaf spots, fruit decay, etc., which do kill the tissues. It has been asserted by many that the vigor of the plant is a protection against infection from plant diseases. Yet in some cases it is found that the vigorous plant is particularly susceptible to forms of parasitic fungi.

The black rot of cabbage is a parasitic fungus, but in order to spread there must be water connection between the outside and inside of the plant. This is established by the drops often seen on the edges of the leaf. Water is most important in its relation to the growth of parasitic fungi. To combat fungi care must be exercised in watering plants. The factor of light is also most important. Experience has shown that plants subject to powdery mildew are benefited by giving half shade. Alkali or acid in the soil also are conditions affecting fungi, as well as the growth of plants. The cabbage, for instance, thrives best in an alkaline soil. It is not easy to correct these conditions, but they must be considered. Where plants are living on one another there is parasitism, but any treatment of parasitism must take into account conditions of soil, water, temperature and light.

On Saturday, February 6, Prof. Wm. Stuart of the Vermont Agricultural Experiment Station read a paper on the etherization of plants for forcing purposes. The lecturer gave in detail the results of many interesting experiments with iliacs, peonies, astibes, bulbs, bulbard and other plants. He concluded as follows:

Briefly summed up, the facts presented in this paper may be stated as follows. Anaesthetics when properly used impart a decided growth impulse to plants. Their effect upon the plant is to arrest growth, extract moisture from the cell protoplasm, and through these physiological derangements imparting a severe shock to the whole

plant which when removed causes a decided growth reaction. Toxic substances, such as alcohol, acetone and other similar agents, while not causing insensibility, unless employed in large amounts, act in a very similar manner to that of anaesthetics and result in a more or less decided growth acceleration.

Non-anaesthetic or toxic agents such as freezing, vacuum, and desiccation all arrest growth and remove moisture from the plant tissues much in the same manner as anaesthetics and toxics. They all seem to possess the power to hasten plant growth during the dormant season. Hot water imparts a distinct shock to the cell protoplasm and tissues and acts as a solvent in softening up the winter protecting scales inclosing the leaf and flowering buds, thereby hastening the winter forcing of shrubs.

A careful consideration of all the factors influencing the growth of plants during their resting period would seem to indicate that there is no one substance which may be said to be superior to all others. Ether because of its more general use has come to be regarded as the anaesthetic to use in plant forcing. There are indications, however, that other substances may serve equally as well and in some instances may give better results than ether. More information is needed along these lines, particularly with respect to the hot water treatment.

W. C. Rust exhibited an extraordinarily fine plant of *Amaryllis* from seed, one spike bearing six magnificent dark red flowers and a second spike coming. The seed from which it was grown was saved from crosses of a California variety on the ordinary type of *amaryllis*. Mr. Rust also showed a handsome flower, semi-double, with ten segments, from same source.

GARDENERS' AND FLORISTS' CLUB OF BALTIMORE.

The Gardeners' and Florists' Club of Baltimore had "Carnation Night" on the date of the regular semi-monthly meeting. The attendance was large, even for an extra night, and the exhibits were of superior quality, and sufficiently abundant in quantity. Toreador from Webber's is a striking variety, reminding one of our old Picoetes. Mr. Rider had vases of *Enchantress*, both pink and white, and also *Lady Bountiful*, all of the very first class as to condition and quality. H. Moss had in addition to *Enchantress*, *Winsor* and *Beacon*. B. G. Merritt had several varieties, as also had Lehr Bros. C. E. Akhurst exhibited a number of un-named seedlings.

Carnation growers for this market adhere pretty closely to *Enchantress* for both white and pink, and *Beacon* for red, other varieties scattering, quite a good number of carnations are shipped on standing orders, keeping our home supply down on sufficiently close lines for both the grower and the retailer.

Mr. John Cook, raiser of the rose *My Maryland*, is suffering from rheumatism and was unable to attend the meeting. The growers who had visited Mr. Cook's establishment reported the rose as doing splendidly.

NEW YORK FLORISTS' CLUB.

A very large attendance—approximately one hundred—was present at the meeting of the New York Florists' Club on Monday evening, Feb. 8th. It was carnation night and the carnation talent was out in full force.

Among the routine proceedings were reports from the bowling committee by C. W. Scott, urging the organization of a team under the club's auspices, to be known as the N. Y. Florists' Club Bowling Club; W. J. Elliott for the dinner committee; a proposal for membership and a resignation; the announcement of the death of W. C. Krick and appointment of Leonard Barron. C. B. Weathered and Chas. Schenck as a committee on resolutions of condolence; report of progress by the outing committee; and the report of the committee on awards for the evening.

Interesting talks on the Indianapolis trip were made by S. S. Butterfield, Frank R. Pierson, Joseph Heacock, Wyncott, Pa., Albert Roper, Tewksbury, Mass. and others, all expressing appreciation of the excellence of the exhibition and the hospitality they had enjoyed. Other speakers of the evening were H. L. Jones of the advertising department of County Life in America; E. A. Stroud of Stafford, Pa.; John Lurie, who was disposed to take issue with Mr. Rudd's views on the color of *Enchantress* carnation and A. Farenwald, Roslyn, Pa., who called attention to the meeting and exhibition of the American Rose Society to be held in Buffalo, March 17.

The Langjahr prizes for the evening were awarded as follows: Best 25 blooms of carnation not yet disseminated, C. W. Ward from Alma Ward. Best 100 *Enchantress*, Harry Turner. Best 100 *Lawson*, V. Hammon. Other exhibits and awards were as follows: Carnation Dorothy Gordon from Jos. Heacock, 90 points and preliminary certificate. Juanita, from Fallow Flower Co., Westport, Conn., 85 points and preliminary certificate. Bay State, A. Roper, Tewksbury, Mass., 90 points and preliminary certificate. Pink seedling No. 30, R. P. Jeffrey & Son, Bellmore, N. Y. Mrs. Pfeuffer, O. V. Zangen, Hoboken. Ruby, S. J. Reuter & Son, Westery, R. I. Neptune, Paul Thomson, West Hartford, Conn. White Seedling, A. Wynne, Stamford, Conn. Lucille, A. F. Longren, Des Plaines, Ill. Baron and Aterglow, Pittsburg Rose and Carnation Co., cultural certificate. Pink Pearl, W. A. Manda, cultural certificate. Lady Bountiful and Winsor, E. A. Stroud, Stafford, Pa., cultural certificate. Red Seedling, C. T. Guenther, Hamburg, N. Y. Seedlings of 1906, S. J. Trepess, Glen Cove, N. Y. Gov. Dineen, *Superba* and *Sangamo* from A. C. Brown, Springfield, Ill., arrived in bad condition. In miscellaneous exhibits there were the following: *Rose My Maryland*, from S. J. Ruter & Son, cultural certificate. *Asparagus elongatus*, W. A. Manda, South Orange, N. J. *Cybotium*, Percy E. Hicks, Oceanic, N. J. *Xiphodiscus railfolia* Bressi, George Grivas, New York. *Begonia East Indian*, W. A. Manda, honorable mention. All the exhibits not otherwise honored, received a vote of thanks.

The bowling committee met and elected John Donaldson president; C.

W. Scott, secretary, and Jos. A. Manda, treasurer. The March meeting of the club will be Rose Meeting.

SOCIETY OF AMERICAN FLORISTS AND ORNAMENTAL HORTICULTURISTS.

Registration of Hybrids.

Public notice is hereby given that Mr. Charles G. Roebling, of Trenton, New Jersey, offers for registration the plants described below. Any person objecting to the registration of these plants or to the use of the proposed names is requested to communicate with the undersigned at once. Failing to receive objection to the registrations the same will be made three weeks from this date.

Hybrid "Cattleya Oakland."—Cattleya Hybrid raised from Cattleya Crispa X Cattleya Hardyana (Young's var.). Habit of growth, intramediate between the two parents and very strong growing. Flowers of good size and substance. Lip 2 inches broad and well rounded; color deep purple. Throat bright yellow with deep bronze veins. Petals 2 1/4 inches wide, color light pink, veined and mottled like Cattleya Hardyana. Sepals 1 inch broad, also light pink in color.

Hybrid "Cattleya Eureka."—Cattleya Hybrid raised from Cattleya crispa X Cattleya Hardyana alba. Habit of growth is much after the style of Cattleya crispa. Flowers of good size and fine substance. Petals and sepals are broad and pure white with quite a little of the Cattleya crispa curl to them. Lip broad and of a very bright deep color with yellow in throat.

Hybrid "Laelio Cattleya Magenta."—Laelio Cattleya Hybrid raised from Laelio tenebrosa X Cattleya maxima. Habit smooth, bulb 15 inches long, single leaved; very like Cattleya maxima but much stronger. Flowers large, the same shape as Laelio tenebrosa flowers but having a rich magenta color throughout.

W. N. RUDD, Secy.

February 5, 1909.

AMERICAN ROSE SOCIETY.

Exhibition at Buffalo, March 17, 18, 19 Inclusive.

The spring exhibition of roses is to be held in the Iroquois Hotel, and here will be headquarters. The proposition is advanced to make it a free exhibit, in other words, to popularize it to the fullest extent.

Buffalo has a large population and Vice-President Hasting is active; his firm will receive any exhibits sent to them.

Mr. J. Howland Clondsley, Secretary of the Buffalo Florists' Club, 584 Main street, is appointed manager of exhibits.

Special prizes have come from various parties not mentioned in the preliminary schedule which has been distributed. Various inquiries are coming concerning exhibits. The spot rose class seems to be awake. The rose is the state flower of New York, and all amateur growers are invited to take a lively interest, for it's "A rose for every home, a bush for every garden."

BENJAMIN HAMMOND,
Secretary.

GREAT ORCHID EXHIBITION.

To Be Held at Boston May 26, 27, 28, 29 and 30, 1910, by the Massachusetts Horticultural Society.

For the best display of orchid plants in bloom, arranged for effect, embracing at least 20 orchid genera and bi-generic hybrids, and unlimited as to number of species, varieties and hybrids, to fill 400 square feet of space.

In the arrangement, stove and greenhouse foliage plants may be used, and the general effect produced with or without such plants will be considered by the judges in making awards as per the following scale of points:

Variety of Orchids.....	30
Quality.....	25
Arrangement and decorative effect.....	25
Novelty of Orchids.....	10

Cut blooms of rare sorts not exceeding in number five per centum of the total number of varieties of Orchid plants in the exhibit will be admissible.

First prize.....	gold medal and \$1000.00
Second prize.....	silver medal and \$500.00
Third prize.....	bronze medal and \$250.00

For the best display of orchid plants in bloom arranged for effect, embracing at least 10 orchid genera and bi-generic hybrids, and unlimited as to number of species, varieties and hybrids, to fill 150 square feet of space.

In the arrangement, stove and greenhouse foliage plants may be used, and the general effect produced with or without such plants will be considered by the judges in making awards as per following scale of points:

Variety of Orchids.....	30
Quality.....	25
Arrangement and decorative effect.....	25
Novelty of Orchids.....	10

Cut blooms of rare sorts not exceeding in number five per centum of the total number of varieties of orchid plants in the exhibit will be admissible.

Commercial growers excluded from competition.

First prize.....	gold medal and \$200.00
Second prize.....	silver medal and 100.00
Third prize.....	bronze medal and \$50.00

For the best recently introduced orchid plant not previously exhibited in the United States.....gold medal

For the best new seedling orchid plant not previously exhibited in the United States.....gold medal

For the largest and best display of cut orchid blooms arranged with ferns or other foliage. Variety and decorative effect will be considered.

First prize.....	gold medal and \$100.00
Second prize.....	silver medal and \$50.00
Third prize.....	bronze medal and \$25.00

For the best collection of cut orchids of new varieties not before exhibited in the United States.

Ferns or other foliage may be used in the arrangement.
First prize.....gold medal

For the best group of flowering and foliage stove or greenhouse plants arranged for effect:

First prize.....	Gold medal and \$100.00
Second prize.....	silver medal and \$50.00

For the best new stove or greenhouse plant in bloom not previously exhibited in the United States.....gold medal

For the best new stove or greenhouse foliage plant exclusive of ferns not previously exhibited in the United States.....gold medal

For the best coniferous plant, not yet disseminated, likely to be hardy in Massachusetts.....gold medal

For the best new shrub, or climber in bloom likely to be hardy in Massa-

chusetts, not previously exhibited in the United States.....gold medal

For the best new hardy herbaceous plant in bloom likely to be hardy in Massachusetts, not previously exhibited in the United States.....gold medal

TENNESSEE STATE NURSERYMEN'S ASSOCIATION.

At the annual meeting in Nashville, Jan. 27th, officers were elected as follows: J. C. Hale, of Winchester, president; A. J. Smith, of Knoxville, W. Y. C. Grant, of Columbia, and Willis Hastings, of Mansfield, vice-presidents; S. M. Bentley, secretary and treasurer.

The legislature was asked to appropriate \$5000 to aid the board of entomology in its fight against insects and fungi that prey on fruit.

CARNATION SHOW AT DETROIT.

The Detroit Florist Club will make a Trade Exhibition of carnations Monday evening, Feb. 15th, and all disseminators of novelties in carnations, roses or other stock are invited to send samples of the same for exhibition. The local trade will be well represented and many visitors expected from adjacent districts. All shipments should be made in time to reach here some time Monday, the 15th, and should be addressed to the Michigan Cut Flower Exchange, 38 Broadway.

J. F. SULLIVAN, Secy.

GARDENERS' AND FLORISTS' CLUB OF BOSTON.

At the next meeting of this club, Tuesday evening, February 16th, M. A. Patten, president of the American Carnation Society, has promised to give a talk. Provision will be made for a large display of carnations on that evening, including novelties and standard varieties.

CLUB AND SOCIETY NOTES.

A meeting was held at the Court House, Norristown, Pa., on Feb. 6, for the purpose of organizing a county horticultural society.

The S. A. F. & O. H. medals and certificates awarded at the National Flower Show have all been delivered. The silver gilt medal is especially handsome.

The School of Commerce and Finance of the Boston Young Men's Christian Association announces a free illustrated lecture by H. B. Fullerton, special agent of the Long Island R. R. Co., Long Island, N. Y., entitled "The Lure of the Land." The lecture will be held in Association Hall, on February 16 at eight o'clock.

The Bulletin of the American Association of Park Superintendents for January, 1909, has just been issued. Park and Boulevard Lighting, Danger from Leaking Gas, Trees and Shrubs for Seaside Planting, Elm Leaf Beetles, Plantations, Weed Killing on Roads and Walks, Surfacing Playgrounds, Park Signs, About Gardeners, Cinder Walks, are some of the subjects ably treated by the representative park superintendents and landscape gardeners of America. This publication alone is well worth the cost of annual membership in the Association.

During Recess

FRENCH GARDENERS IN LONDON.

The French gardeners in London assembled on Saturday, January 23, to celebrate the 20th anniversary of the founding of the Societe Francaise d'Horticulture de Londres, and a very enjoyable international gathering was the result. The meeting was held at the Cafe Royal, Regent street, Sir Albert K. Rolliet being in the chair. The chairman, who is President of the National Chrysanthemum Society, was surrounded and supported by a large number of his brother officers who have always regarded this French institution as a sister society and have largely helped it, especially in its early days.

The toasts of the President of the French Republic and King Edward VII were duly honored, the company rising to sing the Marseillaise and God Save the King on each occasion. Sir Albert Rolliet then proposed amid much applause the toast of the evening, "Success to the Societe Francaise d'Horticulture de Londres," which he did with great ability and no little humor, much appreciated by the French and English visitors alike. Sir Albert is one of the most accomplished after-dinner speakers in England, and is always at home at a horticultural dinner. On this occasion he was fully up to concert pitch, and we regret that the space at our command will not allow us to do him justice. It must suffice to say that the work of the society was most warmly approved by him and he expressed great satisfaction at the excellent relations existing between the French and English horticulturists. He extolled its educational advantages and spoke in the warmest terms of the zeal and ability with which the society had been conducted by its worthy President, Mr. George Schneider.

In response Mr. Schneider thanked the chairman for his kind words, and although he regretted death had thinned their ranks, yet the numbers had increased. Monsieur Ph. de Vilmorin had kindly accepted the post of Honorary President made vacant by the death of their old friend, Monsieur Ouverd. Other speeches were made by Mr. Harman Payne, M. Ingamells, M. Thos. Bevan, Mr. Ingram and Monsieur Ripard.

NEWPORT HORTICULTURAL SOCIETY.

The eleventh annual ball of the Newport Horticultural Society was held in Masonic Hall on the evening of Feb. 3 and, as usual, was well attended. This society has always made the hall decorations a prominent feature in these events, so the old masters of the art were chosen to carry out this work and were ably assisted by many of the lesser lights, with the result that all previous decorations were fairly eclipsed. The walls and platform arches were artistically draped with Southern smilax, which was of an unusually good quality; then hanging from the arches and main ceiling were numerous large baskets of vines, which had been brought into flower by a one-hour forcing process, making a charming effect. Many choice decorations and flowering

plants were used about the stage in forming a very pretty arrangement there. One of the new features which was much admired was the use of rich-looking lace curtains on all the windows, and everything seemed to mingle harmoniously with the sweet strains of the music and the graceful movements of the many merry dancers.

The duties of floor manager were ably performed by John T. Allan, who led the grand march with Miss Mary A. Reynolds, sister of the secretary. Among the strangers present who entered heartily into the spirit of the occasion were Messrs. Thomas J. Grey, P. M. Miller, Wm. A. Riggs and John P. A. Guerincau, all of Boston, Mrs. David McIntosh and Miss Annie McIntosh, of Tuxedo Park, formerly of Newport.

NORTH SHORE HORTICULTURAL SOCIETY.

The annual banquet of this popular organization was held on Wednesday evening, February 10, at the Town Hall, Manchester-by-the-Sea, Mass. Despite the downpour of rain, the attendance was up to the limit of the hall's capacity, all the tickets having been exhausted several days previous. From the time that President Salter took his chair until the closing chorus of Auld Lang Syne the evening was one of unalloyed pleasure for all. D. L. Bingham, the grand old man of Manchester, 95 years of age and still librarian of the town, was the first speaker and gave an interesting account of the early days of market gardening three-quarters of a century ago. No speaker gave greater pleasure than Rev. Wm. F. Powers, who said he had studied botany and could analyze an apple blossom, but had become more expert in synthesis than in botany and was prepared at any moment to give a demonstration thereof by putting together any suitable couples who might present themselves. Among the other speakers were Rev. T. L. Frost, E. O. Orpet and W. N. Craig. After all this the balance of the evening was spent by the young people in dancing.

ST. PAUL vs. MINNEAPOLIS.

On Thursday, February 4, the St. Paul florists bowled against the Minneapolis florists at Deschler's alleys, and although poor scores were made on both sides, they carried off two games against one won by Minneapolis. O. J. Olson of St. Paul made the highest score, 200.

The scores:

ST. PAUL.				
	1	2	3	Total
N. C. Hansen.....	104	148	112	364
Carl Heugan.....	111	160	125	397
John Hill.....	131	122	160	392
H. Puvogel.....	119	154	128	392
O. J. Olson.....	125	134	200	460
	582	658	675	1915

MINNEAPOLIS.				
	1	2	3	Total
Th. Wirth.....	100	112	112	324
E. Meyer.....	112	122	130	364
K. Carlson.....	129	90	119	338
L. Boeglin.....	109	111	146	366
C. N. Ruedlinger.....	138	179	139	456
	588	614	646	1848

C. N. RUEDLINGER.

A LINCOLN WINDOW.



We have had occasion heretofore to call attention to the many clever advertising schemes evolved by Mr. Hughes the enterprising Chicago florist. Store florists have not yet as a class fully comprehended the value of advertising, and especially by original window displays. Mr. Hughes always

spects a subject of direct public interest. Anything this week which relates to Lincoln is sure of attracting notice and the scene portraying his early home surroundings will no doubt draw a crowd. As a conception we think the picture would be improved had the bust been omitted or differently placed.

RHODE ISLAND STATE BOARD OF AGRICULTURE.

The State Board of Agriculture will hold a number of demonstrations in methods of treating the San Jose scale in orchards in different parts of the State during the spring months.

It is now a reasonably well-established fact that the scale can be controlled if the right methods are pursued, and the primary purpose of the demonstration is to instruct fruit growers in the best methods of combating the scale and the solutions and apparatus to be used.

In order that as many sets as of the State as possible may be reached, a few spray outfits will be secured and each one will be placed in the hands of some competent man who will go with the machine and have charge of it and direct the spraying work. Whenever an opportunity for a demonstration is given by the owner of an orchard, the spraying outfit can be kept by the owner of the place long enough to spray all his infested fruit trees and shrubbery. After that the rig and man in charge will be available during a short period for the use of fruit growers in the vicinity in the order in which their applications are sent in to the State Board of Agriculture. Only a few can be accommodated in each neighborhood and "first come first served."

The man in charge of the pump will be paid by the Board of Agriculture. Transportation for the man in charge and the spray rig from and, if neces-

sary, to the nearest electric or railway station must be furnished by the one using the outfit. It is also hoped that those employing the spray outfit will furnish board and lodging for the man in charge during the time he is employed in their orchards. Spray material will be furnished for the demonstrations by the State Board of Agriculture. Material for additional spraying, however, must be furnished by the owner of the orchard.

Suggestions for making this work of greatest value to the fruit growers of the State will be gladly received, and any complaints regarding the work of men in charge will be promptly looked into.

For further information write to A. E. Stone, State Board of Agriculture, State House, Providence, Rhode Island.

Kearney, Neb. Fire originating in the heating plant of Green & Wiley's greenhouse on the night of January 29 partially destroyed three large hot-houses. Cold and broken glass wrought further damage. The insurance expired only a few days previous. The loss is large and quite severe, as Mr. Green is well along in years and has been unfortunate, his greenhouse being almost totally destroyed by hail at one time and at another time it was damaged considerably by flood. Many believe this fire to have been the work of an incendiary.

Oil City, Pa. The greenhouses of R. Reunders were totally destroyed by fire on January 29.

ROYAL HORTICULTURAL SOCIETY OF LONDON.

Considering the severe frosts, thick fogs and generally unfavorable weather at this part of the winter season, at the meeting held by the R. H. S. on Tuesday, January 26, the show of plants and flowers, although meagre as compared with other ones, was rich in novelties in orchids, and some fine new varieties were staged. Hugh Low & Co. showed numerous cypripediums, the finer being *C. auricum* Hyacuum, *C. a. Ville de Paris*, *C. a. Virginalis*, *C. Proctori*, *C. Fascinator*, of an olive green tint suffused with rose and dorsal sepal of white, with a deep purple colored median streak, and on either side a faint suffusion of the same tint; *C. Euryades*, with spotting of a striking kind; *C. Dowlingianum* having distinct purple spotting on the dorsal sepal, and less distinct ones on the lateral petals, pouch cream colored slightly marked with pink. Other striking varieties were observed, as *C. villo-bursif.*, *C. G. E. Moore* and *C. Lecanum autumn.* etc. Lieut.-Colonel G. C. Haldord, of Westonbirt, Gloucestershire, received an award of merit for *Cypripedium* Earl of Tankerville, a cross between *C. exul* and Sanler's variety of *C. nitens*. The dorsal sepal is circular, white, 2 1-2 inches in diameter, and furnished with brown spots, and of a green color at the base. The rest of the flower has a general likeness to *C. insigne*.

Messrs. Charlesworth, formerly of Bradford, Yorkshire, and now of Hayward's Heath, Sussex, obtained a first-class certificate for a plant of *Sophro-laelio-Cattleya*, the petals and sepals of which are of a rosy crimson color; in regard to the tube, the tint is brighter, and the front of the labellum is of a rich tint of crimson, making a gorgeous bloom. The same firm obtained a first-class certificate for *Laelio-Cattleya Felicia*, a cross of *L.-Cattleya Hardyana* and *C. Trianae*, the lip is of a rich velvety crimson, throat of a pale yellow tint, and sepals and petals the tint of an ordinary *C. Trianae*. A pretty *Cypripedium*, named *Heta*, came from Mr. J. Foster Alcock. Messrs. J. Veitch & Sons made a good show with winter flowering plants, including *Begonia Azatha*, a most useful variety, and of long duration of flowering, the second flowering season immediately following the first without the plant needing a resting period. The firm showed the yellow-flowered *Gomphia olivaeaeformis*, an old garden plant rarely seen now. *Crowea latifolia* was well flowered. Sir Trevor Lawrence showed a quantity of spathes of *Anthurium* in great variety and in most instances of abnormally large size.

Mr. W. H. Page of Tangley Nursery, showed *Dafodil Golden Spur*, which has the peculiarity of flowering earlier when grown on his soil than any obtained from the Channel Islands or elsewhere. He made a striking exhibit of retarded lilies, such as *L. speciosum rubrum* and *L. s. album*; also a new apple *Encore*, a large, handsome fruit,

even in outline, with skin, when ripe, of a greenish yellow, slightly flushed, one of the latest keepers, remaining good till June. It is a seedling from Warner's King and Northern Greening.

A pretty looking *Sea Kale* with pink tips to the shoots, and of stout growth, came from Mrs. Trotter, of Dyrham Park, Barnet. Enormous carrots, called *Red Elephant*, were shown by Messrs. Carter & Co., also a beautiful golden yellow incurved chrysanthemum named *Golden Sunset*.

Messrs. Cathush & Sons showed a carnation, a cross between a variety of *Souvenir de la Malmaison* and *Edenblossom*, of some promise. It partakes more of the features of the former, but in tint it is brighter.

FREDERICK MOORE.

OBITUARY.

W. C. Krick.

It is our sad duty to record the death on Feb. 7 of W. C. Krick of Brooklyn, N. Y., well known to the trade for many years as manufacturer of florists' wire designs and the "Krick Letter" for inscriptions. Mr. Krick was for many years a member of the Society of American Florists, and was one of the earliest members of the New York Florists' Club. The funeral on Wednesday was attended by many sorrowing friends in all departments of the trade.

Fred Ashley.

Alfred Ashley, who has been associated with his brother Ernest in the florist business at Allentown, Pa., was thrown from a wagon recently and died on January 28 at the Allentown hospital. He was about 29 years of age.

John Griffith.

John Griffith, who had been engaged in the nursery business for many years, died suddenly at his home in Attica, N. Y., on January 29. In his sixty-ninth year. A daughter, four sisters and a brother survive him.

Mrs. T. C. Mellen.

Mary J. Mellen, aged 79 years, widow of Thomas C. Mellen, died at her home in Weymouth Landing, Mass., on February 4. She leaves a daughter.

Hiram Myers.

Hiram Myers, one of the pioneer florists of Kansas, died at his home in Wellington on January 26, aged 70 years.

Edward T. Elton, Jr.

Edward T. Elton, Jr., an employee of A. A. Weldon at New Britain, Conn., died on January 28, aged 42 years.

John H. Righter.

John H. Righter of Righter & Barton rose growers, Madison, N. Y., died on Feb. 2, aged 61 years.

William A. Munroe.

Wm. A. Munroe, seedsman, Providence, R. I., died suddenly on the morning of January 29.

A METHOD OF CULTIVATING PRIMULA OBCONICA WHICH PAYS.

I give these experiences of a German cultivator which appear in Moller's *Deutsche Gartner-Zeitung*, No. 4, 1909, for the reason that they differ considerably from the general practice. The seeds sown were those of famous Rousloof Hybrids. The seed pans are filled with a mixture of dung bed soil that has laid in a heap for some length of time, to which sand and turfy soil in equal quantities are added. In order to retain moisture the pans are covered with tissue paper. When seed is sown in January, the plantlets should be pricked off in the following month, and in March or April they should be again pricked off, the extreme points of the roots being removed with a knife. In the hurry-scurry of today many of the things done by the old gardener are gone into disuse, and this shortening of the roots is one of them. When the plants have grown in size they are placed in houses having means of good ventilation. In sunny weather the plants must be shaded, as *Primula obconica* cannot bear a hot sun. In May the plants are placed in frames which are kept closed, and they are often syringed by day, but only slightly, for to keep them very wet would work great harm. As will be well understood the plants must be abundantly shaded. After a time the plants must be accustomed to the air, and ventilation gradually increased and be well syringed. In the course of the summer the plants are twice replanted, and kept close after each replanting, gradually inuring them to the air after a brief interval. Finally the lights are taken off the frames and shading materials employed in their stead and the frames often syringed by day.

After or during rainfall manure water is plentifully applied, but not to newly planted ones. All flower buds appearing in the course of the summer are nipped off as soon as observed. In September the plants are potted up, by which operation the larger root masses are not treated too tenderly, but the roots are shortened as much as may be needed. The plants are then placed in frames where the losses and disturbances and formation of new roots is very soon made good. The plants must be well rooted before the commencement of bad weather or all the labor and trouble will go for nothing.

When quite established, the plants should be afforded plenty of air. If flowers are not wanted, remove every bud and they will produce abundantly at a later date. There are several other matters which could be named, but these are not necessary for the professional gardener who pays careful attention to his plants.

FREDERICK MOORE.

SPRING PLANT TRADE.

Preparations for spring plant trade should now be well under way. Lack of careful attention now means a shortage or inferiority of stock for the time when the good grower will reap his next harvest. Easter lilies should be well rooted and started into growth by this time, in order to get them into the market for Easter, April 11. Any neglect now will lead to disappointment and it is better to get plants along far enough so they may be kept cool and hardened off before wanted, rather than to resort to extreme heat to hurry them up at the last minute.

Azaleas for Easter need good light now but should be kept cool for some time yet.

Geraniums which were started last fall should now be potted up and if you are short of any varieties or colors this is the time to supply the deficiency. See Vincent's advertisement and catalogue on this specialty. Cuttings for early fuchsias, salvias and petunias should now be propagated.

If sufficient pansies were not started in cold frames last fall, seed may be sown now, and if carefully tended, will give good plants for spring. To make good stock for bedding-out time sow seed now of verbenas, salvia, lobelia, cobaea, cineraria, ageratum and annual hollyhocks, also Begonias Vernon and Erfordii. These should be sown in flats or pans.

Bulbous stock in pans may be brought in in small lots in succession for spring trade.

PUBLICATIONS RECEIVED.

Beets versus Other Crops; Sugar Beets in Orchards; Money in Beets.—Three little folders by R. L. Adams, director Spreckles Sugar Company Experimental Station. Interesting and convincing.

We have received from H. F. Mitchell Co., Philadelphia, a copy of the souvenir booklet containing a series of illustrations of the finest features of the great industrial parade of "Founders' Week," last October. Among the interesting float pictures is that by the Mitchell Company which, by the way, was the only seed and bulb establishment represented in the parade.

Bulletin 216, New Jersey Experiment Station, treats on "The House Mosquito, a City, Town and Village Problem." From this interesting pamphlet it is learned that while this mosquito is not the variety that gave to New Jersey its world-wide reputation, yet it is just as active in its way, and New Jersey has no monopoly of it. Everybody should have a copy of this bulletin and help in the warfare on the pest.

The Annual Proceedings and Bulletin of the American Rose Society for 1908 has come to hand. The cover is dainty and the tasty appearance of the volume invites a perusal—just what Secretary Hammond aims at, we are sure. The report tells everything one can desire to know concerning the Rose Society and a very full account of the proceedings, papers, etc., at the Chicago meeting in March, 1908. A schedule for the exhibition to take place at Buffalo, March 17, 18, 1909, is included.

GERANIUMS

Our Geranium Catalogue describes one of the largest and best collections in this country, including the best standard and novelties, 2 in. pot plants, \$2.00 per 100 and up.

HARDY POMPON CHRYSANTHEMUMS

Every grower of Chrysanthemum will want to grow the Pompons next fall. We have the best collection to select from, and are acknowledged to be head quarters. \$2.00 per 100. Special prices on large lots.

LOBELIA

KATHLEEN MALLARD. The new double Blue Lobelia. We shall continue this week to offer this Novelty of exceptional Merit at the Special Price of \$2.00 per 100.

DAHLIAS

We have a splendid collection in plants for next spring or roots next fall. Ask for list and prices.

SALVIA

BONFIRE \$2.00 per 100. **ZURICH** \$3.00 per 100.

We also offer a general Collection of Bedding Stock.

R. VINCENT JR. & SONS CO., White Marsh, Md.

YOU RUN NO RISK

IN PLACING YOUR ORDER NOW FOR

CHRYSANTHEMUMS

We give our customers benefit of any reduction which may occur prior to delivery. We have all the best, and are fully conversant with the need of the Commercial grower.

Let us quote you now for present or future delivery. Rooted cutting list now ready.

A Complete List of Aster Seeds **NONE BETTER**

ELMER D. SMITH & CO, ADRIAN, MICH.

CARNATION AND ROSE SHOW

UNDER AUSPICES OF

Boston Co-operative Flower Growers Association

The Park Street Market

SEND FOR PREMIUM LIST

ALL the old and THE BEST of the new varieties. SEE BEFORE BUYING

NEW ENGLAND'S LEADING COMMERCIAL SHOW

FEBRUARY 27H AND 28TH, 1909

HORTICULTURAL HALL, BOSTON

For information write **E. ALLAN PEIRCE, Waltham, Mass.**

CHOICE AMARYLLIS

We make a specialty of the finest strain in the world. A limited supply of 1, 2 and 3 year old bulbs will arrive in a few days. Prices by mail.

KNIGHT & STRUCK
1 Madison Ave., - NEW YORK

SHAMROCK

IRISH. THE REAL THING! GREEN.

Best to order early and grow on for strong plants for St. Patrick's Day. Our stock is very fine. \$4.00 per 100, or post-paid 60c. per dozen.

JOHN F. RUPP, Shiremanstown, Pa.
RUPPTON: The Home of Primroses.

A. N. PIERSON, Inc.

CROMWELL, CONN.

Wholesale Growers of Cut Flowers, Palms and Ferns

OUR SPECIALTIES. Roses, Lily of the Valley and Carnations. We also grow a general assortment of flowers in their season

Hardy Herbaceous Perennials

Well-grown plants of all the standard varieties at reasonable rates.

SEND FOR TRADE CATALOG

DANIEL A. CLARKE
RED OAK NURSERIES, Fiskeville, R. I.

In ordering goods please add, "I saw it in HORTICULTURE"

THE QUALITY YOU CAN MAKE MONEY ON

CANNAS

SOUND PIECES TRUE TO NAME BED ROCK PRICES

Red-Flowering, Green Foliage			
	Per doz.	100	1000
A. Bouvier, 3 ft. Dark crimson.....	\$1.35	\$2.25	\$2.00
Alice Roosevelt, Deep crimson, 4 ft.....	.50	3.50	30.00
Beaute Pottevine, 3 1/2 ft. Dark crimson.....	.35	2.25	20.00
Black Prince, Greeny maroon; 3 to 4 ft.; velvet foliage.....	.50	2.75	25.00
Charles Heiderman, 4 ft. Bright crimson.....	.35	2.25	20.00
Crimson Bedder, 3 ft. Intense scarlet.....	.30	2.00	17.50
Duke of Marlborough, 4 1/2 ft. Dark crimson.....	.35	2.25	20.00
J. D. Elsete, Brilliant vermillion-scarlet 5 ft.....	.35	2.25	20.00
Explorer, Crampel, Deep rich crimson, 5 1/2 ft. Express, Crimson; foliage green Dwarf habit 2 to 2 1/2 ft.....	.60	4.50	40.00
Flamingo, 4 1/2 ft. Intense crimson.....	.30	2.00	17.50
Pres McKinley, Brilliant crimson 2 1/2 to 3 ft.....	.35	2.25	20.00

Pink-Flowering			
	Per doz.	100	1000
L. Patry, Delicate rosy pink, 4 1/2 ft.....	\$0.35	\$2.25	\$20.00
Lucky Antique, Rosy pink, 3 ft.....	.35	2.25	20.00
Louise, A grand pink, tall	.45	3.50	25.00
Martha Washington, Rose, Height 4 1/2 ft. to 6 ft.....	.75	5.00	
Mlle. Berat, 4 1/2 ft. R. scarlet.....	.35	2.25	20.00
Tommyson, Rosy pink; green foliage; 3 1/2 ft.....	.50	3.50	

Orange-Flowered			
	Per doz.	100	1000
President Cleveland, Bright, distinct orange-scarlet, 4 ft.....	\$1.25	\$2.25	\$20.00

Red, Gold-Edged and Spotted

Gladiator, Bright yellow, spotted crimson, green foliage; 4 ft.....	\$0.50	\$2.75	\$25.00
Cinabar, Cinabar red, edged with distinct golden band; 4 1/2 ft.....	.50	2.10	17.50
Queen Charlotte, Scarlet gold edge.....	.70	2.10	17.50
Mme. Croza, 5 1/2 ft. Vermillion, gold border.....	.35	2.15	20.00
Premier, Deep crimson, bordered yellow, 2 1/2 ft.....	.30	2.00	17.50
S. u. v. d' A. Croza, 4 ft. Crimson, gold band.....	.50	4.00	35.00

Yellow Shades

Buttercup, 3 1/2 ft. Clear golden yellow.....	\$1.40	\$2.75	\$25.00
Comte de Beuchard, Yellow, spotted red, 4 1/2 ft.....	.30	2.00	17.50
Florence Vaughan, Yellow, spotted crimson.....	.50	2.75	25.00
L. E. Bailey, Rich yellow, dotted with red; 4 1/2 ft.....	.30	2.00	17.50

White and Cream Shades

Aisace, 3 1/2 ft. Creamy white	\$0.30	\$1.75	\$15.00
--------------------------------	--------	--------	---------

Bronze-Leaved, Red-Flowering

Brandywine, 4 to 5 ft. Dark bronze foliage. Crimson flowers.....	\$0.50	\$4.00	\$35.00
Black Beauty, True, 5 ft. Grand foliage.....	.60	4.50	40.00

David Harum, 3 1/2 ft. Vermilion-scarlet.....	\$0.50	\$2.75	\$25.00
Egandale, 4 ft. Current red.....	.35	2.25	20.00
King Humbert, Fine bronze foliage, orange-scarlet with bright red markings, 4 ft.....	1.00	8.00	75.00
Leonard Vaughan, 4 1/2 ft. Bright scarlet.....	.35	2.25	20.00
Musafolia, The finest foliage Canna, with enormous musa-like leaves, 3 by 5 ft., of a dark green bronzing color.....	.35	2.25	20.00
Philadelphia, A bright glowing red. Height 5 ft.	.75	4.00	30.00
Papa Nardy, Large, rich carmine-red, 4 1/2 ft.....	.30	2.00	17.50
Pillar of Fire, 6 to 7 ft. high; flowers bright crimson-scarlet.....	.75	4.50	40.00
Robusta, Height 6 to 8 ft., with immense foliage.....	.30	1.75	15.00
Shepherdia, Large Salmon flowers, 6 ft.....	.30	1.75	15.00

Orchid-Flowering

Allemania, 4 to 5 ft. Scarlet and yellow. Green foliage.....	\$0.35	\$2.25	\$20.00
Austria, Pure canary yellow; an orchid-flowering type; 5 ft.....	.30	1.75	15.00
Itala, 4 1/2 ft. Green; Red border red yellow.....	.30	2.00	17.50
Kronus, Rich golden yellow, with patches of bright red; 4 1/2 ft.....	.30	1.75	15.00
Mrs. Kate Gray, 6 ft. Green foliage. Scarlet and yellow.....	.30	2.00	17.50
Pennsylvania, 5 ft. Green foliage, Deep scarlet.....	.35	2.25	20.00

CATALOGUE FREE.

We go through the block from 14th Street to 13th Street, but our address is still

ARTHUR T. BODDINGTON, Seedsman, 342 West 14th St., NEW YORK CITY.

CATALOGUES RECEIVED.

Chicago Carnation Co., Joliet, Ill.—Catalogue of this season's novelties in Carnations.

Ford Seed Company, Ravenna, Ohio.—"Ford's Sound Seeds" for 1909. They're all there.

Fraser Nursery Co., Inc., Ala.—Surplus List, Jan. 26, 1909. For Nurserymen and dealers only.

Gate Seed Company, Keokuk, Ia.—Wholesale Price List of Garden, Field and Flower Seeds, 1909.

Canon Floral Co., Ltd., Hamilton, Ont.—Wholesale Price List of Bedding and House Plants, Shrubs, etc.

L. E. Williams, Nottingham, N. H.—Price List of Nursery Grown Evergreens and Collected Native Trees and Plants.

S. M. Isbell & Co., Jackson, Mich.—Catalogue of Northern grown seeds, 1909. 104 pages fully illustrated, covers in colors.

Skidolsky & Irwin Co., Philadelphia, Pa.—Florists' Wholesale Price List of Seeds, Bulbs, Plants, etc. Their first annual catalogue; a comprehensive list.

Frank E. Rue, Peoria, Ill.—General Catalogue for 1909 of Seeds and Bulbs, Plants and Poultry Food. The back cover is devoted to a "Monthly Garden Guide."

Mangelsdorf Bros. Co., Atchison, Kans.—Seed Book, 1909. Vegetables in gay attire and brilliant nasturtiums

are the cover ornaments. Full of illustrations.

Herbert A. Jackson, Forest City Nurseries, Portland, Me.—Wholesale Trade List for 1909. Trees, Shrubs, Nursery Grown Seedlings and Herbaceous Plants.

D. V. Burrell, Rocky Ford, Colo.—Seeds 1909. Of course the melon occupies the place of honor in this catalogue, but all the other goods things in vegetables are there too.

Miss C. H. Lippincott, Minneapolis, Minn.—Lippincott Flower Seeds, 1909 Greeting. Looks for all the world like an Easter present, pretty and dainty outside and in. Mignonette on cover page is good.

Sherman & Eberle, Albany, N. Y.—Seed Catalogue, Spring 1909. An attractive Catalogue, finely executed. The front cover bears a striking illustration of "S. & E. Duke of Albany" bean and on the back is a beautiful lawn view.

Arthur Cowee, Berlin, N. Y.—A Summer with the Gladiolus. This is a little gem in its way. The cover shows a chorionic field of gladioli in bloom at Meadowdale Farm and several 2-color process plates of gladioli varieties are used in the text pages.

Joseph A. Manda, West Orange, N. J.—Catalogue of Orchids, 1909. This is Mr. Manda's first regular catalogue. It is a very comprehensive list of species and hybrids with much interesting data sandwiched in. Every alternate page is left blank for memoranda.

E. G. Hill Company, Richmond, Ind.,

Roses, carnations, chrysanthemums and bedding plants, spring of 1909. A trade catalogue of much interest. A handsome portrait of new rose Relevance adorns the front cover and Baby Margaret chrysanthemum on the back.

A. N. Pierson, Inc., Cromwell, Conn.—Wholesale Trade List of Roses, Carnations, Chrysanthemums, Bedding and other Stock. Killarney and White Killarney are the cover subjects of this excellent catalogue in which the best of the new florists' varieties are listed.

Carl Sonderegger, Beatrice, Neb.—Garden Book for 1909. Grapes and Plums and Vegetables, all in colors, make a strong cover effect, and the contents contain everything in the way of lists and cultural information necessary to make the garden owner happy.

Walter P. Stokes, Philadelphia, Pa.—Stokes' Stand and Seeds. Wide pages, nearly square, leaving plenty of room for the fine half tone cuts with which it is freely embellished. Cover adorned with vegetable cuts in colors. The specialty section is richly printed in dark sepia.

R. Vincent, Jr., & Sons' Co., White Marsh, Md. Wholesale Trade List for 1909 of Vegetables, Greenhouse and Bedding Plants. Everybody knows the Vincent Company. This compact trade list includes all the best things in florists' and market gardeners' plant supplies for spring planting and should be consulted by all interested.

DREER'S SPECIALS FOR FEBRUARY



Adiantum Farleyense The finest lot of five inch pot elegant stock to give a finishing touch to fine work and choice decorations. \$9 per doz., \$70 per 100. In other sizes we can supply:

in pots \$3.50 per doz., \$35 per 100, 4 in. pots \$5 per doz., \$40 per 100
 3 in. pots, fine specimens, \$2 each.

Azalea Mollis These hardy Azaleas are becoming more popular every season; it is profitable stock to handle as it can be forced at a minimum cost. We offer splendid bushy plants, 15 inches high, \$1.50 per doz., \$35 per 100.

Wallflower For early forcing, strong bushy plants in 4 in. pots which will sell readily at a good profit when in flower, \$1.25 per doz., \$8 per 100.

Variegated Aucubas A splendid lot of these plants, so useful for decorative work during winter

Each Doz.	Each Doz.
Very bushy 12 to 15 in. high \$0.30 \$3.00	Very bushy 24 in. high \$0.60 \$7.00
" " 18 " 20 " 4.50	" " 28 to 30 " 7.50 8.00

Specimen plants 3 ft. high, very fine, \$3 each.

Boxwood A splendid lot of globe-shaped specimens about 15 inches high and of same diameter to 11 inch galls, \$1.50 each.

BUSH SHAPED PLANTS for window boxes etc., 10 to 12 inches high, \$2 per doz., \$15 per 100. Larger, heavier plants 12 to 15 inches high, \$3.50 per doz., \$25 per 100.

HENRY A. DREER, 714 Chestnut St. PHILADELPHIA

PHILADELPHIA NOTES.

Visitor this week: Ed Roehrs, Rutherford, N. J.

Mr. and Mrs. Charles Sim of Rossmont, left last week via New Orleans, on a pleasure trip to California and the Golden West.

C. H. Breckbill, Lampeter, Pa., is a new grower who has been making some stir in the local carnation world during the past few years. His plant is of the latest Lord & Burnham construction.

William Kleinheinz of the Widener Conservatories, claims to have the largest and best specimen of Phoenix Roebellini in the country. It stands about five feet above the pot and nearly the same diameter.

Alfred Burton is the American Beauty King this week. He is about the only one worth mentioning as a factor in the A. B. market. Two new Hitchings houses, each 40x250 ft. (as already announced in HORTICULTURE), will be erected in the near future.

Deacon Harris reports that from letters received from Havana, Cuba, Feb. 3, our esteemed citizens, Commodore Westcott, Robert Craig, Daniel Donoghue and party have arrived all well and are feeling fine. They send regards to all old friends and will report further from Isle of Pines.

E. R. Raimbault of Buena, N. J., has retired from the partnership with W. F. La Croix, and has built a new place of about 5000 feet area for violets and other specialties. W. F. La Croix continues in the old establishment, which is about the same size, and is sending some fine lilac to the Philadelphia market.

Immediately after Easter W. C. Smith, 61st and Market streets, will tear down five of his range of greenhouses to make room for forty-one dwelling houses on the Chestnut street

front and running along 61st street to Market street. This will be an opportunity for bargain hunters for cheap glass, pipe and fittings.

Victor Ridenour has started business at the Wolff place at Ridge avenue and Dauphin street. Note specially that this does not mean that Julius Wolff has gone out of business. He is still located at 1617 North 19th street and at Sedgely avenue and 28th street. Ridge avenue and Dauphin street was only a side venture of his son's.

John H. Dodds, superintendent of the Wanamaker estate, uses hydrocyanic acid gas for fumigating his houses, but finds that snagsdragons will not stand nearly so strong a charge of the gas as will most other greenhouse plants. His houses are in the pink of condition and he is glad to give a large part of the credit to his assistants, John Nesbit and S. J. Irvine. A new sport of the golden pansy has originated here which the experts think well of.

The holy calm of the Kingsessing valley was rudely disturbed by a cyclone on the 14th inst. The south end of the W. K. Harris establishment was ripped to pieces, causing a loss estimated anywhere from three to five thousand dollars. The roof of Mark Mills' dwelling house nearby was blown off and deposited two blocks away. Ferdinand Le Gierse's greenhouses on Lancaster avenue were demolished and the proprietor blown into the street, severely cut by flying glass. Henry Engler's place was also ruined and Grakelov Floral Exchange conservatory damaged. A church steeple was blown over and two lives lost, in the same blast. The staid and God-fearing citizens of the locality thought the end of the world had come for sure! Colflesh, Anderson, and several other florists were in the track of the demon, but we believe all escaped with but little damage.

FIRE RECORD.

Newark, N. J.—John J. Broyat, florist, lost three greenhouses by fire, January 31. Loss \$2,000.

Denison, Texas.—The greenhouse of J. D. Orand, 103 Sears St., was burned January 25. Loss is about \$1,000.

Albion, N. Y.—The greenhouses of Julius Duquette were damaged to the extent of \$150 by fire on the morning of Jan. 27.

Montclair, N. J.—The greenhouse establishment of A. S. Wallace on North Fullerton Ave. was damaged \$150 by a fire in the packing room, on January 29.

South Bend, Ind.—An overheated stove in the new store of the South Bend Floral Co. at 216 Michigan St., started a fire which did \$25 damage on January 29.

Whitstone, Long Island.—On the night of February 6th, a fire at the range of houses of Louis Dupuy, destroyed the potting shed, but the fire was under control before doing any serious damage.

ABOUT HOT BEDS.

A very practical and extremely interesting book telling all about hot-beds—their uses, cost and construction — has just been issued by the Gordon-Van Tine Co., 1500 Case St., Davenport, Iowa.

This little handbook gives a wealth of information on the subject. It tells how to construct them, where to locate them, and how to manage them for best results.

Copies are now being distributed free. Send for one.

The Gordon-Van Tine Co. have gone into the manufacture of hot-bed sash on a large scale. Their sash is made of Louisiana red cypress, with blind-mortised, double shouldered joints, at about half the price of old style hot-bed sash. Be sure to read their advt.

Tobacco Paper "NICO-FUME" **LIQUID**
 IS THE **STRONGEST,**
BEST PACKED,
EASIEST APPLIED. **Furnishes the**
Most Nicotine for the Money! **OVER 40% NICOTINE**
By far the
CHEAPEST. **JUST NOTE PRICE!**

24 sheets.....	\$ 0.75	Pint.....	\$ 1.50
144 sheets.....	3.50	1/2 Gallon.....	5.50
288 sheets.....	6.50	Gallon.....	10.50
1728 sheets.....	35.10	5 Gallons.....	47.25

... Manufactured by ...
 THE KENTUCKY TOBACCO PRODUCT CO., Louisville, Ky.

WIZARD BRAND MANURES

Dried, screened and packed in bags of 100 lbs. each.

PULVERIZED SHEEP MANURE

PURE — UNIFORM — RELIABLE

A strong and quick acting manure, highly recommended for carnations and chrysanthemums.

SHREDDED CATTLE MANURE

EASY TO HANDLE AND APPLY

Stronger and better in every way than rough manure. Lasts much longer on the benches. Unequaled for mulching and feeding roses, liquid manuring and mixing with bench and potting soil. Used by all the largest growers.

Ask Your Supply Man or Write Us for Circulars and Prices.

Pulverized Manure Co.

31 Union Stock Yards, CHICAGO

Which Spray Pump?

shall you buy? Buy the Spray Pump that fully meets the demands of the Government Agricultural Scientists and all practical Fruit Growers. These pumps are widely known as

DEMING SPRAYERS and are made in 23 styles for use in small gardens or immense orchards. Write for our free catalog with Spraying Chart. Add 4 cents postage and receive "Spraying for Profit," a useful guide book.

CHARLES J. JAGER CO.
 281-285 Franklin St., Boston

Garden and Sprinkler

straight, round and flat steam nozzle on Kopsay's "shower Maker," \$1.00 each. Saves labor, temper, patience and time. **GET ONE NOW** as you will be satisfied, but if not you, may return it and I'll return your money.

JOSEPH KOPSAV, South Bend, Ind.

The Pennsylvania railroad is about to send a "spraying special" train over its entire system in Pennsylvania. As much of the territory will be covered in February and March as is possible; the balance will be covered in the fall. It will be in charge of Prof. H. A. Surface, economic zoologist of the State Department of Agriculture.

In ordering goods please add "I saw it in HORTICULTURE."

For Trees, Plants, Shrubs and Flowers

USE THE NIAGARA BRAND LIME SULPHUR SOLUTION

It destroys Scale Lice, Spiders and all forms of Aphides, AT THE SAME TIME Mildew, Blight, Rust and other Fungus difficulties
 Used in Winter or Summer — No other remedy has been so universally effective.
 Niagara Brand ARSENATE OF LEAD for chewing insects is equal to the best and better than the most. Ask about our Green House sprayer. Address —

NIAGARA SPRAYER CO., - - Middleport, N. Y.



The Best Bug Killer and Bloom Saver

For PROOF Write to

P. R. Paethorpe Co.
 OWENSBORO, KY.

SOMETHING NEW for GREENHOUSES "SULFOCID" PRATT'S SOLUBLE SULPHUR SUMMER SPRAY

Non-caustic and non-irritating
A FUNGICIDE AND INSECTICIDE FOR FRUIT TREES, VEGETABLES and GREENHOUSES

A promising substitute for Bordeaux mixture. For 10 cts. to cover postage will send sample sufficient for one gallon of spray.

Use 1 part to 75 or 100 parts of water.
B. G. PRATT CO., 50 Church St., New York, U. S. A.

U-N-IT

Spraying device for garden hose. It brings out insoluble, with water, what is put into Globe. Fertilizing solutions, soap solutions, insecticides, fungicides, germicides, etc.

All Seedsmen and Every Florist's Supply House Should Have It.
 Retail price \$3.50 prepaid.
 Wholesale prices on application.

Address: **Dept. H, J. F. CASS MFG. CO, Detroit, Mich.**

DON'T EXPERIMENT

USE TO-BAK-INE

and your stock will be free from insects, clean, and the blooms will not be discolored.

Send for full information of

H. E. FISKE SEED CO.
 13 Faneuil Hall Sq., Boston, Mass.
STUMPP & WALTER CO.,
 50 Barclay St., New York.
HENRY F. MICHELL & CO.,
 1018 Market St., Philadelphia.

E. H. HUNT, Gen'l Agent,
 76-78 Wabash Ave., Chicago.

KILMDEAD TOBACCO DUST

Free from Sand or Dirt Kind FOR FUMIGATING AND DUSTING
 Dusted on Plants it covers large surface. One Quality for Both Uses.

Our Tobacco Dust is the pure tobacco, free from sand and dirt, strong in Nicotine and always of the same strength, making it superior to any dust on the market. Costs you no more than the ordinary product and will do twice the work. 10 lbs. 60c.; 25 lbs. \$1.25; 50 lbs. \$2.00; 100 lbs. \$3.50.

STUMPP & WALTER CO.
 50 Barclay St., New York

In ordering goods please add "I saw it in HORTICULTURE."

Seed Trade

AMERICAN SEED TRADE ASSOCIATION.

Watson S. Woodruff, Orange, Conn., Pres.; J. C. Robinson, Waterloo, Neb., First Vice Pres.; C. E. Kendall, Cleveland, O., Sec'y and Treas. Twenty-seventh annual convention June 22-24, 1929, at Clifton House, Niagara Falls, Ont.

WHOLESALE SEEDSMEN'S LEAGUE.

F. W. Brugerhof, Pres.; Burnet Landreth, Sec'y.

THE CANNERS' CONVENTION.

The Convention of the Canners at Louisville is now a thing of the past, and looking back there are few features which appear to be pre-eminent. The machinery and general display of the supply men was a little the most elaborate we have seen. The hall was handsomely decorated and every effort was made to attract business, but as a business convention it is not to be compared with that of last year at Cincinnati. The attendance was about the same as at Cincinnati, the number of registrations being in the neighborhood of 2100, but it must be borne in mind that a considerable number who always attend these conventions manage to get along without registering.

This year a tax of \$2.00 was imposed by the Canners' Association on all who entered the Exhibition Hall, cepting the members of the National Canned Goods Association. This Association, according to information to hand, comprises about 150 members, and why these members should escape paying the tax, simply because they are members of the National Association, has not been satisfactorily explained. The only explanation given is that the leaders in the National Association movement are seeking to force all of the canners to join this Association, and this is one of the inducements.

Sometimes ago reference was made in HORTICULTURE to the proposed plan of taxing everyone for the privilege of entering the hall. It was stated that the members of the Machinery and Supplies Association regarded this tax as unjustifiable and unwarranted, as they could not understand by what moral right the Canners' Association imposed the tax. The Machinery and Supplies Association secures the hall where the exhibits are held, pays for the transportation back and forth of their machinery, pays for space in the hall, lights, booths, and all the other expenses incidental to such an exhibition. This runs into the hundreds of dollars for many of the exhibitors, and few escape without an expenditure of from one hundred to five hundred dollars. The Canners' Association does not contribute one dollar towards this expense, and although the Machinery and Supplies Association is an entirely independent organization, the Canners, taking advantage of the fact that they can dictate to the other association because they will not resent it, or at least will not rebel against it, are simply asking the Machinery and Supplies Association to contribute towards the maintenance of their organization; in other words, it is a case of might

Gladiolus Bulbs

GLADIOLUS AMERICA

A few points of merit.

Color: A beautiful, soft, flesh pink, very light and much like Enchantress Carnation, except slightly tinged with lavender, which gives it the delicate coloring of the most beautiful Laelias. Words fail to do justice in describing this grand and glorious color; it must be seen to be appreciated. Perisomes: For florists' use, 1 1/2 colors makes it everything to be desired; delicate, attractive and absolutely new; no other color in Gladiolus like it or one-half so beautiful. It has created a sensation in the cut flower markets, selling for more than five times the price of other varieties.

America. The best commercial pink in existence. 1st size bulbs, \$4.00 per 100; \$25.00 per 1000; \$165.00 per 5000.

Augusta. Lovely, pure white with blue anthers. 1 1/2 to 2 1/2 in., \$3.00 per 100; \$15.00 per 1000; \$70.00 per 5000.

Blue Jay (Baron Hulot). Finest blue Gladiolus yet seen. It is a rich, deep color of indigo shade. The only real blue Gladiolus on the market. \$10.00 per 100; \$30.00 per 1000.

Brenchleyensis. Extra fine red variety. 1 1/2 to 2 1/2 in., \$1.50 per 100; \$12.00 per 1000; \$50.50 per 5000.

May. A lovely, pure white flower, finely flaked, bright rosy crimson. 100 1000 5000 \$2.00 \$15.00 \$70.00

Princes. Rich crimson with very deep shading in the throat and broad blotches on lower petals. 100 1000 5000 \$2.00 \$15.00 \$70.00

Salem. Fine salmon-pink, maroon blotches. 100 1000 5000 \$2.00 \$15.00 \$70.00

Gladiolus in Mixture
 Trial Grounds Mixture... 1.50 12.00 45.00
 Groff's Hybrids Mixture... 1.50 12.00 45.00

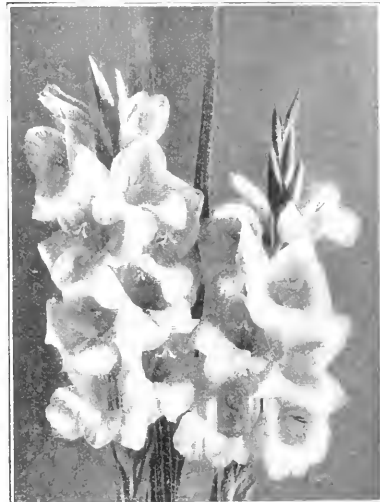

For forcing, and planting during the Spring. By ordering bulbs now, you receive not only the best selection, but the advantage of the following low prices:

Gladiolus in Mixture	100	1000	5000
WHITE AND LIGHT MIXTURE	\$1.50	\$12.00	\$45.00
Pink and Rose Mixture	1.50	12.00	45.00
Red and Scarlet Mixture	1.50	12.00	45.00
Leino's Extra Fine Mixture	1.00	10.00	45.00
AMERICAN HYBRIDS MIXTURE	1.00	8.00	35.00
CHILDISH MIXTURE	1.50	12.00	45.00

STUMPP & WALTER CO., 50 Barclay Street, NEW YORK

FORCING GLADIOLUS

Gladiolus Gandavensis Hybrids
 Many florists plant these in boxes, or among their carnations. In the Winter, they are excellent for decorative purposes and realize good prices, either wholesale or retail. Gladiolus are a good catch-crop and take up but little room. The following are the best for this purpose:

America. The flowers, which are of immense size, are of the most beautiful fleshy pink color, \$4.00 per 100; \$35.00 per 1000.

Augusta. The florists' best white Gladiolus. First-size bulbs, 1 1/2 inches and up. \$2.00 per 100; \$18.00 per 1000. Bulbs 1 1/2 to 1 3/4 in. \$1.75 per 100; \$16.00 per 1000.

Shakespeare. White and rose. \$4.75 per 100; \$45.00 per 1000.

May. Pure white, flaked rosy crimson; the best forcer. Selected bulbs. \$1.75 per 100; \$15.00 per 1000.

Brenchleyensis (true). Flery scarlet. Selected bulbs, \$1.50 per 100; \$13.00 per 1000. First-size bulbs, \$1.25 per 100; \$10.00 per 1000.

Hoddington's White and Light. Extra selected bulbs, 1 1/2 in. and up. \$1.50 per 100; \$14.00 per 1000.

Bulbs 1 1/2 to 1 3/4 in. \$1.25 per 100; \$10.00 per 1000.

American Hybrids. A mixture of the choicest varieties of Gladiolus in cultivation. \$1.00 per 100; \$9.00 per 1000.

ARTHUR T. BODDINGTON SEEDSMAN

342 West 14th Street, NEW YORK CITY

CANNAS

We are the largest Canna growers in the world and can make attractive prices on 200 kinds. Let us quote on your entire list for immediate or spring delivery or contract for permanent roots. Also Caladiums, Gladiolus, Dahlias, Tuberoses, etc.

SHELLROAD CANNA FARMS,
 Grange P. O. Baltimore, Md.

Gladiolus Brenchleyensis

Extra fine Healthy Imported Stock
 1,000 \$10.00 10,000 \$80.00

O. V. ZANGEN
 HOBOKEN, N. J.

TO BUYERS
 Patronize our advertisers. they will treat you right

makes right. Few if any of the machinery or supply men find any particular fault with the payment of \$2.00; it is not the amount of money involved so much as the principle. They furnish an excellent and, as everyone conceded this year, a really splendid exhibition. It is given for the benefit of the Canners, and they resent the action of the Canners' Association in taxing their prospective customers to see a show which they have been to such an expense and labor in preparing. Had the original plan of the Canners' Association been carried out, there would have been a large-sized revolt of their own members, as the original purpose was to tax everyone \$5.00 for a membership badge; but this they wisely cut down to \$2.00. Summing up the situation, it may be said that the members of the Machinery and Supplies Association, neither individually nor collectively, care to antagonize the Canners' Association, or rather the little oligarchy which is now controlling it, by refusing to pay whatever tax they may impose, and the Canners' Association, knowing this fact, are taking full advantage of the situation.

A move was made by the Machinery & Supplies Association, which is likely to have results not exactly anticipated by the rank and file of the members of either body; that is, the decision to hold no exhibits of any character in 1910. The place of meeting, while not definitely fixed, will probably be Atlanta City, and the attendance of the Canners, owing to the absence of any machinery or other exhibits, is likely to be very materially reduced, and it will be interesting as an indication of how great a factor the exhibits have been in drawing the attendance of the Canners from all parts of the country. Those Canners who are advocates of the present management insist that the exhibits of machinery and supplies are a detriment to their conventions, and that the attendance would be larger without these exhibits. They give the Machinery and Supplies Association to understand that they are tolerated only during good behaviour, and that failure on their part to meekly accept orders from the leaders of the Canners' Association would mean their being barred from any future convention of the cannery. Now if the machinery and supplies men expect to maintain an independent organization under their own control, there seems to be but one course open for them, and that is to hold an exhibition and invite the cannery to attend, but without any official connection with the cannery's association. Should the latter see fit to endorse the invitation and decide to hold their convention at the same time it would be very desirable, but there is little doubt that a very large number of cannery would attend, whether the exhibition were officially recognized or not.

Fears were expressed before the convention that the Louisville hotels would be over-taxed by the crowd in attendance, and this was established as a fact, although every effort was made for the comfort and convenience of all present, and the officers of the local committee deserve great praise for their efforts in this direction, particularly Mr. Gordon and Mr. McCon-

ald, who were tireless in their efforts to make every one comfortable and smooth out difficulties of every description.

Among the seed firms represented were Jerome B. Rice Seed Co., Leonard Seed Co., W. W. Barnard Co., W. H. Grenell, Rogers Bros., S. D. Woodruff & Sons, The Everett B. Clark Co., and Hogg & Lytle.

THE BLUE GRASS QUESTION.

Horticulture Publishing Co.

Dear Sirs:—My attention has been called to your comment on an article that was published in the Chicago Florists' Review on December 10th, 1908, under the head of "Grass Seeds," quoting from a circular issued by Conrad Appel of Darmstadt, Germany, casting a reflection upon the American seed dealers and exporters. Those who are well posted in the business will pay no attention whatever to remarks of this kind coming from such sources, but there are others who might take this statement for a fact, inasmuch as it has been published by a reputable journal.

In my business experience—which has extended over quite a number of years—I have never yet found the time that it was not possible to secure a supply of true *Poa pratensis* or Kentucky Blue Grass seed. I have also found that complaints similar to the one made by Conrad Appel, are made based upon some transaction which if thoroughly investigated, would put an entirely different color to the situation and more than likely the shoe would be on the other foot. Quite frequently the price at which the goods are sold has more to do with the transaction than the quality. As a matter of fact I will state that the party in question, or anyone either in the foreign or home trade, can secure from the American dealers, as high a grade, not only of Kentucky Blue Grass, but of all other seeds, as it is possible to secure in any of the markets in the world; but the proper way to secure these qualities is not to go at it like some of our foreign buyers and shop around and place the order at prices known to be lower than the American trade themselves were paying for the highest grades.

As a rule it is not possible for the buyer of any commodity to secure the highest qualities at prices quoted for the lower grades. A little care on the part of the buyer is all that is necessary to be exercised and there will be no occasion for any such blanket statement as this gentleman has used in his circular.

Yours very truly,

ALBERT McCULLOUGH,
Cincinnati, O.

PLANT STAKES—FOR EASTER LILIES

	Per 1000	Per 5000		Per 1000	Per 5000
36 in. long × 1/2 in.	\$5.25	\$25.00	42 in. long × 1/2 in.	\$6.00	\$28.75
36 " " × 3/4 "	5.25	25.00	42 " " × 3/4 "	6.00	28.75
36 " " × 1 "	5.25	25.00	42 " " × 1 "	6.00	28.75

The Above Stakes Dyed Green \$100 per 1000 additional

HYACINTH AND TULIP STAKES—DYED GREEN

12 in. long 150 per 1000, \$1.00 per 1000, \$4.25 per 5000.	18 in. long 200 per 1000, \$4.35 per 1000, \$6.25 per 5000
---	--

Write for a copy of Our New Wholesale Catalog

HENRY F. MICHELL CO., 1018 Market Street, PHILADELPHIA

WATSON ON THE SEED TRADE.

Agent that Blue Grass charge, everybody knows that there are scallwags amongst the dealers in that commodity, but they—the scallwags—are not seedsmen; only speculators. Your defence of the seedsmen I appreciate very much! It's the blasted hyenas on the outskirts of the trade that pose as seedsmen who do the dirt. Even at that, the trade, as a trade, is the cleanest and most honorable, also one of the most difficult, on earth, and don't you forget it! If all the papers would stand fast to your sane and sensible view of things, public opinion would soon veer very close to "hero-worship," instead of the present suspicious attitude. Ignorance, stupidity, selfishness, yellow journalism, shoddy paternalism, and vain glory have combined to vilify the most beneficent agency in the building up of the United States, from Jamestown and Plymouth Rock to the present minute. Every American who is not a friend of the seed trade ought to have fire and brimstone heaped in showers on his head.

G. C. W.

NOTES.

Welland, Ont.—N. Vaughan & Son have purchased a site and will erect a seed cleaning plant.

A first dividend of 8 per cent. has been paid to the creditors of the Tempin Co., late of Calla, O.

CATALOGUES RECEIVED.

J. F. Tonkin, Buffalo, N. Y.—"Seeds of Quality", Season 1909. A mail order list.

Burnett Brothers, New York.—Seeds, Bulbs and Plants, Spring, 1909. A very striking cover illustration of Burnett's Liberty "Tomato" in colors, gives immediate distinction to this catalogue. There are nine pages of novelties and specialties in seeds.

Schlegel & Fottler Co., Boston.—The catalogue is in the usual well-arranged and compact form issued by this firm. Shirley poppies and "Delicious" squash on front and back covers, respectively, in sepia tint, are attractively effective.

H. E. Fiske Seed Co., Boston, Mass.—Seed, Plants, Bulbs, and Poultry supplies. A very neat cover in grey tints shows vegetables on the front and Shirley poppies on the back pages. Arrangement of contents, printing and illustrations are all good.

O. V. Zangen, Hoboken, N. J.—Wholesale Price List for 1909 of Florists' Selected Flower Seeds, Bulbs and Plants. This is a very comprehensive list, compact, yet sufficiently copious and suggestive. Text printed in blue; covers in bronze ink.

BULBS FOR FLORISTS

If you will permit, we would like to mail you our Wholesale Price List for 1909. Drop us a postal.



RALPH M. WARD & CO.
12 W. B'way, N. York
HORSESHOE BRAND.

Mignonette

FARQUHAR'S GIANT

Oz., 75c; 1-4 oz., 25c

R. & J. Farquhar & Co.
6 & 7 South Market Street
BOSTON, MASS.

CANES

Freshly Cut From the Brakes For Your Lilies
Can Be Cut To Any Size

\$5 for 500, \$7 for 1000

Wm. Elliott & Sons
42 Vesey St., New York

When getting up a catalogue or a circular remember that you can buy electros used by us at a low price. An illustration sells the stock in many cases. Horticulture Publishing Co., 11 Hamilton Place.

BRIDGEMAN'S SEED WAREHOUSE
RICKARDS BROS.
Props.
37 East 19th St., - NEW YORK CITY

JAPANESE
THE YOKOHAMA NURSERY CO.
31 BARCLAY STR. NEW YORK.
LILIES
PLANTS
BAMBOO STAKES

C. C. MORSE & CO. 48-56 JACKSON ST., San Francisco, Cal.

The Largest Seed Growers on the Pacific Coast

ONION, LETTUCE, SWEET PEAS,

ALSO

Carrot, Celery, Leek, Mustard, Parsley, Parsnip, Radish, Salsify

LEONARD SEED CO.

CONTRACT GROWERS AND WHOLESALE DEALERS
BEANS, PEAS, SWEET CORN, ONION, GARDEN SEEDS
ONION SETS Get Our Prices 79 and 81
FLOWER SEEDS E. KINZIE STREET, CHICAGO



LILY OF THE VALLEY PIPS

Unexcelled Hamburg or Berlin

TUBEROUS ROOTED BEGONIAS GLOXINIAS

ROSA MULTIFLORA NANA SEED
and all other flower seeds for Florists
SEND FOR CATALOGUE

J. M. THORBURN & CO.
33 BARCLAY ST. Ingress to 38 PARK PLACE
NEW YORK

CAULIFLOWERS CABBAGE SEED
LILY OF THE VALLEY PIPS.

HJALMAR HARTMANN & CO.
12 Stormgade,
COPENHAGEN, DENMARK.

Burpee's Seeds

PHILADELPHIA

Blue List of Wholesale Prices mailed only to those who plant for profit

Vegetable and Flower **SEEDS**
reliable and Tested. Catalogue Mailed Free
WEBBER & DON
Seed Merchants 114 CHAMBERS STREET
NEW YORK

SHEEP MANURE

Pulverized. Free from Adulteration
In Bag, \$18.00 per Ton. Cash with Order
ROBERT SIMPSON
CLIFTON, N. J.

STOCK SEED FOR WINTER BLOOMING

Our strain of Double Branching Stocks is exceptionally true. About 9/8 Double Flowers.
In colors: 1/4 oz. .60 1/2 oz. .75 1/2 oz. .75
Pure White 3/4 " .75

H. E. FISKE SEED CO.
Faneuil Hall Square, BOSTON, MASS.

Winter-flowering SWEET PEA SEED

All Colors Ask for List
A. C. ZVOLANEK

ORIGINATOR. BOUND BROOK, N. J.

NEW CROP SEED

For Early Planting

THOMAS J. GREY CO.
32 SO. MARKET ST., BOSTON, MASS.
BEGONIAS TUBEROUS ROOTED

ALSO
GLOXINIAS, LILY OF VALLEY, SPIREA
Catalogues mailed free on application
Joseph Breck & Sons Corp.
47-54 NO. MARKET ST., BOSTON, MASS.

GEO. E. DOW
Designing and Illustrating

178 Washington St., Boston, Mass.
OUR SPECIALTY
Machine, Booklet, Advertising and Flower PHOTOGRAPHS

Japanese Bulbs, Etc.

R. TANOI, Yokohama, Japan.

Send for catalog and write to Representative
K. TAKEUCHI,
478a Boylston St., Boston, Mass.

QUALITY SEEDS BULBS PLANTS

SEND FOR CATALOGUE.
ARTHUR T. BODDINGTON
343 West 14th St., New York.

To Florists Everywhere

Orders for Cut Flowers and Floral Decorations to be delivered anywhere in the Greater New York, may be placed with us with the certainty that your customers will be satisfied.

Telegraph, telephone or mail such orders to us and be sure that they will be filled as promptly and as carefully as though you did it yourself.

One third discount will be allowed on all orders thus placed with us by Florists outside of the Greater New York.

THE BLOSSOM

Bond and Livingston Sts.,
BROOKLYN, N. Y.

C. C. TREPEL, Manager

WILLIAM J. SMYTH FLORIST

Cor. Michigan Ave. and 31st St., CHICAGO

We ship to all points in Illinois and Iowa.

Phones: Douglas 744, Douglas 523, Douglas 740

M. C. and J. E. HAUSWIRTH

Out of Town orders for Hospitals
Carefully filled.

232 Michigan Ave.
CHICAGO

AUDITORIUM ANNEX Tel. Harrison 585

SAMUEL MURRAY Florist

Coates House Conservatory

1017 BROADWAY, KANSAS CITY, MO.

Both 'Phones 2670 Main.



WASHINGTON,
D. C.

GUDE'S

The Far-Famed Flowers of TORONTO

Delivered on mail or telegraph order for any occasion, in any part of the Dominion.

JOHN H. DUNLOP,
96 Yonge St., Toronto Ont.

The Park Floral Co.

J. A. VALENTINE
Pres.

DENVER, COLORADO

WILLIAM L. ROCK
FLOWER CO.

KANSAS CITY, MO.

will carefully execute orders for Kansas City and any town in Missouri or Kansas.

Palmer's

Buffalo, N. Y.

W. J. PALMER & SON, 304 Main St.

Personal.

Boston visitors: Thomas Knight, New York; H. S. De Forest, Pierson U-Bar Co., New York.

G. H. Hollied, formerly of Webb City, has taken a position with Finn & Son, North Carthage, Mo.

Robert Forbes, formerly at the Colgate Hoyt estate, Oyster Bay, N. Y., is now engaged at Brampton, Ontario.

Visitors at Albany: M. J. Beatus of the Dayton Paper Novelty Co., Dayton, Ohio; S. Keller of Reed & Keller, New York City

O. A. C. Oehmler, chief decorator for Gude Bros., Washington, had the misfortune to drop a shield on his foot, which mashed two of his toes badly. He has in consequence been confined to his room for several days.

STEAMER DEPARTURES

American.

St. Paul, N. Y. Southampton, Feb. 20
New York, N. Y. Southampton, Feb. 27

Atlantic Transport.

AtlANTIC TRANSPORT.

Minnetonka, N. Y. London, Feb. 13
Mesaba, N. Y. London, Feb. 27

Cunard.

Lusitania, N. Y. Liverpool, Feb. 17
Saxonia, Boston-Liverpool, Feb. 24
Mauretania, N. Y. Liverpool, Feb. 24

French Line.

La France, N. Y. Havre, Feb. 18
La Savoie, N. Y. Havre, Feb. 25

North German Lloyd.

Koenig, Seattle, N. Y. Bremen, Feb. 16
Prinz Friedrich Wilhelm, N. Y. Bremen, Feb. 23
Koenigin Luise, N. Y. Mod. Ports, Feb. 27

White Star.

Cymric, Boston-Liverpool, Feb. 17
Cedric, N. Y. Mod. Ports, Feb. 20

C. Leslie Reynolds, of Botanical Gardens, Washington, who was hurt in a runaway accident some time since, is more seriously injured than at first thought, and the X ray has shown several bones broken in his foot.

William Wallace Burnham, recently manager of cut flower department at Bloomingdale's, was the recipient of a beautiful silver tea service, presented by a number of firms with whom he traded. The presentation took place at his home in Brooklyn.

Frank Jencek, a German, who for the past eight years has conducted a florist business in Jamestown, R. I., became violently insane Feb. 7 and was committed to an insane asylum. Jencek's wife died a short time ago, and it is said that this, with business reverses, was the cause of his mind becoming unbalanced.

INCORPORATED.

Utica, N. Y.—Brant Bros., rose growers. H. S. Brant and Johnca Brant of Utica and Elwood, and Mary B. Brant, Madison N. J.; capital, \$10,000.

IN BANKRUPTCY.

Los Gatos, Cal.—George G. Payne. W. A. Coulter, referee.

ALEX. McCONNELL

571 FIFTH AVENUE
NEW YORK CITY

Telegraphic orders forwarded to any part of the United States, Canada, and all principal cities of Europe. Orders transferred or intrusted by the trade to our selection for delivery on steamships or elsewhere receive special attention

Telephone Calls, 487 and 488 38th St

Cable Address, ALEXCONNELL

New York Deliveries

FLOWERS and PLANTS

by special messenger to Steamer,
Theatre or any address in

NEW YORK or BROOKLYN

THOMAS YOUNG, JR.

500 FIFTH AVE., (near 42nd St.)

NEWMAN FLORAL Co.

(Established 1870)

202 Fifth Ave. and
Madison Square. NEW YORK CITY

FLOWERS FOR STEAMER SAILINGS

M. A. BOWE

In the Heart of New York City

1294 Broadway

Tel. 2270, 38th St. NEW YORK

Our Motto—The Golden Rule

DAVID CLARKE'S SONS

Deliver orders from any part of the country to
New York City

Or OUT-GOING STEAMERS

Write or telegraph

2139-2141 Broadway, New York

Telephone 1552-1553 Columbus

YOUNG & NUGENT

42 West 28 St., NEW YORK

"FLOWERS BY TELEGRAPH"

NEW YORK

MYER, FLORIST

Phone 5297 Plaza. 609-611 MADISON AVE.

ALBANY, N. Y.

EYRES

Flowers or Design Work

DELIVERED IN ALBANY AND VICINITY
ON TELEGRAPHIC ORDER.

11 NORTH PEARL ST., ALBANY, N. Y.

Flower Deliveries

In Brooklyn and other Long Island Points
New York City, New Jersey, etc. At Theatres,
Hotels, Steamers or Residences.

WILSON

Fulton St. and Greene Ave., Brooklyn, N. Y.

JOHN BREITMEYER'S SONS

Cor. Miami and Gratiot Aves.
DETROIT, MICH.

Artistic Designs . . .
High Grade Cut Blooms

We cover all Michigan points and good sections of Ohio, Indiana and Canada

PROMPT DELIVERY IN BOSTON

AND ALL NEW ENGLAND POINTS
F. H. HOUGHTON
396 Boylston St., Boston, Mass.

BOSTON'S BEST

In Quality and Design
Can be relied upon when you transfer your retail orders to

EDWARD MACMULKIN
194 Boylston Street, Boston

Send flower orders for delivery in
BOSTON

and all
NEW ENGLAND POINTS
THOS. F. CALVIN
124 Tremont St., Boston

The Original Telegraph Order Florist
WILL DELIVER

Flowers or Designs
to order in Boston and Vicinity. Usual Discount.

J. NEWMAN & SONS, Inc.
Est. 1870 24 TREMONT ST., BOSTON



DANKER, Albany, N. Y.

ORDERS FOR
Choice Flowers and
Floral Emblems
FILLED PROMPTLY

LOUISVILLE, KY.
JACOB SCHULZ,
550 South Fourth Ave.

WELLESLEY COLLEGE
Dana Hall, Walnut Hill and Rockridge Hall
Schools. **TAILBY, Wellesley, Mass.**
Tel. Wellesley 44-1 and 2. Night 44-3.

ATLANTA FLORAL CO.
41 Peachtree Street, **ATLANTA, GEORGIA**

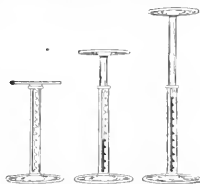

THE NEW IDEA IN PLANT STANDS The Moore-Livingston Graduating or Adjusting

Saves one-half to two-thirds of cost over ordinary galvanized iron stands.

SEND FOR CIRCULAR GIVING FULL PARTICULARS
SOLD BY SEEDSMEN AND SUPPLY HOUSES

If your seedsman does not carry send us his name and we will promptly send full particulars.

Moore-Livingston Co., Patentees and Mfrs., **Lansdowne, Pa.**

NEW RETAIL FLOWER STORES.

- Seattle, Wash.—Samuel Graff.
- Florence, Mass. F. D. Keyes. Parsons Block.
- St. Louis, Mo.—Charles Murray, 4450 Easton Ave.
- Mt. Sterling, Ky.—Graser & Humphries, 45 W. Main St.
- Jacksonville, Fla.—C. A. Mason, in Duval Theatre building.
- San Francisco, Cal.—F. Schlotzhaner, California Market.
- Nyaack, N. Y.—Charles Schmidt, in Columbus Hotel building.
- St. Louis, Mo.—Julius Schaeffer, Sixth street, near Chestnut.
- Mason City, Ia.—Mason City Floral Company, Edward Curtis proprietor.

BUSINESS CHANGES.

Homestead, Pa.—W. D. Faulk has purchased the business of David Geddes, 210 8th avenue.

Pittsburg, Pa.—The flower business and greenhouses of T. J. Allen has been purchased by Linn & Sons.

Pittsburg, Pa.—The stand in the Pittsburg Market formerly owned by John Foss has been sold to Miss Carrie Jordan.

Bristol, Tenn.—The D. S. Simpson Floral Company has made application to have its corporate name changed to The Bristol Floral Company.

NEWS NOTES.

Falmouth, Mass.—H. V. Lawrence is adding a new office building of unique architectural design.

Sioux City, Ia.—J. C. Rensison Co., capital stock \$60,000. Lizzie A. Rensison, president; Fannie L. Rensison, secretary and treasurer.

Des Moines, Ia.—During the gale of January 29 a big chimney was blown over at the Mitchellville Industrial School, falling upon the greenhouse and wrecking it.

Milwaukee, Wis.—The Edlefson Leidiger Company's greenhouses were wrecked by the fall of a chimney during the gale on Friday, January 29, and a damage of \$10,000 in broken glass and frozen plants was sustained.

Reminders of the approaching Portland (Ore.) Rose Festival are being sent out in the form of postal cards, showing rose garden views of great beauty as they are to be found in that

favoured land. Rose Caroline Testoril is the official flower for the festival and the pictures show it growing and blooming in marvelous luxuriance, as though fully conscious of its position of high honor.

THE BEST LETTERS

FOR THOSE
FLORISTS' MADE
USE BY THE

Boston Florist Letter Co.

66 PEARL ST., BOSTON
N. F. McCARTHY, Mgr.

Order direct or buy from your local supply dealer. Insist on having the

BOSTON

Inscriptions, Emblems, etc., Always in Stock

STRING UP

Asparagus and Smilax with

GREEN SILKALINE

There's Nothing So Good.

JOHN C. MEYER & CO., Boston, Mass.

Durand & Marohn

MANUFACTURERS OF

All Kinds of Wire Work

Florists' Wire Designs a Specialty
24 Beaver St., ALBANY, N. Y.

FLORISTS' SUPPLIES

Send for New Catalogue

H. Bayersdorfer & Co.

1129 ARCH ST., PHILADELPHIA

In ordering goods please add "I saw it in HORTICULTURE."

ROBERT J. DYSART Public Accountant and Auditor

Simple methods of correct accounting especially adapted for florists' use.

Books Balanced and Adjusted
Merchants Bank Building

28 STATE STREET, - BOSTON
Telephone, Main 58.

ACACIA PUBESCENS
 \$2.50 per Bunch
 The greatest novelty in YELLOW
 for February
THE LEO NIESSEN CO.
 1209 Arch St., Philadelphia, Pa.
 Open from 7 a. m. to 8 p. m.

Acacia pubescens
 \$2.50 per bunch.
CUT FARLEYENSE
 Highest Quality
 \$12.00 and \$15.00 per 100.

QUALITY
S. S. PENNOCK-MEEHAN CO.
 1608-1620 Ludlow St., Philadelphia

**VIOLETS, VALLEY,
 MIGNONETTE.**
W. E. MCKISSICK & BROS.
 WHOLESALE FLORISTS
 1619-1621 RANSTEAD ST.
 PHILADELPHIA

CUT FLOWER BOXES
EDWARDS FOLDING BOX CO
 MANUFACTURERS
 PHILADELPHIA, PA.

CHAS. W. MCKELLAR
 51 WABASH AVE., CHICAGO

Western Headquarters for Choice Orchids
 Valley, Roses and all Cut Flowers

PETER REINBERG
 WHOLESALE
CUT FLOWERS
 51 Wabash Av., Chicago, Ill.

DAILY CONSIGNMENTS
 From 40 to 60 Growers
 We can care for your outflow wants to
 advantage.

E. F. WINTERSON CO.
 45-47-49 WABASH AVE., CHICAGO

POEHLMANN BROS. CO.
 33-35-37 Randolph St., - CHICAGO
CUT FLOWERS

Greenhouses, - Morton Grove, Ill.

Rice Brothers
 115 N. 6th Street, MINNEAPOLIS, MINN
 WHOLESALE FLORISTS and SUPPLIES
 CUT FLOWERS received twice daily, and can fill
 your orders to your satisfaction. A complete line of
 Hardy Greens - WILD SMILAX, FOXGLOVE,
 HARDY FANCY FERNS, GALAX LEAVES.
 Write for quotations on large quantities.

In ordering goods please add "I saw
 it in HORTICULTURE."

WELCH BROS.
 AMERICAN BEAUTY, KILLARNEY, RICHMOND, PARYLAND AND ALL THE SUPERIOR
 ROSES, LILY OF THE VALLEY, CARNATIONS, ORCHIDS
BEST PRODUCED
 226 Devonshire Street, Boston, Mass.

**WHOLESALE FLOWER MARKETS—TRADE PRICES—Per 100
 TO DEALERS ONLY**

	CHICAGO Feb. 8		TWIN CITIES Feb. 9		PHILA. Feb. 11		BOSTON Feb. 11	
ROSES								
Am Beauty, Fancy and Special...	30.00	to 40.00	35.00	to 45.00	75.00	to 100.00	40.00	to 60.00
" Extra.....	20.00	to 30.00	25.00	to 35.00	50.00	to 60.00	20.00	to 30.00
" No. 1.....	6.00	to 20.00	15.00	to 25.00	25.00	to 40.00	10.00	to 15.00
" Lower grades.....	6.00	to 10.00	8.00	to 15.00	0.00	to 20.00	4.00	to 8.00
Belde, "Maid, Fancy & Special.....	8.00	to 12.00	10.00	to 12.00	12.00	to 15.00	8.00	to 12.00
" Lower grades.....	5.00	to 8.00	6.00	to 10.00	5.00	to 10.00	2.00	to 6.00
Killarney, Fan, & Sp.....	12.00	to 18.00	1.00	to 11.00	12.00	to 15.00	12.00	to 25.00
" Lower grades.....	5.00	to 10.00	8.00	to 10.00	5.00	to 10.00	4.00	to 8.00
Richmond, Fancy & Special.....	12.00	to 18.00	8.00	to 12.00	15.00	to 30.00	12.00	to 25.00
" Lower grades.....	5.00	to 10.00	6.00	to 8.00	4.00	to 10.00	4.00	to 8.00
Chatenay.....	6.00	to 8.00	6.00	to 8.00	4.00	to 15.00	4.00	to 12.00
Golden Gate Ivory, etc.....	6.00	to 8.00	6.00	to 8.00	4.00	to 12.00	4.00	to 12.00
My Maryland.....	10.00	to 15.00
Queen Beatrix.....	to 12.00
Mrs. Mar. Field.....	8.00	to 12.00
CARNATIONS								
Fancy and Re!.....	2.00	to 4.00	3.00	to 4.00	5.00	to 6.00	3.00	to 4.00
Ordinary and White.....	1.50	to 2.00	2.50	to 3.00	2.00	to 4.00	1.50	to 3.00
MISCELLANEOUS								
Cattleyas.....	40.00	to 50.00	40.00	to 50.00	to 5.00	40.00	to 50.00
Cypripediums.....	12.00	to 15.00	8.00	to 10.00	12.50	to 15.00	12.00	to 15.00
Lilacs.....	12.00	to 20.00	10.00	to 14.00	12.50	to 15.00	8.00	to 12.00
Lily of the Valley.....	3.00	to 4.00	2.50	to 3.50	2.00	to 5.00	1.00	to 4.00
Narciss, Paper White.....	3.00	to 4.00	2.00	to 3.50	2.50	to 3.00	1.00	to 2.00
Roman Hyacinth.....	1.00	to 4.00	2.00	to 3.00	2.00	to 3.00	1.00	to 2.00
Daffodils.....	3.00	to 4.00	2.00	to 3.50	3.00	to 4.00	2.00	to 4.00
Freesia.....	2.00	to 4.00	3.00	to 4.50	3.00	to 5.00	1.00	to 2.00
Sweet Peas.....	.75	to 1.00	.75	to 1.25	.50	to 1.50	.75	to 1.00
Gardenias.....	30.00	to 40.00	40.00	to 50.00	35.00	to 50.00	25.00	to 50.00
Violets.....	.50	to .75	.50	to 1.00	.25	to 1.00	.35	to .50
Adiantum.....	1.00	to 1.00	1.00	to 1.25	1.00	to 1.50	.75	to 1.00
Smilax.....	12.00	to 15.00	10.00	to 15.00	12.50	to 15.00	10.00	to 12.50
Asparagus Plumosus, stragg.....	40.00	to 60.00	35.00	to 50.00	50.00	to 75.00	25.00	to 50.00
" " & Spren. (too bech.).....	20.00	to 40.00	20.00	to 25.00	35.00	to 50.00	15.00	to 25.00

J.A. BUDLONG
 37-39 Randolph Street, CHICAGO.
Roses and Carnations WHOLESALE **CUT FLOWERS**
 A Specialty..... GROWER of

HENRY M. ROBINSON & CO.
 15 Province St and 9 Chapman Place - BOSTON, MASS.
 WHOLESALE COMMISSION FLORISTS
Hardy Cut Evergreens and Florists' Supplies
 We have the stuff and can fill all orders, large or small
 WE NEVER DISAPPOINT SATISFACTION GUARANTEED



Prices Quoted in these Columns are for Dealers Only.
 When Writing to Advertisers Please Mention
HORTICULTURE.

Flower Market Reports.

BALTIMORE

As the Lenten season draws near it is customary to crowd in the entertainments a little more closely, preparatory to laying aside of worldly amusements, thereby causing a more liberal use of cut flowers, decorations, etc. The local supply in Baltimore is, however, fully equal to the demand. Lily of the valley does not seem to have been quite so much in favor this season.

BOSTON

Trade in general is not equal to that of last week. The weather conditions are undoubtedly responsible in part. Bulbous stock is rapidly increasing in amount of daily shipments and prices are lower, not only on this class of stock, but the effect is felt all along the line. Roses are so decidedly off crop that they are holding their own. Beauties especially. Carnations are on the downward course and violets are at the very bottom of the chute. Double daffodils are usually perfect for so early in the season. The question of top prices is about settled for this season on all lines. We know the high record; the only concern now is to see how they will go, and that admits of a big guess.

BUFFALO

Conditions have changed but little since last report. Trade has been fairly good, with a scarcity of Beauties and a shortening in supply of medium stock. Brides and Bridesmaids, also of white material generally. Carnations are well cleaned up daily and violets enjoy an increased demand but there is too much lily of the valley to feel comfortable. Sweet peas, mignonette, lilies and bulbous stock are coming in more plentifully but have been moving quite satisfactory. Green goods in good supply, with normal demand.

CHICAGO

February came in with sales a little slow, and stock not of its best. The attenuating of the temperature from summer heat to zero and then back again, naturally had its effect. By the middle of the week trade was brisker, only to lapse again with the downpour which delayed Chicago on Friday. Saturday's business was light. Monday, the 8th, found the market generally with too many carnations for the demand. It looks as if the good qualities of Eucharist had led to an over-planting of this splendid variety. At least the continual shortage of white leads to that conclusion when the counters are full of pink and not enough white to go around for four consecutive weeks. It looks now at this writing as if Lincoln week would make a heavy call for red carnations. The best violet day of the year is anticipated for Valentine Day. Advance orders are already pointing to an unprecedented demand this year. It is not expected that the price will advance.

DETROIT

Business is improving slightly, but the falling off during the past is too much to be overcome this season. Fortunately, the shipping trade has increased very much and the sad conse-

WHOLESALE FLOWER MARKETS.—TO DEALERS ONLY.

	CINCINNATI		DETROIT		BUFFALO		PITTSBURG	
	Feb. 8	Feb. 9	Feb. 8	Feb. 9	Feb. 8	Feb. 9	Feb. 8	Feb. 9
ROSES								
Am. Beauty, Fan, and Sp.	35.00	to 40.00	35.00	to 40.00	60.00	to 80.00	40.00	to 50.00
" Extra	25.00	to 30.00	27.00	to 32.00	40.00	to 50.00	25.00	to 30.00
" No. 1	15.00	to 20.00	18.00	to 25.00	25.00	to 35.00	10.00	to 15.00
" Lower grades	8.00	to 10.00	8.00	to 10.00	6.00	to 8.00	5.00	to 6.00
Bride, 'Maid, P. & S.	6.00	to 8.00	6.00	to 10.00	10.00	to 13.00	10.00	to 12.00
" Low. gr.	3.00	to 5.00	4.00	to 6.00	4.00	to 6.00	6.00	to 8.00
Killarney, Fan, & Sp.	6.00	to 8.00	6.00	to 10.00	10.00	to 12.00	12.00	to 15.00
" Lower grades	3.00	to 5.00	4.00	to 6.00	4.00	to 6.00	5.00	to 8.00
Richmond, Fancy & Special	7.00	to 10.00	7.00	to 10.00	10.00	to 15.00	12.00	to 15.00
" Lower grades	4.00	to 6.00	5.00	to 7.00	5.00	to 8.00	5.00	to 10.00
Chatenay	5.00	to 8.00	3.00	to 8.00	to	5.00	to 10.00
Golden Gate, Ivory, etc.	4.00	to 6.00	3.00	to 8.00	to	5.00	to 10.00
My Maryland	6.00	to 8.00	6.00	to 10.00	10.00	to 13.00	10.00	to 12.00
Queen Beatrice	to	to	to	to
Mrs. Mar. Field	to	to	to	to
CARNATIONS								
Fancy and Novelties	to 3.00	9.00	to 3.00	3.00	to 4.00	2.50	to 3.00
Ordinary	1.50	to 2.00	1.50	to 2.00	2.00	to 3.00	1.50	to 2.00
MISCELLANEOUS								
Cattleyas	to	50.00	to 75.00	5.00	to 75.00	50.00	to 75.00
Orypipediums	to	10.00	to 15.00	12.00	to 15.00	to 15.00
Lilies	10.00	to 12.00	12.50	to 15.00	8.00	to 15.00	10.00	to 12.00
Lily of the Valley	3.00	to 4.00	3.00	to 4.00	3.00	to 4.00	3.00	to 4.00
Sweet Peas	to 3.00	to 3.00	to 3.00	to 3.00
Romax Hya.	8.00	to 3.00	2.00	to 3.00	2.00	to 3.00	2.00	to 3.00
Daffodils	3.00	to 4.00	3.00	to 4.00	3.00	to 4.00	3.00	to 5.00
Freesia	to	2.00	to 3.00	2.00	to 3.00	2.00	to 3.00
Narcis, Paper White	to 3.00	to 3.00	to 3.00	to 3.00
Gardenias	to	50.00	to 75.00	50.00	to 75.00	to
Violets	50	to 75	50	to 75	75	to 1.00	95	to 1.75
Adiantum	to 1.00	to 1.50	50	to 1.50	1.00	to 1.50
Smilax	to 12.50	12.50	to 15.00	12.00	to 15.00	12.50	to 15.00
Asparagus Plumosus, strings	15.00	to 50.00	15.00	to 50.00	25.00	to 50.00	30.00	to 50.00
" & Spren (100 bchs.)	25.00	to 35.00	25.00	to 35.00	25.00	to 50.00	30.00	to 50.00

quences of over production are thereby avoided.

INDIANAPOLIS

Trade conditions the past week have been most satisfactory, stock in almost every line having a good demand. Beauties are not quite so plentiful, but still sufficient to go around. Brides and Bridesmaids are coming in more freely, while Richmond and Killarney are practically off crop with most of the growers. Easter lilies and callas are more than plentiful. Bulbous flowers have become a staple article of the market. All colors and kinds are to be had in quantity. The demand for carnations on McKinley Day was a disappointment for some reason. Mignonette, freesia and daffodils are having a heavy run, while demand for violets varies from day to day according to the weather. Flowering plant trade is daily improving. Cyclamens, lilacs, azaleas, and bulbous stock in pans form the strongest combination. Tomlinson Hall flower market report business ahead of preceding year at this time. Smilax and asparagus have a steady demand, also bronze and green galax.

PHILADELPHIA

Balls, weddings, social world generally, in full swing last week. Flowers called for in large quantities. The best week since Christmas—and rivaling as to prices that high-water period. Everything cleaned up well. Beauties went up to the dollar mark. Carnations five and six. Lent carnations on the 24th, so that these favorable conditions may be expected to continue for another week or ten days. Cattleyas, reported redundant last

week, are now scarce. Fancy white roses have often to be sacrificed at low prices, the demand being mostly to low-priced whites. Pink roses, on the other hand, when of fancy quality, find a ready market. Double violets are scarce and bringing high prices. St. Valentine will be short of his favorite flower this year from all appearances. But there are plenty of pansies, lily of the valley and other shy and modest offerings for the timid and economical devotees of the saint. White lilac never better.

TWIN CITIES

Twin Cities was about the same as the previous week, except in Minneapolis, where the funeral of Mr. Thomas Lowry, president of the Twin City Rapid Transit Co. and the Soo Line, caused a large sale of flowers. The home market was mostly able to fill the demand, with but few exceptions.

WASHINGTON

Barring the fact that bulbous stock is more plentiful and therefore a trifle cheaper, all flowers are holding their prices. The almost continual dark weather has shortened the cut on roses, and the quality has been impaired likewise. The carnations shown in this market, though, are of unusually fine quality. Green is still scarce and bringing good prices.

The "Look-Ahead" Calendars Nos. 1, 2 and 3, of the McFarland Publicity Service, Harrisburg, Pa., have been received at this office. Artistically they are very hands-me; as business-joggers they should fill the bill.

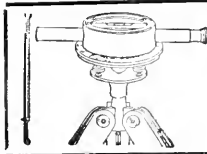

EVERYBODY KNOWS Park, Cemetery and Landscape Gardening cannot be properly done without the aid of an accurate leveling instrument.

Bostrom's Improved Levels, No. 2 at \$15.00 and No. 3 at \$25.00, are conceded by all who **KNOW** to be the only Levels on the market which meet all the requirements, at the price.

Our guarantee back of every Level we sell, and satisfied users in every State in the Union heartily endorse every claim we make.

Shipping weight 12 lbs. Description on request.

BOSTROM-BRADY MFG. CO., 139 Madison Avenue, ATLANTA, GA.

FORD BROTHERS
 48 West 28th Street NEW YORK
FINE ROSES FANCY CARNATIONS
 A Full Line of ALL CUT FLOWERS
 Telephone, 3870 or 3871 Madison Square

H. E. FROMENT
 Wholesale Commission Florist,
 Choice Cut Flowers,
 57 West 28th St. :: NEW YORK
 Telephones: 2200, 2201, Madison Square.

Alfred H. Langjahr
 All choice cut-flowers in season. Send for quotations. Correspondence with shippers of first-class stock invited.
 55 West 28th Street, New York
 Telephones 4626-4627 Madison Square

Edward C. Horan
 Wholesale Florist
 55 WEST 28th ST.
 Tel. 1462 Madison Square New York
 1463

JOHN YOUNG
WHOLESALE FLORIST
 Finest American Beauties and Carnations

51 West 28 St. - NEW YORK
FRANK MILLANG
Wholesale Florist
 55-57 West 26th St., NEW YORK
 Shipments, any quantity, Wholesale Market Rates.

Consignments Requested
 A Good Market and Prompt Returns
GEORGE SALTFOED
 43 W. 28th Street, NEW YORK
 Telephone, 3393 Madison Sq.

VIOLETS
 Finest Grade. Any Quantity
B. S. SLINN
 55-57 W. 26 St., New York

Moore, Hentz & Nash
 Wholesale Commission Florists
 55 and 57 West 26th Street
 Telephone No. 756 Madison Square New York

MILLANG BROS.
 WHOLESALE COMMISSION FLORISTS
 41 West 28th Street
 Telephone 3860 Madison 3861 NEW YORK

JOHN I. RAYNOR
Wholesale Commission Florist SELLING AGENT FOR LARGEST GROWERS
 A full line of Choice Cut Flower Stock for all purposes. Comprises every variety grown for New York market, at current prices
 TEL. 1998 MADISON SQUARE 49 West 28th St., New York City

Walter F. Sheridan
 Wholesale Commission Dealer in
CHOICE CUT FLOWERS
 39 West 28th Street, New York
 Telephone: 3532-3573 Madison Square

HEADQUARTERS FOR NOVELTIES
ORCHIDS A SPECIALTY
 THE HIGHEST GRADE OF **VALLEY** ALWAYS ON HAND
 GARDENIAS, DAISIES, ROSES AND CARNATIONS
JAMES McMANUS, Telephone 763 Mad. Sq. 42 W. 28th St., New York

PHILIP F. KESSLER 55 & 57 W. 26th St., New York City
 Commission Dealer, Wholesale Buyer and Seller of
GUT FLOWERS
 Open from 5 a. m. to 6 p. m. Sunday till 10 a. m.
 Tel. 5243 and 2921 Madison Sq. Res., 345 J., Newtown.
Finest Lilies in the Market Every Day in the Year.

NEW YORK QUOTATIONS PER 100. To Dealers Only

ROSES AND CARNATIONS	Last Half of Week ending Feb. 6 1909		First Half of Week beginning Feb. 8 1909	
	per 100	per 100	per 100	per 100
American Beauty, Fancy and Special.....	50.00	to 100.00	50.00	to 100.00
" " Extra.....	35.00	to 50.00	35.00	to 50.00
" " No. 1.....	35.00	to 20.00	15.00	to 25.00
" " Lower Grades.....	4.00	to 8.00	3.00	to 8.00
Bride, "Pied", Fancy and Special.....	10.00	to 15.00	10.00	to 12.00
" " Lower Grades.....	4.00	to 6.00	3.00	to 5.00
Killarney, Fancy and Special.....	15.00	to 25.00	12.00	to 22.00
" " Lower Grades.....	4.00	to 10.00	4.00	to 8.00
Richmond, Fancy and Special.....	15.00	to 35.00	15.00	to 30.00
" " Lower Grades.....	3.00	to 20.00	3.00	to 10.00
Chatenay.....	4.00	to 25.00	4.00	to 20.00
Ply Maryland.....	4.00	to 12.00	3.00	to 12.00
Golden Gate, Ivory, etc.....	3.00	to 12.00	3.00	to 10.00
Queen Beatrice.....	to	to
Prs. Par. Field.....	to	to
Carnations, Fancy and Novelties.....	5.00	to 8.00	4.00	to 6.00
" " Ordinary and White.....	2.00	to 3.00	2.00	to 3.00

Alexander J. Guttman
THE WHOLESALE FLORIST OF NEW YORK
 34 WEST 28th STREET
 PHONES. 1664-1665 MADISON SQUARE
ENOUGH SAID

TRAENDLY & SCHENCK
 Wholesale Florists
 Furnish best Stock at fair Prices all the year round
 Send for Quotations on Any Variety and Quantity
 Tel. 798, 799 Madison Sq. 44 West 28th St., New York City

GROWERS' CUT FLOWER CO. CUT FLOWERS AT WHOLESALE
VIOLETS, CARNATIONS, ROSES
ORCHIDS, CHRYSANTHEMUMS, LILIES
 Consignments Solicited. Shipments to Order, any Distance
 Telephone East Madison Square
39 West 28th Street, J. J. COAN, Manager NEW YORK

WHOLESALE FLORISTS
54 West 28th St.
NEW YORK
Telephone 3559 Madison Sq.

A. L. YOUNG & CO.

RECEIVERS & SHIP-
PERS OF CUT
FLOWERS.
CONSIGNMENTS SOLICITED.

WILLIAM H. KUEBLER
Brooklyn's Foremost and Best
WHOLESALE COMMISSION HOUSE
A First Class Market for all CUT FLOWERS
28 Wyloughby St., Brooklyn, N. Y.
Tel. 4591 Main

GEORGE COTSONAS & CO.
Wholesale and Retail Dealers in all kinds of
EVERGREENS
Fancy and Dagger Ferns
Bronze and Green Galax
Main Store 50 W. 28 St.
Phone 1202 Mad. Sq. New York



Greater New York Florists' Association, Inc.
Now Open for Cut Flower Consignments
162 Livingston Street, BROOKLYN, N. Y.
Geo. W. Crawbuck Telephone Connection
Manager 3642-43 Main

Henshaw & Fenrich
WHOLESALE FLORISTS
44 West 28th Street, NEW YORK
Phones Mad. Sq. 325, 558-2, 558-3

H. C. BERNING
Wholesale Florist

WHOLESALE COMMISSION **J. K. ALLEN** 106 W. 28th St. NEW YORK
Open 6 a.m. Daily Tel. 167 Madison Sq.
All Grades of Flowers to Suit All Buyers. Consignments Solicited.

1402 Pine Street, ST. LOUIS, MO.
REED & KELLER
122 West 25th St., New York
Florists' Supplies
We manufacture all our
Hotel Designs, Baskets, Wire Work & Novelties
and are dealers in
Glassware Decorative Greens and Florists' Requisites

NEW YORK QUOTATIONS PER 100. To Dealers Only

THE KERVAN CO.
Wholesale Dealers and Shippers of
Decorative Evergreens
Ferns, Galax, Laurel, Fresh Cyneas, Box-
wood, Sphagnum and all Christmas Greens
Send to us for Quotations before Buying.
113 West 28 Street, NEW YORK CITY

MISCELLANEOUS	Last Half of Week ending Feb. 6 1909		First Half of Week beginning Feb. 8 1909	
	Cyripediums	8.00	10.00	8.00
Cattleyas	25.00	35.00	25.00	40.00
Lilies	6.00	10.00	6.00	10.00
Lily of the Valley	1.00	3.00	1.00	3.00
Narcis., Paper White	3.00	3.00	2.00	3.00
Roman Hya.	1.50	2.00	1.00	2.00
Tulips	2.00	4.00	2.00	3.00
Daffodils	3.00	4.50	2.00	3.00
Freesia	2.00	3.00	1.00	3.00
Sweet Peas75	1.50	.75	1.50
Gardenias	20.00	40.00	25.00	40.00
Violets50	.75	.40	.75
Adiantum75	1.00	.75	1.00
Crownatum	1.00	1.25	1.00	1.25
Smilax	10.00	15.00	10.00	15.00
Asparagus Plumosus, strings	25.00	35.00	30.00	35.00
" & Sprea. (100 bchs)	20.00	30.00	25.00	25.00

MICHIGAN CUT FLOWER EXCHANGE, Inc.

NEW YORK MARKET.
With a few exceptions there is a marked increase of stock this week. American Beauties are in limited supply and bring 75c to \$1.00 apiece for specials; the price indicates how small the cut is. Gardenias are none too plentiful and the demand consumes all that comes on the market. The price of Cattleyas has improved as the crop lightens up. Quotations on all other varieties are easier. Though Bridesmaid and Bride are not plentiful, they are selling at reduced figures. There are more Killarneys and Richmonds in the market than a week ago. Carnations are increasing in number.

Violets have improved in price for a few days at least. Golden Spur and daffodils, tulips and freesias are all selling at reduced figures and in the case of the daffodils at a considerable loss. The market is dull and general business quiet in contrast to a week ago.

WHOLESALE COMMISSION FLORISTS
Consignments Solicited
Hardy Fancy Fern Our Specialty
38-40 BROADWAY, DETROIT, MICH.
BRONZE GALAX
I will offer during the next 60 days first class Bronze Galax at \$3.00 per case of 10,000, size 2 3/8 to 3 1/2 in f.o.b. Mt. Airy, N. C. Cash with order. Sample Order Solicited.
G. A. HOLDER, Round Peak, N. C.

Formosa lilies are pronounced a success at Bassett & Washburn's, Chicago. There seems, so far, however, no way of securing a uniform height, the stems ranging all the way from three to six feet tall. The bulbs planted in August gave a fine crop of blooms for the holidays.

In ordering goods please add "I saw it in HORTICULTURE."

Wired Toothpicks
Manufactured by
W. J. COWEE, BERLIN, N. Y.
10,000....\$1.75; 50,000....\$7.50. Sample free.
For sale by dealers

Notice to the Trade.

Millang Bros. at 41 West 28th St, New York City, announce that Charles Millang has no connection with the Firm of Millang Bros.

AUGUST MILLANG.

SAMUEL A. WOODROW
WHOLESALE PLANTSMAN
Palms, Large and Small Ferns, etc.
53 West 30th Street, NEW YORK
Telephone 2083 Madison

Buyer's Directory and Ready Reference Guide

Advertisements under this head, one cent a word. Initials count as words.

Display advertisers in this issue are also listed under this classification without charge. Reference to List of Advertisers will indicate the respective pages.

Buyers falling to find what they want in this list will confer a favor by writing us and we will try to put them in communication with reliable dealers.

ACCOUNTANT

R. J. Dysart, 28 State St., Boston.
For page see List of Advertisers.

AQUILEGIAS

Aquilegias. Genuine Coernela, finest of all. Both plants and seeds from the heart of the Rockies. C. S. Harrison's Select Nursery York, Ncb.

ARAUCARIAS

A. Leuthy & Co., Perkins St. Nurseries, Roslindale, Mass.

For page see List of Advertisers.

Godfrey Aschmann, 1012 West Ontario St., Philadelphia, Pa.

For page see List of Advertisers.

ASPARAGUS

The Geo. Withold Co., 1657 Buckingham Palace, Chicago, Ill.

For page see List of Advertisers.

ASTERS

Elmer D. Smith & Co., Adrian, Mich.
For page see List of Advertisers.

AUCTION SALES

Henry's Horticultural Co., 62 Vesey St., New York.

For page see List of Advertisers.

AZALEAS

A. Leuthy & Co., Perkins St. Nurseries, Roslindale, Mass.

For page see List of Advertisers.

Godfrey Aschmann, 1012 W. Ontario St., Philadelphia, Pa.

For page see List of Advertisers.

Henry A. Dreer, Philadelphia.

Azalea Mollis.

BAMBOO CANES

Yokohama Nursery Co., 31 Barclay Street, New York.

Bamboo Sticks, Colored Green.

For page see List of Advertisers.

BAY TREES.

2000 Bay and Box Trees in all sizes, Pyramid and Standards. Write for list. Julius Roehrs, Rutherford, N. J.

BOILERS

BOILERS. "Burnham" Boilers made for greenhouse heating. Lord & Burnham, 1133 Broadway, N. Y.

Kroeschell Bros. Co., 35 Erie St., Chicago.
For page see List of Advertisers.

BOXWOOD TREES

New England Nurseries, Inc., Bedford, Mass.

For page see List of Advertisers.

BUILDING MATERIAL

BUILDING MATERIAL of all description for All Cypress, Semi-Iron, Iron Frame or Truss Houses. Hot Bed Sash and Frames. Lord & Burnham Co., 1133 Broadway, N. Y.

BULBS AND TUBERS

Joseph Breck & Sons, 47-54 N. Market St., Boston.

For page see List of Advertisers.

J. M. Thornburn & Co., 33 Barclay St., New York.

For page see List of Advertisers.

A. T. Boddington, 342 W. 14th St., N. Y.
For page see List of Advertisers.

Rickards Bros., 37 East 19th St., New York.
For page see List of Advertisers.

H. F. Michell Co., Philadelphia.

For page see List of Advertisers.

BULBS AND TUBERS—Continued

H. E. Fiske Seed Co., Faneuil Hall Sq., Boston.

For page see List of Advertisers.

T. J. Grey & Co., 32 and 33 So. Market St., Boston.

For page see List of Advertisers.

Yokohama Nursery Co., 31 Barclay St., New York.

For page see List of Advertisers.

Ralph M. Ward & Co., 42 W. Broadway, New York.

Japan Lily Bulbs.

For page see List of Advertisers.

K. Takeuchi, 478A Boylston St., Boston. Japanese Bulbs.

For page see List of Advertisers.

Kinchi & Straub, 1200 York City, Chicago. Annyalls Bulbs.

For page see List of Advertisers.

CALADIUMS

Shellroad Canna Farms, Grange, P. O., Baltimore, Md.

For page see List of Advertisers.

CANNAS

A. T. Boddington, 342 W. 14th St., New York.

For page see List of Advertisers.

Dingee & Conard Co., West Grove, Pa.
For page see List of Advertisers.

Shellroad Canna Farms, Grange P. O., Baltimore, Md.

For page see List of Advertisers.

CARNATIONS

F. Dorner & Sons Co., Lafayette, Ind.
Carnation Pink Delight.

For page see List of Advertisers.

Chicago Carnation Co., Joliet, Ill.
For page see List of Advertisers.

Albert Roper, Tewksbury, Mass.
Carnation Bay State.

For page see List of Advertisers.

Bassett & Washburn, Hinsdale, Ill.
Carnation O. P. Bassett.

For page see List of Advertisers.

East Sudbury Greenhouses, So. Sudbury, Mass.

Carnation Cuttings.

For page see List of Advertisers.

Wood Bros., Fishkill, N. Y.
Carnations, Rooted Cuttings.

For page see List of Advertisers.

The E. G. Hill Co., Richmond, Ind.
Carnation Cuttings.

For page see List of Advertisers.

Peter Fisher, Ellis, Mass.
Rooted Cuttings.

For page see List of Advertisers.

S. J. Renter & Son, Westerly, R. I.
For page see List of Advertisers.

Charles H. Tetty, Madison, N. J.
For page see List of Advertisers.

Boston Co-operative Flower Growers' Assn., Boston.
Carnation and Rose Show.

For page see List of Advertisers.

Scheiden & Schone, Chicago
Carnation Wm. H. Taft.

For page see List of Advertisers.

Patten & Co., Tewksbury, Mass.
Carnations, Rooted Cuttings.

For page see List of Advertisers.

Paul Thomson, W. Hartford, Conn.
Carnation Neptune.

For page see List of Advertisers.

J. D. Crockett, Northport, L. I., N. Y.
Carnation Georgia.

For page see List of Advertisers.

CHRYSANTHEMUMS

Chas. H. Totty, Madison, N. J.
Chrysanthemum Novelties.

For page see List of Advertisers.

CHRYSANTHEMUMS—Continued

E. G. Hill Co., Richmond, Ind.
For page see List of Advertisers.

S. J. Renter & Son, Westerly, R. I.
For page see List of Advertisers.

Elmer D. Smith & Co., Adrian, Mich.
For page see List of Advertisers.

Chrysanthemum Golden Glow from 214 in. pots, for early spring delivery, \$1.00 per doz., \$6.00 per 100, \$50.00 per 1000. Stock plants of standard, C. Crocus.

Matchless, Lucy Devaux, Polly Rose and Halliday, \$1.00 per doz.; \$6.00 per 100. Peirce Bros., Waltham, Mass.

Herrington's book on the Chrysanthemum, mailed to your address for 50c., by Horticulture Publishing Co., 11 Hamilton Place, Boston.

CONIFERS

John Waterer & Sons, Ltd., American Nursery, Bugshot, Eng.

For page see List of Advertisers.

CUT FLOWER BOXES.

Edwards Folding Box Co., Philadelphia
For page see List of Advertisers.

Folding cut flower boxes, the best made Write for list. Holton & Hunkel Co., MD Waukee, Wis.

CYCLAMEN.

Thomas Roland, Nahsot, Mass.
For page see List of Advertisers.

DAHLIAS

David Hebert & Son, Atco, N. J.
For page see List of Advertisers.

J. L. Moore, Northboro, Mass.
For page see List of Advertisers.

Peacock Dahlia Farms, Williamstown Junction, N. J.

Dahlia Miss Virginia Manie.
For page see List of Advertisers.

R. Vincent Jr. & Sons Co., White Marsh, Md.
For page see List of Advertisers.

Dingee & Conard Co., West Grove, Pa.
For page see List of Advertisers.

Shellroad Canna Farms, Grange, P. O., Baltimore, Md.

For page see List of Advertisers.

DAHLIAS.

Geo. H. Walker, No. Dighton, Mass.
Wholesale and Retail.

Send your name for my 1909 Catalog and Pocket Guide, ready to mail about Feb. 25th.

East Bridgewater Dahlia Gardens wants your business. If you are looking for dahlias send to the Eastern Dahlia King, J. K. Alexander, East Bridgewater, Mass.

DECORATIVE PLANTS

A. Leuthy & Co., Perkins St. Nurseries, Roslindale, Mass.

For page see List of Advertisers.

Godfrey Aschmann, 1012 W. Ontario St., Phila., Pa.

For page see List of Advertisers.

Joseph Hancock Co., Wyncote, Pa.
For page see List of Advertisers.

The Geo. Withold Co., 1657 Buckingham Palace, Chicago, Ill.

For page see List of Advertisers.

Robert Craig Co., Market and 49th Sts., Philadelphia, Pa.

For page see List of Advertisers.

A. N. Pierson, Inc., Cromwell, Conn.
Palms and Ferns.

For page see List of Advertisers.

DRACAENAS

The Geo. Withold Co., 1657 Buckingham Place, Chicago, Ill.

For page see List of Advertisers.

For List of Advertisers See Page 233

ECONOMY BRACKET

Buxton & Allard, Nashua, N. H.
For page see List of Advertisers.

EVERGREENS

New England Nurseries, Bedford, Mass.
For page see List of Advertisers.
American Nursery Co., 150 Broadway,
New York, N. Y.
For page see List of Advertisers.

Evergreens. Send 25 cents in stamps
for complete work on propagating and
growing Evergreens. C. S. Harrison's
Select Nursery, York, Neb.

FERNS

A. Leuthy & Co., Roslindale, Mass.
For page see List of Advertisers.
H. H. Barrows & Son, Whitman, Mass.
Nephrolepis Whitman.
For page see List of Advertisers.
John Scott, Brooklyn, N. Y.
For page see List of Advertisers.
Frank Oechalin, 2570-3006 W. Adams St.,
Chicago.
Ferns for Dishea.
For page see List of Advertisers.
The Geo. Wittbold Co., 1637 Buckingham
Palace, Chicago, Ill.
For page see List of Advertisers.
Godfrey Achmann, 1012 W. Ontario St.,
Philadelphia.
For page see List of Advertisers.

FERTILIZERS

Pulverized Manure Co., 31 Union Stock
Yards, Chicago, Ill.
Wizard Brand Sheep and Shredded Cattle
Manure.
For page see List of Advertisers.
Robert Simpson, Clifton, N. J.
Sheep Manure.
For page see List of Advertisers.

FEVERFEW

Double Feverfew, 2 1/2 in., \$2.50 pr 100.
B. P. Winch, Framingham, Mass.
Feverfew Little Gem, 80c per 100; \$7.00
per 1000. S. W. Pike, St. Charles, Ill.
2000 Feverfew from 2 1/2 in. \$3.00 per 100,
\$25.00 per 1000. Albert Bailey & Son,
Maynard, Mass.

FLORAL PHOTOGRAPHS

Floral Photographs, Foley's, 226-228 1/2
Bowery, New York.

FLORISTS' LETTERS.

Boston Florist Letter Co., 66 Pearl St.,
Boston, Mass.
For page see List of Advertisers.

FLORISTS SUPPLIES

N. F. McCarthy & Co., 84 Hawley St.,
Boston.
For page see List of Advertisers.
H. M. Robinson & Co., 15 Province St. and
9 Chapman Pl., Boston, Mass.
For page see List of Advertisers.
Reed & Keller, 122 W. 25th St., New York.
For page see List of Advertisers.
H. Bayeradorfer & Co., 1129 Arch St.,
Philadelphia.
For page see List of Advertisers.
Barton & Co., Appleton, N. Y.
Baskets: Crates: Ladders: Boxes.

FLOWERS BY TELEGRAPH

Park Floral Co., Denver, Colo.
For page see List of Advertisers.
Gude Bros. Co., 1214 F St.,
Washington, D. C.
For page see List of Advertisers.
Atlanta Floral Co., Atlanta, Ga.
For page see List of Advertisers.
M. C. & J. E. Hauwirth, 232 Michigan Ave.,
Chicago.
For page see List of Advertisers.
William J. Smyth, Michigan Ave. and 31st
St., Chicago.
For page see List of Advertisers.
George Wittbold Co., 1637-59 Buckingham
Place, Chicago.
For page see List of Advertisers.
Jacob Schulz, 644 4th Ave., Louisville, Ky.
For page see List of Advertisers.

FLOWERS BY TELEGRAPH—

Continued

Thos. F. Galvin, 124 Tremont St., Boston.
For page see List of Advertisers.
F. H. Houghton, 396 Boylston St.,
Boston.
For page see List of Advertisers.
Edward MacMullin, 194 Boylston St.,
Boston.
For page see List of Advertisers.
Hoffman, Florist, 59-61 Massachusetts Ave.,
Boston.
For page see List of Advertisers.
J. Newman & Sons, Inc., 24 Tremont St.,
Boston.
For page see List of Advertisers.
Tully, Wellesley, Mass.
For page see List of Advertisers.
J. Bretmeyer's Sons, Miami and Gratiot
Aves., Detroit, Mich.
For page see List of Advertisers.
Samuel Murray, 1017 Broadway,
Kansas City, Mo.
For page see List of Advertisers.
Wm. L. Rock Flower Co., 1116 Walnut St.,
Kansas City, Mo.
For page see List of Advertisers.
H. G. Eyles, 11 N. Pearl St., Albany, N. Y.
For page see List of Advertisers.
David Clarke's Sons, 2139-2141 Broadway,
New York.
For page see List of Advertisers.
Alex. McConaell, New York.
For page see List of Advertisers.
Robert G. Wilson, Fulton St. & Greene
Ave., Brooklyn, N. Y.
For page see List of Advertisers.
Young & Nugent, 42 W. 28th St., N. Y.
For page see List of Advertisers.
M. Bowe, 1204 Broadway, New York.
For page see List of Advertisers.
Myer, 600-11 Madison Ave., New York.
For page see List of Advertisers.
Thos. Young, Jr., 509 Fifth Ave., New York.
For page see List of Advertisers.
Newman Florist Co., 202 Fifth Ave., and
Madison Sq., New York.
For page see List of Advertisers.
The Blossom (C. C. Trepel, Mgr.),
Boud and Livingston Sts., Brooklyn, N. Y.
For page see List of Advertisers.
Palmer's, Buffalo, N. Y.
For page see List of Advertisers.
F. A. Danker, Albany, N. Y.
For page see List of Advertisers.
J. H. Dunlop, 96 Yonge St., Toronto, Can.
For page see List of Advertisers.

FLOWER POTS

W. H. Ernest, 28th and M Sts.,
Washington, D. C.
For page see List of Advertisers.
A. H. Hews & Co., Cambridge, Mass.
For page see List of Advertisers.
Hilfinger Bros., Ft. Edward, N. Y.
For page see List of Advertisers.
The Peters & Reed Pottery Co.,
Red pots, seed pans, etc.
Zanesville, O.

FOREST SEEDLINGS

To close out quick I offer the following
first-class Stock for Parks, Cemeteries
and Forest Plantings: 100 M. Amorpha
Fruticosa, 1 to 3 ft.; 300 M. Althea Rosea
Stocks, 100 M. Cal. Privet; 500 M. Cal.
Privet Cuttings; 100 M. Black Locust, 4
to 6 ft.; 50 M. Calycanthus Sweet Shrub,
1 to 3 ft.; 150 M. Cercis Canadensis, Red
Bud, 1 to 4 ft.; 60 M. Cornus Stolonifera,
Ozler Dogwood, 1 to 2 ft.; 50 M. Diosyros,
Am. Persimmon, 6 to 30 inches; 50 M. Elm
(white) 1 to 2 ft.; 75 M. Hamamelis, Witch
Hazel, 6 in. to 3 ft.; 50 M. Tulp Poplar,
1 to 8 ft.; 20 M. Sweet Gum, 1 to 6 ft.;
50 M. Black Walnut, 1 to 3 ft.; 20 M.
Wistaria, 1 to 3 ft.; 20 M. Yucca Japane-
tosa, 1 and 2 year Buttercut, Japan Wal-
nut, Ash, Maple, etc. Send for trade list.
I offer my entire stock to close out at low
prices; also a large stock of Tree and
Shrub Seeds, Black Locust, Sweet Gum,
Sycamore, Ash, Red Bud, Persimmon, Bass
Wood, Viburnums, Sugar Maple, Red Cedar
and other Seeds. Forest Nursery & Seed
Co., J. H. Boyd, Prop., R. F. D. No. 2,
McMinnville, Tenn.

GALAX

Michigan Cut Flower Co., 38 and 40 Broad-
way, Detroit, Mich.
For page see List of Advertisers.
George Cotsonas & Co., 60 W. 28th St.,
New York.
For page see List of Advertisers.
The Kervan Co., 113 West 28th St., N. Y.
For page see List of Advertisers.
Rice Bros., 115 N. 6th St., Minneapolis,
Minn.
For page see List of Advertisers.
H. M. Robinson & Co., 15 Province St.
and 9 Chapman Place, Boston.
For page see List of Advertisers.
G. A. Holder, Round Peak, N. C.
Florida Galax.
For page see List of Advertisers.

GERANIUMS

R. Vincent Jr. & Sons Co., White Marsh,
Md.
New and Standard Varieties.
For page see List of Advertisers.
A few hundred fine mixed stock gerani-
ums, all double, \$10.00 per 100. Fine gerani-
ums, 2 1/2 in., \$2.50 per 100. Cash. H. J.
Blanchard, Ashburnham, Mass.

GLADIOLI

J. L. Moore, Northboro, Mass.
For page see List of Advertisers.
E. S. Miller, Wading River, N. Y.
For page see List of Advertisers.
A. T. Boddington, 342 W. 14th St.,
New York.
For page see List of Advertisers.
Shellroad Cann. Farms, Grange, P. O.,
Baltimore, Md.
For page see List of Advertisers.
O. V. Zangen, Hoboken, N. J.
Gladiolus Brenclyensis.
For page see List of Advertisers.
Stumpp & Walter Co., 50 Barclay St.,
New York.
Gladiolus Bulbs.
For page see List of Advertisers.
Gladioli. As good as any and better than
many. Send for trade list. E. E. Stewart,
Rives Junction, Mich.
Brenclyensis Gladioli, \$8.00 per 1000.
Cash with order, please. Estate of Louis
Siebrecht, Floral Park, N. Y.
Cush's hybrids, small size (bulbets),
\$1.00 per 1000, postpaid; named varieties,
\$2.00 per 1000. Henry Field Seed Co., Shen-
andoah, Iowa.

GLASS

Boston Plate & Window Glass Co., Boston.
For page see List of Advertisers.
Standard Plate Glass Co., 26-30 Sudbury
St., Boston.
For page see List of Advertisers.
Foley Mfg. Co., Western Ave., between
25th & 26th Sts., Chicago.
Sharp, Hatridge & Co., 22d & Lumber St.,
Chicago.
For page see List of Advertisers.
Greenhouse glass, lowest prices. John-
ston Glass Co., Hartford City, Ind.
Glass, High Grade, Double Thick Green-
house Glass. Lord & Burnham, 1133 Broad-
way, N. Y.

GLAZING DEVICES

H. A. Dreer, Philadelphia, Pa.
Peerless Glazing Point.
For page see List of Advertisers.
GLAZING POINTS, Lord & Burnham
Special Glazing Nails (Points). Lord &
Burnham, 1133 Broadway, N. Y.

**GREENHOUSE BUILDING MATE-
RIAL**

Lord & Burnham Co.,
1133 Broadway, New York.
For page see List of Advertisers.
Pierson U-Bar Co., 1 Madison Sq., N. Y.
For page see List of Advertisers.
A. T. Stearns Lumber Co., Neponset,
Boston.
For page see List of Advertisers.
King Construction Co., N. Tonawanda,
New York.
For page see List of Advertisers.
Hitchings & Co., 1170 Broadway, New York.
For page see List of Advertisers.

In writing to Advertisers kindly mention Horticulture

GREENHOUSE BUILDING MATERIAL — Continued

J. C. Moninger Co., 117 East Blackhawk St., Chicago, Ill.
For page see List of Advertisers.

Foley Mfg. Co., Western Ave., between 25th & 26th Sts., Chicago.
For page see List of Advertisers.

GREENHOUSE CONSTRUCTION

GREENHOUSE CONSTRUCTION, Semi-Iron Greenhouses, New Truss Houses and Iron Frame Houses, Lord & Burnham, 1133 Broadway, N. Y.

J. A. Payne, 260-274 Culver Ave., Jersey City, N. J.
For page see List of Advertisers.

Foley Mfg. Co., Western Ave., between 25th & 26th Sts., Chicago.
For page see List of Advertisers.

Hitchings & Co., 1170 Broadway, New York.
For page see List of Advertisers.

GREENHOUSE HOSE

Revere Rubber Co., Boston, Mass.
Revere Hose.
For page see List of Advertisers.

GUTTERS

GUTTERS, Cast Iron Gutters, L. & B. Improved V Shaped Gutter with drip gutter attachment, Lord & Burnham, 1133 Broadway, N. Y.

HAIL INSURANCE

Florists' Hall Assn. of America, J. G. Esler, Saddle River, N. J.
For page see List of Advertisers.

HARDY FERNS, MOSS AND GREENS

H. M. Robinson & Co., 15 Province St. and 9 Chapman Pl., Boston, Mass.
For page see List of Advertisers.

Michigan Cut Flower Exchange, 38 and 40 Broadway, Detroit, Mich.
For page see List of Advertisers.

George Cousans & Co., 50 W. 28th St., N. Y.
For page see List of Advertisers.

N. F. McCarthy & Co., 84 Hawley St., Boston.
For page see List of Advertisers.

The Kervan Co., 113 W. 28th St., N. Y.
For page see List of Advertisers.

Rice Bros., 115 N. 6th St., Minneapolis, Minn.
For page see List of Advertisers.

Green and Bronze Lemnition, \$2.50 per 1000. Nice long sprays. Cash. Please address Frank H. Hill, Victoria, Moon Co., N. C.

HEATING APPARATUS

Lord & Burnham Co., 1133 Broadway, New York.
For page see List of Advertisers.

Pierson U-Bar Co., 1 Madison Sq., N. Y.
For page see List of Advertisers.

John A. Payne, 260-274 Culver Ave., Jersey City, N. J.
For page see List of Advertisers.

Kroeschell Bros. Co., 35 Erie St., Chicago.
For page see List of Advertisers.

HELP FURNISHED

Thos. H. Bambrick, 34 S. 7th St., Phila.
For page see List of Advertisers.

HERBACEOUS PERENNIALS

P. Ouwerkerk, P. O. No. 1, Hoboken, N. J.
For page see List of Advertisers.

New England Nurseries, Bedford, Mass.
For page see List of Advertisers.

The Geo. Wittbold Co., 1657 Buckingham Place, Chicago.
For page see List of Advertisers.

HOT-BED SASH

The A. T. Sturges Lumber Co., Neponset, Mass.
For page see List of Advertisers.

Pierson U-Bar Co., 1 Madison Sq., N. Y.
For page see List of Advertisers.

Lord & Burnham Co., 1133 Broadway, N. Y.
For page see List of Advertisers.

Foley Mfg. Co., Western Ave., between 25th & 26th Sts., Chicago.

INSECTICIDES.

Nicotinic kills all greenhouse pests.
P. R. Talbot Co., 129
Eleventh St., Owensboro, Ky.
For page see List of Advertisers.

Stump & Walter Co., 50 Barclay St., New York.
Kilnwood Tobacco Dust.
For page see List of Advertisers.

Ningara Sprayer Co., Middleport, N. Y.
Ningara Brand.
For page see List of Advertisers.

B. G. Pratt Co., New York.
Sulfocide.
For page see List of Advertisers.

Tobacco dust and stems, dust in lbs., 150 to 200 lbs., \$1.00; stems in bales from 350 to 400 lbs., \$2.00. Cash with order; money back if you say so. I lead them all in quality and price. S. R. Levy, Binghamton, N. Y.

"The Fumigating Kind Tobacco Powder"—The first on the market and the kind that has so many imitators, has our guarantee tag of satisfaction or money back, and "The Moon Trade Mark" on every bag, \$3.00 per 100 lbs. The H. A. Stoolhoff Co., Mount Vernon, N. Y., Makers and sellers.

JAPANESE PLANTS

Yokohama Nursery Co., 31 Barclay St., New York.
For page see List of Advertisers.

KENTIAS

Godfrey Aschmann, 1012 W. Ontario St., Phila., Pa.
For page see List of Advertisers.

A. Leuthy & Co., Roslindale, Mass.
For page see List of Advertisers.

Jos. Heacock Co., Wyncoke, Pa.
Single and Made-Up Specimens.
For page see List of Advertisers.

LEVELS FOR LANDSCAPE GARDENING USE

Boatman-Brady Mfg. Co., 132 Madison Ave., Atlanta, Ga.
For page see List of Advertisers.

LILY OF THE VALLEY PIPS

Hjalmar Hartman & Co., 12 Stormgade, Copenhagen, Denmark.
For page see List of Advertisers.

LOBELIAS

Double Lobelia Kathleen Mallard, rooted cuttings, \$1.00 per 100. Cash. Chas. H. Green, Spencer, Mass.

MARGUERITES

Marguerites, Queen Alexandra, \$1.25 per 100, prepaid. S. W. Pike, St. Charles, Ill.

NICO-FUME

Kentucky Tobacco Product Co., Louisville, Ky.
For page see List of Advertisers.

NURSERY STOCK

John Waterer & Sons, Ltd., American Nursery, Bagshot, England.
For page see List of Advertisers.

Cleary's Horticultural Co., 62 Vesey St., New York.
For page see List of Advertisers.

P. Ouwerkerk, 216 Jane St., Weehawken, N. J.
For page see List of Advertisers.

D. J. Twomey, Dept. H, Geneva, N. Y.
For page see List of Advertisers.

American Nursery Co., 150 Broadway, New York, N. Y.
For page see List of Advertisers.

Manual of the Trees of North America, by C. S. Sargent, mailed your address for \$6.00, by Horticulture Publishing Co., 11 Hamilton Place, Boston.

TREES, SHRUBS, ROSES, EVER GREENS, PERENNIALS, HARDY PLANTS, ELLWANGER & BARRY, Rochester, N. Y.

New Hardy Shrub Broadleaf varieties, Vetch, the summer flowering shrub, each \$2.00 per doz.; \$25.00 per 100. Rose Hill Nurseries, New Rochelle, N. Y.

Catalog now ready—Nursery grown evergreens, seedling white pine and hemlock, native trees and plants. L. E. Willians, Nottingham, N. H.

Rhododendrons, Laurel, Spruce, Hemlock, Poplars, E. W. Shepley, De Bruce, Sullivan County, N. Y.

ONION SEED

Federico C. Varela, Tenerife, Canary Ids., Bermuda Onion Seed.

ORCHID PLANTS

Lager & Hurrell, Summit, N. J.
For page see List of Advertisers.

Sander, St. Albans, England.
Importers, Exporters, Growers, Hybridists.
For page see List of Advertisers.

Carrillo & Baldwin, Syracuse, N. Y.
For page see List of Advertisers.

Jos. A. Manda, 191 Valley Road, W. Orange, N. J.
For page see List of Advertisers.

Ordonez Bros., Madison, N. J., Box 106.
For page see List of Advertisers.

Largest stock in the country. Ask for prices. Julius Roehrs, Rutherford, N. J.

PAINT AND PUTTY

PAINT AND PUTTY: Ideal Greenhouse lead; Special Greenhouse Putty. Lord & Burnham, 1133 Broadway, N. Y.

PALMS

A. Leuthy & Co., Ferns St. Nurseries, Roslindale, Mass.
For page see List of Advertisers.

Robert Craig Co., Market and 40th Sts., Philadelphia, Pa.
For page see List of Advertisers.

Joseph Heacock Co., Wyncoke, Pa.
Home-Grown Palms.
For page see List of Advertisers.

PANSY PLANTS.

Pansies, extra fine giant flowering, strong plants, 30 cents per 100; \$2.50 per 1000 Edw. Wallis, Atco, N. J.

PATENTS

Siggers & Siggers, Washington, D. C.
For page see List of Advertisers.

PEAT

Orchid peat, Rotted peat, Azalea peat, Leaf-Mould, Live Sphagnum moss, Baled Sphagnum moss, Green Clump moss, etc. Jobbers' list on application. C. W. Brownell & Co., Walden, N. Y.

Orchid Peat and Moss always on hand. Julius Roehrs Co., Rutherford, N. J.

PEONIES

Peonies only, by the wholesale—best 100 varieties. J. F. Rosenfield, Westpoint, Nebr.

One of the finest collections in America. Send 25 cts. in stamps for new edition of Peony Manual. C. S. Harrison's Select Nursery, York, Neb.

PHLOXES

Send 25 cts in stamps for Phlox Manual. Fine mixed phloxes \$2.00 per 100. C. S. Harrison's Select Nursery, York, Neb.

PHOTOGRAPHS: DESIGNING: ILLUSTRATING

Geo. E. Dow, 178 Washington St., Boston.
For page see List of Advertisers.

PIPE AND FITTINGS

Foley Mfg. Co., between Western Ave. and 26th St., Chicago, Ill.
For page see List of Advertisers.

Kroeschell Bros. Co., 35 Erie St., Chicago.
For page see List of Advertisers.

PIPE AND FITTINGS—Cast Iron and Wrought Pipe, Valves, Elbows, Pipe Hooks, Automatic Air Headers, etc. Lord & Burnham, 1133 Broadway, N. Y.

PLANT STANDS

Moore-Livingston Co., Landsdowne, Pa.
For page see List of Advertisers.

PLANT STAKES

Seale's Telescopic Plant Stakes and Trelises. H. D. Seale & Sons, Elkhart, Ind.

POT HANGERS

Pot hangers, Kramer's \$1 doz. by exp. \$1.25 by mail. I. N. Kramer & Son, Cedar Rapids, Ia.

POINSETTIAS (Artificial)

Poinsettias, artificial decorations our specialty. Sample lots of 50 in 3 sizes, \$4.00; 100 lots, \$7.50; \$10. J. Stern & Co., 125 N. 10th St., Philadelphia, Pa.

For List of Advertisers See Page 233

PRIVET

John Bennett, Atlantic Highlands, N. J.
For page see List of Advertisers.

PRUNING SHEARS

Rhodes Mfg. Co., Dept. R., Grand Rapids, Mich.

RAFFIA

Raffia (colored), 20 beautiful shades. Samples free. R. H. Conroy Co., Camden, N. J.: 810 Washburn Ave., Chicago, Ill.

RETAIL FLORISTS

Park Floral Co., Denver, Colo.
For page see List of Advertisers.
Gude Bros. Co., 1214 F St., Washington, D. C.
For page see List of Advertisers.

Atlanta Floral Co., Atlanta, Ga.
For page see List of Advertisers.

M. C. & J. E. Hauswirth, 232 Michigan Ave., Chicago.

For page see List of Advertisers.

William J. Smyth, Michigan Ave. and 31st St., Chicago.

For page see List of Advertisers.

George Witthold Co., 1657-59 Buckingham Place, Chicago.

For page see List of Advertisers.

Jacob Schulz, 644 4th Ave., Louisville, Ky.

For page see List of Advertisers.

Thos. F. Galvin, 124 Tremont St., Boston.

For page see List of Advertisers.

Frank H. Houghton, 396 Boylston St., Boston.

For page see List of Advertisers.

Edward MacMullin, 194 Boylston St., Boston.

For page see List of Advertisers.

Hoffman, Florist, 59-61 Massachusetts Ave., Boston.

For page see List of Advertisers.

J. Newman & Sons, Inc., 24 Tremont St., Boston.

For page see List of Advertisers.

Talbly, Wellestey, Mass.

For page see List of Advertisers.

J. Brettmever's Sons, Detroit, Mich.

For page see List of Advertisers.

Samuel Murray, 1017 Broadway, Kansas City, Mo.

For page see List of Advertisers.

Wm. L. Rock Flower Co., 1116 Walnut St., Kansas City, Mo.

For page see List of Advertisers.

H. G. Eyres, 11 N. Pearl St., Albany, N. Y.

For page see List of Advertisers.

David Clarke's Sons, 2139-2141 Broadway, New York.

For page see List of Advertisers.

Alex. McConnell, New York.

For page see List of Advertisers.

Robert G. Wilson, Fulton St. and Greene Ave., Brooklyn, N. Y.

For page see List of Advertisers.

Young & Nugent, 42 W. 28th St., N. Y.

For page see List of Advertisers.

M. Bowe, 1294 Broadway, New York.

For page see List of Advertisers.

Myer, 600-11 Madison Ave., New York.

For page see List of Advertisers.

Thos. Young, Jr., 500 Fifth Ave., New York.

For page see List of Advertisers.

Newman Floral Co., 392 Fifth Av. & Madison Sq., New York.

For page see List of Advertisers.

The Blossom (C. C. Trepel, Mgr.), Bond and Livingston Sts., Brooklyn, N. Y.

For page see List of Advertisers.

Palmer's Buffalo, N. Y.

For page see List of Advertisers.

F. A. Danker, Albany, N. Y.

For page see List of Advertisers.

J. H. Dunlop, 96 Yonge St., Toronto, Can.

For page see List of Advertisers.

RHODODENDRONS

John Waterer & Sons, Ltd.

American Nursery, Kingshot, England.

For page see List of Advertisers.

P. Ouwkerk, Hoboken, N. J.

For page see List of Advertisers.

Anthony Waterer, Knapp Hill Nursery, Surrey, Eng.

For page see List of Advertisers.

Henry A. Dreer, Philadelphia.

ROSES

Robert Craig Co., Market and 49th Sts., Philadelphia, Pa.
For page see List of Advertisers.

P. Ouwkerk, P. O. No. 2, Hoboken, N. J.
For page see List of Advertisers.

Julius Roehrs Co., Rutherford, N. J.
Rose Newport Fruity.
For page see List of Advertisers.

Waban Rose Conservatories, Natlek, Mass., and 32 Somerset St., Boston.
New Forcing Rose White Killarney.

The F. R. Pierson Co., White Killarney,
Tarrytown-on-Hudson, N. Y.
For page see List of Advertisers.

S. J. Keuter & Son, Westery, R. I.

For page see List of Advertisers.

Dirgee & Conard Co., West Grove, Pa.
For page see List of Advertisers.

Charles H. Totty, Madison, N. J.
For page see List of Advertisers.

Hand Book of Cultural Notes on Roses Under Glass, by F. P. Brigham, mailed to your address for 25c, by Horticulture Publishing Co., 111 Hamilton Place, Boston.

SEED GROWERS

C. C. Morse & Co., 48-56 Jackson St., San Francisco, Cal.

For page see List of Advertisers.

Hjalmar Hartmann & Co., Cauliflower and Cabbage Seed.

12 Strongdale, Copenhagen, Denmark.
For page see List of Advertisers.

Federico C. Varela, Tenerife, Canary Ids. Bermuda Onion Seed.

SEEDS

T. J. Grey Co., 32 So. Market St., Boston.
For page see List of Advertisers.

Joseph Breck & Sons, 51 and 52 N. Market St., Boston, Mass.
For page see List of Advertisers.

W. Atlee Burpee & Co., Philadelphia.
For page see List of Advertisers.

C. C. Morse & Co., 48-56 Jackson St., San Francisco, Calif.

For page see List of Advertisers.

Arthur T. Boddington, 342 W. 14th St., New York.
For page see List of Advertisers.

H. E. Fiske Seed Co., Faneull Hall Sq., Boston.

For page see List of Advertisers.

Hjalmar Hartmann & Co., 12 Stormgade, Copenhagen, Denmark, Cauliflower and Cabbage Seed.

For page see List of Advertisers.

Rickards Bros., 37 E. 19th St., New York.
For page see List of Advertisers.

R. & J. Farquhar & Co., 67 So. Market St., Boston.

Mignonette Seed.
For page see List of Advertisers.

H. F. Michell Co., 1018 Market St., Phila.

For page see List of Advertisers.

J. M. Thorburn & Co., 33 Barclay St., N. Y.

For page see List of Advertisers.

Leonard Seed Co., Chicago, Ill.

For page see List of Advertisers.

Wm. Elliott & Sons, 42 Vesey St., N. Y.

New Seed.
For page see List of Advertisers.

Weeber & Don, 114 Chambers St., New York.

For page see List of Advertisers.

Seeds. Rocky Mountain Evergreen seeds to large or small quantities. C. S. Harris' Sons' Select Nursery, York, Neb.

Onion Seed. Best crop; truly dependable seed; yellow, red and white Globe. Write for prices. Laughlin Seed Co., Kenton, O.

My own new crop of SALVIA SPLENDENS VARIETIES is now ready: Nana Compacta ZURICH, finest early flowering pot Salvia in existence, selected seeds. Compacta Grandiflora FIREBALL, best of all for pots and groups, selected seeds. Grandiflora Amellorata KING OF THE SCARLETS, unexcelled for late groups, with extra large deep scarlet spikes, selected seeds. Each of above per Tr. Pkt., 50c; 6 Tr. Pkt., \$2.50. Larger quantities on special quotation. O. V. ZANGEN, Seedsman, Hoboken, N. J.

SHAMROCKS

John F. Rupp, Shurenastown, Pa.
For page see List of Advertisers.

SHRUBS

The Geo. Witthold Co., 1657 Buckingham Palace, Chicago.
For page see List of Advertisers.

SILKALINE

John C. Meyer & Co., Boston, Mass.
For page see List of Advertisers.

SPHAGNUM MOSS

Live Sphagnum moss, orchid peat and orchid baskets always on hand. Lager & Hurrell, Summit, N. J.

Sphagnum moss and mountain laurel in bags, bales or car lots. Prices low. Spruce and hemlock in bales. James Day, Box 660, Milford, N. H.

SPRAYERS

"SHOWERMAKER" \$1. Jos. Kopcey, So. Bend, Ind.
For page see List of Advertisers.

Niagara Sprayer Co., Middleport, N. Y.
For page see List of Advertisers.

J. F. Cnss Mfg. Co., Dept. H., Detroit, Mich.

U-N-I-T Globe Sprayer.
For page see List of Advertisers.

Chas. J. Jager Co., Boston.
Deming Spray Pump.

For page see List of Advertisers.

STEAM TRAP

R. Hippard, Youngstown, O.
For page see List of Advertisers.

STRAWBERRY PLANTS

H. L. Crane, Westwood, Mass.
Barrymore Strawberry.
For page see List of Advertisers.

SULFOCID

The B. G. Pratt Co., 50 Church St., Dept. W., New York City.
For page see List of Advertisers.

SWEET PEAS

A. C. Zvolanek, Round Brook, N. J.
Winter Flowering.
For page see List of Advertisers.

TO-BAK-INE

E. H. Hunt, Genl. Agt., 76-78 Waabash Av., Chicago.
For page see List of Advertisers.

TOMATO PLANTS.

20,000 Forcing Tomatoes, 2 1/2 in., \$2.00 per 100. Royal Bros., West Grove, Pa.

VEGETABLE PLANTS

Best Cabbage Plants, any variety, 1000 at \$1.25 or 17; \$1.00 a 1000 for 5000 or more. Special prices on large lots. Special low express rates. The best ASPARAGUS ROOTS. One year old Giant Argenteum at \$1.00 per 100, \$2.00 a 1000. Cash with order please. Alfred Joannett, Mount Pleasant, N. C.

VENTILATING APPARATUS

Pierson U-Bar Co., 1 Madison Sq., N. Y.
For page see List of Advertisers.

Foley Mfg. Co., Western Ave., between 25th & 26th Sts., Chicago.

For page see List of Advertisers.

John A. Payne, 260-274 Culver Ave., Jersey City, N. J.

For page see List of Advertisers.

The Advance Co., Richmond, Ind.
For page see List of Advertisers.

Quaker City Machine Co., Richmond, Ind.
20th Century Ventilating Arm.

For page see List of Advertisers.

VENTILATING MACHINERY. New Model encased, self-oiling gear; Standard Model Open Gear. Lord & Burham, 1133 Broadway, N. Y.

In writing to Advertisers kindly mention Horticulture

FOR "POT LUCK" TRY US...

HEWS STANDARD POTS

POT MAKERS FOR 140 YEARS

WORLD'S LARGEST MANUFACTURERS

WRITE FOR CATALOGUE AND DISCOUNTS

A. H. HEWS & CO., Inc.
CAMBRIDGE, MASS.

452-460 No. Branch St.,
CHICAGO, ILL.

WAX FLOWERS

We are originators of wax designs and still the standard concern. J. Stern & Co., 125 N. 10th St., Philadelphia, Pa.

WIRED TOOTHPICKS

W. J. Cowee, Berlin, N. Y.
For page see List of Advertisers.

WIREWOK

Reed & Keller, 122 W. 25th St., N. Y.
For page see List of Advertisers.

Wirework. Write for our catalogue. Holton & Hunkel Co., Milwaukee, Wis.

William E. Heilsher's Wire Works, 38-40 Broadway, Detroit, Mich.

Headquarters for wire work. Send for list. Hall & Betz, 31 E. 3rd St., Cincinnati, O.

Wirework—Compare our prices with others. Scranton Florist Supply Co., 201 N. 7th St., Scranton, Pa.

WHOLESALE FLORISTS

Boston

N. F. McCarthy & Co., 84 Hawley St., Boston.
For page see List of Advertisers.

H. M. Robinson & Co., 15 Province St. and 9 Chappano Pl., Boston.
For page see List of Advertisers.

Welch Bros., 226 Devonshire St., Boston.
For page see List of Advertisers.

Tatby, Wellesley, Mass.
For page see List of Advertisers.

Chicago

Chas. W. McKellar, 51 Wabash Ave., Chicago.
For page see List of Advertisers.

Peter Reinberg, 51 Wabash Ave., Chicago.
For page see List of Advertisers.

E. F. Woterson Co., 45-49 Wabash Ave., Chicago.
For page see List of Advertisers.

J. A. Budlong, 37-39 Randolph St., Chicago.
For page see List of Advertisers.

Poehlmann Bros. Co., Morton Grove, Ill.
For page see List of Advertisers.

Cromwell, Conn.

A. N. Pierson, Cromwell, Conn.
For page see List of Advertisers.

Detroit

Michigan Cut Flower Exchange, 38 and 40 Broadway, Detroit, Mich.
For page see List of Advertisers.

Minneapolis

Rice Bros., 115 N. 6th St., Minneapolis, Minn.
For page see List of Advertisers.

New York

Ford Bros., 48 W. 28th St., New York.
For page see List of Advertisers.

H. E. Froment, 57 W. 28th St., New York.
For page see List of Advertisers.

WHOLESALE FLORISTS—

New York—Continued

Alex. J. Guttman, 34 W. 28th St., New York.
For page see List of Advertisers.

E. C. Horan, 55 W. 28th St., New York.
For page see List of Advertisers.

A. H. Langjahr, 55 W. 28th St., New York.
For page see List of Advertisers.

Jamea McMannus, 42 W. 28th St., New York.
For page see List of Advertisers.

John I. Raynor, 49 W. 28th St., New York.
For page see List of Advertisers.

W. F. Sheridan, 39 W. 28th St., New York.
For page see List of Advertisers.

Treadly & Scheuck, 44 W. 28th St., New York.
For page see List of Advertisers.

Moore, Hentz & Nash, 55 and 57 W. 26th St., New York.
For page see List of Advertisers.

Wm. H. Kuebler, 28 Willoughby St., Brooklyn, N. Y.
For page see List of Advertisers.

Philip F. Kessler, 55 and 57 W. 26th St., New York.
For page see List of Advertisers.

Milling Bros., 41 W. 28th St., New York.
For page see List of Advertisers.

John Young, 51 W. 28th St., New York.
For page see List of Advertisers.

Greater New York Florists' Association, 162 Livingston St., Brooklyn, N. Y.
For page see List of Advertisers.

George Saltford, 43 W. 28th St., New York.
For page see List of Advertisers.

Frank Milling, 55-57 W. 26th St., New York.
For page see List of Advertisers.

B. S. Riffin, 55-57 W. 26th St., New York.
For page see List of Advertisers.

A. L. Young & Co., 54 W. 28th St., N. Y.
For page see List of Advertisers.

Growers' Cut Flower Co., 89 W. 28th St., New York.
For page see List of Advertisers.

Henshaw & Fenrich, 44 W. 28th St., New York.
For page see List of Advertisers.

J. K. Allen, 106 W. 28th St., New York.
For page see List of Advertisers.

Philadelphia

W. E. McKleslek & Bros., 1619-1621 Rainted St., Philadelphia, Pa.
For page see List of Advertisers.

Leo Niessen Co., 1209 Arch St., Philadelphia, Pa.
For page see List of Advertisers.

The S. S. Pennock-Meehan Co., 1608-13 Ludlow St., Philadelphia, Pa.
For page see List of Advertisers.

St. Louis

H. G. Berolng, 1402 Pine St., St. Louis, Mo.
For page see List of Advertisers.

WHOLESALE PLANTSMAN

Samuel A. Woodrow, 53 W. 30th St., New York.
For page see List of Advertisers.

New Offers in This Issue.

ACACIA PUBESCENS.
S. S. Pennock-Meehan Co., 1608-1620 Ludlow St., Philadelphia, Pa.
For page see List of Advertisers.

ACACIA PUBESCENS.
Leo. Niessen Co., Philadelphia, Pa.
For page see List of Advertisers.

ADIANTUM FARLEYENSE, AZALEA MOLLIS, WALLFLOWERS, AUCUBAS, BOXWOOD.
Henry A. Dreer, Philadelphia, Pa.
For page see List of Advertisers.

CANES FOR LILY STAKES.
Wm. Elliott & Sons, New York City.
For page see List of Advertisers.

DYED PLANT STAKES FOR EASTER LILIES, HYACINTHS, ETC.
Henry F. Mitchell Co., Philadelphia, Pa.
For page see List of Advertisers.

NOTICE TO THE TRADE.
A. Millang, New York City.
For page see List of Advertisers.

POSITION FOR EXPERIENCED MAN.
The McFarland Publicity Service, Harrisburg, Pa.
For page see List of Advertisers.

SALVIA BONFIRE AND ZURICH.
R. Vincent, Jr. & Sons Co., White Marsh, Maryland.
For page see List of Advertisers.

"SHOWERMAKER" SPRAYER.
Joseph Kopsay, South Bend, Ind.
For page see List of Advertisers.

SAVE your weekly copies of this paper. DON'T throw them away.
The contents are always of PERMANENT VALUE and you may need them for reference tomorrow, a year from tomorrow, or still later.

STANDARD FLOWER POTS

Packed in small crates, easy to handle.

	Price per crate	Price per crate
1500 2 in. pots in crate	\$4.88	144 6 in. pots in crate \$3.16
1500 2 1/2 " " " "	5.25	120 7 " " " " " " 4.20
1500 2 3/4 " " " "	6.00	60 8 " " " " " " 3.00
1000 3 " " "	5.00	48 9 in. pots in crate \$3.60
800 3 1/2 " " "	5.80	48 10 " " " " " " 4.80
500 4 " " "	4.50	24 11 " " " " " " 3.60
450 4 1/2 " " "	5.24	24 12 " " " " " " 4.80
320 5 " " "	4.51	12 14 " " " " " " 4.80
210 5 1/2 " " "	3.78	6 16 " " " " " " 4.50

Seed pans, same price as pots. Send for price list of cylinders for Cut Flowers, Hanging Baskets, Lawn Vases, etc. Ten percent off for cash with order. Address Hylinger Bros., Pottery, Fort Edward, N. Y. August Rolker & Sons, Agts. 31 Barclay St., N. Y. City.

Standard Flower.. POTs

If your greenhouses are within six miles of the Capital, write us, we can save you money
W. H. ERNEST
28th and M Street WASHINGTON D. C.

List of Advertisers

Advance, The Co.,.....235	Page	Manda Jos. A.,.....224	Page
Allen J. K.,.....237		MacMillan E. A.,.....223	
American Nursery Co.,.....203		McCarthy N. J.,.....227	
(Eng.),.....203		McConnell Alex.,.....227	
American Nursery Co.,.....203		McFarland Publicity	
Aschmann Hortley,.....204		Service, The,.....233	
Atlanta Floral Co.,.....213		McGill Char. W.,.....224	
Bambrick Thos. H.,.....233		McKissick, W. E. &	
Barrows H. H. & Son,.....204		Bros.,.....224	
Bassett & Washburn,.....202		McManus Jas.,.....226	
Bayersdorfer H. & Co.,.....223		Moninger J. C.,.....225	
Bennett J.,.....202		Meyer J. C. & Co.,.....223	
Berning H. G.,.....222		Micheel H. F. Co.,.....218-20	
Blossom Th.,.....222		Michigan Cut Flower	
Boddington A. T.,.....216-20-211		Exchange,.....227	
Boston Co-operative		Millang Bros.,.....226	
FlowerGrowers' Assn.,.....215		Millang Fraok.,.....226	
Boston Florist Letter		Millang August,.....227	
Co.,.....213		Moninger J. C.,.....225	
B. Stone Plate and Win-		Moore, J. L.,.....204	
dow Glass Co.,.....234		Moore, Hentz & Nash,.....26	
B. Strom-Brady Mfg. Co.,.....225		Moore-Livingston Co.,.....223	
Bowe, M. A.,.....222		Morse C. C. & Co.,.....211	
Breik Joseph & Sons,.....221		Murray Samuel,.....222	
Breidney's J. Sons,.....223		New Eng. Nurseries,.....225	
Burgeman's Seed Warehouse,.....221		Newman Floral Co.,.....202	
Burdlong J. A.,.....224		Newman J. & Sons,.....223	
Burnee W. A. & Co.,.....221		Nagra Sargat,.....224	
Ca. Hills and Baldwin,.....234		Niessen Leo Co.,.....224	
Cass J. F. Mfg. Co.,.....218		Oechsin Frank,.....204	
Chicago Carnation Co.,.....202		Ordonez Bros.,.....204	
Clark Daniel,.....215		Owberkerk P.,.....203	
Clarke's David,.....215		Palehorpe P. R. Co.,.....218	
Cleary's Horticult' Co.,.....203		Parke W. J.,.....212	
Coan J.,.....226		Parf Floral Co.,.....212	
Cotnam Geo. R. Co.,.....227		Patten & Co.,.....222	
Crowe W. J.,.....221		Payne John A.,.....235	
Craig, Robt. Co.,.....203		Peck Dablin,.....215	
Craze H. L.,.....203		Peirce E. Allan,.....215	
Crawback Geo. W.,.....227		Pennock-Meehan Co.,.....224	
Danker F. A.,.....221		Perkins St. Nurseries,.....226	
Dillgee & Conrad,.....202		Pierson A. N.,.....215	
Dorner F. Sons & Co.,.....202		Pierson H. Co.,.....223	
Dow Geo. E.,.....21		Pierson U. Bar Co.,.....215	
Drer H. A.,.....217-213		Poehlman Bros. Co.,.....218	
Dunlop John H.,.....217		Pratt B. G. Co.,.....225	
Durand & Marohn,.....223		Provident Nursery Co.,.....225	
Easart R. J.,.....223		Quaker City Mach. Co.,.....234	
East Sudbury Green-		Kaynor John I.,.....226	
houses,.....202		Keed & Keller,.....227	
Edwards Folding Box Co.,.....224		Rinberg Peter,.....224	
Elfrott Wm & Sons,.....211		Reuter S. J. & Son, Inc.,.....209	
Eller J. C.,.....234		Rever & Fisher Co.,.....235	
Ernest W. H.,.....232		Rice Bros.,.....224	
Eyres,.....222		Rickards Bros.,.....221	
Farquhar R. J. & Co.,.....221		Robison H. M. & Co.,.....224	
Fisher Peter,.....22		Rock Wm. L. Co.,.....222	
Fiske H. E. Seed Co.,.....218-221		Roehrs Julius Co.,.....201-214	
Foley Mfg. Co.,.....235		Roper Albert,.....202	
Ford Bros.,.....226		Roland, Thomas,.....224	
Froment H. E.,.....226		Roiker August & Sons,.....232	
Galvin Thos. F.,.....223		Rupp J. F.,.....215	
Gordon-Van Tine Co.,.....234		Saltford Geo.,.....226	
Greater N. Y. Florists' Association,.....227		Sander & Son,.....204	
Grey T. J. Co.,.....21		Scheiden & Schoss,.....222	
Grower's Cut Flower Co.,.....226		Salt Jacob,.....223	
Gude Bros. Co.,.....222		Scott, John,.....224	
Guttman Alex. J.,.....226		Sharp, Partridge & Co.,.....234	
Hill Assn.,.....234		Shell Road Canna Farms,.....214	
Hartmann Hjalmar & Co.,.....222		Sheridan W. F.,.....226	
Hauswirth M. C. & J. E.,.....222		Syggers & Suggers,.....221	
Heacock Jos. & Co.,.....204		Simpson Robt.,.....221	
Henshaw & French,.....227		Situations & Wants,.....223	
Herbert David & Son,.....204		Simo B. S.,.....226	
Hews A. H. & Co.,.....232		Smith Elmer D.,.....215	
Hilfinger Bros.,.....212		Smyth Wm. J.,.....222	
Hill, The E. G. Co.,.....212		Standard Plate Glass Co.,.....235	
Hippard E.,.....234		Stearns A. T. Lumber Co.,.....234	
Hitchings & Co.,.....215		Stimpp & Waller Co.,.....219-9	
Hoffman,.....223		Taibly,.....223	
Holder G. C.,.....227		Takeuchi K.,.....221	
Horan E. C.,.....226		Tanori Robert,.....221	
Houghton F. H.,.....221		Thomson Paul,.....202	
Hunt E. H.,.....218		Thornburn J. M. & Co.,.....221	
Jager, Chas. J. Co.,.....217		Totty Chas. H.,.....202	
Kervan The Co.,.....228		Trendly & Schenck,.....226	
Kentucky Tobacco Product Co.,.....218		Trape C. C.,.....222	
Keiser, P. F.,.....225		Twomey D. J.,.....203	
King Cons. Co.,.....234		Valentine, J. A.,.....221	
Knapp Hill Nursery,.....213		Vincent R. Jr. & Sons,.....215	
Knight & Struck,.....215		Ward R. M. & Co.,.....221	
Kopcsay Jos.,.....218		Waterer A.,.....203	
Kreschell Bros. Co.,.....235		Waterer John & Sons,.....203	
Kuebler Wm. H.,.....227		Wecher & Don.,.....221	
Lager & Hurrell,.....226		Welch Bros.,.....224	
Lanighr, Alfred H.,.....226		Wilson,.....222	
Leonard Seed Co.,.....221		Winterson E. F. Co.,.....214	
Leith A. & Co.,.....204		Winfield Geo. Co.,.....214	
Lord & Buraham Co.,.....235		Wood Bros.,.....212	
		Woodrow Sam'l A.,.....222	
		Vokoham Nursery Co.,.....221	
		Young A. L.,.....227	
		Young John,.....226	
		Young, Thos. Jr.,.....222	
		Young & Nugent,.....222	
		Zangen O. V.,.....219	
		Zvolanek A. C.,.....221	

WANTS, FOR SALE, ETC.

Advertisements in this column one cent a word. Initials count as words. Cash with order. All correspondence addressed "care HORTICULTURE" should be sent to 11 Hamilton Place, Boston.

HELP WANTED

WE need a man who knows seeds and plants in a practical way and who can write of them in good English. Ability to express himself in few words, easily understood, absolutely essential. Daily newspaper training almost indispensable. Good habits and capacity for hard work necessary. Working knowledge of seed, nursery or florist's trade, experience in an advertising agency, and familiarity with type and other print-shop accessories, highly desirable. If there is such a man open to engagement we can offer him the opportunity of a lifetime. Inquiries invited from persons who possess one or more of the stated qualifications.

— THE —
McFARLAND PUBLICITY SERVICE
Specialists in Horticultural Advertising.

HARRISBURG, PENNA

GOOD MEN

When you need good men, skilled or unskilled, Write:

THOS. H. BAMBRICK

34 South 7th Street Philadelphia

Help of all kinds, including that for Florists, Nurserymen, Seedsmen and the Horticultural trade generally.

WANTED MARCH 15

An experienced, energetic gardener thoroughly acquainted with hardy stock, garden making, grading, trimming, etc. Permanent position to right party. State references and salary.

The Elm City Nursery Co.
NEW HAVEN, CONN.

SALESMAN—Wholesale cut flower trade; must be experienced; good position for the right man. Apply with references and full particulars to W. E. McKissick & Bros., 1019-21 Hanstaden St., Philadelphia.

HORTICULTURE needs a wide-awake representative in every town in the land. Good commission paid on advertising and subscriptions. If you are ambitious, write for terms.

FOR SALE

FOR SALE—An up-to-date greenhouse property in good repair; situated in the State of Massachusetts; 12,000 feet glass, stocked for cut flowers and pot plants; large three-room house, one six-room house, large barn, 6 acres good land; established for 36 years. Doing good business, \$3000-4000. Cash. Reason for selling, owner going out of business. Address P. M. 100, care Horticulture.

FOR SALE—Five greenhouses, glass 16 x 24 by Lord & Buraham, well stocked with cuttings, bedding plants, etc., with nearly new seven room cottage, heated and running water. Two blocks from station in a good growing town. Famous summer resort. On the Jersey coast, one hour from New York by train or boat. Will sell on easy terms. John Bennett, Atlantic Highlands, N. J.

FOR SALE—Retail nursery, sixth year. Doing good, steady and increasing trade. Stock in excellent condition. Only local supply for community of 50,000. For particulars address R. N., care HORTICULTURE, Boston.

FOR SALE—Long established retail florist business in one of largest cities, doing a very profitable business with high class customers. Address P., care HORTICULTURE, 11 Hamilton Place, Boston.

MISCELLANEOUS WANTS

WANTED—Roses from benches, rooted cuttings and one year 11, P. and B. T. roses, Hydrangea Otaka and best hardy shrubs, seedlings of evergreens and perennials, two year Japan anemones, hardy chrysanthemums, Heliosias nives, choice dahlias. State price per 100 and when ready. Address, Melrose Gardens, 90 Melrose St., Providence, R. I.

WANTED TO BUY—Greenhouses and all kinds of greenhouse material; dismantled and removed at once. Best prices. Terms cash. Address, Max Tomback, 24 Avon Place, Newark, N. J.

WANTED TO BUY—Complete green house plants and all kinds of greenhouse material, to be taken down and removed at once. Terms cash. Address I. Susserman, 229 Livingston St., Newark, N. J.

WANTED TO BUY—Complete greenhouse plants and all kinds of greenhouse material, to be taken down and removed at once. Terms cash. Address I. Susserman, 229 Livingston St., Newark, N. J.

BUSINESS CHANCES

WANTED—To unite in partnership in Massachusetts with man needing more capital or assistance in horticultural business wanting expansion; or to join with man thoroughly qualified in horticulture in establishment of new enterprise. Address K., care Horticulture.

PATENTS GRANTED.

- 910,615. Steam Generator. George A. Walton, New York, N. Y.
- 910,801. Boiler Cleaner. Hendrik C. Parri, Sidoarjo, Java.
- 910,905. Flower Pot Support for Jardinieres. John Clements, Philadelphia, Pa.
- 911,023. Boiler. Viola S. Bean, Manchester, N. H., administratrix of Fred S. Bean, deceased.
- 911,073. Lawn Trimmer. Henry L. Rogers, Springfield, Ohio.
- 911,149. Adjustable Flower Stand. Fred H. Moore, Lansdowne, Pa., assignor (one-half to Walter E. Livingston, Lansdowne, Pa.
- 911,297. Means for Connecting Flues to Boiler Sheets. Samuel W. Howell, Brookville, Ind.
- 911,510. Grass Cutter. Frank N. Nash, St. Paul, Minn.
- 911,579. Lawn Mower. George A. Culver, Clarinda, Iowa.

**GREENHOUSES BUILDING OR CON-
TEMPLATED.**

Geigertown, Pa. J. Luther Zerr, addition.
Green Bay, Wis. Chas. D. Clerc, additions.
Corning, N. Y.—A. H. Woepfel, two houses.
Menominee, Mich.—Chas. L. Schultz, additions.
Newark, N. J. E. W. Fengar, range of houses.
Union, N. H.—Frank Varney, house, 50 feet long.
Haddon Heights, N. J. R. Pabst, three houses.
Toronto, Ont. Grobba & Wandrey, range of houses.
Union, N. H.—Frank Varney, vegetable house, 50 ft.
Scarborough, N. Y.—F. R. Pierson Co., house 55 x 350.
Belmont, Mass.—Shaw estate, vegetable house, 40 x 350.
South Sudbury, Mass.—H. Whittemore, improvements.
South Somerset, Mass. Traynor Bros., house 12 x 120.
Chicago, Ill.—James Bombberger, range of houses, with store.
Erie, Pa.—Jesse Frost house, 20 x 100; J. V. Laver, two houses, each 45 x 135.

Albany, N. Y.—R. W. Zobel has had a new boiler installed in his greenhouse by Hitchings & Co. W. W. Hannel of Watervliet has purchased material for several new greenhouses from Hitchings & Co.

CYPRESS SASH BARS
82 feet or longer
HOT BED SASH
PECKY CYPRESS BENCH LUMBER

GREENHOUSES
ERECTED AND EQUIPPED COMPLETE IF DESIRED

Write for Circular "D" and Prices

The A. T. STEARNS LUMBER CO.
NEPONSET, BOSTON, MASS.

USE THE BEST.
Economy Greenhouse Brackets
are used by leading growers everywhere. Send for price list and descriptive circular.
BUXTON & ALLARD, Depl. A., Nashua, N. H.

Evans 20th Century Arm
Will not twist the shafting pipe. Three times the power of old style elbow arms. Sold only with Evans Challenge Machine.
Write for Free Catalogue to
QUAKER CITY MACHINE CO.
Richmond, Ind.

The FLORISTS' HALL ASSOCIATION OF AMERICA, insurer of 29,000,000 sq. ft. of glass. For particulars address
John C. Esler, Secy, Saddle River, N. J.

**BUY HOT-BED SASH AT CUT PRICES
and Build Gold Frames Economically**

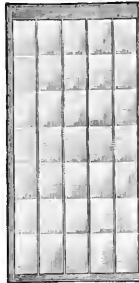

Hot-Bed Sash
3x6-1 1/2
Glazed with 6-Inch Glass
Dealer's Price \$3.50

The problem of finding room for bedding plants is solved by the use of Cold Frames. It is poor economy to overcrowd your greenhouse with plants that are better off outside in cold frames, where they soon become sturdy and in fit condition to plant or market. The capacity of any greenhouse can easily be doubled by building Cold Frames to care for the "overflow."

Florists' Cypress Hot-Bed Sash
Made with Blind-Mortised, Double-Shouldered Joints

Gordon-Van Tine Hot-Bed Sash are better made than the ordinary kind. No open joints. We make the joints moisture-proof and build our Sash extra strong. Only the best grade of Louisiana Red Cypress used. Primed with pure raw linseed oil. Greenhouse putty and plenty of points used. Our prices are 50% less than retail dealers ask for inferior sash. All regular sizes in stock for quick shipment.

Size 3x6-1 1/2—glazed with 6-inch glass, \$1.69
Size 3x6-1 3/4—glazed with 10-inch glass, 1.75

Glass and Glaziers' Supplies
At Lower Prices Than Elsewhere in America

Our enormous purchases of glass enable us to undersell all competitors. We carry a full line of Glaziers' Supplies and sell at cut prices.

Write for Free Catalog Today Get the Catalog and save the dealers' outrageous profits. We guarantee quality, safe delivery and satisfaction. Don't fail to write us.

Gordon-Van Tine Co., 1580 Case St. Davenport, Iowa

THE STANDARD STEAM TRAP

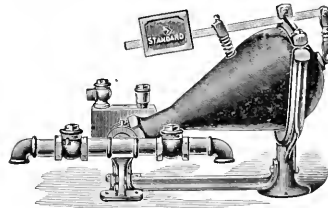

Is acknowledged the best for the florist, because it is durable and does its work without trouble and annoyance, saving its cost by the economy in coal bills.

E. HIPPARD
YOUNGSTOWN, OHIO

GLASS Always Write Us Before Buying
SHARP, PARTRIDGE & CO.
22nd and Lumber Streets, CHICAGO
WE HAVE SOME SNAPS

PATENTS

Trademarks and Copyrights
Send your business direct to Washington Saves time and insures better service. Personal attention guaranteed. Twenty-five years' active service. SPECIALTY: "Working on the Failure of Others."

SIGGERS & SIGGERS
PATENT LAWYERS
Box 9, National Union Building
Washington, D. C.

EVERYTHING FOR
GREENHOUSE
BUILDING

WRITE FOR
INFORMATION
AND PRICES

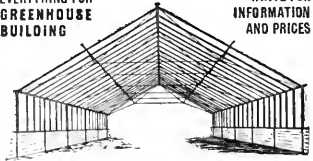

King Greenhouses. King Gutters and Eaves, Trussed Roofs. Ventilating Machinery. Trussed Iron Frame Houses. Tile Benches and Pipe Hangers.

KING CONSTRUCTION COMPANY
NORTH TONAWANDA, N. Y.

BOSTON PLATE & WINDOW GLASS CO.

GREENHOUSE GLASS
German and American

261 to 287 A St., Boston 20-22 Canal St.

Holds Glass Firmly
See the Point **FP**
PERLESS
Glazing Points are the best. No rights or lefts. Box of 1,000 points 75 cts. postpaid.
HENRY A. DEER
754 Chestnut St., Philadelphia

The Payne Steel "T" Bar Greenhouses

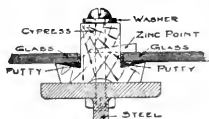

The Lightest The Strongest

Half full Size

HOUSES of this type are constructed with both curved glass eaves and straight glass eaves. Least amount of shadow. Least amount of wood. No drip. Greatest durability.

JOHNA. PAYNE

Greenhouse Designer and Builder
260-274 Culver Avenue

JERSEY CITY, N. J.

KROESCHELL BOILER



MADE OF FIRE BOX FLANGE PLATE
Can not Crack

Water Space in Front, Sides and Back
The Most Popular Boiler Made

SEND FOR CATALOGUE.

KROESCHELL BROS. CO.
35 Erie Street, CHICAGO, ILL.



The Advance Ventilating Apparatus

will take care of the ventilation in a 200 ft. house. We have one machine in a 300 ft. house taking care of the ventilation. It is strong, easily operated and lasting. See our SHELF BRACKETS with steel arms at 10c, all complete. Nothing better. Give size of post or column in ordering. We have other good things.

The Advance Co.
RICHMOND, IND.

GREENHOUSE CONSTRUCTION LUMBER

John C. Moninger Co.
117 E. Blackhawk St., CHICAGO.

"REVERO"

Braided Moulded Construction—Seamless Throughout



LIGHT--STRONG--FLEXIBLE

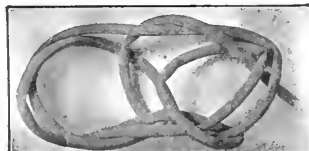

The above cuts represent the non-kinking tendency of Revere as compared with the old style hose of wrapped duck construction

Revere is furnished on Reels in Continuous Lengths up to 500 feet.

Revere Rubber Company, BOSTON, MASS.

NEW YORK
NEW ORLEANS

PHILADELPHIA
MINNEAPOLIS

PITTSBURG
SAN FRANCISCO

CHICAGO
PORTLAND, ORE.

THE FOLEY MFG. CO.

CHICAGO

Completely equipped with up-to-date machinery for the making of material for

GREENHOUSE CONSTRUCTION

From a Full Supply of Thoroughly Seasoned Lumber

Send your sketches to our draughtsmen for completion and suggestion. Permit us to figure your proposed work, large or small.

We guarantee our prices will save you money
FOLEY VENTILATING APPARATUS IS THE BEST
Is Simple in Erecting. Is Easiest of Operation. It Will Last a Lifetime. Its Price is the Lowest. Will Ventilate Any Size House. Prices and Circulars on Application.

Our 1908 Catalogue Greenhouse Material Sent Postpaid on Request.

THE FOLEY MFG. CO., WESTERN AVENUE
25th and 26th STS., CHICAGO

STANDARD PLATE GLASS CO.

Manufacturers—Importers—Jobbers

NOW IS THE TIME TO BUY

FRENCH OR AMERICAN GREENHOUSE GLASS

LOWEST PRICES ON REQUEST

26-30 Sudbury St. BOSTON, MASS. 61-63 Portland St.



OUR IRON RAFTER GREENHOUSE

The materials cost more than the less enduring construction, but they cost less to erect.

QUALITY and QUANTITY of blooms exceed other houses, as you know.

You gain in erection cost: save in repair costs and get more money out of your stock. You have a house that will last fifty years and longer.

Write for our figures on your next house.

Hitchings & Company
1170 Broadway New York

Sometimes You Forget

that we make every part of a greenhouse but the glass — that we sell any part.

You remember us on the bigger things, but often it never enters your head to think of sending to us for a tub of putty or a few fittings.

But you ought to — and here's why: Our sole business is manufacturing every part of a greenhouse. We give it, and it only, our undivided attention.

Everything we make is made with an exact knowledge of just what conditions it must meet, and that is why an ever increasing number from all over the country are continually sending us their orders for just the smaller things.

You know how well we do the big things, and if you only stop to think, it is just because of well done little things that it is possible for us to do so thoroughly and enduringly the big things. So whether white lead, glazing nails, bench fittings, materials not what, first write to

Lord & Burnham Co.

Main Sales Office: 1133 BROADWAY, N.Y.

BOSTON: 519 Tremont Building. PHILADELPHIA: 1215 Filbert St.



WHERE THE PRACTICAL COUNTED FIRST

This range of circular palm house and wings erected in Pittsburg, Pa.

The owner in selecting his greenhouse builders insisted on the following construction features.

First, the houses must be of greatest endurance, so there would be no constant repair costs. Second, they must grow the greatest number of flowers with least expenditure for labor and coal. Third, they must be a "thing of beauty," because they were to be located close to the residence, and in full view from the driveway and street.

The U-Bar won out, and it is winning out every day for these very same reasons. So it is up to you to know every point about the U-Bar, and the catalog tells them — Send for it.

U-BAR GREENHOUSES

PIERSON

DESIGNERS AND BUILDERS



U-BAR CO.

1 MADISON AVE. NEW YORK

HORTICULTURE

Vol. IX.

FEBRUARY 20, 1909

No. 8



DIGITALIS GLOXINIFLORA

*Devoted to the
FLORIST, PLANTSMAN,
LANDSCAPE GARDENER,
and
Kindred Interests*

*Published
EVERY SATURDAY
At 11 Hamilton Place,
BOSTON, MASS.
Subscription, \$1.00*

FEB 20 1909

SINGLE CHRYSANTHEMUMS

From Seed

I am offering seed of Wells' new early flowering singles, in original sealed packets, at 25c and \$1.00 each. These can be sown any time and, planted outside in the Spring, will give you bushels of flowers in early fall, or plants can be lifted and potted when in flower.

— ALSO —

WELLS' NEW HYBRID PENTSTEMONS

This is a new race that shows the most glorious combinations of colors in scarlet, crimson, pink and white. The plants grow 2½ feet high and the flower spike is 18 inches long. No one who has not seen it can form any idea of the brilliant display a bed of these plants presents. No trouble to grow. Simply prick off the seedlings, like asters, and plant outside in May.

Trade packets, 25c and \$1.00 each. Hundreds of seeds in a packet.

CHARLES H. TOTTY, Madison, N. J.

CARNATIONS

	Rooted Cuttings	Fine Healthy Stock
	Per 100	Per 1000
Pres. Seelye	\$6.00	\$50.00
White Enchantress, Beacon	3 50	30.00
Victory, Winsor, Melody, Kingston Pet	3.00	25.00
Dahelm, Enchantress, Lady Bountiful, Mrs Lawson, White Lawson, Red Lawson, Variegated Lawson	2.50	20.00

WOOD BROTHERS
FISHKILL, N. Y.

NEW CARNATION PINK DELIGHT

Waxy Shell Pink. A Grower's and Shipper's favorite. Has a holding color, keeps well, comes on long stems and is early, very free and continuous flowering. March 20th delivery, \$12 per 100; \$100 per 1000.
F. Dorner & Sons Co., La Fayette, Ind.

ROOTED CARNATION CUTTINGS

	\$3.00 per 100
ENCHANTRESS	3.00
WINSOR	3.00
LAWSON	2.00
HARRY FENN	2.00
WHITE PERFECTION	2.50
QUEEN	2.50

PINE-CROFT GREENHOUSES
EAST BROOKFIELD, MASS.

In ordering goods please add "I saw it in HORTICULTURE."

A. N. PIERSON, Inc.
CROMWELL, CONN.

Wholesale Growers of Cut Flowers, Palms and Ferns

OUR SPECIALTIES. Roses, Lily of the Valley and Carnations. We also grow a general assortment of flowers in their season

REMEMBER CHRYSANTHEMUMS

Can be grown smaller than those displayed on the show tables. Some kinds are worthless unless grown to the top notch, others make perfect flowers if not of the largest size.

We grow kinds best for Florists' use in quantity, also for other purposes.

Correspondence Solicited. Catalogue Free.

ELMER D. SMITH & CO , ADRIAN, MICH.

CARNATION AND ROSE SHOW

UNDER AUSPICES OF

Boston Co-Operative Flower Growers Association

The Park Street Market

SEND FOR PREMIUM LIST

ALL the old and THE BEST of the new varieties. SEE BEFORE BUYING

NEW ENGLAND'S LEADING COMMERCIAL SHOW
FEBRUARY 27th AND 28th, 1909

HORTICULTURAL HALL, BOSTON

For information write **E ALLAN PEIRCE, Waltham, Mass.**

SHAMROCK

IRISH. THE REAL THING! GREEN.

Best to order early and grow on for strong plants for St. Patrick's Day. Our stock is very fine. \$4.00 per 100, or post-paid 60c. per dozen.

JOHN F. RUPP, Shiremanstown, Pa.
RUPPTON: The Home of Primroses.

Hardy Herbaceous Perennials

Well-grown plants of all the standard varieties at reasonable rates.

SEND FOR TRADE CATALOG.

DANIEL A. CLARKE
RED OAK NURSERIES, Fiskeville, R. I.

New Rose **White Killarney**

Come and see White Killarney growing at our Scarborough houses, and you will say at once, as every one does who has seen it, it is

The Best White Rose

they have ever seen. You need it if you want to be up to the times, and it will pay you better than any other white rose that you can plant. You will regret it if you do not plant it this year, and you will not regret it if you do.

Big lots are being booked. Get your order in early. Send us order at once, while you think of it. Get early stock. It will not cost you any more to order to-day, while you think of it, than it will two months from now. Be the early bird that catches the worm.

Strong young plants, 2 1/2-inch pots, own-root, ready for delivery beginning February 15th, 1909 \$30.00 per 100; 250 for \$70.00; 500 for \$125.00; 1000 for \$250.00. Grafted plants, ready for delivery beginning March 1st, 1909, \$5.00 per 100 additional.

F. R. PIERSON CO., Tarrytown-on-Hudson NEW YORK.

Newport Fairy

The Rose of the Future For In and Out Door.

FINE, STRONG FIELD-GROWN STOCK
3-4 Shoots 3-4 ft. long

50c each, \$30 per 100, \$250 per 1000

JULIUS ROEHR'S CO.,
RUTHERFORD, N. J.

JOHN WATERER & SON, Ltd. American Nursery Bagshot, England

Are Specialists in the

REALLY HARDY VARIETIES
of Rhododendron Hybrids and in Select Varieties
of Hardy Border Plants

Hardy Rhododendrons, Azaleas, Conifers, Clematis, H. P. Roses, Shrubs and Herbaceous Plants from our **HOLLAND NURSERIES**

Prices Moderate
P. OUWERKERK, 216 Jane St., Weehawken Heights, N. J.

CLEARY'S HORTICULTURAL CO.
Management AMBROSE T. CLEARY
Wholesale Contracting, Jobbing, Auction
HORTICULTURAL PRODUCTS
or every description.
Consignments Received. Surplus Stock Converted
62 Vesey St., NEW YORK

Box Trees

and other **EVERGREENS** for Tubs and Boxes
Our Prices are Always Right—Catalog Free
THE NEW ENGLAND NURSERIES, Inc.
BEDFORD, MASS.

California Privet.

We have 10 acres to offer for sale this Spring. All 2 years old, 2 to 2 1/2 ft. high, 8 to 12 branches and well graded. We are booking orders daily now. \$2.75 per 100; \$22.50 per 1000. 50¢ at 1000 rates.
Packing Free. Cash with Order.

JOHN BENNETT, Atlantic Highlands, N. J.

BARGAINS in TREES and PLANTS

Concord Grapes, \$2.00. Peach, \$3.00 per 100, List Price. D. J. TWOMEY, Dept. H, Geneva, N. Y.

VIBURNUM MOLLE

10,000 of this useful viburnum 2 to 3 ft. and 3 to 4 ft.

Write for prices on these and other good things
EASTERN NURSERIES

HENRY S. CAWSON, Manager, JAMAICA PLAIN, MASS.

ROSES

We have a fine stock of large, dormant field-grown plants, on own roots, including Crimson Rambler, Dorothy Perkins, Clio, Alfred Colomb, Francois Level, Jack, Prince Camille de Rohan, Magna Charta, Ulrich Brunner, Giant of Battles, and many others at \$16.00 per hundred; \$150.00 per thousand. Send for list. Roses, Dahlias and Cannas a specialty.

THE DINGEE & CONARD CO., W. Gr. ve, Pa.

RHODODENDRONS-RHODODENDRONS

An immense stock of all the **hardest known kinds**, 2 to 3 1/2 ft., fine plants and all home grown, many being on own roots, far better than grafted stock—also **R. Catawbiense** seedlings of all colors and seedling **Hardy Azaleas** not to be obtained elsewhere. This is the nursery in which most of the Rhododendrons that have proved **hardy in America** were raised.

GOLDEN YEWS, KALMIAS, and other **HARDY PLANTS** in great variety and of all sizes.

Catalogues on Application

ANTHONY WATERER **KNAP HILL NURSERY** **KNAP HILL**
SURREY, ENGLAND

(NO CONNECTION WHATEVER WITH ANY OTHER FIRM.)

THE PRIZE WINNING STRAWBERRY

The Barrymore

Send for Folder at Once.

H. L. CRANE, Originator,
Westwood, Mass.

ROBERT CRAIG CO.

ROSES, PALMS,

and Novelties in Decorative Plants

MARKET and 49th STREETS., PHILADELPHIA, PA.

In writing to Advertisers kindly mention Horticulture

Foxgloves

Digitalis is extremely popular in the New England States. The reason why this highly ornamental biennial has so far failed to conquer for itself the same prominent position in gardens elsewhere is certainly not to be found in any cultural difficulties. Seeds sown in May will produce small plants, ready for the open field, in June. If properly cared for, they will be strong stocky plants by the beginning of October, when the growing season is over. It is essential to withhold the necessary winter covering, until the surface of the ground is frozen solid. Leaves are here in the north considered the best material for winter protection. Care should be taken, that by after thaws and freezings the ice can at no time form in any thickness around the plants. For this reason I prefer a slightly sloping ground to the level for my foxgloves. Do not uncover too early, for your plants cannot stand sudden changes of warm days and belated hard frosts in spring.

Many garden owners and even hardy plant growers, when hearing fox-gloves mentioned have only in mind the old *Digitalis purpurea*. If they were fully aware of the wonderful marked, spotted and tinted variety of the best up to date gloxiniflora types, or could see the exquisite shades of the large spikes of *Digitalis maculata grandiflora*, I believe foxgloves would soon take their due place in the floral displays of many more gardens and parks. My experience is, whenever these beautiful biennials are shown to their full effect, that is, in strong healthy plants and sufficient number, the desire to have them again follows.

The intense interest and the unreserved admiration for displays of foxgloves by visitors at our northern summer resorts strengthens my belief that they merit more space and general recognition in American gardens. The common *Digitalis purpurea* is very effective when naturalized on the edge of woodlands. South of New York a half-shady position may be sometimes an advantage, for it is apt to prolong the flowering season. Tall spikes of light colored shades of *Digitalis gloxiniflora* against a dark evergreen background produce wonderfully pleasing contrasts. I have seen equally beautiful displays in formal gardens, but in every instance, the aim should be for a fine mass effect. The best results are obtained with improved colors. It is therefore very important for those who wish to grow their own plants to secure seeds of a good strain. The care of the plants and the overwintering is the same as required for the poorest colors.

By far less showy than the above mentioned varieties is *Digitalis lanata*. Its tall erect spikes are born on smooth brown stems. The long narrow pointed leaves are of a dark bright green. What appeals to me most is the remarkable fine brown nerving of the inside of the little white blossoms. Our illustration, a reproduction from a photograph taken in the Mt. Desert nurseries in Bar Harbor, gives a good idea of the habit of growth of this more rarely seen foxglove. Plant lovers,



DIGITALIS LANATA

who like to see odd things in nature always admire its gray hirsute thickly set spikes, with their multitude of queer shaped flowers. *Digitalis lanata* deserves a place in plant collections or perennial borders.

Richard Rothe

A Good Amaryllis

The writer has an amaryllis that is ten years of age. The blossom stalk is 40 inches tall. The blossom stems are 5 to 6 inches long. Its blossoms measure eight inches across, 6 in number, making a wreath-like circle over three feet in circumference. The blossoms are pink laced with white. The seed pods now ripening measure two inches in diameter. The bulb is about five inches in diameter. This plant has never had a rest and it blossoms three or four times per year. Not being familiar with the growth of the amaryllis, I write to ask if this one is not unusually large. I don't know its name if it has any, but I believe it is a hybrid. It was a present to me from Prof. J. F. Cowell, superintendent of the Botanic Gardens at the South Park, Buffalo, N. Y., at the time of the Pan American Exposition.

I am surprised that so beautiful a flower should receive so little attention from florists and plant growers. The plant requires but little care and is not troubled by insects or fungus. It blossoms every three or four months the year round and is long lived. It is an interesting subject for the hybridizer and the plant breeder.

I intend to experiment with it some myself. I see in catalogues from Holland that some new varieties there are valued as high as \$80.00 each.

R. B. White

Rocky Mountain Rambles

v.

Comparatively few of the tourists who seek our western mountains find their way to the Big Horn Mountains in Northern Wyoming. The region is easily accessible and would offer a most delightful place to spend a few weeks. These rugged mountains afforded



THE MOUNTAIN LOOSEWORT
(*Pedicularis Groenlandica*)

In a Meadow of the Big Horn Mountains at an Altitude of 5000 Feet.

a strong resistance to the invasion of the whites during the Sioux Indian outbreaks in the late seventies.

The writer spent a most pleasant time for a few weeks there in 1897, going by way of the Burlington and Missouri River through a part of the sand hills of Nebraska and the southern edge of the Blackhills. The high plain of Wyoming was aglow with the Yuccas, Larkspurs, Stipas, Agropyrons, and Stemless Loco. Sheridan nestled among a low range of hills in the Goose Creek Valley. From this point one can go over the range to the Big Horn Basin or to the Dome Lake and Cloud Peak country. Going up the gentle slope of the valley of Big Goose Creek for some twenty miles, the road leaves the undulating plain and passes up a steep hillside.

Down in the valley the Sage Brush, Townsendia, Erigeron, Biglovia, Gumwood (*Gutierrezia*), and Opuntias were found. Stipas were in evidence everywhere on dry situations. Along the creek were the so-called cottonwood (*Populus angustifolia*), a species of onion (*Allium Schoenoprasum*), with purple flowers, the Shooting Star, and Horsemint (*Monarda fistulosa*), much like our Iowa species but with darker flowers. The low meadows contained Slender Wheat Grass (*Agropyron tenerum*) and sedges of numerous species, also the Wild Timothy (*Backmannia erneaeformis*). At 5000 feet the mountain sides are covered with a Dwarf Nine-Bark (*Physocarpus Torreyi*), the Western Service Berry (*Amaelanchier alaiifolia*), the Dwarf Mountain Maple (*Acer glaberrum*), the Douglas Spruce (*Pseudotsuga Douglasii*), and the western Yellow Pine (*Pinus scopulorum*). The tree and brush-covered slopes and flats open up into large parks. These parks contain a wealth of botanical species: Geranium (*Geranium Rich-*

ardsonii), Larkspur (*Delphinium*) grasses like Meadow Grass (*Poa pratensis*), and stemless Locoweed (*Oxytropis Lambertii*). The Geraniums were knee high and with the other plants made a splendid and glorious sight to behold. At higher altitudes the Lodge Pole Pine covered large areas. Beyond and at still higher altitudes (8800-9000) the country becomes more rugged, and long moranic hills with numerous small lakes occur.

The streams have carved their way through rock and the water passes rapidly over rock and boulder to the valleys beyond. In climbing out of these small canons one finds added interest in the small lakes which are situated a hundred or more feet above the bed of the stream in the moranic drift.

The Crowfoot (*Ranunculus*), Marigold (*Caltha leptosepala*), Aconite (*Aconitum Columbianum*), Shooting Star (*Dodecatheon media*), and Holy Grass (*Hierochloa borealis*) are always plentiful in such places.

Larger lakes also occur and these are bounded by low lying marshes or drift material. On these lakes one finds that interesting water lily (*Nuphar polysepalsus*) with its yellow flowers. The marshes contain the Ledum (*Ledum glandulosum*), Looswort (*Pedicularis Groenlandica*), Sedges (*Carex*), *Poa Wolfii*, and Valerian (*Valeriana acutis*). The gravelly banks contain much of the *Arnica Fendleri*, Cinquefoil (*Potentilla fruticosa*), Kalmia (*Kalmia glauca*), Yarrow



The Canothus with its white blossoms and glossy foliage; in the background the Lodge Pole Pine. The Canothus would make a splendid ornamental plant.

(*Achillea millefolium*), Stone Crop (*Sedum stenopetalum*), and Dwarf Juniper (*Juniperus communis* var. *alpina*). In the rocky canons there is an abundance of Engelmann Spruce (*Picea Englemannii*) and the Balsam Fir (*Abies subalpina*). The alpine flora is not essentially different from that which I have described for the Rockies in Colorado.

The Yellowstone National Park region has always been of interest to botanists. For a distance of several hundred miles the Northern Pacific skirts the Yellowstone River. Near Miles City the Tongue River and at Blatchford the Power River with their brownish-yellow, mud, empty into the Yellowstone. Our eastern Cottonwood and well known Buffalo Berry are familiar objects here. Near Billings low hills skirt this famous stream; on the flood plains one finds the usual Sage Brush and Opuntia. The flood plain of the river is strongly impregnated with alkali; few cultivated plants succeed well here where the mesa above is irrigated.

The change to Livingston is not very great. We are continually ascending the valley till at Livingston it is about 7000 feet above sea level. The Yellowstone comes out of the mountains from Gardner. The railroad has an imposing building and it might be well for the railway to add to the present building and equipment, a museum which should contain all of the interesting material found in that country of both plants and animals; the many interesting features pertaining to the early discoveries of that county, the interesting data pertaining to the expedition of Lewis and Clarke and the wonderful discoveries of Colter, who was a member of that expedition and later explored the park.

The woods about Livingston contain the Western Birch, Alder, Cottonwood (*Populus angustifolia*), Crowfoot, Geranium and Monkey Flower (*Mimulus Jamesii*).

For the amateur botanist an interesting afternoon may be spent in the environs of Livingston. Those who have the time may well spend a few weeks in the Park to visit the geysers and falls. The Tetons outside of the park are grander and more picturesque than the Yellowstone.

Ames, Ia.

S. A. Pammel

British Horticulture

CHANGES AT KEW

Mr. W. Botting Hemsley, F. R. S., has recently retired from his position as chief of the herbarium at Kew. During his long association with Kew Mr. Hemsley has Gardens, having reached the age limit. His connection with the famous botanic gardens dates back to 1869, been a prolific writer on scientific subjects. His first literary work was a contribution to Lindley and Moore's "Treasury of Botany," published in 1866. His researches are incorporated in a number of valuable works, whilst he has been a frequent contributor to the Journal

of the Linnean Society, the Kew Bulletin, and some of the leading horticultural journals. He has been elected a fellow of the Linnean Society, and a fellow of the Royal Society, whilst he recently became a corresponding member of the German Botanical Society. The position Mr. Hemsley has held is one of great importance and responsibility. The collection at the herbarium comprises two million dried plants, whilst there is also a library of nearly 25,000 volumes. An illuminated address expressive of appreciation of Mr. Hemsley's notable services to horticulture was presented to him, signed by present and former colleagues, and numerous botanists who have worked at Kew, besides the botanical staff at the British Museum. Mr. Hemsley's well-earned leisure will be spent in the pursuit of his favorite studies; he has taken up his residence within convenient reach of Kew Gardens. Dr. Otto Stapf is the new chief of the herbarium.

THE SALE OF INSECTICIDES

In the past horticultural sundriesmen have been considerably hampered in their sale of insecticides by the severe legislative restrictions placed upon them. As the result of persistent agitation on the part of the trade the law has undergone a revision. Under the Poisons and Pharmacy Act, 1908, the list of poisonous compounds which may be sold only by registered persons has been materially revised. Under its provisions there is now a repeal of the exclusive right of members of the Pharmaceutical Society to sell poisonous compounds used in agriculture. Hitherto the chemists have enjoyed a monopoly, protected by the State, in dealing in certain chemical compounds, with the result that they were able to keep up the prices. Under the new Act a better condition will prevail, resulting in a great gain to the horticultural trade generally. It will now be possible for the ordinary florist and nurseryman to stock poisonous substances for use against insects and fungoid pests, on their getting a license from the local authority. This will enable many traders to add profitable side lines to their shops, whilst with this unrestricted trade the customers will benefit as regards getting the compounds at a more reasonable figure. The trade triumph in this instance is another proof of the value of well directed organization in securing the object desired. The continuous "pegging away" at last has had its reward.

London, Eng.

W. H. Adsett.

If you like HORTICULTURE and appreciate the efforts of HORTICULTURE'S CORRESPONDENTS to provide for you interesting and instructive reading you can show your appreciation in at least two ways. One way is to recommend the paper to your friends and thus help to increase our subscription list. Another way is to patronize HORTICULTURE'S ADVERTISERS. That will help us all.

HORTICULTURE

VOL. IX

FEBRUARY 20, 1909

NO. 8

PUBLISHED WEEKLY BY

HORTICULTURE PUBLISHING CO.
 11 Hamilton Place, Boston, Mass.

 Telephone, Oxford 399
 W. M. J. STEWART, Editor and Manager

SUBSCRIPTION PRICE

One Year, in advance, \$1.00; To Foreign Countries, \$1.00; To Canada, \$1.50

ADVERTISING RATES

Per Inch, 30 inches to page \$2.00.

Discounts on Contracts for consecutive insertions, as follows:

One month (4 times) 5 per cent.; three months (12 times) 10 per cent.;

six months (26 times) 20 per cent.; one year (52 times) 30 per cent.

Page and half page spaces, special rates on application.

Entered as second-class matter December 8, 1904, at the Post Office at Boston, Mass., under the Act of Congress of March 3, 1879.

CONTENTS

	Page
COVER ILLUSTRATION—Dieffenha glloxiniflora.	
FOXGLOVES—Richard Rothe—Illustrated	241
A GOOD AMARYLLIS—N. B. White	241
ROCKY MOUNTAIN RAMBLES—Prof. L. H. Pamme —Illustrated	242
BRITISH HORTICULTURE—W. H. Adsett	243
OBITUARY—William Findlay, portrait—David Bearn —J. H. Small, Sr., portrait—A. Von Asche—Joseph Dus—John Griffith	245
BOSTON MARKET SHOW—Illustrated	246
The H. F. Mitchell Prize—Illustrated	247
NEWS OF THE CLUBS AND SOCIETIES:	
Gardeners' and Florists' Club of Boston—New Jersey Floricultural Society—American Association of Railroad Gardeners—St. Louis Florists' Club— Nassau County Horticultural Society—Illinois State Florists' Association	248
Morris County Gardeners' and Florists' Club— Pennsylvania Horticultural Society—Rochester Commercial Florists' Association—Connecticut Horticultural Society	249
Society of American Florists—Elberon Horticultu- ral Society—Detroit Florist Club—Chrysanthemum Society of America, Report on New Varieties of 1908	250
Club and Society Notes	251
FEEDING THE CROPS—Wm. H. Bowker	251
HILFINGER BROS.' POTTERY—Illustrated	252
MAKING POTS—Luke J. Doogue	252
SEED TRADE:	
The Outlook	255
Notes	256
OF INTEREST TO RETAIL FLORISTS:	
New Retail Flower Stores—Steamer Departures— The Handy Handle—Business Changes	258
Flowers by Telegraph	259
FLOWER MARKET REPORTS:	
Boston, Chicago, Detroit, Indianapolis, Philadel- phia, Washington	261
New York	263
MISCELLANEOUS:	
Fire Record	254
Personal	254
Catalogues Received	256
Publication Received	256
The Philadelphia Spirit	261
In Bankruptcy	261
News Notes	268
Patent Granted	269
Greenhouses Building or Contemplated	270

A few weeks ago we remarked in these columns the probability that we should shortly see florists raising their single-flowered chrysanthemums from selected seed each year in preference to going to the trouble to propagate from cuttings of named sorts. A leading English horticultural journal has since made approving

comment on our views as expressed, at the same time calling attention to the fact that one of the most noted chrysanthemum specialists in England was already offering such seed there for that purpose. Now comes one of our best known introducers on this side, placing on the market here this self-same strain of seed. We hardly expected our prediction to come true so quickly but have no doubt Mr. Totty's offering in another page of this paper will meet with a ready response from wide-awake growers.

Florists
and the experiment
stations

The State Florists' Association of Illinois has done well in accomplishing in so brief a period so much as is outlined in the report of its work which we present

in this issue. Co-operation with the existing State Experiment Stations on floricultural lines and insisting upon due attention being given at these institutions to research and problems connected more or less directly with ornamental horticulture is, we venture to say, something that many of our local florists' associations have never yet given a serious thought to. The disposition has been rather to look upon the Agricultural Experiment Stations somewhat as the State Fairs are regarded, from afar off, as institutions to be scoffed at. We believe the example set by the Illinois fraternity is worthy of emulation. From what we know of the Experiment Station officials generally we feel safe in saying that they will, to a man, welcome any movement on the part of the floricultural profession towards a more intimate relationship. And, further, we believe the scientific workers in those institutions would be glad to have, as a great aid in giving practical value to their efforts, the friendly interest and co-operation of the men trained in the stern school of commercial experience.

A successful
exploring expedition

The Arnold Arboretum has lately received from its expedition in western China a large quantity of seeds collected on the high mountains which separate China from Thibet. In this last sending of several hundred species there are the seeds of no less than fifty-five species of rhododendrons, many roses, clematis, hydrangeas, hollies, barberries, philadelphus, deutzias, pines, mountain ashes, cherries and crabapples, all new to cultivation. One of the most important, perhaps, of Wilson's recent discoveries is a new lilac with large panicles of lilac and white fragrant flowers which he describes as probably the finest of all the Chinese lilacs. He has secured, too, large quantities of the seeds of the beautiful *Magnolia villosa* and of *Paeonia Delavayi*, a shrubby species with dark maroon-colored flowers. Mr. Wilson's two years' mission in China is nearly finished; but it has been so successful that the Arboretum is sending William Purdom, a young English gardener, on a three years' journey in Shensi and Kensu for the purpose of collecting seeds and specimens of the plants of these botanically unexplored northern and western provinces. Mr. Purdom left Boston for Shanghai on Thursday, 18th inst., and will proceed at once to Peking. It is an interesting and significant fact full of promise, we believe, for American horticulture that the international standing of the Arboretum is now so thoroughly established and generally recognized that for this new enterprise it has been able to obtain in Europe even larger financial assistance than it did for the Wilson expedition.

OBITUARY.

William Findlay.

William Findlay, who for many years was widely known as a fruit grower, died rather suddenly at his home in Newport, R. I., Feb. 12, from diseases incident to old age. Mr. Findlay was born in Largo, Fifeshire, Scotland, in 1831, served his gardening apprenticeship under his father in that neighborhood and afterward worked as a journeyman at Balmey Park, the residence of Lord Rosebery. Coming to this country in 1854 he settled in Newport, R. I., where he spent the remainder of his life, his first position being in charge of the estate known as "Belair" which was owned by a Mr. White, and is now the property of Mrs. G. H. Norman. Several years later Mr. Findlay hired the greenhouses at the estate of the late Governor Lawrence, and engaged in the fruit growing business, also raising large quantities of grape vines of the European varieties,



WILLIAM FINDLAY

which he shipped to California, where there was a great demand for them at that time. In 1873 Mr. Findlay built the large range of fruit houses that still stand on Gibbs avenue and it was here that he raised the choice grapes, nectarines, peaches and outdoor musk melons that made him famous as a fruit grower. When this establishment was in full swing it was the custom of many of the wealthy Newport people to drive in their carriages there to see the fruit and buy their supplies. About this period rose growing under glass was just being considered as a possible paying business so Mr. Findlay wishing to test the method reserved a part of his houses for this purpose which met with great success. It is said that he was the first to grow the "Jack" rose this way. These flowers were shipped to Pennock of Philadelphia, Mr. Findlay receiving for them \$110 per hundred and it may be of interest to note that they were then grown in boxes 15 inches square and one foot deep, one plant to a box. So at this time Mr. Findlay seemed to

be in a fair way to make a fortune but his generous disposition to help all the needy who came in contact with him prevented him from laying up much stores for his declining years, but it is pleasant to know that during those years when age overtook him he was well provided for.

Mr. Findlay married when in middle life but the union proved not to be a lasting success and no relatives are known to survive him in this country. The funeral took place from his late residence Feb. 15, and was fairly well attended by old acquaintances, the Newport Horticultural Society being well represented.

David Bearn.

Advice received by friends in Philadelphia Feb. 11th, announce the death of David Bearn at Kirriemuir, Scotland, January 26th. Mr. Bearn was born at Kirriemuir about 56 years ago, and after serving an apprenticeship in Scotland to the gardening business came to America about the year 1872. He located for a short time with Mr. Carr at Pittsburg, and was later one of the coterie who worked at the celebrated Robert Bust greenhouses in West Philadelphia—among whom may be mentioned, George Anderson, Charles Sim, Robert Kift,—and a number of others who afterwards made their mark in commercial horticulture. He finally started in business for himself at 33rd and Wallace, where he had held an interest previously as silent partner with the late John Kinnear, remaining there until 1893. In the latter year he sold out that property and built a new range at Bala, which he conducted successfully for about 11 years. In 1904, failing health compelled him to sell out and return to Scotland.

David Bearn was a very keen man intellectually and always took a lively interest in club and society affairs. His views on any subject were eagerly sought, and were usually most illuminating. No man had a surer aim for hitting the nail on the head. He would have made a great lawyer had his lines lain in that direction. Combined with his mental gifts was a disposition of the modest and retiring kind—while his shafts of wit, satire, ridicule, or irony were always tempered by the natural dictates of a very warm heart. Few men in this community had such a host of devoted friends. They missed him sorely after his departure for Scotland five years ago; but were always in hope that he would soon be back again.

He was a member of the Florists' Club of Philadelphia, the S. A. F., the Order of Scottish Clans (treasurer of the local lodge of the latter for many years), the Scots Thistle Society, Caledonian Club and other fraternal organizations. He was unmarried, and lived in Kirriemuir at the home of his brother, John. His business affairs in this country are and have been in charge of his friend Charles Sim, of Rosemont, Pa. So passes away another good man and one of the most noted of the older generation that have made Philadelphia horticulture conspicuous.

G. C. WATSON.

J. H. Small, Sr.

The death of J. H. Small, Sr., which occurred at his home on Brentwood

road, Washington, D. C., on Sunday afternoon, Feb. 14, was no surprise to his many friends, as he has been in a very critical condition for some months. Nine years ago Mr. Small had a paralytic stroke from which he never recovered sufficiently to take up active business interests again.

Mr. Small was born in Watford, England, eighty-two years ago, and ever since 1848, when he came to Georgetown as private gardener to Mr. Linthicum, he has been closely associated with the horticultural interests of Washington. He was a horticulturist by heritage, tradition and natural bent, receiving his early training under his paternal grandfather. He completed his course at the Crown estates of Kew and Windsor, at which places he saw much of the present King of England, then a child, and his mother, Queen Victoria. In 1854 Mr. Small went into business for himself, in which business his sons, J. H., Jr., and Albert, later became associated and which has twice outgrown its quarters and now comprises both the Washington and New York concerns.



J. H. SMALL, SR.

The deceased leaves a widow, three sons and six daughters.

The funeral took place Wednesday, Feb. 17, from Oak Hill Chapel, and the interment was at Oak Hill cemetery. The Rev. R. H. McKim, rector of the Church of the Epiphany, of which Mr. Small was a member, conducted the services, and members of the association of oldest inhabitants acted as pall-bearers.

Joseph Dus.

Joseph Dus, employed at the greenhouses of Herman Maenner, Maspath, N. Y., died suddenly on Feb. 8.

A. Von Asche.

A. Von Asche died at his home, Jackson avenue, Long Island City, N. Y., on Feb. 4, aged 50 years.

John Griffith.

John Griffith, formerly a nurseryman of Attica, N. Y., died on Jan. 28, aged 69 years.

BOSTON MARKET SHOW

Following is the schedule of prizes for this notable exhibition which promises to take its place among the great annual shows of this country. It will be held in Horticultural Hall, Boston, on Saturday and Sunday, February 27 and 28. The premium list has been issued in a handsome souvenir volume in which many of the representative firms are represented by liberal advertisements, and of which copies may be had by applying to E. Allan Peirce, Waltham, Mass. The committee in charge of arrangements consists of:

E. Allan Peirce, secretary and treasurer, Waltham, Mass.; Wm. H. Elliott, Brighton; Geo. Cartwright, Park St., Boston; S. J. Goddard, Framingham; Thomas Roland, Nahant; Wm. Sim, Cliffdale; Wm. H. Nicholson, Framingham.

Judges.

S. J. Reuter, Westbury, R. I.; Thos. Roland, Nahant, Mass.; A. H. Fewkes,

Premium List.

Class A, B, C, standard or disseminated varieties only, can compete. Lawn color to be the dividing line for dark pink. Whorl shade for light pink. Enticement for flesh pink in all carnation classes.

CARNATIONS.

Class A.

50 White, Flesh Pink, Light Pink, Dark Pink, Red or Scarlet, Crimson, Variegated, each, first, \$5; second, \$3.

Class B.

25 White, Flesh Pink, Light Pink, Dark Pink, Red or Scarlet, Crimson, Variegated, each, first, \$5; second, \$3.

Class C.

100 blooms in vase; not less than 6 varieties, first, \$2.50; second, \$1.00.

Class D.

100 blooms one variety in a vase, new or standard, Thos. J. Gray Co. silver cup, value \$10. Special prize, cut glass vase, value \$10.

A. H. Hews Co., silver cup, value \$25.

Class H.

Vase of 50 mixed roses, first, \$30; second, \$20.

Class I.

The following prizes to be awarded to growers with not over 30,000 ft. of glass: 25 Brides, Maids, Killarney, Richmond, each, first, \$8; second, \$4.

Class J.

Park St. Flower Market Prize, for not less than 10 or more than 30 blooms of best new Rose undisseminated before 1909; Prize value \$25.

SWEET PEAS.

Class K.

Vase of 100 White, Pink, L. Pink, Lavender, any other color, each, first, \$3; second, \$2.

Class L.

Flower Market prize for the best new Sweet Pea; Prize and certificate.

Class M.

Zvonacek Prize for Zvonacek Collection of not less than 6 standard varieties 100 each. Prize value \$25.

Zvonacek Prize for Zvonacek Collection of 5 standard varieties 25 of each. Prize value \$10.

VIOLETS.

Class N.

Campbell, 2 bunches 100 in each, first, \$5; second, \$3. Any other double variety, 2 bunches, 100 in each, first, \$5; second, \$3.

Class O.

Princess of Wales, 2 bunches, 100 in each, first, \$5; second, \$3. Any other single 2 bunches, 100 in each, first, \$5; second, \$3.

Class P.

Best display of the Boston violet. Wm. Sim prize, value \$10.

Class Q.

Market Prize for best New single violet. Prize and certificate.

MISCELLANEOUS.

Class R.

Vase of 50 Tulips, first, \$5; second, \$3. Vase of 50 Narcissus, first, \$5; second, \$3. 12 varieties of cut billious stock not more than 25 of a variety, first, \$10; second, \$5. 50 Lily of the Valley, first, \$5; second, \$2.

H. F. Alford's Special Prize—Best 12 pots of Easter Lilies, silver cup, value \$25.

Twelve plants of Cyclamen, silver cup, value \$10, special prize, Page Pottery, Peabody, Mass.

Class S.

50 Marguerites, 25 Mizounette, first \$2; second, \$1; 200 Pansies, first, \$5; second, \$3; 25 Antirrhinum, first, \$3; second, \$2. Display of novelty not otherwise classified, first, \$5; second, \$3.

SPECIAL FEATURES.

Gardeners' and Florists' Club of Boston, Special Trophy, value \$25, for the most meritorious display in the show. To be judged by a scale of points covering cultural excellence, commercial serviceability, effectiveness, extent, novelty.

For best decorative basket of carnations not over 100 flowers to be used. Prize value, first, \$15; second, \$10.

S. J. Goddard special premium. For the best bride or bridesmaid bouquet of carnations, \$15.

No other flowers than carnations to be used in any of the above features. Ribbon, any kind of foliage or green may be used.

Park Street Market salesman prize—A Morris Chair for best decorative mound of flowers for table display.

N. B. All exhibits must be staged by 10.30 o'clock A. M. It is very important that this rule should be observed.

The perpetual Flowering Carnation Society will hold a spring show in London, Eng., on March 24.



SOME OF THE SPECIAL PRIZES FOR THE BOSTON MARKET SHOW

Newton Highlands, Mass.; E. A. Wood, West Newton, Mass.; A. H. Lange, Jr., Worcester.

Carnation Committee.

E. Allan Peirce, Waltham, Mass.; S. J. Goddard, Framingham, Mass.; Wm. Nicholson, Framingham, Mass.; M. A. Pratten, Tewksbury, Mass.; Peter Fisher, EHS, Mass.

Rose Committee.

Wm. H. Elliott, Brighton, Mass.; Alex. Montgomery, Natick, Mass.; Eber Holmes, Montrose, Mass.; Harry Pablong, Provi-
dence, R. I.

Violets, Sweet Peas and Miscellaneous.

Wm. Sim, Cliffdale, Mass.; Wm. Spinkley, Woburn, Mass.; Thomas Pegler, Park St., Boston, Mass.; Herman H. Bartch, Waverly.

Plants and Bulbs.

L. W. Mann, Randolph, Mass.; E. Sauermeister, Revereville, Mass.; Thomas Roland, Nahant, Mass.; Geo. Butterworth, So. Framingham; F. J. Dolansky, Lynn.

6 varieties of carnations 50 in a vase.

Peter Fisher, special prize, Best 50 Boston \$6. Best 25 Boston \$4.

Collage Gardens Co., special prize, 50 Boston, book "The American Carnation," by C. W. Ward.

R. Witherstatter, special prize, 50 Atterbury, first, \$6; second, \$4.

F. R. Pierson Co., special prize, 50 Winsor, first, \$6; second, \$4.

Class E.

12 blooms unnamed seedlings, first, \$5; second, \$3; third, \$2.

Class F.

Single bloom, new or standard, short stem, first, 50 cents; second, 25 cents.

1 bloom White, Flesh Pink, Light Pink, Dark Pink, Red or Scarlet, Crimson, Variegated, each, first, 50 cents; second, 25 cents.

ROSES.

Class G.

25 or more American Beauty, first, \$25; 25 Pink, Red, White, each, first, \$10; second, \$5; any other color, first, \$6; second, \$4.

NEWS OF THE CLUBS AND SOCIETIES

GARDENERS' AND FLORISTS' CLUB OF BOSTON.

This club had a glorious meeting last Tuesday evening. There must have been in the neighborhood of two hundred and fifty in attendance, including ten visitors from Providence, R. I., and a number from the North Shore Horticultural Society. The Providence contingent included Messrs. Appleton, Chappell, Hartstra, Hockey, Hazard, McCord, Macnair, J. A. Macrae, Alex Macrae and Sweeney. James Wheeler for the committee on hospital bed for needy members of the craft recommended no action; accepted. President Downs presented the Executive Committee's report, which was accepted without discussion excepting the clause recommending that the club appropriate a special prize for competition at the Market Show on February 27. This brought up an animated discussion resulting in the adoption of the recommendation. Brief talks were made by Messrs. McGregor and Shaw for the North Shore and Macnair and Chappell for Providence. An invitation was received and accepted with thanks to attend the dedication of

French Hall at Amherst on March 12. Six new members were admitted. The club banquet has been set for March 21. Details later.

The exhibition of plants and flowers was quite extensive. R & J Farquhar & Co. showed *Acacia heterophylla*, *Primula obconica grandiflora* and a table of cyclamens, which were given an award of cultural merit. A report of highest merit was given, for the first time in the club's history, for White Killarney rose exhibited by Alex. Montgomery. Wm. Swan of West Manchester showed double rose larkspur and lupins of various colors, receiving a well-deserved honorable mention for the latter. Charles Simpkins of Peabody was the recipient of a similar award for Beauty of Nice, Boston Florists' White and Empress Augusta Victoria stocks. Chas. S. Strout of Biddeford, Me., showed a vase of Winsor carnations that won for him a certificate of cultural merit. A vote of thanks was accorded to each of the following exhibitors: O. M. Whittemore, Framingham, carnations Splendor and Victory; H. A. Stevens, carnation Andree; Peter Fisher, vase of seedlings; James Wheeler, *Primula Kewensis*,

semi-double; H. Schrade, Saratoga Springs, N. Y., carnation Kanariensbird; Alfred E. Parsons, West Manchester, carnation Eucharis; Daniel Whyte, North Easton, *Primula Kewensis*; E. B. Beals, seedling carnations; Jas. D. Clark, a device for protecting trees against ascending insects; F. W. Fletcher, Baronne Rothschild Violets.

A number of exhibits promised from distant points failed to arrive, the storm having delayed trains badly.

The principal event of the evening was the promised talk on Carnation Culture by M. A. Patten, president of the American Carnation Society.

Mr. Patten did not present a prepared paper but talked partly extempore and from brief notes. He said, in part, describing his cultural methods:

"We will start with a healthy cutting, well-rooted but not left too long in the propagating bed. I prefer to pot all my young stock, using sizes of pots adapted to the size of the cuttings. If they require more room I repot into 3 or 3 1/2 in. pots or plant in boxes. Many a good cutting has been ruined by neglect. Keep on the cool side, water carefully, give air in plenty but avoid drafts until they are well established.

"In planting outdoors we leave generally 18 in. between the rows and 6 to 10 in. in the row. Keep the soil open with a hand wheel cultivator. Keep plants well cut back, but it is better not to pinch too much at a time. If properly attended to you should have good sized plants at benching time, August or September, provided the season has been favorable and red spider has forgotten to call on you. The plants after being dug with a garden fork are brought into the workroom, dead leaves removed, and if the balls are dry we water and let them stand a few hours before planting. Plant firm and leave the soil level.

"The carnation is not particular as to soil. Equally good results are obtained in a clay or sandy soil as a general thing, but I think the softer growing kinds have stiffer stems in soil of a clay nature. It is "the man behind" who is responsible for success or failure. Give a good watering to settle the soil. Some support should be given at once to keep the plants upright. We like to shade if they wilt, and think this is better than too much spraying. Disbudding should be regularly attended to and weeds kept down. A sprinkling of lime and a slight dressing of some good fertilizer is beneficial.

"Burst-d blooms are by some attributed to the use of manure water. We have not used any this season and some varieties have bursted more than ever. Perhaps cold water has something to do with it. We used one bed for fertilizer experimenting this year, using soot from the chimney, ground bone, fish and phosphate and pulverized sheep manure, but could not see any difference in growth or flowering. We had a good compost to begin with. Our temperature at night averages 50 to 53 deg., day 60 to 75 deg. if pleasant and 57 to 60 deg. if stormy.

"I like side cuttings from the flowering shoots not too high nor too low.

THE HENRY F. MICHELL COMPANY PRIZE.

To Be Competed for at the Boston Market Exhibiton, February 27-28.



This elegant prize is to be awarded for the best twelve pots of Easter lilies in bloom. It is made of heavy silver plate, twelve inches in diameter, and has a border of beautifully chased acanthus leaves. The tray is mounted on three very massive feet

and makes an ideal piece on which to stand a cut glass vase filled with flowers. As has been the custom for the past few years, Henry F. Michell Co. are awarding this unusual piece in preference to the usual prize cups or trophies given at these flower exhibitions.

Our benches have slate bottoms and we use fresh sand for every batch of cuttings. The best modern type greenhouses are none too good if you want to grow superior carnations."

The subject was discussed quite fully after the close of Mr. Patten's talk. Peter Fisher said that he thinks nothing of a seedling carnation until it is at least three years old, and his final estimate of its value is not made until it is four or five years old.

NEW JERSEY FLORICULTURAL SOCIETY.

The president's reception and annual smoker was held at Orange on Friday, February 12. An oration was delivered upon the life and services of Charles Darwin, whose 100th natal anniversary was reached upon this date, after which the evening was devoted to social intercourse. After President MacRorie had welcomed his guests, addresses were made by Charles H. Totty, Frederick and Charles Atkins of Rutherford, Edward Reagan, secretary of the Morris County Society, Charles Metzger of Thorburn's, and W. E. Maynard of the gardeners' Chronicle. Letters of regret were read from W. J. Stewart, A. T. Boddington and J. Austin Shaw. The Rickards Bros. gave their characteristic songs and Andrew Wilson danced and told funny stories. C. B. Lust gave selections upon the banjo and the Impertual Quartette a number of four-part songs. Light refreshments were served.

The room was decorated with flags in honor of Lincoln's birthday, a centre table of orchids and greenhouse climbers from Julius Roehrs Company staged by Max Richter, orchids from Thomas Jones, and vases of flowers wherever they could be placed. A vase of lilies of the valley from Roehrs was declared to be the finest stock he had imported in thirty years and was remarkable for size of stem, flower and fragrance. The contributions from private estates were as follows:

Charles Hathaway, Max Schneider gardener, narcissus, freesia, hyacinths, cyclamens, violets and carnations; Sydney and Austin Colgate, William Reid, gardener, carnations; A. C. Van Gaasbeck, John J. Dervan, gardener, carnations; Charles A. Munn, John Hayes, gardener, carnations. The judges for the evening were Arthur T. Thomas, Jos. A. Manda and Arthur T. Caparn. J. B. D.

AMERICAN ASSOCIATION OF RAILROAD GARDENERS.

The executive committee of this association met in Chicago on February 12th and decided to hold the next annual meeting at Philadelphia in August. After the meeting a week's trip inspecting railway station grounds in the neighborhood of Philadelphia, New York and Boston will be taken.

Every person regularly employed in the gardening department of American and Canadian railroads is entitled to membership; dues \$1.00 per year.

We are young but have accomplished a great deal in our field; are anxious to have every one that is eligible to become members and attend the convention. All inquiries should be made of Geo. B. Moulder, Sec'y; add ess 111 Cent. R. R. Chicago.

ST. LOUIS FLORIST CLUB.

The February meeting of the Florist Club was the annual carnation meeting and was one of the largest attended the club has had for several months. The announcement that it was to wind up with an entertainment and smoker brought out the large attendance. The exhibition of carnations was not large, but those that were on exhibition were fine. There were only three outside exhibitors: A. C. Brown of Springfield, Ill., who sent Superba, Sangamo and Governor Deneen; A. E. Longren of Des Plaines, Ill., with a fine vase of Lucille, and Chas. Knopf Floral Co., with Mrs. Chas. Knopf and Ruby.

The club members who showed blooms were John Steidle with Rospink Enchantress, Enchantress, Harlowdaren, Beacon, Mrs. Patten and White Perfection; W. J. Pilcher, with Beacon and White Enchantress; Fred Ammann, with a vase of mixed standard blooms; E. W. Guy, a fine vase of White Enchantress.

A committee was appointed to report at the next meeting the best plan to eliminate the "crepe pullers" who are becoming so numerous and bold, going so far as to use the names of leading retailers. This committee consists of Messrs. Windt, Brix and Schoenle. It was decided to hold the Annual Rose Show during the March meeting. The President appointed Piere Schneider, E. Lombard and E. Denker as judges. They brought in the following report: Mrs. Chas. Knopf, 90 points; Lucille, 89; Ruby, 89; Sangamo, 88; Superba, 87; Gov. Deneen, 80. The latter arrived in bad shape. Among the local growers who won first and second prizes were W. J. Pilcher, J. Steidle, E. W. Guy and J. F. Ammann.

There were quite a few visitors, among them being A. C. Brown of Springfield, Ill., Martin Reukauf and J. J. Karins of Philadelphia.

At the subsequent entertainment at the Bismarck, after refreshments had been served President Young called order and made a good talk for the good of the club, and appointed J. J. Beneke toastmaster, who responded and in turn called upon members and visitors for short talks, to which they happily responded.

NASSAU COUNTY HORTICULTURAL SOCIETY.

At the regular monthly meeting, on February 16, the attendance was light, owing to inclement weather, but the monthly points competition was as keenly contested as ever. G. Wilson, gardener to Mr. B. Stern, showed a vase of exceptionally fine gardenias. S. I. Trepress exhibited a beautiful specimen of *Coelogyne cristata*. Paul Reul with freesias, C. Knight carnations, H. Gaut sweet peas, James Elmlic and V. Clores carnations, and F. Gale tomatoes were the other competitors in the competition. There were also displays of flowers, fruit, plants and vegetables from numerous sources conspicuous among which was a collection of indoor grown vegetables from Paul Reul and a dish of lovely oranges by F. Gale.

W. H. MACKENZIE, Cor. Sec.

ILLINOIS STATE FLORISTS' ASSOCIATION.

The fourth annual meeting and exhibition of this useful Society was held at Springfield, Ill., on Tuesday and Wednesday of this week. The attendance from all over the State was very gratifying and the exhibition, which we shall report in full next week, was large and comprehensive, carnations especially strong. A number of interesting papers were read.

President's Address.

After bidding a cheery welcome to the members and visitors and referring with feeling to the fact that the meeting was being held in the home of Lincoln and on the centennial of his birth, President Hey spoke of the valuable work being done by the State Experiment Station and the improved facilities recently completed for the furtherance of this work and stated that it was proposed to go before the legislature this year and ask for an annual appropriation of \$17,500 to carry on the work. The college officials had generously come forward and donated the magnificent sum of \$5,000 out of the college funds to help along and the Association should be deeply grateful. He called attention to the fact that Illinois has now taken first place in the front rank for experiment station usefulness from a floricultural standpoint. Referring to the census of 1910 he said that, following the plan of the Association and the committee of the S. A. F. working in conjunction with the Census Bureau at Washington, it is expected that the record in floricultural statistics will be far more complete than it has ever been hitherto. Continuing, he said:

"Through the efforts of this Association we were enabled to make a better showing at the State Fair. I called your attention to this matter last year and wish to again remind you that there is still room for improvement. The schedule needs revision to bring it up to date and I think the time has arrived when this Association ought to take some action in getting an appropriate building for the Floriculture Exhibit. I would therefore again recommend that a committee be appointed on floriculture at the State Fair.

"I think that the Association would be much benefited by having the different floral centers of the State represented by correspondents with whom the secretary or president could keep in touch. As the old saying has it, 'What is everybody's business is nobody's business,' and it has often been difficult to get information that is needed. I would suggest a similar plan to that of our National Society and I think it would prove of great value to get for our records a complete statistic of our business. This will be especially valuable in furnishing data for our legislative work and other things which our Association will need for its future development. These correspondents should be kept supplied with our literature and other matter and could aid the Association greatly in increasing its membership. At the last convention the Association recommended that certificates of merit be issued to all exhibits worthy of the same. It is hoped that this will bring out a better exhibit."

Concluding, Mr. Hey recommended

that some action should be taken favoring a legislative enactment recognizing some appropriate flower as the State Flower of Illinois and extended appreciative thanks to the officers and members and the University officials for their zealous support and assistance during his two terms of office as president, promising similar interest on his part for whoever should be his successor.

Report of Advisory Committee.

W. N. Rudd reported as Secretary for the Advisory Committee of the Illinois Experiment Station for the year ending February 10, 1909. After giving details of the various meetings of the committee, the planning for and raising funds for the new greenhouses and other essential work Mr. Rudd continued as follows:

In conclusion the committee wishes to make known to the Association the extent of the obligations of the florists of this State to Mr. Eugene Davenport, director of the Experiment Station and to Mr. J. C. Blair, chief of the Department of Horticulture. These gentlemen have shown a most enthusiastic interest in our project and have forwarded our plans in every possible way. It is well known to the members of this committee that the general funds appropriated for the Experiment Station are inadequate and these gentlemen are at all times hard pressed to make both ends meet; therefore their action in drawing upon their scanty resources for \$7500, more than half the total amount needed for our buildings, should be thoroughly appreciated by every member of this Association and your committee believes should be testified to by a vote of thanks. The committee also wishes to signify its high commendation of the work done by Mr. H. B. Dornier. Having been in close touch with him at all times and having made frequent and careful examination we have found nothing to criticize, much to commend and believe that the Station as well as this Association is to be congratulated in securing his valuable services.

We wish to urge upon every member of the Association the desirability of visiting the University as often as possible and of inspecting the work being done for us there. We believe that all will concede that the greenhouse plant is a model commercial plant and well worth the study of all florists as regards construction details and heating apparatus. The committee feels sure that every florist will be made welcome by Mr. Dornier and that the educational value to each one coming from an examination of the work can hardly be overestimated.

The present plant of course is only a beginning and the more glass structures that can be provided the more value we shall get from the work; therefore it should be the duty of every member of this Association to get in touch with Chairman Ammann of the Legislative Committee and assist in every possible legitimate way in securing the passage of the present bill. It should be noted that while we have now two one-hundred-foot houses, if we get the appropriation asked for we shall be able at once to erect four more houses, thus giving us three times the present capacity for doing good work for the florist.

The committee congratulates you upon the great work so well begun and feels that the achievements so far are only a small part of what may be done each year through the years to come, provided that this Association and its individual members keep their shoulders firmly against the wheels and keep pushing.

Mr. Rudd then presented a supplemental report criticising the course of Prof Beal in publishing through various trade papers the results of and deductions from certain investigations regarding thrips and the value of various insecticides which had been paid for by the Station and presumably were its property.

MORRIS COUNTY GARDENERS' AND FLORISTS' SOCIETY.

Calanthe Culture was the theme for our February meeting and Percy Herbert the essayist. A short history of the genus was given, conditions under which they grow in their native habitats, and the beautiful hybrids we have secured under cultivation. Mr. Herbert only dwelt on the deciduous section as these are the ones grown for the Christmas holiday trade in this country. A considerable number is grown by him at Florham Farms and, as most of us have seen his blooms on the plants, we were glad to have him tell us how he did them. The members who came were amply repaid. The details of culture as practiced by him were given from start to finish, and a rising vote of thanks was accorded him. The fumigating was done by a box of fragrant Havanas from President Vyse.

The next meeting, March 10th, will give us fame if at all like its predecessors. It will be "Carnation Night." Of late years the hall has been filled with blooms. Novelties and standards vied with each other for supremacy. The public are invited on that night, for we have treated them to this for a number of years, and we do not wish to disappoint them now. This has given the carnation a great boost, and the carnation is a close second to the rose in Madison. We are counting strongly on the introducers sending us their novelties. I don't know how they can better advertise them, and then it will put another feather in our caps. Exchange has been conspicuous in the exhibits in former years, and knowing that she has the goods on hand, we are looking that way for help. Our own talent will do their best.

EDW. REAGAN, Sec'y

PENNSYLVANIA HORTICULTURAL SOCIETY.

The regular monthly meeting on the 16th inst. was mainly taken up with consideration of the schedules for the spring and fall shows. The spring exhibition will be held March 23d, 24th and 25th. The fall show (usually called the chrysanthemum exhibition) will take place Nov. 9th, 10th, 11th and 12th. The prize list for the spring is now ready and may be had on application to David Rust, the secretary. Resolutions of sympathy were passed on the death of David Bearn, a member of the society for many years and always an active worker on many committees.

ROCHESTER COMMERCIAL FLORISTS' ASSOCIATION.

The meeting, Feb. 11th, of the Rochester Commercial Florists' Association was the most successful in its history. The carnation exhibit, although not large, in quality ranked A1. Among the novelties and recent introductions were Georgia, Apple Blossom, Lucille and a white seedling from Hugo Tuete. The three named varieties were exquisite and reflecting great credit on the introducers. Among the local growers represented were Chas. H. Fry and Frank Bennett, exhibiting Winsor, White Enchantress, Lawson and others. A paper was read by E. H. Rueston, Barnards, N. Y., on red spider, following which many questions were asked and answered, and a lively interest was manifested.

After adjournment, all present—some 65 members and guests—went to Eggleston Hotel, and there sat down to the first annual dinner, after which short speeches were made as follows: "Our Vocation," W. L. Keller; "Sociality," R. G. Salter; "Organization," Ambrose H. Secker.

Among the guests was Mr. Vallett, of Chamber of Commerce, whose remarks were intently listened to, and finished speaking by inviting this association as guests of the Chamber on March 1st, at 8 P. M. Several speakers alluded to the possibility of securing the convention of the S. A. F. for 1910, to be held at Rochester, which fact was received with enthusiasm; also the securing of Convention Hall for a local show this coming fall. Under the direction of President Vick, and by aid of Toastmaster Dildine, the affair was pronounced a complete success.

S.

CONNECTICUT HORTICULTURAL SOCIETY.

The regular meeting of the society was held in County Bldg., Hartford, Conn., Feb. 12. Two new members were elected. Pres. Huss reported having received \$25.00 from A. T. Boddington, to be offered as premiums in the vegetable class at the fall exhibition. A photograph was presented to the society of Mr. May, who, after being connected with the J. J. Goodwin estate for forty years, will make his future home in Florida. Mr. May is a life member, and on going away carries the best wishes of the entire society with him.

The business meeting was followed by an enjoyable "smoker and whist." John Gerard captured the first prize, a handsome clock, and hereafter will have no excuse for appearing at the meetings half an hour late, even if he does come all the way from New Britain. The second prize, a bust of Abraham Lincoln, was awarded to J. Vidbourne, and the third prize, a miniature "Pegasus", went to J. Broderick.

A bunch of catalogues from Elmer D. Smith was on hand and were rapidly absorbed by the members. The next meeting, Feb. 26, will be "Carnation Night," and any exhibits sent to the County Building will be received and cared for by a committee.

ALEX. CUMMING, JR.,

Secretary.

SOCIETY OF AMERICAN FLORISTS AND ORNAMENTAL HORTICULTURISTS.

Tariff Committee Meeting.

In response to a list of questions sent out pretty thoroughly over the United States to importers and growers of plants, many responses have come back. The Tariff Committee will meet on February 21, 1909, at 25 Cortlandt street, New York, to take up the subject as now presented; also to look into the question of transportation relative to ice allowance.

Prizes for Traveling Men.

The following offer is made by President Valentine:

For the purpose of enlisting the traveling men in securing new members of the S. A. F., I hereby offer a first prize of fifty dollars and a second prize of twenty-five dollars to the traveling man securing the two largest numbers of new members to the S. A. F. between now and August 10, 1909.

The conditions of the contest shall be that the winner shall be a traveling representative of some concern dealing in horticultural products or supplies, and he shall forward to the Secretary as soon as received the money received for new memberships. No member shall be accounted a new one whose name appears in the published report for last year.

Before any man can win either of these prizes the membership fees sent to the Secretary by him, under this contest, must have been double the amount of the prize claimed. For the purpose of determining whether new memberships have been secured before Aug. 10, the Secretary shall include

all memberships mailed to him bearing a post mark not later than August 10th.

Should any difference of opinion arise regarding the award under this offer, the matter shall be decided by the members of the executive committee present at the next annual convention of the society in Cincinnati, and their decision shall be final.

The writer will be glad to forward a supply of application blanks and addressed envelopes to any traveling man wishing to enter this competition.
W. N. RUDD, Secretary.
Morgan Park, Ill.

ELBERON HORTICULTURAL SOCIETY.

The first annual dinner of the Elberon (N. J.) Horticultural Society was celebrated at the Deal Country Club on the 10th inst. The tables were beautifully decorated and the menu was all that could be desired. About one hundred enjoyed the feast. Arthur Harrington acted as toastmaster. Among the notable guests present were members of Long Branch City Council Mr. John Shore, W. E. Maynard.

The society held its regular meeting on the 15th inst. After the routine business had been disposed of, N. Butterbach read a paper on Roses, which was listened to with marked attention and followed by a spirited discussion by all the members present, which pleased Mr. Butterbach so much that he thanked the members for the pleasure it gave him to read to such an enthusiastic meeting. A hearty vote of thanks was given Mr. Butterbach.
W. B.

DETROIT FLORIST CLUB.

The Detroit Florist Club held a very successful exhibition at the Michigan Cut Flower Exchange, only the heavy blizzard which has been with us since Saturday night delayed some shipments and many members were deprived of the opportunity to see. Among the exhibits sidetracked were Bertermann Bros.' yellow carnation Jas. Whitecomb Riley, Shasta from Bauer & Smith and Lucille from Highland Park Greenhouses. Van Boeslager's crimson carnation Clara was there in cut and plant form, and really outstripped anything ever shown here. Thos. Brown had some very excellent Beacon, Lawson, Enchantress and Sarah Hill. Many other things could be mentioned but we shall mention only Mr. Plumb's Brides and Bridesmaids, of perfect development and 2-foot stems.

Mr. Gammage of London, Ont., brought pleasure to all with a most interesting discussion of the management of carnation houses. Like all successful men he lays great stress on a proper systematizing of the routine work. To not waste your time by doing work which a \$2.00 a week boy can do; on the other hand, pick the best man on the place to do such important work as planting out. To harvest good flowers, plant in May and 14 in. apart. Mr. Gammage read some exhaustive statistics as to the productive quality of the leading varieties and the expenses connected with growing. His net result of first class flowers per plant per season is considerably less than usually reported, but he considers the season closed by May first. These features properly weighed will explain his low average of eight flowers to the plant.
P. DANZER.

CHRYSANTHEMUM SOCIETY OF AMERICA.

Report of New Chrysanthemums, 1908, Prepared by the Committees Appointed by the Society.

NAME OF VARIETY	WHERE SHOWN	DATE	EXHIBITED BY	COLOR	TYPE	SCALE	COMMITTEES					TOTAL		
							Color	Form	Fluffiness	Stem	foliage		substance	depth
							Com'n	Ex'n	10	15	15	15	10	100
							10	15	15	15	15	15	10	100
Sport of Glory Pacific	Philadelphia	Oct. 17	Samuel Cockburn & Sons, Woodlawn, N. Y.	Pink Pink	Reflex Jap	Com.	12	10	8	13	14	10	6	72
" " " "	New York	" 13	" " " " " " " "	" " " " " " " "	" " " " " " " "	"	15	10	8	14	14	12	5	79
" " " "	Chicago	" 17	" " " " " " " "	" " " " " " " "	" " " " " " " "	"	10	14	10	12	13	5	77	
No. 1	New York	Nov. 11	Geo. H. Hale, SeaBright, N. J.	Light Pink	Jap incurved	Ex.	8	12	4	3	14	10	85	
No. 5	New York	Oct. 24	Howard Nichols, Glenview, Yonkers, N. Y.	Yellow	Japanese	Com.	10	11	7	12	13	12	7	81
No. Name or Number	Cincinnati	Oct. 24	Paul O. Tauer, Lebanon, Ind.	Light Pink	" " " "	"	15	12	10	14	12	8	82	
Sport of Helen Erick	New York	Dec. 5	Paul Fischer, Wood Ridge, N. Y.	White	Jap incurved	"	18	13	8	10	12	7	80	
" " " "	New York	Nov. 21	" " " " " " " "	" " " " " " " "	" " " " " " " "	"	17	13	9	14	12	7	85	
" " " "	Philadelphia	" 27	" " " " " " " "	" " " " " " " "	" " " " " " " "	"	18	12	9	14	12	7	85	
Golden King	" " " "	" 27	Gustavus A. Lotz, Glen Burpie, Mich.	Golden Yellow	" " " "	"	19	13	9	14	13	8	90	
" " " "	" " " "	" 27	" " " " " " " "	" " " " " " " "	" " " " " " " "	"	Ex.	9	14	5	4	13	85	
Fee Orientale	Cincinnati	Oct. 16	E. G. Hill & Co., Richmond, Ind.	Creamy White	Reflex Jap.	Com.	6	12	10	12	11	11	81	
*Yellow Sport J. A. Miller	New York	" 26	A. Herrington, Madison, N. J.	Light Yellow	" " " "	Ex.	9	12	12	5	5	13	86	
Mary Warwick	Philadelphia	" 27	Warrick Bros., Washington, Penna.	Light Pink shading White	Reflex Jap.	"	9	14	4	3	13	30	86	
" " " "	" " " "	" 27	" " " " " " " "	" " " " " " " "	" " " " " " " "	"	Com.	17	13	12	10	14	84	
Sport of Dr. Enquehard	New York	Nov. 17	John J. Keane, Jersey City, N. J.	Light Pink	Jap incurved	"	10	11	9	11	12	6	74	
Mrs. O. H. Halton	" " " "	Oct. 24	Chas. H. Totty, Madison, N. J.	Mahogany Old Gold reverse	" " " "	"	Ex.	17	12	14	14	13	7	87
" " " "	" " " "	" 24	" " " " " " " "	" " " " " " " "	" " " " " " " "	"	Ex.	9	14	15	3	12	85	
Chas. H. Totty	" " " "	" 24	" " " " " " " "	" " " " " " " "	" " " " " " " "	"	Ex.	8	13	15	4	5	13	88
Pocket's Crimson	" " " "	" 24	" " " " " " " "	" " " " " " " "	" " " " " " " "	"	Ex.	10	14	13	4	13	89	
W. K. Brock	Chicago	Nov. 7	" " " " " " " "	Bright Crimson and Gold	" " " "	"	Com.	10	14	15	16	14	8	86
" " " "	New York	" 17	" " " " " " " "	Light Pink	Jap incurved	"	17	14	15	11	13	7	85	
Gloria	Chicago	Oct. 1	Elmer D. Smith & Co., Adrian, Mich.	Daybreak Pink	" " " "	"	15	14	15	14	10	10	85	
" " " "	New York	" 17	" " " " " " " "	" " " " " " " "	" " " " " " " "	"	17	13	15	13	12	8	85	
W. H. Taft	Cincinnati	" 24	" " " " " " " "	" " " " " " " "	" " " " " " " "	"	18	10	10	13	13	10	88	
" " " "	Philadelphia	" 17	" " " " " " " "	" " " " " " " "	" " " " " " " "	"	Ex.	10	14	5	4	14	90	
" " " "	" " " "	" 17	" " " " " " " "	" " " " " " " "	" " " " " " " "	"	Com.	18	13	12	12	13	9	86
" " " "	" " " "	" 17	" " " " " " " "	" " " " " " " "	" " " " " " " "	"	Ex.	9	13	4	4	12	86	
Rose Pocket	Cincinnati	" 24	" " " " " " " "	" " " " " " " "	" " " " " " " "	"	Com.	10	14	15	16	14	8	85
Gro. W. Fook	" " " "	" 24	" " " " " " " "	" " " " " " " "	" " " " " " " "	"	Ex.	12	12	12	5	12	85	
Mrs. J. Boxall	" " " "	Nov. 27	" " " " " " " "	" " " " " " " "	" " " " " " " "	"	Com.	18	11	10	14	13	10	88
*Improved Chadwick	" " " "	" 27	" " " " " " " "	" " " " " " " "	" " " " " " " "	"	Com.	10	13	13	14	10	90	
Mrs. W. E. Ke ley	Chicago	" 27	" " " " " " " "	Yellow	" " " "	"	18	13	9	12	13	9	87	

* The rule governing sports of existing varieties is that they must be submitted to three of the five Committees the average of the three scores to regulate title to certificate. The varieties Improved Chadwick and Yellow Sport of J. A. Miller having been submitted to only one committee each are therefore not entitled to a certificate.
CHARLES W. JOHNSON, Secretary.

FEEDING THE CROPS.

Extracts from "The Yeast of the Soil," a paper read by William H. Bowker before the Massachusetts Horticultural Society.

"The yeast of the soil," as we shall consider it, is not plant food, but low orders of life which exist in the soil and but for which agricultural soils would be practically barren. "The yeast of the soil" is what is scientifically known as bacteria—organisms which thrive in the soil and by means of which, unavailable plant food, especially nitrogen in the form of organic matter, such as stable manure (leaves, stalks, etc.), is rendered available. The great discoveries of Hellebrigel, the leading investigator along this line, demonstrate that higher orders of plant life are dependent upon lower orders of life. We could not profitably grow a corn or potato crop unless these organisms were growing at the same time in the soil, or had previously existed there and done their work.

In the spring of the year, when the weather conditions are usually unfavorable for the propagation and rapid multiplication of these soil "yeast plants," commercial manures are found of great assistance in forcing an early growth by supplying forms of plant food which have been rendered soluble by chemical treatment or are, so to speak, predigested, and ready for the crop to feed upon immediately. Since most of our cultivated crops make their chief growth in from sixty to ninety days, it will be clear that we must have plant food in the soil that will feed the plant from beginning to end, especially in the beginning of the season when the bacteria of the soil, owing to weather conditions, have not gotten under way.

In the majority of cases it is no doubt cheaper and, if not better to apply stable manure in its crude state, directly to the soil, to cultivate it into the soil and allow the bacteria to attack it there; in short, to compost it in the soil rather than beforehand. In many cases it is desirable to use some thoroughly composted stable manure,—manure which has been subjected to the bacterial process, broken down, and a considerable part of its crude plant food converted into available forms. This, however, was deemed more necessary years ago, before commercial manures were introduced. Now that concentrated available plant food can be bought, the necessity of composting manure in advance, is passing out. It is not only a slow process, but more or less wasteful and expensive, for in the process of nitrification through the bacterial action, a considerable amount of ammonia may be set free and wasted into the atmosphere. This always takes place when the compost pile is allowed to "fire fang" and turn white.

It is urged, however, by some experimenters that composting is desirable in order to raise the temperature of the manure pile to a point that will destroy the foul weed seeds, but is not this an expensive way to destroy weed seeds, as obviously it

must expose the compost to loss of ammonia while also consuming time and labor? Except where a very fine seed bed is desired, with considerable humus present, it is believed the compost heap will go out and commercial manures will be used in its place for forcing purposes.

In the matter of fine cultivation, the old theory of cultivation was to kill not only the weeds, but to make the soil light and friable, to admit the air, to encourage the circulation of moisture through the soil, and to make it an acceptable medium for the roots of the crop. The modern theory includes the old and also recognizes the necessity of making the conditions as favorable as possible for the growth of bacteria. Thorough cultivation also conserves the moisture of the soil by means of a fine mulch on the surface, which prevents the moisture from evaporating.

Formerly, the practice was to manure the soil in order to restore lost fertility and to supply, by guess work, deficiencies in the soil, as ascertained by a chemical or a crop analysis of the soil. This method is not now regarded as a practical solution of the problem, for neither chemical analysis nor the growing of crops can be relied upon as a true guide to its enrichment. The chemical analysis of the soil discloses too much that is misleading, and the growing, or even the matured crop, too little that is conclusive.

Modern practice teaches that it is not the soil, but the crop that we should first consider. In a word, we have turned from the soil, which cannot positively answer, full though it is of life, to the living crop which can; so to-day we feed the crop rather than the soil. In the modern sense, therefore, the farmer is a manufacturer and the soil is his machine, into which he puts plant food and out of which, by the aid of nature, including the bacteria and other seen and unseen forces, combined with his own efforts, he takes his product at harvest time. If the soil machine is a good one, that is, of the right texture and retentive of plant food, full of active nitrifying bacteria or "yeast", so much the better. If it has a balance of crop-producing power to its credit, we seek to preserve that balance for an emergency, as the prudent man preserves a balance in the bank in case of panic.

(To be continued)

Otto Katzenstein has a new vegetable named Helianti, which he will introduce next season and for which large claims as to yield and economic value are made. Watch for the advertisement later on, in HORTICULTURE.

JULIUS ROEHRS CO.
Orchids and Stove Plants
Florists' Easter Supplies
RUTHERFORD, N. J.

FROM GROWER TO PLANTER

Ellwanger & Barry's

TREES
Shrubs, Roses
Evergreens
and
Hardy Plants
Are Famous
The World Over

Best stock at reasonable prices. No agents. Commissions saved. Collections unequalled. Beautiful illustrated catalogue mailed free on request.

MOUNT HOPE NURSERIES
ESTABLISHED 1840 Box T, Rochester, N. Y.

ORCHIDS

Just Arrived in Fine Condition
the following East Indian Orchids

DENDROBIUM WARDIANUM, D. CRASSINODE, D. PRIMULINUM, D. T YRSIFLORUM, AND D. CHRYSOTOXA. Others to follow.

WRITE FOR PRICES.

LAGER & HURRELL, Summit, N. J.

JUST ARRIVED

Fine Importation of

Oncidium ornithorrhynchum

Fine strong leafy plants \$1.50 each. \$18.00 doz.
Few specimens..... 2.50 "

JOSEPH A. MANDA, West Orange, N. J.

We Have A Fine Lot of C. Trianae in bloom at very low prices, and will sell plants in bloom or cut blooms at 15 per cent. less than the market price.

ORDONEZ BROS.
Madison, N. J.

ORCHIDS

We are booking orders now for delivery early in the Spring on all commercial CAELEYAS and NOVELTIES. Our prices are right and our guarantee perfect. We sell only first-class goods

CARRILLO & BALDWIN, Secaucus, N. J.

ORCHIDS

Largest Importers, Exporters, Growers and Hybridists in the World
Sander, St. Albans, England
and 235 Broadway, Room 1
NEW YORK CITY

FOR "POT LUCK" TRY US... HEWS STANDARD POTS

POT MAKERS FOR 140 YEARS

WORLD'S LARGEST MANUFACTURERS

WRITE FOR CATALOGUE AND DISCOUNTS

Pearson Street,
LONG ISLAND CITY, N. Y.

A. H. HEWS & CO., Inc.
CAMBRIDGE, MASS.

452-460 No. Branch St.,
CHICAGO, ILL.

HILFINGER BROS.' FLOWER POT MANUFACTORY.



Our illustration shows the process of flower pot making at Fort Edward, N. Y. The large machine seen in the picture is making 8 in. standard pots, and the other is making 2 1/2 in. The establishment of Hilfinger Brothers was begun by John Hilfinger and his sons in 1841, and has since then constantly increased in facilities, growth and output. The senior Mr. Hilfinger died some twenty years ago and the boys stepped into the harness and have conducted it with phenomenal success ever since. There were three of the brothers, Fred, Rupert and Alexander, but Rupert died four years ago. The

firm's specialty is standard flower pots in all sizes, though everything in the line of stone ware, jars, milk vessels, churns, tiling of every description is also manufactured. One machine is capable of producing from 2000 to 8000 flower pots per day, varying in size from 2 to 8 inches, by the changing of dies. Large stocks are kept on hand for immediate shipment, a mill for manufacturing shipping crates, ware sheds, power house and other conveniences enable promptest service and ware has not only been shipped to every state in the Union but to Hawaii, Porto Rico and Cuba.

MAKING POTS.

When a greenhouse man is out of any particular kind of pots, he simply goes to the telephone and calls up the potter, and, if the ghost has walked at frequent intervals, in the course of a very short time the pots, nicely packed, are at his door. Further than this the greenhouse man does not concern himself. The detail of manufacture is nothing to him, and neither is there anything attractive in the technical part of production; the clay, getting it into condition, the losses, the machinery an up-to-date potter requires, the magic of the potter's wheel, the skill of the man at the wheel, etc., all these, and hundreds of other interesting points are unnoticed. But, and notice the "but"—if there are any pots

broken, in the thousands ordered and received, there is sure to follow a many adjectived conversation that will enlighten the potterly man on several points about his miserable self, that he may have quite forgotten.

A visit to a pottery has an element of fascination for even the least interested, and with a good guide to explain things, a pleasant few hours can be spent there. With the potter there has been the same march of progress as in all other manufacturing lines, and machinery and methods have changed and improved to keep in step. The primitive methods in vogue twenty-five years ago, and which were adequate to the times and demands, have been passed up, and pottery making has risen to the dignity of an art, through the process of a few decades of evolution, with new and wonderful machinery, new methods, though with no better workmen, but with those having wider range of skill made pos-

sible by the improvement in their tools.

The press of competition has added to the expense of marketing the products of a pottery, and it means an active brain and a continuous "hot foot" to keep the figures on the right side of the ledger. A man that tries to do the Micawber act of waiting, will have troubled dreams and on awakening will find but little use for clay or machinery.

Years ago a local trade would keep a fellow happy and busy, but the progressive potter of today is not satisfied with a limited sphere, and he reaches far and wide and will ship pots from here to there, and from there back again, thousands of miles east, west, north and south. It takes a live man to meet such a proposition as this.

Under such speedy methods the natural results are that there are very good pots and very bad pots, and it is up to the buyer to get on the right track for the proper goods. You cannot put plants into promises, however strong they may be made.

When trade is dull, and there is no business that can get any duller than the florists' or gardeners, the tedium of the waiting could be killed by taking a day off and visiting a pottery. Even if you have been there before, a good guide will always find something new to show you of interest.

L. J. DOOGUE.

Rochester, N. Y. Paul Thomann has now re-opened his store, he having been closed on account of fire several weeks ago.

The new private greenhouse of Mr. Bonbright, East avenue, is now finished and has been filled with the usual run of palms, ferns, etc., and is now a place well worthy a visit. The gardener in charge is Otto Graesnae, for many years with Ellwanger & Barry.

STANDARD FLOWER POTS

Packed in small crates, easy to handle.

Price per crate		Price per crate	
1500 2 in. pots	in crate \$4.88	144 6 in. pots	in crate \$3.16
1500 2 1/2 "	" " 5.95	120 7 "	" " 4.20
1000 3 "	" " 6.00	60 8 "	" " 3.00
800 3 1/2 "	" " 5.00	HAND MADE	
500 4 "	" " 5.80	48 9 in. pots	in crate \$3.60
450 4 1/2 "	" " 4.50	24 11 "	" " 4.80
320 5 "	" " 5.24	24 12 "	" " 4.80
210 5 1/2 "	" " 4.51	12 14 "	" " 4.80
	" " 3.78	6 16 "	" " 4.50

Send pans, same price as pots. Send for price list of Cylinders for Cut flowers, Hanging Baskets, Lawn Vases, etc. Ten per cent. off for cash with order. Address Hilfinger Bros., Pottery, Fort Edward, N. Y. August Rolker & Sons, Agts. 31 Barclay St., N. Y. City.

Standard POTTS

If your greenhouses are within 500 miles of the Capital, write us, we can save you money

W. H. ERNEST

28th and M Street WASHINGTON D. C.

DREER'S SPECIALS FOR FEBRUARY



Adiantum Farleyense The finest lot of fine-leaved plants we have yet offered; elegant stock to give a finishing touch to the work and choice decorations. \$9 per doz., \$70 per 100. In other sizes we can supply:

4 in. pots \$3.50 per doz., \$25 per 100. 4 in. pots \$5 per doz., \$40 per 100. 6 in. pots, 10 specimens, \$2 each.

Azalea Mollis These hardy Azaleas are becoming more popular every season; it is profitable stock to handle as it can be forced at a minimum cost. We offer splendid bushy plants, 17 inches high, \$4.50 per doz., \$35 per 100.

Wallflower For early forcing, strong bushy plants in 4 in. pots which will sell readily at a good profit when in flower. \$1.25 per doz., \$8 per 100.

Variegated Aucubas A splendid lot of these plants, so useful for decorative work during winter.

Each Doz.	Each Doz.
Very bushy 12 to 15 in. high \$0.30	Very bushy 24 in. high \$0.60
18 " 20 " " 40 " 50 "	28 to 30 " " 75 " 80 "

[Specimen plants 4 ft. high, very fine, \$3 each.]

Boxwood A splendid lot of globe-shaped specimens about 12 inches high and of some diameter in 11 inch pots, \$1.50 each.

BUSH SHAPED PLANTS for window boxes etc., 10 to 12 inches high, \$2 per doz., \$15 per 100. Larger, heavier plants 12 to 15 inches high, \$3.50 per doz., \$25 per 100.

HENRY A. DREER, 714 Chestnut St. PHILADELPHIA

BARGAINS

in KENTIAS and other Decorative Plants, all sizes. Also the following at Lowest Import Prices. Azaleas in bloom from now until Easter. All colors and varieties. A fine lot of Rubbers, Crotons, Araucarias, Pandanus, Asparagus plumosa and Sprengeri.

SMALL FERNS for table decorative purposes at lowest wholesale rates.

A. LEUTHY & CO., Perkins St. Nurseries, ROSLIN DALE, MASS.

HEADQUARTERS FOR

Araucaria Excelsa, 6 in. pots, 6 tiers, 75c, \$1.12 1/2; Robusta Compacta and glauca, 20 to 30 in. high, \$1.10, \$2.00. Ficus elastica, 5 1/2 in., 25c, 35c, 50c. Kentia Belmoreana, 4 to 5 1/2 in., 35c, 50c, 60c; Forsteriana, 5 to 6 in., 50c, 60c, 75c, \$1.00, \$1.25, \$1.50. Boston, Scottii and Whitmanii Ferns, 6 to 7 in. pots, 50c, 75c, \$1.10, \$1.50; Amerpohlii, 5 1/2 in., 35c, 50c. Azalea Apollo in bloom, 75c, \$1.00. Cineraria Hybrida for Easter, 3 in. oc, 6 in. 25c.

GODFREY ASCHMANN 1012 W. Ontario St., PHILADELPHIA, PA.

COLEUS! COLEUS!

	Pr 100 Pr 1000
C. Verschaffelii and Golden Bedder, R. C.	.70 6.00
Same in 3/4 in. pots R. C.	2.00 18.00
Coleus, "ixed R. C.	.60 5.00
Same in 2 1/2 in. pots R. C.	1.75 15.00
Ageratum Steila Gurney and Pauline R. C.	.50 4.00
Same in 3/4 in. pots R. C.	1.00 7.75
Feverfew in 2 1/2 in. pots	2.00
Fuchsias, our selection,	
German Ivy in 2 1/2 in. pots	8.00
English Ivy R. C.	7.75
English Ivy R. C.	1.00

J. E. FELTHOUSE 148-154 Van Vranken Ave., SCHENECTADY, N. Y.

CYCLAMEN GIGANTEUM 5, 6 and 7 in. pots—50c, 75c, and \$1.00 each.

Extra heavy stock of the very best quality.
Thomas Roland, Nahant, Mass.

DECORATIVE PLANTS

Araucaria Excelsa, Pandanus Utilis, Dracaena Indivisa, Kentias, Latanias, Arcas, Etc. Perennials and Shrubs.

4 inch Araucarias,	50 cents each.	6 inch Araucarias,	\$1.00 each.
5 " " " " " " " " " " " "	.75 " " " " " " " " " " " "	7 " " " " " " " " " " " "	\$1.25 and \$1.50 " " "

FERNS FOR DISHES—\$3.50 per 100, \$30.00 per 1000. SEND FOR OUR PRICE LIST. WE HAVE A COMPLETE STOCK

The Geo. Wittbold Co. 1657 Buckingham Place, Chicago, Ill.

FERNS FOR DISHES,

CASH WITH ORDER 2570 to 2606 W. Adams St., Chicago, Ill.

PALMS AND FERNS

DECORATIVE PLANTS JOHN SCOTT

Rutland Road and E. 45th St. Tel. 2890 Bedford BROOKLYN, N. Y.

HEACOCK'S PALMS

Kentia Belmoreana
7-inch pots 32 to 24 inches high \$2.50 each
7-inch pots 36 to 38 inches high 3.00 " "
9-inch tub 42 to 48 inches high 5.00 " "
Made up Kentia Forsteriana
7-inch pots 32 to 24 inches high \$2.50 each
7-inch pots 36 to 38 inches high 3.00 " "
9-inch tub 42 to 48 inches high 5.00 " "
Joseph Heacock Co., Wyncote, Pa.

VEGETABLE PLANTS

FOR TRANSPLANTING
CABBAGE—Wakefield and Succession \$1.00 per 1000
EGG PLANT—N. Y. Improved and Black Beauty \$1.00 per 1000
PEPPER—Bull Nose, Ruby King and Sweet Mountain \$1.00 per 1000
Chinese Giant and Cavendish \$1.00 per 1000
TOMATO—Earliana, Chalk's Jewel and Early June Pink \$1.00 per 1000

CASH WITH ORDER
R. VINCENT, JR., & SONS CO. White Marsh, Md.

If you want to do business Advertise in Horticulture.

Assorted Varieties

From 2 inch pots, \$3.50 per 100; \$30.00 per 1000

FRANK OECHSLIN N.E.P. WHITMANI 2 1/2 in., \$5.00 per 100

N.E.P. WHITMANI 3 1/2 in., \$25.00 per 100

BOSTON FERNS 2 1/2 in., \$3.00 per 100

H. H. BARROWS & SON, Whitman, Mass.

PEACOCK'S NEW DAHLIAS

SEND FOR LIST
PEACOCK DAHLIA FARMS Williamstown Junction, N. J.

DAHLIAS.

Now is the time to place your order for bulbs which will insure you getting named varieties in any quantity; prompt delivery.

DAVID HERBERT & SON, Successors to L. K. Peacock, Inc. ATCO, N. J.

The Northboro Dahlia and Gladiolus Gardens

Offer for Spring 1909
300 selected varieties of Dahlias and one and one-half million large-flowering Gladioli in mixtures, in lots to suit. Send list of your wants. Catalogue free.

J. L. MOORE, Northboro, Mass.

THE QUALITY YOU CAN MAKE MONEY ON

CANNAS

SOUND PIECES TRUE TO NAME BED ROCK PRICES

Red-Flowering, Green Foliage

	Per doz.	100	1000
A. Bouvier. 4 ft. Dark crimson.....	\$3.35	\$	\$23.00
Alce Rosevelt. Deep crimson, 4 ft.....	.60		30.00
Eliee Poltevine. 3 1/2 ft. Dark crimson.....	.35	2.11	20.00
Black Prince. Velvety crimson, 3 to 4 ft; green foliage.....	.50	2.07	25.00
Charles Henderson. 4 ft. Bright crimson.....	.35	2.4	21.00
Crimson Beldier. 2 1/2 ft. Intense scarlet.....	.40	1.00	17.00
Duke of Marlborough. 3 1/2 ft. Dark crimson.....	.35	2.05	20.00
J. D. Fleete. Brilliant vermilion-scarlet 5 ft.....	.35	2.15	20.00
Explorer Campbell. Deep rich crimson 5 1/2 ft. Express. Crimson foliage green. Dwarf habit, 2 to 2 1/2 ft.....	.30	1.75	15.00
Pres. McKinley. Brilliant crimson 2 1/2 to 3 ft.....	.35	2.25	20.00

Pink-Flowering

L. Patry. Delicate rosy pink, 4 1/2 ft.....	\$0.75	\$2.75	\$10.00
Lurray. Aurora rosy pink, 3 ft.....	.35	2.25	20.00
Louise. A grand pink, tall Martha Washington Rose. Height, 2 1/2 to 3 ft, each.....	.75	5.75	
Mlle. Berat. 3 1/2 ft. Rose-carmine.....	.35	2.25	20.00
Tennyson. Rosy pink; green foliage; 3 1/2 ft.....	.50	3.00	

Orange-Flowered

	Per doz.	100	1000
President Cleveland. Bright, distinct orange-scarlet, 4 ft.....	\$3.00	\$2.25	\$21.00

Red, Gold-Edged and Spotted

Gladiator. Bright yellow, spotted crimson, green foliage; 4 ft.....	\$0.50	\$2.75	\$25.00
Gladiator. Crimson, red, edged with distinct golden band; 3 1/2 ft.....	.30	2.00	17.50
Queen Charlotte. Scarlet and gold edge.....	.30	2	17.50
Mme. Crozy. 5 1/2 ft. Vermillion, gold border.....	.35	2.25	20.00
Premier. Deep crimson, bordered yellow, 2 1/2 ft.....	.30	2.00	17.50
Souy d'A. Crozy. 4 ft. Crimson, gold band.....	.50	4.00	35.00

Yellow Shades

Buttercup. 3 1/2 ft. Clear golden yellow.....	\$0.40	\$2.7	\$25.00
Comte de Bouchard. Yellow, spotted red, 4 1/2 ft.....	.30	2.00	17.50
Florence Vaughan. 5 ft. Yellow, spotted crimson.....	.50	2.75	25.00
L. E. Bailey. Rich yellow, dotted with red; 3 1/2 ft.....	.30	2.00	17.50

White and Cream Shades

Ailsae. 3 1/2 ft. Creamy white.....	\$0.30	\$1.75	\$15.00
--	--------	--------	---------

Bronze-Leaved, Red-Flowering

Brandywine. 4 to 5 ft. Dark bronze foliage. Crimson flowers.....	\$0.50	\$4.00	\$15.00
Black Beauty. True, 5 ft. Grand foliage.....	.60	4.50	40.00

	Per doz.	100	1000
David Harum. 5 ft. Vermilion-scarlet.....	\$3.50	\$2.75	\$25.00
Egandale. 4 ft. Curran red.....	.35	2.25	20.00
King Humbert. Fine Bronze foliage. Orange-scarlet with bright red markings, 4 ft.....	1.00	8.00	75.00
Leonard Vaughan. 4 1/2 ft. Bright scarlet.....	.35	2.25	20.00
Musafolia. The finest foliage Canoa, with enormous musa-like leaves, by 5 ft., of a dark green bronze tinged color.....	.35	2.25	20.00
Philadelphia. A bright glowing red. Height 5 ft. Papa Nardy. Large, orange-carmine red, 4 1/2 ft.....	.30	2.00	17.50
Pillar of Fire. 6 to 7 ft. bright flowers bright crimson-scarlet, 6 to 8 ft., with immense foliage.....	.75	4.50	40.00
Robusta. Bright crimson-scarlet, 6 ft.....	.30	1.75	15.00
Shenandoah. Large Salmon flowers, 6 ft.....	.30	1.75	15.00

Orchid-Flowering

Allenmania. 4 to 5 ft. Scarlet and yellow. Green foliage.....	\$0.15	\$2.25	\$20.00
Austria. Pure canary yellow; an orchid-flowering type, 5 ft.....	.30	1.75	15.00
Italia. 4 1/2 ft. Green foliage. Red bord. red yellow.....	.30	2.00	17.50
Kronus. Rich golden yellow, with patches of bright red, 4 ft.....	.30	1.75	15.00
Mrs. Kate Gray. 6 ft. Green foliage. Scarlet and yellow.....	.30	2.00	17.50
Pennsylvania. 4 ft. Green foliage. Deep scarlet.....	.35	2.25	20.00

CATALOGUE FREE.

We go through the block from 14th Street to 13th Street, but our address is still

ARTHUR T. BODDINGTON, Seedsman, 342 West 15th St., NEW YORK CITY.

CLUB AND SOCIETY NOTES.

James H. Burdett succeeds E. A. Kanst as secretary of the Horticultural Society of Chicago.

At their meeting on February 8, the Greater New York Florists' Association elected D. Y. Mellis, president; H. Jahn, vice-president; R. G. Wilson, treasurer; W. A. Phillips, secretary.

The Marion County (Ore.) Horticultural Society has elected the following officers for the ensuing year: C. J. Kurtz, president; John Pemberton and Fnos Presnall, vice-presidents; E. C. Armstrong, secretary and treasurer.

The Rochester Commercial Florists' Association has a membership of about one hundred. The officers are: President, Fred W. Vick; vice-president, A. H. Secker; secretary, H. B. Stringer; treasurer, W. L. Keller.

The Dutchess County Horticultural Society held its annual meeting and election of officers at Poughkeepsie, N. Y., January 29. The following officers were elected: C. J. Reynolds, president; James Blair, vice-president; Geo. Sweet, treasurer, and H. G. Cottam, secretary.

The Philadelphia Florists' Club bowling team went to Washington on Wednesday, 17th, to play a match with the florists there that afternoon. The same evening they played another with the Baltimore team. The date for the return match in Philadelphia has not yet been announced. The visiting team consisted of Connor, Yates, Robertson, Dodds, Holmes and Graham,

The New York Florists' Club's annual banquet, which is to take place on February 27, is already the talk of the town and nearly three times as many tickets have been sold, two weeks in advance, as were taken in any recent year. The committee in charge is moving on new lines and innovations are effective even in New York, where people are popularly supposed to have tried everything. At the rate of demand up to date the probabilities are that all the capacity of the Roman banquet hall at Shanley's will be sold out in advance.

FIRE RECORD.

Dixon, Ill.—The large tank which has supplied water to the greenhouse of Norman Long was burned on Feb. 2.

Kearney, Neb.—On the evening of Jan. 29, Green & Wiley had three greenhouses with their contents badly damaged by a fire which started in the boiler room.

Chicago.—At 2 A. M. Sunday, Feb. 14, the house of Wm. H. Kidwell, 4453 Ellis avenue, was found to be on fire. Mrs. Kidwell awakened first and gave the alarm to her husband and six children. They escaped uninjured, but the furniture is almost a complete loss. At this writing the insurance has not been adjusted. The house itself was not owned by Mr. Kidwell. The fire is supposed to have been caused by an overheated furnace, and the escape of the family is very fortunate. Mr. Kidwell, who is well known in the trade in Chicago, has the sympathy of many friends.

PERSONAL.

Jas. H. Morton, late superintendent of Mt. Hope Cemetery, Boston, has gone to Cuba for a six weeks' sojourn.

Fred Smythe of Wadley & Smythe, New York sailed last week on the Mauretania for a brief European visit.

Edith Lempster has retired from business at Winnipeg, Man., and from the position of corresponding secretary of the Winnipeg Florists' Association.

Mr. and Mrs. Philip Breitmeyer, of Detroit, are in Philadelphia, attending the funeral of Mrs. Grass, Mrs. Breitmeyer's mother, who died on Sunday morning, Feb. 14.

Frank Genick of Jamestown, R. I., has been committed to the State Asylum at Cranston, his mind having given way under the bereavement of his wife's death on January 28.

Miss Eva Ferguson, who for many years has had a flower stand in the grill room at the Masonic Temple, Chicago, was married on Feb. 7 to Benj. Harris, 1027 West North avenue.

P. Welch is packing his grip and getting ready to attend the meeting of the Tariff Committee of the S. A. F. at New York next Wednesday as the New England representative in that important body.

Visitors in Albany, N. Y., this week include S. H. Green, representing H. Bayersdorfer & Co., Phila.; Mr. Bryant, representing A. H. Hews & Co., North Cambridge, Mass.; Julius Roehrs, Jr., Rutherford, N. J.; and Morris Cohn of Wertheimer Bros., New York.

Seed Trade

AMERICAN SEED TRADE ASSOCIATION.

Watson S. Woodruff, Orange, Conn., Pres.; J. C. Robinson, Waterloo, Neb., First Vice-Pres.; C. E. Keudel, Cleveland, O., Sec'y and Treas. Twenty-seventh annual convention June 22-24, 1938, at Clifton House, Niagara Falls, Ont.

WHOLESALE SEEDSMEN'S LEAGUE.

F. W. Bruggerhof, Pres.; Burnet Landreth, Sec'y.

THE OUTLOOK. About Beans.

The demand for green pod beans is surprising in view of the fact that truck farmers ripened a considerable proportion of their plantings last season because they could not get out of them in the green state. The recent severe weather, which extended south as far as Florida, has no doubt made replanting necessary in many sections, though this does not explain the demand only partially. It may be that being somewhat short, the retail trade is buying in anticipation of a demand which may not come. The next six weeks will tell the story.

Wax pod beans seem to be abundant with a few exceptions, and are offered at prices in some instances below the green pods. In view of the scarcity of seed stocks of most of the green string varieties, the prices at which some growers are booking contracts for next season's crop seem very absurd, and just how they can figure any profit is puzzling to the man on the fence.

The Canners' Situation.

Canners are not contracting seed as liberally as last year, and many of them declare the situation they are now facing is the worst in a decade. The three staples, corn, peas and tomatoes, are very heavy, and can only be moved at a great sacrifice in values. The packer who can get cost out of the three items for spot goods is fortunate, as such offers as come from jobbers are generally below cost of production. The outlook for next year is giving little encouragement, and if there is anything approaching a full crop the coming season, such a condition of the industry will develop, and when the smoke clears away many of the weaker canners will be among the has-beens.

As regards the seed pea crop of the coming season, if there is an average of four-fold, prices will suffer a severe sinking spell next fall, and "spot" seed will go at prices far below what "futures" are now selling at. This applies especially to "canners'" varieties, and more particularly to Alaskas. Hundreds of acres of degenerate strains of this variety will be planted by Wisconsin farmers, a much larger acreage than ever before, and we may well ask, "What will the harvest be?"

Costly Economy.

While this seed is really junk, it nevertheless is a factor in determining prices, and many canners will buy it to save 50 cents per bushel on good pedigree seed. It is absolutely impossible to pack high grade goods from such

Gladiolus Bulbs

GLADIOLUS AMERICA

A few points of merit

Color: A beautiful, soft, flesh pink, very light and much like Enchantress Caration, except slightly tinged with lavender, which gives it the delicate coloring of the most beautiful Laelias. Words fail to do justice in describing this grand and glorious color; it must be seen to be appreciated. Purposes: For florists use, it is so or makes it every-thing to be desired; delicate, attractive and absolutely new; no other color in Gladiolus like it or one-half so beautiful. It has created a sensation in the cut flower markets, selling for more than five times the price of other varieties.

America. The best commercial pink in existence. 1st size bulbs, \$4.00 per 100; \$35.00 per 1000; \$175.00 per 5000.

Augusta. Lovely, pure white with blue anthers. 1 1/2 to 2 1/2 in., \$3.00 per 100; \$15.00 per 1000; \$75.00 per 5000.

Blue Jay (Baron Hulot). Finest blue Gladiolus yet seen. It is a rich, deep color of indigo shade. The only real blue Gladiolus on the market \$10.00 per 100; \$50.00 per 1000.

Brenchleyensis. Extra fine red variety. 1 1/2 to 2 1/2 in., \$1.50 per 100; \$12.00 per 1000; \$50.00 per 5000.

May. A lovely, pure white flower, finely flaked, bright rosy crimson. 1000 1000 5000

Principes. Rich crimson with very deep shadings in the throat and broad blotches on lower petals. 1000 1000 5000

Salem. Fine salmon pink, maroon blotches. 1000 1000 5000

Gladiolus in Mixture

Trial Grounds Mixture 1.50 12.00 45.00
Groff's Hybrids Mixture 1.50 12.00 45.00

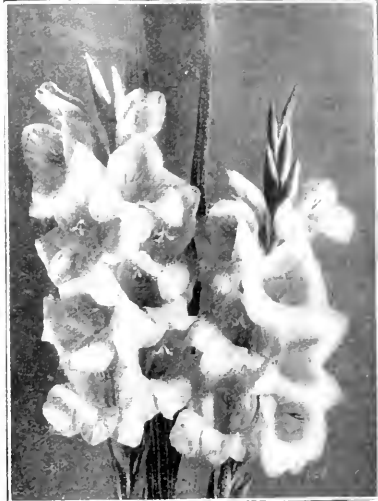

Gladiolus in Mixture 100 1000 5000

WHITE AND LIGHT MIXTURE..... \$1.50 \$12.00 \$45.00
Pink and Rose Mixture 1.50 12.00 45.00
Red and Scarlet Mixture 1.50 12.00 45.00
Lemon's Extra Fine Mixture..... 1.00 10.00 45.00

AMERICAN HYBRIDS MIXTURE

..... 1.00 10.00 45.00

CHILDREN MIXTURE

..... 1.50 12.00 45.00

STUMPP & WALTER CO., 50 Barclay Street, NEW YORK

FORCING GLADIOLUS

Gladiolus Gandavensis Hybrids

Many florists plant these in boxes, or among their carnations, in the Winter. They are excellent for decorative purposes and realize good prices, either wholesale or retail. Gladiolus are a good catch-crop and take up but little room. The following are the best for this purpose:

America. The flowers, which are of immense size, are of the most beautiful flesh-pink color, \$4.00 per 100; \$35.00 per 1000.

Augusta. The florists' best white Gladiolus. First-size bulbs, 1 1/2 inches and up, \$2.00 per 100; \$18.00 per 1000. Bulbs 1 1/2 to 1 3/4 in., \$1.75 per 100; \$16.00 per 1000.

Shakespeare. White and rose. \$4.75 per 100; \$45.00 per 1000.

May. Pure white, flaked rosy crimson; the best forcer. Selected bulbs. \$1.75 per 100; \$15.00 per 1000.

Brenchleyensis (true). Fiery scarlet. Selected bulbs, \$1.50 per 100; \$13.00 per 1000. First-size; bulbs, \$1.25 per 100; \$10.00 per 1000.

Boddington's White and Light. Extra selected bulbs, 1 1/2 in. and up, \$1.50 per 100; \$14.00 per 1000. Bulbs 1 1/2 to 1 3/4 in., \$1.25 per 100; \$10.00 per 1000.

American Hybrids. A mixture of the choicest varieties of Gladiolus in cultivation. \$1.00 per 100; \$9.00 per 1000.

ARTHUR T. BODDINGTON

SEEDSMAN

342 West 14th Street,

NEW YORK CITY

Gladiolus Brenchleyensis

Extra fine Healthy Imported Stock

1,000 \$10.00 10,000 \$80.00

O. V. ZANGEN

HOBOKEN, N. J.

JAPANESE
THE YOKOHAMA NURSERY CO. NEW YORK.
31 BARCLAY STR.
LILIES
PLANTS
BAMBOO STAKES

TO BUYERS

Patronize our advertisers. they will treat you right

seed, but argument is useless when the farmer can save that 50 cents per bushel. To save \$2.00 an acre on his seed, he will sacrifice \$25.00 an acre on his pack. To a mind so constituted, argument is a waste of breath, but many are built on those lines.

NOTES.

A. J. Brown of Grand Rapids, Mich., was a recent New York visitor.

Geo. D. Karsner has been appointed inspector of seeds for the State of Kentucky.

James Harry Laing is now filling the position of representative of Dupuy & Ferguson, seed and bulb dealers, Montreal, P. Q.

Two Rivers, Wis. Louis Hartung has recently received a contract from a seed concern of Rockford, Ill., for the raising of 1000 acres of seed peas. The peas will be raised in this vicinity.

The La Grange Floral & Seed Co., 5th avenue, La Grange, whose going into business we mentioned a few weeks ago, announce their opening Feb. 19 and 20. La Grange is one of the best of Chicago's suburban towns and the seed firm starts under favorable auspices.

At the fifth annual convention of the Canadian Seed Growers' Association held in the Canadian Building, Ottawa, Ont., on February 4th and 5th officers were elected as follows: President, Dr. J. W. Robertson of Macdonald College, Que.; secretary-treasurer, L. H. Newman, Ottawa. The financial statement showed a balance on hand of \$171.38. The total expenditure amounted to \$3,438.50. An adequate grant sufficient for the requirement of the association is given each year. Since the association is now placed on a firm foundation, it is fully expected that it will extend and develop throughout Canada to a still greater degree than it has in the past. Among the speakers were Dr. Chas. Saunders, Experimental Farm, Ottawa; Mr. A. P. McVannell, Perth; Prof. W. Lochead, Macdonald College; Mr. J. W. Gibson, Ottawa; Prof. R. Harcourt, Ontario Agricultural College, and Prof. L. S. Klinck, Macdonald College. Prof. Robertson addressed a large audience on "The call of the land."

CATALOGUES RECEIVED.

F. E. Stewart, Rives Junction, Mich.—Wholesale Trade List of Gladoli for 1909.

Gate City Seed Co., Keokuk, Iowa.—Market Gardeners' Price List, Pocket Edition.

F. W. Dixon, Holton, Kansas.—22nd Annual Catalogue and Price List of Small Fruit Plants.

Forest Nursery and Seed Co., J. H. H. Boyd, Prop., McMinnville, Tenn.—Wholesale Trade List for 1909.

Arthur De Meyer, Ghent, Belgium.—Wholesale Trade List, 1909. Palms, Rays, Azaleas, etc. Illustrated.

Dervaes Ercres, Wetteren, Belgium.—General Catalogue of Fruit and Ornamental Trees, Hardy Herbaceous Plants, etc.

Otto Katzenstein & Co., Atlanta, Ga.—Folder of "Heliants," described as "a

new winter vegetable" of phenomenal yield and superior flavor.

Archias' Seed Store, Corp., Sedalia, Mo.—26th year, "Sure Seeds." Complete in all departments. Covers, vegetables and flowers in colors.

John Peed & Son, West Norwood, London, S. E., England.—Descriptive Catalogue of Vegetable and Flower Seeds for 1909. Several promising novelties are listed in each department.

American Forestry Co., Little Tree Farms, South Framingham, Mass.—These are claimed to be the first purely forest nurseries in America. The list is well adapted for the purpose indicated.

W. W. Barnard Company, Chicago, Ill.—1909 Annual Catalogue of Seeds, Bulbs and Plants. Neat covers in green and white. A useful table of cultural information regarding garden crops is given.

J. L. Moore, Northboro Dahlia and Gladioli Gardens, Northboro, Mass.—Catalogue and Price List for 1909. Also wholesale price list for spring, 1909. A good, practical list, well selected from the innumerable varieties now on the market.

David Herbert & Son, Atco, N. J.—Descriptive Catalogue of Dahlias, 1909. A fine portrait of Jack Rose Dahlia adorns the front cover and Souv de Gustave Douzan the back. The list includes the best of the new and the best of the old varieties in all types.

W. E. Dallwig, Milwaukee, Wis.—Seed Catalogue for 1909. Covers adorned with annual flowers and vegetables in colors. Some very fine full-page illustrations in sepia are introduced in addition to the usual half-tones and wood cuts illustrating the text.

Palisades Nurseries, Sparkill, N. Y.—Wholesale Price List of Hardy Perennials, Shrubs, Bulbs, etc., for 1909. This is a splendid list of the best things in garden material, standard and novelties. Colored plates of *Veronica longifolia subsessilis* and *Aneura italica* Drompore variety are enclosed.

Ratekin's Seed House, Shenandoah, Ia.—Ratekin's Seeds. 25th Annual Catalogue. This is a great book about a great business and anyone wishing to know what is being done in the west to attain the standard of perfection in corn and other farm crops will find much in this catalogue to interest him.

King's Acre Nurseries, Ltd., Hereford, England.—Annual Catalogue, Autumn 1908 and Spring 1909. A very handsome publication. Printed in two colors throughout on heavy cream paper, antique finish. Cover dark sage green, lettered in silver and bound with white cord. There are no illustrations on the text pages but there are several half tone inserts and the effect is good.

Wm. Paul & Sons, Waltham Cross, Herts, England.—Catalogue of Roses. A very valuable publication as a reliable reference book for anyone interested in roses, apart from its use as a business getter for the house sending it out. There are several striking rose portraits, one being a beautiful colored plate of Tea Scented Rose "Hugo Roller," a most distinct and attractive novelty. A colored plate of hybrid Sweetbriar Refulgence forms the frontispiece.

Everything "For the Land's Sake."

The one firm in Boston where all good forms of plant food may be obtained, is the Bowker Fertilizer Company, opposite Faneuil Hall at 43 Chatham St. All greenhouse chemicals, Nitrate of Soda, Ground Bone, Potash Salts, Sheep Manure and Wood Ashes can there be had at first hands.

BOWKER FERTILIZER COMPANY.

Everything "For the Land's Sake."

PUBLICATION RECEIVED.

Bulletin No. 218 of the New Jersey Agricultural Experiment Stations gives lists, conditions and instructions for Vegetable-Fruit Seed Distribution for 1909. Illustrations are given of various strains of crossed corn, hybrid egg-plant and crossed beans.

ASPARAGUS PLUMOSUS NANUS

Greenhouse Home Grown Seed, Best quality.

100 Seeds	\$0.50
500 "	2.25
1000 "	4.00
5000 "	19.00

MICHELL 518 & 1018 MARKET ST
PHILADELPHIA, PA.

In ordering goods please add "I saw it in HORTICULTURE."



Baskets, Grates,
Ladders, Veneers
and Boxes.

BACON & CO.
Appleton, N. Y.

DO NOT aspire to be King of the Belliakers — there's too much competition for that place.

BUY good stuff and pay for it — then insist on getting it. Send for our **BULB LIST** for 1909.



RALPH M. WARD & CO.

12 W. B'way, N. York
HORSESHOE BRAND.

Mignonette

FARQUHAR'S GIANT

Oz., 75c; 1-4 oz., 25c

R. & J. Farquhar & Co.

6 & 7 South Market Street
BOSTON, MASS.

CANES

Freshly Cut From the Brakes For Your Lilies

Can Be Cut To Any Size

\$5 for 500, \$7 for 1000

Wm. Elliott & Sons
42 Vesey St., New York

200,000 CLADIOLI BULBS

3/4 to 1 1/2 inches, \$2 per 1000. 1 1/4 to 1 3/4, \$4 per 1000. 1 1/2 and up, \$5 per 1000.

CALIFORNIA PRIVET

1 yr. well branched, \$20 per 1000. Cash with order. Nice lot of AMERICAN CHESTNUT TREES at a bargain, about 50 LARGE SUGAR TREES, most of them sample trees.

Surplus of STONE TOMATO SEED: Ruby King, Neapolitan, Bull Nose and Sweet Mountain Pepper Seed at a bargain.

I. & J. L. LEONARD, - Iona, N. J.
Vegetable Plant Nurserymen and Seed Growers

In ordering goods please add "I saw it in HORTICULTURE."

BRIDGEMAN'S SEED WAREHOUSE

RICKARDS BROS.

Props.

37 East 19th St., - NEW YORK CITY

C. C. MORSE & CO. 48-56 JACKSON ST., San Francisco, Cal.

The Largest Seed Growers on the Pacific Coast

ONION, LETTUCE, SWEET PEAS,

ALSO

Carrot, Celery, Leek, Mustard, Parsley, Parsnip, Radish, Salsify

LEONARD SEED CO.

CONTRACT GROWERS AND WHOLESALE DEALERS

BEANS, PEAS, SWEET CORN, ONION, GARDEN SEEDS

ONION SETS 79 and 81 FLOWER SEEDS Get Our Prices E. KINZIE STREET, CHICAGO



LILY OF THE VALLEY PIPS

Unexcelled Hamburg or Berlin

TUBEROUS ROOTED BEGONIAS

GLOXINIAS

ROSA MULTIFLORA NANA SEED

and all other flower seeds for Florists

SEND FOR CATALOGUE

J. M. THORBURN & CO.

33 BARCLAY ST. through to 38 PARK PLACE
NEW YORK

C A U L I F L O W E R S
C A B B A G E SEED

LILY OF THE VALLEY PIPS.

HJALMAR HARTMANN & CO.

12 Stormgade,
COPENHAGEN, DENMARK.

Burpee's Seeds

PHILADELPHIA

Blue List of Wholesale Prices mailed only to those who plant for profit

Vegetable and Flower **SEEDS**

Reliable and Tested. Catalogue Mailed Free

WEBBER & DON
Seed Merchants 114 CHAMBERS STREET
NEW YORK

SHEEP MANURE

Pulverized. Free from Adulteration
In Bag, \$18.00 per Ton. Cash with Order

ROBERT SIMPSON
CLIFTON, N. J.

STOCK SEED

FOR WINTER BLOOMING

Our strain of Double Branching Stocks is exceptionally true. About 90% Double Flowers.

In colors: 1/4 oz. .60 oz. \$4.00

Pure White 3/4 " .75 " 5.00

H. E. FISKE SEED CO.

Faneuil Hall Square, BOSTON, MASS.

Winter-flowering

SWEET PEA SEED

All Colors Ask for List

A. C. ZVOLANEK

ORIGINATOR

BOUND BROOK, N. J.

NEW CROP SEED

For Early Planting

THOMAS J. GREY CO.

32 SO. MARKET ST., BOSTON, MASS.

BECONIAS TUBEROUS ROOTED

ALSO

GLOXINIAS, LILY OF VALLEY, SPIREIA

Catalogues mailed free on application

Joseph Breck & Sons Corp.

47-54 NO. MARKET ST., BOSTON, MASS.

CEO. E. DOW

Designing and Illustrating

178 Washington St., Boston, Mass.

OUR SPECIALTY

Machine, Booklet Advertising and Flower PHOTOGRAPHS

Japanese Bulbs, Etc.

R. TANOI, Yokohama, Japan.

Send for catalogue and write to Representative

K. TAKEUCHI,

478a Boylston St., Boston, Mass.

QUALITY SEED BULBS PLANTS

SEND FOR CATALOGUE

ARTHUR T. BODDINGTON

342 West 14th St., New York.

To Florists Everywhere

Orders for Cut Flowers and Floral Decorations to be delivered anywhere in the Greater New York, may be placed with us with the certainty that your customers will be satisfied.

Telegraph, telephone or mail such orders to us and be sure that they will be filled as promptly and as carefully as though you did it yourself.

(One third discount will be allowed on all orders thus placed with us by Florists outside of the Greater New York.

THE BLOSSOM

Bond and Livingston Sts.,
BROOKLYN, N. Y.

C. C. TREPEL, Manager

**WILLIAM J. SMYTH
FLORIST**

Cor. Michigan Ave. and 31st St., CHICAGO

We ship to all points in Illinois and Iowa.

Phones: Douglas 744, Douglas 523, Douglas 740

M. C. and J. E. HAUSWIRTH

Out of Town orders for Hospitals
Carefully filled.

**232 Michigan Ave.
CHICAGO**

AUDITORIUM ANNEX Tel. Harrison 585

**SAMUEL MURRAY
Florist**

Coates House Conservatory
1017 BROADWAY, KANSAS CITY, MO.

Both 'Phones 2670 Main.



WASHINGTON,
D. C.

GUDE'S

**The Far-Famed Flowers of
TORONTO**

Delivered on mail or telegraph order for any occasion, in any part of the Dominion.

JOHN H. DUNLOP,
96 Yonge St., - Toronto, Ont.

The Park Floral Co.

J. A. VALENTINE
Pres.

DENVER, COLORADO

**WILLIAM L. ROCK
FLOWER CO.**

KANSAS CITY, - MO.

will carefully execute orders for Kansas City and any town in Missouri or Kansas.



Buffalo, N. Y.

W. J. PALMER & SON, 304 Main St.

**Of Interest to Retail
Florists**

NEW RETAIL FLOWER STORES.

Clinton, Ia.—Andrew Bather, Fifth avenue.

Oakland, Cal.—N. Roller, 7th street, near Clay.

Northampton, Mass.—F. D. Keyes, Parsons' Block.

New York, N. Y.—M. Durand, 1326 Lexington avenue.

St. Louis, Mo.—Jules E. Schaeffer, 111 North 6th street.

Bloomington, Ill.—Phoenix Nursery Co., Griesheim Building.

La Grange, Ill.—La Grange Floral & Seed Co., Fifth and Harris avenue.

THE HANDY HANDLE.

One of the most useful and ingenious yet simple accessories ever offered to the florist for his own use or to sell to his customers for home use is the device known as Hart's Handy Handle, which is advertised in this issue. It is an easily and quickly adjusted ar-

STEAMER DEPARTURES

American.

St. Louis, N. Y.—Shampton, Mar. 6

New York, N. Y.—Shampton, Feb. 27

Atlantic Transport.

Mesala N. Y.—London, Feb. 27

Mindelaba, N. Y.—London, Mar. 6

Cunard.

Manetania, N. Y.—Liverpool, Feb. 24

Campania, N. Y.—Liverpool, Mar. 3

Ivernia, Boston-Liverpool, Mar. 9

French Line.

La Savoie, N. Y.—Havre, Feb. 25

La Touraine, N. Y.—Havre, Mar. 4

Hamburg-American.

America, N. Y.—Hamburg, Feb. 27

Pretoria, N. Y.—Hamburg, Mar. 6

North German Lloyd.

Prinz Frh. Wm., N. Y.—Havre, Feb. 23

Koenigin Luise, N. Y.—Havre, Feb. 27

Kaiser Wm. II., N. Y.—Havre, Mar. 3

Prinzess Irene, N. Y.—Havre, Mar. 6

White Star.

Tentonic, N. Y.—Shampton, Feb. 24

Patric, N. Y.—Liverpool, Feb. 27

Cretic, Boston-Med. Ports., Feb. 27

range for converting pots or other receptacles of flowering or ornamental plants or cut flowers into baskets with handles. The uses to which it may be put are many and varied, and every florist should have a stock on hand.

BUSINESS CHANGES.

Oak Park, Ill.—Wm. Pfund has sold his greenhouses to the Washington Boulevard Floral Company.

Philadelphia, Pa.—Max H. Rothe has taken the store and greenhouses formerly occupied by H. Sonneborn, Jr., at 7140 Germantown avenue.

Springfield, Mass.—Mark Aitkin has bought the florist business formerly conducted by Lewis in Worcester and has re-opened the store as a branch.

LEUCOTHOE SPECIAL

Green	10 to 16 in.	Sprays	\$1.25 per 1000
	16 " 24 "	"	1.75 " "
	Bronze 10 " 18 "	"	2.25 " "
	GALAX, Bronze or Green	"	.50 " "
	FERN, Dagger or Fancy	"	.65 " "

ELK EVERGREEN CO. SHELL CREEK R. 2. TENN.

ALEX. McCONNELL

571 FIFTH AVENUE
NEW YORK CITY

Telegraphic orders forwarded to any part of the United States, Canada, and all principal cities of Europe. Orders transferred or intrusted by the trade to our selection for delivery on steamships or elsewhere receive special attention.

Telephone Calls, 487 and 488 38th St.

Cable Address, ALEXCONNELL

New York Deliveries

FLOWERS and PLANTS

by special messenger to Steamer,
Theatre or any address in

NEW YORK or BROOKLYN

THOMAS YOUNG, JR.

500 FIFTH AVE., (near 42nd St.)

NEWMAN FLORAL Co.

(Established 1870)

202 Fifth Ave. and
Madison Square, NEW YORK CITY

FLOWERS FOR STEAMER SAILINGS

M. A. BOWE

In the Heart of New York City

1294 Broadway

Tel. 2270, 38th St. NEW YORK

Our Motto—The Golden Rule

DAVID CLARKE'S SONS

Deliver orders from any part of the country to
New York City

Or OUT-GOING STEAMERS

Write or telegraph

2139-2141 Broadway, New York
Telephone 1552-1555 Columbus

YOUNG & NUGENT

42 West 28 St., NEW YORK

"FLOWERS BY TELEGRAPH"

**NEW YORK
MYER, FLORIST**

Phone 5297 Plaza. 609-611 MADISON AVE.

ALBANY, N. Y.

EYRES

Flowers or Design Work

DELIVERED IN ALBANY AND VICINITY
ON TELEGRAPHIC ORDER.

11 NORTH PEARL ST., ALBANY, N. Y.

Flower Deliveries

In Brooklyn and other Long Island Points
New York City, New Jersey, etc. At Theatres,
Hotels, Steamers or Residences.

WILSON

Fulton St. and Greene Ave., Brooklyn, N. Y.

JOHN BREITMEYER'S SONS

Cor. Miami and Gratiot Aves.
DETROIT, MICH.

Artistic Designs . . .
High Grade Cut Blooms

We cover all Michigan points and good sections of Ohio, Indiana and Canada

PROMPT DELIVERY IN BOSTON

AND ALL NEW ENGLAND POINTS
F. H. HOUGHTON
396 Boylston St., Boston, Mass.

BOSTON'S BEST In Quality and Design

Can be relied upon when you transfer your retail orders to

EDWARD MACMULKIN
194 Boylston Street, Boston

Send flower orders for delivery in
BOSTON

and all
NEW ENGLAND POINTS
THOS. F. GALVIN
124 Tremont St., Boston

The Original Telegraph Order Florist
WILL DELIVER

Flowers or Designs
to order in Boston and Vicinity. Usual Discount.

J. NEWMAN & SONS, Inc.
Est. 1870 24 TREMONT ST., BOSTON



DANKER, Albany, N. Y.

ORDERS FOR
Choice Flowers and
Floral Emblems
FILLED PROMPTLY

LOUISVILLE, KY.
JACOB SCHULZ,
550 South Fourth Ave.

WELLESLEY COLLEGE
Dana Hall, Walnut Hill and Rockridge Hall
Schools. **TALBY, Wellesley, Mass.**
Tel. Wellesley 44-1 and 2. Night 44-3.

ATLANTA FLORAL CO.
41 Peachtree Street, ATLANTA, GEORGIA

\$\$\$ SAVED \$\$\$ CUT DOWN EXPENSE.

Why buy expensive baskets, when
HART'S NEW HANDY HANDLE
gives the same effect at trifling cost? Covered with willow and finished in natural wood colors, manufactured in four sizes.

No. 1, 12 in. high \$25.00 per 100	No. 3, 15 in. high \$40.00 per 100
No. 2, 15 " " 30.00 " "	No. 4, 24 " " 50.00 " "

Ask your cut flower jobber to see it, if he has not got it, send us his name and we will send him samples.

GEORGE B. HART, 24 Stone Street,
Rochester, N. Y.

THE NEW IDEA IN PLANT STANDS

The Moore-Livingston Graduating or Adjusting

Saves one-half to two-thirds of cost over ordinary galvanized iron stands.

SEND FOR CIRCULAR GIVING FULL PARTICULARS
SOLD BY SEEDSMEN AND SUPPLY HOUSES

If your seedsman does not carry send us his name and we will promptly send full particulars.

Moore-Livingston Co., Patentees and Mfrs., Lansdowne, Pa.

"FLOWERS BY TELEGRAPH."

Leading Retail Florists Listed by Towns for Ready Reference.

Denver, Colo.—Park Floral Co., 1706 Broadway.
Washington, D. C.—Gude Bros., 1214 F St.
Atlanta, Ga.—Atlanta Floral Co., 41 Peach Tree St.
Chicago—M. C. & J. E. Hanswirth, 232 Michigan Ave.
Chicago—William J. Smyth, Michigan Ave. and 31st St.
Chicago—George Wittbold Co., 1657-59 Buckingham Place.
Louisville, Ky.—Jacob Schult, 644 4th Ave.
Boston—Thos. F. Galvin, 124 Tremont St.
Boston—Frank H. Houghton, 396 Boylston St.
Boston—Edward MacMulkin, 194 Boylston St.
Boston—Hoffman, Florist, 59-61 Massachusetts Ave.
Boston—J. Newman & Sons, Inc., 24 Tremont St.
Boston—Julius A. Zinn, 2 Beacon St.
Wellesley, Mass.—Talby.
Detroit, Mich.—J. Breitmeyer's Sons, Miami and Gratiot Aves.
Kansas City, Mo.—Samuel Murray, 1017 Broadway.
Kansas City, Mo.—Wm. L. Rock Flower Co., 116 Walnut St.
Albany, N. Y.—H. G. Eyres, 11 N. Pearl St.
Albany, N. Y.—F. A. Danker, 40 Maiden Lane.
New York—David Clarke's Sons, 2139-2141 Broadway.
New York—Alex. McConnell, 571 5th Ave.
New York—Young & Nugent, 42 W. 28th St.
New York—M. Bowe, 1294 Broadway.
New York—Myer, 60-11 Madison Ave.
New York—Thos. Young, Jr., 500 Fifth Ave.
New York—Newman Floral Co., 202 Fifth Ave. & Madison Sq.
Brooklyn, N. Y.—The Blossom (C. C. Trepel, Mgr.), Bond and Livingston Sts.
Brooklyn, N. Y.—Robert G. Wilson, Fulton St. and Greene Ave.
Buffalo, N. Y.—Palmer's, 30 Main St.
Toronto, Can.—J. H. Dunlop, 96 Young St.

THE BEST LETTERS

FOR THOSE
FLORISTS' MADE
USE BY THE

Boston Florist Letter Co.
66 PEARL ST., BOSTON
N. F. MCCARTHY, Mgr.

Order direct or buy from your local supply dealer. Insist on buying the

BOSTON
Inscriptions, Emblems, etc., Always in Stock

Durand & Marohn

MANUFACTURERS OF
All Kinds of Wire Work
Florists' Wire Designs a Specialty
24 Beaver St., ALBANY, N. Y.

FLORISTS' SUPPLIES

Send for New Catalogue

H. Bayersdorfer & Co.

1129 ARCH ST., PHILADELPHIA

TRANSFER

Your orders for flower or plant delivery in Eastern New England to

JULIUS A. ZINN,
2 Beacon St., Boston.
Fine Design Work a Specialty.

ACACIA PUBESCENS

\$2.50 per Bunch

The greatest novelty in YELLOW
for February

THE LEO NIESSEN CO.

1209 Arch St., Philadelphia, Pa.

Open from 7 a. m. to 8 p. m.



GARDENIAS

Extra Choice Quality

\$6.00 per doz.

CUT FARLEYENSE

Choice Quality

\$12.00 and \$15.00 per 100.

S. S. PENNOCK - MEEHAN CO.

1608-1620 Ludlow St., Philadelphia

CARNATIONS

Unsurpassed in Quality Orders filled for
Any Quantity.

W. E. McKISSICK & BROS.

WHOLESALE FLORISTS

1619-1621 RANSTEAD ST.
PHILADELPHIA

CUT FLOWER BOXES

EDWARDS FOLDING BOX CO
MANUFACTURERS
PHILADELPHIA, PA.

CHAS. W. McKELLAR

51 WABASH AVE., CHICAGO

Western Headquarters for Choice Orchids
Valley, Roses and all Cut Flowers

PETER REINBERG

WHOLESALE

CUT FLOWERS

51 Wabash Av., Chicago, Ill.

DAILY CONSIGNMENTS

From 40 to 60 Growers

We can care for your cutflower wants to
advantage.

E. F. WINTERSON CO.

45-47-49 WABASH AVE., CHICAGO

POEHLMANN BROS. CO.

33-35-37 Randolph St., - CHICAGO

CUT FLOWERS

Greenhouses, - Morton Grove, Ill.

Rice Brothers

115 N. 6th Street, MINNEAPOLIS, MINN.

WHOLESALE FLORISTS and SUPPLIES

CUT FLOWERS received twice daily, and can fill
your orders to your satisfaction. A complete line of
Hardy Greens - WILD SMILAX, BOXWOOD,
HARDY FANCY FERNS, GALAX LEAVES.

Write for quotations on large quantities.

In ordering goods please add "I saw
it in HORTICULTURE."

WELCH BROS.

AMERICAN BEAUTY, KILLARNEY, RICHMOND, MARYLAND AND ALL THE SUPERIOR
ROSES, LILY OF THE VALLEY, CARNATIONS, ORCHIDS
BEST PRODUCED

226 Devonshire Street,

Boston, Mass.

WHOLESALE FLOWER MARKETS—TRADE PRICES—Per 100 TO DEALERS ONLY

	CHICAGO Feb. 16	TWIN CITIES Feb. 16	PHILA. Feb. 17	BOSTON Feb. 18
ROSES				
Am. Beauty, Fancy and Special.....	40.00	35.00	45.00	40.00 to 75.00
" Extra.....	45.00	40.00	50.00	40.00 to 60.00
" No. 1.....	15.00	25.00	10.00	35.00 to 50.00
" Lower grades.....	13.00	8.00	12.00	15.00 to 4.00
Bride, 'Maid, Fancy & Special.....	10.00	10.00	12.00	12.00 to 15.00
" Lower grades.....	5.00	10.00	6.00	8.00 to 3.00
Killarney, Fan, & Sp.....	4.00	15.00	14.00	15.00 to 18.00
" Lower grades.....	2.00	10.00	10.00	6.00 to 8.00
Richmond, Fancy & Special.....	12.00	15.00	12.00	20.00 to 30.00
" Lower grades.....	5.00	10.00	6.00	8.00 to 4.00
Chatenay.....	6.00	8.00	8.00	8.00 to 12.00
Golden Gate Ivory, etc.....	6.00	10.00	6.00	10.00 to 4.00
Maryland.....	10.00	10.00	10.00	10.00 to 16.00
Queen of Hearts.....	8.00	10.00	10.00	10.00 to 12.00
Mrs. Mar. Field.....	8.00	10.00	10.00	10.00 to 12.00
CARNATIONS				
Fancy and Red.....	2.00	3.00	3.00	4.00 to 5.00
Ordinary and White.....	1.50	2.00	2.50	3.00 to 4.00
MISCELLANEOUS				
Cattleyas.....	40.00	50.00	40.00	53.00 to 63.00
Cypripediums.....	12.00	15.00	8.00	10.00 to 15.00
Lilacs.....	12.00	15.00	8.00	10.00 to 15.00
Lily of the Valley.....	3.00	4.00	2.00	3.00 to 4.00
Narcissus, Paper White.....	3.00	4.00	3.50	2.00 to 4.00
Roman Hyacinth.....	3.00	4.00	2.00	3.00 to 4.00
Daffodils.....	2.00	3.00	2.00	3.00 to 4.00
Freesias.....	3.00	4.00	3.00	4.00 to 6.00
Sweet Peas.....	.75	1.50	.75	1.50 to .75
Gardenias.....	30.00	40.00	50.00	50.00 to 60.00
Violets.....75	.75	1.00 to .35
Anemones.....	1.00	1.00	1.25	1.00 to 1.50
Smilax.....	12.00	15.00	15.00	12.50 to 15.00
Asparagus Plumosus, strigatus.....	40.00	60.00	35.00	50.00 to 25.00
" & Spreng. (100 bchs.).....	20.00	40.00	25.00	35.00 to 15.00

J.A. BUDLONG

37-39 Randolph Street, CHICAGO.

Roses and Carnations
A Specialty.....

WHOLESALE
GROWER of

CUT FLOWERS



HENRY M. ROBINSON & CO.

15 Province St. and 9 Chapman Place - BOSTON, MASS.

WHOLESALE COMMISSION FLORISTS

Hardy Cut Evergreens and Florists' Supplies

We have the stuff and can fill all orders, large or small
WE NEVER DISAPPOINT SATISFACTION GUARANTEED



Prices Quoted in these Columns are for Dealers Only.
When Writing to Advertisers Please Mention
HORTICULTURE.

Flower Market Reports.

WHOLESALE FLOWER MARKETS.

PER 100. TO DEALERS ONLY.

BOSTON. The season is in good running order and between the scarcity of certain staple products and the hustle of the mid-winter social season there is plenty of encouragement for the buyer and incentive for the dealer so that little change in values is likely to occur until Ash Wednesday interposes. The crops have slackened generally, and on some lines, quite decidedly. Sunny weather may make some difference should we get it, but that is an uncertainty at this particular date.

American Beauties are the scarcest flowers in the Chicago market, and what there are of poor quality. Long stemmed ones are hard to get and the price is high, but medium ones are practically an impossibility. The very short ones are usually of so poor a quality as to be worthless. This scarcity of Beauties seems to come periodically according to the growers, and they are rejoicing in the good fortune of having so fine a rose as Richmond to fall back on. The inability, however, to meet the extra demand for Richmond has made extra call for Killarney and Bridesmaids, so Brides are the only roses this week that can be said to really equal the demand. The sales of carnations are increasing and prices are somewhat better than during the past month, especially in red, but there is still a very large supply. There is also an abundance of bulbous stock. Unless a large number of some special color is desired, particularly in red, the buyer has no difficulty in getting what he wants. St. Valentine's Day caused extra demand. Bright colors were, of course, given preference. Florists in general express the belief that the old time valentine is losing ground and boxes of cut flowers gaining in popularity as a Valentine offering. Violets are recognized here as a leading favorite for St. Valentine's Day. All the dealers were prepared with a good supply both home grown and from the Hudson River district, and they made no mistake. Sales would undoubtedly have been large had the weather been pleasanter.

A general satisfaction prevails regarding the improved turn of business. While wholesale prices have not advanced any there is more confidence among retailers and a consequent stiffening up of prices in the retail trade. St. Valentine's day gave this week an especially good finish. As compared with last year we must report the same as last Christmas, a trifle less with prices averaging 20 per cent lower. Considering the scarcity of stock, especially violets, it is difficult to explain the comparatively low prices.

The past week was clear and warm. Everything in season seems to be in abundance. There is a fair amount of work going on among the retailers and trade promises to remain satisfactory until Lent when the usual drop may be expected. All report a big trade on St. Valentine's

	CINCINNATI		DETROIT		BUFFALO		PITTSBURG	
	Feb. 16	Feb. 16	Feb. 16	Feb. 16	Feb. 16	Feb. 16	Feb. 16	
ROSES								
Am Beauty, Fan, and Sp.	35.00	40.00	25.00	40.00	60.00	20.00	40.00	50.00
" Extra	25.00	30.00	27.00	32.00	47.00	50.00	25.00	35.00
" No. 1	15.00	20.00	18.00	23.00	21.00	31.00	12.00	15.00
" Lower grades	8.00	10.00	8.00	10.00	6.00	8.00	10.00	7.00
Bride, "Maid, F. & S.	6.00	8.00	6.00	10.00	10.00	12.00	10.00	12.00
" Low grades	3.00	5.00	3.00	4.00	4.00	5.00	6.00	7.00
Killarney, Fan & Sp.	6.00	8.00	6.00	10.00	10.00	12.00	10.00	15.00
" Lower grades	3.00	5.00	4.00	6.00	4.00	6.00	8.00	10.00
Richmond, Fancy & Special	7.00	10.00	7.00	10.00	10.00	15.00	12.00	15.00
" Lower grades	4.00	6.00	5.00	7.00	5.00	8.00	8.00	10.00
Chateaux	5.00	8.00	5.00	8.00	8.00	10.00	10.00	10.00
Golden Gate, Ivory, etc.	4.00	6.00	3.00	8.00	6.00	10.00
My Maryland
Queen Beatrice
Mrs. Mar. Field
CARNATIONS								
Fancy and Novelty	3.00	9.00	3.00	3.00	4.00	2.50	4.00
Ordinary	1.50	2.00	1.50	2.00	2.00	3.00	1.50	2.00
MISCELLANEOUS								
Cattleyas	50.00	75.00	50.00	75.00	50.00	60.00
Oxyripodium	10.00	15.00	2.00	15.00	12.50	15.00
Lilies	10.00	12.00	10.00	15.00	8.00	10.00	10.00	12.00
Lily of the Valley	3.00	4.00	3.00	4.00	3.00	4.00	3.00	4.00
Narcissus, Paper White	3.00	3.00	2.00	3.00	3.00
Roman Hyacinth	2.00	3.00	2.00	3.00	2.00	3.00	2.00	3.00
Bedolids	5.00	8.00	5.00	8.00	4.00	6.00	4.00	6.00
Freesia	2.00	3.00	2.00	3.00	2.00	3.00
Sweet Peas	.50	1.00	1.00	.80	1.00	.75	1.25
Gardenias	50.00	75.00	50.00	75.00	50.00	75.00
Violets	5.00	7.50	5.00	7.50	7.50	10.00	5.00	10.00
Adiantum	1.00	1.50	.50	1.50	1.50
Smilax	12.00	12.00	15.00	12.00	15.00	12.00	15.00
Asparagus Plumosus, strings	35.00	50.00	35.00	50.00	25.00	50.00	35.00	50.00
" & pren (100 bchs.)	25.00	35.00	25.00	35.00	25.00	50.00	30.00	50.00

Day, equal to if not more than last year. No large sales reported, but a good volume of business on the medium priced stock. Good Beauties are somewhat scarce and are bringing good prices. Good carnations are to be had at reduced figures. There is a good trade in all kinds of bulbous stock. Sweet peas meet with ready sale. Azaleas, cyclamens, primulas, cinerarias and bulbous stock in pans are the plants most called for. Eastern double violets are received daily and are moving well for this time of the year. Trade conditions good on all kinds of green stuff.

The week ending Feb. 13 was one of the best

we have had the pleasure of reporting for some time. Demand was good and stock not over plentiful so that the market was cleaned up at good prices all along the line. Contrary to predictions violets were not scarce, there being plenty to go around. The growers had evidently been holding off in picking in advance and created a wrong impression. One grower who had hardly sent in 500 in a week piled in 5000 for the 13th. Of course the mild weather helped the situation somewhat in violets, while on the other hand it was against roses, which for lack of sunshine were off crop. Violets and daffodils were the two most plentiful items on the market, but both were in prime condition and large quantities were disposed of. American Beauties roses are still scarce. Bride, Bridesmaid, Jardine and Killarney are all keeping up the pace as to quality. The carnation market is in good, healthy form both as to quality and quantity with demand excellent. The

lily of the valley situation has improved, there being but little at any time left hanging in the wholesale market. Orchids continue short and are grabbed up quickly early in the morning. Acacia pubescens is a welcome and desirable feature which the best stores are eagerly reaching for. Gardenias are in fairly good supply and selling well. Paper Whites and Roman hyacinths are in happy contrast to "the lemon" they presented last year; fewer planted, that's the secret; better for all concerned. Some fine freesias are coming in, also a good many that are not so creditable.

The recent warm weather has flooded the Washington market with cut flowers of almost every description. The unusually large demand, though, for funeral work and social gaieties has prevented a serious congestion. Many orders were booked by Washington florists for the "Maine Memorial Services" held Feb. 15th. The retailers announce that the St. Valentine anniversary just passed has broken all records for floral valentines. We hope that each year's record will continue to surpass the last one.

THE PHILADELPHIA SPIRIT.

Neighbors in West Philadelphia, Chestnut Hill and other parts of the city, furnished their expert workmen in two's and three's and half dozen's to help W. K. Harris repair after the cyclone. A decent and friendly spirit highly commendable.

IN BANKRUPTCY.

Quincy, Mass.—Edwin Arnold, liabilities, \$4116; assets, \$1325.

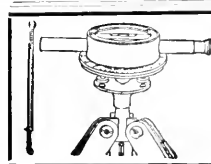

EVERYBODY KNOWS Park, Cemetery and Landscaping

Gardening cannot be properly done without the aid of an accurate leveling instrument.
 Bostrom's Improved Levels, No. 2 at \$15.00 and No. 3 at \$25.00, are cosued by all who KNOW to be the only Levels on the market which meet all the requirements, at the price.
 Our guarantee back of every Level we sell, and satisfied users in every State in the Union heartily endorse every claim we make.
 Shipping weight 22 lbs. Description on request.
BOSTROM-BRADY MFG. CO., 139 Madison Avenue, ATLANTA, GA.

FORD BROTHERS

48 West 28th Street NEW YORK
FINE ROSES FANCY CARNATIONS
 A Full Line of All CUT FLOWERS
 Telephone, 3870 or 3871 Madison Square

H. E. FROMENT

Wholesale Commission Florist,
 Choice Cut Flowers,
 57 West 28th St. :: NEW YORK
 Telephones: 2200, 2201, Madison Square.

Alfred H. Langjahr

All choice cut-flowers in season Send for quotations. Correspondence with shippers of first-class stock invited.
 55 West 28th Street, New York
 Telephones 4628-4627 Madison Square

Edward C. Horan
 Wholesale Florist

55 WEST 28th ST.
 Tel. 1462 Madison Square New York
 1463

JOHN YOUNG
 WHOLESALE FLORIST

Finest American Beauties and Carnations
 51 West 28 St. - NEW YORK

FRANK MILLANG
 Wholesale Florist

55-57 West 26th St., NEW YORK
 Shipments, any quantity, Wholesale Market Rates.

Consignments Requested

A Good Market and Prompt Returns

GEORGE SALT FORD
 43 W. 28th Street, NEW YORK
 Telephone, 3393 Madison Sq

VIOLETS

Finest Grade. Any Quantity
B. S. SLINN
 55-57 W. 26 St., New York

Moore, Hentz & Nash
 Wholesale Commission Florists

55 and 57 West 26th Street
 Telephone No. 756 Madison Square New York

MILLANG BROS.
 WHOLESALE COMMISSION FLORISTS

41 West 28th Street
 Telephone 3560 Madison New York
 3561

JOHN I. RAYNOR
 Wholesale Commission Florist **SELLING AGENT FOR LARGEST GROWERS**
 A full line of Choice Cut Flower Stock for all purposes. Comprises every variety grown for New York market, at current prices
 TEL. 1998 MADISON SQUARE 49 West 28th St., New York City

Walter F. Sheridan
 Wholesale Commission Dealer in
CHOICE CUT FLOWERS
 39 West 28th Street, New York
 Telephone: 3532-3533 Madison Square

HEADQUARTERS FOR NOVELTIES
ORCHIDS A SPECIALTY
 THE HIGHEST GRADE OF **VALLEY** ALWAYS ON HAND
GARDENIAS, DAISIES, ROSES AND CARNATIONS
 Telephone
JAMES McMANUS, 769 Mad. Sq. 42 W. 26th St., New York

PHILIP F. KESSLER 55 & 57 W. 26th St., New York City
 Commission Dealer, Wholesale Buyer and Seller of
CUT FLOWERS
 Open from 5 a. m. to 6 p. m. Sunday till 10 a. m.
 Tel. 5243 and 2921 Madison Sq. Res., 345 J., Newtown.
Finest Lilies in the Market Every Day in the Year.

NEW YORK QUOTATIONS PER 100. To Dealers Only

ROSES AND CARNATIONS	Last Half of Week ending Feb. 13 1909		First Half of Week beginning Feb. 15 1909	
American Beauty, Fancy and Special.....	50.00	to 100.00	50.00	to 75.00
" " Extra.....	35.00	to 50.00	35.00	to 40.00
" " No. 1.....	15.00	to 20.00	15.00	to 23.00
" " Lower Grades.....	3.00	to 25.00	3.00	to 8.00
Bride, 'Field, Fancy and Special.....	10.00	to 12.00	8.00	to 11.00
" " Lower Grades.....	3.00	to 6.00	3.00	to 6.00
Killarney, Fancy and Special.....	12.00	to 20.00	10.00	to 23.00
" " Lower Grades.....	4.00	to 8.00	4.00	to 8.00
Richmond, Fancy and Special.....	15.00	to 30.00	12.00	to 30.00
" " Lower Grades.....	3.00	to 10.00	3.00	to 10.00
Chatenay.....	3.00	to 20.00	4.00	to 15.00
Py Maryland.....	4.00	to 25.00	4.00	to 15.00
Golden Gate, Ivory, etc.....	3.00	to 15.00	3.00	to 10.00
Queen Beatrice.....
Mrs. Har. Field.....
Carnations, Fancy and Novelties.....	4.00	to 5.00	3.00	to 5.00
Ordinary and White.....	2.00	to 3.00	1.50	to 2.00

Alexander J. Guttman
 THE WHOLESALE FLORIST OF NEW YORK
 34 WEST 28th STREET
 PHONES. 1664-1665 MADISON SQUARE
ENOUGH SAID

TRAENDLY & SCHENCK
 Wholesale Florists
 Furnish best Stock at fair Prices all the year round
 Send for Quotations on Any Variety and Quantity
 Tel. 798, 799 Madison Sq. 44 West 28th St., New York City

GROWERS' CUT FLOWER CO. CUT FLOWERS AT WHOLESALE
VIOLETS, CARNATIONS, ROSES
ORCHIDS, CHRYSANTHEMUMS, LILIES
 Consignments Solicited. Shipments to Order, any Distance
 Telephone 3560 Madison Square
39 West 28th Street, J. J. O'NEIL, Manager NEW YORK

WHOLESALE FLORISTS
54 West 28th St.
NEW YORK
Telephone 3559 Madison Sq.

A. L. YOUNG & CO.

RECEIVERS & SHIPPERS OF CUT FLOWERS.
CONSIGNMENTS SOLICITED.

WILLIAM H. KUEBLER
Brooklyn's Foremost and Best
WHOLESALE COMMISSION HOUSE
A First Class Market for all CUT FLOWERS
28 Willoughby St., Brooklyn, N. Y.
Tel. 4501 Main

GEORGE COTSONAS & CO.
Wholesale and Retail Dealers in all kinds of
EVERGREENS
Fancy and Dagger Ferns
Bronze and Green Galax
Main Store 50 W. 28 St.
Phone 1202 Mad. Sq. New York



Greater New York Florists' Association, Inc.
Now Open for Cut Flower Consignments
162 Livingston Street, BROOKLYN, N. Y.
Geo. W. Crawback Telephone Connection
Manager 3642-43 Main

Henshaw & Fenrich
WHOLESALE FLORISTS
44 West 28th Street, NEW YORK
Phones Mad. Sq. 325, 558-2, 558-3

H. G. BERNING
Wholesale Florist

1402 Pine Street, ST. LOUIS, MO.
REED & KELLER
122 West 25th St., New York

Florists' Supplies
We manufacture all our
Hotel Designs, Baskets, Wire Work & Novelties
and are dealers in
Glassware Decorative Greens and Florists' Requisites

THE KERVAN CO.
Wholesale Dealers and Shippers of
Decorative Evergreens
Ferns, Galax, Laurel, Fresh Cycas, Box-wood
Sphagnum and all Florists' Greens
Send to us for Quotations before Buying.
113 West 28 Street, NEW YORK CITY

MICHIGAN CUT FLOWER EXCHANGE, Inc.
WHOLESALE COMMISSION FLORISTS
Consignments Solicited
Hardy Fancy Fern Our Specialty
38-40 BROADWAY, DETROIT, MICH.



Wired Toothpicks
Manufactured by
W. J. COWEE, BERLIN, N. Y.
50,000....\$1.75; 50,000....\$7.50. Sample free.
For sale by dealers

ROBERT J. DYSART
Public Accountant and Auditor
Simple methods of correct accounting
especially adapted for florists' use.
Books Balanced and Adjusted
Merchants Bank Building
28 STATE STREET, - BOSTON
Telephone, Main 58.

WHOLESALE COMMISSION
J. K. ALLEN
106 W. 28th St. NEW YORK
Tel. 167 Madison Sq.
All Grades of Flowers to Suit All Buyers. Consignments Solicited.

NEW YORK QUOTATIONS PER 100. To Dealers Only

MISCELLANEOUS	Last Half of Week ending Feb. 13 1909		First Half of Week beginning Feb. 15 1909	
	Low	High	Low	High
Cypripediums	8.00	10.00	8.00	10.00
Cattleyas	25.00	35.00	25.00	40.00
Lilies	6.00	10.00	6.00	10.00
City of the Valley	1.00	3.00	1.00	3.00
Narcis., Paper White	2.00	3.00	1.50	3.00
Roman Hyac.	1.50	2.00	1.00	2.00
Tulips	2.00	4.00	2.00	3.00
Dailodis	3.00	4.00	2.00	3.00
Freesia	2.00	3.00	1.00	3.00
Sweet Peas	.75	1.50	.75	1.00
Gardenias	20.00	40.00	23.00	40.00
Violets	.50	.75	.15	.60
Adiantum	.75	1.00	.75	1.00
Crowneum	1.00	1.25	1.00	1.25
Smilax	10.00	15.00	10.00	15.00
Asparagus P. umosus, strings	2.00	35.00	80.00	35.00
" & Spreu. (100 bchs)	20.00	30.00	23.00	25.00

NEW YORK MARKET.
It only requires the influence of bright, warm weather, which is reasonably due to arrive about now, to make values sag rapidly in the flower market. While there has been no extreme drop thus far on any line, yet the tendency is unmistakably downward, especially on anything of which there is a normal supply coming in. American Beauty roses have been still in very light supply, the quality averaging poor and the demand for fancy stock exceeding the available product. Other roses show weakness in selling except where of unusually high grade. Carnations and bulbous

stock generally run lower and lower from day to day as cut increases. Violets have little to lose and with pleasant weather may be expected to hold their own for a time.

The S. S. Pennock-Meehan Co. of Philadelphia have completed arrangements to open an up-to-date commission house in Washington, D. C., on March 1st. In addition to cut flowers and plants, a complete line of ribbons and supplies will be handled. The active co-operation of the parent house in Philadelphia will of course be a feature, and will do much to make a success of the venture. Albert Schnell will be manager.

Notice to the Trade.

Millang Bros. at 41 West 28th St, New York City, announce that Charles Millang has no connection with the Firm of Millang Bros.

AUGUST MILLANG.

Buyer's Directory and Ready Reference Guide

Advertisements under this head, one cent a word. Initials count as words.

Display advertisers in this issue are also listed under this classification without charge. Reference to List of Advertisers will indicate the respective pages.

Buyers failing to find what they want in this list will confer a favor by writing us and we will try to put them in communication with reliable dealers.

ACCOUNTANT

R. J. Dycart, 28 State St., Boston.
For page see List of Advertisers.

AQUILEGIAS

Aquilegia. Genuine Coerulea, finest of all. Both plants and seeds from the heart of the Rockies. C. S. Harrison's Select Nursery, York, Neb.

ARAUCARIAS

A. Leuthy & Co., Perkins St. Nurseries, Rosindale, Mass.

For page see List of Advertisers.

Godfrey Aschmann, 1012 West Ontario St., Philadelphia, Pa.

For page see List of Advertisers.

ASPARAGUS

The Geo. Wittbold Co., 1657 Buckingham Palace, Chicago, Ill.

For page see List of Advertisers.

ASTERS

Elmer D. Smith & Co., Adrian, Mich.

AUCTION SALES

Clary's Horticultural Co., 62 Vesey St., New York.

For page see List of Advertisers.

AZALEAS

A. Leuthy & Co., Perkins St. Nurseries, Rosindale, Mass.

For page see List of Advertisers.

Godfrey Aschmann, 1012 W. Ontario St., Philadelphia, Pa.

For page see List of Advertisers.

Henry A. Dreer, Philadelphia.

Azalea Mollis.

For page see List of Advertisers.

BAMBOO CANES

Yokohama Nursery Co., 31 Barclay Street, New York.

Bamboo Sticks, Colored Green.

For page see List of Advertisers.

Wm. Elliott & Sons, New York City.

Lily Stakes.

For page see List of Advertisers.

BAY TREES.

2000 Bay and Box Trees in all sizes, Pyramid and Standards. Write for list. Julius Roehrs, Rutherford, N. J.

BOILERS

BOILERS. "Burnham" Boilers made for greenhouse heating. Lord & Burnham, 1133 Broadway, N. Y.

Kroeschell Bros. Co., 35 Erie St., Chicago.

For page see List of Advertisers.

BOXWOOD TREES

New England Nurseries, Inc., Bedford, Mass.

For page see List of Advertisers.

BUILDING MATERIAL

BUILDING MATERIAL of all description for All Cypress, Semi-Iron, Iron Frame or Truss Houses. Hot Bed Sash and Frames. Lord & Burnham Co., 1133 Broadway, N. Y.

BULBS AND TUBERS

Joseph Breck & Sons, 47-51 N. Market St., Boston.

For page see List of Advertisers.

J. M. Thornburn & Co., 33 Barclay St., New York.

For page see List of Advertisers.

A. T. Boddington, 342 W. 14th St., N. Y.

For page see List of Advertisers.

BULBS AND TUBERS—Continued

Richards Bros., 37 East 19th St., New York.

For page see List of Advertisers.

H. F. Mitchell Co., Philadelphia.

For page see List of Advertisers.

H. E. Pliske Seed Co., Faneuil Hall Sq., Boston.

For page see List of Advertisers.

T. J. Grey & Co., 32 and 33 So. Market St., Boston.

For page see List of Advertisers.

Yokohama Nursery Co., 31 Barclay St., New York.

For page see List of Advertisers.

Elph M. Ward & Co., 12 W. Broadway, New York.

For page see List of Advertisers.

K. Takeuchi, 478A Boylston St., Boston.

For page see List of Advertisers.

Knight & Struck, New York City.

Choice Amaryllis Bulbs.

CALADIUMS

Shellroad Canna Farms, Grange, P. O., Baltimore, Md.

CANNAS

A. T. Boddington, 342 W. 14th St., New York.

For page see List of Advertisers.

Shellroad Canna Farms, Grange, P. O., Baltimore, Md.

CARNATIONS

F. Dörner & Sons Co., Lafayette, Ind.

Carnation, Pink Delight.

For page see List of Advertisers.

Chicago Carnation Co., Joliet, Ill.

For page see List of Advertisers.

Albert Roper, Tewksbury, Mass.

Carnation Bay State.

For page see List of Advertisers.

Bassett & Washburn, Hinsdale, Ill.

Carnation O. P. Bassett.

For page see List of Advertisers.

East Sudbury Greenhouses, So. Sudbury, Mass.

Carnation Cuttings.

For page see List of Advertisers.

Wood Bros., Fishkill, N. Y.

Carnations, Rooted Cuttings.

For page see List of Advertisers.

The E. G. Hill Co., Richmond, Ind.

Carnation Cuttings.

For page see List of Advertisers.

Peter Fisher, Ellis, Mass.

Booted Cuttings.

For page see List of Advertisers.

S. J. Reuter & Son, Westery, R. I.

For page see List of Advertisers.

Charles H. Totty, Madison, N. J.

Boston Co-operative Flower Growers' Assoc., Boston.

Carnation and Rose Show.

For page see List of Advertisers.

Scheiden & Schoes, Chicago

Carnation Wm. H. Taft.

For page see List of Advertisers.

Paul Thomson, W. Hartford, Conn.

Carnation Neptune.

CHRYSANTHEMUMS

Chas. H. Totty, Madison, N. J.

Chrysanthemum Novelties.

For page see List of Advertisers.

E. G. Hill Co., Richmond, Ind.

For page see List of Advertisers.

S. J. Reuter & Son, Westery, R. I.

For page see List of Advertisers.

Elmer D. Smith & Co., Adrian, Mich.

For page see List of Advertisers.

CHRYSANTHEMUMS—Continued

Chrysanthemum Golden Glow from 2-14 in. pots, for early spring delivery, \$1.00 per doz., \$6.00 per 100, \$50.00 per 1000. Stock plants of Montfort, Oct. Frost, Crocus, Matchless, Lucey Devaux, Polly Rose and Halliday, \$1.00 per doz.; \$6.00 per 100. Pelree Bros., Waltham, Mass.

Herrington's book on the Chrysanthemum, mailed to your address for 50c., by Horticulture Publishing Co., 11 Hamilton Place, Boston.

Chrysanthemums from 2 1/2 in. pots, ready now Golden Glow, White Cloud, 6c.; Beatrice May, 5c.; Polly Rose, October Frost, Tousef, BonaBonon, 3c. Henry Trail, Frederick, Md.

CONIFERS

John Waterer & Sons, Ltd., American Nursery, Bugshot, Eng.

For page see List of Advertisers.

CUT FLOWER BOXES.

Edwards Folding Box Co., Philadelphia.

For page see List of Advertisers.

Folding cut flower boxes, the best made. Write for list. Holton & Hunkel Co., Milwaukee, Wis.

CYCLAMEN.

Thomas Roland, Nahant, Mass.

For page see List of Advertisers.

DAHLIAS

David Herbert & Son, Atco, N. J.

For page see List of Advertisers.

J. L. Moore, Northboro, Mass.

For page see List of Advertisers.

Peacock Dahlia Farms, Williamstown Junction, N. J.

Dahlia Miss Virginia Manje.

For page see List of Advertisers.

R. Vincent Jr. & Sons Co., White Marsh, Md.

For page see List of Advertisers.

Shellroad Canna Farms, Grange, P. O., Baltimore, Md.

DAHLIAS.

Geo. H. Walker, No. Dighton, Mass.

Wholesale and Retail.

Send your name for my 1909 Catalog and Pocket Guide, ready to mail about Feb. 25th.

East Bridgewater Dahlia Gardens wants your business. If you are looking for dahlias send to the Eastern Dahlia King, J. K. Alexander, East Bridgewater, Mass.

DECORATIVE PLANTS

A. Leuthy & Co., Perkins St. Nurseries, Rosindale, Mass.

For page see List of Advertisers.

Godfrey Aschmann,

1012 W. Ontario St., Phila., Pa.

For page see List of Advertisers.

Joseph Heacock Co., Wyncote, Pa.

For page see List of Advertisers.

The Geo. Wittbold Co., 1657 Buckingham Palace, Chicago, Ill.

For page see List of Advertisers.

Robert Craig Co., Market and 49th Sts., Philadelphia, Pa.

For page see List of Advertisers.

A. N. Pierson, Inc., Cromwell, Conn.

Palms and Ferns.

For page see List of Advertisers.

DRACAENAS

The Geo. Wittbold Co., 1657 Buckingham Palace, Chicago, Ill.

For page see List of Advertisers.

ECONOMY BRACKET

Buxton & Allard, Nashua, N. H.

For List of Advertisers See Page 270

EVERGREENS

New England Nurseries, Bedford, Mass.
For page see List of Advertisers.
American Nursery Co., 150 Broadway,
New York, N. Y.

Henry A. Brewer, Philadelphia, Pa.
For page see List of Advertisers.
Evergreen. Send 25 cents in stamp
for complete work on propagating and
growing Evergreen. C. S. Hartson's
Select Nursery, York, Neb.

FERNS

A. Leuthy & Co., Roslindale, Mass.
For page see List of Advertisers.
H. H. Barrows & Son, Whitman, Mass.
Nephrolepis Whitman.
For page see List of Advertisers.
John Scott, Brooklyn, N. Y.
For page see List of Advertisers.

Frank Oechlein, 2570-2606 W. Adams St.,
Chicago.
Ferns for Fishes.
For page see List of Advertisers.

The Geo. Wittbold Co., 1657 Buckingham
Palace, Chicago, Ill.
For page see List of Advertisers.

Godfrey Aechmann, 1012 W. Ontario St.,
Philadelphia.
For page see List of Advertisers.

Henry A. Brewer, Philadelphia, Pa.
Adiantum Farleyense.
For page see List of Advertisers.

FERTILIZERS

Falverized Manure Co., 31 Union Stock
Yards, Chicago, Ill.
Wizard Brand Sheep and Shredded Cattle
Manure.

Robert Simpson, Clifton, N. J.
Sheep Manure.
For page see List of Advertisers.

FEVERFEW

Double Feverfew, 2 1/2 in., \$2.50 pr 100.
B. P. Winch, Framingham, Mass.
Feverfew Little Gem, 80 pr 100; \$7.00
per 1000. S. W. Pike, St. Charles, Ill.

2000 Feverfew from 2 1/2 in. \$3.00 per 100,
\$25.00 per 1000. Albert Batley & Son,
Maynard, Mass.

FLORAL PHOTOGRAPHS

Floral Photographs, Foley's, 226-228 1-2
Bowery, New York.

FLORISTS' LETTERS.

Boston Florist Letter Co., 66 Pearl St.,
Boston, Mass.
For page see List of Advertisers.

FLORISTS SUPPLIES

N. F. McCarthy & Co., 84 Hawley St.,
Boston.
For page see List of Advertisers.

H. M. Robinson & Co., 15 Province St. and
9 Chapman Pl., Boston, Mass.
For page see List of Advertisers.

Reed & Keller, 122 W. 23rd St., New York.
For page see List of Advertisers.

H. Bayersdorfer & Co., 1129 Arch St.,
Philadelphia.
For page see List of Advertisers.

Bacon & Co., Appleton, N. Y.
Baskets; Crates; Ladders; Boxes.
For page see List of Advertisers.

FLOWER POTS

W. H. Ernest, 28th and M Sts.,
Washington, D. C.
For page see List of Advertisers.
A. H. Hews & Co., Cambridge, Mass.
For page see List of Advertisers.
Hilfinger Bros., Ft. Edward, N. Y.
For page see List of Advertisers.

The Peters & Reed Pottery Co.,
Red pots, seed pans, etc.
Zanesville, O.

We make Standard Flower Pots, etc.
Write us when in need. Winner Cope &
Bro., Lincoln University, Chester Co., Pa.

FOREST SEEDLINGS

To close out quick I offer the following
first-class stock for Parks, Cemeteries
and Forest Plantings: 100' M. Amorpha
Fruticosa, 1 to 3 ft.; 300' M. Althoa Rosen
Sticks, 100' M. Cal. Privet; 500' M. Cal.
Privet Cuttings; 100' M. Black Locust, 4
to 6 ft.; 50' M. Calycanthus, Sweet Shrub,
1 to 3 ft.; 150' M. Cercis Canadensis, Red
Bud, 1 to 4 ft.; 60' M. Cornus Stolonifera,
Oxler Dogwood, 1 to 2 ft.; 50' M. Diospyros,
Am. Persimmon, 6 to 30 inches; 50' M. Elm
(white) 1 to 2 ft.; 75' M. Hamamelis, Witch
Hazel, 6 in. to 3 ft.; 50' M. Tulp Poplar,
1 to 8 ft.; 20' M. Sweet Gum, 1 to 6 ft.;
50' M. Black Walnut, 1 to 2 ft.; 20' M.
Wistaria, 1 to 3 ft.; 20' M. Yucca Plamen-
tosus, 1 and 2 year Butternut, Japan Wal-
nut, Ash, Maple, etc. Send for trade list.
I offer my entire stock to close out at low
prices; also a large stock of Tree and
Shrub Seeds, Black Locust, Sweet Gum,
Sycamore, Ash, Red Bud, Persimmon, Bass
Wood, Viburnums, Sugar Maple, Red Cedar
and other Seeds. For Nursery & Seed
Co., J. H. Boyd, Prop., R. F. D. No. 2,
McMinnville, Tenn.

GALAX

Michigan Cut Flower Co., 38 and 40 Broad-
way, Detroit, Mich.
For page see List of Advertisers.
George Cotsouas & Co., 50 W. 28th St.,
New York.
For page see List of Advertisers.
The Kervan Co., 113 West 28th St., N. Y.
For page see List of Advertisers.
Rice Bros., 115 N. 6th St., Minneapolis,
Minn.
For page see List of Advertisers.
H. M. Robinson & Co., 15 Province St.
and 9 Chapman Place, Boston.
For page see List of Advertisers.

GERANIUMS

R. Vincent Jr. & Sons Co., White Marsh,
Md.
New and Standard Varieties.
For page see List of Advertisers.
A few hundred fine mixed stock gerani-
ums, all double, \$10.00 per 100. Fine gerani-
ums, 2 1/2 in., \$2.50 per 100. Casa. H. J.
Blanchard, Ashburnham, Mass.
Red Geraniums, 2 1/2 in., \$2.50 per 100.
Jas. T. Baker, Bastleton, Philadelphia, Pa.

GLADIOLI

J. L. Moore, Northboro, Mass.
For page see List of Advertisers.
E. S. Miller, Wading River, N. Y.
A. T. Boddington, 342 W. 14th St.,
New York.
For page see List of Advertisers.
Shellred Canna Ferns, Grange, P. O.,
Baltimore, Md.
O. V. Zangen, Hoboken, N. J.
Gladiolus Brencleyensis.
For page see List of Advertisers.
Stump & Wanner Co., 50 Barclay St.,
New York.
Gladiolus Bulbs.
For page see List of Advertisers.
Gladioli. As good as any and better than
many. Send for trade list. E. E. Stewart,
Rives Junction, Mich.
Brencleyensis Gladioli, \$8.00 per 1000.
Cash with order, please. Estate of Louis
Siebrecht, Floral Park, N. Y.
Groff's hybrid, small size (bulblets),
\$1.00 per 1000, postpaid; named varieties,
\$2.00 per 1000. Henry Field Seed Co., Sheu-
andah, Iowa.

GLASS

Boston Plate & Window Glass Co., Boston
For page see List of Advertisers.
Standard Plate Glass Co., 26-30 Sudbury
St., Boston.
For page see List of Advertisers.
Foley Mfg. Co., Western Ave., between
25th & 26th Sts., Chicago.
Sharp, Partridge & Co., 22d & Lumber St.,
Chicago.
For page see List of Advertisers.
Greenhouse glass, lowest prices. John-
ston Glass Co., Hartford City, Ind.
Glass, High Grade, Double Thick Green-
house Glass, Lord & Burnham, 1133 Broad-
way, N. Y.
Golden-Van Time Co., 150 Case St.,
Davenport, Ia.

GLAZING DEVICES

H. A. Dreer, Philadelphia, Pa.
Peerless Glazing Point.
For page see List of Advertisers.
GLAZING POINTS, Lord & Burnham
Special Glazing Nails (Points), Lord &
Burnham, 1133 Broadway, N. Y.
Golden-Van Time Co., 150 Case St.,
Davenport, Ia.

**GREENHOUSE BUILDING MATE-
RIAL**

Lord & Burnham Co.,
1133 Broadway, New York.
For page see List of Advertisers.
Herson U-Bar Co., 1 Madison Sq., N. Y.
For page see List of Advertisers.
A. T. Stearns Lumber Co., Neposset,
Boston.
For page see List of Advertisers.

King Construction Co., N. Tonawanda,
New York.
For page see List of Advertisers.

Hitchings & Co., 1170 Broadway, New York.
For page see List of Advertiser.

J. C. Moninger Co., 117 East Blackhawk St.,
Chicago, Ill.
For page see List of Advertisers.

Foley Mfg. Co., Western Ave., between
25th & 26th Sts., Chicago.
For page see List of Advertiser.

GREENHOUSE CONSTRUCTION

GREENHOUSE CONSTRUCTION, Semi-
Iron Greenhouse, New Truss Houses and
Iron Frame Houses. Lord & Burnham,
1133 Broadway, N. Y.
J. A. Payne, 260-274 Culver Ave., Jersey
City, N. J.
For page see List of Advertisers.
Foley Mfg. Co., Western Ave., between
25th & 26th Sts., Chicago.
For page see List of Advertisers.

Hitchings & Co., 1170 Broadway, New York.
For page see List of Advertiser.

GREENHOUSE HOSE

Revere Rubber Co., Boston, Mass.
Revere Hose.
For page see List of Advertisers.

GUTTERS

GUTTERS, Cast Iron Gutters, L & B.
improved V Shaped Gutter with drip
gutter attachment. Lord & Burnham, 1133
Broadway, N. Y.

HAIL INSURANCE

Florists' Hall Assn. of America,
J. G. Esler, Saddle River, N. J.
For page see List of Advertisers.

**HARDY FERNS, MOSS AND
GREENS**

H. M. Robinson & Co., 15 Province St.
and 9 Chapman Pl., Boston, Mass.
For page see List of Advertisers.
Michigan Cut Flower Exchange,
38 and 40 Broadway, Detroit, Mich.
For page see List of Advertisers.
George Cotsouas & Co., 50 W. 28th St.,
New York.
For page see List of Advertiser.

N. F. McCarthy & Co., 84 Hawley St.,
Boston.
For page see List of Advertiser.

The Kervan Co., 113 W. 28th St., N. Y.
For page see List of Advertiser.

Rice Bros., 115 N. 6th St., Minneapolis,
Minn.
For page see List of Advertiser.

Green and Bronze Lenticole, \$2.50 per
1000. Nic long sprays. Cash. Please
address: Frank H. Hill, Victoria, Macon
Co., N. C.

HARDY PLANTS

Novelties and Specialties. For over one
hundred distinct new varieties of hardy
plants, all of great commercial value, get
our Wholesale Catalog of Perennials and
Hardy Plants. Fallsdale Nurseries, Spar-
kett, N. Y.

HEATING APPARATUS

Lord & Burnham Co.,
1133 Broadway, New York.
For page see List of Advertiser.

In writing to Advertisers kindly mention Horticulture

HEATING APPARATUS—**Continued**

Pierson U-Bar Co., 1 Madison Sq., N. Y.
For page see List of Advertisers.

John A. Payne, 200-274 Culver Ave., Jersey City, N. J.
For page see List of Advertisers.

Kroencheil Bros. Co., 35 Erie St., Chicago.
For page see List of Advertisers.

HELP FURNISHED

Chas. H. Hambrick, 34 S. 7th St., Phila.
For page see List of Advertisers.

HERBACEOUS PERENNIALS

P. Ouwkerkerk, P. O. No. 1, Hoboken, N. J.
For page see List of Advertisers.

New England Nurseries, Bedford, Mass.
For page see List of Advertisers.

The Geo. Withold Co., 1657 Buckingham Place, Chicago.
For page see List of Advertisers.

HOT-BED SASH

The A. T. Stearns Lumber Co., Neponset, Mass.
For page see List of Advertisers.

Pierson U-Bar Co., 1 Madison Sq., N. Y.
For page see List of Advertisers.

Lord & Burnham Co., 1133 Broadway, N. Y.
For page see List of Advertisers.

Foley Mfg. Co., Western Ave., between 25th & 26th Sts., Chicago.

Gordon-Van Tine Co., 1500 Case St., Davenport, Ia.

INSECTICIDES.

Nicotinole kills all greenhouse pests.
P. R. Palethorpe Co.,
Eleventh St., Owensboro, Ky.
For page see List of Advertisers.

Stump & Walter Co., 50 Barclay St., New York.
Kilmdead Tobacco Dust.
For page see List of Advertisers.

Niagara Sprayer Co., Middleport, N. Y.
Niagara, N. Y.
For page see List of Advertisers.

B. G. Pratt Co., New York.
Sulfocide.
For page see List of Advertisers.

"The Fumigating Kind Tobacco Powder"—The first on the market and the kind that has so many imitations, has our guarantee tag of satisfaction or money back, and "The Moon Trade Mark" on every bag, \$3.00 per 100 lbs. The H. A. Stoothoff Co., Mount Vernon, N. Y., Makers and Sellers.

JAPANESE PLANTS

Yokohama Nursery Co., 31 Barclay St., New York.
For page see List of Advertisers.

KENTIAS
Godfrey Aschmann,
1012 W. Ontario St., Phila., Pa.
For page see List of Advertisers.

A. Leuthy & Co., Roslindale, Mass.
For page see List of Advertisers.

Jos. Hancock Co., Wyncote, Pa.
Single and Made-Up Specimens.
For page see List of Advertisers.

LEVELS FOR LANDSCAPE GARDENING USE.

Bostrom-Brady Mfg. Co., 139 Madison Ave., Albany, Ga.
For page see List of Advertisers.

LILY OF THE VALLEY PIPS

Hjalmar Hartmann & Co., 12 Stormgade, Copenhagen, Denmark.
For page see List of Advertisers.

LOBELIAS

Double Ichiba Kathleen Mallard, rooted cuttings, \$1.00 per 100. Cash. Chas. H. Green, Spencer, Mass.

R. Vincent, Jr. & Son,
White Marsh, Md.
For page see List of Advertisers.

MARGUERITES

Marguerites, Queen Alexandra, \$1.25 per 100, prepaid. S. W. Pike, St. Charles, Ill.

NICO-FUME

Kentucky Tobacco Product Co.
Louisville, Ky.

NURSERY STOCK

John Waterer & Sons, Ltd.,
American Nursery, Bagshot, England.
For page see List of Advertisers.

Cleary's Horticultural Co., 62 Vesey St., New York.
For page see List of Advertisers.

P. Ouwkerkerk, 216 June St., Weehawken Heights, N. J.
For page see List of Advertisers.

D. J. Twomey, Dept. H, Geneva, N. Y.
For page see List of Advertisers.

American Nursery Co., 150 Broadway, New York, N. Y.

Manual of the Trees of North America, by C. S. Sargent, mailed to your address for \$9.00, by Horticulture Publishing Co., 11 Hamilton Place, Boston.

TIGES, SHRUBS, ROSES, EVER GREENS, PEONIES, HARDY PLANTS
ELLWANGER & BARRY, Rochester, N. Y.

New Hardy Shrub—Buddleya variabilis Vetchell, the summer flowering. Libae, 50c each; \$5.00 per doz.; \$25.00 per 100. Rose Hill Nurseries, New Rochelle, N. Y.

Catalog now ready. Nursery grown evergreens, seedling white pine and hemlock, native trees and plants. L. E. Williams, Nottingham, N. H.

Rhododendrons, Laurel, Spruce Hemlock, Poppars, E. W. Sheeley, De Bruce, Sullivan County, N. Y.

ONION SEED

Federico C. Varela, Tenerife, Canary Ids Bermuda Onion Seed.

Onion Seed—1908 Crop; truly dependable seed; yellow, red and white Globe. Write for prices. Laughlin Seed Co., Kenton, O.

ORCHID PLANTS

Lager & Hurrell, Summit, N. J.
For page see List of Advertisers.

Sander, St. Albans, England.
Importers, Exporters, Growers, Hybridists
For page see List of Advertisers.

Carrillo & Baldwin, Syracuse, N. Y.
For page see List of Advertisers.

Jos. A. Manda, 191 Valley Road, W. Orange, N. J.
For page see List of Advertisers.

Ordonez Bros., Madison, N. J., Box 106
For page see List of Advertisers.

Largest stock in the country. Ask for prices. Julius Roehrs, Rutherford, N. J.

PAINT AND PUTTY

PAINT AND PUTTY: Ideal Greenhouse paint; Special Greenhouse Putty. Lord & Burnham, 1133 Broadway, N. Y.

PALMS

A. Leuthy & Co., Perkins St. Nurseries Roslindale, Mass.
For page see List of Advertisers.

Robert Craig Co., Market and 49th St., Philadelphia, Pa.
For page see List of Advertisers.

Joseph Hancock Co., Wyncote, Pa.
Home-Grown Palms.
For page see List of Advertisers.

PANSY PLANTS.

Pansies, extra fine giant flowering, strong plants, 30 cents per 100; \$2.50 per 1000 Edw. Wallis, Atco, N. J.

PATENTS

Siggers & Siggers, Washington, D. C.
For page see List of Advertisers.

PEAT

Orchid peat, Rotted peat, Azalea peat Leaf-Mould, Live Sphagnum moss, Baled Sphagnum moss, Green Clump moss, etc. Jobbers' list on application. C. W. Brownell & Co., Walden, N. Y.

Orchid Peat and Moss always on hand Julius Roehrs Co., Rutherford, N. J.

PEONIES

Peonies only, by the wholesale—best 100 varieties J. F. Rosenfield, Westport, Nehr
One of the finest collections in America. Send 25 cts. in stamps for new edition of Peony Manual. C. S. Harrison's Select Nursery, York, Neb.

PHLOXES

Send 25 cts in stamps for Phlox Manual. Fine mixed phloxes \$2.00 per 100. C. A. Harrison's Select Nursery, York, Neb.

PHOTOGRAPHS: DESIGNING: ILLUSTRATING

Geo. E. Dow, 178 Washington St., Boston.
For page see List of Advertisers.

PIPE AND FITTINGS

Foley Mfg. Co., between Western Ave. and 26th St., Chicago, Ill.
For page see List of Advertisers.

Kroencheil Bros. Co., 35 Erie St., Chicago.
For page see List of Advertisers.

FLIGHT AND FITTINGS, Cast Iron and Wrought Pipe, Valves, Elbows, Pipe Hooks, Automatic Air Headers, etc. Lord & Burnham, 1133 Broadway, N. Y.

PLANT STANDS

Moore-Livingston Co., Landsdowne, Pa.
For page see List of Advertisers.

PLANT STAKES

Seeley's Tiesless Plant Stakes and Tree-lises. H. D. Platt & Sons, Elkhart, Ind.

POT HANGERS

Pot hangers, Kramer's \$1 doz by exp. \$1.25 by mail. L. N. Kramer & Son, Cedar Rapids, Ia.

POINSETTIAS (Artificial)

Poinsettias, artificial decorations our specialty. Sample lots of 50 in 3 sizes, \$4.00; 100 lots, \$6, \$8, \$10. J. Stern & Co., 125 N. 20th St., Philadelphia, Pa.

PRIVET

John Bennett, Atlantic Highlands, N. J.
For page see List of Advertisers.

PRUNING SHEARS

Rhodes Mfg. Co., Dept. R., Grand Rapids, Mich.

RAFFIA

Raffia (colored), beautiful shades. Samples free. H. H. Conroy Co., Camden, N. J.; 810 Washburn Ave., Chicago, Ill.

RHODODENDRONS

John Waterer & Sons, Ltd.,
American Nursery, Bagshot, England.
For page see List of Advertisers.

P. Ouwkerkerk, Hoboken, N. J.
For page see List of Advertisers.

Anthony Waterer, Knap Hill Nursery, Surrey, Eng.
For page see List of Advertisers.

ROSES

Robert Craig Co., Market and 49th St., Philadelphia, Pa.
For page see List of Advertisers.

P. Ouwkerkerk, P. O. No. 2, Hoboken, N. J.
For page see List of Advertisers.

Julius Roehrs Co., Rutherford, N. J.
Rose Newport Fairy.
For page see List of Advertisers.

The F. R. Pierson Co.,
White Killarney,
Tarrytown-on-Hudson, N. Y.
For page see List of Advertisers.

S. J. Reuter & Son, Westery, R. I.
My Maryland.
For page see List of Advertisers.

Dilgee & Conard Co., West Grove, Pa.
For page see List of Advertisers.

Charles H. Totty, Madison, N. J.

ROSES

Hand Book of Cultural Notes on Roses Under Glass, by F. P. Brigham, mailed to your address for 25c, by Horticulture Publishing Co., 11 Hamilton Place, Boston.

SALVIA

R. Vincent, Jr. & Sons Co., White Marsh, Maryland.
Salvia Bonifera and Zurich.
For page see List of Advertisers.

SEED GROWERS

C. C. Morse & Co., 48-66 Jackson St., San Francisco, Cal.
For page see List of Advertisers.

Hjalmar Hartmann & Co.,
Cauliflower and Cabbage Seed,
12 Strømgade, Copenhagen, Denmark.
For page see List of Advertisers.

Federico C. Varela, Tenerife, Canary Ids. Bermuda Onion Seed.

For List of Advertisers See Page 270

SEEDS

T. J. Grey Co., 32 So. Market St., Boston.
For page see List of Advertisers.

Joseph Brock & Sons,
51 and 52 N. Market St., Boston, Mass.
For page see List of Advertisers.

W. Atlee Burpee & Co., Philadelphia.
For page see List of Advertisers.

C. C. Morse & Co., 48-56 Jackson St.,
San Francisco, Calif.
For page see List of Advertisers.

Arthur T. Boddington, 342 W. 14th St.,
New York.
For page see List of Advertisers.

H. E. Flake Seed Co., Faneuil Hall Sq.,
Boston.
For page see List of Advertisers.

Hjalmar Hartmann & Co.,
12 Stormgade, Copenhagen, Denmark.
Cauliflower and Cabbage Seed.
For page see List of Advertisers.

Rickards Bros., 37 E. 10th St., New York.
For page see List of Advertisers.

R. & J. Farquhar & Co., 67 So. Market
St., Boston.
Mignonette Seed.
For page see List of Advertisers.

H. F. Michell Co., 1018 Market St., Phila.
For page see List of Advertisers.

J. M. Thorburn & Co., 33 Barclay St., N. Y.
For page see List of Advertisers.

Leonard Seed Co., Chicago, Ill.
For page see List of Advertisers.

Wm. Elliott & Sons, 42 Vesey St., N. Y.
New Seed.
For page see List of Advertisers.

Weeber & Don, 114 Chambers St., New
York.
For page see List of Advertisers.

Seeds. Rocky Mountain Evergreen seed in large or small quantities. C. S. Harrison's Select Nursery, York, Neb.

My own new crop of SALVIA SPLENDENS VARIETIES is now ready. Nana Compacta ZURICH, finest early flowering pot Salvia in existence, selected seeds Compacta Grandiflora FIREBALL, best of all for pots and groups, selected seeds Grandiflora Ameliorata KING OF THE STARETS, unexcelled for late groups with extra large deep scarlet spikes, selected seeds. Each of above per Tr. Pkt., 50c.; 4 Tr. Pkt., \$2.50. Larger quantities on special quotation. O. V. ZANGEN Seedsman, Hoboken, N. J.

SHAMROCKS

John F. Rupp, Shiremanstown, Pa.
For page see List of Advertisers.

Shamrocks Genuine Irish Shamrocks, original plant coming from country, Downpatrick, Ireland. Two in., without pots, \$4.00 per 100; \$35.00 per 1000; with pots, \$4.50 per 100; \$40.00 per 1000; 250 at 1000 rate. Order early. Terms cash. J. D. Harcourt's Son, Wappingers Falls, N. Y.

SHRUBS

The Geo. Wittbold Co., 1657 Buckingham Palace, Chicago.
For page see List of Advertisers.

SILKLINE

John C. Meyer & Co., Boston, Mass.
For page see List of Advertisers.

SPHAGNUM MOSS

Live Sphagnum moss, orchid peat and orchid baskets also on hand. Lager & Horrell, Summit, N. J.

Sphagnum moss and mountain laurel in bags, bales or car lots. Prices low. Spruce and hemlock in bales. James Day, Box 600, Milford, N. H.

SPRAYERS

"SHOWMAKER." \$1. Jos. Kopcsay, So. Bend, Ind.
For page see List of Advertisers.

Niagara Sprayer Co., Middleport, N. Y.
For page see List of Advertisers.

J. F. Cass Mfg. Co., Dept. II., Detroit, Mich.
U-N-I-T Globe Sprayer.
For page see List of Advertisers.

Chas. J. Jager Co., Boston.
Demirg Spray Pump.
For page see List of Advertisers.

STEAM TRAP

E. Hippard, Yonngstown, O.

STRAWBERRY PLANTS
H. L. Crane, Westwood, Mass.
Barrymore Strawberry.
For page see List of Advertisers.

SULFOCIDE

The B. G. Pratt Co., 50 Church St., Dept. W., New York City.
For page see List of Advertisers.

SWEET PEAS

A. C. Zvolanek, Round Brook, N. J.
Winter Flowering.
For page see List of Advertisers.

TO-BAK-INE

E. H. Hunt, Genl. Agt., 76-78 Wabash Av. Chicago.
For page see List of Advertisers.

TOMATO PLANTS.

20,000 Forcig Tomatoes, 2 1/2 in., \$2.00 per 100. Honey Bros., West Grove, Pa.

VEGETABLE PLANTS

Best Cabbage Plants, any variety, 1000 at \$1.25 only; \$1.00 a 1000 for 3000 or more. Special prices on large lots. Special low express rates. The best asparagus roots. One year old Giant Argetteuil at \$1.00 per 300, \$5.00 a 1000. Cash with order please. Alfred Jouannet, Mount Pleasant, S. C.

VENTILATING APPARATUS

Pierson U-Bar Co., 1 Madison Sq., N. Y.
For page see List of Advertisers.

Foley Mfg. Co., Western Av., between 25th & 26th Sts., Chicago.
For page see List of Advertisers.

John A. Payne, 260-274 Culver Av., Jersey City, N. J.
For page see List of Advertisers.

The Advance Co., Richmond, Ind.
For page see List of Advertisers.

Quaker City Machine Co., Richmond, Ind.
20th Century Ventilating Arm.
For page see List of Advertisers.

VENTILATING MACHINERY. New Model encased, self-oiding gear; Standard Model Open Gear. Lord & Barnham, 1133 Broadway, N. Y.

VIOLETS.

Princess Violets, 2 1/2 in., \$2.50 per 100. Jas. T. Baker, Bristleton, Philadelphia, Pa.

WALLFLOWERS

Henry A. Dreer, Philadelphia, Pa.
For page see List of Advertisers.

WAX FLOWERS

We are originators of wax designs and still the standard concern. J. Stern & Co., 125 N. 10th St., Philadelphia, Pa.

WIRED TOOTHPICKS

W. J. Cowee, Berlin, N. Y.
For page see List of Advertisers

WIREWOK

Reed & Keller, 122 W. 25th St., N. Y.
For page see List of Advertisers.

Wirework. Write for our catalogue. Holton & Hunkel Co., Milwaukee, Wis.
William E. Heischer's Wire Works, 38-40 Broadway, Detroit, Mich.
Headquarters for wire work. Send for list. Bail & Betz, 31 E. 3rd St., Cincinnati, O.
Wirework—Compare our prices with others. Scranton Florist Supply Co., 201 N. 7th St., Scranton, Pa.

WHOLESALE FLORISTS

Boston

N. P. McCarthy & Co., 84 Hawley St., Boston.
For page see List of Advertisers.

H. M. Robinson & Co., 15 Province St and 9 Chapman Pl., Boston.
For page see List of Advertisers.

Welch Bros., 226 Devonshire St., Boston
For page see List of Advertisers.

Talby, Wellesley, Mass.
For page see List of Advertisers.

WHOLESALE FLORISTS—

Chicago

Chas. W. McKellar, 51 Wabash Av., Chicago.
For page see List of Advertisers.

Peter Reinberg, 51 Wabash Av., Chicago.
For page see List of Advertisers.

E. F. Winterson Co., 45-49 Wabash Av., Chicago.
For page see List of Advertisers.

J. A. Endlong, 37-39 Randolph St., Chicago.
For page see List of Advertisers.

Poehlmann Bros. Co., Morton Grove, Ill.
For page see List of Advertisers.

Cromwell, Conn.

A. N. Pierson, Cromwell, Conn.
For page see List of Advertisers.

Detroit

Michigan Cut Flower Exchange, 38 and 40 Broadway, Detroit, Mich.
For page see List of Advertisers.

Minneapolis

Rice Bros., 115 N. 6th St., Minneapolis, Minn.
For page see List of Advertisers.

New York

Ford Bros., 48 W. 28th St., New York.
For page see List of Advertisers.

H. E. Froment, 57 W. 28th St., New York.
For page see List of Advertisers.

Alex. J. Guttman, 34 W. 28th St., New York.
For page see List of Advertisers.

E. C. Horan, 55 W. 28th St., New York.
For page see List of Advertisers.

A. H. Langjahr, 55 W. 28th St., New York.
For page see List of Advertisers.

James McMann, 42 W. 28th St., New York.
For page see List of Advertisers.

John I. Raynor, 49 W. 28th St., New York.
For page see List of Advertisers.

W. F. Sheridan, 39 W. 28th St., New York.
For page see List of Advertisers.

Treadwell & Schenck, 44 W. 28th St., New York.
For page see List of Advertisers.

Moore, Hentz & Nash, 55 and 57 W. 28th St., New York.
For page see List of Advertisers.

Wm. H. Kuebler, 23 Willoughby St., Brooklyn, N. Y.
For page see List of Advertisers.

Phillip F. Keasler, 55 and 57 W. 20th St., New York.
For page see List of Advertisers.

Millang Bros., 41 W. 28th St., New York.
For page see List of Advertisers.

John Young, 51 W. 28th St., New York.
For page see List of Advertisers.

Greater New York Florists' Association, 162 Livingston St., Brooklyn, N. Y.
For page see List of Advertisers.

George Saltford, 43 W. 28th St., New York.
For page see List of Advertisers.

Frank Millang, 55-57 W. 20th St., New York.
For page see List of Advertisers.

B. S. Slinn, 56-57 W. 26th St., New York.
For page see List of Advertisers.

A. L. Young & Co., 54 W. 28th St., N. Y.
For page see List of Advertisers.

Growers' Cut Flower Co., 39 W. 28th St., New York.
For page see List of Advertisers.

Henshaw & Feurich, 44 W. 28th St., New York.
For page see List of Advertisers.

J. K. Allen, 106 W. 28th St., New York.
For page see List of Advertisers.

Philadelphia

W. E. McKinnick & Bros., 1619-1621 Randolp St., Philadelphia, Pa.
For page see List of Advertisers.

Leo Niessen Co., 1200 Arch St., Philadelphia, Pa.
For page see List of Advertisers.

In writing to Advertisers kindly mention Horticulture

WHOLESALE FLORISTS— Philadelphia—Continued

The S. S. Pennock-Meehan Co., 1608-18
Ludlow St., Philadelphia, Pa.
For page see List of Advertisers.

St. Louis

H. G. Berning, 1402 Pine St., St. Louis, Mo.
For page see List of Advertisers.

New Offers in This Issue.

ALL FORMS OF PLANT FOOD AT FIRST HANDS.

Booker Fertilizer Co., Boston, Mass.
For page see List of Advertisers.

ASPARAGUS PLUMOSUS NANUS SEED.

H. F. Michell Co., Philadelphia, Pa.
For page see List of Advertisers.

CARNATION MARCHIONNE.

Bellamy Bros., Syracuse, N. Y.
For page see List of Advertisers.

CARNATIONS, ROOTED CUTTINGS. Fine-craft Greenhouses, East Brookfield, Mass.

For page see List of Advertisers.

COLEUS AND SPRING BEDDING PLANTS.

J. E. Felthousen, Schenectady, N. Y.
For page see List of Advertisers.

GLADIOLUS BULBS, CALIFORNIA PRIVET, AMERICAN CHEST- NUT, TOMATO AND PEP- PER SEED.

J. & J. L. Leonard, Iona, N. J.
For page see List of Advertisers.

HART'S HANDY HANDLE.

Geo. B. Hart, 24 Stone St.,
Rochester, N. Y.
For page see List of Advertisers.

HORICUM.

Hammond's Slug Shot Works, Fishkill-on-
Hudson, N. Y.

For page see List of Advertisers.

INSECT DESTROYING PREPARA- TIONS.

Bowker Insecticide Co., Boston, Mass.
For page see List of Advertisers.

LEUCOTHOE SPECIAL SALE.

Elk Evergreen Co., Shell Creek, Tenn.
For page see List of Advertisers.

ONCIDIUM ORNITHORHYNCEUM.

J. A. Meida, West Orange, N. J.
For page see List of Advertisers.

RETAIL FLORIST.

Julius Zinn, 2 Beacon St., Boston, Mass.
For page see List of Advertisers.

SINGLE CHRYSANTHEMUMS FROM SEED, PENTSTEMONS.

C. H. Toffy, Madison, N. J.
For page see List of Advertisers.

TREES, SHRUBS, ROSES, EVER- GREENS, HARDY PLANTS.

Ellwanger & Barry, Rochester, N. Y.
For page see List of Advertisers.

VEGETABLE PLANTS.

R. Vincent, Jr. & Sons Co., White Marsh,
Maryland.

VIBURNUM MOLLE.

Eastern Nurseries, Jamaica Plain, Mass.
For page see List of Advertisers.

VERBENAS, AGERATUM, FU- CHSIAS, SMILAX, PE- TUNIAS, ETC.

R. Vincent, Jr. & Sons Co., White Marsh,
Maryland.

For page see List of Advertisers.

WIRE WORK.

Durand & Marohn, Albany, N. Y.
For page see List of Advertisers.

WANTS, FOR SALE, ETC.

Advertisements in this column one cent a word. Initials count as words. Cash with order. All correspondence addressed "care HORTICULTURE" should be sent to 11 Hamilton Place, Boston.

HELP WANTED

WE need a man who knows seeds and plants in a practical way and who can write of them in good English. Ability to express himself in few words, easily understood, absolutely essential. Daily newspaper training almost indispensable. Good habits and capacity for hard work necessary. Working knowledge of seed, nursery or florist's trade, experience in an advertising agency, and familiarity with type and other print-shop accessories, highly desirable. If there is such a man open to engagement we can offer him the opportunity of a lifetime. Inquiries invited from persons who possess one or more of the stated qualifications.

— THE —

McFARLAND PUBLICITY SERVICE

Specialists in Horticultural Advertising.

HARRISBURG, PENNA

GOOD MEN

When you need good men,
skilled or unskilled, Write:

THOS. H. BAMBRICK

34 South 7th Street Philadelphia

Help of all kinds, including that for Florists, Nurserymen, Seedsmen and the Horticultural trade generally.

SALESMAN—Wholesale cut flower trade; must be experienced; good position for the right man. Apply with references and full particulars to W. E. McKissick & Bros., 1619-21 Ransford St., Philadelphia.

WANTED To meet thoroughly experienced man to manage established florist store in Boston or will consider partnership. Address, giving experience, F. S., care Horticulture, Boston.

HORTICULTURE needs a wide-awake representative in every town in the land. Good commission paid on advertising and subscriptions. If you are ambitious, write for terms.

SITUATIONS WANTED

SITUATION WANTED—As assistant on private or commercial place by German; 28 years of age; five years' experience in America. At liberty after first of March. Best references. Please state particulars and wages. Address, O. Eckert, S. H. Convent, Albany, N. Y.

FOR SALE

GREENHOUSE PLANT FOR SALE

Consisting of three houses, 32 x 142, 18 x 75 and 10 x 15 respectively, with cold frames and sash. Built by Lord & Parham Co., steam heated with Parham boiler. Strictly up-to-date and with every convenience for commercial business. Owners are in another line of business. Apply to J. E. Norcross, with Jones, Moulton & Stratton, 53 Franklin St., Boston.

FOR SALE—An up-to-date greenhouse; property in good repair; situated in the State of Massachusetts; 12,600 feet glass, stocked for cut flowers and pot plants; large nine-room house, one six-room house, large barn, 6 acres good land; established for 36 years. Doing good business, \$3000-4000. Cash. Reason for selling, owner going out of business. Address P. M. 100, care Horticulture.

FOR SALE—Retail nursery, sixth year, doing good, steady and increasing trade. Stock in excellent condition. Only local supply for community of 50,000. For particulars address R. N., care HORTICULTURE, Boston.

FOR SALE—Long established retail florist business in one of the largest cities, doing a very profitable business, with high class customers. Address F., care HORTICULTURE, 11 Hamilton Place, Boston.

MISCELLANEOUS WANTS

WANTED TO BUY—Greenhouses and all kinds of greenhouse material; dismantled and removed at once. Best prices. Terms cash. Address, Max Tomback, 24 Avon Place, Newark, N. J.

WANTED TO BUY—Complete greenhouse plants and all kinds of greenhouse material, to be taken down and removed at once. Terms cash. Address, L. Susserman, 229 Livingston St., Newark, N. J.

WANTED to lease, and buy later, greenhouses, with land; retail location. State size of houses; size of glass; full particulars. Address Business, 180 Grand St., Jersey City, N. J.

BUSINESS CHANCES

WANTED—To unite in partnership in Massachusetts with man needing more capital or assistance in horticultural business warranting expansion or to join with man thoroughly qualified in floriculture in establishment of new enterprise. Address K., care Horticulture.

NEWS NOTES.

Henry King, a young Scotch gardener from Glasgow, made a sad entry into the new country for which he and his young wife had set out so hopefully on the Laurentian to the Allan line, bound for Boston. His wife became very ill on the voyage and on arrival at Boston was immediately transferred to the Carney Hospital, where she passed away last Saturday night. King, having been detained, in accordance with the law, was not allowed to visit the hospital until after his wife's death.

The legal proceedings instituted three weeks ago against W. L. Lewis, a Worcester, Boston and Marlboro florist, by H. K. W. Andrews & Son of Marlboro, have been settled out of court and the attachment dissolved, so Atty. Joseph A. McGee said today. Atty. McGee, for the plaintiff, and William Clapp for the defendant.

The action was one of contract, and the ad damnum was for \$300. The suit was filed at the city hall two weeks ago, and was to recover for labor and materials alleged to be furnished the defendant by the plaintiff in conducting the floral business in Marlboro.—Worcester (Mass.) Telegram.

"SOLD BY SEED DEALERS"

"HORICUM" H O R I C U M

TRADE MARK

Poly-Sulphides of Calcium 30%. Specific Gravity 1.50

DIRECTIONS FOR USE

San Jose Scale Killer and Fungicide

This preparation is lime, sulphur and salt, making a concentrated Poly-sulphide of Calcium. The salt adds to the adhesive properties, but the destructiveness to Scale Life lies in the Calcium Sulphide.

Aside from its ability to destroy San Jose Scale, HORICUM is a Fungicide, preventing the free development of fungoid troubles. Shake the package thoroughly or take the top off.

The color in its concentrated form is a deep bronze green. Do not pour off the clear liquor only, stir the Horicum from the bottom of the package, and add 20 quarts of water (hot, if you can get it) for ordinary use. For a stronger dilution when the growth is all dormant use 16 parts of water only (hot, if you have it) and spray thoroughly. By grading your dilution you make it any desired strength.

WRITE FOR PAMPHLETS ON BUGS AND BLIGHTS
HAMMOND'S SLUG SHOT WORKS
FISHKILL-ON-HUDSON, N. Y.



San Jose Scale on a Pear.

Kills San Jose SCALE

For Trees, Plants, Shrubs and Flowers

— USE —

THE NIAGARA BRAND LIME SULPHUR SOLUTION

It destroys Scale Lice, Spiders and all forms of Aphides, AT THE SAME TIME Mildew, Blight, Rust and other Fungus difficulties.

Used in Winter or Summer. — No other remedy has been so universally effective.

Niagara Brand ARSENATE OF LEAD for chewing insects is equal to the best and better than the most Ask about our Green House sprayer. Address —

NIAGARA SPRAYER CO., - - Middleport, N. Y.

U-N-IT

Spraying device for garden hose. It brings out insoluble, with water, what is put into Globe. Fertilizing solutions, soap solutions, insecticides, fungicides, germicides, etc.

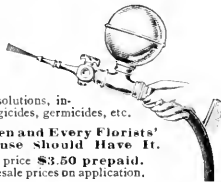

All Seedmen and Every Florists' Supply House should have it.

Retail price \$3.50 prepaid. Wholesale prices on application.

— ADDRESS —

Dept. H, J. F. CASS MFG. CO., Detroit, Mich.

KILMDEAD TOBACCO DUST

Free from Sand or Dirt Kind FOR FUMIGATING AND DUSTING

Dusted on Plants it covers large surface.

One Quality for Both Ties.

Our Tobacco Dust is the pure tobacco, free from sand and dirt, strong in Nicotine and always of the same strength, making it superior to any dust on the market. Costs you no more than the ordinary product and will do twice the work. 10 lbs. 60c; 25 lbs. \$1.25; 50 lbs. \$2.00; 100 lbs. \$3.50.

STUMPP & WALTER CO.
50 Barclay St., New York

PATENT GRANTED.

911,283. Process of Making Complete Fertilizers. John R. Young, Norfolk, Va.

West Orange, N. J.—Joseph A. Manda is making extensive additions to his plant on Valley road. A fine importation of *Oncidium ornithorrhynchum* has just arrived.

DON'T EXPERIMENT

USE

TO-BAK-INE

and your stock will be free from insects, clean, and the blooms will not be discolored.

Send for full information of

H. E. FISKE SEED CO.
13 Faneuil Hall Sq., Boston, Mass.

STUMPP & WALTER CO.,
50 Barclay St., New York.

HENRY F. MICHELL & CO.,
1018 Market St., Philadelphia.

E. H. HUNT, Gen'l Agent,
76-78 Wabash Ave., Chicago.

Which Spray Pump

shall you buy? Buy the Spray Pump that fully meets the demands of the Government Agricultural Scientists and all practical Fruit Growers. These pumps are widely known as

DEMING SPRAYERS and are made in 23 styles for use in small gardens or immense orchards. Write for our new catalog with Spraying Chart. Add 4 cents postage and receive "Spraying for Profit," a useful guide book.

CHARLES J. JAGLER CO.
281-285 Franklin St., Boston

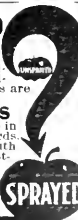

"Every Bug Has his Dose."

Insect-destroying preparations that do their work well and effectively are the cheapest. Bowker's Arsenate of Lead and Bowker's Pyrox are recognized standard insecticides and fungicides for both indoor and outdoor use. Bowker's Insect Emulsion destroys many kind of plant lice, black and green flies, etc. Call or send for catalogue.

BOWKER INSECTICIDE COMPANY
43 CHATHAM ST. BOSTON



The Best Bug Killer and Bloom Saver

For PROOF Write to

P. R. Palethorpe Co.
OWENSBORO, KY.

SOMETHING NEW FOR GREENHOUSES "SULFOCID" PRATT'S SOLUBLE SULPHUR SUMMER SPRAY

Non-caustic and non-irritating
A FUNGICIDE AND INSECTICIDE

FOR FRUIT TREES, VEGETABLES and GREENHOUSES

A promising substitute for Bordeaux mixture. For 10 cts. to cover postage will send sample sufficient for one gallon of spray.

Use 1 part to 75 or 100 parts of water.
B. G. PRATT CO., 50 Church St., New York, U. S. A.



Garden and Sprinkler nozzle and Garden Hose.

Straight, round and flat steam nozzle on Kopsay's "Shower Maker," \$1 00 each. Saves labor, temper, patience and time. GET ONE NOW as you will be satisfied, but if not you may return it and I'll return your money.

JOSEPH KOPCZAY,

South Bend, Ind.

List of Advertisers

Advance, The Co.	291	Leonard J. & J.	257
A len J. K.	263	Leonard Seed Co.	257
American Nursery	(Eng.)	Leathy A. & Co.	253
Aschmann Godfrey	243	Lord & Burnham Co.	272
Atlanta Floral Co.	279	Stand Jos. A.	251
Bacon & Co.	290	MacMullin E. A.	259
Bambrick Thos. H.	288	McCarthy N. F. & Co.	263
Barrows H. H. & Sons	283	McConnell Alex.	258
Bassett & Washburn	268	McFarland Publicity	Service, Inc.
Bayersdorfer H. & Co.	280	McKellar Charles W.	260
Bellamy Bros.	238	McKissick, W. E. & Bros.	260
Bennett J.	270	McMaus Jas.	262
Bernau H. G.	293	Meyer	258
Blossom The	258	Meyer J. & Co.	263
Boddington A. T.	212-251	Mitchell H. F.	260
Boston Co-operative	Flower Growers Assn	250	Michigan Cut Flower Exchange
Flower Growers Assn	250	Millang Bros.	260
Boston Florist Letter	Co	Millang Frank L.	260
Boston Plate and Window Glass Co.	270	Millang August	263
Bostrom-Erady Mfg. Co.	261	Moninger J. C.	271
Bowe, M. A.	258	Moore, J. L.	253
Bowler Fertilizer Co.	258	Moore, Hentz & Nash	262
Bowker Insecticide	260	Moore-Livinston Co.	259
Bre & Joseph & Sons	277	Morse C. C. & Co.	257
Breitweyer's J. Sons	259	Mt Hope Nurseries	251
Bridgeman's Seed Warehouse	257	Murray Samuel	258
Bullong J. A.	260	New Eng. Nurseries	242
Burpee W. A. & Co.	257	Newman Floral Co.	258
Ca rillo & Baldwin	255	Newman J. & Sons	259
Cass J. F. Mfg. Co.	260	Niagara Sprayer Co.	260
Chicago Carnation Co.	298	Nissen Lee	260
Clark Daniel	259	Oechlein Frank	253
Clarke's David, Sons	238	Ordonez Peter	251
Cleary's Horticult Co	240	Quawkerk F.	240
Cornish Geo. & Co.	262	Palethorpe F. R. Co.	258
Cowce W. J.	261	Palmer W. J.	258
Craig, Robt. Co.	240	Park Floral Co.	258
Crane H. L.	240	Fayne John A.	271
Crawback Geo. W.	213	Peacock Dahlia Farms	253
Danker F. A.	250	Peirce E. Allan	250
Dawson H. S.	242	Pennock-Meehan Co.	260
Dawson & Conard Co.	240	Perkins St. Nurseries	253
Derner F. Sons & Co.	239	Pierson, A. N.	240
Dow Geo. E.	257	Pierson F. R. Co.	240
Dreer H. A.	253-270	Pierson U Bar Co.	272
Dunrod John H.	258	Pine-Croft Greenhouses	239
Durand & Marolin	259	Poehlmann Bros. Co.	260
Eberhart R. J.	263	Pratt B. G. Co.	269
Eastern Nurseries	240	Quaker City Mach. Co.	271
East Suburb Greenhouses.	238	Raynor, N. H.	263
Edwards Folding Box Co.	266	Reed & Keller	263
Elk Evergreen Co.	258	Reinberg Peter	270
Elrott Wm & Sons	257	Reuter S. J. & Son	238
Ellwanger & Barry	251	Rice Bros.	270
Euler J. G.	252	Richards Bros.	257
Ernest W. H.	252	Robinson H. M. & Co.	267
Eyres	218	Rock Wm. L. Flo. Co.	258
Faugar R. & I & Co	257	Roehrs Julius	240-241
Felthousen J. E.	253	Roper Albert	258
Fisher Peter	253	Roland, Thomas	253
Fiske H. E. Seed Co.	257-261	Rolker August & Sons	259
Foley Mfg. Co.	271	Rupp J. C.	259
Ford Bros.	262	Salford Geo.	262
Froment H. E.	262	Sander & Son	251
Galvin Thos. F.	250	Scheiden & Schoss	252
Greater N.Y. Florists' Association	263	Schulz Jacob	259
Grey T. J. Co.	257	Scott, John	253
Growers' Cut Flower Co.	262	Sharp, Partridge & Co	271
Gude Bros. Co.	268	Sheridan W. F.	262
Guttman Alex. J.	268	Siggers & Siggers	271
Hall Assn.	271	Simpson Robt.	257
Hammond Paint & Slush Shot Works	169	Situations & Wants	262
Hart Geo. B.	250	Sliva B. S.	262
Hartmann Hjalmar & Co.	257	Smith Elmer D. & Co.	239
Hauswirth M. C. & J. E.	258	Smyth Wm. J.	258
Heacock Jos. & Co.	243	Standard Plate Glass Co.	271
Henshaw & Fenwick	263	Stearns A.T. Lumber Co.	271
Herbert David & Son	253	Stump & Walter Co.	251-269
Hews A. H. & Co.	252	Talby	259
Hilfinger Bros.	250	Takeuchi K.	257
Hill, The E. C. Co.	232	Tanoi R.	257
Hitchings & Co.	271	Thorburn J. M. & Co.	257
Hoffman	250	Totty Chas. H.	259
Horan E. C.	262	Treadwell & Schenck	259
Houghton F. H.	250	Trepel C. C.	258
Hunt B. H.	253	Twomey D. J.	240
Jager, Chas. J.	269	Ydentine, J. A.	258
Kervan The Co.	273	Vincent R. Jr. & Sons	238-253
Kessler, P. F.	272	Ward R. M. & Co.	257
King Cons. Co.	271	Waterer A.	240
Knapp Hill Nursery	240	Wattler John & Sons	240
Kopsay Jos.	250	Weeber & Den.	257
Kraeschell Bros. Co.	271	Welch Bros.	250
Kuebler Wm H.	253	Wilson	250
Lager & Hurrell	251	Winterson O. W. & Co.	253
Langjahr, Alfred H.	252	Withold Geo. Co.	253

"REVERO"

Braided Moulded Construction—Seamless Throughout

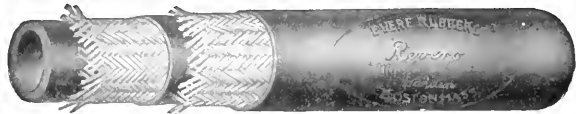

LIGHT -- STRONG -- FLEXIBLE



The above cuts represent the non-kinking tendency of Revero as compared with the old style hose of wrapped duck construction.

Re vero is furnished on Reels in Continuous Lengths up to 500 feet.

Revero Rubber Company, BOSTON, MASS.

NEW YORK PHILADELPHIA PITTSBURG CHICAGO
NEW ORLEANS MINNEAPOLIS SAN FRANCISCO PORTLAND, ORE.

GREENHOUSES BUILDING OR CONTEMPLATED.

Canon City, Col.—L. F. Davis, one house.

Exeter, N. H.—G. W. Hilliard, house, 30x150.

Middletown, N. Y.—J. J. Wood, enlarging.

Highland, Ill.—M. F. Widmer, enlarging.

Watervliet, N. Y.—Henkes Bros., house, 60x200.

Polo, Ill.—H. D. Davis, two houses, each 100 feet long.

Newell, O.—John Goodwin, Grant and Third Sts., one house.

Randolph, Mass.—Clarence Hager, carnation house, 25x150 ft.

Maywood, Ill.—Wagner & Haltnr, range of carnation houses.

Des Plaines, Ill.—Hoerber Bros., range of houses, Foley Mfg. Co., builders.

The King Construction Company has received an order by cable from Messrs. Richon & Hermes, a prominent horticultural concern at Parame, France, for two of their large iron frame greenhouses. Before deciding to increase their greenhouse plant, Mr. Richon made a visit to England, Holland, Belgium and Germany in search of the most modern constructions for their new greenhouses. Two visits were also made to the United States. The fact that the King Construction Company's iron frame greenhouses have finally been selected, is certainly a compliment to the King

Construction Company as well as a tribute to the advanced state of the art of greenhouse construction in the United States. It is stated by the King Construction Company that negotiations are in progress for the placing of other orders and that by the end of the season it is expected that there will be numerous greenhouses of the King type, erected in European countries.

A large representation of the florists of Boston and vicinity attended the committee hearing at the State House February 17 on the bill to exempt steam boilers for "horticultural" purposes from the provisions compelling the employment of a licensed fireman, on the same basis as the exemption of boilers used for "agricultural" purposes. Allan Peirce is the active man in pushing the amendment and expresses confidence of ultimate success.

BOSTON PLATE & WINDOW GLASS CO.

GREENHOUSE GLASS

German and American

261 to 287 A St., Boston 20-22 Canal St.

Holds Glass Firmly
See the Point #2
PEERLESS
Glassing Points are the best. No rights or lefts. Box of 1,000 points 75 cts. postpaid.
HERRY A. BREER
715 Chestnut St., Phila., Pa.

The Payne Steel "T" Bar Greenhouses

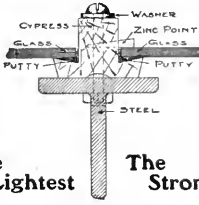

The Lightest The Strongest

Half full Size

HOUSES of this type are constructed with both curved glass eaves and straight glass eaves. Least amount of shadow. Least amount of wood. No drip. Greatest durability.

JOHN A. PAYNE

Greenhouse Designer and Builder

260-274 Culver Avenue

JERSEY CITY, N. J.

KROESCHELL BOILER



MADE OF FIRE BOX FLANGE PLATE
Can not Crack!

Water Space in Front, Sides and Back
The Most Popular Boiler Made
SEND FOR CATALOGUE.

KROESCHELL BROS. CO.
35 Erie Street, CHICAGO, ILL.



The Advance Ventilating Apparatus

These are busy days with us, 24 machines for quick shipment, 21 for shipment later on, together with hosts of orders for good honest work. Why not let us figure on that new house of yours and tell you more about our line? Free circulars and estimates for the asking.

The Advance Co.
RICHMOND, IND.

GREENHOUSE CONSTRUCTION LUMBER

John C. Moninger Co.
117 E. Blackhawk St., CHICAGO.

THE FOLEY MFG. CO.

CHICAGO

Completely equipped with up-to-date machinery for the making of material for

GREENHOUSE CONSTRUCTION

From a Full Supply of Thoroughly Seasoned Lumber

Send your sketches to our draughtsmen for completion and suggestion. Permit us to figure your proposed work, large or small.

We guarantee our prices will save you money FOLEY VENTILATING APPARATUS IS THE BEST

Is Simple In Erecting. Is Easiest of Operation. It Will Last a Lifetime. Its Price is the Lowest. Will Ventilate Any Size House. Prices and Circulars on Application.

Our 1908 Catalogue Greenhouse Material Sent Postpaid on Request.

**THE FOLEY MFG. CO., WESTERN AVENUE
25th and 26th STS., CHICAGO**

STANDARD PLATE GLASS CO.

Manufacturers—Importers—Jobbers

NOW IS THE TIME TO BUY

FRENCH OR AMERICAN GREENHOUSE GLASS

LOWEST PRICES ON REQUEST

26-30 Sudbury St. BOSTON, MASS. 61-63 Portland St.

GLASS

Always Write Us Before Buying
SHARP, PARTRIDGE & CO.
22nd and Lumber Streets, CHICAGO
WE HAVE SOME SNAPS

CYPRESS SASH BARS 82 feet or longer: HOT BED SASH PECKY CYPRESS BENCH LUMBER

GREENHOUSES

ERECTED AND EQUIPPED COMPLETE IF DESIRED

Write for Circular "D" and Prices

The A. T. STEARNS LUMBER CO.
NEPONSET, BOSTON, MASS.



Evans 20th Century Arm
Will not twist the shafting pipe. Three times the power of old style elbow arms Sold only with Evans Challenge Machine
Write for free Catalogue to
QUAKER CITY MACHINE CO.
Richmond, Ind.

The **FLORISTS' HALL ASSOCIATION OF AMERICA**, insurer of 29,000,000 sq. ft. of glass. For particulars address
John C. Esler, Sec'y, Saddle River, N. J.

EVERYTHING FOR GREENHOUSE BUILDING

WRITE FOR INFORMATION AND PRICES

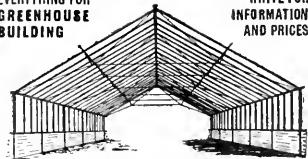

King Greenhouses. King Gutters and Eaves. Trussed Roofs. Ventilating Machinery. Trussed Iron Frame Houses. Tile Benches and Pipe Hangers.

KING CONSTRUCTION COMPANY
NORTH TONAWANDA, N. Y.

PATENTS

Trademarks and Copyrights

Send your business direct to Washington. Saves time and insures better service. Personal attention guaranteed. Twenty-five years' active service. SPECIALTY: "Working on the Failure of Others."

SIGGERS & SIGGERS

PATENT LAWYERS

Box 9, National Union Building
Washington, D. C.



OUR IRON FRAME HOUSE

There is an argument—a strong argument—in favor of putting money into a house that is not an experimental construction. The THEORY of how long a house will last is a good talking point, but the FACT that our Iron Frame Construction has stood the test—the severest kind of tests—makes it the only SAFE PROPOSITION.

Send for our illustrated circulation—Iron Frame Greenhouses for Private Plates.

Hitchings & Company
1170 Broadway New York

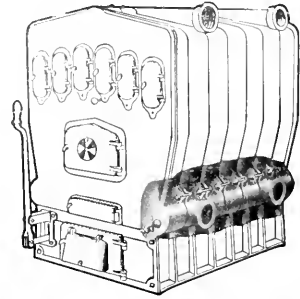

The Advantages of The Burnham Short Tie Bolts

- Much time saved in erecting.
- No blocking up of sections to tighten them.
- Each pair of sections have their own tie bolts.
- You can tighten each section perfectly as you go along.
- When you increase size of boiler by adding sections, you don't have to buy new long tie bolts. We furnish the short bolts and washers with each section.

Send for Catalog

Lord & Burnham Co.
Main Sales Office: 1133 BROADWAY, N. Y.
BOSTON: 849 Tremont Building. PHILADELPHIA: 1215 Filbert St.

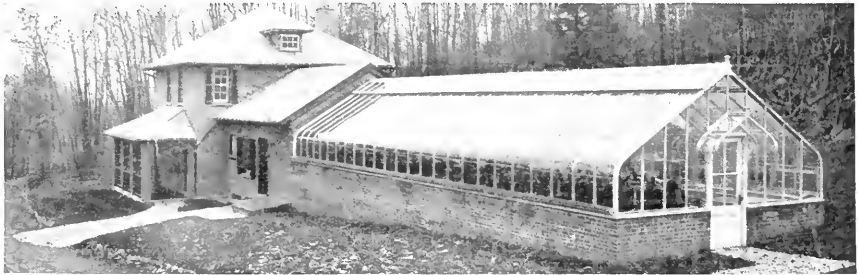

THIS IS A GOOD-SENSED PROPOSITION

You know it is often desirable to have the gardener's cottage connected with the greenhouse, but to attach it direct has objections. We got around the objections in this case by putting the work room between it and the greenhouse. This makes a very handy arrangement.

It is located in Tuxedo Park, and the U-Bar construction was chosen because it is the lightest house and the most attractive.

Have you sent for that catalog? Then why don't you?

U-BAR GREENHOUSES

PIERSON
DESIGNERS AND BUILDERS



U-BAR CO.
1 MADISON AVE. NEW YORK

HORTICULTURE

Vol. IX.

FEBRUARY 27, 1909

No. 9



SEEDING CARNATION "PERSON'S PINK"
F. B. Peterson Co.



DEVOTED TO THE
FLORIST, PLANTSMAN, LANDSCAPE GARDENER AND KINDRED INTERESTS

PUBLISHED EVERY SATURDAY AT 11 HAMILTON PLACE, BOSTON, MASS.

SUBSCRIPTION, \$1 00 PER YEAR



GERANIUMS

We have an immense stock of fine plants from 2 in. pots for immediate shipment at prices running from \$2 per 100 up to 50c. each. We will send 1000, 50 each of 20 varieties our selection for \$18.50. Our Special Geranium Catalogue describes upwards of 250 varieties.

LOBELIA	KATHLEEN MALLARD, - -	\$2.00 per 100
SALVIA	BONFIRE, -	\$2.00 per 100, \$18.50 per 1000
	ZURICH, -	3.00 " " 22.50 " "
ALYSSUM	DWARF DOUBLE, fine for pots	\$2.00 per 100
CINERARIA	MARITIMA and CANDISSIMA, - -	\$2.00 per 100
CENTAUREA	GYMNOCARPA, - -	\$2.00 per 100
ACERATUM	STELLA GURNEY, - -	\$2.00 per 100
	INIMITABLE,	
HARDY POMPON CHRYSANTHEMUMS		\$2.00 per 100
	1000, 50 each of 20 good kinds our selection,	\$18.50

We also have a general line of Bedding Plants. Send for catalogue, only to the trade.

R. VINCENT JR. & SONS CO., White Marsh, Md.

A WIRELESS WINNER

Has Won Absolutely on Its Own Merits. Certificates Innumerable Everywhere
 MASSACHUSETTS HORTICULTURAL SOCIETY'S SILVER MEDAL LAST YEAR
 AMERICAN CARNATION SOCIETY'S GOLD MEDAL THIS YEAR

THAT'S THE RECORD OF
It Is Invincible BAY STATE Buy it and Grow it.
 The noblest carnation ever introduced. White with carmine pencillings.
 ROOTED CUTTINGS, - \$12.00 per 100, \$0.00 per 1000.
ALBERT ROPER, - - TEWKSBURY, MASS.

NEW RED GARNATION O. P. BASSETT

Extra Large Bright Red Free Bloomer

Rooted Cuttings, per 1000, \$60.00 | Rooted CUTTINGS, per 100, \$8.00 | Rooted Cuttings, per 25, \$2.50
 " " per 500, 35 00 " " per 50, 4 50 " " per 12, 1 50
 Ready for delivery Jan. 1st, '09 by the Originators and Growers
BASSETT & WASHBURN, HINSDALE, ILL

CARNATIONS ROSE MY MARYLAND

Standard sorts and all the novelties of merit. Orders booked now for this most promising variety.
 The cream of the commercial sorts. Send for our price list. We can quote you right and supply first class stock.
S. J REUTER & SON, WESTERLY, R. I.

CARNATIONS Rooted Cuttings Fine Healthy Stock

	Per 100	Per 1000
Pres Seelye	\$6.00	\$50.00
White Enchantress, Beacon	3 50	30.00
Victory, Winsor, Melody, Kingston Pet -	3.00	25.00
Daheim, Enchantress, Lady Bountiful, Mrs Lawson, White Lawson, Red Lawson, Variegated Lawson	2 50	20.00

WOOD BROTHERS FISHKILL, N. Y.

ROOTED CUTTINGS

Wm. H. Taft, \$12 per 100; \$30 per 1000

	100	1000
Enchantress	\$1 75	\$15 00
Pink Lawson	1 50	12 50
White Lawson	2 00	18 00
Variegated Lawson	2 75	25 00
Victory	2 50	20 00

SCHIEDEN & SCHOOS, 58-60 Wabash Ave., Chicago.

In ordering goods please add "I saw it in HORTICULTURE."

A. N. PIERSON, Inc. CROMWELL, CONN.

Wholesale Growers of Cut Flowers, Palms and Ferns
 OUR SPECIALTIES, Roses, Lily of the Valley and Carnations. We also grow a general assortment of flowers in their season

GARNATION CUTTINGS

We offer choice varieties for February and later shipments.

	Per 100	Per 1000
Enchantress	\$2.50	\$20.00
White do.	3.50	30.00
Rose Pink do.	2.50	20.00
White Perfection	2.50	20.00
Winsor	3.50	30.00
Melody	2.50	20.00
Beacon	3.50	30.00
Victory	3.50	30.00
Aristocrat	3.50	30.00
Splendor	6.00	50.00
Vesper	3.50	30.00
White Lawson	2.50	20.00

EAST SUDBURY GREENHOUSES, Carnation Specialists

P. O. Address South Sudbury, Mass. Telephone So. Sudbury 20.
 Orders for this stock filled also by
WELCH BROS., 226 Devonshire St., Boston

Rooted Cuttings READY FOR IMMEDIATE DELIVERY

Andrew Carnegie, Delance, Splendor, Pres. Seelye, Afterglow, Lawson-Enchantress, Sarah Hill,
 \$6.00 per 100, \$50 00 per 1000
 White Perfection, White Enchantress, Winsor, Rose Pink Enchantress, Enchantress, Lady Bountiful, Melody, White Lawson.
 \$3.00 per 100 \$25.00 per 1000
CHICAGO CARNATION CO. JOLIET, A. T. PYFER, Mgr. ILL.

Send for our Preliminary List describing and quoting

Chrysanthemums and Carnations.

A fine lot of
Carnation Cuttings ready now.

THE E. G. HILL CO., Richmond, Indiana.

PETER FISHER ELLIS, MASS.

Send for Price List of Carnations

MARCHIONNE

The Money Making White Carnation
 \$10 00 per 100; \$80.00 per 1000

Orders Filled Strictly in Rotation
BELLAMY BROS.
 Successors to L. E. Marquette, SYRACUSE, N. Y.

ROOTED CARNATION CUTTINGS

ENCHANTRESS	\$2 00 per 100
WINSOR	3 00 " "
LAWSON	2 00 " "
HARRY FENN	2 00 " "
WHITE PERFECTION	2 50 " "
QUEEN	2 50 " "

PINE-CROFT GREENHOUSES EAST BROOKFIELD, MASS.

SINGLE CHRYSANTHEMUMS

From Seed

I am offering seed of Wells' new early flowering singles, in original sealed packets, at 25c and \$1.00 each. These can be sown any time and, planted outside in the Spring, will give you bushels of flowers in early fall, or plants can be lifted and potted when in flower.

— ALSO —

WELLS' NEW HYBRID PENTSTEMONS

This is a new race that shows the most glorious combinations of colors in scarlet, crimson, pink and white. The plants grow 2½ feet high and the flower spike is 18 inches long. No one who has not seen it can form any idea of the brilliant display a bed of these plants presents. No trouble to grow. Simply prick off the seedlings, like asters, and plant outside in May.

Trade packets, 25c and \$1.00 each. Hundreds of seeds in a packet.

CHARLES H. TOTTY, Madison, N. J.

Newport Fairy

The Rose of the Future For In and Out Door.

FINE, STRONG FIELD-GROWN STOCK
3-4 Shoots 3-4 ft. long

50c each, \$30 per 100, \$250 per 1000

JULIUS ROEHRS CO.,
RUTHERFORD, N. J.

ROSES

We have a fine stock of large, dormant field-grown plants, on own roots, including Crimson Rambler, Dorothy Perkins, Clio, Alfred Colomb, Francois Levet, Jack, Prince Camille de Rohan, Magda Charta, Ulrich Brunner, Giant of Battles, and many others at \$16.00 per hundred; \$150.00 per thousand. Send for list. Roses, Dahlias and Cannas a specialty.

THE DINGBE & CONARD CO. W. Grove, Pa.

SHAMROCK

IRISH. THE REAL THING! GREEN.

Best to order early and grow on for strong plants for St. Patrick's Day. Our stock is very fine. \$4.00 per 100, or post-paid 60c. per dozen.

JOHN F. RUPP, Shiremanstown, Pa.
RUPPTON: The Home of Primroses.

Hardy Herbaceous Perennials

Well-grown plants of all the standard varieties at reasonable rates.

SEND FOR TRADE CATALOG.

DANIEL A. CLARKE
RED OAK NURSERIES, Fiskeville, R.I.



CHRYSANTHEMUM BELFAST

BELFAST

The New Christmas-Flowering Chrysanthemum

Of the largest size light pink shading to cream. Can be brought into bloom from Thanksgiving to Easter but is at its best about Christmas. Easily grown and claimed to be for the commercial growers the most profitable variety ever introduced. It comes into bloom after every other variety is through, is a great keeper and can be held on the plants for four weeks. Last Spring the originator cut the last blooms April 11. 2½ inch pots 50c., \$5 per doz.; rooted cuttings \$3.50 per doz., \$18 per 100.

Carnation Bay State

Winner of the Gold Medal at Indianapolis. From ¾ inch pots, \$3 per doz. Rooted cuttings of all other desirable varieties, old and new, at lowest prices.

Tuberous, Caladiums, Gloxinias, Tuberous rooted Begonias, Florists' Flower Seeds and Sundries.

Send for Wholesale Price List.

SCHLEGEL & FOTTLER CO.
26-27 So. Market St., Boston

REMEMBER

CHRYSANTHEMUMS

Can be grown smaller than those displayed on the show tables. Some kinds are worthless unless grown to the top notch, others make perfect flowers if not of the largest size.

We grow kinds best for Florists' use in quantity, also for other purposes.

Correspondence Solicited. Catalogue Free.

ELMER D. SMITH & CO, ADRIAN, MICH.

New Rose **White Killarney**

Come and see White Killarney growing at our Scarborough houses, and you will say at once, as every one does who has seen it, it is

The Best White Rose

they have ever seen. You need it if you want to be up to the times, and it will pay you better than any other white rose that you can plant. You will regret it if you do not plant it this year, and you will not regret it if you do.

Big lots are being booked. Get your order in early. Send us order at once, while you think of it. Get early stock. It will not cost you any more to order to-day, while you think of it, than it will two months from now. Be the early bird that catches the worm.

Strong young plants, 2 1/2-inch pots, own-root, ready for delivery beginning February 15th, 1909, \$30.00 per 100; 250 for \$70.00; 500 for \$125.00; 1000 for \$250.00. Grafted plants, ready for delivery beginning March 1st, 1909, \$5.00 per 100 additional.

F. R. PIERSON CO., Tarrytown-on-Hudson NEW YORK.

VIBURNUM MOLLE

10,000 of this useful viburnum 2 to 3 ft. and 3 to 4 ft.

Write for prices on these and other good things

EASTERN NURSERIES

HENRY S. DAWSON, Manager. JAMAICA PLAIN, MASS.

Hardy Rhododendrons, Azaleas, Conifers, Clematis, H. P. Roses, Shrubs and Herbaceous Plants from our **HOLLAND NURSERIES**

Prices Moderate

P. OUWERKERK, 216 Jane St., Weehawken Heights P. O. No. 1, Hoboken, N. J.

GLEARY'S HORTICULTURAL CO.

Management AMBROSE T. CLEARY

Wholesale Contracting, Jobbing, Auction **HORTICULTURAL PRODUCTS** or every description.

Consignments Received. Surplus Stock Converted
62 Vesey St., NEW YORK

Box Trees

and other **EVERGREENS** for Tubs and Boxes
Our Prices are Always Right—Catalog Free
THE NEW ENGLAND NURSERIES, Inc.
BEDFORD, MASS.

ROBERT CRAIG CO.

ROSES, PALMS,

and Novelties in Decorative Plants
MARKET and 49th STREETS., PHILADELPHIA, PA.

Guaranteed Nursery Stock

Of All Varieties and Sizes
WRITE FOR LOWEST PRICES

P. HAMILTON GOODSSELL

200 BROADWAY NEW YORK

BARGAINS IN TREES and PLANTS

Concord Grapes, Saco, Peach, \$3.00 per 100.
List Free. D. J. TWOMEY, Dept. H, Geneva, N. Y.

RHODODENDRONS, ANDROMEDES, KALMIAS AND SPECIMEN EVERGREENS

JOHN WATERER & SONS, Ltd.

AMERICAN NURSERY

BAGSHOT - - - ENGLAND

TREES, EVERGREENS, SHRUBS, VINES, PERENNIAL PLANTS, FRUITS, TRAINED FRUIT TREES, FOREIGN GRAPE VINES, HARDY RHODODENDRONS and R. MAXIMUM in quantity, per hundred or per thousand, very fine. Complete assortments: Careful grading: Low prices.

AMERICAN NURSERY COMPANY,

Sales Department, - - - 150 BROADWAY, NEW YORK CITY.
BLOODGOOD NURSERIES DEPT., - - - Flushing, Long Island.
F. & F. NURSERIES DEPT., - - - Springfield, New Jersey.

RHODODENDRONS-RHODODENDRONS

An immense stock of all the **hardest known kinds**, 2 to 3 1/2 ft., fine plants and all home grown, many being on own roots, far better than grafted stock—also **R. Catawbiense seedlings** of all colors and **seedling Hardy Azaleas** not to be obtained elsewhere. **Best** this is the nursery in which most of the Rhododendrons that have proved **hardy in America** were raised.

GOLDEN YEWS, KALMIAS, and other **HARDY PLANTS** in great variety and of all sizes.

Catalogues on Application

ANTHONY WATERER **KNAP HILL NURSERY** **KNAP HILL**
SURREY, ENGLAND

NO CONNECTION WHATEVER WITH ANY OTHER FIRM.

NURSERY STOCK FOR FLORISTS' TRADE

AMERICAN GROWN ROSES, AZALEAS, RHODODENDRONS
FRUIT AND ORNAMENTAL TREES, SHRUBS, SMALL FRUITS, CLEMATIS,
EVERGREENS

WRITE FOR OUR TRADE LIST

W. & T. SMITH COMPANY **63 YEARS** **GENEVA, N. Y.**
700 ACRES

In writing to Advertisers kindly mention Horticulture

Cypripedium Ursula

This pretty seedling has just flowered in the Wyndhurst collection, from seed sown in February, 1901. It is a little gem, showing strongly the characteristics of the pollen parent *Niobe Shorthillense*, but larger in every detail. The dorsal strongly favors the seed parent *Leeanum Clink* a *berryanum* in shape, but instead of the characteristic spots of that variety, it is beautifully colored, with *Niobe's* blood, radiating from the base until lost in the pure white above. The petals are deeply corrugated on upper edge as in *Niobe* but the influence of *C. Specerianum* is shown in the coloring, and also in the shape of the pouch, which is very wide at the top, the points touching the petals on either side, as seen in the accompanying photograph. It is a well-shaped flower, and a very desirable addition to our collection.

ALFRED J. LOVELESS.

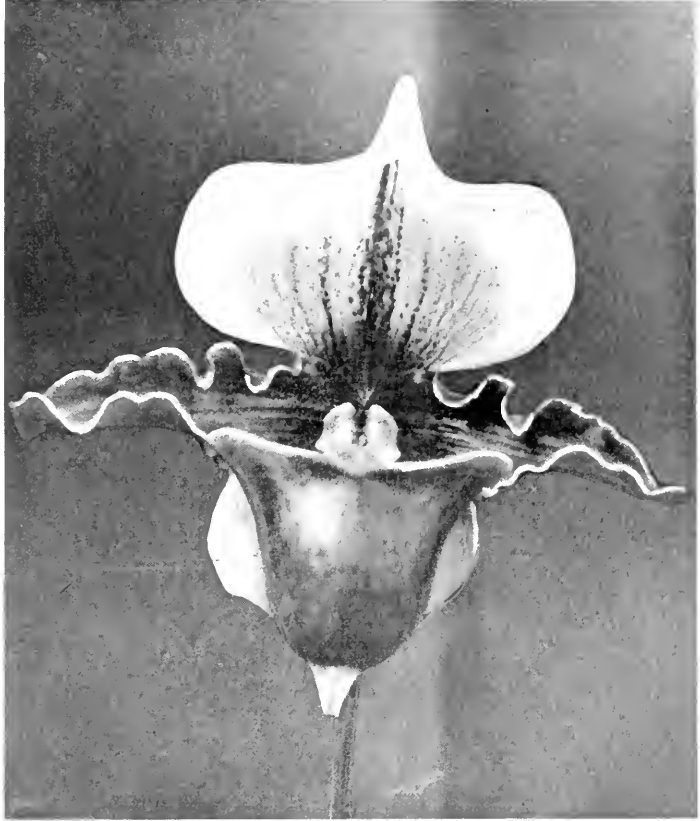

European Horticulture

REMARKABLE PLANTS AT THE ROYAL HORTICULTURAL MEETING FEBRUARY 9, 1909

Notwithstanding the cold weather prevailing at the last meeting of this society the floral display was an especially fine one, orchids, primulas, cyclamens, and forced plants of all kinds being shown in large numbers. Lieut. Colonel Halford showed among other orchids a magnificent plant of *Odontoglossum crispum Harryanum* with three main spikes measuring from 3 to 5 feet in length, the longest having seven subsidiary, short branches. The plant was growing in a 10-inch pot. The same exhibitor showed plants of *Laelio-Cattleya Goldfinch superba*, a hybrid having golden yellow sepals and petals, as is also the base of the throat. The lip is of glowing purple. The hybrid is the result of a cross between *Laelio-Cattleya Warmhamensis* and *Cattleya aurea*. A few other hybrids having similar golden tints on petals and sepals, but various markings and striations were likewise noticed.

Mr. Cookson of Wylam on Tyne, a famous orchidophile, showed many fine plants including the beautiful *Odontoglossum ardentissima Petersii*, and varieties of *Od. Pescatorei*, and was the recipient of a Gold Flora

medal. Mr. Cookson showed a *Brasso-Laelio-Cattleya* named *Cooksoni*, the flowers of an orange-creamy tint. It is scarcely a very showy flower, but is interesting as an example of what hybridists are doing among the most diverse species.

Sir W. Marriott showed one curious hybrid in *Sophracattleya Ceres*, a small sized crimson bloom, and another of *Sophracattleya Marriottiana*, an equally small bloom of vivid crimson. Messrs. Charlesworth & Co. contributed a large collection of orchids. Among their plants there were observed the gorgeous *Cattleya Enid*, a cross between *C. Mossiae* and *C. gigas*; *Laelio-Cattleya Myra*, a splendid flower with a tip of the deepest purple tint; a *Laelio-Cattleya callistoglossa magnifica*; *Brasso-Laelia Helen*, the result of crossing *L. tenebrosa* and *Brassavola Digbyana*. Numerous *Phalaenopsis intermedia*, *P. Schilleriana* var. *vestalis*, *Miltonia Hyland* and *Cattleya* were shown. Among *Cypripediums*, *Thompsoni* was conspicuous, having moss-green colored petals and sepals, and a dorsal sepal of white, purple-tinted at its base. Messrs. Hugh Low; Cypher & Sons; Moore & Co., Ltd., were exhibitors of choice orchids, receiving various awards. Messrs. H. Cannell & Sons

were the exhibitors of a capital lot of *Primula sinensis*. The varieties shown were quite up to their usual high standard, in particular Miss Caroline Ward, White Perfection, Pink Perfection, and Mr. Herbert Bennett, a flower of a pale purple tint, etc.

Mr. Geo. Mount exhibited fine cut blooms of H. T. Rose Joseph Lowe, a salmon pink sport from Mrs. W. J. Grant, with more substance, however, in the flowers. Cyclamens of the grandiflora strain were finely shown by Mr. W. Seward for which he was awarded a silver gilt Banksian medal. A considerable number of *Primula obconica* and *P. o. gigantea* were shown by Mr. T. Ware, showing finer trusses, more decided coloring, and robust growth, than has hitherto been the case with these useful decorative plants.

EUPHORBIA SAPINII

The Gardeners' Chronicle (English) published an account, accompanied by a figure of this interesting plant growing in the Botanic Garden, Brussels. In some respects the plant resembles *E. bupleurifolia*, Jacq, a native of South Africa. This has an erect stem, thick and succulent, and marked all over with the scars occasioned by the falling away of the old leaves, and thus presents a reticulated appearance. The leaves form a terminal cluster, are 4 to 6 inches in length, bright green with a white midrib, and the flowers are yellow. The scars of *E. Sapinii* are swollen and mamillate, and when young they are green and each is furnished with a hard spine, which seems to fall off about the third year. The flowers and bracts are very small, and are produced on very short peduncles from the axils of the leaves. The Brussels plant was introduced from the Congo.

SINNINGIA HYBRIDA (HORT.) DR. MAXWELL T. MASTERS

This is a hybrid plant raised by Herrn E. Benary of Erfurt, and named after the late editor of the "Gardeners' Chronicle." It is stated to be a cross between the *Gloxinia* of gardens, and a species of *Gesneria*. The blooms are drooping, very freely produced, and of a pink color. The petioles are of greater length than in most *Gloxinias* and the roundish ovate leaves are soft and silky to the touch.

Dunderberg Snow

Rocky Mountain Rambles

VI.

In ascending the valley to cross the divide between the Yellowstone and the Gallatin, one has a good view of some of the snow capped peaks of the Yellowstone, and in the low range of mountains known as the Bozeman, along the railroad, one gets a glimpse of arid farming; in these mountain valleys many hundred acres of grain are cultivated without irrigation, in the foothills. There is nothing unusual or striking in the vegetation as we slowly wind up the valley, now on one side of the mountain stream and then on another. Here we found the usual fringe of willow, osier, birch, alder, and Lodge Pole Pine on the steeper slopes, with a few flexile White Pine. At some vantage point we look down on the beautiful Gallatin Valley, one mass of green with

large ranches, green pastures, and grain fields. Going down the valley we came in sight of Bozeman, where is located the Agricultural College, a superb location.

Our train rapidly passes on down the valley and we soon see the famous forks of the Missouri, where the Gallatin, Madison and the old Jefferson meet to form the great stream of the Missouri, which flows northward. We pass up a fork of the old Jefferson but soon leave the stream and reach the divide. The most striking tree here is the Douglas Fir and like many other parts of the Rockies this area is characterized by large areas which have been burned over. This destroys its capacity for retaining water in the soil, so the run off is rapid in the spring.

On the other side of the divide the waters flow to-



The Summer Home of Marcus A. Daly, near Hamilton, Montana. The grounds used to be well kept, a large lawn and splendidly arranged trees.

wards the Pacific and before us lies the Deer Lodge Valley with the city of smelters, Butte and Anaconda. In the environs of Anaconda everything is desolation. The waters of Silver Bow Creek and other streams coming from the mountains are clear but after the discharge from the smelters they are muddy. The streams are not lined with green willows, birches, and alders, but in places dead remains of the various plants, which have been killed by copper sulphate which is contained in the water, are seen. The arsenical and sulphur dioxide fumes also contribute to the killing of these plants.

The mining industry is an important one but some better way should be devised to eliminate these poisonous substances from the water. In a suit brought by one of the ranchers who utilized the water from the Deer Lodge River to irrigate his farm, he lost his case because it was contended by the smelting people of Anaconda and Butte that the water was not injurious and the mining interests were much greater than the agri-

cultural. However, the injurious effects may be observed for fifty miles down the river.

The low mountains this side of Missoula contain the Yellow Pine, Douglas Fir, and the striking western Larch (*Larix occidentalis*) which we found up the canon. During the last part of August it began to lose its foliage and gave the landscape a yellow appearance, indicating the approach of winter.

On our way out, during the middle of July the landscape of the mountains was one mass of green and the valleys aglow with flowers. From Missoula we went up the Bitter Root Valley passing through the old settlements at Stevensville, and the growing villages of Carlton, Coalville, and Hamilton. Hamilton is the county seat of Ravalli County, made famous by the large and splendidly equipped ranches of Marcus A. Daly, who established a beautiful country home near this place. The country hereabouts has become famous as an apple and potato country.

The range of the Bitter Root Mountains from which the waters of the stream of this name come, on the whole is not a lofty one, the highest peaks being about eleven thousand feet high. The mountains are fairly well timbered. There are few lakes and comparatively few meadows in the area visited.

The lower foothills consist of bare slopes with a few trees. These consist of scattered groves of *Pinus ponderosa*, common desert plants like *Artemisia tridentata*, *Purshia tridentata*, and *Achillea millefolium*. The benches on the west slope of the mountains were once thickly covered with *Pinus ponderosa*, which has largely been removed through the operation of large lumber companies.

There is a well marked zonal distribution of the several conifers found in these mountains. The lower zone is occupied by the Yellow Pine (*Pinus ponderosa*), followed by the *Pseudotsuga Douglasii*. This is followed by the Lodge Pole Pine (*Pinus Murrayana*). The *Pinus flexilis* occupies the upper zone of the Lodge Pole Pine region. Engelmann Spruce (*Picea Engelmannii*) and Fir (*Abies subalpina*) occur in the canons and narrow valleys of the streams extending over a considerable altitude, from four thousand feet to timber line.

The Yellow Pine has admirably adapted itself to all the lower, drier slopes; much of this very rocky. The soil is rather thin, but well drained. The young trees are usually scattered in the forest, but when protected they grow as thickly as the Lodge Pole Pine. This pine makes a fairly rapid growth.

The Bitter Root forest reserve is partly located in Montana and partly in Idaho. The eastern part of the reserve has its watershed in the Bitter Root Valley; in the western part of the reserve the water flows to the Clear Water and the Salem Rivers. On the mountain slopes and in the valleys ferns overhang the rocks. Here too we meet the Western *Arbor vitae* (*Tinaja plicata*), a magnificent tree.

In the Lodge Pole Pine zone there are a number of most interesting plants like the Rocky Mountain Columbine, Arnica, Valerian, Bryanthus (*Bryanthus empetrifolia*), Moosegrass (*Xerophyllum Douglasii*) and Gilia.

There are very few open parks in this country. The most extensive visited was at an altitude of 7,500 feet near the head waters of the Blue Joint. At this point

occurring on the outlying lower slopes are groves of the *Pseudotsuga Douglasii* and *P. Murrayana*; farther up on the highest points some *Abies subalpina*, *P. flexilis*, and a little Engelmann Spruce. The most abundant of all, however, was the Lodge Pole Pine. In these open meadows there was an abundance of a Wheat Grass (*Agropyron dasystachyum*), a beautiful blue flower flax the *Linum Lewisii*, which is well known in cultivation, Silver Plant (*Eriogonum umbellatum*) and Blue Grass (*Poa pratensis*), and other Poas; Yarrow (*Achillea millefolium*), antennaria and two species of blue-flowered Aster.

Overhanging the brooks in moist places an abundance of several species of Asters, Erigerons, the *Saxifraga punctata*, *Aconitum columbianum*, *Luzula spadicera*, *Aspidium lochitis*, *Asplenium septentrionale*.

During the middle of August when we were camped between 7,000 and 8,000 feet altitude, the nights were cold. It froze ice every night, while the plants were frozen hard in the morning, but after the sun came out the plants were as green as during the spring season,

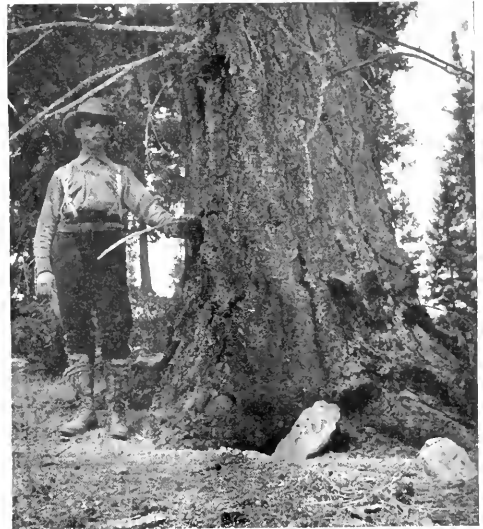

The Douglass Fir in the Bitter Root Mountains. Note the thick bark, an admirable protection against fire.

and the parks and woods were aglow with the *Mimulus Lewisii* and *Aconitum*.

Some of the cultivated plants, especially the forage plants, have been widely naturalized. Red Clover (*Trifolium pratense*), White Clover (*T. repens*), Timothy (*Phleum pratense*), and Blue Grass (*Poa pratensis*), have followed the trails far beyond present limits of the cultivated areas. The clovers are found miles beyond the settlements, frequently along old trails or where lumbering operations were formerly carried on. Fruit culture is successful in the Bitter Root Valley and its tributaries up to altitudes somewhat above 4,000 feet. Orchards have been planted where frosts occur nearly every week in the year. The culture of the potato occurs at altitudes somewhat higher than the apple. Cherries (*Prunus cerasus*), *Prunus domestica* and peaches succeed in the Bitter Root Valley.

HORTICULTURE

VOL. IX FEBRUARY 27, 1909 NO. 9

PUBLISHED WEEKLY BY

HORTICULTURE PUBLISHING CO.
11 Hamilton Place, Boston, Mass.

Telephone, Oxford 377
WM. J. STEWART, Editor and Manager

SUBSCRIPTION PRICE

One Year, in advance, \$1.00. To Foreign Countries, 2.00; To Canada, \$1.50

ADVERTISING RATES

Per Inch, 30 inches to page \$1.00.
 Discounts on Contracts for consecutive insertions, as follows:
 One month (4 times) 5 per cent., three months (12 times) 10 per cent.,
 six months (16 times) 20 per cent., one year (52 times) 30 per cent.
 Page and half page spaces, special rates on application

Entered as second-class matter December 8, 1904, at the Post Office at Boston, Mass., under the Act of Congress of March 3, 1879.

CONTENTS

	Page
COVER ILLUSTRATION—Pierson's Pink	
CYPRIPEDIUM URSULA—Alfred I. Lovelace, Illustrated	277
EUROPEAN HORTICULTURE—Frederick Moore	277
ROCKY MOUNTAIN RAMBLES—Prof. L. H. Pammel, Illustrated	278
AFTER ADJOURNMENT	281
A FIRST PRIZE PLANT GROUP—G. C. W., Illustrated	281
NEWS OF THE CLUBS AND SOCIETIES:	
Illinois State Florists' Association—Washington State Horticultural Association, J. L. Dumas, Portrait—Huntington Horticultural and Agricultural Society—American Rose Society—Gardeners' and Florists' Club of Baltimore	282
National Sweet Pea Society—W. H. Adsett—North Shore Horticultural Society—Newport Horticultural Society—New York Florists' Club—Club and Society Notes	283
DURING RECESS	
Fun in Prospect at Philadelphia—A Good Time at Minneapolis—Albany Florists' Club—Last Call for Dinner	284
OBITUARY:	
George Hemler—Henry S. Terry—Paul Thomson	285
FEEDING THE CROPS—Wm. H. Bowker	286
REGISTRATION OF ORCHIDS—E. O. Orpet	287
"OUR EXPERIMENT STATION"—Prof. H. B. Dornier	288
SEED TRADE—A Utica Seed Store	292
OF INTEREST TO RETAIL FLOWERS:	
New Flower Stores—A Family of Florists—Steamer Departures—Notes	294
FLOWER MARKET REPORTS:	
Baltimore, Boston, Buffalo, Chicago, Philadelphia, Washington	297
New York	299
MISCELLANEOUS:	
A New Plant Label	281
Dahlia Imperialis	283
A Wedding Decoration, Illustrated	285
Greater Boston	284
Personal	285
Publications Received	285
Snow Wrecked Greenhouse, Illustrated	299
Fire Record	296
Incorporated	290
Patents Granted	291
Catalogues Received	292
News Notes	292-297
Accidental Shooting	297
In Bankruptcy	299
Business Changes	299
The Florianer Rose Apple	294
Greenhouses Building or Contemplated	293

Time for a forward movement

Surely, gaining momentum every day, business is improving on all lines. We all feel it and see it and no one can doubt that, barring unforeseen calamities, the promised tide of pros-

perity has set in and we are full of the hopeful spirit which is born of the conviction of another period of "good times" close at hand. Now is the time to "get a move on," to leave apprehension and timidity behind, and to take a big, confident, courageous step forward, seeing that "Fortune is merry and in this mood will give us anything."

It is not unusual for one to be called upon to listen to the recital of the business troubles of an acquaintance and among the commonest of these complaints is that of the dishonesty of some former partner or employee. No doubt the majority of our readers who have been at all in touch with business activities of any extent have had the same experience as ourselves in being made the confidant in troubles of this sort. We are not now going to find fault with the victim for complaining but rather wish to drive home another word on a subject on which we have often held forth—that of the urgent need of a more general adoption by producers and dealers in greenhouse products of modern business methods and up-to-date facilities for stock accounting, sales recording and bill collecting. It is a very poor commentary on any man's business system and natural sagacity that in an avocation so simple in its transactions he can be plucked and plundered month after month and year after year and never suspect it. Absolute immunity is, we grant, impossible but in almost every instance to which our attention has been called, a reasonable insistence upon accuracy in accounting and the systematic use of proper safeguards would have served both as restraint and preventive. The tendency in all mercantile circles, today, is toward shorter accounts and a simplifying of credit systems. No industry needs the reform more than do those the interests of which HORTICULTURE seeks to advance.

Education by precept and practice

The series of talks to the floricultural classes at Amherst Agricultural College by practical men representing the various departments of the florists' industry this season have created unusual interest among the students and given much satisfaction to the instructors and officials. This awakening to a realization that floriculture presents something more than seed germination and botanical analysis, to which attention may be given in regular college work is, happily, not confined to Amherst but is already well under way in several other State agricultural institutions and many more are showing a leaning that way. In this connection, we would call our readers' attention to the very interesting account, which appears on another page of this paper, by Prof. Dornier, of the up-to-date equipment which has been installed at Urbana. Let us hope that every State institution may in the near future be as well provided for. There are, here and there throughout the country, young men—many of them florists' sons—who having had the advantage of an agricultural college education are rapidly rising to prominence and giving evidence that in the near future they will be the big men of their profession. These have in many cases benefited by the practical knowledge gained at home, supplementing the more theoretical college training. The disposition now shown by the colleges to call in the working florist as a coeducator will help wonderfully in a direction in which these institutions have been regarded by many as deficient and will prove particularly serviceable to those young men who have not had the benefit of any previous contact with the practical problems of the business.

After Adjournment

Just the time to buy hot-bed sash, and the tempting offer of the Gordon-Van Tine Company "hitteth ye naile on ye hed." See their advertisement.

Watch the returns from the Flower Market Show in Boston, which we shall publish in full next week. It is within the range of the possibilities that the carnation situation may take on a new aspect after the committees and judges have reported. Indianapolis was all right, but there are a few more counties to be heard from.

If you come to the Boston show take a little time to run down to Bedford street and interview the Revere Rubber Company about that non-kinkable Revere Hose. It has other good points also which they can convincingly explain. If you miss the visit to Boston send to them for a sample.

Meyer, the manufacturer of silk-line, tells us that buyers who have been misled into buying other "just as good thread" because it was cheaper are returning to their first love—the only green thread for stringing asparagus and smilax, and tying up Easter lilies, etc., which is reliable for strength, smoothness and unfading color. His adv. is always in HORTICULTURE.

Delaware farmers want the Legislature to pass a law which will exclude all save Delawareans from selling produce in the Wilmington market. In retaliation, the rest of the country will have to adopt a prohibitory tariff on Delaware peaches. Lots of peaches right here in Washington, anyhow.—Washington Times.

Peaches? Yes, Washington is full of them, and George C. Watson rises to remark that it doesn't take the freestone long to turn into cling-stones down there, either.

The "African jungle flower," as our old friend of fetid odor, *Amorphophallus Rivieri*, is called has been making a stir again, this time in Philadelphia and the fearsome story of its strange antics, "as yet uncatalogued in any horticultural book in this or any other country," to which the Philadelphia Record devotes nearly two columns of valuable (?) space, is so startlingly realistic that our readers will do well to refrain from reading it before going to bed. The dream of the "rabbit fiend" isn't a circumstance to it.

Penneck-Meehan Co.'s new venture, which we mentioned last week and which is announced in our advertising columns in this issue—the opening of a wholesale and commission establishment in Washington for the benefit of the retail dealers of the Capital City—looks to us like a piece of very sagacious business enterprise. The possibilities of Washington as a metropolis have not properly dawned upon the American people. As loyal Bostonians we cannot quite subscribe to the declaration of W. R. Smith, that Washington is about to supplant Boston as the "Hub of the Universe," but we are prepared for almost anything else that may develop in the case of the great city on the Potomac. And Penneck

A FIRST PRIZE PLANT GROUP.

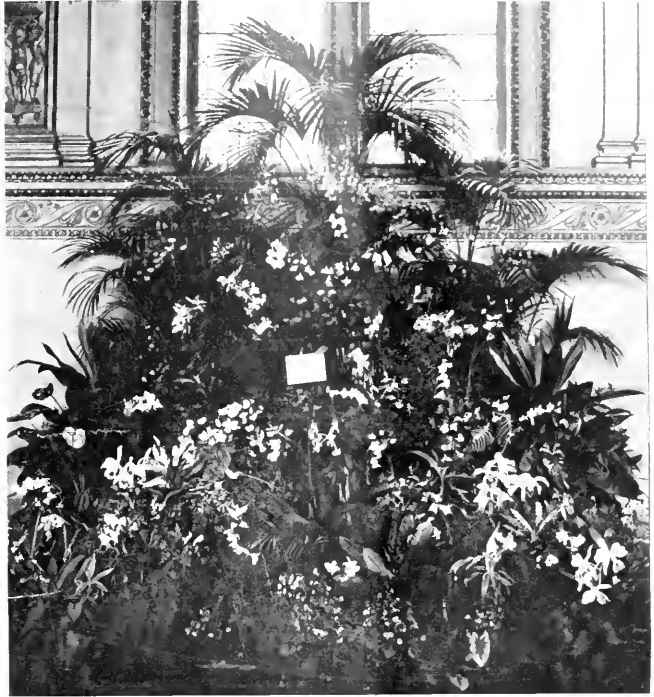

For many years the Dodds' groups of foliage and flowering plants at the Philadelphia shows have carried first honors. Owing to being arranged against the wall and in poor light a good photograph of same has never eventuated. The present illustration by W. H. Rau, while far from satisfactory, is the best we have yet seen.

has evidently done the right thing at the right time.

Jewel, Lemon or Gold Brick?

Luther Burlank has sent to the Portland (Ore.) Rose Festival Association a new rose of his raising which is to be called the "Rose of Oregon" and which Mr. Burlank, with characteristic modesty, declares to be "the most beautiful rose he has ever seen," so says the Portland Journal, which adds: "The committee is willing to trust to his judgment and consequently expectations are great." The rest of the world will try to control its impatience and await with tearful interest the debut of this "most beautiful" creation.

A NEW PLANT LABEL.

The "Alu" plant label is the newest thing in this indispensable garden supply. The metal from which the label is made is aluminum, and it is claimed to be indestructible. By means of a narrow strip of the metal the label can be readily attached to the plant without a rivet of any kind. The strip or strip admits of the label being inserted into the soil.

Many competitors wonder why Dodds usually comes out first. It would be just as easy to tell why one poem is better than another. Dodds couldn't tell himself to save his life. Good plants, simplicity, balance, but above all not too much, is what in our opinion does the winning. Most exhibitors are so anxious that they overcrowd.

G. C. W.

DAHLIA IMPERIALIS.

At a regular meeting of the Newport Horticultural Society held on the evening of Feb. 9th, James Hooper, gardener at the T. K. Gibbs estate, had on exhibition a few handsome flowers of *Dahlia Imperialis* which were examined by a committee consisting of John T. Allan, A. S. Meikle and J. B. Urquhart, and awarded a first class certificate of merit. This dahlia is a distinct species known as the Lily Dahlia, and although grown to some extent in California, is but little known in this section of the country. Mr. Hooper grows it in a greenhouse with a moderate temperature under which conditions it seems to be well adapted for a winter flowering plant, and the following is its description: The plants grow to a height of 10 to 15 feet with heavy spreading foliage, flowers large and drooping with eight rather broad petals of a delicate pinkish ivory color, the yellow disc being encircled by a narrow ring, thus completing a very pleasing combination.

NEWS OF THE CLUBS AND SOCIETIES

ILLINOIS STATE FLORISTS' ASSOCIATION.

The annual convention of this association at Springfield, Ill., of which we gave a partial account in last week's issue closed on Wednesday evening after a very successful meeting. Officers elected were E. G. Gullett, Lincoln, president; G. B. Franks, Champaign, vice-president; J. E. Annemann, Edwardsville, secretary; and F. L. Washburn, Bloomington, treasurer.

Urbana was selected as the meeting place for 1910.

The Springfield Florists' Club gave an elaborate banquet to the visitors at St. Nicholas hotel on Wednesday evening. Charles E. Hay was toastmaster. The toasts were as follows:

Recessions.—On the Carnation Horizon, by W. N. Ridd.

Current Topics.—From a Professional Viewpoint, by Prof. H. B. Dornier.

Inspirations of a Flower Show, by George Asmus.

Springfield: Past, Present and Future, by N. R. Roberts.

The Western End—Is It a Perennial? by Albert T. Hoy.

Showbound In a Friendly Community, by George H. Augermueller.

Afterglow of the American Carnation Society Meeting, by J. E. Annemann.

Report of The Exhibition Judges.

Your judges of the exhibition respectfully report exhibits made by sixteen exhibitors, as follows:

Chicago Carnation Co., Joliet. Vase of Carnation Compest, 86 points (certificate of merit); honorable mention for vases of Melody, White Perfection, Benon, Winsor and Andrew Carnegie; vases of Aristocrat, White Enchantress, Sarah Hill, Splendor, Enchantress and Lawson Enchantress.

Mount Greenwood Cemetery Association, Morgan Park Vase of Carnation Mt. Greenwood, salmon pink, 86 points (certificate of merit); honorable mention for vase of Mrs. J. C. Vaughan carnations; also vase of Seedling 1004 C (certificates exhibited).

Baur & Smith, Indianapolis, Ind. Vase of Shasta carnations (white), 80 points (certificate of merit).

St. Clair Floral Co., Belleville. Vase of Seedling Carnation No. 24 (dark pink), 82 points.

Belle Miller, Springfield. Honorable mention for vases of Variegated Lawson and Mrs. F. W. Lawson; vases of White Perfection, Lady Bonafid and Winsor also exhibited.

Bassett & Washburn, Chicago. Vase of Carnation J. P. Bassett, 86 points (certificate of merit).

A. C. Brown, Springfield. Vase of Superior (pink), 90 points (certificate of merit); Singano (silver pink), 87 points (certificate of merit); Clara May (pink), 82 points; Gay (between purple), 81 points; also vases of Rose Pink Enchantress, Mrs. Totten and 25 seedlings.

Highland Park Greenhouses, Highland Park. Vase of Carnation Lucille (white with shell pink center), 85 points (certificate of merit).

J. E. Annemann, Edwardsville. Honorable mention for vase of Mrs. Potter Palmer; vases of Hope roses, Itha Red, Killarney, Richmond, Chatteray and Alice Roosevelt, also exhibited.

Berthemann Bros., Indianapolis, Ind. Vase of Carnation James Whitecomb Riley (yellow), 87 points, certificate of merit.

Springfield Potter & Mfg. Co. Model Steel internally fired boiler and photo plants.

With A Group, Springfield. Vases of White Lawson, Enchantress, Lady Bonafid and White Enchantress.

W. H. Gullett Sons, Lincoln. Vases of Belle and Ebbelswald roses, honorable mention.

Plants.

A. C. Brown, Springfield. Group of Carnation azuleas and pink carnations.

Carl Reuth, Springfield. Group of various carnations, pelvies, ferns and pans of tulips.

Vernon's Seed Store, Chicago. A line of

flowering and decorative plants, dormant stock and bulbs.

W. Cheimer Bros., New York. General displays of novelties in ribbons, etc.

Miscellaneous.

J. N. Pillsbury, Galesburg. Vase of split carnations, mended with the Pillsbury staples, which we consider a very good thing.

American Flower Co., Detroit, Mich.—Model steam trap.

Lonia Lottery Co., Lonia, Mich. General display of white flower pots, vases, wire hanging baskets and wire designs.

Geo. A. Garland, Beech Plains, Ill. Section of greenhouse showing new truss work, gutters, etc.

Kreischell Bros. Co., Chicago.—Model of heating boiler.

J. C. Moutier Co., Chicago. Section of greenhouse showing new ice clearing hinge.

WASHINGTON STATE HORTICULTURAL ASSOCIATION.

J. L. Dumas, of Dayton who was elected to the presidency of the Washington State Horticultural Association at the annual meeting in Spokane, is a



J. L. DUMAS

President Washington State Horticultural Association.

practical horticulturist and has made a success of apple growing. Mr. Dumas is a native of Missouri, born in Clark county in 1862. He left the old homestead to become a teacher, coming to Washington in 1882, when he entered Whitman College at Walla Walla. After working his way through college he went to Oswego, N. Y., where he attended the Normal and training school, graduating in 1890. He then went to Hawaii as principal of the Honolulu Normal and Training school, and while there he served as lieutenant in the Citizens' Guard during the reconstruction period and was made a citizen under the government without forewarning his allegiance to the United States. He returned to Washington in 1897 and bought 140 acres of land in the Touchet valley. Since then he has served as superintendent of the public schools at Pullman. He was president of the Washington State Educational Association in 1903-4 and was a member of the State Board of Education from 1900 to 1902.

HUNTINGTON HORTICULTURAL AND AGRICULTURAL SOCIETY.

This society will hold its fifth annual carnation exhibition in Sammis' Hall, Huntington, L. L., Friday afternoon and evening, March 5, 1909. The exhibition committee is composed of John R. McCulloch (chairman), Walter Shaw, John D. Schwier, Mrs. W. H. Stoye, Mrs. F. W. Shadbill, Mrs. G. W. Totten, Josina Hurd, Adolph Altus, Richard Cartwright and A. H. Funnell, secretary.

Prizes consisting of certificates and diplomas will be awarded for Carnations as follows: 25 Lawson or other dark pink, 25 Enchantress or other light pink, 25 white, 25 scarlet, 25 crimson, 25 any other variety, 25 assorted, 25 any variety not disseminated; for Roses, 12 Teas, 12 any other variety; for Violets, 100 double, 100 single; for 25 freesias, 25 sweet peas, 12 mignonette, specimen blooming plant (orchids excluded), specimen orchid, specimen foliage plant, spring bulbous or other flowers, greenhouse vegetables.

Plants should be at the hall in the morning. Cut flowers not later than 2 p. m. on day of exhibition. Exhibits sent by express should be addressed in care of John R. McCulloch.

AMERICAN ROSE SOCIETY.

The Schedule Committee and the Executive Committee of the American Rose Society held joint session last Friday in New York City. President Pochmann appointed a committee to consider the examination and requirements of new roses. Robert Simpson of Clifton, N. J., was appointed Chairman. Application for recognition by the Society of three different roses was brought up. The Schedule Committee reported upon their work in revising the schedule, a preliminary copy of which has been published; a report was also given on the awarding of special prizes. The value of the prizes, as computed by Mr. Pierson, is equal to \$1000 at the present time. Several persons have advised us that they would like to put up special prizes for the Puffalo Exhibition and these prizes have not yet been received. The L'Arrouis Hotel will be the headquarters. Papers are being prepared by five different persons upon matters of pertinent interest. Leonard Baron has offered to give an illustrated lecture upon this occasion. All entries from a distance may be sent in care of Vice-President Wm. F. Kasting, 385 Ellicott St. The Exhibition will open Wednesday afternoon at 5 o'clock, March 17, and continue over the 18th and 19th.

BENJ. HAMMOND, Secretary.

GARDENERS' AND FLORISTS' CLUB OF BALTIMORE.

The regular semi-monthly meeting was held on February 22nd. At the next meeting, March 8th the election of officers for the ensuing year will take place, followed by a banquet at The Hotel Caswell cor. of Baltimore and Hanover streets.

NATIONAL SWEET PEA SOCIETY OF ENGLAND.

The committee's annual report recently circulated amongst the members of this society is a record of meritorious achievement, and steady progress. An attractive schedule has been prepared for the summer show. Amongst the prize donors are C. C. Morse & Co., Santa Clara, California, and W. Atlee Burpee, Philadelphia, who are offering prizes in classes for American sweet peas. The new "annual" issued by the Society is an acceptable addition to sweet pea literature. Amongst the articles is one by S. B. Dicks, entitled "Some American Notes." At the outset he gives the United States the credit of having been ten years ahead of Great Britain in popularizing the sweet pea. Working with the same materials as British florists, it is little wonder that the results are in many cases identical, and this has led to a regrettable duplication of names. At the same time, as the leading growers of the United States are some of the most generous supporters of the National Sweet Pea Society, and evince a desire to abide loyally by the decisions of its Floral Committee, there ought not to be any difficulty in bringing about a mutually satisfactory understanding."

W. H. ADSETT.

NORTH SHORE HORTICULTURAL SOCIETY.

At the regular meeting of this society, February 19, Wm. Swan, of the R. C. Hooper estate, showed five distinct sports of *Enchantress* carnation and a display of cut stocks.

Subjects for discussion were from the question box, "Sweet Peas" and "Plants for Christmas Blooming."

The Show Committee in preparing its schedule this year is offering more prizes for fruit than before. They are also offering medals to commercial men for herbaceous plants and gladioli. Schedules will be out soon. Lecture at the next meeting Mar. 5, by J. K. M. L. Farquhar on Dahlias.

ROBERT A. MITCHELL.

NEWPORT HORTICULTURAL SOCIETY.

The regular meeting of the above society was held on the evening of February 23rd, but the inclement weather prevented as large an attendance as usual and very little business was transacted. The executive committee had previously voted to recommend the holding of two exhibitions for the year as usual, and partly prepared a schedule for the June event, the Rose Show, but on account of the small number of members present the recommendation was not acted on at this regular meeting.

NEW YORK FLORISTS' CLUB.

The New York Florists' Club's next meeting, Monday night, March 8, will be "Rose Night." Harry O. May, secretary of the exhibition committee, tells us that already a large and very comprehensive exhibit is assured. Rose growers having anything in the way of new varieties or superior cultivation that they would like to have the New York experts see should not neglect this excellent opportunity.

A WEDDING DECORATION.



The accompanying picture shows, in part, the decoration of All Saints' Cathedral at Albany, N. Y., by H. G. Eyres & Co., for the Hun-Clark wedding. The front of the chancel which

is not shown in the illustration, was decorated with beech sprays, southern smilax and lilies. At the house Mr. Eyres used southern smilax, with American Beauty and white and pink Killarney.

CLUB AND SOCIETY NOTES.

On the evening of February 12 the Milwaukee (Wis.) Florists' Club had a dancing party in Miller's Hall. Four hundred were present and the hall was finely decorated.

E. V. Hallock, Queens, N. Y., president of the New York Florists' Club, will talk at the next meeting of the Gardeners' and Florists' Club of Boston, March 16, on "Bulbous and Tuberos Rooted Plants."

The annual banquet of the Lenox Horticultural Society will be held in Curtis Hotel, Lenox, Mass., March 1. The committee of arrangements is: Edward Jenkins (chairman), Alfred H. Winget, Frederick Hermans and Walter Jack.

The officers chosen for 1909 by the Connecticut Nurserymen's Association at their convention on February 1 at Hartford were: C. R. Burr, president; C. W. Atwater, Collinsville, vice-president; W. W. Hunt, Hartford, treasurer; J. Vidbourne, Hartford, secretary.

At the meeting of the Marion County Horticultural Society at Salem, Ore., on February 7, officers were elected as follows: President, C. J. Kurtz; first vice-president, John Pemberton; second vice-president, Enos Preshall; secretary and treasurer, E. C. Armstrong.

The regular meeting of the Buffalo Florists' Club will be held at their room on Tuesday, March 2nd and as very important matters are to be agreed upon, it is the wish of Pres. Sandford that every member be present on that evening. Election of officers for the ensuing year is on the program and a

lively election is looked for. Papers will be read by A. Bayers and Jos. Street.

At the monthly meeting of the Allen County Horticultural Society, at Iola, Kans., on February 12, the principal topic for consideration was the San Jose scale and the various methods for its destruction. Papers on Catalpa Trees and Berry Culture were presented.

Prof. E. A. Stone delivered a lecture with lantern slides on the evening of Feb. 15 before the Natural History Society at Newport, R. I., on Insects Injurious to Trees. The Newport Horticultural Society was well represented in the audience, and after the lecture comments and questions followed, among the speakers being President James Robertson, Alex MacLellan and other members of that organization.

A bill has been introduced at the State House, Boston, on petition of the firm of Morse & Beals, Lowell, Mass., by which the sale and delivery of flowers on the Lord's Day is authorized. This is the result of the recent order from the police stopping Lowell florists from doing any business on Sunday. There are two sections, as follows:

Senate Number 149—On petition of Morse & Beals, that the sale and delivery of fruit and flowers on the Lord's Day may be authorized. Hearing scheduled to be held before the committee on legal affairs.

Section 1—It shall be lawful for retail dealers in fruit and flowers to sell and deliver the same on the Lord's Day, subject to such restrictions as may be imposed by the licensing board in the city or town where the sale or delivery is made.

Section 2—All acts and parts of acts inconsistent herewith are hereby repealed.

MR. CARNATION GROWER:

Do you appreciate a valued carnation when you see it?

Well, go to the Horticultural Hall on February 27th or 28th at Boston and look at my NEW VARIEGATED CARNATION MRS. PFEUFFER.

It is a money-maker, never bursts; flowers throughout the season, heaviest crop during December and January; a standard keeper and not inclined to disease, sells on sight; in total it has all good qualities a carnation for the commercial man should have and I can prove it as my grower, Mr. John Pfeuffer of Irvington, N. J., has it since 4 years and its vitality grows every year.

ROOTED CUTTINGS — Per 100, \$12.00. Per 1000, \$100.00

O. V. ZANGEN

HOBOKEN,

N. J.

During Recess

FUN IN PROSPECT AT PHILADELPHIA.

The tri-city series of games between Philadelphia, Baltimore and Washington, will be completed in Philadelphia (most likely at the Terminal Alleys) on March 23rd. Washington holds first place having won first at Washington and at Baltimore on the 17th inst. Baltimore rolled second in Washington and third in their home city. Philadelphia came in third at Washington and second at Baltimore. The games of the 23rd ult. are therefore only a matter of deciding second place, Washington having won two out of three. The scores were: at Washington—2472 for Washington, 2390 for Baltimore and 2257 for Philadelphia. At Baltimore—2692 for Washington, 2551 for Philadelphia, 2547 for Baltimore.

A GOOD TIME AT MINNEAPOLIS.

The first dance and social given under the auspices of the Minnesota State Florists' Association, on Feb. 15, was a great success.

Pres. Wirth with Mrs. Wirth led the grand march with about one hundred and forty couples following. About 11 o'clock the whole party lined up and marched to the profusely decorated dining hall, where supper was served. Very little time was spent at the tables as every one was eager for the dance hall and it was not until the early morning hours that the start for home was made. The whole affair was a cred-

it to the association and an encouragement to the members. The committee to whose efficient work the success is due consisted of Messrs. Olson, Boeglin, Nagel and Cady.

ALBANY FLORISTS' CLUB.

Members of the Albany Florists' Club enjoyed their fourth annual banquet at the New Kenmore on the evening of February 18. About forty members were present when President Fred Goldring assumed the duties of toastmaster. He asked for responses from John A. Howe, Jr., Fred A. Danker, James H. Snyder, Rhinebeck John C. McAllister, and Mr. Van Zonnevelt, a traveling salesman for a Holland bulb house. Features of the occasion were the very handsome table decorations contributed by the members and the presence of an orchestra which added much to the enjoyment of the evening. Patrick C. Hyde was chairman of the committee of arrangements.

"LAST CALL FOR DINNER."

This is our final notice of the 22nd annual banquet of the New York Florists' Club, on Saturday evening, Feb. 27th, 1909. The place, Shanley's, corner 42nd St. and Broadway; the hour, reception 7 p. m.; the menu, superb; the music, Prof. C. Van Vleet's famous orchestra; the talent, many vocal artists of high repute, W. J. Elliott and J. Austin Shaw, committee; the speeches, short and brilliant; the toastmaster, Pres. Halleck; the dinner, promptly at 7; the tables, round, seating 8; the decorations, beautiful; the tickets, men \$1.00, ladies \$3.00.

WHAT THE U. S. CENSUS SAYS ABOUT GREATER BOSTON.

Second in Population

Number of people within 50 miles of
 Boston 3,089,159
 Philadelphia 2,790,644
 Chicago 2,688,445
 St. Louis 1,198,454
 (New York Outclasses Other Cities.)

First in Transportation.

Steam and Electric trackage within 50 miles of

Boston 4346 miles
 New York 4183 miles
 Philadelphia 4042 miles
 Chicago 3429 miles
 St. Louis 2452 miles

First in Per Capita Wealth

Boston \$1,942
 New York 1,337
 Philadelphia 1,127
 Chicago 1,016
 St. Louis 918

The Census says One Twentieth of the Wealth of the U. S. is within 50 miles of Boston.

The Census says One Fifth of the Savings of the people of the U. S. is in Massachusetts Savings and Co-operative Banks.

The average Earnings of the People of Massachusetts are 80 per cent greater than the average earnings of the whole people of the U. S.

If you have anything in horticultural goods to sell you can't ignore this territory, in which HORTICULTURE has no near rival among trade journals, for it outclasses them all in circulation. That's why steady advertising in HORTICULTURE must and does pay.



OPENING ANNOUNCEMENT



Commission House for Washington, D. C.

The S. S. PENNOCK-MEEHAN Co. of Philadelphia, beg to announce the opening on or about March 1st, 1909, of an up-to-date Commission House for the sale of

Cut Flowers, Plants, Ribbons and Supplies

This new establishment will be complete in all departments and will be conducted on similar lines to the parent house in Philadelphia, and in close touch and cooperation with same, thus gaining at once the benefit of their twenty years experience; their unexcelled service; the acknowledged ability of its ruling spirits, and its unsurpassed facilities for furnishing "Everything in Cut Flowers and Plants," "Everything in Ribbons and Supplies."

The location selected at **1212 New York Avenue**, is central and commodious and will be in charge of **Mr. ALBERT SCHNELL**, who has wide experience both in Washington and Buffalo.

S. S. PENNOCK-MEEHAN CO.



Personal.

H. Van Koolbergen was a visitor in Albany, N. Y., the past week.

J. D. Cockcroft, carnation grower, Northport, N. Y., is confined to his home by illness.

Miss Cora Powell, aged 25, daughter of Harry Powell, florist at Longview asylum, was quietly married in Newport February 11, to Charles Bate-man, aged 35, of Norwood.—Hamilton (Ohio) Democrat.

John Davidson, who has been gardener for Mr. I. S. Burden at Newport, R. I., for the past two years, has resigned that position and will soon move to Detroit, Michigan, where he has accepted a more important position.

Charles L. Russell, who left the estate of Mr. Joseph H. Choate, Stockbridge, Mass., three years ago to develop a large place for Mr. Wm. F. Sheehan at Roslyn, N. Y., has now engaged with Mr. W. P. Hamilton as manager of his estate, Table Rock Farm, Sterlington, N. Y.

Visitors in Chicago: Victor Huot, Duluth, Minn.; Otto Bentley, New Castle, Ind.; Jos. Rolker, New York; W. Siebrecht, New Rochelle, N. Y.; J. Cruz, Niles Centre, Ill.; W. S. Hizer, Rockford, Ill.; Harry Fisher, Kalamazoo, Mich.; Robert Fulton and F. H. Henry, New York City.

Eugene Gobel will succeed W. L.

Cukerski as superintendent of parks at Grand Rapids, Mich. Mr. Cukerski has been connected with the city parks for eighteen years, and resigns this position to engage in the business of landscape gardener and florist in Grand Rapids.

I. P. Cleary, of the Fruit Auction Company arrived home in New York last Sunday after a two months' sojourn in the old country. He tells us that his visit to the big horticultural producing establishments abroad bore good results and he will have some tempting announcements to make to the readers of HORTICULTURE in the near future.

David Weir, gardener for the Brandegee estate, Brookline, Mass., who was just recovering from illness, was seized with weakness and fell, just as he was lighting a kerosene lamp, one morning early, about two weeks ago. The lamp was knocked down and he sustained a serious burn on the foot from the exploding oil. The fire in the room was extinguished without great damage. Mr. Weir has been confined to his bed ever since.

PUBLICATION RECEIVED.

The Schedule of Premiums offered by the Worcester County (Mo.) Horticultural Society is published and copies can be obtained by writing to the secretary, A. A. Hixon, Horticultural Hall, Worcester, Mass. The first exhibition will take place on Thursday, March 4.

Obituary

George Hemler.

George Hemler, a landscape gardener, a native of Germany died at his home in West Newton, Mass., on February 17, aged 82 years.

Henry A. Terry.

Henry A. Terry died at his home in Crescent, Iowa, on February 13 at the age of 83. Mr. Terry established the first nursery in Pottawattomie County in 1867, having located in that section when 21 years old. He was an esteemed member of the Latter Day Saints' church. A widow and six children survive him.

Paul Thomson.

Paul Thomson, of West Hartford, Conn., whose name has become familiar through his recent introduction of the yellow carnation, Neptune, died on Feb. 10 after a short illness. Mr. Thomson was a Scotchman by birth, but came to West Hartford in 1872. He was a member of the State Grange, the Connecticut Pomological Society, the Veteran Association of Co. K, 1st Regt. C. N. G., and president of the West Hartford Curling Club. A widow and three sons survive him.

Chicago.—H. R. Hughes, the advertising florist, had for his window attraction last week a scene showing George Washington about to try his new hatchet on the garden scenery. It drew a crowd.

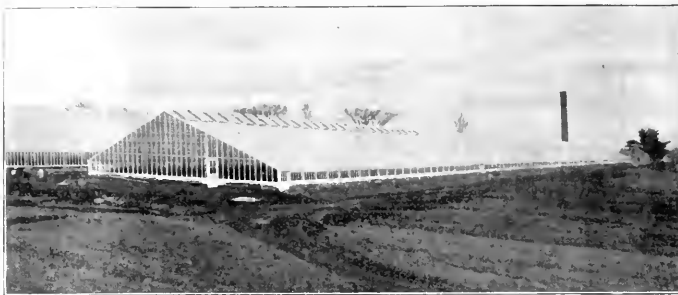

We are the Largest Growers in Massachusetts of

GRAFTED ROSES AND OWN ROOT STOCK

FIRST STOCK SENT OUT MARCH 1st. TO GET THE BEST IN GOOD SEASON ORDER NOW.

American Beauty, Rhea Reid, Killarney, Richmond, Kaiserin, Bride, Bridesmaid, Bon Silene, Safrano, and Perle des Jardins

Our stock of ASPARAGUS PLUMOSUS NANUS is the largest in this country. We are headquarters for cut strings and always have a stock on hand which can be shipped on short notice. EXTRA FINE LONG STRINGS 50 CENTS EACH. Seedlings of Asparagus Plumosus Nanus and Asparagus Sprengerii. Large stock of Asparagus Nanus and Asparagus Sprengerii seed. Send for prices.

W. H. ELLIOTT, NEAR OAK SQUARE BRIGHTON, MASS.

FEEDING THE CROPS.

Extracts from "The Yeast of the Soil," a paper read by William H. Bowker before the Massachusetts Horticultural Society.

(Continued from page 251.)

Potential Fertility.

Chemistry teaches us that plants are composed of certain fixed elements which are supplied by the soil and the air. It further teaches that while there is an abundant supply, yet we have exhausted the three leading elements, nitrogen, phosphoric acid and potash, in available forms; that so-called barren or unproductive soils may be rich in plant food elements, but that these elements are so locked up as to be of little value to the commercial grower, whose chief concern is quick crops for quick returns. In other words, the available plant food (nitrogen, phosphoric acid, and potash) has been exhausted, leaving only the unavailable or what is known as the potential fertility which, by the slow processes of nature, is yielded up too slowly to be depended upon by the commercial farmer.

"The Little Balance."

Therefore, in modern practice, instead of asking the soil how much of the potential fertility can be depended upon for each crop, or what the "natural yield will be" (a question which will never be satisfactorily answered), we now apply what we believe to be necessary to produce the maximum yield over and above the natural yield of the land. In all cases, we find that the actual requirements of plant food for various crops are very small indeed, in many cases not over 200 lbs. of actual plant food (nitrogen, potash

and phosphoric acid)—so little to produce so much, and yet it is absent the crop will be a failure. It is this little essential balance of available plant food which stands between success and failure, and which concerns the modern farmer today. Thus our problem is to supply the "little balance of ready plant food" for the growing crop, as milk or prepared food is supplied to the growing child, and later as cooked or digestible foods are supplied to man.

Stable Manure and Commercial Fertilizers.

It is estimated that a cord of stable manure weighing 4000 lbs. contains on the average 50 lbs. of plant food, worth about \$2, the remainder (3950 lbs.) being water, straw and organic matter. For the 50 lbs. of plant food to be rendered available, we are dependent very largely upon bacterial action in the manure and in the soil. In the old

days, as I have said, we composted manure in advance in order to hasten the process of decomposition and increase its availability. Now, as a rule, depending upon commercial manures for active available plant food, we apply the manure on the soil directly as we produce it or receive it.

While there are only 50 lbs. of actual plant food (nitrogen, phosphoric acid and potash) in a cord of manure, yet we must not overlook the value of the organic matter, straw, etc., not only for the humus which is added to the soil by means of the manure, but also for the improved physical condition which it imparts to the soil. This humus, no commercial manure supplies, and in this respect stable manure is superior to commercial manures, but the value of this excessive amount of humus in stable manure, as a source of plant food, depends, as we have seen, not only upon a thorough distribution of the manure in the soil,

SOME OF OUR SPECIALTIES

- Boxwood Pyramid Shape, 2½ to 3 ft. high, very heavy, \$1.75 each, 3 to 3½ ft high, \$2.50 each. Bush Shape, very heavy, 2 to 2½ ft., \$1.75 each, 2½ to 3 ft. high, \$2.00 each.
- Rhododendrons, Carson's Hardy varieties, 8 to 12 buds, 18 to 24 in. high, at \$75.00 per 100; 12 to 14 buds, 24 to 30 in. high, at \$100.00 per 100.
- Azalea Mollis, 15 to 18 in. high, very bushy and full of buds, at \$35.00 per 100.
- Hybrid Perpetual Roses, strong dormant field grown plants, of our own growing, none better, \$11.00 per 100, \$1.00 per 100.
- Flora Roses, field grown, \$1.00 per 100.
- Hardy Climbing Roses, field grown, 38.00 per 100.
- Tree Roses, hardy varieties, budded on straight stems, 3 to 5 ft. high, \$30.00 per 100.
- Ampelopsis Vellichii, bushy, 2 yr. plants, 3 foot of tops, \$10.00 per 100.

The Storrs & Harrison Co., Painesville, Ohio

but chiefly on normal conditions of warmth and moisture, in order that bacterial action may be induced and by means of which it is rendered available. Thus, when we solely rely on stable manure, we are more dependent on weather conditions than when we apply predigested fertilizers, or part fertilizer and part manure.

Stable manure, as a by-product of the farm, or where it can be bought and hauled at a price that is not in excess of its intrinsic value, will always be a favorite source of fertility, partly because of its plant food, and chiefly because of the humus it supplies, but in market gardening and in general farm practice the best results will usually be obtained when it is used in connection with chemical manures. On the other hand, chemical manures, while not supplying humus, supply in a concentrated way, not only needed plant food, but supply it in forms that anticipate, supplement and, in some cases, promote bacterial action, without which stable manure, and even the organic portion of the fertilizer, would be barren in results. The progressive farmer, therefore, supplements and improves his stable manure by the use of concentrated fertilizers, in the same way as he supplements and improves his hay with the use of concentrated grain foods in feeding his stock.

While it is undoubtedly true that stable manure, all things considered, is the best source of fertility, yet it is by no means the cheapest if one has to buy it, and neither is it absolutely essential in the growing of many farm crops. This is shown by the enormous and rapidly increasing areas which are planted annually to corn, cotton, tobacco, wheat, potatoes, and vegetables, on commercial fertilizers as the sole dependence in the matter of plant food.

Incidentally, it should be noted that twenty years ago, manure sold in Boston stables at about \$10 a cord. Today, unless a stable is very advantageously located, the market gardeners are getting it at a nominal price, and in some cases for the hauling. The introduction of commercial manures has been one of the causes of the reduction in the price of stable manure, for which the gardeners should be thankful. The Germans have a phrase which expresses "manure sick land." With cheap stable manure we are likely to have such a condition around Boston. On such land, commercial manures should be applied in part, and occasionally lime or wood ashes, in order to promote the slightly alkaline condition of the soil which is necessary for satisfactory bacterial growth.

Finally, it seems to me the question as between the purchase of stable manure and commercial fertilizers resolves itself into two parts:—

First: Does one's soil and the character of the crops to be grown require the excessive humus of stable manure for the most profitable returns?

Second: How much can one afford to pay for this humus, knowing that it can often be obtained, or all that is needed, by a rotation of crops or by ploughing in stubble or green crops? Assuming that the actual plant food in a cord of stable manure is worth on a fertilizer basis \$2 per cord, what is the humus, the remainder of the cord, worth; and how much will it cost to haul or freight it, and apply it to one's own soil and crop requirements?

FORCING GLADIOLUS

Gladiolus Gandavensis Hybrids

Many florists plant these in boxes, or among their carnations, in the winter. They are excellent for decorative purposes and realize good prices, either wholesale or retail. Gladiolus are a good catch-crop and take up but little room. The following are the best for this purpose:

America. The flowers, which are of immense size, are of the most beautiful flesh-pink color, \$4.00 per 100; \$35.00 per 1000.

Augusta. The florists' best white Gladiolus. First-size bulbs, 1 1/2 inches and up, \$2.00 per 100; \$18.00 per 1000. Bulbs 1 1/4 to 1 1/2 in. \$1.75 per 100; \$16.00 per 1000.

Shakespeare. White and rose. \$4.75 per 100; \$45.00 per 1000.

May. Pure white, flaked rosy crimson; the best forcer. Selected bulbs. \$1.75 per 100; \$15.00 per 1000.

Brachylepis (true). Flery scarlet. Selected bulbs, \$1.50 per 100; \$13.00 per 1000. First-size bulbs, \$1.25 per 100; \$10.00 per 1000.

Boddington's White and Light Extra selected bulbs, 1 1/2 in. and up. \$1.60 per 100; \$14.00 per 1000. Bulbs 1 1/4 to 1 1/2 in. \$1.25 per 100; \$10.00 per 1000.

American Hybrids. A mixture of the choicest varieties of Gladiolus in cultivation. \$1.00 per 100; \$9.00 per 1000.

ARTHUR T. BODDINGTON

SEEDSMAN

342 West 14th Street,

NEW YORK CITY

REGISTRATION OF ORCHID.

Mr. W. N. Rudd, Sec'y, S. A. F.
Dear Sir:—In a recent issue of HORTICULTURE you advertise for record two Laelio-Cattleya from the Roebling collection. These plants were raised here, from pollen of Mr. Roebling's plants exhibited in Boston in August, 1859; later I sent seedlings to Mr. Roebling's gardener, at that time Mr. Clinkaberry,—as arranged at the time of receiving pollen.

My principal reason for writing in this connection is, that some time since in the autumn of 1907, I exhibited in Boston the Laelia crispa x Cattleya x Hardyana alba cross under the name of Laelio-Cattleya x Johannsoni, and presumably it is so registered in the proceedings of Massachusetts Horticultural Society. Mr. Johannson has recently died, and it is the express wish of the writer that the name of so good a man and able raiser and cultivator of orchids should be commemorated by the Laelio-Cattleya Johannsoni.

The Laelia crispa x Hardyana Young's variety has never to my knowledge been named, certainly not by me, as the similarity of the two crosses was so marked that we did not deem it advisable, and it is also probable that the authorities that decide these matters would not permit the use of separate specific names for these two crosses. The same plant, L. crispa being the one parent, the others being mere varieties of the same thing, hence the L. crispa x C. Hardyana Young's variety would have to rank as a variety of L. C. Johannsoni, provided, of course, that the latter name has not already been anticipated by some raiser in Europe or elsewhere, which we cannot ascertain until the receipt of the recently published and long-needed "Orchid Stud book."

E. O. ORPET.

So. Lancaster, Mass.

CHRYSANTHEMUMS

Golden Glow—plant Middle May to July.—Cut Middle Aug. to Oct.—Pacific Supreme—a longer stem—brighter—non fading glory of the Pacific. White Cloud—an 8 inch lap. Plant and cut same as Glory of Pacific.—Budded now will increase stock to 100 by planting time—Delivery Plants—March \$5.00 per 100; April \$4.50; Bal. Season \$4.00. Budded Cuttings now, post or express paid, \$4.00 per 100; 25 at 100 rates.

J. H. MYERS

ALTOONA, PA.

ORCHIDS

Just Arrived in Fine Condition

the following East Indian Orchids

DENDROBIUM WARDIANUM, D. CRASSINODE, D. PRIMULINUM, D. THYRSIFLORUM, AND D. CHRYSOTOXA. Others to follow.

WRITE FOR PRICES.

LAGER & HURRELL, Summit, N.J.

JUST ARRIVED

Fine Importation of

Oncidium ornithorrhynchum

Fine strong leafy plants..... \$1.50 each. \$18.00 doz.
Few specimens..... 2 50 "

JOSEPH A. MANDA, West Orange, N.J.

ORCHIDS

We offer a large number of fine well established plants at very reasonable prices also Peat, Baskets and Sheep and Chicken Manure.

ORDONEZ BROS., Madison, N. J.
New York Store, 41 WEST 28 ST.

ORCHIDS

We are booking orders now for delivery early in the Spring of all commercial CATTLEYS and NOVELTIES. Our prices are right and our guarantee perfect. We sell only first-class goods.

CARRILLO & BALDWIN, Secaucus, N. J.

ORCHIDS

Largest Importers, Exporters, Growers and Hybridists in the World

Sander, St. Albans, England
and 235 Broadway, Room 1
NEW YORK CITY

JULIUS ROEHRS CO.

Orchids and Stove Plants
Florists' Easter Supplies
RUTHERFORD, N. J.

FOR "POT LUCK" TRY US... HEWS STANDARD POTS

POT MAKERS FOR 140 YEARS

WORLDS LARGEST MANUFACTURERS

WRITE FOR CATALOGUE AND DISCOUNTS

Pearson Street,
LONG ISLAND CITY, N. Y.

A. H. HEWS & CO., Inc.
CAMBRIDGE, MASS.

452-460 No. Branch St.,
CHICAGO, ILL.

OUR EXPERIMENT STATION.

A Paper Read Before the Illinois State Florists' Association by Prof. H. B. Dörner.

As a result of the appropriations of two years ago the Agricultural Experiment Station has undertaken to carry out certain lines of work relating to floriculture. In order to do this so that all parts of the experiments are under perfect control the erection of some new greenhouses was necessary. During the last summer two houses and a service building have been constructed.

In erecting these the aim was to build model commercial houses and as a result the state possesses houses second to none. The ground plan chosen is one which allows of expansion and in fact all parts of the plant have been so designed that new houses can be added without changing or interfering with those already up. The plans call for a range of houses extending east and west from a corridor or connecting house extending north and south. The plans call for detached houses with intervals of 14 feet between. The service building, which also contains the heating plant, connects with the corridor house on the north. All houses can thus be reached from the service building without going outside.

Greenhouses.

The two houses already erected were designed to avoid shading as much as possible and so are of the very lightest construction possible, commensurate with strength. Each house is 105 feet long and 28 feet wide, thus making it possible to have four 100 feet benches, each 4 feet wide.

All parts above the gutters are of clear cypress with sash bars of the type ordinarily used in greenhouse construction. The gutters are of the King pattern made of channel iron supported on posts of 2-inch iron pipe. Each post acts as a down spout and empties into a vitrified tile drain laid along the inside of the wall. Below the gutters, in the side walls, is 24 inches of glass. Ventilation is secured by two lines of interrupted sash operated by Foley ventilating machines.

The walls below the side lights are composed of concrete but constructed differently than those usually built. The iron pipes supporting the gutters are set into concrete piers 12 x 18 inches and extend well into the soil to secure a firm foundation. The walls themselves are formed of large concrete slabs, 5 inches thick reinforced with 3/8 inch iron rods and fit in between the posts. Their ends rest on the concrete piers and are held in place by concrete pillars 8 in. square built about the posts. The sill was anchored to this wall and the side rafters put into place.

The benches are each 100 x 4 feet

and 5 inches deep and are built of pecky cypress supported on 1-inch iron pipes. The walks between the benches are 28 inches wide and those between the benches and walls are 22 inches wide. All walks are of cement.

Service Building.

The service building is a structure 100 feet long by 26 feet wide constructed of wood with plaster finish on the outside. It is situated on the north side of the greenhouses with its longer axis parallel to the longer axis of the greenhouses. A space 16 feet wide was left between the service building and the greenhouses.

One-half of this building is large enough to accommodate three 60 horse power boilers. The concrete floor of this room is about two feet below the floor level of the greenhouses. The other half of the building is devoted to a large work room about 25 feet square, a hall way, an office 13 x 20 feet, a small laboratory, a small room and a lavatory. The work room contains a reinforced concrete floor making it possible to scrub it out whenever necessary.

Beneath this part of the building is a cellar divided into three rooms. Through the largest of these extend all the steam, water and sewer pipes. This makes an excellent room for storage. The other two rooms, which take up the other half of the cellar space, are used as cut flower and cool storage rooms.

Heating Plant.

The heating plant is somewhat different from that used in most places. At the present time power is secured from a 60-horse power tubular boiler, the setting of which was designed to reduce the amount of smoke as much as possible. Draught is secured by a 70-foot brick stack designed to carry 150 horse power if necessary.

The heating system was constructed to be run either as a high or low pressure system. From the top of the boiler a 6-inch lead main drops down into the cellar to the pressure regulator and its accompanying by-pass. From here the main continues and passes under the cross house. At this place branches of 1 1/2-inch pipe come off and passing through 6-inch tile emerge in the greenhouses under the benches and by the side walls.

Under the benches the 1 1/2-inch pipe divides into two 1 1/4-inch pipes, one extending down each side of the bench. These pass down to the other end, cross over, and come back on the opposite. There are also two wall coils, one of which passes around the end to the door. This then gives four lines of pipe under each bench and four on each wall, or 21 pipes in all. Overhead pipes have been omitted altogether.

Each flow and return is fitted with a

regulating valve at the corridor end of the house, and each return before it passes into the main return is fitted with a check valve. The water is returned to the boiler by means of double Morehead traps, one situated in the cellar and the other over the boiler. The greenhouses as well as the service building are furnished with water and electric light from the University plants.

Experiments.

During the present winter these houses have been devoted to an experiment on carnations with chemical fertilizers supplementing stable manures. The object of the experiment is to determine what chemical fertilizers used with manure are best for carnation growing. The results from this experiment will form the foundation for future work on the amount to use for best results. In this work 8 benches, each 100 x 4 feet, were available. Each bench was divided into 16 sections, 6 x 4 feet inside measurement, this leaving some three feet over which was divided into two small sections, one at each end of the bench. The object of this was to have sections protecting the exposed ends of the experimental sections.

Two benches, with 32 sections in all, were used in each experiment, thus repeating the work four times. Each set of benches was planted to a different variety. The sections were numbered from 1 to 32, each number standing for a definite fertilizer combination. As a further precaution the location of the numbers on the benches, in the various experiments, were changed so that each of the numbers appears at different places in the houses. Thus sections occurring at the exposed ends of the house also occur in the center and at the protected end.

(Continued on page 200)

STANDARD FLOWER POTS

Packed in small crates, easy to handle.

Price per crate		Price per crate	
1500 2 in. pots in crate \$4.88	144 6 in. pots in crate \$3.16	120 7 " " " " " 4.20	60 8 " " " " " 3.00
1500 2 1/2 " " " " 5.25			
1500 2 3/4 " " " " 6.00			
1000 3 " " " 5.00	48 9 in. pots in crate \$3.60		
800 3 1/2 " " " 5.80	48 10 " " " 4.30		
500 4 " " " 4.50	24 11 " " " 3.60		
450 4 1/2 " " " 5.24	24 12 " " " 4.80		
320 5 " " " 4.51	12 14 " " " 4.80		
210 5 1/2 " " " 5.78	6 16 " " " 4.50		

Send pans, same price as pots. Send for price list of Cylinders for Cut Flowers, Hanging Baskets, Lawn Vases, etc. Ten cent off for cash with order. Address: **Hilfinger Bros., Pottery, Fort Edward, N. Y.** August Folker & Sons, Agts. 31 Barclay St., N. Y. City.

Standard Flower.. POTS

If your greenhouses are within 500 miles of the Capital, write us, we can save you money

W. H. ERNEST

28th and M Street WASHINGTON D. C.

DREER'S SPECIALS FOR FEBRUARY



Adiantum Farleyense The finest lot of five inch pot elegant stock to have a finishing touch to the work and choice decorations, \$9 per doz., \$70 per 100. In other sizes we can supply:
 2 in. pots \$3.50 per doz., \$25 per 100; 4 in. pots \$5 per doz., \$40 per 100; 5 in. pots, fine specimens, \$2 each.

Azalea Mollis These hardy Azaleas are becoming more popular every season; it is profitable stock to handle as it can be forced at a minimum cost. We offer splendid bushy plants, 15 inches high, \$1.50 per doz., \$35 per 100.

Wallflower For early forcing, strong bushy plants in 4 in. pots which will sell readily at a good profit when in flower, \$1.25 per doz., \$8 per 100.

Variegated Aucubas A splendid lot of these plants, so useful for decorative work during winter

Very bushy 12 to 15 in. high	Each Doz. \$0.20 \$3.00	Very bushy 24 in. high	Each Doz. \$0.60 \$7.00
" " " 18 " 20 " "	" " " 10 4.50	" " " 28 to 30 " "	" " " 75 8.00

Specimen plants 3 ft. high, very fine, \$3 each.

Boxwood A splendid lot of globe-shaped specimens about 15 inches high and of same diameter in 11 inch pails, \$1.50 each.

BUSH SHAPED PLANTS for window boxes etc., 10 to 12 inches high, \$2 per doz., \$15 per 100. Larger, heavier plants 12 to 15 inches high, \$3.50 per doz., \$25 per 100.

HENRY A. DREER, 714 Chestnut St. PHILADELPHIA

BARCAINS

in KENTIAS and other Decorative Plants, all sizes. Also the following at Lowest Import Prices. Azaleas in bloom from now until Easter. All colors and varieties. A fine lot of Rubbers, Crotons, Araucarias, Pandanus, Asparagus plumosa and Sprengeri.

SMALL FERNS

for table decorative purposes at lowest wholesale rates.

A. LEUTHY & CO.,
 Perkins St. Nurseries, ROSLINDALE, MASS.

HEADQUARTERS FOR

Araucaria Excelsa, 6 in pots, 5-6 tiers, 75c, \$1, \$1.25; Robusta Compacta and glauca, 20 to 30 in. high, \$1.00, \$3.00. Ficus elastica, 3/4 in., 25c, 35c, 50c. Kentia Belmoreana, 4 to 5 1/2 in., 35c, 50c, 60c; Forsteriana, 5 to 6 in., 50c, 60c, 75c, \$1.00, \$1.25, \$1.50. Boston, Scottii and Whitmanii Ferns, 6 to 7 in. pots 50c, 75c, \$1.00, \$1.50. Amerpottii, 5 1/2 in., 35c, 50c. Azalea Apollis in bloom, 75c, \$1.00. Cineraria Hybrida for Easter, 3 in. 5c, 6 in. 25c.

GODFREY ASCHMANN
 1012 W. Ontario St., PHILADELPHIA, PA.

COLEUS! COLEUS!

C. Verschaffeltii and Golden Bedder, R. C.	Pr 100	Pr 3000
Same in 2 1/2 in. pots	2.00	18.00
Coleus, Mixed, R. C.	.60	5.00
Same in 2 1/2 in. pots	1.75	15.00
Ageratum Stella Gurney and Pauline, R. C.	.50	
Same in 2 1/2 in. pots	1.00	
Feverfew in 2 1/2 in. pots	2.00	
Fuchsias, our selection, in 2 1/2 in. pots	3.00	
German Ivy, R. C.	.75	
English Ivy, R. C.	1.00	

Cash with Order
J. E. FELTHOUSEN
 148-154 Van Vranken Ave., SCHENECTADY, N. Y.

CYCLAMEN GIGANTEUM

5, 6 and 7 in. pots—50c, 75c, and \$1.00 each.

Extra heavy stock of the very best quality.
Thomas Roland,
 Nahant, Mass.

DECORATIVE PLANTS

Araucaria Excelsa, Pandanus Utilis, Dracaena Indivisa, Kentias, Latanias, Arecas, Etc. Perennials and Shrubs.

4 inch Araucarias, 75 cents each.	6 inch Araucarias, \$1.00 each.
5 " " " 75 " "	7 " " " \$1.25 and \$1.50 "

FERNS FOR DISHES—\$3.50 per 100, \$30.00 per 1000. SEND FOR OUR PRICE LIST. WE HAVE A COMPLETE STOCK.

The Geo. Wittbold Co.
 1657 Buckingham Place, Chicago, Ill.

FERNS FOR DISHES,

CASH WITH ORDER
 2570 to 2606 W. Adams St., Chicago, Ill.

PALMS AND FERNS

DECORATIVE PLANTS

JOHN SCOTT
 Rutland Road and E. 45th St.
 Tel. 5890 Bedford BROOKLYN, N. Y.

PEACOCK'S NEW DAHLIAS

SEND FOR LIST
PEACOCK DAHLIA FARMS
 Williamstown Junction, N. J.

DAHLIAS.

Now is the time to place your order for bulbs which will insure you getting named varieties in any quantity; prompt delivery.
DAVID HERBERT & SON,
 Successors to L. K. Peacock, Inc.
 ATCO, N. J.

The Northboro Dahlia and Gladiolus Gardens

Offer for Spring 1909
 300 selected varieties of Dahlias and one and one half million large-flowering Gladioli in mixtures, in lots to suit. Send list of your wants. Catalogue free.
J. L. MOORE, Northboro, Mass.

Assorted Varieties

From 2 inch pots, \$3.50 per 100; \$30.00 per 1000

FRANK OEGHSLIN

NEP. WHITMANI
 2 1/2 in., \$5.00 per 100
NEP. WHITMANI
 3 1/2 in., \$25.00 per 100
BOSTON FERNS
 2 1/4 in., \$3.00 per 100

H. H. BARROWS & SON, Whitman, Mass.

HEACOCK'S PALMS

Kentia Belmoreana
 7-inch pots, 32 to 34 inches high, \$2.50 each
 7-inch pots, 36 to 38 inches high, 3.00 "
 9-inch tub, 42 to 48 inches high, 5.00 "
 Made up Kentia Forsteriana
 7-inch pots, 34 to 36 inches high, \$2.50 each
 7-inch pots, 36 to 38 inches high, 3.00 "
 9-inch tub, 42 to 48 inches high, 5.00 "
Joseph Heacock Co., Wyncote, Pa.

Gladiolus Brenchleyensis

Extra fine Healthy Imported Stock
 1,000 \$10.00 10,000 \$80.00
O. V. ZANGEN
 HOBOKEN, N. J.

JAPANESE
 THE YOKOHAMA NURSERY CO.
 31 BARCLAY STR. NEW YORK.
 LILIES
 PLANTS
 BAMBOO STAKES

**THE QUALITY
YOU CAN MAKE
MONEY ON**

CANNAS

**SOUND PIECES
TRUE TO NAME
BED ROCK PRICES**

**Red-Flowering, Green
Foliage**

	Per doz.	100	1000
A. Bouvier. 5 ft. Dark crimson.....	\$0.35	\$2.25	\$20.00
Allice Roosevelt. Deep crimson. 4 ft.....	.50	3.50	30.00
Beaute Polveine. 3 1/2 ft. Dark crimson.....	.35	2.25	20.00
Black Prince. Velvety maroon. 3 to 4 ft.; green foliage.....	.50	3.75	25.00
Charles Henderson. 4 ft. Bright crimson.....	.35	2.25	20.00
Crimson Bedder. 3 ft. Intense scarlet.....	.30	2.00	17.50
Duke of Marlborough. 3 1/2 ft. Dark crimson.....	.35	2.25	20.00
J. D. Elsie. Brilliant vermillion-scarlet 5 ft.....	.35	2.25	20.00
Explorateur Crampel. Deep rich crimson 3 1/2 ft.....	.30	1.75	15.00
Express. Crimson; foliage green. Dwarf habit. 2 to 2 1/2 ft.....	.60	4.50	40.00
Pros. McKinley. Brilliant crimson 2 1/2 to 3 ft.....	.35	2.25	20.00
Pink-Flowering			
L. Patry. Delicate rosy pink, 3 1/2 ft.....	\$0.35	\$2.25	\$20.00
Luray. Attractive rosy pink. 3 ft.....	.35	2.25	20.00
Louise. A grand pink, tall Martha Washington.....	.45	3.50	25.00
Rose. Height, 2 1/2 to 3 ft. roc. each.....	.75	5.00	
Mlle. Berni. 4 1/2 ft. Rose-carmine.....	.35	2.25	20.00
Tennyson. Rosy pink; green foliage; 3 1/2 ft.....	.50	3.00	

Orange-Flowered

	Per doz.	100	1000
President Cleveland. Bright, distinct orange-scarlet; 4 ft.....	\$0.35	\$2.25	\$20.00
Red, Gold-Edged and Spotted			
Gladstone. Bright yellow, spotted crimson, green foliage; 4 ft.....	\$0.50	\$2.75	\$25.00
Cinnabar. Cinnabar red, edged with distinct golden band; 4 1/2 ft.....	.30	2.00	17.50
Queen Charlotte. Scarlet gold edge.....	.30	2.00	17.50
Mme. Crozy. 3 1/2 ft. Vermillion, gold border.....	.35	2.25	20.00
Premier. Deep crimson, bordered yellow. 2 1/2 ft.....	.30	2.00	17.50
Souv. d' A. Crozy. 4 ft. Crimson, gold band.....	.50	4.00	35.00

Yellow Shades

Buttercup. 3 1/2 ft. Clear golden yellow.....	\$0.40	\$2.75	\$25.00
Comte de Bouchard. Yellow, spotted red, 4 1/2 ft.....	.30	2.00	17.50
Florence Vaughan. 5 ft. Yellow, spotted crimson.....	.50	2.75	25.00
L. E. Bailey. Rich yellow, dotted with red; 4 1/2 ft.....	.30	2.00	17.50

White and Cream Shades

Alsace. 3 1/2 ft. Creamy white	\$0.30	\$1.75	\$15.00
---------------------------------------	--------	--------	---------

Bronze-Leaved, Red-Flowering

Brandywine. 4 to 5 ft. Dark bronze foliage. Crimson flowers.....	\$0.50	\$4.00	\$35.00
Black Beauty. True. 2 ft. Grand foliage.....	.60	4.50	40.00

	Per doz.	100	1000
David Harum. 3 1/2 ft. Vermillion-scarlet.....	\$0.50	\$2.75	\$25.00
Egadale. 4 ft. Curriet red.....	.35	2.25	20.00
King Humbert. Fine Bronze foliage. Orange-scarlet with bright red markings. 4 ft.....	1.00	8.00	75.00
Leonard Vaughan. 3 1/2 ft. Bright scarlet.....	.35	2.25	20.00
Musafolla. The finest foliage-canna, with enormous musa-like leaves, 3 by 5 ft., of a dark green bronze-tinged color.....	.35	2.25	20.00
Philadelphia. A bright glowing red. Height 5 ft.....	.75	4.00	30.00
Papa Nardy. Large, rich carmine-red, 4 1/2 ft.....	.30	2.00	17.50
Pillar of Fire. 6 to 7 ft. high; flowers bright crimson-scarlet.....	.75	4.50	40.00
Robusta. Height 6 to 8 ft., with immense foliage.....	.30	1.75	15.00
Shenandoah. Large Salmon flowers, 6 ft.....	.30	1.75	15.00

Orchid-Flowering

Allemania. 4 to 5 ft. Scarlet and yellow. Green foliage.....	\$0.35	\$2.25	\$20.00
Austria. Pure canary-yellow; an orchid-flowering type. 5 ft.....	.30	1.75	15.00
Italia. 4 1/2 ft. Green foliage Red bord.-red yellow.....	.30	2.00	17.50
Kroum. Rich golden yellow, with patches of bright red, 5 ft.....	.30	1.75	15.00
Mrs. Kate Gray. 6 ft. Green foliage. Scarlet and yellow.....	.30	2.00	17.50
Pennsylvania. True. Green foliage. Deep pearl.....	.35	2.25	20.00

CATALOGUE FREE.

We go through the block from 14th Street to 13th Street,

342 West 14th St., NEW YORK CITY.

ARTHUR T. BODDINGTON, Seedsman,

(Continued from page 255)

The varieties selected for the work were Enchantress, White Perfection, Beacon, Winsor, as representing a variety of characters, especially in growth of flowers and stems. The fertilizers selected for the work were forms commonly used and are easily procured. Dried blood, sodium nitrate and ammonium sulphate for nitrogen; acid phosphate, raw rock phosphate and steamed bone for phosphorus, and potassium sulphate, kainit and wood ashes for the potassium. Ground limestone and ashes were also used to furnish lime. Sheep manure and well rotted stable manure were also used.

In preparing the sections a definite amount of manure was added to each of the sections excepting those used as checks. The chemical fertilizers were then weighed out and added, and the whole thoroughly incorporated. All chemical fertilizers were applied in quantities to afford an equal amount of the element for which they were used.

All fertilizers were applied before planting with the exception of those containing nitrogen. Of these one-half of the dried blood was added at this time and the remainder later. Of the sodium nitrate and ammonium sulphate only one-fifth was added before planting. The remainder was added later in four installments.

In securing data records are being kept of all the flowers as to size, length of stem, condition of calyx, of the general character of the plants, temperature, watering, etc. From this data and general observations the work for the following year will be planned.

HEAVY SNOW WRECKS GREENHOUSE.

The heavy fall of sleet and snow, Feb. 17, caused the large greenhouse of the George W. Titus Garden Company at Irondequoit, N. Y., to fall in. The house, which was 150 feet in length and 32 in width, was wrecked from one end to the other, nearly every light of glass being broken, and the steel frame badly twisted, and everything planted was destroyed. Mr. Titus used it for vegetable forcing. The greater part of the house was used for lettuce, and it is estimated that fully 10,000 lettuce plants suffered damage from the accident. Mr. Titus also grew cucumbers, parsley and tomatoes in this house. It is said that there were no standards in the center to support the roof. The loss is about \$1500, and no insurance.



FIRE RECORD.

Portland, Me.—The store of E. J. Harmon & Co., Congress street, was damaged by fire on the morning of Feb. 15. The loss, about \$300, is fully covered by insurance.

Paris, Tex.—The greenhouses on the farm of Charles Cawley were destroyed on Feb. 14, with several thousand plants, spraying outfit and a quantity of seed potatoes, beans and peas. No insurance.

INCORPORATED.
Rochester, N. Y.—Geneva Valley Nurseries; capital, \$10,000.

Kittery, Me.—The Kensington Flower Shop has been incorporated. The organizers have a retail flower store at 689 Boylston street, Boston, Mass.

**THE PRIZE WINNING STRAWBERRY
The Barrymore**

Send for Folder at Once.
H. L. CRANE, Originator,
Westwood, Mass.

"SOLD BY SEED DEALERS"

"HORICUM"

TRADE MARK

HORICUM

Poly-Sulphides of Calcium 30%. Specific Gravity 1.50

DIRECTIONS FOR USE

San Jose Scale Killer and Fungicide

This preparation is lime, sulphur and salt, making a concentrated Poly-sulphide of Calcium. The salt adds to the adhesive properties, but the destructiveness to Scale Life lies in the Calcium Sulphide.

Aside from its ability to destroy San Jose Scale, HORICUM is a Fungicide, preventing the free development of fungoid troubles. Shake the package thoroughly or take the top off.

The color in its concentrated form is a deep bronze green. **Do not pour off the clear liquor only, stir the Horicum from the bottom of the package, and add 20 quarts of water (hot, if you can get it) for ordinary use.** For a stronger dilution when the growth is all dormant use 16 parts of water only (hot, if you have it) and spray thoroughly. By grading your dilution you make it any desired strength.



San Jose Scale on a Pear.

Kills San Jose SCALE

WRITE FOR PAMPHLETS ON BUGS AND BLIGHTS
HAMMOND'S SLUG SHOT WORKS
FISHKILL-ON-HUDSON, N. Y.

For Trees, Plants, Shrubs and Flowers

— USE —

THE NIAGARA BRAND LIME SULPHUR SOLUTION

It destroys Scale Lice, Spiders and all forms of Aphides, AT THE SAME TIME Mildew, Blight, Rust and other Fungus difficulties.

Used in Winter or Summer. — No other remedy has been so universally effective.

Niagara Brand ARSENATE OF LEAD for chewing insects is equal to the best and better than the most. Ask about our Green House sprayer. Address —

NIAGARA SPRAYER CO., - - Middleport, N. Y.

U-N-IT

Spraying device for garden hose. It brings out in solution, with water, what is put into it. Globes. Fertilizing solutions, soap solutions, insecticides, fungicides, germicides, etc.

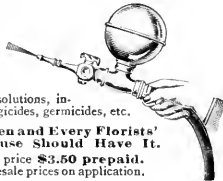

All Seedsmen and Every Florists' Supply House Should Have It.

Retail price \$3.50 prepaid. Wholesale prices on application.

— ADDRESS —

Dept. H. J. F. CASS MFG. CO., Detroit, Mich.

KILMDEAD TOBACCO DUST

Free from Sand or Dirt Kind FOR FUMIGATING AND DUSTING Dusted on Plants it covers large surface. One Quality for Both Uses.

Our Tobacco Dust is the pure tobacco, free from sand and dirt, strong in Nicotine and always of the same strength, making it superior to any dust on the market. Costs you no more than the ordinary product and will do twice the work. 10 lbs. 60c.; 25 lbs. \$1.25; 50 lbs. \$2.00; 100 lbs. \$3.50

STUMPP & WALTER CO.
50 Barclay St., New York

PATENTS GRANTED.

- 911,685. Boiler, Frank S. Snyder, Newburgh, N. Y.
- 911,719. Lawn Mower, William E. Hake, Branch, Ark., assignor to Joseph S. Cotner, Branch, Ark.
- 911,962. Lawn Mower, Thomas Farr, Sutton Coldfield, England.
- 912,127. Lawn Mower, Janet C. Highfield, Seranton, Pa.
- 912,184. Plant Protector, Stephen D. Scott, Howe Valley, Ky.

DON'T EXPERIMENT

USE

TO-BAK-INE

and your stock will be free from insects, clean, and the blooms will not be discolored.

Send for full information of

H. E. FISKE SEED CO.
13 Fanenil Hall Sq., Boston, Mass.

STUMPP & WALTER CO.,
50 Barclay St., New York.

HENRY F. MICHELL & CO.,
1018 Market St., Philadelphia.

E. H. HUNT, Gen'l Agent,
76-78 Wabash Ave., Chicago.

Which Spray Pump

shall you buy? Buy the Spray Pump that fully meets the demands of the Government Agricultural Scientists and all practical Fruit Growers. These pumps are widely known as

DEMING SPRAYERS and are made in 23 styles for use in small gardens or immense orchards. Write for our new catalog with Spraying Chart. Add 4 cents postage and receive "Spraying for Fruit" a useful guide for

CHARLES J. JAGER CO.
291-295 Franklin St., Boston

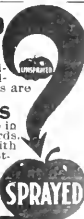

"Every Bug Has his Doer."

Insect-destroying preparations that do their work well and effectively are the cheapest. Bowker's Arsenate of Lead and Bowker's Pyrox are recognized standard insecticides and fungicides for both indoor and outdoor use. Bowker's Insect Emulsion destroys many kind of plant lice, black and green flies, etc. Call or send for catalogue.

BOWKER INSECTICIDE COMPANY
43 CHATHAM ST. BOSTON



The Best Bug Killer and Bloom Saver

For PROOF Write to

P. R. Paethorpe Co.
OWENSBORO, KY.

SOMETHING NEW for GREENHOUSES
"SULFOCID" PRATT'S SOLUBLE SULPHUR SUMMER SPRAY

Non-caustic and non-irritating

A FUNGICIDE AND INSECTICIDE FOR FRUIT TREES, VEGETABLES and GREENHOUSES

A promising substitute for Bordeaux mixture. For 10 cts. to cover postage will send sample sufficient for one gallon of spray.

Use 1 part to 75 or 100 parts of water. **B. G. PRATT CO., 50 Church St., New York, U. S. A.**



Straight, round and flat steam nozzle on Kopsay's "Shower Maker," \$1.00 each. Saves labor, temper, patience and time. **GET ONE NOW** as you will be satisfied, but if not you, may return it and I'll return your money.

JOSEPH KOPSAJ,

South Bend, Ind.

Seed Trade

AMERICAN SEED TRADE ASSOCIATION.

Watson S. Woodruff, Orange, Conn., Pres.; J. C. Robinson, Waterloo, Neb., First Vice-Pres.; C. E. Kendel, Cleveland, O., Sec'y and Treas. Twenty-seventh annual convention June 22-24, 1909, at Clifton House, Niagara Falls, Ont.

WHOLESALE SEEDSMEN'S LEAGUE.

F. W. Bruggerhof, Pres.; Burnet Landreth, Sec'y.

A PROGRESSIVE SEED STORE IN UTICA, N. Y.

The Batchelor Seed Store in Utica has been favorably known for a long time. Of late years it has been owned and operated by H. C. Langdon, but recently has been bought and reorganized by Syracuse capitalists, at the head of whom is C. F. Saul, long and favorably known in the seed trade of Syracuse, N. Y. A new company has been formed with C. F. Saul as president; Douglas M. Ross, as secretary and treasurer. The concern will be operated under the old title, "The Batchelor Seed Store," and will be under the general management of Mr. Ross, who grew up in the Syracuse establishment of Mr. Saul. We wish the new concern abundant success.

CATALOGUES RECEIVED.

Sander & Sons, Bruges, Belgium.—Illustrated Folder of Azalea Indica, Bays, etc.

W. X. Scarff, New Carlisle, O.—Scarff's Fruits for 1909. "Mayflower" peach adorns the cover.

Herman Sievers, Halstenbeck, Germany.—Wholesale Price List of young trees, deciduous and coniferous.

Wilhelm Pfitzer, Stuttgart.—Catalogue and Price List of Vegetable and Flower Seeds, Roses, Bulbs, etc.

Goulds Manufacturing Company, Seneca Falls, N. Y.—Descriptive Illustrated List of Hand and Power Sprayers.

Gate City Seed Co., Keokuk, Ia.—Market Gardeners' Price List. Pocket edition 1909. Grass, Field and Garden Seeds and Onion Sets.

VEGETABLE PLANTS

FOR TRANSPLANTING

CABBAGE—Wakefield and Succession \$1.00 per 1000
EGG PLANT—N. Y. Improved and Black Beauty 60¢, per 100, \$3.00 per 1000
PEPPER—Bull Nose, Ruby King and Sweet Mountain, 40¢, per 100, \$3.00 per 1000
TOMATO—Earline, Clark's Jewel and Early June Pink, 30¢, per 100, \$3.00 per 1000

CASH WITH ORDER

R. VINCENT, JR., & SONS CO.
 White Marsh, Md.



NO W IS THE TIME TO
 ORDER BULBS AND
 AZALEAS FOR FALL
 DELIVERY.

Send for our Price List

Ralph M. Ward & Co., 12 W. B'way,
 New York

Harlan P. Kelsey, Salem, Mass.—American Hardy Rhododendrons. A prettily gotten up and well illustrated pamphlet, with useful cultural information on broad leaved evergreens.

Ross Bros. Company, Worcester, Mass.—Seeds and Agricultural Goods, Farm and Garden Supplies, for 1909. Includes about 30 pages devoted to agricultural tools and machinery.

Eastern Nurseries, Jamaica Plain, Mass.—Wholesale Trade List for Spring, 1909.—This is an up-to-date list including the best hardy shrubs and trees for ornamental planting.

Wm. F. Turner & Co., New Bedford, Mass.—"Prize Medal" Dahlias.—This firm won the medal offered by the German Dahlia Society at the exhibition in Boston last year, also the Dobbie & Co. medal.

Wilhelm Muhle, Temesvar, Austria.—Wholesale Catalogue of Vegetable and Flower Seeds, Plants, Trees and Ornamental Shrubs. Cover brilliantly illustrated with cuttings on front and tree foliage on back page.

Winterson's Seed Store, Chicago, Ill.—General Catalogue of Seeds and Plants. The motto of the house, "Make Your Garden Glad," appears on the title page, together with a striking picture of Vicks' "Mikado Pink" aster.

Ross Bros.' Seed House, Wichita, Kans.—25th Anniversary Seed Book. A very useful little catalogue. Cover particularly chaste and attractive, with a panel and spray of nasturtiums in colors on white on front and irises on back.

Wm. H. Moon Company, Morrisville, Pa.—"Hardy Trees and Plants for Every Place and Purpose." The sort of catalogue that impels people to plant their home grounds. Cover very artistic with decoration of pine cones.

V. Lemoine et Fils, Nancy, France.—Begonia Patrie, Dentzia discolor arcuata, D. discolor densiflora, D. gracilis candelabrum, Hydrangea arborescens grandiflora and Philadelphus mer de glace each have a full page half-tone illustration. The name Lemoine is a sufficient guarantee of the character of the text.

Watkins & Simpson, London, Eng.—Foreign and Colonial Wholesale Catalogue of Garden and Flower Seeds, Season of 1909.—Cover carmine, with illustration of Aster Eclipse on last page. Illustrations in the novelty and specialty section only which lists some very handsome new subjects, especially in annual flowers, which show marked improvement on their respective types.

Vilmorin-Andrieux & Cie, Paris, France.—General catalogue for 1909. The cover illustration of this very comprehensive publication is a half free, half conventional presentation of carnations and nasturtiums in light red and dull green. One colored plate is introduced showing the improved grandiflora type of Primula obovata which is not in the least exaggerated. Other than this the illustrations are old-fashioned wood-cuts throughout.

Everything "For the Land's Sake."

The one firm in Boston where all good forms of plant food may be obtained, is the Bowker Fertilizer Company, opposite Faneuil Hall at 43 Chatham St. All greenhouse chemicals, Nitrate of Soda, Ground Bone, Potash Salts, Sheep Manure and Wood Ashes can there be had at first hands.

BOWKER FERTILIZER COMPANY.

Everything "For the Land's Sake."

NEWS NOTES.

Rogers Park, Ill.—Peter Haerens has bought the Philip greenhouses and will take possession Aug. 1.

Newton Centre, Mass.—John J. Leahy has bought the Cowen greenhouse on White avenue.

Milton, Mass.—A. H. Ferry has bought the old Oakes Ames greenhouses at North Easton for removal.

White Plains, N. Y.—Arthur Dummett, Inc., nurserymen and contractors, of Mount Vernon, will open an office and show room at this place.

Gycas Revoluta

(Sago Palm)

STRONG HEALTHY TRUNKS

Average from 1 to 5 lbs. each

Ready Now

25 pounds for	\$2.25
100 " " "	8.50
300 " " "	24.00

Headquarters for

Dahlia and Canna Roots
 All the Leading Sorts

Write for a copy of our Wholesale Catalog

HENRY F. MICHELL CO.
 1018 and 618 Market St., PHILA.

Mignonette

**FARQUHAR'S
GIANT**

Oz., 75c; 1-4 oz., 25c

R. & J. Farquhar & Co.
6 & 7 South Market Street
BOSTON, MASS.

CANES

Freshly Cut From the
Brakes For Your Lilies
Can Be Cut To Any Size

\$5 for 500, \$7 for 1000

Wm. Elliott & Sons
42 Vesey St., New York

BEST QUALITY SEEDS

30 Years Experience Growing and Selling

PEAS AM. WONDERS \$5.00 bu.; THOS. LANTONS \$4.00 bu.; GRADUS \$5.00 bu.; TELEPHONES \$5.00 bu.; NOTTS' EXCELSTORS \$5.00 bu.; PREMIUM GEMS \$4.50 bu.; DUKE OF ALBANY \$4.75 bu.

ONION YELLOW GLOBE DANVERS \$1.25 per lb., postage free.

Mammoth, Medium, Alsike, Alfalfa, Clover and Timothy

Write for prices. Send for my beautiful 1909 catalogue (free). Samples mailed free.

CHAS. F. SAUL

220-224 JAMES STREET, SYRACUSE, N. Y.

200,000 CLADIOLI BULBS

3/4 to 1 1/4 inches, \$2 per 1000. 1 1/4 to 1 3/4, \$4 per 1000. 1 3/4 and up, \$5 per 1000.

CALIFORNIA PRIVET

1 yr. well branched, \$20 per 1000. Cash with order. Nice lot of AMERICAN CHESTNUT TREES at a bargain, about 50 LARGE SUGAR TREES, most of them sample trees.

Surplus of STONE TOMATO SEED: Ruby King Neapolitan, Bull Nose and Sweet Mountain Pepper Seed at a bargain.

I. & J. L. LEONARD, - Iona, N. J.
Vegetable Plant Nurserymen and Seed Growers

In ordering goods please add "I saw it in HORTICULTURE."

BRIDGEMAN'S SEED WAREHOUSE
RICKARDS BROS.
Props.
37 East 19th St., - NEW YORK CITY

C. C. MORSE & CO. 48-56 JACKSON ST., San Francisco, Cal.
The Largest Seed Growers on the Pacific Coast
ONION, LETTUCE, SWEET PEAS,
ALSO
Carrot, Celery, Leek, Mustard, Parsley, Parsnip, Radish, Salsify

LEONARD SEED CO.
CONTRACT GROWERS AND WHOLESALE DEALERS
BEANS, PEAS, SWEET CORN, ONION, GARDEN SEEDS
ONION SETS FLOWER SEEDS Get Our Prices 79 and 81 E. KINZIE STREET, CHICAGO

Thorburn's Seeds
LILY OF THE VALLEY PIPS
Unexcelled Hamburg or Berlin
TUBEROUS ROOTED BEGONIAS GLOXINIAS
ROSA MULTIFLORA NANA SEED
and all other flower seeds for Florists
SEND FOR CATALOGUE

J. M. THORBURN & CO.
33 BARCLAY ST. through to 38 PARK PLACE
NEW YORK

CAULIFLOWERS
CABBAGE
LILY OF THE VALLEY PIPS.
HJALMAR HARTMANN & CO.
12 Stormgade,
COPENHAGEN, DENMARK.

Burpee's Seeds
PHILADELPHIA

Blue List of Wholesale Prices mailed only to those who plant for profit

Vegetable and Flower **SEEDS**
Reliable and Tested. Catalogue Mailed Free
WEBER & DON
Seed 114 CHAMBERS STREET
Merchanta NEW YORK

SHEEP MANURE
Pulverized. Free from Adulteration
In Bag, \$18.00 per Ton. Cash with Order
ROBERT SIMPSON
CLIFTON, N. J.

STOCK SEED
FOR WINTER BLOOMING
Our strain of Double Branching Stocks is exceptionally true. About 90% Double Flowers.
In colors: - 3/4 oz. .60 oz. \$4.00
Pure White 1/2 " .75 " 5.00
H. E. FISKE SEED CO.
Faneuil Hall Square, BOSTON, MASS.

Winter-flowering
SWEET PEA SEED
All Colors Ask for List
A. C. ZVOLANEK
ORIGINATOR. BOUND BROOK, N. J.

NEW CROP SEED
For Early Planting
THOMAS J. GREY CO.
32 SO. MARKET ST., BOSTON, MASS.
BEGONIAS TUBEROUS ROOTED
ALSO
6LXONIAS, LILY OF VALLEY, SPIREA
Catalogues mailed free on application
Joseph Breck & Sons Corp.
47-54 NO. MARKET ST., BOSTON, MASS.

CEO. E. DOW
Designing and Illustrating
178 Washington St., Boston, Mass.
OUR SPECIALTY
Machine, Booklet. Advertising and Flower PHOTOGRAPHS

Japanese Bulbs, Etc.
R. TANOI, Yokohama, Japan.
Send for catalogue and write to Representative
K. TAKEUCHI,
478a Boylston St., Boston, Mass.

QUALITY SEED BULB PLANTS
SEND FOR CATALOGUE
ARTHUR T. BODDINGTON
349 West 14th St., New York.

To Florists Everywhere

Orders for Cut Flowers and Floral Decorations to be delivered anywhere in the Greater New York, may be placed with us with the certainty that your customers will be satisfied.

Telegraph, telephone or mail such orders to us and be sure that they will be filled as promptly and as carefully as though you did it yourself.

(One third discount will be allowed on all orders thus placed with us by Florists outside of the Greater New York.

THE BLOSSOM

Bond and Livingston Sts.,
BROOKLYN, N. Y.

C. C. TREPEL, Manager

**WILLIAM J. SMYTH
FLORIST**

Cor. Michigan Ave. and 31st St., CHICAGO

We ship to all points in Illinois and Iowa.

Phones: Douglas 744, Douglas 523, Douglas 740

M. C. and J. E. HAUSWIRTH

Out of Town orders for Hospitals
Carefully filled.

**232 Michigan Ave.
CHICAGO**

AUDITORIUM ANNEX Tel. Harrison 585

**SAMUEL MURRAY
Florist**

Coates House Conservatory

1017 BROADWAY, KANSAS CITY, MO.

Both 'Phones 2670 Main.



WASHINGTON,
D. C.

GUDE'S

The Far-Famed Flowers of
TORONTO

Delivered on mail or telegraph order for any occasion, in any part of the Dominion.

JOHN H. DUNLOP,
96 Yonge St., - Toronto, Ont.

The Park Floral Co.

J. A. VALENTINE
Pres.

DENVER, COLORADO

**WILLIAM L. ROCK
FLOWER CO.**

KANSAS CITY, - MO.

will carefully execute orders for Kansas City and any town in Missouri or Kansas.



Buffalo, N. Y.

W. J. PALMER & SDN, 304 Main St.

**Of Interest to Retail
Florists**

NEW RETAIL FLOWER STORES.

Oberlin, O.—H. A. Cook.

Waukegan, Ill. Theo. Myer.

Providence, R. I. John Green, 187 Harrison street.

Denver Col. A. C. Sinram, Tremont and 15th streets.

Minneapolis, Minn.—Souden & Desmond, Hennepin avenue and 9th street.

A FAMILY OF FLORISTS.

Among the progressive florists who have passed the best years of their lives in Chicago is Anton Then. His love for his work has been inherited by his children, and together they represent several branches of the business. At the greenhouse which is in charge of two sons they are carefully watching a very promising red seedling carnation which they intend placing on the market soon. A daughter and Mrs. Then have charge of the re-

STEAMER DEPARTURES

American.

St. Louis, N. Y.—Shampton...Mar. 6

Philadelphia, N. Y.—Shampton...Mar. 13

Atlantic Transport.

Minneapolis, N. Y.—London...Mar. 6

Minnetonka, N. Y.—London...Mar. 29

Cunard.

Campania, N. Y.—Liverpool...Mar. 3

Ivernia, Boston-Liverpool...Mar. 9

Lusitania, N. Y.—Liverpool...Mar. 10

French Line.

La Touraine, N. Y.—Le Havre...Mar. 4

La Bretagne, N. Y.—Le Havre...Mar. 11

Hamburg-American.

Pretoria, N. Y.—Hamburg...Mar. 6

Deutschland, N. Y.—Hamburg...Mar. 11

North German Lloyd.

Kaiser Wm. II, N. Y.—Bremen...Mar. 2

Princess Irene, N. Y.—M. Pts...Mar. 6

Giessenau, N. Y.—Bremen...Mar. 11

Koenig Albert, N. Y.—M. Pts...Mar. 13

White Star.

Adriatic, N. Y.—Shampton...Mar. 3

Majestic, N. Y.—Shampton...Mar. 10

Celtic, N. Y.—Liverpool...Mar. 13

Romanic, Boston-Med. Pts...Mar. 13

tail store and Miss Josie Tien handles their flowers in the market. Such instances of whole families working so harmoniously together are as creditable as they are rare.

NOTES.

Harry C. Heilemann, for seven years with the Leo Niessen Co., Philadelphia, has bought out the retail store of the Graham Floral Co., at 5615 Germantown avenue. This does not include the greenhouses which are still being run by the Graham Co. Mr. Heilemann is a young man of marked ability and pleasing personality, and has every prospect of making a success of his new venture.

O. J. Friedman, well known Chicago florist, at Van Buren and Michigan avenues, has received notice to vacate May 1st. The building is to be torn down, and replaced by a sky scraper. It is understood that Mr. Friedman's new location will be near Jackson Boulevard and Michigan avenue, about a block from his old quarters.

ALEX. McCONNELL

571 FIFTH AVENUE
NEW YORK CITY

Telegraphic orders forwarded to any part of the United States, Canada, and all principal cities of Europe. Orders transferred or intrusted by the trade to our selection for delivery on steamships or elsewhere receive special attention.

Telephone Calls, 487 and 488 38th St.
Cable Address, ALEXCONNELL

New York Deliveries

FLOWERS and PLANTS

by special messenger to Steamer,
Theatre or any address in

NEW YORK or BROOKLYN

THOMAS YOUNG, JR.

500 FIFTH AVE., (near 42nd St.)

NEWMAN FLORAL Co.

(Established 1870)

202 Fifth Ave. and
Madison Square, NEW YORK CITY

FLOWERS FOR STEAMER SAILINGS

M. A. BOWE

In the Heart of New York City

1294 Broadway

Tel. 2270, 38th St. NEW YORK

Our Motto—The Golden Rule

DAVID CLARKE'S SONS

Deliver orders from any part of the country to
New York City

Or OUT-GOING STEAMERS

Write or telegraph

2139-2141 Broadway, New York
Telephone 1552-1553 Columbus

YOUNG & NUGENT

42 West 28 St., NEW YORK

"FLOWERS BY TELEGRAPH"

**NEW YORK
MYER, FLORIST**

Phone 5297 Plaza. 609-611 MADISON AVE.

**ALBANY, N. Y.
EYRES**

Flowers or Design Work

DELIVERED IN ALBANY AND VICINITY
ON TELEGRAPHIC ORDER.

11 NORTH PEARL ST., ALBANY, N. Y.

Flower Deliveries

In Brooklyn and other Long Island Points
New York City, New Jersey, etc. At Theatres,
Hotels, Steamers or Residences.

WILSON

Fulton St. and Greene Ave., Brooklyn, N. Y.

JOHN BREITMEYER'S SONS

Cor. Miami and Gratlot Aves.
DETROIT, MICH.

Artistic Designs . . .
High Grade Cut Blooms

We cover all Michigan points and good sections of Ohio, Indiana and Canada

**PROMPT DELIVERY IN
BOSTON**

AND ALL NEW ENGLAND POINTS
F. H. HOUGHTON
396 Boylston St., Boston, Mass.

BOSTON'S BEST
In Quality and Design

Can be relied upon when you transfer your retail orders to

EDWARD MACMULKIN
194 Boylston Street, Boston

Send flower orders for delivery in
BOSTON

and all
NEW ENGLAND POINTS
THOS. F. CALVIN
124 Tremont St., Boston

The Original Telegraph Order Florist
WILL DELIVER

Flowers or Designs
to order in Boston and Vicinity. Usual Discount.

J. NEWMAN & SONS, Inc.
Est. 1870 24 TREMONT ST., BOSTON



DANKER, Albany, N. Y.

ORDERS FOR
**Choice Flowers and
Floral Emblems**
FILLED PROMPTLY

LOUISVILLE, KY.
JACOB SCHULZ,
550 South Fourth Ave.

WELLESLEY COLLEGE
Dana Hall, Walnut Hill and Rockridge Hall
Schools. TAILBY, Wellesley, Mass.
Tel. Wellesley 44-1 and 2. Night 44-3.

ATLANTA FLORAL CO.
41 Peachtree Street, ATLANTA, GEORGIA

\$\$\$ SAVED \$\$\$ CUT DOWN EXPENSE.

Why buy expensive baskets, when

HART'S NEW HANDY HANDLE

gives the same effect at trilling cost? Covered with willow and finished in natural wood colors, manufactured in four sizes.

No. 1, 12 in. high \$25.00 per 100	No. 3, 15 in. high \$40.00 per 100
No. 2, 15 " " 30.00 " "	No. 4, 24 " " 50.00 " "

Ask your cut flower jobber to see it, if he has not got it, send us his name and we will send him samples.

GEORGE B. HART, 24 Stone Street,
Rochester, N. Y.

THE NEW IDEA IN PLANT STANDS The Moore-Livingston Graduating or Adjusting

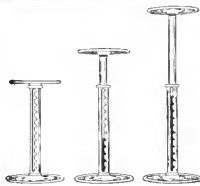

Saves one-half to two-thirds of cost over ordinary galvanized iron stands.

SEND FOR CIRCULAR GIVING FULL PARTICULARS
SOLD BY SEEDSMEN AND SUPPLY HOUSES

If your seedsman does not carry send us his name and we will promptly send full particulars.

Moore-Livingston Co., Patentees and Mfrs., Lansdowne, Pa.

"FLOWERS BY TELEGRAPH."

Leading Retail Florists Listed by Towns for Ready Reference.

- Denver, Colo.—Park Floral Co., 1706 Broadway.
- Washington, D. C.—Gude Bros., 1214 F St.
- Atlanta, Ga.—Atlanta Floral Co., 41 Peach Tree St.
- Chicago—M. C. & J. E. Hauswirth, 232 Michigan Ave.
- Chicago—William J. Smyth, Michigan Ave. and 51st St.
- Chicago—George Wittbold Co., 1057-59 Buckingham Place.
- Louisville, Ky.—Jacob Schulz, 550 South Fourth Ave.
- Boston—Thos. F. Calvin, 124 Tremont St.
- Boston—Frank H. Houghton, 396 Boylston St.
- Boston—Edward MacMulkin, 194 Boylston St.
- Boston—Hoffman, Florist, 59-61 Massachusetts Ave.
- Boston—J. Newman & Sons, Inc., 24 Tremont St.
- Boston—Julius A. Zinn, 2 Beacon St. Wellesley, Mass.—Tallyby.
- Detroit, Mich.—J. Breitmeyer's Sons, Miami and Gratlot Aves.
- Kansas City, Mo.—Sammel Murray, 1017 Broadway.
- Kansas City, Mo.—Wm. L. Rock Flower Co., 1116 Walnut St.
- Albany, N. Y.—H. G. Eyles, 11 N. Pearl St.
- Albany, N. Y.—F. A. Danker, 40 Maiden Lane.
- New York—David Clarke's Sons, 2139-2141 Broadway.
- New York—Alex. McConnell, 571 5th Ave.
- New York—Young & Nugent, 42 W. 28th St.
- New York—M. A. Bowe, 1294 Broadway.
- New York—Myer, 609-11 Madison Ave.
- New York—Thos. Young, Jr., 500 Fifth Ave.
- New York—Newman Floral Co., 202 Fifth Ave. & Madison Sq.
- Brooklyn, N. Y.—The Blossom (C. C. Trepel, Mgr.), Bond and Livingston Sts.
- Brooklyn, N. Y.—Robert G. Wilson, Fulton St. and Greene Ave.
- Buffalo, N. Y.—Palmer's, 304 Main St.
- Toronto, Can.—J. H. Dunlop, 96 Yonge St.

THE BEST LETTERS

FOR THOSE
FLORISTS' MADE
USE OF BY THE



Boston Florist Letter Co.
66 PEARL ST., BOSTON
N. F. MCCARTHY, Mgr.

Order direct or buy from your local supply dealer. Insist on having the

BOSTON

Inscriptions, Emblems, etc., Always in Stock

Durand & Marohn

MANUFACTURERS OF

All Kinds of Wire Work
Florists' Wire Designs a Specialty
24 Beaver St., ALBANY, N. Y.

FLORISTS' SUPPLIES

Send for New Catalogue

H. Bayersdorfer & Co.

1129 ARCH ST., PHILADELPHIA

TRANSFER

Your orders for flower or plant delivery in Eastern New England to

JULIUS A. ZINN,
2 Beacon St., Boston

Fine Design Work a Specialty.

ACACIA PUBESCENS
 \$2.50 per Bunch
 The greatest novelty in **YELLOW**
 for February
THE LEO NIESSEN CO.
 1209 Arch St., Philadelphia, Pa.
 Open from 7 a. m. to 8 p. m.

P M
GARDENIAS
 \$5.00 per Doz.
SECONDS
 \$3.00 & \$4.00 per Doz.
QUALITY
S. S. PENNOCK-MEEHAN CO.
 1608-1620 Ludlow St., Philadelphia

CARNATIONS
 Unsurpassed in Quality. Orders filled for
 Any Quantity.
W. E. MCKISSICK & BROS.
 WHOLESALE FLORISTS
 1619-1621 RANSTEAD ST.
 PHILADELPHIA

WELCH BROS.
 AMERICAN BEAUTY, KILLARNEY, RICHMOND, MARYLAND and ALL THE SUPERIOR
 ROSES, LILY OF THE VALLEY, CARNATIONS, ORCHIDS
BEST PRODUCED
 226 Devonshire Street, Boston, Mass.

CUT FLOWER BOXES
EDWARDS FOLDING BOX CO
 MANUFACTURERS
 PHILADELPHIA, PA.

CHAS. W. MCKELLAR
 51 WABASH AVE., CHICAGO

Western Headquarters for Choice Orchids
 Valley, Roses and all Cut Flowers

PETER REINBERG
 WHOLESALE
CUT FLOWERS
 51 Wabash Av., Chicago, Ill.

DAILY CONSIGNMENTS
 From 40 to 60 Growers
 We can care for your cutflower wants to
 advantage.

E. F. WINTERSON CO.
 45-47-49 WABASH AVE., CHICAGO

POEHLMANN BROS. CO.
 33-35-37 Randolph St., - CHICAGO
CUT FLOWERS
 Greenhouses, - Morton Grove, Ill.

Rice Brothers
 115 N. 6th Street, MINNEAPOLIS, MINN.
WHOLESALE FLORISTS and SUPPLIES
 CUT FLOWERS received twice daily, and can fill
 your orders to your satisfaction. A complete line of
 Hardy Greens - WILD SMILAX, ROYWOOD,
 HARDY FANCY FERNS, GALAX LEAVES.
 Write for quotations on large quantities.

In ordering goods please add "I saw
 it in HORTICULTURE."

**WHOLESALE FLOWER MARKETS—TRADE PRICES—Per 100
 TO DEALERS ONLY**

	CHICAGO Feb. 22	TWIN CITIES Feb. 22	PHILA. Feb. 23	BOSTON Feb. 23
ROSES				
Am. Beauty, Fancy and Special.....	50.00 to 60.00	35.00 to 45.00	60.00 to 75.00	40.00 to 75.00
" " Extra.....	40.00 to 50.00	25.00 to 35.00	40.00 to 50.00	30.00 to 40.00
" " No. 1.....	40.00 to 40.00	15.00 to 25.00	25.00 to 35.00	10.00 to 15.00
" " Lower grades.....	12.00 to 20.00	8.00 to 15.00	6.00 to 20.00	4.00 to 8.00
Bride, "Maid, Fancy & Special.....	10.00 to 12.00	10.00 to 12.00	10.00 to 15.00	6.00 to 8.00
" " Lower grades.....	1.00 to 8.00	6.00 to 10.00	4.00 to 8.00	2.00 to 4.00
Killarney, Fan, & Sp.....	10.00 to 12.00	10.00 to 15.00	12.00 to 15.00	12.00 to 25.00
" " Lower grades.....	4.00 to 8.00	8.00 to 10.00	4.00 to 10.00	4.00 to 8.00
Richmond, Fancy & Special.....	12.00 to 15.00	8.00 to 12.00	20.00 to 25.00	12.00 to 25.00
" " Lower grades.....	3.00 to 10.00	6.00 to 10.00	4.00 to 10.00	4.00 to 8.00
Chateaux.....	6.00 to 8.00	6.00 to 8.00	6.00 to 12.00	4.00 to 12.00
Golden Gate Ivory, etc.....	8.00 to 12.00	6.00 to 8.00	4.00 to 12.00	4.00 to 8.00
My Maryland.....	10.00 to 16.00
Queen Beatrice.....	3.00 to 12.00
Mrs. Mar. Field.....	10.00 to 15.00
CARNATIONS				
Fancy and Red.....	2.00 to 3.00	3.00 to 4.00	5.00 to 6.00	2.00 to 3.00
Ordinary and White.....	1.50 to 2.00	2.50 to 3.00	1.50 to 3.00	1.50 to 2.00
MISCELLANEOUS				
Cattleyas.....	50.00 to 75.00	40.00 to 50.00	60.00 to 75.00	40.00 to 50.00
Cypripediums.....	12.00 to 15.00	8.00 to 10.00	12.00 to 15.00	10.00 to 12.00
Lilies.....	12.00 to 12.00	12.00 to 15.00	8.00 to 12.00
Lily of the Valley.....	2.00 to 4.00	2.00 to 3.00	2.00 to 5.00	1.00 to 4.00
Narciss, Paper White.....	3.00 to 4.00	2.00 to 3.50	3.00 to 4.00
Roman Hyacinth.....	3.00 to 4.00	2.00 to 3.00	2.00 to 3.00	4.00 to 8.00
Dafoedus.....	2.00 to 3.00	2.00 to 3.50	2.00 to 3.00	1.00 to 2.50
Freesia.....	3.00 to 4.50	2.00 to 4.00	2.00 to 3.00
Sweet Peas.....	.75 to 1.00	.75 to 1.25	.50 to 1.00	.75 to 1.00
Gardenias.....	35.00 to 50.00	40.00 to 50.00	50.00 to 50.00	35.00 to 50.00
Violets.....75 to 1.25	.25 to 1.00	.20 to .50
Adiantum.....	1.00 to 1.25	1.00 to 1.50	.75 to 1.00
Smilax.....	12.00 to 15.00	10.00 to 15.00	12.00 to 20.00	10.00 to 12.00
Asparagus Plumose, strings.....	50.00 to 60.00	35.00 to 50.00	50.00 to 75.00	35.00 to 50.00
" " & Sprea. (100 bchs.).....	35.00 to 50.00	20.00 to 25.00	35.00 to 50.00	15.00 to 25.00

J.A. BUDLONG
 37-39 Randolph Street, CHICAGO.
Roses and Carnations
 A Specialty.....
WHOLESALE CUT FLOWERS
 GROWER of

HENRY M. ROBINSON & CO.
 15 Province St. and 9 Chapman Place - BOSTON, MASS.
WHOLESALE COMMISSION FLORISTS
Hardy Cut Evergreens and Florists' Supplies
 We have the stuff and can fill all orders, large or small
 WE NEVER DISAPPOINT SATISFACTION GUARANTEED

Prices Quoted in these Columns are for Dealers Only.
 When Writing to Advertisers Please Mention
HORTICULTURE.

Flower Market Reports.

BALTIMORE Market conditions are fairly firm with a general healthy tone, all good material generally finding sale. The Mysic Shriners gave an eminently successful charity ball last week which took up some of the heavier class of decoration. With the advent of the Lenten season it is to be expected that the cut flower market will experience some depression.

BOSTON A very rainy Asb Wednesday has put the snufflers on whatever trade there was, and we are obliged to report "little doing" on this occasion. Last week made a good record and the chances are that it will hold same for some time against all comers. An awfully awkward surplus of violets obstructs the market and bulbous material is doing a little also in the obstructing business on its own account. Daffodils are particularly plentiful, albeit very fine in quality. Carnations have also taken a drop and are worth about one half what they were ten days ago. Roses of the more desirable kinds remain in short supply and Beauties of high grade are practically unobtainable. Killarney is the steadiest variety on the list. It is seen in grand quality and steps up smiling whenever called upon. It's a wonder. A nice grade of myosotis is in evidence.

BUFFALO For the past two weeks trade has been good and the market fairly cleaned up at noon daily. The demand for carnations is strong as well as for roses which have been considerably off crop for some time past. Long Beauties are still the scarcest article in the market and Richmond has helped out in many corners. Killarney has been in fairly good supply but light in color. Bridesmaid and Bride of short quality have been in heavy demand and at times hard to get, which helped the sale of bulbous stock. Violets are of good quality but have not moved as fast as wished for the past week. Smilax, asparagus, ferns and mignonette are in good supply with normal demand.

CHICAGO At this writing the stringency in the rose market is about the same as last week. The call was heavy for Washington's Birthday and as the stock was limited prices held up to what they had reached for Lincoln week and St. Valentine's Day. It is predicted that by the time this goes to press the strain will be relaxed and prices on Beauty, Richmond and Killarney will have fallen from ten to twenty per cent. The usual shipments from this market to New Orleans were increased for the Mardi Gras festival. Local demand for daffodils is waning and some of the wholesalers have more stock than they can move. Other bulbous stock is going at fair prices, white being in especially good demand for funeral trade. Prices on cattleyas have advanced very decidedly. All the florists both wholesale and retail were at their posts on Monday, Washington's Birthday, but the volume of trade was not so large as Monday generally brings, the previous Saturday and Sunday showing the increase instead.

WHOLESALE FLOWER MARKETS.— PER 100. TO DEALERS ONLY.

	CINCINNATI Feb. 23		DETROIT Feb. 23		BUFFALO Feb. 22		PITTSBURG Feb. 17	
ROSES								
Am. Beauty, Fac. and Sp.	35.00	40.00	35.00	40.00	35.00	50.00	40.00	50.00
" Extra	25.00	30.00	27.00	32.00	25.00	35.00	25.00	35.00
" No. 1	18.00	20.00	18.00	20.00	18.00	25.00	12.00	15.00
" Lower grades	8.00	10.00	8.00	10.00	6.00	10.00	1.00	5.00
Bride, Maid, F. & S.	6.00	8.00	6.00	10.00	10.00	12.00	10.00	12.00
" Low. G.	3.00	5.00	4.00	6.00	4.00	6.00	5.00	8.00
Killarney, Fac. & Sp.	6.00	8.00	6.00	10.00	10.00	12.00	10.00	12.00
" Lower grades	3.00	5.00	4.00	6.00	4.00	6.00	6.00	8.00
Richmond, Fancy & Special	7.00	10.00	7.00	10.00	10.00	12.00	10.00	12.00
" Lower grades	4.00	6.00	5.00	7.00	4.00	6.00	6.00	8.00
Chateauy, Low. G.	5.00	8.00	5.00	8.00	5.00	10.00	5.00	8.00
Golden Gate, Ivory, etc.	4.00	6.00	3.00	8.00	4.00	6.00	4.00	10.00
My Maryland
Queen Beatrix
Mrs. Mar. Field
CARNATIONS								
Fancy and Novelties	3.00	2.00	3.00	2.50	3.00	3.00	4.00
Ordinary	1.50	2.00	1.50	2.00	2.00	2.50	1.00	2.00
MISCELLANEOUS								
Cattleyas	30.00	75.00	50.00	75.00	50.00	75.00
Oyprediums	10.00	15.00	2.00	15.00	15.00
Lilies	12.00	12.50	15.00	15.00	15.00	15.00	12.00
Lily of the Valley	3.00	4.00	3.00	4.00	3.00	4.00	3.00	4.00
Narcis, Paper White	3.00	2.00	3.00	2.00	3.00	2.50	3.00
Roman Hyacinth	2.00	3.00	2.00	3.00	2.00	3.00	2.00	3.00
Freesia	3.00	4.00	3.00	4.00	3.00	4.00	3.00	4.00
Primula	2.00	3.00	2.00	3.00	2.00	2.00	3.00
Sweet Peas	.50	1.00	1.00	1.00	1.00	.75	1.00
Gardenias	50.00	75.00	50.00	75.00	35.00	50.00
Violets75	.50	.75	.50	.75	.50	.75
Adiantum	1.00	1.50	.50	1.50	1.00	1.50
Smilax	12.50	12.50	15.00	15.00	15.00	12.50	15.00
Asparagus Plumosus, strings	35.00	50.00	35.00	50.00	35.00	50.00	30.00	50.00
" & Spreo (two bchs.)	25.00	35.00	25.00	35.00	25.00	35.00	30.00	50.00

PHILADELPHIA The favorable market reported in last issue kept up the past week, and a very satisfactory business was done all along the line. The lengthening days and fairly bright weather had some effect in bringing in larger supplies; but the demand was so good that no appreciable slump was noticeable in prices. The market kept on an even keel, and all good stock found a profitable market. Carnations and violets were probably most affected by the increased output. Gardenias, also, were a little more plentiful. Roses sold better if anything, notwithstanding slightly increased receipts. If any of them hung fire at all, it was among the whites — but even there nothing to speak of. Orchids are still scarce and in excellent demand. The opening days of the week show business brisk, but with Ash Wednesday the situation may take a turn. However, Lent is not nearly the big haul it once was to the flower trade here. There will be lots of business, Lent or no Lent. This is George's Day; we cannot tell a lie!

WASHINGTON At the present time Washingtonians know nothing and talk of nothing but the fast approaching Inauguration. The whole of Pennsylvania Avenue looks like a carpenter's shop. The Court of Honor, which extends the entire length of the White House grounds, facing the Avenue, is to be decorated by Gule Bros. For that purpose they will use thousands of yards of laurel festoons, with wreaths and garlands galore. Prices continue normal except on shipped carnations which have taken a drop. Dozens of social entertainments daily keep the market in a more than

healthy condition. Green of good quality is scarce. Most of the growers are holding it back for the Easter rush.

ACCIDENTAL SHOOTING.
Sunday, February 21, at 10 A. M., as Ernest Oechslin, one of Chicago's well known growers, Gale avenue and Madison street, was in his greenhouse, he was accidentally shot by his nephew who was outside about twenty feet away, examining his uncle's rifle. Mr. Oechslin was hurried to Oak Park Hospital and the course of the bullet located by means of the X-ray. It had entered the lower right lung, passed through his body and is lying against the spine. No attempt has been made at this writing to remove the bullet. The nephew, a frail young man, is completely prostrated by the accident. Mr. Oechslin's greenhouses, full of Easter stock will be ably superintended by his brother during his absence and his many friends wish him a speedy recovery.

NEWS NOTES.
Cleveland, O.—Mrs. J. Warne and Son, florists, have disposed of their property to a real estate firm and will retire from business.
Asheville, N. C. The Deake greenhouses, recently purchased by Dr. Grove, will be torn down to make way for the beautification of the estate. The Biltmore Nursery has charge of the landscape work.

Providence, R. I. Providence had a big "business boom" banquet on Tuesday evening, Feb. 23, in which the floral fraternity took a leading part, practically every firm in the city and environs contributing flowers and plants for the decoration of the Armory and tables.

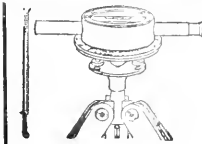

EVERYBODY KNOWS Park Cemetery

Gardening cannot be properly done without the aid of an accurate leveling instrument.

Bostrom's Improved Levels, No. 2 at \$15.00 and No. 3 at \$25.00, are considered by all who KNOW to be the only Levels on the market which meet all the requirements, at the price.

Our customers lack of every Level we sell, and satisfied users to every State in the Union heartily endorse every claim we make.

Shipping weight 12 lbs. Description on request.

BOSTROM-BRADY MFG. CO., 139 Madison Avenue, ATLANTA, GA.

FORD BROTHERS
 48 West 28th Street NEW YORK
FINE ROSES FANCY CARNATIONS
 A Full Line of ALL CUT FLOWERS
 Telephone, 3870 or 3871 Madison Square

H. E. FROMENT
 Wholesale Commission Florist,
 Choice Cut Flowers,
 57 West 28th St. :: NEW YORK
 Telephones: 2200, 2201, Madison Square.

Alfred H. Langjahr
 All choice cut-flowers in season. Send
 for quotations. Correspondence with
 shippers of first-class stock invited.
 55 West 28th Street, New York
 Telephones 4626-4627 Madison Square

Edward C. Horan
 Wholesale Florist
 55 WEST 28th ST.
 Tel. 1462 Madison Square New York
 1463

JOHN YOUNG
WHOLESALE FLORIST
 Finest American Beauties and
 Carnations

51 West 28 St. - NEW YORK
FRANK MILLANG
Wholesale Florist
 55-57 West 26th St., NEW YORK
 Shipments, any quantity, Whole-
 sale Market Rates.

Consignments Requested
 A Good Market and Prompt Returns
GEORGE SALTFOOT
 43 W. 28th Street, NEW YORK
 Telephone, 3303 Madison Sq.

VIOLETS
 Finest Grade. Any Quantity
B. S. SLINN
 55-57 W. 26 St., New York

Moore, Hentz & Nash
 Wholesale Commission Florists
 55 and 57 West 26th Street
 Telephone No, 756
 Madison Square New York

MILLANG BROS.
 WHOLESALE COMMISSION FLORISTS
 41 West 28th Street
 Telephone 3860 Madison
 3861 NEW YORK

JOHN I. RAYNOR
Wholesale Commission Florist **SELLING AGENT FOR LARGEST GROWERS**
 A full line of Choice Cut Flower Stock for all purposes. Comprises every variety
 grown for New York market, at current prices
 TEL. 1998 MADISON SQUARE 49 West 28th St., New York City

Walter F. Sheridan
 Wholesale Commission Dealer in
CHOICE CUT FLOWERS
 39 West 28th Street, New York
 Telephone: 3532-3533 Madison Square

HEADQUARTERS FOR NOVELTIES
ORCHIDS A SPECIALTY
 THE HIGHEST GRADE OF **VALLEY** ALWAYS ON HAND
 GARDENIAS, DAISIES, ROSES AND CARNATIONS
JAMES McMANUS, Telephone 753 Mad. Sq. 42 W. 28th St., New York

PHILIP F. KESSLER 55 & 57 W. 26th St., New York City
 Commission Dealer, Wholesale Buyer
 and Seller of
CUT FLOWERS
 Open from 5 a. m. to 6 p. m. Sunday
 till 10 a. m.
 Tel., 5243 and 2921 Madison Sq. Res., 345 J., Newtown.
Finest Lilies in the Market Every Day in the Year.

NEW YORK QUOTATIONS PER 100. To Dealers Only

ROSES AND CARNATIONS	Last Half of Week ending Feb. 20 1909		First Half of Week beginning Feb. 22 1909	
	American Beauty, Fancy and Special.....	50.00	to 75.00	50.00
" " Extra.....	35.00	to 40.00	35.00	to 40.00
" " No. 1.....	15.00	to 20.00	15.00	to 20.00
" " Lower Grades.....	3.00	to 8.00	3.00	to 8.00
Bride, 'Field, Fancy and Special.....	8.00	to 10.00	8.00	to 12.00
" " Lower Grades.....	3.00	to 6.00	3.00	to 5.00
Killarney, Fancy and Special.....	12.00	to 20.00	10.00	to 20.00
" " Lower Grades.....	4.00	to 8.00	4.00	to 8.00
Richmond, Fancy and Special.....	15.00	to 30.00	12.00	to 30.00
" " Lower Grades.....	3.00	to 10.00	3.00	to 10.00
Chatenay.....	3.00	to 15.00	4.00	to 15.00
Fly Maryland.....	4.00	to 15.00	4.00	to 15.00
Golden Gate, Ivory, etc.....	3.00	to 10.00	3.00	to 10.00
Queen Beatrice.....	to	to
Tre. Par. Field.....	to	to
Carnations, Fancy and Novelties.....	3.00	to 5.00	3.00	to 5.00
" " Ordinary and White.....	2.00	to 3.00	1.50	to 2.00

Alexander J. Guttman
THE WHOLESALE FLORIST OF NEW YORK
 34 WEST 28th STREET
 PHONES. 1664--1665 MADISON SQUARE
ENOUGH SAID

TRAENDLY & SCHENCK
 Wholesale Florists
 Furnish best Stock at fair Prices all the year round
 Send for Quotations on Any Variety and Quantity
 Tel. 798, 799 Madison Sq. 44 West 28th St., New York City

GROWERS' CUT FLOWER CO. CUT FLOWERS AT WHOLESALE
VIOLETS, CARNATIONS, ROSES
ORCHIDS, CHRYSANTHEMUMS, LILIES
 Consignments Solicited. Shipments to Order, any Distance
 Telephone Easy Madison Square
39 West 28th Street, NEW YORK
 J. J. COAN, Manager

WHOLESALE FLORISTS
54 West 28th St.
NEW YORK
Telephone 3659 Madison Sq.

A. L. YOUNG & CO.

RECEIVERS & SHIP-
PERS OF CUT
FLOWERS.
CONSIGNMENTS SOLICITED.

WILLIAM H. KUEBLER
Brooklyn's Foremost and Best
WHOLESALE COMMISSION HOUSE
A First Class Market for all CUT FLOWERS
28 Willoughby St., Brooklyn, N. Y.
Tel. 4591 Maio

GEORGE COTSONAS & CO.
Wholesale and Retail Dealers in all kinds of
EVERGREENS
Fancy and Dagger Ferns
Bronze and Green Galax
Main Store 50 W. 28 St.
Phone 1200 Mad. Sq. New York



Greater New York Florists' Association, Inc.
Now Open for Cut Flower Consignments
162 Livingston Street, BROOKLYN, N. Y.
Geo. W. Crawbuck Telephone Connection
Manager 3642-43 Main

Henshaw & Fenrich
WHOLESALE FLORISTS
44 West 28th Street, NEW YORK
Phones Mad. Sq. 325, 558-2, 558-3

H. C. BERNING
Wholesale Florist
1402 Pine Street, ST. LOUIS, MO.
REED & KELLER
122 West 25th St., New York

WHOLESALE COMMISSION
Open 6 a. m. Daily
J. K. ALLEN
106 W. 28th St. NEW YORK
Tel. 167 Madison Sq.
All Grades of Flowers to Suit All Buyers. Consignments Solicited.

Florists' Supplies
We manufacture all our
Hotel Designs, Baskets, Wire Work & Novelties
and are dealers in
Glassware Decorative Greens and Florists' Requisites

NEW YORK QUOTATIONS PER 100. To Dealers Only

THE KERVAN CO.
Wholesale Dealers and Shippers of
Decorative Evergreens
Ferns, Galax, Laurel, Fresh Cycas, Box-
wood, Sphagnum and all Florists' Greens
Send to us for Quotations before Buying.
113 West 28 Street, NEW YORK CITY

MISCELLANEOUS	Last Half of Week ending Feb. 20 1909		First Half of Week beginning Feb. 22 1909	
Cyripediums	8.00	10.00	8.00	10.00
Cattleyas	25.00	40.00	25.00	50.00
Lilies	6.00	10.00	5.00	10.00
Lily of the Valley	1.00	3.00	1.00	3.00
Nardus, Paper Whites	1.50	3.00	1.50	3.00
Roman Hyacinth	1.00	3.00	1.00	2.00
Tulips	2.00	3.00	1.00	3.00
Daffodils	2.00	3.00	1.50	2.00
Freesia	1.00	3.00	1.00	3.00
Sweet Peas	.75	1.00	.75	1.00
Gardenias	20.00	40.00	22.00	40.00
Violets	.35	.60	.25	.50
Adiantum	.75	1.00	.50	.75
Groenium	1.50	1.25	1.00	1.25
Smilax	10.00	15.00	10.00	15.00
Asparagus Plumosus, strigs.	2.00	35.00	30.00	35.00
" " & Spreo. (100 bchs.)	20.00	25.00	20.00	25.00

MICHIGAN CUT FLOWER EXCHANGE, Inc.
WHOLESALE COMMISSION FLORISTS
Consignments Solicited
Hardy Fancy Fern Our Specialty
38-40 BROADWAY, DETROIT, MICH.

NEW YORK MARKET REPORT.

All indications are for a reaction and downward movement in flower values just as soon as the sunlight and spring warmth now due begin to get in their work on the producing plants. Roses are the only thing of any great influence on the market which have not already felt the effect, and they will not be far behindhand. Carnations are decidedly weaker but in quality they are all that could be desired. The same is true of violets, which as a rule are extra good. Lilies are accumulating, with quality variable and prices according. Many "odds and ends" are in the florists' windows not usually catalogued in the standard lists—such as primulas, myosotis, pansies, forced shrub bloom, yellow and white daisies, etc., and occasionally even a bunch of chrysanthemums, all of which serve to supply the variety needed to keep the flower buying public interested. Flowering plants are gradually coming to the foreground as usual at this season of the year.

BUSINESS CHANGES.

Denver, Col.—The Gallup Floral Co. has removed to 1546 California street.
New York, N. Y.—Abram Jacobs has purchased the retail store of C. A. O'Reilly, 198 Columbus avenue.
Erie, Pa.—The firm of Offerle & Schaal has dissolved and the business will be continued by C. G. Offerle.
Winchendon, Mass.—H. J. Whittemore has commenced the repairing of his greenhouses on River street which were recently gutted by fire.
Grand Rapids, Mich.—The Grand Rapids Floral Co. has removed from 149 to 145 Monroe street and will change its name to Alfred Hanna & Sons.
Rock Island, Ia.—The business of the Long View Floral Co. will hereafter be carried on by Mr. Hensley, he having purchased his partner's interest.

Boston.—William J. Dutton succeeds the late Marston B. Bunker, retail florist at 8 City Hall avenue. Mr. Dutton has been in the employ of Mr. Bunker for some time, and this, with his long previous experience in the Boston flower trade, would seem to insure his success.

IN BANKRUPTCY.

Quincy, Mass. Edward Arnold, florist; liabilities, \$4116; assets, \$1325. Among the unsecured creditors are H. E. Piske Seed Co., A. T. Stearns Lumber Co. and Welch Bros.

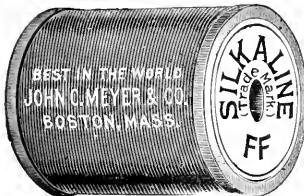

Wired Toothpicks

Manufactured by
W. J. COWEE, BERLIN, N. Y.
50,000....\$1.75; 50,000....\$7.50. Sample free.
For sale by dealers

ROBERT J. DYSART
Public Accountant and Auditor
Simple methods of correct accounting especially adapted for florists' use.
Books Balanced and Adjusted
Merchants Bank Building
28 STATE STREET, BOSTON
Telephone, Main 58.

Buyer's Directory and Ready Reference Guide

Advertisements under this head, one cent a word. Initials count as words.

Display advertisers in this issue are also listed under this classification without charge. Reference to List of Advertisers will indicate the respective pages.

Buyers failing to find what they want in this list will confer a favor by writing us and we will try to put them in communication with reliable dealers.

ACCOUNTANT

R. J. Dyart, 28 State St., Boston.
For page see List of Advertisers.

AGERATUMS

R. Vincent, Jr. & Sons Co., White Marsh,
Maryland.
For page see List of Advertisers.

AQUILEGIAS

Aquilegia. Genuine Coerulea, finest of
all. Both plants and seeds from the heart
of the Rockies. C. S. Harrison's Select
Nursery, York, Neb.

ARAUCARIAS

A. Leuthy & Co., Perkins St. Nurseries,
Roslindale, Mass.
For page see List of Advertisers.

Godfrey Aschmann, 1012 West Ontario St.,
Philadelphia, Pa.
For page see List of Advertisers.

ASPARAGUS

The Geo. Witbold Co., 1657 Buckingham
Place, Chicago, Ill.
For page see List of Advertisers.

AUCTION SALES

Clery's Horticultural Co., 62 Vesey St.,
New York.
For page see List of Advertisers.

AZALEAS

A. Leuthy & Co., Perkins St. Nurseries,
Roslindale, Mass.
For page see List of Advertisers.

Godfrey Aschmann, 1012 W. Ontario St.,
Philadelphia.
Apollo in Bloom.
For page see List of Advertisers.
Henry A. Dreer, Philadelphia.
Azalea Mollis.
For page see List of Advertisers.

BAMBOO CANES

Yokohama Nursery Co., 31 Barclay Street,
New York.
Bamboo Sticks, Colored Green.
For page see List of Advertisers.
Wm. Elliott & Sons, New York City.
Lily Stakes.
For page see List of Advertisers.

BAY TREES.

2000 Bay and Box Trees in all sizes,
Pyramid and Standards. Write for list.
Julius Roehrs, Rutherford, N. J.

BEDDING PLANTS

J. E. Felthousen, Schenectady, N. Y.
For page see List of Advertisers.

BOILERS

BOILERS. "Burnham" Boilers made for
greenhouse heating. Lord & Burham,
1183 Broadway, N. Y.
Kroeschell Bros. Co., 35 Erie St., Chicago.
For page see List of Advertisers.

BOXWOOD TREES

New England Nurseries, Inc., Bedford,
Mass.
For page see List of Advertisers.

BUILDING MATERIAL

BUILDING MATERIAL of all description
for All Cypress, Semi-Iron, Iron
Frame or Truss Houses. Hot Bed Sash
and Frames. Lord & Burham Co., 1183
Broadway, N. Y.

BULBS AND TUBERS

Joseph Breck & Sons, 47-54 N. Market St.,
Boston.
For page see List of Advertisers.

BULBS AND TUBERS—Continued

J. M. Thornburn & Co., 33 Barclay St.,
New York.
For page see List of Advertisers.

A. T. Boddington, 342 W. 14th St., N. Y.
For page see List of Advertisers.

Rickards Bros., 37 East 19th St., New York.
For page see List of Advertisers.

H. F. Mitchell Co., Philadelphia.
For page see List of Advertisers.

H. E. Fiske Seed Co., Faneuil Hall Sq.,
Boston.
For page see List of Advertisers.

T. J. Grey & Co., 32 and 33 So. Market St.,
Boston.
For page see List of Advertisers.

Yokohama Nursery Co., 31 Barclay St.,
New York.
For page see List of Advertisers.

Ralph M. Ward & Co., 12 W. Broadway,
New York.
For page see List of Advertisers.

K. Takeuchi, 478A Boylston St., Boston.
Japanese Bulbs.
For page see List of Advertisers.

CANNAS

A. T. Boddington, 342 W. 14th St.,
New York.
For page see List of Advertisers.

Large assortment of Cannas of the fol-
lowing varieties: Burbank, Pennsylvania,
Berat and Cnebar, at \$1.50 per 100; or
would exchange for dwarf Ageratum, Pe-
verfew, double Alyssum. C. W. Moeckel,
17 Summer St., Fitchburg, Mass.

CARNATIONS

F. Dörner & Sons Co., Lafayette, Ind.
Carnation, Pink Delight.
For page see List of Advertisers.

Chicago Carnation Co., Joliet, Ill.
For page see List of Advertisers.

Albert Roper, Tewksbury, Mass.
Carnation Bay State.
For page see List of Advertisers.

Bassett & Wabanum, Hinsdale, Ill.
Carnation O. P. Bassett.
For page see List of Advertisers.

East Sudbury Greenhouse, So. Sudbury,
Mass.

Carnation Cuttings.

For page see List of Advertisers.

Wood Bros., Fishkill, N. Y.

Carnations, Rooted Cuttings.

For page see List of Advertisers.

The E. G. Hill Co., Richmond, Ind.

Carnation Cuttings.

For page see List of Advertisers.

Peter Fisher, Ellis, Mass.

Rooted Cuttings.

For page see List of Advertisers.

S. J. Reuter & Son, Westery, R. I.

For page see List of Advertisers.

Scheiden & Schoch, Chicago

Carnation Wm. H. Taft.

For page see List of Advertisers.

Bellamy Bros., Syracuse, N. Y.

Carnation Marchbanks.

For page see List of Advertisers.

Fine-craft Greenhouses, East Brookfield,

Mass.

Carnations, Rooted Cuttings.

For page see List of Advertisers.

Victory Carnations, a surplus of 1500

well rooted cuttings without bottom heat

and hardened off, all taken from side

shoots, for \$25.00; samples 10c. A. Rejca

& Son, Poughkeepsie, N. Y.

CHRYSANTHEMUMS

Chsa. H. Totty, Madison, N. J.

Chrysanthemum Novelties.

For page see List of Advertisers.

CHRYSANTHEMUMS—Continued

E. G. Hill Co., Richmond, Ind.
For page see List of Advertisers.

S. J. Reuter & Son, Westery, R. I.
For page see List of Advertisers.

Elmer D. Smith & Co., Adrian, Mich.
For page see List of Advertisers.

C. H. Totty, Madison, N. J.
Single Chrysanthemums From Seed.

For page see List of Advertisers.

Chrysanthemum Golden Glow from 2 1/4
in. pots, for early spring delivery, \$1.00 per
doz., \$6.00 per 100, \$50.00 per 1000. Stock
plants of Montauk, Oct. Frost, Crocus,
Matchless, Lucy Devaux, Polly Rose and
Halliday, \$1.00 per doz.; \$6.00 per 100.
Peirce Bros., Waltham, Mass.

Herrington's book on the Chrysanthemum,
mailed to your address for 50c., by
Horticulture Publishing Co., 11 Hamilton
Place, Boston.

Chrysanthemums from 2 1/2 in. pots, ready
now Golden Glow, White Cloud, 6c.;
Reefer, May, 5c.; Polly Rose, October
Frost, Tonset, Bonnafton, 3c. Henry
Trall, Frederick, Md.

COLEUS

J. E. Felthousen, Schenectady, N. Y.
For page see List of Advertisers.

CONIFERS

John Waterer & Sons, Ltd., American
Nursery, Bagshot, Eng.
For page see List of Advertisers.

CUT FLOWER BOXES.

Edwards Folding Box Co., Philadelphia.
For page see List of Advertisers.

Folding cut flower boxes, the best made.
Write for list. Holton & Hunkel Co., MD
wauke, Wis.

CYCLAMEN.

Thomas Roland, Nahant, Mass.
For page see List of Advertisers.

DAHLIAS

David Herbert & Son, Ateo, N. J.

For page see List of Advertisers.

J. L. Moore, Northboro, Mass.

For page see List of Advertisers.

Peacock Dahlia Farms, Williamstown Jus-
tation, N. J.

For page see List of Advertisers.

R. Vincent Jr. & Sons Co., White Marsh, Md.

For page see List of Advertisers.

DAHLIAS.

Geo. H. Walker, No. Dighton, Mass.

Wholesale and Retail.

Send your name for my 1909 Catalog
and Pocket Guide, ready to mail about
Feb. 25th.

Cinctus, Decorative, Fancy, Show and
Pompon Dahlias. Good commercial varieties,
such as Krimhilde, Countess of Lonada,
Mad. Van Den Deal and other sure
bloomers, strong divided roots in 10 or 20
named varieties, my selection, \$1.00 per 25;
\$3.00 per 100; \$25.00 per 1000. Cash please.
Herrmann Thiemann, Myson, Mass.

East Bridgewater Dahlia Gardens wants
your business. if you are looking for
dahlias send to the Eastern Dahlia King,
J. K. Alexander, East Bridgewater, Mass.

DECORATIVE PLANTS

A. Leuthy & Co., Perkins St. Nurseries,
Roslindale, Mass.

For page see List of Advertisers.

Godfrey Aschmann,

1012 W. Ontario St., Phila., Pa.

For page see List of Advertisers.

Joseph Hancock Co., Wynote, Pa.

For page see List of Advertisers.

For List of Advertisers See Page 305

DECORATIVE PLANTS—Continued

The Geo. Withold Co., 1657 Buckingham Place, Chicago, Ill.
For page see List of Advertisers.
Robert Craig Co., Market and 49th Sts., Philadelphia, Pa.
For page see List of Advertisers.
A. N. Pierson, Inc., Cromwell, Conn.
Palms and Ferns.
For page see List of Advertisers.

DRACAENAS

The Geo. Withold Co., 1657 Buckingham Place, Chicago, Ill.
For page see List of Advertisers.

ECONOMY BRACKET

Buxton & Allard, Nashua, N. H.
For page see List of Advertisers.

EVERGREENS

New England Nurseries, Bedford, Mass.
For page see List of Advertisers.
American Nursery Co., 150 Broadway, New York, N. Y.
For page see List of Advertisers
Henry A. Dreer, Philadelphia, Pa.
For page see List of Advertisers.
Evergreens. Send 25 cents in stamps for complete work on propagating and growing Evergreens. C. S. Harrison's Select Nursery, York, Neb.

FERNS

A. Leuthy & Co., Roslindale, Mass.
For page see List of Advertisers.
H. H. Barrows & son, Whitman, Mass.
Nephrolepis, Whitman.
For page see List of Advertisers.
John Scott, Brooklyn, N. Y.
For page see List of Advertisers.
Frank Oechlein, 2570-2606 W. Adams St., Chicago.
Ferns for Dishes.
For page see List of Advertisers.
The Geo. Withold Co., 1657 Buckingham Place, Chicago, Ill.
For page see List of Advertisers.
Godfrey Aechmann, 1012 W. Ontario St., Philadelphia.
For page see List of Advertisers.
Henry A. Dreer, Philadelphia, Pa.
Adiantum Farleyense.
For page see List of Advertisers.

FERTILIZERS

Pulverized Manure Co., 31 Union Stock Yards, Chicago, Ill.
Wizard Brand Sheep and Shredded Cattle Manure.
Robert Simpson, Clifton, N. J.
Sheep Manure.
For page see List of Advertisers.
Bowker Fertilizer Co., Boston, Mass.
All Ferns of Plant Food at First Hands.
For page see List of Advertisers.

FEVERFEW

Feverfew Little Gem, 80¢ per 100; \$7.00 per 1000. S. W. Pike, St. Charles, Ill.
2000 Feverfew from 2½ in. \$3.00 per 100, \$25.00 per 1000. Albert Batley & Son, Maynard, Mass.
Feverfew, 2½ in., \$2.00 per 100. H. J. Blanchard, Ashburnham, Mass.

FLORAL PHOTOGRAPHS

Floral Photographs, Foley's, 226-228 1/2 Bowersy, New York.

FLORISTS' LETTERS.

Boston Florist Letter Co., 66 Pearl St., Boston, Mass.
For page see List of Advertisers.

FLORISTS SUPPLIES

N. F. McCarthy & Co., 84 Hawley St., Boston.
For page see List of Advertisers.
H. M. Robinson & Co., 15 Province St. and 9 Chapman Pl., Boston, Mass.
For page see List of Advertisers.
Seed & Keller, 122 W. 23th St., New York.
For page see List of Advertisers.
H. Bayerdorfer & Co., 1129 Arch St., Philadelphia.
For page see List of Advertisers.
Bacon & Co., Appleton, N. Y.
Baskets: Crates: Ladders: Boxes.

FLOWER POTS

W. H. Ernest, 28th and M Sts., Washington, D. C.
For page see List of Advertisers.
A. H. Hews & Co., Cambridge, Mass.
For page see List of Advertisers.
Hilinger Bros., Ft. Edward, N. Y.
For page see List of Advertisers.
The Peters & Reed Pottery Co., Zanesville, O.

We make Standard Flower Pots, etc. Write us when in need. Wilmer Cope & Bro., Lincoln University, Chester Co., Pa.

FOREST SEEDLINGS

To close out quick I offer the following first-class stock for Parks, Cemeteries and Forest Plantings: 100 M. Amorpha fruticosa, 1 to 3 ft.; 300 M. Althea Rosen Stocks; 100 M. Cal. Privet; 500 M. Cal. Privet Cuttings; 100 M. Black Locust, 4 to 6 ft.; 50 M. Calycanthus, Sweet Shrub, 1 to 3 ft.; 150 M. Cercis Canadensis, Red Bud, 1 to 4 ft.; 60 M. Cornus Stolonifera, Ozier Dogwood, 1 to 2 ft.; 50 M. Diosyros, Am. Persimmon, 6 to 30 inches; 50 M. Elm (white) 1 to 2 ft.; 75 M. Hamamelis, Witch Hazel, 6 in. to 3 ft.; 50 M. Thuja Poplar, 1 to 8 ft.; 20 M. Sweet Gum, 1 to 6 ft.; 50 M. Black Walnut, 1 to 3 ft.; 20 M. Wistaria, 1 to 3 ft.; 20 M. Yucca filamentosa, 1 and 2 year Butternut, Japan Walnut, Ash, Maple, etc. Send for trade list. I offer my entire stock to close out at low prices; also a large stock of Tree and Shrub Seeds, Black Locust, Sweet Gum, Sycamore, Ash, Red Bud, Persimmon, Bass Wood, Viburnums, Sugar Maple, Red Cedar and other Seeds. Forest Nursery & Seed Co., J. H. H. Boyd, Prop., R. F. D. No. 2, McMinville, Tenn.

FUCHSIAS

R. Vincent, Jr. & Sons Co., White Marsh, Maryland.
For page see List of Advertisers.

GALAX

Michigan Cut Flower Co., 38 and 40 Broadway, Detroit, Mich.
For page see List of Advertisers.
George Cotsouas & Co., 50 W. 28th St., New York.
For page see List of Advertisers.

The Kervan Co., 113 West 28th St., N. Y.
For page see List of Advertisers.
Rice Bros., 115 N. 6th St., Minneapolis, Minn.
For page see List of Advertisers.
H. M. Robinson & Co., 15 Province St. and 9 Chapman Place, Boston.
For page see List of Advertisers.

GERANIUMS

R. Vincent Jr. & Sons Co., White Marsh, Md.
New and Standard Varieties.
For page see List of Advertisers.
A few hundred fine mixed stock geraniums, all double, \$7.00 per 100. Fine geraniums, 2½ in., \$2.00 per 100. Cash. H. J. Blanchard, Ashburnham, Mass.
Red Geraniums, 2½ in., \$2.50 per 100. Jas. T. Baker, Bustleton, Philadelphia, Pa.

GLADIOLI

J. L. Moore, Northboro, Mass.
For page see List of Advertisers.
A. T. Boddington, 342 W. 14th St., New York.
For page see List of Advertisers.
O. V. Zangen, Hoboken, N. J.
Gladioli Breuchleyensis.
For page see List of Advertisers.
Stump & Walter Co., 50 Barclay St., New York.
I. & J. L. Leonard, Iona, N. J.
Gladioli Bulbs.
For page see List of Advertisers.
Breuchleyensis Gladioli, \$8.00 per 1000. Cash with order, please. Estate of Louis Siebrecht, Floral Park, N. Y.
Groff's hybrids, small size (dublets), \$1.00 per 1000, postpaid; named varieties, \$2.00 per 1000. Henry Field Seed Co., Shenandoah, Iowa.

GLASS

Boston Plate & Window Glass Co., Boston
For page see List of Advertisers.
Standard Plate Glass Co., 261-30 Sudbury St., Boston.
For page see List of Advertisers.
Foley Mfg. Co., Western Ave., between 25th & 26th Sts., Chicago.
Sharp, Partridge & Co., 224 & Lumber St., Chicago.
For page see List of Advertisers.
Greenhouse glass, lowest prices. Johnston Glass Co., Hartford Ct., Ind.
Glass, High Grade, Double Thick Greenhouse Glass. Lord & Burnham, 1133 Broadway, N. Y.
Gordon Van Tine Co., LSI Case St., Haverport, Ia.
For page see List of Advertisers.

GLAZING DEVICES

H. A. Dreer, Philadelphia, Pa.
Peerless Glazing Point.
For page see List of Advertisers.
GLAZING POINTS, Lord & Burnham Special Glazing Nibs (Points). Lord & Burnham, 1133 Broadway, N. Y.
Gordon Van Tine Co., 1581 Case St., Haverport, Ia.
For page see List of Advertisers.

GREENHOUSE BUILDING MATERIAL

Lord & Burnham Co., 1133 Broadway, New York.
For page see List of Advertisers.
Fletcher U-Bar Co., 1 Madison Sq., N. Y.
For page see List of Advertisers.
A. T. Stearns Lumber Co., Neponset, Boston.
For page see List of Advertisers.
King Construction Co., N. Tonawanda, New York.
For page see List of Advertisers.
Hitchings & Co., 1170 Broadway, New York.
For page see List of Advertisers.
J. C. Moulner Co., 117 East Blackhawk St., Chicago, Ill.
For page see List of Advertisers.
Foley Mfg. Co., Western Ave., between 25th & 26th Sts., Chicago.
For page see List of Advertisers.

GREENHOUSE CONSTRUCTION

GREENHOUSE CONSTRUCTION, Semi-Iron Greenhouse, New Truss Houses and Iron Frame Houses, Lord & Burnham, 1133 Broadway, N. Y.
J. A. Payne, 264-274 Culver Ave., Jersey City, N. J.
For page see List of Advertisers.
Foley Mfg. Co., Western Ave., between 25th & 26th Sts., Chicago.
For page see List of Advertisers.
Hitchings & Co., 1170 Broadway, New York.
For page see List of Advertisers.

GREENHOUSE HOSE

Revere Rubber Co., Boston, Mass.
Revero Hose.
For page see List of Advertisers.

GUTTERS

GUTTERS, Cast Iron Gutters, L. & B. Improved V Shaped Gutter with drip gutter attachment. Lord & Burnham, 1133 Broadway, N. Y.

HAIL INSURANCE

Florists' Hall Assn. of America.
J. G. Ester, Saddle River, N. J.
For page see List of Advertisers.

HARDY FERNS, MOSS AND GREENS

H. M. Robinson & Co., 15 Province St. and 9 Chapman Pl., Boston, Mass.
For page see List of Advertisers.
Michigan Cut Flower Exchange, 38 and 40 Broadway, Detroit, Mich.
For page see List of Advertisers.
George Cotsouas & Co., 50 W. 28th St., New York.
For page see List of Advertisers.
N. F. McCarthy & Co., 84 Hawley St., Boston.
For page see List of Advertisers.
The Kervan Co., 113 W. 28th St., N. Y.
For page see List of Advertisers.

In writing to Advertisers kindly mention Horticulture

HARDY FERNS, MOSS AND GREENS—Continued

Rice Bros., 115 N. 6th St., Minneapolis, Minn.
For page see List of Advertisers.
Green and Bronze Leucothoe, \$2.50 per 100. Nice long sprays. Cash. Please address Frank H. Hill, Victoria, Macon Co., N. C.

HARDY PLANTS

Novelties and Specialties. For over one hundred distinct new varieties of hardy plants, all of great commercial value, get our Wholesale Catalog of Perennials and Hardy Plants. Publishers: Nurseries, Sparkill, N. Y.

HART'S HANDY HANDLE

Geo. B. Hart, 24 Stone St., Rochester, N. Y.
For page see List of Advertisers.

HEATING APPARATUS

Lord & Burnham Co., 1133 Broadway, New York.
For page see List of Advertisers.

Pierson U-Bar Co., 1 Madison Sq., N. Y.
For page see List of Advertisers.

John A. Payne, 230-274 Culver Ave., Jersey City, N. J.
For page see List of Advertisers.

Kroeschel Bros. Co., 35 Erie St., Chicago.
For page see List of Advertisers.

HELP FURNISHED

Thos. H. Bambrick, 34 S. 7th St., Phila.
For page see List of Advertisers.

HERBACEOUS PERENNIALS

P. Ouwerkerk, P. O. No. 1, Hoboken, N. J.
For page see List of Advertisers.
New England Nurseries, Bedford, Mass.
For page see List of Advertisers.

The Geo. Wirthholz Co., 1657 Buckingham Place, Chicago.
For page see List of Advertisers.

HOT-BED SASH

The A. T. Stearns Lumber Co., Newport, Mass.
For page see List of Advertisers.

Pierson U-Bar Co., 1 Madison Sq., N. Y.
For page see List of Advertisers.

Lord & Burnham Co., 1133 Broadway, N. Y.
For page see List of Advertisers.

Foley Mfg. Co., Western Ave., between 25th & 26th Sts., Chicago.

Gordon-Van Tine Co., 1581 Case St., Davenport, Ia.
For page see List of Advertisers.

HYDRANGEAS.

Hydrangea American Everblooming. Fine field-grown plants. 1 to 2 1/2 inches, \$10.00 to \$15.00 per 100. Berberis Thunbergii, seedlings and strong transplants. Ancon River Drive, Japanese Drive, California Privet. Fine plants for hedges. Lists free. The E. Y. Teas Co., Centerville, Ind.

INSECTICIDES.

Neotolide kills all greenhouse pests. P. R. Palethorpe Co., Eleventh St., Owensboro, Ky.
For page see List of Advertisers.

Stump & Walter Co., 50 Barclay St., New York.

Kilndead Tobacco Dust.
For page see List of Advertisers.

Niagara Sprayer Co., Middleport, N. Y. Niagara Brand.
For page see List of Advertisers.

E. G. Pratt Co., New York. Sulfocide.
For page see List of Advertisers.

Hammond's Slug Shot Works, Fishkill-on-Hudson, N. Y.
For page see List of Advertisers.

Bowker Insecticide Co., Boston, Mass. Insect Destroying Preparations.
For page see List of Advertisers.

"The Fumigating Kind Tobacco Powder"—The first on the market and the kind that has so many imitators, has our guarantee of satisfaction or money back, and "The Moon Trade Mark" on every bag, \$3.00 per 100 lbs. The H. A. Stoothoff Co., Mount Vernon, N. Y., Makers and sellers.

JAPANESE PLANTS

Yokohama Nursery Co., 31 Barclay St., New York.
For page see List of Advertisers.

KENTIAS

Godfrey Aschmann, 1012 W. Ontario St., Phila., Pa.
For page see List of Advertisers.

A. Leuthy & Co., Rosindale, Mass.
For page see List of Advertisers.

Joe. Hancock Co., Wyncoote, Pa. Single and Made-Up Specimens.
For page see List of Advertisers.

LEUCOTHOE

Elk Evergreen Co., Shell Creek, Tenn.

LEVELS FOR LANDSCAPE GARDENING USE.

Bostrom-Brady Mfg. Co., 159 Madison Ave., Atlanta, Ga.
For page see List of Advertisers.

LILY OF THE VALLEY PIPS

Hjalmar Hartmann & Co., 12 Stormgade, Copenhagen, Denmark.
For page see List of Advertisers.

LOBELIAS

Double Lobelia Kathleen Mallard, rooted cuttings, \$1.00 per 100. Cash. Chas. H. Green, Spencer, Mass.

R. Vincent, Jr. & Son, White Marsh, Md.
For page see List of Advertisers.

MARGUERITES

Marguerites, Queen Alexandra, \$1.25 per 100, prepaid. S. W. Pike, St. Charles, Ill.

NICO-FUME

Kentucky Tobacco Product Co., Louisville, Ky.
For page see List of Advertisers.

NURSERY STOCK

John Waterer & Sons, Ltd., American Nursery, Bngsht, England.
For page see List of Advertisers.

Clary's Horticultural Co., 62 Vesey St., New York.
For page see List of Advertisers.

P. Ouwerkerk, 216 Jane St., Weehawken Heights, N. J.
For page see List of Advertisers.

D. J. Twomey, Dept. H, Geneva, N. Y.
For page see List of Advertisers.

I. & J. L. Leonard, Iona, N. J.
For page see List of Advertisers.

Eastern Nurseries, Jamelen Plain, Mass. Viburnum Made.
For page see List of Advertisers.

American Nursery Co., 150 Broadway, New York, N. Y.
For page see List of Advertisers.

ROCK MAPLE SEEDLINGS Per 1000
Sagar of Rock Maple, fine, 2 to 4 ft. \$20.00
" " " " 2 to 3 ft. 12.00
" " " " 1 to 2 ft. 5.00
Samples on request. List free. The E. Y. Teas Co., Centerville, Ind.

Manual of the Trees of North America, by C. S. Sargent, mailed to your address for \$5.00, by Horticulture Publishing Co., 18 Hamilton Place, Boston.

TREES, SHRUBS, ROSES, EVERGREENS, PEONIES, HARDY PLANTS, ELLWANGER & BARRY, Rochester, N. Y.

New Hardy Shrub—Buddleia varialibilis Vetchill, the summer flowering. 1 1/2 doz. each, \$5.00 per doz.; \$35.00 per 100. Rose Hill Nurseries, New Rochelle, N. Y.

Catalog now ready. Nursery grown evergreens, seedling white pine and hemlock, native trees and plants. L. E. Williams, Nottingham, N. H.

Rhododendrons, Laurel, Spruce Hemlock, Poplars, E. W. Sheeley, De Bruce, Sullivan County, N. Y.

ONION SEED

Federico C. Varela, Tenerife, Canary Is. Bermuda Onion Seed.

Onion Seed—1908 Crop; truly dependable seed; yellow, red and white Globe. Write for prices. Langlin Seed Co., Kenton, O.

ORCHID PLANTS

Lager & Hurrell, Summit, N. J.
For page see List of Advertisers.

Sander, St. Albans, England. Importers, Experts, Growers, Hybridists.
For page see List of Advertisers.

Carillo & Baldwin, Seacaucus, N. J.
For page see List of Advertisers.

Jo. A. Manda, 191 Valley Road, W. Orange, N. J.
For page see List of Advertisers.

Ordonez Bros., Madison, N. J., Box 106.
For page see List of Advertisers.

Largest stock in the country. Ask for prices. **Julius Roehrs**, Rutherford, N. J.

PAINT AND PUTTY

PAINT AND PUTTY: Ideal Greenhouse lead; Special Greenhouse Putty. Lord & Burnham, 1133 Broadway, N. Y.

PALMS

A. Leuthy & Co., Perkins St. Nurseries, Rosindale, Mass.
For page see List of Advertisers.

Robert Craig Co., Market and 49th Sts., Philadelphia, Pa.
For page see List of Advertisers.

Joseph Hancock Co., Wyncoote, Pa. Home-Grown Palms.
For page see List of Advertisers.

PANSY PLANTS.

Panicles, extra fine giant flowering, strong plants, 30 cents per 100; \$2.50 per 1000. Edw. Wallis, Atco, N. J.

PATENTS

Siggers & Siggers, Washington, D. C.
For page see List of Advertisers.

PEAT

Orchid peat, Rotted peat, Azalea peat, Leaf-Mould, Live Sphagnum moss, Baled Sphagnum moss, Green Clump moss, etc. Jobbers' list on application. C. W. Brownell & Co., Walden, N. Y.

Orchid Peat and Moss always on hand. **Julius Roehrs Co.**, Rutherford, N. J.

PENTSTEMONS

C. H. Totty, Madison, N. J.
For page see List of Advertisers.

PEONIES

Peonies only, by the wholesale—best 100 varieties. J. F. Rosenfeld, Westpoint, Nehr. One of the finest collections in America. Send 25 cts. in stamps for new edition of Peony Manual. C. S. Harrison's Select Nursery, York, Neb.

PETUNIAS

R. Vincent, Jr. & Sons Co., White Marsh, Maryland.
For page see List of Advertisers.

PHLOXES

Send 25 cts in stamps for Phlox Manual. Fine mixed phloxes \$2.00 per 100. C. S. Harrison's Select Nursery, York, Neb.

PHOTOGRAPHS: DESIGNING: ILLUSTRATING

Geo. E. Dow, 178 Washington St., Boston.
For page see List of Advertisers.

PIPE AND FITTINGS

Foley Mfg. Co., between Western Ave. and 26th St., Chicago, Ill.
For page see List of Advertisers.

Kroeschel Bros. Co., 35 Erie St., Chicago.
For page see List of Advertisers.

PIPE AND FITTINGS. Cast Iron and Wrought Pipe, Valves, Elbows, Pipe Hooks, Automatic Air Headers, etc. Lord & Burnham, 1133 Broadway, N. Y.

PLANT STANDS

Moore-Livingston Co., Lunsdowne, Pa.
For page see List of Advertisers.

PLANT STAKES

Seele's Teless Plant Stakes and Trellises. H. D. Seele & Sons, Elkhart, Ind.

POT HANGERS

Pot hangers, Kramer's \$1 doz. by exp. \$1.25 by mail. I. N. Kramer & Son, Cedar Rapids, Ia.

POINSETTIAS (Artificial)

Poinsettias, artificial decorations on speciality. Sample lots of 50 in 3 sizes, \$4.00; 100 lots, \$6, \$8, \$10. J. Stern & Co., 125 N. 10th St., Philadelphia, Pa.

PRIVET

John Bennett, Atlantic Highlands, N. J.

PRUNING SHEARS

Rhodes Mfg. Co., Dept. R., Grand Rapids, Mich.

RAFFIA

Raffia (colored), 20 beautiful shades. Samples free. R. H. Conroy Co., Camden, N. J.; 810 Washburn Ave., Chicago, Ill.

RHODODENDRONS

John Waterer & Sons, Ltd., American Nursery, Dagshol, England. For page see List of Advertisers.

P. Ouwkerker, Hoboken, N. J. For page see List of Advertisers.

Anthony Waterer, Knap Hill Nursery, Surrey, Eng. For page see List of Advertisers.

ROSES

Robert Craig Co., Market and 40th Sts., Philadelphia, Pa. For page see List of Advertisers.

P. Ouwkerker, P. O. No. 1, Hoboken, N. J. For page see List of Advertisers.

Julius Roosa Co., Rutherford, N. J. Rose Newport Fairy. For page see List of Advertisers.

The F. R. Pierson Co., White Killarney, Tarrytown-on-Hudson, N. Y. For page see List of Advertisers.

S. J. Reuter & Son, Westley, R. I. My Maryland. For page see List of Advertisers.

Dingee & Conard Co., West Grove, Pa. For page see List of Advertisers.

Hand Book of Cultural Notes on Roses Under Glass, by F. P. Brigham, mailed to you address for 25c. by Horticulture Publishing Co., 11 Hamilton Place, Boston.

SALVIAS

R. Vincent, Jr. & Sons Co., White Marsh, Maryland.

Salvias Bonfire and Zurich. For page see List of Advertisers.

SEED GROWERS

C. C. Morse & Co., 48-56 Jackson St., San Francisco, Cal. For page see List of Advertisers.

Hjalmar Hartmann & Co., Canthflower and Cabbage Seed, 12 Stormgade, Copenhagen, Denmark. For page see List of Advertisers.

Federico C. Vardla, Tenerife, Canary Ids. Bermuda Onion Seed.

SEEDS

T. J. Grey Co., 32 So. Market St., Boston. For page see List of Advertisers.

Joseph Breck & Sons, 51 and 52 N. Market St., Boston, Mass. For page see List of Advertisers.

W. Atlee Burpee & Co., Philadelphia. For page see List of Advertisers.

C. C. Morse & Co., 48-56 Jackson St., San Francisco, Calif. For page see List of Advertisers.

Arthur T. Boddington, 342 W. 14th St., New York. For page see List of Advertisers.

H. E. Fiske Seed Co., Fanenl Hall Sq., Boston. For page see List of Advertisers.

Hjalmar Hartmann & Co., 12 Stormgade, Copenhagen, Denmark. For page see List of Advertisers.

Rickards Bros., 37 E. 10th St., New York. For page see List of Advertisers.

R. & J. Farquhar & Co., 67 So. Market St., Boston. Mignonette Seed. For page see List of Advertisers.

H. F. Mitchell Co., 1018 Market St., Phila. For page see List of Advertisers.

J. M. Thorburn & Co., 33 Barclay St., N. Y. For page see List of Advertisers.

Leonard Seed Co., Chicago, Ill. For page see List of Advertisers.

SEEDS - Continued

Wm. Elliott & Sons, 42 Vesey St., N. Y. For page see List of Advertisers.

Weeber & Don, 114 Chambers St., New York. For page see List of Advertisers.

I. & J. L. Leonard, Iona, N. J. Tomato and Pepper Seed. For page see List of Advertisers.

Seeds. Rocky Mountain Evergreen seed in large or small quantities. C. S. Harri-son's Select Nursery, York, Neb.

My own new crop of SALVIA SPLENDENS VARIETIES is now ready: Nana Compacta ZURICH, finest early flowering pot Salvia in existence, selected seeds. Compacta Grandiflora GLOBALL, best of all for pots and groups, selected seeds. Grandiflora Ameliorata KING OF THE SCARLETS, unexcelled for late groups, with extra large deep scarlet spikes, selected seeds. Each of above per Tr. Pkt., 50c.; 6 Tr. Pkt., \$2.50. Larger quantities on special quotation. O. V. ZANGEN, Seedsman, Hoboken, N. J.

SHAMROCKS

John F. Rupp, Shirenanstown, Pa. For page see List of Advertisers.

Shamrocks—Genuine Irish Shamrocks, original plant coming from cemetery, Downpatrick, Ireland. Two in., without pots, \$4.00 per 100; \$30.00 per 1000; with pots, \$4.50 per 100; \$40.00 per 1000; 250 at 1000 rate. Order early. Terms cash. J. D. Harcourt's Son, Wappingers Falls, N. Y.

SHRUBS

The Geo. Witthold Co., 1657 Buckingham Place, Chicago. For page see List of Advertisers.

SILKALINE

John C. Meyer & Co., Boston, Mass. For page see List of Advertisers.

SMILAX

R. Vincent, Jr. & Sons Co., White Marsh, Maryland. For page see List of Advertisers.

SPHAGNUM MOSS

Live Sphagnum moss, orchid peat and orchid baskets always on hand. Lager & Hurrell, Summit, N. J.

Sphagnum moss and mountain laurel in bags, bales or car lots. Prices low. Spruce and hemlock in bales. James Day, Box 660, Milford, N. H.

SPRAYERS

"SHOWERMAKER," \$1. Joe Kopcsay, So. Bend, Ind. For page see List of Advertisers.

Niagara Sprayer Co., Middleport, N. Y. For page see List of Advertisers.

J. F. Cass Mfg. Co., Dept. H., Detroit, Mich. U-N-I-T Globe Sprayer. For page see List of Advertisers.

Chas. J. Jager Co., Boston. Densling Spray Pump. For page see List of Advertisers.

STEAM TRAP

B. Hippard, Youngstown, O. For page see List of Advertisers.

STRAWBERRY PLANTS

H. L. Crane, Westwood, Mass. Barrymore Strawberry. For page see List of Advertisers.

SULFOCIDE

The B. G. Pratt Co., 50 Church St., Dept. W., New York City. For page see List of Advertisers.

SWEET PEAS

A. C. Zvolanek, Round Brook, N. J. Winter Flowering. For page see List of Advertisers.

TO-BAK-INE

E. H. Hunt, Gen. Agt., 76-78 Wabash Av., Chicago. For page see List of Advertisers.

VEGETABLE PLANTS

R. Vincent, Jr. & Sons Co., White Marsh, Md. For page see List of Advertisers.

TOMATO PLANTS.

Comet Tomatoes, 2 1/2 in., \$15.00 per 1000. Roncy Bros., West Grove, Pa.

VENTILATING APPARATUS

Pierson U-Bar Co., 1 Madison Sq., N. Y. For page see List of Advertisers.

Foley Mfg. Co., Western Ave., between 25th & 32nd Sts., Chicago. For page see List of Advertisers.

John A. Payne, 260-274 Culver Ave., Jersey City, N. J. For page see List of Advertisers.

The Advance Co., Richmond, Ind. For page see List of Advertisers.

Quaker City Machine Co., Richmond, Ind. 20th Century Ventilating Arm. For page see List of Advertisers.

VENTILATING MACHINERY. New Model enclosed, self-igning gear; Standard Model Open Gear. Lord & Burnham, 1133 Broadway, N. Y.

VERBENAS

R. Vincent, Jr. & Sons Co., White Marsh, Maryland. For page see List of Advertisers.

VIOLETS.

Princesa Violets, 2 1/2 in., \$2.50 per 100. Jas. T. Baker, Eastleton, Philadelphia, Pa.

WALLFLOWERS

Henry A. Dreer, Philadelphia, Pa. For page see List of Advertisers.

WAX FLOWERS

We are originators of wax designs and still the standard concern. J. Stern & Co., 125 N. 10th St., Philadelphia, Pa.

WIRED TOOTHPICKS

W. J. Cowee, Berlin, N. Y. For page see List of Advertisers.

WIREWORK

Reed & Keller, 122 W. 25th St., N. Y. For page see List of Advertisers.

Durand & Marohn, Albany, N. Y. For page see List of Advertisers.

Wirework. Write for our catalogue. Holton & Hunkel Co., Milwaukee, Wis.

William E. Heilscher's Wire Works, 38-40 Broadway, Detroit, Mich.

Headquarters for wire work. Send for list. Ball & Betz, 31 E. 3rd St., Cincinnati, O.

Wirework—Compare our prices with others. Scranton Florist Supply Co., 201 N. 7th St., Scranton, Pa.

WHOLESALE FLORISTS

Boston

N. F. McCarthy & Co., 84 Hawley St., Boston. For page see List of Advertisers.

H. M. Robinson & Co., 15 Province St. and 9 Chapman Pl., Boston. For page see List of Advertisers.

Weich Bros., 255 Devonshire St., Boston. For page see List of Advertisers.

Tatley, Wellesley, Mass. For page see List of Advertisers.

WHOLESALE FLORISTS—

Chicago

Chas. W. McKellar, 51 Wabash Ave., Chicago. For page see List of Advertisers.

Peter Reinberg, 51 Wabash Ave., Chicago. For page see List of Advertisers.

E. F. Winterson Co., 45-49 Wabash Ave., Chicago. For page see List of Advertisers.

J. A. Ruding, 37-39 Randolph St., Chicago. For page see List of Advertisers.

Poehlmann Bros. Co., Morton Grove, Ill. For page see List of Advertisers.

Cromwell, Conn.

A. N. Pierson, Cromwell, Conn. For page see List of Advertisers.

In writing to Advertisers kindly mention Horticulture

<p>Tobacco Paper IS THE STRONGEST, BEST PACKED, EASIEST APPLIED.</p> <p>24 sheets..... \$ 0.75 144 sheets..... 3.50 288 sheets..... 6.50 1728 sheets..... 35.10</p>	<h1 style="margin: 0;">"NICO-FUME"</h1> <p style="margin: 0;">Furnishes the Most Nicotine for the Money!</p> <p style="margin: 0;">... Manufactured by ... THE KENTUCKY TOBACCO PRODUCT CO., Louisville, Ky.</p>	<p>LIQUID OVER 40% NICOTINE</p> <p style="text-align: right;">By far the CHEAPEST.</p> <p style="text-align: right;">PRICE</p> <p>Pint..... \$ 1.50 ½ Gallon..... 5.50 Gallon..... 10.50 5 Gallons..... 47.25</p>
---	--	---

WHOLESALE FLORISTS—

Continued

Detroit

Michigan Cut Flower Exchange, 38 and 40 Broadway, Detroit, Mich.
For page see List of Advertisers.

Minneapolis

Bice Bros., 115 N. 8th St., Minneapolis, Minn.
For page see List of Advertisers.

New York

Ford Bros., 48 W. 28th St., New York.
For page see List of Advertisers.

H. E. Froment, 57 W. 28th St., New York.
For page see List of Advertisers.

Alex. J. Guttman, 34 W. 28th St., New York.
For page see List of Advertisers.

E. C. Horan, 55 W. 28th St., New York.
For page see List of Advertisers.

A. H. Langjahr, 55 W. 28th St., New York.
For page see List of Advertisers.

James McLannan, 42 W. 28th St., New York.
For page see List of Advertisers.

John I. Raynor, 49 W. 28th St., New York.
For page see List of Advertisers.

W. F. Sheridan, 39 W. 28th St., New York.
For page see List of Advertisers.

Trendly & Schenck, 44 W. 28th St., New York.
For page see List of Advertisers.

Moore, Hentz & Nash, 55 and 57 W. 26th St., New York.
For page see List of Advertisers.

Wm. H. Kuebler, 25 Willoughby St., Brooklyn, N. Y.
For page see List of Advertisers.

Phillip F. Kessler, 55 and 57 W. 26th St., New York.
For page see List of Advertisers.

Milburg Bros., 41 W. 28th St., New York.
For page see List of Advertisers.

John Young, 51 W. 28th St., New York.
For page see List of Advertisers.

Greater New York Florists' Association, 192 Livingston St., Brooklyn, N. Y.
For page see List of Advertisers.

George Saltford, 43 W. 28th St., New York.
For page see List of Advertisers.

Frank Milburg, 55-57 W. 26th St., New York.
For page see List of Advertisers.

B. R. Shina, 55-57 W. 26th St., New York.
For page see List of Advertisers.

A. L. Young & Co., 54 W. 28th St., N. Y.
For page see List of Advertisers.

Growers' Cut Flower Co., 89 W. 28th St., New York.
For page see List of Advertisers.

Henshaw & Fenrich, 44 W. 28th St., New York.
For page see List of Advertisers.

J. K. Allen, 106 W. 28th St., New York.
For page see List of Advertisers.

Philadelphia

W. E. McKissick & Bros., 1619-1621 Randa-stand St., Philadelphia, Pa.
For page see List of Advertisers.

Leo Niessen Co., 1290 Arch St., Philadelphia, Pa.
For page see List of Advertisers.

The S. S. Pennock-Meehan Co., 1608-18 Ludlow St., Philadelphia, Pa.
For page see List of Advertisers.

St. Louis

H. C. Berning, 1402 Pine St., St. Louis, Mo.
For page see List of Advertisers.

New Offers in This Issue.

CARNATION MRS. PFEUFFER AT BOSTON SHOW.

O. V. Zangen, Hoboken, N. J.
For page see List of Advertisers.

CARNATION WINONA.

F. Dornier Sons & Co., La Fayette, Ind.
For page see List of Advertisers.

CHRYSANTHEMUM BELFAST, CARNATIONS, FLORISTS' BULBS AND SEEDS.

Schlegel & Fother Co., 24 & 27 S. Market St., Boston.
For page see List of Advertisers.

CYCAS REVOLUTA: DAHLIA AND CANNA ROOTS.

H. F. Mitchell Co., Philadelphia
For page see List of Advertisers.

CHRYSANTHEMUMS.

J. H. Myers, Altoona, Pa.
For page see List of Advertisers.

GLASS.

Parselsky Bros., Inc., 59 Montrose Ave., Brooklyn, N. Y.
For page see List of Advertisers.

GRAFTED ROSES: OWN ROOT STOCK: ASPARAGUS PL. NANUS.

W. H. Elliott, Brighton, Mass.
For page see List of Advertisers.

NURSERY STOCK.

F. Hamilton Goodsell, 200 Broadway, New York.
For page see List of Advertisers.

NURSERY STOCK FOR FLORISTS.

W. & T. Smith Co., Geneva, N. Y.
For page see List of Advertisers.

OPENING ANNOUNCEMENT COMMISSION HOUSE IN WASHINGTON, D. C.

The S. S. Pennock-Meehan Co.
For page see List of Advertisers.

RHODODENDRONS, ROSES, AMPELOPSIS AND CHOICE NURSERY STOCK.

Stoms & Harrison Co., Painesville, O.
For page see List of Advertisers.

PEAS, ONION, CLOVER AND TIMOTHY SEED.

Charles F. Saul, 220-224 James St., Syracuse, N. Y.
For page see List of Advertisers.

THE FLORIANER ROSE APPLE.

Translated by F. Moore.

By the revision of the normal apple sortiment of Upper Austria, instituted by the council of the agricultural body in Linz, the above named variety found acceptance in the list. In the vicinity of St. Florian this variety is but little cultivated, and more plenti-

fully in the Lun district; and the demand for it is so general that the supply cannot be met, by a long way. The variety is not new and its origin is not known with certainty; and it went under various names till Oberdick in 1859 gave it the name Florianer Rosenapfel. Diel in writing about it called it Pomme tulipe, and gave the name of the raiser as being the Kaplan Vellen. Schmidberger called it the Gestreiften Rosenapfel (striped Rose Apple).

Diel and Schmidberger were the best of friends and the most zealous supporters of fruit culture in the eighteenth century, and were in close correspondence with the most eminent pomologists in France and Germany. It is proved by aged trees that for more than 100 years the variety has existed in the neighborhood of St. Florian.

The variety Gravenstein produces excellent fruit at this place as if the climate was created for it; and the Florianer Rosenapfel as being of equal worth, may be classed with it. The cylindrical shaped fruit with the striped, reddish tinted cheeks, has a delicious flavor. It is at its best from October till January. The tree is of a compact growth, and is very prolific.—"Die Gartenwelt" for January 23, 1909.

WIZARD

TRADE BRAND MARK

MANURES

Dried, screened and packed in bags of 100 lbs. each.

PULVERIZED SHEEP MANURE
PURE — UNIFORM — RELIABLE

A strong and quick acting manure, highly recommended for carnations and chrysanthemums.

SHREDDED CATTLE MANURE
EASY TO HANDLE AND APPLY

Stronger and better in every way than rough manure. Lasts much longer on the benches. Unequaled for mulching and feeding roses, liquid manuring and mixing with bench and potting soil. Used by all the largest growers.

Ask Your Supply Man or Write
Us for Circulars and Prices.

THE
Pulverized Manure Co.
31 Union Stock Yards, CHICAGO

List of Advertisers

Table listing advertisers and their page numbers, including Advance, The Co., American Nursery, and various florists and nurseries.

Table listing advertisers and their page numbers, including Kentucky Tobacco, Young John, and various nursery products.

WANTS, FOR SALE, ETC. Advertisements in this column one cent a word. Initials count as words. Cash with order. All correspondence addressed "care HORTICULTURE" should be sent to 11 Hamilton Place, Boston.

HELP WANTED

WE need a man who knows seeds and plants in a practical way and who can write of them in good English. Ability to express himself in few words, easily understood, absolutely essential.

THE McFARLAND PUBLICITY SERVICE Specialists in Horticultural Advertising. HARRISBURG, PENNA

GOOD MEN

When you need good men, skilled or unskilled, Write: THOS. H. BAMBRICK 34 South 7th Street Philadelphia

SALESMAN—Wholesale cut flower trade; must be experienced; good position for the right man.

WANTED—By March 15, man of good habits who understands general nursery and landscape work.

HORTICULTURE needs a wide-awake representative in every town in the land. Good commission paid on advertising and subscriptions.

GLASS Greenhouse and Hot Bed Plate and Window Glass PARSHESKY BROS., Inc. 59 Montrose Ave., BROOKLYN, N. Y.

FOR SALE GREENHOUSE PLANT FOR SALE Consisting of three houses, 32 x 142, 18 x 75 and 10 x 15 respectively, with cut frames and sash.

FOR SALE—An up-to-date greenhouse; property in good repair; situated in the State of Massachusetts; 12,000 feet glass, stocked for cut flowers and pot plants.

FOR SALE—Retail nursery, sixth year, doing good, steady and increasing trade. Stock in excellent condition.

FOR SALE—Long established retail florist business in one of largest cities, doing a very profitable business with ulth class customers.

MISCELLANEOUS WANTS WANTED TO BUY—Greenhouses and all kinds of greenhouse material; dismantled and removed at once.

WANTED TO BUY—Complete greenhouse plants and all kinds of greenhouse material, to be taken down and removed at once.

BUSINESS CHANCES

WANTED—To unite in partnership in Massachusetts with man needing more capital or assistance in floricultural business warranting expansion.

WANTED—To meet thoroughly experienced man to manage florist store in Boston, or would consider partnership in established business.

Anything of Value to the profession CAN BE SOLD through advertising in Horticulture

GREENHOUSES BUILDING OR CONTEMPLATED.

Newell, W. Va.—John Godwin, one house.

Lisbon Falls, Me.—H. W. Blethen, additions.

Woburn, Mass.—John Newman, violet house.

Eureka Springs, Ark.—C. I. Poor, one house.

Dickersonville, N. Y.—J. C. Rogers, one greenhouse.

White Plains, N. Y.—Arthur Dummett, house, 30 feet.

Colorado Springs, Col.—Endicott & Groves, improvements.

League City, Tex.—J. E. Beerwort, vegetable house, 18x105.

Colorado Springs, Col.—Pike's Peak Floral Co., range of houses.

Beaver, Pa.—Pittsburg & Lake Erie R. R., range of plant houses.

Lexington, Ky.—Honaker Bros., carnation houses, one 28x200, one 28x150; violet house, 20x100.

The King Construction Company has found it necessary to establish a separate department for the handling of all matters pertaining to sales and Mr. H. E. Bates, who is well known among growers in the east, has taken charge. Mr. Bates has in the past been with a number of the large eastern greenhouse building concerns. The organization of this department will enable the King Company to quote promptly in reply to any inquiries for their construction or other goods.

CYPRESS SASH BARS
82 feet or longer
HOT BED SASH
PECKY CYPRESS BENCH LUMBER

GREENHOUSES
ERECTED AND EQUIPPED COMPLETE IF DESIRED

Write for Circular "D" and Prices

The A. T. STEARNS LUMBER CO.
NEPONSET, BOSTON, MASS.

USE THE BEST.
Economy Greenhouse Brackets
are used by leading growers everywhere. Send for price list and descriptive circular.
BUXTON & ALLARD, Depl. A., Nashua, N. H.

Holds Glass Firmly
See the Point
FEELLESS
Glazing Points are the best. No rights or lefts. Box of 1,000 points 75 cts. postpaid.
HENRY A. BEEFEL
714 Chestnut St., Phila., Pa.

The FLORISTS' HALL ASSOCIATION OF AMERICA, insurer of 29,000,000 sq. ft. of glass. For particulars address **John C. Esler, Sec'y, Saddle River, N. J.**

USE COLD FRAMES TO INCREASE GREENHOUSE CAPACITY!



It is easy to avoid overcrowding your establishment with the thousands of young plants that demand so much room. Cold-Frames solve the problem! We sell the best Hot-Bed Sash made, for such low prices that you can double the capacity of your plant at moderate cost.

Transfer Bedding Plants and Plants for Stock to Cold-Frames Until Ready for Planting or Marketing

Build your Cold-Frames, run steam pipes through them and simply use sufficient heat to keep out frost. **It pays big!**

20,000 HOT-BED SASH in Lots to Suit, at Cut Prices!

Gordon-Van Tine Hot-Bed Sash are made of Louisiana Cypress, with blind-mortised, double shouldered joints which are absolutely moisture-proof. Primed with pure raw Linseed Oil. Glazed with Greenhouse Fatty and plenty of points. Strongest, most durable Hot-Bed Sash on the market. Where else can you get them where else in America.

Hot-Bed Sash
Size 3x6 ft.
1 3/4 thick.
Glazed with 6-inch glass
Dealer's Price \$3.50

Size 3x6 1 3/4, glazed with 6-inch glass, \$1.69. Size 3x6-1 3/8, glazed with 10-inch glass, \$1.75.

GLASS AT 300% SAVING! We buy glass in immense quantities, and sell at cut prices that save you 300%.

Write for **FREE CATALOG** of Hot-Bed and Cold-Frame Sash and Florists' Supplies

We guarantee quality, safe delivery and satisfaction or money refunded. Cut prices on every item. Goods shipped without delay. Order from this ad. or get catalog first. Write us today.

GORDON-VAN TINE CO., 1581 Case St., Davenport, Ia.

THE STANDARD STEAM TRAP

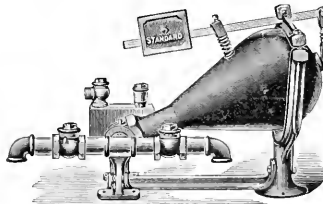

is acknowledged the best for the florist, because it is durable and does its work without trouble and annoyance, saving its cost by the economy in coal bills

E. HIPPARD

YOUNGSTOWN, OHIO

GLASS Always Write Us Before Buying
SHARP, PARTRIDGE & CO.
22nd and Lumber Streets, CHICAGO
WE HAVE SOME SNAPS

PATENTS
Trademarks and Copyrights

Send your business direct to Washington. Saves time and insures better service. Personal attention guaranteed. Twenty-five years' active service. SPECIALTY: "Working on the Failure of Others."

SIGGERS & SIGGERS

PATENT LAWYERS

Box 9, National Union Building
Washington, D. C.

BOSTON PLATE & WINDOW GLASS CO.

GREENHOUSE GLASS

German and American

261 to 287 A St., Boston 20-22 Canal St.

EVERYTHING FOR GREENHOUSE BUILDING

WRITE FOR INFORMATION AND PRICES

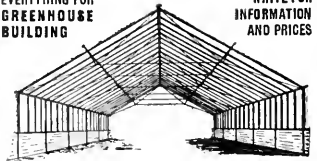

King Greenhouses. King Gutters and Eaves. Trussed Roofs. Ventilating Machinery. Trussed Iron Frame Houses. Tile Benches and Pipe Hangers.

KING CONSTRUCTION COMPANY
NORTH TONAWANDA, N. Y.



Evans 20th Century Arm
Will not twist the shafting pipe. Three times the power of old style elbow arms. Sold only with Evans Challenge Machine.

Write for free Catalogue to
QUAKER CITY MACHINE CO.
Richmond, Ind.

**The Payne Steel
"T" Bar Greenhouses**

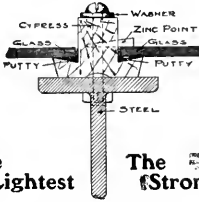

The Lightest The Strongest

Hall full Size

HOUSES of this type are constructed with both curved glass eaves and straight glass eaves. Least amount of shadow. Least amount of wood. No drip. Greatest durability.

JOHNA. PAYNE

Greenhouse Designer and Builder
260-274 Culver Avenue

JERSEY CITY, N. J.

**KROESCHELL
BOILER**



MADE OF FIRE BOX FLANGE PLATE
Can not Crack!

Water Space in Front, Sides and Back
The Most Popular Boiler Made

SEND FOR CATALOGUE.

KROESCHELL BROS. CO.
35 Erie Street, CHICAGO, ILL.

The Advance Ventilating Apparatus

is just what you need for those houses of yours. Made of the best material, it lasts and is strong. Simple and complete in its construction makes it work easily and is quickly set up. Thousands of machines in use in 40 states and only five years on the market proves its merits. Sold at one price to all and at a reasonable profit gives our customers satisfaction and enables others to figure its cost. Free circulars. Free estimates.

The Advance Co.
RICHMOND, IND.

**GREENHOUSE CONSTRUCTION
LUMBER**

John C. Moninger Co.
117 E. Blackhawk St., CHICAGO.

"REVERO"

Braided Moulded Construction—Seamless Throughout



LIGHT -- STRONG -- FLEXIBLE



The above cuts represent the non-kinking tendency of Revere as compared with the old style hose of wrapped duck construction.

Revere is Furnished on Reels in Continuous Lengths up to 500 feet.

**Revere Rubber Company,
BOSTON, MASS.**

NEW YORK
NEW ORLEANS

PHILADELPHIA
MINNEAPOLIS

PITTSBURG
SAN FRANCISCO

CHICAGO
PORTLAND, ORE.

THE FOLEY MFG. CO.

CHICAGO

Completely equipped with up-to-date machinery for the making of material for

**GREENHOUSE
CONSTRUCTION**

From a Full Supply of Thoroughly Seasoned Lumber

Send your sketches to our draughtsmen for completion and suggestion. Permit us to figure your proposed work, large or small.

We guarantee our prices will save you money

FOLEY VENTILATING APPARATUS IS THE BEST

is Simple in Erecting. is Easiest of Operation. It Will Last a Lifetime. Its Price is the Lowest. Will Ventilate Any Size House. Prices and Circulars on Application.

Our 1908 Catalogue Greenhouse Material Sent Postpaid on Request.

**THE FOLEY MFG. CO., WESTERN AVENUE
25th and 26th STS., CHICAGO**

STANDARD PLATE GLASS CO.

Manufacturers—Importers—Jobbers

NOW IS THE TIME TO BUY

FRENCH OR AMERICAN GREENHOUSE GLASS

LOWEST PRICES ON REQUEST

26-30 Sudbury St. BOSTON, MASS. 61-63 Portland St.

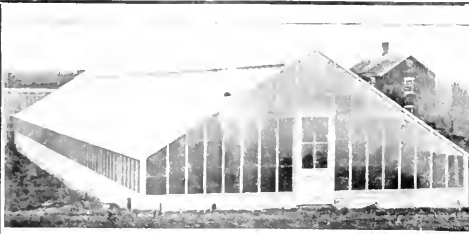

A COMPARISON

When you compare the cost of the wooden house with our Iron Frame House, bear in mind that the Iron Frame costs less to erect, less to keep in repair, and gives you greater returns in quantity and quality of flowers, than the best cypress house made. It is a construction that pays for itself many times over.

The next best proposition is our Half Iron Frame House. Send for circular.

Hitchings & Company
1170 Broadway New York

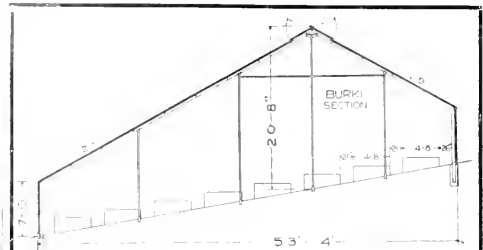

Our Shadeless Ridge Type of House

Its advantage is, none of the benches are shaded by the ridge.

This section is the 53-ft. Sectional Iron Frame house we furnished Mr. Fred Burki this season. His location on a side hill gives him a grade of about 5 feet in fifty.

Robert Simpson built his two 30 x 465 feet houses on the level, and graded them inside to meet his particular ideas.

Here then are examples of medium and wide Shadeless Ridge houses of our Sectional Iron Frame Construction. Each owner declares that they are the houses of the future, no matter what you want to grow.

If you are going to build, think these things over and get in touch with us.

Lord & Burnham Co.

Main Sales Office: 1133 BROADWAY, N.Y.

BOSTON: 870 Tremont Building. PHILADELPHIA: 1215 Filbert St.



THIS IS THE WAY A U-BAR HOUSE LOOKS FROM INSIDE

You have never seen anything that anywhere near approaches it for lightness. Think what it means not only to have no gutter at the eaves, but also no heavier supporting roof members than the U-Bar, at any point of the roof.

Think what this wonderful lightness means in increased blooms, especially just this time of the year when light is at such a premium.

Think what a pleasure such an attractive, beautiful house always is — what a pride you can take in its being "the best there is."

The thing for you to do is to drop in at our office at an early date, or write us at once about the new U-Bar house you want.

U-BAR GREENHOUSES

PIERSON

DESIGNERS AND BUILDERS



U-BAR CO.

1 MADISON AVE. NEW YORK

HORTICULTURE

Vol. IX.

MARCH 6, 1909

No. 10

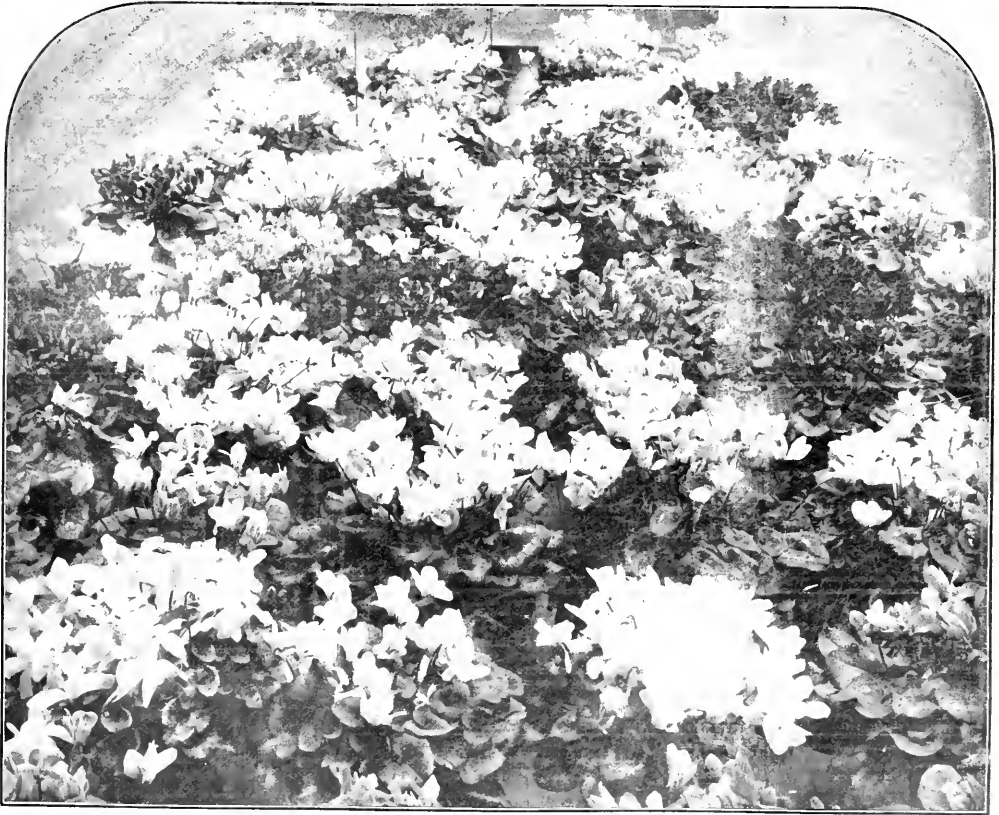

GROUP OF CYCLAMENS

Yearlings, by Thomas Roland, winning Gardeners' and Florists' Club Trophy at Boston Commercial Florists' Exhibition

Devoted to the
**FLORIST, PLANTSMAN,
LANDSCAPE GARDENER,**
and
Kindred Interests

Published
EVERY SATURDAY
At 11 Hamilton Place,
BOSTON, MASS.
Subscription, \$1.00

MAR 6 - 1909

GERANIUMS

We have an immense stock of fine plants from 2 in. pots for immediate shipment at prices running from \$2 per 100 up to 50c. each. We will send 1000, 50 each of 20 varieties our selection for \$18.50. Our Special Geranium Catalogue describes upwards of 250 varieties.

- LOBELIA** KATHLEEN MALLARD, - - \$2.00 per 100
 \$18.50 per 1000
- SALVIA** BONFIRE, - \$2.00 per 100, \$18.50 per 1000
 ZURICH, - 3.00 " 22.50 "
- ALYSSUM** DWARF DOUBLE, fine for pots \$2.00 per 100
- CINERARIA** MARITIMA and CANDISSIMA, - - \$2.00 per 100
- CENTAUREA** GYMNOCARPA, - - \$2.00 per 100
- ACERATUM** STELLA GURNEY, - - \$2.00 per 100
 INIMITABLE, - - " " "
- HARDY POMPON CHRYSANTHEMUMS** per 100
 1000, 50 each of 20 good kinds our selection, \$18.50

We also have a general line of Bedding Plants. Send for catalogue, only to the trade.

R. VINCENT JR. & SONS CO., White Marsh, Md.

A WIRELESS WINNER

Has Won Absolutely on Its Own Merits. Certificates Innumerable Everywhere
 MASSACHUSETTS HORTICULTURAL SOCIETY'S AMERICAN CARNATION SOCIETY'S
SILVER MEDAL LAST YEAR **GOLD MEDAL** THIS YEAR

THAT'S THE RECORD OF
It Is Invincible. **BAY STATE** Buy it and Grow it.

The noblest carnation ever introduced. White with carmine pencillings.

ROOTED CUTTINGS, - \$12.00 per 100, \$ 00.00 per 1000.
ALBERT ROPER, - - - - **TEWKSBURY, MASS.**

NEW RED CARNATION O. P. BASSETT

Extra Large Bright Red Free Bloomer

Rooted Cuttings, per 1000, \$60.00 | Rooted Cuttings, per 100, \$8.00 | Rooted Cuttings, per 25, \$2.50
 per 500, 35 00 " " " per 50, 4 50 " " " per 12, 1 50

Ready for delivery Jan. 1st, '09 by the Originators and Growers

BASSETT & WASHBURN, HINSDALE, ILL

CARNATIONS ROSE MY MARYLAND

Standard sorts and all the novelties of merit. Orders booked now for this most promising variety.

CHRYSANTHEMUMS The cream of the commercial sorts. Send for our price list. We can quote you right and supply first class stock.
S. J REUTER & SON, WESTERLY, R. I.

CARNATIONS	Rooted Cuttings Fine Healthy Stock
Pres Seelye	Per 100 Per 500
White Enchantress, Beacon	3 50 30.00
Victory, Winsor, Melody,	
Kingston Pet.	3 00 25.00
Daheim, Enchantress, Lady Bountiful, Mrs Lawson, White Lawson, Red Lawson, Variegated Lawson	2 50 20.00

WOOD BROTHERS
 FISHKILL, N. Y.

CARNATIONS

WINONA The true pink - At Indianapolis, in class A, won 1st prize in six entries for best vase of 100 blooms of light pink lighter in color than Lawson. A grand commercial sort in great demand. Place your order now for prompt delivery.
 \$6.00 per 100, \$50.00 per 1000
F. DORNER & SONS CO.
 La Fayette, Ind.

ROOTED CUTTINGS

Wm. H. Taft, \$12 per 100; \$30 per 1000

Enchantress	Per 100	Per 1000
Pink Lawson	\$1.75	\$15.00
White Lawson	1.50	12.50
Variegated Lawson	2.75	27.00
Victory	2.50	20.00

SCHIEDEN & SCHOOS, 58-60 Wabash Ave., Chicago.

In ordering goods please add "I saw it in HORTICULTURE."

A. N. PIERSON, Inc.
 CROMWELL CONN.

Wholesale Growers of Cut Flowers, Palms and Ferns

OUR SPECIALTIES. Roses, Lily of the Valley and Carnations. We also grow a general assortment of flowers in their season

CARNATION CUTTINGS

We offer choice varieties for February and later shipments.

	Per 100	Per 1000
Enchantress	\$2.50	\$20.00
White do.	3.50	30.00
Rose Pink do.	2.50	20.00
White Perfection	2.50	20.00
Winsor	3.50	30.00
Melody	2.50	20.00
Beacon	3.50	30.00
Victory	3.50	30.00
Aristocrat	3.50	30.00
Splendor	6 00	50.00
Vesper	3.50	30.00
White Lawson	2.50	20.00

EAST SUBURBY GREENHOUSES,
 Carnation Specialists

P. O. Address South Sudbury, Mass.
 Telephone 50, Sudbury 20.

Orders for this stock filled also by
WELCH BROS., 226 Devonshire St., Boston

Rooted Cuttings READY FOR DELIVERY

March 5 to 20th
 Andrew Carnegie, Defiance, Splendor, Pres. Seelye, Afterglow, Lawson-Enchantress, Sarah Hill,

\$6.00 per 100, \$50.00 per 1000

White Perfection, White Enchantress, Winsor, Rose Pink Enchantress, Enchantress, L. dy Bountiful, Melody, White Lawson,

\$3.00 per 100 \$25.00 per 1000

CHICAGO CARNATION CO.
 JOLIET, A. T. PYFER, Mgr. ILL.

Send for our Preliminary List describing and quoting

Chrysanthemums and Carnations.

A fine lot of

Carnation Cuttings
 ready now.

THE E. G. HILL CO.,
 Richmond, Indiana.

PETER FISHER
 ELLIS, MASS.

Send for Price List of Carnations

MARCHIONESS

The Money Making White Carnation
 \$10 00 per 100; \$80.00 per 1000

Orders Filled Strictly In Rotation
BELLAMY BROS.

Successors to L. E. Marquisse, STRACUSE N Y

ROOTED CARNATION CUTTINGS

ENCHANTRESS	\$3.00 per 100
WINSOR	3 00 " "
LAWSON	2 00 " "
HARRY FENN	2 00 " "
WHITE PERFECTION	2 50 " "
QUEEN	2 50 " "

PINE-CROFT GREENHOUSES
 EAST BROOKFIELD, MASS.

NEW ROISE

WHITE KILLARNEY

We Know You Will Want to Buy White Killarney



Every live, progressive, up-to-date grower who has seen it is buying it; but when you buy White Killarney, be sure you get the right White Killarney (the Waban variety). When you buy from us you get the variety that has been exhibited and certificated and the one that has attracted such favorable mention.

If you are in the vicinity of New York, we should be glad to have you call and see White Killarney growing at our Scarborough range, and you will say at a glance—as everyone who has seen it growing—that it is by far the best white rose that has ever been placed on the market.

It is not only a good winter-flowering rose, but is good the entire year, and it is a splendid shipper. Read the following letter received from Mr. Willis N. Rudd, Secretary of the Society of American Florists, dated January 18th, in which he writes as follows:

"Dear Mr. Pierson: I cannot refrain from writing you and expressing my admiration for the White Killarney as shown at Chicago on Thursday. It is an exquisitely beautiful thing and attracted much attention. I took half the blooms home with me, and they were finer on Saturday than they were at the show. The record is that these blooms were shipped from Tarrytown, staged and exhibited during the afternoon. They were then carefully wrapped up in a box, and remained in that box until one o'clock Friday morning, at which time I reached home, improved in quality up to Saturday, and were in fairly presentable condition on Sunday.

"In addition to being the most beautiful white rose of its class which I have seen, this demonstrates its splendid keeping and shipping qualities.

W. N. RUDD "

We were awarded Silver Cup at National Flower Show, Chicago, for best new rose with White Killarney.

Strong Plants, 2 1/4 inch pots, own roots, \$30.00 per 100; 250 for \$70.00; 500 for \$125.00; 1000 for \$250.00. Grafted plants \$5 per 100 additional.

F. R. PIERSON CO., Tarrytown-on-Hudson, NEW YORK

CHRYSANTHEMUMS
AND
ASTER SEED
ELMER D. SMITH & CO.
ADRIAN, MICH.

2 1-2 Inch Stock Now Ready

Chrysanthemums: Alice Roosevelt, Virginia Poehlmann, dandy mid-season white's best, \$4 per 100; 8-500 per 1000. Alut. Salleron geraniums, Ice Pink, \$2 per 100. 3 inch Boston and Whitman Ferns \$8 per 100. Cash.

I. M. RAYNER, GREENPORT, N. Y.

SCOTT BROS.

CHRYSANTHEMUMS

All the newest and best kinds of Roses, Greenhouse and Outdoor. Grafted or Own Root.

ELMSFORD NURSERIES, Elmsford, N. Y.

CHRYSANTHEMUMS

Golden Glow—plant Middle May to July—Cut Middle Aug. to Oct.—White Cloud—in 8 inch Jap—extra strong stem. Plant late May and early June.—Cut Middle Oct. to Nov. 1st—Pacific Supreme—a longer stemmed—brighter—non-fading glory of the Pacific. Belled now will increase stock to 1 by planting time—Delivery Plants—March \$5 00 per 100; April \$4.50; Bal. Season \$4.00. Rooted Cuttings now, post or express paid, \$4 00 per 100; 25 at 100 rates.

J. H. MYERS, ALTOONA, PA.



CHRYSANTHEMUM BELFAST

BELFAST

The New Christmas-Flowering Chrysanthemum

Of the largest size light pink shading to cream. Can be brought into bloom from Thanksgiving to Easter but is at its best about Christmas. Easily grown and claimed to be for the commercial grower the most profitable variety ever introduced. It comes into bloom after every other variety is through, is a great keeper and can be held on the plants for four weeks. Last Spring the originator cut the last blooms April 11. 3/4 inch pots 5c., \$5 per doz.; rooted cuttings \$2.50 per doz., \$18 per 100.

Carnation Bay State

Winner of the Gold Medal at Indianapolis. From 3/4 inch pots, \$3 per doz. Rooted cuttings of all other desirable varieties, old and new, at lowest prices.

Tuberose, Calladiums, Gloxinias, Tuberous rooted Begonias, Florists' Flower Seeds and Sundries.

Send for Wholesale Price List.

SCHLEGEL & FOTTLER CO.
26-27 So. Market St., Boston

SPRING FLOWER SHOW

BOSTON COOPERATIVE FLOWER MARKET

March 20, in New England's Leading Market, **MUSIC HALL PLACE, BOSTON**

ALL ARE INVITED TO COOPERATE. Send for Premium List.

All Information Promptly Given by Addressing **John McFarland, Sec'y, NORTH EASTON, MASS.**

White Killarney

"Waban Conservatories Variety"

AWARDED REPORT OF HIGHEST MERIT BY G. AND F. CLUB OF BOSTON, FEBRUARY 16, 1909. THE ONLY TIME THAT THE HIGHEST AWARD OF THE CLUB HAS BEEN MADE

We are receiving many compliments for the high quality of the own root stock that we have shipped.

WABAN ROSE CONSERVATORIES
NATICK, MASS.

VIBURNUM MOLLE

10,000 of this useful viburnum 2 to 3 ft. and 3 to 4 ft.

Write for prices on these and other good things

EASTERN NURSERIES

HENRY S. DAWSON, Manager, 14 MAICA PLAIN, MASS

Hardy Rhododendrons, Azaleas, Conifers, Clematis, H. P. Roses, Shrubs and Herbaceous Plants from our **HOLLAND NURSERIES**

Prices Moderate

P. OUWERKERK, 216 Jane St., Weehawken Heights P. O. No. 1, Hoboken, N. J.

CLEARY'S HORTICULTURAL CO.

Management AMBROSE T. CLEARY

Wholesale Contracting, Jobbing, Auction **HORTICULTURAL PRODUCTS** of every description.

Consignments Received. Surplus Stock Converted
62 Vesey St., NEW YORK

Box Trees

and other **EVERGREENS** for Tubs and Boxes
Our Prices are Always Right—Catalog Free
THE NEW ENGLAND NURSERIES, Inc.
BEDFORD, MASS.

ROBERT CRAIG CO.

ROSES, PALMS,

and Novelties in Decorative Plants

MARKET and 49th STREETS., PHILADELPHIA, PA.

Guaranteed Nursery Stock

Of All Varieties and Sizes
WRITE FOR LOWEST PRICES

P. HAMILTON GOODSSELL

200 BROADWAY NEW YORK

Hardy Herbaceous Perennials

Well-grown plants of all the standard varieties at reasonable rates.

SEND FOR TRADE CATALOG.

DANIEL A. CLARKE
RED OAK NURSERIES, Fiskeville, R.I.

BARGAINS in TREES and PLANTS

Concord Grapes, \$2.00. Peach, \$3.00 per 100.
List Free. D. J. TWOMEY, Dept. H, Geneva, N. Y.

ADVERTISE

There is a good Customer somewhere for every good thing you have to offer. *Horticulture* can help you to find him * * *

ADVERTISE

JOHN WATERER & SON, Ltd.

American Nursery Bagshot, England

Are Specialists in the

REALLY HARDY VARIETIES

of Rhododendron Hybrids and in Select Varieties of Hardy Border Plants

SOME OF OUR SPECIALTIES

Boxwood Pyramid Shape, 2½ to 3 ft. high, very heavy, \$1.75 each, 3 to 3½ ft. high, \$2.50 each. Bush Shape, very heavy, 2 to 2½ ft., \$1.75 each, 2½ to 3 ft. high, \$2.00 each.
Rhododendrons, arson's Hardy varieties, 8 to 12 buds, 18 to 24 in. high, at \$75.00 per 100; 12 to 14 buds, 24 to 30 in. high, at \$100.00 per 100
Azalea Hollis, 15 to 18 in. high, very bushy and full of buds, at \$35.00 per 100.
Hybrid Perpetual Roses, strong dormant field grown plants, of our own growing, none better, \$11.00 per 100, \$100 per 1000.
Toss Roses, field grown, \$1.00 per 100.
Hardy Climbing Roses, field grown, \$3.00 per 100.
Tree Roses, hardy varieties, budded on straight stems, 4 to 5 ft. high, \$30.00 per 100.
Ampelopsis Veitchii, bushy, 2 yr. plants, 3 foot of tops, \$10.00 per 100.

The Storrs & Harrison Co., Painesville, Ohio

RHODODENDRONS-RHODODENDRONS

An immense stock of all the **hardest known kinds**, 2 to 3½ ft., fine plants and all home grown, many being on own roots, far better than grafted stock—also **R. Catawblense seedlings** of all colors and **seedling Hardy Azaleas** not to be obtained elsewhere. This is the nursery in which most of the Rhododendrons that have proved **hardy in America** were raised.

GOLDEN YEWES, KALMIAS, and other **HARDY PLANTS** in great variety and of all sizes.

Catalogues on Application

ANTHONY WATERER **KNAP HILL NURSERY** **KNAP HILL**
SURREY, ENGLAND

(NO CONNECTION WHATEVER WITH ANY OTHER FIRM.)

NURSERY STOCK FOR FLORISTS' TRADE

AMERICAN GROWN ROSES, AZALEAS, RHODODENDRONS
FRUIT AND ORNAMENTAL TREES, SHRUBS, SMALL FRUITS, CLEMATIS,
EVERGREENS

WRITE FOR OUR TRADE LIST

W. & T. SMITH COMPANY **63 YEARS** **GENEVA, N. Y.**
700 ACRES

Primula Kewensis



This beautiful hybrid primula, which was sent over from England a few years ago with such high recommendations, has well justified the good opinions which were given it by the raisers. Owing to its parentage it was confidently expected to prove an acquisition of more than ordinary merit, and so far as our experience goes, we have found it to be the most useful primula in cultivation at the present time.

The two parents of *Primula Kewensis*, *Primulas floribunda* and *verticillata*, are both well known greenhouse varieties, which have been extensively grown for many years in cool houses, where they have been highly valued. The hybrid variety has, however, far surpassed its parents, being more floriferous, much more valuable for decorative purposes and when well grown makes a plant which for real beauty cannot be equalled by any other primula in cultivation.

There are quite a few people who have failed to get good results with this primula. The most common complaint is that their plants after having thrown up two or three flower spikes, become exhausted, and cease to produce more. Other growers have tried the plan of "growing on" a few of their last year's plants, but the experiment met with very indifferent results.

Personally we have found no difficulty in growing this primula. Our plan is to sow the seed about the first week in February, and, as soon as the seedlings are large enough, we prick them off into flats and place them on shelves in the coolest house we have. When the plants are ready for a shift we pot them into 2 1/2 inch pots and give successive shifts as required. Like all other primulas they should be grown in frames outside during the summer months and kept well shaded.

Perhaps the best method to follow, when growing *Kewensis* for exhibition, or if you wish a batch for late flowering, is to plant them out in cool frames, about the beginning of June. By this method, they will make huge plants for lifting and potting up, in the fall. As

Kewensis will not flower freely, until the pots are well matted with roots, by the planting out method the plants are from a month to six weeks later in flowering than those which have been grown in pots all summer. This year I noticed *P. Kewensis* grown in this manner, with from a dozen to eighteen spikes in flower at one time, each averaging about eighteen inches in length, foliage being perfect, making a pot plant of unusual beauty and elegance. This primula, from a decorative point of view, is as near being perfect as one could wish. The color of the flowers is of a delightful primrose shade, the foliage is always healthy and green, and with a little care in the watering and picking off dead flowers it will last easily two or three weeks in the dwelling house. As a commercial plant, or merely for decorative purposes under glass *P. Kewensis* is well worthy of a trial.

Wm. W. Brown.

North Easton, Mass.

Pentstemons

Memories of a choice bed of pentstemons are among my earliest recollections of garden flowers and it seems to me strange that such a beautiful flower should be so little grown. Only in the last year or two have they been seen at our exhibitions and gradually the quality has been improved until now some of the finest strains are offered by several enthusiasts who have evidently woken up to the possibilities of this grand flower, and there seems a probability that it will assume its place among the finest of our half hardy perennials.

The imported strains are undoubtedly the best, and this can be readily explained when we consider that a period of many years of the most careful selections has been necessary to produce such perfection of form and color as we see among the varieties of today. No haphazard methods could produce the wonderful strains now in evidence. The most beautiful colors and flowers of immense size, combined with a strong sturdy growth and long spikes of gorgeous bell-shaped flowers, makes it one of the most indispensable garden flowers, for cutting, in beds alone or mixed with other plants.

Seed sown now will produce plants that will flower this season, and cuttings may be taken in the fall, of any desirable kinds worthy of growing another year. They also make good pot plants for the decoration of the conservatory, and never fail to be admired.

If, when planted out in beds, you find the tips of the young leading shoots curled up, by investigating you will find it is caused by a small grub which eats a hole through the centre of the growth, but if these are gone over carefully by hand and removed, even should the centre growth for the present be destroyed, the side shoots will throw up strong and give an abundance of flowers. If given a good rich soil to grow in nothing will give more satisfactory results than a bed of pentstemons.

Alfred J. Lawrence.

HORTICULTURE

VOL. IX MARCH 6, 1909 NO. 10

PUBLISHED WEEKLY BY

HORTICULTURE PUBLISHING CO.
11 Hamilton Place, Boston, Mass.

Telephone, Oxford 292
WM. J. STEWART, Editor and Manager

SUBSCRIPTION PRICE

One Year, in advance, \$1.00; To Foreign Countries, \$2.00; To Canada, \$1.50

ADVERTISING RATES

Per Inch, 30 inches to page \$1.00
 Discounts on Contracts for consecutive insertions, as follows:
 One month (4 times) 5 per cent.; three months (12 times) 10 per cent.;
 six months (26 times) 20 per cent.; one year (52 times) 30 per cent.
 Page and half page spaces, special rates on application.

Entered as second-class matter December 8, 1894, at the Post Office at Boston, Mass., under the Act of Congress of March 3, 1879.

CONTENTS

	Page
COVER ILLUSTRATION—Group of Cyclamens.	
PRIMULA KEWENSIS Wm. McM. Brown—Illustrated	313
PENTSTEMONS—Alfred J. Loveless	313
EUROPEAN HORTICULTURE—Frederick Moore	315
REGARDING "MY MARYLAND"—Wallace R. Pierson	315
BOSTON FLOWER MARKET EXHIBITION:	
List of Awards	316
Views in Exhibition—Illustrations	317
NEWS OF THE CLUBS AND SOCIETIES:	
Florists' Club of Philadelphia—Rochester Commercial Florists' Association—Massachusetts Horticultural Society—Minnesota State Florists' Association—Southampton Horticultural Society	318
Society of American Florists—Bar Harbor Horticultural Society—New London County Horticultural Society	319
American Association of Horticultural Inspectors—Gardeners' and Florists' Association of Toronto, Canada	320
North Shore Horticultural Society, Illustrated—Eastern Branch of American Park Superintendents—Florists' Club of Washington	321
Connecticut Horticultural Society—Illinois State Florists' Association—Detroit Florists' Club—Club and Society Notes	322
OBITUARY:	
E. V. Hallock, portrait Eugene Germain—George A. Dickson Charles Bramley, Sr.—Mrs. G. Wythes	323
SEED TRADE	328
OF INTEREST TO RETAIL FLORISTS:	
New Stores Steamer Departures	326
Flowers by Telegraph	331
FLOWER MARKET REPORTS:	
Boston, Buffalo, Chicago, Indianapolis, Philadelphia, Twin Cities	333
New York	333
DURING RECESS:	
New York Florists' Club	341
MISCELLANEOUS:	
Spraying Fluids	324
Fire Record	324
Personal	326
Philadelphia Notes	328
News Notes	328-342
Incorporated	328
Business Changes	330
In Bankruptcy	336
Pacific Coast Notes	333
Madison (N. J.) Notes	335
Greenhouses Building or Contemplated	342
Patents Granted	342

We are greatly pleased to be able to present so valuable a contribution—valuable because so straight-forward and practical—as appears on another page of this issue over the signature of Wallace R. Pierson on the

experience of this observant man with "My Maryland" rose up to the present time. It is not to be expected that a rose absolutely new will so demonstrate its requirements within the first year of its dissemination that every grower who has invested in a batch of the plants will be found singing its praises as a success in all respects. To condemn an introduction on the basis of a few months' trial is unfair to the variety, unjust to the raiser and disseminator and discouraging to every one who seeks to contribute to the advancement of horticulture by devoting his time and energies to the production of new varieties. It is only by experiment carefully followed up that the ideal conditions for any new plant can be prescribed. Nothing short of that can be called a square deal.

The notable exhibition which has just closed in Boston, of which a full account appears in this paper, was a very different affair from any of its predecessors,

held heretofore in the market salesroom and regarded as a trade affair exclusively. In its direct appeal to the people—its invitation to the public to come to Horticultural Hall and see the products of the commercial flower growers, it opened up a new conception of the opportunities for trade expansion. Possibly the direct exchanges of stock between growers were no larger than under the old arrangements but who will say that the broad benefits to the flower trade of the city were not many fold greater on this occasion? The very creditable presentation of the artistic productions of the retail florists was a long step in the direction of educational publicity. Another year we do not doubt that this department will attain still greater prominence. For best results we would recommend a study of the plan followed at several of the fall exhibitions in Chicago. No better method of bringing out the retail flower dealers has yet been devised.

Some Dutch bulb observations

The improved market values enjoyed during the past winter by forced bulb flowers are attributed generally to the cautious buying of bulbs last summer. Whether the pendulum will now swing to the other side again and excessive buying follow the satisfactory market conditions we do not know but that is not an unlikely eventuality. The Dutchmen are now abroad in the land by scores and it will not be their fault if the import orders are not doubled up. In this connection it may not be out of place to ask what is the matter with the hyacinths. On certain of the popular standard varieties the quality has been deteriorating from year to year until now such sorts as Czar Peter, Charles Dickens in three varieties and Norma no longer fill the bill, Morena being now substituted for Norma, for instance. Within a few years the tulip bulb trade has increased five hundred per cent. while the hyacinth has remained stationary, which is not to be wondered at when we note the inferior quality of the flowers now obtained as compared with the magnificent trusses of bygone days. This collapse of many varieties is attributed by good judges to the unwise methods of culture practiced by many Holland growers who, in their haste to build up stock rapidly, have followed processes of quick reproduction by forcing in heat whereby big healthy-looking but soft bulbs are procured in two or three years instead of four as formerly, with the result that the flowering quality is permanently impaired.

European Horticulture

NEW INTRODUCTIONS IN HELIOTROPES

The earliest to appear in commerce in recent years was Frau van Poschinger of a dark tint which soon became a favorite variety for groups and pot culture, but it now has a strong rival in Mathilde Cremieux, a grand, lilac-blue flower, and an excellent plant for pots, window boxes, groups, etc. The variety is of French origin and is of compact habit, and withal very vigorous. Last year the variety was quite unaffected by the long-continued drought in the summer—a proof of its being capable of withstanding the influences of the weather. It is probably the best heliotrope introduced up to the present year.—Karl Ziskoven in "Moller's Deutsche Gartner-Zeitung, No. 7."

NEW HYBRID ORCHIDS—LAELIO-CATTLEYA FELICIA

This handsome hybrid was raised by Messrs. Charlesworth & Co., Ltd., by crossing L. C. Haroldiana and Cattleya Triane, and was awarded a first-class certificate at the Royal Horticultural Society's meeting on January 26. The hybrid possesses the grand proportions of C. Hardyana with a striking introduction of dark purplish coloring on the edges and front of the side lobes of the labellum, which makes an effective contrast with the silvery white and pink color of the rest of the bloom.

CYPRIPEDIUM EARL OF TANKERVILLE

This striking new hybrid was obtained by Messrs. Sander & Son, St. Albans, by crossing C. exul and C. nitens Sander's variety—a plant which received an award of merit at the R. H. S.'s meeting on January 9, 1906. A portion of the original plant passed into the collection of Lieut. Col. G. L. Holford, who exhibited a flowering plant on January 26 last. There are numbers of hybrid cypripediums with larger flowers than the Earl of Tankerville variety but a more beautiful bloom is difficult to indicate. The bloom is of waxy consistency, and possesses a pure white dorsal sepal, with a small green base, and it bears dark chocolate purple blotches which change on the upper area to rosy purple. The rest of the flower is of a yellowish tint, tinged with brownish purple.

CYCAS REVOLUTA

One of the most valuable plants for decorative purposes is *Cycas revoluta*; but few persons have seen them in flower. Here on the Riviera the plant has found a second home and as solitary objects in groups in the open ground they are frequently met with. These are chiefly of the fruit-bearing sex, the male plant being rarer. The figures given in No. 7 of "Moller's Deutsche Gartner-Zeitung" show the male and female plants in flower and fruit. The male bloom measured 55 cm. in length, and weighed when removed from the plant 5 kg., and as thick as a man's arm. The fruit on the female plant looked like an enormous Globe Artichoke, and measured 59 cm. in diameter. Each single fruit-leaf concealed four fruits, with, in all, 400 seeds. *Cycas revoluta* must be artificially fertilized in June and July. The pollen had to be brought in this case several kilometers.—G. Schmpisser, at Cannes.

THE PRUSSIAN HORTICULTURAL AND THE GERMAN ORCHID SOCIETIES

The immediate effect of the amalgamation of these two societies is to form the much desired National German Horticultural Society, or at least to steer in that direction, although the orchidists may not be inclined to become Prussianized. Next to the Verein Deutscher Rosenfreunde the only special society for the interest of one class of flowers eleven years ago, the Deutsche Dahlien gesellschaft came on to the scheme. In spite

of the zeal with which this society worked, the members soon saw that the field of work must be extended and pushed on with greater vigor. And similarly with other special societies and clubs in Germany.

Sander & Son

Regarding "My Maryland"

We must live with people to know them and the same is true of roses. Killarney is now the leading rose of commerce and we cannot but remember how it was discarded as worthless by more than one expert rose grower when it first came out. With "My Maryland" problems have arisen, but with an understanding of the needs and absolute requirements of this variety, the difficulties have been overcome and I believe success with the variety will be almost universal where the rose is properly treated.

As this article is, in a way, a reply to adverse criticisms of the variety, and as we believe we have solved the problem, I wish to place before the rose growers of the country a few facts concerning "My Maryland" as it has acted with us.

Last season we bought heavily and throughout the months of December, January and February we were receiving wood for grafting purposes from the introducer, and without exception this wood was good-sized canes and the flowers, in many cases left on, were of extra fine quality.

Our planting of "My Maryland" consisted of 4,500 grafted plants, no own-root being used, and were divided in three sections of the place. One thousand were bedded in April in a house of mixed roses. From this one thousand plants we cut an average of over thirty flowers per plant up to December 1st. These plants were then cut hard for wood for grafting and have since been thrown out to make room for Easter stock.

A second one thousand were planted in a house of Bridesmaid and this temperature was entirely unsuited to the variety, and it also was taken out recently to make room for Easter plants.

At Plant No. 2 a house holding 2,500 Maryland was planted June 15th and up to January 1st it has produced 67,000 blooms. From this house we have taken 25,000 blind-wood cuttings and 50,000 eyes for grafting since the date mentioned (Jan. 1st).

We were holding this house 58 degrees to 60 degrees in December and the tendency to stop growing became noticeable, especially so in one bed with poor drainage. Raising the temperature to 64 degrees resulted in increased vigor and the character of the rose changed completely. The house at this date is coming into full crop, in spite of the fact that 3,000 canes have been taken in one day for propagating purposes, and it would be a pleasure to us to show those interested in the rose the house as it stands today.

The solution of the whole problem seems to be heat and by increasing the temperature to at least 62 degrees and not over 65, the rose can be kept productive and profitable in mid-winter, and the nature of the plant is such that it will almost grow itself at other times in the year. Almost every small rose grower has a warm corner and this should be for "My Maryland," and the larger grower, with separate houses or sections, if his heating system works, should be the master of the situation.

Wallace R. Benson

Cromwell, Conn.

THE BOSTON FLOWER MARKET EXHIBITION

The commercial growers of Boston and their co-workers from far and near are entitled to great credit for the splendid show they put up at Horticultural Hall, Boston, on Saturday and Sunday, February 27 and 28. HORTICULTURE felt safe in predicting a sensational success for this undertaking, as there was an unmistakable enthusiasm in the air which said that the local growers would do their best and, that being the fact, the outlook was full of big things.

As might be expected from a trade show at this time of the year, carnations predominated, and there was a vast and inspiring display of these which for quality and beauty was rarely, if ever, been equaled anywhere. The tables with vases of hundreds, fifties and twenty-fives filled the entire centre area of the main hall. Roses were displayed in only moderate quantity, the product running very short at the present time. Violets and sweet peas were seen in large numbers and there were some fine groups of flowering and foliage plants in marketable sizes which, together with the miscellaneous flower groups and the interesting contributions of the ever-willing private gardeners sufficed to fill the hall to repletion and make a picture of rare brilliancy.

In the smaller adjoining hall were displayed the "made up" exhibits of the local flower stores. The number of exhibits in this department was unusually large and in every one of them good taste was displayed. The unsatisfactory results of exhibiting this class of work in a competitive way in the usual exhibition hall style was demonstrated here as elsewhere. Floral baskets of varying pattern and size, each a beautiful object in itself, can never be made to form an attractive picture when arranged in a row on an exhibition table, and the effect is bound to be incongruous no matter how meritorious the individual components may be.

The scoring for certificates of merit resulted as follows: Seedling No. 9 (white), by G. E. Baxton, 85 points; Shasta, by Beur & Smith, 87 points (a big record after 1000-mile trip); crimson seedling by Sam Kinder & Crinson, 50 points; yellow seedling by N. D. Pierce, 74 points; seedling 50x20, by Leonard Cousins, 72 points; J. D. Cockerpot's Georgia arrived in damaged condition, having got overheated by some means on the way, and O. V. Zangen's Mrs. Peterson was also seen under unfavorable conditions.

The "The T. G. Co." class for vase of fifteen color mostly or standard, which the venerable Boston Herald reporter described as "the blooms of the twenty-fives variety," the only competitor, had the advantage of a nice Roper vase from Franklin B. State was Contention, 21, with Alma Ward, but it was outscored by four and Bay State secured the prize.

In 1908 a number of the carnation class of the twenty-fives and prize fell to the Boston growers. In the fifties, according to the list, W. A. Perfection, En-

chantress, Winsor, Beacon and Fenn held this distinction, and in the twenty-fives it was Enchantress, Winsor, Afterglow and Fenn. In the fifties Afterglow had Helen Goddard and Mrs. Patten had Variegated Lawson as seconds, and in the twenty-fives Pres. Seelye had to take second place to White Perfection, and Beacon had to follow Victory.

The Gardeners' and Florists' Club prize for most meritorious exhibit was worthily awarded to Thomas Roland's cyclamens. These were splendid specimens of yearling stock and the varieties were of highest strain, including the new feathered Bush Hill type and the salmon pink colors. The groups of foliage and flowering plants from W. W. Edgar Co. and A. Leuthy were excellent. F. R. Pierson Co. was represented by a fine table of carnations and the two fern novelties, Nephrolepis superbissima and improved elegantissima.

The number of varieties of carnations in evidence was not large, and it is worthy of notice that they were confined mainly to the more recent introductions. Even the great Lawson was represented by but two vases in the entire exhibition. Of the varieties that impressed us most forcibly we might mention Beacon, President Seelye, Helen Goddard, Winsor, Ruby, Gov. Guild, Lady Beautiful, Winona (for color), Genevieve and Pierson's Flesh Pink Winsor, Prosperity Lawson, white seedling No. 30 and crimson seedling No. 60.

In roses W. H. Elliott made an interesting display of the old-fashioned favorites, such as Perle, Safrano, Isabella Sprunt and Bonsilene. The vases of My Maryland from S. J. Reuter & Son and A. N. Pierson (not for competition) were a centre of interest. The display of violets was large and drew a crowd. The sweet pea tables were lovely. Among the newer varieties Greenbrook, white tinged with lavender, was looked upon as the forerunner of a different type of flower from the ordinary. Among the gems of the show were the orchids from Julius Roehrs Co., W. A. Manda and Thos. Watt, gardener for Mrs. H. F. Durant, and cinerarias from Martin Sullivan, gardener for Wm. Whitman.

The contributors in the retail florists' decorative classes were S. Hoffman, The Rosary, Kensington Flower Shop, Penn the Florist, F. H. Houghton and J. J. McCarthy. W. N. Craig showed in this department a beautiful mound of schizanthus and Wm. Sim a mound of sweet peas of exquisite beauty.

Van Bliffe was in evidence with a section of a greenhouse, displaying his qualifications as a builder and trader. Baxton & Allard of Nashua, N. H., had samples of their Economy Blue for greenhouse use on exhibition; this device has not with an enormous sale among growers, especially the plant growers, who use it as a quickly adjusted and reliable shelf supporter.

Among the trade visitors from outside the forty-mile limit were the following: New York State—F. R. Pierson and J. R. Fotheringham, Tarrytown; O. V. Zangen, A. C. Zvolanek, Winifred Rolker, A. Goldenberg, C. W.

Scott, Chas. Schwake, John Scheepers, New York City; E. P. Tracey, Albany; Philip Warner, Newportville; M. W. Gary and W. N. Taylor, Northport, New Jersey—W. A. Manda, South Orange; Ed. Roehrs, Rutherford.

Connecticut—Wallace R. Pierson, Cromwell.

Rhode Island—Mr. and Mrs. S. J. Reuter, Miss Reuter and L. J. Reuter, Westerly; John Gibson and John Marshall, Newport; Peter S. Byrnes, Wickford; N. D. Pierce, Norwood.

New Hampshire—Geo. E. Buxton, Nashua.

Pennsylvania—S. S. Skidelsky, Robert Kitt, Paul Berkowitz, Philadelphia; Maine—H. R. Mitchell, Waterville; Alex. Wallace, Portland; Mr. and Mrs. C. S. Strout, Biddeford.

Massachusetts—E. A. Richards, Greenfield; G. H. Sinclair, Northampton; A. H. Lange and A. A. Hixon, Worcester; Jos. Fuller, Leominster; E. O. Goppert, So. Lancaster; Henry Barton, Westfield, and about everybody of any account within the forty-mile limit of the Hub; also quite a delegation of Dutch bulb salesmen from Holland and Paul Kaese of Hamburg.

LIST OF AWARDS.

Carnations.

CLASS A. Vase of 50. White, F. R. Pierson Co., first, Wm. Nicholson, second; Flesh Pink, Peter Fisher, S. J. Goddard; Light PINK, P. R. Pierson Co., Patten & Co.; Dark Pink, F. R. Pierson Co., S. J. Goddard, Red, Cottage Gardens, Patten & Co.; Crimson, Wm. Nicholson, Wilfrid Wheeler, Variegated, Wm. Nicholson, Patten & Co.

CLASS B. Vase of 25. White, Lemoine Bros., F. R. Pierson Co.; Flesh Pink, Lemoine Bros., Patten & Co.; Light Pink, Lemoine Bros., F. R. Pierson Co.; Dark Pink, Patten & Co., C. S. Strout; Red, Lemoine Bros., A. Batley & Son; Crimson, Ed. Winkler, Lemoine Bros.; Variegated, Patten & Co.

CLASS C. Vase of 100 assorted. Peirce Bros., first; F. R. Pierson Co., second.

CLASS D. Vase of 100, one variety: T. J. Grey cup to Alma Ward for Bay State; cut glass vase to Cottage Gardens for Alma Ward. Six vases of 50 each: A. H. News cup to Cottage Gardens. Fifty Becon, Peter Fisher prize, Wm. Nicholson. Twenty-five Beacon: Peter Fisher prize, Chas. S. Strout. Fifty Beacon: Cottage Gardens prize, S. J. Goddard. Fifty Afterglow: R. Wirtzstatter prizes, F. R. Pierson Co., first, Wm. Nicholson, second. Fifty Winsor: F. R. Pierson Co. prizes, Peirce Bros., first, C. S. Strout, second.

CLASS E. Twelve blooms unnamed seedlings: Peter Fisher, No. 409, scarlet, first; Peirce Bros., dark spot of Winsor, second; Peirce Bros., No. 60, crimson, third.

CLASS F. Best single bloom in the different colors: Various winners.

Roses.

CLASS G. Vase of 2 American Beauty, Waban Rose Conservatory prize, 25 pink, Montrose Greenhouses, first with Biddeford, 25 red, W. H. Elliott, first with Richmond, 25 white, Montrose Greenhouses, first with Biddeford, W. H. Elliott, second with Biddeford 25 any other color, W. H. Elliott, first with Perle.

CLASS H. Vase of 50 mixed roses: A. N. Pierson, first; Montrose Greenhouses, second.

CLASS I. Premiums to be competed for by growers having not over 30,000 feet of glass: No entries.

CLASS J. Vase of best new rose undisseminated before 1909: Park Street Flower Market prize to Waban Rose Conservatory for White Kill rose.

Sweet Peas.

CLASS K. L. M. 100 white: Wm. Sim, first with Florence Denzer; Passive Ave. Greenhouses, second, 100 pink: Sim

VIEWS AT EXHIBITION OF BOSTON MARKET FLORISTS

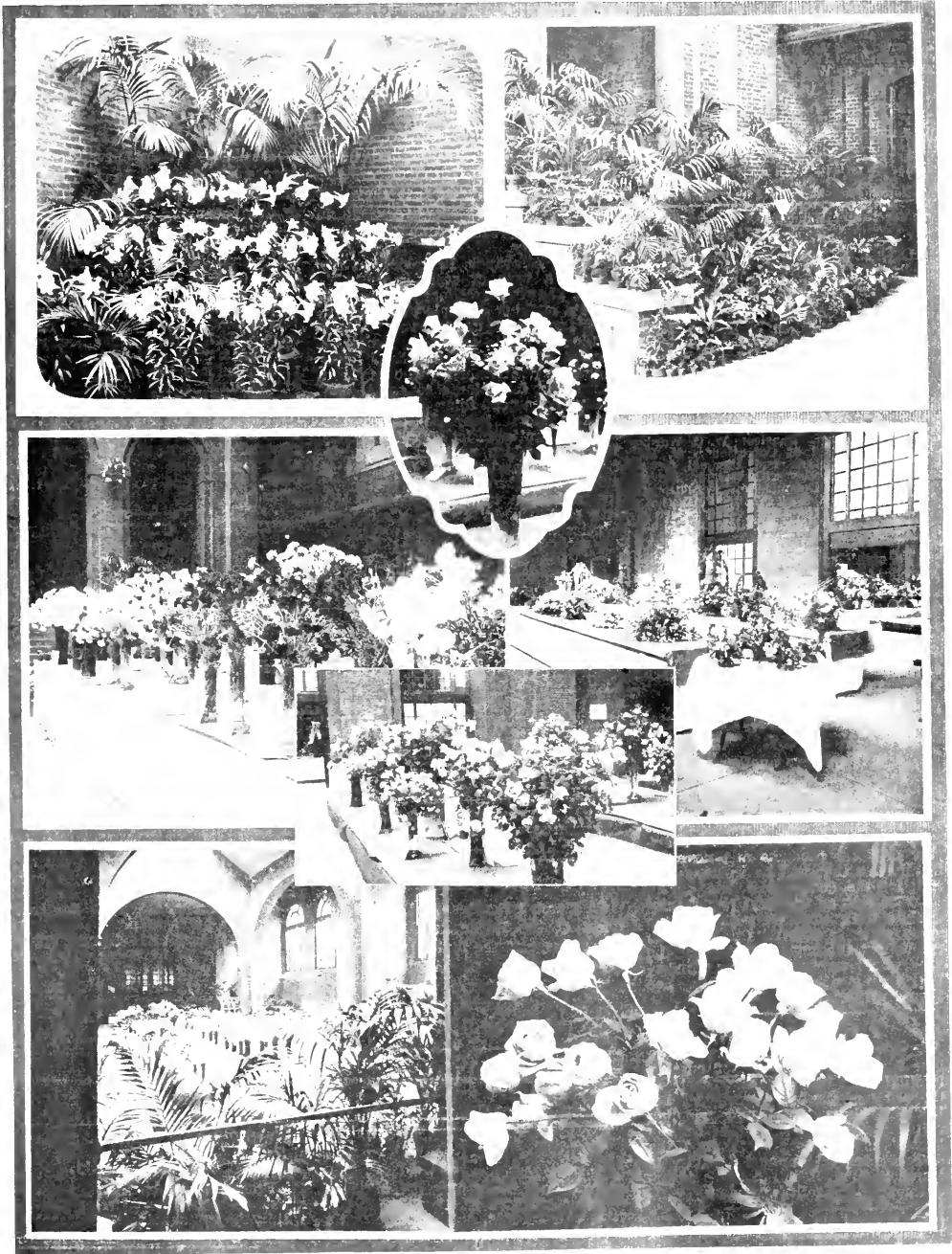

Lilies by Pierre Buis
 A Carnation Table
 View from Balcony

Rose White Killarney by Walter Buis
 Consolation
 Table of Roses

Group of Plants, A. L. Buis
 Some Retail Exhibits
 (L. C. McManis and S. J. Buis)

News of the Clubs and Societies

with Christmas Pink, Passon, second. 100 light pink; A. C. Zvolanek with Gov. Fort. 100 lavender; Wm. Sim with Mrs. Alex. Walling, 100 any other color; Wm. Sim with Greenbrook. Best new variety: Flower Market prize and certificate to A. C. Zvolanek for Pink Beauty, a collection of standard varieties, vases of 100 each; Zvolanek prize to Wm. Sim. Five standard varieties, twenty-five of each; Zvolanek prize to Wm. Sim.

Violets.

CLASSES N, O, P, Q 200 Campbell; H. F. Calder, 200 any other variety; H. W. Sanderson with Farquhar, first; Amelia S. Fraleigh, second. Princess of Wales; Estey Bros., Wm. Sim. Any other single; Wm. Sim with Boston. Best display of Boston violet; Wm. Sim prize to Sidney Hoffman. Best new single violet. Market prize and certificate to Wm. Sim for Kaiser Wilhelm.

Bulbous Stock.

CLASS R. 50 Tulips; J. T. Butterworth, Mann Bros. 50 Narcissus; Mann Bros. A. S. Fraleigh. 12 varieties of bulbous stock; Mann Bros. 50 Lily of the Valley; H. M. Robinson & Co., J. T. Butterworth. 12 pots of Easter Lilies; H. P. Michell prize to P. E. Cross. 12 Cyclamens; T. E. Pottery prize to Thomas Roland. Most Meritorious Exhibit in the Show, Gardeners and Florists' Club prize to Thomas Roland for display of yearling cyclamens.

Miscellaneous.

CLASS S. Marguerites; Wm. Nicholson, S. J. Goddard. Mignonette; Wm. Nicholson, H. Walbecker. Fansies; W. C. Ward. Decorative Basket of Carnations; F. E. Palmer with Boston and Personal prize; second, H. R. Comley with Winsor. Bride or Bridesmaid Bouquet of Carnations; from the Florist with White Perfection. Mound for Tables, Park Street Market prize to F. E. Palmer for Fair Maid and Colognye.

The small grower who is generally represented as yearning for a chance to win a few prizes on his own account without having to struggle against the competition of the big fellows, did not put in an appearance, and the eight very liberal prizes—aggregating \$48 for 100 roses—were untouched.

ANOTHER BOSTON MARKET SHOW.

Boston is to have another commercial florists' show, this time on March 20 at the salesroom of the Music Hall Market, Winter street. The managers and stall holders are very enthusiastic as to the prospects and promise a display of floral products and novelties in all lines that will be worth seeing and, for the dealer who has spring stock to sell, an excellent opportunity to show his goods. We can't have too many of these shows. One a month throughout the business season of the year would waken things up wonderfully in the vicinity of the Hub. See the advertisement.

A SIGN OF SPRING.

Have you heard the robins or the blue birds yet? There's yet another infallible sign of approaching spring—the red flag waving defiantly at the belated wintry blasts or rippling softly in the zephyrs from across the Hudson at 42 Vesey street, and the date set for this annual festivity is March 9. Wm. Elliott & Son's advertisement gives full particulars.

MASSACHUSETTS AGRICULTURAL COLLEGE.

On Wednesday, March 3, W. J. Stewart addressed the students of the short-term course in horticulture on wholesale marketing.

FLORISTS' CLUB OF PHILADELPHIA.

A very interesting paper on the culture of gardenias was read by William Kleinheinz at the monthly meeting of this club, held on the 2nd inst. A lively discussion took place after the reading of the paper, the sharp questions of some of the rose experts leading to the impression that they are envious of the seventy-five cents a bloom, and getting ready to invade new territory.

W. W. Allabaugh, Perkasie, Pa., exhibited a vase of seedling antirrhinums, showing excellent culture and were a striking example of the value of this subject as a cut flower. A vase of the new white carnation, known at present as "Craig's seedling," was shown by W. Kleinheinz, who has been growing a few plants to try it out. Looks like a good thing. Not too stiff in the stem. Pennock-Meehan Co. sent a magnificent lot of Waban White Killarney, which were in fine condition and remarkable as to size and substance. The subject for next meeting will be a talk on Cuba and the Isle of Pines, by Messrs. Craig and Westcott. These gentlemen are bursting with the astonishing things they have discovered in these favored isles during their recent trip, and see "millions in it," and want all of the club members to know of the possibilities.

Robert Kift made an interesting report on what he saw at the Boston trade exhibition Feb. 27. It must have been worth seeing. Robert is always rosy and appreciative. It's a fine thing to be an optimist. But in the voyage of life the rosy sunsets are not all there is to it in getting into port. If the captain and the crew are any good they will think of the hidden rocks and the sharks. Most of the too much optimists I've ever known got skinned alive. Keep your weather eye open as well as your cheerfulness.

ROCHESTER (N. Y.) COMMERCIAL FLORISTS' ASSOCIATION.

On March 1 the Association was the guest of the Rochester Chamber of Commerce, and the invitation was accepted by about 60 members. The most cordial welcome was extended, and after the meeting a bounteous lunch and smoker followed. During the meeting, which was for the purpose of ratifying the plans of the Chamber relative to the building of a larger exhibition hall in connection with the present Convention Hall, the plans were twice discussed by citizens and A. H. Secker presented the views of the association as to the necessity of such addition. Much enthusiasm prevails here concerning the securing of the convention of the S. A. F. for Rochester in 1910, and we hope, with such increased facilities, to be successful in this endeavor. The regular monthly meeting occurs March 8, at which time the subject of a local show this fall will be discussed and a paper read on "Plants for Easter, 1909."

MASSACHUSETTS HORTICULTURAL SOCIETY.

The spring exhibition, always a big affair, at Horticultural Hall, Boston, will be exceptionally so this year, several sensational exhibits having been promised. The most pretentious display of Japanese gardening ever made indoors in this country will be presented by R. & J. Farquhar & Co., occupying about two-thirds of the area of the main hall. Rich accessories have been imported especially from Japan for this stupendous piece of work, and no effort or expense has been or will be spared in making it a truthful and complete representation of gardening art in Japan. Full provision has been made, also, for a display of Easter flowering plants, bulbous flowers, orchids, roses and carnations, for all of which very liberal premiums are offered and also for mantel decorations of plants and flowers for which a silver medal and fifty dollars constitutes the first prize, a bronze medal and thirty dollars second prize, and twenty dollars third prize.

MINNESOTA STATE FLORISTS' ASSOCIATION.

The meeting of the Minnesota State Florists' Association held at Merriam Park, February 23, was fairly well attended, considering the stormy weather. In the exhibition Messrs. Nagel & Son scored 63 1-2 points for Empress Narcissus, 76 for Carnation Winsor and 75 for Carnation Lawson, Karl Haugan 82 1-2 for Cyclamens and 96 for "Violet Prince of Wales."

The subject of the fall flower show was discussed, and the prospects to hold one in one of the two cities are very promising. Messrs. May, Olson and Swanson will report about the matter at the next meeting.

The question came up: How should hly of the valley be packed for cold storage and at what temperature should they be kept? It was decided to submit the question to the trade papers for publication.

The great loss of L. Longiformum amounting to 40 to 60 per cent was discussed. Prof. Le Roy Cady from the Agricultural School will read a paper at the next meeting.

SOUTHAMPTON HORTICULTURAL SOCIETY.

The bi-monthly meeting of this society was held February 18, vice-president E. G. Ager in the chair. After the regular routine of business, E. C. Palmer explained how to grow sweet peas. Discussion followed. Chas. E. Frankenthal gave a few points about the transplanting trees growing within the surrounding woods such as cypresses, mountain laurel, etc.

The schedule for the next show to be held in July, 1909, was sent to every member of the society. There is hope for a keen competition.

C. F. GUILLOZ.



WE WILL OPEN THE SEASON TUESDAY, MARCH 9TH, AT NOON

And will offer on that day by Auction a fresh Importation of
**Choice Roses, dwarf and standard; also Conifers,
Rhododendrons, Azalea Mollis, Hydran-
geas, Privet, Bulbs, Roots, etc.**

W. ELLIOTT & SONS, AUCTIONEERS 42 Vesey St., NEW YORK

SOCIETY OF AMERICAN FLORISTS AND ORNAMENTAL HORTICULTURISTS.

The Legislative and Tariff Committee of the Society of American Florists met on Wednesday, Feb. 24th, 1909, at 35 Cortland street, New York; present, Messrs. Benjamin Hammond, Frank R. Pierson, Patrick O'Mara, J. D. Elsele and Patrick Welch. Mr. E. A. Moseley reported inability to be present on this date. There was a mass of correspondence and Mr. Hammond suggested that Frank R. Pierson act as chairman and he would act as secretary.

The entire committee settled down to business. The following motion was moved and seconded: Resolved, That it is the sense of this committee that the Society of American Florists recommend wherever possible that a specific duty upon bulbs and plants be imposed. Carried.

On motion moved and seconded: Resolved, That the schedule be by count and not by measure. Carried.

On motion moved, seconded and carried: Resolved, That this committee do recommend that the following specific duties be levied on a ratio per one thousand, namely:

Hyalcinths	\$4.00
Tulips	1.50
Narcissi	1.50
Lilliums, all kinds.....	7.50
Lily of the Valley, pips.....	1.50
Lily of the Valley, clumps.....	10.00
Iris, Spanish and English varieties.....	.50
Iris, all other varieties.....	10.00
Oxalis25
Crocus25
Jonquils (Narcissus Jonquilla).....	.50
Izla50
Montbretia50
Galanthus-Snowdrop50
Ranunculus50
Chionodoxa50
Freesia50
Gladioli	1.00
Scillas50
Anemones, bulbous sort.....	1.00
Begonias	2.00
Gloxinias	2.00
Colchicum	1.50
Astilbe	5.00
Callas	10.00
Dahlias	15.00
Paeonies	15.00
Amaryllis	15.00
Atunis	5.00
Richardia	5.00
Zephyranthes50
Crown Imperials	5.00
Cyclameus	5.00
Muscata50

All bulbs, bulbous roots or corms which are cultivated for flowers or foliage not specially provided for in this Act, 50 cents per 1000. Plants will be taken up at next meeting.

On motion moved, seconded and car-

ried: Resolved, That collected orchids be placed on the free list, but that orchids established be subject to a duty of 25 per cent. ad valorem.

It is the intention of the committee to meet with the Seed Trade and Nurserymen's Associations upon all points of common interest.

BENJAMIN HAMMOND, Secretary.

Registration of Carnation.

Mr. W. H. Shumway, of Berlin, Conn., offers for registration the Carnation "Edward" described as follows. This application having been submitted to the American Carnation Society and having received their approval is accepted and the carnation as described is registered:

This new seedling carnation is a product of five years' development. Enchantress is one of its parents; the other not known. The habit of growth is good, branching well, with foliage of good color and substance, easy to propagate, a rapid grower with stems twenty-four to thirty inches; flowers from three to four inches in size, well built up, very full, color a deep pink with good calyx.

W. N. RUDD, Secretary.

February 27, 1909.

BAR HARBOR (ME.) HORTICULTURAL SOCIETY.

A most interesting lecture upon fertilizers was given before this society on February 18 by Prof. W. D. Hurd of the University of Maine. From the analysis given Prof. Hurd of some pulverized sheep manure, it was shown to be worth a little over \$11 a ton. From the analysis of Clay's Fertilizer and Thompson's Vine Manure their value was respectively \$23.36 and \$30 per ton, this being the price at which fertilizers of the same value can be bought. Sheep manure is retailing at \$35 per ton; Clay's fertilizer at \$7 per 100 lbs., Thompson's vine manure at \$6.75 per 100 lbs. About one hundred and thirty members were present.

The first Ladies' Night of the society was held on February 23 in Society Hall. This proved to be the winter event of Bar Harbor, about one hundred and twenty couples being present. After a brief address of welcome by the vice-president, the grand march was led by Miss Vesta Stubbs and William Miller. The floor director, John Stafford, had a most excellent program prepared. He also had charge of the decorations, which were most elabo-

rate, and his corps of aids did themselves credit. Over 1000 feet of garlands were used and the hundreds of Japanese lanterns lighted by electricity, together with the rich costumes of the ladies, produced a gorgeous effect. To Mr. Stafford perhaps more than any other is due the great success of the first Ladies' Night. Refreshments under the direction of Edward Kirk with assistants were served about midnight. Card playing was also enjoyed by many.

A paper on Peonies will be read by William Miller at the meeting on March 4. W. MILLER.

NEW LONDON COUNTY (CONN.) HORTICULTURAL SOCIETY.

This society held its meeting in the parlors of the Buckingham Memorial Hall, Norwich, on February 22nd, President S. Alpheus Gilbert in the chair. Mrs. Edna Miner Rogers, botanist, gave a lecture on evergreens, natives of the vicinity, of which there were 13 species. Mrs. Rogers showed specimens of them all. Several questions were asked and answered. The next speaker was Charles Thos. Beasley, gardener for Mrs. Lanmon, who gave a short practical talk on annuals, dealing particularly with the sweet peas. Mr. Beasley also made numerous valuable suggestions on their cultivation in response to the questions asked him.

**If We Did Not
Blow Our
Horn,
Who Would?**

Send for our Bulb List



Ralph M. Ward & Co.
12 West Broadway
NEW YORK

AMERICAN ASSOCIATION OF HORTICULTURAL INSPECTORS.

The following condensed account of the meeting of the Horticultural Inspectors may be of special interest to nurserymen. As is probably well known, this Association is made up of all the nursery inspectors in the United States. The seventh annual meeting was held at the Rennet Hotel, Baltimore, the first session opening at 8 p. m., December 29th, with President Summers in the chair.

Q. 1. How can a national importation inspection law be secured?

Committee of three appointed by the Chair to take charge of promoting such legislation during the ensuing year.

Q. 2. Is it desirable for this Association to draft an inspection law for adoption by the several states?

Laid on the table.
Q. 3. Is it desirable to change the present method of certification of stock sold by nurseryman, which was not grown in his state?

In connection with this question the following resolution was offered by Dr. J. B. Smith of New Jersey, and adopted:

"That a committee of five members be appointed to formulate a system by means of which the individual members of the Association may notify the other members of the Association of such views concerning special nurserymen, as it may seem desirable for the inspectors of other states to know."

Further remarks showing benefit of the tag system as applied to this subject were made by various members.

Q. 4. What rule should govern the conditions of a certificate to a nurseryman in whose nursery stock San Jose State has been found?

No definite action.
Q. 5. What is the present opinion regarding the dipping of nursery stock in a contact insecticide, as compared with fumigation with hydrocyanic acid gas.

The following resolution adopted: "That it is the sense of this body that the present method of fumigation with hydrocyanic acid gas is the most approved method of treating nursery stock where there is danger of infestation from San Jose State."

Q. 6. What conditions should govern the certification of strawberry plants from nurseries in which the Strawberry Root Louse is known to be present?

The following resolution was adopted: "That it is the sense of this Association that where the Strawberry Root Louse occurs in a nursery patch, if the attack be severe, the patch should be destroyed, but if only a slight infestation, the nurseryman should be required to burn off the patch, and dip plants in tobacco water before shipping."

Q. 7. Peach Yellows.
Resolved, "That this Association recommend that nurserymen, as far as possible, cut scions from bearing healthy trees and urge proper fumigation of all propagated nursery stock used in the nursery with hydrocyanic acid gas."

Q. 8. Crown Gall.
Resolved, "In view of the proven facts that this is a bacterial disease, communicated from one raspberry plant and other plants to another, that the practice on the part of all nurseries of storing raspberry plants visibly affected with Crown Gall with unaffected plants is extremely dangerous, and should be discontinued in the interest of fruit growing."

Election of Officers: The undersigned was elected President for the ensuing year, and Prof. T. B. Symons of Maryland, Secretary-Treasurer.

Respectfully,
F. L. WASHBURN,
Inspector for Minnesota.

E. F. COLLINS.

GARDENERS' AND FLORISTS' ASSOCIATION (TORONTO, CAN.).

The annual exhibition of this society was held on Feb. 24 in St. George's Hall, Toronto; it was open to the public from 3 to 10 P. M., and

FORCING GLADIOLUS

Gladiolus Gandavensis Hybrids

Many florists plant these in boxes, or among their carnations, in the Winter. They are excellent for decorative purposes and realize good prices, either wholesale or retail. Gladiolus are a good catch-crop and take up but little room. The following are the best for this purpose:

America. The flowers, which are of immense size, are of the most beautiful flesh-pink color, \$4.00 per 100; \$35.00 per 1000.

Augusta. The florists' best white Gladiolus. First-size bulbs, 1 1/2 inches and up, \$2.00 per 100; \$18.00 per 1000.

Bulbs 1 1/2 to 1 3/4 in. \$1.75 per 100; \$16.00 per 1000.

Shakespeare. White and rose. \$4.75 per 100; \$45.00 per 1000.

May. Pure white, flaked rose crimson; the best forcer. Selected bulba. \$1.75 per 100; \$15.00 per 1000.

Bronchiyeensis (true). Flery scarlet. Selected bulbs, \$1.50 per 100; \$13.00 per 1000. First-size; bulbs, \$1.25 per 100; \$10.00 per 1000.

Boddington's White and Light. Extra selected bulbs, 1 1/2 in. and up. \$1.50 per 100; \$14.00 per 1000. Bulbs 1 1/2 to 1 3/4 in. \$1.25 per 100; \$10.00 per 1000.

American Hybrids. A mixture of the choicest varieties of Gladiolus in cultivation. \$1.00 per 100; \$9.00 per 1000.

ARTHUR T. BODDINGTON

SEEDSMAN

342 West 14th Street,

NEW YORK CITY

was well patronized. The Toronto Agricultural Society and the Toronto Horticultural Society assisted in the finances. The local growers put up some very fine exhibits.

The H. Weber & Sons Co., Oakland, Md., were awarded the gold medal for vase of best carnations and scored 95 points with Toreador. Its fragrance was a matter of frequent comment, a point which growers of new varieties should remember. Its keeping qualities are good; after traveling three days it stood up in good style. Baur & Smith, Indianapolis, showed Shasta, which excited favorable comment and scored well; J. D. Cockcroft, Northport, N. Y., sent Georgia, but it had suffered in transit, as had also the shipment sent by the Chas. Knopf Floral Co., Richmond, Ind., of Ruby and Mrs. Chas. Knopf. The latter was considered by the judges an improvement in size and form over Enchantress, but color a trifle light.

The Dale Estate put up a fine exhibit of four vases of 100 each Beacon, Enchantress, Winsor and White Enchantress, which scored respectively, 90, 93, 89, 87; also magnificent Bride and Bridesmaid roses with stems three feet long. Other exhibits were by W. Lawrence, Eglinton, very fine Lady Bountiful, Winsor and Enchantress carnations, and mignonette New York Express, with spikes 15 inches long; W. Morgan, Hamilton, Princess violets of enormous size; S. Manton, Eglinton, Dendrobium Wardianum, Cymbidium Lowianum, Cattleya Trianae alba; T. Jay & Son, ferns, including some superb Nephrolepis superbiissima and Amerophillii.

In conclusion I would say that the position taken by the judge was, that the best variety was the one which would attract the buying public the most and quickest.

ORCHIDS

Just Arrived in Fine Condition

the following East Indian Orchids

DENDROBIUM WARDIANUM, D. CRASSINODE, D. PRIMULINUM, D. THYRSIFLORUM, AND D. CHRYSOTOXA. Others to follow.

WRITE FOR PRICES.

LAGER & HURRELL, Summit, N.J.

JUST ARRIVED

Fine Importation

Oncidium ornithorhynchum

Fine strong leafy plants \$1.50 each. \$18.00 doz.
Few specimens..... 2 50 "

JOSEPH A. MANDA, West Orange, N.J.

ORCHIDS

kets and Sheep and Chicken Manure.

ORDONEZ BROS., Madison, N.J.
New York Store, 41 WEST 28 ST.

ORCHIDS

We are booking orders now for delivery early in the Spring on all commercial CATTLEYSAS and NOVELTIES. Our prices are right and our guarantee perfect. We sell only first-class goods.

GARRILLO & BALDWIN, Secaucus, N. J.

ORCHIDS

Largest Importers, Exporters, Growers and Hybridists in the World

Sander, St. Albans, England
and 235 Broadway, Room 1
NEW YORK CITY

JULIUS ROEHRS CO.

Orchids and Stove Plants

Florists' Easter Supplies
RUTHERFORD, N. J.

ORCHIDS! ORCHIDS!

The LIVERPOOL ORCHID & NURSERY CO. (Cowan's) Limited

GATEACRE NURSERIES, Gateacre, near Liverpool IMPORTERS and CULTIVATORS OF ORCHIDS ILLUSTRATED, DESCRIPTIVE AND PRICED CATALOGUE POST-FREE ON APPLICATION Cablegrams "Cowan Gateacre" A. B. C. Code, 5th Ed'n.

NORTH SHORE HORTICULTURAL SOCIETY.

The North Shore Horticultural Society, Manchester, Mass., will offer at their August show the Lord & Burnham Gold Medal for the best group of



greenhouse foliage and flowering plants arranged for effect, each group to cover 100 square feet.

The accompanying cuts which show the obverse and reverse side of this rich medal, will undoubtedly bring out a sharp competition. Following are the names of former winners:

Wm. Inglis, gardener to J. J. Riker, Portchester, N. Y., awarded by Tarry-



town Hort. Society; Thos. A. Lee, gardener to Mrs. M. E. Sand, Ardsley, N. Y.; Dobbs Ferry Hort. Society; Thomas Proctor, gardener for R. W. Patterson, Lenox, Mass.; Lenox Hort. Society; H. Skjoldager, gardener to E. G. Uihlein, Chicago, Ill. National Flower Show.

EASTERN BRANCH OF AMERICAN ASSOCIATION OF PARK SUPERINTENDENTS.

This is the name of a new society, subordinate to the American Association of Park Superintendents, which was organized at Hartford, Conn., on February 26. It was at a little reunion of a few of the original members of the former New England Association that later broadened out into

a national society, which Superintendent Parker of the Hartford park department had called together for the purpose of reviving old comradeships, that the suggestion was made and enthusiastically acted upon to organize a local body which might meet more frequently and cultivate the social and fraternal relations to better advantage than is possible in the national body with its widely scattered membership.

By-laws and rules conformable to those that govern the larger association were adopted, and officers were elected as follows: President, I. A. Pettigrew, Boston; secretary-treasurer, G. A. Parker, Hartford, Conn.; executive committee, the president, secretary-treasurer and W. J. Zartmann of Brooklyn, N. Y. The first meeting will be held in Brooklyn, April 16, 1909.

Among those present were J. A. Pettigrew and J. B. Shea, of Boston park department; Robert Cameron, Botanic Garden, Cambridge, Mass.; G. X. Amrhy, of New Haven parks; Samuel Parsons, Jr., superintendent of New York parks; Geo. A. Parker, of Hartford parks; J. F. Huss, Goodwin Castle, Hartford; J. D. Pitts and Mr. Barker of Providence parks; W. J. Zartmann, superintendent of Prospect Park, Brooklyn; Mr. Ladd of Springfield, and J. H. Hemingway of Worcester, and C. E. Keith of Bridgeport departments, and W. J. Stewart of HORTICULTURE.

FLORISTS' CLUB OF WASHINGTON.

The regular meeting of the Florists' Club was held at Eagle's Hall, March 2. Owing to the stress of business, incident to the approaching inaugural ceremonies, there was an unusually slim attendance.

The re-election of President Kramer was made unanimous, as was that of Vice-President Robertson. For secretary, James L. Carbery re-iterated his declination of the office, despite the pressure brought to bear to the contrary, and O. A. C. Oehlmer was elected. Wm. T. Gude was elected treasurer. On the board of directors, Geo. H. Cooke and Theo. Dietrich were chosen. As is the custom of the club, the new officers will take their seats at the next meeting, which will close with a banquet. Geo. Shaffor was elected chairman of the banquet committee, assisted by J. L. Carbery, J. K. Davis and Geo. H. Cooke. All details will be decided later.

FROM GROWER TO PLANTER

New and Noteworthy

TREES
Shrubs, Roses
Evergreens
Fruits
Hardy Plants

Best Stock at Reasonable Prices. No Agents. Commissions saved. Collections unequalled.

Beautiful Illustrated Descriptive 100 page Catalogue and Guide mailed free upon request.

Ellwanger & Barry
MOUNT HOPE NURSERIES
ESTABLISHED 1840 Box T, Rochester, N. Y.

Newport Fairy

The Rose of the Future For In and Out Door.

FINE, STRONG FIELD-GROWN STOCK

3-4 Shoots 3-4 ft. long

50c each, \$30 per 100, \$250 per 1000

JULIUS ROEHRS CO.,
RUTHERFORD, N. J.

Ampelopsis Quinquefolia

Strong 3-year Plants, 4 to 6 ft. \$55 a Thousand. To the Trade Only

A FULL LINE OF GENERAL ORNAMENTAL NURSERY STOCK

SEND FOR CATALOGUE

EASTERN NURSERIES
JAMAICA PLAIN, MASS.
HENRY S. DAWSON, Mgr.

ROSES

We have a fine stock of large, dormant field-grown plants, on own roots, including Crimson Rambler, Dorothy Perkins, Clio, Alfred Colomb, Francois Levet, Jack, Prince Camille de Rohan, Magna Charta, Ulrich Brunner, Giant of Estates, and many others at \$16.00 per hundred; \$150.00 per thousand. Send for list. Roses, Dahlias and Cannas a specialty.

THE DINGEE & CONARD CO., W. Grove, Pa.

CHRYSANTHEMUM SEED.

Wells' New Early Flowering Singles, packets 25c and \$1.00 each.

PENTSTEMON SEED

Wells' New Hybrids, packets 25c and \$1.00 each

CHARLES H. TOTTY, Hudson, N. J.

Lucille Won Highest Honors

At Springfield, St. Louis and Utica.

A carnation which while a fancy of the highest exhibition type, yet has all the best qualifications as a profitable commercial crop. Its beautiful color

WHITE OVERLaid WITH PINK,

size, stem, perfection of form, habit, productiveness and keeping quality place it unquestionably in the front rank. It is a coming standby and should be in every carnation grower's collection. WRITE FOR DESCRIPTIVE CIRCULAR.

\$12.00 per 100. \$100.00 per 1000. Fine Healthy Stock.

A. F. LONGREN, DesPlaines, Ill., HIGHLAND PARK GREENHOUSES, Highland Park, Ill.

THE QUALITY YOU CAN MAKE MONEY ON

CARNAS

SOUND PIECES TRUE TO NAME BED ROCK PRICES

Red-Flowering, Green Foliage

	Per doz.	100	1000
A. Bouvier, 5 ft. Dark crimson.....	\$0.35	\$2.25	\$20.00
Alice Roosevelt, Deep crimson, 4 ft.....	.50	3.50	30.00
Beaute Polleche, 3 1/2 ft. Dark crimson.....	.35	2.25	20.00
Black Prince, Velvety maroon, 3 to 4 ft; green foliage.....	.50	2.75	25.00
Charles Henderson, 4 ft. Bright crimson.....	.35	2.25	20.00
Crimson Bedder, 3 ft. Intense scarlet.....	.30	2.00	17.50
Duke of Marlborough, 4 1/2 ft. Dark crimson.....	.35	2.25	20.00
J. D. Eisele, Brilliant vermilion-scarlet.....	.35	2.25	20.00
Explorer Crampel, Deep rich crimson 5 1/2 ft. Express, Crimson foliage green, Dwarf, 2 1/2 to 2 1/2 ft.....	.60	4.50	40.00
Pres. McKinley, Brilliant crimson 2 1/2 to 3 ft.....	.35	2.25	20.00

Pink-Flowering

L. Patry, Delicate rosy pink, 4 1/2 ft.....	\$0.35	\$2.25	\$20.00
Luray, Attractive rosy pink, 3 ft.....	.35	2.25	20.00
Louise, A grand pink, tall Martha Washington, Rose, Height, 2 1/2 to 3 ft. 100 each.....	.75	5.00	
Mlle. Berat, 4 1/2 ft. Rese-carmine.....	.35	2.25	20.00
Tennyson, Rosy pink; green foliage; 5 1/2 ft.....	.50	3.50	30.00

CATALOGUE FREE.

Orange-Flowered

Per doz. 100 1000
President Cleveland.
 Bright, distinct orange-red; ft..... \$0.35 \$2.25 \$20.00

Red, Gold-Edged and Spotted

Gladiator, Bright yellow, spotted crimson, green foliage; 4 ft.....	\$0.50	\$2.75	\$25.00
Cinnabar, Cinnabar red, edged with distinct golden band; 4 1/2 ft.....	.30	2.00	17.50
Queen Charlotte, Scarlet gold edge.....	.30	2.00	17.50
Mme. Crozy, 5 1/2 ft. Vermillion, gold border.....	.35	2.25	20.00
Premier, Deep crimson, bordered yellow, 3 1/2 ft.....	.30	2.00	17.50
Souv. d'A. Crozy, 4 ft. Crimson, gold band.....	.50	4.00	35.00

Yellow Shades

Buttercup, 3 1/2 ft. Clear golden yellow.....	\$0.40	\$2.75	\$25.00
Comte de Bouchard, Yellow, spotted red, 4 1/2 ft.....	.30	2.00	17.50
Florence Vaughan, 4 ft. Yellow, spotted crimson.....	.50	2.75	25.00
L. E. Bailey, Rich yellow, dotted with red; 4 1/2 ft.....	.30	2.00	17.50

White and Cream Shades

Alsace, 3 1/2 ft. Creamy white \$0.30 \$1.75 \$15.00

Bronze-Leaved, Red-Flowering

Brandywine, 4 to 5 ft. Dark bronze foliage. Crimson flowers.....	\$0.50	\$4.00	\$35.00
Black Beauty, True, 4 ft. Grand foliage.....	.60	4.50	40.00

We go through the block from 14th Street to 15th Street, but our address is still

	Per doz.	100	1000
David Harum, 3 1/2 ft. Vermilion-scarlet.....	\$0.50	\$2.75	\$25.00
Egmont, 4 ft. Current-red.....	.35	2.25	20.00
King Humbert, Fine Bronze foliage, Orange-scarlet with bright red markings, 4 ft.....	1.00	8.00	75.00
Leonard Vaughan, 4 1/2 ft. Bright scarlet.....	.35	2.25	20.00
Musafolia, The finest foliaged Carna, with enormous musa-like leaves, 3 by 5 ft., of a dark green bronze-tinged color.....	.35	2.25	20.00
Philadelphia, A bright glowing red, Height 5 ft.....	.75	4.50	30.00
Papa Nardy, Large, rich carmine-red, 4 1/2 ft.....	.30	2.00	17.50
Pillar of Fire, 4 to 7 ft. high; flowers bright crimson-scarlet.....	.75	4.50	40.00
Robusta, Height 4 ft., with immense foliage.....	.30	1.75	15.00
Shenandoah, Large Salmon flowers, 6 ft.....	.30	1.75	15.00

Orchid-Flowering

Alemania, 4 to 5 ft. Scarlet and yellow. Green foliage.....	\$0.35	\$2.25	\$20.00
Austria, 3 to 4 ft. low; an orchid-flowering type, 5 ft.....	.30	1.75	15.00
Italia, 4 1/2 ft. Green foliage. Red bordered yellow.....	.30	2.00	17.50
Kronus, Rich golden yellow, with patches of bright red, 5 ft.....	.30	1.75	15.00
Mrs. Kate Gray, 6 ft. Green foliage. Scarlet and yellow.....	.30	2.00	17.50
Pennsylvania, 5 ft. Green foliage. Deep scarlet.....	.35	2.25	20.00

ARTHUR T. BODDINGTON, Seedsman, 342 West 14th St., NEW YORK CITY.

CONNECTICUT HORTICULTURAL SOCIETY.

The regular semi-monthly meeting of the society was held on February 26th, President Huss being the presiding officer. Two new members were admitted. Secretary Alex. Cumming, Jr., who has faithfully and well performed the duties of that office for two years, resigned owing to his immediate departure for Seattle, Washington, to take part in the work on the exposition grounds. He was presented with a purse in recognition of his efficient services to the society, and of the esteem in which he was held. This was "Carnation Night," and a fine exhibit was tabled. The judges were H. A. Pinney, C. Calverly and Newton Osborn, all of Hartford. Their awards were as follows: Whiting's Greenhouses (Carl Peterson, gardener), West Hartford, first; A. N. Pierson, Cromwell, second; J. P. Huss, Hartford, third. W. H. Shumway, of Berlin, received honorable mention for two carnation seedlings. An able and eloquent paper, on "The History of the Carnation," was read by H. A. Pinney, of Hartford, who was tendered a rising vote of thanks. Two fine specimen cyclamen plants, grown from old bulbs, were exhibited by Geo. T. Whitten, of the Hartford School of Horticulture. George W. Smith, of Melrose, was chosen secretary, to succeed Mr. Cumming. President Huss has in preparation a schedule of coming events, announcements of which will be made in due course.

GEORGE W. SMITH, Secretary.

ILLINOIS STATE FLORISTS' ASSOCIATION.

Editor of HORTICULTURE:
 My apology is due to you and to the readers of your paper for having failed to advise you previous to publication that the supplemental report summarized by you in a recent issue as having been presented by me at the meeting of the Illinois State Florists' Society, had been withdrawn after being presented to the meeting.
 The report was withdrawn by my instructions and by vote of the meeting all reference to the matter was expunged from the records.
 Truly yours,
 W. N. RUDD.

February 26, 1909.

DETROIT FLORIST CLUB.

The Detroit Florist Club had a very interesting meeting March 1, and the flower show next fall at the Wayne Casino is now an assured fact. While the affair is just beginning to shape itself still the committee on prizes has completed a schedule which totals the amount of \$1023.00. "Chrysanthemums of course are favored, but handsome prizes are also offered for many other classes of plants. The retailers will exhibit without competition.

F. DANZER.

CLUB AND SOCIETY NOTES.

The Pasadena Gardeners' Association (Calif.) has decided to hold the annual spring flower show on April 1, 2, 3.

The Worcester County Horticultural

Society, Worcester, Mass., will hold its annual reunion and banquet on March 10.

The Miami Valley Nurserymen's Association held their annual banquet at the Phillips House, Dayton, O., on Feb. 18. T. J. Dinmore was elected president and W. N. Scarff of New Carlisle, secretary.

The Massachusetts Fruit Growers' Association will hold its annual meeting in Horticultural Hall, Worcester, on March 10 and 11. On the afternoon of the 11th the Worcester County Horticultural Society will have an exhibition.

At the meeting of the New York Florists' Club on Monday evening, March 8, W. H. Elliott of Brighton, Mass., will give a talk on Roses. An additional prize of a book elegantly bound in red morocco (value \$14.00) for the best vase of new roses, introductions of 1908-9, has been offered by a member of the club.

The lecture at Horticultural Hall, Boston, on Saturday, February 27, was by Mrs. C. R. F. Ladd, on "Rural New England." It was listened to by a large and deeply interested audience and among those who followed in the discussion were Ex-Governor Bachelor, of New Hampshire, secretary of the N. H. Board of Agriculture, C. R. F. Ladd, past master of the Mass. State Grange, and A. A. Hixon, secretary of the Worcester County Horticultural Society. The next lecture, March 6, will be on Propagation of Plants by Jackson Dawson.

**The New Crested
SCOTTII FERN...**

NEPHROLEPIS SCHOLZELI



NEPHROLEPIS SCHOLZELI

This crested sport of Scottii will hold the same position to all the crested forms of Nephrolepis that Scottii now holds to the Boston. It is entirely distinct from all others and will become even more popular than its parent, with which it is identical in every way except that the pinnae are subdivided, giving it a beautiful crested appearance.

We have shown the plant at the exhibitions noted below and have been awarded the following honors:

- SHAW GOLD MEDAL**, St. Louis Horticultural Society, Nov. 3rd, 1908, for "Best plant, of decided merit for cultivation, not previously an article of North American commerce."
- SILVER MEDAL**, offered by the Society of American Florists, through the St. Louis Horticultural Society, Nov. 3rd, 1908, for "The most meritorious plant, or flower of American origin."
- CERTIFICATE OF MERIT**, of the Horticultural Society of St. Louis, Nov. 3rd, 1908.
- SILVER MEDAL**, Pennsylvania Horticultural Society, Philadelphia Nov. 3rd, 1908, for the best new plant.
- CERTIFICATE OF MERIT**, Massachusetts Horticultural Society, Boston, Nov. 6th, 1908.
- CERTIFICATE OF MERIT**, Dutchess County Horticultural Society, Poughkeepsie, N. Y., Oct. 30th, 1908.
- CERTIFICATE OF MERIT**, Morris County Gardeners and Florists Society, Madison, N. J., Oct. 30th, 1908.
- CERTIFICATE OF MERIT**, Chestnut Hill Horticultural Society, Philadelphia, Pa., Nov. 4th, 1908.

We are booking orders now which will be filled in strict rotation June 1st, 1909.

Price per doz., \$3.50; per 100, \$25.00; per 1000, \$200 00. Twenty-five supplied at hundred rate and five hundred at thousand rate.

HENRY A. DREER, 714 CHESTNUT STREET, PHILADELPHIA, PA.

Obituary

E. V. Hallock.

It is a very sorrowful duty we are called to perform in announcing the sudden death from apoplexy, of E. V. Hallock, of Queens, N. Y., president of the New York Florists' Club, on Tuesday night, March 2. Mr. Hallock presided at the annual dinner of the club last Saturday night and was, so far as we know, in his usual health and spirits. The shock will come as a severe one and painful to a host of friends who loved Mr. Hallock. No one could help loving him. His was a genial, affectionate character. Full of the milk of human kindness, with a heart ready to overflow with sympathy for his fellowman he was at all times the personification of the Golden Rule and well worthy of the high regard in which he was held by the trade and society associates without exception.

Mr. Hallock was a well-read horticulturist, experienced especially in the history and culture of bulbous and tuberous rooted plants, a class of plants in which as a member of the old firm of Hallock, Son & Thorpe and the later firm of V. H. Hallock & Sons, he did a very large business, particularly in lilies and gladioli.

Mr. Hallock was appointed a director of the Society of American Florists and Ornamental Horticulturists by President Vaughan in 1905 and again by President Traenkle in 1908, to fill out his own term of one year. Mr. Hallock was elected president of the

New York Florists' Club at the last annual meeting and took his seat at the first meeting in January.

He was to have delivered a lecture on Bulbous and Tuberous-rooted Plants at the meeting of the Gardeners' and Florists' Club of Boston on March 15, and preparations were



E. V. HALLOCK

already under way to extend him special hospitality at that time.

Mr. Hallock has for years taken a lively interest in school gardens and horticultural education for children and has written some very valuable papers for the S. A. F. on that topic.

Eugene Germain.

Eugene Germain, who died in Los Angeles, Calif., on February 18, at the age of 61, was a native of Switzerland and settled in Los Angeles in 1870. In 1882 he started the Germain Fruit Co., and later became president of the Germain Seed & Plant Co., which position he held at the time of his death. In addition to a mammoth seed store he owned the Germain building and the Germain Hotel. He leaves a widow and sons. The business will continue as at present under the management of Fred H. Hunter.

George A. Dickson.

The news of the death of this nurseryman, head of the firm of Messrs. Dicksons, Chester, at his home, Springfield, Newton, Chester, will be received with regret. The deceased was in his 74th year. He entered the Chester City Council in 1879, was elected mayor of that city in 1886, and alderman in 1896; retiring in 1904. He was also a city and county magistrate.

Charles Bramley, Sr.

Chas. Bramley, who has resided in Cleveland, O., since 1855 and conducted a flower business from 1894 to August, 1908, under the firm name of Chas. Bramley & Son, passed away on February 17. His golden wedding was to have been celebrated on February 22. A widow and nine children survive him.

Mrs. G. Wythes.

Some readers of HORTICULTURE will learn with much regret of the death of Mrs. Wythes, whose husband was gardener at Syon House, Brentford, England, for many years.

PREPARE FOR EASTER

Headquarters for Easter Plants

What is the best Double Pink Azalea? It is the Mme. Van Der Cruyssen, originated by the well-known Azalea Specialist, M. Van Der Cruyssen of Belgium. We have a big stock of them; every plant is as round as an apple, just covered with buds, just right for Easter. We have them for 70c, 75c, \$1.00, \$1.25, \$1.50 up to \$2.00 each. Bernard Andreus alb., \$2.25 to \$3.00; some at \$1.50 to \$1.75. Nobe and Deutscher Belle, 75c, \$1.00, \$1.25, \$1.50. Arvaeana, De Schryveriana (best double variegated), 75c, \$1.00, \$1.25, \$1.50, \$2.00. Empress of India, 70c, 75c, \$1.00, \$1.25, \$1.50. Simon Martiner, 60c, 70c, 75c, \$1.00, \$1.25, \$1.50, \$1.75. Apollo (red), 60c, 65c, 75c, \$1.00. Professor Walters, 75c, \$1.00, \$1.25, \$1.50, and some more 200 varieties, 75c, \$1.00, \$1.25, \$1.50. We have Azaleas by the thousand.

Litum Tu tillorum, the best in America, in pot plants, with five buds and upwards to ten buds, 10c per bud; under five buds, 12c per bud.

Cineraria hybrida grandiflora, 6 in., 25c, 35c, 50c, 75c, \$1.00 each.

Hydrangea Otaksa, 6 to 7 in. pots, 75c, 75c, \$1.00.

Spiraea Gladstone, in pots, 50c, 75c, \$1.00.

Superba, Florida, Japonica, 6 in., 75c, 75c, \$1.00.

Araucaria Excelsa largest stock in America, 75c, \$1.00, \$1.25, \$1.50.

Araucaria Robusta compacta and Glauca, 4, 7-8 in. pots, 20 to 35 inches high, 4, 5, 6 tiers, \$1.00, \$2.00, \$3.00.

Kentia Belmoreana, 3/4 to 5/8 in. pots, 5, 7, 10c, 75c.

Forsteriana 5/4, 5/8, 6 in. pots, 60c, 70c, 75c, \$1.00, \$1.25, \$1.50.

Hyacinths, four best varieties, white, pink, light and dark blue, 4 in. pots, \$1.00 per 100.

Tourosol Tulips, three bulbs in 4 in. pot, 15c.

Von Sinn Daffodils, three bulbs in 4 in. pot, \$2.50 to \$3.00 per doz. pots.

Asparagus Plumosa, 3 to 4 cents.

Ferns, 6, 7, 8 inch, such as **Whitmanii**, Boston, Scottii, 50c, 75c, \$1.00, \$1.25, \$1.50. Aneuphobii, 5 to 6 in., 50c, 75c.

Cash with order please. Ment on if pots are wanted

GODFREY ASCHMANN

Wholesale Grower and Importer of Pot Plants
1012 W. Ontario St.
PHILADELPHIA, PENNA.

SPRAYING FLUIDS.

Next to the question of fertilizers no more vital problem confronts the cultivator today than that of fungicides and insecticides. Spraying has within a short space of time come to be universally recognized as an essential of successful horticulture and the natural result of the sudden demand has been the exploiting of a vast number of preparations, each claiming pre-eminence. For some time past we have heard much of the preparations known as V 1, V 2 and V 3 Spray Fluids. These fluids are prepared by the well-known Sheep Dip House, Wm. Cooper & Nephews of Chicago, who have spent considerable time and research in perfecting them and now offer them on their merits, through our advertising columns. The claims made by the manufacturers are very strong and they express full confidence in the results if their preparations are given a trial. They have just issued a booklet containing testimonials and other pertinent matter, which is free for the asking.

FIRE RECORD.

East Orange, N. J. A fire in the greenhouse of O. A. Miller, the orchid specialist, on Feb. 25, ruined plants valued at \$8,000.

Providence, R. I. R. R. Dunbar, of Bristol, has sold two of his greenhouses, one 100 feet, one 150 feet, to John Macrae, who will add them to his present range.

THE MOST BEAUTIFUL FERN EVER INTRODUCED

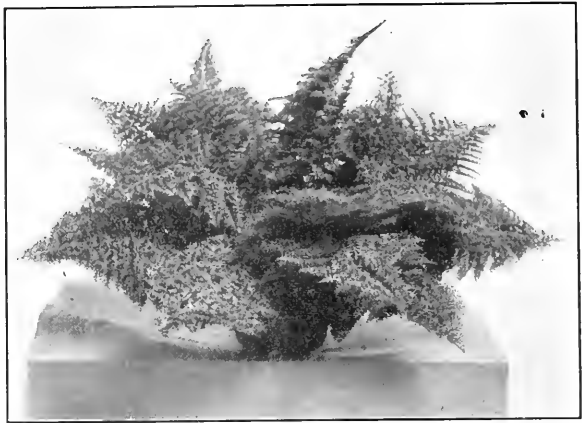

Nephrolepis Magnifica

The most refined development of the Nephrolepis family. The sensational novelty of the season

Strong 2 1-2 inch stock, \$25.00 per 100

Our general stock of ferns is exceptionally good this year. We are prepared to supply any quantity of the following:

BOSTONS, 2 1/4 in. \$3 per 100, \$30 per 1000 WHITMANII, 2 1/4 in. \$5 per 100, \$40 per 1000
WHITMANII, 3 1/2 in. from Bench, \$8 per 100

HENRY H. BARROWS & SON, Whitman, Mass.

Headquarters for Asparagus Plumosus Seed New Crop

GREENHOUSE CROWN		LATH HOUSE CROWN	
100 seeds, .50	5,000 seeds, \$18.50	100 seeds, .40	5,000 seeds, \$13.00
1,000 " 84.00	10,000 " 57.00	1,000 " 50.00	10,000 " 24.00

Write for Our Wholesale Catalogue

HENRY F. MICHELL CO., 1018 Market Street, PHILADELPHIA

Shamrocks

2 1-2 in. pots,
\$1.00 per dozen, \$6.00
per 100.

N. F. MCCARTHY & CO.
84 Hawley St., Boston.

SHAMROCK

IRISH. THE REAL THING! GREEN. Best to order early and grow on for strong plants for St. Patrick's Day. Our stock is very fine. \$3.00 per 100, a post paid 50c per dozen.

JOHN F. RUPP, Shiremanstown, Pa. RUPPTON: The Home of Primroses.

GREENHOUSE G OWN SEEDS

Asparagus plumosus nanus

New Crop Seed Now Ready. Fresh and true to name.
\$4.00 per 1000; 5 M lots \$32.50. Write for special rates on large quantities.

Asparagus Sprengeri
75 cts. per 1000; 10M lots \$5.00.

S. S. PENNOCK-MEEHAN CO.
16 8-20 Ludlow Street, PHILADELPHIA, PA.

In ordering goods please add "I saw it in HORTICULTURE."

DREER'S SPECIALS FOR FEBRUARY



Adiantum Farleyense The finest lot of five inch pot elegant stock to give a finishing touch to fine work and choice decorations. \$9 per doz., \$70 per 100. In other sizes we can supply:

3 in. pots \$3.50 per doz., \$25 per 100; 4 in. pots \$5 per doz., \$40 per 100; 8 in. pots, fine specimens, \$2 each.

Azalea Mollis These hardy Azaleas are becoming more popular every season; it is profitable stock to handle as it can be forced at a minimum cost. We offer splendid bushy plants, 15 inches high, \$1.50 per doz., \$35 per 100.

Wallflower For early forcing, strong bushy plants in 4 in. pots which will sell readily at a good profit when in flower, \$1.25 per doz., \$8 per 100.

Variegated Aucubas A splendid lot of these plants, so useful for decorative work during winter

Each Doz.	Each Doz.
Very bushy 12 to 15 in. high \$0.30 \$3.00	Very bushy 24 in. high \$0.60 \$7.00
15 " 20 " 40 4.50	28 to 30 " 75 8.00

Specimen plants 3 ft. high, very fine, \$3 each.

Boxwood A splendid lot of globe-shaped specimens about 15 inches high and of same diameter to 12 inch pails, \$1.60 each.

BUSH SHAPED PLANTS for window boxes etc., 10 to 12 inches high, \$2 per doz., \$16 per 100. Larger, heavier plants 12 to 15 inches high, \$3.50 per doz., \$25 per 100.

HENRY A. DREER, 714 Chestnut St. PHILADELPHIA

BARGAINS

in KENTIAS and other Decorative Plants, all sizes. Also the following at Lowest Import Prices. Azaleas in bloom from now until Easter. All colors and varieties. A fine lot of Rubbers, Crotons, Araucarias, Pandanus, Asparagus plumosa and Sprengeri.

SMALL FERNS

for table decorative purposes at lowest wholesale rates.

A. LEUTHY & CO.,
Perkins St. Nurseries, ROSLINDALE, MASS.

HEADQUARTERS FOR

Araucaria Excelsa, 6 in. pots, 5-6 tiers, 75c, \$1, \$1.25;
Robusta Compacta and glauca, 20 to 30 in. high, \$1.50, \$3.00. **Ficus elastica**, 5 1/2 in., 25c, 35c, 50c.
Kentia Belmoreana, 4 to 5 1/2 in., 35c, 50c, 60c; **Forsteriana**, 3 to 6 in., 50c, 60c, 75c, \$1.00, \$1.25, \$1.50.
Boston, Scotland and Whitmanii Ferns, 6 to 10 in. pots, 50c, 75c, \$1.00, \$1.50; **Amerophili**, 5 1/2 in., 35c, 50c.
Azalea Apollo in bloom, 75c, \$1.00.
Cineraria Hybrida for Easter, 3 in., 5c, 6 in., 25c.

GODFREY ASCHMANN
1012 W. Ontario St., PHILADELPHIA, PA.

GOLEUS! GOLEUS!

C. Verschaffeltii and Golden Bedder, R. C.	Pr 100	Pr 1000
Same in 2 1/2 in. pots	2.00	18.00
Coleus , Mixed R. C.	60	5.00
Same in 2 1/2 in. pots	1.75	15.00
Ageratum Steia Gurney and Pauline R. C.50	
Same in 2 1/2 in. pots	1.00	
Feverfew R. C.	2.00	
Fuchsias , our selection, in 2 1/2 in. pots	3.00	
German Ivy R. C.75	
English Ivy R. C.	1.00	

Cash with Order

J. E. FELTHOUSE
148-154 Van Vranken Ave., SCHENECTADY, N. Y.

CYCLAMEN GIGANTEUM
5, 6 and 7 in. pots—50c, 75c, and \$1.00 each.

Extra heavy stock of the very best quality.

Thomas Roland,
Nahant, Mass.

DECORATIVE PLANTS

Araucaria Excelsa, Pandanus Utilis, Dracaena Indivisa, Kentias, Latanias, Arecas, Etc. Perennials and Shrubs.

4 inch Araucarias, 50 cents each	6 inch Araucarias, \$1.00 each.
8 " " " "75 " " "	7 " " " " " " " " \$1.25 and \$1.50 "

FERNS FOR DISHES—\$3.50 per 100, \$30.00 per 1000.
SEND FOR OUR PRICE LIST. WE HAVE A COMPLETE STOCK.

The Geo. Wittbold Co.

1657 Buckingham Place, Chicago, Ill.

FERNS FOR DISHES,

Assorted Varieties
From 2 inch pots, \$3.50 per 100; \$30.00 per 1000

CASH WITH ORDER
2570 to 2606 W. Adams St., Chicago, Ill.

FRANK OEGHSLIN

PALMS AND FERNS DECORATIVE PLANTS

JOHN SCOTT
Rutland Road and E. 45th St.
Tel. 3850 Bedford BROOKLYN, N. Y.

PEACOCK'S NEW DAHLIAS

SEND FOR LIST

PEACOCK DAHLIA FARMS
Williflamstow Junction, N. J.

DAHLIAS. Now is the time to place your order for bulbs which will insure you getting named varieties in any quantity; prompt delivery.

DAVID HERBERT & SON,
Successors to L. K. Peacock, Inc.
ATCO, N. J.

The Northboro Dahlia and Gladiolus Gardens

Offer for Spring 1909
300 selected varieties of Dahlias and one and one half million large-flowering Gladioli in mixtures, in lots to suit. Seed list of your wants. Catalogue free.

J. L. MOORE, Northboro, Mass.

Ampelopsis Veitchii, 4 in. pots, \$1.00 per 100; 3 in. pots, \$3.00 per 100. **Ferns, Boston, Scotland**, 4 in. pots, \$1.00 per 100; Boston, 3 in. pots, \$1.00 per 100. **Whitmanii**, 3 in. pots, \$5.00 per 100. **Asparagus Sprengeri**, 4 in. pots, \$3.00 per 100. **Cannas**, **King Humbert, Bl. Blanc**, \$3.00 per 100. **Clematis Paniculata**, 4 in. pots, \$10.00 per 100. 3 in. pots, \$3.00 per 100. **Clematis**, large flowering varieties, 2 years old, dormant plants; **Dicksonii**, **Henry's Andre**, \$2.00 per 100. **Picus, elastica**, 6 in. pots, 25c each.

C. EISELE, 11th & Westmoreland Sts., Philadelphia, Pa.

HEACOCK'S PALMS

Kentia Belmoreana
7-inch pots 32 to 34 inches high \$2.50 each
7-inch pots 36 to 38 inches high 3.00 "

7-inch tub 42 to 48 inches high 5.00 "

Made up **Kentia Forsteriana**
7-inch pots 32 to 34 inches high \$2.50 each
7-inch pots 36 to 38 inches high 3.00 "

9-inch tub 42 to 48 inches high 5.00 "

Joseph Heacock Co., Wyncote, Pa.

Gladiolus Brenchleyensis

Extra fine Healthy Imported Stock
1,000 \$10.00 10,000 \$80.00

O. V. ZANGEN
HOBOKEN, N. J.

JAPANESE NURSERY CO.
LILIES PLANTS
THE YOKOHAMA NURSERY CO. NEW YORK.
31 BARCLAY STR. BAMBOO STAKES

PERSONAL.

Carl Jurgens of Newport, R. I., started on a European tour February 19.

J. B. Klaws of Crawfordsville has taken a position with the Attica Floral Co., Attica, Ind.

Mr. and Mrs. P. Welch, of Boston, are in Washington, enjoying the Inauguration festivities.

H. Hornbrook, recently of Philadelphia, succeeds Edgar Knight as gardener for Clement Moore, Hackensack, N. J.

Visitors in Boston this week: H. S. D. Forest, Winfield Rolker and Charles Lockner, New York City; Paul Berkwitz, Philadelphia.

C. L. Washburn, of Baszett & Washburn, Chicago, has been in poor health for some time and is now taking treatment at West Baden, Ind.

Mrs. Albert Meyer of the Flower Growers' Market, Chicago, lost her father, Ernest Dickinson, on the 23rd. It was the first death in the family for over 50 years.

John Burroughs and John Muir, the California explorer and forestry authority, are starting on a trip together to explore the Grand Canyon of Colorado.

Ernest Oechstin, of Chicago, whose accidental shooting we mentioned in our last issue, is improving nicely and hopes are entertained for his speedy recovery.

Chicago visitors: Mr. Newhall, Aurora Greenhouse Co., Aurora, Ill.; Wm. Graff, Columbus, O.; J. A. Swart, Stirling, Ill.; Mr. and Mrs. Alpha Eberfeld of Kansas City.

Visitors in Albany, N. Y.: J. J. Karins, representing Henry A. Drier, Philadelphia; James Merklejohn, representing H. F. Darrow, and J. Shattis, representing Lion & Co., New York.

Recent visitors in Bar Harbor are Robert Laurie, representing W. W. Rawson & Co.; Thomas Mead, representing Schlegel & Fottler Co., Boston, and D. D. P. Roy representing Vaughan's Seed Store, New York.

Mrs. J. F. Kidwell has been ill for three weeks. Though her case is considered serious the attending physician expects her recovery. Mr. Kidwell has a retail store and greenhouse at 35th St. and Wentworth Ave., Chicago, and is well known to the trade.

Sir D. Morris, late Imperial Commissioner of Agriculture for the West Indies, has been selected for the newly created post of Scientific Adviser to the Secretary of State for the Colonies on matters of an agricultural nature relating to British possessions in the tropics.

Messrs. Nutting & Sons, Ltd., have incorporated with a capital of \$100,000 to take over the business of seed merchants, carried on at 106 Southwark street, London, S. E., as Nutting & Sons, and to adopt an agreement with W. J. Nutting, H. W. W. Nutting and H. R. Nutting.

Frank Schaeffer, who has been foreman for Frank Oechstin, Chicago, for some time, leaves to take an interest with the Aurora Greenhouse Co., Mr. Schaeffer is a competent grower, well known in Chicago, and he will be well qualified to further extend the business of this company.

The Burpee Quality in Sweet Peas

Few Florists' or Market Gardeners located near summer resorts and large towns seem to realize that by planting Sweet Peas early (as early in April as possible) they can add largely to their summer and early fall income. We have recently received letters from progressive planters stating that in 1908 they were able to add hundreds of dollars to the profit side of the ledger by selling Sweet Pea blooms grown from "Burpee's Seeds."

Florists and Market Gardeners like other Horticulturists differ as to what is best—we suggest as the most desirable of their color in the grandiflora type of Sweet Peas:—

	Per oz.	¼ lb.	Per lb.
DOROTHY ECKFORD, The best white.....	\$.06	\$0.15	\$.45
WHITE WONDER, Fre- quently produces six to eight blooms to a spray.....	.10	.25	.75
MRS COLLIER, Best cream or primrose colored.....	.10	.30	1.00
JANET SCOTT, "The Best Pink".....	.06	.15	.40
PRIMA DONNA, Blush pink.....	.06	.10	.35
COUNTRESS OF LATHAM Soft cream pink, very large flowers.....	.06	.15	.40
PRINCE OF WALES, large self-rose colored.....	.06	.15	.45
KING EDWARD VII, The best crimson coriariet.....	.07	.18	.60
QUEEN ALEXANDRA, Bright scarlet.....	.10	.30	1.00
FLORA NORTON, Beautiful rich lavender.....	.06	.15	.40
Mrs. WALTER WRIGHT, I, Deep mauve.....	.06	.15	.45

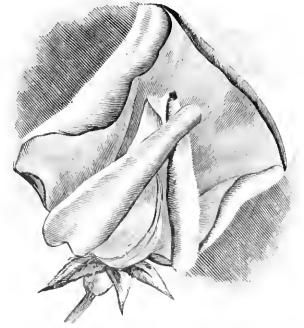

	Per oz.	¼ lb.	Per lb.
BRILLIANT BLUE, (Lord Nelson), Finest dark blue... ..	.12	.35	1.25
BLACK KNIGHT, Rich ma- roni.....	.06	.15	.40
HELEN PIERCE, White ground mottled with blue....	.10	.30	1.00

If you wish the Sweet Peas forwarded by mail postpaid kindly remit at the rate of 8 cts. per lb. additional. The fourteen varieties offered above together with all the other best Grandiflora varieties and also the superb new "Spencers" are fully described in

BURPEE'S FARM ANNUAL FOR 1909

The Leading American Seed Catalog

An elegant book of 174 pages. It is "The Silent Salesman" of the World's Largest Mail Order Seed Trade. It tells the plain truth about the Best Seeds that can be grown. Bound in covers lithographed in nine colors, it shows, with the beautiful colored plates, Seven Superb Novelties in Vegetables, Three New "Spencer" Sweet Peas, and the most beautiful New Giant-flowered Fancies—all accurately painted from nature. It is a **Sale Guide** to success in the garden, and should be consulted by every one who gardens either for pleasure or profit. It is mailed **FREE** to all who appreciate *Quality in seeds*. Shall we mail YOU a copy?

You should also ask for a copy of the **BLUE LIST** which gives special prices quoted **Florists and Market-Gardeners**. Time for planting all seeds is close at hand,—you had better write for either or both catalogs **To-Day**.

W. ATLEE BURPEE & CO., Philadelphia, Pa.

Y Fluid

THE IDEAL WINTER SPRAY

SCALE KILLER & FUNGIGIDE

POWERFUL CLEANSER AND INVIGORATOR

Mixes Instantly. No Sediment. No clogging. Non-injurious to user

COMPARATIVE TEST WILL PROVE ITS MERITS

Quart, \$1.00; Gallon, \$3.00

1 gallon makes 100 gallons. Write for descriptive pamphlet and testimony

PROPS. W. COOPER & NEPHEWS

177 ILLINOIS ST. CHICAGO

Gen'l Agent—CYRIL FRANCKLYN, 62 Beaver Street, New York, N. Y.

THE PRIZE WINNING STRAWBERRY

The Barrymore

Send for Folder at Once.

H. L. CRANE, Originator,
Westwood, Mass.

TARGET BRAND

Weed Killer

Sold at retail by a thousand of seed houses and dealers. Special price in quantities to parks and cemeteries

TARGET BRAND, Box 732, Martinsburg, W. Va.

"SOLD BY SEED DEALERS"

"HORICUM"

HORICUM

TRADE MARK

Poly-Sulphides of Calcium 30%. Specific Gravity 1.50

DIRECTIONS FOR USE

San Jose Scale Killer and Fungicide

This preparation is lime, sulphur and salt, making a concentrated Poly-sulphide of Calcium. The salt adds to the adhesive properties, but the destructiveness to Scale Life lies in the Calcium Sulphide.

Aside from its ability to destroy San Jose Scale, HORICUM is a Fungicide, preventing the free development of fungoid troubles. Shake the package thoroughly or take the top off.

The color in its concentrated form is a deep bronze green. **Do not pour off the clear liquor only**, stir the Horicum from the bottom of the package, and add 20 quarts of water (hot, if you can get it) for ordinary use. For a stronger dilution when the growth is all dormant use 16 parts of water only (hot, if you have it) and spray thoroughly. By grading your dilution you make it any desired strength.

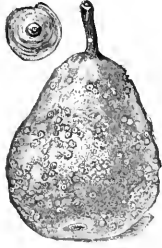

San Jose Scale on a Pear.

Kills San Jose SCALE

WRITE FOR PAMPHLETS ON BUGS AND BLIGHTS
HAMMOND'S SLUG SHOT WORKS
FISHKILL-ON-HUDSON, N. Y.

"Every Bug Has His Dose."

Insect-destroying preparations that do their work well and effectively are the cheapest. Bowker's Arsenate of Lead and Bowker's Pyrox are recognized standard insecticides and fungicides for both indoor and outdoor use. Bowker's Insect Emulsion destroys many kind of plant lice, black and green flies, etc. Call or send for catalogue.

BOWKER INSECTICIDE COMPANY
43 CHATHAM ST. BOSTON

For Trees, Plants, Shrubs and Flowers

USE

THE NIAGARA BRAND LIME SULPHUR SOLUTION

It destroys Scale Lice, Spiders and all forms of Aphids, AT THE SAME TIME Mildew, Blight, Rust and other Fungus difficulties.

Used in Winter or Summer - No other remedy has been so universally effective. Niagara Brand ARSENATE OF LEAD for chewing insects is equal to the best and better than the most. Ask about our Green House sprayer. Address -

NIAGARA SPRAYER CO., - - Middleport, N. Y.

U-N-IT Globe Sprayer.

Brings out in solution, with water, what is put into Globe Insecticides, Germicides, Fungicides, Fertilizing solutions, soap solutions, etc. Practical: saving work, time and money. An investment for every Florist. Tested at 150 pounds water pressure. Write for circulars or better still order one now from your dealer or sent prepaid on receipt of \$3.50.



Dept. H, J. F. CASS MFG. CO, Detroit, Mich.

DON'T EXPERIMENT

USE

TO-BAK-INE

and your stock will be free from insects, clean, and the blooms will not be discolored.

Send for full information of

H. E. FISKE SEED CO.
13 Faneuil Hall Sq., Boston, Mass.

STUMPP & WALTER CO.,
50 Barclay St., New York.

HENRY F. MICHELL & CO.,
1018 Market St., Philadelphia.

E. H. HUNT, Gen'l Agent,
76-78 Wabash Ave., Chicago.

KILMDEAD
The best of all the tobacco dusts for Dusting or fumigating

25 lbs., \$1.00
50 lbs., 1.76
100 lbs., \$ 3.00
200 lbs., 14.00
1000 lbs., \$27.00
2000 lbs., 62.50

Stumpp & Walter Co.
50 Barclay St., New York.

Baskets, Crates, Ladders, Veneers and Boxes.

BACON & CO.
Appleton, N. Y.

PAT. APR. 30 01

Which Spray Pump

shall you buy? Buy the Spray Pump that fully meets the demands of the Government Agricultural Scientists and all practical Fruit Growers. These pumps are widely known as

DEMING SPRAYERS and are made in 23 styles for use in small gardens or immense orchards. Write for our new catalog with Spraying Chart. Add 4 cents postage and receive "Spraying for Profit," a useful guide book.

CHARLES J. JAGER CO.
281-285 Franklin St., Boston

SPRAYED



The Best Bug Killer and Bloom Saver

For PROOF Write to

P. R. Palethorpe Co.
OWENSBORO, KY.

SOMETHING NEW for GREENHOUSES
"SULFOCID"
PRATT'S
SOLUBLE SULPHUR SUMMER SPRAY

Non-caustic and non-irritating
A FUNGICIDE AND INSECTICIDE
FOR FRUIT TREES, VEGETABLES and GREENHOUSES
A promising substitute for Bordeaux mixture. For 10 cts. to cover postage will send sample sufficient for one gallon of spray.
Use 1 part to 75 or 100 parts of water.
B. G. PRATT CO., 50 Church St., New York, U. S. A.

Straight, round and flat steam nozzle on Kopesky's "Shower Maker," \$1.00 each. Saves labor, temper, patience and time. GET ONE NOW and you will be satisfied, but if not you may return it and I'll return your money.

JOSEPH KOPESKY, South Bend, Ind.

Seed Trade

AMERICAN SEED TRADE ASSOCIATION.

Watson S. Woodruff, Orange, Conn., Pres.; J. C. Robinson, Waterloo, N.Y., First Vice Pres.; C. E. Koudel, Cleveland, O., Sec'y and Treas. Twenty-seventh annual convention June 22-23, 1909, at Clifton House, Niagara Falls, Ont.

WHOLESALE SEEDSMEN'S LEAGUE.

F. W. Bruggenhof, Pres.; Burnet Landreth, Sec'y.

Chicago, Ill.—W. W. Barnard Co. has equipped the store at 117 Fifth avenue for the retail trade.

Harrisburg, Pa. The Holmes Seed Co., at a meeting on Feb. 29, voted an increase of \$25,000 in the capital. This increases the capitalization to \$75,000.

Chicago, Ill. Fire destroyed the main building of the Albert Dickinson Company, dealer in seeds, on Feb. 26, and at times the entire plant, which occupies a quarter of a block on West Taylor street, and comprises fifteen buildings, was menaced by the flames. It is said that the fire started from an explosion of gas. Two firemen were slightly injured, but no lives were lost. The loss to the company is not so great as at first estimated and is fully covered by insurance.

VEGETABLE PLANTS

FOR TRANSPLANTING

CABBAGE—Wakenfeld and Succession

EGG PLANT—N Y Improved and Black Beauty, \$1.50 per 1000
 PEPPER—Bull Nose, Ruby King and Sweet Mountain, 40c. per 100, \$3.50 per 1000
 Chinese Giant and Cayenne, 40c. per 100
 TOMATO—Earliana, Chalk's Jewell and Early June Pink, 10c. per 100, \$1.00 per 1000

CHAS. WITH ORDER

R. VINCENT, JR., & SONS CO.
 White Marsh, Md.

200,000 CLADIOLI BULBS
 1/4 to 1 1/2 inches, \$2 per 100, 1 1/2 to 1 3/4, \$4 per 100, 1 3/4 and up, 1 1/2 per 100.

CALIFORNIA PRIVET

1 yr. well branched, \$20 per 1000. Cash with order. Nice lot of AMERICAN CHESTNUT TREES at a bargain, about 50 LARGE SUJAR TREES, most of them sample trees. Surplus of STONE TOMATO SEED, Ruby King, Neapolitan, Bull N. & Sweet Mountain Pepper Seed at a bargain.

I. & J. L. LEONARD, - Iona, N. J.
 Vegetable Plant Nurserymen and Seed Growers

BRIDGEMAN'S SEED WAREHOUSE

RICKARDS BROS.

Props.

37 East 19th St., - NEW YORK CITY

CONTRACT GROWER OF

Vegetable and Flower Seeds

For the Wholesale Trade.
 Write, stating what Seed you want grow.

JOHN S. WEAVER

Glen Mawr Seed Farms. Kinzers, Lancaster Co., Pa.

PHILADELPHIA NOTES.

W. K. Harris has the sympathy of the trade on the death of his daughter, Flora, on Feb. 25.

W. Atlee Burpee and companions arrived home in Philadelphia Feb. 25. All well and a pleasant trip.

Fred Ehret, of Broad and Fairmount avenue, is about again, after a severe siege of inflammation which threatened serious consequences for many days.

John Thatcher, late of Wynnewood, Pa., now located in Virginia, was a visitor in Philadelphia this week. He greeted many of his old-time friends and admirers at the club meeting March 2.

Writing Feb. 26, from Castle Springs, Ariz., Charles Sim, the well-known landscape gardener of Rosemont, Pa., expresses regret to read in HORTICULTURE of the death of his life-long friend, David Bearn, at Kirriemuir, Scotland. Mr. Sim is accompanied by his wife and is making a tour of the Golden West. Their next stop will be Los Angeles, Cal., then San Francisco. Home about the first of April.

John Westcott appeared in his usual haunts on Thursday, the 25th, looking fine after his trip to Southern seas. He is giving them all the earache on the beauties of Cuba and the Isle of Pines. A bungalow la Waretown in the latter island is in prospect; many are saving up for the trip already. Robert Craig and Julius Roehrs were left behind, looking up desirable sites for winter cottages and other interesting propositions.

An informal meeting of the committee of the credit bureau of the Wholesale Seedmen's League was held in Philadelphia on the 26th ult. After business W. Atlee Burpee invited the committee to dinner at the Union League. To make the occasion pleasant for the visitors, Mr. Burpee invited a few of the representative seedsmen of Philadelphia to join the festive board. Among those present were: T. W. Wood, Richmond, Va.; Charles H. Breck, Boston; S. F. Willard, Weathersfield, Conn.; Walter P. Stokes, Robert Bulst, H. W. Tull, Herbert W. Johnson, Purcell Landreth, Howard M. Earl, H. W. Burt and Mr. Smith, attorney for the credit bureau. The scope and usefulness of the bureau to the trade was the serious subject discussed, but wit and wisdom on divers topics had free vent, as might be expected from such a gathering of shining lights.

INCORPORATED.

San Francisco, Cal. The Luther Burbank's Products; Hartland Law, O. E. Law, O. E. Dinner. Capital, "several millions."

Paul Kaese who has been engaged with his father-in-law, William Hageman, in the bulb-importing and apple exporting trade in New York is about to start in business for himself in Hamburg, Germany.

Everything "For the Land's Sake."

The one firm in Boston where all good forms of plant food may be obtained, is the Bowker Fertilizer Company, opposite Faneuil Hall at 43 Chatham St. All greenhouse chemicals, Nitrate of Soda, Ground Bone, Potash Salts, Sheep Manure and Wood Ashes can there be had at first hands.

BOWKER FERTILIZER COMPANY

Everything "For the Land's Sake."

NEWS NOTES.

Toledo, O.—S. W. Peck is rapidly getting settled in his new location on South street.

Calla, O.—The Templin Co. is reported to be paying an eight per cent. dividend through its trustee.

Buffalo, N. Y.—F. H. Stafford and J. Benson have started in the florist business on upper Main street.

Baltimore, Md.—L. H. A. Klein has started in carnation growing at Towson, with H. Bauer as manager.

Geneva, N. Y.—Smith & Gannett are equipping their new florist store at 53 Seneca street with all the modern appliances and will soon take possession.

Cycas Revoluta

(Sago Palm)

STRONG HEALTHY TRUNKS

Average from 1 to 5 lbs. each

Ready Now

25 pounds for\$2.25
100 " " 8.50
300 " " 24.00

Headquarters for

Dahlia and Canna Roots

All the Leading Sorts

Write for a copy of our Wholesale Catalog

HENRY F. MICHELL CO.

1018 and 518 Market St., PHILA.

Mignonette

FARQUHAR'S GIANT

Oz., 75c; 1-4 oz., 25c

R. & J. Farquhar & Co.
6 & 7 South Market Street
BOSTON, MASS.

RELIABLE SEEDS

SOW NOW

CHINESE PRIMROSES large flowered finest strain, Pure White, Pink, Lavender, Blood Red. Each Color separate per 1000 seeds \$2.00, per tr. pk. \$5.00. All Colors, Fine Mixed 1000 seeds \$1.50, per tr. pk. \$5.00.

OBCONICA PRIMROSES large flowered exhibition strain, Carmine, Daybreak, Purple, Pink, Pure White, Lilac. Each Color separate per 1000 seeds \$1.00, per tr. pk. \$5.00. All Colors, Fine Mixed 1000 seeds \$1.00, per tr. pk. \$5.00.

FOR OTHER VARIETIES SEE MY CATALOGUE WHICH WILL BE SENT POST FREE

O. V. ZANGEN, Seedsman
HOBOKEN, N. J.

CANES

Freshly Cut From the Brakes For Your Lilies

Can Be Cut To Any Size

\$5 for 500, \$7 for 1000

Wm. Elliott & Sons
42 Vesey St., New York

BEST QUALITY SEEDS

30 Years Experience Growing and Selling

PEAS AM. WONDERS \$5.00 bu.; THOS. LANTONS \$1.00 bu.; GRADUS \$2.00 bu.; TELEPHONES \$5.00 bu.; NOTT'S EXCELSTORS \$5.00 bu.; PREMIUM GEANS \$1.50 bu.; DUKE OF ALBANY \$4.75 bu.

ONION YELLOW GLOBE DANVERS \$1.25 per lb., postage free.

Mammoth, Medium, Alsike, Alfalfa, Clover and Timothy

Write for prices. Seed for my beautiful 1909 catalogue (free). Samples mailed free.

CHAS. F. SAUL
220-224 JAMES STREET, SYRACUSE, N. Y.

48-56 JACKSON ST.,
C. C. MORSE & CO. San Francisco, Cal.
The Largest Seed Growers on the Pacific Coast

ONION, LETTUCE, SWEET PEAS,

ALSO

Carrot, Celery, Leek, Mustard, Parsley, Parsnip, Radish, Salsify

LEONARD SEED CO.

CONTRACT CROWERS AND WHOLESALE DEALERS

BEANS, PEAS, SWEET CORN, ONION, GARDEN SEEDS

ONION SETS FLOWER SEEDS Get Our Prices 79 and 81 E. KINZIE STREET, CHICAGO

Thorburn's Seeds

LILY OF THE VALLEY PIPS

Unexcelled Hamburg or Berlin

TUBEROUS ROOTED BEGONIAS

GLOXINIAS

ROSA MULTIFLORA NANA SEED

and all other flower seeds for Florists

SEND FOR CATALOGUE

J. M. THORBURN & CO.
33 BARCLAY ST. through to 38 PARK PLACE
NEW YORK

CAULIFLOWER SEED

CABBAGE

LILY OF THE VALLEY PIPS.

HJALMAR HARTMANN & CO.
12 Stormgade,
COPENHAGEN, DENMARK.

Burpee's Seeds

PHILADELPHIA

Blue List of Wholesale Prices mailed only to those who plant for profit

Vegetable and Flower SEEDS

Reliable and Tested. Catalogue Mailed Free

WEBER & DON
Seed Merchants 114 CHAMBERS STREET
NEW YORK

SHEEP MANURE

Pulverized. Free from Adulteration

In Bag, \$18.00 per Ton. Cash with Order

ROBERT SIMPSON
CLIFTON, N. J.

STOCK SEED

FOR WINTER BLOOMING

Our strain of Double Branching Stocks is exceptionally true. About 90% Double Flowers.

In colors: .75 oz. .60 oz.\$1.00
Pure White 3/4 " .75 " 5.00

H. E. FISKE SEED CO.
Faneuil Hall Square, BOSTON, MASS.

Winter-flowering SWEET PEA SEED

All Colors Ask for List

A. C. ZVOLANEK
ORIGINATOR. BOUND BROOK, N. J.

NEW CROP SEED

For Early Planting

THOMAS J. GREY CO.
32 SO. MARKET ST., BOSTON, MASS.

BEGONIAS TUBEROUS ROOTED

ALSO GLOXINIAS, LILY OF VALLEY, SPIREA

Catalogues mailed free on application

Joseph Breck & Sons Corp.
47-54 NO. MARKET ST., BOSTON, MASS.

GEO. E. DOW
Designing and Illustrating

178 Washington St., Boston, Mass.

OUR SPECIALTY
Machine, Booklet Advertising and Flower PHOTOGRAPHS

Japanese Bulbs, Etc.

R. TANOI, Yokohama, Japan.

Send for catalogue and write to Representative

K. TAKEUCHI,
478a Boylston St., Boston, Mass.

QUALITY SEED BULB PLANTS

SEND FOR CATALOGUE

ARTHUR T. BODDINGTON
342 West 14th St., New York.

To Florists Everywhere

Orders for Cut Flowers and Floral Decorations to be delivered anywhere in the Greater New York, may be placed with us with the certainty that your customers will be satisfied.

Telegraph, telephone or mail such orders to us and be sure that they will be filled as promptly and as carefully as though you did it yourself.

One third discount will be allowed on all orders thus placed with us by Florists outside of the Greater New York.

THE BLOSSOM

Bond and Livingston Sts.,
BROOKLYN, N. Y.

C. C. TREPPEL, Manager

WILLIAM J. SMYTH FLORIST

Cor: Michigan Ave. and 31st St., CHICAGO

We ship to all points in Illinois and Iowa.

Phones: Douglas 744, Douglas 523, Douglas 740

M. C. and J. E. HAUSWIRTH

Out of Town orders for Hospitals
Carefully filled.

232 Michigan Ave.
CHICAGO

AUDITORIUM ANNEX Tel. Harrison 585

SAMUEL MURRAY Florist

Coates House Conservatory

1017 BROADWAY, KANSAS CITY, MO.

Both 'Phones 2670 Main.



WASHINGTON,
D. C.

GUDE'S

The Far-Famed Flowers of TORONTO

Delivered on mail or telegraph order for any occasion, in any part of the Dominion.

JOHN H. DUNLOP,
96 Yonge St., Toronto, Ont.

The Park Floral Co.

J. A. VALENTINE
Pres.

DENVER, COLORADO

WILLIAM L. ROCK FLOWER CO.

KANSAS CITY, MO.

will carefully execute orders for Kansas City and any town in Missouri or Kansas.



Buffalo, N. Y.

W. J. PALMER & SON, 304 Main St.

Of Interest to Retail Florists

NEW RETAIL FLOWER STORES.

Westbrook, Me.—N. W. Hannaford, Anderson Block.

New York, N. Y.—Huntner & McAlister, 3427 Broadway.

New York, N. Y.—The Waldorf Floral Co., 15 E. 34th street.

Olean, N. Y.—It is stated that the Olean Floral Co. is going out of business.

Chicago, Ill.—Mrs. H. F. Port, 2126 W. Madison street. Since Mr. Port's death Mrs. Port has continued the greenhouse business at Maywood and will now divide her time between Maywood and the store, which will be under the charge of her daughters.

IN BANKRUPTCY.

Los Gatos, Cal.—The Golden West Nursery Co.

Reading, Mass.—Charles S. Pratt, nurseryman, has filed a petition in bankruptcy; liabilities, \$3751, of which \$1350 is secured; assets, \$575.

STEAMER DEPARTURES

American.

Philadelphia, N. Y.—S'ampton, Mar. 13

St. Paul, N. Y.—S'ampton, Mar. 20

Atlantic Transport.

Minnetonka, N. Y.—London, Mar. 20

Cunard.

Irenna, Boston-Liverpool, Mar. 9

Lusitania, N. Y.—Liverpool, Mar. 10

Mauretania, N. Y.—Liverpool, Mar. 17

French Line.

La Bretagne, N. Y.—Havre, Mar. 11

La Provence, N. Y.—Havre, Mar. 18

Hamburg-American.

Deutschland, N. Y.—Hamb'g, Mar. 11

Pennsylvania, N. Y.—H'b'g, Mar. 13

North German Lloyd.

Guelisau, N. Y.—Bremen, Mar. 11

Koenig Albert, N. Y.—M. Pts., Mar. 13

Roon, N. Y.—Bremen, Mar. 18

Neckar, N. Y.—Med. Ports, Mar. 20

White Star.

Majestic, N. Y.—S'ampton, Mar. 10

Celtic, N. Y.—Liverpool, Mar. 13

Romanic, Boston-Med. Ports, Mar. 13

Oceanic, N. Y.—S'ampton, Mar. 17

BUSINESS CHANGES.

Los Angeles, Cal.—J. D'Ortignac has acquired an interest in the Redondo Floral Co.

Baltimore, Md.—The Stran greenhouses have been leased by W. S. Holloway & Son.

St. Louis, Mich.—The florist business of Kleinhans Bros. will hereafter be conducted by D. Kleinhans.

Washington Court House, O.—Einar Jensen, manager of the Washington Floral Gardens, has bought the Poole & Purllant greenhouses.

Colorado Springs, Col.—H. Monaghan, doing business under the name of Knob Hill Floral Co., has sold the retail department to Carl Hagemeyer.

The Atlas Floral Co., Chicago, will move to 35 Randolph St., the first of May.

ALEX. McCONNELL

571 FIFTH AVENUE
NEW YORK CITY

Telegraphic orders forwarded to any part of the United States, Canada, and all principal cities of Europe. Orders transferred or intrusted by the trade to our selection for delivery on steamships or elsewhere receive special attention.

Telephone Calls, 487 and 488 38th St.
Cable Address, ALEXCONNELL

New York Deliveries

FLOWERS and PLANTS

by special messenger to Steamer,
Theatre or any address in

NEW YORK or BROOKLYN

THOMAS YOUNG, JR.

500 FIFTH AVE., (near 42nd St.)

NEWMAN FLORAL Co.

(Established 1870.)

202 Fifth Ave. and
Madison Square, NEW YORK CITY

FLOWERS FOR STEAMER SAILINGS

M. A. BOWE

In the Heart of New York City
1294 Broadway

Tel. 2270, 38th St. NEW YORK

Our Motto—The Golden Rule

DAVID CLARKE'S SONS

Deliver orders from any part of the country to
New York City

Or OUT-GOING STEAMERS

Write or telegraph

2139-2141 Broadway, New York
Telephone 1552-1553 Columbus

YOUNG & NUGENT

42 West 28 St., NEW YORK

"FLOWERS BY TELEGRAPH"

NEW YORK MYER, FLORIST

Phone 5297 Plaza, 609-611 MADISON AVE.

ALBANY, N. Y.

EYRES

Flowers or Design Work

DELIVERED IN ALBANY AND VICINITY
ON TELEGRAPHIC ORDER.

11 NORTH PEARL ST., ALBANY, N. Y.

Flower Deliveries

In Brooklyn and other Long Island Points
New York City, New Jersey, etc. At Theatres,
Hotels, Steamers or Residences.

WILSON

Fulton St. and Greene Ave., Brooklyn, N. Y.

**JOHN BREITMEYER'S
SONS**

Cor. Miami and Gratiot Aves.
DETROIT, MICH.

**Artistic Designs . . .
High Grade Cut Blooms**

We cover all Michigan points and good sections of Ohio, Indiana and Canada.

**PROMPT DELIVERY IN
BOSTON**

AND ALL NEW ENGLAND POINTS
F. H. HOUGHTON
396 Boylston St., Boston, Mass.

BOSTON'S BEST
In Quality and Design
Can be relied upon when you transfer your retail orders to

EDWARD MACMULKIN
194 Boylston Street, Boston

Send flower orders for delivery in
BOSTON

and all
NEW ENGLAND POINTS
THOS. F. GALVIN
124 Tremont St., Boston

The Original Telegraph Order Florist
WILL DELIVER

Flowers or Designs
to order in Boston and Vicinity. Usual Discount.

J. NEWMAN & SONS, Inc.
Est. 1870 24 TREMONT ST., BOSTON



DANKER, Albany, N. Y.
ORDERS FOR

**Choice Flowers and
Floral Emblems**
FILLED PROMPTLY

**LOUISVILLE, KY.
JACOB SCHULZ,**
550 South Fourth Ave.

WELLESLEY COLLEGE
Dana Hall, Walnut Hill and Rockridge Hall
Schools. TALBY, Wellesley, Mass.
Tel. Wellesley 44-1 and 2. Night 44-3.

ATLANTA FLORAL CO.
41 Peachtree Street, ATLANTA, GEORGIA

**\$\$\$ SAVED \$\$\$
CUT DOWN EXPENSE.**

Why buy expensive baskets, when
HART'S NEW HANDY HANDLE
gives the same effect at trifling cost? Covered with willow and finished in natural wood colors, manufactured in four sizes.

No. 1, 12 in. high \$25.00 per 100	No. 3, 15 in. high \$40.00 per 100
No. 2, 15 " " 30.00 " "	No. 4, 24 " " 50.00 " "

Ask your cut flower jobber to see it, if he has not got it, send us his name and we will send him samples.

GEORGE B. HART, 24 Stone Street,
Rochester, N. Y.

THE NEW IDEA IN PLANT STANDS
**The Moore-Livingston
Graduating or Adjusting**

Saves one-half to two-thirds of cost over ordinary galvanized iron stands.

SEND FOR CIRCULAR GIVING FULL PARTICULARS
SOLD BY SEEDSMEN AND SUPPLY HOUSES

If your seedsman does not carry send us his name and we will promptly send full particulars.

Moore-Livingston Co., Patentees and Mfrs., **Lansdowne, Pa.**

"FLOWERS BY TELEGRAPH."
Leading Retail Florists Listed by
Towns for Ready Reference.

Denver, Colo.—Park Floral Co., 1706 Broadway.
Washington, D. C.—Gude Bros., 1214 F St.
Atlanta, Ga.—Atlanta Floral Co., 41 Peach Tree St.
Chicago—M. C. & J. E. Hauswirth, 232 Michigan Ave.
Chicago—William J. Smyth, Michigan Ave. and 31st St.
Chicago—George Wittbold Co., 1657-59 Buckingham Place.
Louisville, Ky.—Jacob Schulz, 550 South Fourth Ave.
Boston—Thos. F. Galvin, 124 Tremont St.
Boston—Frank H. Houghton, 396 Boylston St.
Boston—Edward MacMulkin, 194 Boylston St.
Boston—Hoffman, Florist, 59-61 Massachusetts Ave.
Boston—J. Newman & Sons, Inc., 24 Tremont St.
Boston—Julius A. Zinn, 2 Beacon St.
Wellesley, Mass.—Talby.
Detroit, Mich.—J. Breitmeyer's Sons, Miami and Gratiot Aves.
Kansas City, Mo.—Samuel Murray, 1017 Broadway.
Kansas City, Mo.—Wm. L. Rock Flower Co., 1116 Walnut St.
Albany, N. Y.—H. G. Eyres, 11 N. Pearl St.
Albany, N. Y.—F. A. Danker, 40 Maiden Lane.
New York—David Clarke's Sons, 2139-2141 Broadway.
New York—Alex. McConnell, 571 5th Ave.
New York—Young & Nugent, 42 W. 25th St.
New York—M. A. Bowe, 1294 Broadway.
New York—Myer, 609-11 Madison Ave.
New York—Thos. Young, Jr., 500 Fifth Ave.
New York—Newman Floral Co., 202 Fifth Ave. & Madison Sq.
Brooklyn, N. Y.—The Blossom (C. C. Trepel, Mgr.), Bond and Livingston Sts.
Brooklyn, N. Y.—Robert G. Wilson, Fulton St. and Greene Ave.
Buffalo, N. Y.—Palmer's, 304 Main St.
Toronto, Can.—J. H. Dunlop, 96 Young St.

THE BEST "LETTERS"

FOR THOSE
FLORISTS' MADE
USE OF BY THE

Boston Florist Letter Co.
66 PEARL ST., BOSTON
N. F. MCCARTHY, Mgr.

Order direct or buy from your local supply dealer. Insist on having the

BOSTON
Inscriptions, Emblems, etc., Always in Stock

Durand & Marohn
MANUFACTURERS OF
All Kinds of Wire Work
Florists' Wire Designs a Specialty
24 Beaver St., ALBANY, N. Y.

FLORISTS' SUPPLIES
Send for New Catalogue

H. Bayersdorfer & Co.
1129 ARCH ST., PHILADELPHIA

TRANSFER
Your orders for flower or plant delivery in Eastern New England to
JULIUS A. ZINN,
2 Beacon St., Boston.
Fine Design Work a Specialty.

KILLARNEY

Best Grown Stock

Special \$20.00 per 100 - Fancy \$12.00 per 100

Double Violets Satisfaction Guaranteed \$5 00 per 1000	Southern Daffodils Fine Southern Stock \$5.00 per 1000
--	--

THE LEO NIESSEN CO.

1209 Arch St., Philadelphia, Pa.
Open from 7 a. m. to 8 p. m.



GARDENIAS

\$5.00 per Doz.

SECONDS
\$3.00 per Doz.

QUALITY

S. S. PENNOCK - MEEHAN CO.

1608-1620 Ludlow St., Philadelphia

CARNATIONS

Unsurpassed in Quality Orders filled for Any Quantity.

W. E. MCKISSICK & BROS.

WHOLESALE FLORISTS
1619-1621 RANSTAD ST.
PHILADELPHIA

WELCH BROS.

AMERICAN BEAUTY, KILLARNEY, RICHMOND, MARYLAND AND ALL THE SUPERIOR
ROSES, LILY OF THE VALLEY, CARNATIONS, ORCHIDS
BEST PRODUCED

226 Devonshire Street, Boston, Mass.

CUT FLOWER BOXES

EDWARDS FOLDING BOX CO

MANUFACTURERS
PHILADELPHIA, PA.

CHAS. W. MCKELLAR

51 WABASH AVE., CHICAGO

WHOLESALE FLOWER MARKETS—TRADE PRICES—Per 100 TO DEALERS ONLY

	CHICAGO March 1		TWIN CITIES March 1		PHILA. March 1		BOSTON March 3	
ROSES								
Am Beauty, Fancy and Special.....	35.00	45.00	30.00	50.00	60.00	75.00	40.00	75.00
" Extra.....	25.00	35.00	30.00	40.00	40.00	50.00	20.00	30.00
" No. 1.....	20.00	25.00	15.00	30.00	25.00	35.00	10.00	15.00
" Lower grades.....	12.00	20.00	8.00	15.00	6.00	20.00	4.00	8.00
Bride, 'Maid, Fancy & Special.....	6.00	10.00	10.00	12.00	12.00	15.00	6.00	8.00
" Lower grades.....	4.00	6.00	4.00	10.00	4.00	10.00	2.00	4.00
Killarney, Fan. & Spa.....	6.00	10.00	12.00	17.00	12.00	15.00	12.00	25.00
" Lower grades.....	4.00	6.00	8.00	12.00	4.00	10.00	4.00	8.00
Richmond, Fancy & Special.....	6.00	10.00	8.00	12.00	20.00	30.00	12.00	25.00
" Lower grades.....	4.00	6.00	6.00	8.00	5.00	20.00	4.00	8.00
Chateaux.....	6.00	8.00	5.00	8.00	5.00	15.00	4.00	15.00
Golden Gate Ivory, etc.....	6.00	8.00	6.00	8.00	4.00	10.00	4.00	8.00
My Maryland.....	10.00	16.00
Queen Peatrice.....	3.00	12.00
Mrs. Mar. Field.....
CARNATIONS								
Fancy and Del.....	2.00	4.00	3.00	4.00	4.00	5.00	2.00	3.00
Ordinary and White.....	1.00	2.00	2.00	3.00	2.50	3.00	1.50	2.00
MISCELLANEOUS								
Cardiase.....	10.00	50.00	40.00	50.00	75.00	40.00	50.00
Cypridiums.....	10.00	12.00	8.00	12.00	10.00	12.00	10.00	12.00
Lilies.....	10.00	12.00	8.00	12.00	10.00	12.00	10.00	12.00
Lily of the Valley.....	2.00	4.00	2.00	3.50	2.00	5.00	1.00	3.00
Narciss, Paper White.....	3.00	4.00	2.00	3.50	2.00	3.00	1.00	2.00
Roman Hyas.....	3.00	4.00	2.00	3.00	2.00	3.00	1.00	2.00
Daffodils.....	2.00	3.00	2.00	3.00	2.00	3.00	1.00	2.00
Freesia.....	2.00	3.00	2.00	3.50	2.00	3.00	1.00	2.00
Sweet Peas.....	.75	1.00	.75	1.25	.45	1.00	.75	1.00
Gardenias.....	30.00	40.00	40.00	50.00	25.00	50.00	25.00	50.00
Violets.....75	.50	1.00	.50	1.00	.20	.50
Adiantum.....	1.00	1.00	1.50	1.50	1.50
Smilax.....	10.00	12.00	10.00	15.00	12.50	15.00	10.00	12.50
Asparagus Plumosus, strings.....	15.00	40.00	35.00	50.00	50.00	75.00	25.00	50.00
" & Sprea. (too bebs.).....	20.00	30.00	20.00	25.00	25.00	50.00	15.00	25.50

Western Headquarters for Choice Orchids
Valley, Roses and all Cut Flowers

PETER REINBERG

WHOLESALE
CUT FLOWERS
51 Wabash Av., Chicago, Ill.

DAILY CONSIGNMENTS

From 40 to 60 Growers
We can care for your cutflower wants to advantage.

E. F. WINTERSON CO.
45-47-49 WABASH AVE., CHICAGO

POEHLMANN BROS. CO.

33-35-37 Randolph St., - CHICAGO

CUT FLOWERS

Greenhouses, - Morton Grove, Ill.

Rice Brothers

115 N. 6th Street, MINNEAPOLIS, MINN.

WHOLESALE FLORISTS and SUPPLIES

CUT FLOWERS received twice daily, and can fill your orders to your satisfaction. A complete line of Hardy Greens - WILD SMILAX, BOXWOOD, HARDY FANCY FERNS, GALAX LEAVES.
Write for quotations on large quantities.

J.A. BUDLONG

37-39 Randolph Street, CHICAGO.

ROSES and CARNATIONS A Specialty.....

WHOLESALE GROWER of **CUT FLOWERS**



HENRY M. ROBINSON & CO.

15 Province St. and 9 Chapman Place - BOSTON, MASS.

WHOLESALE COMMISSION FLORISTS

Hardy Cut Evergreens and Florists' Supplies

We have the stuff and can fill all orders, large or small
WE NEVER DISAPPOINT SATISFACTION GUARANTEED



In ordering goods please add "I saw it in HORTICULTURE."

Prices Quoted in these Columns are for Dealers Only.
When Writing to Advertisers Please Mention
HORTICULTURE.

Flower Market Reports.

BOSTON Outside of the violet and bulbous stock no fault can be found with the present market conditions here. Manifestly the violet is overdue for the time being, but in the long run it may come out as a winner from the viewpoint of the grower. For the wholesaler and retailer it is, however, pretty thin ice. Lily of the valley has taken a downward turn and so have tulips and yellow narcissi. Of roses the stock increases slowly and not sufficiently to affect values. First-class Beauties are practically out of this market for the time being.

A few sunny days **BUFFALO** brought on the stock a little faster than was required the past week, especially carnations and bulbous stock which were in heavy supply, and while the wholesalers were trying to hold up the prices a vast amount was carried along from day to day awaiting an outlet. Lilies, peas, mignonette and other stock except Beauties were too plentiful with no floral work to consume any portion which finds the wholesale market once more carrying an over-supply. Roses are becoming more plentiful each day but no over-supply on this line and prices very satisfactory. The demand for violets has been weak and several bargain signs on this item as well as tulips and daffodils are seen, especially on Friday and Saturday.

An anticipated Lent **CHICAGO** brought a sudden falling off in business. The early part of the week trade was brisk and the flowers rapidly moved off from the wholesalers' counters. But Ash Wednesday marked a turning point and the balance of the week's trade was kept up mostly by funeral orders. Most of the trade report February sales as ahead of anything they had anticipated and in some cases the best in several years. The high quality of the stock no doubt had much to do with the satisfactory results. The scarcity in the supply of Beauties is somewhat abated and there is every promise of a good supply ahead. Killarneys, Richmonds, Chateauxs, &c., are reported by the growers as in fine shape for a big Easter crop. Carnations are almost too plentiful and the sales apt to be slow. A large jar of pussy willows in Poehlmann Bros. gives evidence the spring is near. Daffodils are going very slowly and violets do not find as ready sale as could be desired. Tulips are much in evidence and very few are lost.

Settled weather conditions **DETROIT** have increased counter sales perceptibly while orders are holding their own. Easter lilies are a little more in supply than they have been and the outlook for plenty of them in good healthy form for Easter is excellent. Stock in general is rather scarce, roses being off crop with most of the growers. Bulbous stock is coming in quite liberally and cleans up at good figures. The supply of wild smilax was been

WHOLESALE FLOWER MARKETS.—PER 100. TO DEALERS ONLY.

	CINCINNATI		DETROIT		BUFFALO		PITTSBURGH	
	March 1	March 2	March 1	March 2	March 1	March 1	March 1	March 1
ROSES								
Am. Beauty, Fan, and Sp.	35.00	to 40.00	35.00	to 40.00	40.00	to 50.00	40.00	to 50.00
" Extra	25.00	to 30.00	28.00	to 32.00	25.00	to 30.00	25.00	to 35.00
" No. 1	15.00	to 20.00	20.00	to 25.00	15.00	to 20.00	16.00	to 20.00
" Lower grades	8.00	to 10.00	8.00	to 15.00	5.00	to 8.00	3.00	to 6.00
" Low, Maid, F. & S.	6.00	to 8.00	8.00	to 12.00	10.00	to 12.00	8.00	to 10.00
" Edge	3.00	to 5.00	4.00	to 8.00	4.00	to 6.00	3.00	to 5.00
" Killarney, Fan & Sp.	6.00	to 8.00	8.00	to 12.00	30.00	to 12.00	10.00	to 12.00
" Lower grades	3.00	to 5.00	4.00	to 6.00	4.00	to 6.00	6.00	to 8.00
" Richmond, Fancy & Special	7.00	to 10.00	8.00	to 12.00	10.00	to 12.00	12.00	to 15.00
" Lower grades	4.00	to 6.00	4.00	to 6.00	4.00	to 6.00	6.00	to 8.00
" Chateaux	5.00	to 8.00	5.00	to 8.00	5.00	to 8.00	6.00	to 10.00
" Golden Gate, Ivory, etc.	4.00	to 6.00	4.00	to 6.00	4.00	to 6.00	4.00	to 6.00
" My Maryland	4.00	to 6.00	4.00	to 6.00	4.00	to 6.00	4.00	to 6.00
" Queen Beatrice	4.00	to 6.00	4.00	to 6.00	4.00	to 6.00	4.00	to 6.00
" Mrs. Mar. Field	4.00	to 6.00	4.00	to 6.00	4.00	to 6.00	4.00	to 6.00
CARNATIONS								
Fancy and Novelties	1.00	to 3.00	3.00	to 4.00	2.50	to 3.00	2.00	to 3.00
Ordinary	1.00	to 2.00	2.00	to 3.00	1.50	to 2.00	1.00	to 1.50
MISCELLANEOUS								
Catleyas	50.00	to 75.00
Oxyripiidiums	12.00	to 15.00
Lilies	12.00	to 15.00
Lily of the Valley	3.00	to 4.00	3.00	to 4.00	3.00	to 4.00	2.00	to 3.00
Narciss., Paper White
Roman Hyacinth	2.00	to 3.00	2.00	to 3.00	2.00	to 3.00	2.00	to 3.00
Daffodils	3.00	to 4.00	3.00	to 4.00	3.00	to 4.00	2.00	to 3.00
Freesia
Sweet Peas	.50	to 1.00	.50	to 1.00	.50	to 1.00	.50	to 1.00
Gardenias
Violets	10.00	to 12.75	12.50	to 13.50	8.50	to 7.50	2.25	to 7.50
Adiantum
Smilax
Asparagus Plumosus, strings	25.00	to 50.00	30.00	to 50.00	25.00	to 50.00	30.00	to 50.00
" " & Spreng (too lbs.)	25.00	to 35.00	30.00	to 50.00	25.00	to 50.00	30.00	to 50.00

very poor in quality with no improvement in sight.

The business of **INDIANAPOLIS** the past week was very fair. There was an increasing supply of all stocks but as a rule every thing cleaned up fairly well. American Beauty roses are more plentiful, select stock bringing top-notch prices. Tea roses are more plentiful with prices a trifle lower. The same may be said of carnations. Conditions are more encouraging than they have been for some time. The nearest approach to a glut is with the yellow narcissi which are very abundant. Green goods with exception of smilax are very scarce. Flowering plants have a satisfactory demand. The weather varies from day to day, but is all that could be desired.

Trading last week **PHILADELPHIA** was rather spasmodic. Monday and Tuesday were fairly good, but Ash Wednesday, a stormy Thursday and the first week of Lent, combined to depress conditions. Friday improved things a little, and Saturday was very good. More American Beauty roses are coming in but they are by no means overplentiful as yet. Pink roses, such as Bridesmaid and Killarney, sold better than whites, but the prospects for the latter are better from now on. A few white Killarneys are coming in and find ready sale. Prices eased up a little in the carnation market consequent on larger receipts and dull trading, but the quality of the product is up to high water mark. The mild weather was expected to have affected quality in violets, but so far they are coming in excellent. Of course, they

are so plentiful now that prices have receded very considerably. Single daffodils are less conspicuous, and fine tulips are now a larger feature in the bulbous stock market. Lily of the valley moves nicely and is excellent stock. Early arbutus from the south is coming in freely. Catleyas are producing better, and fine flowers can now be had at reasonable figures.

TWIN CITIES Reports from retailers and wholesalers declare that business is good with supply about equaling demand. Quality is good. Plenty of fine bulbous stock on hand.

Washington reports that flowers are somewhat scarce, owing to so much cloudy, rainy weather, but the supply fully equals the demand on everything.

PACIFIC COAST NOTES.

Rudolph Fischer of San Gabriel, Calif., has returned from a two months tour in the East.

John C. Bodger, Jr., of John Bodger & Sons, Gardena, Calif., has just returned from an extended business trip through the Eastern States and Canada.

San Francisco, Cal.—Lewis Larson, who is accused of having passed spurious checks on fifteen tourists within three days, was arrested in the store of the Wickston Floral Company, 810 Van Ness avenue, on Feb. 20. In each case the man bought \$5 worth of flowers and tendered a check for \$16.50 apparently drawn and indorsed by a prominent business man.

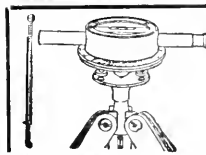

EVERYBODY KNOWS Park, Cemetery and Landscape Gardening cannot be properly done without the aid of an accurate leveling instrument. Bostrom's Improved Levels, No. 2 at \$15.00 and No. 3 at \$25.00, which meet all the requirements, at the price. Our guarantee back of every Level we sell, and satisfied users in every State in the Union heartily endorse every claim we make. Shipping weight 12 lbs. Description on request. **BOSTROM-BRADY MFG. CO., 139 Madison Avenue., ATLANTA, GA.**

FORD BROTHERS

48 West 28th Street NEW YORK

FINE ROSES FANCY CARNATIONS

A Full Line of All CUT FLOWERS

Telephone, 3870 or 3871 Madison Square

H. E. FROMENT

Wholesale Commission Florist,
Choice Cut Flowers,

57 West 28th St. :: NEW YORK

Telephones: 2200, 2201, Madison Square.

Alfred H. Langjahr

All choice cut-flowers in season. Send for quotations. Correspondence with shippers of first-class stock invited.

55 West 28th Street, New York
Telephones 4626-4627 Madison Square

Edward C. Horan
Wholesale Florist

55 WEST 28th ST.

Tel. 1462 Madison Square New York
1463

JOHN YOUNG

WHOLESALE FLORIST

Finest American Beauties and Carnations

51 West 28 St. - NEW YORK

FRANK MILLANG

Wholesale Florist

55-57 West 26th St., NEW YORK

Shipments, any quantity, Wholesale Market Rates.

Consignments Requested

A Good Market and Prompt Returns

GEORGE SALTFOED

43 W. 28th Street, NEW YORK

Telephone, 3393 Madison Sq

VIOLETS

Finest Grade. Any Quantity

B. S. SLINN

55-57 W. 26 St., New York

Moore, Hentz & Nash

Wholesale Commission Florists

55 and 57 West 26th Street

Telephone No. 756
Madison Square

New York

MILLANG BROS.

WHOLESALE COMMISSION FLORISTS

41 West 28th Street

Telephone 3660
3661 Madison

NEW YORK

JOHN I. RAYNOR

Wholesale Commission Florist **SELLING AGENT FOR LARGEST GROWERS**

A full line of Choice Cut Flower Stock for all purposes. Comprises every variety grown for New York market, at current prices

TEL. 1998 MADISON SQUARE

49 West 28th St., New York City

Walter F. Sheridan

Wholesale Commission Dealer in

CHOICE CUT FLOWERS

39 West 28th Street, New York
Telephone: 3532-3533 Madison Square

HEADQUARTERS FOR NOVELTIES
ORCHIDS A SPECIALTY

THE HIGHEST GRADE OF VALLEY ALWAYS ON HAND

GARDENIAS, DAISIES, ROSES AND CARNATIONS

JAMES McMANUS, Telephone 755 Mac St. 42 W. 28th St., New York

PHILIP F. KESSLER

55 & 57 W. 26th St., New York City

Commission Dealer, Wholesale Buyer and Seller of

Open from 5 a. m. to 6 p. m. Sunday till 10 a. m.

CUT FLOWERS

Tel., 5243 and 2921 Madison Sq. Res., 345 J., Newtown.

Finest Lilies in the Market Every Day in the Year.

NEW YORK QUOTATIONS PER 100. To Dealers Only

ROSES AND CARNATIONS	Last Half of Week ending Feb. 27 1909		First Half of Week beginning Mar. 1 1909	
American Beauty, Fancy and Special.....	23.00	to 50.00	25.00	to 50.00
" " Extra.....	15.00	to 20.00	15.00	to 20.00
" " No. 1.....	8.00	to 12.00	8.00	to 12.00
" " Lower Grades.....	2.00	to 6.00	2.00	to 6.00
Bride, "Hald, Fancy and Special.....	6.00	to 10.00	6.00	to 10.00
" " Lower Grades.....	2.00	to 4.00	2.00	to 4.00
Killarney, Fancy and Special.....	8.00	to 12.00	8.00	to 12.00
" " Lower Grades.....	3.00	to 6.00	3.00	to 6.00
Richmond, Fancy and Special.....	13.00	to 25.00	15.00	to 25.00
" " Lower Grades.....	3.00	to 8.00	3.00	to 8.00
Chatenay.....	3.00	to 12.00	3.00	to 12.00
Golden Gate, Ivory, etc.....	3.00	to 8.00	3.00	to 8.00
Hy Parlyland.....	3.00	to 12.00	3.00	to 12.00
Queen Beatrice.....	3.00	to 8.00	3.00	to 8.00
Mrs. Par. Field.....	3.00	to 8.00	3.00	to 8.00
Carnations, Fancy and Novelties.....	2.00	to 4.00	2.00	to 4.00
" Ordinary and White.....	1.00	to 1.50	1.00	to 1.50

Alexander J. Guttman

THE WHOLESALE FLORIST OF NEW YORK

34 WEST 28th STREET

PHONES. 1664-1665 MADISON SQUARE

ENOUGH SAID

TRAENDLY & SCHENCK

Wholesale Florists

Furnish best Stock at fair Prices all the year round

Send for Quotations on Any Variety and Quantity

Tel. 798, 799 Madison Sq.

44 West 28th St., New York City

GROWERS' CUT FLOWER CO.

CUT FLOWERS AT WHOLESALE

VIOLETS, CARNATIONS, ROSES ORCHIDS, CHRYSANTHEMUMS, LILIES

Consignments Solicited. Shipments to Order, any Distance

39 West 28th Street,

Telephone 755 Madison Square

NEW YORK

J. J. O'NEIL, Manager

WHOLESALE FLORISTS
54 West 28th St.
NEW YORK
Telephone 3659 Madison Sq.

A. L. YOUNG & CO.

RECEIVERS & SHIP-
PERS OF CUT
FLOWERS.
CONSIGNMENTS SOLICITED.

WILLIAM H. KUEBLER
Brooklyn's Foremost and Best
WHOLESALE COMMISSION HOUSE
A First Class Market for all CUT FLOWERS
28 Willoughby St., Brooklyn, N. Y.
Tel. 4591 Main

Greater New York Florists' Association, Inc.
Now Open for Cut Flower Consignments
162 Livingston Street, BROOKLYN, N. Y.
Geo. W. Crawbuck Telephone Connection
Manager 3642-43 Main

REED & KELLER
122 West 25th St., New York
Florists' Supplies
We manufacture all our
Hotel Designs, Baskets, Wire Work & Novelties
and are dealers in
Glassware Decorative Greens and Florists' Requisites

THE KERVAN CO.
Wholesale Dealers and Shippers of
Decorative Evergreens
Ferns, Galax, Laurel, Fresh Cycas, Box-
wood, Sphagnum and all Florists' Greens
Send to us for Quotations before Buying
113 West 28 Street, NEW YORK CITY

MICHIGAN CUT FLOWER EXCHANGE, Inc.
WHOLESALE COMMISSION FLORISTS
Consignments Solicited
Hardy Fancy Fern Our Specialty
38-40 BROADWAY, DETROIT, MICH.

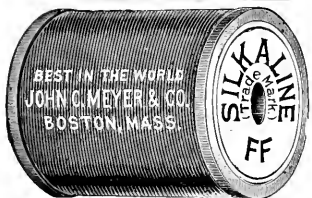

Use Krick's Immortelle Letters

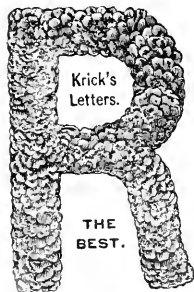

The original and still the best. All others are followers.

All Orders Promptly Attended to.

Send for Samples and Price Lists.

1164-1166 Greene Ave.,

BROOKLYN, - N. Y.

GEORGE COTSONAS & CO.
Wholesale and Retail Dealers in all kinds of
EVERGREENS
Fancy and Dagger Ferns
Bronze and Green Galax
Main Store 50 W. 28 St.
Phone 1202 Mad. Sq. New York

Henshaw & Fenrich
WHOLESALE FLORISTS
44 West 28th Street, NEW YORK
Phones Mad. Sq. 326, 558-2, 558-3

WHOLESALE COMMISSION J. K. ALLEN 106 W. 28th St. NEW YORK
Open 6 a. m. Daily Tel. 167 Madison Sq.
All Grades of Flowers to Suit All Buyers. Consignments Solicited.

NEW YORK QUOTATIONS PER 100. To Dealers Only

MISCELLANEOUS	Last Half of Week ending Feb. 27 1909		First Half of Week beginning Mar. 1 1909	
	100	60	100	60
Cattleyas.....	40.00	10 60.00	43.00	10 69.00
Cypripediums.....	10.00	10 12.00	10.00	10 12.00
Lilies.....	5.00	10 5.00	5.00	10 8.00
Lily of the Valley.....	1.00	10 3.00	1.00	10 3.00
Narcis, Paper White.....	1.00	10 2.00	1.00	10 2.00
Roman Hyacinth.....	1.00	10 2.00	1.00	10 2.00
Tulips.....	2.00	10 3.00	2.00	10 3.00
Daffodils.....	1.00	10 2.00	1.00	10 2.00
Freesia.....	1.00	10 2.00	1.00	10 2.00
Sweet Peas.....	.50	10 1.00	.50	10 1.00
Gardenias.....	40.00	10 50.00	40.00	10 50.00
Violets.....	.30	10 .50	.30	10 .50
Adiantum.....	.75	10 1.00	.75	10 1.00
Growerium.....	1.00	10 1.25	1.00	10 1.25
Smilax.....	8.00	10 10.00	8.00	10 10.00
Asparagus Plumosus, strings.....	20.00	10 30.00	20.00	10 30.00
" & Sprea. (100 bcbs).....	15.00	10 25.00	15.00	10 25.00

NEW YORK MARKET.
Business is of moderate volume since Ash Wednesday came in and it is only because the product increases by very slow steps that the stability of the market is not stampeded. Roses and carnations are on the increase in quantity, but hold their own fairly well against the elements that would depress selling values. Bulbous stock is also in supply ahead of the demand and the tendency is steadily downward. All told, however, no serious cause for dissatisfaction has materialized thus far and nothing has suffered since Lent came in that was not already in the frying-pan.

MADISON (N. J.) NOTES.
Herbert Entwistle leaves Mrs. Julius Catlin's on March 15th.
John Whalen has resigned his position as gardener to C. W. Armour, Normandie Heights.
Dudley Olcott, 2nd, is erecting a gardener's cottage on his place, Normandie Park. Jeffrey Lindaburg takes charge on March 1st.
John Jones, the Convent Florist, has had a very successful orchid season. As may be remembered, he purchased the Robt. D. Foote collection.
William Hyland, now at Mrs. Lord's place, takes charge of Stewart Hart-

horne's place, Short Hills, on April 1st, Arthur Caparn having resigned.
Louis J. Reuter, of S. J. Reuter & Son, Westerly, R. I., lectures on the Carnation on March 10th before the Morris County Gardeners' and Florists' Society. This is the annual carnation night. The society solicits novelties for that occasion. The general public are admitted.
John Downing, grower for Dr. McAlpin, Morris Plains, is going into pears and peaches in pots on quite a large scale. Whatever John does he seems to do well, and he will no doubt acquit himself in this line with credit. Wm. Duckham is the only other grower around here who uses the pot sys-

Wired Toothpicks
Manufactured by
W. J. COWEE, BERLIN, N. Y.
10,000.....\$1.75; 50,000.....\$7.50. Sample free.
For sale by dealers
ROBERT J. DYSART
Public Accountant and Auditor
Simple methods of correct accounting especially adapted for florists' use.
Books Balanced and Adjusted
Merchants Bank Building
28 STATE STREET, - BOSTON
Telephone, Main 58.

Buyer's Directory and Ready Reference Guide

Advertisements under this head, one cent a word. Initials count as words.

Display advertisers in this issue are also listed under this classification without charge. Reference to List of Advertisers will indicate the respective pages.

Buyers falling to find what they want in this list will confer a favor by writing us and we will try to put them in communication with reliable dealers.

ACCOUNTANT

R. J. Dyant, 23 State St., Boston.
For page see List of Advertisers.

AGERATUMS

R. Vincent, Jr. & Sons Co., White Marsh, Maryland.
For page see List of Advertisers.

AMPELOPIS.

Stores & Harrison Co., Palmersville, O.
For page see List of Advertisers.

AQUILEGIAS

Aquilegia. Genuine Coerulea, finest of all. Both plants and seeds from the heart of the Rockies. C. S. Harrison's Select Nursery, York, Neb.

ARAUCARIAS

A. Leuthy & Co., Perkins St. Nurseries, Roslindale, Mass.
For page see List of Advertisers.

Godfrey Aschmann, 1012 West Ontario St., Philadelphia, Pa.
For page see List of Advertisers.

ASPARAGUS

The Geo. Wittbold Co., 1637 Buckingham Place, Chicago, Ill.
For page see List of Advertisers.

W. H. Elliott, Brighton, Mass.
Asparagus, 14. Xmas
Asparagus Sprengeri, 2 in. pots, 2c; \$17 per 1000. Cash, please. A. Rejca & Son, Poughkeepsie N. Y.

AUCTION SALES

Oleary's Horticultural Co., 62 Vesey St., New York.
For page see List of Advertisers.

AZALEAS

A. Leuthy & Co., Perkins St. Nurseries, Roslindale, Mass.
For page see List of Advertisers.

Godfrey Aschmann, 1012 W. Ontario St., Philadelphia.
Apollo in Bloom.
For page see List of Advertisers.

Henry A. Drer, Philadelphia.
Azalea Mollis.
For page see List of Advertisers.

BAMBOO CANES

Yokohama Nursery Co., 31 Barclay Street, New York.
Bamboo Sticks, Colored Green.
For page see List of Advertisers.

Wm. Elliott & Sons, New York City.
Lily Stakes.
For page see List of Advertisers.

BAY TREES.

2000 Bay and Box Trees in all sizes, Pyramid and Standards. Write for list. Julius Roehrs, Rutherford, N. J.

BEDDING PLANTS

J. E. Felthousen, Schenectady, N. Y.
For page see List of Advertisers.

BOILERS

BOILERS. "Burnham" Boilers made for greenhouse heating. Lord & Burnham, 133 Broadway, N. Y.
Kroeschell Bros. Co., 35 Erie St., Chicago.
For page see List of Advertisers.

BOXWOOD TREES

New England Nurseries, Inc., Bedford, Mass.
For page see List of Advertisers.

BUILDING MATERIAL

BUILDING MATERIAL of all description for All Cypress, Semi-Iron, Iron Frame or Truss Houses. Hot Bed Sash and Frames. Lord & Burnham Co., 1133 Broadway, N. Y.

BULBS AND TUBERS

Joseph Breck & Sons, 47-54 N. Market St., Boston.
For page see List of Advertisers.

J. M. Thornburn & Co., 33 Barclay St., New York.
For page see List of Advertisers.

A. T. Boddington, 342 W. 14th St., N. Y.
For page see List of Advertisers.

Richards Bros., 37 East 19th St., New York.
For page see List of Advertisers.

H. F. Mitchell Co., Philadelphia.
For page see List of Advertisers.

H. E. Fiske Seed Co., Fanenll Hall Sq., Boston.
For page see List of Advertisers.

T. J. Grey & Co., 32 and 33 So. Market St., Boston.
For page see List of Advertisers.

Yokohama Nursery Co., 31 Barclay St., New York.
For page see List of Advertisers.

Ralph M. Ward & Co., 12 W. Broadway, New York.
For page see List of Advertisers.

K. Takeuchi, 475A Boylston St., Boston.
Japanese Bulbs.
For page see List of Advertisers.

Schlegel & Fottler Co., 26 & 27 S. Market St., Boston.
For page see List of Advertisers.

Schlegel & Fottler Co., 26 & 27 S. Market St., Boston.
For page see List of Advertisers.

TIBEROSES AND CALADIMUM. Special Prices to Florists and Dealers. per 100 per 1000

Tuberose.—Pearl No. 1, 4 to 6 inch in circum.....	\$7.00
Caladium Esculentum, 5 to 7 inch in circum.....	\$1.10
Caladium Esculentum, 7 to 9 inch in circum.....	2.10
Caladium Esculentum, 10 to 11 inch in circum.....	3.65
Caladium Esculentum, 11 inch and over in circum.....	6.25
Prices include packing and are f. o. b. cars here.	

T. W. WOOD & SONS, Seedsmen, Richmond, Va.

CANNAS

A. T. Boddington, 342 W. 14th St., New York.
For page see List of Advertisers.

Cannas. Beante Polveine, Wilson Border Flamingo, Mlle. Berat, Robusta, \$2.00 per 100. Josiah Young, Troy, N. Y.

CARNATIONS

F. Dornier & Sons Co., Lafayette, Ind. Carnation, Winona
For page see List of Advertisers.

Chicago Carnation Co., Joliet, Ill. Carnation Bay State.
For page see List of Advertisers.

Basett & Washburn, Hinsdale, Ill. Carnation O. P. Bassett.
For page see List of Advertisers.

East Sudbury Greenhouses, So. Sudbury, Mass. Carnation Cuttings.
For page see List of Advertisers.

Wood Bros., Fishkill, N. Y. Carnations, Rooted Cuttings.
For page see List of Advertisers.

CARNATIONS—Continued

The E. H. Hill Co., Richmond, Ind. Carnation Cuttings.
For page see List of Advertisers.

Peter Fisher, Ellis, Mass. Rooted Cuttings.
For page see List of Advertisers.

S. J. Reuter & Son, Westerly, R. I. For page see List of Advertisers.

Schedler & Schoes, Chicago. Carnation Wm. H. Taft.
For page see List of Advertisers.

Bellamy Bros., Syracuse, N. Y. Carnation Marchioness.
For page see List of Advertisers.

Pine-croft Greenhouses, East Brookfield, Mass. Carnations, Rooted Cuttings.
For page see List of Advertisers.

Schlegel & Fottler Co., 26 & 27 S. Market St., Boston.
For page see List of Advertisers.

O. V. Zangen, Hoboken, N. J. Mrs. Pfeuffer.
Carnations, out of 2 1/2 in. pots, strong plants, 400 Winsor, 75 Rose Pink Enchantress, 150 Kingston, 1st, 250 Victory, 50 Mrs. Patten, \$2.50 per 100; 100 Enchantress, 150 Lawson, 75 White Lawson, 75 Variegated Lawson, \$2.00 per 100; 50 Queen Louise, \$1.50 per 100. Cash with order. Henry Hansen, Catskill, N. Y.

CHRYSANTHEMUMS

Schlegel & Fottler Co., 26 & 27 S. Market St., Boston.
Chrysanthemum Balfast.
For page see List of Advertisers.

E. G. Hill Co., Richmond, Ind. For page see List of Advertisers.

S. J. Reuter & Son, Westerly, R. I. For page see List of Advertisers.

Elmer D. Smith & Co., Adrian, Mich. For page see List of Advertisers.

C. H. Totty, Madison, N. J. Single Chrysanthemums From Seed.
For page see List of Advertisers.

J. H. Myers, Altoona, Pa. For page see List of Advertisers.

Chrysanthemum Golden Glow from 2 1/4 in. pots, for early spring delivery, \$1.00 per doz., \$6.00 per 100, \$50.00 per 1000. Stock plants of Montross, Oct. Frost, Crocus, Matchless, Lucy Devaux, Polly Rose and Haliday, \$1.00 per doz.; \$6.00 per 100. Pelree Bros., Waltham, Mass.

Herrington's book on the Chrysanthemum, mailed to your address for 50c. by Horticulture Publishing Co., 11 Hamilton Place, Boston.

Chrysanthemums from 2 1/4 in. pots, ready now: Golden Glow, White Cloud, 6c.; Reatrice May, 5c.; Polly Rose, October Frost, Tonsel, Bonnaffon, 3c. Henry Trull, Frederick, Md.

CLEUE

J. E. Felthousen, Schenectady, N. Y.
For page see List of Advertisers.

CONIFERS

John Waterer & Sons, Ltd., American Nursery, Bagshot, Eng.
For page see List of Advertisers.

CUT FLOWER BOXES.

Edwards Folding Box Co., Philadelphia. For page see List of Advertisers.

Folding cut flower boxes, the best made. Write for list. Holton & Hunkel Co., Milwaukee, Wis.

CYCLAMEN.

Thomas Roland, Nahant, Mass.
For page see List of Advertisers.

DAHLIAS

David Herbert & Son, Atco, N. J.
For page see List of Advertisers.

J. L. Moore, Northboro, Mass.

For page see List of Advertisers.
Peacock Dahlia Farms, Williamstown June

For page see List of Advertisers.

R. Vincent Jr. & Sons Co., White Marsh, Md.
For page see List of Advertisers.

DAHLIAS.

Geo. H. Walker, No. Dighton, Mass.
Wholesale and Retail.

Send your name for my 1909 Catalog and Pocket Guide, ready to mail about Feb. 25th.

Cactus, Decorative, Fancy, Show and Pompon Dahlias. Good commercial varieties, such as Krichmilde, Countess of Lonsdale, Mad. Van Den Deal and other pure bloomers, strictly divided roots in 10 or 20 named varieties my selection, \$1.00 per 25; \$3.00 per 100; \$25.00 per 1000. Cash please. Herrmann Thiemann, Merion, Mass.

East Bridgewater Dahlia Gardens wants your business. If you are looking for dahlias send to the Eastern Dahlia King, J. K. Alexander, East Bridgewater, Mass.

DECORATIVE PLANTS

A. Leuthy & Co., Perkins St. Nurseries Roslindale, Mass.

For page see List of Advertisers.

Godfrey Aschmann,

1012 W. Ontario St. Phila., Pa.

For page see List of Advertisers.

Joseph Heacock Co., Wyncote, Pa.

For page see List of Advertisers.

The Geo. Wittbold Co., 1657 Buckingham Place, Chicago, Ill.

For page see List of Advertisers.

Robert Craig Co., Market and 49th Sts. Philadelphia, Pa.

For page see List of Advertisers.

A. N. Pierson, Inc., Cromwell, Conn.

Palms and Ferns.

For page see List of Advertisers.

DRACAENAS

The Geo. Wittbold Co., 1657 Buckingham Place, Chicago, Ill.
For page see List of Advertisers.

ECONOMY BRACKET

Burton & Allard, Nashua, N. H.

EVERGREENS

New England Nurseries, Bedford, Mass.
For page see List of Advertisers.

American Nursery Co., 150 Broadway, New York, N. Y.

Henry A. Dreer, Philadelphia, Pa.

For page see List of Advertisers.

Evergreens. Send 25 cents in stamps for complete work on propagating and growing Evergreens. C. S. Harrison's Select Nursery, York, Neb.

FERNS

A. Leuthy & Co., Roslindale, Mass.

For page see List of Advertisers.

H. B. Barrows & Son, Whitman, Mass.
Nephrolepis Whitman.

For page see List of Advertisers.

John Scott, Brooklyn, N. Y.

For page see List of Advertisers.
Frank Oeschlin, 2570-2906 W. Adams St., Chicago.

Ferns for Dishes.

For page see List of Advertisers.

The Geo. Wittbold Co., 1657 Buckingham Place, Chicago, Ill.

For page see List of Advertisers.

Godfrey Aschmann, 1012 W. Ontario St., Philadelphia, Pa.

For page see List of Advertisers.

Henry A. Dreer, Philadelphia, Pa.

Adiantum Farleyense.

For page see List of Advertisers.

FERTILIZERS

Palverized Manure Co., 51 Union Stock Yards, Chicago, Ill.

Wizard Brand Sheep and Shredded Cattle Manure.

FERTILIZERS — Continued

Robert Simpson, Clifton, N. J.
Sheep Manure.
For page see List of Advertisers.
Bowker Fertilizer Co., Boston, Mass.
All Forms of Plant Food at First Hands.
For page see List of Advertisers.

FEVERFEW

Feverfew Little Gem, 80¢ per 100; \$7.00 per 1000. S. W. Pike, St. Charles, Ill.

2000 Feverfew from 2½ in. \$5.00 per 100, \$25.00 per 1000. Albert Batley & Son, Maynard, Mass.

Feverfew, 2½ in., \$2.00 per 100. H. J. Blanchard, Ashburnham, Mass.

FLORAL PHOTOGRAPHS

Floral Photographs, Foley's, 226-228 12 Bowery, New York.

FLORISTS' LETTERS.

Boston Florist Letter Co., 66 Pearl St., Boston, Mass.

For page see List of Advertisers.

FLORISTS SUPPLIES

N. F. McCarthy & Co., 84 Hawley St., Boston.

For page see List of Advertisers.

B. M. Robinson & Co., 15 Province St. and 9 Chapman Pl., Boston, Mass.

For page see List of Advertisers.

Reed & Keller, 122 W. 23th St., New York.

For page see List of Advertisers.

M. Bayeradorfer & Co., 1129 Arch St., Philadelphia.

For page see List of Advertisers.

FLOWER POTS

W. H. Ernest, 28th and M Sts., Washington, D. C.

For page see List of Advertisers.

A. H. Hews & Co., Cambridge, Mass.
For page see List of Advertisers.

Hilfinger Bros., Ft. Edward, N. Y.
For page see List of Advertisers.

The Peters & Reed Pottery Co., Red pots, seed pans, etc., Zanesville, O.

We make Standard Flower Pots, etc. Write us when in need. Wilmer Cope & Bro., Lincoln University, Chester Co., Pa.

FUCHSIAS

R. Vincent, Jr. & Sons Co., White Marsh, Maryland.

For page see List of Advertisers.

GALAX

Michigan Cut Flower Co., 38 and 40 Broadway, Detroit, Mich.

For page see List of Advertisers.

George Cotsouas & Co., 50 W. 28th St., New York.

For page see List of Advertisers.

The Kervan Co., 113 West 28th St., N. Y.
For page see List of Advertisers.

Rice Bros., 115 N. 6th St., Minneapolis, Minn.

For page see List of Advertisers.

H. M. Robinson & Co., 15 Province St. and 9 Chapman Place, Boston.

For page see List of Advertisers.

GERANIUMS

R. Vincent Jr. & Sons Co., White Marsh, Md.

New and Standard Varieties.

For page see List of Advertisers.

A few hundred fine mixed stock geraniums, all double, \$7.00 per 100. Fine geraniums, 2½ in., \$2.00 per 100. Cash. H. J. Blanchard, Ashburnham, Mass.

Red Geraniums, 2½ in., \$2.70 per 100. Jas. T. Baker, Bustleton, Philadelphia, Pa.

GLADIOLI

J. L. Moore, Northboro, Mass.
For page see List of Advertisers.

A. T. Boddington, 342 W. 14th St., New York

For page see List of Advertisers.

O. V. Zangen, Hoboken, N. J.

Gladiolus Breuchleyensis.

For page see List of Advertisers.

GLADIOLI — Continued

I. & J. L. Leonard, Iona, N. J.
Gladiolus Pinks.
For page see List of Advertisers.

Breuchleyensis Gladiol, \$5.00 per 1000. Cash with order, please. Estate of Louis Siebrecht, Floral Park, N. Y.

Groff's hybrids, small size (bulbets), \$1.00 per 1000, postpaid; named varieties, \$2.00 per 1000. Henry Field Seed Co., Shenandoah, Iowa.

Gladioli Groff's Hybrids, mixed, 1½ to 2½ in., \$5.00 per 1000; 1 to 1½ in., \$4.00 per 1000; ¾ to 1 in., \$3.00 per 1000. Bulbets, \$1.00 per peck. Ira H. Landis, Lancaster, Pa.

Groff's new Hybrid Gladioli in finest mixture: No. 1, \$5.00 per 1000; No. 2, \$4.00 per 1000; No. 3, 45 to 55, at \$3.00 per 1000; No. 4, at \$2.00; Bulbets, \$4.00 per 1000. Giant Pink bulbets, at \$1.00 per qt.; Mrs. Francis King and Giant Pink mixed bulbets, at \$1.00 per qt. Discounts on large lots. G. B. Babcock, Jamestown, N. Y.

GLASS

Boston Plate & Window Glass Co., Boston
For page see List of Advertisers.

Standard Plate Glass Co., 26-30 Sudbury St., Boston.

For page see List of Advertisers.

Foley Mfg. Co., Western Ave., between 25th & 26th Sts., Chicago.

Sharp, Partridge & Co., 224 & Lumber St., Chicago.

For page see List of Advertisers.

Parshelsky Bros., Inc., 59 Montrose Ave., Brooklyn, N. Y.

For page see List of Advertisers.

Greenhouse glass, lowest prices. Johnston Glass Co., Hartford City, Ind.

Glass, High Grade, Double Thick Greenhouse Glass. Lord & Burnham, 1133 Broadway, N. Y.

Gordon-Van Tine Co., 1581 Case St., Davenport, Ia.

GLAZING DEVICES

H. A. Dreer, Philadelphia, Pa.

Peerless Glazing Point.

For page see List of Advertisers.

GLAZING POINTS, Lord & Burnham Special Glazing Nails (Points), Lord & Burnham, 1133 Broadway, N. Y.

Gordon-Van Tine Co., 1581 Case St., Davenport, Ia.

GREENHOUSE BUILDING MATERIAL

Lord & Burnham Co., 1133 Broadway, New York.

For page see List of Advertisers.

Pierson U-Bar Co., 1 Madison Sq., N. Y.

For page see List of Advertisers.

A. T. Stearns Lumber Co., Neponset, Boston.

For page see List of Advertisers.

King Construction Co., N. Tonawanda, New York.

For page see List of Advertisers.

Hitchings & Co., 1170 Broadway, New York.
For page see List of Advertisers.

J. C. Moulting Co., 117 East Blackhawk St., Chicago, Ill.

For page see List of Advertisers.

Foley Mfg. Co., Western Ave., between 25th & 26th Sts., Chicago.

For page see List of Advertisers.

GREENHOUSE CONSTRUCTION

GREENHOUSE CONSTRUCTION, Semi-Iron Greenhouse, New Truss Houses and Iron Frame Houses. Lord & Burnham, 1133 Broadway, N. Y.

J. A. Payne, 260-274 Culver Ave., Jersey City, N. J.

For page see List of Advertisers.

Foley Mfg. Co., Western Ave., between 25th & 26th Sts., Chicago.

For page see List of Advertisers.

Hitchings & Co., 1170 Broadway, New York.
For page see List of Advertisers.

GREENHOUSE HOSE

Revere Rubber Co., Boston, Mass.

Revere Hose.

For page see List of Advertisers.

In writing to Advertisers kindly mention Horticulture

GUTTERS

GUTTERS, Cast Iron Gutters, L & B Improved V Shaped Gutter with drip gutter attachment. Lord & Burnham, 1133 Broadway, N. Y.

HAIL INSURANCE

Florists' Hall Asso. of America, J. G. Esler, Saddle River, N. J. For page see List of Advertisers.

HARDY FERNS, MOSS AND GREENS

H. M. Robinson & Co., 15 Province St. and 9 Chapman St., Boston, Mass. For page see List of Advertisers.

Michigan Cut Flower Exchange, 38 and 40 Broadway, Detroit, Mich. For page see List of Advertisers.

George Cotsouas & Co., 50 W. 28th St., New York. For page see List of Advertisers.

N. F. McCarthy & Co., 84 Hawley St., Boston. For page see List of Advertisers.

The Kervan Co., 113 W. 28th St., N. Y. For page see List of Advertisers.

McC Bros., 115 N. 6th St., Minneapolis, Minn. For page see List of Advertisers.

Green and Bronze Lencothoe, \$2.50 per 1000. Nicot long sprays. Cash. Please address Frank H. Hill, Victoria, Macon Co., N. C.

HARDY PLANTS

Novelties and Specialties.—For over one hundred distinct new varieties of hardy plants, all of great commercial value, get our Wholesale Catalog of Perennials and Hardy Plants. Palisades Nurseries, Sparkill, N. Y.

HART'S HANDY HANDLE

Geo. B. Hart, 24 Stone St., Rochester, N. Y. For page see List of Advertisers.

HEATING APPARATUS

Lord & Burnham Co., 1133 Broadway, New York. For page see List of Advertisers.

Pierson U-Bar Co., 1 Madison Sq., N. Y. For page see List of Advertisers.

John A. Payne, 260-274 Culver Ave., Jersey City, N. J. For page see List of Advertisers.

Krosschell Bros. Co., 35 Erie St., Chicago. For page see List of Advertisers.

HELP FURNISHED

Thos. H. Bambrick, 34 S. 7th St., Phila. For page see List of Advertisers.

HERBACEOUS PERENNIALS

P. Ouwkerk, P. O. No. 1, Hoboken, N. J. For page see List of Advertisers.

New England Nurseries, Bedford, Mass. For page see List of Advertisers.

The Geo. Withhold Co., 1657 Buckingham Place, Chicago. For page see List of Advertisers.

D. A. Clarke, Red Oak Nurseries, Elskerville, R. I.

HOT-BED SASH

The A. T. Stearns Lumber Co., Neponset, Mass. For page see List of Advertisers.

Pierson U-Bar Co., 1 Madison Sq., N. Y. For page see List of Advertisers.

Lord & Burnham Co., 1133 Broadway, N. Y. For page see List of Advertisers.

Foley Mfg. Co., Western Ave., between 25th & 26th Sts., Chicago.

Gordon-Van Tine Co., 1581 Case St., Dayton, Ia.

HYDRANGEAS.

Hydrangea American Everblooming. Fine field-grown plants 10 to 20 inches, \$10.00 to \$15.00 per 100. Berberis Thunbergii seedlings and strong transplants. Amoor River Peaches, Japanese Triple California Peaches. Fine plants for hedges. Lists free. The E. Y. Teas Co., Centerville, Ind.

INSECTICIDES.

Nicotelle kills all greenhouse pests. P. R. Paethorpe Co., Eleventh St., Ovestonora, Ky. For page see List of Advertisers.

Stump & Walter Co., 50 Barclay St., New York. Kilmhead Tobacco Dust. For page see List of Advertisers.

Niagara Sprayer Co., Middleport, N. Y. Niagara Sprayer Co., Middleport, N. Y. For page see List of Advertisers.

B. G. Pratt Co., New York. Sulfocide. For page see List of Advertisers.

Hammond's Slug Shot Works, Fishkill-on-Hudson, N. Y. For page see List of Advertisers.

Bowker Insecticide Co., Boston, Mass. Insect Destroying Preparations. For page see List of Advertisers.

"The Fumigating Kind Tobacco Powder"—The first on the market and the kind that has so many imitators, has our guarantee tag of satisfaction or money back, and "The Moon Trade Mark" on every bag, \$3.00 per 100 lbs. The H. A. Stoothoff Co., Mount Vernon, N. Y., Makers and sellers.

JAPANESE PLANTS

Yokohama Nursery Co., 31 Barclay St., New York. For page see List of Advertisers.

KENTIAS

Godfrey Aschmann, 1012 W. Ontario St., Phila., Pa. For page see List of Advertisers.

A. Leuthy & Co., Rosludale, Mass. For page see List of Advertisers.

Jos. Hancock Co., Wynote, Pa. Single and Made-Up Specimens. For page see List of Advertisers.

LEVELS FOR LANDSCAPE GARDENING USE.

Bostrom-Brady Mfg. Co., 139 Madison Ave., Atlanta, Ga. For page see List of Advertisers.

LILY OF THE VALLEY PIPS

Hjalmar Hartmann & Co., 12 Stormgade, Copenhagen, Denmark. For page see List of Advertisers.

LOBELIAS

Double Lobelia Kathleen Mallard, rooted cuttings, \$1.00 per 100. Cash. Chas. H. Green, Spencer, Mass.

R. Vincent, Jr. & Son, R. White Marsh, Md. For page see List of Advertisers.

MARGUERITES

Marguerites, Queen Alexandra, \$1.25 per 100, prepaid. S. W. Pike, St. Charles, Ill.

NICO-FUME

Keatock Tobacco Product Co., Louisville, Ky.

NURSERY STOCK

John Waterer & Sons, Ltd., American Nursery, Bagshot, England. For page see List of Advertisers.

Cleary's Horticultural Co., 62 Vesey St., New York. For page see List of Advertisers.

P. Ouwkerk, 216 Jane St., Weehawken Heights, N. J. For page see List of Advertisers.

D. J. Twomey, Dept. H, Geneva, N. Y. For page see List of Advertisers.

I. & J. L. Leonard, Iona, N. J. For page see List of Advertisers.

Eastern Nurseries, Jamaica Plain, Mass. Viburnum Mollie. For page see List of Advertisers.

American Nursery Co., 150 Broadway, New York, N. Y. P. Hamilton Goodsell, 200 Broadway, New York. For page see List of Advertisers.

W. & T. Smith Co., Geneva, N. Y. Nursery Stock for Florists. For page see List of Advertisers.

Storps & Harrison Co., Palmyra, O. For page see List of Advertisers.

NURSERY STOCK — Continued

ROCK MAPLE SEEDLINGS Per 1000
Sagar or Rock Maple, 4 in. to 4 ft. \$20.00
" " " " 1 to 2 ft. 12.00
" " " " 1 to 2 ft. 5.00

Samples on request. List free. The E. Y. Teas Co., Centerville, Ind.

Manual of the Trees of North America, by C. S. Sargent, mailed to your address for \$5.00, by Horticulture Publishing Co., 11 Hamilton Place, Boston.

TREES, SHRUBS, ROSES, EVERGREENS, PEONIES, HARDY PLANTS, ELLWANGER & BARRY, Rochester, N. Y.

New Hardy Shrub—Buddleia varialbils Vetchill, the summer flowering Lilac, 50c. each; \$5.00 per doz.; \$35.00 per 100. Rose Hill Nurseries, New Rochelle, N. Y.

Catalogue now ready. Nursery grown evergreens, seedling white pine and hemlock, native trees and plants. L. E. Williams, Nottingham, N. H.

Rhododendrons, Laurel, Spruce Hemlock, Poplars, E. W. Sheeley, De Bruce, Sullivan County, N. Y.

ONION SEED

Federico C. Varela, Tenerife, Canary (da Bermuda Onion Seed.

Onion Seed—1908 Crop; truly dependable seed; yellow, red and white Globe. Write for prices. Laughlin Seed Co., Kenton, O.

ORCHID PLANTS

Lager & Hurrell, Summit, N. J. For page see List of Advertisers.

Sander, St. Albans, England. Importers, Exporters, Growers, Hybridists. For page see List of Advertisers.

Carrillo & Baldwin, Seacucus, N. J. For page see List of Advertisers.

Joa. A. Manda, 191 Valley Road, W. Orange, N. J. For page see List of Advertisers.

Orlonez Bros., Madison, N. J., Box 105. For page see List of Advertisers.

Largest stock in the country. Ask for price. Julia Roehrs, Rutherford, N. J.

PAINT AND PUTTY

PAINT AND PUTTY: Ideal Greenhouse lead; Special Greenhouse Green. Lord & Burnham, 1133 Broadway, N. Y.

PALMS

A. Leuthy & Co., Perkinla St. Nurseries, Rosludale, Mass. For page see List of Advertisers.

Robert Craig Co., Market and 40th Sts., Philadelphia, Pa. For page see List of Advertisers.

Joseph Hancock Co., Wynote, Pa. Home-Grown Palms. For page see List of Advertisers.

PANSY PLANTS.

Pansies, extra fine giant flowering, strong plants, 30 cents per 100; \$2.50 per 1000 Edw. Wallis, Atco, N. J.

PATENTS

Siggers & Siggers, Washington, D. C. For page see List of Advertisers.

PEAT

Orchid Peat and Moss always on hand Julius Roehrs Co., Rutherford, N. J.

PENTSTEMONS

C. H. Totty, Madison, N. J. For page see List of Advertisers.

PEONIES

Peonies only, by the wholesale—best 100 varieties. J. F. Rosenfield, Westport, Neb. One of the finest collections in America. Send 25 cts. in stamps for new edition of Peony Manual. C. S. Harrison's Select Nursery, York, Neb.

PETUNIAS

R. Vincent, Jr. & Sons Co., White Marsh, Maryland. For page see List of Advertisers.

PHLOXES

Send 25 cts in stamps for Phlox Manual. The mixed phloxes \$2.00 per 100. C. S. Harrison's Select Nursery, York, Neb.

For List of Advertisers See Page 341

PHOTOGRAPHS: DESIGNING: ILLUSTRATING

Geo. F. Dow, 178 Washington St., Boston. For page see List of Advertisers.

PIPE AND FITTINGS

Foley Mfg. Co., between Western Ave. and 26th St., Chicago, Ill. For page see List of Advertisers.

Kroeschell Bros. Co., 35 Erie St., Chicago. For page see List of Advertisers.

PIPE AND FITTINGS. Cast Iron and Wrought Iron, Valves, Elbows, Pipe Hooks, Automatic Air Headers, etc. Lord & Burnham, 1133 Broadway, N. Y.

PLANT STANDS

Moore-Livingston Co., Lansdowne, Pa. For page see List of Advertisers.

PLANT STAKES

Seale's Telesp Plant Stakes and Trellises. H. D. Seale & Sons, Elkhart, Ind.

POT HANGERS

Pot hangers, Kramer's \$1 doz. by exp. \$1.25 by mail. I. N. Kramer & Son, Cedar Rapids, Ia.

POINSETTIAS (Artificial)

Poinsettias, artificial decorations our specialty. Sample lots of 50 in 3 sizes, \$4.00, 100 in \$6.85, \$10. J. Stern & Co., 125 N. 10th St., Philadelphia, Pa.

PRIVET

California privet. 100,000 for transplanting at \$6.00 per 1000; 55,000, 12 to 18 in., 2 to 4 branches, \$8.00 per 1000; 125,000, 12 to 18 in., 3 to 4 branches, \$10.00 per 1000. Boxed and delivered F. O. B. Cash with order. Valdesian Nurseries, Bostic Dept., Bostic, N. C.

PRUNING SHEARS

Rhodes Mfg. Co., Dept. R., Grand Rapids, Mich. For page see List of Advertisers.

RAFFIA

Raffia (colored), 20 beautiful shades. Samples free. R. H. Comey Co., Camden, N. J.; 810 Washburn Ave., Chicago, Ill.

RHODODENDRONS

John Waterer & Sons, Ltd., American Nursery, Englebot, England. For page see List of Advertisers.

P. Ouwkerk, Hoboken, N. J. For page see List of Advertisers.

Anthony Waterer, Knap Hill Nursery, Surrey, Eng. For page see List of Advertisers.

Storrs & Harrison Co., Palmolive, O. For page see List of Advertisers.

ROSES

Robert Craig Co., Market and 49th Sts., Philadelphia, Pa. For page see List of Advertisers.

P. Ouwkerk, P. O. No. 1, Hoboken, N. J. For page see List of Advertisers.

Julius Roehm Co., Rutherford, N. J. Rose Newport Fairy. For page see List of Advertisers.

The F. B. Pierson Co., White Killarney. For page see List of Advertisers.

Tarrytown-on-Hudson, N. Y. For page see List of Advertisers.

S. J. Roeter & Son, Westerly, R. I. My Maryland. For page see List of Advertisers.

Dilgee & Conard Co., West Grove, Pa. For page see List of Advertisers.

Storrs & Harrison Co., Palmolive, O. For page see List of Advertisers.

W. H. Elliott, Brighton, Mass. Hand Book of Cultural Notes on Roses Under Glass, by P. F. Brigham, mailed to your address for 2c, by Horticulture Publishing Co., 11 Hamilton Place, Boston.

SALVIAS

R. Vincent, Jr. & Sons Co., White Marsh, Maryland. For page see List of Advertisers.

Salvias Bonita and Zurich. For page see List of Advertisers.

SEED GROWERS

C. C. Morse & Co., 48-56 Jackson St., San Francisco, Calif. For page see List of Advertisers.

SEED GROWERS—Continued

Hjalmar Hartmann & Co., Cauliflower and Cabbage Seed. 12 Stormgade, Copenhagen, Denmark. For page see List of Advertisers.

Federico C. Varcla, Tenerife, Canary Ids., Bermuda Onion Seed.

SEEDS

T. J. Grey Co., 32 So. Market St., Boston. For page see List of Advertisers.

Joseph Breck & Sons, 51 and 52 N. Market St., Boston, Mass. For page see List of Advertisers.

W. Atlee Burpee & Co., Philadelphia. For page see List of Advertisers.

C. C. Morse & Co., 48-56 Jackson St., San Francisco, Calif. For page see List of Advertisers.

Arthur T. Boddington, 342 W. 14th St., New York. For page see List of Advertisers.

H. E. Fiske Seed Co., Faneuil Hall Sq., Boston. For page see List of Advertisers.

Hjalmar Hartmann & Co., 12 Stormgade, Copenhagen, Denmark. For page see List of Advertisers.

Rickards Bros., 37 E. 19th St., New York. For page see List of Advertisers.

R. & J. Farquhar & Co., 67 So. Market St., Boston. Mignonette Seed. For page see List of Advertisers.

H. F. Michell Co., 1018 Market St., Phila. For page see List of Advertisers.

J. M. Thorburn & Co., 33 Barclay St., N. Y. For page see List of Advertisers.

Leonard Seed Co., Chicago, Ill. For page see List of Advertisers.

Wm. Elliott & Sons, 42 Vesey St., N. Y. New Seed. For page see List of Advertisers.

Webber & Don, 114 Chambers St., New York. For page see List of Advertisers.

I. & J. L. Leonard, Iona, N. J. Tomato and Pepper Seed. For page see List of Advertisers.

Charles F. Saul, 220-224 James St., Syracuse, N. Y. Pans, Onion, Clover and Timothy Seed. For page see List of Advertisers.

Schlegel & Fottler Co., 26 & 27 S. Market St., Boston. For page see List of Advertisers.

Seeds. Rocky Mountain Evergreen seeds in large or small quantities. C. S. Harri-son's Select Nursery, York, Neb. For page see List of Advertisers.

My own new crop of SALVIA SPLENDENS VARIETIES is now ready. Nana Compacta ZURICH, finest early flowering pot Salvia in existence, selected seeds.

Compacta Grandiflora FIREBALL, best of all for pots and groups, selected seeds. Grandiflora Ameliorata KING OF THE SCARLETS, unexcelled for late groups, with extra large deep scarlet spikes, selected seeds. Each of above per Tr. Pkt., 50c; 6 Tr. Pkt., \$2.50. Larger quantities on special quotation. O. V. ZANGEN, Seedsman, Hoboken, N. J.

SHAMROCKS

John F. Rupp, Shilrenmanstown, Pa. For page see List of Advertisers.

Buy now for St. Patrick's Day. Shamrocks (genuine green kind). Buy now and catch the trade. We have them in 1/2 and 1 in. pots, \$1.00 per 100, \$35.00 per 1000, either size. Cash. Leonard Cousins, Jr., Concord Junction, Mass.

Shamrocks—Genuine Irish Shamrocks, original plant coming from cemetery, Downpatrick, Ireland. Two in., without pots, \$3.00 per 100; \$30.00 per 1000; with pots, \$4.50 per 100; \$40.00 per 1000; 250 at 10.00 rate. Order early. Terms cash. J. D. Harcourt's Son, Wappingers Falls, N. Y.

SHRUBS

The Geo. Wirthold Co., 1657 Buckingham Place, Chicago. For page see List of Advertisers.

SILKALINE

John C. Meyer & Co., Boston, Mass. For page see List of Advertisers.

SMILAX

R. Vincent, Jr. & Sons Co., White Marsh, Md. For page see List of Advertisers.

Extra strong bedding plants, \$1.00 per 100; \$8.00 per 1000. Ready for 2 1/2 inch pots. Big bargain. C. W. Moerkel, 17 Summer St., Fitchburg, Mass.

SPHAGNUM MOSS

Live Sphagnum moss, orchid peat and orchid baskets always on hand. Lager & Horrell, Summit, N. J.

Sphagnum moss and mountain laurel in bags, bales or car lots. Prices low. Spruce and hemlock in bales. James Day, Box 600, Milford, N. H.

Ten bales sphagnum, \$7.00. Z. K. Jewett Co., Sparta, Wis.

Sphagnum Moss. Fresh stock, long and clean, guaranteed to be as recommended. Fibrous peat and peat in chunks.

1 sack 75c
2 5-bbl. bales \$3.00
2 10-bbl. bales \$3.00

W. H. Stackhouse, Mgr. Ocean County Moss and Peat Co., Waretown, N. J.

SPRAYERS

"SHOWERMAKER," \$1. Jos. Kopcey, So. Bend, Ind. For page see List of Advertisers.

Niagara Sprayer Co., Middleport, N. Y. For page see List of Advertisers.

J. F. Cass Mfg. Co., Dept. H., Detroit, Mich. U-N-I-T Globe Sprayer. For page see List of Advertisers.

Chas. J. Jager Co., Boston. Deming Spray Pump. For page see List of Advertisers.

STEAM TRAP

E. Hippard, Youngstown, O.

STRAWBERRY PLANTS

H. L. Crane, Westwood, Mass. Barrymore Strawberry Pump. For page see List of Advertisers.

SULFOCID

The B. G. Pratt Co., 50 Church St., Dept. W., New York City. For page see List of Advertisers.

SWEET PEAS

A. C. Zvolanek, Penn'd Brook, N. J. Winter Flowering. For page see List of Advertisers.

TO-BAK-INE

E. H. Hunt, Gen'l. Agt., 76-78 Wabash Av., Chicago. For page see List of Advertisers.

VEGETABLE PLANTS

R. Vincent, Jr. & Sons Co., White Marsh, Md. For page see List of Advertisers.

TOMATO PLANTS.

Comet Tomatoes, 2 1/2 in., \$18.00 per 1000. Roney Bros., West Grove, Pa.

VENTILATING APPARATUS

Pierson U-Bar Co., 1 Madison Sq., N. Y. For page see List of Advertisers.

Foley Mfg. Co., Western Ave., between 25th & 26th Sts., Chicago. For page see List of Advertisers.

John A. Payne, 260-274 Culver Ave., Jersey City, N. J. For page see List of Advertisers.

The Advance Co., Richmond, Ind. For page see List of Advertisers.

Quaker City Machine Co., Richmond, Ind. 20th Century Ventilating Arm. For page see List of Advertisers.

VENTILATING MACHINERY. New Model enclosed, self-acting gear; Standard Model Open gear. Lord & Burnham, 1133 Broadway, N. Y.

VERBENAS

R. Vincent, Jr. & Sons Co., White Marsh, Maryland. For page see List of Advertisers.

VIOLETS.

Princess Violets, 2 1/2 in., \$2.50 per 100. Jas. T. Baker, Bustleton, Philadelphia, Pa.

In writing to Advertisers kindly mention Horticulture

FOR "POT LUCK" TRY US...

HEWS STANDARD POTS

POT MAKERS FOR 140 YEARS

WORLDS LARGEST MANUFACTURERS

WRITE FOR CATALOGUE AND DISCOUNTS

A. H. HEWS & CO., Inc.
CAMBRIDGE, MASS.

Pearson Street,
LONG ISLAND CITY, N. Y.

452-460 No. Branch St.,
CHICAGO, ILL.

WALLFLOWERS

Henry A. Droer, Philadelphia, Pa.
For page see List of Advertisers.

WAX FLOWERS

We are originators of wax designs and still the standard concern. J. Stern & Co., 125 N. 10th St., Philadelphia, Pa.

WIRED TOOTHPICKS

W. J. Cowee, Berlin, N. Y.
For page see List of Advertisers.

WIREWORK

Reed & Keller, 122 W. 25th St., N. Y.
For page see List of Advertisers.

Durand & Marohn, Albany, N. Y.
For page see List of Advertisers.

Wirework—Write for our catalogue. Holton & Hunkel Co., Milwaukee, Wis.

William E. Heilscher's Wire Works, 38-40 Broadway, Detroit, Mich.

Headquarters for wire work. Send for list. Ball & Betz, 31 E. 3rd St., Cincinnati, O.

Wirework—Compare our prices with others. Scranton Floral Supply Co., 201 N. 7th St., Scranton, Pa.

WHOLESALE FLORISTS

Boston

N. F. McCarthy & Co., 84 Hawley St., Boston.
For page see List of Advertisers.

H. M. Robinson & Co., 15 Province St. and 9 Chapman Pl., Boston.
For page see List of Advertisers.

Welch Jones, 236 Devonshire St., Boston.
For page see List of Advertisers.

Taitly, Wellesley, Mass.
For page see List of Advertisers.

Chicago

Chas. W. McKellar, 51 Wabash Ave., Chicago.
For page see List of Advertisers.

Peter Reinberg, 51 Wabash Ave., Chicago.
For page see List of Advertisers.

E. F. Winterson Co., 45-49 Wabash Ave., Chicago.
For page see List of Advertisers.

J. A. Budlong, 37-39 Randolph St., Chicago.
For page see List of Advertisers.

Poehlmann Bros. Co., Morton Grove, Ill.
For page see List of Advertisers.

Cromwell, Conn.

A. N. Pierson, Cromwell, Conn.
For page see List of Advertisers.

Detroit

Michigan Cut Flower Exchange, 38 and 40 Broadway, Detroit, Mich.
For page see List of Advertisers.

Minneapolis

Rice Bros., 118 N. 6th St., Minneapolis.
For page see List of Advertisers.

New York

Ford Bros., 48 W. 25th St., New York.
For page see List of Advertisers.

B. E. Froment, 57 W. 25th St., New York.
For page see List of Advertisers.

Alex. J. Guttman, 34 W. 25th St., New York.
For page see List of Advertisers.

E. C. Horan, 55 W. 25th St., New York.
For page see List of Advertisers.

A. H. Langjahr, 55 W. 25th St., New York.
For page see List of Advertisers.

James McManus, 42 W. 25th St., New York.
For page see List of Advertisers.

John I. Raynor, 49 W. 25th St., New York.
For page see List of Advertisers.

WHOLESALE FLORISTS—

New York—Continued

W. F. Sheridan, 39 W. 28th St., New York.
For page see List of Advertisers.

Fraendly & Schenck, 44 W. 28th St., New York.
For page see List of Advertisers.

Moore, Hentz & Nash, 55 and 57 W. 26th St., New York.
For page see List of Advertisers.

Wm. H. Kuebler, 28 Willoughby St., Brooklyn, N. Y.
For page see List of Advertisers.

Philip F. Kessler, 55 and 57 W. 26th St., New York.
For page see List of Advertisers.

Millang Bros., 41 W. 28th St., New York.
For page see List of Advertisers.

John Young, 51 W. 28th St., New York.
For page see List of Advertisers.

Greater New York Florists' Association, 162 Livingston St., Brooklyn, N. Y.
For page see List of Advertisers.

George Saltford, 43 W. 28th St., New York.
For page see List of Advertisers.

Frank Millang, 55-57 W. 26th St., New York.
For page see List of Advertisers.

B. S. Silnu, 55-57 W. 26th St., New York.
For page see List of Advertisers.

A. L. Young & Co., 54 W. 28th St., N. Y.
For page see List of Advertisers.

Growers' Cut Flower Co., 39 W. 28th St., New York.
For page see List of Advertisers.

Heushaw & Fenrich, 44 W. 28th St., New York.
For page see List of Advertisers.

J. K. Allen, 106 W. 28th St., New York.
For page see List of Advertisers.

Philadelphia

W. E. McKissick & Bros., 1619-1921 Ransted St., Philadelphia, Pa.
For page see List of Advertisers.

Leo Niessen Co., 1209 Arch St., Philadelphia, Pa.
For page see List of Advertisers.

The S. S. Pennock-Meehan Co., 1608-18 Ludlow St., Philadelphia, Pa.
For page see List of Advertisers.

St. Louis

H. G. Bernal, 1402 Pine St., St. Louis, Mo.
For page see List of Advertisers.

WOODENWARE

Bacon & Co., Appleton, N. Y.
Baskets: Crates: Ladders: Boxes.
For page see List of Advertisers.

New Offers in This Issue.

For page see List of Advertisers.

AMPELOPSIS QUINQUEFOLIA.
Eastern Nurseries, Henry F. Dawson, Mgr., Jamaica Plain, Mass.

AUCTION SALE OF ROSES, RHODODENDRONS, HYDRANGEAS, ETC.
Wm. Elliott & Sons, 12 Vesey St., New York, N. Y.

CANNAS, FERNS, AMPELOPSIS VEITCHII.
C. Eisele, 11th and Westmoreland Sts. Philadelphia, Pa.

CARNATION LUCILLE.
A. F. Longren, Des Plaines, Ill.; Highland Park Greenhouses, Highland Park, Ill.

CHRYSANTHEMUMS AND ROSES.
Scott Bros., Elmford, N. Y.

NEW OFFERS—Continued

EASTER STOCK.
Godfrey As Innan, 1012 W. Ontario St., Philadelphia, Pa.

FLORISTS' SPRING SEEDS.
O. V. Zaunig, Hoboken, N. J.

GREENHOUSE BUILDERS.
Geo. M. Garland Co., Des Plaines, Ill.

IMMORTELLE LETTERS.
W. C. Krick, 2134 66 Greene Ave., Brooklyn, N. Y.

NEPHROLEPIS MAGNIFICA.
H. H. Barrows & Son, Whitman, Mass.

NEPHROLEPIS SCHOLZELI.
Henry A. Droer, Philadelphia, Pa.

ORCHIDS.
Liverpool Orchid & Nursery Co., Gateacre, near Liverpool, Eng.

SHAMROCKS.
N. F. McCarthy & Co., 84 Hawley St., Boston.

SPRING FLOWER SHOW.
Music Hall Market, Boston; John McFarland, N. Easton, Mass., Secretary.

SWEET PEAS.
W. Atlee Burpee & Co., Philadelphia.

SYRACUSE RED POTS.
Syracuse Pottery Co., Syracuse, N. Y.

TARGET BRAND WEED KILLER.
The American Horticultural Distributing Co., Martinsburg, W. Va.

VEGETABLE AND FLOWER SEEDS GROWN ON CONTRACT.
John S. Weaver, Glen Mawr Farms, Kinzers, Pa.

V I FLUID.
Wm. Cooper & Nephews, 177 Illinois St., Chicago; J. Yell Fruehling, 62 Beaver St., New York, Agt.

STANDARD FLOWER POTS

Packed in small crates, easy to handle.

	Price per crate	Price per crate
1500 2 in. pots in crate	\$4.88	144 6 in. pots in crate \$3.46
1500 2 1/2 " " " "	5.95	120 7 " " " " " " 4.20
1500 3 " " " "	6.00	60 8 " " " " " " 3.00
1000 3 " " " "	5.00	48 9 in. pots in crate \$3.60
800 3 1/2 " " " "	5.80	48 10 " " " " " " 4.50
500 4 " " " "	4.50	24 11 " " " " " " 3.60
450 4 1/2 " " " "	5.24	24 12 " " " " " " 4.80
320 5 " " " "	4.51	12 14 " " " " " " 4.80
120 5 1/2 " " " "	3.78	6 16 " " " " " " 4.50

Send pans, same price as pots. Send for price list of containers for Cut Flowers, Hanging Baskets, Lawn Vases, etc. Ten percent off for cash with order. Address Hilfinger Bros., Pottery, Fort Edward, N. Y. August Rolker & Sons, Agts. 31 Barclay St., N. Y. City.

Standard Pots

If your greenhouses are within 500 miles of the Capital, write us, we can save you money!

W. H. ERNEST
28th and M Street WASHINGTON D. C.

Syracuse Red Pots

STANDARD SIZES
Florists, we will suit you as to quality and prices. Write for catalogue.

Syracuse Pottery Co., SYRACUSE, N. Y.

List of Advertisers

Table listing various horticultural businesses and their page numbers, including Advance, The Co., Alton J. K., American Nursery, etc.

Table listing various horticultural businesses and their page numbers, including Houghton F. H., Hunt E. H., Jager, Chas. J., etc.

HELP WANTED

GOOD MEN

When you need good men, skilled or unskilled, write: THOS. H. BAMBRICK

34 South 7th Street Philadelphia Help of all kinds, including that for Florists, Nurserymen, Seedsmen and the Horticultural trade generally.

During Recess

NEW YORK FLORISTS' CLUB.

The banquet of the New York Florists' Club, Saturday evening, Feb. 27, was a great success, 159 well-known growers and florists—wholesale and retail—and their friends, attending.

The Roman Banquet Hall never saw a prettier decoration nor catered to a more harmonious gathering. Alex. McConnell was chairman of the decorating committee and D. W. Scott directed the arrangements, ably assisted by Alfred Zeller and a force of artists.

Pres. Hallock's reception began at 6 o'clock, and it was long after 1 Sunday morning when the company, led by Will Rickards, sang "Auld Lang Syne." The menu was high class.

Everything on the bill of fare was provided in abundance; the only regrets are from those unable to be there. The artists all did nobly and aroused great enthusiasm. The orchestra dispensed popular music and in the chorus everybody joined.

Leonard Vaughan was called upon to respond to the toast of the S. A. F. in the absence of his father on account of illness. C. H. Totty spoke eloquently for the Chrysanthemum, S. S. Butterfield for the Press and W. J. Elliott for the Auctioneer.

WANTED—A working head gardener, married man, small family or none; must have thorough experience in outside gardens and green-house; Scotch or German preferred.

WANTED—A gardener familiar with orchid business in every detail. State experience, age, married or single, nationality and salary required. Address Dr. J. F. Shafer, 408 Penn Ave., Pittsburg, Pa.

FOR SALE

FOR SALE—Retail nursery, sixth year, doing rock, steady and increasing trade. Stock in excellent condition.

FOR SALE—Long established retail florist business in one of largest cities, doing a very profitable business with high class customers.

MISCELLANEOUS WANTS

WANTED TO BUY—Greenhouses and all kinds of greenhouse material; dismantled and removed at once.

WANTED TO BUY—Complete greenhouse plants and all kinds of greenhouse material, to be taken down and removed at once.

BUSINESS CHANCES

WANTED—To unite in partnership in Massachusetts with man needing more capital or assistance in floricultural business.

WANTED—To meet thoroughly experienced man to manage florist store in Boston, or would consider partnership in established business.

SITUATIONS WANTED

SITUATION WANTED—First-class German gardener, trustworthy, experienced and competent, aged 29, married, would like position on private estate.

FORESTRY—A young man wishes a position on gentleman's estate. Understands reproduction and improvement cuttings.

Had news received since of the sudden death of the club's president and leading figure in the entertainment detours us. The last words on the program, "Good-night, Good-night Till We Meet in the Morning" impress us with an unrespeakable sadness as we read them to-day.

The next event of importance is the Rose Night of the club on Monday evening, Mar 8. The outing will take place the last week in June or the first week in July.

GLASS

Greenhouse and Hot Bed

SIZES OUR SPECIALTY
THINNESS STOCK

Plate and Window Glass

Write for Our Prices

PARSHELSKY BROS., Inc.
59 Montrose Ave., BROOKLYN, N. Y.

GREENHOUSES BUILDING OR CONTEMPLATED.

- Providence, R. I.—G. Silvaggio, one house.
- Marquette, Mich. E. R. Tauch, one house.
- Greenwich, Conn.—Charles Mallory, one house.
- Athens, Ga.—Athens Floral Co., house, 20 x 100.
- Salem, O.—Grandview Greenhouse Co., one house.
- Hoosick Falls, N. Y.—Mrs. M. H. Marshall, one house.
- Grand Rapids, Mich.—W. L. Cukerski, range of houses.
- W. Lebanon, N. H. Samuel P. French, house, 20 x 100.
- Nashville, Tenn.—Joy Floral Co., two houses, 32 x 400 each.
- Huntington, Ind.—Little Rivers Gardens Co., vegetable house.
- So. Gloucester, Mass.—W. P. Wakefield, 51-foot vegetable house.
- Los Angeles, Cal.—Dieterich & Turner, range of rose houses.
- Wickford, R. I.—Peter Byrnes, two houses, one 28 x 100, one 20 x 100.
- Springfield, Mass. Wm. Schlatter & Son, three houses, each 25 x 123.

PATENTS GRANTED.

- 912,408. Lawn Trimmer. Joseph R. Place, Chicago Heights, Ill.
- 912,493. Lawn Sprinkler. Russell C. Sanders, Pierre, S. D.
- 912,691. Spraying Nozzle. Frank Koenigkramer and Frederick Koenigkramer, Cincinnati, Ohio.

NEWS NOTES.

White Marsh, Md. A miniature cyclone swept over the greenhouses of R. Vincent, Jr. & Sons Co., on Feb. 16, which wrenched the three-story office building from its foundations, broke hundreds of lights of glass and left its mark on everything in its path.

The Geo. M. Garland Co., inventors and manufacturers of the Garland gutters, now includes Harry Garland, son of Geo. M., as secretary of the company. This firm is located at Des Plaines, one of Chicago's suburban towns on the North Western R. R., about seventeen miles out. Their plant is running at full capacity and their space is taxed to the utmost limit, but they expect to enlarge their establishment in the near future. George M. Garland has been in the gutter business for twelve years. This year his specialty is a new truss especially adapted for houses requiring protection against high winds.

"REVERO"

Braided Moulded Construction—Seamless Throughout



LIGHT--STRONG--FLEXIBLE

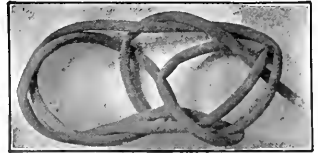

The above cuts represent the non kinking tendency of Revero as compared with the old style hose of wrapped duck construction.

Revero is furnished on Reels in Continuous Lengths up to 500 feet.

Revero Rubber Company,
BOSTON, MASS.

NEW YORK
NEW ORLEANS

PHILADELPHIA
MINNEAPOLIS

PITTSBURG
SAN FRANCISCO

CHICAGO
PORTLAND, ORE.

STANDARD PLATE GLASS CO.

Manufacturers—Importers—Jobbers

NOW IS THE TIME TO BUY

FRENCH OR AMERICAN GREENHOUSE GLASS

LOWEST PRICES ON REQUEST

26-30 Sudbury St. BOSTON, MASS. 61-63 Portland St.

GLASS

Always Write Us Before Buying
SHARP, PARTRIDGE & CO.
22nd and Lumber Streets, CHICAGO
WE HAVE SOME SNAPS

Rhodes Double Cut Pruning Shears

MADE IN ALL STYLES AND SIZES

We pay express charges on all orders.

Write for circulars and prices.

RHODES MFG. CO.
250 Silbey St.
GRAND RAPIDS, MICH.

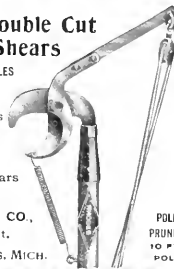

POLE PRUNER 10 FT. POLE

In ordering goods please add "I saw it in HORTICULTURE."

BOSTON PLATE & WINDOW GLASS CO.

GREENHOUSE GLASS

German and American

261 to 287 A St., Boston 20-22 Canal St.

In ordering goods please add "I saw it in HORTICULTURE."

Holds Glass Firmly See the Point #7 **FULL SIZE No 2**

PEERLESS

Glazing Points are the best. No rights or lefts. Box of 1,000 points 75 cts. postpaid.

HENRY A. DREER,
215 Chestnut St., Philadelphia, Pa.

The Payne Steel "T" Bar Greenhouses

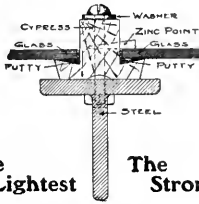

The Lightest The Strongest

Half full Size

HOUSES of this type are constructed with both curved glass eaves and straight glass eaves. Least amount of shadow. Least amount of wood. No drip. Greatest durability.

JOHNA. PAYNE

Greenhouse Designer and Builder
260-274 Culver Avenue

JERSEY CITY, N. J.

KROESCHELL BOILER



MADE OF FIRE BOX FLANGE PLATE
Can not Crack!

Water Space in Front, Sides and Back
The Most Popular Boiler Made
SEND FOR CATALOGUE.

KROESCHELL BROS. CO.
35 Erie Street, CHICAGO, ILL.



The Advance Ventilating Apparatus

is just what you need for these houses of yours. Made of the best material, it lasts and is strong. Simple and complete in its construction makes it work easily and is quickly set up. Thousands of machines in use in 40 states and only five years on the market proves its merits. Sold at one price to all and at a reasonable profit gives our customers satisfaction and enables others to figure its cost. Free circulars. Free estimates.

The Advance Co.
RICHMOND, IND.

GREENHOUSE CONSTRUCTION LUMBER

John C. Moninger Co.
117 E. Blackhawk St., CHICAGO.

THE FOLEY MFG. CO.

CHICAGO

Completely equipped with up-to-date machinery for the making of material for

GREENHOUSE CONSTRUCTION

From a Full Supply of Thoroughly Seasoned Lumber

Send your sketches to our draughtsmen for completion and suggestion. Permit us to figure your proposed work, large or small.

We guarantee our prices will save you money

FOLEY VENTILATING APPARATUS IS THE BEST

Is Simple in Erecting. Is Easiest of Operation. It Will Last a Lifetime. Its Price is the Lowest. Will Ventilate Any Size House. Prices and Circulars on Application.

Our 1908 Catalogue Greenhouse Material Sent Postpaid on Request.

THE FOLEY MFG. CO., WESTERN AVENUE, 25th and 26th STS., CHICAGO

Please note that this is not a $\frac{1}{2}$ in. wire affair but it is made of heavy rods.

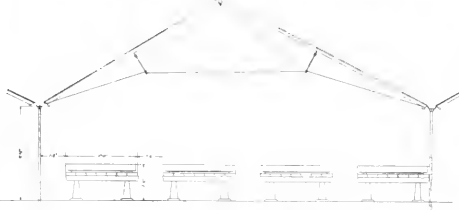

Practical houses on a practical financial basis. If you want an up-to-date house that will save you money,

WRITE

GEO. M. GARLAND CO.

Designers and Builders

DES PLAINES, ILL.

CYPRESS SASH BARS
82 feet or longer
HOT BED SASH
PECKY CYPRESS BENCH LUMBER

GREENHOUSES
ERECTED AND EQUIPPED COMPLETE IF DESIRED

Write for Circular "D" and Prices

The A. T. STEARNS LUMBER CO
NEPONSET, BOSTON, MASS.



Evans 20th Century Arm

Will not twist the shafting pipe. Three times the power of old style elbow arms Sold only with Evans Challenge Machine

Write for free Catalogue to
QUAKER CITY MACHINE CO.
Richmond, Ind.

The FLORISTS' HAIL ASSOCIATION OF AMERICA, Insurer of 29,000,000 sq. ft. of glass. For particulars address John C. Esler, Sec'y, Saddle River, N. J.

EVERYTHING FOR GREENHOUSE BUILDING

WRITE FOR INFORMATION AND PRICES

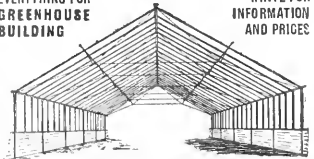

King Greenhouses. King Gutters and Eaves. Trussed Roofs. Ventilating Machinery. Trussed Iron Frame Houses. Tile Benches and Pipe Hangers.

KING CONSTRUCTION COMPANY
NORTH TONAWANDA, N. Y.

PATENTS

Trademarks and Copyrights

Send your business direct to Washington Saves time and insures better service Personal attention guaranteed. Twenty-five years' active service. SPECIALTY: "Working on the Failure of Others."

SIGGERS & SIGGERS

PATENT LAWYERS

Box 9, National Union Building
Washington, D. C.



THE TEST PRACTICAL

The practical part is this: to manufacture materials only, is one thing, but to prove their defects by erecting them ALSO, is quite another. We both manufacture and erect our own materials, which gives us every chance to see defects and make improvements. The question is do you or do you not want the up-to-date enduring construction? If you do, then get into communication with us.

Send at once for Half Iron Frame Circular.

Hitchings & Company
1170 Broadway New York



Some Things You Ought To Know

It's good to have in a convenient form bits of information that will help you in making up your mind—AND YOUR ORDER—for a greenhouse.

Cypress is furnished in even foot lengths only. For instance, a 20 foot wide house, having roof built with the usual pitch, requires a roof bar 12 ft. long. Figure it this way: For every additional 2 ft. of roof bar the width of house is increased 3 ft. 4 in. Thus a 14 ft. bar would make a house 23 ft. 2 in. wide. This rule applies to all bars up to 20 ft. long. Now when you come to buy your materials it's a satisfaction—and a saving—to know that you HAVE AN ESTIMATE THAT COVERS EVERYTHING, GUARANTEEING YOU against a series of vexatious delays—those extra expenses that creep up before you know it and pull your first year's profits down.

An estimate we submit, will completely cover the entire proposition. You won't have a lot of "left-outs." You can be sure of being sure. It's just so much insurance. Get our estimates.

Lord & Burnham Co.

Main Sales Office: 1133 BROADWAY, N.Y.

BOSTON: 819 Tremont Building. PHILADELPHIA: 1215 Filbert St.

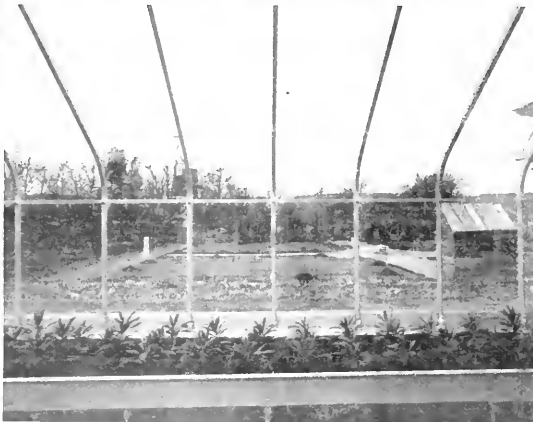

FROM THE INSIDE—OUT

You know there is not a house built today, no matter what the construction, that has the extreme lightness, beauty and practicalness of our U-Bar Curved Eave.

Just look at this side view! You never saw anything like it in any other house! It is the patented U-Bar Construction that makes such an interior possible. At no points are there heavier roof supporting members than you see right in this interior, and all these are galvanized steel, aluminum finished.

If you want a house that you can show to your friends with the satisfaction of knowing it is the lightest and most attractive, "the best there is" then the U-Bar is the house for you.

It might be well to drop us a line at once.

U-BAR GREENHOUSES

PIERSON
DESIGNERS AND BUILDERS



U-BAR CO.
1 MADISON AVE., NEW YORK

HORTICULTURE

Vol. IX.

MARCH 13, 1909

No. 11



CONVENTION SPI

DEVOTED TO THE
FLORIST, PLANTSMAN, LANDSCAPE GARDENER AND KINDRED INTERESTS

PUBLISHED EVERY SATURDAY AT 11 HAMILTON PLACE, BOSTON, MASS.

SUBSCRIPTION, \$1 00 PER YEAR



MAR 15 1909



The NATIONAL FLORAL RIBBON HOUSE

OFFERS A LINE OF
RIBBONS, CHIFFONS AND NETTINGS

EXCELLED BY NONE AT
PRICES BEYOND THE REACH OF COMPETITION
PROGRESSIVE FLORISTS EVERYWHERE USE OUR GOODS

MAY WE SERVE YOU?

Write for Catalogue A containing samples and Catalogue B illustrating modern appliances for corsage and bridal work.

WERTHEIMER BROS. 550 Broadway, NEW YORK CITY

GERANIUMS

We have an immense stock of fine plants from 2 in. pots for immediate shipment at prices running from \$2 per 100 to 50c. each. We will send 1000, 50 each of 20 good sorts, our selection for \$18.50. Our Special Geranium Catalogue describes upwards of 250 varieties.

We have the following in first class stock from 2 in. pots, 25 at 100 rates, 250 at 1000 rates.

	Per 100	Per 1000
Achryanthes, Emersoni - - - - -	\$2.00	\$18.50
" " Besteri Mosioca - - - - -	2.00	18.50
AGERATUM, Imimitable, Princess Pauline - - - - -	2.00	18.50
" " Dwarf White, Stella Gurney - - - - -	2.00	18.50
ALYSSUM, Dwarf Double - - - - -	2.00	18.50
CINERARIA, Maritima, Candidissima - - - - -	2.00	17.50
Centaurea Gynocarpia - - - - -	2.00	17.50
HARDY CHRYSANTHEMUMS. Send for list - - - - -	2.00	17.50
Dahlias. Send for list of Standard and Newer Varieties, only the best, plants for Spring delivery - - - - -	2.00 and up	
Fuchsias, in good varieties - - - - -	2.50	
Hardy English Ivy - - - - -	2.00	15.00
Parlor Ivy, Senecio Scandens - - - - -	2.00	
LOBELIA, Kathleen Mallard, Double - - - - -	2.00	18.50
" " Crystal Palace Gem, Single - - - - -	1.50	
Petunias, Dreer's Superb Single - - - - -	2.00	18.50
Salvia, Bonfire - - - - -	2.00	18.50
" " Zurich - - - - -	3.00	22.50
Smilax, Extra Strong - - - - -	2.00	18.50
Verbena, large flowering, Red, White, Pink and Blue - - - - -	2.00	

R. VINCENT JR. & SONS CO., White Marsh, Md.

SPRING FLOWER SHOW

UNDER AUSPICES OF

BOSTON COOPERATIVE FLOWER MARKET

TO BE HELD

March 20, in New England's Leading Market,

MUSIC HALL PLACE, BOSTON

ALL ARE INVITED TO COOPERATE. Send for Premium List.

All Information Promptly Given by Addressing **John McFarland, Sec'y, NORTH EASTON, MASS.**

Newport Fairy

The Rose of the Future For In and Out Door.

FINE, STRONG FIELD-GROWN STOCK

3-4 Shoots 3-4 ft. long

50c each, \$30 per 100, \$250 per 1000

JULIUS ROEHRS CO.,

RUTHERFORD, N. J.

Ampelopsis Quinquefolia

Strong 3-year Plants, 4 to 6 ft.
\$55 a Thousand. To the Trade Only

A FULL LINE OF

GENERAL ORNAMENTAL NURSERY STOCK

SEND FOR CATALOGUE

EASTERN NURSERIES
JAMAICA PLAIN, MASS.

HENRY S. DAWSON, Mgr.

ROSES

We have a fine stock of large, dormant, field grown plants, on own roots, of the following varieties:

Boule de Neige, Mad. Plantier, Alfred Colomb, Perle des Blancs, Climbing Clothilde Soupert, Archduchess Elizabeth of Austria, Empress of India, Glory of the Exposition of Brussels, Philadelphia Crimson Rambler, Fisher Holmes, Cheshunt Hybrid, Climbing Wootton, Magna Charta, Countess of Roseberry, Louis Vao Route, Dorothy Perkins, Anna de Diesbach, Mad. Alfred Carriere, Vick's Caprice, Sir Thomas Lipton, Francis Lovet, Eugene Furst, Crimson Rambler.

PRICE \$12.50 per 100; \$120 per 1000

Tausendschon, the great new climber, \$20 per 100.

Crimson Baby Rambler, \$16 per 100. Roses, Dahlias and Cannas a Specialty. Catalogue Free

The Dingee and Conard Co. West Grove, Pa.

In ordering goods please add "I saw it in HORTICULTURE."

If We Did Not Blow Our Horn, Who Would?

Send for our Bulb List



Ralph M. Ward & Co.

12 West Broadway

NEW YORK

ROBERT CRAIG CO.

ROSES, PALMS,

and Novelties in Decorative Plants

MARKET and 49th STREETS., PHILADELPHIA, PA.

ROSES FOR SPRING FORCING

Remember You May Deduct 5 Per Cent if Cash Accompanies Order

Hardy Perpetual Roses

We offer exceptionally strong two-year-old dormant, low-budded stock (on Manetti) in the following varieties, true to name:

Alfred Colomb. Carmine.
Anne de Diesbach. Bright carmine.
Ball of Snow. Pure white.
Baron de Bonstetten. Dark crimson shaded.
Baroness Rothschild. Satiny pink; extra.
Captain Christy. Delicate flesh color.
Duke of Edinburgh. Bright vermilion.
Frau Karl Druschki. The finest white in exi tenae.

Fisher Holmes. Dark rich scarlet.
General Jacquemont. Rich velvety crimson.
John Hopper. Beautiful rose-pink.
General Washington. Beautiful red, shaded
 carmine.
La France. The finest light pink.
Margaret Dickson. White, pale flesh center.

Magna Charta. Clear rosy pink.
Mme. Gabriel Luizet. Light, satiny pink.
Mme. Plantier. White.
Mrs. John Laing. Soft pink; most desirable variety.
Paul Neyron. Beautiful dark pink.
Prince Camille de Rohan. Velvety crimson.
Ulrich Brunner. Cherry-red.

The Grand Pink Hybrid Perpetual Rose Mrs. Sharman Crawford. One of the finest Roses grown Deep rosy pink, the outer petals shaded with pale flesh-color, white at the base of petals, and distinct from all other Hybrid Perpetual Roses. Bundle of 5 for 75c; 100 for \$15 00.

We also carry about 25 other varieties. Write for list and price. Prices on Hardy Hybrid Perpetual Rose, \$1.50 for 10; \$12.00 per 100; \$110.00 per 1000.

ENGLISH MOSS ROSES

Assorted, White, Pink, Red. Large dormant plants, from open ground. 85c for 5; \$12.00 per 100.

STANDARD, or TREE ROSES

(Grafted on Rosa Canina or Rugosa Stock) Large well-grown, selected plants in the best and most serviceable varieties. 35c each; \$3.25 for 10; \$25.00 per 100.

Baby Ramblers

THE TREE BABY RAMBLER—Grown as a Standard

35c each; \$3.50 per doz.; \$25.00 per 100.

Mme. Norbert Levavasseur (Baby Rambler). Strong, field-grown plants; \$1.25 for 10; \$12.00 per 100.

Catherine Seimeth. A very important novelty. A white Baby Rambler rose, larger and better flowers than the type. White with yellowish center. It has the true rose perfume in a high degree. 4c each; \$4.00 per doz. \$5.00 per 100; extra strong, 6c each; \$6.00 per doz.; \$45.00 per 100.

Anny Tuller. The pink Baby Rambler, and bound to find favor where the Baby Ramblers are popular. 45c each; \$4.50 per doz.; \$32.00 per 100.

Mrs Wm. H. Cutbush. A grand acquisition to the Baby Rambler class.

Color intense crimson, and exceptionally free-flowering. 25c each; \$1.00 for 5; \$18.00 per 100.

Baby Dorothy. The same in habit as Baby Rambler, but the color of the flowers is similar to Dorothy Perkins. This variety has created quite a sensation when exhibited at the English National Rose Society's and other shows. "Baby Dorothy," when planted out, flowers perpetually from spring until autumn. It makes an excellent pot plant for forcing. Price for strong, field grown plants, 50c each; \$5.00 for bundle of 5; \$35.00 per 100.

Hybrid Tea, or Everblooming Roses

Hybrid Tea, or Everblooming Roses are becoming more popular every year. As hardy as the perpetuals, with slight protection in winter, they give a wealth of bloom all through the summer months and late in the fall till frost checks them.

The Grand New Rose Lyon. Originated by the raiser of Etiole de France. Perpetual flowering. Vigorous grower. The blooms are very large with broad petals, full and globular in form; shrump pink at the ends of the petals, center coral-red or salmon-pink shaded with chrome-yellow. Very fragrant. \$1.25 each; \$12.00 for bundle of 5; \$12.00 for 10.

The Killarney Rose. This is a grand rose for either indoor or outdoor cultivation; is a strong grower, and the blooms, which are of a beautiful pink, are borne in great profusion. Strong, two-year-old field-grown stock, 25c each; \$1.00 for bundle of 5; \$18.00 per 100.

Haman Cochet Roses. The best of all Roses for summer flowering and cutting.
Pink—Color a clear, rich pink changing to silvery rose; very double and fragrant.
White—A sport from the above with all its characteristics; color a beautiful snow-white, at times tinted with the faintest suggestion of blush, the same as is often found in the Bride. 25c each; 75c for bundle of 5; \$12.00 per 100.

Rose, Etiole de France. Flower large, possessing petals of very good substance; magnificent cupped form. Superb crimson-red velvet, the center of the bloom vivid cerise-red. The flowers are very fragrant and last very

long. The Queen of the Everblooming Red Roses. The most free-blooming and vigorous Red Rose ever intro used. Strong, 2-year-old plants, field grown, 25c each; \$1.00 for bundle of 5; \$18.00 per 100.

Grass an Teplitz. No rose in commerce can compare with Grass an Teplitz as a bedder. It is a perfect sheet of richest crimson scarlet all summer. A strong, vigorous grower. Hardy. 25c each; \$1.50 for 10; \$12.00 for 100.

New Hybrid Tea Rose, Queen of Spain. This grand rose is without doubt the Rose of the season, a seedling from Antoine Rivoire and a H. P., with the scent of Souvle le Malmaison; the color is pale flesh, darker in the center. Flowers free erect on stout stems, very full, and of excellent form; petals broad and leathery, a good opener and strong grower. 75c each; \$3.75 for bundle 5.

Countess of Gosford. (New.) A very beautiful variety of the Hybrid Tea class, somewhat resembling Killarney. Color delicate pink; fine flower and bud; splendid accentuation. 6c each; \$1.50 for bundle of 5.

POPULAR HYBRID TEA ROSES

American Beauty, Kaiserin Augusta Victoria, Clothilde Souper, Caroline Testout, Hermosa. 50c each; 75c for bundle of 5; \$12 per 100.

Rambler Roses

Dorothy Perkins. Resembles the Crimson Rambler, except in color, which is a lovely shell-pink. 15c each; 65c for 5; \$11.00 per 100.

Crimson Rambler Rose. American grown. We can supply extra-strong,

2-year-old plants, grown on their own roots, at the following prices: 2 to 4 ft., 15c each; 6 ft. bundle of 5; \$12.00 per 100; 4 to 5 ft. long, 20c each; \$10.00 for 5; \$15.00 per 100; 4 to 6 ft. long, 25c each; \$1.15 for 5; \$18.00 per 100.

Baltimore Belle, pale blush color. **Prairie Queen,** red, changing to pink. 15c each; 65c for 5; \$11.00 per 100.

Well-Known Climbers.

Mme. Plantier, white. **Seven Sisters,** clear pink.

New Climbing Rose, Climbing Frau Karl Druschki. This is a climbing sport from the well known snow-white variety, Frau Karl Druschki, and should become very popular. Good, strong plants are offered as follows: 50c each; \$5.00 for 5.

Our Wholesale Catalogue of Quality seeds and bulbs now ready and it contains forty pages of seeds and bulbs and roses you need, fully described. Write for it today—a postcard will fetch it.

ARTHUR T. BODDINGTON, Seedsman, 342 West 14th St. NEW YORK CITY

**NEW
ROSE**

WHITE KILLARNEY

We Know You Will Want to Buy White Killarney



Every live, progressive, up-to-date grower who has seen it is buying it; but when you buy White Killarney, be sure you get the right White Killarney (the Waban variety). When you buy from us you get the variety that has been exhibited and certificated and the one that has attracted such favorable mention.

If you are in the vicinity of New York, we should be glad to have you call and see White Killarney growing at our Scarborough range, and you will say at a glance—as everyone who has seen it growing—that it is by far the best white rose that has ever been placed on the market.

It is not only a good winter-flowering rose, but is good the entire year, and it is a splendid shipper. Read the following letter received from Mr. Willis N. Ridd, Secretary of the Society of American Florists, dated January 15th, in which he writes as follows:

"Dear Mr. Herson:—I cannot refrain from writing you and expressing my admiration for the White Killarney as shown at Chicago on Thursday. It is an exquisitely beautiful thing and attracted much attention. I took half the blooms home with me, and they were finer on Saturday than they were at the show. The record is that these blooms were shipped from Tarrytown, stored and exhibited during the afternoon. They were then carefully wrapped up in a box, and remained in that box until one o'clock Friday morning, at which time I reached home; improved in quality up to Saturday, and were in fairly presentable condition on Sunday.

In addition to being the most beautiful white rose of its class which I have seen, this demonstrates its splendid keeping and shipping qualities.

W. N. RUDD"

We were awarded Silver Cup at National Flower Show, Chicago, for best new rose with White Killarney.

Strong Plants, 2 1/4 inch pots, own roots, \$30.00 per 100; 250 for \$70.00; 500 for \$125.00; 1000 for \$250.00. Grafted plants \$5 per 100 additional.

F. R. PIERSON CO., Tarrytown-on-Hudson, NEW YORK

CHRYSANTHEMUMS

AND

ASTER SEED

ELMER D. SMITH & CO.

ADRIAN, MICH.

2 1-2 Inch Stock Now Ready

Chrysanthemums: Alice Roosevelt, Virginia Pochmann, dandy madison whites new, \$4 per 100; \$5.00 per 1000. Miel, Sully and geraniums. For Plants, \$2 per 100; 3 inch Boston and Whitman's Form, \$6 per 100. Cash.

I. M. RAYNER, GREENPORT, N. Y.

SCOTT BROS.

CHRYSANTHEMUMS

All the newest and best kinds Roses, Greenhouse and Outdoor. Grafted or Own Root.

ELMSFORD NURSERIES, Elmsford, N. Y.

CHRYSANTHEMUMS

Golden Glow—plant Middle May to July—Cut Middle Aug. to Oct.—White Cloud—an 8 inch tap—extra strong stem. Plant in May, and early June—Cut Middle Oct. to Nov. 1st—P. elite Supreme—a longer stemmed—brighter—non-flowering of the Pacific. Belled now will increase stock in size by planting time—Delivery Plants—March \$5.00 per 100; April \$4.50; Bal. Season \$4.00. Rooted Cuttings now, post or express paid, \$4.00 per 100; as at too rates.

J. H. MYERS, ALTOONA, PA.



CHRYSANTHEMUM BELFAST

CHRYSANTHEMUM SEED,

Wells' New Early Flowering Singles, packets 25c and \$1.00 each

PENTSTEMON SEED

Wells' New Hybrids, packets 25c and \$1.00 each
CHARLES H. TOTTY, Madison, N. J.

The Northboro Dahlia and Gladiolus Gardens

Offer for Spring 1909
100 selected varieties of Dahlias and one and one half million large-flowering Gladioli in mixtures, in lots to suit. Send list of your wants. Catalogue free.

J. L. MOORE, Northboro, Mass.

BELFAST

The New Christmas-Flowering Chrysanthemum

Of the largest size light pink shading to cream. Can be brought into bloom from Thanksgiving to Easter but is at its best about Christmas. Easily grown and claimed to be for the commercial growers the most profitable variety ever introduced. It comes into bloom after every other variety is through, is a great keeper and can be held on the plants for four weeks. Last Spring the originator cut the last blooms April 11. 2 1/2 inch pots 5c; 2 1/2 per doz.; rooted cuttings \$1.50 per doz., \$18 per 100.

Carnation Bay State

Winner of the Gold Medal at Indianapolis. From 3/4 inch pots, \$3 per doz. Rooted cuttings of all other desirable varieties, old and new, at lowest prices.

Tuberose, Caladiums, Gloxinias, Tuberosus rooted Begonias, Florists' Flower Seeds and Sundries.

Send for Wholesale Price List.

SCHLEGEL & FOTTLER CO.

26-27 So. Market St., Boston

**PEACOCK'S
NEW DAHLIAS**

SEND FOR LIST

PEACOCK DAHLIA FARMS

Williamstown Junction, N. J.

DAHLIAS. Now is the time to place your order for bulbs which will insure you getting named varieties in any quantity; prompt delivery.

DAVID HERBERT & SON,
Successors to L. K. Peacock, Inc.
ATCO, N. J.

Roses Under Glass

GREEN-FLY AND RED-SPIDER

With the approach of spring we may expect a rapid increase of green-fly and red-spider and special efforts should be made to exterminate them before they become too numerous.

Fumigating with tobacco stems is a common practice but withal unsatisfactory, as it is almost impossible to fumigate as often as is necessary to keep green-fly in check without at the same time causing injury to the flowers and foliage. The petals of Killarney and other pink varieties are so easily bleached that heavy fumigation sometimes renders the flowers quite unfit for market and although the injury to the foliage may not be so apparent, it is there nevertheless and should not be ignored.

One of the most effective substitutes for tobacco stems and at the same time least injurious to plant life that has come under the writer's observation, is Nicotinic acid. The chief drawback to this preparation is its expense, but if used carefully and at the proper time this may be kept within reasonable bounds. Syringe carefully every time this operation is performed and there will be little trouble from red-spider. Give particular attention to the young plants in pots, as red-spider is one of the most injurious pests they have to contend with in their present stage.

During the remainder of the season when the plants are healthy and vigorous and the soil well filled with roots, considerable benefit may be obtained from the use of liquid food. For this purpose there is nothing safer than the liquid from fresh cow manure which contains many of the elements necessary to plant life and in their proper proportions. For a first application it is important that the liquid be rather weak and the soil not very dry, otherwise, the result may be entirely opposite to that which is expected. As the plants become accustomed to this class of food the preparation may be made stronger without incurring any danger. Of equal importance in the administration of liquid manure is a knowledge of when to apply it—the period of growth in which the plants can use this food to advantage. Plants which have lapsed into a semi-dormant condition should not receive food in any form other than that contained in the soil until, by a judicious use of water, heat and ventilation they have been coaxed into renewed activity and made a new growth of several inches in length.

Conditions over which we have no control are sometimes responsible for the check to root action or other troubles that occasionally retard the growth of our plants, but more often these checks may be traced to indiscriminate use of fertilizers in liquid and other forms and it is only by careful observation of conditions, sound judgment in administering food and frequent

reference to past experiences that we may hope to avoid these troubles in the future.

J. E. Simpson

The Rose in Floral Work

Acknowledged queen of flowers, the rose lifts itself in mighty grandeur above her exquisite but less pretentious sisters of the soil, and for her sweet innocence and ever readiness to mingle with them we bow our tenderest respect and compliments.

We do not speak slightly of all else of Flora's kingdom when lauding the charms of the rose, as each flower in turn can boast its votary, and justly so, as the blossom devoid of beauty and without an admirer is unknown. In its willowy grace and loftiness of mien the rose may be depended upon when displayed with its kind, only, to produce results in the matter of natural charm not to be obtained by the clustering of blooms of any flowering plants not embraced in its class, and it is conceded the rose is in a class, alone. Unselfish by nature it is willing at all times to go hand in hand with a companion of different type, even though its adaptability to such combinations is comparatively slight.

In company with carnations the rose loses its importance, while the carnation itself appears to suffer, the latter being more at ease unaided by the former.

There are opportunities, nevertheless, for roses being used to advantage with other flowers as floral emblems may mutely attest, be they fashioned for the living or the dead.

A funeral wreath composed of roses, any color, furnished at one side with lily of the valley or orchids is pretty and in harmony, while a cluster of roses in contact with a generous bunch of violets on a wreath of galax is by no means disturbing to the eye.

A bridal bouquet of white rosebuds embellished with a few white orchids at one side is beautiful as it is popular. There are other instances where the rose may be used in connection with other flowers with excellent effect, notably in bridal outfits.

What is most desired in the use of roses is an avoidance of commonplace combinations, such as roses and violets, roses and gardenias, roses with sweet peas or lily of the valley; in fact with any small flower in the construction of corsage bouquets, small flowers being infinitely better alone than when in company of the rose, whose prominence enables it to stand alone in the fulness of its dignity.

Wm. H. Long

New York City.

HORTICULTURE

VOL. IX MARCH 13, 1909 NO. 11

PUBLISHED WEEKLY BY
HORTICULTURE PUBLISHING CO.
 11 Hamilton Place, Boston, Mass.

Telephone, Oxford 292
 WM. J. STEWART, Editor and Manager

SUBSCRIPTION PRICE

One Year, in advance, \$1.00. To Foreign Countries, 2.00; To Canada, \$1.50

ADVERTISING RATES

Per Inch, 30 inches to page \$1.00.
 Discounts on Contracts for consecutive insertions, as follows:
 One month (4 times) 5 per cent.; three months (12 times) 10 per cent.;
 six months (16 times) 20 per cent.; one year (52 times) 30 per cent.
 Page end half page space, special rates on application.

Entered as second-class matter December 8, 1904, at the Post Office at Boston, Mass., under the Act of Congress of March 3, 1879.

CONTENTS

	Page.
COVER DESIGN—Roses.	349
ROSES UNDER GLASS—J. E. Simpson	349
THE ROSE IN FLORAL WORK—W. H. Long	351
BRITISH HORTICULTURE—W. H. Adsett	351
AMERICAN ROSE SOCIETY:	
Program for 10th Annual Meeting—Iroquois	352
Hotel, Illustration	353
Schedule of Prizes—Portraits of Officers	353
Portraits of Executive Committee	354
Portraits of Buffalo Florists' Club Officials	355
NEWS OF THE CLUBS AND SOCIETIES:	
Buffalo Florists' Club	355
New York Florists' Club, Illustration—Cincinnati	
Florists' Society—Detroit Florist Club—Newport	
Horticultural Society—Perpetual Flowering Carnation	360
Society	
Gardeners' and Florists' Club of Baltimore—	
Society of American Florists—North Shore Horticultural	361
Society	
Huntington Horticultural and Agricultural Society—American	
Carnation Society—Los Angeles Florists' Club, Portraits—Tarrytown	362
Horticultural Society	
Pittsburgh Florists' and Gardeners' Club—Chicago	
Florists' Club—Dobbs' Ferry Horticultural Association—Club and Society Notes	364
Royal Horticultural Society of England, Frederick	364
Moore	
Gardeners' and Florists' Club of Boston	364
BOSTON CO-OPERATIVE FLOWER MARKET EXHIBITION—Illustrated	358
DURING RECESS	358
OBITUARY—J. Motz—J. B. O'Neil—Funeral Services of E. V. Ballock	364
THE REAL SHAMROCK—G. C. Watson	361c
CARNATION LUCILLE—Illustrated	361c
CULTURE OF THE GARDENIA—William Kleinheuz	364d
PREPARING FOR BEDDING PLANT TIME—Richard J. Hayden	364d
ABOUT CYANIDE OF SODIUM—Alfred J. Lovelace	366
SEED TRADE:	
The Zoigler Sale—Notes	368
OF INTEREST TO RETAIL FLORISTS:	
Novelty in Decoration—Steamer Departures	370
Flowers by Telegraph—New Florists' Stores	371
FLOWER MARKET REPORTS:	
Boston—Buffalo—Chicago—Detroit—Philadelphia—Twin	373
Cities	
New York	375
MISCELLANEOUS:	
William Scott Memorial	355
Personal	356
Movements of Gardeners	357
Philadelphia Personal	357
Albany Personal	357
Rhode Island College Lectures	358
Business Changes	358
Rose Tausenelson—Illustration	364
A Proposed New England Fruit Show	364b
News Notes	364b, 366, 381
Philadelphia Notes	361c
Fire Record	364c
Washington Internation Notes	364d
Greenhouses Building or Contemplated—Incorporated	368, 373

The call
to Buffalo

Important horticultural events follow one another in rapid succession at this season of the year. Indianapolis and the carnation hosts, together with a number of other notable events of more local interest, have barely passed into history when the call to Buffalo is heard and the beloved Queen of Flowers begins preparations for her great annual reception. Although the Rose Society's meeting and exhibition have thus far presented and will probably continue to present in a somewhat lesser degree the distinctly trade aspect which characterizes the corresponding annual affairs of the American Carnation Society yet it is easy to see that this society is now in a way to find its interests in the commercial cut flower field rapidly growing. La Detroit, Kate Moulton, Mrs. Marshall Field, Mrs. Potter Palmer, My Maryland, Rhea Reid, Queen Beatrice, White Killarney and other recent aspirants for recognition in the winter cut flower markets are undoubtedly only the pioneers of a numerous host of American-raised youngsters that are being eagerly nourished and groomed by fond sponsors for coming tests. The awakening is a healthy one, the "still, small voice" whispers seductively of possible triumphs and solid profits and the Rose Society's place is in the forefront.

The garden
rose problem

The motto of the American Rose Society, "A rose for every home, a bush for every garden," well expresses one great aim of that organization. Yet the Society has thus far found very scanty picking in that part of the field and were it not for the substantial support extended by the forcing rose element in the past few years its fate would probably now be a matter of history. Popular support such as is freely accorded in the old country is apparently out of the question, at least for the present, in this country and we might as well accept the fact that the fostering of a general interest along the line of hardy garden rose culture must necessarily be an up-hill task, so long at least as the main reliance for material is on the old-fashioned one-crop varieties. Individually beautiful as the time-honored, so-called H. P. varieties are, their future in a very large section of the United States will amount to but little in view of the expected rapid development of a native race of sturdy ever-bloomers with characteristics of which Killarney, Wellesley, Rhea Reid and other well-tested varieties have only given us a little foretaste. The Rose Society will show wisdom in accepting the situation and devoting its energies in the outdoor field to encouraging the improvement of and extending the popular knowledge of the hardy continuous blooming varieties and leaving the rest to their fate.

About the
"Formosa" lily

Environment and circumstances, avoidable or unavoidable, at some particular stage, have much to do with the final outcome of the culture of a plant, from seed, bulb or cutting and there are generally two or more opinions or kinds of experience forthcoming as soon as any direct opinion, favorable or otherwise, is made public concerning any important recent introduction. The criticism which appears in this issue of HORTICULTURE in regard to the behavior of the Formosa lily bulbs imported this year is a case in point.

Beyond a question it is unprejudiced, and trustworthy, as it is outspoken and explicit, yet we happen to receive by the same mail a high tribute to the Formosa lily as to its behavior this year with Bassett & Washburn of Chicago, who are large growers and who announce their intention of growing the Formosa lily exclusively next year because it has pleased them so well. They do find fault, however, with the great diversity in length of stem under forcing conditions. One of the most extensive growers of lilies for the Boston market says that the Formosa is by far the best lily he has ever grown but he admits that the types are badly mixed. It is to be deplored that the lily situation all over the world wherever bulbs are commercially grown is so unsatisfactory and it intensifies the apprehension to learn of the failure of this latest "hopeful" to make good at any stage. The subject is one for diligent investigation and intelligent discussion.

British Horticulture

SOME FLORAL NOVELTIES

For those garden enthusiasts who delight in securing new attractions for their flower beds there is no lack of variety in the novelties being offered. Gardening here was never more popular than it is at the present time; this is due in a large measure to the skill and enterprise of the trade in continually extending the range of the amateur's interest in floral subjects. There is no limit to the field of selection. For instance, from America has been introduced a new nasturtium of the Tom Thumb variety, Golden Midnight. This has similar foliage to Golden Feather, with neat, deep maroon flowers. This is likely to prove useful as a bedding subject. Queen Alexandra is the popular name selected for a winter stock, of the same type as Beauty of Nice, which produces a profusion of fragrant pure white blooms.

The new Namaqualand daisy, which received an award of merit at the Temple show last summer, is being sent out this spring. This is a dwarf half-hardy annual, with daisy-like flowers of a glossy, salmon-orange shade, with a black central ring. The latest form of the perennial sweet pea is the Picotee, the blooms having a light ground color, edged with pink similar to a picotee. The sweet pea is showing no diminution in the hold it has attained on public favor. Besides the many new kinds which are being issued by the British specialists, some novelties have been imported from across the Atlantic. These include: King Edward Spencer, bright crimson; Apple Blossom Spencer, deep rosy pink; Mrs. Chamberlain Spencer, white tinged with bright rose; Dainty Spencer, pale primrose, changing to white, with pink edge; Princess Alice Spencer, delightful shade of lavender; Mrs. Rontzahn, deep crimson ground, with rose edge, etc.

Progression is the name of a new delphinium, which is described as the purest white variety yet raised. The outer petals are white, the inner three being tinged with pale yellow, the blooms being of a shapely form and imposing size.

Sweet Williams still find a place in many gardens:

Giant White is an attractive hardy biennial, producing good trusses of large smooth-edged blooms. The new asters include Beauty of Colwall, which has received a first-class certificate from the Royal Horticultural Society. The lavender-blue flowers are double, borne erect on stout stems about four feet high. Feltham Blue is also another welcome addition.

Very useful for bedding, the pyramidal forget-me-not will be in demand in many quarters, its upright habit of growth being a notable feature. A new type of sunflower is offered in Starlight; the blooms are of a canary-yellow tint, with graceful twisted petals. This is an improvement on the race of annual sunflowers, particularly adaptable for cut flower purposes.

Rose lovers will appreciate a white variety of the ever-popular Dorothy Perkins, which has emanated from the Colchester Nurseries, where so many good things have been raised. This has secured the gold medal of the National Rose Society. Begonia raisers have been very active in producing new forms of this charming flower. Recent additions comprise: Beatrice Mabbett, pure white, with a lemon shading towards the centre; Amy Bruce, rose colored; Gladys, a dark red variety for hanging baskets; Mrs. G. F. Fry, salmon pink; Mrs. T. R. Rossiter, red-edged yellow with waved petals; Mrs. Peter Clowes, salmon. For bedding purposes a new sort has been raised, producing numerous bright crimson blooms on compact plants; this is known as the Surprise single bedding begonia.

There is always a wide range of chrysanthemums available, as the supplies of the home growers are supplemented by the introductions of the Australian and continental raisers. Amongst the new aspirants for honors are the Rev. R. D. Eyes, white flushed over with delicate pink; W. Howe, a bold incurved Japanese bloom, of a rich crimson-maroon tint, with silvery buff reverse; Melchior Beauty, resembling F. S. Vallis, deep yellow, flushed with crimson; George H. Godfrey, amaranth-purple; F. W. Lever, creamy-white; H. J. Jones, 1908, golden-yellow.

THE NEW EXHIBITION

The "White City" in western London which last year formed the site of the Franco-British exhibition, this season is being utilized for a great Imperial International show, organized by that great Napoleon of the exhibition world, Mr. Imre Kiralfy. An important agricultural and horticultural section has been formed, under the chairmanship of Lord Carrington. Two large flower shows of an international character are being arranged. Many of the leading nurserymen will also make displays of bedding, and an interesting comparison will be provided of the British and continental methods of arranging parterres. I have been appointed Hon. Secretary of this section; any of your readers requiring further information should send a letter to me, addressed, the White City, Shepherd's Bush, London, W. I shall be most happy to afford them every possible assistance. The exhibition promises to be one of the chief attractions of the London season, and crowds are expected from all parts of the empire. The opening takes place on May 1st, the season lasting for six months. Lord Strathearn is acting as President.

Wm. H. Adsett,
London, Eng.

AMERICAN ROSE SOCIETY

Program of 10th Annual Meeting and Spring Exhibition

To be Held at Iroquois Hotel, Buffalo, N. Y., March 17, 18, and 19, 1909

The Annual Meeting of the American Rose Society will open at 7:45 p. m. sharp on Wednesday, 17th, and continue on Thursday, 18th, at 2:30 p. m., or as may be adjourned.

The transaction of business will be in the following order:

Calling to order by President August Pochlmann.—Address by the President.—Reading minutes of previous session.—Secretary's report.—Treasurer's report.—Reports of Committees.—Selection of place for next year's meeting.—Miscellaneous business.—Election of officers.—Appointment of committees. Adjournment.

A question box will be opened at the secretary's desk.

Under the order of essays and discussions, addresses will be made as follows:

First Session.

A Paper by Mr. Walter W. Coles, Kokomo, Ind. "Advantages and Disadvantages of a Wholesale Florist in a Country Town."

A Paper by Mr. J. F. Huss, Hartford, Conn. "The Rose Garden."

Second Session.

A Paper or address, upon "The Value of Soils for Special Work," by Prof. F. C. Corbett, Horticulturist of the Bureau of Plant Industry, Dept. of Agriculture, Washington, D. C.

A Paper, by Mr. George D. Leadle, Springfield, Ohio. "Roses as Popular Home Flowers and how they are grown."

Thursday evening—8 p. m. An illustrated lecture by Leonard Barron of New York City.

THE EXHIBITION.

Judges for 1909.

Adam Graham . . . Cleveland, Ohio
 Peter Bissett . . . Washington, D. C.
 Paul M. Pierson . . . Scarborough, N. Y.
 Lawrence Cotter . . . Jamestown, N. Y.
 George Asmus . . . Chicago, Ill.

Rules and Regulations.

1. All exhibits for competition must be in position by one o'clock, p. m., Wednesday, March 17th, and are not to be removed until after the close of the exhibition.

2. An entrance fee of \$3.00 is required for all non-members. Any person paying dues is entitled to make entry without further fee.

3. All judging shall be by the scale of points given below. No certificate or first premium shall be awarded to any exhibit scaling less than 85 points; no second premium to any exhibit scaling less than 75 points; and no third or special premium to

any exhibit scaling less than 65 points.

4. In all cases where money prizes are offered, plate of equal value may be taken at the option of the winner.

5. All exhibitors winning premiums must keep their respective exhibits in good, fresh condition until the closing of the exhibition.

6. Any article manifestly unfit to show may be excluded by the management and the judges shall withhold any premium when the entries are unworthy of awards. The management may at any time order the removal of an exhibit which is in bad condition. All cut roses (excepting Killarney) in the competitive classes must be from a single growth of the current season.

7. All plants and flowers for com-

petition (except imported plants shown for the first time in this country) must have been grown by the exhibitor for the last three months preceding the exhibition unless otherwise specified.



IROQUOIS HOTEL

and any improperly named variety will disqualify the exhibit.

11. When it is desired that exhibits be staged by the management, notice should be sent in advance, by mail, and a full list of articles, number of packages, number of entries, and notice of when and how they will be shipped should be given. A copy of the letter should be placed inside the package at the top, and such exhibit plainly marked with the section and class in which entered, in addition to the variety label.

NOTE:—For information concerning Exhibition Hall, address J. Rowland Cloudsley, Secretary of Florists' Club, 584 Main street, Buffalo, N. Y.

Scale of Points.

All exhibits will be judged by points in accordance with the following official scales:—

Points of Value.	Competitive Classes.	Novelties for Certificates, Etc.
Size	15	10
Color	20	20
Stem	20	15
Form	15	15
Substance	15	10
Foliage	15	15
Fragrance (for novelties only)	—	5
Distinctiveness	—	10
	100	100

All exhibitors not members shall pay an entrance fee of \$3.00 before placing anything on exhibition.

Schedule of Prizes.

American Rose Society's medals and certificates for novelties.

Gold medal for the best new rose not yet disseminated, whether of domestic or foreign origin. Exhibits to be judged by the official scale of the American Rose Society, and no gold medal to be awarded to any rose scoring less than 95 points.

Silver medal is offered at the same time and under the same conditions for a novelty scoring not less than 85 points.

A Certificate of Merit is awarded to all novelties scoring 80 points, but neither medal or certificate will be issued until the variety is named and 12 blooms shown.

It is further ordered that the complete scores of all the entries in the competition be filed with the Secretary of the American Rose Society before the award of any medal is confirmed. No duplicate medal will be awarded. It is understood that though the award of the gold or silver medal or certificate may be made to the same variety from one exhibitor exhibited in different centers, only one medal will be delivered to the exhibitor.

The Executive Committee of the American Rose Society reserves to itself the right of selection of the judges who shall pass upon the ex-

petition (except imported plants shown for the first time in this country) must have been grown by the exhibitor for the last three months preceding the exhibition unless otherwise specified.

8. The pots or tubs of exhibition plants must be clean; dirty pots or tubs shall be sufficient cause for the judges to disqualify an exhibit.

9. Class cards will be furnished by the management. None other may be used. The class card shall be enclosed in an envelope having on the outside nothing but the number of the exhibitor's entry. The envelope must be sealed before placing it with the exhibit, and must not be opened until after the judges have passed on the exhibit. Any violation of this rule will disqualify an exhibit.

10. Each variety exhibited for competition shall be properly and plainly labeled with its name, in such a manner that it can be easily seen. Label cards, which will be furnished by the management, shall contain nothing but the name of the variety (or, if unnamed, a reference number). The writing or printing must be legible,

hibits in the competition for these medals.

Division A—Pot Roses.

Class 1—Best display of hardy roses in bloom. Exhibit to consist of 150 or more plants, in 30 or more varieties, not more than 10 plants allowed of any one variety, to be grown in pots or tubs, six inches or larger. All types and classes of roses suitable for outdoor planting may be exhibited in this class. First prize \$200, offered by Hon. Philip Breitmeyer, Detroit; second prize \$100, offered by Arthur T. Boddington, New York.

2—Collection of Teas and Hybrid Teas in not less than 5-in. pots, 25 plants or more; first \$25; second \$15.

3—Collection of Wichuraiana Hybrids, 6-in. pots or over, not less than 25 plants; first prize \$25; second \$15.

4—Collection of Hybrid Perpetuals in 6-in. pots or over, not less than 25 plants; first \$25; second \$15.

5—Six climbing roses in not less than 7-in. pots; first \$12; second \$8.

6—Six roses not climbing, in not less than 7-in. pots; first \$12; second \$8.

7—Twelve Baby Ramblers, any variety, in not less than 5-in. pots; first \$6; second \$3.

8—Specimen in pot or tub not climber; first \$5; second \$3.

9—Specimen Crimson Rambler in pot or tub; first \$10, second \$5.

10—Specimen Lady Gay in pot or tub; first \$10; second \$5.

11—Specimen Hiawatha in pot or tub; first \$10; second \$5.

12—Specimen Newport Fairy in pot or tub; first \$10; second \$5.



August POEHLMANN
President.

13—Specimen Dorothy Perkins in pot or tub; first \$10; second \$5.

14—Specimen Yellow Rambler in pot or tub; first \$10; second \$5.

NOTE.—All plants in these classes to be correctly labeled. No exhibit shall be awarded a prize unless in the opinion of the judges the same shall be deemed worthy.

Division B.

15—For the best vase American Beauties, 50 blooms, first \$25; second \$15. First prize offered by Traendly & Schenck, New York City.

16—For the best vase Killarney, 50

blooms, first \$25; second \$15. First prize offered by Eri. Floral Co., Buffalo.

17—For the best vase Richmond, 50 blooms; first \$25; second \$15. First prize offered by Frank M. Pierson, Tarrytown, N. Y.

Division C—Teas and Hybrid Teas.

Twenty-five cut blooms.—Open to all.

18—American Beauty (stems not less than four feet nor more than six feet), first prize \$15, offered by W. J. Palmer & Son; second prize \$10, offered by W. J. Palmer & Son, Buffalo, N. Y.

In classes 19 to 41 the prizes are, in each class, first \$10; second \$5; the varieties are as follows:

- Class 19, Bride, 23, Bridesmaid, 21 Kaiserin Augusta Victoria, 22, Cardinal 23, Rhae Reid, 24, My Maryland, 25, Mrs. Jardine, 26, Mrs. Potter Palmer, 27, Queen Beatrice, 28, Bon Silene, 29, Sony, du President Carnot, 30, Perle des Jardins, 31, Golden Gate, 32, Mme. Abel Chatenay, 33, Mrs. Oliver Ames, 34, Ivory, 35, Liberty, 36, Sunrise, 37, Wesley, 38, Killarney, 39, Richmond, 40, Uncle John, 41, any other named disseminated variety.

Note.—Any variety not named above may be shown in Division C, and first and second prizes may be awarded to each variety shown at the discretion of the judges. Entries are unlimited.

42—Best and largest collection of Teas and Hybrid Teas, 6 or more varieties, not less than 12 flowers of a kind; first \$30, offered by Robert Simpson, Clifton, N. Y.; second \$20, offered by Robert Simpson, Clifton, N. Y.



William F. KASTING
Vice-President.



Benj. HAMMOND
Secretary.



Harry O. MAY
Treasurer.



P. WELCH
Executive Committee



P. J. LYNCH
Executive Committee



PHILLIP BREITMEYER
Executive Committee.

Division D—Twelve Cut Blooms.
Open to private gardeners and amateurs only.

43—American Beauty (stems not less than four feet, nor more than six feet) \$8, offered by Benjamin Hammond, of Fishkill-on-Hudson; 45, offered by Benjamin Hammond.

In classes 44 to 66 the prizes are, in each class, first \$4; second \$2; and the varieties are:

Class 44, Bride, 45, Bridesmaid, 46, Kaiserin Augusta Victoria, 47, Mrs. Pierpont Morgan, 48, Souv. du President Carnot, 49, Perle des Jardins, 50, Bon Silene, 51, Mrs. Oliver Ames, 52, Ivory, 53, Saturno, 54, Golden Gate, 55, Mine Chateau, 56, Liberty, 57, Sunrise, 58, Mrs. Jardine, 59, Cardinal, 60, Lhea Reid, 61, My Maryland, 62, Marechal Neil, 63, any other named variety disseminated.

Note - Any variety not named above

may be shown in Division D and first and second prizes may be awarded to each variety shown, at the discretion of the judges. Entries are unlimited.

44—Best and largest collection of Teas and Hybrid Teas, six of a kind, first \$12; second \$6.

Division E—Hybrid Perpetuals
(Stems not less than twelve inches.)

Open to all.—Prizes are, first \$25, offered by August Pochlmann, Morion Grove, Ill.; second \$15, offered by W. F. Kasting Co., Buffalo, N. Y.

65—For the largest and best collection, not less than twelve varieties, nor less than three of a kind.

Division F—Hybrid Perpetuals
(Stems not less than twelve inches.)

Open to private gardeners and amateurs only.—Prizes are, first \$10, offered by W. F. Kasting Co., Buffalo,

N. Y.; second \$5, offered by Benjamin Hammond, Fishkill-on-Hudson, N. Y.

66—For the best and largest collection, not less than six varieties, and not less than three of a kind.

SPECIAL PRIZES.

Division G.

67. The Dorrance Challenge Prize, valued at \$250.00. For the Best Display of Cut Roses, all Varieties. Offered by Benjamin Dorrance; the winner to hold the prize a year and on relinquishing it to the Society for another competition at the end of that period to receive a silver shield, suitably engraved, as a permanent record of his having held the prize. The names of the winners will be engraved consecutively on the prize.

68. For the best Fifty Blooms of Kate Moulton in the show; a silver vase, valued at \$25.00, offered by



A. FABENSWALD
Executive Committee



PETER BISSET
Executive Committee.



E. GURNEY HILL
Executive Committee.

Henry F. Michell Co., Seedmen, of Philadelphia, Pa.

69. For the best Twelve named varieties of Hybrid Perpetuals in pots. Prize of \$10.00, offered by Kroeschell Bros. Co., Chicago.

70. For the best 100 Richmond. Prize a Silver Vase, value \$40, offered by A. N. Pierson Inc., Cromwell, Conn.

71. For the best arranged vase or other receptacle containing not to exceed one dozen Rosses (American Beauty barred). No foliage or other accessories except Rose foliage permitted. The competition to be open to all florists and employees. Prize, \$10 first; \$5 second. Both offered by J. A. Valentine, Denver, Colo.

72. For the best 25 Killarney Pink or White, prize Silver Cup, value \$25, offered by Welch Bros., Boston, Mass.

73. For the best 36 My Maryland, stems not to be less than 20 inches long on single growth. Prize \$25, offered by A. Farenwald, Roslyn, Pa.

74. For the best 25 My Maryland, Prize \$10, offered by John Cook, Baltimore, Md.

75. For the best 50 Killarney.



J. ROLAND CLOUDSLEY
Superintendent of Exhibition.

Prize a Silver Tray, value \$25, offered by Henry F. Michell Co., Philadelphia, Pa.

76. For the best 25 American Beauties. Prize \$25, offered by The Pulverized Manure Co., Chicago, Ill.

77. For the best collection of Hybrid Wichuraina novelties, not disseminated, five or more plants, in pots or tubs. Prize \$25, offered by Ellwanger & Barry, Rochester, N. Y. The best variety in this collection may receive the Society's Silver Medal; second best, a Bronze Medal, if considered worthy.

78. Special Prize of \$25.00 offered by the Lakeway Rose Gardens, Jamestown, N. Y.

Sweepstake Medal.

The Society of American Florists offers a Silver Medal for the best collection in the exhibition.

The Henry F. Michell Co. offer a beautiful silver tray to be awarded for the best exhibit of fifty pink Killarney roses. It makes an ideal piece on which to stand a cut glass vase, filled with flowers. A space has been provided in the centre of the tray for the inscription of the winner's name.



CHARLES SANDBEORD
Retiring President Buffalo Florists' Club



E. C. BRUCKER
Representative of Horticulture.

WM. SCOTT MEMORIAL.
We have received from Mr. Fred Breitmeier, chairman of the Scott Memorial Fund Committee the following communication, signed by the committee, Fred Breitmeier, A. Guile, John Birnie, H. H. Ritter, E. F. Winterson.

At the Niagara Falls Convention the undersigned were appointed a committee to receive subscriptions for a memorial to the late William Scott. At that time the committee received a large number of subscriptions and many individuals, florists, clubs, business houses and the trade press interested themselves in the movement, turning over to the committee the sums raised by them, together with the names of the contributors.

Consultation with the family of the late Mr. Scott, and with others interested, indicated that possibly the best form that the memorial could take would be a monument to mark the grave in Forest Lawn Cemetery, Buffalo, N. Y. It seemed desirable to complete the matter with as little delay as possible, but considerable time was consumed in that the block of granite most needs be quarried specially in Vermont, for the stone selected. The memorial is now in place, however, and the unexpected balance of the fund has been turned over to Mrs. Scott for the maintenance of the plot.

One hundred and seventy-seven



W. J. PALMER
Chairman Entertainment Committee.

names of contributors are appended subscribing various amounts, the aggregate sum subscribed being \$251.00.

BUFFALO FLORISTS' CLUB.

The regular meeting of the Buffalo Florists' Club was held on Tuesday last, and brought out a good attendance as election of officers for the ensuing year was in order. Benj. Hammond, secretary of the American Rose Society, who was present addressed the club in relation to the coming Rose Show which is to be held at the Iroquois Hotel on March 17. His remarks were brief and to the point and will no doubt help the committee in charge of the show. This being the first Rose Show ever held in this city the committee will spare no effort to make it a notable one.

The following officers were elected for the ensuing year: President, Edw. Slatery; vice-president, Chas. Guenther; secretary, Wm. Legg; financial secretary, D. B. Long; treasurer, W. H. Fiss.



PROF. J. F. COWELL
Chairman Reception Committee

Personal

Visitor in Boston: L. De Smet Duvivier, Gand, Belgium.

Mrs. J. E. Kidwell of Chicago is very low and all hope for her recovery is given up.

H. A. Neuner of Erie, Pa., has taken a position with Van Bochove & Bro., Kalamazoo, Mich.

August Millang and Miss Emma Trojan of New York city, were married on Thursday evening, March 4.

Walter Taepke and Albert Pochelon of Detroit, have started on a trip to eastern cities in search of novelties.

T. Mellstrom representing Sander & Son, Bruges, Belgium, will return to New York on the S. S. Mauretania which sailed from Liverpool March 6.

Prof. Wendell Padock has been elected to take charge of the horticulture department and Prof. W. R. Lazenby of the forestry at the Ohio State University, Columbus, next year.

We regret to learn of the serious illness of Mr. L. B. Craw of the Lord & Burnham Company, New York. Mr. Craw has gone to Buffalo, accompanied by Mrs. Craw, for special medical advice.

Ernest Oechslin, of Chicago, who was accidentally shot by his nephew, continues to improve and expects to return from the hospital in another week. No effort has been made to remove the bullet.

John Bonell, florist, of Meriden, Conn. celebrated his sixty-fifth birthday on the evening of March 2. Music, recitations and a bountiful lunch served by Mrs. Bonell made the occasion a pleasant one.

J. W. Lawrence, of Toronto, Can., was in Chicago with the Mendlesohn Choir, which gave three concerts in that city. Mr. Lawrence did not lay aside all business for music, but went out to see the O. P. Bassett carnation and was so impressed that he could not resist the temptation to order a thousand.

J. H. Pepper, Chicago representative for the Florists' Exchange has been called to the N. Y. office. Mr. Pepper has made many friends during his stay in Chicago who will be very sorry to learn of his intended departure which is set for the 16th inst. Uncle John Thorpe will look after the Chicago business hereafter.

Visitors in New York: E. Wienhoeber, H. N. Bruns, J. C. Vaughan and M. Barker, Chicago; W. Atlee Burpee, Philadelphia; P. Welch, Boston; Harry A. Barnard, with Hugh Low & Co., London; A. Leuthy, Boston; Miss Celia Murray, Montreal; F. Q. Newton H. Carter of Z. J. Carter & Son, and J. F. Bradshaw, Wallace, N. C.

The Burpee Quality in Sweet Peas

Few Florists' or Market Gardeners located near summer resorts and large towns seem to realize that by planting Sweet Peas early (as early in April as possible) they can add largely to their summer and early fall income. We have recently received letters from progressive planters stating that in 08 they were able to add hundreds of dollars to the profit side of the ledger by selling Sweet Pea blooms grown on "Burpee's Selections."

Florists and Market Gardeners like other Horticulturists differ as to what is best - we suggest as the most desirable of their color in the grandiflora type of Sweet Peas:-

	Per oz.	¼ lb.	Per lb.
DOROTHY ECKFORD , The best white.....	\$.06	\$0 15	\$0 45
WHITE WONDER , Fre- quently produces six to eight blooms to a spray.....	10	25	75
MRS COLLIER , Best cream or primrose colored.....	10	30	1 00
JANET SCOTT , "The Best Pink".....	06	15	40
PRIMA DONNA , Blush-pink COUNTESS OF LATHOM Soft cream pink, very large flowers.....	06	15	40
PRINCE OF WALES , large shell-rose colored.....	06	15	45
KING EDWARD VII , The best crimson scarlet.....	07	18	60
QUEEN ALEXANDRA , Bright scarlet.....	10	30	1 00
FLORA NORTON , Beautiful rich lavender.....	06	15	40
Mrs. WALTER WRIGHT , Deep mauve.....	06	15	45

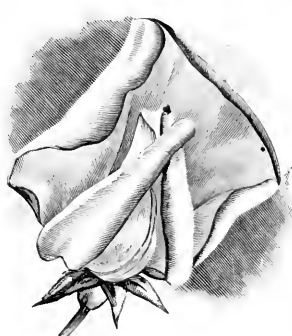

	Per oz.	¼ lb.	Per lb.
BRILLIANT BLUE , (Lord Nelson) Finest dark blue.....	.12	.35	1 25
BLACK KNIGHT , Rich ma- roon.....	.06	.15	.40
HELEN PIERCE , White ground mottled with blue.....	.10	.30	1 00

If you wish the Sweet Peas forwarded by mail postpaid kindly remit at the rate of 8 cts. per lb. additional.

The fourteen varieties offered above together with all the other best Grandiflora varieties and also the superb new Spencers are fully described in

BURPEE'S FARM ANNUAL FOR 1909
The Leading American Seed Catalog

An elegant book of 174 pages. It is "The Silent Salesman" of the World's Largest Mail-Order Seed Trade. It tells the plain truth about the Best Seeds that can be grown. Bound in covers lithographed in nine colors, it shows, with the beautiful colored plates, Seven Superb Novelties in Vegetables, Three New "Spencer" Sweet Peas, and the most beautiful New Giant-flowered Pasties—all accurately painted from nature. It is a Safe Guide to success in the garden, and should be consulted by every one who gardens either for pleasure or profit. It is mailed FREE to all who appreciate quality in seeds. Shall we mail you a copy?

You should also ask for a copy of THE BLUE LIST which gives special prices quoted Florists and Market-Gardeners. Time for planting all seeds is close at hand,—you had better write for either or both catalogs To-Day.

W. ATLEE BURPEE & CO., Philadelphia, Pa.

ROSES READY FOR WORK

	R. C.		2¼ In.			R. C.		2¼ In.	
	per 100	per 1000	per 100	per 1000		per 100	per 1000	per 100	per 1000
American Beauty.....	\$3.50	\$30.00	\$7.00	\$65.00	Killarney.....	3.00	27.50	6.00	55.00
Bridesmaid.....	2.25	22.00	5.00	45.00	Uncle John.....	3.00	27.50	6.00	55.00
Bride.....	2.25	20.00	5.00	45.00	Mrs. Potter Palmer.....	3.00	25.00	5.00	45.00
Richmond.....	2.50	22.00	5.50	50.00					

CHRYSANTHEMUMS

	R. C.		3.00 In.			R. C.		2¼ In.		
	per 100	per 1000	per 100	per 1000		per 100	per 1000	per 100	per 1000	
White					Allice Byron.....	2.50	22.00	3.00	27.50	
Earliest White.....	\$2.50	\$22.00	\$3.50	\$30.00	Timothy Eaton.....	2.50	22.00	3.00	27.50	
October Frost.....	2.50	22.00	3.50	30.00	W. H. Chadwick.....	3.00	25.00	4.00	35.00	
Virginia Poehlmann.....	4.00	35.00	5.00	45.00	Merry Christmas.....	2.50	22.00	3.00	25.00	
Robinson.....	2.20	20.00	2.50	22.00						
Clemantine Tansset.....	3.00	25.00	4.00	35.00	Yellow					
					Golden Wedding.....	3.00	25.00	4.00	35.00	
					Yellow Eaton.....	2.50	22.00	3.00	27.50	
					Col. Appleton.....	2.50	22.00	3.00	27.50	
					Major Benaffron.....	2.50	22.00	3.00	27.50	
					Chautauqua Gold.....	3.00	25.00	4.00	35.00	
					McNiere.....	3.00	25.00	4.00	35.00	
					Maud Dean.....	2.50	22.50	3.50	30.00	
					Intensify.....	2.50	3.50	Schrimpton.....	3.00	4.00

POEHLMANN BROS. CO., Morton Grove, ILL.
Send all orders for cuttings and plants to Morton Grove

Headquarters for Asparagus Plumosus Seed **New Crop**

GREENHOUSE CROWN		LATH HOUSE CROWN	
100 seeds, .50	5,000 seeds, \$18.50	100 seeds, .30	5,000 seeds, \$13.00
1,000 " \$4.00	10,000 " 35.00	1,000 " \$3.00	10,000 " 24.00

Write for Our Wholesale Catalogue

HENRY F. MICHELL CO., 1018 Market Street, PHILADELPHIA

MOVEMENTS OF GARDENERS.

Wm. Huseman, superintendent of parks at Great Falls, Mont., has resigned his position.

William Murphy has resigned his position as manager of the Hugo Johnstone estate at Hamilton, Mass.

Charles Newton recently assistant to Mr. Griffin at the E. T. Gerry greenhouses has succeeded John Davidson as gardener to Mr. I. T. Burden at Newport, R. I.

PHILADELPHIA PERSONALS.

Wm. Fonda of Mandeville & King, Rochester, N. Y., was a visitor recently and was hospitably entertained by Howard M. Earl of W. Atlee Burpee & Co. and P. Joseph Lynch of Dingee & Conard Co. Another recent visitor was Leonard Vaughan of Chicago. He was much interested in the new Michell store and especially in the onion sets that Mr. Henry claimed were from Illinois. On the 5th inst. he left in company with Mr. Burpee to attend the Hallock funeral.

ALBANY PERSONALS.

Thomas Tracey, employee of W. C. Gloeckner, is ill at his home. Herbert Whittle, of the firm of Whittle & Riggs, is also quite ill. Visitors: Mr. Wm. Dykes, representing Ed. Jansen, New York; Mr. E. V. Wood, of Wood Bros., Fishkill, N. Y.; Wm. B. Lake, of Philadelphia.

The number of out-of-town buyers and liberal buying noticed at Elliot's opening auction sale for the season, although one week ahead of the usual date, speaks well for the prospects for business this season.

A THING OF MERIT.

NEW HARDY FLOWERING SHRUB.

Buddleia var. *viridifolia* and *Magnifica*—summer flowering Lilac—blooms when all other shrubs are past. Strong 3 yr. old, 50c. each; \$5.00 per doz.; \$25.00 per 100

Rose Hill Nurseries, New Rochelle, N. Y.

Box Trees

and other **EVERGREENS** for **Tubs and Boxes**
Our Prices are Always Right—Catalog Free
THE NEW ENGLAND NURSERIES, Inc.
BEDFORD, MASS.

Guaranteed Nursery Stock

Of All Varieties and Sizes
WRITE FOR LOWEST PRICES

P. HAMILTON GOODSSELL
200 BROADWAY NEW YORK

Hardy Herbaceous Perennials

Well-grown plants of all the standard varieties at reasonable rates.

SEND FOR TRADE CATALOG.

DANIEL A. CLARKE
RED OAK NURSERIES, Fiskeville, R.I.

BARGAINS in TREES and PLANTS

Concord Grapes, \$2.00. Peach, \$3.00 per 100.
List Free. D. I. TWOMEY, Dept. H, Geneva, N. Y.

**RHODODENDRONS, ANDROMEDES, KALMIAS
AND SPECIMEN EVERGREENS**

JOHN WATERER & SONS, Ltd.

AMERICAN NURSERY

BAGSHOT - - - ENGLAND

SOME OF OUR SPECIALTIES

Boxwood Pyramid Shape. 2½ to 3 ft. high, very heavy, \$1.75 each. 3 to 3½ ft. high, \$2.50 each. **Bush Shape,** var. heavy, 2 to 2½ ft., \$1.75 each. 2½ to 3 ft. high, \$2.00 each.
Rhododendrons, Parson's Hardy varieties, 8 to 12 buds, 18 to 24 in. high, at \$75.00 per 100; 12 to 14 buds, 24 to 31 in. high, at \$100.00 per 100
Azalea Tollis, 15 to 18 in. high, very bushy and full of buds, at \$35.00 per 100.
Hybrid Perpetual Roses, strong dormant field grown plants, of our own growing, none better, \$11.00 per 100, \$100 per 1000.
Gloss Roses, field grown, \$1.00 per 100.
Hardy Climbing Roses, field grown, \$8.00 per 100.
Tree Roses, hardy varieties, budded on straight stems, 4 to 5 ft. high, \$30.00 per 100.
Ampelopsis Veitchii, bushy, 2 yr. plants, 3 foot of tops, \$10.00 per 100.

The Storrs & Harrison Co., Painesville, Ohio

RHODODENDRONS-RHODODENDRONS

An immense stock of all the **hardest known kinds**, 2 to 3½ ft., fine plants and all home grown, many being on own roots, far better than grafted stock—also **R. Catawbiense seedlings** of all colors and **seedling Hardy Azaleas** not to be obtained elsewhere. This is the nursery in which most of the Rhododendrons that have proved **hardy in America** were raised.

GOLDEN YEWES, KALMIAS, and other HARDY PLANTS in great variety and of all sizes.

Catalogues on Application

ANTHONY WATERER Knap Hill Nursery
SURREY, ENGLAND

(NO CONNECTION WHATSOEVER WITH ANY OTHER FIRM.)

NURSERY STOCK FOR FLORISTS' TRADE

AMERICAN GROWN ROSES, AZALEAS, RHODODENDRONS
FRUIT AND ORNAMENTAL TREES, SHRUBS, SMALL FRUITS, CLEMATIS,
EVERGREENS

WRITE FOR OUR TRADE LIST

W. & T. SMITH COMPANY 63 YEARS 700 ACRES **GENEVA, N. Y.**

TREES, EVERGREENS, SHRUBS, VINES, PERENNIAL PLANTS, FRUITS, TRAINED FRUIT TREES, FOREIGN GRAPE VINES, HARDY RHODODENDRONS and R. MAXIMUM in quantity, per hundred or per thousand, very fine. Complete assortments: Careful grading: Low prices.

AMERICAN NURSERY COMPANY,

Sales Department, - - - - - 150 BROADWAY, NEW YORK CITY.
BLOODGOOD NURSERIES DEPT., - - - - - Flushing, Long Island.
F. & F. NURSERIES DEPT., - - - - - Springfield, New Jersey.

CLEARY'S HORTICULTURAL CO.

Management AMBROSE T. CLEARY
Wholesale Contracting, Jobbing, Auction
HORTICULTURAL PRODUCTS
of every description.

Consignments Received. Surplus Stock Converted
62 Vesey St., NEW YORK

Hardy Rhododendrons, Azaleas, Conifers, Clematis, H. P. Roses, Shrubs and Herbaceous Plants from our HOLLAND NURSERIES

Prices Moderate
P. OUWERKERK, 216 Jane St., Weehawken Heights
P. O. No. 1, Hoboken, N. J.

Boston Co-operative Flower Market Exhibition

During Recess



THE MARKET AFTER A FEW MORNING

The Annual Exhibition will be held at the Market, Music Hall Place, Boston, Saturday, March 20.

Schedule of Prizes.

- Class Number.
- A. 1. Killarney—25 flowers, two prizes: 1st prize, Braman & Dow, cut glass, value \$10.00; 2nd prize, \$5.00.
 2. Tidbmond 25 flowers, two prizes: 1st prize, Julius Zinn, cup, value \$25.00; 2nd prize, \$5.00.
 3. Bride—25 flowers, two prizes: 1st prize, \$5.00; 2nd prize, \$3.00.
 4. Bride-maid—25 flowers, two prizes: 1st prize, \$5.00; 2nd prize, \$3.00.
 - B. 5. American Beauty—50 flowers, special prize, salesman's cup, value \$25.00.
 - C. 6. Killarney 50 flowers—W. W. Rawson & Co., cut glass, value \$20.00.
 - D. 7. Richmond—50 flowers, special prize, Boston Plate & Window Glass Co., cup, value \$25.00.
 - E. 8. Bride 50 flowers, prize, cash \$8.00.
 - F. 9. Bride-maid 50 flowers, prize, cash \$8.00.
 - G. 10. Best New Rose of 100—50 flowers, two prizes: 1st prize, Schlegel & Fottler, cup, value \$25.00; 2nd prize, cash \$10.00.

Note—Exhibitors competing in Classes A and B must do so from places not exceeding 35,000 feet of glass.

Classes C, D, E, F and G are open to all.

Carnations.

- H. 11. White 50 flowers, two prizes, \$5.00, \$3.00.
12. Scarlet 50 flowers, two prizes, \$5.00, \$3.00.
13. Light Pink—50 flowers, two prizes, \$5.00, \$3.00.
14. Dark Pink 50 flowers, two prizes, \$5.00, \$3.00.
15. Crimson 50 flowers, two prizes, \$5.00, \$3.00.
16. Variegated 50 flowers, two prizes, \$5.00, \$3.00.
- J. 17. Seedling, but Disseminated—100 flowers, P. J. Gray & Co., value \$25.00.
- K. 18. Seedling, White, Not Disseminated 50 flowers, \$5.00.
19. Seedling, Red, Not Disseminated—50 flowers, \$5.00.
20. Seedling, Dark Pink, Not Disseminated 50 flowers, \$5.00.
21. Seedling, Light Pink, Not Disseminated 50 flowers, \$5.00.
22. Seedling, Scarlet, Not Disseminated 50 flowers, \$5.00.
23. Seedling, Variegated, Not Disseminated 50 flowers, \$5.00.
- L. 24. Vase of 100 Carnations, Any Color—Joseph Brock & Sons, special prize, \$15.00.
- M. 25. Vase of 100 Mixed Carnations, Limited to Six Varieties—A. E. Stearns' Flower Co., special prize, cut glass, value \$25.00.

Violets.

- N. 27. Bunch of 100 Blooms of Lad Home Campbell—Two prizes, \$2.00, \$1.00.
28. Bunch of 100 Blooms of Marie Louise—Two prizes, \$2.00, \$1.00.
29. Bunch of 100 Blooms of any other Double Variety—Two prizes, \$2.00, \$1.00.

30. Bunch of 100 Blooms of Princess of Wales—Two prizes, \$2.00, \$1.00.
- O. 31. Collection of Violets, Display of not less than Five Varieties—H. E. Fiske Seed Co., cup, value \$15.00.

Miscellaneous.

- P. 32. Sun-dragon 25 spikes, Two prizes, \$3.00, \$2.00.
33. Wallflower 25 spikes, Two prizes, \$2.00, \$1.00.
- Q. 34. Lily of the Valley—100 spikes, \$4.00.
- R. 35. Mignonette—25 spikes, \$3.00.
- Sweet Peas, No. 2.
 - S. 36. White—100 flowers, Two prizes, \$2.00, \$1.00.
 37. Pink—100 flowers, Two prizes, \$2.00, \$1.00.
 38. Purple or Lavender—100 flowers, Two prizes, \$2.00, \$1.00.
 39. Any other Color—100 flowers, Two prizes, \$2.00, \$1.00.

Miscellaneous.

- T. 40. Marguerites 50, Two prizes, \$3.00, \$2.00.
 - U. 42. Group of Commercial Foliage and Flowering Plants. Not to cover more than 60 sq. feet of space—A. H. Dews, \$25.00.
 - W. 44. Cyclamen, Plants in Bloom—25 pots, \$10.00.
 - X. 45. Best Arranged Floral Basket—Prize value \$10.00.
 - Y. 46. Best Arranged Center Piece for Table, Cut Flowers—H. M. Robinson & Co., cut glass vase, \$15.00.
 - Z. 47. Best Shower Bouquet for Bride, To be made of Lily of the Valley and Green, \$10.00.
 - M. Floral Wreath, \$15.00.
 48. Best Display of Vegetables Grown under Glass—Hall & Cole, cup, value \$15.00.
- Judges in Classes X, Y, Z and M will be chosen on day of exhibition.

A BOOK EVERY GARDENER WILL FIND USEFUL.

A Garden Diary.—Underwood Each day of the year has a page, and each page is divided into four parts, for the record of four years. It is equal to a shelf full of books. Price \$3.25; by mail, \$3.55.

BUSINESS CHANGE.

Marion, Ind.—Andrew S. Smith has purchased the property of the Marion Floral Co. at Meridian and 31st streets.

Mr. Thos. J. Gray calls our attention to a mistake in our account of the competition at the Boston Market Exhibition last week, stating that instead of two there were ten competitors for his special trophy offered for the best vase of one hundred carnations, one variety, standard or novelty.

GREEK AMERICAN FLORISTS' ASSOCIATION.

The second annual ball of this thriving New York organization took place at the Palm Garden, New York city, on the night of March 2, with all the luxuriance of decoration and liberality of hospitality which characterizes the Greek American who, when he undertakes to do anything, always goes the limit. The attendance was tremendous and included many members of the wholesale trade, as well as the entire retail interests of the city.

The New York Florists' Club bowling contingent has gathered strength in numbers and has good practice meetings regularly now. It begins to look as though they would have something to say at Cincinnati next August, and any other aggregation which aspires to get a look-in would do well to get busy at once. Last Monday afternoon the high scores in four games were as follows:

Mathews	151	Burns	160
Fenich	171	Shaw	165
Schneider	179	Henderson	168
Manda	182	Tallman	150
Lorentz	150	Whitebeck	204

The St. Paul bowlers asked their Twin City brethren to meet them on March 6th in the Saintly City for another tournament. While the scores were pretty good all around they have to get higher a few notches on the Mill City team to beat these old hand bowlers like Olson, Hansen and Dill. Nevertheless, Minneapolis took their licking without saying much, (they might have thought a great deal). The last tournament of the season will take place at Minneapolis, March 15th.

The scores of the teams was as follows:

ST. PAUL.	MINNEAPOLIS.
Dysinger 88-168-169	Wirth 134-111-106
Dansen 169-136-145	Bueglin 98-107-95
Duvogel 119-117-100	Carlson 117-105-153
Dill 159-156-157	Meyer 159-129-117
Olson 176-172-204	Ruedl'cr 87-180-102

RHODE ISLAND COLLEGE LECTURES.

Lectures were given at the Coles Laboratory, Newport, R. I., on the evenings of March 3, 4, 5, under the auspices of the R. I. College of Agriculture and Mechanics Arts. President Edwards of the college opened the first meeting with an explanation of the aim of the lectures, saying the object was to help the owners of homes to get more pleasure and profit from their grounds. The balance of this evening was then used by Professor G. E. Adams with a very interesting lecture on soils. Mr. Henry M. Howard of West Newton, Mass., lectured the two following evenings on vegetable gardening, covering the subject thoroughly, to a very appreciative audience, the Newport Horticultural Society being well represented.

The New Crested SCOTTII FERN...

NEPHROLEPIS SCHOLZELI



NEPHROLEPIS SCHOLZELI

This crested sport of Scottii will hold the same position to all the crested forms of Nephrolepis that Scottii now holds to the Boston. It is entirely distinct from all others and will become even more popular than its parent, with which it is identical in every way except that the pinnae are subdivided, giving it a beautiful crested appearance.

We have shown the plant at the exhibitions noted below and have been awarded the following honors:

- SHAW GOLD MEDAL**, St. Louis Horticultural Society, Nov. 3d, 1908, for "Best plant, of decided merit for cultivation, not previously an article of North American commerce."
- SILVER MEDAL**, offered by the Society of American Florists, through the St. Louis Horticultural Society, Nov. 3rd, 1908, for "The most meritorious plant, or flower of American origin."
- CERTIFICATE OF MERIT**, of the Horticultural Society of St. Louis, Nov. 3rd, 1908.
- SILVER MEDAL**, Pennsylvania Horticultural Society, Philadelphia, Nov. 3rd, 1908, for the best new plant.
- CERTIFICATE OF MERIT**, Massachusetts Horticultural Society, Boston, Nov. 6th, 1908.
- CERTIFICATE OF MERIT**, Dutchess County Horticultural Society, Poughkeepsie, N. Y., Oct. 30th, 1908.
- CERTIFICATE OF MERIT**, Morris County Gardeners and Florists' Society, Madison, N. J., Oct. 30th, 1908.
- CERTIFICATE OF MERIT**, Chestnut Hill Horticultural Society, Philadelphia, Pa., Nov. 4th, 1908.

We are booking orders now which will be filled in strict rotation June 1st, 1909.

Price per doz., \$3.50; per 100, \$25.00; per 1000, \$200.00. Twenty-five supplied at hundred rate and five hundred at thousand rate.

HENRY A. DREER, 714 CHESTNUT STREET, PHILADELPHIA, PA.

Shamrocks

2 1-2 in. pots,
\$1.00 per dozen, \$6.00
per 100.

Carnation Green Coloring
Best in the Market
\$1 per quart. 60c per pint
Ready for immediate shipment

N. F. MCCARTHY & CO.
84 Hawley St., Boston.

ORCHIDS

Cattleya Mendellii arrive in May, Mossiac in June, Gaskelliana in August, Aurea and gigas Hardviana in October. TRUETO TYPE, NO GREEN GLASSES. COLLECTED IN BLOOMING SEASON.

Dendrobium to arrive in April. Miltonia Veitchiana ready now, SPLENDIDTYPE. Miltonia Roezilli in October. DIRECT TO YOU. Order Now.

G. L. FREEMAN, 388 Appleton St., Holyoke, Mass.

ORCHIDS

We are booking orders now for delivery early in the Spring on all commercial CATTLEYAS and NOVELTIES. Our prices are right and our guarantee perfect. We sell only first-class goods.

CARRILLO & BALDWIN, Secaucus, N. J.

ORCHIDS

Largest Importers, Exporters, Growers and Hybridists in the World

Sander, St. Albans, England
and 235 Broadway, Room 1
NEW YORK CITY

ORCHIDS

Just Arrived in Fine Condition
the following East Indian Orchids

DENDROBIUM WARDIANUM, D. CRASSINODE, D. PRIMULINUM, D. THYSIFLORUM, AND D. CHRYSOTOXA. Others to follow.

WRITE FOR PRICES.

LAGER & HURRELL, Summit, N.J.

SHAMROCK
IRISH. THE REAL THING! GREEN.
Best to order early and grow on for strong plants for St. Patrick's Day. Our stock is very fine. \$3.00 per 100, or post-paid 50c. per dozen.

JOHN F. RUPP, Shiremanstown, Pa. RUPPTON: The Home of Primroses.

THE PRIZE WINNING STRAWBERRY
The Barrymore

Send for Folder at Once.

H. L. CRANE, Originator,
Westwood, Mass.

JULIUS ROEHRS & CO.
Orchids and Stove Plants
Florists' Easter Supplies
RUTHERFORD, N. J.

ORCHIDS! ORCHIDS!
The LIVERPOOL ORCHID & NURSERY CO.
(Cowan's) Limited
GATECRE NURSERIES. Gateacre, near Liverpool

IMPORTERS and CULTIVATORS of ORCHIDS ILLUSTRATED, DESCRIPTIVE AND PRICED CATALOGUE POST-FREE ON APPLICATION. Cablegrams "Cowan Gateacre" A. P. C. Code, 5th E. F.

JUST ARRIVED
Fine Importation of
Oncidium ornithorrhynchum

Fine strong leafy plants \$1.50 each. \$18.00 doz
Few specimens 2 50

JOSEPH A. MANDA, West Orange, N.J.

ORCHIDS

We offer a large number of fine well established plants at very reasonable prices also Peat, Baskets and Sheep and Chicken Ladino.

ORDONEZ BROS., Madison, N. J.
New York Store, 41 WEST 28 ST.

NEWS OF THE CLUBS AND SOCIETIES

NEW YORK FLORISTS' CLUB.

The regular monthly meeting on Monday evening, 8th inst., was to have been Rose Night. W. H. Elliott of Boston was to have read a paper on rose culture and preparations had been made for an extensive exhibition of the Queen of Flowers but instead the meeting was turned into a Lodge of Sorrow. No business was transacted and after appropriate remarks by Vice-president Harry Turner, who occupied the chair, and several other members and the report of a set of resolutions on the death of President Hallock by a committee appointed for that purpose the club adjourned.

On the exhibition tables a beautiful array of roses was displayed. The judges examined them and will make their report at the next meeting. White Killarney was shown in fine shape by Waban Rose Conservatories and F. R. Pierson Company. My Maryland from Robert Simpson, A. N. Pierson and Myers & Santman was grand. Nothing finer than Richmond as staged by A. Farenwald has been seen for a long time. Mrs. Jardine, Kate Moulton and Mme. Abel Chatenay were also included in Mr. Simpson's collection, and Mr. Farenwald was further represented by Killarney. The Brant Hentz Flower Company sent superb American Beauties; Valentine Haman, Bridesmaids; W. G. Badgley, Killarney, Bride and Bridesmaid; W. A. Manda, Cherokee and South Orange Beauty and Henry Hentz, Jr., had Bride and Bridesmaid in good form.

Following is the report of the special committee on the death of President Hallock:

Whereas, We, the members of the New York Florists' Club, are overwhelmed with grief at the sudden demise of our friend and President Edw. V. Hallock, who was struck down on the night of March 2 while apparently in the full possession of his health and faculties, and

Whereas, The club has sustained a great loss in the death of its president at the beginning of his term of office, when the prospects of a brilliant year seemed most promising.

He was an able executive, an ar-

dent worker in the club's behalf and exerted his best energies for its upbuilding.

Mr. Hallock stood for all that was elevating in horticulture, lending his speech and pen for its advancement; not the least of his efforts was directed to the introduction of a course of practical horticulture in our public schools.

He was a man whose attractive personality appealed to all; generous, sympathetic; of fine impulses; kind and considerate of the feelings of others, he leaves many friends to mourn him.

Therefore be it

Resolved, That these minutes be spread upon the record of this club and a copy be forwarded to his bereaved family, to whom we tender our deepest sympathy.

W. F. SHERIDAN,
FRANK H. TRAUDNLY,
JOHN YOUNG.

March 8, 1909.

CINCINNATI FLORISTS' SOCIETY.

The Cincinnati Florists' Society have selected the following chairmen of committees in connection with local preparation for the S. A. F. Convention to be held in Cincinnati next August:

President's reception—Albert McCullough, Charles McCullough and Peter Olinger. Entertainment—J. A. Peterson. Badges—E. A. Forter. Program—A. Sunderbruch. Transportation—G. Adrian. Hall—J. W. Rodgers. Women's entertainment—E. G. Gillett and C. E. Critchell. Ball game—Frank Dellar. Bowling—C. E. Critchell.

William Murphy has been selected for recommendation to the S. A. F. executive committee for the position of superintendent of the trade exhibition.

DETROIT FLORIST CLUB.

Next meeting night will bring forth definite plans as to the arrangement of our fall show. Fortunately the sentiment prevails to arrange a genuine show which will interest the public, not one of those bench and bottle compositions which draw the florists only.

NEWPORT HORTICULTURAL SOCIETY.

The Newport Horticultural Society held a real business meeting Tuesday evening, March 9th, when the schedule and other matters connected with the June Show came up and were all settled. This schedule does not differ much from those of recent years except that an important addition was made to the School Children's Classes which is provided for by a substantial donation from Mrs. Lorillard Spencer. Mrs. Robert Goeltz's liberal donation of one hundred dollars a year for five years also provides for two new classes for this show, the first being a specified table of flowering plants, and the other a vase of cut flowers. John B. Urquhart, gardener for Mr. R. L. Beekman, had on the exhibition table a specimen plant of the new fern *Nephrolepis superblissima*, which was its first appearance before this society. On account of its rich dark green color and being unusually well grown it was awarded a first class certificate of merit.

The Society then voted to offer one silver medal and one bronze medal to the New England Dahlia Society for two worthy exhibits of dahlias to be specified later, and shown at the proposed exhibition of the N. E. Dahlia Society this year. The Society also voted to order for distribution to the school children of Newport, a large number of printed leaflets giving helpful directions for the growing of flowers and vegetables.

J. R.

PERPETUAL FLOWERING CARNATION SOCIETY.

The annual general meeting took place at the Hotel Windsor, London, Eng., on Feb. 10. Mr. J. S. Brunton presided, and about a score of the members were present. A scheme for the registration of the names of new varieties has been adopted and nine such have been registered during the year. A variety must gain at least 85 points to entitle it to first-class certificate. Two cups have been presented to the society, one by Lord Howard de Walden and the other by the American Carnation Society.



NEW YORK FLORISTS' CLUB BANQUET

Dreer Special Offer OF Hardy Perennials

NEW OR LITTLE KNOWN VARIETIES WORTHY OF SPECIAL ATTENTION



TROLLIUS (Globe Flower)

PRIMULA CORTUSOIDES SIEBOLDI. These are not so well known as they deserve; they are of free, vigorous growth, and can be flowered in pots in early spring, and respond quickly to forcing when placed in a temperature of 50 degrees, forming pretty pot plants in a short time, making excellent window plants, which meet with ready sale when in bloom.
We offer six distinct varieties, from pure white to the deepest rose in color.
\$1.50 per doz.; \$10.00 per 100.

RUDEBECKIA RAYS OF GOLD. In this new variety we have a refined form of the popular "Golden Glow," to which it is identical in color, habit, etc., but the flowers have narrower petals, full to the centre, forming a perfect ball of gold.
\$1.50 per doz.; \$10.00 per 100.

- ANCHUSA ITALICA DROPMORE VARIETY.** A grand improvement on the type, with intense deep blue flowers. \$2.00 per doz.; \$15.00 per 100.
- ANTHERICUM LILIASTRUM GIGANTEUM.** A giant form of the N. Heron Lily with very large white flowers. \$2.50 per doz.; \$20.00 per 100.
- AQUILEGIA HELENÆ.** One of the best of the Columbinæ, large pretty blue flowers, with large white corolla. \$3.75 per doz.; \$30.00 per 100.
- CAMPANULA PERSICIFOLIA HUMOSA.** A very large semi double form of the peach-leaved Campanula, flowers of a pleasing shade of blue. \$1.50 per doz.; \$10.00 per 100.
- DELPHINIUM GOLD MEDAL HYBRIDS.** The finest strain ever offered to mixed varieties. \$1.25 per doz.; \$10.00 per 100.
- DELPHINIUM BELLADONNA.** The freest flowering of all Delphiniums, it is never out of bloom, beautiful turquoise blue. \$2.00 per doz.; \$15.00 per 100.
- FUNKIA ROBUSTA ELEGANS VARIETA.** A decided improvement on all variegated forms. \$1.50 per doz.; \$10.00 per 100.
- HELENIUM RIVERTON GEM.** A new variety that originated on our trial grounds. Flowers of gold, suffused with bright terra cotta, changing as they mature to a wallflower red. \$1.50 per doz.; \$10.00 per 100.
- HELENIUM RIVERTON BEAUTY.** Another variety which originated with us, quite distinct in color, which is lemon-yellow, with a large disc of purplish-blue. \$1.50 per doz.; \$10.00 per 100.
- HELIANTHUS SPARSIFOLIUS.** The most desirable of all the hardy sunflowers, especially valuable as a cut flower. \$3.75 per doz.; \$30.00 per 100.
- FOUR VALUABLE HEMEROCALIS.** The four varieties here offered are great improvements upon the well-known Yellow Day Lilies.
Aurantiaca. Very large, bright, orange-yellow, sweet-scented flowers. 15 cts. each; \$1.50 per doz.
Aurantiaca Major. Large trumpet-shaped, sweet-scented, deep orange flowers. Requires protection. 35 cts. each; \$3.50 per doz.
Florham. Large golden-yellow sweet-scented flowers; very free flowering. 15 cts. each; \$1.50 per doz.; \$10.00 per 100.
Gold Dust. Large golden-yellow flowers. 15 cts. ea. h; \$1.50 per doz.
- INCARVILLEA DELAVAYI.** Popularly known as the hardy Gloxinia, extra strong roots. \$2.00 per doz.; \$15.00 per 100.
- IRIS PALLIDA DALMATICA FOLIA VARIEGATA.** A strikingly handsome variegated leaved form of this beautiful blue Iris. 35 cts. each; \$3.50 per doz.
- GYSOPHILLA PANICULATA FLORE PLENA.** This is a perfect gem and as a summer cut-flower invaluable. We have a large stock of strong roots to offer this season. \$2.00 per doz.; \$15.00 per 100.
- LUPINUS POLYPHYLLUS ROSEUS.** This is a most attractive rose pink form of Lupines, producing gigantic spikes of flowers. \$1.50 per doz.; \$10.00 per 100.
- PENSTEMON GENTIANOIDES SENSATION.** Gloxinia-like flowers in a variety of bright colors, including rose, cherry, crimson, purple-lilac, etc. For bedding they rival Phloxes, Petunias, etc. Not quite hardy 3-inch pots. \$1.00 per doz.; \$7.00 per 100.
- STOKESIA CYANEA ALBA.** A white form of the popular blue Stokesia, equally valuable and a desirable addition; strong plants. \$1.25 per doz.; \$8.00 per 100.
- CHOICE NEW TROLLIUS.** (New Globe Flowers.) The five varieties listed below are decided improvements on all sorts heretofore offered, of exceptional large size and good rich colors.
Gotterfunke. Large open orange-yellow flowers
Helios. Very free flowering, pure yell. w. on strong branched stems.
Leuchtkugel. One of the finest deep orange red.
Lichtball. Large, globular orange yell. w. flowers on stout stems
Salamander. Soft orange-colored flowers of globular form. 35 cts. each; \$3.50 per doz. The set of 5 for \$1.50

HENRY A. DREER, 714 Chestnut Street, Philadelphia, Pa.

THE GARDENERS' AND FLORISTS' CLUB OF BALTIMORE.

The Club held their regular meeting in the hall of the Florists' Exchange Building. This being the annual meeting the election of officers for the ensuing year was held and all were re-elected, viz.: J. J. Perry, president; Geo. Morrison, vice-president; N. F. Flitton, secretary; Geo. Talbot, financial secretary; F. G. Burger, treasurer, and C. M. Wagner, librarian. The customary banquet was held at the Hotel Caswell and something less than a hundred members partook. The custom of inviting guests was not observed this year, speaking being confined to members of the club. Israel Rosnosky of Michell's, Philadelphia, was present.

SOCIETY OF AMERICAN FLORISTS AND ORNAMENTAL HORTICULTURISTS.

The regular mid-Lent meeting of the executive board is called for Saturday, 8 P. M., March 13 next, at the Sinton Hotel, Cincinnati, Ohio.
By order of President Valentine.

Withdrawal of Registry Application.

Under date of March 1, 1909, Mr. C. G. Roehling, by Mr. James Goodier, gardener, withdraws application of Feb. 5, 1909, for the registration of Cattleya Eureka, stating that he has been informed by Mr. Orpet of South Lancaster, Mass., that the same hybrid was exhibited by him under the name of L. C. Johanson.

W. N. RUDD, Secretary.
March 5, 1909.

NORTH SHORE HORTICULTURAL SOCIETY.

At the North Shore Horticultural Society regular meeting, March 5, J. K. M. L. Farquhar interestingly talked on Dalias. A lively discussion followed, in which it was brought out that dalias were thought to threaten the supremacy of the rose fifty or sixty years ago. Mention was made of the fact that the now popular Cactus, Anemone and other free-flowering forms were formerly discarded as freaks. Propagation, culture, varieties, etc., were discussed.

After adjournment there were refreshments as usual and "heap big" smoke talk.

ROBERT A. MITCHELL.

FOR "POT LUCK" TRY US... HEWS STANDARD POTS

POT MAKERS FOR 140 YEARS

WORLD'S LARGEST MANUFACTURERS

WRITE FOR CATALOGUE AND DISCOUNTS

Pearson Street,
LONG ISLAND CITY, N. Y.

A. H. HEWS & CO., Inc.
CAMBRIDGE, MASS.

452-460 No. Branch St.,
CHICAGO, ILL.

HUNTINGTON (N. Y.) HORTICULTURAL AND AGRICULTURAL SOCIETY.

The fifth annual carnation exhibition of this society was held on March 5. Owing to the quasi blizzard which came the day before, many intending exhibitors failed to get their flowers in. The most conspicuous vase of carnations in the hall was that of "Bay State," exhibited by A. Roper, of Tewksbury, Mass. These were splendid blooms on magnificent stems and were awarded first prize for vase of undisseminated variety. Other awards were White Brothers, 1st for Enchantress and 1st for scarlet, with Beacon, H. F. & A. H. Funnell, 1st for White Enchantress. Huntington Nursery Co., 1st for 25 assorted, August Heckscher, Adolph Ailus, gardener, 1st for roses, both classes, for violets double and single, mignonette, blooming plant, frillage plants, bulbous flowers and greenhouse vegetables. H. L. Pratt, Henry Gaut, gardener, 1st for freesias.

AMERICAN CARNATION SOCIETY.

Carnation Registered.

By The Chicago Carnation Co., Joliet, Ill. "Conquest," Parentage, Day-break Lawson and unknown seedling; color, light pink overlaid with deep rose pink; size of flower, 3 to 3 1/2 inches; habit like Lawson with a stem as long as Enchantress and very stiff.

ALBERT M. HERR.

Lancaster, Pa.

LOS ANGELES (CAL.) FLORIST CLUB.

At a recent meeting of this club the new officers invited the ladies

a huge bouquet of Eschscholtzia California, California's state flower, and a large vase of American Beauty roses, which represented the florist trade of the city. An address was delivered by P. D. Barnhart upon "The Advancement of Floriculture in Southern California". J. G. Morley, superintendent of parks, also spoke entertainingly. Refreshments were served, the orchestra rendered its choicest music at frequent intervals and the evening was pronounced the most enjoyable in the history of the club.

TARRYTOWN HORTICULTURAL SOCIETY.

The February meeting of this society was held on the evening of the 26th instant and was observed as Carnation Night. There was an unusually large attendance of the members, who all seemed mesmerised on seeing such a display of carnations. The prize offered by Mr. Marshall Katonah for three varieties, six of each, brought forward a heavy competition, first honors going to James Stuart, Mamaroneck, who put up Pink Enchantress, Rose Pink Enchantress and Victory in great shape. Robert Angus was second and Thomas Aitchison and W. Jamieson each were awarded an honorable mention. F. R. Pierson Co. exhibited two very promising seedlings, one pure white and the other pink. Both were awarded certificates, and Wm. Roberts, Ossining, also received a certificate for a very dark seedling, and Francis Gibson a cultural certificate for a magnificent bunch of single violets. The work of the evening was devoted to revising the schedules and fixing the dates for the June and fall shows.

W. JAMIESON.



JACOB DEITRICK
President.

and friends and engaged an orchestra of eighteen pieces, under the leadership of Prof. Rudderoff, for the even-



CHARLES WINSEL
Financial Secretary.

ing. The hall was beautifully adorned with flowers and plants by the members. On the president's table stood

STANDARD FLOWER POTS

Packed in small crates, easy to handle.

Price per crate		Price per crate	
1500 2 in. pots in crate	\$4.88	144 6 in. pots in crate	\$3.16
1500 2 1/4 "	5.25	120 7 "	4.20
1500 2 1/2 "	6.00	60 8 "	3.00
1000 3 "	5.00	HAND MADE	
800 3 1/2 "	5.80	48 9 in. pots in crate	\$3.60
500 4 "	4.50	48 10 "	4.30
456 4 1/2 "	5.24	24 12 "	3.60
320 5 "	4.51	12 14 "	4.80
210 5 1/2 "	3.78	6 15 "	4.50

Seed pans, same price as pots. Send for Price List of Cylinders for Cut Flowers, Hanging Baskets, Lawn Vases, etc. Ten per cent. off for cash with order. Address **Hilfinger Bros., Pottery, Fort Edward, N. Y.** August Bolker & Sons, Agts. 31 Barclay St., N. Y. City.

Standard Flower . . POTS

If your greenhouses are within 500 miles of the Capital, write us, we can save you money

W. H. ERNEST

28th and M Street WASHINGTON D. C.

Syracuse Red Pots

STANDARD SIZES

Florists, we will suit you as to quality and prices. Write for catalogue.

Syracuse Pottery Co., SYRACUSE, N. Y.

A Profitable Side Crop

Asparagus plumosus is a main crop with many growers having extensive modern plants but those with less up-to-date establishments, or parts of same defective in lighting or otherwise unsuitable for high grade crops, will find this subject one of the very best. We have prepared a cultural circular giving concise directions how to make money out of this crop. Send for it. No charge. An important feature in asparagus culture is good seed. The P. M. quality of greenhouse grown seed has earned a high reputation for freshness and purity. It is the true nanus and greenhouse grown. Send for trial pkg., 100 seeds fifty cents, if you wish to experiment only. In quantity \$3.75 per 1000 seeds, \$32.50 per 10,000 seeds. Asparagus Sprengeri 75c. per 1000, \$5.00 per 10,000 seeds.

S. S. PENNOCK-MEEHAN CO.

1608 to 1620 Ludlow St., Philadelphia, Pa.
1212 N. Y. Ave., Washington, D. C.

PREPARE FOR EASTER

Headquarters for Easter Plants

What is the best Double Pink Azalea? It is the Mme. Van Der Cruyssen, originated by the well-known Azalea Specialist, M. Van Der Cruyssen of Belgium. We have a big stock of them; every plant is as round as an apple, just covered with buds; just right for Easter. We have them for 60c, 75c, \$1.00, \$1.25, \$1.50 up to \$2.00 each. Herard Andreas alba, \$2.25 to \$3.00; some at \$1.00 to \$1.50. Niole and Deutsche Perle, 75c, \$1.00, \$1.25, \$1.50. Vervaneana, De Schryveriana (best double variegated), 75c, \$1.00, \$1.25, \$1.50, \$2.00. Empress of India, 50c, 60c, 75c, \$1.00, \$1.25, \$1.50. Simon Mardner, 50c, 60c, 75c, \$1.00, \$1.25, \$1.50, \$1.75. Apollo (red), 50c, 60c, 75c, \$1.00. Professor Wolters, 75c, \$1.00, \$1.25, \$1.50, and some more good varieties, 75c, \$1.00, \$1.25, \$1.50. We have Azaleas by the thousand.

Litium Nutiflorum, the best in America, 6 in. pot plants, with five buds and upwards to ten buds, 10c per bud; under five buds, 12c per bud.

Cineraria hybrida grandiflora, 6 in., 25c, 35c, 50c, 75c, \$1.00 each.

Hydrangea Otaksa, 6 to 7 in. pots, 50c, 75c, \$1.00.

Spiraea Gladstone, 6 to 10. pots, 50c, 75c, \$1.00.

Suebia, Floribunda, Japonica, 6 in., 25c, 35c, 50c.

Aracaria Excelsa, largest stock in America, 75c, \$1.00, \$1.25, \$1.50.

Aracaria Robusta Compacta and Glauca, 6-7-8 in. pots, 20 to 35 inches high, 4, 5, 6 tiers, \$1.50, \$2.00, \$3.00.

Kentia Belmoreana, 5/8 to 3/4 in. pots, 50c, 6c, 75c.

Forsteriana, 5/8, 3/4, 6 in. pots, 50c, 60c, 75c, \$1.00, \$1.25, \$1.50.

Hyacinths, four best varieties, white, pink, light and dark blue, 4 in. pots, \$12.00 per 100.

Touresol Tulips, three bulbs in 4 in. pot, 75c.

Van Slon Daffodils, three bulbs in 5 to 6 in. pot, \$2.50 to \$3.00 per doz. pots.

Asparagus Plumosa, 3 to 5 cents.

Ferns, 6, 7, 8 inch, such as **Whitmanii**, **Boston**, **Scottii**, 50c, 75c, \$1.00, \$1.25, \$1.50; **Amerphilli**, 5 to 6 in., 50c, 75c.

Cash with order please. Mention if pots are wanted

GODFREY ASCHMANN

Wholesale Grower and Importer of Pot Plants

1012 W. Ontario St.

PHILADELPHIA, PENNA.

BARGAINS IN DECORATIVE AND FOLIAGE PLANTS

KENTIAS, ARECAS, LATANIAS, in all sizes in the very best condition.

ARACARIAS, RUBBERS, CROTONS, PANDANUSES, ASPARAGUS, COCOS, FERNS for dishes, etc.

EASTER STOCK and BEDDING PLANTS at lowest wholesale rates.

A. LEUTHY & CO.

Perkins St. Nurseries, Roslindale, Mass.

COLEUS! COLEUS!

C. Verschaffeltii and Golden Bedder,	Pr 100	Pr 1000
Same in 2 1/2 in. pots,	R. C. .60	5.00
Same in 3 in. pots,	R. C. 2.00	15.00
Coleus, "Fixed"	R. C. .60	5.00
Same in 2 1/2 in. pots,	R. C. 1.75	15.00
Ageratum Stella Gurney and Pauline	R. C. .50	4.50
Same in 2 1/2 in. pots,	R. C. 1.00	9.00
Feverfew	in 2 1/2 in. pots 2.00	
Fuchsias, our selection,	in 2 1/2 in. pots 3.00	
German Ivy	R. C. 7.50	
English Ivy	R. C. 1.00	

Cash with Order

J. E. FELTHOUSEN

148-154 Van Vranken Ave., SCHENECTADY, N. Y.

CYCLAMEN GIGANTEUM

5, 6 and 7 in. pots—50c, 75c, and \$1.00 each.

Extra heavy stock of the very best quality.

Thomas Mass, Nahant, Mass.

THE MOST BEAUTIFUL FERN EVER INTRODUCED



Nephrolepis Magnifica

The most refined development of the Nephrolepis family. The sensational novelty of the season

Strong 2 1-2 inch stock, \$25.00 per 100

Our general stock of ferns is exceptionally good this year. We are prepared to supply any quantity of the following:

BOSTONS, 2 1/2 in. \$3 per 100, \$30 per 1000 WHITMANII, 2 1/2 in. \$5 per 100, \$40 per 1000
WHITMANII, 3 1/2 in. from Bench, \$8 per 100

HENRY H. BARROWS & SON, Whitman, Mass.

FERNS FOR DISHES,

CASH WITH ORDER

2570 to 2606 W. Adams St., Chicago, Ill.

PALMS AND FERNS DECORATIVE PLANTS

JOHN SCOTT

Rutland Road and E. 45th St. Tel. 2690 Bedford BROOKLYN, N. Y.

In ordering goods please add "I saw it in HORTICULTURE."

SHAMROCKS

The Genuine Article, of Course.

And They're Elegant Plants, too.

\$4.00 and \$6.00 per 100

WELCH BROS.

226 Devonshire St., Boston

VIOLETS Princess of Wales, Lux-onne, California Violets. Rooted Runners, clean and free from disease, \$1.00 per 100, \$8.00 per 1000. Cash with order JACQUES GILBERT, - - - Toylan, Del. Co., Pa

Assorted Varieties From 2 inch pots, \$3.50 per 100; \$30.00 per 1000

FRANK OECHSLIN

Ampelopsis Veitchii, 4 in. pots, \$1.00 per 100; 3 in. pots, 75c per 100. **Ferns, Boston, Scottii**, 4 in. pots; \$1.00 per 100; Boston, 3 in. pots, \$1.00 per 100, Whitmanii, 3 in. pots, \$3.00 per 100. **Asparagus Sprengeri**, 2 in. pots, \$2.00 per 100. **Cannas, King Humbert, Pt. Blanc**, 5 in. pots, \$1.00 per 100. **Clematis Paniculata**, 4 in. pots, \$1.00 per 100; 3 in. pots, 75c per 100. **Clematis**, large flowering varieties, 2 years old, dormant plants; Jackman, Henry, Andre, \$3.00 per 100. **Picus, Elastica**, 6 in. pots, 25c each

G. EISELE, 11th & Westmoreland Sts., Philadelphia, Pa.

HEACOCK'S PALMS

Kentia Belmoreana
7-inch pots.....32 to 34 inches high.....\$2.50 each
7-inch pots.....36 to 38 inches high..... 3.00 "
9-inch tub.....42 to 48 inches high..... 5.00 "
Made up **Kentia Forsteriana**
7-inch pots.....34 to 36 inches high.....\$2.50 each
7-inch pots.....36 to 38 inches high..... 3.00 "
9-inch tub.....42 to 48 inches high..... 5.00 "
Joseph Heacock Co., Wyncote, Pa.

Gladiolus Brenchleyensis

Extra fine Healthy Imported Stock
1,000 \$10.00 10,000 \$80.00

O. V. ZANGEN
HOBOKEN, N. J.

JAPANESE

THE YOKOHAMA NURSERY CO
31 BARCLAY STR. NEW YORK

LILIES

PLANTS

BAMBOO STAKES

WHITE KILLARNEY

"Waban Conservatories Variety"

WE WANT YOUR ORDER

for this beautiful rose which is the finest white rose in existence today for growing cut flowers. We are receiving every day from growers who have purchased our stock, high compliments both as to condition of plants on arrival and also as regards quality of stock. Why not make an effort to see some of our stock?

THEN GIVE US YOUR ORDER AT ONCE

WABAN ROSE CONSERVATORIES NATICK MASS.

THE QUALITY YOU CAN MAKE MONEY ON

CANNAS

SOUND PIECES TRUE TO NAME BED ROCK PRICES

Red-Flowering, Green Foliage

	Per doz.	100	1000
A. Bouvier. 5 ft. Dark crimson.....	\$0.35	\$2.25	\$20.00
Alice Roosevelt. Deep crimson, 4 ft.....	.50	3.50	30.00
Beaute Poltevine. 3½ ft. Dark crimson.....	.35	2.25	20.00
Black Prince. Velvety maroon; 3 to 4 ft; green foliage.....	.50	2.75	25.00
Charles Henderson. 4 ft. Bright crimson.....	.35	2.25	20.00
Crimson Bedder. 3 ft. Intense scarlet.....	.30	2.00	17.50
Duke of Marlborough. 4½ ft. Dark crimson.....	.35	2.25	20.00
J. D. Haese. Brilliant vermilion-scarlet 5 ft.....	.35	2.25	20.00
Explorateur Crampel. Deep rich crimson 3½ ft. Express. Crimson; foliage green. Dwarf habit, 2 to 2½ ft.....	.60	4.50	40.00
Pres. McKinley. Brilliant crimson 2½ to 3 ft.....	.35	2.25	20.00

Pink-Flowering

L. Parry. Delicate rosy pink, 4½ ft.....	\$0.35	\$2.25	\$20.00
Luray. Attractive rosy pink, 3 ft.....	.35	2.25	20.00
Louise. A grand pink, tall Martha Washington. Rose. Height, 2½ to 3 ft. 100 each.....	.75	5.00	
Millie Herat. 4½ ft. Rese-carmine.....	.35	2.25	20.00
Tennyson. Rosy pink; green foliage; 3½ ft.....	.50	3.00	

Orange-Flowered

	Per doz.	100	1000
President Cleveland. Bright, distinct orange-scarlet; 4 ft.....	\$0.35	\$2.25	\$20.00

Red, Gold-Edged and Spotted

Gladiator. Bright yellow, spotted crimson, green foliage; 4 ft.....	\$0.50	\$2.75	\$25.00
Cinnabar. Cinnabar red, edged with distinct golden band; 4½ ft.....	.30	2.00	17.50
Queen Charlotte. Scarlet gold edge.....	.30	2.00	17.50
Mme. Crozy. 5½ ft. Vermilion, gold border.....	.35	2.25	20.00
Premier. Deep crimson, bordered yellow, 2½ ft.....	.30	2.00	17.50
Sou. A. Crozy. 4 ft. Crimson, gold band.....	.50	4.00	35.00

Yellow Shades

Buttercup. 3½ ft. Clear golden yellow.....	\$0.40	\$2.75	\$25.00
Comte de Bouchard. Yellow, spotted red, 4½ ft. Florence Vaughan. 5 ft. Yellow, spotted crimson.....	.50	2.75	25.00
L. E. Bailey. Rich yellow, dotted with red; 4½ ft.....	.30	2.00	17.50

White and Cream Shades

Alsace. 3½ ft. Creamy white.....	\$0.30	\$1.75	\$15.00
----------------------------------	--------	--------	---------

Bronze-Leaved, Red-Flowering

Brandywine. 4 to 5 ft. Dark bronze foliage. Crimson flowers.....	\$0.50	\$4.00	\$35.00
Black Beauty. True. 5 ft. Grand foliage.....	.60	4.50	40.00

	Per doz.	100	1000
David Harum. 3½ ft. Vermilion-scarlet.....	\$0.50	\$2.75	\$25.00
Egandale. 4 ft. Currant-red.....	.35	2.25	20.00
King Humbert. Fine bronze foliage. Orange-scarlet with bright red markings, 4 ft.....	1.00	8.00	75.00
Leonard Vaughan. 4½ ft. Bright scarlet.....	.35	2.25	20.00
Musafolia. The finest foliaged Canna, with enormous musa-like leaves, 3 to 4 ft., of a dark green bronze tinged color.....	.35	2.25	20.00
Philadelphia. A bright glowing red. Height 5 ft. Papa Nary. Large, rich carmine-red, 4½ ft.....	.75	4.00	30.00
Pillar of Fire. 6 to 7 ft. high; flowers bright crimson-scarlet.....	.75	4.50	40.00
Robusta. Height 6 to 8 ft., with immense foliage	.30	1.75	15.00
Shenandoah. Large Salmon flowers, 6 ft.....	.30	1.75	15.00

Orchid-Flowering

Allemanin. 4 to 5 ft. Scarlet and yellow. Green foliage.....	\$0.35	\$2.25	\$20.00
Austria. Pure caesary-yellow; an orchid-flowering type, 5 ft.....	.30	1.75	15.00
Italia. 4½ ft. Green foliage Red bord-red yellow.....	.30	2.00	17.50
Kronus. Rich golden yellow, with patches of bright red, 5 ft.....	.30	1.75	15.00
Mrs. Kate Gray. 6 ft. Green foliage. Scarlet and yellow.....	.30	2.00	17.50
Pennsylvania. 4 ft. Green foliage. Deep scarlet.....	.35	2.25	20.00

CATALOGUE FREE.

We go through the block from 14th Street to 13th Street, but our address is still

ARTHUR T. BODDINGTON, Seedsman, 342 West 14th St., NEW YORK CITY.

PITTSBURG FLORISTS' AND GARDENERS' CLUB.

The meeting of March 10 was well attended. Pres. Burki announced the committees having in charge the necessary arrangements for the Carnation Convention of 1910, the chairman being as follows:

Finance, E. C. Keimeman; exhibition, A. W. Smith, Jr.; reception, C. S. Crall; press, Wm. Falconer; decoration, E. J. F. Zieger.

Bulbous Plants and Flowers was the topic for the meeting, with a competitive display by the private gardeners.

In the forced bulbs class, the prize donated by W. C. Beckert, was won by Fred Wissenbach, gardener for W. L. Mellin. In the class for forced plants in flower other than bulbs, N. C. Madsen, gardener for K. H. Boggs received cultural certificate for three pans of very fine cyclamens. Other exhibitors were Frank Crook, gardener for J. H. Park, who showed pots of tulips, daffodils and hyacinths, plant of *Eranthemum pulchellum*, *Amaryllis* and *Clivia miniata*; North Side Park Conservatories, Jas. Moore, foreman, who showed two pots of *Chorozema varia*; E. C. Ludwig, with vase of mixed bulbous flowers; Phipps Conservatories, Jno. W. Jones, foreman, who showed a large table with tulips, hyacinths, daffodils and cineras. Mr. Jones also showed for the first time before the Club *Narcissus Elvira*, a cross between *Narcissus poeticus ornatus* and *Narcissus Tazetta*, the tender flowering narcissus of which *Paper White* is an example. The cross, *Elvira*, as shown, had a little smaller flower than *Ornatus*, an agreeable perfume, flowers in clusters like the tender type and will force like the tender type but is perfectly hardy out of doors. It attracted considerable attention, and it was thought it would make a plant.

The South View Floral Co., per H. C. Buecheler, manager, showed a large vase of *Rose Pink Enchantress*, cut on Saturday and holding up well Tuesday night. At the preceding Club meeting much complaint was made of the non-keeping qualities of *Rose Pink Enchantress*, and the present exhibitor wished to show that when conditions were favorable it would keep all right. This brought out considerable discussion with the result that it seems that *Rose Pink Enchantress* if grown cool keeps well, but the quantity of flowers produced is lessened.

The retailers ascribe many complaints of the non-keeping qualities of carnations, to the universal use of natural gas in Pittsburg, and where there is imperfect combustion, as frequently happens, the fumes are very harmful to carnations.

Subject for next meeting Easter Plants and Flowers.

H. P. JOELIN, Sec'y.

CHICAGO FLORISTS' CLUB.

This club held its regular monthly meeting on March 4th with a good attendance. The first business was the election of the following new members whose names were proposed at the last meeting:

Chas. Bemis, George Armbrust, F. Merker, D. F. Simons, Chas. Zapfe, F. Krause, F. Haage, F. Ayers, Paul



TAUSENSCHON

New Hardy Rambler; no limit to its sale.

Kubish, Emil Maerz, Chas. S. McColey.

The following names were proposed for membership.

W. F. Scofield, Walter Adams, Geo. Ciser, Michael Fink, Max Ringler, Michael Matcher, R. E. Kurowski, S. W. Baker, John Bell and P. Olsen.

Pres. Asmus added Ollie Beck to the committee on sports and pastimes.

The committee on revision of the by-laws were granted further time. The secretary called attention to the general desire which seemed to prevail among the members for the club to decide upon holding a flower show in the fall of 1909. The question was discussed at length by E. F. Winterson, W. N. Rudd, J. F. Klimmer and others after which the matter was referred to a committee consisting of E. F. Winterson, Walter Scott and P. J. Foley, who should consult with the board of directors of the Chicago Horticultural Society with the object of obtaining the support of that society. Immediate action will then be taken by the Board of Trustees of the club.

It was voted that a ladies' night be held during the month of March and an appropriation was made to cover the cost. The question of life membership came up for discussion with the result that the president will, in the near future, appoint a committee of three to take up the subject and make the proper recommendations. Chas. Morton, formerly of Chicago, now of California, was present and gave an interesting talk on the clubs in his section and the good work they were doing.

The sudden death of E. V. Hallock, of N. Y., was mentioned with regret and the secretary was instructed to telegraph an order for a floral wreath to be sent as a token of esteem from the Chicago Florists' Club. J. H. Pepper, F. F. Bently and J. C. Vaughan were appointed committee to draw up resolutions and send to the bereaved family.

Sec'y J. H. Pepper tendered his resignation with regret, and the club as reluctantly accepted it. Mr. Pepper stated that his recall to N. Y. city had neces-

sitated his action. Louis H. Winterson was elected recording secretary by acclamation to fill the vacancy and the thanks of the Club were tendered to Mr. Pepper for his faithful services.

DOBBS FERRY HORTICULTURAL ASSOCIATION.

A meeting of the Dobbs Ferry Horticultural Association was held in Odd Fellows' Hall, Feb. 27, at which some very creditable exhibits of roses, carnations, sweet peas, violets, etc. were displayed. The judges, Messrs. Knodol, Lindsay and Riley, awarded first prize to J. Holgerson, gardener to Mr. H. T. Seidenberg, and second to Robt. Boreham, gardener to McComb estate; for the best four species of cut flowers cultural certificates were awarded to Messrs. Keeling, Lee and Harnes; and to H. Kastberg, gardener to the Misses Masters, for two bunches of single and double violets. The prize for the next meeting will be for the best flowering plants.

JOHN ERUNGER, Cor. Sec.

CLUB AND SOCIETY NOTES.

The St. Louis Horticultural Society will hold their spring exhibition in the Osceola, March 22-25. O. G. Koenig is secretary.

Prof. Sears of Massachusetts Agricultural College will lecture before the Houghton Horticultural Society, Lynn, Mass., on April 7, on "Fruit Growing from a Commercial Standpoint."

The annual convention and flower show of the National Association of Gardeners will be held in Scheffel Hall, 17th and 3rd Ave., New York City, March 17 and 18. The annual dinner takes place on the evening of March 17.

Jackson Dawson of the Arnold Arboretum was to deliver the last lecture in the Massachusetts Horticultural Society's course on March 6, but owing to his illness his paper was read by Secretary Rich. His theme was "Methods of propagating plants." An unusually large audience was in attendance.

THE ROYAL HORTICULTURAL SOCIETY OF ENGLAND.

A fine display was again made by the trade and fellows of the society, with the result that the hall in Vincent square was occupied in nearly every part. The crush of visitors was very great towards the close of the afternoon.

Orchid Novelties.

I will take certificated orchids first as representing the highest form of the novelty's brought to the notice of the society and visitors. Messrs. Charlesworth & Co. showed *Odontioda Lutetia* derived from a crossing of a species of *Odontioda* with *Odontoglossum luteo-purpureum*. The blooms are 2 1/4 inches wide, the spikes 8 inches in length, on which were eight expanded blooms. It is a brilliant flower of scarlet color, with a mottling of golden yellow. Awards of merit were made by *Brassia Cattleya Cooksoni*, obtained by crossing *Brassia laelia* *Gratorex* and *Cattleya aurea*, the latter greatly employed in making crosses in consequence of the unique influence of the color. The sepals of the hybrid are orange suffused with red; lip rosy purple suffused faintly with orange. This is the most striking feature of the bloom.

Mr. de B. Crawshaw, an amateur of *Odontoglossum* proclivities, showed *Trichopilia suavis*, a native of Costa Rica. The flowers are white, the interior of the throat yellow and having spotting of violet rose on the front and sides. The blooms have the fragrance of hawthorn. Mr. Crawshaw showed *Odontoglossum Cariniferum*, and was awarded a Botanical Certificate. It was a small flower, with a white lip and brown sepals and petals. *Dendrobium Melpomene*, a flower of primrose color, with a brownish purple blotch on the lip. This exhibitor had also *D. Leechianum* and various *Cypripediums*, including *C. Beckmanni*. He was awarded a Silver Banksian medal.

Mr. R. G. Thwaites received an award of merit for *Dendrobium Chesingtonensis* King Cup, a botanist's orchid.

An award of merit fell to Mr. H. A. Tracy for *Cycnocheilus Peruvianum*, the plant having five well developed racemes.

Sir Jeremiah Colman contributed to the show a number of so-called botanical orchids, and among them *Bulbophyllum comassum*, *Dendrobium Mortii*, and *D. Lady Colman* a variety of *D. nobiliss*, in which every part of the flower and its markings are much enlarged, especially the lip.

Lieut. Colonel Holford was awarded a first-class certificate for *Cattleya Trianae* Sir Trevor Lawrence, in which the sepals and petals are of an unusually bright tint and the lip of a rich shade of velvety purple.

M. Maurice Mertens, of Ghent, Belgium, showed a choice collection of *Odontoglossums*, for which he was the recipient of a Silver Banksian medal.

Miscellaneous.

Messrs. J. Vetch and Sons showed an old-fashioned holly-leaved plant in *Crocodylus angustifolia*, which found many admirers among the visitors. Messrs. W. Cutbush & Son showed the rare *Tillipa Kaufmannii*. The flowers

are as regards the upper half of white, the lower half yellow, and the outer petals are flamed with scarlet. The firm showed *Adonis Amurensis*; a hardy, light purple flowered *Azalea*, named *Yodogama* of Japanese origin, the blooms appearing pairwise and very abundant; and *Rhododendron Smithii*, a plant with yellow blossoms, and excellent for forcing.

Carnations.

American and English varieties of carnations formed an exhibition of themselves. Of the first named there were blooms of most of the standard varieties; of English origin, *Fortuna*, a yellow bloom inclined to buff. The bloom is fringed, and is 2 to 2 1/2 inches in diameter, and the calyx does not split. *Snowball* is a large white bloom, round and full of petals, very nearly smooth. Its best flowering season is early spring. It is not a true tree carnation, but a cross between that and a border variety.

FREDERICK MOORE.

A PROPOSED NEW ENGLAND FRUIT SHOW.

The First New England Conference, called by the Governors of the New England States, was held in Boston, Nov. 23, 24, 1908.

At this Conference Prof. John Craig of Cornell University delivered an address on "New England's Opportunity in Orchards," which was followed by suggestions and discussions by the delegates present. This subject matter was referred to the agricultural departments of the several New England States and a representative conference was held at the office of the Massachusetts State Board of Agriculture, Dec. 5th.

At this meeting it was resolved, that this conference recommend to the New England States that a New England Fruit Show, to be participated in by the States of New England, be held in October, 1909, at Boston, and that a representative of the State Board or Commissioner of Agriculture, and one representative from each State Horticultural or Pomological Society, and such others as they may appoint, form a committee for the organization and management of this project.

It was voted to recommend to each State that, where necessary, a special appropriation be made for the collection of State exhibits, and that a committee be appointed from each State in charge of the exhibit from that State. It was further voted that the matter of local arrangements be left to the Massachusetts State Board of Agriculture and the Massachusetts Horticultural Society and that they be requested to call a meeting of the above committee at the earliest possible date.

Such a meeting has been held and arrangements have been made for holding the New England Fruit Show at Horticultural Hall, Boston, on October 19-24 next.

State regulation of horticulture and sale of fruit is provided for in a bill which passed the Washington Senate at its session in Olympia on Feb. 26. In it the office of a horticultural commissioner is created and deputies in 13 districts will be appointed.

Obituary

J. Metz.

J. Metz, a retail florist at 182 East 116th St., New York, died on February 27, at an advanced age. A widow and five children survive him. Mr. Metz has been well and favorably known in the trade for many years. His daughter, who has been buyer for the store since he became unable to attend to it, is the recipient of general condolence and sympathy in the wholesale flower district.

J. B. O'Neil.

J. B. O'Neil, well known to the trade as "Bert" O'Neil, passed away at the home of his father in Elgin, Ill., on March 5. He had been ill for over a year and though he made a brave fight for life tuberculosis claimed him.

Mr. O'Neil was traveling salesman several years for Vaughan's Seed Store and was a young man of much business ability. He had very many friends among the trade who sincerely regret that his career has been cut off in this sad manner.

The funeral services of E. V. Hallock, the late president of the New York Florists' Club, whose sudden death was recorded in our last issue, were held at the family residence in Queens, N. Y., on Saturday, the 6th inst. The house was filled with sorrowing friends, of whom a very large number were members of the flower and seed trade and the New York Florists' Club. Among those from a considerable distance were Mr. and Mrs. J. C. Vaughan and M. Barker, of Chicago; W. Atlee Burpee, of Philadelphia, and W. J. Stewart, of Boston. The floral tributes were many and very beautiful. The interment was in Greenwood cemetery. Mr. Hallock was 58 years of age. Two sisters and two daughters survive him. His wife died a little more than two years ago.

Richard A. Malone, father of Mrs. Thos. F. Galvin of Boston, died at his home in Lancaster, Pa., on March 2, aged 74 years.

NEWS NOTES.

Brooklyn, N. Y.—Andrew Leis, a gardener, committed suicide on March 3 at Hotel Elberon.

Twenty-five thousand acres of land in the French and Italian Riviera are cultivated in the interest of a single French perfumery firm which uses up 2,500,000 pounds of rose leaves and 600,000 pounds of orange blossoms annually.

The third annual meeting of the New England Conference on Rural Progress was held in Boston on March 5, and it was decided to hold a fruit show on an extensive scale in Horticultural Hall on Oct. 19-24. Wilfrid Wheeler of Concord, Mass., is secretary of this enterprise.

The Amesbury and Salisbury Agricultural and Horticultural Society (Mass.) was addressed on March 5 by Miss Mary E. Cutler, of Holliston, on "Profitable Market Gardening."

THE REAL SHAMROCK.

Even at this late day there seems to be some confusion in the public mind as to the identity of the plant known as the "Shamrock."

So many authorities have written on the subject that one might think the matter would be settled by this time, once for all. But no. The merry discussion still goes on. With a sincere desire to add to the harmony of sound, we submit a few points that may help to clarify the situation.

The real shamrock is a three-leaved plant; all authorities are agreed on that. Shamrock and Shamræckh are the Arabic equivalents for trefoil, and the trefoil was held sacred in Iran and was emblematic of the Persian triad long before the days of St. Patrick. St. Patrick used the same idiom in illustrating "trinity in unity" to his flocks in Ireland, and it stands to reason that he did not waste any time about the species of three-leaved plant he picked up to point his moral. It may have been the wood sorrel (*Oxalis acetosella*) of Mr. Bicheno; or the white clover of Prof. Rennie and Dr. Withering (*Trifolium repens*); of the black m-dick (*Medicago lupulina*) of Loudon. In a way, all these authorities are right. The three leaves were there in all of them. So they were all "Shamrocks", of course, according to the Arabic meaning of the word.

It only remains to get at the identity of the plant known among the Celtic people as the "Irish Shamrock."

Mr. Croker points out that as far back as 1485 the Irish themselves considered sorrel and shamrock as entirely distinct. The Irish *Eudibras* printed in 1689 says:

"Springs, happy springs, adorned with sallats,
Which nature purposed for their pallats;
Shamrocks and watercress he shows,
Which was both meat and drink and clothes."

In the same work the Irish are represented as:

"Without a rag, trowsers, or breeches,
Picking up sorrel and sham-rogues."

Another illuminating passage occurs in the "Hespero-neso-graphia," one of the ancient classics of Irish literature:

"Besides all this, vast bundles came
Of sorrel, more than I can name,
And many sheaves I hear there was,
Of shamrocks, and of water grass,
Which there for curious salads pass."

From all of which it would appear that the sorrel and the water cress were considered in a class by themselves by the Irish and that the shamrock was a different plant.

Irish botanists of note, including Keough, Threilkeid, and others assert that all history, romance, sentiment and common sense unite in designating *Trifolium repens* as the true Irish Shamrock. The weight of evidence seems to be in their favor and the studied effort of late years to make it *Trifolium minus* seems to have very little ground to stand on. If one imports a piece of Irish sod with clover on it one has a right to sell it for pieces of eight; but outside of that—anyone with *Trifolium repens* can say with a clear conscience that he has the real "Irish Shamrock."

To my mind, the spirit of interna-

CARNATION LUCILLE.

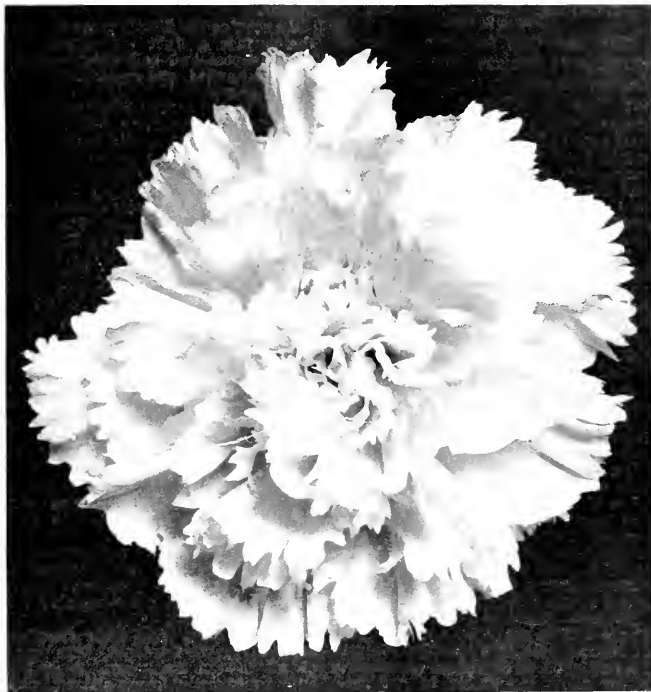

On this page we give a "life-size" of Carnation Lucille, the beautiful novelty being sent out now by A. F. Longren and grown by Fritz Bahr at Highland Park, Ill. It is only a short ride on the Chicago & Milwaukee electric cars and it presents a sight worth going many times further to

see. Unlike Prosperity, which it somewhat resembles in color, Lucille is extremely productive and the stems are strong and very long. The plants are thickly covered with buds and blooms. Lucille is a beautiful flower, easy to grow and makes plenty of cuttings.

tional comity as exemplified in our celebration of St. Patrick's Day is a far more noteworthy and significant sign of the times than any technical controversy over botanical subtleties. Twenty-five years ago all those millions of Irish birth and extraction took the note of St. Patrick's Day—now everybody celebrates that auspicious anniversary from London to Melbourne, New York to Tokyo. And the outward and visible sign is the shamrock. Every florist's store the world over has shamrocks to sell St. Patrick's Day.
"St. Patrick, they say, came up Bantay Bay,
Sitting cross-legged astride on the top of a whale;
And the spalpeens were scared,
And they saucer-eyed stared,
Saying: Arrah be gobbs, 'tis the man in the moon."

But the saint was the real thing, all right, and we all take our hats off to his memory. G. C. W.

FIRE RECORD.

Rehoboth, Mass.—Manuel R. Serpa lost his greenhouse filled with vegetable plants, tools, etc., through a fire that started early on the morning of March 4. He had no insurance.

PHILADELPHIA NOTES.

Among our recent visitors: Ernest Weinhoer, of the Weinhoer Floral Co., and H. N. Bruns, Chicago; Mr. Embden, Mount Vernon, N. Y., representing Dutch, Belgian and German houses.

What is the proper pronunciation of *Leucothoe*? Most of our local florists call it "Lu-co-thea," others, more particular, say it should be "Lu-co-they." Which is right? This evergreen, introduced to the florist trade about twenty years ago, is now one of the most popular and useful subjects. *Catesbaei* is the species used, Virginia to Georgia. All up-to-date wholesale houses now carry it.

[Pronounced Lu-co-thoe, accent on second syllable.—Ed.]

The Elberon Horticultural Society held its regular meeting March 1st. It being exhibition night the following points were awarded: Peter Ewen, for Stock Queen Alexandra, 88 1-3; W. R. Seymour, callas, 78; W. R. Robertson, *Dendrobium*, 90; J. Legat, carnation Lady Bountiful, 81 2-3. At the next meeting, March 15, Wm. Turner will read a paper on some timely subject.

CULTURE OF THE GARDENIA.

Paper read by William Kleinheinz before the Florists' Club of Philadelphia, March 2, 1909.

The best time for propagation of gardenia is January and February. Select your cuttings from strong growing, healthy plants. I have experimented with propagating in sand in half peat and half sand, and also in a mixture of fine chopped sphagnum moss, peat and sand in equal parts, and have found the mixture the best, as I always get the strongest roots on cuttings propagated in this last mentioned composition.

It is very important to give sufficient heat; I should say 75 to 80 degrees on bottom and 70 to 75 degrees on top. Syringe two or three times a day, protect from the sun and never allow any draught to strike the cuttings. Under this treatment the cuttings will be rooted in from twenty to twenty-five days. Then the young plants must be potted into 2-inch pots in a mixture of half peat and half well-rotted compost. Never allow them to get dry, and protect from the sun for three or four days. Keep the house at a temperature of 68 to 72 degrees at night and 75 to 80 degrees in daytime, for about one week, until the young roots are coming through the soil, then commence to reduce the temperature at 65 to 68 degrees at night and 72 to 75 degrees during the daytime, and the young plants will soon begin to grow.

In from three to four weeks the plants will be ready for a shift into 3 or 3½-inch pots, and the shifting must be continued as often as necessary. Never allow the plants to get pot-bound.

All the buds must be removed to secure a good, healthy growth.

In the month of July the plants should be in 5 or 6-inch pots, and this is the time to plant on benches. Be sure to have good drainage in all cases, especially in the benches, as this is a very important item. The soil must be one part rough peat and two parts well rotted compost, with a little sand mixed under. I found it well to mix a little pulverized sheep manure with it.

The distance to plant is about 12 to 15 inches each way, but great care must be exercised in planting, to see that it is not done too deeply, as the young, fibrous roots always run on top and those are the ones to take care of. Plant solidly, but not too firmly, and leave a little drain around each plant, so that every one can be watered separately.

Two weeks after this the bench can be leveled off and packed some, but not too firm, to give the water always a chance to run through the soil quickly.

From September 15th on the critical time begins, as the plants will now show buds, and we all know that the most difficult part of flowering Gardenias in winter is to keep the buds. Great care must be exercised from now on until February 15th.

The falling off of buds is caused by irregular temperature, over-watering, running too dry, and by syringing with very cold water. Great care must be taken to avoid these mishaps. The night temperature should be 65 to 68 degrees, as nearly as possible, but

never below 65 degrees, and in daytime should be about ten degrees higher.

As soon as the fibrous roots show on the surface a light top dressing of half compost and half sheep manure must be applied, and repeated as often as necessary.

This is one treatment under which I have grown Gardenias with success, but I have tried another way also, with good results. I have been growing my plants up to 7-inch pots under glass all summer. August 1st I removed the glass and kept the plants in the open until September 15th. This ripened the wood and the flowering buds could be found at the end of each growth by that time. The plants have to be moved under the glass again when the nights get cooler. I have planted a bench, when the plants have been treated in this manner, by October 1st and cut a very fine crop of flowers from December 15th on.

This method gives anyone the chance to have Gardenias in succession if you have different houses to plant in rotation, as you can hold them in a cool house at about 52 to 55 degrees at night, until wanted for forcing. By planting in the bench, it is understood that I mean to give them the same treatment as in the first method.

The varieties grown are principally Veitchi or Florida and Floribunda. Gardenia Fortunei produces larger flowers, but it is more suitable for summer flowering.

As all plants have their enemies, so, also, has the Gardenia. The worst of all is the mealy-bug. Syringing with a mixture of lemon oil and Rose-leaf keeps them in check, but the best and surest remedy is prevention. This can be accomplished only by heavy syringing with a good force of water, in summertime I would say three times a day, and as the days get shorter reduce to one, or, in bright days, to two applications.

WASHINGTON INAUGURATION NOTES.

March 4th, with its sleet and snow, rain and thunder is, "manks be," a thing of the past. Not for years, as all the world already knows, has Washington been called upon to endure such a storm as swept over it the night of the third and day of the 4th, for more than twelve long hours. Business of every kind was virtually paralyzed. The Court of Honor in front of the White House which had been beautifully decorated by Gude Bros., presented a bedraggled and ragged appearance, and but for the substantial quality of the decorations it would have been entirely ruined.

The hall room, which was decorated by Small, was a marvel of beauty, one of the chief features being a sunken fountain in the center. Here hundreds of pot plants of specimen azaleas, genistas, bougainvillias and baby ramblers were banded from the center up to the outer edge, which was finished by a row of ferns and palms. The entire building was hung with patriotic emblems, among which the colors of the newly made President's alma mater were conspicuous.

PREPARING FOR BEDDING PLANT TIME.

With the approach of long days and the warmth of sunshine, it is necessary that the cutting bench be prepared in readiness in order to have a supply of good plants when bedding-out time arrives.

Prepare your cutting bench and see that it is thoroughly cleaned and replaced with clean fresh sand to a depth of three or four inches, which is sufficient for most bedding plants.

Look over all stock plants that have been carried over from last fall and select cuttings from none but healthy plants; it may be well to state that this is the only means by which a large number of plants are kept true to character.

Athenanthera.—Insert cuttings and if a greater supply is needed than the number of cuttings at your command, divide up old plants and put them in the bench, so that root action is encouraged, after which they may be potted into two-inch pots, which will be sufficient to carry them along, or they may be planted in small flats.

Geraniums that have been carried over winter in two and two-and-one-half-inch pots must now be shifted and pinched. If short of any particular variety take off the tops and insert in cutting bench; these will make thrifty plants by the last of May.

Cuttings of the following plants are best started now, viz., Ageratum, Abutilon, Achyranthus, Stevia, Centaurea candidissima, Fuchsia, Petunia, Begonia maculata, E. Vesuvius and Erfordii. The latter species begonia is frequently raised from seed, but from my experience I find that cuttings make the best plants and are more prolific than if young soft wood cuttings are taken.

In shading the cuttings it would be well to state that a little sun in the early morning and in the late afternoon will not hurt; in fact it is beneficial for it will dry up any moisture that may gather around the cuttings over night, or during the day while shaded, thus preventing damping off.

Cannas need urgent attention. Select the strongest and most promising eyes; put them into small flats; after root action is started pot off into four-inch pots, in which they can remain until bedding out time.

RICHARD J. HAYDEN.

GARDENERS' AND FLORISTS' CLUB OF BOSTON.

The next meeting of the club will be held at Horticultural Hall on Tuesday evening, March 16, 1909, at 8 o'clock. Owing to the decease of Mr. E. V. Italloek of Queens, N. Y., who was to have been the lecturer of the evening, Mr. Robert Cameron of the Harvard Botanical Gardens has kindly volunteered to favor the club with a paper on "Perennial Plants." There will be, as usual, attractive exhibits and other interesting features.

The annual club banquet has been postponed to April 14 at the solicitation of a number of members. Tickets may be had from the officers and members of executive committee, as well as at the coming meeting. It is planned to make the coming banquet the best the club has yet held.

W. N. CRAIG, Secretary.

Lucille Won Highest Honors

At Springfield, St. Louis and Utica.

A carnation which while a fancy of the highest exhibition type, yet has all the best qualifications as a profitable commercial crop. Its beautiful color

WHITE OVERLAID WITH PINK,

size, stem, perfection of form, habit, productiveness and keeping quality place it unquestionably in the front rank. It is a coming standby and should be in every carnation grower's collection. WRITE FOR DESCRIPTIVE CIRCULAR.

\$12.00 per 100. \$100.00 per 1000. Fine Healthy Stock.

A. F. LONGREN, DesPlaines, Ill., HIGHLAND PARK GREENHOUSES, Highland Park, Ill.

CARNATION CUTTINGS

We offer choice varieties for February and later shipments.

	Per 100	Per 1000
Enchantment.....	\$2.50	\$20.00
White do.....	3.50	30.00
Rose Pink do.....	2.50	20.00
White Perfection.....	2.50	20.00
Winsor.....	3.50	30.00
Melody.....	2.50	20.00
Beacon.....	3.50	30.00
Victory.....	3.50	30.00
Aristocrat.....	3.50	30.00
Splendor.....	6.00	50.00
Vesper.....	3.50	30.00
White Lawson.....	2.50	20.00

EAST SUDBURY GREENHOUSES, Carnation Specialists

P. O. Address South Sudbury, Mass.

Telephone No. Sudbury 20

Orders for this stock filled also by

WELCH BROS., 226 Devonshire St., Boston

Send for our Preliminary List describing and quoting

Chrysanthemums and Carnations.

A fine lot of Carnation Cuttings ready now.

THE E. G. HILL CO., Richmond, Indiana.

PETER FISHER ELLIS, MASS.

Send for Price List of Carnations

MARCHIONESS

The Money Making White Carnation \$10 00 per 100; \$80.00 per 1000

Orders Filled Strictly in Rotation

BELLAMY BROS.

Successors to L. E. Marquette. SYRACUSE, N. Y.

CARNATION CUTTINGS

Ready for delivery March 20th to 25th.

Andrew Carnegie, Delicacy, Splendor, Pres. Seelye, Afterglow, Lawson-Enchantment, Sarah Hill, 86 per 100; 850 per 1000, White Perfection, White Enchantress, Winsor, Rose Pink Enchantress, Enchantress, Lady Beautiful, Melody, White Lawson, 85 per 100; 825 per 1000.

Chicago Carnation Co. A. T. Pyfer, Mgr. Joliet, Ill.

CARNATIONS

WINONA—The true pink—At Indianapolis, in class A, won 1st prize in six entries for best vase of 100 blooms of light pink lighter in color than Lawson. A grand commercial sort in great demand. Place your order now for prompt delivery. \$6.00 per 100, \$56.00 per 1000

F. DORNER & SONS CO. La Fayette, Ind.

A. N. PIERSON, Inc. CROMWELL, CONN.

Wholesale Growers of Cut Flowers, Palms and Ferns

OUR SPECIALTIES: Roses, Lily of the Valley, Carnations. We also grow a general assortment of flowers in their season.

CARNATION CUTTINGS READY FOR IMMEDIATE DELIVERY

	Per 100	Per 1000		Per 100	Per 1000
WINSOR (sand or soil)	\$3.00	\$25.00	VICTORY	\$3.00	\$20.00
ROSE PINK ENCHANTRESS	2.50	20.00	DEFIANCE (soil)	6.00	50.00
			ENCHANTRESS (sand)	2.00	18.00

JENSEN & DEKEMA, 674 W. Foster Ave., Chicago

A WIRELESS WINNER

Has Won Absolutely on Its Own Merits. Certificates Innumerable Everywhere
 MASSACHUSETTS HORTICULTURAL SOCIETY'S SILVER MEDAL LAST YEAR
 AMERICAN CARNATION SOCIETY'S GOLD MEDAL THIS YEAR

THAT'S THE RECORD OF
 It is Invincible. **BAY STATE** Buy it and Grow it.

The noblest carnation ever introduced. White with carmine pencillings.
 ROOTED CUTTINGS, - \$12.00 per 100, \$100.00 per 1000.
ALBERT ROPER, - - - - - TEWKSBURY, MASS.

NEW RED GARNATION O. P. BASSETT

Extra Large Bright Red Free Bloomer
 PRICES
 Rooted Cuttings, per 1000, \$60.00 | Rooted Cuttings, per 100, \$8.00 | Rooted Cuttings, per 25, \$2.50
 per 500, \$35.00 | per 50, 4.50 | per 12, 1.50
 Ready for delivery Jan. 1st, '09 by the Originators and Growers
BASSETT & WASHBURN, HINSDALE, ILL.

GARNATIONS ROSE MY MARYLAND

Standard sorts and all the novelties of merit. Orders booked now for this most promising variety.

CHRYSANTHEMUMS S. J. REUTER & SON, WESTERLY, R. I.

CARNATIONS Rooted Cuttings Fine Healthy Stock

	Per 100	Per 1000
Pres. Seelye.....	\$6.00	\$50.00
White Enchantress, Beacon 3 50	3.50	30.00
Victory, Winsor, Melody, Kingston Pet.....	3.00	25.00
Daheim, Enchantress, Lady Beautiful, Mrs. Lawson, White Lawson, Red Lawson, Variegated Lawson	2.50	20.00

WOOD BROTHERS FISHKILL, N. Y.

ROOTED CUTTINGS Wm. H. Taft, \$12 per 100; \$90 per 1000

	100	1000
Enchantress.....	\$1.75	\$15.00
Pink Lawson.....	1.50	12.50
White Lawson.....	2.00	18.00
Variegated Lawson.....	2.75	25.00
Victory.....	2.50	20.00

SCHMIDT & SCHOOLS, 58-60 Wabash Ave., Chicago.

In ordering goods please add "I saw it in HORTICULTURE."

Tobacco Paper IS THE **“NICO-FUME” LIQUID**
STRONGEST, **OVER 40% NICOTINE**
BEST PACKED, **By far the**
EASIEST APPLIED. **CHEAPEST.**

Furnishes the Most Nicotine for the Money! **JUST NOTE PRICE!**

24 sheets.....	\$ 0.75	Pint.....	\$ 1.50
144 sheets.....	3.50	½ Gallon.....	5.50
288 sheets.....	6.50	Gallon.....	10.50
1728 sheets.....	35.10	5 Gallons.....	47.25

... Manufactured by ...
THE KENTUCKY TOBACCO PRODUCT CO., Louisville, Ky.

ABOUT CYANIDE OF SODIUM.
 Bustleton, Pa., Feb. 13, '09.
 Editor HORTICULTURE.
 Dear Sir: In a recent issue of HORTICULTURE, under the heading "Fumigating with Hydrocyanic Acid Gas," and signed Alfred J. Loveless, mention is made of "cyanide of sodium." My druggist wants me to ask you whether you did not make a mistake and mention "sodium" instead of potash. Any information on the subject will be thankfully received.
 Yours truly,
JAMES T. BAKER.
 Bustleton, Pa.

Editor of HORTICULTURE:
 Dear Sir:—As there appears to be some doubt in the minds of many of your readers concerning my statement with reference to the use of cyanide of sodium for fumigating, I beg to state that I made no mistake in the name in my article which appeared in HORTICULTURE, and can assure any of your readers that no ill effect will follow its use, as recommended.
 I have tried purified cyanide of potassium but failed to get the satisfactory results which always attend the use of cyanide of sodium, but feel perfectly safe in saying that if the foliage is quite dry on your plants, equally good results will follow the use of either kind, but the commercial grade is pure enough for the purpose. I have used the imported cyanide of sodium as supplied by A. T. Poddington and also some purchased at our local drug store, and both have been equally satisfactory.
ALFRED J. LOVELESS.

NEWS NOTES.

Geneva, Ill.—William Grote has made an extensive addition to his nursery.

Springfield, O.—The Leedle Floral Co. increased its capital stock from \$10,000 to \$20,000 on February 25.

Rockland, Me.—Mrs. E. C. Mather is planning to increase her office space and to add a bulb cellar at an early date.

Parma, Mich.—E. G. Hubert, at present raising vegetables under glass, intends to add plants in the near future.

Poughkeepsie, N. Y. The bursting of the hot water boiler at the establishment of A. Relyea & Son on Feb.

THE STRAWBERRY BLIGHT, ITS CAUSE AND CURE.

How to more than double the yield of crop without increasing the cost of production. A great discovery. Price of book \$2. Worth \$25.

WM. C. TRIMBLE, Princeton, Ill.

26 caused some inconvenience, but within twelve hours a new boiler was installed and little damage to stock resulted.

Springfield, O.—Harry Reeser has recently bought several acres of land and it is stated will start again in the florist business.

Webb City, Mo.—Mrs. S. S. Breneman has secured H. R. Fisher, a former employe, to manage the place since Mr. Breneman's death.

Stoughton, Mass.—Prior to the distribution of seeds to the school children for their spring work, Robert Hutecheon, the local florist, gave an interesting talk on the subject.

Hastings, Neb.—W. M. Bonnell and Earl Cooper, of Iowa, have purchased ten acres of land and will engage in a wholesale and retail nursery business.

State College, Wash.—One hundred students were in attendance at the first regular short course in horticulture under Prof. W. S. Thorner at the state college this spring.

Wenatchee, Wash.—Prof. Van Holderbeke, formerly State fruit inspector, states that the peach crop in this section has not been damaged by the high winds and a normal crop may be expected.

Albuquerque, N. Mex.—A company, to be known as the Albuquerque Floral Co., has been organized, four acres of land purchased and greenhouses will be at once erected. Mr. Brainard is the manager.

Watertown, Ill.—It is stated that J. J. Staack & Son, of Moline, have taken an option on thirteen acres of land here and will expend \$16,000 in establishing a nursery, but they are not yet ready to make definite statement regarding their plans.

Salt Lake City, Utah.—Under the auspices of the State Board of Horticulture a number of the fruit growers' associations met on Feb. 24 to form an organization to market their crops. J. H. Forristall told of the methods of the Southern California Fruit Exchange.

San Francisco, Cal.—The State Commission of Horticulture, quarantine division, has made its annual report and shows that at the city of San Francisco more than 50,000 packages of fruits, vegetables or trees brought into the state have been examined by them. They have found that the old plan of fumigating did not effect the purpose, so all infected shipments are now destroyed.

WIZARD BRAND MANURES
 Dried, screened and packed in bags of 100 lbs. each.

PULVERIZED SHEEP MANURE
 PURE — UNIFORM — RELIABLE
 A strong and quick acting manure, highly recommended for carnations and chrysanthemums.

SHREDDED CATTLE MANURE
 EASY TO HANDLE AND APPLY
 Stronger and better in every way than rough manure. Lasts much longer on the benches. Unequaled for mulching and feeding roses, liquid manuring and mixing with bench and potting soil. Used by all the largest growers.

Ask Your Supply Man or Write Us for Circulars and Prices.
THE
Pulverized Manure Co.
 31 Union Stock Yards, CHICAGO

In ordering goods please add "I saw it in HORTICULTURE."

Which Spray Pump
 shall you buy? Buy the Spray Pump that fully meets the demands of the Government Agricultural Scientists and all practical Fruit Growers. These pumps are widely known as **DEMING SPRAYERS** and are made in 22 styles for use in small gardens or immense orchards. Write for our 1909 catalog with **Spraying Chart**, Add 4 cents postage and receive "Spraying for Profit," a useful guide book.
CHARLES J. JAGER CO.
 281-285 Franklin St., Boston



SHEEP MANURE
 Pulverized. Free from Adulteration
 In Bag, \$18.00 per Ton. Cash with Order
ROBERT SIMPSON
 CLIFTON, N. J.

TARGET BRAND Weed Killer
 Sold at retail by a thousand of seed houses and dealers. Special price in quantities to parks and cemeteries
TARGET BRAND, Box 732, Martinsburg, W. Va.



Yi Fluid

**THE IDEAL WINTER SPRAY
SCALE KILLER & FUNGIGIDE**

POWERFUL CLEANSER AND INVIGORATOR
Mixes Instantly. No Sediment. No clogging. Non-injurious to user
COMPARATIVE TEST WILL PROVE ITS MERITS

Quart, \$1.00; Gallon, \$3.00

1 gallon makes 100 gallons. Write for descriptive pamphlet and testimony

PROPS. W. COOPER & NEPHEWS
177 ILLINOIS ST. CHICAGO

Gen'l Agent—CYRIL FRANCKLYN, 62 Beaver Street. New York, N. Y.

For Trees, Plants, Shrubs and Flowers

— USE —

THE NIAGARA BRAND LIME SULPHUR SOLUTION

It destroys Scale Lice, Spiders and all forms of Aphides, AT THE SAME TIME Mildew, Blight, Rust and other Fungus difficulties.
Used in Winter or Summer. — No other remedy has been so universally effective.
Niagara Brand ARSENATE OF LEAD for chewing insects is equal to the best and better than the most
Ask about our Greco House sorayer. Address —

NIAGARA SPRAYER CO., - - Middleport, N. Y.

U-N-IT Globe Sprayer.

Brings out in solution, with water, what is put into Globe Insecticides, Germicides, Fungicides, Fertilizing solutions, soap solutions, etc.
Practical: saving work, time and money. — An investment for every Florist
Tested at 150 pounds water pressure. Write for circulars or better still order one now from your dealer or sent prepaid on receipt of \$3.50.



ADDRESS
Dept. H, J. F. CASS MFG. CO, Detroit, Mich.

DON'T EXPERIMENT

USE

To-BAK-INE

and your stock will be free from insects, clean, and the blooms will not be discolored.

Send for full information of

H. E. FISKE SEED CO.
13 Faneuil Hall Sq., Boston, Mass.

STUMPP & WALTER CO.,
50 Barclay St., New York.

HENRY F. MICHELL & CO.,
1018 Market St., Philadelphia.

E. H. HUNT, Gen'l Agent,
76-78 Wabash Ave., Chicago.

KILMDEAD

**The best of all
the tobacco
dusts for**



**Dusting or
fumigating**

25 lbs., \$1.00	100 lbs., \$ 3.00	1000 lbs., \$27.00
60 lbs., 1.75	600 lbs., 14.00	2000 lbs., 62.50

Stumpp & Walter Co. 50 Barclay St. New York.

"Every Bug Has his Dose."

Insect-destroying preparations that do their work well and effectively are the cheapest. Bowker's Arsenate of Lead and Bowker's Pyrox are recognized standard insecticides and fungicides for both indoor and outdoor use. Bowker's Insect Emulsion destroys many kind of plant lice, black and green flies, etc. Call or send for catalogue.

BOWKER INSECTICIDE COMPANY
43 CHATHAM ST. BOSTON



**The Best
Bug Killer and
Bloom Saver**

For PROOF
Write to

P. R. Paletthorpe Co.
OWENSBORO, KY.

SOMETHING NEW for GREENHOUSES

"SULFOCIDÉ"

PRATT'S
**SOLUBLE SULPHUR
SUMMER SPRAY**

Non-caustic and non-irritating
A FUNGICIDE AND INSECTICIDE
FOR FRUIT TREES, VEGETABLES and GREENHOUSES

A promising substitute for Bordeaux mixture. For 10 cts. to cover postage will send sample sufficient for one gallon of spray.
Use 1 part to 75 or 100 parts of water.

B. G. PRATT CO., 50 Church St., New York, U. S. A.

In writing to Advertisers kindly mention Horticulture

Seed Trade

AMERICAN SEED TRADE ASSOCIATION.

Watson S. Woodruff, Orange, Conn., Pres.; J. C. Robinson, Waterloo, Neb., First Vice Pres.; C. E. Kendall, Cleveland, O., Sec'y and Treas. Twenty-seventh annual convention June 22-24, 1909, at Clifton House, Niagara Falls, Ont.

WHOLESALE SEEDSMEN'S LEAGUE.

F. W. Bruggerhof, Pres.; Burnet Landreth, Sec'y.

THE ZIEGLER SALE.

F. L. Ziegler who has for several years conducted a seed and florist business at No. 18 Broadway, also during the summer months at 138 Bellevue avenue, Newport, R. I., recently became bankrupt and the contents of both stores were sold at public auction March 6th. The seeds were arranged in large lots and if good went very cheap, the peas and beans in many cases not averaging two cents per quart. The plants which were mostly fennels, ferns and aspidistras, probably brought their value. Mr. Ziegler will be succeeded in the flower business at the Broadway store by C. Os-

car Schultze the well known Newport nurseryman and florist.

NOTES.

Falmouth, Mass.—The new office and seed store of H. V. Lawrence is nearly ready for occupancy.

Yankton, S. D.—The Garney Seed Co. has found its present quarters over-crowded and has leased another building for a storage warehouse.

Columbus, O.—The Livingston Seed Co. lost about thirty-five hundred dollars' worth of stock in the West Spring street fire, in one of their storage rooms. It was fully insured.

GREENHOUSES BUILDING OR CONTEMPLATED.

Fremont, Neb.—C. H. Green, additions.

Marinette, Wis.—Geo. Vatter, one house.

Baltimore, Md. Harry Ekas, house, 16X120.

Columbiana, O.—Loy Smith, one house.

Guthrie, Okla.—Furrow & Co., house 50 x 150.

Lynn, Mass. F. J. Delansky, range of houses.

Albion, N. Y. J. T. Duquette, range of houses.

Springfield, O.—Leedle Floral Co., two houses.

Waterbury, Conn.—T. S. Lewis, house 20 x 50.

Summit, N. J.—J. N. May, five houses, each 28X25.

Greenville, Mich.—Greenville Floral Co., range of houses.

Pocatello, Ida.—W. A. Staley, extension 18 x 60, also a potting shed.

The King Construction Co., N. Tonawanda, N. Y., reports having received orders since December 1, 1908, from the following:

John N. May, Summit, N. J., five houses, each 28 x 225; H. K. Elston, Rochester, N. Y., house 14 x 18; Thomas Young, Jr., Bound Brook, N. J., two houses, each 25 x 500; W. G. Eisele, West End, N. J., two houses, each 26 x 150, lean-to, 7 x 150; State Hospital, Rochester, N. Y., house 25 x 150; P. & W. O. Jahn, E. Bridgewater, Mass., house 42 x 130; F. C. Mossgraber, Rochester, N. Y., house 28 x 150; John Welsh, N. Y., Upsal Station, Germantown, Pa., house 35 x 300; Ed. Sick, Canadaigua, N. Y., house 22 x 90; R. G. Merritt & Co., Grange, Md., two houses each 32 x 200; C. F. Brehmen, Chillicothe, O., house 42 x 83, two connected houses, each 25 x 83; White Bros., Gasport, N. Y., house 42 x 125; George Haffer, Jr., Irondequoit, N. Y., two houses each 32 x 125; Richon & Hermes, Parame, France, two houses, each 39 x 181.

The Illinois Heater and Manufacturing Co. are nicely settled in their new office at 35 Dearborn street, Chicago, where they have a better opportunity to show their self watering flower boxes and other horticultural specialties.

Everything "For the Land's Sake."

The one firm in Boston where all good forms of plant food may be obtained, is the Bowker Fertilizer Company, opposite Faneuil Hall at 43 Chatham St. All greenhouse chemicals, Nitrate of Soda, Ground Bone, Potash Salts, Sheep Manure and Wood Ashes can there be had at first hands.

BOWKER FERTILIZER COMPANY

Everything "For the Land's Sake."

Michell's Unexcelled ASTERS

QUEEN OF THE MARKET
EXTRA EARLY Tr. pkt. Oz.

Dark Blue	\$1.50	\$0.50
Light Blue29	.10
Crimson29	.50
Pink30	.50
White26	.50
Mixed29	.50

INVINCIBLE

A superior strain of great value to florists for cuttings Tr. pkt. Oz.

Blue	\$1.50	\$1.50
Crimson30	1.50
Lavender30	1.50
Rose-Pink30	1.50
White30	1.50
Mixed30	1.50

Write for our Wholesale Catalog
HENRY F. MICHELL CO.
1018 Market St., PHILA.

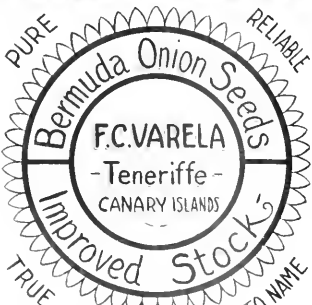

NO COMPLAINTS AND - NO TROUBLE WITH MY SEEDS

Aster Seed

Sale of our unique Aster Lady Roosevelt, pre-eminent chrysanthemum type, The Queen of Autumn. The choicest of the cut flowers marketed the past season at wholesale direct to the retail florist brought \$2.00 per dozen net, bloom stems ranged from 30 to 44 inches in length, flowers from 3 1/2 to 3 3/4 inches in diameter, every blossom upon every plant produced per petal and has been, the past seven years, and also free from disease of any kind, whether rot, yellow or blight, a record we challenge the world to equal. Write ten-losing stamp for return postage to price of seed and other information in relation to culture. Address:

DEPT. B

The Scientific Intense Culture Ranch Co.

SALE 7, OREGON, formerly of Elmhurst, Ill.

VEGETABLE PLANTS

FOR TRANSPLANTING

CABBAGE - Wakefield and Succession \$1.00 per 1000

EGG PLANT - N. Y. Improved and Black Beauty 40cts. per 100, \$1.00 per 1000

PEPPER - Bull Nose, Ruby King and Sweet Mountain 40cts. per 100, \$1.00 per 1000

Chinese Giant and Cayenne, 50cts. per 100

TOMATO - Earliana, Chalk's Jewel and Early June Pink, 50cts. per 100, \$3.00 per 1000

CASH WITH ORDER

R. VINCENT, JR., & SONS CO.
White Marsh, Md.

200,000 GLADIOLI BULBS
1/2 to 1 1/2 inches, \$2 per 1000. 1 1/2 to 1 3/4, \$4 per 1000. 1 3/4 and up, \$5 per 1000.

CALIFORNIA PRIVET

1 yr. well branched, \$20 per 1000. Cash with order. Nice lot of AMERICAN CHESTNUT TREES at a bargain, about 50 LARGE SUGAR TREES, most of them sample trees.

Surplus of STONE TOMATO SEED: Ruby King, Neapolitan, Bull Nose and Sweet Mountain Pepper Seed at a bargain.

I. & J. L. LEONARD, - Iona, N. J.
Vegetable Plant Nurserymen and Seed Growers

Mignonette

**FARQUHAR'S
GIANT**

Oz., 75c; 1-4 oz., 25c

R. & J. Farquhar & Co.
6 & 7 South Market Street
BOSTON, MASS.

RELIABLE SEEDS SOW NOW

CHINESE PRIMROSES large flowered exhibition strain, Pure White, Pink, Mauve, Blood Red. Each Color Separate per 1000 seeds \$2.00, per tr. pk \$5.00. All Colors, Fine Mixed 1000 seeds \$1.50, per tr. pk \$5.00.

OBCONICA PRIMROSES large flowered exhibition strain, Carmine, Daybreak, Purple, Pink, Pure White, Lilac. Each Color Separate per 1000 seeds \$1.00, per tr. pk \$5.00. All Colors, Fine Mixed 1000 seeds \$1.00, per tr. pk \$5.00.

FOR OTHER VARIETIES SEE MY CATALOGUE WHICH WILL BE SENT POST FREE

O. V. ZANGEN, Seedsman, HOBOKEN, N.J.

CANES

Freshly Cut From the Brakes For Your Lilies

Can Be Cut To Any Size

\$5 for 500, \$7 for 1000

Wm. Elliott & Sons
42 Vesey St., New York

BEST QUALITY SEEDS

30 Years Experience Growing and Selling

PEAS AM. WONDERS \$5.00 bu.; THOS. LANTONS \$5.00 bu.; GRADUS \$3.00 bu.; TELEPHONES \$5.00 bu.; NOTTS EXCELSIORS \$5.00 bu.; PREMIUM GEMS \$4.50 bu.; DUKE OF ALBANY \$4.75 bu.

ONION YELLOW GLOBE DANVERS \$1.25 per lb., postage free.

Mammoth, Medium, Alsike, Alfalfa, Clover and Timothy

Write for prices. Send for my beautiful 1909 catalogue (free). Samples mailed free.

CHAS. F. SAUL

220-224 JAMES STREET, SYRACUSE, N. Y.

C. C. MORSE & CO.

48-56 JACKSON ST.,

San Francisco, Cal.

The Largest Seed Growers on the Pacific Coast

ONION, LETTUCE, SWEET PEAS,

ALSO

Carrot, Celery, Leek, Mustard, Parsley, Parsnip, Radish, Salsify

LEONARD SEED CO.

CONTRACT CROWERS AND WHOLESALE DEALERS

BEANS, PEAS, SWEET CORN, ONION, GARDEN SEEDS

UNION SETS 79 and 81 FLOWER SEEDS Get Our Prices E. KINZIE STREET, CHICAGO

Thorburn's Seeds

LILY OF THE VALLEY PIPS

Unexcelled Hamburg or Berlia

**TUBEROUS ROOTED BEGONIAS
GLOXINIAS**

ROSA MULTIFLORA NANA SEED
and all other flower seeds for Florists
SEND FOR CATALOGUE

J. M. THORBURN & CO.
33 BARCLAY ST. through to 38 PARK PLACE
NEW YORK

CABBAGE SEED

LILY OF THE VALLEY PIPS.

HJALMAR HARTMANN & CO.
12 Stormgade,
COPENHAGEN, DENMARK.

Burpee's Seeds

PHILADELPHIA

Blue List of Wholesale Prices mailed only to those who plant for profit

Vegetable and Flower SEEDS
Reliable and Tested. Catalogue Mailed Free
WEBER & DON
Seed Merchants 114 CHAMBERS STREET NEW YORK

BRIDGEMAN'S SEED WAREHOUSE

RICKARDS BROS.

Props.

37 East 19th St., - NEW YORK CITY

CONTRACT GROWER OF
Vegetable and Flower Seeds
For the Wholesale Trade.
Write, stating what Seed you want grown.

JOHN S. WEAVER

Glen Mavr Seed Farms, Kinzers, Lancaster Co., Pa.

STOCK SEED FOR WINTER BLOOMING

Our strain of Double Branching Stocks is exceptionally true. About 90% Double Flowers.

In colors: 1/2 oz. .60 oz. \$4.00
Pure White 3/4 " .75 " 5.00

H. E. FISKE SEED CO.
Faneuil Hall Square, BOSTON, MASS.

Winter-flowering SWEET PEA SEED

All Colors Ask for List
A. C. ZVOLANEK

ORIGINATOR. BOUND BROOK, N. J.

NEW CROP SEED

For Early Planting

THOMAS J. GREY CO.
32 SO. MARKET ST., BOSTON, MASS.

BEGONIAS TUBEROUS ROOTED

ALSO
GLOXINIAS, LILY OF VALLEY, SPIREA

Catalogues mailed free on application
Joseph Breck & Sons Corp.
47-54 NO. MARKET ST., BOSTON, MASS.

Japanese Bulbs, Etc.

R. TANOI, Yokohama, Japan.

Send for catalog and write to Representative
K. TAKEUCHI,
478a Boylston St., Boston, Mass.

GEO. E. DOW Designing and Illustrating

178 Washington St., Boston, Mass.

OUR SPECIALTY
Machine, Booklet, Advertising and Flower
PHOTOGRAPHS

To Florists Everywhere

Orders for Cut Flowers and Floral Decorations to be delivered anywhere in the Greater New York, may be placed with us with the certainty that your customers will be satisfied.

Telegraph, telephone or mail such orders to us and be sure that they will be filled as promptly and as carefully as though you did it yourself.

One third discount will be allowed on all orders thus placed with us by Florists outside of the Greater New York.

THE BLOSSOM

Bond and Livingston Sts.,
BROOKLYN, N. Y.

C. C. TREPEL, Manager

WILLIAM J. SMYTH FLORIST

Cor. Michigan Ave. and 31st St., CHICAGO

We ship to all points in Illinois and Iowa.

Phones: Douglas 744, Douglas 523, Douglas 740

M. C. and J. E. HAUSWIRTH

Out of Town orders for Hospitals
Carefully filled.

232 Michigan Ave. CHICAGO

AUDITORIUM ANNEX Tel. Harrison 585

SAMUEL MURRAY Florist

Coates House Conservatory

1017 BROADWAY, KANSAS CITY, MO.

Both 'Phones 2670 Main.



WASHINGTON,
D. C.

GUDE'S

The Far-Famed Flowers of TORONTO

Delivered on mail or telegraph order for any occasion, in any part of the Dominion.

JOHN H. DUNLOP,
96 Yonge St., - Toronto, Ont.

The Park Floral Co.

J. A. VALENTINE
Pres.

DENVER, COLORADO

WILLIAM L. ROCK FLOWER CO.

KANSAS CITY, - MO.

will carefully execute orders for Kansas City and any town in Missouri or Kansas.



Buffalo, N. Y.

W. I. PALMER & SON, 304 Main St.

Of Interest to Retail Florists

NOVELTY IN DECORATIONS.

As novelty in interior decorations depends somewhat upon the season of the year when made, no better time than the present may be chosen for varied and most beautiful displays.

From the first of February until the middle of April the great assortment of flowering fruit plants, together with lilac, hawthorn, heather, Rambler roses in variety and an endless chain of bulbous flowering material enables the florist to indulge his taste and ingenuity to the limit of his ability.

A Pretty Effect.

A pretty decoration made by one of New York's prominent florists last week is worthy of mention. The parlor mantel was banked with *Whitmanii* ferns, a specimen plant of *wistaria* in bloom forming a centerpiece.

STEAMER DEPARTURES	
American.	
St. Paul, N. Y.-Shampton...	Mar. 20
New York, N. Y.-Shampton...	Mar. 27
Atlantic Transport.	
Minnetonka, N. Y.-London...	Mar. 20
Minneapolis, N. Y.-London...	Mar. 27
Cunard.	
Marretania, N. Y.-Liverpool...	Mar. 17
Saxonia, Boston-Liverpool...	Mar. 23
Campania, N. Y.-Liverpool...	Mar. 24
French Line.	
La Provence, N. Y.-Havre...	Mar. 18
La Savoie, N. Y.-Havre...	Mar. 25
Hamburg-American.	
K's'n A. Vie, N. Y.-Hamburg...	Mar. 20
G. Waldersee, N. Y.-Hamburg...	Mar. 27
North German Lloyd.	
Roon, N. Y.-Bremen...	Mar. 18
Nesker, N. Y.-Amst. Ports...	Mar. 20
Kronp. Geillie, N. Y.-Amst...	Mar. 23
White Star.	
Oreania, N. Y.-Shampton...	Mar. 17
Cymric, Boston-Liverpool...	Mar. 24
Totentide, N. Y.-Shampton...	Mar. 27

Japanese prunus in flower at either end completed a harmonious blending of softest tints. The sprawling fronds of the pale ferns in wild confusion with the flowering plant gave cause for general admiration.

Whitmanii ferns banked in the fireplace and studded with branches of white lilac added much to the beauty of the mantel display.

Suspended from the picture mouldings were sprays of wild smilax, the smaller and more delicate branches being used. Mirrors and doors were in like fashion ornamented.

Southern Smilax Preferable.

For festooning delicate satin and not infrequently expensively frescoed walls, wild smilax is by far safer and more delicate than the softer or greenhouse variety, the slightest pressure of which against a wall leaves a smudge and consequently unhappiness, while the hardy vines are easily adjusted and rarely leave a mark.

The halls and dining room were decorated on practically the same lines as the parlor, plants of white

ALEX. McCONNELL

571 FIFTH AVENUE
NEW YORK CITY

Telegraphic orders forwarded to any part of the United States, Canada, and all principal cities of Europe. Orders transferred or entrusted by the trade to our selection for delivery on steamships or elsewhere receive special attention.

Telephone Calls, 487 and 488 38th St.
Cable Address, ALEXCONNELL

New York Deliveries

FLOWERS and PLANTS

by special messenger to Steamer,
Theatre or any address in

NEW YORK or BROOKLYN

THOMAS YOUNG, JR.

500 FIFTH AVE., (near 42nd St.)

NEWMAN FLORAL Co.

(Established 1870)

202 Fifth Ave. and
Madison Square, NEW YORK CITY

FLOWERS FOR STEAMER SAILINGS

M. A. BOWE

In the Heart of New York City

1294 Broadway

NEW YORK

Tel. 2270, 36th St.

Our Motto—The Golden Rule

DAVID CLARKE'S SONS

Deliver orders from any part of the country to
New York City

Or OUT-GOING STEAMERS

Write or telegraph

2139-2141 Broadway, New York
Telephone 1552-1553 Columbus

YOUNG & NUGENT

42 West 28 St., NEW YORK

"FLOWERS BY TELEGRAPH"

NEW YORK

MYER, FLORIST

Phone 5297 Plaza.

609-611 MADISON AVE.

ALBANY, N. Y.

EYRES

Flowers or Design Work

DELIVERED IN ALBANY AND VICINITY
ON TELEGRAPHIC ORDER.

11 NORTH PEARL ST., ALBANY, N. Y.

Flower Deliveries

In Brooklyn and other Long Island Points
New York City, New Jersey, etc. At Theatres,
Hotels, Steamers or Residences.

WILSON

Fulton St. and Greene Ave., Brooklyn, N. Y.

JOHN BREITMEYER'S SONS

Cor. Miami and Gratiot Aves.
DETROIT, MICH.

Artistic Designs . . .
High Grade Cut Blooms

We cover all Michigan points and good sections of Ohio, Indiana and Canada

PROMPT DELIVERY IN BOSTON

AND ALL NEW ENGLAND POINTS
F. H. HOUGHTON
396 Boylston St., Boston, Mass.

BOSTON'S BEST In Quality and Design

Can be relied upon when you transfer your retail orders to

EDWARD MACMULKIN
194 Boylston Street, Boston

Send flower orders for delivery in
BOSTON
and all

NEW ENGLAND POINTS
THOS. F. GALVIN
124 Tremont St., Boston

The Original Telegraph Order Florist
WILL DELIVER

Flowers or Designs
to order in Boston and Vicinity. Usual Discount.

J. NEWMAN & SONS, INC.
Est. 1870 24 TREMONT ST., BOSTON



DANKER, Albany, N. Y.

ORDERS FOR
Choice Flowers and
Floral Emblems
FILLED PROMPTLY

LOUISVILLE, KY.
JACOB SCHULZ,
550 South Fourth Ave.

WELLESLEY COLLEGE
Dana Hall, Walnut Hill and Rockridge Hall
Schools. TAILBY, Wellesley, Mass.
Tel. Wellesley 44-1 and 2. Night 44-3.

ATLANTA FLORAL CO.
41 Peach tree Street. ATLANTA, GEORGIA



THE NEW IDEA IN PLANT STANDS

The Moore-Livingston Graduating or Adjusting

Saves one-half to two-thirds of cost over ordinary galvanized iron stands.

SEND FOR CIRCULAR GIVING FULL PARTICULARS
SOLD BY SEEDSMEN AND SUPPLY HOUSES

If your seedsman does not carry send us his name and we will promptly send full particulars.

Moore-Livingston Co., Patentees and Mfrs., Lansdowne, Pa.

and lavender lilac appearing wherever an opportunity presented itself.

Another Example.

A similar decoration was furnished for a debutante's reception at the residence of a prominent upper West Ender, the only difference being the substitution of Dorothy Perkins and Apple Blossom Rambler rose plants for the flowers used in the first-named decoration.

The Ball Bouquet Returns.

It may be of interest to a few of the many to learn of the resurrection of the ball bouquet, a relic of many years ago. The debutante of the hour can be readily distinguished by her bouquet. While somewhat larger and less rigid than the affair worn by our grandmothers on similar occasions in the dim past, the ball of today is considered quite proper when suspended by a ribbon bow from the arm of the latest bud.

"FLOWERS BY TELEGRAPH."

Leading Retail Florists Listed by
Towns for Ready Reference.

- Denver, Colo.—Park Floral Co., 1706 Broadway.
- Washington, D. C.—Gude Bros., 1214 F St.
- Atlanta, Ga.—Atlanta Floral Co., 41 Peach Tree St.
- Chicago—M. C. & J. E. Hauswirth, 232 Michigan Ave.
- Chicago—William J. Smyth, Michigan Ave. and 31st St.
- Chicago—George Wittbold Co., 1637-59 Buckingham Place.
- Louisville, Ky.—Jacob Schulz, 550 South Fourth Ave.
- Boston—Thos. F. Galvin, 124 Tremont St.
- Boston—Frank H. Houghton, 396 Boylston St.
- Boston—Edward MacMulkin, 194 Boylston St.
- Boston—Hoffman, Florist, 59 61 Massachusetts Ave.
- Boston—J. Newman & Sons, Inc., 24 Tremont St.
- Beacon—Julius A. Zinn, 2 Beacour St. Wellesley, Mass.—Tailby.
- Detroit, Mich.—J. Breitmeyer's Sons, Miami and Gratiot Aves.
- Kansas City, Mo.—Samuel Murray, 1017 Broadway.
- Kansas City, Mo.—Wm. L. Rock Flower Co., 1116 Walnut St.
- Albany, N. Y.—H. G. Eyres, 11 N. Pearl St.
- Albany, N. Y.—F. A. Danker, 40 Maiden Lane.
- New York—David Clarke's Sons, 2139-2141 Broadway.
- New York—Alex. McCoull, 571 5th Ave.
- New York—Young & Nugent, 42 W. 28th St.
- New York—M. A. Rowe, 1294 Broadway.
- New York—Meyer, 663-11 Madison Ave.
- New York—Thos. Young, Jr., 509 Fifth Ave.
- New York—Newman Floral Co., 202 Fifth Ave. & Madison St.
- Brooklyn, N. Y.—The Blossom (C. C. Trepel, Mgr.), Bond and Livingston Sts.
- Brooklyn, N. Y.—Robert G. Wilson, Fulton St. and Greene Ave.
- Buffalo, N. Y.—Palmer's, 204 Main St.
- Toronto, Can.—J. H. Dunlop, 96 Yonge St.

NEW FLORISTS' STORES.

Toledo, O.—M. Spanner, 246 Summit street.

Atlantic City, N. J.—The Newport Flower Shop.

Lincoln, Ill.—West End Greenhouse, Lehner Block.

Rockville, Conn.—Calverry & Risley, Citizens' Block.

Stuart Ritchie, florist and market gardener, will open a florist store at No. 40 Broadway, Newport, R. I.

The Belmont Floral Co. have just opened a retail flower store, under the management of E. Courtemauche, at 1635 N. Clark street, near Belmont avenue, Chicago.

THE BEST LETTERS

FOR
FLORISTS'
USE



THOSE
MADE
BY THE

Boston Florist Letter Co.

66 PEARL ST., BOSTON

N. F. MCCARTHY, Mgr.

Order direct or buy from your local supply dealer. Insist on having the

BOSTON

Inscriptions, Emblems, etc., Always in Stock

Durand & Marohn

MANUFACTURERS OF

All Kinds of Wire Work

Florists' Wire Designs a Specialty

24 Beaver St., ALBANY, N. Y.

FLORISTS' SUPPLIES

Send for New Catalogue

H. Bayersdorfer & Co.

1129 ARCH ST., PHILADELPHIA

TRANSFER

Your orders for flower or plant delivery in Eastern New England to

JULIUS A. ZINN,

2 Beacour St., Boston

Fine Design Work a Specialty.

BEAUTIES

There is every promise of a better supply of Beauties ahead. They are more plentiful and we expect to offer them at very attractive prices. The quality of our Beauties is well known, and our growers report them in their usual fine shape. Don't think that high quality makes our prices high—for it doesn't. We always charge the lowest market price.

THE LEO NIESSEN CO.

1209 Arch St., Philadelphia, Pa.
Open from 7 a. m. to 8 p. m.



SPRENGER

Extra choice long sprays

50c PER BUNCH

S. S. PENNOCK - MEEHAN CO.

1608-1620 Ludlow St., Philadelphia

DOUBLE and SINGLE VIOLETS

Have grown extra quality

W. E. MCKISSICK & BROS.

WHOLESALE FLORISTS
1619-1621 RANSTEAD ST.
PHILADELPHIA



CHAS. W. MCKELLAR

51 WABASH AVE., CHICAGO

Western Headquarters for Choice Orchids
Valley, Roses and all Cut Flowers

PETER REINBERG
WHOLESALE

CUT FLOWERS
51 Wabash Av., Chicago, Ill.

Long Distance Phone, Central 6004

WINTERSON'S SEED STORE
45-47-49 Wabash Ave., Chicago.

Seedsmen, Plantsmen, Nurserymen
Florists' Supplies

We can supply everything used by the
Florist. SUPPLY CATALOG FREE. Cor-
respondence solicited.

POEHLMANN BROS. CO.
33-35-37 Randolph St., - CHICAGO

CUT FLOWERS

Greenhouses, - Morton Grove, Ill.

Rice Brothers

115 N. 6th Street, MINNEAPOLIS, MINN.
WHOLESALE FLORISTS and SUPPLIES

CUT FLOWERS received twice daily, and can fill
your orders to your satisfaction. A complete line of
Hardy Greens—WILD SMLAX, BOXWOOD,
HARDY FANCY FERNS, GALAX LEAVES,
Write for quotations on large quantities.

In ordering goods please add "I saw
it in HORTICULTURE."

WELCH BROS.

AMERICAN BEAUTY, KILLARNEY, RICHMOND, MARYLAND AND ALL THE SUPERIOR
ROSES, LILY OF THE VALLEY, CARNATIONS, ORCHIDS

BEST PRODUCED

226 Devonshire Street,

Boston, Mass.

WHOLESALE FLOWER MARKETS—TRADE PRICES—Per 100 TO DEALERS ONLY

	CHICAGO March 8		TWIN CITIES March 8		PHILA. March 8		BOSTON March 11	
ROSES								
Am Beauty, Fancy and Special...	40.00	to 50.00	35.00	to 45.00	0.00	to 75.00	40.00	to 75.00
" " Extra.....	30.00	to 40.00	25.00	to 35.00	40.00	to 50.00	20.00	to 30.00
" " No. 1.....	40.00	to 50.00	15.00	to 25.00	25.00	to 35.00	12.00	to 15.00
" " Lower grades.....	12.00	to 20.00	12.00	to 15.00	5.00	to 20.00	4.00	to 8.00
Bride, 'Maid, Fancy & Special.....	5.00	to 8.00	8.00	to 12.00	12.00	to 15.00	6.00	to 8.00
" " Lower grades.....	6.00	to 8.00	6.00	to 8.00	4.00	to 10.00	2.00	to 4.00
Killarney, Fan & Sp.....	6.00	to 8.00	8.00	to 12.00	12.00	to 15.00	1.00	to 25.00
" " Lower grades.....	4.00	to 6.00	4.00	to 8.00	4.00	to 10.00	4.00	to 8.00
Richmond, Fancy & Special.....	4.00	to 6.00	0.00	to 8.00	20.00	to 30.00	12.00	to 25.00
" " Lower grades.....	4.00	to 6.00	4.00	to 8.00	5.00	to 20.00	4.00	to 12.00
Chatenay.....	4.00	to 6.00	4.00	to 8.00	5.00	to 15.00	4.00	to 12.00
Queen Beatrice.....	4.00	to 6.00	4.00	to 8.00	5.00	to 15.00	4.00	to 12.00
Golden Gate Ivory, etc.....	4.00	to 6.00	4.00	to 8.00	4.00	to 10.00	4.00	to 8.00
My Maryland.....	10.00	to 16.00
Queen Beatrice.....	3.00	to 12.00
Mrs. Mac Field.....	to 12.00
CARNATIONS								
Fancy and Re?.....	2.00	to 3.00	2.00	to 3.00	4.00	to 5.00	2.50	to 3.00
Ordinary and White.....	1.00	to 2.00	1.50	to 2.00	2.50	to 3.00	1.50	to 2.50
MISCELLANEOUS								
Castles.....	40.00	to 50.00	40.00	to 50.00	to 75.00	40.00	to 50.00
Cypris.....	10.00	to 12.00	10.00	to 12.00	10.00	to 12.00	10.00	to 12.00
Lilies.....	10.00	to 12.00	10.00	to 12.00	10.00	to 12.00	10.00	to 12.00
Lily of the Valley.....	3.00	to 4.00	3.00	to 4.00	3.00	to 5.00	1.00	to 3.00
Narciss., Paper White.....	2.00	to 3.00	2.00	to 3.00	2.00	to 3.00	1.00	to 2.00
Roman Hyacinth.....	3.00	to 4.00	2.00	to 3.00	2.00	to 3.00	1.00	to 2.00
Daffodils.....	2.00	to 3.00	2.00	to 3.00	2.00	to 3.00	1.00	to 2.00
Freesias.....	2.00	to 3.00	1.50	to 2.50	2.00	to 3.00	2.00	to 3.00
Sweet Peas.....	.50	to 1.00	.75	to 1.00	1.00	to 1.50	.75	to 1.00
Gardenias.....	30.00	to 40.00	40.00	to 50.00	25.00	to 50.00	25.00	to 50.00
Violets.....	50	to 1.00	50	to 1.00	50	to 1.00	50	to 1.00
Adiantum.....	1.00	to 1.00	1.00	to 1.00	1.00	to 1.50	.75	to 1.00
Smilax.....	10.00	to 12.00	10.00	to 15.00	12.50	to 15.00	10.00	to 12.50
Asparagus Plumose, straggles.....	15.00	to 18.00	15.00	to 20.00	50.00	to 75.00	25.00	to 50.00
" " & Sprea. (roo bchs.).....	20.00	to 30.00	20.00	to 25.00	25.00	to 50.00	15.00	to 25.00

J.A. BUDLONG

37-39 Randolph Street, CHICAGO.

Roses and Carnations
A Specialty.....

WHOLESALE
BROWER of CUT FLOWERS



HENRY M. ROBINSON & CO.
15 Province St and 9 Chapman Place - BOSTON, MASS.

WHOLESALE COMMISSION FLORISTS

Hardy Cut Evergreens and Florists' Supplies

We have the stuff and can fill all orders, large or small
WE NEVER DISAPPOINT SATISFACTION GUARANTEED



Prices Quoted in these Columns are for Dealers Only.
When Writing to Advertisers Please Mention
HORTICULTURE.

Flower Market Reports.

BOSTON Business is running along since Lent came in with a steadiness and vigor which is as gratifying as it is unexpected. There are some bad spots, notably the bulb flower sales and values, which emphasize the fact that if importing had not been circumscribed last year somebodies would have been in dire straits by this time. White carnations are in better demand than for many weeks, the call from suburban and country quarters being very lively, and the overstock which has been a fact heretofore, no longer exists. There are practically no high class Beauties in market, and the rose situation is, we think, generally satisfactory, everything finding a ready market. Violets are doing considerably better. Very few doubles are in sight but the singles are superb in quality and they are worn freely at all public occasions. Of course, the demand for shamrocks is at high water mark at present.

The second week in **BUFFALO** Lent passed quite satisfactorily, and while there is an abundance of material on most lines, yet the trade has been somewhat better than a week previous. It is noticed that roses have not been over-plentiful at this time, when in previous years crops were all on and prices very low, a condition which keeps out the carnation to a certain extent. The carnation seems to be becoming more plentiful each day, and while the wholesaler is trying to prevent the Bargain Sale signs, they accumulate much faster than is wished for. Such varieties as Beacon, Winsor, White Perfection and a few others are moved at satisfactory prices, while a good many ordinary ones are carried along awaiting an outlet. In the rose line, Killarney seems to lead in pink, though some excellent Bridesmaids are seen, also Bride, Richmond, Bonsilene, Perle and no over-supply. Beauties are scarce. Bulbous stock is on the quiet side, while peas, violets, mignonette and daisies are having a fair demand.

CHICAGO Trade is slowly reviv- ing. With Ash Wednes- day came an almost complete cessation in business and flowers accumulated and prices were down. A slight improvement has come each week and as we start on the last half of Lent trade seems in a fair way to regain its normal tone. Southern jonquils and lily of the valley are coming in to compete with home-grown and the sales are a little slow in consequence. Violets are also too plentiful. The double ones from the East and the home-grown single ones are alike selling very slowly. In some parts of the market sales are reported brisk enough but at buyers' prices. In carnations red are in fairly good demand and white brings a good price but pink, especially light pink, are found too plentiful in every part of the market. The ease with which Enchantress can be grown makes it a great favorite with the growers and without doubt too many were planted last year. Aristocrat seems to be gaining in favor and has now a fixed place as a good commercial flower.

WHOLESALE FLOWER MARKETS.—TO DEALERS ONLY.

	CINCINNATI March 8		DETROIT March 8		BUFFALO March 8		PITTSBURG March 8	
ROSES								
Am. Beauty, Fan, and Sp.	35.00	to 40.00	35.00	to 40.00	40.00	to 50.00	40.00	to 50.00
" Extra	25.00	to 30.00	28.00	to 32.00	20.00	to 40.00	25.00	to 35.00
" No. 1	15.00	to 20.00	20.00	to 25.00	15.00	to 20.00	10.00	to 20.00
" Lower grades	8.00	to 12.00	8.00	to 15.00	5.00	to 8.00	3.00	to 6.00
Bride, 'Maid, F. & S.	6.00	to 8.00	8.00	to 12.00	10.00	to 12.00	8.00	to 10.00
" Low gr.	3.00	to 5.00	4.00	to 8.00	4.00	to 6.00	3.00	to 6.00
Killarney, Fan, & Sp.	6.00	to 8.00	8.00	to 12.00	10.00	to 12.00	10.00	to 12.00
" Lower grades	3.00	to 5.00	4.00	to 8.00	5.00	to 8.00	6.00	to 8.00
Richmond, Fancy & Special	7.00	to 10.00	8.00	to 12.00	10.00	to 12.00	12.00	to 15.00
" Lower grades	4.00	to 6.00	4.00	to 6.00	4.00	to 6.00	6.00	to 8.00
Chenay	5.00	to 8.00	6.00	to 12.00
Golden Gate, Ivory, etc.	4.00	to 6.00
My Maryland
Queen Beatrix
Mrs. Mar. Field
CARNATIONS								
Fancy and Novelties	to 3.00	3.00	to 4.00	2.50	to 3.00	2.00	to 3.00
Ordinary	1.50	to 2.00	2.00	to 3.00	1.50	to 2.00	1.00	to 1.50
MISCELLANEOUS								
Cattleyas	to	to	to	50.00	to 75.00
Oypripediums	to	to	to	12.00	to 15.00
Lilies	10.00	to 12.00	12.50	to 13.00	8.00	to 15.00	10.00	to 12.00
Lily of the Valley	to	to	to
Narciss., Paper White	to 3.00	3.00	to 4.00	2.00	to 3.00	to 3.00
Roman Hyac.	2.00	to 3.00	2.00	to 4.00	2.00	to 3.00	2.00	to 3.00
Daffodils	3.00	to 4.00	3.00	to 4.00	2.00	to 3.00	2.00	to 3.00
Frits	to	to	to
Sweet Peas	.50	to 1.00	.50	to 1.00	.50	to 1.00	.50	to 1.00
Gardenias	to	to	to	to 50.00
Violets	.50	to .75	.50	to .75	.50	to .75	.50	to .75
Adiantum	to 1.00	1.50	to 2.00	1.50	to 2.00	1.50	to 2.00
Smilax	to 12.00	to 15.00	12.00	to 15.00	12.00	to 15.00
Asparagus Plumosus, strings	35.00	to 50.00	30.00	to 50.00	25.00	to 50.00	30.00	to 50.00
" & Spreng. (100 bchs.)	45.00	to 60.00	30.00	to 50.00	25.00	to 50.00	30.00	to 50.00

It seems to be a little ahead of Lawson in some localities. As one man expressed it—and he has had years of experience with carnations—Aristocrat fits the fancy buyer and Lawson fits the medium buyer. Bridesmaids are rather ahead of Killarney in quality just now and more in demand, though some growers have a good crop of Killarneys at this time. There seem to be plenty of lilies and the different varieties furnish a never-ending topic of discussion.

Everybody reports a re- vival of general satisfaction reigns therefore. Stock is coming in better in quality as well as quantity and is cleaned up daily at good figures.

PHILADELPHIA The market here was fairly good last week considering the inclement weather. The Washington celebration caused some extra demand, which helped out the local situation a little. Stocks came in generally ahead of demand—especially in roses and bulbous material. American Beauty roses are still scarce but showing signs of becoming more plentiful within the next ten days. There was a slight let-up in carnation receipts as compared with latter part of the week previous. The quality continues excellent. Violets are plentiful and good, the local crop being now exceptionally fine, and preferred for freshness and fragrance. Authorities are at variance as to the cattleya situation. Scarce in spots but on the whole we believe quite equal to demand. There is also a conflict of opinion as to the lily of the valley market. After digesting the various

reports from different wholesale centers, it would appear that that item was in fairly good demand, and not quite so plentiful. Sweet peas were never better, the pinks and whites being par excellence. There are too many tulips, freesias, and daffodils. Myosotis, marguerites, alyssum, Easter lilies, callas, and various other minor items drag along in the rear of the situation with more or less satisfaction to their sponsors and users. Hope to have a more rosy report for next week. Looks favorable at this writing.

TWIN CITIES This market has been very good the past week. Prices were a little lower than the week previous. White roses, like Brides are somewhat scarce. Paper Whites are off the market. Other cut flowers are almost more than plentiful, owing to the fine clear weather we have been having of late.

INCORPORATED.
Pittsburg, Pa.—United States Floral Co.; A. T. Lorch, De Haven; H. F. Borch, Pittsburg; G. F. Hofmeister, Carrick; capital, \$325,000.
Rochester, N. Y.—The Phillips Nursery Co.; H. B. Phillips, J. C. Johns, H. F. Gandy; capital, \$5,000.

Charles Morrison, who claims residence in Boston, has been arrested in Bangor, Me., for obtaining goods under false pretences. He was hired by H. H. Gurney & Co. of Auburn, nurserymen, on commission, and his numerous orders led the firm to investigate.



EVERYBODY KNOWS Park, Cemetery and Landscape Gardening cannot be properly done without the aid of an accurate leveling instrument.

Easton's Improved Levels, No. 2 at \$15.00 and No. 3 at \$25.00, are conceded by all who **KNOW** to be the only Levels on the market which meet all the requirements, at the price.

Our guarantee back of every Level we sell, and satisfied users in every State in the Union heartily endorse every claim we make.

Shipping weight 12 lbs. Description on request.

BOSTON-GRADY MFG. CO., 139 Madison Avenue., ATLANTA, GA.

FORD BROTHERS

48 West 28th Street NEW YORK
FINE ROSES FANCY CARNATIONS
 A Full Line of All CUT FLOWERS
 Telephone: 3870 or 3871 Madison Square

H. E. FROMENT

Wholesale Commission Florist,
 Choice Cut Flowers,
 57 West 28th St. :: NEW YORK
 Telephones: 2200, 2201, Madison Square.

Alfred H. Langjahr

All choice cut-flowers in season. Send for quotations. Correspondence with shippers of first-class stock invited.
 55 West 28th Street, New York
 Telephones 4626-4627 Madison Square

Edward C. Horan

Wholesale Florist
 55 WEST 28th ST.
 Tel. 1462 Madison Square New York
 1463

JOHN YOUNG

WHOLESALE FLORIST
 Finest American Beauties and Carnations

51 West 28 St. - NEW YORK

FRANK MILLANG

Wholesale Florist
 55-57 West 26th St., NEW YORK
 Shipments, any quantity, Wholesale Market Rates.

Henshaw & Fenrich

WHOLESALE FLORISTS
 44 West 28th Street, NEW YORK
 Phones Mad. Sq. 325, 558-2, 558-3

VIOLETS

Finest Grade. Any Quantity
B. S. SLINN
 55-57 W. 26 St., New York

Moore, Hentz & Nash

Wholesale Commission Florists
 55 and 57 West 26th Street
 Telephone No. 756 Madison Square New York

MILLANG BROS.

WHOLESALE COMMISSION FLORISTS
 41 West 28th Street
 Telephone 3888 Madison NEW YORK

JOHN I. RAYNOR
Wholesale Commission Florist SELLING AGENT FOR LARGEST GROWERS
 A full line of Choice Cut Flower Stock for all purposes. Comprises every variety grown for New York market, at current prices
 TEL. 1998 MADISON SQUARE 49 West 28th St., New York City

Walter F. Sheridan
 Wholesale Commission Dealer in
CHOICE CUT FLOWERS
 39 West 28th Street, New York
 Telephone : 3532-3533 Madison Square

HEADQUARTERS FOR NOVELTIES
ORCHIDS A SPECIALTY
 THE HIGHEST GRADE OF **VALLEY** ALWAYS ON HAND
GARDENIAS, DAISIES, ROSES AND CARNATIONS
 Telephone 768 Mad. Sq. 42 W. 28th St., New York
JAMES McMANUS

PHILIP F. KESSLER 55 & 57 W. 26th St., New York City
 Commission Dealer, Wholesale Buyer and Seller of
GUT FLOWERS
 Open from 5 a. m. to 6 p. m. Sunday till 10 a. m.
 Tel., 5243 and 2921 Madison Sq. Res., 345 J., Newtown.
Finest Lilies in the Market Every Day in the Year.

NEW YORK QUOTATIONS PER 100. To Dealers Only

ROSES AND CARNATIONS	Last Half of Week ending Mar. 6 1909		First Half of Week beginning Mar. 8 1909	
	1909	1909	1909	1909
American Beauty, Fancy and Special.....	25.00	to 30.00	25.00	to 30.00
" " Extra.....	15.00	to 20.00	15.00	to 20.00
" " No. 1.....	8.00	to 12.00	8.00	to 12.00
" " Lower Grades.....	2.00	to 5.00	2.00	to 5.00
Bride, "Maid, Fancy and Special.....	6.00	to 10.00	6.00	to 10.00
" " Lower Grades.....	2.00	to 4.00	2.00	to 4.00
Killarney, Fancy and Special.....	8.00	to 12.00	8.00	to 12.00
" " Lower Grades.....	3.00	to 6.00	2.00	to 5.00
Richmond, Fancy and Special.....	15.00	to 25.00	10.00	to 15.00
" " Lower Grades.....	2.00	to 8.00	2.00	to 8.00
Chatenay.....	2.00	to 10.00	8.00	to 10.00
Golden Gate, Ivory, etc.....	2.00	to 5.00	2.00	to 5.00
My Maryland.....	3.00	to 12.00	3.00	to 12.00
Queen Beatrix.....	to	to
Mrs. Bar. Field.....	to	to
Carnations, Fancy and Novelties.....	2.00	to 3.00	1.50	to 3.00
" " Ordinary and White.....	1.00	to 1.50	1.00	to 1.50

Alexander J. Guttman
THE WHOLESALE FLORIST OF NEW YORK
 34 WEST 28th STREET
 PHONES. 1664-1665 MADISON SQUARE
ENOUGH SAID

TRAENDLY & SCHENCK
Wholesale Florists
 Furnish best Stock at fair Prices all the year round
 Send for Quotations on Any Variety and Quantity
 Tel. 798, 799 Madison Sq. 44 West 28th St., New York City

GROWERS' CUT FLOWER CO. CUT FLOWERS AT WHOLESALE
VIOLETS, CARNATIONS, ROSES
ORCHIDS, CHRYSANTHEMUMS, LILIES
 Consignments Solicited. Shipments to Order, any Distance
 Telephone 4343 Madison Square
39 West 28th Street, NEW YORK
 J. J. QUINN, Manager

WHOLESALE FLORISTS
54 West 28th St.
NEW YORK
Telephone 3559 Madison Sq.

A. L. YOUNG & CO.

RECEIVERS & SHIP-
PERS OF CUT
FLOWERS.
CONSIGNMENTS SOLICITED.

WILLIAM H. KUEBLER
Brooklyn's Foremost and Best

WHOLESALE COMMISSION HOUSE
A First Class Market for all CUT FLOWERS
28 Willoughby St., Brooklyn, N. Y.
Tel. 4591 Main

Greater New York Florists' Association,
Now Open for Cut Flower Consignments
162 Livingston Street, BROOKLYN, N. Y.
Geo. W. Crawbuck Telephone Connection
Manager 3642-43 Main

REED & KELLER
122 West 25th St., New York
Florists' Supplies
We manufacture all our
Hotel Designs, Baskets, Wire Work & Novelties
and are dealers in
Glassware Decorative Greens and Florists' Requisites

THE KERVAN CO.
Wholesale Dealers and Shippers of
Decorative Evergreens
Ferns, Galax, Laurel, Fresh Cycas, Box-
wood, Sphagnum and all Florists' Greens
Send us for Quotations before Buying.
113 West 28 Street, NEW YORK CITY

MICHIGAN CUT FLOWER EXCHANGE, Inc.
WHOLESALE COMMISSION FLORISTS
Consignments Solicited
Hardy Fancy Fern Our Specialty
38-40 BROADWAY, DETROIT, MICH.

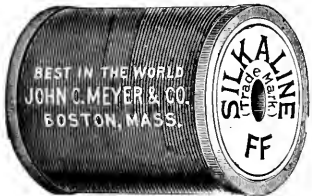

Use Krick's Immortelle Letters

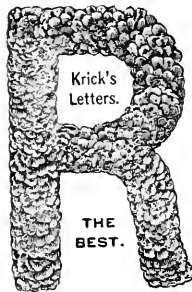

The original and the best. All others are followers.
All Orders Promptly Attended to.
Send for Samples and Price Lists.

1164-1166 Greene Ave.,
BROOKLYN, - N. Y.

GEORGE GOTSONAS & CO.
Wholesale and Retail Dealers in all kinds of
EVERGREENS
Fancy and Dagger Ferns
Bronze and Green Galax
Main Store 50 W. 28 St.
Phone 1202 Mad. Sq. New York

CENTRALLY LOCATED, THE HUB OF THE
FLOWER MARKET SECTION
CHARLES MILLANG
Wholesale Florist
444 Sixth Ave., NEW YORK
Telephone 7062 Madison

WHOLESALE COMMISSION **J. K. ALLEN** 106 W. 28th St.
NEW YORK
Open 6 a. m. Daily Tel. 167 Madison Sq.
All Grades of Flowers to Suit All Buyers. Consignments Solicited.

NEW YORK QUOTATIONS PER 100. To Dealers Only

MISCELLANEOUS	Last Half of Week ending Mar. 6 1909		First Half of Week beginning Mar. 8 1909	
	40.00	to 60.00	40.00	to 60.00
Cattleyas.....	3.00	to 10.00	3.00	to 10.00
Lilies.....	1.00	to 3.00	1.00	to 3.00
Lily of the Valley.....	1.00	to 2.00	1.00	to 2.00
Narciss., Paper Whites.....	1.00	to 2.00	1.00	to 2.00
Roman Hyd.....	1.00	to 3.00	1.00	to 2.00
Tulips.....	1.00	to 2.00	1.00	to 2.00
Daffodils.....	1.00	to 2.00	1.00	to 2.00
Freebies.....	1.00	to 2.00	1.00	to 2.00
Sweet Peas.....	.50	to 1.50	.50	to 1.00
Gardenias.....	20.00	to 50.00	20.00	to 50.00
Violets.....	.30	to .50	.30	to .50
Adiantum.....	.75	to 1.00	.75	to 1.00
Groeneseum.....	1.00	to 1.25	1.00	to 1.25
Smilax.....	8.00	to 10.00	8.00	to 10.00
Asparagus Plumosus, strings.....	2.00	to 3.00	2.00	to 3.00
" " & Spren. (100 bchs).....	15.00	to 25.00	15.00	to 25.00

NEW YORK FLOWER MARKET.
The market has been depressed all through the past week. Buying is very light and the speculative and street trade element are responsible for what little activity is in evidence in the wholesale districts—activity in hammering down values and negotiating for job lots by all the shrewd manoeuvres in which this class of buyers is so trained. The quality of the material offered is generally excellent. There are some weak spots, however, notably the carnations from some growers, which are up-to-mark as to stem but disreputable as to flower; lily of the valley, of which there is more than the usual proportion of low-down grade, and lilies of which there is an unprecedented aggregation of shapes and sizes and degrees of degeneracy in sight. It might also be noted that some stocks of Killarney rose show color weakness as the season advances. On the other hand, Bridesmaid has come to the front in a quality of color and form not seen heretofore this season. Many very poor gardenias are being received. Bulbous flowers are abundant, as usual at this season, and of widely varying degrees of quality, with values down to the lowest notch. Of tulips there is a preponderance of short-petaled, more or less wrinkled flowers. Daffodils are good in all varieties, but their sale is further handicapped by

the presence of the Southern-grown out-door single trumpets which are being shipped here by cratesful. Cattleyas are excellent and in supply sufficient for all demands. The richest thing in sight is *Acacia pubescens*. The quality of this has never been better, sprays from three to five feet long being the rule. Pussy willows and English wall flowers are in every window.

WILLIAM F. KASTING CO.
WHOLESALE FLORISTS
383-387 Ellicott Street
BUFFALO, - N. Y.
Wired Toothpicks
Manufactured by
W. J. COWEE, BERLIN, N. Y.
10,000....\$1.75; 50,000....\$7.50. Sample free.
For sale by dealers

ROBERT J. DYSART
Public Accountant and Auditor
Simple methods of correct accounting especially adapted for florists' use.
Books Balanced and Adjusted
Merchants Bank Building
28 STATE STREET, - BOSTON
Telephone, Main 58.

Buyer's Directory and Ready Reference Guide

Advertisements under this head, one cent a word. Initials count as words.

Display advertisers in this issue are also listed under this classification without charge. Reference to List of Advertisers will indicate the respective pages.

Buyers failing to find what they want in this list will confer a favor by writing us and we will try to put them in communication with reliable dealers.

ACCOUNTANT

R. J. Dymart, 28 State St., Boston.
For page see List of Advertisers.

AGERATUMS

R. Vincent, Jr. & Sons Co., White Marsh, Maryland.
For page see List of Advertisers.

AMPELOPISIS.

Storrs & Harrison Co., Painesville, O.
For page see List of Advertisers.
Eastern Nurseries, Henry F. Dawson, Mgr.,
Ampelopsis Quingrefoia,
Jamaica Plain, Mass.
For page see List of Advertisers.

C. Elsele, 11th and Westmoreland Sts.,
Philadelphia, Pa.
For page see List of Advertisers.

ARGENTINE ASPARAGUS

Argenteuil Asparagus Plants, Frank H. Strow, Orleans, Mass

AQUILEGIA

Aquilegia. Genuine *Coerulea*, finest of all. Both plants and seeds from the heart of the Rockies. C. S. Harrison's Select Nursery, York, Neb.

ARAUCARIAS

A. Leutby & Co., Perkins St. Nurseries, Roslindale, Mass.
For page see List of Advertisers.
Godfrey Aschmann, 1012 West Ontario St., Philadelphia, Pa.
For page see List of Advertisers.

ASPARAGUS

The Geo. Witthold Co., 1657 Buckingham Place, Chicago, Ill.
Asparagus Sprengeri, 2-in. pots, 2c; \$17 per 1000. Cash, please. A. Relyea & Son, Poughkeepsie N. Y.

AUCTION SALES

Oleary's Horticultural Co., 62 Vesey St., New York.
For page see List of Advertisers.
Wm. Elliott & Sons, 42 Vesey St., New York, N. Y.

AZALEAS

A. Leutby & Co., Perkins St. Nurseries, Roslindale, Mass.
For page see List of Advertisers.
Godfrey Aschmann, 1012 W. Ontario St., Philadelphia.
For page see List of Advertisers.
Henry A. Dreer, Philadelphia.
Azalea Mollis.

BAMBOO CANES

Yokohama Nursery Co., 31 Barclay Street, New York
Bamboo Sticks, Colored Green.
For page see List of Advertisers.
Wm. Elliott & Sons, New York City, Lily Stakes.
For page see List of Advertisers.

BAY TREES.

2000 Bay and Box Trees in all sizes, Pyramid and Standards. Write for list. Julius Roehrs, Rutherford, N. J.

BOILERS

BOILERS. "Burnham" Boilers made for greenhouse heating. Lord & Burnham, 1133 Broadway, N. Y.
Kroeschell Bros. Co., 35 Erie St., Chicago.
For page see List of Advertisers.

BEDDING PLANTS

J. E. Felthousen, Schenectady, N. Y.
For page see List of Advertisers.
Rooted cuttings of geraniums, single double and semi-double (mostly red mixed), variegated vinear; Robinson, Merry Christmas and Dr. Engelhard chrysanthemums; Sylvia Zierlich; goodly blue and white; Maid, Chateau, Richmond and Dorothy Perkins roses; started tubers of Austria and Black Beauty cannas; fine clumps of Clematis paniculata, Miss Lincoln pinks, Van Houttei and Anthony Waterer spinous, Japonosiris (cut-out colors), Tritoma Pfitzeri, sweet williams; hollyhocks, double, single and Allegheny (separate colors). These are extra heavy plants. Also have Armstrong's everblooming tuberoses, large and small herbs. Write for prices on what you can use. Will exchange for Enchantress and Beacon carnations.
A. H. DAILEY, FLORIST,
Dandridge Pike, Knoxville, Tenn.

BOXWOOD TREES

New England Nurseries, Inc., Bedford, Mass.
For page see List of Advertisers.

BUILDING MATERIAL

BUILDING MATERIAL of all description for All Cypress, Semi-Iron, Iron Frame or Truss Houses, Hot Bed Sash and Frames. Lord & Burnham Co., 1133 Broadway, N. Y.

BULBS AND TUBERS

Joseph Breck & Sons, 47-54 N. Market St., Boston.
For page see List of Advertisers.
J. M. Thornburn & Co., 33 Barclay St., New York.
For page see List of Advertisers.
A. T. Boddington, 342 W. 14th St., N. Y.
For page see List of Advertisers.
Rickards Bros., 37 East 19th St., New York.
For page see List of Advertisers.
H. F. Mitchell Co., Philadelphia.
For page see List of Advertisers.

H. E. Flske Seed Co., Faneuil Hall Sq., Boston.
For page see List of Advertisers.

T. J. Grey & Co., 32 and 33 So. Market St., Boston.
For page see List of Advertisers.

Yokohama Nursery Co., 31 Barclay St., New York.
For page see List of Advertisers.

Ralph M. Ward & Co., 12 W. Broadway, New York.
For page see List of Advertisers.

K. Takeuchi, 478A Boylston St., Boston.
Japanese Bulbs.
For page see List of Advertisers.

Schlegel & Fottler Co., 26 & 27 S. Market St., Boston.
For page see List of Advertisers.

TIERROSES AND CALADUM.

Special Prices to Florists and Dealers.
Tuberose.—Pearl No. 1, 4 to 6
Caladium Esculentum, 5 to 7
1 inch in circum.....\$1.10 9.00
Caladium Esculentum, 7 to 9
1 inch in circum..... 2.10 18.50
Caladium Esculentum, 9 to 11
1 inch in circum..... 3.65 35.00
Caladium Esculentum, 11 inch
and over 11 circum..... 4.50 45.00
Prices include packing and are f. o. b. cars here.
T. W. WOOD & SONS, Seedsman, Richmond, Va.

CANNAS

A. T. Boddington, 342 W. 14th St., New York.
For page see List of Advertisers.
C. Elsele, 11th and Westmoreland Sts., Philadelphia, Pa.
CANNAS. Beante Poitevine, Crimson Bedder, Flamingo, Mlle. Berat, Robusta, \$2.00 per 100, Josiah Young, Troy, N. Y.
Large assortment of Cannas of the following varieties: Bushank, Pennsylvania, Berat and Oberer, at \$1.50 per 100; or wild exchange for dwarf Ageratum, Fervens, double Alyssum, A. W. Moockel, 17 Summit St., Fitchburg, Mass.

CARNATIONS

F. Dorner & Sons Co., Lafayette, Ind.
Carnation, Winton.
For page see List of Advertisers.
Chicago Carnation Co., Joliet, Ill.
For page see List of Advertisers.
Albert Roper, Tewksbury, Mass.
Carnation Bay State.
For page see List of Advertisers.
Bassett & Washburn, Hingham, Ill.
Carnation O. P. Bassett.
For page see List of Advertisers.

East Sudbury Greenhouses, So. Sudbury, Mass.
Carnation Cuttings.
For page see List of Advertisers.

Wood Bros., Fishkill, N. Y.
Carnations, Rooted Cuttings.
For page see List of Advertisers.

The E. G. Hill Co., Richmond, Ind.
Carnation Cuttings.
For page see List of Advertisers.

Peter Fisher, Ellis, Mass.
Rooted Cuttings.
For page see List of Advertisers.

S. J. Reuter & Son, Westerly, R. I.
For page see List of Advertisers.

Scheiden & Schoos, Chicago.
Carnation Wm. H. Taft.
For page see List of Advertisers.

Bellamy Bros., Syracuse, N. Y.
Carnation Marchions.
For page see List of Advertisers.

Fine-croft Greenhouses, East Brookfield, Mass.
Carnations, Rooted Cuttings.

Schlegel & Fottler Co., 26 & 27 S. Market St., Boston.
For page see List of Advertisers.

A. E. Longren, Des Plaines, Ill.; Highland Park Greenhouses, Highland Park, Ill.
Carnation Laville.
For page see List of Advertisers.

Carnations, out of 24-in. pots, strong plants, 400 Winsor, 75 Rose Pink Enchantress, 150 Kingston Pet, 250 Victory, 50 Mrs. Patten, \$2.50 per 100; 100 Enchantress, 150 Lawson, 75 White Lawson, 75 Variegated Lawson, \$2.00 per 100; 50 Queen Louise, \$1.50 per 100. Cash with order. Henry Hansen, Catskill, N. Y.

CHRYSANTHEMUMS

Schlegel & Fottler Co., 26 & 27 S. Market St., Boston.
Chrysanthemum Belfast.
For page see List of Advertisers.

E. G. Hill Co., Richmond, Ind.
For page see List of Advertisers.

S. J. Reuter & Son, Westerly, R. I.
For page see List of Advertisers.

Elmer D. Smith & Co., Adrian, Mich.
For page see List of Advertisers.

CHRYSANTHEMUMS—Continued

C. H. Totty, Madison, N. J.
Single Chrysanthemums From Seed.
For page see List of Advertisers.

J. H. Myers, Altoona, Pa.
For page see List of Advertisers.

Scott Bros., Elmford, N. Y.
For page see List of Advertisers.

Chrysanthemum Golden Glow from 2 1/4 in. pots, for early spring delivery, \$1.00 per doz., \$6.00 per 100, \$50.00 per 1000. Stock plants of Montmort, Oct. Frost, Crocua, Matchless, Lucy Devaux, Polly Rose and Haliday, \$1.00 per doz., \$6.00 per 100. Peetre Bros., Waltham, Mass.

Herrington's book on the Chrysanthemum, mailed to your address for 50c., by Horticulture Publishing Co., 11 Hamilton Place, Boston.

Chrysanthemums from 2 1/4 in. pots, ready now Golden Glow, White Cloud, 6c.; Beatrice May, 5c.; Polly Rose, October Frost, Touset, Bonnafont, 3c. Henry Trull, Frederick, Md.

COLEUS

J. E. Felthousen, Schenectady, N. Y.
For page see List of Advertisers.

CONIFERS

John Waterer & Sons, Ltd., Americas Nursery, Bagshot, Eng.
For page see List of Advertisers.

CUT FLOWER BOXES.

Edwards Folding Box Co., Philadelphia
For page see List of Advertisers.

Folding cut flower boxes, the best made. Write for list. Holton & Hunkel Co., MD waukee, Wis.

CYCLAMEN.

Thomas Roland, Nahant, Mass.
For page see List of Advertisers.

DAHLIAS

David Herbert & Son, Atco, N. J.
For page see List of Advertisers.

J. L. Moore, Northboro, Mass.
For page see List of Advertisers.

Peacock Dahlia Farms, Williamstown Junction, N. J.
For page see List of Advertisers.

R. Vincent Jr. & Sons Co., White Marsh, Md.
For page see List of Advertisers.

DAHLIAS

Geo. H. Walker, No. Dighton, Mass.
Wholesale and Retail.
Send your name for my 1909 Catalog and Pocket Guide, ready to mail about Feb. 25th.

Cactus, Decorative, Fancy, Show and Pompon Dahlias. Good commercial varieties, such as Kriemhild, Countess of Lonsdale, Mad. Van Den Deal and other sure bloomers, strong divided roots, in 10 or 20 named varieties, my selection, \$1.00 per 25; \$3.00 per 100; \$25.00 per 1000. Cash please. Herrmann Thielmann, Merion, Mass.

Dahlias. Novelties and standard varieties, true to name, a choice list of the best introductions. Send for catalog of dahlias, hollyhocks, hardy plants. Prices always reasonable. W. W. Wilmore, Box 352 Denver, Colo.

East Bridgewater Dahlia Gardens wants your business. If you are looking for dahlias send to the Eastern Dahlia King, J. K. Alexander, East Bridgewater, Mass.

DECORATIVE PLANTS

A. Leuthy & Co., Perkins St. Nurseries, Rosindale, Mass.
For page see List of Advertisers.

Godfrey Aschmann, 1012 W. Ontario St., Phila., Pa.
For page see List of Advertisers.

Joseph Heacock Co., Wyncote, Pa.
For page see List of Advertisers.

The Geo. Wittbold Co., 1657 Buckingham Place, Chicago, Ill.

Robert Craig Co., Market and 49th Sts., Philadelphia, Pa.
For page see List of Advertisers.

A. N. Pierson, Inc., Cromwell, Conn. Palms and Ferns.
For page see List of Advertisers.

DRACAENAS

The Geo. Wittbold Co., 1657 Buckingham Place, Chicago, Ill.

ECONOMY BRACKET

Burton & Allard, Nashua, N. H.
For page see List of Advertisers.

EVERGREENS

New England Nurseries, Bedford, Mass.
For page see List of Advertisers.

American Nursery Co., 150 Broadway, New York, N. Y.
For page see List of Advertisers.

Henry A. Dreer, Philadelphia, Pa.
For page see List of Advertisers.

Evergreen. Send 25 cents in stamps for complete work on propagating and growing Evergreens. C. S. Harrison's Select Nursery, York, Neb.

FERNS

A. Leuthy & Co., Rosindale, Mass.
For page see List of Advertisers.

H. H. Barrows & Son, Whitman, Mass. Nephrolepis Magnifica.
For page see List of Advertisers.

John Scott, Brooklyn, N. Y.
For page see List of Advertisers.

Frank Oechsli, 2570-2606 W. Adams St., Chicago.
Ferns for Dishes.
For page see List of Advertisers.

The Geo. Wittbold Co., 1657 Buckingham Place, Chicago, Ill.

Godfrey Aschmann, 1012 W. Ontario St., Philadelphia.
For page see List of Advertisers.

Henry A. Dreer, Philadelphia, Pa. Nephrolepis Scholzei.
For page see List of Advertisers.

C. Eisele, 11th and Westmoreland Sts., For page see List of Advertisers.

FERTILIZERS

Pulverized Manure Co., 31 Union Stock Yards, Chicago, Ill.

Wizard Brand Sheep and Shredded Cattle Manure.
For page see List of Advertisers.

Robert Simpson, Clifton, N. J. Sheep Manure.
For page see List of Advertisers.

Bowker Fertilizer Co., Boston, Mass. All Forms of Plant Food at First Hands.
For page see List of Advertisers.

FEVERFEW

Feverfew Little Gem, 50c. per 100; \$7.00 per 1000. S. W. Pike, St. Charles, Ill.

2000 Feverfew from 2 1/4 in. \$3.00 per 100, \$25.00 per 1000. Albert Batley & Son, Maynard, Mass.

Feverfew, 2 1/4 in., \$2.00 per 100. H. J. Blanchard, Ashburnham, Mass.

FLORAL PHOTOGRAPHS

Floral Photographs, Foley's, 226-228 1-2 Bowery, New York.

FLORISTS' LETTERS.

Boston Florist Letter Co., 66 Pearl St., Boston, Mass.
For page see List of Advertisers.

W. C. Krick, 214-66 Greene Ave., Brooklyn, N. Y. Immortelle Letters.
For page see List of Advertisers.

FLORISTS SUPPLIES

N. F. McCarthy & Co., 84 Hawley St., Boston.
For page see List of Advertisers.

H. M. Robinson & Co., 15 Province St. and 9 Chapman Pl., Boston, Mass.
For page see List of Advertisers.

Reed & Keller, 122 W. 23th St., New York.
For page see List of Advertisers.

H. Bayersdorfer & Co., 1129 Arch St., Philadelphia.
For page see List of Advertisers.

FLOWER POTS

W. H. Ernest, 28th and M Sts., Washington, D. C.
For page see List of Advertisers.

A. H. Hews & Co., Cambridge, Mass.
For page see List of Advertisers.

FLOWER POTS—Continued

Hilfinger Bros., Ft. Edward, N. Y.
For page see List of Advertisers.

The Peters & Reed Pottery Co., Red pots, seed pans, etc., Zanesville, O.

Syracuse Pottery Co., Syracuse, N. Y. Syracuse Red Pots.
For page see List of Advertisers.

We make Standard Flower Pots, etc. Write us when in need. Wilmer, Coppe & Bro. Lincoln University, Chester Co., Pa.

FUCHSIAS

R. Vincent, Jr. & Sons Co., White Marsh.
For page see List of Advertisers.

GALAX

Michigan Cut Flower Co., 38 and 40 Broadway, Detroit, Mich.
For page see List of Advertisers.

George Cotsonaa & Co., 50 W. 28th St., New York.
For page see List of Advertisers.

The Kervan Co., 113 West 28th St., N. Y.
For page see List of Advertisers.

Rice Bros., 115 N. 6th St., Minneapolis, Minn.
For page see List of Advertisers.

H. M. Robinson & Co., 15 Province St. and 9 Chapman Place, Boston.
For page see List of Advertisers.

GERANIUMS

R. Vincent Jr. & Sons Co., White Marsh, Md.
New and Standard Varieties.
For page see List of Advertisers.

A few double fine mixed stock geraniums, all double, \$7.00 per 100. Fine geraniums, 2 1/4 in., \$2.00 per 100. Cash. H. J. Blanchard, Ashburnham, Mass.

Red Geraniums, 2 1/4 in., \$2.50 per 100, Jas. T. Baker, Bustleton, Philadelphia, Pa.

GLADIOLI

J. L. Moore, Northboro, Mass.
For page see List of Advertisers.

A. T. Boddington, 342 W. 14th St., New York.

O. V. Zangen, Hohenok, N. J. Gladiolius Brecheniensis.
For page see List of Advertisers.

I. & J. L. Leonard, Iona, N. J. Gladiolius Bulbs.
For page see List of Advertisers.

Gladioli Groff's Hybrids, mixed, 1 1/2 to 2 1/4 in., \$5.00 per 1000; 1 to 1 1/2 in., \$4.00 per 1000; 1 1/2 to 1 in., \$3.00 per 1000; Bulb-lets, \$1.00 per pack. Ira H. Landis, Lancaster, Pa.

Groff's new Hybrid Gladioli in finest mixture: No. 1, \$5.00 per 1000; No. 2, \$4.00 per 1000; No. 3, 1/2 to 3/4, at \$3.00 per 1000; Giant Pink bulb-lets, at \$1.00 per qt.; Mrs. Francis King and Giant Pink mixed bulb-lets, at \$1.00 per qt. Discounts on large lots. G. B. Babcock, Jamestown, N. Y.

GLASS

Boston Plate & Window Glass Co., Boston.
For page see List of Advertisers.

Standard Plate Glass Co., 26-30 Sudbury St., Boston.
For page see List of Advertisers.

Foley Mfg. Co., Western Ave., between 25th & 26th Sts., Chicago.

Sharp, Partridge & Co., 22d & Lumber St., Chicago.
For page see List of Advertisers.

Parselsky Bros., Inc., 50 Montrose Ave., Brooklyn, N. Y.
For page see List of Advertisers.

Greenhouse glass, lowest prices. Johnston Glass Co., Hartford City, Ind.

Glass, High Grade, Double Thick Greenhouse Glass. Lord & Burnham, 1133 Broadway, N. Y.

GLAZING DEVICES

H. A. Dreer, Philadelphia, Pa. Peerless Glazing Point.
For page see List of Advertisers.

GLAZING POINTS, Lord & Burnham Special Glazing Nails (Points). Lord & Burnham, 1133 Broadway, N. Y.

In writing to Advertisers kindly mention Horticulture

GREENHOUSE BUILDING MATERIAL

Lord & Burnham Co.,
1133 Broadway, New York.
For page see List of Advertisers.

Pierson U-Bar Co., 1 Madison Sq., N. Y.
For page see List of Advertisers.

A. T. Stearns Lumber Co., Neponset,
Boston.
For page see List of Advertisers.

King Construction Co., N. Tonawanda,
New York.
For page see List of Advertisers.

Hitchings & Co., 1170 Broadway, New York.
For page see List of Advertisers.

J. C. Moninger Co., 117 East Blackhawk St.,
Chicago, Ill.
For page see List of Advertisers.

Foley Mfg. Co., Western Ave., between
25th & 26th Sts., Chicago.
For page see List of Advertisers.

GREENHOUSE CONSTRUCTION

GREENHOUSE CONSTRUCTION, Semi-
Iron Greenhouse, New Truss Houses and
Iron Frame Houses, Lord & Burnham,
1133 Broadway, N. Y.

J. A. Payne, 200-274 Culver Ave., Jersey
City, N. J.
For page see List of Advertisers.

Foley Mfg. Co., Western Ave., between
25th & 26th Sts., Chicago.
For page see List of Advertisers.

Hitchings & Co., 1170 Broadway, New York.
For page see List of Advertisers.

Geo. M. Garland Co., Des Plaines, Ill.
For page see List of Advertisers.

GREENHOUSE HOSE
Revere Rubber Co., Boston, Mass.
Revere Hose.
For page see List of Advertisers.

GUTTERS

GUTTERS, Cast Iron Gutters, L. & B.
Improved V Shaped Gutter with drip
gutter attachment, Lord & Burnham, 1133
Broadway, N. Y.

HAIL INSURANCE

Florists' Hall Assn. of America.
J. G. Esker, Saddle River, N. J.
For page see List of Advertisers.

HARDY FERNS, MOSS AND GREENS

H. M. Robinson & Co., 15 Providence St.
and 9 Chapman Pl., Boston, Mass.
For page see List of Advertisers.

Michigan Cut Flower Exchange,
38 and 40 Eber, Detroit, Mich.
For page see List of Advertisers.

George Cotsouas & Co., 50 W. 28th St.,
New York.
For page see List of Advertisers.

N. F. McCarthy & Co., 84 Hawley St.,
Boston.
For page see List of Advertisers.

The Kervan Co., 113 W. 28th St., N. Y.
For page see List of Advertisers.

Rice Bros., 115 N. 6th St., Minneapolis,
Minn.
For page see List of Advertisers.

HARDY PLANTS

Novelties and Specialties—For over one
hundred different new varieties of hardy
plants, all of great commercial value, get
our Wholesale Catalog of Potentials and
Hardy Plants. Palmsides Nurseries, Spar-
kell, N. Y.

HART'S HANDY HANDLE
Geo. R. Hart, 24 Stone St.,
Boston, N. Y.

HEATING APPARATUS

Lord & Burnham Co.,
1133 Broadway, New York
For page see List of Advertisers.

Pierson U-Bar Co., 1 Madison Sq., N. Y.
For page see List of Advertisers.

John A. Payne, 200-274 Culver Ave., Jersey
City, N. J.
For page see List of Advertisers.

Kroschell Bros. Co., 35 Erie St., Chicago.
For page see List of Advertisers.

HELP FURNISHED

Thos. H. Hambrick, 34 S. 7th St., Phila.
For page see List of Advertisers.

HERBACEOUS PERENNIALS

P. Ouwerkerk, P. O. No. 1, Hoboken, N. J.
For page see List of Advertisers.

New England Nurseries, Bedford, Mass.
For page see List of Advertisers.

The Geo. Withthod Co., 1657 Buckingham
Place, Chicago.

D. A. Clarke, Red Oak Nurseries, Fiske-
ville, R. I.
For page see List of Advertisers.

HOT-BED SASH

The A. T. Stearns Lumber Co., Neponset,
Mass.
For page see List of Advertisers.

Pierson U-Bar Co., 1 Madison Sq., N. Y.
For page see List of Advertisers.

Lord & Burnham Co., 1133 Broadway, N. Y.
For page see List of Advertisers.

Foley Mfg. Co., Western Ave., between
25th & 26th Sts., Chicago.

HYDRANGEAS.

Hydrangea American Everblooming. Fine
field-grown plants, 10 to 20 inches, \$10.00
to \$15.00 per 100. Berberis Thunbergii,
seedlings and strong transplants. Amoor
River Privet, Japanese Privet, California
Privet. Fine plants for hedges. Lists free.
The E. Y. Teas Co., Centerville, Ind.

INSECTICIDES.

Nicotinic kills all greenhouse pests.
P. R. Paethorpe Co.,
Eleventh St., Owensboro, Ky.
For page see List of Advertisers.

Stump & Walter Co., 50 Barclay St.,
New York.
Killed Tobacco Dust.
For page see List of Advertisers.

Niagara Sprayer Co., Middleport, N. Y.
Niagara Brand.
For page see List of Advertisers.

B. G. Pratt Co., New York.
Sniffoide.
For page see List of Advertisers.

Hammond's Slug Shot Works, Fishkill-on-
Hudson, N. Y.
Horicum.

Bowker Insecticide Co., Boston, Mass.
Insect Destroying Preparations.
For page see List of Advertisers.

Wm. Cooper & Nephews, 17 Illinois St.,
Chicago; 441 Franklin, 62 Beaver
St., New York, Act.
V I Fluid
For page see List of Advertisers.

"The Fumigating Kind Tobacco Pow-
der"—The first on the market and the kind
that has so many imitators, has our guar-
antee tag of satisfaction or money back,
and "The Moon Trade Mark" on every bag,
\$3.00 per 100 lbs. The H. A. Stothoff Co.,
Mount Vernon, N. Y., Makers and sellers.

Tobacco dust in 3 lbs. bags, 12 in. by 15,
15 to 200 lbs., \$4.00; 100 lbs. by 10 in. by 15,
250 to 400 lbs., \$2.50. Cash with order,
money back if you say so. I had them all
in quality and price. S. R. Gray, Bing-
hamton, N. Y.

JAPANESE PLANTS

Yokohama Nursery Co., 31 Barclay St.,
New York.
For page see List of Advertisers.

KENTIAS

Godfrey Aschmann,
1012 W. Ontario St., Phila., Pa
For page see List of Advertisers.

A. Leuthy & Co., Roslindale, Mass.
For page see List of Advertisers.

Jos. Hancock Co., Wynote, Pa.
Single and Made-Up Specimens
For page see List of Advertisers.

**LEVELS FOR LANDSCAPE GAR-
DENING USE.**

Rostrom-Brady Mfg. Co., 139 Madison Ave.,
Atlanta, Ga.
For page see List of Advertisers.

LILY OF THE VALLEY PIPS

Hjalmar Hartmann & Co., 12 Stormgade,
Copenhagen, Denmark
For page see List of Advertisers.

LOBELIAS

Double Lechella Kathleen Mallard, rooted
cuttings, \$1.00 per 100. Cash. Chas. H.
Green, Spencer, Mass.

R. Vincent, Jr. & Son,
White Marsh, Md.
For page see List of Advertisers.

MARGUERITES

Marguerites, Queen Alexandra, \$1.25 per
100, prepaid. S. W. Pike, St. Charles, Ill.

NICO-FUME

Kentucky Tobacco Product Co.,
Louisville, Ky.
For page see List of Advertisers.

NURSERY STOCK

John Waterer & Sons, Ltd.,
American Nursery, Bagshot, England.
For page see List of Advertisers.

Clary's Horticultural Co., 62 Vesey St.,
New York.
For page see List of Advertisers.

P. Ouwerkerk, 216 Jane St., Weehawken
Heights, N. J.
For page see List of Advertisers.

D. J. Twomey, Dept. H, Geneva, N. Y.
For page see List of Advertisers.

I. & J. L. Leonard, Iona, N. J.
For page see List of Advertisers.

Eastern Nurseries, Jamaica Plain, Mass.
Yiburnum Mollie.
For page see List of Advertisers.

American Nursery Co., 150 Broadway, New
York, N. Y.
For page see List of Advertisers.

P. Hamilton Goodsell, 200 Broadway,
New York, N. Y.
For page see List of Advertisers.

W. & T. Smith Co., Geneva, N. Y.
Nursery Stock for Florists.
For page see List of Advertisers.

Storrs & Harrison Co., Palmsville, Fla.
For page see List of Advertisers.

ROCK MAPLE SEEDLINGS—Per 1000
Sycar or Rock Maple, fine, 3 to 4 ft. \$29.00
" " " " 2 to 3 ft. 12.00
" " " " 1 to 2 ft. 5.00
Samples on request. List free. The
E. Y. Teas Co., Centerville, Ind.

Manual of the Trees of North America,
by C. S. Sargent, mailed to your address
for \$2.00, by Horticulture Publishing Co.,
11 Hamilton Place, Boston.

**TREES, SHRUBS, ROSES, EVER-
GREENS, PEONIES, HARDY PLANTS.**

ELLWANGER & BARRY, Rochester, N. Y.
New Hardy Shrub—Bud-free Varieties
White and Rose-fl. The summer flower-
ing Blue, 24, each \$5.00 per doz.; \$25.00
per doz. Rose Hill Nurseries, New
Rochelle, N. Y.

Catalog now ready. Nursery grown
conifers, seedling white pine and hem-
lock, native trees and plants. L. E. Wil-
liams, Nottingham, N. H.

Rhododendrons, Laurel, Spruce Hemlock,
Poplars, E. W. Sheely, De Bruce, Sulliv-
van County, N. Y.

UNION SEED

Federico C. Varela, Tenerife, Canary Ids
Bermuda Onion Seed.
For page see List of Advertisers.

ORCHID PLANTS

Lager & Hurrell, Summit, N. J.
For page see List of Advertisers.

Sander, St. Albans, England.
Importers, Exporters, Growers, Hybridists
For page see List of Advertisers.

Capello & Baldwin, Secaucus, N. J.
For page see List of Advertisers.

Jos. A. Manda, 191 Valley Road, W.
Orange, N. J.
For page see List of Advertisers.

Orchard Bros. Madison, N. J. Box 106
For page see List of Advertisers.

Liverpool Orchid & Nursery Co., Gateacre,
near Liverpool, Eng.
For page see List of Advertisers.

Largest stock in the country. Ask for
prices. Julius Roehrs, Rutherford, N. J.

PAINT AND PUTTY

PAINT AND PUTTY: Ideal Greenhouse
lead. Special Greenhouse Putty. Lord &
Burnham, 1133 Broadway, N. Y.

PALMS

A. Leuthey & Co., Perkins St. Nurseries, Roslindale, Mass.
For page see List of Advertisers.
Robert Craig Co., Market and 49th Sts., Philadelphia, Pa.
For page see List of Advertisers.
Joseph Heacock Co., Wynote, Pa. Home-Grown Palms.
For page see List of Advertisers.

PANSY PLANTS.

Pansies, extra fine giant flowering, strong plants, 30 cents per 100; \$2.50 per 1000 Edw. Wallis, Atoe, N. J.

PATENTS

Siggers & Siggers, Washington, D. C.
For page see List of Advertisers.

PEAT

Orchid Peat and Moss always on hand Julius Roehrs Co., Rutherford, N. J.

PENTSTEMONS

C. H. Totty, Madison, N. J.
For page see List of Advertisers.

PEONIES

Peonies only, by the wholesale—best 100 varieties. J. F. Rosenfeld, Westpoint, Nebr.
One of the finest collections in America. Send 25 cts. in stamps for new edition of Peony Manual. C. S. Harrison's Select Nursery, York, Neb.

PETUNIAS

R. Vincent, Jr. & Sons Co., White Marsh, Maryland.
For page see List of Advertisers.

PHLOXES

Send 25 cts in stamps for Phlox Manual Fine mixed phloxes \$2.00 per 100. C. S. Harrison's Select Nursery, York, Neb.

PHOTOGRAPHS: DESIGNING: ILLUSTRATING

Geo. E. Dow, 178 Washington St., Boston
For page see List of Advertisers.

PIPE AND FITTINGS

Foley Mfg. Co., between Western Ave. and 26th St., Chicago, Ill.
For page see List of Advertisers.
Kroeschell Bros. Co., 35 Erie St., Chicago
For page see List of Advertisers.

PIPE AND FITTINGS. Cast Iron and Wrought Pipe, Valves, Elbows, Pipe Hooks, Automatic Air Headers, etc. Lord & Burnham, 1133 Broadway, N. Y.

PLANT STANDS

Moore-Livingston Co., Lansdowne, Pa.
For page see List of Advertisers.

PLANT STAKES

Seele's Tieless Plant Stakes and Trellises. H. D. Seele & Sons, Elkhart, Ind.

POT HANGERS

Pot hangers, Kramer's \$1 doz. by exp. \$1.25 by mail. I. N. Kramer & Son, Cedar Rapids, Ia.
Kirk's Perfect Pot Hanger and Handle. Sample par. to cents postpaid. Send for full particulars. W. C. Kirk, 1164-1165 Greene Ave., Brooklyn, N. Y.

POINSETTIAS / Artificial

Poinsettias, artificial decorations our specialty. Sample lots of 50 in 3 sizes. \$4.00; 100 lots, \$6, \$8, \$10. J. Stern & Co., 125 N. 10th St., Philadelphia, Pa.

POULTRY SUPPLIES

Buff Rock Eggs to Hatch, Triumph breed or any for chickens. Frank H. Snow, Orleans, Mass.

PRIVET

California privet, 100,000 for transplanting at \$5.00 per 1000; 55,000, 12 to 18 in., 2 to 4 branches, \$8.00 per 1000; 25,000, 12 to 18 in., 3 to 4 branches, \$10.00 for 1000 boxed and delivered F. O. B. Cash with order. N. C. Nesbrian Nurseries, Bostic Dept., Bostic, N. C.

PRUNING SHEARS

Rhodes Mfg. Co., Dept. R., Grand Rapids, Mich.

RAFFIA

Raffia (colored), 20 beautiful shades. Samples free. R. H. Comey Co., Camden, N. J.; 810 Washburn Ave., Chicago, Ill.

RASPBERRY PLANTS

Rod Raspberry Plants, all summer, ever-bearing, money-makers. C. C. RYDER, Cunningham, Mass.

RESURRECTION PLANTS

Resurrection plants and earth. Cheap. Ask for prices. William Tell, Austin, Tex.

RHODOENDRONS

John Waterer & Sons, Ltd., American Nursery, Bagshot, England.
For page see List of Advertisers.

P. Ouwkerk, Hoboken, N. J.
For page see List of Advertisers.

Anthony Waterer, Knapp Hill Nursery, Surrey, Eng.
For page see List of Advertisers.

Storrs & Harrison Co., Painesville, O.
For page see List of Advertisers.

ROSES

Robert Craig Co., Market and 49th Sts., Philadelphia, Pa.
For page see List of Advertisers.

P. Ouwkerk, P. O. No. 1, Hoboken, N. J.
For page see List of Advertisers.

Julius Roehrs Co., Rutherford, N. J. Rose Newport Fairy.
For page see List of Advertisers.

The F. R. Pierson Co., Tarrytown-on-Hudson, N. Y. White Killarney.
For page see List of Advertisers.

S. J. Reuter & Son, Westery, R. I. My Maryland.
For page see List of Advertisers.

Dingee & Conard Co., West Grove, Pa.
For page see List of Advertisers.

Storrs & Harrison Co., Painesville, O.
For page see List of Advertisers.

Scott Bros., Hinsford, N. Y.
For page see List of Advertisers.

Hand Book of Cultural Notes on Roses Under Glass, by F. P. Brigham, mailed to your address for 25c., by Horticulture Publishing Co., 11 Hamilton Place, Boston.

SALVIAS

R. Vincent, Jr. & Sons Co., White Marsh, Maryland.
Salvias Bonfire and Zurich.
For page see List of Advertisers.

SEED GROWERS

C. C. Morse & Co., 48-56 Jackson St., San Francisco, Cal.
For page see List of Advertisers.

Ejalmar Hartmann & Co., Cauliflower and Cabbage Seed, 12 Stormgade, Copenhagen, Denmark.
For page see List of Advertisers.

John S. Weaver, Glen Mower Farms, Kinross, Pa.
Vegetable and Flower Seeds Grown on Contract.
For page see List of Advertisers.

Federico C. Varola, Teneriffe, Canary Ids. Bermuda Onion Seed.
For page see List of Advertisers.

SEEDS

T. J. Grey Co., 32 So. Market St., Boston.
For page see List of Advertisers.

Joseph Breck & Sons, 51 and 52 N. Market St., Boston, Mass.
For page see List of Advertisers.

W. Atlee Burpee & Co., Philadelphia.
For page see List of Advertisers.

C. C. Morse & Co., 48-56 Jackson St., San Francisco, Calif.
For page see List of Advertisers.

Arthur T. Boddington, 342 W. 14th St., New York.
For page see List of Advertisers.

H. E. Fiske Seed Co., Faneuil Hall Sq., Boston.
For page see List of Advertisers.

Ejalmar Hartmann & Co., 12 Stormgade, Copenhagen, Denmark.
Cauliflower and Cabbage Seed.
For page see List of Advertisers.

SEEDS — Continued

Rickards Bros., 37 E. 19th St., New York.
For page see List of Advertisers.

R. & J. Farquhar & Co., 67 So. Market St., Boston.
Mignonette Seed.
For page see List of Advertisers.

H. F. Mitchell Co., 1018 Market St., Phila.
For page see List of Advertisers.

J. M. Thorburn & Co., 33 Barclay St., N. Y.
For page see List of Advertisers.

Leonard Seed Co., Chicago, Ill.
For page see List of Advertisers.

Wm. Elliott & Sons, 42 Vesey St., N. Y. New Seed.
For page see List of Advertisers.

Woeber & Don, 114 Chambers St., New York.
For page see List of Advertisers.

I. & J. L. Leonard, Iona, N. J. Tomato and Pepper Seed.
For page see List of Advertisers.

Charles F. Saul, 220-224 James St., Syracuse, N. Y.
Peas, Onion, Clover and Timothy Seed.
For page see List of Advertisers.

Schlegel & Fottler Co., 26 & 27 S. Market St., Boston.
For page see List of Advertisers.

O. V. Zangin, Hoboken, N. J. Florists' String Seeds.
Seeds. Rocky Mountain Evergreen seeds in large or small quantities. C. S. Harrison's Select Nursery, York, Neb.

SHAMROCKS

John F. Rupp, Shrewstown, Pa.
For page see List of Advertisers.

N. F. McCarthy & Co., 84 Hawley St., Boston.
For page see List of Advertisers.

Shamrocks—Genuine Irish Shamrocks, original plant coming from cemetery, Downpatrick, Ireland. Two in., without pots, \$4.00 per 100; \$30.00 per 1000; with pots, \$4.50 per 100; \$40.00 per 1000; 250 at 1000 rate. Order early. Terms cash. J. D. Harcourt's Son, Wappingers Falls, N. Y.

SHRUBS

The Geo. Wittbold Co., 1657 Buckingham Place, Chicago.

SILKALINE

John C. Meyer & Co., Boston, Mass.
For page see List of Advertisers

SMILAX

R. Vincent, Jr. & Sons Co., White Marsh, Md.
For page see List of Advertisers

Extra strong plants, \$1.00 per pair \$8.00 per 1000. Ready for 2 1/2 in. pots. 312 bags, 10 C. W. Moschel, 17 Summer St., Philadelphia, Mass.

SPHAGNUM MOSS

Live Sphagnum moss, orchid peat and orchid baskets always on hand. Lager & Hurrell, Summit, N. J.

Sphagnum moss and mountain laurel in bags, bales or car lots. Prices low. Spruce and hemlock in bags. James Day, Box 650, Milford, N. H.

Ten bales sphagnum, \$7.00.
Z. K. Jewett Co., Sparta, Wis.

Sphagnum Moss, Fresh stock, long and clean, guaranteed to be as recommended. Fibrous peat and peat in chunks.

1 sack, 100 lbs. 75c.
2 5-lb. bales, \$3.00
2 10-lb. bales, \$5.00

W. H. Stackhouse, Mgr. Ocean County Moss and Peat Co., Waretown, N. J.

SPRAYERS

"SHOWERMAKER," \$1. Jos. Kopcsay, St. Bend, Ind.

Niagara Sprayer Co., Middleport, N. Y.
For page see List of Advertisers.

J. E. Cass Mfg. Co., Dept. H., Detroit, Mich.

F. N. I. T. Globe Sprayer.
For page see List of Advertisers

Chas. J. Jager Co., Boston.
Deming Spray Pump.
For page see List of Advertisers.

In writing to Advertisers kindly mention Horticulture

SPRING FLOWER SHOW

Music Hall Market, Boston; John McFarland, N. Easton, Mass., Secretary.
For page see List of Advertisers.

STEAM TRAP

E. Hippard, Youngstown, O.
For page see List of Advertisers

STRAWBERRY PLANTS

H. L. Crane, Westwood, Mass.
Barymore Strawberry.
For page see List of Advertisers.

SULFOCIDE

The B. G. Pratt Co., 50 Church St., Dept. W., New York City.
For page see List of Advertisers.

SWEET PEAS

A. C. Zvolanek, Hound Brook, N. J.
Winter Flowering.
For page see List of Advertisers.
W. Atlee Burpee & Co., Philadelphia.
For page see List of Advertisers.

TO-BAK-INE

E. H. Hunt, Genl. Agt., 70-73 Wabash Av., Chicago.
For page see List of Advertisers.

VEGETABLE PLANTS

R. Vincent, Jr. & Sons Co., White Marsh, Md.
For page see List of Advertisers.

TOMATO PLANTS.

Comet Tomatoes, 2 1/2 In., \$18.00 per 1000.
Roney Bros., West Grove, Pa.

VENTILATING APPARATUS

Pierson 1-Up Bar Co., 1 Madison Sq., N. Y.
For page see List of Advertisers.
Foley Mfg. Co., Western Ave., between 25th & 26th Sts., Chicago.
For page see List of Advertisers.
John A. Payne, 200-274 Culver Ave., Jersey City, N. J.
For page see List of Advertisers.
The Advance Co., Richmond, Ind.
For page see List of Advertisers.

Quaker City Machine Co., Richmond, Ind.
20th Century Ventilating Arm.
For page see List of Advertisers.
VENTILATING MACHINERY, New Model encased, self-oiling gear; Standard Model Open Gear. Lord & Burnham, 1133 Broadway, N. Y.

VERBENAS

R. Vincent, Jr. & Sons Co., White Marsh, Maryland.
For page see List of Advertisers.

VIOLETS.

Princess Violets, 2 1/2 In., \$2.50 per 100.
Jas. T. Baker, Bustleton, Philadelphia, Pa.

WALLFLOWERS

Henry A. Dreer, Philadelphia, Pa.
For page see List of Advertisers.

WAX FLOWERS

We are originators of wax designs and still the standard concern, J. Stern & Co., 125 N. 10th St., Philadelphia, Pa.

WEED KILLER

The American Horticultural Distributing Co., Martinsburg, W. Va.
Target Brand
For page see List of Advertisers.

WIRED TOOTHPICKS

W. J. Cowee, Berlin, N. Y.
For page see List of Advertisers.

WIREWORK

Reed & Keller, 122 W. 25th St., N. Y.
For page see List of Advertisers.
Durand & Marohn, Albany, N. Y.
For page see List of Advertisers.
Wirework. Write for our catalogue.
Holton & Hunkel Co., Milwaukee, Wis.
William E. Heischer's Wire Works, 35-40 Broadway, Detroit, Mich.
Headquarters for wire work. Send for list. Hall & Betz, 31 E. 3rd St., Cincinnati, O.
Wirework—Compare our prices with others. Scranton Florist Supply Co., 201 N. 7th St., Scranton, Pa.

WHOLESALE FLORISTS**Boston**

N. F. McCarthy & Co., 84 Hawley St., Boston.
For page see List of Advertisers.
H. M. Robinson & Co., 15 Province St. and 9 Chapman Pl., Boston.
For page see List of Advertisers.
Welch Bros., 225 Devonshire St., Boston.
For page see List of Advertisers.
Tulhy, Wellesley, Mass.
For page see List of Advertisers.

Chicago

Chas. W. McKellar, 51 Wabash Ave., Chicago.
For page see List of Advertisers.
Peter Reuber, 51 Wabash Ave., Chicago.
For page see List of Advertisers.
E. F. Winterson Co., 45-49 Wabash Ave., Chicago.
For page see List of Advertisers.
J. A. Budlong, 37-39 Randolph St., Chicago.
For page see List of Advertisers.
Foehmann Bros. Co., Morton Grove, Ill.
For page see List of Advertisers.

Cromwell, Conn.

A. N. Pierson, Cromwell, Conn.
For page see List of Advertisers.

Detroit

Michigan Cut Flower Exchange, 38 and 40 Broadway, Detroit, Mich.
For page see List of Advertisers.

Minneapolis

Rice Bros., 115 N. 6th St., Minneapolis, Minn.
For page see List of Advertisers.

New York

Ford Bros., 48 W. 28th St., New York.
For page see List of Advertisers.
H. E. Froment, 57 W. 28th St., New York.
For page see List of Advertisers.
Alex. J. Guttman, 34 W. 28th St., New York.
For page see List of Advertisers.
E. C. Horan, 55 W. 28th St., New York.
For page see List of Advertisers.
A. H. Langjahr, 55 W. 28th St., New York.
For page see List of Advertisers.
James McManus, 42 W. 28th St., New York.
For page see List of Advertisers.
John I. Raynor, 49 W. 28th St., New York.
For page see List of Advertisers.
W. F. Sheridan, 39 W. 28th St., New York.
For page see List of Advertisers.
Trenndly & Schenck, 44 W. 28th St., New York.
For page see List of Advertisers.
Moore, Hentz & Nash, 55 and 57 W. 26th St., New York.
For page see List of Advertisers.
Wm. H. Kuebler, 28 Willoughby St., Brooklyn, N. Y.
For page see List of Advertisers.
Philip F. Kessler, 55 and 57 W. 26th St., New York.
For page see List of Advertisers.
Millang Bros., 41 W. 28th St., New York.
For page see List of Advertisers.
John Young, 51 W. 28th St., New York.
For page see List of Advertisers.
Greater New York Florists' Association, 162 Livingston St., Brooklyn, N. Y.
For page see List of Advertisers.
Frank Millang, 55-57 W. 26th St., New York.
For page see List of Advertisers.
B. S. Silin, 55-57 W. 26th St., New York.
For page see List of Advertisers.
A. L. Young & Co., 54 W. 28th St., N. Y.
For page see List of Advertisers.
Growers' Cut Flower Co., 39 W. 28th St., New York.
For page see List of Advertisers.
Henshaw & Fenrich, 44 W. 28th St., New York.
For page see List of Advertisers.
J. K. Allen, 106 W. 28th St., New York.
For page see List of Advertisers.

WHOLESALE FLORISTS—**Continued****Philadelphia**

W. E. McKislick & Bros., 1610-1621 Ramest St., Philadelphia, Pa.
For page see List of Advertisers.
Leo Nielsen Co., 1209 Arch St., Philadelphia, Pa.
For page see List of Advertisers.
The S. S. Pennock-Meehan Co., 1608-18 Ludlow St., Philadelphia, Pa.
For page see List of Advertisers.

St. Louis

H. G. Bering, 1402 Pine St., St. Louis, Mo.
For page see List of Advertisers.

WOODENWARE

Bayon & Co., Appleton, N. Y.
Baskets; Crates; Ladders; Boxes.

New Offers in This Issue.

See List of Advertisers on opposite page for page on which these offers may be found.

ASTER SEED.

Dept. B. Scientific Intense Culture Ranch Co., Salem, Ore.

ASTER SEED.

H. F. Mitchell Co., Philadelphia.

ASPARAGUS SEED.

S. S. Pennock-Meehan Co., Philadelphia.

Buddleia Variabilis Veitchii and Magnifica.

Rose Hill Nurseries, New Rochelle, N. Y.

Carnation Cuttings.

Jensen & Dekona, 674 W. Foster Ave., Chicago, Ill.

Easter Plants: Bedding Plants.

A. Leuthy & Co., Perkins St. Nurseries, Roslindale, Mass.

Green Coloring.

N. F. McCarthy & Co., 84 Hawley St., Boston.

Greenhouse Building Material.

W. H. Lutton, West Shore Av. Sta., Jersey City, N. J.

Hardy Perennials.

Henry A. Dreer, 714 Chestnut St., Phila.

Orchid Importations.

G. L. Freeman, 388 Appleton St., Holyoke, Mass.

Ribbons, Chiffons, Nettings.

Wertheimer Bros., 500 Broadway, New York, N. Y.

Roses: Chrysanthemums.

Foehmann Bros. Co., Morton Grove, Ill.

Seeds for Plantsmen, Nurserymen, Seedsmen.

E. F. Winterson Co., Chicago.

Shamrocks.

Welch Bros., 226 Devonshire St., Boston.

Standard and Climbing Roses for Spring Sales.

A. T. Boddington, 342 W. 14th St., New York.

Treatise on the Strawberry Blight, its Cause and Cure.

W. E. Trimble, Princeton, Ill.

Wholesale Florists.

William F. Kasting Co., 385-87 Elliott St., Buffalo, N. Y.

Wholesale Florist.

Charles Millang, 44 Sixth Av., New York.

For List of Advertisers See Page 381

List of Advertisers

Table listing advertisers and their page numbers, including Advance, The Co., Barrows H. H., Bassett & Washburn, etc.

Table listing advertisers and their page numbers, including Kasting W. F. Co., Kentucky Tobacco, Product Co., etc.

The Payne Steel "T" Bar Greenhouses. Includes a diagram of the greenhouse structure and text describing its features like 'The Lightest' and 'The Strongest'.

NEWS NOTES.

Reports from Baltimore indicate that during the severe storm on March 3d and 4th few trees in the parks were blown down, but the greatest injury was the breaking of branches.

Prof. L. R. Taft of the State Agricultural College, Michigan, in a recent address before the State Horticultural Society, stated that the poor crop of apples in the state the past year was due to lack of spraying the trees.

The U. S. Civil Service Commission announces two openings, one for a laboratory assistant in the Bureau of Plant Industry, Department of Agriculture; the other for assistant curator, Division of Plants, National Museum, at a salary of \$50 and \$100 per month respectively.

The Lightest The Strongest. HOUSES of this type are constructed with both curved glass eaves and straight glass eaves. Least amount of shadow. Least amount of wood. No drip. Greatest durability. JOHN A. PAYNE Greenhouse Designer and Builder 260-274 Culver Avenue JERSEY CITY, N. J.

USE THE BEST. Economy Greenhouse Brackets are used by leading growers everywhere. Send for price list and descriptive circular. BUXTON & ALLARD, Dept. A, Nashua, N. H.

FOR SALE - A fine estate situated on high ground at Hyde Park, Mass., near Milton. Two minutes from R. R. station, fifteen minutes to Boston. Home, 14 rooms and bath, all conveniences. Corner lot, 47,375 ft. land, fruit and shade trees. Greenhouse, 118 x 33, built 1908, 60 slides, 16 centres, 14 x 24 glass, good opening for commercial florist. Address A. G. Chickering, 33 State St., Boston.

WANTS, FOR SALE, ETC. Advertisements in this column one cent a word. Initials count as words. Cash with order. All correspondence addressed "care HORTICULTURE" should be sent to 11 Hamilton Place, Boston.

HELP WANTED GOOD MEN When you need good men, skilled or unskilled, Write: THOS. H. BAMBRICK 34 South 7th Street Philadelphia Help of all kinds, including that for Florists, Nurserymen, Seedsmen and the Horticultural trade generally.

WANTED A good vegetable grower; also a man for flower garden on private place. Single men and not over 40 years of age. Send references and wages expected, to WILLIAM PLUMB, So. Natick, Mass.

MISCELLANEOUS WANTS WANTED TO BUY - Greenhouses and all kinds of greenhouse material; dismantled and removed at once. Best prices. Terms cash. Address, Max Tomback, 24 Avon Place, Newark, N. J.

WANTED TO BUY - Complete greenhouse plants and all kinds of greenhouse material, to be taken down and removed at once. Terms cash. Address I. Sussnerman, 229 Livingston St., Newark, N. J.

SITUATIONS WANTED SITUATION WANTED - First-class German gardener, trustworthy, experienced and competent, aged 34, married, would like position on private estate. Best of references. Address, Julius Erdman, 3101 R street, N. W., Washington, D. C.

FORESTRY - A young man wishes a position on gentleman's estate. Understands reforestation and improvement cuttings. Also experienced in pruning and 4000-yd. work. J. P. D., 40 Erie St., Boston. SITUATION WANTED - First-class carnation grower, sober and industrious, would like a position in the vicinity of Boston. Can furnish good references. H. M., care of HORTICULTURE, Boston

GLASS

Greenhouse and Hot Bed
SIZES OUR SPECIALTY
PLIENSE STOCK
Plate and Window Glass
Write for Our Prices
PARSHESKY BROS., Inc.
69 Montrose Ave., BROOKLYN, N. Y.

CYPRESS SASH BARS 32 feet or longer
HOT BED SASH
PECKY CYPRESS BENCH LUMBER

GREENHOUSES
ERECTED AND EQUIPPED COMPLETE IF DESIRED

Write for Circular "D" and Prices

The A. T. STEARNS LUMBER CO.
NEPONSET, BOSTON, MASS.

PATENTS

Trademarks and Copyrights
Send your business direct to Washington. Saves time and insures better service. Personal attention guaranteed. Twenty-five years' active service. SPECIALTY: "Working on the Failure of Others."
SIGGERS & SIGGERS
PATENT LAWYERS
Box 9, National Union Building
Washington, D. C.

GREENHOUSE CONSTRUCTION LUMBER

John C. Moninger Co.
117 E. Blackhawk St., CHICAGO.



Evans 20th Century Arm
Will not twist the shafting pipe. Three times the power of old style elbow arms. Sold only with Evans Challenge Machine. Write for free Catalogue to **QUAKER CITY MACHINE CO.** Richmond, Ind.

In ordering goods please add "I saw it in HORTICULTURE."

Holds Glass Firmly
See the Point #2
FEELLESS
Glazing Points are the best. No rights or lefts. Box of 1,000 points 75 cts. pre-paid.
HENRY A. BREER
714 Chestnut St., Phila., Pa.

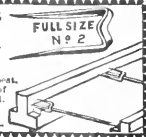

"REVERO"

Braided Moulded Construction—Seamless Throughout



LIGHT--STRONG--FLEXIBLE



The above cuts represent the non-kinking tendency of Revero as compared with the old style hose of wrapped duck construction.
Revero is Furnished on Reels in Continuous Lengths up to 500 feet. Your supply man can furnish it

Revere Rubber Company,
BOSTON, MASS.

NEW YORK PHILADELPHIA PITTSBURG CHICAGO
NEW ORLEANS MINNEAPOLIS SAN FRANCISCO PORTLAND, ORE.

THE STANDARD STEAM TRAP

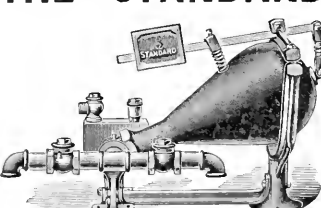

is acknowledged the best for the florist, because it is durable and does its work without trouble and annoyance, saving its cost by the economy in coal bills.

E. HIPPARD
YOUNGSTOWN, OHIO

STANDARD PLATE GLASS CO.

Manufacturers—Importers—Jobbers
NOW IS THE TIME TO BUY
FRENCH OR AMERICAN GREENHOUSE GLASS
LOWEST PRICES ON REQUEST
26-30 Sudbury St. BOSTON, MASS. 61-63 Portland St.

GLASS

Always Write Us Before Buying
SHARP, PARTRIDGE & CO.
22nd and Lumber Streets, CHICAGO
WE HAVE SOME SNAPS

In ordering goods please add "I saw it in HORTICULTURE."
The **FLORISTS' HAIL ASSOCIATION OF AMERICA**, insurer of 29,000,000 sq. ft. of glass. For particulars address **John C. Esler, Sec'y, Saddle River, N. J.**

THE QUESTION OF STRENGTH

IT is conceded that the strongest and most curable structure known is "THE IRON FRAME." And when you have all the **Modern** features combined in this type of construction you have "The Ideal Greenhouse."

The picture shows the beautiful symmetry of my "Curved Iceless Eave"—no heavy antiquated shading members. And I also make a specialty of having my work harmonize with surrounding conditions. Note how the mason work on greenhouse conforms to that on adjacent stable.

The advice of "The Practical Greenhouse Builder" is at your disposal for the asking.

WILLIAM H. LUTTON
West Side Ave. Station, JERSEY CITY



Erected at Davenport Neck, New Rochelle, N. Y.

KROESCHELL BOILER



MADE OF FIRE BOX FLANGE PLATE
Can not Crack!

Water Space in Front, Sides and Back
The Most Popular Boiler Made

SEND FOR CATALOGUE.

KROESCHELL BROS. CO.
35 Erie Street, CHICAGO, ILL.



The Advance Ventilating Apparatus

An Ohio florist sent his order with dimension card ordering machines, etc., and says "I knew your machine and would not try any other." His first purchase. A California man says: "Your machines work fine—could not wish for anything better." A Kansas man sends us his third order for 2 machines, as a proof that we make good our claims. Why hesitate? Get our circular and see the good things we have, and at what prices we are selling them.

The Advance Co.
RICHMOND, IND.

EVERYTHING FOR GREENHOUSE BUILDING

WRITE FOR INFORMATION AND PRICES

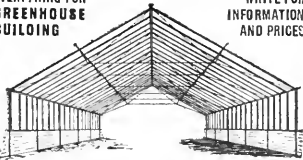

King Greenhouses. King Gutters and Eaves.
Trussed Roofs. Ventilating Machinery.
Trussed Iron Frame Houses.
Tile Benches and Pipe Hangers.

KING CONSTRUCTION COMPANY
NORTH TONAWANDA, N. Y.

THE FOLEY MFG. CO.

CHICAGO

Completely equipped with up-to-date machinery for the making of material for

GREENHOUSE CONSTRUCTION

From a Full Supply of Thoroughly Seasoned Lumber

Send your sketches to our draughtsmen for completion and suggestion. Permit us to figure your proposed work, large or small.

We guarantee our prices will save you money

FOLEY VENTILATING APPARATUS IS THE BEST

Is Simple In Erecting. Is Easiest of Operation. It Will Last a Lifetime. Its Price is the Lowest. Will Ventilate Any Size House. Prices and Circulars on Application.

Our 1908 Catalogue Greenhouse Material Sent Postpaid on Request.

THE FOLEY MFG. CO., WESTERN AVENUE, 25th and 26th STS., CHICAGO

Please Note

that this is not a $\frac{1}{4}$ in. wire affair but it is made of heavy rods.

Practical Houses

on a practical financial basis. If you want an up-to-date house that will save you money,

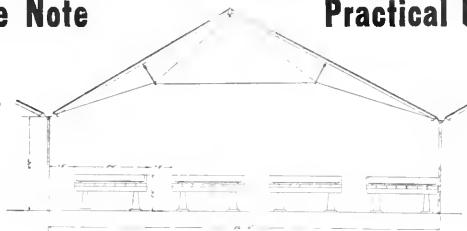

WRITE

GEO. M. GARLAND CO.

Designers and Builders

DES PLAINES, ILL.

BOSTON PLATE & WINDOW GLASS CO.

GREENHOUSE GLASS

GERMAN AND AMERICAN

261 to 287 A Street

BOSTON

20 to 22 Canal Street

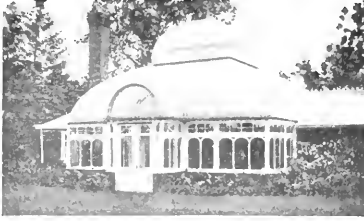

PALM HOUSES

Square ones like this, with curvilinear roof and dome are decidedly ornamental and give an attractiveness to the entire range; but a straight gable, curvilinear house is less expensive.

Of less cost still, is one with the straight roof and high sides, but you don't get quite as much head room. Send for illustrated circular, it shows our several kinds.

Hitchings & Company
1170 Broadway New York

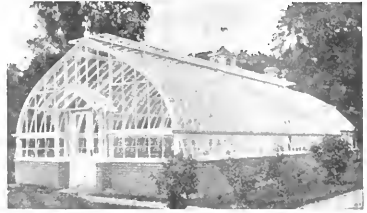

Curvilinear Points

The curvilinear house is always attractive, always practical. It makes a splendid all around house, because of its great lightness, and that the curved roof gives extra head room so longer stemmed plants can be grown. For grape vines they allow greater length vines, which is certainly an advantage. The sectional iron frame, however, makes the best curvilinear house. There are several reasons why now is one of the best times to build. Get in touch with us.

Lord & Burnham Co.
Main Sales Office: 1133 BROADWAY, N.Y.
BOSTON: 87 Tremont Building. PHILADELPHIA: 1215 Filbert St.

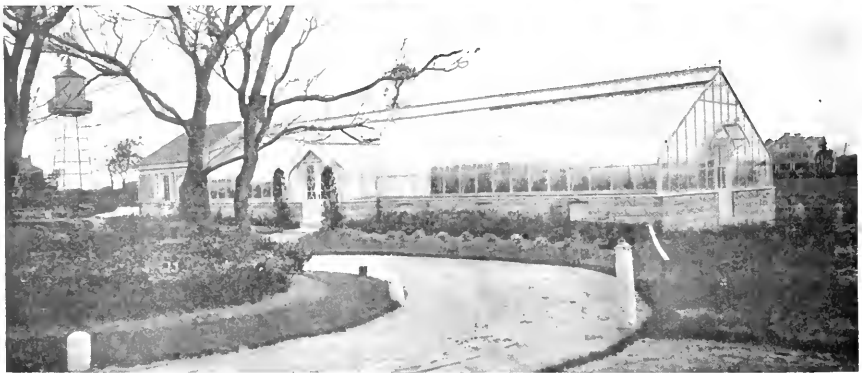

CONSIDERING COSTS

There are two ways of practicing economy: One way — consider prices only. The other consider **results**. It is results that has gained for the U-Bar its reputation.

It is because of these unequalled results that we are asking you to build U-Bar houses. Send for catalog.

U-BAR GREENHOUSES

PIERSON
DESIGNERS AND BUILDERS



U-BAR CO.
1 MADISON AVE. NEW YORK

HORTICULTURE

Vol. IX.

MARCH 20, 1909

No. 12

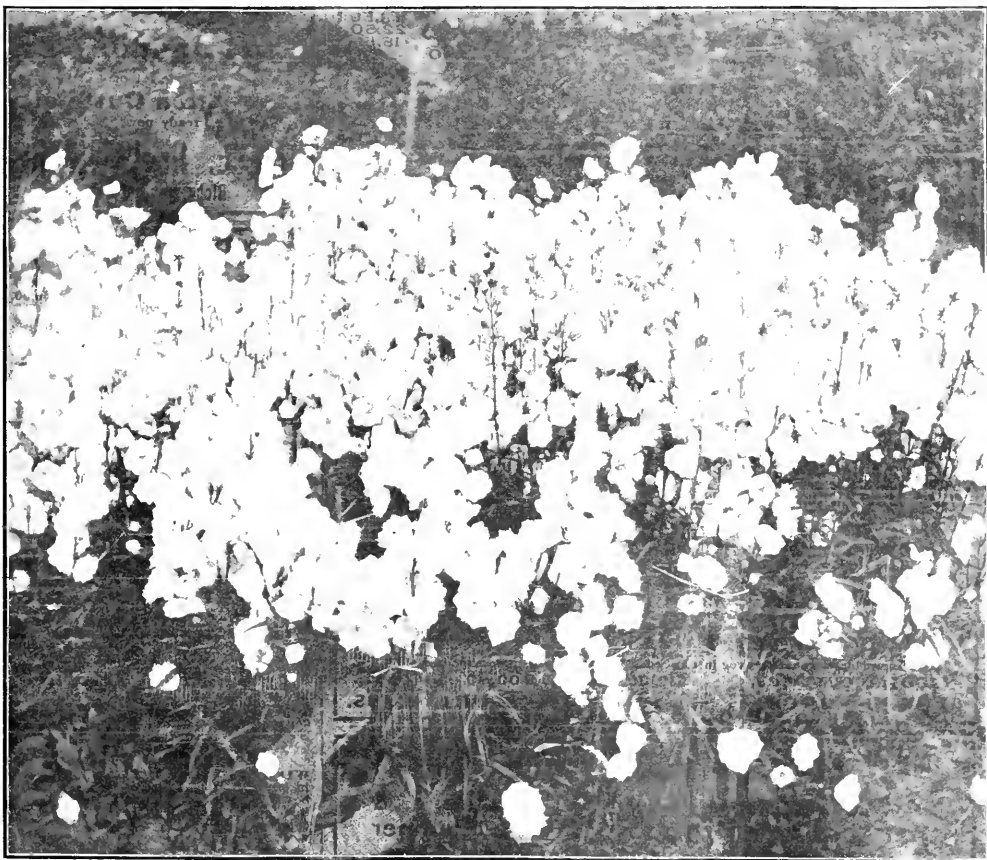

CAMPANULA PERSICIFOLIA MOERHOUSII

(From a photograph taken in The Mt. Desert Nurseries.)



DEVOTED TO THE
FLORIST, PLANTSMAN, LANDSCAPE GARDENER AND KINDRED INTERESTS

PUBLISHED EVERY SATURDAY AT 11 HAMILTON PLACE, BOSTON, MASS.

SUBSCRIPTION, \$1 00 PER YEAR



MAR 22 1909

GERANIUMS

We have an immense stock of fine plants from 2 in. pots for immediate shipment at prices running from \$2 per 100 to 50c. each. We will send 1000, 50 each of 20 good sorts, our selection for \$18.50. Our Special Geranium Catalogue describes upwards of 250 varieties. We have the following in first class stock from 2 in. pots, 25 at 100 rates, 250 at 1000 rates.

	Per 100	Per 1000
Achryanthes, Emersoni - - - - -	\$2.00	\$18.50
" Besterl Mosocco - - - - -	2.00	18.50
AGERATUM, Inimitable, Princess Pauline - - - - -	2.00	18.50
" Dwarf White, Stella Gurney - - - - -	2.00	18.50
ALYSSUM, Dwarf Double - - - - -	2.00	17.50
CINERARIA, Maritima, Candidissima - - - - -	2.00	17.50
Centaura Gymnocarpa - - - - -	2.00	17.50
HARDY CHRYSANTHEMUMS, Send for list - - - - -	2.00	and up
Dahlias, Send for list of Standard and Newer Varieties, only the best, plants for Spring delivery - - - - -	2.50	15.00
Fuchsias, in good varieties - - - - -	2.00	18.50
Hardy English Ivy - - - - -	2.00	18.50
Parlor Ivy, Senecio Scandens - - - - -	2.00	18.50
LOBELIA, Kathleen Mallard, Double - - - - -	1.50	18.50
" Crystal Palace Gem, Single - - - - -	2.00	18.50
Petunias, Dreer's Superb Single - - - - -	2.00	18.50
Salvia, Bonfire - - - - -	2.00	18.50
" Zurich - - - - -	2.00	18.50
Smilax, Extra Strong - - - - -	2.00	18.50
Verbena, large flowering, Red, White, Pink and Blue - - - - -	2.00	18.50

R. VINCENT JR. & SONS CO., White Marsh, Md.

Lucille Won Highest Honors

At Springfield, St. Louis and Utica.

A carnation which while a fancy of the highest exhibition type, yet has all the best qualifications as a profitable commercial crop. Its beautiful color

WHITE OVERLAID WITH PINK,

size, stem, perfection of form, habit, productiveness and keeping quality place it unquestionably in the front rank. It is a coming standby and should be in every carnation grower's collection. WRITE FOR DESCRIPTIVE CIRCULAR.

\$12.00 per 100. \$100.00 per 1000. Fine Healthy Stock.

A. F. LONGREN, DesPlaines, Ill., HIGHLAND PARK GREENHOUSES, Highland Park, Ill.

A WIRELESS WINNER

Has Won Absolutely on Its Own Merits. Certificates Innumerable Everywhere
 MASSACHUSETTS HORTICULTURAL SOCIETY'S SILVER MEDAL LAST YEAR
 AMERICAN CARNATION SOCIETY'S GOLD MEDAL THIS YEAR

THAT'S THE RECORD OF
It Is Invincible. BAY STATE Buy it and Grow it.

The noblest carnation ever introduced. White with carmine pencillings.
ROOTED CUTTINGS, - \$12 00 per 100, \$ 00.00 per 1000.
ALBERT ROPER, - - - TEWKSBURY, MASS.

NEW RED CARNATION O. P. BASSETT

Extra Large Bright Red Free Bloomer

Rooted Cuttings, per 1000, \$60.00 | Rooted Cuttings, per 100, \$8.00 | Rooted Cuttings, per 50, \$2.50
 per 50, \$5.00 | per 50, \$4.50 | per 25, \$1.50

Ready for delivery Jan. 1st, '09 by the Originators and Growers
BASSETT & WASHBURN, HINSDALE, ILL

CARNATIONS ROSE MY MARYLAND

Standard sorts and all the novelties of merit. Orders booked now for this most promising variety.
CHRYSANTHEMUMS The cream of the commercial sorts Send for our price-list. We can quote you right and supply first class stock.
S. J. REUTER & SON, WESTERLY, R. I.

ROOTED Carnation Cuttings

	per 100	per 1000
Afterglow.....	\$6.00	\$50.00
Sarah Hill.....	6.00	50.00
Lawson Enchantress.....	6.00	50.00
Aristocrat.....	4.00	35.00
Beacon.....	3.50	30.00
Crimson Glow.....	3.00	25.00
Mrs. M. A. Patten.....	2.50	20.00

Can also furnish for pots
E. W. FENCAR
 147-187 Linden Avenue Irvington, N. J.

Send for our Preliminary List describing and quoting

Chrysanthemums and Carnations.

A fine lot of
Carnation Cuttings ready now.

THE E. G. HILL CO.,
 Richmond, Indiana.

CARNATIONS Rooted Cuttings Fine Healthy Stock

	Per 100	Per 1000
Pres. Seelye - - - - -	\$6.00	\$50.00
White Enchantress, Beacon 3 50	3.50	30.00
Victory, Winsor, Melody, Kingston Per - - - - -	3.00	25.00
Dahelm, Enchantress, Lady Bountiful, Mrs Lawson, White Lawson, Red Lawson, Variegated Lawson	2.50	20.00

WOOD BROTHERS
 FISHKILL, N. Y.

PETER FISHER ELLIS, MASS.

Send for Price List of Carnations

CARNATION CUTTINGS

Ready for delivery March 20th to 2, th.
 Andrew Carnegie, Delaue, Splendor, Pres. Seelye, Afterglow, Lawson-Enchantress, Sarah Hill, 85 per 100; 850 per 1000, White Perfection, White Enchantress, Winsor, Rose Pink Enchantress, Enchantress, Lady Bountiful, Melody, White Lawson, 83 per 100; 825 per 1000.
 Chicago Carnation Co. A. T. Pyfer, Mgr. Joliet, Ill.

CARNATIONS

WINONA—The true pink—At Indianapolis, in class A, won 1st prize in six entries for best vase of 100 blooms of light pink lighter in color than Lawson. A grand commercial sort in great demand. Place your order now for prompt delivery.
 \$6.00 per 100, \$50.00 per 1000.
F. DORNER & SONS CO.
 La Fayette, Ind.

ROOTED CUTTINGS

Wm. H. Taft, \$12 per 100; \$30 per 1000

	per 100	per 1000
Enchantress.....	\$1.75	\$15.00
Pink Lawson.....	1.50	12.50
White Lawson.....	2.00	18.00
Variegated Lawson.....	2.75	25.00
Victory.....	2.50	20.00

SCHIELO N & SCHOOLS, 48-60 Wabash Ave., Chicago.

In ordering goods please add "I saw it in HORTICULTURE."

NEW ROSE WHITE KILLARNEY

We Know You Will Want to Buy White Killarney



Every live, progressive, up-to-date grower who has seen it is buying it; but when you buy White Killarney, be sure you get the right White Killarney (the Waban variety). When you buy from us you get the variety that has been exhibited and certificated, and the one that has attracted such favorable mention.

If you are in the vicinity of New York, we should be glad to have you call and see White Killarney growing at our Scarborough range, and you will say at a glance—as everyone has who has seen it growing—that it is by far the best white rose that has ever been placed on the market.

It is not only a good winter-flowering rose, but is good the entire year, and it is a splendid shipper. Read the following letter received from Mr. Willis N. Rudd, Secretary of the Society of American Florists, dated January 18th, in which he writes as follows:

"Dear Mr. Pierson:—I cannot refrain from writing you and expressing my admiration for the White Killarney as shown at Chicago on Thursday. It is an exquisitely beautiful thing and attracted much attention. I took half the blooms home with me, and they were finer on Saturday than they were at the show. The record is that these blooms were shipped from Tarrytown, staged and exhibited during the afternoon. They were then carefully wrapped up in a box, and remained in that box until one o'clock Friday morning, at which time I reached home improved in quality up to Saturday, and were in fairly presentable condition on Sunday.

"In addition to being the most beautiful white rose of its class which I have seen, this demonstrates its splendid keeping and shipping qualities.

W. N. RUDD."

We were awarded Silver Cup at National Flower Show, Chicago, for best new rose with White Killarney; also Silver Medal Horticultural Society of New York.

Strong plants, 2 1/2 inch pots, own roots, now ready for delivery, \$30.00 per 100; 250 for \$70.00; 500 for \$125.00; 1000 for \$250.00. Grafted plants, ready April 1st, \$35.00 per 100; 250 for \$82.50; 500 for \$150.00; 1,000 for \$300.00.

F. R. PIERSON CO., Tarrytown on-Hudson, NEW YORK

Newport Fairy
The Rose of the Future For In and Out Door.

FINE, STRONG FIELD-GROWN STOCK
3-4 Shoots 3-4 ft. long

50c each, \$30 per 100, \$250 per 1000

JULIUS ROEHRS CO.,
RUTHERFORD, N. J.

CHRYSANTHEMUMS

Now is the time to procure stock for EXHIBITION BLOOMS. Here is an opportunity for those who contemplate competing at the Shows or intend making a display on their own account

SPECIAL OFFER

To make room we have cut the price in halves of the following 1909 NOVELTIES. **WELLS-Pockett**, C. W. Fook, Frank Jayne, Rose Pickett, Merstham Blush, Mrs. C. H. Tott, and Leslie Morrison. Also the following meritorious NOVELTIES: **Bessie Evans**, Miss Faith Moore, Mrs. Jos. Hygate, R. C. Pulling, Diabola, Mme. Helene Prudhomme, Souv. de Raymond, Hamilton, and Miss Violet Pearson.

Any of the foregoing, 25c. each, five of a kind at 20c. each, and twenty-five of a kind at 15c. each.

THE STOCK IS EXCEPTIONALLY FINE AND READY TO SHIFT

2 1-2 Inch Stock Now Ready

Chrysanthemums: Alice Roosevelt, Virginia Poehmann, dandy midseason whites new, \$4 per 100; \$35.00 per 1000. Mrs. Salter, geraniums, see Prices, \$2 per 100; 3 inch Boston and Whitman Ferns, \$6 per 100. Cash.

L. M. RAYNER, GREENPORT, N. Y.

SCOTT BROS.

CHRYSANTHEMUMS

All the newest and best kinds Roses, Greenhouse and Outdoor. Grafted or Own Root.

ELMSFORD NURSERIES, Elmsford, N. Y.

We are headquarters for the best Commercial Novelties and can now deliver in quantity such sterling sorts as **Gloria, Pres. Taft, and Mrs. W. E. Kelley.**

Of the older sorts best for exhibition we have the following, in the best condition ready to shift, and are making the following low offer: 10c. each, 5 plants of a kind at 5c. each, 25 or more of a kind at 4c. each—**Annie Hamilton, Bessie Godfrey, Brightstuart, Chelloni, C. J. Salter, Dicky Vince, Dubuison-Foubert, Ernest Mileham, F. S. Vallis, Grace Witney, Jos. Stoney, Kitty Lawrence, Lady Hopetoun, Miss Clay Frick, May Seddon, Mrs. Geo. Mileham, Mme. L. Roussel, Mrs. J. E. Dunne, Mrs. F. F. Thompson, Mrs. Walter Jinks, Mrs. Wm. Knox, Mrs. J. C. Neill, Mrs. R. H. Pierson, M. Paul Randet, Naceur-Bey, Nellie Pockett, O. H. Proomhead, Reginald Vallis, Solange, T. Carrington, Wm. Duckham, W. Meredith and W. Wells.**

Our stock of Commercial sorts, including Poppoms and Singles, is complete. We also have Aster Seed of superior quality and best varieties.

ELMER D. SMITH & CO., Mich.

CHRYSANTHEMUMS

Golden Glow—plant Middle May to July—Cut Middle Aug. to Oct.—**White Cloud**—an 8 inch lap—extra strong stem. Plant late May and early June—Cut Middle Oct. to Nov. 1st—**P. civic Supreme**—longer stemmed—brighter—non-fading Glory of the Pacific. Beided now will increase stock to 1 by planting time—**Delivery Plants**—March \$5.00 per 100; April \$4.50; But. Season \$4.00. Rooted Cuttings now, post or express paid, \$4.00 per 100; 25 at 100 rates.

J. H. MYERS, ALTOONA, PA.

NURSERY STOCK FOR FLORISTS' TRADE

AMERICAN GROWS ROSES, AZALEAS, RHODODENDRONS, FRUIT AND ORNAMENTAL TREES, SHRUBS, SMALL FRUITS, CLEMATIS, EVERGREENS

WRITE FOR OUR TRADE LIST

63 YEARS
700 ACRES

W. & T. SMITH COMPANY GENEVA, N. Y.

ROSES

We have a fine stock of large, dormant, field grown plants, on own roots, of the following varieties:

Boule de Neige, Mad. Plantier, Alfred Colomb, Perle des Blancches, Climbing Clothilde Souper, Archduchess Elizabeth of Austria, Empress of India, Glory of the Exposition of Brussels, Philadelphia Crimson Rambler, Fisher Holmes, Cheahunt Hybrid, Climbing Wootton, Magna Charta, Countess of Rosberry, Louis Van Houtte, Dorothy Perkins, Anna de Diesbach, Mad. Alfred Carriere, Vick's Caprice, Sir Thomas Lipton, Francois Levet, Eugene Furet, Crimson Rambler.

PRICE \$12.50 per 100; \$120 per 1000

Tausendschon, the great new climber, \$20 per 100, \$180 per 1000.

Crimson Baby Rambler, \$16 per 100.

Fine plants from 2 1/2 inch pots, Chrysanthemum Glory of the Pacific, \$3.50 per doz.

Roses, Dahlias and Cosmos a Specialty.

Catalogue Free West Grove, Pa.
The Dingee and Conrad Co.

Hardy Rhododendrons, Azaleas, Conifers, Clematis, H. P. Roses, Shrubs and Herbaceous Plants from our HOLLAND NURSERIES

Prices Moderate
P. OUWERKERK, 216 Jane St., Weehawken Heights, N. J.

CLEARY'S HORTICULTURAL CO.
Management AMBROSE T. CLEARY
Wholesale Contracting, Jobbing, Auction
HORTICULTURAL PRODUCTS
of every description.

Consignments Received. Surplus Stock Converted
62 Vesey St., NEW YORK

A THING OF MERIT.
NEW HARDY FLOWERING SHRUB.

Buddleia variegata Vitellia and Maculifera—summer flowering Lilac—blooms when all other shrubs are past. Strong 3 yr. old, 50c. each; \$5.00 per doz.; \$25.00 per 100.

Rose Hill Nurseries, New Rochelle, N. Y.

Box Trees

and other EVERGREENS for Tubs and Boxes
Our Prices are Always Right—Catalog Free
THE NEW ENGLAND NURSERIES, Inc.
BEDFORD, MASS.

Guaranteed Nursery Stock

Of All Varieties and Sizes
WRITE FOR LOWEST PRICES

P. HAMILTON GOODSSELL

200 BROADWAY NEW YORK

Hardy Herbaceous Perennials

Well-grown plants of all the standard varieties at reasonable rates.

SEND FOR TRADE CATALOG.

DANIEL A. CLARKE

REDOAK NURSERIES, Fiskeville, R.I.

BARGAINS in TREES and PLANTS
Concord Grapes, \$2.00. Peach, \$3.00 per 100.
Liat Frez. D. J. TWOMEY, Dept. H, Geneva, N. Y.

In ordering goods please add "I saw it in HORTICULTURE."



CHRYSANTHEMUM BELFAST

BELFAST

The New Christmas-Flowering Chrysanthemum

Of the largest size light pink shading to cream. Can be brought into bloom from Thanksgiving to Easter but is at its best about Christmas. Easily grown and claimed to be for the commercial grower the most profitable variety ever introduced. It comes into bloom after every other variety is through, is a great keeper and can be held on the plants for four weeks. Last Spring the originator cut the last blooms April 11. 2 1/2 inch pots 5c.; \$5 per doz.; rooted cuttings \$2.50 per doz., \$18 per 100.

Carnation Bay State

Winner of the Gold Medal at Iodicaapolis. From 2 1/2 inch pots, \$3 per doz. Rooted cuttings of all other desirable varieties, old and new, at lowest prices.
Tuberose, Caladiums, Gloxinias, Tuberous rooted Begonias, Florists' Flower Seeds and Sundries.

Send for Wholesale Price List.

SCHLEGEL & FOTTLER CO.
26-27 So. Market St. Boston.

ROSES READY FOR WORK

R. C.		2 1/2 In.		R. C.		2 1/2 In.			
per 100	per 1000	per 100	per 1000	per 100	per 1000	per 100	per 1000		
American Beauty...	\$3.50	\$32.00	\$7.00	\$65.00	Killarney	3.00	27.50	6.00	55.00
Empressmaid	2.25	20.00	5.00	45.00	Uncle John	2.00	18.50	4.50	42.00
Bride	2.25	20.00	5.00	45.00	Mrs. Potter Palmer...	3.00	25.00	5.00	45.00
Richmond	2.50	22.00	5.50	50.00					

CHRYSANTHEMUMS

R. C.		2 1/2 In.		R. C.		2 1/2 In.			
per 100	per 1000	per 100	per 1000	per 100	per 1000	per 100	per 1000		
Earliest White....	\$2.50	\$22.00	\$3.50	\$30.00	Alice Byron.....	2.50	22.00	3.00	27.50
October Frost....	2.50	22.00	3.50	30.00	Timothy Eaton....	2.50	22.00	3.00	27.50
Virginia Poehlmann...	4.00	35.00	5.00	45.00	W. H. Chadwick....	3.00	25.00	4.00	35.00
Robinson	2.20	20.00	2.50	22.00	Merry Christmas...	2.50	22.00	3.00	25.00
Clementine Tausset...	3.00	25.00	4.00	35.00					
Yellow									
Monrovia	3.00	25.00	4.00	35.00	Golden Wedding....	3.00	25.00	4.00	35.00
Holiday	2.50	22.00	3.00	27.50	Yellow Eaton.....	2.50	22.00	3.00	27.50
Col. Appleton.....	2.50	22.00	3.00	27.50	Golden Chadwick...	3.50	30.00	4.50	40.00
Major Bonaffant....	2.50	22.00	3.00	27.50	Chautanqua Gold...	3.00	25.00	4.00	35.00
Pink									
McNiece	3.00	25.00	4.00	35.00	Dr. Enguehard....	2.50	22.50	3.50	30.00
Mand Deau.....	2.50	22.50	3.50	30.00	Rosiere	3.00	25.00	4.00	35.00
Red									
Intensely	2.50	3.50			Schrimpton	3.00		4.00	

POEHLMANN BROS. CO., Morton Grove, ILL.
Send all orders for cuttings and plants to Morton Grove

JOHN WATERER & SON, Ltd.

American Nursery Bagshot, England

Are Specialists in the

REALLY HARDY VARIETIES
of Rhododendron Hybrids and in Select Varieties of Hardy Border Plants

SOME OF OUR SPECIALTIES

Boxwood Pyramid Shape, 2 1/2 to 3 ft. high, very heavy, \$1.75 each, 3 to 3 1/2 ft. high, \$2.50 each. **Bush Shape**, very heavy, 2 to 2 1/2 ft., \$1.75 each, 2 1/2 to 3 ft. high, \$2.00 each.
Rhododendrons, Parson's Hardy varieties, 8 to 12 buds, 18 to 24 in. high, at \$75.00 per 100; 12 to 14 buds, 24 to 30 in. high, at \$100.00 per 100.
Azalea Bolls, 15 to 18 in. high, very bushy and full of buds, at \$35.00 per 100.
Hybrid Perpetual Roses, strong dormant field grown plants, of our own growing, none better, \$11.00 per 100, \$100 per 1000.
Loss Roses, field grown, \$1.00 per 100.
Hardy Climbing Roses, field grown, \$3.00 per 100.
Tree Roses, hardy varieties, budded on straight stems, 4 to 5 ft. high, \$30.00 per 100.
Ampelopsis Vetchii, bushy, 2 yr. plants, 3 foot of tops, \$10.00 per 100.

The Storrs & Harrison Co., Painesville, Ohio

Cattleya Luddemanniana alba



Cattleya Luddemanniana is a Venezuelan species not generally cultivated though it has flowers of large size and great beauty; in fact flowers 8 inches across are not uncommon with this species. It was formerly known under the name of *C. speciosissima* and is still catalogued under that name by some growers but the name given above is the accepted one of orchid authorities. Like almost all *Cattleyas* it has its albino forms but these are exceedingly rare so that the illustration of one that has just flowered at Florham Farms should be of more than ordinary interest.

It is the first white form of this species I have ever seen whilst other growers having had a life experience in orchids tell me they have never seen one. Are there any records of a white one having flowered before in this country? I know there are several in Europe but European conditions are not favorable to frequent flowering of this species. The plant in question came to me several years ago and I was informed that it was a white one but the tiny piece consisted of three bulbs not one of them as large as a hickory nut so it has been a matter of years growing it up to prove that it is what it was represented to be. The flowers are of large size, and good substance especially having regard to the small size of the plant which is growing in a five-inch pan.

Although as before said *C. Luddemanniana* is not largely grown it deserves more attention from American growers for it can be made to flower freely and finely in this country with proper treatment. It can stand more heat and more exposure; in fact these are the two essential requisites as compared with the usual treatment accorded to *Cattleyas*.

Some years ago Mr. Geo. Field of Washington grew this *Cattleya* successfully and it flowered abundantly and, if memory serves me rightly, when I saw them they were growing on the back bench of a house devoted to Meteor roses and during the hottest part of the year a piece of cheese cloth was hung down in front of them

to break the bright sun rays as there was no shade on the roof of the house.

At Florham Farms we have had good success also with this *Cattleya* and although it falls short in number of flowers produced as compared with other species the flowers are always of large size and commanding beauty. Another peculiarity about it, too, is its prolonged season of flowering. Our experience would indicate its season of flowering to be from February to April because then we have most flowers from it, but our records show we have cut flowers of it every month in the year except June. I recall cutting some very fine flowers once in December that a prominent New York florist said made *C. Trianae* look like "thirty cents." Another point in its favor is that it has a robust constitution, keeping strong and healthy, and living longer under cultivation than most *Cattleyas* do.

Arthur Herrington

The Florists' Pentstemon

The interesting note by Alfred J. Loveless on these beautiful, half-hardy perennials in *HORTICULTURE* for March 6th should assist in promoting an extended interest in their cultivation and it may be safely assumed that their many merits will be fully appreciated when these handsome plants become better known.

In many of the best estates on the other side of the "pond" *Pentstemons* now form one of the principal attractions of the flower garden and the many fine varieties now on the market are, as Mr. Loveless truly says, the result of much careful hybridizing and selection.

The finest varieties in cultivation are, undoubtedly, those raised by Mr. E. Beckett of the Aldenham Gardens, Elstree, England, who has for many years endeavored to produce large flowers combined with freedom and good constitutions. The result is that some sorts now have flowers three inches across individually. I see that this excellent strain has been introduced to America, and it is to be hoped the *Pentstemon* in its improved state will become as popular here as elsewhere.

I had several years' experience in growing and selecting the best varieties and am quite sure that no finer plants exist for the embellishment of the flower garden during the summer and early fall months, and very few plants require such a small amount of care to bring them to perfection. If one grows them in groups or beds of separate varieties some wonderful effects can be produced, but to do this it is necessary to take cuttings in the fall and plant out in April when frosts have disappeared.

It is very interesting to grow a batch of seedlings and select one's own varieties as there is always sure to be great diversity of color and these will also prolong the display well into the fall as they do not commence to blossom so early as the cuttings. The *Florists' Pentstemon* is well suited to the climatic conditions of this country and in some parts would prove of perennial duration but the most satisfactory results are always obtained by treating them as annuals.

Arthur E. Thatcher

Arnold Arboretum.

European Horticulture

COMING EXHIBITIONS THIS YEAR IN HOLLAND

At Hillegom, Holland, an exhibition of flowering bulbs will be held in April and May in the open air. For this purpose, a large beautifully situated terrain, planted by the local bulb growers will be planted with 200,000 flowering bulbs. Last year, Sassenheim, near Hillegom, held a similar exhibition. This year's exhibition will be opened on April 8 and will be a much more important one.

A NEW VARIETY OF GERBERA JAMESONI

We read of a new variety of this highly decorative plant—a native of South Africa—that has been raised by Mr. R. Adnet of Antibes, in Southern France. It is surprising to note how numerous are the varieties of this brilliant South African species, and how the changes in colors vary from orange-scarlet, yellow and white, according to the desire of the hybridist, and flowers become larger and longer in the stalk. The largest blooms of Adnet's raising have a diameter of 13 cm., against 6 or 7 cm., with stalks of 20-25 cm., less than ten years ago while the stalks of the new Adnet's hybrids measure 50-60 cm. and they are firmer and thicker. Today there is a greater variety of colors than could have been imagined possible a few years ago. These colors range from pale sulphur yellow and creamy white to full *Doronicum* yellow; from a tender rosy peach to salmon pink and scarlet tints, to the deepest clear carmine; out of fifty varieties scarcely two were exactly alike in their tints. The form of the blooms is very varied. It has yet to be proved that blooms are so good for carriage to distant places; but should they well withstand the rough handling inseparable from long journeys by road and rail, we shall have flowers that may rank with carnations and roses, and the demand for seeds of *Gerbera Jamesoni* hybrids will be a lively one.

HEMIGRAPHIS COLORATA

This is a recommendable decorative plant, more particularly for the amateur and private gardener. It has a bushy habit, a vigorous growth and leaves of a leathery texture, serrated at the edges. The plant requires the temperature of the warm greenhouse, and is suitable for the flower stand, and a striking subject for winter gardens and glass-house decoration. The best kind of soil in which to grow this plant should be a light one. Mr. Hoydt states, in "Die Gartenwelt," No. XIII, that he grows his plant in leaf mould, decayed cow dung, and sand intermixed. Liquid manure may be afforded with good effect when in full growth. The older plants are not at all tender, but on the contrary the young ones should be kept close and moist, and protected from strong sunshine. Propagation by means of cuttings should be undertaken in the spring, employing a temperature of about 50 per cent. Fahr. in the bed. Without bottom heat, the production of roots is very slow.

SINGLE FLOWERED CHRYSANTHEMUMS

As is well known, the nature of the soil and climatic conditions exert great influences on the growth of plants and the chrysanthemum is no exception. A cultivator residing at Frankfurt on the Oder purchased forty varieties of single-flowered chrysanthemums in 1906 and 1907, of which some have fully grown up to expectations, deserving of the widest cultivation. And of these the names are given in "Die Gartenwelt," No. IX, of the present year. Cammell's Yellow is in growth most excellent. In form and color of the bloom it resembles a large yellow *Marguerite*. The color is a pure dark yellow, which does not pale with age—not even in pass-

ing out of bloom, and its floriferousness leaves nothing to be desired. It makes a good bush and standard. A fellow plant to this is Freedom which in growth is more vigorous, but the bloom is smaller of a pure white, and very free. It is equally good as a bush and standard. Very acceptable in flowering, pose, and form is Mrs. F. J. Howarth, of a terra-cotta tint. It is an excellent flower for filling vases, and makes a pleasing plant in bush form. One of the darkest tint and a late bloomer is King of Siam, a dwarf habit, and bright red. The following three varieties are similar in the form and color of their blooms and only differ in the height to which they grow and their date of flowering: Mrs. Selby, Flossy and Lady-smith. They are of a bright rose tint, and possess healthy foliage and growth. Mrs. J. Ferguson in habit of growth and shape of the flower is similar to the old Marie Anderson. The tint is a more decided pink, and the plant is earlier in flowering. As a flower for cutting White Swan may be recommended. The flower with its long petals has a good effect. The strong growing Sylvia should not be omitted; it being a variety which forms a magnificent globular bush, thickly set with blooms, the color of which is like that of Ada Owen, but it is larger. For these single flowered chrysanthemums pot culture is to be preferred.

JASMINE PRIMULINUM

This Chinese species is a bright, interesting plant now in flower in the Kew Botanic Garden. The long pendulous shoots are thickly furnished with semi-double yellow flowers. The best way to grow this plant is to place it in the open, in full sunshine in the summer-time, and every encouragement afforded to secure well matured growth. The plant may be gently forced in a minimum warmth of 40 degrees Fabr till January. More warmth develops wood-growth instead of flowers. A plant new to gardens is *Erlangea tomentosa* belonging to Compositae. It is a native of British East Africa. The flowers are like those of a *Eupatorium* and are of a heliotrope color. The plants are about three feet high, and the leaves are of a silvery white color. *Peristrophe speciosa* is a good cool greenhouse plant, freely producing carmine purple flowers for a period of three months.

PRIMULA OBOENICA GRANDIFLORA IN THE OPEN AIR

Usually the gardener, after flowering his plants of *Primula oboenica*, throws them on the rubbish heap. But when it becomes known that these easily grown plants, which flower so abundantly during the winter months can be made to flower with equal freedom in the summer, the gardener will do so no longer. There can be found in every garden much shaded spots, or ground full of the roots of trees and shrubs, in which summer flowering plants of the most modest requirements in regard to soil and position will not succeed. For such parts of a garden, as likewise edging for groups of shrubs, and under thinly planted shrubs and trees and bare parts of a rockery, *Primula* can be put to a useful purpose. The plants should be set out in the spring, at the same time placing a small quantity of fresh soil, containing peat and light turfy loam, or even spent potting-bench soil, failing those. After planting, the plants should then be heavily watered, and occasionally as may be required during dry, hot weather. Sometimes these out-of-doors plants produce a number of large developed specimens, which, if taken up with care and potted, afford in the following winter a quantity of long stalked corymbs, excellent material for cutting.

Fredrick Moore

Some Novelties of Double and Semi-Double Campanula

The bellflower or Campanula is a plant genus very rich in forms and widely different in its varieties. One of the oldest and best known types is the peach-leaved: *Campanula persicifolia*. Clear colors—pure white and various distinct shades of blue—and a marked profusion of well-shaped flowers borne on long wiry stems, are attributes which strongly appeal to the eye of every garden owner. Their long-lasting quality as cut flowers makes them still more worth having, especially since this perennial has proven extraordinarily hardy and under cover well survives the long frigid winters of our northern States. Plant species of high floral value merit the interest of the hybridizer. That the latter's skill and labor was not wasted when turning to the peach-leaved bellflowers, the present begins to show.

The growth of the latest single varieties, when compared with their old parents appears more robust and taller. The individual bells of the grandifloras are decidedly larger in size and, in the most cases, they show improvements in shape and color.

The advance in the double and semi-double class is by no means less remarkable. As the principal part of the work on their further developments has been carried on in Europe, few of the recent novelties are as yet found in American trade catalogues. Most of them are, however, on the trial grounds of our leading hardy herbaceous plant firms and will no doubt be sooner or later disseminated.

Among the latest introductions *Campanula persicifolia* "Capri," in clear bright blue, and "Violeta," in color a few shades darker, both semi-double, are reported to combine fine flowering quality with enormous size of the singular bells. *Coupe d'Azur*, semi-double, of lower growth, and the medium high navy blue variety "Cloche bleue," are of French origin. Wilhelm Pfitzer of Stuttgart in Germany offers, among his novelties *Campanula persicifolia* Pfitzeri, a large flowering, cup-shaped, double or semi-double species, said to be Moerheimi in clear bright blue. Mr. Pfitzer rarely ever exaggerates and if his latest achievement is what is said of it, it is sure to be a winner. *Campanula persicifolia* "Ilumosa," one of the tallest growing semi-double, blue bellflowers, has been introduced to the American trade during the last year.

In double white, *Campanula persicifolia* Moerheimi stands unsurpassed in beauty and floral productions. The sight of a clump of from fifty to one hundred plants grouped together for mass effect is certainly dazzling. It is the immaculate white of the lily and the alabaster gloss of the *alba plena* camellia that greets us. This explains the rapidly growing popularity, both in our country and in Europe, of *Campanula* Moerheimi.

Richard Roth

Northeast Harbor, Me.

Lilium Formosa

[This communication was intended for last week's issue and editorial reference was made therein concerning it, but it was unavoidably crowded out at the finish. Ed.]

Among the recent introductions among the trade is the new Japan lily, *Formosa*. When disseminated in fall of 1907 the supply was so short that one box was shipped to each city, results of which were watched with the keenest interest by all our local growers. A box of

these bulbs was received in Rochester about September 10, 1907. The bulbs were potted and stored in cool place. Not having bench room until after Christmas, they were left and when benched (Jan. 2, 1908) they had a mass of roots, and gave good promise, which was fully verified by results. The plants were grown on, staked as necessary, and when in bloom March 10th, on good strong stems three to four feet long, they averaged five flowers to a plant, and only four bulbs of the entire box were discarded. The remainder were a revelation to all who saw them. Clean, strong and thrifty, good flower, elegant keeper, and congratulations were heard on all sides because at last something had come that was worth having, and on the success of that box in Rochester many orders were given to the firm handling it.

Last fall when the shipments of *Formosa* began to arrive the writer was present at the unpacking of several cases in different establishments. Some were packed in clay, others with just sphagnum moss, and these were badly shrivelled, but all were potted. Results are now apparent, and am sorry to say that *Formosa* lily is far from its standard set by the sample box of year previous. Grown by same grower, under same conditions, there has been a decided falling off in quality both as to blooms and foliage. These conditions prevail wherever *Formosa* is grown here. The growth is very uneven, tall plants, short plants, and apparently *Formosa* is a composite of ten or twelve varieties, for, in looking over the growth of several different shipments, there can be seen wide leaves, narrow leaves, short and long leaves, red stem, white stem, green stem, long jointed, short jointed, and, in fact, apparently all varieties, and hard to tell which is *Formosa*. Perhaps the introducers of this bulb can inform us. The buds this year are not so plentiful, showing a decided falling off, averaging two or three buds each plant, a good many having only one. With a lily so full of promise such as the sample box was, the writer fails to understand how it has taken such a sudden drop in quality. Grown side by side with other lilies, it is certainly not worth the room, and it is to be sincerely hoped that some improvement can be made.

It is a good lily, early, and responds to treatment readily, and I believe could be had in bloom for Christmas if bulbs could be received during latter part of August, without danger of being dug before ripe.

Aubrose H. Cocker

Rochester, N. Y.

Monkshood

There are a number of the various species of *Aconitum* that do well in ordinary garden soil, napellus, the true monkshood, being one of the best. It is also one of the earliest flowering and does well either in sun or shade—although the flowers will last longer if partially protected from hot sun. Responds readily to high cultivation. As seen at Dreer's during one of our last year's visits it is one of the most charming of the long list of hardy perennials and should be in every border although not too near the vegetables nor where children are likely to be playing, on account of the poisonous character of its roots.

G. Watson

HORTICULTURE

VOL. IX MARCH 20, 1909 NO. 12

PUBLISHED WEEKLY BY
HORTICULTURE PUBLISHING CO.
 11 Hamilton Place, Boston, Mass.

Telephone, Oxford 322
 WM. J. STEWART, Editor and Manager

SUBSCRIPTION PRICE

One Year, in advance, \$1.00; To Foreign Countries, 2.00; To Canada, \$1.50

ADVERTISING RATES

Per inch, 30 inches to page \$1.00.
 Discounts on Contracts for consecutive insertions, as follows:
 One month (4 times) 5 per cent.; three months (12 times) 10 per cent.;
 six months (16 times) 20 per cent.; one year (52 times) 30 per cent.
 Page and half page spaces, special rates on application.

Entered as second-class matter December 8, 1904, at the Post Office at Boston, Mass., under the Act of Congress of March 3, 1879.

CONTENTS

	Page
COVER ILLUSTRATION—Campanula Persicifolia Moerheimii.	
CATTLEYA LUDDEMANNIANA ALBA—A. Herrington—Illustrated	389
THE FLORESTERS' PENTSTEMON—Arthur E. Thatcher	389
EUROPEAN HORTICULTURE—Frederick Moore	390
SOME NOVELTIES OF DOUBLE AND SEMI-DOUBLE CAMPANULA—Richard Rothe	391
LILIUM FORMOSA—A. H. Secker	391
MONKSHOOD—G. C. Watson	391
RETAIL FLORESTERS' PROTECTIVE ASSOCIATION OF NEW YORK—Charles A. Dards	393
AMERICAN ROSE SOCIETY: The Annual Meeting—First Session—President's Address—F. R. Pierson, Portrait	394
Secretary's Report—Treasurer's Report—New York the Next Meeting Place	395
Judge's Report—Election of Officers—Special Awards—List of Awards—Thursday Morning's Session	396
NEWS OF THE CLUBS AND SOCIETIES: Massachusetts Horticultural Society	402
Gardeners' and Florists' Club of Boston, Harry A. Barnard, Portrait—Lenox Horticultural Society—St. Louis Horticultural Society—Morris County Gardeners' and Florists' Club	402a
New Jersey Floricultural Society—Detroit Florists' Club—Nassau County Horticultural Society—S. A. F. Executive Board—Connecticut Horticultural Society—Pennsylvania Horticultural Society	402b
Albany Florists' Club—Indiana State Florists' Association—American Association of Park Superintendents—Club and Society Notes	402c
OBITUARY—Louis M. Noe	402c
Patrick Lawlor—Helen C. Pennock—Lafayette A. Gates—J. S. Haskins—J. J. Nussbamer—Harry J. Hess—H. W. Baudry—Mrs. G. A. Rolin	402d
METHODS OF PROPAGATING PLANTS—Jackson Dawson	402d
DURING RECESS—Lenox Horticultural Society	402d
SEED TRADE	404
OF INTEREST TO RETAIL FLORESTERS—Thumb Twiddling—Steamer Departures—New Flower Stores	406
Flowers by Telegraph	407
FLOWER MARKET REPORTS: Boston, Buffalo, Chicago, Detroit, Indianapolis, Philadelphia, Washington	409
New York	411
MISCELLANEOUS: Spring Show at Boston	392
Wanted—Horticultural Editors	393
The Great Orchid Exhibition in Boston in 1910	393
From Curbstone Buyer to Curbstone Peddler	393
Personal	397
Philadelphia Notes—Publications Received	398
Massachusetts Agricultural College	400
Musie Hall Market Exhibition	400
Catalogues Received—An Interesting Decision	404
Business Changes—Fire Record	407
St. Louis Notes	407
Washington Personals—News Notes	411
Movements of Gardeners	417
Greenhouses Building or Contemplated	418
Patents Granted—Incorporated	418

Well wishers of horticulture will be pleased to read the notes from Glen Cove, N. Y., stating that the project for building a horticultural hall as a home for the Horticultural Society there is being carried forward with every prospect of success. No better investment can be made by the supporters of a horticultural organization anywhere, be it Society or Florists' Club. The advantages are so manifest that it is surprising that so few communities, comparatively, are provided with a horticultural hall. We hope to see the Glen Cove project come to a successful realization and then to see many more places stirred into action by the good example there set.

Owning a home

The address by C. A. Dards, setting forth the aims and purposes of the recently organized Retail Florists' Protective Association of New York, which appears in this issue of HORTICULTURE, reads well and we think that all departments of the florist business will be disposed to give a cordial hearing to the views on their mutual relationship so tactfully set forth by Mr. Dards. There is wisdom in the suggestion that growers and owners of large producing establishments should meet, more than has been the custom hitherto, and become better acquainted with the men who are engaged in the distribution of their product. We have, in these columns and elsewhere repeatedly advised such a course as conducive to a better understanding between those engaged in the trade, and tending towards a higher mercantile position for commercial floriculture, particularly in the large cities. There are so many ways in which the florists' business may be elevated and dignified through the earnest and unprejudiced co-operation of the men who are leaders in its various departments that the present agitation, if kept within conservative and conciliatory bounds, cannot fail to have a healthy influence. That it is the intention to so limit it, is very evident from the tone of Mr. Dards' communication.

"Let us reason together"

A suggestion for the rose hybridizer

As everybody knows, many thousands of seedling roses and carnations may be raised before one is produced which is an evident improvement on existing varieties. As time passes and the required standard of quality is raised higher and higher, the proportion of discards keeps on increasing until, as Peter Fisher stated in his address at Amherst the other day, hundreds of varieties are now rejected which would have been considered wonders a few years ago and three or four out of 3,500 are all that are worth saving, even in the product of the most expert and skillful hybridizer. In the case of the carnation the question of selection, in the hands of a man who knows the cardinal points, is a simple matter, as the carnation has only one sphere of usefulness and if a seedling falls short of any one of the requirements there is no alternative but to throw it away. The situation as regards the rose is, however, quite different and it has seemed to us a pity that so many thousands of seedling roses are sent to the rubbish heap every year simply because they do not come up to the standard required in a rose for cut flower purposes under glass and without being given any test as to their possible adaptation for outdoor garden planting. We are inclined to the belief that the possibilities in this direction are not fully taken into consideration by our rose hybridizers so intently engrossed are they in the definite purpose to develop forcing varieties of advanced type. Having in mind the vast room for improvement in the line of garden roses who can say that fortunes have not been thus thrown away?

RETAIL FLORISTS' PROTECTIVE ASSOCIATION OF NEW YORK.

Editor HORTICULTURE:

Because of the many rumors current in the florist trade in this vicinity respecting the aims and purposes of the Retail Florists' Protective Association of New York recently formed, I beg of you the courtesy of a little space in your valuable paper in order to explain some of the main objects of this Association.

For a long time retail florists of New York City have felt that they were in need of cohesion and co-operation. Adverse and predatory conditions, both from within and without the trade, accentuated this need. Retail florists, conducting a business of large volume, paying annually hundreds of thousands of dollars in rents and equally large amounts in wages, are perhaps the only commercial men who have no trade organization to elevate their business, to correct abuses, and to suggest from time to time the means for amelioration. It was these circumstances which called forth the Retail Florists' Protective Association, and which will dictate its policy.

There has been no established system of credit, either between the producer and the retailer, or between the retailer and the customer. It is remarkable that a business of such magnitude should be in this anomalous condition; and the Association purposes, if it be possible by fair and legitimate means, to find a way mutually satisfactory that will conduce to more rational business methods.

Some people have thought that the Association had a grievance because the wholesale or commission men are enforcing short credits. Quite the contrary; we believe that moderately short credits are the best for the retail floral business, and while we would not assume to question any just rule, which any one may make for the conduct of his business, we believe that any rule established should be a just one and should be impartially enforced.

Again, it has been said, that the Association is antagonistic to commission houses. This is entirely erroneous. In a large city like New York, it is indisputable that the retail flower business could not be conducted without commission houses, nor could the growers dispose of their superfluous and lower grade stock without the commission man. But this Association will ask as emphatically as it can, that the commission man confine himself to his legitimate business; that the commission man refrain from competing with his own customers; and that he keep out of the retail part of the work and not undermine the retailer, who is, after all, the mainstay of his business. This position is eminently fair and just. It is reasonable and business-like. It should appeal to the commission man, no less than to the retail florist. And we feel sure that the retail florists throughout the length and breadth of this land will adopt this position to a man, and that the commission man, once he appreciates the equity and justice of the matter, will freely and voluntarily take the same stand.

We believe it to be the growers' duty as well as his self-interest to discourage competition by commission men

in selling at retail. Upon the business of the retailer depends the return to the grower. By injuring and impairing the retailer's business, the grower must and does necessarily suffer. Therefore, the grower, no less than the commission man, is in duty bound to protect those from whom he derives his support and revenue, from unfair competition. This duty should compel the grower and the commission man to take active steps, not to stand by and passively tolerate a practice which strikes at the heart of the trade. A dollar and cent point of view, if no other, should dictate this course. As to the general public, we may be sure of them, because we know they like a square deal.

Retail florists have suffered much from fraudulent and delinquent customers. We mean to provide against this by a central agency, and shall endeavor to uplift the general trade by a better standardization of prices. By protecting the retailer against bad debts, we feel that we are in turn protecting the wholesaler, the grower and the commission man, and here again it is but fair that the retailer receive in turn that measure of fair protection which will eliminate unjust competition on the part of those with whom he deals.

We hope to secure a better enforcement of the law as to the sale of flowers on the streets by unlicensed vendors. The growth of such wrong practices is detrimental not alone to us, but to other men in the floral trade.

We believe that if the growers, the men having large establishments and investments representing many thousands of dollars, were to meet the men who distribute their products to the consumer, and who know the demands and conditions of the trade, it would be of great mutual advantage and productive of highly satisfactory results to both.

And so there are many other matters which can well be taken up and developed to the betterment of the retail floral business in New York City; and if the members of the retail branch of this trade will come forward and assist us with their numbers and their counsel, we feel confident that all retail florists and their business will be materially improved, and that this improvement will reach over to the grower and the commission man, and that a more harmonious equitable and mutually beneficial condition will prevail in the trade generally.

CHAS. A. DARDS,
President, Retail Florists' Protective Association of New York.

SPRING SHOW AT BOSTON.

This brilliant annual event is set for March 24 to 28, at Horticultural Hall, Boston. Particular interest attaches to it this year because of the sensational exhibit of Japanese gardening which is being constructed by R. & J. Farquhar & Co., far excelling anything in this or any other country. It will occupy about two-thirds of the floor space of the large exhibition hall. Much of the material has been brought specially from Japan. M. H. Walsh will as heretofore be a large exhibitor in the Rambler rose classes and extensive contributions of forced plants, spring flowering bulbs, etc., are also assured.

WANTED: HORTICULTURAL EDITORS.

Mr. Editor:—Being a reader of your paper, I have noticed your frequent hits at the inefficiency of the daily papers on matters pertaining to horticulture. They are all guilty of giving us poor reports of things connected with gardening. I do not even exempt the Boston Transcript. But, Mr. Editor, according to your knowledge, has any approach been made to any of the papers by any representative body of horticulturists advising them to secure a practical man; such, for instance, as Robert Cameron of Harvard Botanical Gardens, a man who has the knowledge and facilities to know what is true and what is false concerning those wonderful creations that we hear so much about. Some of us think the press of the Hub of the Universe should take a hint and secure such a one. They have sporting editors, dramatic critics, etc.; why not a horticultural editor?

I should like to hear from others on this matter. I am,

A GARDENER.

THE GREAT ORCHID EXHIBITION AT BOSTON IN 1910.

The preliminary schedule for this notable event has been issued by the Massachusetts Horticultural Society, and those interested can procure copies by applying to Secretary Wm. F. Rich, Horticultural Hall, Boston. Many gold medals are offered and cash prizes from \$100 up to \$1000 in the various plant classes.

FROM CURBSTONE BUYER TO CURBSTONE PEDDLER.

If any street peddler of violets wants to become unpopular all he needs to do is to try to sell his wares to Mrs. Lillian Ashley, a young woman who lives in the Hotel Markwell. She told the West Side Court yesterday why she did not like the flower sellers, and no one blamed her for having a grievance.

She stopped in front of the Hotel Cadillac, Forty-third street and Broadway, on Saturday afternoon and purchased two bunches of violets for seventy-five cents. She had no change, and when the vendor saw a ten dollar bill he said, "Just wait here and I'll get the change."

He shoved the tray in her hands and went in the front door of the Cadillac and out the side door. When last seen he looked as if he was preparing for a Marathon, and was punning strong, with plenty of reserve pep, and getting as far away as he could from his tray of violets.

There are some men around that section of Broadway who would not look surprised if the subway came to life and did a Salome dance. They have been holding a tray of violets and apparently offering them for sale as usual. They rose to the occasion, however, and began to form in line. Some of them who dated the ownership of their last violet at the time of Sysonby's death declared life would not be worth living if they did not have a bunch, and some ticket speculators began to traffic in the advantageous places in the line.

Mrs. Ashley was dismayed and tried to hide the tray with poor success. "Sam" Berger, a theatrical manager, came along and, seeing her predicament, took the tray. The line faded away, but he sold the violets. Mrs. Ashley saw a man at Forty-seventh street and Broadway yesterday who she thought was the one who had taken her money, but he proved an alibi in the West Side Court and was discharged.—N. Y. Herald.

Emil Lange, a florist of New York city, recovered a verdict of \$3,000 against the city in the Supreme Court March 11 for injuries he received when he fell into a coal hole on one of the Staten Island municipal ferry boats.

AMERICAN ROSE SOCIETY

Annual Meeting and Exhibition Held at Iroquois Hotel, Buffalo, New York, March 17, 18, 19

New York Chosen As Next Meeting Place

Officers Elected

PRESIDENT—August Poehlmann, Morton Grove, Ill.; VICE-PRESIDENT—Frank R. Pierson, Tarrytown-on-Hudson, N. Y.; SECRETARY—Benjamin Hammond, Fishkill-on-Hudson, N. Y.; TREASURER—Harry O. May, Summit, N. J.
EXECUTIVE COMMITTEE—For Three Years—Peter Bisset, William F. Kasting.

A bright, sunny afternoon following a somewhat squally morning welcomed the rose lovers to Buffalo, on Wednesday, 17th inst. The gathering of old friends was as usual at these national meetings, delightful, and west, east, north and south met and greeted one another in the rotunda of the Iroquois with hearty gratulation while the exhibits were being put in order and the judges were doing the arduous duty in the big ball room up stairs. Members of the executive board of the S. A. F., fresh from their sessions at Cincinnati, were on hand full of cordiality and enthusiasm and the intimate fraternal spirit always so pronounced between the leaders of the two national bodies was given a fresh kindling.

The First Session.

The first session of the society was called to order at eight o'clock on Wednesday evening by President August Poehlmann, who read the following address, which was attentively and appreciatively followed by the audience:

PRESIDENT'S ADDRESS.

Ladies and Gentlemen, Fellow Members of the American Rose Society: Following previous custom, it devolves upon me to address you at this, our tenth annual convention.

Through the courtesy and cordial invitation extended to this society by the Buffalo Florists' Club, represented by their able leader, Mr. William Kasting, and associates, we find ourselves here tonight. What these men have accomplished to make us feel welcome, no one can fail to see.

Buffalo, lying as it does almost midway between the large rose-growing centers of the East, West, North and South, is ideally situated for our convention and exhibition. It is only eight months ago since the Buffalo Florists' Club, in conjunction with the Niagara florists, participated in entertaining the Society of the American Florists most royally, ample proof that we are indeed in the hands of friends who appreciate our coming, and whom we in turn can but thank most heartily for their brotherly, generous, hospitable spirit.

Here, then, are past friendships renewed, new friendships formed, and

opinions exchanged,—all of which serve to make us enjoy this old world, and enrich us in the knowledge of the beautiful. From these gatherings inspirations are given to something more lofty, more divine; something in the future superior to what we had heretofore.

Here we find the real enthusiast, wrapped up in wonder at the progress made in the growing of the Queen of Flowers, "The Rose."

Who, that has any material interest or love for roses, can help but admire the beautiful specimens arrayed here

located or obtainable. Study well your varieties, their habits, wants and hardiness, the soils and localities wherein they will thrive best, and then proceed. Comparatively little has been done in this line, when we consider the immense unbounded resources at our hands, and the society's aim, which is: "A Rose for every Home, a Bush for every Garden." This branch of the work is left almost entirely to the nurserymen, many of whom have established an immense business, and who, like the commercial rose growers, are ever on the alert for something new with which to delight their customers, and thereby advance their own interests.

By placing the various roses best adapted to the different localities, past the experimental stage where good results are obtained, you will do much toward discrediting the doubts and fears of the investing public and create an unprecedented demand.

In this connection, it occurred to me that a good place to bring outdoor roses more prominently before the public, would be to obtain permission from public officials to plant plots or individual bushes in public squares, gardens or parks, without charge, showing the name of each variety and of the party who supplied them, in small vet plain letters.

One of the principal attractions at these annual exhibitions is to see those new creations of the floral world, those new wonders of the rose kingdom. We see, we like, we buy, we try. They make good, or we lose out. On first failure, we may try again. A race-horse is good only when he makes good. He may be a good looking but be out of the running. So with many of our pets; they are relegated to the background if the remuneration is not sufficient. The ambitious grower is never satisfied to leave the trial of new varieties to his neighbor, but will try himself to find a winner. Often these new things turn out pretty hot ones. It is quite natural that there are many disappointments. It cannot be otherwise. One winner, however, will cover the shortcomings of a multitude of raw ones.

New Roses.

The breeders, hybridizers and introducers of new roses deserve encour-



F. R. PIERSON

Vice-president of the American Rose Society.

for our inspection. Who of you, lovers and growers of the rose, but what came to this gathering with a certain object—that object to improve yourself in your chosen profession?

Out-Door Roses.

In the matter of our-door roses and other subjects, so many valuable suggestions have been submitted in former conventions, which appear in the Annual Bulletins, that I hardly know what more to offer. To my mind, the field for, and sale of, out-door roses is unlimited wherever good rose soil is

agement and support, even if they manage to put one over occasionally. New varieties put life in the business. Keep on striving for high standards; the trade demands it.

In the cut roses, a number of new delegates are in the field looking for recognition. Notably among these are White Killarney and My Maryland. Both will be extensively grown. The society offers ample reward to its exhibitors, and deals fairly with all new introductions.

Progress is Certain.

Your various committees have faithfully attended to and accomplished the work imposed on them. Your secretary in particular was indefatigable and conscientious in the full performance of his duties, to which I can attest by reason of his voluminous correspondence, and deserves the sincere thanks of this society.

I would like to impress once more on all interested in the sale and culture of outdoor roses the need of disseminating reliable knowledge amongst the public.

During our meetings a number of very instructive essays will be read by men experienced in their lines, which will be entitled to our careful thought and consideration. Discussion which usually follows will open up new sources of knowledge and give to us new ideas. Of one thing we are certain: we are progressing with the times; let us forever keep on doing so.

To further the society's work and aim, we want it to be known that all lovers of the rose are welcome to our ranks.

To place the society on a solid financial footing, we ask you to be with us. Annual membership dues are \$3.00; life membership, \$50.00.

To the Buffalo Florists' Club and Associates, who have provided the society with workers to carry on this exhibition, and have looked after the society's welfare, I wish to again express our hearty thanks, hoping that each of you feel well repaid for the pleasure it has given us to be with you.

THE SECRETARY'S REPORT.

Secretary Hammond next gave a synopsis of the minutes of the last convention in an interesting manner, and then read his annual report:

No society could have a more loyal set of backers than has the American Rose Society. The past year has seen the society sustained by a number of men who claimed the privilege of assisting in meeting all expenses. President August I. Poehlmann has taken the keenest interest in affairs. Separated by distance as a society such as this is it requires a long view to keep all matters together and moving.

The schedule of prizes has been carefully revised by the committee appointed by the President, Messrs. J. N. May, Robert Simpson, Alexander Montgomery, Frank R. Pierson and Benjamin Hammond. The first schedule was made up ten years ago and remained in force until this season. Of this schedule Mr. Lonsdale of Girard College, Philadelphia, says it is good for five years.

Last November during the National Flower Show in Chicago a general meeting of the Rose Society was held at which time the sum of \$350 was pledged by the gentlemen then pres-

ent as a fund for the prizes to be offered this spring. At that meeting the important matter of ways and means was talked over freely. The offer of medals as prizes of honor was advised and stress was made of the propriety of making use of the society's medals. The mint of the United States at Philadelphia has the society die. There never has been a gold medal struck, the value of which would be determined by its weight when struck. A few silver and bronze medals were once made. These have been distributed except one bronze medal.

The secretary would suggest as one practical way to largely extend the usefulness and membership of this society that one silver and one bronze medal be offered as a rose prize to local horticultural societies to be known as the American Rose Society's prize for the best display of roses, without any regard to variety, at the local show. But that each society applying for the same, shall have at least one regular and two associate members of the American Rose So-



LEONARD BARRON
Secretary New York Horticultural Society.

ciety. This idea is advanced as the outcome of the discussion at the meeting referred to above. To put this to an available test I am authorized by a gentleman to say that he will pay for six silver and six bronze medals to be used as a start in this direction to popularize our society.

The standing of the American Rose Society seems to be growing, and it should be, for the rose as a commercial flower is the most commanding. The rose growers of America should recognize the society's essential value.

President Poehlmann in response to a demand by interested parties has appointed a committee to pass upon the very important matter of Registration of New Roses. The chairman of that committee is ex-president Robert Simpson. This committee would give us prestige as a regular standing committee, as large interests may come before it for consideration.

The annual bulletin of the society was issued after the close of the cal-

endar year 1902, thus bringing all business up to the year's end. This book tells its own story. The cost of it was a little over half covered by the advertisements furnished by a few at a rate of ten dollars for each page.

Without the least taint of discourtesy the secretary would bring a matter to notice; that is, a request that when a prize is offered in money that it be sent in as soon as possible and furthermore if named for a special purpose and not so won that it may revert at once to the general fund to make good the total amount always required for the regular prize list.

Our life membership has not increased the past year. Our invested fund has, however, reached the total of \$2,350 in the hands of our efficient treasurer Mr. Harry O. May. We have tried to keep in touch with each of our members on record but so far the responses to the annual due bills have not been as full as is desirable.

We have received notice of the death of Miss C. A. Pryer of New Rochelle, N. Y., one of our earliest members and constant supporters.

At the last annual meeting the subject of a rose journal was one of moment. The tentative effort to start it into being with the cost defrayed by an advertising card was side-tracked by the proposition to launch and support it by subscription for a year as a trial. This plan never materialized. In the meantime the Gardeners' Chronicle of New York has offered to give a magazine page each issue for the use of the American Rose Society as its popular paper. I hold a little money sent in for the rose journal project which will be returned.

The show before us is the tenth annual exhibition. Those previously held were in New York, Philadelphia and Boston. In these cities the exhibition was held for succeeding years, in Washington and Chicago one and now in Buffalo, the metropolitan city of western New York, in as fine a hall as the best we have had.

The secretary herewith desires, and properly so, to extend his thanks for the various courtesies and aid he has received from many persons in the interest of the society and most particularly to the editors of the American Florist, The Florists' Exchange, The Florists' Review and HORTICULTURE. If the Rose Society has fame it is largely due to the friendly support received without cost from these publications.

THE TREASURER'S REPORT.

Treasurer May then presented the following report for year ending March 12, 1903:

Receipts	\$2,152.07
Disbursements	1,368.93

To balance on hand..... \$183.14

In addition to the above general account four life members have joined the Society, making a total of fifty-five.

The money of the life membership is added to a Permanent Fund, the interest from which is used in current expenses.

Permanent Fund..... \$2,350.00

Peter Crowe here took the floor and enrolled as the sixtieth life member.

New York the Next Meeting Place.
Frank R. Pierson and Chas. B

THE FRUIT AUCTION COMPANY 200-202-204 Franklin Street NEW YORK

ANNOUNCES DAILY SALES AT AUCTION

of FOREIGN AND DOMESTIC GROWN Roses, Shrubs, Evergreens, etc., Bulbs of every description, Flowering Plants, Palms, Bedding Stock, etc., from leading growers and importers.
Catalogues Mailed on Request. Correspondence Invited.

SPECIAL—On Tuesday, March 23d, we will offer an exceptional assortment of Holland Roses, Rhododendrons, Azaleas, Shrubs, Evergreens, etc. Also a consignment of Tuberoses, Gladioli, Camia Roots, Dahlias, etc., in all sizes—true to name. Thereafter every day (except Monday) throughout the season.

TERMS CASH **JOHN P. CLEARY, Auctioneer** **PROMPT DELIVERY**

Growers and dealers will please note that account sales with remittance is rendered IMMEDIATELY AFTER AUCTION.

THE FRUIT AUCTION CO., 200-202 204 Franklin St., New York

P. O. Box 640.

UNTIL FURTHER NOTICE SALES BEGIN AT 10:30 A. M.

Telephone 1515 Franklin

Weathered then extended an invitation from the Horticultural Society of New York and the New York Florists' Club, respectively, to hold the next meeting in New York City at the Museum of Natural History, and presented a formal invitation from Secretary Leonard Barron of the Horticultural Society. The invitation was accepted by unanimous vote.

Other Business.

Wm. F. Kasting on behalf of the Buffalo Florists' Club invited the visitors to a banquet in the Iroquois Hotel on Thursday evening. The discussion of the disposition of special prizes unawarded at any show was participated in by the debating giants of the society, and the question was finally referred to Messrs. Pierson, Valentine and Farenwald for consideration. Harry A. Barnard of London was here discovered in the audience and called upon for a talk which gave much pleasure, especially when referring to the quality of flowers on exhibition; he said "the half had not been told," and he made some pertinent comparisons between conditions existing here and in England, adding an eloquent plea for the outdoor rose as a subject for the cottage garden.

The Judges' Report.

The judges' report recommended that a committee of three be constituted to examine all entries for exhibition hereafter, to see that exhibits conform strictly to the requirements of the rule, that long stemmed flowers be placed on the floor or on tables not higher than fifteen inches, and provide for uniformity in size and style of vases in each respective class. The latter brought out a debate that will long be remembered, and the whole report was referred to the executive committee with full power.

Election of Officers.

Election of officers was next in order and resulted as follows:

President, August Poehlmann; vice-president, Frank R. Pierson; secretary, Benjamin Hammond; treasurer, Harry O. May; executive members for three years, Peter Bisset and Wm. F. Kasting. Walter W. Coles then read his paper.

The Exhibition.

The exhibition was pronounced su-

perior to last year's. Among the finest things were the decorative group of seven tall vases of White Killarney, fifty flowers in each, also vases of new sports and seedling carnations and fern novelties from The F. R. Pierson Co., Tarrytown; twenty cyclamen plants of extraordinary perfection from Charles Sandiford; the Killarneys and Richmonds from A. Farenwald, which have never been excelled, and the White Killarneys from Waban Conservatories. Mrs. Jardine from several exhibitors was better than ever shown before, and My Maryland was in fine shape.

Special Awards.

The A. N. Pierson vase for 100 Richmond was won by A. Farenwald. For 12 roses (American Beauty barred) W. H. Greaves was first, E. A. Slatery, second. Waban Rose Conservatories took the Welch Bros.' cup with 25 White Killarney. The Farenwald prize for 36 My Maryland went to Robert Simpson, who also took the Cook prize and the Special Prize offered by the Lakeview Rose Gardens. The Michell tray for 50 Killarneys went to A. Farenwald, and the Pulverized Manure Co.'s prize for 25 American Beauties went to Edward Towill.

A special prize was awarded to Fred Burki for 36 Pink Killarney. The Silver Medal and Certificate of Merit were awarded to Waban Rose Conservatories for White Killarney, which scored 87 points.

Among the exhibits not mentioned above were Mrs. Jardine from Robert Scott & Son, not for competition; Cherokee and South Orange Beauty from W. A. Manda; carnations Dorothy Gordon from Joseph Heacock Co., Shasta from Baur & Smith and O. P. Bassett from Bassett & Washburn.

List of Awards.

- 50 blooms Killarney—A. Farenwald, 1st; Bassett & Washburn, 2d.
- 50 blooms Richmond—Edw. Towill.
- 25 blooms American Beauty—Bassett & Washburn, 1st; Edw. Towill, 2d.
- 25 Bride—Poehlmann Bros. Co., 1st; Fred Burki, 2d.
- 25 Bride—Maids Peter Crowe, 1st; Fred Burki, 2d.
- 25 Cardinal—Poehlmann Bros. Co.
- 25 Rhea Reid—W. H. Elliott, 1st; Peter Crowe, 2d.
- 25 My Maryland—Robert Simpson, 1st; A. N. Pierson, 2d.
- 25 Mrs. Jardine—Robt. Scott & Son, 1st; Edw. Towill, 2d.
- 25 Mrs. Potter Palmer—Poehlmann Bros. Co.
- 25 Mme. Abel Chatenay—Robert Simpson, 1st; Poehlmann Bros. Co., 2d.
- 25 Ivory—U. S. Cut Flower Co.

25 Killarney—Poehlmann Bros. Co., 1st; Peter Crowe, 2d.

25 Wellesley—Gude Bros. Co.

25 Richmond—Edw. Towill, 1st; W. H. Elliott, 2d.

Collection of Teas and H. T.'s, six or more varieties, not less than 12 of a kind—Gude Bros. Co.

Thursday Morning's Session.

The judges' report was presented and accepted.

A telegram was received from Mrs. G. M. Hubbard, Twin Oaks, Washington, offering to establish a permanent fund to provide a gold medal to be awarded once in five years to raisers of American varieties of worthy new roses. The offer was accepted and on motion of W. J. Stewart, Mrs. Hubbard was unanimously elected to honorary membership.

F. R. Pierson reported for the special committee recommending that no special awards be hereafter advertised in the schedule until they have been deposited with the society, and that all special premiums offered shall be accepted only on condition that they go to the premium fund of the society if not awarded, unless the donor otherwise specifies.

Geo. D. Leddle then read a paper on "Roses as Popular Home Flowers and how they are grown," for which a vote or thanks was recorded. Leonard Barron then made the offer on behalf of The Garden Magazine to place in the hands of the society's officers gold, silver and bronze medals to be awarded not in competition but as honorariums for progressive achievement by workers in behalf of the rose. This offer was accepted with the thanks of the Society. The paper of J. F. Huss on "The Rose Garden" was then read by President Poehlmann and ordered by vote to be given the widest possible dissemination.

Thursday Evening.

On Thursday evening the banquet was held. Resolutions were read on the death of Louis M. Noe and E. V. Hallock; also final resolutions thanking the local people for their generous courtesy and hospitality.

Mr. Barron presented his stereopticon lecture with slides showing the different purposes for which garden roses can be used, emphasizing the desirability of working along the Rambler lines and urging that the process of development in future must be along the production of varieties from use of species hitherto not used by hybridists.

A. N. PIERSON, Inc., Gromwell, Conn.

Unquestionably the finest rose of recent introduction, offered to the trade today is

WHITE KILLARNEY (Waban Strain)

This we offer for delivery after February 15, 1909, at the following prices:

GRAFFED STOCK.....	1 doz.	100	250	500	1000	2500	5000
OWN ROOT.....		\$5.00	\$8.50	\$15.00	\$30.00	\$67.50	\$125.00
		5.00	30.00	70.00	125.00	250.00	500.00

MY MARYLAND GRAFFED STOCK \$3.00 per doz., \$30.00 per 100, \$150.00 per 1000
OWN ROOTS..... 2.00 " " 10.00 " " 90.00 " "

STANDARD VARIETIES

Betty. (H. T.)	Golden Gate. (T.)	Mme. Abel Chateauy. (H. T.)	Rhea Reid. (H. T.)
Bon Silene. (T.)	Hermosa. (H. T.)	(H. T.)	Richmond. (H. T.)
Bride. (T.)	Ivory. (T.)	Mrs. Jardine. (H. T.)	Rosaline Orr English. (H. T.)
Bridesmaid. (T.)	Kalverin Augusta Vic- toria. (H. T.)	Mrs. Paul Niehoff. (H. T.)	Souv. du President Carnot. (H. T.)
Caroline. (T.)	Kate Moulton. (H. T.)	Mrs. Pierpont Morgan. (T.)	Souvenir de Wootton. (H. T.)
Enchanter. (H. T.)	(H. T.)	Mrs. Potter Palmer. (H. T.)	Uncle John. (T.)
Etoile de France. (H. Killarney. (H. T.)	La Detroit. (H. T.)	Papa Gontier. (T.)	Wellesley. (H. T.)
Etoile de Lyon. (H. T.)	Maman Cochet. (T.)	Queen Beatrice. (H. T.)	White Cochet.

RAMBLERS Crimson Rambler, Dorothy Perkins, Lady Gay, Anny Muller, and the Philadelphia Rambler.

GRAFFED STOCK (Selected Plants)
20c each, \$2.00 per doz., \$15.00 per 100, \$120.00 per 1000. Special prices will be quoted on 500 or more.

COLEUS Rooted Cuttings, 60 and 75 cts. per 100, \$5.00 and \$7.00 per 1000.
AGERATUM, SALVIA, HELIOTROPE, GERMAN VILY, Rooted Cuttings, 75c per 100, \$6.00 per 1000.
ALTERNANTHERA (Red and Yellow), 60c per 100, \$5.00 per 1000. Catalog on application.

PERSONAL.

Frank Rouiller of Hartford, Conn., has just returned from a visit to his parents in Switzerland.

J. H. Grove, formerly of Chicago, has accepted a position in the Crookes Greenhouses, St. Joseph, Mo.

A. Lacroix of San Francisco has moved to Alameda, Calif., where he will continue in his profession of landscape gardener.

Mr. W. Roach employee of F. Daner, Maiden Lane Florist, Albany, N. Y., has been to Providence, R. I., attending the funeral of his brother.

C. L. Washburn of Bassett & Washburn, Chicago, has returned from West Baden, Ind., where he has been taking treatment, much improved in health.

Visitors in Boston: Arthur Zirkman representing M. Rice & Co.; J. J. Karins representing H. A. Dreer; Albert Pochelon and Walter G. Taepke, Detroit.

Visitors in Chicago: H. P. Scherer, Fort Wayne, Ind.; P. A. Obertin, Kenosha, Wis.; T. B. Coumandros, manager Golden Rule Plant Dept., St. Paul, Minn.

Recent visitors at Albany, N. Y.: H. Hansen, Catskill; Jas. Kearns, Jr., Locust Grove Violet Houses, Rhinebeck; Morris Cohn, representing Wertheimer Bros., New York.

Visitors in Boston: P. Hamilton Goodsell, New York; Eric Wetterlow, Manchester, Mass.; Robert Hunnicke, Newport, R. I.; H. A. Barnard, representing Hugh Low & Co., London.

The North Shore Breeze for March 5 presents as a cover illustration a fine portrait of our old friend and florist, Edward S. Knight, now chairman of the Board of Selectmen and member of the Board of Assessors of Man-

chester-by-the-Sea, Mass. We congratulate Manchester on its good judgment, as demonstrated in so good a selection.

Peter Murray has been elected tree warden of Fairhaven, Mass. He has also been awarded the contract for the rare of Cushman Park, the most recent gift of H. H. Rogers to his native town.

William Stuart, of the University of Vermont, Burlington, has received an appointment in the plant bureau of the Department of Agriculture, Washington, D. C., and will take up the work at the close of the college year.

Chicago florists contributed flowers to be sold by twelve young ladies at the Grand Opera House, March 15. Ada Lewis appeared for the first time as a star and the proceeds of the evening were for the benefit of the Anti-Cruelty Society.

ORCHIDS

Largest Importers, Exporters, Growers and Hybridists in the World
Sander, St. Albans, England
and 235 Broadway, Room 1
NEW YORK CITY

JULIUS ROEHRS CO.
Orchids and Stove Plants
Florists' Easter Supplies
RUTHERFORD, N. J.

ORCHIDS

Dendrobium to arrive in April Miltonia Vexillaria ready now, SPLENDIDTYPE. Miltonia Roezii in October. DIRECT TO YOU. Order Now.

C. L. FREEMAN, 388 Appleton St., Holyoke, Mass.

Violet Blue Rose

A Remarkable Novelty

The New Rambler (Violet Blue), hailed by the German rose growers as the forerunner of a genuinely cornflower blue rose, is a seedling of Crimson Rambler, very vigorous and hardy. For descriptions of this great novelty, as well as many others, send for Booklet.

ELLWANGER & BARRY
Mount Hope Nurseries
Box T, Rochester, N. Y.

Ampelopsis Quinquifolia

Strong 3-year Plants, 4 to 6 ft. \$55 a Thousand. To the Trade Only

A FULL LINE OF
GENERAL ORNAMENTAL NURSERY STOCK
SEND FOR CATALOGUE
EASTERN NURSERIES
JAMAICA PLAIN, MASS.
HENRY S. DAWSON, Mgr.

ORCHIDS

Just Arrived in Fine Condition
the following East Indian Orchids
DENDROBIUM WARDIANUM, D. CRASSINODE, D. PRIMULINUM, D. THYSIFLORUM, AND D. CHRYSOTOXA. Others to follow.
WRITE FOR PRICES.
LAGER & HURRELL, Summit, N.J.

JUST ARRIVED

Fine Importation of
Oncidium ornithorrhynchum

Fine strong leafy plants.....\$1.50 each, \$18.00 doz. Few specimens..... 2 50 "

JOSEPH A. MANDA, West Orange, N.J.

ORCHIDS

We offer a large number of fine well established plants at very reasonable prices also Peat, Baskets and Sheep and Chicken Manure.
ORDONEZ BROS., Madison, N. J.
New York Store, 41 WEST 28 ST.

ORCHIDS

We are booking orders now for delivery early in the Spring on all commercial CATTLEYAS and NOVELTIES. Our prices are right and our guarantee perfect. We sell only first-class goods
CARRILLO & BALDWIN, Secaucus, N. J.

Cattleya Mendellii arrive in May, Mossiae in June, Gaskelliana in August, Aurea and glauciflora in October. TRUE TO TYPE. NO GREEN USES. COLLECTED IN BLOOMING SEASON.

C. L. FREEMAN, 388 Appleton St., Holyoke, Mass.

THE QUALITY YOU CAN MAKE MONEY ON

CANNAS

SOUND PIECES TRUE TO NAME BED ROCK PRICES

Red-Flowering, Green Foliage

	Per doz.	100	1000
A. Bouvier. 5 ft. Dark crimson.....	\$9.35	\$2.25	\$20.00
Allice Roosevelt. Deep crimson 4 ft.....	.50	3.50	30.00
Beaute Poltevine. 3 1/2 ft. Dark crimson.....	.35	2.25	20.00
Black Prince. Velvety maroon. 3 to 4 ft.; green foliage.....	.50	2.75	25.00
Charles Henderson. 4 ft. Bright crimson.....	.35	2.25	20.00
Crimson Bicolor. 3 ft. Intense scarlet.....	.30	2.00	17.50
Duke of Marlborough. 3 1/2 ft. Dark crimson.....	.35	2.25	20.00
J. D. Elkie. Brilliant vermilion scarlet 5 ft.....	.35	2.25	20.00
Explorateur Crampel. Deep rich crimson 5 1/2 ft. Express. Crimson foliage green. Dwarf habit. 2 to 2 1/2 ft.....	.60	4.50	40.00
Pres. McKinley. Brilliant crimson 2 1/2 to 3 ft.....	.35	2.25	20.00

Pink-Flowering

L. Patry. Delicate rosy pink, 3 1/2 ft.....	\$9.35	\$2.25	\$20.00
Luray. Attractive rosy pink, 3 ft.....	.35	2.25	20.00
Louise. A grand pink, tall	.45	3.50	25.00
Martha Washington. Rose. Height, 2 1/2 to 3 ft. rose, each.....	.75	5.00	
Mlle. Berat. 4 1/2 ft. Rese-carmine.....	.35	2.25	20.00
Tennison. Rosy pink; green foliage; 3 1/2 ft.....	.50	3.00	

CATALOGUE FREE.

Orange-Flowered

Per doz. 100 1000

Red, Gold-Edged and Spotted

President Cleveland. Bright, distinct orange-scarlet; 4 ft.....	\$9.35	\$2.25	\$20.00
Gladiator. Bright yellow, spotted crimson, green foliage; 4 ft.....	\$9.50	\$2.75	\$25.00
Cinnabar. Cinnabar red, edged with distinct golden band; 4 1/2 ft.....	.30	2.00	17.50
Queen Charlotte. Scarlet gold edge.....	.30	2.00	17.50
Mme. Crozy. 5 1/2 ft. Vermillion, gold border.....	.35	2.25	20.00
Premier. Deep crimson, bordered yellow. 2 1/2 ft.....	.30	2.00	17.50
Souv. d' A. Crozy. 4 ft. Crimson, gold band.....	.50	4.00	35.00

Yellow Shades

Buttercup. 3 1/2 ft. Clear golden yellow.....	\$3.40	\$2.75	\$25.00
Comte de Bonchard. Yellow, spotted red; 4 1/2 ft.....	.30	2.00	17.50
Florence Vaughan. 5 ft. Yellow, spotted crimson.....	.50	2.75	25.00
L. E. Bailey. Rich yellow, dotted with red; 4 1/2 ft.....	.30	2.00	17.50

White and Cream Shades

Alice. 3 1/2 ft. Creamy white	\$9.30	\$1.75	\$15.00
--------------------------------------	--------	--------	---------

Bronze-Leaved, Red-Flowering

Brandywine. 4 to 5 ft. Dark bronze foliage. Crimson flowers.....	\$9.50	\$4.00	\$35.00
Black Beauty. True. 5 ft. Grand foliage.....	.60	4.50	40.00

David Harum. 3 1/2 ft. Vermillion-scarlet.....	\$9.50	\$2.75	\$25.00
Egandale. 4 ft. Currant-red.....	.35	2.25	20.00
King Humbert. Fine bronze foliage, orange-scarlet with bright red markings. 4 ft.....	1.00	8.00	75.00
Leonard Vaughan. 4 1/2 ft. Bright scarlet.....	.35	2.25	20.00
Musafolia. The finest looking Caena, with enormous musa-like leaves, 3 by 5 ft., of a dark green bronze-tinged color.....	.35	2.25	20.00
Philadelphia. A bright glowing red. Height 5 ft.....	.75	4.00	30.00
Papa Nardy. Large, rich carmine-red, 4 1/2 ft.....	.30	2.00	17.50
Pillar of Fire. 6 to 7 ft. high flowers bright crimson-scarlet.....	.75	4.50	40.00
Robusta. Height 6 to 8 ft., with immense foliage.....	.30	1.75	15.00
Shenandoah. Large Salmon flowers, 6 ft.....	.30	1.75	15.00

Orchid-Flowering

Allemania. 4 to 5 ft. Scarlet and yellow.....	\$9.35	\$2.25	\$20.00
Austria. Pure canary-yellow; an orchid-flowering type; 5 ft.....	.30	1.75	15.00
Italia. 4 1/2 ft. Green foliage Red bordered yellow.....	.30	2.00	17.50
Kronus. Rich golden yellow, with patches of bright red, 5 ft.....	.30	1.75	15.00
Mrs. Kate Gray. 6 ft. Green foliage. Scarlet and yellow.....	.30	2.00	17.50
Pennsylvania. 5 ft. Green foliage. Deep scarlet.....	.35	2.25	20.00

We go through the block from 14th Street to 13th Street, but our address is still

ARTHUR T. BODDINGTON, Seedsman, 342 West 14th St., NEW YORK CITY.

PHILADELPHIA NOTES.

M. Barber, Chicago, was a visitor in Philadelphia, March 10th and 11th.

Visitors this week: Albert Pochelon, of L. Bemis Floral Co., and Walter Taepke, Detroit; J. B. Keller, Rochester; and T. Malbraun, Johnstown.

W. P. Craig left for Cuba and Isle of Pines on the 13th inst. Business in connection with his father's 170 acre plantation. If conditions are favorable, may remain at Isle of Pines as resident manager of the estate.

W. C. Smith, 60th and Market Sts., has sold three of his five houses to be torn down. Several buyers are dickering for the other two. The northern section of the place only is to be retained, and the business will be exclusively retail hereafter. The retail business in this section has been rapidly improving of late years.

Much interest has been expressed here about the new sweet pea "Greenbrook," mentioned in a recent number of HORTICULTURE as being the forerunner of a new race of unique form. The raiser has been asked to exhibit some at our spring show opening, Tuesday, the 23rd inst., and continuing three days. The exhibit will no doubt be on hand if the crop is in good form.

The Robert Craig Co. intend to build this summer on their property at Norwood, Del. Co., Pa., and have been inspecting various new structures recently put up by the most expert builders. On the 17th inst. the senior

member of the firm went with D. T. Connor to Brandywine Summit, Chester Co., Pa., to look at one of the latest triumphs of the Lord & Burnham Co., of which firm Mr. Connor is the Philadelphia manager.

Charles Sim. Rosemont, Del. Co., Pa., writes from San Francisco, Cal., March 12th, that he and his party are at the turning point for home in the course of their long trip. He states that San Francisco is very dusty, and that there is an immense amount of building going on, also street improvements galore, after the quake. He speaks in glowing terms of the courtesies extended to all visitors by Samuel McLellan, of Golden Gate Park.

PUBLICATIONS RECEIVED.

We have received from the Home Gardening Association of Cleveland, Ohio, a very interesting report on the aims and work of this excellent organization, with an account of the accomplishments of the pupils in the training gardens for 1908. The report

shows conclusively the good influence exercised by these school garden projects and the readiness and enthusiasm with which the children accept them. They are doing a great and good work.

The New York Agricultural Experiment Station, Directors' Report for 1908, by W. H. Jordan.—This report shows how efficiently the very moderate sums of money appropriated by the state are devoted to the purposes of agricultural education. A new building for administrative and demonstration purposes is asked for. Bulletin No. 205, which accompanies the report, is devoted to a summary of what has been previously published regarding Alfalfa Troubles, and Bulletin No. 306 is on Sulphur Sprays for Blister-Mite.

The Geo. M. Garland Co., Des Plaines, Ill., are sending out a very clever folder in colors which is stamped with "the seal of approval" and is sure to be opened and read by those who receive it. Send for one.

Headquarters for Asparagus Plumosus Seed **New Crop**

GREENHOUSE CROWN		LATH HOUSE CROWN	
100 seeds, .50	5,000 seeds, \$17.50	100 seeds, .40	5,000 " \$12.50
1,000 " \$3.75	10,000 " \$22.50	1,000 " \$2.75	10,000 " \$23.00

Write for Our Wholesale Catalogue

HENRY F. MICHELL CO., **1018 Market Street, PHILADELPHIA**

Dreer Special Offer OF Hardy Perennials

NEW OR LITTLE KNOWN VARIETIES WORTHY OF SPECIAL ATTENTION



TROLLIUS (Globe Flower)

PRIMULA CORTUSOIDES SIEBOLDI. These are not so well known as they deserve; they are of free, vigorous growth, and can be flowered in pots in early spring, and respond quickly to forcing when placed in a temperature of 50 degrees, forming pretty pot plants in a short time, making excellent window plants, which meet with ready sale when in bloom.
We offer six distinct varieties, from pure white to the deepest rose in color, \$1.50 per doz.; \$10.00 per 100.

RUBECKIA RAYS OF GOLD. In this new variety we have a refined form of the popular "Golden Glow," to which it is identical in color, habit, etc., but the flowers have narrower petals, full to the centre, forming a perfect ball of gold, \$1.50 per doz.; \$10.00 per 100.

ANCHUSA ITALICA DROPMORE VARIETY. A grand improvement on the type, with intense deep blue flowers, \$3.00 per doz.; \$15.00 per 100.
ANTHERICUM LILIASTRUM GIGANTEUM. A giant form of the N. Bruno Lily with very large white flowers, \$2.50 per doz.; \$20.00 per 100.
AQUILEGA HELENAE. One of the best of the Columbines, large pretty blue flowers, with large white corolla, 85 cts. per doz.; \$8.00 per 100.
CAMPANULA PERSICIFOLIA HUMOSA. A very large semi double form of the peach leaved Campanula, flowers of a pleasing shade of blue, \$1.50 per doz.; \$10.00 per 100.
DELPHINIUM GOLD MEDAL HYBRIDS. The finest strain ever offered in mixed varieties, \$1.25 per doz.; \$8.00 per 100.
DELPHINIUM BELLADONNA. The freest flowering of all Delphiniums, it is never out of bloom, beautiful turquoise blue, \$2.00 per doz.; \$15.00 per 100.
FUNKIA ROBUSTA ELEGANS VARIATA. A decided improvement on all variegated forms, \$1.50 per doz.; \$10.00 per 100.
HELIENIUM RIVERTON GEM. A new variety that originated on our trial grounds. Flowers old gold, suffused with bright terra cotta, changing as they mature to a wallflower red, \$1.50 per doz.; \$10.00 per 100.
HELIENIUM RIVERTON BEAUTY. Another variety which originated with us, quite distinct in color, which is lemon-yellow, with a large disc of purplish-black, \$1.25 per doz.; \$10.00 per 100.
HELIANTHUS SPARSIFOLIUS. The most desirable of all the hardy sunflowers, especially valuable as a cut flower, 85 cts. per doz.; \$6.00 per 100.
FOUR VALUABLE HEMEROCALIS. The four varieties here offered are great improvements upon the well-known Yellow Day Lilies.

Aurantiaca. Very large, bright, orange-yellow, sweet-scented flowers, 15 cts. each; \$1.50 per doz.
Aurantiaca Major. Large trumpet-shaped, sweet-scented, deep orange flowers. Requires protection, 35 cts. each; \$3.50 per doz.
Florham. Large golden-yellow sweet-scented flowers; very free flowering, 15 cts. each; \$1.50 per doz.; \$10.00 per 100.
Gold Dust. Large golden-yellow flowers, 15 cts. each; \$1.50 per doz.
INCARVILLEA DELAVAYI. Popularly known as the hardy Gloxinia; extra strong roots, \$2.00 per doz.; \$15.00 per 100.
IRIS PALLIDA DALMATICA FOLIA VARIEGATA. A strikingly handsome variegated leaved form of this beautiful blue Iris, 35 cts. each; \$3.50 per doz.
CYPSOPHILLA PANICULATA FLORE PLENA. This is a perfect gem and as a summer cut-flower invaluable. We have a large stock of strong roots to offer this season, \$2.00 per doz.; \$15.00 per 100.
LUPINUS POLYPHYLLUS ROSEUS. This is a most attractive rosy pink form of Lupines, producing gigantic spikes of flowers, \$2.00 per doz.; \$15.00 per 100.
PENSTEMON GENTIANOIDES SENSATION. Gloxinia-like flowers in a variety of bright colors, including red, cherry, crimson, purple, lilac, etc. For bedding they rival Phloxes, Pansies, etc. Not quite hardy; 3-inch pots, \$1.00 per doz.; \$7.00 per 100.
STOKESIA CYANEA ALBA. A white form of the popular blue Stokesia, equally valuable and a desirable addition; strong plants, \$1.25 per doz.; \$8.00 per 100.
CHOICE NEW TROLLIUS. (New Globe Flowers.) The five varieties listed below are decided improvements on all sorts heretofore offered; of exceptional large size and good, rich colors.
Gotterfunke. Large open orange-yellow flowers.
Helios. Very free flowering, pure yellow, on strong branched stems.
Leuchtkugel. One of the finest deep orange reds.
Lichtball. Large, globular orange yellow flowers on stiff stems.
Salamander. Soft orange-colored flowers of globular form, 35 cts. each; \$3.50 per doz. The set of 5 for \$1.50

HENRY A. DREER, 714 Chestnut Street, Philadelphia, Pa.

ROBERT CRAIG CO.
ROSES, PALMS,
and Novelties in Decorative Plants
MARKET and 49th STREETS., PHILADELPHIA, PA.

ROSES FOR EASTER
Crimson and Pink Ramblers
75c to \$5.00 Each.
THOMAS ROLAND, NAHANT, MASS.

The Northboro Dahlia and Gladiolus Gardens
Offer for Spring 1909
300 selected varieties of Dahlias and one and one half million large-flowering Gladioli in mixtures, in lots to suit. Send list of your wants. Catalogue free.
J. L. MOORE, Northboro, Mass.

CHRYSANTHEMUM SEED.
Wells' New Early Flowering Singles, packets 25c and \$1.00 each.
PENSTEMON SEED
Wells' New Hybrids, packets 25c and \$1.00 each.
CHARLES H. TOTT, Madison, N. J.

There are Dahlias, and Dahlias, as everyone knows. But, Peacock leads them all, with His Peerless
"JACK ROSE"
Strong tubes \$1.00 ea. Clumps \$2.50 ea
Send for trade list of New Dahlias
PEACOCK DAHLIA FARMS
Williamstown Junction, N. J.

DAHLIAS. Now is the time to place your order for bulbs which will insure you getting named varieties in any quantity; prompt delivery.
DAVID HERBERT & SON,
Successors to L. K. Peacock, Inc.
ATCO, N. J.

Prices Quoted in these columns are for Dealers Only. When writing to Advertisers please mention HORTICULTURE

FOR "POT LUCK" TRY US...

HEWS STANDARD POTS

POT MAKERS FOR 140 YEARS

WORLDS LARGEST MANUFACTURERS

WRITE FOR CATALOGUE AND DISCOUNTS

Pearson Street,
LONG ISLAND CITY, N. Y.

A. H. HEWS & CO., Inc.
CAMBRIDGE, MASS.

452-460 No. Branch St.,
CHICAGO, ILL.

MASSACHUSETTS AGRICULTURAL COLLEGE.

Dedication of New Buildings.

The dedicatory exercises of French Hall and the Durfee range of greenhouses connected with Massachusetts Agricultural College, Amherst, were held on the afternoon of March 12. Prof. F. A. Waugh presiding. President Butterfield welcomed the people. Prof. E. A. White, W. H. Bowker and J. K. M. L. Farquhar of Boston were the speakers. Mr. Bowker spoke entertainingly of Henry F. French and Nathan Durfee. Mr. Farquhar's subject was, "What the greenhouse has done for horticulture." He showed many views of greenhouse enterprises across the water and told of the various crops grown, closing his address with views in the United States. A flower show was arranged in the laboratory. Designs made by the pupils under the direction of N. J. Fennelly displayed much skill. Carnations were

exhibited by The F. R. Pierson Co., Peter Fisher, Pierce Bros., Patten & Co., J. W. Adams & Co., H. H. Rogers, Jas. Garthley gardener, Worcester Conservatories, E. B. Beals; Waban Rose Conservatories and F. R. Pierson Co. showed White Killarney roses; A. N. Pierson, Eber Holmes, Robert Montgomery, and W. H. Elliott, roses; Wm. Sim, sweet peas and violets, and Edw. MacMulkin, baskets for table decorations.

The Short Course.

The short course which just closed was successful in every respect. This has been largely due to the splendid co-operation shown by the practical men. They have been most generous in giving the students the results of their years of experience. In every case this has been done without remuneration. The college also appreciates deeply the generosity of the practical growers in contributing so liberally to the students' flower exhibit. The townspeople showed a remarkable interest in this exhibit and the laboratory at French Hall was crowded during the hours of exhibition.

Practically all the short course students have positions and there were applications for several more men than the college could supply.

The last day of the course Mr. Wm. Sim of Cliftondale gave a most interesting and instructive talk on "Sweet Pea Growing under Glass." He brought with him fifteen varieties of splendidly grown sweet peas which made his talk especially valuable. E. A. WHITE.

MUSIC HALL MARKET EXHIBITION.

Indications are for a very large and representative show on Saturday, 20th inst., at the Boston Co-operative Flower Market in Music Hall, Boston. Entries have been received from leading carnation growers all over the country and the rose growers, plantmen and producers generally will be well represented.

We have received from Henry A. Dreer, Philadelphia, Pa., a set of beautiful postal cards, giving colored views in their greenhouses, nurseries, aquatic gardens, seed testing fields and ornamental department. Anyone who sends an order to Dreer's gets his acknowledgment on one of these cards, hereafter.

The Third Spring Exhibition of the St. Louis Horticultural Society will be held on March 24-26, at the Grand Ave. Masonic Temple. The rules and prize list have been published and copies may be had on application to the secretary, Otot G. Koenig, 647 1/2 Florissant Ave.



**Baskets, Crates,
Ladders, Veneers
and Boxes.**

BACON & CO.
Appleton, N. Y.

STANDARD FLOWER POTS

Packed in small crates, easy to handle.

Price per crate	Price per crate
1500 2 in. pots in crate \$3.88	144 6 in. pots in crate \$3.16
1500 2 1/2 " " " 5.25	120 " " " 4.20
1500 3 " " " 6.00	60 8 " " " 3.00
1000 3 " " " 5.00	48 10 " " " 4.50
800 3 1/2 " " " 5.80	48 10 " " " 4.50
500 4 " " " 4.50	24 12 " " " 4.80
450 4 1/2 " " " 5.24	24 12 " " " 4.80
320 5 " " " 4.51	12 14 " " " 4.80
210 5 1/2 " " " 3.78	6 16 " " " 4.50

Send pans, same price as pots. Send for price list of Cylinders for Cut Flowers, Hanging Baskets, Lawn Vases, etc. Ten per cent. off for cash with order. Address Hillinger Bros., Pottery, Fort Edward, N. Y. August Folker & Sons, Agts. 31 Barclay St., N. Y. City.

Standard Flower.. POTTS

If your greenhouses are within 500 miles of the Capital, write us, we can save you money

W. H. ERNEST

28th and M Street WASHINGTON D. C.

Syracuse Red Pots

STANDARD SIZES

Florists, we will suit you as to quality and prices. Write for catalogue.

Syracuse Pottery Co., SYRACUSE, N. Y.

SUMMER SCHOOL OF AGRICULTURE.

The summer school of agriculture, established two years ago at Massachusetts Agricultural College in Amherst, will be continued in 1909. In fact it is now regarded as a permanent institution, having proved decidedly popular and successful during the last two summers. The attendance comes from all parts of New England, but most largely from Massachusetts, a surprisingly large proportion being from the cities. School teachers predominate, but a good many land and lot owners go for the sake of the short practical courses in agriculture and horticulture.

The school this year will be run for six weeks in July and August, with courses in field crops, gardening, dairying, fruit growing, live stock, chemistry, plant life, bird life, insect life, etc., etc. Some of these courses are specially designed for grade teachers, some for high school teachers, others for practical people who do not teach, others for clergy, so that everyone who has a week or more to spare can find something useful and interesting to do.

A Profitable Side Crop

Asparagus plumosus is a main crop with many growers having extensive modern plants but those with less up-to-date establishments, or parts of same defective in lighting or otherwise unsuitable for high grade crops, will find this subject one of the very best. We have prepared a cultural circular giving concise directions how to make money out of this crop. Send for it. No charge. An important feature in asparagus culture is good seed. The P. M. quality of greenhouse grown seed has earned a high reputation for freshness and purity. It is the true nanus and greenhouse grown. Send for trial pkg., 100 seeds fifty cents, if you wish to experiment only. In quantity \$3 75 per 1000 seeds, \$32.50 per 10,000 seeds. Asparagus Sprenger 75c. per 1000, \$5.00 per 10,000 seeds.

S. S. PENNOCK-MEEHAN CO.
1608 to 1620 Ludlow St., Philadelphia, Pa.
1212 N. Y. Ave., Washington, D. C.

COLEUS! COLEUS!

C. Verschaffeltii and Golden Beldler,	R. C.	Pr 100	Pr 1000
Same in 2 1/2 in. pots		2.00	15.00
Coleus, mixed	R. C.	.60	5.00
Same in 2 1/2 in. pots		1.75	15.00
Ageratum Steia Gurney and Pauline	R. C.	.50	4.50
Same in 2 1/2 in. pots		1.00	9.00
Feverfew	in 2 1/2 in. pots	2.00	
Fuchsias, our selection			
German Ivy	in 2 1/2 in. pots	3.00	
English Ivy	R. C.	.75	
	R. C.	1.00	

Cash with Order
J. E. FELHOUSEN
148-154 Van Franklen Ave., SCHENECTADY, N. Y.

PREPARE FOR EASTER

Headquarters for Easter Plants

Have LILIES To Burn, To Burn, To Burn

The best in the land, the best in the land, the best in the land.

AZALEAS

To beat the band, To beat the band, To beat the band

What is the best Double Pink Azalea? It is the Mme. Van Der Cruyssen, originated by the well-known Azalea specialist, M. Van Der Cruyssen of Belgium. We have a big stock of them; every plant is as round as an apple, just covered with buds; just right for Easter. We have them for 60c, 75c, \$1.00, \$1.25, \$1.50 up to \$2.00 each. Bernard Andre's alba, \$2.25 to \$3.00; some at \$1.00 to \$1.50. Niobe and Deutsche Perle, 75c, \$1.00, \$1.25, \$1.50. Vervaeana, De Schryveriana (best double variegated), 75c, \$1.00, \$1.25, \$1.50, \$2.00. Empress of India, 50c, 60c, 75c, \$1.00, \$1.25, \$1.50. Simon Mariner, 50c, 60c, 75c, \$1.00, \$1.25, \$1.50, \$1.75. Apollo (red), 50c, 60c, 75c, \$1.00. Professor Wolters, 75c, \$1.00, \$1.25, \$1.50, and some more good varieties, 75c, \$1.00, \$1.25, \$1.50. We have Azaleas by the thousand.

Lilium Nuttiorum, the best in America, 6 in. pot plants, height, 20-25-30 inch and over, with five buds and upwards to ten buds, 10c per bud; under five buds, 12c per bud.

Cineraria hybrida grandiflora. Henry F. Michell's newest improved strain. Our plants this year are very large, big heads of flowers, perfect foliage, and the plants are almost as big as a bushel basket, 6 in., 25c, 30c, 50c, 75c, \$1.00.

Hydrangea Okaka, 6 to 7 in. pots, 50c, 75c, \$1.00.

Spiraea Glauca, 6 in. pots, 50c, 75c, \$1.00.

Superba, Floribunda, Japonica, 6 in., 25c, 35c, 50c.

Araucaria Excelsa largest stock in America, 6 in., 4-6-6-7 tiers, 20-25-30-35 inches high, 75c, \$1.00, \$1.25 to \$1.50.

Araucaria Robusta Compacta and Glauca, 6-7-8 in. pots, 20 to 35 inches high, 4, 5, 6 tiers, \$1.50, \$2.00, \$3.00.

Kentia Belmoreana, 5 1/2 to 6 in. pots, 50c, 60c, 75c.

Forsteriana, 5 1/2, 5 3/4, 6 in. pots, 50c, 60c, 75c, \$1.00, \$1.25, \$1.50.

Ficus Elastica, 3 1/2, 4, 6 in., 50c, 75c, 1.00.

Begonia, New Improved Earlton, a constant bloomer, 3 1/2 in. pots, \$1.25 per doz.

Primula Obconica, full of buds and flowers, 5 to 5 1/2 in. pots, \$2.50 to \$3.00 per doz.

Asparagus Plumosus, 3 to 5 cents.

Ferns, 6, 7, 8 inch, such as **Whitmanii**, Boston, **Scottii**, 50c, 75c, \$1.00, \$1.25, \$1.50; **Amerpholii**, 5 to 6 in., 50c, 75c.

Hybrid Rose Bushes, John Laing, Brunner, Hermosa, and other good sorts; 6 in. pots, 10 inches high, very strong, 50c, 75c, \$1.00.

Crimson Rambler, newest sorts, 5 1/2 to 7 in. pots, 50 to 75c.

Hyacinths, four best varieties, white, pink, light and dark blue, 4 in. pots, \$12.00 per 100.

Touneouli Tulips, this is the best double variegated tulip in existence; three bulbs planted in a 4 in. pot, \$1.00 per dozen pots.

Von Sion Daffodils. Best double yellow daffodil in existence. Three double-nosed bulbs planted in one pot, 5 1/2 to 6 in. pots, \$2.50 to \$3.00 per doz. pots.

All our bulbs are our own importation and are not to be compared with the cheap stuff flooding the market.

Cash with order please. Mention if pots are wanted

GODFREY ASCHMANN

Wholesale Grower and Importer of Pot Plants
1012 W. Ontario St.
PHILADELPHIA, PENNA.

BARGAINS IN DECORATIVE AND FOLIAGE PLANTS

KENTIAS, ARECAS, LATANIAS, in all sizes in the very best condition.

ARAUCARIAS, RUBBERS, CROTONS, PANDANUSES, ASPARAGUS, COCOS, FERNS for dishes, etc.

EASTER STOCK and BEDDING PLANTS at lowest wholesale rates.

A. LEUTHY & CO.

Perkins St. Nurseries, Roslindale, Mass.

THE MOST BEAUTIFUL FERN EVER INTRODUCED

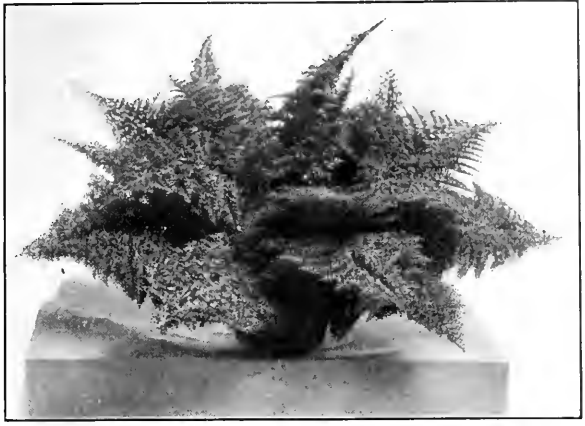

Nephrolepis Magnifica

The most refined development of the Nephrolepis family. The sensational novelty of the season

Strong 2 1-2 inch stock, \$25.00 per 100

Our general stock of ferns is exceptionally good this year. We are prepared to supply any quantity of the following:

WHITMANII, 2 1/2 in. \$5 per 100, \$40 per 1000

WHITMANII, 3 1/2 in. from Bench, \$8 per 100

HENRY H. BARROWS & SON, Whitman, Mass.

Palms



Ferns

Shrubs

Perennials

Send for Our Catalogue.

The GEO. WITTBOLD CO., 1657 Buckingham Place, Chicago, Ill.

FERNS FOR DISHES,

Assorted Varieties
From 2 inch pots, \$3.50 per 100; \$30.00 per 1000

CASH WITH ORDER
2570 to 2606 W. Adams St., Chicago, Ill.

FRANK OEGHSLIN

PALMS AND FERNS

DECORATIVE PLANTS

JOHN SCOTT
Rutland Road and E. 45th St.
Tel. 5490 Bedford BROOKLYN, N. Y.

HEACOCK'S PALMS

Kentia Belmoreana
7-inch pots.....22 to 24 inches high.....\$2.50 each
7-inch pots.....36 to 38 inches high.....3.00 "
9-inch tub.....42 to 48 inches high.....5.00 "

Made up **Kentia Forsteriana**
7-inch pots.....22 to 26 inches high.....\$2.50 each
7-inch pots.....36 to 38 inches high.....3.00 "
9-inch tub.....42 to 48 inches high.....5.00 "

Joseph Heacock Co., Wyncote, Pa.

In ordering goods please add "I saw it in HORTICULTURE."

VIOLETS

Princess of Wales, Luxonne, California Violets. Rooted Runners, clean and free from disease. \$1.00 per 100, \$8.00 per 1000. Cash with order JACQUES GILMET, - Moylan, Del. Co., Pa

FRANK OEGHSLIN

Ampelopsis Veltchii, 4 in. pots, \$10 per 100; 3 in. pots, \$5 per 100. **Ferns**, Boston, **Scottii**, 4 in. pots, \$10.00 per 100; Boston, 3 in. pots, \$4.00 per 100. **Whitmanii**, 3 in. pots, \$5.00 per 100. **Asparagus Sprengeri**, 2 in. pots, \$2.00 per 100. **Cannas**, King Humbert, **Le Blanc**, \$5.00 per 100. **Clematis Paniculata**, 4 in. pots, \$10.00 per 100; 3 in. pots, \$5.00 per 100. **Clematis**, large flowering varieties, 2 years old, dormant plants; Jackson, Henry's, Andre, \$ 5.00 per 100. **Ficus Elastica**, 6 in. pots, 25c each.

C. EISELE, 11th & Westmoreland Sts., Philadelphia, Pa.

Gladiolus Brenchleyensis

Extra fine Healthy Imported Stock
1,000 \$10.00 10,000 \$80.00

O. V. ZANGEN

HOBOKEN, N. J.



TWEMLOW'S
Old English Glazing Putty,
 SEMI-LIQUID,
 For bedding glass in sash or for filling cracks or seams in roof joints or frames
 OF GREENHOUSES OR HOT BEDS.

THIS
PUTTY

Is used in Machine or Bulb.

If too thick for bulb thin with a little Pure Linseed Oil, boiled.

So thinned it can be brushed into any crack or leak, making a solid filling.



THIS
PUTTY

makes a solid bed, impervious to moisture, and holds glass in its place, and will stop any crevice or fault.

When once set on dry wood it does not heave.

MANUFACTURED IN THE UNITED STATES ONLY BY
HAMMOND'S PAINT AND SLUG SHOT WORKS,
 FISHKILL-ON-THE-HUDSON, N. Y.

MASSACHUSETTS HORTICULTURAL SOCIETY.

Dr. H. J. Webber, professor of experimental plant breeding in Cornell University, spoke before the Massachusetts Horticultural Society February 13 in the Saturday lecture course. His subject was "The Outlook for Plant Breeding," and he said in substance:

Despoiling Our Resources.

The nineteenth century has been characterized by Alfred Russell Wallace, the great English biologist and contemporary of Darwin, as a century of despoilation of the natural resources of the world. In our greed for wealth, the soil, minerals, forests and all natural resources, rightly the heritage of the children of the world for all time, have been wantonly depleted without thought of the future generations that must follow us. In the beginning of the twentieth century it is meet that we should pause in our mad race for wealth and thoughtfully consider if we are doing our duty by our children and our children's children, who are to inherit the earth after we are gone. It has been said that the

THE PRIZE WINNING STRAWBERRY
The Barrymore

Send for Folder at Once.

H. L. CRANE, Originator,
 Westwood Mass.

THE STRAWBERRY BLIGHT, ITS CAUSE AND CURE.

How to more than double the yield of crop without increasing the cost of production. A great discovery. Price of Book \$2. Worth \$25.

WM. C. TRIMBLE, - Princeton, Ill.

greatest of all inventions which we inherit is the alphabet, and I presume it may be as truthfully claimed that the greatest of all heritages which have come down to us from our ancestors are the cultivated plants developed by centuries of unconscious selection for man's cultivation and use. As agriculture is the foundation of civilization, so the cultivated plants are the foundation of agriculture, as plants must necessarily precede animals to support them.

The early history of our cultivated plants is shrouded in mystery, the wild types from which they have sprung being in many cases entirely unknown, the modifications which have taken place being so profound in many cases, as to preclude the recognition of the wild prototypes if they are now living. Each century has inherited increasingly better and better sorts from the preceding century. It would seem to us today, that we have nearly reached the limit of perfection, yet I am led to wonder when I review the tremendous possibilities opened to me by my past fifteen years of research in the field of plant breeding, if we are really doing all in this field of development which the world has a right to expect of us.

If we are to feed the increasing millions of our population with our soil depleted in fertility, with our mineral deposits of nitrate of soda, potash and phosphates approaching exhaustion, we must use strenuous methods to improve our plants to the highest degree of efficiency.

Where to Look for Relief.

Where, now, can the breeder enter with profit into this field? When our nitrogen fertilizers fail, where are we to get fertilizers for our great cereal crops which are more important than any other crop in feeding the world? Wheat, corn and rice are not legumes. With what can we fertilize our potatoes, which in many countries, are the staple article of food and the valuation

of which in the world as a whole, exceeds that of our "King Corn." It is quite probable that the various legumes known to fix free nitrogen can be improved, made more important and led to assume a much greater part in food production. Beans, which are nitrogen-fixing legumes, now make a flour, from which buns, biscuits, griddle cakes, etc., can be made which nearly equal similar products from wheat and corn flour. Beans, peas and other legumes, must ultimately be bred particularly for this purpose. Several wild legumes, as yet entirely undomesticated, produce tubers which are fairly large and wholesome as food. These may be bred as substitutes for potatoes, by breeding varieties suited to growth on nitrogen-free soils.

Which Spray Pump

shall you buy? Buy the **Spray Pump** that fully meets the demands of the Government Agricultural Scientists and all practical Fruit Growers. These pumps are widely known as **DEMING SPRAYERS** and are made in 23 styles for use in small gardens or immense orchards. Write for our free catalog with **Spraying Chart**. Add 4 cents postage and receive "Spraying for Profit," a useful guide book.

CHARLES J. JAGER CO.
 281-280 Franklin St., Boston

?

SPRAYED

SHEEP MANURE

Pulverized. Free from Adulteration
 In Bag, \$18.00 per Ton. Cash with Order

ROBERT SIMPSON
 CLIFTON, N. J.



TARGET BRAND
Weed Killer

Sold at retail by a thousand of seed houses and dealers. Special price in quantities to parks and cemeteries

TARGET BRAND, Box 732, Martinsburg, W. Va

NEWS OF THE CLUBS AND SOCIETIES

GARDENERS' AND FLORISTS' CLUB OF BOSTON.

The regular March meeting on the evening of the 16th was well attended and interesting throughout. Communications from the Co-operative Flower Market, inviting the club members to visit their exhibition on Sunday, and from the North Shore Horticultural Society to attend their meeting on March 19, were received and accepted and an invitation for the club to visit in a body the greenhouses of the W. W. Edgar Company on Saturday, April 3, to see the Easter plant display, was referred to the executive committee to make arrangements accordingly. Harry A. Barnard, traveling in the interests of Hugh Low & Co., London, was introduced as a welcome visitor in Boston and in a very few moments had his audience fairly hypnotized by his very clever and entertaining eloquence. He gave unstinted praise for the excellence of the culture especially in carnations that he had seen during the few days he had been in America and for the cordiality with which he had been received by the fraternity. His little speech was brimful of pleasantry and humor and was applauded to the echo.

Robert Cameron was then introduced and read a grand paper on the subject most close to his heart always—a plea for the more general use of hardy perennial plants in parks, cemeteries and rural estates. Mr. Cameron prefaced his paper with a most feeling and tender reference to the fact that he was filling the sad vacancy caused by the sudden death of E. V. Hallock of New York, who was to have been the lecturer of the evening. He referred to Mr. Hallock's death as a great loss to the entire horticultural world and voiced the sympathy felt here for our sister organization in New York, which had lost a noble president and faithful friend.

Mr. Cameron's paper was brilliant in its composition, satirical in places and reasonable and convincing throughout. We hope to be able to reproduce it in our columns in due time. It brought out a goodly response in discussion and a standing vote of thanks was accorded its gifted author.

On the exhibition table were some interesting displays, including Eupatorium Windmannianum and mushrooms from T. Coles, Canna Tarrytown from Eber Holmes, Schizanthus Wisetonensis, and its dwarf variety and S. grandiflora from Duncan Finlayson and an array of eighteen vases, distinct varieties, of sweet peas from Mr. Sim, among which Greenbrook and Pink Beauty and several seedlings were especially noticeable, and for which a report of merit was awarded to Mr. Sim, the other exhibitors being accorded a vote of thanks. The identity of the canna shown as Tarrytown was the topic of some discussion and it is in order for the introducer, F. R. Pierson, to

straighten out the uncertainty existing in the minds of some of the Boston experts.

Seven new members were taken in to the fold.

On motion of James Wheeler it was voted to send letters of sympathy to the family of the late E. V. Hallock and to the New York Florists' Club. Considerable discussion arose over a proposal to donate \$25 for a special prize at the Music Hall Market exhibition and was not carried. F. W. Fletcher drew the attention of members to the proposed increase in the tariff on greenhouse glass and it was voted to send strong protests on the subject to all Massachusetts congressmen, also to the Ways and Means Committee in Washington.

LENOX HORTICULTURAL SOCIETY.

The regular meeting of the Lenox Horticultural Society was held Saturday, March 6th, President A. Jenkins occupying the chair. Messrs. George W. Allwood and D. Ferguson were elected members. Annual and peren-



HARRY A. BARNARD,

Representative of Hugh Low & Co., London; a visitor at the Gardeners' and Florists' Club, Boston.

ennial exhibition will be held July 25th, and the fall exhibition Oct. 26-27. Schedules are printed and can be had upon application to the secretary. A. J. Lovell was awarded a diploma for a display of amaryllis flowers, some of them being very rich in color, and he gave a short talk on their culture. Following the question, "What is the cause of disease in Liliium Harrisii?" a very interesting discussion took place, but no definite conclusion was arrived at. Several instances were cited where large growers had thrown away thousands of diseased plants.

Rose and Carnation night Saturday, April 3rd, and it is safe to say that competition in the various classes will be keen, as carnations are grown quite extensively in and around Lenox. After business is dispensed with there will be a smoker, when members who were not asked to sing at the dinner will have a chance to display their vocal talent.

MORRIS CO. GARDENERS' AND FLORISTS' SOCIETY.

The evening of March 10 was our "Carnation Night" and L. J. Reuter of Westery, R. I., was our essayist. Mr. Reuter's fame as a carnation grower preceded him here, and to this may be credited in a great measure the full house we had. We had to borrow chairs from the outside to accommodate the extra visitors. A very delightful talk on Carnations was given us, the speaker being entirely familiar with every point of the subject. He contrasted solid benches and raised benches and was partial to the solid. He uses both at the present time. He told us of his way of treating cuttings in the sand, which was new to most of us. His house is so arranged that as soon as the cuttings are rooted he can decrease or shut off the bottom heat from a batch without interfering with the one next to it. A rising vote of thanks was tendered him.

We had not as many novelties as other years but what we had was good and so were the standards. A big vase of Alma Ward from Cottage Gardens, Queens, L. I., took every eye and everyone who could carry away a bloom. It got our certificate long ago. Vote of thanks given. A display of Dorothy Gordon from Joseph Heacock, Wyncote, Pa., received a well-merited certificate of merit.

Red seedling No. 1 from John S. Green, Morristown, got certificate of merit last year; vote of thanks. Ruby from S. J. Reuter & Son, was voted "A fine full flower; committee would like to see it in larger quantities to judge for certificate." Through delay in transit President Taft from Scheiden & Schoos, Chicago, came too late to be judged. Three vases of carnations, Robt. Craig, Enchantress and Winsor from A. R. Whitney, H. B. Vyse, gardener, received cultural certificate. Vase mixed carnations from A. C. Van Gaasbeck, Orange, N. J., John Dervan, gardener; cultural certificate. Carnations Variegated Lawson, Winsor and Lawson from G. E. Kissell, Charles Steele, gardener, got a cultural certificate. Carnations Enchantress, Afterglow and Mixed from Florham Farms, A. Herrington, Supt., got cultural certificate.

From Florham Farms were a plant of Cattleya Luddemanniana alba, flowering the first time in this country; first class certificate of merit. Collection of Catt. Luddemanniana, showing some very fine and distinct types; cultural certificate. Collection of stocks—Queen Alexandra, Beauty of Nice and Crimson King; cultural certificate.

Dr. Leslie D. Ward, Andrew R. Kennedy, gardener, had a fine lot of well-grown chinerarias of a very fine strain; cultural certificate. M. B. Metcalf, Orange, N. J., Geo. Wraight, gardener, had a lot of fine stock Empress Elizabeth; cultural certificate. Totty's Amaryllis "Crimson King" showed a remarkable flower.

Among the visitors was H. A. Barnard of the Hugh Low Nurseries, London, Eng. He had at 6 o'clock that evening completed his 48th year with the firm, and he looks good for 25 more. He made a telling speech,

which was cheered to the echo. H. A. Bunyard (same initials) was acting as his guide. The H. A. Bunyard prize for best plant in flower is to be competed for on April 14 next.

April 14 is Rose Night. An essayist from the outside is promised. The carnation men have had their innings now we shall see what the rose men can do. EDW. REAGAN, Sec'y.

NEW JERSEY FLORICULTURAL SOCIETY.

Carnation night was observed by this Society at their rooms in Orange, on the 12th, with appropriate ceremonies. There was a meritorious floral display, a paper on the Carnation by William Lyons and addresses by visitors from other parts. The new Daybreak Pink carnation Mrs. Pfeuffer was displayed by John L. Pfeuffer of Irvington, N. J., who addressed the meeting. He claimed superior advantages for his flower as a commercial sort, as a heavy cropper of good size and fragrance, a free bloomer during the months of December and January. Henry Hornacker of East Orange exhibited some well-grown Victory, which were awarded a certificate of merit. Thomas J. Grey of Boston addressed the meeting, saying: "We have had last week in Boston one of the finest exhibitions of carnations the country has ever seen and we are going to have two more. We have two flower markets, one meeting in Music Hall and the other in the Park Street Church, where it is said 'God is upstairs and the devil in the cellar.' I congratulate you upon the display you have made here tonight, for I have not seen its superior in color or clever cultivation." The paper by William Lyons, gardener to Robert R. D. Foote, of Morristown, N. J., was read by the secretary, as the writer was prevented from coming by sickness in his family. A lively discussion followed its reading upon the merit of outdoor cultivation, feeding and lifting.

The principal exhibitions were as follows:

Carnations by A. C. Van Gaasbeck, gardener John Dervan; Charles Hathaway, gardener Max Schneider; Charles Munn, gardener John Hayes; S. and A. Colgate, gardener William Reid; William Runkle, gardener D. Kindsgrab; Henry Hornacker; Eupatorium, violets, stocks and hyacinths, Max Schneider; stocks Empress Elizabeth, Mr. Metcalf, gardener Geo. Wright; Dendrobium thysiflorum, J. Crosby Brown, gardener Peter Duff; Cattleya Schroderae, Wm. Reid; Orchids, Lager and Hurrell. J. B. Davis.

DETROIT FLORIST CLUB.

The last meeting of the club was made quite interesting through a paper on "Forcing of Dutch Bulbs," read by Mr. Chas. Plumh. It contained no specially new features but all the practical questions were so well covered that there was nothing left to start a discussion after its reading.

The principal general discussion was the coming fall show. It will be a great undertaking, worthy of the efforts of a city twice the size of Detroit. Still enthusiasm is just beginning to get a foothold among the boys and as this club does not know how to spell failure the result can be easily foreseen.

NASSAU COUNTY HORTICULTURAL SOCIETY.

The regular meeting of this Society was held in Pembroke Hall, Glen Cove, N. Y., on Wednesday evening, March 10. President Everett occupied the chair and about fifty members were present. The Horticultural Hall committee appointed two months ago, reported that a suitable site could be acquired at a reasonable cost. On a ballot being taken, a majority voted in favor of the project. Whenever necessary preliminaries are completed the ground will be purchased and steps taken for the erection of a Horticultural Hall in Glen Cove.

A most interesting and instructive paper was read by Mr. Elmslie on "Tree Doctoring." The essayist has made the care of trees his special study for a number of years and dealt with his subject in a practical manner. He emphasized the fact that less "doctoring" would be required if trees were properly cared for when young.

A keen discussion arose over the question of how to prevent and cure the stem-rot so prevalent in forced lettuce. A Mackenzie in answer to this question said there was no cure, but he thought we would have less of the so-called stem-rot if care were taken not to wet the foliage when watering. He also said that a free circulation of air at all times excepting in extremely cold weather is absolutely necessary.

Messrs. Jaenicke, Dunthie and Garrett acted as judges at the monthly competition. G. Wilson again headed the list in the points competition, with a superb lot of W. & D.'s Snowball cauliflower. The points competition was as follows: G. Wilson, cauliflower, 90; V. Cleres, carnations, 89; H. Gant, sweet peas, 85; J. Elmslie, carnations, 85; P. Reul, antirrhinum, 85. G. Wilson was awarded a cultural certificate for Beauty of Nice stock. A. Wilson, Summit, N. J. was elected to active membership.

W. H. MACKENZIE, Cor. Sec'y.

S. A. F. EXECUTIVE BOARD.

Cincinnati.

The Executive Board of the Society of American Florists and Ornamental Horticulturists convened at Cincinnati on Saturday evening, March 13, and the sessions were continued until the 16th. The official report of same will be forthcoming at an early date, but we are at liberty to say that the meeting was enthusiastic and successful in a high degree, and the prospects for the convention next August are exceedingly rosy.

After the evening session on Saturday, the visitors were escorted to the meeting of the local Florists' Society, where hospitality was freely extended and interesting reminiscences indulged in. On Sunday Mr. and Mrs. J. A. Peterson entertained the committee at their home; on Monday a banquet at the Sinton Hotel was enjoyed, and on Tuesday a trip to R. Witterstaetter's was the order of business, and here again hospitalities were unlimited. The banquet on Monday was presided over by Mr. McCullough and brilliant responses were made by President Valentine, Messrs. Eugene Dailedouze, George Asmus, F. H. Traendly, W. N. Rudd, Judge Vesey, E. G. Hill and

many of the local lights, including the veteran, B. P. Critchell, who was an active participant in the first convention, twenty-five years ago.

CONNECTICUT HORTICULTURAL SOCIETY.

The regular semi-monthly meeting of this Society was held on March 12th, President Huss presiding. Two new members, Charles Turner and E. P. Cahill, both of Hartford, were elected. The Society voted to hold a banquet, that has recently been under discussion, on the evening of April 12th, after the Lenten season. James Chambers entertained the meeting by reading a poem by William Miller, entitled "The Gardener's Song;" and J. A. Weber read a short, original paper on the "Culture of Mushrooms," in which he recommended the spawn obtained in this country, rather than that affected by the salt water in transit from Europe. A delightful display of cinerarias was tabled, comprising nearly fifty plants with blooms of various striking colors. The judges were John Gerard and James P. Ralph, of New Britain, and Clarence H. Wiley, of Hartford. John Coombs was awarded a score of 85 points, J. F. Huss 80 points, and J. A. Weber 75 points. Mr. Chambers presented a paper on "The Cineraria," covering well its history and culture. President Huss announced that Prof. F. A. Waugh, of Amherst, Mass., would be present to address the Society at its next meeting on the 26th inst.

GEORGE W. SMITH, Sec'y.

Melrose, Conn.

PENNSYLVANIA HORTICULTURAL SOCIETY.

The regular monthly meeting of this society was rather slimly attended on the 16th inst, on account of the spring show being only one week distant. Routine matters in connection with this event were the principal topics under discussion. Several new prizes for roses were announced. The date of the spring show for 1940 was fixed for March 19 on account of the early Easter next year. James Goodier, gardener for C. G. Roebeling, exhibited and was awarded as follows: Cattleya Trianae Roeblingiana, sepals and petals pure white, lip faintly tinted slate blue; first-class certificate: Cattleya Guatemalensis, Epidendron Auranctia X Cattleya Skinneri; special mention: Dendrobium nobile Ashworthianum, a very fine plant of this pure white dendrobium; first-class certificate.

David Rust, secretary, reports excellent prospects for some good exhibits at the spring show, which opens on Tuesday, 23rd inst., at 2 p. m., continuing Wednesday and Thursday. Cineraria stellata will be a prominent feature, many of the leading growers having made a specialty of this item lately. Primula obovata will be another strong card. The usual show of azaleas, hyacinths and daffodils will be up to high water mark from present indications. All kinds of spring flowers will be strongly represented and it is expected that a good many of the leading novelties in roses and carnations will be on exhibition. The show will undoubtedly be worth coming a long way to see.

ST. LOUIS FLORIST CLUB.

The meeting of the club on March 11 was attended by about twenty members. President Young was ill and Vice-President Edwin Danker failed to appear, so J. F. Ammann was prevailed on to take the chair. It was hoped that J. A. Valentine would arrive in time to talk over convention matters with us, but in this we were disappointed. The various committees reported. The bowling and shooting committees stated that they are organizing teams for the convention; the former bowl every Monday night, John Connon, chairman; the latter meet for practice at Kirkwood every week, Frank Venneman, chairman. J. F. Windt, chairman of the committee to eliminate crepe pulling, said they are doing good work and asked the club to vote that they are opposed to the practice; also to publish the proceedings in the daily papers, which was unanimously carried. The fall flower show was fully discussed and the conclusion reached, that two shows would be a financial loss. On vote it was decided that the secretary should correspond with the secretary of the Horticultural Society in regard to uniting in one big show. Walter Ritzer tendered his resignation, as he is going to South America, and it was accepted with regret. Mr. Ammann spoke feelingly on the death of E. V. Hallock, president of the New York Florists' Club. The meeting then adjourned. The next meeting will be held on April 8.

ALBANY FLORIST CLUB.

A special meeting of the Albany Florist club was held Thursday evening, March 11, at the store of W. C. King. Arrangements were made to hold a floral exhibition in November. Frederick Geldring was named as president, A. De G. Wempe, secretary and Louis Menand, treasurer.

The following committees were named: Hall committee—P. Hyde, A. Whittle, T. Snare, F. Henkes, H. W. Riggs and E. S. Hazeltine; program, printing and advertising—E. F. Meany, W. C. Gloeckner, W. Roach, F. Breare, J. H. Moran; decorating and arrangements—S. Goldring, W. C. Kurth, W. C. King, Philip Bender, F. Conley, C. Sanders, J. Murnane; premium and selection of judges—E. F. Tracey, Wm. W. Hannell, Watervliet, J. H. Snyder, Rhinebeck, Louis Wood, Fishkill, C. Sullivan, P. Warner, Newtonville.

INDIANA STATE FLORISTS' ASSOCIATION.

This association at a meeting held March 2nd, arranged to co-operate with the State Board of Agriculture in the establishment of a department of floriculture at the State Fair this fall. This year premiums amounting to \$1000 will be paid in the floriculture department. A committee was named to make inquiry regarding the sentiment of Indianapolis people toward a fall chrysanthemum show which the florists would like to hold.

The committee consists of H. L. Wiegand, A. F. J. Baur and Fred Hukriede. Reports show that the carnation meeting held here in January was a success from a financial point of view.

AMERICAN ASSOCIATION OF PARK SUPERINTENDENTS.

At a meeting of the American Association of Park Superintendents held at the Genesee Hotel, Buffalo, on March 17, the date for the convention at Seattle, Wash., was set for August 9, 10, 11. President Duncan, Secretary Mulford, Theodore Wirth and J. W. Thompson were appointed a committee to make all arrangements. An invitation was received to spend the fourth day at Tacoma.

THE AMERICAN CARNATION SOCIETY.

Carnation Registered by Dailedouze Bros., Flatbush, N. Y.

"The White House." Color white, very large with stiff stem and excellent calyx; a good keeper, good bloomer and good grower.

ALBERT M. HERR.

Lancaster, Pa.

CLUB AND SOCIETY NOTES.

The Milwaukee, Wis., florists are planning to hold a big flower show in November. H. V. Hunkel is chairman of the committee of arrangements and C. C. Polworth, Nic Zweifel, W. Zimmermann, J. G. Heitmann, A. F. Keller and C. Dallwig are his able assistants.

At the meeting of the Lake Geneva Gardeners' and Foremen's Association (Wis.) on March 6, officers and directors were elected as follows: President, A. J. Smith; vice-president, James Livingston; secretary, Albert H. Reupke; treasurer, Wm. Wahlstedt; Directors, Axel Johnson, Frank Johnson, Wm. P. Longland, Robt. Sampson, Miles Barrett and the officers. Meetings are held the first and third Saturday evening of each month in the Woodmen's Hall.

The fifteenth annual meeting of the Massachusetts Fruit Growers' Association was held at Worcester in Horticultural Hall, March 10, 11. Wilfrid Wheeler of Concord, G. C. Sevey, editor of The New England Homestead, H. L. Frost of Arlington and others spoke on vital topics and discussions followed. A stereopticon lecture by H. B. Fullerton was given in the afternoon, when the Worcester County Horticultural Society united with them. Officers were elected as follows: J. W. Clark, president; E. D. Bliss, vice-president; S. T. Maynard of Northboro, secretary and treasurer; J. E. Ellsworth, auditor.

The Worcester County Horticultural Society, Worcester, Mass., closed its winter session on March 11 with a banquet at which 380 were present. Brief talks followed the feast, wherein A. P. Rugg made a suggestion regarding the cultivation of window gardens, Prof. Craig suggested the better cultivation of the men and women engaged in the business, M. C. Burritt gave a glimpse into the workings of the Department of Agriculture at Washington, H. B. Fullerton extolled the opportunities for raising celery in this section, and W. P. Rich brought the greetings of the Boston Society. Dancing was indulged in until a late hour.

Obituary

Louis M. Noe.

Louis M. Noe, the extensive rose-grower of Madison, N. J., died at his home at 7:30 A. M., Thursday, March 11th, after a lingering illness. Mr. Noe was born in Chatham township, May 13, 1847, and was of French descent, his grandfather, Louis Noe, having come to this country as a soldier with Lafayette and served through the Revolution. He studied law for one year with Guild and Lum, Newark, N. J., but later devoted himself to caring for his landed interests. In 1872 he went into the fruit and nursery business with his brothers-in-law, Samuel and O. N. Brant, under the firm name of Brant, Noe & Brant. From a small beginning, they became the largest peach growers in New Jersey, having 1000 acres in peach trees. Mr. Noe was regarded as an authority on peach culture all over the country. In 1884 he established his rose gardens in Madison, N. J. At the time of his death Mr. Noe had about a million square feet of glass in Madison; besides he owned a half interest in the Brent & Noe Floral Co., of Chicago. American Beauties were his specialty in roses, though he largely grew other kinds. He was a member of the Christ Methodist Church, Madison. A widow and three children survive him. A son, Louis A. Noe; a daughter, Marie, wife of Lincoln Pierson, and another, Miss Lillian May Noe. Mr. Noe was of a sunny disposition, kind-hearted, and a liberal supporter of all worthy enterprises. He was loved by everybody who knew him, and at his funeral which took place at 2 o'clock from Christ Methodist Church, on Sunday, it seemed all Madison turned out, besides the old-time florists many of whom came a great distance. The floral tributes filled two carriages. Orchids, lily of the valley, roses and lilies were in evidence everywhere. A noteworthy piece was one from his employes, an immense design containing no less than fifteen thousand violets.

E. R.

John N. May writes of the late Louis M. Noe: "He was a man of very broad liberal views and was highly respected by all who knew him, courteous, kind and considerate of all his employes, having many other interests outside of his particular business as a rose grower."

Resolutions passed by the board of directors of the New York Cut Flower Company:

Whereas, Louis M. Noe, our friend, counselor and for some time vice-president of our organization, has been called from us by death, leaving a void, which to us seems one that cannot be filled; and

Whereas, We who have been associated with him so long in this organization feel that it is but proper that we place on record our estimate of his character and worth, and the sincere sorrow which each feels at parting with such a dear friend, able associate and worthy co-laborer; therefore, be it

Resolved, That the members of the board of directors of the New York Cut Flower Company do hereby extend to the family their sincere sympathy at this bereavement, assuring them that by his death not only are we made mutually mourners for his beloved and respected friend but that in

the death of Louis M. Nee we have been deprived of the advice and assistance of one of our most useful members.

Resolved, That this preamble and resolution be placed in full on the minutes of this company, a copy of the same be published in the trade papers and also in the local papers of Madison, Chatham and Summit, New Jersey, and that an engrossed copy be sent to the family.

HEINZ BENTZ, JR.,
S. C. NASH,
F. I. MOORE,
Committee.

Patrick Lawlor.

Patrick Lawlor, one of the best-known arboriculturists in the United States, died March 10 at his home, No. 206 Barclay street, Flushing, New York. He was seventy years old, and came from Ireland fifty-nine years ago. For four decades and more he had charge of the old Parsons Nurseries in Flushing. In that capacity he toured the world in search of rare trees, which were shipped to Flushing, and under his management were disseminated.

Helen C. Pennock.

The grim destroyer, which comes to all sooner or later, last week invaded the fold of S. S. Pennock at Lansdowne, Pa. and left that family minus one pet ewe lamb, Helen C. Pennock, aged four. The sympathy of the trade is freely extended to the sorrowing family.

Lafayette A. Gates.

Lafayette A. Gates, a retired florist of Cleveland, O., who had been to Florida in search of health, died at the Grand Hotel, Cincinnati, on February 22. He was 60 years of age and leaves a widow and daughter.

J. S. Haskins.

J. S. Haskins, a native of Vermont, who conducted a florist store at 22d St. and Wabash Avenue, Chicago, for a number of years prior to 1890, passed away on February 28, at the age of 87.

J. J. Nussbaumer.

J. J. Nussbaumer who, for thirteen years has been engaged in the greenhouse business at San Angelo, Texas, died on February 28 at the age of 49. A widow, son and mother survive him.

Harry J. Hess.

Harry, the 12-year old son of J. J. Hess of Omaha, Neb., was stricken with diphtheria and died on March 1. The sympathy of the trade is with the mourning parents.

H. W. Baudry.

Harry W. Baudry, a nurseryman of La Porte, Ind., committed suicide on the morning of March 6, after a prolonged illness.

Mrs. G. A. Rolin.

Mrs. G. A. Rolin, whose husband is a member of the firm of Newlander & Rolin, Denver, Colo., died on March 1.

The increasing importance of the fruit growing industry and the consequent necessity of vigorous spraying led the members of the horticultural society at a recent meeting in Wichita, Kansas, to decide that it would be an advantage to have a plant manufacturing insecticides located in their vicinity. At present the East has a monopoly of this industry and the high freight rates are a burden to the western people.

METHODS OF PROPAGATING PLANTS.

By Jackson Dawson.

As announced in our last week's issue, Jackson Dawson of the Arnold Arboretum was unable to be present at the last of the season's lectures of the Massachusetts Horticultural Society Saturday, March 6, 1909, to speak on "Methods of Propagating Plants," but owing to illness was compelled to send in his paper to be read by Secretary W. P. Rich. J. A. Pettigrew of the Boston Park Commission presided.

Seeds, the paper stated, should always be selected with care, and different seeds require different treatments. Those of the plum and peach, for instance, will not germinate until they have been frozen hard. Many tree seeds are packed in dry earth all winter, and some of the hard kinds must be soaked in warm water before planting. Only fresh seed should be used.

Soil and situation are next to be considered. A deep rich loam well manured and as free from weeds as possible should be selected, sheltered from north and west winds. Planting in rows is preferable to broadcast sowing. Large seeds should be planted twice the depth of the seed—say an inch for beech or oak and two inches for hickory. The soil should be neither dry nor wet. Many tree seeds will not come up until the second year. Red and white maple seeds should be sown as soon as gathered and if well cared for will come up in one year. When seeds are sown in the fall, as soon as the ground is frozen, cover with hay or pine needles. As soon as plants are up they should be cultivated and kept free from weeds. All watering should be stopped after the first of September to harden the wood. Ploughing between the drills is helpful.

Seeds just arrived from foreign stations should be treated with unusual care. If mildewed, they should be treated with a weak solution of copper sulphate. Nearly all deciduous plants should be transplanted after the first year. Box planting is a good system because it facilitates handling of the plants. About April put the boxes in frames where they will get the morning sun. In winter they can be kept in good condition if covered with sphagnum moss or pine needles. The critical time with young conifers is the first three weeks before they have a crown bud. Hot sun and excessive rain kill thousands of trees. After August they will need very little special care.

The propagation of kalmias, rhododendrons and plants of this class is especially difficult, and should not be attempted except in a greenhouse. They must be transplanted frequently. A sprinkling of hot sand will destroy fungi without destroying the plants.

Many shrubs and trees can be grown from cuttings or from pieces of the root. The elm is an example of the latter class. The willows root readily from wood cuttings. Many of the roses it is almost impossible to grow from hard wood. Many plants root easier from soft cuttings in summer than from hard wood cuttings. Shrub cuttings should be five or six inches long but willows may be longer. If the ground is well sheltered cuttings may be planted out in frames or nursery

rows in the fall. The soil should be good and deep and well watered. By the end of the second year they should be ready for transplanting. In growing soft-wood cuttings boxes or frames should be used, and need much more care than the hard ones. The earlier rooted plants can be set out in frames in spring and will be in good shape by winter if well cared for. Plants with stolons or underground stems, can be propagated from cuttings. Many plants wanted on their own roots can be had by layering. Layers are branches of plants cut partly through and buried in soil. They will then root at the eyes or place of cutting. By twisting the branch the flow of sap can be prevented. The sap must be regulated. Almost any branch or vine can be grown this way. Grapes may be cut off from the parent plant in the fall, but maples must be kept on the main plant two years.

Mr. Dawson's paper did not go into all the methods of grafting, but explained some of its features. All woody plants may be grafted. Old orchards may be made vigorous by grafting, although generally grafted plants do not live as long as plants on their own roots. There are some fifty methods of grafting, but these are modifications of some five or six ways. Scions should be cut before the sap is well started, and grafting should be done in the spring. Scions should be well-ripened wood at least one year old. The paper described the various technical processes of inarching, grafting by approach, tongue grafting, bottle grafting, cleft grafting, side grafting, etc. All methods of grafting can be used on roots. Budding consists in taking a bud from one plant, with a piece of bark, and inserting it in a cut in another plant. Most nurserymen propagate more by budding than by grafting.

DURING RECESS.

Lenox Horticultural Society.

The annual dinner of this society was held at the Curtis Hotel Thursday, March 4th, and was a decided success, about eighty members and friends being present. The night was far from being ideal as a blizzard was raging at the time, otherwise the attendance would have been much larger. After doing justice to the good things provided by Landlord Curtis, President A. Jenkins spoke in behalf of the society, and introduced A. McConnachie as toastmaster for the evening. Thos. J. Grey in a humorous speech spoke on behalf of the Gardeners' and Florists' Club of Boston, and the North Shore Horticultural Society. During the course of the evening a telegram was read from A. T. Boddington, New York, regretting his inability to attend and wishing the members a pleasant time. Various other persons contributed to the success of the evening, namely, Mrs. J. Clifford, Mrs. Geo. Mole, Messrs. W. Glennan, F. Howard, W. Jack and W. D. Curtis. Upon a suggestion from the toastmaster a rising vote of appreciation was accorded to W. D. Curtis for the splendid banquet, and closed with the entire party singing Auld Lang Syne. The committee, of which E. Jenkins was chairman, are to be congratulated upon the success attending their efforts.

G. H. INSTONE, Sec'y.

Y₁ Fluid

THE IDEAL WINTER SPRAY
SCALE KILLER & FUNGICIDE

POWERFUL CLEANSER AND INVIGORATOR
Mixes Instantly. No Sediment. No clogging. Non-injurious to user
COMPARATIVE TEST WILL PROVE ITS MERITS
Quart, \$1.00; Gallon, \$3.00
1 gallon makes 100 gallons. Write for descriptive pamphlet and testimony

PROPS. W. COOPER & NEPHEWS
177 ILLINOIS ST. CHICAGO

Gen'l Agent — CYRIL FRANCKLYN, 62 Beaver Street, New York, N. Y.

For Trees, Plants, Shrubs and Flowers

— USE —

THE NIAGARA BRAND LIME SULPHUR SOLUTION

It destroys Scale Lice, Spiders and all forms of Aphides, AT THE SAME TIME Mildew, Blight, Rust and other Fungus difficulties.

Used in Winter or Summer. — No other remedy has been so universally effective.
Niagara Brand ARSENATE OF LEAD for chewing insects is equal to the best and better than the most. Ask about our Green House sprayer. Address —

NIAGARA SPRAYER CO., - - Middleport, N. Y.

U-N-IT Globe Sprayer.

Brings out in solution, with water, what is put into Globe Insecticides, Germicides, Fungicides, Fertilizing solutions, soap solutions, etc. Practical: saving work, time and money. An investment for every Florist. Tested at 150 pounds water pressure. Write for circulars or better still order one now from your dealer or sent prepaid on receipt of \$3.50.

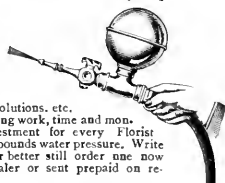

— ADDRESS —

Dept. H, J. F. CASS MFG. CO, Detroit, Mich.

KILMDEAD

The best of all the tobacco dusts for

Dusting or fumigating

Stump & Walter Co. 50 Barclay St. New York.

25 lbs., \$1.00	100 lbs., \$ 2.00	1000 lbs., \$27.00
50 lbs., 1.75	500 lbs., 14.00	2000 lbs., 52.50

DON'T EXPERIMENT

— USE —

TO-BAK-INE

and your stock will be free from insects, clean, and the blooms will not be discolored.

Send for full information of

H. E. FISKE SEED CO.
13 Faneuil Hall Sq., Boston, Mass.
STUMPP & WALTER CO.,
50 Barclay St., New York.
HENRY F. MICHELL & CO.,
1018 Market St., Philadelphia.

E. H. HUNT, Gen'l Agent,
76-78 Wabash Ave., Chicago.

"Every Bug Has his Dose."

Insect-destroying preparations that do their work well and effectively are the cheapest. Bowker's Arsenate of Lead and Bowker's Pyrox are recognized standard insecticides and fungicides for both indoor and outdoor use. Bowker's Insect Emulsion destroys many kind of plant lice, black and green flies, etc. Call or send for catalogue.

BOWKER INSECTICIDE COMPANY
43 CHATHAM ST. BOSTON



The Best Bug Killer and Bloom Saver

For PROOF Write to

P. R. Paethorpe Co.
OWENSBORO, KY.

SOMETHING NEW FOR GREENHOUSES
"SULFOCID" PRATT'S SOLUBLE SULPHUR SUMMER SPRAY

Non-caustic and non-irritating
A FUNGICIDE AND INSECTICIDE FOR FRUIT TREES, VEGETABLES and GREENHOUSES

A promising substitute for Bordeaux mixture. For 10 cts. to cover postage will send sample sufficient for one gallon of spray.

Use 1 part to 75 or 100 parts of water.
B. G. PRATT CO., 50 Church St., New York, U. S. A.

In writing to Advertisers kindly mention Horticulture

Seed Trade

AMERICAN SEED TRADE ASSOCIATION.

Watson S. Woodruff, Orange, Conn., Pres.; J. C. Robinson, Waterloo, Neb., First Vice-Pres.; C. E. Kendel, Cleveland, O., Sec'y and Treas. Twenty-seventh annual convention June 22-24, 1939, at Clifton House, Niagara Falls, Ont.

WHOLESALE SEEDSMEN'S LEAGUE.

F. W. Bruggerhof, Pres.; Burnet Landreth, Sec'y.

NOTES.

Auburn, N. J.—Fire on March 4 completely destroyed the seed house of William England.

St. Louis, Mo.—Walter Retzer, vice-president of the St. Louis Seed Co., St. Louis, Mo., has disposed of his interest in the firm and will go to South America.

CATALOGUES RECEIVED.

Fraser Nursery Company, Huntsville, Ala.—Surplus List No. 2.

S. C. Moon, Morrisville, Pa.—Wholesale Price List for Spring 1939.

W. H. Elliott, Brighton, Mass.—Price List Folder of Roses, Asparagus, etc.

Rockmount Nursery, D. M. Andrews, Prop., Boulder, Colo.—Catalogue of Hardy Garden Material.

Louis P. Faulk, West View, Pa.—Wholesale Price List of Rooted Cuttings and Potted Plants.

Barnes Bros. Nursery Co., Yalesville, Conn.—Descriptive and Illustrative Catalogue of Fruit and Ornamental Trees, Shrubs, etc.

Thomas J. Grey Co., Boston, Mass.—Seed Catalogue for 1939. Full of good material and strong on agricultural implements, as usual.

Mrs. Bessie M. Rupert, Portland, Me.—Descriptive List of Dahlias. A well-selected list, including many of the choicest novelties.

Meier & Shoemaker, Cincinnati, O.—"A Book of Interest to Seed, Plant and Bulb Buyers." Price list of flower and vegetable seeds, plants, etc.

Conard & Jones Company, West Grove, Pa.—Trade Price List, 1939 Illustrated; cover picture, new white Canna "Mont Blanc Improved."

W. W. Rawson & Co., Boston, Mass.—Special Catalogue of Dahlias. A splendid list which every dahlia fancier should have. Handsomely illustrated.

Ralph M. Ward & Co., New York City.—Wholesale List of Lilies and Japan Products, French and Dutch bulbs. Many interesting illustrations, views in Japan, etc.

Wilhelm Pfützer, Stuttgart.—General Catalogue and Price List of Seeds and

Ornamental Plants. As usual, interesting and reliable. Gladioli in colors form cover illustration.

W. A. Manda, South Orange, N. J.—Novelties and Specialties for 1939. *Dracaena Mandaiana* and *Polypodium Mandaianum* are cover illustrations well worthy of the honor.

J. S. Wilson Floral Co., Des Moines, Ia.—Wholesale Trade List, Spring 1939. Undoubtedly the forerunner of something bigger in the future but a good starter for a new concern.

Haskell Implement and Seed Company, Boston, Mass.—General Seed Catalogue. Devoted largely to farm and vegetable garden seeds and agricultural implements. An attractive publication.

Mohican Peony Gardens, Sinking Springs, Pa.—An interesting booklet on the peony, in which is comprised a general price list of one hundred varieties of double peonies, selected as the best extant.

T. C. Thurlow & Co., West Newbury, Mass.—Special Price List of Cherry Hill Nurseries. Ornamental trees and shrubs, deciduous and evergreen, herbaceous plants, etc., are specialties with this well known firm.

M. H. Walsh, Woods Hole, Mass.—Handbook of Roses. A beautiful publication with attractive cover in colors, showing ramblers roses, Snowdrift and Bonnie Belle, on front and Paradise and Excelsa on back page.

W. A. Manda, South Orange, N. J.—"Pocket Garden Dictionary and Catalogue of Everything Pertaining to Horticulture, 1939." A complete list of outdoor and indoor material freely illustrated and carefully edited.

Valdesian Nurseries, Bostic, N. C.—Surplus list of Forest and Shade Trees, Shrubs, Roses, Berry Plants, etc. Wholesale only. A half million of California and Amoor River Privets for spring delivery are among the special offers.

Elm City Nursery Co., New Haven, Conn.—Catalogue for 1939. A publication at once ornamental and useful. Well edited and indexed, and brim full of suggestion and valuable information on the subject of ornamental shrubbery and trees.

Wagner Park Conservatories, Sidney, Ohio.—"A Catalogue of Some Beautiful Flowers." This is an art publication from start to finish, and the taste displayed in its make-up is creditable to author and printer alike. Cover conventional, in two colors on cream-tinted paper.

New England Nurseries, Bedford, Mass.—"New and Rare Things Worth While Planting." This publication is a supplement to the general catalogue sent out by this enterprising nursery establishment. It lists many gems of recent introduction as well as the best of the older varieties that deserve to be more widely known, in trees and shrubs and hardy border plants.

Michell's Unexcelled ASTERS

QUEEN OF THE MARKET	
EXTRA EARLY	Tr. pkt. Oz.
Dark Blue	\$0.20 \$0.63
Light Blue 20 .60
Crimson 20 .60
Pink 20 .60
White 20 .60
Mixed 20 .60

INVINCIBLE

A superior strain of great value to florists for cuttings	
	Tr. pkt. Oz.
Blue\$0.30 \$1.50
Crimson 30 1.50
Lavender 30 1.50
Rose-Pink 30 1.50
White 30 1.50
Mixed 30 1.50

Write for our Wholesale Catalog

HENRY F. MICHELL CO.
1018 Market St., PHILA.

VEGETABLE PLANTS

FOR TRANSPLANTING

CABBAGE—Wakefield and Succession \$1.00 per 1000
EGG PLANT—N. Y. Improved and Black Beauty 4cots. per 100, \$3.00 per 1000
PEPPER—Bull Nose, Ruby King and Sweet Mountain 4cots. per 100, \$3.00 per 1000
Chinese Giant and Cayenne, 5cots. per 100
TOMATO—Earliana, Chalk & Jewell and Early June Pink 3cots. per 100, \$3.00 per 1000

CASH WITH ORDER
R. VINCENT, JR., & SONS CO.
 White Marsh, Md.

200,000 GLADIOLI BULBS

¾ to 1½ inches, \$2 per 1000. 1¾ to 1¾, \$4 per 1000. 1½ and up, \$5 per 1000.

CALIFORNIA PRIVET

1 yr. well branched, \$20 per 1000. Cash with order. Nice lot of **AMERICAN CHESTNUT TREES** at a bargain, about **50 LARGE SUGAR TREES**, most of them sample trees.

Surplus of **STONE TOMATO SEED**: Ruby King Neapolitan, Bull Nose and Sweet Mountain Pepper Seed at a bargain.

I. & J. L. LEONARD, - Iona, N. J.

Vegetable Plant Nurserymen and Seed Growers

BRIDGEMAN'S SEED WAREHOUSE

RICKARDS BROS.

Props.

37 East 19th St., - NEW YORK CITY

Ward's Lily Bulbs

Send for Catalogue



Ralph M. Ward & Co.

12 W. Broadway
 NEW YORK

AN INTERESTING DECISION.

The appeal case in which Alex. Dickson, of Woodlawn Nurseries, Dundrum, Co. Dublin, as defendant, appealed to the higher court against an order of the Master of the Rolls, of May 9th last, whereby he was to desist from using the name and title of Alex. Dickson and Sons, or Alexander Dickson and Sons, has been dismissed with costs.

Randolph, Mass.—P. Bova Conti has purchased the Lucy Clarke estate, on which are six greenhouses fully stocked.

Everything "For the Land's Sake."

The one firm in Boston where all good forms of plant food may be obtained, is the Bowker Fertilizer Company, opposite Faneuil Hall at 43 Chatham St. All greenhouse chemicals, Nitrate of Soda, Ground Bone, Potash Salts, Sheep Manure and Wood Ashes can there be had at first hands.

BOWKER FERTILIZER COMPANY

Everything "For the Land's Sake."

CANES

Freshly Cut From the Brakes For Your Lilies

Can Be Cut To Any Size

\$5 for 500, \$7 for 1000

Wm. Elliott & Sons
42 Vesey St., New York

BEST QUALITY SEEDS

30 Years Experience Growing and Selling

PEAS AM. WONDERS \$5.00 bu.; THOS. LAXTON'S \$3.00 bu.; GRADUS \$3.00 bu.; TELEPHONES \$5.0 bu.; NOTT'S EXCELSIORS \$5.00 bu.; PREMIUM GEMS \$4.50 bu.; DUKE OF ALBANY \$4.75 bu

ONION YELLOW GLOBE DANVERS \$1.75 per lb., postage free.

Mammoth, Medium, Alsike, Alfalfa, Clover and Timothy

Write for prices. Seed for my beautiful 1909 catalogue (free). Samples mailed free.

CHAS. F. SAUL

220-224 JAMES STREET, SYRACUSE, N. Y.

GEO. E. DOW
Designing and Illustrating

178 Washington St., Boston, Mass.

OUR SPECIALTY

Machine, Booklet, Advertising and Flower PHOTOGRAPHS

Mignonette

FARQUHAR'S GIANT

Oz., 75c; 1-4 oz., 25c

R. & J. Farquhar & Co.

6 & 7 South Market Street
BOSTON, MASS.

RELIABLE SEEDS

SOW NOW

CHINESE PRIMROSES large flowered finest exhibition strain, Carmine, Daybreak, Purple, Pink, Pure White, Lilac. Each Color Separate per 1000 seeds \$2.00, per tr. pk. \$.50. All Colors, Fine Mixed 1000 seeds \$1.50, per tr. pk. \$.50.

OBCONICA PRIMROSES large flowered exhibition strain, Carmine, Daybreak, Purple, Pink, Pure White, Lilac. Each Color Separate per 1000 seeds \$1.00, per tr. pk. \$.50. All Colors, Fine Mixed 1000 seeds \$1.00, per tr. pk. \$.50.

FOR OTHER VARIETIES SEE MY CATALOGUE WHICH WILL BE SENT POST FREE

O. V. ZANGEN, Seedsmen
HOBOKEN, N. J.

LEONARD SEED CO.

CONTRACT CROWERS AND WHOLESALE DEALERS

BEANS, PEAS, SWEET CORN, ONION, GARDEN SEEDS

ONION SETS 79 and 81 E. KINZIE STREET, CHICAGO
FLOWER SEEDS Get Our Prices

ESTABLISHED 1802

Thorburn's Seeds

FINE CLUMPS JAPAN IRIS
TUBEROUS ROOTED BEGONIAS
GLOXINIAS

ROSA MULTIFLORA NANA SEED

and all other flower seeds for florists

SEND FOR CATALOGUE

J. M. THORBURN & CO.
33 Barclay Street
NEW YORK

C AULIFLOWERS C A B B A G E E
LILY OF THE VALLEY PIPS.

HJALMAR HARTMANN & CO.
12 Stormgade,
COPENHAGEN, DENMARK.

Burpee's Seeds

PHILADELPHIA

Blue List of Wholesale Prices mailed only to those who plant for profit

Vegetable and Flower **SEEDS**
Reliable and Tested, Catalogue Mailed Free
WEBBER & DON
Seed Merchants 114 CHAMBERS STREET
NEW YORK

CONTRACT GROWER OF
Vegetable and Flower Seeds

For the Wholesale Trade.
Write, stating what Seed you want grown.

JOHN S. WEAVER
Glen Mawr Seed Farms, Kinzers, Lancaster Co., Pa.

STOCK SEED
FOR WINTER BLOOMING
Our strain of Double Branching Stocks is exceptionally true. About 90% Double Flowered.

In colors: 1/4 oz. .60 1/2 oz. 1.00 1 lb. 5.00
Pure White 1/4 oz. .75 1/2 oz. 1.00 1 lb. 5.00
H. E. FISKE SEED CO.
Faneuil Hall Square, BOSTON, MASS.

Winter-flowering
SWEET PEA SEED

All Colors Ask for List
A. C. ZVOLANEK

ORIGINATOR, BOUND BROOK, N. J.

NEW CROP SEED

For Early Planting
THOMAS J. GREY CO.
32 SO. MARKET ST., BOSTON, MASS.

BECONIAS TUBEROUS ROOTED

ALSO
GLOXINIAS, LILY OF VALLEY, SPIREA
Catalogues mailed free on application

Joseph Breck & Sons Corp.
47-54 NO. MARKET ST., BOSTON, MASS.

Japanese Bulbs, Etc.

R. TANOI, Yokohama, Japan.
Send for catalogue and write to Representative
K. TAKEUCHI,
478a Boylston St., Boston, Mass.

To Florists Everywhere

Orders for Cut Flowers and Floral Decorations to be delivered anywhere in the Greater New York, may be placed with us with the certainty that your customers will be satisfied.
 Telegraph, telephone or mail such orders to us and be sure that they will be filled as promptly and as carefully as though you did it yourself.
 One third discount will be allowed on all orders thus placed with us by Florists outside of the Greater New York.

THE BLOSSOM
 Bond and Livingston Sts.,
 BROOKLYN, N. Y.
C. C. TREPEL, Manager

WILLIAM J. SMYTH
FLORIST

Cor. Michigan Ave. and 31st St., CHICAGO
 We ship to all points in Illinois and Iowa.
 Phones: Douglas 744, Douglas 523, Douglas 740

M. G. and J. E. HAUSWIRTH
 Out of Town orders for Hospitals
 Carefully filled.

232 Michigan Ave.
CHICAGO
 AUDITORIUM ANNEX Tel. Harrison 585

SAMUEL MURRAY
Florist

Coates House Conservatory
 1017 BROADWAY, KANSAS CITY, MO.
 Both 'Phones 2670 Main.



WASHINGTON,
D. C.

GUDE'S

The Far-Famed Flowers of
TORONTO

Delivered on mail or telegraph order for any occasion, in any part of the Dominion.
JOHN H. DUNLOP,
 96 Yonge St., - Toronto. Ont.

The Park Floral Co.

J. A. VALENTINE
 Pres.
DENVER, COLORADO
WILLIAM L. ROCK
FLOWER CO.
KANSAS CITY, MO.
 will carefully execute orders for Kansas City and any town in Missouri or Kansas.



Buffalo, N. Y.

W. J. PALMER & SON, 304 Main St.

Of Interest to Retail Florists

THUMB TWIDDLING.

Many new stores open and wonder why customers don't come. The public is coy and has to be wooed. How to woo it, is the question. One thing is sure; the man who sits down with his feet upon the desk waiting for the public to come and woo him is lost. What is wanted in a new store or other enterprise is a man of brains and action. One who the minute he gets on his job makes things begin to happen! Is there business to be got there? How can it be got? Set your wits to work and hustle! Set your subordinates to work and hustle! Not only that, as to ordinary trading, but begin to think of constructive work. Is there a waste space anywhere that can be made productive? An obsolete building that occupies valuable space? A poorly lighted house with nothing in it while it might be growing ferns or asparagus? A swamp to be drained so that

STEAMER DEPARTURES

American.	
New York, N. Y.-S'hampton...	Mar. 27
Atlantic Transport.	
Minneapolis, N. Y.-London...	Mar. 27
Cunard.	
Saxonia, Boston-Liverpool...	Mar. 23
Campania, N. Y.-Liverpool...	Mar. 24
Lusitania, N. Y.-Liverpool...	Mar. 31
French Line.	
La Savoie, N. Y.-Havre...	Mar. 25
La Touraine, N. Y.-Havre...	Apr. 1
Hamburg-American.	
G. Waldersee, N. Y.-H'bg...	Mar. 27
Patricia, N. Y.-Hamburg...	Apr. 3
North German Lloyd.	
Kronp. Ceclie, N. Y.-Bremen...	Mar. 23
Barbarossa, N. Y.-Med. Pts...	Mar. 27
White Star.	
Cymric, Boston-Liverpool...	Mar. 24
Teutonic, N. Y.-S'hampton...	Mar. 24
Cymric, Boston-Med. Ports...	Mar. 27
Baltic, N. Y.-Liverpool...	Mar. 27
Adriatic, N. Y.-S'hampton...	Mar. 31

next year Iris and other cool rooted plants may be grown? The most wonderful things can be done if people will only set their wits to work. Did our pioneer forefathers sit down and twiddle their thumbs and wait for a new president or a new tariff? Get busy—everybody! HORTICULTURE will help you to an outlet and advise as to production.

NEW FLOWER STORES.

Rockford, Ill. Peter Tremulis.
 Holland, Mich.—Charles S. Dutton.
 Watertown, N. Y. Bennett & Son.
 Guilfoyle Block.
 Elmira, N. Y.—Makres & Kominos.
 331 E. Water street.
 New York, N. Y. Fleischmann.
 Fifth avenue and 42d street.
 Monessen, Pa. Earl Luce, 568 Donner avenue; Miss Nellie Jones, manager.

C. S. Griffith, 160 North avenue, will move to the Plaza Hotel, corner N. Clark street and North avenue, Chicago, on April 1.

ALEX. MCGONNELL

571 FIFTH AVENUE
NEW YORK CITY

Telegraphic orders forwarded to any part of the United States, Canada, and all principal cities of Europe. Orders transferred or intrusted by the trade to our selection for delivery on steamships or elsewhere receive special attention.

Telephone Calls, 487 and 488 38th St.
 Cable Address, ALEXCONNELL

New York Deliveries

FLOWERS and PLANTS

by special messenger to Steamer,
 Theatre or any address in

NEW YORK or BROOKLYN

THOMAS YOUNG, JR.

500 FIFTH AVE., (near 42nd St.)

NEWMAN FLORAL Co.

(Established 1870)

202 Fifth Ave. and Madison Square, **NEW YORK CITY**

FLOWERS for STEAMER SAILINGS

M. A. BOWE

In the Heart of New York City

1294 Broadway

Tel. 2270, 38th St. **NEW YORK**

Our Motto—The Golden Rule

DAVID CLARKE'S SONS

Deliver orders from any part of the country to
New York City

Or OUT-GOING STEAMERS

Write or telegraph

2139-2141 Broadway, New York
 Telephone 1554-1555 Columbus

YOUNG & NUGENT

42 West 28 St., NEW YORK

"FLOWERS BY TELEGRAPH"

NEW YORK

MYER, FLORIST

Phone 5297 Plaza. **609-611 MADISON AVE.**

ALBANY, N. Y.

EYRES

Flowers or Design Work

DELIVERED IN ALBANY AND VICINITY
 ON TELEGRAPHIC ORDER.

11 NORTH PEARL ST., ALBANY, N. Y.

Flower Deliveries

In Brooklyn and other Long Island Points
 New York City, New Jersey, etc. At Theatres,
 Hotels, Steamers or Residences.

WILSON

Fulton St. and Greene Ave., Brooklyn, N. Y.

JOHN BREITMEYER'S SONS

Cor. Miami and Gratiot Aves.
DETROIT, MICH.

Artistic Designs . . .
High Grade Cut Blooms

We cover all Michigan points and good sections of Ohio, Indiana and Canada

PROMPT DELIVERY IN BOSTON

AND ALL NEW ENGLAND POINTS
F. H. HOUGHTON
396 Boylston St., Boston, Mass.

BOSTON'S BEST In Quality and Design

Can be relied upon when you transfer your retail orders to

EDWARD MACMULKIN
194 Boylston Street, Boston

Send flower orders for delivery in
BOSTON

and all
NEW ENGLAND POINTS
THOS. F. GALVIN
124 Tremont St., Boston

The Original Telegraph Order Florist
WILL DELIVER

Flowers or Designs

to order in Boston and Vicinity. Usual Discount.

J. NEWMAN & SONS, Inc.
Est. 1870 24 TREMONT ST., BOSTON



DANKER, Albany, N. Y.

ORDERS FOR

Choice Flowers and
Floral Emblems
FILLED PROMPTLY

LOUISVILLE, KY.
JACOB SCHULZ,
550 South Fourth Ave.

WELLESLEY COLLEGE
Dana Hall, Walnut Hill and Rockridge Hall
Schools. TAILBY, Wellesley, Mass.
Tel. Wellesley 44-1 and 2. Night 44-3.

ATLANTA FLORAL CO.
41 Peachtree Street, ATLANTA, GEORGIA

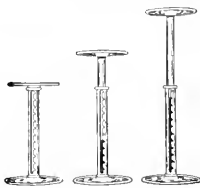

THE NEW IDEA IN PLANT STANDS

The Moore-Livingston Graduating or Adjusting

Saves one-half to two-thirds of cost over ordinary galvanized iron stands.

SEND FOR CIRCULAR GIVING FULL PARTICULARS
SOLD BY SEEDSMEN AND SUPPLY HOUSES

If your seedsman does not carry send us his name and we will promptly send full particulars.

Moore-Livingston Co., Patentees and Mfrs., **Lansdowne, Pa.**

"FLOWERS BY TELEGRAPH."

Leading Retail Florists Listed by Towns for Ready Reference.

- Denver, Colo.—Park Floral Co., 1706 Broadway.
- Washington, D. C.—Gude Bros., 1214 F St.
- Atlanta, Ga.—Atlanta Floral Co., 41 Peach Tree St.
- Chicago—M. C. & J. E. Hauswirth, 232 Michigan Ave.
- Chicago—William J. Smyth, Michigan Ave. and 31st St.
- Chicago—George Wittbold Co., 1657-59 Buckingham Place.
- Louisville, Ky.—Jacob Schulz, 550 South Fourth Ave.
- Boston—Thos. F. Galvin, 124 Tremont St.
- Boston—Frank H. Houghton, 396 Boylston St.
- Boston—Edward MacMulkin, 194 Boylston St.
- Boston—Hoffman, Florist, 59-61 Massachusetts Ave.
- Boston—J. Newman & Sons, Inc., 24 Tremont St.
- Boston—Julius A. Zinn, 2 Beacon St.
- Wellesley, Mass.—Tailby.
- Detroit, Mich.—J. Breitmeyer's Sons, Miami and Gratiot Aves.
- Kansas City, Mo.—Samuel Murray, 1017 Broadway.
- Kansas City, Mo.—Wm. L. Rock Flower Co., 1116 Walnut St.
- Albany, N. Y.—H. G. Eyres, 11 N. Pearl St.
- Albany, N. Y.—F. A. Danker, 40 Malden Lane.
- New York—David Clarke's Sons, 2139-2141 Broadway.
- New York—Alex. McConnell, 571 5th Ave.
- New York—Young & Nugent, 42 W. 28th St.
- New York—M. A. Bowe, 1294 Broadway.
- New York—Myer, 609-11 Madison Ave.
- New York—Thos. Young, Jr., 500 Fifth Ave.
- New York—Newman Floral Co., 202 Fifth Ave. & Madison St.
- Brooklyn, N. Y.—The Blossom (C. C. Trepel, Mgr.), Bond and Livingston Sts.
- Brooklyn, N. Y.—Robert G. Wilson, Fulton St. and Greene Ave.
- Buffalo, N. Y.—Palmer's, 304 Main St.
- Toronto, Can.—J. H. Dunlop, 96 Yonge St.

BUSINESS CHANGES.

- Mohawk, N. Y.—William Dohler has leased the Snell Greenhouses.
- Findlay, O.—William Fellebaum has withdrawn from the firm of E. J. Foster & Co.
- Hion, N. Y.—Edward J. Baker, of Hion has purchased the florist business of Hakes & Son.
- New York, N. Y.—Charles Thorley will move to West 28th street on April 15. A. L. Young & Co. have leased the store at 46 West 28th street.

FIRE RECORD.

Fire completely destroyed the new residence of C. C. Sanders, Henry road, St. Louis, on Monday, March 15, at 4 o'clock A. M. The family were all asleep when the fire was discovered and had to flee for their lives. The loss is covered by insurance. The family have returned to their old home on Delmar blvd.

ST. LOUIS NOTES.

The Schaffer Floral Co., who recently opened a floral establishment on 6th St., have decided that the venture did not pay and will close up the place March 22. Mr. Julius Schaffer, president of the company has accepted a position with Adolph Brx.

J. A. Valentine, president of the S. A. F., stopped over in this city on his way to attend the Executive Committee meeting at Cincinnati on March 13. He was taken in charge by O. G. Koenig, Fred Meinhardt and Theo. Miller, and after an automobile tour of the city and supper at the Washington Hotel, he left on Friday night.

Mr. Morris Cohn, representing Wertheimer Bros., was a visitor in Albany this week.

THE BEST LETTERS

FOR THOSE
FLORISTS' MADE
USE OF BY THE



Boston Florist Letter Co.
66 PEARL ST., BOSTON
N. F. McCARTHY, Mgr.

Order direct or buy from your local supply dealer. Insist on having the

BOSTON

Inscriptions, Emblems, etc., Always in Stock

Durand & Marohn

MANUFACTURERS OF

All Kinds of Wire Work
Florists' Wire Designs a Specialty
24 Beaver St., ALBANY, N. Y.

FLORISTS' SUPPLIES

Send for New Catalogue

H. Bayersdorfer & Co.

1129 ARCH ST., PHILADELPHIA

TRANSFER

Your orders for flower or plant delivery in Eastern New England to

JULIUS A. ZINN,
2 Beacon St., Boston
FINE DESIGN WORK A SPECIALTY

BEAUTIES

BEST, \$6.00 per doz.
30 inch, 5.00 " "
24 " 4.00 " "

KILLARNEY, good stock, \$8.00—\$12.00 per 100
 RICHMOND " " \$8.00—\$12.00 per 100

Special grades of Roses charged accordingly

THE LEO NIESSEN CO.

1209 Arch St., Philadelphia, Pa.

Open from 7 a. m. to 8 p. m.



SPRENGER

Extra choice long sprays
50c PER BUNCH
CATTELYAS

\$6.00 per doz., \$40.00 per 100
 EXTRA SPECIAL QUALITY

S. S. PENNOCK - MEEHAN CO.
 1608-1620 Ludlow St., Philadelphia

DOUBLE and SINGLE VIOLETS

Home grown extra quality

W. E. McKISSICK & BROS.

WHOLESALE FLORISTS

1619-1621 RANSTEAD ST.
 PHILADELPHIA



CHAS. W. MCKELLAR

51 WABASH AVE., CHICAGO

Western Headquarters for Choice Orchids
 Valley, Roses and all Cut Flowers

PETER REINBERG

WHOLESALE

CUT FLOWERS

51 Wabash Av., Chicago, Ill

Long Distance Phone, Central 6004

WINTERSON'S SEED STORE

45-47-49 Wabash Ave., Chicago.

Seedsmen, Plantsmen, Nurserymen
 Florists' Supplies

We can supply everything used by the Florist. SUPPLY CATALOG FREE. Correspondence solicited.

POEHLMANN BROS. CO.

33-35-37 Randolph St., - CHICAGO

CUT FLOWERS

Greenhouses, - Morton Grove, Ill.

Rice Brothers

115 N. 6th Street, MINNEAPOLIS, MINN.
 WHOLESALE FLORISTS and SUPPLIES

CUT FLOWERS received twice daily, and can fill your orders to your satisfaction. A complete line of Hardy Greens—WILD SMILAX, BOXWOOD, HARDY FANCY FERNS, GALAX LEAVES.
 Write for quotations on large quantities.

In ordering goods please add "I saw it in HORTICULTURE."

WELCH BROS.

AMERICAN BEAUTY, KILLARNEY, RICHMOND, MARYLAND AND ALL THE SUPERIOR ROSES, LILY OF THE VALLEY, CARNATIONS, ORCHIDS
BEST PRODUCED

226 Devonshire Street,

Boston, Mass.

WHOLESALE FLOWER MARKETS—TRADE PRICES—Per 100 TO DEALERS ONLY

	CHICAGO March 15		TWIN CITIES March 16		PHILA. March 15		BOSTON March 18	
ROSES								
Am. Beauty, Fancy and Special...	30.00	to 40.00	40.00	to 50.00	50.00	to 60.00	40.00	to 75.00
" Extra.....	20.00	to 30.00	30.00	to 40.00	35.00	to 40.00	20.00	to 30.00
" No. 1.....	10.00	to 20.00	20.00	to 30.00	20.00	to 25.00	10.00	to 15.00
" Lower grades.....	6.00	to 12.00	12.00	to 20.00	6.00	to 15.00	4.00	to 8.00
Bride, "Maid, Fancy & Special.....	6.00	to 10.00	8.00	to 12.00	8.00	to 10.00	6.00	to 8.00
" Lower grades.....	4.00	to 6.00	6.00	to 8.00	3.00	to 5.00	2.00	to 4.00
Killarney, Fan, & Sp.....	3.00	to 12.00	3.00	to 10.00	10.00	to 15.00	12.00	to 25.00
" Lower grades.....	5.00	to 8.00	6.00	to 8.00	3.00	to 8.00	4.00	to 8.00
Richmond, Fancy & Special.....	8.00	to 12.00	6.00	to 8.00	15.00	to 20.00	12.00	to 25.00
" Lower grades.....	5.00	to 8.00	4.00	to 6.00	3.00	to 8.00	4.00	to 8.00
Chateaux.....	5.00	to 8.00	4.00	to 8.00	4.00	to 8.00	4.00	to 8.00
Golden Gate Ivory, etc.....	to	4.00	to 8.00	3.00	to 10.00	4.00	to 8.00
My Maryland.....	to	to	to	10.00	to 16.00
Mrs. M. Field.....	to	to	to	to
CARNATIONS								
Fancy and Red.....	2.00	to 3.00	3.00	to 4.00	3.00	to 4.00	2.50	to 3.00
Ordinary and White.....	1.00	to 2.00	1.50	to 3.00	1.50	to 2.00	1.50	to 2.50
MISCELLANEOUS								
Carnations.....	40.00	to 50.00	40.00	to 50.00	60.00	to 75.00	40.00	to 50.00
Lilies.....	12.00	to 15.00	10.00	to 12.00	10.00	to 12.00	8.00	to 12.00
Lily of the Valley.....	to 3.00	3.00	to 4.00	2.00	to 4.00	2.00	to 3.00
Narciss, Paper White.....	3.00	to 4.00	to 2.50	3.00	to 3.00	1.00	to 2.00
Roman Hyacinth.....	3.00	to 4.00	2.00	to 3.00	2.00	to 3.00	1.00	to 2.00
Tulips.....	3.00	to 4.00	2.00	to 3.00	2.00	to 3.00	to
Daffodils.....	2.00	to 3.00	2.00	to 3.00	2.00	to 3.00	1.00	to 2.00
Freesia.....	3.00	to 4.00	2.00	to 3.00	1.00	to 2.00	2.00	to 3.00
Mignonette.....	4.00	to 6.00	to	2.00	to 3.00	to
Sweet Peas.....	50	to 1.00	.75	to 1.00	.47	to .75	.75	to 1.00
Gardenias.....	30.00	to 40.00	30.00	to 40.00	35.00	to 50.00	25.00	to 50.00
Violets.....	3.50	to 7.50	5.00	to 1.00	.35	to .75	.30	to .50
Adiantum.....	to 1.50	1.00	to 1.50	1.00	to 1.50	.75	to 1.00
Smilax.....	12.00	to 15.00	10.00	to 15.00	15.00	to	10.00	to 15.00
Asparagus Plumosus, strigosa.....	10.00	to 50.00	15.00	to 50.00	50.00	to	25.00	to 50.00
" & Spren. (too heavy).....	35.00	to 36.00	30.00	to 25.00	35.00	to 50.00	15.00	to 25.50

J.A. BUDLONG

37-39 Randolph Street, CHICAGO.

Roses and Carnations
 A Speciality.....
 WHOLESALE GROWER of **CUT FLOWERS**



HENRY M. ROBINSON & CO.

15 Province St. and 9 Chapman Place - BOSTON, MASS.

WHOLESALE COMMISSION FLORISTS

Hardy Cut Evergreens and Florists' Supplies

We have the stuff and can fill all orders, large or small
 WE NEVER DISAPPOINT SATISFACTION GUARANTEED



Prices Quoted in these Columns are for Dealers Only.
 When Writing to Advertisers Please Mention
HORTICULTURE.

Flower Market Reports.

BOSTON The market remains about the same as last week; little if any fluctuations as regards prices. White carnations are more in abundance, with roses a close second. Many large orders have already been received for Easter and it looks on the surface at the present writing that the business of last year would be more than doubled.

The first part of the previous week trade was rather quiet in the cut-flower line though the balance of the week, especially Saturday, found a livelier situation, stock being plentiful, especially colored carnations. White material was in much better demand and cleaned up satisfactorily. Violets were in fine form and sold somewhat better than previous week. Lily of the valley is still on the quiet side, as well as tulips and other bulbous stock. Callas have been in heavy supply with little or no demand. Roses are coming in a little more plentiful and choice stuff sells readily. There is a good supply of greens.

The usual mid-Lent increase in business was looked for and Chicago florists, both wholesale and retail, were not disappointed. What they did not look for, however, was the dropping off of stock. The almost total lack of sunshine for weeks has greatly reduced the supply of nearly everything. There is a special dearth in white carnations, more noticeable because upon them depends the possibility of the green carnation for St. Patrick's Day. While many retailers declare the taste for this unnatural flower is fast dying out the books of the wholesalers find orders increasing. Roses are not plentiful, though good Beauties are not so hard to find as last month. Bridesmaids and Killarneys are close rivals, Killarney bringing a slight advance in price. All bulbous stock is going at fair prices and throughout the season very little has been lost. Two large shipments of eastern violets have had a tendency to keep prices lower than Chicago growers wish and the market continues to remain about the same. Chas. McKellar finds sales on gardenias fairly good. Cattleya Schroederae stock is fine but the trade in general seems to prefer a deeper color. On the whole trade is unusually good for the Lenten season. The sales of shamrock plants are steadily increasing and this season will show a great advance over last.

The reports received from various retailers during the last week are encouraging and the Lenten season so far has been better than usual. Stock is still at low ebb, especially carnations, but the presence of a large variety of bulbous flowers eliminates this scarcity to a great extent.

There has been no perceptible falling off of business since the opening of the Lenten season; the demand for all occasions has averaged up encouragingly and has been well distributed among the dealers. Good Beauties are still scarce, there being no surplus even with the light demand. Tea roses are plentiful

WHOLESALE FLOWER MARKETS.—TO DEALERS ONLY.

	CINCINNATI		DETROIT		BUFFALO		PITTSBURG	
	March 15	March 15	March 15	March 15	March 15	March 15	March 15	March 15
ROSES								
Am. Beauty, Fav. and Sp.	35.00	to 40.00	35.00	to 40.00	30.00	to 50.00	40.00	to 50.00
Extra	25.00	to 30.00	28.00	to 35.00	25.00	to 30.00	20.00	to 30.00
No. 1	15.00	to 20.00	20.00	to 25.00	15.00	to 20.00	6.00	to 15.00
Lower grades	5.00	to 8.00	8.00	to 15.00	5.00	to 8.00	2.00	to 4.00
Bride, "Maid, F. & S.	6.00	to 8.00	8.00	to 15.00	10.00	to 12.00	8.00	to 10.00
Lower grades	5.00	to 6.00	6.00	to 8.00	4.00	to 6.00	3.00	to 4.00
Killarney, Fav. & Sp.	6.00	to 8.00	8.00	to 15.00	10.00	to 12.00	10.00	to 15.00
Lower grades	4.00	to 5.00	4.00	to 6.00	4.00	to 6.00	3.00	to 6.00
Richmond, Fancy & Special	8.00	to 10.00	8.00	to 12.00	10.00	to 12.00	10.00	to 15.00
Lower grades	4.00	to 6.00	4.00	to 6.00	4.00	to 6.00	4.00	to 6.00
Chateau	5.00	to 8.00	6.00	to 10.00
Golden Gate, Ivory, etc.	4.00	to 6.00
My Maryland
Mrs. Mar. Field
CARNATIONS								
Fancy and Novelties	to 3.00	3.00	to 4.00	2.00	to 3.00	2.00	to 4.00
Ordinary	1.50	to 2.00	2.00	to 3.00	1.50	to 2.00	1.00	to 1.50
MISCELLANEOUS								
Cattleyas	no	75.00
Lilies	10.00	to 12.00	12.50	to 15.00	to 12.00
Lily of the Valley	2.00	to 4.00	3.00	to 4.00	3.00	to 4.00	2.00	to 4.00
Narciss, Paper White	2.00	to 3.00	3.00	to 4.00	2.00	to 3.00	2.00	to 3.00
Romab Hyas	3.00	to 3.00	2.00	to 4.00	2.00	to 3.00	1.00	to 3.00
Tulips	3.00	to 5.00	2.00	to 3.00	3.00	to 4.00
Daffodils	2.00	to 3.00	3.00	to 4.00	2.00	to 3.00	3.00	to 4.00
Freesia	2.00	to 3.00	3.00	to 4.00	2.00	to 3.00	1.00	to 3.00
Mignonette	3.00	to 4.00	2.00	to 3.00
Sweet Peas	5.00	to 7.00	5.00	to 7.00	5.00	to 7.00	5.00	to 7.00
Gardenias
Violets	5.00	to 7.50	5.00	to 7.50	5.00	to 7.50	5.00	to 7.50
Adiantum	to 1.00	1.50	to 2.00	1.50	to 1.50
Smilax	10.00	to 12.00	10.00	to 15.00	12.00	to 15.00
Asparagus Plumosus, strigosa	40.00	to 50.00	30.00	to 50.00	35.00	to 50.00	30.00	to 50.00
" " & Spro (too high)	20.00	to 35.00	30.00	to 50.00	25.00	to 50.00	30.00	to 50.00

and sell at a very moderate price. Carnations are fine and cheap. Bulbous stock is quoted at surprisingly low figures and is being displayed in immense quantities. Sweet peas and lily of the valley, violets, daisies, are moved daily in large numbers. The best Easter lilies are sold to advantage. Cattleyas are scarce and have advanced in price. Quantities of green goods are being handled.

A brisk demand for carnations was a leading feature of last week's market. Whites especially were in demand and seemed to be scarcer than usual. The scarcity is not easily explained as these usually bloom as freely as other varieties. The demand is also obscure; but it may be partly explained by the unlovely custom of dyeing them green for St. Patrick's. Roses, also, sold a little better and, as for quality, the Killarneys and Richmonds and Jardines that are now coming in are simply magnificent. As expected, American Beauty has commenced to produce again more freely and is now coming in abundantly, the quality of the long-stem specials being exceptionally fine for the season. Southern daffodils have made their advent in quantity. The large flowered varieties meet with ready sale, but there is very little demand for the small kinds. Tulips are now pretty well cut out, and those coming on are mostly for the Easter market. First-class tulips sold well this year, and it is to be hoped that growers will hold to the same conservative planting policy another year. It is the easiest thing in the world to overdo the tulip market. More than ever the shamrock has been featured

by the retailers for St. Patrick's week this year. There is perhaps not much money in them but they are cheap, and a windowful of them tastefully be-ribboned is a pleasing and popular sight for the passing throng. The department stores gave little pots of these by the hundred thousand free to their customers, which is bad in one way and good in another. One thing is sure: more shamrocks are being sold every year; so that the giving free in past years has evidently helped this trade rather than hurt it, when all is said and done. There are too many violets around for the demand. Lily of the valley is also a trifle too plentiful. Cattleyas have taken on another spurt of blooming and prices are easier. Easter lilies are selling better than callas now—a reversal of recent conditions. There is any amount of mignonette, freesia, lilac, and such minor items to be had on moderate terms. The usual Saturday clean-up to the street men failed on account of the activity of Old Boreas and Jupiter Pluvius.

Now that Washington has pulled itself together a little after the dreadful recent storm, trade has improved and prices have not had their usual Lenten tumble, though this may be partly due to the fact that owing to such continued cloudy weather there is not an overplus of stock. Pennsylvania is shipping flowers here, particularly California violets, at such a ridiculously low figure that local growers cannot begin to compete with them. There has been an immense run on jonquils and narcissi lately for cheap luncheon decorations.

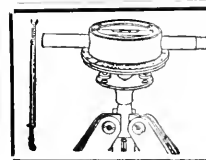

EVERYBODY KNOWS Park, Cemetery and Landscape Gardening cannot be properly done without the aid of an accurate leveling instrument.

Bostrom's Improved Levels, No. 2 at \$15.00 and No. 3 at \$25.00, which meet all the requirements, at the price.

Our guarantee book of every Level we sell, and satisfied users in every State in the Union heartily endorse every claim we make.

Shipping weight 12 lbs. Description on request.

BOSTROM-GRADY MFG. CO., 139 Madison Avenue., ATLANTA, GA.

FORD BROTHERS

48 West 28th Street NEW YORK
FINE ROSES FANCY CARNATIONS
 A Full Line of All CUT FLOWERS
 Telephone, 3870 or 3871 Madison Square

H. E. FROMENT

Wholesale Commission Florist,
 Choice Cut Flowers,
 57 West 28th St. :: NEW YORK
 Telephones: 2200, 2201, Madison Square.

Alfred H. Langjahr

All choice cut-flowers in season. Send for quotations. Correspondence with shippers of first-class stock invited.
 55 West 28th Street, New York
 Telephones 4626-4627 Madison Square

Edward C. Horan
 Wholesale Florist

55 WEST 28th ST.
 Tel. 1462 Madison Square New York
 1463

JOHN YOUNG
 WHOLESALE FLORIST

Finest American Beauties and Carnations
 51 West 28 St. - NEW YORK

FRANK MILLANG
 Wholesale Florist

55-57 West 26th St., NEW YORK
 Shipments, any quantity, Wholesale Market Rates.

Henshaw & Fenrich
 WHOLESALE FLORISTS

44 West 28th Street, NEW YORK
 Phones Mad. Sq. 325, 558-2, 558-3

VIOLETS

Finest Grade. Any Quantity
B. S. SLINN
 55-57 W. 26 St., New York

Moore, Hentz & Nash
 Wholesale Commission Florists

55 and 57 West 26th Street
 Telephone No. 756 Madison Square New York

MILLANG BROS.
 WHOLESALE COMMISSION FLORISTS

41 West 28th Street
 Telephone 3860 Madison 3861 NEW YORK

JOHN I. RAYNOR
 Wholesale Commission Florist SELLING AGENT FOR LARGEST GROWERS
 A full line of Choice Cut Flower Stock for all purposes. Completes every variety grown for New York market, at current prices
 TEL. 1998 MADISON SQUARE 49 West 28th St., New York City

Walter F. Sheridan
 Wholesale Commission Dealer in
CHOICE CUT FLOWERS
 39 West 28th Street, New York
 Telephone: 3532-3533 Madison Square

HEADQUARTERS FOR NOVELTIES
ORCHIDS A SPECIALTY
 THE HIGHEST GRADE OF VALLEY ALWAYS ON HAND
 CARNEDIAS, DAISIES, ROSES AND CARNATIONS
 Telephone
JAMES McMANUS, 759 Mad. Sq. 42 W. 28th St., New York

PHILIP F. KESSLER 55 & 57 W. 26th St., New York City
 Commission Dealer, Wholesale Buyer and Seller of
CUT FLOWERS
 Open from 5 a. m. to 6 p. m. Sunday till 10 a. m.
 Tel. 5243 and 2921 Madison Sq. Res., 345 J., Newtown.
Finest Lilies in the Market Every Day in the Year.

NEW YORK QUOTATIONS PER 100. To Dealers Only

ROSES AND CARNATIONS	Last Half of Week ending Mar. 13 1909		First Half of Week beginning Mar. 15 1909	
American Beauty, Fancy and Special.....	25.00	to 50.00	25.00	to 50.00
" " Extra.....	15.00	to 20.00	15.00	to 20.00
" " No. 1.....	8.00	to 12.00	8.00	to 12.00
" " Lower Grades.....	2.00	to 6.00	2.00	to 6.00
Bride, 'Maid, Fancy and Special.....	6.00	to 10.00	6.00	to 10.00
" " Lower Grades.....	2.00	to 4.00	2.00	to 4.00
Killarney, Fancy and Special.....	8.00	to 12.00	8.00	to 12.00
" " Lower Grades.....	3.00	to 6.00	2.00	to 6.00
Richmond, Fancy and Special.....	15.00	to 25.00	10.00	to 15.00
" " Lower Grades.....	2.00	to 8.00	2.00	to 8.00
Chatenay.....	2.00	to 10.00	2.00	to 10.00
Golden Gate, Ivory, etc.....	2.00	to 5.00	2.00	to 8.00
Ty Maryland.....	3.00	to 15.00	3.00	to 15.00
Mrs. Mar. Field.....	1.00	to	to
Carnations, Fancy and Novelties.....	2.00	to 3.00	1.50	to 3.00
" " Ordinary and White.....	1.00	to 1.50	1.00	to 1.50

Alexander J. Guttman
 THE WHOLESALE FLORIST OF NEW YORK
 34 WEST 28th STREET
 PHONES. 1664-1665 MADISON SQUARE
ENOUGH SAID

TRAENDLY & SCHENCK
 Wholesale Florists
 Furnish best Stock at fair Prices all the year round
 Send for Quotations on Any Variety and Quantity
 Tel. 798, 799 Madison Sq. 44 West 28th St., New York City

GROWERS' CUT FLOWER CO. CUT FLOWERS AT WHOLESALE
VIOLETS, CARNATIONS, ROSES
ORCHIDS, CHRYSANTHEMUMS, LILIES
 Consignments Solicited. Shipments to Order, any Distance
 Telephone 759 Madison Square
39 West 28th Street, J. J. COAN, Manager NEW YORK

WHOLESALE FLORISTS
54 West 28th St.
NEW YORK
Telephone 3559 Madison Sq.

A. L. YOUNG & CO.

RECEIVERS & SHIP-
PERS OF CUT
FLOWERS
CONSIGNMENTS SOLICITED

WILLIAM H. KUEBLER
Brooklyn's Foremost and Best

WHOLESALE COMMISSION HOUSE
A First Class Market for all CUT FLOWERS
28 Willoughby St., Brooklyn, N. Y.
Tel. 4691 Main

Greater New York Florists' Association, Inc.
Now Open for Cut Flower Consignments
162 Livingston Street, BROOKLYN, N. Y.
Geo. W. Crawbuck Telephone Connection
Manager 3642-43 Main

REED & KELLER
122 West 25th St., New York
Florists' Supplies
We manufacture all our
Hotel Designs, Baskets, Wire Work & Novelties
and are dealers in
Glassware Decorative Greens and Florists' Requisites

THE KERVAN CO.
Wholesale Dealers and Shippers of
Decorative Evergreens
Ferns, Galax, Laurel, Fresh Cypas, Box-
wood, Spangnum and all Florists' Greens
Send to us for Quotations before Buying.
113 West 28 Street, NEW YORK CITY

MICHIGAN CUT FLOWER EXCHANGE, Inc.
WHOLESALE COMMISSION FLORISTS
Consignments Solicited
Hardy Fancy Fern Our Specialty
38-40 BROADWAY, DETROIT, MICH.

FOR FLORISTS' USE
There's **NOTHING** as good as
MEYER'S SILKALINE
Don't let them sell you anything else
JOHN C. MEYER & CO., Boston, Mass.

In ordering goods please add "I saw it in HORTICULTURE."

Use Krick's Immortelle Letters

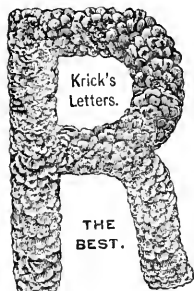

The original and still the best. All others are followers.

All Orders Promptly Attended to.

Send for Samples and Price Lists.

1164-1166 Greene Ave.,
BROOKLYN, - N. Y.

GEORGE COTSONAS & CO.
Wholesale and Retail Dealers in all kinds of
EVERGREENS
Fancy and Dagger Ferns
Bronze and Green Galax
Main Store 50 W. 28 St.
Phone 1200 Mad. Sq. New York

CENTRALLY LOCATED, THE HUB OF THE FLOWER MARKET SECTION
CHARLES MILLANG
Wholesale Florist
444 Sixth Ave., NEW YORK
Telephone 7062 Madison



WHOLESALE COMMISSION J. K. ALLEN 106 W. 28th St. NEW YORK
Open 6 a. m. Daily Tel. 167 Madison Sq.
Shipments of Lily of the Valley and Bulb Flowers Needed

NEW YORK QUOTATIONS PER 100. To Dealers Only

MISCELLANEOUS	Last Half of Week ending Mar. 13 1909		First Half of Week beginning Mar. 15 1909	
Cattleyas.....	40.00	to 60.00	40.00	to 60.00
Lilies.....	3.00	to 10.00	3.00	to 10.00
Lily of the Valley.....	1.00	to 3.00	1.00	to 3.00
Narcis., Paper White.....	1.00	to 2.00	1.00	to 2.00
Roman Hyas.....	1.00	to 3.00	1.00	to 2.00
Tulips.....
Daffodils.....	1.00	to 2.00	1.00	to 2.00
Freesia.....
Mignonette.....
Sweet Peas.....
Gardenias.....	20.00	to 50.00	20.00	to 50.00
Violets.....
Adiantum.....
Smilax.....
Asparagus Plumosus, strigos.....
..... & Soren, (100 bchs)

WASHINGTON PERSONALS.
Peter Bisset of Twin Oaks, has gone to Buffalo to attend the convention of the American Rose Society.

The Washington public, and particularly the friends of the contracting parties, were very much surprised on Friday last when F. H. Kramer and his cashier, Miss Chedel, slipped away in a big touring car and were quietly married in Rockville, Md.

C. L. Reynolds of U. S. Botanic Gardens, who was hurt so seriously some time since by a runaway horse, has had another experience with the same horse, the result being a scarred head, but not so serious as before. His limb is out of the plaster cast.

NEWS NOTES.
N. Strafford, N. H.—Frank R. Jones has leased the Foss greenhouses.

Pendleton, Ore.—F. J. Prann is making preparations to start in the nursery business here.

Rosindale, Mass.—The greenhouses of Oscar Knight, Beach street and Belgrade avenue, were entered on March 12 and a quantity of flowers stolen.

Banksville, Conn.—Fred Farwell has resigned his position as gardener at Conyers Manor and started in business with his uncle, Louis Elliott, at Katonah, N. Y.

NEW YORK MARKET.
The market is in a very inactive condition. The last of the week things seemed literally to go to pieces and on Monday and Tuesday a similar condition prevailed. It was especially pronounced on tea roses. The only bright spot was white carnations, which moved at a lively pace. Orchids and gardenias are in excellent demand.

WILLIAM F. KASTING CO.
WHOLESALE FLORISTS
383-387 Ellicott Street
BUFFALO, - N. Y.
Wired Toothpicks
Manufactured by
W. J. COWEE, BERLIN, N. Y.
10,000.....\$1.75; 50,000.....\$7.50. Sample free.
For sale by dealers

ROBERT J. DYSART
Public Accountant and Auditor
Simple methods of correct accounting especially adapted for florists' use
Books Balanced and Adjusted
Merchants Bank Building
28 STATE STREET, - BOSTON
Telephone, Main 58.

Buyer's Directory and Ready Reference Guide

Advertisements under this head, one cent a word. Initials count as words.

Display advertisers in this issue are also listed under this classification without charge. Reference to List of Advertisers will indicate the respective pages.

Buyers looking to find what they want in this list will confer a favor by writing us and we will try to put them in communication with reliable dealers.

ACCOUNTANT

R. J. Dyarr, 23 State St., Boston.
For page see List of Advertisers.

AGERATUMS

R. Vincent, Jr. & Sons Co., White Marsh, Maryland.
For page see List of Advertisers.

AMPELOPSIS.

Storrs & Harrison Co., Painesville, O.
For page see List of Advertisers.
Eastern Nurseries, Henry F. Dawson, Mgr., Ampelopsis Quincefolia, Jamaica Plain, Mass.
For page see List of Advertisers.
C. Elsele, 11th and Westmoreland Sts.,
For page see List of Advertisers.

ARGENTEUIL ASPARAGUS

Argenteuil Asparagus Plants, Frank H. Snow, Orleans, Mass

AQUILEGIAS

Aquilegia. Genulee Coerulea, finest of all. Both plants and seeds from the heart of the Rockies. C. S. Harrison's Select Nursery, York, Neb.

ARAUCARIAS

A. Leuthy & Co., Perkins St. Nurseries, Roslindale, Mass.
For page see List of Advertisers.
Godfrey Aschmann, 1012 West Ontario St., Philadelphia, Pa.
For page see List of Advertisers.

ASPARAGUS

The Geo. Wittbold Co., 1657 Buckingham Place, Chicago, Ill.
For page see List of Advertisers.
Asparagus Sprenger, 2-in. pots, 2c.; \$17 per 1000. Cash, please. A. Helyea & Son, Poughkeepsie N. Y.

ASPARAGUS SEED

S. S. Pennock-Meehan Co., Philadelphia.
For page see List of Advertisers.

ASTER SEED

Dept. B, Scientific Intense Culture Ranch Co., Salem, Ore.

AUCTION SALES

Olney's Horticultural Co., 62 Vesey St., New York.
For page see List of Advertisers.

AZALEAS

A. Leuthy & Co., Perkins St. Nurseries, Roslindale, Mass.
For page see List of Advertisers.
Godfrey Aschmann, 1012 W. Ontario St., Philadelphia.
For page see List of Advertisers.

BAMBOO CANES

Yokohama Nursery Co., 31 Barclay Street, New York.
Bamboo Sticks, Colored Green.
For page see List of Advertisers.
Wm. Elliott & Sons, New York City, Lily Stakes.
For page see List of Advertisers.

BAY TREES.

3000 Bay and Box Trees in all sizes. Pyramid and Standards. Write for list. Julius Rebers, Rutherford, N. J.

BOILERS

BOILERS. "Burnham" Boilers made for greenhouse heating. Lord & Burnham, 1133 Broadway, N. Y.

Kroeschell Bros. Co., 35 Erie St., Chicago.
For page see List of Advertisers.

BEDDING PLANTS

J. E. Felthousen, Schoeetady, N. Y.
For page see List of Advertisers.
A. Leuthy & Co., Perkins St. Nurseries, Roslindale, Mass.
For page see List of Advertisers.
G. Aschmann, 1012 W. Ontario St., Philadelphia, Pa.
For page see List of Advertisers.

Rooted cuttings of geraniums, single, double and semi-double (mostly red mixed), variegated vines; Robinson, Merry Christmas and Dr. Engelhard chrysanthemums; Salvia Zurich; double alyssum; Brite, Maid, Chateau, Richmond and Dorothy Perkins roses; started tubers of Austria and Black Beauty canna's; fine clumps of Clematis paniculata, Miss Lingard plies, Van Houttei and Anthony Waterer spiraea, Japanese iris (mixed colors), Tritoma Pfitzeri, sweet williams; hollyhocks, double, single and Albecheny (separate colors). These are extra heavy plants. Also have Armstrong's ever-blooming tuberoses, large and small bulbs. Write for prices on what you can use. Will exchange for Enchantress and Beacon carnations.
A. H. DAILEY, FLORIST,
Dandridge Pike, Knoxville, Tenn.

BOXWOOD TREES

New Englad Nurseries, Inc., Bedford, Mass.
For page see List of Advertisers.

BUILDING MATERIAL

BUILDING MATERIAL of all description for All Cypress, Scantiron, Iron Frame or Truss Houses. Hot Bed Sash and Frames. Lord & Burnham Co., 1133 Broadway, N. Y.

BULBS AND TUBERS

Joseph Breck & Sons, 47-54 N. Market St., Boston.
For page see List of Advertisers.
J. M. Thornburn & Co., 33 Barclay St., New York.
For page see List of Advertisers.
A. T. Boddington, 342 W. 14th St., N. Y.
For page see List of Advertisers.
Rickards Bros., 37 East 19th St., New York.
For page see List of Advertisers.
H. F. Mitchell Co., Philadelphia.
For page see List of Advertisers.
H. E. Flske Seed Co., Fanenll Hall Sq., Boston.
For page see List of Advertisers.
T. J. Grey & Co., 32 and 33 So. Market St., Boston.
For page see List of Advertisers.
Yokohama Nursery Co., 31 Barclay St., New York.
For page see List of Advertisers.
Ralph M. Ward & Co., 12 W. Broadway, New York.
For page see List of Advertisers.
K. Takeuchi, 478A Boylston St., Boston. Japanese Bulbs.
For page see List of Advertisers.
Schlegel & Pottler Co., 26 & 27 S. Market St., Boston.
For page see List of Advertisers.

BULBS AND TUBERS - Continued

TUBEROSES AND CALADIUM.
Special Prices to Florists and Dealers.
per 100 per 1000
Tuberose.—Pearl No. 1, 4 to 6
Inch in circum..... \$7.00
Caladium Esculentum, 10 to 7
Inch in circum.....\$1.10 9.00
Caladium Esculentum, 7 to 9
Inch in circum..... 2.10 18.50
Caladium Esculentum, 9 to 11
Inch in circum..... 3.65 35.00
Caladium Esculentum, 11 inch
and over in circum..... 6.50 65.00
Prices include packing and are f. o. b. cars here.
T. W. WOOD & SONS, Seedsmen, Richmond, Va.

CANNAS

A. T. Boddington, 342 W. 14th St., New York.
For page see List of Advertisers.
C. Elsele, 11th and Westmoreland Sts., Philadelphia, Pa.
For page see List of Advertisers.
Large assortment of Cannas of the following varieties: Burbank, Pennsylvania, Berat and Cuebar, at \$1.50 per 100; or would exchange for dwarf Ageratum, Feverfew, double Alyssum, G. W. Moeckel, 17 Sumner St., Fitchburg, Mass.

CARNATIONS

F. Dorner & Sons Co., Lafayette, Ind.
For page see List of Advertisers.
Chicago Carnation Co., Joliet, Ill.
For page see List of Advertisers.
Albert Roper, Tewksbury, Mass.
Carnation Bay State.
For page see List of Advertisers.
Bassett & Waumbur, Hinsdale, Ill.
Carnation Co., Basset.
For page see List of Advertisers.
East Sudbury Greenhouses, So. Sudbury, Mass.
Carnation Cuttings.
For page see List of Advertisers.
Wood Bros., Fishkill, N. Y.
Carnations, Rooted Cuttings.
For page see List of Advertisers.
The E. G. Hill Co., Richmond, Ind.
Carnation Cuttings.
For page see List of Advertisers.
Peter Fisher, Ellis, Mass.
Rooted Cuttings.
For page see List of Advertisers.
S. J. Reuter & Son, Westery, R. I.
For page see List of Advertisers.
Schelden & Schoos, Chicago.
Carnation Wm. H. Taft.
For page see List of Advertisers.
Bellamy Bros., Syracuse, N. Y.
Carnation Marchloases.
Schlegel & Pottler Co., 26 & 27 S. Market St., Boston.
For page see List of Advertisers.
A. F. Logren, Des Plaines, Ill.; Highland Park Greenhouses, Highland Park, Ill.
Carnation Lucille.
For page see List of Advertisers.
Jensen & Dekema, 674 W. Foster Ave., Chicago, Ill.
Carnation Cuttings.

CHRYSANTHEMUMS

Schlegel & Pottler Co., 26 & 27 S. Market St., Boston.
Chrysanthemum Belfast.
For page see List of Advertisers.
E. G. Hill Co., Richmond, Ind.
For page see List of Advertisers.
S. J. Reuter & Son, Westery, R. I.
For page see List of Advertisers.

For List of Advertisers See Page 417

CHRYSANTHEMUMS—Continued

Elmer D. Smith & Co., Adrian, Mich.
For page see List of Advertisers.
C. H. Totty, Madison, N. J.
Single Chrysanthemums From Seed.
For page see List of Advertisers.
J. H. Myers, Altoona, Pa.
For page see List of Advertisers.

Scott Bros., Elmford, N. Y.
For page see List of Advertisers.
Fochmann Bros. Co., Monton Grove, Ill.
For page see List of Advertisers.

Chrysanthemum Golden Glow from 2 1/4 in. pots, for early spring delivery, \$1.00 per doz., \$6.00 per 100, \$50.00 per 1000. Stock plants of Montmort, Oct. Frost, Crocus, Matchless, Lucy Devaux, Polly Rose and Halliday, \$1.00 per doz.; \$6.00 per 100. Pfeiffer Bros., Waltham, Mass.

Golden Glow, R. C., 25 for \$1.00; 100, \$3.50. Profile Supreme, 30 for \$1.00; \$3.00 per 100, prepaid. Best Early Yellow and Pink Mums. Chas. Frost, Keilworth, N. J.

Herrington's book on the Chrysanthemum, mailed to your address for 50c., by Horticulture Publishing Co., 11 Hamilton Place, Boston.

COLEUS

J. E. Felthousen, Schenectady, N. Y.
For page see List of Advertisers.
Coleus, strong rooted cuttings, 10 varieties, including Verschaffeltii and Golden Bedder, 60 cents per 100. Edmund Reardon, Cambridge, Mass.

CONIFERS

John Waterer & Sons, Ltd., American Nursery, Bagshot, Eng.
For page see List of Advertisers.

CUT FLOWER BOXES.

Edwards Folding Box Co., Philadelphia
For page see List of Advertisers.
Folding cut flower boxes, the best made. Write for list. Holton & Hunkel Co., Mill wankee, Wis.

CYCLAMEN.

Thomas Roland, Nahant, Mass.

DAHLIAS

David Herbert & Son, Atco, N. J.
For page see List of Advertisers.
J. L. Moore, Northboro, Mass.
For page see List of Advertisers.
Peacock Dahlia Farms, Williamstown Junction, N. J.
For page see List of Advertisers.
R. Vincent Jr. & Sons Co., White Marsh, Md.
For page see List of Advertisers.

DAHLIAS.

Geo. H. Walker, No. Dighton, Mass.
Wholesale and Retail.
Send your name for my 1909 Catalog and Pocket Guide, ready to mail about Feb. 25th.

Cactus, Decorative, Fancy, Show and Pompon Dahlias. Good commercial varieties, such as Kriemhilde, Countess of Lonsdale, Mad. Van Den Deul and other sure bloomers, strong divided roots in 10 or 20 named varieties by selection, \$1.00 per 25; \$3.00 per 100; \$25.00 per 1000. Cash please. Hermann Thiemann, Meoson, Mass.

Dahlias. Novelties and standard varieties, true to name, a choice list of the best introductions. Send for catalog of dahlias, hollyhocks, hardy plants. Prices always reasonable. W. W. Wilmore, Box 382 Denver, Colo.
East Bridgewater Dahlia Gardens wants your business. If you are looking for dahlias send to the Eastern Dahlia King, J. K. Alexander, East Bridgewater, Mass.

DECORATIVE PLANTS

A. Leuthy & Co., Perkins St. Nurseries Roslindale, Mass.
For page see List of Advertisers.
Godfrey Aschmann, 1012 W. Ontario St., Phila., Pa.
For page see List of Advertisers.
Joseph Hancock Co., Wyncote, Pa.
For page see List of Advertisers.
The Geo. Wittbold Co., 1637 Buckingham Place, Chicago, Ill.
For page see List of Advertisers.

DECORATIVE PLANTS—Continued

Robert Craig Co., Market and 49th Sts., Philadelphia, Pa.
For page see List of Advertisers.
A. N. Pierson, Inc., Cromwell, Conn.
Palms and Ferns.

ECONOMY BRACKET

Burton & Allard, Nashua, N. H.

EVERGREENS

New England Nurseries, Bedford, Mass.
For page see List of Advertisers.
American Nursery Co., 150 Broadway, New York, N. Y.
Henry A. Dreer, Philadelphia, Pa.
For page see List of Advertisers.

Evergreens. Send 25 cents in stamps for complete work on propagating and growing Evergreens. C. S. Harrison's Select Nursery, York, Neb.

FERNS

A. Leuthy & Co., Roslindale, Mass.
For page see List of Advertisers.
H. H. Barrow & Son, Whitman, Mass.
Nephrolepis Magnifica.
For page see List of Advertisers.
John Scott, Brooklyn, N. Y.
For page see List of Advertisers.
Frank Oechslin, 2570-2606 W. Adams St., Chicago.
Ferns for Diasea.
For page see List of Advertisers.
The Geo. Wittbold Co., 1637 Buckingham Place, Chicago, Ill.
For page see List of Advertisers.
Godfrey Aschmann, 1012 W. Ontario St., Philadelphia.
For page see List of Advertisers.
Henry A. Dreer, Philadelphia, Pa.
Nephrolepis Scholzei.
C. Eisele, 11th and Westmoreland Sts.,
For page see List of Advertisers.

Anderson's ferns for in and outdoors. Largest commercial collection in the country. Ask for descriptive catalogue. J. P. Anderson, Fern Specialist, Short Hills,

FERTILIZERS

Pulverized Manure Co., 31 Union Stock Yards, Chicago, Ill.
Wizard Brand Sheep and Shredded Cattle Manure.
Robert Simpson, Clifton, N. J.
Sheep Manure.
For page see List of Advertisers.
Bowker Fertilizer Co., Boston, Mass.
All Forms of Plant Food at First Hands.
For page see List of Advertisers.

FEVERFEW

Feverfew Little Gem, 80c. per 100; \$7.00 per 1000. S. W. Pike, St. Charles, Ill.
2000 Feverfew from 2 1/4 in. \$3.00 per 100, \$25.00 per 1000. Albert Batley & Son, Maynard, Mass.
Feverfew, 2 1/2 in., \$2.00 per 100. H. J. Blanchard, Ashburham, Mass.

FLORAL PHOTOGRAPHS

Floral Photographs, Foley's, 236-223 1-2 Bowery, New York.

FLORISTS' LETTERS.

Boston Florist Letter Co., 66 Pearl St., Boston, Mass.
For page see List of Advertisers.
W. C. Krick, 2164-66 Greene Ave., Brooklyn, N. Y.
Immortal Letters, Chicago.
For page see List of Advertisers.

FLORISTS SUPPLIES

N. F. McCarthy & Co., 84 Hawley St., Boston.
For page see List of Advertisers.
H. M. Robinson & Co., 15 Province St. and 9 Chapman Pl., Boston, Mass.
For page see List of Advertisers.
Reed & Keller, 122 W. 25th St., New York.
For page see List of Advertisers.
H. Bayersdorfer & Co., 1129 Arch St., Philadelphia.
For page see List of Advertisers.
Wertheimer Bros., 534 Broadway, New York, N. Y.
Ribbons, Chiffons, Nettings.

FLOWER POTS

W. H. Ernest, 28th and M Sts., Washington, D. C.
For page see List of Advertisers.
A. H. Hews & Co., Cambridge, Mass.
For page see List of Advertisers.
Hilfinger Bros., Ft. Edward, N. Y.
For page see List of Advertisers.
The Peters & Reed Pottery Co., Red pots, seed pans, etc. Zanesville, O.
Syracuse Pottery Co., Syracuse, N. Y.
Syracuse Red Pots.
For page see List of Advertisers.
We make Standard Flower Pots, etc. Write us when in need.
Wilbur, Cope & Bro., Lincoln University, Chester Co., Pa.

FUCHSIAS

R. Vincent, Jr. & Sons Co., White Marsh, Maryland.
For page see List of Advertisers.

GALAX

Michigan Cut Flower Co., 28 and 40 Broadway, Detroit, Mich.
For page see List of Advertisers.
George Cotsouas & Co., 50 W. 23rd St., New York.
For page see List of Advertisers.
The Kerran Co., 113 West 28th St., N. Y.
For page see List of Advertisers.
Rice Bros., 115 N. 6th St., Minneapolis, Minn.
For page see List of Advertisers.
H. M. Robinson & Co., 15 Province St. and 9 Chapman Place, Boston.
For page see List of Advertisers.

GERANIUMS

R. Vincent Jr. & Sons Co., White Marsh, Md.
New and Standard Varieties.
For page see List of Advertisers.
A few hundred fine mixed stock geraniums, all double, \$7.00 per 100. Fine geraniums, 2 1/2 in., \$2.00 per 100. Cash. H. J. Blanchard, Ashburham, Mass.

GLADIOLI

J. L. Moore, Northboro, Mass.
For page see List of Advertisers.
O. V. Zangen, Hoboken, N. J.
Gladiolus Brechenyensis.
For page see List of Advertisers.
I. & J. L. Leonard, Iona, N. J.
Gladiolus Bulbs.
For page see List of Advertisers.
Gladioli Groff's Hybrids, mixed, 1 1/2 to 2 1/4 in., \$5.00 per 1000; 1 to 1 1/2 in., \$4.00 per 1000; 3/4 to 1 in., \$3.00 per 1000; Bulbets, \$1.00 per peck. Ira H. Landis, Lancaster, Pa.
Groff's new Hybrid Gladioli in finest culture: No. 1, \$5.00 per 1000; No. 2, \$4.00 per 1000; No. 3, 1/2 to 3/4, at \$3.00 per 1000; Giant Pink bulbets, \$4.00 per bus.; \$3.00 per 100; at \$2.00 per 100; at \$1.00 per qt.; Mrs. Francis King and Giant Pink mixed bulbets, at \$1.00 per qt. Discounts on large lots. G. B. Babcock, Jamestown, N. Y.

GLASS

Boston Plate & Window Glass Co., Boston.
For page see List of Advertisers.
Standard Plate Glass Co., 26-30 Sudbury St., Boston.
For page see List of Advertisers.
Foley Mfg. Co., Western Ave., between 25th & 26th Sts., Chicago.
Sharp, Partridge & Co., 22d & Lumber St., Chicago.
For page see List of Advertisers.
Parsheley Bros., Inc., 50 Montrose Ave., Brooklyn, N. Y.
For page see List of Advertisers.
Greenhouse glass, lowest prices. Johnston Glass Co., Hartford City, Ind.
Glass, High Grade, Double Thick Greenhouse Glass. Lord & Burnham, 1133 Broadway, N. Y.

GLAZING DEVICES

H. A. Dreer, Philadelphia, Pa.
Peerless Glazing Point.
For page see List of Advertisers.
GLAZING POINTS, Lord & Burnham Special Glazing Nails (Points). Lord & Burnham, 1133 Broadway, N. Y.

In writing to Advertisers kindly mention Horticulture

GREENHOUSE BUILDING MATERIAL

Lord & Burnham Co.,
1133 Broadway, New York.
For page see List of Advertisers.

Pierson U-Bar Co., 1 Madison Sq., N. Y.
For page see List of Advertisers.

A. T. Stearns Lumber Co., Neponset,
Boston.
For page see List of Advertisers.

King Construction Co., N. Tonawanda,
New York.
For page see List of Advertisers.

Hitchcogs & Co., 1170 Broadway, New York.
For page see List of Advertisers.

J. C. Moninger Co., 117 East Blackhawk St.,
Chicago, Ill.
For page see List of Advertisers.

Foley Mfg. Co., Western Ave., between
25th & 26th Sts., Chicago.
For page see List of Advertisers.

W. H. Lutton, West Shore Av. Sta., Jersey
City, N. J.
For page see List of Advertisers.

GREENHOUSE CONSTRUCTION

GREENHOUSE CONSTRUCTION, Semi-Iron Greenhouse, New Truss Houses and Iron Frame Houses. Lord & Burnham, 1133 Broadway, N. Y.

J. A. Payne, 209-274 Culver Ave., Jersey
City, N. J.
For page see List of Advertisers.

Foley Mfg. Co., Western Ave., between
25th & 26th Sts., Chicago.
For page see List of Advertisers.

Hitchcogs & Co., 1170 Broadway, New York.
For page see List of Advertisers.

Geo. M. Garland Co., Des Plaines, Ill.
For page see List of Advertisers.

GREENHOUSE HOSE

Revere Rubber Co., Boston, Mass.
Revero Hose.
For page see List of Advertisers.

GUTTERS

GUTTERS, Cast Iron Gutters, L & B Improved V Shaped Gutter with drip gutter attachment. Lord & Burnham, 1133 Broadway, N. Y.

HAIL INSURANCE

Florists' Hall Asso. of America,
J. G. Esler, Saddle River, N. J.
For page see List of Advertisers.

HARDY FERNS, MOSS AND GREENS

B. M. Robinson & Co., 15 Province St.
and 9 Chapman Pl., Boston, Mass.
For page see List of Advertisers.

Michigan Cut Flower Exchange,
38 and 40 Broadway, Detroit, Mich.
For page see List of Advertisers.

George Cotsanos & Co., 50 W. 28th St.,
New York.
For page see List of Advertisers.

N. F. McCarthy & Co., 84 Hawley St.,
Boston.
For page see List of Advertisers.

The Kervan Co., 113 W. 28th St., N. Y.
For page see List of Advertisers.

Nice Bros., 115 N. 6th St., Minneapolis,
Minn.
For page see List of Advertisers.

HARDY PERENNIALS

Henry A. Dreyer, 714 Chestnut St., Phila.
For page see List of Advertisers.

HARDY PLANTS

Novelties and Specialties.—For over one hundred distinct new varieties of hardy plants, all of great commercial value, get our Wholesale Catalog of Perennials and Hardy Plants. Palisades Nurseries, Sparkill, N. Y.

HEATING APPARATUS

Lord & Burnham Co.,
1133 Broadway, New York.
For page see List of Advertisers.

Pierson U-Bar Co., 1 Madison Sq., N. Y.
For page see List of Advertisers.

HEATING APPARATUS—Continued

John A. Payne, 209-274 Culver Ave., Jersey
City, N. J.
For page see List of Advertisers.

Kroeschell Bros. Co., 35 Erie St., Chicago.
For page see List of Advertisers.

HELP FURNISHED

Thos. H. Bambrick, 34 S. 7th St., Phila.
For page see List of Advertisers.

HERBACEOUS PERENNIALS

P. Ouwerkerk, P. O. No. 1, Hoboken, N. J.
For page see List of Advertisers.

New England Nurseries, Bedford, Mass.
For page see List of Advertisers.

The Geo. Withhold Co., 1657 Buckingham
Place, Chicago.
For page see List of Advertisers.

D. A. Clarke, Red Oak Nurseries, Fiske-
ville, R. I.
For page see List of Advertisers.

HOT-BED SASH

The A. T. Stearns Lumber Co., Neponset,
Mass.
For page see List of Advertisers.

Pierson U-Bar Co., 1 Madison Sq., N. Y.
For page see List of Advertisers.

Lord & Burnham Co., 1133 Broadway, N. Y.
For page see List of Advertisers.

Foley Mfg. Co., Western Ave., between
25th & 26th Sts., Chicago.

HYDRANGEAS.

Hydrangea American Everblooming. Fine field-grown plants, 10 to 20 inches, \$10.00 to \$15.00 per 100. Boerds, Thunbergii, seedlings and strong transplants. Annon River Privet, Japanese Privet, California Privet. Fine plants for hedges. Lists free. The E. Y. Teas Co., Centerville, Ind.

500 Hydrangeas in bloom for Easter, 4 to 10 blooms; standard stock. Edmund Reardon, Cambridge, Mass.

INSECTICIDES.

Nicotinic kills all greenhouse pests.
F. R. Palethorpe Co.,
Eleventh St., Owensboro, Ky.
For page see List of Advertisers.

Stumpp & Walter Co., 50 Barclay St.,
New York.
Killedead Tobacco Dust.
For page see List of Advertisers.

Niagara Sprayer Co., Middleport, N. Y.
Niagara Brand.
For page see List of Advertisers.

B. G. Pratt Co., New York.
Sulfocide.
For page see List of Advertisers.

Bowker Insecticide Co., Boston, Mass.
Insect Destroying Preparations.
For page see List of Advertisers.

Wm. Cooper & Nephews, 117 Illinois St.,
Chicago; Cyril Franklyn, 62 Beaver
St., New York. Art.
V 1 Fluid.
For page see List of Advertisers.

"The Fumigator, Kind Tobacco Powder"—The first on the market and the kind that has so many imitators, has our guarantee tag of satisfaction or money back, and "The Moon Trade Mark" on every bag, \$3.00 per 100 lbs. The H. A. Stothoff Co., Mount Vernon, N. Y., Makers and sellers.

Tobacco dust 1 1/2 stems, dust in bbls., 15c to 200 lbs., \$4.00; stems in bales from 250 to 400 lbs., \$2.50. Cash with order; money back if you say so. I lead them all in quality and price. S. R. Levy, Birmingham, N. Y.

IVIES

English Ivy, strong, for window boxes; 4-inch pots \$1.50 per doz. Shattuck Nurseries, Barrytown, Dutchess County, N. Y.

JAPANESE PLANTS

Yokohama Nursery Co., 31 Barclay St.,
New York.
For page see List of Advertisers.

KENTIAS

Godfrey Aschmann,
1012 W. Ontario St., Phila., Pa
For page see List of Advertisers.

A. Lenthy & Co., Roslindale, Mass
For page see List of Advertisers.

Jos. Heacock Co., Wyncoete, Pa
Single and Made-Up Specimens
For page see List of Advertisers.

LANTANAS

Violet King, King of all lantanas, rooted cuttings, \$1.00 per 100, 250 for \$7.50, 450 per doz. For large quantities of Violet King, 500 to 5000 lots, send for prices, as I will make them right, for I want to see every florist in the United States handle this variety, as it is a great novelty. Sun-set, new, rooted cuttings, 50c. per doz.; \$3.00 per 100. Eight other grand varieties, rooted cuttings, \$2.00 per 100. All true to name, labelled. Mixed, \$3.00 per 100. Send for price list. Louis P. Faulk, West View, Pa.

LEVELS FOR LANDSCAPE GARDENING USE.

Bostron-Brady Mfg. Co., 159 Madison Ave.,
New York, N. Y.
For page see List of Advertisers.

LILY OF THE VALLEY PIPS

Hjalmar Hartmann & Co., 12 Stormgade,
Copenhagen, Denmark.
For page see List of Advertisers.

LOBELIAS

Double Iabella Kathleen Mallard, rooted cuttings, \$1.00 per 100. Cash. Chas. H. Green, Spencer, Mass.

R. Vincent, Jr. & Son,
White Marsh, Md.
For page see List of Advertisers.

MARGUERITES

Marguerites, Queen Alexandra, \$1.25 per 100, prepaid. S. W. Pike, St. Charles, Ill.

NICO-FUME

Kentucky Tobacco Product Co.,
Louisville, Ky.

NURSERY STOCK

John Waterer & Sons, Ltd.,
American Nursery, Bugshot, England.
For page see List of Advertisers.

Clary's Horticultural Co., 62 Vesey St.,
New York.
For page see List of Advertisers.

P. Ouwerkerk, 216 Jane St., Weehawken
Heights, N. J.
For page see List of Advertisers.

D. J. Twomey, Dept. H, Geneva, N. Y.
For page see List of Advertisers.

J. & J. L. Leonard, Iona, N. J.
For page see List of Advertisers.

Eastern Nurseries, Jamaica Plain, Mass.
Viburnum Mille.
For page see List of Advertisers.

American Nursery Co., 150 Broadway, New
York, N. Y.

F. Hamilton Goodsell, 200 Broadway,
New York.
For page see List of Advertisers.

W. & T. Smith Co., Geneva, N. Y.
Nursery Stock for Florists.
For page see List of Advertisers.

Storrs & Harrison Co., Palmsville, O.
For page see List of Advertisers.

Rose Hill Nurseries, New Rochelle, N. Y.
Buddleya Variabilis Veitchii and Magnifica.
For page see List of Advertisers.

ROCK MAPLE SEEDLINGS. Per 1000
Sugar or Rock Maple, fine, 2 to 4 ft. \$20.00
" " " " " 2 to 3 ft. 12.00
" " " " " 1 to 2 ft. 5.00
Samples or request. Lists free. The
E. Y. Teas Co., Centerville, Ind.

Manual of the Trees of North America,
by C. S. Sargent, mailed to your address
for \$5.00, by Horticulture Publishing Co.,
11 Hamilton Place, Boston.

TREES, SHRUBS, ROSES, EVERGREENS, PERENNIALS, HARDY PLANTS, ELLIENBERG & BARRY, Rochester, N. Y.

New Hardy Shrub—Buddleya variabilis Veitchii and Magnifica, the summer flowering Lilac, 50c. each; \$5.00 per doz.; \$25.00 per 100. Rose Hill Nurseries, New Rochelle, N. Y.

Catalog now ready. Nursery grown evergreens, seedling white pine and hem lock, native firs and plants. L. E. Williams, Nottingham, N. H.

Rhododendrons, Laurel, Spruce Hemlock, Poplars. E. W. Sheeley, De Bruce, Sullivan County, N. Y.

ONION SEED

Federico C. Varella, Tenerife, Canary Is.
Bermuda Onion Seed.

ORCHIDS

Orchid Growers' Manual. By R. S. Williams. 360 Illustrations. \$1.00. 800 pages; descriptions of upwards of 2500 species and varieties of orchideaceous plants, etc. The most complete work on Orchids and orchid culture ever published. Orders filled by HORTICULTURE, 11 Hamilton Place, Boston.

ORCHID PLANTS

Lager & Hurrell, Summit, N. J.
For page see List of Advertisers.
Sander, St. Albans, England.
Importers, Exporters, Growers, Hybridists
For page see List of Advertisers.
Carrillo & Baldwin, Secaucus, N. J.
For page see List of Advertisers.
Jos. A. Manda, 191 Valley Road, W. Orange, N. J.
For page see List of Advertisers.
Ordonez Bros., Madison, N. J., Box 106
For page see List of Advertisers.
Liverpool Orchid & Nursery Co., Gateacre, near Liverpool, Eng.
G. L. Freeman, 388 Appleton St., Holyoke, Mass.
Orchid Importations.
For page see List of Advertisers.
Largest stock in the country. Ask for prices. Julius Roehrs, Rutherford, N. J.

PAINT AND PUTTY

PAINT AND PUTTY: Ideal Greenhouse lead; Special Greenhouse Putty. Lord & Burnham, 1133 Broadway, N. Y.

PALMS

A. Leuthy & Co., Perkins St. Nurseries, Roslindale, Mass.
For page see List of Advertisers.
Robert Craig Co., Market and 49th Sts., Philadelphia, Pa.
For page see List of Advertisers.
Joseph Hancock Co., Wyncote, Pa.
Home-Grown Palms.
For page see List of Advertisers.

PANSY PLANTS

Pansies, extra fine plant flowering, stragg plants, 30 cents per 100; \$2.50 per 1000 Edw. Wallis, Atco, N. J.
Giant Pansy Plants, stocky, field-grown from fall-sown seed, 50 cents per 100; \$3.50 per 1000, prepaid. Cash. Chas. Frost, Kenilworth, N. J.

PATENTS

Siggers & Siggers, Washington, D. C.
For page see List of Advertisers.

PEAT

Orchid Peat and Moss always on hand Julius Roehrs Co., Rutherford, N. J.

PENTSTEMONS

C. H. Totty, Madison, N. J.
For page see List of Advertisers.

PEONIES

Peonies only, by the wholesale—best 100 varieties. J. F. Rosenfield, Westpoint, Neb.
One of the finest collections in America. Send 25 cts. in stamps for new edition of Peony Manual. C. S. Harrison's Select Nursery, York, Neb.

PETUNIAS

R. Vincent, Jr. & Sons Co., White Marsh, Maryland.
For page see List of Advertisers.

PHLOXES

Send 25 cts in stamps for Phlox Manual. Fine mixed phloxes \$2.00 per 100. C. S. Harrison's Select Nursery, York, Neb.

PHOTOGRAPHS: DESIGNING: ILLUSTRATING

Geo. E. Dow, 125 Washington St., Boston
For page see List of Advertisers.

PIPE AND FITTINGS

Foley Mfg. Co., between Western Ave. and 29th St., Chicago, Ill.
For page see List of Advertisers.
Kroeschell Bros. Co., 35 Erie St., Chicago
For page see List of Advertisers.
PIPE AND FITTINGS. Cast iron and Wrought Pipe, Valves, Elbows, Pipe Hooks Automatic Air Headers, etc. Lord & Burnham, 1133 Broadway, N. Y.

PLANT STANDS

Moore-Livingston Co., Lansdowne, Pa.
For page see List of Advertisers.

PLANT STAKES

Seele's Treeless Plant Stakes and Tree Lines. H. D. Seele & Sons, Elkhart, Ind.

POT HANGERS

Pot hangers, Kramer's \$1 doz. by exp., \$1.25 by mail. I. N. Kramer & Son, Cedar Rapids, Ia.
Krick's Perfect Pot Hanger and Handle. Sample pair 10 cents postpaid. Send for full particulars. W. C. Krick, 1164-1165 Greete Ave., Brooklyn, N. Y.

POINSETTIAS (Artificial)

Poinsettias, artificial decorations our specialty. Sample lots of 50 in 3 sizes, \$4.00; 100 lots, \$8. \$5. J. Stern & Co., 125 N. 10th St., Philadelphia, Pa.

POULTRY SUPPLIES

Buff Rock Eggs to Hatch, Triumph brood egg for chickens. Frank H. Snow, Orleans, Mass.

PRIVET

California privet, 100,000 for transplanting at \$4.00 per 1000; 55,000, 12 to 18 in., 2 to 4 branches, \$8.00 per 1000; 125,000, 12 to 18 in., 3 to 5 branches, \$10.00 for 1000. Boxed and delivered F. O. B. Cash with order. Vahlesian Nurseries, Bostic Dept., Bostic, N. C.

PRUNING SHEARS

Rhodes Mfg. Co., Dept. R., Grand Rapids, Mich.

RAFFIA

Raffia (colored), 20 beautiful shades. Samples free. R. H. Conner Co., Camden, N. J.; 810 Washburn Ave., Chicago, Ill.

RASPBERRY PLANTS

Red Raspberry Plants, all summer, ever-bearing, money-makers. C. C. YDELL, Cummans, Mass.

RESURRECTION PLANTS

Resurrection plants and cacti. Cheap. Ask for prices. William Tell, Austin, Tex.

RHODODENDRONS

John Waterer & Sons, Ltd., American Nursery, Bagshot, England.
For page see List of Advertisers.
P. Ouwkerker, Hoboken, N. J.
For page see List of Advertisers.
Anthony Waterer, Knap Hill Nursery, Surrey, Eng.
Storrs & Harrison Co., Painesville, O.
For page see List of Advertisers.

ROSES

Robert Craig Co., Market and 49th Sts., Philadelphia, Pa.
For page see List of Advertisers.
P. Ouwkerker, P. O. No. 1, Hoboken, N. J.
For page see List of Advertisers.
Julius Roehrs Co., Rutherford, N. J.
Rose Newport Fairy.
For page see List of Advertisers.
The F. R. Pierson Co., Tarrytown-on-Hudson, N. Y.
White Killarney.
For page see List of Advertisers.
S. J. Reuter & Son, Westerly, R. I.
My Maryland.
For page see List of Advertisers.
Dingee & Conard Co., West Grove, Pa.
For page see List of Advertisers.
Storrs & Harrison Co., Painesville, O.
For page see List of Advertisers.
Scott Bros., Elmsford, N. Y.
For page see List of Advertisers.
Poehlmann Bros. Co., Morton Grove, Ill.
For page see List of Advertisers.
A. T. Boddington, 342 W. 14th St., New York.
Standard and Climbing Roses for Spring Sales.

Hand Book of Cultural Notes on Roses Under Glass, by F. P. Brigham, mailed to your address for 25c, by Horticulture Publishing Co., 11 Hamilton Place, Boston.

The beautiful new pink rose, MISS KATIE MOULTON is the queen of all pink roses. It's a winner and you should grow it. Price \$30.00 100; 500 \$125.00; 1000 \$200.00; 5000 and upwards \$175 per 1000. Minneapolis Floral Co., Minneapolis, Minn.

SALVIAS

R. Vincent, Jr. & Sons Co., White Marsh, Maryland.
Salvia Bouillon and Zurich.
For page see List of Advertisers.

SEED GROWERS

C. C. Morse & Co., 4856 Jackson St., San Francisco, Cal.
Hjalmar Hartmann & Co., Cauliflower and Cabbage Seed.
12 Stroumgade, Copenhagen, Denmark.
For page see List of Advertisers.
John S. Weaver, Glen Mawr Farms, Kinzers, Pa.
Vegetable and Flower Seeds Grown on Contract.
For page see List of Advertisers.
Federico C. Varela, Tenerife, Canary Ids.
Berma-da Onion Seed.

SEEDS

T. J. Grey Co., 32 So. Market St., Boston.
For page see List of Advertisers.
Joseph Breck & Sons, 51 and 52 N. Market St., Boston, Mass.
For page see List of Advertisers.
W. Albee Burpee & Co., Philadelphia.
For page see List of Advertisers.
C. C. Morse & Co., 4856 Jackson St., San Francisco, Calif.
For page see List of Advertisers.
Arthur T. Boddington, 342 W. 14th St., New York.
For page see List of Advertisers.
H. E. Fiske Seed Co., Faneuil Hall Sq., Boston.
For page see List of Advertisers.
Hjalmar Hartmann & Co., 12 Stroumgade, Copenhagen, Denmark.
Cauliflower and Cabbage Seed.
For page see List of Advertisers.
Rickards Bros., 37 E. 19th St., New York.
For page see List of Advertisers.
R. & J. Farquhar & Co., 67 So. Market St., Boston.
Mignonette Seed.
For page see List of Advertisers.

H. F. Michell Co., 1018 Market St., Phila.
For page see List of Advertisers.
J. M. Thorburn & Co., 33 Broadway St., N. Y.
For page see List of Advertisers.
Leonard Seed Co., Chicago, Ill.
For page see List of Advertisers.
Wm. Elliott & Sons, 42 Vesey St., N. Y.
New Seed.
For page see List of Advertisers.
Weeber & Don, 114 Chambers St., New York.
For page see List of Advertisers.
I. & J. L. Leonard, Iona, N. J.
Tennato and Pepper Seed.
For page see List of Advertisers.
Charles F. Saul, 220-224 James St., Syracuse, N. Y.
Pens, Onion, Clover and Timothy Seed.
For page see List of Advertisers.
Schlegel & Fottler Co., 25 & 27 S. Market St., Boston.
For page see List of Advertisers.
O. V. Zangen, Hoboken, N. J.
Florists' Spring Seeds.
For page see List of Advertisers.
E. F. Whinterson Co., Chicago.
Seeds for Plantsmen, Nurserymen, Seeds-
men.
For page see List of Advertisers.
Seeds, Rocky Mountain Evergreen seeds in large or small quantities. C. S. Harrison's Select Nursery, York, Neb.

SHRUBS

The Geo. Wiltzhoff Co., 1657 Buckingham Place, Chicago.
For page see List of Advertisers.

SILKALINE

John C. Meyer & Co., Boston, Mass.
For page see List of Advertisers.

SMILAX

R. Vincent, Jr. & Sons Co., White Marsh, Maryland.
For page see List of Advertisers.
Extra large plants, \$1.00 per 100; \$8.00 per 1000. Ready for 2 1/2 inch pots. Big hazelnut. C. W. Moeckel, 47 Summer St., Pittsburg, Mass.

In writing to Advertisers kindly mention Horticulture

SPHAGNUM MOSS

Live Sphagnum moss, orchid pest and orchid baskets always on hand. Lager & Hurrell, Summit, N. J.

Sphagnum moss and mountain laurel in bags, bales or car lots. Prices low. Spruce and hemlock in bales. James Day, Box 660, Milford, N. H.

Ten bales sphagnum, \$7.00.

Z. K. Jewett Co., Sparta, Wis.

SPRAYERS

Niagara Sprayer Co., Middleport, N. Y. For page see List of Advertisers.

J. F. Cass Mfg. Co., Dept. H., Detroit, Mich.

U-N-I-T Globe Sprayer.

For page see List of Advertisers.

Chas. J. Jager Co., Boston.

Deming Spray Pump.

For page see List of Advertisers.

STEAM TRAP

E. H. Hppard, Youngstown, O.

STRAWBERRY PLANTS

H. L. Crane, Westwood, Mass.

Barymore Strawberry.

For page see List of Advertisers.

W. E. Trimble, Princeton, Ill.

Treatise on the Strawberry Blight, Its Cause and Cure.

For page see List of Advertisers.

SULFOCIDE

The B. G. Pratt Co., 50 Church St., Dept. W., New York City.

For page see List of Advertisers.

SWEET PEAS

A. C. Zvolanek, Round Brook, N. J.

Winter Flowering.

For page see List of Advertisers.

W. Atlee Burpee & Co., Philadelphia.

TO-BAK-INE

E. H. Hunt, Genl. Agt., 78-78 Wabash Av., Chicago.

For page see List of Advertisers.

TOMATO PLANTS.

Comet Tomatoes, 2 1/2 in., \$18.00 per 1000.

Roney Bros., West Grove, Pa.

VEGETABLE PLANTS

R. Vincent, Jr. & Sons Co., White Marsh, Md.

For page see List of Advertisers.

Best Cabbage Plants: Charleston Wakefield, Succession, Surehead, Alford Early, all 1000 for \$1.10; 2000, \$2.00; 5000, \$4.50. Guaranteed to stand freeze. H. E. Simpson, R. F. D. 1, Piedmont, S. C.

VEGETABLE SEEDS

Just arrived, our reliable vegetable seeds. Buy your fresh seeds now. These are guaranteed fresh and only first class seeds. The Reliable Seed House, 150 Third Street, Hoboken, N. J.

VENTILATING APPARATUS

Plerion U-Bar Co., 1 Madison Sq., N. Y.

For page see List of Advertisers.

Foley Mfg. Co., Western Ave., between 25th & 26th Sts., Chicago.

For page see List of Advertisers.

John A. Payne, 260-274 Culver Ave., Jersey City, N. J.

For page see List of Advertisers.

The Advance Co., Richmond, Ind.

For page see List of Advertisers.

Quaker City Machine Co., Richmond, Ind.

20th Century Ventilating Arm.

For page see List of Advertisers.

VENTILATING MACHINERY, New Model encased, self-oiling gear; Standard Model Open Gear. Lord & Burnham, 1133 Broadway, N. Y.

VERBENAS

R. Vincent, Jr. & Sons Co., White Marsh, Maryland.

For page see List of Advertisers.

VIOLETS.

Princess Violets, 2 1/2 in., \$2.00 per 100.

Jas. T. Baker, Hinstleton, Philadelphia, Pa.

WALLFLOWERS

Henry A. Dreer, Philadelphia, Pa.

For page see List of Advertisers.

WAX FLOWERS

We are originators of wax designs and all the standard concern. J. Stern & Co., 125 N. 10th St., Philadelphia, Pa.

WEED KILLER

The American Horticultural Distributing Co., Martinsburg, W. Va.

Target Brand.

For page see List of Advertisers.

WIRED TOOTHPICKS

W. J. Cowee, Berlin, N. Y.

For page see List of Advertisers.

WIREWORLD

Reed & Keller, 122 W. 25th St., N. Y.

For page see List of Advertisers.

Durand & Marohn, Albany, N. Y.

For page see List of Advertisers.

Wirework. Write for our catalogue.

Holton & Hunkel Co., Milwaukee, Wis.

William E. Heilscher's Wire Works, 38-40 Broadway, Detroit, Mich.

Wirework—Compare our prices with others. Scranton Florist Supply Co., 201 N. 7th St., Scranton, Pa.

WHOLESALE FLORISTS

Boston

N. F. McCarthy & Co., 84 Hawley St., Boston.

For page see List of Advertisers.

H. M. Robinson & Co., 15 Province St. and 9 Chapman Pl., Boston.

For page see List of Advertisers.

Welch Bros., 226 Devonshire St., Boston.

For page see List of Advertisers.

Talby, Wellesley, Mass.

For page see List of Advertisers.

Buifalo, N. Y.

William F. Kasting Co., 383-37 Ellicott St., Buifalo, N. Y.

For page see List of Advertisers.

Chicago

Chas. W. McKellar, 51 Wabash Ave., Chicago.

For page see List of Advertisers.

Peter Reuber, 51 Wabash Ave., Chicago.

For page see List of Advertisers.

E. F. Wintersou Co., 45-49 Wabash Ave., Chicago.

For page see List of Advertisers.

J. A. Bullong, 37-39 Randolph St., Chicago.

For page see List of Advertisers.

Poehlmann Bros. Co., Morton Grove, Ill.

For page see List of Advertisers.

Cromwell, Conn.

A. N. Pierson, Cromwell, Conn.

For page see List of Advertisers.

Detroit

Michigan Cut Flower Exchange, 38 and 40 Broadway, Detroit, Mich.

For page see List of Advertisers.

Minneapolis

Rice Bros., 115 N. 6th St., Minneapolis, Minn.

For page see List of Advertisers.

New York

Ford Bros., 48 W. 28th St., New York.

For page see List of Advertisers.

H. E. Froment, 57 W. 28th St., New York.

For page see List of Advertisers.

Alex. J. Guttman, 34 W. 28th St., New York.

For page see List of Advertisers.

E. C. Horan, 55 W. 28th St., New York.

For page see List of Advertisers.

A. H. Langjahr, 55 W. 28th St., New York.

For page see List of Advertisers.

James McManus, 42 W. 28th St., New York.

For page see List of Advertisers.

John I. Raynor, 49 W. 28th St., New York.

For page see List of Advertisers.

W. F. Sheridan, 39 W. 28th St., New York.

For page see List of Advertisers.

WHOLESALE FLORISTS—

New York—Continued

Friendly & Schenck, 44 W. 28th St., New York.

For page see List of Advertisers.

Moore, Hentz & Nash, 55 and 57 W. 28th St., New York.

For page see List of Advertisers.

Wm. H. Kuebler, 28 Willoughby St., Brooklyn, N. Y.

For page see List of Advertisers.

Philip F. Kessler, 55 and 57 W. 28th St., New York.

For page see List of Advertisers.

Milling Bros., 41 W. 28th St., New York.

For page see List of Advertisers.

John Young, 51 W. 28th St., New York.

For page see List of Advertisers.

Greater New York Florists' Association, 162 Livingston St., Brooklyn, N. Y.

For page see List of Advertisers.

Frauk Millang, 55-57 W. 26th St., New York.

For page see List of Advertisers.

B. B. Slinn, 55-57 W. 26th St., New York.

For page see List of Advertisers.

A. L. Young & Co., 54 W. 28th St., N. Y.

For page see List of Advertisers.

Growers' Cut Flower Co., 39 W. 28th St., New York.

For page see List of Advertisers.

Henshaw & Fenrich, 44 W. 28th St., New York.

For page see List of Advertisers.

J. K. Allen, 106 W. 28th St., New York.

For page see List of Advertisers.

Charles Millang, 444 Sixth Av., New York.

Philadelphia

W. E. McKissick & Bros., 1619-1621 Ransstead St., Philadelphia, Pa.

For page see List of Advertisers.

Leo Nlesco Co., 1209 Arch St., Philadelphia, Pa.

For page see List of Advertisers.

The S. S. Pennock-Meehan Co., 1608-18 Ludlow St., Philadelphia, Pa.

For page see List of Advertisers.

WOODENWARE

Bacon & Co., Appleton, N. Y.

Baskets; Crates; Ladders; Boxes.

For page see List of Advertisers.

New Offers in This Issue.

See List of Advertisers on opposite page for page on which these offers may be found.

CRIMSON AND PINK RAMBLERS.

Thomas Roland, Nahant, Mass.

DAHLIA JACK ROSE.

Pancock Dahlia Farms, Williamstown Junction, N. J.

DAILY AUCTION SALES.

The Fruit Auction Co., 200, 202, 204 Franklin St., New York.

PALMS, SHRUBS, FERNS, PERENNIALS.

Geo. Wittbold Co., 1657 Buckingham Place, Chicago.

ROOTED CARNATION CUTTINGS.

E. W. Fongar, 147-87 Linden Av., Irvington, N. J.

TWEMLOW'S PUTTY.

Hammond's Paint & Slag Shot Works, Fishkill-on-Hudson, N. Y.

VIOLET BLUE ROSE.

Eliwanger & Barry, Rochester, N. Y. Box T.

WHITE KILLARNEY, MY MARYLAND, RAMBLERS.

A. N. Pierson, Cromwell, Conn.

List of Advertisers

Advance, The Co.	419	Jager, Chas. J. Co.	402
Allen J. Nursery	411	Kastling W. F. Co.	421
American Nursery	411	Kervan The Co.	421
Aschman & Godfrey	407	Kessler, P. C.	416
Atlanta Floral Co.	401	King Cons. Co.	410
Bacon & Co.	400	Krick W. C.	411
Bambrick Thos. H.	417	Krosschell Bros.	419
Barrows H. H. & Son	402	Kuebler Wm. H.	411
Basnett & Washburn	386	Lager & Hurrell	397
Bayersdorfer H. & Co.	407	Langjahr, Alfred H.	410
Blossom The Co.	406	Leonard I. & J. L.	404
Boddington A. T.	398	Leonard Seed Co.	405
Boston Florist Letter	398	Leuthy A. & Co.	401
Boston Plate and Win-	407	Longren, A. F.	386
dow Glass Co.	419	Loid & Burnham Co.	420
Bostrom-Brady Mfg.	409	Lutton W. H.	410
Co.	409	Mauds Jos. A.	397
Bowe, M. A.	406	MacMulkis E. A.	407
Bowler Fertilizer Co.	405	McCarthy, F. E. & Co.	407
Bowler Insecticide	405	McClellan	407-411
Co.	405	McConnell Alex.	406
Breck Joseph & Sons	405	McKellar Charles W.	408
Breimeyer's J. & Sons	405	McKissick, W. E. & Sons	408
Brigham's Seed	404	McManus Jas.	410
Warehouse	404	McMurry J. C. & Co.	411
Budlong J. A.	408	Meyer, H. H.	397
Burpee W. A. & Co.	405	Michell H. F. Co.	405
Co.	405	395-403-104	
Carrillo & Baldwin	397	Mitigan Cut Flower	421
Cass J. F. Mfg. Co.	493	Exchange	421
Chicago Carnation	386	Millang Bros.	410
Co.	386	Millang Charles	411
Clarke, Daniel A.	388	Millang Frank	410
Clarke & Davis	406	Moisinger, G. C.	418
Clary's Horticult' Co.	388	Moore, J. L.	399
Clary J. P.	396	Moore, Heinz & Nash	410
Coan J. J.	410	Moore-Livingston Co.	407
Conner, Wm. & Co.	410	Murray Samuel	406
hews	410	New Eng. Nurseries	388
Cotsonas G. & Co.	411	Newman Floral Co.	406
Cowee W. J.	421	Newman J. & Sons	407
Craig, Rubt. Co.	409	Niagara Sprayer Co.	403
Crane H. L.	402	Nissen Leo Co.	409
Crawback Geo. W.	411	Oechlisch Frank	401
Danfer F. A.	407	Ordehne Bros.	397
Dawson H. S.	397	Ouwkerk P. C.	388
Dodge & Conard Co.	388	Paethorpe P. R. Co.	403
Dorner F. Sons & Co.	386	Palmer W. J.	406
Dow Geo. E.	405	Park Floral Co.	406
Dreer H. A.	399	Parshelsky Bros. Inc.	418
Dunlop John H.	409	Payne John A.	417
Durnod & Marston	407	Peacock Dahlia Farms	399
Dyars R. J.	411	Peacock-Meehan	401-408
Eastern Nurseries	397	Perkins St. Nurseries	401
Edwards Folding Box	408	Pierson, A. N.	397
Co.	408	Pierson F. R. & Sons	397
Eisele C.	401	Pierson U Bar Co.	409
Ellett Wm. & Sons	405	Plumb Wm.	417
Ellwanger & Barry	397	Pochlman Bros. Co.	388
Elmsford Nurseries	387	Pratt B. G. Co.	388-408
Euler J. G.	418	Quaker City Mach. Co.	418
Erest W. H.	408	Kaynor, I. M.	387
Eyres	406	Kaynor John I.	410
Farquhar R. & I. & Co.	405	Red Oak Nurseries	388
Feltthousen J. E.	400	Reed & Keller	411
Fenger E. W.	386	Reinberg Peter	408
Fisher Peter	386	Reuter's J. & Son, Inc.	386
Fiske H. E. Seed	403-405	Revere Rubber Co.	418
Foley Mfg. Co.	419	Rice Bros.	418
Ford Bros.	410	Rickards Bros.	404
Freeman G. L.	397	Robinson H. M. & Co.	408
Froment H. E.	410	Ruck Wm. L. Flo. Co.	406
Fruit Auction Co.	396	Roehrs Julius Co.	397-399
Galvin Thos. F.	407	Roper Albert	386
Garland, Geo. M. Co.	413	Roland, Thomas	399
Gillett Jacques	401	Roiker August & Sons	400
Goodsell, F. Hamilton	401	Rose Hill Nurseries	388
Greater N. Y. Florists' Association	411	Sander & Son	397
Grey T. J. Co.	405	Sand, C. E. & Sons	405
Grove's Cut Flower	405	Scheiden & Schons	365
Co.	405	Schlegel & Fottler Co.	386
Gude Bros. Co.	410	Schulz Jacob	407
Gutman Alex. J.	410	Scott Ernest	407
Hill Assn.	418	Scott, John	404
Hammond Painal & Slug	402	Sharp, Partridge & Co.	418
Shot Works	402	Sheridan W. F.	410
Hartmann Hjalmar	402	Siggers & Siggers	418
Co.	402	Syracuse Robt.	402
Hauswirth M. C. & E.	405	Situations & Wants	417
Heacock Jos. & Co.	414	Sloan E. S.	410
Henshaw & Fenrich	410	Smith Elmer D. & Co.	397
Herbert David & Son	410	Smith W. & T. Co.	397
Hews A. H. & Co.	400	Smyth Wm. J.	406
Highland Park Green-	386	Standard Plate Glass	418
houses	386	Co.	418
Hilfinger Bros.	400	Stearns A. T. Lumber	418
Hill, The E. G. Co.	386	Storrs & Harrison Co.	388
Hitchings & Co.	410	Stump & Walter Co.	405
Hofman	410	Syracuse Pottery Co.	400
Horan E. C.	410	Talbly	407
Houghton F. H.	407	Takeuchi K.	405
Hunt E. H.	403	Tanori R.	405
		Target Brand	404

Page	Page		
Thorburn J. M. & Co.	405	Welch Bros.	408
Totry Chas. H.	399	Withbold Geo. Co.	401
Treadly & Schenk	410	Wilson	410
Trepel C. C.	406	Winterer, E. F. Co.	408
Trimbly W. C.	412	Wood Bros.	386
Twomey D. J.	388	Yokohama Nursery Co.	401
Valentine, J. A.	406	Young A. L.	411
Vincent R., Jr. & Sons	386-404	Young John	410
Ward R. M. & Co.	404	Young, Thos., Jr.	406
Waterer John & Sons	388	Young & Nugent	406
Weaver, J. S.	405	Zangen O. V.	401-405
Weber & Dun.	405	Zinn Julius A.	407
		Zvolnack A. C.	405

MOVEMENTS OF GARDENERS.

Victor May, formerly at Elm Court, Lenox, Mass., has taken a position with T. W. Head, at Groton, Conn.

Joseph King is reported to have resigned his position as gardener to Jesse L. Eddie, Normandie Heights, N. J.

Olof Haarbly has resigned his position as gardener to John A. Stewart, Madison Ave., Morristown, and John Whelan, for the past three years gardener to C. W. Armour has secured the position, to begin April 1.

A. R. Kennedy of Brook Lake, Madison, N. J., is reported to have resigned his position. Mr. Kennedy has been one of the most active members of the Morris County Gardeners' and Florists' Society during the time he has been in Madison and prominent in all the exhibitions held by the Society, competitive or otherwise. If the report is true and Mr. Kennedy decides to leave us the Society will feel the loss. The best wishes of every member will be with him wherever he goes.

State Street merchants in Chicago cabled an order for a handsome floral piece to be presented to H. G. Selfridge in London, on the opening of his big department store, March 15. Mr. Selfridge was formerly manager for Marshall Field & Co.

WANTS, FOR SALE, ETC.

Advertisements in this column one cent a word. Initials count as words. Cash with order. All correspondence addressed "care HORTICULTURE" should be sent to 11 Hamilton Place, Boston.

FOR SALE

FOR SALE—A nice estate situated on high ground at Hyde Park, Mass., near Milton. Two minutes from R. R. station. Fifteen minutes to Boston House, 14 rooms and bath, all conveniences. Corner lot, 47,375 ft. land, fruit and shade trees. Greenhouse, 118 x 33, built 1898, 6 on sides, 16 centre, 16 x 24 glass. Good opening for commercial florist. Address A. G. Chickering, 53 State St., Boston.

FOR SALE—Retail nursery, sixth year, doing good, steady and increasing trade. Stock in excellent condition. Only local supply for community of 50,000. For particulars address R. N., care HORTICULTURE, Boston.

MISCELLANEOUS WANTS

WANTED TO BUY—Complete greenhouse house plants and all kinds of greenhouse material, to be taken down and removed at once. Terms cash. Address I. Sussertman, 229 Livingston St., Newark, N. J.

The Payne Steel "T" Bar Greenhouses

The Lightest The Strongest

Half full size

HOUSES of this type are constructed with both curved glass eaves and straight glass eaves. Least amount of shadow. Least amount of wood. No drip. Greatest durability.

JOHNA. PAYNE

Greenhouse Designer and Builder
260-274 Culver Avenue
Jersey City, N. J.

HELP WANTED

GOOD MEN

When you need good men, skilled or unskilled, Write:

THOS. H. BAMBRICK

34 South 7th Street Philadelphia

Help of all kinds, including that for Florists, Nurserymen, Seedsmen and the Horticultural trade generally.

WANTED

A good vegetable grower; also a man for flower garden on private place. Single men and not over 40 years of age. Send references and wages expected to:

WILLIAM PLUMB, So. Natick, Mass.

WANTED—Foreman for planting from landscape plans, nursery planting and propagating in frames. Steady position at moderate salary to competent young man. Small house available April 1st. Isaac Hicks & Son, Westbury Station, L. I.

SITUATIONS WANTED

FORESTRY—A young man wishes a position on gentleman's estate. Understands reproduction and improvement cuttings. Also experienced in pruning and gypsy moth work. J. P. D., 40 Erie St., Dorchester, Mass.

Position desired as draughtsman and surveyor for landscape architect, or in any civil engineering office. Experience. Address O. B., care of HORTICULTURE.

SITUATION WANTED—By first-class grower of Roses, Carnations and general stock. Many years experience in Orchids. Married. References. D. M., care of HORTICULTURE.

Assistant Gardener wanted on a private place, a young man, must be industrious and sober; stable experience. Address A. A. HORTICULTURE, Boston.

GLASS

Greenhouse and Hot Bed

SIZES OUR SPECIALTY
THIENSE STOCK

Plate and Window Glass

Write for Our Prices

PARSHELSKY BROS., Inc.
59 Montrose Ave., BROOKLYN, N. Y.

**GREENHOUSES BUILDING OR
CONTEMPLATED.**

- Somers, Wis.—M. A. Rasmussen, one house.
- Germantown, Pa. E. H. Gerschick, additions.
- St. Louis, Mo. A. G. Greiner, range of houses
- Philadelphia, Pa. Victor Groshens, house 20x500.
- Albuquerque, N. M.—John Woodward additions.
- Augusta, Me.—Eastern Maine State Hospital, one house.
- Wilkesbarre, Pa.—John Maddern, two houses, 15x50, 20x50.
- Beaumont, Tex.—C. J. Axelson, two houses, one 24x162, one 14x110.

PATENTS GRANTED.

- 913,205. Insect Destroyer. Asa O. Elithorp, Dougherty, Okla.
- 913,217. Greenhouse Construction. Eugene F. Kurowski, Chicago, Ill., assignor to The Jno. C. Moninger Co., Chicago, Ill.
- 913,225. Weed-Puller and Tree-Trimmer. Axel N. Moline, St. Joseph, Mo.
- 913,290. Pruning Implement. Eben N. Higley, Somersworth, N. H., assignor to Maude Higley, Somersworth, N. H.
- 913,525. Lawn Mower. Augustus L. Le Vine, Freehold, N. J.

INCORPORATED.

Litchfield, Conn.—The Rosemere Nursery Co. Wm. T. Marsh, John L. Puel, Alice T. Buckley; capital, \$15,000.

GREENHOUSE CONSTRUCTION LUMBER

John C. Moninger Co.
117 E. Blackhawk St., CHICAGO.



Evans 20th Century Arm
Will not twist the shafting pipe. Three times the power of old style elbow arms Sold only with Evans Challenge Machine
Write for Free Catalogue to
QUAKER CITY MACHINE CO.
Richmond, Ind.

Holds Glass Firmly
See the Point **PEERLESS**
FULL SIZE No. 2
Glazing Points are the best. Six rights or 100s. Box of 1,000 points 75 cts. postpaid.
HENRY A. DREER,
214 Chestnut St., Phila., Pa.

“REVERO”

Braided Moulded Construction—Seamless Throughout



LIGHT--STRONG--FLEXIBLE



The above cuts represent the non-kinking tendency of Revero as compared with the old style hose of wrapped duck construction.

Re-vero is Furnished on Reels in Continuous Lengths up to 500 feet. Your supply man can furnish it

Revere Rubber Company,
BOSTON, MASS.

NEW YORK
NEW ORLEANS

PHILADELPHIA
MINNEAPOLIS

PITTSBURG
SAN FRANCISCO

CHICAGO
PORTLAND, ORE.

STANDARD PLATE GLASS CO.

Manufacturers—Importers—Jobbers

NOW IS THE TIME TO BUY

FRENCH OR AMERICAN GREENHOUSE GLASS

LOWEST PRICES ON REQUEST

26-30 Sudbury St.

BOSTON, MASS.

61-63 Portland St.

GLASS

Always Write Us Before Buying
SHARP, PARTRIDGE & CO.
22nd and Lumber Streets, CHICAGO
WE HAVE SOME SNAPS

CYPRESS SASH BARS
82 feet or longer
HOT BED SASH
PECKY CYPRESS BENCH LUMBER

GREENHOUSES

ERECTED AND EQUIPPED COMPLETE IF DESIRED

Write for Circular "D" and Prices

The A. T. STEARNS LUMBER CO.
NEPONSET, BOSTON, MASS.

In ordering goods please add "I saw it in HORTICULTURE."

PATENTS

Trademarks and
Copyrights

Send your business direct to Washington. Saves time and insures better service. Personal attention guaranteed. Twenty-five years' active service. SPECIALTY: "Working on the Failure of Others."

SIGGERS & SIGGERS

PATENT LAWYERS

Box 9, National Union Building
Washington, D. C.

**The FLORISTS' HALL ASSOCIATION
OF AMERICA, insurer of 29,000,000
sq. ft. of glass.** For particulars address
John C. Esler, Secy Saddle River, N. J.

THE QUESTION OF STRENGTH

IT is conceded that the strongest and most durable structure known is "THE IRON FRAME." And when you have all the **Modern** features combined in this type of construction you have "**The Ideal Greenhouse.**"

The picture shows the beautiful symmetry of my "**Curved Iceless Eave**" — no heavy antiquated shading members. And I also make a specialty of having my work harmonize with surrounding conditions. **Note** how the mason work on greenhouse conforms to that on adjacent stable.

The advice of "**The Practical Greenhouse Builder**" is at your disposal for the asking.

WILLIAM H. LUTTON
West Side Ave. Station, JERSEY CITY



Erected at Davenport Neck, New Rochelle, N. Y.

KROESCHELL BOILER



MADE OF FIRE BOX FLANGE PLATE
Can not Crack!

Water Space in Front, Sides and Back
The Most Popular Boiler Made

SEND FOR CATALOGUE.

KROESCHELL BROS. CO.
35 Erie Street, CHICAGO, ILL.

THE FOLEY MFG. CO.

CHICAGO

Completely equipped with up-to-date machinery for the making of material for

GREENHOUSE CONSTRUCTION

From a Full Supply of Thoroughly Seasoned Lumber

Send your sketches to our draughtsmen for completion and suggestion. Permit us to figure your proposed work, large or small.

We guarantee our prices will save you money
FOLEY VENTILATING APPARATUS IS THE BEST
is Simple in Erecting. Is Easiest of Operation. It Will Last a Lifetime. Its Price is the Lowest. Will Ventilate Any Size House. Prices and Circulars on Application.

Our 1908 Catalogue Greenhouse Material Sent Postpaid on Request.

THE FOLEY MFG. CO., WESTERN AVENUE
25th and 26th STS., CHICAGO



The Advance Ventilating Apparatus

is now in use in forty States, in all classes of houses and working under all conditions, and has pleased every customer. Price of machine complete \$10.50 Arms and hangers, &c., at right prices. It will take care of the ventilation of a 200 ft. house readily. Get our estimates and give us a trial.

The Advance Co.
RICHMOND, IND.

EVERYTHING FOR GREENHOUSE BUILDING

WRITE FOR INFORMATION AND PRICES

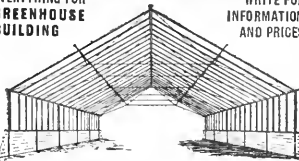

King Greenhouses. King Gutters and Eaves. Trussed Roofs. Ventilating Machinery. Trussed Iron Frame Houses. Tile Benches and Pipe Hangers.

KING CONSTRUCTION COMPANY
NORTH TONAWANDA, N. Y.

Please Note

that this is not a $\frac{1}{4}$ in. wire affair but it is made of heavy rods.

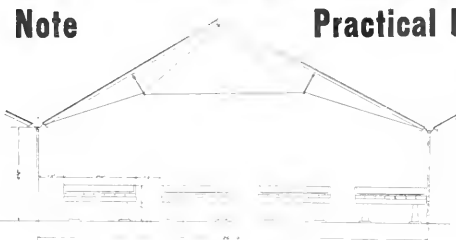

Practical Houses

on a practical financial basis. If you want an up-to-date house that will save you money,

WRITE

GEO. M. GARLAND CO.

Designers and Builders

DES PLAINES, ILL.

BOSTON PLATE & WINDOW GLASS CO.

GREENHOUSE GLASS

GERMAN AND AMERICAN

261 to 287 A Street

BOSTON

20 to 22 Canal Street

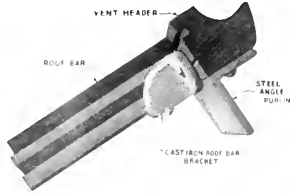

HEADER FACTS

You know that it is not safe construction to depend on a couple of nails, toed into the header, to hold the bars.

The same roof bar brackets that are such stiffeners on our eaves, we also use at the header.

An angle purlin stiffens the cypress header, which is grooved for the glass, and milled with a drip gutter.

Other construction facts shown in new circular — send for it.

Hitchings & Company
 1170 Broadway New York



The Purely Practical

Here's a house 18 ft. wide and 50 ft. long with two compartments. You see the shingle sides are substituted for the usual masonry foundation, which of course makes a less expensive job but quite as attractive. There are many little wrinkles we can point out to you to bring your house within a certain limited expenditure. None of these wrinkles however will in any way affect either the superior growing qualities or endurance of the house. It will be our sectional iron frame construction just the same. The best thing for you to do, is get in touch with us.

Lord & Burnham Co.
 Main Sales Office: 1133 BROADWAY, N.Y.
 BOSTON: 849 Tremont Building. PHILADELPHIA: 1215 Filbert St.



ABOUT ITS ERECTION

Taken side by side, with conditions equal, the U-Bar house can be erected with least trouble and greatest speed. Look at a U-Bar house and it is plain enough why — rafter and roof bars combined in one — the entire frame reduced to a mere web — no complicated fittings to bolt up — one third less glazing to do, because the glass is spaced one third wider — simply straight away work from start to finish. If yours is a case where time counts and where greatest endurance and highest productiveness are requirements, then send for a catalog and get in immediate touch with us

U-BAR GREENHOUSES

PIERSON
 DESIGNERS AND BUILDERS



U-BAR CO.
 1 MADISON AVE. NEW YORK

HORTICULTURE

Vol. IX. MARCH 27, 1909 No. 13

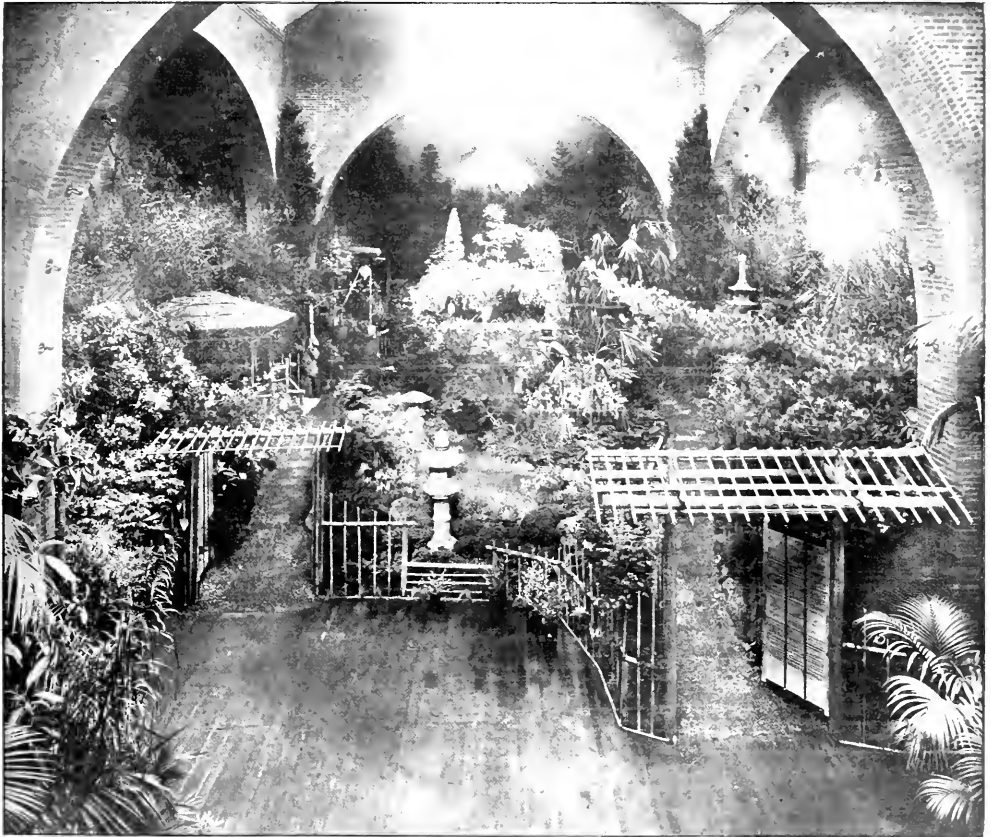

JAPANESE GARDEN AT BOSTON SPRING SHOW
By R. J. Farquhar & Co.

DEVOTED TO THE
FLORIST, PLANTSMAN, LANDSCAPE GARDENER AND KINDRED INTERESTS
PUBLISHED EVERY SATURDAY AT 11 HAMILTON PLACE, BOSTON, MASS.
SUBSCRIPTION, \$1.00 PER YEAR



MAR 29 1909

NEW ROSE

WHITE KILLARNEY

We Know You Will Want to Buy White Killarney



Every live, progressive, up-to-date grower who has seen it is buying it; but when you buy White Killarney, be sure you get the right White Killarney (the Waban variety). When you buy from us you get the variety that has been exhibited and certificated, and the one that has attracted such favorable mention.

If you are in the vicinity of New York, we should be glad to have you call and see White Killarney growing at our Scarborough range, and you will say at a glance—as everyone has who has seen it growing—that it is by far the best white rose that has ever been placed on the market.

It is not only a good winter-flowering rose, but is good the entire year, and it is a splendid shipper. Read the following letter received from Mr. Willis N. Rudd, Secretary of the Society of American Florists, dated January 18th, in which he writes as follows:

"Dear Mr. Pierson:—I cannot refrain from writing you and expressing my admiration for the White Killarney as shown at Chicago on Thursday. It is an exquisitely beautiful thing and attracted much attention. I took half the blooms home with me, and they were finer on Saturday than they were at the show. The town, staged and exhibited during the afternoon. They were then carefully wrapped up in a box, and remained in that box until one o'clock Friday morning, at which time I reached home; improved in quality up to Saturday, and were in fairly presentable condition on Sunday.

"In addition to being the most beautiful white rose of its class which I have seen, this demonstrates its splendid keeping and shipping qualities."

W. N. RUDD."

We were awarded Silver Cup at National Flower Show, Chicago, for best new rose with White Killarney; also Silver Medal Horticultural Society of New York.

Strong plants, 2 1/4 inch pots, own roots, now ready for delivery, \$30.00 per 100; 250 for \$70.00; 500 for \$125.00; 1000 for \$250.00. Grafted plants, ready April 1st, \$35.00 per 100; 250 for \$82.50; 500 for \$150.00; 1,000 for \$300.00.

F. R. PIERSON CO., Tarrytown-on-Hudson, NEW YORK

ROSES
Grafted BY MARYLAND, BRIDE, BRIDESMAID, KILLARNEY, RICHMOND.
Own Root RICHMOND, QUEEN BEATRICE.
 This is A No. 1 Stock from Prize Winning Sources of highest repute.
 2 1/2 to 3 1/2 in. pots. Delivery immediate or will hold until July 1.
MONTROSE GREENHOUSES
MONTROSE, MASS.

A. N. PIERSON, Inc., Cromwell, Conn.
WHITE KILLARNEY (Waban Strain)

GRAFTED STOCK.....	Doz.	50	250	500	1000	2500	5000
		\$5.00	\$25.00	\$50.00	\$100.00	\$250.00	\$500.00

MY MARYLAND GRAFTED.....\$3.00 per doz., \$20.00 per 100, \$150.00 per 1000
OWN ROOT " " 2.00 " " 10.00 " " 90.00 " "
 STANDARD VARIETIES
 Betty, Bon Silene, Bride, Bridesmaid, Cardinal, Enchanter, Etoile de France, Etoile de Lyon, Franz Deegan, Gen. McArthur, Golden Gate, Hermosa, Ivory, Kai Erin Augusta, Victoria, Kate Moulton, Killarney, La Detroit, Maman Cochet, Marechal Niel, Mme. Abel Chatenay, Mrs. Jardine, Mme. Hoste, Mrs. Paul Niehoff, Mrs. Pierpont Morgan, Mrs. Potter Palmer, Papa Gontier, Queen Beatrice, Rhea Reid, Richmond, Rosaline Orr English, Souv. du President Carnot, Souv. de Wootton, Uncle John, Wellesley, White Cochet. The above Grafted (selected plan \$120 cts. each, \$2.00 per doz., \$15.00 per 100, \$110.00 per 1000).

Newport Fairy
 The Rose of the Future For In and Out Door.
FINE, STRONG FIELD-GROWN STOCK
 3-4 Shoots 3-4 ft. long
 50c each, \$30 per 100, \$250 per 1000
JULIUS ROEHRS CO.,
 RUTHERFORD, N. J.

OWN ROOT ROSES
 Killarney, Bride, Bridesmaid, Mme. Abel Chatenay, Ivory, Richmond, Mrs. Paul Niehoff. 2-1/2 in. pots, 75c per doz., \$3.50 per 100, \$31.00 per 1000. 2 1/2 in. pots, \$1.00 per doz., \$6.00 per 100, \$50.00 per 1000.
 Queen Beatrice, Rhea Reid, Mrs. Jardine, Mrs. Potter Palmer, from 2 1/2 in. pots, \$8.00 per 100, \$70.00 per 1000.
BEDDING PLANTS
 COLEUS, Verschaffeltii, Golden Queen, Queen Victoria, Beckwith Gem, Firebrand, Lord Palmerston. Rotted Cuttings by express, \$6.00 per 100, \$5.00 per 1000. Out of 2 1/2 in. pots in May, \$2.00 per 100, \$15.00 per 1000.
 Golden Buzzer, Hero Messy, Pearl of Orange. Fancy Varieties. Twelve kinds not listed above, 75 cts. per 100, \$5.00 per 1000.
 AGERATUM, Stella Gurney Princess Pauline. SALVIA, Splendens, Bonfire and Zurich. HELIOTROPE. Dark blue bedding varieties. GERMAN IVY. 75 cts. per 100, \$6.00 per 1000.
 ALTERNANTHERA. Red and Yellow. 50c per 100, \$5.00 per 1000. From 2 1/2 in. pots, \$2.00 per 100.
 SALLEROL. Rotted Cuttings, \$1.00 per 100, 2 1/2 in. pots, \$2.50 per 100.
CHRYSANTHEMUMS IN QUANTITY. Catalogue on Application.

CHRYSANTHEMUMS
 Golden Glow—plant Middle May to July—Cut Middle Aug. to Oct.—White Cloud—ao 8 inch Jap.—extra strong stem. Plant late May and early June—Cut Middle Oct. to Nov. 1st—Pacific Supreme—no longer stemmed—brighter—non-fading—Clory of the Pacific. Bedded now will increase stock to 10 by planting time—Delivery Plants—March \$5.00 per 100; April \$4.50; Fall Season \$4.00; Rotted Cuttings now, post or express paid, \$4.00 per 100; 25 at 50 rates.
J. H. MYERS, ALTOONA, PA.

CHRYSANTHEMUM SEED.
 Wells' New Early Flowering Singles, packets 25c and \$1.00 each.
PENTSTEMON SEED
 Wells' New Hybrids, packets 25c and \$1.00 each
CHARLES H. TOTTY, Madison, N. J.

Gladiolus Brenchleyensis
 Extra fine Healthy Imported Stock
1,000 \$10.00 10,000 \$80.00
O. V. ZANGEN
HOBOKEN, N. J.

ROSES

We have a fine stock of large, dormant, field grown plants, on own roots, of the following varieties:

Boule de Neige, Mad. Plantier, Alfred Colomb, Perle des Planches, Climbing Clothilde soupert, Archduchess Elizabeth of Austria, Empress of India, Glory of the Exposition of Brussels, Philadelphia Crimson Rambler, Fisher Holmes, Chestnut Hybrid, Climbing Wootton, Magna Charta, Countess of Roseberry, Louis Van Houtte, Dorothy Perkins, Anna de Diesbach, Mad. Alfred Carriere, Vieux Capitaine, Sir Thomas Lipton, Francois Levet, Eugene Furst, Crimson Rambler.

PRICE \$12.50 per 100; \$120 per 1000

Tausendschon, the great new climber, \$20 per 100.

Crimson Baby Rambler, \$16 per 100.

Fine plants from 2 1/2 inch pots, **Chrysanthemum** Glory of the Pacific, \$3.50 per 100.

Roses, Dahlias and Cannas a Specialty.

Catalogue Free

The Dingee and Conard Co. West Grove, Pa.

WHITE KILLARNEY

"WABAN CONSERVATORIES VARIETY"

Order From Us

WABAN ROSE CONSERVATORIES

NATICK, MASS.

Hardy Rhododendrons, Azaleas, Conifers, Clematis, H. P. Roses, Shrubs and Herbaceous Plants from our **HOLLAND NURSERIES**

Prices Moderate

P. OUWERKERK, 216 Jane St., Weehawken Heights, P. O. No. 1, Weehawken, N. J.

GLEARY'S HORTICULTURAL CO.

Management AMBROSE T. GLEARY

Wholesale Contracting, Jobbing, Auction

HORTICULTURAL PRODUCTS

of every description.

Consignments Received. Surplus Stock Converted

62 Vesey St., NEW YORK

A THING OF MERIT.

NEW HARDY FLOWERING SHRUB.

Buddleia variabilis Veltchil and Magnifica—summer flowering Lilac—blooms when all other shrubs are past. Strong 3 yr. old, 50¢; each; \$5.00 per doz.; \$25.00 per 100.

Rose Hill Nurseries, New Rochelle, N. Y.

Box Trees

and other EVERGREENS for Tubs and Boxes

Our Prices are Always Right—Catalog Free

THE NEW ENGLAND NURSERIES, INC.

BEDFORD, MASS.

Guaranteed Nursery Stock

Of All Varieties and Sizes

WRITE FOR LOWEST PRICES

P. HAMILTON GOODSSELL

200 BROADWAY NEW YORK

Hardy Herbaceous Perennials

Well-grown plants of all the standard varieties at reasonable rates.

SEND FOR TRADE CATALOG.

DANIEL A. CLARKE

RED OAK NURSERIES, Fiskeville, R.I.



CHRYSANTHEMUM BELFAST

BELFAST

The New Christmas-Flowering Chrysanthemum

Of the largest size light pink shading to cream. Can be brought into bloom from Thanksgiving to Easter but is at its best about Christmas. Easily grown and claimed to be for the commercial growers the most profitable variety ever introduced. It comes into bloom after every other variety is through, is a great keeper and can be held on the plants for four weeks. Last Spring the originator cut the last blooms April 11. 2 1/2 inch pots sec. \$5 per doz.; rooted cuttings \$4.50 per doz., \$18 per 100.

Carnation Bay State

Winner of the Gold Medal at Indianapolis. From 3/4 inch pots, \$3 per doz. Rooted cuttings of all other desirable varieties, old and new, at lowest prices.

Tuberose, Calladiums, Gloxinias, Tuberous rooted Begonias, Florists' Flower Seeds and Sundries.

Send for Wholesale Price List.

SCHLEGEL & FOTTLER CO.

26-27 So. Market St., Boston.

RHODODENDRONS, ANDROMEDAS, KALMIAS AND SPECIMEN EVERGREENS

JOHN WATERER & SONS, Ltd.

AMERICAN NURSERY

BAGSHOT - - - ENGLAND

SOME OF OUR SPECIALTIES

Boxwood Pyramid Shape, 2 1/2 to 3 ft. high, very heavy, \$1.75 each, 3 to 3 1/2 ft high, \$2.50 each. Bush Shape, very heavy, 2 to 2 1/2 ft., \$1.75 each, 2 1/2 to 3 ft. high, \$2.00 each. Rhododendrons, Parson's Hardy varieties, 8 to 12 buds, 18 to 24 in. high, at \$75.00 per 100; 12 to 14 buds, 24 to 30 in. high, at \$100.00 per 100. Azalea Tolls, 15 to 18 in. high, very bushy and full of buds, at \$35.00 per 100. Hybrid Perpetual Roses, strong dormant field grown plants, of our own growing, none better, \$11.00 per 100, \$100 per 1000. Moss Roses, field grown, \$1.00 per 100. Hardy Climbing Roses, field grown, \$8.00 per 100. Tree Roses, hardy varieties, budded on straight stems, 4 to 5 ft. high, \$30.00 per 100. Ampelopsis Veltchil, bushy, 2 yr. plants, 3 foot of tops, \$10.00 per 100.

The Storrs & Harrison Co., Painesville, Ohio

TREES, EVERGREENS, SHRUBS, VINES, PERENNIAL PLANTS, FRUITS, TRAINED FRUIT TREES, FOREIGN GRAPE VINES, HARDY RHODODENDRONS and R. MAXIMUM in quantity, per hundred or per thousand, very fine. Complete assortments: Careful grading: Low prices.

AMERICAN NURSERY COMPANY,
Sales Department, - - - - 150 BROADWAY, NEW YORK CITY.
BLOODGOOD NURSERIES DEPT., - - - - Flushing, Long Island.
F. & F. NURSERIES DEPT., - - - - Springfield, New Jersey.

NURSERY STOCK FOR FLORISTS' TRADE

AMERICAN GROWN ROSES, AZALEAS, RHODODENDRONS
FRUIT AND ORNAMENTAL TREES, SHRUBS, SMALL FRUITS, CLEMATIS,
EVERGREENS
WRITE FOR OUR TRADE LIST
W. & T. SMITH COMPANY 63 YEARS 700 ACRES GENEVA, N. Y.

Berberis Thunbergii Finest of Hedge Plants

12-13 in., \$5.00 per C. \$40.00 per M.

One year seedlings, 3-5 in. \$5.00 per M. All ready for immediate delivery.

C. R. Burr & Company, Manchester, Conn.

Catasetum maculatum



Male Flowers



Female Flowers

In the great natural order of Orchideae the genus *Catasetum*, together with its allies *Cynoches* and *Mormodes*, stands out very prominently from the rest of that great and varied family. It is not the beauty of their flowers, for these are as a rule more homely than beautiful, but the wonderful construction of these flowers and the habit of producing from the same bulb both male and female flowers which are very distinct from one another both in form and color, that makes these plants so interesting to the lover of flowers and of orchids especially.

Our illustrations show *Catasetum maculatum* with a raceme of eight male flowers and the same plant and pseudo-bulb with a raceme of five female flowers produced about two months later. The male flowers are of a yellowish green color shaded and suffused with brown (usually the flowers of the species are densely spotted with brown) whereas the female flowers are a pea-green with darker shadings of the same color. The male flowers are freely produced on the different species, but it is very seldom one has an opportunity to see female flowers or to see and compare both sexes together. The male flowers, *C. maculatum*, for instance, have been known since 1822 when they were collected by Humboldt and Bonpland at Turbaco, Columbia (see *Orchid Review*, Vol. XVII, p. 38), but female flowers of the genus were not known until 1893 when they appeared at Kew and shortly afterwards at the Royal Botanic Gardens, Glasnevin. They might have appeared elsewhere prior to that time, but were not recognized as belonging to that genus: in fact very little was known in those days of the separation of the two sexes in these genera and to this day the female flowers of some species are still unknown and in a few instances female flowers have appeared where the corresponding male flowers were unknown. It is a very perplexing genus for botanists to work on.

The pictures show the difference between the sexes very plainly except for the two horns which are connected with a case covering the pollen masses. These two antennae or horns descend (or ascend), rather, as the flowers appear to grow upside down) into the pouch and they are so sensitive at the ends, that upon the slightest

touch the pollen mass, consisting of two egg-shaped yellow masses attached to a short column, will be released, jump out with considerable force and stick to whatever insect or other object it may happen to strike.

These sensitive horns which make the male flowers so interesting are absent in the female flowers; the pouch in these latter is much more massive and more globose than in the former and will adhere to the column until the seed is ripe.

The culture of *Catasetum* is very simple. I use *osmunda* fibre with a little sphagnum moss for a compost, small pots and plenty of drainage. While growing they will require stove temperature, suspended where they can get the maximum of light. Water very sparingly until the new pseudo-bulbs commence to swell out, else they are very apt to rot off. After the pseudo-bulbs commence to swell give plenty of water (occasionally liquid manure) until they are fully matured; then water is at first gradually, and later entirely withheld until the plants start to grow again. They are rested in a temperature of 50 degrees to 55 degrees in full sun.

M. J. Cope

Naugatuck, Conn.

The Great International Horticultural Exhibition in Berlin

This big affair instituted by the Verein Zur Beforderung des Gartenbaues and which takes place from April 2-13 this year, in the Berlin Zoological Garden, enjoys the sympathy of the various authorities, corporate bodies, and of a wide section of the public. The Protector of the Verein is the Kaiser Wilhelm II, who will present a magnificent Prize of Honor from the Royal Porcelain factory. The Crown Prince and the Crown Princess intend to award other Prizes of Honor. A number of prizes will be given by many of the cities of Germany.

Friedrich Schroder

HORTICULTURE

VOL. IX MARCH 27, 1909 NO. 13

PUBLISHED WEEKLY BY
HORTICULTURE PUBLISHING CO.
 11 Hamilton Place, Boston, Mass.
 Telephone, Oxford 292
WM. J. STEWART, Editor and Manager

SUBSCRIPTION PRICE

\$2.00 Year, in advance, \$1.00; To Foreign Countries, 2.00; To Canada, \$1.50

ADVERTISING RATES

For each, 30 inches to page \$1.00.
 Discounts on Contracts for consecutive insertions, as follows:
 One month (4 times) 5 per cent.; three months (12 times) 10 per cent.;
 six months (24 times) 20 per cent.; one year (52 times) 30 per cent.
 Page and half page spaces, special rates on application.

Entered as second-class matter December 8, 1904, at the Post Office at Boston, Mass., under the Act of Congress of March 3, 1879.

CONTENTS

	Page
COVER ILLUSTRATION—Japanese Garden at Boston Spring Show.	
CATASETUM MACULATUM—M. J. Pope—Illustrated.	425
THE GREAT INTERNATIONAL HORTICULTURAL EXHIBITION IN BERLIN—Frederick Moore.	425
SODIUM CYANIDE AND POTASSIUM CYANIDE—Dudley M. Pray.	427
BRITISH HORTICULTURE—W. H. Adsett.	427
RECOLLECTIONS OF FATHER TERRY—C. S. Harrison.	427
NEWS OF CLUBS AND SOCIETIES:	
American Rose Society—N. Y. and N. J. Association of Plant Growers—Buffalo Florists' Club—Royal Horticultural Society.	429
New York Florists' Club—North Shore Horticultural Society—American Carnation Society—Club and Society Notes.	430
THE EXHIBITIONS:	
Massachusetts Horticultural Society—Spring Show at Philadelphia.	431
Boston Music Hall Market Exhibition—Illustrated.	432
OBITUARY:	
Marie C. Hauswirth, Portrait—Mrs. Emily Rose Youell.	433
ROSE TOPICS:	
What to Do Among Roses in March, Frederick Moore—My Maryland Rose.	434
Rose Harry Kirk.	435
NOTES ON EASTER PLANTS:	
A Visit to Craig's, G. C. W.	436
A Look-in at Schultheis—Easter Plants in Chicago.	438
SEED TRADE:	
The Season's Record—Bean Scarcity—About Onion Seed.	440
Demoralizing Cuttings—The Free Seed Answer—Hearing on Proposed Seed Inspection Law at Albany—Tariff Committees of American Seedsmen, Florists and Nurserymen.	442
OF INTEREST TO RETAIL FLORISTS:	
Washington Notes—Steamer Departures—Detroit Notes.	444
Flowers by Telegraph—New Flower Stores.	445
FLOWER MARKET REPORTS:	
Boston, Buffalo, Chicago, Philadelphia, Indianapolis.	447
New York.	449
MISCELLANEOUS:	
During Recess.	430
Pierson's Display of White Killarney at Buffalo—Illustration.	430
A Letter to the Donors of the Scott Memorial Fund.	433
An Effective Spray.	438
Personal.	445
News Notes.	436-456
Greenhouses Building or Contemplated.	457
Business Changes.	457
Catalogues Received.	457
Fire Record.	457
Incorporated.	457

An opportune gift

The American Rose Society is to be congratulated on the substantial gift received from Mrs. Gardiner G. Hubbard of Washington, as announced in our news columns last week. Mrs. Hubbard has been a life-long patron of horticulture, formerly at Cambridge, Mass., and later at Twin Oaks, Washington, D. C., from whence have come some widely-known productions—notably nymphaeas raised by her very proficient gardener, Peter Bisset. We hope to see Mrs. Hubbard's good example followed by others not only in the interests of the rose but to encourage and advance the improvement of other floral products. We cannot have too many such friends of the "art which doth mend Nature."

Still they come

While perhaps less altruistic in sentiment, the gift to the Rose Society from our contemporary, The Garden Magazine, is certainly a generous one and the award of the medals offered, in the manner as proposed, cannot fail to awaken an appreciative response. The recognition of meritorious achievement as distinct from competitive preeminence is a step worthy of the highest approbation and if carried on with due care and wisdom will undoubtedly prove a healthy incentive to zealous effort for cultural excellence and in the production of new races and improved types. With the two medal funds above mentioned, three thousand dollars in the treasury, and the cordial support of so many of the most intelligent and progressive men in American Horticulture, a brilliant future seems now assured for the American Rose Society.

A new feature in horticultural exhibitions

The problem of securing the support of the public at horticultural exhibitions, with the double end in view of making these affairs financially profitable and educating the people in flower appreciation and garden art, is far from being satisfactorily solved in this country. To the extent that the spring show now in progress in Boston is an effort in that direction its outcome will be peculiarly interesting and may have a far-reaching bearing on the manner of planning and carrying out future enterprises of like character in Boston and elsewhere. Not all halls are fitted for the placing of such an exhibition as the one under consideration. Adaptability for concerts, balls and similar social affairs and adaptability for garden shows where water may be thrown around with impunity, are not exactly reconcilable under one roof and in this connection it may be stated that the Japanese garden which is so strong a feature in the present show is the only attempt since the completion of the Horticultural building, to take advantage of the peculiar features of this hall on the lines as intended by the gentlemen responsible for its planning. Because of these very departures from the conventional style and construction of assembly halls this building has been the subject of more or less criticism. While it is conceded that radical changes must be made before the hall can be rented to advantage and made to yield the much-needed annual revenue, yet it is gratifying that at last a partial demonstration of its possibilities as originally planned has been given the members and the public. Those who visit this show will perhaps better understand what we have had in mind when urging the necessity of breaking away from the antiquated and unearned-for system of long tables with rows of flower vases and rows of fruit plates if we expect to awaken public interest in horticultural exhibitions.

Sodium Cyanide and Potassium Cyanide

Editor of HORTICULTURE:

Dear Sir:—The following explanation concerning sodium cyanide and potassium cyanide may be of interest to readers of your paper.

Both these substances are composed of cyanide, combined in the one case with sodium and in the other with potassium. With salts of equal purity there would be more cyanide in the sodium cyanide than in the potassium cyanide in the ratio of about 5 to 4. Potash costs more than soda, and there is less soda in the one than there is potash in the other.

When the sulphuric acid is added, the cyanide is let loose and potassium or sodium sulphate is left behind in the dish and, while the sulphate of potash is more valuable than sulphate of soda, this is not a matter of any moment, for it is not common to use this impure sodium sulphate as a fertilizer.

From the horticultural point of view the consideration is the gas made from the sulphuric acid and the cyanide, and it can make little or no difference whence it comes in the case of these two salts.

From the commercial point of view, the question is, to get cyanide as cheaply as possible. It is common to quote prices on these two chemicals not so much per pound for one or the other, but to quote a price in the ratio of about 5 to 4 of the cyanide content. In this case the buyer may pay his money and take his choice unless there are some minor points that may influence him, in one way or the other, of which we have not spoken.

As a matter of fact we would expect that the cyanide in sodium cyanide should be purchased a wee bit cheaper than cyanide in potassium cyanide for the reasons above mentioned; unless the manufacture of the sodium salt is more expensive, which we do not believe. So on the whole there can not be any tremendous advantage in the use of either one over the other.

Rudley M. Pray

British Horticulture

THE PERPETUAL FLOWERING CARNATION SOCIETY

An interesting display is expected at the show which will be held by this Society in London on March 24th. At the annual meeting it was reported that a scheme for the registration of the names of new varieties has been adopted. The scale of points for judging and for awarding certificates and awards of merit has been altered. A variety must gain at least 85 points to entitle it to a first-class certificate, and 75 points to entitle it to an award of merit. The points allowed are as follows: Color, 20; size, 20; fragrance, 10; substance, 10; calyx, 5; habit of plant, 20; form, 15. Two cups have been presented to the Society—one by the American Carnation Society and the other by Lord Howard de Walden. It has been decided that these trophies shall be held as challenge cups in perpetuity.

THE R. H. S. FIXTURES

An exceptionally fine display was made at the forced spring bulbs show at the Royal Horticultural Society's hall on March 9th. An excellent list of fixtures has been arranged by the Society for the remainder of the year. On April 20th an auricula and primula show will be held, and on May 14th there is to be a show of

tulips. The spring flower show takes place at the Temple Gardens on May 26th. The first Masters' memorial lecture is to be delivered by Prof. Hugo de Vries, on June 22. The summer show at Holland Park takes place on July 6. Other important dates are July 21, carnations; July 23, sweet peas; Sept. 16, autumn roses; Dec. 1, colonial grown fruit and vegetables; Dec. 8, winter carnations.

W. H. Adsett,

London, Eng.

Recollections of Father Terry

I had heard occasionally of this patient, hard-working man, and about seven years ago I made him a visit. It was when his glorious peonies were in full bloom. Up to that time his collection was the finest I had ever seen. The man impressed me from the first. His was the soul of beauty. He was a favorite of good mother Nature and seemed at home in her very "holy of holies." How he loved his flowers. We spent a long time among them and I helped him name some of them.

He had already originated some 50 kinds of plums and had named perhaps 75 kinds of peonies. The number afterward reached 100. With soul attuned to the beautiful, with an intense desire to benefit the world with his new creations, in financial matters he was as helpless as a child. I contrasted his condition with Kelsey of England. Taking out half a dozen of his finest, Terry had as choice a collection as Kelsey. The races each was propagating were different; very many of the English born were far too delicate and sensitive to our western condition. Planted side by side, one class in a trying season would hardly produce a flower while those born in Iowa were full of vitality and the great robust blossoms would seem to look down on their foreign sisters with pity.

The difference between the two men was largely in printer's ink. One man was selling plants of no especial merit at enormous prices and another was selling very fine ones at a low price and the whole stock seemed to go begging. I asked him how much he was selling a year? Only about \$100 out of that splendid collection. The sight was pathetic. All around was dilapidation. The barn had been burned up. The house was poor, old, unpainted and uncomfortable. The wife—a noble woman—was working beyond her strength. It recalled the case of Bull of Concord fame—a wonderful faculty for blessing the country and the age and no faculty whatever for getting money out of it.

You need not wonder I took the case, writing for papers with a half million circulation. I told as best I knew how of his grand work. Two years after I visited him again and he was selling \$1,000 worth a year and soon after he sold most of his collection for \$2,500. The help did me good and it was but justice to him.

I spent his 80th birthday with him. His soul was still young and he was planning for the future. He and his wife belonged to one branch of the Saturday Saints. Not the Utah polygamous bunch but to the evangelical branch led by the sons of the founder who are utterly repudiated by the main body of the Mormons. Such a man ought not to be forgotten. He named and put on the market too many peonies. But at least 10 of them are of superior merit. They will perpetuate his memory and his soul will smile through them upon thousands of admirers for years to come.

York, Neb.

C. S. Hammon

NEWS OF THE CLUBS AND SOCIETIES

SOCIETY OF AMERICAN FLORISTS AND ORNAMENTAL HORTICULTURISTS.

Meeting of the Executive Board.

Pursuant to the call of President Valentine the regular mid-Lent meeting of the Executive Board was held at the Sinton Hotel, Cincinnati, March 13, 15 and 16. Those in attendance were President Valentine, Messrs. Traendly, Vesey, Gillett, Dailledouze, Asmus and Rudd.

The usual routine business was transacted, including the adoption of a program for the annual convention next August.

A protest against the charges for space at the late trade exhibition at Niagara Falls was received and after careful consideration of the matter the following resolution was adopted:

"In view of the fact that it is not shown that the parties protesting were charged on any different basis than many other exhibitors who have paid their bills without protest, the board cannot see how in justice to the other exhibitors any rebate can be made in the special cases in question." In view of the dissatisfaction at the late trade exhibit and of the constant friction between exhibitors and managers in years past, it was decided that for the next exhibition the charges for space would be largely reduced and in consideration of that reduction the exhibitors would be required to furnish their own tables and cloth covering for them.

The question of rules for the exhibition was referred to a special committee with instructions to prepare and present at a later session a thorough revision of them.

The report of the treasurer and the financial report of the secretary for the year 1908, and also supplemental reports covering the months of January and February, were received. The financial reports of the secretary were presented as approved and endorsed by a firm of public accountants, in accordance with a resolution adopted at the meeting of 1908. These reports were submitted, together with the vouchers, to a committee consisting of Messrs. Traendly and Vesey, and were examined by them and reported correct, and were then received by the board.

A recommendation from the society for the election of an honorary member was considered, and it was decided that as there was no specific provision for the election of an honorary member in the by-laws, it was inexpedient to authorize such action.

It being considered that the presidential addresses in the past have not been properly acted upon and that many important recommendations have failed of attention, the president was requested to appoint a committee in advance of the convention and to submit to the members of this committee copies of his address, and the committee be instructed to make a special report on the address and its recommendations and some time to be specifically set aside in the program for

a general discussion of the address and its report.

A proposed amendment increasing the fee for life membership from \$25 to \$50 was received and ordered printed in the program for action at the next convention.

A request from the Cincinnati Florists' Club that they be allowed to issue tickets and collect admission from the general public on Thursday in place of receiving any portion of the proceeds of the trade exhibition otherwise, was granted.

It was decided that all interest on the society's funds, both general and permanent, collected during the year 1908 should be transferred to the permanent fund.

In connection with the committee of the local club, the board examined the halls submitted for the trade exhibition and the meetings, namely: two floors in the Music Hall for the trade exhibition and the Ocean Hall for the meetings, and accepted them. The usual appropriations were made for the year.

The secretary was authorized to deposit copies of the old reports of the society now on hand with various experiment stations, libraries and public institutions willing to accept and care for them, when it would appear that such deposit would render them available to the public and advance the general interests of horticulture.

The treasurer's report showed that the permanent fund now amounted to over \$6,000, and it was deemed that steps looking to the permanent investment of the same be taken and a committee consisting of Treasurer Beatty and Messrs. Vesey and Dailledouze was appointed to make such investment.

The following resolution to the memory of the late Edward V. Hallock was received and adopted:

To the memory of Edward V. Hallock.—We, the members of the Executive Committee of the Society of American Florists and Ornamental Horticulturists, in session assembled, have no words at our command that will express our sorrow for the taking from our midst of our fellow worker and beloved friend, E. V. Hallock. We desire to extend to his family our heartfelt sympathy. He was a good man and true, honorable and conscientious and loved by all who knew him. Peace to his ashes; not our, but thy will be done. Therefore be it resolved, that these few lines be spread upon the minutes and a copy be forwarded to the bereaved family.

The Exhibition Rules Committee reported that a proper revision of the rules would require very careful consideration and would take more time than was available. They were therefore given power to act in the matter at a later date.

Mr. Wm. Murphy having been recommended by Vice-President Gillett and the Cincinnati Florists' Club for superintendent of the trade exhibition, was unanimously elected to that office.

A resolution was adopted that no goods should be sold at retail at the trade exhibition of this society. It was also decided that an advisory committee of three should be appointed for the trade exhibition. E. F. Winterston was appointed chairman of the Sports Committee.

Mr. Rodgers having requested the board to name some persons who

would be qualified to speak regarding floriculture before Chautauqua Associations, the following names were suggested: E. G. Hill, Robert Craig, P. O'Mara, John T. Withers, Leonard Baron.

The visit of the board to Cincinnati was made most enjoyable by the hospitality shown by the local members. The banquet at the Sinton House on Monday evening was a most enjoyable event. The entertainment by the club on Saturday night was most thoroughly appreciated and the invitation extended to the board by Mr. and Mrs. Peterson and Mr. and Mrs. Witterstaetter resulted in most enjoyable visits to their beautiful homes and places of business.

The following final resolutions were adopted:

"In closing the session we wish to tender our thanks to the Cincinnati Florists' Club and its members for their friendly reception, their effective assistance and their magnificent hospitality, and our thanks are especially due to Mr. and Mrs. Peterson and Mr. and Mrs. Witterstaetter for inviting us to their homes and receiving us with such lavish and open-handed hospitality."

Registration of Clematis.

Public notice is hereby given that the Jackson & Perkins Company of Newark, N. Y., offer for registration the plant described below. Any person objecting to the registration of this plant, or to the use of the proposed name, is requested to communicate with the undersigned at once. Failing to receive objection to the registration the same will be made three weeks from this date.

Parentage—*Clematis paniculata* X *Clematis viticella* rubra.

Description—Color of flower, deep carmine. Size and shape of flower and manner of blooming is same as *C. paniculata*.

Name—*Clematis paniculata* rubra. - W. N. RUDD, Secretary.

March 19, 1909.

MINNESOTA STATE FLORISTS' ASSOCIATION.

The monthly meeting of the Minnesota State Florists' Association, held at Snelling Ave., March 16 was well attended.

Primula denticulata exhibited by Mr. L. Bröglin scored 72 points; *Primula obconica* by Nagel & Son 79 points, and *Violets Princess of Wales* by Hans Rosacker 78 points. The final report of the entertainment committee was not yet ready, but the chairman, Mr. Olson, reported a probable deficit of about \$20.00. Messrs. Cosgrove and Underwood from the Board of Managers of the Minnesota State Fair were present and explained matters pertaining to the premium list and larger space for exhibits of cut flowers, etc. It is up to the influential members of the association to work the Legislature for satisfactory appropriation. If the money is forthcoming, the Board of Managers will grant us what we ask for.

Mr. W. P. Frazer, from the State Agricultural School, gave a very interesting talk on Fertilizers and their Analysis, which was thoroughly discussed.

AMERICAN ROSE SOCIETY,
Buffalo's Feast.

The banquet which the Buffalo Florists' Club tendered the American Rose Society was held on Thursday evening instead of Friday, as at first announced, on account of out-of-town guests leaving on Friday morning. President Poehlmann called the meeting to order and resolutions were read on the death of Louis M. Noe and E. V. Hallock. W. F. Kasting acted as toastmaster. He was seated between the Mayor of Detroit and the Mayor of Morton Grove, and remarked upon its being a Democratic banquet, but not politically; this allusion by the toastmaster being warmly received. Mr. Poehlmann made entertaining remarks pertaining to the society and the excellent show that was had in Buffalo, and warmly congratulated the committee and the Buffalo Florists' Club on the able manner in which the affair was conducted. A rising vote of thanks was extended to the Buffalo Florists' Club, and the president further stated that he hoped to see the club members and brother florists of Buffalo and adjoining cities and towns at the next convention in New York the coming year.

Thursday, March 17th, being the 62nd birthday of Mr. Robert Craig, the secretary was instructed to telegraph congratulations to him.

Benj. Hammond, secretary of the American Rose Society, was next called upon and made a characteristic speech full of hopeful augury for the future of the society and its patrons.

Alex. Montgomery, past president and one of Boston's leading rose growers, next made an interesting address on cultural and society topics.

Robert Simpson, another ex-president, made brief remarks regarding the work of the society, stating that new members are continually coming in and better exhibits are being shown every year, which proves that the society is growing rapidly and that much interest is being manifested in the excellent shows which have been held.

The "Florist Mayor" of Detroit, Philip Brelmeyer, responded to the toastmaster's congratulatory introduction with characteristic tact and effect.

J. A. Valentine, president of the S. A. F., was next heard from, and his remarks were warmly received. F. R. Pierson, vice-president elect of the society, contributed a brief talk about the coming show next year. He stated that every effort will be made to make it equal the Buffalo exhibition, and incidentally referred to the agitation for tariff revision on bulbs.

Our report of the prize awards at the Rose Show in Buffalo last week omitted to mention the Traendly & Schenck special premium for vase of fifty American Beauties which was won by the Brant & Hentz Floral Company. The prizes for fifty Killarney were contributed by the Erie Floral Company; for fifty Richmond, by F. R. Pierson; for twenty-five American Beauty, by W. J. Palmer & Son; for collection of Teas and Hybrid Teas, by Robert Simpson; for arrangements of twelve roses in vase, by J. A. Valentine, and for thirty-six Killarneys by E. C. Ludwig.

NEW YORK AND NEW JERSEY
ASSOCIATION OF PLANT
GROWERS.

On March 15th, 1909, the members of the New York and New Jersey Association of Plant Growers visited the establishments of their members on Long Island to inspect the Easter crops. There were eighteen in number, and they travelled over the entire Long Island section in Mr. W. H. Siebrecht's automobile touring car.

One of the objects for which the association was incorporated is to foster the trade and to diffuse information as to pot plant growing. With this object in view the happy party called at almost every member's place on Long Island, and examined the plants in stock for the Easter trade. It was a very instructive day for the members and the information which was gathered made it well worth the time which was lost during their absence from their own establishments. The association has followed this practice for two years and has found it so profitable that it intends to continue the same indefinitely. The party started at the place of Herman Dreyer at Elmhurst, and from there proceeded to College Point and visited Anton Schultheis, and after seeing all the houses in that establishment they passed to Whitestone and visited Louis Dupuy, Pankok & Schumacker and the Hinode Florist Company. From there a long run was made to Jamaica, L. I., where they visited A. L. Miller's greenhouses, and from there the party proceeded to Brooklyn, where at Piel Bros. a bounteous course dinner was awaiting them. After dinner they proceeded to the establishment of John Scott in Flatbush, thence to Peter Wagner, Charles Zeller & Sons on Clarkson street, and also on Lettets street, Brooklyn, thence to the houses of Louis Schmutz and Frank Manker. It took considerable time to go through each establishment, and when the rounds had been made it was after six o'clock and the party had enjoyed sufficient fresh air in the automobile to gather up a good appetite for the supper which was served to them in the Consumers' Park.

The following members were in the party: Julius Roehrs, Sr., Herman Dreyer, Louis Dupuy, Frederick H. Dressel, Frank Manker, Herman Manner, A. L. Miller, John Messelm, Pankok & Schumacker, Herman C. Steinhoff, Herman Schoelzel, Anton Schultheis, John Scott, Louis Schmutz, Peter Wagner, Alfred L. Zeller, and William H. Siebrecht, Jr., the secretary and attorney for the association. Mr. H. H. Lorenz had charge of the automobile.

BUFFALO FLORISTS' CLUB.

The regular meeting of the Buffalo Florist Club will be held on Tuesday, April 6th, at their rooms and an urgent request is made by the secretary that every member be present as installation of officers is one of the important features. It is being rumored about that the officers-elect are to tender a champagne banquet after the meeting.

ROYAL HORTICULTURAL SOCIETY OF LONDON.

The meeting of this society held in the hall, Vincent Square, Westminster, on Tuesday, March 9th, was literally packed with exhibits from the trade and amateur cultivators and professional gardeners. The attendance of fellows of the society and general public was exceedingly great from noon onward to the close of the show at 6 P. M.

Orchids were not so numerous as on the previous occasion, and some of the novelties were the same. J. Veitch & Sons, Royal Exotic Nursery, Coombe, Wood, Langley and Feltham, all of them in London or within a few miles of it, contributed hybrid *Cypripediums* of *C. villosum* and *C. Euryalis*, which possessed a good deal of variety in shape, purplish-brown spotting or streaks of that tin on the dorsal sepal, all having also more or less white on the margin. The petals and pouch are of various brown tints, tinged with crimson, and the flowers of varying size. A *Laelio-Cattleya callistoglossa* presented very large blooms and a grand lip of a deep purple color. Other orchids shown by this firm consisted of fine varieties of *Odontoglossum crispum*, *Od. Pescatorei*, a *Dendrobium Ophir*, a hybrid between *Den. aureum* and *Den. signatum*, partaking in color—a primrose yellow—of the first named parent, and also of its fragrance something between violets and primroses.

The flowers of the hybrid have a slight purple stain and a number of striations in the throat. F. Sander & Sons exhibited extensively orchids in flower. These included *Cattleya Trianae* Queen Alexandra, with two very large white blooms having an orange stain in the lower half of the throat; *C. T. elegantissima*, with a pleasing fringed edge to the lip and a large sized flower; *Laelio-Cattleya Blechleyensis Imperiale*, having a deep purple colored lip, and all other parts of the flower of paler tints. A hybrid between *Zygopetalum Perrenoudii* and *Acanthis lepidia*, and having the name *Zygonesia Sanderii*, came from the Sander firm, the *Zygopetalum* parent being the prepotent one, as appeared by the decidedly blue tint of the lip, and other features. *Odontoglossum Harvenstense* var. had a yellow ground and a white margin, beside brown blotches on all the limbs of the flower. *Od. Heleus*, derived from a cross of *Od. Harvenstense* and *Od. Coradinei*, is a beautiful flower having a slight suffusion of pink on the lower half of the petals, and a ground color of lemon yellow on all other parts. The sepals are spotted with brown—a remarkable flower of three inches in width. There were several other hybrids having *Od. Harvenstense* as a parent, *Laelio-Cattleya Firebrand*, a cross of *L.-C. Highburyensis* and *C. Trianae*, has yellowish-rose petals and a rosy purple lip and throat of a crimson tint.

A very extensive collection of various orchids came from the gardens of Sir J. Colman, many of them rare in cultivation and admirable examples of cultivation. I noted among the plants *Dendrobium tetragona*, *Den. speciosum fistiforme*, *Sophro-Laelia Mariottiana*, *Phaio-Calanthe*, the plants hav-

ing chiefly pale tints. These are the Colman varieties; some new Epidendrum—hybrids growing 6 to 8 ft. high and having blooms of various shades of orange-scarlet, hybrids of *Den. nobile alba* mostly showing light tints.

Mr. Cypher, orchid cultivator, Cheltenham, had several fine things, as for instance *Den. Apollo alba* and *Den. Thwartshii* and *Odontoglossum Wigianum*, *Od. amabile* and others.

First-class certificates were awarded to Cattleya Trianae Grand Monarch, a flower of a rosy purple tint in all its parts, excepting the lip, which is of a rich purple tint stained orange in the throat. It was shown by Mr. Monteith Oatvie, of the Shrubbery, Oxford. Messrs. Charlesworth & Co. got a certificate for a plant of *Brasso-Cattleya*. It is a light-colored bloom, boldly fringed with purple. This firm was also awarded a certificate for *Odontioda Bradshawiae*, a vivid scarlet bloom.

NEW YORK FLORISTS' CLUB.

The annual outing will occur on July 1, 1909, at Duer's, Whitestone Landing. The hustling committee in charge, with H. A. Bunyard, chairman, and J. Austin Shaw, secretary, announce details as follows:

"Steamer Isabel starts at 10 A. M. Breakfast at 12. Dinner at 6. Moonlight sail 7 to 9.30. Bowling, dancing, games. Prizes. Souvenir book. Fine orchestra, big crowd. Gardeners' societies, retail organizations all asked to participate. Tickets \$5.00 for lady and gentleman; \$2.00 for extra ladies; \$1.00 for children under 12.

NORTH SHORE HORTICULTURAL SOCIETY.

At the meeting March 19 the subject discussed was *Gloxinias*. A fine vase of carnation Beacon was exhibited by Alfred Parson, gardener for E. S. Grew. The Gardeners' and Florists' Club of Boston were guests of the evening and among those present were President William Downs, John Guerinneau, Julius Iwerlin, George E. Baldwin of Carillo & Baldwin, N. J. and John Kirkegaard of the New England Nurseries, Belford, Mass.

AMERICAN CARNATION SOCIETY. Carnations Registered.

By Bertermann Bros. Co., Indianapolis, Ind.—"James Whitcomb Riley." Color clear, golden yellow; parentage Lawson and unknown yellow seedling; size 3 to 3 1-2 inches; habit like Lawson but with longer stems.

ALBERT M. HERR.

Lancaster, Pa.

CLUB AND SOCIETY NOTES.

The Inter-Town Dahlia Association held its first meeting of the season on March 19, at Ansonia, Conn.

Prof. E. F. Hitchings, state entomologist, delivered a lecture before the Bar Harbor (Me.) Horticultural Society on the evening of March 18.

The Indianapolis Florists' Club held its regular monthly meeting March 19, with a good attendance. The Club will send a bowling team to Cincinnati this summer.

The following officers were elected



PIERSON DISPLAY OF WHITE KILLARNEY AT BUFFALO MEETING OF AMERICAN ROSE SOCIETY

at the March meeting of the Dayton (O.) Florists' Club: H. H. Ritter, president; H. M. Frank, secretary; Geo. Bartholomew, treasurer.

George W. Cable addressed the Springfield (Mass.) Amateur Club on March 11 on the adornment of home grounds, a subject on which the Springfield people seem to be thoroughly aroused just now.

Patrick F. Reynolds has resigned his position as recording secretary for the Newport Horticultural Society. He has been a most courteous and efficient secretary and his resignation on account of other important duties was very much regretted by the society. He is succeeded by Daniel J. Coughlin, a former secretary.

The R. I. Horticultural Society and the R. I. College united in a course of three lectures, which were given at Providence on March 16, 17, 18, by Wilfrid Wheeler on "Small Fruit Growing on the Intensive Plan," H. W. Collingwood on "Successful Orchardring," and J. K. M. L. Parquhar on "Landscape Gardening for Home Decoration," respectively.

Shenandoah, Ia. The Ratekin Seed Co. has announced their intention to erect one of the largest seed houses in the West. The building is to be 60x150, three stories and basement, constructed of brick and cement and fireproof throughout. The approximate cost will be \$50,000.

DURING RECESS.

The Retail Florists' Association of Brooklyn, N. Y., celebrated March 16 with an evening at the theatre and supper later.

The Chicago florists have organized a Bowling club to meet each Friday night at 118 Monroe street. At the first meeting held on the 19th, there was a good attendance and a delightful evening was spent. Allie Zech's team carried off the honors. The absence of the ladies was the only drawback. All florists are invited.

On March 18, St. Paul and Minneapolis got together once more for a friendly contest on the bowling alleys. St. Paul was very confident of winning three games, then two, then one, Minneapolis was just the opposite; after the losing they got sometime ago, they were ready to take another dose. It came out otherwise, Minneapolis beat St. Paul in three successive games. St. Paul challenged Minneapolis for another tournament in St. Paul in the near future.

SCORES.

St. Paul	Minneapolis
Dysinger 118 126 124 Wirth 111 133 106	
Hangan 145 158 107 Reeglin 132 151 151	
Dill 143 102 134 Ruell'g'r 173 166 175	
Hansen 129 120 163 Will 160 145 146	
Olsen 165 157 147 Carlson 125 126 133	
Totals 638 673 675	Totals 701 721 711

EASTER NUMBER NEXT WEEK

A Grand Medium for Spring Trade Advertising

SEND COPY EARLY! EARLY!! EARLY!!!

THE EXHIBITIONS

MASSACHUSETTS HORTICULTURAL SOCIETY.

The great spring exhibition at Horticultural Hall, Boston, long planned and talked about and involving an immense amount of work for many during the past weeks and months is on and the town is full of florist visitors from far and near. The exhibition is not only the most pretensions ever undertaken here but is pronounced by all observers to be the most complete and pleasing they have ever seen. The variety, quality and profusion of the exhibits are grand and bewildering and the public are certainly given full value for their money in the glory of color and verdure, the music and the brilliancy of electrical effect.

The large exhibition hall has never presented so impressive a spectacle. The stupendous effort of the Messrs. Farquhar—the Japanese garden which is very inadequately depicted on our cover page—is the great centre of attraction and the visitors troop in sinuous lines continuously up and down its winding paths, over bamboo bridges, under rocky growths and around pools and cascades overhung with purple and white wisterias and quaint contorted maples and thuyas, among great masses of blooming azaleas, lilies, peonies, magnolias, forsythias, spiraeas and a thousand and one species and varieties of shrubbery and rock garden material. The work of arrangement is finished to perfection, even to the crevices of the rocks which buttress the winding walks, which are filled here and there with ferns and mosses and other appropriate things.

M. H. Walsh's great collection of over fifty trained Rambler roses on each side and magnificent group of greenhouse plants from the Harvard Botanical Garden on the other formed an impressive setting for the approach to the bamboo gates which opened into the Japanese garden. Mr. Walsh's roses included quite a number of new covers, both single and double, and the size of flowers is, in many of them, considerably increased over that of his earlier introductions. He was the winner of a silver and a bronze medal in addition to the cash prizes in this class. The big palms in the Botanical Garden exhibit partially screened the orchestra of young ladies in the balcony, so tall were they.

The lecture hall was a veritable blaze of color. The stage and was filled with an enormous group of Easter flowering and foliage plants from Thomas Roland and the opposite end was correspondingly filled by Ed. MacMulklin. Either one of these groups must have contained more than a thousand dollars' worth of plants. Lesser groups occupied the sides of the hall and alternating between them were the mantels decorated by retail florists. The winning mantel was by MacMulklin; the decorations were yellow and green, acacia, daffodils and pansies being daintily used. Mrs. E. M. Gill with a tasteful arrangement of pink carnations, pink ramblers and green was second and S. Hoffman with masses of Killarney and pink

rambler roses was third. The hall was filled with tables and plant groups with a wealth of floral beauty such as has rarely been gathered together. Great masses of feathery Cineraria stollata, brilliant amaryllises, cyclamens of wonderful beauty, pot roses, stately ericas, azaleas, acacias, long ranks of hyacinths and tulips and thousands of daffodils made a scene not soon forgotten. Especially interesting to the craft was a balloon trained specimen of Gloriosa Rothschildiana beaming over fifty blooms, brought by Arthur Griffin of Newport.

The small hall was radiant with a beautiful display of orchids, carnations, roses, sweet peas, violets and schizanthuses. Roses were effectively shown by F. R. Pierson Co., Waban Rose Conservatories, W. H. Elliott and Montrose Greenhouses, the White Killarney by the first two named being the sensational attraction. Sweet peas by Wm. Sim were in his usual high quality and great variety and Norris F. Conley also staged two vases of peas of phenomenal quality. Patten & Co.'s white Geracieve was a prime attraction among the carnations. In the vestibule John Streifer & Co., had a brilliant group of genistas and standard variegated abutilons.

Among the visitors were W. F. Gude and A. Gude, Washington, D. C.; Henry Wild, Greenwich, Conn.; Frank McMahon, Seabright, N. J.; Ed. Roehrs, Rutherford, N. J.; Chas. Loechner, Max O. Jordan, J. M. Keller, Geo. P. Struck, New York; W. A. Manda, South Orange, N. J.; J. F. Huss, Hartford, Conn.; Timothy McCarthy, Providence, R. I.; R. W. Green, Warwick, R. I.; Wm. Eccles, Oyster Bay, N. Y.; Richard Gardner and Arthur Griffin, Newport, R. I.; C. S. Strout, Biddleford, Me.; Robt. Ballantine, Canandaigua, N. Y.; Jos. Manda, West Orange, N. J.; E. W. Newbrand, Tarrytown, N. Y.; and a whole swarm of North Shore, South Shore and inland New England gardeners and florists.

Special Awards.

R. & J. Farquhar were awarded a gold medal for Japanese garden. Silver medals were given to Mrs. A. W. Blake (J. L. Smith, gardener), for Nephrolepis Piersoni; Mrs. J. M. Sears, Amaryllis; Arthur Griffin, Gloriosa Rothschildiana; Harvard Botanic Garden, artistic display.

First-class certificates of merit were awarded to W. W. Rawson & Co., for Narcissus King Alfred; W. A. Riggs, Rose Tausendschon; Larz Andersn, Laelia elegans; E. O. Orpet, Brassica Nuxasanna (Cattleya Thaysvattana X Prassavola Digbyana); Julius Roehrs Co., Odontoglossum crispum var. E. P. Dane; Julius Roehrs Co., Cattleya Schroederia var. Surprise; E. B. Dane, Cyrtopidium Mandii; M. H. Walsh, Rambler Rose Mail Marion.

Cultural certificates to Thomas Roland for Cytisus racemosus, Wm. McGilivray for Dracaena Godseffiana.

Honorable mention to Robert Ballantine, Dwarf Blue Cinerarias; New Hampshire Agricultural College, seedling carnations.

Vote of thanks to E. O. Orpet for collection of cut orchids.

Regular Prizes.

Azalea Indica—Eight plants, 1st, Edward MacMulklin; 2d, E. W. Breed. Three plants for private growers only; 1st, Wm. Whitman; 2d, Wm. Whitman. Palms—Palm: 1st, Edward MacMulklin; 2d, Mrs. Frederick Ayer; 3d, William Whitman. Ericas—1st, Mrs. Frederick Ayer; 2d, Mrs. Frederick Ayer. Hard-Wooded Greenhouse Plants—2d, J. R. Lawson. Rainier, Rosses—for private growers only; 1st, Miss S. B. Fay. Group of Roses. All classes admissible open to commercial growers only; 1st, M. H. Walsh; 2d, M. H. Walsh. Forced Hardy Herbaceous and Alpine Plants, arranged for effect—1st, Bellevue Greenhouses. Cyclamens—Twelve plants, in not over seven-inch pots; 1st, Dr. C. G. Weld; 2d, J. S. Bailey; 3d, Dr. C. G. Weld. Six plants, in not over ten-inch pots; 1st, E. J. Mitton; 2d, Mrs. Frederick Ayer; 3d, Mrs. Frederick Ayer. Cinerarias—Grandiflora type; 1st, W. A. Riggs; 2d, Dr. C. G. Weld; 3d, J. S. Bailey. Solimantha; 1st, Mrs. J. L. Gardner; 2d, J. S. Bailey; 3d, Mrs. J. L. Gardner. Cinerarias—Stellata type; 1st, Wm. Whitman; 2d, Wm. Whitman; 3d, Mrs. J. L. Gardner. Hyacinths—Six pans, six bulbs of one variety in each pan; 1st, W. A. Riggs; 2d, Wm. Whitman. Single pan, with ten bulbs of one variety; 1st, Mrs. J. L. Gardner; 2d, ditto; 3d, ditto. Early Tulips—1st, Wm. Whitman; 2d, W. A. Riggs; 3d, Mrs. J. M. Sears. Late Tulips—1st, W. A. Riggs; 2d, Mrs. J. L. Gardner. Narcissus—Collection of Large Trumpet varieties; 1st, Wm. Whitman; 2d, W. A. Riggs; 3d, Mrs. J. L. Gardner. Collection of Short Trumpet varieties; 1st, Wm. Whitman; 2d, Mrs. J. L. Gardner. Amaryllises—1st, Mrs. J. M. Sears; 2d, Mrs. J. M. Sears. Group of Easter Flowering Plants—Arranged for effect with palms of other foliage; 1st, Thomas Roland; 2d, Edward MacMulklin. General Display of Spring Bulbous Plants—All classes, arranged with foliage plants; 1st, Wm. Whitman. Orchids—Group of plants, arranged for effect with ferns or other foliage plants; 1st, E. B. Dane; 2d, Seth A. Border; 3d, E. J. Mitton. Specimen plant; 1st, Mrs. A. W. Blake; 2d, Seth A. Border. Rosses—American Beauty; 1st, Waban Rose Conservatories; 2d, F. R. Pierson Co. The Bride; 1st, Montrose Greenhouses. Richmond; 1st, Montrose Greenhouses. 1st, Montrose Greenhouses; 2d, W. H. Elliott. Killarney; 1st, W. H. Elliott. Any other Pink variety; 2d, W. H. Elliott. Any other variety; 3d, W. H. Elliott. Any new named variety not in competition; 1st, E. B. Dane & Co. Miscellaneous Vase of 100 flowers variety; 1st, M. A. Patten. 25 Crimson; 1st, M. A. Patten. 2d, Wilfred Wheeler; 3d, Edward Winkler. 25 Dark Pink; 1st, C. S. Strout. Any Winsor shade variety; 1st, C. S. Strout; 2d, M. A. Patten; 3d, Barker & Co. Embroiders-shade variety; 1st, R. D. Kimball; 2d, M. A. Patten; 3d, M. A. Patten. Scarlet; 1st, John Barr; 2d, M. A. Patten; 3d, R. P. White; 4th, M. A. Patten; 2d, C. S. Strout. White variety; 1st, M. A. Patten; 2d, R. D. Kimball. Yellow Variegated; 1st, M. A. Patten; 2d, R. P. White; 3d, Estey; 4th, Wm. Sim; 3d, H. M. Howard. 100 Double; 1st, J. S. Small; 2d, H. M. Sanders; 3d, Norris F. Conley. Sweet Peas—Two vases, distinct varieties, 100 blooms in each; 1st, Wm. Sim; 2d, Norris F. Conley. 100 Single, Antirrhinum; 1st, R. D. Kimball. Mixed Decorations; 1st, Edw. MacMulklin; 2d, Mrs. E. M. Gill; 3d, Sidney Hoffman.

SPRING SHOW AT PHILADELPHIA.

This annual event occupied three days of the week—Tuesday, Wednesday and Thursday. Although smaller, as to bulk and variety, than most of its predecessors, the quality of the exhibits was never better. Hyacinths, tulips and daffodils, were a leading feature, the competition for the prizes put up by the seedsmen being keen. Azaleas were conspicuous by their absence—the only notable showing in these being three magnificent plants from the Newbold place, with a six-foot spread, occupying a place of honor

in the main hall. Mr. Batchelor had these in the pink of condition and they deserved all honors. *Cineraria stellata* was shown in grand form and was a great attraction. This species has now become one of the most popular of spring subjects for parlor and conservatory use and for decorative effect at a flower show is far ahead of the hybrida.

Lilies were very fine in all classes, and two magnificent pans each with thirty eight dowers greeted visitors on first entering the hall—gracing the newel posts at the bottom of the stairway. The first prize for these went to the Elkins conservatories; but it was touch and go for Jno. Hedland there, as against the Newbold exhibit. Spireas occupied many prominent places and were the leading feature at the east end of the hall. *Primula obovata* was exceptionally well done, the Pepper lot which Mr. Robertson showed setting first mainly for superior size, while the Newbold exhibit although smaller plants was the best as to color. One lovely pure white flower in the latter was admired by everybody. Callas were a feature and were unusually good. An exhibit of the yellow and pink varieties came from Mrs. Penfield's place and reflected credit on John McLeary, the gardener.

The Dreer premiums brought out an interesting lot of herbaceous plants, which occupied the circle in front of the stage. Roses, carnations, and sweet peas were the features in the foyer aisles. The sweet peas were staged by William Sim, of Cliftondale, Mass., and captured the Burpee premium and a silver medal. Fifteen varieties were shown, all of them the new winter-flowering class originated by Zvolanek, and all in grand shape. No such sweet peas have been seen here before. Mr. Sim also exhibited four vases of violets—The Boston, Princess of Wales, Kaiser Wilhelm and Baroness Rothschild. John Cook, Baltimore, sent *Rose My Maryland*, also a vase of his new deep pink variety *Radiancé*—the latter being awarded a certificate of merit. John Stephenson's Sons, the Oak Lane florists, made all the experts sit up and take notice with two magnificent vases of Mrs. Jardine roses. Dorothy Gordon, Mr. Heacock's lovely new pink carnation was the most prominent exhibit in this class and attracted much attention. The Pennock-Meehan Co. sent Mr. Cockerell's new *White Georgia*. T. J. McCormick, Baltimore, sent a fine vase of his new variegated seedling, M. Thaw & Co., of the same city, exhibited seedling number 36, a very dark crimson. An interesting collection of cacti was staged by W. H. Ritter, Philadelphia. The seedsmen made a display of seasonable stock in the lower hallways.

The chief prize winners were: William Robertson, Samuel Batchelor, John McLeary, William Kleinbrinz, John Hedland and William Fowler. A first-class certificate was awarded to Arthur Griffin, Newport, R. I., for a fine plant of *Gloriosa Rothschildiana*, which was staged by Messrs. Knight & Struck of New York. Edward Tovill, Hillside, Pa., fresh from his honors at Buffalo, was on hand with a fine lot of *Rose My Maryland*.

BOSTON MUSIC HALL MARKET EXHIBITION.

The Boston Co-operative Flower Market held an exceptionally fine exhibition at their market Saturday, March 20, it being the first ever held by this organization.

Roses, carnations, violets and sweet peas were the center of attraction, while many exhibits of plants were also shown, those of Thomas Roland and W. F. Walke being deserving of special mention.

The table decorations and some beautiful designs of set pieces contributed by retail florists also attracted much attention.

The sweepstake prize presented to the exhibitor receiving the largest number of firsts was won by Norris F. Comley.

In the novelty class, orange blossoms from Edward Wood, "bachelor buttons" from Thos. Stock, and crotons from J. Rogers were all excellent.

A vase of gardenias from John Mc-

liam Tailby, John McFarland, Edward Wood, Elijah Cartwright.

Carnations.—Albert Roper, John Barr, Louis Small, Wilfred Wheeler, Albert E. Batley.

Miscellaneous.—Norris F. Comley, Carl Striford, J. W. Simpson, James Lister, Alvin H. Burges.

Below is a list of the awards:

Roses.

25 Killarney. Draman & Dow special, Robert Montgomery.

25 Richmond. Julius Zinn cup, Robert Montgomery.

25 Bride. Robert Montgomery, 1st; W. R. Morris, 2d.

25 Bridesmaid. W. R. Morris, 1st; Robt. Montgomery, 2d.

50 American Beauty. F. R. & P. M. Pearson.

50 Killarney. W. W. Rawson & Co. special, W. H. Elliott.

50 Bride. Montrose Greenhouses, 1st; W. R. Morris, 2d.

50 Bridesmaid. W. R. Morris, 1st; Montrose Greenhouses, 2d.

50 New Rose, 1908 and 1909. Schlegel & Futtler cup, Waban Rose Conservatories with White Killarney.

Carnations.

50 Scarlet. H. L. Sheed, 1st, Beacon;



Plant Group Winning Boston Plate and Window Glass Company's Cup at Music Hall Market Show by W. F. Walke.

Farland was one of the prime attractions of the exhibition and was awarded a first prize, as was also the vase of Killarney roses exhibited by Wm. Elliott.

The officers, judges and special committees to whom is due the credit for the success of the enterprise, are:

Elijah Cartwright, President; Donald Carmichael, Treasurer; John McFarland, Secretary.

Directors.—Edward Wood, Robert Montgomery, N. F. Comley, Albert Roper, L. E. Small, James Quinn.

Executive Committee.—John McFarland, Albert Batley, Albert Roper, John Barr, Robert Montgomery.

Judges: Roses.—Alfred R. Hinton, William F. Mollay, Adolph Cartwright; carnations, L. J. Reuter, Donald Carmichael, Thomas Capers; miscellaneous exhibits, Thomas Roland, William Walke, Thomas Greaves.

The committees in charge of the exhibits were as follows:

Roses.—Robert Montgomery, Wil-

fred Wheeler, John Barr, 2d, Beacon.

50 White. Patten & Co., 1st, White Perfection; E. Cartwright, 2d, Lady Bonifant.

50 Light Pink. John Barr, 1st, Winsor; Littlefield & Wyman, 2d, Enchantress.

50 Dark Pink. Littlefield & Wyman, 1st, Lawson; John Barr, 2d, Lawson.

50 Crimson. Wilfrid Wheeler, 1st, Harry Penn; R. F. Winch, 2d, Harry Penn.

50 Variegated. John Barr, 1st, Variegated Lawson; Patten & Co., 2d, Variegated Lawson.

Fair Maid. A. Roper special, L. E. Small.

100 seedlings not disseminated. T. J. Gray & Co. cup, A. Roper, Bay State.

Seedlings not disseminated. 50 White, Patten & Co., Genesee; 50 Crimson, L. E. Small; 50 Dark Pink, Peter Fisher, No. 505; 50 Light Pink, John Barr; 50 Scarlet, A. Roper, Red Seedling; 50 Variegated, A. Roper; 100 Any Color, John Barr, Beacon;

100 Queen, John Barr special, Thomas Capers.

Violets.

100 Lady Campbell. Lewis Smith, 1st; Lewis Small, 2d.

100 Marie Louise. N. F. Comley.

100 Any Other Double. N. F. Comley.

100 Princess of Wales. J. H. Newman, 1st; H. F. Woods, 2d.

Not less than five var. H. E. Fiske Seed Co. Cup. N. F. Comley.

DAILY SALES AT AUCTION

OF FOREIGN AND DOMESTIC CROWN ROSES

SHRUBS, EVERGREENS and BULBS

Of every description, Flowering Plants, Palms, Bedding Stock, etc., etc., from leading growers and importers. Catalogues Mailed on Request. Correspondence Invited.

TUESDAY, MARCH 30, WILL BE A BIG DAY with an exceptional assortment of Holland Roses, Rhododendrons, Azaleas, Shrubs and Evergreens, and a consignment of Tuberoses, Gladioli, Canna Roots, Dahlias, etc., in all sizes—true to name. Sales every day (except Monday) throughout the season.

TERMS CASH

JOHN P. CLEARY, Auctioneer

PROMPT DELIVERY

Growers and dealers will please note that account sales with remittance is rendered IMMEDIATELY AFTER AUCTION.

THE FRUIT AUCTION COMPANY

200-202-204 Franklin Street
NEW YORK

P.O. Box 640.

UNTIL FURTHER NOTICE SALES BEGIN AT 10:30 A. M.

Telephone 1515 Franklin

Sweet Peas.

- 100 White. N. F. Comley, 1st; L. E. Small, 2d.
- 100 Pink. N. F. Comley, 1st and 2d.
- 100 Any Other Color. N. F. Comley.

Miscellaneous.

- 25 Snapdragon. F. L. Hardy, 1st; S. J. Godard, 2d.
 - 25 Wallflower. C. J. Harvey.
 - 100 Lily of the Valley. J. McFarland, 1st; A. N. Pierson, 2d.
 - 50 Marguerites. E. J. Hearn, 1st; N. A. Hudson, 2d.
 - Group of Commercial Foliage and Flowering Plants. A. H. Hews & Co. Prize, Thos. Roland.
 - 25 Pots Cyclamen. John Barr.
 - Floral Basket. Sidney Hoffman.
 - Centerpiece for Table. H. M. Robinson & Co. Prize, H. R. Comley.
 - Bride's Shower Bouquet. Penn the Florist.
 - Wreath. J. A. Zinn & Co.
 - 100 Pansies. W. C. Ward, 1st; N. F. Comley, 2d.
 - Gardenias. J. McFarland.
 - Vegetables grown under glass. Hall & Cole Cup, C. Cummings.
- The cup offered by the Boston Plate & Window Glass Co. for 50 Richmonds not being competed for, was directed by the donors to be awarded for the most meritorious display in the exhibition. The winner was W. F. Walke with the group of plants illustrated on opposite page.

A LETTER TO THE DONORS OF THE SCOTT MEMORIAL FUND.

Dear Friends:
Ever since the movement was started to erect a monument to my beloved husband I wanted to thank you for your kind thoughts. The idea, starting as it did in the minds of a few, soon spread into many and later at Niagara Falls, when in so short a time the sum sufficient to place the stone was raised, I felt that it was a true and sincere appreciation for that which he had given you. Whatever he did for the profession of floriculture and the florists' themselves, he did with all the willingness he could put forth. Shakespeare said, "The evil that men do lives after them; the good is oft interred with their bones." Although true in cases, it was not so with my dear husband, for no greater tribute could be paid to the dead than that which you have erected to his memory. When, as in this case, one dear in memory to you, we stand and read what you have said, which is all that could be said of any man however great in the hall of fame, the massive stone and coldness of the situation disappears and only that remains which means so much to us.

I wish I could thank you one and all for myself and family, but I will resort to the press who have been so kind in this matter.

Very sincerely,

MRS. WM. SCOTT AND FAMILY.

Obituary.

Marie C. Hauswirth.

The death of Mrs. Marie C. Hauswirth of the firm of M. C. & J. E. Hauswirth, Chicago, on Friday, March 19, came as a great shock to her many friends. At her request the news of her illness had been kept from most of her acquaintances and few knew that

Philip Breitmeyer of Detroit, W. F. Kasting of Buffalo and F. Traendley of New York, were among those who sent floral remembrances.

The Ladies' S. A. F. sent a large wreath. This is the first death in the Ladies' S. A. F.

Marie C. Collnot was born at Laupen, a/n, Wuerttenburg, Germany, of French and German parentage, Jan. 5, 1841, and came to this country in early childhood. She was married at eighteen to Philip J. Hauswirth and was associated with him in business till his death, Dec. 4, 1907. Mrs. Hauswirth leaves a son, J. Edwin, her business partner since her husband's death, and a daughter, Elsa Hoyt, two infant grandchildren and a brother, Chas. Collnot.

Mrs. Hauswirth was an affectionate mother and her death will be deeply felt as this is the third time the dread visitor has entered the family within fifteen months. As a business woman Mrs. Hauswirth had few equals and in all her busy store life she yet had time to speak the cheerful word to her friends and assist others whenever possible. Hers was a strong character and as her friends viewed her remains lying under a bank of palms in the same place where they had so lately taken a final look at her late husband, they felt that her strong personality had left a lasting impression though she had scarcely reached middle age.

Interment was at Rosehill cemetery.

Mrs. Emily Rose Youell.

Mrs. Emily Rose Youell, wife of Henry R. Youell, died of heart failure Tuesday evening, Mar. 16th, at the family home, 111 Lexington avenue, Syracuse, N. Y., aged 67 years. Mrs. Youell had been ailing some time with bronchitis, but her death Tuesday came unexpectedly.

Mrs. Youell was born in England, the daughter of John Emily Hubbard, the noted veterinary surgeon. She was married to Henry R. Youell forty years ago. She is survived, besides her husband, by three daughters, Miss Mabel Youell, Mrs. Ernest Edwards of Fayetteville, and Mrs. Christopher J. Lambert of Sherburne, N. Y., and by a son Henry R. Youell.

The sincere sympathy of the trade is extended to the family in their bereavement.



MARIE C. HAUSWIRTH AND GRANDCHILD

she was not in her usual health till informed of her death. Mrs. Hauswirth was taken ill on Mar. 12 and removed to the German Hospital, where an operation for appendicitis was performed March 17, from which she never wholly rallied, passing away at eleven P. M., March 19. The funeral was from the home, 146 Clybourne Ave., Chicago, March 22nd, and was very largely attended. The pall bearers were her business associates, E. C. Whiterson, Joe Curran, Alex. Henderson, Geo. Asmus, E. Blaine and H. N. Bruns.

Among the florists from out of town who attended the funeral were J. A. Valentine of Denver, Colo.; C. C. Pollworth, Milwaukee; Ed. Fancourt, Philadelphia; Fritz Bahr and wife of Highland Park, Ill.

THE QUALITY YOU CAN MAKE MONEY ON

CANNAS

SOUND PIECES TRUE TO NAME BED ROCK PRICES

Red-Flowering, Green Foliage

	Per doz.	100	1000
A. Bouvier. 5 ft. Dark crimson.....	\$0.35	\$2.25	\$22.00
Alice Roosevelt. Deep crimson. 4 ft.....	.50	3.50	30.00
Beaute Polveine. 2½ ft. Dark crimson.....	.35	2.25	20.00
Black Prince. Velvety maroon. 3 to 4 ft. Green foliage.....	.50	2.75	25.00
Charles Henderson. 4 ft. Bright crimson.....	.35	2.25	20.00
Crimson Bivider. 3 ft. Intense scarlet.....	.30	2.00	17.50
Duke of Marlborough. 4½ ft. Dark crimson.....	.35	2.25	20.00
J. D. Elsie. Brilliant vermilion-scarlet 3 ft.....	.35	2.25	20.00
Explorateur Crumple. Deep rich crimson 5½ ft. Express. Crimson foliage green. Dwarf habit. 2 to 2½ ft.....	.60	4.50	40.00
Pres. McKinley. Brilliant crimson 2½ to 3 ft.....	.35	2.25	20.00

Pink-Flowering

L. Patry. Delicate rosy pink, 4½ ft.....	\$0.35	\$2.25	\$20.00
Luray. Attractive rosy pink, 3 ft.....	.35	2.25	20.00
Louise. A grand pink, tall Martha Washington. Rose. Height, 2½ to 3 ft. rose each.....	.75	5.00	
Mlle. Herat. 4½ ft. Rose-carmine.....	.35	2.25	20.00
Tennyson. Rosy pink; green foliage; 5½ ft.....	.50	3.00	

Orange-Flowered

	Per doz.	100	1000
President Cleveland. Bright, distinct orange-scarlet; 4 ft.....	\$0.35	\$2.25	\$20.00

Red, Gold-Edged and Spotted

Gladiator. Bright yellow, spotted crimson, green foliage; 4 ft.....	\$0.50	\$2.75	\$25.00
Cimabar. Cimabar-red, edged with distinct golden band; 4½ ft.....	.30	2.00	17.50
Queen Charlotte. Scarlet gold edge.....	.30	2.00	17.50
Mme. Crozy. 5½ ft. Vermilion, gold border.....	.35	2.25	20.00
Premier. Deep crimson, bordered yellow; 2½ ft.....	.30	2.00	17.50
Souy. D' A. Crozy. 4 ft. Crimson, gold band.....	.50	4.00	35.00

Yellow Shades

Buttercup. 3½ ft. Clear golden yellow.....	\$0.40	\$2.75	\$25.00
Comte de Bonchard. Yellow, spotted red, 4½ ft.....	.30	2.00	17.50
Florence Vaughan. 5 ft. Yellow, spotted crimson.....	.50	2.75	25.00
L. E. Bailey. Rich yellow, dotted with red; 4½ ft.....	.30	2.00	17.50

White and Cream Shades

Alsace. 3½ ft. Creamy white.....	\$0.30	\$1.75	\$15.00
----------------------------------	--------	--------	---------

Bronze-Leaved, Red-Flowering

Brandywine. 4 to 5 ft. Dark bronze foliage. Crimson flowers.....	\$0.50	\$4.00	\$35.00
Black Beauty. True. 5 ft. Grand foliage.....	.60	4.50	40.00

	Per doz.	100	1000
David Harum. 3½ ft. Vermilion-scarlet.....	\$0.50	\$2.75	\$25.00
Egaulde. 4 ft. Currant-red.....	.35	2.25	20.00
King Humbert. Fine Bronze foliage. Orange-scarlet with bright red markings; 4 ft.....	1.00	8.00	75.00
Leonard Vaughan. 4½ ft. Bright scarlet.....	.35	2.25	20.00
Musafled. The finest foliaged Cannas, with enormous musa-lice leaves, 3 by 5 ft. of a dark green bronze-tinged color.....	.35	2.25	20.00
Philadelphia. A bright glowing red. Height 5 ft.....	.75	4.00	30.00
Papa Nardy. Large, rich carmine-red, 4½ ft.....	.30	2.00	17.50
Pillar of Fire. 6 to 7 ft. high; flowers bright crimson-scarlet.....	.75	4.50	40.00
Ronasta. Height 6 to 8 ft., with immense foliage.....	.30	1.75	15.00
Shevadoah. Large Salmon flowers, 6 ft.....	.30	1.75	15.00

Orchid-Flowering

Allemania. 4 to 5 ft. Scarlet and yellow. Green foliage.....	\$0.25	\$2.25	\$20.00
Austria. True canopy yellow; no orchid-flowering type. 5 ft.....	.30	1.75	15.00
Italia. 4½ ft. Green foliage. Red band; red yellow.....	.30	2.00	17.50
Kronus. Rich golden yellow, with patches of bright red foliage.....	.30	1.75	15.00
Mrs. Kate Gray. 6 ft. high. Green foliage. Scarlet and yellow.....	.30	2.00	17.50
Pennsylvania. 5 ft. Green foliage. Deep scarlet.....	.35	2.25	20.00

CATALOGUE FREE.

We go through the block from 14th Street to 13th Street, but our address is still

ARTHUR T. BODDINGTON, Seedsman, 342 West 14th St., NEW YORK CITY.

WHAT TO DO AMONG ROSES IN MARCH.

In this month, early or late according to latitude, elevation and local conditions, all kinds of roses should be pruned, cutting back shoots injured by frost to the first sound, dormant bud. The harder climbing plants on arches, pergolas and fences should be the first to be pruned, removing immature and weak wood, fastening the shoots that are left to the various objects named, at a sufficient distance apart to allow of good growth without much crowding. These climbing varieties, such as the new and scarcer Aid's Pillar (a H. T.), a velvety crimson rose, with large and smooth petals, vigorous and distinct foliage; Bessie Brown, cream-colored, perfect in form and of large size, a variety that has leaped in favor quickly—very fragrant; Climbing Malmae de Watteville, very vigorous in growth; England's Glory, a climbing Tea of the form of Gloire de Dijon, but with longer petals, of a pleasing pink-peach tint, a rampant grower and very floriferous; Helene (T.) Ideal (a new climbing Polyantha), a sport from La France, and an improvement in every respect on that favorite variety; Irish Engineer (H. T.), single flowered, a very strong growing rose of a dazzling scarlet tint, the flowers large and usually borne in trusses of 3 to 15 blooms on erect stems; Madame Levasseur (Polyantha), growth robust, very free flowering, in color rosy crimson; and Rubin (a climbing Polyantha) of a deep crimson tint, and blooms larger than those of Crimson Rambler.

Not all roses may be pruned alike. Austrian Briars, Moss, Hybrid China, Lord Penzance and Sweet Briars should be pruned with the other roses in March, but the chief shortening and thinning of the shoots should have been carried out after the flowering of the last season. At the present, the work on these plants will consist of removing unripe shoots, and grubbing up suckers from the roots. Rampant shoots may be now reduced in length. Hybrid Perpetuals.—In order to compel the production of bloom on this race of roses in succession, the bushes should be pruned at intervals of 14 days, shortening vigorous shoots to one-third or more of their length, and weak ones more severely, having regard to the variety, that is to the 4th or 6th bud from the base of the shoot. Most roses require a rich manure to be spread over the roots just below the surface of the ground, as well as a mulch above it if the land be of a light nature, and a slight layer of crumbly soil spread over it so as to hide its presence.

FREDERICK MOORE.

MY MARYLAND ROSE.

How to Grow It Successfully.

One of the most successful growers of the new rose, My Maryland, during the past season, has been Edward Towill, Roslyn, Montgomery county, Penna. On request of HORTICULTURE Mr. Towill sends the following:

My method applies to solid beds only. One great secret of success is in the night temperature. This must be from 62 to 64 degrees—never lower.

When the season arrives for planting young stock, get your houses all cleaned out. Fill with good, stiff rose soil mixed with about 200 lbs. bone dust to a space to plant say one thousand and rose. The grower must use his own judgment in the matter of space and fertilizer as some soil will take more bone than others, but about 200 lbs. of bone on the average is enough for compost for 1000 plants.

Get nice clean plants from 2-1-2 in. or 3 in. pots; plant them about sixteen inches apart and twelve inches across the bed; water well after planting, keep the houses clear of weeds and

Headquarters for Asparagus Plumosus Seed New Crop

GREENHOUSE CROWN		LATH HOUSE CROWN	
100 seeds, .50	5,000 seeds, \$17.50	100 seeds, .40	5,000 " \$12.50
1,000 " \$2.75	10,000 " \$32.50	1,000 " \$2.75	10,000 " \$23.00

Write for Our Wholesale Catalogue

HENRY F. MICHELL CO., 1018 Market Street, PHILADELPHIA

CHRYSANTHEMUMS.

"Not small weak runty stock grown under benches, but the kind that brings back Dollars for Pennies."

WHITE: Earliest October frost (We have extra fine large stock of this variety), Mrs. Henry Robinson, Clementine Jansen, Alice Byron, Timothy Eaton, Merry Christmas, White Bonafion

YELL. W: Moorovia, Halliday, Appleton, Bonafion, Eaton, Chataqua Gold.

PINK: Mc. Niece, Maud Dean, Dr. Enguehardt, Rosiere.

RED: Intensity, Schrimpton.

All these varieties, rooted cuttings \$2.50 per 100; \$20.00 per 1000. 2 1/2 in. \$3.00 per 100; \$25.00 per 1000.

White Chadwick, Golden Chadwick, Golden Wedding, R. C. \$3.00 per 100; \$27.50 per 1000.

2 1/2 in. \$4.00 per 100; \$35.00 per 1000.

Virginia Boehlmann, R. C. \$4.00 per 100. 2 1/2 in. \$5.00 per 1000.

Golden Glow, R. C. \$5.00 per 100. 2 1/2 inch \$5.00 per 1000.

CARNATIONS.

Enchantress and White Lawson, R. C. \$2.50 per 100; \$22.00 per 1000.

Enchantress, White, Pink and Variegated Lawson, 2 1/2 in. \$3.00 per 100; \$25.00 per 1000.

O. P. Bassett, 2 1/2 in. \$3.00 per 100; 3 1/2 inch \$10.00 per 1000.

Bridesmaids	2 in. or 2 1/2 in.	3 in. or 3 1/2 in.
	100 1000 100 1000	100 1000 100 1000
Brides
Richmond
Perles
Kaiserine
Uncle John

Morton Grove, Ill.

Strong well rooted cuttings and 2 1/2 inch stock.
Sarah Hill, Afterglow, White Perfection, Victory, Rose Pink Enchantress, Winsor, Beacon, White Enchantress, at \$3.00 per 100; \$25.00 per 1000.

Sarah Hill, Howard, Afterglow, Winsor, Beacon, Victory, 2 1/2 in. \$3.50 per 100; \$32.00 per 1000.

ROSES.

American Beauties	2 in. or 2 1/2 in.	3 in. or 3 1/2 in.
	100 1000 100 1000	100 1000 100 1000
My Maryland
My Maryland - Own roots
Killarney - Own roots
Mrs. Potter Palmer

POEHLMANN BROS. COMPANY,

Violet Blue Rose

A Remarkable Novelty

The New Rambler (Violet Blue), hailed by the German rose growers as the forerunner of a genuinely corn-flower blue rose, is a seedling of Crimson Rambler, very vigorous and hardy. For descriptions of this great novelty, as well as many others, send for Booklet.

ELLWANGER & BARRY

Mount Hope Nurseries
Box T, Rochester, N. Y.

Ampelopsis Quinquifolia

Strong 3-year Plants, 4 to 6 ft.
\$55 a Thousand. To the Trade Only

A FULL LINE OF
GENERAL ORNAMENTAL
NURSERY STOCK

SEND FOR CATALOGUE
EASTERN NURSERIES
JAMAICA PLAIN, MASS.
HENRY S. DAWSON, Mgr.

keep the soil loose for a few weeks. Use plenty of water at the growing period. Put a little top dressing of cow manure on when you think the plants are ready to take it; keep the plants growing all the time.

Disbud the same as other roses. Don't cut your roses too early in the fall. Therein lies the reason that so many My Marylands went to sleep last winter. Keep the plants growing all the time. Don't get too greedy in the fall and cut everything in sight. Disbud and keep your plants moving all the time. You can get very long stems by disbudbing the same as with Killarney.

When the fall starts keep the temperature at from 62 to 64 degrees at night. The day temperature should be about 10 or 12 degrees warmer. Give plenty of air when the weather is favorable. Don't keep your houses shut down on bright days. Run a pipe and give a little ventilation—raise the ventilators a little and shut down again. Repeat the same two or three times a day to relieve the stagnation of atmosphere.

Syringe heavily when the weather is favorable because My Maryland is subject to red spider. I water freely and feed the plants often with a dry fertilizer. Water the fertilizer in well every time you apply same, which would be once a week probably. Other soils different from that described would not take it as often. The grower must use his own judgment in this matter of the fertilizer.

I used dried blood, bone flour, poudrette and tankage—separate at different times or mixed. Apply a little between the rows of the plants every week and water same in well.

Fumigate the roses about once a week. As regards mildew, I have not seen any on the plants thus far.

ROSE HARRY KIRK.

Dear Sir: Rose Harry Kirk has now passed through a third winter out of doors without any protection except a three-inch dressing of manure over the surface of the bed. This rose is the greatest acquisition since Killarney. There is not an inch of dead wood on any of the plants. The buds are pushing out to the ends of all the branches.

The beautiful blooms were continuous and plentiful all last season. This is surely the best yellow yet introduced.

Very truly yours,
ROBERT HUEY.
Phila., March 15, 1909.

CHRYSANTHEMUMS

Polly Rose, White and Yellow Bonafion, Balfour, Nonin, Byron, Halladay, Enguehardt, Pacific Strong R. C. \$1.25 per 100

MARQUERITE
QUEEN ALEXANDRA, r.c.
\$1.00 per 100, 2 1/2 in., \$2.00

FUCHSIAS
RED ACHYRANTHUS
BECONIA VESUVIUS
r. c. \$1.00 per 100

HELIOTROPE
r.c. 75c per 100, 2 in., \$2.00 per 100

SWEET ALYSSUM
r.c. 75c per 100, flats \$1.25 per 100

ROSE GERANIUMS
fine 2 1/2 \$2.00 per 100

ENGLISH IVY
3 in. \$3.00 per 100

F. P. SAWYER
Clinton, Mass.

ORCHIDS

Largest Importers, Exporters, Growers and Hybridists in the World
Sander, St. Albans, England
and 235 Broadway, Room 1
NEW YORK CITY

JULIUS ROEHRS CO.

Orchids and Stove Plants
Florists' Easter Supplies
RUTHERFORD, N. J.

ORCHIDS

Dendrobium to arrive in April. Miltonia Veitchiana ready now. SPLENDIDTYPE. Miltonia Roezlii in October. DIRECT TO YOU.
Order Now.
G. L. FREEMAN, 388 Appleton St., Holyoke, Mass.

ORCHIDS

Just Arrived in Fine Condition
the following East Indian Orchids

DENDROBIUM WARDIANUM, D. CRASSINODE, D. PRIMULINODE, D. THYRSIFLORUM, AND D. CHRYSOTOXA. Others to follow.

WRITE FOR PRICES.
LAGER & HURRELL, Summit, N.J.

JUST ARRIVED

Fine Importation of
Oncidium ornithorrhynchum

Fine strong leafy plants.....\$1.50 each. \$18.00 doz.
Few specimens.....2 50 "

JOSEPH A. MANDA, West Orange, N.J.

ORCHIDS

We offer a large number of fine well established plants at very reasonable prices also Peat, Baskets and Sheep and Chicken Manure.
ORDONEZ BROS., Madison, N.J.
New York Store, 41 WEST 28 ST.

ORCHIDS

We are looking orders now for delivery early in the Spring on all commercial CATELYAS and NOVELTIES. Our prices are right and our guarantee perfect. We sell only first-class goods.
CARRILLO & BALDWIN, Secaucus, N. J.

Cattleya Mendelli arrive in May. Mossiae in June. Gaskelliana in August. Aurea and gigas Hardyana in October. TRUETT TYPE. NO GREEN. COLLECTED IN BLOOMING SEASON.

PREPARE FOR EASTER

Headquarters for Easter Plants

Have LILIES To Burn, To Burn, To Burn

The best in the land, the best in the land, the best in the land.

AZALEAS

To beat the band, To beat the band, To beat the band

What is the best Double Pink Azalea? It is the Mme. Van Der Cruyssen, originated by the well-known Azalea Specialist, M. Van Der Cruyssen of Belgium. We have a big stock of them; every plant is as round as an apple, just covered with buds; just right for Easter. We have them for 60c, 75c, \$1.00, \$1.25, \$1.50 up to \$2.00 each. Bernard Andrus alba, \$2.25 to \$3.00; some at \$1.00 to \$1.50. Niobe and Deutsche Verle, 75c, \$1.00, \$1.25, \$1.50. Vervaneana, Die Schryveriana (best double variegated), 75c, \$1.00, \$1.25, \$1.50, \$2.00. Empress of India, 50c, 60c, 75c, \$1.00, \$1.25, \$1.50. Simon Marbler, 50c, 60c, 75c, \$1.00, \$1.25, \$1.50, \$1.75. Apollo (red), 50c, 60c, 75c, \$1.00. Professor Wolters, 75c, \$1.00, \$1.25, \$1.50 and some more good varieties, 75c, \$1.00, \$1.25, \$1.50. We have Azaleas by the thousand.

Lilium tuffitorum, the best in America, 6 in. pot plants, height, 20-25-30 inch and over, with five buds and upwards to ten buds, 10c per bud; under five buds, 12c per bud.

Cincieria hybrida grandiflora. Henry F. Mitchell's newest improved strain. Our plants this year are very large, big Heads of flowers, perfect foliage, and the plants are almost as big as a bushel basket, 6 in., 7 in., 25c, 35c, 50c, 75c, \$1.00.

Hydrangea Otaka, 6 to 7 in. pots, 50c, 75c, \$1.00.

Spiraea Gladstone, 6 in. pot, 50c, 75c, \$1.00.

Superba, Floribunda, Japonica, 6 in., 25c, 35c, 50c.

Araucaria Excelsa largest stock in America, 6 in., 4-5-6-7 tiers, 25-35-30-35 inches high, 75c, \$1.00, \$2.00, 4-10.

Araucaria Robusta Compacta and Glauca, 6-7-8 in. pots, 20 to 35 inches high, 4, 5, 6 tiers, \$1.50, \$2.00, \$3.00.

Kentia Belmoreana, 5 1/2 to 6 in. pots, 50c, 60c, 75c; **Forsteriana**, 5 1/2, 5 1/2, 6 in. pots, 50c, 60c, 75c, \$1.00, \$1.25, \$1.50.

Ficus Elastica, 5 1/2, 6 in., 75c, 50c, 35c.

Begonia, New Improved Florida, a constant bloomer, 3 1/2 in. pots, \$1.50 per doz.

Primula Obconica, full of buds and flowers, 5 to 5 1/2 in. pots, \$2.50 to \$3.00 per doz.

Asparagus Plumosa, 2 to 3 cents.

Ferns, 6, 7, 8 inch, such as **Whitmanii**, **Boston**, **Scottii**, 50c, 75c, \$1.00, \$1.25, \$1.50; **Amerophis**, 5 to 6 in., 50c, 75c.

Hybrid Kose Bushes, John Laing, Brunner, Hermosa, and other good sorts, 4 in. pots, 30 inches high, very strong, 50c, 75c, \$1.00.

Crimson Rambler, newest sorts, 3 1/2 to 4 in. pots, 50 to 75c.

Hyacinths, four best varieties, white, pink, light and dark blue, 4 in. pots, \$1.00 per 100.

Touneolii Tulips, this is the best double variegated tulip in existence, three bulbs planted in a 4 in. pot, \$1.80 per dozen pots.

Von Sion Daffodils. Best double yellow daffodil in existence, three double-nosed bulbs planted in 4 in. pot, 5 1/2 to 6 in. pots, \$2.50 to \$3.00 per doz. pots.

All our bulbs are our own importation and are not to be compared with the cheap stuff flooding the market.

Cash with order please. Mention if plants were wanted

GODFREY ASCHMANN

Wholesale Grower and Importer of Pot Plants
1012 W. Ontario St.
PHILADELPHIA, PENNA.

NEWS NOTES.

Tomlinson Hall market, Indianapolis, report an unusually heavy trade on flowering plants of all kinds.

Warner & Coy who recently opened a new store at 16th and College Ave., Indianapolis, report things going along very satisfactorily.

George Masson, at present on the Daniel Guggenheim estate, will take a position with W. B. Kinney at Oakhurst, N. J., on May 1.

NOTES ON EASTER PLANTS.

The Outlook at Craig's.

To get a line on the latest and best in Easter plants in Philadelphia one naturally looks up first the recognized headquarters—the big establishment of the Robert Craig Co. At this writing, March 17th, the crops are well forward and an excellent idea can be formed of the good things in store for buyers from now to Easter week.

Judging from the three houses devoted to the lilies at this place there need be no fear as to quality of this Easter requisite. The varieties grown are giganteum, Azores and Formosum. The giganteum is liked best, although it is not quite so early as the others, there being a difference of about ten days. We are informed that there has been very little loss from defective bulbs this year.

Azaleas are, of course, a strong feature this year as always. There is no striking novelty but all the old stand-bys are on hand in all sizes.

Mr. Craig had a twinkle in his eye when we came to the hydrangea houses. He knew he had something in store that would make even a calloused critic like the present scribe sit up and take notice. It is not in size alone but form, foliage, and above all, the number of flower heads to each plant that we have to lift our hat to.

Rhododendrons are now in full flower for pre-Easter use, but the majority are held back until the buds show color and are then immediately removed to a cool house for Easter and later. There is considerable call for these among well-to-do suburbanites for porch decorations before their lawn specimens come in bloom at their natural season.

Genistas are still popular as an Easter plant. They like a rather cool temperature, and very little forcing is sufficient—so that some of the older houses that do not have up-to-date heating can be profitably utilized. The smaller sizes in five and six inch pots are the best sellers.

A novelty for this year is a batch of gold and silver leaved maples. These are in tubs and are about five feet high, well-branched and just coming into bud. The bark is pale green.

Of **Crimson Rambler** roses, the old form, also the improved variety known as **Philadelphia Rambler**, are seen in various sizes. The most attractive are plants about 4 ft. high, balloon-trained, 2-1-2 to 3 ft. through. These show fine trusses of bloom—about pea size at present. The new rambler **Tausendschon** (Thousand Beauties) is not quite so forward. Mr. Craig says it is more easily forced and earlier, and will be in good shape as soon as the others. **Tausendschon** was a great seller the past two seasons and the demand has been away ahead of supply.

The **Baby Rambler** is much in evidence being grown mostly in 5, 6 and 7 inch pots, in natural form, although a limited quantity are to be seen grafted in tree form about 2-1-2 ft. above the pot. A few white and pink **Baby Ramblers** are also in sight and a few plants have both white and crimson grafted on the same plant as a novelty. The **Mrs. Cutbush** and **Baby Dorothy** are both grown but they are almost identical as to the shade of

BARGAIN SALE IN ERICAS, ETC.

For Immediate Delivery, to make room.

- BORONIA elatior, pink, in 4-in. pots, \$15.00 per 100.
- EPACRIS alba, white, 3 1/2-in. pots, \$10.00 per 100.
- ERICA persoluta rubra, 3 1/2-in. pots, \$10.00 per 100.

CHRISTMAS VARIETIES FOR GROWING ON

- ERICA melanthera from 5-in. pots, \$15.00 per 100.
- ERICA regerimans, 3-in. pots, \$8.00 per 100.

The above prices are net cash with order. No charges for packing.

BOXWOOD

FOR HOTEL AND VASE WORK

- 12-in. high, 6 in. pots, \$25.00 per 100
- 15-in. " 7-in. " 50.00 " "
- 16-in. " 7-in. " 75.00 " "
- 18-in. " 8-in. " 100.00 " "

Also PYRAMIDS \$3.00, \$4.00, \$5.00, \$6.00 to \$8.00 a Pair.

ANTON SCHULTHEIS

Florist
COLLEGE POINT, - L. I.

pink and seem to be about the same thing in every respect. Lady Gay and Dorothy Perkins are also as popular as ever and are given their full share of attention. One of the finest things is a bench of **Richmonds** in 7s and 8s just coming into bloom. There are also **Magna**, **Druschki**, **Killarney**, **La France** and **Tom Wood**.

In **spiraea** Mr. Craig thinks **Gladstone** beats them all and has discarded the older forms. There are a few only of the new pink **spiraea**, **Queen Alexandra**. There does not seem to be any great demand for this novelty and few growers have plunged in it.

Bougainvillea Sanderiana is one of the choicest of Easter subjects and in great demand among the high-class stores. The specimens run mostly about 3 ft. high with flat, spreading heads about four feet through and literally covered with pink bloom.

A batch of well-done **Lorraine Begonia** is in evidence and although this is usually held as a Christmas plant there is some demand for it at Easter also. Mr. Craig has struck it right this year in propagating this plant and showed with pride a bench of thirty five thousand young plants, the percentage of loss being well under the usual 15 per cent.

Frutescens and **Queen Alexandra** comprise the bulk of the Easter **marguerite** stock although there are a few hundred of the new **Pink Alexandra**. This latter is a charming thing and quite distinct. The center of the flower is bright pink, the petals pure white and more refined in form than the older variety. This originated with

YOU ARE INVITED TO CALL AND INSPECT OUR

EASTER STOCK

Send for Price List

A few of our leading specialties are mentioned below. The late Easter and the fine weather have helped this year and stock is in fine shipping condition.

MRS. CUTBUSH (New) Pink Baby Rambler
This is a good one, in 6-inch pots at \$6 and \$9 per doz.

BABY DOROTHY (New)
Pink Baby Rambler very similar to Mrs. Cutbush.
5-inch pots at \$6 per doz.; 6-inch pots at \$9 per doz.

HYBRID ROSES
We have an unusually large stock of Hybrids which will be just right for Easter; all the best varieties, including Richmond, Fran Karl, Funschki, La France, Mrs. John Laing, Pom Wood, Kilmaree, etc., at \$6 and \$9 per doz.
MAGNA CHARTA, very fine at \$9, \$12, \$15 and \$18 per doz.

HYDRANGEAS
The largest and finest stock of this grand Easter plant that we have ever grown at \$5, \$6, \$9 and \$12 per doz. Larger plants at \$1.50, \$2, \$2.50 \$3, \$4 and \$5 each.

RHODODENDRONS
Single, well-budded plants, including all the best varieties at \$1.50, \$2, \$2.50 \$3, \$3.50 and \$4 each. A few larger plants at \$5 each.

RHODODENDRON PINK PEARL (New)
The most beautiful of all the Rhododendrons at \$2.50, \$3 and \$3.50 each.

BOUGAINVILLEA GLABRA SANDERIANA
Magnificent plants, exceptionally well flowered at \$3.50, \$4, \$5, \$6, \$7.50 and \$10 each.

LILACS
Very fine plants, 6-inch to 8-inch pots at \$2, \$2.50 and \$3 each.

GENISTAS
A grand stock, grown cool and just right for Easter at \$2, \$3, \$4, \$5, \$6 and \$9 per doz. Larger plants at \$2, \$2.50, \$3, \$4, \$5 and \$6 each.

SPIREA GLADSTONE
Our stock is in superb condition.
6-inch pots at \$5.00 each; 7-inch pots at \$7.75 each; 8-inch pots, made up, at \$1 each; 9 and 10-inch pots, made up, at \$1.50 and \$2 each.

PINK SPIREA
Queen Alexandra, very beautiful.
6-inch pots at \$9 per doz.

DOUBLE DAISY, Queen Alexandra
Well grown and well flowered.
3-inch pots at \$1.50 per doz; 4-inch pots at \$2.50 per doz; 5-inch pots at \$4 per doz; 6-inch pots, very fine, at \$6, \$9 and \$12 per doz.

LILIES
Our stock is exceptionally good this year. Plants with from 4 to 8 blooms at 12 cents per bloom; made-up plants with from 12 to 25 blooms at 12 cents per bloom; plants with less than 4 blooms at 15 cents per bloom.

AZALEAS
We have the largest and finest stock of Azaleas we have ever had, including Vander Cursee, Vervaeckera, Emp. of India, Emp. of Brazil, Niobe, Bernard Andria Alba, Prof. Wolters, etc., etc., at \$7.5, \$1, \$1.25, \$1.50, \$2, \$2.50, \$3, \$3.50, \$4, \$5, \$6, \$7.50 and \$10 each. A few larger specimen plants at \$12.50 and \$15 each. Pyramidal Azaleas, very fine, at \$3, \$3.50 and \$4 each. Small Azaleas for Basket Work at \$3 and \$4 per doz.

CRIMSON RAMBLER ROSES
These plants are unusually fine and will be just right for Easter.

6-inch and 7-inch pots at \$1, \$1.25 and \$1.50 each; 8-inch pots at \$2 and \$2.50 each; plants trained in fan and globular shapes, extra fine, at \$2, \$2.50, \$3, \$3.50, \$4, \$5 and \$6 each; a few larger plants at \$7.50 each.

PINK RAMBLER ROSES
Lady Gay and Dorothy Perkins
In great condition; trained into Fan, Globular and Pyramidal Shapes at \$1.25, \$1.50, \$2, \$2.50, \$3, \$3.50 and \$4 each. Special Ball Shapes at \$1.50, \$2 and \$2.50 each. Special Wire Fan Shapes at \$3 each.

TAUSENDSCHON (New) "Thousand Beauties"
This was our finest Cluster last Easter and this year the plants are still better. We cannot recommend the Tausendschon Rambler too highly. Strong plants in 4-inch and 7-inch pots at \$1, \$1.25 and \$1.50 each. Trained plants, Fan, Globular and Pyramidal Shapes, at \$2, \$2.50, \$3, \$3.50, \$4 and \$5 each.

BABY RAMBLE N DARDS
Exceptionally fine plants, 3 to 5 foot stems, at \$1, \$1.25, \$1.50, \$2 and \$2.50 each.

WHITE BABY RAMBLER STANDARDS
At \$1, \$1.25 and \$1.50 each.

STANDARD DOUBLE-BUDDED WHITE AND RED BABY RAMBLER ON SAME PLANT
At \$1.50 each.

WHITE BABY RAMBLERS
Good, strong stock, well flowered, at \$3, \$6 and \$9 per doz.

WHITE BABY RAMBLERS
Very strong plants, well flowered, 6 inch pots, at \$9 per doz.

ROBERT CRAIG CO., Forty-ninth and Market Sts., Phila., Pa

BARGAINS IN DECORATIVE AND FOLIAGE PLANTS

KENTIAS, ARECAS, LATANIAS, in all sizes in the very best condition.

ARAUCARIAS, RUBBERS, CROTONS, PANDANUSES, ASPARAGUS, COCOS, FERNS for dishes, etc.

EASTER STOCK and BEDDING PLANTS at lowest wholesale rates.

A. LEUTHY & CO.
perkins St. Nurseries, Rosindale, Mass.

Palms  *Ferns*
Shrubs *Perennials*

Send for Our Catalogue.

The GEO. WITTBOLD CO., 1657 Buckingham Place, Chicago, Ill.

FERNS FOR DISHES, Assorted Varieties
From 2 inch pots, \$3.50 per 100; \$30.00 per 1000

FRANK OEGHSLIN
CASH WITH ORDER
2570 to 2606 W. Adams St., Chicago, Ill.

COLEUS! COLEUS!

C. Verschaffeltii and Golden Bedder	R. C.	Pr 100	Pr 1000
Same in 2 1/2 in. pots	R. C.	.60	5.00
Coleus, Tixed	R. C.	2.00	15.00
Same in 2 1/2 in. pots	R. C.	.60	5.00
Ageratum Stevia Gurney and Pauline	R. C.	.50	4.50
Same in 2 1/2 in. pots	R. C.	1.00	9.00
Feverfew	R. C.	2.00	
Fuchsias, our selection	R. C.		
German Ivy	R. C.	3.00	
English Ivy	R. C.	1.00	

Cash with Order

J. E. FELTHOUSE
148-154 Van Vranken Ave., SCHENEGADY, N. Y.

HEACOCK'S PALMS

Kentia Belmoreana

7-inch pots	32 to 34 inches high	\$2.50 each
7-inch pots	36 to 38 inches high	3.00 "
9-inch tub	42 to 48 inches high	5.00 "

Made up Kentia Forsteriana

7-inch pots	34 to 36 inches high	\$2.50 each
7-inch pots	36 to 38 inches high	3.00 "
9-inch tub	42 to 48 inches high	5.00 "

Joseph Heacock Co., Wyncote, Pa

In ordering goods please add "I saw it in HORTICULTURE."

VIOLETS Princess of Wales, Lux-onyne, California Violets. Rooted Runners, clean and free from disease, \$1.00 per 100, \$5.00 per 1000. Cash with order. JACQUES GILMET, - Troylan, Del. Co., Pa

NEPHROLEPIS MAGNIFICA

THE SENSATIONAL NOVELTY
Strong 2 1/2 in. stock, \$25.00 per 100.

WHITMANII
2 1/2 in., \$4c.00 per 1000; 3 1/2 in., from Bench, \$8.00 per 100.

H. H. BARROWS & SON, WHITMAN, MASS.

Ampelopsis Veitchii, 4 in. pots, \$10 per 100; 3 in. pots, \$5 per 100. **Ferns, Boston**, 4 in. pots; \$10.00 per 100; Boston, 3 in. pots, \$4.00 per 100. **Asparagus Sprengeri**, 2 in. pots, \$2.00 per 100. **Canna, King Humbert**, \$5.00 per 100. **Clematis Paniculata**, 4 in. pots, \$10.00 per 100; 3 in. pots, \$5.00 per 100. **Clematis**, large flowering varieties, 2 years old, dormant plants: Jackmanii, Henryi, Andrei, \$15.00 per 100. **Ficus Elastic**, 6 in. pots, 25c. each.

C. EISELE
11th and Westmoreland Streets, PHILADELPHIA, PA.

JAPANESE CO.
THE YOKOHAMA NURSERY CO.
31 BARCLAY STR. NEW YORK.
LILIES
PLANTS
BAMBOO STAKES

FOR "POT LUCK" TRY US...

HEWS STANDARD POTS

POT MAKERS FOR 140 YEARS
WORLDS LARGEST MANUFACTURERS
WRITE FOR CATALOGUE AND DISCOUNTS
**Pearson Street,
LONG ISLAND CITY, N. Y.**
**A. H. HEWS & CO., Inc.
CAMBRIDGE, MASS.**
**452-460 No. Branch St.,
CHICAGO, ILL.**

Mr. Keller of Bay Ridge and was bought from him and put on the market last year by Dreers.

Among the foliage plants suitable for Easter, first place must be given to the crotons. This place is famous for these, and they can be seen here by the houseful. Next in importance is *Draecena terminalis*, always a prime favorite when well colored, and it is all that can be desired this year. The new *Draecena Mamulana* is in limited supply and appears to be a grand addition to this family. The green variety (*fragrans*) and the variegated (*Massagea*) are not much in demand for Easter.

Gardenias as pot plants are conspicuous by their absence this year. Presumably the high price of the cut blooms makes this too expensive as a pot plant in competition with azaleas, etc.

We started this little Easter story with the azalea and find we will have to finish with it also, as we omitted to mention a fine lot of the handsome little Japanese azalea with the bright crimson flowers—*Himelegert*. This is a little gem. G. C. W.

A Look In At Schultheis.

Ericas for Easter will be scarce. Last summer was a very severe one for them and many were lost by the New York growers, and the few that were carried through are all sold. Azaleas and rhododendrons will be unusually well flowered this year, judging from what Mr. Schultheis has in sight. Finest of all are the Hy-

drangeas. Never have we seen more shapely plants or more profusely flowered.

Roses are the strongest feature in the Eastern stock this year. Baby Ramblers and Adult Ramblers are seen in goodly quantity but the giant specimens of the latter which have been in evidence other years are missing. The experience last year when the large stock which had taken so much room and labor were left unsold was a practical lesson for the growers and if the buyer wants big Ramblers or big azaleas or big genistas this year he will have to splice three or four small ones together. Flower of Fairfield, the "Ever-blooming" Crimson Rambler is the most interesting thing Mr. Schultheis has. Every shoot brings a flower cluster and the blind growths of the ordinary Crimson Rambler are unknown on this splendid acquisition. Foliage and flowers seem absolutely identical with the old favorite. Nothing prettier or sweeter can be imagined in the *Polyantha* rose line than *Apple Blossom*. In color and fragrance the flower well bears out the resemblance to an apple blossom and the persistency of its petals is one of its strong points. Among the true Ramblers *Leuchstern* makes a pretty picture with its rosy pink petals fading to pure white at the base. We almost forgot to mention *Catherine Zeimet* as one of the most attractive of the dwarf *Polyanthas*, flowers large, double and satiny white.

Mr. Schultheis is a notable exception in one respect—he finds no fault with his lilies. He has tried a novelty in *hyacinth* named *Distinction*. Its color is purplish claret and its principal "distinction" is that nobody likes it.

Easter Plants in Chicago.

The cloudy weather which has prevailed for the past six weeks makes the situation a little difficult to forecast. There has been very little sunshine so far in March, and but three days that could be called bright in February.

To begin with, the favorite flower for the Easter holiday, the Easter lily, will not be overabundant. While most of the growers have a fair stock, the supply is scarcely up to usual quantity, and the stems are generally short. Considerable dissatisfaction has been expressed throughout the winter with the lily bulbs which were so mixed that an unusual number of plants had to be thrown out.

Bulbous stock has sold well all the season and Easter will find no surplus but rather a shortage in this line, especially in pans.

A fair supply exists of *Crimson Rambler*, *Lady Gay*, *Baby Rambler* and other rose stock. Rose stock is not so good as could be desired. The

large trained plants will be almost wholly lacking.

Some plants of "bleeding heart" will be seen and look like a desirable acquisition to the variety of Easter plants.

There appears to be about the usual quantity of azaleas, rhododendrons, *spirea*s and *Primula obconica*.

Among green plants Boston ferns of large size and good quality are decidedly short in supply at present writing.

AN EFFECTIVE SPRAY.

The following testimonials have been received by Wm. Cooper & Nephews, who are advertising their Insecticide Spray in our columns:

Goldboro, N. C., July 4, 1908.

I am glad to state that the use of your V1 Winter Spray Fluid was largely instrumental in saving my grape crop, as also currants and other small fruits.

(Sgd.) J. A. WASHINGTON.

Chappaqua, N. Y., June 18, 1908.

In answer to your letter I may state that the Fluid which you sent me does excellent work. I sprayed about a dozen trees; they are now free from San Jose Scale and looking fine.

(Sgd.) ERNEST ULMER.

Pulteney, N. Y., Nov. 21, 1908.

The V1 Fluid is all right. My trees were in a fine condition all through the year up to the present time; my neighbors all were wondering over it. Half of my apple orchard I sprayed twice, the other half only once. If you could have seen the difference; the one half sprayed twice had larger and finer apples than the half sprayed only once.

(Sgd.) JOHN SCHUSTER.

320 Park St., Upper Montclair, N. J., June 14th, 1908.

Since using your V2 Fluid, where I could find worms by plenty, I now fail to find any. I have also used your V2 on rose bushes for the green fly with good success. My plums, peaches and pears are in very good condition for young trees and are making good growth. Had I used the V1 I think I should have had no trouble with the disease I am fighting now. I shall recommend your fluids for spraying wherever I can.

(Sgd.) JAMES FETCH.

A Profitable Side Crop

Asparagus plumosus is a main crop with many growers having extensive modern plants but those with less up-to-date establishments, or parts of same defective in lighting or otherwise unsuitable for high grade crops,—will find this subject one of the very best. We have prepared a cultural circular giving concise directions how to make money out of this crop. Send for it. No charge. An important feature in asparagus culture is good seed. The P. M. quality of greenhouse grown seed has earned a high reputation for freshness and purity. It is the true nanus and greenhouse grown. Send for trial pkg., 100 seeds fifty cents, if you wish to experiment only. In quantity \$3.75 per 1000 seeds, \$32.50 per 10,000 seeds. *Asparagus Sprengerii* 75c. per 1000, \$5.00 per 10,000 seeds.

S. S. PENNOCK-MEEHAN CO.

1608 to 1620 Ludlow St., Philadelphia, Pa.
1212 N. Y. Ave., Washington, D. C.

STANDARD FLOWER POTS

Packed in small crates, easy to handle.

Price per crate	Price per crate
1500 2 in. pots in crate \$4.88	144 6 in. pots in crate \$3.16
1500 2 1/2 " " " 5.25	120 7 " " " 4.20
1500 3 " " " 6.00	60 8 " " " 3.00
1000 3 " " " 5.00	48 9 in. pots in crate \$3.60
800 3 1/2 " " " 5.80	48 10 " " " 4.80
500 4 " " " 4.50	24 11 " " " 3.60
450 4 1/2 " " " 5.24	24 12 " " " 4.80
320 5 " " " 4.51	12 14 " " " 4.80
210 5 1/2 " " " 3.78	6 16 " " " 4.50

Send pans, same price as pots. Send for price list of Cylinders for Cut flowers, Hanging Baskets, Lawn Vases, etc. Ten per cent. off for cash with order. Address **Hiflinger Bros., Pottery, Fort Edward, N. Y.** August Walker & Sons, Agts. 31 Barclay St., N. Y. City.

Standard Flower.. POTS

If your greenhouse are within 500 miles of the Capital, write us, we can save you money

W. H. ERNEST

28th and M Street WASHINGTON D. C.

Syracuse Red Pots

STANDARD SIZES

Florists, we will suit you as to quality and prices. Write for catalogue.

Syracuse Pottery Co., SYRACUSE, N. Y.

Dreer Special Offer OF Hardy Perennials

NEW OR LITTLE KNOWN VARIETIES WORTHY OF SPECIAL ATTENTION



TROLLIUS (Globe Flower)

PRIMULA CORTUSOIDES SIEBOLDI. These are not so well known as they deserve; they are free, vigorous growth, and can be flowered in pots in early spring, and respond quickly to forcing when placed in a temperature of 50 degrees, forming pretty pot plants in a short time, making excellent window plants, which meet with ready sale when in bloom.

We offer six distinct varieties, from pure white to the deepest rose in color, \$1.50 per doz.; \$10.00 per 100.

RUBECKIA RAYS OF GOLD. In this new variety we have a refined form of the popular "Golden Glow," to which it is identical in color, habit, etc., but the flowers have narrower petals, full to the centre, forming a perfect ball of gold, \$1.50 per doz.; \$10.00 per 100.

- ANCHUSA ITALICA DROPMORE VARIETY.** A grand improvement on the type, with intense deep blue flowers, \$2.00 per doz.; \$15.00 per 100.
- ANTHERICUM LILIASTRUM GIGANTEUM.** A fine form of the N. Bruno Lily with very large white flowers, \$2.50 per doz.; \$20.00 per 100.
- AQUILEGA HELENAE.** One of the best of the Columbines, large pretty blue flowers, with large white corolla, 85 cts. per doz.; \$5.00 per 100.
- CAMPANULA PERSICIFOLIA HUMOSA.** A very large semi double form of the peach leaved Campanula, flowers of a pleasing shade of blue, \$1.50 per doz.; \$10.00 per 100.
- DELPHINIUM GOLD MEDAL HYBRIDS.** The finest strain ever offered in mixed varieties, \$1.25 per doz.; \$8.00 per 100.
- DELPHINIUM BELLADONNA.** The freest flowering of all Delphiniums, it is never out of bloom, beautiful turquoise blue, \$2.00 per doz.; \$15.00 per 100.
- FUNKIA ROBUSTA ELEGANS VARIETA.** A decided improvement on all variegated forms, \$1.50 per doz.; \$10.00 per 100.
- HELENIUM RIVERTON GEM.** A new variety that originated on our trial grounds. Flowers old gold, suffused with bright terra cotta, changing as they mature to a wallflower-red, \$1.50 per doz.; \$10.00 per 100.
- HELENIUM RIVERTON BEAUTY.** Another variety which originated with us, quite distinct in color, which is lemon yellow, with a large disc of purplish-black, \$1.50 per doz.; \$10.00 per 100.
- HELIANTHUS SPARSIFOLIUS.** The most desirable of all the hardy sunflowers, especially valuable as a cut flower, 85 cts. per doz.; \$6.00 per 100.
- FOUR VALUABLE HEMEROCALIS.** The four varieties here offered are great improvements upon the well-known Yellow Day Lilies
- Aurantiaca** Very large, bright, orange-yellow, sweet-scented flowers, 15 cts. each; \$1.50 per doz.
 - Aurantiaca Major.** Large trumpet-shaped, sweet-scented, deep orange flowers. Requires protection, 35 cts. each; \$3.50 per doz.
 - Fiorham.** Large golden yellow sweet-scented flowers; very free flowering, 15 cts. each; \$1.50 per doz.; \$10.00 per 100.
 - Gold Dust.** Large golden-yellow flowers, 15 cts. each; \$1.50 per doz.
- INCARVILLEA DELAVAYI.** Popularly known as the hardy Gloxinia; extra strong roots, \$2.00 per doz.; \$15.00 per 100.
- IRIS PALLIDA DALMATICA FOLIA VARIEGATA.** A strikingly handsome variegated leaved form of this beautiful blue Iris, 35 cts. each; \$3.50 per doz.
- GYPSOPHILLA PANICULATA FLORE PLENA.** This is a perfect gem and as a summer cut-flower invaluable. We have a large stock of strong roots to offer this season, \$2.00 per doz.; \$15.00 per 100.
- LUPINUS POLYPHYLLUS ROSEUS.** This is a most attractive rosy pink form of Lupines, producing gigantic spikes of flowers, \$1.00 per doz.; \$15.00 per 100.
- PENSTEMON GENTIANOIDES SENSATION.** Gloxinia-like flowers in a variety of bright colors, including rose, cherry, crimson, purple, lilac, etc. For bedding they rival Phloxes, Petunias, etc. Not quite hardy; 3-inch pots, \$1.00 per doz.; \$15.00 per 100.
- STOKESIA CYANEA ALBA.** A white form of the popular blue Stokesia, equally valuable and a desirable addition; strong plants, \$1.25 per doz.; \$8.00 per 100.
- CHOICE NEW TROLLIUS.** (New Globe Flowers.) The five varieties listed below are decided improvements on all sorts heretofore offered; of exceptional large size and good, rich colors.
- Gotterfunke.** Large open orange-yellow flowers.
 - Helios.** Very free flowering, pure yellow, on strong branched stems.
 - Leuchtkugel.** One of the finest deep orange reds.
 - Lichtball.** Large, globular orange yellow flowers on stiff stems.
 - Salamander.** Soft orange-colored flowers of globular form, 35 cts. each; \$3.50 per doz. The set of 5 for \$1.50.

HENRY A. DREER, 714 Chestnut Street, Philadelphia, Pa.

ROBERT CRAIG CO.

ROSES, PALMS,

and Novelties in Decorative Plants

MARKET and 49th STREETS., PHILADELPHIA, PA.

ROSES FOR EASTER

Crimson and Pink Ramblers

75c to \$5.00 Each.

THOMAS ROLAND, NAHANT, MASS.

The Northboro Dahlia and Gladiolus Gardens

Offer for Spring 1909

300 selected varieties of Dahlias and one and one half million large-flowering Gladioli in mixtures, in lots to suit. Send list of your wants. Catalogue free.

J. L. MOORE, Northboro, Mass.

DAHLIAS.

Now is the time to place your order for bulbs which will insure you getting named varieties in any quantity; prompt delivery.

DAVID HERBERT & SON,

Successors to L. K. Peacock, Inc. ATCO, N.J.

Those lovely pink tints
Have increasing call
Florists need the best

VIRGINIA MAULE

Divided Roots 50c each. Clumps \$1.00 each.
Strong Plants \$35.00 per 100.

SEND FOR TRADE LIST OF NEW DAHLIAS.

PEACOCK DAHLIA FARMS

Williams'own Junction,
New Jersey.

Prices Quoted in these columns are for Dealers Only. When writing to Advertisers please mention HORTICULTURE

Tobacco Paper
IS THE
**STRONGEST,
BEST PACKED,
EASIEST APPLIED.**

24 sheets.....	\$ 0.75
144 sheets.....	3.50
288 sheets.....	6.50
1728 sheets.....	35.10

“NICO-FUME”

**Furnishes the
Most Nicotine for the Money!**

... Manufactured by ...
THE KENTUCKY TOBACCO PRODUCT CO., **Louisville, Ky.**

LIQUID
OVER 40% NICOTINE

By far the
CHEAPEST.

JUST NOTE PRICE!

Pint.....	\$ 1.50
½ Gallon.....	5.50
Gallon.....	10.50
5 Gallons.....	47.25

Seed Trade

AMERICAN SEED TRADE ASSOCIATION.

Watson S. Woodruff, Orange, Conn.,
Pres.; J. C. Robinson, Waterloo, Neb.,
First Vice-Pres.; C. E. Kendel, Cleveland,
O., Sec'y and Treas. Twenty-seventh annual
convention June 22-24, 1909, at Clifton
House, Niagara Falls, Ont.

WHOLESALE SEEDSMEN'S LEAGUE.

F. W. Bruggerhof, Pres.; Burnet Landreth, Sec'y.

The Season's Record.

The season is drawing towards its close, and seedsmen are making comparisons of the year's business with those of the past and particularly of last year, and while the early part of the season showed a gratifying increase, March has been more or less of a disappointment to most of the mail order houses, and the close of the season is expected to show little if any increase over 1908. Those firms which are not strictly mail order houses cannot as yet make comparisons, as local trade on which many of them mainly depend has scarcely opened. Indications are encouraging, however, that the volume of business will be large, and the close of the season will no doubt show a good and satisfactory average. From the wholesale seedsmen's point of view, business has been excellent up to date, and everything points

SHEEP MANURE

Pulverized. Free from Adulteration
In Bag, \$18.00 per Ton. Cash with Order

ROBERT SIMPSON
CLIFTON, N. J.

THE PRIZE WINNING STRAWBERRY

The Barrymore

Send for Folder at Once.

H. L. CRANE, Originator,
Westwood Mass.

THE STRAWBERRY BLIGHT, ITS CAUSE AND CURE.

How to more than double the yield of crop without increasing the cost of production. A great discovery. Price of book \$2. Worth \$25.

WM. C. TRIMBLE, - Princeton, Ill.

to a continuance of the same until the close of the season.

Bean Scarcity.

Many weeks ago it was stated in HORTICULTURE that green pod beans were in short supply and that a surprise was in store for the trade if there was an active demand from consumers. The demand has been really better than was anticipated, and there is now akin to a famine in the leading green pod sorts, such as Red Valentines, Burpees and Giant Stringless and Black Valentines, the latter having been virtually out of the market since December, such a potent magnet as \$8.00 per bushel failing to draw out any.

The present wholesale price of choice high grade Red Valentine is \$3.50 to \$3.75, with offerings small, while the Stringless Green Pods are selling at \$4.50 to \$5.00, and very few attainable even at these figures.

As these beans are in more or less active demand as late as July, the opinion expressed by a well-known representative of one of the foremost wholesale houses is worthy of note. He says that before the end of July fancy stocks of Red Valentines will bring \$5.00 and Burpees and Giant Stringless will readily draw \$6.00 to \$7.00 per bushel if obtainable at all. All that stands between the planter and a genuine bean famine is the old and often abused Refugee or "1000 to 1" and even these are advancing in prices and should reach \$4.00 per bushel before the demand is satisfied.

Many varieties of peas are unobtainable in quantity, but the season is nearing its end for peas, and excepting a few bags now and then required by retailers, the demand has about ceased.

About Onion Seed.

Onion seed has been in fair demand, but considerable reserve of Yellow Globe Danvers will be carried over. The Flat Danvers and Yellow Strasbourg are well cleaned up, and these varieties will now draw better prices than the Globes. White Portugal is in short supply, as is also White Globe, though the latter is more readily obtained. Of the reds, Wethersfield and Early Flat Red are pretty well used up, but the Red Globes are still in fair supply.

Corn of some varieties is rather short, the medium and extra early sorts in particular, while Stowell's Evergreen seems to be abundant if one may judge by a price list recently sent out by a Connecticut house offering it at \$1.85. One may doubt the wisdom of these cut prices towards

WIZARD BRAND MANURES

Dried, screened and packed in bags of 100 lbs. each.

PULVERIZED SHEEP MANURE

PURE — UNIFORM — RELIABLE
A strong and quick acting manure, highly recommended for carnations and chrysanthemums.

SHREDDED CATTLE MANURE

EASY TO HANDLE AND APPLY
Stronger and better in every way than rough manure. Lasts much longer on the benches. Unequaled for mulching and feeding roses, liquid manuring and mixing with bench and potting soil. Used by all the largest growers.

Ask Your Supply Man or Write Us for Circulars and Prices.

— THE —
Pulverized Manure Co.
31 Union Stock Yards, CHICAGO

“IMP” SOAP SPRAY

Vegetable poisons alone.
Harmless to man.
Deadly to insects.

\$1.50 Single Gallon. Dilute to 25

EASTERN CHEMICAL CO.

Pittsburg Street, Boston, Mass.

In ordering goods please add "I saw it in HORTICULTURE."

Which Spray Pump

shall you buy? Buy the Spray Pump that fully meets the demands of the Government Agricultural Scientists and all practical Fruit Growers. These pumps are widely known as

DEMING SPRAYERS

and are made in 23 styles for use in small gardens or immense orchards. Write for our 1909 catalog with spraying Chart. Add 4 cents postage and receive "Spraying for Profit," a useful guide book.

CHARLES J. JAGER CO.
281-285 Franklin St., Boston



Y₁ Fluid

**THE IDEAL WINTER SPRAY
SCALE KILLER & FUNGIGIDE**

POWERFUL CLEANSER AND INVIGORATOR
Mixes Instantly. No Sediment. No clogging. Non-injurious to user
COMPARATIVE TEST WILL PROVE ITS MERITS
Quart, \$1.00; Gallon, \$3.00
1 gallon makes 100 gallons. Write for descriptive pamphlet and testimony

PROPS. W^m COOPER & NEPHEWS
177 ILLINOIS ST. CHICAGO

Gen'l Agent—CYRIL FRANCKLYN, 62 Beaver Street, New York, N. Y.

"Every Bug Has His Dose."

Insect-destroying preparations that do their work well and effectively are the cheapest. Bowker's Arsenate of Lead and Bowker's Pyrox are recognized standard insecticides and fungicides for both indoor and outdoor use. Bowker's Insect Emulsion destroys many kind of plant lice, black and green flies, etc. Call or send for catalogue.

BOWKER INSECTICIDE COMPANY
43 CHATHAM ST. BOSTON

For Trees, Plants, Shrubs and Flowers
USE
THE NIAGARA BRAND LIME SULPHUR SOLUTION

It destroys Scale Lice, Spiders and all forms of Aphides, AT THE SAME TIME Mildew, Blight, Rust and other Fungus difficulties.
Used in Winter or Summer.—No other remedy has been so universally effective.
Niagara Brand ARSENATE OF LEAD for chewing insects is equal to the best and better than the most. Ask about our Green House sorayer. Address—

NIAGARA SPRAYER CO., - - Middleport, N. Y.

U-N-IT Globe Sprayer.



Brings out in solution, with water, what is put into Globe Insecticides, Germicides, Fungicides, Fertilizing solutions, soap solutions, etc.
Practical: saving work, time and money. An investment for every Florist.
Tested at 150 pounds water pressure. Write for circulars or better still order one now from your dealer or send prepaid on receipt of \$3.50.

ADDRESS—
Dept. H, J. F. CASS MFG. CO, Detroit, Mich.

DON'T EXPERIMENT
USE
To-Bak-INE

and your stock will be free from insects, clean, and the blooms will not be discolored.

Send for full information of

H. E. FISKE SEED CO.
13 Faneuil Hall Sq., Boston, Mass.
STUMPP & WALTER CO.,
50 Barclay St., New York.
HENRY F. MICHELL & CO.,
1018 Market St., Philadelphia.

E. H. HUNT, Gen'l Agent,
76-78 Wabash Ave., Chicago.



The Best Bug Killer and Bloom Saver

For **PROOF**
Write to
P. R. Palethorpe Co.
OWENSBORO, KY.

KILMDEAD
The best of all the tobacco dusts for



Dusting or fumigating

26 lbs., \$1.00 100 lbs., \$ 3.00 1000 lbs., \$27.00
50 lbs., 1.75 500 lbs., 15.00 2500 lbs., 52.00

Stumpp & Walter Co. 50 Barclay St., New York.

SOMETHING NEW for GREENHOUSES
"SULFOCIDÉ"
PRATT'S
SOLUBLE SULPHUR SUMMER SPRAY

Non-caustic and non-irritating
A FUNGICIDE AND INSECTICIDE
FOR FRUIT TREES, VEGETABLES and GREENHOUSES

A promising substitute for Bordeaux mixture. For 10 cts. to cover postage will send sample sufficient for one gallon of spray.
Use 1 part to 75 or 100 parts of water.
B. G. PRATT CO., 50 Church St., New York, U. S. A.

In writing to Advertisers kindly mention Horticulture

the close of the season after having supplied all regular customers at considerably higher prices. These so-called surplus lists at cut prices are very suggestive of the Hebrew clothier, who has his quarterly cut price sales as a means of getting rid of his junk.

Demoralizing Cutting.

The moral obligation of protecting his customers against these cut prices in so far as he can, would seem to rest on every responsible dealer, but many will load up their regular customers at the best prices they can obtain, then offer any surplus they may have at auction prices.

The so-called surplus cut-price list which makes its appearance in the fall even before the season's crops are in store, and appears at intervals of every few weeks until May, is a pernicious way of securing business, and one of the most demoralizing factors with which the trade contends, and should be discouraged if anything approaching stability is to be maintained. But more later.

The Free Seed Answer.

The seedsmen have got their answer from Congress ament the free seed distribution—it being practically a doubling up of the number of packets sent out—the increase being from 36,000,000 in 1909, to 69,000,000 in 1910.

After spending thousands of dollars, passing denunciatory resolutions, and humbly supplicating Congress, this is their reward. Verily the seedsmen's hopes have turned to dead sea fruit. There are reports as to how the Department's orders for seeds have been given which will require some explanation.

Hearing on Proposed Seed Inspection Law at Albany.

Gentlemen:—

At a preliminary meeting called by the writer, at the Hotel Ten Eyck, Albany, March 22nd, at 8 P. M., in order that some action might be taken regarding Assembly Bill No. 736, introduced by Assemblyman Callan, the following seedsmen were present, or were represented at the hearing:

E. E. Brongerhoff, of J. M. Thorburn & Co., and Alex. F. Hoopes, of Peter Henderson & Co., New York; Edward F. Dibble, of Syracuse Falls, N. Y.; F. H. Ebeling, of Syracuse, N. Y.; Geo. H. Price, of Albany, N. Y.; J. M. Lupton, of Mattituck, N. Y.; H. W. Gaudinier, of Troy, N. Y.; Chas. Eckstein, of Whitely Eckstein Seed Co., Buffalo, N. Y.; M. Parker, of Jerome D. Rice Seed Co., Chateaufort, N. Y.; Soil Seed Co., of Troy, N. Y.; Eberle & Bernhardt, and Sherman & Eberle, of Albany, N. Y.; Fonda, James Vicks' Sons, Mandeville & King, Averill, Hathaway, Crossman Bros., Briggs Bros., and Brewster, Crittenden & Co., of Rochester, N. Y.

The above-mentioned parties were also present at the hearing of the bill which took place at 2 P. M. on the following day before the Committee of Agriculture. Mr. C. Fred Poshart, chairman. No definite conclusion was arrived at at the hearing, but Chairman Poshart suggested that we appoint a special committee of seedsmen to draft a bill and co-operate with Assemblyman Callan, and to report to the Committee on Agriculture again on March 30th.

With reference to this act, "To amend the agricultural law, entitled 'An Act in relation to agriculture, constituting chapter one of the consolidated laws in relation to inspection and sale of seeds,'" we understand the

penalty for violation of the law as expressed in Assemblyman Callan's bill is as follows:

"Every person violating any of the provisions of this chapter shall forfeit to the people of the State of New York the sum of not less than fifty dollars nor more than one hundred dollars for the first violation and not less than one hundred dollars nor more than two hundred dollars for the second and each subsequent violation. When such violation consists of the manufacture or production of any prohibited article, each day during which or any part of which such manufacture or production is carried on or continued, shall constitute a separate violation. When the violation consists of the sale, or the offering or exposing for sale or exchange of any prohibited article or substance, the sale of each one of several packages shall constitute a separate violation, and each day on which any such article or substance is offered or exposed for sale or exchange shall constitute a separate violation, and the furnishing of the same for use to each person to whom the same may be furnished shall constitute a separate violation. Whoever by himself or another violates any of the provisions of articles three, four, six, eight and nine, or sections three hundred, four hundred and three hundred fifteen of this chapter or of section one hundred six, one hundred seven and one hundred eight of this chapter, shall be guilty of a misdemeanor, and upon conviction shall be punished by a fine of not less than fifty dollars, nor more than two hundred dollars, or by imprisonment of not less than one month nor more than six months, or by both such fine and imprisonment, for the first offence; and by six months' imprisonment for the second offence."

This is a matter of vital importance, and we fear, owing to the rush of business at this time of the season the matter is not having as careful attention as its importance warrants, and it is sincerely hoped that there will be a good attendance of the seedsmen at the next hearing which is set down for Tuesday, March 30th.

Yours very truly,

MARSHALL H. DURYEA,

2nd Vice President of

American Seed Trade Association.

Tariff Committee Meeting of American Seedsmen, Florists and Nurserymen.

According to arrangement, the Tariff Committee of the Society of American Florists, American Seed Trade Association, and the American Association of Nurserymen, met in Buffalo, at the Hotel Iroquois, to compare notes as to the interests that each had in common. The S. A. F. were represented by Frank R. Pierson, P. Welch and Benjamin Hammond. The other gentlemen present were: J. C. Vaughan and Mr. White of the D. M. Ferry Co., representing the seedsmen; Irving Kouse, W. C. Barry, W. Pitkin, Chas. Brown and S. H. Dayton, representing the nurserymen.

After a conference lasting three hours and a half, the following resolution was passed and signed respectively for the three associations, and this resolution was to be forwarded and used as far as possible with Congress to secure the desired end,—that is, to cut out ad valorem duties and substitute specific, wherever practicable.

We, the members of the American Seed Trade Association, the American Association of Nurserymen, and the Society of American Florists, as represented by our duly authorized Committees, and speaking for these three great industries (practically all agricultural horticultural interests of the United States, unanimously agree upon the following resolution:

Whereas, There is now pending in the National Congress a tariff measure, known as the Payne Bill; and,

Whereas, This bill may without prejudice

Michell's Unexcelled ASTERS

QUEEN OF THE MARKET

EXTRA EARLY	Tr. pkt.	0z.
Dark Blue \$5.00	\$0.60
Light Blue 20
Crimson 20
Pink 60
White 20
Fixed 20

INVINCIBLE

A superior strain of great value to florists for cuttings	Tr. pkt.	0z.
Blue \$0.50	\$1.50
Crimson 30
Lavender 30
Rose-Pink 30
White 30
Fixed 30

Write for our Wholesale Catalog

HENRY F. MICHELL CO.

1018 Market St., PHILA.

VEGETABLE PLANTS

FOR TRANSPLANTING

CABBAGE Wakefield and Succession

..... \$1.00 per 1000

EGG PLANT—N. Y. Improved and Black Beauty

..... \$2.00 per 1000

PEPPER—Bull Nose, Ruby King and Sweet Mountain

..... \$3.00 per 1000

Chinese Giant and Cayenne

..... \$0.50 per 1000

TOMATO—Earliana, Chalk's Jewel and Early June Pink

..... \$2.00 per 1000

CASH WITH ORDER

R. VINCENT, JR., & SONS CO.

White Marsh, Md.

200,000 CLADIOLI BULBS

¾ to 1½ inches, \$2 per 1000. 1½ to 1¼, \$4 per 1000.

1¼ and up, \$5 per 1000.

CALIFORNIA PRIVET

1 yr. well branched, \$50 per 1000. Cash with order.

Nice lot of AMERICAN CHESTNUT TREES at a bargain, about 50 LARGE SUGAR TREES, most of them sample trees.

Surplus of STONE TOMATO SEED: Ruby King, Neapolitan, Bull Nose and Sweet Mountain Pepper Seed at a bargain.

I. & J. L. LEONARD, - Iona, N. J.

Vegetable Plant Nurserymen and Seed Growers

BRIDGEMAN'S SEED WAREHOUSE

RICKARDS BROS.

Props.

37 East 19th St., - NEW YORK CITY

Ward's Lily Bulbs

Send for Catalogue



Ralph M. Ward & Co.

12 W. Broadway

NEW YORK

to the welfare of the public, but, on the contrary, to the great economy of customs administration, be so framed as to relieve all horticultural importers, government officials, etc., of the insupportable difficulties in the way of a fair and equitable administration of any excise upon this class of imports, based on the ad valorem principle; now, therefore, be it

Resolved, That collectively and individually, we appeal to the Congress to make all duties upon Seeds, Nursery Stock, Bulbs, etc., whatever revenue they may be intended to produce, or whatever interests they may protect, upon a specific basis.

J. C. VAUGHAN,

For American Seed Trade Association.

S. H. DAYTON,

For American Association of Nurserymen.

F. R. HEDSON,

For Society of American Florists.

Dated at Buffalo, N. Y., March 18, 1909.

Everything "For the Land's Sake."

The one firm in Boston where all good forms of plant food may be obtained, is the Bowker Fertilizer Company, opposite Faneuil Hall at 43 Chatham St. All greenhouse chemicals, Nitrate of Soda, Ground Bone, Potash Salts, Sheep Manure and Wood Ashes can there be had at first hands.

BOWKER FERTILIZER COMPANY

Everything "For the Land's Sake."

Mignonette

FARQUHAR'S GIANT

Oz., 75c; 1-4 oz., 25c

R. & J. Farquhar & Co.

6 & 7 South Market Street
BOSTON, MASS.

CANES

Freshly Cut From the Brakes For Your Lilies

Can Be Cut To Any Size

\$5 for 500, \$7 for 1000

Wm. Elliott & Sons
42 Vesey St., New York

RELIABLE SEEDS—SOW NOW
PRIMULA OBCONICA GRANDIFLORA

	1000 seeds	Tr. pkt.
Blood red, fine seller	\$.15	\$0.50
Real pink, fine for cut	1.00	.50
Pure white, fine for cut	1.00	.50
Compacta, fine potted	1.50	.50
Mixed Hybrids	1.00	.50

O. V. ZANGEN, - HOBOKEN, N. J.

LEONARD SEED CO.

CONTRACT GROWERS AND WHOLESALE DEALERS
BEANS, PEAS, SWEET CORN, ONION, GARDEN SEEDS
ONION SETS 79 and 81
FLOWER SEEDS Get Our Prices E. KINZIE STREET, CHICAGO

ESTABLISHED 1802

Thorburn's Seeds

FINE CLUMPS JAPAN IRIS
TUBEROUS ROOTED BEGONIAS
GLOXINIAS
ROSA MULTIFLORA NANA SEED
and all other flower seeds for florists

SEND FOR CATALOGUE

J. M. THORBURN & CO.
33 Barclay Street
NEW YORK

CAULIFLOWERS ^E
ABBAGE ^E
LILY OF THE VALLEY PIPS.
HJALMAR HARTMANN & CO.
12 Stormgade,
COPENHAGEN, DENMARK.

Burpee's Seeds
PHILADELPHIA

Blue List of Wholesale Prices mailed only to those who plant for profit!

Vegetable and Flower **SEEDS**
reliable and Tested. Catalogue Mailed Free
WEBER & DON
Seed Merchants 114 CHAMBERS STREET
NEW YORK

CONTRACT GROWER OF

Vegetable and Flower Seeds
For the Wholesale Trade.
Write, stating what Seed you want grown.

JOHN S. WEAVER

Glen Mawr Seed Farms. Kinzers, Lancaster Co., Pa.

STOCK SEED
FOR WINTER BLOOMING

Our strain of Double Branching Stocks is exceptionally true. About 90% Double Flowers.

In colors: - 3/4 oz. .60 oz. \$4.00
Pure White 3/4 " .75 " 5.00

H. E. FISKE SEED CO.
Faneuil Hall Square, BOSTON, MASS.

Winter-flowering
SWEET PEA SEED

All Colors Ask for List
A. C. ZVOLANEK

ORIGINATOR. BOUND BROOK, N. J.

NEW CROP SEED

For Early Planting
THOMAS J. GREY CO.
32 SO. MARKET ST., BOSTON, MASS.

BEGONIAS TUBEROUS ROOTED
—ALSO—
GLOXINIAS, LILY OF VALLEY, SPIREA
Catalogues mailed free on application

Joseph Breck & Sons Corp.
47-54 NO. MARKET ST., BOSTON, MASS.

Japanese Bulbs, Etc.

R. TANOI, Yokohama, Japan.

Send for catalogue and write to Representative
K. TAKEUCHI,
478a Boylston St., Boston, Mass.

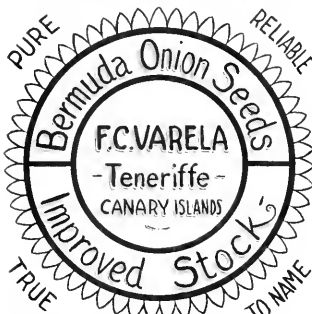

NO COMPLAINTS AND —
NO TROUBLE WITH MY SEEDS

Catalpa Speciosa Seed.

Michigan Grown seed by mail.
500 for \$1.00—5000 for \$8.00

Order from

M. S. HUBBELL, West Toledo Station, Ohio

In ordering goods please add "I saw it in HORTICULTURE."

GEO. E. DOW
Designing and Illustrating

178 Washington St., Boston, Mass.

OUR SPECIALTY
Machine, Booklet, Advertising and Flower
PHOTOGRAPHS

To Florists Everywhere

Orders for Cut Flowers and Floral Decorations to be delivered anywhere in the Greater New York, may be placed with us with the certainty that your customers will be satisfied.

Telegraph, telephone or mail such orders to us and be sure that they will be filled as promptly and as carefully as though you did it yourself.

One third discount will be allowed on all orders thus placed with us by Florists outside of the Greater New York.

THE BLOSSOM

Bond and Livingston Sts.,
BROOKLYN, N. Y.

C. C. TREPPEL, Manager

**WILLIAM J. SMYTH
FLORIST**

Cor. Michigan Ave. and 31st St., CHICAGO

We ship to all points in Illinois and Iowa.

Phones: Douglas 744, Douglas 523, Douglas 740

M. C. and J. E. HAUSWIRTH

Out of Town orders for Hospitals
Carefully filled.

**232 Michigan Ave.
CHICAGO**

AUDITORIUM ANNEX Tel. Harrison 585

**SAMUEL MURRAY
Florist**

Coates House Conservatory

1017 BROADWAY, KANSAS CITY, MO.

Both 'Phones 2670 Main.



WASHINGTON,
D. C.

GUDE'S

The Far-Famed Flowers of
TORONTO

Delivered on mail or telegraph order for any occasion, in any part of the Dominion.

JOHN H. DUNLOP,

96 Yonge St., - Toronto, Ont.

The Park Floral Co.

J. A. VALENTINE
Pres.

DENVER, COLORADO

**WILLIAM L. ROCK
FLOWER CO.**

KANSAS CITY, - MO.

will carefully execute orders for Kansas City and any town in Missouri or Kansas.



Buffalo, N. Y.

W. J. PALMER & SON, 304 Main St.

OF INTEREST TO RETAIL
FLORISTS.

Washington Notes.

The florists report an unusually good business during the past week and on Wednesday, St. Patrick's Day, some of the stores were practically empty of novelties shortly after the middle of the day. Everywhere was green in evidence and green carnations at \$3.00 per 100 went by thousands. One of the prettiest novelties shown was a green crepe paper cover for Shamrock pans which was tied with green ribbon and with a clay pipe attached. The sale of shamrock has almost doubled that of previous years. Carnations are and have been for some weeks, very scarce, owing, no doubt, to the almost continued cloudy weather. There has been a strong demand for gardenias and they easily bring \$5.00 per dozen in the wholesale market. Cheap bulbous stock is hurting the regular standards not a little. A very smooth stranger relieved the Gude Bros. of a little

STEAMER DEPARTURES

American.	
St. Louis, N. Y. Southampton	Apr. 3
Philadelphia, N. Y. Southampton	Apr. 10
Atlantic Transport.	
Mesala, N. Y. London	Apr. 3
Mimelaha, N. Y. London	Apr. 10
Cunard.	
Lusitania, N. Y. Liverpool	Mar. 31
Fremantle, Boston Liverpool	Apr. 6
Laurania, N. Y. Liverpool	Apr. 7
French Line.	
La Touraine, N. Y. Havre	Apr. 1
La Lorraine, N. Y. Havre	Apr. 8
Hamburg-American.	
Patricia, N. Y. Hamburg	Apr. 3
America, N. Y. Hamburg	Apr. 10
North German Lloyd.	
Prinz Friedrich Wilhelm,	
N. Y. Bremen	Apr. 1
Koenigin Luise,	
N. Y. Med. Ports	Apr. 10
White Star.	
Adriatic, N. Y. Southampton	Mar. 31
Cedric, N. Y. Med. Ports	Apr. 3
Gedric, N. Y. Liverpool	Apr. 3
Majestic, N. Y. Southampton	Apr. 7

spare change a few days since. He gave his name as Fred E. Pierce, agent for Admiral E. H. C. Lentz, U. S. N., and ordered flowers to the amount of \$54.00 sent to the Admiral. A cheque for \$75.00 was accepted by the firm and he was given \$21.00 in change. Pierce has since been captured in Cincinnati.

Business is very brisk in DETROIT cut flowers as well as plants. An ever-increasing shipping trade keeps the wholesalers hustling and the stock at low ebb. Lilies are coming in a little more plentifully. This week will see most of the trade hustling in store decorations. Several of the most prominent stores have their spring openings and calls for palms, etc., are brisk. Unfortunately some of the dealers still believe that it pays to rent large palms for two or three days at 50c. per plant. A careful estimate of the price of the plant, cost of keeping, interest on capital invested, and considering that a plant is unsalable after ten decorations, will prove that a charge of 50c. per plant is not adequate.

FRANK DANZER.

ALEX. McCONNELL

571 FIFTH AVENUE
NEW YORK CITY

Telegraphic orders forwarded to any part of the United States, Canada, and all principal cities of Europe. Orders transferred or intrusted by the trade to our selection for delivery on steamships or elsewhere receive special attention.

Telephone Calls, 487 and 488 30th St.
Cable Address, ALEXCONNELL

New York Deliveries

FLOWERS and PLANTS

by special messenger to Steamer,
Theatre or any address in

NEW YORK or BROOKLYN

THOMAS YOUNG, JR.

500 FIFTH AVE., (near 42nd St.)

NEWMAN FLORAL Co.

(Established 1870)

202 Fifth Ave. and
Madison Square, NEW YORK CITY

FLOWERS FOR STEAMER SAILINGS

M. A. BOWE

In the Heart of New York City

1294 Broadway

Tel. 2270, 38th St. NEW YORK

Our Motto—The Golden Rule

DAVID CLARKE'S SONS

Deliver orders from any part of the country to
New York City

Or OUT-GOING STEAMERS

Write or telegraph

2139-2141 Broadway, New York

Telephone 1552-1553 Columbus

YOUNG & NUGENT

42 West 28 St., NEW YORK

"FLOWERS BY TELEGRAPH"

**NEW YORK
MYER, FLORIST**

Phone 5287 Plaza. 609-611 MADISON AVE.

ALBANY, N. Y.

EYRES

Flowers or Design Work

DELIVERED IN ALBANY AND VICINITY
ON TELEGRAPHIC ORDER.

11 NORTH PEARL ST., ALBANY, N. Y.

Flower Deliveries

In Brooklyn and other Long Island Points
New York City, New Jersey, etc. At Theaters,
Hotels, Steamers or Residences.

WILSON

Fulton St. and Greene Ave., Brooklyn, N. Y.

JOHN BREITMEYER'S SONS

Cor. Miami and Gratiot Aves.
DETROIT, MICH.

Artistic Designs . . .
High Grade Cut Blooms

We cover all Michigan points and good sections of Ohio, Indiana and Canada

PROMPT DELIVERY IN BOSTON

AND ALL NEW ENGLAND POINTS
F. H. HOUGHTON
396 Boylston St., Boston, Mass.

BOSTON'S BEST In Quality and Design

Can be relied upon when you transfer your retail orders to

EDWARD MACMULKIN
194 Boylston Street, Boston

Send flower orders for delivery in
BOSTON
and all

NEW ENGLAND POINTS
THOS. F. CALVIN
124 Tremont St., Boston

The Original Telegraph Order Florist
WILL DELIVER

Flowers or Designs
to order in Boston and Vicinity. Usual Discount.

J. NEWMAN & SONS, Inc.
EST. 1870 24 TREMONT ST., BOSTON



DANKER, Albany, N. Y.

ORDERS FOR
Choice Flowers and
Floral Emblems
FILLED PROMPTLY

LOUISVILLE, KY.
JACOB SCHULZ,
550 South Fourth Ave.

WELLESLEY COLLEGE
Dana Hall, Walnut Hill and Rockridge Hall
Schools. TALBY, Wellesley, Mass.
Tel. Wellesley 44-1 and 2. Night 44-3.

ATLANTA FLORAL CO.
41 Peachtree Street, ATLANTA, GEORGIA

"FLOWERS BY TELEGRAPH."

Leading Retail Florists Listed by
Towns for Ready Reference.

- Denver, Colo.—Park Floral Co., 1706 Broadway.
- Washington, D. C.—Gude Bros., 1214 F St.
- Atlanta, Ga.—Atlanta Floral Co., 41 Peach Tree St.
- Chicago—M. C. & J. E. Hanswirth, 232 Michigan Ave.
- Chicago—William J. Smyth, Michigan Ave. and 31st St.
- Chicago—George Wittbold Co., 1657-59 Buckingham Place.
- Louisville, Ky.—Jacob Schulz, 550 South Fourth Ave.
- Boston—Thos. F. Galvin, 124 Tremont St.
- Boston—Frank H. Houghton, 396 Boylston St.
- Boston—Edward MacMulkin, 194 Boylston St.
- Boston—Hoffman, Florist, 59-61 Massachusetts Ave.
- Boston—J. Newman & Sons, Inc., 24 Tremont St.
- Boston—Julius A. Zinn, 2 Beacon St. Wellesley, Mass.—Talby.
- Detroit, Mich.—J. Breitmeyer's Sons, Miami and Gratiot Aves.
- Kansas City, Mo.—Samuel Murray, 1017 Broadway.
- Kansas City, Mo.—Wm. L. Rock Flower Co., 116 Walnut St.
- Albany, N. Y.—H. G. Eyres, 11 N. Pearl St.
- Albany, N. Y.—F. A. Danker, 40 Maiden Lane.
- New York—David Clarke's Sons, 2139-2141 Broadway.
- New York—Alex. McConnell, 571 5th Ave.
- New York—Young & Nugent, 42 W. 28th St.
- New York—M. A. Bove, 1294 Broadway.
- New York—Myer, 609-11 Madison Ave.
- New York—Thos. Young, Jr., 500 Fifth Ave.
- New York—Newman Floral Co., 202 Fifth Ave. & Madison Sq.
- Brooklyn, N. Y.—The Blossom (C. C. Trepel, Mgr.), Bond and Livingston Sts.
- Brooklyn, N. Y.—Robert G. Wilson, Fulton St. and Greene Ave.
- Buffalo, N. Y.—Palmer's, 304 Main St.
- Toronto, Can.—J. H. Dunlop, 96 Yonge St.

PERSONAL.

Visiting New York: Al. Salter, Rochester, N. Y.

E. Johannes has taken a position as foreman at the Schantz greenhouses, Pekin, Ill.

Alfred Pahud and Mrs. Emilie Stecher of Indianapolis were married on March 10.

Frank Lewis of Brampton, Ont., has taken a position with A. M. Terrill at Calgary, Alberta.

Mr. Ed. Winterson of Chicago is recovering from a severely wrenched arm, resulting from a fall.

Frank Mitchell, florist, Waterville, Me., who cut his foot with an axe March 13, is around on crutches.

James Burns of Rochester, N. Y., has taken a position as foreman at the nursery of C. R. Burr & Co., Durham, Conn.

C. C. Shaw of Milford, N. H., president of the State Horticultural Society, was given a public reception on March 20, his eighty-fifth birthday.

Julius Roehrs, wife, daughter and son-in-law sailed from New York last Saturday for Europe, the Ghent Quintennial show being their destination.

Mr. C. Harman Payne has been elected a member of the Chrysanthemum section of the Floral Committee of the Societe Nationale d'Horticulture de France, a distinction not previously

THE BEST LETTERS

FOR THOSE
FLORISTS' R MADE
USE BY THE

Boston Florist Letter Co.

66 PEARL ST., BOSTON
N. F. MCCARTHY, Mgr.

Order direct or buy from your local supply dealer. Insist on having the

BOSTON

Inscriptions, Emblems, etc., Always in Stock

Durand & Marohn

MANUFACTURERS OF

All Kinds of Wire Work
Florists' Wire Designs a Specialty
24 Beaver St., ALBANY, N. Y.

FLORISTS' SUPPLIES

Send for New Catalogue

H. Bayersdorfer & Co.

1129 ARCH ST., PHILADELPHIA

TRANSFER

Your orders for flower or plant delivery in Eastern New England to

JULIUS A. ZINN,

2 Beacon St., Boston.
FINE DESIGN WORK SPECIALTY

conferred upon a foreigner.—Market Growers' Gazette, London.

Harry M. Lubliner, of Lubliner & Trinz, and Miss Beckie Harmon, of Chicago, were married on March 16 at the residence of the bride, on St. Lawrence avenue.

Visitors in Chicago: F. C. Weber, St. Louis, Mo.; R. A. Latham, Minneapolis, Minn.; C. C. Pollworth, Milwaukee, Wis.; J. A. Valentine, Denver, Colo.; E. J. Fancourt of Pennock-Meehan Co., Phila.; Fritz Bahr, Highland Park, Ill.; A. L. Glaser, Dubuque, Ia.; Edward Amerpohl, Janesville, Wis.; A. T. Peterson, Wheaton, Ill.; Mr. Ellison, Jr., of Ellison Floral Co., St. Louis, Mo.

NEW FLOWER STORES.

Bangor, Me.—Mrs. Thomas Allen & Son, 9 Hammond St.

Tecumseh, Mich.—Tecumseh Floral Gardens.

Cleveland, O.—G. M. Nanmann, Superior Ave. and 105th street.

Charlestown, Mass.—Wm. H. Winnett, 8 Waverley Block, City Square.

Chas. McCellar, who has had great success in handling gardenias for the Chicago wholesale market, suggests that florists frequently fall in the handling of these easily injured flowers because they put them in water instead of keeping them in oiled paper.

TRY A SHIPMENT OF OUR

**BRIDES
MAIDS
RICHMOND
KILLARNEY**

At \$6.00, \$8.00 and \$10.00 per 100.

And you will have the best Roses your money can buy at these prices.

THE LEO NIESSEN CO.

1209 Arch St., Philadelphia, Pa.

Open from 7 a. m. to 8 p. m.



SPRENGER

Extra choice long sprays
50c PER BUNCH

CATTLEYAS

\$6.00 per doz., \$40.00 per 100

EXTRA SPECIAL QUALITY

S. S. PENNOCK-MEEHAN CO.

1608-1620 Ludlow St., Philadelphia

DOUBLE and SINGLE VIOLETS

Home grown extra quality

W. E. MCKISSICK & BROS.

WHOLESALE FLORISTS

1619-1621 RANSTEAD ST.
PHILADELPHIA



CHAS. W. MCKELLAR

51 WABASH AVE., CHICAGO

Western Headquarters for Choice Orchids
Valley, Roses and all Cut Flowers

PETER REINBERG
WHOLESALE

CUT FLOWERS

51 Wabash Av., Chicago, Ill

Long Distance Phone, Central 6004

WINTERSON'S SEED STORE

45-47-49 Wabash Ave., Chicago.

Seedsmen, Plantsmen, Nurserymen

Florists' Supplies

We can supply everything used by the Florist. SUPPLY CATALOG FREE. Correspondence solicited.

POEHLMANN BROS. CO.

33-35-37 Randolph St., - CHICAGO

CUT FLOWERS

Greenhouses, - Morton Grove, Ill.

Rice Brothers

115 N. 6th Street, MINNEAPOLIS, MINN.
WHOLESALE FLORISTS and SUPPLIES

CUT FLOWERS received twice daily, and can fill your orders to your satisfaction. A complete line of Hardy Greens—WILD SMILAX, BOXWOOD, HARDY FANCY FERNS, GALAX LEAVES.
Write for quotations on large quantities.

In ordering goods please add "I saw it in HORTICULTURE."

WELCH BROS.

AMERICAN BEAUTY, KILLARNEY, RICHMOND, MARYLAND AND ALL THE SUPERIOR ROSES, LILY OF THE VALLEY, CARNATIONS, ORCHIDS
BEST PRODUCED

226 Devonshire Street,

Boston, Mass.

WHOLESALE FLOWER MARKETS—TRADE PRICES—Per 100 TO DEALERS ONLY

	CHICAGO		TWIN CITIES		PHILA.		BOSTON	
	March 23	March 22	March 23	March 22	March 23	March 22	March 23	March 22
ROSES								
Am. Beauty, Fancy and Special	30.00	to 40.00	40.00	to 50.00	30.00	to 50.00	30.00	to 50.00
" Extra	40.00	to 50.00	50.00	to 60.00	25.00	to 30.00	15.00	to 25.00
" No. 1	1.00	to 20.00	20.00	to 30.00	15.00	to 20.00	10.00	to 12.00
" Lower grades	6.00	to 12.00	10.00	to 20.00	3.00	to 10.00	4.00	to 8.00
Bride, Maid, Fancy & Special	6.00	to 8.00	8.00	to 12.00	8.00	to 10.00	6.00	to 8.00
" Lower grades	4.00	to 6.00	6.00	to 8.00	2.00	to 4.00	2.00	to 4.00
Killarney, Fan, & Sp.	3.00	to 12.00	8.00	to 12.00	10.00	to 12.00	8.00	to 12.00
" Lower grades	4.00	to 8.00	6.00	to 8.00	4.00	to 8.00	2.00	to 6.00
Richmond, Fancy & Special	2.00	to 12.00	8.00	to 12.00	10.00	to 15.00	12.00	to 16.00
" Lower grades	4.00	to 6.00	6.00	to 8.00	2.00	to 4.00	4.00	to 8.00
Chatenay	5.00	to 8.00	4.00	to 8.00	to	2.00	to 8.00
Golden Gate Ivory, etc.	to	4.00	to 8.00	to	3.00	to 8.00
My Maryland	to	to	to	4.00	to 8.00
Mrs. Wm. Field	to	to	to	to
CARNATIONS								
Fancy and Red	2.00	to 3.00	3.00	to 4.00	3.00	to 4.00	2.50	to 3.50
Ordinary and White	1.00	to 2.00	1.50	to 2.00	2.00	to 3.00	1.50	to 2.50
MISCELLANEOUS								
Cattleyas	40.00	to 50.00	40.00	to 50.00	40.00	to 50.00	40.00	to 50.00
Lilies	22.00	to 15.00	8.00	to 12.00	10.00	to 12.00	8.00	to 12.00
Lily of the Valley	to 3.00	3.00	to 4.00	2.00	to 4.00	1.00	to 3.00
Narciss, Paper White	3.00	to 4.00	3.00	to 4.00	2.00	to 3.00	1.00	to 2.00
Roman Hyacinth	3.00	to 4.00	3.00	to 4.00	2.00	to 3.00	1.00	to 2.00
Tulips	3.00	to 4.00	2.00	to 4.00	to	3.00	to 4.00
Daffodils	2.00	to 3.00	2.00	to 3.00	1.00	to 2.00	3.00	to 3.00
Freesia	3.00	to 4.00	2.00	to 3.00	1.00	to 2.00	1.00	to 2.00
Mignonette	4.00	to 6.00	2.00	to 3.00	2.00	to 3.00	1.00	to 4.00
Sweet Peas	to 1.00	.75	to 1.00	.50	to 1.00	.75	to 1.00
Gardenias	30.00	to 40.00	30.00	to 40.00	10.00	to 20.00	10.00	to 20.00
Violets	.50	to .75	.50	to 1.00	.25	to .75	.20	to .50
Adiantum	to 1.50	1.00	to 1.50	1.00	to 1.50	.75	to 1.00
Smilax	18.00	to 15.00	10.00	to 15.00	15.00	to 20.00	15.00	to 18.00
Asparagus Plumosus, strigatus	40.00	to 50.00	35.00	to 50.00	to	50.00	to 50.00
" " & Spreng. (too bech)	35.00	to 30.00	20.00	to 30.00	to	50.00	to 15.00

J.A. BUDLONG
37-39 Randolph Street, CHICAGO.

Roses and Carnations
A Specialty.....
WHOLESALE GROWER of **CUT FLOWERS**



HENRY M. ROBINSON & CO.
15 Province St. and 9 Chapman Place - BOSTON, MASS.

WHOLESALE COMMISSION FLORISTS

Hardy Cut Evergreens and Florists' Supplies

We have the stuff and can fill all orders, large or small
WE NEVER DISAPPOINT SATISFACTION GUARANTEED



Prices Quoted in these Columns are for Dealers Only.
When Writing to Advertisers Please Mention
HORTICULTURE.

Flower Market Reports.

The flower market is generally sluggish this week and should spring weather conditions ensue, as now seems likely, a decided slump in values is a foregone conclusion. Roses are particularly weak and tending downward. They are accompanied by lily of the valley and all bulbous material, excepting lilies, which are doing fairly well. Carnations are also holding their own in good shape, especially the white section.

Trade was quite active the past week especially in the shipping line, though there was no great rush, but during these Lenten days there has to come a day once in a while to keep the clerks awake. Choice lines of stock are arriving daily and the retailers have no complaint to make of waiting for stock to fill orders as the coolers have been on the full house list, another instance where the wholesaler carries the largest portion of stock. Variable weather has made the trade irregular, though a satisfactory business is being done by both retailer and wholesaler. A good portion of white material has been consumed while colored stock was weak in demand. Roses are coming in more plentiful daily. Carnations have fallen off somewhat in supply, though plenty to be had and choice stock, all at prices that no one can complain of. Tulips and daffodils were not plentiful, though no demand for lily of the valley which is excellent. Violets, daisies, pansies, freesia and sweet peas have sold readily. There is a good supply of all greens, including Farleyense Adiantum. The trade is looking forward to one of, if not the best Easter that has been had and every indication points toward it.

Business has steadily improved during the past week. The demand for flowers has been good and the volume of trade consequently increased. White sold as fast as received and orders had to be frequently filled with longer stemmed stock than would have been used had short stock been obtainable. Some of the growers state that the quality of Beauties and other roses never was better than at the present time. Lilies are getting quite scarce. Present prospects are for a shortage in supply for Easter. Bassett & Washburn state that they never before have seen the market so bare of lilies and the price so high at this time of the year, and considered it a sure indication of a scarcity at Easter. Carnations are in good demand, all shipping stock selling out clean every day. White carnations are especially in demand, fancy stock bringing maximum quotations the first of the week. Demand for green is good both in smilax and asparagus. Tulips and daffodils seem to have shortened in supply. Shipping trade was very brisk the latter half of the week and Monday, the 22nd, started the new week in the same way. Wholesalers are very much pleased with the state of trade and look for an active market till Easter.

WHOLESALE FLOWER MARKETS.—TO DEALERS ONLY.

	PER 100.			
	CINCINNATI March 23	DETROIT March 22	BUFFALO March 22	PITTSBURG March 22
ROSES				
Am. Beauty, Fan, and Sp.	35.00 to 40.00	35.00 to 40.00	40.00 to 50.00	40.00 to 50.00
" " Extra	25.00 to 30.00	28.00 to 32.00	25.00 to 30.00	30.00 to 35.00
" " No. 1	15.00 to 20.00	28.00 to 35.00	15.00 to 20.00	30.00 to 35.00
" " Lower grades	8.00 to 10.00	8.00 to 15.00	8.00 to 10.00	10.00 to 15.00
Brid. "Maid, F. & S.	6.00 to 8.00	8.00 to 12.00	10.00 to 12.00	8.00 to 10.00
" " Low. gr.	4.00 to 5.00	4.00 to 5.00	3.00 to 6.00	6.00 to 8.00
Killarney, Fan, & Sp.	6.00 to 8.00	8.00 to 12.00	10.00 to 12.00	10.00 to 15.00
" " Lower grades	4.00 to 5.00	4.00 to 6.00	5.00 to 6.00	3.00 to 5.00
Richmond, Fan, & Special	8.00 to 10.00	8.00 to 12.00	10.00 to 12.00	10.00 to 15.00
" " Fancy grades	4.00 to 6.00	4.00 to 6.00	3.00 to 6.00	4.00 to 8.00
Chatsau	5.00 to 8.00	6.00 to 10.00
Golden Gate, Ivory
My Maryland
Mrs. Mar. Field
CARNATIONS				
Fancy and Novelties	3.00 to 4.00	3.00 to 4.00	3.00 to 4.00	2.00 to 4.00
Ordinary	1.50 to 2.00	2.00 to 3.00	1.50 to 2.00	1.00 to 1.50
MISCELLANEOUS				
Cattleyas	50.00 to 60.00
Lilies	10.00 to 12.00	12.50 to 15.00	8.00 to 15.00	10.00 to 13.00
Lily of the Valley	3.00 to 4.00	3.00 to 4.00	3.00 to 4.00	2.00 to 4.00
Narciss, Paper White	3.00 to 4.00	4.00 to 5.00	3.00 to 4.00
Ronax Ilya	4.00 to 5.00	4.00 to 6.00	4.00 to 6.00	3.00 to 5.00
Tulips	3.00 to 5.00	2.00 to 3.00	3.00 to 4.00
Daffodils	2.00 to 3.00	3.00 to 4.00	2.00 to 3.00	1.00 to 3.00
Freesias	2.00 to 3.00	2.00 to 3.00	2.00 to 3.00	1.00 to 3.00
Adiantum	1.00 to 1.50
Sweet Peas	1.00 to 1.50
Gardenias
Violets
Adiantum	1.00 to 1.50
Smilax	10.00 to 12.50	15.00 to 12.50	15.00 to 12.50
Asparagus Plumosus, strings	40.00 to 50.00	50.00 to 40.00	50.00 to 50.00
" " & Spreu. (two bchs.)	20.00 to 25.00	30.00 to 50.00	25.00 to 50.00	30.00 to 50.00

White carnations PHILADELPHIA are still off crop, with demand unusually brisk. Pinks and reds are more plentiful (especially Enchantress), but on the whole prices have stiffened up very considerably. Winsor, Beacon, Afterglow, Winona are among the favorites. Many of our growers say that Beacon has beaten them all as a money maker this year. There is call for medium sized whites, such as Queen or Boston Market, and the supply of same is very meager. The general run of roses are coming in a little too plentiful—and yet the demand is excellent. Richmonds are an exception. These are not so many and are cleaning up well. American Beauty is holding its improved form in quantity and quality, especially in the long stems. The price of same is firm and it looks now as if this market would hold unbroken until after Easter. Words fail the rose lover when he looks on the glorious Jardines and Killarneys now coming in. All he can do is dance with joy—and buy. Cattleya Schroederiae is the principal orchid coming in. A darker colored variety would sell better. We have heard of gardenias selling at twenty-five cents a dozen. We have also heard of gardenias selling at five dollars a dozen. The chances are the five-dollar grade was the best value. When a thing gets too cheap people don't want it. "R. K." should possess his soul in patience. He never had and never will, and does not have to, compete with the curb men. A first-class store knows that it is good policy to let good stock go to the dump rather than let a customer jew them. If they are allowed to do it once they

will want to do it all the time. The few pennies the curb men gather in don't make much difference one way or the other, and in the main they spread a love of flowers among the common people. Single violets are going well but doubles are rather too plentiful. If this weather holds this crop will be in fine shape for Easter. Callas and lilies are going a little better. So is lily of the valley. All the daffodils now coming in are southern grown. Sweet peas are in better favor and bringing good returns.

For Mid-Lent market conditions remain quite satisfactory. The principal call for the past week was stock for store openings and several large weddings, but a reasonably steady demand exists in all lines. Roses and carnations are plentiful and of good quality and move freely. Beauties are not over plentiful but enough to go around. The warm days have affected the outside bulbs such as Dutch hyacinths, tulips, etc., and in many cases stock that was intended for Easter will be ready long before that time. The market is well stocked with bulbous stuff, the demand for which is good. Orchids, lily of the valley and sweet peas seem to be good property with a lively demand. All the florists are very busy. The prospects point to a good stock of everything except lilies for Easter. This seems to be a good market for cheap green stock.

Retailers and wholesalers report business as good in the Twin Cities during the past week. Supply about equals demand, except bulbous stock which is pretty well used up for the present.



EVERYBODY KNOWS Park, Cemetery and Landscape Gardening cannot be properly done without the aid of an accurate leveling instrument.

Bostrom's Improved Levels, No. 2 at \$15.00 and No. 3 at \$25.00, are conceded by all who KNOW to be the only Levels on the market which meet all the requirements, at the price.

Our guarantee back of every Level we sell, and satisfied users in every State in the Union heartily endorse every claim we make.

Shipping weight 12 lbs. Description on request.

BOSTROM-BRADY MFG. CO., 139 Madison Avenue, ATLANTA, GA.

FORD BROTHERS

48 West 28th Street NEW YORK

FINE ROSES FANCY CARNATIONS

A Full Line of All CUT FLOWERS

Telephone, 3870 or 3871 Madison Square

H. E. FROMENT

Wholesale Commission Florist,
Choice Cut Flowers,

57 West 28th St. :: NEW YORK

Telephones: 2200, 2201, Madison Square.

Alfred H. Langjahr

All choice cut-flowers in season. Send for quotations. Correspondence with shippers of first-class stock invited.

55 West 28th Street, New York

Telephones 4526-4527 Madison Square

Edward C. Horan

Wholesale Florist

55 WEST 28th ST.

tel. 1462 Madison Square New York

JOHN YOUNG

WHOLESALE FLORIST

Finest American Beauties and Carnations

51 West 28 St. - NEW YORK

FRANK MILLANG

Wholesale Florist

55-57 West 26th St., NEW YORK

Shipments, any quantity, Wholesale Market Rates.

Henshaw & Fenrich

WHOLESALE FLORISTS

44 West 28th Street, NEW YORK

Phones Mad. Sq. 325, 558-2, 558-3

VIOLETS

Finest Grade. Any Quantity

B. S. SLINN

55-57 W. 26 St., New York

Moore, Hentz & Nash

Wholesale Commission Florists

55 and 57 West 26th Street

Telephone No. 756 Madison Square New York

MILLANG BROS.

WHOLESALE COMMISSION FLORISTS

41 West 28th Street

Telephones 8660 Madison 3861

NEW YORK

JOHN I. RAYNOR

Wholesale Commission Florist **BELLING AGENT FOR LARGEST GROWERS**

A full line of Choice Cut Flower Stock for all purposes. Comprises every variety grown for New York market, at current prices

TEL. 1998 MADISON SQUARE 49 West 28th St., New York City

Walter F. Sheridan

Wholesale Commission Dealer in

CHOICE CUT FLOWERS

39 West 28th Street, New York
Telephone: 3532-3533 Madison Square

HEADQUARTERS FOR NOVELTIES

ORCHIDS A SPECIALTY

THE HIGHEST GRADE OF VALLEY ALWAYS ON HAND

CARDENIAS, DAISIES, ROSES AND CARNATIONS

Telephone 785 Mad. Sq. 42 W. 28th St., New York
JAMES McMANUS

PHILIP F. KESSLER

55 & 57 W. 26th St., New York City

Commission Dealer, Wholesale Buyer and Seller of

Open from 5 a. m. to 6 p. m. Sunday till 10 a. m.

Tel., 5243 and 2921 Madison Sq. Res., 345 J., Newtown.

CUT FLOWERS

Finest Lilies in the Market Every Day in the Year.

NEW YORK QUOTATIONS PER 100. To Dealers Only

ROSES AND CARNATIONS

	Last Half of Week ending Mar. 20 1909		First Half of Week beginning Mar. 22 1909	
American Beauty, Fancy and Special.....	20.00	to 30.00	20.00	to 30.00
" " Extra.....	10.00	to 12.00	10.00	to 12.00
" " No. 1.....	6.00	to 8.00	6.00	to 8.00
" " Lower Grades.....	2.00	to 4.00	2.00	to 4.00
Bride, Field, Fancy and Special.....	5.00	to 8.00	3.00	to 4.00
" " Lower Grades.....	1.00	to 3.00	1.50	to 2.00
Kilbarny, Fancy and Special.....	6.00	to 8.00	6.00	to 8.00
" " Lower Grades.....	2.00	to 4.00	2.00	to 4.00
Richmond, Fancy and Special.....	8.00	to 10.00	6.00	to 8.00
" " Lower Grades.....	1.00	to 4.00	2.00	to 4.00
Chatenay.....	1.00	to 3.00	1.00	to 3.00
Golden Gate, Ivory, etc.....	1.00	to 6.00	1.00	to 6.00
My Maryland.....	3.00	to 8.00	2.00	to 3.00
Mrs. Har. Field.....
Carnations, Fancy and Novelities.....	2.00	to 3.00	1.50	to 3.00
" " Ordinary and White.....	1.00	to 1.50	1.00	to 1.50

Alexander J. Guttman

THE WHOLESALE FLORIST OF NEW YORK

34 WEST 28th STREET

PHONES. 1664--1665 MADISON SQUARE

ENOUGH SAID

TRAENDLY & SCHENCK

Wholesale Florists

Furnish best Stock at fair Prices all the year round

Send for Quotations on Any Variety and Quantity

Tel. 798, 799 Madison Sq. 44 West 28th St., New York City

GROWERS' CUT FLOWER CO.

CUT FLOWERS AT WHOLESALE

VIOLETS, CARNATIONS, ROSES ORCHIDS, CHRYSANTHEMUMS, LILIES

Consignments Solicited. Shipments to Order, any Distance

39 West 28th Street,

Telephone 737 Madison Square J. J. COAN, Manager

NEW YORK

WHOLESALE FLORISTS
 54 West 28th St.
 NEW YORK
 Telephone 8659 Madison Sq.

A. L. YOUNG & CO.

RECEIVERS & SHIPPERS OF CUT FLOWERS.
 CONSIGNMENTS SOLICITED

WILLIAM H. KUEBLER
 Brooklyn's Foremost and Best

WHOLESALE COMMISSION HOUSE
 A First Class Market for all CUT FLOWERS
 28 Willoughby St., Brooklyn, N. Y.
 Tel. 4591 Main

Greater New York Florists' Association, Inc.
 Now Open for Cut Flower Consignments
 162 Livingston Street, BROOKLYN, N. Y.
 Geo. W. Crawbuck Telephone Connection
 Manager 3642-43 Main

REED & KELLER
 122 West 25th St., New York
Florists' Supplies
 We manufacture all our Metal Designs, Baskets, Wire Work & Novelties and are dealers in Glassware Decorative Greens and Florists' Requisites

THE KERVAN CO.
 Wholesale Dealers and Shippers of **Decorative Evergreens**
 Ferns, Galax, Laurel, Fresh Cypas, Boxwood, Sphagnum and all Florists' Greens
 Send to us for Quotations before Buying.
 113 West 28 Street, NEW YORK CITY

MICHIGAN CUT FLOWER EXCHANGE, Inc.
 WHOLESALE COMMISSION FLORISTS
 Consignments Solicited
Hardy Fancy Fern Our Specialty
 38-40 BROADWAY, DETROIT, MICH.

FOR FLORISTS' USE
 There's **NOTHING** as good as **MEYER'S SILKALINE**
 Don't let them sell you anything else
JOHN C. MEYER & CO., Boston, Mass.

In ordering goods please add "I saw it in HORTICULTURE."

Use Krick's Immortelle Letters

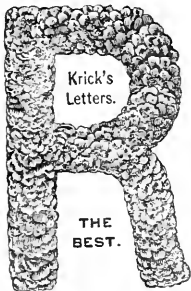

The original and still the best. All others are followers.

All Orders Promptly Attended to.

Send for Samples and Price Lists.

1164-1166 Greene Ave.,
BROOKLYN, - N. Y.

GEORGE COTSONAS & CO.
 Wholesale and Retail Dealers in all kinds of **EVERGREENS**
 Fancy and Dagger Ferns
 Bronze and Green Galax

Main Store 50 W. 28 St.
 Phone 1200 Mad. Sq. New York

CENTRALLY LOCATED, THE HUB OF THE FLOWER MARKET SECTION
CHARLES MILLANG
 Wholesale Florist
 444 Sixth Ave., NEW YORK
 Telephone 7062 Madison

WHOLESALE COMMISSION J. K. ALLEN 106 W. 28th St. NEW YORK
 Open 6 a.m. Daily Tel. 167 Madison Sq.
 Shipments of Lily of the Valley and Bulb Flowers Needed

NEW YORK QUOTATIONS PER 100. To Dealers Only

MISCELLANEOUS	Last Half of Week ending Mar. 20 1909		First Half of Week beginning Mar. 22 1909	
	1909	1909	1909	1909
Cattleyas.....	25.00	50.00	25.00	50.00
Lilies.....	3.00	10.00	3.00	10.00
Lily of the Valley.....	1.00	3.00	1.00	3.00
Narciss., Paper White.....	1.00	2.00	1.00	2.00
Roman Hya.....	1.00	2.00	1.00	2.00
Tulips.....	2.00	4.00	2.00	4.00
Disfodils.....	1.00	2.00	1.00	2.00
Freesia.....	1.00	2.00	1.00	2.00
Algonquette.....
Sweet Peas.....	.50	1.00	.50	1.00
Gardenias.....	5.00	25.00	5.00	25.00
Violets.....	15	.50	.15	.50
Adiantum.....	.75	1.00	.75	1.00
Croweanum.....	1.00	1.25	1.00	1.25
Smilax.....	8.00	10.00	8.00	10.00
Asparagus Plumosus, straggled.....	20.00	30.00	20.00	30.00
" & Sprea. (too bcbs).....	15.00	25.00	15.00	25.00

NEW YORK MARKET.

An embarrassing stagnation which set in two weeks ago and has been growing more pronounced ever since prevails in the cut flower trade, where by the second or third rate flower becomes the leader in selling power and the finest grades are moved with extreme slowness unless the wholesaler is brought to accept the third class price for same. In short, the local trade in the leading florist stores has fallen off until it is able to handle only a small percentage of the grades produced especially for its needs, and the street trade and the distributors who cater to the plebian buyer are the main support and relief of the congested wholesale market. This is particularly true as regards roses. Carnations have not been excessively overstocked and are more readily unloaded but there are a good many bursted and otherwise dilapidated specimens on view. Lilies continue very irregular as to grade, Tulips hold their own fairly well, especially some of the best-grown doubles, but other bulbous stock remains at bottom notch, and violets are distinctly a street-stand flower. Cattleyas are of excellent quality and find a steady market. Dendrobium Wardianum is seen in considerable quantities. There are very many underzested and otherwise imperfect gardenias at present, and even the

best specimens are bringing only about one-half of the prices returned two weeks ago. The retail windows are suggestive of the approach of Easter; azaleas, hydrangeas, baby ramblers and other flowering plants occupying the space in which cut flowers were predominant heretofore.

Oakland, Cal.—The store of H. M. Sanborn, florist, 14th and Clay streets, was ransacked by burglars March 11.

WILLIAM F. KASTING CO.
 WHOLESALE FLORISTS
 383-387 Ellicott Street
BUFFALO, - N. Y.
Wired Toothpicks

Manufactured by
W. J. COWEE, BERLIN, N. Y.
 10,000...\$1.75; 50,000...\$7.50. Sample free.
 For sale by dealers

ROBERT J. DYARSAT
 Public Accountant and Auditor
 Simple methods of correct accounting especially adapted for florists' use.
Books Balanced and Adjusted
 Merchants Bank Building
 28 STATE STREET, - BOSTON
 Telephone, Main 58.

Buyer's Directory and Ready Reference Guide

Advertisements under this head, one cent a word. Initials count as words.

Display advertisers in this issue are also listed under this classification without charge. Reference to List of Advertisers will indicate the respective pages.

Buyers falling to find what they want in this list will confer a favor by writing us and we will try to put them in communication with reliable dealers.

ACCOUNTANT

R. J. Dyaart, 28 State St., Boston.
For page see List of Advertisers.

AMPELOPSIS.

Storrs & Harrison Co., Palmesville, O.
For page see List of Advertisers.
Eastern Nurseries, Henry F. Dawson, Mgr.,
Ampelopsis Quinquefolia,
Jamaica Plain, Mass.
For page see List of Advertisers.
C. Elsele, 11th and Westmoreland Sts.,
For page see List of Advertisers.

ARGENTEUIL ASPARAGUS

Argenteuil Asparagus Plants. Frank H. Snow, Orleans, Mass

AQUATIC PLANTS

Aquarium plants the year round. Wholesale and retail. Send for price list. Schmid's Emporium of Pets, 712 12th Street, Washington, D. C.

AQUILEGIAS

Aquilegas. Genuine Coerulea, finest of all. Both plants and seeds from the heart of the Rockies. C. S. Harrison's Select Nursery, York, Neb.

ARAUCARIAS

A. Leuthy & Co., Perkins St. Nurseries, Rosindale, Mass.
For page see List of Advertisers.
Godfrey Aschmann, 1012 West Ontario St., Philadelphia, Pa.
For page see List of Advertisers.

ASPARAGUS

Asparagus plumosus hemus and Sprenger, 2 in., 1 year old, strong, \$3.00 per 100. E. & C. Woodman, Danvers, Mass.

ASPARAGUS SEED

S. S. Pennock-Mechan Co., Philadelphia.
For page see List of Advertisers.

AUCTION SALES

Oleary's Horticultural Co., 62 Vesey St., New York.
For page see List of Advertisers.
The Fruit Auction Co., 290, 292, 294 Franklin St., New York.
Daily Auction Sales.
For page see List of Advertisers.

AZALEAS

A. Leuthy & Co., Perkins St. Nurseries, Rosindale, Mass.
For page see List of Advertisers.
Godfrey Aschmann, 1012 W. Ontario St., Philadelphia.
For page see List of Advertisers.

BAMBOO CANES

Yokohama Nursery Co., 31 Barclay Street, New York.
Bamboo Sticks, Colored Green.
For page see List of Advertisers.
Wm. Elliott & Sons, New York City.
Lily Stakes.
For page see List of Advertisers.

BAY TREES.

2000 Bay and Box Trees in all sizes, Pyramid and Standards. Write for list. Julius Boehrs, Rutherford, N. J.

BOILERS

BOILERS. "Burnham" Boilers made for greenhouse heating. Lord & Burnham, 1133 Broadway, N. Y.
Kroeschell Bros. Co., 35 Erie St., Chicago.
For page see List of Advertisers.

BEDDING PLANTS

J. E. Felthousen, Schenectady, N. Y.
For page see List of Advertisers.
A. Leuthy & Co., Perkins St. Nurseries, Rosindale, Mass.
For page see List of Advertisers.
G. Aschmann, 1012 W. Ontario St., Philadelphia, Pa.
For page see List of Advertisers.

BEGONIAS

Begonias, Giant Single Tuberos-rooted, Rose, Scarlet, White, Salmon, Crimson, Yellow, Orange, 1 1/2 in. and up, \$22.00 per 100. Special \$1.00 per 100 if an equal number of each of the above seven colors are ordered. Binghamton Seed Co., Binghamton, N. Y.

BOXWOOD TREES

New England Nurseries, Inc., Bedford, Mass.
For page see List of Advertisers.

BUILDING MATERIAL

BUILDING MATERIAL of all description for All Cypress, Southern, Iron Frame Truss Houses. Hot Bed Sash and Frames. Lord & Burnham Co., 1133 Broadway, N. Y.

BULBS AND TUBERS

Joseph Breck & Sons, 47-54 N. Market St., Boston.
For page see List of Advertisers.
J. M. Thornburn & Co., 33 Barclay St., New York.
For page see List of Advertisers.
A. T. Boddington, 342 W. 14th St., N. Y.
For page see List of Advertisers.
Rickards Bros., 37 East 19th St., New York.
For page see List of Advertisers.
H. F. Michell Co., Philadelphia.
For page see List of Advertisers.
H. E. Fiske Seed Co., Faneuil Hall Sq., Boston.
For page see List of Advertisers.
T. J. Grey & Co., 32 and 33 So. Market St., Boston.
For page see List of Advertisers.

Yokohama Nursery Co., 31 Barclay St., New York.
For page see List of Advertisers.
Ralph M. Ward & Co., 12 W. Broadway, New York.
For page see List of Advertisers.
K. Takeuchi, 478A Boylston St., Boston.
Japanese Bulbs.
For page see List of Advertisers.
Schlegel & Fottler Co., 26 & 27 S. Market St., Boston.
For page see List of Advertisers.

TUBEROSES AND CALADIUM.

Special Prices to Florists and Dealers.
Tuberose.—Pearl No. 1, 4 to 6
inch in circum..... \$7.00
Caladium Esculentum, 5 to 7
inch in circum..... \$1.10 0.00
Caladium Esculentum, 7 to 9
inch in circum..... 2.10 18.50
Caladium Esculentum, 9 to 11
inch in circum..... 3.65 35.00
Caladium Esculentum, 11 inch
and over in circum..... 6.50 65.00
Prices include packing and are f. o. b. cars here.
T. W. WOOD & SONS, Seedsmen, Richmond, Va.

CANNAS

A. T. Boddington, 342 W. 14th St., New York
For page see List of Advertisers.
C. Elsele, 11th and Westmoreland Sta., Philadelphia, Pa.
For page see List of Advertisers.
Large assortment of Cannas of the following varieties: Burbank, Pennsylvania, Berat and Cinebar, at \$1.50 per 100; or would exchange for dwarf Agapanum, Peziferia, double Alyssum, C. W. Moeckel, 17 Summer St., Fitchburg, Mass.

CARNATIONS

F. Dorner & Sons Co., Lafayette, Ind.
Carnation, Indiana.
For page see List of Advertisers.
Chicago Carnation Co., Joliet, Ill.
For page see List of Advertisers.
Albert Roper, Tewksbury, Mass.
Carnation Bay State.
For page see List of Advertisers.
Bassett & Waaburn, Hinsdale, Ill.
Carnation O. P. Bassett.
For page see List of Advertisers.
East Sudbury Greenhouses, So. Sudbury, Mass.
Carnation Cuttings.
For page see List of Advertisers.
Wood Bros., Fishkill, N. Y.
Carnations, Rooted Cuttings.
For page see List of Advertisers.
The E. G. Hill Co., Richmond, Ind.
Carnation Cuttings.
Peter Fisher, Ellis, Mass.
Booted Cuttings.
For page see List of Advertisers.
S. J. Reuter & Son, Westery, R. I.
For page see List of Advertisers.
Schelden & Schoss, Chicago.
Carnation Wm. H. Taft.
Schlegel & Fottler Co., 26 & 27 S. Market St., Boston.
For page see List of Advertisers.
A. F. Lorgren, Des Plaines, Ill.; Highland Park Greenhouses, Highland Park, Ill.
Carnation Lucille.
E. W. Fenar, 147-57 Linden Av., Irvington, N. Y.
Rooted Carnation Cuttings.
For page see List of Advertisers.

CHRYSANTHEMUMS

Schlegel & Fottler Co., 26 & 27 S. Market St., Boston.
Chrysanthemum Belfast.
For page see List of Advertisers.
E. G. Hill Co., Richmond, Ind.
For page see List of Advertisers.
S. J. Reuter & Son, Westery, R. I.
For page see List of Advertisers.
Elmer D. Smith & Co., Adrian, Mich.
For page see List of Advertisers.
C. H. Totty, Madison, N. J.
Single Chrysanthemum Medium Seed.
For page see List of Advertisers.
J. H. Myers, Altoona, Pa.
For page see List of Advertisers.
Scott Bros., Elmsford, N. Y.
For page see List of Advertisers.
Poehmann Bros. Co., Morton Grove, Ill.
For page see List of Advertisers.
Chrysanthemum Golden Glow from 214 in. pots, for early spring delivery, \$1.00 per doz., \$6.00 per 100, \$50.00 per 1000. Stock plants of Montrom, Oct. Frost, Crocus, Matchless, Lucey Devaux, Polly Rose and Halliday, \$1.00 per doz.; \$6.00 per 100. Peirce Bros., Waltham, Mass.

For List of Advertisers See Page 455

CHRYSANTHEMUMS - Continued

50,000 Chrysanthemums. White—Timothy Eaton; Mrs. Geo. S. Kall, fine early; Estelle, White Bonaffon, Alice Byron, Ivory, C. Touse, Jeanne Nolin, Oct. Frost, Early Snow, Angele Laurent. Pink—Gloria of Fachin, Dr. Eucward, Mand. Best, Pink Ivory, Rosette. Yellow—Major Bonaffon, Creme, Robt. Uallday; Baby, small yellow, of the button type. Rooted cuttings ready. Send for prices. Wm. Swayne, Box 224, Konnett Square, Pa.

Golden Glow, R. C., 25 for \$1.00; 100, \$3.50. Fred's Supreme, 20 for \$1.00; \$3.00 per 100, prepaid. Best Early Yellow and Plak Mums. Chas. Frost, Kentworth, N. J.

Herrington's book on the Chrysantheum, mailed to your address for 50c., by Horticulture Publishing Co., 11 Hamilton Place, Boston.

COLEUS

J. E. Felthousen, Schenectady, N. Y. For page see List of Advertisers.

Coleus, strong rooted cuttings, 10 varieties, including Vercasaffetti and Golden Bedder, 60 cents per 100. Edmund Reardon, Cambridge, Mass.

CONIFERS

John Waterer & Sons, Ltd., American Nursery, Bagshot, Eng. For page see List of Advertisers.

CUT FLOWER BOXES.

Edwards Folding Box Co., Philadelphia For page see List of Advertisers.

Folding cut flower boxes, the best made White for list. Holton & Hunkel Co., MD wauke, Wis.

DAHLIAS

David Herbert & Son, Atco, N. J. For page see List of Advertisers.

J. L. Moore, Northboro, Mass. For page see List of Advertisers.

Peacock Dahlias Farms, Williamstown Junction, N. J.

Dahlia Jack Rose. For page see List of Advertisers.

R. Vincent Jr. & Sons Co., White Marsh, Md. For page see List of Advertisers.

DAHLIAS

Geo. H. Walker, No. Dighton, Mass. Wholesale and Retail. Send your name for my 1909 Catalog and Pocket Guide, ready to mail about Feb. 25th.

Cactus, Decorative, Fancy, Show and Pompon Dahlias. Good commercial varieties, such as Kriemhilde, Countess of Lonsdale, Mad. Van Den Deal and other sure bloomers, strong divided roots in 19 or 20 named varieties, my selection, \$1.00 per 25; \$3.00 per 100; \$25.00 per 1000. Cash please. Herrmann Thiemann, Merion, Mass.

Dahlias. Novelties and standard varieties, true to name, a choice list of the best introductions. Send for catalog of dahlias, hollyhocks, hardy plants. Prices always reasonable. W. W. Willmore, Box 382 Denver, Colo.

East Bridgewater Dahlia Gardens wants your business. If you are looking for dahlias send to the Eastern Dahlia King, J. K. Alexander, East Bridgewater, Mass.

FOR SALE—Dahlia bulbs, choice varieties, very cheap. Send for catalog. F. A. Treadup, Jr., 28 Lindsey St., New Bedford, Mass.

DECORATIVE PLANTS

A. Lenth & Co., Perkins St. Nurseries Roselindale, Mass. For page see List of Advertisers.

Godfrey Aschmann, 1012 W. Ontario St., Phila., Pa. For page see List of Advertisers.

Joseph Heacock Co., Wyncote, Pa. For page see List of Advertisers.

The Geo. Wittbold Co., 1637 Buckingham Place, Chicago, Ill.

For page see List of Advertisers.

Robert Craig Co., Market and 49th Sts., Philadelphia, Pa.

For page see List of Advertisers.

DRACAENAS

Dracena Indivisa, S. T. 4, 5 and 4 in. Prices on application. E. & C. Woodman, Danvers, Mass.

ECONOMY BRACKET

Borton & Allard, Nashua, N. H. For page see List of Advertisers.

EVERGREENS

New England Nurseries, Bedford, Mass. For page see List of Advertisers.

American Nursery Co., 150 Broadway, New York, N. Y.

For page see List of Advertisers.

Henry A. Dreer, Philadelphia, Pa. For page see List of Advertisers.

Evergreens. Send 25 cents in stamps for complete work on propagating and growing Evergreens. C. S. Harrison's Select Nursery, York, Neb.

FERNS

A. Lenth & Co., Roselindale, Mass. For page see List of Advertisers.

H. H. Barrows & Son, Whitman, Mass. Nephrolepis Magnifica.

For page see List of Advertisers.

John Scott, Brooklyn, N. Y. For page see List of Advertisers.

Frank Oechalin, 2570-2606 W. Adams St., Chicago.

Ferns for Dishes. For page see List of Advertisers.

The Geo. Wittbold Co., 1637 Buckingham Place, Chicago, Ill.

For page see List of Advertisers.

Godfrey Aschmann, 1012 W. Ontario St., Philadelphia.

For page see List of Advertisers.

C. Elsie, 11th and Westmoreland Sts., For page see List of Advertisers.

Anderson's ferns for in and outdoors. Largest commercial collection in the country. Ask for descriptive catalogue. J. F. Anderson, Fern Specialist, Short Hills, N. J.

FERTILIZERS

Palverized Manure Co., 31 Union Stock Yards, Chicago, Ill.

Wilaard Brand Sheep and Shredded Cattle Manure.

For page see List of Advertisers.

Robert Simpson, Clifton, N. J. Sheep Manure.

For page see List of Advertisers.

Bowker Fertilizer Co., Boston, Mass. All Ferns of Plant Food at First Hands.

For page see List of Advertisers.

FEVERFEW

Feverfew Little Gem, 80c. per 100; \$7.00 per 1000. S. W. Pike, St. Charles, Ill.

2000 Feverfew from 2 1/4 in. \$3.00 per 100, \$25.00 per 1000. Albert Batley & Son, Maynard, Mass.

Feverfew, 2 1/2 in., \$2.00 per 100. H. J. Blanchard, Ashburham, Mass.

FLORAL PHOTOGRAPHS

Floral Photographs, Foley's, 226-223 12 Bowery, New York.

FLORISTS' LETTERS.

Boston Florist Letter Co., 66 Pearl St., Boston, Mass.

For page see List of Advertisers.

W. C. Krick, 2154-66 Greece Ave., Brooklyn, N. Y.

Innominately letters. For page see List of Advertisers.

FLORISTS SUPPLIES

N. F. McCarthy & Co., 84 Hawley St., Boston.

For page see List of Advertisers.

H. M. Robinson & Co., 15 Province St. and 9 Chapman Pl., Boston, Mass.

For page see List of Advertisers.

Reed & Keiler, 122 W. 23d St., New York.

For page see List of Advertisers.

H. Bayeradorfer & Co., 1129 Arch St., Philadelphia.

For page see List of Advertisers.

FLOWER POTS

W. H. Ernest, 28th and M Sts., Washington, D. C.

For page see List of Advertisers.

A. H. Hewes & Co., Cambridge, Mass. For page see List of Advertisers.

Hilfinger Bros., Ft. Edward, N. Y. For page see List of Advertisers.

The Peters & Reed Pottery Co., Red pots, seed pans, etc. Zanerville, O.

Syracuse Pottery Co., Syracuse, N. Y. Syracuse Red Pots.

For page see List of Advertisers.

We make Standard Flower Pots, etc. Write us when in need.

Wilmer Cope & Bro., Lincoln University, Chester Co., Pa.

FUCHSIAS

R. Vincent, Jr. & Sons Co., White Marsh, Maryland.

For page see List of Advertisers.

GALAX

Michigan Cut Flower Co., 38 and 40 Broadway, Detroit, Mich.

For page see List of Advertisers.

George Cotsanna & Co., 50 W. 28th St., New York.

For page see List of Advertisers.

The Kervan Co., 113 West 28th St., N. Y. For page see List of Advertisers.

Rice Bros., 115 N. 6th St., Minneapolis, Minn.

For page see List of Advertisers.

H. M. Robinson & Co., 15 Province St. and 9 Chapman Place, Boston.

For page see List of Advertisers.

GERANIUMS

R. Vincent Jr. & Sons Co., White Marsh, Md.

New and Standard Varieties. For page see List of Advertisers.

A few hundred fine mixed cut geraniums, all double, \$7.00 per 100. Fine geraniums, 2 1/2 in., \$2.00 per 100. Cash. H. J. Blanchard, Ashburham, Mass.

GLADIOLI

J. L. Moore, Northboro, Mass. For page see List of Advertisers.

O. V. Zangen, Hoboken, N. J. Gladiolus Brechehyensis.

For page see List of Advertisers.

I. & J. L. Leonard, Iona, N. J. Gladiolus Bulbs.

For page see List of Advertisers.

Groff's new Hybrid Gladioli in finest mixture: No. 1, \$5.00 per 1000; No. 2, \$4.00 per 1000; No. 3, 1/2 to 3/4, at \$3.00 per 1000; No. 4, at \$2.00; Bulbils, \$4.00 per bus.; Giant Pink bulbils, at \$1.00 per qt.; Mrs. Francis King and Giant Pink mixed bulbils, at \$1.00 per qt. Discounts on large lots. G. B. Babcock, Jamestown, N. Y.

GLASS

Boston Plate & Window Glass Co., Boston. For page see List of Advertisers.

Standard Plate Glass Co., 26-30 Sudbury St., Boston.

For page see List of Advertisers.

Foley Mfg. Co., Western Ave., between 25th & 26th Sts., Chicago.

Sharp, Partridge & Co., 224 & Lumber St., Chicago.

For page see List of Advertisers.

Parshelsky Bros., Inc., 59 Montrose Ave., Brooklyn, N. Y.

For page see List of Advertisers.

Greenhouse glass, lowest prices. Johnston Glass Co., Hartford City, Ind.

Glass, 1 1/2 lb. Grade, Double Thick Greenhouse Glass. Lord & Burnham, 1133 Broadway, N. Y.

GLAZING DEVICES

H. A. Dreer, Philadelphia, Pa.

Peerless Glazing Point. For page see List of Advertisers.

GLAZING POINTS, Lord & Burnham Special Glazing Nails (Points). Lord & Burnham, 1133 Broadway, N. Y.

In writing to Advertisers kindly mention Horticulture

GREENHOUSE BUILDING MATERIAL

Lord & Buroham Co.,
1133 Broadway, New York.
For page see List of Advertisers.

Pierson U-Bar Co., 1 Madison Sq., N. Y.
For page see List of Advertisers.

A. T. Stearns Lumber Co., Neponset,
Boston.
For page see List of Advertisers.

King Construction Co., N. Tonawanda,
New York.
For page see List of Advertisers.

Hitchings & Co., 1170 Broadway, New York
For page see List of Advertisers.

J. C. Moulner Co., 117 East Blackhawk St.,
Chicago, Ill.
For page see List of Advertisers.

Foley Mfg. Co., Western Ave., between
25th & 26th Sts., Chicago.
For page see List of Advertisers.

W. H. Lutton, West Shore Av. Sta., Jersey
City, N. J.
For page see List of Advertisers.

GREENHOUSE CONSTRUCTION

GREENHOUSE CONSTRUCTION, Semi-
Iron Greenhouse, New Truss Houses and
Iron Frame Houses. Lord & Buroham,
1133 Broadway, N. Y.

J. A. Payne, 260-274 Culver Ave., Jersey
City, N. J.
For page see List of Advertisers.

Foley Mfg. Co., Western Ave., between
25th & 26th Sts., Chicago.
For page see List of Advertisers.

Hitchings & Co., 1170 Broadway, New York.
For page see List of Advertisers.

Geo. M. Garland Co., Des Plaines, Ill.
For page see List of Advertisers.

GREENHOUSE HOSE

Revere Rubber Co., Boston, Mass.
Revero Hose.
For page see List of Advertisers.

GUTTERS

GUTTERS, Cast Iron Gutters, L & B
Improved V Shaped Gutter with drip
gutter attachment. Lord & Buroham, 1133
Broadway, N. Y.

HAIL INSURANCE

Florists' Hall Asso. of America.
J. G. Esler, Saddle River, N. J.
For page see List of Advertisers.

HARDY FERNS, MOSS AND GREENS

H. M. Robinson & Co., 15 Provost St. and
9 Chapman St., Boston, Mass.
For page see List of Advertisers.

Michigan Cut Flower Exchange,
38 and 40 Broadway, Detroit, Mich.
For page see List of Advertisers.

George Cotaouis & Co., 50 W. 28th St.,
New York.
For page see List of Advertisers.

N. F. McCarthy & Co., 84 Hawley St.,
Boston.
For page see List of Advertisers.

The Kervan Co., 113 W. 28th St., N. Y.
For page see List of Advertisers.

Mcce Bros., 115 N. 8th St., Minneapolis,
Minn.
For page see List of Advertisers.

HARDY PERENNIALS

Henry A. Dreer, 714 Chestnut St., Phila.
For page see List of Advertisers.

HEATING APPARATUS

Lord & Buroham Co.,
1133 Broadway, New York.
For page see List of Advertisers.

Pierson U-Bar Co., 1 Madison Sq., N. Y.
For page see List of Advertisers.

John A. Payne, 260-274 Culver Ave., Jersey
City, N. J.
For page see List of Advertisers.

Kroeschell Bros. Co., 35 Erie St., Chicago.
For page see List of Advertisers.

HELP FURNISHED

Thos. H. Bambrick, 34 S. 7th St., Phila.
For page see List of Advertisers.

HERBACEOUS PERENNIALS

P. Ouwerkerk, P. O. No. 1, Hoboken, N. J.
For page see List of Advertisers.

New England Nurseries, Bedford, Mass.
For page see List of Advertisers.

The Geo. Wittbold Co., 1657 Buckingham
Place, Chicago.
For page see List of Advertisers.

D. A. Clarke, Red Oak Nurseries, Fiske-
ville, R. I.
For page see List of Advertisers.

HOLLYHOCKS

Hollyhocks, chuter's double, white, pink
and crimson; August transplanted; first-
class lot, \$3.00 per 100. Ed. C. Lindsay,
Milford, Del.

HOT-BED SASH

The A. T. Stearns Lumber Co., Neponset,
Mass.
For page see List of Advertisers.

Pierson U-Bar Co., 1 Madison Sq., N. Y.
For page see List of Advertisers.

Lord & Buroham Co., 1133 Broadway, N. Y.
For page see List of Advertisers.

Foley Mfg. Co., Western Ave., between
25th & 26th Sts., Chicago.

HYDRANGEAS

500 Hydrangeas in bloom for Easter, 4
to 10 blooms; splendid stock. Edmund
Reardon, Cambridge, Mass.

INSECTICIDES.

Nicotelle kills all greenhouse pests.
P. R. Palethorpe Co.,
Eleventh St., Owego, N. Y.
For page see List of Advertisers.

Stump & Walter Co., 50 Barclay St.,
New York.
Kiln-dried Tobacco Dust.
For page see List of Advertisers.

Niagara Sprayer Co., Middleport, N. Y.
Niagara Brand.
For page see List of Advertisers.

B. G. Pratt Co., New York.
Sulfocide.
For page see List of Advertisers.

Bowker Insecticide Co., Boston, Mass.
Insect Destroying Preparations.
For page see List of Advertisers.

Wm. Cooper & Nephews, 177 Illinois St.,
Chicago; Cyril Franklyn, 62 Beaver
St., New York, Agt.
V. J. Pluid.
For page see List of Advertisers.

"The Fumigating Kind Tobacco Powder"—The first on the market and the kind that has so many imitators, has our guarantee tag of satisfaction or money back, and "The Moon Trade Mark" on every bag, \$3.00 per 100 lbs. The H. A. Stothoff Co., Mount Vernon, N. Y., Makers and sellers.

Tobacco dust rtd stems, dust in bbls, 150 to 200 lbs., \$4.00; stems in holes from 350 to 400 lbs., \$2.50. Cash with order; money back if you say so. I lead them all in quality and price. S. R. Levy, Binghamton, N. Y.

IVIES

English Ivy, strong, for window boxes; 4-inch pots \$1.50 per ten. Shatenuc Nurseries, Barrytown, Dutchess County, N. Y.

JAPANESE PLANTS

Yokohama Nursery Co., 31 Barclay St.,
New York.
For page see List of Advertisers.

KENTIAS

Godfrey Aschmann,
1012 W. Ontario St., Phila., Pa.
For page see List of Advertisers.

A. Leuthy & Co., Roslindale, Mass.
For page see List of Advertisers.

Jos. Heacock Co., Wyncote, Pa.
Single and Made-Up Specimens.
For page see List of Advertisers.

LANTANAS

Violet King, king of all lantanas, rooted cuttings, \$4.00 per 100, 200 for \$7.50, 60c. per doz. For large quantities of Violet King, 500 to 5000 lots, send for prices, as I will make them right, for I want to see every florist in the United States handle this variety, as it is a great novelty. Sunset, new, rooted cuttings, 50c. per doz.; \$3.00 per 100. Eight other grand varieties, rooted cuttings, \$2.00 per 100. All true to name, labelled, Mixed, \$18.00 per 1000. Send for price list. Louis P. Faulk, West View, Pa.

LEVELS FOR LANDSCAPE GARDENING USE.

Boestrom-Brady Mfg. Co., 139 Madison Ave.,
Atlanta, Ga.
For page see List of Advertisers.

LILY OF THE VALLEY PIPS

Hjalmar Hartmann & Co., 12 Stormgade,
Copenhagen, Denmark.
For page see List of Advertisers.

LOBELIAS

Double Iceland Kathleen Mallard, rooted cuttings, \$1.00 per 100. Cash. Chas. H. Green, Spencer, Mass.

MARGUERITES

Marguerites, Queen Alexandra, \$1.25 per 100, prepaid. S. W. Pike, St. Charles, Ill.

NICO-FUME

Kentucky Tobacco Product Co.,
Louisville, Ky.
For page see List of Advertisers.

NURSERY STOCK

John Waterer & Sons, Ltd.,
American Nursery, Bagshot, England.
For page see List of Advertisers.

Cleary's Horticultural Co., 62 Vesey St.,
New York.
For page see List of Advertisers.

P. Ouwerkerk, 216 Jane St., Weehawken
Heights, N. J.
For page see List of Advertisers.

D. J. Twomey, Dept. H, Geneva, N. Y.
For page see List of Advertisers.

T. & J. L. Leonard, Iona, N. J.
For page see List of Advertisers.

Eastern Nurseries, Jamaica Plain, Mass.
Viburnum Mollie.
For page see List of Advertisers.

American Nursery Co., 150 Broadway, New
York, N. Y.
For page see List of Advertisers.

F. Hamilton Goodsell, 200 Broadway,
New York.
For page see List of Advertisers.

W. & T. Smith Co., Geneva, N. Y.
Nursery Stock for Florists.
For page see List of Advertisers.

Storrs & Harrison Co., Painesville, O.
For page see List of Advertisers.

Rose Hill Nurseries, New Rochelle, N. Y.
Buddleya Variabilis Veitchii and Magnolia.
For page see List of Advertisers.

Manual of the Trees of North America,
by C. S. Sargent, mailed to your address
for \$5.00, by Horticulture Publishing Co.,
11 Hamilton Place, Boston.

TREES, SHRUBS, ROSES, EVERGREENS, PEONIES, HARDY PLANTS, ELLWANGER & BARRY, Rochester, N. Y.

New Hardy Shrub—Buddleya variabilis Veitchii and Magnolia, the summer flowering Lilac, 50c. each; \$5.00 per doz.; \$25.00 per 100. Rose Hill Nurseries, New Rochelle, N. Y.

Catalog now ready. Nursery grown evergreens, seedling white pine and hemlock, native trees and plants. E. Williams, Nottingham, N. H.

Rhododendrons, Laurel, Spruce Hemlock, Poptars, E. W. Sheeley, De Bruce, Sullivan County, N. Y.

ONION SEED

Federico C. Varela, Teneriffe, Canary Ids.
Bermuda Onion Seed.
For page see List of Advertisers.

ORCHIDS

Orchid Growers' Manual. By B. S. Williams. 500 Illustrations, \$10.00. Sixty pages—descriptions of upwards of 2500 species and varieties of orchidaceous plants, etc. The most complete work on orchids and orchid culture ever published. Offers that by HORTICULTURE, 11 Hamilton Place, Boston.

ORCHID PLANTS

Lager & Hurrell, Summit, N. J.
For page see List of Advertisers.

Sander, St. Albans, England.
Importers, Exporters, Growers, Hybridists
For page see List of Advertisers.

Carrillo & Baldwin, Secaucus, N. J.
For page see List of Advertisers.

Joia A. Manda, 191 Vesley Road, W. Orange, N. J.
For page see List of Advertisers.

Ordóñez Bros., Madison, N. J., Box 106.
For page see List of Advertisers.

G. L. Freeman, 388 Appleton St., Holyoke, Mass.
Orchid Importations.
For page see List of Advertisers.

Largest stock in the country. Ask for prices. Julius Roehrs, Rutherford, N. J.

PAINT AND PUTTY

PAINT AND PUTTY: Ideal Greenhouse lead: Special Greenhouse Putty. Lord & Burnham, 1133 Broadway, N. Y.

PALMS

A. Leuthy & Co., Perkins St. Nurseries, Rosindale, Mass.
For page see List of Advertisers.

Robert Craig Co., Market and 49th Sts., Philadelphia, Pa.
For page see List of Advertisers.

Joseph Heacock Co., Wynote, Pa. Home-Grown Palms.
For page see List of Advertisers.

Geo. Witthold Co., 1657 Buckingham Place, Chicago.
For page see List of Advertisers.

PANSY PLANTS.

Pansies, extra fine giant flowering, strong plants 30 cents per 100; \$2.50 per 1000 Edw. Wallis, Atco, N. J.

Giant Pansy Plants, stocky, self-grown from full-sized seed, 50 cents per 100; \$3.50 per 1000, prepaid. Cash. Chas. Frost, Kenilworth, N. J.

Pansies in bud and bloom: none better, \$1.00 per 100; \$8.00 per 1000. Choicest strains—Ed. C. Lindsey, Milford, Del.

PATENTS

Siggers & Siggers, Washington, D. C.
For page see List of Advertisers.

PEAT

Orchid Peat and Moss always on hand Julius Roehrs Co., Rutherford, N. J.

PENTSTEMONS

C. H. Totty, Madison, N. J.
For page see List of Advertisers.

PEONIES

Peonies only, by the wholesale—best 100 varieties. J. F. Rosenfield, Westpoint, Neb.

One of the finest collections in America. Send 25 cts. in stamps for new edition of Peony Manual. C. S. Harrison's Select Nursery, York, Neb.

PHLOXES

Send 25 cts in stamps for Phlox Manual. Fine mixed phloxes \$2.00 per 100, C. S. Harrison's Select Nursery, York, Neb.

PHOTOGRAPHS: DESIGNING: ILLUSTRATING

Geo. E. Dow, 178 Washington St., Boston.
For page see List of Advertisers.

PIPE AND FITTINGS

Foley Mfg. Co., between Western Ave. and 26th St., Chicago, Ill.
For page see List of Advertisers.

Kroeschell Bros. Co., 35 Erie St., Chicago
For page see List of Advertisers.

PIPE AND FITTINGS. Cast Iron and Wrought Pipe, Valves, Elbows, Pipe Hooks, Automatic Air Headers, etc. Lord & Burnham, 1133 Broadway, N. Y.

PLANT STANDS

Moore-Livingston Co., Lansdowne, Pa.

PLANT STAKES

Seale's Telescopic Plant Stakes and Tree Sises. H. D. Seale & Sons, Elkhart, Ind.

POT HANGERS

Pot hangers, Kramer's \$1 doz by exp., \$1.25 by mail. I. N. Kramer & Son, Cedar Rapids, Ia.

Krick's Perfect Pot Hanger and Handle. Sample pair 10 cents postpaid. Send for full particulars. W. C. Krick, 1164-1165 Greene Ave., Brooklyn, N. Y.

POINSETTIAS (Artificial)

Poinsettias, artificial decorations our specialty. Sample lots of 50 in 3 sizes, \$4.00; 100 lots, \$6, \$8, \$10. J. Stern & Co., 125 N. 10th St., Philadelphia, Pa.

POULTRY SUPPLIES

Buff Rock Eggs to Hatch. Triumph brood coop for chickens. Frank H. Snow, Orleans, Mass.

PRIVET

California privet, 100,000 for transplanting at \$6.00 per 1000; 55,000, 12 to 18 in., 2 to 4 branches, \$8.00 per 1000; 125,000, 12 to 18 in., 3 to 5 branches, \$10.00 for 1000. Boxed and delivered. F. O. B. Cash with order. Vallesian Nurseries, Bostie Dept., Bostie, N. C.

RAFFIA

Raffia (colored), 2) beautiful shades. Samples free. R. H. Comey Co., Camden, N. J.; 810 Washburn Ave., Chicago, Ill.

RESURRECTION PLANTS

Resurrection plants and cacti. Cheap. Ask for prices. William Tell, Austin, Tex.

RHODODENDRONS

John Waterer & Sons, Ltd., American Nursery, Bagshot, England.
For page see List of Advertisers.

P. Ouwerkerk, Hoboken, N. J.
For page see List of Advertisers.

Storrs & Harrison Co., Painesville, O.
For page see List of Advertisers.

ROSES

Robert Craig Co., Market and 49th Sts., Philadelphia, Pa.
For page see List of Advertisers.

P. Ouwerkerk, P. O. No. 1, Hoboken, N. J.
For page see List of Advertisers.

Julius Roehrs Co., Rutherford, N. J. Rose Newport Fairy.
For page see List of Advertisers.

The F. R. Pierson Co., Tarrytown-on-Hudson, N. Y. White Killarney.
For page see List of Advertisers.

S. J. Reuter & Son, Westerly, R. I.
For page see List of Advertisers.

Ditgee & Conard Co., West Grove, Pa.
For page see List of Advertisers.

Storrs & Harrison Co., Painesville, O.
For page see List of Advertisers.

Scott Bros., Ebusford, N. Y.
For page see List of Advertisers.

Poehlmann Bros. Co., Morton Grove, Ill.
For page see List of Advertisers.

Ellwanger & Barry, Rochester, N. Y. Box T. Victor Blue Rose.
For page see List of Advertisers.

A. N. Pierson, Cromwell, Conn. White Killarney, My Maryland, Ramblers.
For page see List of Advertisers.

Thomas Roland, Nabant, Mass. Crimson and Pink Ramblers.
For page see List of Advertisers.

Hand Book of Cultural Notes on Roses Under Glass, by F. P. Brigham, mailed to your address for 25c. by Horticulture Publishing Co., 11 Hamilton Place, Boston.

SALVIAS

R. Vincent, Jr. & Sons Co., White Marsh, Maryland.
Salvias Bonfire and Zurich.

SEED GROWERS

C. C. Morse & Co., 48-66 Jackson St., San Francisco, Cal.
For page see List of Advertisers.

Hjalmar Hartmann & Co., Cauliflower and Cabbage Seed.
12 Stromgade, Copenhagen, Denmark.
For page see List of Advertisers.

John S. Weaver, Glen Mawr Farms, Kluzers, Pa.
Vegetable and Flower Seeds Grown on Continent.
For page see List of Advertisers.

Federico C. Varela, Teneriffe, Canary Ids. Bermuda Onion Seed.

SEEDS

T. J. Grey Co., 32 So. Market St., Boston.
For page see List of Advertisers.

Joseph Breck & Sons, 61 and 52 N. Market St., Boston, Mass.
For page see List of Advertisers.

W. Atlee Burpee & Co., Philadelphia.
For page see List of Advertisers.

Arthur T. Boddington, 342 W. 14th St., New York.
For page see List of Advertisers.

H. E. Fiske Seed Co., Fanell Hall Sq., Boston.
For page see List of Advertisers.

Hjalmar Hartmann & Co., 12 Stromgade, Copenhagen, Denmark. Cauliflower and Cabbage Seed.
For page see List of Advertisers.

Rickards Bros., 37 E. 19th St., New York.
For page see List of Advertisers.

R. & J. Farquhar & Co., 67 So. Market St., Boston.
For page see List of Advertisers.

Mignonette Seed.
For page see List of Advertisers.

H. F. Michell Co., 1018 Market St., Phila.
For page see List of Advertisers.

J. M. Thorburn & Co., 33 Barclay St., N. Y.
For page see List of Advertisers.

Leonard Seed Co., Chicago, Ill.
For page see List of Advertisers.

Wm. Elliott & Sons, 42 Vesey St., N. Y. New Seed.
For page see List of Advertisers.

Woeber & Don, 114 Chambers St., New York.
For page see List of Advertisers.

I. & J. L. Leonard, Iona, N. J. Tomato and Pepper Seed.
For page see List of Advertisers.

Charles F. Saul, 220-224 James St., Syracuse, N. Y.
Peas, Onion, Clover and Timothy Seed.

Schlegel & Fattler Co., 25 & 27 S. Market St., Boston.
For page see List of Advertisers.

O. V. Zangen, Hoboken, N. J. Florists' Spring Seeds.
For page see List of Advertisers.

E. F. Whitsoner Co., Chicago.
Seeds for Plantsmen, Nurserymen, Seedsmen.
For page see List of Advertisers.

Seeds. Rocky Mountain Evergreen seeds in large or small quantities. C. S. Harrison's Select Nursery, York, Neb.

SHRUBS

The Geo. Witthold Co., 1657 Buckingham Place, Chicago.
For page see List of Advertisers.

SILKALINE

John C. Meyer & Co., Boston, Mass.
For page see List of Advertisers.

SMILAX

R. Vincent, Jr. & Sons Co., White Marsh, Pa.
For page see List of Advertisers.

Extra strong plants, \$1.00 per 100; \$8.00 per 1000. Ready for 2 1/2 inch pots. Big bargain. C. W. Moeckel, 17 Summer St., Pittsburg, Mass.

SPHAGNUM MOSS

Live Sphagnum moss, orchid peat and orchid baskets always on hand. Lager & Hurrell, Summit, N. J.

Ten bales sphagnum, \$7.00.
Z. K. Jewett Co., Sparta, Wis.

In writing to Advertisers kindly mention Horticulture

SPRAYERS

Niagara Sprayer Co., Middleport, N. Y.
For page see List of Advertisers.
J. F. Cass Mfg. Co., Dept. H., Detroit,
Mich.
U. N. T. Globe Sprayer.
For page see List of Advertisers.
Chas. J. Jager Co., Boston.
Deming Spray Corp.
For page see List of Advertisers.

STEAM TRAP

E. Hippard, Youngstown, O.
For page see List of Advertisers.

STRAWBERRY PLANTS

H. L. Crane, Westwood, Mass.
Berrymore Strawberry.
For page see List of Advertisers.
W. E. Trimble, Princeton, Ill.
Trentise on the Strawberry Bill, Its
Cause and Cure.
For page see List of Advertisers.
Strawberries, Chipman's new seedling.
Perfect, enormously productive, immense in
size and a good keeper. Many of our largest
shippers grow no other. Plants from
young bed, for per 100, \$1.00 per 1000.
Cash. Ed. C. Lindsay, Milford, Del.
Strawberry Plants, Babach and Success,
\$1.50 per 1000. W. N. Fanning, Kensington,
Ct.
Strawberry Plants, best varieties. Circle
Free. A. Florian & Sons, Thomaston,
Ct.

SULFOCURE

The B. G. Pratt Co., 50 Church St., Dept.
W., New York City.
For page see List of Advertisers.

SWEET PEAS

A. C. Zvolanek, Round Brook, N. J.
Winter Flowering.
For page see List of Advertisers.

TO-BAK-INE

E. H. Hunt, Genl. Agt., 76-78 Wabash Av.,
Chicago.
For page see List of Advertisers.

TWEMLOW'S PUTTY

Hammond's Paint & Slug Shot Works,
Fishkill-on-Hudson, N. Y.
For page see List of Advertisers.

VEGETABLE PLANTS

R. Vincent, Jr. & Sons Co.,
White Marsh, Md.
For page see List of Advertisers.

VEGETABLE SEEDS

Just arrived, our reliable vegetable
seeds. Buy your fresh seeds now. These
are guaranteed fresh and only first class
seeds. The Reliable Seed House, 156
Third Street, Hoboken, N. J.

VENTILATING APPARATUS

Plemon U-Bar Co., 1 Madison Sq., N. Y.
For page see List of Advertisers.

Foley Mfg. Co., Western Ave., between
25th & 26th Sts., Chicago.
For page see List of Advertisers.
John A. Payne, 2674 Culver Ave., Jersey
City, N. J.
For page see List of Advertisers.

The Advance Co., Richmond, Ind.
For page see List of Advertisers.
Quaker City Machine Co., Richmond, Ind.
20th Century Ventilating Arm.
For page see List of Advertisers.

VENTILATING MACHINERY. New
Model enclosed, self-oiling gear; Standard
Model Open Gear. Lord & Burnham, 1183
Broadway, N. Y.

VERBENAS

R. Vincent, Jr. & Sons Co., White Marsh,
Maryland.

VINCAS

Vinca var. 5 in., per doz. \$2.00; per
50, \$15.00. E. C. Woodin, Danvers,
Mass.

VIOLETS.

Princess Violets, 2 1/2 in., \$2.60 per 100.
Jas. T. Baker, Bustleton, Philadelphia, Pa.

WALLFLOWERS

Henry A. Dreer, Philadelphia, Pa.
For page see List of Advertisers

WAX FLOWERS

We are originators of wax designs and
still the standard concern. J. Stern & Co.,
125 N. 10th St., Philadelphia, Pa.

WEED KILLER

The American Horticultural Distributing
Co., Martinsburg, W. Va.
Target Brand.

WIRED TOOTHPICKS

W. J. Cowee, Berlin, N. Y.
For page see List of Advertisers.

WIREWORK

Reed & Keller, 122 W. 25th St., N. Y.
For page see List of Advertisers.
Durrand & Marohn, Albany, N. Y.
For page see List of Advertisers.
Wirework. Write for our catalogue.
Holton & Hunkel Co., Milwaukee, Wis.
William E. Heilscher's Wire Works, 38-40
Broadway, Detroit, Mich.
Wirework—Compare our prices with
others. Scranton Florist Supply Co., 201
N. 7th St., Scranton, Pa.

WHOLESALE FLORISTS**Boston**

N. F. McCarthy & Co., 84 Hawley St.,
Boston.
For page see List of Advertisers.
H. M. Robinson & Co., 75 Province St
and 9 Chapman Pl., Boston.
For page see List of Advertisers.
Welch Bros., 226 Devonshire St., Boston
For page see List of Advertisers.
Tally, Wellesley, Mass.
For page see List of Advertisers.

Buffalo, N. Y.

William F. Kasting Co., 383-87 Ellicott St.,
Buffalo, N. Y.
For page see List of Advertisers.

Chicago

Chas. W. McKellar, 51 Wabash Ave.,
Chicago.
For page see List of Advertisers.
Peter Reinberg, 51 Wabash Ave., Chicago
For page see List of Advertisers.
E. F. Winterson Co., 45-49 Wabash Ave.,
Chicago.
For page see List of Advertisers.
J. A. Budlog, 37-39 Randolph St., Chicago.
For page see List of Advertisers.
Poehlmann Bros. Co., Morton Grove, Ill.
For page see List of Advertisers.

Cromwell, Conn.

A. N. Plewson, Cromwell, Conn.
For page see List of Advertisers.

Detroit

Michigan Cut Flower Exchange, 38 and 40
Broadway, Detroit, Mich.
For page see List of Advertisers.

Minneapolis

Rice Bros., 115 N. 6th St., Minneapolis,
Minn.
For page see List of Advertisers.

New York

Ford Bros., 48 W. 28th St., New York.
For page see List of Advertisers.
H. E. Froment, 57 W. 28th St., New York.
For page see List of Advertisers.
Alex. J. Guttman, 34 W. 28th St., New
York.
For page see List of Advertisers.
E. C. Horan, 55 W. 28th St., New York.
For page see List of Advertisers.
A. H. Langjahr, 55 W. 28th St., New York.
For page see List of Advertisers.
James McManus, 42 W. 28th St., New York.
For page see List of Advertisers.
John I. Raynor, 49 W. 28th St., New York.
For page see List of Advertisers.
W. F. Sheridan, 39 W. 28th St., New York.
For page see List of Advertisers.

WHOLESALE FLORISTS—**New York—Continued**

Tresendly & Schenck, 44 W. 28th St., New
York.
For page see List of Advertisers.
Moore, Hentz & Nash, 55 and 57 W. 26th
St., New York.
For page see List of Advertisers.
Wm. H. Kuebler, 28 Willoughby St.,
Brooklyn, N. Y.
For page see List of Advertisers.
Philip F. Kessler, 55 and 57 W. 26th St.,
New York.
For page see List of Advertisers.
Millang Bros., 41 W. 28th St., New York.
For page see List of Advertisers.
John Young, 51 W. 28th St., New York.
For page see List of Advertisers.
Greater New York Florists' Association,
162 Livingston St., Brooklyn, N. Y.,
For page see List of Advertisers.
Frank Millang, 55-57 W. 26th St., New
York.
For page see List of Advertisers.
B. S. Bilhon, 55-57 W. 26th St., New York.
For page see List of Advertisers.
A. L. Young & Co., 54 W. 28th St., N. Y.
For page see List of Advertisers.
Growers' Cut Flower Co., 39 W. 28th St.,
New York.
For page see List of Advertisers.
Henshaw & Fenrich, 44 W. 28th St.,
New York.
For page see List of Advertisers.
J. K. Allen, 107 W. 28th St., New York.
For page see List of Advertisers.
Charles Millang, 441 Sixth Av., New York.
For page see List of Advertisers.

Philadelphia

W. E. McKissick & Bros., 1610-1621 Ran-
stedd St., Philadelphia, Pa.
For page see List of Advertisers.
Leo Nlesso Co., 1209 Arch St., Philadel-
phia, Pa.
For page see List of Advertisers.
The S. S. Pennock-Meehan Co., 1608-18
Ludlow St., Philadelphia, Pa.
For page see List of Advertisers.

WOODENWARE

Bacon & Co., Appleton, N. Y.
Baskets: Crates: Ladders: Boxes.

New Offers in This Issue.**ASTER SEEDS.**

Flmer J. Smith & Co., Adrian, Mich.
For page see List of Advertisers.

BERBERIS THUNBERGII.

C. R. Barr & Co., Manchester, Conn.
For page see List of Advertisers.

CARNATIONS.

Poehlmann Bros. Co., Morton Grove, Ill.
For page see List of Advertisers.

CATALPA SPECIOSA SEED.

M. S. Hubbard, W. Toledo, O.
For page see List of Advertisers.

**CHRYSANTHEMUMS: BEDDING
STOCK.**

F. J. Sawyer, Clinton, Mass.
For page see List of Advertisers.

ERICAS, BOXWOOD.

Anton Schultze's, College Point, N. Y.
For page see List of Advertisers.

"IMP" SOAP SPRAY.

Eastern Chemical Co., Pittsburg St., Boston.
For page see List of Advertisers.

PANSIES.

Gustave Piertrag, W. Orange, N. J.
For page see List of Advertisers.

ROSES, GRAFTED OR OWN ROOT.

Montrose Greenhouses, Montrose, Mass.
For page see List of Advertisers.

For List of Advertisers See Page 455

List of Advertisers

Table listing advertisers and their page numbers, including Advance, The Co., Allen J. K., American Nursery, etc.

Table listing advertisers and their page numbers, including Thorburn J. M. & Co., Totty Chas., Treacy & Schenck, etc.

Beautiful Colored Supplement WITH NEXT WEEK'S ISSUE

EASTER SPECIAL A GOOD NUMBER TO ADVERTISE IN. SEND COPY EARLY! EARLY! EARLY!

MISCELLANEOUS WANTS WANTED TO BUY—Complete green house plants and all kinds of greenhouse material...

WANTS, FOR SALE, ETC. Advertisements in this column one cent a word. Initials count as words. Cash with order. All correspondence addressed "care HORTICULTURE" should be sent to 11 Hamilton Place, Boston.

HELP WANTED GOOD MEN When you need good men, skilled or unskilled, Write: THOS. H. BAMBRICK 34 South 7th Street Philadelphia Help of all kinds, including that for Florists, Nurserymen, Seedsmen and the Horticultural trade generally.

WANTED—Foreman for planting from landscape plans, nursery planting and propagating in frames. Steady position at moderate salary to competent young man. Small house available April 1st. Isaac Hicks & Son, Westbury Station, L. I.

WANTED—First-class greenhouse man for bedding plants, under Head Gardener; married man preferred. Address Supt. of Parks, P. O. Box 1027, Hartford, Conn.

SITUATIONS WANTED FORESTRY—A young man wishes a position on gentleman's estate. Understands reproduction and improvement cuttings. Also experienced in pruning and gypsy moth work. J. P. D., 40 Erie St., Dorchester, Mass.

WANTED—Situation as traveler. Good knowledge of orchids, stove and general plants and shrubs. Practical experience in Europe. Three years in Orchid Dept. of Huch Low & Co. Good appearance; fluent English, German and French. J. Muller, 34 Bayter St., Toronto, Canada.

Assistant Gardener wanted on a private place, a young man, must be industrious and sober; state experience. Address A. A. HORTICULTURE, Boston.

SITUATION WANTED—First-class carnation grower, sober and industrious, would like a position in the vicinity of Boston. Can furnish good references. H. M., care of HORTICULTURE, Boston.

SITUATION WANTED—First class French gardener, married, no children, two years' experience in America and 12 years in France; understands greenhouse work; best references; private place. Address Alexander Buteux, 236 West 36th St., New York City.

FOR SALE—A fine estate situated on high ground at Hyde Park, Mass., near Milton. Two minutes from R. R. station, fifteen minutes to Boston. House, 14 rooms and bath, all conveniences. Corner lot, 47,375 ft. land, first and grade trees. Greenhouse, 118 x 32, built 1908, 6 on side, 16 centre, 16 x 24 glass. Good opening for commercial florist. Address A. G. Cluckering, 53 State St., Boston.

FOR SALE—Retail nursery, sixth year, doing good, steady and increasing trade. Stock in excellent condition. Only local supply for community of 50,000. For particulars address R. N., care HORTICULTURE, Boston.

FOR SALE—Truck Farm, 26 acres, 10,000 ft. of greenhouses, two dwellings, out buildings, good repair, central to seven towns. Price right to quick buyer. Chapin Bros., Pine Brook, Morris Co., N. J.

TWEMLOW'S
Old English Glazing Putty,
 SEMI-LIQUID,
 For bedding glass in sash or for filling cracks or seams in roof joints or frames
 OF GREENHOUSES OR HOT BEDS.

THIS
PUTTY
 Is used in Machine or Bulb.

—

If too thick for bulb thin with a little Pure Linseed Oil, boiled.

—

So thinned it can be brushed into any crack or leak, making a solid filling.



THIS
PUTTY
 makes a solid bed, impervious to moisture, and holds glass in its place, and will stop any crevice or fault.

—

When once set on dry wood it does not heave.

MANUFACTURED IN THE UNITED STATES ONLY BY
HAMMOND'S PAINT AND SLUG SHOT WORKS,
 FISHKILL-ON-THE-HUDSON, N. Y.

STANDARD PLATE GLASS CO.
 Manufacturers—Importers—Jobbers
 NOW IS THE TIME TO BUY
FRENCH OR AMERICAN GREENHOUSE GLASS
 LOWEST PRICES ON REQUEST
 26-30 Sudbury St. BOSTON, MASS. 61-63 Portland St.

GLASS Always Write Us Before Buying
SHARP, PARTRIDGE & CO.
 22nd and Lumber Streets, CHICAGO
 WE HAVE SOME SNAPS

GLASS
 Greenhouse and Hot Bed
 SIZES OUR SPECIALTY
 INTENSE STOCK
Plate and Window Glass
 Write for Our Prices
PARSHELSKY BROS., Inc.
 59 Montrose Ave., BROOKLYN, N. Y.

In ordering goods please add "I saw it in HORTICULTURE."

NEWS NOTES.

Hartford, Conn.—J. H. Gowen has bought the Woodward greenhouse at Broadview Heights.

Clifton, O. John A. Hanscu lost several hundred dollars' worth of plants during the recent storm of sleet and wind.

Albany, N. Y.—Wm. S. Egerton, formerly superintendent of Albany parks, has started in business here as landscape architect and engineer.

Jackson, Tenn. T. L. Metcalfe offered a prize for a name for his greenhouses, and as the result his place will be known hereafter as Jackson's Pride.

So. Hadley Center, Mass.—Benjamin S. White has disposed of his business and taken the position of horticulturist on the estate of Joseph A. Skinner.

Chicago. The florists in the wholesale district are grieving over the death of their mail carrier, Philip Sesterhuber. He had been a daily visitor for over 12 years.

Worcester, Mass. Some vandal entered the greenhouses of Chas. R.

Fish & Co. on the night of March 12, broke over 700 lights of glass and cut over 100 shrubs close to the ground.

Keatchie, La.—The Southern Nut & Nursery Co. has added 600 acres to its present tract and will plant same with trees by April 1. The soil in this location is peculiarly suited to pecans.

Los Angeles, Cal.—Fumigation methods in this county have so impressed the Japanese Government that an offer has been made and accepted by Erwin Dingle, secretary of the Horticultural Commission, to visit the domain of the Mikado in August and introduce the process.

Long Branch, N. J.—W. D. Robertson has resigned his position as gardener to W. D. Kinney and will, on May 1, start in business in the greenhouses that he has recently built on his Monmouth Road property. Mr. Robertson's name has become familiar to the readers of HORTICULTURE through the many prizes he has won.

The complaint made by the Florists' and Gardeners' Club of Rhode Island at a meeting on March 15, that the

Rhode Island College at Kingston was selling the product of its greenhouses in Providence in competition with the regular growers, has brought a statement from President Edwards of the college. He plainly states that the administration knew nothing of the alleged agreement with Prof. Wheeler, but as soon as the matter was brought to the attention of the authorities, steps were taken to discontinue the sales.

BOSTON PLATE & WINDOW GLASS CO.
GREENHOUSE GLASS
 German and American
 261 to 287 A St., Boston 20-22 Canal St.

Holds Glass Firmly
 See the Point 47
PEERLESS
 FULL SIZE No 2

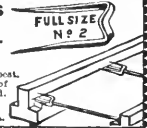

Glazing Points are the best. No rubs or lifts. Box of 1,000 points 75 cts. postpaid.
HENRY A. DREER,
 714 Chestnut St., Phila., Pa.

"REVERO"

Braided Moulded Construction—Seamless Throughout



LIGHT--STRONG--FLEXIBLE



The above cuts represent the non-kinking tendency of Revere as compared with the old style hose of wrapped duck construction

Revere is furnished on reels in continuous lengths up to 500 feet. Your supply man can furnish it

Revere Rubber Company, BOSTON, MASS.

NEW YORK
NEW ORLEANS

PHILADELPHIA
MINNEAPOLIS

PITTSBURG
SAN FRANCISCO

CHICAGO
PORTLAND, ORE.

The Payne Steel "T" Bar Greenhouses

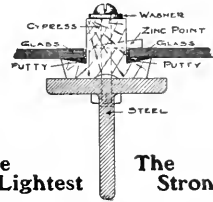

The Lightest The Strongest

Half full Size

HOUSES of this type are constructed with both curved glass eaves and straight glass eaves. Least amount of shadow. Least amount of wood. No drip. Greatest durability.

JOHNA. PAYNE

Greenhouse Designer and Builder
260-274 Culver Avenue

JERSEY CITY, N. J.

USE THE BEST.

Economy Greenhouse Brackets

are used by leading growers everywhere. Send for price list and descriptive circular.

BUXTON & ALLARD, Dept. A, Nashua, N. H.

GREENHOUSES BUILDING OR CONTEMPLATED.

- Newport, R. I.—Wm. Hay, one house.
- Leavenworth, Kan.—C. Hinz, range of houses.
- Putnam, Conn.—Alexander Mann, one house.
- Indianapolis, Ind.—Albert Pettit, one house.
- Independence, Ia.—J. P. Murphy, five houses.
- Indianapolis, Ind.—Smith & Young Co., two houses.
- Chicago, Ill.—Joseph Vacba, two houses, each 22x100.
- Redlands, Cal.—Sidney Hockridge, three vegetable houses.
- W. Manchester, Mass.—C. V. R. Crosby, addition 17x29.
- Toledo, O.—Krueger Bros., three carnation houses, each 20x250.
- Chicago, Ill.—Brant & Noe, two carnation houses, 300 ft. each.

BUSINESS CHANGES.

- N. Milwaukee, Wis.—Albert Groth has bought the greenhouses of C. Johansen.
- Michigan City, Ind.—Miss Lillian Bowes has moved to the Ledbetter building, W. 7th street.
- Cincinnati, O.—Mrs. Wm. Cunningham has leased the greenhouses to A. J. Horning, of Toledo.
- Concord, N. H.—G. J. Benedict, of Canaan, has leased the greenhouses of W. M. Colby at 25 South street.
- Warren, O.—Hartman Bros. have sold their market gardening business to J. F. Davis, of Gardner, Idaho.
- Independence, Ia.—J. P. Murphy has bought out E. M. Bissell, who will retire from business on account of ill health.
- Minneapolis, Minn.—Oscar Carlson has bought out the interest of his partner, Mr. Sandberg, and will carry on the greenhouses alone.

PATENTS GRANTED.

- 913,681. Boiler. Walter A. Berry, Chattanooga, Tenn.
- 913,790. Lawn Trimmer. Jacob Weber, Chicago, Ill.
- 912,791. Lawn Sprinkler. Darius W. Wells, Oakland, Cal.
- 912,953. Implement for Hoeing and Topping Growing Plants. Adolphus P. Granger, Nashua, Iowa.
- 914,227. Weeder. Ambrose Barkley, Pipestone, Minn.

CATALOGUES RECEIVED.

American Nursery Company, New York, N. Y.—Handbook of Trees, Shrubs, Vines, Ornamental Plants and Fruits, for Lawns, Parks, Gardens, Streets and Country Estates. This is a publication worthy of more than a passing notice. It is handsomely printed and illustrated in sepia. It is abridged somewhat as to numbers of varieties which is commendable and the text is accurate and reliable. The covers bear fine illustrations of Abies concolor and hardy rhododendrons.

FIRE RECORD.

- Brunswick, Ms.—The Hamilton greenhouses, leased by Frank Williams, were badly damaged by fire on March 16. Loss \$1,000, with no insurance, is reported.
- Sparta, Wis.—The plant of Z. K. Jewell & Co. was badly damaged by fire in the early morning hours of March 10. The boiler shed was destroyed and the glass in four houses so badly broken that the intense cold prevailing at the time killed the stock. The loss is reported as \$2,500, with no insurance.

INCORPORATED.

- Middletown, Conn.—F. Brewer Co.; W. B. Brewer, Grace A. Brewer, W. U. Pearne.
- Troy, O.—The Southwest Nursery Co., by S. A. Coplock and others; capital, \$10,000.

PATENTS

Trademarks and Copyrights

Send your business direct to Washington Saves time and insures better service. Personal attention guaranteed. Twenty-five years' active service. SPECIALTY: "Working on the Failure of Others."

SIGGERS & SIGGERS

PATENT LAWYERS

Box 9, National Union Building
Washington, D. C.



Erected at Davenport Neck, New Rochelle, N. Y.

THE QUESTION OF STRENGTH

IT is conceded that the strongest and most durable structure known is "THE IRON FRAME." And when you have all the Modern features combined in this type of construction you have "The Ideal Greenhouse."

The picture shows the beautiful symmetry of my "Curved Iceless Eave" — no heavy antiquated shading members. And I also make a speciality of having my work harmonize with surrounding conditions. Note how the mason work on greenhouse conforms to that on adjacent stable.

The advice of "The Practical Greenhouse Builder" is at your disposal for the asking.

WILLIAM H. LUTTON
West Side Ave. Station, JERSEY CITY

KROESCHELL BOILER

MADE OF FIRE BOX FLANGE PLATE
Can not Crack

Water Space in Front, Sides and Back
The Most Popular Boiler Made

SENJ FOR CATALOGUE.

KROESCHELL BROS. CO.
35 Erie Street, CHICAGO, ILL.

Please Note

that this is not a $\frac{1}{2}$ in. wire affair but it is made of heavy rods.

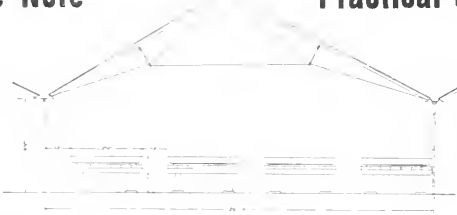

Practical Houses

on a practical financial basis. If you want an up-to-date house that will save you money,

WRITE

GEO. M. GARLAND CO.

Designers and Builders

DES PLAINES, ILL.

THE STANDARD STEAM TRAP

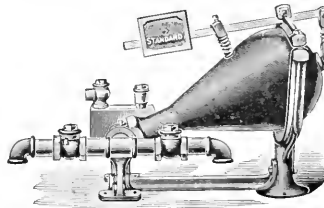

Is acknowledged the best for the florist, because it is durable and does its work without trouble and annoyance, saving its cost by the economy in coal bills.

E. HIPPARD

YOUNGSTOWN, OHIO

The Advance Ventilating Apparatus

is now in use in forty States, in all classes of houses and working under all conditions, and has pleased every customer. Price of machine complete \$10.50. Arms and hangers, &c, at right prices. It will take care of the ventilation of a 300 ft. house readily. Get our estimates and give us a trial.

The Advance Co.
RICHMOND, IND.

EVERYTHING FOR GREENHOUSE BUILDING

WRITE FOR INFORMATION AND PRICES

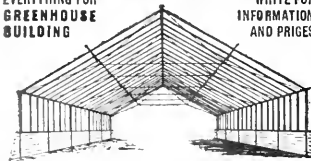

King Greenhouses. King Cutters and Eaves, Trussed Roofs. Ventilating Machinery, Trussed Iron Frame Houses, Tile Benches and Pipe Hangers.

KING CONSTRUCTION COMPANY
NORTH TONAWANDA, N. Y.

CYPRESS SASH BARS 32 feet or longer
HOT BED SASH
PECKY CYPRESS BENCH LUMBER

GREENHOUSES

ERECTED AND EQUIPPED COMPLETE IF DESIRED

Write for Circular "D" and Prices

The A. T. STEARNS LUMBER CO.
NEPONSET, BOSTON, MASS.

In ordering goods please add "I saw it in HORTICULTURE."

GREENHOUSE CONSTRUCTION LUMBER

John C. Moninger Co.
117 E. Blackhawk St., CHICAGO.

Evans 20th Century Arm

Will not twist the shafting pipe. Three times the power of old style elbow arms. Sold only with Evans Challenge Machine.

Write for free Catalogue to
QUAKER CITY MACHINE CO.
Richmond, Ind.

The FLORISTS' HAIL ASSOCIATION OF AMERICA, insurer of 29,000,000 sq. ft. of glass. For particulars address
John C. Ester, Sec'y, Saddle River, N. J.

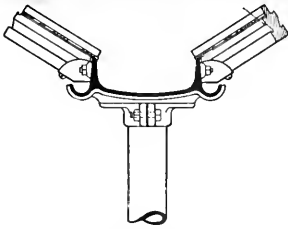

OUR CAST IRON CENTRE GUTTERS

Not cast of brittle stove plate iron — but high grade, tough iron. Are not crooked — are cast smooth and straight.

Lengths of 8 feet 4 inches, making it necessary to use only half the posts required with the shorter gutters that are on the market.

Every gutter of ours is equipped with roof bar brackets which stiffen the roof and prevent bar end rot.

Write for prices.

Hitchings & Company
1170 Broadway New York

THE FOLEY MFG. CO.

CHICAGO

Completely equipped with up-to-date machinery for the making of material for

GREENHOUSE CONSTRUCTION

From a Full Supply of Thoroughly Seasoned Lumber

Send your sketches to our draughtsmen for completion and suggestion. Permit us to figure your proposed work, large or small.

We guarantee our prices will save you money

FOLEY VENTILATING APPARATUS IS THE BEST

Is Simple in Erecting. Is Easiest of Operation. It will Last a Lifetime. Its Prices is the Lowest. Will Ventilate Any Size House. Prices and Circulars on Application.

Send for Catalogue Greenhouse Material sent Postpaid on Request

The Foley Mfg. Co. Western Avenue
CHICAGO 25th & 26th Sts.



WHAT ARE YOU LOOKING FOR?

Just a greenhouse that "answers the purpose," or one that more than answers it? Do you want a house that will produce more blooms through December, January and February than any other house constructed any other way? Then buy a U-Bar. It is the lightest house built—and if it is lightest, it is most productive. It is a house with every possible decay point fully protected.

Send for fully illustrated catalog.

U-BAR GREENHOUSES

PIERSON



U-BAR CO.

DESIGNERS AND BUILDERS

1 MADISON AVE., NEW YORK

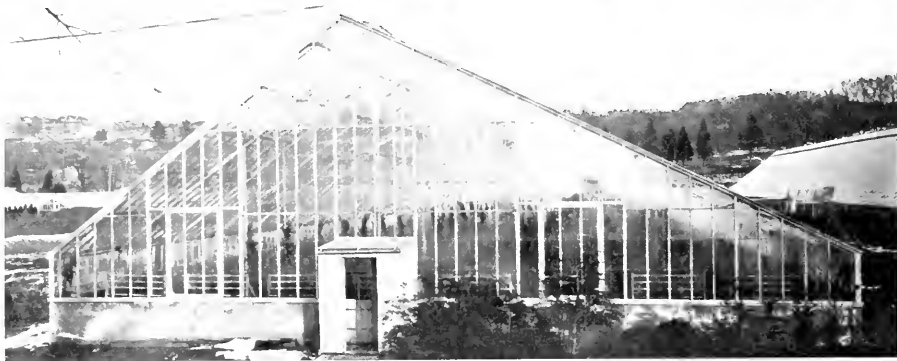

Gable of the last Shadeless Ridge House. The new one is going up to the left of this.

F. R. Pierson Co. Builds Another Iron Frame House

It is to be an exact duplicate of this one which we built for them in 1906, excepting that in place of the wooden sill on top of the concrete wall, Mr. Pierson is going to try out one of concrete. It looks practical to us.

Mr. E. H. Kroninger of Allentown, Pa., who has just ordered a house 57 feet wide and 400 feet long, decided, however, upon our Cast Iron Sills for his concrete sides.

The frame work of the Pierson house is already up. It is 55 feet 6 inches wide by 300 feet long. The north pitch is $37\frac{1}{2}$ degrees, the south $26\frac{1}{2}$ degrees, making a ridge height of 23 feet 5 inches. The sides are 6 feet 6 inches high from grade to the Ice-Clearing Plate at the eaves.

The iron rafters are welded at the eaves to the Guaranteed Wrought Iron Posts which are partially imbedded in the concrete sides, and extend into the solid concrete footing 2½ feet below grade. Reinforced concrete is used up to the usual height of boarding, and tapered off near the top of the inside face to take the sill.

It has been customary to hinge the side sash directly to the fascia on the inner side of the galvanized plate, but here a fascia is not used at all, and the sash are hinged directly to the plate,



Interior, looking towards same gable.

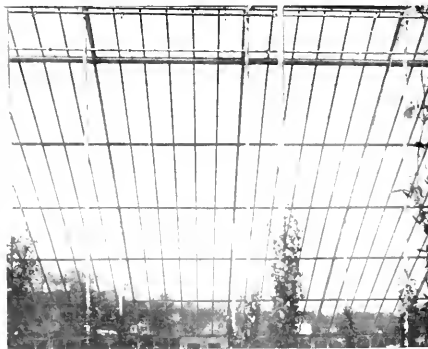

But it is looking directly at the roof itself that you appreciate the lightness and strength of our construction.

greatly decreasing the shade at this point.

When his first house was ordered, Mr. Pierson insisted on having an arrangement of the side ventilation that would extend the least possible into the walks; so "L. & B." got busy and designed a specially compact gear with 6 inch arms, and carried the shaft directly through the posts which serve as bearers. As a result no part of the apparatus extends into the walks beyond the line of the side heating pipes.

In the ridge ventilation the operating rod is brought directly down through the bench and a miter gear used, with a hand wheel placed at side of bench. This leaves the bench entirely free.

The $\frac{1}{2}$ X $1\frac{1}{4}$ inch cypress bars are screwed directly to the angle iron purlins which prevent their shifting.

It is a significant fact that after both Mr. Pierson and Mr. Kroninger, this season, went exhaustively into every feasible kind of construction on the market, they came back to where they started—the L. & B. Sectional Iron Frame.

To build wide houses with experimental constructions which are but a few months old, is taking a risk few growers can afford. When you invest several thousand dollars in a house you should not take chances. The L. & B. Sectional Iron Frame has stood the test of years, and is now, as at the start, the ideal construction.

Before you build give it the very serious consideration it deserves. It will be greatly to your advantage to take it up with us.

LORD & BURNHAM CO. 1153 BROADWAY, NEW YORK and Boston and Philadelphia.

HORTICULTURE

Vol. IX.

APRIL 3, 1909

No. 14

EASTER 1909



DEVOTED TO THE
FLORIST, PLANTSMAN, LANDSCAPE GARDENER AND KINDRED INTERESTS

PUBLISHED EVERY SATURDAY AT 11 HAMILTON PLACE, BOSTON, MASS.

SUBSCRIPTION, \$1 00 PER YEAR



ROSES

Hybrid Wichuraiana, Polyantha and other Rambler Roses of my own raising and foreign origin.

The Best of the Hybrid Perpetuals and Hybrid Teas. A Fine Stock of the beautiful New Lyon Rose.

Hollyhocks, Phloxes, Peonies.

M. H. WALSH, Rose Specialist
WOODS HOLE, MASS.

WATERER'S RHODODENDRONS

CONIFERS, LAURELS, SPECIMEN ORNAMENTALS

FAMED
ALL
OVER
THE
WORLD



SPECIAL
FOR
AMERICAN
TRADE

ORDER NOW FOR NEXT SEASON.

SIZES AND PRICES ON APPLICATION.

JOHN WATERER & SONS

AMERICAN NURSERIES,

BAGSHOT, ENGLAND

HENDERSON'S INVINCIBLE ASTERS.

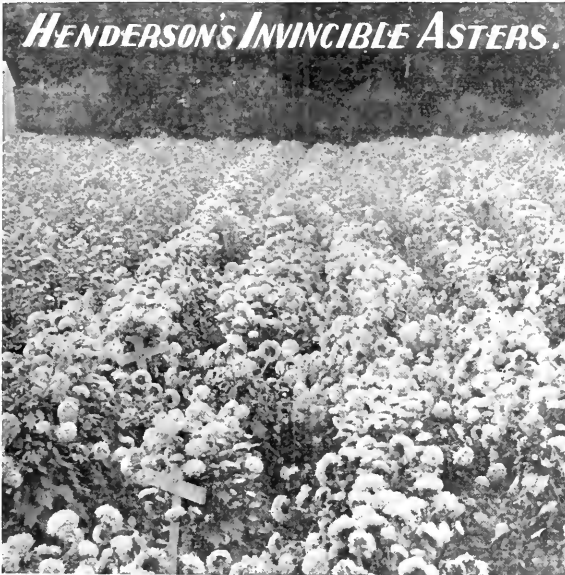

A superior type, of healthy, robust growth, producing long-stemmed flowers of immense size and perfect form.

The plants are of very healthy, robust, branching growth, about two feet high, producing, on long stems, massive, peony-formed flowers of perfect form and faultless outline, and exceedingly double to the very center. When well grown the flowers of Henderson's Invincible Asters average 3½ inches across: 4-inch flowers are quite common, and if grown especially for cut flowers, the side branches pruned, allowing a plant to carry not over 8 or 10 flowers, one flower to a stem, their size will then be enormous, measuring 4½ and 5 inches across. These magnificent blossoms being gracefully poised on strong, well-leaved stems, 15 to 18 inches long, resemble good-sized Chrysanthemums, and are unspassed as cut flowers.

Price of.. Henderson's Invincible Aster Seed

	Pkt.	100 Seeds	Oz.
Rose Pink	\$.15	\$.50	\$3.00
White	.15	.50	3.00
Blue	.15	.50	3.00
Crimson	.15	.50	3.00
Lavender	.15	.50	3.00
Purple	.15	.50	3.00
Mixed Colors	.15	.40	2.50

HENDERSON'S FLORISTS' CA'ALOEUE FOR 1909
(Seeds, Plant., Bulbs, Requisites, etc.) mailed to florists on application

PETER HENDERSON & CO. 35 and 37 GORTLANDT ST. New York

THE QUALITY YOU CAN MAKE MONEY ON

CANNAS

SOUND PIECES "TRUE TO NAME" BED ROCK PRICES

Red-Flowering, Green Foliage

	Per doz.	100	1000
A. Bouvier. 5 ft. Dark crimson	\$.35	\$2.25	\$20.00
Allice Roosevelt. Deep crimson, 4 ft.	.50	3.50	30.00
Beaute Potievine. 3½ ft. Dark crimson	.35	2.25	20.00
Black Prince. Velvety maroon; 3 to 4 ft.; green foliage	.50	2.75	25.00
Charles Henderson. 4 ft. Bright crimson	.35	2.25	20.00
Crimson Bedder. 3 ft. Intense scarlet	.30	2.00	17.50
Duke of Marlborough. 4½ ft. Dark crimson	.35	2.25	20.00
J. D. Eisele. Brilliant vermilion-scarlet 5 ft.	.35	2.25	20.00
Explorateur Crampel. Deep rich crimson 5½ ft.	.30	1.75	15.00
Express. Crimson; foliage green. Dwarf habit, 2 to 2½ ft.	.60	4.50	40.00
Pres. McKinley. Brilliant crimson 2½ to 3 ft.	.35	2.25	20.00

Pink-Flowering

L. Patry. Delicate rosy pink, 4½ ft.	\$.35	\$2.25	\$20.00
Luray. Attractive rosy pink, 3 ft.	.35	2.25	20.00
Louise. A grand pink, tall	.45	3.50	25.00
Martha Washington. Rose. Height, 2½ to 3 ft. 10c. each.	.75	5.00	
Mill. Berat. 4½ ft. Rese-carmine	.35	2.25	20.00
Tennyson. Rosy pink; green foliage; 5½ ft.	.50	3.50	

Orange-Flowered

	Per doz.	100	1000
President Cleveland. Bright, distinct orange-scarlet; 4 ft.	\$.35	\$2.25	\$20.00

Red, Gold-Edged and Spotted

Gladiator. Bright yellow, spotted crimson, green foliage; 4 ft.	\$.50	\$2.75	\$25.00
Cinnabar. Cinnabar red, edged with distinct golden band; 4½ ft.	.30	2.00	17.50
Queen Charlotte. Scarlet gold edge	.30	2.00	17.50
Mme. Crozy. 5½ ft. Vermillion, gold border	.35	2.25	20.00
Premier. Deep crimson, bordered yellow, 3½ ft.	.30	2.00	17.50
Sou. d' A. Crazy. 4 ft. Crimson, gold band	.50	4.00	35.00

Yellow Shades

Buttercup. 3½ ft. Clear golden yellow	\$.40	\$2.75	\$25.00
Comte de Bouchard. Yellow, spotted red, 4½ ft.	.30	2.00	17.50
Florence Vaughan. 5 ft. Yellow, spotted crimson	.50	2.75	25.00
L. E. Bailey. Rich yellow, dotted with red; 4½ ft.	.30	2.00	17.50

White and Cream Shades

Alsace. 3½ ft. Creamy white	\$.30	\$1.75	\$15.00
------------------------------------	-------	--------	---------

Bronze-Leaved, Red-Flowering

Brandywine. 4 to 5 ft. Dark bronze foliage. Crimson flowers	\$.50	\$4.00	\$30.00
Black Beauty. True. 5 ft. Grand foliage	.60	4.50	40.00

	Per doz.	100	1000
David Harum. 3½ ft. Vermilion-scarlet	\$.50	\$2.75	\$25.00
Egmont. 4 ft. Currant-red	.35	2.25	20.00
King Humbert. Fine Bronze foliage. Orange-scarlet with bright red markings, 4 ft.	1.00	8.00	75.00
Leonard Vaughan. 4½ ft. Bright scarlet	.35	2.25	20.00
Musafilia. The finest foliaged Cannas, with enormous musa-like leaves, 3 by 5 ft., of a dark green bronze-tinted color	.35	2.25	20.00
Philadelphia. A bright glowing red. Height 5 ft.	.75	4.00	30.00
Papa Nardy. Large, rich carmine-red, 4½ ft.	.30	2.00	17.50
Pillar of Fire. 6 to 8 ft. high; flowers bright crimson-scarlet	.75	4.50	40.00
Robusta. Height 6 to 8 ft., with immense foliage	.30	1.75	15.00
Shenandoah. Large Salmon flowers, 6 ft.	.30	1.75	15.00

Orchid-Flowering

Allemania. 4 to 5 ft. Scarlet and yellow. Green foliage	\$.35	\$2.25	\$20.00
Austria. Pure canary yellow; low; an orchid-flowering type, 5 ft.	.30	1.75	15.00
Italia. 4½ ft. Green foliage. Red-bord. red scarlet	.30	2.00	17.50
Kronus. Rich golden yellow, with patches of bright red, 5 ft.	.30	1.75	15.00
Mrs. Kate Gray. 6 ft. Green foliage. Scarlet and yellow	.30	2.00	17.50
Pennsylvania. 5 ft. Green foliage. Deep scarlet	.35	2.25	20.00

CATALOGUE FREE.

We go through the block from 14th Street to 13th Street, but our address is still

ARTHUR T. BODDINGTON, Seedsman, 342 West 14th St., NEW YORK CITY.

NEW ROSE WHITE KILLARNEY

We Know You Will Want to Buy White Killarney



Every live, progressive, up-to-date grower who has seen it is buying it; but when you buy White Killarney, be sure you get the right White Killarney (the Waban variety). When you buy from us you get the variety that has been exhibited and certificated, and the one that has attracted such favorable mention.

If you are in the vicinity of New York, we should be glad to have you call and see White Killarney growing at our Scarborough range, and you will say at a glance—as everyone has who has seen it growing—that it is by far the best white rose that has ever been placed on the market.

It is not only a good winter-flowering rose, but is good the entire year, and it is a splendid shipper. Read the following letter received from Mr. Willis N. Rudd, Secretary of the Society of American Florists, dated January 15th, in which he writes as follows:

"Dear Mr. Pierson—I cannot refrain from writing you and expressing my admiration for the White Killarney as shown at Chicago on Thursday. It is an exquisitely beautiful thing and attracted much attention. I took half the blooms home with me, and they were finer on Saturday than they were at the show. The record is that these blooms were shipped from Tarrytown, staged and exhibited during the afternoon. They were then carefully wrapped up in a box, and remained in that box until one o'clock Friday morning, at which time I reached home; improved in quality up to Saturday, and were in fairly presentable condition on Sunday.

In addition to being the most beautiful white rose of its class which I have seen, this demonstrates its splendid keeping and shipping qualities.

W. N. RUDD"

We were awarded Silver Cup at National Flower Show, Chicago, for best new rose with White Killarney; also Silver Medal Horticultural Society of New York.

Strong plants, 2 1/4 inch pots, own roots, now ready for delivery, \$30.00 per 100; 250 for \$70.00; 500 for \$125.00; 1000 for \$250.00. Grafted plants, ready April 1st, \$35.00 per 100; 250 for \$82.50; 500 for \$150.00; 1,000 for \$300.00.

F. R. PIERSON CO., Tarrytown-on-Hudson, NEW YORK

ROSES

Grafted BY MARYLAND, BRIDE, BRIDESMAID, KILLARNEY, RICHMOND.

Own Root RICHMOND, QUEEN BEATRICE.

This is A No. 1 Stock from Prize Winning Sources of highest repute.

2 1/2 to 3 1/2 in. pots. Delivery immediate or will hold until July 1.

MONTROSE GREENHOUSES
MONTROSE, MASS.

ASTER SEEDS

That will produce Good Blooms

CHRYSANTHEMUMS

The Best for Florists

ELMER D. SMITH & CO.
ADRIAN, MICH.

CHRYSANTHEMUMS

Golden Glow—plant Middle May to July—Cut Middle Aug. to Oct.—White Cloud—on 8 inch tap—extra strong stem. Plant late May and early June—Cut Middle Oct. to Nov. 1st—Pacific Supreme—a longer stemmed—brighter—non-fading glory of the Pacific. Bedded now will increase stock to 1 by planting time—Delivery Plants—March \$8.00 per 100; April \$4.50; Bal. Season \$4.00. Rooted Cuttings now, post or express paid, \$4.00 per 100; 25 at 100 rates.

J. H. MYERS, ALTOONA, PA.

A. N. PIERSON, Inc., Cromwell, Conn.

WHITE KILLARNEY (Waban Strain)

	Doz.	100	250	500	1000	2500	5000
GRAFTED STOCK.....	\$8.00	\$55.00	\$25.50	\$159.00	\$306.00	\$687.50	\$1,250.00

MY MARYLAND GRAFTED.....	\$3.00 per doz.,	\$30.00 per 100,	\$150.00 per 1000
OWN ROOT.....	2.00 "	10.00 "	50.00 "

STANDARD VARIETIES

Betty, Bon Silene, Bride, Bridesmaid, Cardinal, Echanter, Etoile de France, Etoile de Lyon, Franz Deegan, Gen. McArthur, Golden Gate, Hermosa, Ivory, Kal erin Augusta, Victoria, Kate Moulton, Killarney, La Detroit, Maman Cochet, Marechal Niel, Mme. Abel Chatenay, Mrs. Jardine, Mme. Haste, Mrs. Paul Nichoff, Mrs. Pierpont Morgan, Mrs. Potter Palmer, Papa Gontier, Queen Beatrice, Rhea Reid, Richmond, Rosaline Orr English, Souv. du President Carnot, Souv. de Wootton, Uncle John, Wellesley, White Cochet. The above Grafted (selected plan \$12 pcts. each, \$2.00 per doz., \$15.00 per 100, \$110.00 per 1000.

OWN ROOT ROSES

Killarney, Bride, Bridesmaid, Mme. Abel Chatenay, Ivory, Richmond, Mrs. Paul Nichoff, 250 pots, 75c per doz., \$35.00 per 100, \$340.00 per 1000. 2 1/2 in. pots, \$1.00 per doz., \$8.00 per 100, \$79.00 per 1000.
Queen Beatrice Rhea Reid, Mrs. Jardine, Mrs. Potter Palmer, from 2 1/2 in. pots, \$8.00 per 100, \$70.00 per 1000.

BEDDING PLANTS

COLEUS. Verschaffeltii, Golden Queen, Queen Victoria, Beckwith Gem, Firebrand, Lord Palmerston. Rooted Cuttings by express, \$0.10 per 100, \$5.00 per 1000. Out of 2 1/2 in. pots in May, \$2.00 per 100, \$15.00 per 1000.

Golden Bedder, Hero Messy, Pearl of Orange. Fanny Varieties. Twelve kinds not listed above, 75 cts. per 100, \$7.00 per 1000.

AGERATUM, Stella Galvya, Princess Pauline, LALYIA, Splendens, Bonaire and Zurich.

HELIOTROPE. Dark blue bedding varieties. GERMAN IVY. 75 cts. per 100, \$6.00 per 1000.

ALTERNANTHERA, Red and Yellow, 50c per 100, \$5.00 per 1000. From 2 1/2 in. pots, \$2.00 per 100.

SALLEROL. Rooted Cuttings, \$1.00 per 100, 2 1/2 in. pots, \$2.50 per 100.

CHRYSANTHEMUMS IN QUANTITY. Catalogue on Application.

CHRYSANTHEMUM SEED.

Wells' New Early Flowering Singles, packets 25c and \$1.00 each.

PENTSTEMON SEED

Wells' New Hybrids, packets 25c and \$1.00 each

CHARLES H. TOTTY, Madison, N. J.

Gladiolus Brenchleyensis

Extra fine Healthy Imported Stock
1,000 \$10.00 10,000 \$80.00

O. V. ZANGEN

HOBOKEN, N. J.

WHITE KILLARNEY

“Waban Conservatories Variety”

The remarkable vigor of our plants is a surprise and pleasure to all our customers

HAVE YOU ORDERED?

After you see the plants, you will want to double your order, as many others have done

WABAN ROSE CONSERVATORIES NATICK, MASS.

ROSES

We have a fine stock of large, dormant, field grown plants, on own roots, of the following varieties:

Boule de Neige, Mad. Plantier, Alfred Colomb, Perle des Blancches, Climbing Corchille, Aurore, Archduchess Elizabeth of Austria, Empress of India, Glory of the Exposition of Brussels, Philadelphia Crimson Rambler, Fisher Holmes, Chesham Hybrid, Climbing Woolton, Magna Charta, Countess of Roseberry, Louis Van Houtte, Dorothy Perkins, Anna de Diesbach, Mad. Alfred Carriere, Vick's Caprice, Sir Thomas Lipton, Francois Levet, Eugene Furst, Crimson Rambler.

PRICE \$12.50 per 100; \$120 per 1000
Tausendschon, the great new climber, \$20 per 100.

Crimson Baby Rambler, \$16 per 100.
Fine plants from 2 1/2 inch pots, Chrysanthemum Glory of the Pacific, \$25.00 per 100.
Roses, Dahlias and Cannas a Specialty.
Catalogue Free

The Dingee and Conard Co., West Grove, Pa.

Ampelopsis Quinquifolia

Per 1000
Strong 1-year plants 2 to 3 ft. \$20.00
" 2-year " 3 to 4 ft. 30.00
" 3-year " 4 to 6 ft. 55.00

TO THE TRADE ONLY

A Full Line of General Ornamental

NURSERY STOCK

SEND FOR CATALOGUE

EASTERN NURSERIES
JAMAICA PLAIN, MASS.

HENRY S. DAWSON, Mgr.

A THING OF MERIT.

NEW HARDY FLOWERING SHRUB.

Buddleia variegata Veitchii and Magnifica, sunnier flowering Lilacs, blooms when all other shrubs are past. Strong 3 yr. old, 50c. each; \$5.00 per doz.; \$25.00 per 100

Rose Hill Nurseries, New Rochelle, N. Y.

Box Trees

and other EVERGREENS for Tubs and Boxes
Our Prices are Always Right—Catalog Free
THE NEW ENGLAND NURSERIES, Inc.
BEDFORD, MASS.

SOME OF OUR SPECIALTIES

Boxwood Pyramid Shape, 2 1/2 to 3 ft. high, very heavy, \$1.75 each, 3 to 3 1/2 ft high, \$2.50 each. Bush Shape, very heavy, 2 to 2 1/2 ft., \$1.75 each, 2 1/2 to 3 ft. high, \$2.00 each.
Rhododendrons, Parson's Hardy varieties, 8 to 12 buds, 18 to 24 in. high, at \$75.00 per 100; 12 to 14 buds, 24 to 30 in. high, at \$100.00 per 100.
Azalea Tolls, 15 to 18 in. high, very bushy and full of buds, at \$35.00 per 100.
Hybrid Perpetual Roses, strong dormant field grown plants, of our own growing, none better, \$11.00 per 100, \$100 per 1000.
Tass Roses, field grown, \$1.00 per 100.
Hardy Climbing Roses, field grown, \$3.00 per 100.
Tree Roses, hardy varieties, budded on straight stems, 4 to 5 ft. high, \$30.00 per 100.
Ampelopsis Veitchii, bushy, 2 yr. plants, 3 foot of tops, \$10.00 per 100.

The Storrs & Harrison Co., Painesville, Ohio

NURSERY STOCK FOR FLORISTS' TRADE

AMERICAN GROWN ROSES, AZALEAS, RHODODENDRONS
FRUIT AND ORNAMENTAL TREES, SHRUBS, SMALL FRUITS, CLEMATIS, EVERGREENS

WRITE FOR OUR TRADE LIST

W. & T. SMITH COMPANY 63 YEARS 700 ACRES GENEVA, N. Y.

Berberis Thunbergii Finest of Hedge Plants

12-18 in., \$5.00 per C. \$40.00 per M.
One year seedlings, 3-5 in. \$5.00 per M. All ready for immediate delivery.

C. R. Burr & Company, Manchester, Conn.

TREES, EVERGREENS, SHRUBS, VINES, PERENNIAL PLANTS, HARDY RHODODENDRONS and R. MAXIMUM in quantity, per hundred or per thousand, very fine. Complete assortments: Careful grading: Low prices.

AMERICAN NURSERY COMPANY,

Sales Department, 150 BROADWAY, NEW YORK CITY.
BLOODGOOD NURSERIES DEPT., Flushing, Long Island.
F. & F. NURSERIES DEPT., Springfield, New Jersey.

Hardy Rhododendrons, Azaleas, Clematis, H. P. Roses, Shrubs and Herbaceous Plants from our HOLLAND NURSERIES

Prices Moderate

P. OUWERKERK, 216 Jans St., Wobesman Heights, P. O. No. 1, Hoboken, N. J.

CLEARY'S HORTICULTURAL CO.

Management AMEROS T. CLEARY
Wholesale Contracting, Jobbing, Auction
HORTICULTURAL PRODUCTS
of every description.
Consignments Received. Surplus Stock Converted
62 Vesey St., NEW YORK

FRUIT, SHADE, and ORNAMENTAL TREES, SHRUBS, ROSES and PLANTS of all kinds at CALL'S NURSERIES, PERRY, O. Call deals direct with his customers and thousands of the best fruit-growers and his customers. Write him for Price List.

RHODODENDRON HYBRIDS and MAXIMUM

Norway Maples 1 1/2", 2-1/2" and 3-1/2" dia.
Dwarf Box 6-7" X.
Blue Spruce Kosteri 4-5' and 5-6'.
California Privet 2 yrs. 20-30" 2-3' and 3-4'.
P. A. KEENE, 1 Madison Ave., New York

In writing to Advertisers kindly mention Horticulture

Rhodora canadense L.



Rhodora canadense is a native shrub, from 2 to 3 feet high, found in rather moist locations from Canada to the mountains of Pennsylvania. As one of the many beautiful representatives of the large plant family, Ericaceae, it is one of our prettiest harbingers of northern spring. When in May, after long and patient waiting, the sun has melted the thick ice and snow in the Canadian forests and birches and alders in the Maine lowlands begin to leave out, then this shrub, on still bare branches, unfolds its masses of bright, purplish pink blossoms. Standing in clusters their vivid tints lend life to the, for the largest part of the year, dreary, comfortless aspect of the northern bogland. Confronted with this bush of fire in the real wilderness the human eye in wondering gaze realizes the fact that Nature in her kindness sometimes strikes the gayest color notes where otherwise the general character of the vegetation seems to be bare of all cheerfulness. Wherever I met *Rhodora canadense* in masses and had the good fortune to see their waves of blossoms in full glory, be it along the edge of the woods, in glades, or on open pastures, they always impressed me as part of the strong tuneful floral interlude of the brief, and, while brief, amazingly active and productive, growing period characteristic to all vegetation of the North.

Seeing this shrub among the more pretentious members of its family, noteworthy the mollis and pontica azaleas or the evergreen Catawbiense varieties of rhododendrons on the shrubby borders of cultivated gardens we are apt to think very little of it. In the wilderness we at once perceive its true significance. Here we understand Ralph Waldo Emerson's beautiful poem on *Rhodora* at a glance.

The aforesaid makes it sufficiently evident that our *Rhodora canadense* is not an ornamental garden shrub in the common meaning of this term. It endures, however, on its native home, the inclemencies of our long winters without the least harm and grows under conditions and in a soil where very few of our more tender flowering garden shrubs will thrive. For this reason it merits its space in wild gardens of our northern states where it is easily naturalized and generally appears well in keeping with the native vegetation. The bright and cheering colors of its masses of little blossoms as floral greetings of the spring are so charming that if seen once they will seldom leave the memory of a true plantlover.

Richard Rothe

Northeast Harbor, Me.

European Horticulture

NEW LILACS RAISED BY THE LATE W. PFITZER, STUTTGART

For many years efforts have been made by hybridists and others to improve the blossom of this harbinger of spring, and handsome shrub. Foremost in the ranks of hybridists is Mr. Victor Lemoine of Nancy, France, who has put into commerce many single and double-flowered varieties. Herr Louis Spath Baumschulenweg, Berlin, is another successful raiser of lilacs who has been especially fortunate in single-flowered varieties. Still more successful was the late Wilhelm Pfitzer of Stuttgart, who carried out his crosses in his private garden, situated at the foot of the Stuttgart Hasenberg, with the newest and best known beautiful varieties. Hundreds of seedlings were selected in flowering time, carefully transplanted, and put under observation in the following years. These were sorted, the best chosen for propagating purposes and the rest thrown away. After repeated selection three varieties, color plates of which are given in *Die Gartenwelt* for March 11, are to be put into commerce next autumn. *Perle von Stuttgart* is double flowered, pearly rose in the bud, passing to lilac rose with a white reflex, with spike of great size and graceful form. *Frau Wilhelm Pfitzer* is single-flowered, of a fine rosy lilac tint, the bloom making a pyramidal slender spike that is very ornate. It is a free bloomer. *Kate Harlin* is likewise single-flowered, of an alabaster white. The flowers are of a large size, stand at an equal distance asunder, and this gives the spike a light, elegant appearance.

BROKEN BRICK IN POTTING SOILS

Much has been said in recent years about the cultivation of Odier (English) *Pelargonium* in the German gardening press; and M. H. Seeger, writing in *Moller's Deutsche Gartner Zeitung*, No. 11, 1909, contributes the following advice regarding potting for these plants: "I plant my English *Pelargoniums* in rich, turfy loam, leaf mould, sand and a good proportion of brick dust mixed with those ingredients. According to my belief the dust is a means of warding off attacks of green fly, at least the fly does not appear as abundantly. I suppose the brick dust imparts a bitter taste to the juices of the plant which the fly does not like. The flowering of the plants is more abundant. I use the brickdust as early as the month of August for the cuttings; and it is my opinion, that the young plants come better through the winters by its use."

FAVORITE VARIETIES OF FUCHSIAS

There are several varieties of the *Fuchsia* which are great favorites in the neighborhood of the Hartz mountains which are regarded by the public as being invaluable, and have been cultivated in that region for many years by the market growers in masses. The plants are favorites with the florists and those who supply the markets for the reason that they grow with rapidity and come to the flowering stage quickly, besides being very free to bloom. February cuttings develop with proper culture into capital market plants by the month of May. These varieties are *Emile de Wildman*, a double white or robust growth and very floriferous. *La Core*, double, calyx carmine, corolla white; the flower large and long enduring. *Mad. Eva Boeg*, single flowered, calyx flesh colored with green points, corolla magenta, and of great length. A good variety for hanging baskets etc., is *Voltaire*, semi-double, calyx scarlet, corolla plum col-

ored with rose red veining; an inexhaustible bloomer. It makes a good standard.

A DISEASE OF VIOLA CORNUTA VARIETIES

A peculiar disease has appeared on the Tufted Pansies (large flowered *Viola Cornuta*) which makes itself apparent in the inward rolling up of the margins of the leaves; and the disease appears mostly in dry weather and in plants growing in poor soil, whilst it is scarcely to be observed during moist weather and in rich soil. In the spring there is scarcely any trace of the disease but in the chief flowering and afterwards the disease becomes very general till autumn when it is much less apparent. The injury done by the mite on the plants attacked, is to greatly lessen the quantity of the bloom, which on healthy plants is uninterrupted till late autumn. The disease has extended itself widely in Switzerland, and it has appeared likewise in England. The cause of the disease is a mite belonging to Eriophydes, in England known as *Eriophya Violat*. The creature lives in the curled-up leaf edge, causing by its sucking of the sap the uprolling of the edge. A similar malady has long been known, according to Darbouc and Howard, to infest *Viola calcarata* and *V. canina*.

THE BOTANIC GARDEN AT KEW

This, the largest botanical garden in the world, which can look backward to an existence of 350 years and is three times larger than the recently established garden at Dahlem near Berlin, was visited in 1908 by 2,716,220 persons, that is, 260,000 more than in the previous year. The number of visitors in the last two years is the highest in the course of its existence. In the last ten years (1898-1907), about 16 $\frac{1}{2}$ millions of people have visited the gardens. The highest number in one day (in August) was 93,388 and the lowest number (January 21), 68 persons.

ENGLISH DAHLIA TRIALS.

We learn that the English National Dahlia Society will hold this year two shows in September next and inaugurate three trials in order to ascertain the varieties suitable for decorative purposes in the flower garden. There will be trials of Show and Fancy varieties at the Royal Horticultural Society's garden at Wisley, Cactus varieties at Shenfield in conjunction with Mr. J. T. West, an eminent dahlia specialist, and of Pompon varieties at Slough, superintended by Mr. C. Turner of the Royal nurseries at that town. Garden Dahlias will be grown under name, and two specimens of each variety should be forwarded to the superintendent of the R. H. S.—Mr. Wright, and addressed, if by railway or the post, to The Gardens, Wisley, Ripley, Surrey, a notice of their despatch being sent by post in either case. In regard to the other trials, new varieties of the Pompon and Cactus varieties are alone invited, which will be grown under numbers. Moreover, comprehensive collections of dahlias in commerce are requested to be sent in not fewer than two plants of each variety, not later than the end of the month of May. Persons wishing to send their new varieties should notify their wish to Mr. E. F. Hawes, Royal Botanic Garden, Regents Park, London, N. W., together with the names of the varieties. Packages should be forwarded carriage paid. The plants will be judged by a special committee of the N. D. S.

SAXIFRAGA DE RAMSAY.

This pretty silvery-leaved Saxifrage bears the name

of an enthusiastic horticulturist, and was raised by Mr. Robert Lindsay, Kames Lodge, Midlothian, N. B., by crossing *S. Macnabiana* and *S. Lantoscana superba*, both of which species have silvery leaves. In habit it favors the last named species. The flowers are white with a few red spots that effectively set off the bloom. The rosettes are of a silvery-grey tint, and the plumose spikes of bloom are bent over as in *S. Lantoscana superba*. It is a good doer but too many flowers should not be allowed to develop. Mortar, rubble or pieces of lime stone should be mixed with the soil, *Saxifragas* having a liking for lime.

SOPHRONITIS ROSSITERIANA

This species differs from the allied garden varieties *S. coccinea* or *S. grandiflora* in having much more brilliant flowers, which are not much smaller. The color of the flower is not easy to describe: it is a glittering red orange that is not common in nature. The color of *Impatiens Holsti* is that nearest to it. The lip shows more of an orange tint. The flowers have a longer petiole, and in consequence are more elevated over the leaves than are those of *S. grandiflora*, the pseudo-bulls are more slender, and erect and the leaves smaller. The plant is a native of Brazil in the high mountains and is met with growing on the rocks, therefore it should be afforded a light position, near the glass, and a moderate degree of warmth. The blooms endure for several weeks in good condition. The plant does not require much moisture at the root nor to be often syringed.—*Die Gartenwelt* for March 6, 1909.

EPIDENDRUM VARIEGATUM. HOOK.

Comes from South America. The blooms are of a yellow color tipped with brown. The roots come much in contact with the air and fix themselves firmly on cork. Certain Epidendrums refuse even this support. Perhaps because the surface of the cork quickly becomes dry is the reason for this, and in any case better results are obtained with plants fastened to cork than to wooden blocks.—*Die Gartenwelt* for March 6, 1909.

A ROSE GARDEN FOR BERLIN.

A project is afoot to form a Weltrosarium, the largest in the world, consisting of 10 morgens of land (a morgen measuring 3,122 square yards, English). Britz, near Berlin, offers the most suitable site for such a garden, the soil, a sandy loam being eminently fitted for the growth of roses, and for which it is celebrated, there being at the present time 125 morgens under rose culture at that place. The rose garden will not only draw visitors at the flowering time of the rose, but will also be available for scientific research by professional people, and laity, at any time.

Sunderick Moore

Godetia Schamini fl. pl.

See Colored Plate With This Issue.

The godetias are excellent border annuals flowering profusely all through the summer and thriving in a rather dry, sunny situation. Nicholson and Bailey class godetia as a sub-genus under *Oenothera*, the Evening Primrose. The beautiful double-flowered variety illustrated was introduced in England three years ago.

A detailed botanical illustration of the plant Godetia schamini. The drawing shows several stems with narrow, lanceolate leaves and clusters of small flowers. The illustration is rendered in a fine-line, stippled style, typical of botanical scientific drawings. The plant is shown in a natural, upright posture, with some stems branching out. The background is plain white, making the dark lines of the plant stand out clearly.

A NEW GODETIA
(GODETIA SCHAMINI FL. PL.)

SUPPLEMENT
HORTICULTURE, VOL. IX, No. 14
APRIL 3, 1906

Brasso-Cattleya Susannae

To the best of our knowledge this is the first hybrid to be exhibited of American origin with *Brassavola Digbyana* as a parent. This was used as a pollen parent the seed bearer being the type plant of *Cattleya* x *Thayeriana*; thus the *Brasso-Cattleya Susannae* contains $\frac{1}{4}$ *C. Schroderae*, $\frac{1}{4}$ *C. intermedia*, and $\frac{1}{2}$ *Brassavola Digbyana*. The color is a uniform pearly pink, and the flowers were fully expanded a month before being exhibited before the Massachusetts Horticultural Society, March 25th, thus showing valuable lasting qualities inherited from *C. Thayeriana*.

Fully expanded, the flowers are five inches across, and the plant though small promises to produce even better results when as strong as one yet unflowered.

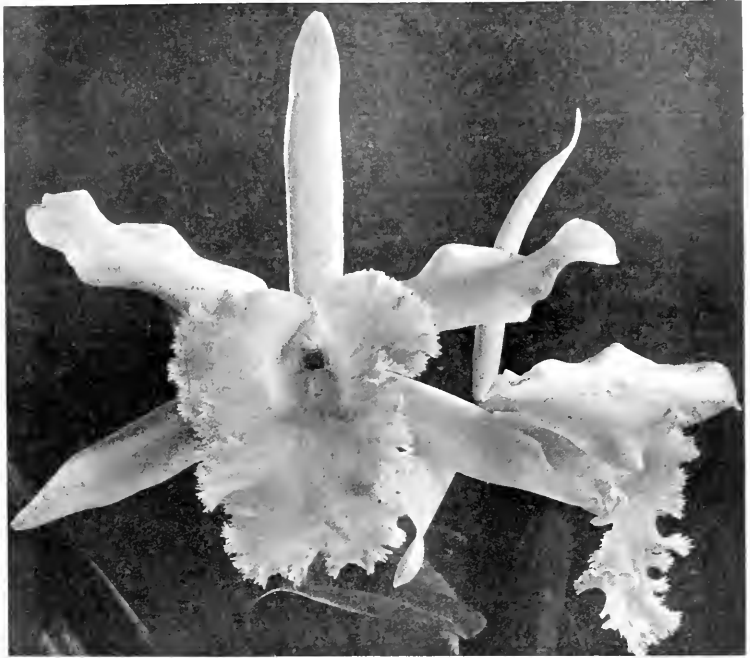

E. O. Orpet.

Horticulture in the Newspapers

Editor HORTICULTURE:

I notice with much interest the note concerning horticultural editors, in your issue of March 20th, and take this opportunity to call attention to the work that is being done by the National Council of Horticulture through its Press Bureau work. It has been the aim of the Council to prepare authentic articles on horticultural matters, that would be acceptable to the newspapers, and at the same time give accurate information to the general public. While the work thus far has not been all that might be hoped for, a good beginning has been made, and the general subject of horticulture has been exploited along broad lines, and renewed interest in various phases of the subject has been created at very little expense.

The Council has on its mailing list, leading newspapers in all sections of the country, as well as newspaper syndicates through whom the articles go to some 2,000 papers, thus reaching a total of nearly 3,000 different publications, with an estimated aggregate weekly circulation of two or three million. The cost of editing and distributing to these papers four short articles has been \$30.00 per week, exclusive of the very small amount spent in the preparation of articles, as most

of them have been prepared free of expense to the Council. With a competent person, giving his full time and thought to this work, articles of the greatest merit might be furnished the entire year, and should have the backing of non-commercial organizations, equally interested in all branches of horticulture and national in its scope. Such organization is embodied in the National Council, and if its endeavor to exploit horticulture could be universally supported, the influence for good could hardly be over-estimated. Moreover, there is a great demand for this kind of information by the newspapers, and the horticultural interests warrant much stronger backing than has thus far been given to further the work.

It seems to me that if all of the horticultural interests could combine, and secure the services of such a man as Mr. Robert Cameron of the Harvard Botanical Gardens to prepare and edit such articles, and distribute them to the newspapers throughout the country, as the Council is now doing, the funds for such work would be well spent and would redound to the profit of the commercial horticulturist, whether he be a landscape gardener, nurseryman, fruitgrower, florist or a seedsman.

H. C. Irish,

St. Louis, Mo.

HORTICULTURE

VOL. IX APRIL 3, 1909 NO. 14

PUBLISHED WEEKLY BY
HORTICULTURE PUBLISHING CO.
11 Hamilton Place, Boston, Mass.

Telephone, Oxford 322
WM. J. STEWART, Editor and Manager

SUBSCRIPTION PRICE

One Year, in advance, \$1.00: To Foreign Countries, \$2.00: To Canada, \$1.50

ADVERTISING RATES

Per Inch, 30 inches to page \$1.00
Discounts on Contracts for consecutive insertions, as follows: \$1.00
One month (4 times) 5 per cent.; three months (13 times) 10 per cent.;
six months (26 times) 20 per cent.; one year (52 times) 30 per cent.
Page and half page space, special rates on application.

Entered as second-class matter December 8, 1904, at the Post Office at Boston, Mass., under the Act of Congress of March 3, 1879.

CONTENTS

Page

COVER DESIGN—Easter, 1909.

RHODORA CANADENSE—Richard Rothe, Illustrated. 467

EUROPEAN HORTICULTURE—Frederick Moore..... 467

GOETIA SCHAMINI FL. PL..... 468

BRASSO-CATTLEYA SUSANNAE—E. O. Orpet, Illustrated 469

HORTICULTURE IN THE NEWSPAPERS—H. C. Irish..... 469

ROSE MY MARYLAND—George Morrison..... 471

THE FORMOSA LILY—Charles Lenker..... 471

THE CONCOLOR OR SILVER FIR OF THE ROCKIES—C. S. Harrison..... 471

NEWS OF THE CLUBS AND SOCIETIES:

Gardeners' and Florists' Club of Boston—Southampton Horticultural Society—Connecticut Horticultural Society—New Orleans Horticultural Society—Detroit Florist Club—Rochester Florists' Association—Scranton Florists' Club—American Carnation Society—Club and Society Notes..... 472

BOSTON SPRING SHOW:

Views in the Japanese Garden..... 473

Views of Various Plant Groups..... 475

THE EXHIBITIONS:

St. Louis Spring Show—Rhode Island Prepares for New England Fruit Show—Exhibition Notes..... 474

THE ROSE GARDEN—J. F. Huss..... 476

WHY SO MANY SMALL GROWERS FAIL WITH ROSES—W. W. Coles..... 477

AMERICAN LANDSCAPE ARCHITECTURE—Prof. F. A. Waugh..... 478

CEMENT BENCH CONSTRUCTION—C. M. Dickinson—Illustrated..... 479

PLANTING FOR WINTER EFFECT IN THE NORTHERN STATES—Geo. E. McClure..... 480

OBITUARY:

Ernest Weber—Edward Pale—Warren B. Madison—Mrs. Wm. E. Doyle—Edward Gill..... 483

SEED TRADE:

The "Pure Seed Bill" at Albany—Plant Imports.. 484

CULTURE OF ASPARAGUS PLUMOSUS..... 494

EXPERIMENT STATIONS AND THE CARNATION GROWER—Prof. H. B. Dornier..... 496

CARNATIONS UP TO DATE—Louis J. Reuter..... 498

SELECTION AND CROSS FERTILIZATION OF THE CARNATION—Peter Fisher..... 500

OF INTEREST TO RETAIL FLORISTS:

Rochester Plant Notes—Steamer Departures..... 504

Flowers by Telegraph—New Stores—Detroit..... 505

FLOWER MARKET REPORTS:

Boston, Buffalo, Chicago, Indianapolis, Phila..... 507

New York—Washington..... 509

MISCELLANEOUS:

Some New Roses..... 474

New Park Commissioner for Boston..... 474

Bureau of Roses in Calif., Felix J. Koch, illus. 477

Short Course Class at Massachusetts Agricultural College—Illustration..... 481

Personal—News Notes..... 484

During Roses—Tri-City Contest at Philadelphia..... 484

Greenhouses Building or Contemplated..... 486

A Valuable Appliance—Patents Granted..... 486

Publications Received..... 488

Catalogues Received..... 492

An Interesting Comparison, G. C. Watson..... 503

Business Changes—An Assignment..... 505

Incorporated..... 509

Boston
warms up

Our news columns in this issue supplement the cheering report of last week in connection with the Spring Exhibition at Boston, with the very gratifying news that the affair will bring an unprecedented profit to the Massachusetts Horticultural Society. The key to the hearts and the pocket books of the Boston public, generally looked upon as imperious, has been found for once, anyway. A contributor to *The Bean Pot* said recently, "Every Boston woman has—A Boston Bag. A subscription to *The Transcript*. A bill at R. H. Stearns. A seat at the Symphony concerts. A rubber plant. A Purpose." Developments of the past fortnight indicate that she has had something else, for the time being, at least—a ticket to the Spring Flower Show and A Purpose to traverse the paths, bridges and grottos of the Japanese Garden, and we might add that it required the services of two policemen at the gates to hold her in check. The two groups of views which we present in this issue, together with the large view used as a cover illustration last week, will, we think, convey to our readers evidence on which to base an idea as to whether or not the Boston woman got full value for her ticket.

Easter
greeting

To its rapidly growing family of readers, HORTICULTURE extends its fifth annual Easter greeting, with sincerest wishes that the cheery confidence and buoyant helpfulness characteristic of these spring days

"While ilka thing in nature join
Their sorrows to forego"

may as the season glides along prove to have been but the foretaste of a happy reality. Apart from its religious sentiment the Easter time awakens in us a joyous response to the exultant spirit of reanimated Nature, the very mention of the word brings the aroma of daffodil, primrose and apple blossom, and he surely must be in the lowest depths of despondency who cannot, under such inspiration, cast off his burden of past reverses and brace himself for a new tussle with fortune. For the florist, Easter has an added significance—a very practical side. For many it means the fruition of long months of preparatory application and unremitting toil. We would express our hope that good weather may favor them at this critical time, that every plant and flower so carefully nurtured through the long winter for this great festival may be just ready at the right moment and that business for the florist throughout this broad land may hum as it has never hummed before.

A success
and its lesson

It is quite evident from the reports on Clubs and Societies which have been appearing in our columns of late that there is awakened activity all along the line and that especially the exhibition enthusiasm is again rampant after a period of timidity due to various causes, one of which was undoubtedly the manifest lack of interest in these enterprises on the part of the public. The unprecedented success of Boston's spring show after so many years of torpidity will no doubt have a bracing effect and arouse new confidence in places where bitter experience has taught wariness heretofore. Some will begin to question whether the public indifference to our displays, put up with so much labor and self-sacrifice, is not, after all, largely our own fault and possibly reflect that we ask too much when we expect the public to interest themselves in our products from the same view point as ourselves. If the Boston experience is to help brace up our courage let it also teach us the lesson we have been so slow to learn, that, if our exhibitions are to

prove financially successful, then in the making of our schedules, in the preliminary exploiting and advertising, and in the management generally, the public caprice must be taken into consideration and first place given to the providing of meritorious novelty—not alone the novelty which inspires the expert grower but that which will appeal irresistibly to the people who draw their wallets at the ticket office. Then let the revival proceed.

Rose My Maryland and Its Requirements

Dear Editor:—

I have noted with considerable interest what has been said in various horticultural papers in reference to the new rose, My Maryland. Most of the writers attribute the failure of some growers to lack of heat. This, I think, is correct, and applies especially in the fall months when a heavy crop has been cut, and perhaps cut rather far back in order to get long stems.

Some growers may have been deceived by the action of the rose itself during the hot months in making such a free and wonderful growth, but this in itself is some proof that it enjoyed heat. I note that most writers recommend a temperature of 62 to 65 degrees. I have grown it on a bench rather successfully at 60 degrees and I have seen it growing at Mr. Cook's for three years on the bench also, at about the same temperature, and at all times doing well. It may of course demand a somewhat higher temperature in the solid bed, and it may do even better than I have seen it, at a higher temperature on the bench. At any rate I see no reason why any one should fail with the rose if they keep it at a somewhat high temperature and are mindful of the fact that it is a gross feeder.

Baltimore, Md.

George Morrison

The Formosa Lily

Editor HORTICULTURE:

Dear Sir:—Noticing the article written by Mr. Ambrose Secker, I beg to differ from him as to the results obtained in forcing *Lilium Formosa*, as they have been giving me excellent results. I had only 6-8 size bulbs and have run as high as seven flowers to the stalk. I potted mine in 4-inch pots and put under carnation bench until December, then planted out in benches where chrysanthemums had been grown previously, with temperature at night 50-55 degrees and days 70 degrees, until buds were well formed, then I ran the temperature up to 80 degrees in day time. As to their not being true I must say that *Formosas* were not offered to me as a special sort. That there has been a lot of substituting done is without a doubt. I have seen two lots in two different places which were bought for *L. Formosa*; well, they were simply trash.

Fremport, L. I.

Chas. Linker

The Concolor or Silver Fir of the Rockies

The finest tree on the Hinnewell estate at Wellesley, Mass., was of this kind when I last visited the place. The Tenney estate at Methuen has some noble specimens. T. C. Thurlow has some of exquisite beauty. The pungen, though so resplendent while young gets ragged at 25 and has to be discarded, but the concolor keeps right on, growing more beautiful with age. Take one of the silver type out in the open where it can develop and there is nothing to surpass it. There is another remarkable thing about it; though growing so far from the sea, when moved east it will endure the ocean spray as well as any evergreen we have.

Go with me into their own habitat. We find them in the most brilliant dress at an altitude of 10,000 feet above sea level. Here is a grove of them in gala attire. Some are light green, others are of a deeper color. The last year's growth is of sapphire, the new growth is emerald, both with silver tinting; the under side of the needle is ermine. So there are several shadings on the same tree. One tree has large purple cones; another beside it has those of pale green. These cones are about the size of an ear of early sweet corn. As they mature the color deepens, and from them there exudes a gum clear as crystal.

Now stand back and let the sun and gentle breeze put all this beauty on exhibition. The older and newer growth show marked variations. The cones are in harmonious contrast with the foliage, while the clear gum is flashing like diamonds. Take it all in all there is beauty enough to lure one across a continent.

As with the pungen there is a marked individuality in them. Here, for instance, stands one in the open where it has a chance to develop. Could it be transferred in all its native splendor to the grounds of an eastern millionaire it would be beyond price. It is shapely and cone-like in form—the body straight as an arrow. It is of that rich and varied glauca or silvery coloring. It flashes and shimmers in its radiance. Yes, it is the most charming tree on earth, increasing in beauty till it is a century old. It is one of the best for the East, and in the West I have known it to endure a succession of dry years in the sod out on the open prairie.

In Minnesota and the Dakotas it is very beautiful, but owing to the seed being gathered in the foot-hills it is somewhat tender. This year, however, a very heavy freeze caught all the foot-hills seed and there was not a cone on the trees. Going higher up, where they were growing among the pungen and Engelmann spruce, they seeded abundantly and one man secured about 1,000 pounds.

These high altitudes correspond with the north. You go up the mountain from the temperate zone to the arctic circle. In the foot-hills the oak is of fair size; as you ascend it is smaller and smaller, till it is the size of the currant bush. Then above timber line there is nothing; you are in the Arctic zone. So seed from the upper belt will be hardly all over the north and in Manitoba This upper belt also has trees of exquisite beauty.

York, Nebraska.

C. S. Hamron

NEWS OF THE CLUBS AND SOCIETIES

GARDENERS' AND FLORISTS' CLUB OF BOSTON.

Field Day.

The club will hold a field day on Saturday, April 3, 1909, at Waverley, Mass. Members and friends are invited to take electric car leaving Park Street Station for Waverley at 1 P. M. Any who cannot leave in time for this car will arrive in season by taking the following one.

The establishment of W. W. Edgar Co., near Waverley R. R. Station will first be visited. Many of our members will have pleasant reminiscences of previous visits paid here. After an inspection of the stock growing here, Edgar Bros. will be visited, and later the establishment of Peirce Bros. in Waltham. The character of the Easter stock to be seen at the places named, should make the visit one of peculiar interest and profit, and a large attendance is hoped for.

Annual Banquet.

As already announced, the annual club banquet will be held at Horticultural Hall, on Wednesday evening, April 14, 1909. From the advance sale of tickets, it is evident that the coming occasion will be more largely attended than ever before.

Tickets are \$1.50, and can be had from William Downs, J. W. Duncan, W. N. Craig, James Wheeler, Joshua Lawson, Peter Fisher, J. K. M. L. Farquhar, Robert Cameron, and Peter M. Miller. Order what you need, at once; positively none will be sold after Saturday, April 10.

Reception at 6 o'clock; banquet at 6.30. As toastmaster we will have Judge C. W. Hoyt of Nashua, N. H. There will be a few select songs and readings appropriate to the occasion.

A fine orchestra will furnish music for the dancing, which it is hoped will be under way not later than 9 P. M.

All contributions of flowers should be addressed to Decoration Committee, Gardeners' and Florists' Club, Horticultural Hall, Boston, not later than 3 P. M., on the afternoon of banquet.

Regular Club Meeting.

In a later circular, members will be notified of the lecturer for our meeting on April 20. Suffice to say now that we have something interesting in store. Mr. L. J. Reuter, Westerly, R. I., will favor us with a paper on roses. Paste these dates in your hat:

Field Day at Waverley, April 3, 1 P. M.

Club Banquet, April 14, 6 P. M.

Regular Club Meeting, April 20, 8 P. M. W. N. CRAIG, Secretary.

WILLIAM DOWNS, President.

SOUTHAMPTON HORTICULTURAL SOCIETY.

A special meeting of this society was held Thursday, March 18, President Halsey in the chair. G. W. Gomersall, landscape architect of Nyack, addressed the meeting on the arrangement of flower beds. His lecture was very interesting and was followed by questions and discussions.

CH. H. GUILLOZ.

CONNECTICUT HORTICULTURAL SOCIETY.

The regular fortnightly meeting of the society was held on the 26th instant, President Huss presiding. About forty members were present, emphasizing the need of more commodious quarters, as some occasionally are obliged to stand. The business proceedings were promptly dispatched, including the accession of one new member, J. M. Harper, of Hartford; and the extension of a rising vote of thanks to Mr. Huss, and the award to him of the society's diploma, for his exhibition of a half-dozen beautiful specimen plants of amaryllis, which were the objects of many flattering comments. The meeting was then addressed by Prof. E. A. White, of the department of floriculture of the Massachusetts Agricultural College, who gave a very comprehensive view, assisted by powerful lantern slides, of the great work being carried on by his college in fitting students for the vocations of floriculturists, landscape gardeners, market gardeners, etc. Many modern greenhouse plants were illustrated, and the tendency toward light but strong sash in greenhouse construction, to minimize shade, was emphasized. The lecture was greatly enjoyed and a vote of thanks tendered to the lecturer. The lantern was under the efficient care of Herbert O. Warner, of Hartford. The society's forthcoming banquet will be held on April 12th, at Long's Hotel, Hartford. To avoid Fast Day, the next meeting of the society will be held on April 2d, and will be favored by an address by John Gerard, of New Britain, on "Revelations of the great seed houses of Europe."

GEORGE W. SMITH, Secretary.

NEW ORLEANS HORTICULTURAL SOCIETY.

The regular meeting of this society was held on March 18 in Kolb's hall. After routine business, the subject of beautifying the city was taken up and upon suggestion of Secretary Panter a motion was made and unanimously carried that the services of the society be tendered to the city officials to assist them in beautifying the city. Several rare orchids were exhibited by J. A. Newsham, who gave some interesting facts regarding them. P. A. Chopin spoke of the Harrisii lilies from St. James as being superior to the Bermuda lilies. E. Baker read a paper on "Elementary horticulture in public schools," which received a vote of thanks and the indorsement of the society.

DETROIT FLORIST CLUB.

A special meeting of the club was well attended and started the ball towards a fall show next Nov. 10, 11, 12, 13. The Wayne Pavilion is a most suitable place measuring 200 x 110 ft.—quite a size but not one whit too large to hold all the enthusiasm the members are showing.

ROCHESTER (N. Y.) FLORISTS' ASSOCIATION.

At the last regular meeting of the Rochester Florists' Association action was taken and decided upon to hold a plant and flower show this fall. That the exhibition committee is out for all there is to it, is noticeable on account of the calling of a special meeting for the purpose of enlarging this committee to twenty members. Our membership has grown by leaps and includes all the prominent nurserymen, seedsmen and supply house representatives, and from the boundless enthusiasm which exists, this—the first Rochester flower show—promises to be a hummer. Chairman Chas. Vick of this committee has assured us of the very liberal support of the business men here in the matter of prizes and of their desire to see such a floral show a complete success.

SCRANTON (PA.) FLORIST CLUB.

The second annual show of this club was held on March 27, 28, with fine exhibits from local florists and novelties from a distance. T. B. McClintock, William Macdonald and Schultheis & Co., were largely represented among the prize winners in numerous classes; G. R. Clark competed successfully in the various rose classes, taking first in all except White Killarney when F. R. Pierson Co. was first and second went to him. Among the exhibits not for competition A. N. Pierson had a vase of rose My Maryland, Joseph Heacock Co. sent carnation Dorothy Gordon, J. W. Webster & Avoca, Pa., had a fine display of ferns and flowering plants. The judges were George Payne, Dover, N. J., Paul Mader, Stroudsburg, and William Clark Scranton.

AMERICAN CARNATION SOCIETY.

Carnations registered.—By Dana R. Herron, Olean, N. Y.—"Olean." Parentage, Winsor and unknown seedling of Winsor growth; color, pink; size of flower, 3-1-2 inches; habit, long, stiff stems with perfect calyx; a very full and fragrant flower.

ALBERT M. HERR.

Lancaster, Pa.

CLUB AND SOCIETY NOTES.

The Pasadena Gardeners' Association (Calif.) will hold their annual spring show on April 12 and 13.

The regular monthly meeting of the Florists' Club of Washington, D. C., which would have been held next week, has been postponed till the second Tuesday after Easter to prevent its conflicting with the Easter rush.

The Milwaukee Florist Club have named Nov. 14 to 18 as the dates for their flower show, in order not to conflict with the shows in the large cities in the West. They hope with a premium list of \$5000 to secure exhibits from all sections of the country.

The Tri-City Florists' Club at the last meeting at Davenport, Ia., elected the following officers: President, C. O. E. Boehm; vice-presidents, H. Pauli,

HORTICULTURE BOSTON SPRING SHOW

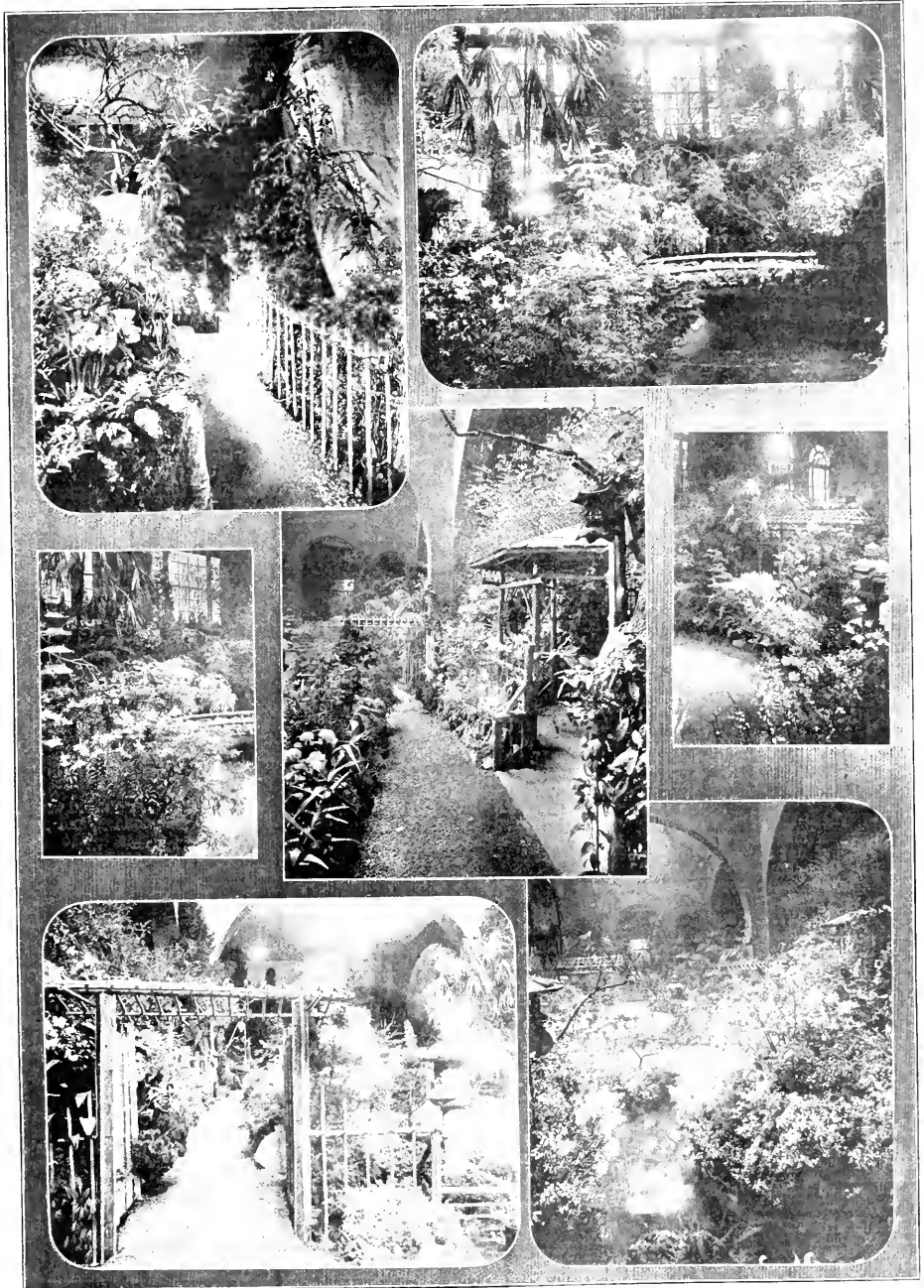

VIEWS IN THE JAPANESE GARDEN AT HORTICULTURAL HALL
Exhibit of R. & J. Farquhar & Co.

H. Gaethje, John Staack; secretary, John Temple; treasurer, Wm. Knees. The meeting on April 8 will be held with Wm. Knees in Moline.

The Boston Market Gardeners' Association were the guests of Walter E. and Edwin Leuk, at their greenhouses in Halifax, Mass., on March 20. After a tour of the eight immense houses they were conducted to the shipping room where a banquet was served, followed by the regular business meeting. Prof. Haskins of the Hatch Experiment Station spoke on "Fertilizers" and Prof. Pickett of N. H. Agricultural College on the "Relation of the Experiment Station to the Farmer and Market Gardener." The party left on a special at five o'clock.

ST. LOUIS SPRING SHOW.

On Wednesday, Thursday and Friday of the past week the St. Louis Horticultural Society held their third annual spring flower show with good success. Although the exhibition was not as large as promised those in the trade who viewed it say that it was a real pretty show and the stock, both plants and cut flowers, on exhibition was of the best quality. The city park department had the largest display, having eight separate groups in different parts of the hall; those of course were not for competition.

Fred H. Weber was the only one who showed "made-up" retail work, he entering in all classes and taking all the first prizes. Wm. Schray & Sons, Koenig Floral Co., C. Young & Sons Co., showed some extra fine blooming bulb stock and competed in all classes. Among those who showed out flowers were Chicago Carnation Co., W. J. & M. S. Vesey, John Steidle, J. F. Ammann and A. C. Brown. F. C. Weber and Theo. Miller showed out stock in designs, making very attractive displays, but not for competition.

Vaughan's Greenhouses and Geo. Kuhl showed some well-grown plants. Visitors present from outside the city were W. J. Vesey, Fort Wayne, Ind.; Geo. Kuhl, Pekin, Ill.; Albert Hey, Western Springs, Ill.; J. F. Ammann, Edwardsville, and A. T. Pyfer, Joliet, Ill. The judges were Andrew Meyer, Sr., R. F. Tesson and Albert Hey.

A band of music during the evening made things pleasant for the visitors. On the opening day the rain-storm kept many away but on the last two days the weather was fine and the evening attendance was large.

The awards as handed out by the judges were as follows:

Collection of Bulbous Plants in bloom, Wm. Schray & Sons, first; Koenig Floral Co., second.

Fifty foliage and blooming plants, Wm. Schray & Son, first; C. Young & Sons, second.

Ten geraniums in bloom, Koenig Floral Co., first; C. Young & Sons Co., second. Mignonette, Geo. B. Windler.

Specimen plant in bloom, Wm. Schray & Sons, first; C. Young & Sons, second.

Lily of the valley, Wm. Schray & Sons.

Pansies, Wm. Schray & Sons.

Five vases of carnations, 5 varieties, 27 flowers each, John Steidle, first, with Bevon, Harlowarden, Enchantress, Rose Pink Enchantress and White Perfection;

Chicago Carnation Co., second, with Bevon, A. Carmele, Enchantress, White Enchantress and White Perfection.

Fifty white carnations, Chicago Carnation Co., first, with White Perfection; W. J. & M. S. Vesey, second, with White Lawson.

Fifty light pink, W. J. & M. S. Vesey, first, with Pink Lawson; Chicago Carnation Co., second, with Splendor.

Fifty dark pink, Chicago Carnation Co., first, with Aristocrat; W. J. & M. S. Vesey, second, with Lawson.

Fifty red, Chicago Carnation Co., first, with Victory.

Fifty, any other color, W. J. & M. S. Vesey, first, with Winsor.

Twenty-five pink roses, John Steidle, first, with Killarney; J. F. Ammann, second, with Chateaux.

Table decoration of spring flowers, W. J. & M. S. Vesey, first, Bride; J. F. Ammann, second, Bride.

Twenty-five red roses, J. F. Ammann, first, Richmond.

Lily of the valley, F. H. Weber, first. Violets, F. H. Weber.

Basket of spring flowers, F. H. Weber, first; Koenig Floral Co., second.

Table decoration of spring flowers, F. H. Weber.

Display of hardy shrubs in bloom, Wm. Schray & Sons, first; Koenig Floral Co., second.

RHODE ISLAND PREPARES FOR NEW ENGLAND FRUIT SHOW.

A meeting was held at the rooms of the State Board of Agriculture at the State House, Providence, R. I., March 23 to organize a State Branch of the New England Fruit Show which is to be held in Horticultural Hall, Boston, October 19-24 next, and the following gentlemen were elected as an exhibition committee to represent the State of Rhode Island:

R. M. Bowen of Providence, chairman; John J. Dunn of Providence, secretary and treasurer; Prof. A. E. Stene for Washington county; William Williams, Bristol county; Thomas G. Mathewson, Kent county; Louis G. K. Clarner, Providence county, and James Robertson for Newport county.

Mr. R. M. Bowen was also previously elected vice-president of the combined New England organization in connection with the Fruit Show. An effort will also be made to hold a Corn exhibition in connection with the Fruit Show.

J. R.

EXHIBITION NOTES.

The paid attendance on one day alone—Friday, March 26—at the Boston Spring Show, exceeded by 20 per cent., the entire receipts for the four days' show one year ago and so lively was the popular interest that it was decided to keep the exhibition open for another week. New exhibits have been placed in the general classes and the Japanese Garden is even more attractive than it was last week, many of the wisterias and other flowering shrubs having come into fuller bloom. Among the new exhibits this week is a remarkable display of sweet peas from William Sim, the equal of which has never been staged in this country. The public interest continues unabated and it seems now assured that the affair will net a clear profit to the Massachusetts Horticultural Society of at least \$5000.

Exhibition matters seem to be looking up in an encouraging way in various other places. We learn from the Milwaukee papers that the Milwaukee Florists' Club is planning for a mammoth show to be held November

14 to 18, next, at the Auditorium, for which a premium list of \$5000 is being prepared. Our Milwaukee brethren seem to realize the necessity of having something out of the stereotyped run to bring out the public. According to our information this is to be accomplished possibly by the presence of Luther Burbank and some of the products of that widely-advertised gentlemen.

The preliminary list of premiums offered by the Horticultural Society of Lake Forest, Ill., for the third annual exhibition, to be held in the third week of July, 1909, has just been received. It is a very comprehensive schedule, with no less than 173 classes provided for vegetables, fruit, plants, flowers, floral arrangements, models of landscape garden work, etc. J. W. Scharfenberg, Lake Forest, is secretary.

The North Shore Horticultural Society is also early in the field with a neat schedule of prizes for two exhibitions to be held at Manchester, Mass., in July and August. Besides the regular cash prizes a big list of special premiums donated by friends of the Society, is offered, including valuable cups and medals. John D. Morrison is secretary.

And still another preliminary premium list has come to our desk. The Detroit Florist Club announces that it will hold a Fall Flower Show in Wayne Pavilion, November 10 to 13. The schedule comprises over one hundred classes, cash premiums throughout, only three of which are open to competition outside of the membership of the Club.

SOME NEW ROSES.

Of these worth growing mention may be made of Evangeline, a hybrid Wichuriana (Walsh); flowers white, carmine tipped, coming in clusters, with petals 2 inches across. The leaves are of coppery tint and large size.

Goldfinch (Paul & Son, 1907); a deep golden yellow flower shaded with violet changing to pale canary, and produced in abundant trusses. The plant is rather rampant in growth.

Starlight (Paul & Son, 1908); a single-flowered variety, with blooms having much prettiness, and which are large in size; white suffused with pink of a velvety texture.

Tausendschon (Schwartz, 1906); one of the most beautiful of Polyantha varieties, with flowers of the tint of peach bloom, which changes to rosy carmine as it ages. It is fragrant and produces about a dozen blooms in a truss.

F. M.

NEW PARK COMMISSIONER FOR BOSTON.

Mayor Hibbard has announced the appointment of Robert Swain Peabody to succeed Charles E. Stratton as a member of the board of park commissioners for the city of Boston. He is a graduate of Harvard, is a former president of the American Institute of Architects and is president of the Boston Society of Architects.

In a moment of absent-mindedness last week we recorded Mr. Julius Roehrs as en route for the Ghent quinquennial exhibition. The Berlin exhibition is what we ought to have said, of course.

BOSTON SPRING SHOW



Plant Group by Edw. MacMillan,
 Mantel by Mrs. E. M. Gill,
 Rose Group by M. H. Walsh

Gloriosa Rothschildiana by Arthur Griffin

Plant group by Harvard Botanic Garden,
 Mantel by Sibbey Hoffman,
 Plant Group by Thomas Roland

THE ROSE GARDEN.

Written for the American Rose Society Meeting at Buffalo, N. Y., by J. F. Huss, Hartford, Conn.

It may be an inopportune moment to write, when nature is in winter garb, about the Rose Garden; still the very name is enough for the rose lover to stimulate his thoughts, which bring back everything so highly interesting in the rose garden. Everyone may not care to have a garden of roses exclusively, but who among lovers of flowers would not like to have in his own garden such a scene as that of three years ago which the Rose Committee witnessed at our place in Hartford, which for private uses may be taken as a model.

But we cannot leave the rose with this notice. Grand as are the masses of roses we have occasionally met with, we have never yet seen anything even approaching our conception of the scenes of grandeur and beauty that might be worked out by the massing of the modern varieties of roses. A rose garden is now almost indispensable, either as a part of, or as an adjunct to, every large and comprehensive garden. If in the original plan of a garden it cannot be conveniently worked in with the general floral arrangement, then a separate piece of ground is set aside for the purpose. This I have often seen, and always found it a most interesting spot. But apart from the immediate question, whether there is a separate rose garden or not, roses should be found plentifully in every general garden, on account of the varied forms they are capable of assuming, either naturally or by training. They are seldom out of place anywhere. What with dwarfs, standards and climbers, there exists ample material to adorn the most select position, or to obliterate the most awkward spots, bringing them into harmony with the general design. But what should the form of a rose garden be? I will give my ideas as briefly as possible.

The Form of the Rose Garden.

It should be formed, if possible, on level ground, with as many beds as the space selected will allow. Such beds should be four feet wide, planted with three or four rows of plants, two feet apart, and a grass border three of four feet between beds will enable anyone to reach each plant to cut the roses without stepping into the bed. Such grass borders are very easily kept, mowing them once a week with the lawn mower. At the same time this grass walk sets off the flowers to great advantage. With some fifteen or twenty beds, with a double amount of well selected, best flowering varieties, say, forty plants in each bed, it will well make a very attractive collection. These beds may be in the form of a square or oblong. The rose garden can be made very attractive and artistic. All depends upon the gardener who has charge, or upon the landscape gardeners who have to make designs for a small bed or a regular rose garden. The rose garden should be surrounded with a border, three feet in width, which should enclose it, planted with Hybrid Teas, a few fine standards of French Briers, or of laxa stock, which are the two most flexible stems for the layering in the fall. A very light wire fence with a three-

fourths inch iron post, with two or three wires a foot or eighteen inches apart, and planted with Crimson Rambler roses will make an excellent appearance from the distance.

Pergolas and Terraces.

A still further imposing scene can be obtained by forming a pergola, which can be easily constructed with three-fourths inch gas pipe driven into an eighteen inch cedar or locust post, eight feet high with a cross on the top from one post to the other, with a grass walk between, as many of our rose visitors will remember having seen at our place, which was pronounced by all as a veritable Paradise of Roses. Such a pergola or arch should be planted with as many varieties as there are posts, or not more than two to a post, as with our progress in hybridization of so many valuable climbing roses the choice is at everyone's command; and the most gorgeous sights can be obtained of most bewildering beauty with plants that bring forth their blossoms at the same periods as the Hybrid Perpetuals, Teas or Hybrid Teas. Again a rose garden may be laid out on a terrace, as ours is located. There may be a bank sodded or sown with grass seed. But such a bank should be in full harmony with the rest of the rose garden and should be planted with trailing roses pinned down, making it a "bed of roses." It will add greatly to the rose garden. Good taste and art should be exemplified in every detail of a rose garden. We have a great many dwarf roses, like the Baby Ramblers and the Midget roses, that are used to form borders, especially around Hybrid Perpetual beds, to hide the bare ground. They are very attractive, and the result is one that will meet with delightful approval from every lover of rose gardens.

Soil and Manure.

Almost any soil will grow roses, as we see them in yards or gardens, providing a proper selection of varieties is made, and attention is given to the application of suitable manure. Roses, of course, enjoy a rich soil, but to keep adding cow, horse, and pig manure upon a naturally rich ground is not as beneficial as a change to nitrate of soda in the case of light soils, or soda for those that are naturally very close and stiff. This subject is therefore more a question of judicious manuring than selection. The Golden Rule is to add what the ground is most deficient in, and never to apply close moisture-retaining manure to a soil that is naturally stiff and moist. A very dry and sandy compost may easily be made suitable, by adding a few loads of stiff fibrous loam and clay, also by manuring with fairly well-rotted cow manure; while in many cases, by adopting the opposite plan, a stiff, poor soil may be worked into equally good condition. The ideal material is fairly stiff, not too wet, and, not less than at least three feet in depth, with a good drainage, so that by heavy showers the roots are not left in water. With such well-prepared rose beds they can be enriched at will. Roses will thrive perfectly well for at least eight to ten years. After that time, if still in good condition, they should be gradually transplanted in late fall, the plants well pruned out, suckers cleaned out,

and the soil deeply trenched and mixed with good rotted manure, and the roses replanted, when they will thrive anew and will last for many years. But we should never lose sight of the newer varieties of roses, using them to supplant such older varieties as have lost their usefulness. A wide-awake gardener or lover of roses will naturally keep up with the times.

Pruning and Tying.

Pruning in the New England States cannot be very well done before the 1st of April, as the uncovering of the winter protection is usually begun by that date. This has been my experience. The pruning of every class of roses is a very vital operation. All useless wood should be carefully cut out, retaining only the good strong canes, and Hybrid Perpetuals and Hybrid Teas are pruned alike, say, a foot from the ground. You can easily retain the same height from year to year, as they should always, every year, be renewed with new canes and the old ones cut out. As to climbing roses the pruning is very different, as you keep five or six long canes around each of the posts you have for the arch, and keep these young ones as long as they cover the intended arch, or pergola. The old wood is cut, but sometimes we have not enough canes to fill the desired effect, and one or two of last year's growth is retained, and the side shoots are cut back to two or three eyes. The canes are then very carefully tied up with fine willows, as the European well-trained gardener uses, or with any other material as is commonly used, in such a clean way, so that strong winds will not move them from their holdings. The same operation is used to decorate a wire fence. As for the trailing roses, they are pinned down so as to cover well the bank with the low canes, and top shoots are cut back to two or three eyes. The pruning done, the soil is at once loosed up carefully with a spade fork.

Watering, Mulching and General Care.

One thing should not be lost sight of, and that is, to have water close and conveniently at hand. As soon as the plants begin to bring up the growth of leaves, they need to be syringed nearly every day, to keep red spider, aphid, and green flies away in the dry season. This method has been followed with splendid success for many years. And when later the rose bug or chater appears, slugshot is used with splendid effect, and having the water on hand, can easily be cleaned off before visitors arrive. There is nothing more inviting than to see a clean, well-kept rose garden with clean leaves and perfect flowers, but careful watchfulness has to be kept constantly over it. At the beginning or middle of June give a good mulching with short stable manure of two or three inches thick, as roses like a cool footing, and this is extremely beneficial to excellent culture, preventing the soil cracking or drying off, and it is the means also of retaining good foliage and better perfection of bloom. And when the blooms make their appearance great care should be taken of the common enemy, the rose bug, which is a very troublesome one in most localities; they must be picked off and careful watch maintain-

BUNGALOWS AND ROSES IN CALIFORNIA.

ed. The withered flowers must also be carefully picked up, and no petals left on the ground. This is a strict rule among well-kept rose gardens. A watchful eye should be always kept on budded roses, as they often throw up suckers, which must be at once removed, or mischief will be the result. I have seen at Lenox, a fine rose bed that was neglected for two years, and on the third year there was nothing left but suckers, which had outgrown all the grafts. At the beginning of August the plants will have thrown root canes from three to five feet high. These should be cut back to three feet. This simple light pruning will strengthen the canes for the following flower season, and at the same time will give a pleasing sight of uniform harmony to the garden.

Winter Protection.

Winter protection, in this cold, heartless latitude, plays a very important part. One who comes from south of New York would not think of protecting roses, as experience has taught us all over the New England States, except where near salt water. At the end of November or December, or in fact as soon as heavy frosts are due, but before such frosts arrive, standard roses are detached from their stalks and the crowns bent down. A hole in the ground is made and the crown laid in it and partly covered up with the soil, with two cross sticks to hold the branches down. All Rambblers are laid down in the same manner. Hybrid Teas and Hybrid Perpetuals are bent half down tied over each other, and as soon as heavy frost is in sight all the rose garden is covered with a light layer of leaves, and with long straw manure or bed hay. One year we did not cover our rambblers, and in the spring all were frozen to the very bottom. I find a little extra work will save lots of trouble, and pay well in the end.

WHY SO MANY SMALL GROWERS FAIL WITH ROSES.

Paper read before the American Rose Society meeting at Buffalo, N. Y., by W. W. Coles.

In traveling over the country visiting floral establishments we find that not over 20 per cent. of the small growers make a success of roses. In fact, by far the larger per cent. do not get enough out of their rose space to pay for the fuel. I have reference only to the florists who grow roses, carnations, and a general assortment of flowers and plants in a limited area. I know there are quite a number of florists, with 10,000 to 25,000 feet of glass, who make a specialty of roses and whose stock is a credit to many of the larger growers. But this paper is for the small, all around grower, and if it benefits even a very small per cent. I shall feel well repaid for the short time it has taken me to pen these remarks.

Conditions.

The first great handicap is a lack of suitable conditions. Carnations bedding plants and a general line of stock are grown in the same house, in same temperature, with success varying from fair to very good. Then roses are attempted. Under such conditions they cannot be kept at the proper temperature without hurting the other



Famous as are the bungalows of California, half their charm, it is undisputable, would be lost were they robbed of their floral decorations. The trailing rose, in particular, gives beauty to the

bungalows, and down near the base of Mt. Lowe, porticos, touched off with the climbers, touch the heart of every stranger. The photo shows such a one.

FELIX J. KOCH.

stock. Often they cannot be properly syringed on account of soaking other stock close by, and red spider gets a foot hold. Sometimes doors left open carelessly or necessarily for other purposes, causes a draught and starts mildew. On account of spoiling tender stuff in the house, fumigation is put off and aphids gets a hold. Shading is put on for other stock, and roses suffer under their part of it. Under such conditions it is practically useless to try to grow roses.

If a separate house can be devoted to roses the above conditions can be eliminated. But even then there are usually many difficulties. A night fireman is seldom kept and while the temperature may be kept right in daytime it is allowed to fall at night. Then the grower usually has so many other duties that the houses are sometimes neglected. If the house was not built for roses perhaps the heating is inadequate and things cannot be kept right even with the best of attention. The above are conditions as they exist in hundreds of places. Added to this is a lack of knowledge of rose growing, and greatest of all, whether the knowledge be great or small, is the lack of doing what is known. The grower knows that he should plant early in June but it is put off on account of the press of other work. He knows he should syringe and fumigate regularly, but for one reason or another it is not done. We will give a few general cultural remarks but insist that the grower's success depends on combined knowledge and doing.

Culture.

On such places the grower usually puts in a batch of cuttings, roses, carnations, geraniums, etc., in January or February. When rooted they are usually potted off and grown in the same house with a miscellaneous lot of plants. The result is usually a weak lot of plants covered with red spider and mildew. They are shifted from 2-inch pots to 3-inch and sometimes grown under shaded glass. Sometime in June or July they are planted on a bench, the glass still shaded, and a few panes of glass out here and there; which, however, he will put in good shape next week. But next week he is busy with the funeral work and the

following week the carnations in the field must be hoed or weeded and he thinks the roses will grow if they receive water once a day. The result is, in September or October, when his plants should be strong and healthy for the winter, they are weak and puny, but the red spider and mildew are still with them. To make matters worse a few roses are needed during the summer for funeral work and the life is cut out of the plants to save (as the grower thinks) expenses. A few roses are usually cut in October and November at a time when they can be bought from \$2.00 to \$4.00 per 100, but from December 1 to April 1, when roses are wanted and usually scarce, his plants are standing still and do not return enough to pay for the fuel it takes to keep them alive.

The Remedy.

In the first place the small grower or retail florist who uses but an average of 75 to 100 roses per week should not try to grow his own cut roses. He would make more money to buy them from some good grower, but those who feel that they must or will grow their stock should plant nothing but strong, healthy, clean plants. If he cannot grow them he should buy them and plant them in good rich, new, mellow soil, some time during the month of June. If the house is shaded, even if only slightly, see that it is all removed.

The next important thing is to repair all broken glass and as soon as one is broken or blown out replace it at once as you would have to do in winter. From July 1 to September 1 give them lots of air and lots of water at all times. I firmly believe there are more roses ruined during the summer for want of water and air than from any other cause. It is money well spent to hire sufficient help in June to plant roses, as one month in June and July for roses planted on a bench is worth three times as much as in October and November. Keep the buds pinched off until the plants are strong and healthy and breaking freely, and at this point a top dressing of cow manure will be beneficial.

Do not grow too many varieties. For the small grower or beginner I would recommend but three kinds:

Brides, Bridesmaids and Richmond. Don't fool with the American Beauty; let the Beauty specialists attend to them.

If roses must be grown in a small way give them as many of the advantages that they receive on larger places as possible. Acquire as much knowledge as can be gained from reading and practical experience and then see how large a percent of this knowledge can be put into practice.

AMERICAN LANDSCAPE ARCHITECTURE.

Professor F. A. Waugh of Amherst spoke before the Massachusetts Horticultural Society on February 20, on "American Landscape Architecture."

The art of landscape gardening is now well established in America, he said. A considerable number of professional landscape gardeners serve a constantly widening circle of clients, and a new and higher standard of public taste is being raised. It is worth while to ask the question whether in landscape architecture we have achieved anything worthy of our time, anything responding to the spirit of the twentieth century, anything distinctive, representative, national, American.

"This," he said, "is precisely the question I seek to raise. My subject is not 'Landscape Architecture in America,' but 'American Landscape Architecture.' The former subject is quite worth while, but it leads straight to the latter. We ought to study whatever landscape architecture there may be in the land, but finally we want to know what there is in it that is American."

An Unworked Field for Criticism.

Continuing, the lecturer said the field of landscape architecture criticism is almost unknown; and this fact presents unquestionably the greatest handicap under which the art labors. The landscape architects themselves appear to be not only blind to this defect, but they seem almost to present an organized opposition to every improvement in this direction.

He considered the refinement which criticism has brought to literature. "A progressive literature without constant criticism is an impossibility. Most productive writers recognize this. They welcome intelligent criticism, even when it rests heavily on their own works. Some writers and all publishers industriously cultivate criticism. In like manner the arts of acting, painting, sculpture and music enjoy the stimulus and direction of a well organized criticism. On every hand, in every art (except only landscape architecture) criticism is welcomed and the critic is recognized as filling a position of legitimate service."

An Attitude of Disapproval.

Professor Waugh here gave interesting facts concerning his own correspondence with landscape architects in America. Some data and some valuable expressions of opinion have been secured, he said, but the big result of the whole investigation is to show the very general and hearty suspicion in which all such inquiries are held. Some landscape gardeners politely but firmly refused to give any information regarding their own works or anybody's else.

"Let us understand now and ever-

more," said he, "that this attitude is wrong and harmful. The right way is to welcome and assist criticism. Well-informed, intelligent criticism will clear the air, will set a standard of taste, will foster a wider and better appreciation of our gracious art, will tend to the improvement of technique, will set higher ideals before our professional workers, and in a thousand ways will help both the makers and the enjoyers of landscape pictures."

The speaker then passed to a consideration of American works and workers, through the Colonial period, the ante-bellum period, the post-bellum period and the present time, which, he said, is marked by a wide development and popularization of the art, and by many skillful workers and "an unprecedented eclecticism in style."

Downing and Olmstead Compared.

He told of Andrew Jackson Downing, "by all odds the first American landscape gardener," who was a nurseryman before he became a gardener. Judged by the number of and character of his disciples, this name is the most illustrious in the entire history of American agriculture, horticulture or gardening, Professor Waugh declared. He aimed at the informal or "natural" style, which, however, was apt to be constrained and stiff and far short of the present day style.

Frederick Law Olmstead, the leading designer of the period after the Civil War, was spoken of at length, and some of the public places he beautified were described in words of praise. "Of these," said the speaker, "the best known are the World's Fair at Chicago (especially the Wooded Island and Lagoon), Mount Royal Park, Montreal; Bltmore, N. C., and the railway station grounds of the Boston & Albany Railroad. If we add to this list Franklin Park, Boston, and the Muddy River Parkway we have a reasonably representative selection of his best and most characteristic work.

"Olmstead introduced a new appreciation of natural scenery. He first taught us to admire Nature in her own dress. Downing was a lover of natural landscape, but this element of his character was not brought strongly forward in his landscape gardening. Adaptation to site and surroundings was the keynote of Olmstead's work, and this also amounted to a new discovery in landscape art. He discovered the native flora. Gardeners everywhere were planting Japanese magnolias, purple beeches and Camperdown elms. Olmstead turned boldly, and not without violent opposition to the commonest roadside shrubs. With the richest indigenous flora of any country in the world, we were still planting the species and varieties of European nurseries. We may remark further that this use of the native flora was the one Olmstedian principle most quickly acclaimed and adopted by others.

Use of Native Plants.

"The native plants were used in large quantities. Common dogwood and viburnums were put in by carloads. For the first time in the history of landscape art, plants were adequately massed. This principle was not carried to extreme, however; and in fact it has not yet received the development which it merits. Indigenous

plants were given their natural environment. Much attention was given to the development of this principle, especially by some of the followers of Olmstead.

"His roads were peculiar and characteristic—and peculiarly and characteristically successful. A considerable part of their success is due to their adaptation to the contour of the land. He appears to have been the first conscientiously to adopt the principle of rhythm in natural landscape composition, though any artist composing freely and with a proper feeling for his work will inevitably follow this method more or less. This method cannot be formulated in a sentence, but every artist at least will understand what it signifies."

The Opportunities in America.

In conclusion Prof. Waugh said:

"Landscape gardening now enjoys unprecedented opportunities in America. These opportunities come both through the presence here of many excessively wealthy patrons of the art and through the democratic patronage of municipalities and public institutions.

"The old controversies over styles have been hushed and instead of them we now enjoy a remarkably catholic taste and eclecticism of treatment. We have all grades of the natural style, every shade of adaptation of the Italian style, examples of the Japanese style, and hundreds of excellent works which meet the requirements put upon them frankly and adequately without reference to any set "style." This breaking away from set and conventional styles indicates that American landscape gardening has now taken root in its own soil. The services of the profession have passed largely from private into public fields. The leading problems now are not private estates of gentlemen, but municipal parks, playgrounds, and city planning. So broad a field of benevolent humanitarianism was never before opened to any art.

The Outlook.

"My own judgment is that American landscape architecture, as it comes more and more to its proper estate, will be influenced more and more by the native landscape. It will conform itself in a larger and more fundamental way to the topography and the scenery of the continent. American landscape architecture will some day utilize the boundless resources of natural scenery. Niagara Falls must some day be the center of a public park. The Yellowstone geyser region is already reserved and should some day be developed by the skilled hand of a competent landscape architect. The big trees fall into the same order. And some day the Rocky Mountains, the great plains, the Florida Everglades, the Great Lakes, the Mississippi and the Hudson, Lake Champlain and the Adirondacks must all be opened up to public use as a past generation opened up the coal mines of Pennsylvania, the forests of Wisconsin and the gold veins of California. Here is the most magnificent opportunity that landscape architecture ever had, and this is the field in which this greatest of all arts will become finally, magnificently and characteristically American."

CEMENT BENCH CONSTRUCTION

This topic is becoming more important each year owing to the increased price of lumber, and the fact that in a few years it decays and has to be renewed, which is not only a source of annoyance to the grower but also a large item of expense. A properly constructed cement bench will last as long,

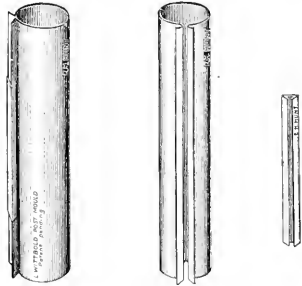

Fig. 1.

and even longer, than the greenhouse itself. Robert Simpson, Clifton, N. J., who is growing roses on cement benches, says there is no difference in the stock grown on cement benches and that grown on wooden benches, under the same conditions. This is also true with carnations, bedding and bulbous stock, and decorative stock.

In the most practical benches the sides, bottom and posts are as one continuous piece of cement. Temporary posts, 2 x 4, are driven in the ground within five inches of the height you wish the bench. These posts are in two rows, four feet apart each way. On the top of these posts are run 2 x 4 stringers, standing on edge. On these stringers are placed cross boards, 1 x 6,

and cut six inches longer than the desired width of the bench. Every eighth and ninth board from the end has a half circle cut out so that when the edges of the two boards are placed together a round hole five inches in diameter will be formed. There should be two rows of these holes, each hole four feet apart each way.

Under these holes the soil should be removed, digging a hole about eight inches in diameter and four inches deep, filling same with wet cement. Into this wet cement the five-inch cement posts should be imbedded, so that the top of each post comes flush with the cross boards, or flooring. It is easier to distribute these cement posts and to imbed them in the wet cement as the flooring is being constructed.

The posts can be manufactured at odd times by the use of the Wittbold Leg Mold (Fig. 1), 25 of these leg molds being sufficient to manufacture as many posts as may be needed.

On the cross flooring of six-inch boards a clamp (Fig. 2) should be nailed or screwed, spaced four feet apart on each side. Against these clamps a side board, seven inches wide, should stand on edge. You will note that Fig. 2 clamp comes in two pieces, the outer part of which should be screwed or nailed to the boards, or flooring.

When the outer boards are placed, wire netting should be run the entire length of the bench, and so turned up as to come flush with the top of the side boards. After the wire netting is placed another board, six inches wide, should be placed in the inner part of the clamp (Fig. 2). After this is done the cement is ready to be poured. When the cement is poured this will give one inch of cement on the sides and one inch on the bottom, and this wet cement will thoroughly

unite with the top of the cement posts already placed.

Fig. 3 shows the use of drainage slots, which are a shell of iron sheet-top, and one and a half inch at bottom, and contain two grooves into which the wire netting can be fitted.

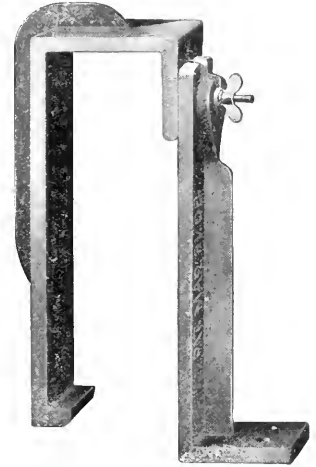
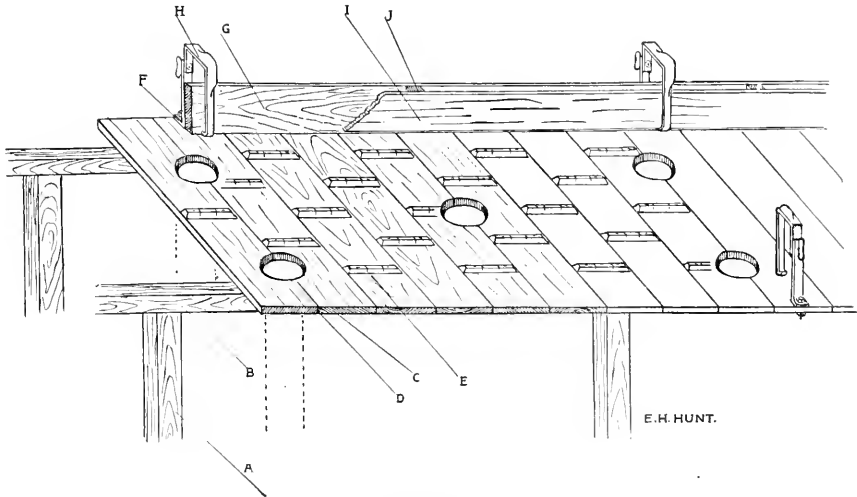

Fig. 2.

This method of drainage is preferred by some, while others prefer the round ring, six inches long, one inch wide at holes made after the cement has partially hardened by the use of the drainage tool. These holes can be spaced as near or far apart as the requirements of the soil or conditions may require.

After the cement is thoroughly hardened the six-inch inner board can be



E.H.HUNT.

Fig. 3.

- KEY TO FIG. 3.
 A Temp. 2x4 Posts.
 B Temp. 2x4 Cross Stringers.
 C Temp. Flooring.

- D Opening for Cement Post.
 E Drainage Slots.
 F Outside Clamp.
 G Beard of Mold.

- H Inner Part of Clamp.
 I Inner Board of Mold.
 J One-inch Plug holding the Inner and Outer one-inch Boards apart

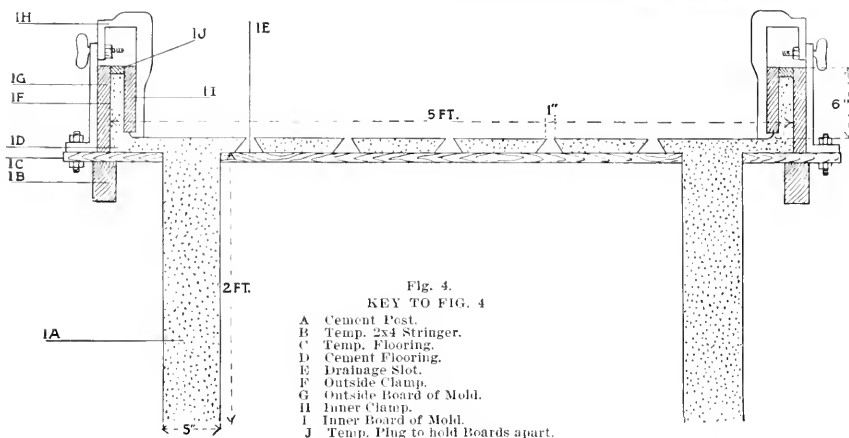

removed, the inner part of the clamp be taken off, the temporary posts removed, and the stringers and flooring will then drop, and you can use the lumber for the construction of other benches.

Fig. 3 will illustrate the method of applying the clamps; Fig. 4 will show cross section of the bench. The completed bench is simply one continuous piece of cement, with one inch side board and one inch of cement flooring.

supported by five-inch posts. There are no other supports or obstructions except these posts. This bench can be constructed at a cost for material of 2 1-4c per square foot.

C. M. DICKINSON.

PLANTING FOR WINTER EFFECT IN THE NORTHERN STATES.

A Paper by George E. McClure, before the Society of American Florists.

During the really marvelous decade through which we have passed, in which the masses have shown a response to the education which has been imparted to them by the many landscape gardeners, artists and nature lovers, who have labored with such untiring devotion to the cause of outdoor art, the people of the northern states have learned to appreciate the beauties of the winter season, and though, to many, the term winter is equivalent to death, in that all activity of growth is at rest, they do not realize that rest is as necessary as growth and that even in the tropics there is a season of rest though it may not be expressed in the same manner as in our snowbound latitudes, yet to others winter means only a change from the pervading green of summer, through the high coloration of fall, to the gray effect of the woods and the brilliant berry and evergreen effects with a ground work and background of glistening snow. The subtle effects are always lost in summer by the massive foliage and it is only the hand of winter that can reveal them to us

The Long Northern Winters.

When we realize that in the northern parts of the northern states there is a winter season of from four to five months' duration, it behooves us to study our material thoroughly in order to make our home surroundings, whether large estates or small dry lots, as attractive and delightful as the art of the landscape artist can suggest.

Winter Pictures.

The aim of this paper, which might more properly be called "planting for

winter effect in the northern part of the northern states," is to stimulate the growing desire of aesthetic people in this belt of our country, to produce landscape pictures which will gladden and cheer through the winter season. Although many excellent articles have appeared in recent years in our best journals on the subject of planting for winter effect, yet almost all of this valuable information has been written for winter effects which could be produced in the latitude of New York City or along the Atlantic Coast as far north as Boston, and in many cases this information, as applied to the region of the Great Lakes has often resulted in partial, if not complete failure. This has served to discourage those who sought to reproduce the winter pictures painted by writers from a more temperate region. Although a great many of the trees and shrubs which are useful for planting for winter effect, come from foreign lands and are useful in this country only when extremes in temperature are not very severe, yet a long list of iron-clad materials is at hand to select from for the extremely cold regions of our northern states.

The Beautiful Winter Woods.

When we contemplate planting for winter effect, the mind turns first to the evergreens, then to berry plants, and to the bright colored branches of the dogwoods and osiers, etc., but seldom do we think of the beautiful effect of the winter woods, the persistent foliage of some of the beeches and oaks, which although brown and dry, yet is cheerful in its effect. Little is thought of the beautiful shades of brown, grey and white, in the trunk and branch, or of the variety of the framework of the various trees, which gives an element of strength to the winter landscape, or to the variety in trees and shrubs, in the delicate tracery of their

smaller twigs, as evidenced by some of the birches and alders, etc., in the trees, and in the shrubs by such as *Stephanandra flexuosa*, the coral berry (*Symphoricarpos vulgaris*) and some of the spiraea. Among the deciduous trees which are attractive during winter might be mentioned the oriental plane (*Platanus occidentalis*), which, with its pendant balls of fruit borne high against the sky, seem to take away the barrenness of the deciduous trees, and is suggestive of the Christmas decorations so admired by the young folks, on Christmas trees. While this tree is beautiful in winter it has also much to recommend it as a fast growing tree for summer effect. Its beautiful bark, with the irregular patches of green and grey, is also interesting in the winter season. In much the same manner the liquidambar (*Liquidambar styraciflua*) is interesting with its firm in pendant spiked balls. Its symmetrical form of growth and extremely corky branches are noticeable to those who are only casual observers. The shell bark hickory (*Hickoria ovata*) while suggestive of strength is also especially interesting on account of its peculiar bark formation, which is unlike any other common species of tree. If planted near the shell bark hickory and other trees with rough bark the American Beech (*Fagus ferruginea*) shows to advantage, as its grey bark is the smoothest of any of our hardy American trees, and never fails to attract attention from those who seek the beauties of winter as found in our woods. It is also especially attractive in winter as the young trees often hold their dry leaves as do some of the oaks well into the winter. Among other trees which might be mentioned as being attractive in winter, from the standpoint of their bark coloration, are the yellow branched linden (*Tilia platyphyllos* var. *aurea*), the Babylo-

nian willow (*Salix Babylonica*), and the white willow (*Salix alba*) with its brownish yellow branches, the white poplar (*Populus alba*) and its fastigiate variety *Bolleana* with their grey-green bark, *Acer Pennsylvanicum* with its white striped bark and greenish twigs, the red birch (*Betula nigra*) with its brown bark, the canoe birch (*Betula papyrifera*), the white birch (*Betula populifolia*), and the European white birch (*Betula alba*) are the most beautiful white barked trees. Their graceful outlines are one of the delights of winter landscape, but unfortunately they are afflicted with the birch borer, which, in some localities, is so destructive that the culture of the trees has been abandoned. When it is possible for them to thrive they are charming if planted along with some of the pines, such as the white pine (*Pinus strobus*), and the pitch pine (*Pinus rigida*). The birches also thrive in sandy soil, which is favorable to the pines themselves. The effect of the white bark against the perpetual green background of the pines is to many more delightful in winter than when the birches are covered with their summer foliage. This beautiful effect is particularly noticeable in the region of Albany, N. Y., where it is the feature of the winter landscape.

The Mixed Forest.

Excellent winter effects are also obtained by what the forester terms the "Mixed Forest," which is a mixture of deciduous and coniferous trees. This forest growth is often to be found along the Great Lakes belt, and the effect is often very beautiful. It would be well if we would learn from nature and reproduce these effects in our parks and large estates. While it is out of the realm of this paper to mention fall coloration effects, this "Mixed Forest" effect is unparalleled when we behold the tints of the maples mixed with the dark green pines, and the impression produced is one that lingers in the memory of the most casual observer.

The Conifers.

While we can secure much pleasure from the observation of trees in their bark, twig and fruit formation, yet the most impressive winter effects are largely produced by using the hardy coniferous evergreen with a lavish hand. In this connection it may be said that an infinite variety of evergreens is not necessary to produce fine effects, and while the list of the iron-clad evergreens, suitable for northern climate, is woefully short, yet we have no reason to be disturbed. On larger places the liberal planting of pines and hemlocks for screening unsightly buildings and checking the force of the winter winds will have much to do with the successful treatment of the place, for one can better appreciate the subtle beauties of a winter landscape if protected from the force of the icy wind by an effective screen of tall and stately evergreen trees. The most useful large growing pines for northern planting are the white pine (*P. Strobus*), the Austrian pine (*P. Anstrica*), and the Scotch pine (*P. sylvestris*). The soft effect of the delicate needles of the white pine when young, and its stately appearance when old, place it pre-eminently in the lead, while the larger needles of

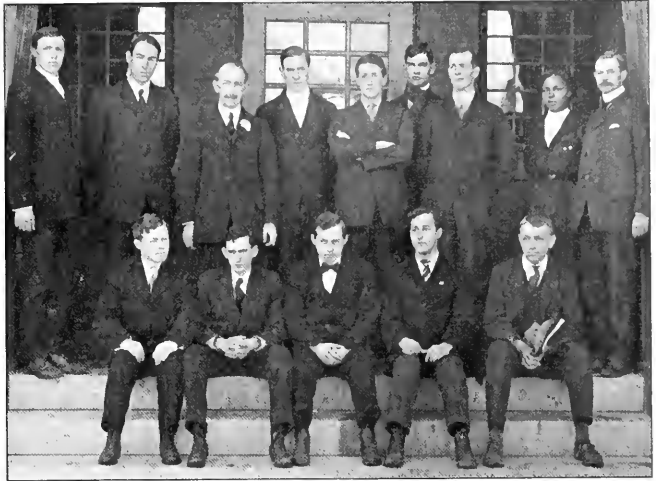

SHORT COURSE CLASS AT MASSACHUSETTS AGRICULTURAL COLLEGE

the Austrian and Scotch pines contrast well and give variety. The only objection to the use of the American hemlock is that it cannot be employed near large cities on account of the smoke and sulphur gases, which are always present in manufacturing districts. In both large and small places the Douglass spruce (*Pseudotsuga Douglassi*) with its dark green foliage and the Colorado blue spruce (*Picea pungens*) and its varieties, *glauca* and *Kosteriana*, give variety to the winter landscape. For immediate effect and for filling in between the more permanent pines and spruces the Norway spruce (*Picea excelsa*) is useful, but as it very often outlives its usefulness at an early age it is only useful for the purpose of temporary effects. The mountain pine (*P. Mughus*) is the most useful of the low growing evergreens for our northern climate and is not out of place on the smallest lawn. When massed at the foot of larger evergreens it is extremely effective. Some of the junipers can safely be employed in the north. And by far the most effective of all is *Juniperus virginiana glauca* the glaucous form of the common red cedar. It is much more hardy than the type and it will thrive in the smoky atmosphere of the city as will no other cedar. Its whitish effect, like that of the Colorado blue spruce, is particularly striking. *Juniperus Chinensis stricta* is also an evergreen of the first rank for the north.

For low planting (*Juniperus Sabina*) the savin Juniper is excellent, while *Juniperus communis var. nana*, which is still lower in growth, gives us an opportunity to produce an evergreen carpet when it is desired. As a useful hardy evergreen we cannot overlook the Japanese yew (*Taxus cuspidata*). It is a welcome addition to the list of really hardy evergreens. The American arborvitae (*Thuja occidentalis*) in its numerous varieties is also useful as a northern evergreen, but prefers the shelter given by wind breaks. Its

golden variety (*Var. aurea*) is extremely useful as it is really golden and adds a touch of bright color which harmonizes well with the prevailing deep green of the majority of evergreens. In sheltered positions it is safe to use the pea fruited *retinospora* (*R. pisifera*), and in some cases the silver *retinospora* (*R. squarrosa var. Veitchii*), but although this is fairly hardy it is often injured by the winter sun. While the evergreens enumerated do not include all of the coniferae that are hardy along the region of the Great Lakes, yet they do include the very hardiest species, and these are sufficient to produce a winter picture, which as far as coniferae are concerned, will be effective and leave little to be desired.

The Broad Leaved Evergreens.

What is true of the paucity of the really hardy coniferous evergreens in the Great Lakes or northern regions, is still more true of the broad leaved evergreens. One of the very few which is hardy under all conditions is the *Yucca* (*Y. filamentosa*); when planted in large masses it is a cheering sight in winter, to say nothing of its profusion of bloom in summer. It is doubly welcome, but its value as a winter plant is its chief asset. Even a solitary specimen on the lawn is an evidence of life in the snow.

The rhododendrons, which are first thought of among the broad leaved evergreens, can be used safely and effectively in the northern part of the northern states, but only under the most ideal conditions, and with the best of care, and it is only too often that they eke out a bare existence. Conditions under which they would flourish in the regions of New York and Philadelphia would be fatal in the lake regions, and success is only reached by eternal vigilance. When such a sight is seen as that in Highland Park, Rochester, N. Y., we are forced to believe that rhododendrons will thrive and be considered a factor

THE BOSTON VIOLET

The people today are looking for New Violets just as much as they are for new roses or carnations.

THE BOSTON VIOLET

For the past three years has been placed before the most skeptical buyer in America and they prefer it to any other.

THERE'S A REASON

The Boston Violet is the largest, the most fragrant, it has a very pleasant color, and it is a great keeper.

PRICES — \$2 per 12. \$120 per 100, \$100 per 1000

PRINCESS OF WALES VIOLET — \$15 per 1000

WILLIAM SIM, : : CLIFTONDALE, MASS.

THE BOSTON VIOLET

Is a variety that is early grown, it is the strongest grower and is in crop from September to May.

THE BOSTON VIOLET

Was awarded a First Class Certificate of Merit by the Massachusetts Horticultural Society and a Report of Superior Merit by the Gardeners' and Florists' Club of Boston.

in the winter gardens of the north. If the planting beds are thoroughly prepared and epsom salts judiciously used they will be a success. Very effective grouping can be obtained by using the great laurel (*R. maximum*), *R. Catawbiense*, and the numerous hardy hybrids.

What is true of the rhododendrons is also true of the mountain laurel (*Kalmia latifolia*) and *Andromeda floribunda*. The boxwood (*Buxus sempervirens*) cannot be called a northern plant, but the more uncommon *Buxus arborescens* will stand a temperature below zero without covering if well established. Excellent examples of it are to be seen in Geneva, N. Y., which are over four feet in height. Its foliage is coarser but it is an excellent substitute for the European species. Its usefulness as a winter plant cannot be overestimated, especially in formal work. I have the temerity to mention this species of box only after having seen it withstand severe winters.

The best evergreen ground cover is undoubtedly the periwinkle (*Vinca minor*). Its ability to thrive under adverse conditions of light render it useful for other things besides winter effect. It is an excellent ground cover between evergreens and rhododendrons; its cheerful green is not only beautiful to the eye, but the plant acts as a protection from deep freezing of the soil. When it is planted in mass in the open, or on the edge of shrub border, in company with *Rosa blanda*, it makes a unique combination, as the brilliant large fruits of the rose are borne near the ground and just over

the groundwork of green vinca, the effect is suggestive of the Christmas season.

Another broad leaved evergreen which is useful in the northern latitudes is *Euonymus radicans*, which as a low climber takes the place of the English Ivy. As a creeper it is seen at its best. The sun of February and March often burns some of the upper leaves, but whenever it produces its red berries it is a thing to be desired.

The Japanese honeysuckle (*Lonicera Halliana*), while not considered an evergreen, yet retains its green leaves until long after Christmas in sheltered situations, when used as a trailer, but not when used as a climber as the leaves are more exposed to frost and wind and are not as persistent. As this plant is used for covering banks in open ravines, and around rocks and boulders, it has a cheery effect on a winter day.

Berried Shrubs and Trees.

One of the chief delights of a winter garden is the effect of the berried shrubs and trees, and of course we always think of berried plants in relation to Christmas, and very naturally to the holly that is so extensively used at that time. The northerner is denied the use of this most regal plant, but whenever evergreen leaves and red berries can be combined, it is regarded as the highest perfection of winter effect.

A few years ago I conceived the idea of using the winter berry, or leafless holly (*Ilex verticillata*), which is more profuse with its berries than the southern holly, along with the Eng-

lish privet (*Ligustrum vulgare*), mixing the two kinds and planting in masses. The privet retains part of its green leaves until January and has splendid trusses of brilliant black berries, and the effect of these black berries and green leaves, with the dense masses of red berries of the leafless holly, give the effect that is obtained in English gardens by the famous holly plant. The *Ilex* is vigorous as also is the privet, and the whole in time becomes a tangled mass and the effect glorious. Sometimes the leafless holly is planted along with the mountain laurel, but as the laurel is low and the *Ilex* high, the green leaves and berries are not together and the effect not as good. Even though it is not always possible to secure a background of green for berried plants in the winter, it is not always desirable as the snow itself is a sufficient background for many berried plants. Among the most common and best of our berried plants are the common barberry (*B. vulgaris*) with its racemes of brilliant berries which remain well into the winter, the Japanese barberry (*B. Thunbergii*) with its single yet thickly borne berries of as brilliant a hue, and the high bush cranberry (*Viburnum opulus*), whose bright and large trusses of berries last until the new leaves are formed in the spring, and are very striking. Many of the endless number of forms of *Crataegus* are useful for winter effect, and although their fruits are not persistent during the entire winter season, yet many are glorious in the early winter. *Euonymus Bungeanus* holds its fruits very long; in fact it is better than the "Wahoo," or

strawberry tree (E. Americana). The sea buckthorn (Hippophae Rhamnoides) is also attractive in winter because of its yellow black dotted fruit, which is very persistent. Many of the roses are extremely beautiful as their fruits are often large. One of the best is the Japanese rose (Rosa rugosa), whose large haws or berries are highly colored and remain long on the plant to brighten up the landscape. Rosa multiflora, whose fruits, although smaller, are borne in large clusters and last all winter. Rosa lutescens has the largest fruit, some of which are one inch long and are borne in clusters of four. Rosa blanda is also useful.

The privets, both the common (L. vulgare) and the Japanese (L. Itoha), have large clusters of shining black berries, and are very striking with a background of the snow. The snow-berry (S. racemosus) with its profuse masses of white berries, and the coral berry (S. vulgaris) are both splendid species for effective winter planting. When planted in masses in richly prepared borders, they produce riotous masses of fruit. The European buckthorn (Rhamnus catharticus), so often used for a wind break, has attractive black fruits, as has also Rhodotypos kerrioides. The stag-horn sumac (Rhus typhina) produces a marked effect in a winter landscape with its antler-like dense clusters of berries. The smooth sumac (R. glabra) is also useful as a winter fruit plant.

The European mountain ash (Sorbus aucuparius) with its bright red berries in large clusters is especially useful for winter effect, and the yellow berried form is also useful for variety. With an evergreen background they are especially attractive. Among the vines for winter effect nothing can surpass the bitter-sweet (Celastrus scandens) with its winter array of orange berries, when the vine is allowed to grow as a shrub, forming an uneven mass of twining stems; covered with attractive fruits it is particularly fine. C. articulatus is also a splendid berried vine similar to the bitter-sweet. Vitis heterophylla, whose grape-like clusters of whitish-blue berries offer a variety in berry color, are also interesting from the standpoint of winter effect.

The variety of berried plants is not seriously limited by the effect of the higher latitudes, and when planting for winter effect is planned we may enjoy a profusion of color all winter, which will please the eye and make our winter walk through park or home grounds a joy which belongs peculiarly to the winter season.

Bright Colored Twigs and Stems.

One of the very best opportunities for brightening up the winter landscape is offered to us with a lavish hand in the bright colored branches and twigs in shrubs and trees. Who of us has not been charmed after the leaves have fallen with a large mass of the red osier dogwood (Cornus stolonifera) as seen from the window of a train; the effect is lasting. A number of the cornus are useful in planting for winter effect. The best is C. alba Siberica, and C. stolonifera for red stems, and C. stolonifera var. flavi-

ramea for the yellow effect of its branches. When planted in large masses beside the brilliant green branches of Kerria Japonica, the effect is really wonderful. There are numerous species of cornus, among which might be mentioned C. Amomum and C. circinata, with bright colored bark which gives us shades of color, which are useful for winter effect, and as their berries are quite persistent and usually of a bluish white shade, the contrast between stems and fruit is good. The red stems of Rosa lucida are also used to advantage.

In large shrub borders, along margins of ponds and edges of creeks, the brilliant colors form an important part of the winter landscape. About the best are the golden branched willow (Salix vitellina var. aurea) and the variety Britzensis with reddish branches. Salix viminalis, the basket willow, has also bright yellow stems and is especially valuable. Salix purpurea, the purple osier gives us a chance to introduce a purple hue into the winter landscape, which in the distance is particularly enchanting. Salix palmarum has also purple branches and is very useful. As a purple branched shrub, Berberis vulgaris purpurea, the purple leaved barberry, is often used in small plantations.

(To be continued)

OBITUARY.

Ernest Weber.

Another sudden death among the Chicago florists was that of Ernest Weber, which occurred Mar. 23. The funeral was from the residence, 2386 Lincoln Ave., Mar. 25, and was largely attended by his friends in the trade.

Ernest Weber came to Chicago direct from Germany, twenty-five years ago. After working for various florists, Mr. Weber and his brother Fred started in business together. Later on Fred was ready for a place of his own, and since that time Ernest has continued the business alone. Mr. Weber was known as a very successful grower and his loss will be felt in the market as well as socially. He left no children and the sympathy of the trade is extended to the invalid wife. Mr. Weber was ill but two days with erysipelas and his sudden death was a great shock.

Mrs. William E. Doyle.

Katherine E., wife of William E. Doyle of Boston, died on March 29 from the effects of a shock with which she was recently stricken. Mrs. Doyle was born in E. Cambridge, Mass., in 1848. She is survived by her husband and three children.

Warren B. Madison.

Warren B. Madison, professor of animal husbandry at the State Agricultural College, Kingston, R. I., died on March 22, of pneumonia. He has been

FROM GROWER TO PLANTER

Ellwanger & Barry's

TREES

Shrubs, Roses Evergreens and Hardy Plants

Are Famous The World Over

Best stock at reasonable prices. No agents. Commissions saved. Collections unequalled. Beautiful illustrated catalogue mailed free on request.

MOUNT HOPE NURSERIES
ESTABLISHED 1840 Box T, Rochester, N. Y.

Newport Fairy

The Rose of the Future For In and Out Door.

FINE, STRONG FIELD-GROWN STOCK

3-4 Shoots 3-4 ft. long

50c each, \$30 per 100, \$250 per 1000

JULIUS ROEHRS CO.,
RUTHERFORD, N. J.

Rhubarb and Asparagus Roots

Plant your Rhubarb now for next winter's forcing at only 4 cents each for large clumps. You can divide them into 3 parts, costing you a little over one cent.

Our Asparagus roots are from seed costing \$4 per pound. This brand of asparagus brings \$40 to \$600 per acre. I have 500,000 asparagus and 50,000 rhubarb.

WARREN SHINN, Nurseryman, WOODSTOWN, N. J.

connected with the college since 1902 and has been very successful in his work.

Edward Dale.

Edward Dale, native of Dorking, Surrey, England, died in Brampton, Ont., on March 17, aged 82 years. Mr. Dale settled in Canada in 1873 and engaged in the market gardening and florist business. He was the father of Thomas Edward and William Dale.

Edward Gill.

Edward Gill, a native of New Jersey, and prominent in horticulture on the Pacific coast, died in W. Berkeley, Calif., at the age of 69.

Seed Trade

AMERICAN SEED TRADE ASSOCIATION.

Watson S. Woodruff, Orange, Conn., Pres.; J. C. Robinson, Waterloo, Neb., First Vice Pres.; C. E. Keadel, Cleveland, O., Sec'y and Treas. Twenty-seventh annual convention June 22-24, 1909, at Clifton House, Niagara Falls, Ont.

WHOLESALE SEEDSMEN'S LEAGUE.

F. W. Bruggerhof, Pres.; Burnet Landreth, Sec'y.

THE "PURE SEED BILL" AT ALBANY.

At the second hearing on Assemblyman Callan's Pure Seed Bill, which took place at Albany March 20, the following gentlemen were present: F. A. Sherman, of Sherman & Eberle and D. Bennett, of Barber & Bennett, Albany, N. Y.; H. W. Gordinier and Nott, of Nott Seed Co., Troy, N. Y.; Alex. Forbes, of Peter Henderson & Co., and Marshall H. Duryea, of Henry Nungesser & Co., New York City.

The bill in question has been amended along the lines of adulteration, and while we cannot yet give any definite information, we have every reason to believe that Chairman Boshart's committee on agriculture will report favorably on it.

PLANT IMPORTS.

Entered at New York, March 23 to 30, 1909:

From Rotterdam: A. T. Boddington, 2 cs. bulbs; H. F. Darrow, 29 cs. plants; Wm. Elliott & Sons, 49 cs. do., 14 cs. trees; McHutchison & Co., 165 cs. plants, 16 hls. do.; P. Ouwerkerk, 69 cs. trees; C. B. Richard & Co., 11 cs. plants, 1290 cs. shrubbery; O. J. Smith, 18 cs. plants; Stump & Walter Co., 4 cs. trees; Sundry forwarders, 166 cs. plants, 15 hls. do., 12 cs. trees.

From Belgium: Alpers & Mott, 3 pgs. plants; Hussa & Co., 5 cs. plants; Vaughan's Seed Store, 1 cs. plants.

Via Havre: American Express Co., 12 cs. plants; O. G. Hempstead & Son, 4 cs. plants; Sundry forwarders, cs. do.

From Scotland: H. F. Darrow, 4 cs. trees; Perry, Rye & Co., 11 boxes plants; J. M. Thorburn & Co., 20 bgs. grass seed.

Via Southampton: American Tobacco Co., 158 cs. plants, 68 cs. trees; H. F. Darrow, 23 cs. plants, 13 pgs. seed; C. C. Abel & Co., 25 pgs. plants; Hussa & Co., 9 pgs. do.; McHutchison & Co., 40 cs. do.; Maltus & Ware, 16 cs. do.; C. B. Richard & Co., 8 cs. do.; August Rolker & Sons, 8 cs. do.; Stump & Walter Co., 47 cs. do., 2 cs. trees; F. B. Vandegrift & Co., 50 cs. plants; Sundry forwarders, 5 cs. do., 3 cs. trees.

Via London: American Tobacco Co., 35 cs. plants, 27 blls. trees.

From Germany: C. F. Meyer, 5 cs. plants.

BULBS OF QUALITY

Begonias, Single, under color.....	100	\$2.75
" Double " " " " " " " " " "	5.00	
" Filled " " " " " " " " " "	10.00	
Gloxinas, under color " " " " " " " "	4.00	
Pearl Tuberoses, \$7.00 thousand " " " "	1.00	

Schlegel & Fottler Co.

26 & 27 So. Market St., BOSTON, MASS.

PERSONAL.

T. B. Pritchard, of Indianapolis, has taken a position with Clarke Bros., Portland, Ore.

John G. Heinl has been appointed secretary of the new park board of Terre Haute, Ind.

F. R. Mathison of Waltham, Mass., who has been indisposed for a month of more is out again, much improved.

Mrs. J. F. Sullivan of Detroit who has been suffering from blood-poison is slowly improving but is not yet out of danger.

George F. Mass, of New York City, son of G. H. Mass, florist, of Woodstock, Vt., was married recently to Miss Emma Trumpheller.

W. G. Haebich, formerly with the Northwestern State Hospital for the Insane, has accepted a position with the Henry Salzer Co., La Crosse, Wis.

The friends of Ernest Oechlin of Chicago regret to learn that he is not recovering from his recent accident as fast as had been expected. Mr. Oechlin is still confined to his bed, although removed from the hospital two weeks ago.

Visitors in Boston: J. S. Hay, representing H. A. Dreer; Wm. Miller, Edw. Kirk and Wm. Burton, Bar Harbor, Me.; Ernest H. Chamberlain, New Bedford, Mass.; J. R. Shield, Dalton, Mass.; A. T. De la Mare, N. Y.; William Appleton and M. Sweeney, Providence, R. I.; Julius Rusitzky, representing Wm. Peirce, New Bedford, Mass.; Louis Dupuy, Whitestone, N. Y.; T. Mellstrom, New York.

Chicago visitors: Paul Beyer, So. Bend, Ind.; H. A. Fisher, Kalamazoo, Mich.; Mr. and Mrs. J. A. Soper, Rockford, Ill.; H. A. Barnard, representing Hugh Low & Co., England; J. F. Johnson, Ft. Smith, Ark.; Mr. and Mrs. M. C. Sadevater, Rockford, Ill.; C. A. Schnell of the Donaldson Co., Minneapolis, Minn., and Mr. Donaldson, Jr.

Visitors at Philadelphia spring show: Isaac H. Moss, Thos. Patterson, Albert Fiedler, Chas. Klutsch, Jno. J. Perry, Chas. L. Seybold, Matthew McRichmond, F. G. Burger, wife and son, all of Baltimore, Md.; George H. Cooke, W. H. Ernest, Fred H. Kramer and wife, Geo. Shaffer, G. G. Hammer, J. E. Field, H. T. Waters, Harry Jones, all of Washington.

DURING RECESS.

Last week saw another struggle on the bowling alleys between Washington, Philadelphia and Baltimore, at Philadelphia. Scores were as follows: Philadelphia—Robertson, Graham, Holmes, Huttenlock, Dunham, 794, 770, 869; Washington—Cooke, Shaffer, Hammer, Ernest, Field, 844, 837, 798; Baltimore—Klutsch, Moss, Perry, McRichmond, Seybold, 693, 825, 764. Totals: Washington, first, 2479; Philadelphia, second, 2433; Baltimore, third, 2282.

NEWS NOTES.

Derry, N. H.—W. J. Kingsbury has engaged Samuel Bloomfield of Windham as foreman.

Mason City, Ia.—The Patten Nursery will hereafter be operated as a government experiment station.

Providence, R. I.—The Providence Forestry Co., Inc., has started in business. E. H. Armstrong is president.

Wichita, Kan.—C. P. Mueller is re-decorating his store in Mission style and will add a conservatory in the rear.

Boston, Mass.—J. J. O'Brien, recently doing business on Boylston street, has filed a petition in bankruptcy; liabilities, \$3,902.06; no available assets.

Boston, Mass.—The amendments to the Massachusetts boiler bill that would exempt boilers in greenhouses from inspection have been rejected, and the bill has been referred to the next general court.



Baskets, Crates,
Ladders, Veneers
and Boxes.

BACON & CO.
Appleton, N. Y.

VEGETABLE PLANTS

FOR TRANSPLANTING

CABBAGE—Wakefield and Succession \$1.00 per 1000
EGG PLANT—N. Y. Improved and Black Beauty .40cts. per 100, \$.30 per 1000
PEPPER—Bull Nose, Ruby King and Sweet Mountain, .40cts. per 100, \$.30 per 1000
Chinese Giant and Cayenne, .40cts. per 100
TOMATO—Earliana, Chalk's Jewel and Early June Pink, .40cts. per 100, \$.20 per 1000
Stone, Favorite and Paragon, Small plants \$.20 per 1000.
CELERY—Small for transplanting, White Plume and Golden Self Blanching, \$.100 per 1000.

CASH WITH ORDER

R. VINCENT, JR., & SONS CO.
White Marsh, Md.

Montreal M. Melon

The largest and best flavored Musk Melon in existence. Grows to weigh as much as 20 pounds, and fetches \$2.00 to \$3.00 each. GENUINE SEED per package postpaid sec. with cultural directions.

Do not confuse this with the American variety.

Dupuy & Ferguson
MONTREAL, CANADA

THE PRIZE WINNING STRAWBERRY

The Barrymore

Send for Folder at Once.

H. L. CRANE, Originator,
Westwood Mass.

THE STRAWBERRY BLIGHT, ITS CAUSE AND CURE.

How to more than double the yield of crop without increasing the cost of production. A great discovery. Price of book \$2. Worth \$25.

WM. C. TRIMBLE, - Princeton, Ill.

MICHELL'S PRIMULA OBCONICA SEED

	Tr. Pkt.
Grandiflora Compacta	\$0 50
" Fimbriata (1- 6oz. \$1.25)	.50
" Gigantea (Arends)	.50
" Kermesina (1- 6oz. \$1.5)	.40
" Rowen (1-16 oz. \$1.00)	.30
" White (1-16 oz. \$1.25)	.30
" Mixed (1-8 oz. \$1.00)	.30

PRIMULA CHINENSIS FIMBRIATA

MICHELL'S PRIZE MIXTURE
Beautifully fringed varieties. Tr. pkt. \$1 00,
\$2.00 per 1-16 oz.

Write for our Wholesale Catalog

HENRY F. MICHELL CO.
1018 Market St., PHILA.

Mignonette

**FARQUHAR'S
GIANT**

Oz., 75c; 1-4 oz., 25c

R. & J. Farquhar & Co.

6 & 7 South Market Street
BOSTON, MASS.

CANES

Freshly Cut From the
Brakes For Your Lilies

Can Be Cut To Any Size

\$5 for 500, \$7 for 1000

Wm. Elliott & Sons
42 Vesey St., New York

RELIABLE SEEDS—SOW NOW
PRIMULA OBCONICA GRANDIFLORA

	1000 seeds	Tr. pkt.
Blood red, fine seller\$1.50	\$0.50
Real pink, fine for cut 1.00	.50
Pure white, fine for cut 1.00	.50
Compacta, fine potter 1.50	.50
Mixed Hybrids 1.00	.50

O. V. ZANGEN, - HOBOKEN, N. J.

LEONARD SEED CO.

CONTRACT GROWERS AND WHOLESALE DEALERS
BEANS, PEAS, SWEET CORN, ONION, GARDEN SEEDS
ONION SETS
FLOWER SEEDS Get Our Prices
79 and 81
E. KINZIE STREET, CHICAGO

ESTABLISHED 1802

*Thorburn's
Seeds*

FINE GLUMPS JAPAN IRIS
TUBERDUS ROOTED BEGONIAS
GLOXINIAS
ROSA MULTIFLORA NANA SEED
and all other flower seeds for
florists
SEND FOR CATALOGUE

J. M. THORBURN & CO.
33 Barclay Street
NEW YORK

CABBAGE SEED
LILY OF THE VALLEY PIPS.

HJALMAR HARTMANN & CO.
12 Stormgade,
COPENHAGEN, DENMARK.

Burpee's Seeds

PHILADELPHIA

Blue List of Wholesale Prices mailed
only to those who plant for profit

Ward's Lily Bulbs

Send for Catalogue



Ralph M. Ward & Co.
12 W. Broadway
NEW YORK

BRIGEMAN'S SEED WAREHOUSE

RICKARDS BROS.

Props.

37 East 19th St., - NEW YORK CITY

STOCK SEED

FOR WINTER BLOOMING

Our strain of Double Branching Stocks is exceptionally true. About 90% Double Flowers.

In colors: .. 1/2 oz. .60 oz. \$4.00
Pure White 1/2 " .75 " 5.00

H. E. FISKE SEED CO.
Faneuil Hall Square, BOSTON, MASS.

Winter-flowering
SWEET PEA SEED

All Colors Ask for List
A. C. ZVOLANEK

ORIGINATOR. BOUND BROOK, N. J.

NEW CROP SEED

For Early Planting

THOMAS J. GREY CO.
32 SO. MARKET ST., BOSTON, MASS.

BEGONIAS TUBERDUS ROOTED

—ALSO—
GLOXINIAS, LILY OF VALLEY, SPIREA
Catalogue mailed free on application

Joseph Breck & Sons Corp.
47-54 NO. MARKET ST., BOSTON, MASS.

Japanese Bulbs, Etc.

R. TANOI, Yokohama, Japan.

Send for catalog and write to Representative
K. TAKEUCHI,
478a Boylston St., Boston, Mass.

Everything "For the Land's Sake."

The one firm in Boston where all good forms of plant food may be obtained, is the Bowker Fertilizer Company, opposite Faneuil Hall at 43 Chatham St. All greenhouse chemicals, Nitrate of Soda, Ground Bone, Potash Salts, Sheep Manure and Wood Ashes can there be had at first hands.

BOWKER FERTILIZER COMPANY

Everything "For the Land's Sake."

SHEEP MANURE

Pulverized. Free from Adulteration
In Bag, \$18.00 per Ton. Cash with Order

ROBERT SIMPSON
CLIFTON, N. J.

CEO. E. DOW
Designing and Illustrating

178 Washington St., Boston, Mass.
OUR SPECIALTY
Machine, Booklet, Advertising and Flower
PHOTOGRAPHS

GREENHOUSES BUILDING OR CONTEMPLATED.

- Ft. Morgan, Colo.—L. J. Reid, one house.
 Norwich, Conn.—E. F. Quinn, additions.
 Sea Girt, N. J.—G. H. Gregory, one house.
 Greenville, Ill.—Z. H. Zbinden, one house.
 Harrisburg, S. D.—C. H. Vaughan, additions.
 Evansville, Ind.—Austin Wallace, house 42 x 100.
 Ross, Calif.—John Martin, carnation house, 25 x 75.
 Janesville, Wis.—Edw. Amerpohl, three houses.
 Hightstown, N. J.—Tracy H. Norton, violet house.
 Far Rockaway, N. Y.—J. F. Marsden, one house.
 E. Defiance, O.—Karl Scharffenberger, range of houses.
 Norwich, Conn.—Mrs. William C. Lenman, rose house, 18 x 33.
 Rowayton, Conn.—Traendly & Schenck, two houses, 50 x 300.
 Fargo, N. D.—Shotwell Floral Co., three houses, each 25 x 100; potting shed 16 x 66.
 Ashtabula, O.—R. W. Griswold, Jr., 12 houses; Dunbar & Hopkins, ten houses; Griswold Greenhouse Co., six houses; Adams Bros., five houses; Gallup Bros., three houses.

A VALUABLE APPLIANCE.

Simultaneous with the spring air, the robins and the daffodils, the wide awake grower begins to consider plans for extending and rebuilding his houses and improving his heating apparatus. For the man with this spring fever on we have a word of candid advice—that is, read the advertisement of the Castle Circulator in this issue. Growers who installed this device last year are enthusiastic in appreciation of its usefulness to them. We have seen the testimonials and know the men who wrote them.

PATENTS GRANTED.

- 914,453. Land Roller and Pulverizer. William Pfarrer, Syracuse, N. Y.
 914,708. Plant Protector. Jennie P. Duval, Kansas City, Mo.
 914,731. Hedge Trimmer. Louis Klitsch and Otto W. Thogode, Brooklyn, N. Y.
 911,875. Hedge Trimmer. Daniel F. Roche, Jr., Newport, R. I.
 914,947. Brush Axe. Fred Hammerly, Silvana, Wash.



THIS KILLS MILDEW EVERY TIME

FOR PARTICULARS WRITE
Benjamin Dorrance ROSE GROWERS
 Dorrance, Penna.

“REVERO”
Braided Moulded Construction—Seamless Throughout



LIGHT--STRONG--FLEXIBLE

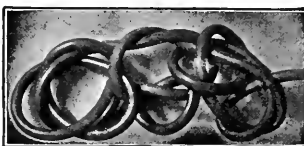

The above cuts represent the non-kinking tendency of Revero as compared with the old style hose of wrapped duck construction.

Revero is furnished on Reels in Continuous Lengths up to 500 feet. Your supply man can furnish it

Revero Rubber Company,
BOSTON, MASS.

- | | | | |
|-------------|--------------|---------------|----------------|
| NEW YORK | PHILADELPHIA | PITTSBURG | CHICAGO |
| NEW ORLEANS | MINNEAPOLIS | SAN FRANCISCO | PORTLAND, ORE. |

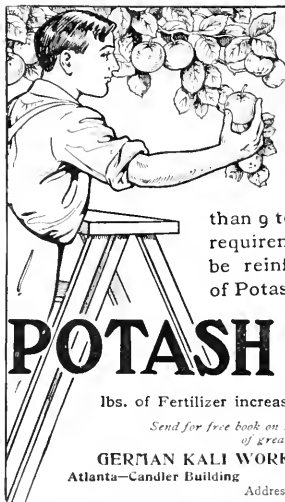

Potash

is not the only plant food required to make plants productive; but commercial fertilizers which contain less

Potash

than 9 to 12 per cent (according to the requirements of different crops), should be reinforced with Sulfate or Muriate of Potash, until they are well balanced.

POTASH

POTASH IS PROFIT

Potash makes larger, sounder, finer flavored fruit. Every 2 lbs. of Sulfate or Muriate of Potash added to 100

lbs. of Fertilizer increases the Potash by 1 per cent.

Send for free book on Fertilizing, prepared by practical experts, of great value to the fruit grower.

GERMAN KALI WORKS, 93 Nassau Street, New York
 Atlanta—Candler Building Chicago—Monadnock Block
 Address Office Nearest You.



TARGET BRAND Weed Killer

Sold at retail by a thousand of seed houses and dealers. Special price in quantities to parks and cemeteries

TARGET BRAND, Box 732, Martinsburg, W. Va.

In ordering goods please add "I saw It in HORTICULTURE."

Which Spray Pump

shall you buy? Buy the Spray Pump that fully meets the demands of the Government Agricultural Scientists and all practical Fruit Growers. These pumps are widely known as

DEMING SPRAYERS

and are made in 27 styles for use in small gardens or immense orchards. Write for our 100 page catalog with Spraying Chart. Add 5 cents postage and receive "Spraying for Profit," a beautiful guide book.

W. HARTL'S J. JAGGER CO.
 231-285 Franklin St., Boston



Y₁ Fluid

THE IDEAL WINTER SPRAY
SCALE KILLER & FUNGIGIDE

POWERFUL CLEANSER AND INVIGORATOR
Mixes Instantly. No Sediment. No clogging. Non-injurious to user
COMPARATIVE TEST WILL PROVE ITS MERITS
Quart, \$1.00; Gallon, \$3.00
1 gallon makes 100 gallons. Write for descriptive pamphlet and testimony

PROPS. W^M COOPER & NEPHEWS
177 ILLINOIS ST. CHICAGO
Gen'l Agent—CYRIL FRANCKLYN, 62 Beaver Street, New York, N. Y.

For Trees, Plants, Shrubs and Flowers

— **USE** —

THE NIAGARA BRAND LIME SULPHUR SOLUTION

It destroys Scale Lice, Spiders and all forms of Aphides, AT THE SAME TIME Mildew, Blight, Rust and other Fungus difficulties.
Used in Winter or Summer.—No other remedy has been so universally effective.
Niagara Brand ARSENA TE OF LEAD for chewing insects is equal to the best and better than the most Ask about our Green House sprayer. Address—

NIAGARA SPRAYER CO., - - Middleport, N. Y.

MASSACHUSETTS

Experiment Station Analysis
Average three years
63%

SOLUBLE PLANT FOODS

EASTERN CHEMICAL CO.
Pittsburg Street, Boston, Mass.

KILMDEAD

The best of all
the tobacco
dusts for



**Dusting or
fumigating**

25 lbs., \$1.00 100 lbs., \$3.00 1000 lbs., \$27.00
50 lbs., 1.75 200 lbs., 14.00 2000 lbs., \$25.00

Stump & Walter Co. 50 Barclay St., New York.

DON'T EXPERIMENT

— **USE** —

TO-BAK-INE

and your stock will be free from insects, clean, and the blooms will not be discolored.

Send for full information of

H. E. FISKE SEED CO.
13 Faneuil Hall Sq., Boston, Mass.
STUMPP & WALTER CO.,
50 Barclay St., New York.
HENRY F. MICHELL & CO.,
1018 Market St., Philadelphia.

E. H. HUNT, Gen'l Agent,
76-78 Wabash Ave., Chicago.

"Every Bug Has his Dose."

Insect-destroying preparations that do their work well and effectively are the cheapest. Bowker's Arsenate of Lead and Bowker's Pyrox are recognized standard insecticides and fungicides for both indoor and outdoor use. Bowker's Insect Emulsion destroys many kind of plant lice, black and green flies, etc. Call or send for catalogue.

BOWKER INSECTICIDE COMPANY
43 CHATHAM ST. BOSTON



**The Best
Bug Killer and
Bloom Saver**

For PROOF
Write to
P. R. Paethorpe Co.
OWENSBORO, KY.

SOMETHING NEW for GREENHOUSES

"SULFOCID"™

PRATT'S
**SOLUBLE SULPHUR
SUMMER SPRAY**

Non-caustic and non-irritating
A FUNGICIDE AND INSECTICIDE
FOR FRUIT TREES, VEGETABLES and GREENHOUSES

A promising substitute for Bordeaux mixture. For 10 cts. to cover postage will send sample sufficient for one gallon of spray.
Use 1 part to 75 or 100 parts of water.
B. G. PRATT CO., 50 Church St., New York, U. S. A.

In writing to Advertisers kindly mention Horticulture

Heacock's Kentias

Our stock consists of healthy HOME-GROWN,
WELL ESTABLISHED plants



Kentia Belmoreana

5-in. pot, 6 to 7 leaves, 18 in. high.....	Per doz.	100
5-in. " " " 20 in. "	\$6.00	\$50.00
	9.00	70.00
	Each	
6-in. " " " 24 in. "	\$1.00	12.00
7-in. " " " 32 to 34 in. high.....	2.50	30.00
7-in. " " " 36 to 38 in. "	3.00	36.00
9-in. tub " " 42 to 48 in. " very heavy.....	5.00	

Kentia Forsteriana (Made-up)

7-in. pot, 4 plants to pot, 34 to 36 in. high	at \$2.50
7-in. " 4 " " 36 to 38 in. "	at 3.00
9-in. tub, 4 " " tub, 44 to 48 in. "	at 5.00
9-in. " 4 " " 4 ft. high, heavy	at 6.00

All measurements are from top of pot.

Joseph Heacock Co., Wyncote, Pa.

PUBLICATIONS RECEIVED.

Pronunciation of Plant Names. Published by The Gardeners' Chronicle, Ltd., London, England. This little volume is reprinted from the list of generic names prepared originally by the Rev. C. Butler, M. A., and published in the Gardeners' Chronicle in 1908. Perusing it we find that it does not follow the Nicholson pronunciations as given in the Dictionary of Gardening and indeed, where Nicholson has attempted to introduce pronunciations radically different from common usage the list now before us adheres to the popular pronunciation in a majority of cases. The volume is one which every gardener and florist should have at all times conveniently at hand. The Gardeners' Chronicle has put the craft under obligation to it for providing this useful information in so compact and convenient a form. The book is neatly bound in cloth and can be supplied from the office of HORTICULTURE, post paid, at 50 cents per copy.

Cyclopedia of American Agriculture, by L. H. Bailey. Volume IV., Farm and Community. Published by the Macmillan Company, New York. This is the last volume of the series. Like its predecessors it is colossal in its scope and to give any adequate idea of the contents or even an outline of the broad topics treated in the brief space of a newspaper notice is an impossibility. Dr. Bailey has drawn upon a wide list of helpers in the work, no less than 137 contributors to this volume alone being listed, many of them writers, investigators and edu-

cators of world-wide repute, and a further list of 181 is given of those who have assisted in reading proof and in other ways. The agricultural wealth of North America, The historical evolution of North American agriculture, Phases of the agricultural shift, The natural resources of agriculture, Law and labor, Business organizations in agriculture, Social and service association, Education by means of agriculture, Governmental

and legal aid and control are the broad divisions under which the topics are classed. Eighty pages are devoted to biographical sketches of men eminent in the history and development of agriculture and rural life in America. Many portraits are here given and there are 25 full page half-tones as well as numerous figures interspersed throughout the book, which contains 650 pages, octavo.

We think it can be stated without

NEW GERANIUMS

If you are interested in Geraniums we would call your Special attention to the collection of 1907-1908 Novelties we have to offer this season, fully described on pages 3-17 of our 1909 Geranium catalogue, as near as possible with the introducer's description. We have made a specialty of importing New Varieties for several years, and fully believe that this represents the best collection we have ever offered, or in fact the best collection ever gotten together in this country, embracing a range of diversified coloring with combinations of marking almost endless. Every color and shade in Geraniums is among them.

SPECIAL OFFER FOR IMMEDIATE ACCEPTANCE. OUR SELECTION OF KINDS.

For \$10.00 we will send one each of 100 kinds made up from the 1907 and 1908 Novelties For \$6.00 we will send one each of 50 1908 Varieties. For \$5.00 we will send one each of 50 1907 Varieties. These offers are for strictly Cash and our selection of kinds. Do not ask us to send less than the number mentioned in each offer. In standard kinds we have an immense stock of fine plants from 2 in. pots at prices running from \$2.00 per 100 to 50c each. We will send 1000, 50 each of 20 good sorts our selection, for \$18.50. Cash with order.

We have the following in fine shape from 2 in. pots, \$2.00 per 100, \$18.50 per 1000: 25 of one kind at 100 rates; 250 of one kind at 1000 rates.

Achlyrites Emersonii and Besteri Mosinca, Ageratum, 5 kinds, Alyssum, Cineraria Maritima, Gaudichaudiana, Centaurea Gymnocarpa, Hardy English Ivy, Farlow Ivy, Lobelia Kathleen Maird and Crystal Palace Gen., Petunia Dreer's Superb Single, Salvia Bonfire Smilax, Verbena, Cotone Golden Bedder, Verschaffeltii, Queen Victoria and Eldorado, Tradescantia
Salvia Zurich, \$3.00 per 100, \$22.50 per 1000.
Hardy Chrysanthemums, 75 kinds, \$2.00 per 100; 1000 our selection 50 kinds \$18.50.

R. VINCENT, JR., & SONS CO., White Marsh, Md.

ORCHIDS=ORCHIDS=ORCHIDS

Now is Your Time to Buy Orchids

FOR THE

Great Orchid Exhibition of 1910

We Have Prize Winning Stock. Send for Prices.

JULIUS ROEHRS CO., Rutherford, N. J.

fear of contradiction that no work hitherto published has contained so much, so enlightening and so interesting information on the great economic, social and humanitarian topics inseparably connected with and dependent upon the mighty industry which we call American agriculture. The previous volumes have covered the questions one must consider in the choice, layout and organization of a farm, practical reviews of the crop products of the farm and a discussion of the animal products. All these are of the highest value to the agriculturist and in their usefulness are practically inseparable but the volume now issued is really perfect in itself and is full of information of much interest and value to many to whom the previous volumes would not appeal directly. It will be no mistake, therefore, for such to purchase Volume IV. as an independent work, complete in itself. The book can be supplied from the office of HORTICULTURE at publisher's price, \$5.00 net.

The annual Report of the U. S. Department of Agriculture for year ending June 30, 1908, has been issued. It is a volume of 862 pages filled with information on all topics relating to agriculture and so diversified that the reader, whoever he may be, and wherever his interest may lie, is sure to find something in it directly applicable to his own needs. The different bureaus and divisions are all represented by their special reports. It is interesting to learn from the report of the Chief of the Bureau of Plant Industry that the work of establishing the Easter lily bulb industry in southwestern California has made rapid and encouraging progress during the past year. One firm has three acres in cultivation and expect to have from fifteen to twenty acres during the coming season. It has been found that a marketable bulb can be raised in California in one year from

In ordering goods please add "I saw it in HORTICULTURE."

PANSY PLANTS Fine Plants ready to bloom, of my well known strain, \$2.50 per 100; large plants in bud and bloom, \$1.00 per 100, \$8.00 per 1000.
GERANIUMS, best kinds, double
PETUNIAS (Dreer's), VINCA var., **PARLOR IVY**, STOCKS, fine plants, 2 1/2 in., \$2.00 per 100; 300 for \$5.00.
CABBAGE PLANTS E. J. Wakefield, ready to plant out, \$1.25 per 1000; 5000 for \$5.00.

J. C. SCHMIDT, Bristol, Pa.

ORCHIDS Cattleya Mossiae

has arrived in first-class condition. We sell our plants at our store, 41 West 28th St., New York. Our PRICES are LOW and our STOCK is FIRST-CLASS. Write us for particulars and prices and by so doing you will be sure of the facts.

ORDONEZ BROS., Madison, N. J.

ORCHIDS

Cattleya Mendill arrive in May, Mossiae in June, Gaskelliana in August, Aurea and gigas Hardyana in October TRUE TO TYPE, NO GREEN USES. COLLECTED IN BLOOMING SEASON.

Dendrobium to arrive in April. Miltonia Vexillaria ready now, SPLENDID TYPE. Miltonia Roez III in October. DIRECT TO YOU. Order Now.

G. L. FREEMAN, 388 Appleton St., Holyoke, Mass.

ORCHIDS

Largest Importers, Exporters, Growers and Hybridists in the World

Sander, St. Albans, England and 235 Broadway, Room 1 NEW YORK CITY

the date of setting out the small seedlings.

Vol. 6, No. 20, Bulletin of the New York Botanical Garden has been issued, under date of March 22, 1909. It contains the annual report of the officers in the different departments, schedule of expenditures and list of members. The report of Dr. Britton, Director-in-Chief, shows that noteworthy progress has been made during the year in the development of all departments of the Garden. The collections of living plants, herbarium specimens and books have been much increased. A part of the second series of public conservatories has been completed. The work of collecting plants in Tropical America has been continued and the educational work, such as lectures, scientific meetings, etc., has been carried on with gratifying results.

Annual Report of the Forestry Department of the City of Springfield, Mass., for 1908. W. F. Gale is City Forester of Springfield and this report shows that he is doing good work.

ORCHIDS

Just Arrived in Fine Condition the following East Indian Orchids

DENDROBIUM WARDIANUM, D. CRASSINODE, D. PRIMULINUM, D. THYSIFLORUM, AND D. CHRYSOTOXA. Others to follow.

WRITE FOR PRICES.

LAGER & HURRELL, Summit, N.J.

JUST ARRIVED

Fine Importation of

Oncidium ornithorrhynchum

Fine strong leafy plants.....\$1.50 each. \$13.00 doz
 Few specimens..... 2 50 "

JOSEPH A. MANDA, West Orange, N.J.

ORCHIDS

We are booking orders now for delivery early in the Spring on all commercial **CATELEYAS** and **NOVELTIES**. Our prices are right and our guarantee perfect. We sell only first-class goods.

CARRILLO & BALDWIN, Secaucus, N. J.

In ordering goods please add "I saw it in HORTICULTURE."

Telephone 759

WHERE QU

The reputation of always carrying the highest class of goods will assure success to any dealer **Whole**

Many More Orchids
Are Being Used and Sold
This Year
Than There Were
Last Year

Headquarters McMANUS

If You **Aspire** to Hold the Leading Position as a Florist in Your Town You Must Carry Orchids—Not as an Occasional Tid-bit—That might have Sufficed a Few Years Ago—but as a Daily Stock, as regular as Roses or Carnations. **REMEMBER** They Alone Open the Door to the Best Trade.



JAMES I

Wholesale Cut

42 WEST 28TH

Madison Square

QUALITY COUNTS

Wholesale or Retail

**"Give me but that and let the world rub;
There I'll Stick."**

There Will Be
Many More Used and Sold
Next Year
Than There Are
This Year

McMANUS Headquarters

I am the Largest Dealer in Orchids in America. Just Now, Cattleya Schroderae, Dendrobium Wardianum, and Nobile, Phalaenopsis, Oncidiums, Coelogynes and Cymbidiums are in.

Try An Assorted Box.

Also Finest Gardenias, Daisies, Lily of the Valley and Everything Rare and Choice.



McMANUS

Flower Specialist

111 W. 40th ST., NEW YORK



FOR "POT LUCK" TRY US...

HEWS STANDARD POTS

POT MAKERS FOR 140 YEARS
WORLDS LARGEST MANUFACTURERS

Pearson Street,
LONG ISLAND CITY, N. Y.

WRITE FOR CATALOGUE AND DISCOUNTS
A. H. HEWS & CO., Inc.
CAMBRIDGE, MASS.

452-460 No. Branch St.,
CHICAGO, ILL.

CATALOGUES RECEIVED.

W. H. Barrett, Adrian, Mich.—High Grade Tomato Seeds, 1909 Crop. Illustrated.

William Perry, Coolspring, Del.—Price List for Strawberry Plants. A good selection.

Charles W. Schneider, Little Silver, N. J.—List of Hardy Perennial Plants, Dahlias, Shrubs.

Hope Greenhouses, Providence, R. I. Folder of Flowers and Plants, with Easter Greetings.

L. D. Jackson, Los Angeles, Cal.—Folder of Trees, Shrubs, Roses, Palms, Hardy and Tender Plants.

Alonzo J. Bryan, Washington, N. J. Wholesale Price List of Pot Growth Flowering and Truck Garden Plants.

W. B. Whittier & Co., South Framingham, Mass.—Wholesale Trade List of Framingham Nurseries for Spring, 1909.

Guthrie-Lorenze Co., Des Moines, Ia. Seed Catalogue for 1909. Colored cover illustrations of garden vegetables.

B. Hammond Tracy, Wenham, Mass.—Cedar Acres Gladioli. A handsomely illustrated little publication with cover in colors.

Diggs & Beadles, Richmond, Va.—Seed Catalogue for 1909. Cover illus-

STANDARD FLOWER POTS

Packed in small crates, easy to handle.

	Price per crate		Price per crate
1500 2 1/2 in. pots in crate	\$4.38	144 6 in. pots in crate	\$3.16
1500 2 3/4 " " " "	5.25	1207 " " " "	3.00
1500 2 3/8 " " " "	6.00		
HAND MADE			
1000 3 " " " "	5.00	48 9 in. pots in crate	\$3.60
800 3 1/2 " " " "	5.80	48 10 " " " "	4.20
500 4 " " " "	4.50	24 11 " " " "	3.60
450 4 1/2 " " " "	5.74	24 12 " " " "	4.80
320 5 " " " "	4.51	12 14 " " " "	4.50
210 5 1/2 " " " "	3.78	6 16 " " " "	4.50

Send pans, same price as pots. Send for price list of Cylinders for Cut flowers, Hanging Baskets, Lawn Vases, etc. Ten per cent. off for cash with order. Address **Hilfinger Bros., Pottery, Fort Edward, N. Y.** August Roiker & Sons, Agts. 31 Barclay St., N. Y. City.

Standard Flower.. POTS

If your greenhouses are within five miles of the Capital, write us, we can save you money

W. H. ERNEST

28th and M Street WASHINGTON D. C.

Syracuse Red Pots
STANDARD SIZES

Florists, we will suit you as to quality and prices. Write for catalogue.

Syracuse Pottery Co., SYRACUSE, N. Y.

trations of vegetables and nasturtiums in colors.

M. Crawford Company, Cuyahoga Falls, Ohio.—1909 Catalogue of Strawberry Plants. Contains excellent cultural notes.

I. N. Kramer & Son, Cedar Rapids, Ia.—General Catalogue for 1909 of Seeds, Bulbs, Plants and Garden Implements. Illustrated.

George H. Walker, North Dighton, Mass.—Price List of Dahlias for 1909. Includes many of the finest novelties offered for the first time.

M. E. Chandler, Elmhurst Nursery, Argentine, Kansas.—Spring Catalogue of Hardy Perennials, Ornamental Trees and Shrubs, Small Fruits, etc.

Wm. Toole & Sons, Baraboo, Wis.—Guide to Pansy Culture. This is a catalogue of choice pansy seeds and plants, shabby and decorative plants.

D. Hill, Dundee, Ill.—Catalogue and Planting Guide of Evergreens and General Nursery Stock for 1909. Also Wholesale Price List of Ornamentals.

Andorra Nurseries, Chestnut Hill, Philadelphia, Pa.—Price List of Specimen Trees, Shrubs, Roses and Fruit for Spring, 1909. An extensive and useful list.

F. H. Ebeling, Syracuse, N. Y.—General Catalogue of Seeds, Bulbs and Garden Implements. Cover handsomely illustrated with lantanas in colors and garden vegetables.

Clintou Falls Nursery Co., Owatonna, Minn.—Illustrated Price List of Fruit and Ornamental Nursery Stock, Hardy Border Plants, etc. Also Catalogue of Farm, Field, Lawn and Garden Seeds.

Metairie Ridge Nursery Co., New Orleans, La.—General Catalogue. With rich cover in colors and gold and finely illustrated, especially in department showing styles of bridal and other bouquets.

Kersbergen Brothers, Boskoop, Holland.—Wholesale Trade List for Fall 1909 and Spring 1910. Includes a colored plate of Polyantha rose Boskoop Baby, a cross between Mme. Norbert Levasseur and Euprosiue.

Eastern Nurseries, Jamaica Plain, Mass.—Price List of Hardy Trees, Shrubs and Vines. Also Wholesale Trade List. Both of these lists are very comprehensive, embracing the finest of the new as well as the old hardy ornamental shrubs.

George Hollis, South Weymouth, Mass.—List of Choice Peonies. Two

very handsome portraits are given of Beauty's Mask and Lucy E. Hollis, both seedlings of Mr. Hollis' raising, which have received merited recognition in recent peony exhibitions.

Durand & Marohn, Albany Wire Works, Albany, N. Y.—Illustrated catalogue of wire work and wire designs of every description for florists' use. This concern, established for 47 years, is recognized as making staple goods, artistic in design and well constructed.

Howard & Smith, Los Angeles, Cal.—General Catalogue for Flowering, Bulbous and Decorative Plants. This is a catalogue quite out of the ordinary in typographical beauty and the half tone illustrations are second to none we have seen in publications of this character. Delphinium Belladonna hybrids and Bougainvillea spectabilis are chosen as cover adornments.

Bobbinck & Atkins, Rutherford, N. J.—General Catalogue of Ornamental Deciduous and Evergreen Nursery Stock, Small Fruits, Trained Fruit Trees, Hardy Herbaceous Plants, etc.—This is a very handsome and complete publication, creditable to the enterprising firm who send it out. The cover is tasteful and artistic and illustrations are excellent throughout.

DAHLIA CLUMPS

Four Varieties

\$4.00 per 100
**Miller Red, Bird of Passage,
Arabella and Pompon White**

From a satisfied customer:—

"I am offered elegant Dahlias at three cents, but your stock last year was nice and I am going to give you the preference."

GEORGE B. HART,

24 STONE ST., ROCHESTER, N. Y.

DAHLIAS

Three new Cactus Seedlings.

Also all the latest European Novelties.

SEND FOR CATALOG.

WM. H. RICHARDSON, New Bedford, Mass.

Dreer Special Offer OF Hardy Perennials

NEW OR LITTLE KNOWN VARIETIES WORTHY OF SPECIAL ATTENTION



TROLLIUS (Globe Flower)

PRIMULA CORTUSOIDES SIEBOLDI. These are not so well known as they deserve; they are of free, vigorous growth, and can be flowered in pots in early spring, and respond quickly to forcing when placed in a temperature of 30 degrees, forming pretty pot plants in a short time, making excellent window plants, which meet with ready sale when in bloom.
We offer six distinct varieties, from pure white to the deepest rose in color, \$1.50 per doz.; \$10.00 per 100.

RUDBECKIA RAYS OF GOLD. In this new variety we have a refined form of the popular "Golden Glow," to which it is identical in color, habit, etc., but the flowers have narrower petals, full to the centre, forming a perfect ball of gold, \$1.50 per doz.; \$10.00 per 100.

ANCHUSA ITALICA DROPMORE VARIETY. A grand improvement on the type, with intense deep blue flowers, \$2.00 per doz.; \$15.00 per 100.
ANTHERICUM LILIASTRUM GIGANTEUM. A giant form of the N. Frumilly with very large white flowers, \$1.50 per doz.; \$10.00 per 100.
AQUILEGIA HELENAE. One of the best of the Columbinæ, large pretty blue flowers, with large white corolla, \$1.25 cts. per doz.; \$8.00 per 100.
CAMPANULA PERSICIFOLIA HUMOSA. A very large semi-double form of the peach-leaved Campanula, flowers of a pleasing shade of blue, \$1.50 per doz.; \$10.00 per 100.
DELPHINIUM GOLD MEDAL HYBRIDS. The finest strain ever offered in mixed varieties, \$1.25 per doz.; \$8.00 per 100.
DELPHINIUM BELLADONNA. The freest flowering of all Delphiniums, it is over out of bloom, beautiful turquoise blue, \$2.00 per doz.; \$15.00 per 100.
FUNKIA ROBUSTA ELEGANS VARIEGATA. A decided improvement on all variegated forms, \$1.50 per doz.; \$10.00 per 100.
HELENIUM RIVERTON GEM. A new variety that originated on our trial grounds. Flowers old gold, suffused with bright terra cotta, changing as they mature to a wallflower-red, \$1.50 per doz.; \$10.00 per 100.
HELENIUM RIVERTON BEAUTY. Another variety which originated with us, quite distinct in color, which is lemon-yellow, with a large disc of purplish-black, \$1.50 per doz.; \$10.00 per 100.
HELIANTHUS SPARSIFOLIUS. The most desirable of all the hardy sunflowers, especially valuable as a cut flower, 85 cts. per doz.; \$6.00 per 100.
FOUR VALUABLE HEMEROCALIS. The four varieties here offered are great improvements upon the well-known Yellow Day Lilies.

Aurantiaca. Very large, bright, orange-yellow, sweet-scented flowers, 15 cts. each; \$1.50 per doz.
Aurantiaca Major. Large trumpet-shaped, sweet-scented, deep orange flowers. Requires protection, 35 cts. each; \$3.50 per doz.
Florham. Large golden-yellow sweet-scented flowers; very free flowering 15 cts. each; \$1.50 per doz.; \$10.00 per 100.
Cold Dust. Large golden-yellow flowers, 15 cts. each; \$1.50 per doz.
INCARVILLEA DELAVAYI. Popularly known as the hardy Gloxinia; extra strong roots, \$2.00 per doz.; \$15.00 per 100.
IRIS PALLIDA DALMATICA FOLIA VARIEGATA. A strikingly handsome variegated leaved form of this beautiful blue Iris, 35 cts. each; \$3.50 per doz.
GYPSOPHILLA PANICULATA FLORE PLENA. This is a perfect gem and a summer cut-flower invaluable. We have a large stock of strong roots to offer this season, \$2.00 per doz.; \$15.00 per 100.
LUPINUS POLYPHYLLUS ROSEUS. This is a most attractive rosy pink form of Lupines, producing gigantic spikes of flowers, \$2.00 per doz.; \$15.00 per 100.
PENSTEMON GENTIANOIDES SENSATION. Gloxinia-like flowers in a variety of bright colors, including red, cherry, crimson, purple, blue, etc. For bedding they rival Phloxes, Petunias, etc. Not quite hardy, 3-inch pots, \$1.00 per doz.; \$7.00 per 100.
STOKESIA CYANEA ALBA. A white form of the popular blue Stokesia, equally valuable and a desirable addition; strong plants, \$1.25 per doz.; \$8.00 per 100.
CHOICE NEW TROLLIUS. (New Globe Flowers.) The five varieties listed below are decided improvements on all sorts heretofore offered; of exceptional large size and good, rich colors.
Gotterfunke. Large open orange-yellow flowers.
Helios. Very free flowering, pure yellow, on strong branched stems.
Leuchtkugel. One of the finest deep orange reds.
Lichtball. Large, globular orange-yellow flowers on stiff stems.
Salamander. Soft orange-colored flowers of globular form, 25 cts. each; \$3.50 per doz. The set of 5 for \$15.00

HENRY A. DREER, 714 Chestnut Street, Philadelphia, Pa.

The Northboro Dahlia and Gladiolus Gardens

Offer for Spring 1909

300 selected varieties of Dahlias and one and one half million large-flowering Gladioli in mixtures, 10 lots to suit. Send list of your wants. Catalogue free.

J. L. MOORE, Northboro, Mass.

DAHLIAS. Now is the time to place your order for bulbs which will insure you getting named varieties in any quantity; prompt delivery.

DAVID HERBERT & SON,
Successors to L. K. Peacock, Inc.
ATCO, N.J.

NEW CREATIONS IN DAHLIAS

Jack Rose, Virginia Maule, Ethel Schmidt, Sensation, Big Chief, Gladys, Rose Pink Century, Fringed 20th Century, Fringed Beauty. 50 cts. each, \$5.00 per doz., \$35.00 per 100. Strong plants now ready.

PRINCESS VICTORIA. \$1.00 each, \$10.00 per doz., strong plants. A superb collection of new Cactus Dahlias. Send for new descriptive catalogue.

Peacock Dahlia Farms, Wilmington Junction, N.J.

Prices Quoted in these columns are for Dealers Only. When writing to Advertisers please mention HORTICULTURE

PREPARE FOR EASTER

Headquarters for Easter Plants

Have LILIES

To Burn, To Burn, To Burn
The best in the land, the best in the land, the best in the land.

AZALEAS

To beat the band, To beat the band, To beat the band

What is the best Double Pink Azalea? It is the Mme. Van Der Cruyssen, originated by the well-known Azalea Specialist, M. Van Der Cruyssen of Belgium. We have a big stock of them; every plant is as good as an apple, just covered with buds; just right for Easter. We have them for 60c, 75c, \$1.00, \$1.25, \$1.50 up to \$2.00 each. Bernard Andreas alba, \$1.25 to \$2.00; some at \$1.00 to \$1.50. Niche and Deutchle Herle, 75c, \$1.00, \$1.25, \$1.50. Yervaeuana, De Nohryeriana (best double variegated), 75c, \$1.00, \$1.25, \$1.50, \$2.00. Empress of India, 50c, 60c, 75c, \$1.00, \$1.25, \$1.50. Simon Marler, 50c, 60c, 75c, \$1.00, \$1.25, \$1.50, \$1.75. Apollo (red), 50c, 60c, 75c, \$1.00. Professor Wolters, 75c, \$1.00, \$1.25, \$1.50, and some more good varieties, 75c, \$1.00, \$1.25, \$1.50. We have Azaleas by the thousands.

Lilium Nuttillorum, the best in America, 6 in. pot plants, height, 20-25-30 inch and over, with five buds and upwards to ten buds, 10c per bud; under five buds, 12c per bud.

Cineraria hybrida grandiflora. Henry F. Mitchell's newest improved strain. Our plants this year are very large, big Heads of Flowers, perfect foliage, and the plants are almost as big as a bushel basket. 6 in., 25c, 35c, 50c, 75c, \$1.00.

Hydrangea Otakasa, 6 to 7 in. pots, 50c, 75c, \$1.00, \$1.25, \$1.50, \$2.00. **Empress of India**, 50c, 60c, 75c, \$1.00, \$1.25, \$1.50. **Simon Marler**, 50c, 60c, 75c, \$1.00, \$1.25, \$1.50, \$1.75. **Araucaria Excelsa** largest stock in America, 6 in., 4-5-6-7 tiers, 2-25-30-35 inches high, 75c, \$1.00, \$1.25 to 1.50.

Araucaria Robusta Compacta and Glauca, 6-7-8 in. pots, 20 to 35 inches high, 4, 5, 6 tiers, \$1.50, \$2.00, \$3.00.

Kentia Belmoreana, 5/8 to 5/2 in. pots, 50c, 60c, 75c. **Forsteriana**, 5/8, 5/4, 6 in. pots, 50c, 60c, 75c, \$1.00, \$1.25, \$1.50.

Ficus Elastica, 5/4, 5/2, 6 in., 25c, 35c, 50c. **Begonia**, New Improved Erfordii, a constant bloomer, 5/2 in. pots, \$2.00 per doz.

Primula Obconica, full of buds and flowers, 5 to 5 1/2 in. pots, \$2.50 to \$3.00 per doz.

Asparagus Plumosus, 3 to 5 cents.

Ferns, 6, 7, 8 inch, such as **Whitmanii**, Boston, Scottii, 50c, 75c, \$1.00, \$1.25, \$1.50; **Amerphobii**, 5 to 6 in., 50c, 75c.

Hybrid Rose Bushes, John Laing, Brunner, Hermosa, and other good sorts, 6 in. pots, 30 inches high, very strong, 50c, 75c, \$1.00.

Crimson Rambler, newest sorts, 5/2 to 6 in. pots, 50 to 75c.

Hyacinths, four best varieties, white, pink, light and dark blue, 4 in. pots, \$1.00 per 100.

Touneouel Tulips, this is the best double variegated tulip in existence, three buds planted in a 4 in. pot, \$1.50 per dozen pots.

Van Sion Daffodils. Best double yellow daffodil in existence. Three double-nosed bulbs planted in one pot, 5/2 to 6 in. pots, \$2.50 to \$3.00 per doz. pots.

All our bulbs are our own importation and are not to be compared with the cheap stuff flooding the market

Gash with order please. Mention if pots are wanted
GODFREY ASCHMANN
Wholesale Grower and Importer of Pot Plants
1012 W. Ontario St.
PHILADELPHIA, PENNA.

CULTURE OF ASPARAGUS PLUMOSUS.

The following article is a synopsis of the experience of many growers and has been edited by Charles E. Meehan, one of the most extensive growers of the Philadelphia market.

There are various species and varieties of asparagus grown for ornamental purposes. The commonest of all is the smilax (*Asparagus Medeoloides*), which has been grown by florists for generations.

Asparagus plumosus has also been grown for many years, and *Asparagus Sprengeri* is another well-known subject. The best of all, *Asparagus plumosus nanus*, is not a dwarf variety, as its name would imply, but is distinguished chiefly by the fullness and flatness of its fronds, so that the botanical name is largely a misnomer. The variety itself is very distinct indeed, and great care should be taken (in buying seeds) that the genuine *nanus* is procured.

Many other highly well-ported people are ignorant of the vast difference. The new crop seeds are usually ready in January, and as soon thereafter as convenient they may be sown. The variety is a shy seeder. In a whole house there may be only a few seed-bearing strings. Growers should, therefore, fight shy of cheap offers in this connection, as the true *nanus* cannot be sold cheap.

Any good rich soil, covered with a little sand, will do to start the seed in. The temperature should be about 65 deg., and as nearly constant as possible.

When the plant is well-rooted transplant to a deeper soil, or into a three-inch pot. In its young stage the plant is salable for filling ferneries and like purposes, and when a year old should be planted into solid beds for string development. It is usually grown in solid beds and should have perfect drainage. This matter of drainage is one of the most important points. It will not prove a profitable subject unless it has good drainage. Lay the bed carefully with rocks at the bottom so that the water can escape freely. Over this put a compost of heavy loam, leaf mould, and well-rooted cow manure. The plant is a heavy feeder and one-fifth of cow manure is not too much.

A well-lighted house is not essential, although better results can be obtained where conditions are modern and ideal. If there be height enough to run the strings up to seven or eight feet, the crop can be grown fairly well. Set the plants about eight inches apart and ten inches between the rows. Frequent

BARGAIN SALE IN ERICAS, ETC.

For Immediate Delivery, to make room.

- BORONIA elatior, pink, in 4-in. pots, \$15.00 per 100.
- EPACRIS alba, white, 3/4-in. pots, \$10.00 per 100.
- ERICA persoluta rubra, 3/4-in. pots, \$10.00 per 100.

CHRISTMAS VARIETIES FOR GROWING ON

- ERICA melanthera from 5-in. pots, \$15.00 per 100.
- ERICA regemiriana, 3-in. pots, \$8.00 per 100.

The above prices are net cash, with order. No charges for packing.

BOXWOOD

FOR HOTEL AND VASE WORK

- 12-in. high, 6 in. pots,\$25.00 per 100
- 15 in. " " 7-in. "50.00 " "
- 16 in. " " 7-in. "75.00 " "
- 18 in. " " 8 in. "100.00 " "

Also PYRAMIDS \$3.00, \$4.00, \$5.00, \$6.00 to \$8.00 a Pair.

ANTON SCHULTHEIS

Florist

COLLEGE POINT. - L. I.

syrringing is necessary to keep down red spider and other insect enemies. The strings should run from horizontal wires, one set at the bottom of the bed and the other on the roof of the house. The strings should be green, so as to harmonize with the foliage when cut. Meyer's Silkkaine in various sizes is the best.

When the plant is well established it is not only the leader that is profitable, but the young sprays can be taken from the bottom and sold without injuring the plant.

As soon as the first crop is cut new strings are put in and another crop started. This goes on year after year, and as the plant gets older it becomes more vigorous and profitable for eight or ten years. After that time it is desirable to take up the plants and fill up the bed with fresh soil and manure.

The houses must be shaded from the hot sun as soon as bright weather commences in the spring. White lead, whitening and kerosene oil is the mixture generally used. In many places the cut worm has been a serious pest in asparagus culture, and about the only remedy is to pick them during the night, as they generally take shelter under the thick foliage during the day. The late William Scott said tersely:

"More and more every year do I see the great usefulness of a bed of *Plumosis* in a retail establishment. We would be lost without it. Don't attempt to grow it on a bench. Give it a foot of good soil on top of mother earth. Like all its family it likes plenty of manure."

Don't forget that all the *Asparagus* family are gross feeders. Top dress frequently—at least once or twice in a season. Beds should be four feet wide with two-foot walks between, so as to give convenience for stringing and training.

EASTER PLANTS

Lilies, Azaleas, Hydrangeas, Ramblers
Spiraeas, Geraniums

Shrubs and Bedding Plants

CHRYSANTHEMUM CUTTINGS READY

All Best Varieties

Come and see us, or send list of your wants and we will make price quotations.

WM. W. EDGAR CO., Waverley, Mass.

YOU ARE INVITED TO CALL AND INSPECT OUR

EASTER STOCK

A few of our leading specialties are mentioned below. The late Easter and the fine weather have helped this year's stock is in fine shipping condition.

Send for Price List

MRS. CUTBUSH (New) Pink Baby Rambler
This is a good one, in 6-inch pots at \$6 and \$9 per doz.

BABY DOROTHY (New)
Pink Baby Rambler very similar to Mrs. Cutbush.

5-inch pots at \$6 per doz.; 6-inch pots at \$9 per doz.

HYBRID ROSES

We have an unusually large stock of Hybrids which will be just right for Easter; all the best varieties, including Richmond, Frau Karl Druschki, La France, Mrs. John Laing, Tom Wood, Kilbarney, etc., at \$6 and \$9 per doz. **MAGN. CHIEF**, a very fine at \$9, \$12, \$15 and \$18 per doz.

HYDRANGEAS

The largest and finest stock of this grand Easter plant that we have ever grown at \$5, \$6, \$9 and \$12 per doz. Larger plants at \$1.50, \$2, \$2.50, \$3, \$4 and \$5 each.

RHODODENDRONS

Simply, well-budded plants, including all the best varieties at \$1.50, \$2, \$2.50, \$3, \$3.50 and \$4 each. A few larger plants at \$5 each.

RHODODENDRON PINK PEARL (New)

The most beautiful of all the Rhododendrons at \$2.50, \$3 and \$3.50 each.

BOUGAINVILLEA GLABRA SANDERIANA
Magnificent plants, exceptionally well flowered at \$3.50, \$4, \$5, \$6, \$7.50 and \$10 each.

LILACS

Very fine plants, 6-inch to 8-inch pots at \$2, \$2.50 and \$3 each.

GENISTAS
A grand stock, grown cool and just right for Easter at \$2, \$3, \$4, \$5, \$6 and \$9 per doz. Larger plants at \$2, \$2.50, \$3, \$4, \$5 and \$6 each.

SPIREA GLADSTONE

Our stock is in superb condition. 6-inch pots at \$5.00 each; 7-inch pots at \$7.75 each; 8-inch pots, made up, at \$1 each; 9 and 10-inch pots, made up, at \$1.50 and \$2 each.

PINK SPIREA

Queen Alexandra, very beautiful. 6-inch pots at \$9 per doz.

DOUBLE DAISY, Queen Alexandra
Well grown and well flowered.

3-inch pots at \$1.50 per doz.; 4-inch pots at \$2.50 per doz.; 5-inch pots at \$4 per doz.; 6-inch pots, very fine, at \$6, \$9 and \$12 per doz.

LILIES

Our stock is exceptionally good this year. Plants with from 4 to 8 blooms at 12 cents per bloom; made-up ones with from 12 to 25 blooms at 12 cents per bloom; plants with less than 4 blooms at 15 cents per bloom.

AZALEAS

We have the largest and finest stock of Azaleas we have ever had, including Vander Cruyce, Vervaeckera, Emp. of India, Emp. of Brazil, Nobe, Bernard Andica Alba, Prof. Wolters, etc., etc., at \$75, \$1, \$1.25, \$1.50, \$2, \$2.50, \$3, \$3.50, \$4, \$5, \$6, \$7.50 and \$10 each. A few larger specimen plants at \$12.50 and \$15 each. Pyramid Azaleas, very fine, at \$3, \$3.50 and \$4 each. Small Azaleas for Basket Work at \$3 and \$4 per doz.

CRIMSON RAMBLER ROSES
These plants are unusually fine and will be just right for Easter. 6-inch and 7-inch pots at \$1, \$1.25 and \$1.50 each; 5-inch pots at \$2 and \$2.50 each; plants trained in fan and globular shapes, extra fine, at \$2, \$2.50, \$3, \$3.50, \$4, \$5 and \$6 each; a few larger plants at \$7.50 each.

PINK RAMBLER ROSES

Lady Gay and Dorothy Perkins
In great condition; trained into Fan, Globular and Pyramidal Shapes at \$1.25, \$1.50, \$2, \$2.50, \$3, \$3.50 and \$4 each. Special Ball Shapes at \$1.50, \$2 and \$2.50 each. Special Wire Fan Shapes at \$5 each.

TAUSENDOSCHON (New) "Thousand Beauties"
This was our finest climber last Easter and this year the plants are still better. We cannot recommend the Tausendoschon Rambler too highly. Strong plants in 6-inch and 7-inch pots at \$1, \$1.25 and \$1.50 each. Trained plants, Fan, Globular and Pyramidal Shapes, at \$2, \$2.50, \$3, \$3.50, \$4 and \$5 each.

BABY RAMBLE NDARDS

Exceptionally fine plants, 3 to 5 foot stems, at \$1, \$1.25, \$1.50, \$2 and \$2.50 each.

WHITE BABY RAMBLER STANDARDS
At \$1, \$1.25 and \$1.50 each.

STANDARD DOUBLE-BUDDED WHITE and RED BABY RAMBLER ON SAME PLANT
At \$1.50 each.

BABY RAMBLERS

Good, strong stock, well flowered, at \$3, \$6 and \$9 per doz.

WHITE BABY RAMBLERS

Very strong plants, well flowered, 6-inch pots, at \$9 per doz.

ROBERT CRAIG CO., Forty-ninth and Market Sts., Phila., Pa

BARGAINS IN DECORATIVE AND FOLIAGE PLANTS
KENTIAS, ARECAS, LATANIAS, in all sizes in the very best condition.
ARAUCARIAS, RUBBERS, CROTONS, PANDANUSES, ASPARAGUS, COCOS, FERNS for dishes, etc.
EASTER STOCK and BEDDING PLANTS at lowest wholesale rates.
A. LEUTHY & CO.
perkins St. Nurseries, Roslindale Mass.

Palms Ferns
Wittbold
Shrubs Perennials
FLORIST
Send for Our Catalogue.
The GEO. WITTBOLD CO., 1657 Buckingham Place, Chicago, Ill.

FERNS FOR DISHES, Assorted Varieties
From 2 inch pots, \$3.50 per 100; \$30.00 per 1000
FRANK OEGHSLIN
CASH WITH ORDER
2670 to 2606 W. Adams St., Chicago, Ill.

COLEUS! COLEUS!
C. Verschaffeltii and Golden Bedder, - - - R. C. .60 5.00
Same in 2 1/2 in. pots - - - 2.00 15.00
Coleus, mixed - - - R. C. .60 5.00
Same in 2 1/2 in. pots - - - 1.75 15.00
Ageratum Stella Gurney and Pauline - - - R. C. .50 4.50
Same in 2 1/2 in. pots - - - 1.00 9.00
Feverfew - - - in 2 1/2 in. pots 2.00
Fuchsias, our selection - - - R. C. 3.00
German Ivy - - - in 2 1/2 in. pots .75
English Ivy - - - R. C. 1.00
Cash with Order
J. E. FELTHOUSEN
148-154 Van Frankan Ave., SCHENECTADY, N. Y.

PALMS AND FERNS
DECORATIVE PLANTS
JOHN SCOTT
Rutland Road and E. 45th St.
Tel. 889 Bedford BROOKLYN, N. Y.

ROBERT CRAIG CO.
ROSES, PALMS,
and Novelties in Decorative Plants
MARKET and 49th STREETS., PHILADELPHIA, PA.

Ampelopsis Veitchii, 4 in. pots, \$10 per 100; 3 in. pots, \$5 per 100. **Ferns, Boston**, 4 in. pots; \$10.00 per 100; Boston, 2 in. pots, \$3.00 per 100. **Asparagus sprengeri**, 2 in. pots, \$2.00 per 100. **Canna King Humbert**, \$5.00 per 100. **Clematis paniculata**, 4 in. pots, \$10.00 per 100; 3 in. pots, \$5.00 per 100. **Clematis**, large flowering varieties, 2 years old, dormant plants; Jackman, Henry, Andre, \$5.00 per 100. **Ficus Elastica**, 6 in. pots, 25c. each.
Carnations R. C. from soil, Enchantress, Dorothy, Robert Craig, Elbon, Flora Hill, B. Market, \$2.00 per 100; Winsor, \$3.00 per 100. **Geraniums**, standard varieties from 3 in. pots, \$4.00 per 100; 4 in. pots, \$6.00 per 100.
C. EISELE
11th and Westmoreland Streets, PHILADELPHIA, PA.

NEPHROLEPIS MAGNIFICA
THE SENSATIONAL NOVELTY
Strong 2 1/2-in. stock, \$25.00 per 100.
WHITMANII
2 1/2-in., \$46.00 per 1000; 3 1/2-in., from Bench, \$8.00 per 100.
H. H. BARROWS & SON, WHITMAN, MASS.

ROSES FOR EASTER
Crimson and Pink Ramblers
75c to \$5.00 Each.
THOMAS ROLAND, NAHANT, MASS.

JAPANESE
THE YOKOHAMA NURSERY CO. NEW YORK.
LILIES
PLANTS
BAMBOO STAKES

WHAT THE EXPERIMENT STATIONS ARE DOING FOR THE CARNATION GROWER.

Read before the American Carnation Society at Indianapolis by H. B. Dornier.

During the past fifteen years the continually increasing demand for carnations has necessarily led to an increase in the greenhouse space devoted to the cultivation of this plant. With this increase many new and perplexing problems have been forced upon us. There is hardly a plant that has more diseases and insect pests affecting it.

In those states where many carnations are grown the experiment stations have attempted, from time to time, to solve some of these problems. The results of these studies have been published in bulletins and reports of the stations.

Most of the work in the past has been done on a small scale with just a few plants, and the results, to a certain degree, are rather indefinite. Today it is realized, that to have results comparable with commercial work, one must carry on these experiments on a commercial scale. Many of the stations are now building or have built greenhouses which are devoted entirely to special floricultural crops.

In looking over the work done by the various stations one finds that the problems of ten or fifteen years ago are not altogether the problems of today. Some of the earliest work on the carnation was on rust and its prevention and destruction. At that time the carnations were not rust-resistant and were easily affected. Since those days the varieties sent out each year have been more resistant each year until today the rust is not the enemy that it formerly was. No chemical has been found as yet that will eradicate it, and its disappearance is due to a change in the constitution of the host. Its worst days are over.

Stem-rot has been discussed time and time again, but no effective method has been devised for its destruction. Its disappearance will also follow on the breeding of resistant varieties.

The questions of today then seem to be along the line of carnation breeding, methods for the prevention and destruction of insect enemies and problems of nutrition, or, in other words, the proper use of fertilizers.

In order to secure the necessary data for this paper, the writer sent a letter to the director of each agricultural experiment station in the United States requesting such information as could be given regarding results that have been published and also the work which is being carried on at the present time.

No attempt shall be made to discuss the work of the stations in detail, but to give a brief resume of what has been done and what they are doing at present.

The requirements of the carnation naturally prohibit its being grown in certain parts of the country, and so many stations carry on no work along this line. This includes most of the states south of the Mason and Dixon line, and also many of the western states. Replies have been received to

most of these, but the report is naturally incomplete as some have failed to answer. In addition to this information data was secured from an examination of the literature published.

It will be found that most work has been done by the stations of those states which may be called carnation centers. The troubles of the carnation growers were important enough to occupy a part of their time.

Among the stations from which replies have been received are a number where no work has been done. This is not due to a lack of interest but because very few, if any, carnations are grown in the state, and so time and funds have been expended on other crops. Among these are the following southern and western states: New Mexico, California, Louisiana, West Virginia, Alabama, Utah, Montana, Wyoming, Kentucky, Maine, Minnesota and North Dakota also have done nothing along this line.

Florida has attempted to grow carnations but found that northern varieties all failed in the south. The variety Augusta was sent out from there as the only variety suitable for the state. South Carolina grows a few carnations but has carried on no experiments, as there are few floral establishments in the state. In North Carolina the work has been recent and some time has been devoted to root-knot of carnations. Virginia has done nothing but expects to take up work in floriculture in the near future.

Pennsylvania has also done nothing but expects to take up some carnation work as soon as new houses are finished. Ohio has done a little on sub-irrigation and crossing but has published nothing. Michigan has done nothing, due to lack of equipment. Wisconsin has no facilities at present, but floricultural work will begin as soon as new houses are completed. Iowa grows a few plants for class work but has given them no attention as a crop. Kansas has done some work on control of rust but has published nothing. Missouri has confined her work entirely to practical methods of preventing rust and suggests use of dry Bordeaux mixture. In Oregon a little work has been done but no data published. In Washington only a few carnations are grown for class work. Commercially few carnations are planted; time and space being devoted to roses.

Thus far the report shows that there are some stations in carnation growing sections at which floricultural work would be carried on if they had the proper equipment and funds. Several of these have greenhouses under construction and will take up this line of work in the near future. There are, however, a number of stations at which much work has been done with the carnation and where still more is being done.

At the New Hampshire station the following problems are now under consideration:

1. "A test of the value of farm manures judiciously used in the compost heap, as a means of improving the growth of plants, size and other points of excellence in the flower."

2. "A test of the value of commercial fertilizers applied as a top dressing to carnation benches."

3. "How to account for the earliness and free flowering of carnations,

the theory being worked out in seedlings."

4. "Pot culture of carnations during summer months in cold frames compared to field culture."

5. "House culture of carnations compared to outside culture."

6. "Suitable soils for winter culture of carnations."

7. "Inheritance of color in carnations."

New Hampshire has devoted to this work at present time 2500 square feet of glass.

In Vermont Mr. Stuart has done some interesting work on crossing carnations, the results of which appear in the 20th annual report of the station. The work consists of a study of seasonal influence in crossing relative to seed production in which Mr. Stuart arrives at the conclusion that early crosses are most successful, giving a higher percentage of successes, a larger number of seeds and a higher percentage of germination. Some attention has also been given to Mendelian inheritance in the carnation with respect to the unit characters of single and double. He finds that the law holds good in the case of the carnation.

In Massachusetts some work has been done at both stations. At the Hatch station two bulletins have been published. Number 10 deals with fertilizers for carnations and Number 80 gives directions for spraying. The 17th report gives some notes on soil sterilization and the 14th some notes on stem-rot. In the reports of the state station are found notes on stem-rot and analyses of carnations.

In bulletin 128 the Rhode Island station gives the results of soil treatment in culture of carnations. At present a fifty-foot house is devoted to experiments on the effect of various kinds of physical and chemical soil treatment upon carnation growth. This is now only in its second season and nothing has been published as yet.

Connecticut has issued various notes on results of experiments with carnation diseases, effect of lime on development and the use of commercial fertilizers. These have been published in the station reports of 1896, 1897, 1899, 1900 and 1906.

At the Cornell station the carnation has been used in various experiments as crossing, influence of electric and acetylene light, influence of fertilizers on vegetative parts and on vigor, quantity and viability of pollen. Records have been made of work but not printed as yet.

At the State station at Geneva some very comprehensive work has been done. The latest bulletin published (Technical Bulletin No. 7) contains the results of a very careful study of the bud-rot, its causes and control. In addition to this publication the following bulletins have also been issued: No. 100 on methods of "Combating Carnation Rust"; No. 128, "Effects of Common Salt on the Growth of Carnations and Carnation Rust"; No. 164, on "Leaf Spot"; No. 175, "A Parasite upon Carnation Rust"; No. 186 contains notes on stem-rot.

In New Jersey investigations have recently been taken up. At the present time a study is being made of the physical condition of the redshale soil using various proportions of sand and organic matter.

In Bulletin 127 the Maryland station

AZALEAS

\$0.75, \$1.00, \$1.25, \$1.50, \$1.75, \$2.00, \$2.50, \$4.00, \$5.00, \$6.00, \$8.00, \$15.00 each.

BABY AZALEAS for Basket Work \$4.00 per doz.

RAMBLERS

\$0.75, \$1.00, \$1.50, \$2.00, \$2.50. BABY RAMBLERS, TAUSENDSCHONS and HERMOSAS at lowest rates.

SPIREAS

\$4.00, \$5.00, \$6.00 per dozen. GLADSTONE \$9.00, \$12.00 per dozen; PINK \$9.00 and \$12.00 per dozen.

BOUGAINVILLEAS

\$4.00, \$5.00, \$7.50, \$15.00 and \$20.00 each.

DEUTZIAS

6, 7, 8, 10 inch; \$0.75, \$1.00, \$1.20, \$1.75 each.

HYBRID ROSES

6 inch, \$4.00, \$5.00, \$6.00, \$9.00 per doz.

POT LILIES

per bud and flower 15c; plants with 5 blooms or less 17c.

CUT LILIES

\$2.00 per doz.; \$15.00 per 100.

HYDRANGEAS

\$0.75, \$1.00, \$1.25, \$1.50, \$2.00, \$2.50, \$5.00.

CROTONS

\$0.50, \$0.75, \$1.00.

GOLD and SILVER MAPLES

\$3.00, \$4.00 and \$5.00 each.

Cut Flowers

Finest long stemmed Killarneys, Richmonds, Jardines, Bridesmaids, and Beauties for Easter. All other popular flowers of the best quality. Price List on request.

Easter Plants

Special Offer For 1909

WE have for this Easter the finest lot of Easter plants we have ever handled. The late Easter and fine weather have enabled our growers to get their stock in perfection without undue forcing, so that everything is well hardened off and in prime shipping condition. Don't be misled about

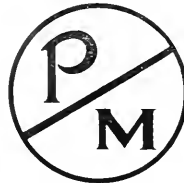

QUALITY

the lily situation. We have sized things up and know that good stock is worth 15 cents this year. We will not sell a bloom (in any quantity however large) for less. Place your orders early. Lilies ship best if not too open. All shipments are at risk and expense of customer.

SEND FOR PRICE LIST

S. S. PENNOCK-MEEHAN CO.

The Wholesale Florists of Philadelphia

1608-1620 Ludlow Street

CARDENIAS

100 to 150 buds and blooms, \$1.50, \$2.00, \$3.00, \$5.00 each. N. B. Open flowers always limited.

CINERARIAS

\$3.00, \$4.00 and \$5.00 per doz.

DAISIES

\$0.50, \$1.00, \$3.00 each; YELLOW \$1.00, \$1 50 each.

GENISTAS

\$0.75, \$1.00, \$1.25, \$1.75, \$2.75.

RHODODENDRONS

\$1.50, \$2.50, \$3.00, \$4.00, \$5.00, \$10.00 each.

RUBBERS

\$0.50, \$0.75, \$1.00, \$1.25 each. FERNS, DAFFODILS, HYACINTHS, TULIPS, PRIMULAS, GERANIUMS, etc. Full assortment at lowest prices.

Ribbons and Supplies

Everything in Florists' Ribbons right up to date. Crepe Paper, Greens of all descriptions and all the Staple Florists Requisites. Catalog on request.

FOR THE FINEST GRADES OF CUT FLOWERS ALL THE
TIME, INCLUDING EASTER

SEND TO

Moore, Hentz & Nash
Wholesale Commission Florists
55 and 57 West 26th Street
New York
TELEPHONE No. 756 MADISON SQ.

FRANK L. MOORE, Chatham, N. J.

HENRY HENTZ, JR., Madison, N. J.

JON'N NASH, New York.

has some very interesting notes on the effects of fertilizer on stiffness of stem, effect of varying amounts of nitrogen, the earliness, different time of setting carnations, continuous cropping without changing soil, and bursting of carnations due to location on bench. At the present time investigations are being carried on to determine effect of cutting selection on vigor of plant and development of color types from seed. A house 20x50 is being devoted to this work.

In Indiana the results of the most important work were given in Bulletin 59 on "Bacteriosis of Carnations." This disease was considered to be due to bacteria but is now known to be caused by punctures of insects and is called Stigmonose. A number of articles also appeared in trade journals at various times. No work is now being done due to lack of greenhouses.

At Illinois the past year was devoted to the repression of thrips on carnations, and during the season from October, 1907, to June 15, 1908, over 68,000 buds were examined; most of the work was done with tobacco compounds. The results of the work have not been published yet.

During the present year two houses, 165x28 feet, are being devoted to an experiment with carnations, testing the value of chemical fertilizers as supplementing stable manures. This experiment comprises thirty combinations of fertilizers, which are repeated with four different varieties in order to check results: 3200 plants are used in the experiment. The fertilizers used are dried blood, sodium nitrate, ammonium sulphate for nitrogen, acid phosphate, ground rock and bone meal for phosphorus, potassium sulphate, wood ashes and kainit for potassium and lime. Several years will be required to complete the work.

The only work done by Nebraska is on the bud-rot of carnation and its accompanying mite. The results of this work were published as Bulletin No. 103.

Ten stations have not been heard from, and as most of them are in regions unfavorable to carnation growing, have probably done no work along this line.

A study of the report will show that the real work in floriculture at the stations is in its infancy, and that the work along the line of carnations is just beginning. The time is not far distant when each station will be devoting a certain amount of time to it.

CARNATIONS UP TO DATE.

A paper read before the Morris County Gardeners' and Florists' Society, March 10, 1909, by Louis J. Reuter, West-terly, R. I.

Carnation culture has already been discussed times without number, and my observations have led me to conclude that each grower has to work out for himself the proper treatment which is required to correspond with the local conditions as they exist. Therefore it is not my intention to go into any lengthy talk on the culture of carnations.

It is possible to lay down certain fundamental principles for the beginner, but these may serve only as a starter and a guide. The resultant success must depend on his own powers to observe, and his ability to distinguish good effects from bad.

Carnations may be seen growing under certain widely differing conditions, such as Enchantress, for instance, growing with a night temperature of 52 deg. and a day temperature of 62 to 65 deg. Then, on the other hand, I have seen very excellent Enchantress growing with a night temperature of 48 deg. and a day temperature of 70 deg. The latter seems to me to be a case of unusual treatment, but where is the room for criticism when the results are satisfactory?

Again we come to the fact that one grower holds his carnations on what we would call decidedly the dry side, and possibly the next day visit another where the soil in the beds is exactly the reverse, and still both have equally good crops. We are constantly finding things to puzzle us in the way of culture and, for that reason, it would seem that explicit cultural directions are worth nothing more than a hint and a guide.

The subject of concrete benches is at this time receiving considerable attention. From an economical point of view these benches have an advantage over those constructed of wood, but the question which arises in my mind is whether raised benches are superior to solid beds with good drainage? Here we come again to the same conclusion: Be guided by your own experience. If no better stock can be grown on the raised benches, then it is much cheaper to use solid beds. My experience has led me to favor the solid beds.

At the present time considerable experimenting is being done in the way of building these concrete benches.

Some are moulded entire, with bottoms, sides, stringers and supports practically in one piece. Others use movable slabs for the bottom, and these can be made at odd times during the winter, ready for the summer rush of repairing and rebuilding. One point which strikes me as important is that the slabs be made as thin as possible and still be strong enough to carry the load. It is also important that the concrete be as porous as possible. The slab about 8 inches wide seems to be better than one 12 inches or more. By using narrow pieces, the drainage is made better, and they should be laid at least an inch apart. What I have stated about these benches is not taken from personal experience, but from what I have seen at other establishments which I have visited. Where raised benches are used, I believe that the concrete constructions will prove to be a good thing, and any ingenious man should be able to work out a cheap and satisfactory way for constructing the same.

There is one subject which has caused many of us some trouble this year, and I would say a few words about that now. My talks with numerous florists since fall, not only growers but store keepers and commission men, have brought out the complaint that the flowers of several of our best varieties are not keeping well. It is true that this season has given us bad weather to contend with, but still we have varieties which practically never give us cause for complaint. Growing conditions, no doubt, may cause this trouble to a certain extent, but we are nevertheless sure that the trouble cannot be entirely avoided, even if great care is taken in ventilating, watering and feeding. What we must do, however, is to watch the new varieties carefully and steer clear of the poor keepers. Such varieties get the wholesale grower into trouble with the retailers, and the retailer with his customers, and the ultimate result is to hurt the sale of the carnation.

The numerous reports in the trade papers have covered very thoroughly the many new varieties which have been shown this season, but a few words further may not be out of place at this time. It is not my intention to speak of every new variety which has been shown. There are too many for me to attempt that, but I will simply say a few words about several which have made an impression on me while at the Indianapolis meeting of

EASTER SHIPMENTS

Tulips, and other stock required for the Easter demand. We are ready to quote prices and your order given now will be filled properly and on time.

LONGIFLORUM LILIES

in pots or cut, carefully packed and delivered direct from greenhouses.

THESE ARE FIRST QUALITY LILIES.

OUR SUPPLY OF

Beauty, Richmond, Killarney, Bride and 'Maid Roses and Carnations in Leading-Sorts

has never been excelled and prices are very reasonable. Folding Boxes, Baskets, Wire Designs, All Green Material and Other Supplies

AT LOWEST WHOLESALE RATES

WELCH BROTHERS,

**226 DEVONSHIRE ST.,
BOSTON, MASS.
TELEPHONE MAIN 6267.**

the Carnation Society, and also those seen at several establishments which I have visited. The show in Boston two weeks ago brought out many of the favorites, and at that time it was possible to judge several varieties as to their keeping qualities on account of the long distance they had traveled before being staged.

Bay State has shown up well wherever exhibited. It shows good keeping qualities and is a large, bold, attractive flower, with excellent stem. There seems to be no other variegated in sight to compete with this variety.

Apple Blossom is a very well formed flower, with the general color effect resembling Prosperity, but not as deep in color as the latter (quite often coming all white). The stem is very good, and it is surely a good traveler as well as an attractive novelty.

Pink Delight has been well thought of by nearly every one who has seen it, especially those who have seen the plants growing at Lafayette. The blooms are not very large, but enough so for commercial purposes, and the form and stem are very good. It is a true salmon pink, and should take well with the public. As a producer it seems to give excellent results.

While at Lafayette we saw a large number of seedlings of all colors and types, but two scarlets and a crimson stand the strongest in my memory. They will be undoubtedly heard from later. I believe one of the scarlets—Hoosier Lad—is to be introduced next season. The latter is a fancy bloom, with good color and the growth is heavy and strong in every way.

W. N. Ruidl also showed a very promising crimson which is still under

number. The form of bloom, stem and color are good, and it is claimed to be a good producer and a clean grower.

Ruby has been shown well in a number of exhibitions. It is a fancy bloom, having excellent form and stem. The color is not too dark, and as a keeper it outpoints the average crimson grown heretofore. The growth is ideal, free, upright and clean.

A vase of crimson shown in Boston by F. R. Johnson Co. was also very attractive. This variety should be heard from later, as it holds up well with the best in sight, as to color, form and stem.

If I were asked what variety of those being introduced this year pleased me most of all I have seen, it would be hard for me to decide. But I must say a few words in particular for May Day. In this variety we find a shade of color which had been lacking among our commercial sorts. The color is a clear, lively satin pink, but that is not saying enough. We cannot find any standard variety to compare it with. When Enchantress of good color is placed beside it, May Day receives all the attention. It is in the Enchantress shade but a great improvement; the stem is strong and graceful, of good length and, judging from the plants seen growing at Richmond, we would call it a good producer.

The Chas. Knopf Floral Co. have a seedling named Admiration, to be introduced next year, which should take well with the growers. The points of excellency in this variety are, in a few words, large handsomely formed blooms, strong stem, and ideal calyx. The color is the most attractive point, however, it being an even, soft pink,

Now is the proper time to place your order for Lilies, Roses, Carnations, Sweet Peas, Violets, Daffodils,

Now is the proper time to place your order for Lilies, Roses, Carnations, Sweet Peas, Violets, Daffodils,

deeper than Enchantress, with no salmon, and it does not fade out at the edges.

Sangamo and Superba are both excellent varieties, having very long stems, with sufficient strength to hold the flowers erect. They are both good keepers.

Dorothy Gordon resembles Rose Pink Enchantress very much, but is a decided improvement over that sort.

In whites, we have several showing up well. Shasta has attracted considerable attention by its nearly perfect form and pure glistening white petals and good keeping qualities. Mrs. J. C. Vaughan impresses me as a white from which we may expect something good. The flower is well built, loose and attractive, and it is of good size and of excellent stem. I have not seen it growing, but from reports of those who have, would say that it is free and clean. The cuttings at any rate are starting out in good shape, showing a vigorous habit.

Although the bloom of Georgia is not very large, it is of good commercial size, and if it will produce freely this variety should prove valuable. It is a good keeper and the color pure white.

I neglected to mention among the scarlets Mrs. O. P. Bassett, which was shown in Indianapolis. In the scarlet classes it showed up well, and we hope to find in this one a profitable variety. Some growers have been disappointed in Beacon this year, and with victory steadily losing friends, there is room for a good commercial scarlet.

For some years back, the market has been bare of yellow carnations, but there are now three in sight. It re-

To the RETAIL FLORISTS!

Am. Beauties
Ulrich Brunners
Killarneys
Richmonds
Chatenays
Maids
Brides
Golden Gates
Gardenias
Orchids
Smilax
Tulips
Valley

Our facilities in your behalf are unequalled.
Our growers are among the best in the country.
We are in the most convenient section of the

Wholesale Cut Flower District

We give you the benefit of our immense supplies and variety
at fair and convenient prices.

We never disappoint you.

This is our eleventh year.

We are here to serve you.

We want to please you, and we can.

Give us your confidence.

Very truly yours,

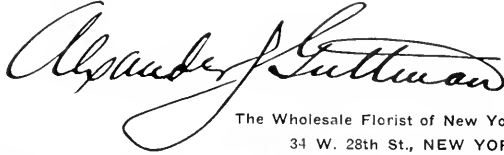

The Wholesale Florist of New York.

34 W. 28th St., NEW YORK.

Phone 1664
1665 Mad. Square.

Violets
Carnations
Asparagus
Sweet Peas
Forget-me-nots
Daisies
Jonquils
Daffodils
Hyacinths
Pansies
Stocks
etc.

To the FLOWER GROWERS!

We must have more stock for our ever increasing business.
We are very short of VIOLETS and CARNATIONS.

Will Send Returns Twice Weekly

This is our eleventh year.

We are in the best locality.

We have absolutely the largest and best equipped wholesale

CUT FLOWER ESTABLISHMENT in this country.

Give us your confidence.

Very truly yours,



The Wholesale Florist of New York.

34 W. 28th St., NEW YORK.

Phone 1664
1665 Mad. Square.

mains to be seen what will become of them. We should at least get one from these. J. Whiteomb Riley is a very striking bloom, bold and rugged, with Lawson characteristics. A point of value in this sort is the absence of pink or red markings. The bloom is a clear color of the ideal shade of yellow, not too dark nor too light. Kanarie Bird as staged in Boston showed up well, and Mr. Pierce of Norwood, R. I., has a yellow with a fine stem, the bloom somewhat resembling the old Eldorado. Although the sale of yellow carnations is not heavy, there is always a chance to use a limited number to an advantage, and a good one will be welcomed.

A visit to the new range of the E. G. Hill Co is especially interesting this year. Novelties in roses and carnations are to be seen here, and there are several carnations on trial which should be heard from. I cannot mention any one in particular, as it would be necessary for one to watch them in growth and habit in order to decide which is best for commercial purposes. I remember, however, that a white and a scarlet looked especially good. The concrete construction of benches is being tried here, and we found this establishment interesting throughout on account of its up-to-date equipment.

SELECTION AND CROSS FERTILIZATION OF THE CARNATION.

A paper read by Peter Fisher, Ellis, Mass., at the Massachusetts Agricultural College, Amherst, Mass., February 24, 1909.

I presume you have already been addressed on the subject of the best types of greenhouse construction, and as this plays a very important part in the improvement of the carnation, I will merely touch upon the subject.

My preference is for a span-roofed structure, with continuous ventilation, on each side of the ridge, and on sides, with raised benches, thus insuring a free circulation of air. The house may be built running north and south, or east and west, as location and other circumstances permit.

The east and west aspect has the advantage for about six weeks in mid-winter: the north and south about equal during early spring and fall, with a decided advantage during hot weather.

Selection of Varieties for Crossing Purposes.

Only the healthiest and most vigorous stock procurable should be used and such varieties as embrace a wide range of self-colors are most desirable.

To obtain the best results, the col-

ors should be classified, keeping the different shades of light pink, dark pink, whites, crimson, reds, etc., together. By following up this method, a much larger percentage will come true to color in crossing than where this is done promiscuously or haphazard.

A High Standard of Culture Is Essential to Best Results.

If the plants at the period of cross-fertilizing are in robust health, producing strong, vigorous shoots, which usually mean correspondingly large blooms, the seeds will invariably be large, of much greater vitality, producing strong and vigorous seedlings, from which one may naturally expect something phenomenal.

On the other hand, if the parent plants are poorly grown, weak, spindling, and lacking in stamina, their seedling progeny is sure to be of like quality. The most decided results, and greatest advances in my experience have always been obtained from parent plants exhibiting unusual strength and vigor.

There is not, as far as I know, any means of ascertaining beforehand just what the result of a cross will be. If crosses are made between colors of a like shade and their progeny year

EASTER LILIES
\$12.50 Per Hundred.



WE NEVER DISAPPOINT
Satisfaction Guaranteed.

American Beauties,
Brides and Brides-
maids, Richmonds and
Killarneys, Valley, First
Sprangeri and Plumosa

BOSTON, MASS.
HENRY M. ROBINSON & CO.
WHOLESALE CUTTIES-SON FLORETTES

Hardy Cut Evergreens and Florists' Supplies

We have the stock, can fill all orders.
No order too large or too small.
Write, telephone or Telegram.

Orders filled promptly, property and to your satisfaction.
Tel: 2317-2618 Main—25260 Foot Hill.

15 Province Street and 9 Chappin Place.

Southern Wild Smilax, Fancy and Decker Ferns,
Bronze and Green Calyx, Cut Boxwood,
Sprays, Laurel Wreaths, I. Laurel,
Petunias, Branch Laural, Moss.



ORDERS placed with us means that you can depend on us.

H. E. FROMENT

Wholesale Florist

57 West 28th St.

NEW YORK

A FULL LINE OF

Choice Seasonable Flowers

after year, by continuing this method the seedlings will, to a large extent, be a reproduction of the parents as to color. Habit of plant will often resemble either parent, or be exactly intermediate, but there is no certainty in the matter, as the most un-looked for colors appear at times, such as a pure white from the crossing of two reds, or vice versa. We can only hope and work towards the desired end, and if we stick to it long enough success will ultimately crown our efforts. One can invariably attain to anything they make up their mind for, providing they have the staying qualities, which defeat only spurs on to greater effort, and here let me tell you is the explanation for the "good luck" of many. It comes simply by stick-to-it-iveness. By some I have been termed "lucky" in the production of some desirable varieties. I leave this to your own judgment. For instance, I worked six years without satisfactory results, to procure a worthy successor to "Daybreak."

About "Luck."

During these years I raised hundreds of similar color, but, as the song says, "There was always something wrong." Flowers too small, or too large and split or stems too weak, plants lacking in constitution, something out of balance. In these efforts I had been using the pollen of Daybreak on other varieties. It occurred to me that I might be working along the wrong lines, so I reversed my tactics. By using the pollen of the Lawson color cerise on the variety Mrs. Bradt, a white ground variegated with

red—1 procured Enchantress. The Lawson was raised from Daybreak, a flesh colored variety pollen from Van Leeuwen, a dark pink.

You see the color of Daybreak cropping out. Was this simply CHANCE or was it the working out of Mendell's theory? There is food for reflection and careful study along these lines. Again when I tell you that from a batch of first-year seedlings tested three years ago, we retained 250 scarlets for a test in the greenhouse, today we have three left of the 250 varieties, with the possibility of disseminating ONE. Of the remaining 3250 we retained four with a possibility of disseminating 2 or 3 at most. Think of it—4 out of 3500, then tell me where the luck comes in! Yet a few years ago hundreds of those varieties so discarded would have been called wonders. It is owing to the present high standard of the carnation that it becomes more difficult each year to produce a decided acquisition. Yet, looking backward through the earliest years of my experiments, I can see where I discarded many a fine carnation through this critical sifting down. Still it is much better to be on the safe side.

The Time to Work.

The best time to commence cross fertilization is during late October or early November, that is, just after the disappearance of flies and bees that usually come into the greenhouses on the approach of cold weather.

Pollen at this season is also more plentiful than during December, Janu-

ary or February. The best time in the day to cross fertilize is from 11 A. M. to 2 P. M., the earlier the better (providing, of course, that the day is warm and sunny, and the pollen perfectly dry). In transferring the pollen, some use a magnifying glass, camel's hair brush and pair of tweezers. I have never used either, until recently when I find it necessary to use eye glasses. I do not believe in the method practiced by some in removing the petals of the flower when half developed, as I think it injurious to the normal development of the other important parts of the flower, so essential to success. My custom is to split the calyx in three or four places, so that the petals can drop down around the stem, thus leaving the pistil, stamens, anthers and stigma fully exposed to light and air. The stamens can in this way be easily removed between the thumb and finger (fore-finger) with the anthers and pollen intact, and transmitted as desired.

In using the camel's hair brush for conveying the pollen there is danger of getting it mixed, as it is difficult to clean the brush, before using on a different cross. In crossing, one should always have a definite object in view—an ideal to work up to. Keep in mind the very best of the various types now in existence—also their defects, then go to work with a determination to excel. The first requisite and one to be always kept in mind is a healthy, vigorous constitution, that means disease resisting; next comes color, always indispensable, for no matter if all other

The Hub of the Market

The newest, lightest, best equipped and best located Wholesale Establishment, right in the centre of the

Cut Flower Market District of New York

With a life-long experience in the Flower Trade and every needed facility, I am prepared to serve you by supplying

THE BEST STOCK IN THE MARKET

at reasonable prices, or selling your product for you on commission to the best advantage.

Please call or write for information. Shall have a full line of best

Easter Flowers and Plants

Charles Millang, 444 Sixth Avenue, cor. 27th St.
NEW YORK

points have been obtained and the color is undesirable, the plant is only good for re-crossing, because of its desirable habits; then one must work for the necessary stem and strong calyx to hold the flower erect; size, form, substance and last but not least fragrance, must all be considered—fragrance I regard as indispensable. The process of cross-fertilization is so simple that I need not go into it in detail.

Applying the Pollen.

One must study the various varieties to be used, and fine judgment is sometimes required to know when the flowers have reached the proper stage for the experiment. In some varieties the pollen is perfectly ripe and ready for use as soon as the flower expands, while in others it does not appear for several days after the bloom develops. On the ends of the stamens are the anthers which, when they burst, produce the pollen. When ripe it is in the form of a powder. The stigma is the part to which the pollen is applied and as it reaches the proper stage for fertilization the upper surface assumes a rough, hairy appearance. It is now ready for crossing, and upon this surface the pollen should be spread, being careful that it is properly ripe and dry, when it will be seen to adhere easily. If fertilization has taken place, the petals of the flower will wilt and fade within from one to two days, and often in a few hours, which is a sure indication that the operation has been a success.

After the petals dry up, they may be removed without danger of injury to the seed pod forming, and to prevent accumulation of moisture which might

otherwise cause the pod to decay.

Flowers fertilized early in October and November will usually ripen their seed in about 6 or 7 weeks.

Gathering the Seed.

The seed pods should be picked with 4 to 6 inches of stem attached, carefully wrapped in paper, or enclosed in envelopes and allowed to dry thoroughly. This usually requires about 2 weeks. The seed should then be carefully removed and planted at once.

Flats thoroughly drained with a layer of 1 to 2 inches of ashes, over which a like quantity of sifted loam of a light sandy nature has been spread, makes an ideal compost. Level off carefully, press moderately firm, sow in rows 1 to 1-2 inches apart and 1-2 inch deep, which can be made by pressing a narrow strip of wood into the soil, cover carefully with about 1-2 inch soil, water with a fine sprinkler and place upon a shelf in a light situation out of the reach of mice, who are extremely fond of carnation seeds—one mouse, if he "gets busy" will destroy hundreds of seeds in a night. This happened to me one season when I had sown the seeds in 4-inch pots, which were placed on a bench, and I had omitted to cover them with a sheet of glass, as was my custom then. I lost almost an entire season's seeds by my neglect in one night, and I confess I did not feel very kindly toward that mouse next morning.

Care of the Seedlings

Great care should be taken to keep the soil moderately moist. If the sun is bright a paper should be spread over the flats during the day, and removed towards evening. This prevents

too rapid evaporation. The seed will usually germinate in from four to ten days, when all shading should be removed and the flats kept in a light airy position free of draughts. It requires good judgment in watering to prevent damping off by excess of moisture, or injury by becoming too dry. When the seedlings have developed their second leaves, they should be transplanted into small pots or flats; I prefer the latter as there is less danger of a check by becoming too dry. They should be kept in a light, airy position to insure a compact growth, in a night temperature of 45 to 50 degrees. Then they can be planted in the field during May when danger of check from frosts has passed. Plant in rows similar to general varieties. Those making a compact, bushy growth should not be stopped back but allowed to bloom, to determine whether it is worthy of being transplanted into the greenhouse later for a further test. Those inclined to run up with a single stem and no side growths should have the centres pinched out, so as to induce a bushy growth, so valuable later, should the variety prove an acquisition. The idea of encouraging the seedlings to bloom early is to be able to select from the field those worthy of further trial in the greenhouse. This enables one to save much valuable space that might otherwise be taken up by worthless sorts.

Selection.

It is often desirable to save single varieties exhibiting profuse blooming qualities and healthy, vigorous constitutions,—select those with a strong well formed calyx, and wide

LILIES FOR YOU

The same High Grade for Easter that we Have Been Furnishing in Years Past

Packed in Boxes of Twenty-five Pots each, nicely Crated over the Top. Our Packing is undoubtedly the BEST IN THE UNITED STATES. Average 5 flowers to the plant. One extra plant, gratis, in each Crate.

Prices in Case Lots, 12 1-2c. per Flower. Five or more cases 12c. per Flower. ORDER EARLY so that we may be able to Ship them Direct from the Greenhouses without rehandling.

AND DON'T FORGET

that we carry a full line of fresh flowers, all varieties and the LARGEST STOCK OF FLORISTS' SUPPLIES IN NEW ENGLAND.

N. F. McCARTHY & CO.

Wholesale Florists and Supply Dealers

84 Hawley St., Boston

petal, make the single variety the seed bearer, using pollen from extra double and even split varieties. Later I may be able to give more definite data from experiments in this direction. Beacon is the first variety I have disseminated, raised from a single yellow variety crossed with a double scarlet seedling. The selection of desirable colors is a very important matter. One is apt to get enthused about some particular shade, prejudiced in favor of his own, so to speak, for you know every fellow usually "thinks his own crow the blackest."

The buying public are, after all, the

real critics and I have found it to be a pretty safe rule to abide by the taste and selection of the ladies, as they inspect and comment upon the various shades of color, in the seedling house. I can well remember when Enchantress was in its second year with some 35 plants in bloom, the ladies used to stop and exclaim, "Magnificent, Exquisite"—of course a smile of satisfaction on my part was the result, as I thought, "Here is a winner"

In conclusion let me urge upon you to get all the theory you can—put it into practice—but don't stick to any man's "say so." Work with a definite object in view—keep careful notes—watch results, and keep before you as a watchword and guide to success, first, last and all along—the word, "Selection."

AN INTERESTING COMPARISON.

The wholesale prices quoted Feb. 20 for the Covent Garden flower market furnish some interesting figures when compared with prices on this side. We find gardenias \$1.00 to \$1.50 per dozen, against our \$4.00 to \$5.00; Cattleyas \$2.00 to \$3.00, against our \$6.00 to \$9.00; but there is not such a vast difference when it comes to roses and carnations. Bridesmaid and Liberty are quoted at \$8.00 to \$12.00 per 100, while Enchantress and Lawson bring \$5.00 to \$4.00. Niphetos, Mermet and Perle seem to be still standard varieties over there. "Generals"—by which we presume they mean General Jacqueminot—are quoted at from \$8.00 to \$10.00 per 100. Our great American standby, American

Beauty, is not quoted at all. Neither are Richmond, Killarney, nor even the Bride, French Brunners being the highest price on the list, being quoted at from \$2.00 to \$2.25 per dozen. Anemones, myosotis, daffodils and similar subjects are quoted by the dozen bundles, so it is not so easy to make comparisons. Lilacs and smilax are quoted by the bunch; but the Londoners evidently think this word unsuitable for asparagus, as that item is listed by the bundle and is honored by being quoted in three grades—long, medium and short. White Ten-Week stocks and mimosa are quoted by the "pad." Why these could not be put into a bunch or a bundle is somewhat obscure. Perhaps the commission men use these to pad the returns to their growers. Perhaps the ladies use these items as shoulder pads or bustles. Anything is possible when it comes to the vagaries of fashion.

G. C. WATSON.

A Profitable Side Crop

Asparagus plumosus is a main crop with many growers having extensive modern plants but those with less up-to-date establishments, or parts of same defective in lighting or otherwise unsuitable for high grade crops,—will find this subject one of the very best. We have prepared a cultural circular giving concise directions how to make money out of this crop. Send for it. No charge. An important feature in asparagus culture is good seed. The P. M. quality of greenhouse grown seed has earned a high reputation for freshness and purity. It is the true nanus and greenhouse grown. Send for trial pkg., 100 seeds fifty cents, if you wish to experiment only. In quantity \$3.75 per 1000 seeds, \$32.50 per 10,000 seeds. Asparagus Sprengeri 75c. per 1000, \$5.00 per 10,000 seeds.

S. S. PENNOCK-MEEHAN CO.

1608 to 1620 Ludlow St., Philadelphia, Pa.
1212 N. Y. Ave., Washington, D. C.

SPECIALLY GOOD EASTER LILIES

All cut, none in pots. The finest in town, bar none. \$1.50 to \$1.80 per doz. buds and blooms. In excellent condition for shipping. Inquire at once—THEY ARE GOING FAST.

LILLEY & UPTON,

Wholesale Florists

1614 Sansom Street, - Philadelphia.

To Florists Everywhere

Orders for Cut Flowers and Floral Decorations to be delivered anywhere in the Greater New York, may be placed with us with the certainty that your customers will be satisfied.

Telegraph, telephone or mail such orders to us and be sure that they will be filled as promptly and as carefully as though you did it yourself.

One third discount will be allowed on all orders thus placed with us by Florists outside of the Greater New York.

THE BLOSSOM

Bond and Livingston Sts.,
BROOKLYN, N. Y.

C. C. TREPEL, Manager

**WILLIAM J. SMYTH
FLORIST**

Cor. Michigan Ave. and 31st St., CHICAGO

We ship to all points in Illinois and Iowa.

Phones: Douglas 744, Douglas 523, Douglas 740

M. C. and J. E. HAUSWIRTH

Out of Town orders for Hospitals
Carefully filled.

**232 Michigan Ave.
CHICAGO**

JOBITORUM ANNEX Tel. Harrison 585

**SAMUEL MURRAY
Florist**

Coates House Conservatory

1017 BROADWAY, KANSAS CITY, MO.

Both 'Phones 2670 Main.



WASHINGTON,

D. C.

GUDE'S

**The Far-Famed Flowers of
TORONTO**

Delivered on mail or telegraph order for any occasion, in any part of the Dominion.

JOHN H. DUNLOP,
96 Yonge St., - Toronto, Ont.

the Park Floral Co.

J. A. VALENTINE
Pres.

DENVER, COLORADO

**WILLIAM L. ROCK
FLOWER CO.**

KANSAS CITY, - MO.

will carefully execute orders for Kansas City and any town in Missouri or Kansas.



Buffalo, N. Y.

W. J. PALMER & SON, 304 Main St.

**Of Interest to Retail
Florists**

ROCHESTER (N. Y.) PLANT NOTES.

Appropos of the approaching Easter season, local florists are quite apprehensive. Owing to the continued cloudiness and many sudden changes in temperature, all material has to be hurried along, especially lilies of the Giganteum and Multiflorum varieties. There will be a noticeable shortage of these plants, whilst of all other kinds of plants there seems to be an abundance. Some exceedingly well grown plants of *Schizanthus Wisetonensis* are to be seen at the greenhouses of R. Sibley (E. Berry, gardener). These are in 6 inch pots, and a perfect mass of orchid-shaped flowers which need only to be seen to be fully appreciated. This plant can be very profitably grown from seed, and is useful either cut or potted.

STEAMER DEPARTURES	
American.	
Philadelphia, N. Y.-S'ampton	Apr. 10
St. Paul, N. Y.-S'ampton	Apr. 17
Atlantic Transport.	
Minnehaha, N. Y.-London	Apr. 10
Minnetonka, N. Y.-London	Apr. 17
Cunard.	
Ivernia, Boston-Liverpool	Apr. 6
Lunenburg, N. Y.-Liverpool	Apr. 7
Caronia, N. Y.-Liverpool	Apr. 10
French Line.	
La Lorraine, N. Y.-Havre	Apr. 8
La Provence, N. Y.-Havre	Apr. 15
Hamburg-American.	
Amerika, N. Y.-Hamburg	Apr. 10
Cleveland, N. Y.-Hamburg	Apr. 17
Leyland Line.	
Winifredian, Boston-Liverpool	Apr. 14
North German Lloyd.	
Kaiser Wilhelm II., N. Y.-B'n.	Apr. 6
K'n Luis, N. Y.-Med. Pts.	Apr. 10
K'n'r. Wilhelm, N. Y.-Bremen	Apr. 13
White Star.	
Majestic, N. Y.-S'ampton	Apr. 7
Celtic, N. Y.-Liverpool	Apr. 10
Oceanic, N. Y.-S'ampton	Apr. 14
Romanic, Boston-Med. Ports	Apr. 17

The new rambler rose 'Tausendschon' can be seen in plenty at Salter Bros.' This rose is proving to be of exceptional keeping quality, and as an outdoor climber is very satisfactory. Some plants of Wiman's rambler (Majenta) are also seen, its rich color and large flower heads looming up among many other plants.

The new designs of Hart's Handy Handle are fully appreciated by the store men here, and have met with great approval wherever displayed. The retail trade find it a decided acquisition in trimming effects.

W. J. Palmer of Buffalo, already recognized as one of the foremost florists of the country, has entered the field of literature with an interesting series of notes accompanied by six illustrations of new bridal bouquets in the Ladies Home Journal for April, 1909. The cover carries a beautiful picture in colors of one of the handsomest of these, a bouquet made of lily of the valley, cattleyas and Farleyense fern. Its simplicity of arrangement conveys a good lesson to those florists who think a big mop of dangling ribbons is an indispensable adjunct in tasteful bridal bouquet making.

ALEX. McCONNELL

571 FIFTH AVENUE
NEW YORK CITY

Telegraphic orders forwarded to any part of the United States, Canada, and all principal cities of Europe. Orders transferred or intrusted by the trade to our selection for delivery on steamships or elsewhere receive special attention.

Telephone Calls, 487 and 488 38th St.
Cable Address, ALEXCONNELL

New York Deliveries

FLOWERS and PLANTS

by special messenger to Steamer,
Theatre or any address in

NEW YORK or BROOKLYN

THOMAS YOUNG, JR.

500 FIFTH AVE., (near 42nd St.)

NEWMAN FLORAL Co.

(Established 1870)

202 Fifth Ave. and
Madison Square, NEW YORK CITY

FLOWERS FOR STEAMER SAILINGS

M. A. BOWE

In the Heart of New York City

1294 Broadway

Tel. 2270, 38th St. NEW YORK

Our Motto—The Golden Rule

DAVID CLARKE'S SONS

Deliver orders from any part of the country to
New York City

Or OUT-GOING STEAMERS

Write or telegraph

2139-2141 Broadway, New York

Telephone 1552-1553 Columbus

YOUNG & NUGENT

42 West 28 St., NEW YORK

"FLOWERS BY TELEGRAPH"

NEW YORK

MYER, FLORIST

Phone 5297 Plaza.

609-611 MADISON AVE.

ALBANY, N. Y.

EYRES

Flowers or Design Work

DELIVERED IN ALBANY AND VICINITY
ON TELEGRAPHIC ORDER.

11 NORTH PEARL ST., ALBANY, N. Y.

Flower Deliveries

In Brooklyn and other Long Island Points
New York City, New Jersey, etc. At Theatres,
Hotels, Steamers or Residence.

WILSON

Fulton St. and Greene Ave., Brooklyn, N. Y.

**JOHN BREITMEYER'S
SONS**

Cor. Miami and Gratiot Aves.
DETROIT, MICH.

**Artistic Designs . . .
High Grade Cut Blooms**

We cover all Michigan points and good sections of Ohio, Indiana and Canada

**PROMPT DELIVERY IN
BOSTON**

AND ALL NEW ENGLAND POINTS
F. H. HOUGHTON
386 Boylston St., Boston, Mass.

BOSTON'S BEST
In Quality and Design

Can be relied upon when you transfer your retail orders to

EDWARD MACMULKIN
194 Boylston Street, Boston

Send flower orders for delivery in

BOSTON

and all

NEW ENGLAND POINTS
THOS. F. GALVIN
124 Tremont St., Boston



TRANSFER

Your orders for flower or plant delivery in Eastern New England to

JULIUS A. ZINN,

2 Beacon St., Boston

FINE DESIGN WORK ASPE IALTY

DANKER, Albany, N. Y.

ORDERS FOR

**Choice Flowers and
Floral Emblems**

FILLED PROMPTLY

LOUISVILLE, KY.

JOUBERT SCHULZ,
550 South Fourth Ave.

WELLESLEY COLLEGE

Dana Hall, Walnut Hill and Rockridge Hall
Schools. **TALBY, Wellesley, Mass.**
Tel. Wellesley 44-1 and 2. Night 44-3.

ATLANTA FLORAL CO.

41 Peachtree Street, ATLANTA, GEORGIA

"FLOWERS BY TELEGRAPH."

Leading Retail Florists Listed by Towns for Ready Reference.

- Denver, Colo.—Park Floral Co., 1706 Broadway.
- Washington, D. C.—Gude Bros., 1214 F St.
- Atlanta, Ga.—Atlanta Floral Co., 41 Peach Tree St.
- Chicago—M. C. & J. E. Hauswirth, 232 Michigan Ave.
- Chicago—William J. Smyth, Michigan Ave. and 31st St.
- Chicago—George Wittbold Co., 1657-59 Buckingham Place.
- Louisville, Ky.—Jacob Schulz, 550 South Fourth Ave.
- Boston—Thos. F. Galvin, 124 Tremont St.
- Boston—Frauk H. Houghton, 386 Boylston St.
- Boston—Edward MacMulkin, 194 Boylston St.
- Boston—Hoffman, Florist, 59-61 Massachusetts Ave.
- Boston—J. Newman & Sons, Inc., 24 Tremont St.
- Boston—Julius A. Zinn, 2 Beacon St.
- Wellesley, Mass.—Talby.
- Detroit, Mich.—J. Breitmeyer's Sons, Miami and Gratiot Aves.
- Kansas City, Mo.—Samuel Murray, 1017 Broadway.
- Kansas City, Mo.—Wm. L. Rock Flower Co., 116 Walnut St.
- Albany, N. Y.—H. G. Eyres, 11 N. Pearl St.
- Albany, N. Y.—F. A. Danker, 40 Maiden Ln.
- New York—David Clarke's Sons, 2139-2141 Broadway.
- New York—Alex. McConnell, 571 5th Ave.
- New York—Young & Nugent, 42 W. 28th St.
- New York—M. A. Bowe, 1294 Broadway.
- New York—Myer, 608-11 Madison Ave.
- New York—Thos. Young, Jr., 500 Fifth Ave.
- New York—Newman Floral Co., 202 Fifth Ave. & Madison Sq.
- Brooklyn, N. Y.—The Blossom (C. C. Treph, Mgr.), Bond and Livingston Sts.
- Buffalo, N. Y.—Robert G. Wilson, Fulton St. and Greene Ave.
- Buffalo, N. Y.—Palmer's, 304 Main St.
- Toronto, Can.—J. H. Dunlop, 96 Yonge St.

NEW FLOWER STORES.

- Pride's, Mass.—Benjamin I. Edwards.
- Milwaukee, Wis.—W. Helwig, Mitchell street.
- Conneaut, O.—C. H. Burdick, 226 Broad street.
- Westbrook, Me.—N. W. Hannaford, Anderson Block.
- Norristown, Pa.—Muller, the Florist, 57 E. Main street.
- Buffalo, N. Y.—J. Benson Stafford opened his store on Main St., March 27. Mr. Stafford has been connected with W. J. Palmer & Sons, of Buffalo for many years, also with Geo. M. Stumpp, New York City.
- Hy. Weber, the hustling Central Park grower, has opened a branch store on Grant Street.

We can truly see that **DETROIT** Lent is about over, not alone because some are beginning to pickle flowers but because our attention is already on preparatory work and booking orders for Easter. Looking backwards we can safely say that Lent has been better than several weeks before. A general revival of trade in the retail district can be noticed and this ought to strengthen our hopes for a very busy Easter. All indications point towards it and it will be mainly up to ourselves to make a success and deliver such goods as will give satisfaction although the price paid for them may have been out of the ordinary.

THE BEST LETTERS

FOR THOSE
FLORISTS' MADE
USE OF BY THE



Boston Florist Letter Co.

66 PEARL ST., BOSTON

N. F. MCCARTHY, Mgr.

Order direct or buy from your local supply dealer. Insist on having the

BOSTON

Inscriptions, Emblems, etc., Always in Stock

Durand & Marohn
MANUFACTURERS OF

All Kinds of Wire Work
Florists' Wire Designs a Specialty
24 Beaver St., ALBANY, N. Y.

FLORISTS' SUPPLIES

Send for New Catalogue

H. Bayersdorfer & Co.

1129 ARCH ST., PHILADELPHIA

Wired Toothpicks

Manufactured by

W. J. COWEE, BERLIN, N. Y.

50,000....\$1.75; 50,000....\$7.50. Sample free.
For sale by dealers

BUSINESS CHANGES.

- Brewster, Wash.—Geo. T. Crane has bought the Dowst Nurseries.
- Gloucester, Mass.—Albert B. Tuck, florist, has taken the store vacated by John Nelson.
- Terre Haute, Ind.—John A. Winton has purchased a half interest in the Terre Haute Rose & Carnation Co.
- Corry, Penn.—Mrs. M. E. Caldwell has transferred her stock from the store on Center street to her greenhouse.
- Morris, Ill.—I. Krohn and J. H. Rohmer have bought the Colberg greenhouses and will conduct them as the Morris Floral Co.
- Buffalo, N. Y.—"Sangster the Florist" and successor to Mohart Co., now located at 1197 Jefferson St., will remove to 1291 Jefferson St., about May 15.
- Jackson, Tenn.—P. C. Wilson has bought the florist business of the Robbins-Sparkman Co., and will supply the flowers from his greenhouse near Riverside Cemetery.

AN ASSIGNMENT.

M. Butler & Son, the old established florist firm of Berkeley Avenue, Newport, R. I., have made an assignment for the equal benefit of all creditors and James Blake the assignee has ordered all the contents of the greenhouses to be sold at public auction on April 3. The plant stock is chiefly palms, ferns and hydrangeas.

Roses for EASTER

We will as usual have a good supply of Beauties and Roses for Easter, and believe that no better stock is coming to Philadelphia than we offer.

Order your Easter Stock from

THE LEO NIESSEN CO.

1209 Arch St., Philadelphia, Pa.
Open from 7 a. m. to 8 p. m.



SPRENGERI

Extra choice long sprays
50c PER BUNCH

CATTLEYSAS

\$6.00 per doz., \$40.00 per 100
EXTRA SPECIAL QUALITY

S. S. PENNOCK-MEEHAN CO.
1608-1620 Ludlow St., Philadelphia

DAgger FERNs

Good Quality
\$3.00 per 1000

W. E. McKISSICK & BROS.
WHOLESALE FLORISTS
1619-1621 RANSTEAD ST.
PHILADELPHIA



CHAS. W. McKELLAR
51 WABASH AVE., CHICAGO

Western Headquarters for Choice Orchids
Valley, Roses and all Cut Flowers

PETER REINBERG
WHOLESALE
CUT FLOWERS
51 Wabash Av., Chicago, Ill.

Long Distance Phone, Central 6004
WINTERSON'S SEED STORE
45-47-49 Wabash Ave, Chicago.
Seedsmen, Plantsmen, Nurserymen
Florists' Supplies

POEHLMANN BROS. CO.
33-35-37 Randolph St., - CHICAGO
CUT FLOWERS

Greenhouses, - Morton Grove, Ill.

Rice Brothers
118 N. 6th Street, MINNEAPOLIS, MINN.
WHOLESALE FLORISTS and SUPPLIES

CUT FLOWERS received twice daily, and can fill your orders to your satisfaction. A complete line of Hardy Greens - WILD SMILAX, BOXWOOD, HARDY FANCY FERNS, GALAX LEAVES.

Write for quotations on large quantities.
In ordering goods please add "I saw It in HORTICULTURE."

WELCH BROS.

AMERICAN BEAUTY, KILLARNEY, RICHMOND, MARYLAND AND ALL THE SUPERIOR
ROSES, LILY OF THE VALLEY, CARNATIONS, ORCHIDS
BEST PRODUCED
226 Devonshire Street, Boston, Mass.

WHOLESALE FLOWER MARKETS—TRADE PRICES—Per 100 TO DEALERS ONLY

	CHICAGO March 28		TWIN CITIES March 29		PHILA. March 29		BOSTON April 1	
ROSES								
Am. Beauty, Fancy and Special...	25.00	to 35.00	40.00	to 50.00	40.00	to 50.00	30.00	to 50.00
" Extra.....	20.00	to 25.00	30.00	to 40.00	25.00	to 30.00	15.00	to 25.00
" No. 1.....	15.00	to 20.00	20.00	to 30.00	15.00	to 25.00	10.00	to 20.00
" Lower grades.....	5.00	to 15.00	10.00	to 20.00	4.00	to 8.00	4.00	to 8.00
Bride, "Maid, Fancy & Special.....	6.00	to 8.00	8.00	to 10.00	8.00	to 10.00	6.00	to 8.00
" Lower grades.....	3.00	to 6.00	4.00	to 8.00	4.00	to 6.00	4.00	to 6.00
Killarney, Fan, & Sp.....	3.00	to 8.00	8.00	to 12.00	4.00	to 15.00	8.00	to 12.00
" Lower grades.....	3.00	to 6.00	6.00	to 8.00	6.00	to 8.00	2.00	to 6.00
Richmond, Fancy & Special.....	6.00	to 8.00	8.00	to 12.00	15.00	to 18.00	12.00	to 16.00
" Lower grades.....	4.00	to 6.00	6.00	to 8.00	4.00	to 6.00	4.00	to 6.00
Chateaus.....	6.00	to 8.00	4.00	to 8.00	4.00	to 6.00	3.00	to 6.00
Golden Gate Ivory, etc.....	5.00	to 6.00	4.00	to 8.00	4.00	to 8.00	3.00	to 6.00
My Maryland.....	6.00	to 15.00	4.00	to 12.00
Mrs. Mar. Field.....
CARNATIONS								
Fancy and Red.....	2.00	to 3.00	3.00	to 4.00	3.00	to 4.00	3.00	to 4.00
Ordinary and White.....	to 1.50	2.00	to 3.00	2.00	to 3.00	1.50	to 2.50
MISCELLANEOUS								
Cattleyas.....	30.00	to 40.00	35.00	to 45.00	to 50.00	40.00	to 50.00
Lilies.....	12.00	to 15.00	10.00	to 12.00	to 12.50	8.00	to 10.00
Lily of the Valley.....	3.00	to 4.00	3.00	to 4.00	2.00	to 4.00	1.00	to 3.00
Marcis, Paper White.....	3.00	to 4.00	3.00	to 4.00	to 10.00	1.00	to 2.00
Roman Hya.....	3.00	to 4.00	3.00	to 4.00	2.00	to 3.00	1.00	to 2.00
Tulips.....	3.00	to 4.00	2.00	to 4.00	3.00	to 4.00	2.00	to 4.00
Daffodils.....	3.00	to 4.00	3.00	to 4.00	3.00	to 4.00	2.00	to 3.00
Freesias.....	3.00	to 4.00	3.00	to 4.00	3.00	to 4.00	1.00	to 2.00
Mignonette.....	3.00	to 4.00	3.00	to 4.00	2.00	to 3.00	1.00	to 2.00
Sweet Peas.....	5.00	to 1.00	.75	to 1.00	.75	to 1.00	.75	to 1.00
Gardenias.....	25.00	to 30.00	30.00	to 40.00	25.00	to 30.00	10.00	to 25.00
Violets.....	5.00	to .75	.75	to 1.00	50	to .75	50	to .50
Adonis.....	1.00	to 1.25	1.00	to 1.50	1.00	to 1.50	.75	to 1.00
Smilax.....	15.00	to 20.00	10.00	to 15.00	to 15.00	10.00	to 15.00
Asparagus Plumosa, string.....	40.00	to 50.00	35.00	to 50.00	35.00	to 50.00	25.00	to 50.00
" & Sprea. (too beh.).....	35.00	to 50.00	20.00	to 30.00	35.00	to 50.00	15.00	to 25.00

J.A. BUDLONG

37-39 Randolph Street, CHICAGO.

Roses and Carnations
A Specialty.....
WHOLESALE GROWER of CUT FLOWERS



HENRY M. ROBINSON & CO.
15 Province St. and 9 Chapman Place - BOSTON, MASS.
WHOLESALE COMMISSION FLORISTS

Hardy Cut Evergreens and Florists' Supplies

We have the stuff and can fill all orders, large or small
WE NEVER DISAPPOINT SATISFACTION GUARANTEED



Prices Quoted in these Columns are for Dealers only.
When Writing to Advertisers Please Mention HORTICULTURE.

Flower Market Reports.

BOSTON The "early bird" in search of the Easter worm is abroad in the land and is keeping the wholesale dealer busy giving quotations and taking orders for Easter shipments but, apart from this, very little is going on in the cut flower business. In fact, things are almost at a standstill and it is fortunate that the product is not heavy as there is little encouragement in sight. The supply is moved fairly well under the circumstances. White carnations are an exception to the general rule and are enjoying a little activity due to the light supply. The plant trade has been good, Easter orders being given well in advance and the stock unsold in growers' hands already reduced to the remnants.

BUFFALO Trade has been fairly good the past week but high prices are out of the question. The buyers practically have their way, as the abundance of all stock received by the wholesalers daily accumulates too fast. Roses are in oversupply. All varieties, including Beauties, are more plentiful, but the high prices of some days back has still a tendency to obstruct sales. Other materials such as sweet peas are very fine and have sold quite readily, while violets have no special demand. Lily of the valley is going slow, though it is hoped it will make up during Easter time. Other stock in good supply.

CHICAGO Will the Easter demand be unusually great, and if so, will there be stock enough to meet it? are the questions Chicago florists are trying to answer just now. Lilies always the cause of anxiety as Easter approaches, are unusually so this year. There may be lilies enough to go around, as some claim, but that there are enough that are good is quite another question. The fact that the large retail stores have placed their orders earlier than usual is of significance. Also that some of the heaviest growers had booked their entire stock before the first shipments began, means that there is nothing left for "repeat" orders or for the man who waits till the last week to place his order. The man who can sell any kind of a lily may find it easy, but the man who uses only good lilies will have to be alert. With carnations the matter is different. While many growers have their plants off crop there are enough whose plants are in right condition to permit a fairly good supply. This is especially true if we have a few days of sunshine. The scarcity of the white carnation still exists and must throughout the season, for it seems to result from a lack of planting, an over abundance of pale pink taking its place. These will work off well at Easter. Both the quality and supply of roses are good at this writing and unless weather is extremely unfavorable will remain so. Bulbous stock, cut and in pans, have sold well all the winter and no great amount has therefore been kept back for the close of Lent. A feeling generally prevails that the Lenten season of 1909 has been a good one for the florist and as the end approaches many express themselves as highly gratified.

WHOLESALE FLOWER MARKETS.—PER 100. TO DEALERS ONLY.

	CINCINNATI March 30	DETROIT March 30	BUFFALO March 30	PITTSBURG March 30
ROSES				
Am. Beauty, Fan, and Sp.....	50.00 to 60.00	25 00 to 35 00	30.00 to 45.00	30.00 to 40.00
" Extra..... to 50.00	20 00 to 25 00	15.00 to 30.00	20.00 to 35.00
" No. 1..... to 40.00	10 00 to 20 00	10.50 to 15.50	10.00 to 15.00
" Lower grades..... to 30.00	6 00 to 15 00	3.00 to 5.00	3.00 to 5.00
Bride, "Maid, F. & S.....	6 00 to 7 00	6 00 to 8 00	10 00 to 12 00	5 00 to 10 00
" Low. Gr.....	3 00 to 6 00	4 00 to 6 00	3 00 to 6 00	3 00 to 4 00
Killarney, Fan, & Sp.....	10 00 to 12 00	6 00 to 8 00	10 00 to 12 00	10 00 to 12 00
" Lower grades.....	6 00 to 8 00	4 00 to 6 00	4 00 to 6 00	6 00 to 8 00
Richmond, Fancy & Special.....	10 00 to 12 00	6 00 to 10 00	10 00 to 12 00	10 00 to 12 00
" Lower grades.....	6 00 to 8 00	4 00 to 6 00	3 00 to 6 00	6 00 to 8 00
Chateaux, No. 1.....	4 00 to 10 00	4 00 to 6 00	4 00 to 6 00	4 00 to 10 00
Golden Gate, Ivory, etc.....	3 00 to 8 00	4 00 to 8 00	3 00 to 8 00	3 00 to 8 00
My Maryland..... to 10 00 to 10 00 to 10 00 to 10 00
Mrs. Mar. Field..... to 10 00 to 10 00 to 10 00 to 10 00
CARNATIONS				
Fancy and Novelties.....	3 00 to 4 00	3 00 to 4 00	3 00 to 4 00	3 00 to 4 00
Ordinary.....	1 00 to 2 00	1 00 to 2 50	1 50 to 3 00	1 00 to 2 00
MISCELLANEOUS				
Cattleyas..... to 75.00 to 75.00	50.00 to 60.00 to 75.00
Lilies.....	15.50 to 15.00	12.50 to 15.00	8.00 to 15.00	12.50 to 15.00
Lily of the Valley.....	2 00 to 4 00	3 00 to 4 00	3 00 to 4 00	2 00 to 4 00
Narcis, Paper White.....	2 00 to 4 00	3 00 to 4 00	3 00 to 4 00	2 00 to 3 00
Romoa Hya.....	1 00 to 3 00	3 00 to 4 00	3 00 to 3 00	1 00 to 3 00
Tulips.....	3 00 to 4 00	3 00 to 4 00	2 00 to 3 00	3 00 to 4 00
Daffodils.....	1 00 to 4 00	3 00 to 3 00	2 00 to 3 00	1 00 to 4 00
Freesias.....	2 00 to 3 00	3 00 to 4 00	2 00 to 3 00	1 00 to 3 00
Mignonette.....	3 00 to 10 00	10 00 to 15 00	2 00 to 3 00	3 00 to 4 00
Sweet Peas.....	.75 to 1 00	.50 to 1 00	.50 to 1 00	.75 to 1 00
Gardenias.....	25.00 to 35.00	30 00 to 40 00 to 1 00	25 00 to 35 00
Violets.....	50 to 75	50 to 75	50 to 75	50 to 75
Adiantum..... to 1 00 to 1 00	1 50 to 1 50	1 25 to 1 50
Smilax..... to 15.00 to 15.00	12.50 to 15.00	12.50 to 15.00
Asparagus Plumosus, strings.....	30.00 to 35.00	50.00 to 75.00	40.00 to 50.00	30.00 to 50.00
" " & Spreu (too bchs.)..... to 25.00	30 00 to 50 00	25 00 to 30 00	30 00 to 50 00

INDIANAPOLIS Trade the past week has been brisk and active. Store openings of various kinds have been using not only quantities of decorative material but flowering plants and cut flowers. There has been no overstock of anything. Good Beauties and all other varieties of roses can be had for nearly half what they were two weeks ago. The quantity, quality and demand of carnations could not be more satisfactory. Easter lilies are somewhat on the scarce side. A large supply of fine sweet peas are having a good run. Violets are cheap, with supply ahead of demand. Bulbous stock of all kinds continues plentiful. The topic of vital interest at present is Easter stock. Should this warm spell keep up it would hasten stock along and perhaps cause a scarcity. Lilies seem to be very scarce with some growers. There appears to be great demand for green goods of all kinds. The sale of plants is increasing daily.

PHILADELPHIA The usual pre-Easter slump took place last week in the cut flower market. Such a condition was not unlocked for, but it was greatly aggravated by the activity of some one or more of our retailers with political influence stirring up the police department again to keep the curbstone men off Market and Chestnut Sts.—a spasmodic and periodical exploit as unwise as it is pernicious to the best interests of all the trade; especially at this season of the year when the curb men are of the greatest advantage in keeping the market from a disastrous break prejudicial to all concerned. The usual Saturday clean-up did not take place in consequence,

and much of the week's surplus had to go to the dump. Roses on the whole were of excellent quality and in large supply—considerably more than the market could absorb—and prices as a rule broke badly. American Beauties sold out fairly well. Many specials had finally to go for same rates as lower grades, however, and the general situation was distinctly under the previous week's quotations. Richmonds have been scarce but have taken on a new spurt and are more plentiful. Killarneys and Jardines make a better showing both as to price and quality than Brides or Bridesmaids. The carnation situation is not quite so congested as in roses, and stocks have cleaned up fairly well. Single violets are nearly over. The outlook for Easter on the violet crop is that they will be on the scarce side. The main dependence will have to be on frame grown stock. The quality of the lily of the valley now coming in is only fair, and the demand is sluggish. Considering present conditions, sweet peas are holding their own very well, and are one of the most satisfactory items. Prices good, quality good, demand all right. No life in the cattleya market. First quality gardenias are in demand but there is a large amount of poor grade stock that is hard to move at any price. Easter lilies are selling well. The Easter bookings for these, both cut and plants are very lively, many of the best stocks being already engaged. The early bookings were at from ten to twelve but the market has stiffened within the week and nothing decent can now be had for less than fifteen to seventeen. Out of town demand for the general run of Easter plants is excellent.

EVERYBODY KNOWS

Gardeeving cannot be properly done without the aid of an accurate leveling instrument

Bostrom's Improved Levels, No. 3 at \$16.00 and No. 3 at \$25.00, are conceded by all who **KNOW** to be the only levels on the market which meet all the requirements, at the price.

Our guarantee back of every Level we sell, and satisfied users in every State in the Union heartily endorse every claim we make.

Shipping weight 12 lbs. Description on request.

BOSTROM-BRADY MFG. CO., 133 Madison Avenue., ATLANTA, GA.

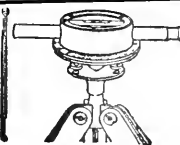

FORD BROTHERS
 48 West 28th Street NEW YORK
FINE ROSES FANCY CARNATIONS
 A Full Line of All CUT FLOWERS
 Telephone, 3870 or 3871 Madison Square

H. E. FROMENT
 Wholesale Commission Florist,
 Choice Cut Flowers,
 57 West 28th St. :: NEW YORK
 Telephones: 2200, 2201, Madison Square.

Alfred H. Langjahr
 All choice cut-flowers in season. Send for quotations. Correspondence with shippers of first-class stock invited.
 55 West 28th Street, New York
 Telephone 4626-4627 Madison Square

Edward C. Horan
 Wholesale Florist
 55 WEST 28th ST.
 Tel. 1462 Madison Square NEW YORK

JOHN YOUNG
WHOLESALE FLORIST
 Finest American Beauties and Carnations
 51 West 28 St. - NEW YORK

FRANK MILLANG
 Wholesale Florist
 55-57 West 26th St., NEW YORK
 Shipments, any quantity. Wholesale Market Rates.

Henshaw & Fenrich
WHOLESALE FLORISTS
 44 West 28th Street, NEW YORK
 Phones Mad. Sq. 326, 558-2, 558-3

VIOLETS
 Finest Grade. Any Quantity
B. S. SLINN
 55-57 W. 26 St., New York

Moore, Hentz & Nash
 Wholesale Commission Florists
 55 and 57 West 26th Street
 Telephone No. 756 New York
 Madison Square

MILLANG BROS.
 WHOLESALE COMMISSION FLORISTS
 41 West 28th Street
 Telephone 8880 Madison NEW YORK
 3661

JOHN I. RAYNOR
Wholesale Commission Florist SELLING AGENT FOR LARGEST GROWERS
 A full line of Choice Cut Flower Stock for all purposes. Comprises every variety grown for New York market, at current prices
 TEL. 1998 MADISON SQUARE 49 West 28th St., New York City

Walter F. Sheridan
 Wholesale Commission Dealer in
CHOICE CUT FLOWERS
 39 West 28th Street, New York
 Telephone: 3532-3533 Madison Square

HEADQUARTERS FOR NOVELTIES
ORCHIDS A SPECIALTY
 THE HIGHEST GRADE OF **VALLEY** ALWAYS ON HAND
 GARDENIAS, DAISIES, ROSES AND CARNATIONS
 Telephone
JAMES McMANUS, 759 Mad. Sq. 42 W. 28th St., New York

PHILIP F. KESSLER 55 & 57 W. 26th St., New York City
 Commission Dealer, Wholesale Buyer and Seller of
CUT FLOWERS
 Open from 5 a. m. to 6 p. m. Sunday till 10 a. m.
 Tel. 5243 and 2921 Madison Sq. Res. 345 J., Newtown.
Finest Lilies in the Market Every Day in the Year.

NEW YORK QUOTATIONS PER 100. To Dealers Only

ROSES AND CARNATIONS	Last Half of Week ending Mar. 27 1909	First Half of Week beginning Mar. 29 1909
	American Beauty, Fancy and Special.....	12.00 to 25.00
" " Extra.....	8.00 to 12.00	8.00 to 12.00
" " No. 1.....	5.00 to 8.00	5.00 to 8.00
" " Lower Grades.....	1.00 to 3.00	1.00 to 3.00
Bride, Field, Fancy and Special.....	4.00 to 6.00	4.00 to 6.00
" " Lower Grades.....	1.00 to 3.00	1.00 to 3.00
Killarney, Fancy and Special.....	6.00 to 10.00	6.00 to 10.00
" " Lower Grades.....	1.50 to 3.00	1.10 to 3.00
Richmond, Fancy and Special.....	6.00 to 12.00	6.00 to 12.00
" " Lower Grades.....	1.00 to 3.00	1.00 to 4.00
Chatenay.....	1.50 to 12.00	1.50 to 12.00
Golden Gate, Ivory, etc.....	1.00 to 6.00	1.00 to 6.00
Ty Maryland.....	2.00 to 15.00	2.00 to 15.00
Mrs. Har. Field..... to to
Carnations, Fancy and Novelties.....	3.00 to 6.00	3.00 to 6.00
" " Ordinary and White.....	1.00 to 3.00	1.00 to 3.00

Alexander J. Guttman
THE WHOLESALE FLORIST OF NEW YORK
 34 WEST 28th STREET
 PHONES. 1664--1665 MADISON SQUARE
ENOUGH SAID

TRAENDLY & SCHENCK
 Wholesale Florists
 Furnish best Stock at fair Prices all the year round
 Send for Quotations on Any Variety and Quantity
 Tel. 798, 799 Madison Sq. 44 West 28th St., New York City

GROWERS' CUT FLOWER CO. CUT FLOWERS AT WHOLESALE
VIOLETS, CARNATIONS, ROSES
ORCHIDS, CHRYSANTHEMUMS, LILIES
 Consignments Solicited. Shipments to Order, any Distance
 Telephone East Madison Square
39 West 28th Street, J. J. O'GAN, Manager NEW YORK

WHOLESALE FLORISTS
54 West 28th St.
NEW YORK
Telephone 3559 Madison Sq.

A. L. YOUNG & CO.

RECEIVERS & SHIP-
PERS OF CUT
FLOWERS.
CONSIGNMENTS SOLICITED.

WILLIAM H. KUEBLER
Brooklyn's Foremost and Best
WHOLESALE COMMISSION HOUSE
A First Class Market for all CUT FLOWERS
28 Willoughby St., Brooklyn, N. Y.
Tel. 4591 Main

GEORGE COTSONAS & CO.
Wholesale and Retail Dealers in all kinds of
EVERGREENS
Fancy and Dagger Ferns
Bronze and Green Galax
Main Store 50 W. 28 St.
Phone 1808 Mad. Sq. New York



Greater New York Florists' Association, Inc.
Now Open for Cut Flower Consignments
162 Livingston Street, BROOKLYN, N. Y.
Geo. W. Crewbuck Telephone Connection
Manager 3642-43 Main

CENTRALLY LOCATED, THE HUB OF THE
FLOWER MARKET SECTION
CHARLES MILLANG
Wholesale Florist
444 Sixth Ave., NEW YORK
Telephone 7062 Madison

REED & KELLER
122 West 25th St., New York
Florists' Supplies
We manufacture all our
Metal Designs, Baskets, Wire Work & Novelties
and are dealers in
Glasware Decorative Greens and Florists' Requisites

WHOLESALE COMMISSION J. K. ALLEN 106 W. 28th St.
NEW YORK
Open 6 a.m. Daily Tel. 167 Madison Sq.
Shipments of Lily of the Valley and Bulb Flowers Needed.

THE KERVAN CO.
Wholesale Dealers and Shippers of
Decorative Evergreens
Ferns, Galax, Laurel, Fresh Cycas, Box-
wood, Spagnum and all Florists' Greens
Send to us for Quotations before Buying.
113 West 28 Street, NEW YORK CITY

MICHIGAN CUT FLOWER EXCHANGE, Inc.
WHOLESALE COMMISSION FLORISTS
Consignments Solicited
Hardy Fancy Fern Our Specialty
38-40 BROADWAY, DETROIT, MICH.

NEW YORK QUOTATIONS PER 100. To Dealers Only

MISCELLANEOUS	Last Half of Week ending Mar. 27 1909		First Half of Week beginning Mar. 29 1909	
	to	50.00	30.00	to 50.00
Cattleyas.....	30.00	50.00	30.00	50.00
Lilies.....	6.00	10.00	6.00	10.00
Lily of the Valley.....	1.00	3.00	1.00	3.00
Narcis., Paper White.....	2.00	2.00
Roman Hya.....	1.00	2.00	1.00	2.00
Tulips.....	2.00	4.00	2.00	4.00
Daffodils.....	1.35	2.00	2.00
Freesias.....	1.00	2.00	1.00	2.00
Mignonette.....	1.50	3.00	1.00	3.00
Sweet Peas.....	.25	1.00	.20	.75
Gardenias.....	5.00	35.00	5.00	35.00
Violets.....	.25	.40	.25	.40
Adiantum.....	.75	1.00	.75	1.00
..... Croweanum.....	1.00	1.25	1.00	1.25
Smilax.....	8.00	12.00	8.00	12.00
Asparagus Plumosus, strings.....	25.00	25.00	80.00	25.00
..... " & Soren. (100 bchs).....	10.00	25.00	15.00	25.00

NEW YORK MARKET.

The flower market experienced a very poor week's business last week and the present conditions are not much better. The situation is perhaps a little more easily handled on account of somewhat reduced receipts on certain lines, but the supply of everything is more than ample. Beauties are not so plentiful, carnations are not too abundant and the bulbous stock is about even with the demand. The line most affected by the lack of activity is the tea roses. These drag along very wearily and the special grades are hardest to handle. Nothing is said about Easter as yet that is worth quoting except that there seems to be a well-founded impression that lilies of first quality will not be in over supply. Plant dealers are practically sold out on all desirable staples.

WASHINGTON NOTES.

Cold weather has retarded out-of-door planting and packing, and cut down the flower supply. There is a scarcity of Easter lilies reported and those of poorer quality than is usual.

Boston.—W. H. Elliott is about to open a city distributing depot for his product, on Park street.

INCORPORATED.

The Aitken Co., conducting a flower business in Springfield and Worcester, Mass., have incorporated with capital of \$5,000. C. S. Meacham is president, Mark Aitken, treasurer.

Bangor, Me.—New Floral Co., E. G. Hutchins, E. B. Hutchins, C. A. Hutchins; capital, \$10,000.

WILLIAM F. KASTING CO.
WHOLESALE FLORISTS
383-387 Ellicott Street
BUFFALO, - N. Y.

WANTED. Consigners of Carnations, Violets and Roses. Also can handle a large quantity of Easter Plants, I guarantee you good returns.

Write at Once.
THE SEA SHORE CUT FLOWER MARKET,
812 Atlantic Ave., Atlantic City, N. J.

ROBERT J. DYSART
Public Accountant and Auditor
Simple methods of correct accounting especially adapted for florists' use.
Books Balanced and Adjusted
Merchants Bank Building
28 STATE STREET, - BOSTON
Telephone, Main 58.

FOR FLORISTS' USE
There's **NOTHING** as good as
MEYER'S SILKALINE
Don't let them sell you anything else
JOHN C. MEYER & CO., Boston, Mass.
In ordering goods please add "I saw it in HORTICULTURE."

Use Krick's Immortelle Letters

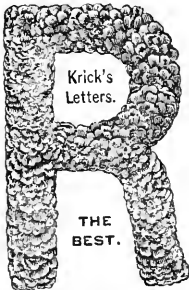

The original and still the best. All others are followers.

All Orders Promptly Attended to.

Send for Samples and Price Lists.

1164-1166 Greene Ave.,
BROOKLYN, - N. Y.

Buyer's Directory and Ready Reference Guide

Advertisements under this head, one cent a word. Initials count as words.

Display advertisers in this issue are also listed under this classification without charge. Reference to List of Advertisers will indicate the respective pages.

Buyers failing to find what they want in this list will confer a favor by writing us and we will try to put them in communication with reliable dealers.

ACCOUNTANT

R. J. Dyart, 28 State St., Boston.
For page see List of Advertisers.

AMPELOPSIS.

Storrs & Harrison Co., Palmesville, O.
For page see List of Advertisers.
Eastern Nurseries, Henry F. Dawson, Mgr.,
Ampelopsis Quinquefolia,
Jamaica Plain, Mass.
For page see List of Advertisers.
C. Elsie, 11th and Westmoreland Sts.,
For page see List of Advertisers.

ARGENTEUIL ASPARAGUS

Argenteuil Asparagus Plants. Frank H. Snow, Orleans, Mass.
Asparagus Roots, \$5 per 1000. Send for circular with extract from experiment station report, how this kind returned \$839.87 per acre. California Privet, stocky 12 to 18 inch plants, \$5.00 per 100; \$25.00 per 1000. West Jersey Nurseries, Bridgeton, N. J.

AQUATIC PLANTS

Aquarium plants the year round. Wholesale and retail. Send for price list. Schmid's Emporium of Pets, 712 12th Street, Washington, D. C.

AQUILEGIAS

Aquilegia Genoline Coerulea, finest of all. Both plants and seeds from the heart of the Rockies. C. S. Harrison's Select Nursery, York, Neb.

ARAUCARIAS

A. Leuthy & Co., Perkins St. Nurseries, Roslindale, Mass.
For page see List of Advertisers.
Godfrey Aschmann, 1012 West Ontario St., Philadelphia, Pa.
For page see List of Advertisers.

ASPARAGUS

Asparagus plumosus nanus and Sprungeri, 2 in., 1 year old, strong, \$3.00 per 100. E. & C. Woodman, Danvers, Mass.
Asparagus Plumosus Nanus Seed. California grown, 1000, \$2.50; 5000, \$10.00. Special rates on larger lots. Jackson Nursery, 1932 Trinity St., Los Angeles, Cal.

ASPARAGUS SEED

S. S. Pennock-Meehan Co., Philadelphia.
For page see List of Advertisers.

ASTER SEEDS

Elmer D. Smith & Co., Adrian, Mich.
For page see List of Advertisers.

AUCTION SALES

Osbey's Horticultural Co., 62 Vesey St., New York.
For page see List of Advertisers.
The Fruit Auction Co., 200, 202, 204 Franklin St., New York.
Daily Auction Sales.

AZALEAS

A. Leuthy & Co., Perkins St. Nurseries, Roslindale, Mass.
For page see List of Advertisers.
Godfrey Aschmann, 1012 W. Ontario St., Philadelphia.
For page see List of Advertisers.

BAMBOO CANES

Yokohama Nursery Co., 31 Barclay Street, New York.
Bamboo Sticks, Colored Green.
For page see List of Advertisers.
Wm. Elliott & Sons, New York City.
Lily Stakes.
For page see List of Advertisers.

BAV TREES.

3000 Bay and Box Trees in all sizes, Pyramid and Standards. Write for list. Julius Roehrs, Rutherford, N. J.

BEDDING PLANTS

J. E. Felthousen, Schenectady, N. Y.
For page see List of Advertisers.
A. Leuthy & Co., Perkins St. Nurseries, Roslindale, Mass.
For page see List of Advertisers.
G. Aschmann, 1012 W. Ontario St., Philadelphia, Pa.
For page see List of Advertisers.
F. P. Sawyer, Clinton, Mass.
For page see List of Advertisers.
Rooted Cuttings, Fuchsias, Heliotrope, Salvia Zurich, Bonfire, 75c. per 100. Ageratum Gurney, German Ivy, 50c. per 100. Cash with order. F. A. Ezold, Haddam, Conn.

BEGONIAS

Begonias, Giant Single Tuberosus-rooted, Rose, Scarlet, White, Salmon, Crimson, Yellow, Orange, 1 1/2 in. and up, \$22.00 per 1000. Special \$1.90 per 100 if an equal number of each of the above seven colors are ordered. Binghamton Seed Co., Binghamton, N. Y.

BOILERS

BOILERS. "Burnham" Boilers made for greenhouse heating. Lord & Burnham, 1183 Broadway, N. Y.

Kreoschell Bros. Co., 35 Erie St., Chicago.
For page see List of Advertisers.

BOXWOOD TREES

New England Nurseries, Inc., Bedford, Mass.
For page see List of Advertisers.
Anton Schultheis, College Point, N. Y.
For page see List of Advertisers.

BUILDING MATERIAL

BUILDING MATERIAL of all description for All Cypress, Seal-iron, Iron Frame or Truss Houses, Hot Bed Sash and Frames. Lord & Burnham Co., 1183 Broadway, N. Y.

BULBS AND TUBERS

Joseph Breck & Sons, 47-54 N. Market St., Boston.
For page see List of Advertisers.
J. M. Thornburn & Co., 33 Barclay St., New York.
For page see List of Advertisers.
A. T. Boddington, 342 W. 14th St., N. Y.
For page see List of Advertisers.
Richards Bros., 37 East 19th St., New York.
For page see List of Advertisers.
H. F. Mitchell Co., Philadelphia.
For page see List of Advertisers.
H. E. Fiske Seed Co., Faneuil Hall Sq., Boston.
For page see List of Advertisers.
T. J. Grey & Co., 32 and 33 So. Market St., Boston.
For page see List of Advertisers.
Yokohama Nursery Co., 31 Barclay St., New York.
For page see List of Advertisers.
Raiph M. Ward & Co., 12 W. Broadway, New York.
For page see List of Advertisers.
K. Takeuchi, 475A Boylston St., Boston.
Japanese Bulbs.
For page see List of Advertisers.
Schlegel & Fottler Co., 26 & 27 S. Market St., Boston.
For page see List of Advertisers.

CANNAS

A. T. Boddington, 342 W. 14th St., New York.
For page see List of Advertisers.

C. Elsie, 11th and Westmoreland Sts., Philadelphia, Pa.
For page see List of Advertisers.

Large assortment of Cannas of the following varieties: Burbank, Pennsylvania, Berat and Clebar, at \$1.50 per 100; or would exchange for dwarf Ageratum, Fervent, double Alyssum. C. W. Moeckel, 17 Summer St., Fitchburg, Mass.

CANTELOUPE SEED

Burrell Gem and Tiptop Cantaloupe Seed, selected from best netted melons. Seed fresh and offered by the world's largest cantaloupe grower. 3 new sorts free with each order. Lb. by mail, 60 cents. H. Clay Beebe, Olney, Colo., R. No. 1.

CARNATIONS

F. Dorner & Sons Co., Lafayette, Ind.
Carnation, Indiana.

Chicago Carnation Co., Joliet, Ill.
For page see List of Advertisers.

Albert Roper, Tewksbury, Mass.
Carnation Bay State.

For page see List of Advertisers.
Bassett & Washburn, Hinsdale, Ill.
Carnation O. P. Bassett.

For page see List of Advertisers.
Wood Bros., Fishkill, N. Y.
Carnations Rooted Cuttings.

For page see List of Advertisers.
The E. G. Hill Co., Richmond, Ind.
Carnation Cuttings.

For page see List of Advertisers.
Peter Fisher, Ellis, Mass.
Rooted Cuttings.

S. J. Reuter & Son, Westerly, R. I.
For page see List of Advertisers.

Poehlmann Bros. Co., Morton Grove, Ill.
For page see List of Advertisers.

E. W. Fenger, 147-87 Linden Av., Irvington, N. J.
Rooted Carnation Cuttings.
For page see List of Advertisers.

CHRYSANTHEMUMS

Schlegel & Fottler Co., 26 & 27 S. Market St., Boston.
Chrysanthemum Belfast.

E. G. Hill Co., Richmond, Ind.
For page see List of Advertisers.

S. J. Reuter & Son, Westerly, R. I.
For page see List of Advertisers.

Elmer D. Smith & Co., Adrian, Mich.
For page see List of Advertisers.

C. H. Totty, Madison, N. J.
Single Chrysanthemums From Seed.
For page see List of Advertisers.

J. H. Myers, Altoona, Pa.
For page see List of Advertisers.

Scott Bros., Elmford, N. Y.
For page see List of Advertisers.

Poehlmann Bros. Co., Morton Grove, Ill.
For page see List of Advertisers.

F. P. Sawyer, Clinton, Mass.
For page see List of Advertisers.

Chrysanthemum Golden Glow from 2-14 in. pots, for early spring delivery, \$1.00 per doz., \$6.00 per 100, \$50.00 per 1000. Stock plants of Montmore, Oct. Frost, Crocus, Matchless, Lucy Devaux, Folly Rose and Halliday, \$1.00 per doz.; \$6.00 per 100. Peirce Bros., Waltham, Mass.

For List of Advertisers See Page 516

CHRYSANTHEMUMS — Continued

50,000 Chrysanthemums. White—Timothy Eaton; Mrs. Geo. S. Kallb. fine, early; Estelle, White Bonaffon, Alice Hyron, Lucy, C. Toussot, Jeanne Nomin, Oct. Frost, Early Snow, Angele Laurent. Pink—Glory of Pacific, Dr. Enguehard, Maud Dean, Pink Ivory, Rosette. Yellow—Maud Bonaffon, Crown, Robt. Holliday; Italy, small yellow, of the button type. Rooted cuttings ready. Send for prices. Wm. Swayne, Box 225, Kennett Square, Pa.

Golden Glow, R. C., 25 for \$1.00; 100, \$3.50. Pacific Supreme, 50 for \$1.00; \$3.00 per 100, prepaid. Best Early Yellow and Pink Mums. Chas. Frost, Kenilworth, N. J.

For Sale—Chrysanthemums, Henry Parr, Maj. Bonaffon, and Dr. Enguehard, \$1.25 per 100; \$10.00 per 1000. Cash please. Wm. E. Mosher, 232 North St., New Bedford, Mass.

Herrington's book on the Chrysanthemum, mailed to your address for 50c. by Horticulture Publishing Co., 11 Hamilton Place, Boston.

COLEUS

J. E. Felthousen, Schenectady, N. Y. For page see List of Advertisers.

Coleus. Strong rooted cuttings, 10 choice varieties, 60 cents per hundred. Verschaffeltii and Golden Boder 75 cents per hundred. Edmund Reardon, Cambridge, Mass.

CONIFERS

John Waterer & Sons, Ltd., American Nursery, Bagshot, Eng. For page see List of Advertisers.

CUT FLOWER BOXES.

Edwards Folding Box Co., Philadelphia For page see List of Advertisers.

Folding cut flower boxes, the best made Write for list. Holton & Hunkel Co., MUwaukee, Wis.

DAHLIAS

David Herbert & Son, Atco, N. J. For page see List of Advertisers.

J. L. Moore, Northboro, Mass. For page see List of Advertisers.

Peacock Dahlia Farms, Williamstown Junction, N. J. Dahlia Jack Rose. For page see List of Advertisers.

R. Vincent Jr. & Sons Co., White Marsh, Md. For page see List of Advertisers.

DAHLIAS.

Geo. H. Walker, No. Dighton, Mass. Wholesale and Retail. Send your name for my 1909 Catalog and Pocket Guide, ready to mail about Feb. 25th.

Cactus, Decorative, Fancy, Show and Pompon Dahlias. Good commercial varieties, such as Kriemhilde, Countess of Lousdale, Mad. Van Den Deel and other true bloomers, strictly divided roots in 10 or 20 named varieties by selection, \$1.00 per 25; \$3.00 per 100; \$25.00 per 1000. Cash please. Herrmann Thiemann, Mucson, Mass.

Dahlias. Novelties and standard varieties, true to name, a choice list of the best introductions. Send for catalog of dahlias, hollyhocks, hardy plants. Prices always reasonable. W. W. Willmore, Box 282 Denver, Colo.

East Bridgewater Dahlia Gardens wants your business. If you are looking for dahlia seed to the Eastern Dahlia King J. K. Alexander, East Bridgewater, Mass.

FOR SALE—Dahlia bulbs, choice varieties, very cheap. Send for catalog. P. A. Treadup, Jr., 28 Lindsey St., New Bedford, Mass.

DECORATIVE PLANTS

A. Leuthy & Co., Perkins St. Nurseries, Roslindale, Mass. For page see List of Advertisers.

Godfrey Aschmann, 1012 W. Ontario St., Phila., Pa. For page see List of Advertisers.

DECORATIVE PLANTS—Continued

Joseph Heseock Co., Wyncote, Pa. For page see List of Advertisers.

The Geo. Wittbold Co., 1657 Buckingham Place, Chicago, Ill. For page see List of Advertisers.

Robert Craig Co., Market and 49th Sts., Philadelphia, Pa. For page see List of Advertisers.

DRACAENAS

Dracaena Indivisa, S. T. G. 5 and 4 in. Prices on application. E. & C. Woodman, Danvers, Mass.

ECONOMY BRACKET

Buxton & Allard, Nahua, N. H. For page see List of Advertisers.

ERICAS

Anton Schultheis, College Point, N. Y. For page see List of Advertisers.

EVERGREENS

New England Nurseries, Bedford, Mass. For page see List of Advertisers.

American Nursery Co., 150 Broadway, New York, N. Y. For page see List of Advertisers.

Henry A. Dreer, Philadelphia, Pa. For page see List of Advertisers.

Evergreens. Send 25 cents in stamps for complete work on propagating and growing Evergreens. C. S. Harrison's Select Nursery, York, Neb.

FERNS

A. Leuthy & Co., Roslindale, Mass. For page see List of Advertisers.

H. H. Barrow & Son, Whitman, Mass. Nephrolepis Magnifica. For page see List of Advertisers.

John Scott, Brooklyn, N. Y. For page see List of Advertisers.

Frank Oechlein, 2570-2606 W. Adams St., Chicago. Ferns for Dishca. For page see List of Advertisers.

The Geo. Wittbold Co., 1657 Buckingham Place, Chicago, Ill. For page see List of Advertisers.

Godfrey Aschmann, 1012 W. Ontario St., Philadelphia. For page see List of Advertisers.

C. Elsele, 11th and Westmoreland Sts., For page see List of Advertisers.

Anderson's ferns for in and outdoors. Largest commercial collection in the country. Ask for descriptive catalogue. J. F. Anderson, Fern Specialist, Short Hills, N. J.

FERTILIZERS

Pulverized Manure Co., 31 Union Stock Yards, Chicago, Ill.

Wisard Brand Sheep and Shredded Cattle Manure.

Robert Simpson, Clifton, N. J. Sheep Manure. For page see List of Advertisers.

Bowker Fertilizer Co., Boston, Mass. All Forms of Plant Food at First Hand. For page see List of Advertisers.

FEVERFEW

2000 Feverfew, 2 1/2 in., \$3.00 per 100, \$25.00 per 1000. Albert Bailey & Son, Maynard, Mass.

Feverfew, 2 1/2 in., \$2.00 per 100. H. J. Blanchard, Ashburnham, Mass.

FLORAL PHOTOGRAPHS

Floral Photographs. Foley's, 225-223 T-2 Bowery, New York.

FLORISTS' LETTERS.

Boston Florist Letter Co., 66 Pearl St., Boston, Mass. For page see List of Advertisers.

W. C. Krick, 2154-66 Greene Ave., Brooklyn, N. Y. Immortelle Letters. For page see List of Advertisers.

FLORISTS SUPPLIES

N. F. McCarthy & Co., 84 Hawley St., Boston. For page see List of Advertisers.

H. M. Robinson & Co., 15 Province St. and 9 Chapman Pl., Boston, Mass. For page see List of Advertisers.

Reed & Keller, 122 W. 23th St., New York. For page see List of Advertisers.

M. Bayeradorfer & Co., 1129 Arch St., Philadelphia. For page see List of Advertisers.

FLOWER POTS

W. H. Ernest, 25th and M Sts., Washington, D. C. For page see List of Advertisers.

A. H. Hewa & Co., Cambridge, Mass. For page see List of Advertisers.

Hillinger Bros., Ft. Edward, N. Y. For page see List of Advertisers.

The Peters & Reed Pottery Co., Red pots, seed pans, etc. Zanesville, O.

Syracuse Pottery Co., Syracuse, N. Y. Syracuse Red Pots. For page see List of Advertisers.

We make Standard Flower Pots, etc. Write us when you need. Wilmer Cope & Bro. Lincoln University, Chester Co., Pa.

FUCHSIAS

R. Vincent, Jr. & Sons Co., White Marsh, Maryland. For page see List of Advertisers.

GALAX

Michigan Cut Flower Co., 38 and 40 Broadway, Detroit, Mich. For page see List of Advertisers.

George Cotsanos & Co., 50 W. 28th St., New York. For page see List of Advertisers.

The Kervan Co., 113 West 28th St., N. Y. For page see List of Advertisers.

Elca Bros., 115 N. 8th St., Minneapolis, Minn. For page see List of Advertisers.

H. M. Robinson & Co., 15 Province St. and 9 Chapman Place, Boston. For page see List of Advertisers.

GERANIUMS

R. Vincent Jr. & Sons Co., White Marsh, Md. New and Standard Varieties. For page see List of Advertisers.

A few hundred fine mixed stock geraniums, all double, \$7.00 per 100. Fine geraniums, 2 1/2 in., \$2.00 per 100. Cash. H. J. Blanchard, Ashburnham, Mass.

GLADIOLI

J. L. Moore, Northboro, Mass. For page see List of Advertisers.

O. V. Zangen, Hingham, N. J. Gladiolus Brenehelyca. For page see List of Advertisers.

I. & J. L. Leonard, Iona, N. J. Gladiolus Bulbs.

GLASS

Boston Plate & Window Glass Co., Boston. For page see List of Advertisers.

Standard Plate Glass Co., 26-30 Sudbury St., Boston. For page see List of Advertisers.

Foley Mfg. Co., Western Ave., between 25th & 26th Sts., Chicago.

Sharp, Partridge & Co., 22d & Lumber St., Chicago. For page see List of Advertisers.

Parselsky Bros., Inc., 59 Montrose Ave., Brooklyn, N. Y. For page see List of Advertisers.

Greenhouse glass, lowest prices. Johnston Glass Co., Hartford City, Ind.

Glass, High Grade, Double Thick Greenhouse Glass. Lord & Burnham, 1133 Broadway, N. Y.

In writing to Advertisers kindly mention Horticulture

GLAZING DEVICE

H. A. Dreer, Philadelphia, Pa.
Peerless Glazing Point.
For page see List of Advertisers.

GLAZING POINTS, Lord & Burnham
Special Glazing Nails (Points), Lord &
Burnham, 1133 Broadway, N. Y.

GREENHOUSE BUILDING MATERIAL

Lord & Burnham Co.,
1133 Broadway, New York.
For page see List of Advertisers.

Pierson U-Bar Co., 1 Madison Sq., N. Y.
For page see List of Advertisers.

A. T. Stearns Lumber Co., Neponset,
Boston.
For page see List of Advertisers.

King Construction Co., N. Tonawanda,
New York.
For page see List of Advertisers.

Hitchings & Co., 1170 Broadway, New York.
For page see List of Advertisers.

J. C. Moninger Co., 117 East Blackhawk St.,
Chicago, Ill.
For page see List of Advertisers.

Foley Mfg. Co., Western Ave., between
25th & 26th Sts., Chicago.
For page see List of Advertisers.

W. H. Lutton, West Shore Av. Sta., Jersey
City, N. J.
For page see List of Advertisers.

GREENHOUSE CONSTRUCTION

GREENHOUSE CONSTRUCTION, Semi-
Iron Greenhouse, New Truss Homes and
Iron Frame Houses, Lord & Burnham,
1133 Broadway, N. Y.

J. A. Payne, 260-274 Culver Ave., Jersey
City, N. J.
For page see List of Advertisers.

Foley Mfg. Co., Western Ave., between
25th & 26th Sts., Chicago.
For page see List of Advertisers.

Hitchings & Co., 1170 Broadway, New York.
For page see List of Advertisers.

Geo. M. Garland Co., Des Plaines, Ill.
For page see List of Advertisers.

GREENHOUSE HOSE

Revere Rubber Co., Boston, Mass.
Revere Hose.
For page see List of Advertisers.

GUTTERS

GUTTERS, Cast Iron Gutters, L & B
Improved V Shaped Gutter with drip
gutter attachment, Lord & Burnham, 1133
Broadway, N. Y.

HALL INSURANCE

Florists' Hall Asso. of America.
J. G. Esler, Saddle River, N. J.
For page see List of Advertisers.

HARDY FERNS, MOSS AND GREENS

H. M. Robinson & Co., 15 Province St.
and 9 Chapman Pl., Boston, Mass.
For page see List of Advertisers.

Michigan Cut Flower Exchange,
38 and 40 Broadway, Detroit, Mich.
For page see List of Advertisers.

George Cotsouas & Co., 50 W. 28th St.,
New York.
For page see List of Advertisers.

N. F. McCarthy & Co., 84 Hawley St.,
Boston.
For page see List of Advertisers.

The Kervan Co., 113 W. 28th St., N. Y.
For page see List of Advertisers.

Elce Bros., 115 N. 6th St., Minneapolis,
Minn.
For page see List of Advertisers.

HARDY PERENNIALS

Henry A. Dreer, 714 Chestnut St., Phila.
For page see List of Advertisers.

HEATING APPARATUS

Lord & Burnham Co.,
1133 Broadway, New York.
For page see List of Advertisers.

Pierson U-Bar Co., 1 Madison Sq., N. Y.
For page see List of Advertisers.

John A. Payne, 260-274 Culver Ave., Jersey
City, N. J.
For page see List of Advertisers.

Kroeschell Bros. Co., 35 Erie St., Chicago.
For page see List of Advertisers.

HELP FURNISHED

Chas. H. Bambrick, 34 S. 7th St., Phila.
For page see List of Advertisers.

HERBACEOUS PERENNIALS

P. Ouwkerk, P. O. No. 1, Hoboken, N. J.
For page see List of Advertisers.

New England Nurseries, Bedford, Mass.
For page see List of Advertisers.

The Geo. Wittbold Co., 1857 Buckingham
Place, Chicago.
For page see List of Advertisers.

D. A. Clarke, Red Oak Nurseries, Flske-
ville, R. I.

HOLLYHOCKS

Hollyhocks, Clater's double, white, pink
and crimson; August transplanted; first-
class lot, \$3.00 per 100. Ed. C. Lindsay,
Milford, Del.

HOT-BED SASH

The A. T. Stearns Lumber Co., Neponset,
Mass.
For page see List of Advertisers.

Pierson U-Bar Co., 1 Madison Sq., N. Y.
For page see List of Advertisers.

Lord & Burnham Co., 1133 Broadway, N. Y.
For page see List of Advertisers.

Foley Mfg. Co., Western Ave., between
25th & 26th Sts., Chicago.

HYDEANGEAS

500 Hydrangeas in bloom for Easter, 4
to 10 blooms; splendid stock. Edmund
Reardon, Cambridge, Mass.

INSECTICIDES

Nicotine kills all greenhouse pests.
P. R. Palethorpe Co.,
Eleventh St., Owensboro, Ky.
For page see List of Advertisers.

Stump & Walter Co., 50 Barclay St.,
New York.
Killed Tobacco Dust.
For page see List of Advertisers.

Niagara Sprayer Co., Middleport, N. Y.
Niagara Brand.
For page see List of Advertisers.

B. G. Pratt Co., New York.
Sulfocide.
For page see List of Advertisers.

Rowker Insecticide Co., Boston, Mass.
Insect Destroying Preparations.
For page see List of Advertisers.

Wm. Cooper & Nephews, 177 Illinois St.,
Chicago; Cyril Franklyn, 62 Beaver
St., New York, Ast.

V. I. Ehrig.
For page see List of Advertisers.

Eastern Chemical Co., Pittsburg St., Boston.
"DMT" Soap Spray.
For page see List of Advertisers.

"The Fumigating Kind Tobacco Powder"
—The first on the market and the kind
that has so many imitators, has our guaran-
tee of satisfaction or money back,
and "The Moon Trade Mark" on every bag,
\$2.00 per 100 lbs. The H. A. Stothoff Co.,
Mount Vernon, N. Y., Makers and sellers.

Tobacco dust and stems, dust in bids,
150 to 200 lbs., \$4.00; stems in bales from
350 to 400 lbs., \$2.50. Cash with order;
money back if you say so. I lead them all
in quality and price. S. R. Levy, Bingham-
ton, N. Y.

IVIES

English Ivy, strong, for window boxes;
4-leaf pots \$1.50 per ten. Shattume Nur-
series, Barrytown, Dutchess County, N. Y.

JAPANESE PLANTS

Yokohama Nursery Co., 31 Barclay St.,
New York.
For page see List of Advertisers.

KENTIAS

Godfrey Schinnoo,
1012 W. Ontario St., Phila., Pa.
For page see List of Advertisers.

A. Leuthy & Co., Roslindale, Mass.
For page see List of Advertisers.

Jos. Hancock Co., Wyncote, Pa.
Single and Made-Up Specimens.
For page see List of Advertisers.

LANTANAS

Violet King, king of all lantanas, rooted
cuttings, \$4.00 per 100, 200 for \$7.50, 35c.
per doz. For large quantities of Violet
King, 500 to 5000 lots, send for prices, as I
will make them right, for I want to see
every florist in the United States handle
this variety, as it is great novelty. Sun-
set, new, rooted cuttings, 50c. per doz.;
\$3.00 per 100. Eight other grand varieties,
rooted cuttings, \$2.00 per 100. All true to
name, labelled. Mixed, \$18.00 per 1000.
Send for price list. Louis P. Faulk, West
View, Pa.

LEVELS FOR LANDSCAPE GAR- DENING USE.

Bostrom-Brady Mfg. Co., 139 Madison Av.,
Atlanta, Ga.
For page see List of Advertisers.

LILLY OF THE VALLEY PIPS

Hjalmar Hartmann & Co., 12 Stormgade,
Copenhagen, Denmark.
For page see List of Advertisers.

MARGUERITES

Marguerites, Queen Alexandras, \$1.25 per
100, prepaid. S. W. Pike, St. Charles, Ill.

NICO-FUME

Kentucky Tobacco Product Co.,
Louisville, Ky.

NURSERY STOCK

John Waterer & Sons, Ltd.,
American Nursery, Bagshot, England.
For page see List of Advertisers.

Cleary's Horticultural Co., 62 Vesey St.,
New York.
For page see List of Advertisers.

P. Ouwkerk, 216 Jane St., Weehawken
Heights, N. J.
For page see List of Advertisers.

I. & J. L. Leonard, Iona, N. J.
Eastern Nurseries, Jamaica Plain, Mass.
Viburnum Moile.
For page see List of Advertisers.

American Nursery Co., 150 Broadway, New
York, N. Y.
For page see List of Advertisers.

P. Hamilton Goodsell, 200 Broadway,
New York.
W. & T. Smith Co., Geneva, N. Y.
Nursery Stock for Florists.
For page see List of Advertisers.

Storrs & Harrison Co., Palmesville, O.
For page see List of Advertisers.

C. R. Burr & Co., Manchester, Conn.
Berber's Thumbail.
For page see List of Advertisers.

Rose Hill Nurseries, New Rochelle, N. Y.
Buddleia Variabilis Veitchii and Magnifica.
For page see List of Advertisers.

Manual of the Trees of North America,
by C. S. Sargent, mailed to four copies
for \$6.00, by Horticulture Publishing Co.,
11 Hamilton Place, Boston.

TREES, SHRUBS, ROSES, EVER-
GREENS, PEONIES, HARDY PLANTS,
ELLWANGER & BARRY, Rochester, N. Y.

New Hardy Shrub—Buddleia variabilis
Veitchii and the superb flowering
Lilac, 50c. each; \$5.00 per doz.; \$25.00
per 100. Rose Hill Nurseries, New
Rochelle, N. Y.

Catalog now ready. Nursery grown
evergreens, seedling white pine and hem-
lock, native trees and plants. L. E. Wil-
liams, Nottingham, N. H.

Rhododendrons, Laurel, Spruce Hemlock,
Loblars, E. W. Sheeley, De Bruce, Sulli-
van County, N. Y.

For List of Advertisers See Page 516

ONION SEED

Federico C. Varela, Tenerife, Canary Ids.
Bermuda Onion Seed.

ORCHIDS

Orchid Growers' Manual By B. S. Williams. 500 illustrations, \$10.00. 800 pages; descriptions of upwards of 2500 species and varieties of orchidaceous plants, etc. The most complete work on orchids and orchid culture ever published. Orders filled by HORTICULTURE, 11 Hamilton Place, Boston.

ORCHID PLANTS

Lager & Hurrell, Summit, N. J.
For page see List of Advertisers.
Sander, St. Albans, England.
Importers, Exporters, Growers, Hybridists
For page see List of Advertisers.
Carrillo & Baldwin, Saucunus, N. J.
For page see List of Advertisers.
Jos. A. Manda, 191 Valley Road, W.
Orange, N. J.
For page see List of Advertisers.
Ordonez Bros., Madison, N. J., Box 105.
For page see List of Advertisers.
G. L. Freeman, 388 Appleton St., Holyoke,
Mass.
Orchid Importations.
For page see List of Advertisers.

Largest stock in the country. Ask for prices. Julius Roehrs, Rutherford, N. J.

PAINT AND PUTTY

PAINT AND PUTTY: Ideal Greenhouse lead; Special Greenhouse Putty. Lord & Burnham, 1133 Broadway, N. Y.

PALMS

A. Leuthy & Co., Perkasie St. Nurseries,
Roslindale, Mass.
For page see List of Advertisers.
Robert Craig Co., Market and 40th Sts.,
Philadelphia, Pa.
For page see List of Advertisers.
Joseph Heacock Co., Wyncote, Pa.
Home-Grown Palms.
For page see List of Advertisers.
Geo. Wittbold Co., 1657 Buckingham Place,
Chicago.
For page see List of Advertisers.

PANSY PLANTS.

Pansies in bud and bloom; none better, \$1.00 per 100; \$8.00 per 1000. "Choice" strains. Ed. C. Lindsay, Milford, Del.
Giant Ex. Pansies in bloom, \$2.00 per 100; \$18.00 per 1000. Geo. S. Baylies, Wrennah, N. Y.
Gustave Freytag, W. Orange, N. J.

PATENTS

Siggers & Siggers, Washington, D. C.
For page see List of Advertisers.

PEAT

Orchid Peat and Moss always on hand
Julius Roehrs Co., Rutherford, N. J.

PENTSTEMONS

C. H. Totty, Madison, N. J.
For page see List of Advertisers.

PEONIES

Peonies only, by the wholesale—best 100 varieties. J. F. Rosenfield, Westpoint, Neb.
One of the finest collections in America. Send 25 cts. in stamps for new edition of Peony Manual. C. S. Harrison's Select Nursery, York, Neb.

PHLOXES

Send 25 cts in stamps for Phlox Manual. Fine mixed phloxes \$2.00 per 100. C. S. Harrison's Select Nursery, York, Neb.

PHOTOGRAPHS: DESIGNING: ILLUSTRATING

Geo. E. Dow, 178 Washington St., Boston
For page see List of Advertisers.

PIPE AND FITTINGS

Foley Mfg. Co., between Western Ave. and 26th St., Chicago, Ill.
For page see List of Advertisers.

Kroeschell Bros. Co., 35 Erie St., Chicago
For page see List of Advertisers.

PIPE AND FITTINGS: Cast Iron and Wrought Pipe, Valves, Elbows, Pipe Hooks Antomitic Air Headers, etc. Lord & Burnham, 1133 Broadway, N. Y.

POT HANGERS

Pot hangers, Kramer's \$1 doz. by exp. \$1.25 by mail. I. N. Kramer & Son, Cedar Rapids, Ia.

Krick's Perfect Pot Hanger and Handle. Sample pair 10 cents postpaid. Send for full particulars. W. C. Krick, 1164-1165 Greene Ave., Brooklyn, N. Y.

POINSETTIAS (Artificial)

Poinsettias, artificial decorations our specialty. Sample lots of 50 in 3 sizes, \$4.00; 100 lots, \$6, \$8, \$10. J. Stern & Co., 125 N. 10th St., Philadelphia, Pa.

POULTRY SUPPLIES

Buff Rock Eggs to Hatch, Triumph brood coop for chickens. Frank H. Snow, Orleans, Mass.

PRIVET

California privet, 100,000 for transplanting at \$6.00 per 1000; 55,000, 12 to 18 in., 2 to 4 branches, \$8.00 per 1000; 125,000, 12 to 18 in., 3 to 5 branches, \$10.00 for 1000. Boxed and delivered F. O. B. Cash with order. Valdesian Nurseries, Bostic Dept., Bostic, N. C.

RAFFIA

Raffia (colored), 20 beautiful shades. Samples free. R. H. Comey Co., Camden, N. J., 810 Washburn Ave., Chicago, Ill.

RESURRECTION PLANTS

Resurrection plants and cacti. Cheap. Ask for prices. William Tell, Austin, Tex.

RHODODENDRONS

John Waterer & Sons, Ltd.,
American Nursery, Bagshot, England.
For page see List of Advertisers.
P. Ouwerkerk, Hoboken, N. J.
For page see List of Advertisers.
Storrs & Harrison Co., Painesville, O.
For page see List of Advertisers.

ROSES

Robert Craig Co., Market and 40th Sts.,
Philadelphia, Pa.
For page see List of Advertisers.
P. Ouwerkerk, P. O. No. 1, Hoboken, N. J.
For page see List of Advertisers.
Julius Roehrs Co., Rutherford, N. J.
Rose Newport Fairy.
For page see List of Advertisers.
The F. R. Pierson Co.,
Tarrytown-on-Hudson, N. Y.
White Killarney.
For page see List of Advertisers.
S. J. Reuter & Son, Westerly, R. I.
My Maryland.
For page see List of Advertisers.
Dilgee & Conard Co., West Grove, Pa.
For page see List of Advertisers.
Storrs & Harrison Co., Painesville, O.
For page see List of Advertisers.
Scott Bros., Elmford, N. Y.
For page see List of Advertisers.
Pochmann Bros. Co., Morton Grove, Ill.
For page see List of Advertisers.
Ellwanger & Barry, Rochester, N. Y., Box T.
For page see List of Advertisers.
A. N. Pierson, Cromwell, Conn.
White Killarney, My Maryland, Ramblers.
For page see List of Advertisers.
Thomas Roland, Nahant, Mass.
Crimson and Pink Ramblers.
For page see List of Advertisers.
Montrose Greenhouses, Montrose, Mass.
Roses, Grafted and Own Root.
For page see List of Advertisers.

The beautiful new pink rose, MISS KATE MOULTON is the queen of all pink roses. It's a winner and you should grow it. Price \$30.00 100; 500 \$125.00; 1000 \$200.00; 5000 and upwards \$175 per 1000. Minneapolis Floral Co., Minneapolis, Minn.
Hand Book of Cultural Notes on Roses Under Glass, by E. P. Brigham, mailed to your address for 25c. by Horticulture Publishing Co., 11 Hamilton Place, Boston.

SALVIA

R. Vincent, Jr. & Sons Co., White Marsh, Maryland.
Salvia Bonfire and Zurich.

SEED GROWERS

Hjalmar Hartmann & Co.,
Cauliflower and Cabbage Seed.
12 Stormgade, Copenhagen, Denmark
For page see List of Advertisers.

John S. Weaver, Glen Mawr Farms,
Kinzers, Pa.
Vegetable and Flower Seeds Grown on Contract.

Federico C. Varela, Tenerife, Canary Ids.
Bermuda Onion Seed.

SEEDS

T. J. Grey Co., 32 So. Market St., Boston.
For page see List of Advertisers.

Joseph Breck & Sons,
51 and 52 N. Market St., Boston, Mass.
For page see List of Advertisers.

W. Allee Burpee & Co., Philadelphia.
For page see List of Advertisers.

Arthur T. Boddington, 342 W. 14th St.,
New York.
For page see List of Advertisers.

H. E. Flake Seed Co., Panell Hall Sq.,
Boston.
For page see List of Advertisers.

Hjalmar Hartmann & Co.,
12 Stormgade, Copenhagen, Denmark
For page see List of Advertisers.

Rickards Bros., 37 E. 19th St., New York.
For page see List of Advertisers.

R. & J. Farquhar & Co., 67 So. Market
St., Boston.
Mignonette Seed.
For page see List of Advertisers.

H. F. Michell Co., 1015 Market St., Phila.
For page see List of Advertisers.

J. M. Thorburn & Co., 33 Barclay St., N. Y.
For page see List of Advertisers.

Leonard Seed Co., Chicago, Ill.
For page see List of Advertisers.

Wm. Elliott & Sons, 42 Vesey St., N. Y.
New Seed.
For page see List of Advertisers.

Weeber & Don, 114 Chambers St., New
York.
J. & J. L. Leonard, Iona, N. J.
Tomato and Pepper Seed.

Schlegel & Fottler Co., 26 & 27 S. Market
St., Boston.
For page see List of Advertisers.

O. V. Zangen, Hoboken, N. J.
Florists' Spring Seeds.
For page see List of Advertisers.

E. P. Winterston Co., Chicago.
Seeds for Plautmen, Nurserymen, Seedmen.
For page see List of Advertisers.

M. S. Habbell, W. Toledo, O.
Catalpa Speciosa Seed.

Seeds. Rocky Mountain Evergreen seeds in large or small quantities. C. S. Harrison's Select Nursery, York, Neb.

SHRUBS

The Geo. Wittbold Co., 1657 Buckingham
Place, Chicago.
For page see List of Advertisers.

SILKALINE

John C. Meyer & Co., Boston, Mass.
For page see List of Advertisers.

SMILAX

R. Vincent, Jr. & Sons Co., White Marsh,
For page see List of Advertisers

Extra strong plants, \$1.00 per 100; \$8.00 per 1000. Ready for 2 1/2 inch pots. Big bargain. C. W. Moerkel, 17 Summer St., Philadelphia, Mass.

SPHAGNUM MOSS

Live Sphagnum moss, orchid peat and orchid baskets always on hand. Lager & Hurrell, Summit, N. J.

Sphagnum moss and mountain laurel in bags, bales or ear lots. Prices low. Spruce and hemlock in bales. James Day, Box 660, Milford, N. H.

In writing to Advertisers kindly mention Horticulture

SPRAYERS

Niagara Sprayer Co., Middleport, N. Y.
For page see List of Advertisers.
J. F. Cass Mfg. Co., Dept. H., Detroit,
Mich.
U-N-I-T Globe Sprayer.
For page see List of Advertisers.
Chas. J. Jager Co., Boston.
Dennis Spray Corp.
For page see List of Advertisers.

STEAM TRAP

E. Hlippard, Youngstown, O.

STRAWBERRY PLANTS

H. L. Crane, Westwood, Mass.
Harrimony Strawberry.
For page see List of Advertisers.
W. E. Triamble, Princeton, Ill.
Treatise on the Strawberry Blight, its
Cause and Cure.
For page see List of Advertisers.
Strawberries, Chipman's new seedling.
Perfect, enormously productive, immense in
size and a good keeper. Many of our largest
shippers grow no other. Plants from
young bed, 75c. per 100; \$1.00 per 1000.
Cash. Ed. C. Lindsay, Milford, Del.
Strawberry Plants, Babach and Success,
\$1.50 per 1000. W. N. Fanning, Kensington,
Ct.
Strawberry Plants, best varieties. Circular
free. A. Florian & Sons, Thomaston,
Ct.
300 Strawberry Plants St. Your selection.
List free. Wm. Perry, Cool Spring,
Del.

SULFOCID

The E. G. Pratt Co., 50 Church St., Dept.
W., New York City.
For page see List of Advertisers.

SWEET PEAS

A. C. Zvoltnek, Round Brook, N. J.
Winter Flowering.
For page see List of Advertisers.

TO-BAK-INE

E. H. Hunt, Genl. Agt., 76-78 Wabash Av.,
Chicago.
For page see List of Advertisers.

TWEMLOW'S PUTTY

Hammond's Paint & Sling Shot Works,
Fishkill-on-Hudson, N. Y.

VEGETABLE PLANTS

R. Vincent, Jr. & Sons Co.,
White Marsh, Md.
For page see List of Advertisers.

VEGETABLE SEEDS

Just arrived, our reliable vegetable
seeds. Buy your fresh seeds now. These
are guaranteed fresh and only first class
seeds. The Reliable Seed House, 156
Third Street, Hoboken, N. J.

VENTILATING APPARATUS

Pierson U-Bar Co., 1 Madison Sq., N. Y.
For page see List of Advertisers.
Foley Mfg. Co., Western Ave., between
25th & 26th Sts., Chicago.
For page see List of Advertisers.
John A. Payne, 250-274 Culver Ave., Jersey
City, N. J.
For page see List of Advertisers.
The Advance Co., Richmond, Ind.
For page see List of Advertisers.
Quaker City Machine Co., Richmond, Ind.
20th Century Ventilating Arm.
For page see List of Advertisers.
VENTILATING MACHINERY, New
Model, enclosed, self-rolling gear, Standard
Model Open Gear. Lord & Burham, 1133
Broadway, N. Y.

VINCAS

Vinca var., 5 in., per doz., \$2.00; per
100, \$15.00. E. & C. Woodman, Danvers,
Mass.

VIOLETS.

Princess Violets, 2½ in., \$2.00 per 100,
Jas. T. Baker, Bustleton, Philadelphia, Pa.

WALLFLOWERS

Henry A. Dreer, Philadelphia, Pa.
For page see List of Advertisers.

WAX FLOWERS

We are originators of wax designs and
still the standard concern. J. Stern & Co.,
125 N. 10th St., Philadelphia, Pa.

WEED KILLER

The American Horticultural Distributing
Co., Martinsburg, W. Va.
Target Brand.
For page see List of Advertisers.

WIRED TOOTHPICKS

W. J. Cowee, Berlin, N. Y.
For page see List of Advertisers.

WIREWOK

Reed & Keller, 122 W. 25th St., N. Y.
For page see List of Advertisers.
Durand & Marohn, Albany, N. Y.
For page see List of Advertisers.
Wirework. Write for our catalogue.
Holton & Hunkel Co., Milwaukee, Wis.
William E. Heilscher's Wire Works, 38-40
Broadway, Detroit, Mich.
Wirework—Compare our prices with
others. Scranton Florist Supply Co., 201
N. 7th St., Scranton, Pa.

WHOLESALE FLORISTS**Boston**

N. F. McCarthy & Co., 84 Hawley St.,
Boston.
For page see List of Advertisers.
H. M. Robinson & Co., 75 Province St.
and 9 Chapman Pl., Boston.
For page see List of Advertisers.
Welch Bros., 226 Devonshire St., Boston.
For page see List of Advertisers.
Tatly, Wellesley, Mass.
For page see List of Advertisers.

Buffalo, N. Y.

William F. Kastling Co., 383-87 Elliott St.,
Buffalo, N. Y.
For page see List of Advertisers.

Chicago

Chas. W. McKellar, 51 Wabash Ave.,
Chicago.
For page see List of Advertisers.
Peter Reinberg, 51 Wabash Ave., Chicago.
For page see List of Advertisers.
E. F. Winterston Co., 45-49 Wabash Ave.,
Chicago.
For page see List of Advertisers.
J. A. Budlong, 37-39 Randolph St., Chicago.
For page see List of Advertisers.
Poehlmann Bros. Co., Morton Grove, Ill.
For page see List of Advertisers.

Cromwell, Conn.

A. N. Flerson, Cromwell, Conn.
For page see List of Advertisers.

Detroit

Michigan Cut Flower Exchange, 38 and 40
Broadway, Detroit, Mich.
For page see List of Advertisers.

Minneapolis

Rice Bros., 115 N. 6th St., Minneapolis,
Minn.
For page see List of Advertisers.

New York

Ford Bros., 48 W. 28th St., New York.
For page see List of Advertisers.
H. E. Fromont, 57 W. 28th St., New York.
For page see List of Advertisers.
Alex. J. Guttman, 34 W. 28th St., New
York.
For page see List of Advertisers.
E. C. Horan, 55 W. 28th St., New York.
For page see List of Advertisers.
A. H. Langjahr, 55 W. 28th St., New York.
For page see List of Advertisers.
James McManus, 42 W. 28th St., New York.
For page see List of Advertisers.
John J. Raynor, 49 W. 28th St., New York.
For page see List of Advertisers.
W. F. Sheridan, 39 W. 28th St., New York.
For page see List of Advertisers.

WHOLESALE FLORISTS—**New York—Continued**

Friendly & Schenck, 44 W. 28th St., New
York.
For page see List of Advertisers.
Moore, Hentz & Nash, 55 and 57 W. 28th
St., New York.
For page see List of Advertisers.
Wm. H. Kuehler, 28 Willoughby St.,
Brooklyn, N. Y.
For page see List of Advertisers.
Philip F. Kessler, 55 and 57 W. 28th St.,
New York.
For page see List of Advertisers.
Millang Bros., 41 W. 28th St., New York.
For page see List of Advertisers.
John Young, 51 W. 28th St., New York.
For page see List of Advertisers.
Greater New York Florists' Association,
162 Livingston St., Brooklyn, N. Y.,
For page see List of Advertisers.
Frank Millang, 55-57 W. 28th St., New
York.
For page see List of Advertisers.
B. S. Silin, 55-57 W. 28th St., New York.
For page see List of Advertisers.
A. L. Young & Co., 54 W. 28th St., N. Y.
For page see List of Advertisers.
Growers' Cut Flower Co., 39 W. 28th St.,
New York.
For page see List of Advertisers.
Henshaw & Fenrich, 44 W. 28th St.,
New York.
For page see List of Advertisers.
J. K. Allen, 106 W. 28th St., New York.
For page see List of Advertisers.
Charles Millang, 444 Sixth Av., New York.
For page see List of Advertisers.

Philadelphia

W. E. McKlesick & Bros., 1610-1621 Ran-
stead St., Philadelphia, Pa.
For page see List of Advertisers.
Leo Nielsen Co., 1290 Arch St., Philadel-
phia, Pa.
For page see List of Advertisers.
The S. S. Pennock-Meehan Co., 1608-18
Ludlow St., Philadelphia, Pa.
For page see List of Advertisers.

WOODENWARE

Baron & Co., Appleton, N. Y.
Baskets; Crates; Ladders; Boxes.
For page see List of Advertisers.

New Offers in This Issue.

**AUTOMATIC CIRCULATOR: BAR-
GAIN IN ELECTRIC CIRCUL-
ATORS.**

The Castle Co., 170 Summer St., Boston.
For page see List of Advertisers.

**BOSTON AND PRINCESS OF
WALES VIOLETS.**

William Sim, Cliftondale, Mass.
For page see List of Advertisers.

**BEGONIAS, GLOXINIAS,
TUBEROSES.**

Schlegel & Fottler Co., Boston, Mass.
For page see List of Advertisers.

CATTLEYA MOSSIAE.

Ordonez Bros., Madison, N. J.
For page see List of Advertisers.

CHOICE FLORISTS' DAHLIAS.

Geo. B. Hart, 24 Stone St., Rochester, N. Y.
For page see List of Advertisers.

COAL FOR GREENHOUSE USE.

Bader Coal Co., Board of Trade Bldg.,
Boston.
For page see List of Advertisers.

DAHLIAS.

Wm. H. Richardson, New Bedford, Mass.
For page see List of Advertisers.

For List of Advertisers See Page 516

NEW OFFERS—Continued

EASTER FLOWERS.

Chas. Millang, 444 Sixth Av., cor. 27th St., New York.
For page see List of Advertisers.

EASTER PLANTS AND FLOWERS.

S. S. Pennock-Mechan Co., 1098-20 Ludlow St., Philadelphia.
For page see List of Advertisers.

EASTER PLANTS.

Wm. W. Edgar Co., Waverly, Mass.
For page see List of Advertisers.

EASTER FLOWERS.

H. E. Froment, 57 W. 28th St., New York.
For page see List of Advertisers.

EASTER FLOWERS.

Moore, Heutz & Nash, 55 & 57 W. 26th St., New York.
For page see List of Advertisers.

EASTER FLOWERS: GREEN GOODS.

H. M. Robinson & Co., 15 Province St., Boston.
For page see List of Advertisers.

EASTER LILIES.

Lilley & Upton, 1514 Sanson St., Phila.
For page see List of Advertisers.

HENDERSON'S INVINCIBLE ASTER SEED.

Peter Henderson & Co., 25 & 37 Cortlandt St., New York.
For page see List of Advertisers.

HEADQUARTERS FOR ORCHIDS AND SPECIAL EASTER FLOWERS.

James McManus, 42 W. 28th St., New York.
For page see List of Advertisers.

ICE CLEARING EAVES.

King Construction Co., No. Tonawanda, N. Y.
For page see List of Advertisers.

LILIES AND OTHER EASTER SPECIALTIES.

N. F. McCarthy & Co., 84 Hwayler St., Boston.
For page see List of Advertisers.

LILIES AND EASTER FLOWERS.

Welch Bros., 226 Devonshire St., Boston.
For page see List of Advertisers.

MASTICA.

E. O. Pierce Co., 12 W. Broadway, New York.
For page see List of Advertisers.

MONTREAL MUSK MELON.

Duppy & Ferguson, Montreal, Can.
For page see List of Advertisers.

NEW AND CHOICE GERANIUMS

R. Vincent, Jr., & Sons Co., White Marsh, Md.

PRIZE-WINNING ORCHIDS.

Jullius Rodes Co., Rutherford, N. J.
For page see List of Advertisers.

PRIMULA SEED.

H. E. Mitchell Co., Philadelphia.
For page see List of Advertisers.

PEERLESS GLASS REPAIR CLAMP.

Alex. Kleber, Watertown, Wis.
For page see List of Advertisers.

POTASH FERTILIZER.

Geiman Kali Works, 36 Nassau St., New York.
For page see List of Advertisers.

RHUBARB AND ASPARAGUS ROOTS.

Warren Shinn, Woodstown, N. J.
For page see List of Advertisers.

RHODODENDRON HYBRIDS, MAXIMUM, MAPLES, PRIVET.

P. A. Koene, 1 Madison Av., New York.
For page see List of Advertisers.

NEW OFFERS—Continued

ROSES FOR EASTER.

Leo Niessen Co., Philadelphia.
For page see List of Advertisers.

ROSES: H. T., H. P., RAMBLERS.

M. H. Walsh, Woods Hole, Mass.
For page see List of Advertisers.

SPECIAL SPRING ANNOUNCEMENT.

Alex. J. Guttman, 34 W. 28th St., New York.
For page see List of Advertisers.

SPRING PLANTS: BEDDING STOCK.

J. C. Schmidt, Bristol, Pa.
For page see List of Advertisers.

SULPHUR BURNER FOR GREENHOUSE FUMIGATION.

Benj. Dorrance, Rose Growers, Dorrance, Pa.
For page see List of Advertisers.

SPECIAL KENTIA OFFER.

Joseph Heacock Co., Wyncofe, Pa.
For page see List of Advertisers.

SPECIAL RHODODENDRON OFFER.

John Waterer & Sons, Bagshot, Surrey, England.
For page see List of Advertisers.

SOLUBLE PLANT FOOD.

Eastern Chemical Co., Boston, Mass.
For page see List of Advertisers.

SPECIAL DAHLIA OFFERS

Pearcock Dahlia Farms, Williamstown Junction, N. J.

TREES, ROSES, SHRUBS.

Call's Nurseries, Perry, O.
For page see List of Advertisers.

WANTED: CONSIGNMENTS OF EASTER PLANTS, ETC.

Sea Shore Cut Flower Market, Atlantic City, N. J.
For page see List of Advertisers.

USEFUL BOOKS.

We can supply the following books, postpaid, at the prices listed:—

Roses and How to Grow Them. By Many Experts. Price, \$1.10.

The New Encyclopedia of American Horticulture. L. H. Bailey. Four volumes: \$2.00.

How to Plan the Home Grounds. S. Parsons, Jr. Price, \$1.10.

How to Make a Vegetable Garden. Edith L. Fullerton. Price, \$2.20.

The Art of Landscape Gardening. By Humphrey Repton. Price, \$3.20.

Manual of the Trees of North America. C. S. Sargent. Price, \$6.00.

Soils: How to Handle and Improve Them. S. W. Fletcher. Price, \$2.50.

FOR SALE OR RENT

FOR SALE OR RENT—Five greenhouses, horse, five rooms, improvements; barn, carriage house, sheds; all in good repair. One minute to depot, on main street; 20 minutes to Boston; five minutes to two lines of electric. Only florist in large town. Established twenty years. For further particulars address E. G. Blaney, Swampscott, Mass.

MISCELLANEOUS WANTS

WANTED TO BUY—Complete greenhouse plants and all kinds of greenhouse material to be taken down and removed at once. Terms cash. Address I. Snesserman, 229 Livingston St., Newark, N. J.

WANTED—One Pandanus lilies, large plant; state size and price. Scott Bros., Elmsford, N. Y.

WANTS, FOR SALE, ETC.

Advertisements in this column one cent a word. Initials count as words. Cash with order. All correspondence addressed "care HORTICULTURE" should be sent to 11 Hamilton Place, Boston.

HELP WANTED

GOOD MEN

When you need good men, skilled or unskilled, Write:

THOS. H. BAMBRICK

34 South 7th Street Philadelphia

Help of all kinds, including that for Florists, Nurserymen, Seedsmen and the Horticultural trade generally.

WANTED—Foreman for planting from landscape plans, nursery planting and propagating in frames. Steady position at moderate salary to competent young man. Small house available April 1st. Isaac Hicks & Son, Westbury Station, L. I.

WANTED—First-class greenhouse man for bedding plants, under Head Gardener; married man preferred. Address Supt. of Parks, P. O. Box 1027, Hartford, Conn.

GARDENER OR SUPERINTENDENT—I can with confidence recommend a man as above, competent, sober, honest and willing. Apply William Downs, Chestnut Hill, Mass.

SITUATIONS WANTED

WANTED—Situation as traveler. Good knowledge of orchids, stove and general plants and shrubs. Practical experience in Europe. Three years in Orchid Dept. of Huch Low & Co. Good appearance; fluent English, German and French. J. Muller, 34 Hayer St., Toronto, Canada.

Assistant Gardener wanted on a private place, a young man, must be industrious and sober; state experience. Address A. A. HORTICULTURE, Boston.

SITUATION WANTED—First-class French gardener, married, no children, two years' experience in America and 12 years in France; understands greenhouse work; best references; private place. Address Alexander Buteux, 236 West 36th St., New York City.

WANTED—A working head gardener, married man, small family or none; have thorough experience in outside gardens and greenhouses; Scotch or German preferred. Apply by letter to F. H. Beebe, 6 Beacon St., Boston, Mass.

FOR SALE

FOR SALE—A nice estate situated on high ground at Hyde Park, Mass., near Milton. Two minutes from R. R. station, fifteen minutes to Boston. House, 14 rooms and bath, all conveniences. Corner lot, 47,375 ft. land, fruit and shade trees. Greenhouse, 118 x 32, built 1908. 6 on sides, 16 centre, 16 x 24 glass. Good opening for commercial florist. Address A. G. Chickering, 53 State St., Boston.

FOR SALE—Retail nursery, sixth year, doing good, steady and increasing trade. Stock in excellent condition. Only local supply for community of 50,000. For particulars address R. N., care HORTICULTURE, Boston.

FOR SALE—Truck Farm, 36 acres, 10,000 ft. of greenhouses, two dwellings, out buildings, good repair; central to seven towns. Price right to quick buyer. Chapin Bros., Pine Brook, Morris Co., N. J.

List of Advertisers

Page	Page
Advance, The Co.	418
Allen, J. K.	509
American Nursery Co.	466
American Nursery (Eng.)	462
Andrango-Godfrey	494
Atlanta Floral Co.	503
Bader Coal Co.	517
Bacon & Co.	484
Bambrick Thos. H.	515
Barrows H. & Son	495
Bassett & Washburn	464
Bayersdorfer H. & Co	505
Blossom The	504
Boddington A. T.	463
Boston Florist Letter	509
Boston Plate and Window Glass Co.	517
Bostrom-Brady Mig. Co.	507
Brewer, M. A.	504
Bowker Fertilizer Co.	484
Bowker Insecticide Co.	487
Bre Joseph & Sons	485
Breitneyer, J. Sons	503
Bridgeman's Seed Warehouse	485
Brown, J. A.	516
Burnee W. A. & Co.	485
Burr C. R. & Co.	466
Buxton & Allard	518
Call Nurseries	465
Carillo & Baldwin	489
Castle Co. W. Co.	519
Chicago Carnation Co.	464
Clare's David Sons	514
Clary's Horticultural Co.	506
Coop J. J.	508
Copper, Wm. & Nephews	487
Cotsonas Geo. & Co.	505
Cowee W. J.	505
Craig, Robt. Co.	495
Crace H. L.	484
Crawback Geo. W.	509
Danker F. A.	515
Dawson H. S.	466
Dunge & Conard Co.	466
Dorner F. Sons & Co.	484
Dorrance Egan	486
Dow Geo. E.	485
Dreer H. A.	493-517
Dunlop John H.	504
Dupuy & Ferguson	484
Durand & Maroho	505
Dysart R. J.	509
Eastern Chemical Co.	487
Eastern Nurseries	466
Edgar, W. W. Co.	494
Edwards Folding Box Co.	506
Elsche	495
Elliott Wm & Sons	485
Ellwanger & Barry	483
Elmsford Nurseries	494-495
Euler J. G.	492
Ernest W. H.	492
Eyres	514
Farrowhar R. I. & Co.	495
Falthousen J. E.	495
Fenger E. W.	494
Flske H. E. Seed Co.	485-487
Foley Mig. Co.	518
Ford Bros.	498
Freeman G. L.	484
Froment H. E.	501-508
Galvin Thos. F.	495
Garland, Geo. M. Co.	518
Gerran Kal. W. Co.	485
Greater N.Y. Florists' Association	510
Grey T. J. Co.	485
Grocers' Cut Flower Co.	508
Gude Bros. Co.	504
Guttman Alex. J.	500-508
Hall Asso.	517
Hart, Geo. B.	492
Hartmann Hjalmar & Co.	485
Hauswirth M. C. & E. C.	484
Hendock Inc. Co.	488
Henderson Peter & Co.	463
Henshaw & Fenrich	508
Herbert David & Son	493
Hew A. H. & Co.	492
Hilfner Bros.	492
Hill, The E. C. Co.	464
Hitchings & Co.	518
Hoffman	496
Horan E. C.	508
Houghton F. H.	505
Hunt E. H.	487

Page	Page
Stearns A.T. Lumber Co.	518
Storrs & Harrison Co.	496
Stump & Walter Co.	487
Syracuse Pottery Co.	492
Tally	505
Takeuchi K.	485
Tanoi R.	483
Target Brand	486
Thorburn J. M. & Co.	485
Totty Chas. H.	485
Treadwell & Schenck	508
Trepel C. C.	504
Trumble Wm. C.	484
Valentine, J. A.	504
Vicent R. Jr. & Sons	484-483
Waban Rose Conservatories	466
Walsh M. H.	466
Ward R. M. & Co.	481
Waterer John & Sons	462
Welch Bros.	499-506
Withold Geo. Co.	495
Wilson	504
Winterson, E. F. Co.	500
Wood Bros.	464
Yokohama Nursery Co.	495
Young A. L.	509
Young John	508
Young Thos, Jr.	504
Young & Nugent	504
Zangen O. V.	485
Zinn Julius A.	505
Zvolanek A. C.	481

The Payne Steel "T" Bar Greenhouses

The Lightest The Strongest
Half Full Size

HOUSES of this type are constructed with both curved glass eaves and straight glass eaves. Least amount of shadow. Least amount of wood. No drip. Greatest durability.

JOHNA. PAYNE

Greenhouse Designer and Builder
260-274 Culver Avenue
JERSEY CITY, N. J.

NEWS NOTES.

S. Hornbrook has taken a position as gardener for Clement Moore, Hackensack, N. J.

Brockton, Mass.—Violets suspended from the ceiling were the anniversary decorations of a department store, and over a thousand bunches were used.

In ordering goods please add "I saw it in HORTICULTURE."

ICE CLEARING EAVES

ANGLE iron eaves are fast replacing the old style heavy wooden eave plates. They are MORE DURABLE, CAST LESS SHADOW and give the house more stiffness.

SO MUCH OF THE ANGLE IRON IS EXPOSED TO THE INNER HEAT OF THE HOUSE, that they CLEAR OFF ICE very quickly.

Sash Bar Clips

NO SOLID CLIP OR SOCKET TO CATCH AND HOLD THE MOISTURE. NO MITER CUTS OF THE BAR—THE WHOLE BAR IS EXPOSED TO THE AIR, JUST RESTS ON and BUTTS AGAINST THE CLIP. CAN BE PAINTED ANY TIME ALL OVER. NOTE THE LUG CAST ON

THE TONGUE TO RECEIVE THE GLASS. ALL NICE POINTS COVERED IN THIS EAVE, EVEN TO THE DRIP GUTTER. SAMPLE CLIP MAILED UPON REQUEST, FOR EAVE OR GUTTER. ASK ABOUT THAT IRON FRAME GREENHOUSE.

King Construction Co.

Address: Lock Box 623A. North Tonawanda, N. Y.

PATENTS

Trademarks and Copyrights

Send your business direct to Washington. Saves time and insures best service. Personal attention guaranteed. Twenty-five years' active service. SPECIALTY: "Working on the Failure of Others."

SIGGERS & BIGGERS

PATENT LAWYERS
Box 9, National Union Building
Washington, D. C.

GREENHOUSE CONSTRUCTION LUMBER

John C. Moninger Co.
117 E. Blackhawk St., CHICAGO.

Evans 20th Century Arm
Will not twist the shafing pipe. Three times the power of old style elbow arms. Sold only with Evans Challenge Machine. Write for Free Catalogue to QUAKER CITY MACHINE CO. Richmond, Ind.

THE QUESTION OF STRENGTH

IT is conceded that the strongest and most durable structure known is "THE IRON FRAME." And when you have all the **Modern** features combined in this type of construction you have "The Ideal Greenhouse."

The picture shows the beautiful symmetry of my "Curved Iceless Eave" — no heavy antiquated shading members. And I also make a specialty of having my work harmonize with surrounding conditions. Note how the mason work on greenhouse conforms to that on adjacent stable.

The advice of "The Practical Greenhouse Builder" is at your disposal for the asking.

WILLIAM H. LUTTON
West Side Ave. Station, JERSEY CITY

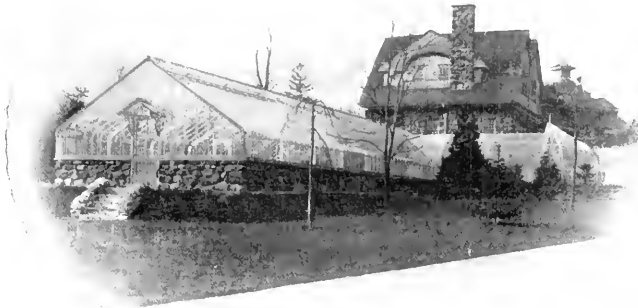

Erected at Davenport Neck, New Rochelle, N. Y.

COAL Pocahontas Smokeless Coal Blossburg Smokeless Coal

The above steam coals are peculiarly adapted to **FLORISTS'** use. Prominent features are **HIGH EVAPORATION, LOW ASH, LOW SULPHUR, HIGH CARBON, and HIGH HEAT UNITS.** Permit us to figure on your year's requirements, deliverable as called for.

CARGOES CONSTANTLY ARRIVING AT ALL NEW ENGLAND PORTS

The Bader Coal Company, F. B. LAYTON
Telephone Fort Hill 2044 Board of Trade Building, Boston, Mass. Gen'l Sales Agent

STANDARD PLATE GLASS CO.
Manufacturers—Importers—Jobbers
NOW IS THE TIME TO BUY
FRENCH OR AMERICAN GREENHOUSE GLASS
LOWEST PRICES ON REQUEST
26-30 Sudbury St. BOSTON, MASS. 61-63 Portland St.

GLASS
Greenhouse and Hot Bed
SIZES OUR SPECIALTY
INTENSE STOCK
Plate and Window Glass
Write for Our Prices
PARSHELSKY BROS., Inc.
59 Montrose Ave., BROOKLYN, N. Y.

GLASS Always Write Us Before Buying
SHARP, PARTRIDGE & CO.
22nd and Lumber Streets, CHICAGO
WE HAVE SOME SNAPS

MASTICA
FOR Greenhouse Glazing
USE IT NOW.
F. O. PIERCE CO.
12 W. BROADWAY
NEW YORK

BOSTON PLATE & WINDOW GLASS CO.
GREENHOUSE GLASS GERMAN AND AMERICAN
261 to 287 A Street BOSTON 20 to 22 Canal Street

Holds Glass Firmly
See the Point **PEERLESS**
Glazing Points are the best. No rights or lefts. Box of 1,000 points 15 cts. postpaid.
HENRY A. DEER,
714 Chestnut St., Phila., Pa.

ONE SAYS
It is the best thing. Others say it is the handiest thing. Lots of them say there is nothing like it. Everybody has something good to say about the
Peerless Glass Repair Clamps, \$1.00 per 100.
At Your Dealer or by
ALEXANDER KLOKNER, Wauwatosa, Wis.

Mastica is elastic and tenacious, admits of expansion and contraction. Putty becomes hard and brittle. Broken glass more easily removed without breaking of other glass as occurs with hard putty. Lasts longer than putty. Easy to apply.
THE FLORISTS' HAIL ASSOCIATION OF AMERICA, insurer of 29,000,000 sq. ft. of glass. For particulars address
John G. Esler, Jr., Saddle River, N. J.

The Castle Automatic Circulator

The Summit of Perfection. No Device has ever been Invented for Forced Hot Water Circulation which will do what this little machine accomplishes, for Economy in First Cost or in Operation. Requires no Supervision or Manual Manipulation. Prices and Discounts on Automatic Circulator, several sizes, with or without Motors, also Testimonials from Large Greenhouse Establishments, east or west, furnished on Application.

While the method of producing a forced circulation of liquids is the same as in the Original Electric Circulator, some modifications in construction which we consider to be of vital importance are made.

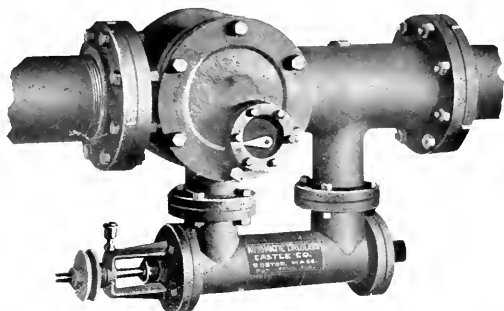

The great improvement of its being equipped with a valve which requires no manual manipulation to change from forced to gravity circulation will be at once recognized as extremely valuable.

A is a light brass valve, hinged as shown at K, on the outer end of valve shaft fitted with index pointer H, protruding through valve casing as shown in half tone. This index shows at a glance the position of the valve in the pipe. When the propeller C is running the liquid is drawn in at the arrow I, follows the cones shown by 2, 3, 4 and 5, as it impinges on valve A, the valve being very light, is thrown up as shown, closing the gravity system and passes on into system as shown by 6. The instant the propeller ceases to act the valve A drops and opens up an unobstructed gravity flow from 1, 7 and 8 to the system. It has been demonstrated that for ordinary and usual duty there is no advantage to be gained by use of three way valve which must be operated manually. Another valuable feature of this style of Circulator is it can be readily installed by any one who has the mechanical ability to cut out a length of return pipe sufficient to take in the top I, screwing on the flanges J, J, (which are furnished) and bolting the pipe and Circulator flanges together. The propeller chamber, B, is fitted to top I rigidly, consequently the propeller shaft E cannot be sprung or crumpled in its bearings F, K, L, and is always in line with top I and return pipe. The pulley S is attached on projecting end of shaft E and supported by bearing F, held in place by saddle D. The bearings F, K, L are bored out in

absolute truth, the backward thrust of propeller being taken up by step M and cap N. The shaft propeller and bearings are made of best Tobin bronze, bearings K and L have water lubrication, F is fitted with oil cup. The motor may be placed wherever desired and connected by round or flat belt

passing of any part of the electric current to the apparatus, which we have found sometimes occurs if the motor is not kept clean, thereby losing power and giving a shock of greater or less intensity to any one coming in contact with the Circulator or attachments. The motor may be operated by an electric switch placed in any convenient place, and at a distance from the boiler or fire room, as the instant the propeller starts into action the automatic valve is thrown up and the water passes into the boiler and system, when the electric current is switched off the propeller stopping the valve drops and the gravity system becomes operative. In cases where the electric current is not obtainable, or too expensive, gasoline engine or water motors may be used. It is not necessary to run Circulator continuously. As soon as the thermometer on the return shows approximately (within ten to fifteen degrees) the temperature of the flow from the boiler, it can be shut down, the automatic valve opens to full capacity, and the pipes and water therein, being all heated to within a few degrees of each other, the gravity operation is so accelerated that the system will keep up its heat for from one to three hours.

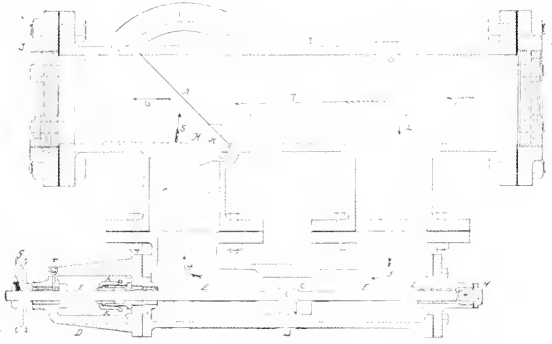

W. W. CASTLE PATENTED FEBRUARY 23, 1909. PATENT APPLIED FOR. W. W. CASTLE'S AUTOMATIC CIRCULATOR

to pulley S. It will be recognized that this is a very desirable feature, as the motor may be located away from the dust, ashes and heat of the heating apparatus, also obviating any necessity of insulating it to prevent, in using an electric motor, the

is so accelerated that the system will keep up its heat for from one to three hours. The Circulators are built in three sizes, Nos. 2, 3 and 4, with tops on compactness to return complete up to eight inches in diameter.

A Special Bargain. I have on hand, complete, ready for delivery, three new No. 4 and one No. 3, of the original Electric Circulator which will be sold at less than one-half price F. O. B. Boston. This is a genuine bargain. We should not make this offer were it not that our stock-rooms must be cleared to make room for the Automatic Type which we are now making exclusively. Don't delay if you want them.

W. W. CASTLE COMPANY,
170 Summer Street, Boston.

SPLENDID PARK GREENHOUSES

AN octagon palm house with curvilinear houses on either side, erected by us at Central Park, Davenport, Iowa, makes a layout both highly ornamental and every way practical,—and a park proposition surely must embody both. Back of the palm house is the work room with bedding plant houses on each side of it. If you would like to look it over, we shall be glad to forward you a photograph.

Our work extends over the entire country. We recently erected an ornamental range of houses at Menlo Park, California, and are now shipping materials for another greenhouse at San Francisco. WHEN CALIFORNIANS ARE WILLING TO "PAY THE FREIGHT" FROM NEW YORK, IT CERTAINLY LOOKS WELL FOR THE SUPERIORITY OF L. & B.'S CONSTRUCTION.

If you intend building a greenhouse send for our 72 page Greenhouse Book, or perhaps our Handy Hand Book, which illustrates every part used in a greenhouse, would be of more service to you. We also issue our Two P's catalog, which is filled with useful information.

If you will advise us what you have in mind, we will send whichever catalog best meets your needs.

LORD AND BURNHAM COMPANY

1133 BROADWAY, NEW YORK and Boston and Philadelphia.



We thought the readers of Horticulture would be interested in this startlingly light interior of a U-Bar house, and suggest that you write to PIERSON U-BAR COMPANY, 1 Madison Avenue, New York, for their catalog.

HORTICULTURE

Vol. IX.

APRIL 10, 1909

No. 15



CINERARIA SILIATA

DEVOTED TO THE
FLORIST, PLANTSMAN, LANDSCAPE GARDENER AND KINDRED INTERESTS

PUBLISHED EVERY SATURDAY AT 11 HAMILTON PLACE, BOSTON, MASS.

SUBSCRIPTION, \$1 00 PER YEAR



CHRYSANTHEMUMS.

"Not small weak runty stock grown under benches, but the kind that brings back Dollars for Pennies."

WHITE: Earliest October Frost. We have extra fine large stock of this variety. Mrs. Henry Robinson, Clementine Touset, Alice Byron, Timothy Eaton, Merry Christmas, White Bonafide.

VELLAW: Monrovia, Halliday, Appleton, Bonafide, Eaton, Chatauga Gold.

PINK: Mc. Niece, Maud Dean, Dr. Foguehardt, Rosette.

RED: Intensity, Schrimpton.

All these varieties, rooted cuttings \$2.00 per 100; \$20.00 per 1000. 2 1/2 in. \$3.00 per 100; \$25.00 per 1000.

White Chadwick, Golden Chadwick, Golden Wellbrog, R. C. \$3.00 per 100; \$27.50 per 1000. 2 1/2 in. \$4.00 per 100; \$35.00 per 1000.

Virginia Pochlmann, R. C. \$4.00 per 100. 2 1/2 in. \$5.00 per 1000.

Golden Glow, R. C. \$3.00 per 100. 2 1/2 inch \$6.00 per 1000.

CARNATIONS.

Strong well rooted cuttings and 2 1/2 inch stock. Sarah Hill, Afterglow, White Perfection, Victory, Rose Pink Enchantress, Winsor, Beacon, White Enchantress, at \$1.00 per 100; \$10.00 per 1000.

Sarah Hill, Lloyd, Afterglow, Winsor, Beacon, Victory, 2 1/2 in. \$2.50 per 100; \$22.00 per 1000.

Enchantress and White Lawson, R. C. \$2.50 per 100; \$22.00 per 1000.

Enchantress, White, Pink and Variegated Lawson, 2 1/2 in. \$3.00 per 100; \$26.00 per 1000.

O. P. Bassett. 2 1/2 in. \$8.00 per 100; 3 1/2 inch \$10.00 per 100.

ROSES.

2 in. or 2 1/2 in.	3 in. or 3 1/2 in.
100	1000
1000	10000

American Beauties.....\$7.00 \$45.00 \$50.00 \$35.00
 My Maryland Grafted strong stock.....20.00
 My Maryland Own roots.....15.00
 Killarney Own roots.....\$6.00 \$55.00 7.50
 Mrs. Potter Palmer.....5.00 15.00

Bridesmaids	2 in. or 2 1/2 in.	3 in. or 3 1/2 in.
Brides	100	1000
Richmond\$5.00	\$45.00 \$6.50
Perle5.00	45.00 6.50
Kaiserine5.00	45.00 6.50
Uncle John4.00	35.00

POEHLMANN BROS. COMPANY,

Morton Grove, Ill.

DAHLIA CLUMPS

Four Varieties

\$4.00 per 100

Miller Red, Bird of Passage, Arabella and Pompon White

From a satisfied customer:—

"I am offered elegant Dahlias at three cents, but your stock last year was nice and I am going to give you the preference."

GEORGE B. HART,
24 STONE ST., ROCHESTER, N.Y.

NEW CREATIONS IN DAHLIAS

Jack Rose, Virginia Maule, Ethel Schmidt, Sensation, Big Chief, Gladys, Rose Pink Century, Fringed 20th Century, Fringed Beauty. 50 cts. each, \$5.00 per doz., \$35.00 per 100. Strong plants now ready.

PRINCESS VICTORIA. \$1.00 each, \$10.00 per doz., strong plants. A superb collection of new Cactus Dahlias. Send for new descriptive catalogue.

Peacock Dahlia Farms, Williamstown Junc., N. J.

ROOTED

Carnation Cuttings

	100	1000
Afterglow.....	\$6.00	\$50.00
Sarah Hill.....	6.00	50.00
Lawson Enchantress.....	6.00	50.00
Aristocrat.....	4.00	35.00
Beacon.....	3.50	30.00
Crimson Glow.....	3.00	25.00
Mrs. M. A. Patten.....	2.50	20.00

Can also furnish from pots

E. W. FENCAR
147-187 Linden Avenue Irvington, N. J.

A WIRELESS WINNER

Has Won Absolutely on Its Own Merits. MASSACHUSETTS HORTICULTURAL SOCIETY'S SILVER MEDAL LAST YEAR

Certificates Innumerable Everywhere AMERICAN CARNATION SOCIETY'S GOLD MEDAL THIS YEAR

THAT'S THE RECORD OF

It is Invincible. **BAY STATE** Buy it and Grow it.

The noblest carnation ever introduced. White with carmine pencillings.

ROOTED CUTTINGS, - \$12.00 per 100, \$100.00 per 1000. ALBERT ROPER, - - TEWKSBURY, MASS.

Send for our Preliminary List describing and quoting

Chrysanthemums and Carnations.

A fine lot of Carnation Cuttings ready now.

THE E. G. HILL CO.,
Richmond, Indiana.

CARNATIONS ROSE MY MARYLAND

Standard sorts and all the novelties of merit. Orders booked now for this most promising variety

The cream of the commercial sorts. Send for our price list. We can quote you right and supply first class stock.

CHRYSANTHEMUMS S. J. REUTER & SON, WESTERLY, R. I.

CARNATIONS Rooted Cuttings Fine Healthy Stock

	Per 100	Per 1000
Pres. Seelye - - - - -	5.00	\$50.00
White Enchantress, Beacon 3 50	3.50	30.00
Victory, Winsor, Melody, Kingston Pet - - - - -	3.00	25.00
Daheim, Enchantress, Lady Roundful, Mrs. Lawson, White Lawson, Red Lawson Variegated Lawson	2 50	20.00

WOOD BROTHERS
FISHKILL, N. Y.

CARNATIONS CARNATIONS

White Perfection, White Enchantress, \$3.00 per 100; \$25.00 per 1000.	Splendor - - - - - \$5 per 100 \$40 per 1000
Lady Beautiful, Enchantress, Rose Pink Enchantress, Winsor, White Lawson \$3.00 per 100; \$20.00 per 1000.	Lawson Enchantress 5.00 40.00
Melody, \$3.00 per 100; \$22.50 per 1000	Andrew Carnegie 6.00 50.00
Our stock won the Cottage Garden Cup at the National Flower Show.	Beacon - - - - - 4.00 35.00
	Afterglow - - - - - 6.00 50.00
	Gov. Deneen - - - - - 10.00

CHICAGO CARNATION CO., A. T. Py'er, Mgr. JOLIET, ILL.

CARNATIONS

WISCONSIN—The true pink—At Indianapolis, in class A, won 1st prize in six entries for best vase of 100 blooms of light pink lighter in color than Lawson. A grand commercial sort in great demand. Place your order now for prompt delivery. \$6.00 per 100, \$50.00 per 1000. **F. DORNER & SONS CO.** La Fayette Ind. C.

DAHLIAS.

Now is the time to place your order for dahlias which will insure you getting named varieties in any quantity, prompt delivery. **DAVID HERBERT & SON** Successors to L. K. Peacock, Inc. ATCO, N. J.

The Northboro Dahlia and Gladiolus Gardens

Offer for Spring 1909 300 selected varieties of Dahlias and one and one half million large-flowering Gladioli in mixtures, in lots to suit. Send list of your wants. Catalogue free. **J. L. MOORE, Northboro, Mass.**

In writing to Advertisers kindly mention Horticulture

NEW ROSE WHITE KILLARNEY

We Know You Will Want to Buy White Killarney



Every live, progressive, up-to-date grower who has seen it is buying it; but when you buy White Killarney, be sure you get the right White Killarney (the Waban variety). When you buy from us you get the variety that has been exhibited and certificated, and the one that has attracted such favorable mention.

If you are in the vicinity of New York, we should be glad to have you call and see White Killarney growing at our Scarborough range, and you will say at a glance—as everyone has who has seen it growing—that it is by far the best white rose that has ever been placed on the market.

It is not only a good winter-flowering rose, but is good the entire year, and it is a splendid shipper. Read the following letter received from Mr. Willis N. Rudd, Secretary of the Society of American Florists, dated January 15th, in which he writes as follows:

"Dear Mr. Pierson:—I cannot refrain from writing you and expressing my admiration for the White Killarney as shown at Chicago on Thursday. It is an exquisitely beautiful thing and attracted much attention. I took half the blooms home with me, and they were finer on Saturday than they were at the show. The record is that these blooms were shipped from Tarrytown, staged and exhibited during the afternoon. They were then carelessly wrapped up in a box, and remained in that box until one o'clock Friday morning, at which time I reached home; improved in quality up to Saturday, and were in fairly presentable condition on Sunday.

"In addition to being the most beautiful white rose of its class which I have seen, this demonstrates its splendid keeping and shipping qualities.

W. N. RUDD."
We were awarded Silver Cup at National Flower Show, Chicago, for best new rose with White Killarney; also Silver Medal Horticultural Society of New York.

Strong plants, 2 1/4 inch pots, own roots, now ready for delivery, \$30.00 per 100; 250 for \$70.00; 500 for \$125.00; 1000 for \$250.00. Grafted plants, ready April 1st, \$35.00 per 100; 250 for \$82.50; 500 for \$150.00; 1,000 for \$300.00.

F. R. PIERSON CO., Tarrytown-on-Hudson, NEW YORK

ROSES

Grafted by TARRYTOWN, BRIDE, BRIDESMAID, KILLARNEY, RICHMOND.

Own Root RICHMOND, QUEEN BEATRICE.

This is A No. 1 Stock from Prize Winning Sources of highest repute.

2 1/2 to 3 1/2 in. pots. Delivery immediate or will hold until July 1.

MONTROSE GREENHOUSES
MONTROSE, MASS.

SCOTT BROS. CHRYSANTHEMUMS

All the Newest and Best Sorts

—ALSO—

ROSES Grafted and Own Root for Greenhouse and Outdoors

ELMSFORD NURSERIES, Elmsford, N.Y.

ASTER SEEDS
That Will Produce Good Blooms.

CHRYSANTHEMUMS
The Best For Florists.

ELMER D. SMITH & CO.
Adrian, Mich.

CHRYSANTHEMUMS

Golden Glow—plant Middle May to July—Cut Middle Aug. to Oct.—White Cloud—20 8 inch Jap.—extra strong stem. Plant late May and early June—Cut Middle Oct. to Nov. 1st—Pacific Supreme—a longer stemmed—brighter—non-fading Glory of the Pacific. Bledid now will increase stock to 1 by planting time—Delivery Plants—March \$5 00 per 100; April \$4.50; Bal. Season \$4.00. Rooted Cuttings oow, post or express paid, \$4 00 per 100; 25 at 100 rates.

J. H. MYERS, ALTOONA, PA.

A. N. PIERSON, Inc., Cromwell, Conn.

WHITE KILLARNEY (Waban Strain)

GRAFTED STOCK.....	Doz.	100	250	500	1000	2500	5000
		\$35.00	\$82.50	\$150.00	\$300.00	\$687.50	\$1250.00

MY MARYLAND GRAFTED.....	\$3.00 per doz.	\$30.00 per 100.	\$150.00 per 1000
OWN ROOT	2.00 "	20.00 "	90.00 "

STANDARD VARIETIES

Betty, Bon Silene, Bride, Bridesmaid, Cardinal, Eclair, Etoile de France, Etoile de Lyon, Franz Deegan, Gen. McArthur, Golden Gate, Hermosa, Ivory, Kaiserin Augusta Victoria, Kate Moulton, Killarney, La Detroit, Maman Cochet, Marechal Niel, Mme. Abel Chateau, Mrs. Jardine, Mme. Hoste, Mrs. Paul Niehoff, Mrs. Pierpont Morgan, Mrs. Potter Palmer, Papa Gontier, Queen Beatrice, Rhea Reid, Richmond, Rosaline Orr English, Souv. du President Carnot, Souv. de Wootton, Uncle John, Wellesley, White Cochet. The above Grafted (selected plants) 20 cts. each, \$2.00 per doz., \$15.00 per 100, \$120.00 per 1000.

OWN ROOT ROSES

Killarney, Bride, Bridesmaid, Mme. Abel Chateau, Ivory, Richmond, Mrs. Paul Niehoff. 2 1/2 in. pots, \$1.00 per doz., \$6.00 per 100, \$50.00 per 1000.
Queen Beatrice, Rhea Reid, Mrs. Jardine, Mrs. Potter Palmer, from 2 1/2 in. pots, \$8.00 per 100, \$70.00 per 1000.

BEDDING PLANTS

COLEUS, Verschalletii, Golden Queen, Queen Victoria, Beckwith Gem, Firebrand, Lord Palmerston. Rooted Cuttings by express, \$0.60 per 100, \$5.00 per 1000. Out of 2 1/2 in. pots in May, \$2.00 per 100, \$15.00 per 1000.
Golden Bedder, Hero, Messy, Pearl of Orange. Fancy Varieties. Twelve kinds not listed above. 75 cts. per 100, \$5.00 per 1000.
AGERATUM, Stella Gurney, Princess Pauline. SALVIA, Splendens, Bonlire and Zurich.
HELIOTROPE. Dark blue bedding varieties. GERMAN IVY. 75 cts. per 100, \$6.00 per 1000.
ALTERNANTHERA, Red and Yellow. 50c per 100, \$5.00 per 1000. From 2 1/2 in. pots, \$2.00 per 100.
SALLEROL, Rooted Cuttings, \$1.00 per 100, 2 1/2 in. pots, \$2.50 per 100.
CHRYSANTHEMUMS IN QUANTITY. Catalogue on Application.

CHRYSANTHEMUM SEED.

Wells' New Early Flowering Singles, packets 25c and \$1.00 each.

PENTSTEMON SEED

Wells' New Hybrids, packets 25c and \$1.00 each
CHARLES H. TOTTY, Madison, N. J.

2 1-2 Inch Stock Now Ready

Chrysanthemums: Alice Roosevelt, Virginia Poeblmann, dandy midseason whites new, \$4 per 100; \$35.00 per 1000. Mad. Sallerol geraniums, Ice 1 1/2 inks, \$2 per 100. 2 inch Boston and Whitman Ferns, \$6 per 100. Cansb.

I. M. RAYNER, GREENPORT, N. Y.

ROSES

We have a fine stock of large, dormant, field grown plants, on own roots, of the following varieties:

Boule de Neige, Mad. Plantier, Alfred Colomb, Perle des Blancches, Climbing Clothilde Souper, Archduchess Elizabeth of Austria, Empress of India, Glory of the Exposition of Brussels, Philadelphia Crimson Rambler, Fisher Holmes, Cheshnut Hybrid, Climbing Woorfont, Magna Charta, Countess of Roseberry, Louis Van Houtte, Darcey Perkins, Anna de Diesbach, Mad. Alfred Carriere, Vieux's Caprice, Sir Thomas Lipton, Francois Luyet, Eugene Fuest, Crimson Rambler.

PRICE \$12.50 per 100; \$120 per 1000

Tausendschon, the great new climber, \$20 per 100.

Crimson Baby Rambler, \$16 per 100.

Fine plants from 1 1/2 inch pots, Chrysanthemum

Glory of the Pacific, \$3.50 per 100.

Roses, Dahlias and Camas a Specialty.

Catalogue Free

The Dingee and Conard Co., West Grove, Pa.

Ampelopsis Quinquifolia

Strong 1-year plants	2 to 3 ft.	\$29.00
" 2-year "	3 to 4 ft.	30 00
" 3-year "	4 to 6 ft.	55 00

TO THE TRADE ONLY

A Full Line of General Ornamental

NURSERY STOCK

SEND FOR CATALOGUE

EASTERN NURSERIES
JAMAICA PLAIN, MASS.
 HENRY S. DAWSON, Mgr.

Box Trees

and other **EVERGREENS** for **Tubs** and **Boxes**
 Our Prices are Always Right—Catalog Free
THE NEW ENGLAND NURSERIES, Inc.
BEDFORD, MASS.

Hardy Rhododendrons, Azaleas, Conifers, Clematis, H. P. Roses, Shrubs and Herbaceous Plants from our HOLLAND NURSERIES

Prices Moderate
 P. OUWERKERK, 210 Jane St., Weehawken Heights, E. O. No. 1, Hoboken, N. J.

CLEARY'S HORTICULTURAL CO.
 Management AMEROS T. CLEARY
 Wholesale Contracting, Jobbing, Auction
HORTICULTURAL PRODUCTS
 or every description.
 Consignments Received. Surplus Stock Converted
62 Vesey St., NEW YORK

FRUIT, SHADE, and ORNAMENTAL TREES, SHRUBS, ROSES and PLANTS of all kinds at **CALL'S NURSERIES, PERRY, O.** Call deals direct with his customers and thousands of the best fruit-growers are his customers. Write him for Price List.

RHODODENDRON HYBRIDS and MAXIMUM

Norway Peeples 1 1/2", 2-2 1/2" and 3 1/2-3" dia.
 Dwarf Box 6-8" X.
 Blue Spru c Kosterii 4-5' and 5-6'.
 California Privet 2 yrs. 20-30" 2-3' and 3-4'.
P. A. KEENE, 1 Madison Ave., New York

GERANIUMS

We have an immense stock of fine plants from 2 in. pots at \$2.00 per 100, \$18.50 per 1000 and up. We will send 1000, 50 each of 20 good sorts, our selection, for \$18.50 Cash, or we will send 1000 from 3 in. pots, in good assortment, for \$35.00 per 100, \$25.00 per 1000.

	Per 100	Per 1000
	2 in. 3 in.	2 in. 3 in.
ACHYRANTHES, Emerson and Mosaica.....	\$2.00	\$3.00
AGERATUM, 5 kinds.....	2.00	3.00
ALYSSUM, Dwarf and Giant.....	2.00	
CENTAUREA Gymnocarpa.....	2.00	3.00
CINERARIA Maritima.....	2.00	3.00
HARDY ENGLISH IVY.....	2.00	
PARLOR IVY, Senecio Scandens.....	2.00	
LOBELIA, Kathleen Mallard.....	2.00	3.00
" Crystal Palace Gem.....	1.50	
PETUNIAS, Dreer's Single Superb.....	2.00	
SALVIA Bonfire.....	2.00	3.00
SALVIA Zurich.....		3.00 4.00
SAXIFRAGA SARMEN-TOSA.....		3.00
SMILAX, Extra Strong.....		2.00
VERBENAS, Red, White, Pink and Blue.....		2.00
COLEUS, Verschaffeltii, Golden Bedder, Queen Victoria, Eldorado.....		2.00 3.00
TRADESCANTIA, Dark Variegated.....		2 00
HARDY POMPOMCHRYS-ANTHEMUMS, 75 Varieties.....		2.00

Write for prices on large lots. We will make interesting Special Prices for Cash.

R. VINCENT, JR., & SONS CO., White Marsh, Md.

JOHN WATERER & SON, Ltd.

American Nursery Bagshot, England

Are Specialists in the

REALLY HARDY VARIETIES

of Rhododendron Hybrids and in Select Varieties of Hardy Border Plants

SOME OF OUR SPECIALTIES

Boxwood Pyramid Shape, 2 1/2 to 3 ft. high, very heavy, \$1.75 each, 3 to 3 1/2 ft. high, \$2.50 each. Bush Shape, very heavy, 2 to 2 1/2 ft., \$1.75 each, 2 1/2 to 3 ft. high, \$2.00 each. Rhododendrons, Parson's Hardy varieties, 8 to 12 buds, 18 to 24 in. high, at \$75.00 per 100; 12 to 14 buds, 24 to 30 in. high, at \$100.00 per 100. Azalea Hollis, 15 to 18 in. high, very bushy and full of buds, at \$35.00 per 100. Hybrid Perpetual Roses, strong dormant field grown plants, of our own growing, none better, \$11.00 per 100, \$100 per 1000. Moss Roses, field grown, \$1.00 per 100. Hardy Climbing Roses, field grown, \$8.00 per 100. Tree Roses, hardy varieties, budded on straight stems, 4 to 5 ft. high, \$30.00 per 100. Ampelopsis Veitchii, bushy, 2 yr. plants, 3 foot of tops, \$10.00 per 100.

The Storrs & Harrison Co., Painesville, Ohio

NURSERY STOCK FOR FLORISTS' TRADE

AMERICAN GROWN ROSES, AZALEAS, RHODODENDRONS
 FRUIT AND ORNAMENTAL TREES, SHRUBS, SMALL FRUITS, CLEMATIS,
 EVERGREENS

WRITE FOR OUR TRADE LIST

W. & T. SMITH COMPANY 63 YEARS 700 ACRES GENEVA, N. Y.

Berberis Thunbergii Finest of Hedge Plants

12-18 in., \$5.00 per C. \$40.00 per M.

One year seedlings, 3-5 in. \$5.00 per M. All ready for immediate shipment.

C. R. Burr & Company, Manchester, Conn.

Prices Quoted in these Columns are for Dealers Only.
 When Writing to Advertisers Please Mention
HORTICULTURE.

Campanula Glomerata



CAMPANULA GLOMERATA DAHURICA

Courtesy Mt. Desert Nurseries

The clustered bellflower, *Campanula glomerata*, is a hardy perennial meriting general attention both by the landscape gardeners and garden owners. Plants produce large, dense clusters of funnel-shaped blossoms in great profusion. The prettiest and for that reason best known variety thereof is *Campanula glomerata dahurica*. This bellflower blooms from June to August, being at its best on Mount Desert Island in Maine by the middle or latter part of June, single stalks reaching a height of about 18 inches. Their terminal, bright violet blue

flowers have proven to be a very desirable material for filling vases. As a garden plant our campanula gives a most effective border in front of taller herbaceous plantations, and has also been used to good advantage in rock gardens. It survives the winters of the northern states well under cover of leaves while south of New York it may require little or no special protection. The clustered bellflowers prefer an open position, thriving best in well matured and cultivated garden soil. Under favorable conditions plants spread out very rapidly and in the course of a few years form a perfect mass of roots, plants and subsequently flowering stalks.

Similar in its habit is *Campanula glomerata alba*, a pure white form possessing the same free-flowering qualities as the former, while the new *Campanula glomerata acaulis* bears its bright blue, densely-set clusters on short stalks. The vivid green of the leaves of this novelty adds considerably to the beauty of its general appearance. I believe that *Campanula glomerata acaulis* has a just claim for liberal space in American rock gardens.

Richard Rothe

Northeast Harbor, Me.

European Horticulture

THE ROYAL HORTICULTURAL SOCIETY

We may at length rejoice in the fact of winter having left these islands and that all the seasonable operations in gardens, orchards and fields can proceed without hindrance from the elements. As was noted, the Vincent Square Hall forced plants are even now the main stay of the horticulturist, but plants of the open air will soon be making their appearance. On Tuesday, March 23, the hall was filled to overflowing with choice things of the garden. The more striking of these was Messrs. Sutton & Son's grand display of cactus-flowered cineraria: such a lot of plants of this dwarf floriferous strain has never been seen before in this country. They are a great improvement on the leggy, straggling stellata strain, and are a long way ahead of them as decorative plants for the greenhouse, cool conservatory, jardiniere, etc. Among other specialties, a fine lot of rhododendrons, Ascot Brilliant, Pink Pearl and Mirabile, carrying grand trusses and big, beautiful blooms came from Messrs. J. Veitch & Sons. Messrs. Heath and Sons showed a comprehensive collection of the once greatly admired, fragrant-leaved Cape Geraniums, which fashion banished for fifty or more years. Now we are getting them back again, with some additional varieties, thanks to the efforts in hybridizing of the late Dr. E. Bonavia. Messrs. W. Bull & Son seem to be waking up

after playing a Rip Van Winkle part for several years. This firm once famed for the introduction of new orchids and other species of plants, showed some fine hippastrums.

Carnations were greatly in evidence, and Messrs. W. Cutbush & Son had a new variety in Lady Millar—a cross between Enchantress and the creamy pink Souvenir de la Malmaison. It takes after the latter in build and color, and is a full flower. Lady Nora Brassy is another novelty of the Robert Craig strain, in color royal purple. A singular looking Begonia Saturne, having flowers of a lurid pink tint mounted on very tall stems was an exhibit from Messrs. Cannell. H. B. May who is far-famed for his fern culture showed a beautiful selection of species and varieties, the osmundas being varied and highly ornamental. We observed cristata undulata and purpurascens.

Orchids were fairly abundant. Messrs. Sander & Sons showed *Cypripedium Curtisii* Sander's variety; *Phaius hybridus*, a cross between *P. grandifolius* and *P. Wallichi*; the flower has brown sepals and petals and is of a crimson color in the throat. Messrs. Charlesworth & Co. showed a new *Phaius* F. W. Wigan, a brilliant colored variety having a rich rosy crimson lip and throat.

Fredrick Moore

HORTICULTURE

Keep up
your advertising

Is it possible for a business to get so strong and its owner so widely known and influential that he can safely discontinue advertising?

Statistics say—No. The brightest and brainiest business men of today who keep their finger constantly on the pulse of modern commercial affairs say—No. They declare that while a competitor exists or there is a chance for a competitor to start, while there are other goods in the same line that have access to the market, it is conclusive that any concern, however successful and popular hitherto, must keep everlastingly at it. Cease to strive and it will not be long before competitors will sprint ahead and then it will soon be in the air that you are becoming a back number. And when that does happen it will cost you more than all you have saved by your ill-advised economy and deluded self-confidence to regain the ground you have lost.

Cineraria stellata has only in very recent years come to the front in our horticultural exhibitions and then, as a rule, contributed by the private gardeners, the commercial growers apparently pinning their faith on the well-known "hybrida" type with its more conspicuous and highly developed individual blossoms and more compact habit. We think, however, that the stellata section of this useful spring flowering greenhouse annual is worthy of much more general cultivation. Rapid improvement has been made in brilliancy and variety of color, size of flower and symmetry of habit since its first appearance at Horticultural Hall, Boston, about a dozen years ago. Considering the beauty of the plants shown at this year's exhibition of the Massachusetts Horticultural Society we can hardly subscribe to our European correspondent's characterization of *C. stellata* as "leggy and straggly." On this point we think the picture on our cover page, which shows one of the group of plants exhibited by Martin Sullivan, is good evidence of the tidiness of the plant and the fact that the stellata groups almost eclipsed the fancy-flowered varieties in the eye of the visiting public tells the rest of the story. Florists should grow it in quantity not only for pot plant purposes, but for use in cut state for decorative work.

Our news columns this week record the starting of two more societies,—the Tree Doctors', already launched, and the Sweet Pea enthusiasts, about to be. At the present rate of increase we shall before long have a myriad of clubs, societies and associations each working to advance the interests of its particular niche in American horticulture. We are glad to see them breeding. There's plenty of room in the Temple of Fame for all and the sum total of their specialized work must add immeasurably to our horticultural knowledge and influence. There is no department of horticulture and its allied industries that cannot be advanced and strengthened by organized work under unselfish and broad-spirited policies. Any other policy, especially a censorious spirit as regards other organizations, should be carefully guarded against. "In union there is strength" applies to organizations with equal force as to individuals. Mutual respect, mutual toleration and frequent, joint action on matters of mutual interest is the very best sort of preventive against misunderstandings and reprisals. Some day, perhaps, the great opportunity may come and the right man appear, with the adequate qualities of leadership, to make the S. A. F. the acceptable meeting ground for all these diverse yet interwoven interests. Why not?

VOL. IX

APRIL 10, 1909

NO. 15

PUBLISHED WEEKLY BY
HORTICULTURE PUBLISHING CO.
11 Hamilton Place, Boston, Mass.

Telephone, Oxford 292

WM. J. STEWART, Editor and Manager

SUBSCRIPTION PRICE

One Year, in advance, \$1.00; To Foreign Countries, \$1.50; To Canada, \$1.50
ADVERTISING RATES

Per Inch, 30 inches to page \$1.00.
Discounts on Contracts for consecutive insertions, as follows:
One month (4 times) 5 per cent.; three months (13 times) 10 per cent.;
six months (16 times) 20 per cent.; one year (52 times) 30 per cent.
Page ad half page spaces, special rates on application.

Entered as second class matter December 8, 1904, at the Post Office at Boston, Mass under the Act of Congress of March 3, 1879.

CONTENTS

Page

COVER ILLUSTRATION— <i>Cineraria stellata</i> .	
CAMPANULA GLOMERATA—Richard Rothe—Illustrated	525
EUROPEAN HORTICULTURE—Frederick Moore	525
MORE ABOUT FORMOSA LILY A. H. Secker	527
CLIMBING ROSES UNDER GLASS—Alexander Montgomery	527
ART IN THE GARDEN Arthur Smith	527
NEWS OF THE CLUBS AND SOCIETIES—Connecticut Horticultural Society—New England Dahlia Society—American Carnation Society—A New Organization—A Proposed Sweet Pea Association—Society of American Florists	528
Closing Events of the Boston Exhibition—Florists' Club of Philadelphia—Chicago Florists' Club—Perpetual Flowering Carnation Society—Club and Society Notes	529
DURING RECESS—Gardeners' and Florists' Club of Boston—Chicago Florists' Club—Bowling Records, 530	
OBJUTARY—William Hagemann—Horace C. Smith—Wm. H. Derby—J. B. Boland—Chas. Reed—Henry Eherhardt	534
SEED TRADE—The Free Seed Distribution—Ad Valorem versus Specific Duties—Important Action by the Wholesale Seedmen's League—Notes	536
OF INTEREST TO RETAIL FLORISTS: Detroit—Steamer Departures—New Flower Stores, 538 Flowers by Telegraph	539
FLOWER MARKET REPORTS: Boston, Chicago, Indianapolis, Philadelphia	541
New York	543
MISCELLANEOUS: Movements of Gardeners	529
Personal	531
A New Nursery Concern	531
Philadelphia Notes	532
Greenhouses Building or Contemplated	532-543
Catalogues Received	536
Incorporated	536
News Notes	539
Business Changes	541
A Verdict for Alphonse Pericat	543

Gardening on natural lines

The "Japanese Garden" which has taken Boston by storm during the past two weeks will, we believe, prove to have been much more than a transient sensation. As an impressive example of the possibilities in gardening it may mark the beginning of a new era, the popularizing of home gardens arranged on lines following the simple beauty of Nature's work and the abandonment of the crude and unnatural arrangements with which the people, for lack of education in better things, have surrounded their homes. It was a revelation to the public and has set them a-thinking. Its conception and arrangement was a triumph of artistic genius.

More about Formosa Lily

Editor HORTICULTURE:

Dear Sir:—Note concerning Formosa Lily from Charles Lenker in last week's issue much appreciated. I am glad to see these opinions in the trade papers, and this is a means that should be taken more generally in bringing the growers' troubles and successes before the trade. If I have been correctly informed, the lily in question grows wild in Formosa, and is there gathered by natives and shipped to Japan, for repacking or growing on. If I can see clearly, and from reports of local and distant growers, the demand for Formosa bulbs was enormous last year, so much so that some orders were refused, and others cut in two. How then were orders filled if not from these imported wild bulbs? Some growers secured good bulbs as perhaps Mr. Lenker did, giving perfect satisfaction, but what about the many who were sadly disappointed in the product of the Formosa bulbs—one grower of 1500 having fully 50 per cent with but two flowers on, remainder three to five. As to temperature, mine were treated as formerly, when good results were secured, and other bulbs grown in same house with same treatment have prospered amazingly. But Formosa—alas.

My object in writing to HORTICULTURE was for the purpose of drawing the attention of the trade, and incidentally the introducers to facts as they are. The very fact that Mr. Lenker "has seen two lots in two different places," is cumulative evidence that "trash" has been substituted. Is it not time that some measures were adopted for protection against such substitution? However, it's up to the dealers handling the bulb. I must reiterate my first statement, that the Formosa as first grown by me was A 1. and more like them could be very profitably used. To discard the variety would be utter folly. What we do want, however, is good healthy first-class bulbs packed to reach us in good condition.

Rochester, N. Y.

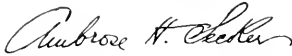

Climbing Roses under Glass

Editor HORTICULTURE:

I would like to know what temperature is best for growing climbing roses. Those I have are Marechal Neil, Lamarque, Gloire de Dijon. I would also like to know if they would do any better if the glass was shaded.

E. G.

The proper temperature at which to grow climbing roses such as Marechal Neil does not differ materially from that required for the ordinary tea roses, that is, while the plants are making the growth from which the flowers are to come later on. It is in the process of ripening the wood and starting up again to get the crop that a little manipulating of the temperature is required. This is done by gradually lowering the temperature and withholding water until the wood assumes a nice firm appearance. Here is really the most important part of the operation, for, without well ripened wood, the flowers will be few and of poor quality. In starting them up after the ripening treat them about the same as a Hybrid Perpetual, beginning with 45 degrees and gradually increasing until the maximum temperature is reached, which should not exceed 60 degrees. If you follow this course successfully you will have "a sight fit for the gods."

Natick, Mass.



Art in the Garden

From the earliest time of which we have any record the more civilized of mankind has been wont to plant a garden near his dwelling place, and some of the earliest books were on the subject of gardening; but at no period has the love of gardening—in its widest sense—been more general than at the present time which is doubtless evolved from the hereditary inclination for this pursuit in which men and women have indulged throughout all time; and there is probably no more fascinating recreation than the developing of ideals in gardening effects, a pleasurable occupation which can be followed by both rich and poor.

The art of gardening has probably never been at a higher standard of excellence than at the present day, but this is, however, more the case in connection with the growing of individual plants to perfection together with the propagation and growing of plants in general: in these matters the average professional gardener needs little or no instruction. But the word "Art" in the title of this paper is used in a totally different sense.

A CAUSE OF FAILURE

Many of the most successful raisers of plants, who take numerous prizes at fairs, are often wanting in artistic taste, and are apparently unable to lay out and plant a garden in an artistic manner. The many failures which one sees are, in most cases, evidently caused by the fact that the individual responsible did not understand how to apply artistic principles to the designing of the garden rather than to any want of skill in carrying out the details. It is in this connection that we use the term "art," and there is no reason why our gardens should not be examples of the truest and highest art.

Landscape architecture (we use the term in preference to landscape gardening because gardening is more the cultivation of and caring for plants) is unquestionably a fine art, for art is the creation of organized beauty, whether upon canvas, marble or the surface of the earth.

As various degrees of talent exist among artists in oils, water-colors and stone, the same variation in skill is to be found in landscape artists. To excel in either of these branches of art a born and trained artist is required, and although the possession of genius like that of Raphael or Turner is more a question of endowment than training, at the same time a genius requires to study first principles, and every one studying along those lines is capable more or less of increasing his knowledge of and skill in the art he follows.

FIDELITY TO NATURE IS TRUE ART

The dominant object of ornamental gardening should be to beautify home surroundings, and this can only be accomplished by composing into a pleasing picture, lawns, trees, shrubs and other accessories of a garden. But to have anything beautiful and artistic it must be true. The ancient Greeks knew this, hence their success in giving form to beautiful things. A garden should be the home of the highest form of art because it is the home of the natural and living, not artificial and dead, things. True art is always marked by fidelity to nature, and it is the want of naturalness which often causes our gardens to be inartistic.

In this connection we do not overlook the fact that in a few positions what is known as the "architectural" is more appropriate than the "natural" style, but such positions are very rare, and exist only in sufficient numbers to prove the natural to be the more perfect.



(To be continued.)

NEWS OF THE CLUBS AND SOCIETIES

CONNECTICUT HORTICULTURAL SOCIETY.

To avoid Fast Day (which is April 9th in this State), our Society's first meeting of the month was held on the 2d instant. Owing to the slight indisposition of President J. F. Huss, the first vice-president, John Gerard, of New Britain, presided. One new member was received; namely, Otto Gubitz, of Hartford. A very interesting and instructive paper was read by Mr. Gerard, giving a vivid description of the plans and operations of some of the great seed houses of Europe, whose names are little known to the public, because of the fact that they never advertise, but whose institution and great activities are well known to the European and even transatlantic seed trade. Mr. Gerard received a vote of thanks from the Society. A small collection of choice gloxinia blooms, contributed by T. B. Brown, of Windsor, was tabled. Messrs. James Chambers and J. A. Weber were appointed to judge the display. Their report was of a commendatory character, and, on their recommendation, a vote of thanks was passed to Mr. Brown. The secretary was instructed to communicate with the proper officials of the New Haven and New London County Horticultural Societies, with a view to the arrangement of a joint one-day's outing, next fall, to Amherst, Mass., especially to see the work of the agricultural college and the experiment station there. Walter L. Goodwin (State senator from this district) and J. A. Weber were appointed a committee to use their endeavors to effect the passage of a bill now before the legislature of this State, appropriating \$9,000 (instead of \$4,500, as heretofore) of the State funds for the aid of incorporated agricultural societies in giving premiums. If the bill be enacted, our society will receive \$200 annually, for this purpose, instead of \$100.

GEORGE W. SMITH,
Secretary.

NEW ENGLAND DAHLIA SOCIETY.

This Society announces its second annual exhibition to be held at Horticultural Hall, Boston, on September 10, 11 and 12, 1909. The schedule which is now out provides for 126 classes of which 16 are special—the others covering the various classes of dahlias and providing for the award of ribbons and diplomas. Copies of the schedule may be obtained from the secretary, Maurice Fuld, 5 Union street, Boston.

AMERICAN CARNATION SOCIETY.

The American Carnation Society members please take notice, that all of the papers, etc., pertaining to the secretary's office have been forwarded to our new secretary, A. F. J. Baur, Indianapolis, Ind.

Dues, registrations and all other matters pertaining to this office should now be addressed to Mr. Baur.

Respectfully yours,

ALBERT M. HERR.

A NEW ORGANIZATION.

On Monday, March 29th, at a meeting held in the offices of the Munson-Whitaker Company, New York, a new organization had its birth which will be known as the Employers' Association of Landscape Foresters and Commercial Entomologists.

The rules adopted by the society are very stringent, and, as indicated by its name, it is exclusively for employers actively engaged in the business and able in every way to qualify in the practice of scientific tree surgery and commercial entomology.

Its objects are to promote good fellowship and individual improvement, and, as a body, to fight the "tree butchers" and fraudulent dopers, who are everywhere mutilating trees and imposing upon the public, and it is hoped that with such an organization much will be done in advancing the interest of the public, through the members and press, in the protection of our beautiful trees from diseases and the destructive work of insect pests by scientific treatment, thus placing the science of tree surgery and commercial entomology on a higher plane.

The following charter members were enrolled: John T. Withers, Jersey City, president; James E. Whitaker, Boston, vice-president; F. A. Bartlet, Stamford, Conn., secretary-treasurer; H. L. Frost, Boston and Chester L. Whitaker, New York, examining committee; Lewis H. Wise, Jersey City, and G. H. Allen, New York.

Another meeting will be held some time in April to complete the organization. A special meeting will be called by the president in the near future to enroll new members. A number of applications have already been received. A convention will be held annually to discuss scientific matters in connection with the profession and to enlighten the public in the care and preservation of our beautiful trees.

After the meeting a banquet was held in the fashionable "barn room" at Mouquins, Sixth avenue. After the genial president had welcomed the guests he introduced Mr. H. L. Frost as Toastmaster, who very ably filled that position. Dr. George E. Stone, Ph. D., botanist and pathologist of the Massachusetts Agricultural College, Amherst, Mass., was the chief speaker of the evening and gave some interesting reviews in connection with his experience in the use of wood preservatives in the treatment of cavities. Addresses were made by Messrs. Leonard Barron, W. E. Maynard and H. L. Jones. George H. Wyckoff and W. B. Pratt gave interesting talks on the value of oils and leads for the destruction of our insect enemies. Mr. Wyckoff's partner, Mr. Rose, John F. Marion and Alex. Guttman, all made entertaining remarks and Addison T. Hastings, City Forester and Park Superintendent of Jersey City, outlined the extensive work being done in that city. The floral decorations of the table, generously contributed by Mr. Guttman, were very beautiful.

A PROPOSED SWEET PEA ASSOCIATION.

The following letter which has been widely distributed among sweet pea specialists, is self explanatory:

April 3rd, 1909.

Dear Sir—Acquiescing in the desire to start a National Sweet Pea Association, on the lines of other kindred societies, I write to ask you for your support in an effort to stimulate a general acceptance of the idea, and to give impetus to the good seed that has fallen, so that it may bring forth a hundred fold and blossom into a live and useful organization.

The Sweet Pea is the poor man's Orchid, easy of culture and loved by all, is becoming more popular every year and can be seen in flower practically all the year round, thanks to the so called Christmas varieties.

President Harry Turner of the New York Florists' Club, will lend his influence to the project, inasmuch that the June meeting (with the consent of the club) will be set aside for a Sweet Pea exhibition; on this date, June 14th, it is proposed to organize the National Sweet Pea Association and to arrange a program for future action.

The exhibition will be a modest first effort. W. Atlee Burpee writes that "he would be pleased indeed to offer a cup and contribute towards the expenses of establishing such a society." Arthur T. Boddington also promises a cup and any necessary contribution.

Won't you help the cause along either by your good wishes and moral support or other manifestations of good will and interest? It is going to be a success—it must be a success. Awaiting your kind reply,

Truly yours,

HARRY A. BUNYARD,

Secretary pro tem.

SOCIETY OF AMERICAN FLORISTS AND ORNAMENTAL HORTICULTURISTS.

Registration of Begonia.

Public notice is hereby given that J. A. Peterson, of Westwood, Cincinnati Ohio, offers for registration the plant described below. Any person objecting to the registration of this plant or to the use of the proposed name is requested to communicate with the undersigned at once. Failing to receive objection to the registration the same will be made three weeks from this date.

Name President Taft.—Description—A sport from Begonia "Agatha"; it originated in our greenhouse about 2 years ago. In growth it is much stronger and sturdier than Agatha or Gloire de Lorraine, to which class it belongs. In color a beautiful shade of soft rosy-pink, deeper and richer than Agatha or Gloire de Lorraine. The flowers more than cover a silver dollar. It is a free and continuous bloomer from November to April. Height about 15 to 18 inches. Foliage large, shining, dark green.

W. N. RUDD,

Secretary.

K.

Date—April 2, 1909.

CLOSING EVENTS OF THE BOSTON SPRING EXHIBITION.

The spring exhibition at Horticultural Hall, Boston, closed on Sunday night, April 3, after a phenomenal run of 11 days. The door receipts amounted to nearly \$7,000, and the treasury of the Massachusetts Horticultural Society will be enriched by fully \$5,000. On Saturday fully 2,000 school children attended the show on special invitation. Extra prizes for new exhibits were bestowed on S. J. Goddard for carnations, R. D. Kimball, Edw. MacMulkin, Miss S. B. Fay, Thomas Roland, John Barr, Mrs. E. M. Gill, Harvard Botanic Garden and others. Wm. Sim got a silver medal for sweet peas and two certificates of merit for violets and James F. M. Farquhar had conferred upon him the unusual honor of a special diploma for distinguished service in the artistic landscape skill shown in the construction and arrangement of the Japanese Garden, which was so important a factor in the success of the exhibition. This is the second instance of the bestowal of such an award during the eighty years of existence of the society, the only other similar award having been made to the late Marshall P. Wilder many years ago.

FLORIST CLUB OF PHILADELPHIA.

The monthly meeting of this club, held on the 6th inst., was rather slimly attended, most of the members being busy with Easter work. John Westcott gave an interesting talk on his recent trip to the Isle of Pines. For a winter resort, Mr. Westcott thinks the island par excellence, and has serious thoughts of making it an auxiliary to Barnegat Bay. William P. Craig threw rather a damper on the subject from a business standpoint, and was corroborated by Messrs. Graef and Coleman who had spent eight days with him on the island investigating. The mosquitos are fierce, the jiggers ferocious and the heat and drouth very trying. Transportation poor and expensive. No harbors and no deep water. The gentlemen mentioned stated that they were glad they had made the trip, glad they went and still gladder to get away again. Robert Craig's real estate speculation at this Caribbean paradise is accordingly knocked on the head.

CHICAGO FLORISTS' CLUB.

The regular monthly meeting of the Chicago Florists' Club was held at the Union restaurant, April 1st.

Ten new members were accepted. Considerable time was taken up with a discussion of the by-laws and copies of the proposed changes will be printed and circulated at the next meeting. Andrew Benson, rose grower for Bassett & Washburn gave a talk on the rose show in Buffalo. Four new names were proposed for membership.

Wm. G. Badgley is to lecture on the Rose before the Morris Co. Gardeners' and Florists' Society on April 14. "Rose Night" is a big night with this club. Usually quite a number of novelties are shown. The club is making efforts to get as many as possible this year. Madison and Chatham are expected to do their part in standard varieties.

PERPETUAL FLOWERING CARNATION SOCIETY.

The cultivation of the winter flowering carnation is extending in Great Britain rapidly, especially in the south; and nothing fosters it more than the fine displays to be observed at the exhibitions of the Perpetual Flowering Carnation Society and those of the R. H. S. The much older tree carnations still find cultivators among the craft, but their heyday is over, for, although the colors of the blooms are in many instances admirable, and the forms good, the plants are as a whole lacking in vigor, length of flower stems, and size of the blooms. And gardeners prefer the new strains with their larger blooms, fine distinct colors, great vigor of growth, and the florists prefer them as general decorative material. We are still inclined to value the non-searated blooms of the carnation of all sections and endeavors a e being put forth to impart this smoothness to the new varieties, and doubtless will result in the desired end being attained; and we shall then have the looked for perfection of form, together with large size of bloom and the glorious tints now getting so common on the American and English strains. The show held on March 24 at R. H. S. Hall was of great extent and largely consisted of amateurs' contributions; the trade contributed also to some extent and had held over their exhibits from the Royal Horticultural Society's meeting on the previous day, thus adding to the interest of the show. The blooms were of higher quality than at any previous show.

The American Carnation Society offered a challenge cup for three vases containing new varieties put into commerce by Americans in 1906, and two following years. Messrs. Bell & Sheldon, carnation specialists of Guernsey, were awarded this cup for the varieties Afterglow, Aristocrat and Winsor; 2nd, Mr. A. F. Dutton, who showed Winsor, Afterglow and Victory. Mr. C. Engel was 3rd.

For a group of not fewer than twelve varieties shown on a table 10 feet by 3 feet, and any kind of foliage allowed for a decorative purpose, only one exhibitor appeared—Mr. Hayward Mathias. This group consisted of Gladys—a dark crimson bloom, smooth petalled, and of the perfection of form; excellent blooms were observed of Winsor, Britannia, Mrs. Lawson, Mrs. H. Barnett, White Perfection, White Lawson, Enchantress, Robert Craig, etc. The exhibitor was awarded the 1st prize.

In the color classes the best 36 blooms, white, W. H. Lancashire was 1st; and in the 18 blooms class, white, Bell & Sheldon took the 1st prize with Lady Bountiful. In the blush class, W. H. Lancashire was 1st with Enchantress; in the larger class, that for 36 blooms, Bell & Sheldon took the 1st prize in the class for light pink, salmon, or rose colored varieties, with Winsor in the 36 blooms class; and Mr. Dutton was the winner in the 18 blooms class with Rose White Enchantress. For 36 blooms, deep pink, W. H. Lancashire was 1st for grand blooms of Mrs T. W. Lawson, and Bell & Sheldon for the best 18 blooms, with Afterglow. C. Engelmann took 1st for Carola, a bloom of a deep crimson tint of good

substance in the petals, which are serrated; Bell & Sheldon were the 1st in the class for 18 blooms of the same color, with President. The best in the larger class for scarlet blooms was Victory, shown by the Newport Carnation Nursery, and the best 18 blooms of the same color were shown by Bell & Sheldon, viz., Britannia. In the class for 18 blooms of any other, Jessica, shown by the Newport Carnation Nursery, was 1st; and Mr. C. Engelmann, 1st, was the exhibitor of 12 blooms of any variety not yet sent out with Carola.

There were some "decorative classes" in which bouquets, vases of varieties, baskets of market carnations, ladies' sprays and button-hole bouquets, entered for prizes.

The trade exhibits consisted of groups of cut blooms and Mr. H. Burnett was the recipient of a gold medal for an excellent group of the finest varieties. A silver gilt medal was awarded to Messrs. Hugh Low & Co., for a capital and lavish exhibit arranged in a sort of temple. In this display Black Chief was noted—a flower in color and shape like the old Clove carnation, and very free flowering. C. Engelmann received a gold medal for a big display. No awards were made to any new carnations.

The show was an undoubted success, and the attendance of the public particularly gratifying to the promoters.

FREDERICK MOORE.

CLUB AND SOCIETY NOTES.

The contract for erecting the new building for the New Hampshire Horticultural Society at Dover, has been awarded to the Central Building Co., of Worcester, Mass.

The annual meeting of the Albany Florist Club was held April 1st and largely attended. Two new members were admitted. The coming floral show was discussed. The next meeting will be held May 6 at the store of W. C. King.

The Gardeners' and Florists' Club of Baltimore were favored with a talk by Richard Vincent, Jr., at their meeting on March 22, and a superb exhibit of geraniums from his extensive stock at White Marsh including over 150 varieties. Ulrich Brunner roses were exhibited by M. Hannigan.

MOVEMENTS OF GARDENERS.

Sabine Botton succeeds Robert Marshall as gardener at Peter B. Bradley's, Hingham, Mass.

John Fraser is reported to have resigned his position as gardener to Philip Kearney, Columbia Road, Morristown, N. Y.

Robert Marshall has left Bradley Hill, Hingham, Mass., and has taken charge of the J. R. de Lamar estate at Glen Cove, N. Y.

Roland H. Messenger has resigned his position at the Bradley greenhouses, Brattleboro, Vt., and taken a position with C. W. Dunham.

Wm. H. Thomas, for the past twelve years gardener to P. C. Blanchard, Convent, N. J., has given up his situation. Mr. Blanchard does not expect to keep up the place this year, but will rent it if possible. Mr. Thomas was the first secretary of the Morris County Gardeners' and Florists' Society.

During Recess

GARDENERS' AND FLORISTS' CLUB OF BOSTON.

Saturday, April 3, was "Field Day" and a good number of the members of the club took advantage of the secretary's invitation and enjoyed the trip to Waverley, to get a glimpse of the Easter stock. The greenhouses of the W. W. Edgar Company were first visited and Mrs. Edgar with Mr. Bartsch, the foreman, was present to extend a cordial welcome to the visitors. After an inspection of the contents of the houses a light lunch was partaken of and President Downs made brief appreciative remarks, calling for three cheers for Mrs. Edgar, which were promptly given. Wm. J. Stewart and M. H. Norton were called upon as old friends of the late Mr. Edgar and each responded expressing pleasure at seeing the stock in such creditable shape for the Easter demand. All were favorably impressed, particularly with the lilies and azaleas, of which there was a grand display. Especially suggestive as a good use of extra space was the row of tomatoes trained against the back side of the large-plant houses and also on the supports of the roof. They carried a heavy crop of fruit rapidly ripening and indicated a very profitable result.

The next place visited was the Edgar Brothers' two big houses nearby. These houses, one 20x200, the other 40x200, are planted exclusively to sweet peas, with young stocks for Decoration Day blooming, between the rows. The peas were planted late hence have not yet reached the height of the crop but it is believed by the Messrs. Edgar that they will acceptably fill the gap between the winter market crop, which will soon be on the wane, and the summer supply from outside.

Next and last Peirce Brothers' big range on the road to Waltham was visited and as usual, much was in sight to interest and instruct. Peirce Bros. started with 75,000 bulbs, Formosa Giganteum and Multiflorum. The Formosas are all gone now. The

ORCHIDS Cattleya Mossiae

has arrived in first-class condition. We sell our plants at our store, 41 West 28th St., New York. Our PRICES are LOW and our STOCK is FIRST-CLASS. Write us for particulars and prices and by so doing you will be sure of the facts.

ORDONEZ BROS., Madison, N. J.

ORCHIDS

Cattleya Mendellii arrive in May, Mossiae to June, Gaskelliana in August, Aurea and gligas Hardyana in October TRUE TO TYPE, NO GREENHOUSE USES. COLLECTED IN BLOOMING SEASON.

Dendrobium to arrive in April. Miltonia Vexillaria ready now, SPLENDID TYPE. Miltonia Roezlii in October. DIRECT TO YOU. Order Now.

G. L. FREEMAN, 388 Appleton St., Holyoke, Mass.

stock look very fine and the loss from unsound bulbs has been less than usual. Spinas, azaleas, carnations, etc. are all grown, as everything has always been, in Peirce Bros.' in enormous quantity and the electric vans will get no rest for this week.

CHICAGO FLORISTS' CLUB.

The Chicago Florists' Club gave a Ladies' Night, April 2, at the Grand Pacific Hotel. A very enjoyable evening was spent and the attendance was good. It was pronounced by all to be a success. Similar occasions are planned to occur in the near future. Mrs. Geo. Asmus, Miss Ludwig and Mrs. Leonard Kill carried off the ladies' prizes in the games, while Messrs. Johnson, Kruehen and Scott won the honors for the gentlemen. Refreshments were served.

On the same evening occurred the regular meeting of the Florists' Bowling Club. Though at a busy time the attendance was larger than before and the members are enthusiastic over the outlook.

In the handicap game that evening E. Johnson of Randall's, won 1st, August Barnett of Hunt's, 2nd, Wm. Graff of Friedman's, 3rd.

BOWLING RECORDS.

Astoria and Flatbush, N. Y., met on the bowling alleys at Astoria to contest for supremacy, under the double inspiration of old rivalries and a watch and silver cup put up as prizes by Phil. Kessler. Astoria won the whole outfit. Scores in the two scrimmages were as follows:

Astoria.		Flatbush.			
Miesen.	129	127	Zeller.	93	131
Johnson.	129	121	Schultz.	122	132
Schlicht, W.	115	100	DeLoe, P.	121	127
Hinsman.	119	114	Workey.	122	119
Kessler.	142	162	DeLoe, H.	107	173
Donaldson.	157	144	Riley.	194	172
Lorenz.	136	146	Brady.	151	177
Schlicht, H.	126	104	Schlicht, Jr.	121	100
Dorhofer.	144	115	Blockman.	194	146
Schwake.	110	111	Shaw.	150	129
1377 1390		1357 1392			
Total 2767		Total 2749			

St. Paul and Minneapolis had another bowling match on April 1 at St. Paul. It being April 1, Minneapolis fooled St. Paul and let them win. St.

ORCHIDS

Just Arrived in Fine Condition

the following East Indian Orchids

DENDROBIUM WARDIANUM, D. CRASSINODE, D. PRIMULINUM, D. THYSIFLORUM, AND D. CHRYSOTOXA. Others to follow.

WRITE FOR PRICES

LAGER & HURRELL, Summit, N.J.

JUST ARRIVED

Fine Importation of

Oncidium ornithorrhynchum

Fine strong leafy plants \$1.50 each. \$18.00 doz
Few specimens 50

JOSEPH A. MANDA, West Orange, N.J.

ORCHIDS

We are booking orders now for delivery early in the Spring on all commercial CATTLEYS and NOVELTIES. Our prices are right and our guarantee perfect. We sell only first-class goods

CARRILLO & BALDWIN, Secaucus, N. J.

IMPORTED ORCHIDS

Now Arriving

Julius Roehrs Co.

RUTHERFORD, N. J.

ORCHIDS

Largest Importers, Exporters, Grocers and Hybridists in the World

Sander, St. Albans, England
and 23 Broadway, Room 1
NEW YORK CITY

THE BOSTON VIOLET

Unequaled for Productiveness, Beauty and Popularity.

In Crop from September to May.
Plants \$2.00 per doz. \$1.00 per 100; \$100.00 per 1000
Princess of Wales \$15.00 per 1000.

WILLIAM SIM, - Cliftondale, Mass.

A Profitable Side Crop

Asparagus plumosus is a main crop with many growers having extensive modern plants but those with less up-to-date establishments, or parts of same defective in lighting or otherwise unsuitable for high grade crops,—will find this subject one of the very best. We have prepared a cultural circular giving concise directions how to make money out of this crop. Send for it. No charge. An important feature in asparagus culture is good seed. The P. M. quality of greenhouse grown seed has earned a high reputation for freshness and purity. It is the true nanus and greenhouse grown. Send for trial pkg., 100 seeds fifty cents, if you wish to experiment only. In quantity \$3.75 per 1000 seeds, \$32.50 per 10,000 seeds. Asparagus Sprengeri 75c. per 1000, \$5.00 per 10,000 seeds.

S. S. PENNOCK-MEEHAN CO.

1608 to 1620 Ludlow St., Philadelphia, Pa
1212 N. Y. Ave., Washington, D. C.

THE QUALITY YOU CAN MAKE MONEY ON

CANNAS

SOUND PIECES TRUE TO NAME BED ROCK PRICES

Red-Floored, Green Foliage

	Per doz.	100	1000
A. Bouvier, 5 ft. Dark crimson, 4 ft.	\$.35	\$2.25	\$20.00
Alice Roosevelt, Deep crimson, 4 ft.50	3.50	30.00
Beaure Pottevine, 3 1/2 ft. Dark crimson, 3 ft.35	2.25	20.00
Black Prince, Velvety maroon, 3 to 4 ft. green foliage,50	3.75	25.00
Charles Henderson, 4 ft. Bright crimson, 3 ft.35	2.25	20.00
Crimson Bieder, 3 ft. Intense scarlet,30	2.00	17.50
Duke of Marlborough, 3 1/2 ft. Dark crimson,35	2.25	20.00
J. D. Eisele, Brilliant vermilion-scarlet 5 ft.35	2.25	20.00
Explorer Crampel, Deep rich crimson 3 1/2 ft. Express, Crimson foliage, Dwarf habit, 2 to 2 1/2 ft.60	4.50	40.00
Pres. McKinley, Brilliant crimson 2 1/2 to 3 ft.35	2.25	20.00

Pink-Floored

L. Patry, Delicate rosy pink, 3 1/2 ft.	\$.35	\$2.25	\$20.00
Luray, Attractive rosy pink, 3 ft.35	2.25	20.00
Louise, A grand pink, tall Martha Washington, Rose, Height, 2 1/2 to 3 ft. rose, each,75	5.00	
Mile. Berat, 2 1/2 ft. Rose-carmine,35	2.25	20.00
Tennyson, Ruby and white, green foliage, 5 1/2 ft.50	3.00	

CATALOGUE FREE.

Orange-Flowered

	Per doz.	100	1000
President Cleveland, Bright, distinct orange-scarlet, 4 ft.	\$.35	\$2.25	\$20.00

Red, Gold-Edged and Spotted

Gladiator, Bright yellow, spotted crimson, green foliage, 4 ft.	\$.50	\$2.75	\$25.00
Cinnabar, Cinnabar-red, edged with distinct golden band, 4 1/2 ft.30	2.00	17.50
Queen Charlotte, Scarlet gold edge, 4 1/2 ft.30	2.00	17.50
Mme. Crozy, 5 1/2 ft. Vermillion, gold border,35	2.25	20.00
Fremiter, Deep crimson, bordered yellow, 2 1/2 ft.30	2.00	17.50
Souv. d' A. Crozy, 4 ft. Crimson, gold band,50	4.00	35.00

Yellow Shades

Buttercup, 3 1/2 ft. Clear golden yellow,	\$.30	\$2.75	\$25.00
Comte de Beauchard, Bright, spotted red, 4 1/2 ft.30	2.00	17.50
Florence Vaughan, 5 1/2 ft. Yellow, spotted crimson,50	2.75	25.00
L. E. Bailey, Rich yellow, dotted with red, 4 1/2 ft.30	2.00	17.50

White and Cream Shades

Alsace, 3 1/2 ft. Creamy white,	\$.30	\$1.75	\$15.00
--------------------------------------	-------	--------	---------

Bronze-Leaved, Red-Floored

Brandywine, 4 to 5 ft. Dark bronze foliage, Crimson flowers,	\$.50	\$4.00	\$35.00
Black Beauty, True, 5 ft. Grand foliage,60	4.50	40.00

We go through the block from 14th Street to 13th Street, but our address is still

David Harum, 3 1/2 ft. Vermillion-scarlet,	\$.50	\$2.75	\$25.00
Egandale, 4 ft. Currant-red,35	2.25	20.00
King Hubert, Fine bronze foliage, Orange-scarlet with bright red markings, 4 ft.	1.00	8.00	75.00
Leonard Vaughan, 4 1/2 ft. Bright scarlet,35	2.25	20.00
Musafolia, The finest foliaged Canna, with enormous mus-like leaves, 3 by 5 ft. of a dark green bronze-tinged color,35	2.25	20.00
Philadelphia, A bright glowing red, Height 5 ft.75	4.00	30.00
Papa Nardy, Large, rich carmine-red, 4 1/2 ft.30	2.00	17.50
Pillar of Fire, 6 to 7 ft. high, flowers bright crimson-scarlet,75	4.50	40.00
Robusta, Height 6 to 8 ft., with immense foliage,30	1.75	15.00
Sherardian, Large Salmon flowers, 6 ft.30	1.75	15.00

Orchid-Floored

Allemania, 4 to 5 ft. Scarlet and yellow, Green foliage,	\$.35	\$2.25	\$20.00
Austria, Pure canary yellow, an orchid-floored type, 5 ft.30	1.75	15.00
Italia, 4 1/2 ft. Green foliage Red bord. red yellow,30	2.00	17.50
Kronus, Rich golden yellow, with patches of bright red, 5 ft.30	1.75	15.00
Mrs. Kate Gray, 6 ft. Green foliage, Scarlet and yellow,30	2.00	17.50
Pennsylvania, 5 ft. Green foliage, Deep scarlet,35	2.25	20.00

342 West 14th St., NEW YORK CITY.

Paul was somewhat surprised at the joke.

	St. Paul	Minneapolis
Furvel, 149	97	155
Dill, 152	155	135
Haugan, 196	127	138
Hansen, 142	176	151
Olson, 141	154	175
	797	769
	814	589
		684
		672

The New York Florists' Bowling Club will bowl at Thum's Alleys, on Monday afternoon, April 12, instead of Monday evening as the regular meeting of the Florists' Club takes place on that evening.

A NEW NURSERY CONCERN.

The Lowell M. Palmer estate at Stamford, Conn., has been sold to the Fernwood Nursery. The Fernwood Nursery has recently been incorporated, with the following officers: B. J. Ezechel, president; J. J. Davidson, vice-president; L. G. Bernheimer, secretary and treasurer, New York office 53 West 30th street. The president of the company, B. J. Ezechel, is well known for many years among the florist trade of New York. Sam A. Woodrow, recently engaged in the wholesale plant business at 53 W. 30th street, has been engaged as traveling salesman.

The L. M. Palmer estate, for many years under the supervision of that expert plantsman, A. Hans, is far-famed for the splendid collection of hardy conifers, rhododendrons and ferns gathered together and raised by Mr. Hans. The estate consists of about eighty acres.

PERSONAL.

Visitors in Toledo—Robert Rahaley and Alb. Poehlein of Detroit, Mich.

Chicago visitors: A. T. Pyfer, Joliet, Ill.; Alex. Siegel, St. Louis, Mo.

H. R. Hughes, Chicago, is convalescent, following a severe attack of La Grippe with heart complications

Visitors in Albany: Harry Meyer of Louis Meyer & Bro., New York; Fred M. Simon, agent for Wolf & Co., Philadelphia.

Miss Ethel Merrill of Portland is in charge of the new flower store opened at Westbrook, Me., recently by N. W. Hannaford.

R. LeRoy Laughlin has taken charge of the business of the Laughlin Seed Co., at Kenton, O., which includes their eastern agency.

Wm. McM. Brown, who has contributed some interesting cultural articles for HORTICULTURE during the past year, has resigned his posi-

tion with W. N. Craig on the Ames estate, North Easton, Mass., and started on April 9 for the Pacific coast, with a view to possibly locating there.

Willard Asmus ten-year-old son of George Asmus of the Schiller Co., Chicago, is recovering from an attack of incipient appendicitis.

Visitors in Boston—E. J. Harmon, Portland, Me.; John Wilson, Burlington, Vt.; Prof. E. A. White, Amherst, Mass.; D. F. Roy, Marion, Mass.

Arthur Smith has resigned his position with Peter Smith & Sons, Detroit, Mich., and will start in business as a landscape architect at Spokane, Wash.

W. Desmond, formerly with the L. S. Donaldson Co., Minneapolis, has gone into partnership with T. Souden. Their store is located on Hennepin avenue, where they occupy a very prominent corner and make a fine window display. Charles Snell, formerly of New York and later of Chicago, is the successor of W. Desmond at L. S. Donaldson's.

Headquarters for Asparagus Plumosus Seed New Crop

GREENHOUSE GROWN			LATH HOUSE GROWN		
100 seeds, .50	5,000 seeds, \$17.50	100 seeds, .40	5,000 " \$12.50		
1,000 " \$9.75	10,000 " \$32.50	1,000 " \$2.75	10,000 " \$23.00		

Write for Our Wholesale Catalogue

HENRY F. MICHELL CO., 1018 Market Street, PHILADELPHIA

PHILADELPHIA NOTES.

Chester Davis, gardener for the late William P. Henze, the millionaire-locomotive builder, has been left a bequest of five thousand dollars in the will of the deceased. Mr. Davis has been a faithful employee for many years and Mr. Henze did credit to himself in recognizing efficiency and loyalty. But why don't our millionaires go in for and leave some of their surplus to the Horticultural Society? The wise ones around Boston did that, fifty years ago, and look where horticulture is there today!

A campaign of education in this direction is a crying need. There are oceans of money around Philadelphia, and all it needs to get a good big endowment fund for our Horticultural Society is to bring its merits and possibilities forcibly before our leading citizens while they are alive. William Schaeffer (all honor to his memory) gave us our ball but nothing to run it with. What's the matter with the rest of our wealthy men? There is grave

danger at this juncture that we may lose the ball, even. Things are at a crisis.

Personally I think now is the time to call a big meeting of everybody interested to devise ways and means for saving the ball and getting an endowment fund sufficient to make the ball effective. It would be a shame and a disgrace to let things go by the board when we have a three-quarter million property in our grasp with only a bonded debt of two hundred thousand a nuisance.

Where is Burpee, where is Dreer, where is Buist, where is Landreth, where is Meehan, where are all the other old names that have helped to make Philadelphia horticulture famous. Don't any of them want to turn a hand to save that beautiful building which Frank Miles Day designed and which is recognized everywhere as a model of its kind and the crowning monument for all time of its founder, William L. Schaeffer? It is unbelievable that they can be so indifferent.

What is wanted is not their money but their influence and push. If they will put their shoulders to the wheel and interest their millionaire friends, things will soon be put on a solid financial foundation and be kept there.

Howard M. Earl, manager for W. A. Burpee & Co., for the first time in twenty years was laid flat on his back with a severe sick spell, last week of March the result of overwork and fierce weather. He is about again much to his own joy and that of all concerned. Reported to be a laid patient. Probably lack of practice.

P. Joseph Lynch of the Dingee & Conard Co., West Grove, has just returned from a sojourn at Charlotte, N. C., where he has been superintending the planting of outdoor roses for his firm. The climate and other features at this point have been found to be particularly favorable for this class of stock.

GREENHOUSES BUILDING OR CONTEMPLATED.

Tipton, Ind.—C. King, one house.
Whitman, Mass. Lewis Reed, additions.

Upton, Mass. A. A. Bowker, additions.
Stratford, Conn. Sniffin Bros., two houses.

Albany, N. Y. Park Department, one house.

Whitestone, N. Y. J. McMullen, two houses.

Lynn, Mass. F. J. Delansky, five side-hill houses.

Ship Rock, N. M.—Indian school, range of houses.

Pawtucket, R. I. M. J. Leach, two houses, each 40x200.

Marion, Mass. Converse Estate, range of conservatories.

Archbold, O. Carl Baer, carnation house, 27x206, lean-to, 5x206.

Mansfield, Mass.—Mrs. M. Barnes, two houses, one 150 feet, one 175 feet.

BARCAIN SALE IN ERICAS, ETC.

For Immediate Delivery, to make room.

BORONIA elatior, pink, in 4 in. pots, \$15.00 per 100.

EPACRIS alba, white, 3 1/2-in. pots, \$10.00 per 100.

ERICA persoluta rubra, 3 1/2-in. pots, \$10.00 per 100.

CHRISTMAS VARIETIES FOR GROWING ON

ERICA melanthera from 5-in. pots, \$15.00 per 100.

ERICA regerminans, 3-in. pots, \$8.00 per 100.

The above prices are net cash with order. No charges for packing.

BOXWOOD

FOR HOTEL AND VASE WORK

12-in. high, 6 in. pots, \$25.00 per 100
15-in. " 7-in. " 50.00 " " "
16-in. " 7-in. " 75.00 " " "
18-in. " 8-in. " 100.00 " " "

Also PYRAMIDS \$3.00, \$4.00, \$5.00, \$6.00 to \$8.00 a Pair.

ANTON SCHULTHEIS

Florist

COLLEGE POINT, - L. I.

We have on hand a large consignment of

Japanese Bamboo Canes

Fine Strong Quality.

NATURAL	Per 1000
6 ft. heavy, original bundle of 2500 @	\$4.25
4 ft. medium, " " " 2500 @	3.50
5-6 ft. pencil thickness " " " 500 @	3.25
4-5 ft. " " " 500 @	2.75
3 ft. " " " 1000 @	2.25

GREEN COLORED

1 1/2 ft. original bundle of	100 @ \$1.50
2 ft. " " "	400 @ 3.00
2 1/2 ft. " " "	400 @ 3.00
3 ft. " " "	400 @ 3.50
3 1/2 ft. " " "	400 @ 3.75

Sold in original bundles only. Samples on application.

Cycas Stems

Fine straight stems, in case lots of 300 lbs. assorted, 4-10 lbs., 1/2-4 lbs., 1/2-2 lbs., 2-10 lbs. \$12.50 per case.

Kudzu Vine Roots

Strong heavy quality.....1000 @ \$50.00
.....100 @ 7.50.

The Yokohama Nursery Co.

31 Barclay St., N. Y. City.

PANSY PLANTS Fine Plants ready to bloom, of my well known strain, \$2.50 per 100; large plants in bud and bloom, \$1.00 per 100, \$3.00 per 100.

GERANIUMS, best kinds, double, PETUNIAS (French), VINCAs var., PARLOR IVY, STOCKS, fine plants, 2 1/2 in., \$2.00 per 100; 300 for \$1.00.

CABBAGE PLANTS E. J. Wakefield, ready to plant out, \$1.25 per 1000; 5000 for \$5.00.

J. C. SCHMIDT, Bristol, Pa.

IPOMOEA NOCTIFLORA

Best pure white moonvine in the market, very fragrant and as big as a saucer. On this variety we have a world-wide reputation as growers and shippers for the last twenty years.

Price, 2 1/2 in. pots, \$5.00 per 100, 10,000 are now ready.

Godfrey Aschmann

1012 West Ontario St., Philadelphia, Pa.

Newport Fairy

The Rose of the Future For In and Out Door.

FINE, STRONG FIELD-GROWN STOCK

3-4 Shoots 3-4 ft. long

50c each, \$30 per 100, \$250 per 1000

JULIUS ROEHRS CO.,

RUTHERFORD, N. J.

Hardy Perennial Plants.

Arabis Alpina superba 75 doz. \$ 5.00 per 100
Flora Plena " " " 6.00 " " "
Delphinium Kelway Hybrids Strong field grown plants \$1.50 " " " 10.00 " " "
Hollyhocks, White Allegheny " " " 1.25 " " " 8.00 " " "
Stokesia Cyanea Alba field-grown plants 1.25 " " " 8.00 " " "
Phlox decussata A choice collection of new, rare and standard varieties, field-grown plants, including B. Comte, F. O. Von Lassburg, (Geo. A. Stroehlein, Gen'l. Von Heutz, Consul H. Frost, R. P. Struthers and others. \$6.00 per 100.

Wm. Tricker, - Arlington, N. J.

Gladiolus Brenchleyensis

Extra fine Healthy Imported Stock 1,000 \$10.00 10,000 \$80.00

O. V. ZANGEN

HOBOKEN, - - - - - N. J.

FLOWERING PLANTS

Send for Price List

You are invited to call and inspect our stock. A few leading specialties mentioned below.

MRS. CUTBUSH (New) Pink Baby Rambler
This is a good one, in 6-inch pots at \$6 and \$9 per doz.

BABY DOROTHY (New)
Pink Baby Rambler very similar to Mrs. Cutbush.
5-inch pots at \$6 per doz.; 6-inch pots at \$9 per doz.

HYBRID ROSES
We have an unusually large stock of Hybrids which will be just right for Easter; all the best varieties, including Richmond, Fran Karl Dmschki, La France, Mrs. John Laing, Tom Wood, Klammy, etc., at \$6 and \$9 per doz.
MAGNA CHARTA, very fine at \$9, \$12, \$15 and \$18 per doz.

HYDRANGEAS
The largest and finest stock of this grand Easter plant that we have ever grown at \$5, \$6, \$9 and \$12 per doz. Larger plants at \$1.50, \$2, \$2.50, \$3, \$4 and \$5 each.

RHODODENDRONS
Slipely, well-budded plants, including all the best varieties at \$1.50, \$2, \$2.50, \$3, \$3.50 and \$4 each. A few larger plants at \$5 each.

RHODODENDRON PINK PEARL (New)
The most beautiful of all the Rhododendrons at \$2.50, \$3 and \$3.50 each.

BOUGAINVILLEA GLABRA SANDERIANA
Magnificent plants, exceptionally well flowered at \$2.50, \$4, \$5, \$6, \$7.50 and \$10 each.

LILACS
Very fine plants, 6-inch to 8-inch pots at \$2, \$2.50 and \$3 each.

GENISTAS
A grand stock, growing cool and just right for Easter at \$2, \$3, \$4, \$5, \$6 and \$9 per doz. Larger plants at \$2, \$2.50, \$3, \$4, \$5 and \$6 each.

SPIREA GLADSTONE
Our stock is in superb condition.
6-inch pots at \$5.00 each; 7-inch pots at \$7.50 each; 8-inch pots, made up, at \$1 each; 9 and 10-inch pots, made up, at \$1.50 and \$2 each.

PINK SPIREA
Queen Alexandra, very beautiful.
6-inch pots at \$9 per doz.

DOUBLE DAISY, Queen Alexandra
Well grown and well flowered.
3-inch pots at \$1.50 per doz.; 4-inch pots at \$2.50 per doz.; 5-inch pots at \$4 per doz.; 6-inch pots, very fine, at \$6, \$9 and \$12 per doz.

LILIES
Our stock is exceptionally good this year. Plants with from 4 to 8 blooms at 12 cents per bloom; made-up pans with from 12 to 25 blooms at 12 cents per bloom; plants with less than 4 blooms at 15 cents per bloom.

AZALEAS
We have the largest and finest stock of Azaleas we have ever had, including Vander Chuyse, Vervaeckera, Emp. of Bulgaria, Emp. of Brazil, Niobe, Bernard Andra Alba, Prof. Wolters, etc., etc., at \$7.50, \$8, \$1.50, \$1.50, \$2, \$2.50, \$3, \$3.50, \$4, \$5, \$6, \$7.50 and \$10 each. A few larger specimen plants at \$12.50 and \$15 each. Pyramid Azaleas, very fine, at \$3, \$3.50 and \$4 each. Small Azaleas for Basket Work at \$3 and \$4 per doz.

CRIMSON RAMBLER ROSES
These plants are unusually fine and will be just right for Easter.

6-inch and 7-inch pots at \$1, \$1.25 and \$1.50 each; 8-inch pots at \$2 and \$2.50 each; plants trained in fan and globular shapes, extra fine, at \$2, \$2.50, \$3, \$3.50, \$4, \$5 and \$6 each; a few larger plants at \$7.50 each.

PINK LADY OAY and Dorothy Perkins
In great condition; trained into Fan, Globular and Pyramidal Shapes at \$1.25, \$1.50, \$2, \$2.50, \$3, \$3.50 and \$4 each. Special Ball Shapes at \$1.50, \$2 and \$2.50 each. Special Wire Fan Shapes at \$3 each.

TAUSENDSCHON (New) "Thousand Beauties"
This was our finest Cluster last Easter and this year the plants are still better. We cannot recommend the Tausendschon Rambler too highly. Strong plants in 6-inch and 7-inch pots at \$1, \$1.25 and \$1.50 each. Trained plants, Fan, Globular and Pyramidal Shapes, at \$2, \$2.50, \$3, \$3.50, \$4 and \$5 each.

BABY RAMBLE NDARDS
Exceptionally fine plants, 3 to 5 foot stems, at \$1, \$1.25, \$1.50, \$2 and \$2.50 each.

WHITE BABY RAMBLER STANDARDS
At \$1, \$1.25 and \$1.50 each
STANDARD DOUBLE-BUDDED WHITE AND RED BABY RAMBLER ON SAME PLANT
At \$1.50 each.

BABY RAMBLERS
Good, strong stock, well flowered, at \$3, \$6 and \$9 per doz.

WHITE BABY RAMBLERS
Very strong plants, well flowered, 6-inch pots, at \$6 per doz.

ROBERT CRAIG CO., Forty-ninth and Market Sts., Phila., Pa

BARGAINS IN DECORATIVE AND FOLIAGE PLANTS

KENTIAS, ARECAS, LATANIAS, in all sizes in the very best condition

ARAUCARIAS, RUBBERS, CROTONS, PANDANUSES, ASPARAGUS, COCOS, FERNS for dishes, etc.

EASTER STOCK and BEDDING PLANTS at lowest wholesale rates.

A. LEUTHY & CO.
Perkins St. Nurseries, Roslindale, Mass.

COLEUS! COLEUS!

C. Verschaffeltii and Golden Beeder	Pr 100	Pr 100
Same in 2 1/2 in. pots	60	5.00
Coleus, mixed	2.00	15.00
Same in 2 1/2 in. pots	60	5.00
Ageratum Stevia Gurney and Pauline	1.75	15.00
Same in 2 1/2 in. pots	.50	4.50
Feverfew	1.00	9.00
Fuchsias, our selection	2.00	
Same in 2 1/2 in. pots	3.00	
German Ivy	R. C.	.75
English Ivy	R. C.	1.00

Cash with Order
J. E. FELTHOUSE
148-154 Van Vranken Ave., SCHENECTADY, N. Y.

NEPHROLEPIS MAGNIFICA

THE SENSATIONAL NOVELTY
Strong 2 1/2-in. stock, \$25.00 per 100.

WHITMANII

2 1/2-in., \$40.00 per 1000; 3 1/2-in., from Bench, \$8.00 per 100.

H. H. BARROWS & SON, WHITMAN, MASS.

Palms Ferns



Shrubs Perennials

Send for Our Catalogue.

The GEO. WITTBOLD CO., 1657 Buckingham Place, Chicago, Ill.

FERNS FOR DISHES, Assorted Varieties
From 2 inch pots, \$3.50 per 100; \$30.00 per 1000

CASH WITH ORDER
2570 to 2606 W. Adams St., Chicago, Ill.

FRANK OECHSLIN

PALMS AND FERNS DECORATIVE PLANTS

JOHN SCOTT
Rutland Road and E. 45th St.
Tel. 2890 Bedford BROOKLYN, N. Y.

Draecena Indivisa, 4-in. 10c. Scotti and Boston Ferns, 4-in. 12c.; 5-in. 20c. Asparagus Plumosus, 4-in. \$2; Sprenger, 2-in. \$2, 3-in. \$4, 4-in. \$6. Viven var., 2-in. \$2. Cannabis Egandale, David Harum, Marlborough, America. Pennsylvania, K. Gray, Black Beauty, Alphonse Bouvier, \$1.75 per 100. English Ivy, H. C., 75c. per 100. Hydrangea P. G., 3 in. \$1.00; 1 1/2 H. 5c.

J. H. DANN & SON, Westfield, N. Y.

Begonia Gloire de Lorraine

Leaf Stock, June Delivery, \$15 per 100, \$14 per 1000

Stock guaranteed to be absolutely free from disease.

THOMAS ROLAND, NAHANT, MASS.

BARGAINS

Ampelopsis Veitchii, 4 in. pots, \$10 per root; 3 in. pots, \$5 per root. Asparagus Sprenger, 2 in. pots, \$3.00 per 100. Cannabis, King Humbert, \$5.00 per 100. Clematis Paniculata, 4 in. pots, \$20.00 per root; 3 in. pots, \$5.00 per 100. Clematis, large flowering varieties, 2 year old plants, Jackman, Henry, Andre, \$3.00 per dozen; Occident, \$2.00 per dozen.

Carnations. R. C. from soil, Enchantress, Dorothy, Ellen, Flora Hill, P. Market, \$2.00 per root; Winsor, \$3.00 per root. Geraniums, standard varieties, from 3 in. pots, \$1.00 per root; 4 in. pots, \$6.00 per 100.

C. EISELE
11th and Westmoreland Streets,
PHILADELPHIA, PA.

HEACOCK'S PALMS

Kentia Belmoreana
7-inch pots.....\$2 to 34 inches high.....\$5.50 each
7-inch pots.....\$6 to 38 inches high..... 3.00 "
9-inch tub.....\$2 to 48 inches high..... 5.00 "
Male up Kentia Forsteriana
7-inch pots.....\$2 to 36 inches high.....\$5.50 each
7-inch pots.....\$6 to 38 inches high..... 3.00 "
9-inch tub.....\$2 to 48 inches high..... 5.00 "
Joseph Heacock Co., Wyncote, Pa.

Tobacco Paper "NICO-FUME" LIQUID
 IS THE STRONGEST, BEST PACKED, EASIEST APPLIED.
 OVER 40% NICOTINE
 By far the CHEAPEST.
 JUST NOTE PRICE!

24 sheets.....\$ 0.75
 144 sheets..... 3.50
 288 sheets..... 6.50
 1728 sheets..... 35.10

Furnishes the Most Nicotine for the Money!

... Manufactured by ...
 THE KENTUCKY TOBACCO PRODUCT CO., Louisville, Ky.

Pint.....\$ 1.50
 1/2 Gallon..... 5.50
 Gallon..... 10.50
 5 Gallons..... 47.25

FOR "POT LUCK" TRY US..
HEWS STANDARD POTS
POT MAKERS FOR 140 YEARS — **WORLDS LARGEST MANUFACTURERS**

WRITE FOR CATALOGUE AND DISCOUNTS

Pearson Street, LONG ISLAND CITY, N. Y. **A. H. HEWS & CO., Inc.** 452-460 No. Branch St., CHICAGO, ILL.
 CAMBRIDGE, MASS.

Obituary.

William Hagemann.

This well known importer died on Saturday, April 3, at his residence in Bloomfield, N. J., aged 51 years. Mr. Hagemann had been sick but two days but the attack which proved fatal was one of the series extending back for several months and, in fact, he has been in failing health for two years or more. The funeral was held on Wednesday, April 7.

Mr. Hagemann was deservedly popular with the florist trade of this country, among whom he was widely known, his specialty being lilies, lily of the valley, etc. Previous to his coming to New York he had been en-

gaged in the same business with headquarters in Philadelphia. He was an exceedingly shrewd and far-seeing business man, a genius in his line and with his magnetic personality and tact succeeded in business ventures that would have staggered men of ordinary calibre. Among his competitors in trade Mr. Hagemann was always regarded with the greatest respect and the regret at his demise is deep and sincere among all those with whom he came in contact.

His son-in-law, Paul Kaese, who had been in business with him for a number of years, had left for Hamburg one week previous to Mr. Hagemann's death, to start in business there but he has now been recalled.

Horace C. Smith.

Horace C. Smith, 73, connected for many years with florist establishments and market gardening interests, died on April 2, at his home in Springfield, Mass. He located in Springfield in 1878, and for eight years was foreman of N. J. Herrick's greenhouses, now owned by Mark Altken.

William H. Derby.

William H. Derby, one of the oldest residents of Revere, Mass., and also one of the best known market gardeners, died on March 31. He leaves one son. He was for many years chairman of the committee on annual appropriations by the town.

J. B. Boland.

J. B. Boland of San Francisco, Cal., died on March 24 at the age of 52. Mr. Boland was a member of the firm of Boland & Sievers at one time and later conducted an independent business. At the time of his death he was located in Kearny street.

Charles Reed.

Charles Reed, one of the pioneer florists of Orange, N. J., died on March 20 at the age of 87. Mr. Reed was a native of Brighton, England, and came to

America in 1860. He is survived by a widow, three sons and a daughter.

The death of Henry Eberhardt, florist, of Catonsville, Md., is announced.

WIZARD BRAND MANURES

Dried, screened and packed in bags of 100 lbs. each.

PULVERIZED SHEEP MANURE
 PURE — UNIFORM — RELIABLE

A strong and quick acting manure, highly recommended for carnations and chrysanthemums.

SHREDDED CATTLE MANURE
 EASY TO HANDLE AND APPLY

Stronger and better in every way than rough manure. Lasts much longer on the benches. Unequaled for mulching and feeding roses, liquid manuring and mixing with bench and potting soil. Used by all the largest growers.

Ask Your Supply Man or Write Us for Circulars and Prices.

Pulverized Manure Co.
 31 Union Stock Yards, CHICAGO

Which Spray Pump

shall you buy? Buy the Spray Pump that fully meets the demands of the Government Agricultural Scientists and all practical Fruit Growers. These pumps are widely known as

DEMING SPRAYERS and are made in 23 styles for use in small gardens or immense orchards. Write for our 1909 catalog with Spraying Chart. Add 4 cents postage and receive "Spraying for Fruit," a useful guide book.

CHARLES J. JAGER CO.
 281-280 Franklin St., Boston



STANDARD FLOWER POTS

Packed in small crates, easy to handle.

Price per crate	Price per crate
1500 2 in. pots in crate \$4.88	144 6 in. pots in crate \$3.50
1500 2 1/2 " " " 5.25	120 7 " " " 4.20
1500 2 3/4 " " " 6.00	60 8 " " " 3.00
1000 3 " " " 5.00	HAND MADE
800 3 1/2 " " " 5.80	48 9 in. pots in crate \$3.60
500 4 " " " 4.50	48 10 " " " 4.80
450 4 1/2 " " " 5.24	24 11 " " " 3.60
320 5 " " " 4.51	24 12 " " " 4.80
210 5 1/2 " " " 3.78	12 14 " " " 4.50
	6 16 " " " 4.50

Seed pans, same price as pots. Send for price list of Cylinders for Cut flowers, Hanging Baskets, Lawn Vases, etc. Ten per cent. off for cash with order. Address **Hilfinger Bros., Pottery, Fort Edward, N. Y.** August Rolker & Sons, Agts. 31 Barclay St., N. Y. City.

Standard Flower . . POTTS

If your greenhouses are within 500 miles of the Capitol, write us, we can save you money

W. H. ERNEST

28th and M Street WASHINGTON D. C.

Syracuse Red Pots

STANDARD SIZES

Florists, we will suit you as to quality and prices. Write for catalogue.

Syracuse Pottery Co., SYRACUSE, N. Y.

Y₁ Fluid

**THE IDEAL WINTER SPRAY
SCALE KILLER & FUNGIGIDE**

POWERFUL CLEANSER AND INVIGORATOR
Mixes Instantly. No Sediment. No clogging. Non-injurious to user
COMPARATIVE TEST WILL PROVE ITS MERITS
Quart, \$1.00; Gallon, \$3.00
1 gallon makes 100 gallons. Write for descriptive pamphlet and testimony

PROPS. W. M. COOPER & NEPHEWS
177 ILLINOIS ST. CHICAGO

Gen'l Agent—CYRIL FRANCKLYN, 62 Beaver Street, New York, N. Y.

For Trees, Plants, Shrubs and Flowers
USE
THE NIAGARA BRAND LIME SULPHUR SOLUTION

It destroys Scale Lice, Spiders and all forms of Aphides, AT THE SAME TIME Mildew, Blight, Rust and other Fungus difficulties.
Used in Winter or Summer. — No other remedy has been so universally effective.
Niagara Brand **ARSENATE OF LEAD** for chewing insects is equal to the best and better than the most.
Ask about our Green House sprayer. Address —

NIAGARA SPRAYER CO., - - Middleport, N. Y.

“IMP”
SOAP SPRAY

Vegetable poisons alone.
Harmless to man.
Deadly to insects.

\$1.50 Single Gallon. Dilute to 25

EASTERN CHEMICAL CO.
Pittsburg Street, Boston, Mass.

KILMDEAD
The best of all
the tobacco
dusts for



Dusting or
fumigating

25 lbs., \$1.00
60 lbs., 1.75
100 lbs., \$ 3.00
600 lbs., 14.00
1000 lbs., \$27.00
2000 lbs., \$2.50

Stump & Walter Co.
50 Barclay St.
New York.

DON'T EXPERIMENT
USE
To-BAK-INE

and your stock will be free from insects, clean, and the blooms will not be discolored.

Send for full information of

H. E. FISKE SEED CO.
13 Faneuil Hall Sq., Boston, Mass.
STUMPP & WALTER CO.,
50 Barclay St., New York.
HENRY F. MICHELL & CO.,
1018 Market St., Philadelphia.

E. H. HUNT, Gen'l Agent,
76-78 Wabash Ave., Chicago.

“Every Bug Has his Dose.”

Insect-destroying preparations that do their work well and effectively are the cheapest. Bowker's Arsenate of Lead and Bowker's Pyrox are recognized standard insecticides and fungicides for both indoor and outdoor use. Bowker's Insect Emulsion destroys many kind of plant lice, black and green flies, etc. Call or send for catalogue.

BOWKER INSECTICIDE COMPANY
43 CHATHAM ST. BOSTON



**The Best
Bug Killer and
Bloom Saver**

For **PROOF**
Write to

P. R. Palethorpe Co.
OWENSBORO, KY.

SOMETHING NEW for GREENHOUSES
“SULFOCIDÉ”
PRATT'S
SOLUBLE SULPHUR SUMMER SPRAY

Non-caustic and non-irritating
A FUNGICIDE AND INSECTICIDE
FOR FRUIT TREES, VEGETABLES and GREENHOUSES

A promising substitute for Bordeaux mixture. For 10 cts. to cover postage will send sample sufficient for one gallon of spray.
Use 1 part to 75 or 100 parts of water.

B. G. PRATT CO., 50 Church St., New York, U. S. A.

In writing to Advertisers kindly mention Horticulture

Seed Trade

AMERICAN SEED TRADE ASSOCIATION.

Watson S. Woodruff, Orange, Conn., Pres.; J. C. Robinson, Waterloo, Neb., First Vice-Pres.; C. E. Kendall, Cleveland, O., Sec'y and Treas. Twenty-seventh annual convention June 2-24, 1909, at Clifton House, Niagara Falls, Ont.

WHOLESALE SEEDSMEN'S LEAGUE.

F. W. Bruggerhof, Pres.; Burnet Landreth, Sec'y.

THE FREE SEED DISTRIBUTION.

In Seed Trade Notes of March 27th, it was stated that the free seed distribution for 1909-'10 was to be increased from 30,000,000 to 60,000,000 packets. An error was made in the number of packets in the 1908 distribution as the actual number was slightly under 29,000,000. This of course, is not important excepting for purposes of comparison. Just what bearing this immense number of packets or rather weight, will have on the annual deficit of the Post Office Department may be surmised by the statement that if paid for at regular rates it would mean a difference of approximately \$250,000, but this does not cover the entire cost and exact figures cannot be given.

It may or may not be generally known that after the regular bids for the 1909-'10 distribution were disposed of and contracts awarded, a supplementary contract in the shape of a lump sum approximately \$60,000 was awarded to one of the California growers. Many of the items included in this contract are not produced in California, and the successful bidder will have to procure them from other growers in this country and Europe. Only a limited number were asked to bid on this contract, and the winner is said to have made an extraordinarily low bid, many thousands of dollars below the next lowest bidder. Those who are acquainted with all of the facts think the successful bidder will have some difficulty in masticating the mouthful he has bitten off. But more of this anon.

AD VALOREM VERSUS SPECIFIC DUTIES.

The efforts of the seedsmen to get a specific duty on seeds, seems in a fair way to be realized despite the attempts of an assistant appraiser to prevent it. This official, who is a thorough seedsman and, up to two years ago when he received his appointment, identified with the trade, not content with remaining neutral, has seen fit to butt into this tariff matter and proffer advice to the Ways and Means Committee of the House in opposition to the aims of the seedsmen. He is a very valiant defender of the government, and seems to fear that poor old simple Uncle Sam will become the victim of the designing seed dealer.

The fact that the tariff is so framed that the government cannot get the worst of it unless by deliberate fraud, seems to have escaped the notice of our zealous friend. If the market value of the goods a dealer imports advances after his purchase is made, he

must pay duty on the advance and possibly be penalized in addition, but no allowance is ever made for a decline below the purchase price. Paying duty on the market value is all well enough, but it should be the market price at time of entry whether higher or lower than the purchase price. Under the present system of levying duties no importer can tell what his goods are going to cost, and as most wholesale seedsmen sell the larger part of their imports in advance of the receipt of the goods, they are compelled to base their selling price on the purchase price, and any advance above the latter means more paid in duties which means a reduction in profit, sometimes to the vanishing point. This is why the specific duty is desired, as the dealer can always know what his goods are going to cost him, and there is no good reason why the tariff on seeds cannot be so framed. To illustrate how this works out in actual practice, one of the heaviest importers purchased abroad 50,000 lbs. of turnip seed to cost laid down about 12c. On this basis the firm sold 10,000 lbs. at an advance of 5c. per lb. Now, supposing they had been compelled to pay duty on a valuation of 15c. or 20c. per lb., what would have become of their profit? If a specific duty of 4c. per lb. were levied on the seed they would know exactly what it was going to cost, and all anxiety and uncertainty would be removed. Such a duty would be slightly in excess of the present 30 per cent. ad valorem, and over a period of years would be perfectly just to the government. The fact that the man who buys his goods on the market after harvest has to pay more is no sound argument against this proposition.

IMPORTANT ACTION BY THE WHOLESALE SEEDSMEN'S LEAGUE.

Bristol, Pennsylvania, April 3, 1909.

At a meeting of the Board of Directors of the Wholesale Seedsmen's League in New York City, April 1st, the following motions were offered and passed, and on the next day mailed to the President of the United States and the Secretary of Agriculture.

BURNET LANDRETH,

Secretary Wholesale Seedsmen's League.

Resolved, That the Board of Directors of the Wholesale Seedsmen's League deplore the constantly increasing tendency to swell the amount expended by the United States Department of Agriculture for the purpose of purchase and distribution of common varieties of garden seeds.

The Board respectfully suggests to the President of the United States and the Secretary of Agriculture that a considerable saving or retrenchment in the expenses of the Government could be made by the abolishment of such appropriation without in any way impairing the effectiveness of the Department of Agriculture; and that a further considerable saving to the Government could be effected by relieving the Post Office Department of the expenses incurred in the carrying and distribution of the enormous quantity of franked seeds sent out by the Department of Agriculture.

The Board is of the opinion that the free distribution of common varieties of garden seeds and field seeds is of no practical value to the farmers and gardeners of this country, but, to the contrary, is a downright injustice and restraint of trade inflicted upon the seed business.

The Board believes that a continuance of this practice certainly does not tend towards the best development of the na-

MICHELL'S PRIMULA OBCONICA SEED

	Tr. Pkt.
Grandiflora Compacta	\$0.50
" Fimbriata (1-6 oz. \$1.25)	.75
" Gigantea (Arends)	.50
" Kermesina (1-1/2 oz. \$1.50)	.40
" Korea (1-1/2 oz. \$1.00)	.30
" White (1-1/2 oz. \$1.25)	.30
" Mixed (1-8 oz. \$1.00)	.30

PRIMULA CHINENSIS FIMBRIATA

MICHELL'S PRIZE MIXTURE
Beautifully fringed varieties. Tr. pkt. \$1.00,
\$2.00 per 1-1/2 oz.

Write for our Wholesale Catalog

HENRY F. MICHELL CO.
1018 Market St., PHILA.

tion, as it encourages a dependence upon the Government, which is entirely foreign to the feelings and patriotism of the American people.

Resolved, That while the Wholesale Seedsmen's League as an organization, and its members individually, raise no objection whatever to the fair testing of seeds of grasses, clovers, and other farm seeds, for the purpose of determining if they are adulterated or misbranded, the Association and its members do object to the methods of the agents of the Department of Agriculture of the United States in obtaining such samples for test, as being unfair to the seed merchants and growers, in that the merchants and growers have no knowledge that the samples so reported upon actually come from them.

It seems to the Seedsmen's League but fair that the agent obtaining the samples should leave the merchant or grower a portion of that identical sample under Governmental seal, as provided in the case of testing milk, fertilizers, etc., under the laws of the State of New York and other States.

NOTES.

Hallowell, Me.—Manager Jerrow, of the Elm Brook Farm, has opened a seed store.

Counter trade is still unsatisfactory owing almost entirely to cold, backward weather. Fears are expressed that if the weather does not soon turn warm it will be too late to recover lost ground.

CATALOGUES RECEIVED.

Gursey Seed Co. Yankton, S. D.—"Seeds that Grow and Satisfy," for Spring, 1909. Strongly agricultural. Covers in colors.

Yankton Nursery, Yankton, S. D.—42nd Annual Catalog, Spring, 1909. Covers adorned with colored plates of Viburnum lantana and Compass Cherry.

A. E. McKenzie Co., Ltd., Brandon, Man.—13th Annual Catalogue of "Gold Standard Seeds." Vegetable, Flower and Agricultural List with handsome covers in colors and gold.

INCORPORATED.

Tampa, Fla.—The Reliable Seed Co.

Hartford, Conn.—Northeastern Forestry Co.; capital, \$10,000.

Everything "For the Land's Sake."

The one firm in Boston where all good forms of plant food may be obtained, is the Bowker Fertilizer Company, opposite Faneuil Hall at 43 Chatham St. All greenhouse chemicals, Nitrate of Soda, Ground Bone, Potash Salts, Sheep Manure and Wood Ashes can there be had at first hands.

BOWKER FERTILIZER COMPANY

Everything "For the Land's Sake."

SHEEP MANURE

Pulverized. Free from Adulteration in Bag, \$18.00 per Ton. Cash with Order

ROBERT SIMPSON CLIFTON, N. J.

GEO. E. DOW
Designing and Illustrating
178 Washington St., Boston, Mass.

OUR SPECIALTY
Machine, Booklet, Advertising and Flower PHOTOGRAPHS

VEGETABLE PLANTS

FOR TRANSPLANTING

CABBAGE - Wakefield and Succession \$1.50 per 1000
EGG PLANT - N. Y. Improved and Haack Beauty 40cts. per 10. \$3.00 per 1000
PEPPER - Bull Nose, Ruby King and Sweet Mountain 40cts. per 100, \$3.00 per 1000
Chinese Giant and Cayenne, 50cts. per 100
TOMATO - Earliana, Chalk's Jewel and Early June Pink, 30cts. per 100, \$3.00 per 1000
Stone, Favorite and Paragon, Small plants \$1.00 per 1000.
CELERY - Small for transplanting, White Plume and Golden Self Blanching. \$1.00 per 1000.

CASH WITH ORDER

R. VINCENT, JR., & SONS CO.
White Marsh, Md.

THE PRIZE WINNING STRAWBERRY
The Barrymore

Send for Folder at Once.

H. L. CRANE, Originator,
Westwood Mass.

Mignonette

FARQUHAR'S GIANT

Oz., 75c; 1-4 oz., 25c

R. & J. Farquhar & Co.

6 & 7 South Market Street

BOSTON, MASS.

SHEEP MANURE

IT'S STERILIZED

Free from Weed Seeds.

\$24.00 Ton;

\$7.00 quarter of Ton.

Wm. Elliott & Sons
42 Vesey St., New York

RELIABLE SEEDS—SOW NOW

PRIMULA OBCONICA GRANDIFLORA
1000 seeds Tr. pkt.
Blood red, fine seller.....\$1.50 \$0.50
Real pink, fine for cut..... 1.00 .50
Pure white, fine for cut..... 1.00 .50
Compacta, fine potter..... 1.50 .50
Mixed Hybrids..... 1.00 .50
O. V. ZANGEN, - HOBOKEN, N. J.

LEONARD SEED CO.

CONTRACT CROWERS AND WHOLESALE DEALERS

BEANS, PEAS, SWEET CORN, ONION, GARDEN SEEDS

ONION SETS FLOWER SEEDS Get Our Prices 79 and 81 E. KNIZIE STREET, **CHICAGO**

ESTABLISHED 1802

Thorburn's Seeds

FINE CLUMPS JAPAN IRIS
TUBEROUS ROOTED BEGONIAS
GLOXINIAS

ROSA MULTIFLORA NANA SEED

and all other flower seeds for florists

SEND FOR CATALOGUE

J. M. THORBURN & CO.
33 Barclay Street
NEW YORK

CAULIFLOWERS^S E E D
CABBAGE
LILY OF THE VALLEY PIPS.

HJALMAR HARTMANN & CO.
12 Stormgade,
COPENHAGEN, DENMARK.

Burpee's Seeds
PHILADELPHIA

Blue List of Wholesale Prices mailed only to those who plant for profit

Ward's Lily Bulbs

Send for Catalogue

Ralph M. Ward & Co.
12 W. Broadway
NEW YORK



BRIDGEMAN'S SEED WAREHOUSE

RICKARDS BROS.

Props.

37 East 19th St., - NEW YORK CITY

STOCK SEED

FOR WINTER BLOOMING

Our strain of Double Branching Stocks is exceptionally true. About 90% Double Flowers.

In colors: 1/2 oz. .60 oz. \$4.00
Pure White 3/4 " .75 " 5.00

H. E. FISKE SEED CO.
Faneuil Hall Square, BOSTON, MASS.

Winter-flowering
SWEET PEA SEED

All Colors Ask for List
A. C. ZVOLANEK

ORIGINATOR. BOUND BROOK, N. J.

NEW CROP SEED

For Early Planting

THOMAS J. GREY CO.

32 SO. MARKET ST., BOSTON, MASS.

BEGONIAS TUBEROUS ROOTED

—ALSO—
GLOXINIAS, LILY OF VALLEY, SPIREA

Catalogues mailed free on application

Joseph Breck & Sons Corp.
47-54 NO. MARKET ST., BOSTON, MASS.

BULBS OF QUALITY

Begonias, Single, under color.....\$2.75
" Double " " 5.00
" Frilled " " 10.00
Gloxinias, under color..... 4.00
Pearl Tuberoses, \$7.00 thousand..... 1.00

Schlegel & Fottler Co.

26 & 27 So. Market St., BOSTON, MASS.

To Florists Everywhere

Orders for Cut Flowers and Floral Decorations to be delivered anywhere in the Greater New York, may be placed with us with the certainty that your customers will be satisfied.

Telegraph, telephone or mail such orders to us and be sure that they will be filled as promptly and as carefully as though you did it yourself.

One third discount will be allowed on all orders thus placed with us by Florists outside of the Greater New York.

THE BLOSSOM

Bond and Livingston Sts.,
BROOKLYN, N. Y.

C. C. TREPEL, Manager

**WILLIAM J. SMYTH
FLORIST**

Cor. Michigan Ave. and 31st St., CHICAGO

We ship to all points in Illinois and Iowa.

Phones: Douglas 744, Douglas 523, Douglas 740

**HAUSWIRTH THE
FLORIST**

Out of Town orders for Hospitals
Carefully filled.

**232 Michigan Ave.
CHICAGO**

JOBITORUM ANNEX Tel. Harrison 585

**SAMUEL MURRAY
Florist**

Coates House Conservatory

1017 BROADWAY, KANSAS CITY, MO.

Both 'Phones 2670 Main.



WASHINGTON,
D. C.

GUDE'S

The Far-Famed Flowers of
TORONTO

Delivered on mall or telegraph order for any occasion, in any part of the Dominion.

JOHN H. DUNLOP,
96 Yonge St., - Toronto, Ont.

The Park Floral Co.

J. A. VALENTINE
Pres.

DENVER, COLORADO

**WILLIAM L. ROCK
FLOWER CO.**

KANSAS CITY, - MO.

will carefully execute orders for Kansas City and any town in Missouri or Kansas.



Buffalo, N. Y.

W. J. PALMER & SON, 304 Main St.

Of Interest to Retail Florists

DETROIT Business is very good and everybody feels buoyant over the outlook for this coming the most important week in the florist business. The growers have plenty of stock in very good condition indeed wherewith the retailer sees his opportunity to give good satisfaction to his customers. Now is the chance for the wholesaler and retailer to compare notes. Consider the work it entails to deliver say 1000 carnations and 200 pots of lilies to the retailers' store. It is not small indeed. But how many boxes and pot covers, not to speak of wrapping paper will the retailer need to pack this number of flowers and plants and how many deliveries will he have to make?

STEAMER DEPARTURES

American.
St. Paul, N. Y., S'hampton... Apr. 17
New York, N. Y., S'hampton... Apr. 24

Atlantic Transport.
Minnetonka, N. Y., London... Apr. 17
Minneapolis, N. Y., London... Apr. 24

Cunard.
Mauretania, N. Y., Liverpool... Apr. 14
Saxonia, Boston-Liverpool... Apr. 20
Campania, N. Y., Liverpool... Apr. 21

French Line.
La Provence, N. Y., Havre... Apr. 15
La Savoie, N. Y., Havre... Apr. 22

Hamburg-American.
Cleveland, N. Y., Hamburg... Apr. 17
Pres. Grant, N. Y., Hamburg... Apr. 21

Leyland Line.
Winifredia, Boston-L'pool... Apr. 14
Bohemian, Boston-Liv'pool... Apr. 21

North German Lloyd.
K'pr. Wilhelm, N. Y., Bremen... Apr. 13
K'pr. Ceclio, N. Y., Bremen... Apr. 20

White Star.
Oceanic, N. Y., S'hampton... Apr. 14
Republic, Boston-Med. Pts... Apr. 17
Teutonic, N. Y., S'hampton... Apr. 21
Republic, N. Y., Med. Ports... Apr. 23

NEW FLOWER STORES.

Chicago, Ill. J. A. Mendel, 578 West 18th street.

Brooklyn, N. Y.—C. C. Trepel, Fulton street; Wm. Humphreys, manager.

Richmond, Ind.—The E. G. Hill Floral Co.

Tuscaloosa, Ala.—Miss M. Ryan.

Cincinnati, O.—Leo Fern, 336 West 4th street.

Newark, O.—Charles Duer, Arcade Building.

Chicago, Ill.—Mrs. W. Hutchinson has opened a retail flower store at 388 Western avenue.

Prof. E. A. White, of Massachusetts Agricultural College, Amherst, lectured before the Houghton Horticultural Society, Lynn, on April 7. Ornamental Gardens and Garden Material was his subject.

Chicago, Ill.—The business of M. C. & J. E. Hauswirth will be continued by J. E. Hauswirth under the name of Hauswirth, the Florist. Mr. Hauswirth is a young man of good business ability, and while his mother's death means a great personal and business loss to him, he will carry on the business, assisted by his wife. The young couple have the best wishes of the trade for their success.

ALEX. McCONNELL

571 FIFTH AVENUE
NEW YORK CITY

Telegraphic orders forwarded to any part of the United States, Canada, and all principal cities of Europe. Orders transferred or intrusted by the trade to our selection for delivery on steamships or elsewhere receive special attention.

Telephone Calls, 487 and 488 38th St.
Cable Address, ALEXCONNELL

NEWMAN FLORAL Co.

(Established 1870)

202 Fifth Ave. and Madison Square, NEW YORK CITY

FLOWERS FOR STEAMER SAILINGS

M. A. BOWE

In the Heart of New York City

1294 Broadway

Tel. 2270, 38th St. NEW YORK

Our Motto—The Golden Rule

DAVID CLARKE'S SONS

Deliver orders from any part of the country to
New York City

OR OUT-GOING STEAMERS

Write or telegraph

2139-2141 Broadway, New York

Telephone 1552-1553 Columbus

YOUNG & NUGENT

42 West 28 St., NEW YORK

"FLOWERS BY TELEGRAPH"

**NEW YORK
MYER, FLORIST**

Phone 5297 Plaza. 609-611 MADISON AVE.

ALBANY, N. Y.

EYRES

Flowers or Design Work

DELIVERED IN ALBANY AND VICINITY
ON TELEGRAPHIC ORDER.

11 NORTH PEARL ST., ALBANY, N. Y.

Flower Deliveries

In Brooklyn and other Long Island Points
New York City, New Jersey, etc. At Theaters,
Hotels, Steamers or Residences.

WILSON

Fulton St. and Greene Ave., Brooklyn, N. Y.

**DANKER, Albany,
N. Y.**

ORDERS FOR

Choice Flowers and
Floral Emblems
FILLED PROMPTLY

WELLESLEY COLLEGE

Dana Hall, Walnut Hill and Rockridge Hall
Schools. TAILBY, Wellesley, Mass.

Tel. Wellesley 44-1 and 2. Night 44-3.

ATLANTA FLORAL CO.

41 Peachtree Street, ATLANTA, GEORGIA

JOHN BREITMEYER'S SONS

Cor. Miami and Gratiot Aves.
DETROIT, MICH.

Artistic Designs . . .
High Grade Cut Blooms

We cover all Michigan points and good sections of Ohio, Indiana and Canada

PROMPT DELIVERY IN BOSTON

AND ALL NEW ENGLAND POINTS
F. H. HOUGHTON
896 Boylston St., Boston, Mass.

BOSTON'S BEST

In Quality and Design

Can be relied upon when you transfer your retail orders to

EDWARD MACMULKIN
194 Boylston Street, Boston

Send flower orders for delivery in BOSTON

and all
NEW ENGLAND POINTS
THOS. F. CALVIN
124 Tremont St., Boston



TRANSFER

Your orders for flower or plant delivery in Eastern New England to

JULIUS A. ZINN,
2 Beacon St., Boston
FINE DESIGN WORK AS PEALTY

Orders by Wire Receive Prompt and Careful Execution

J. Newman & Sons

Corporation

24 Tremont Street, BOSTON

Theater, Steamer and Funeral Flowers Our Specialty
We can refer to leading florists in all principal cities.
Established 1870.

LOUISVILLE, KY.
JACOB SCHULZ,
550 South Fourth Ave.

FLORISTS' SUPPLIES

Send for New Catalogue

H. Bayersdorfer & Co.

1129 ARCH ST., PHILADELPHIA

"FLOWERS BY TELEGRAPH."

Leading Retail Florists Listed by
Towns for Ready Reference.

- Denver, Colo.—Park Floral Co., 1706 Broadway.
- Washington, D. C.—Gude Bros., 1214 F St.
- Atlanta, Ga.—Atlanta Floral Co., 41 Peach Tree St.
- Chicago—Hauswirth, "The Florist," 232 Michigan Ave.
- Chicago—William J. Smyth, Michigan Ave. and 31st St.
- Chicago—George Wittbold Co., 1637-59 Buckingham Place.
- Louisville, Ky.—Jacob Schulz, 550 South Fourth Ave.
- Boston—Thos. F. Calvin, 124 Tremont St.
- Boston—Frank H. Houghton, 896 Boylston St.
- Boston—Edward MacMulkin, 194 Boylston St.
- Boston—Hoffman, Florist, 59-61 Massachusetts Ave.
- Boston—J. Newman & Sons, Inc., 24 Tremont St.
- St. Louis—Julius A. Zinn, 2 Beacon St.
- Wellesley, Mass.—Tully.
- Detroit, Mich.—J. Breitmeyer's Sons, Miami and Gratiot Aves.
- Kansas City, Mo.—Samuel Murray, 1017 Broadway.
- Kansas City, Mo.—Wm. L. Rock Flower Co., 1116 Walnut St.
- Albany, N. Y.—H. G. Eyres, 11 N. Pearl St.
- Albany, N. Y.—F. A. Danker, 40 Madison Lane.
- New York—David Clarke's Sons, 2139-2141 Broadway.
- New York—Alex. McConnell, 571 5th Ave.
- New York—Young & Nugent, 42 W. 23th St.
- New York—M. A. Bowe, 1294 Broadway.
- New York—Myer, 609-11 Madison Ave.
- New York—Newman Floral Co., 202 Fifth Ave. & Madison Sq.
- Brooklyn, N. Y.—The Blossom (C. C. Trepet, Mgr.), Bond and Livingston Sts.
- Brooklyn, N. Y.—Robert G. Wilson, Fulton St. and Greene Ave.
- Buffalo, N. Y.—Palmer's, 304 Main St.
- Toronto, Can.—J. H. Dunlop, 96 Yonge St.

NEWS NOTES.

- Hannibal, O.—The greenhouse of Emil Rist was destroyed by fire on March 20.
- Bridgeport, Conn.—Wm. Crighton has taken a position with James Horan & Son, florists.
- Richfield, N. J.—On March 23 fire in the greenhouses of Joseph Penka destroyed his entire stock.
- Sweet Briar, Va.—David Harris intends to add plants and flowers to his present market gardening business.
- St. Paul, Minn.—It is reported that the stock of the Warrendale Floral Co. has been closed out at Sheriff's sale.
- Rockford, Ill.—W. H. Hizer has leased a tract of land in South Main street and will start in the greenhouse and nursery business.
- Atlanta, Ga.—The Westview Floral Co. lost considerable stock through the breaking of a large window during the heavy storm on the night of March 24.
- Calumet, Mich.—W. J. Bloy, who purchased the business of the Lutef Floral Co., in the Holman block, will continue it under the name of Calumet Floral Co.
- Professor C. S. Sargent, Maurice L. de Vilmorin, and Graf Fritz von Schwerin, have become honorary members of the Arboricultural Society of Austria-Hungary.
- M. Ernest Calvet, the famous hor-

THE BEST LETTERS

FOR THOSE
FLORISTS' MADE
USE BY THE



Boston Florist Letter Co.
66 PEARL ST., BOSTON
N. F. MCCARTHY, Mgr.

Order direct or buy from your local supply dealer. Insist on having the

BOSTON

Inscriptions, Emblems, etc., Always in Stock

Durand & Marohn

MANUFACTURERS OF

All Kinds of Wire Work
Florists' Wire Designs a Specialty
24 Beaver St., ALBANY, N. Y.

Wired Toothpicks

Manufactured by

W. J. COWEE, BERLIN, N. Y.

\$0,000....\$1.75; \$5,000....\$7.50. Sample free.
For sale by dealers

iculturist and raiser of new chrysanthemums, has been made an officer d'Academie, an honor usually bestowed on professors, literary men and journalists who have contributed to the instruction of the public.

Clinton, Mass.—A. W. Schneider has been appointed superintendent of Central park, and M. F. O'Malley superintendent of Franklin park. Wm. McGowan takes the position of superintendent of moth extermination.

Golden City, Utah. It is stated that W. T. Stillwell has resigned his position on the Park Commission and B. Van der Schuit, gardener at the Deaf and Blind School, will succeed him.

Mr. F. G. Crane is having erected on his estate at Dalton, Mass., a large range of greenhouses. Also a very up-to-date gardener's cottage. John R. Shield, who has been with the Crane family for a number of years, will have charge of this place.

Boston.—Having gone to Messina with Edmund Billings, to assist in the distribution of the Massachusetts relief fund, Philip L. Carbone, the Boylston street florist, who returned March 31, on the Ivernia, found an uncle, aunt and cousin had been buried in the ruins of the stricken city. He assisted in the recovery of their bodies.

Mr. Carbone has been abroad for about three months in the relief work, and to a Boston Journal reporter, who was the first to shake hands with him at quarantine, he declared that many American women—some of them tourists, and others trained nurses—were among the real heroines of the fearful disaster, though little has been cabled to this country of their work.

SWEET PEAS

Choice stock of all colors. Ordered a few days in advance we can furnish them in thousand lots of one color or more. This stock is not to be compared with what is usually offered.

THE LEO NIESSEN CO.

1209 Arch St., Philadelphia, Pa.
Open from 7 a. m. to 8 p. m.



SWEET PEAS

For April Weddings.

Our growers have extra fine crops coming on just right for present wants.

\$1.00 per 100.

S. S. PENNOCK-MEEHAN CO.
1608-1620 Ludlow St., Philadelphia

DAGGER FERNS

Good Quality
\$3.00 per 1000

W. E. McKEISSICK & BROS.

WHOLESALE FLORISTS

1619-1621 RANSTEAD ST.
PHILADELPHIA

CUT FLOWER BOXES
EDWARDS FOLDING BOX CO.
MANUFACTURERS
PHILADELPHIA, PA.

CHAS. W. MCKELLAR

51 WABASH AVE., CHICAGO

Western Headquarters for Choice Orchids
Valley, Roses and all Cut Flowers

PETER REINBERG

WHOLESALE

CUT FLOWERS

51 Wabash Av., Chicago, Ill.

Long Distance Phone, Central 6004

WINTERSON'S SEED STORE

45-47-49 Wabash Ave., Chicago.

Seedsmen, Plantsmen, Nurserymen
Florists' Supplies

We can supply everything used by the Florist. SUPPLY CATALOG FREE. Cor-
respondence solicited.

POEHLMANN BROS. CO.

33-35-37 Randolph St., - CHICAGO

CUT FLOWERS

Greenhouses, - Morton Grove, Ill.

Rice Brothers

118 N. 6th Street, MINNEAPOLIS, MINN.

WHOLESALE FLORISTS and SUPPLIES

CUT FLOWERS received twice daily, and can fill your orders to your satisfaction. A complete line of Hardy Greens - WILD SMILAX, BOXWOOD, HARDY FANCY FERNS, GALAX LEAVES.
Write for quotations on large quantities.

In ordering goods please add "I saw it in HORTICULTURE."

WELCH BROS.

AMERICAN BEAUTY, KILLARNEY, RICHMOND, MARYLAND AND ALL THE SUPERIOR
ROSES, LILY OF THE VALLEY, CARNATIONS, ORCHIDS

BEST PRODUCED

226 Devonshire Street,

Boston, Mass.

WHOLESALE FLOWER MARKETS—TRADE PRICES—Per 100 TO DEALERS ONLY

	CHICAGO April 5		TWIN CITIES April 5		PHILA. April 7		BOSTON April 8	
ROSES								
Am. Beauty, Fancy and Special...	15.00	to 45.00	40.00	to 50.00	50.00	to 60.00	40.00	to 50.00
" Extra.....	25.00	to 35.00	30.00	to 40.00	35.00	to 45.00	20.00	to 30.00
" No. 1.....	15.00	to 25.00	20.00	to 30.00	25.00	to 35.00	12.00	to 15.00
" Lower grades.....	10.00	to 18.00	10.00	to 20.00	4.00	to 15.00	6.00	to 15.00
Bride, "Maid, Fancy & Special.....	18.00	to 10.00	8.00	to 12.00	12.00	to 15.00	10.00	to 12.00
" Lower grades.....	4.00	to 8.00	4.00	to 8.00	4.00	to 10.00	4.00	to 12.00
Killarney, Fan, & Sp.....	10.00	to 15.00	8.00	to 10.00	12.00	to 20.00	20.00	to 33.00
" Lower grades.....	4.00	to 8.00	4.00	to 8.00	4.00	to 10.00	4.00	to 12.00
Richmond, Fancy & Special.....	10.00	to 15.00	8.00	to 12.00	15.00	to 25.00	20.00	to 33.00
" Lower grades.....	6.00	to 8.00	6.00	to 8.00	4.00	to 15.00	4.00	to 12.00
Chatenay.....	6.00	to 10.00	4.00	to 10.00	4.00	to 10.00	4.00	to 12.00
Golden Gate Ivory, etc.....	6.00	to 10.00	to 10.00	4.00	to 12.00	4.00	to 12.00
My Maryland.....	to 10.00	to 10.00	to 10.00	6.00	to 20.00
Mrs. Mar. Fields.....	to 10.00	to 10.00	to 10.00	to 10.00
CARNATIONS								
Fancy and Re.....	5.00	to 6.00	5.00	to 6.00	4.00	to 8.00	4.00	to 6.00
Ordinary and White.....	3.00	to 4.00	4.00	to 5.00	3.00	to 4.00	2.00	to 3.00
MISCELLANEOUS								
Calliys.....	50.00	to 60.00	43.00	to 50.00	60.00	to 75.00	40.00	to 50.00
Lilies.....	10.00	to 15.00	12.50	to 15.00	12.50	to 15.00	12.00	to 15.00
Lily of the Valley.....	3.00	to 4.00	3.00	to 4.00	2.00	to 5.00	1.00	to 3.00
Narciss, Paper White.....	2.00	to 4.00	to 4.00	2.00	to 3.00	1.00	to 2.00
Roman Hyas.....	2.00	to 3.00	3.00	to 4.00	2.00	to 3.00	1.00	to 2.00
Tulips.....	3.00	to 5.00	3.00	to 4.00	3.00	to 4.00	2.00	to 4.00
Daffodils.....	3.00	to 4.00	2.50	to 3.00	2.50	to 3.00	2.00	to 3.00
Freesia.....	6.00	to 10.00	3.00	to 4.00	2.00	to 4.00	1.00	to 2.00
Nigone.....	3.00	to 6.00	2.00	to 3.00	to 1.00	1.00	to 4.00
Sweet Peas.....	.75	to 1.00	.75	to 1.00	1.00	to 1.50	.75	to 1.00
Gardenias.....	25.00	to 40.00	30.00	to 45.00	25.00	to 50.00	10.00	to 25.00
Violets.....	.75	to 1.25	1.25	to 1.50	.50	to 1.50	.50	to 1.00
Adiantum.....	to 1.00	1.00	to 1.50	1.00	to 1.50	.75	to 1.00
Smilax.....	15.00	to 20.00	15.00	to 22.00	15.00	to 20.00	12.00	to 17.00
Asparagus Plumosus, strigatus.....	10.00	to 20.00	10.00	to 20.00	10.00	to 20.00	10.00	to 20.00
" " & Spreb. (too hchs.).....	20.00	to 30.00	20.00	to 30.00	30.00	to 50.00	15.00	to 25.00

J.A. BUDLONG

37-39 Randolph Street, CHICAGO.

Roses and Carnations
A Specialty.....
WHOLESALE GROWER of CUT FLOWERS



HENRY M. ROBINSON & CO.

15 Province St. and 9 Chapman Place - BOSTON, MASS.

WHOLESALE COMMISSION FLORISTS

Hardy Cut Evergreens and Florists' Supplies

We have the stuff and can fill all orders, large or small
WE NEVER DISAPPOINT SATISFACTION GUARANTEED



Prices Quoted in these Columns are for Dealers Only.

When Writing to Advertisers Please Mention
HORTICULTURE.

Flower Market Reports.

BOSTON On the eve of the great spring festival of flowers we can see nothing to prevent its being the most satisfactory Easter ever enjoyed by the florists of Boston and New England. The demand from far and near which the wholesale markets have experienced all through the week has far exceeded the record to date and is recognized as a good pointer as to what may be expected at the finish. Lilies are practically all sold, four days before Easter and the predicted scarcity seems inevitable. They are of varying quality but the full price will undoubtedly be realized for the low grade stock which those who wait until the last minute will be forced to take. In all other flowers quality is all that could be asked. Carnations are very fine but in light supply as compared with the call; this applies especially to the whites. Roses are very abundant and good. Violets have received a knock-out blow in the hot days of this week—the warmest on record for April—and the prospects for the single violet are very gloomy. The double ones will profit by the situation. All bulbous stock is over plentiful, including lily of the valley which is in very light demand. There is a distinct activity in the line of fancy and specialty flowers such as orchids, gardenias, yellow daisies, etc., which it will not be possible for the market to meet. Smilax is getting scarce. The plant growers are completely sold out on everything worth having, in the flowering plant line.

At this writing the **CHICAGO** Easter outlook is very good and even with the doubtful condition of the weather which is warm and cloudy, most florists feel reasonably sure that the unusually brisk Lenten trade will close with a lively Easter. If the weather continues very warm it will hurry stock but this will be an advantage in carnations, for the supply not over plentiful all winter, is decidedly short now. This is especially true in white, so many being used for confirmation and other church services. Violets can scarcely be counted upon and the demand for sweet peas has increased accordingly. Good mignonette is decidedly scarce and the buyers having made up their minds to do without it, it sells slowly. Really fine lilies are seen in abundance at the beginning of the week and they are selling as high as 15c. per bud and bloom in some cases, but the opinion is prevalent that before the week is out first-class lilies will be scarce. Roses were very plentiful during the past week. Trad started out brisk early in the week, but on Wednesday and Thursday buyers were scarce and stock accumulated; but by the last of the week all was worked off and trade was normal again. That roses will be much more in evidence than carnations at Easter is certain, but it is not expected that roses will fall below a fair price for the season. Plant trade has been very heavy and everything is sold out close.

There has been a fair amount of business doing for the season the past week. The supply

WHOLESALE FLOWER MARKETS.—PER 100. TO DEALERS ONLY.

	CINCINNATI April 4	DETROIT April 4	BUFFALO April 7	PITTSBURG April 5, 7
ROSES				
Am. Beauty, Fan, and Sp.	50.00 to 60.00	45.00 to 50.00	40.00 to 50.00	40.00 to 50.00
" " Extra	50.00 to 50.00	30.00 to 40.00	30.00 to 35.00	30.00 to 35.00
" " No. 1	2.00 to 30.00	12.00 to 30.00	10.00 to 15.00
" " Lower grades	6.00 to 20.00	6.00 to 12.00	3.00 to 8.00
Bride, Maid, F. & S.	8.00 to 7.00	10.00 to 18.00	10.00 to 18.00	5.00 to 10.00
" " Low gr.	3.00 to 2.00	5.00 to 8.00	4.00 to 7.00	3.00 to 4.00
Killarney, Fan, & Sp.	10.00 to 12.00	10.00 to 12.00	10.00 to 12.00	10.00 to 15.00
" " Lower grades	6.00 to 8.00	5.00 to 8.00	5.00 to 8.00	6.00 to 8.00
Richmond, Fancy & Special	10.00 to 12.00	10.00 to 15.00	12.00 to 15.00	15.00 to 20.00
" " Lower grades	6.00 to 8.00	5.00 to 10.00	4.00 to 7.00	8.00 to 10.00
Chatenay	4.00 to 10.00	5.00 to 1.00	4.00 to 10.00
Golden Gate, Ivory, etc.	3.00 to 8.00	3.00 to 8.00
My Maryland
CARNATIONS				
Fancy and Novelties	3.00 to 4.00	to 4.00	3.00 to 6.00	5.00 to 6.00
Ordinary	1.00 to 2.00	3.00 to 5.00	4.00 to 6.00	3.00 to 4.00
MISCELLANEOUS				
Cattleyas	75.00 to 50.00	60.00 to 70.00
Lilies	12.50 to 15.00	15.50 to 15.00	12.00 to 15.00	12.50 to 15.00
Lily of the Valley	2.00 to 4.00	5.00 to 4.00	3.00 to 4.00	2.00 to 4.00
Narciss, Paper White	2.00 to 4.00	3.00 to 4.00	2.00 to 3.00	2.00 to 3.00
Roman Hyacinth	1.00 to 3.00	2.00 to 3.00	1.00 to 3.00
Tulips	3.00 to 4.00	3.00 to 4.00	2.00 to 3.00	3.00 to 4.00
Daffodils	1.00 to 4.00	1.00 to 4.00	1.00 to 2.00	1.00 to 4.00
Freesia	2.00 to 3.00	3.00 to 4.00	2.00 to 3.00	2.00 to 3.00
Mignonette	2.00 to 1.00	3.00 to 5.00	2.00 to 4.00	2.00 to 4.00
Sweet Peas	.75 to 1.00	1.00 to 1.00	.60 to 1.00	.75 to 1.00
Gardenias	35.00 to 35.00	25.00 to 35.00
Violets	50 to 75	75 to 1.00	75 to 1.25	95 to 75
Adiantum	1.50 to 1.50	.50 to 1.50	1.25 to 1.50
Smilax	15.00 to 15.00	15.00 to 15.00
Asparagus Plumosus, strings	10.00 to 25.00	30.00 to 50.00	40.00 to 50.00	30.00 to 50.00
Asparagus Plumosus, & Spreng. (100 bchs.)	25.00 to 30.00	25.00 to 50.00	30.00 to 50.00

and demand seem to be more equally balanced this Lenten season than for a long time as there has been no semblance of a glut and the near approach of the great demand practically removes all likelihood of trouble in this respect. Stock in general, both cut flowers and plants, has rarely if ever been seen in better condition. American Beauty roses have at last become visible and prices have receded considerably. All other roses of extra quality move well at fair prices. Carnations are plentiful and cheap. Snapdragon of fine quality is seen and much called for by particular houses who are glad of a change. Sweet peas have a good call; the quality was never better. Lilies and smilax appear to be very scarce around this vicinity. The Easter outlook is very promising in most lines although there does not seem to be as much stock in sight as other years.

Flowers of all **PHILADELPHIA** kinds were very abundant last week and trading rather sluggish as was to be expected. Prices generally ruled low. American Beauty roses improved in quality, and cleaned up better than the general run of stock; Richmonds are keeping up their improved tone, both as to quality and quantity. Bride and Bridesmaid are altogether too plentiful—especially the former. Mrs. Jardine and Killarney were never better, and are among the most satisfactory items on the market. The carnation crop seems to have slackened up very considerably. There is little demand for violets and very few coming in. Cattleya Schroderae continues the leader in the orchid market. The few other kinds coming in

are not in sufficient quantity to cut any figure. Sweet peas are improving in quality and a little later will be in fine shape. The growers of these aim to have a good crop coming in for April and May weddings. Indications point to unusual quality and abundance this year. We have seen better lily of the valley than is now around but it is very fair stock all the same and commands normal figures. Bad weather and the fair quarantine prevented the usual Saturday clean up.

BUSINESS CHANGES.

Chicago, Ill.—After May 1, E. L. Eaton will be located at 75 Jackson boulevard.
Dalton, Mass.—R. Engelman, florist, has removed his headquarters to the Durgin-McManus store.
Carthage, Mo.—Finn & Son, florists, have moved their downtown office to the Osborn News stand.
Eaton, Pa.—D. Burrows Nevins has purchased the greenhouses and retail store of Arthur L. Raub.
Salt Lake City, Utah.—J. F. Walk has taken over the interest of his partner in the Child-Walk Co.
Iowa Falls, Ia.—W. H. Hall has rented the Riverside Greenhouses, and will take possession July 1.
Ft. Wayne, Ind.—The Sherron greenhouses have been sold to E. F. and A. J. Lantimer and the former will be in charge of the place.

Chicago, Ill.—The John Davis Co. having disposed of their business to the Crane Co., some of the employees of the former concern will organize as a heating specialty company under the firm name of the John Davis Supply Co., it is said.

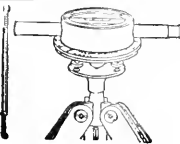

EVERYBODY KNOWS Park, Cemetery and Landscape Gardening cannot be properly done without the aid of an accurate leveling instrument.

Bostrom's Improved Levels, No. 2 at \$15.00 and No. 3 at \$25.00, are conceded by all who KNOW to be the only Levels on the market which meet all the requirements, at the price.

Our guarantee back of every Level we sell, and satisfied users in every State in the Union heartily endorse every claim we make.

Shipping weight 12 lbs. Description on request.

BOSTROM-GRADY MFG. CO., 139 Madison Avenue., ATLANTA, GA.

FORD BROTHERS

48 West 28th Street NEW YORK

FINE ROSES FANCY GARNATIONS

A Full Line of All CUT FLOWERS

Telephone, 3870 or 3871 Madison Square

H. E. FROMENT

Wholesale Commission Florist,
Choice Cut Flowers,

57 West 28th St. :: NEW YORK

Telephones: 2200, 2201, Madison Square.

Alfred H. Langjahr

All choice cut-flowers in season Send for quotations. Correspondence with shippers of first-class stock invited.

55 West 28th Street, New York
Telephones 4626-4627 Madison Square

Edward C. Horan

Wholesale Florist

55 WEST 28th ST.

Tel. 1462
1403 Madison Square New York

JOHN YOUNG

WHOLESALE FLORIST

Finest American Beauties and Carnations

51 West 28 St. - NEW YORK

FRANK MILLANG

Wholesale Florist

55-57 West 26th St., NEW YORK

Shipments, any quantity, Wholesale Market Rates.

Henshaw & Fenrich

WHOLESALE FLORISTS

44 West 28th Street, NEW YORK

Phone Mad. Sq. 325, 558-2, 858-3

VIOLETS

Finest Grade. Any Quantity

B. S. SLINN

55-57 W. 26 St., New York

Moore, Hentz & Nash

Wholesale Commission Florists

55 and 57 West 26th Street

Telephone No. 756
Madison Square New York

MILLANG BROS.

WHOLESALE COMMISSION FLORISTS

41 West 28th Street

Telephone 3860
3861 Madison NEW YORK

JOHN I. RAYNOR
Wholesale Commission Florist SELLING AGENT FOR
LARGEST GROWERS
A full line of Choice Cut Flower Stock for all purposes. Complares every variety grown for New York market, at current prices
TEL. 1908 MADISON SQUARE 49 West 28th St., New York City

Walter F. Sheridan
Wholesale Commission Dealer in
CHOICE CUT FLOWERS
39 West 28th Street, New York
Telephone: 3532-3533 Madison Square

HEADQUARTERS FOR NOVELTIES
ORCHIDS A SPECIALTY
THE HIGHEST GRADE OF **VALLEY** ALWAYS ON HAND
GARDENIAS, DAISIES, ROSES AND CARNATIONS
JAMES McMANUS, Telephone 753 Mid. Sq. 42 W. 28th St., New York

PHILIP F. KESSLER 55 & 57 W. 26th St., New York City
Commission Dealer, Wholesale Buyer and Seller of
Open from 5 a. m. to 6 p. m. Sunday till 10 a. m.
Tel., 5243 and 2927 Madison Sq. Res., 345 J., Newtown.
CUT FLOWERS
Finest Lilies in the Market Every Day in the Year.

NEW YORK QUOTATIONS PER 100. To Dealers Only

ROSES AND CARNATIONS	Last Half of Week ending Apr. 3 1909		First Half of Week beginning Apr. 5 1909	
	American Beauty, Fancy and Special.....	12.00	25.00	25.00
" " Extra.....	8.00	12.00	12.00	20.00
" " No. 1.....	5.00	8.00	6.00	10.00
" " Lower Grades.....	1.00	3.00	2.00	3.00
Bride, "Told, Fancy and Special.....	4.00	6.00	4.00	10.00
" " Lower Grades.....	1.00	3.00	1.00	3.00
Killarney, Fancy and Special.....	6.00	10.00	8.00	15.00
" " Lower Grades.....	1.50	3.00	1.50	3.00
Richmond, Fancy and Special.....	6.00	12.00	8.00	15.00
" " Lower Grades.....	1.00	3.00	1.00	4.00
Chatenay.....	1.50	12.00	1.50	12.00
Golden Gate, Ivory, etc.....	1.00	6.00	1.00	6.00
Ty Maryland.....	6.00	15.00	2.00	15.00
Tres. Tar. Field.....	1.00	3.00	1.00	3.00
Carnations, Fancy and Novelties.....	3.00	6.00	3.00	6.00
" " Ordinary and White.....	1.00	2.00	1.00	2.00

Alexander J. Guttman
THE WHOLESALE FLORIST OF NEW YORK
34 WEST 28th STREET
PHONES. 1664-1665 MADISON SQUARE
ENOUGH SAID

TRAENDLY & SCHENCK
Wholesale Florists
Furnish best Stock at fair Prices all the year round
Send for Quotations on Any Variety and Quantity
Tel. 798, 799 Madison Sq. 44 West 28th St., New York City

GROWERS' CUT FLOWER CO. CUT FLOWERS
AT
WHOLESALE
VIOLETS, CARNATIONS, ROSES
ORCHIDS, CHRYSANTHEMUMS, LILIES
Consignments Solicited. Shipments to Order, any Distance
39 West 28th Street, Telephone 1877 Madison Square
J. J. COAK, Mgr. NEW YORK

WHOLESALE FLORISTS
54 West 28th St.
NEW YORK
Telephone 3559 Hudson Sq.

A. L. YOUNG & CO.

RECEIVERS & SHIP-
PERS OF CUT
FLOWERS.
CONSIGNMENTS SOLICITED.

WILLIAM H. KUEBLER
Brooklyn's Foremost and Best
WHOLESALE COMMISSION HOUSE
A First Class Market for all CUT FLOWERS
28 Willoughby St., Brooklyn, N. Y.
Tel. 4591 Main

Greater New York Florists' Association, Inc.
Now Open for Cut Flower Consignments
162 Livingston Street, BROOKLYN, N. Y.
Geo. W. Crabweck Telephone Connection
Manager 3642-43 Main

REED & KELLER
122 West 25th St., New York
Florists' Supplies
We manufacture all our
Metal Designs, Baskets, Wire Work & Novelties
and are dealers in
Glassware Decorative Greens and Florists' Requisites

THE KERVAN CO.
Wholesale Dealers and Shippers of
Decorative Evergreens
Ferns, Galax, Laurel, Fresh Cycas, Box-
wood, Sphagnum and all Florists' Greens
Seed to us for Quotations before Buying.
113 West 28 Street, NEW YORK CITY

MICHIGAN CUT FLOWER EXCHANGE, Inc.
WHOLESALE COMMISSION FLORISTS
Consignments Solicited
Hardy Fancy Fern Our Specialty
38-40 BROADWAY, DETROIT, MICH.

FOR FLORISTS' USE
There's **NOTHING** as good as
MEYER'S SILKALINE
Don't let them sell you anything else
JOHN C. MEYER & CO., Boston, Mass.

In ordering goods please add "I saw
it in HORTICULTURE."

KRICK'S
PERFECT FLOWER POT HANDLE

Once Used Always Used



Send for Price List

SAMPLE PAIR 10 CENTS POSTPAID

Patented

1164-1166 Greene Ave.
BROOKLYN, N. Y.

GEORGE COTSONAS & CO.
Wholesale and Retail Dealers in all kinds of
EVERGREENS
Fancy and Dagger Ferns
Bronze and Green Galax
Main Store 50 W. 28 St.
Phone 1202 Mad. Sq. New York

CENTRALLY LOCATED, THE HUB OF THE
FLOWER MARKET SECTION
CHARLES MILLANG
Wholesale Florist
444 Sixth Ave., NEW YORK
Telephone 7062 Madison



WHOLESALE COMMISSION J. K. ALLEN 106 W. 28th St. NEW YORK
Open 6 a. m. Daily Tel. 167 Madison Sq
Shipments of Lily of the Valley and Bulb Flowers Needed

NEW YORK QUOTATIONS PER 100. To Dealers Only

MISCELLANEOUS	Last Half of Week ending Apr. 3 1909	First Half of Week beginning Apr. 5 1909
	Cattleyas.....	30.00 to 50.00
Lilies.....	6.00 to 10.00	8.00 to 12.00
Lily of the Valley.....	1.00 to 3.00	1.00 to 3.00
Narciss. Paper White.....	1.00 to 2.00	1.00 to 2.00
Roman Hyac.....	1.00 to 2.00	1.00 to 2.00
Tulips.....	2.00 to 4.00	2.00 to 4.00
Daffodils.....	1.50 to 2.00	1.00 to 2.00
Freesia.....	1.00 to 2.00	1.00 to 2.00
Mignonette.....	1.00 to 3.00	1.00 to 3.00
Sweet Peas.....	.25 to 1.00	.30 to .75
Gardenias.....	5.00 to 35.00	5.00 to 35.00
Violets.....	.25 to .45	.25 to .50
Adiantum.....	.75 to 1.00	.75 to 1.00
Crocus.....	1.00 to 1.25	1.00 to 1.25
Smilax.....	8.00 to 12.00	8.00 to 12.00
Asparagus Plumosus, strigis.....	23.00 to 25.00	40.00 to 25.00
& Spreng. (two bchs)	10.00 to 25.00	15.00 to 25.00

NEW YORK MARKET.
Warm weather and the usual pre-Easter quiet have held the flower market about where it was one week ago—very much in the dumps. At present writing the stores are giving their attention mainly to the plant trade, having cleaned out the stock of the growers completely and now standing to unload it on the appreciative public. As on previous occasions the cut flower man must stand back as patiently as possible and wait until notified his turn has come. In the meantime the unseasonable weather has been pushing crops along and its effect on most of the cut flower stock is decidedly hurtful. But with more moderate weather conditions there is no doubt the stock provided for the flower buyers will be all right as to quality and quantity. Violets are on the downward course but everything else will be had in abundance with the possible exception of lilies.

A VERDICT FOR ALPHONSE PERICAT.
The trial before Judge Broomall and a jury, March 29, 30 and 31, at Media, Delaware County, Pa., of suit of Elna Wilson of Philadelphia, against Alphonse Pericat of Collingdale, Delaware County, Pa., resulted in a verdict for the defendant. This suit was for the recovery of approximately \$1,400—

money derived from the sale of orchid flowers alleged to have been wrongfully appropriated by Pericat when employed as gardener by the Wilsons, and is the third suit of a similar character in all of which the defendant has been acquitted. Samuel S. Pennock and David Rust of Philadelphia were prominent witnesses at the trial. A counter suit for twenty thousand dollars has been instituted by Pericat for false arrest.

GREENHOUSES BUILDING OR CONTEMPLATED.
W. Springfield, Mass.—H. S. Hyde, Brattleboro, Vt. C. W. Dunham, range of houses.
Janesville, Wis. Janesville Floral Co., three houses, 26x150 feet each.

WILLIAM F. KASTING CO.
WHOLESALE FLORISTS
383-387 Ellicott Street
BUFFALO, - N. Y.
ROBERT J. DYSART
Public Accountant and Auditor
Simple methods of correct accounting especially adapted for florists' use.
Books Balanced and Adjusted
Merchants Bank Building
28 STATE STREET, - BOSTON
Telephone, Main 58.

Buyer's Directory and Ready Reference Guide

Advertisements under this head, one cent a word. Initials count as words.

Display advertisers in this issue are also listed under this classification without charge. Reference to List of Advertisers will indicate the respective pages.

Buyers failing to find what they want in this list will confer a favor by writing us and we will try to put them in communication with reliable dealers.

ACCOUNTANT

R. J. Dyart, 28 State St., Boston.
For page see List of Advertisers.

AMPELOPSIS.

Storrs & Harrison Co., Plainville, O.
For page see List of Advertisers.
Eastern Nurseries, Henry F. Dawson, Mgr., Ampelopsis Quincefolia, Jamaica Plain, Mass.
For page see List of Advertisers.

C. Elsele, 11th and Westmoreland Sts.,
For page see List of Advertisers.

AQUATIC PLANTS

Aquarium plants the year round. Wholesale and retail. Send for price list. Schmidt's Emporium of Pets, 712 12th Street, Washington, D. C.

AQUILEGIAS

Aquilegia. Genuine Coerulea, finest of all. Both plants and seeds from the heart of the Rockies. C. S. Harrison's Select Nursery, York, Neb.

ARAUARIAS

A. Leuthy & Co., Perkins St. Nurseries, Roslindale, Mass.
For page see List of Advertisers.
Godfrey Aschmann, 1012 West Ontario St., Philadelphia, Pa.
For page see List of Advertisers.

ARGENTEUIL ASPARAGUS

Argenteuil Asparagus Plants. Frank H. Snow, Orleans, Mass.
Asparagus Roots, \$5 per 1000. Send for circular with extract from experiment station report, how this kind returned \$80-\$7 per acre. California Privet, stocky 12 to 18 inch plants, \$5.00 per 100; \$25.00 per 1000. West Jersey Nurseries, Bridgeton, N. J.

ASPARAGUS

Asparagus plumosus nanus and Sprengerii, 2 in., 1 year old, strong, \$3.00 per 100. E. & C. Woodman, Danvers, Mass.

Asparagus Plumosus Nans Seed. California grown, 1000, \$2.50; 5000, \$10.00. Special rates on larger lots. Jackson Nursery, 1932 Trinity St., Los Angeles, Cal.

ASPARAGUS SEED

S. S. Penneck-Meehan Co., Philadelphia.
For page see List of Advertisers.

ASTERS.

New Aster. Lady Roosevelt. Exquisite old rose blossom. 4 in. stem, 26 in. erect, pest-free. 40 seeds, \$1.00, and smaller quantities. Allan Wilson, Chestertown, Md.

Asters, 2 to 2 1/2 in. high, \$8.00 per 1000. Only the choicest old and kinds included in the collection. H. J. Blanchard, Ashburnham, Mass.

ASTER SEEDS

Elmer D. Smith & Co., Adrian, Mich.
For page see List of Advertisers.

Peter Henderson & Co., 35 & 37 Cortlandt St., New York.
Henderson's Invaluable.

AUCTION SALES

Oleary's Horticultural Co., 62 Vesey St., New York.

FOR PAGE SEE LIST OF ADVERTISERS.

AUTOMATIC CIRCULATOR

The Castle Co., 170 Summer St., Boston.
Bargain in Electric Circulators.

AZALEAS

A. Leuthy & Co., Perkins St. Nurseries, Roslindale, Mass.
For page see List of Advertisers.
Godfrey Aschmann, 1012 W. Ontario St., Philadelphia.
For page see List of Advertisers.

BAMBOO CANES

Yokohama Nursery Co., 31 Barclay Street, New York.
Bamboo Sticks, Colored Green.
For page see List of Advertisers.
Wm. Elliott & Sons, New York City.
Lily Stakes.

BAY TREES.

2000 Bay and Box Trees in all sizes, Pyramid and Standards. Write for list. Julius Roehrs, Rutherford, N. J.

BEDDING PLANTS

J. E. Felthousen, Schenectady, N. Y.
For page see List of Advertisers.
A. Leuthy & Co., Perkins St. Nurseries, Roslindale, Mass.
For page see List of Advertisers.
G. Aschmann, 1012 W. Ontario St., Philadelphia, Pa.
For page see List of Advertisers.
F. P. Sawyer, Clinton, Mass.
J. C. Schmidt, Bristol, Pa.
For page see List of Advertisers.

Rooted Cuttings, Fuchsias, Heliotrope, Salvia Zurich, Boufire, 75c. per 100. Ageratum Gurney, German Ivy, 50c. per 100. Cash with order. F. A. Eyzod, Haddam, Conn.

Salvia, 2 1/2 to 3 in. high, 1 1/2c. each. Colosa scandens, 2 1/2 in., 2c. each. 50 Asparagus Sprengeri, 5 in., nice plants, 25c. each. H. J. Blanchard, Ashburnham, Mass.

BOILERS

BOILERS. "Burnham" Boilers made for greenhouse heating. Lord & Burnham, 1133 Broadway, N. Y.

Kroeschell Bros. Co., 35 Erie St., Chicago.
For page see List of Advertisers.

BOOKS

Send to us for any horticultural publication you desire and we can furnish it promptly. Horticulture, 11 Hamilton Place, Boston.

BOXWOOD TREES

New England Nurseries, Inc., Bedford, Mass.
For page see List of Advertisers.
Anton Schultheis, College Point, N. Y.
For page see List of Advertisers.

4000 nice dwarf boxwood, 6 and 8 in. size, \$1.50 and \$2.00 per 100; \$15.00 and \$18.00 per 1000. John Keady, Mt. Joy, Pa.

BUILDING MATERIAL

BUILDING MATERIAL of all description for All Cypress, Semi-Iron, Iron Frame or Truss Houses. Hot Bed Sash and Frames. Lord & Burnham Co., 1133 Broadway, N. Y.

BULBS AND TUBERS

Joseph Breck & Sons, 47-54 N. Market St., Boston.
For page see List of Advertisers.
J. M. Thornburn & Co., 33 Barclay St., New York.
For page see List of Advertisers.
A. T. Boddington, 342 W. 14th St., N. Y.
For page see List of Advertisers.

BULBS AND TUBERS - Continued

Rickards Bros., 37 East 19th St., New York.
For page see List of Advertisers.

H. F. Mitchell Co., Philadelphia.
For page see List of Advertisers.

H. E. Flske Seed Co., Faneuil Hall Sq., Boston.
For page see List of Advertisers.

T. J. Grey & Co., 32 and 33 So. Market St., Boston.
For page see List of Advertisers.

Yokohama Nursery Co., 31 Barclay St., New York.
For page see List of Advertisers.

Ralph M. Ward & Co., 12 W. Broadway, New York.
For page see List of Advertisers.

K. Takeuchi, 478A Boylston St., Boston.
Japanese Bulbs.

Schlegel & Fottler Co., 25 & 27 S. Market St., Boston.
Begonias, Gloxinias, Tuberoses.

For page see List of Advertisers.

CANNAS

A. T. Boddington, 342 W. 14th St., New York.
For page see List of Advertisers.

C. Elsele, 11th and Westmoreland Sts., Philadelphia, Pa.
For page see List of Advertisers.

CANTELOUPE SEED

Lurrell Gem and Tiptop Cantaloupe Seed, selected from best netted melons. Seed fresh and offered by the world's largest cantaloupe grower. 2 new sorts free with each order. 1 lb. by mail, 60 cents. H. Clay Beebe, Olney, Colo., E. No. 1.

CARNATIONS

F. Dörner & Sons Co., Lafayette, Ind.
Carnation, Wmونا.
For page see List of Advertisers.

Chicago Carnation Co., Juliet, Ill.
For page see List of Advertisers.

Albert Roper, Tewksbury, Mass.
Carnation Bay State.
For page see List of Advertisers.

Bassett & Washburn, Hinsdale, Ill.
Carnation O. P. Bassett.

Wood Bros., Fishkill, N. Y.
Carnations, Rooted Cuttings.
For page see List of Advertisers.

The E. G. Hill Co., Richmond, Ind.
Carnation Cuttings.
For page see List of Advertisers.

S. J. Reuter & Son, Westery, R. I.
For page see List of Advertisers.

Poehmann Bros. Co., Morton Grove, Ill.
For page see List of Advertisers.

E. W. Fengar, 147-57 Linden Av., Irvington, N. J.
Rooted Carnation Cuttings.
For page see List of Advertisers.

CHRYSANTHEMUMS

E. G. Hill Co., Richmond, Ind.
For page see List of Advertisers.

S. J. Reuter & Son, Westery, R. I.
For page see List of Advertisers.

Elmer D. Smith & Co., Adrian, Mich.
For page see List of Advertisers.

C. H. Totty, Madison, N. J.
Single chrysanthemums From Seed.
For page see List of Advertisers.

J. H. Myers, Alhona, Pa.
For page see List of Advertisers.

Scott Bros., Elmsford, N. Y.
For page see List of Advertisers.

For List of Advertisers See Page 549

CHRYSANTHEMUMS - Continued

Poehlmann Bros. Co., Morton Grove, Ill.
For page see List of Advertisers.
F. P. Sawyer, Clinton, Mass.

Chrysanthemum Golden Glow from 3 1/4 in. pots, for early spring delivery, \$1.00 per doz., \$6.00 per 100, \$50.00 per 1000. Stock plants of Montmort, Oct. Frost, Crocus, Matchless, Lucy Deraux, Polly Rose and Holladay, \$1.00 per doz.; \$6.00 per 100. Felice Ross, Waltham, Mass.

50,000 Chrysanthemums. White—(Timothy Eaton); Mrs. Geo. S. Kahl, fine, early; Estelle, White Bonaffon, Alice Byron, Ivory, C. Touseil, Jeanne Nonin, Oct. Frost, Early Snow, Angele Laurent. Pink—(Glory of Pacific, Dr. Enguehard, Maud Dean, Pink Ivory, Rosette, Yellow—Major Bonaffon, Crema, Robt. Halliday; Baby, small yellow, of the button type. Rooted cuttings ready. Send for prices. Wm. Swayne, Box 226, Kennett Square, Pa.

Golden Glow R. C., 7.5, \$1, 100, \$3.50. Pacific Supreme, 30, \$1, 100, \$3. Prepaid. Best early frost and pink mums now ready. Chas. Frost, Kenilworth, N. J.

Herrington's book on the Chrysanthemum, mailed to your address for 50c., by Horticulture Publishing Co., 11 Hamilton Place, Boston.

COAL FOR GREENHOUSE USE

Bader Coal Co., Board of Trade Bldg., Boston.

COLEUS

J. E. Felthousen, Schenectady, N. Y.
For page see List of Advertisers.

Coleus. Strong rooted cuttings, 10 choice varieties, 60 cents per hundred. Verschaffeltii and Golden Buzzer 75 cents per hundred. Edmund Reardon, Cambridge, Mass.

Coleus. A few thousand rooted cuttings of Lord Palmerston and other best varieties mixed at 60 cents per 100. Cash with order, please. Hope Greenhouses, 279 Massachusetts Ave., Providence, R. I.

CONIFERS

John Waterer & Sons, Ltd., American Nursery, Bagshot, Eng.
For page see List of Advertisers.

CUT FLOWER BOXES.

Edwards Folding Box Co., Philadelphia
For page see List of Advertisers.

Folding cut flower boxes, the best made Write for list. Holton & Hunkel Co., Milwaukee, Wis.

DAHLIAS

David Herbert & Son, Ateo, N. J.
For page see List of Advertisers.

J. L. Moore, Northboro, Mass.
For page see List of Advertisers.

Peacock Dahlia Farms, Williamstown Junction, N. J.
For page see List of Advertisers.

R. Vincent Jr. & Sons Co., White Marsh, Md.
For page see List of Advertisers.

Geo. B. Hart, 24 Stone St., Rochester, N. Y. (Choice Florists' Dahlias).
For page see List of Advertisers.

Wm. H. Richardson, New Bedford, Mass.

DAHLIAS.

Geo. H. Walker, No. Dighton, Mass.
Wholesale and Retail

Send your name for my 1909 Catalog and Pocket Guide, ready to mail about Feb. 25th.

Cactus, Decorative, Fancy, Show and Pompon Dahlias. Good commercial varieties, such as Kriebitz, Countess of Londale, Mad. Van Den Deal and other sure bloomers, strong divided roots in 10 or 20 named varieties my selection, \$1.00 per 25; \$3.00 per 100; \$25.00 per 1000. Cash please. Herrmann Thiemann, Mconson, Mass.

Dahlias. Novelties and standard varieties, true to name, a choice list of the best introductions. Send for catalog of dahlias, hollyhocks, hardy plants. Prices always reasonable. W. W. Willmore, Box 882 Denver, Colo.

The Dahlia—Peacock—Mailed for 30 cents by Horticulture, 11 Hamilton Place, Boston.

DAHLIAS - Continued

East Bridgewater Dahlia Gardens wants your business. If you are looking for dahlias send to the Eastern Dahlia King, J. K. Alexander, East Bridgewater, Mass.

DECORATIVE PLANTS

A. Leuthy & Co., Perkins St. Nurseries, Rosindale, Mass.
For page see List of Advertisers.

Godfrey Aschmann,

1012 W. Ontario St., Phila., Pa.
For page see List of Advertisers.

Joseph Heacock Co., Wyncoote, Pa.
For page see List of Advertisers.

The Geo. Wittbold Co., 1637 Buckingham Place, Chicago, Ill.
For page see List of Advertisers.

Robert Craig Co., Market and 49th Sts., Philadelphia, Pa.
For page see List of Advertisers.

DRACAENAS

Dracaena Indivisa, 8, 7, 6, 5 and 4 in. Prices on application. E. & C. Woodman, Danvers, Mass.

ECONOMY BRACKET

Burton & Allard, Nashua, N. H.
For page see List of Advertisers.

ERICAS

Anton Schulthels, College Point, N. Y.
For page see List of Advertisers.

EVERGREENS

New England Nurseries, Bedford, Mass.
For page see List of Advertisers.

American Nursery Co., 150 Broadway, New York, N. Y.
For page see List of Advertisers.

Henry A. Dreer, Philadelphia, Pa.

Evergreens. Send 25 cents in stamps for complete work on propagating and growing Evergreens. C. S. Harrison's Select Nursery, York, Neb.

FERNS

A. Leuthy & Co., Rosindale, Mass.
For page see List of Advertisers.

H. H. Barrows & Son, Whitman, Mass. Nephrolepis Magnifica.
For page see List of Advertisers.

John Scott, Brooklyn, N. Y.

Frank Oechslein, 2570-2606 W. Adams St., Chicago.

Ferns for Fishes.

For page see List of Advertisers.

The Geo. Wittbold Co., 1637 Buckingham Place, Chicago, Ill.
For page see List of Advertisers.

Godfrey Aschmann, 1012 W. Ontario St., Philadelphia.
For page see List of Advertisers.

C. Elsie, 11th and Westmoreland Sts., Anderson's ferns for in and outdoors. Largest commercial collection in the country. Ask for descriptive catalogue. J. F. Anderson, Fern Specialist, Short Hills, N. J.

FERTILIZERS

Pulverized Manure Co., 31 Union Stock Yards, Chicago, Ill.

Wizard Brand Sheep and Shredded Cattle Manure.
Robert Simpson, Clifton, N. J. Sheep Manure.
For page see List of Advertisers.

Bowker Fertilizer Co., Boston, Mass. All Forms of Plant Food at First Hands.
For page see List of Advertisers.

German Kali Works, 93 Nassau St., New York.
Potash Fertilizer.

FEVERFEW

2000 Feverfew from 2 1/4 in. \$3.00 per 100, \$25.00 per 1000. Albert Batley & Son, Maynard, Mass.

Feverfew, 3 1/2 in. \$3.00 per 100, 4 in. \$5.00 per 100. H. J. Blanchard, Ashburnham, Mass.

FLORAL PHOTOGRAPHS

Floral Photographs. Foley's, 223-223 1-2 Bowery, New York.

FLORISTS' LETTERS.

Boston Florist Letter Co., 66 Pearl St., Boston, Mass.
For page see List of Advertisers.

W. C. Krick, 2164-66 Greene Ave., Brooklyn, N. Y.
Immortelle Letters.

FLORISTS SUPPLIES

N. F. McCarthy & Co., 84 Hawley St., Boston.

For page see List of Advertisers.

H. M. Robinson & Co., 15 Province St. and 9 Chapin Pl., Boston, Mass.
For page see List of Advertisers.

Reed & Keller, 122 W. 25th St., New York.
For page see List of Advertisers.

M. Bayerdorfer & Co., 1129 Arch St., Philadelphia.
For page see List of Advertisers.

FLOWER POTS

W. H. Ernest, 28th and M Sts., Washington, D. C.

For page see List of Advertisers.

A. H. Hewa & Co., Cambridge, Mass.
For page see List of Advertisers.

Hilfinger Bros., Ft. Edward, N. Y.
For page see List of Advertisers.

The Peters & Reed Pottery Co., Red pots, seed pans, etc. Zanesville, O.

Syracuse Pottery Co., Syracuse, N. Y. Syracuse Red Pots.
For page see List of Advertisers.

We make Standard Flower Pots, etc. Write us when in need. Wilmer Cope & Bro. Lincoln University, Chester Co., Pa.

FRUIT TREES

Dwarf Fruit Trees, by F. A. Wagh, mailed to your address for 55 cents by Horticulture Publishing Co., 11 Hamilton Place, Boston.

The Culture of Fruit Trees in Pots, by Josh Grace, \$1.30; mailed to your address by Horticulture Pub. Co., 11 Hamilton Place, Boston.

FUCHSIAS

R. Vincent, Jr. & Sons Co., White Marsh, Maryland.
For page see List of Advertisers.

GALAX

Michigan Cut Flower Co., 38 and 40 Broadway, Detroit, Mich.
For page see List of Advertisers.

George Cotsonas & Co., 50 W. 25th St., New York.

For page see List of Advertisers.

The Kervan Co., 113 West 28th St., N. Y.
For page see List of Advertisers.

Rice Bros., 115 N. 6th St., Minneapolis, Minn.
For page see List of Advertisers.

H. M. Robinson & Co., 15 Province St. and 9 Chapin Place, Boston.
For page see List of Advertisers.

GERANIUMS

R. Vincent Jr. & Sons Co., White Marsh, Md.
New and Standard Varieties.
For page see List of Advertisers.

GLADIOLI

J. L. Moore, Northboro, Mass.
For page see List of Advertisers.

O. V. Zangen, Hoboken, N. J.

Gladiolus Brenclyevensis.
For page see List of Advertisers.

GLASS

Boston Plate & Window Glass Co., Boston.
For page see List of Advertisers.

Standard Plate Glass Co., 26-30 Sudbury St., Boston.
For page see List of Advertisers.

Foley Mfg. Co., Western Ave., between 25th & 26th Sts., Chicago.
For page see List of Advertisers.

In writing to Advertisers kindly mention Horticulture

GLASS—Continued

Sharp, Partridge & Co., 22d & Lumber St., Chicago.

For page see List of Advertisers.

Farsheysky Bros., Inc., 59 Montrose Ave., Brooklyn, N. Y.

For page see List of Advertisers.

Greenhouse glass, lowest prices. Johnson Glass Co., Hartford City, Ind.

Glass, High Grade, Double Thick Greenhouse Glass, Lord & Burnham, 1133 Broadway, N. Y.

GLAZING DEVICE

H. A. Dreer, Philadelphia, Pa.

Peerless Glazing Point

For page see List of Advertisers.

GLAZING POINTS, Lord & Burnham Special Glazing Nails (Points). Lord & Burnham, 1133 Broadway, N. Y.

GREENHOUSE BUILDING MATERIAL

Lord & Burnham Co.,

1133 Broadway, New York.

For page see List of Advertisers.

Pierson U-Bar Co., 1 Madison Sq., N. Y.

For page see List of Advertisers.

A. T. Stearns Lumber Co., Neponset, Boston.

For page see List of Advertisers.

King Construction Co., N. Tonawanda, New York.

For page see List of Advertisers.

Hitchings & Co., 1170 Broadway, New York

For page see List of Advertisers.

J. C. Moulner Co., 117 East Blackhawk St., Chicago, Ill.

For page see List of Advertisers.

Foley Mfg. Co., Western Ave., between 25th & 26th Sts., Chicago.

For page see List of Advertisers.

W. H. Lutton, West Shore Av. Sta., Jersey City, N. J.

For page see List of Advertisers.

GREENHOUSE CONSTRUCTION

GREENHOUSE CONSTRUCTION, Semi-Iron Greenhouse, New Truss Houses and Iron Frame Greenhouses, Lord & Burnham, 1133 Broadway, N. Y.

J. A. Payne, 260-274 Culver Ave., Jersey City, N. J.

For page see List of Advertisers.

Foley Mfg. Co., Western Ave., between 25th & 26th Sts., Chicago.

For page see List of Advertisers.

Hitchings & Co., 1170 Broadway, New York

For page see List of Advertisers.

Geo. M. Garland Co., Des Plaines, Ill.

For page see List of Advertisers.

GREENHOUSE HOSE

Revere Rubber Co., Boston, Mass.

Revere Hose.

For page see List of Advertisers.

GUTTERS

GUTTERS, Cast Iron Gutters, L & B Improved V Shaped Gutter with drip gutter attachment. Lord & Burnham, 1133 Broadway, N. Y.

HAIL INSURANCE

Florists' Hall Assn. of America.

J. G. Esler, Saddle River, N. J.

For page see List of Advertisers.

HARDY FERNS, MOSS AND GREENS

H. M. Robinson & Co., 15 Province St. and 9 Chapman Pl., Boston, Mass.

For page see List of Advertisers.

Michigan Cut Flower Exchange,

38 and 40 Broadway, Detroit, Mich.

For page see List of Advertisers.

George Cotaonas & Co., 50 W. 23rd St., New York.

For page see List of Advertisers.

N. F. McCarthy & Co., 84 Hawley St., Boston.

For page see List of Advertisers.

The Kervan Co., 113 W. 28th St., N. Y.

For page see List of Advertisers.

Wice Bros., 115 N. 6th St., Minneapolis, Minn.

For page see List of Advertisers.

HARDY PERENNIALS

Henry A. Dreer, 714 Chestnut St., Phila.

HEATING APPARATUS

Lord & Burnham Co., 1133 Broadway, New York.

For page see List of Advertisers.

Pierson U-Bar Co., 1 Madison Sq., N. Y.

For page see List of Advertisers.

John A. Payne, 260-274 Culver Ave., Jersey City, N. J.

For page see List of Advertisers.

Krosschell Bros. Co., 35 Erie St., Chicago.

For page see List of Advertisers.

HELP FURNISHED

Thos. H. Bambrick, 34 S. 7th St., Phila.

For page see List of Advertisers.

HERBACEOUS PERENNIALS

P. Ouwerkerk, P. O. No. 1, Hoboken, N. J.

For page see List of Advertisers.

New England Nurseries, Bedford, Mass.

For page see List of Advertisers.

The Geo. Wittbold Co., 1637 Buckingham Place, Chicago.

For page see List of Advertisers.

HOLLYHOCKS

Hollyhocks, Chater's double, white, pink and crimson, August transplants, first-class lot, \$3.00 per 100. Ed. C. Lindsay, Milford, Del.

HOT-BED SASH

The A. T. Stearns Lumber Co., Neponset, Mass.

For page see List of Advertisers.

Pierson U-Bar Co., 1 Madison Sq., N. Y.

For page see List of Advertisers.

Lord & Burnham Co., 1133 Broadway, N. Y.

For page see List of Advertisers.

Foley Mfg. Co., Western Ave., between 25th & 26th Sts., Chicago.

HYDRANGEAS.

500 Hydrangeas in bloom for Easter, 4 to 10 blooms; splendid stock. Edmund Reardon, Cambridge, Mass.

INSECTICIDES.

Nicotelle kills all greenhouse pests.

F. R. Falchtorpe Co.,

Eleventh St., Owenboro, Ky.

For page see List of Advertisers.

Stump & Walter Co., 50 Barclay St., New York.

Kilmdead Tobacco Dust.

For page see List of Advertisers.

Niagara Sprayer Co., Middleport, N. Y.

Niagara Brand.

For page see List of Advertisers.

B. G. Pratt Co., New York.

Sulfoicide.

For page see List of Advertisers.

Bowker Insecticide Co., Boston, Mass.

Insect Destroying Preparations.

For page see List of Advertisers.

Wm. Cooper & Nephews, 177 Illinois St., Chicago; Cyril Franklin, 62 Beaver St., New York, Agt.

V I Field.

For page see List of Advertisers.

Eastern Chemical Co., Pittsburg St., Boston.

"HIT" Soap Spray.

For page see List of Advertisers.

"The Fumigating Kind Tobacco Powder"—The first on the market and the kind that has so many imitators, has our guarantee tag of satisfaction or money back, and "The Moon Trade Mark" on every bag, \$3.00 per 100 lbs. The H. A. Stothoff Co., Mount Vernon, N. Y., Makers and sellers.

Tobacco dust and stems, dust in bibs, 150 to 200 lbs., \$4.00; stems in bales from 350 to 400 lbs., \$2.50. Cash with order; money back if you say so. I had them all in quality and price. S. R. Levy, Binghamton, N. Y.

IVIES

English Ivy, strong, for window boxes; 4-inch pots \$1.50 per ten. Shatenue Nurseries, Barrytown, Dutchess County, N. Y.

JAPANESE PLANTS

Yokohama Nursery Co., 31 Barclay St., New York.

For page see List of Advertisers.

KENTIAS

Godfrey Aschmann, 1012 W. Ontario St., Phila., Pa.

For page see List of Advertisers.

A. Leuthy & Co., Roslindale, Mass.

For page see List of Advertisers.

Jos. Heacock Co., Wyncote, Pa.

Single and Made-Up Specimens.

For page see List of Advertisers.

LANTANAS

Violet King, king of all Lantanas, rooted cuttings, \$4.00 per 100, 200 for \$7.50, 350 per doz. For large quantities of Violet King, 500 to 5000 lots, send for prices, as I will make them right, for I want to see every florist in the United States handle this variety, as it is a great novelty. Sunset, new, rooted cuttings, 50c. per doz.; \$3.00 per 100. Eight other grand varieties, rooted cuttings, \$2.00 per 100. All true to name, labelled. Mixed, \$18.00 per 1000. Send for price list. Louis P. Faulk, West View, Pa.

LEVELS FOR LANDSCAPE GARDENING USE.

Bostrom-Brady Mfg. Co., 139 Madison Ave., Atlanta, Ga.

For page see List of Advertisers.

LILY OF THE VALLEY PIPS

Hjalmar Hartmann & Co., 12 Stormgade, Copenhagen, Denmark.

For page see List of Advertisers.

MARGUERITES

Marguerites, Queen Alexandra, \$1.25 per 100, prepaid. S. W. Pike, St. Charles, Ill.

MASTICA

F. O. Pierce Co., 12 W. Broadway, New York.

For page see List of Advertisers.

MONTREAL MUSK MELON

Dupuy & Ferguson, Montreal, Can.

NICO-FUME

Kentucky Tobacco Product Co., Louisville, Ky.

For page see List of Advertisers.

NURSERY STOCK

John Waterer & Sons, Ltd., American Nursery, Bagshot, England.

For page see List of Advertisers.

Cleary's Horticultural Co., 62 Veney St., New York.

For page see List of Advertisers.

P. Ouwerkerk, 216 Jane St., Weehawken Heights, N. J.

For page see List of Advertisers.

Eastern Nurseries, Jamaica Plain, Mass.

For page see List of Advertisers.

American Nursery Co., 150 Broadway, New York, N. Y.

For page see List of Advertisers.

W. & T. Smith Co., Geneva, N. Y.

Nursery Stock for Florists.

For page see List of Advertisers.

Storrs & Harrison Co., Palmsville, O.

For page see List of Advertisers.

C. R. Burr & Co., Manchester, Conn.

Berberis Thunbergii.

For page see List of Advertisers.

Call's Nurseries, Perry, O.

Trees, Roses, Shrubs.

For page see List of Advertisers.

P. A. Keene, 1 Madison Av., New York; Rhododendron Hybrids, Maximum, Maples, Privet.

For page see List of Advertisers.

Rose Hill Nurseries, New Rochelle, N. Y. Buddleia Variablis Veitchii and Magnolia.

Manual of the Trees of North America, by C. S. Sargent, mailed to your address for \$3.00, by Horticulture Publishing Co., 11 Hamilton Place, Boston.

TREES, SHRUBS, ROSES, EVERGREENS, PONIES, HARDY PLANTS, ELLWANGER & BARRY, Rochester, N. Y.

NURSERY STOCK—Contin

New Hardy Shrub—*Buddleia variflora* Veltchil and *Magnolia*, the summer flowering Lilac. 50c. each; \$5.00 per doz.; \$25.00 per 100. Rose Hill Nurseries, New Rochelle, N. Y.

Catalog now ready. Nursery grown evergreens, seedling white pine and hemlock, native trees and plants. L. E. Williams, Nottingham, N. H.

ONION SEED

Federico C. Varela, Tenerife, Canary Is. Bermuda Onion Seed.

ORCHIDS

Orchid Growers' Manual. By B. S. Williams. 500 Illustrations, \$10.00. 800 pages; descriptions of upwards of 2700 species and varieties of orchidaceous plants, etc. The most complete work on Orchids and orchid culture ever published. Orders filled by HORTICULTURE, 11 Hamilton Place, Boston.

ORCHID PLANTS

- Lager & Hurrell, Summit, N. J. For page see List of Advertisers.
- Sander, St. Albans, England. Importers, Exporters, Growers, Hybridists. For page see List of Advertisers.
- Carrillo & Baldwin, Secaucus, N. J. For page see List of Advertisers.
- Joia A. Maada, 191 Valley Road, W. Orange, N. J. For page see List of Advertisers.
- Ordonez Bros., Madison, N. J., Box 105. Cattleya Mossiae. For page see List of Advertisers.
- G. L. Freeman, 388 Appleton St., Holyoke, Mass. Orchid Importations. For page see List of Advertisers.
- Largest stock in the country. Ask for prices. Julius Roehrs, Rutherford, N. J.

PAINT AND PUTTY

PAINT AND PUTTY: Ideal Greenhouse lead; Special Greenhouse Putty. Lord & Burnham, 1133 Broadway, N. Y.

PALMS

- A. Leuthy & Co., Perkins St. Nurseries, Roslindale, Mass. For page see List of Advertisers.
- Robert Craig Co., Market and 49th Sts., Philadelphia, Pa. For page see List of Advertisers.
- Joseph Heacock Co., Wyncote, Pa. Home-Grown Palms. For page see List of Advertisers.
- Geo. Wittbold Co., 1657 Buckingham Place, Chicago. For page see List of Advertisers.

PANSY PLANTS.

Pansies in bud and bloom; none better, \$1.00 per 100; \$8.00 per 1000. Choicest strains. Ed. C. Lindsay, Milford, Del. Giant Ex. Pansies in bloom, \$2.00 per 100; \$18.00 per 1000. Geo. S. Baylies, Wenonah, N. J.

PATENTS

Siggers & Siggers, Washington, D. C. For page see List of Advertisers.

PEAT

Orchid Peat and Moss always on hand Julius Roehrs Co., Rutherford, N. J.

PEERLESS REPAIR CLAMP

Alex. Klokner, Wauwatosa, Wis.

PENTSTEMONS

C. H. Totty, Madison, N. J. For page see List of Advertisers.

PEONIES

Peonies only, by the wholesale—best 100 varieties. J. F. Rosefield, Westpoint, Nehr. One of the finest collections in America. Send 25 cts. in stamps for new edition of Peony Manual. C. S. Harrison's Select Nursery, York, Neb.

PHLOXES

Send 25 cts in stamps for Phlox Manual Fine mixed phloxes \$2.00 per 100. C. S. Harrison's Select Nursery, York, Neb.

PHOTOGRAPHS: DESIGNING: ILLUSTRATING

Geo. E. Dow, 178 Washington St., Boston. For page see List of Advertisers.

PIPE AND FITTINGS

Foley Mfg. Co., between Western Ave. and 26th St., Chicago, Ill.

Krosschell Bros. Co., 35 Erie St., Chicago. For page see List of Advertisers.

PIPE AND FITTINGS. Cast Iron and Wrought Pipe, Valves, Elbows, Pipe Hooks, Automatic Air Headers, etc. Lord & Burnham, 1133 Broadway, N. Y.

PLANT STAKES

Seele's Tieless Plant Stakes and Trellises. H. D. Seele & Sons, Elkhart, Ind.

POT HANGERS

Pot hangers, Kramer's \$1 doz. by exp. \$1.25 by mail. I. N. Kramer & Son, Cedar Rapids, Ia.

Krick's Perfect Pot Hanger and Handle. Sample pair 10 cents postpaid. Send for full particulars. W. C. Krick, 1164-1166 Greene Ave., Brooklyn, N. Y.

POINSETTIAS (Artificial)

Poinsettias, artificial decorations our specialty. Sample lots of 50 in 3 sizes, \$4.00; 100 lots, \$6, \$8, \$10. J. Stern & Co., 125 N. 10th St., Philadelphia, Pa.

POULTRY SUPPLIES

Buff Rock Eggs to Hatch, Triumph brood coop for chickens. Frank H. Suov, Orleans, Mass.

PRIVET

California privet, 100,000 for transplanting at \$3.00 per 100; 55,000, 12 to 18 in., 2 to 4 branches, \$8.00 per 100; 125,000, 12 to 18 in., 3 to 5 branches, \$10.00 for 1000. Boxed and delivered F. O. B. Cash with order. Valdesian Nurseries, Bostic Dept., Rostle, N. C.

RAFFIA

Raffia (colored), 20 beautiful shades. Samples free. R. H. Comey Co., Camden, N. J.; 810 Washburn Ave., Chicago, Ill.

RHODODENDRONS

- John Waterer & Sons, Ltd., American Nursery, Bagshot, England. For page see List of Advertisers.
- P. Ouwerkerk, Hoboken, N. J. For page see List of Advertisers.
- Storrs & Harrison Co., Painesville, O. For page see List of Advertisers.

ROSES

- Robert Craig Co., Market and 49th Sts., Philadelphia, Pa. For page see List of Advertisers.
- P. Ouwerkerk, P. O. No. 1, Hoboken, N. J. For page see List of Advertisers.
- Julius Roehrs Co., Rutherford, N. J. Rose Newport Fairy. For page see List of Advertisers.
- The F. R. Pierson Co., Tarrytown-on-Hudson, N. Y. White Killarney. For page see List of Advertisers.
- S. J. Reuter & Son, Westerly, R. I. My Maryland. For page see List of Advertisers.
- Dirgee & Conard Co., West Grove, Pa. For page see List of Advertisers.
- Storrs & Harrison Co., Painesville, O. For page see List of Advertisers.
- Scott Bros., Elmford, N. Y. For page see List of Advertisers.
- Poehlmann Bros. Co., Morton Grove, Ill. For page see List of Advertisers.
- Ellwanger & Barry, Rochester, N. Y., Box T. A. N. Pierson, Cromwell, Conn. White Killarney, My Maryland, Rambler. For page see List of Advertisers.
- Thomas Roland, Nahant, Mass. Crimson and Pink Rambler.
- Montrose Greenhouses, Montrose, Mass. Roses, Grafted or Own Root. For page see List of Advertisers.
- M. H. Walsh, Woods Hole, Mass. H. T., H. P., Rambler.

ROSES—Continued

The Rose, by H. B. Ellwanger, mailed for \$1.50 by Horticulture, 11 Hamilton Place, Boston.

Hand Book of Cultural Notes on Roses Under Glass, by F. P. Brigham, mailed to your address for 25c. by Horticulture Publishing Co., 11 Hamilton Place, Boston.

RHUBARB AND ASPARAGUS ROOTS

Warren Shinn, Woodstown, N. J.

SALVIAS

- R. Vincent, Jr. & Sons Co., White Marsh, Maryland.
- Salvias Bonfire and Zurich. For page see List of Advertisers.

SEED GROWERS

- Hjalmar Hartmann & Co., Cauliflower and Cabbage Seed, 12 Strømgade, Copenhagen, Denmark. For page see List of Advertisers.
- Federico C. Varela, Tenerife, Canary Is. Bermuda Onion Seed.

SEEDS

- T. J. Grey Co., 32 So. Market St., Boston. For page see List of Advertisers.
- Joseph Breck & Sons, 51 and 52 N. Market St., Boston, Mass. For page see List of Advertisers.
- W. Atlee Burpee & Co., Philadelphia. For page see List of Advertisers.
- Arthur T. Boddington, 342 W. 14th St., New York. For page see List of Advertisers.
- H. E. Flske Seed Co., Faneuil Hall Sq., Boston. For page see List of Advertisers.
- Hjalmar Hartmann & Co., 12 Strømgade, Copenhagen, Denmark, Cauliflower and Cabbage Seed. For page see List of Advertisers.
- Richarda Bros., 37 E. 19th St., New York. For page see List of Advertisers.
- R. & J. Farquhar & Co., 6-7 So. Market St., Boston. Mignonette Seed. For page see List of Advertisers.
- H. F. Michell Co., 1018 Market St., Phila. For page see List of Advertisers.
- J. M. Thorburn & Co., 33 Barclay St., N. Y. For page see List of Advertisers.
- Leonard Seed Co., Chicago, Ill. For page see List of Advertisers.
- Wm. Elliott & Sons, 42 Vesey St., N. Y. New Seed. For page see List of Advertisers.
- Schlegel & Fottler Co., 26 & 27 S. Market St., Boston. For page see List of Advertisers.
- O. V. Zangen, Hoboken, N. J. Florists' Spring Seeds. For page see List of Advertisers.
- E. F. Winterson Co., Chicago. Seeds for Plantsmen, Nurserymen, Seedsmen. For page see List of Advertisers.
- Seeds. Rocky Mountain Evergreen seeds in large or small quantities. C. S. Harrison's Select Nursery, York, Neb.

SHRUBS

The Geo. Wittbold Co., 1657 Buckingham Place, Chicago. For page see List of Advertisers.

SILKALINE

John C. Meyer & Co., Boston, Mass. For page see List of Advertisers.

SMLAX

R. Vincent, Jr. & Sons Co., White Marsh, For page see List of Advertisers.

Extra strong plants, \$1.00 per 100; \$8.00 per 1000. Ready for 2 1/2 inch pots. Big bargain. C. W. Moeckel, 17 Summer St., Pittsburg, Mass.

In writing to Advertisers kindly mention Horticulture

SOLUBLE PLANT FOOD

Eastern Chemical Co., Boston, Mass.

SPHAGNUM MOSS

Live Sphagnum moss, orchid peat and orchid baskets always on hand. Lager & Hurrell, Summit, N. J.

Sphagnum moss and mountain laurel in bags, bales or car lots. Prices low. Spruce and hemlock in bales. James Day, Box 690, Milford, N. H.

SPRAYERSNiagara Sprayer Co., Middleport, N. Y.
For page see List of Advertisers.

J. F. Cass Mfg. Co., Dept. H., Detroit, Mich.

U-N-I-T Globe Sprayer.

Chas. J. Jager Co., Boston, Deming Spray Pump.
For page see List of Advertisers.**STEAM TRAP**E. Hippard, Youngstown, O.
For page see List of Advertisers.**STRAWBERRY PLANTS**H. L. Crane, Westwood, Mass.
Berrymore Strawberry.
For page see List of Advertisers.W. E. Trimble, Princeton, Ill.
Treatise on the Strawberry Blight, its Cause and Cure.

Strawberries, Chipman's new seedling. Perfect, enormously productive, immense in size and a good keeper. Many of our largest shippers grow no other. Plants from young bed, 75¢ per 100; \$4.00 per 1000. Cash. Ed. C. Lindsay, Milford, Del.

Strawberry Plants, Buback and Success, \$1.50 per 1000. W. N. Fanning, Kensington, Ct.

Strawberry Plants, best varieties. Circular free. A. Florian & Sons, Thomaston, Ct.

300 Strawberry Plants \$1. Your selection. List free. Wm. Perry, Cool Spring, Del.

SULFOCIDEThe B. G. Pratt Co., 50 Church St., Dept. W., New York City.
For page see List of Advertisers.**SULPHUR BURNER**

Benj. Dorrance, Rose Growers, Dorrance-ton, Pa.

SWEET PEASA. C. Zvolnek, Round Brook, N. J.
Winter Flowering.
For page see List of Advertisers.**TO-BAK-LINE**E. H. Hunt, Genl. Agt., 76-78 Wabash Av., Chicago.
For page see List of Advertisers.**VEGETABLE PLANTS**R. Vincent, Jr. & Sons Co.,
White Marsh, Md.
For page see List of Advertisers.**VEGETABLE SEEDS**

Just arrived, our reliable vegetable seeds. They are fresh seeds now. These are guaranteed fresh and only first class seeds. The Reliable Seed House, 156 Third Street, Hoboken, N. J.

VENTILATING APPARATUSPierson U-Bar Co., 1 Madison Sq., N. Y.
For page see List of Advertisers.Foley Mfg. Co., Western Av., between 25th & 26th Sts., Chicago.
For page see List of Advertisers.John A. Payne, 260-274 Culver Ave., Jersey City, N. J.
For page see List of Advertisers.The Advance Co., Richmond, Ind.
For page see List of Advertisers.Qusker City Machine Co., Richmond, Ind.
20th Century Ventilating Arm.
For page see List of Advertisers.

VENTILATING MACHINERY, New Model enclosed, self-acting gear; Standard Model Open Gear. Lord & Burnham, 1133 Broadway, N. Y.

VERBENAS

Verbenas, 2½ to 3 in. high, 1c. each. Best varieties to be got, all desirable colors. H. J. Blanchard, Ashburnham, Mass.

VINCAS

Vinea var., 5 in. per doz., \$2.00; per 100, \$15.00. E. & C. Woodman, Danvers, Mass.

VIOLETS.William Sim, Chftondale, Mass.
Boston and Princess of Wales Violets.
For page see List of Advertisers.

Good, strong California Violets, \$1.00 per 100, \$8.00 per 1000. Chas. M. Allen, 603 Broadway, Fall River, Mass.

Princess Violets, 2½ in., \$2.00 per 100, Jas. T. Baker, Bustleton, Philadelphia, Pa.

WALLFLOWERS

Henry A. Dreer, Philadelphia, Pa.

WAX FLOWERS

We are originators of wax designs and still the standard concern. J. Stern & Co., 125 N. 10th St., Philadelphia, Pa.

WEED KILLERThe American Horticultural Distributing Co., Martinsburg, W. Va.
Target Brand.**WIRED TOOTHPICKS**W. J. Cowee, Berlin, N. Y.
For page see List of Advertisers.**WIREWORK**Reed & Keller, 122 W. 25th St., N. Y.
For page see List of Advertisers.Durand & Marohn, Albany, N. Y.
For page see List of Advertisers.

Wirework. Write for our catalogue. Holton & Hunkel Co., Milwaukee, Wis.

William E. Heilscher's Wire Works, 38-40 Broadway, Detroit, Mich.

Wirework—Compare our prices with others. Scranton Florist Supply Co., 201 N. 7th St., Scranton, Pa.

WHOLESALE FLORISTS**Boston**N. P. McCarthy & Co., 84 Hawley St., Boston.
For page see List of Advertisers.H. M. Roblnson & Co., 75 Province St. and 9 Chapman Pl., Boston.
For page see List of Advertisers.Welch Bros., 226 Devonshire St., Boston.
For page see List of Advertisers.Tally, Wellesley, Mass.
For page see List of Advertisers.**Buifalo, N. Y.**William F. Kasting Co., 383-37 Elliott St., Buffalo, N. Y.
For page see List of Advertisers.**Chicago**Chas. W. McKellar, 51 Wabash Ave., Chicago.
For page see List of Advertisers.Peter Reinberg, 51 Wabash Ave., Chicago.
For page see List of Advertisers.E. F. Winterson Co., 45-49 Wabash Ave., Chicago.
For page see List of Advertisers.J. A. Budlong, 37-39 Randolph St., Chicago.
For page see List of Advertisers.Poehlmann Bros. Co., Morton Grove, Ill.
For page see List of Advertisers.**Cromwell, Conn.**A. N. Pierson, Cromwell, Conn.
For page see List of Advertisers.**WHOLESALE FLORISTS—****Continued****Detroit**Michigan Cut Flower Exchange, 38 and 40 Broadway, Detroit, Mich.
For page see List of Advertisers.**Minneapolis**Rice Bros., 115 N. 8th St., Minneapolis, Minn.
For page see List of Advertisers.**New York**Ford Bros., 48 W. 28th St., New York.
For page see List of Advertisers.H. E. Froment, 57 W. 28th St., New York.
For page see List of Advertisers.Alex. J. Guttman, 34 W. 28th St., New York.
For page see List of Advertisers.E. C. Horan, 55 W. 28th St., New York.
For page see List of Advertisers.A. H. Langjahr, 55 W. 28th St., New York.
For page see List of Advertisers.James McManus, 42 W. 28th St., New York.
For page see List of Advertisers.John I. Raynor, 49 W. 28th St., New York.
For page see List of Advertisers.W. F. Sheridan, 39 W. 28th St., New York.
For page see List of Advertisers.Traendly & Schenck, 44 W. 28th St., New York.
For page see List of Advertisers.Moore, Hentz & Nash, 55 and 57 W. 26th St., New York.
For page see List of Advertisers.Wm. H. Kuebler, 28 Willoughby St., Brooklyn, N. Y.
For page see List of Advertisers.Philip F. Kessler, 55 and 57 W. 26th St., New York.
For page see List of Advertisers.Millang Bros., 41 W. 28th St., New York.
For page see List of Advertisers.John Young, 51 W. 28th St., New York.
For page see List of Advertisers.Greater New York Florists' Association, 162 Livingston St., Brooklyn, N. Y.
For page see List of Advertisers.Frank Millang, 55-57 W. 26th St., New York.
For page see List of Advertisers.B. S. Stinn, 55-57 W. 26th St., New York.
For page see List of Advertisers.A. L. Yong & Co., 54 W. 28th St., N. Y.
For page see List of Advertisers.Growers' Cut Flower Co., 89 W. 28th St., New York.
For page see List of Advertisers.Henshaw & Fenrich, 44 W. 28th St., New York.
For page see List of Advertisers.J. K. Allen, 106 W. 28th St., New York.
For page see List of Advertisers.Charles Millang, 44 1/2 Sixth Av., New York.
For page see List of Advertisers.**Philadelphia**W. E. McKissick & Bros., 1619-1621 Bannstead St., Philadelphia, Pa.
For page see List of Advertisers.Leo Nielsen Co., 1200 Arch St., Philadelphia, Pa.
For page see List of Advertisers.The S. S. Pennock-Meehan Co., 1608-10 Ludlow St., Philadelphia, Pa.
For page see List of Advertisers.**WOODENWARE**Bacon & Co., Appleton, N. Y.
Baskets: Crates; Ladders; Boxes.**For List of Advertisers See Page 549**

List of Advertisers

Table listing advertisers and their page numbers, including Advance, The Co., American Nursery, Achmann Godfrey, etc.

Table listing advertisers and their page numbers, including Ward R. M. & Co., Yokohama Nursery, Waterer John & Sons, etc.

New Offers in This Issue.

- ASPARAGUS PLUMOSUS SEED. H. P. Michell Co., Philadelphia.
BAMBOO CANES NATURAL AND GREEN: CYCAS STEMS: KUDZU VINE ROOTS.
BEGONIA GLOIRE DE LORRAINE.
DRACAENAS, FERNS, CANNAS.
FLOWER POT HANDLE.
HARDY PERENNIALS.
SHEEP MANURE.

HELP WANTED

GOOD MEN

When you seek good men, skilled or unskilled, Write: THOS. H. BAMBRICK 34 South 7th Street Philadelphia

GARDENER OR SUPERINTENDENT—I can with confidence recommend a man as above, competent, sober, honest and willing. Apply William Downes, Chestnut Hill, Mass.

FOR SALE

FOR SALE Some 30,000 feet of glass in good condition. Will sell at a bargain and on easy terms. Reason for selling don't know anything about the business and can't hire competent men to run the house. H. F. CRAWFORD, Crawford Greenhouses, Montello Station, Brockton, Mass.

Greenhouse Plant For Sale

Consisting of three houses, 32x142, 18x75 and 10x15 respectively, with cold frames and sash. Built by Lord & Burnham Co., steam heated with Burnham boiler. Strictly up-to-date and with every convenience for commercial business. Apply to J. E. Norcross, with Jones, McDuffee & Stratton, 33 Franklin St., Boston.

FOR SALE—A fine estate situated on high ground at Hyde Park, Mass., near Milton. Two minutes from I. R. station, fifteen minutes to Boston. House, 14 rooms and bath, all conveniences. Corner lot, 47,375 ft. land, fruit and shade trees. Greenhouse, 118 x 33, built 1908, 6 on sides, 16 central, 16 x 24 glass. Good opening for commercial florist. Address A. G. Chickering, 53 State St., Boston.

FOR SALE OR RENT—Five greenhouses, house, fire rooms, improvements; barn, carriage house, sheds; all in good repair. One minute to depot, on main street; 20 minutes to Boston; five minutes to two lines of electric cars. Only florist in large town. Established twenty years. For further particulars address E. G. Blaney, Swampscott, Mass.

FOR SALE—Retail nursery, sixth year, doing good, steady and increasing trade. Stock in excellent condition. Only local supply for community of 50,000. For particulars address R. N., care HORTICULTURE, Boston.

FOR SALE—Truck Farm, 36 acres, 10,000 ft. of greenhouses, two dwellings, out buildings, good repair; central to seven towns. Price right to quick buyer. Chapin Bros., Pine Brook, Morris Co., N. J.

GREENHOUSE property for sale; 2 houses, built 2 years; 4000 sq. ft. glass; hot water heated to 65 deg.; 2 acres best land. Modern house of 8 rooms and bath; barn 25 ft sq. Everything first-class. Chas. L. Pierce, Holbrook, Mass.

FOR SALE—Special 16 x 18 and 16 x 24 double thick glass in "A" and "B" qualities. Buy now and save money. Write PARSHLBY BROTHERS, INC., 50 Montrose Ave., Brooklyn, N. Y.



SITUATIONS WANTED

- SITUATION WANTED—By first-class nurseryman; up-to-date landscape man, capable of designing and carrying out landscape work in every detail; forestry work. Salary or commission. References from present and past employers. Full charge money. Would invest money in reliable concern. Married. No drinker. Address Nurseryman, 180 Grand St., Jersey City, N. J.
SITUATION WANTED—As head gardener or superintendent. Twenty years' experience under glass and out doors in all branches. Married; no children; no drinker. First-class references. Permanent place. Address Gardener, 13 Decatur St., Boston, Mass.
Fostling desired as draughtsman and surveyor for landscape architect, or in any civil engineering office. Experience. Address O. B., care of HORTICULTURE.
WANTED TO BUY—Complete greenhouse house plants and all kinds of greenhouse material, to be taken down and removed at once. Terms cash. Address I. Snesserman, 229 Livingston St., Newark, N. J.
WANTED—One Pandanus Utilis, large plant; state size and price. Scott Bros., Elmsford, N. Y.

REVERO

THE MODERN GARDEN HOSE FOR LAWNS, GARDENS, GREENHOUSES, STABLES, ETC.

BRAIDED FABRIC, MOULDED CONSTRUCTION, SEAMLESS THROUGHOUT
 LIGHT—STRONG—FLEXIBLE

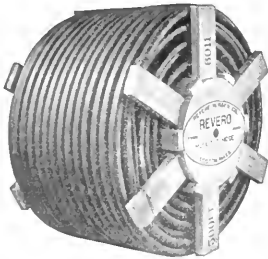

Revero is furnished on Reels in Continuous Lengths up to 500 ft. Your Supply House can furnish "Revero."

Write for Catalog



OLD STYLE—READILY KINKS



REVERO—NON KINKING

REVERE RUBBER COMPANY
BOSTON, MASS.

NEW YORK
 NEW ORLEANS

PHILADELPHIA
 MINNEAPOLIS

PITTSBURG
 SAN FRANCISCO

CHICAGO
 PORTLAND, ORE.

STANDARD PLATE GLASS CO.

Manufacturers—Importers—Jobbers

NOW IS THE TIME TO BUY

FRENCH OR AMERICAN GREENHOUSE GLASS

LOWEST PRICES ON REQUEST

26-30 Sudbury St. BOSTON, MASS. 61-63 Portland St.

GLASS

Always Write Us Before Buying
SHARP, PARTRIDGE & CO.
 22nd and Lumber Streets, CHICAGO
 WE HAVE SOME SNAPS

BOSTON PLATE & WINDOW GLASS CO.

GREENHOUSE GLASS

GERMAN AND AMERICAN

261 to 287 A Street BOSTON 20 to 22 Canal Street

Holds Glass Firmly
 See the Point **PEERLESS**
 Glazing Points are the best. No putty or telfer. Box of 1,000 points 75 cts. postpaid.
HENRY A. DREER,
 214 Chestnut St., Phila., Pa.

USE THE BEST.
Economy Greenhouse Brackets
 are used by leading growers everywhere. Send for price list and descriptive circular.
BUXTON & ALLARD, Dept. A, Nashua, N. H.

The Payne Steel "T" Bar Greenhouses

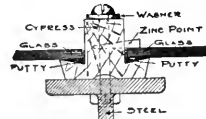

The Lightest The Strongest

Half full Size

HOUSES of this type are constructed with both curved glass eaves and straight glass eaves. Least amount of shadow. Least amount of wood. No drip. Greatest durability.

JOHNA. PAYNE

Greenhouse Designer and Builder
 260-274 Culver Avenue

JERSEY CITY, N. J.

GLASS

Greenhouse and Hot Bed

SIZES OUR SPECIALTY
 IMPENSE STOCK

Plate and Window Glass

Write for Our Prices

PARSHELSKY BROS., Inc.

59 Montrose Ave., BROOKLYN, N. Y.

MASTICA

FOR Greenhouse Glazing

USE IT NOW.
F. O. PIERCE CO.
 12 W. BROADWAY
 NEW YORK

Mastica is elastic and tenacious, admits of expansion and contraction. Putty becomes hard and brittle. Broken glass more easily removed without breaking of other glass as occurs with hard putty. Lasts longer than putty. Easy to apply.

PATENTS

Trademarks and Copyrights

Send your business direct to Washington. Saves time and insures better service. Personal attention guaranteed. Twenty-five years' active service. SPECIALTY: "Working on the Failure of Others."

SIGGERS & SIGGERS

PATENT LAWYERS

Box 9, National Union Building
 Washington, D. C.

THE QUESTION OF STRENGTH

IT is conceded that the strongest and most durable structure known is "THE IRON FRAME." And when you have all the Modern features combined in this type of construction you have "The Ideal Greenhouse."

The picture shows the beautiful symmetry of my "Curved Iceless Eave" — no heavy antiquated shading members. And I also make a speciality of having my work harmonize with surrounding conditions. Note how the mason work on greenhouse conforms to that on adjacent stable.

The advice of "The Practical Greenhouse Builder" is at your disposal for the asking.

WILLIAM H. LUTTON
West Side Ave. Station, JERSEY CITY



Erected at Davenport Neck, New Rochelle, N. Y.

KROESCHELL BOILER

MADE OF FIRE BOX FLANGE PLATE
Can not Crack

Water Space in Front, Sides and Back
The Most Popular Boiler Made

SEND FOR CATALOGUE.

KROESCHELL BROS. CO.
35 Erie Street, CHICAGO, ILL.

Please Note
that this is not a $\frac{1}{2}$ in. wire affair but it is made of heavy rods.

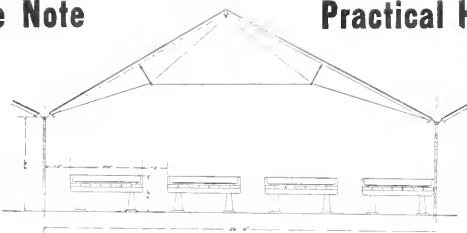

Practical Houses

on a practical financial basis. If you want an up-to-date house that will save you money,

WRITE

GEO. M. GARLAND CO.
Designers and Builders **DES PLAINES, ILL.**

THE STANDARD STEAM TRAP

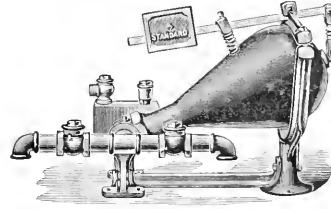

is acknowledged the best for the florist, because it is durable and does its work without trouble and annoyance, saving its cost by the economy in coal bills.

E. HIPPARD

YOUNGSTOWN, OHIO

EVERYTHING FOR GREENHOUSE BUILDING WRITE FOR INFORMATION AND PRICES

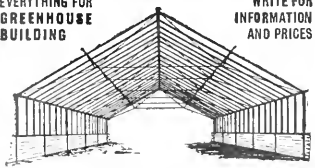

King Greenhouses. King Gutters and Eaves. Trussed Roofs. Ventilating Machinery. Trussed Iron Frame Houses. Title Benches and Pipe Hangers.

KING CONSTRUCTION COMPANY
NORTH TONAWANDA, N. Y.

THE FLORISTS' HALL ASSOCIATION OF AMERICA, insurer of 29,000,000 sq. ft. of glass. For particulars address John C. Esler, Secy, Saddle River, N. J.

The Advance Ventilating Apparatus

Our motto, a square deal — best of goods, easy and long service at fair prices. Get our estimate on your needs. See what we can do for you. Thousands of machines in use in forty states and only five years on the market, certainly indicates high quality of goods and excellent service. Send for our latest prices and circular.

The Advance Co.
RICHMOND, IND.

GREENHOUSE CONSTRUCTION LUMBER

John C. Moninger Co.
117 E. Blackhawk St., CHICAGO.

Evans 20th Century Arm

Will not twist the shafting pipe. Three times the power of old style elbow arms. Sold only with Evans Challenge Machine

Write for free Catalogue to
QUAKER CITY MACHINE CO.
Richmond, Ind.

CYPRESS SASH BARS
82 feet or longer
HOT BED SASH
PECKY CYPRESS BENCH LUMBER

GREENHOUSES

ERECTED AND EQUIPPED COMPLETE IF DESIRED

Write for Circular "D" and Prices

The A. T. STEARNS LUMBER CO.
NEPONSET, BOSTON, MASS.



OUR IRON RAFTER GREENHOUSE

The materials cost more than the less enduring construction, but they cost less to erect.

QUALITY and QUANTITY of blooms exceed other houses, as you know.

You gain in erection costs; save in repair costs and get more money out of your stock. You have a house that will last fifty years and longer.

Write for our figures on your next house.

Hitchings & Company
1170 Broadway New York



The Palm House

PERHAPS you have been thinking that a curvilinear palm house with a tower might cost too much, so why not this even span, straight roofed one? You see they can be made very pleasing in effect.

This one, in connection with several other houses, was erected for the Agricultural College at Storrs, Conn. It is our Sectional Iron Frame Construction.

If this suggestion solves your problem, let us hear from you. If it doesn't, write anyway, for there is no doubt we can give you something else that WILL just fit your case.

Lord & Burnham Co.

Main Sales Office: 1133 BROADWAY, N.Y.
BOSTON: 819 Tremont Building. PHILADELPHIA: 1215 Filbert St.

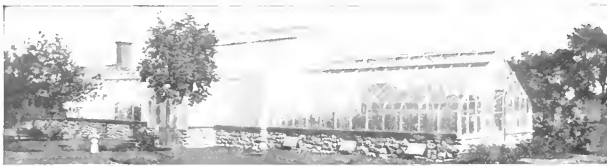

HERE you have a charming little layout, with palm house, two wings and a cosy sort of work room at the end. Perchance this or something similar might suit you? If not, how about the one below?

YOU see in this one the palm house runs the opposite way from the one above, and is considerably larger. The work room is under the left hand house. Of course, there are numerous other combinations that can be made, but in any case the U-Bar construction can never look anything but attractive — it is always the lightest house and so matters least whether located north and south, or east and west.

Let us hear from you

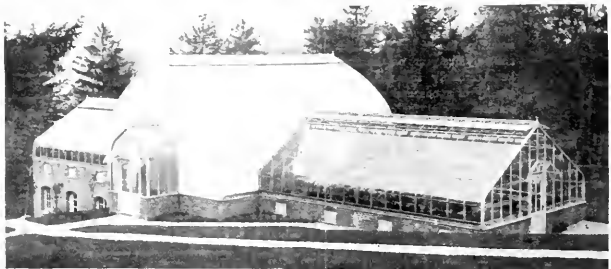

U-BAR GREENHOUSES

PIERSON
DESIGNERS AND BUILDERS



U-BAR CO.
1 MADISON AVE. NEW YORK

HORTICULTURE

Vol. IX.

APRIL 17, 1909

No. 16



ADIANTUM FARLEYENSE.



DEVOTED TO THE
FLORIST, PLANTSMAN, LANDSCAPE GARDENER AND KINDRED INTERESTS

PUBLISHED EVERY SATURDAY AT 11 HAMILTON PLACE, BOSTON, MASS.

SUBSCRIPTION, \$1.00 PER YEAR



CHRYSANTHEMUMS.

"Not small weak runty stock grown under benches, but the kind that brings back Dollars for Pennies."

WHITE: Earliest October frost (We have extra fine large stock of this variety), Mrs. Henry Robinson, Clementine Touset, Alice Byron, Timothy Eaton, Merry Christmas, White Bonnaiffon.

YELLOW: Monrovia, Halliday, Appleton, Bonnaiffon, Eaton, Chataaugus Gold.

PINK: Mc. Niece, Maul Deau, Dr. Eaguehardt, Rosiere.

RED: Intensity, Shrimpton.

All these varieties, rooted cuttings \$2.50 per 100; \$20.00 per 1000. 2 1/2 in. \$3.00 per 100; \$25.00 per 1000.

White Chadwick, Golden Chadwick, Golden Wedding, R. C. \$3.00 per 100; \$25.00 per 1000. 2 1/2 in. \$4.00 per 100; \$35.00 per 1000.

Virginia Poehlmann, R. C. \$4.00 per 100. 2 1/2 in. \$5.00 per 100.

Golden Glow, R. C. \$5.00 per 100. 2 1/2 inch \$6.00 per 100.

CARNATIONS.

Strong well rooted cuttings and 2 1/2 inch stock. Sarah Hill, Afterglow, White Perfection, Victory, Rose Pink Enchantress, Winsor, Beacon, White Enchantress, at \$3.00 per 100; \$25.00 per 1000.

Sarah Hill, Llo. d, Afterglow, Winsor, Beacon, Victory, 2 1/2 in. \$3.50 per 100; \$32.00 per 1000.

Enchantress and White Lawson, R. C. \$2.50 per 100, \$22.00 per 1000.

Enchantress, White, Pink and Variegated Lawson, 2 1/2 in. \$3.00 per 100; \$25.00 per 1000.

O. P. Basset. 2 1/2 in. \$8.00 per 100; 3 1/2 inch \$10.00 per 100.

ROSES. 2 in. or 2 1/2 in. 3 in. or 3 1/2 in. 100 1000 100 1000

American Beauties... \$7.00 \$65.00 \$9.00 \$85.00

My Maryland Grafted strong stock... 30.00

My Maryland Own roots... 12.00

Killarney Own roots... \$3.00 \$25.00 7.50

Mrs. Potter Palmer... 5.00 45.00 6.50

POEHLMANN BROS. COMPANY,

Bridesmaids 2 in. or 2 1/2 in. 3 in. or 3 1/2 in. 100 1000 100

Brides... \$5.00 \$45.00 \$6.50

Richmond... }

Perles... 5.00 45.00 6.50

Kaiser... 5.00 45.00 6.50

Uncle John... 4.00 35.00

Morton Grove, Ill.

NEW CREATIONS IN DAHLIAS

Jack Rose, Virginia Maule, Ethel Schmidt, Sensation, Big Chief, Gladys, Rose Pink Century, Fringed 20th Century, Fringed Beauty. 50 cts. each, \$5.00 per doz., \$35.00 per 100. Strong plants now ready.

PRINCESS VICTORIA. \$1.00 each, \$10.00 per doz., strong plants. A superb collection of new Cactus Dahlias. Send for new descriptive catalogue.

Peacock Dahlia Farms, Williamstown Junc., N. J.

The Carnation that Always Beats Everything in Sight Wherever Shown

BAY STATE

Winner of Gold and Silver Medals. Buy Now. Fine Healthy Stock

ROOTED CUTTINGS, - \$12.00 per 100, \$100.00 per 1000.

ALBERT ROPER, TEWKSBURY, MASS.

CHRYSANTHEMUMS

Rooted Cuttings and Pot Plants. Write for list and prices. ALL OF THE BEST ONES.

S. J. REUTER & SON, WESTERLY, R. I.

CARNATIONS **CARNATIONS**

White Perfection in White Enchantress, \$3.00 per 100; \$25.00 per 1000.

Lady Bountiful, Enchantress, Rose Pink Enchantress, Winsor, White Lawson, \$3.00 per 100; \$25.00 per 1000.

Melody, \$3.00 per 100; \$22.50 per 1000

Our stock won the Cottage Garden Cup at the National Flower Show.

CHICAGO CARNATION CO., A. T. Pyfer, Mgr. JOLIET, ILL.

DAHLIAS. Now is the time to place your order for bulbs which will insure you getting named varieties in any quantity, prompt delivery.

DAVID HERBERT & SON. Successors to L. K. Peacock, Inc. ATCO, N. J.

The Northboro Dahlia and Gladiolus Gardens offer for Spring 1909 350 selected varieties of Dahlias and one and one half million large-flowering Gladioli in mixtures, in lots to suit Seed list of your wants. Catalogue free.

J. L. MOORE, Northboro Mass.

In ordering goods please add, "I saw it in HORTICULTURE"

CHRYSANTHEMUMS

I have now ready 100,000 plants of 300 varieties, Large Flowered, Singles, Pompons, etc. These are fine stock from 2 1/2 inch pots

All the standards such as Robinson, Bonnaiffon, Duckham, Clay Frick, Beatrice May, Mrs. Partridge, Polly Rose in large quantities at

\$3 per 100, \$25 per 1000

Write me what you want and see what I can do for you

CHARLES H. TOTTY
Madison, N. J.

CARNATIONS

Fine Healthy Stock From 2 inch Pots. Per 100 Per 1000

Pres. Seelye - - - - - \$6.00 \$50.00

White Enchantress, Beacon Victory, Winsor, Melody, Kingston Per - - - - - 4.00 35.00

Dahelm, Lady Bountiful, Mrs. Lawson, White Lawson, Red Lawson Variegated Lawson 3 50 30.00

CHRYSANTHEMUMS

Rooted Cuttings

G. W. Childs, Miss Clay Frick, White Shaw, Early Snow, Mrs. Jas. Marshall, Mayor Weaver, The Harriott, Yellow Eaton, \$2.00 per 100, \$15.00 per 1000.

A. J. Blifour, Autumn Glory, Ada Spaulding, Dr. Enguehard Duro by Devens, Geo. Kalb, Glory of the Pacific, Harry Lay, H. W. Reiman, Ivory, Jeanne Nonin, J. E. Lager, J. H. Troy, J. K. Shaw, Dawson, Meta, Monrovia, Mrs. Jerome Jon s, Honie Wanamaker, Mrs. Alice Byron, Mrs. Baer, Mrs. Robt. T. Arthur, Major Bonnaiffon, Tad F. Bergmann, Nagoya, Polly Rose, Robt. Halliday, Timothy Eaton, W. H. Lincoln, Wm. Duckham, etc., \$1.50 per 100.

Send for Catalogue of Roses, cwn root and grafted, and other miscellaneous stock

WOOD BROTHERS
FISHKILL, N. Y.

Send for our Preliminary List describing and quoting

Chrysanthemums and Carnations.

A fine lot of Carnation Cuttings ready now.

THE E. G. HILL CO.,
Richmond, Indiana.

CARNATIONS

WISONA—The true pink—At Indianapolis, in class A, won 1st prize in six entries for best vase of 100 blooms of light pink lighter in color than Lawson. A grand commercial sort in great demand. Place your order now for prompt delivery. \$6.00 per 100, \$50.00 per 1000

F. DORNER & SONS CO.
La Fayette Ind.

AT LAST GOOD YELLOW CARNATION NEPTUNE

A fine flower and a free bloomer. Rooted cuttings from soil, \$6.00 per 100; \$50.00 per 1000.

Also Winsor, Harlowarden, \$3.00 per 100; Lawson, Variegated Lawson, \$2.00 per 100; Fair Maid, \$1.50 per 100.

PAUL THOMSON ESTATE, West Hartford, Conn.

NEW ROSE

WHITE KILLARNEY

We Know You Will Want to Buy White Killarney



Every live, progressive, up-to-date grower who has seen it is buying it; but when you buy White Killarney, be sure you get the right White Killarney (the Waban variety). When you buy from us you get the variety that has been exhibited and certified, and the one that has attracted such favorable mention.

If you are in the vicinity of New York, we should be glad to have you call and see White Killarney growing at our Scarborough range, and you will say at a glance—as everyone has who has seen it growing—that it is by far the best white rose that has ever been placed on the market.

It is not only a good winter-flowering rose, but is good the entire year, and it is a splendid shipper. Read the following letter received from Mr. Willis N. Rudd, Secretary of the Society of American Florists, dated January 18th, in which he writes as follows:

"Dear Mr. Pierson:—I cannot refrain from writing you and expressing my admiration for the White Killarney as shown at Chicago on Thursday. It is an exquisitely beautiful thing and attracted much attention. I took half the blooms home with me, and they were finer on Saturday than they were at the show. The record is that these blooms were shipped from Tarrytown, staged and exhibited during the afternoon. They were then carelessly wrapped up in a box, and remained in that box until one o'clock Friday morning, at which time I reached home; improved in quality up to Saturday, and were in fairly presentable condition on Sunday.

"In addition to being the most beautiful white rose of its class which I have seen, this demonstrates its splendid keeping and shipping qualities."

W. N. RUDD."

We were awarded Silver Cup at National Flower Show, Chicago, for best new rose with White Killarney; also Silver Medal Horticultural Society of New York.

Strong plants, 2 1/4 inch pots, own roots, now ready for delivery, \$30.00 per 100; 250 for \$70.00; 500 for \$125.00; 1000 for \$250.00. Grafted plants, ready April 1st, \$35.00 per 100; 250 for \$82.50; 500 for \$150.00; 1,000 for \$300.00.

F. R. PIERSON CO., Tarrytown-on-Hudson, NEW YORK

ROSES

Grafted MY MARYLAND, BRIDE, BRIDESMAID, KILLARNEY, OWN ROOT.

Own Root RICHMOND, QUEEN BEATRICE.

This is A No. 1 Stock from Prize Winning Sources of highest repute.

2 1/4 to 3 1/4 in. pots. Delivery immediate or will hold until July 1.

MONTROSE GREENHOUSES
MONTROSE, MASS.

Newport Fairy

The Rose of the Future For In and Out Door.

FINE, STRONG FIELD-GROWN STOCK
3-4 Shoots 3-4 ft. long

50c each, \$30 per 100, \$250 per 1000

JULIUS ROEHRS CO.,
RUTHERFORD, N. J.

STOCKS (Gilly Flower.)

grown and shipped in 2 1/2 in. paper pots, no retarding. Great Memorial Week seller, either at pot or cut. Newport Beauty strain of immense size of bloom, Faust delicate pink, Lophistopholes deep blood red, also mixed white, blue, pink, red \$4.00 per 100, 200 for \$7.00.

J. H. Myers, ALTOONA, PA.

A. N. PIERSON, Inc., Cromwell, Conn.

WHITE KILLARNEY (Waban Strain)

GRAFTED STOCK.....	Doz.	100	250	500	1000	2500	5000
	\$6.00	\$55.00	\$82.50	\$150.00	\$300.00	\$687.50	\$1,250.00

MY MARYLAND GRAFTED.....	\$3.00 per doz.	\$30.00 per 100	\$150.00 per 1000
OWN ROOT ..	2.00 " "	10.00 " "	50.00 " "

STANDARD VARIETIES

Bet y. Bon Sil'ene, Bride, Bridesmaid, Cardinal, Enchanter, Etoile de France, Etoile de Lyon, Franz Deegan, Gen. McArthur, Golden Gate, Hermosa, Ivory, Kaiserin Augusta, Victoria, Kate Moulton, Killarney, La Detroit, Maman Cochet, Marechal Niel, Mme. Abel Chatenay, Mrs. Jardine, Mme. Hoste, Mrs. Paul Niehoff, Mrs. Pierpont Morgan, Mrs. Potter Palmer, Papa Gontier, Queen Beatrix, Rhea Reid, Richmond, Rosaline Orr English, Souv. du President Carnot, Souv. de Wootton, Uncle John, Wellesley, White Cochet. The above Grafted (selected plan \$120 cts. each, \$2.00 per doz., \$15.00 per 100, \$120.00 per 1000.

OWN ROOT ROSES

Killarney, Bride, Bridesmaid, Mme. Abel Chatenay, Ivory, Richmond, Mrs. Paul Niehoff, 25c. per 100, \$5.00 per doz., \$35.00 per 100. 2 1/4 in. pots, \$6.00 per 100, \$50.00 per 1000.
Queen Beatrix Rhea Reid, Mrs. Jardine, Mrs. Potter Palmer, from 2 1/2 in. pots, \$8.00 per 100, \$70.00 per 1000.

BEDDING PLANTS

COLEUS, Verschaffeltii, Golden Queen, Queen Victoria, Beckwith Gem, Firebrand, Lord Palmerston. Rooted Cuttings by express, \$0.60 per 100, \$5.00 per 1000. Out of 2 1/2 in. pots in May, \$2.00 per 100, \$15.00 per 1000.
Golden Bedder, Hero, Messy, Pearl of Orange. Fancy Varieties. Twelve kinds not listed above, 75 cts. per 100, \$5.00 per 1000.
AGERATUM, Stella Gurney, Princess Pauline. SALVIA, Splendens, Bonfire and Zurich. HELIOTROPE. Dark blue bedding varieties. GERMAN IVY. 75 cts. per 100, \$6.00 per 1000.
ALTERNANTHERA, Red and Yellow. 50c. per 100, \$5.00 per 1000. From 2 1/2 in. pots, \$2.00 per 100.
SALLEROL, Rooted Cuttings, \$1.00 per 100, 2 1/2 in. pots, \$2.50 per 100.
CHRYSANTHEMUMS IN QUANTITY. Catalogue on Application.

SCOTT BROS. 2 1-2 Inch Stock Now Ready

CHRYSANTHEMUMS

All the Newest and Best Sorts

ROSES Grafted and Own Root for Greenhouse and Outdoors

ELMSFORD NURSERIES, Elmsford, N.Y.

Chrysanthemums: Alice Roosevelt, Virginia Foebmann, dandy midseason whites new, \$4 per 100; \$35.00 per 1000. Mad. Sallierot geraniums, Ice Pinks, \$2 per 100, 3 inch Boston and Whitman Ferns, \$6 per 100. Cash.

I. M. RAYNER, GREENPORT, N. Y.

"The Most Distinct and Beautiful Plant

in Our Easter Stock this Year was Rhododendron Pink Pearl. We could have sold many times the number we had." The above quotation gives the experience of a Leading Fifth Ave., New York Retailer. It voices the sentiment of all who have tried this lovely Rhododendron.

Rhododendron Pink Pearl

The Noblest Representative of its Type.

Color

Richly flushed
Shell Pink,

Flowers

Largest of all
Rhododen-
drons

Trusses

Enormous
Size



Growth

Strong and
Vigorous

Forcing Quality

Has no
Superior

Bloom

Very
Floriferous

Field Culture of Rhododendrons at Bagshot

We are the Holders of the Original Stock

and have an immense number of plants in all sizes to select from for forcing purposes for next season. We anticipate a very heavy call and would respectfully advise placing orders as soon as possible as the earliest orders will be the first to be considered.

JOHN WATERER & SONS, American Nurseries, Bagshot, England

HEADQUARTERS FOR

Conifers, Rhododendrons, Laurels and Specimen Ornaments for the American Trade.

Papaver nudicaule

South of New York sometimes as early as March, around Boston in April and along the sea coast of Maine in May, the Iceland poppies begin to open their nodding, dark green masses of buds. This papaver as native of the mountainous districts of the northern hemisphere is especially well adapted for the climatic conditions of the New England States; at least, I cannot remember having seen it grown to better perfection elsewhere. Hardly has the winter cover of dry leaves been removed when the pinnate, glaucous foliage, which so far had been lying flat on the frozen ground, commences to rise and, within a few days, as a compact clump of thrifty looking leafage reminds us that spring has come again. Soon the egg-shaped buds borne on erect stems appear above the leaves, waiting for the first real warm day to burst open. From now on the Iceland poppy bed is one of the most attractive features of a garden. It is literally aglow with the brightest tints of white, sulphur yellow and red-orange in wonderfully pure solid shades. Light frosts seldom prove seriously injurious to flowers of *Papaver nudicaule*. The next day usually sees them here in the north again swaying in the light May breeze. Their petals possess the same silky lustre as those of the larger flowering annual Shirley poppies. Stems are of good substance, long and thin. Iceland poppies are very useful for table decorations and for filling vases. The length of their spring flowering extends for over a month. After that the plants bloom sparingly until late in autumn, when once more they turn floriferous.



Papaver nudicaule though often classed among the perennials is nevertheless more generally grown as a biennial by progressive herbaceous plant firms. Sowing the seed in spring means a fresh supply of young strong plants for the following year. Like most of the poppies they are rather difficult to transplant while in growing state. It is therefore a wise policy to establish and overwinter plants where they are desired to flower the coming spring. Needless to say, with the necessary care given during the growing season Iceland poppies add much to the cheerful vernal aspect of the garden and homeground.

Richard Rothe

Northeast Harbor, Me.

Roses Under Glass

REPOTTING AND CARE

Repotting is one of the most important of the grower's duties at this season, and stress of other work should prove no excuse for neglecting this duty. Our next season's success depends entirely upon the condition of the stock we plant and if this be weak, starved and pot-bound the produce will find neither a ready nor early market. A half-inch shift is preferred by some growers to a larger one. This, while entailing more work, saves a good deal of room—an item of some importance just now. Plants shifted from a 2½ inch to a 3 inch pot require no drainage. The bulk of the soil added is so small that, providing the soil is properly packed and the material upon which they are set is free from mud, there is no danger of souring.

For a half-inch shift the soil used should be rather fine and not too moist. Disturb the ball as little as possible and leave ample room for water. It is advisable when using new pots not to mix them with the old ones, as they absorb so much moisture that the amount of water necessary in the first watering would reduce the

soil in the old pots to the consistency of mud. Repotted plants should not be allowed to accumulate until there is not a vacant space left in the potting shed. Draughts are very injurious to the soft young growths; and could a more draughty place be devised than the average potting shed?

Young stock, by reason of its soft growing condition, is very susceptible to mildew, and a prey to green fly and red spider, and great care must be taken to guard against these pests if a reputation for good stock is desired.

Watering young plants in pots is a tedious operation if done properly, and to obtain the best results requires good judgment and plenty of patience. When syringing the grafted plants use as little pressure as possible until they are staked and tied, and even then it is not advisable to syringe with the freedom that you would own root stock.

J. E. Simpson

HORTICULTURE

VOL. IX

APRIL 17, 1909

NO. 16

PUBLISHED WEEKLY BY HORTICULTURE PUBLISHING CO. 11 Hamilton Place, Boston, Mass.

Telephone, Oxford 222

WM. J. STEWART, Editor and Manager

SUBSCRIPTION PRICE

One Year, in advance, \$1.00; Ten Foreign Countries, \$2.00; To Canada, \$1.50

ADVERTISING RATES

Per Inch, 30 Inches to page \$1.00.

Discounts on Contracts for consecutive insertions, as follows:

One month (4 times) 5 per cent.; three months (13 times) 10 per cent.;

six months (16 times) 20 per cent.; one year (52 times) 30 per cent.

Page and half page spaces, special rates on application.

Entered as second-class matter December 8, 1904, at the Post Office at Boston, Mass. under the Act of Congress of March 3, 1879.

CONTENTS

Page

COVER DESIGN—Adiantum Farleyense. PAPAVER NUDICAULE—Richard Rothe—Illustrated. 557 ROSES UNDER GLASS—J. E. Simpson. 557 EUROPEAN HORTICULTURE—Frederick Moore. 559 ADIANTUM FARLEYENSE—James Robertson. 559 NEWS OF THE CLUBS AND SOCIETIES: New York Florists' Club—Pittsburgh Florists' and Gardeners' Club. 560 New Jersey Floricultural Society—American Carnation Society—Gardeners' and Florists' Club of Baltimore—Lenox Horticultural Society—St. Louis Florist Club—French Chrysanthemum Society—National Horticultural Society of France—Engelmann Botanical Club. 561 EASTER TRADE REPORTS: New York Cut Flower Market—New York Plant Market. 568 Philadelphia, Chicago, Boston. 568a Baltimore, Buffalo, Detroit, Indianapolis, St. Louis, Washington, A Reminiscence. 568b DURING RECESS: Gardeners' and Florists' Club of Boston. 568c OBITUARY: Bartosa Rodriguez—Warren Baker—Dr. Persifor Frazer—William Freytag—Joseph Sondermann—John Lent—Adolph Mielzele—E. F. Daly. 568c SEED TRADE: Wholesale Seedsmen's League—Legislative Doings—A Thriving Youngster—Beans and Cucumbers. 568d OFF OF INTEREST TO RETAIL FLORISTS: New Flower Stores—Steamer Departures. 570 A Fine Wreath, Illustrated—Flowers by Telegraph. 571 MISCELLANEOUS: Publications Received. 561 Chicago Notes. 562 Easter Brieflets. 562 A Conical Situation. 562 Tariff on Greenhouse Glass—Benj. Hammond. 562 Personal. 568c Patents Granted. 566 Greenhouses Building or Projected. 568d News Notes. 570-575 Philadelphia Notes. 573 Business Changes. 575 Incorporated. 575 Maine Law Affecting Nurserymen. 581

with the wisdom of caution in praising or condemning any flower or plant on its isolated record in any one locality or any one country. In other words even a well-grounded theory based upon practice and experience can sometimes be overturned.

Those who can and do "read between the lines" and are clever in assembling and interpreting movements and tendencies at wide-distance vision are generally disposed to accept as a conclusion that we are now on the eve of an era of great business activity and consequent prosperity. Seed trade, nursery trade, landscape development and the horticultural industries generally are reported to have displayed unmistakable vitality this spring and those who are in a position to judge are unanimous in the belief that, barring unforeseen possibilities of disaster, this is but the beginning of an enormous spring activity to be followed by one still greater next year. This outlook should be taken very seriously into consideration by those of our readers who are in a position to do so and a course mapped out and followed whereby full advantage may be made of it. HORTICULTURE hopes to be taken into partnership in the enterprise which these conditions will surely awaken. No medium exists with better opportunity or facility for contributing the publicity which is an inseparable part of all modern commercial enterprise and none will give more earnest attention and co-operation in any movement on the line of a "bigger, better, busier" horticulture.

We have endeavored to give our readers a rather extended and detailed report in this issue of the Easter trade in various centers, more particularly New York, which is easily the leading flower and plant market in the country. We believe that these reports will be found worthy of careful perusal for it is only when well-informed through the medium of reliable data that the grower can plan his investments wisely and prepare with good judgment for next year's needs. The business of Easter plant growing as a specialty is generally looked upon as one yielding a substantial profit. The manifest prosperity of men who have gone into it extensively fairly justifies this assumption but we rise to remark that its risks are many and the planning which must be done many months ahead requires the exercise of business sagacity of no mean order. It is with a wish to help the growers and dealers who must soon make up their import schedules for next year's material, if possible, that we devote so much space to the details of the Easter results, particularly where these results might be of value in estimating the trend of the demand from year to year. We trust we have covered the ground in a little more useful manner than is the case with most so-called Easter reports and if HORTICULTURE'S efforts are credited with having exceptional value we shall feel well repaid.

Our European correspondent makes interesting reference in this issue to the trouble experienced by British growers in getting good stiff stems of their Enchantress carnations. We think the comment will be looked upon by the majority of American carnation growers as a somewhat singular one, for Enchantress as grown by our experts seldom shows any lack in the respect mentioned. Whatever the cause may be the fact is only one of many which should impress us

"Circumstances alter cases."

European Horticulture

BEGONIA SEMPERFLORENS HYBRIDA DORNROSCHEIN

This beautiful hybrid of *Begonia Socotrana*, fertilised with *B. semperflorens* Lubeca was raised by Herr Moritz König of Wiesbaden. It was, however, like so many other *Socotrana* crosses unnoticed for years, as was the case with *Gloire de Lorraine* which was rediscovered 9 years after its birth, and also with the Veitchian winter-flowering begonias. The bloom is of a silky, pretty rose-pink tint; the leaves are egg shaped and of a fresh green color. The plant begins to form side shoots while yet little more than a cutting, and at a height of 9 inches has become a globular bush and begins to bloom. The plant prefers a light soil, like that found suitable for cyclamens. It is impatient of continuous rainy weather when employed out of doors in beds and groups, the flowers dropping, to reappear on the advent of sunny weather. In the winter season the plant must be placed in a light warm and dry position. If the plant has come through the winter in a good condition, it will afford fifty or more cuttings.

PERPETUAL FLOWERING CARNATIONS

Whether it is the excessive size of the blooms of the present race of the fine American and English carnations and consequently their great weight, or that interbreeding has produced weakness of the stems, the drooping poise of the blooms was very noticeable among those exhibited at the recent show of the Perpetual Flowering Carnation Society. Some of the varieties, notably, *Enchantress* and *White Perfection* had excessively weak stems, and some of them were broken where they touched the edge of the vases. We seem to need greater robustness of growth if the blooms are to remain as large as they now are. Or failing that improvement, a reduction of size in the bloom. Perhaps the addition of silica, or potash, or lime to the soil in which the plants are grown, might impart strength and rigidity to the stems, as these substances do in the case of wheat and other cereals. A drooping carnation may do for plants standing on a window sill, to be observed from below, as we see them in the Tyrol and Italy, but such flowers are out of place in a vase placed on a level with, or below the eye.

A DISEASE OF COFFEE

The cultivation of coffee is being seriously threatened in many parts of the tropical world by a fungus, *Hemileia vastatrix*, nearly allied to rust that infests the wheat plant; and its ravages were very evident about 1880 in the coffee plantations in Ceylon. It is commonly known as the coffee leaf disease, and may be recognized by the clusters of yellow spores which appear mostly on the lower sides of the leaves of affected bushes. So great have been the ravages of this fungus in Ceylon that whereas the exports of coffee from that island were about £3,000,000 in 1880 they now amount to only £25,000. Mr. G. Massee in his "Revision of the genus *Hemileia*" (Kew Bulletin, 1906) gives the geographical distribution. "In the East it is found in India, Java, Sumatra, Malacca, Singapore and the Philippines; also in Mauritius, Madagascar, Fiji and Samoa. In Africa the Arabian coffee has been attacked, namely in German East Africa, Natal, and in the vicinity of Victoria Nyanza. In the northern part of the Transvaal, a small but flourishing industry has been destroyed. The im-

portation of coffee seeds or plant from infected countries is now prohibited."

THALICTRUM DIFTEROCARPUM

This is a Chinese species introduced to British gardens by Mr. Wilson, who found it on mountains 4000 feet above sea level. The plant is hardy in the temperate parts of the world, and is a welcome addition to the herbaceous border; it possesses panicles of small, reddish purple blooms, growing to a height of about 4 feet. The *Thalictiums*, (*Meadow Rue*) are mostly low growing fragile plants, with, in some cases, fern-like leaves; *T. minus*, (*Maidenhair Meadow Rue*) might be easily mistaken for the maidenhair fern. They make pretty objects on the rockery, and the leaves are very suitable for mixing with flowers in bouquets. This Chinese novelty is figured in *The Gardeners' Chronicle* for April 3 last.

THE PROVINCIAL HORTICULTURAL UNION OF HANOVER

As a striking instance of the great activity of a province in matters connected with gardening I take the following from the recently issued report. For a number of years the Union has endeavored to foster among the school children a knowledge of the care and cultivation of flowering plants, to which end it distributes annually 5,000 plants together with printed directions for their cultivation. It likewise fosters the cultivation of plants among the working population in general and members of the Union and inaugurates flower shows and the distribution of plants to the value of 200 m. yearly. By lectures and excursions to celebrated gardens and in other directions the Union does its best to inculcate an interest in all matters pertaining to the garden. At the end of the year 1908 the members numbered 635 and the funds in hand amounted to 6,000 m.

Jacobus Broeze

Adiantum Farleyense

The subject of our cover illustration is an excellent specimen of *Adiantum Farleyense* which variety we believe to be the most graceful of all ferns when well grown. This specimen shown, grown at the R. L. Beekman estate, Newport R. I., is barely two years old and in a 10-inch pot has a circumference of nearly ten feet in the condition shown. And as Mr. Urquhart, the grower, has unflinching success with these year after year we partly state the seemingly ideal conditions under which they are grown. The greenhouse is a low even-span curvilinear with ground glass lightly shaded throughout the year. The night temperature is kept about 75 degrees, and the day temperature higher of course. The main propagating season is in March and April when old plants are broken up and crowns with one eye are put in the open bench of clean sharp sand where they usually root well within two weeks and are potted in small pots and plunged in a bench of moss till they are well established then potted on into larger pots as they seem to demand; finely chopped half-rotted sod with a good mixture of cow manure is used at each shift. Liquid manure of various kinds is also freely used. This house is occupied almost entirely by ferns of this variety, and overcrowding is always avoided.

James Robertson

NEWS OF THE CLUBS AND SOCIETIES

NEW YORK FLORISTS' CLUB.

The attendance at the April meeting of the New York Florists' Club on Monday evening, 12th inst., was very gratifying, considering that it was the day following Easter Sunday. There were between fifty and sixty members present, among the visitors being Wm. H. Elliott, of Boston; E. J. Norman, of Lee, Mass.; W. J. Bruerman, representative of J. Schilpaand & Sons, Hillegom, Holland and H. A. Barnard of Hugh Low & Co., England, the last named gentleman just concluding his first visit to America and about to sail for home full of honors and orders. Mr. Elliott was present for the purpose of reading his paper on rose culture, deferred from the March meeting on account of the death of President Hallock. Easter trade reports have crowded out this very interesting essay, but it will appear in next week's issue. It was to be regretted that so few rose growers were present to listen to it, there being not over half a dozen rose men in the audience. There were no exhibits, the display of roses intended to supplement this lecture having been staged at the March meeting, at which time no business was done, for reasons already stated. Many reports and deferred matters were disposed of at this time. Among them was the report of the committee on awards, giving cultural certificates to F. K. Pierson Co. for White Killarney, Robert Simpson for My Maryland, Mrs. Jardine and Mme. Abel Chateny, to the Brant Hentz Flower Co. for American Beauty, to W. G. Badgley for Killarney, B. Ide and B. Idesmaid, to V. Hanman for Bridesmaid, to A. Farenwald for Richmond and Killarney, and to Henry Hentz, Jr., for B. Ide and Bridesmaid; vote of thanks to F. R. Pierson Co. for My Maryland, Mye & Samman for My Maryland, W. A. Manda for Cherokee and South Orange Beauty, and Robert Simpson for Kate Moulton; first prize, book presented by J. Anstin Shaw, to Watan Rose Conservatories for White Killarney.

The outing committee reported full particulars of the great annual picnic to take place on July 1.

Jos. A. Manda announced that a series of fifteen games would be inaugurated at the bowling alleys next Monday to determine who the five fortunate men would be who should represent New York at the convention in Cincinnati next August. Mr. Manda incidentally suggested that the bowling fraternity were ready to receive anything in the way of prizes which their talents might be disposed to bestow. We hope the response to this will be generous. It would help to stir up the waning sporting spirit of the Metropolitans.

H. A. Barnard brought up the matter of the proposed institution of a national Sweet Pea Association, and

after a discussion by various members a vote was carried offering the courtesy of the club, use of its hall, vases, etc., on the occasion of the opening meeting and sweet pea exhibition next June. Cups for award at that time have been promised by Peter Henderson & Co., W. W. Lawton & Co., A. J. Boddington, W. Albee Burpee, and others are expected.

After the reading of Mr. Elliott's paper a very lively debate ensued. Replying to questions, Mr. Elliott said that in the case of Killarney, growths should be pinched back two consecutive times on young plants; the following growth may be allowed to come to bloom. He had found that Killarneys cut pinched back at some time for a holiday crop would bloom in three weeks; but an Easter cut an interval of seven weeks should be allowed for the crop to come on. Richmond would require four days more. For Carstairs one week longer should be given.

F. R. Pierson talked at some length and very interestingly. He agreed with Mr. Elliott as to the economy of the large modern rose house. The business is rapidly becoming a manufacturing business, with the opportunity of cheap coal, cheap transportation and cheap labor taken full advantage of, and the day of the small grower is gone. Permanency and durability are important factors in the structures of today, which ought to be good for 100 years. You can't build too good and temporary buildings are an extravagance. Mr. Pierson said he was inclined to go back to the system of solid borders, partially because of the saving in the matter of renewal of soil and plants as compared with benches. Incidentally he remarked that the much dreaded eel-worm is principally dryness.

Mr. Elliott was asked whether he found the heating and management of a 1,000 foot house to compare favorably with that of an equal space cut up into a number of smaller houses, and his reply was Yes, because of simplicity of operation, the even distribution of the heated air over the lower part of the house and the short time required to reach the men their required duties. Patrick O'Mara had some interesting observations to present and H. A. Barnard told of his amazement at the extent of some of the establishments he had visited while in America and the uniform excellence of the product. Chas. Louker deplored the tendency away from art and towards the manufacturing idea in the cut flower industry. A. J. Guttman and John Nugent also contributed to the feast of reason. Mr. Nugent advocating the establishment of a great central market in New York for the sale of flowers, with shipping facilities and other means for preserving the business lost through lack of these things. C. B. Wa harel interogated Mr. Elliott on the length of such bars and the dangers of spliced bars. Mr. Elliott said that he had bars, all one piece, 38 feet in length, but this length was the limit. Spliced bars seemed to be generally looked upon with distavor amongst those present, but they are indispensable in the very wide houses many growers are disposed to build nowadays.

PITTSBURG FLORISTS' AND GARDENERS' CLUB.

Change of Meeting Place.

The regular monthly meeting, April 6th, was the last the Pittsburg Florists' and Gardeners' Club will ever hold in the German Beneficial Union building where the Club has met since March, 1902. The building has been sold and will be torn down May 1st. The hall occupied was convenient and accessible, and the boys will not soon forget the interesting meetings, the fine exhibitions and, above all, the good-fellowship that was cemented by the attendance and companionship at the old hall. President Burki named the executive committee, E. C. Reine-man, Jno. L. Wyland and Jno. Bader, as committee to have in charge the securing of a new meeting place. Meanwhile the May meeting will be held at the rooms of the Pittsburg Cut Flower Co., 222 Oliver Ave.

Headquarters for Carnation Convention.

In the matter of the meeting of the Carnation Convention with us in January, 1930, the exhibition and entertainment committees reported that a hall could be secured at the Fort Pitt Hotel for the exhibition and could be cleared in time and used for the banquet and guest rooms. The Fort Pitt is a new hotel in the business part of the city, convenient and accessible to the theatres, and to Union Station, and its management is first-class. The club authorized the securing and making the Fort Pitt Hotel, corner 10th St. and Penn Ave., Pittsburg, as headquarters of the Carnation Convention for 1930.

The private gardeners' committee for the season June 1929-May 1930 reported a schedule of exhibits for prizes which was accepted and ordered printed.

Exhibits.

The exhibits before the club were not so large and varied as usual, it being too near Easter, but Frank Crook, gardener for J. H. Park, showed three plants of *Cineraria stellata* in 8-in. pots that had a spread of three to four feet each and two pots of *Dendrobium nobile* that showed a great profusion of bloom and were unusually fine specimens. Mr. Crook was awarded a certificate of merit for his exhibit. Phipps Conservatories, Jno. W. Jones, Foreman, showed a variety of hydrangeas in bloom, one of which—*Hydrangea Japonica*—attracted attention from its oddity. There were also a number of specimen plants of Easter lilies.

Keeping Enchantress Carnations.

Mr. Crall, a large carnation grower of Monongahela, having taken notice of the discussion at the last two meetings in regard to the keeping qualities of Enchantress carnations, brought in two bunches of carnations, one each of Rose Link Enchantress and Enchantress, one bunch cut on the 19th of March and the other on the 29th of March. The bunches were in fair condition, especially the one cut the 29th of March. The other was a little the worse for wear but was still presentable. Mr. Crall says he does not wait

until the blooms are fully open before cutting, but lets them develop in water. He grows Enchantress at a temperature of 45-48 degrees, and the cellar in which he keeps the cut blooms has a temperature of about 50 degrees.

The subject for the May number is "Bedding Plants."

H. P. JOSLIN, Sec'y.

NEW JERSEY FLORICULTURAL SOCIETY.

The regular monthly meeting of the New Jersey Floricultural Society was held on April 9 at their rooms in Orange when Charles H. Totty addressed the gathering on the chrysanthemum. His remarks were largely historical of the flower and he predicted even greater development in the next thirty-five years. Cultural features were brought out in the discussion which followed, both departments of which Mr. Totty filled to perfection, the clearness and force of his statements in the first being rivalled by the directness of the second, which distinguish him as both business man and cultivator.

A letter from Daniel MacRorie upon the scenery and flora of the Pacific coast was received with marked approbation. Mr. MacRorie is just in receipt of a large invoice of Philippine orchids of which the cold spring weather so far has prevented the delivery to eastern buyers.

The usual display of the season's flowers was made. A vase of *Andromeda Japonica*, grown in the open, by William Reid, gardener for S. & A. Colgate, filled the room with its fragrance.

J. B. DAVIS.

THE AMERICAN CARNATION SOCIETY.

Nic Zweifel, North Milwaukee, Wis., registers new carnation Badger State. Nelson Fisher x Enchantress; color dark pink like Lawson; size 3 to 3 1/2 inches; very rapid grower and extremely free; flowers do not fade in hot weather; stems long and graceful; Calyx never busts. A money-maker.

Same grower registers new carnation Bright Spot. Lawson x Enchantress; color pure bright cerise of even shade; size 3 1/2 inches; early and very prolific; healthy and strong grower; flowers well shaped, and are good keepers; stems long and wiry; calyx does not burst.

A. F. J. BAUR, Sec.

Indianapolis, Ind.

GARDENERS' AND FLORISTS' CLUB OF BALTIMORE.

The Gardeners' and Florists' Club held their semi-monthly meeting on Monday the 12th. Attendance only fair, attributable doubtless to the strenuous times of Easter. One thing was noticeable in comparison with the previous meeting held on the 29th ulto. At that meeting small spots of pessimism here and there through the audience could be detected, but at the last meeting all this had vanished and the members were shaking hands with themselves and each other. Easter had come and gone and left behind no cause for complaint. F. G. Dokken-wald of New York was a visitor.

LENOX HORTICULTURAL SOCIETY.

The annual Rose and Carnation night of the Lenox Horticultural Society was held in their rooms, Saturday April 3rd, and was a decided success. This meeting was one of the largest and most interesting the society has had for some time, the members turning out in full force, and being amply rewarded for their trouble. Seldom, if ever, has there been seen such a magnificent display of roses and carnations in Berkshire county, and it reflects great credit upon the gardening fraternity of Lenox and its vicinity. An exhibit upon which special praise was bestowed was a vase of rose White Killarney, "Waban Variety", exhibited by F. R. Pierson Co. The flowers staged were in perfect condition, and were awarded a first class certificate—the society's highest award. Another exhibit of sterling merit was a vase of fifty flowers, carnation Bay State, exhibited by the introducer, A. Roper. This seems to combine all the desirable qualities of a first class variety. It is so much ahead of any other variegated carnation as to place it in a class by itself, and was unanimously awarded a first class certificate. The standard varieties were shown by the exhibitors in first class shape. Beacon took the honor as a scarlet white Rose Pink Enchantress, Enchantress, Winsor, Afterglow and White Perfection were equally well shown in their respective classes. The following is the list of the principal awards: A. J. Loveless, first for 24 Enchantress, Winsor, 12 Rose Pink Enchantress and second for 24 Beacon. A. H. Wingett; first for 24 Beacon, 12 White Perfection, Enchantress and Afterglow. S. Carquist; first for 12 Beacon, second for 12 Enchantress and White Enchantress. D. Dunn; second for 12 Beacon and Rose Pink Enchantress. A. McConnachie; third for 12 Enchantress, and White Enchantress. F. Heeremans; first for a mixed vase of fifty, also a diploma for a fine vase of *Gardenia Veitchii*.

The judges were Messrs. E. Jenkins, W. Jack, R. Speire and G. Breed.

Sidney Witney was unanimously elected an active member of the society. E. Jenkins gave an interesting description of the recent Boston Spring Show, which he described as the best exhibition he had ever seen anywhere, laying particular stress on the beautiful Japanese garden arranged by R. & J. Farouhar & Co. and complimented that firm on their enterprise.

After the business of the evening was disposed of refreshments were served, and after cigars had been passed the evening was enlivened with songs and recitations by several of the members present. A most enjoyable evening was brought to a close as the clock struck twelve.

GEORGE H. INSTONE, Secretary.

ST. LOUIS FLORIST CLUB.

The St. Louis Florist Club was unable to hold its regular monthly meeting as advertised on last week Thursday afternoon. There were not enough present to make up a quorum. This was owing to the fact that most of us were kept at home preparing for Easter business. The next meeting will be held on Thursday afternoon, May 12th, at 2 o'clock.

FRENCH CHRYSANTHEMUM SOCIETY.

This flourishing society now counts 772 members. Its official organ "Le Chrysanthème" has just reached its 111th number and we note that the next show and convention of the society will be held at Marseilles towards the end of October next. We observe that the well known raiser Monsieur Ernest Calvat has recently been appointed by the French government an officer d'Academie which is the fourth decoration conferred upon this eminent raiser of novelties.

C. H. P.

NATIONAL HORTICULTURAL SOCIETY OF FRANCE.

The annuaire of this society just issued, is a bulky volume uniform with the society's journal and contains 225 pages. Its contents consist of the annual report for 1908 showing a total increase of members, after allowing for deaths and resignations, of 275 for the year. The rules and list of officers and committees occupy a few pages and the rest of the volume—182 pages is devoted to a list of the various grades of members, and corresponding societies.

C. H. P.

ENGELMANN BOTANICAL CLUB.

The Engelmann Botanical Club held its regular monthly meeting Monday night in the Central High School Bldg., St. Louis. One of the features of the meeting was the lecture of L. P. Jensen, landscape gardener for the Busch Estate, on "Natural Effects in the Planting of Modern Parks and Private Places." The meeting was largely attended by its members and visitors from the trade. W. W. Ohlweiler, the secretary, invited all interested to be present.

PUBLICATIONS RECEIVED.

The receipt of the last month's issue of *La Villa Ed Il Giardino* reminds us that those interested in Italian horticulture will find it a serviceable magazine. The editor is N. Severi and the offices are at 34 Piazza Rusticucci, Rome.

A useful map with key to all the plantations in the Arnold Arboretum of Harvard University, Jamaica Plain, Mass., has just been issued. Visitors to the grounds who are desirous of locating any particular group will find this diagram exceedingly valuable.

Our bright little Belgian contemporary, *La Tribune Horticole* is giving at fortnightly intervals, special plates of photographs of the foreign members of the Ghent Quinquennial Jury. In the last number to hand we notice a series of the English jurors. Short biographical notices in each case are given in the text.

Proceedings of the 18th. annual meeting of the American Carnation Society. This volume is similar to its predecessors, giving the proceedings, discussions etc., at the convention of the American Carnation Society held in Indianapolis, on January 27 and 28, 1909, list of members, etc. An excellent portrait of president M. A. Patten forms the frontispiece.

CHICAGO NOTES.

Wm. J. Smyth must be wondering what will happen next Easter. One year ago, three days before Easter, an automobile came dashing through the large plate glass window on the Michigan avenue side of his store, making a wreck of everything in its path, and on Tuesday of Easter week this year the wind, blowing a gale, forced open the rear door and instantly the \$500 window on the 21st street side passed into the street. Boards were placed up for protection till some old sash could be procured for temporary repair.

C. A. Samuelson had a very pretty Easter window. The floor was covered with moss and the back enclosed with a fence and gate done in white. On either side of the gate were beautiful specimen plants of Lady Gay roses three or four feet high, and gardenias, and a few smaller plants carried out the garden effect.

An event of considerable importance in Chicago is the annual sale of flowers for the benefit of destitute crippled children. The Children's Flower Association, numbering 200, of which Mrs. Lysander Hill is president, was organized several years ago, the object being to sell flowers raised by the children themselves, and has among its patronesses some of the leading society women of Chicago. Last year the sale netted \$1,500 for the organization and this year the amount was doubled. The sale occurs on the Saturday before Easter and cuts quite a figure in the volume of business done by the retail trade, as the flowers sold have long since been far beyond the ability of the little folks to grow. Some florists maintain that a considerable decrease is felt in their sales as a consequence. Prizes were given for the best plants raised by children, and this feature of encouraging children to love and care for plants is in itself one of the best features of the enterprise and far reaching in its possibilities.

Ed. Hauswirth found his first Easter as head of the store to be a successful one. He especially noted the increased demand for Killarney roses. His trade was about evenly divided on plants and cut flowers.

The supply of carnations proved to be larger than anticipated and the price lowered towards the end of the week. Some Enchantress were left over. White was in great demand early in the week. Green stuff sold well and was considered scarce. Short lilies were left over but not in any very large quantities.

Friedman was nicely settled in his new store in connection with the Stratford Hotel on Michigan avenue. Here he has an excellent salesroom, good workroom and basement. Everything is nicely fitted up and he will be better prepared than ever to handle his large trade. Specimen plants of Hiawatha rose were an attractive feature in his window display.

During Easter week a hail storm passed over the north part of Chicago, catching quite a number of florists in its path. About Then lost 1,500 lights of glass, some stock plants and his hot beds containing fancy plants. Julius Ristow, John H. Miller and others lost more or less during the three minutes that the storm pre-

vailed. J. A. Budlong and the Reinbergs also sustained a slight loss.

Mr. and Mrs. O. P. Bassett of Hinsdale have returned from Hot Springs, Va., where Mr. Bassett has been to regain his health.

Many florists found it easier to sell small and medium plants than to sell carnations at \$1.50 per doz.

There was a downpour of rain, accompanied by a strong wind Monday following Easter. All are thankful it did not occur the day before.

EASTER BRIEFLETS.

Bridgeport, Conn.—John Reek & Sons surpassed all previous efforts in their Easter show.

Monson, Mass.—The Fuller greenhouses were kept open evenings to accommodate the Easter visitors.

Lincoln, Ill.—Gullett & Son opened a down town salesroom during the Easter season for the convenience of their patrons.

Greenwich, Conn.—Alex. Mead & Son rented a vacant store on Greenwich avenue for the display of their large Easter stock.

Hartford, Conn.—It needed only the announcement that "The show is on" to make the store of John Coombs on Main street the busiest place in town last week.

Salem, Mass.—W. T. Walke, whose business has grown from one house to seven in the last nine years, opened his houses to the public during the Easter display.

Youngstown, O.—John Walker held his annual reception at his greenhouses at Crab Creek on April 4, and throngs of people took advantage of the opportunity to inspect his Easter stock.

A COMICAL SITUATION.

By one of those funny slips which sometimes happen even in the best regulated of Legislatures the Massachusetts House last week passed to engrossment a bill which forbids any person to give his neighbor a plant, tree or shrub without a grower's license under penalty of from \$25 to \$100 fine.

The bill got by the committee on bills in the third reading and this clause in the original bill was carried along with the plain intention, as its backers stated, of having a State nursery inspection to protect trees and plants from disease and insects. Reconsideration will doubtless be given.

Frank Millang, the wholesale florist of New York City, has been very sick with pneumonia for more than a week, and two trained nurses are in attendance. He is getting along as well as could be expected under the conditions and we hope to report him as out of danger next week.

A Profitable Side Crop

Asparagus plumosus is a main crop with many growers having extensive modern plants but those with less up-to-date establishments, or parts of same defective in lighting or otherwise unsuitable for high grade crops, will find this subject one of the very best. We have prepared a cultural circular giving concise directions how to make money out of this crop. Send for it. No charge. An important feature in asparagus culture is good seed. The P. M. quality of greenhouse grown seed has earned a high reputation for freshness and purity. It is the true nanus and greenhouse grown. Send for trial pkg., 100 seeds fifty cents, if you wish to experiment only. In quantity \$3.75 per 1000 seeds, \$32.50 per 10,000 seeds. Asparagus Sprenger 75c. per 1000, \$5.00 per 10,000 seeds.

S. S. PENNOCK-MEEHAN CO.

1608 to 1620 Ludlow St., Philadelphia, Pa.
1212 N. Y. Ave., Washington, D. C.

ASTER SEEDS

That Will Produce Good Blooms.

CHRYSANTHEMUMS

The Best For Florists.

ELMER D. SMITH & CO.
Adrian, Mich.

TARIFF ON GREENHOUSE GLASS.

The cost of greenhouse glass at present is low. The Payne bill for greenhouse sizes remains the same; it is to be expected that a combination will be made to bring higher prices. The Tariff Committee of the Society of American Florists urge each user of glass to write to their State Senators and Congressmen requesting a reduction of at least a half a cent a pound on common window glass. The rate of glass, if it is to be affected at all, can only be done by prompt action on the part of an extended constituency. The Society in their annual meetings have at various times expressed very decided feelings upon this matter of high cost of glass, and one of the primal causes was that competition from abroad was out of the question. The present status of the bill before the Congress is not past the debatable point, but what is to be done should be done at once, and every man who has any direct interest in the matter can do his part if he informs personally his Congressmen and the Senators from his state what his views are.

BENJAMIN HAMMOND.

Mois Frey has retired from the superintendency of Lincoln Park, Chicago, and has started in actively at his own place at Crown Point, Ind.

Headquarters for Asparagus Plumosus Seed New Crop

GREENHOUSE CROWN		LATH HOUSE CROWN	
100 seeds, .50	5,000 seeds, \$17.50	100 seeds, .40	5,000 " \$12.50
1,000 " \$8.75	10,000 " \$32.50	1,000 " \$27.75	10,000 " \$23.00

Write for Our Wholesale Catalogue

HENRY F. MICHELL CO.,
1018 Market Street,
PHILADELPHIA

ORCHIDS

We have just received the following Orchids in superb condition and solicit your inquiry for same.

Phalaenopsis amabilis, P. Schilleriana, VANDA SANDERIANA

Oncidium varicosum Rogersii, O. splendendum, O. crispum, O. Forbei, O. sarcodes, O. Wentworthiana, Odontoglossum grande, Miltonia candida, M. spectabilis, M. flavescens, Lycaste Skinneri, scuticaria Steelii, Zygopetalum crinitum, Z. Gautieri, Cattleya Wernerii.

To arrive in a few days: **Cattleya Trianae, Odontoglossum crispum, Cattleya labiata, Dendrobium formosum, D. noble, D. thrysiflorum, Vanda coerulea, Cattleya Percivaliana, and many more.** Write for prices.

LAGER & HURRELL
SUMMIT, N. J.

ORDONEZ BROS., Madison, N. J.

ORCHIDS

CATLYEA MOSSIAE, has arrived in first-class condition.

Our **PRICES** are **LOW** and our **STOCK** is **FIRST-CLASS**. Write us for particulars and prices and by so doing you will be **sure** of the facts.

Plants are **FOR SALE AT THE STORE OF**
AUGUST MILLANG
41 WEST 28 STREET, NEW YORK

JUST ARRIVED

Fine Importation of

Oncidium ornithorrhynchum

Fine strong leafy plants.....\$1.50 each. \$18.00 doz
Few specimens.....2 50 "

JOSEPH A. MANDA, West Orange, N. J.

ORCHIDS

We are booking orders now for delivery early in the Spring on all commercial **CATLYEAS** and **NOVELTIES**. Our prices are right and our guarantee perfect. We sell only first-class goods.

CARRILLO & BALDWIN, Secaucus, N. J.

IMPORTED ORCHIDS

Now Arriving

Julius Roehrs Co.

RUTHERFORD, N. J.

ORCHIDS

Largest Importers, Exporters, Growers and Hybridists in the World

Sander, St. Albans, England
and 235 Broadway, Room 1
NEW YORK CITY

CATLYEA TRIANAE

Fresh Stock. Just Arrived.
in good time to make strong growth
and flower this season.

Dendrobium Wardianum, noble and thrysiflorum fine specimens,
\$2 00 to \$3.00 each.

G. L. FREEMAN, 388 Appleton St., Holyoke, Mass.

Palms
Shrubs



Ferns
Perennials

Send for Our Catalogue.

The **GEORGE WITTOLD CO.**, 1657 Buckingham Place, Chicago, Ill.

FERNS FOR DISHES,

Assorted Varieties
From 2 inch pots, \$3.50 per 100; \$30.00 per 1000

FRANK OECHSLIN

CASH WITH ORDER
2570 to 2606 W. Adams St., Chicago, Ill.

COLEUS! COLEUS!

C. Verschaffeltii and Golden Bedder, - - - - - R. C.	Pr 100	Pr 1000
Same in 3/4 in. pots - - -	60	5 00
Coleus , flxed - - - - - R. C.	2.00	15.00
Same in 3/4 in. pots - - -	.60	5.00
Same in 1/2 in. pots - - -	1.75	15.00
Ageratum Stella Gurney and Pauline - - - - - R. C.	.50	4.50
Same in 3/4 in. pots - - -	1.00	9.00
Feverfew - - - - - in 2 1/2 in. pots	2.00	
Fuchsias , our selection, in 2 1/2 in. pots	3.00	
German Ivy - - - - - R. C.	.75	
English Ivy - - - - - R. C.	1.00	

Cash with Order

J. E. FELTHOUSE

148-154 Van Vranken Ave., SCHENECTADY, N. Y.

NEPHROLEPIS MAGNIFICA

THE SENSATIONAL NOVELTY
Strong 2 1/2-in. stock, \$25.00 per 100.

WHITMANII

2 1/2-in., \$40.00 per 1000; 3 1/2-in., from Bench, \$8.00 per 100.

H. H. BARROWS & SON, WHITMAN, MASS.

ROBERT CRAIG CO.

ROSES, PALMS,

and Novelties in Decorative Plants

MARKET and 49th STREETS., PHILADELPHIA, PA.

Gladiolus Brenchleyensis

Extra fine Healthy Imported Stock
1,000 \$10.00 10,000 \$80.00

O. V. ZANGEN

HOBOKEN, N. J.

THE BOSTON VIOLET

Unequaled for Productiveness,
Beauty and Popularity.

In Crop from September to May.
Plants \$2.00 per doz. \$12.00 per 100; \$100.00 per 1000
Princess of Wales \$15.00 per 1000.

WILLIAM SIM, Cliftondale, Mass.

PANSY PLANTS

Fine Plants ready to bloom, of my well known strain, \$2.50 per 100; large plants in bud and bloom, \$5.00 per 100, \$8.00 per 1000.
GERANIUMS, best kinds, double **PETUNIAS** (Dreco's), **VINCA** var., **PINK OK IVY**, **SIOXKS** fine plants, 2 1/2 in., \$2.00 per 100; 30 for \$5.00.
CABBAGE PLANTS, E. J. Wakefield, ready to plant out, \$1.25 per 1000, 5000 for \$5.00.

J. G. SCHMIDT, Bristol, Pa.

Kentias, Arcas, Latanias, Cocos, Phoenix, Araucarias, Rubbers, Crotons, Pandanus, Asparagus, Ferns for Dishes, 200,000 Bedding Plants, also Rooted Cuttings of Coleus at lowest wholesale rates.

Orders taken for imported plants for fall delivery

A LEUTHY & CO.

PERKINS ST. NURSERIES

ROSLINDALE, MASS.

BARCAINS

Ampelopsis Veitelli, 4 in. pots, \$10 per 100; 3 in. pots, \$5 per 100. **Asparagus Sprengeri**, 2 in. pots, \$2.00 per 100. **Cannas, King Humbert**, \$5.00 per 100. **Clematis Punctulata**, 4 in. pots, \$5.00 per 100; 3 in. pots, \$3.50 per 100. **Clematis**, large flowering varieties, 2 year old plants, **Jackmani, Henryi, Andre**, \$3.00 per dozen; **Coccinea**, \$2.00 per dozen.

Carnations R. C. from soil, **Eachantriss, Dorothy, Elben, Flora Hill, B. Market**, \$2.00 per 100; **Winsor**, \$1.00 per 100. **Geraniums**, standard varieties, from 3 in. pots, \$4.00 per 100; 4 in. pots, \$6.00 per 100.

C. EISELE

11th and Westmoreland Streets,
PHILADELPHIA, PA.

HEACOCK'S PALMS

Kentia Belmoreana
7-inch pots.....22 to 34 inches high.....\$2.50 each
7-inch pots.....36 to 38 inches high.....3.00 "
9-inch tub.....42 to 48 inches high.....5.00 "

Made up **Kentia Forsteriana**
7-inch pots.....34 to 36 inches high.....\$2.50 each
7-inch pots.....36 to 38 inches high.....3.00 "
9-inch tub.....42 to 48 inches high.....5.00 "

Joseph Heacock Co., Wyncote, Pa.

PALMS AND FERNS

DECORATIVE PLANTS

JOHN SCOTT

Rutland Road and E. 45th St.
Tel. 2896 Bedford **BROOKLYN, N. Y.**

Dracaena Indivisa, 4-in. 10c. **Scotti** and **Boston Ferns**, 4-in. 12c.; 5-in. 20c. **Asparagus Plumosus**, 2-in. S2; **Sprengeri**, 2-in. S2, 3 in. \$4, 4 in. \$6. **Vinca** var., 2 in. S2. **Cantus** **Eachantriss**, **David Harum**, **Marlborough**, **America**, **Pennsylvania**, **K. Gray**, **Black Beauty**, **Alphonse Duvoyier**, **11.75** per 100. **English Ivy**, R. C. 75c. per 100. **Hydrangea P. G.**, 3 ft. Sc. 1 1/2 ft. 5c.

J. H. DANN & SON, Westfield, N. Y.

Begonia Gloire de Lorraine

Leaf Stock, June Delivery, \$15 per 100,
\$145 per 1000

Stock guaranteed to be absolutely free from disease.

THOMAS ROLAND, NAHANT, MASS.

50,000 Surplus Cannas 50,000

We have the following surplus Cannas on hand, either F. O. B. Chicago, or New York. They are in fine condition and absolutely true to name and packed 250 in a case.

Crimson Shades

- A. Bouvier, 5 ft.
- Alice Roosevelt, 4 ft.
- Beaute Poitevine, 3½ ft.
- Charles Henderson, 4 ft.
- Crimson Bedder, 3 ft.
- Duke of Marlborough, 4½ ft.
- J. D. Eisele, 5 ft.
- Exploateur Crampbel, 5½ ft.
- Express, 2 to 2½ ft.
- Flamingo, 4½ ft.
- Pres. McKinley, 2½ to 3 ft.

Pink Shades

- L. Patry, 4½ ft.
- Luray, 3 ft.
- Louise.
- Martha Washington, 2½ to 3 ft.
- Mlle. Berat, 4½ ft.
- Tennyson, 5½ ft.

Orange Shades

- Pres. Cleveland,
- Red, Gold-Edged and Spotted.
- Gladiator, 4 ft.
- Cinnabar, 4½ ft.
- Mme Croz, 5½ ft.
- Premier, 2½ ft.
- Souv. de Anton Crozy, 4 ft.

Yellow Shades

- Buttercup, 3½ ft.
- Comte de Bouchard, 4½ ft.
- L. E. Bailev, 4½ ft.

White Shades

- Alsace, 3½ ft.

Bronzed-Leaved

- Brandywine, 4 to 5 ft.
- Black Beauty, true, 5 ft.
- Davia Harum, 3½ ft.
- Egandale, 4 ft.
- Musafolia, 5 ft.
- Philadelphia, 5 ft.
- Robusta, 6 to 8 ft.
- Shenandoah, 6 ft.

Orchid Flowering

- Allemania, 4 to 5 ft.
- Austria, 5 ft.
- Kronus, 5 ft.
- Mrs. Kate Gray, 6 ft.
- Pennsylvania, 5 ft.
- Indiana, 4½ ft.

Chicago Orders may be sent to

The Winterson Seed Store

49 Wabash Ave., CHICAGO, ILL.

50,000 Surplus Cannas 50,000

ARTHUR T. BODDINGTON,

SEEDSMAN

342 West 14th St., New York City.

TAKE YOUR PICK

— AT —

\$1.75 per 100

\$4.00 for Case of 250

\$15.00 per 1000

F. O. B. New York

\$2.00 per 100

\$4.25 for Case of 250

\$16.00 per 1000

F. O. B. Chicago

FROM GROWER TO PLANTER

Ellwanger & Barry's

TREES

Shrubs, Roses Evergreens

and **Hardy Plants**

Are Famous The World Over

Best stock at reasonable prices. No agents. Commission saved. Collections unequalled. Beautiful illustrated catalogue mailed free on request.

MOUNT HOPE NURSERIES
ESTABLISHED 1840 Box T, Rochester, N. Y.

We have on hand a large consignment of

Japanese Bamboo Canes

Fine Strong Quality.

NATURAL	Per 1000
6 ft. heavy, original bundle of 4500 @	\$4.25
1 ft. medium, " " 2500 @	3.50
5 ft. pencil thickness " " 5000 @	3.25
4.5 ft. " " " 5000 @	2.75
3 ft. " " " 5000 @	2.25

GREEN COLORED

1½ ft. original bundle of 4000 @	\$1.20
2 ft. " " " 4000 @	1.85
2½ ft. " " " 4000 @	3.00
3 ft. " " " 4000 @	3.50
3½ ft. " " " 4000 @	3.75

Sold in original bundles only. Samples on application.

Cycas Stems

Fine straight stems, in case lots of 500 lbs. assorted. 4—10 lbs., ½—4 lbs., ½—2 lbs., 2—10 lbs. \$19.50 per case.

Kudzu Vine Roots

Strong heavy quality.....1000 @ \$50.00
" " " " 100 @ 7.50

The Yokohama Nursery Co

31 Barclay St., N. Y. City.

IPOMOEA NOCTIFLORA

Best pure white moonvine in the market, very fragrant and as big as a saucer. On this variety we have a world-wide reputation as growers and shippers for the last twenty years.

Price, 2½ in. pots, \$5.00 per 100. 10,000 are now ready.

Godfrey Aschmann

1012 West Ontario St., Philadelphia, Pa.

A 256 PAGE BOOK FREE

Every gardener or greenhouse owner will want one of these books. It contains over 2500 valuable hints and pointers for the grower and 700 remedies for diseases and insects. It gives you formulas for standard remedies and is worth \$5.00 to anyone who is in the trade.

WRITE FOR THIS BOOK

If you have no printed letter head send us 25c to pay the cost of printing and the postage and the book will be sent to you promptly. You will never regret buying one of these books and if you have a printed card, envelope, letter head or stationary of any kind, you will get the book, postage prepaid, free of cost.

JOHN C. MONINGER CO., 117 E. Blackhawk Street, **CHICAGO**

FOR "POT LUCK" TRY US... HEWS STANDARD POTS

POT MAKERS FOR 140 YEARS

WORLD'S LARGEST MANUFACTURERS

WRITE FOR CATALOGUE AND DISCOUNTS

Pearson Street,
LONG ISLAND CITY, N. Y.

A. H. HEWS & CO., Inc.
CAMBRIDGE, MASS.

452-460 No. Branch St.,
CHICAGO, ILL.

PATENTS GRANTED.

- 915,146. Plant Support. William H. Woerner, Omaha, Nebr.
- 915,247. Boiler Flue Cleaner. Richard W. Hamann, St. Louis, Mo., assignor to Eugene J. Feiner, St. Louis, Mo.
- 915,696. Fruit Holding Receptacle. Frank Perry and Otto S. Nordholt, Ludington, Michigan.
- 916,728. Insecticide Distributer. Clinton H. Leggett, New York, N. Y.
- 916,762. Fumigating Apparatus. Clarence E. McFadden, near Fullerton, Cal.

STANDARD FLOWER POTS

Packed in small crates, easy to handle.

Price per crate	Price per crate
1500 2 in. pots in crate \$4.88	144 6 in. pots in crate \$3.16
1500 2 1/2 " " " 5.25	120 " " " 3.00
1500 3 " " " 6.00	60 8 " " " 3.00
1000 3 " " " 5.00	48 9 in. pots in crate \$3.60
800 3 1/2 " " " 5.80	48 10 " " " 4.80
500 4 " " " 4.50	24 11 " " " 3.60
450 4 1/2 " " " 5.24	24 12 " " " 4.80
370 5 " " " 4.51	12 14 " " " 4.80
210 5 1/2 " " " 3.78	6 16 " " " 4.50

HAND MADE

Send pans, same price as pots. Send for price list of Cylinders for Cut flowers, Hanging Baskets, Lawn Vases, etc. Ten per cent. off for cash with order. Address **Hilfinger Bros., Pottery, Fort Edward, N.Y.** August Rolker & Sons, Agts. 31 Barclay St., N. Y. City.

Standard Flower.. POTTS

If your greenhouses are within 500 miles of the Capital, write us, we can save you money

W. H. ERNEST

28th and M Street WASHINGTON D. C.

Syracuse Red Pots

STANDARD SIZES

Florists, we will suit you as to quality and price. Write for catalogue.

Syracuse Pottery Co., SYRACUSE, N. Y.

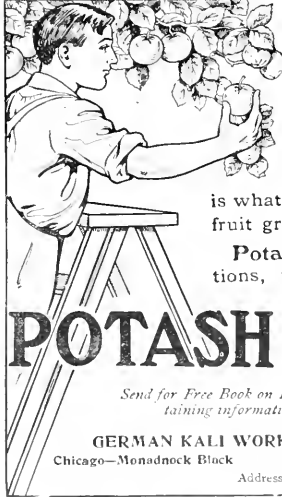

Fruit Full-sized Fine Flavored

appeals to the eye as well as the palate. Its perfection spells market-value.

Quality as well as quantity is what makes the right balance in the fruit grower's ledger.

Potash, when used in right proportions, insures full-sized, sound, richly flavored fruit that carries well and brings high prices.

POTASH

POTASH IS PROFIT

Send for Free Book on Fertilizing, prepared by experts and containing information indispensable to horticulturists.

GERMAN KALI WORKS, 93 Nassau Street, New York
Chicago—Monadnock Block Atlanta—Candler Building

Address Office Nearest You.

**THIS
KILLS
MILDEW
EVERY
TIME**



FOR PARTICULARS WRITE
**Benjamin Dorrance
ROSE GROWERS
Dorranceton, Penna.**

In ordering goods please add "I saw it in HORTICULTURE."

Which Spray Pump

shall you buy? Buy the Spray Pump that fully meets the demands of the Government Agricultural Scientists and all practical Fruit Growers. These pumps are widely known as

DEMING SPRAYERS and are made in 22 styles for use in small gardens or immense orchards.

Write for our new catalog with Spraying Chart. Add 4 cents postage and receive "Spraying for Fruit," a useful guide-book.

CHARLES J. JAGER CO.
281-285 Franklin St., Boston



SPRAYED

TARGET BRAND Weed Killer



Sold at retail by a thousand of seed houses and dealers. Special price in quantities to parks and cemeteries.

TARGET BRAND, Box 732, Martinsburg, W. Va.

Y₁ Fluid

**THE IDEAL WINTER SPRAY
SCALE KILLER & FUNGIGIDE**

POWERFUL CLEANSER AND INVIGORATOR
Mixes Instantly. No Sediment. No clogging. Non-injurious to user
COMPARATIVE TEST WILL PROVE ITS MERITS
Quart, \$1.00; Gallon, \$3.00
1 gallon makes 100 gallons. Write for descriptive pamphlet and testimonny

PROPS. W. COOPER & NEPHEWS
177 ILLINOIS ST. CHICAGO

Gen'l Agent—CYRIL FRANCKLYN, 62 Beaver Street, New York, N. Y.

For Trees, Plants, Shrubs and Flowers

— USE —

THE NIAGARA BRAND LIME SULPHUR SOLUTION

It destroys Scale Lice, Spiders and all forms of Aphides, AT THE SAME TIME Mildew, Blight, Rust and other Fungus difficulties.
Used in Winter or Summer. — No other remedy has been so universally effective.
Niagara Brand ARSENATE OF LEAD for chewing insects is equal to the best and better than the most.
Ask about our Green House sprayer. Address —

NIAGARA SPRAYER CO., - - Middleport, N. Y.

MASSACHUSETTS

Experiment Station Analysis
Average three years
63%
SOLUBLE PLANT FOODS

EASTERN CHEMICAL CO.
Pittsburg Street, Boston, Mass.

KILMDEAD

The best of all
the tobacco
dusts for



Dusting or
fumigating

25 lbs. \$1.00	100 lbs. 5 00	1000 lbs. 27 00
50 lbs. 1 75	500 lbs. 14 00	2000 lbs. 52 50

Stump & Walker Co. 50 Barclay St., New York.

DON'T EXPERIMENT

USE

To-BAK-INE

and your stock will be free from insects, clean, and the blooms will not be discolored.

Send for full information of

H. E. FISKE SEED CO.
13 Faneuil Hall Sq., Boston, Mass.
STUMPP & WALTER CO.,
50 Barclay St., New York.
HENRY F. MICHELL & CO.,
1018 Market St., Philadelphia.
E. H. HUNT, Gen'l Agent,
76-78 Wabash Ave., Chicago.

"Every Bug Has his Dose."

Insect-destroying preparations that do their work well and effectively are the cheapest. Bowker's Arsenate of Lead and Bowker's Pyrox are recognized standard insecticides and fungicides for both indoor and outdoor use. Bowker's Insect Emulsion destroys many kind of plant lice, black and green flies, etc. Call or send for catalogue.

BOWKER INSECTICIDE COMPANY
43 CHATHAM ST. BOSTON



The Best
Bug Killer and
Bloom Saver

For PROOF
Write to

P. R. Paletthorpe Co.
OWENSBORO, KY.

SOMETHING NEW for GREENHOUSES

"SULFOCIDÉ"

PRATT'S
SOLUBLE SULPHUR SUMMER SPRAY

Non-caustic and non-irritating
A FUNGICIDE AND INSECTICIDE
FOR FRUIT TREES, VEGETABLES and GREENHOUSES

A promising substitute for Bordeaux mixture. For 10 cts. to cover postage will send sample sufficient for one gallon of spray.
Use 1 part to 75 or 100 parts of water.

B. G. PRATT CO., 50 Church St., New York, U. S. A.

In writing to Advertisers kindly mention Horticulture

EASTER TRADE REPORTS

NEW YORK CUT FLOWER MARKET.

The General Situation.

Reports vary somewhat as to the amount of cut flower business done as compared with the plant trade and as compared with the flower trade of recent years. Nobody expects a sensational flower trade at Easter nowadays, but it is gratifying to learn that this year the cut flower more than held its own. From the standpoint of the flower grower and wholesale dealer, therefore, Easter for 1909 may fairly be pronounced a success in a general way and there is reason to hope that henceforth both plant and flower departments will make steady growth on parallel lines, neither one at the expense of the other.

Roses.

There was a generous supply of roses but the cut was not phenomenally heavy and acceptable stock was fairly well cleaned up. Early in the week considerable stored stuff was brought in under compulsion of the hot weather then prevailing and at the close the other extreme was reached in the shipment to the markets of quantities of tiny buds in so undeveloped a state that they would never swell under any circumstances. That there are growers silly enough to follow either of these courses today seems incredible, but it is nevertheless true. Of Beauty there was just about enough to go around, a few left. Killarney was the most popular variety but there were some of the most miserable specimens under this name that we ever saw. All through the list the quality varied greatly, from superb down to useless. Reds experienced a lighter demand than the pale varieties and the special classes moved more reluctantly than the medium grades. Bride and Bridesmaid hardly held their own, however, and had the crop been as heavy as it was last year there would have been trouble. Where the dealer showed a disposition to hold up to a specified price they went hard.

Violets.

The receipts of violets were enormous. It was estimated that the shipments from the Rhinebeck district on Friday and Saturday amounted to fully three million flowers. A considerable proportion of these looked as though they should have been picked two weeks sooner and the effect of the spell of hot weather at the first of the week was generally evident. The violet growers were caught by the high temperature and doubtless many high hopes were shattered. Single violets as received were useless as a rule. A tremendous number of violets were unloaded—the majority at bargain figures. They were in evidence everywhere on Sunday, having, with the exception of lily of the valley, a practical monopoly of the corsage wear. It must not be assumed from this fact, however, that fashionable New York has taken the violet back into favor. The great quantity worn was due to their cheapness more than to anything else and the big stores in the swell neighborhoods handled but a few.

Lilies.

The same story as given concerning lily plants will apply here. Predictions of scarcity were well verified. The quality of the stock offered varied greatly, the high grade flowers being in a very small minority. Large quantities of small, soft, raggy lilies were seen on all sides but the demand was so far in advance of the supply that anything which would hold a semblance to a lily found a buyer at some price and the fortunate holders of good ones set the selling figure at whatever limit they chose.

Carnations.

Carnations were in reasonably ample supply and good quality. Looking over the shipments in the wholesale places the preponderance of Enchantress was remarkable. It really seemed as though fully one half of the entire receipts was made up of that variety and in many cases they were of grand quality. The demand for any except the white and the lighter colors was unaccountably weak. Carnations have been bringing such good prices of late as compared with last years record, that an advance in Easter values would not have been surprising. It did not come, however, and prices kept well within last year's limits.

Lily of the Valley and Bulb Flowers.

Lily of the valley surprised its friends. It took on a spurt Saturday afternoon which held out until the close of business on Sunday, cleaning up every existing scrap of the fragrant little flowers which have been so generally neglected of late. Just why or how it happened nobody knows, but the corner was a vigorous one while it lasted. Other material such as daffodils, tulips, callas, hyacinths, etc., was not in over-supply and sold satisfactorily, excepting a large quantity of southern grown daffodils which the street fakirs got at their own price, if they would accept them.

Miscellaneous.

We must confess that we have never realized the possibilities in stock culture until seeing some Beauty of Nice at McManns' which opened our eyes in amazed admiration. We don't know who grew it but hope he will do some more on the same line. Sweet peas were plentiful in all grades of goodness and badness. Extra grades brought fine prices. Orchids were not abundant and gardenias were particularly scarce, the prices soaring. Oncidium ampliatum was a welcome addition to the list of acceptable orchids. Good greens gave but little trouble this year, the accumulation being less than usual at Easter.

NEW YORK PLANT MARKET.

The Selection.

The selection of plants offered for the New York Easter market was not as large as in former years. Lilies, azaleas, rambler roses and hydrangeas were the principal stock seen in all the stores, regardless of location or society grade. Another noticeable fact was the almost entire ab-

sence of large specimens in any line, medium and small-sized plants being carried almost exclusively. One man put the situation very tersely when he remarked that the three to five dollar Easter plant now has its innings in the high-class stores. A good many plants were left over in some of the stores and they were practically all of the higher-cost grade.

"Made Up" Arrangements and Ribbons.

It may be stated further that the elaborate jardinières and other combination arrangements of plants which had such a big run of popularity in New York for a few years back are no longer a controlling feature and the demand for tiny heathers, mosses, ferns and odds and ends of various kinds which were largely used for filling in around the larger central specimens has consequently fallen off. The public fancy turns not only to the low-priced affair but to a single good plant rather than a mixture, and another tendency that cannot be mistaken is toward the abandonment of lavish ribbon and tissue paper adornment such as prevailed in other years. Some ribbon is used but not in quantity approaching even the consumption of last year. Chiffons and such trimmings were very sparingly used, and among the best stores the idea prevails that a good plant requires no decking to sell it. In pots and jardinières there were a good many pretty patterns used, and pot covers of waterproof crepe or more substantial material were quite generally favored.

The General Result.

Overconfidence on the part of the retailers, based on last year's complete clean-up, was the cause of too liberal buying in advance by many who purchased far in excess of their investments of last year, literally cleaning the growers out of everything presentable. The speculation ended somewhat disastrously for some, the stock left on hand after Easter had gone being far too heavy for comfort.

Roses.

Army Muller was a gem among the dwarf growing polyanthas. Tausendschon was an equally sensational success among the true Ramblers. Among the other varieties which have elbowed the once exclusive Crimson Rambler out of its throne were Hiawatha, Delight, Sweetheart, Leuchsterne, Alice Steinhoff, Newport Fairy, Dorothy Perkins, Lady Gay and several others. It may be said in passing that many of these roses lacked in profusion of bloom and the growers might easily improve upon them next year. Among the bush roses Frau Karl Druschki was far in the lead and sold at sight.

Lilies.

Lilies were seen in all degrees of decrepitude—some with stalks not over six inches in height. Superior plants were the exception, yet there were some. All were sold, however in pots or pans, and the call was for many

more than could be found. The apprehensions of two weeks back as to the lily situation were fully justified.

Azaleas and Rhododendrons.

Azaleas were the mainstay of the Easter plant market. They blazed up in great masses everywhere, in stores of high and low degree. They did not strike us as being up to former quality, foliage being scanty and flowers small and soft. Rhododendrons were also inferior, with flowers no larger than a primrose in many cases and giving evidence of overforcing or some other mismanagement. An exception was the variety Pink Pearl. This, as a rule, was simply superb and it was easily the best seller in its class. The flowers were large and the trusses enormous, and a particular quality noted was the fact that the trusses do not all come into bloom at the same moment but follow one another.

Miscellaneous.

Hydrangeas in several varieties were abundant. Most of them well-flowered but some insufficiently hardened off. Daisies were never better. Ericas were seen but sparingly, a few Porellana, regerinmans and Cavendishii in the exclusive stores being the main stock. Metrosideros, snow balls, Japanese cherries, almonds, boronias and a few other things out of the common run were occasionally seen. We almost forgot to mention genistas; these were used only in small quantity and many were left unsold. Acacias were conspicuously absent. Lilacs were very handsome—the best ever, but they were poor sellers. Dwarf bougainvilleas made a grand record. Of spiræas, the Gladstone type was seen in fair quantity, but the old Japonica seems to have been abandoned entirely.

PHILADELPHIA EASTER REPORT.

Cut Flowers.

With the exception of Wednesday, clear, cool weather prevailed, and a very satisfactory business was had—most of the dealers reporting an increase over last year. Wednesday was too warm, and had a bad effect on flowers, especially roses, for the balance of the week. The amount of business done was certainly enormous, and by Friday and Saturday many items were in short supply. This was notably the case with gardenias, lily of the valley, cattleyas and red roses. By red roses we do not mean American Beauties, as these were abundant, especially in the higher grades. Bridesmaids, Jardines and Killarneys were in splendid shape and equal to all requirements. White roses were a little draggy, if anything. Carnations, although good, were a little soft, but they sold well and brought good prices. There were enough violets to go around—mostly doubles. Towards the end orchids went up with a jump to seventy-five, and those who had placed their orders early around fifty were the wise ones. Schrodæra continues the malin variety. A little too light-colored, but the best to be had. Special lavender sweet peas were in great demand, and brought fancy prices. Other colors were good seconds, and the sweet pea men have nothing to complain about. Contrary to expectation, lily of the valley was one of the most called-for

items, and got quite scarce towards the last. Not a spray was to be had in wholesale centers on Saturday evening and retailers were buying from each other. Easter lilies cleaned out wonderfully well, and prices stiffened up considerably towards the last of the week. The market started with 8, 9, 10, 12; but those who had sized up the situation carefully, held out for 15 and 17 for choice stock of the proper length and got it. The calla men made the mistake of holding up their crops too long. They brought better prices early in the game. Good gardenias were very scarce. Fair stock went readily and even rubbish found a market. Snagdragons hung fire. Southern daffodils by the cart-load everywhere; no money in them for anybody. The street men fared well this year on account of the good weather. The business, on the whole, we think was fully equal to previous years. The only complaints we hear, come from the mill sections, such as Kensington, Frankford, Manayunk, etc. These are of course, attributable to the manufacturing depression of the past year and a half.

Plants.

Authorities agree, almost unanimously, that the plant trade this year was the best ever. Clear, cool, sunny weather brought the people out, and the attractive displays along the highways and byways all over the city were irresistible in charming the dollars out of the public pocket. A little hesitation was manifest around the city hall plaza up to Thursday on account of the disastrous weather of 1908, but after that a great transformation took place and the courageous ones reaped a great reward. In the stores, selling commenced on Tuesday and kept up unabated to the end. Everything went, except a few very large ramblers, azaleas and rhododendrons. Medium to small plants had all the call. Azaleas and lilies were the leaders as usual. Spireas, genistas, Rambler roses, deutzias, hydrangeas, daisies, rhododendrons, bougainvilleas, cinerarias, etc., were conspicuous as usual—as were also the lower-priced items, such as: hyacinths, tulips, daffodils, primulas and geraniums. There was nothing particularly new or striking, but most of the stock was well done, excepting lilies—many of these being on the pigmy order. The fault of the bulbs of course. It is impossible for any grower to fail in handling this crop properly. The pigmys went to the department stores and the street men mostly. Houses like Craig were sold out of lilies and azaleas very early and were at their wits end to find stock enough to satisfy their oldest and most cherished customers. Could have sold a great deal more if they had had the goods.

CHICAGO

Now that the Easter holiday is over the vexed lily problem has become a matter of history. Reports from all parts of the city are verifying our prediction that there would not be an over supply of good lilies. No good lilies were left over and they brought better prices on Saturday than earlier in the week. The market closed strong and more could have been sold had they been available. Very few flowers were shipped into Chicago from

the east. Quantities of out-door narcissi were shipped from the south. This did not affect the sales of good home grown flowers, however. Violets were a disappointment all around. Those arriving from the east on Thursday and Friday were worthless owing to the warm weather, but on Saturday quality was better and brought returns.

The Chicago market was at the mercy of a record breaking spell of weather; had the weather been favorable Chicago would have done double the business for Easter. During the week the thermometer ranged from 78 degrees on Tuesday to 20 degrees on Saturday, with a snow storm, a hail storm and a gale. The only real shortage was in Beauty roses. Long ones were in demand and not one half the orders could be filled. Killarney kept up well in quality and many wholesalers could have handled more of these and Richmond had they had them. Bride and Bridesmaid were about equal to the demand.

Owing to the weather and other local conditions many retailers found it unusually hard this year to foresee the demand for Easter. Some laid in a larger supply of cut flowers, especially carnations, than they could dispose of at the advanced price and this trade turned to plants. Others bought heavily of the large plants only to find the demand seemed all for medium.

BOSTON

Boston, in common with most other floral centres, experienced a very satisfactory Easter. The severe weather complained of elsewhere was not in evidence in New England territory, except for the two unseasonably hot days at the beginning of the week and things were generally favorable for those who wished to sell or to buy Easter plants or Easter flowers. The early part of the week was the most favorable as regards wholesale prices. Following time honored custom, growers maintained an embargo on a goodly proportion of their product early in the week, thus contributing to stable values on most things, if fresh, and then let everything loose on Saturday and thus ruined the market on that day by the over-crowding. Prices on many things were considerably lower than at any time during the week. On violets particularly there was abundant evidence of the flowers having been kept too long on the plants; many of them dropped to pieces on being taken from the shipper's box. On lilies the demand far exceeded the supply and they cleaned up in quick order. The advertised prices were adhered to, but there was plenty of opportunity to advance them had the dealer been disposed to do so. Killarney and Richmond were the best sellers among the roses. Bride and Bridesmaid fell a little behind. White carnations made a good record, but the colored ones were too abundant, and of Enchantress there were many more than the market had need for. Sweet peas went off in very lively fashion.

All that can be said advantageously of the plant trade is that it was very strong—in fact, a record-breaker. But only the moderate-sized and moderate-priced things were wanted. The growers sold out clean, well in ad-

vance, and the retailers followed suit when the time came. There was little of any consequence left over. Lilies were cleaned out early and many buyers had to be disappointed.

BALTIMORE The cut flower market generally has kept pretty evenly balanced as to supply and demand, even during the Lenten season there has been little cause for complaint on the part of either the grower or the buyer. There have been occasions when one or two kinds may have fallen a little short, as in the case of violets, etc., but taken as a whole market matters have gone along very satisfactorily. The Easter trade has been fully equal to that of last year—some claim better—and prices have ranged about the same. In addition to the bulbous stock which kept in excellent shape for the Easter holidays, azaleas, roses—of the Rambler type—Bermuda lilies, rhododendrons and hydrangeas were the most popular. The material generally was in fine shape. We noticed that a batch of hydrangeas grown by one of our houses was finished off better than is usual, the foliage being much tougher and the flowers "pinked" up very nicely. The lasting qualities of this kind of plant is so much enhanced by this hardening process and it is withal so easily effected that it is matter for surprise that growers, especially those having customers they wish to retain, are not more careful in this matter. The writer has noticed this defect in the finishing of hydrangeas in cities other than Baltimore. The cut flowers principally handled in this market for Easter are lilies and callas, roses, carnations, peas, violets, etc., with all varieties of bulbous stock, Cattleyas, gardenias, etc., are offered only in limited quantities.

BUFFALO Monday and Tuesday of the past (Easter) week the weather was ideal and every indication pointed to one of the best, if not a record-breaking Easter business. Trade opened up on Wednesday and advance orders for plants and cut stock came in abundance; but a break in the climate on Thursday with an all day rain and the temperature dropping to 20 degrees, saddened the faces of the trade. On Friday an all day blizzard with enough snow for good sleighing did not help but made the situation still worse. The lily was the leader in the plant line and there was no over supply; but all were sold out by the wholesalers as soon as unloaded. Azaleas also sold well while other stock such as bulbous stuff, hydrangeas, roses, rhododendrons and spirea had enjoyed a fair demand. In the cut flower line there is the usual amount to state. Shipping trade was fairly good and orders were filled with no shortage or notations marked "best could do" as stock was plentiful and good. White carnations were in good demand as well as other colors and there were plenty to fill all wants. White Perfection was had in fine quality, also Beacon and Victory in red; Winsor also in fine form. Roses had a good demand, especially Killarney and Richmond, Kaiserin and Carnot, and excellent stock was received and a good cleaning up was had. Beauties were in good supply and the demand

was for short grades and only a fair demand for the long stuff. Violets were in heavy supply and hardly an order was filled that did not call for a few. There was plenty to be had and the wholesaler had enough left over to fill a good many more orders. Lily of the valley was in fine form and sold well, also peas, the demand being for lavender and pink. Cut lilies cleaned up well. Mignonette was carried over, with a good portion of bulbous stock. All in all, reports from the trade state a good Easter business but would have been much better "if" that dreadful snow storm had struck some point further north, as little business was done on Friday.

DETROIT Although the week doled out a composition of weather which was anything but good and its bad effect must have been felt generally, Saturday brought out the buyers in full force and it was not long before last year's record was reached and overcome in quantity of sales with prices same as last year. Medium priced baskets seemed to be preferred to azaleas. Lilies of course held the lead in the plant line. In cut flowers violets were away ahead in demand for corsage wear. Roses and lily of the valley and many other artistic combinations were also great favorites. Everybody is well pleased with the result.

INDIANAPOLIS The Easter trade was very similar to a year ago; perhaps a little better. Prices of lilies, both cut and in pot, were a little higher than before owing to the shortage. The demand for bulbous stock was much better than other years, although quantities of other stock was handled. The list of finely grown flowering plants embraced all the commercial kinds obtainable, but nothing in the way of a novelty was seen. Lilies in pots and tubs were probably the best sellers, next azaleas and Ramblers. Pansies, forget-me-nots, mignonette and Hiac brought good prices. Tomlinson Hall market florists report the biggest trade in years. There were about fifty additional flower vendors about town Easter week, which made inroads on store trade. Every plant grower reports a clean-up, and the majority of the retailers report a most satisfactory Easter trade.

ST. LOUIS The St. Louis Easter trade was large. The cut-flower trade was fully as heavy as in former years and the plant trade was very much larger—some say fully 50 per cent. more than last year. The West End florists report an enormous sale in everything in blooming plants, and some of their show houses look it this Monday morning. In the plant line as well as cut-flowers lilies sold away above all others. Lilies were not too many and everybody reports sold clean out. Azaleas and hydrangeas also had a big call. In other plants everything that looked well sold readily at good prices. Our wholesalers had plenty of everything in roses, carnations, lilies and callas. Sweet peas were in abundance, so was lily of the valley and Von Sion daffodils. California violets, too, were more than enough. These have seen their best days and their quality brought them but small prices. Amer-

ican Beauties in fancy grades were very scarce. Carnations sold well when good. We noticed a great deal of pickled stock in these which, of course, were left unsold. From the reports from the trade in all parts of the city, taking everything in consideration, it was about as good an Easter as we have ever had.

It is claimed by **WASHINGTON** Washington florists that the Easter just ended has been a record-breaker for sales. It was feared at one time when the mercury went tumbling down on Good Friday eve, that business would be injured to no little extent, but such was not the case, for flowers of all kinds were in demand, with the exception of azaleas, which were superseded in favor by the lavender rhododendron. The decrease in both quality and quantity of the Easter lily is causing some concern, and unless something is done, and that right soon, to ward off inferior stock being brought into the country, Easter will have to be represented by another emblem. In this section fruit is not far advanced and it is thought that the recent "snap" did the fruit no harm.

A REMINISCENCE.

Three years ago, following the Easter trade of 1906, HORTICULTURE spoke as follows regarding the violet business:

"Here, indeed, was a Waterloo. Given the brightest, balmiest Easter morning that ever dawned and it would have been beyond the possibilities to find outlet for the avalanche of violets that poured into this market Saturday afternoon. The American Express alone brought 1000 cases, each containing from 2500 to 6000 violets; this accounts for the "cup-Hudson" supply only. Much of this could have been placed through the week previous at fair figures had the growers not hoarded it; as it was, the great majority laid in the crates untouched until Monday. When, if lucky, it went to the greengro for something to cover express charges."

Again, one year later, we referred to the subject as follows:

"Many of them, perhaps half the supply, were of inferior quality and were well-sold at low prices; needless and with dropping prices thousands were sold on the streets which otherwise would have been thrown away and there were some even too poor to elicit an offer of purchase from the smallest street merchant. The grower who imagined it good business policy to keep his stock on the plant until it was no longer a violet will now perhaps see things in a different light."

This year's report on the violet situation corroborates the advice above quoted. But doubtless we shall see the lesson rubbed in every spring for many years to come before it will make any impression on our friends up the Hudson."

The proofreader can sympathise with the Arizona law makers who, in framing a recent horticultural commission bill, provided for the employment of an "etymologist." The Phoenix Republican, in commenting thereon, says, "We need the 'etymologist'" and now that we have got him, though perhaps inadvertently, let us keep him. If the horticulturists think they need an etymologist, let a new bill be passed creating that office."

During Recess

GARDENERS' AND FLORISTS' CLUB OF BOSTON.

The annual banquet and dance of this prosperous organization took place at Horticultural Hall, Boston, on Wednesday evening, April 14. It was one of the worst nights of the season in the way of weather a heavy down-pour of rain with blustering wind making it most unpropitious for such an affair, yet there were over 150 members and their ladies present and notwithstanding its drawbacks the affair was a brilliant success from start to finish. Wit and beauty were there in full quota and music and merriment reigned supreme.

The tables were spread in the lecture hall and were beautifully adorned with flowers, there being no less than fifty large vases of roses, carnations, snapdragons, lilies, larkspurs, salpiglossis and daffodils, contributed by generous members and many hundreds of Killarney and Richmond roses were scattered among the asparagus that would cover the table cloth. We should like to name all the donors but that being impracticable we shall mention none now except to say that Wm. Sim provided an enormous bunch of sweet peas such as he only can grow, for every lady present. Officers, floor directors, aids and all committees are to be congratulated on the completeness of the arrangements and the faultless manner in which they were carried forward until the midnight hour brought the last dance.

Judge C. W. Hoyt, past master of the toastmaster's art outdid his record which all know is a brilliant one. His introductions were felicitous, witty and graceful and his finishing address at the close of the speech making was a gem calculated to inspire everyone connected with the organization with new zeal for its welfare.

President William Downs made a brief introductory speech, appreciative of the good attendance and then introduced the toastmaster who expressed his delight at the opportunity to again meet his old friends, complimenting the club on its prosperity and the fraternal relations which it has for over twenty-one years promoted among the gardeners and florists of Boston. He made a warm, kindly reference to treasurer Edward Hatch, absent in the south on account of illness, but present in spirit and as one well entitled to the love and respect of the horticultural community for his loyal and generous services to the club.

Secretary W. N. Craig spoke next, in words of earnest welcome, topped off with anecdotes told only as this very ingenious gentleman can tell them. He stated that the club's membership is at high water mark at the present time. Vice-president J. W. Duncan followed. He promised something new and sensational in the program for the next regular meeting and invited the ladies to be present at that time. J. K. M. L. Farquhar in a scholarly address referred to the special work being carried on by the club such as the landscape gardening classes and other educational effort, and referred to Edward Hatch as one of the club's staunchest friends. Rob-

ert Cameron spoke briefly in his imitable way and then Peter Fisher was introduced as a man whose reputation encircled the world. He pleaded inability as a speaker but "made good" all the same. Thos. J. Grey, one of the pioneers, made a witty speech, congratulatory and practical in spirit and received with abundant applause. Miss Hannigan contributed some songs, beautifully rendered, and Miss Riford a piano solo. Corbie's orchestra furnished music throughout the evening. "Auld Lang Syne" was participated in by the entire company and Judge Hoyt was declared a "Jolly Good Fellow" in due and ancient form.

Then Floor Director Peter M. Miller assumed his duties and the young blood of Boston horticulture got busy.

PERSONAL.

James Hargreaves has been chosen superintendent of parks at East Liverpool, Ohio.

John Chapman, late of Chicago, has taken a position with Adolph Brix, St. Louis, Mo.

Pierre Schneider, of Kirkwood, Mo., is now in the employ of A. C. Canfield, Springfield, Ill.

Harry Ludwick, of Coatesville, Pa., will be found hereafter with C. P. Bernhard, North Brook, Pa.

George Bestor of Huntington, Ind., fell from a table in his greenhouses and injured himself severely.

John A. Booth, of Newport, R. I., has taken a position as foreman with John E. Thayer, So. Lancaster, Mass.

Harry A. Barnard, representing Hugh Low & Co., England, sailed for home on April 14 on the Manretania.

Frank Moore, of Flint, N. Y., has gone to Baltimore, Md., to take charge of the interests of the Moore & Carvy Plant Co.

Archie Varden, formerly in the greenhouses of the Ames estate, N. Easton, Mass., has taken a position with a florist in Trenton, N. J.

Chas. F. Brown, who sold his establishment at West Grove a short time ago, has taken a position with his brother, James Brown, at Coatesville, Pa.

John Gardner, has resigned as landscape gardener on the Glessner estate, Littleton, N. H., to take the position as assistant horticulturalist at the Baron de Hirsch agricultural school at Woodside, N. J.

On the evening of April 8 a party of friends called upon W. W. Westland, former superintendent to Francis Blake, Auburndale, Mass., and presented him with a purse containing \$60.00 in gold as a testimonial of their esteem and their appreciation of the many kind entertainments they had received around his fireside. Interesting remarks were made by William Riggs, who introduced T. J. Grey as a proper person to make the presentation speech, which he did very feelingly. The gift was gratefully accepted and the heartfelt thanks of the host and hostess returned. A collation was served and a musical entertainment closed a very enjoyable evening.

Obituary.

Bartosa Rodriguez.

This well known botanist, and author of a celebrated work on the Flora of Brazil, according to a communication from Rio de Janeiro, died in that city on March 6, last, at the age of 67 years. He was the introducer of many valuable plants. Born at Minas, he devoted himself to commerce for a time; was at a later date secretary of trade school, teacher of drawing, and lastly director of the botanical gardens at Rio Janeiro. His chief work was entitled "An Iconography of Brazilian Orchids" (14 volumes, illustrated with 1000 colored plates).

Warren Baker.

It is our sad duty to report the death on the 6th inst. of Warren Baker, second son of William J. Baker, the well known wholesale commission florist of Philadelphia. Deceased was 30 years of age and unmarried. Since he arrived at man's estate he was associated with his father in the wholesale flower trade and proved himself an exceptionally loyal and efficient helper in the business. His bright and genial personality made him hosts of friends and customers, and his early demise comes as a distinct shock to the trade generally.

William Freytag.

William Freytag, a well-known florist of Milwaukee, Wis., took his own life by asphyxiation on April 7. He has been in ill health for some time and the cares of business overwhelmed him. He was 43 years of age. A widow and one son survive him.

Dr. Persifor Frazer.

Dr. Persifor Frazer, professor of chemistry for the Pennsylvania Horticultural Society, died April 7th, aged 62. Deceased was famed as a handwriting expert in addition to his scientific standing, in which he had an international reputation.

Joseph Sondermann.

Joseph Sondermann, born in Germany, died in Brooklyn, N. Y., on April 4, aged 63. For thirty years he has been engaged in the florist business in Flatbush.

Adolph Mieliez.

Adolph Mieliez, 74, of Springfield, Mass., a well-known pioneer in floriculture a quarter century or more ago, broke his neck April 18 by falling from a wagon, dying almost instantly.

E. F. Daly.

Edward F. Daly, a florist of 19th street and Prospect Park, West, died at his home in Brooklyn, N. Y., on April 9.

John Lent.

John Lent, a pioneer florist of the Ohio valley, died April 2, aged 70, at the home of his daughter in Etna, Pa.

Seed Trade

AMERICAN SEED TRADE ASSOCIATION.

Watson S. Woodruff, Orange, Conn.,
 Pres.; J. C. Robinson, Waterloo, Neb.,
 First Vice-Pres.; C. E. Kendel, Cleveland,
 O., Sec'y and Treas. Twenty-seventh annual
 convention June 22-24, 1909, at Clifton
 House, Niagara Falls, Ont.

WHOLESALE SEEDSMEN'S LEAGUE.

F. W. Bruggerhof, Pres.; Burnet Lamb,
 Cath, Sec'y.

Wholesale Seedsmen's League.

The meeting of the board of directors called for the 14th inst. has been postponed on account of illness in the families of two of its members. The new tariff bill was the special matter scheduled for consideration. The following letter is self-explanatory:

April 13, 1909.

F. W. Bruggerhof, Esq.,
 Messrs. J. M. Thorburn & Co., New
 York, N. Y.

My Dear Mr. Bruggerhof:—I am very sorry I shall not have the pleasure of seeing you tomorrow as I have just received word that the President of our company is in the same unfortunate position as myself in having a son very ill, therefore, the Board Meeting has been postponed.

Even if I have to come on to New York especially I shall certainly make it a point to do so as soon as I can see my way clear so as to see you personally.

Think you will be interested in the enclosed copy that I have had made from pages 80 and 81 of the new Senate Bill. While this leaves parsley, corn salad, endive, leek, lettuce, salsify, squash and tomatoes at 10c. per lb., yet I think you will agree with me that it is most desirable that we should have specific duties.

With kindest regards,

Sincerely yours,

W. ATEE BÜRPEE.

The following is the excerpt referred to by Mr. Burpee as having been copied from pp. 80 and 81 of the Senate bill.

(Advance Committee Report.)

61st Congress—1st Session.

H. R. 1438.

In the Senate of the United States,

April 10, 1909.

Read twice and referred to the Committee on Finance.

AN ACT—To provide revenue, equalize duties, and encourage the industries of the United States, and for other purposes.

261 Potatoes, twenty-five cents per bushel of sixty pounds.

262 Seeds: castor Beans or seeds, twenty-five cents per bushel of fifty pounds; flaxseed or linseed and other oil seeds not specially provided for twenty-five cents per bushel of fifty-six pounds;

poppy seeds, fifteen cents per bushel; mushroom spawn and spinach seed, one cent per pound; beet, except sugar beet, celery, parsley, radish, turnip and ruta-baga seed, four cents per pound; cabbage, collard, kale and kohlrabi seed, eight cents per pound;

egg plant and pepper seed twenty-five cents per pound; seeds of all kinds not specially provided for in this section, ten cents per pound.

263 Straw, one dollar and fifty cents per ton.

264 Teazels, thirty per centum ad valorem.

265 Vegetables in their natural state, not specially provided for in this section, twenty-five cents per centum ad valorem.

The good work done by individuals in the effort to secure specific duties has been quite conspicuous and the trade at large is under obligations to all of them. One of the most active and earnest workers in this connection has been Mr. J. C. Vaughan of

Chicago, as the following letter of appreciation from Mr. Burpee will show:

April 13, 1909.

Mr. J. C. Vaughan, Chicago, Ill.
 My Dear Mr. Vaughan:—The enclosed copy of letter to D. M. Ferry & Co. will explain itself.

While the writer has worked earnestly with our Members of Congress and Senator Penrose he is inclined to believe that the seed trade owes more to you than to any one other individual in the way of securing the prospects for specific duties.

Very truly yours,

W. ATEE BÜRPEE.

Legislative Doings.

New York state seedsmen and particularly the grass seed houses, were much disturbed over a bill introduced in the Legislature some weeks ago prescribing, as such measures usually do, impossible conditions, but it is not likely to pass at this session, or if it does, its teeth will be drawn. The writer has this from a source unquestionably reliable, therefore the trade need not lie awake o'nights worrying over it.

Most conservative reliable houses admit that the right kind of bill, drawn on reasonable practical lines would be of benefit to honest dealers, and unquestionably some sort of regulation is needed, but the framers of such bills are usually ignorant of the matters they are trying to regulate, and in addition more or less politics is always injected into such measures.

Fortunately for the seedsmen of this state, many of them have "friends at Court," and there is not much danger of any drastic or injurious legislation being enacted. A few such friends at Washington would spare them many anxious hours.

A Thriving Youngster.

Among the younger of the Mail Order houses which has been having a steady and healthy growth may be mentioned the Joseph Harris Co., of Cold Water, N. Y. This business was founded by the late Joseph Harris, one of the foremost agricultural writers of his day, and under the able management of his son, Mr. S. M. Harris, the business has, without the burning of any red fire, attained large proportions, and at the same time has earned a most enviable reputation. The home of this firm is at Moreton Farm, but a few miles from Rochester, N. Y., an ideal country place, and destined in time to become almost as much of a household word wherever seeds are used, as "Fardhook." This firm is a credit to the trade, and young Mr. Harris has earned most hearty congratulations.

Beans and Cucumbers.

No hidden supplies of the Bush lima beans have been uncovered, and the conclusion has been reached that the supply of these beans is exhausted and this is especially true of the Burpee types. The same will be said of the leading varieties of green pod, snap or string beans at the close of the season.

Prices of the standard varieties of cucumbers have eased off materially, but many of the most popular sorts of musk melons are not procurable at all. What another crop failure would mean can be readily imagined.

Cold backward weather still retards counter trade and last week this was of

Aster Seed

Our Aster seed is grown for us by experienced and reliable growers, and cannot be excelled for quality of seed and purity of stock.

Improved Semple's Branching

A strain which has been secured by years of careful selection.

	Tr. Pkt	Oz.
Crimson40	1.50
Lavender40	1.50
Shell Pink40	1.50
Rose Pink40	1.50
Purple40	1.50
White40	1.50
Mixed40	1.50

For other varieties see our General Wholesale Catalogue; a copy mailed for the asking.

HENRY F. MICHELL CO.

1018 Market St.,

PHILA.

a decidedly wintry character. A severe snow storm ending in a hard freeze swept Central and Western New York, and it seemed much more like the middle of January than April.

GREENHOUSES BUILDING OR CONTEMPLATED.

Kankakee, Ill.—Faber Bros., one house.

Somerset, Mass.—Traynor Bros., one house.

Menominee, Mich.—Charles Schultz, additions.

Kennewick, Wash.—C. M. Stockman, one house.

Baldwinville, Mass.—T. J. Symons, one house.

W. LaFayette, Ind.—H. Roth, improvements.

Madisonville, N. J.—Chas. Roberts, conservatory.

Elmhurst, Ill.—Kemel & Wendland, three houses.

Wakefield, Mass.—Edward Winkler, house, 40 x 150.

Greenwich, Conn.—Mrs. E. M. Blake, range of houses.

Murray Hill, N. J.—L. B. Coddington, one house.

Media, Pa.—Asa Bonsell, Cumberland Cemetery, one house.

Albany, N. Y.—Park Dept., house, 26 x 52; propagating house, 11 x 52.

Twin Lake, Mich.—Earl Stearns, one house; Floyd Oliver, one house.

Hoerber Bros. are employing a larger force of men to push work on their new plant at Evanston, just north of Chicago.



Baskets, Crates,
 Ladders, Veneers
 and Boxes.

BACON & CO.
 Appleton, N. Y.

Everything "For the Land's Sake."

The one firm in Boston where all good forms of plant food may be obtained, is the Bowker Fertilizer Company, opposite Faneuil Hall at 43 Chatham St. All greenhouse chemicals, Nitrate of Soda, Ground Bone, Potash Salts, Sheep Manure and Wood Ashes can there be had at first hands.

BOWKER FERTILIZER COMPANY

Everything "For the Land's Sake."

SHEEP MANURE

Pulverized. Free from Adulteration in Bag, \$18.00 per Ton. Cash with Order

ROBERT SIMPSON
CLIFTON, N. J.

CEO. E. DOW
Designing and Illustrating

178 Washington St., Boston, Mass.
OUR SPECIALTY
Machine, Booklet, Advertising and Flower PHOTOGRAPHS

VEGETABLE PLANTS

FOR TRANSPLANTING
CABBAGE—Wakefield and Succession \$1.50 per 1000
EGG PLANT—N.Y. Improved and Black Beauty 40cts. per 100, \$3.00 per 1000
PEPPER—Bull Nose, Ruby King and Sweet Mountain, 40cts. per 100, \$3.00 per 1000
Chinese Giant and Cayenne, 50cts. per 100
TOMATO—Earliana, Chalk's Jewel and Early June Pink, 50cts. per 100, \$2.00 per 1000
Stone, Favorite and Paragon, small plants \$1.00 per 1000.
CELERY—Small for transplanting, White Plume and Golden Self Blanching, \$1.00 per 1000.

CASH WITH ORDER
R. VINCENT, JR., & SONS CO.
White Marsh, Md.

THE PRIZE WINNING STRAWBERRY
The Barrymore

Send for Folder at Once.
H. L. CRANE, Originator,
Westwood Mass.

Mignonette

FARQUHAR'S GIANT

Oz., 75c; 1-4 oz., 25c

R. & J. Farquhar & Co.

6 & 7 South Market Street
BOSTON, MASS.

SHEEP MANURE

IT'S STERILIZED
Free from Weed Seeds.
\$24.00 Ton;
\$7.00 quarter of Ton.

Wm. Elliott & Sons
42 Vesey St., New York

RELIABLE SEEDS—SOW NOW
PRIMULA OBCONICA GRANDIFLORA

	1000 seeds	Tr. pkt.
Blood red, fine seller.....	\$1.50	\$3.50
Real pink, fine for cut.....	1.00	.50
Pure white, fine for cut.....	1.00	.50
Compacta, fine potted.....	1.50	.50
Mixed Hybrids.....	1.00	.50

O. V. ZANGEN, - HOBOKEN, N. J.

LEONARD SEED CO.

CONTRACT CROWERS AND WHOLESALE DEALERS
BEANS, PEAS, SWEET CORN, ONION, GARDEN SEEDS
ONION SETS Get Our Prices 79 and 81
FLOWER SEEDS E. KINZIE STREET, CHICAGO

ESTABLISHED 1802



FINE CLUMPS JAPAN IRIS
TUBEROUS ROOTED BEGONIAS
GLOXINIAS
ROSA MULTIFLORA NANA SEED
and all other flower seeds for florists
SEND FOR CATALOGUE
J. M. THORBURN & CO.
33 Barclay Street
NEW YORK

CAULIFLOWERS
CABBAGE

LILY OF THE VALLEY PIPS.
HJALMAR HARTMANN & CO.
12 Stormgade,
COPENHAGEN, DENMARK.

Burpee's Seeds
PHILADELPHIA

Blue List of Wholesale Prices mailed only to those who plant for profit

Ward's Lily Bulbs

Send for Catalogue
Ralph M. Ward & Co.
12 W. Broadway
NEW YORK

BRIDGEMAN'S SEED WAREHOUSE

RICKARDS BROS.
Props.
37 East 19th St., - NEW YORK CITY

STOCK SEED
FOR WINTER BLOOMING
Our strain of Double Branching Stocks is exceptionally true. About 90% Double Flowers.
In colors: 1/2 oz. .60 oz.\$4.00
Pure White 1/2 " .75 " 5.00
H. E. FISKE SEED CO.
Faneuil Hall Square, BOSTON, MASS.

Winter-flowering
SWEET PEA SEED
All Colors Ask for List
A. C. ZVOLANEK
ORIGINATOR. BOUND BROOK, N. J.

NEW CROP SEED
For Early Planting
THOMAS J. GREY CO.
32 SO. MARKET ST., BOSTON, MASS.

BEGONIAS TUBEROUS ROOTED
ALSO
GLOXINIAS, LILY OF VALLEY, SPIREA
Catalogues mailed free on application
Joseph Breck & Sons Corp.
47-54 NO. MARKET ST., BOSTON, MASS.

BULBS OF QUALITY

Begonias, Single, under color.....	100
" Double " " ".....	\$2.75
" Filled " " ".....	5.00
Gloxinias, under color.....	10.00
Pearl Tuberoses, \$7.00 thous.....	4.00
	1.00

Schlegel & Fottler Co.
26 & 27 So. Market St., BOSTON, MASS.

To Florists Everywhere

Orders for Cut Flowers and Floral Decorations to be delivered anywhere in the Greater New York, may be placed with us with the certainty that your customers will be satisfied.

Telegraph, telephone or mail such orders to us and be sure that they will be filled as promptly and as carefully as though you had it yourself.

One third discount will be allowed on all orders thus placed with us by Florists outside of the Greater New York.

THE BLOSSOM

Bond and Livingston Sts.,
BROOKLYN, N. Y.

C. C. TREPPEL, Manager

**WILLIAM J. SMYTH
FLORIST**

Cor. Michigan Ave. and 31st St., CHICAGO

We ship to all points in Illinois and Iowa.

Phones: Douglas 744, Douglas 523, Douglas 740

**HAUSWIRTH THE
FLORIST**

Out of Town orders for Hospitals
Carefully filled.

**232 Michigan Ave.
CHICAGO**

PHOTORIUM ANNEX Tel. Harrison 585

**SAMUEL MURRAY
Florist**

Coates House Conservatory

1017 BROADWAY, KANSAS CITY, MO.

Both 'Phones 2670 Main.



WASHINGTON,
D. C.

GUDE'S

**The Far-Famed Flowers of
TORONTO**

Delivered on mail or telegraph order for any occasion, in any part of the Dominion.

JOHN H. DUNLOP,
96 Yonge St., - Toronto, Ont.

The Park Floral Co.

J. A. VALENTINE
Pres.

DENVER, COLORADO

**WILLIAM L. ROCK
FLOWER CO.**

KANSAS CITY, - MO.

will carefully execute orders for Kansas City and any town in Missouri or Kansas.



Buffalo, N. Y.

W. J. PALMER & SON, 304 Main St.

**Of Interest to Retail
Florists**

NEW FLOWER STORES.

Coatesville, Pa. S. P. Shrom 317 Main street.

Reading, Pa. I. H. Anderson, proprietor of the Brookside Greenhouses, will open a store for the sale of his stock.

Springfield, Mass. Frank J. Sullivan, proprietor of "The Flower Shop", Worthington street, has taken James P. Linnehan into partnership.

New York, N. Y. Thorley moves this week from the store on Broadway, where he has been located so many years, to 27 West 28th street, near Broadway.

San Francisco, Cal. The retail florists are gradually returning to their old quarters down town. J. H. Sievers

STEAMER DEPARTURES

American.	
New York, N. Y.-S'hampton...Apr 24	St. Louis, N. Y.-S'hampton...May 1
Atlantic Transport.	
Minneapolis, N. Y.-London...Apr 24	Mesaba, N. Y.-London...May 1
Cunard.	
Saxonia, Boston-Liverpool...Apr 20	Campania, N. Y.-Liverpool...Apr 21
Carmania, N. Y.-Liverpool...Apr 24	
French Line.	
La Savoie, N. Y.-Havre...Apr 22	La Touraine, N. Y.-Havre...Apr 29
Hamburg-American.	
Pres. Grant, N. Y.-Hamburg...Apr 21	Kais. A. Vic., N. Y.-Hamburg...Apr 24
Leyland Line.	
Bohemian, Boston-Liverpool...Apr 21	Devonian, Boston-Liverpool...Apr 28
North German Lloyd.	
K'pr. Corflie, N. Y.-Bremen...Apr 30	Koonig Alber, N. Y.-Med. P...Apr 24
K. W. der G., N. Y.-Bremen...Apr 27	
White Star.	
Teutonic, N. Y.-S'hampton...Apr 21	Baltic, N. Y.-Liverpool...Apr 24

has opened on Powell street, the Sievers Floral Co. and the Art Floral Co. have closed their up-town stores and are now on Geary street. Podesta & Baldochi are on Grant avenue, and E. Matria will soon be in that vicinity.

NEWS NOTES.

Fall River, Mass. The greenhouses constructed and equipped by the Weathered Co. of Jersey City, N. J., at Oak Grove Cemetery have just been turned over to the Park board, and will be stocked as rapidly as possible. They are models and are a valuable addition to the cemetery property.

Budapest The Hungarian Horticultural Society in celebration of its existence for a quarter of a century, will inaugurate an international horticultural exhibition in the Palace of Industry in 1910, lasting from May 5 to 15. The undertaking is under the patronage of Archduke Josef. The programme will appear in the Hungarian, German and French languages.

Among the sufferers in the recent wind and hail storm in the vicinity of Chicago were Anton Then, J. A. Budlong, F. E. Carlson, Fred Weber, H. Bauske, W. Krentz, N. J. Kruchten, Peter Reinberg, J. Vacha & Sons, John Miller. All lost heavily, in some places hardly a light of glass being left in place.

ALEX. McCONNELL

571 FIFTH AVENUE
NEW YORK CITY

Telegraphic orders forwarded to any part of the United States, Canada, and all principal cities of Europe. Orders transferred or intrusted by the trade to our selection for delivery on steamships or elsewhere receive special attention.

Telephone Calls, 487 and 488 38th St.
Cable Address, ALEXCONNELL

NEWMAN FLORAL Co.

(Established 1870)

202 Fifth Ave. and Madison Square, NEW YORK CITY

FLOWERS FOR STEAMER SAILINGS

M. A. BOWE

In the Heart of New York City

1294 Broadway

Tel. 2770, 38th St. NEW YORK

Our Motto—The Golden Rule

DAVID CLARKE'S SONS

Deliver orders from any part of the country to
New York City

Or OUT-GOING STEAMERS

Write or telegraph

2139-2141 Broadway, New York
Telephone 1552-1553 Columbus

YOUNG & NUGENT

42 West 28 St., NEW YORK

"FLOWERS BY TELEGRAPH"

NEW YORK

MYER, FLORIST

Phone 5297 Plaza. 609-611 MADISON AVE.

ALBANY, N. Y.

EYRES

Flowers or Design Work

DELIVERED IN ALBANY AND VICINITY
ON TELEGRAPHIC ORDER.

11 NORTH PEARL ST., ALBANY, N. Y.

Flower Deliveries

In Brooklyn and other Long Island Points
New York City, New Jersey, etc. At Theaters,
Hotels, Steamers or Residences.

WILSON

Fulton St. and Greene Ave., Brooklyn, N. Y.

**DANKER, Albany,
N. Y.**

ORDERS FOR

Choice Flowers and
Floral Emblems

FILLED PROMPTLY

WELLESLEY COLLEGE

Daos Hall, Walnut Hill and Rockridge Hall
Schools. TAILBY, Wellesley, Mass.
Tel. Wellesley 44-1 and 2. Night 44-3.

ATLANTA FLORAL CO.

41 Peachtree
Street, ATLANTA, GEORGIA

JOHN BREITMEYER'S SONS

Cor. Miami and Gratiot Aves.
DETROIT, MICH.

Artistic Designs . . .
High Grade Cut Blooms

We cover all Michigan points and good sections of Ohio, Indiana and Canada

PROMPT DELIVERY IN BOSTON

AND ALL NEW ENGLAND POINTS
F. H. HOUGHTON
396 Boylston St., Boston, Mass.

BOSTON'S BEST In Quality and Design

Can be relied upon when you transfer your retail orders to

EDWARD MACMULKIN
194 Boylston Street, Boston

Send flower orders for delivery in
BOSTON

and all
NEW ENGLAND POINTS
THOS. F. GALVIN
124 Tremont St., Boston

A FINE WREATH.



The wreath illustrated was made by Julius A. Zinn of Boston. The choice material of which it was composed

and the faultless arrangement of the flowers are plainly shown. It is an object lesson in good taste.

"FLOWERS BY TELEGRAPH."

Leading Retail Florists Listed by Towns for Ready Reference.

- Denver, Colo.—Park Floral Co., 1706 Broadway.
- Washington, D. C.—Gude Bros., 1214 F St.
- Atlanta, Ga.—Atlanta Floral Co., 41 Peach Tree St.
- Chicago—Hanswirth, "The Florist," 232 Michigan Ave.
- Chicago—William J. Smyth, Michigan Ave. and 31st St.
- Chicago—George Wittbold Co., 1637-59 Buckingham Place.
- Louisville, Ky.—Jacob Schnitz, 550 South Fourth Ave.
- Boston—Thos. F. Galvin, 124 Tremont St.
- Boston—Frank H. Houghton, 396 Boylston St.
- Boston—Edward MacMulkin, 194 Boylston St.
- Boston—Hoffman, Florist, 59-61 Massachusetts Ave.
- Boston—J. Newman & Sons, Inc., 24 Tremont St.
- Boston—Julius A. Zinn, 2 Beacon St.
- Wellesley, Mass.—Tally.
- Detroit, Mich.—J. Breitmeyer's Sons, Miami and Gratiot Aves.
- Kansas City, Mo.—Samuel Murray, 1017 Broadway.
- Kansas City, Mo.—Wm. L. Rock Flower Co., 1116 Walnut St.
- Albany, N. Y.—H. G. Eyres, 11 N Pearl St.
- Albany, N. Y.—F. A. Danker, 49 Malden Lane.
- New York—David Clarke's Sons, 2139-2141 Broadway.
- New York—Alex. McConnell, 571 5th Ave.
- New York—Young & Nuzent, 42 W. 28th St.
- New York—M. A. Rowe, 1234 Broadway.
- New York—Myer, 600-H Madison Ave.
- New York—Newman Floral Co., 202 Fifth Ave. & Madison Sq.
- Brooklyn, N. Y.—The Blossom (C. C. Tredel, Mgr.), Bond and Livingston Sts.
- Brooklyn, N. Y.—Robert G. Wilson, Fulton St. and Greene Ave.
- Buffalo, N. Y.—Palmer's, 304 Main St.
- Toronto, Can.—J. H. Duntop, 96 Yonge St.

THE BEST LETTERS

FOR **R** THOSE
FLORISTS' MADE
USE BY THE

Boston Florist Letter Co.

66 PEARL ST., BOSTON
N. F. McCARTHY, Mgr.

Order direct or buy from your local supply dealer. Insist on having the

BOSTON

Inscriptions, Emblems, etc., Always in Stock

Durand & Marohn

MANUFACTURERS OF
All Kinds of Wire Work
Florists' Wire Designs a Specialty
24 Beaver St., ALBANY, N. Y.

Wired Toothpicks

Manufactured by
W. J. COWEE, BERLIN, N. Y.
10,000.....\$1.75; 50,000.....\$7.50. Sample free.
For sale by dealers



TRANSFER

Your orders for flower or plant delivery in Eastern New England to

JULIUS A. ZINN,
2 Beacon St., Boston
FINE DESIGN WORK ASPE IALTY

Orders by Wire Receive Prompt and Careful Execution

J. Newman & Sons

24 Tremont Street, BOSTON
Theater, Steamer and Funeral Flowers Our Specialty
We can refer to leading florists in all principal cities.
Established 1879.

LOUISVILLE, KY.
JACOB SCHULZ,
550 South Fourth Ave.

FLORISTS' SUPPLIES

Send for New Catalogue
H. Bayersdorfer & Co.
1129 ARCH ST., PHILADELPHIA

SWEET PEAS
 Extra Selected Stock
 \$1.00 per 100
DAGGER FERNS
 \$2.50 per 1000
THE LEO NIESSEN CO.
 1209 Arch St., Philadelphia, Pa.
 Open from 7 a. m. to 8 p. m.

 **American Beauty ROSES**
 SPECIALS, \$35 per 100; FANCYS, \$30 per 100;
 EXTRAS, \$25 per 100; FIRSTS, \$20 per 100
S. S. PENNOCK - MEEHAN CO.
 1608-1620 Ludlow St., Philadelphia

LILY OF THE VALLEY
ORANGE BLOSSOMS FOR APRIL WEDDINGS
W. E. McKESSICK & BROS.
 WHOLESALE FLORISTS
 1619-1621 RANSTEAD ST.
 PHILADELPHIA

WELCH BROS.
 AMERICAN BEAUTY, KILLARNEY, RICHMOND, MARYLAND AND ALL THE SUPERIOR
 ROSES, LILY OF THE VALLEY, CARNATIONS, ORCHIDS
BEST PRODUCED
 226 Devonshire Street, Boston, Mass.

CUT FLOWER BOXES
EDWARDS FOLDING BOX CO
 MANUFACTURERS
 PHILADELPHIA, PA.

CHAS. W. MCKELLAR
 51 WABASH AVE., CHICAGO

Western Headquarters for Choice Orchids
 Valley, Roses and all Cut Flowers

PETER REINBERG
 WHOLESALE
CUT FLOWERS
 51 Wabash Av., Chicago, Ill.

Long Distance Phone, Central 6004
WINTERSON'S SEED STORE
 45-47-49 Wabash Ave., Chicago.

Seedsman, Plantmen, Nurserymen
 Florists' Supplies
 We can supply everything used by the Florist. SUPPLY CATALOG FREE. Correspondence solicited.

POEHLMANN BROS. CO.
 33-35-37 Randolph St., - CHICAGO

CUT FLOWERS
 Greenhouses, - Morton Grove, Ill.

Rice Brothers
 2118 N. 6th Street, MINNEAPOLIS, MINN.
WHOLESALE FLORISTS and SUPPLIES
 CUT FLOWERS received twice daily, and can fill your orders to your satisfaction. A complete line of Hardy Greens - WILD SMILAX, BOXWOOD, HARDY FANCY FERNS, GALAX LEAVES.
 Write for quotations on large quantities.

In ordering goods please add "I saw it in HORTICULTURE."

WHOLESALE FLOWER MARKETS—TRADE PRICES—Per 100 TO DEALERS ONLY

	CHICAGO April 12		TWIN CITIES April 12		PHILA. April 12		BOSTON April 12	
ROSES								
Am. Beauty, Fancy and Special.....	25.00	to 15.00	40.00	to 50.00	50.00	to 60.00	25.00	to 35.00
" Extra.....	18.00	to 25.00	30.00	to 40.00	40.00	to 50.00	12.00	to 15.00
" No. 1.....	12.00	to 15.00	20.00	to 30.00	22.00	to 30.00	4.00	to 8.00
" Lower grades.....	6.00	to 12.00	10.00	to 20.00	8.00	to 20.00	2.00	to 3.00
Bride, 'Maid, Fancy & Special.....	6.00	to 8.00	8.00	to 10.00	12.00	to 15.00	6.00	to 8.00
" Lower grades.....	5.00	to 6.00	6.00	to 8.00	6.00	to 8.00	2.00	to 4.00
Killarney, Fac. & Sp.....	6.00	to 8.00	8.00	to 10.00	12.00	to 15.00	2.00	to 16.00
" Lower grades.....	3.00	to 5.00	6.00	to 8.00	6.00	to 8.00	2.00	to 3.00
Richmond, Fancy & Special.....	6.00	to 8.00	8.00	to 12.00	15.00	to 25.00	12.00	to 20.00
" Lower grades.....	3.00	to 5.00	6.00	to 8.00	8.00	to 15.00	2.00	to 8.00
Chateaux.....	4.00	to 6.00	4.00	to 8.00	6.00	to 15.00	4.00	to 10.00
Golden Gate Ivory, etc.....	3.00	to 6.00	4.00	to 8.00	6.00	to 15.00	4.00	to 10.00
My Maryland.....	6.00	to 20.00
Mrs. Mar. Field.....
CARNATIONS								
Fancy and Rel.....	3.00	to 4.00	3.00	to 4.00	3.00	to 4.00	1.50	to 3.00
Ordinary and White.....	2.00	to 3.00	2.00	to 3.00	2.00	to 3.00	1.00	to 2.00
MISCELLANEOUS								
Carleyas.....	50.00	to 60.00	35.00	to 45.00	50.00	to 60.00	40.00	to 50.00
Lilies.....	10.00	to 12.00	10.00	to 12.00	12.50	to 15.00	10.00	to 12.50
Lily of the Valley.....	2.00	to 4.00	3.00	to 4.00	3.00	to 4.00	1.00	to 3.00
Narciss, Paper White.....	2.00	to 3.00	3.00	to 4.00	3.00	to 4.00	1.00	to 1.00
Roman Hyas.....	3.00	to 4.00	3.00	to 4.00	3.00	to 4.00	1.00	to 2.00
Tulips.....	3.00	to 4.00	3.00	to 4.00	2.00	to 3.00	2.00	to 4.00
Daffodils.....	3.00	to 4.00	3.00	to 4.00	2.00	to 3.00	2.00	to 3.00
Freesia.....	1.00	to 2.00	2.00	to 3.00	2.00	to 3.00	1.00	to 2.00
Nigonelette.....	4.00	to 6.00	2.00	to 3.00	3.00	to 4.00	1.00	to 2.00
Sweet Peas.....	50	to 1.00	75	to 1.00	50	to 1.00	75	to 1.00
Gardenias.....	25.00	to 30.00	30.00	to 42.00	25.00	to 30.00	16.00	to 35.00
Violets.....	50	to 75	50	to 75	50	to 1.00	25	to 50
Adiantum.....	1.00	1.00	to 1.50	1.00	to 1.50	75	to 1.00
Smilax.....	15.00	to 20.00	10.00	to 15.00	15.00	to 20.00	12.00	to 17.00
Asparagus Plumosus, strings.....	10.00	to 50.00	35.00	to 50.00	40.00	to 50.00	35.00	to 50.00
" " & Spreo. (100 bchs.).....	20.00	to 30.00	20.00	to 30.00	40.00	to 50.00	15.00	to 25.00

J.A. BUDLONG
 37-39 Randolph Street, CHICAGO.
Roses and Carnations A Specialty.....
 WHOLESALE GROWER of **CUT FLOWERS**

 **HENRY M. ROBINSON & CO.**
 15 Province St. and 9 Chapman Place - BOSTON, MASS.
 WHOLESALE COMMISSION FLORISTS
Hardy Cut Evergreens and Florists' Supplies
 We have the stuff and can fill all orders, large or small
 WE NEVER DISAPPOINT SATISFACTION GUARANTEED 

Prices Quoted in these Columns are for Dealers Only.
 When Writing to Advertisers Please Mention HORTICULTURE.

PHILADELPHIA NOTES.

A consignment of ten plants of the new hybrid rhododendrons (Metternichii x Catawbiense) has been received by H. Waterer from Japan, and will be carefully tested as to their suitability for the American climate. The variety Metternichii was discovered in Japan about 1875, by Metternich. The new hybrids are remarkable for their fine foliage, and show every indication of being hardy. These ten plants are all that are known to have reached this country so far. The habit is very fine. Colors: white and pink.

A carload of cattleyas arrived at Chestnut Hill recently. These are for a new venture by the enterprising brothers, George and Alfred Burton. Alfred Burton states that one half will go to his establishment, the other to that of his brother George. This business is auxiliary to the rose growing, which will be continued as heretofore. Much new glass has been put up here of recent years, and more is under way.

Supplementing the remarks made in last week's issue as to the danger of our Horticultural Hall being lost to the Horticultural Society it should be noted that while the William L. Schaffer bequest prohibited the sale of the real estate his sister who survived him had that privilege and before she died gave the trustees power to sell if they thought it for the best interests of the Society.

A syndicate built the hall under an improvement lease of 30 years issuing bonds to cover the cost. Some money was made the first few years for the syndicate but none of the bonds were paid off. Of late years, in fact ever since the Bellevue-Stratford was opened, many of the fashionable set have gone there with their social functions, and the revenue of the hall has fallen off to such an extent that it is losing money. The bond holding syndicate are therefore sick of the proposition and would undoubtedly be glad to sell out as there seems little hope of getting their money back.

Then there's the Schaffer trustees. Would they sell? Unless there is a strong sentiment manifested by members of the P. H. S. against it, it is feared they would. All kinds of arguments could be brought in favor of so doing and self-seeking interests with political influence would soon compel an abandonment of the property for little or nothing unless there is powerful opposition to it.

What is needed is, first an effort by the friends of the Society to buy off the syndicate. Then, get our wealthy people to so endow the Society that it will leave an income sufficient to carry on its work without renting the hall. The renting of the hall and the resulting revenue is what subjects the property to enormous taxation. The taxation would very likely amount to more than the revenue and could be escaped entirely if the Society worked only for the encouragement of horticulture and not as a business venture.

A man like Wm. F. Dreer, for instance, with the aid and cooperation of the Schaffer trustees is the proper party to take hold. With his stand-

WHOLESALE FLOWER MARKETS. — TO DEALERS ONLY.

	CINCINNATI April 13		DETROIT April 12		BUFFALO April 12		PITTSBURGH April 14	
ROSES								
Am. Beauty, Fan, and Sp.	35.00	to 40.00	45.00	to 50.00	35.00	to 40.00	30.00	to 35.00
Extra	30.00	to 35.00	40.00	to 45.00	25.00	to 30.00	15.00	to 20.00
No. 1	15.00	to 20.00	2.00	to 3.00	17.00	to 15.00	8.00	to 12.00
Lower grades	6.00	to 8.00	6.00	to 20.00	8.00	to 17.00	3.00	to 5.00
Bride, Maid, F. & S.	6.00	to 8.00	10.00	to 14.00	8.00	to 10.00	8.00	to 10.00
Lower grades	5.00	to 6.00	5.00	to 12.00	4.00	to 6.00	3.00	to 6.00
Killarney, Fan, & Sp.	6.00	to 8.00	10.00	to 12.00	8.00	to 10.00	8.00	to 15.00
Lower grades	3.00	to 5.00	5.00	to 8.00	4.00	to 6.00	4.00	to 6.00
Richmond, Fancy & Special	8.00	to 10.00	10.00	to 15.00	8.00	to 10.00	8.00	to 15.00
Lower grades	5.00	to 6.00	5.00	to 12.00	4.00	to 6.00	4.00	to 6.00
Chatenay	6.00	to 8.00	5.00	to 10.00	6.00	to 8.00	3.00	to 10.00
Golden Gate, Ivory, etc.	5.00	to 8.00
My Maryland
Mrs. Mar. Field
CARNATIONS								
Fancy and Novelties	3.00	to 4.00	to 5.00	2.50	to 3.00	2.00	to 3.00
Ordinary	1.50	to 2.00	3.00	to 4.00	2.00	to 2.50	1.50	to 2.00
MISCELLANEOUS								
Cattleyas	to 50.00	60.00	to 75.00	50.00	to 75.00
Lilies	10.00	to 12.50	12.50	to 15.00	8.00	to 15.00	10.00	to 15.00
Lily of the Valley	3.00	to 4.00	3.00	to 4.00	3.00	to 4.00	3.00	to 4.00
Narciss, Paper White	to 3.00	3.00	to 4.00	2.00	to 3.00	2.00	to 3.00
Roman Hyas	2.00	to 3.00	2.00	to 3.00	1.00	to 3.00
Tulips	3.00	to 5.00	3.00	to 4.00	3.00	to 3.00	2.00	to 3.00
Daffodils	2.00	to 3.00	3.00	to 4.00	2.00	to 3.00	2.00	to 3.00
Freesia	2.00	to 3.00	to 1.00	2.00	to 3.00	2.00	to 3.00
Mignonette	2.00	to 5.00	3.00	to 5.00	2.00	to 3.00	2.00	to 3.00
Sweet Peas	to 50	to 1.00	to 1.00	to 1.25
Cardenias	25.00	to 35.00	25.00	to 35.00
Violets	to 75	75	to 1.00	to 1.00	to 75
Adiantum	to 1.00	to 1.50	to 1.50	to 1.25
Senilax	13.00	to 12.50	to 15.00	to 15.00	12.10	to 15.00
Asparagus Plumosus, strings	40.00	to 50.00	30.00	to 50.00	40.00	to 50.00	30.00	to 50.00
& Spreu, (100 bchs.)	20.00	to 25.00	30.00	to 50.00	40.00	to 50.00	30.00	to 50.00

NEWS NOTES.

ing and influence among the wealthy people of the State he would be a powerful factor in raising a proper endowment fund for this time honored society of which he and his forbears are and have been distinguished members and workers.

E. J. Fancourt of the Pennock-Meehan Co. has returned home from a two months tour—north, west and south. He reports condition of the retail florist trade not quite so good as it was a year ago, especially in the west. Buffalo was one of the busiest cities he visited, and conditions generally seemed to be more favorable in the eastern states. If new building be any evidence of returning prosperity there is certainly a great deal more of it in the east this year.

George Santman, late manager for the Florez gardens, has located at Hatfield, Pa., and has taken his son into partnership. The establishment is known as the Orville Greenhouse, and the firm name is Geo. Santman & Son.

A white magnolia is blooming at the corner of 12th and Walnut. The land there is worth \$172.00 per square foot. It isn't every magnolia that has a gold plated foot-stool like that. The yellow crocuses are in bloom on my lawn at Lansdowne. The festive commuter carries bundles of lawn seed, sweet peas and spades. I guess it's spring all right, at last.

Rock Island, Ill.—In the gale of April 7 whole sections of glass were destroyed in the greenhouses of Henry Gaetje, L. Stapp, and others of the florists in the track of the wind on April 7.

Branchville, Conn.—G. D. White intends to start in the florist business at Sunnysbrook farm, it is said.

Adams, Mass.—A. J. Boothman lost a large amount of glass in the high wind that prevailed on April 9.

New York, N. Y.—Christatos & Koster, florists, have leased for a term of years the building at 717 Madison avenue.

Marion, Ill.—The Copeland greenhouse was badly damaged in the cyclone which swept over the town on April 6.

Detroit, Mich.—The floral establishment of Frank Holzengel was so threatened by destruction with wind on April 7 that it was found necessary to anchor the building with wire ropes.

Dunmore, Pa.—Arthur Reynolds, florist, on his return home on the evening of April 4, found that his bride of six months had committed suicide. Domestic unhappiness is said to be the cause.

New York.—The office of the Fernwood Nursery of Stamford, Conn., will be established at 50 West 50th street, New York, on May 1.

Charles Millang secured the big store on the street floor of the Coogan building, Sixth avenue and 26th street, for an Easter plant branch. George Bradshaw and Mike Hart, both veterans in the wholesale trade, attended to customers with neatness and dispatch.

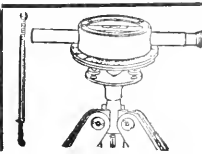

EVERYBODY KNOWS Park, Cemetery and Landscape

Gardening cannot be properly done without the aid of an accurate leveling instrument

Bostrom's Improved Levels, No. 2, at \$25.00 and No. 3, at \$25.00, are considered by all who KNOW to be the only Levels on the market which meet all the requirements, at the price.

Our guarantee back of every Level we sell, and satisfied users in every State in the Union heartily endorse every claim we make.

Shipping weight 2 lbs. Description on request.
BOSTROM-BRADY MFG. CO., 139 Madison Avenue., ATLANTA, GA.

FORD BROTHERS

48 West 28th Street NEW YORK
FINE ROSES FANCY CARNATIONS
 A Full Line of All CUT FLOWERS
 Telephone, 3870 or 3871 Madison Square

H. E. FROMENT

Wholesale Commission Florist,
 Choice Cut Flowers,
 57 West 28th St. :: NEW YORK
 Telephones: 2200, 2201, Madison Square.

Alfred H. Langjahr

All choice cut-flowers in season. Send for quotations. Correspondence with shippers of first-class stock invited.
 55 West 28th Street, New York
 Telephone 4636-4637 Madison Square

Edward C. Horan

Wholesale Florist
 55 WEST 28th ST.
 Tel. 1462, 1463 Madison Square New York

JOHN YOUNG

WHOLESALE FLORIST
 Finest American Beauties and Carnations

51 West 28 St. - NEW YORK

FRANK MILLANG

Wholesale Florist
 55-57 West 26th St., NEW YORK
 Shipments, any quantity, Wholesale Market Rates.

Henshaw & Fenrich

WHOLESALE FLORISTS
 44 West 28th Street, NEW YORK
 Phones Mad. Sq. 325, 558-2, 558-3

VIOLETS

Finest Grade, Any Quantity

B. S. SLINN

55-57 W. 26 St., New York

Moore, Hentz & Nash

Wholesale Commission Florists

55 and 57 West 26th Street

Telephone No. 756 New York
 Madison Square

MILLANG BROS.

WHOLESALE COMMISSION FLORISTS
 41 West 28th Street

Telephone 3660 3661 Madison NEW YORK

JOHN I. RAYNOR

Wholesale Commission Florist SELLING AGENT FOR LARGEST GROWERS
 A full line of Choice Cut Flower Stock for all purposes. Comprises every variety grown for New York market, at current prices
 TEL. 1998 MADISON SQUARE 49 West 28th St., New York City

Walter F. Sheridan

Wholesale Commission Dealer in
CHOICE CUT FLOWERS
 39 West 28th Street, New York
 Telephone: 3532-3533 Madison Square

HEADQUARTERS FOR NOVELTIES ORCHIDS A SPECIALTY

THE HIGHEST GRADE OF VALLEY ALWAYS ON HAND
 GARDENIAS, DAISIES, ROSES AND CARNATIONS
 Telephone
JAMES McMANUS, 759 Mad. Sq. 42 W. 28th St., New York

PHILIP F. KESSLER 55 & 57 W. 26th St., New York City
 Commission Dealer, Wholesale Buyer and Seller of

Open from 5 a. m. to 6 p. m. Sunday till 10 a. m. **CUT FLOWERS**
 Tel. 5243 and 2921 Madison Sq. Res. 345 J., Newtown.
Finest Lilies in the Market Every Day in the Year.

NEW YORK QUOTATIONS PER 100. To Dealers Only

	Last Half of Week ending Apr. 10 1909		First Half of Week beginning Apr. 12 1909	
ROSES AND CARNATIONS				
American Beauty, Fancy and Special.....	25.00	to 50.00	25.00	to 30.00
" " Extra.....	15.00	to 20.00	12.00	to 20.00
" " No. 1.....	5.00	to 10.00	6.00	to 10.00
" " Lower Grades.....	1.00	to 3.00	2.00	to 3.00
Bride, "Maid, Fancy and Special.....	6.00	to 10.00	4.00	to 10.00
" " Lower Grades.....	1.00	to 3.00	1.00	to 3.00
Killarney, Fancy and Special.....	10.00	to 15.00	6.00	to 10.00
" " Lower Grades.....	1.50	to 3.00	1.50	to 3.00
Richmond, Fancy and Special.....	6.00	to 15.00	6.00	to 10.00
" " Lower Grades.....	1.00	to 3.00	1.00	to 4.00
Chatenay.....	1.50	to 12.00	1.50	to 10.00
Golden Gate, Ivory, etc.....	1.00	to 6.00	1.00	to 6.00
Ty Maryland.....	2.00	to 15.00	2.00	to 10.00
Lrs. Par. Field.....
Carnations, Fancy and Novelties.....	3.00	to 6.00	3.00	to 4.00
" Ordinary and White.....	1.00	to 2.00	1.00	to 2.00

Alexander J. Guttman
THE WHOLESALE FLORIST OF NEW YORK
 34 WEST 28th STREET
 PHONES. 1664--1665 MADISON SQUARE
ENOUGH SAID

TRAENDLY & SCHENCK

Wholesale Florists
 Furnish best Stock at fair Prices all the year round
 Send for Quotations on Any Variety and Quantity
 Tel. 798, 799 Madison Sq. 44 West 28th St., New York City

GROWERS' CUT FLOWER CO. CUT FLOWERS AT WHOLESALE
VIOLETS, CARNATIONS, ROSES ORCHIDS, CHRYSANTHEMUMS, LILIES
 Shipments to Order, any Distance
 Consignments Solicited.
 Telephone 1533 Madison Square
39 West 28th Street, J. J. COAN, Manager NEW YORK

WHOLESALE FLORISTS
54 West 28th St.
NEW YORK
Telephone 3569 Madison Sq.

A. L. YOUNG & CO.

RECEIVERS & SHIP-
PERS OF CUT
FLOWERS.
CONSIGNMENTS SOLICITED.

WILLIAM H. KUEBLER
Brooklyn's Foremost and Best
WHOLESALE COMMISSION HOUSE
A First Class Market for all CUT FLOWERS
28 Willoughby St., Brooklyn, N. Y.
Tel. 4591 Main

Greater New York Florists' Association, Inc.
Now Open for Cut Flower Consignments
162 Livingston Street, BROOKLYN, N. Y.
Geo. W. Crawbuck Telephone Connection
Manager 3642-43 Main

REED & KELLER
122 West 25th St., New York
Florists' Supplies
We manufacture all our
Metal Designs, Baskets, Wire Work & Novelties
and are dealers in
Glassware Decorative Greens and Florists' Requisites

THE KERVAN CO.
Wholesale Dealers and Shippers of
Decorative Evergreens
Ferns, Galax, Laurel, Fresh Cycas, Box-
wood, Spagnnum and all Florists' Greens
Send us for Quotations before Buying.
113 West 28 Street, NEW YORK CITY

MICHIGAN CUT FLOWER EXCHANGE, Inc.
WHOLESALE COMMISSION FLORISTS
Consignments Solicited
Hardy Fancy Fern Our Specialty
38-40 BROADWAY, DETROIT, MICH.

FOR FLORISTS' USE
There's **NOTHING** as good as
MEYER'S SILKALINE
Don't let them sell you anything else
JOHN C. MEYER & CO., Boston, Mass.
In ordering goods please add "I saw
it in HORTICULTURE."

KRICK'S
PERFECT FLOWER POT HANDLE

Once Used Always Used



Send for Price List

SAMPLE PAIR 10 CENT9 POSTPAID

Patented

1164-1166 Greene Ave.
BROOKLYN, N. Y.

GEORGE COTSONAS & CO.
Wholesale and Retail Dealers in all kinds of
EVERGREENS
Fancy and Dagger Ferns
Bronze and Green Galax
Main Store 50 W. 28 St.
Phone 1300 Mad. Sq. New York

CENTRALLY LOCATED, THE HUB OF THE
FLOWER MARKET SECTION
CHARLES MILLANG
Wholesale Florist
444 Sixth Ave., NEW YORK
Telephone 7062 Madison



BUY
BOSTON FLOWERS
N. F. MCCARTHY & CO.,
84 Hawley St.
BOSTON'S BEST HOUSE

WHOLESALE COMMISSION J. K. ALLEN 106 W. 28th St. NEW YORK
Open 6 a.m. Daily Tel. 167 Madison Sq
Shipments of Lily of the Valley Needed.

NEW YORK QUOTATIONS PER 100. To Dealers Only

MISCELLANEOUS	Last Half of Week ending Apr. 10 1909		First Half of Week beginning Apr. 12 1909	
Cattleyas.....	30.00	75.00	50.00	60.00
Lilies.....	10.00	15.00	8.00	10.00
Lily of the Valley.....	2.00	4.00	1.00	3.00
Narciss, Paper White.....	2.00	2.00
Roman Hyacinth.....	2.00	1.00	2.00
Tulips.....	2.00	4.00	2.00	4.00
Daffodils.....	1.50	2.00	2.00
Freesia.....	1.00	2.00	1.00	2.00
Mignonette.....	1.00	3.00	1.00	3.00
Sweet Peas.....	.25	1.50	.20	.75
Gardenias.....	20.00	50.00	15.00	50.00
Violets.....	.50	.75	.15	.40
Adiantum.....	.75	1.00	.75	1.00
..... Croweanum.....	1.00	1.25	1.00	1.25
Smilax.....	8.00	12.00	8.00	12.00
Asparagus Plumosus, strings.....	25.00	25.00	20.00	25.00
..... & Sprea. (100 bchs).....	10.00	25.00	15.00	25.00

BUSINESS CHANGES.
Lancaster, Pa.—Hammond & Gompf took possession of their new store at 24 W. Orange street on April 1.
Bay City, Mich.—H. F. Potrag and C. B. Schweers have started in business in the Reuther greenhouses.
Cleveland, O.—Ehrbar & Connors have purchased the store of the Ohio Floral Co. in the Majestic Theatre building.
Fort Collins, Colo.—Mrs. Blanchard has purchased the College Floral Store, formerly owned by Miss L. B. Johnston.

INCORPORATED.
Niles, Ill.—Blameuser Floral Co., E. H., E. C., Mary Blameuser; capital, \$25,000.
St. Louis, Mo.—Auspurger & Sons, Co.; D. W., A. M. and M. D. Auspurger; capital, \$2,400.
Dallas, Tex.—Green Floral Co.; E. H. R. Green, Harry Donnelly, E. Corley, A. Miller; capital, \$125,000.
New York, N. Y.—Honduras Rubber Co.; to grow, cultivate and dispose of rubber plants, tropical fruits and vegetables; capital, \$2,000,000.
Chicago, Ill.—Greenhouse Vegetable Co.; Robt. F. Dilger, L. Becker, P. Nanzig; to deal in vegetables, truck and other garden products; capital, \$2,500.

NEWS NOTES.
Pontiac, Mich.—A. B. Lewis is making important changes in the interior of his store.
Burlington, Ia.—The Bock greenhouses were badly wrecked in the tornado of April 9.
Athol, Mass.—The greenhouse of Warren Lee was threatened by fire April 12, but only slight damage was done.
Morristown, N. J.—Gen. E. B. Meany, of Madison avenue, is having a "Maze" in miniature, patterned after that of Hampton Court, Enslaud, arranged on his estate. John Scarry is the architect.

WILLIAM F. KASTING CO.
WHOLESALE FLORISTS
383-387 Ellicott Street
BUFFALO, - N. Y.
ROBERT J. DYSART
Public Accountant and Auditor
Simple methods of correct accounting
specially adapted for florists' use.
Books Balanced and Adjusted
Merchants Bank Building
28 STATE STREET, - BOSTON
Telephone, Main 58.

Buyer's Directory and Ready Reference Guide

Advertisements under this head, one cent a word. Initials count as words.

Display advertisers in this issue are also listed under this classification without charge. Reference to List of Advertisers will indicate the respective pages.

Buyers falling to find what they want in this list will confer a favor by writing us and we will try to put them in communication with reliable dealers.

ACCOUNTANT

R. J. Dyarnt, 25 State St., Boston.
For page see List of Advertisers.

AMPELOPSIS.

Starrs & Harrison Co., Palmesville, O.
For page see List of Advertisers.
Eastern Nurseries, Henry P. Dawson, Mgr.,
Ampelopsis *Quinquefolia*,
Jamaica Plain, Mass.

For page see List of Advertisers.
C. Elsele, 11th and Westmoreland Sts.,
For page see List of Advertisers.

AQUATIC PLANTS

Aquarium plants the year round. Wholesale and retail. Send for price list. Schmidt's Aquariums, 67 Pets, 712 12th Street, Washington, D. C.

AQUILEGIAS

Aquilegia Genoule Coerulea, finest of all. Both plants and acaeda from the heart of the Rockies. C. S. Harriano's Select Nursery, York, Neb.

ARAUARIAS

A. Leuthy & Co., Perkins St. Nurseries, Roslindale, Mass.
For page see List of Advertisers.
Godfrey Aschmann, 1012 West Ontario St., Philadelphia, Pa.
For page see List of Advertisers.

ARGENTEUIL ASPARAGUS

Asparagus Roots, \$5 per 1000. Send for circular with extract from experiment station report, how this kind returned \$53.87 per acre. California Privet, stocky 12 to 18 inch plants, \$3.00 per 100; \$25.00 per 1000. West Jersey Nurseries, Bridgeton, N. J.

ASPARAGUS

Asparagus *plumosus nanus* and Sprenger, 2 in., 1 year old, strong, \$3.00 per 100. E. & C. Woodman, Danvers, Mass.

ASPARAGUS SEED

S. S. Pennock-Meehan Co., Philadelphia.
For page see List of Advertisers.
H. F. Mitchell Co., Philadelphia.
For page see List of Advertisers.
Asparagus *plumosus nanus* Seed. California grown, 1000, \$2.50; 5000, \$10.00. Special rates on larger lots. Jackson Nursery, 1922 Trinity St., Los Angeles, Cal.
Asparagus *plumosus nanus* seeds, any quantity, 20c. per 100; \$2.00 per 1000; \$8.75 per 5000. Peter Mack, Orlando, Fla.

ASTERS.

Asters, 2 to 2 1/2 in. high \$8.00 per 1000. Only the choicest colors and kinds included in the collection. H. J. Blanchard, Ashburnham, Mass.

ASTER SEED

Elmer D. Smith & Co., Adrian, Mich.
For page see List of Advertisers.

AUCTION SALES

Oleary's Horticultural Co., 62 Vesey St., New York.
For page see List of Advertisers.

AZALEAS

A. Leuthy & Co., Perkins St. Nurseries, Roslindale, Mass.
For page see List of Advertisers.
Godfrey Aschmann, 1012 W. Ontario St., Philadelphia.
For page see List of Advertisers.

BAMBOO CANES

Yokohama Nursery Co., 31 Barclay Street, New York.
Bamboo Sticks, Colored Green.
For page see List of Advertisers.

BAY TREES.

2000 Bay and Box Trees in all sizes, Pyramid and Standards. Write for list. Julius Roehrs, Rutherford, N. J.

BEDDING PLANTS

J. E. Felthousen, Schenectady, N. Y.
For page see List of Advertisers.
A. Leuthy & Co., Perkins St. Nurseries, Roslindale, Mass.
For page see List of Advertisers.
G. Aschmann, 1012 W. Ontario St., Philadelphia, Pa.
For page see List of Advertisers.
J. C. Schmidt, Bristol, Pa.
For page see List of Advertisers.
Thomas Roland, Nahant, Mass.
Begonia Gloire De Lorraine.
For page see List of Advertisers.

Rooted Cuttings, Fuchsias, Heliotrope, Salvia Zurich, Bonfire, 75c. per 100. Ageratum Gurney, German Ivy, 50c. per 100. Cash with order. F. A. Ezold, Haddam, Conn.

Salvia, 2 1/2 to 3 in. high, 14c. each. Cobaea scandens, 2 1/2 in., 2c. each. 50 Asparagus Sprenger, 3 in. nice plants, 25c. each. H. J. Blanchard, Ashburnham, Mass.

BOILERS

BOILERS. "Buroham" Boilers made for greenhouse heating. Lord & Burham, 1133 Broadway, N. Y.

Kroeschell Bros. Co., 35 Erie St., Chicago.
For page see List of Advertisers.

BOOKS

Send to us for any horticultural publication you desire and we can furnish it promptly. Horticulture, 11 Hamilton Place, Boston.

BOXWOOD TREES

New England Nurseries, Inc., Bedford, Mass.
For page see List of Advertisers.
Anton Schulthess, College Point, N. Y.
1000 nice dwarf boxwood, 6 and 8 in. size, \$1.50 and \$2.00 per 100; \$15.00 and \$18.00 per 1000. John Keady, Mt. Joy, Pa.

BUILDING MATERIAL

BUILDING MATERIAL of all description for All Cypress, Semi-Iron, Iron Frame or Truss Houses, Hot Bed Sash and Frames. Lord & Burham Co., 1133 Broadway, N. Y.

BULBS AND TUBERS

Joseph Breck & Sons, 47-54 N. Market St., Boston.
For page see List of Advertisers.
J. M. Thornburn & Co., 33 Barclay St., New York.
For page see List of Advertisers.
A. T. Boddington, 342 W. 14th St., N. Y.
For page see List of Advertisers.
Rickards Bros., 37 East 19th St., New York
For page see List of Advertisers.
H. F. Mitchell Co., Philadelphia.
For page see List of Advertisers.
H. E. Fiske Seed Co., Faneuil Hall Sq., Boston.
For page see List of Advertisers.
T. J. Grey & Co., 32 and 33 So. Market St., Boston.
For page see List of Advertisers

BULBS AND TUBERS - Continued

Yokohama Nursery Co., 31 Barclay St., New York.
For page see List of Advertisers.
Ralph M. Ward & Co., 12 W. Broadway, New York.
For page see List of Advertisers.
Schlegel & Pottler Co., 26 & 27 S. Market St., Boston.
Begonias, Gloxinias, Tuberoses.
For page see List of Advertisers.

CANNAS

A. T. Boddington, 342 W. 14th St., New York.
For page see List of Advertisers.
C. Elsele, 11th and Westmoreland Sts., Philadelphia, Pa.
For page see List of Advertisers.
J. H. Dann & Son, Westfield, N. Y.
For page see List of Advertisers.

CANTALOUPE SEED

Burrell Gem and Tiptop Cantaloupe Seed, selected from best netted melons. Seed fresh and offered by the world's largest cantaloupe grower. 3 new sorts free with each order. Lb. by mail, 60 cents. H. Clay Beebe, Olney, Colo., R. No. 1.

CARNATIONS

F. Dorner & Sons Co., Lafayette, Ind. Carnation, Whom.
For page see List of Advertisers.
Chicago Carnation Co., Joliet, Ill.
For page see List of Advertisers.
Albert Roper, Tewksbury, Mass. Carnation Bay State.
For page see List of Advertisers.
Wood Bros., Flahkll, N. Y. Carnations, Rooted Cuttings.
For page see List of Advertisers.
The E. G. Hill Co., Richmond, Ind. Carnation Cuttings.
For page see List of Advertisers.
S. J. Reuter & Son, Westery, R. I.
For page see List of Advertisers.
Poeblmann Bros. Co., Morton Grove, Ill.
For page see List of Advertisers.
E. W. Pengar, 147-87 Linden Av., Irvington, N. J.
Rooted Carnation Cuttings.

CHRYSANTHEMUMS

E. G. Hill Co., Richmond, Ind. For page see List of Advertisers.
S. J. Reuter & Son, Westery, R. I. For page see List of Advertisers.
Elmer D. Smith & Co., Adrian, Mich. For page see List of Advertisers.
C. H. Totty, Madison, N. J. Single Chrysanthemums From Seed. For page see List of Advertisers.
J. H. Myers, Altoona, Pa. For page see List of Advertisers.
Scott Bros., Elmsford, N. Y. For page see List of Advertisers.
Poeblmann Bros. Co., Morton Grove, Ill. For page see List of Advertisers.

100 commercial varieties, including Pompon and Hairy, \$12.50 per 100. Satisfaction guaranteed. Wm. Ebmann, Jr., Corfu, N. Y.

Chrysanthemum Golden Glow from 2-1/4 in. pots for early spring delivery, \$1.00 per doz., \$6.00 per 100, \$50.00 per 1000. Stock plants of Mootmort, Oct. Frost, Crocus, Matchless, Lucy Devaux, Polly Rose and Hilday, \$1.00 per doz.; \$6.00 per 100. Peirce Bros., Waltham, Mass.

For List of Advertisers See Page 581

CHRYSANTHEMUMS - Continued

Golden Glow R. C. 15, \$1, 100, \$3.50.
Pacific Supreme 20, \$1, 100, \$3. Prepaid.
Best early yellow and pink mums, now ready. Chas. Frost, Kenilworth, N. J.

Herrington's book on the Chrysantheum, mailed to your address for 50c. H. Horticulture Publishing Co., 11 Hamilton Place, Boston.

COAL FOR GREENHOUSE USE

Bader Coal Co., Board of Trade Bldg., Boston.
For page see List of Advertisers.

COLEUS

J. E. Felthous, Schenectady, N. Y.
For page see List of Advertisers.

Coleus. Strong rooted cuttings, 10 choice varieties, 60 cents per hundred. Vershaefeltii and Golden Redder 75 cents per hundred. Edmund Reardon, Cambridge, Mass.

Coleus. A few thousand rooted cuttings of Lord Palmerston and other best varieties mixed at 49 cents per 100. Cash with order, please. Hope Greenhouses, 279 Massachusetts Ave., Providence, R. I.

CONIFERS

John Waterer & Sons, Ltd., American Nursery, Bagshot, Eng.
For page see List of Advertisers.

CUT FLOWER BOXES.

Edwards Folding Box Co., Philadelphia
For page see List of Advertisers.

Folding cut flower boxes, the best made write for list. Holton & Hunkel Co., Milwaukee, Wis.

CYCAS STEMS

Yokohama Nursery Co., 31 Bayley St., New York.
For page see List of Advertisers.

Cycas stems, true long-leaved variety. Stems range in weight from 1/2 lb. to 10 lbs. Per 10 lbs., at 10c; 50 lbs., at 8c; 300 lbs., at 7c. Johnson Seed Co., 217 Market St., Philadelphia, Pa.

DAHLIAS

David Herbert & Son, Atco, N. J.
For page see List of Advertisers.

J. L. Moore, Northboro, Mass.
For page see List of Advertisers.

Peacock Dahlia Farms, Williamstown Junction, N. J.
For page see List of Advertisers.

R. Vincent Jr. & Sons Co., White Marsh, Md.
For page see List of Advertisers.

Geo. B. Hart, 24 Stone St., Rochester, N. Y. (Choice Florists' Dahlias.)

DAHLIAS.

Geo. H. Walker, No. Dighton, Mass. Wholesale and Retail.

Send your name for my 1909 Catalog and Pocket Guide, ready to mail about Feb. 25th.

Cactus, Decorative, Fancy, Show and Pompon Dahlias. Good commercial varieties, such as Kriemhilde, Countess of Lonsdale, Mad. Van Den Deal and other true bloomers, strong divided roots in 10 or 20 named varieties by selection, \$1.00 per 25; \$3.00 per 100; \$25.00 per 1000. Cash please. Herrmann Thiemann, Mercon, Mass.

Dahlias. Novelties and standard varieties, true to name, a choice list of the best introductions. Send for catalog of Dahlias, hollyhocks, hardy plants. Price always reasonable. W. W. Willmore, Box 882 Denver, Colo.

The Dahlia-Peacock.—Mailed for 30 cents by Horticulture, 11 Hamilton Place, Boston.

East Bridgewater Dahlia Gardens wants your business. If you are looking for dahlias send to the Eastern Dahlia King J. K. Alexander, East Bridgewater, Mass.

Dahlias, bold grown clumps, standard varieties, cheap. Jantzen & Hoebel, Hicksville, L. I.

DAHLIAS - Continued

DAHLIA PULSES, 50 cents per dozen. All varieties listed below at 3 cents each, or 50 cents per dozen; if to be sent by mail, 75 cents per dozen.

CACTI & VARIETIES. Beatrice, Bertha Mawley, Bradecomb, Brumhilde, Capstan, Family Gem, Bankward, Dr. Jameson, Earle of Pembroke, Fire Brand, Ernest Glasse, General Bellor, Gabriel, Galland, Island Queen, John Roche, J. P. Clark, Kriemhilde, Lady, Lady Edd Talbot, Mary Servage, Matchless, Montelodie, Mrs. Chas. Turner, Mrs. Bennett, Mrs. Jewett, Mr. Moore, St. Catherine, Queen Wilhelmine, Spary Crown, Star Fish, Sparkler, Ulland, Valder, Wildland.

SHOW VARIETIES: A. D. Livoni, Arabella, Amazon, Beauty, Bird of Passage, Dawn of Day, Fascination, Dr. J. P. Kirkland, Girdle-Lone Golden Age, Hannah Holland Pink, Keystone, Lulu, Mary D. Hallock, M. La Nille, Modesty, Mary Belle, Mrs. Browning, Mrs. Cleaveland, Mrs. Dexter, Orator, Penelope, Peri, Rob. Brounfield, Starling, Wm. Bolles, White Swan.

DECORATIVE VARIETIES: Atlanta, American Flag, Beauty of Brompton, Black Prince, Countess of Pembroke, Dolly, Eloise, Fink Bassett, Jumbo, Lady Allington, Lucille, Maid of Kent, Nymphia, Princess Christian Progress.

Above stock is held grown, sound and true to name. Catalogue free to all. C. Peirce, Dighton, Mass.

DECORATIVE PLANTS

A. Leuthy & Co., Perkins St. Nurseries, Rosendale, Mass.
For page see List of Advertisers.

Godfrey Aschmann, 1012 W. Ontario St., Phila., Pa.
For page see List of Advertisers.

Joseph Heavock Co., Wyncote, Pa.
For page see List of Advertisers.

The Geo. Wittbold Co., 1637 Buckingham Place, Chicago, Ill.
For page see List of Advertisers.

Robert Craig Co., Market and 49th Sts., Philadelphia, Pa.
For page see List of Advertisers.

DRACAENAS

Dracena Indivisa, 8, 7, 6, 5 and 4 in. Prices on application. E. & C. Woodman, Danvers, Mass.

J. H. Dunn & Son, Westfield, N. Y.
For page see List of Advertisers.

ECONOMY BRACKET

Burton & Allard, Nashua, N. H.

ERICAS

Anton Schultze, College Point, N. Y.

EVERGREENS

New England Nurseries, Bedford, Mass.
For page see List of Advertisers.

American Nursery Co., 150 Broadway, New York, N. Y.
For page see List of Advertisers.

Evergreens. Send 25 cents in stamps for complete work on propagating and growing Evergreens. C. S. Harrison's Select Nursery, York, Neb.

FERNS

A. Leuthy & Co., Rosendale, Mass.
For page see List of Advertisers.

H. H. Barron & Son, Whitman, Mass
For page see List of Advertisers.

John Scott, Brooklyn, N. Y.
For page see List of Advertisers.

Frank Oechslin, 2570-2606 W. Adams St., Chicago.

Ferne for Dishes.
For page see List of Advertisers.

The Geo. Wittbold Co., 1637 Buckingham Place, Chicago, Ill.
For page see List of Advertisers.

Godfrey Aschmann, 1012 W. Ontario St., Philadelphia.

For page see List of Advertisers.

C. Elsele, 11th and Westmoreland Sts., Erie, Pa. For page see List of Advertisers.

J. H. Dunn & Son, Westfield, N. Y.
For page see List of Advertisers.

FERNS - Continued

Anderson's ferns for in and outdoors. Largest commercial collection in the country. Ask for descriptive catalogue. J. E. Anderson, Fern Specialist, Short Hills, N. J.

FERTILIZERS

Pulverized Manure Co., 31 Union Stock Yards, Chicago, Ill.
Wizard Brand Sheep and Shredded Cattle Manure.

Robert Simpson, Clifton, N. J. Sheep Manure.
For page see List of Advertisers.

Bowker Fertilizer Co., Boston, Mass. All Forms of Plant Food at First Hands.
For page see List of Advertisers.

German Kalk Works, 93 Nassau St., New York.
Potash Fertilizer.

For page see List of Advertisers.

Wm. Elliott & Sons, 12 Vesey St., New York.
Sheep Manure.

For page see List of Advertisers.

FEVERFEW

2000 Feverfew from 2 1/2 in. \$3.00 per 100, \$25.00 per 1000. Albert Batley & Son, Maynard, Mass.

Feverfew, 3 1/2 in. \$3.00 per 100, 4 in. \$3.00 per 100. H. J. Blanchard, Ashburnham, Mass.

FLORAL PHOTOGRAPHS

Floral Photographs, Foley's, 226-228 1-2 Bowery, New York.

FLORISTS' LETTERS

Boston Floral Letter Co., 66 Pearl St., Boston, Mass.
For page see List of Advertisers.

FLORISTS SUPPLIES

N. F. McCarthy & Co., 84 Hawley St., Boston.
For page see List of Advertisers.

H. M. Robinson & Co., 15 Province St. and 9 Chapman Pl., Boston, Mass.

Reed & Keller, 122 W. 25th St., New York.
For page see List of Advertisers.

W. Bayerdorfer & Co., 1120 Arch St., Philadelphia.
For page see List of Advertisers.

FLOWER POTS

W. H. Ernest, 28th and M Sts., Washington, D. C.
For page see List of Advertisers.

A. H. Heus & Co., Cambridge, Mass.
For page see List of Advertisers.

Hilfinger Bros., Ft. Edward, N. Y.
For page see List of Advertisers.

The Peters & Reed Pottery Co., Red pots, seed pans, etc. Zanesville, O.

Syracuse Pottery Co., Syracuse, N. Y. Syracuse Red Pots.
For page see List of Advertisers.

We make Standard Flower Pots, etc. Write us when in need.
Wilmer Cope & Bro.

Lincoln University, Chester Co., Pa.

FLOWER POT HANDLE

W. C. Krick, 1164-66 Greene Av., Brooklyn, N. Y.
For page see List of Advertisers.

FRUIT TREES

Dwarf Fruit Trees, by F. A. Waugh, mailed to your address for 25 cents by Horticulture Publishing Co., 11 Hamilton Place, Boston.

The Culture of Fruit Trees in Pots, by Josh Braze, \$1.30; mailed to your address by Horticulture Pub. Co., 11 Hamilton Place, Boston.

FUCHSIAS

R. Vincent, Jr. & Sons Co., White Marsh, Maryland.
For page see List of Advertisers.

In writing to Advertisers kindly mention Horticulture

GALAX

Michigan Cut Flower Co., 38 and 40 Broadway, Detroit, Mich.
For page see List of Advertisers.

George Cotsouas & Co., 50 W. 28th St., New York
For page see List of Advertisers.

The Kerran Co., 113 West 28th St., N. Y.
For page see List of Advertisers.

Rice Bros., 115 N. 6th St., Minneapolis, Minn.
For page see List of Advertisers.

H. M. Robinson & Co., 15 Province St. and 9 Chapman Place, Boston.
For page see List of Advertisers.

GERANIUMS

R. Vincent Jr. & Sons Co., White Marsh, Md.
New and Standard Varieties.
For page see List of Advertisers.

Mme. Safford, 2 in., \$2.00 per 100; \$18.00 per 1000; or will exchange for Boston Geraniums and Cammas. Wm. Doak, Piquette, R. I.

GLADIOLI

J. L. Moore, Northboro, Mass.

For page see List of Advertisers.

O. V. Zaagen, Hoboken, N. J.

Gladiolus Brenclyensis.

For page see List of Advertisers.

GLASS

Boston Plate & Window Glass Co., Boston
For page see List of Advertisers.

Standard Plate Glass Co., 26-30 Sudbury St., Boston.
For page see List of Advertisers.

Foley Mfg. Co., Western Ave., between 25th & 26th Sts., Chicago.
For page see List of Advertisers.

Sharp, Partridge & Co., 221 & Lumber St., Chicago.
For page see List of Advertisers.

Greenhouse glass, lowest prices. Johnston Glass Co., Hartford City, Ind.

Glass, High Grade, Double Thick Greenhouse Glass. Lord & Burham, 1133 Broadway, N. Y.

GLAZING DEVICE

H. A. Dreer, Philadelphia, Pa.

Peerless Glazing Point.

For page see List of Advertisers.

GLAZING POINTS, Lord & Burham Special Glazing Nails (Points). Lord & Burham, 1133 Broadway, N. Y.

GREENHOUSE BUILDING MATERIAL

Lord & Burham Co., 1133 Broadway, New York.

For page see List of Advertisers.

Pierson U-Bar Co., 1 Madison Sq., N. Y.
For page see List of Advertisers.

A. T. Stearns Lumber Co., Neponset, Boston.
For page see List of Advertisers.

King Construction Co., N. Tonawanda, New York.
For page see List of Advertisers.

Hitchings & Co., 1170 Broadway, New York.
For page see List of Advertisers.

J. C. Moninger Co., 117 East Blackhawk St., Chicago, Ill.
For page see List of Advertisers.

Foley Mfg. Co., Western Ave., between 25th & 26th Sts., Chicago.
For page see List of Advertisers.

W. H. Lutton, West Shore Av. Sta., Jersey City, N. J.
For page see List of Advertisers.

GREENHOUSE CONSTRUCTION*

GREENHOUSE CONSTRUCTION, Semi-Iron Greenhouse, New Truss Houses and Iron Frame Houses. Lord & Burham, 1133 Broadway, N. Y.

J. A. Payne, 260-274 Culver Ave., Jersey City, N. J.
For page see List of Advertisers.

Foley Mfg. Co., Western Ave., between 25th & 26th Sts., Chicago.
For page see List of Advertisers.

Hitchings & Co., 1170 Broadway, New York
For page see List of Advertisers.

Geo. M. Garland Co., Des Moines, Ill.
For page see List of Advertisers.

GREENHOUSE HOSE

Revere Rubber Co., Boston, Mass.

Revere Hose.

For page see List of Advertisers.

GUTTERS

GUTTERS, Cast Iron Gutters, L & B Improved Shaped Gutter with drip gutter attachment. Lord & Burham, 1133 Broadway, N. Y.

HAIL INSURANCE

Florists' Hall Assn. of America.

J. G. Esler, Saddle River, N. J.

For page see List of Advertisers.

HARDY FERNS, MOSS AND GREENS

H. M. Robinson & Co., 15 Province St. and 9 Chapman Pl., Boston, Mass.

For page see List of Advertisers.

Michigan Cut Flower Exchange, 38 and 40 Broadway, Detroit, Mich.

For page see List of Advertisers.

George Cotsouas & Co., 50 W. 28th St., New York.

For page see List of Advertisers.

N. F. McCarthy & Co., 84 Hawley St., Boston.

For page see List of Advertisers.

The Kerran Co., 113 W. 28th St., N. Y.

For page see List of Advertisers.

Rice Bros., 115 N. 6th St., Minneapolis, Minn.

For page see List of Advertisers.

HARDY PERENNIALS

William Tricker, Arlington, N. J.

For page see List of Advertisers.

HEATING APPARATUS

Lord & Burham Co., 1133 Broadway, New York.

For page see List of Advertisers.

Pierson U-Bar Co., 1 Madison Sq., N. Y.

For page see List of Advertisers.

John A. Payne, 260-274 Culver Ave., Jersey City, N. J.

For page see List of Advertisers.

Kroschel Bros. Co., 35 Erie St., Chicago.

For page see List of Advertisers.

HELP FURNISHED

Thos. H. Bambrick, 34 S. 7th St., Phila.

For page see List of Advertisers.

HERBACEOUS PERENNIALS

P. Ouwkerk, P. O. No. 1, Hoboken, N. J.

For page see List of Advertisers.

New England Nurseries, Bedford, Mass.

For page see List of Advertisers.

The Geo. Wittbold Co., 1657 Buckingham Place, Chicago.

For page see List of Advertisers.

HOLLYHOCKS

Hollyhocks, Chater's double, white, pink and crimson; August transplanted; first-class lot, \$3.00 per 100. Ed. C. Lindsay, Milford, Del.

HOT-BED SASH

The A. T. Stearns Lumber Co., Neponset, Mass.

For page see List of Advertisers.

Pierson U-Bar Co., 1 Madison Sq., N. Y.

For page see List of Advertisers.

Lord & Burham Co., 1133 Broadway, N. Y.

For page see List of Advertisers.

Foley Mfg. Co., Western Ave., between 25th & 26th Sts., Chicago.

HYDFANGEAS.

500 Hydrangeas in bloom, 1 to 1 1/2 inches, splendid stock. Edmund Reardon, Cambridge, Mass.

INSECTICIDES

Necotide kills all greenhouse pests.

P. R. Palethorpe Co., Eleventh St., Owensboro, Ky.

For page see List of Advertisers.

Stump & Walter Co., 50 Barclay St., New York.

Kilnhead Tobacco Dust

For page see List of Advertisers.

INSECTICIDES—Continued

Niagara Sprayer Co., Middleport, N. Y.

For page see List of Advertisers.

B. G. Pratt Co., New York.

Sulfoicide.

For page see List of Advertisers.

Bowker Insecticide Co., Boston, Mass.

Insect Destroying Preparations.

For page see List of Advertisers.

Wm. Cooper & Nephews, 177 Illinois St., Chicago; Cyril Franklyn, 62 Beaver St., New York, Agt.

For page see List of Advertisers.

Eastern Chemical Co., Pittsburg St., Boston.

"IMP" Soap Spray.

"The Fumigating Kind Tobacco Powder"—The first on the market and the kind that has so many imitators, has our guarantee tag of satisfaction or money back, and "The Moon Trade Mark" on every bag, \$3.00 per 100 lbs. See H. A. Stoughton Co., Mount Vernon, N. Y., Makers and sellers.

JAPANESE PLANTS

Yokohama Nursery Co., 31 Barclay St., New York.

For page see List of Advertisers.

KENTIAS

Godfrey Aschmann, 1012 W. Ontario St., Phila., Pa.

For page see List of Advertisers.

A. Leuty & Co., Roslindale, Mass.

For page see List of Advertisers.

Jos. Hancock Co., Wyncote, Pa.

Single and Made-Up Specimens.

For page see List of Advertisers.

LANTANAS

Violet King, king of all lantanas, rooted cuttings, \$1.00 per 100, 200 for \$7.50, 65c per doz. For large quantities of Violet King, 500 to 5000 lots, send for prices, as I will make them right, for I want to see every florist in the United States handle this variety, as it is a great novelty. Sunset, new, rooted cuttings, 50c per doz.; \$3.00 per 100. Eight other grand varieties, rooted cuttings, \$2.00 per 100. All true to name, labelled Mixed, \$18.00 per 1000. Send for price list. Louis P. Faulk, West View, Pa.

For page see List of Advertisers.

For page see List of Advertisers.

For page see List of Advertisers.

For page see List of Advertisers.

For page see List of Advertisers.

For page see List of Advertisers.

For page see List of Advertisers.

For page see List of Advertisers.

For page see List of Advertisers.

For page see List of Advertisers.

For page see List of Advertisers.

For page see List of Advertisers.

For page see List of Advertisers.

For page see List of Advertisers.

For page see List of Advertisers.

For page see List of Advertisers.

For page see List of Advertisers.

For page see List of Advertisers.

For page see List of Advertisers.

For page see List of Advertisers.

For page see List of Advertisers.

For page see List of Advertisers.

For page see List of Advertisers.

For page see List of Advertisers.

For page see List of Advertisers.

For page see List of Advertisers.

For page see List of Advertisers.

For page see List of Advertisers.

For page see List of Advertisers.

For page see List of Advertisers.

For page see List of Advertisers.

For page see List of Advertisers.

For page see List of Advertisers.

For page see List of Advertisers.

For page see List of Advertisers.

For page see List of Advertisers.

For page see List of Advertisers.

For page see List of Advertisers.

For page see List of Advertisers.

For page see List of Advertisers.

For page see List of Advertisers.

For page see List of Advertisers.

For page see List of Advertisers.

For page see List of Advertisers.

For page see List of Advertisers.

For page see List of Advertisers.

For page see List of Advertisers.

For page see List of Advertisers.

For page see List of Advertisers.

For page see List of Advertisers.

For page see List of Advertisers.

For page see List of Advertisers.

For page see List of Advertisers.

For page see List of Advertisers.

For page see List of Advertisers.

For page see List of Advertisers.

NURSERY STOCK—Continued

Call's Nurseries, Perry, O.
Trees, Roses, Shrubs.

For page see List of Advertisers.

P. A. Keene, 1 Madison Av., New York.
Rhododendron Hybrids, Maximum, Maple,
Privet.

For page see List of Advertisers.

Manual of the Trees of North America,
by C. S. Sargent, mailed to your address
for \$6.00, by Horticulture Publishing Co.,
11 Hamilton Place, Boston.

**TREES, SHRUBS, ROSES, EVER-
GREENS, PEONIES, HARDY PLANTS,
ELLWANGER & BARRY, Rochester, N. Y.**

New Hardy Shrub—*Buddleia variabilis*
Vetehii and Magnifica, the summer flower-
ing Lilac, 50c. each; \$5.00 per doz.; \$25.00
per 100. Rose Hill Nurseries, New
Rochelle, N. Y.

Catalog now ready. Nursery grown
evergreens, seedling white pine and hem-
lock, native trees and plants. L. E. Wil-
hams, Nottingham, N. H.

ONION SEED

Federico C. Varela, Tenerife, Canary Ids.
Bermuda Onion Seed.

ORCHIDS

Orchid Growers' Manual. By B. S. Wil-
hams. 300 illustrations, \$10.00. 800 pages;
descriptions of upwards of 2500 species and
varieties of orchidaceous plants, etc. The
most complete work on Orchids and orchid
culture ever published. Orders filled by
HORTICULTURE, 11 Hamilton Place,
Boston.

ORCHID PLANTS

Lager & Hurrell, Summit, N. J.
For page see List of Advertisers.

Saunders, St. Albans, England.
Importers, Exporters, Growers, Hybridists
For page see List of Advertisers.

Carrillo & Baldwin, Caracas, N. J.
For page see List of Advertisers.

Jos. A. Manda, 191 Valley Road, W.
Orange, N. J.
For page see List of Advertisers.

Ordonez Bros., Madison, N. J., Box 106
Cattleya Mossiae.

For page see List of Advertisers.

G. L. Freeman, 388 Appleton St., Holyoke,
Mass.

Orchid Importations.
For page see List of Advertisers.

Largest stock in the country. Ask for
prices. Julius Roehrs, Rutherford, N. J.

PAINT AND PUTTY

PAINT AND PUTTY: Ideal Greenhouse
lead; Special Greenhouse Putty. Lord &
Burnham, 1133 Broadway, N. Y.

PALMS

A. Leuthy & Co., Perkins St. Nurseries,
Roslindale, Mass.

For page see List of Advertisers.

Robert Craig Co., Market and 49th Sts.,
Philadelphia, Pa.

For page see List of Advertisers.

Joseph Heacock Co., Wyncote, Pa.
Home-Grown Palms.

For page see List of Advertisers.

Geo. Wittbold Co., 1657 Buckingham Place,
Chicago.

For page see List of Advertisers.

PANSY PLANTS.

J. C. Schmidt, Bristol, Pa.
For page see List of Advertisers.

Pansies in bud and bloom; none better,
\$1.00 per 100; \$8.00 per 1000. Choicest
strains. Ed. C. Lindsey, Milford, Del.

PATENTS

Siggers & Siggers, Washington, D. C.
For page see List of Advertisers.

PEAT

Orchid Peat and Moss always on hand
Julius Roehrs Co., Rutherford, N. J.

PENTSTEMONS

C. H. Totty, Madison, N. J.
For page see List of Advertisers.

PEONIES

Peonies only, by the wholesale—best 100
varieties. J. F. Rosenfield, Westport, Nbr.

One of the finest collections in America.
Send 25 cts. in stamps for new edition of
Peony Manual. C. S. Harrison's Select
Nursery, York, Neb.

PHLOXES

Send 25 cts in stamps for Phlox Manual
Fine mixed phloxes \$2.00 per 100. C. S.
Harrison's Select Nursery, York, Neb.

**PHOTOGRAPHS: DESIGNING: IL-
LUSTRATING**

Geo. E. Dow, 178 Washington St., Boston.
For page see List of Advertisers.

PIPE AND FITTINGS

Foley Mfg. Co., between Western Ave. and
26th St., Chicago, Ill.

Kroeschell Bros. Co., 35 Erie St., Chicago.
For page see List of Advertisers.

PIPE AND FITTINGS. Cast Iron and
Wrought Pipe, Valves, Elbows, Pipe Hooks,
Antoine & A. Hecker, 100 E. Lord &
Burnham, 1133 Broadway, N. Y.

PLANT STAKES

Seele's Teelless Plant Stakes and Trel-
lises. H. D. Seele & Sons, Elkhart, Ind.

POT HANGERS

Pot hangers, Kramer's \$1 doz. by exp.,
\$1.25 by mail. I. N. Kramer & Son, Cedar
Rapids, Ia.

POINSETTIAS (Artificial)

Poinsettias, artificial decorations our
specialty. Sample lots of 50 in 3 sizes,
\$4.00; 100 lots, \$6.88; \$10. J. Stern & Co.,
125 N. 10th St., Philadelphia, Pa.

RAFFIA

Raffia (colored), 20 beautiful shades.
Samples free. R. H. Comey Co., Camden,
N. J.; 810 Washburn Ave., Chicago, Ill.

RESURRECTION PLANTS

Resurrection plants and cacti. Cheap.
Ask for prices. William Tell, Austin, Tex.

RHODODENDRONS

John Waterer & Sons, Ltd.,
American Nursery, Hagsholm, England.
For page see List of Advertisers.

P. Ouwerkerk, Hoboken, N. J.
For page see List of Advertisers.

Storrs & Harrison Co., Painesville, O.
For page see List of Advertisers.

ROSES

Robert Craig Co., Market and 49th Sts.,
Philadelphia, Pa.

For page see List of Advertisers.

P. Ouwerkerk, E. O. No. 1, Hoboken, N. J.
For page see List of Advertisers.

Julius Roehrs Co., Rutherford, N. J.
Rose Newport Fairy.

For page see List of Advertisers.

The F. R. Pierson Co.,
Tarrytown-on-Hudson, N. Y.

White Killarney, N. Y.
For page see List of Advertisers.

S. J. Reuter & Son, Westery, R. L.
My Maryland.

For page see List of Advertisers.

Dingee & Conard Co., West Grove, Pa.
For page see List of Advertisers.

Storrs & Harrison Co., Painesville, O.
For page see List of Advertisers.

Scott Bros., Elmford, N. Y.
For page see List of Advertisers.

Poehlmann Bros. Co., Morton Grove, Ill.
For page see List of Advertisers.

Ellwanger & Barry, Rochester, N. Y., Box T.
For page see List of Advertisers.

A. N. Pierson, Cromwell, Conn.
White Killarney, My Maryland, Ramblers.
For page see List of Advertisers.

Montrose Greenhouses, Montrose, Mass.
Roses, Grafted or Own Root.
For page see List of Advertisers.

ROSES—Continued

The Rose, by H. B. Ellwanger; mailed
for \$1.30 by Horticulture, 11 Hamilton
Place, Boston.

Hand Book of Cultural Notes on Roses
Under Glass, by E. P. Brigham, mailed to
your address for 25c., by Horticulture Pub-
lishing Co., 11 Hamilton Place, Boston.

SALVIAS

R. Vincent, Jr. & Sons Co., White Marsh,
Maryland.

Salvias Gondre and Zurich.
For page see List of Advertisers.

SEED GROWERS

Hjalmar Hartmann & Co.,
Cauliflower and Cabbage Seed.

12 Stormgade, Copenhagen, Denmark.
For page see List of Advertisers.

Federico C. Varela, Tenerife, Canary Ids.
Bermuda Onion Seed.

SEEDS

T. J. Grey Co., 32 So. Market St., Boston.
For page see List of Advertisers.

Joseph Breck & Sons,
51 and 52 N. Market St., Boston, Mass.
For page see List of Advertisers.

W. Atlee Burpee & Co., Philadelphia.
For page see List of Advertisers.

Arthur T. Boddington, 342 W. 14th St.,
New York.

For page see List of Advertisers.

H. E. Flake Seed Co., Faneuil Hall Sq.,
Boston.

For page see List of Advertisers.

Hjalmar Hartmann & Co.,
12 Stormgade, Copenhagen, Denmark.
Cauliflower and Cabbage Seed.

For page see List of Advertisers.

Richarda Bros., 37 E. 19th St., New York.
For page see List of Advertisers.

R. & J. Farquhar & Co., 6-7 So. Market
St., Boston.

Mignonette Seed.
For page see List of Advertisers.

H. F. Mitchell Co., 1018 Market St., Phila.
For page see List of Advertisers.

J. M. Thorburn & Co., 33 Barclay St., N. Y.
For page see List of Advertisers.

Leonard Seed Co., Chicago, Ill.
For page see List of Advertisers.

Wm. Elliott & Sons, 42 Vesey St., N. Y.
New Seed.

For page see List of Advertisers.

Schlegel & Fottler Co., 26 & 27 S. Market
St., Boston.

For page see List of Advertisers.

O. V. Zaegen, Hoboken, N. J.
Florists' Spring Seeds.

For page see List of Advertisers.

E. F. Winterson Co., Chicago.
Seeds for Plantsmen, Nurserymen, Seeds-
men.

For page see List of Advertisers.

Seeds. Rocky Mountain Evergreen seeds
in large or small quantities. C. S. Harri-
son's Select Nursery, York, Neb.

SHRUBS

The Geo. Wittbold Co., 1657 Buckingham
Place, Chicago.

For page see List of Advertisers.

SILKALINE

John C. Meyer & Co., Boston, Mass.
For page see List of Advertisers.

SMILAX

R. Vincent, Jr. & Sons Co., White Marsh,
Maryland.

For page see List of Advertisers.

SOLUBLE PLANT FOOD

Eastern Chemical Co., Boston, Mass.
For page see List of Advertisers.

SPHAGNUM MOSS

Live Sphagnum moss, orchid peat and
orchid baskets always on hand. Lager &
Hurrell, Summit, N. J.

Sphagnum moss and mountain laurel in
bags, bales or cwt. lots. Prices low. Spruce
and hemlock in bales. James Day, Box 660,
Milford, N. H.

In writing to Advertisers kindly mention Horticulture

SPRAYERS

Niagara Sprayer Co., Middleport, N. Y.
For page see List of Advertisers.
Chas. J. Jager Co., Boston.
Deming Spray Pump.
For page see List of Advertisers.

STEAM TRAP

E. Hippard, Youngstown, O.

STRAWBERRY PLANTS

H. L. Crane, Westwood, Mass.
Barrimore Strawberry.
For page see List of Advertisers.
Strawberries, Chipman's new seedling, Perfect, enormously productive, immense in size and a good keeper. Many of our largest shippers grow no other. Plants from young bed, 50c per 100; \$1.00 per 1000. Cash. Ed. V. Lindsay, Milford, Del.
Strawberry Plants, Reliance and Success, \$1.50 per 1000. W. N. Fanning, Kensington, Ct.
300 Strawberry Plants \$1. Your selection. List free. Wm. Petty, Cool Spring, Del.

SULFOCIDES

The B. G. Pratt Co., 59 Church St., Dept. W., New York City.
For page see List of Advertisers.

SULPHUR BURNER

Benj. Dorrance, Rose Growers, Dorrance.
For page see List of Advertisers.

SWEET PEAS

A. C. Zvolanek, Round Brook, N. J.
Winter Flowering.
For page see List of Advertisers.

TO-BAK-INE

E. H. Hunt, Genl. Agt., 76-78 Wabash Av., Chicago.
For page see List of Advertisers.

VEGETABLE PLANTS

R. Vincent, Jr. & Sons Co., White Marsh, Md.
For page see List of Advertisers.
Transplanted tomato and lettuce plants, 25c per 100. C. A. Forster, Wintthrop, Me.

VEGETABLE SEEDS

Just arrived, our reliable vegetable seeds. Buy your fresh seeds now. These are guaranteed fresh and only first class seeds. The Reliable Seed House, 156 Third Street, Hoboken, N. J.

VENTILATING APPARATUS

Pierson U-Bar Co., 1 Madison Sq., N. Y.
For page see List of Advertisers.
Poley Mfg. Co., Western Ave., between 25th & 26th Sts., Chicago.
For page see List of Advertisers.
John A. Payne, 260-274 Culver Ave., Jersey City, N. J.
For page see List of Advertisers.
The Advance Co., Richmond, Ind.
For page see List of Advertisers.
Quaker City Machine Co., Richmond, Ind.
20th Century Ventilating Arm.
For page see List of Advertisers.

VENTILATING MACHINERY, New Model enclosed self-acting gear, Standard Open Gear. Lord & Burnham, 1183 Broadway, N. Y.

VERBENAS

Verbenas, 2 1/2 to 3 in. high, 1c each. Best varieties, 10c doz, all desirable colors. H. J. Blanchard, A-lburtown, Mass.

VINCAS

Vinea var., 5 in., per doz., \$2.00; per 100, \$15.00. E. & C. Woodin, Danvers, Mass.

VIOLETS.

William Sim, Chittenden, Mass.
Boston and Pittsford, Violets.
For page see List of Advertisers.
Good, strong California Violets, \$1.00 per 100, \$8.00 per 1000. Chas. M. Allen, 608 Broadway, Fall River, Mass.
Princesses Violets, 2c, 10c, \$2.00 per 100. Jas. T. Baker, Bustleton, Philadelphia, Pa.

WAX FLOWERS

We are originators of wax designs and still the standard concern, J. Stero & Co., 125 N. 10th St., Philadelphia, Pa.

WEED KILLER

The American Horticultural Distributing Co., Martinsburg, W. Va.
Target Brand.
For page see List of Advertisers.

WIRED TOOTHPICKS

W. J. Cowee, Berlin, N. Y.
For page see List of Advertisers.

WIREWORK

Reed & Keller, 122 W. 25th St., N. Y.
For page see List of Advertisers.
Durand & Marohn, Albany, N. Y.
For page see List of Advertisers.
Wirework. Write for our catalogue. Holton & Hunkel Co., Milwaukee, Wis.
William E. Heischer's Wire Works, 38-40 Broadway, Detroit, Mich.
Wirework—Compare our prices with others. Scranton Florist Supply Co., 201 N. 7th St., Scranton, Pa.

WHOLESALE FLORISTS**Boston**

N. F. McCarthy & Co., 84 Hawley St., Boston.
For page see List of Advertisers.
H. M. Chapman & Co., 75 Province St. and 9 Robinson Pl., Boston.
For page see List of Advertisers.
Welch Bros., 226 Devonshire St., Boston.
For page see List of Advertisers.
Talby, Wellealey, Mass.
For page see List of Advertisers.

Buffalo, N. Y.

William F. Kasting Co., 333-37 Elliott St., Buffalo, N. Y.
For page see List of Advertisers.

Chicago

Chas. W. McKellar, 51 Wabash Ave., Chicago.
For page see List of Advertisers.
Peter Reubner, 51 Wabash Ave., Chicago.
For page see List of Advertisers.
E. F. Wintersou Co., 45-49 Wabash Ave., Chicago.
For page see List of Advertisers.
J. A. Budlong, 37-39 Randolph St., Chicago.
For page see List of Advertisers.
Poehlmann Bros. Co., Morton Grove, Ill.
For page see List of Advertisers.

Cromwell, Conn.

A. N. Pierson, Cromwell, Conn.
For page see List of Advertisers.

Detroit

Michigan Cut Flower Exchange, 38 and 40 Broadway, Detroit, Mich.
For page see List of Advertisers.

Minneapolis

Rice Bros., 115 N. 6th St., Minneapolis, Minn.
For page see List of Advertisers.

New York

Ford Bros., 48 W. 25th St., New York.
For page see List of Advertisers.
H. E. Froment, 57 W. 25th St., New York.
For page see List of Advertisers.
Alex. J. Guttman, 34 W. 25th St., New York.
For page see List of Advertisers.
E. C. Horan, 55 W. 25th St., New York.
For page see List of Advertisers.
A. H. Langjahr, 55 W. 25th St., New York.
For page see List of Advertisers.
James McManus, 42 W. 25th St., New York.
For page see List of Advertisers.

John J. Raynor, 49 W. 25th St., New York.
For page see List of Advertisers.
W. F. Sheridan, 39 W. 25th St., New York.
For page see List of Advertisers.
Trendly & Schenck, 44 W. 25th St., New York.
For page see List of Advertisers.
Moore, Heutz & Nash, 55 and 57 W. 26th St., New York.
For page see List of Advertisers.

WHOLESALE FLORISTS—**Continued**

Wm. H. Kuebler, 28 Willoughby St., Brooklyn, N. Y.
For page see List of Advertisers.
Philip F. Kessler, 55 and 57 W. 26th St., New York.
For page see List of Advertisers.
Milling Bros., 41 W. 28th St., New York.
For page see List of Advertisers.
John Young, 51 W. 28th St., New York.
For page see List of Advertisers.
Greater New York Florists' Association, 162 Livingston St., Brooklyn, N. Y.
For page see List of Advertisers.
Frank Millang, 55-57 W. 26th St., New York.
For page see List of Advertisers.
B. E. Slinn, 55-57 W. 26th St., New York.
For page see List of Advertisers.
A. L. Young & Co., 54 W. 28th St., N. Y.
For page see List of Advertisers.
Growers' Cut Flower Co., 89 W. 28th St., New York.
For page see List of Advertisers.
Henshaw & Fenrich, 44 W. 28th St., New York.
For page see List of Advertisers.
J. K. Allen, 106 W. 28th St., New York.
For page see List of Advertisers.
Charles Millang, 44 Sixth Av., New York.
For page see List of Advertisers.

Philadelphia

W. E. McKissock & Bros., 1619-1621 Ransstead St., Philadelphia, Pa.
For page see List of Advertisers.
Leo Niessen Co., 1200 Arch St., Philadelphia, Pa.
For page see List of Advertisers.
The S. S. Pennock-Meehan Co., 1608-16 Ludlow St., Philadelphia, Pa.
For page see List of Advertisers.

WOODENWARE

Bacon & Co., Appleton, N. Y.
Baskets: Crates: Ladders: Boxes.
For page see List of Advertisers.

New Offers in This Issue.

See List of Advertisers on opposite page for page on which these offers may be found.

ASTER SEED.

H. F. Mitchell Co., Philadelphia, Pa.
CARNATION NEPTUNE.
Paul Thomson Estate, West Hartford, Conn.

CATTLEYA TRIANAE JUST ARRIVED.

G. L. Freeman, 388 Appleton St., Holbrook, Mass.

CHRYSANTHEMUMS.

C. H. Tetty, Madison, N. J.

CHRYSANTHEMUMS ROOTED CUTTINGS.

Wood Bros., Fishkill, N. Y.

COLEUS: IMPORTED PLANTS FOR FALL DELIVERY.

A. Leuthy & Co., Perkins St., Nurseries, Roslindale, Mass.

DEUTZIA, PAEONIAS, WEIGELA, PRIVAT.

C. R. Burr & Co., Manchester, Conn.

FLORISTS' SCRAP BOOK.

John C. Moninger Co., 117 E. Blackhawk St., Chicago.

NORWAY SPRUCE.

Maurice J. Brinton, Christina, Pa.

ORCHIDS JUST RECEIVED.

Lager & Hurrell, Summit, N. J.

RHODODENDRON PINK PEARL.

John Waterer & Son, Bartslet, Eng.

STOCKS.

J. H. Myers, Altoona, Pa.

SURPLUS STOCK CANNAS.

A. T. Boddington, 342 W. 14th St., New York.

For List of Advertisers See Page 581

List of Advertisers

Page	Page
Advance, The Co.	583
Allen, J. K.	575
American Nursery	575
J. (Eng.)	566
American Nursery Co	564
Aschmann Godfrey	565
Atlanta Floral Co.	570
Bader Coal Co.	583
Bacon & Co.	568
Bambrick, Thos. H.	584
Barrons H. H. & Son	569
Reyersdorfer H. & Co	571
Blossom, T. C.	570
Boddington A. T.	565
Boström Florist	572
Boström Florist	571
Boström Plate and Win-	571
ow Glass Co.	572
Boström-Brady Mig.	572
Co.	583
Bowe, M. A.	570
Bowker Fertilizer Co.	569
Bowker Insecticide	569
Co.	567
Brook Joseph & Sons	569
Breitmeier's J. Sons	569
Bridgeman's Seed	569
Warehouse	569
Brinton, Maurice J.	564
Budington	571
Burpee W. A. & Co.	569
Burr C. R. & Co.	564
Call Nurseries	564
Carroll & Baldwin	563
Chicago Carnation	564
Co.	563
Clarke's David, Sons	570
Cleary's Horticult' Co	564
Coan J.	574
Cooper, Wm. & Co.	575
hews	575
Cossons Geo. & Co.	575
Cowee W. J.	571
Craig, Robt. Co.	583
Crane H. L.	569
Crawback Geo. W.	575
Crawford, H. F.	581
Danker F. A.	570
Dano, J. H. & Son.	563
Dawson H. S.	564
Diage & Conard Co.	564
Orner F. Sons & Co	564
Dorrance Benj.	566
Dow Geo. E. & Co.	579
Drer H. A.	584
Dunlop John H.	570
Durand & Marohn.	571
Dysart R. J.	567
Eastern Chemical Co.	572
Eastern Nurseries	564
Edwards Folding Box	564
Co.	572
Egle C.	569
Elliot Wm & Sons	565
Elmsford Nurseries	555
Elminger & Barry	565
Elder J. G.	566
Ernest W. H.	566
Eyres	570
Farnbar R. & J. Co.	569
Fenhouler J. E.	563
Fiske H. E. Seed	569
567-569	
Foley Mig. Co.	584
Ford Bros.	574
Freeman G. L.	573
Fremont H. E. & Co.	574
Galvin Thos. F.	581
Garland, Geo. M.	583
German Kali Works	566
Greater N. Y. Florists' Association	575
Grey T. J. Co.	569
Growers' Cut Flower Co.	574
Gude Bros. Co.	579
Gutman Alex. J.	574
Hall Asso.	583
Hartmann Hjalmar & Co.	569
Hauswirth the Florist	579
Heacock Jos. Co.	583
Henshaw & Fenrich	574
Herbert David & Son	574
Hewes A. H. & Co.	574
Hilfinger Bros.	566
Hill, The E. G. Co.	584
Hitchings & Co.	584
Hoffman	574
Horan E. C.	574
Houghton F. H.	571
Hunt E. H.	567
Jager, Chas. J. Co.	566
Kastine W. F. Co.	575
Keene P. A.	564
Kerwan The Co.	575
Kessler, P. F.	574

Page	Page
Ward R. M. & Co.	569
Waterer John & Sons	566
Welch Bros.	572
Winfield Geo. Co.	563
Wilson	570
Winterson, E. F. Co.	572
Wood Bros.	554
Yokohama Nursery Co	565
Young A. L.	575
Young John	574
Young & Nugent	579
Zangen O. V.	563-569
Zinn Julius A.	571
Zvolanek A. C.	569

HELP WANTED

GOOD MEN

When you need good men, skilled or unskilled, Write:

THOS. H. BAMBRICK

34 South 7th Street Philadelphia

Help of all kinds, including that for Florists, Nurserymen, Seedsmen and the Horticultural trade generally.

GARDENER OR SUPERINTENDENT—I can with confidence recommend a man as above, competent, sober, honest and willing. Apply William Downs, Chestnut Hill, Mass.

FOR SALE

FOR SALE Some 30,000 feet of glass in good condition. Will sell at a bargain and on easy terms. Reason for selling don't know anything about the business and can't hire competent men to run the house.

H. F. CRAWFORD,
CRAWFORD GREENHOUSES
Mentello Station, Brockton, Mass.

Greenhouse Plant For Sale

Consisting of three houses, 22x142, 18x75 and 10x15 respectively, with cold frames and sash. Built by Lord & Burnham Co., steam heated with Burnham boiler. Strictly up-to-date and with every convenience for commercial business. Apply to J. B. Narcross, with Jones, McDanee & Stratton, 23 Franklin St., Boston.

FOR SALE—A fine estate situated on high ground at Hyde Park, Mass., near Milton. Two minutes from R. R. station, fifteen minutes to Boston. House, 14 rooms and bath, all conveniences. Corner lot, 47,375 ft. land, fruit and shade trees. Greenhouse, 118 x 33, built 1908, 6 on sides, 16 centre, 16 x 24 glass. Good opening for commercial florist. Address A. G. Cheleking, 53 State St., Boston.

FOR SALE—Retail nursery, sixth year, doing good, steady and increasing trade. Stock in excellent condition. Only local supply for community of 50,000. For particulars address R. N., care HORTICULTURE, Boston.

GREENHOUSE property for sale; 2 houses, built 2 years; 4000 sq. ft. glass; hot water heated to 65 deg.; 2 acres best land. Modern house of 8 rooms and bath; barn 25 ft. sq.; the best first-class. Chas. L. Pierce, Holbrook, Mass.

FOR SALE—Special 16 x 18 and 16 x 24 double thick glass in "A" and "B" qualities. Buy now and save money. Write MARTELBSKY BROTHERS, INC., 50 Montrose Ave., Brooklyn, N. Y.

SITUATIONS WANTED

CARNATION SPECIALIST of over twenty years' experience in growing and marketing would like to hear from parties wanting the services of such a man. Address T. F. M., Room 419, 170 Summer St., Boston, Mass.

SITUATION WANTED as assistant on private place. Single. Strictly sober and industrious. Commercial greenhouse experience. Age 26. References. Address E. W. S., 87 Carew St., Springfield, Mass.

MAINE LAW AFFECTING NURSERYMEN.

An act passed by the Maine Legislature requires that all "agents or other parties excepting growers who wish to sell nursery stock shall make application for an agent's license and shall file with the state entomologist the names and addresses of nurseries or parties from which they purchase their stock. Any violation of this requirement shall be fined not less than \$10 nor more than \$50 for each offense."

It also defines nursery stock as follows: "For the purpose of this act the term nursery stock is hereby applied to all fruit and ornamental trees, shrubs and vines, and includes currant, gooseberry, blackberry and raspberry bushes, also strawberry plants," so that all parties who are raising such stock for the purpose of selling the same in Maine should apply for a certificate.

In ordering goods please add "I saw it in HORTICULTURE."

MASTICA
FOR Greenhouse Glazing
USE IT NOW.
F. O. PIERCE CO.
12 W. BROADWAY
NEW YORK

Mastica is elastic and tenacious, admits of expansion and contraction. Putty becomes hard and brittle. Broken glass more easily removed without breaking of other glass as occurs with hard putty. Lasts longer than putty. Easy to apply.

PATENTS
Trademarks and Copyrights
Send your business direct to Washington Saves time and insures better service Personal attention guaranteed Twenty-five years' active service. SPECIALTY: "Working on the Failure of Others."
SIGGERS & SIGGERS
PATENT LAWYERS
Box 9, National Union Building
Washington, D. C.

MISCELLANEOUS WANTS

WANTED TO BUY—Complete greenhouse plants and all kinds of greenhouse material, to be taken down and removed at once. Terms cash. Address L. Suesserman, 229 Livingston St., Newark, N. J.

WANTED—One Pandanus CUTLIS, large plant; state size and price. Scott Bros., Elmford, N. Y.

REVERO

THE MODERN GARDEN HOSE

FOR LAWNS, GARDENS, GREENHOUSES, STABLES, ETC.

BRAIDED FABRIC, MOULDED CONSTRUCTION, SEAMLESS THROUGHOUT

LIGHT—STRONG—FLEXIBLE

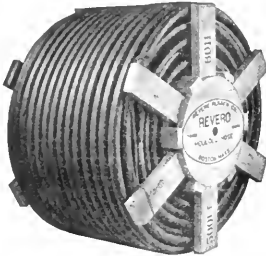

Revero is furnished on Reels in Continuous Lengths up to 500 ft. Your Supply House can furnish "Revero."

Write for Catalog

REVERE RUBBER COMPANY
BOSTON, MASS.

NEW YORK
NEW ORLEANS

PHILADELPHIA
MINNEAPOLIS

PITTSBURG
SAN FRANCISCO

CHICAGO
PORTLAND, ORE.



OLD STYLE—READILY KINKS



REVERO—NON KINKING

The Payne Steel "T" Bar Greenhouses

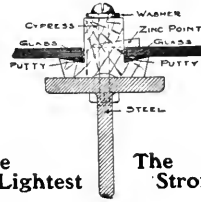

The Lightest The Strongest

Half full size

HOUSES of this type are constructed with both curved glass caves and straight glass caves. Least amount of shadow. Least amount of wood. No drip. Greatest durability.

JOHNA. PAYNE

Greenhouse Designer and Builder
260-274 Culver Avenue

JERSEY CITY, N. J.

CYPRESS SASH BARS
82 feet or longer
HOT BED SASH
PECKY CYPRESS BENCH LUMBER

GREENHOUSES

ERECTED AND EQUIPPED COMPLETE IF DESIRED

Write for Circular "D" and Prices

The A. T. STEARNS LUMBER CO.
NEPONSET, BOSTON, MASS.

STANDARD PLATE GLASS CO.

Manufacturers—Importers—Jobbers

NOW IS THE TIME TO BUY

FRENCH OR AMERICAN GREENHOUSE GLASS

LOWEST PRICES ON REQUEST

26-30 Sudbury St. BOSTON, MASS. 61-63 Portland St.

GLASS Always Write Us Before Buying
SHARP, PARTRIDGE & CO.
22nd and Lumber Streets, CHICAGO
WE HAVE SOME SNAPS

BOSTON PLATE & WINDOW GLASS CO.
GREENHOUSE GLASS GERMAN AND AMERICAN

261 to 287 A Street BOSTON 20 to 22 Canal Street

A WIRELESS MESSAGE - A BUY YOUR BUILDING MATERIAL - WOOD - IRON - GLASS - FROM FOLEY

IF YOU WANT **BIG RESULTS**

BUY FROM WHO RUNS THE IN THE YOU WILL WEARA CAUSED BY FROM GROWN IN

PHIL FOLEY FACTORY CITY OF CHICAGO. SMILE PROFITS CROPS HOUSES

WESTERN, WEDGEMAN AND SPRINGFIELD, ILL. 23 1/2 TO 26 1/2 STS CHICAGO

Holds Glass Firmly
See the Point #2

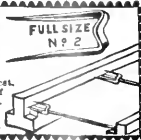

PEERLESS
Glassing Points are the best. No rights or lefts. Box of 1,000 points 75 cts. postpaid.
HENRY A. DREER,
714 Chestnut St., Phila., Pa.



Evans 20th Century Arm

Will not twist the shafting pipe. Three times the power of old style elbow arms. Sold only with Evans Challenge Machine.

Write for free Catalogue to **QUAKER CITY MACHINE CO.**
Richmond, Ind.

THEY'RE STICKING OUT all over these pages.

WHAT ?

Bargains in good stock.

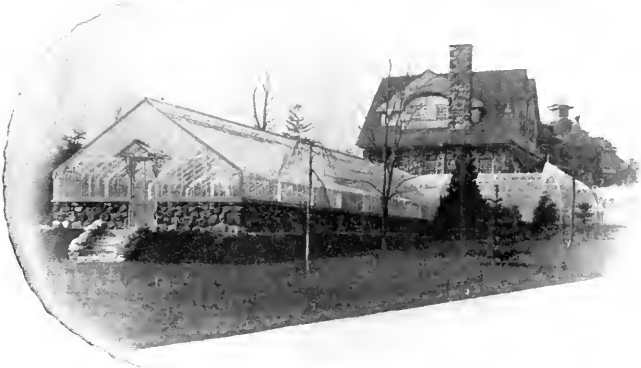

Erected at Davenport Neck, New Rochelle, N. Y.

THE QUESTION OF STRENGTH

IT is conceded that the strongest and most durable structure known is "THE IRON FRAME." And when you have all the Modern features combined in this type of construction you have "The Ideal Greenhouse."

The picture shows the beautiful symmetry of my "Curved Iceless Eave" — no heavy antiquated shading members. And I also make a specialty of having my work harmonize with surrounding conditions. Note how the mason work on greenhouse conforms to that on adjacent stable.

The advice of "The Practical Greenhouse Builder" is at your disposal for the asking.

WILLIAM H. LUTTON
West Side Ave. Station, JERSEY CITY

COAL Pocahontas Smokeless Coal Blossburg Smokeless Coal

The above steam coals are peculiarly adapted to FLORISTS' use. Prominent features are HIGH EVAPORATION, LOW ASH, LOW SULPHUR, HIGH CARBON, and HIGH HEAT UNITS. Permit us to figure on your year's requirements, deliverable as called for.

CARGOES CONSTANTLY ARRIVING AT ALL NEW ENGLAND PORTS

The Bader Coal Company, F. B. LAYTON
Gen'l Sales Agent

Telephone Fort Hill 2044

Board of Trade Building, Boston, Mass.

KROESCHELL BOILER

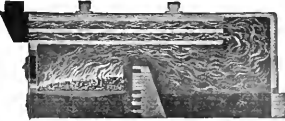

MADE OF FIRE BOX FLANGE PLATE
Can not Crack

Water Space in Front, Sides and Back
The Most Popular Boiler Made
SEND FOR CATALOGUE.

KROESCHELL BROS. CO.
35 Erie Street, CHICAGO, ILL.

GREENHOUSE CONSTRUCTION LUMBER

John C. Moninger Co.
117 E. Blackhawk St., CHICAGO.

The FLORISTS' HALL ASSOCIATION OF AMERICA, insurer of 29,000,000 sq. ft. of glass. For particulars address
John C. Esler, Secy, Saddle River, N. J.

Please Note

that this is not a $\frac{1}{4}$ in. wire affair but it is made of heavy rods.

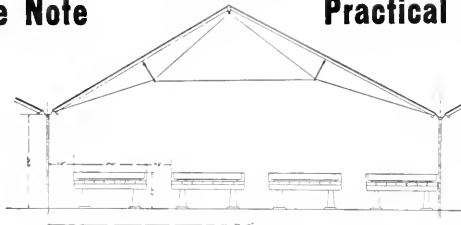

Practical Houses

on a practical financial basis. If you want an up-to-date house that will save you money,

WRITE

GEO. M. GARLAND CO.

Designers and Builders

DES PLAINES, ILL.



The Advance Ventilating Apparatus

Our motto, a square deal — best of goods, easy and long service at fair prices. Get our estimate on your needs. See what we can do for you. Thousands of machines in use in forty states and only five years on the market, certainly indicates high quality of goods and excellent service. Send for our latest prices and circular.

The Advance Co.
RICHMOND, IND.

EVERYTHING FOR GREENHOUSE BUILDING

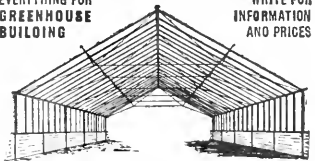

WRITE FOR INFORMATION AND PRICES

King Greenhouses. King Gutters and Eaves. Trussed Roofs. Ventilating Machinery. Trussed Iron Frame Houses. Tile Benches and Pipe Hangers.

KING CONSTRUCTION COMPANY
NORTH TONAWANDA, N. Y.

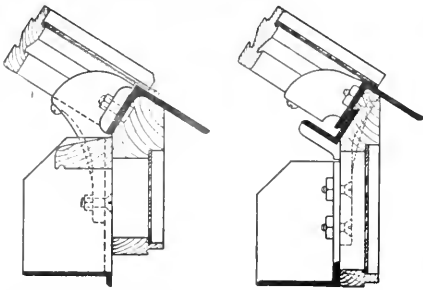

EAVE PLATES

Here are two kinds: our regular Standard Galvanized Steel Eave, which is the simplest and most practical — and the same plate equipped with a Galvanized Steel Drip Gutter. This last is a combination which we patented as long ago as December, 1901.

Both these plates have the cast iron roof bar brackets which firmly secure the bars to the plates and prevent end rot.

Hitchings & Company
 1170 Broadway New York

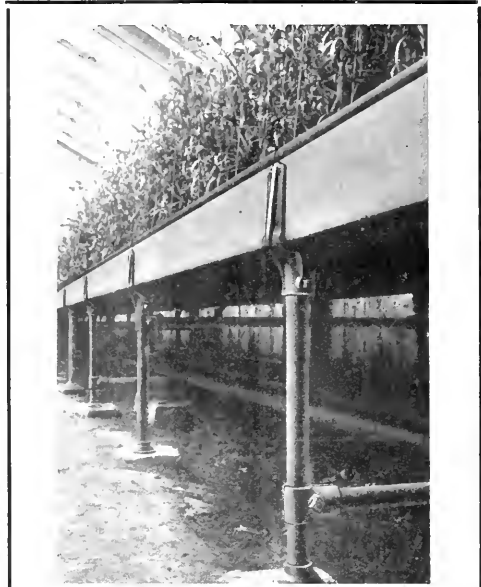

INDESTRUCTIBLE BENCH

Will last a life time — no repairs — easy to erect — easy to take down — perfect drainage — costs less in the end than concrete. Write Lord & Burnham Company, Irvington-on-Hudson, N.Y. for circular.

For Example, Take the U-Bar Palm House

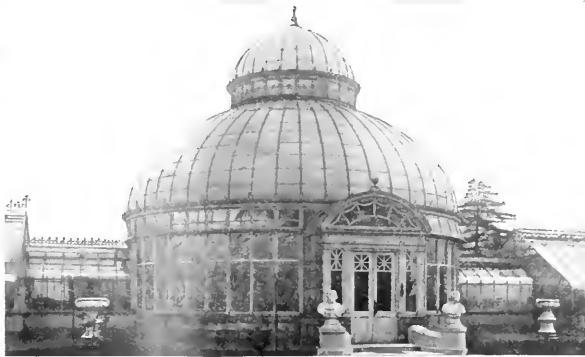

and you can see at once how decidedly more effective this curvilinear, circular house is than a square shaped affair, or even one with octagon corners, would be. Fact is, the U-Bar is the only construction that can be used in building a successful curvilinear palm house — it is the most adaptable construction of the day.

It is the ideal construction for private estates, parks, public institutions and florists' show rooms.

U-BAR GREENHOUSES

PIERSON
 DESIGNERS AND BUILDERS



U-BAR CO.
 1 MADISON AVE. NEW YORK

HORTICULTURE

Vol. IX. APRIL 24, 1909 No. 17

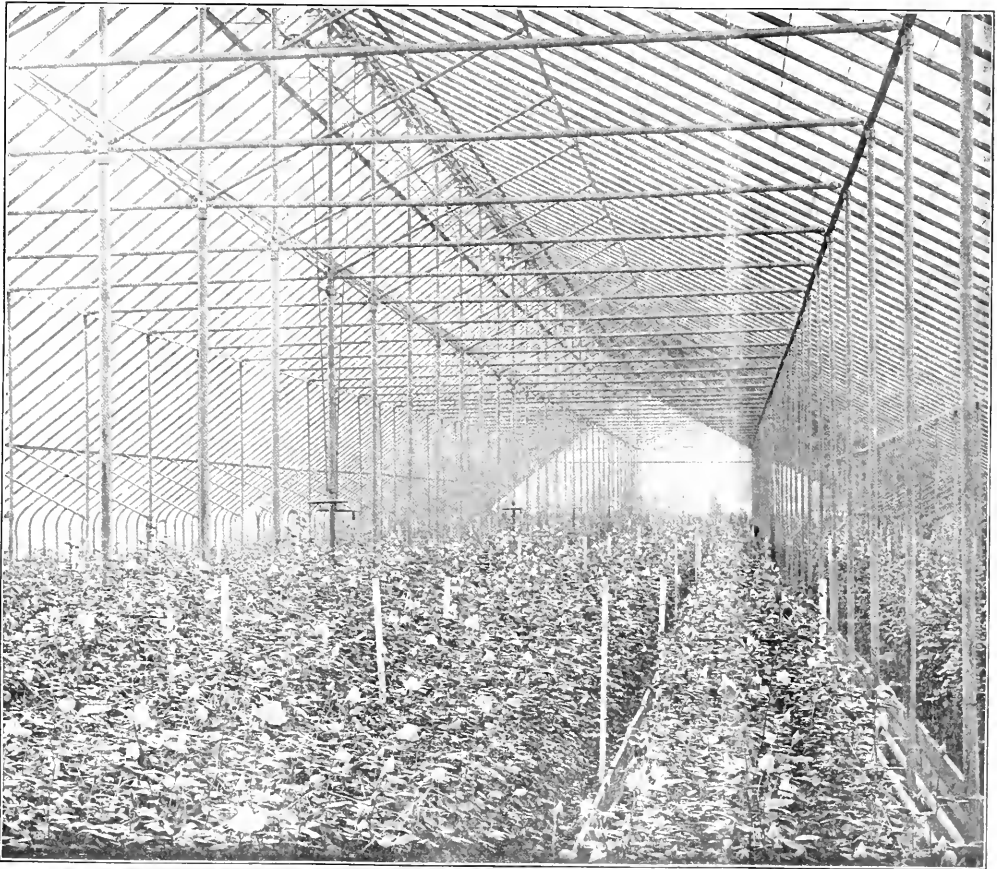

A HOUSE OF WHITE KILLARNEY ROSE
F. R. Herson Co., Scarborough, N. Y.



DEVOTED TO THE
FLORIST, PLANTSMAN, LANDSCAPE GARDENER AND KINDRED INTERESTS

PUBLISHED EVERY SATURDAY AT 11 HAMILTON PLACE, BOSTON, MASS.

SUBSCRIPTION, \$1 00 PER YEAR



CHRYSANTHEMUMS.

"Not small weak runty stock grown under benches, but the kind that brings back Dollars for Pennies."

WHITE: Earliest October Frost (We have extra fine large stock of this variety), Mrs. Henry Robinson, Clementine Touset, Alice Byron, Timothy Eaton, Merry Christmas, White Bonaffon.

YELLOW: Monrovia, Halliday, Appleton, Bonaffon, Eaton, Chataqua Gold.

PINK: Mc. Nice, Maud Dean, Dr. Enguehardt, Rosiere.

RED: Intensity, Schrimpton.

All these varieties, rooted cuttings \$2.50 per 100; \$30.00 per 1000. 2 1/2 in. \$3.00 per 100; \$75.00 per 1000.

White Chadwick, Golden Chadwick, Golden Wedding, R. C. \$3.00 per 100; \$27.50 per 1000.

2 1/2 in. \$4.00 per 100; \$35.00 per 1000.

Virginia Pochlmann, R. C. \$4.00 per 100. 2 1/2 in. \$5.00 per 1000.

Golden Glow, R. C. \$5.00 per 100. 2 1/2 in. \$5.00 per 1000.

CARNATIONS.

Enchantress and White Lawson, R. C. \$7.50 per 100; \$72.00 per 1000.

Enchantress, White, Pink and Variegated Lawson. 2 1/2 in. \$3.00 per 100; \$24.00 per 1000.

O. P. Bassett. 2 1/2 in. \$2.00 per 100; 3 1/2 in. \$10.00 per 1000.

2 in. or 2 1/2 in. 3 in. or 3 1/2 in.

Bridesmaids } 1000 1000 1000 1000

Brides } \$5.00 \$15.00 \$6.50

Richmond } 5.00 45.00 6.50

Perles } 5.00 45.00 6.50

Kaiserin } 5.00 45.00 6.50

Uncle John } 5.00 45.00 6.50

Strong well rooted cuttings and 2 1/2 inch stock. Sarah Hill, Aterglow, White Perfection, Victory, Rose Pink Enchantress, Winsor, Beacon, White Enchantress, at \$1.00 per 100; \$75.00 per 1000.

Sarah Hill, Elo. d., Aterglow, Winsor, Beacon, Victory, 2 1/2 in. \$3.50 per 100; \$32.00 per 1000.

ROSES.

American Beauties... \$7.00 \$65.00 \$9.00 \$85.00

My Maryland (Grafted strong stock)... 25.00

My Maryland Own roots... 12.00

Killarney Own roots... \$6.00 \$55.00 7.50

Mrs. Potter Palmer... 5.00 45.00 6.50

POEHLMANN BROS. COMPANY,

Morton Grove, Ill.

NEW CREATIONS IN DAHLIAS

Jack Rose, Virginia Maule, Ethel Schmidt, Sensation, Big Chief, Gladys, Rose Pink Century, Fringed 20th Century, Fringed Beauty. 50 cts. each, \$5.00 per doz., \$35.00 per 100. Strong plants now ready.

PRINCESS VICTORIA. \$1.00 each, \$10.00 per doz., strong plants. A superb collection of new Cactus Dahlias. Send for new descriptive catalogue.

Peacock Dahlia Farms, Williamstown Junc., N. J.

The Carnation that Always Beats Everything in Sight Wherever Shown

BAY STATE

Winner of Gold and Silver Medals. Buy Now. Fine Healthy Stock

ROOTED CUTTINGS, - \$12.00 per 100, \$100.00 per 1000.

ALBERT ROPER, TEWKSBURY, MASS.

CHRYSANTHEMUMS

Rooted Cuttings and Pot Plants

Write for list and prices. ALL OF THE BEST ONES.

S. J. REUTER & SON, WESTERLY, R. I.

CARNATIONS

White Perfection, White Enchantress, \$3.00 per 100; \$25.00 per 1000.
Lady Mounifull, Enchantress, Rose Pink Enchantress, Winsor, White Lawson, \$3.00 per 100; \$20.00 per 1000.
Melody, \$3.00 per 100; \$22.50 per 1000

Our stock won the Cottage Garden

CHICAGO CARNATION CO.,

CARNATIONS

Splendor - \$5 per 100 \$40 per 1000
Lawson - Enchantress 5 00 40 00
Andrew Carnegie 6 00 50 00
Beacon - 4 00 35 00
Aterglow - 6 00 50 00
Joy-Dancen - 10 00 50 00

Cup at the National Flower Show.

A. T. Pyfer, Mgr. JOLIET, ILL.

2 1/2 Stock Chrysanthemums

Golden Glow, Pacific Supreme, White Cloud, Lynnwood Hall, \$5 per 100; Golden Eagle \$10 per 100; Virginia Pochlmann, Alice Roosevelt, \$4 per 100, \$35 per 1000; October Frost, Appleton, White Bonaffon, Touset and all commercial, \$3 per 100, \$25 per 1000. Cash.

I. M. RAYNER GREENPORT, L. I., N. Y.

GARDENIAS

Fine, large Jessamines (gardenias) with beautiful foliage, two grades:

Stems from 8 to 12 in., \$6 per 1000

" " " 12 to 18 in. " " "

f o. b. Alvin Terms strictly Cash or C O D.

MISS A. WASHINGTON, ALVIN, TEX.

In ordering goods please add "I saw it in HORTICULTURE."

CHRYSANTHEMUMS

I have now ready 100,000 plants of 300 varieties, Large Flowered, Singles, Pompons, etc. These are fine stock from 2 1/4 inch pots

All the standards such as Robinson, Bonaffon, Duckham, Clay Frick, Beatrice May, Mrs. Partridge, Polly Rose in large quantities at

\$3 per 100, \$25 per 1000

Write me what you want and see what I can do for you

CHARLES H. TOTT
Madison, N. J.

CARNATIONS

Fine Healthy Stock From 2 inch Pots.

Per 100 Per 1000

Pres. Seelye - \$6.00 \$50.00

White Enchantress, Beacon 4.50 40.00

Victory, Winsor, Melody, 4.00 35.00

Kingston Pet - 4.00 35.00

Daheim, Lady Mounifull, Trs.

Lawson, White Lawson, Red

Lawson, Variegated Lawson 3 50 30.00

CHRYSANTHEMUMS

Rooted Cuttings

G. W. Childs, Miss Clay Frick, White Shaw,

Early Snow, Trs. Jas. Marshall, Mayor

Weaver, The Harriott, Yellow Eaton, \$2.00

per 100; \$15.00 per 1000.

A. J. Balfour, Autumn Glory, Ada Spaulding,

Dr. Enguehardt, Dorothy Devens, Geo.

Kaib, Glory of the Pacific, Harry Tey, H. W.

Reiman, Ivory, Jeanne Nonin, J. E. Lager,

J. H. Troy, J. K. Shaw, Glad Dean, Meta,

Monrovia, Trs. Jerome Jon-s, Minnie Wansamaker,

Trs. Alice Byron, Trs. Baer, Trs. Robert McArthur, Major Bonaffon, Glad F.

Bergmann, Nagoya, Polly Rose, Rbtt. Halliday,

Timothy Eaton, W. H. Lincoln, Wm. Duckham, etc., \$1.50 per 100.

*Send for Catalogue of Roses, cwn root and grafted, and other miscellaneous stock

WOOD BROTHERS

FISHKILL, N. Y.

Send for our Preliminary List describing and quoting

Chrysanthemums and Carnations.

A fine lot of Carnation Cuttings ready now.

THE E. G. HILL CO.,
Richmond, Indiana.

CARNATIONS

WINONA - The true pink - At Indianapolis, in class A, won 1st prize in six entries for best vase of 100 blooms of light pink lighter in color than Lawson. A grand commercial sort in great demand. Place your order now for prompt delivery. \$6.00 per 100, \$50.00 per 1000

F. DORNER & SONS CO. La Fayette Ind.

SCOTT BROS. CHRYSANTHEMUMS All the Newest and Best Sorts

ALSO ROSES Grafted and Own Root for Greenhouse and Outdoors
ELMSFORD NURSERIES, Elmsford, N. Y.

NEW ROSE

WHITE KILLARNEY

We Know You Will Want to Buy White Killarney



Every live, progressive, up-to-date grower who has seen it is buying it; but when you buy White Killarney, be sure you get the right White Killarney (the Waban variety). When you buy from us you get the variety that has been exhibited and certified, and the one that has attracted such favorable mention.

If you are in the vicinity of New York, we should be glad to have you call and see White Killarney growing at our Scarborough range, and you will say at a glance—as everyone has who has seen it growing—that it is by far the best white rose that has ever been placed on the market.

It is not only a good winter-flowering rose, but is good the entire year, and it is a splendid shipper. Read the following letter received from Mr. Willis N. Rudd, Secretary of the Society of American Florists, dated January 18th, in which he writes as follows:

"Dear Mr. Pierson:—I cannot refrain from writing you and expressing my admiration for the White Killarney as shown at Chicago on Thursday. It is an exquisitely beautiful thing and attracted much attention. I took half the blooms home with me, and they were finer on Saturday than they were at the show. The record is that these blooms were shipped from Tarrytown, staged and exhibited during the afternoon. They were then carelessly wrapped up in a box, and remained in that box until one o'clock Friday morning, at which time I reached home, improved in quality up to Saturday, and were in fairly presentable condition on Sunday.

"In addition to being the most beautiful white rose of its class which I have seen, this demonstrates its splendid keeping and shipping qualities.

W. N. RUDD."

We were awarded Silver Cup at National Flower Show, Chicago, for best new rose with White Killarney; also Silver Medal Horticultural Society of New York.

Strong plants, 2 1/4 inch pots, own roots, now ready for delivery, \$30.00 per 100; 250 for \$70.00; 500 for \$125.00; 1000 for \$250.00. Grafted plants, ready April 1st, \$35.00 per 100; 250 for \$82.50; 500 for \$150.00; 1,000 for \$300.00.

F. R. PIERSON CO., Tarrytown-on-Hudson, NEW YORK

ROSES

Good Grafted Killarney 2 1/4 in. \$12.00 per 100
Good Own Root Richmond, \$4.00 per 100 pots
White Cherokee, One year old, 3 plants in a 7 in. pot, 25c. a pot.
MONTROSE GREENHOUSES
MONTROSE, MASS.

Newport Fairy

The Rose of the Future For In and Out Door.
FINE, STRONG FIELD-GROWN STOCK
 3-4 Shoots 3-4 ft. long
 50c each, \$30 per 100, \$250 per 1000
JULIUS ROEHR'S CO.,
 RUTHERFORD, N. J.

STOCKS (Gilly Flower.)

grown and shipped in 2 1/2 in. paper pots, no retarding, Great Memorial Week seller, either at pot or out. Newport Beauty strain of immense size of bloom, Faust delicate white, Tephistophol a deep blood red, also mixed white, blue, pink, red \$4.00 per 100, 200 for \$7.00

J. H. Myers, ALTOONA, PA.

A. N. PIERSON, Inc., Cromwell, Conn.

WHITE KILLARNEY (Waban Strain)

GRAFTED STOCK.....	Doz.	100	250	500	1000	2500	5000
	\$6.00	\$7.00	\$8.20	\$19.00	\$36.00	\$87.50	\$1,250.00

MY MARYLAND GRAFTED \$3.00 per doz., \$30.00 per 100, \$150.00 per 1000
 OWN ROOT 2.00 " " 10.00 " " 90.00 " "

STANDARD VARIETIES

Bet y. Bon Silene, Bride, Bridesmaid, Cardinal, Enchanter, Etoile de France, Etoile de Lyon, Franz Deegan, Gen. McArthur, Golden Gate, Hermosa, Ivory, Kal-erin Augusta Victoria, Kate Moulton, Killarney, La Detroit, Maman Cochet, Marechal Niel, Mme. Abel Chatenay, Mrs. Jardine, Mme. Hoste, Mrs. Paul Niehoff, Mrs. Pierpont Morgan, Mrs. Potter Palmer, Papa Gontier, Queen Bearrice, Rhea Reid, Richmond, Rosaline Orr English, Souv. du President Carnot, Souv. de Wootton, Uncle John, Wellesley, White Cochet. The above Grafted (selected plan) 2 1/2 cts. each, \$2.00 per doz., \$15.00 per 100, \$110.00 per 1000.

OWN ROOT ROSES

Killarney, Bride, Bridesmaid, Mme. Abel Chatenay, Ivory, Richmond, Mrs. Paul Niehoff, 2-in. pots, 75c per doz., \$3.50 per 100, \$31.00 per 1000. 2 1/2-in. pots, \$1.00 per doz., \$6.00 per 100, \$50.00 per 1000.
 Queen Bearrice Rhea Reid, Mrs. Jardine, Mrs. Potter Palmer, from 2 1/2-in. pots, \$8.00 per 100, \$70.00 per 1000.

BEDDING PLANTS

COLEUS, Verschaffeltii, Golden Queen, Queen Victoria, Beckwith Gem, Firebrand, Lord Palmerston. Rooted Cuttings by express, \$0.65 per 100, \$5.00 per 1000. Out of 2 1/2 in. pots in May, \$2.00 per 100, \$15.00 per 1000.
 Golden Bedder, Hero Messy, Pearl of Orange. Fancy Varieties. Twelve kinds out listed above, 75 cts. per 100, \$5.00 per 1000.
 AGERATUM, Stella Gurney, Princess Pauline. SALVIA, Splendens, Bonfire and Zurich. HELIOTROPE. Dark blue bedding varieties. GERMAN IVY. 75 cts. per 100, \$6.00 per 1000.
 ALTERNANTHERA, Red and Yellow. 50c per 100, \$5.00 per 1000. From 2 1/2 in pots, \$2.00 per 100.
 SALLEROL, Rooted Cuttings, \$1.00 per 100, 2 1/2 in. pots, \$2.50 per 100.
 CHRYSANTHEMUMS IN QUANTITY. Catalogue on Application.

DAHLIAS.

Now is the time to place your order for bulbs which will assure you getting named varieties in any quantity; prompt delivery.

DAVID HERBERT & SON,

Successors to L. K. Peacock, Inc.
ATCO, N. J.

The Northboro Dahlia and Gladiolus Gardens

offer for Spring 1909 300 selected varieties of Dahlias and one and one half million large-flowering Gladioli in mixtures, in lots to suit. Send list of your wants. Catalogue free.
J. L. MOORE, Northboro, Mass.

ROSES

We have a fine stock of large, dormant, field grown plants, on own roots, of the following varieties:

Boule de Neige, Mad. Planiter, Alfred Colomb, Paris des Champs, Climbing Clothilde Sompert, Archduchess Elizabeth of Austria, Empress of India, Glory of the Exposition of Brussels, Philadelphia Crimson Rambler, Fisher Home, Chestnut Hybrid, Climbing Wootton, Magna Charta, Countess of Rosberry, Louis Van Houthe, Dorothy Perkins, Anna de Diesbach, Mad. Alfred Carriere, Vick's Caprice, Sir Thomas Lipton, Fraucola Levet, Eugene Furst, Crimson Rambler.

PRICE \$12.50 per 100; \$120 per 1000

Tausendschon, the great new climber, \$20 per 100.

Crimson Baby Rambler, \$16 per 100. Fine plants from 2½ inch pots, Chrysanthum Glory of the Pacific, \$3.50 per 100.

Roses, Dahlias and Cannas a Specialty. Catalogue Free

The Dingee and Conard Co. West Grove, Pa.

Ampelopsis Quinquifolia

	Per 1000
Strong 1-year plants 2 to 3 ft.	\$20.00
" 2-year " 3 to 4 ft.	30.00
" 3-year " 4 to 6 ft.	55.00

TO THE TRADE ONLY
A Full Line of General Ornamental

NURSERY STOCK
SEND FOR CATALOGUE

**EASTERN NURSERIES
JAMAICA PLAIN, MASS.**
HENRY S. DAWSON, Mgr.

BARGAINS For Immediate Delivery

10,000 Berberis Thunbergii Seed lins.	Per M.
3-5 in.	\$5.00
	Per C.
200 Berberis Purple Leaf, 18-24 in.	\$5.00
275 Dentzia Candida, 2-3 ft.	5.00
200 Dentzia Crenata, 2-3 ft.	5.00
400 Dentzia Gracilis, 12-18 in. bushy	5.00
150 Norway Spruce, 18-24 in.	10.00
100 Paonia, assorted, 2 yrs. No. 1	8.00
275 Paonia, red, 2 yrs. No. 1	8.00
75 Paonia, pink, 2 yrs. No. 1	8.00
75 Paonia, bluish white, 2 yrs. No. 1	10.00
200 Arbor Vitae, 18-24 in.	10.00
200 Clematis Paniculata, 2 yrs. No. 1	8.00
150 Hall's Japan Honey-suckle, 2 yrs No 1	6.00
3,000 California Privet, 12-18 in.	2.00

G. R. Burr & Company Manchester Conn.

Box Trees

and other EVERGREENS for Tubs and Boxes
Our Prices are Always Right—Catalog Free
THE NEW ENGLAND NURSERIES, Inc.
BEDFORD, MASS.

Hardy Rhododendrons, Azaleas, Conifers, Clematis, H. P. Roses, Shrubs and Herbaceous Plants from our
HOLLAND NURSERIES
Prices Moderate

P. OUWERKERK, 216 Jane St., Woburn Heights P. O. No. 1, Hoboken, N. J.

CLEARY'S HORTICULTURAL CO.
Management AMBROSE T. CLEARY
Wholesale Contracting, Jobbing, Auction
HORTICULTURAL PRODUCTS
of every description.

Consignments Received. Surplus Stock Convert
62 Vesey St., NEW YORK

GERANIUMS

Special offer of strong plants, from 2 in. pots our selection of 10 kinds, 500 for \$25.25, 1000 for \$15.00. Cash with order. From 3 in. pots, \$3.00 per 100, \$25.00 per 1000.

DAHLIAS

We have one of the finest collections in the country of good distinct commercial varieties at \$2.00 per 100 and up for plants ready for shipment now. Then we have Jack Rose, Virginia Maud, Big Chief, Rose Pink Century, Fringed 20th Century, Rebecca Mayhew, etc., at 50c. each, \$5.00 per doz., \$55.00 per 100. We will send 1000 in 20 good distinct cut flower sorts, our selection, for \$18.50.

	Per 100	Per 1000
	2 in. 3 in.	2 in. 3 in.
AGERATUM, 5 kinds	\$2.00	\$3.00
ALYSSUM, Dwarf and Giant	2.00	
CENTAUREA Gymnocarpa	2.00	3.00
ACHYRANTHES, Emer- son and Moslaca	2.00	3.00
CINERARIA Maritima	2.00	3.00
HARDY ENGLISH IVY	2.00	
PARLOR IVY, Senecio Scandens	2.00	
LOBELIA, Kathleen Mallard Crystal Palace Gem	2.00 1.50	3.00
PETUNIAS, Dreer's Superb Single	2.00 3.00	
SALVIA Bonfire	2.00	3.00
SALVIA Zurich		3.00 4.00
SAXIFRAGA SARMENTOSA		3.00
SMILAX, Extra Strong		2.00
VERBENAS, Red, White, Pink and Blue		2.00 3.00
COLEUS, Verschaffeltii, Golden Bader, Queen Victoria, Eldorado, etc.		2.00 3.00
TRADESCANTIA, Dark Variegated		2.00
HARDY POMPON CHRYS- ANTHEMUMS, 75 Varieties		2.00

R. VINCENT, JR., & SONS CO., White Marsh, Md.

SOME OF OUR SPECIALTIES

Boxwood Pyramid Shape, 2½ to 3 ft. high, very heavy, \$1.75 each, 3 to 3½ ft. high, \$2.50 each. **Bush Shape**, very heavy, 2 to 2½ ft., \$1.75 each, 2½ to 3 ft. high, \$2.00 each. **Rhododendrons**, Parson's Hardy varieties, 8 to 12 buds, 18 to 24 in. high, at \$75.00 per 100; 12 to 14 buds, 24 to 30 in. high, at \$100.00 per 100. **Azalea Hollis**, 15 to 18 in. high, very bushy and full of buds, at \$35.00 per 100. **Hybrid Perpetual Roses**, strong dormant field grown plants, of our own growing, none better, \$1.00 per 100, \$100 per 1000. **Moss Roses**, field grown, \$1.00 per 100. **Hardy Climbing Roses**, field grown, \$3.00 per 100. **Tree Roses**, hardy varieties, budded on straight stems, 4 to 5 ft. high, \$30.00 per 100. **Ampelopsis Vetchii**, bushy, 2 yr. plants, 3 foot of tops, \$10.00 per 100.

The Storrs & Harrison Co., Painesville, Ohio

RHODODENDRONS, ANDROMEDAS, KALMIAS AND SPECIMEN EVERGREENS

JOHN WATERER & SONS, Ltd.

AMERICAN NURSERY

BAGSHOT - - - ENGLAND

RHODODENDRONS

Rhododendron hybrids, 1-2 ft. and 2-3 ft.
Hardy varieties and assorted colors.
Rhododendron maximum, 2-3 ft. and Kalmia latifolia, 2-3 ft. Collected plants in ear pots.
Koster Blue Spruce, 4-5 ft. and 6-8 ft.
Transplanted 2 years ago.
Azalea mollis, 15-18 in. fine plants.
All the above selected stock. Write for prices.
P. A. KEENE, 1 Madison Ave., New York

NORWAY SPRUCE

Shapely well furnished trees, two or more times transplanted. Good roots and good color.

1000 1½ to 2 ft.	at \$ 7.00 per 100
1000 2 to 2½ ft.	at 10.00 "
1000 2½ to 3 ft.	at 12.00 "
500 3 to 4 ft.	at 15.00 "

MAURICE J. BRINTON, CHRISTIANA, PA.

Hardy Perennial Plants.

Old Fashioned Garden Flowers—Larkspur, Foxglove, Sweet William, Hollyhocks. A choice selection. The New Anemone Italica Droppore variety. Strong pot-grown plants \$1.50 per doz. \$10.00 per 100.
WM. TICKER, Arlington, N. J.

GLADIOLI NAMED VARIETIES

Childs and Gandavensis Seedlings, Madeira Vines, Cinnamon Vines, Oxalis, Spotted Callas, and Iris Germanica. Write for prices.
E. S. MILLER, Wading River, N. Y.

TO BUYERS
Patronize our advertisers. they will treat you right

Art in the Garden

(Continued from page 527)

FAULTY EDUCATION

In these days schools of art are to be found in almost every city, but it is to be feared that these do not always foster true artistic feeling, as they give so little encouragement to the observation of nature. No doubt these schools are productive of good in certain directions as they assist in producing persons capable of designing useful decorative work and the adapting of geometrical forms to various articles of use and ornament. But skill and cleverness in this work may exist without any true artistic feeling; in fact the latter is usually discouraged by the system pursued at these institutions.

Whatever opinion one may have of the methods of decorating the interiors of our homes, there can be nothing but condemnation when this decorative process of geometrical patterns is brought into the garden, thereby causing the foregrounds of beautiful scenery to be daubed with flower beds formed like a piece of linoleum.

Beauty is not attained by simply filling a garden with beautiful flowers. The total effect of a garden so filled is often marred by the separate effect of its contents. One may have an artistic garden, or a botanical garden—a museum of plants, or a garden like a figured carpet, but not all at the same time.

FORMALITY DESTRUCTIVE OF REAL BEAUTY

The merely decorative ideas of gardeners have often marred our gardens by means of what are known as "carpet-bedding," "mosaic culture," and the "bedding-out" system; in these the natural beauties of plants are lowered to the level of mere color designs, without any reference to the habits and characters of the plants themselves, clipping being generally resorted to for the purpose of keeping the patterns geometrical. No one who is a lover of flowers and who is capable of seeing beauty in nature, would allow his garden to be desecrated by this tracery work.

William Morris in his "Hopes and Fears for Art" wrote thus in connection with this subject: "Another thing also much too commonly seen is an aberration of the human mind, which otherwise I should have been ashamed to warn you of. It is technically called "carpet-bedding." Need I explain it further? I had rather not, for when I think of it, even when alone, I blush with shame at the thought." This kind of decoration seems to have been introduced and kept up as a manifestation of a gorgeous and highly elaborate style of gardening—a style which suggests the thought of enormous cost and enormous labor.

THE CHARM OF SIMPLICITY

If an artist wants a subject for a painting he never goes to a garden of this kind. No true artist would prostitute his brush by portraying these "aberrations of human intellect." If he wishes for a beautiful picture he goes along rural byways and there finds many examples of the beautifying effect of flowers being allowed to grow as nature designed they should, and in these cases sees artistic expression based upon the best foundation, viz., simplicity. It was the charm of simplicity which made many of the old-fashioned gardens so restful alike to the eye and brain. In this I do not include the old topiary work—another aberration of the human mind, copied from the Italians and introduced when people were limited to only a few species of shrubs—which is nothing but a brutal murdering of the beautiful forms of trees, mere barbering in fact.

In striving to surround a country home with beautiful

effects we must keep simplicity and naturalness, as opposed to formalness, continually in our mind's eye. If one sees a garden remarkable for its precision, the strictly geometrical sequence of its flower beds, trees closely clipped for the purpose of "harmonizing with the house," and a general air of stiffness pervading the entire surroundings, it may be passed at once with contempt as it has no artistic value.

THERE IS NO ABSOLUTE RULE

Many gardens of this description are designed in a building architect's office and are supposed to "fit the house." In all probability the same plan has been used for many other gardens, and it is a fact that they are often drawn without the designer ever seeing the spot beforehand, or having anything before him except the plan of the house. It is a great mistake to suppose there is such a thing as strict rule in landscaping which is capable of being applied to all sorts of situations. Every home and its surroundings invites its own plan, which when executed should give the property added charms of originality, variety, and character. Conventionalism is entirely out of place in a garden, and it is quite impossible to make a design which will fit every situation.

Artistic landscape architecture will never become capable of being governed by stereotyped rules and regulations, except that what Ruskin wrote may be safely laid down as an axiom, "Nothing is great as a work of art for the production of which either rules or models can be given." The more the laying out of gardens is guided by rules, or fashion, the less it becomes an art and the more a manufacture.

THE BANE OF MONOTONY

Apart from artistic considerations pure and simple, there is also the monotony which is to be found in many gardens which is so painful, and which does away with the possibility of finding any restful, refreshing feeling in them. It must never be forgotten that change and variety are as much a necessity in gardens to satisfy the aesthetic perceptions, to raise pleasurable emotions in the heart and mind, as in books, a gallery of paintings or sculpture. We can no more expect to derive pleasure from a monotonous garden where the bedding is principally on one pattern, than we should from a universe in which clouds, hills, and trees were all of one shape and size. There is nothing satisfying nor lasting about artificiality.

The botanical system of Linnaeus, for instance, a splendid contribution to human knowledge which did more in its day to enlarge the view of the vegetable kingdom than anything before it, was a purely artificial system. But all artificial systems must sooner or later pass away. None knew better than the great Swedish botanist himself that his system, being artificial, was but provisional. Nature must be read in her own light, and as the botanical field became more cultivated the system of Jussieu and De Candolle slowly emerged, unfolding itself as naturally as the petals of one of its own flowers, and, forcing itself upon men's intelligence as the very voice of nature, supplanted the Linnaean system forever.

PERNICIOUS FASHION

Not only is the lack of variety between different parts of a garden bad in itself, but with stereotyped bedding and geometrical borders all gardens become more or less alike; especially when a certain style is, for the time being, fashionable. In these cases there is not only a depressing monotony in our own garden, but when we visit others we find much the same thing; whereas when

true artistic feeling is brought to bear, each garden has a character of its own and every garden its own special features. The landscape architect must make his design thoroughly to fit the situation, and, regardless of fleeting fashion, should use the same pure taste in arranging the living elements of the picture he wishes to produce as an artist does in creating with his brush and colors.

The banefulness of fashion is in nothing more apparent than in the matter of terraces. Allowing architects of houses to interfere with the laying out of gardens is very often the cause of too much terrace, and the ordinary landscape gardener, following mere custom, will even make a terrace on level ground and induce the owner to spend large sums on excavating and walls which have no other effect than to absolutely spoil the place. There are of course situations in which terraces are more or less admissible, as where the ground slopes rapidly from the house and in positions where a level piece of lawn cannot be obtained without, but many country seats have had what might have been fine lawns spoiled by terraces.

AVOID TERRACES

The idea of a terrace was first brought from Italy. At one time an Italian garden was considered the proper thing, but the results of introducing a style—which owing to local circumstances is quite correct in the place where it originated—into a totally different environment, has been in most cases only productive of hideousness. Terraces are necessary on the hillsides in Italy, and were first formed in a rough way by the peasants, otherwise the ground could not have been put to any use, as it is the only means whereby the soil can be kept on the steep slopes. Also on these Italian terraces the beautiful olive is planted which has a double value: it gives a natural and therefore artistic effect, and is at the same time a source of profit to the planter.

Even in those situations where terraces may be considered indispensable, the walls can only be looked upon as necessary evils. Much might be done, although rarely attempted, to soften the bad effect of walls in an ornamental garden by covering them with life in the shape of creepers and other plants.

PLANTING FOR WINTER EFFECT.

In designing a garden the winter half of the year is too often forgotten or ignored, due, perhaps, to the fact that there are many even among lovers of the country who fail to appreciate the charms that may be found in the garden in the depth of winter, and who therefore cannot realize the possibilities in this direction. In this connection we see another point against the inartistic bedding system, for the beds in winter are nothing but mounds of brown earth and the reverse of pleasing even to the inartistic eye. It is a great mistake to suppose there is only bleakness and desolation in the winter. The many evergreens of all shades and shapes capable of enduring winters with a temperature below zero, and the still larger number for the more temperate climates, must, to everyone with any knowledge of plants, forbid such a supposition. Then there are amongst the deciduous species many having their bark of bright pleasing hues, harmonizing well with the dark evergreens and thereby adding additional charm to the winter picture.

A KNOWLEDGE OF PLANTS ESSENTIAL.

Bearing this brief outline of the general principles of our subject in mind, it must be apparent that to be successful a landscape artist must not only be capable of designing the framework, as it were, of a garden, but he must have a thorough knowledge of plants. Without the latter it is impossible for anyone to achieve a result which will be truly a work of art.

Every plant has its own peculiar character. Shape, color of leaves and bark at the different seasons, height and habit of growth, evergreen or deciduous; these and other traits all go to make up character. The characters of plants must be known and studied before any one can compose them into a harmonious whole. To expect success without this knowledge is like expecting a person without any knowledge of the tones of music to compose an opera. But, as it is true that even with a knowledge of music one may be unable to compose, so likewise the possession of a thorough knowledge of plants does not necessarily include the gift of designing artistic landscape effects.

The wide range of plants which in the present day can be used in landscape architecture, the equally numerous varieties of situations which the designer can be called upon to deal with preclude the, what may be termed, practical side of this question being touched upon in this paper. Nor, as previously mentioned, is it possible to lay down any fixed rules. Every situation has its own distinctive natural features, with which the artist must harmonize his garden. The fundamental point is to study nature, and it will be found that "Nature never did betray the heart that loved her."

William S. Seward

Davallias

The genus *davallia* contains some of the most useful forms that are known to commerce. *D. Mariesii* trained over peat to form junks, monkeys, elephants, etc., demonstrate to what useful purposes many *davallias* can be put to. A native of Borneo is *D. parvula*, the fronds of which never exceed one inch in length, and being situated on the rhizome rather closer than in many *davallias* lends itself readily to treatment when allowed to grow over an old peat stump; in this form it is useful when employed in table decoration, a miniature pyramid of living fern being at once novel and distinct. Perhaps one of the best known varieties is *D. canariensis* (hare's foot fern), its prostrate stems creeping downwards over the side of the pot. It is a good subject for the dwelling room.

Another meritorious dwarf variety is *D. Tyermanni*, fronds dark, of leathery texture, silver rhizome, and of great durability for cut purposes. *D. dissecta* is a rapid grower, excellent when raised from spores in its small state, and *D. bullata* makes a charming subject for basketwork. Among the larger varieties one of the best known possibly is *D. filijensis plumosa*, the rhizomes of which are usually horizontal, in this respect differing from *D. canariensis*, although both varieties are identical in regard to the brown scales and thickness. *D. plumosa* is an excellent exhibition plant and so also is *D. hirta cristata*, usually known as *Microlepia hirta cristata*, the pale green color of its heavily tasseled fronds making it remarkably distinct. It will thrive in a night temperature of 50 degrees, therefore is suitable for house decoration. This variety does not readily produce spores but is easily divided with success. *D. tenuifolia Veitchiana* is one of the most graceful varieties in cultivation, an excellent subject for basket work and does not dislike the sun; it grows erect from the centre from two to three feet high and its light feathery fronds bend gracefully over and around the basket.

In regard to cultivation very little loam should be used. They delight in compost chiefly consisting of

Trained Rambler Roses

As Grown by Wm. Kleinheinz, Ogontz, Pa.



LADY GAY

"Umbrella." Three in a 14-in. Pot.



DOROTHY PERKINS

"Pyramid." Three in a 14-in. Pot.



DOROTHY PERKINS

"Balloon." Three in a 14-in. Pot.

Our photographs illustrate some of the results obtainable from these rambler roses with care in the culture and training. The specimens were grown by William Kleinheinz of the Widener Conservatories, Ogontz, Penna., and comprise, each three plants grouped in a 14-inch pot each plant having been grown one year

in a seven-inch pot before being combined to three in a 14-inch.

peat, sand and a little charcoal. Watering overhead should be avoided and plenty of water is desirable at the roots. The creeping stems should be kept recumbent on the surface of the soil and kept pegged down either to the soil or to the outer surface of the basket, although in the latter case tying may be adopted. In case it is desirable to confine the creeping stems, cutting off the tips may be resorted to without injury to the plant. During the resting season water may be partially withheld although by no means entirely.

indication that horticulture, despite the temporary depression, is retaining its hold on the British public.

THE FLOWER MARKET

The floral department of Covent Garden market has lately been abundantly supplied with roses, Catharine Mermet particularly making a good show. Other varieties finding favor with market growers include Bridesmaid, Kaiserin A. Victoria, General Jacqueminot, Marechal Niel, Perle des Jardins. Carnations make a good display, but values are much lower than was formerly the rule. Amongst the whites, White Perfection is well to the fore. The bulb growers are now reaping their floral harvest. Large quantities of daffodils are being sent from the Scilly Islands. Some good specimens of lilac have been forwarded from French and English growers. The tulips coming forward include some excellent samples of the Darwin varieties. In the pot plant section, azaleas are a prominent feature, whilst there are some good lines in ericas, such as E. Cavendishii, E. persoluta alba, and E. Willmoreana. There is also a bright array of stocks, cinerarias, cyclamens, tulips and hyacinths.

A VALUABLE BEQUEST

British horticulture has benefited materially from the will of the late Mr. John Innes, of Merton, Surrey. A sum which will produce £8,000 per annum has been left for the endowment of a horticultural institution. A scheme has now been framed by the Charity Commissioners. In addition to the maintenance of a park at Merton, and minor charities the principal sum is to be utilized "to establish and maintain the institution for the purposes of affording practical and scientific training for those engaged or desiring to be engaged in the industry or employment of horticulture."

British Horticulture

THE TRADE OUTLOOK

So far the season has been very unfavorable for the nursery trade. The long, and at times severe winter, has put everything behind, whilst considerable damage has in many cases been caused by the frost. The bad weather has also prevented a prompt execution of the orders, as it has been impossible to get on the land to handle the stock. Then again, the general depression which exists in trade throughout the country is bound to exert its influence in this branch of commerce. There is one bright ray in the gloomy outlook, and that is the increased attention which is now given to gardening amongst villa-residents. The wide extension of the number who are enthusiasts in this health-promoting hobby has proved very beneficial to the nursery and seed trade, and has given a great impetus to the business in late years. Judging from the heavy advertising bills of some firms, an enormous trade must be done in catering for the amateurs. The fact that about a dozen gardening papers are flourishing in this country is also another

HORTICULTURE

VOL. IX

APRIL 24, 1909

NO. 17

PUBLISHED WEEKLY BY
HORTICULTURE PUBLISHING CO.
 11 Hamilton Place, Boston, Mass.

Telephone, Oxford 292

WM. J. STEWART, Editor and Manager

SUBSCRIPTION PRICE

One Year, in advance, \$7.00; To Foreign Countries, 8.00; To Canada, \$5.00

ADVERTISING RATES

Per Inch, 30 inches to page \$1.00.

Discount on Contracts for consecutive insertions, as follows:

One month (4 times) 5 per cent.; three months (12 times) 10 per cent.;

six months (16 times) 20 per cent.; one year (52 times) 30 per cent.

Page and half page spaces, special rates on application.

Entered as second-class matter December 8, 1904, at the Post Office at Boston, Mass. under the Act of Congress of March 3, 1879.

CONTENTS

	Page
COVER ILLUSTRATION—A House of White Killarney Rose.	
ART IN THE GARDEN—Arthur Smith.....	589
DAYALLIAS—Vernon T. Sherwood.....	590
TRAINED RAMBLER ROSES—Geo. C. Watson—Illustrated.....	591
BRITISH HORTICULTURE—W. H. Adsett.....	591
AFTER ADJOURNMENT.....	592
NEWS OF THE CLUBS AND SOCIETIES:	
Gardeners' and Florists' Club of Boston—Pasadena Gardeners' Association—Society of American Florists—Nassau County Horticultural Society—New Orleans Horticultural Society.....	594
Morris County Gardeners' and Florists' Society—Minnesota State Florists' Association—Pennsylvania Horticultural Society—Royal Horticultural Society.....	595
Park Superintendents' Meet—Dobbs Ferry Horticultural Association—Ladies' Society of American Florists' Club and Society Notes.....	596
DURING RECESS:	
Florists' Club of Washington—St. Paul vs. Minneapolis.....	596
THE ROSE GROWERS' PROBLEMS—Wm. H. Elliott, SEED TRADE:	598
The Frank S. Platt Company—Crop Prospects in California—A Letter to the Seed Trade—Notes.....	602
OF INTEREST TO RETAIL FLORISTS:	
Easter at Morristown, N. J.—Steamer Departures—Washington.....	604
Flowers by Telegraph—New Flower Stores.....	605
FLOWER MARKET REPORTS:	
Boston, Buffalo, Chicago, Philadelphia, Twin Cities, New York.....	607
MISCELLANEOUS:	
A New Plant Establishment.....	593
Rose Baby Dorothy, Illustration.....	593
Personal.....	593
A House of White Killarney Rose.....	593
Philadelphia Notes.....	600
News Notes.....	605-609
Movements of Gardeners.....	607
Business Changes.....	607
Incorporated.....	607
Greenhouses Building or Contemplated.....	615
Lord & Burnham Company to Have Chicago Office.....	615
Catalogues Received.....	615
Patents Granted.....	617

The call of duty

It is not pleasant to contemplate the possibility of the Pennsylvania Horticultural Society's losing their beautiful home, Horticultural Hall, in Philadelphia. And to think of the Philadelphia Florists' Club having to vacate those hospitable quarters where the spirit of brotherly love has shined its lustre so many years and the stranger within the gates has always found a warm welcome—why, it's simply preposterous and it would be a calamity of far more than local application. The entire country will watch eagerly for the good news that Philadelphia's shining lights in horticulture have been equal

to the emergency and that Horticultural Hall has been saved to horticulture for all time.

Boston
 in 1920, perhaps

Among the propositions of sensational magnitude for the future, the suggestion of an International Fair at Boston in 1920 in honor of the three hundredth anniversary of the landing of the Pilgrims, will take first rank. Just how much force there is behind the project is not yet apparent and whether Boston will care to repeat the experience which other cities have gone through, especially in the way of recovery from the effects of these big Expositions, is a question, but if it is to be undertaken the intervening time—eleven years—is not too long in which to fully prepare for an enterprise so colossal in character and in commemoration of an event so momentous in the history of human progress. Should the project be undertaken it goes without saying that the horticultural department of it will be in all respects away ahead of any previous effort in that direction.

The rose and its advancement

We are inclined to agree with W. H. Elliott's opinion as expressed at the meeting of the Gardeners' and Florists' Club of

Boston, that the rose is now well started on the same road that the carnation has been travelling for some time back—that is, that the number of new roses produced from now on will be sufficient to relegate successively to the rear and final obscurity, varieties that may attain prestige and popularity in the flower market. As is well-known the list of commercial carnations of ten years ago is practically extinct and a similar fate probably awaits the pet varieties of today after a few years roll along and bring to the front new and improved varieties. And this may be expected without considering the oft-debated theories of the deterioration of varieties under greenhouse culture. The long reign of the Bride, Bride-maid and American Beauty is not likely to be duplicated by any of their successors. Once fairly under way the business of producing new varieties of roses will undoubtedly make things interesting for the trade and there is no good reason why the carnation history should not be repeated in the case of the rose.

The cement greenhouse bench

The question of cement versus wooden benches for greenhouse use has been a prolific subject for discussion within the past few years.

Some of our ingenious fellow florists have put their inventive brains at work and, as our columns have testified from time to time, the result has been the placing on the market of several methods of construction—each having some valid claim on the attention of the growers who, after life long experience with short-lived wooden structures, are ready to listen to the facts regarding something more durable and more satisfactory. There have been establishments where, with the needed help and facilities, "home made" cement benches have been constructed and made to fill all requirements. We believe, however, that better satisfaction will come in the long run to those who turn over the work to the specialists who are doing it as a business and who, with the competition now existing, are not likely to charge for the work anything more than a fair figure. Whatever trivial objections may arise as to the use of cement benches it cannot be denied that the tendency in greenhouse structural work today is away from wood or other short-lived material and the man whose repair bills are the smallest will have most to say in establishing the selling price of the greenhouse products of the future.

After Adjournment

The gardenia, as is its custom at this season of the year, is about to come down from its lofty perch and give everybody a chance to get acquainted. See advertisement of Miss A. Washington.

Greenhouse men who have used the Revere Hose this season speak well of its lasting quality. For lawns and garden plantations it has already a first-class record. One of its best recommendations is its freedom from kinkiness.

The florists' supply men are gradually warming up for Decoration Day and the June wedding and graduation gaieties. Watch the advertising columns of HORTICULTURE if you have anything ahead in that line. You'll have no need to look anywhere else. Ask the specialty and supply men who advertise in HORTICULTURE to send you price-lists and prospectuses.

"Horticentristers have discovered that roses and wignonette cannot live together. If the two flowers are placed together in a vase both wither within half an hour."—Boston Globe.

The author of this remarkable bit of news didn't go back far enough in his investigation before forming his conclusions. Chances are that those roses and that mignonette came from rival establishments and were too well-trained to enjoy one another's society. Why, we have repeatedly known flowers to drop from first quality to third rate in the simple process of crossing from one wholesale establishment to a rival place on the opposite side of W. 28th St.

We have seen a copy of a Brooklyn, N. Y., paper in which appears in full an address on "Fletcher and Fletcherism" made by J. Austin Shaw before the Franklin Literary Society. We allude to it now, because the lecturer is "one of us" well known to the trade, and further because his subject—that of health and longevity—is one that will appeal to every human being. Therefore, there may be many who would like to read it—for it is very readable—and no doubt our friend Shaw would be glad to supply any applicants. Nearly two centuries ago there lived a man, John Armstrong by name, who in an essay on the Art of Preserving Health, wrote:

"Of right and wrong he taught truths as refined as ever Athens heard; And (strange to tell) he practiced what he preached."

So we now serve notice on Brother Shaw that an Argus-eyed watch will be put upon him when next John Nugent carves a turkey for the New York Florists' Club.

During the past two years HORTICULTURE has taken opportunity on various occasions to call the attention of the plant and flower growers to that labor-saving, fuel-saving and worry-saving invention known as the Castie Automatic Circulator. We did this, as we do it now, because we believe we are conferring a substantial benefit on the horticultural fraternity in so doing. We are pleased to be able to publish in full the following letter from

Thomas Roland of Nahant, Mass., which should be carefully perused by any grower using hot water for greenhouse heating. As to Mr. Roland, he is known all over the country as an expert plant grower with no superior, a trustee of the Massachusetts Horticultural Society and a man whom no inducement would influence to write such a testimonial unless every statement was unqualifiedly true.

Copy.

Nahant, Mass., April 24, 1909.

My Dear Sir: Last September I had you install one of your automatic circulators in my plant at Nahant. In order to heat these houses water had to travel 700 feet and 15 feet below the boilers. Previous to placing the circulator I was compelled to use steam, running an extra boiler to supply heat for these houses. I have used the past winter hot water solely, changing the steam system over entirely. The upper houses were also attached to the forced circulation, and I am pleased to report that not only have I received great benefit in those houses which were on same level as boiler, but with those 15 feet below the level have been able to maintain and regulate the heat to my utmost satisfaction. No other apparatus that I have ever seen or knew of could give me the same economical results. I consider your new circulator an indispensable adjunct to any heating system.

I propose to extend my plant by constructing new houses on this lower level the coming summer. Convinced that the question of heating same by hot water from my central station is satisfactorily demonstrated, I cannot see where I could afford to be without it.

Should be pleased to show the system to any interested, and you are at liberty to quote me fully to any one desiring information. Yours truly,

(Signed) T. ROLAND.

A NEW PLANT ESTABLISHMENT.

Brief mention was made in our columns last week of the resignation of Alois Frey from the position of head gardener at Lincoln Park to conduct a commercial business at Crown Point, Ind. Mr. Frey has raised some noteworthy crosses, especially in cinerarias and chrysanthemums and these will be among the specialties at his new place. Some of his best new anemone-flowered and single chrysanthemums are catalogued and illustrated in Elmer D. Smith's latest list. They were among the most admired features at the National Flower Show in Chicago last November.



ROSE BABY DOROTHY

As a Pot Plant, Can Be Sold by Thousands.

Personal

J. Hanna has taken a position with the Baur Floral Co., Erie, Pa.

Miss Cora Haggood has taken a position with J. V. Lavar, Erie, Pa.

The Alpha Floral Co., Chicago, are fortunate in securing the services of Miss Elsie Schnapp.

John C. Elliott has taken charge of Dr. L. D. Ward's place, "Brooklake," Madison, N. J.

Mrs. W. J. Smyth of Chicago has been called to California on account of the death of one of her parents.

O. Heeb, manager for Charles Eisner of Pittsburg, Pa., is reported as ill with blood poisoning from rose thorns.

Charles Biederman of the firm of Biederman & Schultz, florists, Kansas City, Mo., was stricken with hemorrhage on April 12.

F. W. Timme, well-known florist and writer on florists' topics, is said to be recovering rapidly from a recent paralytic stroke, at his home in Chicago.

James Hutchinson, for three years orchid hatcher to Dr. Shafer, Pittsburg, Pa., has given up private gardening and taken up landscape work in and around Pittsburg.

The Meriden (Ct.) Journal in a recent issue presents the portrait of Linus Birdsey, a prominent nurseryman of the town, who observed his eighty-fourth birthday recently and is still vigorous and active.

Lyman B. Crow of the Lord & Burnham Company, who recently underwent a very serious operation at the hospital, is now at home and improving rapidly, and anticipates being back in the harness about May 1st.

John Heereman of Palmetto Bluffs, S. C., formerly superintendent to A. R. Whitney, Morristown, N. J., spent, with his family, a few days with his successor there, H. B. Vyse. Now he goes to see his brothers Fred and Harry in Lenox.

Merlin Harris has left the Plant estate, Groton, Conn., to take a position with Dr. Shafer, Pittsburg, Pa. Mr. Harris' experience amongst orchids, gained in the orchid department of Hugh Low & Co., Enfield, London, eminently fits him for this position.

A HOUSE OF WHITE KILLARNEY ROSE.

Our columns contain more than the usual proportion of rose matter this week and favorable mention is made of White Killarney, the sensational introduction of the present season. Our cover illustration shows a view taken early in the season in one of the big Pierson houses devoted to this variety at Scarborough, N. Y. This rose has made a phenomenal record so far at the Waban Rose Conservatories where it originated and with the F. R. Pierson Company who are joint disseminators and at every exhibition where it has appeared it has been the centre of attraction and honor. Orders for stock are enormous and the fight for supremacy in the flower market over the Bride will soon be on.

NEWS OF THE CLUBS AND SOCIETIES

GARDENERS' AND FLORISTS' CLUB OF BOSTON.

It has been noted that the attendance at the April meeting of this club is invariably the smallest of the entire year. The fact is readily explained, of course. Still, seventy-five is not a bad audience, especially when the quality grades high, and that was the number approximately which turned out last Tuesday evening to greet Louis Reuter and listen to his excellent paper on Roses, which appears in another part of this issue of HORTICULTURE.

Mr. Reuter's talk was listened to with close attention and its close was the signal for a regular "held night" of debate, participated in by W. H. Elliott, Eber Holmes, Kenneth and Duncan Finlayson, J. W. Duncan and other war horses and lasting until the participants had to scurry for the last trains home.

In answer to questions Mr. Reuter said that all his roses are grafted stock with the exception of Chateau and a few of My Marylaud. Regarding the latter he said that the grafted stock seemed more inclined to take a winter rest than the own-root plants and for this and other reasons he is disposed to favor the own-root system for this variety. He will, however, try a few more grafted stock the coming year, with a little higher temperature and will also give this promising variety a trial for summer blooming.

W. H. Elliott suggested that the aggregate results from a section of 100 running feet of bench would be a better basis for comparison of profit than the record of the number of flowers cut. His experience had been that Richmond, Bride and Bridesmaid, had yielded scarcely one-half of the results which Killarney had given him. Rhea Reid had been a disappointment at the finish but it just narrowly missed being a big success and he proposed to hold on to it for another trial. Eber Holmes pronounced Killarney to be the best paying rose grown. Bridesmaid better than Bride. He advocated low benches—12 to 18 inches—for economy. He spoke of the risk of allowing blooms of new varieties to get out of the introducers' hands and instanced how certain parties had propagated White Killarney surreptitiously from fragments of stems and said that the wise man would keep his novelties absolutely under lock and key. He estimated that in the hands of a clever propagator with adequate facilities, a single eye might be increased to a quarter million rooted cuttings within two years.

On the exhibition table were some superb exhibits, including Rhododendron precox from Robert Cameron, snap-dragon from Wm. Swan, semi-double rose pink larkspur from W. N. Craig, My Maryland rose from S. J. Reuter & Son, alpine plants from Mr. Cole and roses in variety from Montrose Greenhouses.

Rhododendron precox is one of the deciduous species which blooms before the foliage appears. It is a hybrid between *R. ciliatum* and *R. viburnum*, the flowers crimson pink. Mr. Swan said that his antirrhinums had been raised

from cuttings last June from seed which he had been selecting for seven years and kept at 40 deg. to 45 deg. during the winter. Four to five spikes were left on each plant. These spikes were of extraordinary size—nearly two feet of flowers and buds. Mr. Craig stated that his larkspur had been sown in late November. The flowers keep fully ten days in water. In a discussion concerning Canna Tarrytown it was asserted by Mr. Holmes and others that it is quite distinct from Canna Admiral Dewey.

An invitation was received from E. J. Shaylor for the club to visit his peony gardens in June.

PASADENA GARDENERS' ASSOCIATION.

The fourth annual spring flower show of Pasadena Gardeners' Association was held on April 1, 2 and 3, the show being opened by Mayor Thomas Earley, who gave a brief address. Three years ago this show was held for the first time in the Auditorium, which was a small hall over one of the business houses. Step by step it has grown, and the promoters found it necessary to erect two large tents near the famous Hotel Green.

The tropical effect and appearance presented a most impressive spectacle. The exhibit of Henry E. Huntington was a grand sight. Tree ferns, *Cocos plumosa* and many other palms of the like nature mingled with rare flowering shrubs, and a fine plant of *Bougainvillea lateria* by E. H. Rust made a fine spectacle. Howard & Smith also had a very interesting exhibit of flowering plants and Japanese shubbery, illuminated at night by Japanese lanterns. Some very fine water lilies were exhibited by E. D. Sturtevant. Thomas Chisholm of the Pasadena Nursery presented a fine display of dwarf Japanese shubbery and ferns.

The regular prize list was lengthy, comprising carnations, roses, antirrhinums, pansies, nicotiana, schizanthus, phloxes, stocks, sweet peas, violets, marguerites, *Gerbera Jamesoni*, delphiniums and a general list of annual garden flowers, besides callas, irises, watsomias and bulbous stock; also peonies and other herbaceous stock and shrub bloom. The winners were equally numerous, the list of winners of firsts numbering between 25 and 30 exhibitors, mostly amateurs, among which the names of Mrs. S. W. Allerton, C. H. Garvey, Mrs. E. M. Fowler, D. R. Cameron and W. F. Kendall were most often repeated. A number of special awards and certificates of merit were also distributed.

SOCIETY OF AMERICAN FLORISTS AND ORNAMENTAL HORTICULTURISTS.

Advisory Committee for the S. A. F. Trade Exhibition at Cincinnati.

President Valentine has appointed the remaining two members of the Advisory Committee for the Trade Exhibition. The committee now stands: Albert McCullough, chairman; R. Witterstaetter, E. G. Gillett, W. N. RUDD, Secretary.

April 16, 1909.

NASSAU COUNTY HORTICULTURAL SOCIETY.

The regular monthly meeting of this Society was held in Penbrooke Hall, Glen Cove, on Wednesday evening, April 14th, with a good attendance. Messrs. Holloway, MacKenzie and Ingram acted as judges at the monthly exhibition. G. Wilson was again leader in the points competition and now has a substantial lead in the fight for the gold medal.

The judges' awards were as follows: G. Wilson, Fran Karl Druschki roses, 93. Paul Reul, antirrhinums, 86 1-3. Valentine Cleres, carnations, 86 1-3. Henry Gant, sweet peas, 86. James Elmslie, carnations, 81 1-3. Some of the flowers and plants for exhibition were also worthy of note. Especially fine was *Miltonia Bleueana nobilior*, shown by Julius Roehrs Co. of Rutherford, for the first time in America. The judges awarded it a certificate of merit.

E. Fardell was awarded a cultural certificate for a vase of Queen Alexandra stock. A pan of *Salvia Zurich* shown by Paul Reul was much admired.

J. Ingram read a paper on orchids. Previous to starting business as a landscape gardener, Mr. Ingram grew orchids extensively and successfully in a private establishment. His essay therefore was interesting and instructive. The essayist dealt briefly with the catleya fly, but offered no suggestion as to how it could be entirely eradicated. It can be kept in check, he said, by persistent fumigation and by cutting out infected eyes or buds.

On request Mr. Roehrs explained the origin of *Miltonia Bleueana*. He said it originated in France about fifteen years ago and is a cross between *M. vexillaria* and *M. Roezlii*. *M. Bleueana* is still scarce as it is difficult to grow. Mr. Wilson and E. Fardell gave brief talks on how they grew their respective exhibits.

W. H. MACKENZIE, Cor. Sec'y.

NEW ORLEANS HORTICULTURAL SOCIETY.

The regular meeting of the above society was held on April 15. In the absence of President R. Steckler, Vice-president H. Scheuermann presided. Trade reports were made by several members, in which it was shown that the Easter business was a great deal better than last year, many florists having a larger demand than they could accommodate.

An invitation to the members of the society to attend the annual barbecue given by A. Alost of Rose Villa, Gentilly Road, on May 2 was received and accepted with pleasure, and a committee on transportation, etc., consisting of J. Steckler, P. Abele and P. A. Chopin was appointed.

R. Eichling, grower for the U. J. Virgin establishment, exhibited some fine specimens of snap-dragon, Spanish iris, and sweet peas. J. A. Newsham exhibited some carnations which he had grown out of doors, which were as good as and in better condition than those brought here from the North, and he found that they last longer than northern grown carnations.

CHAS. R. PANTER, Sec'y

MORRIS COUNTY GARDENERS' AND FLORESTIS' SOCIETY.

A very interesting meeting was held April 14th. It being the annual "Rose Night," something like sixty members were present. Wm. G. Badgley, of Chatham, read a paper on the Rose. It was a very able effort and received a rising vote of thanks. The growers engaged in an entertaining and interesting after-discussion. A fact was brought out that I haven't seen in print yet, which is that the American Beauty grown in cement benches has proved almost a failure. This was a universal expression amongst the large growers around here. The theory advanced is that, being a gross feeder, it absorbs an injurious element from the cement. Whatever the cause, the fact remains the same and a timely warning was given to those thinking of experimenting in that line. Among those who discussed this and other points of the rose were David Falconer, John R. Mitchell, Wm. Muhlmichel, Wm. G. Badgley, Joseph P. Ruizicha and Chas. H. Totty.

The various exhibits were fine. In novelties, F. R. Pierson Co. had White Killarney in grand form, and S. J. Renter sent My Maryland. Both received certificates of merit as well as a vote of thanks. Cultural certificates were received by the following:

Brant-Hentz Floral Co. for American Beauty; Joseph P. Ruizicha for American Beauty, Bride, Bridesmaid and Richmond. Geo. Harvey for Bride and Bridesmaid. David Falconer for Bridesmaid. Wm. G. Badgley for Bride, Bridesmaid and Killarney. C. A. Work, gardener Wm. Muhlmichel, for Richmond. Mrs. G. F. Stone, gardener Ernest Wilde, for Killarney. C. R. Hedden, gardener Alex. Michel, for glonjinias.

H. B. Vyse, gardener to A. R. Whitney, Morristown, secured the Bunyard special prize for best plant in flower, with a magnificent plant of *Cineraria stellata*. This makes the second time Mr. Vyse has captured this prize. Last year a specimen of *Calceolaria hybridia* did the work for him.

A most unusual and attractive exhibit of indoor grown vegetables was made by Florham Farms. In quality and appearance they were A No. 1 and arranged with rare taste. Sweet corn, peas, new potatoes, lettuce, cauliflower, string beans, cucumbers, tomatoes, carrots, turnips and a number of other things were in it. Besides a cultural certificate the committee awarded a gratuity prize of \$5.00 which on motion of Mr. Herrington went to the grower, Percy Herbert.

Wednesday and Thursday, Oct. 27 and 28 next, were the days on which it was decided to hold our next annual Flower Show, in Assembly Rooms, Madison, N. J.

The society promised its support to the new Sweet Pea Society about to be organized. H. A. Bunyard is interested in this. He also seeks to induce every member to attend the annual outing of the N. Y. Florists' Club.

We had with us our past president, John Heeremans of Bluffton, S. C., who is still one of our active members and a hearty welcome was given him. He goes on a visit to his brother Fred, in Lenox, before returning south.

"Fertilizers" is the subject slated for May. We hope to secure a speaker

from the State Experiment Station in New Brunswick.

EDWARD REAGAN, Sec.

MINNESOTA STATE FLORESTIS' ASSOCIATION.

At the meeting on April 13, at Merriam Park, the Fair Committee of the association reported progress. If the state fair management is able to get an appropriation from the legislature for a new Agricultural Building, then our prospects are bright, for we'll not only get about all the space we've been asking for this year, but the premium list, submitted by the committee, will be accepted. If we cannot get the room wanted, the premium list will be cut pro rata. The question came up, whether it would be advisable to lower the annual dues of the society (at present \$5.00), so as to enable more of the employees to become members; or if a lower rate should be established for employees only. The sentiment was that a special lower rate would look too much like charity and would not put the employees on the same footing as the employers. Motion was made that each employer should make a special effort to bring, if possible, every one of his employees to the next meeting and then have it discussed. What are they doing in other organizations in regard to the above?

Professor A. G. Ruggles, of the Agricultural Experiment Station, gave a very interesting talk about insects in general and the anatomy of caterpillars, of which an enlarged model was shown. A hearty vote of thanks was given to Mr. Ruggles.

PENNSYLVANIA HORTICULTURAL SOCIETY.

The regular monthly meeting of this society was held on the 19th inst. On account of the bad weather, exhibits were very limited. A motion was passed inviting the National Association of Gardeners to hold their convention and exhibition during the society's spring exhibition, March 15, 16 and 17, 1910. William Kleinheinz, gardener for P. A. B. Widener, is the president of the association this year, and stated that already fifteen cups were offered for competition in various classes. Resolutions were passed on the death of Persifer Frazer, who held the position of professor of chemistry for the society for many years. A committee was appointed to arrange the dates, etc., of the annual sweet pea, peony and rose exhibitions. This committee consists of Messrs. Lonsdale, Long, Batchelor, McLeary, Kleinheinz and Hurley. Several additional prizes will be offered for Hybrid Tea roses—this class being now of commanding importance and becoming more popular every year. The dates of the shows mentioned cannot be fixed ahead, as it all depends on the earliness or lateness of the season. At least ten days' notice will be given to intending exhibitors.

The Grand River Valley Horticultural Society met at Grand Rapids, Mich., on April 13, and the subject of pruning was under discussion. W. L. Ciferski, former superintendent of parks, spoke on pruning of ornamentals in an interesting manner.

ROYAL HORTICULTURAL SOCIETY.

An extensive exhibition took place at the Society's Hall, London, on April 5, at which orchids formed the chief attraction, and narcissi, forced hardy shrubs, carnations and cinerarias the next items of interest. Conspicuous in the display of Messrs. Armstrong & Brown were *Dendrobium noble* *Virginalis*, *D. Alice Bound*—a largely magnified *D. Wardianum*, *D. Bryan*—a white flower with an orange-colored stain in the throat (traversed by crimson lines), *D. Rubens grandiflorum*, *D. Cybele nobiliss*, *D. Artemisia*—a fine spike of flowers with rose colored sepals and petals—and a rich velvety patch on the lip, and the pure white flowered *D. Jamesianum*; the yellow-flowered *Laelio-Cattleya Mercia*, *Brasso-Cattleya Madame Hye*, *Odontoglossum Rolfeae*, *O. Ossulstonii*, etc. Messrs. Charlesworth & Co. showed among other orchids of merit *Laelio-Cattleya Elinor*, a bloom of a bright orange tint, *Phaius Normanii* the blooms of which are of a light pink tint and the lip of a lurid purple with a few golden yellow lines running down it. *L. C. Dominiana* was a gorgeous flower, and the truss consisted of five large blooms. *Odontioda Lutetia*—and a *Brasso-Cattleya Marathon* were attractive hybrids.

Messrs. J. Veitch & Sons showed *Brasso-Cattleya Veitchi*, the conspicuous feature of the bloom being the purple colored throat stained with orange and striped with crimson. *Cymbidium insigne Sanderi* has flesh pink sepals and petals and a lip densely spotted with crimson. H. S. Goodson, Putney, showed a *Sophr-Laelio-Cattleya*, a nice plant bearing three expanded flowers, and *Odontodia Ernest Henry* (*Odontoglossum Queen Alexandra* *x Cochlioda Noetziiana*).

A. W. Jansen was exhibitor of a variety of *Cattleya Schroderae* under the name of Irene, a large bloom with a much fringed lip and yellow staining in the throat, the general color of the flower a light mauve. From Sander & Sons came the beautiful *Cattleya elata* (*C. Trianae* and *C. Lawrenceanum*) and a handsome *Odontoglossum Dreadnaught* for which an award of merit was bestowed; *Odontoglossum Angle*, a grand spike with eight expanded blooms—award of merit. Lieut. Col. G. H. Holford received a like award for *Od. Sylvia*, a cross of *O. cirrhosum* and *O. Rolfeae*. Sir Trevor Lawrence, president of the society, was awarded a botanical certificate for the curious orchid *Megaclinium bufo* which has a black-brown knifeblade-like spike up which minute flowers appear to creep in single file.

Miss Clara Mangles showed cross bred Himalayan *Rhododendron* *Rose Mangles* whose blooms are slender, campanulate in shape, outwardly rose pink as regards the lower shaft; and inside the tube, and at the edges of the flower of a pale pink tint. White flowered *R. campylocarpum* and *R. Hookeri* *Rose Queen* were other notable varieties shown.

Messrs. Paul & Son were the exhibitors of the new Wichuraiana rose, *Lady Godiva*, a sport from Dorothy Perkins, a blush colored bloom, very pretty and free; and a hybrid musk

rose Snowstorm A variety that forms a dwarf climber or a bush. It is a perpetual and continuous bloomer. The blossoms are white, and of small size, coming in bunches of 5 to 25.

FREDERICK MOORE.

PARK SUPERINTENDENTS MEET.

An informal meeting of Park Superintendents and those of kindred work was held April 16th, ten members present, at the Litchfield Mansion, the headquarters of the Park Department of the Boroughs of Brooklyn and Queens of New York City.

They received a most copious welcome from Park Commissioner Kennedy and Park Superintendent Zartman. The photographs of the New York parks to go to Seattle were exhibited and admired, and also an exhibit of methods of treating injured trees and of preventing insect troubles. There was a walk through Prospect Park with free discussion of the different features and modes of construction, a visit to the Flower Garden Cafe, an automobile ride through the Ocean Parkway to Seaside Park of twelve acres, which has the record of the quickest constructed park in this country of its size,—it was completed in forty-three days after the first stroke, and is a beautiful spot which now gives no suggestion of its quick construction, for the work shows all the evidence of thoroughness.

A lunch was enjoyed at the Montauk Club, followed by a discussion on park administration in which Commissioner Kennedy gave some most valuable facts and suggestions. A talk by J. A. Pettigrew of Boston, on how to prevent the destruction of roads by automobiles was very valuable. He seems to have found a method. Altogether it was a profitable and enjoyable meeting.

John H. Beatty, Superintendent of Parks, Borough of Manhattan, New York city; Peter Zuger, Supervisor of Gardening, Park Department, Hartford; and C. H. Hachler, Superintendent of Mr. Clarence Mackay's estate in Roslyn, were elected members. The next meeting is to be held in Boston, June 15th.

DOBBS FERRY HORTICULTURAL ASSOCIATION.

A meeting of this association was held in Odd Fellows Hall, Saturday evening, April 10th. Some very fine plants suitable for Easter decoration were exhibited and the judges, Messrs. Scriber, Heath and Bradley, awarded first prize, also cultural certificate to H. Keeling, gardener for Mr. J. Scott McComb, for a fine specimen hydrangea, and 2nd prize, also cultural certificate to H. Kastberg, gardener, to the Misses Masters, for white azalea. Claude Wilson and R. Borcham also exhibited fine plants. The prize for the next meeting will be for three varieties of outdoor flowers.

J. BRUNGER, Cor. Sec.

LADIES' SOCIETY OF AMERICAN FLORISTS.

Mrs. J. C. Vaughan, President, L. S. A. F., has appointed the following Committees on Resolutions: Mrs. Geo. Asmus, Mrs. E. F. Winterston and Mrs. James P. Foley, upon the death of Mrs. P. J. Hauswirth, Chicago, Ill.; Mrs. W.

CHRYSANTHEMUMS

We have the following ready for immediate delivery, which are the best for Commercial use. We do not include the Exhibition sorts, but will be pleased to quote those desiring such, 25 of a kind at Hundred rates, 250 at Thousand rates.

EARLY

- Clémentine Touzet**—Best second early white, Oct. 20.
- Early Snow**—Similar to Polly Rose, Oct. 10.
- Glory of Pacific**—Pink, Oct. 15.
- Joory**—White, very popular, Oct. 15.
- John K. Shaw**—Ball shaped pink, Oct. 5.
- Monrovia**—Best second early yellow, Sept. 25.
- Miss A. Byron**—Ball shaped white, 50 and early
- October Frost**—Earliest large white, Oct. 0.
- Pink Ivory**—Second early pink
- Polly Rose**—White sport from Pacific
- Robert Halliday**—Light yellow, Oct. 20.

MIDSEASON

- Col. D. Appleton**—Best commercial yellow, Nov. 1.
- Dr. Englehard**—Pink, easy doer, Nov. 10.
- Mrs. H. W. Bucklow**—Ball shaped white, Nov. 1.
- Mrs. H. Robinson**—Incurred white, Oct. 25
- Major Bonallton**—Incurred light yellow, Nov. 1.
- White Weaver**—Bright pink, Nov. 10.
- Silver Wedding**—
- Timothy Eaton**—Large white, Nov. 5.
- Vivand Morel**—Bright pink, Nov. 5.
- Yellow Eaton**—Large yellow, Nov. 5.

LATE

- Helen Erick**—Best bright pink, Nov. and Dec.
- Miss Jeanne Nolan**—Largest white, Nov. & Dec.
- John Furton**—Latest pink, Dec.
- Lavender Queen**—Light lavender, Nov. 20.
- Minnie Bailey**—Pink, Nov. 20.
- Mrs. J. Jones**—Incurred white, Nov. 15.
- Nagoya**—A good late yellow, Nov. 20.
- White Bonaffant**—Incurred white, Nov. 15.
- Yonoma**—Reflexed pure white, Nov. and Dec.
- Yellow Mrs. J. Jones**—Sport from Mrs. Jones, Nov. 15
- Price**—Plants, \$3.00 per 100; \$25.00 per 1000.
- R. C.—\$2.00 per 100; \$17.50 per 1000.

- Alma**—Soft Lavender.
- Emo**—Small light yellow.
- Iva**—Amber.
- Kent**—Dwarf Yellow.

Price—Plants, \$3.00 per 100; \$25.00 per 1000.

MIDSEASON

- A. J. Ballfour**—Dwarf bright pink, Nov. 10.
- Crocus**—Fine light yellow, Oct. 25.
- Golden Wedding**—Bright yellow, Nov. 15
- Mrs. E. D. Smith**—Dwarf incurred yellow, Nov. 1.
- Orgawa**—Beautiful bronze, Oct. 25.
- Pres. Roosevelt**—Inc. white, pink center, Nov. 15.
- Sunburst**—Thanksgiving yellow.

LATE

- Intensify**—Bright crimson, Nov. 10.
- Veneta**—Incurred white, late bud, Dec. 1.
- W. H. Chadwick**—Incurred white, Nov. and Dec.
- Price**—Plants, \$1.00 per 100; \$5.00 per 1000.
- R. C.—\$3.00 per 100; \$5.00 per 1000.

- Beatrice May**—Very large white, Oct. 25.
- Price**—Plants, \$3.00 per 100; \$25.00 per 1000.
- R. C.—\$4.00 per 100; \$35.00 per 1000.

- Golden Glow**—Best early yellow, Aug. 10 Oct.
- Pacific Supreme**—An Improved Pacific, Oct. 15.
- White Cloud**—Early midseason white, Oct. 25.
- Golden Chadwick**—Excellent late yellow, Nov. and Dec.

- W. J. Crossley**—A crimson to follow intensity.
- Price**—Plants, \$6.00 per 100; \$50.00 per 1000.
- R. C.—\$4.00 per 100; \$35.00 per 1000.

- Chadwick Improved**—(New) Pure white.
- Mrs. J. Boxall**—(New) Incurred pink late.
- Price**—Plants only, \$2.00 per 100; \$15.00 per 1000.

- Pres. Taft**—(New) Fine incurred white, Nov. 1.
- Gloria**—(New) Enchantress pink, Oct. 10.
- Mrs. W. E. Kelley**—(New) Late bright yellow.
- Price**—Plants only, \$4.00 per 100; \$35.00 per 1000.

POMPONS

- Klondike**—Bright yellow.
- Lulu**—Pure white
- Oreva**—Deep Rose.
- Skibo**—Chamois early.
- Price**—Plants, \$2.50 per 100; \$20.00 per 1000.

We have many other varieties in stock; if the foregoing does not supply your need send us a list of your wants' For more complete description see our Catalogue which gives best bud, height of plant and flowering period.

IT IS FREE ON APPLICATION.

This advertisement will be changed each week to compare with stock on hand.

ELMER D. SMITH & CO., Adrian, Mich.

J. Vesey to appoint two associates to act with her upon the death of Mrs. D. E. Gorman, Williamsport, Pa.; Mrs. F. H. Traendly, Mrs. John Scott and Mrs. John V. Phillips, extending sympathy to E. V. Hallock and family. Will the above committees report to the secretary as soon as possible?
By order of President Mrs. J. C. Vaughan.
MRS. CHAS. H. MAYNARD, Sec.

CLUB AND SOCIETY NOTES.

The California State Floral Society met in San Francisco on April 10, when H. Plath was re-elected president. The fall exhibition is scheduled for October 14, 15, 16, at the Fairmont Hotel, and the premium list is ready for distribution. Among the managers are D. MacRorie, J. R. Atkinson, J. W. Bagge, Charles Abraham, William Kettlewell.

The horticultural department of the Illinois State Fair, Springfield, has secured for next fall's exhibit all of the rotunda of the Dome Building, a circular space containing about 13,000 sq ft. of floor space, exclusive of the main aisle. There are premiums of over \$2700 offered in this department. The walls will be well decorated and every facility offered for making the finest display ever shown in the state, outside of the Coliseum in Chicago. The Superintendent of the Department is arranging for private space for the florists to make up their artistic designs and pieces in the building, and is also trying to arrange for cooling rooms.
GEORGE ARMUS,
Member State Committee.

During Recess

FLORISTS' CLUB OF WASHINGTON.

The regular monthly meeting of the Florists' Club was held at Congress Hall Hotel, on Tuesday evening, April 20th, having been postponed two weeks owing to Easter. After a short business session all repaired to the banquet hall where professional talent, of the musical class, entertained the guests. Prof. Pastorina's band furnished sweet music, and elaborate floral decorations in the form of semi-circular banks of palms, azaleas, rhododendrons and cherry blossoms completed the scene. Separate tables, with centrepieces of Killarney roses filled the room.

Wm. F. Gude, toastmaster of the evening, in his usual happy manner introduced the talent of the evening. E. T. Eadt, a Holland bulb grower, and Mr. Tiller, of the Washington Times, were guests of the evening. Geo. Shaffer, the retiring secretary, was presented with a silver tray. O. A. Oehmler, the newly appointed secretary, entered upon his duties, and the club is to be congratulated at having secured the services of so competent a man. At midnight the banquet, which had begun at 9.15 o'clock, came to an end, as all pleasant things must.

ST. PAUL vs. MINNEAPOLIS.

It is quite some time since I reported a game between St. Paul and Minneapolis as the last one of the season. But "revenge is sweet," and so on

Thursday, April 15, the St. Paul team came to Minneapolis to get their medicine. Now they are willing to give us yet another bout. In St. Paul, on April 22, the question was put to the Minneapolis team as to whether they would take another beating, but no vote was taken.

The scores of April 15 were as follows:

St. Paul.	Minneapolis.
Dysinger 88 142 160	Wirth 164 98 172
Hangan 130 115 128	Meyer 144 156 131
Swanson 122 162 174	Boeglin 107 150 155
Hansen 99 177 117	Wilf 140 162 157
Puvogel 109 117 123	Carlson 147 124 156
Dill 112 182 125	Ruedlger 108 146 164
660 835 827	860 832 915

50,000 Surplus Cannas 50,000

We have the following surplus Cannas on hand, either F. O. B. Chicago, or New York. They are in fine condition and absolutely true to name and packed 250 in a case.

Crimson Shades

- A. Bouvier, 5 ft.
- Alice Roosevelt, 4 ft.
- Beaute Poitevine, 3½ ft.
- Charles Henderson, 4 ft.
- Crimson Bedder, 3 ft.
- Duke of Marlborough, 4½ ft.
- J. D. Eiseler, 5 ft.
- Explorateur Crampel, 5½ ft.
- Express, 2 to 2½ ft.
- Flamingo, 4½ ft.
- Pres. McKinley, 2½ to 3 ft.

Pink Shades

- L. Patry, 4½ ft.
- Luray, 3 ft.
- Louise.
- Martha Washington, 2½ to 3 ft.
- Mlle. Berat, 4½ ft.
- Tennyson, 5½ ft.

Orange Shades

- Pres. Cleveland.
- Red, Gold-Edged and Spotted.
- Gladiator, 4 ft.
- Cinnabar, 4½ ft.
- Mme. Crozy, 5½ ft.
- Premier, 2½ ft.
- Souv. de Anton Crozy, 4 ft.

Yellow Shades

- Buttercup, 3½ ft.
- Comte de Bouchard, 4½ ft.
- L. E. Bailev, 4½ ft.

White Shades

- Alsace, 3½ ft.

Bronzed-Leaved

- Brandywine, 4 to 5 ft.
- Black Beauty, true, 5 ft.
- David Harum, 3½ ft.
- Egandale, 4 ft.
- Musafolia, 5 ft.
- Philadelphia, 5 ft.
- Robusta, 6 to 8 ft.
- Shenandoah, 6 ft.

Orchid Flowering

- Allemania, 4 to 5 ft.
- Austria, 5 ft.
- Kronus, 5 ft.
- Mrs. Kate Gray, 6 ft.
- Pennsylvania, 5 ft.
- Indiana, 4½ ft.

TAKE YOUR PICK

AT

\$1.75 per 100

\$4.00 for Case of 250

\$15.00 per 1000

F. O. B. New York

\$2.00 per 100

\$4.25 for Case of 250

\$16.00 per 1000

F. O. B. Chicago

Chicago Orders may be sent to

The Winterson Seed Store

49 Wabash Ave., CHICAGO, ILL.

50,000 Surplus Cannas 50,000

ARTHUR T. BODDINGTON,

SEEDSMAN

342 West 14th St., New York City.

We have on hand a large consignment of

Japanese Bamboo Canes

Fine Strong Quality.

NATURAL	Per 1000
6 ft. heavy, original bundle of	400 @ \$4.25
6 ft. medium, " " "	250 @ 3.50
5-6 ft. pencil thickness " " "	500 @ 3.25
4-5 ft. " " "	300 @ 2.75
3 ft. " " "	1000 @ 2.25

GREEN COLORED

1½ ft. original bundle of	400 @ \$1.20
2 ft. " " "	400 @ 1.85
2½ ft. " " "	400 @ 3.00
3 ft. " " "	400 @ 3.50
3½ ft. " " "	400 @ 3.75

Sold in original bundles only. Samples on application.

Cycas Stems

Fine straight stems, in case lots of 500 lbs. assorted. 4—10 lbs., ½—4 lbs., ½—2 lbs., 2—10 lbs. \$12.50 per case.

Kudzu Vine Roots

Strong heavy quality.....1000 @ \$50.00
.....100 @ 7.50

The Yokohama Nursery Co

31 Barclay St., N. Y. City.

IPOMOEA NOCTIFLORA

Best pure white moonvine in the market, very fragrant and as big as a saucer. On this variety we have a world-wide reputation as growers and shippers for the last twenty years.

Price, 2½ in. pots, \$5.00 per 100. 10,000 are now ready.

Godfrey Aschmann

1012 West Ontario St., Philadelphia, Pa.

Begonia Gloire de Lorraine

Leaf Stock, June Delivery. \$15 per 100, \$145 per 1000, from 2½ in. pots. Stock guaranteed to be absolutely free from disease.

THOMAS ROLAND, NAHANT, MASS.

JARDINIERE FERNS

N BEST VARIETIES. VERY FINE STOCK. \$3.50 per 100, \$30.00 per 1000

ROSE HILL NURSERIES

New Rochelle, N. Y.

THE ROSE GROWER'S PROBLEMS.

A Paper Read Before the New York Florists' Club by William H. Elliott.
In Memoriam.

I do not think there was ever a time when I felt so hopelessly unable to rise to the demands of the occasion as at the present. To interest in any way the members of this club, or the rose growers of this, the great floral center in the world would seem enough to undertake under ordinary conditions; but it seems hard, indeed, coming as I do now, with a sorrowful and heavy heart caused by the going out of that brilliantly beautiful personality that it has been our great privilege to know, to honor and to love. No matter how bright the light of his genial, kindly countenance shines in our hearts and memory, or how thankful we feel to have known him, it will be impossible to go on with our ordinary, everyday affairs without something of that serious and thoughtful life entering into our thoughts and meditations.

Under these conditions I know you will expect the few words I have to say to you tonight will be a deeper, more serious view of the rose grower's problems.

The Price of Success.

You who are rose growers know, and those thinking of entering upon that career should know, that it is necessary to consecrate your lives to this work. It must not be taken up without very serious consideration. The only way to succeed is to pay the price, and that is an overwhelming and everlasting determination to put forth every ounce of energy you have. You must make it your religion and your life—and why not? You must enter into partnership with the power that moves the universe. What grander work than developing the beauties of nature that thousands may have pleasure?

Planning the Establishment.

To those starting new, and to many who are not well located, a proper site for a rose growing plant is of the greatest importance. First, a good soil, an abundant water supply, a large level tract of land near the railroad station (it is better to go twenty-five miles farther out into the country, if you can get two miles nearer the railroad station, as the extra cost of teaming coal over that two miles will a great deal more than make up for the extra expense in express). A large farm in a small town will usually solve this problem best, as in larger towns, farms are too great a distance from the station. A full and complete plan of an up-to-date rose growing plant will require a great deal of care, time, serious thought. All of us should plan ahead carefully what we intend to do, changing and re-changing for years, that we may develop along the best lines. My recommendation is the large house. My latest house, 60 x 124 ft. I find none too

Advantages of Large Houses.

large. The advantages over smaller houses are many and are summed up in the fact that they produce better stuff and more of it. We do not find that those that have built the large houses have given them up and gone back to the smaller ones. Those who have built large houses build still

larger when they build again. The report from North Wales, Pa., is that their house built two years ago is too small, although 150 feet wide. They have now planned, and I believe are under way, in the construction of a house that is 172 feet wide and 700 feet long; over 110,000 feet under one roof, with proper construction; and good construction, is absolutely necessary in these large, high houses. I believe that such a house will be a success, although I might hesitate to recommend the building of such a house.

An investment is necessary to carry out a properly planned rose growing business. First of all, you will have to invest your heart and soul, all your courage, and be ready to put in at all times, good large amounts of patience, untiring hard work. Also a love for your business and the rose, like the love of a mother for her offspring. You will also need some money, but that is a secondary matter to the stock of courage that you should have.

Cultural Advice.

The best roses are not grown by any secret process, but by the most careful attention to every detail. Eternal vigilance is the price of good roses. You will find it true every time that the man who produces superior stock does so by a more careful and painstaking method. If anything has been accomplished by the use of chemicals, I should like to know it. I have not been able to obtain good results from their use. I find plenty of care and cow manure produce much better and surer results. Do not deceive your self in regard to reasons for success. We sometimes know why we fail, but why we succeed is harder to answer.

When they grow well, there are 4000 reasons why they do so. We may know what a dozen of them are, and if, by chance, we learn one or two more, we think we have solved the whole problem.

Are we getting from the experiment stations all we should? How many of us make an effort to get the knowledge, or to assist them in any way with the work that they are doing? I don't think we have used the experiment stations fairly. They are doing a great work, and should be called on to help us in the solving of many of our problems.

Timing the Crops and Selecting the Varieties.

Aim to cut your roses when the demand is good. The grower that produces a large supply on an overstocked market and a small supply when the market is short, must not expect to get a very large return. In Boston we have a good demand in August; in October the rose market seems always to be overstocked. From the middle of January to the middle of February is a time of very short

A Profitable Side Crop

Asparagus plumosus is a main crop with many growers having extensive modern plants but those with less up-to-date establishments, or parts of same defective in lighting or otherwise unsuitable for high grade crops,—will find this subject one of the very best. We have prepared a cultural circular giving concise directions how to make money out of this crop. Send for it. No charge. An important feature in asparagus culture is good seed. The P. M. quality of greenhouse grown seed has earned a high reputation for freshness and purity. It is the true nasus and greenhouse grown. Send for trial pkg., 100 seeds fifty cents, if you wish to experiment only. In quantity \$3.75 per 1000 seeds, \$32.50 per 10,000 seeds. Asparagus Sprengeri 75c. per 1000, \$5.00 per 10,000 seeds.

S. S. PENNOCK-MEEHAN CO.

1608 to 1620 Ludlow St., Philadelphia, Pa.
1212 N. Y. Ave., Washington, D. C.

PANSY PLANTS Fine Plants ready to bloom, of my well known strain, \$2.50 per 100; large plants in bud and bloom, \$1.00 per 100, \$8.00 per 1000.
GERANIUMS, best kinds, double **PETUNIAS** (Three's), **VIOLA** var. **PARLOR IVY**, **STOCKS**, fine plants, 2 1/2 in., \$2.00 per 100; 30c for \$5.00.
CABBAGE PLANTS, E. J. Wakefield, ready to plant out, \$1.25 per 1000; 5000 for \$5.00.

J. C. SCHMIDT, Bristol, Pa.

supply. This is the time that takes our best efforts to cover.

How do you decide which old kind to give up to make room for the new? What are you going to take out to make room for the White Killarney? Will you give up the Bride this year? Do you think the White Killarney will replace the Bride? Have you given up your Maids, and are you growing Killarneys instead? I have given up Maids; next year I expect to give up Brides. What about the other new kinds? Rhea Reid I shall continue to grow but not very extensively. This rose came very near to being one of the best roses ever produced. Maryland I think very well of, and a good, safe one to grow. William R. Smith is a very promising rose for summer. I intend to grow it, but only to a limited extent. Kaiserine don't give any light-colored summer rose much show. Mrs. Jardine and Queen Beatrice I have discarded.

In closing, the last word I will say is in regard to the economy and saving that I have found best to practice. For many years, at the first, I thought it most important to save my money, but I now find that the money is not near as important as the saving of your nerve force. Your courage and brain force, also your health and bodily force, and with what is expected of you in these high-pressure times, you will need them all.

Headquarters for Asparagus Plumosus Seed New Crop

GREENHOUSE GROWN

100 seeds, .50	5,000 seeds, \$17.50
1,000 " \$8.75	10,000 " \$32.50

LATH HOUSE GROWN

100 seeds, .40	5,000 " \$12.50
1,000 " \$2.75	10,000 " \$23.00

Write for Our Wholesale Catalogue

HENRY F. MICHELL CO., 1018 Market Street, PHILADELPHIA

ORCHIDS

We have just received the following Orchids in superb condition and solicit your inquiry for same.

CATTLEYA TRIANAE

best type known, free flowering and of great variation. Superb plants, fresh, plump and well leaved. By dozen, hundred or case.

ODONTOGLOSSUM CRISPUM

Pacho type, splendid plants in perfectly fresh condition.

Phalaenopsis amabilis, P. Schilleriana, VANDA SANDERIANA

Oncidium varicosum Rogersii, O. splendens, O. crispum, O. Forbei, O. sarcoidea, O. Wentworthiana, Odonotoglossum grande, Miltonia candida, M. spectabilis, M. flavescens, Lycaste Skinneri, Scutellaria Stecchii, Zygopetalum crinitum, Z. Gautieri.

To arrive in a few days: Cattleya labiata, Dendrobium formosum, D. nobile, D. thrysiflorum, Vanda coerulea, Cattleya Percivaliana, and many more. Write for prices.

LAGER & HURRELL
SUMMIT, N. J.

ORDONEZ BROS., Madison, N. J.

ORCHIDS

CATTLYEA MOSSIAE, has arrived in first-class condition. Our PRICES are LOW and our STOCK is FIRST-CLASS. Write us for particulars and prices and by so doing you will be sure of the facts.

Plants are FOR SALE AT THE STORE OF
AUGUST MILLANG
41 WEST 28 STREET, NEW YORK

JUST ARRIVED

Fine Importation of

Oncidium ornithorrhynchum

Fine strong leafy plants.....\$1.50 each. \$18.00 doz.
Few specimens..... 2 50 "

JOSEPH A. MANDA, West Orange, N. J.

ORCHIDS

We are booking orders now for delivery early in the Spring on all commercial CATTLEYAS and NOVELTIES. Our prices are right and our guarantee perfect. We sell only first-class goods

CARRILLO & BALDWIN, Secaucus, N. J.

IMPORTED ORCHIDS

Now Arriving

Julius Roehrs Co.

RUTHERFORD, N. J.

CATTLEYA TRIANAE

Fresh Stock. Just Arrived.

in good time to make strong growth and flower this season.

Dendrobium Wardianum, oobite and thrysiflorum fine specimens,
\$2 00 to \$3.00 each.

G. L. FREEMAN, 388 Appleton St., Holyoke, Mass.

Palms
Shrubs



Ferns
Perennials

Send for Our Catalogue.

The GEO. WITTBOLD CO., 1657 Buckingham Place, Chicago, Ill.

FERNS FOR DISHES,

Assorted Varieties
From a 2 inch pots, \$3.50 per 100; \$30.00 per 1000

CASH WITH ORDER
2570 to 2606 W. Adams St., Chicago, Ill.

FRANK OECHSLIN

COLEUS! COLEUS!

C. Verschaffeltii and Golden Bedder, - - - - - R. C.	Pr 100	Pr 1000
Same in 2 1/2 in. pots - - - - -	60	5 00
Coleus, Mixed - - - - - R. C.	2.00	15 00
Same in 2 1/2 in. pots - - - - -	60	5 00
Ageratium Steila (Gurney and Pauline) - - - - - R. C.	1.75	15 00
Same in 2 1/2 in. pots - - - - -	.50	4 50
Feverfew - - - - - R. C.	1.00	9 00
Same in 2 1/2 in. pots - - - - -	2.00	
Fuchsias, our selection, - - - - -	3 00	
German Ivy - - - - - R. C.	75	
English Ivy - - - - - R. C.	1.00	

Cash with Order

J. E. FELTHOUSE

148-154 Van Vranken Ave., SOHENECTADY, N. Y.

NEPHROLEPIS MAGNIFICA

THE SENSATIONAL NOVELTY
Strong 2 1/2-in. stock, \$25.00 per 100.

WHITMANII

2 1/2-in., \$46.00 per 1000; 3 1/2-in., from Bench, \$8.00 per 100.

H. H. BARROWS & SON, WHITMAN, MASS.

ROBERT CRAIG CO.

ROSES, PALMS,

and Novelties in Decorative Plants

MARKET and 49th STREETS, PHILADELPHIA, PA.

Gladiolus Brenchleyensis

Extra fine Healthy Imported Stock
1,000 \$10.00 10,000 \$80.00

O. V. ZANGEN
HOBOKEN, N. J.

THE BOSTON VIOLET

Unequaled for Productiveness, Beauty and Popularity.

In Crop from September to May.
Plants \$2.00 per doz; \$12.00 per 100; \$100.00 per 1000.
Princess of Wales \$15.00 per 1000.

WILLIAM SIM, Clifftondale, Mass.

ORCHIDS

Largest Importers, Exporters, Growers and Hybridists in the World

Sander, St. Albans, England
and 235 Broadway, Room 1
NEW YORK CITY

Kentias, Arecas, Latanias, Cocos, Phoenix, Araucarias, Rubbers, Crotons, Pandanus, Asparagus, Ferns for Dishes. 200,000 Bedding Plants, also Rooted Cuttings of Coleus at lowest wholesale rates.

Orders taken for imported plants for fall delivery

A. LEUTHY & CO.

PERKINS ST. NURSERIES

ROSLINDALE, MASS.

BARCAINS

Ampelepis Veitchii, 4 in. pots, \$10 per 100; 3 in. pots, \$5 per 100. Asparagus Sprengeri, 2 in. pots, \$2.00 per 100. Cannabis, King Humbert, \$5.00 per 100. Clematis Paniculata, 4 in. pots, \$100 per 100; 3 in. pots, \$5.00 per 100. Clematis, large flowering varieties, 2 year old plants, Jackman, Henry, Andre, \$3.00 per dozen; Cocci-nea, \$2.00 per dozen.

Carnations, R. C. from soil, Enchantress, Dorothy, Elton, Flora Hill, E. Market, \$2.00 per 100; Winsor, \$3.00 per 100. Geraniums, standard varieties, from 3 in. pots, \$3.00 per 100; 4 in. pots, \$6.00 per 100.

The following stock from 2 1/2 pots at \$2.50 per 100. Heliotrope, blue and white, Fuchsias, 4 varieties. Alyssum Carpet of Snow, Phlox Drummondii, DWARF Verbena, Emp. William, 2 alvia, Bonfire and Zurich, Verbena, Parlor Ivy, Petunias, Cal-Giants and Star, Feverfew Little Gem, Coleus Verschaffeltii, Golden Bedder and Quadricolor. Alternantheras, 4 varieties.

Chrysanthemums, new early varieties, Autumn Glow, White Cloud, Pacific Supreme, from 2 1/2 in. pots, \$5.00 per 100.

C. EISELE

11th and Westmoreland Streets,
PHILADELPHIA, PA.

HEACOCK'S PALMS

Kentia Belmoreana
7-inch pots.....32 to 34 inches high.....\$2.50 each
7-inch pots.....36 to 38 inches high..... 3 00 "
9-inch tub.....42 to 48 inches high..... 5 00 "
Made up Kentia Forsteriana
7-inch pots.....34 to 36 inches high.....\$2.50 each
7-inch pots.....36 to 38 inches high..... 3 00 "
9-inch tub.....42 to 48 inches high..... 5 00 "
Joseph Heacock Co., Wyncote, Pa.

PALMS AND FERNS DECORATIVE PLANTS

JOHN SCOTT

Rutland Road and E. 45th St.
Tel. 2890 Bedford BROOKLYN, N. Y.

Draecena Indivisa, 4-in. 10c. Scotti and Boston Ferns, 4-in. 12c.; 5-in. 20c. Asparagus Plumosus, 2-in. \$2; Sprengeri, 2-in. \$2. 3-in. \$4, 4-in. \$6. Vinca var. 2-in. \$2. Cannabis Egandale, David Harum, Marlborough, America, Pennsylvania, K. Gray, Black Beauty, Alphonse Rouvier, \$1.75 per 100. English Ivy, R. C., 75c. per 100. Hydrangea P. G., 3 ft. Sc.; 1 1/2 ft. 5c.

J. H. DANN & SON Westfield, N. Y.

A 256 PAGE BOOK FREE

Every gardener or greenhouse owner will want one of these books. It contains over 2500 valuable hints and pointers for the grower and 700 remedies for diseases and insects. It gives you formulas for standard remedies and is worth \$5.00 to anyone who is in the trade.

WRITE FOR THIS BOOK

If you have no printed letter head send us 25c to pay the cost of printing and the postage and the book will be sent to you promptly. You will never regret buying one of these books and if you have a printed card, envelope, letter head or stationary of any kind, you will get the book, postage prepaid, free of cost.

JOHN G. MONINGER CO., 117 E. Blackhawk Street, CHICAGO

Tobacco Paper

IS THE

**STRONGEST,
BEST PACKED,
EASIEST APPLIED.**

24 sheets.....	\$ 0.75
144 sheets.....	3.50
288 sheets.....	6.50
1728 sheets.....	35.10

"NICO-FUME" LIQUID

OVER 40% NICOTINE

By far the
CHEAPEST.

**Furnishes the
Most Nicotine for the Money**

JUST NOTE PRICE!

... Manufactured by ...
THE KENTUCKY TOBACCO PRODUCT CO., Louisville, Ky.

Pint.....	\$ 1.50
1/2 Gallon.....	5.50
Gallon.....	10.50
5 Gallons.....	47.25

PHILADELPHIA NOTES.

E. J. Fancourt of the Pennock-Meehan Co. left on the 19th inst for a week's trip on firm's business to Baltimore and Washington.

Robert Crawford, Jr. is rusticated at Atlantic City after an unusually strenuous season. Business has been better at this point than any previous period of the firm's history.

The Dreer Arboretum is the title given to the new experimental garden at Riverton, N. J., by yours truly, Mr. Eisele and Mr. Clark are far too modest to claim a high sounding name like that. Nevertheless we believe the cognomen is almost justified when the large number of new and rare shrubs and hardy plants from all parts of the world are considered.

The collection is located on the southwest banks of the extensive lily ponds and consists of many new and rare specimens among which were noted: *Buddleiaraphirolepis*, a shrub which, according to the authorities, does best on light well-drained soil—conditions which can hardly be claimed for the location next to the lily pond; *Spirea bumalda* Walluf, a dwarf shrub of the same sub-family as the well known *Anthony Waterer*; *Azalea canescens*, a variety belonging to the nudiflora section, which is a native of the eastern states.

Among the new deutzias we noted the variety *fostruosa* belonging to the gracilis section but unknown to cultivation generally; also *Lonicera Maackii*, *Rhododendron myrsinifolium*, *Senecio elivorum*, *Azalea mollis* L. J. Endtz, *Dimorphanthus Manchuricus* fol. var., *Rhododendron fimbriatum*, *Andromeda calyculata pumila*, *Ligustrum lucieionum*, *Demorphanthus argentea* var.

Deutzia discolor major and a host of other rare things in evergreen and deciduous shrubs.

The garden is for the testing of items not generally known or grown in our climate and will no doubt be a valuable auxiliary to the business and a centre of interest to visitors of an enquiring turn of mind. Next year the intention is to plant all around the eastern banks of the lily ponds with a still larger collection.

If you want to see things done with a rush and yet with a system so accurate that it is almost impossible for an error to occur, visit the Dreer packing sheds in April. Hundreds of men are at work at the benches, helpers are scurrying up with box-loads and barrow-loads, wagons are starting off every few minutes for boat or train—a most inspiring bustle all around that makes even your scribe wiggle his pencil faster than usual.

Roses are going out rapidly at present. One range of potted plants under glass comprises about fifty thousand square feet of space and looks like a field of wheat. Mr. Eisele says that one of the surprises this year is the demand for Penzance Sweet Briars. An experimental section for outdoor testing of new Hybrid Teas was established last year and proved so interesting that it has been largely extended this year. Two hundred varieties, most of them unknown in this country, are now under test. This will be a Mecca for rose enthusiasts during the coming summer. An important development of last summer's work was the discovery of *La Detroit*. Mr. Eisele declares this to be one of the best bedding roses extant—more flowers and a stronger grower than any other. Mark that down.

WIZARD

TRADE BRAND MARK

MANURES

Dried, screened and packed in bags of 100 lbs. each.

PULVERIZED SHEEP MANURE
PURE — UNIFORM — RELIABLE

A strong and quick acting manure, highly recommended for carnations and chrysanthemums.

SHREDDED CATTLE MANURE
EASY TO HANDLE AND APPLY

Stronger and better in every way than rough manure. Lasts much longer on the benches. Unequaled for mulching and feeding roses, liquid manuring and mixing with bench and potting soil. Used by all the largest growers.

Ask Your Supply Man or Write Us for Circulars and Prices.

— THE —

Pulverized Manure Co.
31 Union Stock Yards, CHICAGO

Which Spray Pump

shall you buy? Buy the Spray Pump that fully meets the demands of the Government Agricultural Scientists and all practical Fruit Growers. These pumps are widely known as

DEMING SPRAYERS and are made in 23 styles for use in small gardens or immense orchards. Write for our 100 page catalog with Spraying Chart. Add 4 cents postage and receive "Spraying for Profit," a useful guide book.

CHARLES J. JAGER CO.
281-285 Franklin St., Boston

SPRAYED

Y₁ Fluid

**THE IDEAL WINTER SPRAY
SCALE KILLER & FUNGIGIDE**

POWERFUL CLEANSER AND INVIGORATOR
Mixes Instantly. No Sediment. No clogging. Non-injurious to user
COMPARATIVE TEST WILL PROVE ITS MERITS
Quart, \$1.00; Gallon, \$3.00
1 gallon makes 100 gallons. Write for descriptive pamphlet and testimony

PROPS. W. COOPER & NEPHEWS
177 ILLINOIS ST. CHICAGO

Gen'l Agent—CYRIL FRANCKLYN, 62 Beaver Street, New York, N. Y.

For Trees, Plants, Shrubs and Flowers
— USE —
THE NIAGARA BRAND LIME SULPHUR SOLUTION

It destroys Scale Lice, Spiders and all forms of Aphides, AT THE SAME TIME Mildew, Blight, Rust and other Fungus difficulties.
Used to Winter or Summer — No other remedy has been so universally effective.
Niagara Brand **ARSENATE OF LEAD** for chewing insects is equal to the best and better than the most.
Ask about our Green House strayer. Address—

NIAGARA SPRAYER CO., - - Middleport, N. Y.

“IMP”
SOAP SPRAY

Vege'able poisons alone.
Harmless to man.
Deadly to insects.

\$1.50 Single Gallon. Ditu'e to 25

EASTERN CHEMICAL CO.
Pittsburg Street, Boston, Mass.

KILMDEAD
The best of all
the tobacco
dusts for



**Dusting or
fumigating**

25 lbs. \$1.00 100 lbs. \$ 2.00 1000 lbs. \$27.00
60 lbs. \$1.75 2000 lbs. \$52.00

Stump & Walter Co.
50 Barclay St.
New York.

DON'T EXPERIMENT
USE
To-BAK-INE

and your stock will be free from insects, clean, and the blooms will not be discolored.

Send for full information of

H. E. FISKE SEED CO.
13 Faneuil Hall Sq., Boston, Mass.

STUMPP & WALTER CO.,
50 Barclay St., New York.

HENRY F. MICHELL & CO.,
1018 Market St., Philadelphia.

E. H. HUNT, Gen'l Agent,
76-78 Wabash Ave., Chicago.

“Every Bug Has his Dose.”

Insect-destroying preparations that do their work well and effectively are the cheapest. Bowker's Arsenate of Lead and Bowker's Pyrox are recognized standard insecticides and fungicides for both indoor and outdoor use. Bowker's Insect Emulsion destroys many kind of plant lice, black and green flies, etc. Call or send for catalogue.

BOWKER INSECTICIDE COMPANY
43 CHATHAM ST. BOSTON



**The Best
Bug Killer and
Bloom Saver**

For **PROOF**
Write to

P. R. Palethorpe Co.
OWENSBORO, KY.

SOMETHING NEW for GREENHOUSES
“SULFOCIDÉ”
PRATT'S
**SOLUBLE SULPHUR
SUMMER SPRAY**

Non-caustic and non-irritating
A FUNGICIDE AND INSECTICIDE
FOR FRUIT TREES, VEGETABLES and GREENHOUSES

A promising substitute for Bordeaux mixture. For 10 cts. to cover postage will send sample sufficient for one gallon of spray.
Use 1 part to 75 or 100 parts of water.

B. G. PRATT CO., 50 Church St., New York, U. S. A.

In writing to Advertisers kindly mention Horticulture

Seed Trade

AMERICAN SEED TRADE ASSOCIATION.

Watson S. Woodruff, Orange, Conn., Pres.; J. C. Robinson, Watertown, Neb., First Vice Pres.; C. E. Kendei, Cleveland, O., Sec'y and Treas. Twenty-seventh annual convention June 22-24, 1900, at Clifton House, Niagara Falls, Ont.

WHOLESALE SEEDSMEN'S LEAGUE.

F. W. Bruggerhof, Pres.; Burnet Landreth, Sec'y.

The Frank S. Platt Company.

The Frank S. Platt Co. of New Haven, Conn., have sold the large building which they are now occupying and Mr. Platt is now planning to retire, though, as he expressed it recently, it may be one year or possibly two before he is wholly out of harness. He intends to turn the business over to the young men associated with him, and just how long before they have absolute control depends on the capacity they show for management. Mr. Platt has served a long apprenticeship in the seed business, having commenced away back in 1856, and he is far from being a patriarch at that. He may be said to be the father of several prosperous florists who learned their business in his employ, as well as one or two vigorous young seed houses. Mr. Platt has built up a large and prosperous business, and has always been a credit to the trade. He was one of the pioneers in the growing of seed Lima beans in California, and despite the vigorous competition of recent years, still does a large business in that line. It was not learned just when the new owners are to have possession, nor where the Frank S. Platt Co. is to have their new home, but doubtless this question will receive the careful and wise consideration for which the head of this house has always been noted.

Crop Prospects in California.

At this season of the year the various seed dealers throughout the United States and Canada are naturally anxious to get some idea as to the crop prospects here in California. The writer begs to state that we have had a very severe winter with more rain than we have had here for fifty years past. The result has been that on low lands many seed crops have suffered and in various instances total acreages of various seeds have been destroyed. This is especially true on onion crops that were being grown on the Sacramento and San Joaquin River district. One seed grower lost 150 acres; another seed grower lost 25 acres. These losses were caused by the breaking of a levee which flooded the land. In the Santa Clara valley district the onions have suffered as a whole by excessive water fully 25 per cent. some crops of onions being totally destroyed while other crops of onions are looking remarkably well. It is the writer's opinion that there still remains in good condition sufficient onion going to seed to supply a reasonable demand of the seed trade for the season of 1910.

Lettuce at the present writing is being reseeded and at the best we cannot look forward to any large crop of this seed. Of onion, as said before,

there will be enough to go around with the probable exception of Red Wethersfield and White Portugal. These two sorts, it is our opinion, will be very short. Of carrot, there is a very limited acreage growing here in California this season. What crops are planted are looking well and we can see no reason why we should not harvest a good crop of this seed. Salsify is doing well. Sweet peas are doing very well. Radish promises a good crop. Celery, collards, beet, kohlrabi, leek, spinach, parsley, parsnip, mustard and endive all promise a good crop at this time.

CHAS. P. BRASLAN.

A Letter to the Seed Trade.

Bristol, Pa., April 14, 1903.

Now the Finance Committee of the Senate, presided over by the Hon. N. W. Aldrich, is actively considering the subject of the tariff is the time to write that committee, to the effect that all the seedsmen of the United States are unanimously in favor of a specific duty rather than an ad valorem, but solely with the idea of simplifying the system of assessment on importations, and to avoid the irritation of Custom House penalties.

Will you not today write to Senator Aldrich to this effect?

Respectfully,
BURNET LANDRETH.

Personal and News Notes.

There has been some improvement in the demand for canned goods, and a more optimistic feeling is permeating that line of business.

The situation affecting green pod beans has been greatly relieved by offerings from the growers. Had it not been for this, prices would be ruling much higher at the present time.

O. H. Dickinson of Springfield, Mass., or as he is affectionately known to his friends, "Dick," has been laid up with a severe attack of grippe. He is out again much to his own joy and that of his friends, and busy as never before.

Counter trade is now in full blast, and there are not enough hours in the day to enable seedsmen to transact their business. It is fortunate that union hours do not obtain in the seed business, or many houses would have to shut up shop.

Jerome B. Rice, with his wife and son, have been spending a short vacation at Atlantic City, and all have returned home greatly invigorated and refreshed. Mr. Rice's popularity continues to grow with advancing years, and no seedman is more universally respected or beloved by his colleagues.

John C. Caswell, manager of the garden seed department for The W. E. Barrett Co., of Providence, R. I., who has spent a great part of the past winter in a hospital where he underwent two critical operations, is again at his desk. He is hardly able as yet to engage in a Marathon race, but is able to direct the affairs of his department, much to his own satisfaction and the relief and pleasure of his superiors.

The Senate has granted the request of the seedsmen by amending the

Aster Seed

Our Aster seed is grown for us by experienced and reliable growers, and cannot be excelled for quality of seed and purity of stock.

Improved Semple's Branching

A strain which has been secured by years of careful selection.

	Tr. Pkt	Oz.
Crimson40	\$1.50
Lavender40	1.50
Shell Pink40	1.50
Rose Pink40	1.50
Purple40	1.50
White40	1.50
Mixed40	1.50

For other varieties see our General Wholesale Catalogue; a copy mailed for the asking.

HENRY F. MICHELL CO.
1018 Market St., PHILA.

tariff bill as it went to them from the House, and placing a specific duty on seeds. It is hoped this will not be changed when the bill passes the Senate and goes to conference. Those having the matter in charge should be alert at that time to prevent this.

It may or may not be generally known, that the McMoran-Gray Co., of Port Huron, Mich., are not growing any contract peas for future delivery. Taking advantage of the high prices of peas the past fall and winter, they have sold off their seed-stocks excepting just enough to produce their own seed-stock for 1910. Mr. Gray is no longer connected with the concern.

McMinnville, Ore.—G. S. Crego, the aster specialist, will grow his seed here this season.

Amherst, Mass.—A seed house belonging to Lafayette Goodell was destroyed by fire on April 13.

Ottawa, Can.—Graham Bros. contemplate the erection of an up-to-date seed storehouse on the land they have recently acquired on Sparks St.

Monticello, Fla.—D. H. Gilbert is adding a two-story brick building for storing watermelon seeds. He has planted 1,200 acres this year, and hopes to harvest about 125,000 pounds of the fruit.

The Office of Public Buildings and Grounds, Washington, D. C., announces that sealed proposals, in duplicate, will be received until 2 p. m., May 10, for furnishing during the year ending June 30, 1910, florists' supplies; flower pots; paints, oils, glass, etc.; iron pipe and plumbers' supplies; manure and fertilizers; lime, cement, felt, etc.; sod; fuel; lumber. Separate proposals for each class. Further information can be obtained from Spencer Cosby at above address.

GEO. E. DOW
Designing and Illustrating
178 Washington St., Boston, Mass.
OUR SPECIALTY
Machine, Booklet, Advertising and Flower
PHOTOGRAPHS

Everything "For the Land's Sake."

The one firm in Boston where all good forms of plant food may be obtained, is the Bowker Fertilizer Company, opposite Faneuil Hall at 43 Chatham St. All greenhouse chemicals, Nitrate of Soda, Ground Bone, Potash Salts, Sheep Manure and Wood Ashes can there be had at first hands.

BOWKER FERTILIZER COMPANY

Everything "For the Land's Sake."

Mignonette

FARQUHAR'S GIANT

Oz., 75c; 1-4 oz., 25c

R. & J. Farquhar & Co.
6 & 7 South Market Street
BOSTON, MASS.

SHEEP MANURE

IT'S STERILIZED
Free from Weed Seeds.
\$24.00 Ton;
\$7.00 quarter of Ton.

Wm. Elliott & Sons
42 Vesey St., New York

RELIABLE SEEDS—SOW NOW

PRIMULA OBCONICA GRANDIFLORA
1000 seeds Tr. pkt.
Blood red, fine seller.....\$1.50 \$0.50
Real pink, fine for cut..... 1.00 .50
Pure white, fine for cut..... 1.00 .50
Compacta, fine potter..... 1.50 .50
Mixed Hybrids 1.00 .50
O. V. ZANGEN, - HOBOKEN, N. J.

LEONARD SEED CO.

CONTRACT GROWERS AND WHOLESALE DEALERS
BEANS, PEAS, SWEET CORN, ONION, GARDEN SEEDS
ONION SETS Get Our Prices 79 and 81
FLOWER SEEDS E. KINZIE STREET, CHICAGO

ESTABLISHED 1802

Thorburn's Seeds

FINE CLUMPS JAPAN IRIS
TUBEROUS ROOTED BEGONIAS
GLOXINIAS
ROSA MULTIFLORA NANA SEED
and all other flower seeds for florists

SEND FOR CATALOGUE
J. M. THORBURN & CO.
33 Barclay Street
NEW YORK

CABBAGE SEED

LILY OF THE VALLEY PIPS.
HJALMAR HARTMANN & CO.
12 Stormgade,
COPENHAGEN, DENMARK.

Burpee's Seeds

PHILADELPHIA
Blue List of Wholesale Prices mailed only to those who plant for profit.

Ward's Lily Bulbs

Send for Catalogue
Ralph M. Ward & Co.
12 W. Broadway
NEW YORK

BRIDGEMAN'S SEED WAREHOUSE

RICKARDS BROS.

Props.
37 East 19th St., - NEW YORK CITY

STOCK SEED

FOR WINTER BLOOMING
Our strain of Double Branching Stocks is exceptionally true. About 90% Double Flowers.
In colors: - 3/4 oz. .60 ea. \$4.00
Pure White 3/4 " .75 " 5.00
H. E. FISKE SEED CO.
Faneuil Hall Square, BOSTON, MASS.

Winter-flowering SWEET PEA SEED

All Colors Ask for List
A. C. ZVOLANEK
ORIGINATOR, BOUND BROOK, N. J.

NEW CROP SEED

For Early Planting
THOMAS J. GREY CO.
32 SO. MARKET ST., BOSTON, MASS.

BEGONIAS TUBEROUS ROOTED

—ALSO—
GLOXINIAS, LILY OF VALLEY, SPIREA
Catalogue mailed free on application
Joseph Breck & Sons Corp.
47-54 NO. MARKET ST., BOSTON, MASS.

BULBS OF QUALITY

100
Begonias, Single, under color.....\$2.75
" Double " " 5.00
" Frilled " " 10.00
Gloxinias, under color..... 4.00
Pearl Tuberoses, \$7.00 thous..... 1.00

Schlegel & Fottler Co.
26 & 27 So. Market St., BOSTON, MASS.

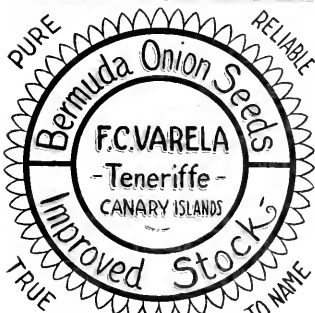

NO COMPLAINTS AND -
NO TROUBLE WITH MY SEEDS

In ordering goods please add "I saw it in HORTICULTURE."

VEGETABLE PLANTS

FOR TRANSPLANTING
CABBAGE—Wakefield and Succession \$1.00 per 1000
EGG PLANT—N. Y. Improved and Black Beauty 40cts. per 100, \$3.00 per 1000
PEPPER—Bull Nose, Ruby King and Sweet Mountain 40cts. per 100, \$3.00 per 1000
Chinese Giant and Cayenne, 50cts. per 100
TOMATO—Earlina, Chalk's Jewel and Early June Pink, 30cts. per 100, \$2.00 per 1000
Stone, Favorite and Faragon, Small plants \$1.00 per 1000.
CELERY—Small for transplanting, White Flame and Golden Self Blanching, \$1.00 per 1000.
CASH WITH ORDER
R. VINCENT, JR., & SONS CO.
White Marsh, Md.

To Florists Everywhere

Orders for Cut Flowers and Floral Decorations to be delivered anywhere in the Greater New York may be placed with us with the certainty that your customers will be satisfied.

Telegraph, telephone or mail such orders to us and be sure that they will be filled as promptly and as carefully as though you did it yourself.

One third discount will be allowed on all orders thus placed with us by Florists outside of the Greater New York.

THE BLOSSOM

Bond and Livingston Sts.,
BROOKLYN, N. Y.

C. C. TREPPEL, Manager

WILLIAM J. SMYTH FLORIST

Cor. Michigan Ave. and 31st St., CHICAGO

We ship to all points in Illinois and Iowa.

Phones: Douglas 744, Douglas 523, Douglas 740

HAUSWIRTH THE FLORIST

Out of Town orders for Hospitals
Carefully filled.

232 Michigan Ave.
CHICAGO

AUDITORIUM ANNEX Tel. Harrison 585

SAMUEL MURRAY Florist

Coates House Conservatory

1017 BROADWAY, KANSAS CITY, MO.

Both 'Phones 2670 Main.



WASHINGTON,

D. C.

GUDE'S

The Far-Famed Flowers of TORONTO

Delivered on mail or telegraph order for any occasion, in any part of the Dominion.

JOHN H. DUNLOP,
96 Yonge St., - Toronto, Ont.

The Park Floral Co.

J. A. VALENTINE,
Pres.

DENVER, COLORADO

WILLIAM L. ROCK
FLOWER CO.

KANSAS CITY, MO.

will carefully execute orders for Kansas City and any town in Missouri or Kansas.



Buffalo, N. Y.

W. J. PALMER & SON, 304 Main St.

Of Interest to Retail Florists

EASTER AT MORRISTOWN, N. J.

A large volume of Easter retail trade was done in Morristown, which is essentially a retailers' town. Pot plants of good quality were in great demand. From 6 to 8 in. seem to be a taking size, convenient to carry or handle. Lots of Rambler roses of the Dorothy Perkins type were everywhere; good 6 to 8 in. pans of tulips sold well; hyacinths, three to four in a pot and 6 to 8 in. pans of daffodils did well, and good lilies found ready sale. But reports are that 25 per cent. of the bulbs were no good, which of course materially increased the cost of production. Hydrangea sale was not large. Forced as they are, they seem to be a little too soft to last long in

STEAMER DEPARTURES

American.

St. Louis, N. Y.-Shampton...May 1
Philadelphia, N. Y.-Shampton...May 8

Atlantic Transport.

Mesaba, N. Y.-London...May 1
Minnehaha, N. Y.-London...May 8

Cunard.

Lusitania, N. Y.-Liverpool...Apr. 28
Ivernia, N. Y.-Liverpool...May 4
Mauretania, N. Y.-Liverpool...May 5

French Line.

La Lorraine, N. Y.-Havre...May 6
La Touraine, N. Y.-Havre...Apr. 29

Hamburg-American.

Pennsylvania, N. Y.-Hamb'g...Apr. 28
Deutschland, N. Y.-Hamburg...Apr. 29
Pres. Lincoln, N. Y.-Hamb'g...May 5

Leyland Line.

Cestrian, Boston-Liverpool...Apr. 28

North German Lloyd.

K. W. der G., N. Y.-Bremen...Apr. 27
Neckar, N. Y.-Med. Ports...May 1
K. Wilhelm II, N. Y.-Bremen...May 4

White Star.

Adriatic, N. Y.-Shampton...Apr. 28
Arctic, N. Y.-Liverpool...May 1
Cymric, Boston-Liverpool...May 1

the house. Azaleas were the finest we ever had and lots were sold. E. A. Holton, H. C. Holmes, John Jones, Marcus Force, R. A. Elliott and George Bird, all report a great deal better business than last year. The florists hope that this little ripple of prosperity is the harbinger of a strong wave to come. E. R.

The usual post-WASHINGTON Easter quiet has not settled down upon Washington owing to the fact that there are at least 5,000 daughters attending the Annual D. A. R. Conference which is now in session in Washington. Social affairs of the most elaborate character are the order of the day and of course, wherever fair woman goes, flowers must needs go with her.

The annual banquet of the Connecticut Horticultural Society was held at Long's Hotel, Hartford, on April 12. Thirty-eight members were present and after the edibles were disposed of, President Huss welcomed the guests and introduced A. C. Sternberg as toastmaster. John Gerard, E. W. Schultz, H. A. Pinney, W. P. Bristol and J. A. Creilly were among the speakers. An enjoyable evening was spent.

ALEX. McCONNELL

571 FIFTH AVENUE
NEW YORK CITY

Telegraphic orders forwarded to any part of the United States, Canada, and all principal cities of Europe. Orders transferred or intrusted by the trade to our selection for delivery on steamships or elsewhere receive special attention.

Telephone Calls, 487 and 488 38th St.
Cable Address, ALEXCONNELL

NEWMAN FLORAL Co.

(Established 1870)

202 Fifth Ave. and Madison Square, NEW YORK CITY

FLOWERS FOR STEAMER SAILINGS

M. A. BOWE

In the Heart of New York City

1294 Broadway

Tel. 2770, 38th St. NEW YORK

Our Flotte—The Golden Rule

DAVID CLARKE'S SONS

Deliver orders from any part of the country to
New York City

OR OUT-GOING STEAMERS

Write or telegraph

2139-2141 Broadway, New York
Telephone 1559-1555 Columbus

YOUNG & NUGENT

42 West 28 St., NEW YORK

"FLOWERS BY TELEGRAPH"

NEW YORK MYER, FLORIST

Phone 5297 Plaza. 609-611 MADISON AVE.

ALBANY, N. Y.

EYRES

Flowers or Design Work

DELIVERED IN ALBANY AND VICINITY
ON TELEGRAPHIC ORDER.

11 NORTH PEARL ST., ALBANY, N. Y.

Flower Deliveries

In Brooklyn and other Long Island Points
New York City, New Jersey, etc. At Theaters,
Hotels, Steamers or Residences.

WILSON

Fulton St. and Greene Ave., Brooklyn, N. Y.

DANKER, Albany, N. Y.

ORDERS FOR

Choice Flowers and
Floral Emblems
FILLED PROMPTLY

WELLESLEY COLLEGE

Dana Hall, Walnut Hill and Rockridge Hall
Schools. TAILBY, Wellesley, Mass.
Tel. Wellesley 44-1 and 2. Night 44-3.

ATLANTA FLORAL CO.

41 Peachtree Street, ATLANTA, GEORGIA

JOHN BREITMEYER'S SONS

Cor. Miami and Gratiot Aves.
DETROIT, MICH.

**Artistic Designs . . .
High Grade Cut Blooms**

We cover all Michigan points and good sections of Ohio, Indiana and Canada

PROMPT DELIVERY IN BOSTON

AND ALL NEW ENGLAND POINTS
F. H. HOUGHTON
396 Boylston St., Boston, Mass.

BOSTON'S BEST In Quality and Design

Can be relied upon when you transfer your retail orders to

EDWARD MACMULKIN
194 Boylston Street, Boston

Send flower orders for delivery in
BOSTON

and all
NEW ENGLAND POINTS
THOS. F. GALVIN
124 Tremont St., Boston



TRANSFER

Your orders for flower or plant delivery in Eastern New England to

JULIUS A. ZINN,
2 Beacon St., Boston
FINE DESIGN WORK A SPECIALTY

Orders by Wire Receive Prompt and Careful Execution

J. Newman & Sons
Corporation
24 Tremont Street, BOSTON

Theater, Steamer and Funeral Flowers Our Specialty
We can refer to leading florists in all principal cities.
Established 1870.

**LOUISVILLE, KY.
JACOB SCHULZ,**
550 South Fourth Ave.

FLORISTS' SUPPLIES

Send for New Catalogue
H. Bayersdorfer & Co.
1129 ARCH ST., PHILADELPHIA

"FLOWERS BY TELEGRAPH."

Leading Retail Florists Listed by Towns for Ready Reference.

- Denver, Colo.—Park Floral Co., 1706 Broadway.
- Washington, D. C.—Gude Bros., 1214 F St.
- Atlanta, Ga.—Atlanta Floral Co., 41 Peach Tree St.
- Chicago—Hauswirth, "The Florist," 232 Michigan Ave.
- Chicago—William J. Smyth, Michigan Ave. and 31st St.
- Chicago—George Wittbold Co., 1657-59 Buckingham Place.
- Louisville, Ky.—Jacob Schulz, 550 South Fourth Ave.
- Boston—Thos. F. Galvin, 124 Tremont St.
- Boston—Frank H. Houghton, 396 Boylston St.
- Boston—Edward MacMulkin, 194 Boylston St.
- Boston—Hoffman, Florist, 59-61 Massachusetts Ave.
- Boston—J. Newman & Sons, Inc., 24 Tremont St.
- Roston—Julius A. Zinn, 2 Beacon St.
- Wellesley, Mass.—Tallyy.
- Detroit, Mich.—J. Breitmeyer's Sons, Miami and Gratiot Aves.
- Kansas City, Mo.—Samuel Murray, 1017 Kansas City, Mo.—Wm. L. Rock Flower Co., 1136 Walnut St.
- Albany, N. Y.—H. G. Eyres, 11 N. Pearl St.
- Albany, N. Y.—F. A. Danker, 40 Malden Lane.
- New York—David Clarke's Sons, 2139-2141 Broadway.
- New York—Alex. McCConnell, 571 5th Ave.
- New York—Young & Nugent, 42 W. 28th St.
- New York—M. A. Bowe, 1294 Broadway.
- New York—Myer, 609-11 Madison Ave.
- New York—Newman Floral Co., 202 Fifth Ave. & Madison St.
- Brooklyn, N. Y.—The Blossom (C. C. Trepel, Mgr.), Bond and Livingston Sts.
- Brooklyn, N. Y.—Robert G. Wilson, Fulton St. and Greene Ave.
- Buffalo, N. Y.—Palmer's, 304 Main St.
- Toronto, Can.—J. H. Dunlop, 96 Yonge St.

NEW FLOWER STORES.

- Huntington, Ind.—Hatten & Bierberich.
- Hackensack, N. J.—H. S. Mabie, 148 Main St.
- Philadelphia, Pa.—Louis Bergen, 6117 Germantown Av.
- New York, N. Y.—Angell & Specheris, 1241 Amsterdam Av.
- Asheville, N. C.—Rocklin & Lehman, 405 Fourth St. (branch store).
- New Castle, Pa.—J. J. Beck is making many improvements in his store.
- Johnstown, Penn.—Wm. Schmidt has moved into a new store at 120 Franklin St.
- Lynn, Mass.—John O. J. Frost will sell flowers in connection with his stand on Selman St.
- New York, N. Y.—P. F. McKenny, 503 Fifth Av.; Hamilton Court Flower Shop, 134 Hamilton Place.
- Lancaster, Pa.—B. F. Barr & Co., have taken possession of their handsome new store on Duke street.

NEWS NOTES.

- Moorestown, N. J.—Arthur J. Collins, florist, was the victim of a swindler to the extent of \$10, recently. After placing a good sized order the party asked Mr. Collins to cash a check for him. The check proved to be spurious and notification was received that the goods were unclaimed.
- Lowell, Mass.—The restrictions of the Sunday closing law were keenly felt in this city on Easter Sunday, when many people left their homes expecting to be able to purchase flowers to take to the cemeteries, only to be disappointed. Why, newspapers, cigars

FOR DECORATION DAY

Metal Floral Designs
Magnolia Wreaths
Moss Wreaths
Ruscus Wreaths
Cycas Wreaths

A. HERRMANN

Manufacturer of
Metal Floral Designs
Importer and Dealer in
Florists' Supplies

404-412 E. 34th Street
NEW YORK CITY

Ask for Catalogue

THE BEST LETTERS

FOR THOSE
FLORISTS' MADE
USE OF BY THE



Boston Florist Letter Co.
66 PEARL ST., BOSTON
N. F. McCarthy, Mgr.

Order direct or buy from your local supply dealer. Insist on having the

BOSTON

Inscriptions, Emblems, etc., Always in Stock

Durand & Marohn

MANUFACTURERS OF
All Kinds of Wire Work
Florists' Wire Designs a Specialty
24 Beaver St., ALBANY, N. Y.

Wired Toothpicks

Manufactured by
W. J. COWEE, BERLIN, N. Y.
50,000...\$1.75; 50,000...\$7.50. Sample free.
For sale by dealers

and tobacco do not come under the ban, but are considered "necessities of life," is a question that is agitating the citizens now.

Mt. Clemens, Mich.—A slight fire occurred in the store of the Mt. Clemens Floral Co., 22 Macomb St., on April 8.

SWEET PEAS

Extra Selected Stock
75c.—\$1.00 per 100

DAGGER FERNS

\$2.50 per 100

THE LEO NIESSEN CO.

1209 Arch St., Philadelphia, Pa.
Open from 7 a. m. to 8 p. m.



American Beauty ROSES

SPECIALS, \$25 per 100; FANCYS, \$20 per 100;
EXTRAS, \$15 per 100; FIRSTS, \$12.50 per 100

S. S. PENNOCK-MEEHAN CO.
1608-1620 Ludlow St., Philadelphia

LILY OF THE VALLEY ORANGE BLOSSOMS

(FOR APRIL WEDDINGS)

W. E. MCKISSICK & BROS.

WHOLESALE FLORISTS
1619-1621 RANSTAD ST.
PHILADELPHIA

CUT FLOWER BOXES
EDWARDS FOLDING BOX CO
MANUFACTURERS
PHILADELPHIA, PA.

CHAS. W. MCKELLAR

51 WABASH AVE., CHICAGO

Western Headquarters for Choice Orchids
Valley, Roses and all Cut Flowers

PETER REINBERG WHOLESALE

CUT FLOWERS

51 Wabash Av., Chicago, Ill.

Long Distance Phone, Central 6004

WINTERSON'S SEED STORE

45-47-49 Wabash Ave., Chicago.

Seedsman, Plantsmen, Nurserymen
Florists' Supplies

We can supply everything used by the
Florist. SUPPLY CATALOG FREE. Cor-
respondence solicited.

POEHLMANN BROS. CO.

33-35-37 Randolph St., - CHICAGO

CUT FLOWERS

Greenhouses, - Morton Grove, Ill.

Rice Brothers

115 N. 6th Street, MINNEAPOLIS, MINN.

WHOLESALE FLORISTS and SUPPLIES

CUT FLOWERS received twice daily, and can fill
your orders to your satisfaction. A complete line of
Hardy Greens - WILD SMILAX, BOXWOOD,
HARDY FANCY FERNS, GALAX LEAVES.
Write for quotations on large quantities.

In ordering goods please add "I saw
it in HORTICULTURE."

WELCH BROS.

AMERICAN BEAUTY, KILLARNEY, RICHMOND, MARYLAND AND ALL THE SUPERIOR
ROSES, LILY OF THE VALLEY, CARNATIONS, ORCHIDS
BEST PRODUCED

226 Devonshire Street, Boston, Mass.

WHOLESALE FLOWER MARKETS—TRADE PRICES—Per 100 TO DEALERS ONLY

	CHICAGO April 19	TWIN CITIES April 19	PHILA. April 19	BOSTON April 19
ROSES				
Am. Beauty, Fancy and Special...	25.00 to 30.00	35.00 to 45.00	25.00 to 30.00	25.00 to 35.00
" " Extra	20.00 to 25.00	30.00 to 35.00	14.00 to 20.00	12.00 to 15.00
" " No. 1	15.00 to 20.00	16.00 to 25.00	8.00 to 15.00	4.00 to 8.00
" " Lower grades	5.00 to 10.00	10.00 to 16.00	3.00 to 8.00	1.00 to 3.00
Bride, "Maid, Golden Gate, F. & S.	6.00 to 8.00	8.00 to 10.00	8.00 to 10.00	5.00 to 8.00
" " Lower grades	3.00 to 6.00	6.00 to 8.00	3.00 to 5.00	2.00 to 4.00
Killarney, Fan, & Sp.	6.00 to 8.00	8.00 to 12.00	10.00 to 15.00	8.00 to 10.00
" " Lower grades	3.00 to 6.00	6.00 to 8.00	3.00 to 5.00	1.00 to 3.00
Richmond, Fancy & Special	6.00 to 8.00	8.00 to 10.00	10.00 to 15.00	8.00 to 10.00
" " Lower grades	3.00 to 6.00	6.00 to 8.00	3.00 to 5.00	1.00 to 3.00
Chateaux	3.00 to 8.00	4.00 to 8.00	1.00 to 8.00
My Maryland	4.00 to 12.00	6.00 to 20.00
CARNATIONS				
Fancy and Ref.	3.00 to 4.00	3.00 to 3.50	3.00 to 4.00	2.00 to 3.00
Ordinary and White	1.00 to 2.00	2.00 to 3.00	1.50 to 2.00	1.00 to 1.50
MISCELLANEOUS				
Cattleyas to 75.00	40.00 to 50.00 to 75.00	50.00 to 75.00
Lilies	10.00 to 15.00	12.00 to 15.00	8.00 to 12.50	6.00 to 8.00
Lily of the Valley	3.00 to 4.00	3.00 to 4.00	2.00 to 5.00	1.00 to 3.00
Tulips	3.00 to 4.00	2.00 to 3.00	2.00 to 3.00	2.00 to 4.00
Daffodils	3.00 to 4.00	2.00 to 3.00	1.50 to 2.00	1.00 to 3.00
Niggonette to 4.00	3.00 to 3.50	1.50 to 3.00	1.00 to 4.00
Sweet Peas50 to 1.00	.75 to 1.00	1.00 to 1.00	.50 to .75
Geraniums	30.00 to 40.00	25.00 to 30.00	10.00 to 40.00	10.00 to 15.00
Violets50 to .75	1.00 to 1.25	1.00 to 1.50	.75 to 1.00
Adiantum	1.00 to 1.50	1.00 to 1.50	1.00 to 1.50	.75 to 1.00
Smilax	15.00 to 20.00	15.00 to 25.00	15.00 to 25.00	12.00 to 17.00
Asparagus Plumosus, strings	35.00 to 50.00	35.00 to 50.00	50.00 to 50.00
" " & Sprea. (two bchs)	30.00 to 50.00	20.00 to 30.00	35.00 to 50.00	15.00 to 15.50

J.A. BUDLONG

37-39 Randolph Street, CHICAGO.

Roses and Carnations A Specialty.....

WHOLESALE GROWER of CUT FLOWERS



HENRY M. ROBINSON & CO.

15 Province St. and 9 Chapman Place - BOSTON, MASS.

WHOLESALE COMMISSION FLORISTS

Hardy Cut Evergreens and Florists' Supplies

We have the stuff and can fill all orders, large or small
WE NEVER DISAPPOINT SATISFACTION GUARANTEED



Prices Quoted in these Columns are for Dealers Only.
When Writing to Advertisers Please Mention
HORTICULTURE.

Flower Market Reports.

BOSTON Business in Boston is veritably in the dumps. It was not long after Easter before symptoms of congestion began to appear and the spell of hot weather added to the Patriots' Day holiday was all that was necessary to smash the Moorings and precipitate a stampede on all lines. The most regrettable feature of the situation is the high quality which characterizes most of the material marketed. The stuff is entirely too good for such a predicament and the slaughter figures at which it must be unloaded. The "street merchant" has his innings and he knows it all too well.

BUFFALO A few days of real spring weather and plenty of sunshine brought on stock so fast that the wholesalers could not handle it to advantage and by the middle of the previous week there was a flood of everything and values were much on a decline. Roses are making up for the shortage during the winter and any quantity can be had at low figures. Carnot and Kaiserin have been added to the list but have had only a fair demand. Bridesmaid and Bride are in heavy supply but Killarney has the preference. Crops are heavy in the carnation life, also. Lilies, which should have been in for Easter are now to be had in any quantity; also callas, with little demand. Peas have sold readily and are taking the place of violets; the latter are nearing their end. Lily of the valley has made up for lost time. The only thing scarce is smilax; other greens are in fair supply.

CHICAGO The usual reaction followed Easter and the early part of the week found trade practically at a standstill and stock shipped in added to that left unsold on Easter Sunday, soon caused an accumulation hard to move off. In the week after Easter the effect of the increasing plant trade is felt more and more. Some dealers are very strongly of the opinion that the quiet spell lasts about as long as the life of the plants and, barring funeral work, there will be few flowers sold till the plants are gone from the homes of their customers. Carnations are particularly plentiful and hard to dispose of. Some good violets are coming in again. Sweet peas are of good quality but prices low. American Beauties are again getting equal to the demand and all other roses are coming in faster than they can be disposed of. Cattleyas are between crop and at present scarce in consequence. Gardenias are also scarce and southern crop still several weeks off. Callas are here in numbers and call for them light.

PHILADELPHIA. Weddings and other social gaieties came thick and fast the week after Easter, reaching their culminating point Wednesday, when some of the big retail stores declared they were rushed almost as much as on an Easter Friday. Since then business has receded somewhat although there is still a good deal going on. The advancing season has brought crops in on the jump so that the congestion is very

WHOLESALE FLOWER MARKETS.—TO DEALERS ONLY.

	CINCINNATI		DETROIT		BUFFALO		PITTSBURG	
	April 2	April 19	April 19	April 19	April 19	April 19	April 19	April 19
ROSES								
Am. Beauty, Fan, and Sp.	35.00	to 40.00	45.00	to 50.00	25.00	to 30.00	30.00	to 40.00
" Extra	30.00	to 35.00	30.00	to 40.00	17.00	to 25.00	20.00	to 25.00
" No. 1	15.00	to 20.00	15.00	to 20.00	12.00	to 17.00	10.00	to 15.00
" Lower grades.	6.00	to 8.00	6.00	to 20.00	5.00	to 8.00	1.00	to 4.00
Bride, "Maid, Golden Gate, F. & S.	6.00	to 8.00	10.00	to 18.00	8.00	to 10.00	8.00	to 10.00
" Low grades	3.00	to 5.00	5.00	to 8.00	4.00	to 6.00	3.00	to 6.00
Killarney, Fan, & Sp.	6.00	to 8.00	10.00	to 12.00	8.00	to 10.00	6.00	to 8.00
" Lower grades	3.00	to 5.00	5.00	to 8.00	4.00	to 6.00	3.00	to 4.00
Richmond, Fancy & Special.	8.00	to 10.00	10.00	to 15.00	8.00	to 10.00	6.00	to 8.00
" Lower grades	5.00	to 6.00	6.00	to 10.00	4.00	to 6.00	3.00	to 4.00
Chateaux	5.00	to 6.00	6.00	to 10.00	6.00	to 8.00	5.00	to 6.00
My Maryland	5.00	to 6.00	6.00	to 10.00	6.00	to 8.00	5.00	to 6.00
CARNATIONS								
Fancy and Novelties	3.00	to 4.00	3.00	to 5.00	2.00	to 3.00	2.00	to 3.00
Ordinary	1.50	to 2.00	3.00	to 4.00	1.50	to 2.00	1.00	to 1.50
MISCELLANEOUS								
Cattleyas	10.00	to 15.00	12.50	to 15.00	8.00	to 15.00	6.00	to 12.00
Lilies	3.00	to 4.00	3.00	to 4.00	3.00	to 4.00	1.00	to 4.00
Lily of the Valley	3.00	to 4.00	3.00	to 4.00	3.00	to 4.00	1.00	to 4.00
Tulips	3.00	to 5.00	3.00	to 4.00	2.00	to 3.00	2.00	to 3.00
Daffodils	2.00	to 3.00	3.00	to 4.00	2.00	to 3.00	1.00	to 1.50
Mignonette	2.00	to 5.00	3.00	to 5.00	2.00	to 3.00	2.00	to 3.00
Sweet Peas	.40	to .50	.30	to .40	.50	to 1.00	.25	to 1.00
Gardenias	25.00	to 35.00	10.00	to 15.00	10.00	to 15.00	25.00	to 35.00
Violets	5.00	to 7.50	7.50	to 1.00	.40	to .50	.25	to .50
Adoniam	10.00	to 1.00	1.00	to 1.50	.50	to 1.00	1.00	to 1.50
Smilax	10.00	to 12.00	10.00	to 15.00	10.00	to 15.00	5.00	to 20.00
Asparagus Plumosus, strings	40.00	to 50.00	30.00	to 50.00	40.00	to 50.00	30.00	to 50.00
" & Spreo. (100 bchs.)	20.00	to 25.00	30.00	to 50.00	25.00	to 50.00	30.00	to 50.00

severe. This is especially the case with roses. What business there is seems to call more for carnations, sweet peas, lily of the valley, etc., rather than roses. Cattleyas are exceedingly scarce and the few that are coming in are eagerly snapped up. The local supply is entirely inadequate and outside points when called on have been unable to furnish any relief. The hot weather is bringing the gardenia crop on again and values are much lower. Another week will probably see the last of the violets. Lilies sold well up to the middle of the week but are now slacking up. There are few tulips and daffodils about.

TWIN CITIES Easter in the Twin Cities did not turn out what it should have. Although business was as good as last year's, the expectations were to beat last year's output. The retailers in Minneapolis have quite some stock left over—not very much of any particular thing, but a little of almost anything that would not be much good anywhere after a few days. While pot plants went fairly good, tulips, daffodils, etc. and even lilies, were too abundant. The wholesalers especially have some "left overs" in bulbous stock. As usual prices were cut early Saturday afternoon in some places. Easter over, there was a general rest all around.

MOVEMENTS OF GARDENERS.
Hamilton, Mass. Ed. Davies has taken the position of gardener on the estate of Hugo Johnstone.

Orange, N. J.—S. Wyatt has succeeded John Dervan with A. C. Van Gaasbeck.

BUSINESS CHANGES.

Tyler, Texas.—The Sneed Nursery & Orchard Co. have filed articles of dissolution.

Canal Dover, O.—Daniel Wyss has purchased land just out of the city on which he intends to start a nursery.

Pittsburg, Pa.—William Flemm has retired from the firm of Breitenstein & Flemm and the new name of the house will be Breitenstein & Co.

Santa Cruz, Cal.—Ernest A. Bailey, has bought a one-half interest in the A. Mitting Calla Lily Bulb Co. A. Mitting will be president and manager; Ernest A. Bailey will be secretary and treasurer.

INCORPORATED.

Plainfield, N. J.—Van Zandt & Voorhes; capital, \$50,000. To deal in seeds, fertilizers, etc.

Rochester, N. Y.—Home Planters' Association; directors, Harry B. Phillips, Stuart Hamilton, H. E. Grady.

Providence, R. I.—The Meschantit Nursery Co.; J. Rogan, F. I. McCanna, J. A. Lee; capital, \$5,000. For buying, selling and cultivating all kinds of flowers, seeds and nursery products.

L. Merton Gage, Orange, Mass., writes that he is testing this year nearly 400 named varieties of gladioli, 175 of which are advanced novelties, and will also plant a large quantity of seed, including seed of his own crossing. He promises a report on these novelties next fall in HORTICULTURE.

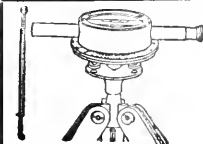

EVERYBODY KNOWS

Park, Cemetery and Landscape Gardening cannot be properly done without the aid of an accurate leveling instrument.

Bostrom's Improved Levels, No. 2 at \$14.00 and No. 3 at \$25.00, are covered by all who KNOW to be the only levels on the market which meet all the requirements, at the price.

Our guarantee back of every Level we sell, and satisfied users in every State in the Union heartily endorse every claim we make. Shipping weight 12 lbs. Description on request.

BOSTROM-BRADY MFG. CO., 139 Madison Avenue, ATLANTA, GA.

FORD BROTHERS

48 West 28th Street NEW YORK

FINE ROSES FANCY GARNATIONS

A Full Line of All CUT FLOWERS

Telephone, 3870 or 3871 Madison Square

H. E. FROMENT

Wholesale Commission Florist,
Choice Cut Flowers,

57 West 28th St. :: NEW YORK

Telephones: 2200, 2201, Madison Square.

Alfred H. Langjahr

All choice cut-flowers in season. Send for quotations. Correspondence with shippers of first-class stock invited.

55 West 28th Street, New York

Telephones 4626-4627 Madison Square

Edward C. Horan

Wholesale Florist

55 WEST 28th ST.

tel. 1462 Madison Square New York

JOHN YOUNG

WHOLESALE FLORIST

Finest American Beauties and Carnations

51 West 28 St. - NEW YORK

FRANK MILLANG

Wholesale Florist

55-57 West 26th St., NEW YORK

Shipments, any quantity, Wholesale Market Rates.

Henshaw & Fenrich

WHOLESALE FLORISTS

44 West 28th Street, NEW YORK

Phones Mad. Sq. 325, 558-2, 588-3

VIOLETS

Finest Grade. Any Quantity

B. S. SLINN

55-57 W. 26 St., New York

Moore, Hentz & Nash

Wholesale Commission Florists

55 and 57 West 26th Street

Telephone No. 756 Madison Square New York

MILLANG BROS.

WHOLESALE COMMISSION FLORISTS

41 West 28th Street

Telephone 3660 3661 Madison

NEW YORK

JOHN I. RAYNOR
Wholesale Commission Florist SELLING AGENT FOR LARGEST GROWERS
 A full line of Choice Cut Flower Stock for all purposes, Comprises every variety grown for New York market, at current prices
 TEL. 1998 MADISON SQUARE 49 West 28th St., New York City

Walter F. Sheridan
Wholesale Commission Dealer in
CHOICE CUT FLOWERS
 39 West 28th Street, New York
 Telephone: 3532-3533 Madison Square

HEADQUARTERS FOR NOVELTIES
ORCHIDS A SPECIALTY
 THE HIGHEST GRADE OF **VALLEY** ALWAYS ON HAND
 GARDENIAS, DAISIES, ROSES AND CARNATIONS
 Telephone
JAMES McMANUS, 759 Mad. Sq. 42 W. 28th St., New York

PHILIP F. KESSLER 55 & 57 W. 26th St., New York City
 Commission Dealer, Wholesale Buyer and Seller of
CUT FLOWERS
 Open from 5 a. m. to 6 p. m. Sunday till 10 a. m.
 Tel., 5243 and 2921 Madison Sq. Res., 345 J. Newtown.
Finest Lilies in the Market Every Day in the Year.

NEW YORK QUOTATIONS PER 100. To Dealers Only

	Last Half of Week ending Apr. 17 1909		First Half of Week beginning Apr. 19 1909	
ROSES AND CARNATIONS				
American Beauty, Fancy and Special.....	15.00	to 25.00	15.00	to 25.00
" " Extra.....	8.00	to 10.00	8.00	to 10.00
" " No. 1.....	4.00	to 6.00	4.00	to 6.00
" " Lower Grades.....	5.00	to 3.00	.50	to 3.00
Bride, "Field, Golden Gate, Fancy and Special.....	4.00	to 8.00	4.00	to 8.00
" " Lower Grades.....	1.00	to 2.00	1.00	to 2.00
Killarney, Fancy and Special.....	5.00	to 8.00	5.00	to 8.00
" " Lower Grades.....	1.00	to 3.00	1.00	to 3.00
Richmond, Fancy and Special.....	6.00	to 13.00	6.00	to 10.00
" " Lower Grades.....	1.00	to 3.00	1.00	to 3.00
Chatenay.....	1.00	to 8.00	1.00	to 8.00
Py Laryland.....	1.50	to 10.00	1.50	to 10.00
Carnations, Fancy and Novelities.....	2.00	to 4.00	2.00	to 4.00
" " Ordinary and White.....	1.00	to 1.50	1.00	to 1.50

Alexander J. Guttman
THE WHOLESALE FLORIST OF NEW YORK
 34 WEST 28th STREET
 PHONES. 1664-1663 MADISON SQUARE
ENOUGH SAID

CENTRALLY LOCATED, THE HUB OF THE FLOWER MARKET SECTION

CHARLES MILLANG
 Wholesale Florist
 444 Sixth Ave., NEW YORK
 Telephone 7062 Madison

GEORGE COTSONAS & CO.
 Wholesale and Retail Dealers in all kinds of
EVERGREENS
 Fancy and Dagger Ferns
 Bronze and Green Galax
 Main Store 50 W. 28 St.
 Phone 1902 Mad. Sq. New York

GROWERS' CUT FLOWER CO. CUT FLOWERS AT WHOLESALE
VIOLETS, CARNATIONS, ROSES
ORCHIDS, CHRYSANTHEMUMS, LILIES
Consignments Solicited. Shipments to Order, any Distance
 Telephone 697 Madison Square
39 West 28th Street, NEW YORK
 J. J. COAN, Manager

WHOLESALE FLORISTS
54 West 28th St.
NEW YORK
Telephone 8559 Madison Sq.

A. L. YOUNG & CO.

RECEIVERS & SHIPPERS OF CUT FLOWERS.
CONSIGNMENTS SOLICITED

WILLIAM H. KUEBLER
Brooklyn's Foremost and Best
WHOLESALE COMMISSION HOUSE
A First Class Market for all CUT FLOWERS
28 Willoughby St., Brooklyn, N. Y.
Tel. 4691 Main

WILLIAM F. KASTING CO.
WHOLESALE FLORISTS
383-387 Ellicott Street
BUFFALO, - N. Y.



Greater New York Florists' Association, Inc.
Now Open for Cut Flower Consignments
162 Livingston Street, BROOKLYN, N. Y.
Geo. W. Crawbuck Telephone Connection
Manager 3642-43 Main

ROBERT J. DYSART
Public Accountant and Auditor
Simple methods of correct accounting especially adapted for florists' use.
Books Balanced and Adjusted
Merchants Bank Building
28 STATE STREET, - BOSTON
Telephone, Main 58.

REED & KELLER
122 West 25th St., New York
Florists' Supplies
We manufacture all our
Metal Designs, Baskets, Wire Work & Novelties
and are dealers in
Massawese Decorative Greens and Florists' Requisites

WHOLESALE COMMISSION J. K. ALLEN 106 W. 28th St. NEW YORK
Open 6 a. m. Daily
Shipments of Lily of the Valley Needed
Tel. 167 Madison Sq

THE KERVAN CO.
Wholesale Dealers and Shippers of
Decorative Evergreens
Ferns, Galax, Laurel, Fresh Cycas, Boxwood, Spagnuolo and all Florists' Greens
Send to us for Quotations before Buying.
113 West 28 Street, NEW YORK CITY

MICHIGAN CUT FLOWER EXCHANGE, Inc.
WHOLESALE COMMISSION FLORISTS
Consignments Solicited
Hardy Fancy Fern Our Specialty
38-40 BROADWAY, DETROIT, MICH.

FOR FLORISTS' USE
There's **NOTHING** as good as
MEYER'S SILKALINE
Don't let them sell you anything else
JOHN C. MEYER & CO., Boston, Mass.

In ordering goods please add "I saw it in HORTICULTURE."

KRICK'S PERFECT FLOWER POT HANDLE

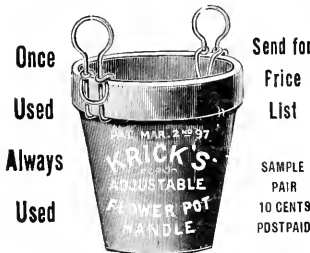

Once Used Always Used

Send for Price List

SAMPLE PAIR 10 CENTS PDSTPAID

Patented

1164-1166 Greene Ave.
BROOKLYN, - N. Y.

NEW YORK QUOTATIONS PER 100. To Dealers Only

MISCELLANEOUS

	Last Half of Week ending Apr. 17 1909	First Half of Week beginning Apr. 19 1909
Cattleyas.....	50.00 to 75.00	50.00 to 75.00
Lilies.....	4.00 to 6.00	4.00 to 6.00
Lily of the Valley.....	1.00 to 3.00	1.00 to 3.00
Tulips.....	1.00 to 3.00	1.00 to 3.00
Daffodils.....	1.00 to 2.00	1.00 to 2.00
Mignonette.....	1.00 to 3.00	1.00 to 3.00
Sweet Peas.....	2.00 to 6.00	2.00 to 6.00
Gardenias.....	5.00 to 25.00	5.00 to 25.00
Violets.....	.15 to .35	.15 to .35
Adiantum.....	.50 to 1.50	.50 to 1.50
Smilax.....	8.00 to 12.00	8.00 to 12.00
Asparagus Plumosus, strings.....	15.00 to 25.00	15.00 to 25.00
" " & Spreu. (too bchs).....	10.00 to 25.00	10.00 to 25.00

NEW YORK MARKET.

A very heavy supply of all varieties of roses and carnations has been coming to this market during the past week, under the incentive of the precocious weather and there is no compensating demand for the goods, which have been accumulating each day in hopeless surfeit. Not roses and carnations alone but the general stock of cut flowers are all in overwhelming abundance and prices are on the rapid decline, all semblance of stability having disappeared.

NEWS NOTES.

Council Bluffs, Ia.—The whirlwind on April 9 damaged the Lainson greenhouses to the extent of \$75.

Billings, Mont.—W. H. Ralston, and M. I. Tuttle of Ft. Morgan, Colo., are actively interested, it is said, in the formation of a nursery company which will make a specialty of small fruits.

Saturday, April 24, has been designated as Arbor Day, in Massachusetts, by the proclamation of Governor Draper, who urges the planting of new trees or the care of those already planted, on that day.

It is stated that the mayor of Tokio, Japan, has offered to the City of Washington, a thousand Japanese cherry

trees to be planted along the new pleasure driveway which has just been opened along the Potomac River south of the monument grounds and that the gift has been accepted by the president.

Detroit, Mich.—The largest flower show ever tendered the Detroit public was the Easter show at the Horticultural building at Belle Isle. In addition to the more than three thousand lilies, there were azaleas, orchids, etc. It is said that nearly a million plants are ready to be distributed among the parks.

Pueblo, Col.—William Joxen has brought suit against G. A. Rodell to collect \$1,150, which he alleges is due through a deal in nursery stock. He has obtained an injunction restraining Rodell from disposing of any of the stock until the matter can be heard by the Court. The plaintiff asks for a receiver for the property.

Worcester, Mass.—Fire in the seed and agricultural warehouse of Ross Bros., on April 13, caused a loss of between two and three thousand dollars, chiefly on lime and fertilizers stored in the basement. Prompt action by the fire department prevented the spread of the flames to the upper stories where the seeds were stored.

Buyer's Directory and Ready Reference Guide

Advertisements under this head, one cent a word. Initials count as words.

Display advertisers in this issue are also listed under this classification without charge. Reference to List of Advertisers will indicate the respective pages.

Buyers failing to find what they want in this list will confer a favor by writing us and we will try to put them in communication with reliable dealers.

ACCOUNTANT

R. J. Dysart, 23 State St., Boston.
For page see List of Advertisers.

AMPELOPIS.

Storrs & Harrison Co., Palmesville, O.
For page see List of Advertisers.
Eastern Nurseries, Henry F. Dawson, Mgr.,
Ampelopsis Quilquefoila.
Jamaica Plain, Mass.
For page see List of Advertisers.
C. Elsele, 11th and Westmoreland Sts.,
For page see List of Advertisers.

AQUATIC PLANTS

Aquarium plants the year round. Wholesale and retail. Send for price list. Schmidt's Emporium of Pets, 712 12th Street, Washington, D. C.
Choice hardy water lily roots, red, white, pink and yellow. Write for prices. W. J. Richards, Wayland, Ohio.

AQUILEGIAS

Aquilegia. Genuine Coerulea, finest of all. Both plants and seeds from the heart of the Rockies. C. S. Harrison's Select Nursery, York, Neb.

ARAUCARIAS

A. Leuthey & Co., Perkins St. Nurseries, Roslindale, Mass.
For page see List of Advertisers.
Godfrey Aschmann, 1012 West Ontario St., Philadelphia, Pa.
For page see List of Advertisers.

ARGENTEUIL ASPARAGUS

Asparagus Roots, \$5 per 1000. Send for circular with extract from experiment station report, how this kind returned \$29.87 per acre. California Privet, stocky 12 to 18 inch plants, \$5.00 per 100; \$25.00 per 1000. West Jersey Nurseries, Bridgeton, N. J.

ASPARAGUS

Asparagus plumosus nanus and Sprenger, 2 in., 1 year old, strong, \$3.00 per 100. E. & C. Woodman, Danvers, Mass.

ASPARAGUS SEED

S. S. Pennock-Meehan Co., Philadelphia.
For page see List of Advertisers.
H. F. Michell Co., Philadelphia.
For page see List of Advertisers.
Asparagus Plumosus Nanus Seeds, any quantity, 3c. per 100; \$2.00 per 1000; \$8.75 per 5000. Peter Mack, Orlando, Fla.

ASTERS.

Asters, 2 to 2 1/2 in. high, \$8.00 per 1000. Only the choicest colors and kinds included in the collection. H. J. Blanchard, Ashburnham, Mass.

ASTER SEED

Elmer D. Smith & Co., Adrian, Mich.
For page see List of Advertisers.
H. F. Michell Co., Philadelphia, Pa.

AUCTION SALES

Wheary's Horticultural Co., 62 Vesey St., New York.
For page see List of Advertisers.

AZALEAS

A. Leuthey & Co., Perkins St. Nurseries, Roslindale, Mass.
For page see List of Advertisers.
Godfrey Aschmann, 1012 W. Ontario St., Philadelphia.
For page see List of Advertisers.

BAMBOO CANES

Yokohama Nursery Co., 31 Barclay Street, New York.
Bamboo Sticks, Colored Green.
For page see List of Advertisers.

BAY TREES.

2000 Bay and Box Trees in all sizes. Pyramid and Standards. Write for list. Julius Roehrs, Rutherford, N. J.

BEDDING PLANTS

J. E. Felthousen, Schenectady, N. Y.
For page see List of Advertisers.
A. Leuthey & Co., Perkins St. Nurseries, Roslindale, Mass.
For page see List of Advertisers.
G. Aschmann, 1012 W. Ontario St., Philadelphia, Pa.
For page see List of Advertisers.
J. C. Schmidt, Bristol, Pa.
For page see List of Advertisers.
Thomas Roland, Nahant, Mass.
Begonia Gloire De Lorraine.

Rooted Cuttings, Fuchsias, Heliotrope, Salvia Zurich, Bonfire, 75c. per 100. Ageratum Gurney, German Ivy, 50c. per 100. Cash with order. F. A. Bzold, Haddam, Conn.

Salvia, 2 1/2 to 3 in. high, 1 1/2c. each. Cobaea scandens, 2 1/2 in., 2c. each. 50 Asparagus Sprengeri, 3 in., nice plants, 25c. each. H. J. Blanchard, Ashburnham, Mass.
Vines variegated, finest stock, heavy and long, \$10 and \$12.50 per 100. R. C. S. A. Nutt geraniums, fine, \$10 per 1000. R. C. Golden gladiol, \$1 per 100. Cash. Bellamy Bros., 297 Delaware St., Syracuse, N. Y.

Geraniums S. A. Nutt, extra fine plants from 4 in. pots at 6c. Asparagus Sprengeri, from 4 in. pots at 6c. Satisfaction guaranteed. Brant Bros., Inc., Utica, New York.

BOILERS

BOILERS. "Burnham" Boilers made for greenhouse heating. Lord & Burnham, 1133 Broadway, N. Y.
Kroeschell Bros. Co., 35 Erie St., Chicago.
For page see List of Advertisers.

BOOKS

John C. Moninger Co., 117 E. Blackhawk St., Chicago.
Florists' Scrap Book.
For page see List of Advertisers.
Send to us for any horticultural publication you desire and we can furnish it promptly. Horticulture, 11 Hamilton Place, Boston.

BOXWOOD TREES

New England Nurseries, Inc., Bedford, Mass.
For page see List of Advertisers.

BUILDING MATERIAL

BUILDING MATERIAL of all description for All Cypress, Semi-Iron, Iron Frame or Truss Houses, Hot Bed Sash and Frames. Lord & Burnham Co., 1133 Broadway, N. Y.

BULBS AND TUBERS

Joseph Breck & Sons, 47-54 N. Market St., Boston.
For page see List of Advertisers.
J. M. Thornburn & Co., 33 Barclay St., New York.
For page see List of Advertisers.
A. T. Boddington, 342 W. 14th St., N. Y.
For page see List of Advertisers.

BULBS AND TUBERS - Continued

Rickards Bros., 37 East 19th St., New York.
For page see List of Advertisers.
H. F. Michell Co., Philadelphia.
For page see List of Advertisers.
H. E. Flske Seed Co., Faneuil Hall Sq., Boston.
For page see List of Advertisers.
T. J. Grey & Co., 32 and 33 So. Market St., Boston.
For page see List of Advertisers.
Yokohama Nursery Co., 81 Barclay St., New York.
For page see List of Advertisers.
Ralph M. Ward & Co., 12 W. Broadway, New York.
For page see List of Advertisers.
Schlegel & Fottler Co., 26 & 27 S. Market St., Boston.
Begonias, Gloxinias, Tuberoses.
For page see List of Advertisers.

CALADIUMS

Caladiums, giant flowering; bulbs offered for first time. Produce grand results, much better than esculentum, \$1.50 per 12; \$10 per 100. Martin Benson, Dougla, Ills.

CANNAS

A. T. Boddington, 342 W. 14th St., New York.
For page see List of Advertisers.
C. Elsele, 11th and Westmoreland Sts., Philadelphia, Pa.
For page see List of Advertisers.
J. H. Dann & Son, Westfield, N. Y.
For page see List of Advertisers.

CANTALOUPE SEED

Burrell Gem and Tiptop Cantaloupe Seed, selected from best netted melons. Seed fresh and offered by the world's largest cantaloupe grower. 3 new sorts free with each order. Lb. by mail, 60 cents. H. Clay Beebe, Elber, Colo., R. No. 1.

CARNATIONS

F. Dorner & Sons Co., Lafayette, Ind.
Carnation, Wilmom.
For page see List of Advertisers.
Chicago Carnation Co., Joliet, Ill.
For page see List of Advertisers.
Albert Roper, Tewksbury, Mass.
Carnation Bay State.
For page see List of Advertisers.
Wood Bros., Fishkill, N. Y.
Carnations, Rooted Cuttings.
For page see List of Advertisers.
The E. G. Hill Co., Richmond, Ind.
Carnation Cuttings.
For page see List of Advertisers.
S. J. Reuter & Son, Westery, R. I.
For page see List of Advertisers.
Poehlmann Bros. Co., Morton Grove, Ill.
For page see List of Advertisers.
Paul Thomson Estate, West Hartford, Conn.
Carnation Neptune.

CHRYSANTHEMUMS

E. G. Hill Co., Richmond, Ind.
For page see List of Advertisers.
S. J. Reuter & Son, Westery, R. I.
For page see List of Advertisers.
C. H. Totty, Madison, N. J.
Single Chrysanthemums From Seed.
For page see List of Advertisers.
J. H. Myers, Altoona, Pa.
For page see List of Advertisers.
Wood Bros., Fishkill, N. Y.
Chrysanthemums, Rooted Cuttings.
For page see List of Advertisers.

For List of Advertisers See Page 615

CHRYSANTHEMUMS — Continued

Scott Bros., Elmford, N. Y.
For page see List of Advertisers.
Poehlmann Bros. Co., Morton Grove, Ill.
For page see List of Advertisers.

CHRYSANTHEMUMS.

BEST COMMERCIAL.

SEE DISPLAY AD. PAGE 596.

ELMER D. SMITH & CO.,

ADRIAN,

MICH.

100 commercial varieties, including Pompon and Hairy, \$42.50 per 100. Satisfaction guaranteed. Wm. Elmann, Jr., Corfu, N. Y.

Chrysanthemum Golden Glow from 2 1/4 in. pots, for early spring delivery, \$1.00 per doz., \$6.00 per 100, \$50.00 per 1000. Stock plants of Montmore, Oct. Frost, Crocus Matchless, Lucy Devaux, Polly Rose and Halliday, \$1.00 per doz.; \$6.00 per 100. Peirce Bros., Waltham, Mass.

Herrington's book on the Chrysanthemum, mailed to your address for 50c. by Horticulture Publishing Co., 11 Hamilton Place, Boston.

Golden Glow and Pacific Supreme, the best early yellow and pink mums. R. C. \$3 per 100, prepaid; 24 in. pots, \$4; 25 at 100 rates. Chas. Frost, Kenilworth, N. J.

CLEMATIS

5000 Clematis paniculata, extra strong, out of 2 in. pots, \$2 per 100; 3 in. pots, \$5 per 100. If not satisfactory will return your money. Samuel V. Smith, 3223 Goodwin St., Philadelphia, Pa.

COAL FOR GREENHOUSE USE

Bader Coal Co., Board of Trade Bldg., Boston.

COLEUS

J. E. Felthousen, Schenectady, N. Y.
For page see List of Advertisers.

A. Leuthy & Co., Perkins St. Nurseries, Roslindale, Mass.

For page see List of Advertisers.
Coleus. A few thousand rooted cuttings of Lord Palmerston and other best varieties mixed at 60 cents per 100. Cash with order, please. Hope Greenhouses, 279 Massachusetts Ave., Providence, R. I.

For Sale. Coleus, ten choice sorts, including Verschaffeltii and Golden Bolder, from 2 1/2 in. pots, at \$1.00 per hundred, \$15.00 per thousand. Edmund Reardon, Cambridge A. Mass.

CONIFERS

John Waterer & Sons, Ltd., American Nursery, Bagshot, Eng.
For page see List of Advertisers.

OUT FLOWER BOXES.

Edwards Folding Box Co., Philadelphia
For page see List of Advertisers.

Folding cut flower boxes, the best made Write for list. Holton & Honkel Co., MD Wauke, Wis.

CYCAS STEMS

Yokohama Nursery Co., 31 Barclay St., New York.
For page see List of Advertisers.

Special offer of Cycas Stems, true long leaved variety. Stems range in weight from 1/2 lb. to 10 lbs. Price, 10 to 50 lbs., at 7 1/2c.; 100 lbs., at 7c.; case lots of 300 lbs., at 6 1/2c. We have the stems and will grade to your liking. Johnson Seed Co., 217 Market St., Philadelphia, Pa.

DAHLIAS

David Herbert & Son, Atco, N. J.
For page see List of Advertisers.

J. L. Moore, Northboro, Mass.
For page see List of Advertisers.

Peacock Dahlia Farms, Williamstown Junction, N. J.

For page see List of Advertisers.
B. Vincent Jr. & Sons Co., White Marsh, Md.
For page see List of Advertisers.

DAHLIAS — Continued

DAHLIAS.

Geo. H. Walker, No. Dighton, Mass.
Wholesale and Retail.
Send your name for my 1909 Catalog and Pocket Guide, ready to mail about Feb. 25th.

Cactus, Decorative, Fancy, Show and Pompon Dahlias. Good commercial varieties, such as Kriemhilde, Countess of Lonsdale, Mad. Van Den Deal and other sure bloomers, strong divided roots in 10 or 20 named varieties my selection, \$1.00 per 25; \$3.00 per 100; \$25.00 per 1000. Cash please. Herrmann, Theimann, Mercon, Mass.

Dahlias. Novelties and standard varieties, true to name, a choice list of the best introductions. Send for catalog of dahlias, hollyhocks, hardy plants. Price always reasonable. W. W. Wilmore, Box 352 Derrier, Colo.

The Dahlia.—Peacock.—Mailed for 30 cents by Horticulture, 11 Hamilton Place, Boston.

Dahlias, field group clumps, standard varieties, cheap. Jantzen & Hoebel, Hicksville, L. I.

DAHLIA PILLS. 50 cents per dozen. All varieties listed below at 5 cents each, or 50 cents per dozen; if to be sent by mail, 75 cents per dozen.

CACTUS VARIETIES. Beatrice, Bertha Mayry, Crisidamaal, Brubilde, Captain, Cannel Gem, Bankward, Dr. Jameson, Earle of Pembroke, Fire Brand, Ernest Glasse, General Buller, Gabriel, Gailiard, Island Queen, John Roche, J. P. Clark, Kriemhilde, Lady, Lady Edd, Talbot, Mary Servace, Matchless, Montefiore, Mrs. Chas. Turner, Mrs. Bennett, Mrs. Jewett, Mr. Moore, St. Catherine, Queen Wilhelmina, Starry Crown, Star Fish, Sparkler, Upland, Volker, Wieland.

GROW VARIETIES: A. D. Livoni, Arabella, Amazon, Beauty, Bird of Passage, Dawn of Day, Fascination, Dr. J. P. Kirkland, Goldenrod, Golden Ace, Hannah Holland Pink, Keystone, Lulu, Mary D. Hallock, M. La Nile, Modesty, Mary Belle, Mrs. Browning, Mrs. Cleveland, Mrs. Dexter, Orator, Penelope, Peri, Rob. Brounfield, Starter, Wm. Robbins, White Swan.

DECORATIVE VARIETIES. Atlanta, American Flag, Beauty of Brentwood, Black Prince, Countess of Pembroke, Dolly, Eloise, Frank Bassett, Jumbo, Lady Allington, Lucille, Maid of Kent, Nymphia, Princess Christian Progress.

Above stock is field grown, sound and true to name. Catalogue free to all. C. Peirce, Dighton, Mass.

DECORATIVE PLANTS

A. Leuthy & Co., Perkins St. Nurseries, Roslindale, Mass.

Imported Plants for Fall Delivery.
For page see List of Advertisers.

Godfrey Aschmann,
1012 W. Ontario St., Phila., Pa.
For page see List of Advertisers.

Joseph Hancock Co., Wyncote, Pa.
For page see List of Advertisers.

The Geo. Wittbold Co., 1657 Buckingham Place, Chicago, Ill.

For page see List of Advertisers.

Robert Craig Co., Market and 49th Sts., Philadelphia, Pa.

For page see List of Advertisers.

DRAECAENAS

Dracaena Indivisa, 8, 7, 6, 5 and 4 in. Prices on application. E. & C. Woodman, Danvers, Mass.

J. H. Dunn & Son, Westfield, N. Y.
For page see List of Advertisers.

EVERGREENS

New England Nurseries, Bedford, Mass.
For page see List of Advertisers.

American Nursery Co., 150 Broadway, New York, N. Y.

Evergreens. Send 25 cents in stamps for complete work on propagating and growing Evergreens. C. S. Harrison's Select Nursery, York, Neb.

FERNS

A. Leuthy & Co., Roslindale, Mass.
For page see List of Advertisers.

FERNS — Continued

R. H. Barrows & Son, Whitman, Mass.
Nephrolepis Magnifica.
For page see List of Advertisers.

John Scott, Brooklyn, N. Y.
For page see List of Advertisers.

Frank Oechslin, 2570-2604 W. Adams St., Chicago.

Ferns for Dishes.
For page see List of Advertisers.

The Geo. Wittbold Co., 1657 Buckingham Place, Chicago, Ill.

For page see List of Advertisers.

Godfrey Aschmann, 1012 W. Ontario St., Philadelphia.

For page see List of Advertisers.

C. Elsee, 11th and Westmoreland Sts., For page see List of Advertisers.

J. H. Dunn & Son, Westfield, N. Y.
For page see List of Advertisers.

Anderson's ferns for in and outdoors. Largest commercial collection in the country. Ask for descriptive catalogue. J. P. Anderson, Fern Specialist, Short Hills, N. J.

FERTILIZERS

Fulvurized Manure Co., 31 Union Stock Yards, Chicago, Ill.

Wisard Brand Sheep and Shredded Cattle Manure.

For page see List of Advertisers.

Robert Simpson, Clifton, N. J.
Sheep Manure.

Bowker Fertilizer Co., Boston, Mass.
All Forms of Plant Food at First Hands.
For page see List of Advertisers.

German Kall Works, 93 Nassau St., New York.
Potash Fertilizer.

Wm. Elliott & Sons, 42 Vesey St., New York.
Sheep Manure.

For page see List of Advertisers.

FEVERFEW

2000 Feverfew from 2 1/4 in. \$3.00 per 100, \$25.00 per 1000. Albert Batley & Son, Maynard, Mass.

Feverfew, 3 1/2 in. \$3.00 per 100, 4 in. \$5.00 per 100. H. J. Blanchard, Ashburnham, Mass.

FLORAL PHOTOGRAPHS

Floral Photographs, Foley's, 226-228 12 Bowery, New York.

FLORISTS' LETTERS.

Boston Florist Letter Co., 66 Pearl St., Boston, Mass.

For page see List of Advertisers.

FLORISTS' SUPPLIES

N. F. McCarthy & Co., 84 Hawley St., Boston.

For page see List of Advertisers.

H. M. Robinson & Co., 15 Province St. and 9 Chapman Pl., Boston, Mass.

For page see List of Advertisers.

Reed & Keller, 122 W. 25th St., New York.
For page see List of Advertisers.

M. Bayerdorfer & Co., 1129 Arch St., Philadelphia.

For page see List of Advertisers.

FLOWER POTS

W. H. Ernest, 28th and M Sts., Washington, D. C.

For page see List of Advertisers.

A. H. Hews & Co., Cambridge, Mass.
For page see List of Advertisers.

Hillinger Bros., Ft. Edward, N. Y.
For page see List of Advertisers.

The Peters & Reed Pottery Co., Red pots, seed pans, etc. Zanesville, O.

Syracuse Pottery Co., Syracuse, N. Y. Syracuse Red Pots.

For page see List of Advertisers.

We make Standard Flower Pots, etc. Write us when in need.

Wilmer Cope & Bro. Lincoln University, Chester Co., Pa.

In writing to Advertisers kindly mention Horticulture

FLOWER POT HANDLE

W. C. Krefok, 1964-66 Greene Av., Brooklyn, N. Y.
For page see List of Advertisers.

FRUIT TREES

Dwarf Fruit Trees, by E. A. Wagh, mailed to your address for 55 cents by Horticulture Publishing Co., 11 Hamilton Place, Boston.

"The Culture of Fruit Trees in Pots, by Josh Kane, \$1.30; mailed to your address by Horticulture Publ. Co., 11 Hamilton Place, Boston.

FUCHSIAS

R. Vincent, Jr. & Sons Co., White Marsh, Maryland.
For page see List of Advertisers.

GALAX

Michigan Cut Flower Co., 38 and 40 Broadway, Detroit, Mich.
For page see List of Advertisers.

George Cotsomas & Co., 50 W. 28th St., New York.
For page see List of Advertisers.

The Kervan Co., 113 West 28th St., N. Y.
For page see List of Advertisers.

Rice Bros., 115 N. 6th St., Minneapolis, Minn.
For page see List of Advertisers.

H. M. Robinson & Co., 15 Province St. and 9 Chapman Place, Boston.
For page see List of Advertisers.

GARDEN HOSE

Revere Rubber Co., Boston, Mass.
For page see List of Advertisers.

GARDENIAS

Gardenias, commonly called Grandiflora Cape Jasmine, well rooted, field-grown plants, from 1 to 2 1/2 ft. in height, 25c. each; \$15 per 100. Cash or C. O. D. Cook & Cook, Alvin, Tex.

GERANIUMS

R. Vincent Jr. & Sons Co., White Marsh, Md.
New and Standard Varieties.
For page see List of Advertisers.

Mme. Sullerot, 2 ft., \$2.00 per 100; \$18.00 per 1000; or will exchange for Beacan Carnations and Cannabis. Wm. Doel, Pasching, R. 1.

GLADIOLI

J. L. Moore, Northboro, Mass.
For page see List of Advertisers.
O. V. Zangen, Hoboken, N. J.
Gladiolus Breuchleyensis.
For page see List of Advertisers.

GLASS

Boston Plate & Window Glass Co., Boston
For page see List of Advertisers.

Standard Plate Glass Co., 26-30 Sudbury St., Boston.
For page see List of Advertisers.

Foley Mfg. Co., Western Ave., between 25th & 26th Sts., Chicago.
For page see List of Advertisers.

Sharp, Partridge & Co., 22d & Lumber St., Chicago.
For page see List of Advertisers.

Greenhouse glass, lowest prices. Johnston Glass Co., Hartford City, Ind.

Glass, High Grade, Double Thick Greenhouse Glass. Lord & Burnham, 1133 Broadway, N. Y.

GLAZING DEVICE

H. A. Drear, Philadelphia, Pa.
Peerless Glazing Point.
For page see List of Advertisers.

GLAZING POINTS, Lord & Burnham Special Glazing Nails (Points). Lord & Burnham, 1133 Broadway, N. Y.

GOLD FISH

Extra large Gold Fish, Spawners, suitable for outdoor aquariums and fountains, \$5.00 per doz.; \$5.00 per 2 doz. Jos. Volz & Son, Sta. L., Cincinnati, Ohio.

GREENHOUSE BUILDING MATERIAL

Lord & Burnham Co., 1133 Broadway, New York.
For page see List of Advertisers.

Pierson U-Bar Co., 1 Madison Sq., N. Y.
For page see List of Advertisers.

GREENHOUSE BUILDING MATERIAL—Continued

A. T. Stearns Lumber Co., Neponset, Boston.
For page see List of Advertisers.

King Construction Co., N. Tonawanda, New York.
For page see List of Advertisers.

Hitchings & Co., 1170 Broadway, New York.
For page see List of Advertisers.

J. C. Moninger Co., 117 East Blackhawk St., Chicago, Ill.
For page see List of Advertisers.

Foley Mfg. Co., Western Ave., between 25th & 26th Sts., Chicago.
For page see List of Advertisers.

W. H. Lutton, West Shore Av. Sta., Jersey City, N. J.

GREENHOUSE CONSTRUCTION

GREENHOUSE CONSTRUCTION, Semi-Iron Greenhouse, New Truss Houses and Iron Frame Houses. Lord & Burnham, 1133 Broadway, N. Y.

J. A. Payne, 260-274 Culver Ave., Jersey City, N. J.
For page see List of Advertisers.

Foley Mfg. Co., Western Ave., between 25th & 26th Sts., Chicago.
For page see List of Advertisers.

Hitchings & Co., 1170 Broadway, New York.
For page see List of Advertisers.

Geo. M. Garland Co., Des Plaines, Ill.
For page see List of Advertisers.

GREENHOUSE HOSE

Revere Rubber Co., Boston, Mass.
Revero Hose.
For page see List of Advertisers.

GUTTERS

GUTTERS, Cast Iron Gutters, L & B. Improved V Shaped Gutter with drip gutter attachment. Lord & Burnham, 1133 Broadway, N. Y.

HAIL INSURANCE

Florists' Hail Assn. of America.
J. G. Esler, Saddle River, N. J.
For page see List of Advertisers.

HARDY FERNS, MOSS AND GREENS

H. M. Robinson & Co., 15 Province St. and 9 Chapman Pl., Boston, Mass.
For page see List of Advertisers.

Michigan Cut Flower Exchange, 38 and 40 Broadway, Detroit, Mich.
For page see List of Advertisers.

George Cotsomas & Co., 50 W. 28th St., New York.
For page see List of Advertisers.

N. F. McCarthy & Co., 84 Hawley St., Boston.
For page see List of Advertisers.

The Kervan Co., 113 W. 28th St., N. Y.
For page see List of Advertisers.

Rice Bros., 115 N. 6th St., Minneapolis, Minn.
For page see List of Advertisers.

HEATING APPARATUS

Lord & Burnham Co., 1133 Broadway, New York.
For page see List of Advertisers.

Pierson U-Bar Co., 1 Madison Sq., N. Y.
For page see List of Advertisers.

John A. Payne, 260-274 Culver Ave., Jersey City, N. J.
For page see List of Advertisers.

Kroeschell Bros. Co., 35 Erie St., Chicago.
For page see List of Advertisers.

HELP FURNISHED

Thos. H. Bambrick, 34 S. 7th St., Phila.
For page see List of Advertisers.

HERBACEOUS PERENNIALS

P. Ouwerkerk, P. O. No. 1, Hoboken, N. J.
For page see List of Advertisers.

New England Nurseries, Bedford, Mass.
For page see List of Advertisers.

The Geo. Wiffblad Co., 1857 Buckingham Place, Chicago.
For page see List of Advertisers.

William Tricker, Arlington, N. J.
For page see List of Advertisers.

HOT-BED SASH

The A. T. Stearns Lumber Co., Neponset, Mass.
For page see List of Advertisers.

Pierson U-Bar Co., 1 Madison Sq., N. Y.
For page see List of Advertisers.

Lord & Burnham Co., 1133 Broadway, N. Y.
For page see List of Advertisers.

Foley Mfg. Co., Western Ave., between 25th & 26th Sts., Chicago.

INSECTICIDES.

Nicotide kills all greenhouse pests.
P. R. Palethorpe Co.,
Eleventh St., Owensboro, Ky.
For page see List of Advertisers.

Stump & Walter Co., 50 Barclay St., New York.
Kilndead Tobacco Dust.
For page see List of Advertisers.

Niagara Sprayer Co., Middleport, N. Y.
For page see List of Advertisers.

B. G. Pratt Co., New York.
Sulfocide.
For page see List of Advertisers.

Bowker Insecticide Co., Boston, Mass.
Insect Destroying Preparations.
For page see List of Advertisers.

Wm. Cooper & Nephews, 177 Illinois St., Chicago, Cylrl Franklyn, 62 Beaver St., New York, Agt.
V 1 Fluid.
For page see List of Advertisers.

Eastern Chemical Co., Pittsburg St., Boston.
"MIP" Soap Spray.
For page see List of Advertisers.

"The Fumigating Kind Tobacco Powder"—The first on the market and the kind that has so many imitators, has our guarantee tag of satisfaction or money back, and "The Moon Trade Mark" on every bag, \$3.00 per 100 lbs. The H. A. Stoothoff Co., Mount Vernon, N. Y., Makers and sellers.

JAPANESE PLANTS

Yokohama Nursery Co., 31 Barclay St., New York.
For page see List of Advertisers.

KENTIAS

Godfrey Aschmann,
1012 W. Ontario St., Phila., Pa.
For page see List of Advertisers.

A. Leuthy & Co., Roslinville, Mass.
For page see List of Advertisers.

Jos. Hancock Co., Wyncote, Pa.
Single and Made-Up Specimens.
For page see List of Advertisers.

LEVELS FOR LANDSCAPE GARDENING USE.
Bostrom-Brady Mfg. Co., 159 Madison Ave., Atlanta, Ga.
For page see List of Advertisers.

LILY OF THE VALLEY PIPS

Hjalmer Hartmann & Co., 12 Stormgade, Copenhagen, Denmark.
For page see List of Advertisers.

MASTICA

F. O. Pierce Co., 12 W. Broadway, New York.
For page see List of Advertisers.

NICO-FUME

Kentucky Tobacco Product Co., Louisville, Ky.
For page see List of Advertisers.

NURSERY STOCK

John Waterer & Sons, Ltd., American Nursery, Bagshot, England.
For page see List of Advertisers.

Cleary's Horticultural Co., 62 Vesey St., New York.
For page see List of Advertisers.

P. Ouwerkerk, 216 June St., Weehawken, N. J.
For page see List of Advertisers.

Eastern Nurseries, Jamaica Plain, Mass.
Viburnum Mollé.
For page see List of Advertisers.

American Nursery Co., 150 Broadway, New York, N. Y.

W. T. Smith Co., Geneva, N. Y.
Nursery Stock for Florists.

For List of Advertisers See Page 615

NURSERY STOCK—Continued

Storrs & Harrison Co., Painesville, O.
For page see List of Advertisers.
C. R. Burr & Co., Manchester, Conn.
Dettzia Tacomas, Weizels, Privat.
For page see List of Advertisers.
Cull's Nurseries, Perry, O.
Trees, Roses, Shrubs.

P. A. Keene, 1 Madison Av., New York.
Rhododendron Hybrids. Maximum, Maple, Privat.

For page see List of Advertisers.
Maurice J. Brinton, Christlana, Pa.
Norway Spruce.
For page see List of Advertisers.

Manual of the Trees of North America,
by C. S. Sargent, mailed to your address
for \$3.00, by Horticulture Publishing Co.,
11 Hamilton Place, Boston.

**TREES, SHRUBS, ROSES, EVER
GREENS, PERENNIALS, HARDY PLANTS**
ELLWANGER & BARRY, Rochester, N. Y.

New Hardy Shrub—Buddleia variabilis
Vetichli and Magnolia, the summer flower-
ing Lilac, 50c. each; \$5.00 per doz.; \$25.00
per 100. Rose Hill Nurseries, New
Rochelle, N. Y.

Catalog now ready. Nursery grown
evergreens, seedling white pine and hem-
lock, native trees and plants. L. E. Wil-
iams, Nottingham, N. H.

ONION SEED

Federico C. Varela, Tenerife, Canary Is.
Hermuda Onion Seed.
For page see List of Advertisers.

ORCHIDS

Orchid Growers' Manual. By B. S. Wil-
liams. 500 illustrations, \$10.00. 800 pages;
descriptions of upwards of 2700 species and
varieties of orchidaceous plants, etc. The
most complete work on Orchids and orchid
culture ever published. Orders filled by
HORTICULTURE, 11 Hamilton Place,
Boston.

ORCHID PLANTS

Lager & Hurrell, Summit, N. J.
For page see List of Advertisers.

Sander, St. Albans, England.
Importers, Exporters, Growers, Hybridists
For page see List of Advertisers.

Carrillo & Baldwin, Secaucus, N. J.
For page see List of Advertisers.

Jos. A. Manda, 191 Valley Road, W.
Orange, N. J.
For page see List of Advertisers.

Ordonez Bros., Madison, N. J., Box 105.
Cattleya Mossiae.
For page see List of Advertisers.

G. L. Freeman, 388 Appleton St., Holyoke,
Mass.

Orchid Importations.
For page see List of Advertisers.
Largest stock in the country. Ask for
prices. Julia Roehrs, Rutherford, N. J.

PAINT AND PUTTY

PAINT AND PUTTY: Ideal Greenhouse
lead; Special Greenhouse Putty. Lord &
Burnham, 1153 Broadway, N. Y.

PALMS

A. Leuthy & Co., Perkins St. Nurseries,
Roslindale, Mass.
For page see List of Advertisers.

Robert Craig Co., Market and 49th Sts.,
Philadelphia, Pa.
For page see List of Advertisers.

Joseph Hancock Co., Wyncote, Pa.
Home-Grown Palms.
For page see List of Advertisers.

Geo. Witthold Co., 1657 Buckingham Place,
Chicago.
For page see List of Advertisers.

PANSY PLANTS

J. C. Schmidt, Bristol, Pa.
For page see List of Advertisers.

Giant Pansy Plants, stocky, from fall-
sown seed, 50c. per 100, prepaid; \$3.50 per
1000, not prepaid. Chas. Frost, Kenil-
worth, N. J.

PATENTS

Siggers & Siggers, Washington, D. C.
For page see List of Advertisers.

PEAT

Orchid Peat and Moss always on hand
Julius Roehrs Co., Rutherford, N. J.

PENTSTEMONS

C. H. Totty, Madison, N. J.
For page see List of Advertisers.

PEONIES

Peonies only, by the wholesale—best 100
varieties. J. F. Rosenfield, Westpoint, Neb.
One of the finest collections in America.
Send 25 cts. in stamps for new edition of
Peony Manual. C. S. Harrison's Select
Nursery, York, Neb.

PHLOXES

Send 25 cts in stamps for Phlox Manual
Fine mixed phloxes \$2.00 per 100. C. S.
Harrison's Select Nursery, York, Neb.

**PHOTOGRAPHS: DESIGNING: IL-
LUSTRATING**

Geo. E. Dow, 178 Washington St., Boston.
For page see List of Advertisers.

PIPE AND FITTINGS

Foley Mfg. Co., between Western Ave. and
24th St., Chicago, Ill.
Kroschell Bros. Co., 35 Erie St., Chicago.
For page see List of Advertisers.

PIPE AND FITTINGS. Cast iron and
Wrought Pipe, Valves, Elbows, Pipe Hooks,
Automatic Air Headers, etc. Lord &
Burnham, 1133 Broadway, N. Y.

PLANT STAKES

Seele's Tieless Plant Stakes and Trel-
lises. H. D. Seele & Sons, Elkhart, Ind.

POT HANGERS

Pot hangers, Kramer's \$1 doz. by exp.,
\$1.25 by mail. I. N. Kramer & Son, Cedar
Rapids, Ia.

Krick's Perfect Pot Hanger and Handle.
W. C. Krick, 1164 1166 Greene Ave.,
Brooklyn, N. Y.
For page see List of Advertisers.

POINSETTIAS (Artificial)

Poinsettias, artificial decorations our
specialty. Sample lots of 50 in 3 sizes,
\$4.00; 100 lots, \$6, \$8, \$10. J. Stern & Co.,
125 N. 10th St., Philadelphia, Pa.

RAFFIA

Raffia (colored), 20 beautiful shades.
Samples free. R. H. Comey Co., Camden,
N. J.; 810 Washburn Ave., Chicago, Ill.

RESURRECTION PLANTS

Resurrection plants and cacti. Cheap.
Ask for prices. William Tell, Austin, Tex.

RHODODENDRONS

John Waterer & Sons, Ltd.,
American Nursery, Bingshot, England.
For page see List of Advertisers.

P. Ouwkerk, Hoboken, N. J.
For page see List of Advertisers.

Storrs & Harrison Co., Painesville, O.
For page see List of Advertisers.

ROSES

Robert Craig Co., Market and 49th Sts.,
Philadelphia, Pa.
For page see List of Advertisers.

P. Ouwkerk, P. O. No. 1, Hoboken, N. J.
For page see List of Advertisers.

Julius Roehrs Co., Rutherford, N. J.
Rose Newport Fairy.
For page see List of Advertisers.

The F. R. Pierson Co.,
Tarrytown-on-Hudson, N. Y.
White Killarney.
For page see List of Advertisers.

S. J. Reuter & Son, Westerly, R. I.
My Maryland.
For page see List of Advertisers.

Dingee & Conard Co., West Grove, Pa.
For page see List of Advertisers.

Storrs & Harrison Co., Painesville, O.
For page see List of Advertisers.

Scott Bros., Elmsford, N. Y.
For page see List of Advertisers.

ROSES—Continued

Poehlmann Bros. Co., Morton Grove, Ill.
For page see List of Advertisers.

Ellwanger & Barry, Rochester, N. Y., Box T.
A. N. Pierson, Cromwell, Conn.
White Killarney, My Maryland, Ramblera.
For page see List of Advertisers.

Mourouse Greenhouses, Montrose, Mass.
Roses, Grafted or Own Root.
For page see List of Advertisers.

The Rose, by H. B. Ellwanger; mailed
for \$1.30 by Horticulture, 11 Hamilton
Place, Boston.

Hand Book of Cultural Notes on Roses
Under Glass, by F. P. Brigham, mailed to
your address for 25c. by Horticulture Pub-
lishing Co., 11 Hamilton Place, Boston.

SALVIAS

R. Vincent, Jr. & Sons Co., White Marsh,
Maryland.
Salvias Bonifida and Zurich.
For page see List of Advertisers.

SEED GROWERS

Hjalmar Hartmann & Co.,
Cauliflower and Cabbage Seed.
12 Stormgade, Copenhagen, Denmark.
For page see List of Advertisers.

Federico C. Varela, Tenerife, Canary Is.
Hermuda Onion Seed.
For page see List of Advertisers.

SEEDS

T. J. Grey Co., 32 So. Market St., Boston.
For page see List of Advertisers.

Joseph Breck & Sons,
51 and 52 N. Market St., Boston, Mass.
For page see List of Advertisers.

W. Atlee Burpee & Co., Philadelphia.
For page see List of Advertisers.

Arthur T. Boddington, 342 W. 14th St.,
New York.
For page see List of Advertisers.

H. E. Flake Seed Co., Faneuil Hall Sq.,
Boston.
For page see List of Advertisers.

Hjalmar Hartmann & Co.,
12 Stormgade, Copenhagen, Denmark,
Cauliflower and Cabbage Seed.
For page see List of Advertisers.

Rickards Bros., 37 E. 19th St., New York.
For page see List of Advertisers.

R. & J. Farquhar & Co., 67 So. Market
St., Boston.
Mignonette Seed.
For page see List of Advertisers.

H. F. Mitchell Co., 1018 Market St., Phila.
For page see List of Advertisers.

J. M. Thorburn & Co., 33 Barclay St., N. Y.
For page see List of Advertisers.

Leonard Seed Co., Chicago, Ill.
For page see List of Advertisers.

Wm. Elliott & Sons, 42 Vesey St., N. Y.
New Seed.
For page see List of Advertisers.

Schlegel & Fottler Co., 26 & 27 S. Market
St., Boston.
For page see List of Advertisers.

O. V. Zangen, Hoboken, N. J.
Florist's Spring Seeds.
For page see List of Advertisers.

E. F. Winterston Co., Chicago.
Seeds for Plantmen, Nurserymen, Seeds-
men.
For page see List of Advertisers.

Seeds. Rocky Mountain Evergreen seeds
in large or small quantities. C. S. Harri-
son's Select Nursery, York, Neb.

SHRUBS

The Geo. Witthold Co., 1657 Buckingham
Place, Chicago.
For page see List of Advertisers.

SILKALINE

John C. Meyer & Co., Boston, Mass.
For page see List of Advertisers.

SMILAX

R. Vincent, Jr. & Sons Co., White Marsh,
For page see List of Advertisers

SOLUBLE PLANT FOOD

Eastern Chemical Co., Boston, Mass.

In writing to Advertisers kindly mention Horticulture

SPHAGNUM MOSS

Live Sphagnum moss, orchid peat and orchid baskets always on hand. Lager & Hurrell, Summit, N. J.

Sphagnum moss and mountain laurel in bags, bales or car lots. Prices low. Spruce and hemlock in bales. James Day, Box 660, Milford, N. H.

SPRAYERS

Niagara Sprayer Co., Middleport, N. Y.
For page see List of Advertisers.

Chas. J. Jager Co., Boston.
Denitig Spray Pump.
For page see List of Advertisers.

STEAM TRAP

K. Hippard, Youngstown, O.
For page see List of Advertisers.

STOCKS

J. H. Myers, Altoona, Pa.
For page see List of Advertisers.

STRAWBERRY PLANTS

H. L. Crane, Westwood, Mass.
Barymore Strawberry.

Strawberry Plants, Bubach and Success, \$1.50 per 1000. W. N. Fanning, Kensington, Ct.

300 Strawberry Plants St. Your selection. List free. Wm. Perry, Cool Spring, Del.

SULFOCID

The B. G. Pratt Co., 50 Church St., Dept. W., New York City.
For page see List of Advertisers.

SULPHUR BURNER

Benj. Dorrance, Rose Growers, Dorrance-ton, Pa.

SWEET PEAS

A. C. Zvolanek, Round Brook, N. J.
Winter Flowering.
For page see List of Advertisers.

TO-BAK-INE

E. H. Hunt, Geol. Agt., 76-78 Wabash Av., Chicago.
For page see List of Advertisers.

TUBEROSIS

Tuberosis. Extra quality Double Pearl Tuberosis, clean, large bulbs 4-6 inches in circumference, 50c. per 100, 80c. per 1000; 5000 for \$27.50. Johnson Seed Co., 217 Market St., Philadelphia, Pa.

VEGETABLE PLANTS

R. Vincent, Jr. & Sons Co.,
White Marsh, Md.
For page see List of Advertisers.

VEGETABLE SEEDS

Just arrived, our reliable vegetable seeds. Buy your fresh seeds now. These are guaranteed, fresh and only first class seeds. The Reliable Seed House, 156 Third Street, Hoboken, N. J.

VENTILATING APPARATUS

Pleasant U-Bar Co., 1 Madison Sq., N. Y.
For page see List of Advertisers.

Foley Mfg. Co., Western Ave., between 25th & 26th Sts., Chicago.
For page see List of Advertisers.

John A. Payne, 260-274 Culver Ave., Jersey City, N. J.
For page see List of Advertisers.

The Advance Co., Richmond, Ind.
For page see List of Advertisers.

Quaker City Machine Co., Richmond, Ind.
20th Century Ventilating Arm.
For page see List of Advertisers.

VENTILATING MACHINERY. New Model enclosed, self-acting gear; Standard Model Open Gear. Lord & Burnham, 1183 Broadway, N. Y.

VERBENAS

Verbenas, 2 1/2 to 3 in. high, 1c. each. Best varieties to be got. First class colors. H. J. Blanchard, Ashburn, Md., Mass.

Lemon Verbena, R. C. Co., 75c. per 100, prepaid. Chas. Frost, Kew-Forest, N. Y.

VINGAS

Vinca var., 5 in., per doz., \$2.00; per 100, \$15.00. E. & C. Woodman, Danvers, Mass.

VIOLETS.

William Slim, Chiltondale, Mass.
Boston and Princess of Wales Violets.
For page see List of Advertisers.

Good, strong California Violets, \$1.00 per 100, \$8.00 per 1000. Chas. M. Allen, 608 Broadway, Fall River, Mass.
Princess Violets, 2 1/2 in., \$2.60 per 100.
Jas. T. Baker, Bustleton, Philadelphia, Pa.

WAX FLOWERS

We are originators of wax designs and still the standard concern. J. Stero & Co., 125 N. 10th St., Philadelphia, Pa.

WEED KILLER

The American Horticultural Distributing Co., Martinsburg, W. Va.
Target Brand.

WIRED TOOTHPICKS

W. J. Cowee, Berlio, N. Y.
For page see List of Advertisers.

WIREWOK

Reed & Keller, 122 W. 25th St., N. Y.
For page see List of Advertisers.
Durand & Maroho, Albany, N. Y.
For page see List of Advertisers.

Wirework. Write for our catalogue. Holton & Hunkel Co., Milwaukee, Wis.
William E. Heisler's Wire Works, 38-40 Broadway, Detroit, Mich.

Wirework—Compare our prices with others. Scranton Florist Supply Co., 201 N. 7th St., Scranton, Pa.

WHOLESALE FLORISTS**Boston**

N. F. McCarthy & Co., 84 Hawley St., Boston.
For page see List of Advertisers.

H. M. Robinson & Co., 75 Province St. and 9 Chapanak Pl., Boston.

Welch Bros., 226 Devonshire St., Boston.
For page see List of Advertisers.

Tally, Wellesley, Mass.
For page see List of Advertisers.

Buffalo, N. Y.

William F. Kasting Co., 282-87 Elliott Ct., Buffalo, N. Y.
For page see List of Advertisers.

Chicago

Chas. W. McKellar, 51 Wabash Ave., Chicago.
For page see List of Advertisers.

Peter Reinberg, 51 Wabash Ave., Chicago.
For page see List of Advertisers.

E. F. Winterson Co., 45-49 Wabash Ave., Chicago.
For page see List of Advertisers.

J. A. Budlog, 37-39 Randolph St., Chicago.
For page see List of Advertisers.

Poehlmann Bros. Co., Morton Grove, Ill.
For page see List of Advertisers.

Cromwell, Conn.

A. N. Pierson, Cromwell, Conn.
For page see List of Advertisers.

Detroit

Michigan Cut Flower Exchange, 38 and 40 Broadway, Detroit, Mich.
For page see List of Advertisers.

Minneapolis

Rice Bros., 115 N. 6th St., Minneapolis, Minn.
For page see List of Advertisers.

New York

Ford Bros., 48 W. 25th St., New York.
For page see List of Advertisers.

H. E. Fromont, 57 W. 25th St., New York.
For page see List of Advertisers.

Alex. J. Guttman, 34 W. 25th St., New York.
For page see List of Advertisers.

E. C. Horan, 55 W. 25th St., New York.
For page see List of Advertisers.

WHOLESALE FLORISTS—**Continued**

A. H. Langjahr, 56 W. 28th St., New York.
For page see List of Advertisers.

James McManus, 42 W. 25th St., New York.
For page see List of Advertisers.

John I. Raynor, 49 W. 25th St., New York.
For page see List of Advertisers.

W. F. Sheridan, 39 W. 25th St., New York.
For page see List of Advertisers.

Moore, Hentz & Nash, 55 and 57 W. 26th St., New York.
For page see List of Advertisers.

Wm. H. Kuebler, 28 Willoughby St., Brooklyn, N. Y.
For page see List of Advertisers.

Philip F. Kessler, 55 and 57 W. 26th St., New York.
For page see List of Advertisers.

Millang Bros., 41 W. 28th St., New York.
For page see List of Advertisers.

John Young, 51 W. 28th St., New York.
For page see List of Advertisers.

Greater New York Florists' Association, 162 Livingston St., Brooklyn, N. Y.
For page see List of Advertisers.

Frank Millang, 55-57 W. 26th St., New York.
For page see List of Advertisers.

B. S. Blinn, 55-57 W. 26th St., New York.
For page see List of Advertisers.

A. L. Young & Co., 54 W. 28th St., N. Y.
For page see List of Advertisers.

Growers' Cut Flower Co., 39 W. 28th St., New York.
For page see List of Advertisers.

Henshaw & Fenrich, 44 W. 28th St., New York.
For page see List of Advertisers.

J. K. Allen, 106 W. 28th St., New York.
For page see List of Advertisers.

Charles Millang, 444 Sixth Av., New York.
For page see List of Advertisers.

Philadelphia

W. E. McKasick & Bros., 1619-1621 Rancaster St., Philadelphia, Pa.
For page see List of Advertisers.

Leo Niessen Co., 1209 Arch St., Philadelphia, Pa.
For page see List of Advertisers.

The S. S. Pennock-Meehan Co., 1608-18 Ludlow St., Philadelphia, Pa.
For page see List of Advertisers.

WOODENWARE

Brown & Co., Appleton, N. Y.
Baskets; Crates; Ladders; Boxes.

New Offers in This Issue.

See List of Advertisers on opposite page for page on which these offers may be found.

AUTOMATIC CIRCULATOR.

W. W. Castle Co., 170 Summer St., Boston.

CATTLEYA TRIANAE; ODONTOGLOSSUM CRISPUM.

Lager & Hurrell, Summit, N. J.

CEMENT BENCHES.

E. H. Hunt, 76-78 Wabash Av., Chicago.

FERNS FOR JARDINIERS.

Rose Hill Nurseries, New Rochelle, N. Y.

GARDENIAS.

Miss A. Washington, Alvin, Texas.

GLADIOLI; MADEIRA VINES, ETC. E. S. Miller, Wading River, N. Y.

METAL FLORAL DESIGNS FOR DECORATION DAY.

A. Herrmann, 404-412 E. 34th St., New York.

OLD-FASHIONED GARDEN FLOWERS.

Wm. Tricker, Arlington, N. J.

SPECIAL OFFER OF COMMERCIAL CHRYSANTHEMUMS.

Elmer D. Smith & Co., Adrian, Mich.

WHITE CHEROKEE ROSE.

Montrose Greenhouses, Montrose, Mass.

For List of Advertisers See Page 615

List of Advertisers

Advance, The Co.,	619
Allen J. K.,	609
American Nursery	(Figs.)
Achmann Godfrey,	583
Atlanta Floral Co.,	604
Bambrick Thos. H.,	615
Barnes H. H. & Son,	599
Beyerstorfer H. & Co.,	605
Blossom The Co.,	604
Bodding A. T.,	557
Boston Florist Letter	Co.,
Bo. tou Plate and Win-	dow Glass Co.,
Boston Early Mig.	Co.,
Bowen, M. A.,	604
Bowler Fertilizer Co.,	603
Bowler Insecticide	Co.,
Bre. k Joseph & Sons	603
Breitweyer J. J. Sons,	605
Bridgman's Seed	Warehouse
Brinton, Maurice J.,	588
Burdock J. A.,	600
Burpee W. A. & Co.,	614
Burr C. R. & Co.,	588
Carrillo & Baldwin	559
Castle & Co.,	619
Chicago Carnation	Co.,
Clarke's David, Sons,	684
Clarke's Horticult' Co.,	88
Coan J. J.,	608
Cooper, Wm. & Nep-	ew
Cotonas Geo. & Co.,	606
Crowley W. J.,	605
Cuckey Geo. W.,	609
Danber F. A.,	604
Dann, J. H. & Son,	599
Dawson H. S.,	558
Dodge & Cobard Co.,	588
Donner F. Sons & C.	606
Doyner, E.,	602
Dreer H. A.,	618
Dunlop John H.,	604
Dunham & Harshb.,	605
Dysart R. J.,	609
Eastern Chemical Co.,	588
E. Iwards Fording Box	Co.,
Eisele, C.,	606
Elmer Wm & Sons,	606
Elmsford Nurser etc.,	586
Ester J. G.,	619
Ernest W. H.,	607
Eyres,	604
Fayoubar R. J. & Co.,	603
Feltchouses J. E.,	606
Flake H. E. Seed Co.,	601-603
Foley Mig. Co.,	619
Ford Bros.,	608
Freeman G. L.,	599
Froment H. E.,	608
Galvin Thos. F.,	605
Garland, Geo. M. Co.,	615
German Kali Works,	560
Greater N. Y. Florist	Association,
Grey T. J. Co.,	603
Growers' Cut Flower	Co.,
Gude Bros. Co.,	608
Guttman Alex. J.,	604
Hall Assn.,	619
Hartmann Hjalmar &	Co.,
Hauswirth the Florist	603
Hawcock Jos. Co.,	599
Henshaw & Fenrich,	608
Herbert David & Son,	587
Herman A.,	605
Hewes A. H. & Co.,	617
Hilfinger Bros.,	607
Hill, The F. G. Co.,	586
Hippard E.,	611
Hitchings & Co.,	618
Hoffman,	605
Horan E. C.,	608
Houghton F. H.,	605
Hunt E. H.,	611-616
Jager, Chas. J. Co.,	600
Kastling W. F. Co.,	606
Keene P. A.,	580
Kentucky Tobacco Co.,	Product Co.,
Kervan The Co.,	600
Kessler, P. F.,	608
King Cons. Co.,	618

Krick W. C.,	609
Kroeschel Bros. Co.,	618
Kuebler Wm H.,	609
Lager & Hurrell	599
Langshy, Alfred H.,	608
Leonard Seed Co.,	603
Leuthy A. & Co.,	599
Lord & Burnham Co.,	620
Manda Jos. A.,	599
MacMullin E. A.,	605
McCarthy N. F.,	609
McConnell Alex.,	604
McKellar Charles W.,	606
McIntosh, W. E., &	Bros.,
McMaus Jas.,	608
Meyer,	604
Meyer J. C. & Co.,	609
Micheli H. F. Co.,	598-601
Michigan Cut Flower	Exchange,
Millang Bros.,	608
Millaga Charles,	608
Millaga Frank,	608
Miller E. S.,	608
Moninger J. C.,	605-618
Montrose Green-	house,
Moore, J. L.,	587
More, Lentz & Nash	608
Murray Samuel,	604
Myers, J. H.,	587
New Eng. Nurseries,	588
Newman Floral Co.,	604
Newman J. & Sons,	605
Niagara Spray Co.,	601
Niessen Leo Co.,	606
O'Connell Frank,	599
Ordenez Bros.,	589
Ouwkerk P.,	592
Paiethorpe P. R. Co.,	601
Palmer W. J.,	604
Park Floral Co.,	604
Payne John A.,	608
Peacock Dahlia Farms,	606
Pennock-Mechan Co.,	595-600
Perkins St.,	598-599
Pierce, F. O. Co.,	617
Pierson, A. N.,	587
Pierson F. R. Co.,	620
Pierson U. Bar.,	589
Poehlman Bros. Co.,	58-66
Pratt B. G. Co.,	601
Puberted Manure Com-	pany
Quaker City Mach. Co.,	618
Raynor, I. M.,	608
Raynor John L.,	608
Reed & Keller,	609
Reuter & Co.,	617
Reuter S. J. & Son,	575
Revere Rubber Co.,	600
Rice Bros.,	606
Richards Bros.,	603
Robinson H. M. & Co.,	606
Roch Wm. L. Flo. Co.,	604
Roehrs Julius Co.,	587-594
Roper Albert,	586
Roland, T. James,	607
Rolker August & Sons	517
Rose Hill Nurseries,	597
Sander & Son,	599
Schlegel & Fottler Co.,	608
Schmidt J. C.,	593
Schulz Jacob,	605
Scott H. M.,	586
Scott, John,	599
Sharp, Partridge & Co.,	617
Sheridan W. J.,	617
Siggers & Siggers,	619
Sim, Wm.,	599
Situations & Wants,	615
Slinn H. S.,	597
Smith Elmer D. & Co.,	564
Smith Wm. J.,	604
Standard Plate Glass	Co.,
St.,	617
Stearns & T. Lumber	618
Storrs & Harrison Co.,	619
Stump & Walter Co.,	601
Syracuse Pottery Co.,	617
Taihy,	604
Thorn J. M. & Co.,	613
Totry Chas. H.,	586
Treppel C.,	608
Tricker, Wm.,	584
Valentine, J. A.,	604
Varela F. C.,	563
Vincent R. Ir. & Sons,	588-603
Ward R. M. & Co.,	603

Page	
Washington Miss A.,	586
Water John & Sons,	588
Welch Bros.,	606
Withold Geo. Co.,	599
Wilson.,	604
Woodrow, E. F. Co.,	608
Wood Bros.,	586

Page	
Yokohama Nursery Co.,	599
Young A. L.,	609
Young John.,	608
Young & Nugent.,	604
Ziegen O. V.,	599-603
Zinn Julius A.,	605
Zvolanek A. C.,	602

CATALOGUES RECEIVED.

McCray Refrigerator Company, Kendallville, Ind.—Florist Catalog No. 71. It bears a rose in colors on its title-page and is handsomely gotten up on heavy coated paper which shows off to good advantage the illustrations of display ice boxes which this company manufactures especially for florists' store use. Some of these are carried in stock and others are made to order only but all are artistic in design and undoubtedly well adapted for practical use.

Lager & Hurrell, Summit, N. J.—Descriptive Illustrated Catalogue and Price List of Orchids. A very striking and beautiful production, the most elaborate in its line we have ever seen. The ornament of the front cover is a faithful reproduction in colors of Cypripedium insigne Sanderae, on a green background. The lettering, in yellow and orange, gives a luminous effect which will attract immediate attention. The illustrations throughout are very fine, showing press-work of a quality seldom found in horticultural catalogues. Every orchid lover should have a copy.

LORD & BURNHAM COMPANY TO OPEN A CHICAGO OFFICE.

The Lord & Burnham Co., Irvington, New York and Boston, are about to open an office in Chicago.

Mr. George Sykes will have charge of this, and will be there after May 1st. The office will be located in the Rookery Building, which is handy on La Salle street.

GREENHOUSES BUILDING OR CONTEMPLATED.

Foxboro, Mass.—F. H. Baldwin, one house.

Marietta, Pa.—A. R. McKain, one house.

Norwich, N. Y.—E. F. Quinn, additions.

Long Branch, N. J.—W. G. Eisele, one house.

Dansville, N. Y.—Winters & Prophet, one house for tomatoes.

Tarrytown-on-Hudson, N. Y.—The F. R. Pierson Co., one house, 56 x 375.

SITUATIONS WANTED

SITUATION WANTED by good grower of roses, carnations, bedding and nursery stock. Long experience in good wholesale and retail places. Good worker; sober; reliable. Permanent place and good treatment expected. State wages with house; salary and commission considered. Applications, Address Boxes, care of HORTICULTURE, Boston.

SITUATION WANTED as assistant on private place. Single. Strictly sober and industrious. Commercial greenhouse experience. Age 26. References. Address E. W. S., 87 Carew St., Springfield, Mass.

YOUNG man would like situation as assistant gardener. Have excellent references as to abilities, etc. Herbert Palmer, North St., Hingham, Mass.

WANTS, FOR SALE, ETC.
 Advertisements in this column one cent a word. Initials count as words. Cash with order. All correspondence addressed "care HORTICULTURE" should be sent to 11 Hamilton Place, Boston.

HELP WANTED
GOOD MEN
 When you need good men, skilled or unskilled, Write:
THOS. H. BAMBRICK
 34 South 7th Street Philadelphia
 Help of all kinds, including that for Florists, Nurserymen, Seedsmen and the Horticultural trade generally.

HORTICULTURE needs a wide-awake representative in every town in the land. Good commission paid on advertising and subscriptions. If you are ambitious, write for terms.

GARDENER OR SUPERINTENDENT—I can with confidence recommend a man as above, competent, sober, honest and willing. Apply William Downs, Chestnut Hill, Mass.

FOR SALE

Greenhouse Men Attention.

FOR SALE—About 10 acres with 900 ft. frontage on the C. & N. W. R. R. Main Line West, at Winfield. Land south slope to Spring Brook, extra fine black soil for outdoor planting, and the best location for a town house near Chicago. The distance from Wulls Street Depot is 27 miles. It is out in the clear air, away from the Chicago smoke, and is an ideal spot for this purpose. Price of this tract is only \$200. Will sell 5 to 10 acres. Go out with us and see it. Vandercook & Skidmore, Owners, 108 Le Salle Street, Chicago.

FOR SALE—A fine estate situated on high ground at Hyde Park, Mass., near Milton. Two minutes from R. R. station. Fifteen minutes to Boston. House, 14 rooms and bath, all conveniences. Corner lot, 47,375 ft. land, fruit and shade trees. Greenhouse, 118 x 33, built 1908, 6 on sides, 16 centre, 16 x 24 glass. Good opening for commercial florist. Address A. G. Clickering, 53 State St., Boston.

FOR SALE—Retail nursery, sixth year, doing good, steady and increasing trade. Stock in excellent condition. Only local party for community of 50,000. For particulars apply to R. N., care HORTICULTURE, Boston.

GREENHOUSE property for sale; 2 houses, built 2 years; 4000 sq. ft. glass; hot water heated to 65 deg.; 2 acres best land. Modern house of 8 rooms and bath; barn 25 ft sq. Everything first-class. Chas. L. Pierce, Holbrook, Mass.

FOR SALE—Special 16 x 15 and 16 x 24 double thick glass in "A" and "B" qualities. Buy now and save money. Write PARSHLEYS BROTHERS, INC., 59 Montrose Ave., Brooklyn, N. Y.

MISCELLANEOUS WANTS

WANTED TO BUY—Complete green house plants and all kinds of greenhouse material, to be taken down and removed at once. Terms cash. Address I. Susserman, 229 Livingston St., Newark, N. J.

WANTED—One Pandanus Urtis, large plant; state size and price. Scott Bros., Elmsford, N. Y.

Progressive Men Yet Careful Growers

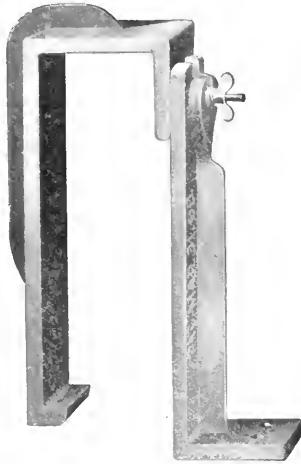

WITTOLD CLAMP.

ARE INSTALLING CEMENT BENCHES

and building them themselves along the Wittbold one-piece construction by using the Wittbold Clamps and Leg Moulds and are thus saving 25% in first cost and the expense and annoyance of rebuilding. These are facts that can be proven.

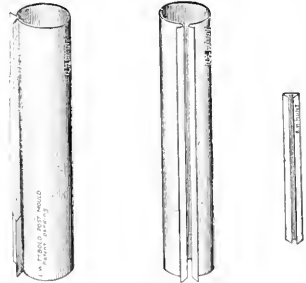

WITTOLD LEG MOULD.

Send for our Bench booklet and be convinced.

E. H. HUNT. 76 - 78 WABASH AVENUE
CHICAGO

Obituary.

John Scott.

John Scott, widely known as an expert plant grower, and an ex-president of the New York Florists' Club, met with a sudden and tragic death on the evening of Monday, 19th inst., in front of his greenhouses on Midwood street, Flatbush, N. Y. Aloysius Gross, who had been employed by Mr. Scott as night foreman for the past two years and had recently been discharged for neglect of his duties, had called Monday forenoon to seek re-employment, but Mr. Scott reminded the man that he had been taken back several times through pity for his family, but declared that he had made up his mind to part with him for good. Gross went away muttering threats and returned soon after 6 o'clock armed with a revolver. He renewed his appeal to Mr. Scott to give him a job again, and when ordered off the premises broke into violent abuse. He was ejected by Mr. Scott and his foreman Mr. MacKenzie and just as he reached the road he drew his revolver and fired. The bullet struck Scott in the left breast directly over the heart and death was almost instantaneous. This terrible calamity has cast a gloom over all the trade in New York and wherever the news has reached, for John Scott was exceedingly popular and his perseverance and industry in the business which he has laboriously built up won for him the right and title to the respect of every admirer of a self-made, prosperous business man.

Mr. Scott was a native of Newlandrig, Dalkeith, Scotland. He served his apprenticeship at the Marquis of Lothian's, New Battle Abbey, under William Priest. He next went to the nursery of Ireland & Thompson at Edinburgh, from whence he went to



JOHN SCOTT

work again under Mr. Priest at the Earl of Englington's place. Taymouth Castle and Rosemont House were later assignments. Then, in 1889 he came to America and was first employed under David Irving at Hoosick Falls, N. Y.; next under James Boyd, at Levi P. Morton's place in Rhinebeck,

and later under Thomas Emerson, at the Dinsmore Estate in Staatsburg. He finally took a position in charge of the F. Scholes Greenhouses in Brooklyn, which, within three months became a commercial establishment, in which Mr. Scott had a joint interest. About nine years ago he built in Flatbush, and on several occasions has largely increased the glass capacity, moving the original Brooklyn greenhouses and business to the Flatbush location.

He was elected president of the New York Florists' Club in December, 1905, and made an efficient and painstaking presiding officer. Since the organization of the New York and New Jersey Plant Growers' Association he has been an active member of that body also. Mr. Scott's name is indelibly fixed in the minds of florists everywhere, through its association with the valuable nephrolepis sport which bears his name. He leaves a widow and four children, the oldest a daughter of seven years. His age was forty-two years.

Joseph Anthony.

Joseph Anthony, head of the Anthony Union Nursery Co., died at Austin, Ark., on March 29, aged 42. A widow, two sons and three daughters survive him.

W. H. Henderson.

William H. Henderson, a chrysanthemum specialist of Cedarville, N. J., passed away on April 1.

J. J. Kent.

James J. Kent, a florist of Pittsburgh, Pa., died at his home on April 12.

PATENTS GRANTED.

- 915,897. Flower Pot Cover, Matilda Skorness, Appleton, Minn.
- 915,975. Lawn Protector. Enoch E. Lillegren, Minneapolis, Minn.
- 916,106. Tree Protector. James D. Clark, Watertown, Mass.
- 916,255. Lawn and Garden Hose Holder. John R. Barrows, Los Angeles, Cal.

Chicago, Ill.—The glaziers' strike has been settled by arbitration in the form of a compromise, the strikers agreeing to accept one-half the advance asked for. This strike has caused much inconvenience to Chicago florists. The Garfield Park Conservatories particularly suffered on account of the delay.



MASTICA
FOR Greenhouse Glazing
USE IT NOW.
F. O. PIERCE CO.
12 W. BROADWAY
NEW YORK

Mastica is elastic and tenacious, admits of expansion and contraction. Putty becomes hard and brittle. Broken glass more easily removed without breaking of other glass as occurs with hard putty. Lasts longer than putty. Easy to apply.

STANDARD FLOWER POTS

Packed in small crates, easy to handle.		Price per crate	
1500 2 1/2 in. pots in crate	\$4.88	144 6 in. pots in crate	\$3.16
1500 2 3/4 " " " "	5.25	120 7 " " " "	4.20
1500 2 3/8 " " " "	6.00	60 8 " " " "	3.00
1000 3 " " " "	5.00	HAND MADE	
800 3 1/2 " " " "	5.80	48 9 in. pots in crate	\$3.60
500 4 " " " "	4.50	48 10 " " " "	4.80
450 4 1/2 " " " "	5.24	24 11 " " " "	3.60
320 5 " " " "	4.51	24 12 " " " "	4.80
210 5 1/2 " " " "	3.78	6 16 " " " "	4.50

Seed pans, same price as pots. Send for price list of Cylinders for Cut flowers, Hanging Baskets, Lawn Vases, etc. 10c per cent. off for cash with order. Address Hilfinger Bros., Pottery, Fort Edward, N. Y. August Rolker & Sons, Agts. 31 Barclay St., N. Y. City.

Standard Flower . . . POTTS

If your greenhouses are within 500 miles of the Capital, write us, we can save you money

W. H. ERNEST

28th and M Street WASHINGTON D. C.

Syracuse Red Pots

STANDARD SIZES

Florists, we will suit you as to quality and prices. Write for catalogue.

Syracuse Pottery Co., SYRACUSE, N. Y.

FOR "POT LUCK" TRY US... HEWS STANDARD POTTS

POT MAKERS FOR 140 YEARS

WORLD'S LARGEST MANUFACTURERS

WRITE FOR CATALOGUE AND DISCOUNTS

Pearson Street,
LONG ISLAND CITY, N. Y.

A. H. HEWS & CO., Inc.
CAMBRIDGE, MASS.

452-460 No. Branch St.,
CHICAGO, ILL.

REVERO
THE MODERN GARDEN HOSE
FOR LAWNS, GARDENS, GREENHOUSES, STABLES, ETC.

BRAIDED FABRIC, MOULDED CONSTRUCTION, SEAMLESS THROUGHOUT

LIGHT—STRONG—FLEXIBLE

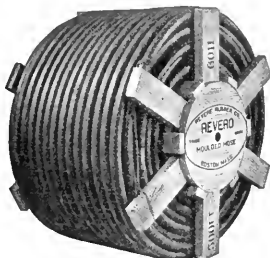

OLD STYLE—READILY KINKS

Revero is furnished on Reels in Continuous Lengths up to 500 ft. Your Supply House can furnish "Revero."



REVERO—NON KINKING

Write for Catalog

REVERE RUBBER COMPANY
BOSTON, MASS.

NEW YORK
NEW ORLEANS

PHILADELPHIA
MINNEAPOLIS

PITTSBURG
SAN FRANCISCO

CHICAGO
PORTLAND, ORE.

STANDARD PLATE GLASS CO.

Manufacturers—Importers—Jobbers

NOW IS THE TIME TO BUY

FRENCH OR AMERICAN GREENHOUSE GLASS

LOWEST PRICES ON REQUEST

26-30 Sudbury St.

BOSTON, MASS.

61-63 Portland St.

BOSTON PLATE & WINDOW GLASS CO.
GREENHOUSE GLASS GERMAN AND AMERICAN

261 to 287 A Street

BOSTON

20 to 22 Canal Street

GLASS Always Write Us Before Buying
SHARP, PARTRIDGE & CO.
22nd and Lumber Streets, CHICAGO
WE HAVE SOME SNAPS

A New Curved Eave House



Talk about a house being light, you can't beat this!



You know from the very look of it that it is the practical curved eave.



It is 50 feet long and 18 feet wide. The first curved eave house erected in Richmond County, New York.

YOU will like our way of doing it. We retain all the strong structural features of our Flat Rafter house without columns for supporting the roof, and simply change the detail at the eaves. In doing this, however, we have in no way weakened the house at that point, but have increased its lightness, and a good many say it is a more attractive looking house.

There is one thing certain, we have a Curved Eave House that is not so high priced as to make you unhappy.

We have a special way of constructing the eave which we want to tell you about. We will explain it fully in replying to your letter.

Hitchings & Company

1170 Broadway New York

THE STANDARD STEAM TRAP

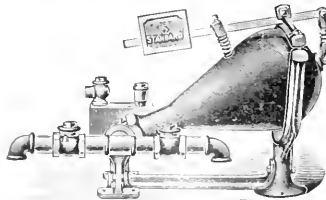

is acknowledged the best for the florist, because it is durable and does its work without trouble and annoyance, saving its cost by the economy in coal bills.

E. HIPPARD

YOUNGSTOWN, OHIO



Evans 20th Century Arm
Will not twist the shaving pipe. Three times the power of old style elbow arms. Sold only with Evans Challenge Machine.
Write for literature to
QUAKER CITY MACHINE CO.
Richmond, Ind.

Holds Glass Firmly
See the Point **PEERLESS**
Glazing Points are the best. No rubs or lifts. Box of 1,000 points 75 cts. postpaid.
HENRY A. DRER,
714 Chestnut St., Phila., Pa.

FULL SIZE No 2

The Payne Steel "T" Bar Greenhouses

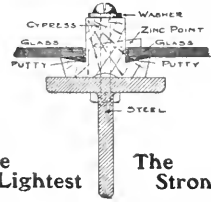

The Lightest The Strongest

Half full Size

HOUSES of this type are constructed with both curved glass eaves and straight glass eaves. Least amount of shadow. Least amount of wood. No drip. Greatest durability.

JOHNA. PAYNE
Greenhouse Designer and Builder
260-274 Culver Avenue
JERSEY CITY, N. J.

KROESCHELL BOILER

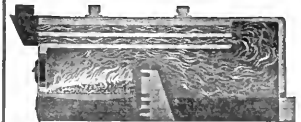

MADE OF FIRE BOX FLANGE PLATE
Can not Crack

Water Space in Front, Sides and Back
The Most Popular Boiler Made
SEND FOR CATALOGUE.

KROESCHELL BROS. CO.
35 Erie Street, CHICAGO, ILL.

EVERYTHING FOR GREENHOUSE BUILDING WRITE FOR INFORMATION AND PRICES

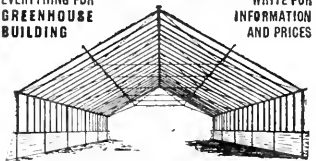

King Greenhouses. King Gutters and Eaves. Trussed Roofs. Ventilating Machinery. Trussed Iron Frame Houses. Tile Benches and Pipe Hangers.

KING CONSTRUCTION COMPANY
NORTH TONAWANDA, N. Y.

GREENHOUSE CONSTRUCTION LUMBER

John C. Moninger Co.
117 E. Blackhawk St., CHICAGO.

The Castle Automatic Circulator

The Summit of Perfection. No Device has ever been Invented for Forced Hot Water Circulation which will do what this little machine accomplishes, for Economy in First Cost or in Operation. Requires no Supervision or Manual Manipulation. Prices and Discounts on Automatic Circulator, several sizes, with or without Motors, also Testimonials from Large Greenhouse Establishments, east or west, furnished on Application.

While the method of producing a forced circulation of liquids is the same as in the Original Electric Circulator, some modifications in construction which we consider to be of vital importance are made.

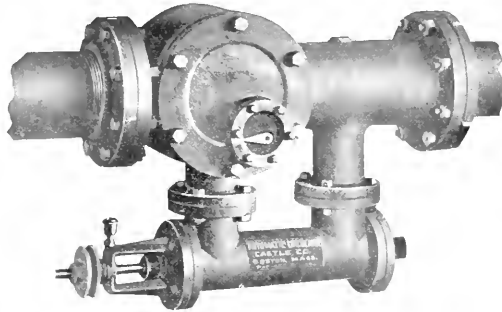

The great improvement of it being equipped with a valve which requires no manual manipulation to change from forced to gravity circulation will be at once recognized as extremely valuable.

We are prepared to estimate and contract for Boilers, Pipe, etc. Our Steel Plate Boilers are specially constructed for us, and have proved to be *marvellously economical and efficient.*

W. W. CASTLE CO., Heating Engineers

170 SUMMER ST., BOSTON, MASS.



The Advance Ventilating Apparatus

THE ADVANCE MACHINE is the simplest, strongest and most easily operated machine on the market. \$5.00 buys it all complete. Takes care of all that the shafting pipe will carry.

Double Strength Pipe . . . 8c
Single Strength Pipe . . . 5c
all painted, drilled, straightened and furnished with our Patent Couplings—best thing on earth for this work. Get our estimates now, see what our customers say. We guarantee satisfaction.

The Advance Co.
RICHMOND, IND.

Please Note

that this is not a $\frac{1}{2}$ in. wire affair but it is made of heavy rods.

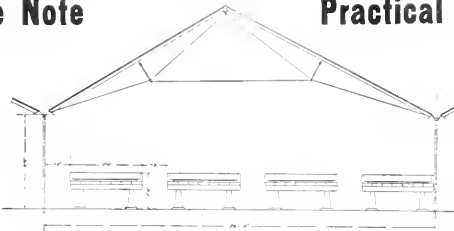

Practical Houses

on a practical financial basis. If you want an up-to-date house that will save you money,

WRITE

GEO. M. GARLAND CO.

Designers and Builders

DES PLAINES, ILL.

PATENTS

Trademarks and Copyrights

Send your business direct to Washington. Saves time and insures better service. Personal attention guaranteed. Twenty-five years' active service. SPECIALTY: "Working on the Failure of Others."

SIGGERS & SIGGERS
PATENT LAWYERS
Box 9, National Union Building
Washington, D. C.

A WIRELESS MESSAGE

IF YOU WANT

BUY FROM WHO RUNS THE IN THE YOU WILL WEAR CAUSED BY FROM GROWN IN

BIG RESULTS

PHIL FOLEY FACTORY CHICAGO. SMILE PROFITS CROPS HOUSES

THE BEST BUILDING MATERIAL WOOD IRON GLASS ROPE CEMENT

CHICAGO

CYPRESS SASH BARS
82 feet or longer
HOT BED SASH
PECKY CYPRESS BENCH LUMBER

GREENHOUSES
ERECTED AND EQUIPPED COMPLETE IF DESIRED

Write for Circular "D" and Prices

The A. T. STEARNS LUMBER CO.
NEPONSET, BOSTON, MASS.

The FLORESTERS' HALL ASSOCIATION OF AMERICA, insurer of 29,000,000 sq. ft. of glass. For particulars address John C. Esler, Sec'y, Saddle River, N. J.

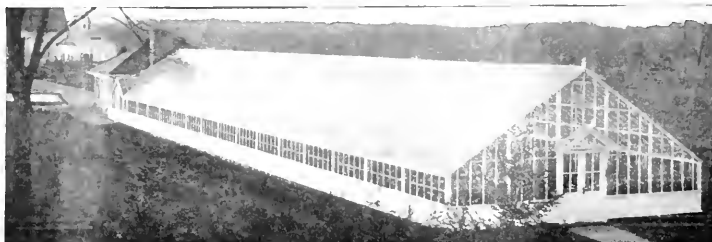

This House Will Interest You Gardeners

YOU see it was this way: the owner, Mr. Weber of Stamford, Conn., wanted a house for practical producing purposes. The ornamental side was not so decidedly important, so the house was designed to suit the location. It is 30 feet wide and 141 feet long. The house is divided into three compartments, for general plants, carnations and roses.

A Cast Iron Sill job with masonry walls Later he intends building a duplicate work room is for the connecting passage These pictures were taken two weeks ago attractive arranging of the plants and the gardener, has every reason to be very proud of. If you are thinking of building, be sure



would have been more expensive. house and the gablet on the side near the to this future house. this Saturday. The splendid condition and vines make an interior Mr. J. Thompson, proud of. to let us know.

LORD AND BURNHAM COMPANY

Irvington-on-Hudson, N. Y.

New York

Boston

Phila.

Chicago

For Example, Take the U-Bar Palm House



and you can see at once how decidedly more effective this curvilinear, circular house is than a square shaped affair, or even one with octagon corners, would be. Fact is, the U-Bar is the only construction that can be used in building a successful curvilinear palm house — it is the most adaptable construction of the day.

It is the ideal construction for private estates, parks, public institutions and florists' show rooms.

U-BAR GREENHOUSES

PIERSON



U-BAR CO.

DESIGNERS AND BUILDERS

1 MADISON AVE. NEW YORK

HORTICULTURE

Vol. IX.

MAY 1, 1909

No. 18

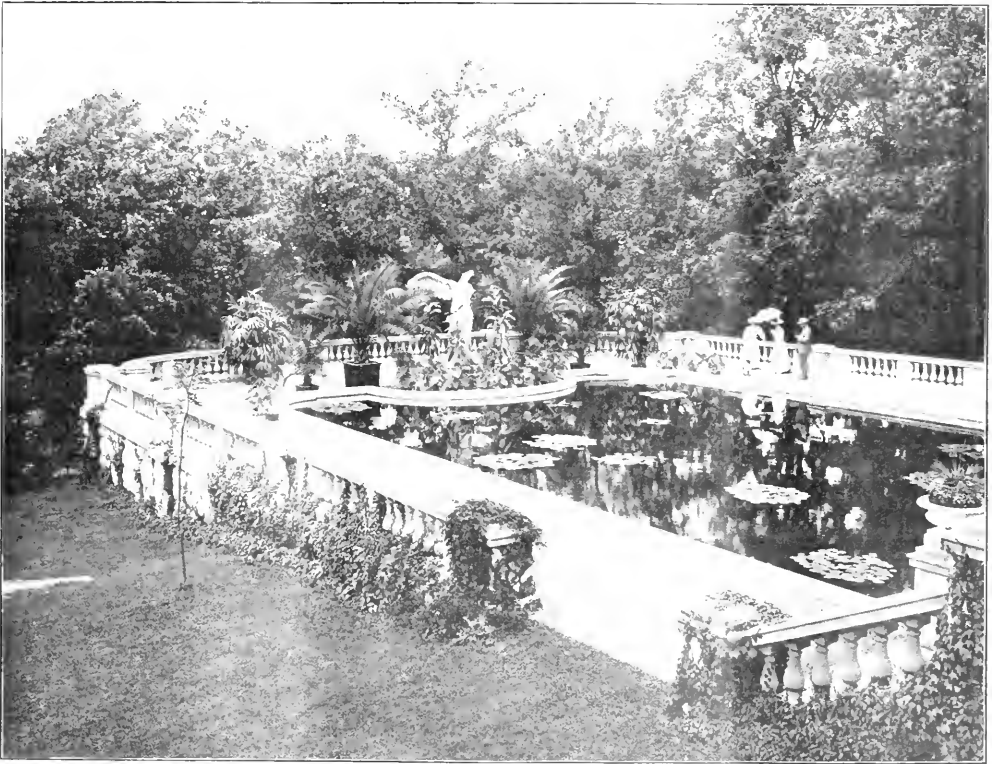

AQUATIC POOL IN A "FRENCH GARDEN"

R. R. Colgate Estate, Sharon, Conn., laid out and planted by R. & T. D. G. Hay & Co.

*Devoted to the
FLORIST, PLANTSMAN,
LANDSCAPE GARDENER,
and
Kindred Interests*

*Published
EVERY SATURDAY
At 11 Hamilton Place,
BOSTON, MASS.
Subscription, \$1.00*

CHRYSANTHEMUMS.

Not small, weak runty stock grown under benches, but the kind that brings back Dollars for Pennies.

WHITE: Earliest October Frost (We have extra fine large stock of this variety), Mrs. Henry Robinson, Clemantine Touse, Alice Byron, Timothy Eaton, Merry Christmas, White Bonnafoon.

YELLOW: Monrovia, Halliday, Appleton, Bonnafoon, Eaton, Chataqua Gold.

PINK: Mc. Niece, Maud Dean, Dr. Enguehardt, Rosiere.

RED: Intensity, Schrimpton.

All these varieties, rooted cuttings \$2.00 per 100; \$30.00 per 1000. 2 1/2 in. \$3.00 per 100; \$35.00 per 1000.

White Chadwick, Golden Chadwick, Golden Wedding, R. C. \$3.00 per 100; \$27.50 per 1000. 2 1/2 in. \$4.50 per 100; \$35.00 per 1000.

Virginia Foellmann, R. C. \$4.00 per 100. 2 1/2 in. \$5.00 per 1000.

Golden Glow, R. C. \$5.00 per 100. 2 1/2 inch \$5.00 per 100.

CARNATIONS.

Strong well rooted cuttings and 2 1/2 inch stock.

Sarah Hill, Afterglow, White Perfection, Victory, Rose Pink Enchantress, Winsor, Beacon, White Enchantress, at \$3.00 per 100; \$35.00 per 1000.

Sarah Hill, Lloyd, Afterglow, Winsor, Beacon, Victory, 2 1/2 in. \$3.50 per 100; \$32.00 per 1000.

Enchantress and White Lawson, R. C. \$2.50 per 100; \$22.00 per 1000.

Enchantress, White, Pink and Variegated Lawson, 2 1/2 in. \$4.50 per 100; \$25.00 per 1000.

O. P. Basset. 2 1/2 in. \$8.00 per 100; 3 1/2 inch \$10.00 per 100.

ROSES. 2 in. or 2 1/2 in. 3 in. or 3 1/2 in. American Beauties... \$2.00 100 \$25.00 1000

My Maryland - Grafted strong stock... \$20.00

My Maryland - Own roots... \$12.00

Killarney - Own roots... \$5.00 \$25.00 7.50

Mrs. Potter Palmer... \$2.00 100 \$25.00 1000

Bridesmaids } 2 in. or 2 1/2 in. 3 in. or 3 1/2 in. 100 1000 100

Brides... \$5.00 \$25.00 \$6.50

Richmond... \$5.00 100 45.00 6.50

Perle... \$5.00 100 45.00 6.50

Kaiser... \$5.00 100 45.00 6.50

POEHLMANN BROS. COMPANY,

Morton Grove, Ill.

NEW CREATIONS IN DAHLIAS

Jack Rose, Virginia Maule, Ethel Schmidt, Sensation, Big Chief, Gladys, Rose Pink Century, Fringed 20th Century, Fringed Beauty. 50 cts. each, \$5.00 per doz., \$35.00 per 100. Strong plants now ready.

PRINCESS VICTORIA. \$1.00 each, \$10.00 per doz., strong plants. A superb collection of new Cactus Dahlias. Send for new descriptive catalogue.

Peacock Dahlia Farms, Williamstown Junc., N. J.

The Carnation that Always Beats Everything in Sight Wherever Shown

BAY STATE

Winner of Gold and Silver Medals. Buy Now. Fine Healthy Stock

ROOTED CUTTINGS, - \$12.00 per 100, \$100.00 per 1000.

ALBERT ROPER, TEWKSBURY, MASS.

CHRYSANTHEMUMS

Rooted Cuttings and Pot Plants

Write for list and prices. ALL OF THE BEST ONES.

S. J. REUTER & SON, WESTERLY, R. I.

CARNATIONS

White Perfection in White Enchantress, \$3 00 per 100; \$25.00 per 1000.

Lady Bountiful, Enchantress, Rose Pink Enchantress, Winsor, White Lawson, \$3 00 per 100; \$20.00 per 1000.

Melody, \$3.00 per 100; \$22.50 per 1000.

Our stock won the Cottage Garden Cup at the National Flower Show.

CHICAGO CARNATION CO.,

CARNATIONS

Splendor - \$5 per 100 \$40 per 1000

Lawson - Enchantress 5 00 40.00

Andrew Carnegie 6 00 50.00

Beicon - 4 00 35.00

Afterglow - 6 00 50.00

Ouv. Deneen - 10 00

A. T. Pyfer, Mgr. JOLIET, ILL.

COMMERCIAL CHRYSANTHEMUMS

For varieties and prices see page 506, last week's Horticulture. Also full quota of other kinds suitable for any purpose.

ELMER D. SMITH & CO., - Adrian, Mich.

CARNATIONS Fine Healthy Stock From 2 inch Pots. Per 100 Per 1000

Pres. Seelye - \$6.00 \$50.00

White Enchantress, Beacon 4.50 40.00

Victory, Winsor, Melody, Kingston Per 4.00 35.00

Dahelm, Lady Bountiful, Mrs. Lawson, White Lawson, Red Lawson, Variegated Lawson 3.50 30.00

CHRYSANTHEMUMS Rooted Cuttings

G. W. Childs, Miss Clay Frick, White Shaw, Early Snow, Mrs. Jas. Marshall, Mayor Weaver, The Harriott, Yellow Eaton, \$2.00 per 100; \$15.00 per 1000.

A. J. Balfour, Autumn Glory, Ada Spaulding, Dr. Enguehardt, Doro by Devens, Geo. Kalb, Glory of the Pacific, Harry Ray, H. W. Reiman, Ivory, Jeanne Nonin, J. E. Lager, J. H. Troy, J. K. Shaw, Claud Dean, Meta, Monrovia, Mrs. Jerome Jon s, Minnie Wamsaker, Mrs. Alice Byron, Mrs. Baer, Mrs. Robert McArthur, Major Bonnafoon, Glad F. Bergmann, Nagoya, Polly Rose, Robt. Halliday, Timothy Eaton, W. H. Lincoln, Wm. Duckham, etc., \$1.50 per 100.

Send for Catalogue of Roses, own root and grafted, and other miscellaneous stock.

WOOD BROTHERS FISHKILL, N. Y.

Send for our Preliminary List describing and quoting

Chrysanthemums and Carnations.

A fine lot of Carnation Cuttings ready now.

THE E. G. HILL CO., Richmond, Indiana.

2 1/2 Stock Chrysanthemums

Golden Glow, Pacific Supreme, White Cloud, Lynwood Hall, \$5 per 100; Golden Eagle \$10 per 100; Virginia Poehlmann, Alice Roosevelt, \$4 per 100, \$35 per 1000; October Frost, Appleton, White Bonnafoon, Touse, and all commercial, \$3 per 100, \$25 per 1000. Cash.

I. M. RAYNER GREENPORT, L. I. N. Y.

CARNATIONS

For IMMEDIATE DELIVERY From 2 inch pots

White Perfection... \$3.00 per 100

Winona... 6 00 "

Deliance... 4 00 "

Red Chief... 3 00 "

Winsor... 3 00 "

F. Dorner & Sons Co., LA FAYETTE, IND.

SCOTT BROS. CHRYSANTHEMUMS

All the Newest and Best Sorts

ROSES Grafted and Own Root for Greenhouse and Outdoors

ELMSFORD NURSERIES, Elmsford, N. Y.

GARDENIAS

Fine, large Jessamines (gardenias) with beautiful foliage, two grades.

Stems from 8 to 12 in., \$6 per 1000

Stems " 12 to 18 in., 9 " "

f. o. b. Alvin Terms strictly Cash or C. O. D

MISS A. WASHINGTON, ALVIN, TEX.

In writing to Advertisers kindly mention Horticulture

NEW ROSE

WHITE KILLARNEY

We Know You Will Want to Buy White Killarney



Every live, progressive, up-to-date grower who has seen it is buying it; but when you buy White Killarney, be sure you get the right White Killarney (the Waban variety). When you buy from us you get the variety that has been exhibited and certificated, and the one that has attracted such favorable mention.

If you are in the vicinity of New York, we should be glad to have you call and see White Killarney growing at our Scarborough range, and you will say at a glance—as everyone here has—what it is growing—that it is by far the best white rose that has ever been placed on the market.

It is not only a good winter-flowering rose, but is good the entire year, and it is a splendid shipper. Read the following letter received from Mr. Willis N. Rudd, Secretary of the Society of American Florists, dated January 18th, in which he writes as follows:

"Dear Mr. Pierson—I cannot refrain from writing you and expressing my admiration for the White Killarney as shown at Chicago on Thursday. It is an exquisitely beautiful thing and attracted much attention. I took half the blooms home with me, and they were finer on Saturday than they were at the show. The record is that these blooms were shipped from Tarrytown, staged and exhibited during the afternoon. They were then carelessly wrapped up in a box and remained in that box until one o'clock Friday morning, at which time I reached home; improved in quality up to Saturday, and were in fairly presentable condition on Sunday.

In addition to being the most beautiful white rose of its class which I have seen, this demonstrates its splendid keeping and shipping qualities.

W. N. RUDD."

We were awarded Silver Cup at National Flower Show, Chicago, for best new rose with White Killarney; also Silver Medal Horticultural Society of New York.

Strong plants, 2 1/4 inch pots, own roots, now ready for delivery, \$30.00 per 100; 250 for \$70.00; 500 for \$125.00; 1000 for \$250.00. Grafted plants, ready April 1st, \$35.00 per 100; 250 for \$82.50; 500 for \$150.00; 1,000 for \$300.00.

F. R. PIERSON CO., Tarrytown-on-Hudson, NEW YORK

ROSES

Good Grafted Killarney 2 1/4 in. \$12.00 per 100
 Good Own Root Richmond, \$4.00 per 100 pots
 White Cherokee, One year old, 3 plants in a 7 in. pot. 25c. a pot.

MONTROSE GREENHOUSES
MONTROSE, MASS.

Newport Fairy

The Rose of the Future For In and Out Door.

FINE, STRONG FIELD-GROWN STOCK
 3-4 shoots 3-4 ft. long
 50c each, \$30 per 100, \$250 per 1000

JULIUS ROEHR'S CO.,
 RUTHERFORD, N. J.

STOCKS (Gilly Flower.)

grown and shipped in 2 1/2 in. paper pots, no retarding. Great Memorial Week seller, either at pot or cut. Newport Beauty strain of immense size of bloom, most delicate pink. **Telephoto's** deep blood red, also mixed white, blue, pink, red \$4.00 per 100, 200 for \$7.00

J. H. Myers, ALTOONA, PA.

A. N. PIERSON, Inc., Cromwell, Conn.

WHITE KILLARNEY (Waban Strain)

GRAFTED STOCK	Doz.	100	250	500	1000	2500	5000
		\$35.00	\$82.50	\$150.00	\$300.00	\$687.50	\$1,250.00

MY MARYLAND GRAFTED ... \$3.00 per doz., \$20.00 per 100, \$150.00 per 1000
 OWN ROOT ... 2.00 " " " 10.00 " " " 90.00 " " "

STANDARD VARIETIES

Betty, Bon Silene, Bride, Bridesmaid, Cardinal, Enchanter, Etoile de France, Etoile de Lyon, Franz Dezan, Gen. McArthur, Golden Gate, Hermosa, Ivory, Kalerin Augusta Victoria, Kate Moulton, Killarney, La Detroit, Maman Cochet, Marechal Niel, Mme. Abel Chatenay, Mrs. Jardine, Mme. Hoste, Mrs. Paul Niehoff, Mrs. Pierpont Morgan, Mrs. Potter Palmer, Papa Gontier, Queen Beatrice, Rhea Reid, Richmond, Rosaline Orr English, Souv. du President Carnot, Souv. de Wootton, Uncle John, Wellesley, White Cochet. The above Grafted (selected plan's) 20 cts. each, \$2.00 per doz., \$15.00 per 100, \$120.00 per 1000.

OWN ROOT ROSES

Killarney, Bride, Bridesmaid, Mme. Abel Chatenay, Ivory, Richmond, Mrs. Paul Niehoff. 2-in. pots, 75c per doz., \$3.50 per 100, \$30.00 per 1000. 2 1/2-in. pots, \$1.00 per doz., \$6.00 per 100, \$50.00 per 1000.
 Queen Beatrice, Rhea Reid, Mrs. Jardine, Mrs. Potter Palmer, from 2 1/2-in. pots, \$8.00 per 100, \$70.00 per 1000.

BEDDING PLANTS

COLEUS, Verschoeff's Golden Queen, Queen Victoria, Beckwith Gem, Firebrand, Lord Palmerston. Rooted Cuttings by express, \$3.00 per 100, \$5.00 per 1000. Out of 2 1/2 in. pots in May, \$2.00 per 100, \$15.00 per 1000.
Golden Bedder, Hera, Messy, Pearl of Orange. Fancy Varieties. Twelve kinds not listed above, 75 cts. per 100, \$5.00 per 1000.
AGERATUM, Stella Gurney, Princess Pauline. **SALVIA**, Splendens, Bonfire and Zurich. **HELIOTROPE**, Dark blue bedding varieties. **GERMAN IVY**, 75 cts. per 100, \$5.00 per 1000. **ALTERNANTHERA**, Red and Yellow, 50c per 100, \$5.00 per 1000. From 2 1/2 in. pots, \$2.00 per 100. **SALLEROL**, Rooted Cuttings, \$1.00 per 100, 2 1/2 in. pots, \$2.50 per 100.
CHRYSANTHEMUMS IN QUANTITY. Catalogue on Application.

DAHLIAS.

Now is the time to place your order for bulbs which will insure you getting named varieties in any quantity; prompt delivery.

DAVID HERBERT & SON,

Successors to L. K. Peacock, Inc.
ATCO, N. J.

The Northboro Dahlia and Gladiolus Gardens

Offer for Spring 1909

300 selected varieties of Dahlias and one and one half million large-flowering Gladioli in mixtures, in lots to suit. Send list of your wants. Catalogue free.

J. L. MOORE, Northboro, Mass

ROSES

We have a fine stock of large, dormant, field grown plants, on own roots, of the following varieties:

Boule de Neige, Mad. Plantier, Alfred Colomb, Perle des Blanches, Climbing Clothilde Sompert, Archduchess Elizabeth of Austria, Empress of India, Glory of the Exposition of Brussels, Philadelphia Crimson Rambler, Fisher Holmes, Che-sunt Hybrid, Climbing W. H. H. Magna Charta, Countess of Rosberry, Louis Van Houtte, Dorothy Perkins, Anna de Diesbach, Mad. Alfred Carriere, Yick's Caprice, Sir Thomas Lipton, Francois Veveit, Eugene First, Crimson Rambler.

PRICE \$12.50 per 100; \$1.20 per 1000
Tausendschon, the great new climber, \$20 per 100.

Crimson Baby Rambler, \$16 per 100.
 Fine plants from 2 1/2 inch pots, Chrysanthemum Glory of the Pacific, \$3.50 per 100.

Roses, Dahlias and Cannas a Specialty.
 Catalogue Free

The Dingee and Conard Co. West Grove, Pa.

Ampelopsis Quinquifolia

Strong 1-year plants 2 to 3 ft.	Per 1000
" 2-year " 3 to 4 ft.	\$20.00
" 3-year " 4 to 6 ft.	\$5.00

TO THE TRADE ONLY
 A Full Line of General Ornamental NURSERY STOCK
 SEND FOR CATALOGUE
EASTERN NURSERIES
JAMAICA PLAIN, MASS.
 HENRY S. DAWSON, Mgr.

Box Trees
 and other EVERGREENS for Tubs and Boxes
 Our Prices are Always Right—Catalog Free
THE NEW ENGLAND NURSERIES, Inc.
BEDFORD, MASS.

Hardy Rhododendrons, Azaleas, Conifers, Clematis, H. P. Roses, Shrubs and Herbaceous Plants from our
HOLLAND NURSERIES
 Prices Moderate

P. OUWERKERK, 216 Jane St., Wrentham Heights, P. O. No. 1, Hoboken, N. J.

CLEARY'S HORTICULTURAL CO.
 Management AMBROSE T. CLEARY
 Wholesale Contracting, Jobbing, Auction
HORTICULTURAL PRODUCTS
 of every description.
 Consignments Received. Surplus Stock Convert
 62 Vesey St., NEW YORK

NORWAY SPRUCE
 Shapely well furnished trees, two or more times transplanted. Good roots and good color.

1000 1 1/2 to 2 ft. a	7.00 per 100
1000 2 to 2 1/2 ft. a	10.00 "
1000 2 1/2 to 3 ft. a	12.00 "
500 3 to 4 ft. a	15.00 "

MAURICE J. BRINTON, CHRISTIANA, PA.
Hardy Perennial Plants.

Old Fashioned Garden Flowers—Larkspur, Foxglove, Sweet William, Hollyhocks. A choice selection. The New Anchusa Italica Prognose variety. Strong pot-grown plants \$1.50 per doz. \$10.00 per 100.

WM. TRICKER, Arlington, N. J.

GERANIUMS, DAHLIAS AND BEDDING PLANTS

We have one of the most complete collections of Geraniums in the country, containing every color and type found in the Geraniums. Every one of our 75 Standard Varieties at \$2.00 and \$3.00 per 100 are Broad and Butter Winners, and among our 31 New Varieties of special merit are some that are going to fix the standard in the future. Every one is a Gem, not high in price, only \$4.00 and \$6.00 per 100.

Our Novelties should, coming as they do from the leading introducers of the world, represent the highest development of Geraniums at the present time. A collection of 100 Varieties, our selection of 1907 and 1908 Novelties, will be sent for \$10.00.

Special offer of 1000 good, strong plants from 2 in. pots, our selection of 20 distinct kinds from among our Standard and Newer Varieties, for \$15.00 cash. From 3 in. pots \$3.00 per 100, \$25.00 per 1000, in a good assortment.

CANNAS

Strong plants from 3 in. pots: J. D. Eisele, Egandale, Alphonse Bouvier, Mme. Crozy, and Florence Vaughan, \$4.00 per 100. Jean Tissot, President Myers, Louisiana, Pennsylvania, \$5.00 per 100.

DAHLIAS

We have one of the finest collections in the country of good distinct Commercial Varieties at \$2.00 per 100 and up for plants ready for shipment. Then we have Jack Rose, Virginia Maule, Big Chief, Rose Pink Century, Fringed 20th Century, Rebecca Mayhew, etc., at 50c. each, \$5.00 per doz., \$35.00 per 100. We will send 1000 in 20 good distinct Flat Flower Sorts, our selection, for \$35.50.
 See issue of April 24th of Our Wholesale Catalogue for complete list of Bedding plants.

R. VINCENT, JR., & SONS CO., White Marsh, Md.

CHRYSANTHEMUMS

I have now ready 100,000 plants of 300 varieties, Large Flowered, Singles, Pompons, etc. These are fine stock from 2 1/4 inch pots.

All the standards such as Robinson, Bonnaffon, Duckham, Clay Frick, Beatrice May, Mrs. Partridge, Polly Rose in large quantities at

\$3 per 100, \$25 per 1000

Ralph Curtis, Marie Masse, Horace Martin and other new early kinds, **\$10.00 per 100.**

Write me what you want and see what I can do for you.

CHARLES H. TOTTY, MADISON, N. J.

JOHN WATERER & SON, Ltd.
American Nursery Bagshot, England
 Are Specialists in the
REALLY HARDY VARIETIES
 of Rhododendron Hybrids and in Select Varieties of Hardy Border Plants

TREES, EVERGREENS, SHRUBS, VINES, PERENNIAL PLANTS, FRUITS, TRAINED FRUIT TREES, FOREIGN GRAPE VINES, HARDY RHODODENDRONS and R. MAXIMUM in quantity, per hundred or per thousand, very fine. Complete assortments: Careful grading: Low prices.

AMERICAN NURSERY COMPANY,
 Sales Department, - - - - 150 BROADWAY, NEW YORK CITY.
BLOODGOOD NURSERIES DEPT., - - - - Flushing, Long Island.
F. & F. NURSERIES DEPT., - - - - Springfield, New Jersey.

Prices Quoted in these Columns are for Dealers Only.
 When Writing to Advertisers Please Mention
HORTICULTURE.

European Horticulture

HIPPEASTRUMS AT J. VEITCH & SONS

The firm of J. Veitch & Sons is famous the world over for the introduction of new plants from almost every part of the globe, its travellers having explored almost every country in turn, and succeeded in every instance in introducing meritorious plants to English gardens, whence these have reached continental cultivators. In this connection, their efforts in improving the shapes and tints have been remarkable in the case of Hippeastrums (Amaryllis). At the present date (April 10) a fine collection of varieties were to be observed in the new house built for these bulbs. This span-roofed house of 60 feet in length and 22 feet broad, has a brick-built bed 7 feet wide running down the centre, and there are beds 31½ feet wide, built against the ends and sides. These are furnished with hot water pipes, having valves for the regulation of the temperature of the beds in which the bulbs are plunged. Spent tan forms the plunging material of the beds. The progenitors of the race of Hippeastrums grown at this nursery were Leopoldi—a Brazilian hybrid of a creamy white color, the tips of the segments white and the central parts of the flower crimson—and Empress of India, which was raised in Holland, and this cross has resulted in the great variety in color observed in the Hippeastrums of the present day: at the same time there has been an elimination of the green color of the base and medium ribs of the segments. The flowers are more reflected at the points, and the segments broader; so that in some flowers the edge is truly circular, and without indentations. Among the finest of the year, so far—for there are scores to open their flowers—are Marcus, a crimson self; Neila, scarlet, with white bands on two of the segments; Titan, ground of the upper segments lined with crimson, lower ones pure white; Nevada, a crimson self; Gamos, orange-scarlet; Idothea, a crimson self; Queen Alexandra, white ground flamed with scarlet; Optima, a scarlet bloom with a white band on all the segments, except the lowermost; and Ravenna, a royal scarlet. There were many others of almost equally fine quality. The firm is endeavoring to raise a yellow variety, and seeing that some of the newer varieties show faint traces of that color in the basal parts and the middle ribs of the segments, the quest will probably meet with success.

NOTONIA GRANTII

A handsome succulent under this name was figured and described in the issue of the "Gardeners' Chronicle" for April 10, 1909. The plant was found in Mozambique, during Speke and Grant's expedition to discover

the source of the river Nile, in 6 deg. 50 min. South latitude; and was by them given the name *Kleinia* sps. in Speke's "Nile Journal." Colonel Grant described the flower as blood red. The color varies, and the cultivated plant has flowers of an orange-scarlet tint. The species is identical with *Cacalia semperviva*, Forsk., a native of tropical Arabia, and was named by Ascherson *Notonia semperviva*, a name under which it will probably remain in some Continental gardens. There are several dried specimens at Kew bearing the name of this *Notonia*, all of which are more robust than the ordinary *N. Grantii* as introduced by Miss Edith Cole from Somaliland, and first raised from seeds by Mr. J. Lynch, curator of the Cambridge Botanical Garden. *Notonia Grantii* is an easy plant to grow and flower.

IMPERIAL INTERNATIONAL EXHIBITION, LONDON

An exhibition will be held at Shepherd's Bush, London, W., opening in May and closing in October of the present year. Group 8 is devoted to horticulture as follows: Appliances and processes used in horticulture and arboriculture; apparatus and objects used for ornamenting gardens, vases, pots, chairs, garden seats, etc.; garden architecture, kitchen garden plants, fruit and fruit trees; trees, shrubs, ornamental plants and flowers; greenhouse and hothouse plants; horticultural and nursery seeds and stock, grass and other seeds.

J. A. Moore

Improvements at Kew

That Kew Gardens are still a popular institution amongst Britishers was evidenced on Easter Monday, when over 40,000 visitors passed through the gates, to admire the countless floral attractions. Keen interest was taken in the new water garden. This occupies the site of the old medicinal ground to the north of one of the museums. The dimensions of the seven tanks are 104 feet by 62 feet. The centre tank and four corner ones will be used for Nymphaeas and other aquatics, whilst the two side ones will be set apart for bog plants. This addition will still further add to the value and variety of Kew's unique attractions. This is one department of the Government's activity which is always popular, and no one is found to criticise the outlay involved. The Gardens have a world-wide reputation, for representatives come from all quarters to inspect the priceless collection, whilst its value as a training centre is everywhere recognized. Former Kew students occupy positions of importance in all parts of the globe. The training received equips a man for filling the highest posts in the horticultural world.

W. H. Adsett.

HORTICULTURE

VOL. IX

MAY 1, 1909

NO. 18

PUBLISHED WEEKLY BY
HORTICULTURE PUBLISHING CO.
 11 Hamilton Place, Boston, Mass.

Telephone, Oxford 392
 WM. J. STEWART, Editor and Manager

SUBSCRIPTION PRICE

One Year, in advance, \$1.00; To Foreign Countries, \$2.00; To Canada, \$1.50
 ADVERTISING RATES

Per Inch, 30 inches to page \$1.00
 Discounts on Contracts for consecutive insertions, as follows:
 One month (4 times) 5 per cent.; three months (12 times) 10 per cent.;
 six months (26 times) 20 per cent.; one year (52 times) 30 per cent.
 Page and half page spaces, special rates on application.

Entered as second-class matter December 8, 1904, at the Post Office at Boston, Mass.,
 under the Act of Congress of March 3, 1879.

CONTENTS

	Page
COVER ILLUSTRATION—Aquatic Pool in a "French Garden."	
EUROPEAN HORTICULTURE—Frederick Moore.....	625
IMPROVEMENTS AT KEW—W. H. Adsett.....	625
PROFESSOR GOODALE RESIGNS CHAIR AT HARVARD—Portrait.....	627
PUBLICATIONS RECEIVED.....	627
NEWS OF THE CLUBS AND SOCIETIES:	
Connecticut Horticultural Society—Florists' and Gardeners' Club of Rhode Island—Society of American Florists—American Carnation Society—Chrysanthemum Society of America.....	628
Club and Society Notes.....	629
PITTSBURGH SPRING SHOWS—James Hutchinson.....	629
ROSES UNDER GLASS—Louis J. Reuter.....	630
CARNATION SHASTA—Illustrated.....	631
PHALAENOPSIS SCHILLERIANA—Frederick Moore.....	631
ARBORVITAE MONUMENTALIS—Martin L. Benson.....	631
A DESTRUCTIVE EXPLOSION.....	632
REFLECTIONS ON THE TORONTO CATASTROPHE—W. W. Castle.....	632
THE OUTLOOK FOR PLANT BREEDING—Dr. H. J. Webber.....	633
OBITUARY:	
Benjamin Simonito—Walter S. Hogg—Lewis J. Risser—Robert Cragg—Herman Dreyer—W. A. Reichardt—Mrs. A. K. Peterson.....	634
PLANTING FOR WINTER EFFECT IN THE NORTHERN STATES—George E. McClure.....	636
SEED TRADE:	
A Questionable Policy—Seed Stocks Running Low and Values Soaring—Notes.....	638
OF INTEREST TO RETAIL FLORISTS:	
Detroit—Steamer Departures.....	640
Flowers by Telegraph.....	641
FLOWER MARKET REPORTS:	
Boston—Chicago—Indianapolis—Philadelphia.....	643
New York.....	645
MISCELLANEOUS:	
Nursery Inspection in New York.....	627
Chicago Notes.....	629
New Head Gardener for Providence Parks, Portrait—Fred C. Greene.....	633
A Tender Appreciation.....	633
Catalogues Received.....	636-638
To Extend and Improve Minneapolis Parks.....	636
Patents Granted.....	636
News Notes.....	640-643
Business Changes Philadelphia Notes.....	641
Business Changes.....	641
Philadelphia Notes.....	641
Albany Notes—Personal.....	643
A Cure for Red Spider—A. H. Secker.....	645
Fowling at St. Paul.....	645
Greenhouses Building or Contemplated.....	651

The hippeastrum for florists' use

Our London correspondent writes interestingly of the progress being made in the improvement of the Hippeastrums by the Veitels. We know that other British and continental breeders are also working on this beautiful genus and we have been able to record notable successes in this line of late by some of our own private gardeners. Some two years

ago a series of articles on Amaryllis by John Thorpe attracted considerable attention. It is very likely that with the increased interest being manifested in their improvement and multiplication we shall presently see the amaryllis attaining popularity as a florists' specialty as a cut flower and as a pot plant. There would seem to be plenty of room for it at Easter, especially, as a companion for the lilies and to liven up their monotonous white. Possibly some ingenious hybridist may find a way to produce Hippeastrums with more upright flowers poised on more graceful and slender stems, which would add materially to their decorative value as cut flowers.

The rose breeders' double chance

Our views on the duality of the rose hybridisers' field as editorially expressed in the issue of HORTICULTURE for March 20th gain confirmation in the April 15th number of *The Garden* in which a life-sized drawing of E. G. Hill's Rhea Reid is given in connection with interesting notes on the behavior of this American rose in England. The writer says that "It is difficult to select a rose of finer growth or one more hardy. It has stood an indifferent summer and a very severe winter and spring. It is difficult to name a more hardy and all-round useful rose." It is well known that Mr. Hill's aim and ambition with Rhea Reid was to establish a new high record in the forcing rose class. We cannot yet say that he has not done so but it is fairly well settled, after but one season's test, that in Rhea Reid he has put out an ever-blooming garden rose *par excellence*, for it has lived through the winter in the vicinity of Boston unscathed and the flowers produced last summer rivalled the best of the H. P. standards. The rose breeder has two chances where the carnation breeder has but one.

After the explosion

The news of the lamentable disaster at Toronto has doubtless awakened disquietude and anxiety in many places where hitherto confidence has been taken on trust as it were. The conviction forces itself that what has occurred in Toronto is liable to happen elsewhere at any moment wherever steam heating outfits are maintained without full realization of the ever-present peril. "He is truly wise who gains wisdom from another's mishap" and it is to be hoped that the lesson taught in this instance may be well taken to heart by any who have been unmindful of the mighty volcanoes slumbering in the heating outfit of the modern greenhouse establishment. Knowledge acquired in the little stoke-holes of the old-time hot water heaters counts for little in the operation of the vast flower factories which are now springing up on all sides and the boiler house, from being an ordinary adjunct in the florists' equipment, has now become the most important department. In the light of recent events it is realized that the topic demands more attention than we have been giving it and we are glad to be able to publish the very practical advice contained in the communication in another column of this paper from the pen of W. W. Castle, a man well informed on the subject of heating engineering, and what he has to say is worth a very careful reading. We shall not be surprised if one result of this destructive boiler explosion should be the substitution of safe hot-water systems under forced circulation in many places where steam has been in use heretofore. One thought more—should not the widespread sympathy which has been expressed by American growers on behalf of their stricken fellow craftsmen "across the line" take some more substantial form, such as contributions of material for re-stocking? The case is surely one to justify some concerted action.

PROFESSOR GOODALE RESIGNS CHAIR AT HARVARD.

George Lincoln Goodale, Fisher professor of natural history and director of the botanic gardens at Harvard University since 1888, has resigned, his resignation to take effect the first of this coming September. It is understood that he will continue his interest in the development of the Botanical Museum at Harvard.

George Lincoln Goodale was born in Maine, in 1829, (eldest son of Lion. Stephen L. Goodale, for more than twenty years Secretary of the Maine Board of Agriculture). He graduated from Amherst College in 1860, and from the Harvard Medical School in 1863. From 1863 to 1866 he was an instructor in the Portland School for Medical Instruction, from 1867 to 1872 Professor of Natural Science in Bowdoin College and of Materia Medica in the Medical School of Maine. In 1872 he began work as instructor and



PROF. GEORGE L. GOODALE.

University Lecturer at Harvard University. He was appointed Assistant Professor in 1873, Professor of Botany in 1878, and Fisher Professor of Natural History in 1888. He has served as Director of the Botanic Garden since 1879.

Professor Goodale is a member of the National Academy of Science, and of the American Philosophical Society, as well as of the American Academy of Science. He has served as President of the American Naturalists and of the American Association for the Advancement of Science. He is a Fellow of the Royal Geographical Society, and an Honorary member of the New Zealand Institute. He is one of the Associate Editors of the American Journal of Science, to which he contributes critical reviews. His publications have been principally in the department of Plant-Physiology and Economic Botany. He was instrumental in establishing a botanical station in Cuba, in connection with the Botanic Garden of Harvard University, where interesting experiments in the im-

provement of plants are in progress under the supervision of Mr. Robert M. Grey. The Head-Gardeners who have been associated with Professor Goodale at the Botanic Garden in Cambridge, are Messrs. William Falconer, W. A. Manda and Robert Cameron.

Professor Goodale's place will not be easily filled. Always a courteous gentleman, his relationship with every employee of the garden and with all who have had occasion to call upon him for advice has been of the sort that inspires affectionate respect. S. A. P. members who were present at the Providence Convention in 1897 will pleasantly remember Prof. Goodale's delightfully illustrated lecture on "Our Favorite Exotic Plants in Their Own Homes."

PUBLICATIONS RECEIVED.

Transactions of the Massachusetts Horticultural Society for the year 1908. Part II.—Comprises full reports of trustees, librarian, exhibition and other committees, prize awards during the year, necrology and list of members.

The Florists' Scrap Book. Published by John C. Moninger Co., Chicago, Ill. It would take a volume as big as the book itself—256 pages—to adequately tell everything it contains, so concise and comprehensive is it. The index alone takes up nine pages. The contents are compiled from the florists' trade papers, with proper credit given, and there is thus brought into convenient, easily-accessible form a vast accumulation of valuable cultural information and instructive material on the thousand and one problems every florist must meet. To be more explicit, there are over 2500 useful hints and pointers on greenhouse, store and nursery management; also about 750 remedies for various insects and diseases. The book is not only useful for the beginner, but the expert grower will find it of value also. It gives directions for making the many remedies used in greenhouses and also formulas for same. The price of the book is \$1.00, but copies may be obtained free by complying with request in advertisement of John C. Moninger on page 600, issue of April 24.

The Orchid Stud Book.—After five years of anticipation we are at last favored with the results of the collaboration of R. A. Rolfe and C. C. Hurst in their attempt to straighten out the nomenclature of the ever-increasing work of the orchid hybridist. It is safe to assume that the immensity of their self-imposed task, did not at the commencement, disclose itself, but it must soon have been apparent that their original promise of date of issue could never be fulfilled. We have the compensation in that up to date no omissions appear and the thorough way in which cross references are arranged makes it easy for the reader to ascertain readily if any particular cross has been made, by whom, and the date of exhibition or publication, as the case may be.

To give an illustration of the process of "boiling down" adopted, we note that the original cross *Cypripedium x aureum* has had applied to it no less than thirty-nine other names,

and the remarkable part of it is that Jules Hye, the raiser of *C. x aureum* named thirty-two of these, presumably out of the same seed capsule and doubtless, all differing. These thirty-eight other names now are relegated to the position of synonyms or in some cases perhaps they may live as varietal forms of *C. x aureum*. This is primarily why the work was begun and it is proposed in the columns of the *Orchid Review* to keep it up to date as the years go on in the way of supplementary data as it accumulates.

Of American-raised orchids there seems to be a complete list, garnered from various publications, as they appeared. One curious instance might be cited where the raiser was in a seemingly legitimate way, robbed of the credit of being the original exhibitor and his name classed as a synonym. In 1902 *Laelio-Cattleya Gladys* was shown in Boston (*L. tenebrosa x C. Gaskelliana alba*) and was awarded a certificate; a few weeks later a similar plant was shown in London as *L-C Eva*, and registered as such. Then M. Cogniaux discovers that the name *Gladys* had been pre-empted and in *Gardeners' Chronicle*, states that this cross must be known as *L-C Orpetiana*. The "Stud Book" however recognizes *L-C Eva* only. Such matters are all in the way of simplification and we rejoice that the present generation of gardeners now has something to refer to that has for its object fairness and simplification.

The names of the raisers of the plants are treated alike whether in the employ of a commercial concern or in private collections, in that they do not appear in the work, the compilers doubtless reasoning that gardeners come and go but the collection lives on, though often times in memory only.

Interesting introductory chapters are given, both cultural and historical with a list of the published literature on the subject from 1847 to date, also there are 120 illustrations of notable hybrids interspersed through the text, several of which we recognize as of American origin.

Cultivators will find the "Orchid Stud Book" a necessity, and may now simplify the names of their plants, for one of the most valuable features is the treatment of commemorative names, thus, *Cypripedium x Mdlle Gabrielle Moens*, must in future be known as *C. x Moensiae*—a distinct gain to the cult.

Copies of the book may be had by addressing The Editor, *Orchid Review*, 12 Lawn Crescent, Kew Gardens, London, Eng., or will be supplied from the office of HORTICULTURE, Boston, Mass., at \$2.25 each.

NURSERY INSPECTION IN NEW YORK.

The bill of Senator Raines providing for a more rigid supervision by the State Department of Agriculture to prevent the bringing of diseased nursery stock into New York state from other states was signed on April 21 by Governor Hughes. The new law also seeks the extermination of diseases and the brown tall moth and all other insect pests infesting trees, shrubs and vines. An appropriation of \$25,000 is provided.

NEWS OF THE CLUBS AND SOCIETIES

CONNECTICUT HORTICULTURAL SOCIETY.

The regular meeting of this society was held on the 23d of April, President J. E. Huss presiding. After a brief business session, the audience withdrew to a large room, in the County Building, where about 100 people listened to a very helpful, instructive and interesting lecture by our former president, John T. Withers, now of Jersey City, N. J., on the subject of America's historic trees, tree surgery, shrub pruning, etc., illustrated by a stereopticon. Mr. Withers showed great command of his subject, as the result of his wide experience in forestry and landscape gardening. The Liberty Tree, which stands on the campus of St. John's College at Annapolis, Md.; the Wethersfield Elm, which adorns our adjoining town; the Lancaster Elm, near Amherst, Mass.; the Evergreen Oak, at St. Louis, Mo.; the Indian Chestnut, at Yonkers, N. Y.; and many other famous trees, were pictured and described. The Liberty Tree is a tulip, of great historic interest, and probably 600 to 800 years old. Fifty-six tons of concrete were recently employed by Mr. Withers in restoring this tree to a safe condition against winds and further deterioration. The Charter Oak, dear to the memory of all Connecticut residents, which blew down in 1856, and in which the colonial charter was once hidden against Andros, the representative of James II., was believed to be 1400 years old, and was so eaten by decay that 29 firemen could stand within it a year before it fell. The Wethersfield Elm, now 150 years old, has a circumference of 28 feet, and a height of 127 feet, and a spread of 166 feet. Mr. Withers explained graphically the methods employed in tree surgery. After the duramen, or interior heart wood, has rotted out, and the albumen, or outer heart wood, is nearly extinct, vital functions continue in the tree as long as the cambium layer is intact, and if the cavity made by the decay can be completely filled with concrete in such a manner as to exclude air and water; and the speaker declared that thousands of trees that have been allowed to die, might have been spared if modern means had been used for the purpose. He illustrated the utility of the use of tin covers, bark, etc., to place over holes to arrest decay, and the use of iron bands to hold limbs together, the bands finally constricting the flow of the tree fluids, and acting as a girdle. The planting, nursing and general care of ornamental trees and shrubs received full attention; and the lecturer pointed out the frequent mistakes made in the annual pruning of such plants as the spiraea, the azalea, the forsythia, and the rhododendron, which form their blossom buds during the previous year. The lecture was free, but with a good admission fee, and reflects credit upon the knowledge and ability of the speaker and the beneficent work of the Connecticut Horticultural Society, which has now over 100 active members.

A pleasant feature of the evening

was the exhibition by Hugh Kirk of a rare plant, about 18 inches high, in a six-inch pot. It was brought from the Cape of Good Hope, 25 years ago, by a lady missionary, and was identified by the late Prof. Meacham as *Bowia volubilis*, named after J. Bowie, collector for Kew. The owner believes that there is no other plant of the kind in the country. Its green bulb is about the size of an orange, and annually throws up a twining, slender plant, with curving and forked branches, which has blossomed but once since the owner has had it. It is cultivated at Kew Gardens.

GEORGE W. SMITH, Secretary.

FLORISTS' AND GARDENERS' CLUB OF RHODE ISLAND.

This club held a waim meeting in Swartz Hall, Providence, on April 19. Prof. H. J. Wheeler, a member of the club and director of the Experiment Station at Kingston, had been charged by James Hockey and others at a previous meeting of the club with breach of a promise made several years ago, to the effect that the R. I. College would not sell any of its carnations or other product in the Rhode Island market in competition with resident growers. Prof. Wheeler was present to explain his position, showing that the sales complained of had been made since a change of officers had occurred in which his responsibility had ceased, and that to the best of knowledge had now been discontinued. A motion was unanimously passed exonerating Prof. Wheeler from all intention to violate any promise and from any responsibility in the sales complained of. Prof. Wheeler then gave an interesting account of the work being done at the Experiment Station.

SOCIETY OF AMERICAN FLORISTS AND ORNAMENTAL HORTICULTURALISTS.

Registration of Hydrangea.

Public notice is hereby given that Mr. E. Y. Teas, of Centerville, Wayne Co., Ind., offers for registration the plant described below. Any person objecting to the registration of this plant or to the use of the proposed name is requested to communicate with the undersigned at once. Failing to receive objection to the registration, the same will be made three weeks from this date.

Hydrangea cinerea sterilis, "Teas' Snowball Hydrangea"; collected from forest; a sport from *Hydrangea cinerea*; growth upright, spreading; foliage glaucous, pointed, serrated; height 4 feet; flowers snow-white.

W. N. RIDD, Secretary

April 23, 1909.

AMERICAN CARNATION SOCIETY.

F. Schramm, Park Ridge, Ill., registers new carnation Kathleen B. W. Sport from Mrs. Thos. W. Lawson; color light pink; size 3 inches. This registration is provisional, subject to the decision of the judges at the next annual meeting as to its distinctiveness.

A. F. J. BAUR, Sec.

CHRYSANTHEMUM SOCIETY OF AMERICA.

It is the earnest desire of those interested in this Society to increase its membership.

It should be understood the secretary is the only officer receiving a salary, and he only a nominal sum, much less than the work involved deserves.

The other officers, including the executive committee and the members of the committees who judge the new varieties each year, perform their duties solely for the welfare of the society.

The work of the committees deserves unlimited endorsement from all persons interested in this branch of floriculture.

There was a time when new varieties were sent out in large numbers upon the merits as they appeared to the originator and in many cases they did not sustain the glowing description applied. Today all new comers must be indorsed by the society's committees to interest the public to any degree. Some may say all the certificated varieties do not come up to the standards. I know from experience there is no favoritism shown in the awards. The members of these committees are not superhuman and cannot discern from the six blooms submitted, certain defects that are either constitutional or controlled by cultural conditions. I refer to those susceptible to disease, difficult of propagation, insufficient petalage, etc. They give their unbiased opinion of the six blooms before them and that is all any mortal man can do. These gentlemen are certainly entitled to the hearty support and praise of every grower, for the unselfish zeal they have manifested in devoting time and money to this work.

Their benevolence enables the Society to protect the buying public against worthless sorts.

I feel there are too few commercial and exhibition growers interested in this charitable work.

I say charitable because we save dollars for every grower by indicating the best kinds for his purpose and do this without compensation. Am I asking too much of any grower, either private or commercial, to send C. W. Johnson, Sec., Rockford, Ill., \$2.00 (the annual membership fee)?

All of us spend this small amount in some foolish way without benefit. Some may say it is unnecessary to join the Society as its important matters are made public through the trade papers without additional cost. This is true, but we all have a moral obligation which should not be lost sight of.

The florists of this country are like one large family whose interests are in sympathy. One grower's failure with a certain crop, prevents him from meeting his obligations and thus his misfortune bounds and rebounds to others in the trade. If this organization through its efforts has pointed out the best sorts and has thus been a benefactor it is up to those receiving such service to join hands and assist.

Let us hope every one in the trade has interest in the welfare of all and

has pride enough to support this worthy cause by giving liberally of moral and a small amount of financial support. ELMER D. SMITH, Pres.

CLUB AND SOCIETY NOTES.

The Indianapolis Florists' Club held its monthly meeting April 14. The premium list for the Indiana State Fair may be secured from A. F. J. Baur.

About fifty guests were present at the clam-bake tendered the Utica Florists' Club by Dr. W. A. Rowlands, at Whitesboro, N. Y., on April 15. The following officers were nominated for the coming year: President, L. J. Baker; vice-president, Seward Hakes; secretary, J. C. Spencer; treasurer, C. F. Seitzer.

CHICAGO NOTES.

In the Wholesale District.

Chicago florists in the wholesale district were the recipients of a novel announcement this week. It was a nicely gotten up card and contained the announcement of the wedding of Mr. Robt. Rahaley and Miss Helen Murphy of Detroit, along with some good advice to the Chicago florists as to the kindness they ought to show the timid pair on their honeymoon. It was signed "Some of the Detroit Florists." Mr. Rahaley is the manager of the Michigan Cut Flower Exch. of Detroit, and a cordial welcome awaits him and his bride.

Chicago has two fine young women in the commission business and both are very successful. Miss Hertha V. Tonner was one of the original founders of the Flower Growers' Market, and is now on her seventh year. Miss M. C. Gunterberg is also located in the Market, but started some time later.

At Pochmann Bros.' wholesale store were seen blooms of carnation Trea-tor. It is a novelty somewhat on the order of Conquest, having deep pink petal with a decided rim of white. It has however a deeply fringed edge while Conquest has not, but on the other hand Conquest has a more uniform shade of pink, and a wider rim of white.

Florists are in danger of an ice famine. It was announced on Monday that the drivers of the ice wagons are threatening to strike. It is hoped that their differences may be settled amicably.

Spring Plant Work.

The outlook for plants for Decoration Day trade and for general bedding stock is only fair. Growers are now bending their energies toward getting everything in readiness for the approaching season. The amount of cold, cloudy weather makes this rather a difficult problem to face. Stock in general and geraniums in particular will require skillful handling in order to be ready on time.

Chicago growers are now potting up their dormant poinsettias, getting them started so they will produce the young cuttings that will make the plants for next Christmas.

The Inventors.

The Geo. M. Garland Co. of Des Plaines, Ill., are perfecting an arrangement for emptying and refilling a greenhouse in an almost incredible short time. They expect to place it

PITTSBURGH SPRING SHOWS.



PART OF EASTER SHOW

AT H. C. FRICK GREENHOUSES, PITTSBURGH.

The Pittsburg spring exhibitions at Schenley Park and in the private conservatories this season fully maintain the high standard for which they are famous. The healthy, friendly rivalry amongst the plantmen who make these exhibitions possible has much to do with this excellence; nothing mediocre counts, and the best is none too good for the Pittsburg public who by these semi-annual, special efforts have become educated, and critical in matters horticultural.

The Schenley Park display is one of the best ever seen in western Pennsylvania and Supt. G. W. Burke and M. J. Jones are receiving the congratulations of the admiring populace. Many things are worthy of special mention, chiefly a display of H. P. roses in superb health and floriferousness. An innovation which attracts a large share of attention is a large compartment devoted almost entirely to old-fashioned flowers, amongst which are batches of several species of native cypripediums. One of the most beautiful and useful of the charming spring flowers is Ornithogalum Arabicum which would make a valuable addition to the number of cut flower subjects suitable for Easter. Mr. Jones carries over the bulbs and thinks they improve with age. The orchids make a creditable display

on the market in 1910.

The Des Plaines Floral Co. are the inventors of a very substantial crate, which will fold. It is for shipping long flowers and several of them folded and tied together will make only a light package.

Personal.

The engagement of Miss Lillian Bloom and Wm. Feniger of Toledo, O., is announced and the wedding will take place in September. Miss Bloom is stenographer for Bassett & Washburn, Chicago. The customary reception took place on April 25th, at the home of the bride to be.

Mrs. O. P. Bassett of Hinsdale, Ill., was taken very seriously ill upon her

Some fine plants of *Dendrobium thrysiliflorum*, *D. nobile*, *D. chrysoxanthum* and *D. densiflorum* were noticed. A fine plant of *Laelia purpurata* which has been hurried into flower makes a good display. The azaleas, rhododendrons, geistias, cinerarias, calcotarias, lilies and other seasonal plants are splendid examples of cultural skill. The arrangement is one of the features of the show leaving nothing to be desired.

The Peacock Greenhouses do credit to Supt. Jenkinson and his foreman Alex. McLeod. Everything is of a high order. To mention all the creditable features would be too great a demand on space. The exhibition is seen by large crowds daily.

At the Heinz greenhouses J. Featherstone has prepared a display which is away ahead of anything attempted here in previous years and augers well for future displays in these fine conservatories. Seasonable subjects are here in fine condition.

While the D. M. Clemson place is not advertised as open, gardener Jas. Wiseman turns no one away and has good reason to be proud of the fine condition of the greenhouses. His Easter display is fine, while the roses, carnations and other things in the reserves department are a surprise to his visitors. JAS. HUTCHINSON.

return from Hot Springs, Va., and was removed to the Mary Thompson Hospital in Chicago. At this writing, April 26, there is a very slight improvement in her condition though she is still very low.

Ernest Oechslin is able to be out after his recent shooting accident, but is far from being fully recovered.

L. Coatsworth of Bentley & Coatsworth has been a sufferer from rheumatism the entire winter. Mr. Coatsworth has been away for treatment, but does not show any decided improvement.

Chicago Visitors: Frank Smith, of Smith & Fetters, Cleveland, O.; Wm. Feniger, Toledo, O.; Edw. Amerpohl, Jamesville, O.

ROSES UNDER GLASS.

A Paper on "Comparative Results" by Louis J. Reuter, Westery, E. L., before the Gardeners' and Florists' Club of Boston.

It has been somewhat of a puzzle to me to know what line to take in talking on roses at this meeting. Although I sometimes find myself talking as though I really had very definite ideas on methods of growing roses I generally get back again to the point where I think that I am only a student and that what seems to be a settled fact today is surrounded by questions tomorrow.

The subject "Roses" is broad enough in a way but when I come down here to your shows I am struck with the idea that the growers for this market know quite a lot about roses. It would be much easier for me to show what I don't know than that it would what I think I know. Consequently I shall not try to say anything regarding culture in general. The Boston growers know some things about growing most any crop. Anyone who is not aware of that had better come here to some of the shows. He will see exhibits of all kinds and will find that within a not very great distance from Boston there are located men who can hold their head up with the best in all lines, so I have decided to say a few words in the way of comparing the results from a few of our standard varieties.

Bridesmaid Outblooms Bride.

Of course, we must consider Brides and Bridesmaids first and my first impulse was to escape the bother of following out a maze of figures and say that these two varieties were alike in productiveness but I met a surprise there. Whether this is only a local condition or not I am not prepared to say but I found the Bridesmaid to produce the better. It has always been apparent to me that our stock of this variety was a little more thrifty, better able to resist mildew, etc., and I was a little bit reluctant to pass by the opportunity while I was poring over our records of satisfying myself as to the productiveness of these two old standbys. I found that our plants have cut as high as twelve blooms more of Bridesmaids than of Brides for the year. This number represents the limit, but in every case Brides fell short. As to the average price on these two there is little to be said. They hold about the same in the long run. This leaves the Bridesmaid with an advantage.

Killarney's Advantage.

Next we come to Killarney. This variety takes kindly to our conditions and we are able to get good stems and good color, but it is hardly as good a producer as Bridesmaid, and here is one important point to be considered. We cut short and weak-stemmed blooms of the latter while on Killarney we cut nothing less than No. 1 grade. All short breaks are pinched and left for double joint stems. The market price also favors the Killarney and with the public inclining to it when a pink rose is wanted, we must place it at the head of the list. How long this condition will last is a question. Bridesmaid had been the only standby as a pink rose for quite a number of years and we are now glad for a change, but the buying public are not going to be satisfied with nothing but Killarney

as a pink rose any more than they were with Bridesmaid. Of the new ones none seems more likely to succeed in taking a share of the honors than My Maryland. It will by no means crowd out Killarney, but it will find a place if it can be grown properly. (Regarding this I want to say a few words later.)

Richmond, Chatenay, Jardine, Reid.

Richmond does not take kindly to our soil. I can hardly think that other growers who cut such excellent blooms get as low returns per plant as we do. We cut good stock, but not enough of them and are trying to find a soil which will suit them better. Another year we may find different results, but our experience thus far has not been very satisfactory. Chatenay is a heavy producer, ranking close to Bridesmaid and is really a surprise when the season's average is considered. In grading there is an advantage at once, a good percentage of blooms being No. 1 and better. There are two main reasons why this rose is not more generally grown. First, it has a bud too light for warm weather. Until the cool nights come on it is impossible to cut blooms with sufficient body for them to be salable and the same condition exists by the early part of June. The other reason is that the buying public seem to consider Chatenay only as a novelty. A limited quantity will find a good sale but I don't think it would be wise to plant very heavily. Mrs. Jardine has not been a success with us, it being shy and also weak in color during the time when the sun is strong. A perfect bloom of this rose is really very handsome and such blooms as were offered in the Philadelphia market at Christmas time would always find a ready sale at a good price. Rhea Reid has been a stubborn variety and we found it necessary to discard it early this spring because it was not paying and we needed the room.

Bride's Great Rival.

With the coming of White Killarney, Bride will have its first strong competitor and there seems little doubt that this grand new rose will be received with a strong welcome. It seems to be the general opinion of the store men who had a good chance to form an idea, that this variety will prove a strong favorite for some time at least. It surely will be as good a producer as Pink Killarney and consequently should be more profitable than Bride.

My Maryland, Its Behavior and Prospects.

Now for a few more words concerning My Maryland. There has been a great deal said about this variety lately and several articles in the trade papers which have spoken well for the rose have kept well within the bounds of truth. There is no good reason for doubting the great value of My Maryland as a forcing rose and not only is it good in winter, but it is especially good in the summer. The blooms have good substance, enough petals and hold their color so well that it will surely be appreciated during July and August. It is not susceptible to mildew or black spot and as a producer I believe that the best we now have will be pushed to hold first place. No doubt it has been inclined in some

places towards resting this winter, but is that surprising? We didn't know the rose and its requirements and practically every one who grew it took every eye that could be used for grafting or cuttings, robbing the plants so much that it is not at all strange that the cuts were not heavy in some cases. It is a fact, however, that it has been made to produce very well by quite a few growers this year even though the most trying part of the season and I will venture to say that next year will tell us a different story. We don't know yet how good it can be grown and it is very probable that we have heard the worst and only a small part of the good.

Number of Blooms Per Plant.

I will try to give an idea as to what some of the varieties I have mentioned may be expected to cut. I have never gathered any definite ideas as to what other growers can get from their plants, but the following statements will give some faint idea at least as to what a plant may do. There are several things to be considered in stating what a lot of roses will cut per plant. Where the cut is given from a house of first year stock we must consider when the stock was housed, whether it was in the spring or June or July. If we are speaking of carried over stock we must consider how they have been handled. We have cut from one house up to date, twenty months without a break. The plants were not rested last summer and are still doing well. In this case a count may be taken for a full twelve months.

Where we rest a house each summer and carry it over two or more years, it is possible to count on ten months flowering. This is an advantage which carried over plants have over young stock planted each year, but when the stock passes the third year they seem to gradually cut less, and two or three years at the most seems to be the limit for growing our forcing roses. From a house of Bridesmaids which cut ten months in their second year we took fifty-three blooms per plant. This same house is cutting well now in its third year and had no rest last summer, but it will not equal that cut this year.

The best cutting we have done for ten months on Brides was forty blooms per plant and Killarney thirty-eight to forty, but the Killarney had hardly the full ten months to its credit. Chatenay has cut for us forty-two blooms for eight-and-one-half months, during which time the buds were of good quality, but to have run them longer into the summer would have been of little consequence. I cannot give an average cut from Richmond as we have never handled them in a way that will permit comparison with our other sorts.

Other Factors in Estimating Relative Value.

These records which I have mentioned do not mean that these are given because they are the best cuts I could find, but are simply a statement of last year. A house of roses may no doubt be made to produce better than these and it is also true that we may expect to fall below these figures at any time. All I have in mind is to give a general idea of the matter.

When forming conclusions as to the

relative values of these varieties mentioned, it is necessary that the subject be considered from all sides. While there is a difference in the productiveness of several varieties there are also facts to be taken into consideration before deciding which is the most profitable. While Killarney will not produce as heavily as Bridesmaids the higher percentage of No. 1 grade and better with no No. 3 at all which are cut from Killarney gives this sort the advantage at once. And so it is with all the varieties. To make sure which are the best paying ones a record must be kept of the cuts, prices and grade of blooms.

In conclusion I would say that I believe Killarney ranks first, Bridesmaid and Bride next in order named with a possibility that Richmond may come in close to Bridesmaid.

CARNATION SHASTA.

Shasta is the result from a pink seedling crossed with Enchantress. The color is pure glistening white,



always. The flower is round, moderately fringed and built up nicely in the centre. In size it runs from 3 to 3½ inches. Messrs. Baur & Smith say that the calyx never splits. The stem is of good length and always supports the bloom upright as the picture shows. The growth is strong, healthy and upright. It keeps well and travels fine. Its earliness, freedom in blooming and freedom from any tendency to crop warrant high hopes as to its future. Messrs. Patten & Co. of Tewksbury will grow part of the stock and will assist in disseminating Shasta next season.

An inquest was held at Dover last week on a boy named Piper, aged 13, who had died in great agony from tetanus which had been developed, according to the medical testimony, as a result of a pricked hand which the lad had sustained through slipping on to a gooseberry bush when jumping over a fence. The doctor stated that the chances were a million to one against tetanus occurring from such a mishap.—*Market Grocers' Gazette.*

PHALAEOPSIS SCHILLERIANA.

We take the following from an article on the cultivation of Phalaenopsis Schilleriana, appearing on April 3, in the "Gartenwelt." According to the writer, a head gardener at Potsdam, R. Blasfeld by name, the importation of the plant, is in spite of all precautions still a venturesome business. In the past, when Ph. Schilleriana could be found in abundance in its native habitats, large quantities arrived in Europe in a dead state. Meanwhile the collecting of the plant is considerably more costly, and not so remunerative, the plants not being found in districts readily accessible. On this ground, efforts have been made to lessen the chances of loss of plants by fastening them on wooden laths with the leaves hanging downwards and stuffing palm fibre between the plants, hindering the lodgement of moisture in the hearts of the plants, which in non-established condition means the death of the plants. The plants remain in their home for one year, bound to the laths or block, and are as well cultivated as is possible; and then having become attached to these, they are fastened into suitable chests and forwarded to their destination.

When the plants arrive at the end of the journey they are brought into a cool, dry house and gradually inured to light, warmth and moisture. The sprinkling of the plants is avoided during the first few weeks so as to prevent loss of the leaves. When the roots begin to show signs of life they are carefully loosened with the blade of a knife from the wood and placed in orchid baskets of the usual kind, or in earthenware pans, which have holes near the rim by which they may be suspended. The material placed about the plants should consist of quite freshly gathered sphagnum and polypodium roots, which in both cases should be but slightly chopped, and a small quantity of charcoal. The greatest care should be taken in arranging the roots in the pans or baskets. The base of a plant should be placed 12 cm. above the surface of the pan or basket, and quite free, so that no danger of decay can occur, as is often the case in a night—a misfortune which is feared generally, and the causes of which remain scientifically unknown at the present time. A layer of fresh moss should be laid over all, and the plant hung in the most suitable part of the house; otherwise the roots attach themselves so firmly to the staging that it is impossible to remove them by later repanning, etc.; and their loss may easily result in that of the leaves. For a time, after the transference of the plants to new baskets and pans the house should be kept at a temperature of 68 degrees to 71 degrees Fahr., shaded and moist, and water applied from above, quite lightly, and with a syringe. With increase of rooting, increase by degrees the amount of water applied and admit more sun-heat, but always moist and buoyant. Ventilation should be very moderate. In sunny weather the leaves may be plentifully syringed in the morning hours. According to need the house must be shaded, but the marbling of the leaves becomes more distinct with the admission of sunlight.

FREDERICK MOORE.

ARBOR-VITAE MONUMENTALIS.

This new and distinct arbor-vitae was found growing among a lot of American and pyramidal arbor-vitae seedlings in Illinois some fifteen years ago. It soon attracted attention by its distinct habit of growth and its rich dark green color. Each succeeding year's growth has added to its beauty and it is now a superb specimen sixteen feet high. The half-tone gives a fair idea of the appearance of the original tree, but shows it more pointed than it is, on account of photograph being taken on a windy day. Its habit of growth is the most upright of all arbor-vitae, forming without



shearing, almost a perfect column, the diameter continuing the same until near the top of the tree. With slight shearing they form the most perfect columns of living green. The foliage is fine and soft, borne on slender, wiry stems, which gives it an elegant plume-like appearance, never stiff and rigid as in other compact sorts. The soft foliage gives the tree a graceful wavelike effect which adds much to its beauty. The rich dark shade of green is retained during winter, the trees never turning brownish or yellow as do other varieties. It is practically seedless, rarely showing any of the objectionable seed pods and is fully as hardy as the American arbor-vitae. A very fine variety for growing in tubs for decorative purposes.

MARTIN LEWIS BENSON.

DESTRUCTIVE EXPLOSION.

On Wednesday, April 21, at 1.30 p.m., a terrific explosion occurred at the greenhouses of F. C. Miller & Sons, Bracondale, Ont., wrecking practically the entire four acres of glass houses, the boiler house and smoke stack, ruining the stock and entailing a loss estimated at \$50,000 to \$60,000 (in which there is, of course, no insurance).

Only one boiler exploded but it did the work of a dozen. The boiler that exploded was 6 ft. 6 in. in diameter and 16 ft. long. Each section of a plate was torn (although half inch in thickness) like a sheet of paper; one section weighing probably 1½ tons was hurled about 400 yards into an adjoining field, another section, same size and weight about half that distance, and the remaining section is missing. The tubes from this boiler were scattered over an area about 600 yards in diameter. One small pump boiler weighing over three tons was hurled by the force of the explosion fully 100 yards from where it was set, not a pipe connection intact. A chimney 80 feet high, 4 feet in diameter, was razed. The bricks, mortar and fragments of boiler fittings were hurled in all directions, showered over houses, breaking bars and glass and completely demolishing the houses. The debris dropped on plants, cutting and breaking stuff on benches. Two new King houses 28 ft. wide, 300 ft. long, only completed last fall and furthest from the explosion had two 4 in. boiler tubes dropped on ridge, smashing all the supports, bars, glass, etc., for a space 25 ft. in length and about half the glass of these new houses was broken by flying missiles. The complete destruction of everything was pitiable, but considering the seriousness and completeness of the wreck, it is a cause for thankfulness that although all the employees were at work just after dinner not one was injured beyond a few cuts from the flying glass. It is marvellous that nothing in the way of a more serious nature to human life occurred. Several of the local florists as soon as they learned of the wreck proceeded as quickly as possible with men and tools to try to render assistance, but there was too much of it to do anything, except protect what stock could be removed to neighboring greenhouses, which was done as expeditiously as possible. The two new houses are being re-glazed and these will be filled with stock.

One small boiler is being installed for pumping water and another temporary for heat. Frosty nights have prevailed since and additional damage is feared until some heating is installed.

Further comment upon the disaster, its cause and its lesson will be found in another column.

REFLECTIONS ON THE TORONTO CATASTROPHE.

Editor HORTICULTURE:

I have received clipping from Toronto papers describing the explosion of boiler and consequent wreckage of the Miller Greenhouses at Bracondale.

I just here wish to call the attention of your readers to the lesson taught by this catastrophe. In all effects of this nature those who are or may be interested, at first bluish ask "What was the cause?" The effect all can see; deplorable as it was in loss

of property, still the absence of loss of life to those who were in jeopardy cannot but be looked upon as exceedingly fortunate, to say the least.

It appears to be the old, old story of a boiler installed in an improper manner, operated unskillfully or of such condition generally as made it a menace to life and property. Just what the boiler was there is nothing to show, but judging from experience, should be inclined to guess it was either a second-hand article or worn out in service for which it was originally intended. Too valuable for the junk heap (as is generally the case) it may have been purchased with the understanding that it would be just the article for the greenhouse man to operate at not to exceed one-fifth of the pressure designed for, and at a price very greatly reduced from what one of the same size, etc., would cost newly constructed and installed.

This is an old story to me. In an experience of some years past I have run across scores of boilers which were a menace every moment. Bought with an idea that they were cheap, they were fit only for a scrap heap, but the purchaser was advised that they were all right, having been in use, the seller don't trouble to say how long or how hard, but will magnificently do greenhouse duty for many years, "having been operated upon a pressure of 90 to 150 pounds, not a leak, nor a bit of trouble for years, it will just fill your necessities at the duty you ask for (25 to 35 pounds) for an indefinite period,—and just think, you can get it into your place all ready for operation at one-fifth or less of what a new one would cost you; we have got to put one in its place of larger capacity, which is our only reason for raking it out, etc.," ad libitum, ad nauseam. Many times I have heard this story from the innocent purchasers; many times I have been told by purveyors of this stuff, "Why, it is good enough to heat up a little greenhouse shack; what are you 'butting in' for;—you know the boiler inspector won't let us run it any longer, and a penny saved is two earned; are you trying to rob us?"—generally supplementing the whole by a proposition of "There will be 5 per cent. in it if you will place it."

I do not say, for I do not know that this 115 H. P. exploded boiler was of this class, but "I have notions" of that line, simply from the fact that I have run against scores of greenhouses fitted for steam heating with this junk heap stuff. Why more do not go up as forcibly as this one in Toronto did is almost inexplicable; possibly, as in some I have seen, they give out gradually rather than suddenly and thereby the calamity is averted. Why, but yesterday a large grower equipped with steam heating said, "There is a heap of truth in what you say, for only last summer I took out one of my boilers, and I tell you I could punch a hole in it with a tack hammer anywhere on the line of the brick setting." When asked what he took it out for, the answer was "Well, she leaked some for a couple of seasons and bran wouldn't tighten her, so I pulled her out; didn't cost me much anyway." At the suggestion "If it had blown up and killed some one, do you apprehend you were responsible;" a shoulder shrug was the answer; at another,

"Suppose it had gone up and blown your house into smithereens," the reply, "That would have been tough luck;" apparently filled his conceptions of loss or gain. All disasters have an element of instruction to the thoughtful, and this one it might be well to heed. Many "don'ts" may well be considered.

To any who desire to use steam, either high or low:

Don't run any risks by installing second-hand boilers, particularly unless they have been carefully inspected by qualified experts and determined to be unquestionably safe for the duty called for.

Don't, if the inspector reports a certain limit not to be exceeded in the operation of a steam boiler, assume that he was "fussy and theoretical" and take any chances by exceeding that limit.

Don't neglect, even though it may cost something, to have your boilers inspected yearly or oftener.

Don't place the operating of a steam plant in the hands of any one not fully qualified to give you positive certainty from injury to the boilers or their surroundings.

Don't deceive yourself that because an employee is strong and able to keep up heat by shovelling fuel that he is competent to give you best results in economy of operation.

Don't be deluded by the idea that because you see water in the water column that the boiler has the same level; the water column may be plugged by mud and dangerously unreliable. All columns are, or should be, fitted with pet cocks and should be tried at least twice a day.

Don't assure yourself that because a boiler is fitted with a safety valve it of necessity renders your boiler safe with no attention. It may get stuck fast and be unable to operate. Raise the valve once a day to be sure it is all right.

Don't neglect to have blow-off cocks tested each day, and be sure your boiler pump or steam trap is in proper condition. The blow-off may be leaking, draining the water from the boiler or your pump or trap not delivering water.

Don't use steam boilers for heating purposes if you can possible place a hot-water system. A properly installed force-circulation hot-water system is the most flexible, reliable and economical in existence and entirely free from destructive collapse.

The old hackneyed remark "What caused the explosion will never be known" is in this as in many similar cases used. From the reports of the disaster there can be no doubt to my mind; viz. too much fire; little, if any, water at first in the boiler; or a sudden influx of the same on heated crown sheet. Report says "Fireman had only been in charge two days." Must have therefore been unfamiliar with the boiler and its fittings. "Fire was started up but one-half hour before the explosion." Probably a quick kindling one, heating the plates to an extent that an ordinary supply of water would flash into steam instantaneously and produce a pressure equal to a heavy charge of dynamite.

If the "Don'ts" enumerated had been in mind and followed out, the disaster would have been averted.

WILLIAM W. CASTLE.

OUTLOOK FOR PLANT BREEDING.

A Paper by Dr. H. J. Webber, Cornell University.

(Continued from page 602)

Variations.

The fact that we can improve plants depends upon the occurrence of variations. No two plants are alike in all respects, and while the difference between individuals of the same species or variety is ordinarily slight, still there occasionally occurs a marked variation or sport which may be of an entirely different and new type. Breeders now recognize three types of variations: fluctuations, mutations and variations due to hybridization. Fluctuating variations are the slight individual variations which are not considered to be heritable, but which are doubtless in some degree transmitted. In the case of mutations or sports, as gardeners call them, we have a variation of larger degree which in general reproduces its characters through the seed. A typical illustration of such a variation is found in the Dwarf Cupid sweet pea, which was suddenly produced from one of the ordinary tall sorts, and which reproduced its character in its progeny. It is the discovery of these striking variations or mutations which have given rise to the great majority of our new varieties of cultivated plants. This is particularly true in the cereals, vegetables, and all plants regularly propagated by seeds. Fultz and Gold Coin wheat were such chance discoveries of mutations reproducing true to seed. Among fruits a large share of our standard varieties were found as accidental variations, but here in many cases accidental hybridization is probably responsible for the variation.

The use of variations produced by hybridization is of the greatest importance, but is well understood by horticulturists and need not be discussed in detail.

Producing Variations by Artificial Means.

One of the great practical problems before breeders is to learn how to produce variations, specially mutations, by artificial means. They are evidently the result of changed conditions of some sort, but what these conditions are which influence the changes should be understood so that the breeder may force the variation and not be compelled to await the slow and uncertain action of natural causes. Experiments have indicated that mutations may be stimulated by injections into the plant, of chemical solutions such as zinc sulphate, calcium nitrate, and the like, and many experiments on this method are now in progress.

Other experiments and observations indicate that very great changes in temperature at certain periods in the life of the plant may lead it to produce mutations. Experiments are being conducted also in feeding plants with different chemical solutions and out of the mass of evidence now being

accumulated it seems probable that some method will be discovered by which we may induce plants to produce these marked changes or mutations which are of such value to the breeder. It does not now seem probable that we will be able to guide the direction of the change but if we can increase the number of the variations we will increase our chances of getting the ones showing desirable improvements.

Bud Variation.

The importance of breeders giving careful attention to bud variation was emphasized by the speaker. We know that occasionally a tree will produce on one branch a variety of fruit different from that on the rest of the tree, and the same is true with flowers. The cause of this is a change that takes place in the bud instead of through the seed and sexual reproduction. Every tree is of a complex nature and every bud on a tree differs from every other bud on the same tree. As simple and fundamental as this truth is, it is scarcely recognized as it is difficult to find anywhere an orchard in which buds used for budding or grafting have been selected. It is generally recognized that buds reproduce their kind when used in propagation. If we take buds from a Baldwin apple tree they produce Baldwin apples, but horticulturists know that the fruit of Baldwin apples from Colorado, Washington, Arizona and New York, regions differing widely in climate and altitude, are of different shapes, color and flavor. No evidence is available to prove that these changes are not something inherited. If we examine the trees in an orchard of Baldwin apples, we may find one tree that will produce well and another immediately by its side which is a poor producer, and yet they are both Baldwin apple trees; both have all the characteristics of the Baldwin, one, however, is a good producer and the other is not. It is these latter good yielders that bring in the money. We have evidence to show that these good and bad characters are largely transmitted to the bud progeny, yet we pay almost no attention to the plants from which we select buds or cuttings. An orchard will last for a hundred years, and we plant largely for our children, yet we pay little heed to the selection of the buds which we use in propagation.

Inducement to Experiment.

In conclusion the speaker urged every horticulturist and farmer to adopt a breeding fad, to select some one plant which they will breed, as Jersey cows and Berkshire hogs are now bred. It costs an apple grower nothing to make a few hybrids of different varieties each year. The seeds of these hybrids can be grown in a corner of the garden at little expense until they produce sprouts two or three feet high when, buds or scions can be taken and top worked into large trees. Such experiments if made generally would unquestionably, in a short time, result in the discovery of many improved varieties and the names of their producers would go down in history as have the names of Colonel Baldwin, the originator of the Baldwin apple and John Bull, the originator of the Concord grape.

NEW HEAD GARDENER FOR PROVIDENCE PARKS.

We are sorry to learn that Joseph D. Fitts, for many years superintendent of Roger Williams Park, Providence, R. I., has resigned the position, for Mr. Fitts is a most estimable gentleman and an ideal official. But we are pleased in an equal degree to know that Mr. Fitts' successor is a gardener so capable and popular as Fred C. Greene. Mr. Greene has been for eleven years engaged in the laying out of Senator Aldrich's estate on Warwick Neck, now acknowledged to be one of the most beautiful in New England. Mr. Greene is an English-



FRED C. GREENE.

man and learned his art on the estate of Lord Rosebery. He spent eight years on the Cheney estate at Wellesley and the Lawrence place at Medford, Mass., before going to Rhode Island.

A TENDER APPRECIATION.

The widow of John Scott whose sudden death was noted in our last issue, desires to express to his many friends who so tenderly and lavishly demonstrated their love for him, in their presence and beautiful floral mementoes, her sincere appreciation of their kindness and sympathy.

In her great affliction, the memory of this universal token to his life and character will remain a constant consolation.

565 Midwood street, Brooklyn.

USEFUL BOOKS.

We can supply the following books, postpaid, at the prices listed:—

Roses and How to Grow Them. By Many Experts. Price, \$1.10.

The New Cyclopaedia of American Horticulture. L. H. Bailey. Four volumes: \$2.00.

How to Plan the Home Grounds. S. Parsons, Jr. Price, \$1.10.

How to Make a Vegetable Garden. Edith L. Fullerton. Price, \$2.20.

The Art of Landscape Gardening. By Humphrey Repton. Price, \$3.20.

Progressive Men Yet Careful Growers

ARE INSTALLING CEMENT BENCHES

and building them themselves along the Wittbold one-piece construction by using the Wittbold Clamps and Leg Moulds and are thus saving 25% in first cost and the expense and annoyance of rebuilding. These are facts that can be proven.

Send for our Bench booklet and be convinced.

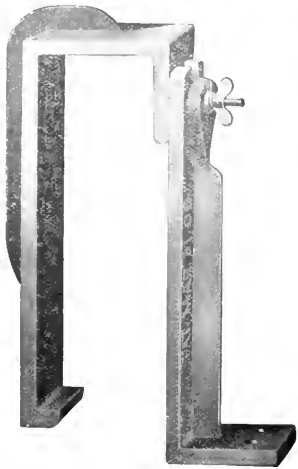

WITTBOLD CLAMP.

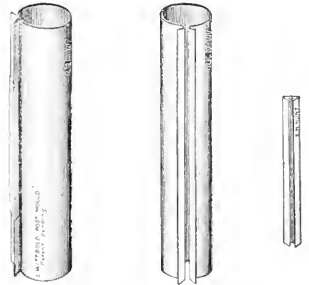

WITTBOLD LEG MOULD.

E. H. HUNT, 76 - 78 WABASH AVENUE CHICAGO

Obituary.

Benjamin Simonito.

It is with regret many florists will read of the death, on March 29, of "Ben" Simonito, a remarkable cultivator of the tulip, auricula and carnation. Following his father's business—that of table knife blade maker—he worked for Messrs. J. Rodgers & Sons, Sheffield, England. His chief delight was, nevertheless, to be among plants, and he gave up knife-making about 28 years ago and devoted his attention to his plants. This "workman florist," as he was sometimes called, carried on floriculture under the most adverse conditions imaginable, in one of the smokiest parts of Sheffield. The following are the names of his finest varieties of auriculas: Rev. F. D. Horner, green edged; James Hannaford, green edged; Frank, grey edged; Heather Bell, white edged; Ruby, a beautiful red edge; Mrs. Douglas, a pretty blue self, and Tallisman. The deceased followed his occupation till about three weeks before his death. He was in his 74th year, and is survived by a son and daughter.

Walter S. Hogg.

Walter Soon Hogg, long identified with the florists' business in Providence, R. I., and one of the pioneers in that line, died suddenly at his home, on Sunday night, of hemorrhage of the brain. While he had not been in good health for some time, his indisposition did not keep him in the house. Sunday he attended morning church ser-

vice and later was at the Bible School session.

Mr. Hogg was a native of Scotland, and was 65 years of age. He was but a child when he came to America and acquired his education in the public schools of Providence. In 1864 he established a place of business at the corner of Benefit and Meeting Streets, his being the fourth green house built here. He was a man of quiet and retiring disposition but always to be found when the local Florists' Club or the fraternity in any capacity needed a friend and enjoyed the respect and affection of the trade always. He leaves a widow and one daughter.

Lewis J. Risser.

Lewis J. Risser, proprietor of the Mosbaek Greenhouse Co., Onarga, Ill., who died suddenly in New York, on April 13, was born at Ashland, O., on September 19, 1848. Mr. Risser was more widely known as president of the Troquois Canning Co., a very large concern in its line. The announcement of his sudden death, by the company, closed with this sentence, which expresses the sentiment of all who knew him: "A brave soul, a loyal friend and a lover of mankind gone to his eternal rest." A widow and daughter survive him and will continue his various business enterprises.

Robert Cragg.

In Rochester, N. Y., Robert Cragg passed quietly away after a short illness, on April 5th. Deceased was 65 years of age and for many years had been associated with his son-in-law, George Hart, in the commission house, and had endeared himself to all local

florists by his quiet, unassuming ways, his friendly solicitude, and strict attention to every detail in business. Of sterling integrity, his absence was noticed by all, and the many kind inquiries for him was a splendid testimonial to his popularity and the sympathy of the trade is extended to the bereaved ones.

Herman Dreyer.

As we go to press a telegram announces the sudden death of Herman Dreyer, Elmhurst, N. Y., at noon on April 28. Mr. Dreyer was a well-known plant grower for many years. His greenhouses were formerly located at Flatbush, but a fortunate sale of the property for railroad purposes brought very substantial results and he removed to Elmhurst where a range of new houses was erected. Mr. Dreyer was an active member of the New York and New Jersey Plant Growers' Association, well-known and popular among a large circle of acquaintances in the trade.

W. A. Reichardt.

William A. Reichardt, head of the firm of Reichardt & Schulte, seed dealers of Houston, Texas, died April 3 at the age of 33. Mr. Reichardt was well known in southern Texas and his funeral was largely attended.

Mrs. A. K. Peterson.

Mrs. A. K. Peterson of Wheaton, Ill., died at her home on April 20th. Mr. and Mrs. Peterson had lived in Wheaton many years and were engaged in the florists' business.

ORCHIDS

We have just received the following Orchids in superb condition and solicit your inquiry for same.

CATTLEYA TRIANAE

Best type known, free flowering and of great variation. Superb plants, fresh, plump and well leaved. By dozen, hundred or case.

ODONTOGLOSSUM CRISPUM

Pacho type, splendid plants in perfectly fresh condition.

Phalaenopsis amabilis, P. Schilleriana,

VANDA SANDERIANA

Oncidium varicosum Rogersii, O. splendendum, O. crispum, O. Forbei, O. sarcodea, O. Wentworthiana, Odontoglossum grande, Miltonia candida, M. spectabilis, M. flavescens, Lycaste skinneri, Scuticaria Steelii, Zygopetalum crinitum, Z. Gaultieri.

To arrive in a few days: Cattleya labiata, Dendrobium formosum, D. noble, D. thrysi-Horum, Vanda coerulea, Cattleya Percivaliana, and many more. Write for prices.

LACER & HURRELL

SUMMIT, N. J.

ORDONEZ BROS., Madison, N. J.

ORCHIDS

CATTLYEA MOSSIAE, as arrived in first-class condition.

Our PRICES are LOW and our STOCK is FIRST-CLASS. Write us for particulars and prices and by so doing you will be sure of the facts.

Plants are FOR SALE AT THE STORE OF
AUGUST MILLANG
47 WEST 28 STREET, NEW YORK

JUST ARRIVED

Fine Importation of

Oncidium ornithorrhynchum

Fine strong leafy plants \$1.50 each. \$18.00 doz
Few specimens..... 2 50 "

JOSEPH A. MANDA, West Orange, N. J.

ORCHIDS

We are booking orders now for delivery early in the Spring on all commercial CATTLEYS and NOVELTIES. Our prices are right and our guarantee perfect. We sell only first-class goods.
CARRILLO & BALDWIN, Secaucus, N. J.

IMPORTED ORCHIDS

Now Arriving

Julius Roehrs Co.

RUTHERFORD, N. J.

CATTLEYA TRIANAE

Fresh Stock. Just Arrived.
in good time to make strong growth and flower this season.

Dendrobium Wardianum, noble and thrysi-form fine specimens,
\$2 00 to \$3.00 each.

G. L. FREEMAN, 388 Appleton St., Holyoke, Mass.

Palms
Shrubs



Ferns
Perennials

Send for Our Catalogue.

The GEO. WITTBOLD CO., 1657 Buckingham Place, Chicago, Ill.

FERNS FOR DISHES,

Assorted Varieties
From 2 inch pots, \$1.50 per 100; \$30.00 per 1000

CASH WITH ORDER
2570 to 2606 W. Adams St., Chicago, Ill.

FRANK OECHSLIN

COLEUS! COLEUS!

C. Verschaffeltii and Golden Bedder, - - - - - R. C.	Pr 100	Pr 1000
Same in 2 1/2 in. pots - - -	.60	5 00
Coleus, Mixed - - - - - R. C.	2.00	15 00
Same in 2 1/2 in. pots - - -	.60	5 00
Ageratium Stella Gurney and Pauline - - - - - R. C.	.50	4 50
Same in 2 1/2 in. pots - - -	1.00	9 00
Feverfew - - - - - in 2 1/2 in. pots	2.00	
Fuchsias, our selection,		3 00
German Ivy - - - - - in 2 1/2 in. pots	R. C.	7 5
English Ivy - - - - - R. C.	1.00	

Cash with Order

J. E. FELTHOUSEN

148-154 Van Vranken Ave., SCHENECTADY, N. Y.

NEPHROLEPIS MAGNIFICA

THE SENSATIONAL NOVELTY
Strong 2 1/2-in. stock, \$25.00 per 100.

WHITMANII

2 1/2-in., \$40.00 per 1000; 3 1/2-in., from Bench, \$8.00 per 100.

H. H. BARROWS & SON, WHITMAN, MASS.

ROBERT CRAIG CO.

ROSES, PALMS,

and Novelties in Decorative Plants

MARKET and 49th STREETS, PHILADELPHIA, PA.

Gladiolus Brenchleyensis

Extra fine Healthy Imported Stock
1,000 \$10.00 10,000 \$80.00

O. V. ZANGEN

HOBOKEN, N. J.

THE BOSTON VIOLET

Unexcelled for Productiveness, Beauty and Popularity.

In Crop from September to May.
Plants \$2.00 per doz. \$12.00 per 100; \$100.00 per 1000
Princess of Wales \$15.00 per 1000.

WILLIAM SIM, Cliftondale, Mass.

ORCHIDS

Largest Importers, Exporters, Growers and Hybridists in the World

Sander, St. Albans, England
and 235 Broadway, Room 1
NEW YORK CITY

Kentias, Arecas, Latanias, Cocos, Phoenix, Araucarias, Rubbers, Crotons, Pandanus, Asparagus, Ferns for Dishes. 200,000 Bedding Plants, also Rooted Cuttings of Coleus at lowest wholesale rates.

Orders taken for imported plants for fall delivery

A. LEUTHY & CO.

PERKINS ST. NURSERIES

ROSLINDALE, MASS.

BARCAINS

Ampelopsis Veitchii, 3 in. pots, \$5 per 100. Clematis Paniculata, 4 in. pots, \$10.00 per 100; 3 in. pots, \$5.00 per 100. Clematis, large flowering varieties, 2 year old plants, Jackman, Henry, Andre, \$3.00 per dozen; Coccinea, \$2.00 per dozen. Carnations, R. C. from soil, Dorothy, Elbon, Flora Hill, B. Market, \$2.00 per 100; Geraniums, standard varieties, from 3 in. pots, \$4.00 per 100; 4 in. pots, \$5.00 per 100.

Lobelia, double blue, 2 1/2 in. pots, \$3.00 per 100. Moon Vines, true large-flowering white variety, 2 1/2 in. pots, \$3.00 per 100; 3 in. pots, \$4.00 per 100.

The following stock from 2 1/2 in. pots at \$2.50 per 100. Heliotrope, blue and white. Fuchsias, 4 varieties. Alyssum Carpet of Snow. Phlox Drummondii, Dwarf Lobelia, Emp. William, Sylvia, Bonfire and Zurich. Verbena, Parlor Ivy, Petunias, Cal. Giants and Star. Feverfew, Little Gem. Coleus Verschaffeltii, Golden Bedder and Quadricolor. Alternantheras, 4 varieties; Golden Feverfew, Chrysanthemums, standard varieties.

Chrysanthemums, new early varieties, Autumn Glow, White Cloud, Pacific Supreme, rom 2 1/2 in. pots, \$5.00 per 100.

C. EISELE

11th and Westmoreland Streets,
PHILADELPHIA, PA.

HEACOCK'S PALMS

Kentia Belmoreana
7-inch pots.....34 to 34 inches high.....\$2.50 each
7-inch pots.....36 to 38 inches high..... 3 00
9-inch tub.....42 to 48 inches high..... 5 00

Made up Kentia Forsteriana
7-inch pots.....34 to 36 inches high.....\$2.50 each
7-inch pots.....36 to 38 inches high..... 3 00
9-inch tub.....42 to 48 inches high..... 5 00
Joseph Heacock Co., Wyncote, Pa.

PALMS AND FERNS DECORATIVE PLANTS

JOHN SCOTT

Rutland Road and E. 45th St.
Tel. 2890 Bedford BROOKLYN, N. Y.

JARDINIERE FERNS

IN BEST VARIETIES. VERY FINE STOCK.
\$.35 per 100, \$.30 per 1000

ROSE HILL NURSERIES

New Rochelle, N. Y.

PLANTING FOR WINTER EFFECT IN THE NORTHERN STATES.

A Paper by George E. McClure, before the Society of American Florists.

(Continued from page 150)

Effects in Soft Colors.

For gray effects in stem and twig coloration, we can resort to the sea buckthorn (*Hippophae rhamnoides*), and to one of the Oleasters (*Eleagnus argentea*). Effects in gray are sometimes very desirable in the winter landscape picture. For effects in green branches, we have the grass green stems of *Kerria Japonica*, and the green stemmed variety of the red dogwood (*Cornus sanguinea viridissima*), and the golden bell (*Forsythia viridissima*).

We look to the coral berry (*Symphoricarpos vulgaris*) for a magenta shade. For soft brown shades we have ample opportunity to select from a long list, such as *Stephanandra flexuosa*, *Spiraea callosa*, the golden bell (*Forsythia suspensa*), the tree of heaven (*Ailanthus glandulosa*), *Crataegus crenata*, and many others.

Many fail to notice the beautiful soft effects that can be obtained by mass planting of the brown-stemmed shrubs and trees, but it is particularly agreeable during the months of January and February to see a mass of brown stems as a relief from the blinding glare of the sun on the snow. It is then that we value the brown stemmed shrubs along with the osiers and dogwoods.

In order to secure exceedingly good effects in stem coloration it is well to remember that the highest color is produced in the growth of the current year and in order to secure this growth we must not be afraid to prune heavily in the spring, so as not to destroy the effect in winter. This is particularly true of the willows, dogwoods and hennias.

Plan Your Planting with a Definite Purpose.

All planting should be done to a definite purpose. If it is for a place that is to be occupied throughout the entire year, we should not fail to make ample provision for the effect which we can produce in the winter. If successfully planned, such a planting would be a work of art, which would not only appeal to every artistic eye, but would at the same time serve as an education to the people.

The efforts of many landscape gardeners in the past have been to plan for summer effects only, and we are often sated with the profusion of summer blooms. It is in the winter that we more fully appreciate what we can get by way of color and tone.

Do Not Disfigure the Winter Landscape.

Too often we see the home grounds arrayed with bundles of straw, burlap and barnyard refuse, and the graceful shrubs which are absolutely hardy and need no protection, tied up in an unspeakable manner, suggestive of the hair dressing of an African chief.

The effective arrangement of plants for winter effect can never be taught

GIANT ASPARAGUS AND RHUBARB

I have roots of the Imperial Palmetto Asparagus that cut seven stalks to a bunch which sells at 5 to 6 dollars per dozen bunches wholesale. Will bring you in \$400.00 to \$500.00 per acre. Also great Rhubarb clumps that will give you immense crop next spring.

WARREN SHINN, Nurseryman, Woodstown, N. J.

as it is more difficult than the more or less stereotyped summer effects can possibly be, yet it is worthy of careful study and will repay every effort. Winter travel and constant observation will enable us to add to our storehouse of knowledge.

The growing desire for out-of-door exercise, especially in winter, when indoor ventilation is so often neglected, cannot be too much emphasized and if it can be stimulated by the creation of better winter gardens and by rendering more beautiful the great out of doors, in the winter season, the art of the landscape profession will have taken a long stride forward.

CATALOGUES RECEIVED.

Howard Gardner, Greensboro, N. C.—Seed Catalogue 1909. Cover in colors.

Basil Perry, Cool Spring, Del.—Descriptive Catalogue of Choice Strawberry Plants, etc.

Horace B. Keizer, West Street Nursery, Reading, Mass.—A little 8-page announcement of this new enterprise.

Peacock Dahlia Farms, Williamstown June, N. J.—“New Creations in Dahlias.” An illustrated descriptive list of new dahlias.

Pasadena Nursery, T. Chisholm, Pasadena, Cal.—Descriptive List of Hardy and Tender Plants, Trees, Palms, Roses, etc., for 1909.

Conard & Jones Co., West Grove, Pa.—How to Grow Roses. A serviceable list with cultural directions for the guidance of the amateur. Well illustrated.

Yokohama Nursery Co., Ltd. New York and Yokohama.—Wholesale List of Japanese Lily Bulbs, Nursery Stock and Seeds. A very full and useful price list of indispensable florists' material.

Good & Reese Co., Champion City Greenhouses, Springfield, O.—Spring Trade List. For Florists, Nurserymen and Dealers Only. Devoted to roses and standard varieties of florists' stock. Also Special List of Peonies from same firm.

Shatennuc Nurseries, Barrytown, N. Y.—Flowering Shrubs, Herbaceous Plants, Trees for Ornament and Shade. A very handsome catalogue, profusely illustrated with fine half tones. Covers in sepia ink showing Japanese anemone on front and a lovely water garden view on back. A new departure is the use of the inside pages of cover for illustrations, the subject being hydrangeas and rhododendron plantations, and the omission of the name of the concern from the covers, entirely.

TO EXTEND AND IMPROVE MINNEAPOLIS PARKS.

The Minnesota legislature during its last session passed a bill, permitting Minneapolis to issue bonds to the amount of \$350,000, to be used mainly for lake connections—Lake Calhoun, Lake of the Isles and Cedar Lake. A portion of it will be used for extending the system of boulevards, improving some of the smaller squares in the different parts of the city and for adding two or three more houses to the present greenhouse plant. If the council votes favorably on the bond issue, which no doubt it will, as the money will be spent all over the city and all the improvement associations are pushing it, Superintendent Wirth will be one of the busiest men in Minneapolis.

PATENTS GRANTED.

- 916,984. Liquid Sprayer and Sprinkler. Henry Bleynehl, Chicago, Ill.
- 917,377. Sprinkler. Benjamin J. Sweeney, Wichita, Kan.
- 917,483. Automatic Fan System of Heating. Cassius C. Peck, Rochester, N. Y.
- 917,494. Steam Superheater. Wilhelm Schmidt, Wilhelmshoeh, near Cassel, Germany.
- 917,655. Plant Support. Baltzer K. Pittman and Edward N. Kring, Fairbury, Ill.
- 917,909. Lawn Sprinkler and Hose-Reel. Christian Buehler, St. Mary's, Ohio, assignor to William Jaspersen, St. Mary's, Ohio.
- 918,239. Edge Tripper for Lawns. Charles C. Wheeler, Holland, Mich.

A Profitable Side Crop

Asparagus plumosus is a main crop with many growers having extensive modern plants but those with less up-to-date establishments, or parts of same defective in lighting or otherwise unsuitable for high grade crops,—will find this subject one of the very best. We have prepared a cultural circular giving concise directions how to make money out of this crop. Send for it. No charge. An important feature in asparagus culture is good seed. The P. M. quality of greenhouse grown seed has earned a high reputation for freshness and purity. It is the true nanus and greenhouse grown. Send for trial pkg., 100 seeds fifty cents, if you wish to experiment only. In quantity \$3.75 per 1000 seeds, \$32.50 per 10,000 seeds. Asparagus Sprenger 75c. per 1000, \$5.00 per 10,000 seeds.

S. S. PENNOCK-MEEHAN CO.

1608 to 1620 Ludlow St., Philadelphia, Pa.
1212 N. Y. Ave., Washington, D. C.

DREER'S HARDY CLIMBERS

	Per doz.	Per 100		Per doz.	Per 100
Akebia Quinata, 4 inch pots	\$1.25	\$ 8.00	Clematis Boskoop Seedling or Sieboldi	3.00	20.00
" " 6 " "	2.00	15.00	" Duchess of Edinburgh	3.00	20.00
Ampelopsis Veitchi, 4 " "	1.50	10.00	" Henryi	3.00	20.00
" " 5 " "	2.00	15.00	" Mme. Baron Veillard	3.00	20.00
Ampelopsis Virginica, 5 " "	1.25	8.00	" Ville de Lyon	3.00	20.00
" " 6 " "	2.00	15.00	" Coccinea	1.25	8.00
Ampelopsis Lowii (new), 4 " " 75c each	7.50	" Crispia	1.25	8.00
Aristolochia Siphon, heavy plants	4.00	30.00	" Integrifolia Durandi	4.00
Bigoonia Grandiflora, strong roots	3.00	20.00	Honeysuckle Halleana, 4 inch pots	1.00	7.00
" " Radican, " "	1.50	10.00	" Evergreen, 4 " "	1.00	7.00
Caestrus Scandens, 5 inch pots	2.00	15.00	" Variegated, 4 " "	1.00	7.00
Clematis Paniculata, 3 1/2 inch pots	1.50	10.00	Lathyrus White Pearl (new)	3.50
" " Montana, strong plants	1.50	10.00	Wistaria Sinensis Blue	3.50	25.00
" " Grandiflora (new)	3.50	" " White	4.00	30.00
" " Rubens (new)	8.00	Vitis Henryana (new), 60c each	6.00
" " Jackmani two year	3.00	20.00			

HARDY CLIMBING ROSES

Strong Two Year Old Field-Grown Plants.

Now Established in 5 and 6 inc h pots

	Per 100		Per 100
Baltimore Belle	\$20.00	Sweet Briar Brenda	25.00
Climbing Clothilde Soupert	25.00	Trier-White Rambler	25.00
Crimson Rambler	25.00	William Allen Richardson	30.00
Dorothy Perkins	25.00	Wichuraiana Memorial Rose	15.00
Lady Gay	25.00	" Evergreen Gem	20.00
Philadelphia Rambler	25.00	" Gardena	20.00
Prairie Queen	20.00	" Pink Roamer	20.00
Sweet Briar	15.00	" South Orange Perfection	20.00
" " Lord Penzance	25.00	" Triumph	20.00
" " Lady Penzance	25.00	" Universal Favorite	20.00
" " Meg Merriles	25.00	Yellow Rambler	20.00
" " Anne of Gierstein	25.00		

HENRY A. DREER,

714 Chestnut Street, PHILADELPHIA

ANNOUNCEMENT

We have arranged with MESSRS. PATTEN & Co., Tewksbury, Mass., to grow part of the stock of **White Carnation Shasta** and to assist in disseminating it next season 1910. We have 12,000 plants between us. Orders may be sent to them or us with the assurance that from either place only strictly first class cuttings will be sent out. Shasta scored 80 points at the A. C. S. Convention, Jan. 27-28, 1909, and was generally conceded the best looking new variety in the whole show. It is a money maker for both grower and dealer.

Both Messrs. Patten & Co. and ourselves are booking orders now at \$12.00 per 100; \$100.00 per 1000.

BAUR & SMITH, Cor. 38th St. and Senate Ave., Indianapolis, Ind.

IPOMOEA NOCTIFLORA

Best pure white moonvine in the market, very fragrant and as big as a saucer. On this variety we have a world-wide reputation as growers and shippers for the last twenty years.

Price, 2 1/2 in. pots, \$5.00 per 100. 10,000 are now ready.

Godfrey Aschmann

1012 West Ontario St., Philadelphia, Pa.

PANSY PLANTS Fine Plants ready to bloom, of my well known strain, \$2.50 per 100; large plants in bud and bloom, \$1.00 per 100, \$8.00 per 1000.

GERANIUMS, best kinds, double **PETUNIAS** (Dreer's), **VINGA** var., **PAKLOK IVY**, **STOCKS**, fine plants, 2 1/2 in., \$2.00 per 100; 300 for \$5.00.

CABBAGE PLANTS E. J. Wakefield, ready to plant out, \$1.25 per 1000; 5000 for \$5.00.

J. G. SCHMIDT, Bristol, Pa.

All Plants are Ready to Ship Now,

Geraniums, red, white, pink, and salmon, 2 1/2 in. stock \$3.00; 3 in. \$5.00; 4 in. \$8.00. **Vinca vines**, 2 1/2 in. extra fine, \$4.00; 3 1/2 in. \$5.00; 4 in. extra size, \$7.50. **Dracaena indivisa**, large 6 in. plants, at 35c. In blooming plants, we have a fine lot of 4 in. Baby Ramblers, Souperets and Hermosa, which will close out at \$30.00 per hundred; 5 and 6 in. at \$6.00, \$9.00 and \$12.00 per dozen. **Cobaea vines**, in 4 in. at \$12.50 per hundred. Extra fine **Salvia** at \$2.50, 2 1/2 in. stock; 3 in. \$7.50; 4 in. \$12.50. A large lot of **Santolina**, at \$2.50. Besides above, we have **Coleus** of every description, and all other plants for bedding purposes. **Of Cannea** we have 2500 King Humberts, red and yellow fine 3 in. stock at \$4.00 per hundred. Send for lists of same. We give you plants worth the money. Write **Geo. A. Kuhl, Wholesale Grower, PEKIN, - ILL.**

Begonia Gloire de Lorraine

Leaf Stock, June Delivery, \$15 per 100, \$148 per 1000, from 2 1/2 in. pots

Stock guaranteed to be absolutely free from disease.

THOMAS ROLAND, NAHANT, MASS.

We have on hand a large consignment of

Japanese Bamboo Canes

Fine Strong Quality.

NATURAL	Per 1000
6 ft. heavy, original bundle of	2500 @ \$4.25
6 ft. medium, " "	2500 @ 3.50
5-6 ft. pencil thickness " "	5000 @ 3.25
4-5 ft. " " " "	5000 @ 2.75
3 ft. " " " "	5000 @ 2.25

GREEN COLORED	Per 1000
1 1/2 ft. original bundle of	4000 @ \$1.20
2 ft. " " "	4000 @ 1.85
2 1/2 ft. " " "	4000 @ 3.00
3 ft. " " "	4000 @ 3.50
3 1/2 ft. " " "	4000 @ 3.75

Sold in original bundles only. Samples on application.

Cycas Stems

Fine straight stems, in case lots of 300 lbs. assorted. 4-10 lbs., 1/2-4 lbs., 1/4-2 lbs., 2-10 lbs. \$19.50 per case.

Kudzu Vine Roots

Strong heavy quality.....1000 @ \$5.00
" " " ".....100 @ 50c

The Yokohama Nursery Co

31 Barclay St., N. Y. City.

GLADIOLI NAMED VARIETIES

Childs and Gandavensis Seedlings, Madeira Vines, Cinnamon Vines, Oxalis, Spotted Callas, and Iris Germanica. Write for prices.

E. S. MILLER, Wading River, N.Y.

Seed Trade

AMERICAN SEED TRADE ASSOCIATION.

Watson S. Woodruff, Orange, Conn., Pres.; J. C. Robinson, Waterloo, Neb., First Vice Pres.; C. E. Kendall, Cleveland, O., Sec'y and Treas. Twenty-seventh annual convention June 23-24, 1909, at Clifton House, Niagara Falls, Ont.

WHOLESALE SEEDSMEN'S LEAGUE.

F. W. Bruggenhorf, Pres.; Burnet Landreth, Sec'y.

A Questionable Policy.

Reference was made a few weeks since to the supplementary contract for garden seeds awarded by the Department of Agriculture to one of the California seed growers, but no thought was there of reflecting on the integrity of the successful bidder. Indeed, no question that everything was not entirely square and above board has ever been raised. In referring to the very low price at which report says this contract was secured, the thought in the mind of the writer was the absurdly low quotations made by nearly all seedsmen and seed growers when bidding for the government order—prices usually much lower than they would quote to one another. The fact of the large quantities wanted does not justify many of these very low figures, the result of which is to cause erroneous impressions of standards of values in the minds of Department officials or employees, who cannot be convinced that many of these prices are below cost of production, which is often the case. The idea that seeds are cheap and of little value is fostered if not created by this unfortunate custom, and wholly incorrect views of the seedsmen's profits are formed. The latter statement is based on a remark of one of the southern Congressmen when the appropriation for the free seed distribution was under debate in the House two years ago. Comparing the prices in some of the retail catalogues with those paid by the Department of Agriculture for the same varieties, this salon characterized the seedsmen as robbers and swindlers and the disparity between the two sets of prices seems to give some sort of justification for his rabid utterance.

Seed Stocks Running Low and Values Soaring.

From all parts of the country come reports of great activity in the retail seed business, and all indications now point to a record year. The large jobbing houses are very busy, and have to report items sold out every day. In fact never were stocks so broken and so many items exhausted. Most ample crops will be needed to bring stocks up to average quantities, as with the exception of a very few lines, reserves are very small or wholly wiped out. Growers of seed beans have had their troubles getting out their seed stocks this year, and many who based their contracting prices on the basis of last year's figures paid the farmers, have found themselves facing the alternative of not putting out their seed or of doing business for practically nothing. While manufactured products have greatly declined, and are going to still lower levels,

agricultural products are, on the other hand, establishing new high records. Practically everything the farmer produces is unusually high, not a few abnormally above average prices, and when one begins to talk of contracted crops, he finds that the farmer has high and lofty ideas of values, and moreover is pretty firm in standing by his guns. It is said that much of the winter wheat crop of Michigan has winterkilled and will be plowed up, and about the only crops that can be substituted are potatoes, corn, peas and beans, and this will enable the seed grower to secure his acreage, but owing to the present high price of potatoes, they will be largely substituted and beans will be a second choice.

Notes.

Falmouth, Mass.—The new seed store and greenhouses of H. V. Lawrence are considered models of their kind, being equipped with all modern improvements.

Fredonia, N. Y.—It is announced that H. L. Cumming and F. W. Case have increased their stock in the Fredonia Seed Co. and have taken the management of the company.

Sioux Falls, S. D.—O. S. Jones & Co., seedsmen of Madison, S. D. have purchased land on Phillips avenue, on which they will erect a three-story building and transfer their seed business to this place.

CATALOGUES RECEIVED.

Jno. D. Imlay, Zanesville, O.—"A Few Choice Seeds and Plants," 26th Year.

W. B. Longstreth, Gratiot, O.—Longstreth's Seed Annual and Bargain Catalog.

John R. Box, Croydon, Eng.—Annual Garden Guide of Seeds, Begonias, Bulbs, Sundries, etc.

S. I. Galloway, Eaton, O.—Wholesale Price List of Hardy Herbaceous Plants and Perennials, Spring, 1909.

Friedr. C. Ponrencke, Altona, Hamburg.—Wholesale Price List of Flower and Vegetable Seeds and Herbaceous Plants.

Schaum & Van Tol, "The Hansa Nurseries," Boskoop, Holland. Wholesale Trade List of Nursery Stock 1909-1910.

Thompson & Morgan, Ipswich, Eng.—Catalogue of Choice Seeds for 1909. Established 53 years. A compact and very full list, without illustrations.

V. Lemoine & Fils, Nancy, France.—Catalogue for Spring and Summer

Fresh Palm Seeds

Just Received

	Per 100	1000	5000
KENTIA BELMOREANA	\$.80	\$4.00	\$18.00
KENTIA FORSTERIANA	1.50	4.50	20.00
COCOS WEDDELLIANA	1.00	7.50	35.00
PHOENIX RECLINATA	1.50	3.00	13.00
PHOENIX CANARIENSIS	1.50	3.00	13.00
SEAPORTULIA BIRMANENS	1.75	6.00	27.00
LANTANA TORBONICA	1.50	2.50	10.00
ARECA LUTESCENS	1.00	7.50	30.00

ARTHUR T. BODDINGTON,

Seedsman
342 W. 14th St., New York

1909. Always an interesting volume to the garden enthusiast who likes to keep informed as to the new and meritorious introductions for which this house is noted.

Portland Seed Co., Spokane, Wash., and Portland, Ore.—Complete 1909 Catalogue. The half dozen departments in this catalogue are distinguished by being printed each on a paper of different tint. The covers are in red, green and white.

Wood Brothers, Fishkill, New York.—Trade List for January to May, 1909. Plants and rooted cuttings of roses, cannas, carnations, chrysanthemums, geraniums, verbenas and a general collection of bedding plants are listed at attractive wholesale rates.

Ellwanger & Barry, Rochester, N. Y.—General Catalogue. As always a finely illustrated and instructive list of Fruit and Ornamental Trees, Shrubs, Roses, Peonies and Hardy Border Plants. Also Abridged List of New and Noteworthy Varieties and an excellent pamphlet on How to Have Roses, by William C. Barry, reprinted from *The Country Gentleman*.

Sutton & Sons, Reading, England.—Sutton's Amateur's Guide in Horticulture for 1909. This publication is a model of catalogue making just as the seeds it lists are recognized as standard, the world over. It is a wide volume of nearly 200 pages on heavy paper, profusely illustrated with half-tone cuts. The cover is robin's egg blue, bearing no imprint except the royal arms in the centre of the front cover and the autograph of Sutton & Sons in silver.

PRIMULA SEED

PRIMULA CHINENSIS FIMBRIATA

	Tr.	Pkt.	Tr.	Pkt.
Alba Magnifica	\$.60	\$1.00		
Chiswick Red	60	1.00		
Holborn Blue	60	1.00		
Kermesina Splendens	60	1.00		
Rosy Morn.	60	1.00		
Michelp's Prize Mixture, beautifully fringed varieties	60	1.00		

PRIMULA OBCONICA GRANDIFLORA

	Tr.	Pkt.
Compacta	\$.60	1.00
Fimbriata (1-16 oz., \$1.25)	50	
Gigantea (Arends)	50	
Kermesina (1-16 oz., \$1.50)	40	
Rosea (1-16 oz., \$1.00)	30	
White (1-16 oz., \$1.25)	30	
Mixed (1-8 oz., \$1.00)	30	

Write for our Wholesale Catalogue.

HENRY F. MICHELL CO.
1018 Market St., PHILA.

Everything "For the Land's Sake."

The one firm in Boston where all good forms of plant food may be obtained, is the Bowker Fertilizer Company, opposite Faneuil Hall at 43 Chatham St. All greenhouse chemicals, Nitrate of Soda, Ground Bone, Potash Salts, Sheep Manure and Wood Ashes can there be had at first hands.

BOWKER FERTILIZER COMPANY

Everything "For the Land's Sake."

VEGETABLE PLANTS

- BEEFS. Crosby, Egyptian and Eclipse, \$1.25 per 1000.
CABBAGE. Field Crown, all leading varieties, \$1.50 per 1000.
CELERY. White Plume, Golden Self Blanching and Giant Pascal, \$1.25 per 1000.
EGG PLANT. N. Y. Improved and Black Beauty, \$1.00 per 1000.
LETTUCE. Big Boston, Poston Market, Tennis Ball and Grand Rapids, \$1.00 per 1000.
PEPPERS. Ruby King, Bull Nose, Sweet Mountain and Neapolitan, \$3.00 per 1000. Chinese Giant and Cayenne, 50c per 1000.

CASH WITH ORDER

R. VINCENT, JR., & SONS CO. White Marsh, Md.



Baskets, Grates, Ladders, Veneers and Boxes.

BACON & CO. Appleton, N. Y.

In ordering goods please add "I saw it in HORTICULTURE."

GEO. E. DOW Designing and Illustrating 178 Washington St., Boston, Mass. OUR SPECIALTY Machine, Booklet, Advertising and Flower PHOTOGRAPHS

Mignonette

FARQUHAR'S GIANT

Oz., 75c; 1-4 oz., 25c

R. & J. Farquhar & Co.

6 & 7 South Market Street BOSTON, MASS.

SHEEP MANURE

IT'S STERILIZED Free from Weed Seeds. \$24.00 Ton; \$7.00 quarter of Ton.

Wm. Elliott & Sons 42 Vesey St., New York

RELIABLE SEEDS—SOW NOW

Table listing various seeds like Primula obconica Grandiflora, Blood red, fine seller, etc. with prices.

LEONARD SEED CO.

CONTRACT GROWERS AND WHOLESALE DEALERS BEANS, PEAS, SWEET CORN, ONION, GARDEN SEEDS ONION SETS FLOWER SEEDS Get Our Prices E. KINZIE STREET, CHICAGO

ESTABLISHED 1802



FINE CLUMPS JAPAN IRIS TUBEROUS ROOTED BEGONIAS GLOXINIAS ROSA MULTIFLORA NANA SEED

and all other flower seeds for florists

SEND FOR CATALOGUE

J. M. THORBURN & CO. 33 Barclay Street NEW YORK

BRIDGEMAN'S SEED WAREHOUSE

RICKARDS BROS. Props.

37 East 19th St., - NEW YORK CITY

STOCK SEED

FOR WINTER BLOOMING Our strain of Double Branching Stocks is exceptionally true. About 90% Double Flowers. In colors: 3/4 oz. .60 05.....\$4.00 Pure White 3/4 " .75 ".....5.00 H. E. FISKE SEED CO. Faneuil Hall Square, BOSTON, MASS.

Winter-flowering SWEET PEA SEED

All Colors Ask for List A. C. ZVOLANEK ORIGIMATOR. BOUND BROOK, N. J.

NEW CROP SEED

For Early Planting THOMAS J. GREY CO. 32 SO. MARKET ST., BOSTON, MASS.

BEGONIAS TUBEROUS ROOTED

GLOXINIAS, LILY OF VALLEY, SPIREA Catalogues mailed free on application

Joseph Breck & Sons Corp. 47-54 NO. MARKET ST., BOSTON, MASS.

BULBS OF QUALITY

Table listing bulb types like Begonias, Double, Filled, Glorinas, Pearl Tuberoses with prices.

Schlegel & Fottler Co.

26 & 27 So. Market St., BOSTON, MASS.

CAULIFLOWERS CABBAGE

LILY OF THE VALLEY PIPS. HJALMAR HARTMANN & CO. 12 Stormgade, COPENHAGEN, DENMARK.

Burpee's Seeds

PHILADELPHIA

Blue List of Wholesale Prices mailed only to those who plant for profit

Ward's Lily Bulbs

Send for Catalogue



Ralph M. Ward & Co. 12 W. Broadway NEW YORK

To Florists Everywhere

Orders for Cut Flowers and Floral Decorations to be delivered anywhere to the Greater New York, may be placed with us with the certainty that your customers will be satisfied.

Telegraph, telephone or mail such orders to us and be sure that they will be filled as promptly and as carefully as though you did it yourself.

One third discount will be allowed on all orders thus placed with us by Florists outside of the Greater New York.

THE BLOSSOM

Bond and Livingston Sts.,
BROOKLYN, N. Y.

C. C. TREPEL, Manager

**WILLIAM J. SMYTH
FLORIST**

Cor. Michigan Ave. and 31st St., CHICAGO

We ship to all points in Illinois and Iowa.

Phones: Douglas 744, Douglas 523, Douglas 740

**HAUSWIRTH THE
FLORIST**

Out of Town orders for Hospitals
Carefully filled.

**232 Michigan Ave.
CHICAGO**

AUDITORIUM ANNEX Tel. Harrison 585

**SAMUEL MURRAY
Florist**

Coates House Conservatory

1017 BROADWAY, KANSAS CITY, MO.

Bath 'Phones 2670 Main.



WASHINGTON,
D. C.

GUDE'S

**The Far-Famed Flowers of
TORONTO**

Delivered on mail or telegraph order for any occasion, in any part of the Dominion.

JOHN H. DUNLOP,
98 Yonge St., - Toronto, Ont.

The Park Floral Co.

J. A. VALENTINE,
Pres.

DENVER, COLORADO

**WILLIAM L. ROCK
FLOWER CO.**

KANSAS CITY, - MO.

will carefully execute orders for Kansas City and any town in Missouri or Kansas.



Buffalo, N. Y.

W. J. PALMER & SON, 304 Main St.

**Of Interest to Retail
Florists**

Ever since Easter the DETROIT stores have been kept busy in a satisfactory manner, but with most of us it was a chance of cleaning up the surplus left from the holiday. Were it not for the general tendency to produce more and more, this over-stock would not exist and its existence is not to be a criterion of the Easter business. Local seed stores are in the middle of a very busy season which at present promises to out-do last year. The weather is still cool and discouraging which keeps the plant business back. A good many new plantings are made around private homes but not as extensive as last year.

STEAMER DEPARTURES

American.

Philadelpa, N. Y.-Shampton, May 8
St. Paul, N. Y.-Shampton, May 15

Atlantic Transport.

Minnehaha, N. Y.-London, May 8

Minnewaska, N. Y.-London, May 15

Cunard.

Iverna, N. Y.-Liverpool, May 4

Maurtaun, N. Y.-Liverpool, May 5

Caronia, N. Y.-Liverpool, May 6

La Lorraine, N. Y.-Havre, May 6

French Line.

La Provence, N. Y.-Havre, May 13

Hamburg-American.

Pres. Lincoln, N. Y.-Hamb., May 5

Bluecher, N. Y.-Hamburg, May 12

Leyland Line.

Canadian, Boston-Liverpool, May 12

North German Lloyd.

K. Wilhelm II, N. Y.-Bremen, May 4

Barbassou, N. Y.-Med. Pts., May 8

Kp. Wilhelm, N. Y.-Bremen, May 11

White Star.

Majestic, N. Y.-Shampton, May 5

Celtic, N. Y.-Liverpool, May 6

Canopic, Boston-Med. Ports, May 9

NEWS NOTES.

Frankfort, Ky.—F. W. Meyer, formerly florist at the Iowa State College, has taken a lease of the Henry estate.

W. Hartford, Conn.—R. R. Thomson has taken charge of the florist business of his father, the late Paul Thomson.

The floral decorations at the McCann-Goodwin wedding in Albany, N. Y., on April 14, by Amos F. Balfourt, were exceptionally elaborate and somewhat unusual from the fact that yellow was largely used in the color effect.

Memphis, Tenn.—C. H. Hune was given a verdict for \$1,000 damages against Pinkney Latham, Jr., by a jury, on April 15. Mr. Hune, who is manager of the Memphis Floral Company, had accepted five plants for storage from Mr. Latham a year ago last winter. Four were returned in good order but the fifth could not be found, and Latham caused a warrant to be issued charging Mr. Hune with breach of trust. A few hours afterwards Mr. Latham withdrew the warrant and Mr. Hune then filed suit for \$10,000 for false arrest and malicious persecution. The suit was hotly contested by both sides.

ALEX. McCONNELL

571 FIFTH AVENUE
NEW YORK CITY

Telegraphic orders forwarded to any part of the United States, Canada, and all principal cities of Europe. Orders transferred or intrusted by the trade to our selection for delivery on steamships or elsewhere receive special attention.

Telephone Calls, 487 and 488 38th St.

Cable Address, ALEXCONNELL

NEWMAN FLORAL Co.

(Established 1870)

202 Fifth Ave. and
Madison Square, NEW YORK CITY

FLOWERS FOR STEAMER SAILINGS

M. A. BOWE

In the Heart of New York City

1294 Broadway

Tel. 2770, 38th St. NEW YORK

Our Motto—The Golden Rule

DAVID CLARKE'S SONS

Deliver orders from any part of the country to

New York City

Or OUT-GOING STEAMERS

Write or telegraph

2139-2141 Broadway, New York

Telephone 1552-1553 Columbus

YOUNG & NUGENT

42 West 28 St., NEW YORK

"FLOWERS BY TELEGRAPH"

NEW YORK

MYER, FLORIST

Phone 5297 Plaza.

609-611 MADISON AVE.

ALBANY, N. Y.

EYRES

Flowers or Design Work

DELIVERED IN ALBANY AND VICINITY

ON TELEGRAPHIC ORDER.

11 NORTH PEARL ST., ALBANY, N. Y.

Flower Deliveries

In Brooklyn and other Long Island Points
New York City, New Jersey, etc. At Theaters,
Hotels, Steamers or Residences.

WILSON

Fulton St. and Greene Ave., Brooklyn, N. Y.

**DANKER, Albany,
N. Y.**

ORDERS FOR

Choice Flowers and
Floral Emblems

FILLED PROMPTLY

WELLESLEY COLLEGE

Dana Hall, Walnut Hill and Rockridge Hall
Schools. TAILBY, Wellesley, Mass.
Tel. Wellesley 44-1 and 2. Night 44-3.

ATLANTA FLORAL CO.

41 Peachtree
Street, ATLANTA, GEORGIA

FOR MEMORIAL DAY 1909

All the Indispensables as well as the Cream of the Useful and Appropriate Novelties for this, The Florists' "Day of Days."

Memorial Wreaths in Porcelain, Metal, Immortelles, Laurel, Cycas, etc., Inscriptions, Sheaves, etc.

The Best Stock and The Largest Stock Ever Offered.

H. BAYERSDORFER & CO., 1129 Arch Street, PHILADELPHIA, PA.

JOHN BREITMEYER'S SONS

Cor. Miami and Gratiot Aves.
DETROIT, MICH.

Artistic Designs . . .
High Grade Cut Blooms

We cover all Michigan points and good sections of Ohio, Indiana and Canada

BOSTON'S BEST

In Quality and Design

Can be relied upon when you transfer your retail orders to

EDWARD MACMULKIN

194 Boylston Street, Boston

Send flower orders for delivery in

BOSTON

and all

NEW ENGLAND POINTS

THOS. F. GALVIN

124 Tremont St., Boston



TRANSFER

Your orders for flower or plant delivery in Eastern New England to

JULIUS A. ZINN,

2 Beacon St., Boston

FINE DESIGN WORK A SPECIALTY

Orders by Wire Receive Prompt and Careful Execution

J. Newman & Sons

Corporation

24 Tremont Street, BOSTON

Theater, Steamer and Funeral Flowers Our Specialty
We can refer to leading florists in all principal cities.
Established 1870.

LOUISVILLE, KY.

JACOB SCHULZ,

550 South Fourth Ave.

"FLOWERS BY TELEGRAPH."

Leading Retail Florists Listed by Towns for Ready Reference.

Denver, Colo.—Park Floral Co., 1706 Broadway.

Washington, D. C.—Gude Bros., 1214 F St.

Atlanta, Ga.—Atlanta Floral Co., 41 Peach Tree St.

Chicago—Hanswirth, "The Florist," 232 Michigan Ave.

Chicago—William J. Smyth, Michigan Ave. and 31st St.

Chicago—George Wittbold Co., 1657-59 Buckingham Place.

Louisville, Ky.—Jacob Schulz, 550 South Fourth Ave.

Boston—Thos. F. Galvin, 124 Tremont St.

Boston—Edward MacMulkin, 194 Boylston St.

Boston—Hoffman, Florist, 59-61 Massachusetts Ave.

Boston—J. Newman & Sons, Inc., 24 Tremont St.

Boston—Julius A. Zinn, 2 Beacon St.

Wellesley, Mass.—Tally.

Detroit, Mich.—J. Breitmeyer's Sons, Miami and Gratiot Aves.

Kansas City, Mo.—Samuel Murray, 1017 Broadway.

Kansas City, Mo.—Wm. L. Rock Flower Co., 1116 Walnut St.

Albany, N. Y.—H. G. Eyres, 11 N. Pearl St.

Albany, N. Y.—F. A. Danker, 40 Malden Lane.

New York—David Clarke's Sons, 2139-2141 Broadway.

New York—Alex. McConnell, 571 5th Ave.

New York—Young & Nugent, 42 W. 28th St.

New York—M. A. Bowe, 124 Broadway.

New York—Myer, 693-11 Madison Ave.

New York—Newman Floral Co., 202 Fifth Ave. & Madison Sq.

Brooklyn, N. Y.—The Blossom (C. C. Trepel, Mgr.), Bond and Livingston Sts.

Brooklyn, N. Y.—Robert G. Wilson, Fulton St. and Greene Ave.

Buffalo, N. Y.—Palmer's, 304 Main St.

Toronto, Can.—J. H. Dunlop, 96 Yonge St.

BUSINESS CHANGES.

Denver, Colo.—J. Hamlin has taken the business of C. Dankworth.

New York, N. Y.—Gunther Bros. have moved to 110 W. 28th Street.

New Castle, Ind.—Weiland & Olinger have purchased the greenhouses of L. A. Jenning.

Janesville, Wis.—Edward Amerpohl has purchased the greenhouses of Dr. C. G. Wright.

Rockford, Ill.—J. W. Ingalls & Co. have moved their green houses to Lawson street.

Lewiston, Ill.—E. Bearce has purchased the plant of Wm. Jones and will take possession in the fall.

Newport, R. I.—H. J. Hass, florist, has leased a tract of land on Bliss Road for horticultural purposes.

Newcastle, Ind.—Otto Bentley has purchased the half interest of his partner in the Bentley-Coatsworth

Co. \$30,000 is said to be the price paid.

Richmond, Me.—L. B. Billings has purchased the greenhouse of L. B. Dingley and will take possession at once.

Hoopeston, Ill.—Andrew Peterson, florist, has bought out his partner's interest and will continue the business alone.

Mankato, Minn.—E. C. Willard's greenhouse was damaged by fire to the extent of several hundred dollars on April 12.

Santa Clara, Cal.—H. H. Hazleton has succeeded to the business of Hazleton Bros. and is looking for a new location for his greenhouses.

Dés Moines, Ia.—The Lozier Floral Co. has vacated its stand on 518 Walnut street and at last accounts was looking for a desirable down town location.

PHILADELPHIA NOTES.

George L. Pennock, of C. & G. L. Pennock, rose growers, Lansdowne, Pa., left on the 27th ult. on an inspection trip to New York and Boston. Among other places of interest on his program—28th St., Scarborough, Natick and Brighton.

C. M. Keegan, retail florist, 104 13th street, is offering a composition of 25 per cent. to his creditors. Mr. Keegan succeeded the William Graham Co., at the same address. The intention seems to be to settle up the concern on this basis and quit. The alternative of course is the usual legal procedure.

THE BEST LETTERS

FOR THOSE
FLORISTS' R MADE
USE BY THE

Boston Florist Letter Co.

66 PEARL ST., BOSTON

N. F. McCARTHY, Mgr.

Order direct or buy from your local supply dealer. Insist on having the

BOSTON

Inscriptions, Emblems, etc., Always in Stock

**NEW CROP
DAGGER FERNS**
Clean Stock
\$2.50 Per 1000

THE LEO NIESSEN CO.
1209 Arch St., Philadelphia, Pa.
Open from 7 a. m. to 8 p. m.



**Ribbons for Commencements
and Other Social Functions**

Pattern Killarney - Exact Match for the Killarney Rose

No. 7 width, price \$0.65	No. 60 width, price \$2.25
" 16 " " 1.15	" 60 " " 2.75
" 22 " " 1.35	" 150 " " 3.50
" 49 " " 1.75	

Pattern 1614 - Exact Match for the Am. Beauty Rose, shaded effect exactly like the flower.

No. 40 width, price \$2.00 No. 8. width, price \$3.00
Gauze for Shower Bouquets, Chiffons All Widths and Colors. New Combination Ribbons for All Colors of Sweet Peas. Samples on Request.

S. S. PENNOCK-MEEHAN CO.
1608-1620 Ludlow St., Philadelphia

CUT FRONDS
Adiantum Groweanum
\$1 00 per 100 Excellent Value.
W. E. McKISSICK & BROS.
WHOLESALE FLORISTS
1619-1621 RANSTEAD ST.
PHILADELPHIA

CUT FLOWER BOXES
EDWARDS FOLDING BOX CO
MANUFACTURERS
PHILADELPHIA, PA.

CHAS. W. MCKELLAR
51 WABASH AVE., CHICAGO

Western Headquarters for Choice Orchids
Valley, Roses and all Cut Flowers

PETER REINBERG
WHOLESALE
CUT FLOWERS
51 Wabash Av., Chicago, Ill.

Long Distance Phone Central 6004
WINTERSON'S SEED STORE
45-47-49 Wabash Ave., Chicago.

Seedsman, Plantsmen, Nurserymen
Florists' Supplies
We can supply everything used by the Florist. SUPPLY CATALOG FREE. Correspondence solicited.

POEHLMANN BROS. CO.
33-35-37 Randolph St., - CHICAGO
CUT FLOWERS

Greenhouses, - Morton Grove, Ill.

Rice Brothers
P. 115 N. 6th Street, MINNEAPOLIS, MINN.
WHOLESALE FLORISTS and SUPPLIES
CUT FLOWERS received twice daily, and can fill your orders to your satisfaction. A complete line of Hardy Greens - WILD SMILAX, BOXWOOD, HARDY FANCY FERNS, GALAX LEAVES.
Write for quotations on large quantities.

In ordering goods please add "I saw it in HORTICULTURE."

WELCH BROS.
AMERICAN BEAUTY, KILLARNEY, RICHMOND, PARYLAND AND ALL THE SUPERIOR ROSES, LILY OF THE VALLEY, CARNATIONS, ORCHIDS
BEST PRODUCED
226 Devonshire Street, Boston, Mass.

WHOLESALE FLOWER MARKETS—TRADE PRICES—Per 100 TO DEALERS ONLY

	CHICAGO April 26	TWIN CITIES April 26	PHILA. April 27	BOSTON April 29
ROSES				
Am. Beauty, Fancy and Special...	25.00 to 30.00	30.00 to 35.00	20.00 to 30.00	30.00 to 35.00
" " Extra	20.00 to 25.00	25.00 to 30.00	15.00 to 20.00	12.00 to 15.00
" " No. 1	10.00 to 20.00	15.00 to 20.00	10.00 to 15.00	4.00 to 8.00
" " Lower grades	3.00 to 6.00	4.00 to 8.00	3.00 to 8.00	1.00 to 3.00
Bride, 'Maid, Golden Gate, P. & S.	5.00 to 8.00	6.00 to 8.00	10.00 to 15.00	5.00 to 8.00
" " Lower grades	3.00 to 5.00	4.00 to 6.00	3.00 to 8.00	1.00 to 4.00
Killarney, Fau. & Sp.	6.00 to 8.00	7.00 to 10.00	10.00 to 15.00	8.00 to 10.00
" " Lower grades	3.00 to 6.00	5.00 to 7.00	3.00 to 8.00	1.00 to 6.00
Richmond, Fancy & Special	6.00 to 8.00	7.00 to 10.00	12.00 to 20.00	8.00 to 10.00
" " Lower grades	3.00 to 6.00	5.00 to 7.00	3.00 to 10.00	1.00 to 6.00
Chatenay	4.00 to 8.00	4.00 to 8.00	1.00 to 10.00
My Maryland	4.00 to 12.00	6.00 to 10.00
CARNATIONS				
Fancy and Red	3.00 to 3.00	3.00 to 3.00	3.00 to 4.00	3.00 to 3.00
Ordinary and White	1.50 to 2.00	1.50 to 2.00	1.00 to 3.00	1.00 to 1.50
MISCELLANEOUS				
Carthays	60.00 to 75.00	40.00 to 50.00	75.00 to 75.00
Lilies	6.00 to 10.00	8.00 to 12.00	8.00 to 10.00	6.00 to 8.00
Lily of the Valley	3.00 to 4.00	3.00 to 4.00	2.00 to 5.00	2.00 to 4.00
Tulips	2.00 to 3.00	2.00 to 3.00	3.00 to 4.00
Daisies	2.00 to 3.00	3.00 to 3.00	1.50 to 3.00	1.50 to 2.00
Mignonette	5.00 to 8.00	2.50 to 3.00	1.50 to 4.00	1.00 to 4.00
Sweet Peas50 to 1.00	.75 to 1.00	.50 to 1.00	.50 to .75
Gardenias	20.00 to 30.00	25.00 to 35.00	10.00 to 25.00	10.00 to 25.00
Violets50 to 1.00	.75 to 1.00	.25 to .75	.15 to .40
Adiantum	1.00 to 1.50	1.00 to 1.50	.75 to 1.00
Smilax	1.00 to 2.00	1.00 to 2.00	15.00 to 25.00	15.00 to 20.00
Asparagus Plumosus, strings	25.00 to 50.00	35.00 to 50.00	50.00 to 50.00
" " & Sprays (too heavy)	25.00 to 50.00	20.00 to 30.00	35.00 to 50.00	15.00 to 25.00

J.A. BUDLONG
37-39 Randolph Street, CHICAGO.
Roses and Carnations A Specialty.....
WHOLESALE GROWER of **CUT FLOWERS**

HENRY M. ROBINSON & CO.
15 Province St. and 9 Chapman Place - BOSTON, MASS.
WHOLESALE COMMISSION FLORISTS
Hardy Cut Evergreens and Florists' Supplies
We have the stuff and can fill all orders, large or small
WE NEVER DISAPPOINT SATISFACTION GUARANTEED

Prices Quoted in these Columns are for Dealers Only.
When Writing to Advertisers Please Mention HORTICULTURE.

Flower Market Reports.

WHOLESALE FLOWER MARKETS.—PER 100 TO DEALERS ONLY.

BOSTON Much colder weather for the past week has had the effect of retarding the heavy crops that were beginning to overburden this market and conditions are generally much better than at the time we made our last report on the flower situation. Demand has livened up somewhat, prices are more stable and a better feeling prevails all around. Quality was never better. All varieties of roses are being received in fine shape, including high class Carnots from cold houses. Two items are scarce—smilax and lily of the valley. The former is always in short supply in April but the lily of the valley situation is somewhat peculiar. Ever since Easter, it has shown unexpected activity.

The Chicago market is in a normal condition. Large shipments of flowers are coming in and prices consequently low but these low prices have induced buyers to come into the market who do not generally do so. The volume of trade is therefore very large. Business this year has been fully equal to that of last spring. The cold wet weather has held back outdoor stuff and no glut is expected. Beauties are doing exceptionally well. Carnations are in great supply but all really good shipping stock is moved promptly. Mr. Washburn says he is unable to fully meet the demand for the O. P. Bassell carnation. The rose supply is very large. Killarney being in heavy crop, as indeed are most of the varieties. The cold weather has shut off the lilacs that were coming in from southern Illinois. At Washington Heights, just outside Chicago, sweet peas six inches in height were reported frozen on April 25th.

INDIANAPOLIS The week following Easter was a most successful one for all concerned, the growers being well prepared for all demands. The better classes of goods sold well, but there was a noticeable reduction in all grades of roses. American Beauties are in fine quality, the supply equal to demand. Carnations are holding their own but prices have receded somewhat. Bulb stock is on the wane. Sweet peas are handled in great quantities, the quality has never been better. Lily of the valley and orchids appear to be scarce. Lilac and violets are about over for this season. Anything in green goods is to be had at regular prices. Some good mignonette, snapdragon and stocks are seen. The plant growers are now devoting their time to bedding stock, but the planting does not become active till about the tenth of May.

An avalanche of flowers rolled down on Philadelphia last week. Ten times as much as the market could use. The demand was about the usual for this time of year; but was entirely inadequate to make any impression on the mountain of supply. The warm weather from the 17th to the 20th, loosed a regular cataract of flowers of all kinds—the worst that has ever been experienced at same date within

	CINCINNATI April 27		DETROIT April 27		BUFFALO April 27		PITTSBURG April 26	
ROSES								
Am. Beauty, Fan, and Sp.	30.00	to 40.00	25.00	to 35.00	25.00	to 33.00	30.00	to 40.00
" Extra	25.00	to 30.00	20.00	to 25.00	17.00	to 25.00	20.00	to 25.00
No. 1	15.00	to 20.00	15.00	to 20.00	12.50	to 17.00	10.00	to 15.00
" Lower grades	8.00	to 10.00	4.00	to 12.00	5.00	to 8.00	6.00	to 10.00
Bride, "Maid, Golden Gate, F. & S.	6.00	to 8.00	6.00	to 8.00	8.00	to 10.00	8.00	to 10.00
" Low gr.	3.00	to 5.00	4.00	to 6.00	4.00	to 6.00	3.00	to 6.00
Killarney, Fan, & Sp.	9.00	to 10.00	8.00	to 10.00	8.00	to 10.00	6.00	to 8.00
" Lower grades	3.00	to 5.00	4.00	to 6.00	4.00	to 6.00	3.00	to 4.00
Richmond, Fancy & Special	8.00	to 10.00	6.00	to 8.00	8.00	to 10.00	6.00	to 8.00
" Lower grades	4.00	to 6.00	4.00	to 6.00	4.00	to 6.00	3.00	to 4.00
Chateaux	6.00	to 8.00	4.00	to 6.00	6.00	to 8.00	2.00	to 4.00
My Maryland
CARNATIONS								
Fancy and Novelties	2.00	to 3.00	3.00	to 4.00	2.00	to 3.00	2.00	to 3.00
Ordinary	1.00	to 2.00	1.00	to 2.00	1.50	to 2.00	1.00	to 1.50
MISCELLANEOUS								
Cardeyas	to 50.00	60.00	to 75.00	50.00	to 75.00
Lilies	10.00	to 12.00	12.50	to 15.00	8.00	to 15.00	6.00	to 12.00
Lily of the Valley	3.00	to 4.00	3.00	to 4.00	3.00	to 4.00	3.00	to 4.00
Tulips	3.00	to 4.00	2.00	to 3.00	2.00	to 3.00	3.00	to 4.00
Daffodils	2.00	to 3.00	2.00	to 3.00	2.00	to 3.00	to 1.50
Mignonette	2.00	to 4.00	6.00	to 8.00	2.00	to 3.00	2.00	to 3.00
Sweet Peas	5.00	to 5.00	4.00	to 6.00	4.00	to 6.00	2.00	to 4.00
Geraniums	25.00	to 35.00
Violets	.25	to .75	.50	to .75	.30	to .50	.25	to .50
Adiantum	to 1.50	.50	to 1.50	to 1.25
Smilax	10.00	to 12.50	3.00	to 20.00	15.00	to 20.00	3.00	to 20.00
Asparagus Plumosus, strings	15.00	to 40.00	30.00	to 50.00	40.00	to 50.00	30.00	to 50.00
" & Spren. (100 bchs.)	20.00	to 25.00	30.00	to 50.00	25.00	to 50.00	30.00	to 50.00

the memory of the oldest. Quality was all that could be expected. The outlook for this week is more promising. Crops are shortening up a little and a larger number of weddings and other functions for the end of the month are on the cards.

ALBANY NOTES.

A special meeting of the committee of the flower show was held at the store of W. C. King, on Thursday, April 29th.

Visitors at Albany: J. J. Karins, representing Henry A. Dreer, Philadelphia; Ed. Roehrs of the Julius Roehrs Co., Rutherford, N. J.

W. C. Kurth and Ely D. Burke have purchased the store, 518 Broadway, and will open up same about May 1 under the name of the Broadway Florist.

Mr. R. W. Zobel has sold his greenhouses and stock to Fred. Keller who is in the employ of the Julius Roehrs Co., Rutherford, N. J., who will take possession the 15th of May. Mr. Zobel is confined to his home with a severe attack of inflammatory rheumatism.

PERSONAL.

Frank Sealey, of Millbrook, N. Y., has taken a position with Miss C. A. Bliss, New Canaan, Conn.

M. E. Estep, of Chicago, landscape gardener, has opened offices at 407 Mohawk Block, Spokane, Wash.

The recovery of James McKella, secretary of the Florists' Club of Columbus, O., from the operation for appendicitis, is now fully assured.

Visitors in Boston this week: Martin Reukauf, representing H. Bayersdorfer & Co., Philadelphia; A. Zirkman, representing M. Rice & Co., Philadelphia; J. J. Van Waveren, Hillsom, Holland; Andrew Wilson, Summit, N. J.; George C. Watson, Philadelphia, Pa.

NEWS NOTES.

Victoria, B. C.—Fairview Esquimalt Greenhouses, two houses 126 x 205.

Columbus, O.—Wm. Graff has secured a five years' lease of the store room adjoining his present establishment.

Chicago, Ill.—It is said that C. Clemenson intends to erect an up-to-date florists' place on the land he recently acquired at 78th St. and R. R. Ave.

Indianapolis, Ind.—The legislature has recently appropriated a generous sum for the parks and Supt. H. Tall is having a large number of trees, shrubs and perennials set out for the adornment of the city.

Philadelphia, Pa.—Bids for the completion of the park and boulevard plan for League Island Park were received on April 26 by the Department of Public Safety. The present appropriation allows \$500,000 for this project. About \$3,000,000 will have been expended upon this scheme when completed.

Residents of North Abington, Mass., are greatly stirred over the discovery that vandals had slashed and cut off with knives and axes last Monday night, some 1700 young trees belonging to the Bay State Nurseries, the damage amounting to several hundred dollars. The police are working on the case and a special town meeting may be called.

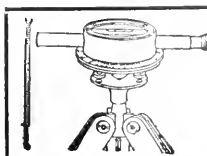

EVERYBODY KNOWS Park, Cemetery and Landscape Gardening cannot be properly done without the aid of an accurate leveling instrument.
 Bostrom's Improved Levels, No. 2 at \$15.00 and No. 3 at \$50.00, are conceded by all who KNOW to be the only Levels on the market which meet all the requirements, at the price.
 Our guarantee back of every Level we sell, and satisfied users in every State to the Union heartily endorse every claim we make.
 Shipping weight 12 lbs. Description on request.
BOSTROM-BRADY MFG. CO., 139 Madison Avenue, ATLANTA, GA.

FORD BROTHERS

48 West 28th Street NEW YORK

FINE ROSES FANCY CARNATIONS

A Full Line of All CUT FLOWERS

Telephone, 3870 or 3871 Madison Square

H. E. FROMENT

Wholesale Commission Florist,
Choice Cut Flowers,

57 West 28th St. :: NEW YORK

Telephones: 2200, 2201, Madison Square.

Alfred H. Langjahr

All choice cut-flowers in season. Send for quotations. Correspondence with shippers of first-class stock invited.

55 West 28th Street, New York

Telephones 4626-4627 Madison Square

Edward C. Horan

Wholesale Florist

55 WEST 28th ST.

tel. 1462 Madison Square New York

JOHN YOUNG

WHOLESALE FLORIST

Finest American Beauties and Carnations

51 West 28 St. - NEW YORK

FRANK MILLANG

Wholesale Florist

55-57 West 26th St., NEW YORK

Shipments, any quantity, Wholesale Market Rates.

Henshaw & Fenrich

WHOLESALE FLORISTS

44 West 28th Street, NEW YORK

Phones Mad. Sq. 325, 558-2, 558-3

VIOLETS

Finest Grade. Any Quantity

B. S. SLINN

55-57 W. 26 St., New York

Moore, Hentz & Nash

Wholesale Commission Florists

55 and 57 West 26th Street

Telephone No. 756
Madison Square

New York

MILLANG BROS.

WHOLESALE COMMISSION FLORISTS

41 West 28th Street

Telephone 3860
3861 Madison

NEW YORK

JOHN I. RAYNOR

Wholesale Commission Florist SELLING AGENT FOR LARGEST GROWERS

A full line of Choice Cut Flower Stock for all purposes. Comprises every variety grown for New York market, at current prices

TEL. 1998 MADISON SQUARE

49 West 28th St., New York City

Walter F. Sheridan

Wholesale Commission Dealer in

CHOICE CUT FLOWERS

39 West 28th Street, New York

Telephone: 3532-3533 Madison Square

HEADQUARTERS FOR NOVELTIES

ORCHIDS A SPECIALTY

THE HIGHEST GRADE OF VALLEY ALWAYS ON HAND

GARDENIAS, DAISIES, ROSES AND CARNATIONS

JAMES McMANUS Telephone 759 Mad. Sq. 42 W. 28th St., New York

PHILIP F. KESSLER

55 & 57 W. 26th St., New York City

Commission Dealer, Wholesale Buyer and Seller of

Open from 5 a. m. to 6 p. m. Sunday till 10 a. m.

Tel., 5243 and 2921 Madison Sq., Res., 345 J., Newtown.

CUT FLOWERS

Finest Lilies in the Market Every Day in the Year.

NEW YORK QUOTATIONS PER 100. To Dealers Only

ROSES AND CARNATIONS

	Last Half of Week ending Apr. 24 1909		First Half of Week beginning Apr. 25 1909	
American Beauty, Fancy and Special.....	15.00	to 25.00	15.00	to 25.00
" " " Extra.....	8.00	to 10.00	8.00	to 12.00
" " " No. 1.....	4.00	to 6.00	4.00	to 6.00
" " " Lower Grades.....	5.00	to 3.00	3.00	to 3.00
Bride, "Held, Golden Gate, Fancy and Special.....	4.00	to 6.00	4.00	to 6.00
" " " Lower Grades.....	1.00	to 2.00	1.00	to 2.00
Killarney, Fancy and Special.....	5.00	to 8.00	5.00	to 8.00
" " " Lower Grades.....	1.00	to 3.00	1.00	to 3.00
Richmond, Fancy and Special.....	6.00	to 12.00	6.00	to 10.00
" " " Lower Grades.....	1.00	to 3.00	1.00	to 3.00
Chafney.....	1.00	to 8.00	1.00	to 8.00
By Maryland.....	1.50	to 10.00	1.50	to 10.00
Carnations, Fancy and Novelties.....	2.00	to 3.00	2.00	to 3.00
" " Ordinary and White.....	1.00	to 1.50	1.00	to 1.50

Alexander J. Guttman

THE WHOLESALE FLORIST OF NEW YORK

34 WEST 28th STREET

PHONES. 1664-1665 MADISON SQUARE

ENOUGH SAID

CENTRALLY LOCATED, THE HUB OF THE FLOWER MARKET SECTION

CHARLES MILLANG

Wholesale Florist

444 Sixth Ave., NEW YORK

Telephone 7062 Madison

GEORGE COTSONAS & CO.

Wholesale and Retail Dealers in all kinds of EVERGREENS

Fancy and Dagger Ferns

Bronze and Green Galax

Main Store 50 W. 28 St.

Phone 1202 Mad. Sq.

New York

GROWERS' CUT FLOWER CO.

CUT FLOWERS AT WHOLESALE

VIOLETS, CARNATIONS, ROSES ORCHIDS, CHRYSANTHEMUMS, LILIES

Consignments Solicited. Shipments to Order, any Distance

39 West 28th Street,

Telephone 3537 Madison Square

NEW YORK

J. J. COAN, Manager

WHOLESALE FLORISTS
54 West 28th St.
NEW YORK
Telephone 3559 Madison Sq.

A. L. YOUNG & CO.

RECEIVERS & SHIP-
PERS OF CUT
FLOWERS.
CONSIGNMENTS SOLICITED.

WILLIAM H. KUEBLER
Brooklyn's Foremost and Best

WHOLESALE COMMISSION HOUSE
A First Class Market for all CUT FLOWERS
28 Willoughby St., Brooklyn, N. Y.
Tel. 4591 Main

Greater New York Florists' Association, Inc.
Now Open for Cut Flower Consignments
162 Livingston Street, BROOKLYN, N. Y.
Geo. W. Crewbuck Telephone Connection
Manager 3642-43 Main

REED & KELLER
122 West 25th St., New York
Florists' Supplies
We manufacture all our
Metal Designs, Baskets, Wire Work & Novelties
and are dealers in
Glassware Decorative Greens and Florists' Requisites

THE KERVAN CO.
Wholesale Dealers and Shippers of
Decorative Evergreens
Ferns, Galax, Laurel, Fresh Cycas, Box-
wood, Sphagnum and all Florists' Greens
Send to us for Quotations before Buying.
113 West 28 Street, NEW YORK CITY

MICHIGAN CUT FLOWER EXCHANGE, Inc.
WHOLESALE COMMISSION FLORISTS
Consignments Solicited
Hardy Fancy Fern Our Specialty
38-40 BROADWAY, DETROIT, MICH.

FOR FLORISTS' USE
There's **NOTHING** as good as
MEYER'S SILKALINE
Don't let them sell you anything else
JOHN C. MEYER & CO., Boston, Mass.

In ordering goods please add "I saw
it in HORTICULTURE."

Order by Name
Krick's Genuine Immortelle Letters, Etc.
The Best and Cheapest. Accept no
Substitute. Every Letter Marked
W. C. KRICK
1164-66 Greene Av., Brooklyn, N. Y.
For Sale by all Supply Houses

Durand & Marohn
MANUFACTURERS OF
All Kinds of Wire Work
Florists' Wire Designs a Specialty
24 Beaver St., ALBANY, N. Y.

Wired Toothpicks
Manufactured by
W. J. COWEE, BERLIN, N. Y.
\$20,000....\$1.75; \$50,000....\$7.50. Sample free.
For sale by dealers

WILLIAM F. KASTING CO.
WHOLESALE FLORISTS

383-387 Ellicott Street
BUFFALO, - N. Y.

ROBERT J. DYSART
Public Accountant and Auditor
Simple methods of correct accounting
especially adapted for florists' use.
Books Balanced and Adjusted
Merchants Bank Building
28 STATE STREET, - BOSTON
Telephone, Main 58.

WHOLESALE COMMISSION 106 W. 28th St
J. K. ALLEN NEW YORK
Open 6 a.m. Daily Tel. 167 Madison Sq
Shipments of Lily of the Valley Needed



NEW YORK QUOTATIONS PER 100. To Dealers Only

MISCELLANEOUS	Last Half of Week ending Apr. 24 1909		First Half of Week beginning Apr. 26 1909	
	per 100	per 100	per 100	per 100
Cattleyas.....	50.00	to 75.00	50.00	to 75.00
LILIES.....	4.00	to 6.00	4.00	to 6.00
Lily of the Valley.....	1.00	to 3.00	1.00	to 3.00
Tulips.....	1.00	to 2.00	1.00	to 2.00
Daffodils.....	1.00	to 2.00	1.00	to 2.00
Mignonette.....	1.00	to 3.00	1.00	to 3.00
Sweet Peas (per 100 bunches).....	2.00	to 6.00	2.00	to 6.00
Gardenias.....	1.00	to 25.00	5.00	to 25.00
Violets.....	.15	to .35	.15	to .35
Adiantum.....	.50	to 1.50	.50	to 1.50
Smilax.....	15.00	to 20.00	15.00	to 20.00
Asparagus Plumosus, strigis.....	15.00	to 25.00	15.00	to 25.00
" & Spreu. (too bche).....	10.00	to 25.00	10.00	to 25.00

NEW YORK MARKET.
Low temperatures and backward weather generally have called a halt on the immense shipments of flowers forced on the wholesale trade by reason of the summery weather of the previous week, and while the situation is by no means ideal, yet it is less discouraging than it was during last week's almost complete stagnation. No fault can be found, as a rule, with the quality of the product at present. What is wanted is more activity in the retail call and a more pronounced willingness on the part of the retailers to give the greenhouse product preference over the garden shrub and tree bloom.

A CURE FOR RED SPIDER.
Mr. E. Ruestow of Barnard's, N. Y., has after many years experimenting, found a cure for Red Spider. His application or remedy is so simple that for a cent or two a whole house may soon be under control, as the writer has seen hundreds of dead spiders on the ground four weeks after applying the remedy. What the composition is, Mr. Ruestow keeps to himself, as he is now trying to interest the government or some society to reimburse him for his trouble and he has nothing to sell, either liquid or solid. The spiders

drop off dead without the aid of syringing, from two to six weeks after treatment. In a paper read before the local Florists' Association, Mr. Ruestow guaranteed to kill spiders by his remedy, and offers to demonstrate to any person the results of his labor. This is the second year of trial and from the writer's view point (I have picked dead spiders from carnation bench and seen the bodies magnified 135 times), it certainly appears very successful.

A. H. SECKER
Rochester, N. Y.
DURING RECESS.
Bowling at St. Paul.

The last tournament between St. Paul and Minneapolis took place at the Swiss Casino at St. Paul, April 22. Minneapolis lost two out of three games. Of the eighteen games rolled during the season St. Paul scored 11 and Minneapolis 7. Total average score, St. Paul, 142.33; Minneapolis, 140.82.

Scores of last match game were as follows:

St. Paul	Minneapolis
Drsinger 195 163 139	Wirth 137 116 121
Hill 164 123 187	Meyer 114 143 145
Hangan 122 110 191	Wihl 144 106 155
Olson 149 132 160	Ruedl'er 145 189 212
Pyrogl 127 147 157	Carlson 126 127 198
725 675 814	666 741 734

Buyer's Directory and Ready Reference Guide

Advertisements under this head, one cent a word. Initials count as words.

Display advertisers in this issue are also listed under this classification without charge. Reference to List of Advertisers will indicate the respective pages.

Buyers failing to find what they want in this list will confer a favor by writing us and we will try to put them in communication with reliable dealers.

ACCOUNTANT

R. J. Dyrant, 28 State St., Boston.
For page see List of Advertisers.

ALYSSUM

Sweet Alyssum, Little Gem, 2½ in., \$1.50 per 100. A. B. Campbell, Cochransville, Pa.

AMPELOPSIS.

Storrs & Harrison Co., Palmesville, O.
Eastern Nurseries, Henry F. Dawson, Mgr., Ampelopsis Quinquefolia, Jamaica Plain, Mass.
For page see List of Advertisers.
C. Elsele, 11th and Westmoreland Sts.,
For page see List of Advertisers.

AQUATIC PLANTS

Aquarium plants the year round. Wholesale and retail. Send for price list. Schmid's Emporium of Pets, 712 12th Street, Washington, D. C.

Choice hardy water lily roots, red, white, pink and yellow. Write for prices. W. J. Richards, Wayland, Ohio.

AQUILEGIA

Aquilegia. Gennole Coerulea, finest of all. Both plants and seeds from the heart of the Rockies. C. S. Harrison's Select Nursery, York, Neb.

ARAUCARIAS

A. Leuthy & Co., Perkins St. Nurseries, Roslindale, Mass.
For page see List of Advertisers.
Godfrey Aschmann, 1012 West Ontario St., Philadelphia, Pa.
For page see List of Advertisers.

ASPARAGUS SEED

S. S. Pennock-Meehan Co., Philadelphia. For page see List of Advertisers.
H. F. Michell Co., Philadelphia.
For page see List of Advertisers.
Asparagus Thimosis Nains Seeds, any quantity, 20c. per 100; \$2.00 per 1000; \$5.75 per 5000. Peter Mack, Orlando, Fla.

ASTERS.

Asters, 2 to 2½ in. high, \$8.00 per 1000. Only the choicest colors and kinds included in the collection. H. J. Blanchard, Ashburnham, Mass.

ASTER SEED

Elmer D. Smith & Co., Adrian, Mich.
For page see List of Advertisers.
H. F. Michell Co., Philadelphia, Pa.

AUCTION SALES

Owens's Horticultural Co., 62 Vesey St., New York.
For page see List of Advertisers.

AUTOMATIC CIRCULATOR

W. W. Castle Co., 170 Summer St., Boston.
For page see List of Advertisers.

AZALEAS

A. Leuthy & Co., Perkins St. Nurseries, Roslindale, Mass.
For page see List of Advertisers.
Godfrey Aschmann, 1012 W. Ontario St., Philadelphia.
For page see List of Advertisers.

BAMBOO CANES

Yokohama Nursery Co., 31 Barclay Street, New York.
Bamboo Sticks, Colored Green.
For page see List of Advertisers.

BAY TREES.

2000 Bay and Box Trees in all sizes. Pyramid and Standards. Write for list. Julius Roehrs, Rutherford, N. J.

BEDDING PLANTS

J. E. Feltthouse, Schenectady, N. Y.
For page see List of Advertisers.
A. Leuthy & Co., Perkins St. Nurseries, Roslindale, Mass.
For page see List of Advertisers.
G. Aschmann, 1012 W. Ontario St., Philadelphia, Pa.
For page see List of Advertisers.
J. C. Schmidt, Bristol, Pa.
For page see List of Advertisers.
Thomas Roland, Nahant, Mass.
Begonia Gloire De Lorraine.
For page see List of Advertisers.

Salvia, 2½ to 3 in. high, 1½c. each. Cuban scandens, 2½ in., 2c. each. 50 Asparagus Sprenger, 5 in., nice plants, 25c. each. H. J. Blanchard, Ashburnham, Mass.

Vine, variegated, finest stock, heavy and long, \$10 and \$12.50 per 100. R. C. S. A. Nutt geraniums, fine, \$10 per 1000. R. C. Golden Glow, \$4 per 100. Cash. Bellamy Bros., 207 Delaware St., Syracuse, N. Y.

Geraniums S. A. Nutt, extra fine plants from 4 in. pots at 6c. Asparagus Sprenger, from 4 in. pots at 6c. Satisfaction guaranteed. Brant Bros., Inc., Utica, New York.

BOILERS

BOILERS. "Burnham" Boilers made for greenhouse heating. Lord & Burnham, 1183 Broadway, N. Y.

Kroeschel Bros. Co., 35 Erie St., Chicago.
For page see List of Advertisers.

BOXWOOD TREES

New England Nurseries, Inc., Bedford, Mass.
For page see List of Advertisers.

BUILDING MATERIAL

BUILDING MATERIAL of all descriptions for All Cypress, Senglers, Iron Frame or Truss Houses. Hot Bed Sash and Frames. Lord & Burnham Co., 1183 Broadway, N. Y.

BULBS AND TUBERS

Joseph Breck & Sons, 47-54 N. Market St., Boston.
For page see List of Advertisers.
J. M. Thornburn & Co., 33 Barclay St., New York.
For page see List of Advertisers.

A. T. Boddington, 342 W. 14th St., N. Y.
For page see List of Advertisers.
Rickards Bros., 37 East 19th St., New York.
For page see List of Advertisers.

H. F. Michell Co., Philadelphia.
For page see List of Advertisers.
H. E. Flake Seed Co., Faneuil Hall Sq., Boston.
For page see List of Advertisers.

T. J. Grey & Co., 32 and 33 So. Market St., Boston.
For page see List of Advertisers.

Yokohama Nursery Co., 31 Barclay St., New York.
For page see List of Advertisers.
Ralph M. Ward & Co., 12 W. Broadway, New York.
For page see List of Advertisers.

Schlegel & Fottler Co., 26 & 27 S. Market St., Boston.
Begonias, Gloxinias, Tuberoses.
For page see List of Advertisers.

CANNAS

A. T. Boddington, 342 W. 14th St., New York.
For page see List of Advertisers.
C. Elsele, 11th and Westmoreland Sts., Philadelphia, Pa.
For page see List of Advertisers.

J. H. Dann & Son, Westfield, N. Y.
For page see List of Advertisers.
Cannus, King Humbert, 3 in., \$6.00 per 100. Louisiana variegated plants, \$2.50 per 100. A. B. Campbell, Cochransville, Pa.

CARNATIONS

F. Dorner & Sons Co., Lafayette, Ind. Carnation, Winona.
For page see List of Advertisers.

Chicago Carnation Co., Juliet, Ill. For page see List of Advertisers.

Albert Roper, Tewksbury, Mass. Carnation Bay State.
For page see List of Advertisers.

Wood Bros., Fishkill, N. Y. Carnations, Rooted Cuttings.
For page see List of Advertisers.

The E. G. Hill Co., Richmond, Ind. Carnation Cuttings.
For page see List of Advertisers.

S. J. Reuter & Son, Westery, R. I. For page see List of Advertisers.

Poehlmann Bros. Co., Morton Grove, Ill. For page see List of Advertisers.

CEMENT BENCHES

E. H. Hunt, 76-78 Wabash Av., Chicago.
For page see List of Advertisers.

CHRYSANTHEMUMS

E. G. Hill Co., Richmond, Ind. For page see List of Advertisers.
S. J. Reuter & Son, Westery, R. I. For page see List of Advertisers.

C. H. Totty, Madison, N. J. Single Chrysanthemums From Seed.
For page see List of Advertisers.

J. H. Myers, Altona, Pa. For page see List of Advertisers.

Wood Bros., Fishkill, N. Y. Chrysanthemums Rooted Cuttings.
For page see List of Advertisers.

Scott Bros., Elmsford, N. Y. For page see List of Advertisers.
Poehlmann Bros. Co., Morton Grove, Ill. For page see List of Advertisers.

Elmer D. Smith & Co., Adrian, Mich. Special Offer of Commercial Chrysanthemums.

For page see List of Advertisers.
100 commercial varieties, including Pompon and Hairy, \$12.50 per 100. Satisfaction guaranteed. Wm. Ehmann, Jr., Cortu, N. Y.

Chrysanthemum Golden Glow from 2 1/4 in. pots, for early spring delivery, \$1.00 per doz., \$6.00 per 100, \$50.00 per 1000. Stock plants of Montmort, Oct. Frost, Crocus, Matchless, Lucy Devaux, Polly Rose and Hailday, \$1.00 per doz., \$6.00 per 100. Peirce Bros., Waltham, Mass.

Herrington's book on the Chrysanthemum, mailed to your address for 50c., by Horticulture Publishing Co., 11 Hamilton Place, Boston.

Golden Glow and Pacific Supreme, the best early yellow and pink forms. R. C. \$3 per 100, prepaid; 2 1/4 in. pots, \$4; 25 at 100 rates. Chas. Frost, Kenilworth, N. J.

CLEMATIS

5000 Clematis paniculata, extra strong, out of 2 in. pots, \$2 per doz. 3 in. pots, \$3 per 100. If not satisfactory will return your money. Samuel V. Smith, 3223 Goodman St., Philadelphia, Pa.

For List of Advertisers See Page 651

COAL FOR GREENHOUSE USE

Bader Coal Co., Bond of Trade Bldg., Boston.
For page see List of Advertisers.

COLEUS

J. E. Felthousen, Schenectady, N. Y.
For page see List of Advertisers.

A. Leuthy & Co., Perkins St. Nurseries, Roslindale, Mass.
For page see List of Advertisers.

For Sale, Coleus, ten choice sorts, including Verschaffeltii and Golden Belder, from 2 1/2 in. pots, at \$1.75 per hundred, \$15.00 per thousand. Edmund Reardon, Cambridge A. Mass.

CONIFERS

John Waterer & Sons, Ltd., American Nursery, Bagshot, Eng.
For page see List of Advertisers.

CUT FLOWER BOXES.

Edwards Folding Box Co., Philadelphia
For page see List of Advertisers.

Folding cut flower boxes, the best made Write for list. Holton & Hunzel Co., MD wauke, Wis.

CYCAS STEMS

Yokohama Nursery Co., 31 Barclay St., New York.
For page see List of Advertisers.

Special offer of Cycas Stems, true long leaved variety. Stems range in weight from 1/2 lb. to 10 lbs. Price, 40 to 50 lbs. at 75c.; 100 lbs., at 7c.; case lots of 300 lbs., at 61c. We have the stems and will grade to your liking. Johnson Seed Co., 217 Market St., Philadelphia, Pa.

DAHLIAS

David Herbert & Son, Atco, N. J.
For page see List of Advertisers.

J. L. Moore, Northboro, Mass.
For page see List of Advertisers.

Peacock Dahlia Farms, Williamstown Junction, N. Y.
For page see List of Advertisers.

R. Vincent Jr. & Sons Co., White Marsh, Md.
For page see List of Advertisers.

DAHLIA BULBS, 50 cents per dozen. All varieties listed below at 5 cents each, or 50 cents per dozen; if to be sent by mail, 75 cents per dozen.

CACTUS VARIETIES: Beatrice, Bertha Mawley, Bridesmaid, Brumhilde, Captain, Camels Gem, Dankward, Dr. Jameson, Earle of Pembroke, Fire Brand, Frost Glass, General Butler, Gabriel, Galliard, Island, Queen, John Roche, J. P. Clark, Kriemhilde, Lovely, Lady Eud Talbot, Mary Service, Matchless, Montefiore, Mrs. Chas. Turner, Mrs. Bennett, Mrs. Jewett, Mr. Moore, St. Catherine, Queen Wilhelmina, Starry Crown, Star Fish, Sparkler, Jauldier, Volker, Wieland.

SHOW VARIETIES: A. D. Livoni, Arabella, Amazon, Beauty, Bird of Passage, Dawn of Day, Fascination, Dr. J. P. Kirkland, Girldstone, Golden Age, Hannah Holland Pink, Keystone, Lulu, Mary D. Hallowell, M. La Nille, Modesty, Mary Belle, Mrs. Frowning, Mrs. Cleveland, Mrs. Dexter, Orator, Penelope, Peri, Rob. Bromfield, Startler, Wm. Rollins, White Swan.

DECORATIVE VARIETIES: Atlanta, American Flag, Beauty of Brentwood, Black Prince, Countess of Pembroke, Dolly, Eloise, Frank Bassett, Jumbo, Lady Allington, Lucille, Maid of Kent, Nymphia, Princess Christian Progress.

Above stock is held grown, sound and true to name. Catalogue free to all. C. Peirce, Dighton, Mass.

DAHLIAS.

Geo. H. Walker, No. Dighton, Mass.
Wholesale and Retail.
*Send your name for my 1909 Catalog and Pocket Guide, ready to mail about Feb. 25th.

Cactus, Decorative, Fancy, Show and Pompon Dahlias. Good commercial varieties, such as Kriemhilde, Countess of Londonderry, Mad. Van Den Driessche, other sure bloomers, strong divided roots in 10 or 20 named varieties no selection, \$1.00 per 25; \$3.00 per 100; \$25.00 per 1000. Cash please. Hermann Thiemann, Merion, Mass.

DAHLIAS—Continued

Dahlia. Novelties and standard varieties, true to name, a choice list of the best introductions. Send for catalog of dahlias, bollylocks, hardy plants. Price always reasonable. W. W. Wilmore, Box 382 Denver, Colo.

The Dahlia-Peacock—Mailed for 30 cents by Horticulture, 11 Hamilton Place, Boston.

DECORATIVE PLANTS

A. Leuthy & Co., Perkins St. Nurseries, Roslindale, Mass.

Imported Plants for Cash Delivery.
For page see List of Advertisers.
Godfrey Aeschmann,
1012 W. Ontario St., Phila., Pa.
For page see List of Advertisers.

Joseph Heacock Co., Wyncote, Pa.
For page see List of Advertisers.

The Geo. Wittbold Co., 1637 Buckingham Place, Chicago, Ill.
For page see List of Advertisers.

Robert Craig Co., Market and 49th Sts., Philadelphia, Pa.
For page see List of Advertisers.

DRACAENAS

J. H. Dann & Son, Westfield, N. Y.

EVERGREENS

New England Nurseries, Bedford, Mass.
For page see List of Advertisers.

American Nursery Co., 150 Broadway, New York, N. Y.
For page see List of Advertisers.

Evergreens. Send 25 cents in stamps for complete work on propagating and growing Evergreens. C. S. Harrison's Select Nursery, York, Neb.

FERNS

A. Leuthy & Co., Roslindale, Mass.
For page see List of Advertisers.

H. H. Barrows & Son, Whitman, Mass.
Nephrolepis Magnifica.
For page see List of Advertisers.
John Scott, Brooklyn, N. Y.
For page see List of Advertisers.

Frank Oechslin, 2570-2600 W. Adams St., Chicago.
Ferns for Diabec.
For page see List of Advertisers.

The Geo. Wittbold Co., 1637 Buckingham Place, Chicago, Ill.
For page see List of Advertisers.

Godfrey Aeschmann, 1012 W. Ontario St., Philadelphia.
For page see List of Advertisers.

C. Eisele, 11th and Westmoreland Sts., New York.
For page see List of Advertisers.

Rose Hill Nurseries, New Rochelle, N. Y.
Ferns for Jauldier.
For page see List of Advertisers.

J. H. Dann & Son, Westfield, N. Y.
Anderson's ferns for in and outdoors. Largest commercial collection in the country. Ask for descriptive catalogue. J. P. Anderson, Fern Specialist, Short Hills, N. J.

FERTILIZERS

Pulverized Manure Co., 31 Union Stock Yards, Chicago, Ill.
Wizard Brand Sheep and Shredded Cattle Manure.

Bowker Fertilizer Co., Boston, Mass.
All Forms of Plant Food at First Hands.
For page see List of Advertisers.

German Kall Works, 93 Nassau St., New York.
Potash Fertilizer.

Wm. Elliott & Sons, 42 Vesey St., New York.
Sheep Manure.
For page see List of Advertisers.

FEVERFEW

2000 Feverfew from 2 1/2 in. \$3.00 per 100, \$25.00 per 1000. Albert Batley & Son, Maynard, Mass.

Feverfew, 3/4 in. \$3.00 per 100, 4 in. \$5.00 per 100. H. J. Blanchard, Ashburnham, Mass.

FLORAL PHOTOGRAPHS

Floral Photographs, Foley's, 223-228 1-2 Bowery, New York.

FLORISTS' LETTERS.

Boston Florist Letter Co., 66 Pearl St., Boston, Mass.
For page see List of Advertisers.

FLORISTS SUPPLIES

N. F. McCarthy & Co., 84 Hawley St., Boston.
For page see List of Advertisers.

H. M. Robinson & Co., 15 Province St. and 9 Chapman Pl., Boston, Mass.
For page see List of Advertisers.

Reed & Keller, 122 W. 25th St., New York.
For page see List of Advertisers.

M. Bayersdorfer & Co., 1129 Arch St., Philadelphia.
For page see List of Advertisers.

A. Herrmann, 404-412 E. 34th St., New York.
Metal Floral Designs for Decoration Day.

FLOWER POTS

W. H. Ernest, 28th and M Sts., Washington, D. C.
For page see List of Advertisers.

A. H. Hews & Co., Cambridge, Mass.
For page see List of Advertisers.

Hilfinger Bros., Ft. Edward, N. Y.
For page see List of Advertisers.

The Peters & Reed Pottery Co., Red pots, seed pans, etc. Zanesville, O.

Syracuse Pottery Co., Syracuse, N. Y.
Syracuse Red Pots.
For page see List of Advertisers.

We make Standard Flower Pots, etc. Write us when in need. Wilmer Cope & Bro. Lincoln University, Chester Co., Pa.

FLOWER POT HANDLE

W. C. Krick, 1164-66 Greene Av., Brooklyn, N. Y.

FRUIT TREES

Dwarf Fruit Trees, by F. A. Waugh, mailed to your address for 55 cents by Horticulture Publishing Co., 11 Hamilton Place, Boston.

FUCHSIAS

R. Vincent, Jr. & Sons Co., White Marsh, Maryland.
For page see List of Advertisers.

GALAX

Michigan Cut Flower Co., 38 and 40 Broadway, Detroit, Mich.
For page see List of Advertisers.

George Cotsouas & Co., 50 W. 25th St., New York.
For page see List of Advertisers.

The Kerran Co., 113 West 23th St., N. Y.
For page see List of Advertisers.

Rice Bros., 115 N. 6th St., Minneapolis, Minn.
For page see List of Advertisers.

H. M. Robinson & Co., 15 Province St. and 9 Chapman Place, Boston.
For page see List of Advertisers.

GARDEN HOSE

Revere Rubber Co., Boston, Mass.
For page see List of Advertisers.

GARDENIAS

Miss A. Washington, Alvin, Texas.
For page see List of Advertisers.

GERANIUMS

R. Vincent Jr. & Sons Co., White Marsh, Md.
New and Standard Varieties.
For page see List of Advertisers.

Mrs. Sallerol, 2 in. \$2.00 per 100; \$18.00 per 1000; or will exchange for Beacon Carnations and Cannas. Wm. Doel, Pascoag, R. I.

Geraniums, large plants, bud and bloom, out of 3 1/2 in. pots. S. A. Nutt and others. \$7.00 per 100; cash. Stephen Chase, Nashua, N. H.

Geraniums in bud and bloom, S. A. Nutt, Buchner, etc. All stock out of 2 1/2 in. pots. \$6.00 per 100. Cash with order. Leonard Cousins, Jr., Concord Junction, Mass.

In writing to Advertisers kindly mention Horticulture

GLADIOLI

J. L. Moore, Northboro, Mass.
For page see List of Advertisers.
E. S. Miller, Wading River, N. Y.
For page see List of Advertisers.
O. V. Zaegen, Hoboken, N. J.
Gladolus Brenclyenensis.
For page see List of Advertisers.

GLASS

Boston Plate & Window Glass Co., Boston.
For page see List of Advertisers.
Standard Plate Glass Co., 26-30 Sudbury St., Boston.
For page see List of Advertisers.
Foley Mfg. Co., Western Ave., between 25th & 26th Sts., Chicago.
For page see List of Advertisers.
Sharp, Partridge & Co., 22d & Lumber St., Chicago.
For page see List of Advertisers.
Greenhouse glass, lowest prices. Johnston Glass Co., Hartford City, Ind.
Glass, High Grade, Double Thick Greenhouse Glass. Lord & Burnham, 1133 Broadway, N. Y.

GLAZING DEVICE

H. A. Dreer, Philadelphia, Pa.
Peerless Glazing Point.
For page see List of Advertisers.
GLAZING POINTS, Lord & Burnham
Special Glazing Nails (Points). Lord & Burnham, 1133 Broadway, N. Y.

GREENHOUSE BUILDING MATERIAL

Lord & Burnham Co.,
1133 Broadway, New York.
For page see List of Advertisers.
Pierson U-Bar Co., 1 Madison Sq., N. Y.
For page see List of Advertisers.
A. T. Stearna Lumber Co., Neponset, Boston.
For page see List of Advertisers.
King Construction Co., N. Tonawanda, New York.
For page see List of Advertisers.
Hitchings & Co., 1170 Broadway, New York.
For page see List of Advertisers.
J. C. Moulger Co., 117 East Blackhawk St., Chicago, Ill.
For page see List of Advertisers.
Foley Mfg. Co., Western Ave., between 25th & 26th Sts., Chicago.
For page see List of Advertisers.

GREENHOUSE CONSTRUCTION

GREENHOUSE CONSTRUCTION, Semi-Iron Greenhouse, New Truss Houses and Iron Frame Houses. Lord & Burnham, 1133 Broadway, N. Y.
J. A. Payne, 260-274 Culver Ave., Jersey City, N. J.
For page see List of Advertisers.
Foley Mfg. Co., Western Ave., between 25th & 26th Sts., Chicago.
For page see List of Advertisers.
Hitchings & Co., 1170 Broadway, New York.
For page see List of Advertisers.
Geo. M. Garland Co., Des Plaines, Ill.
For page see List of Advertisers.

GREENHOUSE HOSE

Revere Rubber Co., Boston, Mass.
Revere Hose.
For page see List of Advertisers.

GUTTERS

GUTTERS, Cast Iron Gutters, L. & B. Improved V Shaped Gutter with drip gutter attachment. Lord & Burnham, 1133 Broadway, N. Y.

HEATING APPARATUS

Lord & Burnham Co.,
1133 Broadway, New York.
For page see List of Advertisers.
Pierson U-Bar Co., 1 Madison Sq., N. Y.
For page see List of Advertisers.
John A. Payne, 260-274 Culver Ave., Jersey City, N. J.
For page see List of Advertisers.
Kroeschell Bron. Co., 35 Erie St., Chicago.
For page see List of Advertisers.

HAIL INSURANCE

Florists' Hill Assn. of America.
J. G. Esler, Saddle River, N. J.
For page see List of Advertisers.

HARDY FERNS, MOSS AND GREENS

H. M. Robinson & Co., 15 Province St. and 9 Chapman Pl., Boston, Mass.
For page see List of Advertisers.
Michigan Cut Flower Exchange,
38 and 40 Broadway, Detroit, Mich.
For page see List of Advertisers.
George Cotnam & Co., 50 W. 28th St., New York.
For page see List of Advertisers.
N. F. McCarthy & Co., 84 Hawley St., Boston.
For page see List of Advertisers.
The Kervan Co., 113 W. 28th St., N. Y.
For page see List of Advertisers.
Rice Bros., 115 N. 6th St., Minneapolis, Minn.
For page see List of Advertisers.

HELP FURNISHED

Thos. H. Bambrick, 34 S. 7th St., Phila.
For page see List of Advertisers.

HERBACEOUS PERENNIALS

P. Ouwkerk, P. O. No. 1, Hoboken, N. J.
For page see List of Advertisers.
New England Nurseries, Bedford, Mass.
For page see List of Advertisers.
The Geo. Wittbold Co., 1657 Buckingham Place, Chicago.
For page see List of Advertisers.
William Tricker, Arlington, N. J.
For page see List of Advertisers.

HOT-BED SASH

The A. T. Stearna Lumber Co., Neponset, Mass.
For page see List of Advertisers.
Pierson U-Bar Co., 1 Madison Sq., N. Y.
For page see List of Advertisers.
Lord & Burnham Co., 1133 Broadway, N. Y.
For page see List of Advertisers.
Foley Mfg. Co., Western Ave., between 25th & 26th Sts., Chicago.

INSECTICIDES.

Nicotide kills all greenhouse pests.
F. R. Falchoppe Co.,
Eleventh St., Owensboro, Ky.
For page see List of Advertisers.
Stunpp & Walter Co., 50 Barclay St., New York.
Kilmdead Tobacco Dust.
For page see List of Advertisers.
Niagara Sprayer Co., Middleport, N. Y.
Niagara Brand,
For page see List of Advertisers.
B. G. Pratt Co., New York.
Sulfochide.
For page see List of Advertisers.
Bowker Insecticide Co., Boston, Mass.
Insect Destroying Preparations.
For page see List of Advertisers.
Wm. Cooper & Nephews, 177 Hinds St., Chicago; Cyril Franklin, 62 Beaver St., New York, Agt.
V 1 Fluid.
For page see List of Advertisers.

Eastern Chemical Co., Pittsburg St., Boston.
"IMP" Soap Spray.

"The Fumigating Kind Tobacco Powder"—The first on the market and the kind that has so many imitators, has our guarantee tag of satisfaction or money back, and "The Moon Trade Mark" on every bag, \$3.00 per 100 lbs. The H. A. Stoothoff Co., Mount Vernon, N. Y., Makers and sellers.

JAPANESE PLANTS

Yokohama Nursery Co., 31 Barclay St., New York.
For page see List of Advertisers.

KENTIAS

Godfrey Aschmann,
1012 W. Ontario St., Phila., Pa.
For page see List of Advertisers.
A. Leuzy & Co., Roslindale, Mass.
For page see List of Advertisers.
Jos. Heacock Co., Wynote, Pa.
Single and Made-Up Specimens.
For page see List of Advertisers.

LEVELS FOR LANDSCAPE GARDENING USE.

Bostron-Brady Mfg. Co., 189 Madison Ave.,
Atlanta, Ga.
For page see List of Advertisers.

LILY OF THE VALLEY PIPS

Hjalmar Hartmann & Co., 12 Stormgade,
Copenhagen, Denmark.
For page see List of Advertisers.

MADEIRA VINES

E. S. Miller, Wading River, N. Y.
For page see List of Advertisers.

MASTICA

F. O. Pierce Co., 12 W. Broadway, New York.
For page see List of Advertisers.

NICO-FUME

Kentucky Tobacco Product Co.,
Louisville, Ky.

NURSERY STOCK

John Waterer & Sons, Ltd.,
American Nursery, Bagshot, England.
For page see List of Advertisers.
Cleary's Horticultural Co., 62 Vesay St.,
New York.
For page see List of Advertisers.
P. Ouwkerk, 216 Jane St., Weehawken Heights, N. J.
For page see List of Advertisers.
Eastern Nurseries, Jamaica Plain, Mass.
Viburnum Mollis.
For page see List of Advertisers.
American Nursery Co., 150 Broadway, New York, N. Y.
For page see List of Advertisers.
Storrs & Harrison Co., Painesville, O.
For page see List of Advertisers.
C. R. Burr & Co., Manchester, Conn.
Dontzia Paeonias, Weigelia, Privet.
P. A. Keene, 1 Madison Av., New York.
Rhododendron Hybrids, Maximum, Maples,
New York, Privet.
Maurice J. Brinton, Christiansa, Pa.
Norway Spruce.
For page see List of Advertisers.
Manual of the Trees of North America,
by C. S. Sargent, mailed to your address
for \$6.00, by Horticulture Publishing Co.,
11 Hamilton Place, Boston.

TREES, SHRUBS, ROSES, EVERGREENS, PEONIES, HARDY PLANTS, ELLWANGER & BARRY, Rochester, N. Y.

New Hardy Shrub—Buddleia variabilis Vetchii and Magnifica, the summer flowering Lilac, 50c. each; \$5.00 per doz.; \$25.00 per 100. Rose Illini Nurseries, New Rochelle, N. Y. Privet.

Catalog now ready. Nursery grown evergreens, seedling white pine and hemlock, native trees and plants. L. E. Williams, Nottingham, N. H.

OLD-FASHIONED GARDEN FLOWERS

Wm. Tricker, Arlington, N. J.
For page see List of Advertisers.

ONION SEED

Federico C. Varela, Tenerife, Canary Ids.
Bermuda Onion Seed.

ORCHID PLANTS

Lager & Hurrell, Summit, N. J.
For page see List of Advertisers.
Sander, St. Albans, England.
Importers, Exporters, Growers, Hybridists.
For page see List of Advertisers.
Carrillo & Balduino, Seacaucus, N. J.
For page see List of Advertisers.
Jos. A. Manda, 191 Valley Road, W. Orange, N. J.
For page see List of Advertisers.
Ordouez Bros., Madison, N. J., Box 106.
Cattleya Mossiae.
For page see List of Advertisers.
G. L. Freeman, 388 Appleton St., Holyoke, Mass.
Orchid Importations.
For page see List of Advertisers.
Largest stock in the country. Ask for prices. Julius Roehrs, Rutherford, N. J.

For List of Advertisers See Page 651

PAINT AND PUTTY

PAINT AND PUTTY: Ideal Greenhouse lead; Special Greenhouse Putty. Lord & Burnham, 1133 Broadway, N. Y.

PALMS

A. Leuty & Co., Perkins St. Nurseries, Roslindale, Mass.

For page see List of Advertisers.

Robert Craig Co., Market and 49th Sts., Philadelphia, Pa.

For page see List of Advertisers.

Joseph Hancock Co., Wroctote, Pa. Home-Grown Palms.

For page see List of Advertisers.

Geo. Witthold Co., 1657 Buckingham Place, Chicago.

For page see List of Advertisers.

PANSY PLANTS.

J. C. Schmidt, Bristol, Pa. For page see List of Advertisers.

Giant Pansy Plants, stocky, from fall-sown seed, 50c. per 100, prepaid; \$3.50 per 1000, not prepaid. Chas. Frost, Kenilworth, N. J.

Fansies, large, field grown, transplanted plants, very choice colors, \$10.00 per 1000. Cash. Stephen Chase, Ashua, N. H.

PATENTS

Siggers & Siggers, Washington, D. C. For page see List of Advertisers.

PEAT

Orchid Peat and Moss always on hand. Julius Roehrs Co., Rutherford, N. J.

PEONIES

Peonies only, by the wholesale—best 100 varieties. J. F. Rosenfield, Westport, Nebr. One of the finest collections in America. Send 25 cts. in stamps for new edition of Peony Manual. C. S. Harrison's Select Nursery, York, Neb.

PENTSTEMONS

C. H. Totty, Madison, N. J.

PHLOXES

Send 25 cts in stamps for Phlox Manual Fine mixed phloxes \$2.00 per 100. C. S. Harrison's Select Nursery, York, Neb.

PHOTOGRAPHS: DESIGNING: ILLUSTRATING

Geo. E. Dow, 178 Washington St., Boston. For page see List of Advertisers.

PIPE AND FITTINGS

Foley Mfg. Co., between Western Ave. and 26th St., Chicago, Ill.

Kroeschell Bros. Co., 35 Erie St., Chicago. For page see List of Advertisers.

PIPE AND FITTINGS. Cast Iron and Wrought Pipe, Valves, Elbows, Pipe Hooks, Automatic Air Headers, etc. Lord & Burnham, 1133 Broadway, N. Y.

PLANT STAKES

Seele's Tiesee Plant Stakes and Trellises. H. D. Seele & Sons, Elkhart, Ind.

POT HANGERS

Pot hangers, Kramer's \$1 doz. by exp. \$1.25 by mail. I. N. Kramer & Son, Cedar Rapids, Ia.

Krick's Perfect Pot Hanger and Handle. W. C. Krick, 1164-1166 Greene Ave., Brooklyn, N. Y.

POINSETTIAS (Artificial)

Poinsettias, artificial decorations our specialty. Sample lots of 50 in 3 sizes, \$4.00; 100 lots, \$6, \$8, \$10. J. Stern & Co., 125 N. 10th St., Philadelphia, Pa.

PRIVET

California Privet, well rooted cuttings, \$4.00 per 1000; 1 year old, \$10.00 per 1000. A. B. Campbell, Cochranville, Pa.

RAFFIA

Raffia (colored), 20 beautiful shades. Samples free. R. H. Comey Co., Camden, N. J.; 810 Washburn Ave., Chicago, Ill.

RESURRECTION PLANTS

Resurrection plants and cacti. Cheap. Ask for prices. William Tell, Austin, Tex.

RHOODOENDRONS

John Waterer & Sons, Ltd., American Nursery, Bagshot, England.

For page see List of Advertisers.

P. Ouwerkerk, Hoboken, N. J. For page see List of Advertisers.

Storrs & Harrison Co., Painesville, O.

ROSES

Robert Craig Co., Market and 49th Sts., Philadelphia, Pa.

For page see List of Advertisers.

P. Ouwerkerk, P. O. No. 1, Hoboken, N. J. For page see List of Advertisers.

Julius Roehrs Co., Rutherford, N. J. Rose Newport Fairy.

For page see List of Advertisers.

The F. R. Pierson Co., Tarrytown-on-Hudson, N. Y.

White Killarney. For page see List of Advertisers.

S. J. Reuter & Son, Westery, R. I. My Maryland. For page see List of Advertisers.

Dingee & Conard Co., West Grove, Pa. For page see List of Advertisers.

Storrs & Harrison Co., Painesville, O. For page see List of Advertisers.

Scott Bros., Elmsford, N. Y. For page see List of Advertisers.

Poehlmann Bros. Co., Morton Grove, Ill. For page see List of Advertisers.

A. N. Pierson, Cromwell, Conn. White Killarney, My Maryland, Ramblers. For page see List of Advertisers.

Montrose Greenhouses, Montrose, Mass. White Cherokee Rose.

For page see List of Advertisers.

The Rose, by H. B. Ellwanger; mailed for \$1.30 by Horticulture, 11 Hamilton Place, Boston.

Hand Book of Cultural Notes on Roses Under Glass, by F. P. Brigham, mailed to your address for 25c. by Horticulture Publishing Co., 11 Hamilton Place, Boston.

Grafted rose plants, Brides and Bridesmaids, extra large, strong, healthy plants, 1800 in 3 1/2 and 4-in. pots, \$12.00 per 100; 900 in 2 1/2 in. pots, \$10.00 per 100. Cash with order. Apply, W. S. Wilson Estate, Wellesley, Mass.

SALVIAS

R. Vincent, Jr. & Sons Co., White Marsh, Maryland.

Salvia Bonfire and Zurich. For page see List of Advertisers.

Salvia splendens, 2 1/2 in., \$1.75 per 100. A. B. Campbell, Cochranville, Pa.

SEED GROWERS

Hjalmar Hartmann & Co., Cauliflower and Cabbage Seed.

12 Stromgade, Copenhagen, Denmark. For page see List of Advertisers.

Federico C. Varela, Tenerife, Canary Ids. Bermuda Onion Seed.

SEEDS

T. J. Grey Co., 32 So. Market St., Boston. For page see List of Advertisers.

Joseph Breck & Sons, 51 and 52 N. Market St., Boston, Mass. For page see List of Advertisers.

W. Atlee Burpee & Co., Philadelphia. For page see List of Advertisers.

Arthur T. Boddington, 342 W. 14th St., New York.

For page see List of Advertisers.

H. E. Flske Seed Co., Faneuil Hall Sq., Boston.

For page see List of Advertisers.

Hjalmar Hartmann & Co., 12 Stromgade, Copenhagen, Denmark, Cauliflower and Cabbage Seed.

For page see List of Advertisers.

Rickarda Bros., 37 E. 19th St., New York. For page see List of Advertisers.

SEEDS—Continued

R. & J. Farquhar & Co., 67 So. Market St., Boston.

Mignonette Seed. For page see List of Advertisers.

H. F. Michell Co., 1018 Market St., Phila. For page see List of Advertisers.

J. M. Thorburn & Co., 33 Barclay St., N. Y. For page see List of Advertisers.

Leonard Seed Co., Chicago, Ill. For page see List of Advertisers.

Wm. Elliott & Sons, 42 Vesey St., N. Y. New Seed. For page see List of Advertisers.

Schlegel & Fottler Co., 26 & 27 S. Market St., Boston.

For page see List of Advertisers.

O. V. Zangen, Hoboken, N. J. Florists' Spring Seeds.

For page see List of Advertisers.

E. F. Waterson Co., Chicago. Seeds for Plantmen, Nurserymen, Seedmen.

For page see List of Advertisers.

Seeds. Rocky Mountain Evergreen seeds in large or small quantities. C. S. Harrison's Select Nursery, York, Neb.

SHRUBS

The Geo. Witthold Co., 1657 Buckingham Place, Chicago.

For page see List of Advertisers.

SILKALINE

John C. Meyer & Co., Boston, Mass. For page see List of Advertisers.

SMILAX

R. Vincent, Jr. & Sons Co., White Marsh.

SOLUBLE PLANT FOOD

Eastern Chemical Co., Boston, Mass. For page see List of Advertisers.

SPHAGNUM MOSS

Live Sphagnum moss, orchid peat and orchid baskets always on hand. Lager & Hurrell, Summit, N. J.

Sphagnum moss and mountain laurel in bags, bales or car lots. Prices low. Spruce and hemlock in bales. James Day, Box 660, Milford, N. H.

SPRAYERS

Niagara Sprayer Co., Middleport, N. Y. For page see List of Advertisers.

Chas. J. Jager Co., Boston. Deming Spray Pump.

For page see List of Advertisers.

STEAM TRAP

E. Hippard, Youngstown, O.

STOCKS

J. H. Myers, Altoona, Pa. For page see List of Advertisers.

STRAWBERRY PLANTS

H. L. Crane, Westwood, Mass.

300 Strawberry Plants \$1. Your selection. List free. Wm. Perry, Cool Spring, Del.

SULFOCIDIE

The B. G. Pratt Co., 59 Church St., Dept. W., New York City.

For page see List of Advertisers.

SULPHUR BURNER

Benj. Dorrance, Rose Growers, Dorrance-ton, Pa.

For page see List of Advertisers.

SWEET PEAS

A. C. Zvolnsnek, Round Brook, N. J. Winter Flowerlog.

For page see List of Advertisers.

TO-BAK-LINE

E. H. Hunt, Genl. Agt., 70-73 Wabash Av., Chicago.

For page see List of Advertisers.

In writing to Advertisers kindly mention Horticulture

TUBEROSSES

Tuberoses. Extra quality Double Pearl Tuberoses, clean, large bulbs 4-6 inches in circumference, 50c. per 100; \$6 per 1000; 5000 for \$27.50. Johnson Seed Co., 217 Market St., Philadelphia, Pa.

VEGETABLE PLANTS

R. Vincent, Jr. & Sons Co.,
White Marsh, Md.
For page see List of Advertisers.

VEGETABLE SEEDS

Just arrived, our reliable vegetable seeds. Buy your fresh seeds now. These are guaranteed fresh and only first class seeds. The Reliable Seed House, 156 Third Street, Hoboken, N. J.

VENTILATING APPARATUS

Pleason U-Bar Co., 1 Madison Sq., N. Y.
For page see List of Advertisers.

Poley Mfg. Co., Western Ave., between
25th & 26th Sts., Chicago.
For page see List of Advertisers.

John A. Payne, 230-274 Culver Ave., Jersey
City, N. J.
For page see List of Advertisers.

The Advance Co., Richmond, Ind.
For page see List of Advertisers.

Quaker City Machine Co., Richmond, Ind.
20th Century Ventilating Arm.
For page see List of Advertisers.

VENTILATING MACHINERY, New
Model encased, self-rolling gear; Standard
Model Open Gear. Lord & Burnham, 1183
Broadway, N. Y.

VERBENAS

Verbenas, 2 1/2 to 3 in. high, 1c. each.
Best varieties to be got, all desirable colors.
H. J. Blanchard, Ashburnham, Mass.

Lemon Verberna, R. C., 75c. per 100. pre-
paid. Chas. Frost, Kenilworth, N. J.

J. C. Schmidt, Bristol, Pa.
For page see List of Advertisers.

VINCAS

Vinca Yara, rooted plants, 75c. per 100.
A. B. Campbell, Cochranville, Pa.

VIOLETS.

William Slim, Cliftondale, Mass.
Boston and Princess of Wales Violets.
For page see List of Advertisers.

Good, strong California Violets, \$1.00 per
100, \$8.00 per 1000. Chas. M. Allen, 608
Broadway, Fall River, Mass.

Princess Violets, 2 1/2 in., \$2.00 per 100.
Jas. T. Baker, Bustleton, Philadelphia, Pa.

WAX FLOWERS

We are originators of wax designs and
still the standard concern, J. Stern & Co.,
125 N. 10th St., Philadelphia, Pa.

WEED KILLER

The American Horticultural Distributing
Co., Martinsburg, W. Va.
Target Brand.
For page see List of Advertisers.

WIRED TOOTHPICKS

W. J. Cowee, Berlin, N. Y.
For page see List of Advertisers.

WIREWORK

Reed & Keller, 122 W. 25th St., N. Y.
For page see List of Advertisers.

Durand & Marohn, Albany, N. Y.
For page see List of Advertisers.

Wirework. Write for our catalogue.
Holton & Hunkel Co., Milwaukee, Wis.

William E. Heilscher's Wire Works, 38-40
Broadway, Detroit, Mich.

Wirework—Compare our prices with
others. Scranton Florist Supply Co., 201
N. 7th St., Scranton, Pa.

WHOLESALE FLORISTS
Boston

N. F. McCarthy & Co., 84 Hawley St.,
Boston.
For page see List of Advertisers.

H. M. Robinson & Co., 75 Province St.
and 9 Chapman Pl., Boston.
For page see List of Advertisers.

WHOLESALE FLORISTS—**Continued**

Welch Bros., 226 Devonshire St., Boston.
For page see List of Advertisers.

Taitby, Wellesley, Mass.
For page see List of Advertisers.

Buffalo, N. Y.

William F. Kasting Co., 383-87 Elliott St.,
Buffalo, N. Y.
For page see List of Advertisers.

Chicago

Chas. W. McKellar, 51 Wabash Ave.,
Chicago.
For page see List of Advertisers.

Peter Reinberg, 51 Wabash Ave., Chicago.
For page see List of Advertisers.

E. F. Winterson Co., 45-40 Wabash Ave.,
Chicago.
For page see List of Advertisers.

J. A. Budlong, 37-39 Randolph St., Chicago.
For page see List of Advertisers.

Poehlmann Bros. Co., Morton Grove, Ill.
For page see List of Advertisers.

Cromwell, Conn.

A. N. Pierson, Cromwell, Conn.
For page see List of Advertisers.

Detroit

Michlgan Cut Flower Exchange, 38 and 40
Broadway, Detroit, Mich.
For page see List of Advertisers.

Minneapolis

Rice Bros., 115 N. 6th St., Minneapolis,
Minn.
For page see List of Advertisers.

New York

Ford Bros., 48 W. 28th St., New York.
For page see List of Advertisers.

H. E. Froment, 57 W. 28th St., New York.
For page see List of Advertisers.

Alex. J. Gutman, 34 W. 23th St., New
York.
For page see List of Advertisers.

M. C. Moran, 55 W. 28th St., New York.
For page see List of Advertisers.

A. H. Langjahr, 55 W. 28th St., New York.
For page see List of Advertisers.

James McManus, 42 W. 28th St., New York.
For page see List of Advertisers.

John I. Raynor, 49 W. 28th St., New York.
For page see List of Advertisers.

W. F. Sheridan, 39 W. 28th St., New York.
For page see List of Advertisers.

Moore, Heutz & Nash, 55 and 57 W. 26th
St., New York.
For page see List of Advertisers.

Wm. H. Knebler, 28 Willoughby St.,
Brooklyn, N. Y.
For page see List of Advertisers.

Philip F. Kessler, 55 and 57 W. 26th St.,
New York.
For page see List of Advertisers.

Milang Bros., 41 W. 28th St., New York.
For page see List of Advertisers.

John Young, 51 W. 28th St., New York.
For page see List of Advertisers.

Greater New York Florists' Association,
162 Livingston St., Brooklyn, N. Y.,
For page see List of Advertisers.

Frank Milang, 55-57 W. 26th St., New
York.
For page see List of Advertisers.

B. S. Simon, 55-57 W. 26th St., New York.
For page see List of Advertisers.

A. L. Young & Co., 54 W. 28th St., N. Y.
For page see List of Advertisers.

Growers' Cut Flower Co., 39 W. 28th St.,
New York.
For page see List of Advertisers.

Henshaw & Fenrich, 44 W. 28th St.,
New York.
For page see List of Advertisers.

J. K. Allen, 106 W. 28th St., New York.
For page see List of Advertisers.

Charles Milang, 44 Sixth Av., New York.
For page see List of Advertisers.

WHOLESALE FLORISTS—**Continued****Philadelphia**

W. E. McKlesick & Bros., 1619-1621 Bas-
stead St., Philadelphia, Pa.
For page see List of Advertisers.

Leo Niessen Co., 1209 Arch St., Philadel-
phia, Pa.
For page see List of Advertisers.

The S. S. Pennock-Meehan Co., 1608-18
Ludlow St., Philadelphia, Pa.
For page see List of Advertisers.

WOODENWARE

Bacon & Co., Appleton, N. Y.
Baskets; Crates; Ladders; Boxes.
For page see List of Advertisers.

New Offers in This Issue.**BEDDING PLANTS.**

Geo. A. Kuhl, Pekin, Ill.
For page see List of Advertisers.

BEDDING PLANTS: CANNAS.

R. Vincent, Jr. & Sons Co., White Marsh,
Maryland.
For page see List of Advertisers.

**CARNATIONS FOR IMMEDIATE
DELIVERY.**

F. Dörner & Sons Co., La Fayette, Ind.
For page see List of Advertisers.

CARNATION SHASTA.

Bair & Smith, 38th & Senate Sts., Indian-
apolis, Ind.
Patten & Co., Tewksbury, Mass.
For page see List of Advertisers.

**DOUBLE LOBELIA: MOONVINES,
ESTC.**

C. Elsele, 11th & Westmoreland Sts., Phila.
For page see List of Advertisers.

**GIANT ASPARAGUS AND RHU-
BARB.**

Warren Shinn, Woodstown, N. J.
For page see List of Advertisers.

GLASS.

Parshelsky Bros., Inc., 59 Montrose Av.,
Brooklyn, N. Y.
For page see List of Advertisers.

**HARDY CLIMBERS: FIELD GROWN
RAMBLERS.**

Henry A. Dreer, 714 Chestnut St., Phila.
For page see List of Advertisers.

IMMORTELE LETTERS.

W. C. Kreck, 1164-66 Greene Ave., Brook-
lyn, N. Y.
For page see List of Advertisers.

IMPERIAL PLANT FOOD.

Eastern Chemical Co., Pittsburgh, Pa.,
Boston.
For page see List of Advertisers.

MEMORIAL DAY SUPPLIES.

H. Bayersdorfer & Co., 1129 Arch St.,
Philadelphia.
For page see List of Advertisers.

PALM SEED.

A. T. Boddington, 342 W. 14th St., New
York.
For page see List of Advertisers.

PAYNE "P" BAR GREENHOUSES.

John A. Payne, 230-274 Culver Av., Jersey
City, N. J.
For page see List of Advertisers.

PRIMUM SEED.

H. F. Mitchell Co., Philadelphia.
For page see List of Advertisers.

**RIBBONS FOR COMMENCEMENTS
AND SOCIAL FUNCTIONS.**

S. S. Pennock-Meehan Co., Philadelphia.
For page see List of Advertisers.

SHELF BRACKETS.

King Construction Co., N. Tonawanda, N. Y.
For page see List of Advertisers.

TESTED BOILERS.

W. W. Castle Co.,
170 Sumner St., Boston, Mass.
For page see List of Advertisers.

For List of Advertisers See Page 651

LIST OF ADVERTISERS

Advance, The Co.	563
Allan J. K.	561
American Nursery	561
(Eog.)	561
American Nursery Co.	564
Achmann Godfrey	567
Athana Floral Co.	560
Bacon & Co.	539
Bader Coal Co.	565
Bambrick Thos. H.	561
Barrows H. H. & Son	535
Barn, Smith & Co.	537
Bayersdorfer H. & Co.	541
Blossom The	540
Bodding A. T.	538
Boston Florist Letter	541
Co.	541
Boston Plate and Wla	541
Low Glass Co.	564
Bostrom-Brady Mfg.	543
Co.	543
Bowe, M. A.	530
Bowler Fertilizer Co.	539
Bowler Insecticide	543
Co.	543
Broek Joseph & Son	539
Brumbyer's J. Sons	541
Bridgeman's Seed	539
Warehouse	539
Brinton, Maurice J.	524
Budwig, J. A.	542
Burpee W. A. & Co.	539
Carrillo & Baldwin	535
Castle W. W. Co.	553
Chicago Carnation	543
Clark's David Sons	540
Clary's Horticult' Co	524
Coan J. J.	544
Cooper, Wm. & Nep	543
Lawrence	552
Cotoasas Geo. & Co.	544
Cowce W. J.	545
Craig, Robt. Co.	535
Crawback Geo. W.	545
Daker F. A.	540
Dawson H. S.	524
Dudge & Conrad Co.	524
Dorner F. Sons & Co.	524
Dorrance Benj.	552
Dow Geo. E.	539
Dreer H. A.	537-55
Dunlop John H.	540
Durand & Maroh.	545
Dysart R. J.	545
Eastern Chemical Co.	552
Eastern Nurseries	524
Edwards Folding Box	542
Co.	542
Eisele C.	555
Elliot Wm & Sons	539
Elmsford Nurseries	522
Ester J.	553
Ernest W. H.	553
Eyles	540
Farquhar R. & J. & Co.	539
Falkonson J. E.	535
Fiske H. E. Seed Co.	539-552
Foley Mfg. Co.	564
Ford Bros.	564
Freeman G. L.	564
Fromet H. E.	544
Galvin Thos. F.	541
Garland, Geo. M. Co.	555
German Kalm Flowers	553
Greater N.Y. Florists	553
Association	545
Grey T. J. Co.	539
Growers' Cut Flower	543
Co.	543
Gude Bros. Co.	540
Hallman Alex. J.	544
Hall Asso.	563
Hartmann Hjalmar & Co.	539
Hauswirthke Florist	549
Hancock Jos. Co.	535
Henshaw & Fenrich	543
Herbert David & Son	543
Hews A. H. & Co.	524
Hilfinger Bros.	563
Hill, The E. G. Co.	522
Hitchings & Co.	556
Hoffman	541
Honan E. C. Co.	524
Hunt E. H.	534-552
Jager, Chas. J. Co.	552
Kasting W. F. Co.	545
Kernan The Co.	544
Kessler, P. F.	564
King Cons. Co.	555
Krick W. C.	545
Kroschell Bros. Co.	555

Kuebler Wm. H.	545
Kuhl Geo. A.	537
Lager & Hurrell	535
Langjahr, Alfred H.	544
Leonard Seed Co.	539
Leuchs A. & Co.	544
Lord & Buraham Co.	526
Manda Jos. A.	535
MacMullen E. A.	541
McCarthy N. F. & Co.	545
McCConnell Alex.	540
McKellar Charles W.	542
McKisick, W. E. & Bros.	542
McManus Jas.	544
Meyer	540
Meyer J. C. & Co.	545
Michell H. F. Co.	538-552
Michigan Cut Flower Exchange	545
Millang Bros.	544
Millang Charles	544
Millang Frank	544
Miller E. S.	537
Moninger J. C.	555
Montross Green	539
Moore, J. L.	532
Moore, Heatz & Nash	544
Murray Samuel	539
Myers, J. H.	532
New Eog. Nurseries	524
Newman Floral Co.	540
Newman J. & Sons	541
Niagara Sprayer Co.	552
Niesse Leo. Co.	542
Oechsli Frank	535
Ordonez Bros.	535
Ouwerkkerk P.	524
Paithorpe P. R. Co.	552
Palmer W. J.	540
Park Florist Co.	540
Parshley Bros.	554
Payoe John A.	554
Peacock Dabbia Farms	522
Pennock-Meehan Co.	526-542
Perkins St. Nurseries	535
Pierce, F. O. Co.	553
Pierson, A. N.	529
Pierson F. R. Co.	523
Pierson U Bar Co.	556
Poehlmann Bros. Co.	522-542
Pratt B. G. Co.	552
Quaker City Mach. Co.	555
Raynor, I. M.	522
Raynor John L.	544
Rice & Keller	545
Reinberg Peter	542
Reuter S. J. & Son	522
Revers Rubber Co.	554
Rice Bros.	542
Rickards Bros.	539
Robison H. M. & Co.	542
Rock Wm. L. Flo. Co.	54
Roehrs Julius Co.	523-535
Roper Albert	532
Roland, Thomas	527
Rolker August & Sons	553
Rose Hill Nurseries	535
Saader & Son	535
Schlegel S. Fötter Co.	539
Schmidt J. C.	537
Schulz Jacob	542
Scott Bros.	522
Scott, John	535
Shay Partridge & Co.	554
Sheridan W. F.	544
Shinn Warren	556
Siggers & Siggers	535
Sims, Wm. J.	535
Situations & Waots	551
Silvan B. S.	544
Smith Elmer D. & Co.	522
Smith W. J. Co.	553
Standard Plate Glass Co.	554
Stearns A. T. Lumber Co.	539
Stump & Walter Co.	552
Syracuse Pottery Co.	553
Tailby	540
Target Brand	552
Thorburn J. M. & Co.	539
Torty Chas. H.	522
Trepe C. J.	540
Tricker, Wm.	524
Valentine, J. A.	540
Vincent R. J. & Sons	524-539

WANTS, FOR SALE, ETC.
 Advertisements in this column one cent a word. Initials count as words. Cash with order. All correspondence addressed "Horticulture" should be sent to 11 Hamilton Place, Boston.

HELP WANTED

GOOD MEN

When you need good men, skilled or unskilled, Write:

THOS. H. BAMBRICK

34 South 7th Street Philadelphia

Help of all kinds, including that for Florists, Nurserymen, Seedsmen and the Horticultural trade generally.

WANTED FOR PRIVATE ESTATE

Foreman, with good knowledge of general greenhouse work, vegetables and general routine work; single, strictly sober and ambitious. Englishman or Scotchman preferred. Good wages to right man. Give full particulars first letter. WM. H. GRIF-FITHS, Box 448 Lake Forest, Ill.

FOR SALE

Greenhouse Men Attention.

FOR SALE—About 100 acres with 900 ft. frontage on the C. & N. W. R. Main Line West, at Winfield. Land south slope to Spring Brook, extra fine black soil for outdoor planting, and the best location for a Spring House near Chicago. The distance from Wells Street Depot is 27 miles. It is out in the clear air, away from the Chicago smoke, and is an ideal spot for this purpose. Price now this tract is only \$2000. Will sell 5 or 10 acres. Go out with us and see it. Vandercok & Skidmore, Owners, 108 Le Salle Street, Chicago.

FOR SALE—A fine estate situated on high ground at Park Mass., near Milton. Two minutes from R. R. station, fifteen minutes to Boston. House, 14 rooms and bath, all conveniences. Corner lot, 47,375 ft. land, fruit and shade trees. Greenhouse, 118 x 33, built 1908, 6 on sides, 16 centre, 16 x 24 glass. Good opening for commercial florist. Address A. G. Chickering, 53 State St., Boston.

GREENHOUSE property for sale, 3 houses, built year ago, 4000 sq. ft. glass; hot water heated to 85 deg.; 2 acres best land. Modern house of 8 rooms and bath; barn 25 ft sq. Everything first-class. Chas. L. Pierce, Holbrook, Mass.

FOR SALE—Special 16 x 18 and 16 x 24 double thick glass "A" and "B" qualities. Buy now and save money. Write PARSHLEY BROTHERS, INC., 59 Montrose Ave., Brooklyn, N. Y.

MISCELLANEOUS WANTS

WANTED TO BUY—Complete green house plants and all kinds of greenhouse material, to be taken down and removed at once. Terms cash. Address I. Suesserman, 229 Livingston St., Newark, N. J.

WANTED TO BUY—Greenhouses and dwelling house in good repair with 3 acres or more of land, within 20 miles of Boston. Address 16 Bedford St., Lexington, Mass.

WANTED—One Pandanus Urtis, large plant; state size and price. Scott Bros., Elmsford, N. Y.

SITUATIONS WANTED

SITUATION WANTED—Gardener, married, German, 20 years' experience, wants a position. Address H. Traue, care F. Drake, Florist, Pittsfield, Mass.

DON'T EXPERIMENT
USE
TO-BAK-INE

and your stock will be free from insects, clean, and the blooms will not be discolored.

Send for full information of

H. E. FISKE SEED CO.
13 Faneuil Hall Sq., Boston, Mass.

STUMPP & WALTER CO.,
50 Barclay St., New York.

HENRY F. MICHELL & CO.,
1018 Market St., Philadelphia.

E. H. HUNT, Gen'l Agent,
76-78 Wabash Ave., Chicago.

IMPERIAL Plant Food

All soluble and available.

Average Official Analysis:

Nitrogen..... 13%
Phos. Acid..... 23%
Potash..... 27%

63%

EASTERN CHEMICAL CO.
Pittsburg Street, Boston, Mass.

KILMDEAD
The best of all the tobacco dusts for
Dusting or fumigating



25 lbs. \$1.00 100 lbs. \$ 3.00 1000 lbs. \$27.50
50 lbs. 1.75 500 lbs. 14.00 2000 lbs. 52.50

Stump & Walter Co. 50 Barclay St. New York.

COOPER'S SPRAY FLUIDS

LATEST DISCOVERY

Progressive Growers Investigate
32 page Booklet of British, American and Canadian Testimony free for the asking

Eastern Agent - CYRIL FRANKLYN
62 Beaver St., New York, N. Y.

Sole Proprietors
WILLM. COOPER & NEPHEWS
177 Illinois Street, CHICAGO

THIS KILLS MILDEW EVERY TIME



FOR PARTICULARS WRITE
Benjamin Dorrance
ROSE GROWERS
Dorranceton, Penna.

In ordering goods please add "I saw it in HORTICULTURE."

Which Spray Pump

shall you buy? Buy the Spray Pump that fully meets the demands of the Government Agricultural Scientists and all practical Fruit Growers. These pumps are widely known as

DEMING SPRAYERS
and are made in 23 styles for use in small gardens or immense orchards. Write for our 1909 catalog with Spraying Chart. Add 4 cents postage and receive "Spraying for Profit," a useful guide book.

CHARLES J. JAGER CO.
281-285 Franklin St., Boston



TARGET BRAND Weed Killer



Sold at retail by a thousand of seed houses and dealers. Special price on quantities to parks and cemeteries.

TARGET BRAND, Box 732, Martinsburg, W. Va.

"Every Bug Has His Dose."

Insect-destroying preparations that do their work well and effectively are the cheapest. Bowker's Arsenate of Lead and Bowker's Pyrox are recognized standard insecticides and fungicides for both indoor and outdoor use. Bowker's Insect Emulsion destroys many kind of plant lice, black and green flies, etc. Call or send for catalogue.

BOWKER INSECTICIDE COMPANY
43 CHATHAM ST. BOSTON

The Best Bug Killer and Bloom Saver



NICOTINIC BUG KILLER

For PROOF Write to
P. R. Paethorpe Co.
OWENSBORO, KY.

SOMETHING NEW for GREENHOUSES
"SULFOCIDÉ"
PRATT'S
SOLUBLE SULPHUR SUMMER SPRAY

Non-caustic and non-irritating
A FUNGICIDE AND INSECTICIDE
FOR FRUIT TREES, VEGETABLES and GREENHOUSES

A promising substitute for Bordeaux mixture. For 10 cts. to cover postage will send sample sufficient for one gallon of spray.
Use 1 part to 75 or 100 parts of water.

B. G. PRATT CO., 50 Church St., New York, U. S. A.

In ordering goods please add "I saw it in HORTICULTURE."

For Trees, Plants, Shrubs and Flowers
USE
THE NIAGARA BRAND LIME SULPHUR SOLUTION

It destroys Scale Lice, Spiders and all forms of Aphides, AT THE SAME TIME Mildew, Blight, Rust and other Fungus difficulties.

Used in Winter or Summer — No other remedy has been so universally effective.

Niagara Brand ARSENATE OF LEAD for chewing insects is equal to the best and better than the most Ask about our Green House sprayer. Address —

NIAGARA SPRAYER CO., - - Middleport, N. Y.

In writing to Advertisers kindly mention Horticulture

THE CASTLE BOILER

Don't Take Any Chances of having the labor and earnings of years wiped out in a moment by operating a dangerous heating system. We furnish Steel-plate, tested Boilers, built to order under our specifications. We have many that have been in use for past three years and upon request will be pleased to furnish testimonials to any who are contemplating rebuilding or making additions to their heating plants. We are confident we can show such an economy in first cost, reliability, and above all in expense of operation as will appeal to the good business sense of any contemplating new construction or remodeling what has been in use. It is never troublesome to us to promptly reply to inquires and our steady aim is to be of assistance to our customers by way of advice and estimates.

We can also furnish Cast Iron Boilers of recognized high efficiency.

For forced circulation nothing has yet been produced to equal the **AUTOMATIC CIRCULATOR**. Its economy and absolute reliability have been demonstrated wherever it has been installed. Read testimonial of Thomas Roland in last week's issue of Horticulture, page 593.

W. W. CASTLE CO., 170 Summer Street, Boston, Mass.

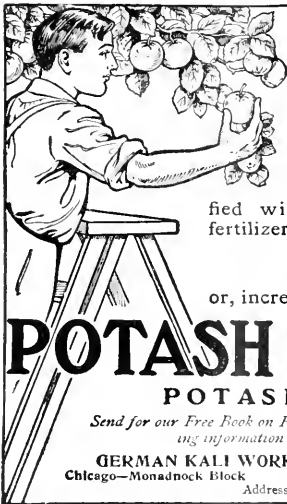

Flavor and Flesh

are the aim of the fruit grower. The flavor should be rich and the flesh firm and solid. To secure the best of both is the mark of highest success in horticulture.

If you have not been satisfied with results heretofore, try a fertilizer with more

POTASH

or, increase the Potash in the low-grade goods by adding Sulfate of Potash or Muriate of Potash.

POTASH

POTASH IS PROFIT

Send for our Free Book on Fertilizing, prepared by experts and containing information indispensable to horticulturists.

GERMAN KALI WORKS, 93 Nassau Street, New York
Chicago—Monadnock Block Atlanta—Candler Building
Address Office Nearest You.

CYPRESS SASH BARS
82 feet or longer
HOT BED SASH
PECKY CYPRESS BENCH LUMBER

GREENHOUSES

ERECTED AND EQUIPPED COMPLETE IF DESIRED

Write for Circular "D" and Prices

The A. T. STEARNS LUMBER CO.
NEPONSET, BOSTON, MASS.

The Advance Ventilating Apparatus

THE ADVANCE MACHINE is the simplest, strongest and most easily operated machine on the market. Takes care of all that the shading pipe will carry. Double Strength Pipe . 8c Single Strength Pipe . 5c all pointed, drilled, straightened and furnished with our Patent Couplings—best thing on earth for this work. Get our estimates now, see what our customers say. We guarantee satisfaction.

The Advance Co.
RICHMOND, IND.

Mastica is elastic and tenacious, admits of expansion and contraction. Putty becomes hard and brittle. Broken glass more easily removed without breaking of other glass as occurs with hard putty. Lasts longer than putty. Easy to apply.

Syracuse Red Pots

STANDARD SIZES

Florists, we will suit you as to quality and prices. Write for catalogue.

Syracuse Pottery Co., SYRACUSE, N. Y.

STANDARD FLOWER POTS

Packed in small crates, easy to handle.

Price per crate		Price per crate	
1500 2 in. pots in crate	\$4.38	144 6 in. pots in crate	\$3.16
1500 2 1/2 " " "	5.25	120 7 " " "	4.00
1000 3 " " "	6.00	60 8 " " "	3.00
800 3 1/2 " " "	5.80	HAND MADE	
500 4 " " "	4.50	48 9 in. pots in crate	\$3.60
450 4 1/2 " " "	5.24	48 10 " " "	4.80
200 5 " " "	4.54	24 11 " " "	4.80
210 5 1/2 " " "	3.78	6 10 " " "	4.50

Send pails, same price as pots. Send for price list of Cylinders for Cut flowers, Hanging Baskets, Lawn Vases, etc. Ten per cent. off for cash with order. Address **Hilfinger Bros., Pottery, Fort Edward, N. Y.** August Rolker & Sons, Agts. 31 Barclay St., N. Y. City.

Standard Flower . . . POTTS

If your greenhouses are within 500 miles of the Capital, write us, we can save you money

W. H. ERNEST

26th and M Street WASHINGTON D. C.

The FLORISTS' HAIL ASSOCIATION OF AMERICA, insurer of 29,000,000 sq. ft. of glass. For particulars address:

John C. Esler, Sec'y, Saddle River, N. J

In ordering goods please add "I saw it in HORTICULTURE."

PATENTS

Trademarks and Copyrights

Send your business direct to Washington Saves time and insures better service. Personal attention guaranteed. Twenty-five years' active service. SPECIALTY: "Working on the Failure of Others."

SIGGERS & SIGGERS
PATENT LAWYERS
Box 9, National Union Building
Washington, D. C.

Anything of Value to the profession CAN BE SOLD through advertising in Horticulture

REVERO

THE MODERN GARDEN HOSE FOR LAWNS, GARDENS, GREENHOUSES, STABLES, ETC.

BRAIDED FABRIC, MOULDED CONSTRUCTION, SEAMLESS THROUGHOUT

LIGHT—STRONG—FLEXIBLE

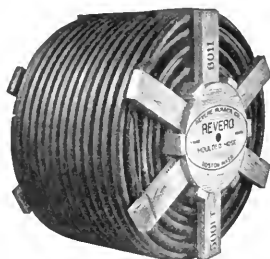

Revero is furnished on Reels in Continuous Lengths up to 500 ft. Your Supply House can furnish "Revero."

Write for Catalog



OLD STYLE—READILY KINKS



REVERO—NON KINKING

**REVERE RUBBER COMPANY
BOSTON, MASS.**

NEW YORK
NEW ORLEANS

PHILADELPHIA
MINNEAPOLIS

PITTSBURG
SAN FRANCISCO

CHICAGO
PORTLAND, ORE.

STANDARD PLATE GLASS CO.

Manufacturers—Importers—Jobbers

NOW IS THE TIME TO BUY

FRENCH OR AMERICAN GREENHOUSE GLASS

LOWEST PRICES ON REQUEST

26-30 Sudbury St. BOSTON, MASS. 61-63 Portland St.

BOSTON PLATE & WINDOW GLASS CO.

GREENHOUSE GLASS GERMAN AND AMERICAN

261 to 287 A Street

BOSTON

20 to 22 Canal Street

GLASS Always Write Us Before Buying
SHARP, PARTRIDGE & CO.
22nd and Lumber Streets, CHICAGO
WE HAVE SOME SNAPS

GLASS

Greenhouse and Hot Bed

SIZES OUR SPECIALTY
IMMENSE STOCK

Plate and Window Glass

Write for Our Prices

PARSHELSKY BROS., Inc.
59 Montrose Ave., BROOKLYN, N. Y.



The Payne Steel "T" Bar Greenhouses

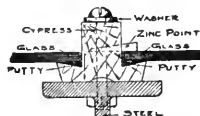

The Lightest The Strongest

Half full Size

HOUSES of this type are constructed with both curved glass eaves and straight glass eaves. Least amount of shadow. Least amount of wood. No drip. Greatest durability.

JOHNA. PAYNE

Greenhouse Designer and Builder
260-274 Culver Avenue

JERSEY CITY, N. J.

FOR "POT LUCK" TRY US...
HEWS STANDARD POTS

POT MAKERS FOR 140 YEARS

WORLD'S LARGEST MANUFACTURERS

WRITE FOR CATALOGUE AND DISCOUNTS

Pearson Street,
LONG ISLAND CITY, N. Y.

A. H. HEWS & CO., Inc.
CAMBRIDGE, MASS.

452-460 No. Branch St.,
CHICAGO, ILL.

DECORATION DAY PREPARATION

At this time of the year the capacity of every Greenhouse is taxed to its limit. Bench room is the one important feature to consider. Remember how well our

SHELF BRACKETS

will relieve this situation, and save time, trouble and room. The **lightest, strongest, and most durable** on the market. Made for $\frac{3}{4}$ in. to 2 in. Pipe.

NET PRICES

12 in. Single, 18c. Each. 8 in. Single, 14c. Each. 8 in. Double, 20c. Each.
Please mention size of pipe post when ordering.

KING IRON FRAME GREENHOUSES

are still leading, and if you "ask the man who has one" you will know why.

Send for Bulletin No. 26 Describing Valley Gutter.

KING CONSTRUCTION CO., - N. Tonawanda, N. Y.

Address Lock Box 623-E



COAL Pocahontas Smokeless Coal Blossburg Smokeless Coal

The above steam coals are peculiarly adapted to FLORISTS' use. Prominent features are HIGH EVAPORATION, LOW ASH, LOW SULPHUR, HIGH CARBON, and HIGH HEAT UNITS. Permit us to figure on your year's requirements, deliverable as called for.

CARGOES CONSTANTLY ARRIVING AT ALL NEW ENGLAND PORTS

The Bader Coal Company, F. B. LAYTON
Gen'l Sales Agent

Telephone Fort Hill 2044

Board of Trade Building, Boston, Mass.

KROESCHELL BOILER



MADE OF FIRE BOX FLANGE PLATE
Can not Crack!

Water Space in Front, Sides and Back
The Most Popular Boiler Made
SEND FOR CATALOGUE.

KROESCHELL BROS. CO.
35 Erie Street, CHICAGO, ILL.

GREENHOUSE CONSTRUCTION LUMBER

John C. Moninger Co.
117 E. Blackhawk St., CHICAGO.

Please Note

that this is not a $\frac{1}{2}$ in. wire affair but it is made of heavy rods.

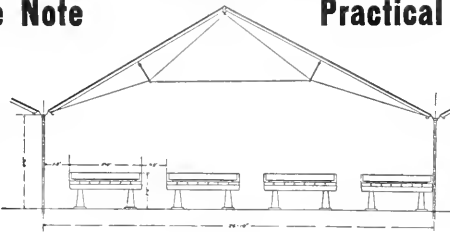

Practical Houses

on a practical financial basis. If you want an up-to-date house that will save you money,

WRITE

GEO. M. GARLAND CO.

Designers and Builders

DES PLAINES, ILL.



Evans 20th Century Arm

Will not twist the shafting pipe. Three times the power of old style elbow arms. Sold only with Evans Challenge Machine.

Write for free Catalogue to
QUAKER CITY MACHINE CO.
Richmond, Ind.

Holds Glass Firmly

See the Point **HP**

PEERLESS

Glazing Points are the best. No rights or lefts. Box of 1,000 points 75 cts. postpaid.

HENRY A. DHEER,
714 Chestnut St., Philadelphia, Pa.

FULL SIZE
No. 2

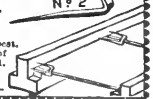

In ordering goods please add, "I saw it in HORTICULTURE"



A New Curve Eave Greenhouse

An advancement in construction — our tested Flat Iron Rafter House with a new light—strong—Curved Eave. A practical and attractive house.

Write us about it.

Hitchings & Company
1170 Broadway New York



ANOTHER HOUSE AT STAMFORD, CONN.

THIS is Mr. Heroy's, and is just up the hill from Mr. Weber's which we showed you last week. Found A. Wynne, the gardener just leaving when we dropped around with our camera. He certainly cracks up the Sectional Iron Frame House alright. Had the photo taken from the other end, turned our good you could have better seen what a splendid little layout of stepped up houses Mr. Heroy has. After all is said and done, you can't beat the L & B way of building. Let us hear from you now and then — especially now.

Lord & Burnham Co.
IRVINGTON, N. Y.

New York

Boston

Philadelphia

Chicago

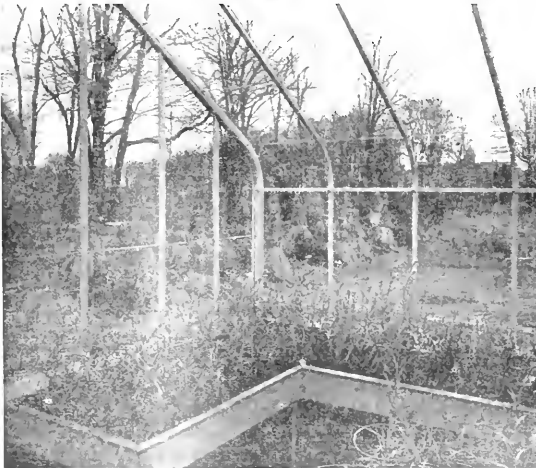

THIS IS THE WAY A U-BAR HOUSE LOOKS FROM INSIDE

You have never seen anything that anywhere near approaches it for lightness. Think what it means not only to have no gutter at the eaves, but also no heavier supporting roof members than the U-Bar, at any point of the roof.

Think what this wonderful lightness means in increased blooms, especially just this time of the year when light is at such a premium.

Think what a pleasure such an attractive, beautiful house always is — what a pride you can take in its being "the best there is."

The thing for you to do is to drop in at our office at an early date, or write us at once about the new U-Bar house you want.

U-BAR GREENHOUSES

PIERSON
DESIGNERS AND BUILDERS



U-BAR CO.
1 MADISON AVE., NEW YORK

HORTICULTURE

Vol. IX. MAY 8, 1909 No. 19



DENDROBIUM SUPERBUM DUBLI

Devoted to the
**FLORIST, PLANTSMAN,
LANDSCAPE GARDENER,**
and
Kindred Interests

Published
EVERY SATURDAY
At 11 Hamilton Place,
BOSTON, MASS.
Subscription, \$1.00

CHRYSANTHEMUMS.

"Not small weak runty stock grown under benches, but the kind that brings back Dollars for Pennies."

WHITE: Earliest October root (We have extra fine large stock of this variety), Mrs. Henry Robinson, Clematiae Touset, Alice Byron, Timothy Eaton, Merry Christmas, White Bonafide.
YELLOW: Monrovia, Halliday, Appleton, Bonafide, Eaton, Chataqua Gold.
PINK: Mc, Niece, Maud Dean, Dr. Enguehardt, Rosiere.
RED: Intensity, Schrimptoon.

All these varieties, rooted cuttings \$2.50 per 100; \$20.00 per 1000. 2 1/2 in. \$3.00 per 100; \$25.00 per 1000.
 White Chadwick, Golden Chadwick, Golden Wedding, R. C. \$3.00 per 100; \$27.50 per 1000. 2 1/2 in. \$4.00 per 100; \$35.00 per 1000.
 Virginia Foehlmann, R. C. \$4.00 per 100. 2 1/2 in. \$5.00 per 100.
 Golden Glow, R. C. \$5.00 per 100. 2 1/2 inch \$6.00 per 100.

CARNATIONS.

Strong well rooted cuttings and 2-1 1/2 inch stock.
 Sarah Hill, Afterglow, White Perfection, Victory, Rose Pink Enchantress, Winsor, Beacon, White Enchantress, at \$3.00 per 100; \$30.00 per 1000.
 Sarah Hill, Llo.d, Afterglow, Winsor, Beacon, Victory, 2 1/2 in. \$3.50 per 100; \$32.00 per 1000.

ROSES. 2 in. or 2 1/2 in. 3 in. or 3 1/2 in.
 American Beauties.....100 1000
 My Maryland Grafted strong stock.....20.00
 My Maryland Own roots.....12.00
 Killarney Own roots.....\$6.00 \$55.00 7.50
 Mrs. Potter Palmer.....5.00 45.00 6.50

Enchantress and White Lawson, R. C. \$2.50 per 100; \$22.00 per 1000.
 Enchantress, White, Pink and Variegated Lawson, 2 1/2 in. \$3.00 per 100; \$25.00 per 1000.
 O. P. Bassett, 2 1/2 in. \$8.00 per 100; 3 1/2 inch \$10.00 per 100.

POEHLMANN BROS. COMPANY, Morton Grove, Ill.

CARNATIONS

Fine Healthy Stock From 2 inch Pots.
 Pres. Seelye.....\$6.00 \$50.00
 White Enchantress, Beacon 4.50 40.00
 Victory, Winsor, Melody, Kingston Pet.....4.00 35.00
 Dabheim, Lady Bountiful, Mrs. Lawson, White Lawson, Red Lawson, Variegated Lawson 3.50 30.00

CHRYSANTHEMUMS

Rooted Cuttings
 Q. W. Childs, Miss Clay Frick, White Shaw, Early Snow, Mrs. Jas. Marshall, Hayer Weaver, The Harriott, Yellow Eaton, \$2.00 per 100, \$15.00 per 1000.
 A. J. Balfour, Autumn Glory, Ada Spaulding, Dr. Enguehardt, Dorothy Devens, Geo. Kalb, Glory of the Pacific, Harry Ray, H. W. Keiman, Ivory, Jeanne Nonin, J. E. Lager, J. M. Troy, J. K. Shaw, Field Dean, Meta, Monrovia, Mrs. Jerome Jones, Linnie Waagmakers, Mrs. Alice Byron, Mrs. Baer, Mrs. Robert McArthur, Major Bonaffont, Tad F. Bergmann, Nagoya, Polly Rose, Robt. Holiday, Timothy Eaton, W. H. Lincoln, Wm. Duckham, etc., \$1.50 per 100.

Send for Catalogue of Roses, cut root and grafted, and other miscellaneous stock.

WOOD BROTHERS
 FISHKILL, N. Y.

ANNOUNCEMENT

We have arranged with MESSRS. PATTEN & Co., Tewksbury, Mass., to grow part of the stock of **White Carnation Shasta** and to our new assist in disseminating it next season 1910. We have 12,000 plants between us. Orders may be sent to them or us with the assurance that from either place only strictly first class cuttings will be sent out. Shasta scored 89 points at the A. C. S. Convention, Jan. 27-28, 1909, and was generally conceded the best looking new variety in the whole show. It is a money maker for both grower and dealer.

Both Messrs. Patten & Co. and ourselves are booking orders now at \$12.00 per 100; \$100.00 per 1000.

BAUR & SMITH, Cor. 38th St. and Senate Ave., Indianapolis, Ind.

NEW CREATIONS IN DAHLIAS

Jack Rose, Virginia Maule, Ethel Schmidt, Sensation, Big Chief, Gladys, Rose Pink Century, Fringed 20th Century, Fringed Beauty. 50 cts. each, \$5.00 per doz., \$35.00 per 100. Strong plants now ready.

PRINCESS VICTORIA. \$1.00 each, \$10.00 per doz., strong plants. A superb collection of new Cactus Dahlias. Send for new descriptive catalogue.

Peacock Dahlia Farms, Williamstown Junc., N. J.

CHRYSANTHEMUMS

Rooted Cuttings and Pot Plants Write for list and prices. ALL OF THE BEST ONES.
S. J. REUTER & SON, WESTERLY, R. I.

COMMERCIAL CHRYSANTHEMUMS

For varieties and prices see page 506 of Horticulture for April 24th. Also full quota of other kinds suitable for any purpose.

ELMER D. SMITH & CO., - Adrian, Mich.

CHRYSANTHEMUMS 50,000 Rooted Cuttings
 White—Timothy Eaton; Mrs. Geo. S. Kolb, fine early; Estelle, White Bonafide, Alice Byron, Ivory, C. Touset, Jeanne Nonin, Octo. or Frost, Early Snow, Angèle Laurent, Pink—Glory of the Pacific, Dr. Enguehardt, Maud Dean, Pink Ivory, Yellow—Major Bonafide, Crema, Robt. Holiday, "Baby," small yellow, of the button type, \$2.00 per 100, \$15.00 per 1000. J. Bonette, \$2.00 per 100.
 W. L. SWAYNE, Box 226, Kennett Square, Pa.

Begonia Gloire de Lorraine
 Leaf Stock, June Delivery, \$15 per 100, \$145 per 1000, from 21 in pots
 Stock guaranteed to be absolutely free from disease.
THOMAS ROLAND, NAHANT, MASS.

Send for our Preliminary List describing and quoting

Chrysanthemums and Carnations.

A fine lot of Carnation Cuttings ready now.

THE E. G. HILL CO., Richmond, Indiana.

White Perfection Our stock won the Cottage Gardens National Flower Show. Our stock is the best. \$3.00 per 100. \$25.00 per 1000 from sand. \$27.50 per 1000 from soil.

White Enchantress We have the best stock of the pure white. \$3.00 per 100. \$25.00 per 1000.

Orders booked now for field-grown plants EARLY DELIVERY.
CHICAGO CARNATION CO. Joliet, Ill.
 A. T. Pyfer, Mgr.

FOR IMMEDIATE DELIVERY CARNATIONS

From 2 inch pots
 White Perfection.....\$8.00 per 100
 Winona.....6.00 "
 Defiance.....4.00 "
 Red Chief.....3.00 "
 Winsor.....3.00 "

F. Dorner & Sons Co., LA FAYETTE, IND.

SCOTT BROS. CHRYSANTHEMUMS

All the Newest and Best Sorts
 ALSO
 ROSES Grafted and Own Root for Greenhouse and Outdoors
ELMSFORD NURSERIES, Elmsford, N.Y.

GARDENIAS

Fine, large Jessamines (gardenias) with beautiful foliage, two grades.
 Stems from 8 to 12 in., \$6 per 1000 " 12 to 18 in., " 9 "
 T. O. B. Alvin Terms strictly Cash or C. O. D.
MISS A. WASHINGTON, ALVIN, TEX.

NEW ROSE

WHITE KILLARNEY

We Know You Will Want to Buy White Killarney



Every live, progressive, up-to-date grower who has seen it is buying it; but when you buy White Killarney, be sure you get the right White Killarney (the Waban variety). When you buy from us you get the variety that has been exhibited and certified, and the one that has attracted such favorable mention.

If you are in the vicinity of New York, we should be glad to have you call and see White Killarney growing at our Scarborough range, and you will say at a glance—as everyone has who has seen it growing—that it is by far the best white rose that has ever been placed on the market.

It is not only a good winter-flowering rose, but is good the entire year, and it is a splendid shipper. Read the following letter received from Mr. Willis N. Rudd, Secretary of the Society of American Florists, dated January 18th, in which he writes as follows:

"Dear Mr. Pierson:—I cannot refrain from writing you and expressing my admiration for the White Killarney as shown at Chicago on Thursday. It is an exquisitely beautiful thing and attracted much attention. I took half the blooms home with me, and they were finer on Saturday than they were at the show. The record is that these blooms were shipped from Tarrytown, staged and exhibited during the afternoon. They were then carefully wrapped up in a box, and remained in that box until one o'clock Friday morning, at which time I reached home; improved in quality up to Saturday, and were in fairly presentable condition on Sunday.

"In addition to being the most beautiful white rose of its class which I have seen, this demonstrates its splendid keeping and shipping qualities.

W. N. RUDD."
We were awarded Silver Cup at National Flower Show, Chicago, for best new rose with White Killarney; also Silver Medal Horticultural Society of New York.

Strong plants, 2 1/4 inch pots, own roots, now ready for delivery, \$30.00 per 100; 250 for \$70.00; 500 for \$125.00; 1000 for \$250.00. Grafted plants, ready April 1st, \$35.00 per 100; 250 for \$82.50; 500 for \$150.00; 1,000 for \$300.00.

F. R. PIERSON CO., Tarrytown-on-Hudson, NEW YORK

ROSES

Good Grafted Killarney 2 1-4
\$12.00 per 100 in.
Good Own Root Richmond, \$4.00 per 100 pots

White Cherokee, One year old, 3 plants in a 7 in. pot. 25c. a pot.
500 Kaiserin, grafted, good plants 2 1/4 and 3 in. pots, \$12.00 per 100
400 Queen Beatrice, Own root, 3 in. pots, extra good, \$5.00 per 100

MONTROSE GREENHOUSES
MONTROSE, MASS.

2 1/2 Stock Chrysanthemums

Golden Glow, Pacific Supreme, White Cloud, Lynwood Hill, \$5 per 100; Golden Eagle \$10 per 100; Virginia Poehmann, Alice Roosevelt, \$4 per 100, \$35 per 1000; October Frost, Appleton, White Bonaffon, Touseit and all commercials, \$3 per 100, \$25 per 1000 Cash.

I. M. RAYNER
GREENPORT, L. I. N. Y.

GLADIOLI NAMED VARIETIES

Childs and Gandavensis Seedlings, Madeira Vines, Cinnamon Vines, Oxalis, Spotted Callas, and Iris Germanica. Write for prices.

E. S. MILLER, Wading River, N.Y.

A. N. PIERSON, Inc., Cromwell, Conn.

WHITE KILLARNEY (Waban Strain)

	Doz.	100	250	500	1000	2500	5000
GRAFTED STOCK.....	\$8 00	\$35 00	\$82 50	\$150 00	\$300 00	\$675 00	\$1,250 00

MY MARYLAND GRAFTED.....	\$3.00 per doz.	\$30.00 per 100.	\$150.00 per 1000
OWN ROOT	2.00 "	10.00 "	90.00 "

STANDARD VARIETIES

Betty, Bon Silene, Bride, Bridesmaid, Cardinal, Eucharist, Etolle de France, Etolle de Lyon, Franz Deegan, Gen. McArthur, Golden Gate, Hermosa, Ivory, Kaiserin Augusta Victoria, Kate Moulton, Killarney, La Detroit, Maman Cochet, Marechal Niel, Mme. Abel Chateau, Mrs. Jardine, Mme. Hoste, Mrs. Paul Niehoff, Mrs. Pierpont Morgan, Mrs. Potter Palmer, Papa Gontier, Queen Beatrice, Rhea Reid, Richmond, Rosaline Orr English, Souv. du President Carnot, Souv. de Wootton, Uncle John, Westley, White Cochet. The above Grafted (selected plan's) 20 cts. each, \$2.00 per doz., \$15.00 per 100, \$120.00 per 1000.

OWN ROOT ROSES

Killarney, Bride, Bridesmaid, Mme. Abel Chateau, Ivory, Richmond, Mrs. Paul Niehoff. 2-in. pots, 75c per doz., \$3.50 per 100, \$30.00 per 1000. 2 1/4-in. pots, \$1.00 per doz., \$6.00 per 100, \$50.00 per 1000.
Queen Beatrice, Rhea Reid, Mrs. Jardine, Mrs. Potter Palmer, from 2 1/4-in. pots, \$5.00 per 100, \$70.00 per 1000.

BEDDING PLANTS

COLEUS. Verschaffeltii, Golden Queen, Queen Victoria, Beckwith Gem, Firebrand, Lord Palmerston. Rooted Cuttings by express, \$0.63 per 100, \$5.00 per 1000. Out of 2 1/2 in. pots in May, \$2.00 per 100, \$15.00 per 1000.
Golden Bedder, Hero, Messy, Pearl of Orange. Fancy Varieties. Twelve kinds not listed above, 75 cts. per 100, \$5.00 per 1000.
AGERATUM. Stefa Gurney, Princess Pauline. SALVIA. Splendens, Bonfire and Zurich.
HELIOTROPE. Dark blue bedding varieties. GERMAN IVY. 75 cts. per 100, \$6.00 per 1000.
ALTERNANTHERA. (Red and Yellow). 50c per 100, \$5.00 per 1000. From 2 1/4 in pots, \$2.00 per 100.
SALLEROL. Rooted Cuttings, \$1.00 per 100, 2 1/4 in. pots, \$2.50 per 100.
CHRYSANTHEMUMS IN QUANTITY. Catalogue on Application.

DAHLIAS.

Now is the time to place your order for bulbs which will insure you getting named vs. varieties in any quantity; prompt delivery.

DAVID HERBERT & SON,
Successors to L. K. Peacock, Inc.
ATCO, N.J.

The Northboro Dahlia and Gladiolus Gardens

Offer for Spring 1909
100 selected varieties of Dahlias and one and one half million large-flowering Gladioli in mixtures, in lots to suit. Send list of your wants. Catalogue free.

J. L. MOORE, Northboro, Mass

ORCHIDS

We have just received the following Orchids in superb condition and solicit your inquiry for same.

CATTLEYA TRIANAE

best type known, free flowering and of great variation. Superb plants, fresh, plump and well leaved. By dozen - hundred or case.

ODONTOGLOSSUM CRISPUM

Pacho type, splendid plants in perfectly fresh condition.

Phalaenopsis amabilis, P. Schilleriana, VANDA SANDERIANA

Oncidium varicosum Rogersii, O. splendendum, O. crispum, O. Forbeii, O. sarcodes, O. Wentworthiana, Odontoglossum grande, Miltonia candida, M. spectabilis, M. flavescens, Lycaste Skinnerii, Scuticaria Steecli, Zygopetalum crinitum, Z. dautleri.

To arrive in a few days: Cattleya labiata, Dendrobium formosum, D. oobole, D. thrysiotum, Vanda coerulea, Cattleya Percivaliana, and many more. Write for prices.

LAGER & HURRELL

SUMMIT, N. J.

ORCHIDS ORCHIDS

Would you like to buy first-class plants for less price than anybody else sells for? Also without disease. The facts must be proved at once therefore we are giving a special sale of our strong and healthy

C. Mossiae, 450 bulbs for \$40.00 a case, also C. Percivaliana, well established plants, 9 to 12 bulbs, \$1.00 a-piece.

Expect C. Labiata, C. Gigas Sanderiana and others shortly.

ORDONEZ BROS.

MADISON, N. J.

IMPORTED ORCHIDS

Now Arriving

Julius Roehrs Co.

RUTHERFORD, N. J.

CATTLEYA TRIANAE

Fresh Stock, Just Arrived, in good time to make strong growth and flower this season.

Dendrobium Wardlanum, noble and thrysiotum five specimens, \$2 00 to \$3 00 each.

C. L. FREEMAN, 388 Appleton St., Holyoke, Mass.

Palms

Shrubs



Ferns

Perennials

Send for Our Catalogue.

The GEO. WITTBOLD CO., 1657 Buckingham Place, Chicago, Ill.

FERNS FOR DISHES,

CASH WITH ORDER

2570 to 2606 W. Adams St., Chicago, Ill.

GOLEUS! GOLEUS!

C. Verschaffeltii and Golden Bedder, R. C.	Pr 100	Pr 1000
Same in 2 1/2 in. pots	2.00	15.00
Coleus, Mixed R. C.	.60	5.00
Same in 2 1/2 in. pots	1.75	15.00
Ageratum Stella Gurney and Pauline R. C.	.50	4.50
Same in 2 1/2 in. pots	1.00	9.00
Feverfew in 2 1/2 in. pots	2.00	
Fuchsias, our selection, in 2 1/2 in. pots	3.00	
German Ivy in 2 1/2 in. pots	R. C. 75	
English Ivy R. C.	1.00	

Cash with Order

J. E. FELTHOUSE

148-154 Van Wanken Ave., SCHENECTADY, N. Y.

NEPHROLEPIS MAGNIFICA

THE SENSATIONAL NOVELTY Strong 2 1/2-in. stock, \$25.00 per 100.

WHITMANII

2 1/2-in., \$40.00 per 1000; 3 1/2-in., from Bench, \$8.00 per 100.

H. H. BARROWS & SON, WHITMAN, MASS.

ROBERT CRAIG CO.

ROSES, PALMS,

and Novelties in Decorative Plants

MARKET and 49th STREETS., PHILADELPHIA, PA.

FRESH IMPORTED ORCHIDS.

Arrived in Splendid Condition: Cattleya Trianae, Mossiae, Gigas, Skinnerii, Oncidium Splendidum, Gramothorhynchum, Westworthianum, Phalaenopsis Schilleriana and Amabilis, Lycaste Skinnerii, Vanda Boxallii, Laelia Superbicus Odontoglossum grande. Write for prices.

JOSEPH A. MANDA.

191 Valley Road West Orange, N. J.

ORCHIDS

We are booking orders now for delivery early in the Spring on all commercial CATTLEYS and NOVELTIES. Our prices are right and our guarantee perfect. We sell only first-class goods

CARRILLO & BALDWIN, Secaucus, N. J.

ORCHIDS

Largest Importers, Exporters, Growers and Hybridists in the World

Sander, St. Albans, England

and 235 Broadway, Room 1

NEW YORK CITY

Assorted Varieties From 2 inch pots, \$3.50 per 100; \$36.00 per 1000

FRANK OEGHSLIN

Kentias, Arecas, Latanias, Cocos, Phoenix, Araucarias, Rubbers, Crotons, Pandanus, Asparagus, Ferns for Dishes. 200,000 Bedding Plants, also Rooted Cuttings of Coleus at lowest wholesale rates.

Orders taken for imported plants for fall delivery

A. LEUTHY & CO.

PERKINS ST. NURSERIES

ROSLINDALE, MASS.

BARGAINS

Ampelopsis Veltchii, 3 in. pots, \$5 per 100. Clematis Poniculata, 4 in. pots, \$10.00 per 100; 3 in. pots, \$5.00 per 100. Clematis, large flowering varieties, 2 year old plants, Jackmanii, Henryi, Andrei, \$3.00 per dozen; Coccinea, \$2.00 per dozen.

Carnations, R. C. from soil, Dorothy, Elton, \$3.00 per 100; Geraniums, standard varieties, from 3 in. pots, \$3.00 per 100; 4 in. pots, \$4.00 per 100.

Lobelia, double blue, 2 1/2 in. pots, \$3.00 per 100.

Moon Vines, true large-flowering white variety, 2 1/2 in. pots, \$3.00 per 100; 3 in. pots, \$4.00 per 100. The following stock from 2 1/2 pots at \$2.50 per 100.

Fuchsias, 4 varieties. Alyssum Carpet of Snow. Phlox Drummondii, Dwarf Lobelia, Emp. William, Salvia, Bonfire and Zurich, Verbenas, Parlor Ivy, Petunias, Cal. Giants and Star. Feverfew Little Gem, Coleus, Golden Bedder and Quadricolor. Alternantheras, 4 varieties, Golden Feverfew, Chrysanthemums, standard varieties.

Chrysanthemums, new early varieties, Autumn, Glow, White Cloud, Pacific Supreme, from 2 1/2 in. pots, \$5.00 per 100.

C. EISELE

11th and Westmoreland Streets, PHILADELPHIA, PA.

HEACOCK'S PALMS

Kentia Belmoreana

7-inch pots \$2 to 34 inches high \$3.50 each
7-inch pots \$5 to 36 inches high 3.00 "
9-inch tub \$4 to 48 inches high 5.00 "

Made up Kentia Forsteriana

7-inch pots \$3 to 36 inches high \$2.50 each
7-inch pots \$5 to 38 inches high 3.00 "
9-inch tub \$4 to 48 inches high 5.00 "

Joseph Heacock Co., Wyncote, Pa.

PALMS AND FERNS DECORATIVE PLANTS

JOHN SCOTT

Rutland Road and E. 45th St. Tel. 2890 Bedford BROOKLYN, N. Y.

JARDINIERE FERNS

IN BEST VARIETIES. VERY FINE STOCK. \$3.50 per 100, \$30.00 per 1000

ROSE HILL NURSERIES

New Rochelle, N. Y.

Dendrobium Superbum Dearei

The cover illustration this week represents two distinct forms of *D. superbum* Dearei in the collection of Mrs. B. B. Tuttle of Naugatuck, Conn. The one on the right was exhibited in Boston in the spring of 1906, where it was awarded the silver medal of the Massachusetts Horticultural Society. It was shortly afterward figured in *HORTICULTURE* (Vol. III, page 547) and in *Orchid Review* (Vol. XIV, page 177).

Shortly after that another plant out of the same importation flowered and proved to be a white form, but was considered to be only a cutting from the other plant as it was then very small and produced only one flower. However, it has since developed into a nice plant and is far superior to the other in form and texture, the older plant having the habit of curling and twisting its sepals and petals, a common occurrence in the species. As to color, both are of the purest white with a faint lemon-yellow hue in the throat. The flower seen above the spray of *D. s. Dearei* represents a good form of the type species and gives one an excellent idea what a grand thing the white form is.

Dendrobium superbum requires plenty of heat during the growing season and a decided rest after the bulbs have formed. From the time the plants start to grow until the young growths are well rooted great care is necessary to keep the atmosphere of the house in which they are growing sweet by giving a little air at all times, else some of the young growths are sure to rot off; better to grow them cooler with plenty of fresh air than to try to maintain a high temperature by keeping the house closed tight. A weekly dip in weak manure water from the time the new growths have rooted until they have finished will work wonders in the way of building up good strong pseudo bulbs and consequently a good crop of flowers.

M. J. Pope

Naugatuck, Conn.

British Horticulture

AMONGST THE ROSES

Today (April 23rd) is St. George's Day, and roses are being generally worn, in honor of the English patron saint. This "wearing of the rose" is of modern introduction. The increased attention paid to this custom has resulted in a fillip being given to the rose trade and the fact that these fragrant blooms can now be obtained at a reasonable price has had the effect of giving it a big impetus. The London market was well supplied with roses, and for some time past these have been sold for ridiculously low prices. The extra demand for the festival, however, somewhat improved matters. Amongst the varieties which were seen to advantage this week at Covent Garden were Marechal Neil, Mrs. John Laing, Capt. Hayward, Kaiserin A. Victoria, Bridesmaid, Bride, Richmond, General Jacqueminot, and others. Roses formed a special feature at the fortnightly show of the Royal Horticultural Society on Tuesday. There were one or two novelties which attracted attention. George Mount, of Canterbury, had amongst his collection Frau Lilla Rautenstrauch, a German importation. This is a rose with pale, conical blooms, lightly shaded with rose. Wm. Paul and Sons, of Waltham Cross, made a feature of a German rose, apparently the nearest approach to a blue rose which has yet been reached. It bears the unattractive title of Veilchenblau, but on this side it has been given the English name of Blue Ram-

bler. It is stated to be a sport from the popular Crimson Rambler. The rose is a vigorous climber, with bold semi-double blooms of a violet-blue tint. Of course the shade is not a true blue, but it is a step in the direction of obtaining that great novelty, which has been so much talked of, and so belated in appearing.

AURICULAS AND PRIMULAS

The lateness of the season was evidenced at the annual show of the National Auricula and Primula Society this week. There was in consequence a falling off in the number of exhibitors, and less competition in the various classes. Several of the successful exhibitors of former years were absent. The best group of primroses and polyanthus plants arranged for effect was exhibited by Mr. Mortimer, of Rowledge, Farnham. Certificates were awarded to the following auriculas: Sweetness, an Alpine variety of shapely form, of a purple tint, shading to lilac; Queen of Spain, a self show variety of a maroon tint—shown by James Douglas; Harbinger, green edged show variety, shown by W. Smith; Bracknell, an Alpine variety with a large yellow eye, shown by Phillips & Taylor; Alexander Dean, an Alpine variety of deep maroon tint, with a yellow centre, shown by F. W. Price, of the Beckenham Horticultural Society. On the same day the Royal Horticultural Society granted awards of merit to the following auriculas: Admiration, a gray edged flower with a sulphur tinted centre; Claud Halero, yellow centre and crimson petals, changing to bronzy-red at the margin; Robert Bruce, gray edged with sulphur shaded centre; Ulleswater, purple edged with whitish centre. The Society also granted a first-class certificate for Primula Porresti, which was exhibited by Messrs. Bees, Ltd. This is an attractive new species from the High Alps of Yunnan, China. The blooms are of deep yellow, with an orange colored eye. Leaves, ovate-elliptical with crenate margins.

W. G. Adsett.

Orchids at Royal Horticultural Society

On April 20 Charlesworth & Co. obtained an award of merit for an *Epi-Laelia* obtained by crossing *Epidendrum macrochilum* rosea, and *Laelia purpurata*; and a botanical certificate for *Pleurothallis Bisichenallei*, the flowers of which are very small and of a chocolate brown tint. Interesting it may be, but destitute of decorative value. F. Sander & Sons received an award of merit for an extra large flowered plant of their variety of *Miltonia Bleiana*. Other plants shown by this firm were *Laelio-Cattleya Choletiana*, large loosely built blooms which are developed in straggling bunches; sepals and petals of a light purple color; the lip stained of a darker tinge, with yellow in the throat; *Cattleya Schroderae* The Queen is large and white, with a stain of orange in the throat. Two *Odontoglossums* were shown named Dreadnought II and Dreadnought III; the first a cross between O. Prince Albert and O. secpitrum. Both have brown blotches on a yellow ground color but the blooms differ in size. Sir Trevor Lawrence, President of the Society, received an award of merit for *Odontoglossum Loochistiensis*, and *Od. aureo-fulvum*, a flower having a yellow ground color spotted and blotched with bright brown.

J. J. Moore

HORTICULTURE

VOL. IX

MAY 8, 1909

NO. 19

PUBLISHED WEEKLY BY
HORTICULTURE PUBLISHING CO.
 11 Hamilton Place, Boston, Mass.

Telephone, Oxford 292

WM. J. STEWART, Editor and Manager

SUBSCRIPTION PRICE

Per Year, in advance, \$1.00. To Foreign Countries, \$2.00; To Canada, \$1.50

ADVERTISING RATES

Per inch, 30 inches to page..... \$1.00.

Diagonals on Contracts for consecutive insertions, as follows:

One month (4 times) 5 per cent.; three months (12 times) 10 per cent.;

six months (16 times) 20 per cent.; one year (52 times) 30 per cent.

Page and half page spaces, special rates on application.

Entered as second-class matter December 8, 1904, at the Post Office at Boston, Mass under the Act of Congress of March 3, 1879.

CONTENTS

COVER ILLUSTRATION—Dendrobium superbum Deare!	Page
DENDROBIUM SUPERBUM DEARE!—M. J. Pope.....	661
BRITISH HORTICULTURE—W. H. Adsett.....	661
ORCHIDS AT ROYAL HORTICULTURAL SOCIETY	
—Frederick Moore.....	661
OBITUARY.....	663
THE CHRYSANTHEMUM—Charles H. Totty.....	663
NEWS OF THE CLUBS AND SOCIETIES:	
American Pomological—North Shore Horticultural—	
Florists' Club of Philadelphia—New York Florists'	
Club—Winnipeg Florists' Association—American	
Carnation Society—Florists' Club of Washington—	
Newport June Show—Notes.....	664
New England Fruit Show.....	668
SEED TRADE—Bush Limas Short—Damage in the	
Norfolk District—Ely Seed Company—Pea Pros-	
pects—New York Pure Seed Bill—Notes.....	670
OF INTEREST TO RETAIL FLORISTS — Business	
Troubles — Steamer Departures — Winnipeg Trade	
Notes—Washington—New Flower Stores.....	672
Flowers by Telegraph—A Florist Robbed.....	673
FLOWER MARKET REPORTS:	
Boston, Buffalo, Chicago, Detroit, Indianapolis.....	675
Philadelphia, New York.....	677
MISCELLANEOUS:	
News Notes.....	663, 666, 668
Greenhouses Wrecked—Illustrated.....	665
Greenhouses Building or Contemplated—George	
Sykes, Portrait.....	665
Truss-Roof Greenhouses in Gale.....	665
Wreck of Miller Greenhouses—Illustrated.....	665
Philadelphia Notes.....	665
Personal.....	665, 668
The Tree Agent—Apples in New England.....	668
Publications Received.....	668
Conservatories at Central Park, Davenport, Ia.....	668
Incorporated—Business Changes.....	673
Patents Granted.....	683
Harvard Takes Up the Moth Fight.....	683
Chicago Notes.....	684

A society and a duty

The appeal of President Elmer D. Smith in last week's issue of HORTICULTURE, for a more widespread and hearty support for the Chrysanthemum Society of America is well seconded in the brief communication from C. H. Totty in this issue. HORTICULTURE is fully in sympathy with the sentiments expressed by these gentlemen. That the splendid work which the C. S. A. has done during its existence might have been done fully as well under the auspices of the S. A. F. and the gentlemen who have given so freely of their own time and money relieved of the unpleasant financial worry connected with it, is undoubtedly true. But the S. A. F. has not been disposed to undertake it and until some mutually acceptable system can be devised the C. S. A. should have the full and hearty support of every florist whose knowledge of what varieties are best to grow and how to grow them is directly due to the intelligent and really philanthropic work this useful society has been conducting. It will be a reproach to the chrysanthe-

mum growers of America if a willing response is not forthcoming.

What
 "pure seed"
 means

Among our newspaper clippings of late we find frequent congratulatory reference, editorial or correspondence, to the various statutes passed by legislatures from time to time providing severe penalties for the selling of impure seeds. The ignorance and prejudice which inspire most of these articles are apparent in the implication all through that the seed dealers are in the habit of intentionally adulterating their wares in the same manner for instance as a milk man might mix water with his milk and that legal means are necessary to restrain him, overlooking the fact that purity in seed, reversing the situation as it applies to milk, is not a primary condition but a consummation approached or reached only through successive processes of cleaning and elimination. In calling for the strict enforcement of these laws we incline to the belief that these writers forget in their enthusiasm that the purification demanded must be paid for and the cost must of necessity fall finally upon the consumer. Buyers have demanded cheap seed and they have got it. While it would be absurd to assert that there have been no rascals or dishonesty in the seed business yet, as a general thing, we believe it has been usually possible for those who wanted pure seed and were willing to pay its value, to procure it. Under the new laws the difference will be that they must pay the price of pure seed or go without. When low-grade is banished low-price goes with it and nobody will rejoice thereat more heartily than the seedsman himself.

Change of
 policy at the Bussey
 Institution

We have read with considerable interest a lengthy article contributed to the *Country Gentleman*, in which changes recently made in the policy and management at the Bussey Institution, Harvard's Agricultural School, are severely criticised and the record of the Institution under former methods put forward as evidence that it was satisfactorily fulfilling its proper functions as intended by its founder. As we understand it, it is not proposed that the Bussey Institution shall be a teaching institution any longer except for a few special students, but that it shall be an institution for scientific research. While not disposed to take issue with the writer of the article in the *Country Gentleman* as to the propriety or wisdom of this change of policy we must say that his presentation of the case seems hardly a fair one. From the very fact that at times there were fewer students than instructors in the Institution it is not unreasonable to say that from the standpoint of public appreciation and support the Bussey was a failure as a school of agriculture and this notwithstanding the fact that some very brilliant young men went through its courses and also that among its instructors were men who labored loyally and whom the graduates will always hold in affectionate esteem. The shortcomings which have long been apparent seem to have at last dawned upon the Corporation of Harvard University and in trying to remodel the Institution along some more useful lines they are presumably doing what they feel to be their serious duty. The names of the gentlemen entrusted with the work of carrying out the new policy are such as to warrant a reasonable hope that in the next twenty-five years results of great importance to agriculture and horticulture will be obtained. In the meantime Amherst offers opportunities for practical horticultural education such as would be forever impossible in a place like the Bussey Institution.

Obituary.

John A. Shellem.

Philadelphia lost one of its prominent figures in the florist trade this week in the demise of John A. Shellem, who passed away on the 3rd inst. after a long illness and was buried May 6th. Robert Craig and Robert Kift, two of his close personal friends, were among the pall bearers, and many of the leading members of the trade attended the funeral.

Mr. Shellem was born and brought up in the southern section of Philadelphia known as "The Neck," and as a young man was an iron moulder, with a keen taste in an amateur way for floriculture, which later having inherited means—he turned to commercial account, starting in 1880 as a florist at 17th and Tasker streets. Two windfalls came his way; the first, when the property at the latter point was purchased by the city for a school site; the second, when the leased Clark greenhouses on South Broad street were taken for a new street. On both, substantial profits came to the owner, who afterwards built an extensive range of greenhouses at Magazine lane and latterly had a retail store just below 17th and Tasker streets. As a grower Mr. Shellem never posed as anything out of the common, nevertheless he raised a few things that made some mark, among them being the rose W. R. Smith; an improved large-flowering pure white freesia; the Early Snow chrysanthemum, a standard white, generally considered the superior of Polly Rose of the same earliness; and the Craigi croton, which is now recognized as one of the very best of the oak-leaved type.

Personally, Mr. Shellem was of a modest and retiring disposition; warm hearted to a fault; enthusiastic in the artistic advancement of floriculture, and always a willing coadjutor in all movements for the general welfare of the trade. He joined the local Florists' Club almost at its inception, twenty-four years ago, and the Pennsylvania Horticultural Society at the same time. The Society of American Florists counted him among its members also, and he was a regular attendant at nearly all of its annual conventions. A widow, six sons and one daughter survive him, all of whom are grown up. The business will be continued by the family. Mr. Shellem was 59 years of age and was universally respected as one of the most genial and likable men in the business, and that, too, in a city where the craft is noted for containing such a large proportion of men who follow and adorn their escutcheon "Brotherly Love", and do their level best to live up to it in spite of the strenuous competition and conditions of modern business life.

George D. Bennett.

George D. Bennett, who has been foreman at the Boston Public Garden, Boston, for nearly a quarter of a century, died on April 25, aged 49 years. About three weeks previous Mr. Bennett had his leg severely injured by a falling limb from a tree which was

trimming and was taken to the hospital, where pneumonia ensued and proved fatal. He was a most industrious and valuable man in the important position which he filled so long and his death leaves a vacancy which will not be readily filled. Mr. Bennett served under his father, the late Henry Bennett, on the Cheney estate at Wellesley, Mass., when a young man and proved a clever pupil of a good instructor.

Mrs. Gottfried Amling.

Laurette, wife of Gottfried Amling, died on April 24 in her sixty-eighth year. A husband and nine children survive her, of whom Albert F., of Maywood, Ernest C. of Chicago and William, who has recently moved from Milwaukee to Maywood, are well known to the trade.

S. W. Marshall.

Samuel W. Marshall, nurseryman, of Fresno, Calif., died on April 15. He is survived by a widow and son; the latter has been actively associated in business with him.

Foster Udell.

Foster Udell, known as the apple king, is dead at Brockport, N. Y. His orchards were famous and were inspected annually by the Cornell University students.

M. P. Carn.

Maurice P. Carn, for many years gardener to W. W. Justice of Manheim, Pa., died on April 25. He was born in Whitemarsh, Pa., fifty-five years ago.

Edward Hennessy.

Edward Hennessy, one of the most expert gardeners in the country, died at Elizabeth, N. J., April 20, in his sixty-fourth year.

Thomas Kennedy.

Thomas Kennedy, employed for many years in the Swan Point Cemetery, Providence, R. I., died on April 21, aged 62.

L. B. Baxter.

L. B. Baxter, nurseryman, died on April 21 at Nichols, Mo., aged 48.

In the haste consequent upon the receipt of the news of the death of Herman Dreyer, just as last week's paper was ready for the press, we inadvertently mentioned Flatbush, N. Y., as Mr. Dreyer's former place of business. We should have written Woodside, Mr. Dreyer was 50 years of age. The funeral was held on Saturday, May 1, and was attended by many florists and plant growers for the New York market. He leaves a wife and three children.

NEWS NOTES.

Warren, O.—J. H. Brown & Son have leased the Gaskill greenhouses.

Ames, Ia.—The hail storm on April 28 did considerable damage to the greenhouses in town.

Everett, Mass.—Osgood Bros., the Woodlawn florists, have opened a down-town office in the Everett Associates' Building.

IN MEMORIAM.

Resolutions adopted by the Florists' Club of Philadelphia, at its meeting, May 4th, 1909, upon the death of David Bearn:

We, the members of The Florists' Club of Philadelphia, having heard with deep regret of the death of one of our oldest and most beloved members, David Bearn, extend our heartfelt sympathy to his brother, John, and other members of the family. We have lost one that took an active part and was deeply interested in Horticulture, or anything that tended to the advancement of the same, also that we have lost a true and tried friend. (Signed) JOHN WESTCOTT, GEORGE ANDERTSON, Committee.

Resolutions adopted by the Florists' Club of Philadelphia, at its meeting, May 4th, 1909, upon the death of John A. Shellem:

Whereas, The Florists' Club of Philadelphia having heard with deep regret of the death of their fellow-member, John A. Shellem,

Resolved, That the Club hereby expresses its deep sense of loss in the passing away of this most estimable brother, who has been with us for so many years, through storm and sunshine, and who has always been most enthusiastic in every movement for the general welfare of the trade.

Resolved Further, That we hereby put ourselves on record in appreciation of the sterling worth of our deceased brother in all his relations socially and commercially, and of the affection in which we held him for his open and kindly disposition, and

Further Resolved, That we record here with a few of his noted achievements in the improvement of commercial florists' plants, namely the Rose W. R. Smith, the Croton Craigi, the Early Snow Chrysanthemum, and the large flowering pure white Freesia. These, among other good things, will be a lasting monument to his memory and will keep fond recollection vivid longer than stone or marble.

Resolved Further, That a copy of these resolutions, suitably engrossed, be sent to the family of the deceased. (Signed) EDWIN LONSDALE, GEORGE C. WATSON, Committee

THE CHRYSANTHEMUM.

Editor HORTICULTURE.

The notes of Pres. Smith in your last issue regarding increasing the membership of the C. S. A. are timely and to the point and it is a fact that though many florists watch the report of the different committees in the fall, still they are indifferent about joining the society and becoming actively interested in it. Some there are I know who believe that all the work now being done by the different societies such as the Rose Society, the Carnation Society and the Chrysanthemum Society should be done by sub-committees of the S. A. F., and I am not prepared to say but what that would be the ideal way. In the meantime however, what should be done about it? Surely the Chrysanthemum Society is worth the annual dues of \$2.00 (which is all the applicant is asked to contribute) to every florist in the country, not to mention the hundreds of private gardeners and amateur growers who can all find valuable information in its yearly report. Pres. Smith and his committees are willing to work and make this the banner year for this Society, so brother growers show your interest in the matter. In the common slang of the day "It's up to you."

C. H. TOTTY.

Havre de Grace, Md.—Chas. Uffler has taken a position with C. E. Bryan, Mt. Pleasant.

NEWS OF THE CLUBS AND SOCIETIES

AMERICAN POMOLOGICAL MEETING.

Thirty-first Biennial Conference, St. Catharines, Ontario, Canada, September 14-16, 1909.

The Executive Committee of this national organization has accepted a joint invitation tendered by the Ontario Fruit Growers' Association, the Niagara District Fruit Growers and the St. Catharines Horticulture Society to meet at the city of St. Catharines this year. Arrangements are rapidly progressing for a reunion of unusual value and interest at this attractive place on September 14-16, 1909.

An unusual feature lies in the fact that the Ontario government has recognized the importance of the coming of this society to Canada by placing a substantial sum of money at the disposal of the committee on arrangements. This committee includes representatives of the provincial as well as local societies.

The secretary of the Pomological Society was invited to meet with this general committee on arrangements at a conference recently called at St. Catharines for the purpose of organizing such a systematic campaign making for instruction and entertainment as would place the success of the convention beyond all peradventure. He was greatly impressed by the business-like and energetic way in which the main and important features involving preliminary arrangements were adjusted. The sub-committees are attacking with vigor and enthusiasm the respective pieces of work assigned to them.

The secretary is glad to report that an unusually large number of state horticultural societies have appointed delegates to attend the St. Catharines meeting. This will insure a wide representation and a diversity of interests which will present exceptional opportunity for considering in a satisfactory way legislative questions of inter-state significance. It is also to be noted that a great exhibition of Canadian-grown, Lake Ontario fruits will be in progress at the time of the meeting affording a splendid opportunity for a study of these northern varieties.

The fruit region between Niagara and Toronto is the most intensively cultivated region in Canada. Excursions through this famous section will be arranged for the pleasure and profit of the visitors.

The program may be expected to include the latest and best in the entire field of pomology. Arrangements are now making for the presentation of subjects of present-day importance by the leading authorities.

Early September is a delightful period in the Lake Ontario section. All members of this historic society should arrange to attend this convention, now members are welcomed. Full particulars will be issued later by circular direct to each member, but in the meantime a note should be

made of the time and place, and all members should plan accordingly.

L. A. GOODMAN, President
Kansas City, Mo.

JOHN CRAIG, Secretary.
Ithaca, N. Y.

NORTH SHORE HORTICULTURAL SOCIETY.

The schedule of prizes offered for the June and August exhibitions of this society, at Manchester, Mass., for 1909, has been received. For the Rose Show, June 30 and July 1, there are no less than eighteen special prizes for novices and five for vegetables, including several cups and medals. There are, besides, forty-eight regular classes. It is the sentiment of the society to welcome competition from outside its immediate territory, and exhibitors from a distance will receive attention. Eric H. Wetterlow is chairman of the show committee and John D. Morrison, from whom copies of the prize list may be procured, is secretary.

FLORISTS' CLUB OF PHILADELPHIA.

Two remarkable specimens of pelargoniums were shown by Samuel Batchelor at the monthly meeting of the Club, held on the 4th inst. These were in 8 in. pots, three feet high and the same in diameter and covered with flowers. Resolutions of sympathy were adopted for David Bearn and John A. Shelton, both of whom had been long active and esteemed workers in the membership of the Club. Routine matters occupied the balance of the evening.

NEW YORK FLORISTS' CLUB.

At the next meeting of the N. Y. Florists' Club, Monday evening, May 10, Patrick O'Mara will read a paper prepared by the venerable Chas. L. Allen of Floral Park on "Plant Development." As Mr. Allen is, unfortunately, at present in ill health, it will be impossible for him to attend the Club in person and read the paper himself; hence Mr. O'Mara has kindly consented to read the paper at that meeting.

JOHN YOUNG, Secretary.

THE WINNIPEG FLORISTS' ASSOCIATION.

This association had a most successful year. We held one flower and vegetable show which was both socially and financially a grand success, and this year we are making arrangements for a much better one, every member working hard to that end.

A. R. KING, Sec'y.

AMERICAN CARNATION SOCIETY.

Baur & Smith, Indianapolis, Ind., registered new carnation *Skasta*. Par-ange, pink seedling x *Euchantress*; color, pure glistening white at all times; bloom well formed and 3 to 3½ inches in size; extra free and early in blooming and does not crop; does not split its calyx.

A. F. J. BAUR, Sec.

FLORISTS' CLUB OF WASHINGTON.

The regular monthly meeting of the Florists' Club of Washington was held at Gude's Hall on the night of May 1th. There was a fair attendance of members and the greater part of the meeting was consumed in discussing the desirability of holding a flower show in Washington next fall and the plans for same. Peter Bisset, John Robertson and O. A. C. Oehmler spoke warmly in favor of it. No definite plans were formulated.

NEWPORT JUNE SHOW.

The premium list for the June Exhibition of the Newport Horticultural Society has been issued. There are 56 classes covering decorative plants in groups and specimens, cut flowers—mainly roses—fruit, vegetables, children's exhibits, etc. Mrs. Golet offers two special premiums of \$25 each which are sure to excite some lively competition. One is for best table of flowering plants, size 6 x 6 ft.—50 per cent. for plants, 50 per cent. for arrangement. The other is for best vase of cut flowers, with the same specifications. Copies of this schedule can be had on application to the secretary Daniel J. Coughlin, Newport, R. I. James Robertson is president of the society. The show will open on the afternoon of June 23 and close on the evening of the 24th.

CLUB AND SOCIETY NOTES.

The Rhode Island Legislature has recently appropriated \$1,000 for the Newport Horticultural Society, \$1,000 for the Rhode Island Horticultural Society, and \$800 for the Woonsocket Horticultural Society.

At the April meeting of the North Shore Horticultural Society, Manchester, Mass., president James Salter led the discussion on vegetables, a topic in which much interest was manifested. Resolutions were adopted on the death of Mrs. Charles Head, an active supporter of the society.

At the exhibition of the Royal Horticultural Society, London, on April 20, Messrs. Paul & Son exhibited several new *Wichuraiana* hybrid roses. One of these, named *Iceberg*, has a double flower of a diameter of four inches, and is white; *Agate* is another of this race, smaller and less double; *Sea Shell* is a pink, single flower.

J. Vetch & Sons, Ltd., among a variety of plants in pots, showed *Clerodendron myrmecophilum*, a plant with dark green lanceolate leaves of a leathery texture, and pyramidal spikes of orange colored, small flowers; *Malvastrum hypomadamum*, a plant extremely floriferous, flowers white and stained at the base of the petals with purple.

Lenox, Mass.—The Lenox Horticultural Society has contributed \$180 to the fire relief fund.

GREENHOUSES WRECKED BY HAIL.

Our illustrations show the effect of the recent disastrous hail storm on



the greenhouses of J. T. Conger, Hartwell, Ohio. Much glass in the Mill Creek Valley in southern Ohio was broken by this great storm. As shown



in the pictures, Mr. Conger had to use sacking as a cover for his houses, almost every light of glass having been destroyed.

GREENHOUSES BUILDING OR CONTEMPLATED.

Chicago, Ill.—Fred Vasthoff, one house.

Cleveland, N. Y.—David Will, one house.

Anderson, Ind.—Robert Ellis, one house.

Lawton, Mich.—Isabel Bitely, violet house.

Hartland, N. Y.—White Bros., one house.

Conshocton, O.—W. Clary, house 24 x 150.

Chicago, Ill.—George Reinberg, rebuilding.

Pleasant Prairie, Wis.—S. Fredson, one house.

Meadville, Pa.—G. W. Haas & Son, improvements.

Bethlehem, Pa.—John E. Haines, rose house, 30 x 60.

Allentown, Pa.—E. N. Kroninger, two houses, 65 x 100.



GEORGE SYKES.

In charge of the Lord & Burnham Company's new office, Rookery Building, Chicago.

Cleveland, O.—John Blechschmidt, three houses, 25 x 300.

W. Fairview, Pa.—Harry Miller, two houses, each 150 feet.

Wellington, Kan.—Worden Nursery, storage house, 80 x 120.

Lewiston, Me.—E. Saunders, house, to x 600; old houses rebuilt.

W. Bethlehem, Pa.—Weiskopf & Papsch, two houses, 30 x 100.

Hagerstown, Md.—Henry A. Bester & Sons, two houses, 30 x 150.

Baldwin, N. Y.—G. T. Schuneman, three violet houses, each 30 x 150.

Monticello, Ind.—Fred Roberts will rebuild the Otstot greenhouse on his place on E. Ohio St., and build a new house.

Lansing, Kan.—Masson & Amussen are rapidly improving their recently acquired property. They have arranged with the K. C. W. railroad to ship their coal direct to their greenhouses.

TRUSS-ROOF GREENHOUSES IN THE GALE.

The following is self-explanatory: HORTICULTURE Publishing Co., 11 Hamilton Place, Boston, Mass.

Dear Sirs: When making mention of the damage done to the houses of Hoerber Bros. of Des Plaines, you will do us a favor if you will kindly advise your readers that, although these buildings were in our own town, none of our material whatsoever was used in the construction of the same. As you are undoubtedly aware four houses of Hoerber Bros. were wrecked in the recent wind storm and a rumor has reached us that those houses were erected with our truss construction and it is for this reason we are willing you to correct this mistake, for our truss construction withstood the high wind better than did the houses in the locality with purlin posts.

We are this day in receipt of a letter from Pechmann Bros. of Marton Grove, in which they state that the truss roof houses withstood the recent high winds better than did the houses erected with purlin posts.

Trusting that you will comply with our request, and advise your readers that Hoerber Bros. did not use our truss construction in these houses, we remain,

Very truly yours,
GEORGE M. GARLAND CO.
Des Plaines, Ill., May 4, 1909.

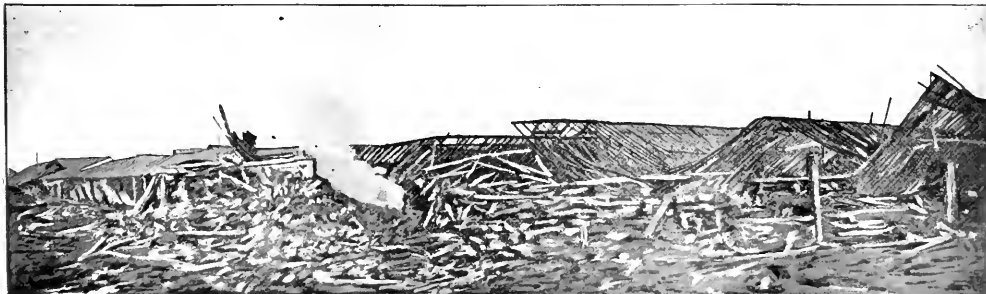

WRECK OF MILLER GREENHOUSES

Due to Boiler Explosion. See Our Last Week's Issue.

Wm. Hagemann & Co.

Hudson Terminal Building, 30 CHURCH ST.
NEW YORK

The business formerly carried on by Mr. Wm. Hagemann (who died on April 3rd, 1909) *is being continued* at the same address as heretofore under the management of Mr. PAUL KASE (for many years associated in the business with Mr. Hagemann) and Mrs. WM. HAGEMANN.

PERSONAL.

Visitor in Boston, Thomas Madsen, representing Erichard Frederiksen, Lndby, Denmark.

M. Rice & Co., of Philadelphia, announce that Frank L. Farny, formerly of Chicago, has been added to their staff of traveling representatives.

Mr. Philippe de Vilmorin, of Messrs. Vilmorin, Andrieux & Co., Paris, France, has been recently appointed by the French Government a counselor of the foreign commerce of France.

James George, who has been in charge since a month ago of the R. D. Evans estate at Beverly Cove, Mass., where President Taft is to spend the summer, is doing some extensive planting and arranging in anticipation of a very lively summer.

Albany Visitors: Mr. Jas. B. McArdle representing Vaughan's Seed store; H. Ritzweld representing Goldsmond & Son, Lisse, Holland; C. S. Ford representing A. Hermann, New York; Arthur Zirkman representing M. Rice & Co., Phila.

NEWS NOTES.

Warren, O. The Gaswill greenhouses have been leased by George L. Brown of Syracuse, N. Y.

Altoona, Pa.—Myers Bros. contemplate a change into larger quarters and differ in location.

Minneapolis, Minn.—Miss H. B. Whitted, 31 So. 5th St. was again the victim of a burglar, but little of value was secured. This is the third attempt of the kind this year.

PHILADELPHIA NOTES.

A miniature cyclone struck the vicinity of Girard College on the 1st inst. Three of the tall electric light towers in the college grounds were wrecked, and Mr. Lonsdale, superintendent of the gardens and grounds, reports great damage to trees, shrubbery and flower beds.

Work will commence next week on the new range of greenhouses at Norwood, Delaware County, for the Robert Craig Co. Four houses, each 27-1-3 x 300 ft. will be erected and ready for planting by the first of July. The Lord & Burham Co., have contract for the material. The erecting will be by a local contractor. Robert Craig in answer to inquiry states that it is not likely that their present establishment at 49th and Market St. will be given

up for two years yet. The Norwood property is 16 acres in extent.

Some new assets have been discovered in connection with the Keegan Flower Store and it is now reported that the creditors are favorable to accepting a composition of 50 per cent. and allowing the business to be continued.

A. E. Brown, of W. Atlee Burpee & Co., has taken a cottage for the summer at Atlantic City and will move into same next week.

Charles P. Poryzees, of 15th and Chestnut St., will sail shortly on a trip to Europe for rest, recuperation and a long deferred visit to relatives.

Mrs. Howard M. Earl, who underwent a critical operation at the Woman's Hospital recently, is reported almost recovered, and expects to return to her home on Saturday, 8th inst.

ROSE PLANTS

Fine, Strong, Healthy, 3-inch pots

American Beauty	\$7.00 per 100	\$65.00 per 1000
Richmond	4.00 "	35.00 "
Chatenay	4.00 "	35.00 "
Ivory	4.00 "	35.00 "
Bride & Maid	4.50 "	40.00 "

Asp. 5 prengerii, 4-in. pots, \$8.00 per 100.

Asp. Plumosus, 3-in. pots, 5.00 "

Smilax, 3-in. pots, 4.00 "

UNITED STATES CUT FLOWER CO.,

Elmira, N. Y.

Chrysanthemums

WHITE—Merza, Kalb, J. Jones (cream), J. Nonin, Clay Frick, Lady Fitzwygam, Polly Rose, Oct. Frost, C. Touset, A. Byron, T. Eaton.

YELLOW—Monrovia, Halliday, Bonnaffon.

RED—Shrimpton, Intensely.

PINK—Dr. Enguehard, Rosler, Winter Cheer, Maud Dean, Montmort (Early).

All above varieties, rooted cuttings, \$1.50 per hundred, \$12.50 per thousand. **GOLDEN GLOW**, \$4.00 per hundred.

BEDDING PLANTS

HYDRANGEAS IN POTS AND TUBS

WM. W. EDGAR CO., Waverley, Mass.

ADIANTUM CUNEATUM, strong 4 in. pot plants, ready for shift, \$3.00 per 100.
CHRYSANTHEMUMS, leading varieties, 2 in., \$2.50 per 100, \$20.00 per 1000.
MARANTA LASANGANA, fine for ferneries, \$6.00 per 100.
FICUS ELASTICA, 5 in. pot plants, 18-24 in. high, \$4.00 per 100.
IVY GERANIUMS, strong 3/4 in. pot plants, *Souv. de Charles Turner* and *Jeanne d'Arc*, \$3.00 per 100.
SALVIA ZURICH, *Fireball*, *Baron Prince*, *Clara Bedman*, *Spendens*, 2 in., \$1.00 per 100, \$15.00 per 1000; 3 in., \$5.00 per 100.
FUCHSIAS, 10 varieties, 2 1/2 in., \$2.50 per 100, \$25.00 per 1000.
COLEUS VERSCHAFFELTI and **GOLDEN CROWN**, 2 in., \$2.50 per 100, \$20.00 per 1000.
LANTANAS, strong 2 1/2 in. pots, \$3.00 per 100.
BEGONIA ERFORDAI, *Vulcan*, *Vernon*, fine for pots or bedding, \$2.50 per 100, \$20.00 per 1000.
DAHLIAS, well established pot plants, all leading varieties, \$3.50 per 100.
COBEA SCANDENS, 2 1/2 in., \$4.00 per 100.

The STORRS & HARRISON CO.
PAINESVILLE, O.

Anything of Value

to the profession

CAN BE SOLD

through advertising in

Horticulture

IPOMOEA NOCTIFLORA

Best pure white moonvine in the market, very fragrant and as big as a saucer. On this variety we have a world-wide reputation as growers and shippers for the last twenty years.

Price, 2 1/2 in. pots, \$5.00 per 100. 10,000 are now ready.

Godfrey Aschmann

1012 West Ontario St., Philadelphia, Pa.

GERANIUMS, DAHLIAS AND BEDDING PLANTS

We have one of the most complete collections of Geraniums in the country, containing every color and type found in the Geraniums. Every one of our 75 Standard Varieties at \$2.00 and \$3.00 per 100 are Bread and Butter Winners, and among our 34 New Varieties of special merit are some that are going to fix the standard in the future. Every one is a Gem, not high in price, only \$1.00 and \$6.00 per 100.

Our Novelties should, coming as they do from the leading introducers of the world, represent the highest development of Geraniums at the present time. A collection of 100 Varieties, our selection of 1907 and 1908 Novelties, will be sent for \$10.00.

Special Offer of 1000 good, strong plants from 2 in. pots, our selection of 20 distinct kinds from among our Standard and Newer Varieties, for \$15.00 cash. From 3 in. pots \$3.00 per 100, \$25.00 per 1000, in a good assortment.

CANNAS

Strong plants from 3 in. pots. J. D. Eisele, Egandale, Alphonse Bouvier, Mme. Crozy, and Florence Vaughan, \$4.00 per 100. Jean Tissot, President Myers, Louisiana, Pennsylvania, \$5.00 per 100.

DAHLIAS

We have one of the finest collections in the country of good distinct Commercial Varieties at \$2.00 per 100 and up for plants ready for shipment. Then we have Jack Rose, Virginia Manie, Big Chief, Rose Pink Century, Fringed 20th Century, Rebecca Mayhew, etc., at 50c. each, \$5.00 per doz., \$35.00 per 100. We will send 1000 in 20 good distinct Cut Flower Sorts, our selection, for \$18.50.

See issue of April 24th or Our Wholesale Catalogue for complete list of Bedding plants.

R. VINCENT, JR., & SONS CO., White Marsh, Md.

CHRYSANTHEMUMS

I have now ready 100,000 plants of 300 varieties, Large Flowered, Singles, Pompons, etc. These are fine stock from 2 1/4 inch pots.

All the standards such as **Robinson, Bonnaffon, Duckham, Clay Frick, Beatrice May, Mrs. Partridge, Polly Rose** in large quantities at

\$3 per 100, \$25 per 1000

Ralph Curtis, Marie Masse, Horace Martin and other new early kinds, \$10.00 per 100.

Write me what you want and see what I can do for you.

CHARLES H. TOTT, MADISON, N. J.

At Reasonable Prices

Attractive Stock
 Now Ready Winsor Carnation 2 1/2 in. Pots \$3.00 per 100, German Ivy \$2.00, Salvia \$2.00, Vinca Var. \$2.50 Queen Louise, The Queen, G. Lord and Prosperator Carnation from soil, at \$15.00 per 1000. Out of frame, just right for the field.

COHANZIE CARNATION GREENHOUSES NEW LONDON, CONN.

PANSY PLANTS Fine Plants ready to bloom, of my well known strain, \$2.50 per 100; large plants in bud and bloom, \$1.00 per 100, \$8.00 per 1000.

GERANIUMS, best kinds, double **PETUNIAS** (Dreer's), **VINCA** var., **PARLOR IVY**, **STOCKS**, fine plants, 2 1/2 in., \$2.00 per 100; 300 for \$5.00.

CABBAGE PLANTS E. J. Wakefield, ready to plant out, \$1.25 per 1000; 5000 for \$5.00.

J. C. SCHMIDT, Bristol, Pa.

JAPANESE
 THE YOKOHAMA NURSERY CO.
 51 BARCLAY STR. NEW YORK.
LILIES
PLANTS
BAMBOO STAKES

THE BOSTON VIOLET

Unequaled for Productiveness, Beauty and Popularity.

In Crop from September to May.

Plants \$2.00 per doz; \$12.00 per 100; \$100.00 per 1000. Princess of Wales \$15.00 per 1000.

WILLIAM SIM, Cliftondale, Mass.

Gladiolus Brenchleyensis

Extra fine Healthy Imported Stock
1,000 \$10.00 10,000 \$80.00

O. V. ZANGEN

HOBOKEN, N. J.

NEW ENGLAND FRUIT SHOW.

On Oct. 19 to 24 next, inclusive, a New England fruit show will be held at the building of the Horticultural Society, Huntington and Massachusetts avenues, as a result of the conference of governors of the New England states last fall.

The objects of this exhibition are to stimulate interest in fruit growing among the farmers of New England, to show the consuming public that New England fruit can be grown that is equal in appearance and superior in quality to that now grown in the West.

The committee in charge has set \$10,000 as the sum needed for the premium list. In Massachusetts alone agricultural and similar organizations have already pledged upwards of \$1200. Prizes will be offered for all fruits and will be for quality and appearance of all recognized varieties and in all styles of package.

THE TREE AGENT.

As he appears to the Bangor News.

Without regard to Governor Fernald's wishes about the right date for our Arbor day, which in theory should come to Maine regularly every year, the drapper chap who called on you last winter and ate corn beef and cabbage at your table, and seemed to like it, and then walked off easily to make other money—bearing your autograph for six peach trees, two banana bushes and a choice lager beer tree—this treeman comes to see you at the very time you are out of money and demands cold cash on delivery in spite of your personal inclinations in the matter, and without even asking to learn the cause of death of the trees you bought and paid for last year. You recall now that as you stood above the chopping block and brought your axe down with a great whack upon the stalks of the dead and mummified treedots that you then and there resolved to buy no more trees from anybody, but here he is again with the old smile on his face and the old story on his tongue, and nothing new but some bundles of lead pencils that were grown in the nurseries of Rochester, N. Y.

The company makes good all losses from death, does it? A sort of life insurance company against deceased trees is it? Not much! When an old countryman has worked days and sat up nights, over sixty young trees, when he has blistered his hands and watered the trees with his sweat and his tears, you cannot replace them.

It is just as if the doctor who had killed your baby should say he would drop around and bring you another baby that was "just as good." There is no substitution for the things we work for and suffer for. The traveling tree man is a sweet and bezziling companion over a table rebruent under loads of baked beans and brown bread. He will sell you what you want at his prices, but if you do not know what you want or are not absolutely sure of it, a farmer will receive a greater measure of mercy from a society of the Black Hand in Shilly than he can hope for from the chap who sells you defective fruit from copper plate samples, that have been colored by hand or else "made in Germany."

—Bangor News.

APPLES IN NEW ENGLAND.

New Englanders who put their money into orange culture in the south should think a moment on the statement of the expert who says that apple culture in New England offers the greatest return and is less hazardous than any other class of orchardry to which New England is adapted. He says there is plenty of cheap land in this part of the south that is admirably adapted to apple raising. Yet a proportion—sometimes a very large proportion—of the apples sold in New England markets come from other sections, and see by them at the good prices now obtained by the fact that the dealers have to pay a good profit abroad and then the freight charges for bringing them into this section. It would appear that some people with capital are neglecting an obvious chance to make a good return on the investment if only and at home, where they can watch their investment closely. *Brooklyn Enterprise.*

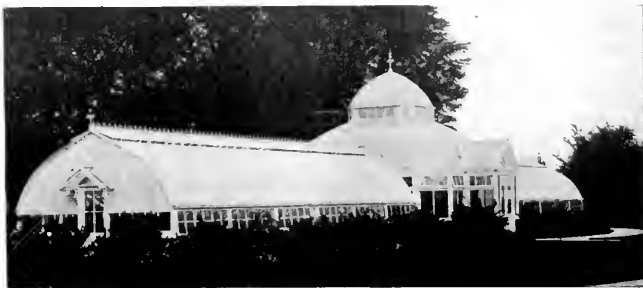

RANGE OF CONSERVATORIES AT CENTRAL PARK, DAVENPORT, IA.

Erected by Lord & Burnham Company

NEWS NOTES.

Beverly Farms, Mass.—The Pierce Nursery has secured the contract for planting hedge and trees on the Lee estate.

Paducah, Ky.—C. L. Brunson & Co., have been engaged to supply the plants for the stations of the N. C. & St. L. R. R.

John E. Dwyer, formerly manager for Burr & Co., has leased four acres of land in Manchester, Conn., and will start in the nursery business.

Windsor Locks, Conn.—The Brainard Floral & Nursery Co., have received the order to beautify the grounds around Memorial Hall.

Portersville, Pa.—A demonstration in spraying was held on the Oliver farm on April 23, under the direction of inspector F. L. McClure. J. L. Fisher of Pittsburgh was the lecturer.

The Boston & Maine has contracted with Loring Underwood, a landscape architect of Boston, to plant 1000 wild rose bushes between the Fitchburg and Southern division tracks, at the new Belmont station.

The New York State Forestry Commission is making preparations to plant seed for 600,000 Norway spruce at Randolph, Vt. The International Paper Company is engaged in a similar enterprise at Randolph.

PERSONAL.

Miles Dietrich has taken a position at the Simonds greenhouse, Barre, Mass.

R. L. Woodward has returned to Indianapolis, Ind. and started in landscape gardening.

Ernest A. Asmus, formerly of Chicago has been placed in charge of the Muskrat Nursery on the Government forest reserve at Helena, Mont.

Frank N. Howe of Hartford, has taken a position as manager of landscape and nursery work for George Johnson & Son, Providence, R. I.

J. M. Prost, formerly an assistant in West Park, successfully passed the recent civil service examination and has been appointed city forester of Chicago with a salary of \$2,000.

CATALOGUES RECEIVED.

Yokohama Nursery Co., Ltd., Yokohama, Japan.—1909-10 Descriptive Catalogue of Bulbs, Plants, Seeds. Enclosed in covers of wood veneer fastened with knots of vermilion floss and lettered in gold. This publication proclaims its Japanese origin in external appearance. It is finely illustrated with half-tone engravings, and six full-page plates in beautiful colors, of lilies, Pink Cherokee roses, Magnolia parviflora flore semipleno, Viburnum Carlesii, Kudzu vine and decorated parcelain flower pots.

The Twenty-Sixth Annual Report of the Board of Park Commissioners of Minneapolis, Minn., recently issued is not only a splendid record of praiseworthy progress in park construction but an art volume as well. The cover illustration a scene in Mississippi Park—in colors, and the many full-page half-tone views inserted throughout the volume are fine examples of reproductive art and the typographical work throughout is fully up to the high standard of the contents. A number of diagrams and maps are bound with the book and are interesting as showing the character of the improvements contemplated under the supervision of that energetic superintendent, Theodore Wirth.

N. F. McCarthy & Co. are having an unusually fine stock of spring planting material, both hardy and tender, at their Tuesday and Friday plant auction sales at 84 Hawley street, Boston. The attendance at these sales is excellent and growers having surpluses to dispose of will find this a prompt and effectual means of reducing stock. Catalogues of each sale are issued in advance and mailed to applicants.

Cincinnati, O. The park commission has rented for a term of ten years the Jackson Nurseries on Price Hill. The nursery stock on the premises belonging to D. R. Herrick was purchased for \$2,000.

SIBERIAN ARBOR VITAE

The finest dwarf Evergreen
Hedge Plant.

Ellwanger & Barry

Mount Hope Nurseries

ROCHESTER, N. Y.

DREER'S HARDY CLIMBERS

	Per doz.	Per 100		Per doz.	Per 100
Akebia Quinata, 4 inch pots	\$1.25	\$ 8.00	Clematis Boskoop Seedling or Sieboldi	3.00	20.00
" " 6 " "	2.00	15.00	" Duchess of Edinburgh	3.00	20.00
Ampelopsis Veitchi, 4 " "	1.50	10.00	" Henryi	3.00	20.00
" " 5 " "	2.00	15.00	" Mme. Baron Veillard	3.00	20.00
Ampelopsis Virginica, 5 " "	1.25	8.00	" Ville de Lyon	3.00	20.00
" " 6 " "	2.00	15.00	" Coccinea	1.25	8.00
Ampelopsis Lowii (new), 4 " " 75c each	7.50	" Crispa	1.25	8.00
Aristolochia Siphio, heavy plants	4.00	30.00	" Integrifolia Durandi	4.00
Bigonina Grandiflora, strong roots	3.00	20.00	Honeysuckle Halleana, 4 inch pots	1.00	7.00
" Radicans,	1.50	10.00	" Evergreen, 4 " "	1.00	7.00
Celastrus Scandens, 5 inch pots	2.00	15.00	" Variegated, 4 " "	1.00	7.00
Clematis Paniculata, 3 1/2 inch pots	1.50	10.00	Lathyrus White Pearl (new)	3.50
" Montana, strong plants	1.50	10.00	Wistaria Siccensis Blue	3.50	25.00
" " Grandiflora (new)	3.50	" " White	4.00	30.00
" " Rubens (new)	8.00	Vitis Henryana (new), 60c each	6.00
" Jackmani two year,	3.00	20.00			

HARDY CLIMBING ROSES

Strong Two Year Old Field-Grown Plants.

Now Established in 5 and 6 inch pots

	Per 100		Per 100
Baltimore Belle	\$20.00	Sweet Briar Brenda	25.00
Climbing Clothilde Soupert	25.00	Trier-White Rambler	25.00
Crimson Rambler	25.00	William Allen Richardson	30.00
Dorothy Perkins	25.00	Wichuraiana Memorial Rose	15.00
Lady Gay	25.00	" Evergreen Gem	20.00
Philadelphia Rambler	25.00	" Gardenia	20.00
Prairie Queen	20.00	" Pink Roamer	20.00
Sweet Briar	15.00	" South Orange Perfection	20.00
" " Lord Penzance	25.00	" Triumph	20.00
" " Lady Penzance	25.00	" Universal Favorite	20.00
" " Meg Merriles	25.00	Yellow Rambler	20.00
" " Anne of Gierstein	25.00		

HENRY A. DREER,

714 Chestnut Street, PHILADELPHIA

ROSES

We have a fine stock of large, dormant, field grown plants, on own roots, of the following varieties:

Boule de Neige, Mad. Planter, Alfred Colomb, Perle des Blancs, Climbing Clothilde Soupert, Archduchess Elizabeth of Austria, Empress of India, Glory of the Exposition of Brussels, Philadelphia Crimson Rambler, Fisher Holmes, Chestnut Hybrid, Climbing Wootton, Magna Charta, Countess of Rosberry, Louise Van Houtte, Dorothy Perkins, Anna de Diesbach, Mad. Alfred Carriere, Vick's Caprice, Sir Thomas Lipton, Francois Levet, Eugene Furst, Crimson Rambler.

PRICE \$12.50 per 100; \$120 per 1000

Tausendschon, the great new climber, \$20 per 100.

Crimson Baby Rambler, \$16 per 100.

Fine plants from 2 1/2 inch pots, **Chrysanthemum Glory of the Pacific**, \$3.50 per 100.

Roses, Dahlias and Cactus a Speciality. Catalogue Free

The Dingee and Conard Co. West Grove, Pa.

Ampelopsis Quinquifolia

Strong 1-year plants 2 to 3 ft. \$20.00
 " 2-year " 3 to 4 ft. 30.00
 " 3-year " 4 to 6 ft. 55.00

TO THE TRADE ONLY
 A Full Line of General Ornamental NURSERY STOCK
 SEND FOR CATALOGUE

EASTERN NURSERIES
JAMAICA PLAIN, MASS.
 HENRY S. DAWSON, Mgr.

RHODODENDRONS, ANDROMEDAS, KALMIAS AND SPECIMEN EVERGREENS

JOHN WATERER & SONS, Ltd.
 AMERICAN NURSERY

BAGSHOT - - - ENGLAND

Newport Fairy

The Rose of the Future For In and Out Door.

FINE, STRONG FIELD-GROWN STOCK
 3-4 Shoots 3-4 ft. long
 50c each, \$30 per 100, \$250 per 1000

JULIUS ROEHRS CO.,
 RUTHERFORD, N. J.

Box Trees

and other EVERGREENS for Tubs and Boxes
 Our Prices are Always Right—Catalog Free

THE NEW ENGLAND NURSERIES, Inc.
 BEDFORD, MASS.

Hardy Rhododendrons, Azaleas, Conifers, Clematis, H. P. Roses, Shrubs and Herbaceous Plants from our **HOLLAND NURSERIES**
 Prices Moderate

P. OUWERKERK, 216 Jane St., Weehawken Heights, N. J.

HEMLOCKS

Fine trees 2-3 feet and 3-4 feet. Also other Evergreens.

Ellwanger & Barry
 Mount Hope Nurseries
 ROCHESTER, N. Y.

GLEARY'S HORTICULTURAL CO.

Management AMBROSE T. GLEARY

Wholesale Contracting, Jobbing, Auction
HORTICULTURAL PRODUCTS
 of every description.

Consignments Received. Surplus Stock Converted
62 Vesey St., NEW YORK

Seed Trade

AMERICAN SEED TRADE ASSOCIATION.

Watson S. Woodruff, Orange, Conn., Pres.; J. C. Robinson, Waterloo, Neb., First Vice-Pres.; C. E. Kendeel, Cleveland, O., Secy and Treas. Twenty-seventh annual convention June 22-24, 1909, at Clifton House, Niagara Falls, Ont.

WHOLESALE SEEDSMEN'S LEAGUE.

F. W. Bruggerhof, Pres.; Burnet Landuth, Sec'y.

Bush Limas Short.

The fierce character of the weather the past week largely paralyzed counter trade, but with the prospects of clear and warmer weather business should hum the coming week. A few bushels of Burpee's Bush Limas came to light last week, and were snapped up at \$10.00 per bu., so report says. Beyond all question these beans will be short again, as confidential information clearly shows that there is very slight chance of growers raising enough to fill orders. Whenever the embargo is lifted further information will be given.

Damage in the Norfolk District.

Last week's storm has done immense damage to garden truck in the Norfolk district and in the South and West generally, and it is now so late that replanting is impracticable. It can be done, of course, but the crops would come into market in the north at the same time as the Northern crops, which would mean sick and demoralized markets and no profit. If not heavy loss, especially to the southern truckers. Seedsmen doing business with truckers in the Norfolk district are liable to find collections slow this season, as the loss has not been on crops entirely, but has extended to building and other property which the trucker will want to make good before he pays out money for anything else. It isn't a pleasing prospect.

Ely Seed Co.

It is said that the Ely Seed Co. are going to move and take a store, though the location has not been given. This concern has been rapidly forging to the front and though they have had an uphill fight, grit and perseverance have carried them along to where success now seems assured. They surely have fought a good fight and kept the faith, in that they have done business on the square and their integrity is universally recognized. More success to 'em.

Pea Prospects.

Planting of peas in Michigan is progressing, but what shall the harvest be? The canneries are praying for a short crop, the seedsmen, or at least seed growers, for a large one. Here is a conflict of interests. Can both be accommodated? "The prayers of the righteous avail much." Take your choice.

Fresh Palm Seeds

Just Received

	Per 100	1000	5000
KENTIA BELMOREANA.....	\$0.50	\$4.00	\$18.00
KENTIA FORSTERIANA.....	.50	4.50	20.00
COCOS WEDDELLIANA.....	1.00	7.50	35.00
PHOENIX RECLINATA.....	.50	3.00	13.00
PHOENIX CANARIENSIS.....	.50	3.00	13.00
SEALFOETIA ELIAGANS.....	.75	4.00	25.00
LATANIA BORBONICA.....	.30	2.50	10.00
ARECA LUTESCENS.....	1.00	7.50	35.00

ARTHUR T. BODDINGTON,

Seedsmen
342 W. 14th St., New York

NEW YORK PURE SEED BILL.

The amended pure seed bill introduced in the N. Y. State Assembly by Mr. Callan has passed both the Assembly and Senate and is now before the Governor for his signature. If the Governor signs it, as he probably will, the bill will go into effect July 1, 1909. Following is the text of the bill:

ARTICLE XVI.

Inspection and Sale of Seeds.

Section 390. Inspection and sale of seeds.—No person shall sell, offer, expose or have in his possession for sale for the purpose of seeding, any seeds or cereals, grasses, clovers or forage plants in quantities exceeding one pound, unless every receptacle, package, sack or bag containing such seeds, or a label securely attached thereto, is marked in a plain indelible manner as follows: and said marks shall be on the receptacle, package, sack or bag itself if there is more than ten per centum of injurious foreign seed:

a. With the full name and address of the seller.

b. With the name of the kind or kinds of seeds, except in the case of mixtures prepared for special purposes, when so labeled, and the name of any foreign injurious seeds present to the extent of five per centum or over by count and the name and per centum of the following adulterants, if present, which adulterants shall not be taken into consideration when estimating the five per centum herein above referred to:

- Yellow trefoil in red clover.
- Yellow trefoil, burr clover, sweet clover or dodder, in alfalfa.
- Canadian blue grass in Kentucky blue grass.
- Meadow fescue or rye grass in orchard grass.

c. Yellow trefoil in alsike clover.

e. With the claimed per centum of purity of the sample by count which shall be not more than five above the per centum determined by official examination.

Section 391. Samples, publication of results of examinations: Samples of seed shall be taken in duplicate, both samples to be sealed promptly and one to be referred and, if accepted, to be delivered at the time of taking to the person apparently in charge and a receipt taken therefor, unless refused. No action shall be maintained for violation of this statute if the seed was not sold or exposed for sale. The commissioner of agriculture is hereby authorized to publish from time to time the results of seed examination, together with the names and addresses of dealers from whom the samples examined were taken.

Section 2. This act shall take effect July one, nineteen hundred and nine.

Notes.

Vaughan's Seed Store has removed from number 14 to 25 Barclay street, New York.

Norristown, Pa.—A three-story seed and flower store is being built by W. H. Catanese, 323 De Kalb St.

Hjalmar Hartmann & Co., the leading cauliflower and cabbage seed dealers of Denmark, have moved their stores and offices to the new building, Logangsstraede 20, Copenhagen. Am-

erican buyers of cauliflower and cabbage seed at wholesale will please make note.

Chicago, Ill.—Henry H. Poole who died recently at Kewanee, Ill., of pneumonia, was office manager of the Albert Dickinson Seed Co. for twenty years.

European sources of information indicate that there is a very considerable shortage in the crop of Kentia seed this season, more especially in Forsteriana. The consequence is a smart rise in price, the later prices showing an advance of nearly one-third over previous quotations.

Denver, Colo.—The Barteldes Seed Co. has recently acquired the land at 1525 Fifteenth St. on which their poultry department is located, and will now erect a new and spacious building at a cost of \$50,000. Manager C. R. Root of this company was recently elected president of the Colorado National Apple Exposition.

CATALOGUES RECEIVED.

Mosbaek Greenhouse Co., Onarga, Ill. Trade List of Hardy Perennials.

Frantz De Laet, Conich, Belgium.—General catalogue of Cacti and other succulents.

E. H. Hunt, Chicago, is making a specialty of the De-fiance Fumigating Lamp, which burns kerosene and is an excellent device for fumigating greenhouses with To-Bak-Ine or other insecticides of similar character.

PRIMULA SEED

PRIMULA CHINENSIS FIMBRIATA

	1/2 Tr. Pkt.	Tr. Pkt.
Alba Magnifica.....	\$0.60	\$1.00
Chiswick Red.....	.60	1.00
Holborn Blue.....	.60	1.00
Kermesina Splendens.....	.60	1.00
Rosy Morn.....	.60	1.00
Michell's Prize Mixture, beautifully fringed varieties...	.60	1.00

PRIMULA OBCONICA GRANDIFLORA

	Tr. Pkt.	\$0.50
Compacta.....		
Fimbriata (1-16 oz., \$1.25).....	.50	
Gigantea (Arends).....	.50	
Kermesina (1-16 oz., \$1.50).....	.40	
Rosea (1-16 oz., \$1.00).....	.30	
White (1-16 oz., \$1.25).....	.30	
Mixed (1-8 oz., \$1.00).....	.30	

Write for our Wholesale Catalogue.

HENRY F. MICHELL CO.
1018 Market St., PHILA.

Everything "For the Land's Sake."

The one firm in Boston where all good forms of plant food may be obtained, is the Bowker Fertilizer Company, opposite Faneuil Hall at 43 Chatham St. All greenhouse chemicals, Nitrate of Soda, Ground Bone, Potash Salts, Sheep Manure and Wood Ashes can there be had at first hands.

BOWKER FERTILIZER COMPANY

Everything "For the Land's Sake."

VEGETABLE PLANTS

BEETS. Crosby, Egyptian and Eclipse, \$1.25 per 1000.
CABBAGE. Field Crows, all leading varieties, \$1.50 per 1000, 10,000 and over, 85¢ per 1000.
CELERY. White Plume, Golden Self Blanching and Giant Pascal, \$1.25 per 1000.
EGG PLANT. N. Y. Improved and Black Beauty, \$3.00 per 1000.
LETTUCE. Big Boston, Boston Market, Tennis Ball and Grand Rapids, \$1.00 per 1000.
PEPPERS. Ruby King, Bull Nose, Sweet Mountain and Neapolitan, \$3.00 per 1000. Chinese Giant and Cayenne, 50¢ per 100.

CASH WITH ORDER

R. VINCENT, JR., & SONS CO.
 White Marsh, Md.

Cycas Revoluta

Good, Strong, Healthy

TRUNKS

25 pounds \$2.25
 100 " 8.50
 300 " 24.00

MICHELL 1018 MARKET ST. PHILA. PA.

GEO. E. DOW
 Designing and Illustrating
 178 Washington St., Boston, Mass.
 OUR SPECIALTY
 Machine, Booklet, Advertising and Flower PHOTOGRAPHS

Mignonette

FARQUHAR'S GIANT

Oz., 75c; 1-4 oz., 25c

R. & J. Farquhar & Co.

6 & 7 South Market Street
 BOSTON, MASS.

LEONARD SEED CO.

CONTRACT GROWERS AND WHOLESALE DEALERS
BEANS, PEAS, SWEET CORN, ONION, GARDEN SEEDS
 ONION SETS Get Our Prices 79 and 81 E. KINZIE STREET, CHICAGO
 FLOWER SEEDS

ESTABLISHED 1802

Thorburn's Seeds

FINE CLUMPS JAPAN IRIS
 TUBEROUS ROOTED BEGONIAS
 GLOXINIAS

ROSA MULTIFLORA NANA SEED

and all other flower seeds for florists

SEND FOR CATALOGUE

J. M. THORBURN & CO.
 33 Barclay Street
 NEW YORK

C AULIFLOWERS C A B B A G E E E D

LILY OF THE VALLEY PIPS.

HJALMAR HARTMANN & CO.
 Longangsstraede 20,
 COPENHAGEN, DENMARK.

Burpee's Seeds

PHILADELPHIA

Blue List of Wholesale Prices mailed only to those who plant for profit.

Ward's Lily Bulbs

Send for Catalogue



Ralph M. Ward & Co.
 12 W. Broadway
 NEW YORK

SHEEP MANURE

ITS STERILIZED

Free from Weed Seeds.

\$24.00 Ton;
 \$7.00 quarter of Ton.

Wm. Elliott & Sons
 42 Vesey St., New York

RELIABLE SEEDS—SOW NOW

PRIMULA OBCONICA GRANDIFLORA
 1000 seeds Tr. pkt.
 Flood red, fine seller.....\$1.50 \$0.50
 Real pink, fine for cut..... 1.00 .50
 Pure white, fine for cut..... 1.00 .50
 Compact, fine potted..... 1.50 .50
 Mixed Hybrid..... 1.00 .50
 O. V. ZANGEN, - HOBOKEN, N. J.

BRIDGEMAN'S SEED WAREHOUSE

RICKARDS BROS.

Props.

37 East 19th St., - NEW YORK CITY

STOCK SEED

FOR WINTER BLOOMING

Our strain of Double Branching Stocks is exceptionally true. About 90% Double Flowers.

In colors: .35 oz. .50 oz. .75 " 5.00
 Pure White 3/4 " .75 " 5.00

H. E. FISKE SEED CO.
 Faneuil Hall Square, BOSTON, MASS.

Winter-flowering SWEET PEA SEED

All Colors Ask for List
A. C. ZVOLANEK

ORIGIMATOR. BOUND BROOK, N. J.

NEW CROP SEED

For Early Planting

THOMAS J. GREY CO.
 32 SO. MARKET ST., BOSTON, MASS.

BEGONIAS TUBEROUS ROOTED

—ALSO—
 GLOXINIAS, LILY OF VALLEY, SPIREA
 Catalogues mailed free on application

Joseph Breck & Sons Corp.
 47-54 NO. MARKET ST., BOSTON, MASS.

BULBS OF QUALITY

Begonias, Single, under color..... 100 \$2.75
 " Double " " " 5.00
 " Filled " " " 10.00
 Gloxinias, under color..... 4.00
 Pearl Tuberoses, \$7.00 thous..... 1.00

Schlegel & Fottler Co.

26 & 27 So. Market St., BOSTON, MASS.

To Florists Everywhere

Orders for Cut Flowers and Floral Decorations to be delivered anywhere in the Greater New York, may be placed with us with the certainty that your customers will be satisfied.
 Telegraph, telephone or mail, such orders to us and be sure that they will be filled as promptly and as carefully as though you did it yourself.
 One third discount will be allowed on all orders thus placed with us by Florists outside of the Greater New York.

THE BLOSSOM
 Bond and Livingston Sts.,
 BROOKLYN, N. Y.
C. C. TREPPEL, Manager

WILLIAM J. SMYTH
FLORIST

Cor. Michigan Ave. and 31st St., CHICAGO
 We ship to all points in Illinois and Iowa.
 Phones: Douglas 744, Douglas 523, Douglas 740

HAUSWIRTH THE FLORIST
 Out of Town orders for Hospitals
 Carefully filled.

232 Michigan Ave.
CHICAGO
 AUDITORIUM ANNEX Tel. Harrison 585

SAMUEL MURRAY
Florist

Coates House Conservatory
 1017 BROADWAY, KANSAS CITY, MO.
 Both 'Phones 2670 Main.



WASHINGTON,
 D. C.

GUDE'S

The Far-Famed Flowers of
TORONTO

Delivered on mail or telegraph order for any occasion, in any part of the Dominion.
JOHN H. DUNLOP,
 96 Yonge St., Toronto, Ont.

The Park Floral Co.

J. A. VALENTINE,
 Pres.

DENVER, COLORADO

WILLIAM L. ROCK
FLOWER CO.

KANSAS CITY, MO.
 will carefully execute orders for Kansas City and any town in Missouri or Kansas.



Buffalo, N. Y.

W. J. PALMER & SON, 304 Main St.

Of Interest to Retail Florists

BUSINESS TROUBLES.

St. Paul, Minn.—The failure of the Warrendale Floral Co. is reported, with liabilities of \$7,500, and no assets.

Pawtucket, R. I.—The Rhode Island Greenhouses are to be sold at auction on May 8 in order to meet the claims of creditors.

Washington, D. C.—J. M. Hammer filed a voluntary petition in bankruptcy April 28; assets, \$523. (\$200 exempt), liabilities, \$2803.

Philadelphia, Pa.—J. Stern & Co. of 125 N. 10th St., has been petitioned into bankruptcy, and the Court has been asked to appoint a receiver.

STEAMER DEPARTURES

American.	
St. Paul, N. Y.—Shampton...	May 15
New York, N. Y.—Shampton...	May 22
Atlantic Transport.	
Minnewaska, N. Y.—London...	May 15
Minneapolis, N. Y.—London...	May 22
Cunard.	
Cunaplan, N. Y.—Liverpool...	May 12
Saxonia, Boston—Liverpool...	May 18
Lusitania, N. Y.—Liverpool...	May 19
French Line.	
La Provence, N. Y.—Havre...	May 13
La Savoie, N. Y.—Havre...	May 20
Hamburg-American.	
Bluecher, N. Y.—Hamburg...	May 12
Amerika, N. Y.—Hamburg...	May 15
Leyland Line.	
Canadian, Boston—Liverpool...	May 12
North German Lloyd.	
Kp. Wilhelm, N. Y.—Bremen...	May 11
Berlin, N. Y.—Med. Ports...	May 15
Kp. Cecilie, N. Y.—Bremen...	May 15
White Star.	
Oceanic, N. Y.—Shampton...	May 12
Cretic, N. Y.—Med. Ports...	May 15
Cedic, N. Y.—Liverpool...	May 15

WINNIPEG TRADE NOTES.

The trade here was exceptionally good this year. Flowering plants sold better than ever at good prices. Cut flowers also went good, about equal to last year. Bedding plants of all kinds are looking splendid, but the weather conditions are poor—snow and wind storms and too much frost for this time of the year. Otherwise the prospects for spring business are very bright and daily enquiries for garden plants give promise of a very active retail trade.

The up-town stores WASHINGTON report business a little improved over last week, but not much difference about the market centers. The cold, rain and wind of the greater portion of last week not only cut down the quality and quantity of flowers, but it threw a very decided damper on all kinds of entertainments. There are numerous weddings looked for this month which will go far toward making the Washington florists "look pleasant."

NEW FLOWER STORES.

Reading, Pa.—Irvin H. Anderson.
 Chicago, Ill.—Park Flower Shop, 1091 E. 58th St.
 Kenton, O.—Wm. Sabransky, branch store in J. E. Gasser's drug store.

ALEX. McCONNELL

571 FIFTH AVENUE
 NEW YORK CITY

Telegraphic orders forwarded to any part of the United States, Canada, and all principal cities of Europe. Orders transferred or intrusted by the trade to our selection for delivery on steamships or elsewhere receive special attention.
 Telephone Calls, 487 and 488 38th St.
 Cable Address, ALEXCONNELL

NEWMAN FLORAL Co.

(Established 1870)

202 Fifth Ave. and Madison Square, NEW YORK CITY
FLOWERS FOR STEAMER SAILINGS

M. A. BOWE

In the Heart of New York City
1294 Broadway
 Tel. 2270, 38th St. NEW YORK
 Our Motto—The Golden Rule

DAVID CLARKE'S SONS

Deliver orders from any part of the country to
 New York City
Or OUT-GOING STEAMERS
 Write or telegraph
 2139-2141 Broadway, New York
 Telephone 1550-1553 Columbus

YOUNG & NUGENT

42 West 28 St., NEW YORK
 "FLOWERS BY TELEGRAPH"

NEW YORK MYER, FLORIST

Phone 5297 Plaza. 609-611 MADISON AVE.

ALBANY, N. Y.

EYRES

Flowers or Design Work

DELIVERED IN ALBANY AND VICINITY ON TELEGRAPHIC ORDER.

11 NORTH PEARL ST., ALBANY, N. Y.

Flower Deliveries

In Brooklyn and other Long Island Points New York City, New Jersey, etc. At Theaters, Hotels, Steamers or Residences.

WILSON

Fulton St. and Greene Ave., Brooklyn, N. Y.

DANKER, Albany, N. Y.

ORDERS FOR
Choice Flowers and Floral Emblems
 FILLED PROMPTLY

WELLESLEY COLLEGE

Dana Hall, Walnut Hill and Rockridge Hall Schools. TAILBY, Wellesley, Mass.
 Tel. Wellesley 44-1 and 5. Night 44-3.

ATLANTA FLORAL CO.

41 Peachtree Street, ATLANTA, GEORGIA

FOR MEMORIAL DAY 1909

All the Indispensables as well as the Cream of the Useful and Appropriate Novelties for this, The Florists' "Day of Days."

Memorial Wreaths in Porcelain, Metal, Immortelles, Laurel, Cycas, etc., Inscriptions, Sheaves, etc.

The Best Stock and The Largest Stock Ever Offered.

H. BAYERSDORFER & CO., 1129 Arch Street, PHILADELPHIA, PA.

JOHN BREITMEYER'S SONS

Cor. Miami and Gratiot Aves.
DETROIT, MICH.

Artistic Designs . . .
High Grade Cut Blooms

We cover all Michigan points and good sections of Ohio, Indiana and Canada

BOSTON'S BEST

In Quality and Design

Can be relied upon when you transfer your retail orders to

EDWARD MACMULKIN

194 Boylston Street, Boston

Send flower orders for delivery in

BOSTON

and all

NEW ENGLAND POINTS

THOS. F. GALVIN

124 Tremont St., Boston



TRANSFER

Your orders for flower or plant delivery in Eastern New England to

JULIUS A. ZINN,

2 Beacon St., Boston.

FINE DESIGN WORK A SPECIALTY

Orders by Wire Receive Prompt and Careful Execution

J. Newman & Sons

Corporation

24 Tremont Street, BOSTON

Theater, Steamer and Funeral Flowers Our Specialty

We can refer to leading florists in all principal cities. Established 1870.

LOUISVILLE, KY.

JACOB SCHULZ,

550 South Fourth Ave.

"FLOWERS BY TELEGRAPH."

Leading Retail Florists Listed by Towns for Ready Reference.

- Denver, Colo.—Park Floral Co., 1706 Broadway.
- Washington, D. C.—Gude Bros., 1214 F St.
- Atlanta, Ga.—Atlanta Floral Co., 41 Peach Tree St.
- Chicago—Hanswirth, "The Florist," 232 Michigan Ave.
- Chicago—William J. Smyth, Michigan Ave. and 31st St.
- Chicago—George Wittbold Co., 1057-59 Buckingham Place.
- Louisville, Ky.—Jacob Schulz, 550 South Fourth Ave.
- Boston—Thos. F. Galvin, 124 Tremont St.
- Boston—Edward MacMulkin, 194 Boylston St.
- Boston—Hoffman, Florist, 59-61 Massachusetts Ave.
- Boston—J. Newman & Sons, Inc., 24 Tremont St.
- Boston—Julius A. Zinn, 2 Beacon St.
- Wellesley, Mass.—Talby.
- Detroit, Mich.—J. Breitmeyer's Sons, Miami and Gratiot Aves.
- Boston—Samuel Murray, 1017 Broadway.
- Kansas City, Mo.—Wm. L. Rock Flower Co., 1116 Walnut St.
- Albany, N. Y.—H. G. Eyres, 11 N. Pearl St.
- Albany, N. Y.—F. A. Danker, 40 Malden Lane.
- New York—David Clarke's Sons, 2130-2141 Broadway.
- New York—Alex. McConnell, 571 5th Ave.
- New York—Young & Nugent, 42 W. 28th St.
- New York—M. A. Bowe, 1204 Broadway.
- New York—Myer, 608-11 Madison Ave.
- New York—Newman Floral Co., 202 Fifth Ave. & Madison Sq.
- Brooklyn, N. Y.—The Blossom (C. C. Trepel, Mgr.), Bond and Livingston Sts.
- Brooklyn, N. Y.—Robert G. Wilson, Fulton St. and Greene Ave.
- Buffalo, N. Y.—Palmer's, 304 Main St.
- Toronto, Can.—J. H. Dunlop, 96 Yonge St.

FLORIST ROBBED.

Henry Russe, 1614 South Grand avenue, stopped in front of 3869 Pomon avenue Saturday evening with a wagon laden with flowers which he offered for sale. Four negroes took a hand in the bargaining:

"Ah wants er germanian," said one. He bought two or three other plants and tendered a \$5 gold piece. Russe drew forth a capacious bag containing \$100 in bills and change, but he could not break the five so he put the bag back into his coat pocket and went into a store. The one negro got his change and the other three decamped. A little later Russe discovered that his bag and the \$100 had been slipped from his pocket. The police are after the negroes.—*St. Louis Star.*

INCORPORATED.

New York, N. Y.—Wm. Hagemann Co.; V. P. Donohoe, R. S. Batson, C. S. Clark: Capital, \$50,000.

BUSINESS CHANGES.

Nevada, Mo.—C. H. Hollid has purchased the Welterm greenhouses.

Cincinnati, O.—Carl Yager has bought the florist store of Mrs. Henry Glins.

Salem, Va.—J. Schartzter has succeeded J. J. Curran at the Salem Conservatories.

Bangor, Me.—Frank P. Lane has taken over the greenhouse plant of Carl Beers on Mt. Hope avenue and will run it in connection with his place on Columbia street.

Chicago, Ill.—The Palace Floral Co., 189 No. Clark St., has been purchased by E. Armstrong, formerly with Wield & Risch.

Pansy Garden Flower Shop, Miss Grace Sawyer, proprietor, moved May 1st to 2027 W. Madison St., where she will have much better accommodations.

J. W. Walters will carry a stock of flowers in connection with his stationery and cigar store at 2020 West Madison St., formerly occupied by Miss Sawyer.

A. W. Morgan, for many years a prominent florist of Danville, Ill., has purchased the business of Mr. Iralson, 588 43rd St., Chicago. Mr. Morgan sold his business in Danville one year ago with the intention of retiring but the call of the trade was too strong and he could not resist. The Iralson store will be continued under the old name for a time.

THE BEST LETTERS

FOR THOSE
FLORISTS' MADE
USE OF BY THE



Boston Florist Letter Co.

66 PEARL ST., BOSTON

N. F. McCARTHY, Mgr.

Order direct or buy from your local supply dealer. Insist on having the

BOSTON

Inscriptions, Emblems, etc., Always in Stock

ROSE PLANTS

RICHMOND

2½ inch pots, \$5.00 per 100. \$40.00 per 1000.
3 inch pots, \$6.00 per 100. \$50.00 per 1000.

<p>KAISERINE</p> <p>3 inch pots, Extra fine plants— Well worth the price. \$8.00 per 100.</p>	<p>BRIDES and MAIDS</p> <p>¾ inch pots, \$6.00 per 100. \$50.00 per 1000.</p>
--	--

READY FOR DELIVERY NOW

THE LEO NIESSEN CO.

1209 Arch St., Philadelphia, Pa.
Open from 7 a. m. to 8 p. m.

To Cut Flower Growers and Retail Florists

IF YOU

want to find a market for your product
want a regular or special supply of the product of the best growers

Consult the Advertisements on these Wholesale Flower Pages

The Advertisers Represented Here are the Leading Concerns in the Wholesale Flower Trade

CUT FRONDS

Adiantum Croleanum

\$1.00 per 100. Excellent Value.

W. E. McKISSICK & BROS.

WHOLESALE FLORISTS
1619-1621 RANSTEAD ST.
PHILADELPHIA

WELCH BROS.

AMERICAN BEAUTY, KILLARNEY, RICHMOND, MARYLAND AND ALL THE SUPERIOR ROSES, LILY OF THE VALLEY, CARNATIONS, ORCHIDS
BEST PRODUCED
226 Devonshire Street, Boston, Mass.

CUT FLOWER BOXES

EDWARDS FOLDING BOX CO
MANUFACTURERS
PHILADELPHIA, PA.

CHAS. W. MCKELLAR

51 WABASH AVE., CHICAGO

Western Headquarters for Choice Orchids
Valley, Roses and all Cut Flowers

WHOLESALE FLOWER MARKETS—TRADE PRICES—Per 100 TO DEALERS ONLY

	CHICAGO May 3	TWIN CITIES May 3	PHILA. May 4	BOSTON May 6
ROSES				
Am. Beauty, Fancy and Special.....	25.00	to 10.00	30.00	to 35.00
" Extra.....	15.00	to 25.00	25.00	to 30.00
" No. 1.....	10.00	to 15.00	15.00	to 20.00
" Lower grades.....	5.00	to 10.00	3.00	to 10.00
Bride, "Maid, Golden Gate, F & S.....	5.00	to 8.00	6.00	to 8.00
" Lower grades.....	3.00	to 5.00	4.00	to 6.00
Killarney, Pac. & Sp.....	3.00	to 5.00	8.00	to 10.00
" Lower grades.....	3.00	to 5.00	6.00	to 8.00
Richmond, Fancy & Special.....	3.00	to 8.00	6.00	to 10.00
" Lower grades.....	3.00	to 5.00	4.00	to 6.00
Chateaux.....	4.00	to 8.00	6.00	to 8.00
My Maryland.....	5.00	to 10.00
				6.00 to 8.00
CARNATIONS				
Fancy and Red.....	3.00	to 4.00	3.00	to 4.00
Ordinary and White.....	2.00	to 3.00	2.00	to 3.00
MISCELLANEOUS				
Carthaya.....	40.00	to 60.00	50.00	to 60.00
Lilies.....	10.00	to 12.00	7.00	to 13.00
Lily of the Valley.....	1.00	to 4.00	3.00	to 4.00
Tulips.....	3.00	to 4.00	3.00	to 4.00
Daffodils.....	2.00	to 3.00	3.00	to 4.00
Mignonette.....	3.00	to 4.00	2.50	to 3.50
Sweet Peas.....	5.00	to 7.00	7.50	to 10.00
Gardenias.....	30.00	to 40.00	25.00	to 35.00
Violets.....	1.50	to 1.75	1.75	to 2.00
Adiantum.....	1.00	to 1.50	1.00	to 1.50
Smilax.....	12.00	to 15.00	10.00	to 15.00
Asparagus Plumosus, strings.....	35.00	to 50.00	35.00	to 50.00
" & Sprea. (100 bchs.).....	25.00	to 35.00	20.00	to 30.00

PETER REINBERG

WHOLESALE

CUT FLOWERS

51 Wabash Av., Chicago, Ill.

Long Distance Phone Central 6004

WINTERSON'S SEED STORE

45-47-49 Wabash Ave., Chicago.
Seedsmen, Plantmen, Nurserymen
Florists' Supplies

We can supply everything used by the Florist. SUPPLY CATALOG FREE. Correspondence solicited.

POEHLMANN BROS. CO.

33-35-37 Randolph St., - CHICAGO

CUT FLOWERS

Greenhouses, - Morton Grove, Ill.

Rice Brothers

2118 N. 6th Street, MINNEAPOLIS, MINN.

WHOLESALE FLORISTS and SUPPLIES

CUT FLOWERS received twice daily, and can fill your orders to your satisfaction. A complete line of Hardy Greens—WILD SMILAX, BOXWOOD, HARDY FANCY FERNS, GALAX LEAVES.
Write for quotations on large quantities.

In ordering goods please add "I saw it in HORTICULTURE."

J.A. BUDLONG

37-39 Randolph Street, CHICAGO.

Roses and Carnations
A Specialty.....

WHOLESALE GROWER of **CUT FLOWERS**

HENRY M. ROBINSON & CO.

15 Province St. and 9 Chapman Place - BOSTON, MASS.

WHOLESALE COMMISSION FLORISTS

Hardy Cut Evergreens and Florists' Supplies

We have the stuff and can fill all orders, large or small
WE NEVER DISAPPOINT SATISFACTION GUARANTEED

Prices Quoted in these Columns are for Dealers Only.
When Writing to Advertisers Please Mention
HORTICULTURE.

Flower Market Reports.

BOSTON The present week finds the flower market in excellent condition, strong and healthy. Shipments clean up promptly every day at prices that compare well with those prevailing at a corresponding date in any recent year. From accounts received from various centres it would appear that Boston is the strongest flower market in the country for the time being. Carnations are in brisk demand and the available supply is hardly equal to the emergency. As to quality, stock in general has never been better at this time of the year. This is true of practically every standard variety of flower. Shipping trade to New England points is quite brisk.

March weather with a **BUFFALO** good variety in the line of high wind, rain, snow and sleet was had the past week which did not help the trade. Roses and carnations came in quite abundant the first part of the week but the latter dropped off in supply; on Friday and Saturday everything in these lines cleaned up. Kaiserin, Carnot, Richmond and Killarney roses also fell off in supply, but Bridesmaids and Brides in all grades seemed to remain with the wholesaler. Beauties have been in good supply but have not moved too freely. The demand has been more for sweet peas, lily of the valley, daisies and orchids, the latter being rather scarce and prices holding firm. Violets had little or no demand, and prices were away below quotation. Indoor Poeticus narcissi are had, also outdoor jonquils, which have moved quite satisfactorily. Callas and longiflorums are in abundant supply. Greens are plentiful, especially adiantum, but smilax is still on the scarce list.

Chicago had a queer **CHICAGO** May day. A pelting, blinding snow storm lasting all day and driven by a fierce wind. In spite of it all the wholesale florists did a good business on that day and Sunday. During the earlier part of the week trade was quiet though the market did not show any great depression. It was a week of unusual storms and this naturally reduced the supply somewhat and also the local demand. The retailers felt the loss of transient trade and especially those in close proximity to the opera houses. On Monday, May 3rd, business was good. The supply was not large and carnations especially sold quickly. Roses also moved briskly. Callas are very abundant. Forced Spanish Iris in purple, yellow and white are in the market. Snap-dragons seem to take well here. They are used extensively in wedding decorations. Forest fires are said to have been the cause of the present high price of ferns.

With the exception of **DETROIT** two days last week was as brisk as the previous one. The lifeblood of business runs steadily without any special excitement. Those two days mentioned night as well be stricken from the calendar. Snow and thunder storms of remarkable violence brought all business close to a standstill. It was an exhibition of meteorological sarcasm



RIBBONS FOR COMMENGEMENTS AND OTHER SOCIAL FUNCTIONS

PATTERN KILLARNEY—Exact Match for the Killarney Rose

No. 7 width, price \$a.65 No. 22 width, price \$1.35 No. 100 width, price \$a.75
 " 10 " " 1.15 " 40 " " 1.70 " 150 " " 3.50

PATTERN 1614—Exact Match for the Am. Beauty Rose, shaded effect exactly like the flower

No. 40 width, price \$3.00 No. 80 width, price \$3.00

Gauze for Shower Bouquets. Chiffons all Widths and Colors. New Combination Ribbons for All colors of Sweet Peas. Samples on Request.

S. S. PENNOCK-MEEHAN CO., 1608-1620 Ludlow St., Philadelphia

WHOLESALE FLOWER MARKETS. — PER 100 TO DEALERS ONLY.

	CINCINNATI May 4		DETROIT May 2		BUFFALO May 5		PITTSBURG May 5	
ROSES								
Am. Beauty, Fan, and Sp.....	35.00	to 40.00	30.00	to 35.00	25.00	to 33.00	30.00	to 25.00
" Extra	15.00	to 30.00	20.00	to 30.00	17.00	to 25.00	10.00	to 15.00
" No. 1	15.00	to 20.00	20.00	to 20.00	12.00	to 15.00	5.00	to 8.00
" Lower grades.....	8.00	to 12.00	4.00	to 10.00	3.00	to 6.00	8.00	to 4.00
Bride, "Maid, Golden Gate, F. & S.	6.00	to 8.00	5.00	to 8.00	to 8.00	6.00	to 8.00
" " Low. gr.	3.00	to 5.00	3.00	to 5.00	3.00	to 6.00	3.00	to 4.00
Killarney, Fan, & Sp.....	6.00	to 8.00	5.00	to 8.00	to 8.00	8.00	to 10.00
" Lower grades.....	3.00	to 5.00	3.00	to 5.00	2.00	to 6.00	2.00	to 6.00
Richmond, Fancy & Special.....	8.00	to 10.00	4.00	to 6.00	to 8.00	8.00	to 10.00
" Lower grades.....	4.00	to 6.00	1.00	to 3.00	3.00	to 6.00	2.00	to 6.00
Chateaus.....	6.00	to 8.00	3.00	to 6.00	to 8.00	2.00	to 8.00
My Maryland.....	to 8.00	to 8.00	to 8.00	to 8.00
CARNATIONS								
Fancy and Noveltes.....	3.00	to 4.00	2.50	to 3.00	2.00	to 3.00	2.00	to 3.00
Ordinary.....	1.50	to 2.00	1.00	to 2.00	1.50	to 2.00	1.00	to 1.50
MISCELLANEOUS								
Callieyas.....	to 10.00	35.00	to 50.00	60.00	to 75.00	50.00	to 75.00
Lilies.....	10.00	to 12.00	10.00	to 12.50	8.00	to 12.00	8.00	to 12.00
Lily of the Valley.....	2.00	to 4.00	2.00	to 4.00	3.00	to 4.00	3.00	to 4.00
Tulips.....	3.00	to 4.00	2.00	to 3.00	2.00	to 3.00	3.00	to 4.00
Daffodils.....	2.00	to 3.00	3.00	to 4.00	2.00	to 3.00	to 1.00
Mignonette.....	2.00	to 3.00	6.00	to 8.00	2.00	to 4.00	to 3.00
Sweet Peas.....	5.00	to 1.00	to 7.50	5.00	to 1.00	5.00	to 1.00
Gardenias.....	35	to 50	to 10	to 25.00	to 25.00
Violets.....	to 1.00	50	to 75	40	to 50	25	to 50
Adiantum.....	to 1.00	1.00	to 1.50	1.50	to 1.50	1.00	to 1.25
Smilax.....	10.00	to 12.75	15.00	to 20.00	to 15.00	to 10.00
Asparagus Plumosas, striggs.....	40.00	to 50.00	30.00	to 50.00	25.00	to 50.00	35.00	to 50.00
" & Spreu. (100 hchs.).....	20.00	to 35.00	30.00	to 50.00	25.00	to 50.00	35.00	to 40.00

and although reports are milder the occasional hail storms do not seem to have done much damage to speak of. A worse effect have the now following floods, many of the growers staying up day and night to prevent their firing boxes from being flooded. The Clinton River, a peaceable little stream near Mt. Clemens, has become a raging torrent and the boiler houses of Breitmeyer and Klage are several feet under water, so that no firing can be done. This condition of affairs is entirely novel, never having been experienced before.

There was a perceptible depression in the market during the first part of the week, but toward the end business became very brisk, Saturday being exceptionally so. The various stores are now availing themselves of the ample supply of dogwood and fruit-tree blossoms, and

some very good window effects are being obtained. Lilac, lily of the valley and other outside stuff are advancing very rapidly, but the cool nights are retarding vegetation. The sale of plants and bedding stock will soon play an important part in local business. All kinds of good roses are obtainable at satisfactory prices. Richmond roses are finding very slow sale. Any quantity of carnations are to be had with little variation as to quality or price. Callas and Easter lilies are more plentiful than at any time since Easter. There is a good, steady demand for lily of the valley, sweet peas, daisies, mignonette, pansies, forget-me-not and snap-dragon. Bulbous stock and violets are about over for this season. The general report from the wholesalers is fairly good and business is about normal. Smilax is selling well, also plumosus and the best grade of maiden-
(Continued on page 677)

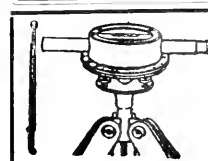

EVERYBODY KNOWS Park, Cemetery and Landscape Gardening cannot be properly done without the aid of an accurate leveling instrument.
 Bostrom's Improved Levels, No. 2 at \$15.00, No. 3 at \$25.00, are conceded by all who KNOW to be the only Levels on the market which meet all the requirements, at the price.
 Our guarantee back of every Level we sell, and satisfied users in every State in the Union heartily endorse every claim we make.
 Shipping weight 22 lbs. Description on request.
BOSTROM-BRADY MFG. CO., 139 Madison Avenue, ATLANTA, GA.

FORD BROTHERS

48 West 28th Street NEW YORK

FINE ROSES FANCY GARNATIONS

A Full Line of All CUT FLOWERS

Telephone, 3870 or 3871 Madison Square

H. E. FROMENT

Wholesale Commission Florist,
Choice Cut Flowers,

57 West 28th St. :: NEW YORK

Telephones: 2200, 2201, Madison Square.

Alfred H. Langjahr

All choice cut-flowers in season. Send for quotations. Correspondence with shippers of first-class stock invited.

55 West 28th Street, New York

Telephones 4424-4427 Madison Square

Edward C. Horan

Wholesale Florist

55 WEST 28th ST.

tel. 1462 Madison Square New York

JOHN YOUNG

WHOLESALE FLORIST

Finest American Beauties and Carnations

51 West 28 St. - NEW YORK

FRANK MILLANG

Wholesale Florist

55-57 West 26th St., NEW YORK

Shipments, any quantity, Wholesale Market Rates.

Henshaw & Fenrich

WHOLESALE FLORISTS

44 West 28th Street, NEW YORK

Phones Mad. Sq. 325, 588-2, 588-3

VIOLETS

Finest Grade. Any Quantity

B. S. SLINN

55-57 W. 26 St., New York

Moore, Hentz & Nash

Wholesale Commission Florists

55 and 57 West 26th Street

Telephone No. 756
Madison Square

New York

MILLANG BROS.

WHOLESALE COMMISSION FLORISTS

41 West 28th Street

Telephone 3660
3661 Madison

NEW YORK

JOHN I. RAYNOR
Wholesale Commission Florist **SELLING AGENT FOR LARGEST GROWERS**
A full line of Choice Cut Flower Stock for all purposes. Comprises every variety grown for New York market, at current prices.
TEL. 1998 MADISON SQUARE 49 West 28th St., New York City

Walter F. Sheridan
Wholesale Commission Dealer in
CHOICE CUT FLOWERS
39 West 28th Street, New York
Telephone: 3532-3533 Madison Square

HEADQUARTERS FOR NOVELTIES
ORCHIDS A SPECIALTY
THE HIGHEST GRADE OF **VALLEY** ALWAYS ON HAND
GARDENIAS, DAISIES, ROSES AND GARNATIONS
JAMES McMANUS, Telephone 759 Mad. Sq. 42 W. 28th St. New York

PHILIP F. KESSLER 55 & 57 W. 26th St., New York City
Commission Dealer, Wholesale Buyer and Seller of
CUT FLOWERS
Open from 5 a. m. to 6 p. m. Sunday till 10 a. m.
Tel., 5243 and 2921 Madison Sq. Res., 345 J., Newtown.
Finest Lilies in the Market Every Day in the Year.

NEW YORK QUOTATIONS PER 100. To Dealers Only

ROSES AND GARNATIONS	Last Half of Week ending May 1 1909		First Half of Week beginning May 3 1909	
	American Beauty, Fancy and Special.....	8.00	to 15.00	8.00
" " Extra.....	5.00	to 8.00	5.00	to 8.00
" " No. 1.....	3.00	to 4.00	3.00	to 4.00
" " Lower Grades.....	.50	to 1.00	.50	to 1.00
Bride, "Gold, Golden Gate, Fancy and Special.....	4.00	to 6.00	4.00	to 6.00
" " Lower Grades.....	1.00	to 3.00	1.00	to 3.00
Killarney, Fancy and Special.....	4.00	to 8.00	4.00	to 8.00
" " Lower Grades.....	1.00	to 3.00	1.00	to 3.00
Richmond, Fancy and Special.....	4.00	to 8.00	4.00	to 8.00
" " Lower Grades.....	1.00	to 3.00	1.00	to 3.00
Chatenay.....	1.00	to 8.00	1.00	to 8.00
Py Maryland.....	1.00	to 8.00	1.00	to 8.00
Carnations, Fancy and Novelties.....	2.00	to 3.00	2.00	to 4.00
Ordinary and White.....	1.00	to 1.50	1.00	to 2.00

Alexander J. Guttman
THE WHOLESALE FLORIST OF NEW YORK
34 WEST 28th STREET
PHONES. 1664-1665 MADISON SQUARE
ENOUGH SAID

CENTRALLY LOCATED, THE HUB OF THE FLOWER MARKET SECTION
CHARLES MILLANG
Wholesale Florist
444 Sixth Ave., NEW YORK
Telephone 7062 Madison

GEORGE COTSONAS & CO.
Wholesale and Retail Dealers in all kinds of
EVERGREENS
Fancy and Dagger Ferns
Brooze and Green Galax
Main Store 50 W. 28 St.
New York
Phone 2200 Mad. Sq.

GROWERS' CUT FLOWER CO.
CUT FLOWERS AT WHOLESALE
VIOLETS, CARNATIONS, ROSES
ORCHIDS, CHRYSANTHEMUMS, LILIES
Consignments Solicited. Shipments to Order, any Distance
39 West 28th Street, Telephone 3532-3533 Madison Square
NEW YORK
J. J. CURAN, Manager

WHOLESALE FLORISTS
54 West 28th St.
NEW YORK
Telephone 3559 Madison Sq.

A. L. YOUNG & CO.

RECEIVERS & SHIP-
PERS OF CUT
FLOWERS.
CONSIGNMENTS SOLICITED.

WILLIAM H. KUEBLER
Brooklyn's Foremost and Best
WHOLESALE COMMISSION HOUSE
A First Class Market for all CUT FLOWERS
28 Willoughby St., Brooklyn, N. Y.
Tel. 4591 Main

Greater New York Florists' Association, Inc.
Now Open for Cut Flower Consignments
142 Livingston Street, BROOKLYN, N. Y.
Geo. W. Crawback Telephone Connection
Manager 3642-43 Main

REED & KELLER
123 West 28th St., New York
Florists' Supplies
We manufacture all our
Metal Designs, Baskets, Wire Work & Novelties
and are dealers in
Glassware Decorative Greens and Florists' Requisites

THE KERVAN CO.
Wholesale Dealers and Shippers of
Decorative Evergreens
Ferns, Galax, Laurel, Fresh Cycas, Hor-
wood, Spagnum and all Florists' Greens
Send to us for Quotations before Buying.
113 West 28 Street, NEW YORK CITY

MICHIGAN CUT FLOWER EXCHANGE, Inc.
WHOLESALE COMMISSION FLORISTS
Consignments Solicited
Hardy Fancy Fern Our Specialty
38-40 BROADWAY, DETROIT, MICH.

FOR FLORISTS' USE
There's **NOTHING** as good as
MEYER'S SILKALINE
Don't let them sell you anything else
JOHN C. MEYER & CO., Boston, Mass.
In ordering goods please add "I saw
it in HORTICULTURE."

Order by Name
Krick's Genuine Immortelle Letters, Etc.
The Best and Cheapest. Accepted as
Substitute. Every Letter Mailed
W. C. KRICK
1164-66 Greene Av., Brooklyn, N. Y.
For Sale by all Supply Houses

Durand & Marohn
MANUFACTURERS OF
All Kinds of Wire Work
Florists' Wire Designs a Specialty
24 Beaver St., ALBANY, N. Y.

Wired Toothpicks
Manufactured by
W. J. COWEE, BERLIN, N. Y.
20,000....\$1.75; 50,000....\$7.50. Sample free.
For sale by dealers

WILLIAM F. KASTING CO.
WHOLESALE FLORISTS
383-387 Elliott Street
BUFFALO, - N. Y.

ROBERT J. DYSART
Public Accountant and Auditor
Simple methods of correct accounting
especially adapted for florists' use.
Books Balanced and Adjusted
Marchants Bank Building
28 STATE STREET, - BOSTON
Telephone, Main 58.



WHOLESALE COMMISSION J. K. ALLEN 106 W. 28th St
NEW YORK
Open 6 a.m. Daily Tel. 167 Madison Sq
Shipments of Lily of the Valley Needed

NEW YORK QUOTATIONS PER 100. To Dealers Only

MISCELLANEOUS	Last Half of Week ending May 1 1909		First Half of Week beginning May 3 1909	
	Low	High	Low	High
Cattleyas.....	40.00	60.00	40.00	60.00
Lilies.....	4.00	6.00	4.00	6.00
Lily of the Valley.....	1.00	2.00	1.00	2.00
Tulips.....	1.00	2.00	1.00	2.00
Daffodils.....	1.00	2.00	1.00	2.00
Mignonette.....	1.00	2.00	1.00	2.00
Sweet Peas (per 100 bunches).....	3.00	8.00	3.00	8.00
Gardenias.....	10.00	30.00	10.00	30.00
Violets.....	.15	.35
Adiantum.....	.75	1.50	.75	1.50
Smilax.....	10.00	15.00	10.00	15.00
Asparagus Plumosus, strings.....	20.00	30.00	20.00	30.00
" " & Spreu. (100 bchs).....	12.00	25.00	12.00	25.00

Flower Market Reports.
(Continued from page 675)

hair fern. Hydrangeas are the principal attraction in pot plants at present. The common ferns, both fancy and dagger, are getting quite scarce.

The situation in PHILADELPHIA proved considerably last week. Trading was more active, and the influx of stock fell off a good deal. Quite a number of weddings and other social functions took place, and one big event in especial—the Taft reception at the Union League—had a markedly good effect on the general tone of the market. Richmond roses, cattleyas, sweet peas, and gardenias, were the most active stocks. American Beauty roses were in good supply, and sold fairly well; but at prices much in favor of the buyer. The man who had a good order got what he wanted, generally at a good deal less than quoted figures. Brides and Bridesmaids were in over supply. Killarneys sold better than any other pink—with the exception of Jardine. There are a few Marylands coming in again, and finding a ready market. They are rather short stemmed. Carnations are cleaning up well, and it looks as if there would be no surplus of these until after Memorial Day. The special

carnation event known as "Mother's Day" is slated for next Sunday, which ought to make a good demand for Friday and Saturday. Easter lilies and the general run of stock abundant and in fair demand. Smilax is the only scarce item among greens. New ferns are commencing to arrive.

NEW YORK MARKET.

This a time of plenty—a surfeit of plenty—in the New York cut flower market. Not plenty of business or plenty of money, but plenty of roses and other things that the anxious grower and bewildered wholesaler would like to see moving on. Our price quotations tell the story concerning American Beauty only in part, for most of the sales are made at the lowest figure quoted for each grade. All through the rose list the best grades are the most difficult to realize on. Carnations are not so heavily overloaded as other things and are enjoying a little better call.

Cincinnati and vicinity was visited by a damaging hail storm on April 20. Among the heaviest losers in the trade were W. K. Partridge, Max Rudolph, Geo. Corbett, Walter Grey, J. T. Conger and Geo. Meyer.

In ordering goods please add "I saw it in HORTICULTURE"

Buyer's Directory and Ready Reference Guide

Advertisements under this head, one cent a word. Initials count as words.

Display advertisers in this issue are also listed under this classification without charge. References to List of Advertisers will indicate the respective pages.

Buyers failing to find what they want in this list will confer a favor by writing us and we will try to put them in communication with reliable dealers.

ACCOUNTANT

E. J. Dysart, 28 State St., Boston.
For page see List of Advertisers.

ALYSSUM

Sweet Alyssum, Little Gem, 2½ in., \$1.50 per 100. A. B. Campbell, Cochranville, Pa.

AMPELOPSIS.

Eastern Nurseries, Henry F. Dawson, Mgr., Ampelopsis Quinquefolia, Jamaica Plain, Mass.
For page see List of Advertisers.

C. Elsie, 11th and Westmoreland Sts., For page see List of Advertisers.

AQUATIC PLANTS

Aquarium plants the year round. Wholesale and Retail. Send for price list. Schmidt's Emporium of Pets, 712 12th Street, Washington, D. C.

AQUILEGIA

Aquilegia. Genuine Coerulea, finest of all. Both plants and seeds from the heart of the Rockies. C. S. Harrison's Seed Nursery, York, Neb.

ARAUCARIAS

A. Leuthy & Co., Perkins St. Nurseries, Roslindale, Mass.

For page see List of Advertisers.

Godfrey Aschmann, 1012 West Ontario St., Philadelphia, Pa.
For page see List of Advertisers.

ASPARAGUS SEED

S. S. Pennock-Meehan Co., Philadelphia. Asparagus Plumosus Nanus Seeds, any quantity, 30c. per 100; \$2.00 per 1000; \$8.75 per 5000. Peter Mack, Orlando, Fla.

ASTERS.

Asters, 2 to 2½ in. high. \$8.00 per 1000. Only the choicest colors and kinds included in the collection. H. J. Blanchard, Ashburnham, Mass.

AUCTION SALES

Oleary's Horticultural Co., 62 Vesey St., New York.

For page see List of Advertisers.

AZALEAS

A. Leuthy & Co., Perkins St. Nurseries, Roslindale, Mass.

For page see List of Advertisers.

Godfrey Aschmann, 1012 W. Ontario St., Philadelphia.

For page see List of Advertisers.

BAMBOO CANES

Yokohama Nursery Co., 31 Barclay Street, New York.

Bamboo Sticks, Colored Green.

For page see List of Advertisers.

BAY TREES.

2000 Bay and Box Trees in all sizes, Pyramid and Standard. Write for list. Julius Roehrs, Rutherford, N. J.

BEDDING PLANTS

J. E. Felthousen, Schenectady, N. Y.
For page see List of Advertisers.

A. Leuthy & Co., Perkins St. Nurseries, Roslindale, Mass.

For page see List of Advertisers.

G. Aschmann, 1012 W. Ontario St., Philadelphia, Pa.

For page see List of Advertisers.

BEDDING PLANTS—Continued

R. Vincent, Jr. & Sons Co., White Marsh, Maryland.

For page see List of Advertisers.

J. C. Schmidt, Bristol, Pa.

For page see List of Advertisers.

Thomas Roland, Nahant, Mass.

Begonia Gloire De Lorraine.

For page see List of Advertisers.

Geo. A. Kuhl, Pekin, Ill.

Salvia, 2½ to 3 in. high, 1½c. each. (Various scandens, 2½ in., 2c. each. H. J. Blanchard, Ashburnham, Mass.

Vinca variegated, finest stock, heavy and long, \$10 and \$12.50 per 100. R. C. S. A. Nutt geraniums, blue, \$10 per 1000. R. C. Golden Glow, \$4 per 100. Cash. Bellamy Bros., 207 Delaware St., Syracuse, N. Y.

Geraniums S. A. Nutt, extra fine plants from 4 in. pots at 6c. Asparagus Sprenger, from 4 in. pots at 6c. Satisfaction guaranteed. Brant Bros., Inc., Utica, New York.

BOILERS

BOILERS. "Burnham" Boilers made for greenhouse heating. Lord & Burnham, 1183 Broadway, N. Y.

W. W. Castle Co.,

170 Summer St., Boston, Mass.

Tested Boilers.

For page see List of Advertisers.

Kroeschell Bros. Co., 35 Erie St., Chicago.

For page see List of Advertisers.

BOOKS

Pronunciation of Plant Names, sent for 50 cents, postpaid, by HORTICULTURE PUB. CO., 11 Hamilton Place, Boston.

BOXWOOD TREES

New England Nurseries, Inc., Bedford, Mass.

For page see List of Advertisers.

BUILDING MATERIAL

BUILDING MATERIAL of all description for All Cypress, Semi-Iron, Iron Frame or Truss Houses, Hot Bed Sash and Frames. Lord & Burnham Co., 1183 Broadway, N. Y.

BULBS AND TUBERS

Joseph Breck & Sons, 47-54 N. Market St., Boston.

For page see List of Advertisers.

J. M. Thornburn & Co., 33 Barclay St., New York.

For page see List of Advertisers.

A. T. Boddington, 342 W. 14th St., N. Y.

For page see List of Advertisers.

Rickards Bros., 37 East 19th St., New York.

For page see List of Advertisers.

H. F. Mitchell Co., Philadelphia.

For page see List of Advertisers.

H. E. Fiske Seed Co., Faneuil Hall Bldg., Boston.

For page see List of Advertisers.

T. J. Grey & Co., 32 and 33 So. Market St., Boston.

For page see List of Advertisers.

Yokohama Nursery Co., 31 Barclay St., New York.

For page see List of Advertisers.

Ralph M. Ward & Co., 12 W. Broadway, New York.

For page see List of Advertisers.

Schlegel & Fottler 76, 26 & 27 S. Market St., Boston.

Begonias, Gloxinias, Tuberoses.

For page see List of Advertisers.

CANNAS

A. T. Boddington, 342 W. 14th St., New York.

For page see List of Advertisers.

C. Elsie, 11th and Westmoreland Sts., Philadelphia, Pa.

For page see List of Advertisers.

R. Vincent, Jr. & Sons Co., White Marsh, Maryland.

For page see List of Advertisers.

J. H. Dann & Son, Westfield, N. Y.

For page see List of Advertisers.

Cannas, King Humbert, 3 in., \$6.00 per 100. Louisiana, started plants, \$2.50 per 100. A. B. Campbell, Cochranville, Pa.

Cannas started from seed, \$2.00 per 100; from pots, \$5.00 per 100. J. B. Shurtleiff & Son, Cushman Ave., Revere, Mass.

CARNATIONS

Baur & Smith, 38th & Senate Sts., Indianapolis, Ind.

Patten & Co., Tewksbury, Mass.

Carnation Shasta.

For page see List of Advertisers.

F. Dorner & Sons Co., Lafayette, Ind.

Carnations for Immediate Delivery.

For page see List of Advertisers.

Chicago Carnation Co., Joliet, Ill.

For page see List of Advertisers.

Albert Roper, Tewksbury, Mass.

Carnation Bay State.

Wood Bros., Fishkill, N. Y.

Carnations, Rooted Cuttings.

For page see List of Advertisers.

The E. G. Hill Co., Richmond, Ind.

Carnation Cuttings.

For page see List of Advertisers.

S. J. Reuter & Son, Westery, R. I.

For page see List of Advertisers.

Foehmann Bros. Co., Morton Grove, Ill.

For page see List of Advertisers.

CEMENT BENCHES

E. H. Hunt, 76-78 Vanhous Av., Chicago.

CHRYSANTHEMUMS

E. G. Hill Co., Richmond, Ind.

For page see List of Advertisers.

S. J. Reuter & Son, Westery, R. I.

For page see List of Advertisers.

C. H. Totty, Madison, N. J.

For page see List of Advertisers.

J. H. Myers, Altoona, Pa.

For page see List of Advertisers.

Wood Bros., Fishkill, N. Y.

Chrysanthemums Rooted Cuttings.

For page see List of Advertisers.

Scott Bros., Elmford, N. Y.

For page see List of Advertisers.

Foehmann Bros. Co., Morton Grove, Ill.

For page see List of Advertisers.

Elmer D. Smith & Co., Adrian, Mich.

Special Offer of Commercial Chrysanthemums.

For page see List of Advertisers.

100 commercial varieties, including Pompon and Hairy, \$12.50 per 100. Satisfaction guaranteed. Wm. Ehmann, Jr., Corfu, N. Y.

Chrysanthemum Golden Glow from 2 1/4 in. pots, for early spring delivery, \$1.00 per doz., \$6.00 per 100, \$50.00 per 1000. Stock plants of Montmort, Oct. Frost, Crocus, Matchless, Lucifer, Devaux, Polly Rose and Holiday, \$1.00 per doz.; \$6.00 per 100. Peirce Bros., Waltham, Mass.

Herrington's book on the Chrysanthemum, mailed to your address for 50c., by Horticulture Publishing Co., 11 Hamilton Place, Boston.

Golden Glow and Pacific Supreme, the best early yellow and pink mums, R. C., \$2 per 100, prepaid; 2 1/4 in. pots, \$4; 25 at 100 rates. Chas. Frost, Kenilworth, N. J.

For List of Advertisers See Page 683

CLEMATIS

5000 Clematis paniculata, extra strong, out of 2 in. pots, \$2. per 100; 3 in. pots, \$5 per 100. If not satisfactory will return your money. Samuel V. Smith, 3223 Goodman St., Philadelphia, Pa.

COAL FOR GREENHOUSE USE

Bader Coal Co., Board of Trade Bldg., Boston.

COLEUS

J. E. Felthousen, Schenectady, N. Y. For page see List of Advertisers.
A. Leuthy & Co., Perkins St. Nurseries, Roslindale, Mass. For page see List of Advertisers.

CONIFERS

John Waterer & Sons, Ltd., American Nursery, Hagshot, Eng. For page see List of Advertisers.

CUT FLOWER BOXES.

Edwards Folding Box Co., Philadelphia. For page see List of Advertisers.
Folding cut flower boxes, the best made. Write for list. Holton & Hunkel Co., Milwaukee, Wis.

CYCAS TREES

Yokohama Nursery Co., 31 Barclay St., New York. For page see List of Advertisers.

CYCLAMEN.

Cyclamen Splendens Giganteum, in true colors, including the new salmon "Rhub of Wandsbeck," 2 1/2 in. pots, \$4.00 per 100. (Chrysanthemum R. C. Pacific and Parisiense, \$1.00 per 100. Sash. G. A. Thiele, Asylum Pike, Frankford, Pa.

DAHLIAS

David Herbert & Son, Atco, N. J. For page see List of Advertisers.
J. L. Moore, Northboro, Mass. For page see List of Advertisers.
Peacock Dahlia Farms, Williamstown Junction, N. J. For page see List of Advertisers.
R. Vincent Jr. & Sons Co., White Marsh, Md. For page see List of Advertisers.

DAHLIA RULES. 50 cents per dozen. All varieties listed below at 5 cents each, or 50 cents per dozen; if by sent by mail, 75 cents per dozen.

CACTUS VARIETIES: Beatrice, Bertha Mawley, Bridesmaid, Brumhead, Capstern, Candace Gen. Bunker, Dr. Jameson, Earle of Pembroke, Fire Brand, Ernest Glasse, General Buller, Gabriel, Galliard, Island Queen, John Roche, J. P. Clark, Kriemhild, Lovely, Lady Edd Talbot, Mary Service, Montrose, Montefiore, Mrs. Chas. Turner, Mrs. Bennett, Mrs. Jewett, Mr. Moore, St. Catherine, Queen Wilhelmina, Starry Crown, Star Fish, Sparkler, Thland, Volker, Wilmund.

SHOW VARIETIES: A. D. Livou, Arabella, Amazon, Beauty, Bird of Passage, Dawn of Day, Fascination, Dr. J. P. Kirkland, Girdlestone, Golden Age, Hannah Holland Pink, Keystone, Lady Mary D. Hallock, M. La Nille, Modesty, Mary Belle, Mrs. Browning, Mrs. Cleaveland, Mrs. Dexter, Orator, Penelope, Peri, Rob. Bromfield, Startler, Wm. Collins, White Swan.

DECORATIVE VARIETIES: Atlanta, American Flag, Beauty of Brentwood, Black Prince, Countess of Pembroke, Dolly, Eloise, Frank Bassett, Jumbo, Lady Allington, Lucille, Marie de Kent, Nymphia, Princess Christian Progress.
Above stock is field grown, sound and true to name. Catalogue free to all. C. Peirce, Dighton, Mass.

DAHLIAS.

Geo. H. Walker, No. Dighton, Mass. Wholesale and Retail.
Send your name for my 1909 Catalog and Pocket Guide, ready to mail about Feb. 25th.

Cactus, Decorative, Fancy, Show and Pompon Dahlias. Good commercial varieties, such as Kriemhild, Countess of Lonsdale, Mad. Van Den Dem and other sure bloomers, strictly divided roots in 10 or 20 named varieties my selection, \$1.00 per 25; \$3.00 per 100; \$25.00 per 1000. Cash please. Hermann Thiemann, Mazon, Mass.

DAHLIAS—Continued

Dahlias. Novelties and standard varieties, true to name, a choice list of the best introductions. Send for catalog of dahlias, hollyhocks, hardy plants. Price always reasonable. W. W. Wilmore, Box 882 Denver, Colo.

DECORATIVE PLANTS

A. Leuthy & Co., Perkins St. Nurseries, Roslindale, Mass. Imported Plants for Fall Delivery. For page see List of Advertisers.
Godfrey Aschmann, 1012 W. Ontario St., Phila., Pa. For page see List of Advertisers.
Joseph Hancock Co., Wyncote, Pa. For page see List of Advertisers.
The Geo. Wittbold Co., 1637 Buckingham Place, Chicago, Ill. For page see List of Advertisers.
Robert Craig Co., Market and 49th Sts., Philadelphia, Pa. For page see List of Advertisers.

EVERGREENS

New England Nurseries, Bedford, Mass. For page see List of Advertisers.
American Nursery Co., 150 Broadway, New York, N. Y.
Evergreens. Send 25 cents in stamps for complete work on propagating and growing Evergreens. C. S. Harrison's Select Nursery, York, Neb.

FERNS

A. Leuthy & Co., Roslindale, Mass. For page see List of Advertisers.
H. H. Barrows & Son, Whitman, Mass. Nephrolepis Magdlica. For page see List of Advertisers.
John Scott, Brooklyn, N. Y. For page see List of Advertisers.
Frank Oechslin, 2570-2696 W. Adams St., Chicago. Ferns for Dishes. For page see List of Advertisers.
The Geo. Wittbold Co., 1637 Buckingham Place, Chicago, Ill. For page see List of Advertisers.
Godfrey Aschmann, 1012 W. Ontario St., Philadelphia. For page see List of Advertisers.
C. Elsele, 11th and Westmoreland Sts., For page see List of Advertisers.
Rose Hill Nurseries, New Rochelle, N. Y. Ferns for Jardinieres. For page see List of Advertisers.
Anderson's ferns for in and outdoors. Largest commercial collection in the country. Ask for descriptive catalogue. J. F. Anderson, Fern Specialist, Short Hills, N. J.

FERTILIZERS

Palverized Manure Co., 31 Union Stock Yards, Chicago, Ill.
Wisard Brand Sheep and Shredded Cattle Manure. For page see List of Advertisers.
Bowler Fertilizer Co., Boston, Mass. All Ferns of Plant Food at First Hands. For page see List of Advertisers.
German Kall Works, 93 Naassu St., New York. Potash Fertilizer.
Wm. Elliott & Sons, 42 Vesey St., New York. Sheep Manure. For page see List of Advertisers.
Eastern Chemical Co., Pittsburg St., Boston. Imperial Plant Food.

FLORAL PHOTOGRAPHS

Floral Photographs. Foley's, 226-228 1-2 Bowery, New York.

FLORISTS' LETTERS.

Boston Florist Letter Co., 66 Pearl St., Boston, Mass. For page see List of Advertisers.

FLORISTS SUPPLIES

N. F. McCarthy & Co., 84 Hawley St., Boston. For page see List of Advertisers.
H. M. Robinson & Co., 15 Province St. and 9 Chapin Pl., Boston, Mass. For page see List of Advertisers.
Reed & Keller, 122 W. 25th St., New York. For page see List of Advertisers.
M. Bayerdorfer & Co., 1129 Arch St., Philadelphia. Memorial Day Supplies. For page see List of Advertisers.
W. C. Krick, 1164-66 Greene Av., Brooklyn, N. Y. Immortelle Letters. For page see List of Advertisers.
S. S. Pennock-Meehan Co., Philadelphia. Ribbons for Commencements and Social Functions. For page see List of Advertisers.

FLOWER POTS

W. H. Ernest, 28th and M Sts., Washington, D. C. For page see List of Advertisers.
A. H. Hews & Co., Cambridge, Mass. For page see List of Advertisers.
Hilfinger Bros., Ft. Edward, N. Y. For page see List of Advertisers.
The Peters & Reed Pottery Co., Red pots, seed pans, etc. Zanesville, O.
Syracuse Pottery Co., Syracuse, N. Y. Syracuse Red Pots. For page see List of Advertisers.
We make Standard Flower Pots, etc. Write us when in need. Wilmer Cope & Bro. Lincoln University, Chester Co., Pa.

FRUIT TREES

Dwarf Fruit Trees, by F. A. Waugh, mailed to your address for 55 cents by Horticulture Publishing Co., 11 Hamilton Place, Boston.

GALAX

Michigan Cut Flower Co., 35 and 40 Broadway, Detroit, Mich. For page see List of Advertisers.
George Cotonas & Co., 50 W. 23rd St., New York. For page see List of Advertisers.
The Kervan Co., 118 West 23rd St., N. Y. For page see List of Advertisers.
Elce Bros., 115 N. 6th St., Minneapolis, Minn. For page see List of Advertisers.
H. M. Robinson & Co., 15 Province St. and 9 Chapin Place, Boston. For page see List of Advertisers.

GARDEN HOSE

Revere Rubber Co., Boston, Mass. For page see List of Advertisers.

GARDENIAS

Miss A. Washington, Alvin, Texas. For page see List of Advertisers.

GERANIUMS

R. Vincent Jr. & Sons Co., White Marsh, Md. New and Standard Varieties. For page see List of Advertisers.
Geraniums, large plants, bud and bloom, out of 3 1/2 in. pots. E. A. Nutt and others, \$7.00 per 100. Cash. Stephen Chase, Nashua, N. H.
Geraniums in bud and bloom, S. A. Nutt, Buchner, etc., A1 stock out of 3 1/2 in. pots, \$6.00 per 100. Cash with order. Leonard Cousins, Jr., Concord Junction, Mass.
Salleron Geraniums, strong plants from 2 1/2 in. pots, \$2.50 per 100. J. B. Shurtleff & Son, Cushman Ave., Revere, Mass.

GIANT ASPARAGUS AND RHUBARB.

Warren Shinn, Woodstown, N. J.

GLADIOLI

J. L. Moore, Northboro, Mass. E. S. Miller, Wading River, N. Y. For page see List of Advertisers.
O. V. Zangen, Hoboken, N. J. Gladiolius Brenchleyensis. For page see List of Advertisers.

In writing to Advertisers kindly mention Horticulture

GLASS

- Boston Plate & Window Glass Co., Boston.
For page see List of Advertisers.
- Standard Plate Glass Co., 26-30 Sudbury St., Boston.
For page see List of Advertisers.
- Foley Mfg. Co., Western Ave., between 25th & 26th Sts., Chicago.
For page see List of Advertisers.
- Sharp, Partridge & Co., 22d & Lumber St., Chicago.
For page see List of Advertisers.
- Parshelsky Bros., Inc., 59 Montrose Av., Brooklyn, N. Y.
For page see List of Advertisers.
- Greenhouse glass, lowest prices. Johnson Glass Co., Hartford City, Ind.
Glass, High Grade, Double Thick Greenhouse Glass. Lord & Burnham, 1183 Broadway, N. Y.

GLAZING DEVICE

- H. A. Dreer, Philadelphia, Pa.
Peerless Glazing Point.
For page see List of Advertisers.

- GLAZING POINTS, Lord & Burnham Special Glazing Nails (Points). Lord & Burnham, 1183 Broadway, N. Y.

GREENHOUSE BUILDING MATERIAL

- Lord & Burnham Co., 1183 Broadway, New York.
For page see List of Advertisers.
- Pierson U-Bar Co., 1 Madison Sq., N. Y.
For page see List of Advertisers.
- A. T. Stearns Lumber Co., Neponset, Boston.
For page see List of Advertisers.
- King Construction Co., N. Tona-wanda, New York.
For page see List of Advertisers.
- Hitchings & Co., 1170 Broadway, New York.
For page see List of Advertisers.
- J. C. Moninger Co., 117 East Blackhawk St., Chicago, Ill.
For page see List of Advertisers.
- Foley Mfg. Co., Western Ave., between 25th & 26th Sts., Chicago.
For page see List of Advertisers.

GREENHOUSE CONSTRUCTION

- GREENHOUSE CONSTRUCTION, Semi-Iron Greenhouse, New Truss Houses and Iron Frame Houses. Lord & Burnham, 1183 Broadway, N. Y.
- J. A. Payne, 260-274 Culver Ave., Jersey City, N. J.
For page see List of Advertisers.
- Foley Mfg. Co., Western Ave., between 25th & 26th Sts., Chicago.
For page see List of Advertisers.
- Hitchings & Co., 1170 Broadway, New York.
For page see List of Advertisers.
- Geo. M. Garland Co., Des Plaines, Ill.
For page see List of Advertisers.

GREENHOUSE HOSE

- Revere Rubber Co., Boston, Mass.
Revere Hose.
For page see List of Advertisers.

GUTTERS

- GUTTERS, Cast Iron Gutters, L. & B. Improved V Shaped Gutter with drip gutter attachment. Lord & Burnham, 1183 Broadway, N. Y.

HEATING APPARATUS

- Lord & Burnham Co., 1183 Broadway, New York.
For page see List of Advertisers.
- Pierson U-Bar Co., 1 Madison Sq., N. Y.
For page see List of Advertisers.
- John A. Payne, 260-274 Culver Ave., Jersey City, N. J.
For page see List of Advertisers.
- Kronschell Bros. Co., 35 Erie St., Chicago.
For page see List of Advertisers.

HAIL INSURANCE

- Florists' Hall Assn. of America.
J. G. Ester, Saddle River, N. J.
For page see List of Advertisers.

HARDY CLIMBERS

- Henry A. Dreer, 714 Chestnut St., Phila.
For page see List of Advertisers.

HARDY FERNS, MOSS AND GREENS

- H. M. Robinson & Co., 15 Province St. and 9 Chpsman Pl., Boston, Mass.
For page see List of Advertisers.
- Michigan Cut Flower Exchange, 38 and 40 Broadway, Detroit, Mich.
For page see List of Advertisers.
- George Cotsouas & Co., 50 W. 28th St., New York.
For page see List of Advertisers.
- N. F. McCarthy & Co., 84 Hawley St., Boston.
For page see List of Advertisers.
- The Kervan Co., 113 W. 28th St., N. Y.
For page see List of Advertisers.
- Rice Bros., 115 N. 6th St., Minneapolis, Minn.
For page see List of Advertisers.

HELP FURNISHED

- Thos. H. Bambrick, 34 S. 7th St., Phila.
For page see List of Advertisers.

HERBACEOUS PERENNIALS

- P. Ouwerkerk, P. O. No. 1, Hoboken, N. J.
For page see List of Advertisers.
- New England Nurseries, Bedford, Mass.
For page see List of Advertisers.
- The Geo. Wittbold Co., 1657 Buckingham Place, Chicago.
For page see List of Advertisers.
- William Tricker, Arlington, N. J.

HOT-BED SASH

- The A. T. Stearns Lumber Co., Neponset, Mass.
For page see List of Advertisers.
- Pierson U-Bar Co., 1 Madison Sq., N. Y.
For page see List of Advertisers.
- Lord & Burnham Co., 1183 Broadway, N. Y.
For page see List of Advertisers.
- Foley Mfg. Co., Western Ave., between 25th & 26th Sts., Chicago.

INSECTICIDES.

- Nicotidee kills all greenhouse pests.
P. R. Palethorpe Co., Eleventh St., Owensboro, Ky.
For page see List of Advertisers.
- Stump & Walter Co., 50 Barclay St., New York.
Kilnhead Tobacco Dust.
For page see List of Advertisers.
- Niagara Sprayer Co., Middleport, N. Y.
Niagara Brand.
For page see List of Advertisers.
- B. G. Pratt Co., New York.
Sulfocide.
For page see List of Advertisers.
- Bowker Insecticide Co., Boston, Mass.
Insect Destroying Preparations.
For page see List of Advertisers.

- Wm. Cooper & Nephews, 177 Illinois St., Chicago; Cyril Franklin, 62 Beaver St., New York, Agt.
V 1 Fluid.
- Eastern Chemical Co., Pittsburgh St., Boston.
"IMP" Soap Spray.
For page see List of Advertisers.

- "The Fumigating Kind Tobacco Powder"—The first on the market and the kind that has so many imitators, has our guarantee of satisfaction or money back, and "The Moon Trade Mark" on every bag, \$5.00 per 100 lbs. The H. A. Stothoff Co., Mount Vernon, N. Y., Makers and sellers.

JAPANESE PLANTS

- Yokohama Nursery Co., 31 Barclay St., New York.
For page see List of Advertisers.

KENTIAS

- Godfrey Aschmann, 1012 W. Ontario St., Phila., Pa.
For page see List of Advertisers.
- A. Leuthy & Co., Roslindale, Mass.
For page see List of Advertisers.
- Jos. Heacock Co., Wyncote, Pa.
Single and Made-Up Specimens.
For page see List of Advertisers.

LEVELS FOR LANDSCAPE GARDENING USE.

- Bostrom-Brady Mfg. Co., 159 Madison Ave., Atlanta, Ga.
For page see List of Advertisers.

LILY OF THE VALLEY PIPS

- Hjalmar Hartmann & Co., Långguststræde 20, Copenhagen, Denmark.
For page see List of Advertisers.

LOBELIAS

- C. Eisele, 11th & Westmoreland Sts., Phila.
Double Lobelia.
For page see List of Advertisers.

MADEIRA VINES

- E. S. Miller, Wading River, N. Y.
For page see List of Advertisers.

MASTICA

- F. O. Pierce Co., 12 W. Broadway, New York.
For page see List of Advertisers.

MOONVINES

- C. Eisele, 11th & Westmoreland Sts., Phila.
For page see List of Advertisers.

NICO-FUME

- Kentucky Tobacco Product Co., Louisville, Ky.
For page see List of Advertisers.

NURSERY STOCK

- John Waterer & Sons, Ltd., American Nursery, Bagshot, England.
For page see List of Advertisers.
- Clary's Horticultural Co., 62 Vesey St., New York.
For page see List of Advertisers.
- P. Ouwerkerk, 216 Jane St., Weehawken Heights, N. J.
For page see List of Advertisers.
- Essex Nurseries, Jamaica Plain, Mass.
Viburnum Mollie.
For page see List of Advertisers.
- American Nursery Co., 150 Broadway, New York, N. Y.
Maurice J. Brinton, Christiansa, Pa.
Norway Spruce.
For page see List of Advertisers.
- Manual of the Trees of North America, by C. S. Sargent, mailed to your address for \$5.00, by Horticulture Publishing Co., 11 Hamilton Place, Boston.
- TREES, SHRUBS, ROSES, EVERGREENS, PEONIES, HARDY PLANTS, ELLWANGER & BARRY, Rochester, N. Y.
New Hardy Shrub—Buddleia variabilis Vetchin and Magnolia, the summer flowering Lilac, 50c. each; \$5.00 per doz.; \$25.00 per 100. Rose Hill Nurseries, New Rochelle, N. Y.
Catalog now ready. Nursery grown evergreens, seedling white pine and hemlock, native trees and plants. L. E. Williams, Nottingham, N. H.

OLD-FASHIONED GARDEN FLOWERS

- Wm. Tricker, Arlington, N. J.

ORCHID PLANTS

- Lager & Hurrell, Summit, N. J.
For page see List of Advertisers.
- Sander, St. Albans, England.
Importers, Exporters, Growers, Hybridists.
For page see List of Advertisers.
- Carrillo & Baldwin, Secaucus, N. J.
For page see List of Advertisers.
- Joia A. Manda, 191 Valley Road, W. Orange, N. J.
For page see List of Advertisers.
- Ordonez Bros., Madison, N. J., Box 106.
Cattleya Mossiae.
For page see List of Advertisers.
- G. L. Freeman, 388 Appleton St., Holyoke, Mass.
Orchid Importations.
For page see List of Advertisers.
- Largest stock in the country. Ask for prices. Julius Roehrs, Rutherford, N. J.
Native Orchids. Hugo Kind, Hammon-ton, N. J.

For List of Advertisers See Page 683

PAINT AND PUTTY

PAINT AND PUTTY: Ideal Greenhouse lead; Special Greenhouse Putty. Lord & Burnham, 1133 Broadway, N. Y.

PALMS

A. Leuthy & Co., Perkins St. Nurseries, Roslindale, Mass.
For page see List of Advertisers.

Robert Craig Co., Market and 49th Sts., Philadelphia, Pa.
For page see List of Advertisers.

Joseph Heacock Co., Wyncote, Pa. Home-Grown Palms.
For page see List of Advertisers.

Geo. Wittbold Co., 1657 Buckingham Place, Chicago.
For page see List of Advertisers.

PANSY PLANTS.

J. C. Schmidt, Bristol, Pa.
For page see List of Advertisers.

SUPERB STRAIN READY NOW.

Fall-transplanted pansies, in bud and bloom. A trial order will convince you that these are the best you ever handled. \$1.25 per 100; \$10.00 per 1000.
Cash with order.

LEONARD COLPINS, JR., Concord Junction, Mass.

Giant Pansy Plants, stocky, from fall-grown seed, 50c. per 100, prepaid; \$3.50 per 1000, not prepaid. Chas. Frost, Kenilworth, N. J.

Pansies, large, field grown, transplanted plants, very choice colors, \$10.00 per 1000. Cash. Stephen Chase, Nashua, N. H.

PATENTS

Siggers & Siggers, Washington, D. C.
For page see List of Advertisers.

PEAT

Orchid Peat and Moss always on hand Julius Roehrs Co., Rutherford, N. J.

PEONIES

Peonies only, by the wholesale—best 100 varieties. J. F. Rosenfield, Westpoint, Nebr.

One of the finest collections in America Send 25 cts. in stamps for new edition of Peony Manual. C. S. Harrison's Select Nursery, York, Neb.

PHLOXES

Send 25 cts in stamps for Phlox Manual Fine mixed phloxes \$2.00 per 100. C. S. Harrison's Select Nursery, York, Neb.

PHOTOGRAPHS: DESIGNING: ILLUSTRATING

Geo. E. Dow, 178 Washington St., Boston.
For page see List of Advertisers.

PIPE AND FITTINGS

Foley Mfg. Co., between Western Ave. and 26th St., Chicago, Ill.

Kroeschell Bros. Co., 35 Erie St., Chicago
For page see List of Advertisers.

PIPE AND FITTINGS. Cast Iron and Wrought Pipe, Valves, Elbows, Pipe Hooks, Automatic Air Headers, etc. Lord & Burnham, 1133 Broadway, N. Y.

PLANT STAKES

Seele's Timeless Plant Stakes and Trellises. H. D. Seele & Sons, Elkhart, Ind.

POT HANGERS

Pot hangers, Kramer's \$1 doz. by exp. \$1.25 by mail. I. N. Kramer & Son, Cedar Rapids, Ia.

Krick's Perfect Pot Hanger and Handle. W. C. Krick, 1164-1166 Greene Ave., Brooklyn, N. Y.

PRIVET

California Privet, well rooted cuttings, \$4.00 per 1000; 1 year old, \$10.00 per 1000. A. B. Campbell, Cochranville, Pa.

RAFFIA

Raffia (colored), 20 beautiful shades. Samples free. R. H. Comey Co., Camden, N. J.; 810 Washburn Ave., Chicago, Ill.

RESURRECTION PLANTS

Resurrection plants and cacti. Cheap. Ask for prices. William Tell, Austin, Tex.

RHODODENDRONS

John Waterer & Sons, Ltd., American Nursery, Bagshot, England.
For page see List of Advertisers.

P. Ouwerkerk, Hoboken, N. J.
For page see List of Advertisers.

ROSES

Robert Craig Co., Market and 49th Sts., Philadelphia, Pa.
For page see List of Advertisers.

P. Ouwerkerk, P. O. No. 1, Hoboken, N. J.
For page see List of Advertisers.

Julius Roehrs Co., Rutherford, N. J. Rose Newport Fairy.
For page see List of Advertisers.

The F. R. Pierson Co., Tarrytown-on-Hudson, N. Y. White Killarney.
For page see List of Advertisers.

S. J. Reuter & Son, Westerly, R. I. My Maryland.
For page see List of Advertisers.

Dilgee & Conard Co., West Grove, Pa.
For page see List of Advertisers.

Scott Bros., Elmsford, N. Y.
For page see List of Advertisers.

Poehlmann Bros. Co., Morton Grove, Ill.
For page see List of Advertisers.

A. N. Pierson, Cromwell, Conn. White Killarney, My Maryland, Ramblers.
For page see List of Advertisers.

Henry A. Diner, 714 Chestnut St., Phila. Field Grown Ramblers.
For page see List of Advertisers.

Montrose Greenhouses, Montrose, Mass.
For page see List of Advertisers.

The Rose, by H. B. Ellwanger; mailed for \$1.30 by Horticulture, 11 Hamilton Place, Boston.

Hand Book of Cultural Notes on Roses Under Glass, by F. P. Brigham, mailed to your address for 25c. by Horticulture Publishing Co., 11 Hamilton Place, Boston.

Grafted rose plants, Brides and Bridesmaids, extra large, strong, healthy plants, 1800 in 3 1/2 and 4-in. pots, \$12.00 per 100; 900 in 2 1/2-in. pots, \$10.00 per 100. Cash with order. Apply, W. S. Wilson Estate, Wellesley, Mass.

SALVIAS

Salvia splendens, 2 1/2 in., \$1.75 per 100. A. B. Campbell, Cochranville, Pa.

SEED GROWERS

Hjalmar Hartmann & Co., Cauliflower and Cabbage Seed. Langangstrosede 20, Copenhagen, Denmark.
For page see List of Advertisers.

SEEDS

T. J. Grey Co., 32 So. Market St., Boston.
For page see List of Advertisers.

Joseph Breck & Sons, 51 and 52 N. Market St., Boston, Mass.
For page see List of Advertisers.

W. Atlee Burpee & Co., Philadelphia.
For page see List of Advertisers.

Arthur T. Boddington, 342 W. 14th St., New York.
Palm Seed.
For page see List of Advertisers.

H. E. Flake Seed Co., Faneull Hall Sq., Boston.
For page see List of Advertisers.

Hjalmar Hartmann & Co., Langangstrosede 20, Copenhagen, Denmark. Cauliflower and Cabbage Seed.
For page see List of Advertisers.

Rickards Bros., 87 E. 19th St., New York
For page see List of Advertisers.

SEEDS - Continued

R. & J. Farquhar & Co., 67 So. Market St., Boston.
Mignonette Seed.
For page see List of Advertisers.

H. F. Michell Co., 1018 Market St., Phila. Primula Seed.
For page see List of Advertisers.

J. M. Thorburn & Co., 35 Barclay St., N. Y.
For page see List of Advertisers.

Leonard Seed Co., Chicago, Ill.
For page see List of Advertisers.

Wm. Elliott & Sons, 42 Vesey St., N. Y. New Seed.
For page see List of Advertisers.

Schlegel & Fottler Co., 26 & 27 S. Market St., Boston.
For page see List of Advertisers.

O. V. Zauggen, Hoboken, N. J. Florists' Spring Seeds.
For page see List of Advertisers.

E. F. Winterson Co., Chicago. Seeds for Plantsmen, Nurserymen, Seedsmen.
For page see List of Advertisers.

Seeds, Rocky Mountain Evergreen seeds in large or small quantities. C. S. Harrison's Select Nursery, York, Neb.

SHRUBS

The Geo. Wittbold Co., 1657 Buckingham Place, Chicago.
For page see List of Advertisers.

SHELF BRACKETS

King Construction Co., N. Tonawanda, N. Y.
For page see List of Advertisers.

SILKALINE

John C. Meyer & Co., Boston, Mass.
For page see List of Advertisers.

SOLUBLE PLANT FOOD

Easter Chemical Co., Boston, Mass.

SPHAGNUM MOSS

Live Sphagnum moss, orchid peat and orchid baskets always on hand. Lager & Hurrell, Summit, N. J.

Sphagnum moss and mountain laurel in bags, bales or car lots. Prices low. Spruce and hemlock in bales. James Day, Box 660, Milford, N. H.

SPRAYERS

Niagara Sprayer Co., Middleport, N. Y.
For page see List of Advertisers.

Chas. J. Jager Co., Boston. Deming Spray Pump.
For page see List of Advertisers.

STEAM TRAP

B. Hippard, Yongestown, O.
For page see List of Advertisers.

STOCKS

J. H. Myers, Altoona, Pa.

STRAWBERRY PLANTS

300 Strawberry Plants \$1. Your selection. List free. Wm. Perry, Cool Spring, Del.

Strawberries (Kelly) \$2.50 per 1000. Cash. Hugo Kind, Hammonston, N. J.

SULFOCIDE

The B. G. Pratt Co., 50 Church St., Dept. W., New York City.
For page see List of Advertisers.

SULPHUR BURNER

Benj. Dorrance, Rose Growers, Dorrance, Pa.

SWEET PEAS

A. C. Zvolnaek, Round Brook, N. J. Water Flowering.
For page see List of Advertisers.

TO-BAK-INE

E. H. Hunt, Genl. Agt., 76-78 Wabash Av., Chicago.
For page see List of Advertisers.

In writing to Advertisers kindly mention Horticulture

VEGETABLE PLANTS

R. Vincent, Jr. & Sons Co.,
White Marsh, Md.
For page see List of Advertisers.

Vegetable plants now ready, all cold frame grown and hardened ready for outdoor planting. Calmar, Charleston, Wakefield and Early Summer at \$2.00 per M, \$15.00 per 10,000. Egg Plants, Black Beauty and New York Spineless, \$1.50 per 100. Tomato plants, Earliana, Chalk's Jewel, June Pluk and Allen's Best, \$1.00 per 100, \$6.00 per M. Caudidower, Early Snowball, 75c per 100, \$1.00 per M. Pepper plants, Ruby King, 75c per 100, \$1.00 per M. Cash with order. All plants by express, receiver to pay charges. Address W. F. Allen, Salisbury, Md.

VEGETABLE SEEDS

Just arrived, our reliable vegetable seeds. Buy your fresh seeds now. These are guaranteed fresh and only first class seeds. The Reliable Seed House, 158 Third Street, Hoboken, N. J.

VENTILATING APPARATUS

Pierson C-Ba Co., 1 Madison Sq., N. Y.
For page see List of Advertisers.

Foley Mfg. Co., Western Ave., between 25th & 26th Sts., Chicago.
For page see List of Advertisers.

John A. Payne, 260-274 Culver Ave., Jersey City, N. J.
For page see List of Advertisers.

The Advance Co., Richmond, Ind.
For page see List of Advertisers.

Quaker City Machine Co., Richmond, Ind.
20th Century Ventilating Arm.
For page see List of Advertisers.

VENTILATING MACHINERY. New Model encased, self-oiling gear; Standard Model Open Gear. Lord & Burnham, 1138 Broadway, N. Y.

VERBENAS

Verbenas, 2½ to 3 in. high, 1c each. Best varieties to be got, all desirable colors. H. J. Blanchard, Ashburnham, Mass.

Lemon Verbena, E. C., 75c per 100, prepaid. Chas. Frost, Kenilworth, N. J.

J. C. Schmidt, Bristol, Pa.
For page see List of Advertisers.

VINCAS

Vinca Var., rooted plants, 75c per 100. A. B. Campbell, Cochransville, Pa.

VIOLETS.

William Sim, Cliftondale, Mass.
Boston and Princess of Wales Violets.
For page see List of Advertisers.

Good, strong California Violets, \$1.00 per 100, \$8.00 per 1000. Chas. M. Allen, 608 Broadway, Fall River, Mass.

Princess Violets, 2½ in., \$2.00 per 100. Jas. T. Baker, Bustleton, Philadelphia, Pa.

WEED KILLER

The American Horticultural Distributing Co., Martinsburg, W. Va.
Target Brand.

WIRED TOOTHPICKS

W. J. Cowee, Berlin, N. Y.
For page see List of Advertisers.

WIREWORK

Reed & Keller, 122 W. 25th St., N. Y.
For page see List of Advertisers.

Dunand & Marohn, Albany, N. Y.
For page see List of Advertisers.

Wirework. Write for our catalogue. Holton & Hunkel Co., Milwaukee, Wis.

William E. Hellscher's Wire Works, 38-40 Broadway, Detroit, Mich.

Wirework—Compare our prices with others. Scranton Florist Supply Co., 201 N. 7th St., Scranton, Pa.

WHOLESALE FLORISTS**Boston**

N. F. McCarthy & Co., 84 Hawley St., Boston.
For page see List of Advertisers.

H. M. Robinson & Co., 75 Province St. and 9 Chapman Pl., Boston.
For page see List of Advertisers.

WHOLESALE FLORISTS—**Continued**

Welch Bros., 226 Devonshire St., Boston.
For page see List of Advertisers.

Talbly, Wellesley, Mass.
For page see List of Advertisers.

Buffalo, N. Y.

William F. Kasting Co., 383-87 Ellicott St., Buffalo, N. Y.
For page see List of Advertisers.

Chicago

Chas. W. McKellar, 51 Wabash Ave., Chicago.
For page see List of Advertisers.

Peter Reinberg, 51 Wabash Ave., Chicago.
For page see List of Advertisers.

E. F. Winterson Co., 45-49 Wabash Ave., Chicago.
For page see List of Advertisers.

J. A. Budlong, 37-39 Randolph St., Chicago.
For page see List of Advertisers.

Poehlmann Bros. Co., Morton Grove, Ill.
For page see List of Advertisers.

Cromwell, Conn.

A. N. Pierson, Cromwell, Conn.
For page see List of Advertisers.

Detroit

Michigan Cut Flower Exchange, 38 and 40 Broadway, Detroit, Mich.
For page see List of Advertisers.

Minneapolis

Rice Bros., 115 N. 6th St., Minneapolis, Minn.
For page see List of Advertisers.

New York

Ford Bros., 48 W. 23th St., New York.
For page see List of Advertisers.

H. E. Froment, 57 W. 23th St., New York.
For page see List of Advertisers.

Alex. J. Guttman, 34 W. 28th St., New York.
For page see List of Advertisers.

E. C. Horan, 55 W. 28th St., New York.
For page see List of Advertisers.

A. H. Langjahr, 55 W. 28th St., New York.
For page see List of Advertisers.

James McMannus, 42 W. 28th St., New York.
For page see List of Advertisers.

John I. Raynor, 40 W. 28th St., New York.
For page see List of Advertisers.

W. F. Sheridan, 30 W. 28th St., New York.
For page see List of Advertisers.

Moore, Hentz & Nash, 55 and 57 W. 28th St., New York.
For page see List of Advertisers.

Wm. H. Kuehler, 28 Willoughby St., Brooklyn, N. Y.
For page see List of Advertisers.

Philip F. Kessler, 65 and 57 W. 26th St., New York.
For page see List of Advertisers.

Milling Bros., 41 W. 28th St., New York.
For page see List of Advertisers.

John Young, 51 W. 28th St., New York.
For page see List of Advertisers.

Greater New York Florists' Association, 162 Livingston St., Brooklyn, N. Y.,
For page see List of Advertisers.

Frank Milling, 65-67 W. 28th St., New York.
For page see List of Advertisers.

B. S. Sinn, 65-67 W. 26th St., New York.
For page see List of Advertisers.

A. L. Young & Co., 64 W. 28th St., N. Y.
For page see List of Advertisers.

Growers' Cut Flower Co., 89 W. 28th St., New York.
For page see List of Advertisers.

Henshaw & Fenrich, 44 W. 28th St., New York.
For page see List of Advertisers.

WHOLESALE FLORISTS—**New York—Continued**

J. K. Allen, 106 W. 28th St., New York.
For page see List of Advertisers.

Charles Milling, 444 Sixth Av., New York.
For page see List of Advertisers.

Philadelphia

W. E. McKisick & Bros., 1619-1621 East 4th St., Philadelphia, Pa.
For page see List of Advertisers.

Leo Niessen Co., 1209 Arch St., Philadelphia, Pa.
For page see List of Advertisers.

The S. S. Pennock-Meehan Co., 1608-10 Ludlow St., Philadelphia, Pa.
For page see List of Advertisers.

WOODENWARE

Bacon & Co., Appleton, N. Y.
Baskets: Crates: Ladders: Boxes.

New Offers in This Issue.**BEDDING PLANTS.**

Storrs & Harrison Co., Painesville, O.
For page see List of Advertisers.

BULB IMPORTERS AND EXPORTERS.

Wm. Hagemann & Co., Hudson Terminal Bldg., New York.
For page see List of Advertisers.

CARNATIONS.

Cobanzie Carnation Co., New London, Conn.
For page see List of Advertisers.

CARNATIONS.

Chicago Carnation Co., Joliet, Ill.
For page see List of Advertisers.

CHRYSANTHEMUMS: BEDDING PLANTS: HYDRANGEAS.

Wm. W. Edgar Co., Waverley, Mass.
For page see List of Advertisers.

CHRYSANTHEMUMS, ROOTED CUTTINGS.

William Swayne, Kennett Square, Pa.
For page see List of Advertisers.

CYCAS REVOLUTA.

H. F. Mitchell Co., Philadelphia, Pa.
For page see List of Advertisers.

HEMLOCKS.

Eilwanger & Barry, Rochester, N. Y.
For page see List of Advertisers.

IMP SOAP SPRAY.

Eastern Chemical Co., Pittsburg St., Boston.
For page see List of Advertisers.

ORCHIDS FRESH IMPORTED.

Joseph A. Manda, 191 Valley Rd., W. Orange, N. J.
For page see List of Advertisers.

ORCHIDS, SPECIAL SALE.

Ordmead Bros., Madison, N. J.
For page see List of Advertisers.

ROSE PLANTS.

U. S. Cut Flower Co., Elmira, N. Y.
For page see List of Advertisers.

ROSES: KAISERIN, GRAFTED; QUEEN BEATRICE, OWN ROOT.

Montrose Greenhouses, Montrose, Mass.
For page see List of Advertisers.

SIBERIAN ARBOR VITAE.

Eilwanger & Barry, Rochester, N. Y.
For page see List of Advertisers.

WILSON'S PLANT OIL.

Wilson Plant Oil & Fertilizer Co., Chatham, N. J.
For page see List of Advertisers.

For List of Advertisers See Page 683

LIST OF ADVERTISERS

Advance, The Co.....687	Lager & Hurrell.....660
Allen J. K.....687	Langjahr, Alfred H.....676
America Nursery.....687	Leonard Seed Co.....671
Bayersdorfer H. & Co.....669	Leahy A. & Co.....669
Achmann & Goldrey.....667	Lord & Burnham Co.....688
Atbata Floral Co.....674	Manda Jns. A.....660
Bambrick Thos. H.....683	MacMullen E. A.....673
Barrows H. H. & Son.....660	McCarthy N. F. & Co.....677
Baur & Smith.....658	McConnell Alex.....672
Bayersdorfer H. & Co.....673	McKellar Charles W.....674
Blossom The.....672	McKissick, W. E. & Son.....674
Bodding on A. T.....670	McManus Jas.....676
Boston Florist Letter Co.....673	Meyer.....672
Boston Glass and Window Plate Co.....686	Meyer J. C. & Co.....677
Bottom-Brady Mfg Co.....675	Michell H. F. Co.....679-671-685
Bowe, M. A.....672	Michigan Cut Flower Exchange.....677
Bowker Fertilizer Co.....671	Millang Bros.....676
Bowker Insecticide.....684	Millang Charles.....676
Breck Joseph & Sons.....671	Millang Frank.....676
Breitmeier's J. Sons.....673	Miller E. S.....659
Bridgeman's Seed Warehouse.....671	Moninger J. C.....687
Brinton, Maurice J.....659	Montrose Greenhouses.....659
Budlong J. A.....674	Moore, J. L.....659
Burpee W. A. & Co.....671	Moore, Henry & Nashberg Mt Hope Nurseries.....679
Carrillo & Baldwin.....660	Murray Samuel.....672
Castle Co. W. W.....684	New Eng. Nurseries.....669
Chicago Carnation.....658	Newman Floral Co.....672
Clarke's David, Sons.....672	Newman J. & Sons.....673
Cleary's Horticultural Co.....669	Niagara Sprayer Co.....685
Coan J. J.....676	Nissen Leo. Co.....674
Cochran Carnation Greenhouses.....667	Oechslein Frank.....660
Cosans Geo. & Co.....676	Ordenez Bros.....660
Cowce W. J.....672	Ouwwerker P.....669
Craig, Robt. Co.....660	Palmer P. R. Co.....685
Crawback Geo. W.....677	Palethorpe J. J.....672
Danker F. A.....672	Park Floral Co.....674
Dawson H. S.....669	Parshelsky Bros.....686
Diange & Conrad Co.....669	Payne John A.....687
Dorner F. Sons & Co.....658	Peacock Dahlia Farms 683
Dow Gen. E.....671	Peacock-Meehan Co.....675
Dreer H. A.....666-687	Perkins St. Nurseries.....660
Dunlop John H.....672	Pierce, F. O. Co.....686
Durand & Marohn.....677	Pierson, A. N.....659
Dysart R. J.....677	Pierson, F. R. Co.....679
Eastern Chemical Co.....685	Pierson U Bar Co.....688
Eastern Nurseries.....669	Pohlmann Bros. Co.....658-674
Edgar Wm. & Co.....667	Plutzerized Manure Co.....685
Edwards Folding Box Co.....674	Quaker City Mfg Co.....687
Ellis C. Co.....674	Rayner, I. M.....659
Elliot Wm & Sons.....671	Rayner John L.....676
Elmsford Nurseries.....658	Reed & Keller.....677
Ellwanger & Barry.....669	Reinberg Peter.....674
Ester J. G.....686	Reuter S. J. & Son, Inc.....685
Ernest W. H.....686	River Rubber Co.....672
Eyres.....672	Rice Bros.....674
Farquhar R. J. & Co.....671	Rickards Bros.....671
Felthousen J. E.....660	Robinson H. M. & Co.....674
Fiske H. E. Seed Co.....685	Rock Wm. L. Fla. Co.....672
Fisher Mig. Co.....672	Rochers Julius Co.....660-669
Ford Bros.....676	Roland, Thomas.....658
Freeman G. L.....660	Rolker August & Sons.....686
Front H. E.....676	Rose Hill Nurseries.....660
Galvin Thos. F.....673	Sander & Son.....660
Garland, Geo. M. Co.....687	Schlege & Fettle Co.....669
Garner W. F. Florists' Association.....677	Schmidt J. C.....677
Grey T. J. Co.....671	Schulz Jacob.....671
Grower's Cut Flower Co.....676	Scott Bros.....658
Gude Bros. Co.....672	Scott, John.....687
Gutman Alex. J.....676	Sharp, Partridge & Co.....686
Hagemann Wm.....666	Sheridan W. F.....676
Hai Assn.....686	Sigers & Sigers.....687
Hartmann Hjalmar & Co.....671	Sim, Wm.....687
Haushwitz the Florist.....672	Situations & Wants.....687
Hancock Jos. Co.....660	Slinn B. S.....676
Henshaw & Fenrich.....676	Smith Elmer D. & Co.....658
Herbert David & Son.....659	Smyth Wm. J.....672
Hews A. H. & Co.....686	Standard Fine Glass Co.....686
Hoffinger Bros.....686	Stearns A. T. Lumber Co.....687
Hill, The E. G. Co.....678	Storrs & Harrison.....667
Hippard E. C.....688	Stump & Walter Cn.....688
Hitchings & Co.....688	Swayne Wm.....659
Hoffman.....673	Syracuse Pottery Co.....686
Horan E. C.....676	Tailly.....672
Hunter E. H.....686	Thorburn J. M. & Co.....671
Hunt, P. F. Co.....676	Totty Chas. H.....672
Kastner W. F. Co.....677	Trepel C. Co.....672
Kentucky Tobacco Product Co.....685	United States Cut Flower Co.....666
Kervan The Co.....677	Valentine, J. A.....672
Kessler, P. F. Co.....676	Vincent Jr. & Sons.....671
Kiss Cons. Co.....687	Ward R. M. & Co.....671
Krick W. C.....677	Washington Miss A.....659
Kroeschell Bros. Co.....687	
Kriebler Wm H.....677	

Waterer John & Sons.....669	Yokohama Nursery Co.....671
Welch Bros.....674	Young A. L.....677
Withold Geo. Co.....669	Young John.....676
Wilson.....672	Young & Nugent.....672
Wilson Plant Oil and Fertilizer Co.....675	Zanz O. V.....667-671
Winterson, E. F. Co.....674	Zinz Julius A.....673
Wood Bros.....658	Zvolanek A. C.....671

PATENTS GRANTED.

918,563. Combination Flower Pot. William W. Lewis, Cohasset, Mass.
918,677. Weed Extirminator and Cultivator. Albert J. Jones, Ritzville, Wash.
919,017. Weed Extirminator. Edwin E. Jackson, Newton, Kans.
918,633. Grading Machine. Carl O. Wold, Minneapolis, Minn.
919,364. Heating System. Hermann Lempp and William G. Fisher, Lynn, Mass., assignors to General Electric Company.
919,528. Steam Boiler. Walter A. Berry, Chattanooga, Tenn., assignor of one-half to Raymond W. Frawley, Chattanooga, Tenn.
919,532. Machine for Treating Flax and Other Fiber Yielding Plants. Eugene Bosse, Salem, Oregon.
919,655. Flower Holding and Grave-Covering Device. John C. Van Aken, Ridgway, Pa.
919,673. Ventilator for Greenhouses. George B. Anderson, Hyde Park, Mass., assignor to James F. M. Farquhar, Boston, Mass.
919,737. Lawn Sprinkler. Lester G. Loomis and Paul I. Tuttle, Ingwood, Cal.
919,768. Shipping Package. John G. Reber, Chicago, Ill., assignor to The J. W. Sefton Manufacturing Company, Anderson, Ind.
919,977. Pruning Knife. Steve Szekfu, Red Bluff, Cal.

HARVARD TAKES UP THE MOTH FIGHT.

With Governor Draper's approval, a collaboration has been effected between Harvard University and Frank W. Rane, State Forester, whereby the supervision of the future campaign against the gipsy and browntail moths in Massachusetts is to rest with the university, which will entrust it to the highest authority at its command at no cost to the Commonwealth, though the actual cost of a part of the work will come out of the state gipsy moth appropriation. Furthermore, a Harvard alumnus provides a special fund for a fungus-hunting expedition to Japan, which is likely to prove of great benefit. This visit to Japan will be made by Dr. G. P. Clinton, mycologist of the Connecticut Agricultural Experiment Station, who has had wide experience with fungus diseases of the browntail. He goes abroad to look for diseases that will attack the gipsy moth as well.

WANTS, FOR SALE, ETC.

Advertisements in this column one cent a word. Initials count as words. Cash with order. All correspondence addressed "care HORTICULTURE" should be sent to 11 Hamillon Place, Boston.

HELP WANTED

GOOD MEN

When you need good men, skilled or unskilled, Write:

THOS. H. BAMBRICK

34 South 7th Street Philadelphia

Help of all kinds, including that for Florists, Nurserymen, Seedsmen and the Horticultural trade generally.

Carpenters and Glaziers. Write King Construction Co., New Amsterdam Hotel, Fourth St., and 21st St., New York.

SITUATIONS WANTED

SITUATION WANTED—Gardener, married, German, 20 years' experience, wants a position. Address H. Grate, care F. Drake, Florist, Pittsfield, Mass.

WANTED—Position as laborer in nursery, orchard, or truck farm for summer. Well educated, and experienced. C. A. Richards, 724 W. Johnson St., Madison, Wisconsin.

FOR SALE

FOR SALE—Five greenhouses, house, five rooms, improvements; barn, carriage house, sheds; all in good repair. One minute to depot, on main street; 20 minutes to Boston; five minutes to two lines of electric. Only florist in large town. Established twenty years. For further particulars address E. G. Blaney, Swampscott, Mass.

FOR SALE—Special 16 x 18 and 16 x 24 double thick glass in "A" and "B" qualities. Buy now and save money! Write PARSHELSKY BROTHERS, INC., 50 Montrose Ave., Brooklyn, N. Y.

MISCELLANEOUS WANTS

WANTED TO BUY—Complete green house plants and all kinds of greenhouse material, to be taken down and removed at once. Terms cash. Address L. Sussnerman, 229 Livingston St., Newark, N. J.

WANTED—One Pandanus Utilis, large plant; state size and price. Scott Bros., Elmford, N. Y.

USEFUL BOOKS.

We can supply the following books, postpaid, at the prices listed:—

Roses and How to Grow Them. By Many Experts. Price, \$1.21.

The New Cyclopaedia of American Horticulture. L. H. Bailey. Four volumes, \$20.00.

How to Plan the Home Grounds. S. Parsons, Jr. Price, \$1.10.

How to Make a Vegetable Garden Edith L. Fullerton. Price, \$2.20.

The Art of Landscape Gardening. By Humphrey Repton. Price, \$3.20.

Manual of the Trees of North America. C. S. Sargent. Price, \$6.00.

Soils: How to Handle and Improve Them. S. W. Fletcher. Price, \$3.20.

CHICAGO NOTES.

The Great Storm.

The culmination of a stormy week was reached last Wednesday night when Chicago was struck by the most severe wind, rain, hail and thunder storm known to many of the florists who have lived there for half a century. The hail, driven by the fierce wind, would have done much damage had the hail stones been large, which fortunately they were not. During Wednesday and Thursday the rainfall was three inches, on ground already soaked. On Saturday, May 1st, those who had planted their young carnations in the field found them sticking out through the ice.

The heavy rainfall coming after the frequent showers of the past month on ground already soaked completely flooded the low ground in the market gardening district. Mr. Kraush at 75th St. and Jeffrey Ave., lost his entire plant used principally for vegetables.

The N. C. Moore greenhouses at Morton Grove suffered much. The tall chimney was struck by lightning and in falling ruined the heating and watering systems. Six-inch iron pipes were twisted like straw in the terrible gale.

Pochlmann Bros., Morton Grove, estimate their loss at \$1500 to \$2000, and think they are fortunate to come through a cyclone so well. The west end of their rose range is entirely out and the stock more or less injured.

Kirecht Bros. of Morton Grove had a 12 ft. section, including rafters, taken from their greenhouses, leaving both ends standing.

J. C. Brooks, also of Morton Grove, was fortunate in escaping with slight damage.

Most of Evanston escaped with a bad scare. It looked as if the many establishments were to be wiped out but the storm passed them by. Michael Keding, a vegetable grower, had the roof of his barn lifted and dropped on the greenhouse, demolishing it pretty thoroughly.

At Frank Oechlin's the small chimney on his storage house was blown over, breaking in the roof and demolishing, among other things, some fine plants of boxwood, just imported, and considerable glass. He estimates his loss at \$200.

Hoerber Bros., who are building a range at Des Plaines, had five houses up but no glass set. The frame work for four was completely wrecked. The loss will be mostly for labor.

Heim Bros. of Blue Island are also heavy losers.

A. W. Meyer, whose greenhouses are at Dalton, thought his place was gone, for he was directly in the path of the storm. Just as it reached his corner the wind turned to the north, passing him by with almost no injury.

At Frank Ben's the greenhouses danced in the wind, but Mr. Ben had no idea of giving up his possessions so easily. He and his men risked their lives by trying to hold down, by means of hose, the corners of a new house, 40 feet wide, and he succeeded.

H. P. Gerhardt of Winnetka was not so fortunate. A greenhouse may be held down but a smokestack cannot be held up. In falling it severed the ends of the houses, letting the wind under

the glass, which took the roof of the entire plant. Total loss, seven houses, barn and dwelling.

C. Clemensen, 8128 Sherman Ave., So. Chicago, is receiving the congratulations of his friends at his miraculous escape. He saw brick buildings blow down and freight cars pile up. The air was filled with flying bricks and cap stones weighing three and four hundred pounds were falling from the new buildings. Mr. Clemensen did not venture out for the two hours the storm lasted there, and when he did he hardly recognized the vicinity, so terrible was the destruction. What was his astonishment to find his 20,000 feet of glass safe and sound.

H. C. Blunt and Chas. Wiffin of Des Plaines, Ill., both suffered loss from the overflowing of the Des Plaines river. The water put out the fires and made it almost impossible to pick the flowers.

The Sick People.

Fred Klingel, of Geo. Reinberg's wholesale store, is suffering from bronchitis. Phil Schupp is able to be back at his desk, after a tussle with grip. Louis Coatsworth, after suffering all winter with rheumatism, is now recovering from an attack of appendicitis. Mrs. O. P. Bassett is slowly improving and is now considered out of danger.

Miscellaneous.

The son of N. P. Miller, greenhouse builder, will be married June 9th to Miss Margaret Schaefer. Miss Josepha Thien will be bridesmaid.

Imported pot plants of magnolia have proved unsatisfactory in the Chicago market. Calceolarias are seen in very beautiful colors but they do not sell well.

According to the report from the weather bureau April made a record for rain fall over an inch higher than ever before. It was 7.73 this year and the highest previous was that for April 1882—6.73.

Provincetown, Mass.—J. & A. E. Brian have recently started in the greenhouse business here under the name of Pilgrim Greenhouses.

"Every Bug Has His Doze."

Insect-destroying preparations that do their work well and effectively are the cheapest. Bowker's Arsenate of Lead and Bowker's Pyrox are recognized standard insecticides and fungicides for both indoor and outdoor use. Bowker's Insect Emulsion destroys many kind of plant lice, black and green flies, etc. Call or send for catalogue.

BOWKER INSECTICIDE COMPANY
43 CHATHAM ST. BOSTON

Which Spray Pump?

Which shall you buy? Buy the Spray Pump that fully meets the demands of the Government Agricultural Scientists and all practical Fruit Growers. These pumps are widely known as

DEMING SPRAYERS and are made in 22 styles for use in small gardens or immense orchards. Write for our free catalog with Spraying Chart. Add 4 cents postage and receive "Spraying for Profit," a useful guide book.

CHARLES J. JAGER CO.
281-289 Franklin St., Boston

SPRAYED

YOU DON'T HAVE TO

Heat your houses with a boiler that is **dangerous** or a system that is **uncertain**. Put in an outfit that you can rely upon. Costs no more—sometimes less. Write to us for particulars, testimonials and advice. This costs you nothing. Do It Now.

W. W. Castle Company

Heating Engineers, Manufacturers of the Castle Boiler, The Electric Circulator, and System of Forced Circulation for Hot Water.

170 Summer Street,

Boston

Tobacco Paper "NICO-FUME" LIQUID
 IS THE STRONGEST, BEST PACKED, EASIEST APPLIED.
 FURNISHES THE Most Nicotine for the Money
 ... Manufactured by ...
 THE KENTUCKY TOBACCO PRODUCT CO., Louisville, Ky.

By far the CHEAPEST.
 JUST NOTE PRICE!

24 sheets.....	\$ 0.75	Pint.....	\$ 1.50
144 sheets.....	3.50	½ Gallon.....	5.50
288 sheets.....	6.50	Gallon.....	10.50
1728 sheets.....	35.10	5 Gallons.....	47.25

An Absolute Success
 in Killing Scale and All Other Insect Pests on Trees, Shrubs and Garden Plants, including the notorious LACE FLY ON RHODODENDRONS without injury to the foliage.
WILSON'S PLANT OIL
 Well Tested and Its Efficacy Fully Demonstrated
TRY IT!
 Wilson Plant Oil & Fertilizer Co., Chatham, N. J.

WIZARD BRAND MANURES
 Dried, screened and packed in bags of 100 lbs. each.

PULVERIZED SHEEP MANURE
 PURE — UNIFORM — RELIABLE
 A strong and quick acting manure, highly recommended for carnations and chrysanthemums.

SHREDDED CATTLE MANURE
 EASY TO HANDLE AND APPLY
 Stronger and better in every way than rough manure. Lasts much longer on the benches. Unequaled for mulching and feeding roses, liquid manuring and mixing with bench and potting soil. Used by all the largest growers.

For Trees, Plants, Shrubs and Flowers
 — USE —
THE NIAGARA BRAND LIME SULPHUR SOLUTION
 It destroys Scale Lice, Spiders and all forms of Aphides, AT THE SAME TIME Mildew, Blight, Rust and other Fungus difficulties.
 Used in Winter or Summer. — No other remedy has been so universally effective.
 Niagara Brand ARSENATE OF LEAD for chewing insects is equal to the best and better than the most Ask about our Green House sprayer. Address —
NIAGARA SPRAYER CO., - - Middleport, N. Y.

Ask Your Supply Man or Write Us for Circulars and Prices.
 — THE —
Pulverized Manure Co.
 31 Union Stock Yards, CHICAGO

DON'T EXPERIMENT
 USE
TO-BAK-INE
 and your stock will be free from insects, clean, and the blooms will not be discolored.
 Send for full information of
H. E. FISKE SEED CO.
 13 Faneuil Hall Sq., Boston, Mass.
STUMPP & WALTER CO.,
 50 Barclay St., New York.
HENRY F. MICHELL & CO.,
 1018 Market St., Philadelphia.
E. H. HUNT, Gen'l Agent,
 76-78 Wabash Ave., Chicago.

IMP SOAP SPRAY
 THREE SUCCESSFUL YEARS
 Outdoor or Indoor
 ELM BEETLE OR WHITE FLY
EASTERN CHEMICAL CO.
 Pittsburg Street, Boston, Mass.

The Best Bug Killer and Bloom Saver

 For PROOF Write to
P. R. Paethorpe Co.
 OWENSBORO, KY.

KILMDEAD
 The best of all the tobacco dusts for

 Dusting or Fumigating
 25 lbs., \$1.00 100 lbs., \$ 3.00 1000 lbs., \$27.00
 50 lbs., 1.75 500 lbs., 14.00 2000 lbs., 52.50
Stumpp & Walter Co.
 50 Barclay St. New York.

SOMETHING NEW for GREENHOUSES
"SULFOCIDES"
 PRATT'S
SOLUBLE SULPHUR SUMMER SPRAY
 Non-caustic and non-irritating
A FUNGICIDE AND INSECTICIDE
 FOR FRUIT TREES, VEGETABLES and GREENHOUSES
 A promising substitute for Bordeaux mixture, For 10 cts. to cover postage will send sample sufficient for one gallon of spray.
 Use 1 part to 75 or 100 parts of water.
B. G. PRATT CO., 50 Church St., New York, U. S. A.

REVERO

THE MODERN GARDEN HOSE
FOR LAWNS, GARDENS, GREENHOUSES, STABLES, ETC.

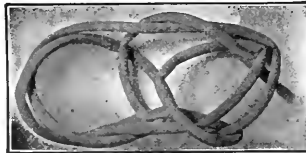
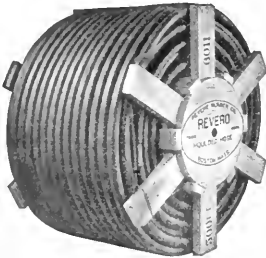
BRAIDED FABRIC, MOULDED CONSTRUCTION, SEAMLESS THROUGHOUT
LIGHT—STRONG—FLEXIBLE



OLD STYLE—READILY KINKS



REVERO—NON KINKING

Revero is furnished on Reels in Continuous Lengths up to 500 ft. Your Supply House can furnish "Revero."

Write for Catalog

REVERE RUBBER COMPANY
BOSTON, MASS.

NEW YORK PHILADELPHIA PITTSBURG CHICAGO
NEW ORLEANS MINNEAPOLIS SAN FRANCISCO PORTLAND, ORE.

STANDARD PLATE GLASS CO.

Manufacturers—Importers—Jobbers

NOW IS THE TIME TO BUY

FRENCH OR AMERICAN GREENHOUSE GLASS

LOWEST PRICES ON REQUEST

26-30 Sudbury St. BOSTON, MASS. 61-63 Portland St.

BOSTON PLATE & WINDOW GLASS CO.

GREENHOUSE GLASS

GERMAN AND AMERICAN

261 to 287 A Street BOSTON 20 to 22 Canal Street

GLASS

Always Write Us Before Buying
SHARP, PARTRIDGE & CO.
22nd and Lumber Streets, CHICAGO
WE HAVE SOME SNAPS

GLASS

Greenhouse and Hot Bed

SIZES OUR SPECIALTY
IMMENSE STOCK

Plate and Window Glass

Write for Our Prices

PARSHELSKY BROS., Inc.
59 Montrose Ave., BROOKLYN, N. Y.

MASTICA
FOR Greenhouse Glazing
USE IT NOW.
F. O. PIERCE CO.
12 W. BROADWAY
NEW YORK

Mastica is elastic and tenacious, admits of expansion and contraction. Putty becomes hard and brittle. Broken glass more easily removed without breaking of other glass as occurs with hard putty. Lasts longer than putty. Easy to apply.

STANDARD FLOWER POTS

Packed in small crates, easy to handle.

Price per crate		Price per crate	
1500 2 1/2 in. pots in crate	\$4.88	144 6 in. pots in crate	\$3.16
1500 2 1/4 " " "	5.25	120 7 " " "	4.00
1500 2 1/2 " " "	6.00	60 8 " " "	3.00
1000 3 " " "	5.00	HAND MADE	
800 3 1/2 " " "	4.80	48 9 in. pots in crate	\$3.60
500 4 " " "	4.50	48 10 " " "	4.80
450 4 1/2 " " "	5.24	24 11 " " "	3.60
320 5 " " "	4.51	24 12 " " "	4.80
210 5 1/2 " " "	3.75	12 14 " " "	4.80
		6 16 " " "	4.50

Seed pans, same price as pots. Send for price list of Cylinders for Cut flowers, Hanging Baskets, Lawn Vases, etc. Ten per cent. off for cash with order. Address **Hilfinger Bros., Pottery, Fort Edward, N.Y.** August Rolker & Sons, Agts. 31 Barclay St., N. Y. City.

Standard Flower .. POTTS

If your greenhouses are within 500 miles of the Capital, write us, we can save you money

W. H. ERNEST

28th and M Street WASHINGTON D. C.

Syracuse Red Pots

STANDARD SIZES

Florists, we will suit you as to quality and prices. Write for catalogue.

Syracuse Pottery Co., SYRACUSE, N. Y.

The FLORESTA HAIL ASSOCIATION OF AMERICA, insurer of 29,000,000 sq. ft. of glass. For particulars address

John C. Esler, Sec'y, Saddle River, N. J.

In ordering goods please add "I saw it in HORTICULTURE."

FOR "POT LUCK" TRY US...

HEWS STANDARD POTS

POT MAKERS FOR 140 YEARS

WORLD'S LARGEST MANUFACTURERS

WRITE FOR CATALOGUE AND DISCOUNTS

A. H. HEWS & CO., Inc.
CAMBRIDGE, MASS.

Pearson Street,
LONG ISLAND CITY, N. Y.

452-460 No. Branch St.,
CHICAGO, ILL.

Light
Graceful
Durable

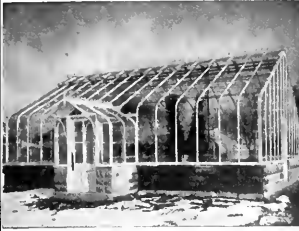

22 ft. wide without columns

Payne "T"
Bar Greenhouse

any width and length. Every bar galvanized steel. Absolutely dripless. No breakage of glass at eaves. Every kind of greenhouse construction. Estimates furnished.

JOHN A. PAYNE

Designer and Builder

260-274 Culver Ave. Jersey City, N. J.

KROESCHELL BOILER



MADE OF FIRE BOX FLANGE PLATE
Can not Crack.

Water Space in Front, Sides and Back
The Most Popular Boiler Made

SEND FOR CATALOGUE.

KROESCHELL BROS. CO.

35 Erie Street, CHICAGO, ILL.



The Advance Ventilating Apparatus

THE ADVANCE MACHINE will take care of all the ventilating sash that the shafting pipe will carry well. We dare any other line to give you better, longer and easier service than we will. \$10.50 for the machine all complete, made of the very best material in a mechanical manner assures of long life and the most satisfactory service. Our shafting pipe is the best grade, new, painted, straightened, drilled and furnished with our new couplings at 8c for the double and 5c for the single strength pipe. Give us a chance to show you what we can do.

The Advance Co.
RICHMOND, IND.

GREENHOUSE CONSTRUCTION LUMBER

John C. Moninger Co.
117 E. Blackhawk St., CHICAGO.

Please Note

that this is not a $\frac{1}{2}$ in. wire affair but it is made of heavy rods.

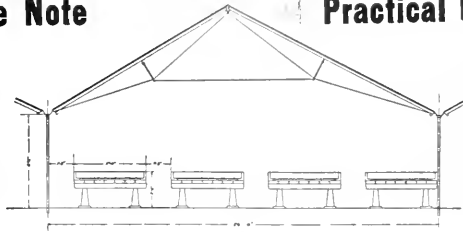

WRITE

GEO. M. GARLAND CO.

Designers and Builders

DES PLAINES, ILL.

THE STANDARD STEAM TRAP

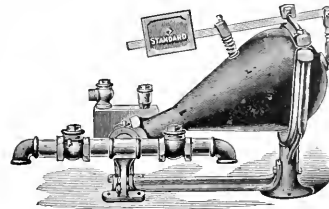

is acknowledged the best for the florist, because it is durable and does its work without trouble and annoyance, saving its cost by the economy in coal bills.

E. HIPPARD

YOUNGSTOWN, OHIO



EVERYTHING FOR GREENHOUSE BUILDING

WRITE FOR INFORMATION AND PRICES

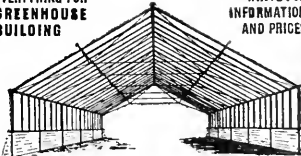

King Greenhouses. King Cutters and Eaves, Trussed Roofs. Ventilating Machinery, Trussed Iron Frame Houses, Tile Benches and Pipe Hangers.

KING CONSTRUCTION COMPANY
NORTH TONAWANDA, N. Y.



Evans 20th Century Arm

Will not twist the shafting pipe. Three times the power of old style elbow arms. Sold only with Evans Challenge Machine.

Write for free Catalogue to
QUAKER CITY MACHINE CO.
Richmond, Ind.

Practical Houses

on a practical financial basis. If you want an up-to-date house that will save you money,

CYPRESS SASH BARS

82 feet or longer
HOT BED SASH
PECKY CYPRESS BENCH LUMBER

GREENHOUSES

ERECTED AND EQUIPPED COMPLETE IF DESIRED

Write for Circular "D" and Prices

The A. T. STEARNS LUMBER CO.
NEPONSET, BOSTON, MASS.

PATENTS

Trademarks and Copyrights

Send your business direct to Washington. Saves time and insures better service. Personal attention guaranteed. Twenty-five years' active service. SPECIALTY: "Working on the Failure of Others."

SIGGERS & SIGGERS

PATENT LAWYERS

Box 9, National Union Building
Washington, D. C.

Holds Glass Firmly

See the Point $\frac{1}{2}$ " FULL SIZE N P 2
PEERLESS

Glazing Points are the best. No rights or titles. Box of 1,000 points 75 cts. postpaid.
HENRY A. DREER,
714 Chestnut St., Philadelphia, Pa.





Our Cover Contract Covers You

By "cover" we mean H & Co. do the entire thing—heating plant, ventilating apparatus, erect your house throughout—**one contract with one firm** to do the whole completed thing, as one. Such a contract has these strong points—you do business with one firm—all parts of the work go forward without delays—everything is on the spot—you hold one firm liable, you make all settlements with one firm, and you get the best construction obtainable, and are sure of pleasant dealing. Write for particulars.

Hitchings & Company
1170 Broadway · New York



Interior of Our Shadeless Ridge House

55 feet 6 inches wide and 300 feet long—
five of which we have erected for the
F. R. Pierson Co. at Scarborough, N.Y.
and now another one is about ready to leave the factory. They are the Sectional Iron Frame Construction, which has stood every test for years. You cannot afford to put up experimental constructions only a few months old—let the other fellow pay for the experiments.

LORD AND BURNHAM COMPANY,
Irvington-on-Hudson, N. Y.
New York — Boston — Philadelphia — Chicago



We know the readers of Horticulture will be interested in this startlingly light interior of a U-Bar house, and suggest that you write to **PIERSON U-BAR COMPANY**, 1 Madison Avenue, New York, for their catalog.

HORTICULTURE

Vol. IX. MAY 15, 1909 No. 20



APRIL HERBACEOUS BORDER
At Harvard Botanical Garden

Photo by Robert Cameron

Devoted to the
FLORIST, PLANTSMAN,
LANDSCAPE GARDENER,
and
Kindred Interests

Published
EVERY SATURDAY
At 11 Hamilton Place,
BOSTON, MASS.
Subscription, \$1.00

CHRYSANTHEMUMS.

"Not small weak rusty stock grown under benches, but the kind that brings back Dollars for Pennies."

WHITE: Earliest October Frost (We have extra fine large stock of this variety), Mrs. Henry Robinson, Clementine Touset, Alice Byron, Timothy Eaton, Merry Christmas, White Bonaffon.

YELLOW: Monrovia, Halliday, Appleton, Bonaffon, Eaton, Chataqua Gold.

PINK: Mc. Nice, Maud Dean, Dr. Enguehardt, Rosiere.

RED: Intersity, Schrimpton.

All these varieties, rooted cuttings \$2.50 per 100; \$3.00 per 100, 2 1/2 in. \$3.00 per 100; \$4.50 per 100.

White Chadwick, Golden Chadwick, Golden Wedding, R. C. \$3.00 per 100; \$4.50 per 100.

Virginia Boehlmann, R. C. \$4.00 per 100, 2 1/2 in. \$5.00 per 100.

Golden Glow, R. C. \$5.00 per 100, 2 1/2 inch \$6.00 per 100.

CARNATIONS.

Enchantress and White Lawson, R. C. \$2.50 per 100; \$2.00 per 1000.

Enchantress, White, Pink and Variegated Lawson, 2 1/2 in. \$3.00 per 100; \$25.00 per 1000.

O. F. Bassett, 2 1/2 in. \$8.00 per 100; 3 1/2 inch \$10.00 per 100.

2 in. or 2 1/2 in. 3 in. or 3 1/2 in.

Bridesmaids 100 1000 100

Brides 100 1000 100

Richmond 100 1000 100

Perle 100 1000 100

Kaiserin 100 1000 100

Uncle John 100 1000 100

Strong well rooted cuttings and 2 1/2 inch stock.
— Sarah Hill, Atterglow, White Perfection, Victory, Rose Pink Enchantress, Winsor, Beacon, White Enchantress, at \$3.00 per 100; \$15.00 per 1000.
— Sarah Hill, H. D. Atterglow, Winsor, Beacon, Victory, 2 1/2 in. \$3.50 per 100; \$32.00 per 1000.

ROSES. 2 in. or 2 1/2 in. 3 in. or 3 1/2 in.
100 1000 100 1000
American Beauties... \$7.00 \$15.00 \$3.00 \$35.00
My Maryland - Grafted strong stock... 20.00
My Maryland - Own roots... 12.00
Killarney - Own roots... \$6.00 \$35.00 7.50
Mrs. Potter Palmer... 5.00 45.00 6.50

POEHLMANN BROS. COMPANY,

Morton Grove, Ill.

CHRYSANTHEMUMS

I have now ready 100,000 plants of 300 varieties, Large Flowered, Singles, Pompons, etc. These are fine stock from 2 1/4 inch pots.

All the standards such as Robinson, Bonaffon, Duckham, Clay Frick, Beatrice May, Mrs. Partridge, Polly Rose in large quantities at

\$3 per 100, \$25 per 1000

Ralph Curtis, Marie Masse, Horace Martin and other new early kinds, \$10.00 per 100.

Write me what you want and see what I can do for you.

CHARLES H. TOTTY, MADISON, N. J.

CHRYSANTHEMUMS

Rooted Cuttings and Pot Plants

Write for list and prices. ALL OF THE BEST ONES.

S. J. REUTER & SON, WESTERLY, R. I.

COMMERCIAL CHRYSANTHEMUMS

For varieties and prices see page 506 of Horticulture for April 24th. Also full quota of other kinds suitable for any purpose.

ELMER D. SMITH & CO., - Adrian, Mich.

Our New Carnation SHASTA

is always pure white, is always in bloom and is always high grade.

\$12.00 per 100, \$100.00 per 1000. Send Order now to **PATTEN & CO., Tewksbury, Mass. BAUR & SMITH, Indianapolis, Ind.**

Attractice Stock At Reasonable Prices
Now Ready Winsor Carnation 2 1/2 in. Pots \$5.00 per 100, German Ivy \$2.00, Salvia \$2.00, Vinca Var. \$2.50, Queen Louise, The Queen, G. L. and Inspector Carnation from soil, at \$15.00 per 100. Out of frame, just right for the field.
COHANZIE CARNATION GREENHOUSES NEW LONDON, CONN.

CHRYSANTHEMUMS 50,000 Rooted Cuttings
White—Timothy Eaton; Mrs. Geo. S. Kolb, fine early; Estelle, White Bonaffon, Alice Byron, Ivory, C. Touset, Jeannie Nonin, October Frost, Early Snow, Angele Laurent, Pink—Glory of the Pacific, Dr. Enguehardt, Maud Dean, Pink Ivory, Yellow—Major Bonaffon, Cremo, Robt. Halliday, "Baby," small yellow, of the button type \$2.00 per 100, \$15.00 per 1000, J. Rosette, \$3.00 per 100.
W. L. SWAYNE, Box 220, Kennett Square, Pa.

GARNATIONS Fine Healthy Stock

From 2 Inch Pots. Per 100 Per 1000
Pres. Seelye - - - - - \$6.00 \$50.00
White Enchantress, Beacon 4.50 40.00
Victory, Winsor, Melody, Kingston Pet - - - - - 4.00 35.00
Dahelm, Lady Bountiful, Mrs. Lawson, White Lawson, Red Lawson, Variegated Lawson 3.50 30.00

CHRYSANTHEMUMS Rooted Cuttings

G. W. Childs, Miss Clay Frick, White Shaw, Early Snow, Mrs. Jas. Marshall, Flay Weaver, The Harriott, Yellow Eaton, \$2.00 per 100, \$15.00 per 1000.
A. J. Balfour, Autumn Glory, Ada Spaulding, Dr. Enguehardt, Dorothy Devens, Geo. Kalb, Glory of the Pacific, Harry Tray, H. W. Reiman, Ivory, Jeanne Nonin, J. E. Lager, J. H. Troy, J. K. Shaw, Paul Dean, Meta, Monrovia, Mrs. Jerome Jones, Minnie Wanamaker, Mrs. Alice Byron, Mrs. Baer, Mrs. Robt. McArthur, Major Bonaffon, Glad F. Bergmann, Nagoya, Polly Rose, Robt. Halliday, Timothy Eaton, W. H. Lincoln, Wm. Duckham, etc., \$1.50 per 100.
Send for Catalogue of Roses, cwn root and grafted, and other miscellaneous stock.

WOOD BROTHERS FISHKILL, N. Y.

Send for our Preliminary List describing and quoting

Chrysanthemums and Carnations.

A fine lot of Carnation Cuttings ready now.

THE E. G. HILL CO., Richmond, Indiana.

MARY TOLMAN

A New Light Salmon Pink Carnation for 1910.

\$12.00 per 100, \$100.00 per 1000.

A. E. Hunt & Co., Evansville, Ill. Chicago Carnation Co., Joliet, Ill. Hunt Bros., - - Park Ridge, Ill.

FOR IMMEDIATE DELIVERY CARNATIONS

From 2 inch pots
White Perfection.....\$3.00 per 100
Winona..... 6.00 "
Defiance..... 4.00 "
Red Chief..... 5.00 "
Winsor..... 5.00 "
F. Dorner & Sons Co., LA FAYETTE, IND.

SCOTT BROS. CHRYSANTHEMUMS

All the Newest and Best Sorts
ALSO
ROSES Grafted and Own Root for Greenhouse and Outdoors
ELMSFORD NURSERIES, Elmsford, N. Y.

GARDENIAS

Fine, large Jessamines (gardenias) with beautiful foliage, two grades.
Stems from 8 to 12 in., \$6 per 1000
" " 12 to 18 in., " " 9 " " C.O.D
i. o. b. Alvin. Terms strictly Cash or C.O.D
MISS A. WASHINGTON, ALVIN, TEX.

NEW ROSE WHITE KILLARNEY

We Know You Will Want to Buy White Killarney

Every live, progressive, up-to-date grower who has seen it is buying it; but when you buy White Killarney, be sure you get the right White Killarney (the Waban variety). When you buy from us you get the variety that has been exhibited and certificated, and the one that has attracted such favorable mention.

If you are in the vicinity of New York, we should be glad to have you call and see White Killarney growing at our Scarborough range, and you will say at a glance—as everyone has who has seen it growing—that it is by far the best white rose that has ever been placed on the market.

It is not only a good winter-flowering rose, but is good the entire year, and it is a splendid shipper. Read the following letter received from Mr. Willis N. Rudd, Secretary of the Society of American Florists, dated January 18th, in which he writes as follows:

"Dear Mr. Pierson:—I cannot refrain from writing you and expressing my admiration for the White Killarney as shown at Chicago on Thursday. It is an exquisitely beautiful thing and attracted much attention. I took half the blooms home with me, and they were finer on Saturday than they were at the show. The record is that these blooms were shipped from Tarrytown, staged and exhibited during the afternoon. They were then carelessly wrapped up in a box and remained in that box until one o'clock Friday morning, at which time I reached home; improved in quality up to Saturday, and were in fairly presentable condition on Sunday.

"In addition to being the most beautiful white rose of its class which I have seen, this demonstrates its splendid keeping and shipping qualities.

W. N. RUDD."

We were awarded Silver Cup at National Flower Show, Chicago, for best new rose with White Killarney; also Silver Medal Horticultural Society of New York.

Strong plants, 2 1/4 inch pots, own roots, now ready for delivery, \$30.00 per 100; 250 for \$70.00; 500 for \$125.00; 1000 for \$250.00. Grafted plants, ready April 1st, \$35.00 per 100; 250 for \$82.50; 500 for \$150.00; 1,000 for \$300.00.



F. R. PIERSON CO., Tarrytown-on-Hudson, NEW YORK

ROSES

Good Grafted Killarney 2 1-4 in. \$12.00 per 100
 Good Own Root Richmond, \$4.00 per 100 pots

White Cherokee, One year old, 3 plants in a 7 in. pot. 25c. a pot.
 500 Kaiserin, grafted, good plants 2 1/4 and 3 in. pots, \$12.00 per 100
 400 Queen Beatrice, Own root, 3 in. pots, extra good, \$5.00 per 100

MONTROSE GREENHOUSES

MONTROSE, MASS.

A. N. PIERSON, Inc., Cromwell, Conn.

WHITE KILLARNEY (Waban Strain)

	Doz.	100	250	500	1000	2500	5000
GRAFTED STOCK.....	\$8.00	\$55.00	\$82.50	\$150.00	\$300.00	\$687.50	\$1,250.00

MY MARYLAND	GRAFTED	OWN ROOT
	...\$3.00 per doz.,	...\$2.00 per 100,
	10.00 per 100,	90.00

STANDARD VARIETIES

Betty, Bon Silene, Bride, Bridesmaid, Cardinal, Enchanter, Etoile de France, Etoile de Lyon, Franz Deegan, Gen. McArthur, Golden Gate, Hermosa, Ivory, Kaiserin Augusta Victoria, Kate Moulton, Killarney, La Detroit, Maman Cochet, Marechal Niel, Mme. Abel Chatenay, Mrs. Jardine, Mme. Hoste, Mrs. Paul Niehoff Mrs. Pierpont Morgan, Mrs. Potter Palmer, Papa Gontier, Queen Beatrice, Rhea Reid, Richmond, Rosaline Orr English, Souv. du President Carnot, Souv. de Wootton, Uncle John, Wellesley, White Cochet. The above Grafted selected plant \$20 cts. each, \$2.00 per doz., \$15.00 per 100, \$120.00 per 1000.

OWN ROOT ROSES

Killarney, Bride, Bridesmaid, Mme. Abel Chatenay, Ivory, Richmond, Mrs. Paul Niehoff. 2 1/4 in. pots, 75c per doz., \$3.50 per 100, \$30.00 per 1000. 2 1/2 in. pots, \$3.00 per doz., \$6.00 per 100, \$50.00 per 1000.
 Queen Beatrice, Rhea Reid, Mrs. Jardine, Mrs. Potter Palmer, from 2 1/2 in. pots, \$8.00 per 100, \$70.00 per 1000.

BEDDING PLANTS

COLEUS, Verschaffeltii, Golden Queen, Queen Victoria, Beckwith Gem, Firebrand, Lord Palmerston. Rooted Cuttings by express, \$0.60 per 100, \$5.00 per 1000. Out of 2 1/4 in. pots in May, \$2.00 per 100, \$15.00 per 1000.
 Golden Beder, Hero, Messy, Pearl of Orange. Fancy Varieties. Twelve kinds not listed above, 75 cts. per 100, \$5.00 per 1000.
 AGERATUM, Stella Gurney, Princess Pauline. SALVIA, Splendens, Bonfire and Zurich. HELIOTROPE. Dark blue bedding varieties. GERMAN IVY. 75 cts. per 100, \$6.00 per 1000.
 ALTERNANTHERA, Red and Yellow, 50c per 100, \$5.00 per 1000. From 2 1/4 in. pots, \$2.00 per 100.
 SALLEROL, Rooted Cuttings, \$1.00 per 100, 2 1/4 in. pots, \$2.50 per 100.
 CHRYSANTHEMUMS IN QUANTITY. Catalogue on Application.

2 1/2 Stock Chrysanthemums

Golden Glow, Pacific Supreme, White Cloud, Lynwood Hall, \$5 per 100; Golden Eagle \$10 per 100; Virginia Poehmann, Alice Roosevelt, \$4 per 100, \$35 per 1000; October Frost, Appleton, White Bonafant, Touset and all commercials, \$3 per 100, \$25 per 1000 Cash.

I. M. RAYNER

GREENPOT, L. I., N. Y.

GLADIOLI NAMED VARIETIES

Childs and Gandavensis Seedlings, Madeira Vines, Cinnamon Vines, Oxalis, Spotted Callas, and Iris Germanica. Write for prices.

E. S. MILLER, Wading River, N. Y.

CANNAS

Strong plants from pots 25 leading varieties, \$5.00 per 100.

ESTATE OF DAVID FISHER, Woburn, Mass.

In ordering goods please add "I saw t in HORTICULTURE."

PANSY PLANTS

Fine Plants ready to bloom, of my well known strain, \$2.50 per 100; large plants in bud and bloom, \$1.00 per 100, \$8.00 per 1000.

GERANIUMS, best kinds, double PETUNIAS (Dwarf), VINCA var., PARLOR IVY, STOCKS, fine plants, 2 1/2 in., \$2.00 per 100; 300 for \$5.00.

CABBAGE PLANTS E. J. Wakefield, ready to plant out, \$1 25 per 1000; 5000 for \$5.00.

J. C. SCHMIDT, Bristol, Pa.

ORCHIDS

We have just received the following Orchids in superb condition and solicit your inquiry for same.

CATTLEYA TRIANAE

best type known, free flowering and of great variation. Superb plants, fresh, plump and well leaved. By dozen hundred or case.

ODONTOGLOSSUM CRISPUM

Pacho type, splendid plants in perfectly fresh condition.

Phalaenopsis amabilis, P. Schilleriana, VANDA SANDERIANA

Oncidium varicosum Rogersii, O. splendidum, O. crispum, O. Forbeii, O. sarcoodes, O. Wentworthiana, Odontoglossum grande, Miltonia candida, M. spectabilis, M. flavescens, Lycaste Skinneri, Scuticaria Steecli, Zygopetalum crinitum, Z. Gautieri.

To arrive in a few days: Cattleya labiata, Dendrobium formosum, D. nobile, D. thrysliflorum, Vanda coerulea, Cattleya Percivaliana, and many more. Write for prices.

LAGER & HURRELL

SUMMIT, N. J.

ORCHIDS ORCHIDS

Would you like to buy first-class plants for less price than anybody else sells for? Also without disease. The facts must be proved at once therefore we are giving a special sale of our strong and healthy

C. Mossiae, 450 bulbs for \$40.00 a case, also C. Percivaliana, well established plants, 9 to 12 bulbs, \$1.00 a-piece.

Expect C. Labiata, C. Gigas Sanderiana and others shortly.

ORDONEZ BROS.

MADISON, N. J.

IMPORTED ORCHIDS

Now Arriving

Julius Roehrs Co.

RUTHERFORD, N. J.

ORCHIDS Just Arrived Splendid Plants.

Dendrobium, Wardianum, Nobile, Flowering Dec. to April, \$1.50 and Upward each.

CATTLEYAS Mendelii, Mossiae, Speciosissima, Gigas, Gigas Sanderiana, Chrysothota, or Aurca. ORDER NOW.

C. L. FREEMAN, 388 APPLETON STREET, HOLYOKE, MASS.

Palms
Shrubs



Ferns
Perennials

Send for Our Catalogue.

The GEO. WITTBOLD CO., 1657 Buckingham Place, Chicago, Ill.

FERNS FOR DISHES,

CASH WITH ORDER

2570 to 2606 W. Adams St., Chicago, Ill.

COLEUS! COLEUS!

C. Verschaffeltii and Golden Bedder, R. C.	Pr 100	Pr 1000
Same in 2 1/2 in. pots	2.00	15.00
Coleus, flixed R. C.	.60	5.00
Same in 2 1/2 in. pots	1.75	15.00
Ageratum Stella Gurney and Pauline R. C.	.50	4.50
Same in 2 1/2 in. pots	1.00	9.00
Feverfew in 2 1/2 in. pots	2.00	
Fuchsias, our selection, in 2 1/2 in. pots	3.00	
German Ivy R. C.	.75	
English Ivy R. C.	1.00	

Cash with Order

J. E. FELTHOUSEN

148-154 Van Vranken Ave., SCHENECTADY, N. Y.

NEPHROLEPIS MAGNIFICA

THE SENSATIONAL NOVELTY

Strong 2 1/2-in. stock, \$25.00 per 100.

WHITMANII

2 1/2-in., \$40.00 per 1000; 3 1/2-in., from Bench, \$8.00 per 100.

H. H. BARROWS & SON, WHITMAN, MASS.

ROBERT CRAIG CO.

ROSES, PALMS,

and Novelties in Decorative Plants

MARKET and 49th STREETS., PHILADELPHIA, PA.

FRESH IMPORTED ORCHIDS.

Arrived in Splendid Condition: Cattleya Trianae, Mossiae, Gigas, Skinnerii, Oncidium Splendidum, Orthorrhynchum, Wentworthianum, Phalaenopsis Schilleriana and Amabilis, Lycaste Skinnerii, Vanda Boxallii, Laelia Superbissima, Odontoglossum grande. Write for prices.

JOSEPH A. MANDA

191 Valley Road West Orange, N. J.

ORCHIDS

We are booking orders now for delivery early in the Spring on all commercial CATTLEYAS and NOVELTIES. Our prices are right and our guarantee perfect. We sell only first-class goods

CARRILLO & BALDWIN Secaucus N. J.

ORCHIDS

Largest Importers, Exporters, Growers and Hybridists in the World

Sander, St. Albans, England and 235 Broadway, Room 1 NEW YORK CITY

Assorted Varieties FRANK OECHSLIN

From 2 inch pots, \$3.50 per 100; \$30.00 per 1000

Kentias, Arecas, Latanias, Cocos, Phoenix, Araucarias, Rubbers, Crotons, Pandanus, Asparagus, Ferns for Dishes. 200,000 Bedding Plants, also Rooted Cuttings of Coleus at lowest wholesale rates.

Orders taken for imported plants for fall delivery
A. LEUTHY & CO.
PERKINS ST. NURSERIES
ROSLINDALE, MASS.

BARCAINS

Ampelopsis Vitellchi, 3 in. pots, \$5 per 100. Clematis Paniculata, 4 in. pots, \$10.00 per 100; 3 in. pots, \$5.00 per 100. Clematis, large flowering varieties, 2 year old plants, Jackman, Henry, Andre, \$3.00 per dozen; Coccinea, \$2.00 per dozen. Begonias, White, Scarlet, Pink and Humboldt, 2 in. pots, \$3.00 per 100. Hydrangea Otakea, 2 1/2-2 in. pots, \$3.00 per 100. Carnations, R. C. from soil, Dorothy, Elton, \$3.00 per 100; Geraniums, standard varieties, from 3 in. pots, \$4.00 per 100; 4 in. pots, \$6.00 per 100. Lobelia, double blue, 2 1/2 in. pots, \$3.00 per 100. Moon Vines, true large flowering white variety, 2 1/2 in. pots, \$2.00 per 100. The following stock from 2 1/2 pots at \$2.50 per 100. Fuchsias, 4 varieties. Alysium Carpet of Snow. Phlox Drummondii, Dwarf Lobelia, Emp. William, Salvia, Bonfire and Zurich, Verbena, Parlor Ivy, Petunias, Cal. Giants and Star, Feverfew Little Gem, Coleus. Golden Bedder and Quadriflor. Alternanthera, 4 varieties, Golden Feather, Chrysanthemums, standard varieties. Cupheas, White Snapdragon, Lantana, LeNain, Chrysanthemum, the early varieties. Glow, White Cloud, Pacific Supreme, from 2 1/2 in. pots, \$3.00 per 100.

C. EISELE

11th and Westmoreland Streets, PHILADELPHIA, PA.

HEACOCK'S PALMS

7-inch pots 2 to 2 1/2 inches high	\$2.50 each
7-inch pots 3 to 3 1/2 inches high	3.00 "
9-inch tub 4 to 4 1/2 inches high	5.00 "
Made up Kentia Forsteriana	
7-inch pots 2 to 2 1/2 inches high	\$2.50 each
7-inch pots 3 to 3 1/2 inches high	3.00 "
9-inch tub 4 to 4 1/2 inches high	5.00 "

Josr ph Heacock Co., Wyncote, Pa.

PALMS AND FERNS

DECORATIVE PLANTS

JOHN SCOTT
Rutland Road and E. 45th St.
Tel. 8890 Bedford BROOKLYN, N. Y.

JARDINIERE FERNS

IN BEST VARIETIES. VERY FINE STOCK.

\$3.50 per 100, \$30.00 per 1000

ROSE HILL NURSERIES
New Rochelle, N. Y.

Amaryllis Johnsoni



The illustration herewith shows a well grown *Amaryllis Johnsoni* in a 6-inch pot which was recently shown before the Newport Horticultural Society by Colin Robertson, gardener for Mrs. Robert Goelet, and awarded a first-class certificate for cultural merit, it having two flower spikes over two feet long with fine unusually large flowers on each, and all in good condition. This variety is said to have been raised by a watchmaker in England over 100 years ago, but although old it is still one of the best of its color which is a rich dark red with stripes through each segment.

Amaryllises, like many other old-fashioned plants, have had periodical spells of popularity and justly deserve a more prominent place in our plant collections than they have at present. They are suitable for many different uses and adaptable to various forms of treatment which makes them valuable for both professionals and amateurs and as flowering pot plants they fulfill more requirements than many of the popular kinds of the present. They can be retarded or forced into flower at almost any season of the year, have few insect enemies, require little room space on account of their sparse foliage and have a range of superb colors suitable for almost any taste.

James Robertson

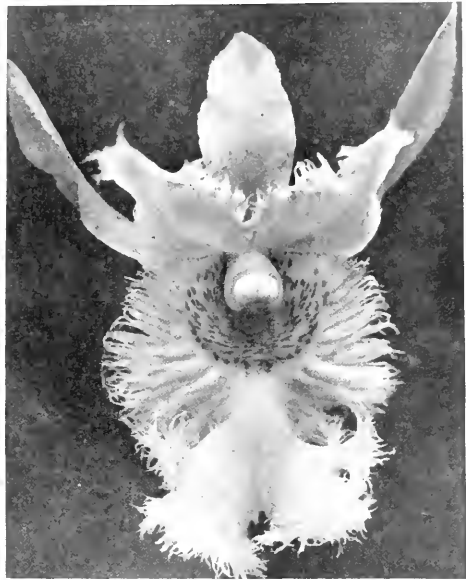
Chondroryncha fimbriata

The accompanying picture shows one of the most curious flowers in the wonderful family *Orchidææ*. The plants are of easy culture and very floriferous yet strangely enough are seldom seen in American collections. The habit of the plant somewhat resembles that of an *odontoglossum* with long narrow leaves, but without pseudo-bulbs. The roots are very fleshy and require plenty of water at all times. We have had splendid results with this species, by giving it the same treatment as we give *odontoglossums*, having had as many as a dozen flowers open at one time on a small plant in a five-inch pot and afterwards on the same plant a continuous succession of solitary flowers for several months. The flowers seem abnormally large in comparison to the size of the plant. The color of sepals and petals is creamy white; the lip is also cream color with purple spots and blotches under the column and the margins are wonderfully crisp and fimbriated. The scape bears only one flower. A moist, cool treatment in summer is essential. In winter, full sunshine may be given, providing the atmosphere is not too dry. Thrips are very partial to the foliage of this genus, and if allowed to infest the plants for even a short time will do irreparable damage.

James Hutchinson

HORTICULTURE

VOL. IX MAY 15, 1909 NO. 20

PUBLISHED WEEKLY BY
HORTICULTURE PUBLISHING CO.
 11 Hamilton Place, Boston, Mass.
 Telephone, Oxford 322
WM. J. STEWART, Editor and Manager

Subscription Price

One Year, in advance, \$1.00; To Foreign Countries, 1.50; To Canada, \$1.50

Advertising Rates

Per Inch, 30 inches to page \$1.00
 Discounts on Contracts for consecutive insertions, as follows:
 One month (4 times) 5 per cent.; three months (13 times) 10 per cent.;
 six months (26 times) 20 per cent.; one year (52 times) 30 per cent.
 Page and half page spaces, special rates on application.

Entered as second-class matter December 8, 1904, at the Post Office at Boston, Mass. under the Act of Congress of March 3, 1879.

CONTENTS

COVER ILLUSTRATION: April Herbaceous Border.....	Page
AMARYLLIS JOHNSONI James Robertson—Illustrated.....	693
CHONORHYNCHA FIMBRIATA—James Hutchinson—Illustrated.....	693
HOUSE OF FLOWERS—Illustrated.....	695
OBITUARY:	
Mrs. Orland Bassett—Mrs. J. F. Huss—A. C. Schroeder—John Dallas—Adolph Frost—Grant Thorburn—Jacob Schneider—J. C. Rossow—Mrs. Harriet H. Smith.....	695
NEWS OF THE CLUBS AND SOCIETIES:	
Gardeners' and Florists' Club of Baltimore—Chicago Florists' Club—New York Florists' Club—Pittsburgh Florists' and Gardeners' Club—Chrysanthemum Society of America.....	696
Society of American Florists—National Horticultural Society of France.....	697
Club and Society Notes.....	698
DURING RECESS:	
Buffalo Florists' Club—New Orleans Horticultural Society.....	698
HARDY PERENNIALS AND THEIR VARIOUS USES—Robert Cameron.....	702
OF INTEREST TO RETAIL FLORISTS:	
Washington—Steamer Departures.....	704
Flowers By Telegraph.....	705
FLOWER MARKET REPORTS:	
Boston, Buffalo, Chicago, Indianapolis, Philadelphia, New York.....	707
THE WHITE FLY.....	716
MISCELLANEOUS:	
Personal.....	695
Movements of Gardeners.....	695
The Gardening World.....	695
Carnations at Joliet.....	698
May, Poetry.....	698
Park Improvements at Denison.....	700
Chicago Street Trees.....	700
Baltimore Outdoor Crops.....	700
Detroit Nursery Trade.....	700
Garden Life Year Book.....	700
Seed Trade Notes.....	702
Carnation Notes.....	704
Business Troubles.....	706
Business Changes.....	706
Incorporated.....	709
Philadelphia Notes.....	714
Fire Record.....	714
Greenhouses Building or Contemplated.....	715
Wind and Hail.....	715
News Notes.....	716

shipped flowers and if it should be demonstrated that carnations can be successfully grown outdoors in April to compete with the greenhouse product from farther north the result is likely to be far reaching. The possibilities in flower production are still far from being realized but it has been demonstrated over and over again that the loss of a shipping trade and consequent casting upon the home market the resultant surplus has a most demoralizing effect on values, especially where the facilities for production are being rapidly multiplied.

"Mothers' Day" and the Florist

So far as we have been able to learn, the proposed new holiday, "Mothers' Day," on which date once a year everybody was requested to wear a

white carnation in tribute to his or her mother was met with very scant observance last Sunday, insofar as the display of a carnation in the button hole could be construed as an offering on the altar of filial devotion. From press clippings that have come to us from various sources it would seem that the major portion of the people prefer to honor their mothers in their own way and look askance at the suggestion that the public parading of a carnation in the button-hole once a year can in any sense promote a sentiment which should be, and presumably is, uppermost in the heart of every normal human being, not one day but every day in the 365. The phase of the matter that most directly concerns us is, however, the question of how far the florist can safely go in pushing forward a proposition of this kind. It must be apparent to the thinking man that a too urgent advocacy by the florist is pretty liable to be misinterpreted, thus affording an opening for comment on the motives for such activity which may react injuriously on a business that has already suffered too much through short-sighted policies.

Six long days a week enough

If there is one particular more than another in which reform is sorely needed in the florists' business, it is in the long hours and Sunday work which, because of fixed habit and timidity,

have come to be regarded as unavoidable. Public holidays are among the florists' hardest working days and Sunday work has become so engrafted into the customs of the trade that any suggestion that it might be curtailed or discontinued altogether is met with incredulity and any attempt on the part of local authorities to enforce Sunday closing is resented by the florists themselves as an injustice. Yet it is undoubtedly true that most of the Sunday toil of the seller of flowers might well be dispensed with, provided an agreement is entered into and faithfully kept by all concerned. The public are, of course, always ready to accept as a prerogative any service, regardless of the amount of self-sacrifice it may impose upon others, and the initiative for reform in this case must come from the florists themselves. The public will fall into line when they are convinced that they must and not before. In these days of ever-ready universal communication by telephone and inexhaustible wholesale supplies of flowers within easy reach, the reasons which originally necessitated keeping open during long and unusual hours in anticipation of sudden calls no longer exist. We often marvel at the uncomplaining, patient submission of employes in the florist trade to the exactions of their business as at present conducted. The wholesale dealers in New York, we are informed, have all agreed to close up on Sundays regularly hereafter. The retailers would do well to follow suit.

A cloud on the horizon

In our issue of April 24, it was stated by the secretary of the New Orleans Horticultural Society that our dear carnations exhibited by one of the members were in as good and even better condition than those brought from the north and were found to last longer. New Orleans and other cities in the same section have been good buyers for northern

Obituary.

Mrs. Orland P. Bassett.

Mrs. Orland P. Bassett died at the Mary Thompson Hospital in Chicago, May 7th, after an illness of three weeks. She was taken ill returning from Hot Springs, Va., with Mr. Bassett who had spent some time there for his health. She appeared to be getting along nicely and her recovery was expected when the disease took a fatal turn and she passed away. Mrs. Bassett was prominent in the social life of Hinsdale, and her husband is the senior member of the firm of Bassett & Washburn. The funeral was held on Sunday, May 9th, at the home in Hinsdale and interment was at Oak Forest Cemetery at that place.

Mrs. J. F. Huss.

Mrs. Helen E. Huss, wife of John F. Huss, superintendent at the J. J. Goodwin estate, Hartford, Conn., died on Sunday morning, May 9, after an illness of three months. She was the second wife of Mr. Huss and the circumstances of her sickness and death were especially pathetic as her illness developed shortly after his marriage last winter. Four little children are again left motherless and the deepest sympathy is felt for Mr. Huss in this affliction.

John Dallas.

We have just received word of the death at Danbury, Conn., of John Dallas, formerly in the florist business at Fairfield, Conn., and later in charge of Ventford Hall, the beautiful estate of G. H. Morgan, Lenox, Mass. Mr. Dallas leaves a son and two daughters. He was a member of the Lenox Horticultural Society.

A. C. Schroeder.

Alvin Charles Schroeder, one of the older florists of Bayonne, N. Y., died on May 2, at the age of sixty-nine. Mr. Schroeder was a native of Germany but settled in Bayonne forty-five years ago and had there built up an extensive business. Two sons, Frederick W. O. and Rustin L., survive him.

Adolph Frost.

Adolph Frost, a native of Germany but a resident of the United States since 1857, and the oldest florist in Cortland, N. Y., died on April 29 at the age of 78. A daughter and son survive him, the latter carrying on the business which his father established.

Grant Thorburn.

Grant Thorburn, brother to the late J. M. Thorburn, and grandson of the founder of the seed house of J. M. Thorburn & Co., New York, died in Paris, France, April 30, aged 81.

Jacob Schneider.

Jacob Schneider, carnation grower at Rogers Park, Chicago, died May 5th. He was ill but a few days with pneumonia. He leaves a wife and two children.

J. C. Rossow.

J. C. Rossow, a well known grower for the New York market, died on

April 29, at an advanced age. His home was at Carlstadt, N. J.

Mrs. Harriet H. Smith.

Mrs. Harriet H. Smith, mother of Frank Smith of Smith & Fetters, Cleveland, O., died on May 2. Interment at Bristol, Conn.

HOUSE OF FLOWERS.

The accompanying illustration is reproduced from our Belgian contemporary *La Tribune Horticole*. It is stated that this house was during the summer of 1908 the best adorned in all Belgium. This branch of gardening art is not given the attention it should have in this country. A few examples

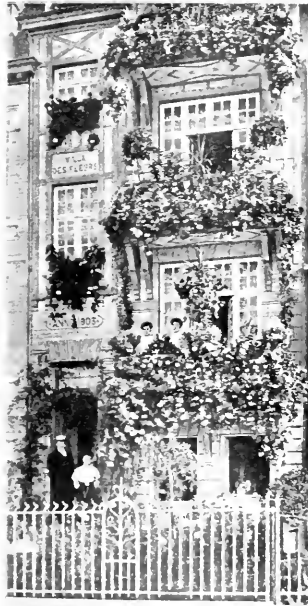

like this house herewith pictured, in both residential and business streets, would soon excite the public interest to the extent that the object lesson would be very generally followed and the demand for plants suitable for such work amazingly increased. It is up to the florists themselves to set the fashion. Do it this season.

THE GARDENING WORLD.

This old established English gardening paper, after an existence of nearly a quarter of a century, has ceased to appear. It has been taken over by the proprietors of "Garden Life," a well known horticultural journal for amateurs, with which it is now incorporated. The first number following the amalgamation will be considerably enlarged, and will be entitled "Special Amalgamation Number of Garden Life," the old title being no longer used. It is published by the Cable-Printing and Publishing Co., London, Eng., a business concern that is specially interested in providing literature for the amateur gardeners of the United Kingdom. C. H. P.

Personal

Robert George has taken a position with C. E. Wingate, Lawrence, Mass.

Visitors in New York: C. C. Cropp, Chicago; Ernest Benary, Jr., Erfurt, Germany.

Carl Jurgens of Newport, just returned from a trip to Spain, was a visitor in New York this week.

J. H. Slocombe, florist of Townsend Ave., New Haven, Conn., is reported to be recovering from the shock with which he was recently stricken.

Visitors in Boston: W. A. Koch, Denmark; E. J. Fancourt, Philadelphia, Pa.; Ralph M. Ward, New York, N. Y.; Winfried Rolker, New York.

Andrew Ferguson, of Detroit, who has been ill most of the winter has been taken to the hospital and an operation is thought to be necessary.

Daniel MacRorie, who recently opened a new business in San Francisco, reports the arrival of an importation of Phalaenopsis in perfect condition.

Lyman B. Crow of the Lord & Burnham Company, made his first visit a few days ago to his office in New York since his recovery from a very critical surgical operation.

Recent reports from Luther Burbank state that he is indisposed and unable to receive visitors at his Santa Rosa home. Needless to say, every one wishes him a speedy recovery.

W. McE. Brown, a frequent contributor to HORTICULTURE, has accepted a position on the Coryell estate, Menlo, California. This is one of the most noted orchid establishments on the Pacific Coast.

Lyman B. Brainerd, president of the Hartford Steam Boiler Inspection and Insurance Company, has been elected a member of the board of park commissioners, Hartford, Conn., to succeed Rev. W. DeLoss Love.

MOVEMENTS OF GARDENERS.

John McMillan of Roxbury, Mass., has accepted a position as head gardener on the estate of Mrs. C. Adolph Low, Sharon, Conn.

Jacob Reid has taken a position as head gardener on the Bradley estate, Brattleboro, Vt. Mr. Reid was gardener on the Mitchell estate, Norwich, Conn.

James S. Hutchinson, who for forty years has held the position of foreman of the gardens in Allegheny Park, Pittsburgh, Pa., retired to private life on April 30. He is 80 years of age.

NEWS OF THE CLUBS AND SOCIETIES

GARDENERS' AND FLORISTS' CLUB OF BALTIMORE.

This club held its semi-monthly meeting on the evening of May 10 in the hall of the Florists' Exchange Building. The attendance was somewhat above the average and an excellent spirit—social and business—prevailed.

A feature of this club which may not be common to the fraternity in other cities (the Sec. would be glad to learn by the reports of clubs generally whether it is so or otherwise) is the payment of (\$100) one hundred dollars upon the death of a member in good standing to the beneficiary named on the deceased member's certificate. This endowment is paid from a fund known as the "Benefit fund" and, of course, is kept entirely from the general fund. When this benefit fund is reduced below the \$100 mark an assessment of one dollar is made upon each member. A charge of one dollar is made for the certificate, upon each candidate when elected a member. At this meeting a good-natured discussion arose as to whether it is equitable to those who join the club in their youth, or in the heyday of life, to admit to membership those who had passed the age—say 50—as hitherto none has been debarred on account of age. There was, however, so broad and fraternal a spirit prevalent amongst the members that the whole matter was tabled, so that as heretofore the mere matter of age is no obstacle.

It was decided to hold the annual family picnic about the middle of July and a committee was appointed to complete arrangements for the event. Each summer for several years the club has been entertained by one of our public spirited citizens, Mr. William Lanahan, at his beautiful suburban home "Blenheim," a comparatively short distance beyond the city limits. Both Mr. and Mrs. Lanahan are the very soul of hospitality, and the visit to "Blenheim" is always looked upon as a red letter day in the history of the club. The Maryland Horticultural Society will hold its summer meeting at Mountain Lake Park, and as most of the members of the club are also members of that association, the larger proportion of the membership will attend this outing also.

CHICAGO FLORISTS' CLUB.

The regular meeting of the Chicago Florists' Club was held May 6, with a good attendance. The committee appointed to consult with the Horticultural Society of Chicago concerning the advisability of holding a flower show in November reported favorably and a further conference will be held regarding the concessions, all of which the Chicago Florists' Club desire, in return for which they will assume all liabilities. The second reading of the proposed by-laws was postponed until the next meeting, on account of the absence of the chairman of that committee.

NEW YORK FLORISTS' CLUB.

Nearly fifty members attended the May meeting of this Club last Monday evening—a fair number considering that the busy season is now at its height for the majority of club members. Considerable time was devoted to committee reports. H. A. Bunyard reported good progress on the program for the July outing, solicited portraits of all the members to be used therein and announced that A. T. Boddington's store would be closed during the day of the picnic.

Obituary resolutions, signed by Messrs. Schenck and Weathered, on the death of W. C. Krick were presented and adopted. Messrs. Birnie, Marshall and Weston were appointed to prepare resolutions on the death of ex-President John Scott, Messrs. Donaldson, J. Manda and Schultz were intrusted with a similar duty in relation to the late R. Dreyer and Messrs. O'Mara, Sheridan and Young on behalf of the late J. H. Starin, who was an honorary member.

Mr. C. L. Allen's paper on "Plant Development" was read by S. S. Butterfield, its author being unable to attend, owing to infirmity.

Joe Manda gave a graphic account of his efforts to awaken pride and enthusiasm among the bowlers and his disappointment at the lack of interest taken in the practice games. He said his patience was about exhausted and a stirring speech by his fellow-bowler, Bob Berry, didn't seem to change his mind. John Birnie then brought up the subject of a plant market for New York with the object of inducing the club members to participate in the agitation of this most important project. After discussion Messrs. Nugent, Birnie, Totty, Miller, and Schmutz were appointed a committee on behalf of the Club to investigate the subject and report at the next meeting.

On the exhibition tables a very fine display of spring plants was spread out. A special vote of thanks was given John Birnie through whose efforts among the market growers the exhibits were made. The exhibition committee reported cultural certificates to John Tschupp & Co., for geraniums and dwarf fuchsias, Herman Mende for geraniums, Rex begonias and mignonette, Robert Leach for candytuft and heliotrope, Charles Hunt for hydrangeas, geraniums, fuchsias and pansies; vote of thanks to John Lappe for Phlox subulata, F. Engeln for coleus, Chas. Schmieg for *Bellis perennis*, John Reichert Estate for rambler roses and *Verbenas*, H. C. Steinhoff for rambler roses, A. C. Schroeter & Son for coleus, John Birnie for geraniums, heliotrope and verbenas, George Fich for marigolds, Hartmann & Wagenfohr for Bruschki roses and A. L. Brown for vincas. Most of the above named plants were shown in quantity in large flats and were ideal as to culture and variety.

The May exhibition of the Massachusetts Horticultural Society will be held on Saturday and Sunday, May 22 and 23, at Horticultural Hall, Boston.

PITTSBURGH FLORISTS' AND GARDENERS' CLUB.

The meeting of the club on Tuesday, May 4th, was well attended. Usually it has been the case that the early spring months have shown a falling off in attendance, but this spring it has been very gratifying to see how well the meetings have been maintained. As the building where the club has held its meetings for seven years is about to be torn down, the May meeting was held with the Pittsburg Cut Flower Co.

The exhibition committee reported that arrangements had been completed with the Fort Pitt Hotel, the headquarters for the Carnation Convention in January, 1910, and the banquet hall secured for the desired dates.

The private gardeners had a display which drew much attention. Frank Crook, gardener for J. H. Park, exhibited a Boston fern with fronds 6 ft. in length, making the diameter of the spread of the plant 12 ft., *Cibotium Barometis*, *Nephrolepis Davallioides furcans* and *Clerodendron Balfourii* in bloom. N. C. Madsen with R. H. Boggs, Sewickley, showed specimens of *Rehmannia angulata* in bloom, dwarf Comet aster and sweet peas. F. Burki showed *salvias* and fine specimen *coleus*. Godwin Bros. of Bridgeville showed a collection of geraniums and Mat Schweiger geraniums and pelargoniums. The judges, Wm. Loew and B. Elliott awarded a certificate of merit to Frank Crook for three ferns, and to N. C. Madsen for dwarf Comet aster and *Rehmannia angulata*.

R. Karlstrom and I. Rosnosky, representing respectively W. A. Manda of South Orange, N. J. and H. F. Michell Co. of Philadelphia were with us and made addresses in optimistic vein.

The subject for next meeting is Outdoor Roses and Peonies, with a competitive display of out door roses by the private gardeners, for which a prize has been offered by Mrs. R. H. Boggs of Sewickley.

H. P. JOSLIN, Sec'y.

CHRYSANTHEMUM SOCIETY OF AMERICA.

President Elmer D. Smith has appointed Chas. H. Totty, Madison, N. J.; Edwin Jenkins, Lenox, Mass., and I. L. Powell, Millbrook, N. Y. to serve as the executive committee for the ensuing year.

The Massachusetts Horticultural Society and the Lenox, Mass., Horticultural Society have affiliated with the Chrysanthemum Society of America for the year 1909 and C. S. A. trophies will be offered for chrysanthemums at the fall shows of these societies.

As secretary of this society I heartily endorse all that President Smith has written regarding the wishes of the officers of the Chrysanthemum Society to increase its membership. We need every chrysanthemum enthusiast and shall be pleased with the support of everyone who grows a chrysanthemum.

CHAS. W. JOHNSON,
Secretary.

Scarcity For Memorial Day ?

**That's What Some Say, But it Needn't Worry You
Act in Time, That's All**

We are ready to book your order and prepared to fill it, for Beauty, Killarney, Liberty and all other Standard Varieties of Roses; Carnations, Stocks, Lilies, Spiræa, Sweet Peas, Daisies and Seasonable Flowers in Full Assortment.

Special — HARDY FERNS — Special

Finest Quality of Hardy Ferns, Leucothoe, Galax, etc., and a Complete Line of Inscriptions, Cycas, Sheaves, Immortelles, Baskets, Vases and other Supplies

SEND NOW for Supply Catalogue and Cut Flower Price List

**WELCH BROS. . 226 Devonshire Street
BOSTON**

**SOCIETY OF AMERICAN FLORISTS
AND ORNAMENTAL HOR-
TICULTURISTS.**

The National Flower Show Com-
mittee.

President Valentine has appointed the following committee to take up and formulate plans for holding another National Flower Show: F. R. Pierson, chairman; F. H. Traendly, New York; J. K. M. L. Farquhar, Boston; W. J. Stewart, Boston; Edwin Lonsdale,

Philadelphia; Robert Craig, Philadel-
phia; committee to have power to add
to its membership at discretion.

It is the intention that this com-
mittee shall have entire charge of for-
mulating the preliminary arrange-
ments for a show and that it will be
prepared to report at the next Con-
vention, suggesting a time to hold the
show, the city in which it shall be
held, and to perfect and present a
complete organization to carry forward
the project to completion.

W. N. RUDD, Secretary.

May 7, 1909.

**NATIONAL HORTICULTURAL SO-
CIETY OF FRANCE.**

The annual spring show will be held
in Paris on May 17 to 23 and a sched-
ule comprising 370 classes has been
issued. In conjunction therewith a
Horticultural Congress will be held in
the hall of the society on May 19 and
20. Papers on various subjects of
horticultural interest will be read, a
list of which accompanies the show
schedule.
C. H. P.

ANNOUNCEMENT

JOHN SCOTT Rutland Road,
Flatbush, N. Y.

THE business of the late John Scott will continue under able manage-
ment. The reputation of the house for the finest plants and cut
flowers will be maintained. The patronage and confidence of the
Trade is solicited. This opportunity is taken to gratefully acknowledge
the kindness and sympathy of all for his family and to guarantee that the
same care and enterprise characterizing the record and reputation of
Mr. Scott in the past will be continued.

Richmond, American Beauties, Killarney's, Brides and Mads, valley, Easter Lilies, Smilax, Carna-plumosis.

New Crop Dagger and Fancy Ferns
\$2.00 Thousand

BOSTON, MASS.
Henry M. Robinson & Co.
Wholesale Commission Florists
Hardy Cut Evergreens and Florists Supplies

115 Province St. and 9 Chapman Place
Telephone 2617-2618 Main, Ft. Hill 252-00

Southern Wild Smilax extra fine quality Brilliant Purple and Green Glax, Cut Waxwood Sprays, Luscious Sprays, Laurel Wreaths, Branch Laurel, Laurel Testooning, Green and Sprague, num figs

Orders placed with us means that you can depend on us.

We never disappoint. Satisfaction guaranteed.



A Philadelphia Orchid Grower OFFERS BARGAINS

100 CASES CATTLEYA TRIANAE
just arrived from abroad; plants with 8, 12, 15, 20 and 25 bulbs each; 40 to 45 plants in each case; will run on an average 450 bulbs to the case:—
\$40.00 per Case

60 CASES CATTLEYA SCHRODERAE
will arrive about May 25th; plants with 8, 12, 15, 20 and 25 bulbs each; about 40 plants to the case, averaging about 400 bulbs each:—
\$55.00 per Case

60 CASES CATTLEYA GIGAS
will arrive about May 25th, plants with 8, 12, 15, 20 and 25 bulbs each; about 40 plants to the case, averaging about 400 bulbs each:—
\$55.00 per Case

f. o. b. Philadelphia for prompt order and if unsold.

Will break cases at a reasonable advance on above rates, say:—lots of plants averaging 100 bulbs, 7½ per cent; 25 bulbs 12½ per cent.

Anyone who desires **ESTABLISHED PLANTS** can be accommodated at very reasonable figures in all the commercial varieties such as:—**Trianae, gigas, Schroederae, Gaskelliana, labiata, speciosissima** and 12 of the best varieties of **Cypripediums**

Alphonse Pericat, ORCHID SPECIALIST, COLLINGDALE, PHILA., PA.

During Recess

BUFFALO FLORISTS' CLUB.

The regular meeting of this club was held on Tuesday evening, May 4. The regular routine of business was shortened on account of the festivities that the entertainment committee had prepared. The sport opened with a blindfold boxing match which afforded much amusement. This was followed by a handicap wrestling match between two boys and "Cyclone" Baumgartner, the latter being downed in short order. Other events in the line of wrestling and sparring, a pie-eating contest, etc., were greatly enjoyed. The entertainment concluded with a few games of pedro, in which ex-President Sandiford carried off first prize, a motor cycle. The committee is to be congratulated on furnishing such a pleasant evening's entertainment.

NEW ORLEANS HORTICULTURAL SOCIETY.

About fifty members of this society assembled on the afternoon of May 2 at the residence of A. Alost, in Gentilly avenue, for their annual outing and barbecue. A tempting banquet was spread, at which C. R. Panter acted as toastmaster, and among the guests was Mayor Bohman. Toasts were given in honor of the Mayor, and in response Mr. Bohman made a speech. At the close of the banquet a beautiful silver service was present-

ed to Mr. and Mrs. Alost by Mr. Panter in the name of the Horticultural Society.

A good attendance was reported at the Chicago Florists' bowling club last Friday. The honors were carried off in the handicap as follows: 1st prize, W. Wolff; 2nd, Frank Ayers; 3rd, Fred Kraus.

CLUB AND SOCIETY NOTES.

Louis J. Reuter gave an interesting talk on Roses before the New London County Horticultural Society, at Norwich, Conn., on May 3.

The annual convention of the Greenhouse Vegetable Growers' and Market Gardeners' Association will be held in Ashtabula, O., October 12.

The trustees of the Worcester County Horticultural Society, Worcester, Mass., have appropriated \$100 for the N. E. Fruit Show to be held in October.

E. C. Sears of Mass. Agricultural College, addressed the members of the Houghton Horticultural Society, Lynn, Mass., on May 6, on commercial fruit growing.

At the meeting of the Dobbs Ferry, N. Y., Horticultural Association on April 24, H. Keilling was awarded first prize for outdoor flowers and H. Kastberg second. E. Kane, gardener for E. L. Coster, showed some nice blooms. Mr. Kastberg read a paper on the Chrysanthemum. Lord & Barnham Co. have offered a gold medal for the fall exhibition for four varieties of chrysanthemum, three of each.

CARNATIONS AT JOLIET, ILL.

Manager Pyfer says the rumor that the Chicago Carnation Co. has sold its retail store is unfounded, though there is a proposition for leasing it under consideration, their wholesale business demanding all of their attention. Mr. Pyfer expressed his belief that there had been an over production of Enchantress this season, making white carnations rather scarce in and about Chicago. When asked which had his preference as a commercial white, White Perfection or White Enchantress, he said the latter if the best strain was used. He places White Enchantress above White perfection for commercial use—because it makes larger plants from late cuttings in the same length of time in the field, and makes more cuttings without sacrificing blooms. Conquest, which is to be sent out next year has kept up to its previous good record. Sangamo originated by A. C. Brown of Springfield, Ill. and Mary Tolman by A. E. Hunt of Evanston will be sent out jointly by the originators respectively and the Chicago Carnation Company. Sangamo is similar to Winsor in color with stem as stiff and as large and it is claimed that it will out-bloom that variety. Mary Tolman is a light flesh pink. This makes three novelties of high promise now in sight.

MAY.

For thee, sweet month, the groves green
In vales sweet,
If not the first, the fairest of the year,
For thee, the Graces lead the dancing
hours,
And Nature's ready pencil paints the
flowers.

—JOHN DRYDEN.

Chrysanthemums

WHITE—Merza, Kalb, J. Jones (cream), J. Nonin, Clay Frick, Lady Fitzwiggam, Polly Rose, Oct. Frost, C. Touset, A. Byron, T. Eaton.

YELLOW—Monrovia, Halliday, Bonnaifon.

RED—Shrimpton, Intensity.

PINK—Dr. Enguehard, Rosier, Winter Cheer, Maud Dean, Pontmore (Early).

All above varieties, rooted cuttings, \$1.50 per hundred, \$12.50 per thousand. **GOLDEN GLOW**, \$4.00 per hundred.

BEDDING PLANTS

HYDRANGEAS IN POTS AND TUBS

WM. W. EDGAR CO., Waverley, Mass.

ADIANTUM CUNEATUM, strong 4 in. pot plants, ready for shift, \$3.00 per 100.

CHRYSANTHEMUMS, leading varieties, 2 in., \$2.50 per 100, \$20.00 per 1000.

MARANTA LASANGANA, fine for ferneries, \$6.00 per 100.

FIGUS ELASTICA, 5 in. pot plants, 15-24 in. high, \$1.00 per 100.

IVY GERANIUMS, strong 3/4 in. pot plants, **Sauv. de Charles Turner** and **Jeanne d'Arc**, \$1.00 per 100.

SALVIA ZURICH, **Fireball**, **Paragon Prince**, **Clara Bedman**, Splendens, 2 in., \$1.50 per 100, \$3.00 per 1000, 3 in., \$5.00 per 100.

FUCHSIAS, 12 varieties, 3/4 in., \$3.50 per 100, \$32.00 per 1000.

COLEUS VERSCHAFFELI and **GOLDEN CROWN**, 2 in., \$2.50 per 100, \$20.00 per 1000.

LANFANAS, strong 3/4 in. pots, \$3.00 per 100.

BEGONIA ERIFORMIS, **Valcan**, **Vernon**, fine for pots or bedding, \$2.50 per 100, \$20.00 per 1000.

DAHLIAS, well established pot plants, all leading varieties, \$3.50 per 100.

COBEA SCANDENS, 3/4 in., \$4.00 per 100.

The STORRS & HARRISON CO.
PAINESVILLE, O.

IPOMOEA NOCTIFLORA

Best pure white moonvine in the market, very fragrant and as big as a saucer. On this variety we have a world-wide reputation as growers and shippers for the last twenty years.

Price, 2 1/2 in. pots, \$5.00 per 100. 10,000 are now ready.

Godfrey Aschmann

1012 West Ontario St., Philadelphia, Pa.

THE BOSTON VIOLET

Unequaled for Productiveness, Beauty and Popularity.

In Crop from September to May. Plants \$2.00 per doz \$12.00 per 100; \$100.00 per 1000. Princess of Wales \$15.00 per 1000.

WILLIAM SIM, Cliftondale, Mass.

Begonia Gloire de Lorraine

Leaf Stock, June Delivery, \$15 per 100, \$145 per 1000, from 2 1/2 in pots

Stock guaranteed to be absolutely free from disease.

THOMAS ROLAND, NAHANT, MASS.

The Northboro Dahlia and Gladiolus Gardens

Offer for Spring 1909
300 selected varieties of Dahlias and one and one half million large-flowering Gladioli in mixtures, in lots to suit. Send list of your wants, Catalogue free

J. L. MOORE, Northboro, Mass

DAHLIAS. Now is the time to place your order for bulbs which will insure you getting named varieties in any quantity; prompt delivery.

DAVID HERBERT & SON,
Successors to L. K. Peacock, Inc.
ATCO, N.J.

In ordering goods please add "I saw it in HORTICULTURE"

GERANIUMS, DAHLIAS AND BEDDING PLANTS

We have one of the most complete collections of Geraniums in the country, containing every color and type found in the Geraniums. Every one of our 75 Standard Varieties at \$2.00 and \$3.00 per 100 are Bred and Butter Winners, and among our 24 New Varieties of special merit are some that are going to fix the standard in the future. Every one is a Gem, not high in price, only \$1.00 and \$6.00 per 100.

Our Novelties should, coming as they do from the leading introducers of the world, represent the highest development of Geraniums at the present time. A collection of 100 Varieties, our selection of 1907 and 1908 Novelties, will be sent for \$10.00.

Special Offer of 1000 good, strong plants from 2 in. pots, our selection of 20 distinct kinds from among our Standard and Newer Varieties, for \$15.00 cash. From 3 in. pots \$3.00 per 100, \$25.00 per 1000, in a good assortment.

CANNAS

Strong plants from 3 in. pots. J. D. Elsele, Egandale, Alphonse Bourvier, Mme. Crozy, and Florence Vaughan, \$4.00 per 100. Jean Tissot, President Myers, Louisville, Pennsylvania, \$5.00 per 100.

DAHLIAS

We have one of the finest collections in the country of good distinct Commercial Varieties at \$2.00 per 100 and up for plants ready for shipment. Then we have Jack Rose, Virginia Maule, Big Chief, Rose Pink Century, Fringed 20th Century, Rebecca Mayhew, etc., at 50c. each, \$5.00 per doz., \$35.00 per 100. We will send 1000 in 20 good distinct Cut Flower Sorts, our selection, for \$18.50.

See issue of April 24th of Our Wholesale Catalogue for complete list of Bedding plants.

R. VINCENT, JR., & SONS CO., White Marsh, Md.

ROSE PLANTS

Fine, Strong, Healthy

3-inch pots	Per 100	Per 1000	2 1/2-inch pots	Per 100	Per 1000
American Beauty	\$7.00	\$65.00	American Beauty	\$5.50	\$50.00
Richmond	4.00	35.00	Richmond	3.00	25.00
Chatenay	4.00	35.00	Chatenay	3.00	25.00
Ivory	4.00	35.00	Ivory	3.00	25.00
Bride & Maid	4.50	40.00	Bride & Maid	3.50	30.00

Asp. Sprengerl, 4-in. pots, \$8.00 per 100.
Asp. Plumosus, 3-in. pots, 5.00 "
Smilax, 3-in. pots, 4.00 "

UNITED STATES CUT FLOWER CO., Elmira, N. Y.

THE WORLD'S BEST DAHLIAS

The following speaks for international confidence in the merits of Peacock's New Dahlias. A CONFIDENCE NEVER BETRAYED.

Messrs. Peacock, New Jersey, Rothsay, 28th April, 1909.

Dear Sirs:—We are favoured with a copy of your Dahlia catalogue and will thank you to send us carefully packed, by post,—

6 plants of new Dahlia Jack Rose, and

6 plants of Virginia Maule.

We hope that these will travel safely as we would like to try these new varieties.

Yours faithfully,
DOBBIE & CO.

Every Seedsmen and Florist will consult their best interest in sending for our catalogue of "NEW CREATIONS IN DAHLIAS," NEW DECORATIVE SHOW, FANCY, ART OR PAPER-FLOWERED, CENTIFOLY and CACTUS DAHLIAS.

Guaranteed just as represented. Reference—National State Bank, Camden, N. J.

PEACOCK DAHLIA FARMS, Williamstown Junction, N. J.

JAPANESE NURSERY CO.
THE YOKOHAMA NURSERY CO.
31 BARCLAY STR. NEW YORK.
LILIES
PLANTS
BAMBOO STAKES

JULIUS ROEHRS CO.,

RUTHERFORD
N. J.

Large stock of Bay Trees, Box Trees, Blue Spruce, Choice Evergreens, etc.,
all in finest condition.

Palms, Stove Plants, Begonias, Hydrangeas in all sizes and prices.

ORCHIDS

Fine assortment on hand of both newly imported and semi-established.

LET US QUOTE YOU PRICES.

PARK IMPROVEMENT AT DENISON.

Denison, Texas, on April 24, held a Tag Day and at that time raised \$900.00 for the purpose of landscaping and beautifying the city parks. The City Commission (Denison has a commission form of government) has arranged to add about \$1200.00 of the city funds to the amount raised and this will be spent in the most judicious manner possible. The site of Forest Park, as it is called, is a four-acre plot of ground lying in the heart of the city hitherto little used. It rises gradually towards the center and is covered with a fine growth of oak trees.

A cement walk system will be installed with a large fountain and basin in the center. The basin will be made large enough to be used for aquarium purposes and will be well stocked with gold fish. Flower beds are being laid out at frequent intervals. One part of the park is laid off for a baseball field and playground and it is expected to utilize the park for band concerts, celebrations, etc.

CHICAGO STREET TREES.

Mr. Prost, City Forester of Chicago, has begun taking a tree census of the city. Until recently property owners could plant in front of their lots such trees as happened to strike their fancy or as could be most easily obtained. The result was not pleasing to the eye and not being adapted to the soil many trees made stunted growth or died outright. Recently the city council passed a tree regulation ordinance by the terms of which no tree or shrub can be set out in any street until its variety has been approved, its situation designated and a free permit for its planting issued by the city forester. Another duty of this official is "to advise, without charge, owners and occupants of lots regarding the kind of trees, plants and shrubbery and the method of planting best adapted to or most desirable on particular streets." Citizens are being urged to take up the matter in various neighborhoods and consult the forester jointly with to the improvement of their own locality.

Berkeley, Cal.—A special short course in horticulture is being conducted at the Berkeley University for prospective county horticultural commissioners.

BALTIMORE OUTDOOR CROPS.

The planting out of summer stuff has not yet become general at this date, May 10th, owing largely to the fact that the temperature has shown its capacity for variation by falling about 10 degrees in less than 24 hours—going down to and even below the freezing point. It is an established fact that a goodly portion of the earlier blooming fruits have been seriously injured, not in Maryland only but also in the state of Delaware. One condition that has made our fruits more susceptible to injury by spring frosts is that for some two or three years there has been a spell of very mild weather, in either the very early spring or late winter, of sufficient intensity and duration to swell the buds to a quite considerable extent. In this condition a few warm days causes them to expand so that the organs of fructification are exposed to the atmosphere and in this condition, although the thermometer may not indicate that the freezing point has been reached, it is often sufficiently low to kill the bloom—or more correctly, to kill the pistil.

DETROIT NURSERY TRADE.

Market business has not yet commenced here. Frost and rain about us constantly have prevented the plantmen from moving their stock and no relief is yet in sight. Planting in the field is impossible even on high ground. The ground is so heavily soaked with water that it will not absorb any more and ploughing is impossible. The plight in which the nurseryman finds himself can be easily seen from the foregoing.

GARDEN LIFE YEAR BOOK.

This is a new venture on the part of the Cable Printing & Publishing Co., of London. It is a neatly printed octavo of 298 pages in which appear: A calendar of garden operations, The rose season of 1908, Sweet peas in 1908, Chrysanthemums of 1908, Carnations, The Dahlia Year, Some choice orchids, The ferns of 1908, Present day fruit culture, Vegetable growing in 1908, Horticulture past and present, Flowers, fruits and vegetables certified by the R. H. S. in 1908, Select varieties of common vegetables and fruit, Some famous gardens, Societies.

The chief novelty in this publication is that part entitled "Who's Who in Horticulture?" This is a list of many

of the most eminent men connected with British horticulture, giving their names and in some cases a brief outline of their work and distinctions.

C. H. P.

The Revere Rubber Company are sending out a handsome colored wall hanger which should prove an excellent help in making sales of Revere hose wherever this popular florists' hose is sold. Better than even this, however, is the general satisfaction this non-kinkable hose is giving in places where it is used. We have yet to hear one word of complaint concerning its serviceability and it is in evidence in almost every establishment we visit, for outdoor or indoor use.

Full information regarding this hose can be secured at any of the branch stores of the company or at the home office in Boston, Mass. Branch stores are located at New York, Philadelphia, Pittsburgh, Chicago, Minneapolis, New Orleans, San Francisco and Portland, Oregon. A copy of the above mentioned show-card will be sent free of charge to any dealer requesting same.

"Right on the Spot —That's All!"

Variegated Periwinkle, out of 4 in. pots, strong.....	\$3.00
Variegated Periwinkle, Routed Cuttings.....	.50
Variegated Periwinkle, Routed Cuttings.....	.50
Clematis Paniculata, out of 4 in.	10.00
Clematis Paniculata, out of 3 in.	5.00
Clematis Paniculata, out of 2 in.	2.00
Lobelia, Dwarf Blue, strong, out of 3 in.	3.00
Cobaea Scandens, strong plants, out of 4 in.	8.00
Stevia, variegated, out of 2 in.	2.00
Alyssum, very dwarf, out of 3 in.	3.00
Glechoma or Ground Ivy, out of 3 in.	3.00
Single Petunias, dwarf, out of 3 in.	3.00
Ageratum, blue, dwarf, out of 3 in.	3.00
Dracaena Indivisa, out of 2 in.	2.00
Choicest varieties of Geraniums, extra fine, out of 4 in.	7.00

Cash with order.

SAMUEL V. SMITH
3323 Goodman St., Philadelphia, Pa.

FOR SALE

FOUR EXTRA LARGE

Latania Borbonica Palms

From 10 to 12 feet high and spread; in cypress boxes. Also six smaller

LATANIA PALMS

in boxes. All splendid specimen plants. Can ship by freight after May 1.

JOHN RALPH Saratoga Springs, N. Y.

DREER'S HARDY CLIMBERS

	Per doz.	Per 100		Per doz.	Per 100
Akebia Quinata, 4 inch pots	\$1.25	\$ 8.00	Clematis Boskoop Seedling or Sieboldi	3.00	20.00
" 6 " " "	2.00	15.00	" Duchess of Edinburgh	3.00	20.00
Ampelopsis Veitchii, 4 " " "	1.50	10.00	" Henry	3.00	20.00
" 5 " " "	2.00	15.00	" Mme. Baron Veillard	3.00	20.00
Ampelopsis Virginica, 5 " " "	1.25	8.00	" Ville de Lyon	3.00	20.00
" 6 " " "	2.00	15.00	" Coccinea	1.25	8.00
Ampelopsis Lowii (new), 4 " " 75c each	7.50	...	" Crispa	1.25	8.00
Aristolochia Siphon, heavy plants	4.00	30.00	" Integrifolia Durandi	4.00	...
Bignonia Grandiflora, strong roots	3.00	20.00	Honeysuckle Halleana, 4 inch pots	1.00	7.00
" Radicans	1.50	10.00	" Evergreen, 4 " "	1.00	7.00
Celastrus Scandens, 5 inch pots	2.00	15.00	" Variegated, 4 " "	1.00	7.00
Clematis Paniculata, 3 1/2 inch pots	1.50	10.00	Lathyrus White Pearl (new)	3.50	...
" Montana, strong plants	1.50	10.00	Wistaria Sinensis Blue	3.50	25.00
" Grandiflora (new)	3.50	...	" White	4.00	30.00
" Rubens (new)	8.00	...	Vitis Henryana (new), 60c each	6.00	...
" Jackmani two year	3.00	20.00			

HARDY CLIMBING ROSES

Strong Two Year Old Field-Grown Plants.

Now Established in 5 and 6 inch pots

	Per 100		Per 100
Baltimore Belle	\$20.00	Sweet Briar Brenda	25.00
Climbing Clothilde Soupert	25.00	Trier-White Rambler	25.00
Crimson Rambler	25.00	William Allen Richardson	30.00
Dorothy Perkins	25.00	Wichuraiana Memorial Rose	15.00
Lady Gay	25.00	" Evergreen Gem	20.00
Philadelphia Rambler	25.00	" Gardenia	20.00
Prairie Queen	20.00	" Pink Roamer	20.00
Sweet Briar	15.00	" South Orange Perfection	20.00
" Lord Penzance	25.00	" Triumph	20.00
" Lady Penzance	25.00	" Universal Favorite	20.00
" Meg Merriles	25.00	Yellow Rambler	20.00
" Anne of Gierstein	25.00		

HENRY A. DREER, 714 Chestnut Street, PHILADELPHIA

Ampelopsis Quinquifolia

Strong 1-year plants 2 to 3 ft. \$20.00
 " 2-year " 3 to 4 ft. 30.00
 " 3-year " 4 to 6 ft. 55.00

TO THE TRADE ONLY
 A Full Line of General Ornamental
NURSERY STOCK
 SEND FOR CATALOGUE

EASTERN NURSERIES
JAMAICA PLAIN, MASS.
 HENRY S. DAWSON, Mgr.

JOHN WATERER & SON, Ltd.
American Nursery Bagshot, England

Are Specialists in the
REALLY HARDY VARIETIES
 of Rhododendron Hybrids and in Select Varieties
 of Hardy Border Plants

ROSES
 A SPECIALTY
 The Dingee & Conard Co., West Grove PA.

Pot Grown Vines
 Ampelopsis Veitchii
 Virginia Creeper
 Hall's Honeysuckle

SPLENDID PLANTS FOR IMMEDIATE EFFECT.
ELLWANGER & BARRY, MOUNT HOPE NURSERIES, ROCHESTER, N.Y.

Box Trees
 and other EVERGREENS for Tubs and Boxes
 Our Prices are Always Right—Catalog Free
THE NEW ENGLAND NURSERIES, INC.
BEDFORD, MASS.

TREES, EVERGREENS, SHRUBS, VINES, PERENNIAL PLANTS, FRUITS, TRAINED FRUIT TREES, FOREIGN GRAPE VINES, HARDY RHODODENDRONS and R. MAXIMUM in quantity, per hundred or per thousand, very fine. Complete assortments: Careful grading: Low prices.

AMERICAN NURSERY COMPANY,
 Sales Department, 150 BROADWAY, NEW YORK CITY.
BLOODGOOD NURSERIES DEPT., Flushing, Long Island.
F. & F. NURSERIES DEPT., Springfield, New Jersey.

Cannas
 Dry roots: Italia, Cleveland, Austria, Egandale, Marlboro, America, Penna, Black Beauty, \$1.50 per 100. Kate Gray, mixed with red, \$1.25 per 100. Asparagus Sprengeri, 2 in., \$1.75, 3 in., \$4.00, 4 in., \$6.00 per 100. Dracena indiv., 4 in., 10c. English Ivy, 4 in., \$2.00; R.C. 75c per 100.

J. H. DANN & SON, WESTFIELD, N. Y.

CLEARY'S HORTICULTURAL CO.
 Management AMBROSE T. CLEARY
 Wholesale Contracting, Jobbing, Auction
HORTICULTURAL PRODUCTS
 of every description.
 consignments Received. Surplus Stock Convert
62 Vesey St., NEW YORK

Hardy Rhododendrons, Azaleas, Conifers, Clematis, H. P. Roses, Shrubs and Herbaceous Plants from our
HOLLAND NURSERIES
 Prices Moderate
P. OUWERKERK, 216 Jane St., Weehawken Heights P.O. No. 1, Hoboken, N.J.

HARDY PERENNIALS AND THEIR VARIOUS USES.

Paper read on Tuesday, March 16, before the Gardeners' and Florists' Club of Boston by Robert Lamore, superintendent of Harvard University Botanic Garden, Cambridge, Mass.

Our beloved brother, Mr. Halleck Taylor, was going to speak to you this evening, was called from among us so suddenly that it is with heart-felt sorrow I stand before you, with another subject, but one very closely related to the one he was to talk to you about. Only a few months ago we had to mourn the loss of a brother in our club, and indeed we sincerely sympathized with our sister club, in this, their great bereavement. For it is not only their loss but ours as well and in fact, a loss to the entire horticultural world.

These sudden calls come so unexpectedly, that I get comfort from the words of one of our greatest American orators, who said: "Yes, after all, it may be best, just at the happiest, sunniest hour of all the voyage, while eager winds are kissing every sail, to dash against the unseen rock at id in an instant hear the billows roar above a sunken ship. For, whether in mid-sea or among the breakers of the farther shore, a wreck at last must mark the end of each and all. And every life, no matter if its every hour is rich with love and every moment jewelled with a joy, will at its close become a tragedy as sad and deep and dark as can be woven of the warp and woof of mystery and death."

A Plea for More Hardy Perennials in Parks, Cemeteries and Large Grounds.

You will all admit that herbaceous perennials are important in garden work. Well, the question may be asked, if they are so important, why don't we find them used more liberally in such places as parks, large rural cemeteries and other large grounds? To answer this question satisfactorily it will take a very long paper indeed. However, it may not be amiss to give a few of the reasons why they are not often seen in such places.

Reasons Why Hardy Perennials Are Not Used More Abundantly.

You are all well aware that when any large piece of work—such as a park or large cemetery is contemplated, the first thought that comes to the commissioners or trustees of such places is, who is the best landscape gardener (or the more highly sounding name landscape architect) to take charge of his important work? The landscape architect of today has some training in how to make plantations of trees and shrubs and the right proportions to give them. In his plantations of trees and shrubs he plants acres, but when he comes to hardy perennials he assumes his misuses by feet or yards. In his meager information of hardy perennials he has not been able to grasp the many ways in which these hardy subjects can be used. Another reason why they are used so sparingly is that it takes a few years to know whether shrubbery is planted correctly or not, but the first year shows the results of planting and growing hardy perennials, satisfactory or otherwise, the first year. I suggest that we should try

Primulas for Christmas

SOW SEED NOW

B's Matchless Giant, pure white; B's Matchless Giant, blush white; B's Matchless Giant, rose; B's Matchless Giant, scarlet; B's Matchless Giant, royal blue; B's Matchless Giant, mixed. Each 1/2 trade packet, 60c; trade packet, \$1.00

Primula obconica gigantea Kermesina deep crimson Primula obconica gigantea alba, pure white Primula obconica gigantea lilacina, beautiful lilac. Primula obconica gigantea rosea, lovely pink Primula obconica gigantea grandiflora, mixed, containing pure white to deep crimson.

Each of above 1/2 trade packet, 30c; trade packet, 50c. Primula toribunda grandiflora (buttercup) 1/2 trade pack-1, 30c; trade packet, 50c. Forbesi (baby Primrose). Trade packet, 25c Primula Kewensis (Giant Buttercup) 1/2 trade packet, 60c; trade packet, \$1.00.

ARTHUR T. EDDINGTON, 342 W. 14th Street, New York

using these plants as little as possible. Sometimes it is the fault of the superintendent or the person in charge. He may have been trained in early years as an engineer or a clerk in an office, or as we have had them in Cambridge, in charge of our parks, to water the potatoes. Many like this "back" the right training and are not in sympathy with this work, in fact do not know how to plant correctly. These are a few of the reasons, but no doubt some of you can think of many more.

Good Knowledge Required to Do This Work Correctly.

A person who is going to use hardy perennials ought to know his plants, not only their names, but the height, habit and color of the flowers and foliage and the most likely places they will grow in. He also ought to have good taste to arrange the various plants so that the flowers that are in bloom at any given time shall group well in form and color. It also requires study and forethought to get the best and most suitable plants for the different seasons.

Planting in the Parks on Too Small a Scale.

The planting that has been done in parks of perennials has been so insignificant and out of proportion with other things, that we are in sympathy with those who have said they were out of place. Instead of using a dozen plants, hundreds or even thousands of one kind of plant ought to have been used to bring about striking effects that would make impressions never to be forgotten. In nature, we find the plants liberally not in little patches but by the acre. You all remember, no doubt, the fields of golden rod, of asters, and many other plants which can easily be recalled to your memories. Why not create such planting in our parks? Not in borders but naturalizing them in suitable places and make large, impressive pictures. If one objects to foreign plants, there is no country in the world that has more beautiful plants than we have and there are any quantity that can easily be naturalized.

Parks as a Means to Draw the People Out of the Slums.

The common people do not go to our parks early enough in the year. I mean the masses of the people, those who can only afford a five-cent ride or those who live and grow up among bricks. The rich, or those who have carriages and automobiles, enjoy our parks all the time. I love the harbingers of spring, whether birds, flowers

or flowers, and would suggest that millions of early spring bulbs be naturalized in our parks, so that the people will come and see them in March and April. Why not naturalize one million of the common snow drop, which comes into flower at this time? Do the same with crocuses, squills, grape hyacinths, glories of the snow, species of tulips, dog-tooth violets, sanguinaria, trilliums, Anemone Canadensis, cardinal flowers and many others. In the front rows between the herbaceous plants we use scillas, chionodoxas, crocuses, snowdrops and grape hyacinths. In early spring before the herbaceous plants have much more than made their appearance above the ground, the tulips, narcissi, scillas, chionodoxas and grape hyacinths are in full bloom and make a most pleasing effect.

(To be continued)

SEED TRADE NOTES.

On May 11, W. P. Stokes of Philadelphia, lectured before the employees of The McFarland Organizations, Harrisburg, Pa., on "How Seeds are Grown and How they are Sold."

Seed stores in the middle west report counter trade as very good during the past week. Stocks are pretty well cleaned up and now that weather has become settled the outlook for the balance of the season is bright. Market gardeners are feeling better although they will be at considerable loss on account of injury to crops occasioned by unseasonable frosts and unusually wet weather. Seeding for onion sets is practically completed.

PRIMULA SEED

Table with 3 columns: Seed Name, Price per 1/2 oz., Price per 1 oz. Includes items like Alba Magnifica, Chiswick Red, Holborn Blue, Kermesina splendens, Rosy Morn, and Michell's Prize Mixture.

PRIMULA OBCONICA GRANDIFLORA

Table with 3 columns: Seed Name, Price per 1/2 oz., Price per 1 oz. Includes items like Compacta, Fimbriata, Gigantea Aretina, Kermesina, Rosea, White, and Mixed.

Write for our Wholesale Catalogue. HENRY F. MICHELL CO. 1018 Market St., PHILA.

Everything "For the Land's Sake."

The one firm in Boston where all good forms of plant food may be obtained, is the Bowker Fertilizer Company, opposite Faneuil Hall at 43 Chatham St. All greenhouse chemicals, Nitrate of Soda, Ground Bone, Potash Salts, Sheep Manure and Wood Ashes can there be had at first hands.

BOWKER FERTILIZER COMPANY

Everything "For the Land's Sake."

VEGETABLE PLANTS

- BEETS.** Crosby, Egyptian and Eclipse, \$1.25 per 1000.
- CABBAGE.** Field Grown, all leading varieties, \$1.00 per 1000. 10,000 and over, 85¢ per 1000.
- CELERY.** White Plume, Golden Self Blanching and Giant Pascal, \$1.25 per 1000.
- EGG PLANT.** N. Y. Improved and Black Beauty, \$3.00 per 1000.
- LETTUCE.** Big Boston, Boston Market, Tennis Ball and Grand Rapids, \$1.00 per 1000.
- PEPPERS.** Ruby King, Bull Nose, Sweet Mountain and Neapolitan, \$3.00 per 1000. Chinese Giant and Cayenne, 50¢ per 1000.

CASH WITH ORDER

R. VINCENT, JR., & SONS CO.
White Marsh, Md.

Cycas Revoluta

Good, Strong, Healthy
TRUNKS

25 pounds	\$2.25
100 "	8.50
300 "	24.00

MICHELL 1018 MARKET ST. PHILA., PA.

GEO. E. DOW
Designing and Illustrating
178 Washington St., Boston, Mass.
OUR SPECIALTY
Machine, Booklet, Advertising and Flower
PHOTOGRAPHS

Mignonette

FARQUHAR'S GIANT

Oz., 75c; 1-4 oz., 25c

R. & J. Farquhar & Co.

6 & 7 South Market Street
BOSTON, MASS.

SHEEP MANURE

ITS STERILIZED
Free from Weed Seeds.
\$24.00 Ton;
\$7.00 quarter of Ton.

Wm. Elliott & Sons
42 Vesey St., New York

RELIABLE SEEDS—SOW NOW
PRIMULA OBCONICA GRANDIFLORA

1000 seeds	Tr. pkt.	
Flood red, fine seller.....	\$1.50	\$0.50
Real pink, fine for cut.....	1.00	.50
Pure white, fine for cut.....	1.00	.50
Compacta, fine potted.....	1.50	.50
Mixed Hybrids.....	1.00	.50

O. V. ZANGEN, - HOBOKEN, N. J.

LEONARD SEED CO.

CONTRACT CROWERS AND WHOLESALE DEALERS
BEANS, PEAS, SWEET CORN, ONION, GARDEN SEEDS
FLOWER SEEDS Get Our Prices
79 and 81 E. KINZIE STREET, CHICAGO

ESTABLISHED 1802

Thorburn's Seeds

FINE CLUMPS JAPAN IRIS
TUBEROUS ROOTED BEGONIAS
GLOXINIAS
ROSA MULTIFLORA NANA SEED
and all other flower seeds for florists

SEND FOR CATALOGUE
J. M. THORBURN & CO.
33 Barclay Street
NEW YORK

BRIDGEMAN'S SEED WAREHOUSE

RICKARDS BROS.
Props.
37 East 19th St., - NEW YORK CITY

STOCK SEED FOR WINTER BLOOMING

Our strain of Double Branching Stocks is exceptionally true. About 90% Double Flowers.
In colors: 24 oz. .60 or.....\$4.00
Pure White 24 " .75 ".....5.00
H. E. FISKE SEED CO.
Faneuil Hall Square, BOSTON, MASS.

Winter-flowering SWEET PEA SEED

All Colors Ask for List
A. C. ZVOLANEK
ORIGINATOR. BOUND BROOK, N. J.

NEW CROP SEED

For Early Planting
THOMAS J. GREY CO.
32 SO. MARKET ST., BOSTON, MASS.

BEGONIAS TUBEROUS ROOTED
GLOXINIAS, LILY OF VALLEY, SPIREA
Catalogues mailed free on application

Joseph Breck & Sons Corp.
47-54 NO. MARKET ST., BOSTON, MASS.

BULBS OF QUALITY

Begonias, Single, under color.....	\$2.75
" Double " " ".....	5.00
" Fritted " " ".....	10.00
Gloxinias, under color.....	4.00
Pearl Tuberoses, \$7.00 thous.....	1.00

Schlegel & Fottler Co.
26 & 27 So. Market St., BOSTON, MASS.

CABBAGE SEED
LILY OF THE VALLEY PIPS.

HJALMAR HARTMANN & CO.
Løngangsstraede 20,
COPENHAGEN, DENMARK.

Burpee's Seeds
PHILADELPHIA

Blue List of Wholesale Prices mailed only to those who plant for profit

Ward's Lily Bulbs

Send for Catalogue
Ralph M. Ward & Co.
12 W. Broadway
NEW YORK



To Florists Everywhere

Orders for Cut Flowers and Floral Decorations to be delivered anywhere in the Greater New York, may be placed with us with the certainty that your customers will be satisfied.

Telegraph, telephone or mail such orders to us and be sure that they will be filled as promptly and as carefully as though you did it yourself.

One third discount will be allowed on all orders thus placed with us by Florists outside of the Greater New York.

THE BLOSSOM

Bond and Livingston Sts.,
BROOKLYN, N. Y.

C. C. TREPEL, Manager

**WILLIAM J. SMYTH
FLORIST**

Cor. Michigan Ave. and 31st St., CHICAGO

We ship to all points in Illinois and Iowa.

Phones: Douglas 744, Douglas 523, Douglas 740

HAUSWIRTH THE FLORIST

Out of Town orders for Hospitals

Carefully filled.

**232 Michigan Ave.
CHICAGO**

AUDITORIUM ANNEX Tel. Harrison 585

**SAMUEL MURRAY
Florist**

Coates House Conservatory

1017 BROADWAY, KANSAS CITY, MO.

Both 'Phones 2670 Main.



WASHINGTON,
D. C.

GUDE'S

**The Far-Famed Flowers of
TORONTO**

Delivered on mail or telegraph order for any occasion, in any part of the Dominion.

JOHN H. DUNLOP,
96 Yonge St., - Toronto, Ont.

The Park Floral Co.

J. A. VALENTINE,
Pres.

DENVER, COLORADO

**WILLIAM L. ROCK
FLOWER CO.**

KANSAS CITY, - MO.

will carefully execute orders for Kansas City and any town in Missouri or Kansas.



Buffalo, N. Y.

W. J. PALMER & SON, 304 Main St.

**Of Interest to Retail
Florists**

Washington is experiencing one of the latest and coldest spring for years, with the result that there is not an over plus on any one flower, but most of the dealers report themselves as more than satisfied with conditions. A good many peonies are coming from the south, but are not up to the standard in quality. Nearly lilac has been a total failure, and as yet no water lilies are on the market. Sunday was celebrated as Mother's day in Washington, which made a run on white carnations, consuming all in the city long before the closing hour for the stores. It is

STEAMER DEPARTURES

American.	
New York, N. Y.-Shampton...	May 22
St. Louis, N. Y.-Shampton...	May 29
Atlantic Transport.	
Minneapolis, N. Y.-London...	May 22
Minnetonka, N. Y.-London...	May 29
Cunard.	
Saxonia, Boston-Liverpool...	May 18
Luistania, N. Y.-Liverpool...	May 19
Carmania, N. Y.-Liverpool...	May 22
French Line.	
La Savoie, N. Y.-Havre...	May 20
La Touraine, N. Y.-Havre...	May 27
Hamburg-American.	
Cleveland, N. Y.-Hamburg...	May 22
Pres. Grant, N. Y.-Hamburg...	May 26
K. A. Victoria, N. Y.-Hamburg...	May 29
Leyland Line.	
Bohemian, Boston-Liverpool...	May 25
North German Lloyd.	
K. W. d. Luise, N. Y.-Med. Pts...	May 22
K. W. d. Grosse, N. Y.-B'm'n...	May 25
White Star.	
Tontonic, N. Y.-Shampton...	May 19
Baltic, N. Y.-Liverpool...	May 22
Romanic, Boston-Med. Ports...	May 22
Adriatic, N. Y.-Shampton...	May 26
Cymric, Boston-Liverpool...	May 29

thought that this will be an annual observance in all the large cities. Owing to the unveiling of several new statues during the past week there has been a great demand for outside decoration of laural.

CHICAGO NOTES.

Spring Plant Trade.

The supply of Boston ferns is decidedly short in Chicago. There has been a heavy demand throughout the entire season. In some cases they were pushed on a little to make room for Christmas stock and the steady demand since has about consumed the supply. Many growers last year found themselves over-stocked and consequently did not grow enough this year.

Geraniums are as a rule decidedly backward this year and many growers are going to find it very difficult to get stock in bloom for Decoration Day trade which is so nearly upon us. This applies to all varieties. The wet weather last August started the difficulty and the continued damp and cloudy weather this spring has added to it. Other bedding plants seem to be in about the normal condition and there will probably be enough to take care of the trade.

The Ringler Rose Co. having a wholesale business in nursery stock, seeds, bulbs, etc., at 39 Market street, have opened up a retail store, for the

ALEX. McCONNELL

571 FIFTH AVENUE
NEW YORK CITY

Telegraphic orders forwarded to any part of the United States, Canada, and all principal cities of Europe. Orders transferred or intrusted by the trade to our selection for delivery on steamships or elsewhere receive special attention.

Telephone Calls, 487 and 488 38th St.
Cable Address, ALEXCONNELL

M. A. BOWE

In the Heart of New York City
1294 Broadway
NEW YORK

Tel. 2770, 38th St.

Our Motto—The Golden Rule

DAVID CLARKE'S SONS

Deliver orders from any part of the country to
New York City

Or OUT-GOING STEAMERS

Write or telegraph

2139-2141 Broadway, New York

Telephone 1559-1553 Columbus

YOUNG & NUGENT

42 West 28 St., NEW YORK

"FLOWERS BY TELEGRAPH"

ALBANY, N. Y.

EYRES

Flowers or Design Work

DELIVERED IN ALBANY AND VICINITY
ON TELEGRAPHIC ORDER.

11 NORTH PEARL ST., ALBANY, N. Y.

Flower Deliveries

In Brooklyn and other Long Island Points
New York City, New Jersey, etc. At Theaters,
Hotels, Steamers or Residences.

WILSON

Fulton St. and Greene Ave., Brooklyn, N. Y.

**DANKER, Albany,
N. Y.**

ORDERS FOR

**Choice Flowers and
Floral Emblems**

FILLED PROMPTLY

WELLESLEY COLLEGE

Dana Hall, Walnut Hill and Rockridge Hall
Schools. TAILBY, Wellesley, Mass.

Tel. Wellesley 44-1 and 2. Night 44-3.

ATLANTA FLORAL CO.

41 Peachtree Street, ATLANTA, GEORGIA

USEFUL BOOKS.

We can supply the following books, postpaid, at the prices listed:—
Roses and How to Grow Them. By Many Experts. Price, \$1.21.

The New Cyclopaedia of American Horticulture. L. H. Bailey. Four volumes, \$20.00.

How to Plan the Home Grounds. S. Parsons, Jr. Price, \$1.10.

How to Make a Vegetable Garden. Edith L. Fullerton. Price, \$2.20.

FOR MEMORIAL DAY 1909

All the Indispensables as well as the Cream of the Useful and Appropriate Novelties for this, The Florists' "Day of Days."

Memorial Wreaths in Porcelain, Metal, Immortelles, Laurel and Bay Leaves, Magnolia Leaves, Green and Bronze, etc., Inscriptions, Sheaves, etc.

The Best Stock and The Largest Stock Ever Offered.

H. BAYERSDORFER & CO., 1129 Arch Street, PHILADELPHIA, PA.

JOHN BREITMEYER'S SONS

Cor. Miami and Gratiot Aves.
DETROIT, MICH.

Artistic Designs . . .
High Grade Cut Blooms

We cover all Michigan points and good sections of Ohio, Indiana and Canada.

BOSTON'S BEST

In Quality and Design

Can be relied upon when you transfer your retail orders to

EDWARD MACMULKIN
194 Boylston Street, Boston

Send flower orders for delivery in

BOSTON

and all

NEW ENGLAND POINTS
THOS. F. GALVIN
124 Tremont St., Boston



TRANSFER

Your orders for flower or plant delivery in Eastern New England to

JULIUS A. ZINN,
2 Beacon St., Boston

FINE DESIGN WORK A SPECIALTY
Orders by Wire Receive Prompt and Careful Execution

J. Newman & Sons

Corporation

24 Tremont Street, BOSTON
Theater, Steamer and Funeral Flowers Our Specialty
We can refer to leading florists in all principal cities.
Established 1870.

LOUISVILLE, KY.
JACOB SCHULZ,
550 South Fourth Ave.

busy season only, at 69 5th avenue. They have a good location for this kind of business and if the venture proves a success it will become a yearly event.

Personal.

Visitors: C. H. Perkins of the Jackson & Perkins Co., Newark, N. Y.; P. M. Koster, Boskoop, Holland; H. A. Fisher, Kalamazoo, Mich.; Harry E. Philpott, Winnipeg, Manitoba; J. H. Duyveus, Jr., Aalsmeer, Holland. John Thorpe is convalescing after an attack of bronchitis. His many friends are glad to see him up again and hope for a complete and speedy recovery.

The young son of George Asmus is recovering from an operation for appendicitis.

Obituary notes of Mrs. O. P. Bassett and Jacob Schneider will be found in the column devoted to that purpose, also an interesting note about street tree planting appears in nursery department of this issue.

Miss Hertha Tonner reports the visit of a brother from South Dakota, accompanied by his bride.

Robt. Rahaley and bride, of Detroit, reached Chicago and found the florists all on the lookout for them, thanks to the timely warning given by their Detroit friends. The couple was not very much in evidence about the market, due no doubt to the shyness mentioned on the announcement cards so generously distributed among the trade.

A Coming Benedict.

The engagement of John A. Then and Olga Hauke will be announced at a dinner participated in by the two families Sunday, May 16th. Mr. Then is a very popular young florist, son of Anton Then, whose entire family are engaged in various ways in the florists' business.

A Failure.

J. W. Niesen filed a petition in bankruptcy May 4, with liabilities placed at \$3,055, and assets \$326. For several years Mr. Niesen has had a retail store and greenhouses at 753 Forty-seventh street, which is considered a fine location.

N. Cambridge, Mass.—Robert E. Sands and George H. Conant, Jr., have started in the wholesale and retail plant business at 67 Garfield street, under the firm name of Sands & Conant.

"FLOWERS BY TELEGRAPH."

Leading Retail Florists Listed by Towns for Ready Reference.

- Denver, Colo.—Park Floral Co., 1706 Broadway.
- Washington, D. C.—Gude Bros., 1214 F St.
- Atlanta, Ga.—Atlanta Floral Co., 41 Peach Tree St.
- Chicago—Hauswirth, "The Florist," 232 Michigan Ave.
- Chicago—William J. Smyth, Michigan Ave. and 31st St.
- Chicago—George Wittbold Co., 1657-59 Buckingham Place.
- Louisville, Ky.—Jacob Schulz, 550 South Fourth Ave.
- Boston—Thos. F. Galvin, 124 Tremont St.
- Boston—Edward MacMulkin, 194 Boylston St.
- Boston—Hoffman, Florist, 59-61 Massachusetts Ave.
- Boston—J. Newman & Sons, Inc., 24 Tremont St.
- Boston—Julius A. Zinn, 2 Beacon St.
- Wellesley, Mass.—Tally.
- Detroit, Mich.—J. Breitmeyer's Sons, Miami and Gratiot Aves.
- Kansas City, Mo.—Samuel Murray, 1017 Broadway.
- Kansas City, Mo.—Wm. L. Rock Flower Co., 1116 Walnut St.
- Albany, N. Y.—H. G. Eyres, 11 N. Pearl St.
- Albany, N. Y.—F. A. Danker, 40 Maiden Lane.
- New York—David Clarke's Sons, 2130-2141 Broadway.
- New York—Alex. McConnell, 571 5th Ave.
- New York—Young & Nugent, 42 W. 28th St.
- New York—M. A. Bowe, 1294 Broadway.
- Brooklyn, N. Y.—The Blossom (C. C. Trepel, Mgr.), Bond and Livingston Sta.
- Brooklyn, N. Y.—Robert G. Wilson, Fulton St. and Greene Ave.
- Buffalo, N. Y.—Palmer's, 304 Main St.
- Toronto, Can.—J. H. Dunlop, 96 Yonge St.

New York, N. Y.—Joseph G. Leikens has added the flower stand in the Plaza Hotel to his other acquisitions in this line.

THE BEST LETTERS

FOR THOSE
FLORISTS' MADE
USE OF BY THE



Boston Florist Letter Co.

66 PEARL ST., BOSTON

N. F. MCCARTHY, Mgr.

Order direct or buy from your local supply dealer. Insist on having the

BOSTON

Inscriptions, Emblems, etc., Always in Stock

ROSE PLANTS

RICHMOND

2½ inch pots, \$5.00 per 100, \$4.00 per 1000.
3 inch pots, \$6.00 per 100, \$50.00 per 1000.

<p>KAISERINE 3 inch pots, Extra fine plants Well worth the price, \$8.00 per 100.</p>	<p>BRIDES and MAIDS ¾ inch pots, \$6.00 per 100, \$50.00 per 1000.</p>
--	---

READY FOR DELIVERY NOW

THE LEO NIESSEN CO.

1209 Arch St., Philadelphia, Pa.
Open from 7 a. m. to 8 p. m.

To Cut Flower Growers and Retail Florists

IF YOU

want to find a market for your product

want a regular or special supply of the product of the best growers

Consult the Advertisements on these Wholesale Flower Pages

The Advertisers Represented Here are the Leading Concerns in the Wholesale Flower Trade

NEW CROP BEAUTIES

\$1.00 to \$3.00 per Doz.

W. E. McKISSICK & BROS.

WHOLESALE FLORISTS
1619-1621 RANSTEAD ST.
PHILADELPHIA

WELCH BROS.

AMERICAN BEAUTY, KILLARNEY, RICHMOND, MARYLAND and ALL THE SUPERIOR ROSES, LILY OF THE VALLEY, CARNATIONS, ORCHIDS

BEST PRODUCED

226 Devonshire Street, Boston, Mass.

CUT FLOWER BOXES

EDWARDS FOLDING BOX CO
MANUFACTURERS
PHILADELPHIA, PA.

CHAS. W. McKELLAR

51 WABASH AVE., CHICAGO

Western Headquarters for Choice Orchids
Valley, Roses and all Cut Flowers

PETER REINBERG

WHOLESALE
CUT FLOWERS
51 Wabash Av., Chicago, Ill.

Long Distance Phone, Central 6004

WINTERSON'S SEED STORE

45-47-49 Wabash Ave., Chicago.

Seedsmen, Plantsmen, Nurserymen
Florists' Supplies

We can supply everything used by the Florist. SUPPLY CATALOG FREE. Correspondence solicited.

POEHLMANN BROS. CO.

33-35-37 Randolph St., - CHICAGO

CUT FLOWERS

Greenhouses, - Morton Grove, Ill.

Rice Brothers

118 N. 6th Street, MINNEAPOLIS, MINN.

WHOLESALE FLORISTS and SUPPLIES

CUT FLOWERS received twice daily, and can fill your orders to your satisfaction. A complete line of Hardy Greens 2" WILD SMILAX, BOXWOOD, HARDY FANCY FERNS, GALAX LEAVES.

Write for quotations on large quantities.

In ordering goods please add "I saw it in HORTICULTURE."

WHOLESALE FLOWER MARKETS—TRADE PRICES—Per 100 TO DEALERS ONLY

	CHICAGO May 10	TWIN CITIES May 10	PHILA. May 11	BOSTON May 13
ROSES				
Am. Beauty, Fancy and Special.....	25.00 to 30.00	30.00 to 35.00	15.00 to 20.00	10.00 to 15.00
" Extra.....	30.00 to 35.00	25.00 to 30.00	10.00 to 15.00	15.00 to 20.00
" No. 1.....	15.00 to 20.00	20.00 to 25.00	6.00 to 10.00	4.00 to 8.00
" Lower grades.....	4.00 to 10.00	4.00 to 10.00	2.00 to 6.00	1.00 to 3.00
Bride, 'Maid, Golden Gate, F & S.....	6.00 to 8.00	5.00 to 8.00	6.00 to 8.00	5.00 to 8.00
" Lower grades.....	3.00 to 5.00	3.00 to 5.00	2.00 to 4.00	1.00 to 4.00
Killarney, Fan, & Sp.....	6.00 to 8.00	8.00 to 10.00	6.00 to 10.00	8.00 to 10.00
" Lower grades.....	3.00 to 5.00	6.00 to 8.00	2.00 to 4.00	1.00 to 6.00
Richmond, Fancy & Special.....	6.00 to 8.00	6.00 to 8.00	8.00 to 12.00	8.00 to 10.00
" Lower grades.....	3.00 to 5.00	4.00 to 6.00	2.00 to 4.00	1.00 to 5.00
Chateaux.....	4.00 to 6.00	6.00 to 8.00	2.00 to 6.00	1.00 to 8.00
My Maryland..... to to	3.00 to 8.00	6.00 to 10.00
CARNATIONS				
Fancy and Red.....	3.00 to 4.00	3.00 to 4.00	3.00 to 4.00	2.00 to 3.00
Ordinary and White.....	1.50 to 2.00	2.00 to 3.00	1.50 to 2.00	1.00 to 1.50
MISCELLANEOUS				
Carthays.....	40.00 to 50.00	50.00 to 60.00	50.00 to 60.00	35.00 to 50.00
Lilies.....	50.00 to 60.00	10.00 to 12.00	6.00 to 8.00	8.00 to 10.00
Lily of the Valley.....	3.00 to 4.00	3.00 to 4.00	2.00 to 4.00	2.00 to 4.00
Tulips.....	3.00 to 4.00	3.00 to 4.00 to 2.00	2.00 to 4.00
Dahodils..... to 3.00	3.00 to 4.00 to 1.00 to 1.00
Nigrette..... to 4.00	3.00 to 4.00	1.50 to 2.00	1.00 to 4.00
Sweet Peas.....	.75 to 1.00	.75 to 1.00	.50 to 1.00	.50 to .75
Gardenias..... to 30.00	40.00 to 50.00	25.00 to 30.00	10.00 to 25.00
Violets..... to 1.00	.75 to 1.00 to 1.00	.15 to .20
Adiantum.....	1.00 to 1.50	1.00 to 1.50	1.00 to 1.50	.75 to 1.00
Smilax.....	15.00 to 20.00	15.00 to 20.00	15.00 to 20.00	12.00 to 15.00
Asparagus Plumosus, strings.....	50.00 to 60.00	35.00 to 50.00	35.00 to 50.00	25.00 to 50.00
" & Spren. (100 bchs.).....	35.00 to 50.00	30.00 to 30.00	35.00 to 50.00	15.00 to 25.00

J.A. BUDLONG

37-39 Randolph Street, CHICAGO.

Roses and Carnations A Specialty..... **WHOLESALE GROWER of CUT FLOWERS**

BUSINESS TROUBLES.

St. Joseph, Mo.—W. C. Kennedy has filed a petition in bankruptcy; liabilities, \$8,000, assets, \$3,500.

Cincinnati, O.—W. K. Partridge, florist, has filed a deed of assignment and attributes this step to his heavy loss in the recent hailstorm. Two years ago a similar storm did even greater damage to his plant. He gives his assets as \$40,000 and liabilities as \$30,000.

BUSINESS CHANGES.

Blommsburg, Pa.—C. W. Miller has bought the greenhouses of Davis Bros. on Fourth St., and A. W. Duy has purchased the plant on Light St.

New York, N. Y.—Charles Millang has acquired a five years' lease of the premises on the ground floor of the Coogan Building, 55 W. 26th street, recently vacated by B. S. Slinn.

Flower Market Reports.

BOSTON. Business is decidedly off this week as compared with last. Beautiful sunny weather has, as usual, its two effects, which always offset one another—good transient demand but augmented supply—and although there is a quite active call, prices are broken badly and while published quotations are practically unchanged large quantities of material have changed hands this week at prices more appetizing to the buyer than to the seller. A sanguine spirit prevails, however, and a noise is heard approaching which is much like the sound of Decoration Day hustle.

BUFFALO Trade was quite active the past week, especially in the carnation line, the demand for white being as heavy as for St. Patrick's day and prices holding firm throughout the week. The supply in all colors shortened up considerably, but there was plenty to supply all demands. Bride and Bridesmaid roses have been abundant, while Carnot, Kaiserin, Richmond and Killarney were shorter in supply but all were of excellent quality. American Beauties have been in heavy supply with demand more for mediums and short grades. Sweet peas have taken the place of violets and sell readily, also daisies, lily of the valley and pansies. Outdoor material has made its appearance, also daffodils, tulips, etc. A few days of hot weather and warm rain have forced them in rapidly. The only scarce articles at present are good ferns and smilax; other greens are quite abundant.

CHICAGO The first week of May opened brisk and everything went at good prices. Carnations sold well and the demand for roses was very gratifying. The supply of Beauties is large and the quality excellent. The extremely high temperature of the early part of the week, brought on the stock and the market experienced a lively increase in business. Later the thermometer dropped and rain put an end to the business flurry, though it was felt most on Saturday. Most growers held back their stock Friday looking for better weather but Saturday was one of those raw days that drive away trade. The first of this week found business generally dull and flowers left over from Saturday. Mother's Day developed no special demand for white carnations in this market. Several houses reported extra shipments to various large towns on Friday but their home sales were not above normal. Southern peonies are arriving in rather poor condition. Some consignments have fallen to pieces as soon as removed from the box. Red gladioli, forced, are in the market and sell fairly well at \$1.50 per dozen. If cold weather continues outdoor stock will be very scarce for Memorial Day.

INDIANAPOLIS The cut flower trade has been somewhat better in certain lines, due more to the shortening up of supplies than to any increased demand. This has manifested itself more the past week than any time this spring, owing to dark, cool



RIBBONS FOR COMMENCEMENTS AND WEDDINGS.

PATTERN KILLARNEY—Exact Match for the Killarney Rose

No. 7 width, price \$0.65	No. 22 width, price \$1.35	No. 100 width, price \$2.75
" 10 " 1.15	" 47 " 1.70	" 150 " 3.50
" 16 " 1.45	" 60 " 2.25	

PATTERN 1614—Exact Match for the Am. Beauty Rose, shaded effect exactly like the flower

No. 40 width, price \$2.00	No. 82 width, price \$3.00
----------------------------	----------------------------

Gauze for Shower Bouquets, Chiffons all Widths and Colors, New Combination Ribbons for All colors of Sweet Peas. Samples on Request.

S. S. PENNOCK-MEEHAN CO., 1608-1620 Ludlow St., Philadelphia

WHOLESALE FLOWER MARKETS.—PER 100 TO DEALERS ONLY.

	CINCINNATI May 11		DETROIT May 10		BUFFALO May 11		PITTSBURG May 11	
ROSES								
Am. Beauty, Fan, and Sp.	30.00	35.00	30.00	35.00	25.00	33.00	12.00	15.00
" Extra	25.00	30.00	25.00	30.00	17.00	25.00	8.00	10.00
" No. 1	15.00	20.00	20.00	22.00	13.00	15.00	5.00	6.00
" Lower grades	3.00	4.00	4.00	10.00	3.00	6.00	8.00	3.00
Bride, "Maid, Golden Gate, F. & S.	5.00	8.00	5.00	8.00	5.00	5.00	6.00	8.00
" Low. gr.	3.00	5.00	3.00	5.00	2.00	6.00	2.00	4.00
Killarney, Fan, & Sp.	6.00	8.00	5.00	8.00	5.00	8.00	7.00	10.00
" Lower grades	3.00	5.00	3.00	5.00	2.00	6.00	4.00	6.00
Richmond, Fancy & Special	8.00	10.00	10.00	10.00	10.00	8.00	8.00	10.00
" Lower grades	4.00	6.00	1.00	3.00	3.00	6.00	4.00	6.00
Chateau	5.00	8.00	3.00	8.00	5.00	5.00	4.00	10.00
My Maryland	5.00	8.00	3.00	8.00	5.00	5.00	4.00	10.00
CARNATIONS								
Fancy and Novelties	1.00	3.00	2.50	3.00	2.00	3.00	2.00	3.00
Ordinary	1.00	2.00	1.00	2.00	1.50	2.00	1.00	1.50
MISCELLANEOUS								
Catclays	10.00	12.00	35.00	50.00	60.00	75.00	50.00	75.00
Lilies	3.00	4.00	10.00	15.00	8.00	12.00	8.00	12.00
Lily of the Valley	3.00	4.00	3.00	4.00	3.00	4.00	3.00	4.00
Tulips	2.00	3.00	2.00	3.00	2.00	3.00	2.00	3.00
Daffodils	2.00	3.00	3.00	4.00	3.00	4.00	3.00	4.00
Mignonne	2.00	3.00	6.00	8.00	2.00	4.00	4.00	5.00
Sweet Peas	5.00	7.50	5.00	7.50	5.00	7.50	5.00	7.50
Gardenias	2.00	3.00	2.00	3.00	2.00	3.00	2.00	3.00
Violets	5.00	7.50	5.00	7.50	5.00	7.50	5.00	7.50
Adiantum	1.00	1.00	1.00	1.50	1.50	1.50	1.00	1.25
Smilax	12.00	15.00	15.00	20.00	20.00	15.00	20.00	20.00
Asparagus Plumose, strings	40.00	50.00	30.00	50.00	45.00	50.00	30.00	50.00
" & Spruce (100 bchs.)	30.00	25.00	30.00	50.00	25.00	50.00	35.00	50.00

weather. The quality of Beauties, tea roses, and carnations has not been better this spring, with the demand ahead of the supply. Sweet peas continue one of the best selling items on the list. Iris, pansies and lilac are much called for. The cool weather has held back the bedding plant trade which will come with a rush as soon as the weather permits. All kinds of greens seem to be scarce especially smilax and good common ferns. Violets are a thing of the past for this season. Pot hydrangeas and Crimson Ramblers are about the only things seen in the flowering plant line.

PHILADELPHIA. With the exception of a little spurt towards the end of the week on white flowers, there was very little life in last week's market. On Friday, Saturday and Sunday the demand for white carnations and white roses consequent on

the so called "Mother's Day" was very brisk and prices on these soared to Christmas and Easter figures. American Beauty roses were very plentiful, and this (Monday) morning the week starts out with a regular avalanche of these. Other varieties of roses are practically in the same boat. The crop of carnations is not quite so redundant and these move off better on the whole than roses. There are enough orchids for all demands. Gardenias are not moving quite so freely as last week. The quality of the sweet pea crop is exceptionally fine at present and while prices rule low immense quantities are disposed of. They are the popular low priced flower of this season and fill the gap caused by the absence of the violet. Peonies promise well for Decoration Day the portions being as large as a quarter May 10th. They should be in bloom

(Continued on page 700)

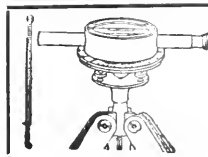

EVERYBODY KNOWS

Gardeening cannot be properly done without the aid of an accurate leveling instrument.

Bostrom's Improved Levels, No. 2 at \$15.00 and No. 3 at \$25.00, are conceded by all who KNOW to be the only levels on the market which meet all the requirements, at the price.

Our guarantee back of every Level we sell, and satisfied users in every State in the Union heartily endorse every claim we make.

Shipping weight 12 lbs. Description on request.
BOSTROM-BRADY MFG. CO., 139 Madison Avenue. ATLANTA, GA.

FORD BROTHERS

48 West 28th Street NEW YORK

FINE ROSES FANCY CARNATIONS

A Full Line of All CUT FLOWERS

Telephone, 3870 or 3871 Madison Square

H. E. FROMENT

Wholesale Commission Florist,
Choice Cut Flowers,

57 West 28th St. :: NEW YORK

Telephones: 2200, 2201, Madison Square.

Alfred H. Langjahr

All choice cut-flowers in season. Send for quotations. Correspondence with shippers of first-class stock invited.

55 West 28th Street, New York
Telephones 4626-4627 Madison Square

Edward C. Horan

Wholesale Florist

55 WEST 28th ST.

tel. 1462 Madison Square New York

JOHN YOUNG

WHOLESALE FLORIST

Finest American Beauties and Carnations

51 West 28 St. - NEW YORK

FRANK MILLANG

Wholesale Florist

55-57 West 26th St., NEW YORK

Shipments, any quantity, Wholesale Market Rates.

Henshaw & Fenrich

WHOLESALE FLORISTS

44 West 28th Street, NEW YORK

Phones Mad. Sq. 325, 558-2, 558-3

VIOLETS

Finest Grade. Any Quantity

B. S. SLINN

55-57 W. 26 St., New York

Moore, Hentz & Nash

Wholesale Commission Florists

55 and 57 West 26th Street

Telephone No. 756 Madison Square New York

MILLANG BROS.

WHOLESALE COMMISSION FLORISTS

41 West 28th Street

Telephone 3460 3661 Madison NEW YORK

JOHN I. RAYNOR

Wholesale Commission Florist **SELLING AGENT FOR LARGEST GROWERS**

A full line of Choice Cut Flower Stock for all purposes. Comprises every variety grown in New York market, at current prices

TEL. 1998 MADISON SQUARE 49 West 28th St., New York City

Walter F. Sheridan

Wholesale Commission Dealer in

CHOICE CUT FLOWERS

39 West 28th Street, New York
Telephone : 3532-3533 Madison Square

HEADQUARTERS FOR NOVELTIES ORCHIDS A SPECIALTY

THE HIGHEST GRADE OF VALLEY ALWAYS ON HAND

GARDENIAS, DAISIES, ROSES AND CARNATIONS

Telephone JAMES McMANUS, 759 Mad. Sq. 42 W. 28th St., New York

PHILIP F. KESSLER 55 & 57 W. 26th St., New York City

Commission Dealer, Wholesale Buyer and Seller of

Open from 5 a. m. to 6 p. m. Sunday till 10 a. m. **CUT FLOWERS**

Tel., 5243 and 2921 Madison Sq. Res., 345 J., Newtown. **Finest Lilies in the Market Every Day in the Year.**

NEW YORK QUOTATIONS PER 100. To Dealers Only

ROSES AND CARNATIONS

	Last Half of Week ending May 8 1909	First Half of Week beginning May 10 1909
American Beauty, Fancy and Special.....	3.00 to 15.00	6.00 to 10.00
" " Extra.....	5.00 to 8.00	5.00 to 6.00
" " No. 1.....	3.00 to 4.00	3.00 to 4.00
" " Lower Grades.....	.50 to 1.00	.50 to .00
Bride, "Gold, Golden Gate, Fancy and Special.....	4.00 to 6.00	3.00 to 4.00
" " Lower Grades.....	.50 to 3.00	.50 to 1.00
Killarney, Fancy and Special.....	4.00 to 6.00	3.00 to 4.00
" " Lower Grades.....	.50 to 3.00	.50 to 1.00
Richmond, Fancy and Special.....	4.00 to 6.00	3.00 to 4.00
" " Lower Grades.....	.50 to 3.00	.50 to 1.00
Chatenay.....	1.00 to 6.00	1.00 to 6.00
Fly Maryland.....	1.00 to 6.00	1.00 to 6.00
Carnations, Fancy and Novelties.....	2.00 to 3.00	1.00 to 2.00
" " Ordinary and White.....	.75 to 1.00	.50 to .75

Alexander J. Guttman

THE WHOLESALE FLORIST OF NEW YORK

34 WEST 28th STREET

PHONES. 1664--1665 MADISON SQUARE

ENOUGH SAID

CENTRALLY LOCATED, THE HUB OF THE FLOWER MARKET SECTION

CHARLES MILLANG

Wholesale Florist

444 Sixth Ave., NEW YORK

Telephone 7062 Madison

GEORGE COTSONAS & CO.

Wholesale and Retail Dealers in all kinds of

EVERGREENS

Fancy and Dagger Ferns
Bronze and Green Galax

Main Store 50 W. 28 St.

Phone 2200 Mad. Sq. New York

GROWERS' CUT FLOWER CO. CUT FLOWERS AT WHOLESALE

VIOLETS, CARNATIONS, ROSES
ORCHIDS, CHRYSANTHEMUMS, LILIES

Consignments Solicited. Shipments to Order, any Distance

39 West 28th Street, Telephone 637 Madison Square J. J. COAN, Manager NEW YORK

WHOLESALE FLORISTS
54 West 28th St.
NEW YORK
Telephone 3559 Madison Sq.

A. L. YOUNG & CO.

RECEIVERS & SHIPPERS OF CUT FLOWERS.
CONSIGNMENTS SOLICITED

WILLIAM H. KUEBLER
Brooklyn's Foremost and Best

WHOLESALE COMMISSION HOUSE
A First Class Market for all CUT FLOWERS
28 Willoughby St., Brooklyn, N. Y.
Tel. 4591 Main

Greater New York Florists' Association,
Now Open for Cut Flower Consignments
162 Livingston Street, BROOKLYN, N. Y.
Geo. W. Crawbuck Telephone Connection
Manager 3642-43 Main

REED & KELLER
122 West 28th St., New York
Florists' Supplies
We manufacture all our Metal Designs, Baskets, Wire Work & Novelties and are dealers in Glassware Decorative Greens and Florists' Requisites

THE KERVAN CO.
Wholesale Dealers and Shippers of Decorative Evergreens Ferns, Galax, Laurel, Fresh Cycas, Boxwood, Sphagnum and all Florists' Greens
Send to us for Quotations before Buying.
113 West 28 Street, NEW YORK CITY

MICHIGAN CUT FLOWER EXCHANGE, Inc.
WHOLESALE COMMISSION FLORISTS
Consignments Solicited
Hardy Fancy Fern Our Specialty
38-40 BROADWAY, DETROIT, MICH.

FOR FLORISTS' USE
There's **NOTHING** as good as **MEYER'S SILKALINE**
Don't let them sell you anything else
JOHN C. MEYER & CO., Boston, Mass.
In ordering goods please add "I saw it in HORTICULTURE."

Order by Name
Krick's Genuine Immortelle Letters, Etc.
The Best and Cheapest. Accept no Substitute. Every Letter Marked
W. C. KRICK
1164-66 Greene Av., Brooklyn, N. Y.
For Sale by all Supply Houses

Durand & Marohn
MANUFACTURERS OF
All Kinds of Wire Work
Florists' Wire Designs a Specialty
24 Beaver St., ALBANY, N. Y.

Wired Toothpicks
Manufactured by
W. J. COWEE, BERLIN, N. Y.
20,000.....\$1.75; 50,000.....\$7.50. Sample free.
For sale by dealers

WILLIAM F. KASTING CO.
WHOLESALE FLORISTS

383-387 Ellicott Street
BUFFALO, - N. Y.

ROBERT J. DYSART
Public Accountant and Auditor
Simple methods of correct accounting especially adapted for florists' use.
Books Balanced and Adjusted
Merchants Bank Building
28 STATE STREET, - BOSTON
Telephone, Main 58.

WHOLESALE COMMISSION
Open 6 a. m. Daily
J. K. ALLEN
Shipments of Lily of the Valley Needed



NEW YORK QUOTATIONS PER 100. To Dealers Only

MISCELLANEOUS	Last Half of Week ending May 8 1909		First Half of Week beginning May 10 1909	
	to	to	to	to
Cattleyas.....	30.00	50.00	30.00	50.00
Lilies.....	4.00	6.00	3.00	6.00
Lily of the Valley.....	1.00	3.00	1.00	3.00
Daffodils.....	1.00	2.00	1.00	2.00
Mignonette.....	3.00	8.00	3.00	8.00
Sweet Peas (per 100 bunches).....	10.00	30.00	10.00	30.00
Gardenias.....	75	1.50	75	1.50
Adiantum.....	20.00	30.00	20.00	30.00
Smilax.....	10.00	15.00	10.00	15.00
Asparagus Plumosus, strings.....	12.00	25.00	12.00	25.00
" " & Spreu. (100 bchs).....				

Flower Market Reports.

(Continued from page 707)
by the 25th if weather is favorable. The early officinalis variety—red, pink, and white,—has been in for ten days. Outdoor irises, blue and yellow mostly, are conspicuous—as are also lilac and dogwood sprays. Church work called for a good many Easter lilies at the wind up but not enough to absorb the week's surplus.

The oldest inhabitant of the wholesale flower district recalls no time when the trade prices of roses and carnations sustained such a sudden and stunning blow as they have experienced during the past few days. Conditions as described in our trade report for last week only hinted at the demoralization which was impending. All items in the list are keeping company together at the foot of the toboggan slide and in fact our price quotations as published afford only a very inadequate idea of the facts as known to those who are on the spot as growers and wholesale dealers. It would seem that every rose and carnation plant is bent upon putting forth a belated product sufficient to even up in numbers for any and all remissures during the recent winter season. Of American Beauty roses there are veritable carloads—sufficient to have produced snug fortunes for their owners had they been obtainable a few

weeks ago but now, alas, hardly able to realize the cost of cutting, packing and transportation and to rub it in "good and proper," other markets in a similar predicament are unloading their surpluses here as a last ditch resort. All other roses are in proportionately the same fix, carnations bringing scarcely 25 per cent of the returns of a few days back. Southern lilacs are coming in by the dozen bales and the climax of faith in New York's capacity to digest anything that comes along is seen in bundles of undeveloped pine buds sent all the way from Missouri. It is, indeed, an experience altogether calculated to cause anyone building new greenhouses to sit down and do some figuring and induce something akin to the shivers in any grower pinning his faith to the old-time houses and the ways of "the good old days."

San Francisco florists report good business, orchids, carnations, violets and roses being in good demand.

INCORPORATED.
Madera, Cal.—The Tighe Ranch Co., W. C. and H. B. Tighe, W. B. Broyle; capital, \$50,000; to engage in horticulture, agriculture, viticulture, etc.
Chatham, N. J.—The Noe Farm, to engage on farming and rose growing; capital, \$150,000.

Buyer's Directory and Ready Reference Guide

Advertisements under this head, one cent a word. Initials count as words.

Display advertisers in this issue are also listed under this classification without charge. Reference to List of Advertisers will indicate the respective pages.

Buyers falling to find what they want in this list will confer a favor by writing us and we will try to put them in communication with reliable dealers.

ACCOUNTANT

R. J. Dyart, 23 State St., Boston.
For page see List of Advertisers.

ALYSSUM

Dwarf alyssum from 2 in. pots, at \$2.00 per 100. Jas. T. Baker, Hastington, Philadelphia, Penn.

AMPELOPSIS.

Eastern Nurseries, Henry F. Dawson, Mgr., Ampelopsis Quinquefolia.
Jamaica Plain, Mass.

For page see List of Advertisers.

C. Elsele, 11th and Westmoreland Sts.,
For page see List of Advertisers.

AQUATIC PLANTS

Aquarium plants the year round. Wholesale and retail. Seed for price list. Schmidt's Emporium of Pets, 712 12th Street, Washington, D. C.

AQUILEGIA

Aquilegia. Genuine Coerulea, finest of all. Both plants and seeds from the heart of the Rockies. C. S. Harrison's Select Nursery, York, Neb.

ARAUCARIAS

A. Lenth & Co., Perkins St. Nurseries, Roslindale, Mass.

For page see List of Advertisers.

Godfrey Aschmann, 1012 West Ontario St., Philadelphia, Pa.

For page see List of Advertisers.

ARBOR VITAE

Arbor Vitae, Monumentalis, most beautiful of all; the compact, most popular evergreen. Strong pot grown plants for nursery planting \$2 per 12, postpaid. Rose Valley, Longola, Ill.

ASPARAGUS SEED

Asparagus Plumosus Nanus Seeds, any quantity, 30c. per 100; \$2.00 per 1000; \$8.75 per 5000. Peter Mack, Orlando, Fla.

Asparagus Plumosus Seed, fresh, lath-house grown, \$2.00 per 1000. Special price in quantities. Immediate delivery. Cash. Oak Grove Nurseries, Office, 104 North Los Angeles St., Los Angeles, Cal.

ASTERS.

Asters, 2 to 2 1/2 in. high, \$8.00 per 1000. Only the choicest colors and kinds included in the collection. H. J. Blanchard, Ashburnham, Mass.

AUCTION SALES

Overy's Horticultural Co., 62 Vesey St., New York.

For page see List of Advertisers.

AZALEAS

A. Lenth & Co., Perkins St. Nurseries, Roslindale, Mass.

For page see List of Advertisers.

Godfrey Aschmann, 1012 West Ontario St., Philadelphia.

For page see List of Advertisers.

BAMBOO CANES

Yokohama Nursery Co., 31 Barclay Street, New York.

Bamboo Sticks, Colored Green.

For page see List of Advertisers.

BAY TREES.

2000 Bay and Box Trees in all sizes, Pyramid and Standards. Write for list. Julius Roehrs, Rutherford, N. J.

BEDDING PLANTS

J. E. Felthousen, Schenectady, N. Y.
For page see List of Advertisers.

BEDDING PLANTS—Continued

A. Lenth & Co., Perkins St. Nurseries, Roslindale, Mass.

For page see List of Advertisers.

G. Aschmann, 1012 W. Ontario St., Philadelphia, Pa.

For page see List of Advertisers.

R. Vincent, Jr. & Sons Co., White Marsh, Maryland.

For page see List of Advertisers.

J. C. Schmidt, Bristol, Pa.

For page see List of Advertisers.

Thomas Roland, Nahant, Mass.

Begonia Gloire De Lorraine.

For page see List of Advertisers.

Storrs & Harrison Co., Palmesville, O.

For page see List of Advertisers.

Wm. W. Edgar Co., Waverley, Mass.

For page see List of Advertisers.

C. Elsele, 11th and Westmoreland Sts., Philadelphia, Pa.

For page see List of Advertisers.

Salvia, 2 1/2 to 3 in. high, 15c. each. Cobaea scandens, 2 1/2 in., 2c. each. H. J. Blanchard, Ashburnham, Mass.

Vinca variegated, finest stock, heavy and long, \$10 and \$12.50 per 100. R. C. S. A. Nutt geraniums, fine, \$10 per 1000. R. C. Golden Glow, \$4 per 100. Cash. Bellamy Bros., 207 Delaware St., Syracuse, N. Y.

Geraniums S. A. Nutt, extra fine plants from 4 in. pots at 6c. Asparagus Sprenger, from 4 in. pots at 6c. Satisfaction guaranteed. Brant Bros., Inc., Utica, New York.

BOILERS

BOILERS "Burnham" Boilers made for greenhouse heating. Lord & Burnham, 1183 Broadway, N. Y.

W. W. Castle Co.,
170 Summer St., Boston, Mass.
Tested Boilers.

Kroeschell Bros. Co., 35 Erie St., Chicago.
For page see List of Advertisers.

BOOKS

Pronunciation of Plant Names, sent for 50 cents, postpaid, by HORTICULTURE PUBL. CO., 11 Hamilton Place, Boston.

BOXWOOD TREES

New England Nurseries, Inc., Bedford, Mass.

For page see List of Advertisers.

BUILDING MATERIAL

BUILDING MATERIAL of all description for All Cypress, Semi-Iron, Iron Frame or Truss Houses. Hot Bed Sash and Frames. Lord & Burnham Co., 1183 Broadway, N. Y.

BULBS AND TUBERS

Joseph Breck & Sons, 47-54 N. Market St., Boston.

For page see List of Advertisers.

J. M. Thornburn & Co., 33 Barclay St., New York.

For page see List of Advertisers.

A. T. Boddington, 342 W. 14th St., N. Y.

For page see List of Advertisers.

Rickards Bros., 37 East 19th St., New York.

For page see List of Advertisers.

H. F. Michell Co., Philadelphia.

For page see List of Advertisers.

H. E. Flske Seed Co., Faneuil Hall Sq., Boston.

For page see List of Advertisers.

T. J. Grey & Co., 32 and 33 So. Market St., Boston.

For page see List of Advertisers.

Yokohama Nursery Co., 81 Barclay St., New York.

For page see List of Advertisers.

BULBS AND TUBERS—Continued

Ralph M. Ward & Co., 12 W. Broadway, New York.

For page see List of Advertisers.

Schlegel & Fottler Co., 26 & 27 S. Market St., Boston.

Begonias, Gloxinias, Tuberoses.

For page see List of Advertisers.

Wm. Hagemann & Co., Hudson Terminal Bldg., New York.

bulb Importers and Exporters.

CANNAS

C. Elsele, 11th and Westmoreland Sts., Philadelphia, Pa.

For page see List of Advertisers.

R. Vincent, Jr. & Sons Co., White Marsh, Maryland.

For page see List of Advertisers.

Cannas started from sand, \$2.00 per 100; from pots, \$3.00 per 100. J. E. Shurtleff & Son, Cushman Ave., Revere, Mass.

CARNATIONS

Baur & Smith, 38th & Senate Sts., Indianapolis, Ind.

Patten & Co., Tewksbury, Mass.

Carnation Shasta.

For page see List of Advertisers.

F. Dörner & Sons Co., Lafayette, Ind. Carnations for Immediate Delivery.

For page see List of Advertisers.

Chicago Carnation Co., Joliet, Ill. For page see List of Advertisers.

Wood Bros., Fishkill, N. Y.

Carnations, Rooted Cuttings.

For page see List of Advertisers.

The E. G. Hill Co., Richmond, Ind. Carnation Cuttings.

For page see List of Advertisers.

Poehlmann Bros. Co., Morton Grove, Ill. For page see List of Advertisers.

Columbia Carnation Co., New London, Conn. For page see List of Advertisers.

CHRYSANTHEMUMS

E. G. Hill Co., Richmond, Ind. For page see List of Advertisers.

S. J. Reuter & Son, Westery, B. I. For page see List of Advertisers.

C. H. Totty, Madison, N. J. For page see List of Advertisers.

Wood Bros., Fishkill, N. Y. Chrysanthemums Rooted Cuttings.

For page see List of Advertisers.

Scott Bros., Elmsford, N. Y. For page see List of Advertisers.

Poehlmann Bros. Co., Morton Grove, Ill. For page see List of Advertisers.

Elmer D. Smith & Co., Adria, Mich. Special Offer of Commercial Chrysanthemums.

For page see List of Advertisers.

William Swayne, Kennett Square, Pa. Rooted Cuttings.

For page see List of Advertisers.

Wm. W. Edgar Co., Waverley, Mass. For page see List of Advertisers.

100 commercial varieties, including Pompon and Hairy, \$12.50 per 100. Satisfaction guaranteed. Wm. Ehmann, Jr., Corfu, N. Y.

Chrysanthemum Golden Glow from 2 1/4 in. pots, for early spring delivery, \$1.00 per doz., \$6.00 per 100, \$50.00 per 1000. Stock plants of Montmore, Oct. Frost, Crocea, Matchless, Lucy Devaux, Polly Rose and Halliday, \$1.00 per doz.; \$5.00 per 100. Petre Bros., Waltham, Mass.

Herrington's book on the Chrysanthemum, mailed to your address for 50c., by Horticulture Publishing Co., 11 Hamilton Place, Boston.

For List of Advertisers See Page 715

CHRYSANTHEMUMS—Continued

Golden Glow and Pacific Supreme, the best early yellow and pink mums, R. C. \$3 per 100, prepaid; 2 1/2 in. pots, \$4; 2 1/2 to 104 rates. Chas. Fros', Kenilworth, N. J.

COAL FOR GREENHOUSE USE

Bader Coal Co., Board of Trade Bldg., Boston.
For page see List of Advertisers.

GOLEUS

J. E. Felthousen, Schenectady, N. Y.
For page see List of Advertisers.
A. Leuthy & Co., Perkins St. Nurseries, Roslindale, Mass.
For page see List of Advertisers.

CONIFERS

John Waterer & Sons, Ltd., American Nursery, Bagshot, Eng.
For page see List of Advertisers.

CUT FLOWER BOXES.

Edwards Folding Box Co., Philadelphia
For page see List of Advertisers.
Folding cut flower boxes, the best made write for list. Holton & Hunkel Co., Milwaukee, Wis.

CYCLAMENS

Cyclamen Splendens Giganteum, in five true colors, including the new salmon "Rhin of Wandsbeck," 2 1/2 in. pots, \$4.00 per 100, Chrysanthemum R. C. Pacific and Polly Rose, \$1.00 per 100. Cash. G. A. Thiele, Asylum Pike, Frankford, Pa.

DAHLIAS

David Herbert & Son, Atco, N. J.
For page see List of Advertisers.
J. L. Moore, Northboro, Mass.
For page see List of Advertisers.
Peacock Dahlia Farms, Williamstown Junction, N. J.
For page see List of Advertisers.
R. Vincent Jr. & Sons Co., White Marsh, Md.
For page see List of Advertisers.

DAHLIAS.

Geo. H. Walker, No. Dighton, Mass.
Wholesale and Retail.
Send your name for my 1909 Catalog and Pocket Guide, ready to mail about Feb. 25th.
Cactus, Decorative, Fancy, Show and Pompon Dahlias. Good commercial varieties, such as Kriemhild, Countess of Lonsdale, Mad. Van Den Deal and other sure bloomers, strong divided roots in 10 or 20 named varieties, selection, \$1.00 per 25; \$3.00 per 100; \$25.00 per 1000. Cash please. Hermann Thiemann, Meisau, Mass.

DECORATIVE PLANTS

A. Leuthy & Co., Perkins St. Nurseries, Roslindale, Mass.
Imported Plants for Fall Delivery.
For page see List of Advertisers.
Godfrey Aschmann, 1012 W. Ontario St., Phila., Pa.
For page see List of Advertisers.
The Geo. Wittbold Co., 1657 Buckingham Place, Chicago, Ill.
For page see List of Advertisers.
Robert Craig Co., Market and 49th Sts., Philadelphia, Pa.
For page see List of Advertisers.

EVERGREENS

New England Nurseries, Bedford, Mass.
For page see List of Advertisers.
American Nursery Co., 150 Broadway, New York, N. Y.
For page see List of Advertisers.
Evergreens. Send 25 cents in stamps for complete work on propagating and growing Evergreens. C. S. Harriman's Select Nursery, York, Neb.

FERNS

A. Leuthy & Co., Roslindale, Mass.
For page see List of Advertisers.
H. H. Barrows & Son, Whitman, Mass.
Nephrolepis Magnifica.
For page see List of Advertisers.

FERNS—Continued

John Scott, Brooklyn, N. Y.
For page see List of Advertisers.
Frank Oechlin, 2670-2606 W. Adams St., Chicago.
Ferns for Dishes.
For page see List of Advertisers.
The Geo. Wittbold Co., 1657 Buckingham Place, Chicago, Ill.
For page see List of Advertisers.
Godfrey Aschmann, 1012 W. Ontario St., Philadelphia, Pa.
For page see List of Advertisers.
C. Eisele, 11th and Westmoreland Sts., For page see List of Advertisers.
Rose Hill Nurseries, New Rochelle, N. Y.
Ferns for Jardinieres.
For page see List of Advertisers.
Anderson's ferns for in and outdoors. Largest commercial collection in the country. Ask for descriptive catalogue. J. E. Anderson, Fern Specialist, Short Hills, N. J.

FERTILIZERS

Fulverised Manure Co., 31 Union Stock Yards, Chicago, Ill.
Wizard Brand Sheep and Shredded Cattle Manure.
Bowker Fertilizer Co., Boston, Mass.
All Forms of Plant Food at First Hands.
For page see List of Advertisers.
German Kalk Works, 93 Nassau St., New York.
Potash Fertilizer.
For page see List of Advertisers.
Wm. Elliott & Sons, 42 Vesey St., New York.
Sheep Manure.
For page see List of Advertisers.

FLORAL PHOTOGRAPHS

Flora! Photographs, Foley's, 226-228 1-2 Bowery, New York.

FLORISTS' LETTERS.

Boston Florist Letter Co., 66 Pearl St., Boston, Mass.
For page see List of Advertisers.

FLORISTS SUPPLIES

N. F. McCarthy & Co., 84 Hawley St., Boston.
For page see List of Advertisers.
H. M. Robinson & Co., 15 Province St. and 9 Chapman Pl., Boston, Mass.
For page see List of Advertisers.
Reed & Keller, 122 W. 26th St., New York
For page see List of Advertisers.
H. Bayersdorfer & Co., 1129 Arch St., Philadelphia.
Memorial Day Supplies.
For page see List of Advertisers.
W. C. Krick, 1164-66 Greene Ave., Brooklyn, N. Y.
Immortelle Letters.
For page see List of Advertisers.
S. S. Pennock-Meehan Co., Philadelphia.
Ribbons for Commemorative and Weddings.
For page see List of Advertisers.

FLOWER POTS

W. H. Ernest, 28th and M Sts., Washington, D. C.
For page see List of Advertisers.
A. H. Hews & Co., Cambridge, Mass.
For page see List of Advertisers.
Hillgrove Bros., Ft. Edward, N. Y.
For page see List of Advertisers.
The Peters & Reed Pottery Co., Red pots, seed pans, etc., Zanesville, O.
Syracuse Pottery Co., Syracuse, N. Y.
Syracuse Red Pots.
For page see List of Advertisers.
We make Standard Flower Pots, etc. Write us when in need.
Wilmer Cope & Bro., Lincoln University, Chester Co., Pa.

FRUIT TREES

Dwarf Fruit Trees, by F. A. Waugh, mailed to your address for 55 cents by Horticulture Publishing Co., 11 Hamilton Place, Boston.

GALAX

Michigan Cut Flower Co., 85 and 40 Broadway, Detroit, Mich.
For page see List of Advertisers.
George Coutsouas & Co., 50 W. 28th St., New York.
For page see List of Advertisers.
The Kervan Co., 113 West 28th St., N. Y.
For page see List of Advertisers.
Elice Bros., 115 N. 6th St., Minneapolis, Minn.
For page see List of Advertisers.
H. M. Robinson & Co., 15 Province St. and 9 Chapman Place, Boston.
For page see List of Advertisers.

GARDEN HOSE

Revere Rubber Co., Boston, Mass.
For page see List of Advertisers.

GARDENIAS

Miss A. Washington, Alvin, Texas.
For page see List of Advertisers.

GERANIUMS

R. Vincent Jr. & Sons Co., White Marsh, Md.
New and Standard Varieties.
For page see List of Advertisers.
Geraniums, large plants, bud and bloom, out of 3 1/2 in. pots. S. A. Nutt and others, \$7.00 per 100. Cash. Stephen Chase, Nashua, N. H.
Geraniums in bud and bloom, S. A. Nutt, Bunker, etc., All stock out of 3 1/2 in. pots, \$6.00 per 100. Cash with order. Leonard Cousins, Jr., Concord Junction, Mass.
Shallered Geraniums, strong plants from 2 1/2 in. pots, \$2.50 per 100. J. B. Shurtleff & Son, Cushman Ave., Revere, Mass.

GLADIOLI

J. L. Moore, Northboro, Mass.
For page see List of Advertisers.
E. S. Miller, Wading River, N. Y.
For page see List of Advertisers.
O. V. Zangen, Hoboken, N. J.
Gladiolus Brenclyensis.

GLASS

Boston Plate & Window Glass Co., Boston.
For page see List of Advertisers.
Standard Plate Glass Co., 20-30 Sudbury St., Boston.
For page see List of Advertisers.
Foley Mfg. Co., Western Ave., between 25th & 26th Sts., Chicago.
For page see List of Advertisers.
Sharp, Partridge & Co., 22d & Lumber St., Chicago.
For page see List of Advertisers.
Parshefsky Bros., Inc., 50 Montrose Av., Brooklyn, N. Y.
For page see List of Advertisers.
Greenhouse glass, lowest prices. Johnston Glass Co., Hartford City, Ind.
Glass, High Grade, Double Thick Greenhouse Glass. Lord & Burnham, 1133 Broadway, N. Y.

GLAZING POINTS

H. A. Dreer, Philadelphia, Pa.
Peerless Glazing Point.
For page see List of Advertisers.
GLAZING POINTS, Lord & Burnham Special Glazing Nails (Points). Lord & Burnham, 1133 Broadway, N. Y.

GREENHOUSE BUILDING MATERIAL

Lord & Burnham Co., 1133 Broadway, New York.
For page see List of Advertisers.
Pierson U-Bar Co., 1 Madison Sq., N. Y.
For page see List of Advertisers.
A. T. Stearns Lumber Co., Neponset, Boston.
For page see List of Advertisers.
King Construction Co., N. Tonawanda, New York.
For page see List of Advertisers.
Hitchings & Co., 1170 Broadway, New York.
For page see List of Advertisers.
J. C. Montgero Co., 117 East Blackhawk St., Chicago, Ill.
For page see List of Advertisers.
Foley Mfg. Co., Western Ave., between 25th & 26th Sts., Chicago.
For page see List of Advertisers.

In writing to Advertisers kindly mention Horticulture

GREENHOUSE CONSTRUCTION

GREENHOUSE CONSTRUCTION, Semi-Iron Greenhouse, New Truss Houses and Iron Frame Houses. Lord & Burnham, 1133 Broadway, N. Y.

J. A. Payne, 230-274 Culver Ave., Jersey City, N. J.

For page see List of Advertisers.

Foley Mfg. Co., Western Ave., between 25th & 26th Sts., Chicago.

For page see List of Advertisers.

Hitchings & Co., 1170 Broadway, New York.

For page see List of Advertisers.

Geo. M. Garland Co., Des Plaines, Ill.

GREENHOUSE HOSE

Revere Rubber Co., Boston, Mass.

Revere Hose.

For page see List of Advertisers.

GUTTERS

GUTTERS, Cast Iron Gutters, L. & B. Improved V Shaped Gutter with drip gutter attachment. Lord & Burnham, 1133 Broadway, N. Y.

HEATING APPARATUS

Lord & Burnham Co., 1133 Broadway, New York.

For page see List of Advertisers.

Pierson U-Bar Co., 1 Madison Sq., N. Y.

For page see List of Advertisers.

John A. Payne, 230-274 Culver Ave., Jersey City, N. J.

For page see List of Advertisers.

Kroeschel Bros. Co., 35 Erie St., Chicago.

For page see List of Advertisers.

HAIL INSURANCE

Florist's Hall Asso. of America.

J. G. Esler, Saddle River, N. J.

For page see List of Advertisers.

HARDY CLIMBERS

Henry A. Dreer, 714 Chestnut St., Phila.

For page see List of Advertisers.

HARDY FERNS, MOSS AND GREENS

H. M. Robinson & Co., 15 Province St. and 9 Chapman Pl., Boston, Mass.

For page see List of Advertisers.

Michigan Cut Flower Exchange,

38 and 40 Broadway, Detroit, Mich.

For page see List of Advertisers.

George Cotonas & Co., 50 W. 25th St., New York.

For page see List of Advertisers.

N. F. McCarthy & Co., 84 Hawley St., Boston.

For page see List of Advertisers.

The Kervan Co., 113 W. 25th St., N. Y.

For page see List of Advertisers.

Wice Bros., 115 N. 6th St., Minneapolis, Minn.

For page see List of Advertisers.

HELP FURNISHED

Thos. H. Bambrick, 34 S. 7th St., Phila.

For page see List of Advertisers.

HERBACEOUS PERENNIALS

P. Ouwkerk, P. O. No. 1, Hoboken, N. J.

For page see List of Advertisers.

New England Nurseries, Bedford, Mass.

For page see List of Advertisers.

The Geo. Wittbold Co., 1657 Buckingham Place, Chicago.

For page see List of Advertisers.

HOT-BED SASH

The A. T. Stearns Lumber Co., Neponset, Mass.

For page see List of Advertisers.

Pierson U-Bar Co., 1 Madison Sq., N. Y.

For page see List of Advertisers.

Lord & Burnham Co., 1133 Broadway, N. Y.

For page see List of Advertisers.

Foley Mfg. Co., Western Ave., between 25th & 26th Sts., Chicago.

HYDRANGEAS.

Wm. W. Edgar Co., Worcester, Mass.

For page see List of Advertisers.

INSECTICIDES.

Nicotine kills all greenhouse pests.

P. R. Palethorpe Co.,

Eleventh St., Owensboro, Ky.

For page see List of Advertisers.

Stompp & Walter Co., 50 Barclay St., New York.

Kilmind Tobacco Dust.

For page see List of Advertisers.

Niagara Sprayer Co., Middleport, N. Y.

Niagara Brand.

For page see List of Advertisers.

E. G. Pratt Co., New York.

Sulfidice.

Bowker Insecticide Co., Boston, Mass.

Insect Destroying Preparations.

For page see List of Advertisers.

Wm. Cnoper & Nephews, 177 Illinois St., Chicago;

Cyril Francklyn, 62 Beaver St., New York.

Ag. Y 1 Fluid.

For page see List of Advertisers.

Eastern Chemical Co., Pittsburg St., Boston.

"IMP" Soap Spray.

For page see List of Advertisers.

"The Fumigating Kind Tobacco Powder"—The first on the market and the kind that has so many imitators, has our guarantee tag of satisfaction or money back, and "The Moon Trade Mark" on every bag, \$3.00 per 100 lbs. The H. A. Stoothoff Co., Mount Vernon, N. Y., Makers and sellers.

JAPANESE PLANTS

Yokohama Nursery Co., 31 Barclay St., New York.

For page see List of Advertisers.

KENTIAS

Godfrey Aschmann,

1012 W. Ontario St., Phila., Pa.

For page see List of Advertisers.

A. Leuthy & Co., Rosindale, Mass.

For page see List of Advertisers.

Joe. Heacock Co., Wyncote, Pa.

Single and Made-Up Specimens.

For page see List of Advertisers.

LEVELS FOR LANDSCAPE GARDENING USE.

Rostron-Brady Mfg. Co., 189 Madison Ave., Atlanta, Ga.

For page see List of Advertisers.

LILY OF THE VALLEY PIPS

Hjalmar Hartmann & Co., Langaugstraede

20, Copenhagen, Denmark.

For page see List of Advertisers.

LOBELIAS

C. Elsele, 11th & Westmoreland Sts., Phila.

Double Lobelia.

For page see List of Advertisers.

MADEIRA VINES

E. S. Miller, Wading River, N. Y.

For page see List of Advertisers.

MASTICA

F. O. Pierce Co., 12 W. Broadway, New York.

For page see List of Advertisers.

MOON VINES

C. Elsele, 11th & Westmoreland Sts., Phila.

For page see List of Advertisers.

MYRTLE

Myrtle, blue for cemetery planting, \$2.00 per 100; \$17.50 per 1000. Geo. A. Dhouan, Sta. H., Cincinnati, Ohio.

NICO-FUME

Kentucky Tobacco Product Co., Louisville, Ky.

NURSERY STOCK

John Waterer & Sons, Ltd., American Nursery, Bagshot, England.

For page see List of Advertisers.

Cleary's Horticultural Co., 62 Vesey St., New York.

For page see List of Advertisers.

F. Ouwkerk, 216 Jane St., Weehawkes Heights, N. J.

For page see List of Advertisers.

NURSERY STOCK — Continued

Eastern Nurseries, Jamaica Plain, Mass.

For page see List of Advertisers.

American Nursery Co., 150 Broadway, New York, N. Y.

For page see List of Advertisers.

Manual of the Trees of North America,

by C. S. Sargent, mailed to your address for \$5.00, by Horticulture Publishing Co., 11 Hamilton Place, Boston.

TREES, SHRUBS, ROSES, EVERGREENS, PEONIES, HARDY PLANTS.

ELLWANGER & BARRY, Rochester, N. Y.

For page see List of Advertisers.

New Hardy Shrub—Buddleya variabilis

velutina and Magnolia, the summer flowering Lilac, 50c. each; \$5.00 per doz.; \$25.00 per 100. Rose Hill Nurseries, New Rochelle, N. Y.

Catalog now ready. Nursery grown evergreens, seedling white pine and hemlock, native trees and plants. L. E. Williams, Nottingham, N. H.

ORCHID PLANTS

Lager & Horrell, Summit, N. J.

For page see List of Advertisers.

Sander, St. Albans, England.

Importers, Exporters, Growers, Hybridists.

For page see List of Advertisers.

Carrillo & Baldwin, Seacaucus, N. J.

For page see List of Advertisers.

Jo. A. Manda, 191 Valley Road, W. Orange, N. J.

For page see List of Advertisers.

Ordenez Bros., Madison, N. J., Box 106.

Cattleya Mossline.

For page see List of Advertisers.

G. L. Freeman, 388 Appleton St., Holyoke, Mass.

Orchid Importations.

For page see List of Advertisers.

Largest stock in the country. Ask for prices. Julius Roehrs, Rutherford, N. J.

Native Orchids. Hugo Kind, Hammon-ton, N. J.

PAINT AND PUTTY

PAINT AND PUTTY: Ideal Greenhouse lead; Special Greenhouse Putty. Lord & Burnham, 1133 Broadway, N. Y.

PALMS

A. Leuthy & Co., Perkins St. Nurseries, Rosindale, Mass.

For page see List of Advertisers.

Robert Craig Co., Market and 49th Sts., Philadelphia, Pa.

For page see List of Advertisers.

Joseph Heacock Co., Wyncote, Pa.

Home-Grown Palms.

For page see List of Advertisers.

Geo. Wittbold Co., 1657 Buckingham Place, Chicago.

For page see List of Advertisers.

PANSY PLANTS.

J. C. Schmidt, Bristol, Pa.

For page see List of Advertisers.

SUPERB STRAIN—READY NOW.

Fall-transplanted pansies, in bud and bloom. A trial order will convince you that these are the best you ever handled.

\$1.25 per 100; \$10.00 per 1000.

Cash with order.

LEONARD COUSINS, JR., Concord Junction, Mass.

Glant Pansy Plants, stocky, from fall-grown seed, 50c. per 100, prepaid; \$3.50 per 1000, not prepaid. Chas. Frost, Kenilworth, N. J.

Pansies, large, field grown, transplanted plants, very choice colors, \$10.00 per 1000. Cash. Stephen Chase, Nashua, N. H.

PATENTS

Siggers & Siggers, Washington, D. C.

For page see List of Advertisers.

PEAT

Orchid Peat and Moss always on hand.

Julius Roehrs Co., Rutherford, N. J.

PEONIES

Peonies only, by the wholesale—best 100 varieties. J. F. Rosenfield, Westpoint, Nebr.
One of the finest collections in America. Send 25 cts. in stamps for new edition of Peony Manual. C. S. Harrison's Select Nursery, York, Neb.

PHLOXES

Send 25 cts in stamps for Phlox Manual Fine mixed phloxes \$2.00 per 100. C. S. Harrison's Select Nursery, York, Neb.

PHOTOGRAPHS: DESIGNING: ILLUSTRATING

Geo. E. Dow, 178 Washington St., Boston. For page see List of Advertisers.

PIPE AND FITTINGS

Foley Mfg. Co., between Western Ave. and 26th St., Chicago, Ill.

Kroeschell Bros. Co., 35 Erie St., Chicago. For page see List of Advertisers.

FIVE AND FITTINGS. Cast Iron and Wrought Pipe, Valves, Elbows, Pipe Hooks, Automatic Air Headers, etc. Lord & Burnham, 1133 Broadway, N. Y.

PLANT STAKES

Seele's Telespa Plant Stakes and Trellises. H. D. Seele & Sons, Elkhart, Ind.

POT HANGERS

Pot hangers, Kramer's \$1 doz. by exp. \$1.25 by mail. I. N. Kramer & Son, Cedar Rapids, Ia.

RAFFIA

Raffia (colored), 20 beautiful shades. Samples free. R. H. Cameron, Camden, N. J.; 810 Wasburn Ave., Chicago, Ill.

RHODODENDRONS

John Waterer & Sons, Ltd., American Nursery, Bagshot, England. For page see List of Advertisers.

P. Ouwerkerk, Hoboken, N. J. For page see List of Advertisers.

ROSES

Robert Craig Co., Market and 49th Sts., Philadelphia, Pa. For page see List of Advertisers.

P. Ouwerkerk, P. O. No. 1, Hoboken, N. J. For page see List of Advertisers.

Julius Roehrs Co., Rutherford, N. J. Rose Newport Fairy.

The F. R. Pierson Co., Tarrytown-on-Hudson, N. Y. White Killarney. For page see List of Advertisers.

S. J. Reuter & Son, Westerly, R. I. My Maryland. For page see List of Advertisers.

Dingee & Conard Co., West Grove, Pa. For page see List of Advertisers.

Scott Bros., Elmford, N. Y. For page see List of Advertisers.

Poehlmann Bros. Co., Morton Grove, Ill. For page see List of Advertisers.

A. N. Pierson, Cromwell, Conn. White Killarney, My Maryland, Ramblers. For page see List of Advertisers.

Henry A. Dreer, 714 Chestnut St., Phila. Field Crown Ramblers. For page see List of Advertisers.

Montrose Greenhouses, Montrose, Mass. Kaiserlin, Grafted; Queen Beatrice, Own Root. For page see List of Advertisers.

U. S. Cut Flower Co., Elmira, N. Y. Rose Plants. For page see List of Advertisers.

The Rose, by H. B. Ellwanger; mailed for \$1.30 by Horticulture, 11 Hamilton Place, Boston.

Hand Book of Cultural Notes on Roses Under Glass, by F. P. Brigham, mailed to your address for 25c. by Horticulture, Publishing Co., 11 Hamilton Place, Boston.

Grafted rose plants, Brides and Bride-maids, extra large, strong, healthy plants, 1800 in 3 1/2 and 4-in. pots, \$12.00 per 100; 900 in 2 1/2-in. pots, \$10.00 per 100. Cash with order. Apply, W. S. Wilson Estate, Wellesley, Mass.

SEED GROWERS

Hjalmar Hartmann & Co., Caniflower and Cabbage Seed. Langangstraede 29, Copenhagen, Denmark. For page see List of Advertisers.

SEEDS

T. J. Grey Co., 32 So. Market St., Boston. For page see List of Advertisers.

Joseph Hreck & Sons, 51 and 52 N. Market St., Boston, Mass. For page see List of Advertisers.

W. Atlee Burpee & Co., Philadelphia. For page see List of Advertisers.

Arthur T. Boddington, 342 W. 14th St., New York. Paton Seed. For page see List of Advertisers.

H. E. Fiske Seed Co., Faneull Hall Sq., Boston. For page see List of Advertisers.

Hjalmar Hartmann & Co., Langangstraede 29, Copenhagen, Denmark. Caniflower and Cabbage Seed. For page see List of Advertisers.

Richards Bros., 37 E. 19th St., New York. For page see List of Advertisers.

R. & J. Farquhar & Co., 67 So. Market St., Boston. Mignonette Seed. For page see List of Advertisers.

H. F. Michell Co., 1018 Market St., Phila. Primula Seed. Cyas Revoluta. For page see List of Advertisers.

J. M. Thorburn & Co., 33 Barclay St., N. Y. For page see List of Advertisers.

Leonard Seed Co., Chicago, Ill. For page see List of Advertisers.

Schlegel & Fottler Co., 26 & 27 S. Market St., Boston. For page see List of Advertisers.

O. V. Zangen, Hoboken, N. J. Florists' Spring Seeds. For page see List of Advertisers.

E. F. Winterston Co., Chicago. Seeds for Plantmen, Nurserymen, Seeds men. For page see List of Advertisers.

Seeds. Rocky Mountain Evergreen seeds in large or small quantities. C. S. Harrison's Select Nursery, York, Neb.

SHRUBS

The Geo. Wittbold Co., 1657 Buckingham Place, Chicago. For page see List of Advertisers.

SHELF BRACKETS

King Construction Co., N. Tonawanda, N. Y.

SILKALINE

John C. Meyer & Co., Boston, Mass. For page see List of Advertisers.

SPHAGNUM MOSS

Live Sphagnum moss, orchid peat and orchid baskets always on hand. Lager & Horrell, Summit, N. J.

SPRAYS

Niagara Sprayer Co., Middleport, N. Y. For page see List of Advertisers.

Chas. J. Jager Co., Boston. Deming Spray Pump. For page see List of Advertisers.

STEAM TRAP

E. Hippard, Youngstown, O.

STRAWBERRY PLANTS

300 Strawberry Plants \$1. Your selection. List free. Wm. Perry, Cool Spring, Del.

Strawberries (Kelly) \$2.50 per 1000. Cash. Hugo Kind, Hamonton, N. J.

SULFOCID

The B. G. Pratt Co., 50 Church St., Dept. W. New York City.

SULPHUR BURNER

Benj. Dorrance, Rose Growers, Dorrance, Pa. For page see List of Advertisers.

SWEET PEAS

A. C. Zvolanek, Round Brook, N. J. White Marsh, Md. Winter Flowering. For page see List of Advertisers.

TO-BAK-INE

E. H. Hunt, Genl. Agt., 70-78 Wabash Av., Chicago. For page see List of Advertisers.

VEGETABLE PLANTS

R. Vincent, Jr. & Sons Co., White Marsh, Md. For page see List of Advertisers.

Vegetable plants now ready, all cold frame grown and hardened ready for outdoor planting. Cabbage, Charleston, Wakefield and Early Summer at \$2.00 per M, \$15.00 per 10,000. Egg Plants, Black Beauty and New York Spineless, \$1.50 per 100. Tomato plants, Earliana, Chalk's Jewell, June 17th and Allen's Best, \$1.00 per 100, \$6.00 per M. Cauliflower, Early Snowball, 75c per 100, \$4.00 per M. Pepper plants, Ruby King, 75c per 100, \$4.00 per M. Cash with order. All plants by express, receiver to pay charges. Address W. F. Allen, Salisbury, Md.

VEGETABLE SEEDS

Just arrived, our reliable vegetable seeds. Buy your fresh seeds now. These are guaranteed fresh and only first class seeds. The Reliable Seed House, 155 Third Street, Hoboken, N. J.

VENTILATING APPARATUS

Pierson U-Bar Co., 1 Madison Sq., N. Y. For page see List of Advertisers.

Foley Mfg. Co., Western Ave., between 25th & 26th Sts., Chicago. For page see List of Advertisers.

John A. Payne, 260-274 Culver Ave., Jersey City, N. J. For page see List of Advertisers.

The Advance Co., Richmond, Ind. For page see List of Advertisers.

Quaker City Machine Co., Richmond, Ind. 20th Century Ventilating Arm. For page see List of Advertisers.

VENTILATING MACHINERY. New Model enclosed, self-rolling gear. Standard Model Open Gear. Lord & Burnham, 1133 Broadway, N. Y.

VERBENAS

Verbenas, 2 1/2 to 3 in. high, i.e. each. Best varieties to be got, all desirable colors. H. J. Blanchard, Ashburnham, Mass. J. C. Schmidt, Bristol, Pa. For page see List of Advertisers.

VIOLETS.

William Sim, Cliftondale, Mass. Boston and Princess of Wales Violets. For page see List of Advertisers.

Good, strong California Violets, \$1.00 per 100, \$8.00 per 1000. Chas. M. Allen, 608 Broadway, Fall River, Mass.

Princess Violets, 2 1/2 in., \$2.00 per 100. Jas. T. Baker, Bustleton, Philadelphia, Pa.

WEED KILLER

The American Horticultural Distributing Co., Marltonburg, W. Va. Target Brand. For page see List of Advertisers.

WILSON'S PLANT OIL

Wilson Plant Oil & Fertilizer Co., Chatham, N. C. For page see List of Advertisers.

WIRED TOOTHPICKS

W. J. Cowee, Berlin, N. C. For page see List of Advertisers.

WIREWOK

Reed & Keller, 122 W. 25th St., N. Y. For page see List of Advertisers.

Durand & Marohn, Albany, N. Y. For page see List of Advertisers.

Wirework. Write for our catalogue. Holton & Hunkel Co., Milwaukee, Wis.

William E. Hellscher's Wire Works, 38-40 Broadway, Detroit, Mich.

Wirework—Compare our prices with others. Scranton Flower Supply Co., 301 N 7th St., Scranton, Pa.

In writing to Advertisers kindly mention Horticulture

WHOLESALE FLORISTS — Boston

- N. F. McCarthy & Co., 84 Hawley St., Boston.
For page see List of Advertisers.
- H. M. Robinson & Co., 75 Province St. and 9 Chapin Pl., Boston.
For page see List of Advertisers.
- Welch Bros., 226 Devonshire St., Boston.
For page see List of Advertisers.
- Tally, Wellesley, Mass.
For page see List of Advertisers.

Buffalo, N. Y.

- William F. Kasting Co., 383-87 Elliott St., Buffalo, N. Y.
For page see List of Advertisers.

Chicago

- Chas. W. McKellar, 51 Wabash Ave., Chicago.
For page see List of Advertisers.
- Peter Reinberg, 51 Wabash Ave., Chicago.
For page see List of Advertisers.
- E. F. Wilerson Co., 45-49 Wabash Ave., Chicago.
For page see List of Advertisers.
- J. A. Budlong, 37-39 Randolph St., Chicago.
For page see List of Advertisers.
- Poehlmann Bros. Co., Morton Grove, Ill.
For page see List of Advertisers.

Cromwell, Conn.

- A. N. Pierson, Cromwell, Conn.
For page see List of Advertisers.

Detroit

- Michigan Cut Flower Exchange, 38 and 40 Broadway, Detroit, Mich.
For page see List of Advertisers.

Minneapolis

- Elce Bros., 115 N. 6th St., Minneapolis, Minn.
For page see List of Advertisers.

New York

- Ford Bros., 48 W. 28th St., New York.
For page see List of Advertisers.
- H. E. Froment, 57 W. 28th St., New York.
For page see List of Advertisers.
- Alex. J. Gntman, 34 W. 28th St., New York.
For page see List of Advertisers.
- H. C. Horan, 55 W. 28th St., New York.
For page see List of Advertisers.
- A. H. Langjahr, 55 W. 28th St., New York.
For page see List of Advertisers.
- James McManus, 42 W. 28th St., New York.
For page see List of Advertisers.
- John I. Raynor, 49 W. 28th St., New York.
For page see List of Advertisers.
- W. F. Sheridan, 39 W. 28th St., New York.
For page see List of Advertisers.
- Moore, Hertz & Nash, 65 and 57 W. 28th St., New York.
For page see List of Advertisers.
- Wm. H. Kuebler, 25 Willoughby St., Brooklyn, N. Y.
For page see List of Advertisers.
- Philip F. Kessler, 65 and 57 W. 28th St., New York.
For page see List of Advertisers.
- Millang Bros., 41 W. 28th St., New York.
For page see List of Advertisers.
- John Young, 51 W. 28th St., New York.
For page see List of Advertisers.
- Greater New York Florists' Association, 162 Livingston St., Brooklyn, N. Y.
For page see List of Advertisers.
- Frank Millang, 55-57 W. 28th St., New York.
For page see List of Advertisers.
- B. S. Silna, 55-57 W. 28th St., New York.
For page see List of Advertisers.
- A. L. Young & Co., 54 W. 28th St., N. Y.
For page see List of Advertisers.
- Growers' Cut Flower Co., 89 W. 28th St., New York.
For page see List of Advertisers.
- Henehaw & Fenrich, 44 W. 28th St., New York.
For page see List of Advertisers.

WHOLESALE FLORISTS — New York — Continued

- J. K. Allen, 106 W. 28th St., New York.
For page see List of Advertisers.
- Charles Millang, 44 Sixth Av., New York.
For page see List of Advertisers.

Philadelphia

- W. E. McKissick & Bros., 1610-1621 Broad St., Philadelphia, Pa.
For page see List of Advertisers.
- Leo Niessen Co., 1209 Arch St., Philadelphia, Pa.
For page see List of Advertisers.
- The S. S. Pennock-Meehan Co., 1808-17 Ludlow St., Philadelphia, Pa.
For page see List of Advertisers.

New Offers in This Issue.

BARGAINS IN CATTLEYS.

- Alphonse Pericat, Collingdale, Phila., Pa.
For page see List of Advertisers.

BAYS, CHOICE CONIFERS.

- Julius Roehrs Co., Rutherford, N. J.
For page see List of Advertisers.

BEDDING PLANTS.

- S. V. Smith, 3223 Goodman St., Phila., Pa.
For page see List of Advertisers.

CANNAS.

- Estate of David Fisher, Woburn, Mass.
For page see List of Advertisers.

CARNATION MARY TOLMAN.

- Chicago Carnation Co., Joliet, Ill.
A. E. Hunt & Co., Evanston, Ill.
Hunt Bros., Park Ridge, Ill.
For page see List of Advertisers.

CANNAS, SPRENGER, ETC.

- J. H. Dann & Son, Westfield, N. Y.
For page see List of Advertisers.

CONTINUATION OF BUSINESS.

- John Scott, Rutland Road, Flatbush, N. Y.
For page see List of Advertisers.

DAHLIAS OF INTERNATIONAL REPUTATION.

- Peacock Dahlia Farms,
Williamstown Junction, N. J.
For page see List of Advertisers.

DENDROBIUMS, CATTLEYS, JUST ARRIVED.

- G. L. Freeman, Holyoke, Mass.
For page see List of Advertisers.

LATANIA BORBONICA LARGE SPECIMENS.

- John Ralph, Saratoga Springs, N. Y.
For page see List of Advertisers.

MEMORIAL DAY CUT FLOWERS, HARDY FERNS AND SUPPLIES.

- Welch Bros., 226 Devonshire St., Boston.
For page see List of Advertisers.

PALMS, HYDRANGEAS, STOVE PLANTS.

- Julius Roehrs Co., Rutherford, N. J.
For page see List of Advertisers.

POT GROWN VINES.

- Ellwanger & Barry, Rochester, N. Y.
For page see List of Advertisers.

PRIMUM SEED.

- A. T. Boddington, 342 W. 14th St., New York.
For page see List of Advertisers.

ROSES.

- Dingee Conard Co., West Grove, Pa.
For page see List of Advertisers.

ROSES, LILIES, FERNS, GREENS.

- H. M. Robinson & Co., 15 Province St., Boston.
For page see List of Advertisers.

PHILADELPHIA NOTES.

August Doemling of Lansdowne, is well under way with the erection of his new greenhouse addition of five houses, each 20 x 200 ft. In this new range which is a duplicate of his first roses will be grown under the solid bed system, Lord & Burnham are furnishing the materials.

W. A. Leonard of Wycombe Ave. will plant three houses in My Maryland this season. He has proved this variety to be profitable for eleven months out of the twelve. Two houses will be devoted to White Killarney.

Wm. Didden & Sons have opened a new retail store at 224 South 52nd St. The premises are 60 feet deep and 29 feet wide and are being fitted up in style suitable for artistic up-to-date trade.

Many growers of Easter lilies are dubious about planting giganteums this season on account of the early Easter, 1910. August Doemling says he has no misgivings on the point and can get them in easily by March 15th. He has promised to write a short account of how to do it for the benefit of HORTICULTURE'S readers. Look for this valuable story in an early issue.

7000 white carnations were distributed by the company among the subway trolley employees on Saturday. Each donation has this tag attached:—

"All I am or hope to be,
I owe to my sainted mother."

—Abraham Lincoln.
Frank Polites had the order for these.

Strawbridge & Clothier's big department store celebrated "Mother's Day" by giving away to its customers many thousands of white roses. Now let some one start a Daddy's Day. Give the old man a chance.

The J. Ellwood Lee Co. of Conshohocken, have just finished planting a forty acre field of Belladonna plants at this point for use in their medical factory. There are signs up all around the field "Danger" to warn off children and chickens from the deadly nightshade. We trust the local hotel men will not mistake this for mint for their juleps. The secretary of the P. H. S. lives there.

Visitors this week: Edward Roehrs, Rutherford, N. J.; W. C. Langbridge, Cambridge, N. Y.

FIRE RECORD.

Astoria, N. Y.—W. H. Siebrecht's place was badly damaged and considerable stock lost on May 2 through a fire that started near the boiler.

Jamestown, N. D.—Fire which is supposed to have originated in the furnace room of the Wheeler Floral Co., on May 2, destroyed about \$2,000 worth of property.

The Century Club has offered the following prizes for the annual show of the El Paso County Horticultural Society to be held at Colorado Springs, Colo., in August: Silver cup, valued at \$15, for best exhibit of sweet peas; \$20 cup for best kept premises of any club member; \$20 cup for best kept home premises of a member of fire or police departments.

LIST OF ADVERTISERS

Advertiser	Page
Advance, The Co.	719
Allen J. K.	709
American Nursery	705
(Engl.)	705
American Nursery Co	701
Aschmann & Co.	699
Atlanta Floral Co.	704
Bader Coal Co.	719
Baumbach Thos. H.	715
Barrons H. H. & Son	699
Baur & Smith	699
Bayersdorfer H. & Co	705
Beecher Thos.	704
Boddington A. H.	702
Boston Florist Letter	702
Co.	705
Bojon Plate and Win-	705
dow Glass Co.	718
Bostrum-Brady Mfg.	702
Co.	707
Brewer M. A.	704
Bowker Fertilizer Co.	703
Bowker Insecticide	703
Co.	717
Breck Joseph & Neg.	713
Breitmeyer's J. Sons	705
Bridgeman's Seed	705
Warehouse	703
Biedling J. A.	703
Burpee W. A. & Co.	703
Carillo & Baldwin	699
Chicago Carnation	703
Co.	630
Clark's David, Sons	704
Clear's Hortical Co	703
Coen J. J.	708
Cohaniz Carnation	703
Greenhouses	690
Coper. Wm. & Neg.	717
hews	717
Cousons Geo. & Co.	708
Crowe W. J.	709
& Robt. Co.	709
Crawback Geo. W.	709
Danker F. A.	704
Dann J. H. & Son	701
Dawson H. S.	701
Eastern Nurseries	714
Edgar Wm. & Co.	699
Edwards Folding Box	706
Co.	692
C. C.	692
Elliot Wm & Sons	703
Elmsford Nurseries	690
Ellwanger & Barry	701
Egger J. C.	718
Erment W. H.	718
Eyes	704
Farquhar R. J. & Co.	703
Falthouses J. E.	692
Fisher David, Est. of	691
Flake H. E. Seed Co.	703-716
Foley Mfg. Co.	719
Ford Florist	708
Freeman G. L.	692
Froment H. E.	708
Galvin Thos. F.	705
German Kali Works	717
Greiner N. Y. Florist	717
Association	709
Grey T. J. Co.	703
Growers' Cut Flower	703
Co.	708
Gude Bros. Co.	708
Gutman Alex. J.	708
Hall Asso.	7 8
Hartmann Hjalmar &	703
Co.	703
Hauswirth the Florist	701
Hiscock Jns. Co.	692
Henshaw & Fenrich	708
Herbert David & Son	699
Hew A. H. & Co.	718
Hilfinger Bros.	718
Hill, The E. G. Co.	630
Hitchings & Co.	720
Hoffman	708
Horan E. C.	708
Hunt E. H.	716
Jager, Chas. J. Co.	717
Kastling W. F. Co.	709
Kervan The Co.	709
Kessler P. F. & Co.	708
King Cons. Co.	710
Krick W. C.	709
Kraeschell Bros. Co.	714
Kuebler Wm. & Co.	719

Advertiser	Page
Lager & Hurrell	692
Langjahr, Alfred H.	703
Leard Seed Co.	708
Leudy & Co.	703
Lord & Burnham Co.	702
Manda Jos. A.	699
MacMurry E. A. & Co.	705
McCarthy N. F. & Co.	709
McConnell Alex.	704
McKall Charles W.	706
McKissick, W. E. &	706
McManus Jas.	706
Meyer J. C. & Co.	709
Michell H. F. Co.	702-703-716
Michigan Cut Flower	709
Exchange	709
Millang Bros.	708
Minlog Charles	708
Millang Frank	708
Miller E. S.	691
Moninger J. C.	719
Montrose Green	691
houses	691
Moore, J. L.	699
Moore, Hentz & Nash	708
H. Hays Nurseries	708
Murray Samuel	704
New Eng. Nurseries	701
Newman J. & Sons	705
Niagara Sprayer Co.	717
Niessen Leo. Co.	706
Oechlin Frank	692
Ordonez Bros.	692
Ouwkerk P. R. Co.	717
Palmer W. J.	704
Park Floral Co.	719
Parshelsky Bros.	719
Patten & Co.	690
Payne John A.	718
Peacock Dahlia Farms	699
Pennock-Mechau Co.	707
Perinat Alphonse	698
Perkins N. C.	719
Pierce, F. O. Co.	719
Pierson, A. N.	691
Pierson F. R. Co.	692
Plehn U. Bar. Co.	706
Poehlman Bros. Co.	630-706
Quaker City Mach. Co	719
Ralph John	702
Rayner, I. M.	691
Raynor John I.	708
Reed & Keller	706
Reinberg Peter	709
Reuter S. & Son, Inc.	690
Revere Rubber Co.	718
Rice Bros.	708
Rickards Bros.	703
Robinson H. M. & Co.	698
Rock Wm. L. Fla. Co.	704
Roehrs Julius Co.	692-709
Roland, Thomas	703
Rohler August & Sons	698
Rose Hill Nurseries	692
Sander & Son	692
Schlegel & Fottler Co.	703
Schmidt J. C.	691
Schulz Jacob	708
Scott Bros.	690
Scott, John	692-697
Simpf, Partridge & Co	718
Sheridan W. F.	708
Shiggs & Siggers	710
Sim, Wm.	699
Situations & Wants	715
Sittin B. S.	708
Smith Elmer D. & Co.	690
Smith Suml V.	710
Smyth Wm. J.	704
Standard Plate Glass	708
Co.	718
Stearns A. T. Lumber	708
Co.	719
Stears & Harrison	699
Stump & Waller Co.	716-717
Swayne Wm.	699
Synapse Fetterly Co.	718
Twyth	716
Target Brand	716
Tordura J. M. & Co.	703
Tosty Chas. H.	690
Tread C. Co.	704
United States Cut Flower	699
Co.	709
Valentine, J. A.	704
Vincent R. J. & Sons,	690-703
Ward R. M. & Co.	703
Washington Miss A.	690

WANTS, FOR SALE, ETC.

Advertisements in this column one cent a word. Initials count as words. Cash with order. All correspondence addressed "care HORTICULTURE" should be sent to 11 Hamilton Place, Boston.

HELP WANTED

GOOD MEN

When you need good men, skilled or unskilled, Write:

THOS. H. BAMBRICK

34 South 7th Street Philadelphia

Help of all kinds, including that for Florists, Nurserymen, Seedsmen and the Horticultural trade generally.

SITUATIONS WANTED

Employer wants a position for gardener who has given good satisfaction as superintendent of large estate. Address T. care HORTICULTURE, Boston.

FOR SALE BARGAINS

Three Horizontal Tabular sec. hand Boilers, 5 ft. diameter 15 ft. shell, 76 tubes 3 in. diameter with Lamphrey mouth piece, and all trimmings. One ditto 15 ft. long 6 ft. diameter, has 124 ft. tubes 3 in. diameter 14 in. long. Complete with trimmings and new safety valve. Other second hand boilers not as good. Also headquarters for pipe, fittings, valves and Revere Hose. Write for prices.

BUNXTON & ALLARD
64 E. Pearl St., Nashua, N. H.
Manufacturers of Improved Economy Brackets.

FOR SALE—Five greenhouses, house, five rooms, improvements; barn, carriage house, sheds; all in good repair. One minute to Boston, on main street; 20 minutes to Chelsea; five minutes to two lines of electric; only 10 min. in large town. Established twenty years. For further particulars address E. G. Blaney, Swampscott, Mass.

FOR SALE—Special 16 x 18 and 16 x 24 double thick glass in "A" and "B" qualities. Buy low and save money. Write **PARSIELSKY BROTHERS, INC.**, 50 Montrose Ave., Brooklyn, N. Y.

FOR SALE—7000, 16x24, double thick glass, 100 per light, F.O.B.; twenty lights per box. Address Frank M. Richardson, Littleton, N. H.

FOR SALE—500 Rhododendron Catawbiense, this season's importations, 2 1/2 ft. high, full of bud, \$12 per doz.; \$80 per 100. Wagner Park Conservatories, Sidney, Ohio.

MISCELLANEOUS WANTS

WANTED TO BUY—Complete green house plants and all kinds of greenhouse material, to be taken down and removed at once. Terms cash. Address I. Sussman, 229 Livingston St., Newark, N. J.

WANTED—One Pandanus Utilis, large plant; state size and price. **Scott Bros.**, Elmsford, N. Y.

broken during the recent hailstorm. Hess & Swoboda lost 50,000 feet; A. Donahue, 20,000; Chas. Ederer, 20,000; B. Florh, 15,000; Paul Paulson, 8,000; Arnold's 10,000; S. Faulkner, George Zimmer and private greenhouses from 500 to 4,000 square feet, each.

WIND AND HAIL.

Coraopolis, Pa.—T. E. Beckert lost considerable glass in the recent severe wind storm.

Cleveland, O.—Mrs. E. G. Wilson's greenhouse was completely destroyed by the heavy storm of last week.

De Haven, Pa.—F. H. Westhoff is reported to have suffered to a considerable extent during the heavy storm of wind and rain that recently visited this locality.

Omaha, Nebr.—The Omaha Bee reports 150,000 square feet of glass

THE WHITE FLY.

Editor HORTICULTURE:

Would you please ask through your columns what remedies are used against white fly on tomatoes, lettuce, paragoniums, etc., under glass? They are trying to eat me up almost, they are so numerous. Smoking with tobacco paper causes the floor to be white next morning but does not check the hatching of new generations. They seem to hatch in a very short time. Is there an inexpensive, practical remedy for this pest? G. B.

Circular No. 19 of the Massachusetts Agricultural Experiment Station, issued November, 1908, gives the following information relative to the white fly and its destruction. By C. E. Hood, B. S.

This insect has become a very serious pest in greenhouses, and were it not possible to hold it in check, the crop each winter where it is present would be a total failure. It is not confined to the tomato alone but also attacks cucumbers, lettuce, melons, tobacco, geraniums and many other plants, and is not only important in hot houses, but in summer does considerable damage out of doors.

The egg of the white fly is oval in shape, somewhat pointed at one end. The rounded end of the egg is fastened to the leaf so the egg will hang down if the leaf is horizontal. In about two weeks these eggs will hatch into tiny young, which crawl around for a few hours and then insert their beaks into the leaf and suck the juices until full grown, which is about two weeks from the time they hatch. After passing through the pupa stage, a T-shaped opening is made in the back and the adult fly emerges. The mouth parts of both the young and fly are formed for sucking. They push their beaks into the succulent portions of the leaf and extract the juices, and as a result, the leaf soon dies and falls to the ground. Most of the harm, however, seems to be done by the young. Some time after the leaves are infested, there is a sticky substance exuded over the leaf, on which a black fungus grows, which soon covers the entire under surface of the leaf, making it sooty in appearance.

Remedies.

There are two methods of attacking this insect. 1. Fumigating with hydrocyanic acid gas. 2. Spraying with contact insecticides, such as a solution of Bowker's Tree Soap.

Fumigation is the most successful and most satisfactory method for the control of this insect that has as yet been discovered, though the gas produced is a deadly poison and extreme caution must be exercised in its use. It is essential in fumigating that the cubic contents or amount of space in the house be known, that the right amount of chemicals to use may be determined. The best proportions to use of the cyanide, sulphuric acid and water are:—

- 1 part cyanide of potassium (98 per cent) of 99 per cent.
- 2 parts commercial sulphuric acid.
- 4 parts water.

The water should be first poured into an earthen or granite ware receiving vessel (do not use a metal one), the acid is then added and finally the cyanide, as directed more fully below. Use 50 grams of cyanide per cubic foot of space in the house or box to be fumigated. When the amount of cyanide necessary has been determined, put it in a paper bag. Close the ventilators and firmly fasten every door of the house except the one used by the operator. When all is ready, take the cyanide, all the lungs with air, drop the cyanide into the vessel containing the water and seal and fasten the house immediately, lock the last door and notice the time.

After the required time has passed, open the doors and give the gas plenty of time to escape before you enter. This gas is very poisonous, so do not enter the house during treatment. Fumigate after sunset, allowing three hours exposure. In venting afterward, the amount of artificial heat that can be supplied and the outside temperature must be taken into consideration, so that no injury to the plants will result from the lowering of the temperature. Three such treatments, at intervals

of about twelve days, will usually completely rid the house of the white fly.

Johnson's work entitled "Fumigation Methods" is indispensable to anyone who has occasion to use hydrocyanic acid gas as an insecticide. The book can be purchased for \$1.00 of the publishers, Orange Tree Co., 72 & 74 Lafayette Place, New York City. To those interested in greenhouse fumigation, pages 9-11, 118 and 124-16 are especially recommended.

If the cyanide treatment seems undesirable, use a fumigant and a contact insecticide, such as "Nicotifield," manufactured by The Tobacco Warehousing and Trading Co., Louisville, Kentucky, for the fumigant; and Bowker's Tree Soap, manufactured by The Bowker Insecticide Co., Boston, Mass., for the insecticide.

For each 2000 cubic feet of space, from one to two ounces of Nicotifield should be used according to the tightness of the house. This treatment should last all night, and the next day the plants should be syringed with a solution of Bowker's Tree Soap at the rate of one ounce in one gallon of water. One such combined treatment should be sufficient for several weeks. If a second treatment is desirable, fumigate the same as before, one week later, and spray as before two weeks after the first treatment.

NEWS NOTES.

Cheswick, Pa.—Arthur and John James have started in the L. I. Neff greenhouses.

Centerville, Ia.—T. M. Stagner has started in the greenhouse business on South 21st St.

Uniondale, Ind.—Miss Eva Brickley is in charge of the greenhouse recently erected here.

Enid, Okla.—A. D. Zimmerman, formerly of Ottawa, Kan., is starting in the florist business here.

Stratford, Conn.—F. E. Beach, florist, has purchased the Wells greenhouse and is having it removed.

Des Moines, Ia.—The Lozier Floral Co. has purchased the building at 410 E. 6th St., and will occupy it immediately.

Gardner, Mass.—Riverside Greenhouses, Incorporated, has asked through counsel for dissolution of the corporation.

Jefferson City, Mo.—A bill to prevent the dissemination of the San Jose scale throughout the state passed the House on April 28.

Cuyahoga Falls, O.—M. Crawford, has sold his stock of gladiolus bulbs to Mallory & Bridge, Lake Mills, Wis. He will give his attention henceforth to raising seedlings.

Anaheim, Cal.—The Eucalyptus Hardwood Company has been organized by C. S. Crisney, A. G. Williams and C. S. Gibbs. 360 acres of land have been purchased in Kern County and will be planted to eucalyptus trees.

Sparkist, N. Y.—W. C. Duncan, florist, is reported as having disappeared and his relatives are anxiously searching for tidings of him. He was last seen at the New York Cut Flower Exchange, 55 West 26th street, on May 4. Anyone who can throw any light on his whereabouts will confer a favor by notifying the family. He is 6 feet 2 inches tall and weighs 250 pounds. He lived in Astoria for many years before going to Sparkist.

New York, N. Y.—John Wendell, florist at 611 Central avenue, was driving across the Williamsburg bridge on May 11 when a rein snapped and at the same instant the shrill

DON'T EXPERIMENT

USE

TO-BAK-INE

and your stock will be free from insects, clean, and the blooms will not be discolored.

Send for full information of

H. E. FISKE SEED CO.
13 Faneuil Hall Sq., Boston, Mass.

STUMPP & WALTER CO.,
50 Barclay St., New York.

HENRY F. MICHELL & CO.,
1018 Market St., Philadelphia.

E. H. HUNT, Gen'l Agent,
76-78 Wabash Ave., Chicago.



**THIS
KILLS
MILDEW
EVERY
TIME**

FOR PARTICULARS WRITE

Benjamin Dorrance
ROSE GROWERS
Dorranceton, Penna.

IMP SOAP SPRAY

THREE SUCCESSFUL YEARS

Outdoor or Indoor
ELM BEETLE OR
WHITE FLY

EASTERN CHEMICAL CO.
Pittsburg Street, Boston, Mass.



**TARGET BRAND
Weed Killer**

Sold at retail by a thousand of seed houses and dealers. Special price in quantities to parks and cemeteries

TARGET BRAND, Box 732, Martinsburg, W. Va.

whistle of a tug boat startled his horse. The animal dashed across the bridge, scattering his stock of potted plants in all directions. Mr. Wendell was thrown out and received severe scalp wounds; one ear was nearly torn off.

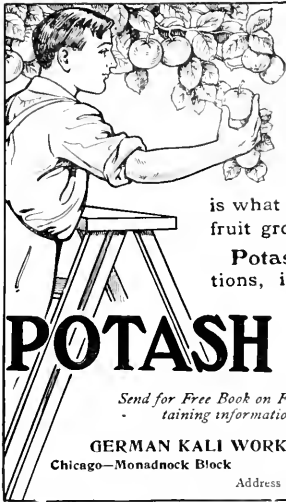

**Fruit Full-sized
Fine Flavored**

appeals to the eye as well as the palate. Its perfection spells market-value.

Quality as well as quantity is what makes the right balance in the fruit grower's ledger.

Potash, when used in right proportions, insures full-sized, sound, richly flavored fruit that carries well and brings high prices.

POTASH

POTASH IS PROFIT

Send for Free Book on Fertilizing, prepared by experts and containing information indispensable to horticulturists.

GERMAN KALI WORKS, 93 Nassau Street, New York
Chicago—Monadnock Block Atlanta—Candler Building
Address Office Nearest You.

"Every Bug Has His Dose."

Insect-destroying preparations that do their work well and effectively are the cheapest. Bowker's Arsenate of Lead and Bowker's Pyrox are recognized standard insecticides and fungicides for both indoor and outdoor use. Bowker's Insect Emulsion destroys many kind of plant lice, black and green flies, etc. Call or send for catalogue.

BOWKER INSECTICIDE COMPANY
43 CHATHAM ST. BOSTON

An Absolute Success

in Killing Scale and All Other Insect Pests on Trees, Shrubs and Garden Plants, including the notorious

LACE FLY on RHODODENDRONS
without injury to the foliage.

WILSON'S PLANT OIL

Well Tested and Its Efficacy Fully Demonstrated

TRY IT!

Wilson Plant Oil & Fertilizer Co., Chatham, N. J.

For Trees, Plants, Shrubs and Flowers

— USE —

THE NIAGARA BRAND LIME SULPHUR SOLUTION

It destroys Scale Lice, Spiders and all forms of Aphides, AT THE SAME TIME Mildew, Blight, Rust and other Fungus difficulties.
Used in Winter or Summer. — No other remedy has been so universally effective.
Niagara Brand ARSENATE OF LEAD for chewing insects is equal to the best and better than the most. Ask about our Green House sprayer. Address —

NIAGARA SPRAYER CO., - - Middleport, N. Y.



**The Best
Bug Killer and
Bloom Saver**

For PROOF
Write to

P. R. Paethorpe Co
OWENSBORO, KY.

KILMDEAD
The best of all
the tobacco
dusts for

Dusting or
fumigating

25 lbs. \$1.00	100 lbs. \$ 3.00	1000 lbs. \$27.00
50 lbs. 1.75	500 lbs. 14.00	2000 lbs. 62.00

Swamp & Water Co 50 Barclay St. New York.



LATEST DISCOVERY

Progressive Growers Investigate

32 page Booklet of
British, America and Canadian Testimony
free for the asking

Eastern Agent—CYRIL FRANKLYN
62 Beaver St., New York, N. Y.

Sole Proprietors
WILLM COOPER & NEPHEWS
177 Illinois Street, CHICAGO

Which Spray Pump

shall you buy? Buy the
Spray Pump that fully meets the
demands of the Government Agri-
cultural Scientists and all practical
Fruit Growers. These pumps are
widely known as

DEMING SPRAYERS
and are made in 23 styles for use in
small gardens or immense orchards.
Write for our free catalogue with
Spraying Chart. Add 4 cents post-
age and receive "Spraying for
Fruit," a useful guide book.

CHARLES J. JAGER LU.
281-285 Franklin St., Boston



In writing to Advertisers kindly mention Horticulture

REVERO

THE MODERN GARDEN HOSE FOR LAWNS, GARDENS, GREENHOUSES, STABLES, ETC.

BRAIDED FABRIC, MOULDED CONSTRUCTION, SEAMLESS THROUGHOUT
 LIGHT—STRONG—FLEXIBLE

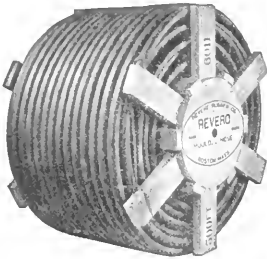

Revero is furnished on Reels in Continuous Lengths up to 500 ft. Your Supply House can furnish "Revero."

Write for Catalog

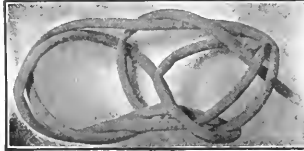

OLD STYLE—READILY KINKS



REVERO—NON KINKING

REVERE RUBBER COMPANY
BOSTON, MASS.

NEW YORK
 NEW ORLEANS

PHILADELPHIA
 MINNEAPOLIS

PITTSBURG
 SAN FRANCISCO

CHICAGO
 PORTLAND, ORE.

STANDARD PLATE GLASS CO.

Manufacturers—Importers—Jobbers

NOW IS THE TIME TO BUY

FRENCH OR AMERICAN GREENHOUSE GLASS

LOWEST PRICES ON REQUEST

26-30 Sudbury St. BOSTON, MASS. 61-63 Portland St.

BOSTON PLATE & WINDOW GLASS CO.

GREENHOUSE GLASS

GERMAN AND AMERICAN

261 to 287 A Street BOSTON; 20 to 22 Canal Street

GLASS

Always Write Us Before Buying
SHARP, PARTRIDGE & CO.
 22nd and Lumber Streets, CHICAGO
 WE HAVE SOME SNAPS

FOR "POT LUCK" TRY US...

HEWS STANDARD POTS

POT MAKERS FOR 140 YEARS

WORLD'S LARGEST MANUFACTURERS

WRITE FOR CATALOGUE AND DISCOUNTS

Pearson Street,
 LONG ISLAND CITY, N. Y.

A. H. HEWS & CO., Inc.
 CAMBRIDGE, MASS.

452-460 No. Branch St.,
 CHICAGO, ILL.

The Payne Steel "T" Bar Greenhouses

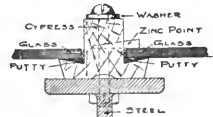

The Lightest The Strongest

Half Full Size

HOUSES of this type are constructed with both curved glass eaves and straight glass eaves. Least amount of shadow. Least amount of wood. No drip. Greatest durability.

JOHNA. PAYNE

Greenhouse Designer and Builder

260-274 Culver Avenue

JERSEY CITY, N. J.

STANDARD FLOWER POTS

Packed in small crates, easy to handle.

	Price per crate		Price per crate
1500 2 1/2 in. pots	in crate \$4.88	144 6 in. pots	in crate \$3.16
1500 2 1/4 " " "	5.25	120 7 " " "	4.20
1500 2 1/8 " " "	6.00	60 8 " " "	3.00
1000 3 " " "	5.00	HAND MADE	
800 3 1/2 " " "	5.80	48 9 in. pots	in crate \$3.60
500 4 " " "	4.50	48 10 " " "	4.80
456 4 1/2 " " "	5.24	24 11 " " "	3.60
380 5 " " "	4.51	12 12 " " "	4.80
210 5 1/2 " " "	3.78	6 16 " " "	4.50

Seed pans, same price as pots. Send for price list of Cylinders for Cut flowers, Hanging Baskets, Lawn Vases, etc. 10 per cent. off for cash with order. Address **Hilfinger Bros., Pottery, Fort Edward, N. Y.** August Holker & Sons, Agts. 31 Barclay St., N. Y. City.

Standard Flower POTS

If your greenhouses are within 500 miles of the Capital, write us, we can save you money

W. H. ERNEST

28th and M Street WASHINGTON D. C.

Syracuse Red Pots

STANDARD SIZES

Florists, we will suit you as to quality and prices. Write for catalogue.

Syracuse Pottery Co., SYRACUSE, N. Y.

In ordering goods please add "I saw it in HORTICULTURE."

The **FLORESTA** HALL ASSOCIATION OF AMERICA, insurer of 29,000,000 sq. ft. of glass. For particulars address

John C. Ester, Secy Saddle River, N. J.

COAL Pocahontas Smokeless Coal Blossburg Smokeless Coal

The above steam coals are peculiarly adapted to FLORISTS' use. Prominent features are HIGH EVAPORATION, LOW ASH, LOW SULPHUR, HIGH CARBON, and HIGH HEAT UNITS. Permit us to figure on your year's requirements, deliverable as called for.

CARGOES CONSTANTLY ARRIVING AT ALL NEW ENGLAND PORTS

The Bader Coal Company, Gen'l Sales Agent

Telephone Fort Hill 2044

Board of Trade Building, Boston, Mass.

EVERYTHING FOR GREENHOUSE BUILDING

WRITE FOR INFORMATION AND PRICES

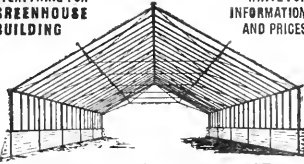

King Greenhouses. King Cutters and Eaves. Trussed Roofs. Ventilating Machinery. Trussed Iron Frame Houses. Tile Benches and Pipe Hangers.

KING CONSTRUCTION COMPANY
NORTH TONAWANDA, N. Y.

GLASS

Greenhouse and Hot Bed

SIZES OUR SPECIALTY
IMMENSE STOCK

Plate and Window Glass

Write for Our Prices

PARSHELSKY BROS., Inc.
59 Montrose Ave., BROOKLYN, N. Y.

MASTICA

FOR Greenhouse Glazing

USE IT NOW.

F. O. PIERCE CO.
12 W. BROADWAY
NEW YORK



Mastica is elastic and tenacious, admits of expansion and contraction. Putty becomes hard and brittle. Broken glass more easily removed without breaking of other glass, as occurs with hard putty. Lasts longer than putty. Easy to apply.

Holds Glass Firmly

See the Point

FULL SIZE
N P 2

PEERLESS

Glazing Points are the best. No rights or lefts. Box of 1,000 points 75 cts. postpaid.

HENRY A. DREER,
714 Chestnut St., Phila., Pa.

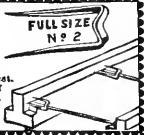

A WIRELESS MESSAGE - BY TELETYPE

IF YOU WANT

BUY FROM WHO RUNS THE BUSINESS IN THE CITY OF CHICAGO.

PHIL FOLEY FACTORY CITY OF CHICAGO.

YOU WILL WEAR A BIG SMILE CAUSED BY PROFITS FROM GROWN IN CROPS HOUSES

RESULTS

WESTERN, ARTS, SAN, AND CASH, BELL, WID 25 22 26 27 28 29

CHICAGO

BUY YOUR BUILDING MATERIAL - WOOD - IRON - GLASS FROM FOLEY

CYPRESS SASH BARS 32 feet or longer
HOT BED SASH
PECKY CYPRESS BENCH LUMBER

GREENHOUSES
ERECTED AND EQUIPPED COMPLETE IF DESIRED

Write for Circular "D" and Prices

The A. T. STEARNS LUMBER CO.
NEPONSET, BOSTON, MASS.

PATENTS

Trademarks and Copyrights

Send your business direct to Washington. Saves time and insures better service. Personal attention guaranteed. Twenty-five years' active service. SPECIALTY: "Working on the Failure of Others."

SIGGERS & SIGGERS

PATENT LAWYERS

Box 9, National Union Building
Washington, D. C.

KROESCHELL BOILER



MADE OF FIRE BOX FLANGE PLATE
Can not Crack

Water Space in Front, Sides and Back
The Most Popular Boiler Made

SEND FOR CATALOGUE.

KROESCHELL BROS. CO.
35 Erie Street, CHICAGO, ILL.

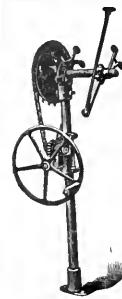

The Advance Ventilating Apparatus

THE ADVANCE MACHINE will take care of all the ventilating sash that the shafting pipe will carry well. We dare any other line to give you better, longer and easier service than we will. \$10.50 for the machine all complete, made of the very best material in a mechanical manner assures of long life and the most satisfactory service. Our shafting pipe is the best grade, new, painted, straightened, drilled and furnished with our new couplings at 8c for the double and 5c for the single strength pipe. Give us a chance to show you what we can do.

The Advance Co.
RICHMOND, IND.

GREENHOUSE CONSTRUCTION LUMBER

John C. Moninger Co.
117 E. Blackhawk St., CHICAGO.



Evans 20th Century Arm

Will not twist the shafting pipe. Three times the power of old style elbow arms. Sold only with Evans Challenge Machine.

Write for free Catalogue to
QUAKER CITY MACHINE CO.
Richmond, Ind.

In writing to Advertisers kindly mention Horticulture



This Everlasting Pounding

on our materials—our greenhouses, has but one thing in view—we want you to want our materials—our houses, and there's only one way to keep acquainted and that's to keep after you and after your order. We don't want one order only, but also the next one. We know we won't get the next one if the first is not all we say—that's why we build so good a house—the reason you are sure of pleasant dealing.

Hitchings & Company
1170 Broadway New York

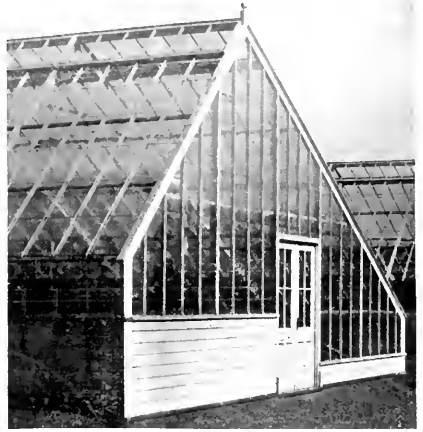

OUR SHADELESS RIDGE TYPE

This is a gable of one of Robert Simpson's houses. It is the Sectional Iron Frame Construction. Let us tell you about the interesting details of this construction as used in these houses.

LORD AND BURNHAM COMPANY,
Irvington-on-Hudson, N. Y.
New York — Boston — Philadelphia — Chicago



WHY THE U-BAR WINS

If you would just take the time to go and see a U-Bar house and talk with a U-Bar gardener, then you would appreciate how downright truthful we are in saying it is the lightest, most productive house built.

The main structural point of the U-Bar house is the combining of the rafter and roof bar in one, making the U-Bar. This combination is no larger than the single roof bars used in other houses. It does away entirely with the heavy iron supporting members, and makes possible the only successful curved eave.

The glass is spaced 24 inches instead of 16.

The core bar is soaked in a chemical preservative, before putting it in the galvanized steel U-Bar casing.

All iron parts are painted with a special aluminum finish which remains bright for years without attention.

To sum it up then—the U-Bar is indisputably the highest type of greenhouse construction. The ideal construction for private estates, parks, public institutions and florists' showrooms. Send for the catalog.

U-BAR GREENHOUSES

PIERSON
DESIGNERS AND BUILDERS



U-BAR CO.
1 MADISON AVE., NEW YORK

HORTICULTURE

Vol. IX. MAY 22, 1909 No. 21



SPRING BEDDING AT HARVARD BOTANICAL GARDEN
Tulips and Forget-Me-Not.

Photo by Robert Cameron



DEVOTED TO THE
FLORIST, PLANTSMAN, LANDSCAPE GARDENER AND KINDRED INTERESTS

PUBLISHED EVERY SATURDAY AT 11 HAMILTON PLACE, BOSTON, MASS.

SUBSCRIPTION, \$1.00 PER YEAR



CHRYSANTHEMUMS.

"Not small weak runty stock grown under benches, but the kind that brings back Dollars for Pennies."

WHITE: Earliest October! root (We have extra fine large stock of this variety), Mrs. Henry Robinson, Clementine Tassett, Alice Byron, Timothy Eaton, Merry Christmas, White Bonaffon.

YELLOW: Monrovia, Halliday, Appleton, Bonaffon, Eaton, Chataqua Gold.

PINK: Mc. Niece, Maud Deao, Dr. Enguehard, Rosiere.

RED: Intensity, Schrimpton.

All these varieties, rooted cuttings \$2.00 per 100; \$30.00 per 1000. 2 1/2 in. \$3.00 per 100; \$25.00 per 1000.

White Chadwick, Golden Chadwick, Golden Wedding, R. C. \$3.00 per 100; \$27.50 per 1000. Virginia Boehlmann, R. C. \$4.00 per 100. 2 1/2 in. \$5.00 per 1000.

Golden Glow, R. C. \$5.00 per 100. 2 1/2 inch \$6.00 per 1000.

CARNATIONS.

Strong well rooted cuttings and 2 1-2 Inch stock.

Sarah Hill, Afterglow, White Perfection, Victory, Rose Pink Enchantress, Winsor, Beacon, White Enchantress, at \$3.00 per 100; \$25.00 per 1000.

Sarah Hill, Lio. C., Afterglow, Winsor, Beacon, Victory, 2 1/2 in. \$3.50 per 100; \$32.00 per 1000.

ROSES.

1 in. or 2 1/2 in. 3 in. or 3 1/2 in.
100 1000 100 1000
American Beauties... \$7.00 \$65.00 \$9.00 \$85.00
My Maryland Grafted strong stock... 20.00

My Maryland - Own roots 42.00
Killarney - Own roots. \$6.00 \$55.00 7.50
Mrs. Potter Palmer..... 5.00 45.00 6.50

POEHLMANN BROS. COMPANY,

Enchantress and White Lawson, R. C. \$2.50 per 100; \$22.00 per 1000.

Enchantress, White, Pink and Variegated Lawson, 2 1/2 in. \$3.00 per 100; \$25.00 per 1000.

O. P. Bassett. 2 1/2 in. \$8.00 per 100; 3 1/2 inch \$10.00 per 100.

2 10. or 2 1/2 in. 3 10. or 3 1/2 in.

Bridesmaids } 100 1000 100
Brides } \$5.00 \$45.00 \$6.50
Richmond ()

Perles 5.00 45.00 6.50
Kaiserine 5.00 45.00 6.50
Uncle John 4.00 35.00

Morton Grove, Ill.

CARNATIONS Fine Healthy Stock From 2 Inch Pots.

Pres. Seelye - - - - - Per 100 Per 1000
White Enchantress, Beacon 4.00 40.00

Victory, Winsor, Melody, Kingston Pet - - - - - 4.00 35.00

Deilm, Lady Bountiful, Mrs. Lawson, White Lawson, Red Lawson, Variegated Lawson 3.50 30.00

CHRYSANTHEMUMS Rooted Cuttings
O. W. Childs, Miss Jack Frick, White Shaw, Early Snow, Mrs. Jas. Marshall, Flavour Weaver, The Harriott, Yellow Eaton, \$2.00 per 100, \$15.00 per 1000.

A. J. Ballour, Autumn Glory, Ada Spaulding, Dr. Enguehard, Dorothy Devens, Geo. Kalb, Glory of the Pacific, Harry Hay, H. W. Reiman, Ivory, Jeanne Nonin, J. E. Lager, J. H. Troy, J. K. Shaw, Maud Dean, Meta, Monrovia, Mrs. Jerome Jones, Winnamaker, Mrs. Alice Byron, Mrs. Baer, Mrs. Robert McArthur, Major Bonaffon, Mad F. Bergmann, Nagoya, Polly Rose, Robt. Halliday, Timothy Eaton, W. H. Lincoln, Wm. Duckham, etc., \$1.50 per 100.

Send for Catalogue of Roses, cwn root and grafted, and other miscellaneous stock.

WOOD BROTHERS

FISHKILL, N. Y.

CHRYSANTHEMUMS

I have now ready 100,000 plants of 300 varieties, Large Flowered, Singles, Pompons, etc. These are fine stock from 2 1/2 inch pots.

All the standards such as Robinson, Bonaffon, Duckham, Clay Frick, Beatrice May, Mrs. Partridge, Polly Rose in large quantities at

\$3 per 100, \$25 per 1000

Ralph Curtis, Marie Masse, Horace Martin and other new early kinds, **\$10.00 per 100.**

Write me what you want and see what I can do for you.

CHARLES H. TOTT, MADISON, N. J.

CHRYSANTHEMUMS

Rooted Cuttings and Pot Plants

Write for list and prices. ALL OF THE BEST ONES.

S. J. REUTER & SON, WESTERLY, R. I.

Our New Carnation SHASTA

is always pure white, is always in bloom and is always high grade.

\$12.00 per 100, \$100.00 per 1000. Send Order now to **PATTEN & CO., Tewksbury, Mass. BAUR & SMITH, Indianapolis, Ind.**

White Bonaffon
The Chrysanthemum Everybody Should Grow.

I have Rooted Cuttings, Cool Green, Sturdy Sto k, \$ 2.50 per 1000

H. L. CAMERON,
North Cambridge, Mass.

FOR SALE

100 *Dracaena Indivisa* in six inch pots, strong plants, \$20.00 for the lot or \$3.00 per doz.

CASH WITH ORDER

P. M. OLM, BATH, ME.

Kentia Belmoreana

Delivery from now on Per 1000 Per 100
String seedlings, ready to go in
2 1/2 in. pot..... \$25 00 \$3.00
2 1/2 inch plants, fine bushy stuff 75 00 8.00

Cocos Weddelliana

Fine established healthy plants Per 1000 Per 100
from 2 1/2 in. pots..... \$90 00 \$10.00
Satisfaction Guaranteed.

O. V. ZANGEN, Seedsm n, Hoboken, N. J.

In ordering goods please add "I saw

" in HORTICULTURE."

Send for our Preliminary List describing and quoting

Chrysanthemums and Carnations.

A fine lot of Carnation Cuttings ready now.

THE E. G. HILL CO.,
Richmond, Indiana.

MARY TOLMAN

A New Light Salmon Pink Carnation for 1910.

\$12.00 per 100. \$100.00 per 1000.

A. E. Hunt & Co., Evansville, Ill.
Chicago Carnation Co., Joliet, Ill.
Hunt Bros., - - Park Ridge, Ill.

CARNATIONS

F. DORNER & SONS CO.
LaFayette, Ind.

SCOTT BROS. CHRYSANTHEMUMS
All the Newest and Best Sorts

ROSES Grafted and Own Root for Greenhouse and Outdoors

ELMSFORD NURSERIES, Elmsford, N. Y.

CHRYSANTHEMUMS 50.000 Rooted Cuttings
White - Timothy Eaton; Mrs. Geo. S. Koll, fine early; Estelle, White Bonaffon, Alice Byron, Ivory, O. Touset, Jeanne Nonin, October Frost, Early Snow, Angele Laurent. Pink - Glory of the Pacific, Dr. Enguehard, Maud Dean, Pink Ivory Yellow - Major Bonaffon, Creso, Robt. Halliday, "Baby" - small yellow, of the button type. \$2.00 per 100, \$15.00 per 1000. J. Rosette, \$3.00 per 100.
W. L. SWAYNE, Box 226, Kennett Square, Pa.

NEW ROSE WHITE KILLARNEY

We Know You Will Want to Buy White Killarney

Every live, progressive, up-to-date grower who has seen it is buying it; but when you buy White Killarney, be sure you get the right White Killarney (the Waban variety). When you buy from us you get the variety that has been exhibited and certificated, and the one that has attracted such favorable mention.

If you are in the vicinity of New York, we should be glad to have you call and see White Killarney growing at our Scarborough range, and you will say at a glance—as everyone rose that has ever been placed on the market.

It is not only a good winter-flowering rose, but is good the entire year, and it is a splendid shipper. Read the following letter received from Mr. Willis N. Rudd, Secretary of the Society of American Florists, dated January 18th, in which he writes as follows:

"Dear Mr. Pierson:—I cannot refrain from writing you and expressing my admiration for the White Killarney as shown at Chicago on Thursday. It is an exquisitely beautiful thing and attracted much attention. I took half the blooms home with me, and they were finer on Saturday than they were at the show. The record is that these blooms were shipped from Tarrytown, staged and exhibited during the afternoon. They were then carefully wrapped up in a box, and remained in that box until one o'clock Friday morning, at which time I reached home; improved in quality up to Saturday, and were in fairly presentable condition on Sunday.

In addition to being the most beautiful white rose of its class which I have seen, this demonstrates its splendid keeping and shipping qualities.

W. N. REDD."
We were awarded Silver Cup at National Flower Show, Chicago, for best new rose with White Killarney; also Silver Medal Horticultural Society of New York.

Strong plants, 2 1/4 inch pots, own roots, now ready for delivery, \$30.00 per 100; 250 for \$70.00; 500 for \$125.00; 1000 for \$250.00. Grafted plants, ready April 1st, \$35.00 per 100; 250 for \$82.50; 500 for \$150.00, 1000 for \$300.00.



F. R. PIERSON CO., Tarrytown-on-Hudson, NEW YORK

TO MAKE ROOM

All well grown stock in first class condition

Rubbers, 4 inch	20c
" " 6 "	25c
Vincas, 2 "02c
Plumosos, 4 "05c
" " 3 year04c
*Mums, cuttings02c
" Nonin, out of pots.....	.04c
Sprengerii, 3 year04c

Cash with order or satisfactory references

WILLIAM C. SMITH

Market and 61st Street

Philadelphia, - - Pa.

5000 GOLDEN GLOW

2 1/2 ready, \$35 per 7 L. C. \$27 per 7
2000 White Cloud and Pacific Supreme
2 1/2 inch, and W. C. prices as above
Dorner's new Golden Eagle, \$10 per 100
October Frost, Nonin, Tousey, Enguehard, Golden Wedding, and all standard Chrysanthemums
2 1/2 Inch, \$2.50 per 100, \$23 per 7 L. C. \$15.50

I. M. RAYNER GREENPORT, L. I. N. Y. CANNAS

Strong plants from pots 25 leading varieties, \$5.00 per 100.

ESTATE OF DAVID FISHER, Woburn, Mass

A. N. PIERSON, Inc., Cromwell, Conn.

WHITE KILLARNEY (Waban Strain)

	Doz.	100	250	500	1000	2500	5000
GRAFTED STOCK	\$6.00	\$55.00	\$82.50	\$150.00	\$300.00	\$657.50	\$1,250.00

MY MARYLAND OWN ROOT ... \$3.00 per doz., \$30.00 per 100, \$150.00 per 1000
10.00 " " 90.00 " "

STANDARD VARIETIES

Betty, Bon Silene, Bride, Bridesmaid, Cardinal, Enchanter, Etoile de France, Etoile de Lyon, Franz Deegan, Gen. McArthur, Golden Gate, Hermosa, Ivory, Kaiserin Augusta Victoria, Kate Moulton, Killarney, La Detroit, Maman Cochet, Marechal Niel, Mme. Abel Chatenay, Mrs. Jardine, Mme. Hoste, Mrs. Paul Niehoff, Mrs. Pierpont Morgan, Mrs. Potter Palmer, Papa Gontier, Queen Beatrice, Rhea Reid, Richmond, Rosaline Orr English, Souv. du President Carnot, Souv. de Wootton, Uncle John, Wellesley, White Cochet. The above Grafted \$1.20 cts. each, \$12.00 per doz., \$15.00 per 100, \$10.00 per 1000.

OWN ROOT ROSES

Killarney, Bride, Bridesmaid, Mme. Abel Chatenay, Ivory, Richmond, Mrs. Paul Niehoff. 2 1/2 in. pots, 75c per doz., \$3.50 per 100, \$31.00 per 1000. 2 1/2 in. pots, \$1.00 per doz., \$8.00 per 100, \$50.00 per 1000.
Queen Beatrice, Rhea Reid, Mrs. Jardine, Mrs. Potter Palmer, from 2 1/2 in. pots, \$5.00 per 100, \$70.00 per 1000.

BEDDING PLANTS

COLEUS, Verschaffeltii, Golden Queen, Queen Victoria, Beckwith Gem, Firebrand, Lord Palmerston. Rooted Cuttings by express, \$10.00 per 100, \$5.00 per 1000. Out of 2 1/2 in. pots in May, \$2.00 per 100, \$15.00 per 1000.
Golden Bedder, Hero, Messy, Pearl of Orange. Fancy Varieties. Twelve kinds not listed above, 75 cts. per 100, \$5.00 per 1000.
AGERATUM, Stella Gurney, Princess Pauline. SALVIA, Splendens, Bonfire and Zurich.
HELIOTROPE. Dark blue bedding varieties. GERMAN IVY. 75 cts. per 100, \$5.00 per 1000.
ALTERNANTHERA. Red and Yellow. 50c per 100, \$5.00 per 1000. From 2 1/2 in. pots, \$2.00 per 100.
SALLEROL, Rooted Cuttings, \$1.00 per 100, 2 1/2 in. pots, \$2.50 per 100.
CHRYSANTHEMUMS IN QUANTITY. Catalogue on Application.

GLADIOLI NAMED VARIETIES

Childsi and Gandavensis Seedlings
Madeira Vines, Cinnamon Vines, Oxalis, Spotted Callag, and Iris Germanica. Write for prices.

E. S. MILLER, Wading River, N.Y.

PANSY PLANTS Fine Plants ready to bloom, of my well known strain, \$5.00 per 100; large plants in bud and bloom, \$1.00 per doz., \$8.00 per 1000.
GERANIUMS, best kinds, double
PETUNIAS (Dreer's), VINE A var., PARLOK IVY, STOCKS, fine plants, 2 1/2 in., \$2.00 per 100; 10c for \$5.00.
CABBAGE PLANTS E. J. Wakefield, ready to plant out, \$1.25 per 1000; 500c for \$5.00.

J. G. SCHMIDT, Bristol, Pa.

ORCHIDS ORCHIDS

Would you like to buy first-class plants for less price than anybody else sells for? Also without disease. The facts must be proved at once therefore we are giving a special sale of our strong and healthy

C. Mossiae, 450 bulbs for \$40.00 a case, also C. Percivaliana, well established plants, 9 to 12 bulbs, \$1.00 a-piece.

Expect C. Labiata, C. Gigas Sanderiana and others shortly.

ORDONEZ BROS.
MADISON, N. J.

IMPORTED ORCHIDS

Now Arriving
Julius Roehrs Co.
RUTHERFORD, N. J.

FRESH IMPORTED ORCHIDS.

Arrived in Splendid Condition: Cattleya Trianae, Mossiae, Gigas, Skinnerii, Oncidium Splendidum, Ornithorhynchum, Wentworthianum, Phalaenopsis Schilleriana and Amabilis, Lycaste Skinnerii, Vanda Boxallii, Laelia Superbicus Odontoglossum grande Write for prices.
JOSEPH A. MANDA.
191 Valley Road West Orange, N. J.

ORCHIDS

We are booking orders now for delivery early in the Spring on all commercial **CATLEYAS** and **NOVELTIES**. Our prices are right and our guarantee perfect. We sell only first-class novelties.
GARRILLO & BALDWIN Secaucus N. J.

ORCHIDS

Largest Importers, Exporters, Growers and Hybridists in the World
Sander, St. Albans, England
and 235 Broadway, Room 1
NEW YORK CITY

NEPHROLEPIS MAGNIFICA

THE SENSATIONAL NOVELTY
Strong 2 1/2-in. stock, \$25.00 per 100.
WHITMANII
2 1/4-in., \$40.00 per 100; 3 1/4-in., from Bench, \$8.00 per 100.

H. H. BARROWS & SON, WHITMAN, MASS.

ROBERT CRAIG CO.

ROSES, PALMS,
and Novelties in Decorative Plants
MARKET and 49th STREETS., PHILADELPHIA, PA.

Freshly Imported Unestablished Orchids

We beg to inform you that the undermentioned ORCHIDS, have arrived in very fine condition, Special Price List of which will be mailed on application.

- | | | |
|-----------------------------|--------------------------------------|--|
| Cattleya Trianae | Oncidium Leucochilum | Phalaenopsis Schilleriana |
| Cattleya Skinneri | Odontoglossum Grande | Vanda Coerulea |
| C. Percivaliana | Odontoglossum Crispum | Vanda Sanderiana |
| Laelia Superbicus | Lycaste Skinneri | Vanda Boxallii |
| Laelia Ancaps | Miltonia Candida | Also a number of Acridea, etc., in fine condition. |
| L. Abida | Miltonia Spectabilis | Dendrobium Thyrsiflorum |
| Oncidium Varicosum Rogersii | Miltonia Flavescens | Dendrobium Formosum |
| Oncidium Crispum | Zygotetulum Crinellum | Dendrobium Chrysotoxum |
| Oncidium Scarodes | Zygotetulum Maxillare var. Gaultieri | Dendrobium Sundsiatum |
| Oncidium Forbesii | Scuticaria Steeili | Dendrobium Fimbriatum |
| Oncidium Splendidum | Phalaenopsis Amabilis | |
| Oncidium Wentworthianum | | |

To arrive in a few days, Cattleya Labiata, C. Mossiae, C. Schroederiae, C. Mendellii and many more. We also recommend our large stock of established plants and supplies, such as Peat, Live Moss, Baskets, Books on Orchids, etc.

LAGER & HURRELL, Summit, N. J.

ORCHIDS Just Arrived Splendid Plants.

Dendrobiums, Wardianum, Nobile, Flowering Dec. to April, \$1.50 and Upward each.
CATTLEYAS Mendellii, Mossiae, Speciosissima, Gigas, Gigas Sanderiana, Chrysotora, or Aurea. **ORDER NOW.**
C. L. FREEMAN, 388 APPLETON STREET, HOLYOKE, MASS.

Palms
Shrubs



Send for Our Catalogue.

Ferns
Perennials

The GEO. WITTBOLD CO., 1657 Buckingham Place, Chicago, Ill.

FERNS FOR DISHES, Assorted Varieties

From 2 inch pots, \$3.50 per 100; \$30.00 per 1000

CASH WITH ORDER
2570 to 2606 W. Adams St., Chicago, Ill.

FRANK OECHSLIN

GOLEUS! GOLEUS!

- | | | |
|---|--------|---------|
| C. Verschaffeltii and Golden Bedder R. C. | Pr 100 | Pr 1000 |
| Same in 2 1/2 in. pots R. C. | .60 | 5.00 |
| Coleus, Mixed R. C. | 2.00 | 15.00 |
| Same in 2 1/2 in. pots R. C. | .60 | 5.00 |
| Ageratum Stella Gurney and Pauline R. C. | .50 | 4.50 |
| Same in 2 1/2 in. pots R. C. | 1.00 | 9.00 |
| Feverfew in 2 1/2 in. pots | 2.00 | |
| Fuchsias, our selection in 2 1/2 in. pots | 3.00 | |
| German Ivy R. C. | .75 | |
| English Ivy R. C. | 1.00 | |

Cash with Order
J. E. FELTHOUSEN
148-154 Van Vranken Ave., SCHENECTADY, N. Y.

PALMS AND FERNS DECORATIVE PLANTS

JOHN SCOTT
Rutland Road and E. 45th St.
Tel. 8850 Bedford BROOKLYN, N. Y.

JARDINIERE FERNS

IN BEST VARIETIES. VERY FINE STOCK.
\$3.50 per 100, \$30.00 per 1000

ROSE HILL NURSERIES

New Rochelle, N. Y.

BARCAINS

- Ampelopsis Veitchii**, 3 in. pots, \$5 per 100. **Clematis Paniculata**, 4 in. pots, \$10.00 per 100; 3 in. pots, \$5.00 per 100. **Clematis**, large flowering varieties, 2 year old plants, Jackman, Henryi, Andre, \$3.00 per dozen; Coccinea, \$2.00 per dozen. **Bouvardias**, White, scarlet, Pink and Humboldtii, 2 in. pots, \$3.00 per 100. **Hydrangea Otaksa**, 2 1/2 in. pots, \$3.00 per 100. **Carnations**, R. C. from soil, Dorothy, Elbon, \$2.00 per 100; **Geraniums**, standard varieties, from 3 in. pots, \$1.00 per 100; 4 in. pots, \$6.00 per 100. **Lobelia**, double blue, 2 1/2 in. pots, \$3.00 per 100. **Moon Vines**, true large-flowering white variety, 2 1/2 in. pots, \$3.00 per 100. The following stock from 2 1/2 pots at \$2.50 per 100.
- Fuchsias**, 4 varieties. **Alyssum** Carpet of Snow, **Phlox Drummondii**, **Dwarf Lobelia**, Emp. William, **Salvia**, Bonnie and Zurich, **Verbenas**, **Parlor Ivy**, **Petunias**, Cal. Giants and Star, **Feverfew** Little Gem, **Coleus**, Golden Bedder and **Quindriolor Alternantheras**, 4 varieties, **Golden Feather**, **Chrysanthemums**, standard varieties. **Cuphaeas**, **White Snapdragon**, **Lantana**, **LeNain**, **Chrysanthemums**, new early varieties, **Autumn Glow**, **White Cloud**, **Pacific Supreme**, from 2 1/2 in. pots, \$3.00 per 100.

C. EISEL
11th and Westmoreland Streets,
PHILADELPHIA, PA.

HEACOCK'S PALMS

- Kentia Belmoreana
7-inch pots 32 to 34 inches high \$2.50 each
7-inch pots 35 to 38 inches high 3.00 "
9-inch tub 42 to 48 inches high 5.00 "
Made up Kentia Forsteriana
7-inch pots 34 to 36 inches high \$2.50 each
7-inch pots 35 to 38 inches high 3.00 "
9-inch tub 42 to 48 inches high 5.00 "

Joseph Heacock Co., Wyncote, Pa.

Cattleyas in California



The accompanying illustration shows one side of a cattleya house at the well-known establishment of Mr. J. B. Coryell, Menlo Park, California. The entire house is filled with *Cattleya Trianae* between two and three thousand plants, and finer stuff I have never seen. The entire stock was imported two years ago, and at the present time shows decided evidence of the care and attention which Mr. McDonald, the head gardener, has given them.

Mr. Coryell is catholic in his tastes and there is no phase of gardening in which he does not take pleasure. In addition to a large and varied collection of orchids occupying several large houses, there are a number of houses devoted to stove and greenhouse plants, all of which show evidence of a high degree of cultural skill.

W. W. Brown

Menlo, California.

Orchids at the Berlin International Exhibition

There was no favorable position set apart for orchids at this exhibition, and the hall was spoilt for these plants by its many dark corners due to the cathedral glass of the windows. Herr Otto Beyrodt, Marienfelde, exhibited a large group containing many species and varieties. Especially good were the plants of *Cymbidium insigne* (syn. *C. Sanderæ*), a large number of which were imported a few years ago. This species is difficult to bring into flower; and is grown under cold treatment by some, and slightly warm by other cultivators. Once the cultivation is carried out under rational treatment it will take its place as a free-flowering

plant for cutting purposes. Of this exhibitor's other plants mention may be made of the large-flowered white *Miltonia* x *Bleuana*. Herr Beyrodt had among others a *Cattleya Trianae* Blue King, with broad sepals and petals and a peculiar colored lip; a pretty *Cattleya Schroderae* with almost white petals and sepals, lip broad with a border of a light tint, and a dark colored patch in the centre. To the right and left of his large group, Herr Beyrodt showed a large variety of orchids for affording cut bloom. In every way he had not spared expense or trouble, to show the importance and purposes of his establishment, and he was awarded the Prize of Honor given by the city of Berlin.

Herr W. Hennis, Hildesheim, put up a portion of an importation of orchids in excellent condition, together with several *Cattleya Schroderae* alba, and a white *Calanthe Hennisiana* as varieties.

M. Firmin Lambeau, Brussels, showed a group of the handsomest *Cypripediums*, *odontoglossums* and *cattleyas*, all of them crosses or hybrids. This amateur, an enthusiastic and celebrated orchidist, who spares no expense in adding to his collection, has accumulated an enormous capital in his glasshouses; and it frequently happens that at the orchid auctions in London, he will purchase plants which he may be desirous of obtaining, without any price limit. These treasures are cultivated by his clever headgardener, De Munter, who appears especially to have much success with *miltonias*. *Cypripedium* x *Delbekeanum*, a variety which has marks of *C. bellatulum* strain, was bought in England for a few shillings where it probably never came to perfection. It is now flowering for the first time with M. Lambeau, and is one of the finest *Cypripediums* extant and worth a lot of money. Of other crosses mention may be made of those of *odontoglossums*; viz., the three wine-red, *O.* x *von Armin Crüwen*, *O.* x *Kronprinz Wilhelm*, *O.* x *Empereur Guillaume II.* Further there were the following: *Odontoglossum crispum* W. J. Whitely, flowers large with brown spotting on the sepals. *O. c. Fascinator*, *O. ardentissima*, whose almost wholly brown flowers are a strikingly conspicuous feature; *O. c. var. Rolfe*, and *O. c. Loochristiense*. Among a number of remarkable *Cypripediums* was *C. x Dr. Clinge Doorenbos* which is fine variety for cutting. The plant bore enormous flowers on stalks two feet in height; the color green with brown stripes. Of *cattleyas* the more interesting were the beautiful albino *C. x Suzanne Hye de Crom*, *Laelio-cattleya* x *Firmini*, a large-flowered hybrid with deep yellow sepals and petals and deeper colored lip (*C. Mossiae* x *L. cinnabarina*). There were several other hybrids of *Laelia* and *Cattleya* including some in which *C. aurea* was one of the parents; but few showed any influence of this last species. *C. x nivea* is a hybrid of *C. intermedia* alba and a large-flowered white *cattleya*, and is a handsome flower, similar to one shown at Ghent last year under the name of *C. x Dusseldorffii* var. *Undine*. There were likewise some fine *Brassavola* hybrids, viz., *Brasso-cattleya* x *Queen Alexandra* (*Brassavola Digby* x *C. Mossiae* alba) with pure white sepals and petals and prettily fringed lip. Similar was *Brasso-cattleya* x *Langleyensis*, in which *C. Schroderae* was one of the parents; and *Brasso-cattleya* x *Veitchii*, in which *C. Mossiae* played a part. *L. c. x Fredk Boyle* (*Laelia anceps* x *Cattleya Trianae*) a var. midway between the two parents. This exhibitor was awarded the magnificent prize of Honor given by the Prince of Thurn and Taxis for his admirable group.

Fredrick Moore

(To be continued.)

HORTICULTURE

VOL. IX MAY 22, 1909 NO. 21

PUBLISHED WEEKLY BY
HORTICULTURE PUBLISHING CO.
 11 Hamilton Place, Boston, Mass.

Telephone, Oxford 222
 WM. J. STEWART, Editor and Manager

SUBSCRIPTION PRICE

One Year, in advance, \$1.00. To Foreign Countries, 2.00. To Canada, \$1.50

ADVERTISING RATES

Per Inch, 30 inches to page
 Discounts on Contracts for consecutive insertions, as follows:
 One month (4 times) 5 per cent., three months (12 times) 10 per cent.,
 six months (24 times) 20 per cent., one year (48 times) 30 per cent.
 Page and half page space, special rates on application.

Entered as second-class matter December 8, 1904, at the Post Office at Boston, Mass.
 under the Act of Congress of March 3, 1879.

CONTENTS

COVER ILLUSTRATION—Spring Bedding.....	Page
CATTLEEAS IN CALIFORNIA—Wm. McM. Brown— Illustrated.....	725
ORCHIDS AT THE BERLIN INTERNATIONAL EX- HIBITION—Frederick Moore.....	725
PLANTING FOR WINTER EFFECT—A. E. Thatcher.....	727
BEAUTIFYING THE WASTE PLOTS—W. H. Adsett.....	727
NEWS OF THE CLUBS AND SOCIETIES:	
Pennsylvania Horticultural Society—Nassau County Horticultural Society—Commercial Florists' Associa- tion of Rochester—Dayton Florists' Club—Morris County Gardeners' and Florists' Society—Engelmann Botanical Club.....	728
Newport Horticultural Society, Illustrated—St. Louis Florists' Club—National Dahlia Society—New Jersey Floricultural Society.....	729
Society of American Florists—Gardeners' and Flor- ists' Club of Boston—Cincinnati Florists' Society— National Sweet Pea Society.....	730
Boom the Chrysanthemum Society.....	736
Club and Society Notes.....	742
Royal Horticultural Society.....	752
Florists' Hall Association.....	754
SOUTHERN GROWN BEAUTIES—Illustrated.....	730
HARDY PERENNIALS: THEIR USES—R. Cameron.....	731
GRAFTING CACTUS—Frederick Moore.....	734
SEED TRADE:—Unfavorable Weather Conditions— Planting Delayed—Personal Notes.....	738
OF INTEREST TO RETAIL FLOWERS:	
Business Changes—Steamer Departures.....	740
Flowers by Telegraph—New Flower Stores.....	741
FLOWER MARKET REPORTS:	
Boston, Chicago, Detroit, Philadelphia.....	742
New York.....	745
GIGANTISM BY MARCH 20—Aug. Doemling.....	751
DURING RECESSION:—Ye Whimsical Sayings of H. A. B.....	752
OBITUARY—Mrs. John Galvin.....	752
MISCELLANEOUS:	
Forestry at Massachusetts Agricultural College.....	736
News Notes.....	736-741-743-745
Catalogues Received—Greenhouses Building.....	738
Detroit Notes.....	740
Chicago Notes.....	741
Philadelphia Notes.....	743
Personal Incorporated.....	745
Horticulture in the Ascendant.....	759
Movements of Gardeners.....	752
Patents Granted.....	754

We announce with pleasure the return of Mr. Rehder returns of HORTICULTURE's valued correspondent, Alfred Rehder, from his European visit. The new hardy things collected by Mr. Wilson in China for the Arnold Arboretum are now sufficiently advanced to furnish Mr. Rehder with the material for some exceedingly interesting and valuable contributions and these will appear in HORTICULTURE exclusively.

Memorial Day possibilities

Only one week more intervenes until the great national floral holiday comes around again. This is the florists' own day in many communities; it should be in all, from the Atlantic to the Pacific.

Full of sentiment, full of pathos, each year its hold upon the heart of the people becomes stronger, its observance more impressive. The florist is called upon to do his part and the day and its ceremonies are inseparably linked with his art. It is his duty to prepare for it, lavishly and confidently. Wisely handled there is almost no limit to the Memorial Day flower market. Moderate prices and generous liberality are the key to the situation. Let the florist meet them on these grounds and the people will not go afield for their Memorial flowers. There is no good reason why this anniversary should not far outstrip Christmas and Easter in the magnitude of its flower trade, everywhere, as indeed it already does in many of the New England cities and towns.

The salesman's ally

Not long ago a certain dealer who had been advertising to a considerable extent in the horticultural trade papers for some years confided to us his intention to cut out the greater part of his trade advertising as he concluded that his traveling salesmen accomplished much more for him in the way of business. Should he carry out his expressed purpose we believe he has some unpleasant experiences ahead—not immediately perhaps, but by the time his aggressive trade rivals have begun to encroach on his domain, as any firm which backs up its traveling representatives with liberal and systematic advertising of the goods they carry is bound to do sooner or later. Every salesman on the road realizes the great value of the advance publicity which trade journal advertising gives. The advertising paper actually does the work of a vast number of vaucouriers at an infinitesimal cost and the drummer, called upon to follow after, finds the road far smoother and his task much easier than when he has to start out unheralded and unaided. Those dealers who do not realize this truth through their natural discernment are likely to have it forced upon them sooner or later, for trade advertising, in the opinion of long-headed judges, is only in the "rooted cutting" stage as yet.

The outlook for the nurserymen

The next important national society event on the 1909 program is the thirty-fourth annual convention of the American Association of Nurserymen which takes place at Rochester, N. Y., early in June. No doubt it will be a record breaker for the nurserymen in some respects, for their time-honored association will find abundant stimulus to renewed activity and vigor in the place of meeting this year, a city which stands pre-eminent, without a rival as a nursery centre and rich in all the resources which contribute to the success of such a gathering and, further, such an organization cannot but feel the inspiration of the awakening of the American people to a keener appreciation than ever before of the utility and beauty of trees and shrubbery in landscape, park and garden. Our beautiful gardens, avenues and parks on the one side and fruitful orchards with their product on the other, stand as living monuments to the nursery industry, but what we see today is little more than the beginning. The nursery interests are destined to increase rapidly as the resolution grows upon our people to convert the desert and waste places into gardens and restore to nature the charms of which we have been robbing her for centuries. The Nurserymen's Association has before it the duty and the privilege to carry the standard and uphold the prestige of the great industry which it represents and, under broad policies and wise leadership, its opportunity for useful work would seem to be almost unlimited.

Winter Color in the Garden

When one considers the large number of people who spend the winter and early spring months in their country homes it is somewhat surprising that more attention is not given to the beautifying of the garden at this period for, while every effort is made to produce a bright display during the spring, summer and autumn months one very rarely sees any attempt made to make the grounds more interesting and brighter throughout the dull season of the year. Among hardy ornamental shrubs there is an abundance of excellent material suitable for this purpose which, I believe, only requires to be better known to become more largely used, and if a portion of our public gardens and grounds was devoted to the grouping of these shrubs with brightly colored stems their value would soon become apparent. In the Arnold Arboretum and on the Boston parkways, especially around Jamaica Pond some good examples, principally of the scarlet barked willow, may now be seen and one can easily imagine the brilliant mass of coloring produced by planting a group of so highly ornamental a shrub as this.

The number of subjects capable of producing a bright effect with their stems, as is I have previously said, quite large and if one has sufficient space to devote the best results are obtained by planting groups, either large or small, of different varieties in a juxtaposition to each other so that the various scarlets, whites, greens, browns and reds of different shades form a most pleasing contrast. Such planting when once accomplished requires very little attention, but some of the varieties, which I shall enumerate, must be pruned hard to the ground every spring so soon as the sap commences to rise, for by only allowing the varieties to make an annual growth the color is much more vivid and uniform.

In addition to their winter beauty many of the under mentioned shrubs are valuable for their flowering properties while others are conspicuous in the autumn by reason of their highly colored foliage or ornamental fruits, and for massing on the banks of streams or ponds some are specially well adapted, the reflection in the water being doubly effective. No country possesses better advantages for producing these vivid colors at their best than North America as the warm sunlight of summer is necessary to thoroughly ripen the wood and the subsequent frosts also help to intensify the various shades of the barks.

The majority of shrubs with scarlet or bright stems belong to the Cornus or Dogwood family and conspicuous among them are *C. alba* and its varieties *siberica*, *Goucheaultii* and *variegata*. The two latter have, in addition to their bright red stems, very handsome variegated foliage which produces a most effective sheet of color when grouped. *Cornus Baileyi* and *C. stolonifera* are also very desirable, the stems of both being of a brilliant color. One of the brightest reds we have is the Red Osier or scarlet-barked willow which is a very excellent subject for grouping and will grow freely in any good soil though one naturally expects to find it by the water's edge; a position in which it looks thoroughly at home. Golden barked shrubs are not quite so numerous but there are two very excellent varieties which contrast well with the reds. They are *Salix alba vitellina*, the golden stemmed willow and *Cornus stolonifera flaviramea*, Golden Dogwood. All the above excepting the last named produce the most pleasing results if pruned hard back to the ground every year and the Golden Dogwood is improved by receiving this treatment occasionally. Shrubs with bright green stems are very ornamental if planted in quantity and specially noteworthy sorts are *Kerria Japonica* and its two varieties *flore-pleno* and

variegata. These require very little pruning, it being only necessary to remove the old stems when they become brown with age. For sheltered positions where the North and East winds will not mar their appearance the *Cytisus* and *Genistas* are very valuable, for few shrubs are more admired when in flower and in winter they are an effective mass of green. The most suitable varieties of *Cytisus* are; *albus*, *præcox* and the several forms of *C. Scoparius*, all of which resent being pruned after they have attained a fair size.

A large number of flowering shrubs have warm brown stems in winter which associate well with the brighter hues and materially assist in producing a pleasing combination of color. Some of the most desirable are *Spiræa Douglasii*, which should be pruned right down every year when it will form a level bed of pink blossom in summer; *Spiræa canescens*, a white flowered species; *Forsythia suspensa* with pale brown stems; *Berberis vulgaris* and the *Symphoricarpus*. Although the *Pyrus* family are not particularly noticeable, in the same way as the dogwoods, for the beauty of their stems in winter there are two varieties, viz: *P. nigra* and *P. arbutifolia*, which are very attractive when planted in quantity. In the Eastern Nurseries at Holliston I recently saw two fine plantations of these pyruses and the color of the stems which is red with a suffusion of white made them very attractive. In addition to their winter beauty these two shrubs are desirable for their wealth of spring blossom and magnificent foliage in the autumn.

The above list includes only a few varieties suitable for this kind of planting and is by no means exhaustive. There are, in fact, many more equally useful as I have mentioned, which are hardy, of easy cultivation and have something to recommend them at all seasons of the year.

Arthur E. Thatcher
Arnold Arboretum.

Beautifying the Waste Plots

The societies which are in operation in New York and Philadelphia for cultivating the waste lands in the towns have their counterpart in an organization which has been formed on this side. Mr. Joseph Fels, the Hon. Sec., informs me that the work of the English Vacant Land Society during its first season has been so successful in actual tangible results that it now feels justified in applying for further financial support. From landowners or their agents the committee solicit the loan of unused and vacant plots of land, either in the Metropolis or in the country. The committee agree to give up possession of the land within seven days, if required to do so. An appeal is made to seedsmen, growers and merchants for seeds, plants and garden tools for the use of the cultivators. Financial support is also invited from the public for the approaching season, when some £20,000 will be needed. Already a successful start has been made in the cultivation of vacant plots in various parts of London, and it is now hoped to considerably extend this list in the approaching season. R. Lewis Castle, who has a wide experience in commercial horticulture, is acting as the superintendent, and he is doing his utmost to promote the complete success of the undertaking, which fills an undoubted want amongst our British institutions.

W. H. Adsett.

London, Eng.

NEWS OF THE CLUBS AND SOCIETIES

PENNSYLVANIA HORTICULTURAL SOCIETY.

An invitation has been extended to the Chrysanthemum Society of America to hold their next annual convention and exhibition under the P. H. S. auspices in Philadelphia next November, on the dates fixed for the regular local exhibition, Nov. 9th to 12th. William Kleinheinz made a report from the executive committee of the Gardeners' Society in regard to the prizes for the spring show. Thirty-two cups have been donated so far and these will be awarded for meritorious exhibits other than the usual subjects covered by the P. H. S. prize list. The latest offering is a gold medal by the Lord & Burnham Company which will be awarded to the best group of foliage and flowering plants. A silver gilt cup will be given to winner of the most prizes, the award to be made on points—three for firsts, two for seconds and one for thirds. The peony exhibition will be held afternoon and evening of May 27th. All exhibits to be staged before three o'clock. The date for the rose show will be announced later.

Certificate of merit for culture was awarded to Samuel Batchelor for an exhibit of May-flowering tulips; special mention to William Fowler for two varieties of tree peonies, Countess of Clews and Christine Kelway; certificate of merit to H. Harry A. Dreer for *Ampelopsis* Lowi, a new and graceful variety with small foliage.

Prize list for the peony show can be had on application to the secretary, David Rust, Broad and Locust St., Philadelphia.

NASSAU COUNTY HORTICULTURAL SOCIETY.

This society held its regular monthly meeting on Wednesday evening, May 14th, in Pembroke Hall, Glen Cove, N. Y. President Everett occupied the chair. There was a good attendance, about fifty members being present.

Messrs. Johnston, Duthie and Mackenzie acted as judges at the monthly exhibition. Paul Reul led in the points competition with a meritorious exhibit of mixed antirrhinums which stood about 6 feet high, with about 2½ feet of flower stem. The awards were as follows: P. Reul, antirrhinums, 90 points; G. Wilson, carnations, 80 points; H. Gaur, culinary peas, 86 2-3 points; O. Cleres, *Asparagus Sprengeri*, 83 1-3 points.

There was, as usual, a very good display of flowers and vegetables for exhibition, noteworthy amongst which was a vase of *Gladiolus Blushing Bride*, staged by E. Farwell, Great Neck. *Blushing Bride* is a fine thing and ought to be more widely grown than it is. A. Reidenbach was awarded a cultural certificate for a vase of sweet peas, as were also V. Cleres and H. Gaur for cauliflower and Lima beans, respectively.

A. Mackenzie read a very able paper on "Growing Chrysanthemums for Exhibition." The Society awarded Mr.

Mackenzie a vote of thanks for his excellent paper.

Mr. Johnston, who a few weeks ago returned from a three months' visit to Scotland, has promised to give an account of his travels at the June meeting.

The Society holds its Rose Show on June 23rd.

WM. H. MACKENZIE,
Corresponding Secretary.

COMMERCIAL FLORISTS' ASSOCIATION OF ROCHESTER, N. Y.

This hustling association is planning for a flower show to be held November 2, 3 and 4. It is expected that every florist in Rochester will have an exhibit and in addition there will be choice displays from the gardens of prominent Rochester and neighborhood amateur florists. The show will be unique in so many ways that it is expected to attract the attention of members of the trade in all parts of the country. It will be original in that there will not be a vase or table in the exhibit. Convention Hall, where the show is to be given, will be laid out as a garden and the exhibits will all be placed on the floor. Instead of walking up and down between flower laden tables, spectators will pass along beautiful walks, under arbors, through palm forests, and to a cascade that will have its origin back on the stage at one end of the hall. The garden idea will be carried out from plans already prepared by a well known landscape artist. Ceilings and side walls will be hung with southern smilax.

Florists and nurserymen who are interested in the show, which has been under consideration since the florists held their banquet last winter, met last Saturday night at James Vick's Sons' offices for the purpose of going over the floor plans and perfecting other details. Every one present was enthusiastic. Charles H. Vick is chairman of the general committee and H. B. Stringer is secretary. The subcommittee are: Floor and decoration—F. J. Keller, E. P. Wilson, R. G. Salter, G. B. Hart. Finance—W. L. Keller, Wm. C. Barry, Sidney R. Clarke, W. H. Dildine, A. H. Salter. Exhibitions and awards—J. M. Keller, Ambrose Secker, F. W. Vick, E. R. Schlegel, C. B. Ogsten. Music—F. W. Vick. Advertising—Sidney R. Clarke, Thomas F. Brown, A. H. Salter, William Pitkin, Charles J. Brown.

DAYTON FLORISTS' CLUB.

The last meeting of this club was with J. F. Young. After the preliminary business was over, E. E. Schaefer spoke on the subject, "Would a co-operative supply house be a benefit to the florist?" and the discussion that followed showed that the florists were generally in favor of buying their supplies as they were required. Mrs. B. B. Hendricks' remarks on "Giving away flowers," favored making a gift to a good customer when paying a bill, but the donation of flowers in quantity to churches, lodges, etc., was deprecated by all who took part in the after discussion.

MORRIS COUNTY GARDENERS' AND FLORISTS' SOCIETY.

Prof. Lipman, of the New Jersey Agricultural and Experiment Station of New Brunswick, N. J., gave a lecture before the Morris County Gardeners' and Florists' Society on the evening of May 12 on "Soils and Fertilizers." Fifteen years of hard work at the station in this line eminently fitted the professor for giving us an interesting and instructive talk, and the fifty-two members who heard him got up as one man to give him a rising vote of thanks. To enable the farmer and the gardener to work intelligently is the aim of the station, and all over the state experiments are carried on with this object in view. "To produce the most at the minimum of cost in the aim of us all, and to do this older methods have to be laid one side, and changing conditions have to be met. Soils are not what they were, and so we are learning to supply just what is needed for our crop," said the doctor.

Many questions were asked, and Professor Lipman was always ready to discuss a point and throw light on little understood problems.

We had quite an informal exhibition. Wm. Duckham had a collection of flowering shrubs, hardy herbaceous flowers and spring bulbs. Alexander Brown, gardener to Geo. Macculloch Miller, had a fine lot of antirrhinum. G. F. Neipp of Floral Hill Gardens, Chatham, had a fine collection of tulips, and so had Alexander Michel, gardener to Chas. R. Hedden. Madison, John Dunn, Alfred Neipp and Wm. Wilschrey were elected to membership. The annual flower show for this year is to be held in Madison on Oct. 27 and 28, Wednesday and Thursday. The schedule is nearly revised and next meeting will complete it. During July and August there will be no meetings, as has been the custom for some years.

E. REAGAN, Sec'y.

ENGELMANN BOTANICAL CLUB.

The Engelmann Botanical Club of St. Louis held its annual field meeting Saturday, May 8, at the old U. S. Grant farm, which is owned by the Adolphus Busch estate. L. P. Jensen, head gardener for the Busch estate, had charge of the meeting and saw to it that the members were made comfortable during their stay. The visitors roamed over the fields all day, gathering wild flowers of all kinds, and a fine spread was served after the meeting. The club held its regular meeting the following Monday, May 10, in the Central High School building, where all the flowers and plants from the field meeting were displayed. The meeting was a well attended, very interesting one, especially the discussion on the flowers of Arkansas and south western Missouri, there being several noted visitors present from kindred societies.

NEWPORT HORTICULTURAL SOCIETY.

At the meeting of this society held on the evening of May 11th three tropaeolum plants were on exhibition in competition for prizes offered by Mr. I. L. Lorrillard. The first prize of \$12 was awarded to Andrew Dorward, gardener for Mrs. T. J. Emery, for a very large and handsome specimen in bush form; a double red for a centre surrounded by a double yellow. The second prize of \$8 was awarded to Stewart Ritchie for a very pretty plant of double yellow trained in pyramid shape. The third plant was the variety Jarrattii trained in balloon shape. The accompanying pictures give an idea of how all looked.

ST. LOUIS FLORIST CLUB.

This club held its May meeting on the afternoon of May 13, with thirteen present, in Bowman's Hall. After the regular opening exercises had been disposed of, President Young called for reports from all committees.

The trustees reported that they wish more time to find a suitable meeting hall and at next meeting they would make a favorable report. They were by a vote instructed to make all arrangements for the club's annual outing to take place some time in July. As the club has gone out of the show



Trained Nasturtium, First Prize. Newport Horticultural Society.

business the trustees were ordered to sell to the highest bidder all belongings of the club for holding flower shows, which have been in storage for the past two years.

The communication from the St. Louis Horticultural Society asking the club's co-operation and the offer of a special prize for the best fall show will be taken up for discussion at the June meeting of the club.

The president appointed W. C. Smith to take charge of the club delegation to the S. A. F. convention, look after transportation and other details to make the members comfortable in their trip to Cincinnati and return. A large delegation of members have pledged themselves to make the trip. Fred Weber, treasurer, reported plenty of money on hand. The matter of life membership was taken up and fully discussed and assigned to the June meeting. Before adjournment, Mr. J. F. Windt and Henry Johan announced that both had become grandfathers since the last meeting, so after the adjournment the members feasted at their expense and hearty congratulations were extended.

NATIONAL DAHLIA SOCIETY.

The recent issue of this Society's schedule of prizes for 1909 reminds us that the London Dahlia Union and the National Dahlia Society of London are now one. The amalgamation took place early in the year, and the show arrangements are practically the same as before. There will be one held on the 2nd and 3rd of September at the Crystal Palace and another on 21st and 22nd September in the Royal Botanic Society's Gardens, Regents Park. Accompanying the schedule is the 1909 supplement to the official catalogue which contains lists of the new dahlias to be sent out in 1909 and revised selections in the different sections of this popular flower. Mr. E. F. Hawes and Mr. H. H. Thomas the old secretaries of the two societies thus united have been appointed joint secretaries of the N. D. S.

C. H. P

NEW JERSEY FLORICULTURAL SOCIETY.

W. A. Manda addressed the society at their regular monthly meeting on the 11th, which was observed as a special rose night. The speaker stated that his special attention had been given to out-door grown rather than greenhouse stock and then, dividing his topic into classes, made a rapid survey of the best varieties now in general use in the various departments of horticulture. Among the interesting points that he brought out were the facts that the Cherokee rose will not cross; that dry leaves and hemlock boughs make the best protection in winter; that by the use of barbed wire fencing a more effective display may be made where Wihuraiana is employed. He spoke also of the inspiration that recent shows had been under the guidance of the Rose Society and of the forth-coming shows in England next year.

John Hayes told of a grafted rose which had been growing for between thirty-five and forty years under glass at "The Terraces." Rev. Louis H. Lightipe, botanist to the society, spoke of the vigor of the Cherokee rose in the southern states particularly around Jacksonville, Fla. He also described the process of freezing where the stem splits the same as a water-pipe and if covered and permitted to thaw in the dark, no bad result will follow. The floral display was from neighboring estates and quite up to the usual standard. W. A. Manda and John Hayes were the judges for the evening.

JOS. B. DAVIS.



Trained Nasturtium, Second Prize. Newport Horticultural Society.

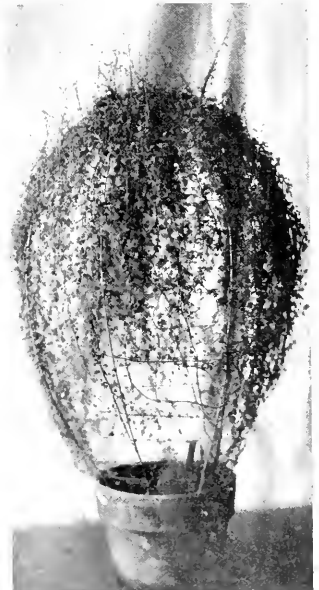

Trained Nasturtium, Third Prize. Newport Horticultural Society.

**SOCIETY OF AMERICAN FLORISTS
AND ORNAMENTAL HOR-
TICULTURISTS.**

Window Glass and the Tariff.

As a commodity affecting the thousands of greenhouse men, large and small, glass stands a very important factor. The duty levied on glass per pound practically cut out European competition, and prices until about eighteen months ago ran high. The gradation of import price is pound rate of 1 3-8c. for size not exceeding 10 x 15, for size not over 16 x 24 1 7-8c., and so on running higher as the increase of sizes goes until 4 3-8c. per pound is reached.

When the section of the Tariff Bill came up before the Senate for action, the Hon. Elihu Root, Senator from New York State, took up the side of reduction, urging a modification of the present rates. Senator Simmonds of North Carolina, ably took the same ground, urging at any rate a material reduction upon the sizes in common use. The introduction of machine to take the place of hand-blown glass, and the contest for control of the market is the cause of prevailing low price during the past year. The bill as it goes back to the House of Representatives will in many cases show marked changes. The national demand is surely on all lines for a reduction of duties when summed up as a whole; localities will and do urge strongly in favor of their own interest. Mr. Frank R. Pearson, chairman of the S. A. F. Tariff Committee, has been to Washington twice on behalf of the interests of the S. A. F., and no one in close touch with affairs realizes the clash of interests one with another, and how some remote and unlooked for item will affect even the flower grower.

BENJAMIN HAMMOND,
Secretary Tariff Committee S. A. F.

**GARDENERS' AND FLORISTS'
CLUB OF BOSTON.**

The May meeting, held at Horticultural Hall, Boston, last Tuesday evening, was attended by one hundred and forty members, all interested in the promised lecture on Aquatic Gardening by Peter Bisset of Washington. Unfortunately, Mr. Bisset was unable to be present in person, but his paper was well-presented by J. W. Duncan as reader, and James F. M. Parquhar as operator of the stereopticon. The slides shown by Mr. Bisset were very beautiful.

There were no less than fifteen queries in the question box, which called forth interesting answers and sometimes lively debate. Among the subjects thoroughly discussed was the substance called "Tanaloot" as to its effect when used as a band on tree trunks to prevent the ascent of insects. It was unreservedly condemned as injurious by practically all who had tried it. It was acknowledged, however, that the harm noted may have, in some instances, been caused by too deep cutting of the bark.

Votes of thanks were accorded to the following exhibitors: Eber Holmes for Canna Tazewell and Killamoy rose, Wm. T. Archer for Hoya carnosa and N. W. Fletcher for

SOUTHERN GROWN BEAUTIES.



The accompanying illustration shows a vase of American Beauties with 9 to 12 ft. stems, grown in solid beds by the Metairie Ridge Nursery Company, New Orleans, La. These plants are three years old and were planted on benches the first year and transplanted to solid beds two years ago. The secretary writes that they find, after several years' trial of roses on benches, that the solid beds are the best for that climate, and they are now planting all

their roses in solid beds for next year. This seems to prove beyond question that long-stemmed roses, especially American Beauties, can be grown in southern latitudes as well as elsewhere. Years ago it was always contended that roses, especially Beauties, could not be grown under glass in that climate. It adds something to our editorial note of two weeks ago concerning the growing of carnations of good quality outdoors in New Orleans.

Everblooming Salvia and pink Marguerite.

CINCINNATI FLORISTS' SOCIETY.

There was a good attendance at the May 8th meeting. Henry Schwarz read an interesting paper on the history of the society. The present officers were re-nominated as they have begun the work in connection with the entertainment of the S. A. F. in August, and could more readily complete it than a new board. R. Wiltz, secretary for the financial committee reported that money is coming in well for the entertainment fund. The directors and chairman of the various committees will meet every Monday evening at the Sinton Hotel until after the convention.

NATIONAL SWEET PEA SOCIETY.

This flourishing English Society has recently issued its annual Year Book for 1909, and its schedule of prizes. The ninth annual Exhibition in London will be held on July 23, next, in the Royal Horticultural Hall, Westminster, and the third provincial show will take place at Saltire on the 12th of the same month. It is a comprehensive publication of 50 pages, containing all information as to the classes provided and several illustrations of the handsome silver cups offered for competition. The annual report, balance sheet and list of officers also appear. Roughly speaking, the income for 1908 amounted to a total of \$2865.

HARDY PERENNIALS AND THEIR VARIOUS USES.

By Robert Cameron.

Continued from Page 702, Issue of May 15.

Florists and Their Homes.

Are the florists and the nurserymen doing the best they can to make their homes and places of business pleasing and attractive and are they trying to teach the people to love and use plants more abundantly around their homes? Some florists have very beautiful grounds, nicely kept, while others have miserable dilapidated places. There is less reason for a florist, above all others, to have an unsightly and untidy place. He has always plenty of material growing around him and knows how to make it grow. Therefore around his home there should always be a pleasing and satisfying picture. If you don't keep your place neat and tidy and have plenty of plants and flowers around your places of business and homes, how can you expect to urge your customers to grow more plants when you do not show them a good example?

Immortal Burns has said:

"O wad some Power the ziffle gie us
To see ourselves as others see us,
It wad frae mair a blunder free us,
An' foolishness nae."

Private Estates.

I am pleased that some of our large private estates have taken up this subject seriously and are naturalizing bulbs and other plants by the thousands, in woodlands and other places. William N. Craig of North Easton, is doing this work finely. Charles Sander at Prof. Sargent's place has done excellent work. Mr. Henry Hunnevell, of Wellesley, has planted liberally and has obtained good results. And on the North Shore we have quite a number of good examples.

In England this kind of work is done on a very large scale. At Kew Gardens a few years ago they had only a few small patches of plants that were naturalized. Now they have acres of snow-drops, crocuses, squills and many other things which are seen and enjoyed when they are in bloom, by hundreds of thousands of people from the thickly populated parts of London.

Some of you will say, these bulbs are too expensive to plant in such large quantities as I have recommended. You will be surprised if you buy in large quantities to find how cheaply they can be bought.

The Herbaceous Border.

There are many ways in which hardy perennials can be used, but the most common way is in the mixed border. Many persons think it is an easy matter to plant and maintain a herbaceous flower border, but if one is to have flowers during the Spring, Summer and Fall, and maintain a good scheme of color, it is by no means the easy thing that it is commonly supposed to be. A person may have many plants of good kinds and they may grow satisfactorily, but that does not make a border or garden; that merely makes a collection.

So, if we are to have beautiful gardens and borders, the chief point we should keep in view is to use them with careful selection and definite purpose, always aiming that they shall make beautiful pictures. Two borders may contain the same number and kinds of plants; the one may be plant-

A Prosperous Florist is like the Bee - Never Idle

We have plants to sell, so have thousands of other florists.

But we have quantity, quality and prices that few can offer.

Our immense stock of bedding plants is now ready, every hole and corner full for immediate shipment.

Geraniums, S. A. Nutt (best crimson), John Doyle and other reds, Miss Thibaut and Jean Vland (pink), 4-in. pots, \$7.00 per 100.

Polevine, Albion (single white) **Ivy geraniums**, \$7.00 per 100.

Scarlet Sage Chra Bedman, 4-in., \$7.00 per 100; 3-in., \$4.00 per 100.

Ageratum, best of the blue dwarf, 4-in. pots, in bloom, \$6.00 per 100.

Heliotropis, best of blue dwarf variety, 4-in. pots in bloom, \$7.00 per 100.

Begonia Vernon, best dark red, and others, \$7.00 per 100.

Begonia Flambeau, on account of its waxy foliage (pink flowers in summer), is valuable for window boxes, vases, and makes a striking appearance. 5 1/2-in. pots, \$2.00 per doz.; 4-in. pots, \$1.00 per doz.

Fuchsias, assorted, in bud, 4-in. pots, \$6.00 per 100.

Petunias, double assorted, 4-in. pots, \$7.00 per 100.

Lantanas, assorted, 4-in. pots, in bloom, \$7.00 per 100.

Nasturtiums, dwarf assorted, 4-in. pots, \$6.00 per 100.

Stocks, German, six weeks, 4-in. pots, \$7.00 per 100.

Vincas, variegata and periwinkle, 4-in. pots, \$12.00 per 100.

Colmea scandens, 4-in., 8c.

Clematis, 4-in. pots, Henderson, Polevine, Bismark, Mlle. Perat, etc., \$8.00 per 100; King Humbert, 4-in., 10c.

Mignonette, 4-in., 7c.

Aster Victoria, German, 5 best sorts, \$3.00 per 100.

Honeysuckle, large, 6-in., 50c; 10 plants sold at 100 rates.

SMALL PLANTS

Petunia California Giant, 5-in. pots, \$4.00 per 100.

Petunia limitata, 2 1/2-in. pots, \$3.00 per 100.

Verbenas, assorted, in bud, 2 1/2-in. pots, \$3.00 per 100.

Colons, Verschaffeltii, Golden Bedder and Queen Victoria, \$3.00 per 100.

Colons, fancy leaved, 2 1/2-in. pots, \$4.00 per 100.

Marigold, Tagetes or French dwarf, 3-in. pots, \$3.00 per 100.

Centaurea Gammocarpa (Busty Miller), 2 1/2-in. pots, \$3.00 per 100.

Factor or German Ivy, 2 1/2-in. pots, \$3.00 per 100.

Salpiglossis, assorted, 2 1/2-in. to 3-in. pots, \$3.00 per 100.

Lobelia Crystal Palace (blue), 2 1/2-in. pots, \$3.00 per 100.

Tradescantia, green and variegated, 2 1/2-in. pots, \$3.00 per 100.

Kenilworth Ivy, 2 1/2-in. pots, \$3.00 per 100.

Thunbergia, or Black Eyed Susan, 2 1/2-in. pots, \$3.00 per 100.

Cuphea, or clear plant, 2 1/2-in. pots, \$3.00 per 100.

Vinca variegata, 3-in., \$4.00 to \$5.00 per 100.

Ageratum, blue, dwarf, 3-in. pots, \$4.00 per 100.

Asparagus Plumosus Nanus, 3-in. pots, \$1.00 per 100; 2-in. pots, \$3.00 per 100, \$25.00 per 1000.

Cosmos, early varieties, separate colors, made up 2 plants in a pot, \$3.00 per 100.

Summer Chrysanthemums, best varieties, 3-in. pots, \$4.00 per 100; 4-in. pots, \$7.00 per 100.

Erythrum Aureum (Golden Feather), 2 1/2-in. pots, \$3.00 per 100.

Roses, Climbing Lady Gay, Crimson Rambler, B. Perkins, 5 1/2-in. to 6-in. pots, \$50. 30c to 40c.

Arancauris Robusta Compacta and **Excelsa Glauca**, Specimen plants, 7 to 8 in. pots, 25 to 35 inches high, \$1.50, \$2.00, \$2.50, \$3.00 each.

Arancia Excelsa, 25, 25 to 40 inches high, 6-in. pots, 5 to 6 tiers, \$1.00, \$1.25. New crop, 40c, 50c, 60c, 70c.

Kenia Belmoreana and **Forssteriana**, just arrived from Belgium per steamer Manitou, in first class shape, 70c, \$1.00, \$1.50 to \$2.00 each.

MOONLIPS

4-in. pots, nicely stocked up, \$12.00 per 100; 3-in. pots, \$8.00 per 100; 2 1/2-in. pots, \$5.00 per 100.

All goods must travel at purchaser's risk. Cash with order, please.

Please state if you want stock shipped in or out of pots.

1012
Godfrey Aschmann, West Ontario St. Philadelphia, Pa.
IMPORTER, WHOLESALE GROWER and SHIPPER OF POT PLANTS

BAY TREES, BOXWOOD, PALMS, ARAUCARIAS,
AND OTHER DECORATIVE MATERIAL
Evergreens In all Choicest Varieties. **Ficus Elastica** 2 1/2-inch pots, \$15.00 per 100.
CLEMATIS, and all other Vines and Climbers.
Trained Fruit Trees, Greenhouse Grapes, Herbaceous Plants, Trees and Shrubs.
We shall be pleased to give special prices on lists.
ASK FOR WHOLESALE CATALOGUE.
BOBBINK & ATKINS Nurserymen and Florists **Rutherford, N. J.**

ed in such a way that everything is jarring, displeasing and unrestful, while the other may be planted with the same material but, in such a way that it makes an impression of pleasing satisfaction; in fact, it makes a series of satisfying pictures. To learn to see the difference in these pictures and how to put them in their right places, is to recognize gardening as a fine art.

In forming plantations and borders, the right thing to do is to place the plants with such care that they shall form a part of a harmonious whole and that portions will show a series of pictures.

The Color Scheme.

We do not give enough attention to our color scheme, and in almost every garden I know this is a very weak point. Much of the success of a border

or garden depends on giving thought and study to get pleasing color effects. Many times good material is useless in our scheme, either from ignorance or lack of forethought. A plant may not be ugly in itself, but, when placed in a wrong environment, may make a very distasteful picture. We all know how to grow the plants, but it is another question of how to place them that they may give the best effects and make the most beautiful pictures. If we are to be successful with our borders we ought to give more study to the color scheme, as there is so much depending on it that we certainly can greatly profit by giving much more attention to it than we have in the past. I am not posing as one who can teach you in this line, but I can see where most of us are very unsuccessful in making our border compositions.

Richmonds,
American Beauties,
and Maidens, Valley, Canary,
Easter Lilies, Smilax, Sprengeri and
Plumms us.

Orders placed with us
depend on us.

New Crop Dagger and Fancy Ferns
12,000,000
\$2.00 Thousand

**HENRY M. ROBINSON
& CO.**
Wholesale Commission Florists
Hatch Cut Evergreens and
Flowers Supplies

15 Province St. and 9 Chapin Place
Telephone 2017-2018 Main, Ft. Hill 28290

Southern Wild Smilax extra fine quality. Brilliant
Bronze and Green Galax, Cut Boxwood
Sprays, Lemon Tree Sprays, Laurel and
Wreaths, Branch Laurel,
Green and Spikard
num Trees

We never
disappoint. Satisfaction
guaranteed.



A Philadelphia Orchid Grower
OFFERS
BARGAINS

100 CASES
CATTLEYA TRIANAE
just arrived from abroad; plants with 8, 12, 15, 20 and 25 bulb's each; 40 to
45 plants in each case; will run on an average 450 bulbs the case; —
\$40.00 per Case

60 CASES
CATTLEYA SCHRODERAE
will arrive about May 25th; plants with 8, 12, 15, 20 and 25 bulbs each;
about 40 plants to the case, averaging about 400 bulbs each; —
\$55.00 per Case

60 CASES
CATTLEYA CICAS
will arrive about May 25th; plants with 8, 12, 15, 20 and 25 bulbs each;
about 40 plants to the case, averaging about 400 bulbs each; —
\$55.00 per Case

I. o. b. Philadelphia for prompt order and if unsold.

Will break cases at a reasonable advance on above rates, say: — lots
of plants averaging 100 bulbs, 7½ per cent; 25 bulbs 12½ per cent.

Anyone who desires **ESTABLISHED PLANTS** can
be accommodated at very reasonable figures in all the commercial varieties
such as: — *Trianae*, *gigas*, *Schroederae*, *Gaskelliana*, *lablata*,
speciosissima and 12 of the best varieties of *Cypripediums*

ORCHID SPECIALIST
Alphonse Pericat, COLLINGDALE, PHILA., PA.

Rose Standish Nichols, who is an authority on garden color, has this to say: "Harmony is closely connected with scale and proportion. It is to be obtained not merely by the right combination of contrasting colors, but by the skillful association of various shades of the same color. The importance and position to be allotted to the dominant colors must be thought out carefully.

"Green is the foundation of all gardens. Other colors may come and go but, so long as the vegetation retains a vestige of life, green is bound to predominate, though it tints the foliage, not the flowers. To the uneducated eye all green looks alike, but to the trained observer it includes an infinite number of different shades varying from the pale gray of the mullein leaf to the rich purplish bronze of the galax. As a foil and as a background the foliage of a plant, apart from its flowers, should weigh in the decision as to its location.

"Now as to the arrangement of flower colors. An easy road to success is to begin by selecting only flowers of the same color and of such shades as will go together anyhow and anywhere. Then, if accidents occur and a plant strays from its appointed place, no harm results.

"Blue (varying from pale lavender to indigo and the deepest purple) is the best color for this experiment. In Summer, when green is invariably the predominant hue of the landscape blue is its most agreeable complement. Besides, few shades of blue are apt to swamp each other, though they do not go equally well together.

"Yellow is more dangerous to use

freely. Masses of deep yellow or orange are too glaring to be agreeable in the foreground; only the paler lemon shades can be employed in large quantities, yellow is apt to become too prevalent.

"Red is peculiarly difficult to handle successfully. There are certain of its shades which are almost sure to strike a false note in any symphony of color — intense magenta, crude vermilion and fiery orange-scarlet are so hard to assimilate that it is better to omit them altogether in the beginning. Salmon-pinks and maroon-reds are far more satisfactory.

"In small quantities white is excellent, but a little goes a long way. A pre-eminently white garden is rather flat and uninteresting. It is better as a contrasting accessory than as a dominating color. Also it is useful in bridging over a transition or graduation from one color to another.

"Contrast, cleverly introduced, enhances the value of every color. Blue becomes bluer and red, redder, when foiled against pure white. Look at Madonna lilies beside larkspur. Where red is used in such large quantities that it might pall upon the eye, it is delightfully relieved by an admixture of blue. The beauty of vast fields of red poppies, mingled with blue cornflowers, never fails to command admiration. Purplish irises and yellow day-lilies are also a familiar but always pleasing combination.

"The height of this kind of art is to know when and where to introduce a dash of harmonious discord. Just the right amount of discord in the proper place adds a touch of piquancy to the composition, as salt to meat. Large

beds of Shirley poppies, for instance, are prettier for including both salmon and rose-pink, both crimson and scarlet. Yet, under other conditions, these shades are impossible to combine. Indeed, harmonious discord is the last expression of color in the garden and should not be attempted by an amateur."

Size of Masses.

The scale in proportion of grouping the plants must be given serious consideration. If we are planning our borders for an arrangement of color the first thing we must consider is to get general effect. Individual specimens, although they may be beautiful, must be sacrificed if they catch the eye too forcibly. Bold planting is always best and plants should be grouped in numbers of the same kind, varying in quantity according to the size of the garden border. Large groups of plants can be massed and repeated at intervals, if desired, but parallel lines should be avoided as far as possible.

Planting the Border.

The old-fashioned border, when only a few bulbous plants were used, is a thing of the past. The modern border must contain a liberal supply of all kinds of bulbs and all sorts of hardy herbaceous plants which will give a continuous show of blossoms from early Spring until the end of October. The charm of a border like this is its changeableness. One has not to look at the same picture for more than one week or sometimes for not more than one day. Our border is never tiresome, its past is a pleasant memory, its future a delightful anticipation and its blossoms an accurate calendar of



PEONIES

All the standard varieties of the large flowering sweet-scented chinensis section; pink, white, crimson, blush, scarlet, etc.

\$5.00 and \$6.00 per 100

for any color, or assorted.

Fancy varieties of Peonies, of unusual color and form.

\$8.00 per 100

Festiva Maxima, and novelties in Peonies, the choicest coming to this market:—

\$10.00 and \$12.50 per 100

American Beauty Roses

Our growers have made special preparations and will have an ample supply of the choicest long stemmed flowers.

SPECIALS.....	\$2.50 per dozen
.....	2.00 per 100
FANCYS.....	2.00 per dozen
.....	18.00 per 100
EXTRAS.....	1.75 per dozen
.....	12.50 per 100
FIRSTS.....	1.50 per dozen
.....	10.00 per 100
SECONDS.....	8.00 per 100
THIRDS.....	6.00 per 100

Decoration Day Orders.

WE will be exceptionally strong on Peonies and American Beauty roses this year. Crops just on time and of the highest quality. Place your order as much in advance as possible.

Sweet Peas

The most popular low priced flower for this season, filling admirably the violet gap.

.50, .75 and \$1.00 per 100; all colors.

S. S. PENNOCK-MEEHAN CO.

The Wholesale Florists of Philadelphia
1608-1620 Ludlow Street

RIBBONS

For commencements and weddings. We mention a few. Send for our illustrated catalogue for complete list.

PATTERN KILLARNEY Exact Match for the Killarney Rose

No. 7 width.....	price \$o./5
No. 36 width.....	" 1.15
No. 22 width.....	" 1.35
No. 49 width.....	" 1.70
No. 76 width.....	" 2.25
No. 102 width.....	" 2.75
No. 150 width.....	" 3.50

PATTERN 1614

Exact Match for the Am. Beauty Rose, shaded effect exactly like the flower.

No. 49 width.....	price \$2.00
No. 80 width.....	" 3.00

Gauze for Shower Bouquets. Chiffons all Widths and Colors. New Combination Ribbons for All colors of Sweet Peas. Samples on Request.

Weekly Price Current

This contains weekly quotations of all the leading market flowers at date, Roses, Carnations, Orchids, Gardenias, Lilies and the minor subjects according to season. Every florist should be on this list. Write for copy.

the seasons. There is a continual change of flowers. It is here where the herbaceous border has the advantage over the bedding system. Not only is the frequent changing of the flowers of special interest, but in early Spring to a keen observer the color effects of the young foliage and stems are quite conspicuous and very interesting. The herbaceous border comes nearer nature's way of doing things than the bedding system, hence the reason why we enjoy it so much.

Background and Location.

No doubt a herbaceous border is more attractive and gives more satisfaction when it has a suitable background. A background of shrubbery is always pleasing, but such a background is not always procurable. There is one precaution which one should always take and that is to see that the border is not near large trees. Otherwise there is sure to be failure and disappointment. The roots of the trees get into the border and steal the food from the plants. The strong-growing kinds soon become weak and sickly and fail to give the expected show of flowers.

The outline of the border is not of so much importance, but the one that gives the most satisfaction is one where the lines are uneven or sinuous.

Best Kinds of Soil and Its Preparation.

After selecting the location the next consideration is the soil. If of moderate depth, any kind of soil will grow the plants; that is, many of the kinds, provided that plenty of manure is given; but a deep loam, if well trenched, of medium texture that does not need an annual supply of manure

is the best. Of course, all have not such a soil at their command and therefore recourse must be had to supplying the most suitable ingredients to the varying soils that have to be dealt with. A deep loam, if well trenched and given a good dressing of well rotted manure, will need little, if any, other dressing for four or five years. This is of great importance, both as regards saving labor and well doing of the plants, as many kinds of herbaceous perennials attain their most perfect development when left undisturbed for years. The only safe way to enrich the border during this long period is to give it a liberal top dressing late in the fall of well rotted stable manure. The snow, frost and rain will wash most of the top dressing into the soil before the plants begin to grow. We like stable manure much better than commercial fertilizers as it is much more lasting and gives better results. Clay soils should be trenched at least two feet deep, and plenty of leaf soil worked in with manure.

Replanting the Border.

Every fourth or fifth year we dig all the plants from our herbaceous borders and trench the ground. In this process of trenching the earth is completely turned over to the depth of two feet and we work into the soil a liberal supply of well rotted cow manure. In turning over the soil to this depth it gives an opportunity to remove all roots and weeds from it. Not only does the soil need enriching but there are many of the strong growing kinds of herbaceous plants that need lifting and breaking up. The

plants are degenerate, the growth becomes weak, the flowers small and few in number; examples of such are phloxes, larkspur, asters, rudbeckias and chrysanthemums. When overhauling the border in this way there are many plants that require just as careful handling as if moving a large tree. The plants are very sensitive to rough handling and, if not done with care, they do not grow or flower as well for some time afterwards. Examples of such plants are Adonis vernalis and Statice latifolia. Clematis recta if not lifted and planted with care does not grow more than eighteen inches the first season, whereas it ought to grow four feet. The best time to do this kind of work is in September. The nights begin to get cool then, we are liable to get showers, the soil has not lost any of its warmth and the plants are able to make new roots and growth before Winter sets in.

How to Arrange the Plants.

In planting our borders we try to get the tallest plants near the back and are careful not to get plants of the same height to follow one another, as an uneven line when the plants are fully grown is much more pleasing. We work the smaller plants to the front where they have not to struggle with the tall-growing kinds and, as they are mostly all lovers of sunshine, in such a position they have a much better chance to get sufficient light.

Of late years we have adopted the system of setting the large plants in the back rows about four feet apart and in the spaces between we grow large colonies of bulbous plants.

A MODERN METHOD OF GRAFTING CACTUS, ETC.

We note in Die Gartenwelt a method of grafting Epiphyllum truncatum on stems of Pereskia aculeata. The time of year chosen is that customary in this country, viz. January and February, at which period the plants are at rest, and require but little moisture. The grafts are simply attached by applying the two surfaces of stock and scion together. The stock is grasped firmly at a point 8-10 inches above the soil, and a cut made slantingly over a bud, and the thorns found at that height are carefully removed, and in order that the scion may be readily attached the leaf is cut off. The scion should be round and of the same size as the stock, and it must be cut slantingly in like manner; having done this the two surfaces should be placed together and a pin of some metal other than steel, run through both so that they are held firmly, and be bound carefully with thin bast, and then tied to a stick, and the pin removed. In this manner 8-12 scions may be worked on a plant. The grafted plants should then be laid in a sloping manner on the propagating bed, the tops being somewhat raised. In bright weather shade is required, and a moderate amount of moisture applied. In about three weeks the union is complete; and the young shoots formed on the stock may be removed, and struck as cuttings if such are wanted. After a few weeks, the leaves on the stock are cut off, and if necessary the ligatures, and air is afforded. The plants may be placed on a shelf or stage in an intermediate house, so that new shoots may develop on the crowns. In the middle of the month of May place the plants in a lukewarm frame and later report them. As a pottling compost a friable soil consisting of two parts decayed wood, if possible that of decayed bark, one part leaf mould, and one part dung bed soil. Good drainage is very essential. The plants should be ventilated, syringed and shaded according to their needs. They will in the course of the summer make pretty little bushes. About the middle of September, a warm, light house or pit should be cleared for them, and at the beginning of October they will be showing their flower buds, which in early flowering species develop with rapidity. At this period the plants should be afforded water regularly, and must not be allowed to become dry at the root, or be exposed to the fumes of smoke or to gas, or the buds will drop.

Epiphyllums are much too seldom grown. The old method of wedge grafting seldom affords compact crowns, and several years go by ere a good plant is developed. Owing perhaps to this lack of knowledge of a more rapid method, the Epiphyllums have retreated into the background as saleable subjects. They are however paying plants in the winter months, good for the decoration of rooms, and readily acustoming themselves to the prevailing conditions. Early flowering varieties are E. alba violacea, violacea grandiflora, and violacea andillora superba; the last named two having long extended large flowers, coming in abundance, in November. E. truncatum,

CHRYSANTHEMUMS

We have the following ready for immediate delivery, which are the best for Commercial use. We do not include the Exhibition sorts, but will be pleased to quote those desiring such.

25 of a kind at 100, 250 at 1000 rate.

EARLY

- Clementine Tonset**—Second early white, Oct. 20.
- Early Snow**—Similar to Polly Rose, Oct. 10.
- Glory of Pacific**—Pink, Oct. 15.
- Ivory**—White, very popular, Oct. 20
- John K. Shaw**—Ball shaped pink, Oct. 5.
- Maorovia**—Best second early yellow, Sept. 25.
- Miss A. Byron**—Ball shaped white, second early.
- October Frost**—Earliest large white, Oct. 10.
- Pink Ivory**—Second early pink.
- Polly Rose**—White sport from Pacific.
- Robert Halliday**—Light yellow, Oct. 20.

MIDSEASON

- Col. D. Appleton**—Best commercial yellow, Nov. 1.
- Dr. Enguehard**—Pink, easy doer, Nov. 10.
- Major Bonaffon**—Incurred light yellow, Nov. 1.
- Mayor Weaver**—Bright pink, Nov. 10

LATE

- Helen Frick**—Best bright pink, Nov. and Dec.
 - Mlle Jeanne Nonie**—Largest white, Nov. & Dec.
 - John Burton**—Latest pink, Dec.
 - Minnie Bailey**—Pink, Nov. 20.
 - Mrs. J. Jones**—Incurred white, Nov. 15.
 - White Bonaffon**—Incurred white, Nov. 15.
 - Yellow Mrs. Jones**—Sport from Mrs. Jones, Nov. 15
- Price—Plants, \$3.00 per 100; \$25.00 per 1000.
R. C.—\$2.00 per 100; \$17.50 per 1000.

- Alma**—Soft Lavender.
- Eno**—Small bright yellow.
- Iva**—Amber.
- Keut**—Dwarf Yellow.

Price—Plants, \$3.00 per 100; \$15.00 per 1000.

MIDSEASON

- A. J. Balfour**—Dwarf bright pink, Nov. 10.
- Mrs. E. D. Smith**—Dwarf incurred yellow, Nov. 1.
- P. E. Roosevelt**—Lac, white, pink center, Nov. 15.
- Sunburst**—Thanksgiving yellow.

LATE

- Intensita**—Bright crimson, Nov. 10.
 - Veneta**—Incurred white, late bud, Dec. 1.
 - W. H. Chadwick**—Incurred white, Nov. and Dec.
- Price—Plants, \$4.00 per 100; \$35.00 per 1000.
R. C.—\$3.00 per 100; \$25.00 per 1000.
- Beatrice May**—Very large white, Oct. 20.
- Price—Plants, \$5.00 per 100; \$45.00 per 1000.
R. C.—\$4.00 per 100; \$35.00 per 1000.

NEW AND SCARCE SORTS

- Golden Glow**—Best early yellow, Aug. to Oct.
- Price—Plants \$4.00 per 100; \$35.00 per 1000.
Routed cuttings, \$3 per 100; \$25 per 1000.
- Pacific Supreme**—An Improved Pacific, Oct. 15.
- W. J. Crossley**—A crimson to follow Intensity.
- Price—Plants, \$6.00 per 100; \$50.00 per 1000.
R. C.—\$4.00 per 100; \$35.00 per 1000.
- Chadwick Improved**—Pure white.
- Mrs. J. Boxall**—Incurred pink late.
- Price—Plants only, \$2.00 per 100; \$15.00 per 1000.
- Pees, Taft**—Fine incurred white, Nov. 1.
- Gloria**—Enchantress pink, Oct. 10.
- Mrs. W. E. Kelley**—Late bright yellow, Nov. 15.
- Price—Plants only, \$4.00 per 100; \$35.00 per 1000.

POMPONS

Routed Cuttings, \$2.50 per 100; \$20.00 per 1000.

We have many other varieties in stock; if the foregoing does not supply your need send us a list of your wants. For more complete description see our Catalogue which gives best bud, height of plant and flowering period.

IT IS FREE ON APPLICATION.

ELMER D. SMITH & CO., Adrian, Mich.

ADIANTUM CUNEATUM, strong 4 in. pot plants, re dy for shift, \$8.00 per 100.

CHRYSANTHEMUMS, leading varieties, 2 in., \$3.50 per 100, \$20.00 per 1000.

MARANTHA HASANEGANA, fine for ferneries, \$6.00 per 100.

FICUS ELASTICA, 5 in. pot plants, 10-24 in. high, \$10.00 per 100.

IVY GERANIUMS, strong 2 1/2 in. pot plants, **Souv. de Charles Turner** and **Jeanne d'Arc**, \$3.00 per 100.

SALVIA ZURICH, Fireball, **Baron Prince**, **Clara Bedman**, **Spindens**, 2 in., \$3.00 per 100, \$25.00 per 1000; 3 in., \$5.00 per 100.

FUCHSIAS, 12 varieties, 2 1/2 in., \$2.50 per 100, \$20.00 per 1000.

COLEUS YERSCHAFFETTI and **GOLDEN CROWN**, 2 in., \$2.50 per 100, \$20.00 per 1000.

LANTANAS, strong 2 1/2 in. pots, \$3.00 per 100.

BEGONIA ERFORDIA, **Vulcan**, **Vernon**, fine for pots or bedding, \$2.50 per 100, \$20.00 per 1000.

DATHIUS, well established pot plants, all leading varieties, \$3.50 per 100.

BEGONIA REX, 2 1/2 in., in pots, \$4.00 per 100.

The STORRS & HARRISON GO.
PAINESVILLE, O.

and truncatum multiflorum, both having pendant growths and rich red flowers are later in blooming. E. spectabilis rosea with a pendant habit of growth, and short stubby flowers, and pretty little heads, and E. purpureum, with dark green stems, an extraordinary fast grower, and somewhat pendant habit, having bright purple flowers, are useful decorative plants. Others of the genus deserving of attention are E. Ruckeriaenum; Harrisoni; salmonum album and rubrum, the last two being miniature, small-flowered varieties, with pendant growth. E. tricolor blooms freely and is a beautiful variety, as likewise E. Gaertneri. E. phyllantoides with rose-colored flowers, coming early in the year, and flowering three to four times annually, is a valuable plant. It seeds

freely, and is for that reason good for crossing with others.
FREDERICK MOORE.

kentias, Arecas, Latanias, Cocos, Phoenix, Araucarias, Rubbers, Crotons, Pandanus, Asparagus, Ferns for Dishes.

200,000 Bedding Plants, also Routed Cuttings of Coleus at lowest wholesale rates.

Orders taken for imported plants for fall delivery

A. LEUTHY & CO.
PERKINS ST. NURSERIES
ROSLINDALE, MASS.

**HEADQUARTERS FOR THE STOCK YOU WILL NEED
FOR YOUR DECORATION DAY TRADE**

**PRICES WILL BE RIGHT!
SO WILL THE STOCK**

You know that if you have been one of our customers. You WILL know if you become one now.

EVERYTHING IN SEASON

J. A. BUDLONG, 37-39 Randolph St., CHICAGO

IPOMOEA NOCTIFLORA

Best pure white moonvine in the market, very fragrant and as big as a saucer. On this variety we have a world-wide reputation as growers and shippers for the last twenty years.

Price, 2 1/2 in. pots, \$5.00 per 100.
10,000 are now ready.

Godfrey Aschmann

1012 West Ontario St., Philadelphia, Pa.

THE BOSTON VIOLET

Unequaled for Productiveness, Beauty and Popularity.

In Crop from September to May.
Plants \$3.00 per doz. \$12.00 per 100; \$100.00 per 1000.
Princess of Wales \$15.00 per 1000.

WILLIAM SIM, Cliftondale, Mass.

Begonia Gloire de Lorraine

Leaf Stock, June Delivery, \$15 per 100,
\$145 per 1000, from 2 1/2 in pots
Stock guaranteed to be absolutely free from disease.

THOMAS ROLAND, NAHANT, MASS.

**The Northboro Dahlia and
Gladiolus Gardens**

Offer for Spring 1909
500 selected varieties of Dahlias and one and one half million large-flowering Gladioli in mixtures, in lots to suit. Send list of your wants. Catalogue free

J. L. MOORE, Northboro, Mass

DAHLIAS. Now is the time to place your order for bulbs which will insure you getting named varieties in any quantity; prompt delivery.

DAVID HERBERT & SON,
Successors to L. K. Peacock, Inc.
ATCO, N. J.

In ordering goods please add "I saw it in HORTICULTURE."

GERANIUMS, DAHLIAS AND BEDDING PLANTS

We have one of the most complete collections of Geraniums in the country, containing every color and type found in the Geraniums. Every one of our 75 Standard Varieties at \$2.00 and \$3.00 per 100 are Bred and Butter Winners, and among our 34 New Varieties of special merit are some that are going to fix the standard in the future. Every one is a Gem, not high in price, only \$1.00 and \$6.00 per 100.

Our Novelties should, coming as they do from the leading introducers of the world, represent the highest development of Geraniums at the present time. A collection of 100 Varieties, our selection of 1907 and 1908 Novelties, will be sent for \$10.00.

Special Offer of 1000 good, strong plants from 2 in. pots, our selection of 20 distinct kinds from among our Standard and Newer Varieties, for \$15.00 cash. From 3 in. pots \$3.00 per 100, \$25.00 per 1000, in a good assortment.

CANNAS

Strong plants from 3 in. pots. J. D. Elsie, Egandale, Alphonse Bouvier, Mme. Crozy, and Florence Vaughn, \$4.00 per 100. Jenn Tissot, President Myers, Louksana, Pennsylvania, \$5.00 per 100.

DAHLIAS

We have one of the finest collections in the country of good distinct Commercial Varieties at \$2.00 per 100 and up for plants ready for shipment. Then we have Jack Rose, Virginia Maule, Big Chief, Rose Pink Century, Fringed 20th Century, Rebecca Mayhew, etc., at 50c. each, \$5.00 per doz., \$35.00 per 100. We will seed 1000 in 20 good distinct Cut Flower Sorts, our selection, for \$18.50.

See issue of April 24th of Our Wholesale Catalogue for complete list of Bedding plants.

R. VINCENT, JR., & SONS CO., White Marsh, Md.

ROSE PLANTS

Fine, Strong, Healthy

3-inch pots		2 1/2-inch pots	
American Beauty	\$7.00	American Beauty	\$5.50
Richmond	4.00	Richmond	3.00
Chatenay	4.00	Chatenay	3.00
Ivory	4.00	Ivory	3.00
Bride & Maid	4.50	Bride & Maid	3.50
Asp. Sprengerii	4-in. pots, \$8.00 per 100.		
Asp. Plumosus	3-in. pots, 5.00 "		
Smilax	3-in. pots, 4.00 "		

UNITED STATES CUT FLOWER CO., Elmira, N. Y.

THE WORLD'S BEST DAHLIAS

The following speaks for international confidence in the merits of Peacock's New Dahlias. A CONFIDENCE NEVER BETRAYED.

Messrs. Peacock, New Jersey, Rothasay, 25th April, 1909.

Dear Sirs:—We are favoured with a copy of your Dahlia catalogue and will thank you to send us carefully packed by post,—
4 plants of new Dahlia Jack Rose, and
4 plants of Virginia Maule.

We hope that these will travel safely as we would like to try these new varieties.
Yours faithfully,
DOBBIE & CO.

Every Seedsmen and Florist will consult their best interest in sending for our catalogue of "NEW CREATIONS IN DAHLIAS," NEW DECORATIVE SHOW, PANSY, ART OR PANSY-FLOWERED, CENTURY and CACTUS DAHLIAS.

Guaranteed just as represented. Reference—National State Bank, Camden, N. J.

PEACOCK DAHLIA FARMS, Williamstown Junction, N. J.

JAPANESE
THE YOKOHAMA NURSERY CO.
31 BARCLAY STR. NEW YORK.
LILIES
PLANTS
BAMBOO STAKES

JULIUS ROEHRS CO., RUTHERFORD N. J.

Large stock of Bay Trees, Box Trees, Blue Spruce, Choice Evergreens, etc., all in finest condition.

Palms, Stove Plants, Begonias, Hydrangeas in all sizes and prices.

ORCHIDS

Fine assortment on hand of both newly imported and semi-established.

LET US QUOTE YOU PRICES.

FORESTRY AT MASSACHUSETTS AGRICULTURAL COLLEGE.

From the beginning the Massachusetts Agricultural College has paid considerable attention to forestry. Courses of lectures have frequently been given, prizes offered and interest aroused in other ways. A considerable number of graduates from the institution have gone into forestry work and some of these are recognized today as amongst the leading professional foresters of the country. Nevertheless, there has been a strong feeling in recent years that the college ought to do more for forestry, and that in particular there should be established permanent courses dealing with modern professional forestry and forest management.

While something still depends upon the action of the present legislature, matters have progressed far enough now to make it seem fairly certain that the work can be opened up to advantage this coming autumn, with the opening of the fall semester, September, 1909. The plan is definitely to establish a complete and permanent department of forestry in the Division of Horticulture. President Butterfield and Professor Waugh have been for some months engaged in a quiet search for a suitable man to head this department. While the man has not been selected, there are two or three very promising candidates in view. No serious trouble is anticipated in securing a good man for the work.

The present plan is to offer two straight years of professional forestry. These will be given in the form of elective courses covering junior and senior years, and will have very much the same standing in the college curriculum as landscape gardening and botany now have. The courses will be available, therefore, not only to men who wish to become professional foresters, but a certain amount of the work can be elected by landscape gardeners, tree doctors, farm managers, or any other students who, for any reason, are interested in forestry. In all probability some short courses will also be given. Professor F. William Hancock, state forester, will continue on the staff of the college faculty as lecturer in forestry and will assist the department in various ways.

The courses of study proposed, though strictly professional and reasonably complete in themselves, are not expected to duplicate the work done at such forestry schools as Harvard and Yale. The work in those in-

stitutions is post graduate in character, while at Massachusetts Agricultural College, the courses will be of undergraduate grade. Furthermore, a definite understanding has been secured between the Massachusetts Agricultural College and the two institutions named looking toward direct cooperation. It is expected that men who take forestry courses at M. A. C. and afterward go to Yale and Harvard forest schools will receive full credit for such courses.

The establishment of this new department means a decided advance. It is a big undertaking, but one which is sure to succeed because of the widespread interest in forestry.

BOOM THE CHRYSANTHEMUM SOCIETY.

Editor of HORTICULTURE:

Dear Sir:—As a member of the Chrysanthemum Society of America I wish to express my appreciation and extend my hearty support to President Smith's appeal for an increase in membership of that organization. Mr. Smith very truly points to the benefits conferred to the growers of chrysanthemums generally by the work of the C. S. A. and its committees. And while he does not do so he undoubtedly could have offered practical suggestions which if acted upon would materially increase the benefits conferred. The work of the organization may not be above criticism (if you happen to know anything in the universe that is, please hold up your hand) and sincere criticism is solicited. But standing off with your hands in your pockets and criticising the other fellow, seldom accomplishes anything. In traveling the highway of human progress, you have probably noticed that it is pretty generally up hill, and for every one that is willing to give a helping hand to push the benzine buggy, there are nine who meander contentedly along, either doing nothing themselves or ridiculing the efforts of those who are, but ready to get in and ride as soon as the machine decides to go, or the top of the hill has been reached and there is prospect of a comfortable coast down the other side.

Perhaps it may seem like imposing upon good nature to ask it, but will not each member of the C. S. A. make a special effort to get at least one new member during the remainder of the year? I will guarantee to send one myself.

I. L. POWELL.

Millbrook, N. Y.

NEWS NOTES.

Seattle, Wash.—According to the annual report of the State Commissioner of Horticulture, a total of 1,186,470 packages of fruit grown in the state were taken by the Seattle market. In apples alone Seattle took 468,917 boxes as compared with 75,600 boxes taken by Tacoma and 62,169 boxes taken by Spokane.

Rochester, N. Y.—The McCollom tract of 120 acres has just been purchased by the Champlain Realty Company, a subsidiary company of the International Paper concern whose agent has charge of all its woodlands and proposes to use this tract as a nursery for raising Norway spruce and pine. 600,000 seedlings will be planted this year, and it is the plan to plant this number every year, at the end of four years transplanting them in the field, thus maintaining a steadily growing supply of spruce and pine. The forestry policy of this company may well be studied by many owners of waste lands so called.

“Right on the Spot —That's All”

Variegated Periwinkle, out of 4-in. pots, strong	\$8.00
Variegated Periwinkle, out of 2-in. pots	2.50
Variegated Periwinkle, Rooted Cuttings00
Clematis Paniculata, out of 4-in.	10.00
Clematis Paniculata, out of 3-in.	5.00
Clematis Paniculata, out of 2-in.	2.00
Lobelia, Dwarf Blue, strong, out of 3-in.	3.00
Cobaea scandens strong plants, out of 4-in.	8.00
Stevia, variegated, out of 2-in.	2.00
Alyssum, very dwarf, out of 3-in.	3.00
Lobelia, Dwarf Blue, strong, out of 3-in.	3.00
Single Petunias, dwarf, out of 3-in.	3.00
Ageratum, blue, dwarf, out of 3-in.	3.00
Dracopis Andivisa, out of 2-in.	2.00
Finest varieties of Geraniums, extra fine, out of 4-in.	7.00

Cash with order.

SAMUEL V. SMITH
3323 Goodman St., Philadelphia, Pa.

FOR SALE

FOUR EXTRA LARGE

Latania Borbonica Palms

From 10 to 12 feet high and spread; in cypress boxes. Also six smaller **LATANIA PALMS** in boxes. All splendid specimen plants. Can ship by freight after May 1.

JOHN RALPH Saratoga Springs, N. Y.

PERENNIALS POT AND NURSERY GROWN

**Big Plants
Little Money**

We have a surplus of the following sorts in perfect condition for planting out. The field plants can be liberally divided for growing on for next Fall and Spring sales, which affords a rare opportunity of getting up a stock of these very saleable and popular Old Fashioned Flowers at smallest cost. Many of these are quoted elsewhere (wholesale) at \$15.00 per 100. Our price as long as they last \$5.00 per 100, 75c per dozen except where otherwise noted. No less than twenty-five of one variety at 100 rate or 6 at dozen rate. *F* means field grown, 2 in., 2½ in. and 3 in. means measurements of pots in which they are growing.

Achillea
Cerse Queen F
The Pearl F and 3 in.
Tomentosum F

Agrostemma Cor. F

Ajuga Reuevensis F

Antemis Kelwayii F

Aster Perennial
to ten best sorts F and 2½ in.

Andreibita Hendersonii 2 in.

Bocconia Cordata F

Campanula
Albiflora F
Latiflora F
Media 3 colors 3 in.
Pasciflora F
Pyramidalis 3 in.

Chelone Glabra and Lyonii F

Daisy Shasta 3 in.

Dalphinium
Formosum Hybrids 3 in.
Chinensis Wh. and Blue 3 in.

Eupatorium Ageratoides F

Goelostimum F and 3 in.

Gaillardia Grandiflora F

Grasses
Eulalia Univita F
Phalaris Arundin. F

Helenium Autm. Sup. F
" **Gran. Stria F**
" **Hoopsil F and 3 in.**

Helianthus
Maximiliana F
Mollis Grandifl. F
Multiflorus Pl. F and 3 in.
Miss Mollis F

Heliosis Frutcher F

Hemerocallis Flava F
" **Thunbergii F**

Heuchera Sangulnea F and 3 in.
" **Alba and Rosea F**
Hibiscus Moschatua F
Hollyhock Dil. and Sgle. F
Iris Japan mix. F
Lobelia Cardinalis F
Lupinus Poly. Roseos 3 in.
Lycnis Chalcid F
" **Semperflorens 3 in.**
" **Viscaria splen. F**
Lythrum Roseum Sup. F
Mouraria Didyma Spl. F and 3 in.
Myosotis Palus. Semp. 3 in.
Nepeta Glechoma F and 3 in.
Oenothera Youngii F
Papaver Orientalis 3 in.
Penstemon
" **Earhart Torreyi F and 3 in.**
Phlox
" **Decussata 20 sorts F**
" **Suffru. Miss Lingard F**

Platycodon Grand. F

Rehmannia Angulata 3 in.

Rudbeckia Autm. Glory F

Salvia Pitterii 2½ in.

Santolina Incana F

Spirea Japonica F
" **Palmaria F**
" **Elegans F**
" **Venusta F**

Sweet William
" **Barbatus 3 in.**
" **Lat. Atro. fl. pl. 3 in.**

Veronica
" **Long. Subsessilis F and 3 in.**
" **Spicata F and 3 in.**

Vinea Minor field clumps

Viola
" **Double English 3 in.**
" **Princess of Wales 3 in.**
" **Wallflower English 2½ in.**

HERBS AND A FEW OTHERS WE ARE OFFERING AT 50c per doz. \$3.50 per 100

Chrysanthemum
Hardy Pompon and Hardy Ig.
Flowering 2½ in. in 20 sorts

Delphinium
Formosum Hybs. 2 in.

Epilobium
Augustidolum F

Euphorbia
Ceruleata F

Funkia
Albo Marginata F

Herbs
" **Chives F and 3 in.**
" **Lavender 2 in.**
" **Mentha Spearmint 3 in.**
" **Peppermint 3 in.**
" **Folia Var. 3 in.**
" **Rosemary 2 in.**

Herbs
" **Sage Holt's Mam. F and 2½ in.**

Pardanthus Chinen F

Physostegia Virginica F
" **Alba F**

Phlox Subulata 3 colors F

Polygonum Cuspidatum F

Pyrethrum
" **Roseum Hyb. Grand 2 in.**

Rubackia
" **Submontana F**
" **Golden Glow F**

Sedum Taxima Alba F

Tradescantia Vir. Alba F

Viola Cornuta 4 colors 2½ in.

PALISADES NURSERIES, Inc., SPARKILL, N. Y.

GROWERS OF HARDY PLANTS

Ampelopsis Quinquifolia

Per 1000
Strong 1-year plants 2 to 3 ft. \$20.00
" 2-year " 3 to 4 ft. 30.00
" 3-year " 4 to 6 ft. 55.00

TO THE TRADE ONLY
A Full Line of General Ornamental
NURSERY STOCK
SEND FOR CATALOGUE

EASTERN NURSERIES
JAMAICA PLAIN, MASS.
HENRY S. DAWSON, Mgr.

**RHODODENDRONS, ANDROMEDAS, KALMIAS
AND SPECIMEN EVERGREENS**

JOHN WATERER & SONS, Ltd.
AMERICAN NURSERY

BAGSHOT - - - ENGLAND

ROSES
A SPECIALTY

The Dingee & Conard Co., West Grove, PA.

Box Trees
and other EVERGREENS for Tubs and Boxes
Our Prices are Always Right—Catalog Free

THE NEW ENGLAND NURSERIES, Inc.
BEDFORD, MASS.

BEAUTIFUL PURPLE LEAVED JAPAN MAPLES

Fine plants from tubs about 2 3 ft. in height shipped with ball, ensuring perfect success in transplanting—\$2.00 to \$3.00 each. Now is the time to plant.

ELLWANGER & BARRY, MOUNT HOPE NURSERIES Rochester, N. Y.

ORDER NOW

Pink of Condition for Memorial Day

Upwards of 40,000 Hydrangea Otaka, 4, 5, 6, 7 and 8 in. pots, price first lead 2 c. and 10c each additional lead. Strong 2½ in. stock for growing on \$3.00 per 100; \$3.50 per 100.

Dracena Indivisa, clean thirty plants, 3 in., \$6.00; 4 in., \$12.00; 5 in., \$22.50; 6 in., \$45.00 per 100.

Rose Plants, well rooted stock out of 3 in. (Bride, Bridesmaid, Ivory Uncle John and Golden Gate), \$4.00 per 100; \$35.00 per 100.

Hydrangeas. Specimen plants in tubs for late flowering. Write for prices.

F.O.B. Packing Free Our Station

HATCHER Amsterdam and Schenectady, N. Y.

Hardy Rhododendrons, Azaleas, Conifers, Clematis, H. P. Roses, Shrubs and Herbaceous Plants from our HOLLAND NURSERIES

Prices Moderate

P. OUWERKERK, 216 Jane St., Weehawken Heights F.O. No. 1, Hoboken, N. J.

American Grown Roses

Fruit and Ornamental Trees, Shrubs, Small Fruits, Clematis, Evergreens.

Write for Trade List.

W. & T. SMITH CO.
Geneva, N. Y.

Cannas

Dry roots: Italia, Cleveland, Austria, Egandale, Marlborough, America, Penna, Black Beauty, \$1.50 per 100. Kate Gray, mixed with red, \$1.25 per 100. Asparagus Sprengeri, 2 in., \$1.75; 3 in., \$4.00; 4 in., \$6.00 per 100. Dracena indiv. 4 in., 10c. English Ivy, 2 in., \$2.00; R. C. 75c per 100. Rex Begonia, 2 in., 3c.

H. DANN & SON, WESTFIELD, N. Y.

Seed Trade

AMERICAN SEED TRADE ASSOCIATION.

Watson S. Woodruff, Orange, Conn., Pres.; J. C. Robinson, Waterloo, N. Y., First Vice-Pres.; C. E. Kendel, Cleveland, O., Sec'y and Treas. Twenty-seventh annual convention June 22-24, 1909, at Clifton House, Niagara Falls, Ont.

WHOLESALE SEEDSMEN'S LEAGUE.

F. W. Bruggerhof, Pres.; Burnet Landreth, Sec'y.

Unfavorable Weather Conditions.

Occasional complaints of seeds rotting in the ground are drifting in, and the number of such complaints are likely to be legion as the weather could not better serve that purpose than the assortment we have been getting for several weeks. As a rule complainants are not considerate enough to admit that the failures in germination are due to the weather, but charge such failure directly to the seeds. Explanations are usually ineffective, and though veteran seedsmen may consider themselves immune, the manner in which many of these complaints are made is, to be very mild, most irritating. It goes with the business, however, and there is no escape.

Planting Delayed.

From numerous reports received during the past week, things are not going serenely in the planting of seed crops. Wisconsin and Michigan have been too cold and wet to permit the planting of peas, excepting in a very few instances, where small lots of Alaskas and other hardy peas have been "muddied" in, and these will prove largely a failure. As late as May 12th not ten per cent. of the peas had been planted. This means that they will blossom just at the hottest time of midsummer followed by the unavoidable blight. How serious this may prove none can say but it is causing growers some anxiety even now. Of course it may be all in the cards for the season to give us a bumper crop, but beyond dispute it starts under a decided handicap. Still let us hope for a fair crop, or a short one even, in preference to anything of the bumper order, as no greater misfortune could befall the growers than such a crop at this juncture, and particularly of the canners' varieties.

The Coming Convention.

Only a few weeks more and the seedsmen will gather at Niagara Falls, and they should have a most enjoyable time if good weather smiles on them. If it is only proverbial June variety nothing more can be asked—for "What is so lovely as a day in June?"

Retail trade continues active, but in lessening volume each week. It will be well into June before the business subsides, and it will be found one of the most prosperous the trade has ever experienced.

Personal.

Mr. and Mrs. Burpee are planning their third annual trip to Europe and it is said their two eldest boys will accompany them. This comes to us by wireless, but the sailing date is not known.

Howard M. Earl will start shortly on his annual or semi-annual trip to the Pacific Coast. It is said Mr. Earl may visit Europe on his return from the coast. While there is doubtless much enjoyment to be extracted from these trips, they mean hours and days of most strenuous physical and mental labor.

Notes.

Sioux Falls, S. D. The O. S. Jones Seed Co. have decided to build at once a re-enforced concrete building to cost about \$35,000. It will be three stories and basement, 44 feet front, 142 feet deep, and must be completed before November 1 according to the terms of the contract. Bids will be asked for as soon as plans are completed.

From the vicinity of Chicago we learn that some of the onion set growers in the Bowmanville district have been so delayed by the spring rains that they are only just able at this writing to get on their ground to plant it. In the neighborhood of Pullman and Riverside the ground is higher and more progress has been made. But while the season is late, still the old advice may safely be followed, "Plant onion seed while the cherries are in bloom."

Leesley Bros., growers of onion sets outside the Chicago limits on the south west, have only just completed their planting. The cold wet spring has greatly delayed this work. A little over one hundred pounds of seed to the acre is used, making an enormous aggregate on such a large place. They plant by means of a beet drill and by attaching four of these, are able to cover the ground very rapidly. Leesley Bros. are progressive young men. They have lately leased a tract of two hundred more acres to further extend their business.

CATALOGUES RECEIVED.

James Cocker & Sons, Aberdeen, Scotland.—Descriptive Catalogue of Roses, Border Plants, Shrubs and Trees.

Erhard-Frederiksen, Swindengegaard, Denmark.—Wholesale price list of cauliflower, cabbage, and turnip seeds and grains.

Barrett Manufacturing Company; address, all leading cities in U. S.—Illustrated book of Tarvia, the great dust-laying composition for roadways.

John Gerard, New Britain, Conn.—Wholesale Price List of Pansy Seeds. Mr. Gerard is probably the most widely known importer of high grade pansy seed in America. His list is exceedingly useful and every pansy grower should ask him for a copy. The product of seven of the best pansy specialists in Europe is represented.

PRIMULA SEED

PRIMULA CHINENSIS FIMBRIATA

	Tr. Pkt.	Tr. Pkt.
Alba Magnifica.....	\$0.60	\$1.00
Chilwick Red.....	60	1.00
Holburn Blue.....	60	1.00
Kermesina Splendens.....	60	1.00
Rosy Morn.....	60	1.00
Micheel's Prize Mixture, beautifully fringed varieties...	60	1.00

PRIMULA OEGONICA GRANDIFLORA

	Tr. Pkt.
Compacta.....	\$0.50
Fimbriata (1-16 oz., \$1.25).....	.50
Gigantea (Arends).....	.50
Kermesina (1-16 oz., \$1.50).....	.40
Rosea (1-16 oz., \$1.00).....	.30
White (1-16 oz., \$1.25).....	.30
Mixed (1-8 oz., \$1.00).....	.30

Write for our Wholesale Catalogue.

HENRY F. MICHELL CO.

1018 Market St.,

PHILA.

GREENHOUSES BUILDING OR CONTEMPLATED.

Napanee, Ind.—C. A. Doswell, one house.

Adams, Mass.—A. J. Boothman, one house.

Greenport, N. Y.—Augustus Ham, one house.

Baltimore, Md.—Hilpert & Hammen, one house.

Topsfield, Mass.—Bradley W. Palmer, one house.

Maquoketa, Ia.—Mrs. J. Odgers, three houses.

Kokomo, Ind.—L. A. Coles, one house, 35x300.

Cambridge, Mass.—Sidney Hoffman, carnation house.

Union Center, N. Y.—W. H. Davis, range of houses.

Benton Harbor, Mich.—C. Edinborough, one house.

Holly, Mich.—H. J. Green, enlarging and improving greenhouses.

Kalamazoo, Mich.—G. Van Bochove & Bro., four violet houses, each 22x300.

Ithaca, N. Y.—The State Legislature has appropriated \$30,000 for the erection of greenhouses to be built for the department of horticulture of Cornell University.

VEGETABLE PLANTS

BETS. Crosby, Egyptian and Eclipse, \$1.25 per 1000.

CABBAGE. Field Crown, all leading varieties, \$1.00 per 1000. 10,000 and over, 85¢ per 1000.

CELERY. White Plume, Golden Self Blanching and Giant Pascal, \$1.25 per 1000.

EGG PLANT. N. Y. Improved and Black Beauty, \$3.00 per 1000.

LETTUCE. Big Boston, Boston Market, Tennis Ball and Grand Rapids, \$1.00 per 1000.

PEPPERS. Ruby King, Bull Nose, Sweet Mountain and Neapolitan, \$3.00 per 1000. Chinese Giant and Cayenne, 50¢ per 1000.

CASH WITH ORDER

R. VINCENT, JR., & SONS CO.
White Marsh, Md.

Everything "For the Land's Sake."

The one firm in Boston where all good forms of plant food may be obtained, is the Bowker Fertilizer Company, opposite Faneuil Hall at 43 Chatham St. All greenhouse chemicals, Nitrate of Soda, Ground Bone, Potash Salts, Sheep Manure and Wood Ashes can there be had at first hands.

BOWKER FERTILIZER COMPANY

Everything "For the Land's Sake."

BEGONIAS TUBEROUS & ROOTED

ALSO
GLOXINIAS, LILY OF VALLEY, SPIREA

Catalogues mailed free on application
Joseph Breck & Sons Corp.
47-54 NO. MARKET ST., BOSTON, MASS.

BULBS OF QUALITY

Begonias, Single, under color.....	\$2.75
" Double	5.00
" Fritted	10.00
Gloxinias, under color.....	4.00
Pearl Tuberoses, \$7.00 thous.....	1.00

Schlegel & Fottler Co.
26 & 27 So. Market St., BOSTON, MASS.

Burpee's Seeds
PHILADELPHIA

Blue List of Wholesale Prices mailed only to those who plant for profit

Ward's Lily Bulbs

Send for Catalogue
 **Ralph M. Ward & Co.**
12 W. Broadway
NEW YORK

GEO. E. DOW
Designing and Illustrating
178 Washington St., Boston, Mass.
OUR SPECIALTY
Machine, Booklet, Advertising and Flower PHOTOGRAPHS

Primulas for Christmas

SOW SEED NOW

B's Matchless Giant, pure white; B's Matchless Giant, blush white; B's Matchless Giant, rose; B's Matchless Giant, scarlet; B's Matchless Giant, royal blue; B's Matchless Giant, mixed. Each 1-2 trade packet, 60c; trade packet, \$1.00.

Primula obconica gigantea Kermesina deep crimson. Primula obconica gigantea alba, pure white. Primula obconica gigantea lilacina, beautiful lilac. Primula obconica gigantea rosea, lovely pink. Primula obconica gigantea grandiflora, mixed, containing pure white to deep crimson.

Each of above 1-2 trade packet, 30c; trade packet, 50c.
Primula floribunda grandiflora (buttercup) 1-2 trade pack t, 30c; trade packet, 50c.
Forbesi (Baby Primrose). Trade packet, 25c. Primula Kewensis (Giant Buttercup) 1-2 trade packet, 60c; trade packet, \$1.00.

Seedsman
ARTHUR T. BODDINGTON, 342 W. 14th Street, New York

LEONARD SEED CO.

CONTRACT CROWERS AND WHOLESALE DEALERS
BEANS, PEAS, SWEET CORN, ONION, GARDEN SEEDS
ONION SETS Get Our Prices E. 79 and 81 KINZIE STREET, CHICAGO
FLOWER SEEDS

ESTABLISHED 1802

Thorburn's Seeds

FINE CLUMPS JAPAN IRIS
ASPARAGUS PLUMOSUS NANUS SEED
ASPARAGUS PLUMOSUS ROBUSTUS SEED

ROSA MULTIFLORA NANA SEED
and all other flower seeds for florists
SEND FOR CATALOGUE

J. M. THORBURN & CO.
33 Barclay Street
NEW YORK

Mignonette

FARQUHAR'S GIANT

Oz., 75c; 1-4 oz., 25c

R. & J. Farquhar & Co.

6 & 7 South Market Street
BOSTON, MASS.

SHEEP MANURE

IT'S STERILIZED
Free from Weed Seeds.
\$24.00 Ton;
\$7.00 quarter of Ton.

Wm. Elliott & Sons
42 Vesey St., New York

RELIABLE SEEDS—SOW NOW

PRIMULA OBCONICA GRANDIFLORA
1000 seeds Tr. pkt.
Floral red, fine seller.....\$1.50 \$0.50
Real pink, fine for cut..... 1.00 .50
Pure white, fine for cut..... 1.00 .50
Compacta, fine potter..... 1.50 .50
Mixed Hybrids..... 1.00 .50
O. V. ZANGEN, - HOBOKEN, N. J.

C AULIFLOWERS SEED
C A B B A G E S E E D

LILY OF THE VALLEY PIPS.
HJALMAR HARTMANN & CO.
Longangsstraede 20,
COPENHAGEN, DENMARK.

BRIDGEMAN'S SEED WAREHOUSE

RICKARDS BROS.

Props.
37 East 19th St., - NEW YORK CITY

STOCK SEED
FOR WINTER BLOOMING

Our strain of Double Branching Stocks is exceptionally true. About 90% Double Flowers.
In colors; - 3/4 oz. .60 oz. \$1.00
Pure White 3/4 " .75 " 5.00
H. E. FISKE SEED CO.
Faneuil Hall Square, BOSTON, MASS.

Winter-flowering SWEET PEA SEED

All Colors Ask for List
A. C. ZVOLANEK
ORIGIMATOR. BOUND BROOK, N. J.

NEW CROP SEED

For Early Planting
THOMAS J. GREY CO.
32 SO. MARKET ST., BOSTON, MASS.

To Florists Everywhere

Orders for Cut Flowers and Floral Decorations to be delivered anywhere in the Greater New York, may be placed with us with the certainty that your customers will be satisfied.
 Telegraph, telephone or mail such orders to us and be sure that they will be filled as promptly and as carefully as though you did it yourself.
 One third discount will be allowed on all orders thus placed with us by Florists outside of the Greater New York.

THE BLOSSOM
 Bond and Livingston Sts.,
 BROOKLYN, N. Y.
C. C. TREPPEL, Manager

**WILLIAM J. SMYTH
 FLORIST**

Cor. Michigan Ave. and 31st St., CHICAGO
 We ship to all points in Illinois and Iowa.
 Phones: Douglas 744, Douglas 523, Douglas 740

HAUSWIRTH THE FLORIST
 Out of Town orders for Hospitals
 Carefully filled.
**232 Michigan Ave.
 CHICAGO**
 AUDITORIUM ANNEX Tel. Harrison 585

**SAMUEL MURRAY
 Florist**
 Coates House Conservatory
 1017 BROADWAY, KANSAS CITY, MO.
 Both 'Phones 2670 Main.



**WASHINGTON,
 D. C.
 GUDE'S**

The Far-Famed Flowers of
TORONTO
 Delivered on mail or telegraph order for any occasion, in any part of the Dominion.
JOHN H. DUNLOP,
 96 Yonge St., - Toronto, Ont.

The Park Floral Co.
 J. A. VALENTINE,
 Pres.

DENVER, COLORADO
**WILLIAM L. ROCK
 FLOWER CO.**
 KANSAS CITY, - MO.
 will carefully execute orders for Kansas City and any town in Missouri or Kansas.



Buffalo, N. Y.
 W. L. PALMER & SON, 304 Main St.

Of Interest to Retail Florists

BUSINESS CHANGES.

Indianapolis, Ind.—A. W. Brandt has purchased the florist store of Wm. Billingsley.

Denver, Col.—The Gallup Floral Co., 1547 California street, has gone out of business.

Hopedale, Ill.—Joseph Hafinger and Harry Squires have purchased the Hopedale Nurseries.

Lincoln, Neb.—Joe B. Frey, for many years manager for Frey & Frey, has started in business for himself.

Wellesley, Mass.—Arthur Capers has leased the Wilson greenhouses and will make a specialty of carnations.

No. Pomona, Calif.—A. W. Pooley has purchased the chrysanthemum business of Mrs. Julia Marneg, but she will continue to carry other stock as heretofore.

STEAMER DEPARTURES

Allan.	
Nunuidian, Boston-Glasgow...	May 23
American.	
St. Louis, N. Y.-Shampton...	May 29
Philadelphia, N. Y.-Shampton...	June 5
Atlantic Transport.	
Minnetonka, N. Y.-London...	May 29
Minnehaha, N. Y.-London...	June 5
Cunard.	
Mauretania, N. Y.-Liverpool...	May 29
Ivernia, Boston-Liverpool...	June 1
Campania, N. Y.-Liverpool...	June 2
Coronia, N. Y.-Liverpool...	June 5
French Line.	
La Touraine, N. Y.-Havre...	May 27
La Lorraine, N. Y.-Havre...	June 3
Hamburg-American.	
Pres. Grant, N. Y.-Hamburg...	May 26
K. A. Victoria, N. Y.-Hamburg...	May 26
Pennsylvania, N. Y.-Hamburg...	June 2
Batavia, N. Y.-Med. Ports...	June 3
Leyland Line.	
Bohemia, Boston-Liverpool...	May 25
North German Lloyd.	
K. W. d. Grosse, N. Y.-B'm'd'n...	May 25
K. Wilhelm H., N. Y.-B'm'd'n...	June 1
Prin. Irene, N. Y.-Med. Ports...	June 5
White Star.	
Adriatic, N. Y.-Shampton...	May 26
Cynric, Boston-Liverpool...	May 29
Arabic, N. Y.-Liverpool...	May 29
Majestic, N. Y.-Shampton...	June 2

DETROIT NOTES.

Detroit and Mt. Clemens florists can congratulate themselves over the lucky escape from a hurricane last Saturday afternoon. This storm has done a good deal of damage around Kalamazoo, in fact early press dispatches state that several florists lost every light of glass, but this could not be verified. The storm passed out to Lake St. Clair, between Detroit and Mt. Clemens, destroying over a mile of telephone and suburban railway poles. The telephone service was seriously crippled for several hours and suburban railways had to be abandoned altogether.

Mr. Klage has just finished a beautiful cold storage room 29 x 25 all concrete—the best of its kind in this district.

Mrs. J. F. Sullivan made her first appearance in the store Saturday. We all are glad and congratulate her on her recovery from a 9-weeks' serious illness with blood poison.

FRANK DANZER.

ALEX. McCONNELL
 571 FIFTH AVENUE
 NEW YORK CITY

Telegraphic orders forwarded to any part of the United States, Canada, and all principal cities of Europe. Orders transferred or entrusted by the trade to our selection for delivery on steamships or elsewhere receive special attention.
 Telephone Calls, 487 and 488 38th St.
 Cable Address, ALEXCONNELL

M. A. BOWE

In the Heart of New York City
1294 Broadway
 Tel. 279, 38th St. **NEW YORK**
 Our Motto—The Golden Rule

DAVID CLARKE'S SONS

Deliver orders from any part of the country to
 New York City
 Or OUT-GOING STEAMERS
 Write or telegraph
2139-2141 Broadway, New York
 Telephone 1559-1553 Columbus

YOUNG & NUGENT
 42 West 28 St., NEW YORK
 "FLOWERS BY TELEGRAPH"

ALBANY, N. Y.
EYRES
 Flowers or Design Work
 DELIVERED IN ALBANY AND VICINITY
 ON TELEGRAPHIC ORDER.
11 NORTH PEARL ST., ALBANY, N. Y.

Flower Deliveries
 In Brooklyn and other Long Island Points
 New York City, New Jersey, etc. At Theaters,
 Hotels, Steamers or Residences.
WILSON
 Fulton St. and Greene Ave., Brooklyn, N. Y.

**DANKER, Albany,
 N. Y.**
 ORDERS FOR
**Choice Flowers and
 Floral Emblems**
 FILLED PROMPTLY

WELLESLEY COLLEGE
 Dana Hall, Walnut Hill and Rockridge Hall
 Schools. **TALLEY, Wellesley, Mass.**
 Tel. Wellesley 44-1 and 2. Night 44-3.

ATLANTA FLORAL CO.
 41 Peachtree Street, **ATLANTA, GEORGIA**

USEFUL BOOKS.
 We can supply the following books, postpaid, at the prices listed:—
 Roses and How to Grow Them. By Many Experts. Price, \$1.21.
 The New Cyclopaedia of American Horticulture. L. H. Bailey. Four volumes, \$20.00.
 How to Plan the Home Grounds. S. Parsons, Jr. Price, \$1.10.
 How to Make a Vegetable Garden Edith L. Fullerton. Price, \$2.20.

JOHN BREITMEYER'S SONS

Cor. Miami and Gratiot Aves.
DETROIT, MICH.

Artistic Designs . . .
High Grade Cut Blooms

We cover all Michigan points and good sections of Ohio, Indiana and Canada

BOSTON'S BEST

In Quality and Design

Can be relied upon when you transfer your retail orders to

EDWARD MACMULKIN

194 Boylston Street, Boston

Send flower orders for delivery in

BOSTON

and all

NEW ENGLAND POINTS

THOS. F. GALVIN

124 Tremont St., Boston



TRANSFER

Your orders for flower or plant delivery in Eastern New England to

JULIUS A. ZINN,

2 Beacon St., Boston

FINE DESIGN WORK A SPECIALTY

Orders by Wire Receive Prompt and Careful Execution

J. Newman & Sons

Corporation

24 Tremont Street, BOSTON

Theater, Steamer and Funeral Flowers Our Specialty
We can refer to leading florists in all principal cities.
Established 1879

LOUISVILLE, KY.

JACOB SCHULZ,

550 South Fourth Ave.

NEW FLOWER STORES.

New York, N. Y.—F. G. Shanley, 1363 St. Nicholas avenue.

St. Louis, Mo.—Joseph Goldbach, 1806 Olive street.

NEWS NOTES.

Dayton, O.—The National Plant Co. is in the hands of a receiver and has been advertised for sale.

Attica, Ind.—The greenhouses of the Attica Floral Co. were severely damaged by a recent hall storm.

One hundred and fourteen entries have been made in the contest for the Springfield (Mass.) Republican's prizes for attractive door yards.

CHICAGO NOTES.

Among the Growers.

H. C. Blewitt of Des Plaines, Ill., regards the price of sweet peas as having averaged too low the entire season to be profitable, though he is by no means intending to abandon them. He has fourteen benches, seventy five by five feet, and grows the standard varieties in pink, white and lavender. He is testing a new shell pink and a lavender that is almost a sky blue which, if they prove worthy, he will grow extensively next year. The old variety, Emily Henderson, he finds the best summer white.

Trade in the vicinity of the cemeteries is unusually lively. The backward season has made this work, always crowded into a small space of time, more than ever so. The man with stocky geranium plants in bloom now, is much sought after. The supply is not likely to meet the demand.

Frank Bet thinks there will be no geraniums to spare on Decoration Day, as advance orders are taking everything unusually early. Vincas appear to be a little scarce also, owing probably to the dry summer of last year.

Frank Oechslin looks for a prolonged spring trade. Geraniums not in bloom now will come on late and help out in the shortage so generally found in early June.

A. W. Myers handles a great many lilacs. He says that while they are later than last year, the few hot days have hurried them on so that they will be all past by Decoration Day.

Sam Pearse is still cutting daffodils and his stock looks as fresh as ever in the season. He reports bulbous stock on the whole as much more of a success this year than last.

The A. L. Randall Co. has secured a ground floor location at 98 Lake St. for their seed and poultry department and have put the business in charge of Mr. Seeley, formerly with Vaughan's Seed Store.

Personal.

Ernest Oechslin is able to beat out his greenhouses again, but feels decidedly weaker for the terrible experience he has gone through. The home of J. Meschler, superintendent of the Jewish Cemetery, was entered and money and clothing stolen, it is reported.

Miscellaneous.

H. R. Hughes has again been drawing crowds with a modern advertisement—a May party participated in by French dolls. Posted above the outside of the entrance was an invitation to one hundred children to come to a May party Saturday night, a real affair a stage to be placed in the window where the children were to dance to the music of an orchestra and a May queen to be crowned on a throne. When the evening came the crowd on the street may have numbered one thousand. They began to arrive by six o'clock, and at ten there were many still watching the happy scene. The Sunday papers had cuts and Mr. Hughes probably scored his best entertainment in the history of the store. Mr. Hughes' methods of advertising are unique and costly but he says they pay.

What looks like a good carnation support will be put on the market by

a leading supply house and full description given next week. It is the invention of Mr. French of Poehliman Bros.

Two warm days, May 12th and 13th, brought out the blossoms on the fruit trees. There was no gradual opening up. The trees were perfectly bare on the 12th and in full bloom on the 13th.

Florists will have no trouble getting their ice. The differences between the dealers and their drivers have been settled.

The Bohannon Floral Co. will move on June 1 to the new University Club building, 11 Monroe street.

"FLOWERS BY TELEGRAPH."

Leading Retail Florists Listed by Towns for Ready Reference.

- Denver, Colo.—Park Floral Co., 1706 Broadway.
- Washington, D. C.—Gude Bros., 1214 F St.
- Atlanta, Ga.—Atlanta Floral Co., 41 Peach Tree St.
- Chicago—Hanswirth, "The Florist," 232 Michigan Ave.
- Chicago—William J. Smyth, Michigan Ave. and 31st St.
- Chicago—George Witthold Co., 1657-59 Buckingbam Place.
- Louisville, Ky.—Jacob Schulz, 550 South Fourth Ave.
- Boston—Thos. F. Galvin, 124 Tremont St.
- Boston—Edward MacMulkin, 194 Boylston St.
- Boston—Hoffman, Florist, 60-61 Massachusetts Ave.
- Boston—J. Newman & Sons, Inc., 24 Tremont St.
- Boston—Julius A. Zinn, 2 Beacon St.
- Wellesley, Mass.—Talbly.
- Detroit, Mich.—J. Breitmeyer's Sons, Miami and Gratiot Aves.
- Kansas City, Mo.—Samuel Murray, 1017 Broadway.
- Kansas City, Mo.—Wm. L. Rock Flower Co., 1116 Walnut St.
- Albany, N. Y.—H. G. Eyres, 11 N. Pearl St.
- Albany, N. Y.—F. A. Danker, 40 Maiden Lane.
- New York—David Clarke's Sons, 2130-2141 Broadway.
- New York—Alex. McConnell, 571 5th Ave.
- New York—Young & Nugent, 42 W. 28th St.
- New York—M. A. Bove, 1234 Broadway.
- Brooklyn, N. Y.—The Blossom (C. C. Trepel, Mgr.), Bond and Livingston Sts.
- Brooklyn, N. Y.—Robert G. Wilson, Fulton St. and Greene Ave.
- Buffalo, N. Y.—Palmer's, 304 Main St.
- Toronto, Can.—J. H. Dunlop, 96 Yonge St.

THE BEST LETTERS

FOR
FLORISTS'
USE

THOSE
MADE
BY THE

Boston Florist Letter Co.
66 PEARL ST., BOSTON
N. F. McCARTHY, Mgr.

Order direct or buy from your local supply dealer. Insist on having the

BOSTON
Inscriptions, Emblems, etc., Always in Stock

FLORISTS' SUPPLIES
Send for New Catalogue
H. Bayersdorfer & Co.
1129 ARCH ST., PHILADELPHIA

Beauties Ferns
 \$2.50 per doz. **New Crop**
 Special price in larger quantities **\$2.50 per 1000**

THE LEO NIESSEN CO.
 1209 Arch St., Philadelphia, Pa.
 Open from 9 a. m. to 3 p. m.

To Cut Flower Growers and Retail Florists

IF YOU want to find a market for your product
 want a regular or special supply of the product of the best growers

Consult the Advertisements on these Wholesale Flower Pages

The Advertisers Represented Here are the Leading Concerns in the Wholesale Flower Trade

NEW CROP BEAUTIES
 \$1.00 to \$3.00 per Doz.

W. E. MCKISSICK & BROS.
 WHOLESALE FLORISTS
 1619-1621 RANSTEAD ST.
 PHILADELPHIA

WELCH BROS.
 AMERICAN BEAUTY, KILLARNEY, RICHMOND, MARYLAND AND ALL THE SUPERIOR ROSES, LILY OF THE VALLEY, CARNATIONS, ORCHIDS
BEST PRODUCED
 226 Devonshire Street, Boston, Mass.

CUT FLOWER BOXES
 EDWARDS FOLDING BOX CO
 MANUFACTURERS
 PHILADELPHIA, PA.

CHAS. W. MCKELLAR
 51 WABASH AVE., CHICAGO

WHOLESALE FLOWER MARKETS—TRADE PRICES—Per 100 TO DEALERS ONLY

	CHICAGO May 17	TWIN CITIES May 17	PHILA. May 18	BOSTON May 20
ROSES				
Am. Beauty, Fancy and Special	20.00	25.00	30.00	25.00
" Extra	15.00	20.00	25.00	20.00
" No. 1	10.00	15.00	20.00	15.00
" Lower grades	4.00	5.00	6.00	5.00
Bride, Maid, Golden Gate F. & S.	5.00	10.00	15.00	10.00
" Lower grades	3.00	4.00	5.00	4.00
Killarney, Fan, & Special	5.00	10.00	15.00	10.00
" Lower grades	3.00	4.00	5.00	4.00
Richmond, Fancy & Special	5.00	10.00	15.00	10.00
" Lower grades	3.00	4.00	5.00	4.00
Cherney	1.00	2.00	3.00	2.00
My Maryland	1.00	2.00	3.00	2.00
CARNATIONS				
Fancy and Red	3.00	4.00	5.00	4.00
Ordinary and White	1.50	2.00	3.00	2.00
MISCELLANEOUS				
Carleyas	50.00	70.00	100.00	75.00
Lilies	10.00	12.00	15.00	12.00
Lily of the Valley	1.00	1.50	2.00	1.50
Mignonette	3.00	4.00	5.00	4.00
Sweet Peas	.50	1.00	1.50	1.00
Gardenias	50.00	70.00	100.00	75.00
Petunias	4.00	5.00	6.00	5.00
Tulips	1.00	1.50	2.00	1.50
Stocks	4.00	5.00	6.00	5.00
Snapdragons	2.00	3.00	4.00	3.00
Amarants	1.00	1.50	2.00	1.50
Smilax	80.00	100.00	120.00	100.00
Asparagus Phloxes, strings	4.00	5.00	6.00	5.00
" & Sprays (100 lbs.)	35.00	45.00	55.00	45.00

Western Headquarters for Choice Orchids
 Valley, Roses and all Cut Flowers

PETER REINBERG
 WHOLESALE
CUT FLOWERS
 51 Wabash Av., Chicago, Ill.

Long Distance Phone Central 6004
WINTERTON'S SEED STORE
 45-47-49 Wabash Ave. Chicago.
 Seedsman, Plantmen, Nurserymen
 Florists' Supplies

We can supply everything used by the Florist. SUPPLY CATALOG FREE. Correspondence solicited.

J.A. BUDLONG
 37-39 Randolph Street, CHICAGO.
Roses and Carnations A Specialty WHOLESALE GROWER of **CUT FLOWERS**

POEHLMANN BROS. CO.
 33-35-37 Randolph St., - CHICAGO
CUT FLOWERS
 Greenhouses, - Morton Grove, Ill.

Rice Brothers
 115 N. 6th Street, MINNEAPOLIS, MINN.
 WHOLESALE FLORISTS and SUPPLIES
 CUT FLOWERS received white and can fill every order to your satisfaction. Complete line of Hardy Greens—Wills' SMILAX—BLACKWOOD, HAPPY FANCY FERNS, GARDEN LEAVES.
 Write for quotations on large quantities.

CLUB AND SOCIETY NOTES.

The Northern Indiana Florists Association will hold their annual convention at Winona Lake early in June.

The Florida State Horticultural Society held their annual meeting at the Beaulieu Hotel at North Easton and the Harvard Botanical Garden at Cambridge, Mass., May 19-21. The committee which is splendidly done at both places under the superintendency of N. Craig and Robert Cameron, was to report and all those in the

In ordering goods please add "I saw it in HORTICULTURE."

Flower Market Reports.

WHOLESALE FLOWER MARKETS.—TO DEALERS ONLY.

BOSTON. Market is reported as "no good" this week. A visit to the various marts

where flowers are distributed by growers or commission dealers confirms this assertion for the stock is piled up in hopeless profusion and values exist on paper only, for no offer, however low, is refused. Last week was fairly good and no cause for complaint was in evidence until the present week. All eyes are turned to next week with its Memorial Day activity to retrieve the losses of the present. As to quality, nothing but praise can be accorded to the stock which is being sent in. The cool weather is, no doubt, partially responsible for the excellent quality which compares favorably with the very best product of the early spring season.

A rather unsatisfactory **CHICAGO** week from a business standpoint completed the first half of May. The supply was greater than the demand in nearly all lines, especially in roses. The week opened rather slow with considerable stock on hand from Saturday and business continued dull throughout the week, Thursday being perhaps the best day. Friday, usually a good shipping day was a disappointment. Everyone has a good crop of Beauties on and all other roses are fine in quality. Kaiserins are now coming in freely, some with long stems. Pansies are plentiful but quality a little poor. They do not have the substance so desirable in pansy stock and sell slowly or are thrown away in many cases. Candytuft in white and lavender is in stock. Cattleya Mossiae are seen at McKellar's and are of fine quality. Carnations are selling too freely for such good stock and if the warm weather continues they will be hurried along faster than growers like with Decoration Day just ahead. Lilacs are not out yet but are coming in from southern Illinois. The very last of the bulbous stock is being cut now. Sweet peas are coming with very short stems. Callas are in excess of the demand, a condition which has prevailed most of the season. Flowers shipped from the south now are limited to peonies, of which there are many and of fine quality. Trillium, well known as Wake Robin, is in the market. It attracts attention but does not bring the dollars. Daisies are on rather short stems but sell fairly well. The violet season is over. The last boxes received were entirely worthless.

DETROIT All of us ought to be well satisfied with local trade conditions. When supply is good in quality, liberal in quantity and cleaned up every day we certainly have no cause for complaint. Of course, outdoor stuff is very backward and this will influence Decoration Day business, but while the weather is bad the plant man will have his inning but temporarily must exercise a good deal of patience.

PHILADELPHIA When the weather is good and business is humming it's a fairly pleasant job being a market reporter. When the weather is too good, and the market no good, there's only one job worse, and that's writ-

	CINCINNATI May 18	DETROIT May 18	BUFFALO May 17	PITTSBURG May 17
ROSES				
Am. Beauty, Fan and Sp.	30.00 to 35.00	30.00 to 35.00	20.00 to 25.00	15.00 to 20.00
" " Extra	25.00 to 30.00	25.00 to 30.00	15.00 to 20.00	10.00 to 15.00
" " No. 1	15.00 to 20.00	12.00 to 16.00	5.00 to 10.00	4.00 to 6.00
" " Lower grades	5.00 to 8.00	6.00 to 10.00	2.00 to 5.00	1.00 to 3.00
Bride, "Maid, Golden Gate, F. & S	6.00 to 8.00	6.00 to 8.00	7.00 to 8.00	8.00 to 10.00
" " Low grades	3.00 to 4.00	4.00 to 6.00	2.00 to 3.00	1.00 to 2.00
Killarney, Fan, & Sp.	6.00 to 8.00	6.00 to 8.00	7.00 to 8.00	6.00 to 10.00
" " Lower grades	3.00 to 5.00	4.00 to 6.00	2.00 to 3.00	2.00 to 4.00
Richmond, Fancy & Special	8.00 to 10.00	8.00 to 10.00	8.00 to 10.00	6.00 to 10.00
" " Lower grades	4.00 to 6.00	4.00 to 6.00	5.00 to 6.00	4.00 to 6.00
Chateaux	5.00 to 8.00	6.00 to 8.00	6.00 to 8.00	2.00 to 5.00
My Maryland	5.00 to 8.00	5.00 to 8.00	5.00 to 8.00	5.00 to 8.00
CARNATIONS				
Fancy and Novelties	1.00 to 3.00	3.00 to 4.00	2.50 to 3.00	2.00 to 3.00
Ordinary	1.00 to 2.00	2.00 to 3.00	1.50 to 2.00	1.00 to 2.00
MISCELLANEOUS				
Cattleyas	13.00 to 13.00	35.00 to 55.00	60.00 to 75.00	50.00 to 75.00
Lilies	3.00 to 4.00	10.00 to 15.00	8.00 to 12.00	8.00 to 12.00
Lily of the Valley	3.00 to 4.00	3.00 to 4.00	3.00 to 4.00	3.00 to 4.00
Mignonette	2.00 to 3.00	3.00 to 4.00	3.00 to 4.00	3.00 to 4.00
Sweet Peas	.50 to .75	.50 to 1.00	.40 to .75	.25 to .75
Geraniums	10.00 to 10.00	20.00 to 30.00	20.00 to 30.00	20.00 to 30.00
Peonies	4.00 to 4.00	4.00 to 6.00	4.00 to 6.00	4.00 to 6.00
Daisies	1.00 to 1.00	.75 to 1.00	.75 to 1.50	.50 to 1.50
Stocks	1.00 to 1.00	3.00 to 5.00	2.00 to 4.00	1.00 to 3.00
Soapdragon	1.00 to 1.00	4.00 to 8.00	4.00 to 8.00	3.00 to 6.00
Adiantum	1.00 to 1.00	1.00 to 1.50	.50 to 1.00	1.00 to 1.50
Smilax	12.00 to 15.00	15.00 to 15.00	15.00 to 15.00	15.00 to 15.00
Asparagus Plumosus, strings	40.00 to 50.00	30.00 to 50.00	50.00 to 60.00	30.00 to 50.00
" " & Sprea. (100 bchs.)	20.00 to 25.00	30.00 to 50.00	50.00 to 100.00	35.00 to 50.00

ing up the death notices. This week every wholesale center seems to wear sackcloth and ashes in its atmosphere—wrapt in a cloud of sable by day and the stillness of death by night. When one asks the god of the machine in such places "how's things this week?" he looks at you with a woeful countenance and points to a pile of boxes containing thousands and thousands of the choicest gems of the universe, and says: "don't ask—we haven't opened these yet and probably never will!" All of which is very depressing to a sympathetic scribe who delights in describing the cheerful side of things; so he trusts that this week you will excuse him from going into the gruesome details. Some of the growers were growing last week about the smallness of their returns. When these good souls get their returns next week they better take a bracer in advance. In the words of Worcester and Webster it is surely a case of "cheer up—the worst is yet to come!" Good roses were cleaning up on Saturday, the 1st inst., to the street men, at two dollars per thousand. On the whole, we think the week ought to be baptized "Donation Week." There were no prices—if there were one would have had to use a million magnifying X-Ray microscope to see them.

PHILADELPHIA NOTES.

Mr. and Mrs. Joseph Heacock sailed on the 20th inst. for Bermuda. They expect to be home again in about ten days.

David Beattie has resigned his position with Fred Ehret and engaged with Julius Wolff, Jr.

Wallace Faust, late with Keegan, intends to start in business for himself on South 12th, between Chestnut and Walnut streets, a locality in which he has long been a well-known and popular figure.

Visitor this week: John De Buck with a consignment of orchids from South America.

Alfred Burton is busy with building operations on the new range back of the old establishment and has same ready for planting. In line with the spirit of the times he is following up the demand for orchids and will devote a part of his place to this crop.

George Burton, nearby, has also been extending his area of glass—in part for orchids. On this place was noted a strong favor for the tile bench. Much has been said about this as an economical and healthy aid to commercial culture, and when a conservative like Mr. Burton takes it up there must be something worth considering. It seems the difference of cost between this and wood is only trifling.

The Joseph Heacock Co. have completed the remodeling of their plant, bringing same up to modern standards over the whole establishment. The staller houses have been rebuilt two and three to one in some cases. In other cases the partitions have been removed, thus giving greater facilities in heating and working operations. Besides palms, orchids and Killarney roses, which are the leading crops, an interesting specialty at present is their new pink carnation, Dorothy Gordon, a novelty which has won honors when exhibited and which will be put on the market next spring.

NEWS NOTES.

Everett, Mass.—Osgood Bros., florists, report that two men have been soliciting orders in their name without authority, and warn the public against them.

Cambridge, Mass.—H. L. Cameron, North Cambridge, a leader in high-quality spring bedding stock for the Boston market, has the contract to supply all the bedding material for Cambridge Centers and all the geraniums for Norumbega park. From two to three thousand geraniums are carried away every morning by Mr. Cameron's greenhouses by the rail. The season is backward and geraniums as well as other slow-growing bedding stock are very late in coming into bloom.

FORD BROTHERS

48 West 28th Street NEW YORK
FINE ROSES FANCY CARNATIONS
 A Full Line of All CUT FLOWERS
 Telephone, 3870 or 3871 Madison Square

H. E. FROMENT

Wholesale Commission Florist,
 Choice Cut Flowers,
 57 West 28th St. :: NEW YORK
 Telephones: 2200, 2201, Madison Square.

Alfred H. Langjahr

All choice cut-flowers in season. Send for quotations. Correspondence with shippers of first-class stock invited.

55 West 28th Street, New York
 Telephone 4826-4827 Madison Square

Edward C. Horan
 Wholesale Florist

55 WEST 28th ST.
 Tel. 1462 Madison Square New York
 1463

JOHN YOUNG

WHOLESALE FLORIST
 Finest American Beauties and Carnations

51 West 28 St. - NEW YORK

FRANK MILLANG

Wholesale Florist
 55-57 West 26th St., NEW YORK
 Shipments, any quantity, Wholesale Market Rates.

Henshaw & Fenrich
 WHOLESALE FLORISTS

44 West 28th Street, NEW YORK
 Phones Mad. Sq. 326, 558-2, 558-3

VIOLETS

Finest Grade. Any Quantity
B. S. SLINN

55-57 W. 26 St., New York

Moore, Hentz & Nash

Wholesale Commission Florists

55 and 57 West 26th Street
 Telephone No. 756
 Madison Square New York

MILLANG BROS.

WHOLESALE COMMISSION FLORISTS
 41 West 28th Street
 Telephone 3880 Madison
 3881 New YORK

JOHN I. RAYNOR
 Wholesale Commission Florist SELLING AGENT FOR LARGEST GROWERS
 A full line of Choice Cut Flower Stock for all purposes. Comprises every variety grown for New York market, at current prices.
 TEL. 1908 MADISON SQUARE 49 West 28th St., New York City

Walter F. Sheridan
 Wholesale Commission Dealer in
CHOICE CUT FLOWERS
 39 West 28th Street, New York
 Telephone: 3532-3533 Madison Square

HEADQUARTERS FOR NOVELTIES
ORCHIDS A SPECIALTY
 THE HIGHEST GRADE OF **VALLEY** ALWAYS ON HAND
 GARDENIAS, DAISIES, ROSES AND CARNATIONS
 Telephone
JAMES McMANUS, 759 Mad. Sq. 42 W. 28th St., New York

NEW YORK QUOTATIONS PER 100. To Dealers Only

ROSES AND CARNATIONS	Last Half of Week ending May 15 1909		First Half of Week beginning May 17 1909	
American Beauty, Fancy and Special.....	6.00	10.00	5.00	12.00
" " Extra.....	4.00	6.00	3.00	4.00
" " No. 1.....	3.00	4.00	2.00	3.00
" " Lower Grades.....	.50	1.0050
Bride, "Pala, Golden Gate, Fancy and Special.....	2.00	4.00	2.00	4.00
" " Lower Grades.....	.50	1.0050
Killarney, Fancy and Special.....	3.00	4.00	3.00	4.00
" " Lower Grades.....	.50	1.0050
Richmond, Fancy and Special.....	3.00	4.00	1.00	5.00
" " Lower Grades.....	.50	1.0050
Chatenay.....	.50	6.00	.50	5.00
Ply Maryland.....	1.00	6.00	.50	5.00
Carnations, Fancy and Novelties.....	1.00	2.00	1.00	3.00
" " Ordinary and White.....	.50	.7550

Alexander J. Guttman
 THE WHOLESALE FLORIST OF NEW YORK
 34 WEST 28th STREET
 PHONES. 1664-1665 MADISON SQUARE
ENOUGH SAID

CENTRALLY LOCATED, THE HUB OF THE FLOWER MARKET SECTION
CHARLES MILLANG
 Wholesale Florist
 444 Sixth Ave., NEW YORK
 Telephone 7062 Madison

GEORGE COTSONAS & CO.
 Wholesale and Retail Dealers in all kinds of **EVERGREENS**
 Fancy and Digger Ferns
 Bronze and Green Galax
Main Store 50 W. 28 St.
 Phone 1208 Mad. Sq. New York

GROWERS' CUT FLOWER CO. CUT FLOWERS AT WHOLESALE
VIOLETS, CARNATIONS, ROSES
ORCHIDS, CHRYSANTHEMUMS, LILIES
 Consignments Solicited. Shipments to Order, any Distance
 Telephone 6277 Madison Square
39 West 28th Street, NEW YORK
 J. J. COAN, Manager

Durand & Marohn **Wired Toothpicks**
 MANUFACTURERS OF
All Kinds of Wire Work
 Florists' Wire Designs a Specialty
 24 Beaver St., ALBANY, N. Y.
 Manufactured by
W. J. COWEE, BERLIN, N. Y.
 50,000....\$1.75; 50,000....\$7.50. Sample free.
 For sale by dealers

WHOLESALE FLORISTS
54 West 28th St.
NEW YORK
Telephone 3559 Madison Sq.

A. L. YOUNG & CO.

RECEIVERS & SHIPPERS OF CUT FLOWERS.
CONSIGNMENTS SOLICITED.

WILLIAM H. KUEBLER
Brooklyn's Foremost and Best
WHOLESALE COMMISSION HOUSE
A First Class Market for all CUT FLOWERS
28 Willoughby St., Brooklyn, N. Y.
Tel. 4591 Main

WILLIAM F. KASTING CO.
WHOLESALE FLORISTS
383-387 Ellicott Street
BUFFALO, - N. Y.



Greater New York Florists' Association, Inc.
Now Open for Cut Flower Consignments
162 Livingston Street, BROOKLYN, N. Y.
Geo. W. Crawbuck Telephone Connection
Manager 3642-43 Main

ROBERT J. DYSART
Public Accountant and Auditor
Simple methods of correct accounting especially adapted for florists' use.
Books Balanced and Adjusted
Merchants Bank Building
28 STATE STREET, - BOSTON
Telephone, Main 58.

REED & KELLER
123 West 25th St., New York
Florists' Supplies
We manufacture all our Metal Designs, Baskets, Wire Work & Novelties and are dealers in Glassware Decorative Greens and Florists' Requisites

WHOLESALE COMMISSION J. K. ALLEN
Open 6 a.m. Daily
Shipments of Lily of the Valley Needed
106 W. 28th St. NEW YORK
Tel. 167 Madison Sq.

THE KERVAN CO.
Wholesale Dealers and Shippers of **Decorative Evergreens**
Ferns, Galax, Laurel, Fresh Cypas, Boxwood, Sphagnum and all Florists' Greens
Send to us for Quotations before Buying.
113 West 28 Street, NEW YORK CITY

NEW YORK QUOTATIONS PER 100. To Dealers Only

MICHIGAN CUT FLOWER EXCHANGE, Inc.
WHOLESALE COMMISSION FLORISTS
Consignments Solicited
Hardy Fancy Fern Our Specialty
38-40 BROADWAY, DETROIT, MICH.

MISCELLANEOUS

	Last Half of Week ending May 15 1909	First Half of Week beginning May 17 1909
Cattleyas.....	20.00 to 35.00	20.00 to 35.00
Lilies.....	3.00 to 5.00	2.00 to 4.00
Lily of the Valley.....	1.00 to 2.00	.50 to 2.00
Ponies.....	3.00 to 6.00	3.00 to 6.00
Doisies.....	.25 to .50	.25 to .50
Sweet Peas (per 100 bunches).....	1.00 to 2.00	1.00 to 2.50
Stocks.....	.75 to 1.00	.75 to 1.00
Mignonette.....	1.00 to 5.00	1.00 to 5.00
Gardenias.....	2.00 to 12.00	2.00 to 12.00
Adiantum.....	.50 to 1.00	.50 to 1.00
Smilax.....	10.00 to 15.00	10.00 to 15.00
Asparagus Pinnosus, strings.....	20.00 to 30.00	20.00 to 35.00
" " & Sprea. (100 bchs).....	12.00 to 25.00	15.00 to 25.00

NEW YORK MARKET REPORT.

We regret that we are not able to record any appreciable change for the better in conditions in this flower market here as compared with last week. The situation remains about as recorded in our last issue. A glut of everything encumbers the market and with very little demand. There is no fixed value on anything. Among the seasonable products are lilies, which are very abundant, and peonies which are in moderate supply only as yet but are expected to add to the burden within a few days.

and Miss Mae Davis were married at Dorchester, Mass., on May 16.

R. W. Wells, for the past three years connected with the Central Floral Co., Kalamazoo, Mich., was presented with an elegant watch charm by his associates on the occasion of his departure for his new position in Chicago.

INCORPORATED.

Sneboygan, Wis.—John H. Allen Seed Co., E. M. Parmelee, W. B. Lucas, A. L. Sommer; capital, \$110,000.

PERSONAL.

Visitors in Boston: H. H. Battles and George Rauch, Philadelphia.

Charles Agnew has taken a position with the Baur Floral Co., Erie, Pa.

A. Wiegand and wife of Indianapolis, Ind., contemplate a European tour this summer.

J. K. M. L. Farquhar of Boston, will start in June for an extended European trip.

St. Louis, Mo.—Charles Cannon is now manager of the store of the Maryland Floral Co. at 4651 Maryland avenue.

A. Jackson Norton, son of M. H. Norton, ex-president of the S. A. F.,

NEWS NOTES.

New York, N. Y.—The Manhattan Flower Market opened for business on May 8 at 46 West 28th street.

Percy Morse, a young seed grower of Watsonville, near Salinas, Calif., was killed in an automobile accident on the 16th inst.

M. Cochran Armour of Chicago has purchased sixty-five acres of land in Pasadena, Cal., for residence, and sunken gardens are to form one of the landscape features.

HORTICULTURE is a bang-up journal of floriculture and every florist in the trade should give it hearty support.
MERTON L. GAGE.
Orange, Mass., May 17, 1909.



Order by Name
Krick's Genuine Immortelle Letters, Etc.

The Best and Cheapest. Accept no Substitute. Every Letter Marked

W. C. KRICK
1164-66 Greene Av., Brooklyn, N. Y.
For Sale by all Supply Houses

NEWS NOTES.

Greensboro, N. C.—W. C. Porter has leased the Smith greenhouses on South Cedar street extension.

Wheeling, W. Va.—Otto Kalreuth, who was the florist at Mozart Park until the park department relinquished its operations, will carry on business in his own name hereafter.

Wakefield, Mass.—Charles C. Ball has taken the Wiley greenhouses, corner of North and Yale avenues, and after putting them in up-to-date condition will start in business.

Buyer's Directory and Ready Reference Guide

Advertisements under this head, one cent a word. Initials count as words.

Display advertisers in this issue are also listed under this classification without charge. Reference to List of Advertisers will indicate the respective pages.

Buyers failing to find what they want in this list will confer a favor by writing us and we will try to put them in communication with reliable dealers.

ACCOUNTANT

E. J. Dyars, 28 State St., Boston.
For page see List of Advertisers.

ALYSSUM

Dwarf alyssum from 2 in. pots, at \$2.00 per 100. Jas. T. Baker, Rustleton, Philadelphia, Penn.

AMPELOPIS.

Eastern Nurseries, Henry F. Dawson, Mgr., Ampelopsis Quinquefolia, Jamaica Plain, Mass.
For page see List of Advertisers.

C. Elsele, 11th and Westmoreland Sts.,
For page see List of Advertisers.

AQUATIC PLANTS

Aquarium plants the year round. Wholesale and retail. Send for price list. Schmidt's Emporium of Pets, 712 12th Street, Washington, D. C.

AQUILEGIAS

Aquilegias. *Genule Coerulea*, finest of all. Both plants and seeds from the heart of the Rockies. C. S. Harrison's Select Nursery, York, Neb.

ARAUCARIAS

A. Leuthy & Co., Perkins St. Nurseries, Roslindale, Mass.

For page see List of Advertisers.

Godfrey Aschmann, 1012 West Ontario St., Philadelphia, Pa.
For page see List of Advertisers.

ASPARAGUS SEED

A-sparagus Plumosus. Seed, fresh, lath-house grown, \$2.50 per 1000. Special price in quantities. Immediate delivery. Cash. Oak Grove Nurseries, Ohio, 404 North Los Angeles St., Los Angeles, Cal.

ASTERS.

Asters, 2 to 2 1/2 in. high, \$8.00 per 1000. Only the choicest colors and kinds included in the collection. H. J. Blanchard, Ashburnham, Mass.

AUCTION SALES

Oleary's Horticultural Co., 62 Vesey St., New York.

AZALEAS

A. Leuthy & Co., Perkins St. Nurseries, Roslindale, Mass.

For page see List of Advertisers.

Godfrey Aschmann, 1012 W. Ontario St., Philadelphia.
For page see List of Advertisers.

BAMBOO CANES

Yokohama Nursery Co., 31 Barclay Street, New York.

Bamboo Sticks, Colored Green.
For page see List of Advertisers.

BAY TREES.

300 Bay and Box Trees in all sizes, Pyramid and Standards. Write for list. Julius Koehrs, Rutherford, N. J.

BEDDING PLANTS

J. E. Felthousen, Schenectady, N. Y.
For page see List of Advertisers.

A. Leuthy & Co., Perkins St. Nurseries, Roslindale, Mass.

For page see List of Advertisers.

G. Aschmann, 1012 W. Ontario St., Philadelphia, Pa.

For page see List of Advertisers.

R. Vincent, Jr. & Sons, White Marsh, Maryland.
For page see List of Advertisers.

J. C. Schmidt, Bristol, Pa.
For page see List of Advertisers.

BEDDING PLANTS—Continued

Thomas Roland, Nahant, Mass.
Begonia Gloire De Lorraine.

For page see List of Advertisers.

Storrs & Harrison Co., Palmesville, O.

For page see List of Advertisers.

Wm. W. Edgar Co., Waverley, Mass.

C. Elsele, 11th and Westmoreland Sts., Philadelphia, Pa.

For page see List of Advertisers.

S. V. Smith, 3223 Goodman St., Phila., Pa.

For page see List of Advertisers.

Saltz, 2 1/2 to 3 in. high, 1 1/2c each.

Cobaea scandens, 2 1/2 in., 2c each. H. J. Blanchard, Ashburnham, Mass.

Vinca variegated, finest stock, heavy and long, \$10 and \$12.50 per 100. R. C. S. A. Nut geraniums, doz, \$10 per 1000.

R. C. Golden Glow, \$4 per 100. Cash.

Bellsmy Bros., 207 Delaware St., Syracuse, N. Y.

BEGONIA REX

J. H. Dunn & Son, Westfield, N. Y.

For page see List of Advertisers.

BOILERS

BOILERS. "Burnham" Boilers made for greenhouse heating. Lord & Burnham, 1183 Broadway, N. Y.

Kroeschell Bros. Co., 35 Erie St., Chicago.

For page see List of Advertisers.

BOOKS

Pronunciation of Plant Names, sent for 50 cents, postpaid, by HORTICULTURE PUBL. CO., 11 Hamilton Place, Boston.

BOXWOOD TREES

New England Nurseries, Inc., Bedford, Mass.

For page see List of Advertisers.

BUILDING MATERIAL

BUILDING MATERIAL of all description for All Cypress, Semi-Iron, Iron Frame or Truss Houses. Hot Bed Sash and Frames. Lord & Burnham Co., 1183 Broadway, N. Y.

BULBS AND TUBERS

Joseph Breck & Sons, 47-54 N. Market St., Boston.

For page see List of Advertisers.

J. M. Thornburn & Co., 33 Barclay St., New York.

For page see List of Advertisers.

A. T. Boddington, 342 W. 14th St., N. Y.

For page see List of Advertisers.

Rickards Bros., 37 East 10th St., New York.

For page see List of Advertisers.

H. F. Mitchell Co., Philadelphia.

For page see List of Advertisers.

H. E. Flske Seed Co., Fanenll Hall Sq., Boston.

For page see List of Advertisers.

T. J. Grey & Co., 32 and 38 So. Market St., Boston.

For page see List of Advertisers.

Yokohama Nursery Co., 31 Barclay St., New York.

For page see List of Advertisers.

Ralph M. Ward & Co., 12 W. Broadway, New York.

For page see List of Advertisers.

Schlegel & Fottler Co., 26 & 27 S. Market St., Boston.

Begonias, Gloxinias, Tuberoses.

For page see List of Advertisers.

CANNAS

C. Elsele, 11th and Westmoreland Sts., Philadelphia, Pa.

For page see List of Advertisers.

R. Vincent, Jr. & Sons Co., White Marsh, Maryland.

For page see List of Advertisers.

CANNAS—Continued

Estate of David Fisher, Woburn, Mass.
For page see List of Advertisers.

J. H. Dunn & Son, Westfield, N. Y.
For page see List of Advertisers.

Cannas started from sand, \$2.00 per 100; from pots, \$5.00 per 100. J. B. Shurtleff & Son, Cushman Ave., Revere, Mass.

CARNATIONS

Baur & Smith, 38th & Senate Sts., Indianapolis, Ind.

Patten & Co., Tebbury, Mass.

Carnation Shasta.

For page see List of Advertisers.

F. Dorner & Sons Co., Lafayette, Ind.

Carnations for Immediate Delivery.

For page see List of Advertisers.

Chicago Carnation Co., Joliet, Ill.

For page see List of Advertisers.

Wood Bros., Plakhill, N. Y.

Carnations, Rooted Cuttings.

For page see List of Advertisers.

The E. G. Hill Co., Richmond, Ind.

Carnation Cuttings.

For page see List of Advertisers.

Poehlmann Bros. Co., Morton Grove, Ill.

For page see List of Advertisers.

Cohanzy Carnation Co., New London, Conn.

CATTLEYAS

Alphonse Perlet, Collingdale, Phila., Pa.

For page see List of Advertisers.

CHRYSANTHEMUMS

E. G. Hill Co., Richmond, Ind.
For page see List of Advertisers.

S. J. Reuter & Son, Westery, R. I.

For page see List of Advertisers.

C. H. Totty, Madison, N. J.

For page see List of Advertisers.

Wood Bros., Pliskill, N. Y.

Chrysanthemums Rooted Cuttings.

For page see List of Advertisers.

Scott Bros., Elmstord, N. Y.

For page see List of Advertisers.

Poehlmann Bros. Co., Morton Grove, Ill.

For page see List of Advertisers.

Elmer D. Smith & Co., Adrian, Mich.

Special Offer of Commercial Chrysanthemums.

For page see List of Advertisers.

William Swayne, Kennett Square, Pa.

Rooted Cuttings.

For page see List of Advertisers.

Wm. W. Edgar Co., Waverley, Mass.

100 commercial varieties, including Pompon and Hairy, \$12.50 per 100. Satisfaction guaranteed. Wm. Ehmann, Jr., Corfu, N. Y.

Chrysanthemum Golden Glow from 2 1/4 in. pots, for early spring delivery, \$1.00 per doz., \$6.00 per 100, \$50.00 per 1000. Stock plants of Montmore, Oct. Frost, Crocus, Matchless, Lucy Devaux, Polly Rose and Halliday, \$1.00 per doz.; \$6.00 per 100. Felice Bros., Waltham, Mass.

Herrington's book on the Chrysanthemum, mailed to your address for 50c, by Horticulture Publishing Co., 11 Hamilton Place, Boston.

Golden Glow and Pacific Supreme, the best early yellow and pink mums, R. C., \$3 per 100, prepaid; 2 1/2 in. pots, \$4; 25 at 100 rates. Chas. Froes', Kentworth, N. J.

COAL FOR GREENHOUSE USE

Bader Coal Co., Board of Trade Bldg., Boston.

For List of Advertisers See Page 751

COLEUS

J. E. Felthousen, Schenectady, N. Y.
For page see List of Advertisers.
A. Leathy & Co., Perkins St. Nurseries,
Roslindale, Mass.
For page see List of Advertisers.

CONIFERS

John Waterer & Sons, Ltd., American
Nursery, Bagshot, Eng.
For page see List of Advertisers.
Julius Roehrs Co., Rutherford, N. J.
For page see List of Advertisers.

OUT FLOWER BOXES.

Edwards Folding Box Co., Philadelphia
For page see List of Advertisers.
Folding out flower boxes, the best made
Write for list. Holton & Hunkel Co., MD
Wauke, Wis.

DAHLIAS

David Herbert & Son, Atco, N. J.
For page see List of Advertisers.
J. L. Moore, Northboro, Mass.
For page see List of Advertisers.
Peacock Dahlia Farms, Wilkesstown June
ton, N. J.
For page see List of Advertisers.
R. Vincent Jr. & Sons Co., White Marsh, Md.
For page see List of Advertisers.

DAHLIAS.

Geo. H. Walker, No. Dighton, Mass.
Wholesale and Retail.
Send your name for my 1909 Catalog
and Pocket Guide, ready to mail about
Feb. 25th.

Cactus, Decorative, Fancy, Show and
Pompon Dahlias. Good commercial varie-
ties, such as Kriemhilde, Countess of Long-
dale, Mad. Van Den Deal and other sure
bloomers, strong divided roots in 10 or 20
named varieties my selection, \$1.00 per 25;
\$3.00 per 100; \$25.00 per 1000. Cash please.
Herrmann Pileman, Mecon, Mass.

DECORATIVE PLANTS

A. Leathy & Co., Perkins St. Nurseries
Roslindale, Mass.
Imported Plants for Fall Delivery.
For page see List of Advertisers.
Godfrey Aschmann,
1012 W. Ontario St., Phila., Pa.
For page see List of Advertisers.
Joseph Hancock Co., Wyncote, Pa.
For page see List of Advertisers.
The Geo. Wittbold Co., 1057 Buckingham
Place, Chicago, Ill.
For page see List of Advertisers.
Robert Craig Co., Market and 49th Sts.,
Philadelphia, Pa.
For page see List of Advertisers.

EVERGREENS

New England Nurseries, Bedford, Mass.
For page see List of Advertisers.
American Nursery Co., 150 Broadway,
New York, N. Y.
Evergreens. Send 25 cents in stamps
for complete work on propagating and
growing Evergreens. C. S. Harrison's
Select Nursery, York, Neb.

FERNS

A. Leathy & Co., Roslindale, Mass.
For page see List of Advertisers.
H. H. Barrow & Son, Whitman, Mass.
Nephrrolepis Magnifica.
For page see List of Advertisers.
John Scott, Brooklyn, N. Y.
For page see List of Advertisers.
Frank Oechlin, 2570-2606 W. Adams St.,
Chicago.
Ferns for Fishes.
For page see List of Advertisers.
The Geo. Wittbold Co., 1057 Buckingham
Place, Chicago, Ill.
For page see List of Advertisers.
Godfrey Aschmann, 1012 W. Ontario St.,
Philadelphia.
For page see List of Advertisers.
C. Eisele, 11th and Westmoreland Sts.,
For page see List of Advertisers.

FERNS - Continued

Rose Hill Nurseries, New Rochelle, N. Y.
Ferns for Jardinieres.
For page see List of Advertisers.
Anderson's ferns for in and outdoors.
Largest commercial collection in the coun-
try. Ask for descriptive catalogue. J. F.
Anderson, Fern Specialist, Short Hills, N. J.

FERTILIZERS

Pulverized Manure Co., 31 Union Stock
Yards, Chicago, Ill.
Wisard Brand Sheep and Shredded Cattle
Manure.
For page see List of Advertisers.
Bowker Fertilizer Co., Boston, Mass.
All Forms of Plant Food at First Hand.
For page see List of Advertisers.
German Kall Works, 93 Nassau St.,
New York.
Potash Fertilizer.
Wm. Elliott & Sons, 42 Vesey St.,
New York.
Sheep Manure.
For page see List of Advertisers.

FLORAL PHOTOGRAPHS

Floral Photographs, Foley's, 220-223 1-2
Bowery, New York.

FLORISTS' LETTERS.

Boston Florist Letter Co., 66 Pearl St.,
Boston, Mass.
For page see List of Advertisers.

FLORISTS SUPPLIES

N. F. McCarthy & Co., 84 Hawley St.,
Boston.
For page see List of Advertisers.
H. M. Robinson & Co., 15 Province St. and
9 Chapman Pl., Boston, Mass.
For page see List of Advertisers.
Reed & Keller, 122 W. 25th St., New York.
For page see List of Advertisers.
M. Bayersdorfer & Co., 1129 Arch St.,
Philadelphia.
For page see List of Advertisers.
W. C. Krick, 1164-66 Greene Av., Brook-
lyn, N. Y.
Immortelle Letters.
For page see List of Advertisers.
S. S. Pennock-Meehan Co., Philadelphia.
For page see List of Advertisers.

FLOWER POTS

W. H. Ernest, 25th and M Sts.,
Washington, D. C.
For page see List of Advertisers.
A. H. Hews & Co., Cambridge, Mass.
For page see List of Advertisers.
Hilfinger Bros., Ft. Edward, N. Y.
For page see List of Advertisers.
The Peters & Reed Pottery Co.,
Red pots, seed pans, etc.
Zanesville, O.
Syracuse Pottery Co., Syracuse, N. Y.
Syracuse Red Pots.
For page see List of Advertisers.
We make Standard Flower Pots, etc.
Write us when in need.
Wilmer Cope & Bro.
Lincoln University, Chester Co., Pa.

FRUIT TREES

Dwarf Fruit Trees, by F. A. Waugh,
mailed to your address for 55 cents by
Horticulture Publishing Co., 11 Hamilton
Place, Boston.

GALAX

Michigan Cut Flower Co., 38 and 40 Broad-
way, Detroit, Mich.
For page see List of Advertisers.
George Cotsanaka & Co., 50 W. 25th St.,
New York.
For page see List of Advertisers.
The Kervan Co., 113 West 25th St., N. Y.
For page see List of Advertisers.
Rice Bros., 115 N. 6th St., Minneapolis,
Minn.
For page see List of Advertisers.
H. M. Robinson & Co., 15 Province St.
and 9 Chapman Place, Boston.
For page see List of Advertisers.

GARDEN HOUSE

Revere Rubber Co., Boston, Mass.
For page see List of Advertisers.

GARDENIAS

Miss A. Washington, Alvin, Texas.

GERANIUMS

R. Vincent Jr. & Sons Co., White Marsh,
Md.
New and Standard Varieties.
For page see List of Advertisers.
Godfrey Aschmann, Philadelphia, Pa.
For page see List of Advertisers.
Geraniums, large plants, bud and bloom,
out of 3 1/2 in. pots. S. A. Nutt and others,
\$7.00 per 100. Cash. Stephen Chase,
Nashua, N. H.
Geraniums in bud and bloom. S. A. Nutt,
Buchner, etc. At stock out of 3 1/2 in. pots,
\$3.00 per 100. Cash with order. Leonard
Cousins, Jr., Concord Junction, Mass.
Silleroi Geraniums, strong plants from
2 1/2 in. pots, \$2.50 per 100. J. B. Shurtleff
& Son, Cushman Ave., Revere, Mass.
Geraniums. S. A. Nutt, out of 3 1/2 in.
pots, in bud and bloom, \$3.00 per 100. Cash.
O. B. Keurick, 52 Alexander Ave., Belmont,
Mass.

GLADIOLI

J. L. Moore, Northboro, Mass.
For page see List of Advertisers.
E. S. Miller, Wading River, N. Y.
For page see List of Advertisers.

GLASS

Boston Plate & Window Glass Co., Boston
For page see List of Advertisers.
Standard Plate Glass Co., 29-30 Sudbury
St., Boston.
For page see List of Advertisers.
Foley Mfg. Co., Western Ave., between
25th & 26th Sts., Chicago.
For page see List of Advertisers.
Sharp, Partridge & Co., 221 & Lumber St.,
Chicago.
For page see List of Advertisers.
Parschelsky Bros., Inc., 59 Montrose Av.,
Brooklyn, N. Y.
For page see List of Advertisers.
Greenhouse glass, lowest prices. John-
ston Glass Co., Hartford City, Ind.
Glass, High Grade, Double Thick Green-
house Glass. Lord & Burnham, 1183 Broad-
way, N. Y.

GLAZING POINTS

H. A. Dreer, Philadelphia, Pa.
Peerless Glazing Point.
For page see List of Advertisers.

GLAZING POINTS, Lord & Burnham
Special Glazing Nails (Poling). Lord &
Burnham, 1183 Broadway, N. Y.

GREENHOUSE BUILDING MATERIAL

Lord & Burnham Co.,
1183 Broadway, New York.
For page see List of Advertisers.
Pierson U-Bar Co., 1 Madison Sq., N. Y.
For page see List of Advertisers.
A. T. Stearns Lumber Co., Neponset,
Boston.
For page see List of Advertisers.
King Construction Co., N. Tonawanda,
New York.
For page see List of Advertisers.
Hitchings & Co., 1170 Broadway, New York.
For page see List of Advertisers.
J. C. Moulting Co., 117 East Blackhawk St.,
Chicago, Ill.
For page see List of Advertisers.
Foley Mfg. Co., Western Ave., between
25th & 26th Sts., Chicago.
For page see List of Advertisers.

GREENHOUSE CONSTRUCTION

GREENHOUSE CONSTRUCTION, Semi-
iron Greenhouse, New Truss Houses and
Iron Frame Houses. Lord & Burnham,
1183 Broadway, N. Y.
J. A. Payne, 260-274 Culver Ave., Jersey
City, N. J.
For page see List of Advertisers.
Foley Mfg. Co., Western Ave., between
25th & 26th Sts., Chicago.
For page see List of Advertisers.
Hitchings & Co., 1170 Broadway, New York.
For page see List of Advertisers.

In writing to Advertisers kindly mention Horticulture

GREENHOUSE HOSE

Revere Rubber Co., Boston, Mass.
Revero Hose.
For page see List of Advertisers.

GUTTERS

GUTTERS, Cast Iron Gutters, L. & E. Improved V Shaped Gutter with drip gutter attachment, Lord & Burnham, 1133 Broadway, N. Y.

HEATING APPARATUS

Lord & Burnham Co.,
1133 Broadway, New York.
For page see List of Advertisers.
Pierson U-Bar Co., 1 Madison Sq., N. Y.
For page see List of Advertisers.
John A. Payne, 260-274 Culver Ave., Jersey City, N. J.
For page see List of Advertisers.
Krosschell Bros. Co., 35 Erie St., Chicago.
For page see List of Advertisers.

HAIL INSURANCE

Florists' Hail Asso. of America,
J. G. Esler, Saddle River, N. J.
For page see List of Advertisers.

HARDY CLIMBERS

Henry A. Dreer, 714 Chestnut St., Phila.

HARDY FERNS, MOSS AND GREENS

H. M. Robinson & Co., 15 Province St. and 9 Chapman Pl., Boston, Mass.
For page see List of Advertisers.
Michigan Cut Flower Exchange,
38 and 40 Broadway, Detroit, Mich.
For page see List of Advertisers.

George Cotsanos & Co., 50 W. 28th St., New York.
For page see List of Advertisers.

N. F. McCarthy & Co., 84 Hewley St., Boston.
For page see List of Advertisers.

The Kervan Co., 113 W. 28th St., N. Y.
For page see List of Advertisers.

Rice Bros., 115 N. 6th St., Minneapolis, Minn.
For page see List of Advertisers.

HELP FURNISHED

Thos. H. Bambrick, 34 S. 7th St., Phila.
For page see List of Advertisers.

HERBACEOUS PERENNIALS

P. Ouwkerk, P. O. No. 1, Hoboken, N. J.
For page see List of Advertisers.
New England Nurseries, Bedford, Mass.
For page see List of Advertisers.
The Geo. Wittbold Co., 1657 Buckingham Place, Chicago.
For page see List of Advertisers.

HOT-BED SASH

The A. T. Stearna Lumber Co., Neponset, Mass.
For page see List of Advertisers.

Pierson U-Bar Co., 1 Madison Sq., N. Y.
For page see List of Advertisers.

Lord & Burnham Co., 1133 Broadway, N. Y.
For page see List of Advertisers.

Foley Mfg. Co., Western Ave., between 25th & 26th Sts., Chicago.

HYDRANGEAS.

Jellies Rudus Co., Rutland, N. J.
For page see List of Advertisers.

Wm. W. Edgar Co., Waverley, Mass.

INSECTICIDES.

Neoticle kills all greenhouse pests.
P. R. Palerthoro Co.,
Eleventh St., Owensboro, Ky.
For page see List of Advertisers.

Stump & Walter Co., 50 Barclay St., New York.
Kilmdead Tobacco Dust.
For page see List of Advertisers.

INSECTICIDES—Continued

Niagara Sprayer Co., Middleport, N. Y.
Niagara Brand.
For page see List of Advertisers.
Bowker Insecticide Co., Boston, Mass.
Insect Destroying Preparations.
For page see List of Advertisers.

Wm. Cooper & Nephews, 177 Illinois St., Chicago; Cyril Francklyn, 62 Beaver St., New York, Agt.
V. L. Child.

For page see List of Advertisers.
Eastern Chemical Co., Pittsburg St., Boston.
"IMP" Soap Spray.
For page see List of Advertisers.

"The Fumigating Kind Tobacco Powder"—The first on the market and the kind that has so many imitations, has our guarantee tag of satisfaction or money back, and "The Moon Trade Mark" on every bag, \$3.00 per 100 lbs. The H. A. Stoothoff Co., Mount Vernon, N. Y., Makers and sellers.

JAPANESE PLANTS

Yokohama Nursery Co., 31 Barclay St., New York.
For page see List of Advertisers.

KENTIAS

Godfrey Aschmann,
1012 W. Ontario St., Phila., Pa.
For page see List of Advertisers.

A. Leuthy & Co., Rosindale, Mass.
For page see List of Advertisers.

Joe. Heacock Co., Wyncote, Pa.
Single and Made-Up Specimens.
For page see List of Advertisers.

LEVELS FOR LANDSCAPE GARDENING USE.

Bostrom-Brady Mfg. Co., 189 Madison Ave., Atlanta, Ga.

LILY OF THE VALLEY PIPS

Hjalmar Hartmann & Co., Langangstrade 20, Copenhagen, Denmark.
For page see List of Advertisers.

LOBELIAS

C. Elsele, 11th & Westmoreland Sts., Phila.
Double Lobelia.
For page see List of Advertisers.

MADEIRA VINES

E. S. Miller, Wading River, N. Y.
For page see List of Advertisers.

MASTICA

F. O. Pierce Co., 12 W. Broadway, New York.
For page see List of Advertisers.

MOON VINES

C. Elsele, 11th & Westmoreland Sts., Phila.
For page see List of Advertisers.
Godfrey Aschmann, Philadelphia, Pa.
For page see List of Advertisers.

MYRTLE

Myrtle, blue for cemetery planting, \$2.00 per 100; \$17.50 per 1000. Geo. A. Dhanan, Sta. H., Cincinnati, Ohio.

NICO-FUME

Kentucky Tobacco Product Co., Louisville, Ky.
For page see List of Advertisers.

NURSERY STOCK

John Waterer & Sons, Ltd., American Nursery, Bagshot, England.
For page see List of Advertisers.

Cleary's Horticultural Co., 62 Vesey St., New York.

P. Ouwkerk, 216 Jane St., Weehawken Heights, N. J.
For page see List of Advertisers.

Eastern Nurseries, Jamaica Plain, Mass.
For page see List of Advertisers.

American Nursery Co., 150 Broadway, New York, N. Y.

Manual of the Trees of North America, by C. S. Sargent, mailed to your address for \$9.00, by Horticulture Publishing Co., 11 Hamilton Place, Boston.

NURSERY STOCK—Continued

TREES, SHRUBS, ROSES, EVERGREENS, PEONIES, HARDY PLANTS. ELLWANGER & BARRY, Rochester, N. Y.
For page see List of Advertisers.

New Hardy Shrub—Buddleia variabilis Veitchii and Magnolia, the summer flowering Lilac, 50c each; \$5.00 per doz.; \$25.00 per 100. Rose Hill Nurseries, New Rochelle, N. Y.

Catalog now ready. Nursery grown evergreens, seedling white pine and hemlock, native trees and plants. L. E. Williams, Nottingham, N. H.

ORCHID PLANTS

Lager & Hurrell, Summit, N. J.
For page see List of Advertisers.

Sender, St. Albans, England. Importers, Exporters, Growers, Hybridists.
For page see List of Advertisers.

Carrillo & Baldwin, Seacuca, N. J.
For page see List of Advertisers.

Jo. A. Manda, 191 Valley Road, W. Orange, N. J.
For page see List of Advertisers.

Ordenez Bros., Madison, N. J., Box 106. Cattleya Mossiae.
For page see List of Advertisers.

G. L. Freeman, 388 Appleton St., Holyoke, Mass.
Orchid Importations.
For page see List of Advertisers.

Largest stock in the country. Ask for prices. Juliana Roehrs, Rutherford, N. J.

Native Orchids. Hugo Kind, Hammon-ton, N. J.

PAINT AND PUTTY

PAINT AND PUTTY: Ideal Greenhouse lead; Special Greenhouse Putty. Lord & Burnham, 1133 Broadway, N. Y.

PALMS

A. Leuthy & Co., Perkins St. Nurseries, Rosindale, Mass.
For page see List of Advertisers.

Robert Craig Co., Market and 49th Sts., Philadelphia, Pa.
For page see List of Advertisers.

Joseph Heacock Co., Wyncote, Pa. Home-Grown Palms.
For page see List of Advertisers.

Geo. Wittbold Co., 1657 Buckingham Place, Chicago.
For page see List of Advertisers.

John Ralph, Saratoga Springs, N. Y. Lantanis Barbours Large Specimens.
For page see List of Advertisers.

Julius Roehrs Co., Rutherford, N. J.
For page see List of Advertisers.

Specimen Lantanis Palms, 5 in. pots, \$1.20 each; 8 1/2 in. pots \$2.00 each. Specimen Lantanis Palms, 14 in. pots \$2.00 each, \$20.00 per doz. Wagner Park Conservatories, Sidney, Ohio.

PANSY PLANTS.

J. C. Schmidt, Bristol, Pa.
For page see List of Advertisers.

SUPERB STRAIN—READY NOW.

Fall-transplanted pansies, in bud and bloom. A trial order will convince you that these are the best you ever handled.
\$1.25 per 100; \$10.00 per 1000.

Cash with order.
LEONARD COUSINS, JR., Mass. Concord Junction.

Giant Pansy Plants, stocky, from fall-sown seed, 50c. per 100, prepaid; \$3.50 per 1000, not prepaid. Chas. Frost, Kenilworth, N. J.

Pansies, large, field grown, transplanted plants, very choice colors, \$10.00 per 1000. Cash. Stephen Chase Nashua, N. H.

PATENTS

Siggers & Siggers, Washington, D. C.
For page see List of Advertisers.

For List of Advertisers See Page 751

PEAT

Orchid Peat and Moss always on hand.
Julius Reehrs Co., Rutherford, N. J.

PEONIES

Peonies only, by the wholesale—best 100 varieties. J. F. Rosenfeld, Westpoint, Neb.
One of the finest collections in America. Send 25 cts. in stamps for new edition of Peony Manual. C. S. Harrison's Select Nursery, York, Neb.

PHLOXES

Send 25 cts in stamps for Phlox Manual. Fine mixed phloxes \$2.00 per 100. C. A. Harrison's Select Nursery, York, Neb.

PHOTOGRAPHS: DESIGNING: ILLUSTRATING

Geo. E. Dow, 178 Washington St., Boston. For page see List of Advertisers.

PIPE AND FITTINGS

Foley Mfg. Co., between Western Ave. and 26th St., Chicago, Ill.

Kroeschell Bros. Co., 35 Erie St., Chicago. For page see List of Advertisers.

PIPE AND FITTINGS. Cast Iron and Wrought Pipe, Valves, Elbows, Pipe Hooks, Automatic Air Headers, etc. Lord & Burnham, 1133 Broadway, N. Y.

PLANT STAKES

Seele's Treeless Plant Stakes and Trellises. H. D. Seele & Sons, Elkhart, Ind.

POT HANGERS

Pot hangers, Kramer's \$1 doz. by exp., \$1.25 by mail. I. N. Kramer & Son, Cedar Rapids, Ia.

RAFFIA

Raffia (colored), 20 beautiful shades. Samples free. R. H. Comey Co., Camden, N. J.; 810 Washburn Ave., Chicago, Ill.

RHODODENDRONS

John Waterer & Sons, Ltd., American Nursery, Bagshot, England. For page see List of Advertisers.

P. Ouwerkerk, Hoboken, N. J. For page see List of Advertisers.

ROSES

Robert Craig Co., Market and 49th Sts., Philadelphia, Pa. For page see List of Advertisers.

P. Ouwerkerk, P. O. No. 1, Hoboken, N. J. For page see List of Advertisers.

The F. R. Pierson Co., Tarrytown-on-Hudson, N. Y. White Killarney. For page see List of Advertisers.

S. J. Reuter & Son, Westery, R. I. My Maryland. For page see List of Advertisers.

Dingee & Conard Co., West Grove, Pa. For page see List of Advertisers.

Scott Bros., Elmford, N. Y. For page see List of Advertisers.

Poehlmann Bros. Co., Morton Grove, Ill. For page see List of Advertisers.

A. N. Pierson, Cromwell, Conn. White Killarney, My Maryland, Ramblers. For page see List of Advertisers.

Henry A. Dreer, 714 Chestnut St., Phila. Field Grown Ramblers.

Montrose Greenhouses, Montrose, Mass. Kaiserin, Grafted; Queen Beatrice, Own Root.

U. S. Cut Flower Co., Elmira, N. Y. Rose Plants. For page see List of Advertisers.

The Rose, by H. R. Ellwanger; mailed for \$1.30 by Horticulture, 11 Hamilton Place, Boston.

Hand Book of Cultural Notes on Roses Under Glass, by F. P. Brigham, mailed to your address for 25c. by Horticulture Publishing Co., 11 Hamilton Place, Boston.

SALVIA

Salvia: Fine stock from 3/4 in. pots, \$5.00 per 100. Leonard Cousins, Jr., Concord Junction, Mass.

SEED GROWERS

Hjalmar Hartmann & Co., Cauliflower and Cabbage Seed. Langangstræde 20, Copenhagen, Denmark. For page see List of Advertisers.

SEEDS

T. J. Grey Co., 32 So. Market St., Boston. For page see List of Advertisers.

Joseph Breck & Sons, 51 and 52 N. Market St., Boston, Mass. For page see List of Advertisers.

W. Allee Burpee & Co., Philadelphia. For page see List of Advertisers.

Arthur T. Boddington, 342 W. 14th St., New York. Palm Seed. For page see List of Advertisers.

H. E. Fiske Seed Co., Faneuil Hall Sq., Boston. For page see List of Advertisers.

Hjalmar Hartmann & Co., Langangstræde 20, Copenhagen, Denmark. Cauliflower and Cabbage Seed. For page see List of Advertisers.

Richards Bros., 37 E. 19th St., New York. For page see List of Advertisers.

R. & J. Farquhar & Co., 67 So. Market St., Boston. Mignonette Seed. For page see List of Advertisers.

H. F. Michell Co., 1018 Market St., Phila. Primula Seed. For page see List of Advertisers.

J. M. Thorburn & Co., 33 Barclay St., N. Y. For page see List of Advertisers.

Leonard Seed Co., Chicago, Ill. For page see List of Advertisers.

Schlegel & Fottler Co., 26 & 27 S. Market St., Boston. For page see List of Advertisers.

O. V. Zangen, Hoboken, N. J. Florida's Spring Seeds. For page see List of Advertisers.

E. F. Winterson Co., Chicago. Seeds for Plantsmen, Nurserymen, Seeds men. For page see List of Advertisers.

Seeds. Rocky Mountain Evergreen seeds in large or small quantities. C. S. Harrison's Select Nursery, York, Neb.

SHRUBS

The Geo. Wittbold Co., 1857 Buckingham Place, Chicago. For page see List of Advertisers.

SILKALINE

John C. Meyer & Co., Boston, Mass. For page see List of Advertisers.

SPHAGNUM MOSS

Live Sphagnum moss, orchid peat and orchid baskets always on hand. Lager & Hurrell, Summit, N. J.

SPRAYERS

Niagara Sprayer Co., Middleport, N. Y. For page see List of Advertisers.

Chas. J. Jager Co., Boston. Deming Spray Pump. For page see List of Advertisers.

STEAM TRAP

E. Hippard, Youngstown, O. For page see List of Advertisers.

STOVE PLANTS

Julius Reehrs Co., Rutherford, N. J. For page see List of Advertisers.

STRAWBERRY PLANTS

300 Strawberry Plants \$1. Your selection. List free. Wm. Perry, Cool Spring, Del.

SULPHUR BURNER

Benj. Dorrance, Rose Growers, Dorrance-ton, Pa.

SWEET PEAS

A. C. Zvonack, Bound Brook, N. J. Winter Flowering. For page see List of Advertisers.

TO-BAK-INE

E. H. Hunt, Genl. Agt., 76-78 Wabash Av., Chicago. For page see List of Advertisers.

VEGETABLE PLANTS

R. Vincent, Jr. & Sons Co., White Marsh, Md. For page see List of Advertisers.

Vegetable plants now ready, all cold frame grown and hardened ready for outdoor planting. Cabbage, Charleston, Wakefield and Early Summer at \$2.00 per M., \$15.00 per 10,000. Egg Plants, Black Beauty and New York Spineless, \$1.50 per 100. Tomato plants, Earliana, Chalk's Jewell, June Pink and Allen's Best, \$1.00 per 100, \$6.00 per M. Cauliflower, Early Snowball, 75c per 100, \$4.00 per M. Pepper plants, Ruby King, 75c per 100, \$4.00 per M. Cash with order. All plants by express, receiver to pay charges. Address W. F. Allen, Salisbury, Md.

VENTILATING APPARATUS

Piercon U-Bar Co., 1 Madison Sq., N. Y. For page see List of Advertisers.

Foley Mfg. Co., Western Ave., between 25th & 26th Sts., Chicago. For page see List of Advertisers.

John A. Payne, 260-274 Culver Ave., Jersey City, N. J. For page see List of Advertisers.

The Advance Co., Richmond, Ind. For page see List of Advertisers.

Quaker City Machine Co., Richmond, Ind. 2nd Century Venting Arm. For page see List of Advertisers.

VENTILATING MACHINERY. New Model encased, self-losing gear; Standard Model Open Gear. Lord & Burnham, 1133 Broadway, N. Y.

VERBENAS

Verbenas, 2 1/2 to 3 in. high, 1c. each. Best varieties to be got, all desirable colors. H. J. Blanchard, Ashburnham, Mass. J. C. Schmidt, Bristol, Pa. For page see List of Advertisers.

VIOLETS.

William Sim, Cliftondale, Mass. Boston and Princess Violets. For page see List of Advertisers. 1000 California Violets, \$1.00 per 100; good rooted divisions from cold frame. Allen Bros., Leominster, Mass. Princess Violets, 2 1/2 in., \$2.00 per 100. Jas. T. Baker, Binstleton, Philadelphia, Pa.

WEED KILLER

The American Horticultural Distributing Co., Martinsburg, W. Va. Target Brand.

WILSON'S PLANT OIL

Wilson Plant Oil & Fertilizer Co., Chatham, N. J. For page see List of Advertisers.

WIRED TOOTHPICKS

W. J. Cowee, Berlin, N. Y. For page see List of Advertisers.

WIREWORK

Reed & Keller, 122 W. 25th St., N. Y. For page see List of Advertisers.

Durand & Marohn, Albany, N. Y. For page see List of Advertisers.

Wirework. Write for our catalogue. Holton & Hunkel Co., Milwaukee, Wis. William E. Heilscher's Wire Works, 83-40 Broadway, Detroit, Mich.

Wirework—Compare our prices with others. Scranton Florist Supply Co., 301 N. 7th St., Scranton, Pa.

WHOLESALE FLORISTS

Boston

N. F. McCarthy & Co., 84 Hawley St., Boston. For page see List of Advertisers.

H. M. Robinson & Co., 75 Province St. and 9 Channing Pl., Boston. For page see List of Advertisers.

Welch Bros., 228 Devonshire St., Boston. For page see List of Advertisers.

In writing to Advertisers kindly mention Horticulture

WHOLESALE FLORISTS— Boston—Continued

Tally, Wellesley, Mass.
For page see List of Advertisers.

Buffalo, N. Y.

William F. Kasting Co., 283-87 Elliott St.,
Buffalo, N. Y.
For page see List of Advertisers.

Chicago

Chas. W. McKellar, 51 Wabash Ave.,
Chicago.
For page see List of Advertisers.

Peter Reuberg, 51 Wabash Ave., Chicago.
For page see List of Advertisers.

E. F. Winterson Co., 45-49 Wabash Ave.,
Chicago.
For page see List of Advertisers.

J. A. Budlong, 37-39 Randolph St., Chicago.
For page see List of Advertisers.

Poehlmann Bros. Co., Morton Grove, Ill.
For page see List of Advertisers.

Cromwell, Conn.

A. N. Pierson, Cromwell, Conn.
For page see List of Advertisers.

Detroit

Michigan Cut Flower Exchange, 38 and 40
Broadway, Detroit, Mich.
For page see List of Advertisers.

Minneapolis

Rice Bros., 115 N. 6th St., Minneapolis,
Minn.
For page see List of Advertisers.

New York

Ford Bros., 48 W. 28th St., New York.
For page see List of Advertisers.

H. E. Froment, 57 W. 28th St., New York.
For page see List of Advertisers.

Alex. J. Guttman, 34 W. 28th St., New
York.
For page see List of Advertisers.

H. C. Horan, 55 W. 28th St., New York.
For page see List of Advertisers.

A. H. Langjahr, 56 W. 28th St., New York.
For page see List of Advertisers.

James McManus, 42 W. 28th St., New York.
For page see List of Advertisers.

John I. Raynor, 49 W. 28th St., New York.
For page see List of Advertisers.

W. F. Sheridan, 39 W. 28th St., New York.
For page see List of Advertisers.

Moore, Hertz & Nash, 65 and 57 W. 28th
St., New York.
For page see List of Advertisers.

Wm. H. Knebler, 28 Willoughby St.,
Brooklyn, N. Y.
For page see List of Advertisers.

Philip F. Kessler, 65 and 57 W. 28th St.,
New York.

Millang Bros., 41 W. 28th St., New York.
For page see List of Advertisers.

John Young, 51 W. 28th St., New York.
For page see List of Advertisers.

Greater New York Florists' Association
162 Livingston St., Brooklyn, N. Y.
For page see List of Advertisers.

Frank Millang, 55-57 W. 28th St., New
York.
For page see List of Advertisers.

B. B. Silno, 55-57 W. 28th St., New York.
For page see List of Advertisers.

A. L. Young & Co., 54 W. 28th St., N. Y.
For page see List of Advertisers.

Growers' Cut Flower Co., 39 W. 28th St.,
New York.
For page see List of Advertisers.

Henshaw & Fenrich, 44 W. 28th St.,
New York.
For page see List of Advertisers.

J. K. Allen, 106 W. 28th St., New York.
For page see List of Advertisers.

Charles Millang, 444 Sixth Av., New York
For page see List of Advertisers.

WHOLESALE FLORISTS— Philadelphia

W. E. McKissock & Bros., 1619-1621 Ban
stead St., Philadelphia, Pa.
For page see List of Advertisers.

Leo Nielsen Co., 1209 Arch St., Philadel-
phia, Pa.
For page see List of Advertisers.

The S. S. Pennock-Meehan Co., 1608-16
Ludlow St., Philadelphia, Pa.
For page see List of Advertisers.

New Offers in This Issue.

AMERICAN GROWN ROSES:
SHRUBS; EVERGREENS;
SMALL FRUITS.

W. & T. Smith Co., Geneva, N. Y.
For page see List of Advertisers.

BAY TREES, BOXWOOD, PALMS,
ARAUCARIAS.

Bodshick & Atkins, Rutherford, N. J.
For page see List of Advertisers.

COCOS WEDDELIANA; KENTIA
BELMOREANA.

O. V. Zaugen, Hoboken, N. J.
For page see List of Advertisers.

COMMERCIAL CHRYSANTHEMUMS
FOR IMMEDIATE DELIVERY.

Elmer D. Smith & Co., Adrian, Mich.
For page see List of Advertisers.

DECORATION DAY HYDRANGEAS,
ROSES, DRACAENAS.

Hatler, Amsterdam & S-henstadt, N. Y.
For page see List of Advertisers.

DRACAENA INDIVISA.

P. M. Olm, Bath, Me.
For page see List of Advertisers.

FRESHLY IMPORTED UNESTAB-
LISHED ORCHIDS.

Lager & Hurrell, Summit, N. J.
For page see List of Advertisers.

GREENHOUSE BUILDING MAT-
RIAL.

S. Jacobs & Sons, 1329-63 Flushing Ave.,
Brooklyn, N. Y.
For page see List of Advertisers.

GREENHOUSES FOR SALE.

Thomas M. Lynch, 236 Main St., Pough-
keepsie, N. Y.
For page see List of Advertisers.

HEADQUARTERS FOR DECORA-
TION DAY STOCK.

J. A. Budlong, 37-39 Randolph St., Chicago.
For page see List of Advertisers.

HARDY PLANTS.

Palisades Nurseries, Sparkill, N. Y.
For page see List of Advertisers.

JAPAN IRIS, ASPARAGUS PL.
NANUS and ROBUSTUS.

J. M. Thornburn & Co., 33 Barclay St.,
New York.
For page see List of Advertisers.

MEMORIAL DAY FLOWERS AND
SUPPLIES.

S. S. Pennock-Meehan Co., Philadelphia.
For page see List of Advertisers.

PURPLE LEAVED JAPAN MAPLES.

Ellwanger & Barry, Rochester, N. Y.
For page see List of Advertisers.

RUBBERS; VINCAS; PLUMOSUS;
CHRYSANTHEMUMS.

William C. Smith, Market & 61st St.,
Philadelphia.
For page see List of Advertisers.

SPECIAL GARDEN HOSE.

Crestline Mfg. Co., Crestline, O.
For page see List of Advertisers.

WHITE BONNAFFON CHRYSAN-
THEMUMS.

H. L. Cameron, N. Cambridge, Mass.
For page see List of Advertisers.

HORTICULTURE IN THE ASCEN- DANT.

"Man has been in quest of rural happiness ever since the expulsion of Adam and Eve from the garden of Eden. He has tried the large grain and stock farm, only to find the long winter too lonesome or his work too much isolated from his neighbors, so he gladly exchanged the country for what appeared to be a charming city life, but now we see men from all walks of city life seeking homes in the rural districts of the United States, not to become general farmers, but to take up some special phase of the work and in the majority of instances it is fruit growing."

W. S. Thornbent, professor of horticulture at the experimental station at Washington State College, Pullman, said this on a recent visit to Spokane, when he also delivered an address before the Spokane County Horticultural Society.

"The Yankee of today," he added, "is true to his former traits; those living in the city are in quest of rural happiness, while those of the country are looking forward to the time when they will have money enough to revel in the joys of city life."

"Horticulture in its broad sense materially aids in solving this problem inasmuch as it demands small farms, thickly populated sections, which makes possible electric railways and lights, telephones, rural mail routes and, in a measure, combines the best of city and country in one useful and busy life.

"Many are desirous of becoming proficient in the craft, but expect to do so only in a classroom or well-equipped library. Such men can never learn to thoroughly appreciate the work until they have come in personal contact with all the practical phases of the work, but the west demands a practical man—one who can do as well as tell the other fellow how to do.

"The department of horticulture has had 26 calls for trained horticulturists in the last 12 months, at salaries ranging from \$1,200 to 1,400 a year for the small farm, to from \$3,000 to \$5,000 for the company orchards. These calls have been without exception for theoretical as well as for practical men. They say it is not good form to look ahead too far, but judging from the demands of the last 15 years a thoroughly trained horticulturist will have no difficulty in securing a first-class position in the future.

"The broad scope of the field of practical horticulture is in a measure responsible for this demand for trained men. A prominent horticulturist said recently the field is so broad that a person may follow any one of 26 general lines of work and yet remain entirely within the ranks of the profession.

"When one considers the almost unlimited opportunities that are open to trained nurserymen, florists, seedmen, landscape gardeners, fruit growers, plant breeders experiment station workers and teachers of horticulture, he is then able to more fully appreciate the extent of the field of horticulture that has been opened to the

For List of Advertisers See Page 751

LIST OF ADVERTISERS

Page	Page
Advance, The Co., 755	Lager & Hurrell, 744
Allen, J. K., 745	Langhary, Alfred H., 744
American Nurseries, 740	Leonard Seed Co., 739
(Eng.), 737	Leuthy A. & Co., 739
Aechmann Godfrey	Lord & Burnham Co., 756
731-735	Lynch Thos. M., 751
Athens Floral Co., 740	
Bambrick Thos. H., 743	Manda Jos. A., 744
Barrows H. H. & Son, 744	MacMulklin E. A., 744
Baur & Smith, 744	McCarty N. F. & Co., 745
Bayersdorfer H. & Co., 745	McConnell Alex., 745
Blossom The, 740	McKellar Charles W., 749
Bobnik & Atkins, 741	McKissick, W. E. & Bros., 744
Boddington A. T., 739	McManus Jas., 744
	Meyer J. C. & Co., 745
Boston Florist Letter, 739	Michell H. C. F. Co., 745
Co., 744	
Boston Plate and Win- dow Glass Co., 754	Michigan Cut Flower Ex- change, 745
Bowe, M. A., 740	Milling Bros., 744
Bowker Fertilizer Co., 749	Milling Charles, 744
Bowker Insecticide Co., 753	Milling Frank, 748
Breik Joseph & Sons, 759	Miller E. S., 743
Breitmeier F. J. Sons, 744	Moninger J. C., 744
Bridgeman's Seed Warehouse, 739	Moore, L., 735
Blong J. A., 735-744	Moore, Heats & Nash, 744
Burpee W. A. & Co., 739	Mt Hope Nurseries, 735
	Murray Samuel, 740
Cameron H. L., 744	
Carrillo & Baldwin, 744	New Eng. Nurseries, 737
Chicago Carnation Co., 744	Newman J. & Sons, 744
Clark's David, 750	Niagara Spray Co., 753
Coast J. J., 744	Niessen Leo. Co., 742
Cooper Wm. & Nep- cows, 753	Oecoblin Frank, 744
Cosmons Geo. & Co., 744	Olm F. M., 744
Croce W. J., 744	Orndorff Bros., 744
Craig, Robt. Co., 744	Ouwenkerk P., 737
Crawback Geo. W., 745	
Crestline Mfg. Co., 744	Palisades Nurseries, 737
Danker F. A., 744	Paethorpe P. K. Co., 743
Dase J. H. & Son, 744	Palmer W. J., 740
Dawson H. S., 737	Park Floral Co., 740
Dingee & Conrad Co., 737	Farselsky Bros., 754
Dorner F. Sons & Co., 722	Parten & Co., 744
Dow Geo. E., 739	Payne John A., 755
Dreer H. A., 754	Peacock Dahlias Farms, 753
Dunlop John H., 740	Peacock-Mechan Co., 733
Durand & Marohn, 744	
Dyck R. J., 745	Pericat Alphonse, 732
Eastern Chemical Co., 752	Perkies St. Nurseries, 734
Eastern Nurseries, 737	Pierce, F. O. Co., 754
Edwards Folding Box Co., 742	Pierston A. N., 743
Eisler C., 744	Pierston U Bar Co., 756
Elliot Wm & Sons, 739	Poehlmann Bros. Co., 744
Elmsford Nurseries, 722	722-742
Ellwanger & Barry, 737	Pulverized Manure Co., 753
Elder J. G., 755	Quaker City Mach. Co., 754
Ernest W. H., 744	Ralph John, 736
Eyres, 740	Raylor, I. M., 744
	Raynor John L., 744
Farquhar R. J. & Co., 739	Reed & Keller, 745
Felthousen J. E., 724	Reinberg Peter, 742
Fisher David, 744	Reuter S. & Sons, 750
Fiske H. E. Seed Co., 739-753	Revere Rubber Co., 755
	Rice Bros., 744
Foley Mfg. Co., 754	Richardts Bros., 739
Ford Bros., 744	Robinson H. M. & Co., 737
Freeman G. L., 744	Rock Wm L. Flo. Co., 749
Froment H. E., 744	Rochrs Julius Co., 724-736
Fuller, Est. of David, 723	Roland, Thomas, 735
Galvin Thos. F., 741	Rolker August & Sons, 754
Greater N.Y. Florists Association, 745	Rose Hill Nurseries, 744
Grey T. J. Co., 739	Sander & Son, 744
Growers' Cut Flower Co., 744	Schlegel & Fidler Co., 739
Gude Bros., 744	Schm J. C., 743
Gutman Alex. J., 744	Schulz Jacob, 743
	Scott Bros., 722
Hall Assn., 755	Scott, John, 724
Harnmann Hjalmar & Co., 739	Sharp & Bergler Co., 754
Hatcher, 739	Sheridan W. F., 744
Hauswirth the Florist, 740	Siggers & Siggers, 755
Heacock Jos. Co., 724	Sim. Wm., 735
Henshaw & Feorig, 744	Situations & Wants, 753
Herbert David, 740	Slimo B. S., 744
Hews A. H. & Co., 754	Smith Elmer D. & Co., 734
Hilfinger Bros., 754	Smith Sam'l W., 736
Hill, The E. G. Co., 752	Smith W. E. & Sons, 723
Hippard E., 755	Smith W. T., 737
Hitchings & Co., 744	Smyth Wm. J., 740
Hoffman, 744	Standard Plate Glass Co., 754
Horan E. C., 744	Stearns A. T. Lumber Co., 754
Hunt Bros., 748	Storrs & Harrison, 754
Hunt E. H., 725-753	Stump & Walter Co., 753
Jacobs S. & Sons, 755	
Jager, Chas. J. Co., 753	Swayze Wm., 722
Kasting W. F. Co., 745	Syracuse Pottery Co., 754
Kervan The Co., 745	
King Cons. Co., 755	Thornburn J. H. & Co., 739
Knick W. C., 744	Toty Chas. H., 744
Kroeschell Bros. Co., 755	Treple C. C., 740
Kuebler Wm H., 745	
Ky. Tobacco Product Co., 751	United States Cut Flower Co., 735

Page	Page
Valentine, J. A., 740	Winterson, E. F. Co., 742
Vincent R. Jr. & Sons, 735-738	Wood Bros., 722
Ward R. M. & Co., 739	Yokohama Nursery, 707
Waterer John & Sons, 757	Young A. L., 744
Welch Bros., 742	Young John, 744
Withold Geo. Co., 724	Young & Nugent, 740
Wilson, 740	
Wilson Plant Oil and Fertilizer Co., 753	Zangen O. V., 742-739
	Zinn Julius A., 744
	Zvolanek A. C., 749

trained man or woman, and those who like it will make no mistake in carefully considering its merits as a life work."

Professor Thornber intimated that too many men are going into horticulture in these days of fruit growing prosperity in the Northwest as a final resort to accumulate a fortune or simply as an easy way of obtaining a comfortable income, adding:

"While the opportunities are unlimited and the profession is far from being full, let no one indulge in it with dreams of sudden riches."

GIGANTEUMS IN BLOOM BY MARCH 20TH, 1910.

One of our most successful growers of Lilium giganteum, contrary to the general impression, says there is no difficulty about getting these in bloom by March 20th. His treatment is as follows (written specially for the benefit of readers of HORTICULTURE):

Lilium giganteum if grown successfully is one of the best paying crops. For the last five years we have grown this variety mostly and have had it in bloom almost every month in the year. Many growers are afraid to force it for an early Easter, but experience has taught us that if Easter should come on March 15th we could have giganteums in bloom then as well as April 15th.

The best and surest way to grow it is to push it as quick and fast as you are able. For an early Easter like March 27th, put up your bulbs in the first week of December and put them in the warmest house you have on the place, where the temperature runs between 65 and 70 degrees at night, under the bench, but don't forget the hose, as the water plays the important part in the beginning. Soak them every day till the tops commence to show. A lily bulb is like a good many other bulbs in that it takes a tropical temperature to give it a quick start.

In two weeks the growth will be about 2-3 inches long but keep them under the bench till the growth is about 8 inches long which will help you to get a much longer stem. It will not take longer than four or five weeks to get them 8 or 10 inches in height. From now on you can put them on top of the bench and your battle is won when you have a healthy lily 8 to 10 inches. With a moderate temperature and a skillful grower you will have no trouble in getting them in at the right time. Of course after you have them on the bench you must use the water more carefully according to the temperature of the house as the roots of a lily don't care for too much water after they are well started.

AG. DOEMLING.
Lansdowne, Pa.

WANTS, FOR SALE, ETC.
Advertisements in this column one cent a word. Initials count as words. Cash with order. All correspondence addressed "care HORTICULTURE" should be sent to 11 Hamilton Place, Boston.

HELP WANTED

GOOD MEN

When you need good men, skilled or unskilled, Write:

THOS. H. BAMBRICK
34 South 7th Street Philadelphia

Help of all kinds, including that for Florists, Nurserymen, Seedsmen and the Horticultural trade generally.

HORTICULTURE needs a wide-awake representative in every town in the land. Good commission paid on advertising and subscriptions. If you are ambitious, write for terms.

SITUATIONS WANTED

Employer wants a position for gardener who has given good satisfaction as superintendent of large estate. Address T, care HORTICULTURE, Boston.

FOR SALE

FOR SALE

The GREENHOUSE PROPERTY, to close the ESTATE OF M. J. LYNCH, Deceased

The old established greenhouse property of the late M. J. Lynch, on the South Road, near the city of Poughkeepsie, N. Y., consisting of Sixteen Greenhouses, 30,000 square feet of Glass with entire stock of Palms, Roses, Carnations, Bedding Plants, and Plants of all kinds, etc.

Eight-room Dwelling, with hot-water heating and slate roof, also,

Five-room Gardener's Cottage, adjoining Greenhouses.

Large, substantial Carriage House.

This is a valuable location, with ample water supply, adjoining Rural cemetery, on line of Wappingers trolley, one mile and a quarter from Court House.

For Particulars Apply

THOMAS M. LYNCH
256 Main St., Poughkeepsie, N. Y.

FOR SALE—Special 16 x 18 and 16 x 24 double thick glass in "A" and "B" qualities. Buy now and save money. Write PARSEK & BROTHERS, INC., 50 Montrose Ave., Brooklyn, N. Y.

FOR SALE—7000, 16x24, double thick glass, 10c. per light. F.O.B. twenty lights per box. Address Frank M. Richardson, Littleton, N. H.

MISCELLANEOUS WANTS

WANTED TO BUY—Complete greenhouse plants and all kinds of greenhouse material, to be taken down and removed at once. Terms cash. Address I, Newark, N. J.

WANTED—One Pandanus Uttil, large plant, state size and price. Scott Bros., Elmsford, N. Y.

Tobacco Paper

IS THE

STRONGEST,

BEST PACKED,

EASIEST APPLIED.

24 sheets.....	\$ 0.75
144 sheets.....	3.50
288 sheets.....	6.50
1728 sheets.....	35.10

"NICO-FUME"

Furnishes the
Most Nicotine for the Money

... Manufactured by ...

THE KENTUCKY TOBACCO PRODUCT CO., Louisville, Ky.

LIQUID

OVER 40% NICOTINE

By far the

CHEAPEST.

JUST NOTE PRICE!

Pint.....	\$ 1.50
½ Gallon.....	5.50
Gallon.....	10.50
5 Gallons.....	47.25

During Recess

YE WHIMSICAL SAYINGS OF
H. A. B.

The "dummy" for the program of the annual picnic of the New York Florists' Club is before us. The "Greetynge" which adorns the first page, the work of the irrepressible Harry Bunyard, is decidedly original, so we reproduce it for the perusal of our readers during recess.

GREETYNGE.

Oyez! Oyez! Oyez!

About this thyme ye almanacke sayes, looke out for ye New Yorke Florists' Clubbe annual bean feast, when ye stately dames, ye faire damsels, ye gallante gentlemen and ye joyous cherubs, gather on ye greene, to gambol and frolycke, fill veselues up at ye barbecue and toast ye one another wythe meade and milke from ye caske and gentle bossie, and smoke ye pipe of peace.

As ye lion layeth down wythe ye lambe, so will ye grower of gawe posies minste wythe ye wholesaile and retayle merchant prince, and shie castors at ye seed man and other campe followers.

So, hall all ye workers amonge ye flowers, hall and foregather on ye annual holliday, leave care behind and brynge ye smite and faire spouse or blushynge mate and sweethearte and ye offsprynge, and joine in ye merrie feaste and frolycke.

Ye good ship Ysabelle will bear ye to sylvan glaydes flowynge wythe ye milk and honeye, and bear ye safely back under ye watchful and silverie moone when ye faire ladies and younge gallants can toll each other of ye love and constancy and of ye joyous daye while dancing ye stately minuet, and dodging ye cupid's arrowe.

So ye Committee praye ye all to come on ye joyous anniversarye.

H. A. B.

MOVEMENTS OF GARDENERS.

Stephen Ayer of White Haven, Pa., has taken a position with T. M. McLaughlin, Chestnut Hill, Philadelphia. Wm. Crighton has taken a position with Hunter & Son, Englewood, N. J.

WELL SATISFIED.

Please discontinue my ad. Am well satisfied with results. Had only small surplus. Will remember you next time.
G. A. THEILE.

Frankford, Pa., May 17, 1909.

ROYAL HORTICULTURAL SOCIETY.

At the recent exhibition of this society Messrs. Barr & Sons made a fine showing of bulbous plants including many novelties. In tulips, mention may be made of T. Brunhilde with yellow and white tints, novel in coloring and of great size. Of narcissus, some of the most beautiful were, Salmonetta, a N. Leedsii with a corona of apricot color; N. poeticus grandiflorus; N. poeticus Epic; N. Leedsii Peach; N. incomparabilis Argent, in whose flower the corona is doubled; Cassandra, a N. poeticus variety; Janet Image, a giant Leedsii; N. poeticus The Bride; N. p. Galvin and Dorothy Wemyss among white flowered varieties. Among yellow flowered Narcissus, Hon. Mrs. Joelynn is a fine trumpet variety; Ranger Johnson is another. N. Gloria Mundi, an incomparabilis variety and Monarch, a trumpet, were capital flowers. This firm showed new varieties differing in some respects from older ones, some possessing coronas more brilliant in color as these are wider spread. Such are Masterpiece, N. triandrus hybrids, White Lady and others. A silver gilt Banksian medal was awarded the group.

J. Veitch & Sons showed among other interesting things a large number of hybrids of Phyllocaetus, very pretty plants for early summer flowering and needing only intermediate house treatment, for which a silver gilt flora medal was awarded. Messrs. Veitch also exhibited a large collection of Himalayan rhododendrons and hybrids of these species, of which the more showy in color or size of the blooms were Mrs. Butler, pale pink flowers, fragrant; Mrs. Thiselton Dyer, flowers of a shade of lilac; Pink Pearl; Thompsoni, blood red; Kewensis a hybrid of R. Aucklandi, lush, very beautiful; Dr. Stocker (new) white with a pink eye; Falconeri; Glory of Penjerick, a fine hybrid of R. Aucklandi, etc.

The display of roses was very extensive, all the well-known ramblers of European and American origin being shown in large numbers. Among the exhibitors in this department were Messrs. Veitch & Sons, F. Cant & Co., B. Cant & Sons, Hugh Low & Co., W. Paul & Son and G. Mount. In the group shown by the latter there were pyramids of the new H. T., Joseph Lowe, sent out by Messrs. Lowe and Sawyer, of Uxbridge, a bloom of a soft rose tint, with a very pleasing bud. Rhea Reid as shown was not the equal of Liberty or of Capt. Hayward, being smaller and less good in tint than either.

OBITUARY.

Mrs. John Galvin.

Mrs. John Galvin, widow of the late superintendent of Boston's public grounds, died at her home in Dorchester, Mass., on May 15. Mrs. Galvin had reached the ripe age of ninety years. She was born in Limerick County, Ireland, and came to this country when a young girl. She married John Galvin in 1847 and they lived happily together until the death of Mr. Galvin 54 years later; their home a centre of good cheer and a model of hospitality.

Two daughters and three sons, with many grandchildren and great-grandchildren, survive. Of the sons, John Mitchell Galvin, for a number of years Boston city clerk, and recently a candidate for Congress, is well-known in politics, and Dr. George W. Galvin is widely famed as a surgeon. Her third son, Thomas F. Galvin, has continued his father's business and is a commanding figure in the flower trade of Boston.

Her eldest daughter is the widow of Capt. George P. Ryan, room-mate of Admiral Sampson at the naval academy, who was lost off Hatteras in November, 1877. Her youngest daughter is Mrs. Charles M. Drake of Boston.

The meeting of the Connecticut Horticultural Society at Hartford, on May 14 was presided over by Vice-President John Gerard. A committee consisting of G. W. Smith, W. W. Hunt and G. T. Whiton was appointed to draft a set of resolutions of sympathy with President Huss in the loss of his wife. G. W. Smith delivered an interesting address on "Milk Analysis" for which a vote of thanks was passed by the society. Some splendid Marshall strawberries, grown under glass by Mr. Huss, received an award of merit.

IMP SOAP SPRAY

THREE SUCCESSFUL YEARS

Outdoor or Indoor

ELM BEETLE OR
WHITE FLY

EASTERN CHEMICAL CO.

 Pittsburg Street, Boston, Mass.

An Absolute Success

in Killing Scale and All Other Insect Pests on Trees, Shrubs and Garden Plants, including the notorious **LACE FLY ON RHODODENDRONS** without injury to the foliage.

WILSON'S PLANT OIL

Well Tested and Its Efficacy Fully Demonstrated

TRY IT!

Wilson Plant Oil & Fertilizer Co., Chatham, N. J.

For Trees, Plants, Shrubs and Flowers

— USE —

THE NIAGARA BRAND LIME SULPHUR SOLUTION

It destroys Scale Lice, Spiders and all forms of Aphides, AT THE SAME TIME Mildew, Blight, Rust and other Fungus difficulties.

Used in Winter or Summer. — No other remedy has been so universally effective.

Niagara Brand ARSENATE OF LEAD for chewing insects is equal to the best and better than the most. Ask about our Green House sprayer. Address —

NIAGARA SPRAYER CO., - - Middleport, N. Y.

DON'T EXPERIMENT

USE

To-BAK-INE

and your stock will be free from insects, clean, and the blooms will not be discolored.

Send for full information of

H. E. FISKE SEED CO.
13 Faneuil Hall Sq., Boston, Mass.

STUMPP & WALTER CO.,
50 Barclay St., New York.

HENRY F. MICHELL & CO.,
1018 Market St., Philadelphia.

E. H. HUNT, Gen'l Agent,
76-78 Wabash Ave., Chicago.

WIZARD

TRADE MARK

BRAND MANURES

Dried, screened and packed in bags of 100 lbs. each.

PULVERIZED SHEEP MANURE

PURE — UNIFORM — RELIABLE

A strong and quick acting manure, highly recommended for carnations and chrysanthemums.

SHREDDED CATTLE MANURE

EASY TO HANDLE AND APPLY

Stronger and better in every way than rough manure. Lasts much longer on the benches. Unequaled for mulching and feeding roses, liquid manuring and mixing with bench and potting soil. Used by all the largest growers.

Ask Your Supply Man or Write Us for Circulars and Prices.

— THE —

Pulverized Manure Co.
31 Union Stock Yards, CHICAGO

KILMDEAD

The best of all the tobacco dusts for



Dusting or Fumigating

25 lbs., \$1.00	100 lbs., \$3.00	1000 lbs., \$27.00
50 lbs., 1.75	500 lbs., 14.00	2000 lbs., 52.00

Stumpp & Walter Co. 50 Barclay St., New York.



The Best Bug Killer and Bloom Saver

For PROOF Write to

P. R. Palethorpe Co.
OWENSBORO, KY.

"Every Bug Has His Dose."

Insect-destroying preparations that do their work well and effectively are the cheapest. Bowker's Arsenate of Lead and Bowker's Pyrox are recognized standard insecticides and fungicides for both indoor and outdoor use. Bowker's Insect Emulsion destroys many kind of plant lice, black and green flies, etc. Call or send for catalogue.

BOWKER INSECTICIDE COMPANY
43 CHATHAM ST. BOSTON



LATEST DISCOVERY

Progressive Growers Investigate!

33 page Booklet of British, American and Canadian Testimony free for the asking

Eastern Agent—CYRIL FRANKLYN
62 Beaver St., New York, N. Y.

Sole Proprietors
WILLM COOPER & NEPHEWS
177 Illinois Street, CHICAGO

Which Spray Pump

What shall you buy? Buy the Spray Pump that fully meets the demands of the Government Agricultural Scientists and all practical Fruit Growers. These pumps are widely known as

DEMING SPRAYERS and are made in 23 styles for use in small gardens or immense orchards.

Write for our 1800 catalog with Spraying Chart. Add 4 cents postage and receive "Spraying for Profit," a useful guide book.

CHARLES J. JAGEL CO.
281-286 Franklin St., Boston



In ordering goods please add "I saw it in HORTICULTURE."

FOR "POT LUCK" TRY US...
HEWS STANDARD POTS

POT MAKERS FOR 140 YEARS

WORLDS LARGEST MANUFACTURERS

WRITE FOR CATALOGUE AND DISCOUNTS

A. H. HEWS & CO., Inc.
 CAMBRIDGE, MASS.

452-460 No. Branch St.,
 CHICAGO, ILL.

Pearson Street,
 LONG ISLAND CITY, N. Y.

GLASS

Greenhouse and Hot Bed

SIZES OUR SPECIALTY
 IMMENSE STOCK

Plate and Window Glass

Write for Our Prices

PARSHELSKY BROS., Inc.
 59 Montrose Ave., BROOKLYN, N. Y.

STANDARD FLOWER POTS

Packed in small crates, easy to handle.

Price per crate	Price per crate	
1500 2 in. pots in crate \$4.38	144 6 in. pots in crate \$3.16	
1500 2 1/2 " " " 5.25	120 7 " " " 4.20	
1500 3 " " " 6.00	60 8 " " " 3.00	
1000 3 " " " 5.00	HAND MADE	
800 3 1/2 " " " 5.80	48 9 in. pots in crate \$3.60	
500 4 " " " 4.50	24 11 " " " 3.60	
450 4 1/2 " " " 5.24	24 12 " " " 4.80	
320 5 " " " 4.51	12 14 " " " 4.80	
210 5 1/2 " " " 3.78	6 16 " " " 4.50	

Seed pans, same price as pots. Send for price list of Cylinders for Cut flowers, Hanging Baskets, Lawn Vases, etc. Ten percent. off for cash with order. Address Hilfinger Bros., Pottery, Fort Edward, N. Y. August Rolker & Sons, Agts. 31 Barclay St., N. Y. City.

Standard Flower .. POTTS

If your greenhouses are within 500 miles of the Capital, write us, we can save you money

W. H. ERNEST
 28th and M Street WASHINGTON D. C.

Syracuse Red Pots

STANDARD SIZES

Florists, we will suit you as to quality and prices. Write for catalogue.

Syracuse Pottery Co., SYRACUSE, N. Y.

HOSE

CRESTLINE SPECIAL Garden Hose. Made in three different weights. A tough, durable hose that has the life in it. Every section guaranteed.

Price with couplings:	5 only	6 ply	7 ply
1/2 in. per 50 ft.	\$4.00	\$5.00	\$5.50
3/4 in. per 100 ft.	7.75	9.75	10.75
1 in. per 50 ft.	11.50	15.50	16.50
1 1/4 in. per 100 ft.	8.75	10.75	11.75

Immediate shipment. Express or freight. THE CRESTLINE MFG. CO., Box 258, Crestline, O.

THE FLORISTS' HAIL ASSOCIATION.

In addition to the recently published list of losses by hail adjusted by the association Treasurer Heacock reports the following paid since May 10: Hess & Swoboda, Omaha, Neb., \$2,178.64; J. T. Temple, Davenport, Ia., \$90.48; William Gos, Davenport, Ia., \$6.25; Chas. Ederer, Omaha, Neb., \$1,601.46; H. Roth, W. Lafayette, Ind., \$285.58; Blackman Bros., Navad, Ia., \$155.25; A. Woerner, Clinton, Ia., \$10.54.

STANDARD PLATE GLASS CO.

Manufacturers—Importers—Jobbers

NOW IS THE TIME TO BUY

FRENCH OR AMERICAN GREENHOUSE GLASS

LOWEST PRICES ON REQUEST

26-30 Sudbury St. BOSTON, MASS. 61-63 Portland St.

BOSTON PLATE & WINDOW GLASS CO.

GREENHOUSE GLASS GERMAN AND AMERICAN

261 to 287 A Street BOSTON 20 to 22 Canal Street

GLASS Always Write Us Before Buying SHARP, PARTRIDGE & CO. 22nd and Lumber Streets, CHICAGO WE HAVE SOME SNAPS

MASTICA FOR Greenhouse Glazing

 USE IT NOW.
 F. O. PIERCE CO.
 12 W. BROADWAY
 NEW YORK

Mastica is elastic and tenacious, admits of expansion and contraction. Putty becomes hard and brittle. Broken glass more easily removed without breaking of other glass as occurs with hard putty. Lasts longer than putty. Easy to apply.

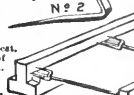
Holds Glass Firmly See the Point #1
PEERLESS Glazing Points are the best. No right or left. Box of 1000 points 75 cts. postpaid.

 HENRY A. DREER,
 214 Chestnut St., Phila., Pa.

GREENHOUSE CONSTRUCTION LUMBER

John C. Moninger Co.

117 E. Blackhawk St., CHICAGO.

Evans 20th Century Arm

 Will not twist the shafting pipe. Three times the power of old style elbow arms. Sold only with Evans Challenge Machine. Write for Free Catalogue to QUAKER CITY MACHINE CO. Richmond, Ind.

IF YOU WANT BIG RESULTS
 BUY FROM WHO RUNS THE CITY OF CHICAGO
 YOU WILL WEAR A SMILE CAUSED BY PROFITS FROM GROWN IN PRODUCE HOUSES
 PHIL FOLEY FACTORY CITY OF CHICAGO
 ESTABLISHED 1857
 CHICAGO
 WIRELESS MESSAGE
 YOUR BUSINESS MATERIAL WOOD ZIRO PAPER LUMBER FROM

CYPRESS SASH BARS \$2 feet or longer
HOT BED SASH
PECKY CYPRESS BENCH LUMBER

GREENHOUSES

ERECTED AND EQUIPPED COMPLETE IF DESIRED

Write for Circular "D" and Prices

The A. T. STEARNS LUMBER CO.
 NEPONSET, BOSTON, MASS.

Light
Graceful
Durable

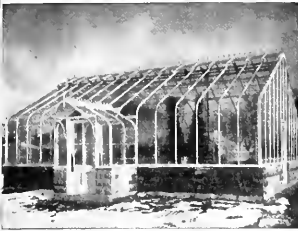

22 ft. wide without columns

**Payne "T"
Bar Greenhouse**

any width and length. Every bar galvanized steel. Absolutely dripless. No breakage of glass at eaves. Every kind of greenhouse construction. Estimates furnished.

JOHN A. PAYNE

Designer and Builder

260-274 Culver Ave. Jersey City, N. J.

**KROESCHELL
BOILER**



MADE OF FIRE BOX FLANGE PLATE
Can not Crack

Water Space in Front, Sides and Back
The Most Popular Boiler Made

SEND FOR CATALOGUE.

KROESCHELL BROS. CO.

35 Erie Street, CHICAGO, ILL.

Everything for
Greenhouse
Building

Write for information and
prices

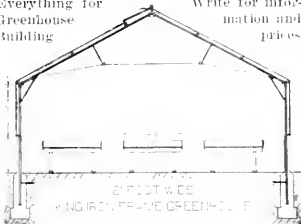

In Widths from 14 feet 0 inches to 54 feet 0 inches.
Without p. sts.

**KING TRUSS SASH BAR HOUSES.
IRON GUTTERS AND EAVES
IRON AND CYPRESS BENCHES.
VENTILATING MACHINERY.**

KING CONSTRUCTION CO.
NORTH TONAWANDA, N. Y.

**The FLORESTA'S HAIL ASSOCIATION
OF AMERICA, insurer of 29,000,000
sq. ft. of glass.** For particulars address

John G. Esler, Sec'y, Saddle River, N. J.



**80 REELS, 40,000 FEET
A DAILY SHIPMENT OF "REVERO GARDEN HOSE"**

Indestructible — Light — Strong — Flexible.

Wears longest, stands most abuse. Seamless, braided, moulded construction

ASK YOUR SUPPLY MAN FOR "REVERO"

PUT UP ON REELS IN 500 FT. LENGTHS

REVERE RUBBER COMPANY

Boston, New York, Philadelphia, Pittsburg, Chicago,
Minneapolis, New Orleans, San Francisco, Portland, Ore.

THE STANDARD STEAM TRAP

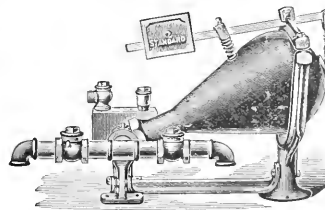

is acknowledged the best for the
florist, because it is durable and
does its work without trouble and
annoyance, saving its cost by the
economy in coal bills.

E. HIPPARD

YOUNGSTOWN, OHIO

S. JACOBS & SONS

1350-1363 Flushing Ave., BROOKLYN, N. Y.

MANUFACTURERS OF

**GREENHOUSE MATERIAL — VENTILATING APPARATUS — PUTTY
JOBBERS IN: GREENHOUSE GLASS — BOILERS — PIPE — FITTINGS**

We carry on hand everything necessary for the complete Erecting, Heating, Ventilating or
Repairing of Greenhouses. Let us quote you.

PATENTS

Trademarks and
Copyrights

Send your business direct to Washington.
Saves time and insures better service.
Personal attention guaranteed.
Twenty-five years' active service.
SPECIALTY: "Working on the Failure
of Others."

SIGGERS & SIGGERS

PATENT LAWYERS

Box 9, National Union Building
Washington, D. C.



**The Advance Ventila-
ting Apparatus**

THE ADVANCE MACHINE
will take care of all the ventila-
ting sash that the shafting pipe
will carry well. We dare any
other line to give you better,
longer and easier service than
we will. \$10.50 for the machine
all complete, made of the very
best material in a mechanical
manner assures of long life and
the most satisfactory service.
Our shafting pipe is the best
grade, new, painted, straight-
ened, drilled and furnished with
our new couplings at 8c for the
double and 6c for the single
strength pipe. Give us a chance
to show you what we can do.

The Advance Co.
RICHMOND, IND.

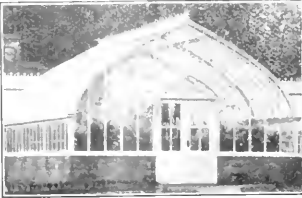

If You Are Going to Build This Year

Let's get together and talk this greenhouse matter over. In another month building will be going merrily on, and you want to have things all settled, so your new greenhouse will be among the number. Now you know the kind of house we build—and that there is none better—you know that we have a reputation for pleasant dealing, so send for our illustrated matter—and let's get together and do business.

Hitchings & Company
1170 Broadway New York



NOTE that this is the L & B Sectional Iron Frame Construction, with the Guaranteed Wrought Iron Post partly impeded in the concrete sides. Also that our Close-Working Side Ventilation Apparatus is used, and that the Ice-Clearing Eave Plate has a U-shaped Drip Gutter. This is not an experimental construction a few months old.

LORD AND BURNHAM COMPANY,
Irvington-on-Hudson, N. Y.

NEW YORK BOSTON PHILADELPHIA CHICAGO

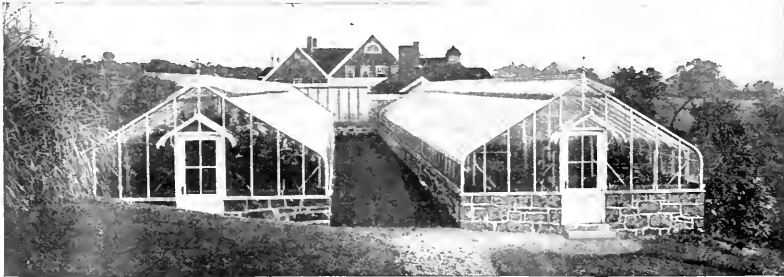

THESE GREENHOUSES LOOK LIKE BUSINESS— AND YET HOW ATTRACTIVE

And why shouldn't a greenhouse be attractive? What is the use of building those heavy, illy proportioned affairs when you can get effects like this and have houses that will grow more and better plants and flowers?

Everyone, of course, claims their greenhouses to be the best, but there is one thing certain, none are as light as the U-Bar, and the lighter a house is the better it is—any gardener knows that.

You see **this construction of ours is patented, and no one else can build these houses.** If you want a house freest from repairs, one that treats easily, and will out-strip any other house in the quantity and quality of flowers, then you want the U-Bar. Send for Catalog.

U-BAR GREENHOUSES

PIERSON
DESIGNERS AND BUILDERS



U-BAR CO.
1 MADISON AVE. NEW YORK

HORTICULTURE

Vol. IX.

MAY 29, 1909

No. 22

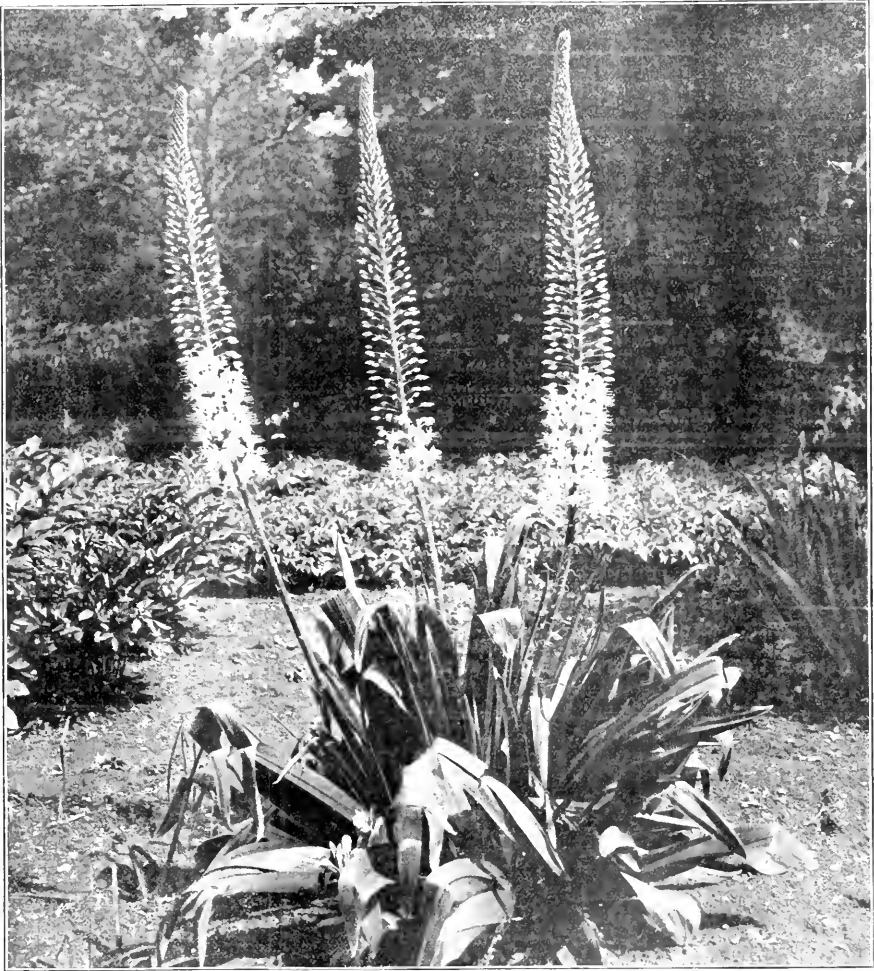

EREMURUS ROBUSTUS

DEVOTED TO THE
FLORIST, PLANTSMAN, LANDSCAPE GARDENER AND KINDRED INTERESTS

PUBLISHED EVERY SATURDAY AT 11 HAMILTON PLACE, BOSTON, MASS.

SUBSCRIPTION, \$1.00 PER YEAR



MAY 29 1909

CHRYSANTHEMUMS

I have now ready 100,000 plants of 300 varieties, Large Flowered, Singles, Pompons, etc. These are fine stock from 2 1/4 inch pots.

All the standards such as Robinson, Bonnaffon, Duckham, Clay Frick, Beatrice May, Mrs. Partridge, Polly Rose in large quantities at

\$3 per 100, \$25 per 1000

Ralph Curtis, Marie Masse, Horace Martin and other new early kinds, \$10.00 per 100.

Write me what you want and see what I can do for you.

CHARLES H. TOTT, MADISON, N. J.

CHRYSANTHEMUMS.

"Not small weak runty stock grown under benches, but the kind that brings back Dollars for Pennies."

WHITE: Earliest October Frost (We have extra fine large stock of this variety), Mrs. Henry Robinson, Clementine Touset, Alice Byron, Timothy Eaton, Merry Christmas, White Bonnaffon.
YELLOW: Moorovia, Halliday, Appleton, Bonaffon, Eaton, Chataqua Gold.
PINK: Maud Dezo, Dr. Enguehard.
RED: Intensity, Schrimpton.

All these varieties, rooted cuttings \$2.50 per 100; \$20.00 per 1000. 2 1/4 in. \$3.00 per 100; \$25.00 per 1000.
Golden Wedding, R. C. \$3.00 per 100; \$27.50 per 1000. 2 1/4 in \$4.00 per 100; \$35.00 per 1000.
Golden Glow, R. C. \$5.00 per 100. 2 1/4 inch \$6.00 per 100.

ROSES. 2 in. or 2 1/2 in. 3 in. or 3 1/2 in.
American Beauties....\$7.00 \$65.00 \$9.00 \$85.00
Killarney—Own roots. \$6.00 \$35.00 7.50
Mrs. Potter Palmer....5.00 45.00 6.50

2 in. or 2 1/2 in.
Bridemaids } 100 1000
Brides..... }\$5.00 \$45.00
Richmond... }
Kaiserrie.....5.00 45.00 \$6.50
Uncle John.....4.00 35.00

POEHLMANN BROS. COMPANY,

Morton Grove, Ill.

EARLY MUMS

Should be planted at once for best results. We have the following in quantity ready for immediate delivery. Also full quota of midseason and late sorts for those ready to plant. Price on application.

EARLY

GLORY OF PACIFIC POLLY ROSE ROBERT HALLIDAY
IVORY GOLDEN GLOW OCTOBER FROST

Price \$3.00 per 100, \$25.00 per 1000.

PACIFIC SUPREME, \$4.00 per 100, \$35.00 per 1000.

VIRGINIA POEHLMANN, \$5.00 per 100.

Not less than 25 of a kind at 100, 250 at 1000 rate.

ELMER D. SMITH & CO., Adrian, Mich

CHRYSANTHEMUMS

Rooted Cuttings and Pot Plants

Write for list and prices. ALL OF THE BEST ONES.

S. J. REUTER & SON,

WESTERLY, R. I.

Our New Carnation

is always pure white, is always in bloom and is always high grade.

SHASTA

\$12.00 per 100, \$100.00 per 1000. Send Order now to

PATTEN & CO., Tewksbury, Mass. BAUR & SMITH, Indianapolis, Ind.

White Bonnaffon

The Chrysanthemum Everybody Should Grow.

I have Rooted Cuttings, Cool Green, Sturdy Stock, \$12.50 per 1000

H. L. CAMERON,
North Cambridge, Mass.

THE BOSTON VIOLET

Unequaled for Productiveness, Beauty and Popularity.

In Crop from September to May.
Plants \$3.00 per doz \$25.00 per 100; \$200.00 per 1000
Princess of Wales \$15.00 per 1000.

WILLIAM SIM, Cliftondale, Mass.

GARNATIONS

Fine Healthy Stock From 2 inch Pots.
Per 100 Per 1000
Pres. Seelye - - - \$6.00 \$50.00
White Enchantress, Beacon 4.50 40.00
Victory, Winsor, Melody,
Kingston Pet - - - 4.00 35.00
Daheim, Lady Hountiful, Mrs.
Lawson, White Lawson, Red
Lawson, Variegated Lawson 3.50 30.00

CHRYSANTHEMUMS

Rooted Cuttings
G. W. Childs, Miss Clay Frick, White Shaw, Early Snow, Mrs. Jas. Marshall, Mayor Weaver, The Harriott, Yellow Eaton, \$2.00 per 100, \$15.00 per 1000.
A. J. Ballour, Autumn Glory, Ada Spaulding, Dr. Enguehard, Dorothy Devens, Geo. Kalb, Glory of the Pacific, Harry Day, H. W. Reiman, Ivory, Jeannette Nonin, J. E. Lager, J. H. Troy, J. K. Shaw, Laud Dean, Meta, Moorovia, Mrs. Jerome Jones, Minnie Wannamaker, Mrs. Alice Byron, Mrs. Baer, Mrs. Robert McArthur, Tator Bonnaffon, And F. Bergmann, Nagoya, Polly Rose, Robt. Halliday, Timothy Eaton, W. H. Lincoln, Wm. Duckham, etc., \$1.50 per 100.

Send for Catalogue of Roses, own root and grafted, and other miscellaneous plants.

WOOD BROTHERS FISHKILL, N. Y.

Send for our Preliminary List describing and quoting

Chrysanthemums and Carnations.

A fine lot of Carnation Cuttings ready now.

THE E. G. HILL CO.,
Richmond, Indiana.

MARY TOLMAN

A New Light Salmon Pink Carnation for 1910.

\$12.00 per 100. \$100.00 per 1000.

A. E. Hunt & Co., Evansville, Ill.
Chicago Carnation Co., Joliet, Ill.
Hunt Bros., - - Park Ridge, Ill.

GARNATIONS

F. DORNER & SONS CO.
LaFayette, Ind.

SCOTT BROS. CHRYSANTHEMUMS

All the Newest and Best Sorts
ALSO
ROSES Grafted and Own Root for Greenhouse and Outdoors

ELMSFORD NURSERIES, Elmsford, N.Y.

CHRYSANTHEMUMS

Rooted Cuttings \$0.000
White—Timothy Eaton; Mrs. Geo. S. Kolb, fine early; Estelle, White Bonnaffon, Alice Byron, Ivory, C. Touset, Jeanette Nonin, October Frost, Early Snow, Anglie Laurent, Pink—Glory of the Pacific, Dr. Enguehard, Maud Deau, Pink Ivory Yellow—Major Bonnaffon, Cremo, Robt. Halliday, "Baby," small yellow, of the button type, \$2.00 per 100, \$15.00 per 1000. J. Rosette, \$3.00 per 100.
W. T. SWAYNE, Box 226, Kennett Square, Pa

WHITE KILLARNEY

It is needless to say much about the value of this

NEW WHITE ROSE

its value is so well established. In support of this statement, we might say that we intend to plant not less than 20,000 for our own growing. We have a splendid stock of both grafted and own-root plants, which we can deliver immediately on receipt of order,—gilt-edged planting stock. We guarantee perfect satisfaction.

STRONG PLANTS, 2 1/4 in. pots, own-root, \$30.00 per 100; 250 for \$70.00; \$250.00 per 1000.
GRAFTED PLANTS, \$35.00 per 100; 250 for \$82.50; \$300.00 per 1000.

HYDRANGEAS IN BUD AND BLOOM

We offer fine plants, well budded, just beginning to show color; in splendid shape for immediate use.
 6-in. pots, 4-5 blooms each, \$9.00 per dozen.

Large Plants in Tubs

We have a large stock of splendid plants grown in tubs and half-barrels for July and August flowering.
 Fine plants in tubs, \$2.00 each. Extra large plants in half-barrels, \$5.00 each.

A FEW SEASONABLE SPECIALTIES

BOXWOOD PYRAMDAL. Fine plants 3 ft. high, \$2.00 each; 4 ft. high, \$3.00 each; 4 1/2 ft. high, \$4.00 each.
RUBBER PLANTS (Ficus elastica). Very large, bushy plants in tubs 4 ft. high, fine for summer decoration, \$3.50 each; 6-in. pots, 3 1/2 ft. high, \$9.00 per dozen.
PANDANUS VEITCHII. Fine plants, 6-in. pots, \$12.00 per dozen.

PHOENIX ROBELENI. Extra fine plants; 5-in. pots, \$18.00 per dozen.
CROTONS. Strong plants, 3-in. pots, \$3.00 per dozen; 5-in. pots, \$6.00 per dozen; 6-in. pots, \$8.00 per dozen.
CANNAS. *Beaute de Poltevine*, *Buttercup*, *Souy d'Antoine Crozy*, *Pierpont's Premier*, *Mme. Berat*, *L. Fairy*, *Florance Vaughan*, etc. Strong started plants, 3 1/2-in. pots, \$6.00 per 100. Dormant roots, \$3.00 per 100, \$25.00 per 1,000.

CALADIUM ESCULENTUM. Started plants, \$6.00 per 100.
GERANIUMS. Double Gen. Grant. Extra fine plants, 3 1/2-in. pots, \$8.00 per 100.
GERANIUMS. Assorted, 3 1/2-in. pots, \$8.00 per 100.
VINCA VARIEGATA. 4-in. pots, extra heavy, \$12.00 per 100.
NASTURTIUMS. 3-in. pots, \$4.00 per 100.

F. R. PIERSON CO.,

Tarrytown-on-Hudson,
 NEW YORK

Fine Rubbers at 20c.

All well grown stock in first class condition

Rubbers, 4 inch	each	.20c
" 6 "25c
Vincas, 4 "02c
Plumosus, 2 "05c
" 3 year04c
Mums, cuttings02c
" Nonin, out of pots....		.04c
Sprengeri, 3 year04c

Cash with order or satisfactory references

WILLIAM C. SMITH

Market and 61st Street

Philadelphia, - - Pa.

5000 GOLDEN GLOW

2 1/2 ready, \$35 per fl., R. C. \$27 per fl.
 2000 White Cloud and Pacific Supreme 2 1/2 inch, and R. C. prices as above
 Dorner's new Golden Eagle, \$10 per 100
 October Frost, Nonin, Touset, Enguehard, Golden Wedding, and all standard Chrysanthemums
 2 1/2 inch, \$2.50 per 100, \$23 per fl., R. C. \$15 less

I. M. RAYNER

GREENPORT, L. I. N. Y.

Perles, Brides and Maids for Planting

Per 100
 1000 Brides and Maids, 3 inch strong, \$4.00
 1000 Perles, 3 inch, ready for shift, \$6.00
 Pittsburg Rose & Carnation Co., Gibsonia, P. O., Pa.

A. N. PIERSON, Inc., Cromwell, Conn.

WHITE KILLARNEY (Waban Strain)

GRAFTED STOCK.....	Doz.	100	250	500	1000	2500	5000
		\$8.00	\$35.00	\$82.50	\$150.00	\$300.00	\$687.50
							\$1,250.00

MY MARYLAND GRAFTED.....\$3.00 per doz., \$20.00 per 100, \$150.00 per 1000
 OWN ROOT .. 2.00 " " " 10.00 " " " 90.00 " " "

STANDARD VARIETIES

Betty, Bon Silece, Bride, Bridesmaid, Cardinal, Enchanter, Etolle de France, Etolle de Lyon, Franz Deegan, Gen. McArthur, Golden Gate, Hermosa, Ivory, Kaiserin Augusta Victoria, Kate Moulton, Killarney, La Detroit, Maman Cochet, Marschal Niel, Mme. Abel Chatenay, Mrs. Jardine, Mme. Hoste, Mrs. Paul Niehoff, Mrs. Pierpont Morgan, Mrs. Potter Palmer, Papa Gontier, Queen Bearrice, Rhea Reid, Richmond, Rosaline Orr English, Souv. du President Carnot, Souv. de Wootton, Uncle John, Wellesley, White Cochet. The above Grafted (selected plant's) 20 cts. each, \$2.00 per doz., \$15.00 per 100, \$150.00 per 1000.

OWN ROOT ROSES

Killarney, Bride, Bridesmaid, Mme. Abel Chatenay, Ivory, Richmond, Mrs. Paul Niehoff. 3-in. pots, 75c per doz., \$3.50 per 100, \$31.00 per 1000. 2 1/2-in. pots, \$1.00 per doz., \$6.00 per 100, \$50.00 per 1000.
 Queen Bearrice, Rhea Reid, Mrs. Jardine, Mrs. Potter Palmer, from 2 1/2-in. pots, \$8.00 per 100, \$70.00 per 1000.

BEDDING PLANTS

COLEUS. *Verschaffeltii*, Golden Queen, Queen Victoria, Beckwith Gem, Firebrand, Lord Palmerston. Rooted Cuttings by express, \$0.60 per 100, \$5.00 per 1000. Out of 2 1/2 in. pots in May, \$2.00 per 100, \$15.00 per 1000.
 Golden Bedder, Hero, Messy, Pearl of Orange. Fancy Varieties. Twelve kinds not listed above, 75 cts. per 100, \$5.00 per 1000.
 AGERATUM, Stella Gurney, Princess Pauline. SALVIA, Splendens, Bonfire and Zurich. HELIOTROPE. Dark blue bedding varieties. GERMAN FLY. 75 cts. per 100, \$6.00 per 1000. —, ALTERNANTHERA, Red and Yellow, 50c per 100, \$5.00 per 1000. From 2 1/2 in. pots, \$2.00 per 100. SALLEROL Rooted Cuttings, \$1.00 per 100, 2 1/2 in. pots, \$2.50 per 100.
 CHRYSANTHEMUMS IN QUANTITY. Catalogue on Application.

GLADIOLI NAMED VARIETIES

Childsi and Gandavensis Seedlings
 Madeira Vines, Cinnamon Vines, Oxalls, Spotted Callas, and Iris Germanica. Write for prices.

E. S. MILLER, Wading River, N.Y.

Aster Plants

Sample's, Vick's and Queen of the Market, grown from the best Seed, fine plants, in White, Blue and Pink, \$2.50 per 1000; 5000 for \$10.00.
 TOMATOES, best var., \$1.50 per 1000.
 CALLIFLOWER, PEPPERS, EGG PLANTS, \$2.50 per 1000.

J. C. SCHMIDT, Bristol, Pa.

**ORDONEZ BROS., Madison, N. J.
ORCHIDS**

CATLEYA MOSSIAE, has arrived in first-class condition. Our PRICES are LOW and our STOCK is FIRST-CLASS. write us for particulars and prices and by so doing you will be sure of the facts.

Plants are FOR SALE AT THE STORE OF
AUGUST MILLANG
41 WEST 28 STREET, NEW YORK

IMPORTED ORCHIDS
Now Arriving
Julius Roehrs Co.
RUTHERFORD, N. J.

FRESH IMPORTED ORCHIDS.
Arrived in Splendid Condition: Cattleya Trianae, Mossiae, Gigas, Skinnerii, Oncidium Splendidum, Oralithorhynchum, Ventworthianum, Phalaenopsis Schilleriana and Amabilis, Lycaste Skinnerii, Vanda Boxallii, Laelia Superbicus Odontoglossum grande. Write for prices.
JOSEPH A. MANDA,
191 Valley Road West Orange, N. J.

ORCHIDS
We are booking orders now for delivery early in the Spring on all commercial CATLEYS and NOVELTIES. Our prices are right and our guarantee perfect. We sell only first-class goods
CARRILLO & BALDWIN Secaucus N. J.
ORCHIDS
Largest Importers, Exporters, Growers and Hybridists in the World
Sander, St. Albans, England
and 235 Broadway, Room 1
NEW YORK CITY

NEPHROLEPIS MAGNIFICA
THE SENSATIONAL NOVELTY
Strong 2½-in. stock, \$25.00 per 100.
WHITMANII
2¼-in., \$40.00 per 100; 3¼-in., from Bench, \$8.00 per 100.

H. H. BARROWS & SON, WHITMAN, MASS.
ROBERT CRAIG CO.
ROSES, PALMS,
and Novelties in Decorative Plants
MARKET and 49th STREETS., PHILADELPHIA, PA.

ROSES
A SPECIALTY
The Dingee & Conard Co. West Grove PA.

JAPANESE
THE YOKOHAMA NURSERY CO.
31 BARCLAY ST. NEW YORK.
LILIES
PLANTS
BAMBOO STAKES

PHALAEENOPSES AND VANDAS

Importations Received Every Two Months

Phalaenopsis Amabilis
Phalaenopsis Schilleriana
Phalaenopsis Sanderiana
Phalaenopsis Stuartiana

Vanda Sanderiana
Vanda Batemannii
Vanda Boxallii
Dendrobium Superbum

We also receive many other varieties of Orchids from the South Pacific and East Indies. We respectfully solicit your inquiry in this line.

MACRORIE - McLAREN COMPANY
721 Crocker Bldg., San Francisco, California, U. S. A.

LAGER & HURRELL
ORCHIDS
Established and Fresh Imported. **SUMMIT, N. J.**

Fresh Stock Direct from Collectors
ORCHIDS
GATTLEYAS LABIATA, MENDELII, MOSSIAE, GIGAS, SPECIOSISSIMA, GIGAS SANDERIANA, CHRYSOTOXA, AUREA.
Ordering now insures prompt delivery. Send for prices.
C. L. FREEMAN, 388 APPLETON STREET, HOLYOKE, MASS.

Palms  Ferns
Shrubs **Wittbold FLORIST** Perennials
Send for Our Catalogue.
The GEO. WITTBOLD CO., 1657 Buckingham Place, Chicago, Ill.

FERNS FOR DISHES, Assorted Varieties
From 2 inch pots, \$3.50 per 100; \$30.00 per 1000
CASH WITH ORDER
2870 to 2606 W. Adams St., Chicago, Ill.
FRANK OEGHSLIN

IPOMOEA NOCTIFLORA
Best pure white moonvine in the market, very fragrant and as big as a saucer. On this variety we have a world-wide reputation as growers and shippers for the last twenty years.
Price, 2½ in. pots, \$5.00 per 100, 10,000 are now ready.
Godfrey Aschmann
1012 West Ontario St., Philadelphia, Pa.

COLEUS! COLEUS!
C. Verschaffeltii and Golden Bedder, R. C. .60 5.00
Same in 2½ in. pots .200 15.00
Coleus, mixed, R. C. .60 5.00
Same in 2½ in. pots .175 15.00
Ageratum Stella Gurney and Pauline, R. C. .50 4.50
Same in 2½ in. pots .100 9.00
Feverfew, in 2½ in. pots 2.00
Fuchsias, nur selection, in 2½ in. pots 3.00
German Ivy, R. C. .75
English Ivy, R. C. 1.00
Cash with Order
J. E. FELTHOUSE
148-154 Van Brankon Ave., SCHENECTADY, N. Y.

Kentias, Arecas, Latanias, Cocos, Phoenix, Araucarias, Rubbers, Crotons, Pandanus, Asparagus, Ferns for Dishes. 200,000 Bedding Plants, also Rooted Cuttings of Coleus at lowest wholesale rates.
Orders taken for imported plants for fall delivery
A. LEUTHY & CO.
PERKINS ST. NURSERIES
ROSLINDALE, MASS.

PALMS AND FERNS
DECORATIVE PLANTS
JOHN SCOTT
Rutland Road and E. 45th St.
Tel. 860 Bedford **BROOKLYN, N. Y.**
JARDINIERE FERNS
IN BEST VARIETIES. VERY FINE STOCK.
\$.35 per 100, \$30.00 per 1000
ROSE HILL NURSERIES
New Rochelle, N. Y.

Davallia fijensis

The accompanying illustration represents a fine specimen of *Davallia fijensis* grown for Mrs. B. B. Tuttle of Naugatuck, Conn. It would make a nice companion to that fine specimen of *Adiantum Farleyense* grown by Mr. Urquhart and pictured in *HORTICULTURE* April 17 last. But it takes more than two years to grow this fern to that size.

This plant has been on the premises for the last fourteen years to my knowledge, and heaven only knows how many years prior to that. It has never been broken up or divided and has not been repotted for over six or seven years, but it keeps on growing and producing its two crops of fronds annually which are very useful for cutting as they have great lasting qualities. The specimen stands now three feet high and measures over four and one-half feet in diameter.

The plant receives liberal waterings with liquid manure while making its new fronds until these are fully



developed and hard water is gradually withheld and sparingly given until the old fronds are cut and the plant starts to grow again.

M. J. Pope

Naugatuck, Conn.

Notes from the Arnold Arboretum

The ornamental Apples have bloomed again splendidly this year at the Arnold Arboretum and particularly the large group at the foot of Peter's Hill was a mass of white and pink and presented a glorious sight while the bloom was in its prime. Among the numerous kinds more or less well known I should like to draw attention to three desirable but very little known forms. One of them is *Malus floribunda* var. *Arnoldiana* (*M. Arnoldiana*) which originated at the Arnold Arboretum some time ago, but was described and published as a new variety only a few months ago. There is as yet only one plant in existence but grafts have been distributed last winter and it will probably be in trade before very long. *Malus floribunda Arnoldiana* is much like the well known *M. floribunda* but superior to it chiefly on account of its larger and more numerous flowers which are of a somewhat lighter color. It is a beautiful shrub, the spreading and gracefully arching branches loaded with large slender-stalked flowers carmine pink in bud and nearly white when fully open. The yellow berry-like fruits are also larger than in *M. floribunda*.

Another Apple which merits to be better known is *Malus atrosanguinea*, supposed to be a hybrid between *M. Halliana* and *M. rivularis* or perhaps *M. Toringo*. It is one of the few Apples with decidedly pink flowers and forms a shrub or small tree with slender branches densely covered with carmine pink flowers. On account of its denser habit and more closely set flowers it is a more effective shrub for planting in groups than *Malus*

Halliana, though the latter is certainly more graceful if seen at close range with its larger individual flowers of a purer pink. The third Apple with pink flowers is *M. Niedzwetzkyana* which, however, is inferior in beauty to the two others, as it is a coarser tree and less free flowering. All three are valuable for the color of their flowers as they form a pleasing contrast with other flowering Apples which all have white or but slightly pinkish flowers at least when they are fully open.

A third little known species is *Malus Sargentii* very distinct in habit from other Apples. It is a low shrub scarcely exceeding three or four feet in height with almost horizontally spreading branches loaded with pure white flowers. It blooms about a week later than most other Apples, at the same time with *M. Toringo* which it resembles much in foliage, but *M. Toringo* has smaller pinkish flowers and slenderer partly arching branches.

A few years ago we received plants of *Cercis chinensis* which have proved hardy at the Arboretum and show that this beautiful species can be grown successfully in this latitude. *Cercis chinensis* is a much finer plant than the native *C. canadensis*; it has larger flowers produced in great profusion and blooms very freely even as a young plant. It is certainly a valuable addition to our early flowering shrubs particularly as shrubs with pink flowers are not very numerous.

During the coming week the Lilacs and *Rhododendron Katajifori* will be in full bloom and will form then the most attractive feature of the Arboretum.

Alfred Rehder

HORTICULTURE

VOL. IX

MAY 29, 1909

NO. 22

PUBLISHED WEEKLY BY

HORTICULTURE PUBLISHING CO.
11 Hamilton Place, Boston, Mass.

 Telephone, Oxford 322
WM. J. STEWART, Editor and Manager
SUBSCRIPTION PRICE

One Year, in advance, \$1.00; To Foreign Countries, 2.00; To Canada, \$1.50

ADVERTISING RATES

 Per Inch, 30 inches to page
 Rates on Contracts for consecutive insertions, as follows: \$1.00
 One month (4 times) 5 per cent.; three months (12 times) 10 per cent.;
 six months (16 times) 20 per cent.; one year (52 times) 30 per cent.
 Full and half page spaces, special rates on application.

 Entered as second-class matter December 8, 1904, at the Post Office at Boston, Mass.,
 under the Act of Congress of March 3, 1879.

CONTENTS

	Page
COVER ILLUSTRATION— <i>Eremurus robustus</i> .	
DAVALLIA FIGENSIS—M. J. Pope—Illustrated.....	761
NOTES FROM THE ARNOLD ARBORETUM—Alfred Rehder	761
EUROPEAN HORTICULTURE—Frederick Moore.....	763
THE EREMURUSES.....	763
NEWS OF THE CLUBS AND SOCIETIES: Massachusetts Horticultural Society—New Orleans Horticultural Society—Horticultural Society of New York—Minnesota State Florists' Association—Amer- ican Rose Society—Club and Society Notes.....	764
OBITUARY: Charles L. Allen, Portrait—John Cassidy—M. J. Jorns—Charles F. Hilton.....	765
HARDY PERENNIALS AND THEIR USES—Robert Cameron	766
CATTELEYA MOSSIAE—Wm. McM. Brown.....	767
BOSTON PUBLIC GARDEN—Luke J. Doogue—Illus- trated	768
ANEMONE SPECIES AND VARIETIES—Frederick Moore	769
SOME OF OUR PROBLEMS AS ROSE GROWERS— Prof. L. C. Corbett.....	770
SEED TRADE: The Backward Season—A Word for the Cannors— A Banner Year—Suit Against Blue Grass Growers— Notes	774
OF INTEREST TO RETAIL FLORISTS: New Flower Stores—Steamer Departures—An Anni- versary and a Conratulation.....	776
Flowers By Telegraph.....	777
FLOWER MARKET REPORTS: Boston, Buffalo, Philadelphia, Twin Cities.....	779
New York, Detroit, Indianapolis.....	781
Chicago, Washington.....	786
MISCELLANEOUS: Personal	765
The Veterans, Poetry.....	765
<i>Arabis alhida</i>	766
Greenhouses Building or Contemplated.....	771
The Fulfillment of a Prophecy.....	772
Chestnut Tree Fungus.....	772
Movements of Gardeners.....	772
Chicago Notes.....	772
Nursery Notes.....	772
Incorporated.....	772
News Notes.....	774
Catalogues Received.....	774
Business Changes.....	777
Patents Granted.....	788

theory be true that the chill comes from the numerous icebergs that have been seen floating along the coast, then a continuance of the low temperatures may perhaps be expected and the result should be greatly to the advantage of the flower business, the cool weather serving to keep people in the city later than usual. The outlook is certainly good for a lively June business and we think that those who make liberal preparation for it will not be disappointed.

Our reports from the various wholesale flower centres for the past few weeks indicate a very unsatisfactory state of affairs. The usual explanation advanced for a congested market—overproduction—is, of course, easy to fall back upon but when in the course of a day's travels in crowded shopping districts and among the residences of rich and poor alike, one sees scarcely a flower worn on the person or displayed in the window of either home or store, it seems logical to inquire why this abundance of floral material is not more generally distributed and to reason that so long as ninety-nine out of every hundred people are destitute of flowers this talk about overproduction is largely fallacy.

Standing, one morning not long since, on West 28th street, the centre of the inadequate methods of distribution of great wholesale flower trade of New York, we saw one department store wagon loaded up with a purchase said to amount to over six hundred dollars, yet that wagon load was comparatively an insignificant item in the grand total of the daily wholesale distribution through this and other channels entirely outside of what are known as the legitimate retail flower stores. It is evident to any one familiar with these wholesale marts that really a very small proportion of each day's receipts can be consumed by the regular flower stores as at present conducted and the conviction is forced upon us that there is something radically defective in our accepted methods of flower distribution. Everybody is fond of flowers: they like to see them and to have them constantly about the home, the office and the person, and in every place of public resort. To supply even a small fraction of probable buyers would require many times the biggest "over production" ever yet seen. From this distance it looks to us as if the majority of the retail flower sellers were sleeping at the post. The question of what can be done to create and stimulate a wider, more stable and permanent market is a very live one.

Important

If you have sent money or important communications by mail to this office within the past two weeks and have not received our acknowledgement of same please communicate with us with full particulars at once, as we have reason to suspect that mail addressed to us may have been stolen.

The spring we have been passing through will long be remembered for its protracted series of cold days and nights. Of course, no one can tell how soon it may veer around and give us an equally vigorous roast but if the

A forecast
for June

European Horticulture

THE BERLIN INTERNATIONAL EXHIBITION

In continuation of the remarks concerning new varieties of plants in last week's issue, mention may be made of the dwarf *Impatiens Holstii* varieties now becoming popular on the continent of Europe and in Great Britain. *I. H. nana Liegnitzia*, a variety by Herr Otto of Liegnitz in Germany, grows to a height of scarcely 10 inches, and when it is in full bloom it is a pretty object, the color being an orange red. The blooms are not so readily detached as those of *I. Sultani* varieties—an advantage. The plant does well in a pot, and as a bedder in half shady situations, and bids fair to become a general favorite.

Primula obconica grandiflora Feurkonegin is an improvement on *P. o. kermesina* the color being more fiery and carmine like. It was raised by Herr Arends, of Ronsdorf; who, it may be stated, is noted for his *P. o. gigantea* varieties, which excel the best foreign ones, surpassing even those of the Dutch raisers—a fact very noticeable at the Berlin show. In varieties of *Primula sinensis*, one named *Morgenrote* shown by Herr Palmann of Eberswalde was much admired. It is a chance seedling, and it will without doubt be speedily followed by *Abendrote* of a similar tint. This is the way with the Germans.

NEW ROSES

Madame Leon Pein is of a silvery blush tint; in the centre whitish orange, these tints being heightened by various fine shades. The flower is extraordinarily enduring. The flower bud is of the favored filbert form which on expanding shows the full beauty of the flower, set off by the shining leathery foliage. An abundant blooming variety, it is well adapted for second early and late forcing and for a solitary specimen as well as for beds. It is said to have a preference for a heavy soil. The variety is classed as a Hybrid Tea.

MARQUIS DE SIXETY. This likewise belongs to the Hybrid Tea race, and of the color of red ochre—quite a peculiar one among roses. In growth the plant is vigorous and admirably adapted for producing flowers with moderately long stalks. It is a good bedding rose, or for making specimen plants.

MADAME PHIL. RIVOIRE, is an apricot-yellow rose, having a tinge of carmine, very large, and of pretty shape, inclining to globular with a fine fragrance. This variety is less adapted for forcing than for growing in cold frames, for beds, and for pot culture in the cold greenhouse.

SENA TEUR ST. ROMME. This scarcely known Hybrid Tea that was put into commerce in 1905 is of a coppery salmon red tint, and china pink, with a yellow ground color shaded carmine. The flower in the bud state is filbert shaped, and when fully expanded, it becomes a large, beautiful bloom, nearly weather proof; as is also the plant itself.

PRINCE DE BULGARIE, H. T. is getting to be well known by rosarians everywhere. The flowers are pink

on a yellowish ground color, with over all a deep rose tinge, medium size, and, in the bud stage, not very effective. The bloom is firm, of good substance, does not suffer in color or fragrance by long transportation and has a promising future as a cut flower.

THE FLORA GARDEN, COLOGNE

The municipality of Cologne have the intention to take over the large Flora Gardens, at that city, which cover 6½ hektar, and were laid out in the period 1862-1864, and are owned by a joint stock company. The authorities have the intention to turn the Garden into a botanical institute. The director of the small botanical garden facing the *Vorgebirgstor*, which had hitherto served for study and school purposes, is Dr. Esser. The city will acquire the site for 500,000 Flora shares.

A MATERIAL FOR TYING-IN GRAFTS AND BUDS

In this country and Germany bast by preference is the material used for ligatures in grafting and budding; whereas about Orleans, cotton or woollen thread are thus employed for roses and peaches, and bast for others. At Plantieres, Metz, the leaves of a marsh plant, *Sparganium ramosum* are used for this purpose, and it possesses considerable advantages, in its breadth; it must sometimes be divided, and it affords an airtight bandage; cutting into the bark is avoided, and removal in the spring is not required.

BERBERIS ANGULIZANS

The above species of barberry, is one amongst twenty others cultivated by the Henkel Nursery Co. at Darmstadt. It is worthy of notice by the gardener on account of the wonderful tints the foliage assumes in late summer, and retains till the leaves are destroyed by frost. The plant possesses elegant pendulous shoots, and the foliage when old, becomes leathery, and of orange and green and red tints, making the shrub exceedingly decorative in the autumn months. The leaves offer beautiful material for bouquets, and other florists' articles at that season; and the shrub has a good effect on a rockery, or as a group on the lawn.

Sandercock Moore

The Eremurus

See Cover Illustration.

The eremurus are among the most majestic plants of the hardy garden. With their grand spikes, six to ten feet in height, of sweet scented white, pink or golden flowers they make a conspicuous object in the garden landscape in June and July. The species most desirable are *Himalaicus*, white, *Bungei*, bright yellow, *Robustus*, peach pink and *Elwesianus* rose pink. A sunny but sheltered position is to be preferred. The succulent flower scapes are easily snapped by the wind and should be staked.

The greatest difficulty in growing *Eremurus* in the latitude of New England lies in guarding the young shoots from frost. They start early in April throwing up strong shoots two to three inches in diameter which, because of their rapid growth and succulent condition, are very easily injured. A slight mulch of straw should therefore replace the heavier winter mulching which is usually removed from herbaceous borders in the early days of April.

NEWS OF THE CLUBS AND SOCIETIES

MASSACHUSETTS HORTICULTURAL SOCIETY.

The annual free May exhibition was held at Horticultural Hall, Boston, on Saturday and Sunday, 22nd and 23rd inst. It was an excellent and fairly representative show for the season, which is quite backward. Spring flowering shrubbery, bulb flowers and other early outdoor bloom were abundant. From Robert Cameron of the Botanical garden came a most interesting selection of the best of the old and new narcissi and Darwin tulips. W. W. Rawson & Co. were represented by a very extensive collection of Darwin and Cottage tulips, said to comprise over 500 varieties. The Boston Park Department made a big display of tree and shrub flowers such as red and white flowering dogwood, Azalea Vaseyi, pyruses, etc. The largest exhibitor in this section was R. & J. Farquhar & Co., who staged great masses of Hlases, tulips, pansies, violas and other showy material among which the brilliant orange Trollius Japonica Excelsior attracted general attention. Francis Skinner showed fine trusses of Rhododendron giganteum and received honorable mention thereof.

Among the exotic displays the groups from Julius Roehrs Co., Rutherford, N. J., were particularly worthy. In the orchid group was a fine specimen of Laelia-cattleya Canhamianum var. Rex to which a first class certificate was awarded. The Pescatorei odontoglossums were the best-bloomed we have seen in a long time. Other attractions were a pure white Cattleya Mendelli and superb specimens of Phalaenopsis Rimestadtiana. A bronze medal was awarded for this display. The Roehrs group of stove plants also contained many gems, including Tradescantia Regina which was accorded honorable mention. J. T. Butterworth staged two specimen plants of Cattleya Mossie which won for him a silver medal. They bore upwards of fifty perfect flowers each and were constantly the centre of a group of admiring gardeners. W. A. Riggs won a cultural certificate with some pyramidal trained ivy geraniums and Cero-lethron Balfourii, the latter with unusually heavy flower trusses. A group of probably bloomed plants of Calceolaria puzosii Golden Queen, from E. J. Milton was much admired. Mrs. J. L. Gardner had a fine table of cattleyas, cypripediums, miltonias, etc. In the large Farquhar group previously mentioned a quantity of forced material was included. Particularly interesting were some neat little Crotus dahlias blooming in 2 1/2-inch pots. Among them were Rose, Glory of Baarn, Garibaldi, Duke Henry and others. A new drop-the hydrangea from Nikko, Japan and some forced rhododendrons were also among the popular contributions.

The Bellevue Nurseries sent, among other interesting forced hardy plants,

oriental poppies blooming in 2 1/2-inch pots, Campanula Moerhousii, etc. Old Town Nurseries were awarded honorable mention for a display of Doronicum excelsum. From Mrs. F. Ayer came a gorgeous display of bloom of Campanula Albidum, all colors, and a specimen Queen Alexandra daisy, pink flowered. Zonal pelargoniums from W. Whitman, carnations from M. A. Parrott, pansies from Mrs. A. W. Blake, and a varied display from Mrs. E. M. Gill complete the list. A bronze medal was awarded to the Park Department for their shrub group, a first-class certificate to Mrs. Ayer for pink Marguerite and honorable mention to R. & J. Farquhar & Co. and W. W. Rawson & Co. in addition to the special awards already mentioned.

NEW ORLEANS HORTICULTURAL SOCIETY.

The above society met May 20, at their headquarters in Kolb's Hall. The committee on last outing reported a good time at A. Alost's handsome place on Gentilly Road, and that the host had surpassed himself in his efforts to entertain the members and guests. Votes of thanks were tendered the Stocker Seed Co. and the Metairie Ridge Nursery Co. for the loan of vehicles to convey the members and guests to Mr. Alost's hospitable domicile. It was decided not to have the annual outing to Grand Isle this year, but instead to hold the July meeting at one of the suburban resorts, have election of officers and terminate the event with a banquet.

J. A. Newsham exhibited fine flowers of Cattleya Mendelli and Laelia Digbyana, and R. Eichling, of the U. J. Virgin Co., showed several specimens of the Japanese flowering beans, which are very ornamental for shade purposes and for cut flowers in the summer.

A letter was received from the secretary of the Crop Pest Commission of the state, inclosing circulars relative to the brown-tail moth and calling attention to the law which makes it obligatory to report to the Commission any importations of foreign plants.

C. R. PANTER, Sec.

HORTICULTURAL SOCIETY OF NEW YORK.

The summer exhibition of this society will be held in the Museum building, New York Botanical Garden, Bronx Park, N. Y., on Saturday, June 5th, 1909, and will remain open to the public on Sunday, June 6th. Liberal premiums, open to all competitors, are offered by the New York Botanical Garden, to be awarded by the exhibition committee of the Council of the Horticultural Society of New York. Peonies, hardy roses, shrubs, rhododendrons, irises, etc., are specially provided for and the exhibition committee has at its disposal a sum of money which may be awarded for any meritorious exhibits of hardy plants or flowers not specified in the schedule. Exhibits under this class are specially solicited.

MINNESOTA STATE FLORISTS' ASSOCIATION.

The attendance at the meeting which was held at Meriam Park, May 18, was rather small, owing to the rush of the spring business. The committee on fall flower show will report later as to whether it held the show will be in Minneapolis or in St. Paul. Messrs. Holm, A. Swanson, Nagel and Ruedlinger were appointed a committee to arrange for a picnic in July. Otto Will, who returned lately from his wedding tour around the world, gave a short but very interesting talk on Japan and China and promised to give an illustrated lecture next winter.

AMERICAN ROSE SOCIETY.

Mrs. Gertrude Hubbard, a lady of Washington, D. C., has established a Gold Medal fund for the American Rose Society, by placing the sum of two hundred and fifty dollars in the treasury of our society, the interest accruing from which shall each five years be used for a gold medal, to be awarded to the most promising new rose of American origin. Mrs. Hubbard all her life has taken much interest in stimulating and encouraging people young and old, to make attractive homes and keep surroundings pretty. She was created the first honorary member of the Rose Society. Peter Bisset, superintendent of "Twin Oaks," Washington, was Mrs. Hubbard's agent in the matter.

Doubleday, Page & Co., New York City, have submitted a proposition of interest concerning the awarding of a series of medals, which will be acted upon at the next meeting of the executive committee.

Roses are being planted out this year more extensively than common, and if the rose bush growers are wise, they will throw their support to the American Rose Society by becoming active members.

BENJAMIN HAMMOND, Sec.,
Fishkill-on-Hudson, N. Y., May 24, '09.

CLUB AND SOCIETY NOTES.

The next meeting of the American Peony Society will be held at Cottage Gardens, Queens, N. Y., on Tuesday and Wednesday, June 8 and 9.

The Tri-City Florists' Club met on May 13 with H. Pauli at Davenport, Iowa, and transacted routine business Refreshments were served later.

The North Shore Horticultural Society, Manchester, Mass., was addressed on May 23, by Samuel B. Crombie of Los Angeles, Calif., on "Horticulture in California." Mr. Crombie is a native of Manchester.

At the meeting of the State Floral Society of San Francisco on May 14, President Plath reported that over \$1,250 had been contributed for cash prizes for the October flower show; also that an attractive display of fruits would be made.

The New London County Horticultural Society met at Norwich on May

17 and after a short business session Alfred Flowers of New London presented an able paper on "Herbaceous Perennials," and Mrs. E. M. Rogers spoke on the coming of spring as shown by the flowers, in an entertaining manner. A vote of thanks was accorded both speakers.

Intending exhibitors at the 1909 shows of the Massachusetts Horticultural Society should not be deterred by the absence of the usual liberal cash prizes in some of the schedule classes. At a recent meeting of the trustees the sum of \$750. was appropriated for special use by the plant and flower committee in recognition of deserving exhibits.

PERSONAL.

C. Voyes of Merrill, Wis., has gone to Washington, Ind., to start in the florist business.

Mr. H. G. Eyres of Albany has returned from a week's fishing trip spent at Twitchell Lake.

Mr. Hoffman has resigned his position as florist and landscape gardener at the Carlisle Indian School, Carlisle, Pa.

Oakes Ames was appointed head of the Botanic Gardens of Harvard University at the recent meeting of the corporation.

Visitors in Boston: Ed. Roehrs and Jas. Muller, Rutherford, N. J.; W. A. Manda, South Orange, N. J.; Mrs. Joseph M. Gasser, Cleveland, Ohio.

Edward Ashcroft and Miss Rena Shulmire, employees of the Pittsburg Cut Flower Co., Pittsburg, Pa., were married on May 14, and will reside at Avalon.

On the completion of his twenty-fifth year as grower for Bertermann Bros. Co., of Indianapolis, Alvin Schreiber was presented with a gold watch by the firm.

Visitors at Albany last week: S. D. Green, representing H. Bayersdorfer & Co., Philadelphia; M. Cohen, representing Wertheimer Bros., New York City; S. Kahn, representing H. H. Berger & Co., New York City.

Percy F. Williams of Natick, Mass., and Miss Frances K. Heard of Auburn, Ala., are to be married on June 3. Mr. Williams is a graduate of Massachusetts Agricultural College and holds the position of assistant in horticulture at the Alabama Polytechnic Institute.

Albert E. Mauff of Denver and Ira Cline of Paonia, Colo., have been appointed by Governor Shafroth as members of the Colorado State Board of Horticulture. Mr. Mauff was elected to the city council in the spring of 1907 on the Municipal Ownership ticket and served with distinction. His record in the city council and his general good citizenship commended him to the governor. He will take the place of Mrs. Martha Shute, who has been secretary of the board for more than twelve years. Mr. Mauff's name appears on the membership list of the S. A. F. from 1903 to 1906, inclusive.

Obituary.

Charles L. Allen.

This widely-known horticulturist and writer died at his home in Floral Park, Long Island, N. Y., on May 21, aged 81 years. Mr. Allen was for many years engaged in the seed, plant and bulb business in Queens and Floral Park, the gladiolus and lilies having been specialties with him. He was well informed on horticultural and scientific



CHARLES L. ALLEN

matters and was the possessor of one of the finest private horticultural libraries in this country. He was a very clever writer and entertaining talker and was the author of several valuable books. Personally, he was widely appreciated for his geniality and comradeship. His two sons, Charles H. Allen, carnation grower, of Floral Park, and Wm. Stuart Allen, the

wholesale florist, are well known in the trade.

John Cassidy.

John Cassidy, a native of Ireland, but a resident of Long Island City since early manhood, died on May 18, aged 98. He was engaged in the florist business near Calvary Cemetery and his sons, who have been associated with him for many years, will continue the business.

M. J. Jorns.

M. J. Jorns, of Iowa, horticulturist of the American department of agriculture, died in San Juan May 17, of typhoid fever. The body will be sent to New York on board the steamer Coamo.

Charles F. Hilton.

Charles F. Hilton, park commissioner for the city of Lynn, Mass., died of heart disease on May 20, in his 74th year.

THE VETERANS.

(Denis A. McCarthy, in the New York Sun.)

Every year they're marching slower,
Every year they're stooping lower,
Every year the lilting music stirs the hearts of older men,
Every year the flags above them
Seem to bend and bless and love them
As if grieving for the future when they'll never march again.

Every year that day draws nearer—
Every year the truth is clearer
That the men who saved the nation from the severing southern sword
Soon must pass away forever
From the scene of their endeavor,
Soon must answer to the roll call of the angel of the Lord.

Every year with dwindling number,
Loyal still to those that slumber,
Forth they march to where already many have found peace at last,
And they place the fairest blossoms
O'er the silent, mould'ring bosoms
Of the valiant friends and comrades of the battles of the past.

Every year grow dimmer, duller,
Tattered flag and faded color;
Every year the hands that bear them find a harder task to do,
And the eyes that only brightened
When the blaze of battle lightened,
Like the tattered flags they follow are grown dim and faded too.

Every year we see them massing,
Every year we watch them passing,
Scarcely pausing in our hurry after pleasure,
after gain,
But the battle flags above them
Seem to bend and bless and love them,
And through all the lilting music sounds
an undertone of pain!

Newport, Ky.—Frank Ernsterhoff, a well-known florist of Highland Ave., Fort Thomas, arrested last week charged with wilful destruction of property preferred by the Bell Telephone Company, was again arrested May 17 and placed under a peace bond of \$500. The Bell Telephone also swore out this affidavit against him in Magistrate Quehl's court, charging him with threatening to shoot anyone who attempted to erect a telephone pole at the corner of his premises in Highland avenue. When employees of the company attempted to erect the pole, the police allege, Ernsterhoff appeared with a gun and threatened to shoot them. Both cases will be tried before Magistrate Quehl.—Cincinnati Com. Tribune.

HARDY PERENNIALS AND THEIR VARIOUS USES.

By Robert Cameron.

Continued from page 759, Issue of May 23.

The Rock Garden.

There are many estates and gardens which have natural rocky banks or hillsides which can be made very attractive with a rock garden and, in fact, there are many hardy perennials that give better satisfaction than when grown in any other part of the garden. A well constructed and tastefully arranged rock garden can be made one of the most pleasing features of our grounds.

The meaningless mounds of stones such as we see in our public garden is by no means the best conception of a rock garden. In fact, a rock garden should be a close imitation of a rocky mountain, though, of course, on a very small scale. It should have crevices and pockets, and these should be filled with soils to suit the requirements of the various plants.

The plants used should be largely the low growing kinds, such as aubrietias, creeping phloxes, houseleeks, sedums, columbines, pinks, ajugas, arabis and many others too numerous to mention here.

Other Uses for Hardy Perennials.

There are many other places besides the herbaceous border and rock garden where hardy perennials can be used with good effect. Lilies are at their best when planted in rhododendron beds. Along water margins there are many plants which lend themselves very pleasingly and give excellent effects, such as irises, cardinal flowers, lythrum and many kinds of grasses.

Another use which the large growing perennials are admirably adapted for, is to produce sub-tropical effects. There are quite a number of plants which can be used in this way. For example, sunflowers, compass-plants, bocconias, Arunda donax, Eulalia Japonica and its varieties, aralias, acanthuses, polygonums, rheums, heracleums, centaureas, eryngiums and echinops.

There are many hardy perennials which make showy and attractive beds on the lawn. Phlox procumbens, P. subulata and P. reptans are all good for early work. Stellaria Holostea is very good in early summer. The tall growing phloxes, peonies, irises and the tall, graceful grasses—all lend themselves readily to this kind of work.

Care is Needed to Be Successful.

Many people make a great mistake when they imagine that herbaceous plants, when once planted, will take care of themselves afterwards. There is no class of plants, that I know of, which will give good results if constant attention is not paid to them. Herbaceous plants are just like other plants—their wants and needs must be carefully looked after. An important matter is that of staking and supporting. The stakes or sticks ought never to show. They must be so arranged to give the needful support, while allowing the plant its natural freedom. The only time when stakes are tolerated is for the short time when they have been put in for plants which attain a great height. There is a great



ARABIS ALPESTRIS.

Photo by Robert Cameron

knack in staking and it takes some experience to do it properly.

A newly planted border is not always satisfactory the first year. Many of the plants do not grow vigorously enough and do not fill up the space allotted to them.

Annual Plants Are Useful.

There are many annuals which blend very pleasingly with the perennials and can be used to fill up the vacancies, but care must be given to selecting the proper color so that if a color scheme has been conducted it will not be injured. Annuals are used to fill up the vacancies, where the spring bulbs have been growing in the border. I know there are some who object to using annuals among perennials, but there is no other class of plants which harmonize so pleasingly with them. One of the best writers in England on this class of plants even advocates the use of bedding plants and the plunging of plants in pots to give the proper effects. I certainly do not agree with her, but I see no harm in using annuals quite liberally. In nature we see no strict lines drawn between perennials and annuals in her groupings of plants.

Select List of Good Perennials.

There is almost an endless supply of showy hardy perennials, and it would be useless to give a very long list of them, as they can be found in most of the fine catalogues sent out by the different nurserymen. All I will do is to give the names of a few of the best things for spring, summer and fall.

The earliest plants to flower are the snowdrops, of which the best kinds are Galanthus Elwesii and G. nivalis. Next come the crocuses, of which the yellow kinds bloom first—then the whites and blues follow. In the early flowering squills the best are Scilla bifolia and S. bifolia alba, S. sibirica and S. sibirica alba. The glories-of-the-snow are charming. Chionodoxa Luciflora and its variety grandiflora and sardensis are the ones which give

the best satisfaction. Fritillaria imperialis and its various varieties are good, so is Fritillaria meleagris. The most pleasing of the grape hyacinths are Muscari botryoides, M. botryoides album, M. commutatum and M. compactum.

A few of the most satisfactory tulips for the border are in the early kinds, Artus, La Belle Alliance, Yellow Prince, La Precieuse, Joost von Vondel, white, Duchesse de Parma, Chrysolora.

A few of the best Darwins are Clara Butt, rosy salmon; Galatea, vivid vermilion; Glory, fiery scarlet; Gretchen, silvery white; Harry Veitch, deep maroon; Isis, fiery crimson, one of the very best; Kate Greenaway, very soft flesh-colored nearly white; Madame Krelage, a perfect beauty, soft rosy pink edged light rose. Mr. Farncombe Sandars is all right, dazzling crimson red; Mrs. Cleveland, a charming flower, soft rosy pink. Pride of Haarlem beats them all, cerise-scarlet; Psyche, most lovely flower, delicate pink. Queen Wilhelmina, the best of all the rose-colored Darwins. Sierra van Flora, one of the earliest to flower and very good indeed, vivid rosy-red. Torch is very nice fiery red. Most of the Darwin tulips are lovely things and we have grown thirty varieties, the above being the best kinds.

Cottage or late May flowering tulips. Out of thirty kinds we have grown the following are the ones we liked the best. Bouton d'Or, deep yellow, very pleasing; fulgens, very long stems, dark scarlet crimson; Gesneriana, color brilliant carmine and its forms are probably some of the most satisfactory tulips. We have some bulbs growing in the same place for twenty years. Golden Crown, very fine yellow; Inglescombe, scarlet, is very good. Isabella or Shandon Bells are good tulips, pleasing color creamy yellow changing to dark magenta; La Candeur, very handsome white. La Merveille is one of the largest tulips and probably the most fragrant, salmon-orange color. Picotee, or Maiden's Blush, one of the most satisfactory cottage tulips, white

suffused rose at the top; Dame Elegante, very good white.

We grow a number of species of tulips and the following are the kinds we prize the most; *Fosteriana*, *Kauffmanniana*, *linifolia*, *Greigii*, *sylvestris*, *Oculis-solis*, *Ostrowskiana* and *peris-a*.

Last spring we grew over ninety varieties of narcissi and we can't say too much in their praise as garden plants. Other bulbs which might be added to the above are: *Allium Moly*, *Bulbocodium vernum*, *Camassia esculenta* and *C. Fraseri*, *erythroniums*, *galtonias* and *Scilla campanulata*.

For early flowering the following are good; *Alyssum saxatile*, with its golden yellow flowers; *arules*, several species, *corulea*, *chrysantha*, *glandulosa* and *Stuarti* being the best. *Arabis albidia*, *Phlox procumbens*, *P. subulata* and its varieties are showy dwarf plants. *Polemonium reptans* and *P. coeruleum* are good for blue flowers. There are many kinds of veronicas, the choicest being *V. rupestris*, *V. gentianoides*, *V. incana*, *V. paniculata* and *V. latifolia*.

Pentstemons, which are hardy and reliable, are *P. digitalis*, *P. diffusus*, *P. ovatus*, *P. barbatus*, *P. barbatus* var. *Torreyi* and pubescens; *Pyrethrum roseum*, very fine, has many forms, both double and single, the single flowers are very pleasing. *Clematis recta* has panicles of beautiful white flowers. *Dianthus barbatus* and many other species are good. *Campanula Carpatia* makes pleasing tufts of blue. Of delphiniums there are many kinds and all are exceptionally showy plants. *Dicentra spectabilis*, or bleeding heart, is one of the most graceful hardy plants we have in early Summer. *Orobus vernus*, fine early dwarf pea flowering plant. *Lychnis chalcedonica* and *L. viscaria* fl. pl. are both good. *Primula veris* and *P. vulgaris* and their varieties are well known. *Campanula persicifolia* and its white flowered variety are of medium height bellflowers. Peonies, herbaceous kinds are all excellent plants. *Papaver nudicaule* is a showy dwarf poppy and orientale and its varieties are without doubt the showiest of hardy plants. German irises are good border plants and will flourish in almost any situation. *Iris laevigata* and its numerous varieties are extra fine for late Summer, but require more moisture than the German irises. *Geranium sanguineum* is about a foot high and has a profusion of red flowers. *Baptisia Australis* gives good racemes of blue flowers in June. *Erigeron speciosus* and *Aster alpinus* are the two best composite we have in early Summer.

For the late flowering kinds the following are good: *Aconitum autumnale*, *A. napellus* and its varieties are good blue kinds. *Anemone Japonica* and its varieties are exceptionally good late white and pink flowering plants. The best asters for border use are *novae-anglie* and its varieties, *turbidellus* and *Shortii*. *Boltonia latissima* and *Bocconia cordata* are tall, showy plants. *Platycodon grandiflorum* is a grand perennial and flowers for several seasons. *Coreopsis grandiflora* and *Gaillardia grandiflora* are choice perennials. *Heliopsis mollis*, *Helenium autumnale* and *Hoopesii* are good plants for the back row of the border. *Monarda didyma* is the best of the horse-mints. *Pyrethrum uliginosum*,

when well grown, is very showy. The best of the rudbeckias are *speciosa*, *submontanosa*, and *Golden Glow*. *Scabiosa caucasica* is the finest of all the scabioses. *Statice latifolia* is the best of the sea lavenders. *Veronica subsessilis* is very choice. *Sedum spectabile* is the handsomest of the stone-crops. *Oenothera Missouriensis* has the largest flowers of all the evening primroses. *Eryngium amethystinum* has roundish heads of flowers with a very striking blue color. The best of the day lilies are *Hemerocallis flava*, *H. Dumortieri*, *aurantiaca* var. *major* and *flava*. Lilies, where they do well, are always pleasing. The following kinds are the most easily grown: *L. bulbiferum*, *L. Canadense*, *L. candidum*, *L. croceum*, *L. elegans*, *L. Hansonii*, *L. speciosum*, *L. tenuifolium* and *L. tigrinum*. To these might be added foxgloves, hollyhocks and the late flowering phloxes. If time would permit, many more kinds could be mentioned.

It is very important to know some plants that are not desirable for border use. The objectionable plants are rather showy, but when they get into the border they are a perpetual expense. They grow so rapidly and spread so quickly that they kill the weaker plants that grow near them. The most troublesome of these are *Achillea serrata*, *Aegopodium Podogragia*, *Anemone Canadensis*, *Saponaria officinalis*, *Stachys palustris* and *Helopsis laevis*.

There are many inquiries about perennials that will grow under trees and in other shady places. I have found the following very satisfactory: *Vancouveria hexandra*, *hepaticas*, *asarums*, *Ajuga reptans*, *Orobus vernus*, lily of the valley and many kinds of ferns.

Winter Protection.

The winter protection of herbaceous perennials is important. Plants that are not reliably hardy can be protected with any material which is not too moist or close. Most of the perennial plants that are in ordinary cultivation need no protection, but in the Eastern states we find that a coating of some mulch that keeps them from excessive freezing and thawing during the winter is very beneficial to the plants. If barnyard manure be used a double advantage is obtained; the plants are kept in good condition and, from the leachings during the winter, the plants obtain food. Leaves of deciduous trees, pine leaves and hay are all good for protection. The dressing for protection should not be applied until the ground is well frozen; that will be about the first of December. The covering need not be very thick—two or three inches is enough. The covering is not so much intended to keep out the frost as to prevent alternate freezing and thawing by which the plants are thrown out of the ground, the roots broken and exposed to the sun and air. If the ground is kept frozen all winter this trouble is avoided. The covering should be removed as soon as the weather will permit in the spring.

The propagation of perennials is either by seed, cuttings or divisions of the plants. Plants are easily raised from seed, and a stock of plants can be obtained quickly in this way. Many writers on perennial plants decry the

so-called bedding plants, such as geraniums, colens, heliotrope and the like. I do not want to do this, as all kinds of showy plants are desirable in garden decoration if they are used correctly. What I do want to point out is that the person who hasn't a greenhouse need not be discouraged. There is ample material to select from among deciduous trees, evergreen trees, shrubbery of all kinds and herbaceous perennials. There are no bedding plants that will compare with irises, larkspur, daffodils and lilies.

Another point which is in favor of the hardy plants is that long before the geranium, colens and heliotrope have left the greenhouse we have enjoyed the charming early spring flowers, such as squills, snowdrops, crocuses, tulips, phlox, white-cress, hepaticas and violets. Not only have we the hardy plants in the early spring, but late in the fall when all our tender plants are housed.

In conclusion I would like to advise you to have plenty of thrift and honesty in your gardens and you will be always happy. Now I will say good-night to the poppies, lilies, "daffy-down-dillies" and all the rest of the distinguished company of old-fashioned plants which I love so much.

CATTELEYA MOSSIAE.

In these days of quick transportation, when orchid collecting has been reduced to a fine art, and orchids can be shipped to this country with a comparatively small percentage of loss, we hear now and again of some marvelous specimens which, having successfully withstood the ordeal of shipment, develop into noble plants and delight the orchid lover's eye with their wealth of gorgeous blossoms.

The *Cattleya Mossiae* figured in the accompanying illustration is a case in point. Here we have a plant which was received amongst a case of imported *Mossiae* two years ago. At the



time of writing, there are forty-six blooms on the plant. Personally, I have never seen a more perfect specimen, either in Europe or in this country.

In the illustration only one side of the plant is shown, but the blooms were evenly distributed all over the plant. This specimen is one of many in the Coryell collection at Menlo Park, California. At the time the photograph was taken the plant was doing duty on the table at a reception which accounts for the fern-orchid specimens, which, while more or less necessary, from the decorator's point of view, would have been better dispensed with as an illustration.

WM. Mc. M. BROWN.

Catlin.

Boston Public Garden.

ITS EARLY HISTORY AND THE BEAUTY OF ITS TREES

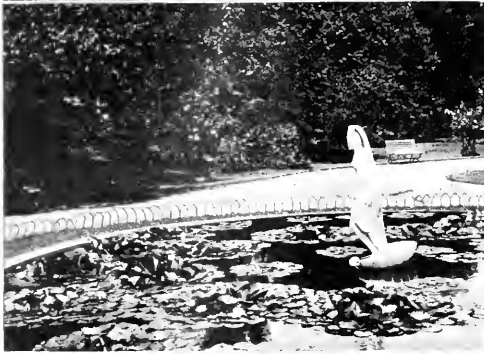

EARLY SPRING BEDDING
THE LILY POND

Forty years ago, what is now known as the Public Garden was a half-inundated patch that was a very small section of a great tract of useless marshy land comprising much of what is known as the South End and Back Bay of Boston. The residents of the city in those days, still living, delight in rehearsing their boyish escapades in this section, and in the light of its present populous condition a well-developed lump of faith is needed to accept the almost incredible tales of adventure they tell. To be told that where Commonwealth Avenue exists with its hundreds of palatial residences, broad drives and velvety lawns, was once an oozy waste of mud seems like a choice fairy tale. But the existence of pictures attest the fact and truth of such conditions. Through many vicissitudes which at times seriously threatened its existence the Public Garden has risen from the ignominy of marsh land to the dignity of being one of the most noted examples of formal gardens in the United States, if not in the world.

The Garden and Common in their early history were one, and it was not until about 1859 that it began to take on its present character. It was in this year that the pond was constructed since which time the process of better-

ment has gone steadily on. Shortly following this, the walks and flower beds were constructed under the then superintendent, John Galvin. In quick succession came the fountains, monuments, fences, etc., and despite some severe criticisms of the work, it can be safely said that the object of utility was kept steadily in view, and if the artistic was slighted in the laying out of the walks, and a few other things, it was done with intent to best serve a busy and hurrying public. The objection to the manner of laying out the walks has been very severe. It has been contended that there are too many, that they lead aimlessly to nowhere in some cases, while in others they are objectionable because of their straight lines. There may be too many walks if the garden was to be treated as a private place, but where the public is concerned, walks straight and in numbers are what must be supplied. The bridge that spans the pond has been very playfully called the Bridge of Size. When one is bent on criticism there is nothing but what can be made to feel the lash.

The facilities for handling plants at the beginning were wholly inadequate, and it was necessary to purchase most of the stock in open market. A small greenhouse that was situated in the Public Garden proved almost useless and it was removed. During his first

A VISTA
THE BRIDGE

year in the office of superintendent, William Doogue turned over his Floral Place Greenhouses to the city, and later, new greenhouses were built in the South End of the city, and some years after larger accommodations were found in Dorchester, where the greenhouses are at present, twenty-five in number.

While the garden has attracted attention for its floral decorations, too little attention has been given to that upon which the success of the floral has been dependent, namely, the trees. Thirty years ago there were but few trees on the Public Gardens, and those of insignificant character. The place at that time had a bare, flat look, and from the main walk almost every walk could be traced in its entirety, bare and unbroken. The sky line was one of chimney tops, brick walls, glaring windows.

To remedy this bareness, and to cover as much as possible the worm-like walks, trees were freely planted, and today, in looking across the garden, only glimpses of walks can be seen, leading in and out through the foliage of the trees, the chimney top sky line has been obliterated, and in its stead are the waving tops of trees. On the Arlington street side, on the sidewalk, a row of elms serve as a screen of green to hide from the view of visitors the sight of the neighboring

residences. The variety and symmetrical growth of these trees on the garden has made the frame which has added to, and made possible, the much-lauded flower exhibit. Comparatively few seem to realize the most important part that the trees play in this setting and the development has been so gradual, and one's memory of what had been so unreliable, that the trees have seemed as something that always existed and were merely incidental to the flower beds.

It is doubtful if in any park of equal size in the world could be found so varied a collection of trees such as there is in the Public Garden in which there are so many magnificent individual specimens and surely in no place so closely situated to the busy city life, almost at the doors of railroads and warehouses. To those that know trees this spot has been a sort of Paradise and it is a matter of regret that the public in general is not more conversant with tree life.

Another great enjoyment which but few avail themselves of, is the openings of vistas that have been purposely arranged. In every direction are these views possible. One across the pond towards the spire of the Arlington Street church is especially beautiful.

In the list of trees to be found here are the following kinds: Purple beech, wonderfully beautiful trees, sumach, mulberry, catalpa, hornbeam, coffee tree, hawthorn, sophora, white birch, golden chain, varnish tree, tulip tree, ginkgo, maple, red bud, red-flowering horse chestnut, peach, yellow wood, willow, linden, English and American elm, spindle tree, crab, etc. On the rockery in the lower part of the pond is planted a group of willows and these in summer form a waving and graceful mass of green that festoons itself to the water's edge. Some years ago this spot was connected by a walk to the main garden but its transformation into an island with the addition of foliage setting has been a distinct improvement. In several places about the edge of the pond small trees have been so grouped as to form an opening to accommodate a number of settees, affording shade to those resting there, but not restricting the view.

At the time most of the garden trees were planted, because of the bareness of the place and looking for an immediate foliage effect, they were placed much closer together than would be warranted in other locations and conditions. As the years passed the evil results of this planting began to manifest themselves, as was anticipated, and to remedy conditions many trees have been transplanted and some removed. The work of transplanting was done in the winter after the pond had frozen. The trees were dug around and at a suitable time were drawn to their new places on skids. Where it was necessary to go across the pond the work was easily accomplished. While a great amount of this transplanting was done for many years the necessity for still more extended work in this line becomes more insistent each year and at no very distant time a thorough renovation and elimination will be absolutely imperative to preserve the

harmony that has contributed so fully to the attractiveness of the Public Garden, in past seasons.

While the summer time is the most favorable time to visit the garden, still it does not lose its attractiveness even in winter. The rhododendron and evergreen beds are protected by the placing of hemlock and spruce trees about them, so arranged to give a natural effect to the grouping. Many of these temporary evergreens are also formed into screens around benches about the walks, and these places thus screened are eagerly sought on pleasant days during the winter. This temporary placing of trees adds an attractive feature and is decorative as well as useful. The pond in winter is kept in good skating condition and the hundreds of skaters gliding about make an animated winter picture. Considerable damage results from careless and thoughtless persons during the skating season but happily this has grown less during late years.

To anyone visiting the Public Garden in the summer I would say, get acquainted with the trees there; notice the beauty of the specimens, their groupings, the colorings, the eliminating of unsightly skyline, the possibility of long vistas. These are the things that make the garden attractive and even a person who feels no particular liking for trees cannot but be impressed by their beauty as here used. The flowers are beautiful but without the setting of the trees which are a monument to the foresight of the late superintendent, their combinations and colorings would amount to but little.

LUKE J. DOOGUE.

ANEMONE SPECIES AND VARIETIES.

At the present season many of these species form attractive plants in English gardens, being planted on rockwork, in the mixed herbaceous border, as edgings to groups and beds of evergreen shrubs, in the partial shade of the latter, in which position they grow and flower admirably. They are chiefly natives of the temperate and southern parts of Europe, northern Hindoostan, Japan, and America. Their flowering season falls mostly in the months of March and two following months; they can be easily propagated by division of the roots or tubers in September and October, replanting the divisions in a fertile, sandy soil. The Hepaticas, the beautiful spring flowering plants of the English cottage gardens, so commonly met with, whose flowers are rose colored, purple, blue, lilac or white, belong to the genus *Anemone*. The plants grow about eight inches in height and flower abundantly. *H. angulosa* is the only other species, and of this species there are but two varieties, differing chiefly in the size of their blooms. Their color is lilac.

A. Japonica, a tall growing species, now numbering some seven or eight varieties or sports, may be propagated from cuttings of the roots planted in light, sandy soil, placed in a cool frame

and kept close till roots form. At the Royal Horticultural Society's gardens at Chiswick, about 60 years ago, this species was crossed with *Anemone vitifolia*—a Himalayan species, the latter being the pollen parent, and some beautiful varieties resulted from the cross. *A. coronaria* and *A. stellata* give us the florist's varieties.

Anemone angulosa is a species with flowers twice as large as those of the common Hepatica and of a sky-blue tint, and distinguished from it by its five lobed and toothed leaves. It comes from Transylvania and is perfectly hardy, although it is a plant that requires protection from cold winds, such as that afforded by other plants, or sheltering rockwork.

Anemone Apennina has starry erect flowers of a bright blue tint, and two inches in diameter. The plant grows in close tufts, above which the flowers appear thickly. It is one of the prettiest of our spring flowers, and is an ornament in the garden border as on a rockery. Its flowering season in these islands is March and April.

Anemone blanda possesses flowers of a rich blue color and larger than those of *A. Apennina*, and it grows to a height of from four to six inches, and flowers in March and in some years in February. The plant is quite hardy, and forms a capital subject for planting on rockwork or in the "wild garden."

Anemone coronaria, known generally as the Poppy Anemone, comes from the Mediterranean region and has been a favorite garden plant from immemorial times. There are many varieties, both single and double, and invaluable for spring flowering. The single flowered varieties come readily from seeds which afford an endless variety of colors; whereas the double flowered varieties should be planted in the autumn or spring, the former being the better season. The plant grows to a height of about seven inches, according to the quality of the soil.

Anemone fulgens is a flower of a dazzling vermilion color, and the plant is perfectly hardy. The flowers are supported on stems one foot in height arising from a dwarf tuft of deeply lobed leaves. The plant is well suited for planting in beds or on the rockery, and its flowering season is April and May.

Anemone Hepatica is one of the commonest plants, and is hardy in every situation, and welcomed everywhere for its exquisite beauty. There are single varieties in red, white, blue, pink, mauve and crimson tints, as well as double blue; all excellent plants for making edgings to beds of dwarf peat loving plants. The flowering season here is March and April. The double flowering Hepaticas are multiplied by division and the single ones by seed.

Anemone Pavoniana, or Peacock Windflower, is a plant rarely seen in our gardens, although it is deserving of more general cultivation. The flowers are of less size than the common garden anemones, and of a cinnamon red color and quite double. The plant is a native of the south of Europe, and is common in gardens in the south of France. Propagation is by division when growth ceases in the summer, or in early spring.

A. Pulsatilla, the Passover Flower. This species, indigenous in Great Brit-

ain, a fine distinct perennial, flowering in March, April and May, has a bell-shaped flower of mauve purple with yellow anthers, found on the Chiltern Hills, and the downs of Surrey and Sussex, dotted over the turf. In such positions, it just shows through the short grass, but in sheltered places, even there it develops to a larger size and flowers abundantly. In the rich soil of a garden the plant is much more vigorous and freer flowering. There are white, red and lilac varieties.

The above-named species and varieties of Anemones are the more generally cultivated in English gardens. A. Halleri is a late form of A. Pulsatilla.

FREDERICK MOORE.

London.

SOME OF OUR PROBLEMS AS ROSE GROWERS.

A paper prepared by Prof. L. C. Corbett of the Bureau of Agriculture, Washington, D. C., for the Annual Meeting of the American Rose Society, Mar. 16-18, 1909, held at Buffalo, N. Y.

Heat, light, water and soil are the big four with which the plant grower, be he farmer, gardener or florist, is concerned. In nature all of these factors are more or less in the class of variables. The farmer and gardener working in the open and dependent upon natural sources for heat, light, moisture and soil are playing at a game of chance. The two factors that it is within his power to modify are moisture and soil. By irrigation the water content of the soil can be regulated. By the judicious use of fertilizers and manure the food supply of the plant can be modified. Aside from these two alternatives the farmers and gardeners are totally dependent upon nature's kind provisions. The florist carries the cultivation of plants one step further from the field of chance by safeguarding the temperature factor. The florist may or should be able to control three of the determining factors in plant growth, viz., heat, moisture and soil. His variable should be confined to the light factor alone. Our modern greenhouses have been well planned so as to cut out as little light as possible by the use of light framework and large glass. The great weakness in our present scheme of greenhouse construction lies in the total disregard of the laws of reflection and refraction. The fact that a glass roof can be so constructed that it will allow a very large percentage of light and heat rays of the sun to penetrate the house at certain hours of the day and to reflect or throw off a large percentage of the same rays at other hours of the day, has, it would appear, been given altogether too little consideration both by florists, physiologists and physicists. This is one of the respects in which practice is far behind. The available knowledge on this phase of construction seems to have been almost entirely ignored by the practical florist and greenhouse builder. Much thought is spent in designing gutters, sash bars and ventilating apparatus, while the pitch of the roof and the direction of the ridge,

factors which directly measure the value of the houses, are entirely ignored. It is therefore evident that the florist may in a measure at least influence the light factor. While he cannot increase or decrease the actual hours of sunshine, he can by properly planning his houses afford his plants the maximum benefit of the light provided in nature. Researches which have been conducted along this line clearly indicate the value of light as a factor in plant growth. Prolonging the light period by artificial means has been demonstrated by Bailey, Rane, the writer and others, decidedly hastens growth. Should we not then give this factor the full attention its importance deserves?

The temperature and moisture requirements of plants are given far more consideration than light by florists, but it is surprising to note the great lack of available general information upon so simple a matter of properly providing for the requisite amount of radiation in a greenhouse for a particular purpose in a definite locality. Too often this important matter is left to the local plumber, who has no idea of the problem involved, or how to solve it. Yet heat is the greatest charge against the growing account.

Moisture is the coin of the realm with the gardener and the florist; both deal in products the chief constituent of which is water. A pure and adequate water supply intelligently used is a determining factor in garden and floral undertakings. Now we come to the soil, an absolute essential to the success of every commercial agricultural enterprise, the source of the livelihood and wealth of the major portion of the earth's inhabitants; yet what shall we say of it, it is so complex? If we consider its derivation we find the rocks yielding to the action of frost, water and air to supply the mineral matter, vegetation springs up to ripen and decay, and thus contribute humus, another factor as important as the mineral. The decomposition of organic matter in the soil sets to work other forces which are no less important than the primary constituents themselves. The combination of the organic and the mineral substances creates a condition which makes it possible for many low forms of animal and plant life to exist in this medium we call soil. These low forms are some of them helpful and some of them hindrances to the plant grower. The introduction of this host of tenants complicates things and renders what was formerly thought to be simply a chemical problem, a very intricate, combined chemical and bacteriological puzzle. Some aspects of this puzzle are yet so new and difficult that no prediction dare be made at this time regarding their importance to agriculture. Enough has been determined, however, to prove that an important lead has been struck. The value of nitrogen gathering bacteria is sufficient evidence of the richness of this new field. Knowledge of the way in which nitrogen gathering bacteria work gives us a clue to the solution of one of the most difficult problems in the maintenance of soil fertility. It explains the division of labor in nature and gives a reason for crop rotation. The same laws that govern the

rotation of crops in field operations come into play to our advantage in the soil heap. The compost heap should consist of organic material in the form of soils and manure so combined with mineral matter in the form of loam and clay as to enable decomposition and nitrification to take place rapidly. The florist's business is not merely to place available food in a natural soil, but to combine the several constituents for fertile soil in such manner as to secure that mechanical condition and food supply calculated to best meet the requirements of the particular crop under consideration. In this respect the florist has an advantage again over the gardener and the farmer. But can any one describe the ideal soil for any particular crop? Can any one say that a soil consisting of 10 per cent. organic matter, 30 per cent. clay, 40 per cent. loam and 20 per cent. sand is an ideal soil for roses, for carnations, for lettuce, or for any other crop? I think not. Our knowledge upon these important points is of the empirical kind. An experienced gardener makes up a potting soil; he mixes it with his hands, and if it appears too heavy he adds sand; if not sufficiently fibrous, he adds leaf mould or peat; just why he adds these substances he cannot tell, neither can he describe to you the exact consistency and character of his ideal rose soil; yet his knowledge of the requirements of a particular crop leads him to make the changes above noted to bring the soil to his ideal of the requirements for the particular crop. Can this empirical knowledge or idea be reduced to exact terms? Is the exact amount of available plant food and the proportion of sand, clay, humus in this ideal soil measurable? If it is we can obtain a basis for exact experiments to determine whether or not the gardener's judgment of an ideal soil for a particular crop is correct. If these factors are not measurable we are as much at sea in our experimental work as is the gardener. It is all simply a matter of judgment. Up to the present I am sorry to say that the whole matter is largely dependent upon experiences and judgment. Soils differ so in composition and physical properties even when, so-called, like materials are used in their make-up, and we know so little regarding the influence of bacterial action which is consistently working in the soil that it is practically impossible in the present state of our knowledge to reduce the soil factor to exact measurement. A much more accurate idea of the relative influence of heat, light, water and soil can be secured under greenhouse conditions than in the open, but even here, while we know infinitely more than did the early gardeners, our knowledge is far from exact. It may be that exact data will never be possible, but certain it is that the knowledge that is so rapidly accumulating will clear up many dark places and we hope soon put us in possession of facts to replace empiricism. Until more knowledge is available we must continue, each to determine for himself under his own environment, the most profitable combination for the compost and the varieties best suited to this soil and his market. "There is no royal road to knowledge," and the intelligent, painstaking care is the only way to spell success.

GREENHOUSES BUILDING OR CONTEMPLATED.
 Somerville, Mass.—G. Cabral, one house.
 Rhinebeck, N. Y.—B. Tremper, one house.
 Fishkill, N. Y.—Geo. M. Russell, two houses.
 Elmhurst, Cal.—Domoto Bros., house, 35x400.
 Beverly, Mass.—E. N. Prebles, house, 90 feet.
 Omaha, Neb.—At Hanscom Park, one house.
 Harrisburg, Va.—John Fallon, range of houses.
 Morenci, Mich.—Le Roy Sutton, range of houses.
 Marinette, Wis.—Geo. Vatter, range of houses.
 Hastings, Mich.—Chase & Wilcox, two houses.
 E. Oakland, Cal.—A. H. Hills, two orchid houses.
 Lewiston, Me.—Ernest Saunders, house, 600 feet.
 Kankakee, Ill.—Chas. Shafer, one carnation house.
 Alexandria, Va.—D. G. Grilloboertzer, two rose houses, each 45x280.

GERANIUMS, DAHLIAS AND BEDDING PLANTS

We have one of the most complete collections of Geraniums in the country, containing every color and type found in the Geraniums. Every one of our 75 Standard Varieties at \$2.00 and \$3.00 per 100 are Bred and Butter Winners, and among our 34 New Varieties of special merit are some that are going to fix the standard in the future. Every one is a Gem, not high in price, only \$4.00 and \$6.00 per 100.

Our Novelties should, coming as they do from the leading Introdurers of the world, represent the highest development of Geraniums at the present time. A collection of 100 Varieties, our selection of 1907 and 1908 Novelties, will be sent for \$10.00.

Special Offer of 1000 good, strong plants from 2 in. pots, our selection of 20 distinct kluds from among our Standard and Never Varieties, for \$15.00 cash. From 3 in. pots \$3.00 per 100, \$25.00 per 1000, in a good assortment.

CANNAS

Strong plants from 3 in. pots. J. D. Elsele, Egandale, Alphonse Bouvier, Mme. Crozy, and Florence Vaughan, \$4.00 per 100. Jean Tissot, President Myers, Loomisana, Pennsylvania, \$5.00 per 100.

DAHLIAS

We have one of the finest collections in the country of good distinct Commercial Varieties at \$2.00 per 100 and up for plants ready for shipment. Then we have Jack Rose, Virginia Maule, Big Chief, Rose Pink Century, Fringed 20th Century, Rebecca Mayhew, etc., at 50c. each, \$5.00 per doz., \$35.00 per 100. We will send 1000 in 20 good distinct Cut Flower Sorts, our selection, for \$18.50.

See issue of April 24th or Our Wholesale Catalogue for complete list of Bedding plants.

R. VINCENT, JR., & SONS CO., White Marsh, Md.

"Right on the Spot — That's All"

- Variogated Periwinkle, out of 4-in. pots, 100 \$8.00
- strong \$8.00
- Variogated Periwinkle out of 2 in pots 2.50
- Variogated Periwinkle Rooted Cuttings .50
- Clematis Paniculata, out of 4-in. 10.00
- Clematis Paniculata, out of 3-in. 5.00
- Clematis Paniculata, out of 2-in. 2.00
- Lobelia, Dwarf Blue, strong, out of 3-in. 3.50
- Cobaea Scandens strong plants, out of 4-in. 8.50
- Stevia, variegated, out of 2-in. 2.50
- Alyssum, very dwarf, out of 3-in. 3.50
- Glechoma or Ground Ivy, out of 3-in. 3.50
- Single Petunias dwarf, out of 3 in. 3.50
- Ageratum, blue, dwarf, out of 3-in. 3.50
- Dracaena Indivisa, out of 2-in. 2.00
- Choicest varieties of Geraniums, extra fine, out of 4-in. 7.00

Cash with order.

SAMUEL V. SMITH

3323 Goodman St., Philadelphia, Pa.

PEACOCK'S CELEBRATED NEW DAHLIAS

JACK ROSE and other cut flower sorts.
 SEND FOR CATALOG.
Peacock Dahlia Farms
 Williamstown Junction, N. J.

The Northboro Dahlia and Gladiolus Gardens

Offer for Spring 1909
 100 selected varieties of Dahlias and one and one half million large-flowering Gladioli in mixtures, in lots to suit. Send list of your wants. Catalogue free.
J. L. MOORE, Northboro, Mass

DAHLIAS.

Now is the time to place your order for bulbs which will insure you getting named varieties in any quantity; prompt delivery.
DAVID HERBERT & SON,
 Successors to L. K. Peacock, Inc.
 ATCO, N. J.

SEED OF THE IMPERIAL PALMETTO ASPARACUS

I have some seed of this giant bean, selected from the best beds in South Jersey. This Asparagus brings \$400 to \$500 per acre. Now is the time to plant.

WARREN SHINN
 WOODSTOWN, N. J.

ADIANTUM CUNEATUM, strong 4 in. pot plants, ready for shift, \$8.00 per 100.
CHRYSANTHEMUMS, leading varieties, 2 in., \$5.50 per 100, \$50.00 per 1000.
MARANTHA TIASANGIANA, fine for ferneries, \$6.00 per 100.
FICUS ELASTICA, 5 in. pot plants, 15-24 in. high, \$4.00 per 100.
IVY GERANIUMS, strong 2 1/2 in. pot plants, Souv. de Charles Turner and Jeanne d'Arc, \$3.00 per 100.
SALVIA ZURICH, Fireball, Baron Prince, Clara Bedman, Splendens, 2 in., \$3.00 per 100, \$ 5.00 per 1000; 3 in., \$5.00 per 100.
FUCHSIAS, 10 varieties, 2 1/2 in., \$2.50 per 100, \$25.00 per 1000.
COLEUS VERSCHAFFELTI and **GOLDEN CROWN**, 2 in., \$2.50 per 100, \$20.00 per 1000.
LANTANAS, strong, 2 1/2 in. pots, \$3.00 per 100.
BEGONIA ERKORDIA, Vulcan, Vernon fine for pots or bedding, \$2.50 per 100, \$20.00 per 1000.
DAHLIAS, well established pot plants, all leading varieties, \$3.50 per 100.
BEGONIA REX, 2 1/2 in., in pots, \$4.00 per 100.

The STORRS & HARRISON CO.
 PAINESVILLE, O.

ROSE PLANTS

Fine, Strong, Healthy

	3-inch pots	Per 100	Per 1000	2 1/2-inch pots	Per 100	Per 1000
American Beauty	\$7.00	\$65.00		American Beauty	\$5.50	\$50.00
Richmond	4.00	35.00		Richmond	3.00	25.00
Chatenay	4.00	35.00		Chatenay	3.00	25.00
Ivory	4.00	35.00		Ivory	3.00	25.00
Bride & Maid	4.50	40.00		Bride & Maid	3.50	30.00

Asp. Sprengeri, 4-in. pots, \$8.00 per 100.
 Asp. Plumosus, 3 in. pots, 5.00 "
 Smilax, 3-in. pots, 4.00 "

UNITED STATES CUT FLOWER CO., Elmira, N. Y.

CANNAS

Strong plants, out of 4 in. pots.
 Leading sorts:
 Bouvier, McKinley, Henderson,
 Florence Vaughan
 \$8.00 per 100
 Robust, 4 in. pots, \$6.00 per 100
 " " " 48.00 per 1000

Gallardia, out of 4 in. pots, \$6.00 per 100
 Oriental Poppy, 4 in. pots, \$6.00 "
 English Ivy, 4 in. pots, \$8.00 "

J. W. ADAMS & CO., Springfield, Mass.

Cannas

Dry roots: Italia, Cleveland, Austria, Egandale, Marlborough, America, Penna. Black Beauty, \$1.50 per 100. Kate Gray, mixed with red, \$1.25 per 100. Asparagus Sprengeri, 2 in., \$1.75, 3 in., \$4.00, 4 in., \$5.00 per 100. Dracaena Indiv. 4 in., 10c. English Ivy, 2 in., \$2.00; R. C. 75c per 100. Rex Begonia, 2 in., 3c.
J. H. DANN & SON, WESTFIELD, N. Y.

In ordering goods please add "I saw it in HORTICULTURE."

CANNAS

Strong plants from pots 25 leading varieties, \$5.00 per 100.
ESTATE OF DAVID FISHER, Woburn, Mass.

JULIUS ROEHRS CO., RUTHERFORD N. J.

Large stock of Bay Trees, Box Trees, Blue Spruce, Choice Evergreens, etc., all in finest condition.

Palms, Stove Plants, Begonias, Hydrangeas in all sizes and prices.

ORCHIDS

Fine assortment on hand of both newly imported and semi-established.

LET US QUOTE YOU PRICES.

THE FULFILMENT OF A PROPHECY.

Boblink & Atkins' nurseries at Rutherford, N. J., have come to be one of the show places of the New York neighborhood. The grounds are very extensive and are planted with an eye to general impressive decorative effect as well as commercial utility. The flowering shrubbery and hardy perennial fields have been for some weeks a glorious expanse of color and the enormous quantities of this sort of material which have been shipped this season gives confirmation to Mr. Atkins' foresight and sagacity when, some seven or eight years ago, in addressing a meeting of the New York Florists' Club, he predicted this boom on hardy perennials and urged the florists to prepare for it. Many thought he was too sanguine at the time but he has the goods and the business to show for it now. A force of about two hundred men has been employed this spring.

CHESTNUT TREE FUNGUS.

Prof. J. F. Collins of Brown university in a speech before the Rhode Island Horticultural Society May 19, told of a new disease, very destructive to chestnut trees, of which he had found eight or ten cases in the region of Pocasset.

The disease is very conspicuous and, except in the early stages, easy of diagnosis. On limbs with smooth bark the fungus shows dead sunken patches of bark, covered with yellow, orange or brown pustules of the fruiting fungus. If the spot is on the trunk of a large limb with thick bark, there is no obvious change in the appearance of the bark, but the bark, when tapped usually sounds hollow.

He likened this disease to pear blight, and said that no simple method of preservation has been found. The department of agriculture advises everyone who has chestnut trees affected with this disease to destroy the trees immediately.

MOVEMENTS OF GARDENERS.

John Kemp, lately foreman with Mr. A. Price on the G. M. Laughlin place, Woodland road, Pittsburg, Pa., has taken charge of Mrs. Barr's place, South Orange, N. J.

W. H. Drake of Kenosha, Wis., has taken a position as foreman at Klehm's Nursery, Arlington Heights, Ill.

CHICAGO NOTES.

Poehlmann's New Range.

Eight new houses at Plant A and thirteen at Plant B are nearing completion. All benches will be supported by cement posts. Two half-houses will be supplied with cement benches of the Wittbold construction and six half-houses of the Garland construction, the latter in larger quantity no doubt owing to the fact that they had been tested last year. Of the respective merits of the two time alone will tell and very possibly each inventor will find some points where improvement can be made. One specific difference is that the Garland bench can be taken apart and moved about while the Wittbold bench is stationary, making a difference also in cost of construction. A considerable number of the new houses (the writer has forgotten the exact number) are built with the Garland truss, which it is claimed makes the house more secure in a heavy wind, as it both holds the house from going down and from going up. Chicago is fortunate in having two such young men as Garland and Wittbold and their inventions are always watched with interest, while florists in general realize their good fortune in having a Poehlmann to try them.

Among the Growers.

Chicago growers are gradually working into orchid growing. Poehlmann Bros. are now cutting from their house and will probably increase their stock another year. George Reinberg is already quite well established in the orchid growing business.

A New Wholesale Store.

Vaughan & Sperry's new wholesale store will be one of the finest and best equipped in the district. The floor space is 40 x 50 feet; the refrigerator is 8 x 24 feet placed in a cool room 18 x 40 feet. All the front part is well provided with natural light. The vault and office will be models in construction and the firm will have every convenience for handling their rapidly growing business. Vaughan & Sperry started in the wholesale commission business nearly five years ago and as a live and dependable firm they have made good.

During Recess.

The Chicago Florists' Bowling Club had an enjoyable evening on the 21st at their usual place, 118 Monroe street. Four teams participated and Henry Kruchten made the highest average,

John Zech second, and William Wolf third. At the meeting on the 4th of June prizes will be given for the best bowling. Beginning with that meeting the averages will be kept to make up the team for the convention at Cincinnati.

News and Personal Notes.

"Raisek the Florist", 1553 Ogden avenue, will build a conservatory in connection with his retail store during the summer. Mr. Raisek has a very attractive store and the new addition will further add to his already fine equipment.

Mr. and Mrs. August Poehlmann are in Milwaukee, called there by the illness of Mr. Poehlmann's mother.

Sweet peas are in an enormous quantity. One man sold 22,000 last Saturday. His greenhouse force worked till after dark pulling them. The returns were very small considering quality.

Mr. Brooks of Morton Grove finds the red carnation Nelson Fisher to be just the one for him to grow.

The florists' supply houses are having their usual rush to fill orders.

Wholesale Market.

Complete report of the Chicago Wholesale Flower Market will be found on page 786.

NURSERY NOTES.

Newport, Kan.—J. A. Neede has started in the nursery business in this place.

Wood River, Nebr.—J. W. Weldon has purchased a half interest in the Estelle Nursery.

Harlingen, Tex.—J. George Bowyer has assumed charge of the Harlingen Nurseries and will carry them on this season in connection with the Gonzalez Nurseries, making his headquarters at Harlingen.

INCORPORATED.

Loveland, Colo.—Loveland Nursery Co.: N. A. Cramer, O. H. Egge, H. A. Cooch; capital, \$5,000.

Begonia Gloire de Lorraine

Leaf Stock, June Delivery, \$15 per 100,
\$145 per 1000, from 2 1/2 in pots.
Stock guaranteed to be absolutely free from disease.

THOMAS ROLAND, NAHANT, MASS.

HEACOCK'S KENTIAS



Our stock consists of healthy, HOME-GROWN WELL ESTABLISHED Plants

Kentia Belmoreana

		Per doz.	100
5-in. pot,	6 to 7 leaves,	18 in. high\$6.00 \$50.00
			Each
6-in. " "	" "	22 to 24 in. high\$1.00 12.00
6-in. " "	" "	24 to 26 in. " 1.25 15.00
6-in. " "	" "	26 to 28 in. " 1.50 18.00
9-in. tub	" "	42 to 48 in. " 5.00

Kentia Forsteriana

		Each.	Per doz.
6-in. pot,	5 to 6 leaves,	28 to 30 in. high\$1.00 \$12.00
6-in. " "	6 leaves,	30 to 32 in. " 1.25 15.00
6-in. " "	6 leaves,	34 to 36 in. " 1.50 18.00

Made-up Kentia Forsteriana

9-in. tub,	4 plants,	42 to 48 in. high\$4.00 each
12-in. " "	4 plants,	6 feet high heavy15.00 each

Joseph Heacock Co., WYNCOTE, PA.

Kentia Belmoreana

Delivery from now on.	Per 1000	Per 300
Strong seedlings, ready to go in		
2½ in. pot.....	\$25.00	\$3.00
2¼ inch plants, fine bushy stuff	75 00	8.00

Cocos Weddelliana

Fine established healthy plants	Per 1000	Per 300
from 2¼ in. pots.....	\$90 00	\$10.00
Satisfaction Guaranteed.		

O. V. ZANGEN, Seedsman, Hoboken, N. J.

Box Trees

and other EVERGREENS for Tubs and Boxes
Our Prices are Always Right—Catalog Free
THE NEW ENGLAND NURSERIES, Inc.
BEDFORD, MASS.

Hardy Rhododendrons, Azaleas, Conifers, Clematis, H. P. Roses, Shrubs and Herbaceous Plants from our
HOLLAND NURSERIES

Prices Moderate
P. OUWERKERK, 216 Jane St., Weehawken Heights
P. O. No. 1, Hoboken, N. J.

American Grown Roses

Fruit and Ornamental Trees, Shrubs, Small Fruits, Clematis, Evergreens.

Write for Trade List.

W. & T. SMITH CO.
Geneva, N. Y.

JOHN WATERER & SON, Ltd.

American Nursery Bagshot, England

Are Specialists in the

REALLY HARDY VARIETIES

of Rhododendron Hybrids and in Select Varieties of Hardy Border Plants

BAY TREES, BOXWOOD, PALMS, ARAUCARIAS, AND OTHER DECORATIVE MATERIAL

Evergreens In all Choicest Varieties. Ficus Elastica 2¼-inch pots, \$15.00 per 100.

CLEMATIS, and all other Vines and Climbers.

Trained Fruit Trees, Greenhouse Grapes, Herbaceous Plants, Trees and Shrubs.

We shall be pleased to give special prices on lists.

ASK FOR WHOLESALE CATALOGUE.

BOBBINK & ATKINS Nurserymen and Florists Rutherford, N. J.

TREES, EVERGREENS, SHRUBS, VINES, PERENNIAL PLANTS, FRUITS, TRAINED FRUIT TREES, FOREIGN GRAPE VINES, HARDY RHODODENDRONS and R. MAXIMUM in quantity, per hundred or per thousand, very fine. Complete assortments: Careful grading: Low prices.

AMERICAN NURSERY COMPANY,
Sales Department, 150 BROADWAY, NEW YORK CITY.
BLOODGOOD NURSERIES DEPT., Flushing, Long Island.
F. & F. NURSERIES DEPT., Springfield, New Jersey.

In writing to Advertisers kindly mention Horticulture

Seed Trade

AMERICAN SEED TRADE ASSOCIATION.

Watson S. Woodruff, Orange, Conn.,
First Vice Pres.; C. E. Kendall, Cleveland,
O., Sec'y and Treas. Twenty seventh
annual convention June 22-24, 1909, at Clifton
House, Niagara Falls, Ont.

WHOLESALE SEEDSMEN'S LEAGUE.

F. W. Kruegerhof, Pres. Bruno Land
sath, Sec'y.

The Backward Season.

The weather still remains cold and vegetation is very backward. In this latitude, that of northern New England and New York, trees are not yet in full leaf, and where growth is so slow and long retarded the leaves never attain the size they do when growth is rapid and weather is warm. Planting is still delayed, and even now peas are not all in the ground which should have been in three or four weeks ago. It is time corn was planted yet very little sugar corn has gone into the ground, and that little is more likely to rot than to grow. It is not unlikely that considerable replanting will be necessary and those carrying seed of good sample and vitality can get pretty strong prices for it. Prices on future seed corn are much firmer than a month ago, and this is reflected in the canned product, which has advanced nearly ten cents from the low point and strongly held with probability of further advances in the near future. Canned peas are also firming up and in fact the entire list of canned fruits and vegetables are showing more signs of life and activity. This is of interest to seedsmen, as the canner's trade forms a considerable percentage of their business. The improved business outlook in the canning industry is but one of the many symptoms of a general business revival for which all are devoutly thankful.

A Word for the Cannerns.

The strong letter of Dr. H. W. Wiley, head of the Bureau of Chemistry of the National Department of Agriculture, in endorsement of the wholesomeness and purity of canned goods as a whole, and particularly fruits and vegetables, should go far towards offsetting the work of notoriety-seeking ignoramuses. These foolish creatures have filled columns in the yellow press, and even conservative publications have opened their columns to this tommy rot, as witness the effusion of one Fanny Morris Smith in the Outlook for April. If it were a gambling proposition one might not hesitate to take the long end of a "hundred to one shot" that she had never been in a modern canning factory while in operation, if she has ever seen the inside of one. The writer can state with full knowledge of the facts, that while a few obscure nondescript concerns may possibly use preservatives or "dope" of some sort, no responsible packer ever uses or has occasion to use anything of the kind excepting perhaps in condiments such as catsup, chili sauce, etc., in which 1-10 of 1 per cent. benzoate of soda is

Reliable Flower Seeds PRIMULA KEWENSIS

New Verbena Scented

YELLOW PRIMROSE

A cross between P. Floeribunda and P. Verticillata, of strong, vigorous growth, producing numerous spikes, bearing four to six whorls of bloom, of large size, and of a clear, canary yellow color. Trade pkt. 50c.

WRITE FOR OUR WHOLESALER CATALOGUE.

HENRY F. MICHELL CO.,

1018 Market St., Phila.

used and one would have to consume an entire bottle to get this 1-10 of 1 per cent. This is the official declaration of the commission appointed by President Roosevelt, and comprising the most eminent men of their profession. So much is said about the canning industry because its prosperity is a matter of grave moment to many seedsmen and seed growers, and every one knowing the facts should make it his duty to dissipate the absolutely unwarranted prejudice which so widely exists.

A Banner Year.

Although now nearly the first of June, counter trade is still active, and bids fair to continue for some weeks yet, though of course, in diminishing volume. As a whole the trade will have little to complain of, and most dealers will doubtless regard this a banner year. The alarming reports which drifted in from California some weeks ago have subsided, as there was probably little foundation for them. Some day the trade will be caught napping by this persistent cry of wolf when there is no wolf. But that is another story.

Suit Against Blue Grass Growers.

Mt. Sterling, Ky., May 17.—Commonwealth Attorney Alexander Connor, or Owingsville, has filed suit in the Montgomery Circuit Court against the Kentucky Blue Grass Seed Company and M. O. Cockrell, J. M. Bigstaff of this city, D. S. Gay of Winchester, J. S. Wilson, Woodford and Caterby Spears of Paris, Bourbon, alleging the formation and agreement between the parties of a pool trust or organization for the purpose of controlling the blue grass seed crop and fixing a specific price. The suit is brought under the anti-trust act in Kentucky, and the sum of \$5,000 each is asked from the individuals and the company, a total of \$35,000. The Kentucky Blue Grass Seed Company has its headquarters in this city, where it has one of the largest and best equipped seed cleaning plants in the United States. The suit will be tried at the September term of the Montgomery Circuit Court.—Lexington (Ky.) Herald.

NOTES.

Toledo, O.—The Ohio Seed Co. has made an assignment to C. K. Friedman, attorney. The assets are given as \$1,000 in personal property.

S. F. Leonard, of the Leonard Seed Co., Chicago, sails for Europe on S. S. Minnetonka from New York, June 5.

D. S. Wright, salesman for the Lake Shore Seed Co. of Dunkirk, N. Y., included Porto Rico in his recent business trip.

NEWS NOTES.

Gardenias have been unusually late in blooming this season in Texas.

Omaha, Neb.—The Dole Floral Co. was among the sufferers by hail in the recent storm.

Vassar, Mich.—Reports come of damage done to several greenhouses by the severe storm of wind and hail on May 16.

Boise, Idaho.—The Boise 50,000 Club asked for exhibits from the farms and orchards to display at the opening of their new rooms.

Newport, R. I.—John R. Drexel has contracted for the construction of a small lake for an aquatic garden on his summer estate here.

Winchendon, Mass.—The greenhouses on the estate of the late Ephraim Murdock were sold at auction on May 17 to various bidders, to be removed within thirty days.

Pawtucket, R. I.—The Rhode Island Greenhouses when put up at auction May 15 were bid in by the Industrial Trust Co., which held a mortgage for \$8,000 with interest, for \$6,500.

The W. W. Castle Company of Boston, reports a spirited demand for greenhouse heating apparatus. Last week they placed three of their largest size hot water boilers and five automatic hot water circulators.

CATALOGUE RECEIVED.

Edward S. Schmid, Washington, D. C.—Birds, Gold Fish and Pet Stock, Aquatic Plants, etc. Illustrated and including valuable instructions as to care and food, etc.

VEGETABLE PLANTS

BETS. Crosby, Egyptian and Eclipse, \$1.25 per 1000.

CABBAGE. Field Grown, all leading varieties, \$1.00 per 1000, 10,000 and over, 85c per 1000.

CELERY. White Plume, Golden Self Blanching and Giant Pascal, \$1.25 per 1000.

EGG PLANT. N. Y. Improved and Black Beauty, \$3.00 per 1000.

LETTUCE. Big Boston, Boston Market, Tennis Ball and Grand Rapids, \$1.00 per 1000.

PEPPERS. Ruby King, Bull Nose, Sweet Mountain and Neapolitan, \$3.00 per 1000. Chinese Giant and Cayenne, 50c per 1000.

CASH WITH ORDER

R. VINCENT, JR., & SONS CO.
White Marsh, Md.

Everything "For the Land's Sake."

The one firm in Boston where all good forms of plant food may be obtained, is the Bowker Fertilizer Company, opposite Faneuil Hall at 43 Chatham St. All greenhouse chemicals, Nitrate of Soda, Ground Bone, Potash Salts, Sheep Manure and Wood Ashes can there be had at first hands.

BOWKER FERTILIZER COMPANY

Everything "For the Land's Sake."

BECONIAS TUBEROUS ROOTED

—ALSO—
GLOXINIAS, LILY OF VALLEY, SPIREA
Catalogues mailed free on application

Joseph Breck & Sons Corp.
47-54 NO. MARKET ST., BOSTON, MASS.

BULBS OF QUALITY

Begonias, Single, under color.....	100
" Double " " " " " " " " " " " "	\$2.75
" Frilled " " " " " " " " " " " "	5.00
Gloxinias, under color.....	4.00
Pearl Tuberoes, \$7.00 thous.....	3.00

Schlegel & Fottler Co.
26 & 27 So. Market St., BOSTON, MASS.

Burpee's Seeds
PHILADELPHIA

Blue List of Wholesale Prices mailed only to those who plant for profit.

Ward's Lily Bulbs

Send for Catalogue
 **Ralph M. Ward & Co.**
12 W. Broadway
NEW YORK

GEO. E. DOW
Designing and Illustrating
178 Washington St., Boston, Mass.
OUR SPECIALTY
Machine, Booklet, Advertising and Flower
PHOTOGRAPHS

Primulas for Christmas

SOW SEED NOW

B's Matchless Giant, pure white; B's Matchless Giant, blush white; B's Matchless Giant, rose; B's Matchless Giant, scarlet; B's Matchless Giant, royal blue; B's Matchless Giant, mixed. Each 1-2 trade packet, 60c; trade packet, \$1.00.

Primula obconica gigantea Kermsesina deep crimson. Primula obconica gigantea alba, pure white. Primula obconica gigantea Illicina, beautiful lilac. Primula obconica gigantea rosea, lovely pink. Primula obconica gigantea grandiflora, mixed, containing pure white to deep crimson.

Each of above 1-2 trade packet, 30c; trade packet, 50c.

Primula floribunda grandiflora (Buttercup) 1-2 trade packet, 30c; trade packet, 50c. Forbes (Baby Primula). Trade packet, 35c. Primula Kewensis (Giant Buttercup) 1-2 trade packet, 60c; trade packet, \$1.00.

ARTHUR T. BODDINGTON, Seedsman, 342 W. 14th Street, New York

LEONARD SEED CO.

CONTRACT GROWERS AND WHOLESALE DEALERS
BEANS, PEAS, SWEET CORN, ONION, GARDEN SEEDS
ONION SETS **Get Our Prices** 79 and 81
FLOWER SEEDS **E. KINZIE STREET, CHICAGO**

ESTABLISHED 1802

Thorburn's Seeds

FINE CLUMPS JAPAN IRIS
ASPARAGUS PLUMOSUS NANUS⁷³ SEED
ASPARAGUS PLUMOSUS ROBUSTUS SEED
ROSA MULTIFLORA NANA SEED
and all other flower seeds for florists
SEND FOR CATALOGUE
J. M. THORBURN & CO.
33 Barclay Street
NEW YORK

SHEEP MANURE

IT'S STERILIZED
Free from Weed Seeds.
\$24.00 Ton;
\$7.00 quarter of Ton.
Wm. Elliott & Sons
42 Vesey St., New York

RELIABLE SEEDS—SOW NOW

PRIMUMA OBCONICA GRANDIFLORA
1000 seeds Tr. pkt.

Flood red, fine seller.....	\$1.50	\$0.50
Real pink, fine for cut.....	1.00	.60
Pure white, fine for cut.....	1.00	.50
Compacta, fine potted.....	1.50	.50
Mixed Hybrids.....	1.00	.50

O. V. ZANGEN, - HOBOKEN, N. J.

CAULIFLOWER'S
C A B B A G E
LILY OF THE VALLEY PIPS.
HJALMAR HARTMANN & CO.
Longansstraede 20,
COPENHAGEN, DENMARK.

Mignonette

FARQUHAR'S GIANT

Oz., 75c; 1-4 oz., 25c

R. & J. Farquhar & Co.

6 & 7 South Market Street
BOSTON, MASS.

BRIDGEMAN'S SEED WAREHOUSE

RICKARDS BROS.

Props.
37 East 19th St., - NEW YORK CITY

STOCK SEED

FOR WINTER BLOOMING
Our strain of Double Branching Stocks is exceptionally true. About 90% Double Flowers.

In colors; ..	1/4 oz. .50	oz. \$1.00
Pure White ..	1/4 " .75	" 1.00

H. E. FISKE SEED CO.
Faneuil Hall Square, BOSTON, MASS.

Winter-flowering SWEET PEAS

have been the best moneymakers the past winter.
NEW PRICE LIST of those celebrated Sweet Pea seeds will be ready soon. Send for it to the originator

Ant. C. Zvelanek, Bound Brock, N. J.

NEW CROP SEED

For Early Planting
THOMAS J. GREY CO.
32 SO. MARKET ST., BOSTON, MASS.

To Florists Everywhere

Orders for Cut Flowers and Floral Decorations to be delivered anywhere in the Greater New York, may be placed with us with the certainty that your customers will be satisfied.
 Telegraph, telephone or mail such orders to us and be sure that they will be filled as promptly and as carefully as though you did it yourself.
 One third discount will be allowed on all orders thus placed with us by Florists outside of the Greater New York.

THE BLOSSOM

Bond and Livingston Sts.,
 BROOKLYN, N. Y.

C. C. TREPPEL, Manager

**WILLIAM J. SMYTH
 FLORIST**

Cor. Michigan Ave. and 31st St., CHICAGO

We ship to all points in Illinois and Iowa.
 Phones: Douglas 744, Douglas 523, Douglas 740

HAUSWIRTH THE FLORIST
 Out of Town orders for Hospitals
 Carefully filled.

**232 Michigan Ave.
 CHICAGO**
 AUDITORIUM ANNEX Tel. Harrison 585

**SAMUEL MURRAY
 Florist**

Coates House Conservatory
 1017 BROADWAY, KANSAS CITY, MO.
 Both 'Phones 2670 Main.



WASHINGTON,
 D. C.

GUDE'S

The Far-Famed Flowers of
TORONTO

Delivered on mail or telegraph order for any occasion, in any part of the Dominion.
JOHN H. DUNLOP,
 96 Yonge St., - Toronto, Ont.

The **Park Floral Co.**

J. A. VALENTINE,
 Pres.

DENVER, COLORADO
**WILLIAM L. ROCK
 FLOWER CO.**
 KANSAS CITY, MO.

will carefully execute orders for Kansas City and any town in Missouri or Kansas.



Buffalo, N. Y.

W. J. PALMER & SON, 304 Main St.

Of Interest to Retail Florists

NEW FLOWER STORES.

Wheaton, Ill.—Jacob Rohr.
 Tonawanda, N. Y.—J. D. Schultz.
 Allegan, Mich.—Conklin & Hudson.
 Buffalo, N. Y.—Stroh's Quality Flower Shop, A. J. Beyer, manager.
 St. Louis, Mo.—The Mullinphy Flower Co., North Grand avenue (branch).

Adams, Mass.—Cornelius and Thos. Boothman, sons of A. J. Boothman, have leased a store on Park street and will handle the products of their father's greenhouses.

STEAMER DEPARTURES

Line	Destination	Departure
American	Allan	
	Nunuidlan, Boston-Glasgow	June 11
	Philadelphia, N. Y.-S'ampton	June 5
	St. Paul, N. Y.-S'ampton	June 12
Atlantic Transport		
	Mimelaha, N. Y.-London	June 5
	Minnewaska, N. Y.-London	June 12
Cunard		
	Ivernia, Boston-Liverpool	June 1
	Campania, N. Y. Liverpool	June 5
	Caronia, N. Y.-Liverpool	June 12
French Line		
	La Lorraine, N. Y.-Havre	June 8
	La Provence, N. Y.-Havre	June 10
Hamburg-American		
	Pennsylvania, N. Y.-H'burg	June 1
	Batavia, N. Y.-Med. Ports	June 5
	Deutschland, N. Y.-Hamburg	June 8
Leyland Line		
	Winifredan, Boston-Liverpool	June 9
North German Lloyd		
	K. Wilhelm II, N. Y.-Bremen	June 1
	Pr. Irene, N. Y.-Med. Ports	June 5
	Kp. Wilhelm, N. Y.-Bremen	June 8
White Star		
	Majestic, N. Y.-S'ampton	June 5
	Celtic, N. Y.-Liverpool	June 12
	Oceanic, N. Y.-S'ampton	June 9
Red Star		
	Zeeland, N. Y.-Antwerp	June 5

AN ANNIVERSARY AND A CONGRATULATION.

One of our widely known Boston florists, Julius A. Zinn, has just observed the tenth anniversary of his starting in business. For many years previous, however, Mr. Zinn was no stranger to the flower trade of the city, for in his place of employment he was known as a faithful worker, patiently at his post early and late and it is but natural, now that he has attained a well-earned prosperity, congratulations sincere should be extended. Channing said that "Man owes his growth, his energy, chiefly to the striving of the will; that conflict with difficulty which we call effort." Mr. Zinn is a literal demonstration of this truth. He early sized up the demands of the flower buying people of New England, "batted in" with a generous combination of business sagacity and artistic skill, which has won for him first honors on several occasions in the horticultural exhibitions, and has extended his lines profitably far beyond the environs of Boston. He has made good use of his ten years and there is plenty of equal opportunity in every populous community in the land for more young men with "pluck" in their make-up.

ALEX. McCONNELL

571 FIFTH AVENUE
 NEW YORK CITY

Telegraphic orders forwarded to any part of the United States, Canada, and all principal cities of Europe. Orders transferred or intrusted by the trade to our selection for delivery on steamships or elsewhere receive special attention.
 Telephone Calls, 487 and 488 38th St.
 Cable Address, ALEXCONNELL

M. A. BOWE

In the Heart of New York City

1294 Broadway

NEW YORK

No. 276, 38th St.

Our Motto—The Golden Rule

DAVID CLARKE'S SONS

Deliver orders from any part of the country to

New York City

Or OUT-GOING STEAMERS

Write or telegraph

2139-2141 Broadway, New York
 Telephone 1552-1553 Columbus

YOUNG & NUGENT

42 West 28 St., NEW YORK

"FLOWERS BY TELEGRAPH"

ALBANY, N. Y.

EYRES

Flowers or Design Work

DELIVERED IN ALBANY AND VICINITY
 ON TELEGRAPHIC ORDER.

11 NORTH PEARL ST., ALBANY, N. Y.

Flower Deliveries

In Brooklyn and other Long Island Points
 New York City, New Jersey, etc. At Theatres,
 Hotels, Steamers or Residences.

WILSON

Fulton St. and Greene Ave., Brooklyn, N. Y.

DANKER, Albany, N. Y.

ORDERS FOR

Choice Flowers and
 Floral Emblems

FILLED PROMPTLY

WELLESLEY COLLEGE

Dana Hall, Walnut Hill and Rockridge Hall
 Schools. TAILBY, Wellesley, Mass.
 Tel. Wellesley 44-1 and 2. Night 44-3.

ATLANTA FLORAL CO.

41 Peachtree Street, ATLANTA, GEORGIA

USEFUL BOOKS.

We can supply the following books, postpaid, at the prices listed:—
 Roses and How to Grow Them. By Many Experts. Price, \$1.21.
 The New Cyclopedia of American Horticulture. L. H. Bailey. Four volumes, \$20.00.
 How to Plan the Home Grounds. S. Parsons, Jr. Price, \$1.10.
 How to Make a Vegetable Garden. Edith L. Fullerton. Price, \$2.20.

Money in June Is Easy Enough if You Make a Reach for It

Prepare for the Commencements and Graduations

Tens of thousands of graduates are expecting Floral Gifts from their friends. Art Baskets in Willow, Twigs and Bronze, Lace Bouquet Holders and other dainty receptacles can be sold by tens of thousands and if you show our goods specially prepared for this use, they will sell

LIKE HOT CAKES

Let us send you a list of them. Don't delay for we have some novelties that are Cracker-Jacks.

H. BAYERSDORFER & CO.,

1129 Arch St., Phila., Pa.

JOHN BREITMEYER'S SONS

Cor. Miami and Gratiot Aves.
DETROIT, MICH.

Artistic Designs . . .
High Grade Cut Blooms

We cover all Michigan points and good sections of Ohio, Indiana and Canada

BOSTON'S BEST In Quality and Design

Can be relied upon when you transfer your retail orders to

EDWARD MACMULKIN
194 Boylston Street, Boston

Send flower orders for delivery in

BOSTON

and all

NEW ENGLAND CITY
THOS. F. GALVIN
124 Tremont St., Boston



TRANSFER

Your orders for flower or plant delivery in Eastern New England to

JULIUS A. ZINN,
2 Beacon St., Boston

FINE DESIGN WORK A SPECIALTY
Orders by Wire Receive Prompt and Careful Execution

J. Newman & Sons
Corporation

24 Tremont Street, BOSTON

Theater, Steamer and Funeral Flowers Our Specialty
We can refer to leading florists in all principal cities.
Established 1870.

LOUISVILLE, KY.
JACOB SCHULZ,
550 South Fourth Ave.

BUSINESS CHANGES.

New York, N. Y.—N. C. Schreiner has given up his wholesale florist business at 41 W. 28th street.

Mobile, Ala.—J. P. Russell, for the last four years connected with the place, has leased the Chatogue Greenhouses.

New Castle, Ind.—The Frederick J. Bentley Co. succeeds the Bentley-Coatsworth Co., with Otto Bentley as manager of the plant here and his brother in charge of the retail branch in Chicago.

Colorado Springs, Col.—The Pike's Peak Floral Co. has bought the greenhouse business and property of William Clark and will now engage in retail business. W. E. Crump will have charge of the sales department for the company and Edward Johnson of the greenhouses and growing. Mr. Clark retains and will continue in his nursery business.

NEWS NOTES.

Peekskill, N. Y.—C. H. Robinson has leased the entire building in which he is now located.

Beverly, Mass.—J. W. Philbrick, florist, is to move into a new store on Abbott street as soon as it is completed.

Cambridge, Mass.—Sands & Conant, who have recently started in the wholesale and retail plant business, are located at 463 Mt. Auburn street.

West Springfield, Mass.—Daniel S. Law, of Centre Barnstead, N. H., has leased Waldheim, the estate of the late Adolph Mieliez, and will carry on the business of fruit and flower growing.

St. Louis, Mo.—The Bentzen Floral Co. expect to have their handsome new store and show house, corner Grand avenue and Herbert street, ready for occupancy by the last of August.

Cincinnati, O.—Arrangements have been made by the Unemployed Protective Association to observe Memorial Day by decorating the graves of the unknown dead in potter's field. Adam Miller, the Clifton florist, is at the head of the committee for this purpose. Several florists have already

consented to donate flowers for this purpose, and the schools and churches will be asked to help out with floral contributions.

"FLOWERS BY TELEGRAPH."

Leading Retail Florists Listed by Towns for Ready Reference.

- Denver, Colo.—Park Floral Co., 1706 Broadway.
- Washington, D. C.—Gude Bros., 1214 F St.
- Atlanta, Ga.—Atlanta Floral Co., 41 Peach Tree St.
- Chicago—Hauswirth, "The Florist," 232 Michigan Ave.
- Chicago—William J. Smyth, Michigan Ave. and 31st St.
- Chicago—George Wittbold Co., 1657-59 Buckingham Place.
- Louisville, Ky.—Jacob Schulz, 550 South Fourth Ave.
- Boston—Thos. F. Galvin, 124 Tremont St.
- Boston—Edward MacMulkin, 194 Boylston St.
- Boston—Hoffman, Florist, 59-61 Massachusetts Ave.
- Boston—J. Newman & Sons, Inc., 24 Tremont St.
- Roston—Julius A. Zinn, 2 Beacon St.
- Louisville, Mass.—Talby.
- Detroit, Mich.—J. Breitmeyer's Sons, Miami and Gratiot Aves.
- Kansas City, Mo.—Samuel Murray, 1017 Broadway.
- Kansas City, Mo.—Wm. L. Rock Flower Co., 1116 Walnut St.
- Albany, N. Y.—H. G. Eyres, 11 N. Pearl St.
- Albany, N. Y.—F. A. Danker, 40 Malden Lane.
- New York—David Clarke's Sons, 2139-2141 Broadway.
- New York—Alex. McConnell, 571 5th Ave.
- New York—Young & Nugent, 42 W. 28th St.
- New York—M. A. Rowe, 1234 Broadway.
- Brooklyn, N. Y.—The Blossom (C. C. Trepel, Mgr.), Bond and Livingston Sts.
- Brooklyn, N. Y.—Robert G. Wilson, Fulton St. and Greene Ave.
- Buffalo, N. Y.—Palmer's, 304 Main St.
- Toronto, Can.—J. H. Dunlop, 96 Yonge St.

THE BEST LETTERS

FOR THOSE
FLORISTS' MADE
USE BY THE



Boston Florist Letter Co.

66 PEARL ST., BOSTON

N. F. McCARTHY, Mgr.

Order direct or buy from your local supply dealer. Insist on having the

BOSTON

Inscriptions, Emblems, etc.. Always in Stock

June Weddings & Commencements

CATTLEYS \$7.50 per dozen.
 BEAUTIES \$2.50 per dozen.
 VALLEY \$3.00-\$4.00 per 100.
 GOOD ROSES \$6.00 per 100.
 PEAS 75 cts. — \$1.00.

THE LEO NIESSEN CO.

1209 Arch St., Philadelphia, Pa.
 Open from 7 a. m. to 8 p. m.

To Cut Flower Growers and Retail Florists

IF YOU

want to find a market for your product

want a regular or special supply of the product of the best growers

Consult the Advertisements on these Wholesale Flower Pages

The Advertisers Represented Here are the Leading Concerns in the Wholesale Flower Trade

NEW CROP BEAUTIES

\$1.00 to \$3.00 per Doz.

W. E. McKISSICK & BROS.

WHOLESALE FLORISTS
 1619-1621 RANSTEAD ST.
 PHILADELPHIA

CUT FLOWER BOXES
EDWARDS FOLDING BOX CO
 MANUFACTURERS
 PHILADELPHIA, PA.

CHAS. W. MCKELLAR

51 WABASH AVE., CHICAGO

Western Headquarters for Choice Orchids
 Valleys, Roses and all Cut Flowers

PETER REINBERG WHOLESALE

CUT FLOWERS

51 Wabash Av., Chicago, Ill.

Long Distance Phone, Central 6004
WINTERSON'S SEED STORE
 45-47-49 Wabash Ave., Chicago.

Seedsmen, Plantsmen, Nurserymen
 Florists' Supplies

We can supply everything used by the Florist. SUPPLY CATALOG FREE. Correspondence solicited.

POEHLMANN BROS. CO.

33-35-37 Randolph St., - CHICAGO

CUT FLOWERS

Greenhouses, - Morton Grove, Ill.

Rice Brothers

118 N. 6th Street, MINNEAPOLIS, MINN.
 WHOLESALE FLORISTS and SUPPLIES

CUT FLOWERS received twice daily, and can fill your orders to your satisfaction. A complete line of Hardy Greens — WILD SMILAX, BOXWOOD, HARDY FANCY FERNS, GALAX LEAVES.
 Write for quotations on large quantities.

In ordering goods please add "I saw it in HORTICULTURE."

WELCH BROS.

AMERICAN BEAUTY, KILLARNEY, RICHMOND, MARYLAND AND ALL THE SUPERIOR ROSES, LILY OF THE VALLEY, CARNATIONS, ORCHIDS

BEST PRODUCED

226 Devonshire Street,

Boston, Mass.

WHOLESALE FLOWER MARKETS—TRADE PRICES—Per 100 TO DEALERS ONLY

	CHICAGO May 24	TWIN CITIES May 24	PHILA. May 25	BOSTON May 27
ROSES				
Am. Beauty, Fancy and Special...	25.00 to 30.00	30.00 to 35.00	15.00 to 20.00	18.00 to 25.00
" Extra	30.00 to 25.00	30.00 to 30.00	12.50 to 15.00	13.00 to 15.00
" No. 1	15.00 to 20.00	10.00 to 20.00	8.00 to 10.00	4.00 to 8.00
" Lower grades	6.00 to 10.00	5.00 to 10.00	2.00 to 4.00	2.00 to 3.00
Bride, 'Maid, Golden Gate, F. & S.	6.00 to 8.00	6.00 to 10.00	4.00 to 6.00	5.00 to 8.00
" Lower grades	4.00 to 6.00	4.00 to 6.00	1.00 to 3.00	2.00 to 4.00
Killarney, Fan, & Sp.	8.00 to 10.00	6.00 to 10.00	6.00 to 10.00	8.00 to 10.00
" Lower grades	4.00 to 6.00	4.00 to 6.00	2.00 to 4.00	2.00 to 6.00
Richmond, Fancy & Special	6.00 to 8.00	8.00 to 12.00	6.00 to 10.00	8.00 to 10.00
" Lower grades	4.00 to 6.00	6.00 to 8.00	2.00 to 4.00	3.00 to 6.00
Chateau	4.00 to 8.00	6.00 to 12.00	2.00 to 4.00	1.00 to 8.00
My Maryland to to	2.00 to 10.00	6.00 to 10.00
CARNATIONS				
Fancy and Red	3.00 to 4.00	3.00 to 5.00	3.00 to 4.00	3.00 to 4.00
Ordinary and White	1.50 to 2.00	1.00 to 4.00	1.00 to 2.00	1.50 to 2.50
MISCELLANEOUS				
Cattleyas	40.00 to 60.00	50.00 to 75.00	40.00 to 60.00	35.00 to 50.00
Lilies	10.00 to 13.00	10.00 to 12.50	10.00 to 12.50	6.00 to 8.00
Lily of the Valley	3.00 to 4.00	3.00 to 4.00	2.00 to 4.00	2.00 to 4.00
Mignonette	3.00 to 4.00	2.00 to 3.50	3.00 to 3.00	1.00 to 4.00
Sweet Peas	40.00 to 1.00	.75 to 1.00	.50 to 1.00	.50 to .75
Geraniums	50.00 to 100.00	50.00 to 100.00	30.00 to 25.00	10.00 to 25.00
Peonies	3.00 to 8.00	6.00 to 8.00	6.00 to 10.00	6.00 to 8.00
Daisies	1.00 to 1.50	1.00 to 1.50	.50 to 1.00	.50 to 1.00
Stocks	6.00 to 8.00	4.00 to 12.00 to 4.00	2.00 to 4.00
Snapdragon	8.00 to 10.00	10.00 to 12.00	4.00 to 8.00	2.00 to 6.00
Adiantum	1.00 to 1.00	1.00 to 1.50 to 1.00	.75 to 1.00
Smilax	15.00 to 20.00	20.00 to 25.00 to 20.00	12.00 to 15.00
Asparagus Plumosa, strigosa	40.00 to 60.00	30.00 to 50.00 to 50.00	25.00 to 35.00
" " & Sprea. (100 bchs.)	20.00 to 40.00	30.00 to 50.00 to 50.00	15.00 to 25.00

J.A. BUDLONG

37-39 Randolph Street, CHICAGO.

Roses and Carnations
 A Specialty.....

WHOLESALE GROWER of CUT FLOWERS

HENRY M. ROBINSON & CO.

15 Province St. and 9 Chapman Place - BOSTON, MASS.

WHOLESALE COMMISSION FLORISTS

Hardy Cut Evergreens and Florists' Supplies

New Crop Dagger and Fanc. Ferns \$2.00 per Thousand.

We have the stuff and can fill all orders, large or small
 WE NEVER DISAPPOINT SATISFACTION GUARANTEED

Prices Quoted in these Columns are for Dealers Only.

When Writing to Advertisers Please Mention

HORTICULTURE.

Flower Market Reports.

BOSTON This is a hustling week with growers and wholesalers alike. A tremendous quantity of material has been ordered in advance, at full prices and all indications point to a volume of business for Memorial Day, exceeding anything on record for this or any other holiday in the year. The variety of flowers in the market is largely increased by heavy cuts of astilbes, stocks, and other things specially grown for the occasion and roses from cold houses are being received in quantity now. Carnations are called for in enormous quantities, colored varieties especially, but many lots are in poor condition, indicating over-storage and should warm weather ensue at the close of the week, as is probable, the trouble will be greatly aggravated.

Trade has been much on the quiet side for the past two weeks and up to Friday last, there being an over-supply on almost everything on the cut flower line. Roses have been too abundant, especially Bride and Bridesmaid of ordinary quality, for which there was little or no demand. Beauties as well were in heavy supply, but moved rather slowly and at prices away below quotations. Peas were also included, together with lilies and outdoor tulips, narcissi, etc. Carnations were not coming in too plentifully, but the market being in such condition they also accumulated and added to the surplus which was being carried along from day to day. On Friday everything brightened up and continued through Saturday and Sunday when a good portion was cleaned up and on Monday, the 24th, the market got back in condition. Roses and carnations as well as other material (save lilies of the valley) were sold out early in the day and the outlook for the week-end is bright, orders being booked for Memorial Day, and a record-breaking week's business is looked for by the trade.

PHILADELPHIA. Since our last report a change has come over the scene. Not that the week of 17th to 22nd was an improvement as regards business over that of 10th to 15th, but there were a few cold stormy days and these had a decided effect in checking production. A fairly good clean-up of the week's surplus took place on the 22nd, and Memorial week starts out with a clean sheet, and with prospects for an active business. There will not be any great redundancy of stock in any line. If nothing unforeseen happens a satisfactory business will be done at reasonable prices with fair returns to both grower and retailer. Pre-memorial week outlook is decidedly encouraging considering what we have gone through. The American Beauty rose crop is beginning to show the effects of the advancing season and the choicest now coming in are from young plants grown specially as a crop for from now on. Brides and Bridesmaids are also beginning to show the strain; but Richmonds are holding their own splendidly so far. Killarneys are showing up much better than Jardines for the time being, but it will surprise no one should Jardine get into alignment again very soon and

even forge ahead of her running mate. Marylands are improving in quality steadily from week to week. Carnations are taking a breathing spell after their recent blooming spurt. We do not look for any great surplus of these for a while. Peonies in this locality are held back by the cold weather. We thought a flush of them would be in by the 27th but it looks a little doubtful today (24th).

However, a couple of warm days will do wonders. Outdoor sweet peas are just commencing. These are from fall-sown seed, with frame protection, of course. By frame protection is meant boards alongside each row covered with panes of glass, a straw covering being put on or taken off according to the weather. This gives a gain of about three weeks over the regular outdoor product. The demand for gardenias has fallen off somewhat and the crop is smaller also. Cattleya Mossiae is the star in the orchid line at present. Snowballs are the leading outdoor flower this week, outside of peonies. Irises and May tulips are nearly over. Blue cornflower and white spirea are factors. Lilacs are practically over.



Again we have the June girl with us, claiming the choicest for her adornment.

She will want the finest of Sweet Peas, Valley, Cattleyas, Gardenias and Roses, of which we will have a magnificent supply.

- SWEET PEAS**
Laved r, Pink, White and Flesh; 75c. to \$1.00.
- VALLEY**
In unlimited quantities; \$3.00, \$4.00.
- CATLEYA MOSSIAE**
Per doz., \$7.50; per hundred \$50.00.
- GARDENIAS**
Per doz., specials \$3.00; 1st, \$2.00.
- BEAUTIES**
Specials per doz. \$3.00; per hundred \$20.00. Plenty of mixed grades, \$1.00 to \$2.00 per doz.
- RICHMOND, KILLARNEY (Pink and White), JARDINE, MARYLAND.** Specials \$12.00; F \$10.00; X \$8.00; 1st \$6.00; 2nd \$4.00.
- KAISERINES, MAIDS, BRIDES**
X \$8.00; 1st \$6.00; 2nd \$4.00.
- PAEONIES**
1st quality, Pink and White mainly, \$5.00 and \$6.00.
- Fancy and Novelties,** \$8.00 to \$10.00.

S. S. PENNOCK - MEEHAN CO.
1608-1620 Ludlow Street
PHILADELPHIA, PA.

Twin City business TWIN CITIES has been quite good of late. Prospects for Decoration Day are very promising; owing to the late spring there will not be any out-of-door flowers for the next two weeks. Roses and carnations have gone up already, and other cut flowers, like peonies, etc., are bringing a pretty good price.

(Continued on page 754)

WHOLESALE FLOWER MARKETS. PER 100. TO DEALERS ONLY.

	CINCINNATI May 25	DETROIT May 24	BUFFALO May 24	PITTSBURG May 24
ROSES				
Am. Beauty, Fan, and Sp.	20.00 to 25.00	30.00 to 35.00	20.00 to 25.00	15.00 to 20.00
Extra	15.00 to 20.00	25.00 to 30.00	15.00 to 20.00	10.00 to 15.00
" No. 1	10.00 to 12.00	15.00 to 20.00	8.00 to 10.00	4.00 to 6.00
" Lower grades	4.00 to 8.00	6.00 to 10.00	3.00 to 5.00 to 6.00
Bride, Maid, Golden Gate, F. & S.	6.00 to 8.00	6.00 to 8.00	7.00 to 8.00	6.00 to 10.00
Low gr.	3.00 to 5.00	4.00 to 6.00	3.00 to 5.00	2.00 to 4.00
Killarney, Fan, & Sp.	8.00 to 10.00	8.00 to 10.00	7.00 to 8.00	6.00 to 10.00
" Lower grades	3.00 to 5.00	4.00 to 6.00	3.00 to 5.00	2.00 to 4.00
Richmond, Fancy & Special.	6.00 to 8.00	6.00 to 8.00	8.00 to 10.00	6.00 to 10.00
Lower grades	4.00 to 6.00	4.00 to 6.00	3.00 to 5.00	2.00 to 4.00
Chatenay	6.00 to 8.00	6.00 to 8.00	3.00 to 5.00	2.00 to 4.00
My Maryland to to to to
CARNATIONS				
Fancy and Novelties	2.00 to 3.00	3.00 to 4.00	3.00 to 4.00	2.00 to 3.00
Ordinary	1.00 to 2.00	1.00 to 3.00	2.00 to 3.00 to 1.00
MISCELLANEOUS				
Cattleyas to	35.00 to 50.00	60.00 to 75.00	50.00 to 75.00
Daisies	8.00 to 10.00	10.00 to 15.00	8.00 to 10.00	8.00 to 12.00
Lilies	3.00 to 4.00	3.00 to 4.00	3.00 to 4.00	3.00 to 4.00
Lily of the Valley	3.00 to 4.00	3.00 to 4.00	2.00 to 3.00	2.00 to 3.00
Mignonette	2.00 to 3.00	2.00 to 3.00	2.00 to 3.00	2.00 to 3.00
Sweet Peas	50 to 75	50 to 100	50 to 100	25 to 75
Gardenias to	20.00 to 30.00 to	20.00 to 30.00
Peonies	4.00 to 5.00	4.00 to 7.00	5.00 to 8.00	4.00 to 5.00
Stocks	3.00 to 4.00	3.00 to 5.00	1.00 to 2.00	1.50 to 2.50
Snappragon	1.00 to 2.00	4.00 to 5.00	1.00 to 2.00	1.00 to 3.00
Adiantum	1.00 to 2.00	1.00 to 2.00	1.00 to 2.00	1.00 to 2.00
Smilax	10.00 to 12.00 to 15.00 to 15.00 to 20.00
Asparagus Plumosus, strings	40.00 to 50.00	30.00 to 50.00	50.00 to 60.00	30.00 to 50.00
" & sprea (100 bchs.)	20.00 to 25.00	30.00 to 50.00	25.00 to 50.00	35.00 to 50.00

FORD BROTHERS

48 West 28th Street NEW YORK

FINE ROSES FANCY CARNATIONS

A Full Line of All CUT FLOWERS

Telephone, 3870 or 3871 Madison Square

H. E. FROMENT

Wholesale Commission Florist,
Choice Cut Flowers,

57 West 28th St. :: NEW YORK

Telephones: 2200, 2201, Madison Square.

Alfred H. Langjahr

All choice cut-flowers in season. Send for quotations. Correspondence with shippers of first-class stock invited.

55 West 28th Street, New York
Telephones 4620-4627 Madison Square

Edward C. Horan

Wholesale Florist

55 WEST 28th ST.

Tel. 1462 Madison Square New York

JOHN YOUNG

WHOLESALE FLORIST

Finest American Beauties and Carnations

51 West 28 St. - NEW YORK

FRANK MILLANG

Wholesale Florist

55-57 West 26th St., NEW YORK

Shipments, any quantity, Wholesale Market Rates.

Henshaw & Fenrich

WHOLESALE FLORISTS

44 West 28th Street, NEW YORK

Phones Mad. Sq. 325, 558-2, 888-3

VIOLETS

Finest Grade. Any Quantity

B. S. SLINN

55-57 W. 26 St., New York

Moore, Hentz & Nash

Wholesale Commission Florists

55 and 57 West 26th Street

Telephone: No. 756
Madison Square

New York

MILLANG BROS.

WHOLESALE COMMISSION FLORISTS

41 West 28th Street

Telephone 3880 Madison
3881

NEW YORK

JOHN I. RAYNOR

Wholesale Commission Florist SELLING AGENT FOR LARGEST GROWERS

A full line of Choice Cut Flower Stock for all purposes. Comprises every variety grown for New York market, at current prices

TEL. 1998 MADISON SQUARE

49 West 28th St., New York City

Walter F. Sheridan

Wholesale Commission Dealer in

CHOICE CUT FLOWERS

39 West 28th Street, New York

Telephone: 3532-3533 Madison Square

**HEADQUARTERS FOR NOVELTIES
ORCHIDS A SPECIALTY**

THE HIGHEST GRADE OF VALLEY ALWAYS ON HAND
GARDENIAS, DAISIES, ROSES AND CARNATIONS

Telephones
JAMES McMANUS, 763 Mad. Sq. 42 W. 28th St., New York

NEW YORK QUOTATIONS PER 100. To Dealers Only

ROSES AND CARNATIONS	Last Half of Week ending May 22 1909		First Half of Week beginning May 24 1909	
	American Beauty, Fancy and Special.....	6.00	to 10.00	6.00
" " Extra.....	4.00	to 6.00	4.00	to 6.00
" " No. 1.....	3.00	to 4.00	3.00	to 4.00
" " Lower Grades.....	.50	to 1.00	.50	to 1.00
Bride, 'Held, Golden Gate, Fancy and Special.....	2.00	to 4.00	2.00	to 4.00
" " Lower Grades.....	.50	to 1.00	.50	to 1.00
Killarney, Fancy and Special.....	3.00	to 4.00	3.00	to 4.00
" " Lower Grades.....	.50	to 1.00	.50	to 1.00
Richmond, Fancy and Special.....	3.00	to 4.00	3.00	to 4.00
" " Lower Grades.....	.50	to 1.00	.50	to 1.00
Chatenay.....	.50	to 6.00	.50	to 6.00
Ply Maryland.....	1.00	to 6.00	1.00	to 6.00
Carnations, Fancy and Novelties.....	2.00	to 4.00	2.00	to 4.00
" " Ordinary and White.....	1.00	to 2.00	1.00	to 2.00

Alexander J. Guttman
THE WHOLESALE FLORIST OF NEW YORK
34 WEST 28th STREET
PHONES. 1664-1665 MADISON SQUARE
ENOUGH SAID

CENTRALLY LOCATED, THE HUB OF THE FLOWER MARKET SECTION

CHARLES MILLANG

Wholesale Florist

444 Sixth Ave., NEW YORK

Telephone 7062 Madison

GEORGE COTSONAS & CO.

Wholesale and Retail Dealers in all kinds of EVERGREENS

Fancy and Digger Ferns
Bronze and Green Galax

Main Store 50 W. 28 St.

Phone 1202 Mad. Sq. New York

GROWERS' CUT FLOWER CO. CUT FLOWERS
WHOLESALE
VIOLETS, CARNATIONS, ROSES
ORCHIDS, CHRYSANTHEMUMS, LILIES
Shipments to Order, any Distance
39 West 28th Street, Telephone 637 Madison Square
J. J. COAN, Manager NEW YORK

Durand & Marohn

MANUFACTURERS OF

All Kinds of Wire Work

Florists' Wire Designs a Specialty

24 Beaver St., ALBANY, N. Y.

Wired Toothpicks

Manufactured by

W. J. COWEE, BERLIN, N. Y.

50,000....\$1.75; 50,000....\$7.50. Sample free.

For sale by dealers

NOTICE!

Manhattan Flower Market

Ship us some stock. We need a large supply of all kinds of flowers, Roses, Carnations, Sweet Peas, Narcissus, Summer Stock, etc., for our new store. Reliability and responsibility first-class. Good prices and prompt returns. Good opportunity.

WHOLESALE FLORISTS
54 West 28th St.
NEW YORK
Telephone 3659 Madison Sq.

A. L. YOUNG & CO.

RECEIVERS & SHIPPERS OF CUT FLOWERS.
CONSIGNMENTS SOLICITED.

WHOLESALE FLORISTS
46 W. 28th St., NEW YORK
Telephone: 1016 Madison Sq.

WILLIAM H. KUEBLER
Brooklyn's Foremost and Best
WHOLESALE COMMISSION HOUSE
A First Class Market for all CUT FLOWERS
28 Willoughby St., Brooklyn, N. Y.
Tel. 4591 Main

Greater New York Florists' Association, Inc.
Now Open for Cut Flower Consignments
162 Livingston Street, BROOKLYN, N. Y.
Geo. W. Crawback Telephone Connection
Manager 3642-43 Main

REED & KELLER
122 West 28th St., New York
Florists' Supplies
We manufacture all our
Metal Designs, Baskets, Wire Work & Novelties
and are dealers in
Glassware Decorative Greens and Florists' Regalia

THE KERVAN CO.
Wholesale Dealers and Shippers of
Decorative Evergreens
Ferns, Galax, Laurel, Fresh Cypas, Boxwood, Sphagnum and all Florists' Greens
Send to us for Quotations before Buying.
113 West 25 Street, NEW YORK CITY

MICHIGAN CUT FLOWER EXCHANGE, Inc.
WHOLESALE COMMISSION FLORISTS
Consignments Solicited
Hardy Fancy Fern Our Specialty
38-40 BROADWAY, DETROIT, MICH.

FOR FLORISTS' USE
There's **NOTHING** as good as
MEYER'S SILKALINE
Don't let them sell you anything else
JOHN C. MEYER & CO., Boston, Mass.

Order by Name
Krick's Genuine Immortelle Letters, Etc.
The Best and Cheapest. Accept no Substitute. Every Letter Marked
MRS. L. F. KRICK
1164-66 Greene Av., Brooklyn, N. Y.
For Sale by all Supply Houses

Shenandoah, Ia.—Henry Field has purchased the entire Terry collection of peonies and other herbaceous plants, and will remove same to his ground in Shenandoah in the early fall where he will develop them. The Terry collection of peonies was referred to in a recent issue of HORTICULTURE and is a valuable one.

WILLIAM F. KASTING CO.
WHOLESALE FLORISTS
383-387 Ellicott Street
BUFFALO, - N. Y.

ROBERT J. DYSART
Public Accountant and Auditor
Simple methods of correct accounting especially adapted for florists' use.
Books Balanced and Adjusted
Merchants Bank Building
28 STATE STREET, - BOSTON
Telephone. Malo 58.



WHOLESALE COMMISSION J. K. ALLEN 106 W. 28th St. NEW YORK
Open 6 a.m. Daily Tel. 167 Madison Sq.
Shipments of Lily of the Valley Needed.

NEW YORK QUOTATIONS PER 100. To Dealers Only

MISCELLANEOUS	Last Half of Week ending May 22 1939		First Half of Week beginning May 24 1939	
	Cattleyas.....	20.00	to 35.00	20.00
Lilies.....	3.00	to 5.00	3.00	to 4.00
Lily of the Valley.....	1.00	to 2.00	.50	to 2.00
Peonies.....	3.00	to 6.00	3.00	to 6.00
Daisies.....	.25	to .50	.25	to .50
Stocks.....	1.00	to 2.00	1.00	to 2.00
Mignonette.....	.50	to 1.00	.50	to 1.00
Sweet Peas (per 100 bunches).....	5.00	to 5.00	1.00	to 5.00
Gardenias.....	2.00	to 12.00	2.00	to 12.00
Adiantum.....	.50	to 1.00	.50	to 1.00
Smilax.....	10.00	to 15.00	10.00	to 15.00
Asparagus Plumosus, strigs.....	20.00	to 30.00	20.00	to 30.00
" " & Spreu. (100 bchs.).....	12.00	to 25.00	15.00	to 25.00

FLOWER MARKET REPORTS.

(Continued from page 770)

This is an uncertain week in New York wholesale markets—a "waiting game" in fact. Local business is exceedingly quiet and the wholesale establishments are loaded up with an enormous amount of material, both outdoor and indoor, and the latter is on the downward road as to quality. As Memorial Day approaches there is a disposition to stiffen up on prices in anticipation of heavy shipping orders from points north and east particularly, but nobody looks for anything sensational in the way of demand. Price quotations as given have very little application to the actual sales as made from day to day of late, but are as near an average between asking and selling rates as it is possible to make.

Business is very satisfactory to all and with the weather becoming more seasonable planting out orders are rushing everyone to the limit. Flowers

of all kinds are coming in in fine quality and quantity and all find a fair market. Many of the growers are badly disappointed with Baby gladioli. They were careful about planting them at different times, but somehow or other they all bloom at once. Decoration Day will find a very low supply here on account of the backward season.

The market is INDIANAPOLIS somewhat better than it was a week ago and, while there are large quantities of roses beyond what the demand calls for, stock moves along somehow. Carnations move very well and as the weather keeps cool prices have not fallen any; they will probably stiffen up very perceptibly for Decoration Day. Quantities of outside shrubbery is in bloom now. Cattleyas, lily of the valley and sweet peas are extremely plentiful. There seems to be quite a scarcity of greens, especially good common fern. The bedding plant men say that business has never been better and the first of June will see a clean out.

(Continued on page 780)

Buyer's Directory and Ready Reference Guide

Advertisements under this head, one cent a word. Initials count as words.

Display advertisers in this issue are also listed under this classification without charge. Reference to List of Advertisers will indicate the respective pages.

Buyers falling to find what they want in this list will confer a favor by writing us and we will try to put them in communication with reliable dealers.

ACCOUNTANT

R. J. Dyrart, 28 State St., Boston.
For page see List of Advertisers.

ALYSSUM

Dwarf alyssum from 2 in. pots, at \$3.00 per 100. Jas. T. Baker, Busketon, Philadelphia, Penn.

AMPELOPSIS.

Eastern Nurseries, Henry F. Dawson, Mgr., Ampelopsis Quinquefolia.
Jamaica Plain, Mass.

C. Elsele, 11th and Westmoreland Sts., Philadelphia, Pa.

AQUATIC PLANTS

Aquarium plants the year round. Wholesale and retail. Send for price list. Schmidt's Emporium of Pets, 712 12th Street, Washington, D. C.

AQUILEGIAS

Aquilegia. Genuine Coerulea, finest of all. Both plants and seeds from the heart of the Rockies. C. S. Harrison's Select Nursery, York, Neb.

ARAUCARIAS

A. Leuthy & Co., Perkins St. Nurseries, Roslindale, Mass.
For page see List of Advertisers.

Godfrey Aschmann, 1012 West Ontario St., Philadelphia, Pa.
For page see List of Advertisers.

ASPARGUS PLUMOSUS

William C. Smith, Market & 61st St., Philadelphia.
For page see List of Advertisers.

Asparagus Plumosus, 2½ in., \$3.00 per 100; Sprougeri, seedlings, 100, per 100; 3 in., \$3.50 per 100. Edwin Bishop, Roslyn, Md.

ASPARGUS SEED

Asparagus Plumosus Seed, fresh, lath-house grown, \$2.00 per 1000. Special price to quantities. Immediate delivery. Cash. Oak Grove Nurseries, Office, 404 North Los Angeles St., Los Angeles, Cal.

ASTERS.

Asters, 2 to 2½ in. high, \$8.00 per 1000. Only the choicest colors and kinds included in the collection. H. J. Blanchard, Ashburnham, Mass.

Asters—Field grown. Trego, white, rose and shell pink, mixed; Rosbaly's selected purple and lavender, mixed, white separate, \$2.50 per 1000. For several years we have used most of the new varieties offered with a view of securing an ideal florist's strain. Last season we acquired the Trego and found it the most satisfactory of them all. A. & G. Rosbaly, Pemberton, N. J.

AZALEAS

A. Leuthy & Co., Perkins St. Nurseries, Roslindale, Mass.
For page see List of Advertisers.

Godfrey Aschmann, 1012 W. Ontario St., Philadelphia.
For page see List of Advertisers.

BAMBOO CANES

Yokohama Nursery Co., 31 Barclay Street, New York.

Bamboo Sticks, Colored Green.
For page see List of Advertisers.

BAY TREES.

Bolbink & Atkins, Rutherford, N. J.
For page see List of Advertisers.

200 Bay and Box Trees in all sizes, Pyramid and Standard. Write for list. Julius Reehrs, Rutherford, N. J.

BEDDING PLANTS

J. E. Felthousen, Schenectady, N. Y.
For page see List of Advertisers.

A. Leuthy & Co., Perkins St. Nurseries, Roslindale, Mass.
For page see List of Advertisers.

G. Aschmann, 1012 W. Ontario St., Philadelphia, Pa.
For page see List of Advertisers.

R. Vincent, Jr. & Sons Co., White Marsh, Maryland.
For page see List of Advertisers.

J. C. Schmidt, Bristol, Pa.
For page see List of Advertisers.

Thomas Roland, Nahant, Mass.
Begonia Gloire De Lorraine.
For page see List of Advertisers.

Storrs & Harrison Co., Painesville, O.
For page see List of Advertisers.

C. Elsele, 11th and Westmoreland Sts., Philadelphia, Pa.

S. V. Smith, 3233 Goodman St., Phila., Pa.
For page see List of Advertisers.

Salvia, 2½ to 3 in. high, 1½c. each. C. Cohea scandens, 2½ in., 2c. each. H. J. Blanchard, Ashburnham, Mass.

Vinca variegata, finest stock, heavy and long, \$1.00 and \$1.50 per 100. Cash. Bellamy Bros., 207 Delaware St., Syracuse, N. Y.

BEGONIAS

Begonia Varoon and Luminosa, \$5.00, \$6.00 and \$7.00 per 100. Rose Hill Nurseries, New Rochelle, N. Y.

BEGONIA REX

J. H. Dann & Son, Westfield, N. Y.
For page see List of Advertisers.

BOILERS

BOILERS. "Burnham" Boilers made for greenhouse heating. Lord & Burnham, 1133 Broadway, N. Y.

Kroeschel Bros. Co., 35 Erie St., Chicago.
For page see List of Advertisers.

BOOKS

Pronunciation of Plant Names, sent for 50 cents, postpaid, by HORTICULTURE. PUB. CO., 11 Hamilton Place, Boston.

BOXWOOD TREES

New England Nurseries, Inc., Bedford, Mass.
For page see List of Advertisers.

Bolbink & Atkins, Rutherford, N. J.
For page see List of Advertisers.

BUILDING MATERIAL

BUILDING MATERIAL of all description for All Cypress, Semi-Iron, Iron Frame of Truss Houses, Hot Bed Sash and Frames. Lord & Burnham Co., 1133 Broadway, N. Y.

BULBS AND TUBERS

Joseph Breck & Sons, 47-54 N. Market St., Boston.
For page see List of Advertisers.

J. M. Thornburn & Co., 33 Barclay St., New York.
For page see List of Advertisers.

A. T. Boddington, 342 W. 14th St., N. Y.
For page see List of Advertisers.

Richard Bros., 37 East 19th St., New York.
For page see List of Advertisers.

H. F. Michell Co., Philadelphia.
For page see List of Advertisers.

H. E. Flske Seed Co., Faneuil Hall Sq., Boston.
For page see List of Advertisers.

BULBS AND TUBERS—Continued

T. J. Grey & Co., 32 and 38 So. Market St., Boston.
For page see List of Advertisers.

Yokohama Nursery Co., 31 Barclay St., New York.
For page see List of Advertisers.

Ralph M. Ward & Co., 12 W. Broadway, New York.
For page see List of Advertisers.

Schlegel & Fottler Co., 26 & 27 S. Market St., Boston.

Begonias, Gloxinias, Tuberoses.
For page see List of Advertisers.

CANNAS

C. Elsele, 11th and Westmoreland Sts., Philadelphia, Pa.

R. Vincent, Jr. & Sons Co., White Marsh, Maryland.
For page see List of Advertisers.

Estate of David Fisher, Woburn, Mass.
For page see List of Advertisers.

J. H. Dann & Son, Westfield, N. Y.
For page see List of Advertisers.

Cannas started from sand, \$2.00 per 100; from pots, \$5.00 per 100. J. B. Shurtleff & Son, Cushman Ave., Revere, Mass.

CARNATIONS

Baur & Smith, 35th & Senate Sts., Indianapolis, Ind.

Patten & Co., Tewksbury, Mass.
Carnation Shasta.
For page see List of Advertisers.

F. Dörner & Sons Co., Lafayette, Ind.
Carnations for Immediate Delivery.
For page see List of Advertisers.

Chicago Carnation Co., Joliet, Ill.
Mary Tolman.
For page see List of Advertisers.

Wood Bros., Fishkill, N. Y.
Carnations, Rooted Cuttings.
For page see List of Advertisers.

The E. G. Hill Co., Richmond, Ind.
Carnation Cuttings.
For page see List of Advertisers.

Poehlmann Bros. Co., Morton Grove, Ill.
For page see List of Advertisers.

CATTLEYS

Alphonse Pericat, Collingdale, Phila., Pa.

CHRYSANTHEMUMS

E. G. Hill Co., Richmond, Ind.
For page see List of Advertisers.

S. J. Renter & Son, Westerly, R. I.
For page see List of Advertisers.

C. H. Totty, Madison, N. J.
For page see List of Advertisers.

Wood Bros., Fishkill, N. Y.
Chrysanthemums Rooted Cuttings.
For page see List of Advertisers.

Scott Bros., Elmsford, N. Y.
For page see List of Advertisers.

Poehlmann Bros. Co., Morton Grove, Ill.
For page see List of Advertisers.

Elmer D. Smith & Co., Adrian, Mich.
Special Offer of Commercial Chrysanthemums.
For page see List of Advertisers.

William Swayne, Kennett Square, Pa.
Rooted Cuttings.
For page see List of Advertisers.

H. L. Cameron, N. Cambridge, Mass.
White Bonafon.
For page see List of Advertisers.

William C. Smith, Market & 61st St., Philadelphia.
For page see List of Advertisers.

For List of Advertisers See Page 787

CHRYSANTHEMUMS—Continued

100 commercial varieties, including Pompon and Hairy, \$12.50 per 100. Satisfaction guaranteed. Wm. Ehmann, Jr., Corfn, N. Y.

Chrysanthemum Golden Glow from 3-14 in. pots, for early spring delivery, \$1.00 per doz., \$6.00 per 100, \$50.00 per 1000. Stock plants of Montmort, Oct. Froot, Crocus, Matchless, Lucy Devaux, Polly Rose and Emerald, \$1.00 per doz., \$6.00 per 100. Petcoe Bros., Waltham, Mass.

Herrington's book on the Chrysanthemum, mailed to your address for 50c, by Horticulture Publishing Co., 11 Hamilton Place, Boston.

Golden Glow and Pacific Supreme, R. C., \$2.75 per 100, prepaid; 1000 not prepaid, \$25; from 2 1/2 in. pots, \$3.50 per 100. Chas. Frost, Kenilworth, N. J.

COAL FOR GREENHOUSE USE

Bader Coal Co., Board of Trade Bldg., Boston.
For page see List of Advertisers.

COLEUS

J. E. Felthousen, Schenectady, N. Y.
For page see List of Advertisers.

A. Leuthy & Co., Perkins St. Nurseries, Roslindale, Mass.
For page see List of Advertisers.

CONIFERS

John Waterer & Sons, Ltd., American Nursery, Bagshot, Eng.
For page see List of Advertisers.

Julius Rosbush Co., Rutherford, N. J.
For page see List of Advertisers.

OUT FLOWER BOXES.

Edwards Folding Box Co., Philadelphia
For page see List of Advertisers.
Folding cut flower boxes, the best made Write for list. Holton & Hunkel Co., Milwaukee, Wis.

DAHLIAS

David Herbert & Son, Atco, N. J.
For page see List of Advertisers.

J. L. Moore, Northboro, Mass.
For page see List of Advertisers.

Peacock Dahlia Farms, Williamstown Junction, N. J.
For page see List of Advertisers.

R. Vincent Jr. & Sons Co., White Marsh, Md.
For page see List of Advertisers.

DAHLIAS.

Geo. H. Walker, No. Dighton, Mass.
Wholesale and Retail.
Send your name for my 1909 Catalog and Pocket Guide, ready to mail about Feb. 25th.

Dahlia, divided roots, \$1.00 the doz., including such varieties as Thomas Parkin, Mrs. Roosevelt, Sour de Gustave Duzon, Standard Beauty, Catherine Duer, 20th Century, Gen. Buller, Dainty, Frank Smith, Livoni, White Swan and 25 other sorts, all selected as good for cut flowers. A. & G. Rosbach, Pemberton, N. J.

DECORATION DAY STOCK

S. S. Pennock Meehan Co., Philadelphia. Memorial Day Flowers and Supplies.

J. A. Dudding, 37-59 Randolph St., Chicago. Hatcher, Amsterdam & Schenectady, N. Y.

DECORATIVE PLANTS

A. Leuthy & Co., Perkins St. Nurseries, Roslindale, Mass.
Imported Plants for Early Delivery.
For page see List of Advertisers.

Godfrey Aschmann, 1012 W. Ontario St., Phila., Pa.
For page see List of Advertisers.

Joseph Heacock Co., Wyncote, Pa.
For page see List of Advertisers.

The Geo. Wittbold Co., 1637 Buckingham Place, Chicago, Ill.
For page see List of Advertisers.

Robert Craig Co., Market and 49th Sts., Philadelphia, Pa.
For page see List of Advertisers.

DRACAENAS

P. M. Olin, Bath, Me.
Dracaena Individua

EVERGREENS

New England Nurseries, Bedford, Mass.
For page see List of Advertisers.

American Nursery Co., 150 Broadway, N. Y.
For page see List of Advertisers.

Evergreen. Send 25 cents in stamps for complete work on propagating and growing Evergreens. C. S. Harrison's Select Nursery, York, Neb.

FERNS

A. Leuthy & Co., Roslindale, Mass.
For page see List of Advertisers.

H. B. Barrows & Son, Whitman, Mass.
Nephrolepis blagayana.
For page see List of Advertisers.

John Scott, Brooklyn, N. Y.
For page see List of Advertisers.

Frank Oechslein, 2570-2606 W. Adams St., Chicago.
Ferns for Dishes.
For page see List of Advertisers.

The Geo. Wittbold Co., 1637 Buckingham Place, Chicago, Ill.
For page see List of Advertisers.

Godfrey Aschmann, 1012 W. Ontario St., Philadelphia.
For page see List of Advertisers.

Jardiniere Ferns, 6-7 best varieties, \$3.50 per 100; \$30.00 per 1000. Rose Hill Nurseries, New Rochelle, N. Y.

C. Elsele, 11th and Westmoreland Sts., Rose Hill Nurseries, New Rochelle, N. Y.
Ferns for Jardiniere.
For page see List of Advertisers.

Anderson's ferns for in and outdoors. Largest commercial collection in the country. Ask for descriptive catalogue. J. F. Anderson, Fern Specialist, Short Hills, N. J.

FERTILIZERS

Pulverized Manure Co., 31 Union Stock Yards, Chicago, Ill.
Wisard Brand Sheep and Shredded Cattle Manure.

Bowker Fertilizer Co., Boston, Mass.
All Forms of Plant Food at First Hands.
For page see List of Advertisers.

German Kall Works, 93 Nassau St., New York.
Potash Fertilizer.
For page see List of Advertisers.

Wm. Elliott & Sons, 42 Vesey St., New York.
Sheep Manure.
For page see List of Advertisers.

FLORAL PHOTOGRAPHS

Floral Photographs, Foley's, 223-228 1-2 Bowery, New York.

FLORISTS' LETTERS.

Boston Florist Letter Co., 66 Pearl St., Boston, Mass.
For page see List of Advertisers.

FLORISTS SUPPLIES

N. F. McCarthy & Co., 84 Hawley St., Boston.
For page see List of Advertisers.

H. M. Robinson & Co., 15 Province St. and 9 Chapman Pl., Boston, Mass.
For page see List of Advertisers.

Reed & Keller, 122 W. 25th St., New York.
For page see List of Advertisers.

M. Bayersdorfer & Co., 1129 Arch St., Philadelphia.
For page see List of Advertisers.

W. C. Krick, 1164-66 Greene Av., Brooklyn, N. Y.
Immortelle Letters.

S. S. Pennock-Meehan Co., Philadelphia.
For page see List of Advertisers.

FLOWER POTS

W. H. Ernest, 28th and M Sts., Washington, D. C.
For page see List of Advertisers.

FLOWER POTS—Continued

A. H. Hewa & Co., Cambridge, Mass.
For page see List of Advertisers.

Hildiger Bros., Ft. Edward, N. Y.
For page see List of Advertisers.

The Peters & Reed Pottery Co., Red pots, seed pans, etc. Zanesville, O.

Syracuse Pottery Co., Syracuse, N. Y.
Syracuse Red Pots.
For page see List of Advertisers.

We make Standard Flower Pots, etc. Write us when in need. Wiltner Cope & Bro., Lincoln University, Chester Co., Pa.

FRUIT TREES

Dwarf Fruit Trees, by F. A. Waugh, mailed to your address for 55 cents by Horticulture Publishing Co., 11 Hamilton Place, Boston.

GALAX

Michigan Cut Flower Co., 38 and 40 Broadway, Detroit, Mich.
For page see List of Advertisers.

George Cotonas & Co., 50 W. 28th St., New York.
For page see List of Advertisers.

The Kervan Co., 118 West 28th St., N. Y.
For page see List of Advertisers.

Bice Bros., 115 N. 6th St., Minneapolis, Minn.
For page see List of Advertisers.

H. M. Robinson & Co., 15 Province St. and 9 Chapman Place, Boston.
For page see List of Advertisers.

GARDEN HOSE

Revere Rubber Co., Boston, Mass.
For page see List of Advertisers.

Crestline Mfg. Co., Crestline, O.
For page see List of Advertisers.

GERANIUMS

R. Vincent Jr. & Sons Co., White Marsh, Md.
New and Standard Varieties.
For page see List of Advertisers.

Godfrey Aschmann, Philadelphia, Pa.
For page see List of Advertisers.

Geraniums, large plants, bud and bloom, out of 3 1/2 in. pots. S. A. Nutt and others, \$7.00 per 100. Cash. Stephen Chase, Nashua, N. H.

Salleri's Geraniums, strong plants from 2 1/2 in. pots, \$2.50 per 100. J. B. Shurtliff & Son, Cushman Ave., Revere, Mass.

GLADIOLI

J. L. Moore, Northboro, Mass.
For page see List of Advertisers.

E. S. Miller, Wading River, N. Y.
For page see List of Advertisers.

GLASS

Boston Plate & Window Glass Co., Boston.
For page see List of Advertisers.

Standard Plate Glass Co., 26-30 Sudbury St., Boston.
For page see List of Advertisers.

Foley Mfg. Co., Western Ave., between 25th & 26th Sts., Chicago.
For page see List of Advertisers.

Sharp, Partridge & Co., 22d & Lumber St., Chicago.
For page see List of Advertisers.

Parshelsky Bros., Inc., 59 Montrose Av., Brooklyn, N. Y.
For page see List of Advertisers.

Greenhouse glass, lowest prices. Johnston Glass Co., Hartford City, Ind.
Glass, High Grade, Double Thick Greenhouse Glass. Lord & Burnham, 1183 Broadway, N. Y.

GLAZING POINTS

H. A. Dreer, Philadelphia, Pa.
Peerless Glazing Point.
For page see List of Advertisers.

GLAZING POINTS, Lord & Burnham Special Glazing Nails (Points). Lord & Burnham, 1183 Broadway, N. Y.

In writing to Advertisers kindly mention Horticulture

GREENHOUSE BUILDING MATERIAL

- Lord & Burnham Co.,
1133 Broadway, New York.
For page see List of Advertisers.
- Pierson U-Bar Co., 1 Madison Sq., N. Y.
For page see List of Advertisers.
- A. T. Stearns Lumber Co., Neponset,
Boston.
For page see List of Advertisers.
- King Construction Co., N. Townsanda,
New York.
For page see List of Advertisers.
- Hitchings & Co., 1170 Broadway, New York.
For page see List of Advertisers.
- J. C. Moninger Co., 117 East Blackhawk St.,
Chicago, Ill.
For page see List of Advertisers.
- Foley Mfg. Co., Western Ave., between
25th & 26th Sts., Chicago.
For page see List of Advertisers.
- S. Jacobs & Sons, 1359-63 Flushing Ave.,
Brooklyn, N. Y.

GREENHOUSE CONSTRUCTION

- GREENHOUSE CONSTRUCTION, Semi-
Iron Greenhouse, New Truss Houses and
Iron Frame Houses, Lord & Burnham,
1133 Broadway, N. Y.
- J. A. Payne, 260-274 Culver Ave., Jersey
City, N. J.
For page see List of Advertisers.
- Foley Mfg. Co., Western Ave., between
25th & 26th Sts., Chicago.
For page see List of Advertisers.
- Hitchings & Co., 1170 Broadway, New York.
For page see List of Advertisers.

GREENHOUSE HOSE

- Revere Rubber Co., Boston, Mass.
Revere Hose.
For page see List of Advertisers.
- GREENHOUSES FOR SALE**
- Thomas M. Lynch, 256 Main St., Pough-
keepsie, N. Y.
For page see List of Advertisers.

GUTTERS

- GUTTERS, Cast Iron Gutters, L. & B.
Improved V Shaped Gutter with drip
gutter attachment, Lord & Burnham, 1133
Broadway, N. Y.

HEATING APPARATUS

- Lord & Burnham Co.,
1133 Broadway, New York.
For page see List of Advertisers.
- Pierson U-Bar Co., 1 Madison Sq., N. Y.
For page see List of Advertisers.
- John A. Payne, 260-274 Culver Ave., Jersey
City, N. J.
For page see List of Advertisers.
- Krosschell Bros. Co., 35 Erie St., Chicago.
For page see List of Advertisers.

HAIL INSURANCE

- Florists' Hall Assn. of America,
J. G. Esler, Saddle River, N. J.
For page see List of Advertisers.
- HARDY FERNS, MOSS AND
GREENS**
- E. M. Robinson & Co., 15 Province St.
and 9 Chatham Pl., Boston, Mass.
For page see List of Advertisers.
- Michigan Cut Flower Exchange,
38 and 40 Broadway, Detroit, Mich.
For page see List of Advertisers.
- George Cotsouas & Co., 50 W. 23th St.,
New York.
For page see List of Advertisers.
- N. F. McCarthy & Co., 84 Hawley St.,
Boston.
For page see List of Advertisers.
- The Kervan Co., 113 W. 28th St., N. Y.
For page see List of Advertisers.
- Elce Bros., 115 N. 6th St., Minneapolis,
Minn.
For page see List of Advertisers.

HARDY PLANTS

- Palisades Nurseries, Sparkill, N. Y.

HELP FURNISHED

- Thos. H. Bambrick, 34 S. 7th St., Phila.
For page see List of Advertisers.

HERBACEOUS PERENNIALS

- P. Ouwkerk, P. O. No. 1, Hoboken, N. J.
For page see List of Advertisers.
- New England Nurseries, Bedford, Mass.
For page see List of Advertisers.
- The Geo. Wittbold Co., 1657 Buckingham
Place, Chicago.
For page see List of Advertisers.

HOLLYHOCKS

- Hollyhocks, best single and double
strains, plants to flower, \$8.00 per 100;
\$75.00 per 1000, Rose Hill Nurseries, New
Rochelle, N. Y.

HOT-BED SASH

- The A. T. Stearns Lumber Co., Neponset,
Mass.
For page see List of Advertisers.
- Pierson U-Bar Co., 1 Madison Sq., N. Y.
For page see List of Advertisers.
- Lord & Burnham Co., 1133 Broadway, N. Y.
For page see List of Advertisers.
- Foley Mfg. Co., Western Ave., between
25th & 26th Sts., Chicago.

HYDRANGEAS.

- Julius Roehrs Co., Rutherford, N. J.
For page see List of Advertisers.

INSECTICIDES.

- Nicotinole kills all greenhouse pests.
P. B. Palethorpe Co.,
Eleventh St., Owensboro, Ky.
For page see List of Advertisers.
- Stump & Walter Co., 50 Barclay St.,
New York.
Killed Tobacco Dust.
For page see List of Advertisers.
- Niagara Sprayer Co., Middleport, N. Y.
Niagara Brand.
For page see List of Advertisers.
- Bowker Insecticide Co., Boston, Mass.
Insect Destroying Preparations.
For page see List of Advertisers.
- Wm. Cooper & Nephews, 177 Illinois St.,
Chicago; C. H. Franklyn, 62 Beaver
St., New York, Agt.
V 1 Fluid.
For page see List of Advertisers.
- Eastern Chemical Co., Pittsburg St., Boston.
"IMP" Soap Spray.
For page see List of Advertisers.
- "The Fumigating Kind Tobacco Pow-
der"—The first on the market and the kind
most has so many imitators, has our guar-
anteed tag of satisfaction or money back,
and "The Moon Trade Mark" on every bag
\$5.00 per 100 lbs., The H. A. Stoothoff Co.,
Mount Vernon, N. Y., Makers and sellers.

JAPANESE PLANTS

- Yokohama Nursery Co., 31 Barclay St.,
New York.
For page see List of Advertisers.

KENTIAS

- Godfrey Aschmann,
1012 W. Ontario St., Phila., Pa.
For page see List of Advertisers.
- A. Leuthy & Co., Roslindale, Mass.
For page see List of Advertisers.
- Joe. Heacock Co., Wyncote, Pa.
Single and Made-Up Specimens.
For page see List of Advertisers.
- G. V. Zangen, Hoboken, N. J.
For page see List of Advertisers.

LILY OF THE VALLEY PIPS

- Hjelmjar Hartmann & Co., Langgaststraede
20, Copenhagen, Denmark.
For page see List of Advertisers.

LOBELIAS

- C. Elsele, 11th & Westmoreland Sts., Phila.
Double Lobelia.

MADIRA VINES

- E. S. Miller, Wading River, N. Y.
For page see List of Advertisers.

MASTICA

- F. O. Pierce Co., 12 W. Broadway, New
York.
For page see List of Advertisers.

MOON VINES

- C. Elsele, 11th & Westmoreland Sts., Phila.
Godfrey Aschmann, Philadelphia, Pa.
For page see List of Advertisers.
- Ipomoea Grandiflora, extra strong, grown
from seed, 2 1/2 in., \$3.50 per 100; 3 in., \$5.00.
Edwin Bishop, Roslyn, Md.

MYRTLE

- Myrtle, blue for cemetery planting, \$2.00
per 100; \$17.50 per 1000. Geo. A. Dhonau,
Sta. H., Cincinnati, Ohio.

NICO-FUME

- Kentucky Tobacco Product Co.,
Louisville, Ky.

NURSERY STOCK

- John Waterer & Sons, Ltd.,
American Nursery, Bagshot, England.
For page see List of Advertisers.
- P. Ouwkerk, 216 Jane St., Weehawken
Heights, N. J.
For page see List of Advertisers.
- Eastern Nurseries, Jamaica Plain, Mass.
- American Nursery Co., 150 Broadway, New
York, N. Y.
For page see List of Advertisers.
- W. & T. Smith Co., Geneva, N. Y.
For page see List of Advertisers.
- Ellwanger & Barry, Rochester, N. Y.
Purple Leaved Japan Maples.
- Manual of the Trees of North America,
by C. S. Sargent, mailed to your address
for \$9.00, by Horticulture Publishing Co.,
11 Hamilton Place, Boston.

**TREES, SHRUBS, ROSES, EVER-
GREENS, PEONIES, HARDY PLANTS,
ELLWANGER & BARRY, Rochester, N. Y.**

- New Hardy Shrub—Buddleia variabilis
Veltchii and Magnolia, the summer flower-
ing Lilac, 50c, each; \$5.00 per doz.; \$25.00
per 100. Rose Hill Nurseries, New
Rochelle, N. Y.

- Catalog now ready. Nursery grows
evergreens, seedling white pine and hem-
lock, native trees and plants. L. E. Wil-
lams, Nottingham, N. H.

ORCHID PLANTS

- Lager & Hurrell, Summit, N. J.
Fresh Imported and Established Orchids.
For page see List of Advertisers.
- Sander, St. Albans, England.
Importers, Exporters, Growers, Hybridists.
For page see List of Advertisers.
- Carrillo & Baldwin, Seacaucus, N. J.
For page see List of Advertisers.
- Joe. A. Manda, 191 Valley Road, W.
Orange, N. J.
For page see List of Advertisers.
- Ordonez Bros., Madison, N. J., Box 106.
Cattleya Mossiae.
For page see List of Advertisers.
- G. L. Freeman, 388 Appleton St., Holyoke,
Mass.
Orchid Importations.
For page see List of Advertisers.
- Largest stock in the country. Ask for
prices. Julius Roehrs, Rutherford, N. J.
- Native Orchids. Hugo King, Hammon-
ton, N. J.

PAINT AND PUTTY

- PAINT AND PUTTY: Ideal Greenhouse
lead, Special Greenhouse Putty, Lord &
Burnham, 1133 Broadway, N. Y.

PALMS

- A. Leuthy & Co., Perkins St. Nurseries,
Roslindale, Mass.
For page see List of Advertisers.
- Robert Craig Co., Market and 49th Sts.,
Philadelphia, Pa.
For page see List of Advertisers.
- Joseph Heacock Co., Wyncote, Pa.
Home-Grown Palms.
For page see List of Advertisers.

For List of Advertisers See Page 787

PALMS—Continued

Geo. Wittbold Co., 1657 Buckingham Place, Chicago.
For page see List of Advertisers.

John Ralph, Saratoga Springs, N. Y.
Latania Bourbonica Large Specimens.

Julius Roehrs Co., Rutherford, N. J.
For page see List of Advertisers.

Edwin K. Atkins, Rutherford, N. J.
For page see List of Advertisers.

O. V. Zangen, Hoboken, N. J.
For page see List of Advertisers.

Specimen Latania Palms, 8 in. pots, \$1.50 each, \$15 per doz. Specimen Latania Palms, 10-in. pots, \$2.00 each, \$20.00 per doz. Wagner Park Conservatories, Sidney, Ohio.

PANSY PLANTS.

J. C. Schmidt, Bristol, Pa.
For page see List of Advertisers.

SUPERB STRAIN—READY NOW.
Fall-transplanted pansies, in bud and bloom. A trial order will convince you that these are the best you ever handled. \$1.25 per 100; \$10.00 per 1000.

LEONARD COUSINS, JR.,
Concord Junction, Mass.
Pansies, large, field grown, transplanted plants, very choice colors, \$10.00 per 1000. Cash. Stephen Chase, Nashua, N. H.

PATENTS

Siggers & Siggers, Washington, D. C.
For page see List of Advertisers.

PEAT

Orchid Peat and Moss always on hand
Julius Roehrs Co., Rutherford, N. J.

PEONIES

Peonies only, by the wholesale—best 100 varieties. J. F. Rosenfeld, Westpoint, Nebr.

One of the finest collections in America. Send 25 cts. in stamps for new edition of Peony Manual. C. S. Harrison's Select Nursery, York, Neb.

PHLOXES

Send 25 cts in stamps for Phlox Manual. Fine mixed phloxes \$2.00 per 100. C. S. Harrison's Select Nursery, York, Neb.

Phlox, Hardy Perennial. Lost assorted varieties, strong plants, \$2.00 per 100; \$40.00 per 1000. Rose Hill Nurseries, New Rochelle, N. Y.

PHOTOGRAPHS: DESIGNING: ILLUSTRATING

Geo. E. Dow, 178 Washington St., Boston.
For page see List of Advertisers.

PIPE AND FITTINGS

Foley Mfg. Co., between Western Ave. and 26th St., Chicago, Ill.

Kroeschell Bros. Co., 35 Erie St., Chicago.
For page see List of Advertisers.

PIPE AND FITTINGS. Cast Iron and Wrought Pipe, Valves, Elbows, Pipe Hooks, Automatic Air Headers, etc. Lord & Surham, 1133 Broadway, N. Y.

PLANT STAKES

Seele's Tiesless Plant Stakes and Trelises. H. D. Seele & Sons, Elkhart, Ind.

POT HANGERS

Pot hangers, Kramer's \$1 doz. by exp., \$1.25 by mail. I. N. Kramer & Son, Cedar Rapids, Ia.

RAFFIA

Raffia (colored), 20 beautiful shades. Samples free. R. H. Conroy Co., Camden, N. J.; 810 Washburn Ave., Chicago, Ill.

RHODODENDRONS

John Waterer & Sons, Ltd., American Nursery, Bagshot, England.
For page see List of Advertisers.

P. Ouwkerk, Hoboken, N. J.
For page see List of Advertisers.

ROSES

Robert Craig Co., Market and 49th Sts., Philadelphia, Pa.
For page see List of Advertisers.

P. Ouwkerk, P. O. No. 1, Hoboken, N. J.
For page see List of Advertisers.

The F. B. Pierson Co., Tarrytown-on-Hudson, N. Y.
White Killarney.
For page see List of Advertisers.

Dingee & Conard Co., West Grove, Pa.
For page see List of Advertisers.

Scott Bros., Elmford, N. Y.
For page see List of Advertisers.

Poehlmann Bros. Co., Morton Grove, Ill.
For page see List of Advertisers.

A. N. Pierson, Cromwell, Conn.
White Killarney, My Maryland, Ramblers.
For page see List of Advertisers.

U. S. Cut Flower Co., Elmira, N. Y.
Rose Plants.
For page see List of Advertisers.

W. & T. Smith Co., Geneva, N. Y.
American Grown Roses.
For page see List of Advertisers.

Roses, Maid's and Richmonds, strong 4 in. stock, \$8.00 per 100. Rose Hill Nurseries, New Rochelle, N. Y.

The Rose, by H. B. Ellwanger; mailed for \$1.30 by Horticulture, 11 Hamilton Place, Boston.

Hand book of Cultural Notes on Roses Under Glass, by F. P. Brigham, mailed to your address for 25c. by Horticulture Publishing Co., 11 Hamilton Place, Boston.

RUBBER PLANTS

William C. Smith, Market & 61st St., Philadelphia.
For page see List of Advertisers.

SEED GROWERS

Hjalmar Hartmann & Co., Cauliflower and Cabbage Seed. Laungstraede 24, Copenhagen, Denmark.
For page see List of Advertisers.

SEEDS

T. J. Grey Co., 32 So. Market St., Boston.
For page see List of Advertisers.

Joseph Breck & Sons, 51 and 52 N. Market St., Boston, Mass.
For page see List of Advertisers.

W. Atlee Burpee & Co., Philadelphia.
For page see List of Advertisers.

Arthur T. Boddington, 342 W. 14th St., New York.
Palm Seed.
For page see List of Advertisers.

H. E. Flake Seed Co., Faneuil Hall Sq., Boston.
For page see List of Advertisers.

Hjalmar Hartmann & Co., Laungstraede 24, Copenhagen, Denmark. Cauliflower and Cabbage Seed.
For page see List of Advertisers.

Richards Bros., 37 E. 10th St., New York.
For page see List of Advertisers.

R. & J. Farquhar & Co., 67 So. Market St., Boston.
Mignonette Seed.
For page see List of Advertisers.

H. F. Mitchell Co., 1018 Market St., Philadelphia.
Prunist Seed.
For page see List of Advertisers.

J. M. Thorburn & Co., 33 Barclay St., N. Y.
For page see List of Advertisers.

Leonard Seed Co., Chicago, Ill.
For page see List of Advertisers.

Schlegel & Fottler Co., 26 & 27 S. Market St., Boston.
For page see List of Advertisers.

O. V. Zangen, Hoboken, N. J.
Florists' Spring Seeds.
For page see List of Advertisers.

E. F. Winterson Co., Chicago.
Seeds for Plantsmen, Nurserymen, Seedsmen.
For page see List of Advertisers.

Seeds. Rocky Mountain Evergreen seeds in large or small quantities. C. S. Harrison's Select Nursery, York, Neb.

SHRUBS

The Geo. Wittbold Co., 1657 Buckingham Place, Chicago.
For page see List of Advertisers.

SILKALINE

John C. Meyer & Co., Boston, Mass.
For page see List of Advertisers.

SPHAGNUM MOSS

Live Sphagnum moss, orchid peat and orchid baskets always on hand. Lager & Hurrell, Summit, N. J.

SPRAYERS

Niagara Sprayer Co., Middleport, N. Y.
For page see List of Advertisers.

Chas. J. Jager Co., Boston.
Deming Spray Pump.
For page see List of Advertisers.

STEAM TRAP

B. Hippard, Youngstown, O.

STOVE PLANTS

Julius Roehrs Co., Rutherford, N. J.
For page see List of Advertisers.

STRAWBERRY PLANTS

300 Strawberry plants \$1. Your selection. List free. Wm. Perry, Cool Spring, Del.

SULPHUR BURNER

Benj. Dorrance, Rose Growers, Dorrance, Pa.

SWEET PEAS

A. C. Zvolanek, Round Brook, N. J.
Winter Flowering.
For page see List of Advertisers.

TO-BAK-INE

E. H. Hunt, Genl. Agt., 76-78 Wabash Av., Chicago.
For page see List of Advertisers.

VEGETABLE PLANTS

R. Vincent, Jr. & Sons Co., White Marsh, Md.
For page see List of Advertisers.

Vegetable plants now ready, all cold frame grown and hardened ready for outdoor planting. Cabbage, Charleston, Wakefield and Early Summer at \$2.00 per M, \$15.00 per 10,000. Egg Plants, Black Beauty and New York Spineless, \$1.50 per 100. Tomato plants, Earliana, Chalk's Jewell, June Pink and Allen's Best, \$1.00 per 100, \$6.00 per M. Cauliflower, Early Snowball, 75c per 100. Egg Plants, Black Beauty, Ruby King, 75c per 100, \$4.00 per M. Cash with order. All plants by express, receiver to pay charges. Address W. F. Allen, Salisbury, Md.

Tomatoes, Earliana, Chalk's Jewell, Grant-on-Earlmore, \$1.25 per 100. Transplanted Pepper and Egg plant, 50c per 100. Sweet Potato plants, \$2.50 per 100. Cabbage, Jersey Wakefield, \$1.00 per 1000. Edwin Hishop, Roslyn, Md.

VENTILATING APPARATUS

Pierson U-Bar Co., 1 Madison Sq., N. Y.
For page see List of Advertisers.

Foley Mfg. Co., Western Ave., between 25th & 26th Sts., Chicago.
For page see List of Advertisers.

John A. Payne, 230-27 Culver Ave., Jersey City, N. J.
For page see List of Advertisers.

The Advance Co., Richmond, Ind.
For page see List of Advertisers.

Quaker City Machine Co., Richmond, Ind., 20th Century Ventilating Arm.
For page see List of Advertisers.

VENTILATING MACHINERY. New Model encased, self-acting gear; Standard Model Open Gear. Lord & Burnham, 1133 Broadway, N. Y.

VERBENAS

Verbenas, 2 1/2 to 3 in. high, 1c each. Best varieties to be got, all desirable colors. H. J. Blanchard, Ashburnham, Mass.

J. C. Schmidt, Bristol, Pa.
For page see List of Advertisers.

In writing to Advertisers kindly mention Horticulture

VIOLETS.

William Sim, Cliftondale, Mass.
 Boston and Princess of Wales Violets.
 For page see List of Advertisers.
 1000 California Violets, \$1.00 per 100;
 good rooted divisions from cold frame.
 Allen Bros., Leonhaster, Mass.
 Princess Violets, 2½ in., \$2.00 per 100.
 Jas. T. Baker, Bustleton, Philadelphia, Pa.

VINCAS

William C. Smith, Market & 61st St.,
 Philadelphia.
 For page see List of Advertisers.

WEED KILLER

The American Horticultural Distributing
 Co., Martinsburg, W. Va.
 Target Brand.
 For page see List of Advertisers.

WILSON'S PLANT OIL

Wilson Plant Oil & Fertilizer Co.,
 Chatham, N. Y.
 For page see List of Advertisers.

WIRED TOOTHPICKS

W. J. Cowee, Berlin, N. Y.
 For page see List of Advertisers.

WIREWOK

Reed & Keller, 122 W. 25th St., N. Y.
 For page see List of Advertisers.
 Durand & Maroha, Albany, N. Y.
 For page see List of Advertisers.
 Wirework. Write for our catalogue.
 Holton & Hunkel Co., Milwaukee, Wis.
 William E. Heilscher's Wire Works, 88-40
 Broadway, Detroit, Mich.
 Wirework—Compare our prices with
 others. Scranton Florist Supply Co., 301
 N. 7th St., Scranton, Pa.

WHOLESALE FLORISTS

See List of Advertisers on opposite page
 for page on which these wholesale
 flower advertisements may
 be found.

Boston

N. F. McCarthy & Co., 84 Hawley St.,
 Boston.
 H. M. Robinson & Co., 15 Province St.
 and 9 Chapman Pl., Boston.
 Welch Bros., 226 Devonshire St., Boston.
 Talby, Wellfleet, Mass.

Buffalo, N. Y.

William F. Kasting Co., 383-87 Elliott St.,
 Buffalo, N. Y.

Chicago

Chas. W. McKellar, 51 Wabash Ave.,
 Chicago.
 Peter Reinberg, 51 Wabash Ave., Chicago.
 E. F. Winterson Co., 45-49 Wabash Ave.,
 Chicago.
 J. A. Budlong, 37-39 Randolph St., Chicago.
 Poehlmann Bros. Co., Morton Grove, Ill.
 Cromwell, Conn.

A. N. Pierson, Cromwell, Conn.

Detroit

Michigan Cut Flower Exchange, 38 and 40
 Broadway, Detroit, Mich.

Minneapolis

Rice Bros., 115 N. 6th St., Minneapolis,
 Minn.

New York

Ford Bros., 48 W. 28th St., New York.
 E. B. Froment, 57 W. 28th St., New York.
 Alex. J. Guttman, 34 W. 28th St., New
 York.
 H. C. Horan, 55 W. 28th St., New York.
 A. H. Langjahr, 55 W. 28th St., New York.
 James McMannus, 42 W. 28th St., New York.
 John I. Raynor, 49 W. 28th St., New York.

WHOLESALE FLORISTS—**New York—Continued**

W. F. Sheridan, 89 W. 28th St., New York.
 Moore, Heits & Naab, 55 and 57 W. 20th
 St., New York.
 Wm. H. Koebler, 28 Willoughby St.,
 Brooklyn, N. Y.
 Milling Bros., 41 W. 28th St., New York
 John Young, 51 W. 28th St., New York.
 Greater New York Florists' Association,
 122 Livingston St., Brooklyn, N. Y.,
 Frank Millang, 55-57 W. 28th St., New
 York.
 B. B. Silina, 55-57 W. 28th St., New York
 A. L. Young & Co., 54 W. 28th St., N. Y.
 Growers' Cut Flower Co., 89 W. 28th St.,
 New York.
 Henehaw & Fenrich, 44 W. 28th St.,
 New York.
 J. K. Allen, 106 W. 28th St., New York
 Charles Millang, 444 Sixth Ave., New York.

Philadelphia

W. E. McKisick & Bros., 1019-1021 Ben
 stead St., Philadelphia, Pa.
 Leo Niessen Co., 1209 Arch St., Philadel-
 phia, Pa.
 The S. S. Pennock-Meehan Co., 1008-10
 Ludlow St., Philadelphia, Pa.

New Offers in This Issue.

See List of Advertisers on opposite page
 for page on which these offers may
 be found.

ASTER PLANTS.

J. C. Schmidt, Bristol, Pa.

AUTOMATIC CIRCULATOR.

W. W. Castle Co., 170 Summer St., Boston.

CANNAS; BEDDING STOCK.

J. W. Adams & Co., Springfield, Mass.

CHOICE STOCK FOR THE JUNE GIRL.

S. S. Pennock-Meehan Co., Philadelphia.

FLORISTS' SUPPLIES FOR COMMENCEMENTS.

H. Bayersdorfer & Co., 1129 Arch St.,
 Philadelphia.

GLASS; PIPE AND FITTINGS.

Metropolitan Material Co., 1292-1402 Met-
 ropoian Ave., Brooklyn, N. Y.

HYDRANGEAS; SEASONABLE SPECIALTIES.

The F. R. Pierson Co., Tarrytown-on-
 Hudson, N. Y.

IMPERIAL PALMETTO ASPARAGUS SEED.

Warren Shinn, Woodstock, N. J.

KENTIAS.

Jos. Hancock Co., Wyncote, Pa.

KROESCHELL BOILERS, GENERATORS, PIPING SYSTEM.

Kroeschell Bros. Co., 35 Erie St.,
 Chicago, Ill.

NURSERY FOREMAN WANTED.

Elm City Nursery Co., New Haven, Conn.

ORCHIDS DIRECT FROM COLLECTORS.

G. L. Freeman, Holyoke, Mass.

PHALAEENOPSES AND VANDAS.

MacLorie-M-Laren Co., 721 Crocker Bldg.,
 San Francisco, Cal.

REVERO GARDEN HOSE AND HANGER.

Revere Rubber Co., 77 Bedford St., Boston.

NEW OFFERS—Continued**ROSES.**

Pittsburgh Rose & Carnation Co., Gib-
 sonia, Pa.

THE CASTLE BOILER.

W. W. Castle Co., 170 Summer St., Boston.

THE "GEORGE C. WATSON" CIGAR.

The Cesserly Cigar Mfg. Co., 2257 Oxford
 St., Philadelphia.

WHOLESALE FLORISTS.

Manhattan Flower Market, 46 W. 28th St.,
 New York.

WINTER FLOWERING SWEET PEAS.

A. C. Zvolanek, Bound Brook, N. J.

Flower Market Reports.

(Continued from page 781)

A week of sunshine has
 CHICAGO had a tendency to in-
 crease the amount of

stock, though the weather has con-
 tinued surprisingly cold, the thermom-
 eter registering almost to the freezing
 point. Sunday morning, May 23rd,
 everything was covered with a white
 frost. So far as has been learned no
 serious damage has been done. Every-
 thing in planting has been more or less
 delayed, especially in the soft plants.
 All idea of home grown peonies was
 abandoned some days ago, the buds be-
 ing scarcely formed one week before
 Decoration Day. Those coming in
 from southern Illinois and Indiana are
 all that can be desired, arriving fresh
 and firm. The stock from Memphis
 and points farther south is gone and
 florists who shipped to Chicago two
 weeks ago are now sending here for
 their peonies. Roses are not in so big
 a crop as a month ago. Carnations are
 not likely to get so low again for some
 time. Green stuff is not at all plentiful,
 smilax decidedly scarce and common
 ferns still bringing a good price. In
 addition to the usual variety in
 carnations and roses there are tulips
 in all colors, but some especially fine
 red ones, forget-me-not, snap dragons
 in every color and with stems reach-
 ing to six feet, stocks, sweet peas, apple
 blossoms, wild violets, jasmine
 from the south and peonies. The great
 vases of callas still stand on practical-
 ly every counter in the wholesale mar-
 ket. The pansy growers are disap-
 pointed this year. Sales have not been
 up to last year's. The blooms seem to
 lack substance and wilt easily. Many
 growers find their cut of roses is dim-
 inishing just as they will be most in
 demand. One of the largest growers
 reports his cut as little more than one-
 half of what it was two weeks ago.

The heavy rains of
 WASHINGTON Friday and Satur-
 day last saved the

early crops from almost total destruc-
 tion. The drought in this section was
 becoming appalling. All out-of-door
 roses have been kept back by the cold
 and it is hoped that they will be in
 their prime for Decoration Day. Near-
 by peonies are just coming in in
 any quantity, and considering the un-
 favorable season are very good indeed.

LIST OF ADVERTISERS

Adams J. W. & Co.	771
Advance, The Co.	790
Allan J. K.	781
American Nursery	(Eng.) 773
American Nursery Co.	773
Arnheim Godfrey	760
Atlanta Floral Co.	776
Bader Coal Co.	791
Bambrick Thos. H.	787
Barrows H. H. & Son	766
Baur & Smith	758
Bayersdorfer H. & Co.	777
Blossom	776
Bobbin & Atkins	773
Boddington A. T.	775
Boston Florist Letter Co.	777
Boston Plate and Window Glass Co.	790
Bova, M. A.	776
Bowker Fertilizer Co.	775
Bowker Insect Co.	789
Breck Joseph & Sons	775
Breitmeyer J. Sons	777
Bridgeman's Seed	775
Warehouse	775
Budlong J. A.	778
Burpee W. A. & Co.	775
Cameron H. L.	758
Carrillo & Baldwin	760
Cassery Cigar Mfg Co.	787
Castle W. W. & Co.	788
Chicago Carnation Co.	758
Clarke's David, Sons	776
Coan J. J.	780
Cooper Wm. & Nephews	789
Cotnam Geo. & Co.	780
Covey W. J.	780
Craig, Robt. Co.	786
Crawchuck Geo. W.	781
Crestline Mfg. Co.	790
Danker F. A.	776
Dann J. H. & Son	771
Dingee & Conrad Co.	760
Dorner F. Sons & Co.	758
Dow Geo. E.	775
Dreer H. A.	791
Dunlop John H.	776
Durand & Marohn	780
Dysart R. J.	781
Eastern Chemical Co.	788
Edwards Folding Box Co.	778
Elliot Wm & Sons	775
Elm City Nursery Co.	786
Elmsford Nurseries	758
Euler J. G.	791
Ernest W. H.	788
Eyres	776
Faehrich R. & J. Co.	775
Faithoussen J. E.	760
Fisher David, Est.	771
Fiske H. E. Seed Co.	775
Foley Mfg. Co.	790
Ford Bros.	779
Freeman C. L.	760
Froment H. E.	781
Galvin Thos. F.	777
German Kali Works	789
Greater N.Y. Florists' Association	781
Grey T. J. Co.	775
Growers' Cut Flower Co.	776
Gude Bros. Co.	776
Gutmann Alex. J.	780
Hall Asso.	791
Hartmann Hjalmar & Co.	775
Hauswirth with the Florist	776
Heacock Jos. Co.	773
Henshaw & Fenrich	780
Herbert David & Son	771
Hews A. H. & Co.	788
Hilfinger Bros.	788
Hill The E. G. Co.	758
Hitchings & Co.	790
Hoffmann	777
Horan E. C.	780
Hunt A. E. & Co.	758
Hunt Bros.	758
Jager, Chas. J. Co.	789
Kasting W. F. Co.	781
Kervan The Co.	781
King Cons. Co.	780
Krick W. C.	781
Kroeschell Bros. Co.	791
Kuebler Wm H.	785
Lager & Hurrell	760
Langjahr, Alfred H.	780
Leonard Seed Co.	775
Leathly A. & Co.	760
Lord & Burnham	779
Lynch Thos. M.	787
MacMulklin E. A.	777
MacKorrie-McLaren Co.	760
Manda Jos. A.	760
Manhattan Flower Mkt	781
McCarthy N. F. & Co.	781
McConnell Alex.	776
McKellar Charles W.	778
McKissick, W. E. & Bros.	778
McManus Jas.	780
Metropolitan Material Co.	790
Meyer J. C. & Co.	781
Michell H. F. Co.	774
Michigan Cut Flower Exchange	781
Millang Bros.	780
Millang Charles	780
Millng Frank	780
Miller E. S.	759
Moninger J. C.	791
Moore, J. L.	771
Moore, Hents & Nash	786
Murray Samuel	776
New Eng. Nurseries	773
Newman J. & Sons	778
Niagara Sprayer Co.	789
Niessen Leo. Co.	778
Oechalin Frank	760
Ordono Bros.	760
Ouwertkerk F.	773
Palethorpe P. R. Co.	789
Palmer W. J. & Son	776
Park Floral Co.	776
Parselsky Bros.	790
Patten & Co.	758
Payne John A.	790
Peacock Dahlia Farms	771
Pennock-Meehan Co.	779
Perkins St. Nurseries	760
Pierce, F. O. Co.	750
Pierson, A. N., Inc.	759
Person F. R. Co.	792
Pierson U Bar Co.	792
Pittsburg Rose & Carnation Co.	759
Poehlmann Bros. Co.	758-778
Quaker City Mach. Co.	791
Rayner, L. M.	789
Kaynor John L.	780
Reed & Keller	781
Reuber Peter	778
Reuter S. J. & Son, Inc.	778
Richter Lulher Co.	788
Rice Bros.	778
Rickards Bros.	775
Robins H. M. & Co.	778
Rock Wm. Jr. Fla. Co.	779
Rothers Julius Co.	760
Roland, Thomas	772
Robert August & Sons	788
Rose Hill Nurseries	760
Sander & Son	760
Schleier & Fottler Co.	780
Schmidt J. C.	759
Schulz Jacob	777
Scott Bros.	778
Scott, John	778
Sharp, Partridge & Co.	790
Sheridan W. F.	780
Shaw Warren	777
Siggers & Suggers	790
Sim, Wm.	768
Situations & Wants	787
Shn B. S.	780
Sith Elm. D. & Co.	758
Smith Saml V.	771
Smith W. C.	759
Smith W. & T. Co.	773
Smits Wm. J.	776
Standard Plate Glass Co.	790
Stearns A. T. Lumber Co.	777
Stein Elm. D. & Co.	758
Stiers & Harrison	771
Stump & Walter Co.	789
Sweeney Wm.	789
Syracuse Pottery Co.	788
Tailly	776
Target Brand	788
Thorburn J. M. & Co.	775
Totty Chas. H.	758
Treple C. C.	778

United States Cut Flower Co.	771
Valentine, J. A.	776
Vincent R. Jr. & Sons	771-774
Ward R. M. & Co.	775
Waterer John & Sons	773
Welch Bros.	778
Withold Geo. Co.	760
Wilson	776
Wilson Plant Oil and Fertilizer Co.	789
Winteron, E. F. Co.	778
Wood Bros.	758
Yokohama Nursery Co.	791
Young A. L.	781
Young John	780
Young & Nugent	776
Zangen O. V.	773-777
Zinn Julius A.	773
Zvolack A. C.	775

**THE CIGAR THAT MADE
George Watson Famous.**
**THE FINEST
FIVE CENT CIGAR
ON EARTH.**



THE "GEORGE C. WATSON" PANATELLA.
\$5.00 per 100. Mail or Express Prepaid.

Made of clean, clear, well-selected Havana, with genuine Samatra wrapper. This is a free smoking, full five-inch, light and elegant panatella. Packed in boxes of 50 and 100.

In ordering please state whether light, dark or medium preferred. Mention Horticulture.

CASSERLY CIGAR MFG. CO.
2237 Oxford St.,
PHILADELPHIA, PA.

SITUATIONS WANTED
Employer wants a position for gardener who has given good satisfaction as superintendent of large estate. Address T., care HORTICULTURE, Boston.

MISCELLANEOUS WANTS
WANTED TO BUY—Complete greenhouse plants and all kinds of greenhouse material, to be taken down and removed at once. Terms cash. Address I. Snesman, 229 Livingston St., Newark, N. J.

WANTED—One Pandanus Utilis, large plant; state size and price. Scott Bros., Elmford, N. Y.

In writing advertisers kindly mention HORTICULTURE.

HELP WANTED

GOOD MEN

When you need good men, skilled or unskilled, Write:

THOS. H. BAMBRICK
34 South 7th Street Philadelphia

Help of all kinds, including that for Florists, Nurserymen, Seedsmen and the Horticultural trade generally.

WANTED NURSERY FOREMAN

Permanent position for right party. Must be well up on growing high grade ornamentals and a good handler of men.

Landscap Foreman

Experienced in carrying out landscape work and familiar with ornamental stock.

THE ELM CITY NURSERY CO.
NEW HAVEN, CONNECTICUT.

FOR SALE FOR SALE

The GREENHOUSE PROPERTY, to close the ESTATE of M. J. LYNCH, Deceased

This is a large established greenhouse property of the late M. J. Lynch, on the South Road, near the city of Poughkeepsie, N. Y., consisting of Sixteen Greenhouses, 30,000 square feet of Glass with entire stock of Palms, Roses, Carnations, Bedding Plants, and Plants of all kinds, etc.

Eight-room Dwelling, with hot-water heating and slate roof, also,

Five-room Gardener's Cottage, adjoining Greenhouses.

Large, substantial Carriage House.

This is a valuable location, with ample water supply, adjoining Rural Cemetery, on line of Wappingers trolley, one mile and a quarter from Court House.

For Particulars Apply
THOMAS M. LYNCH

256 Main St., POUGHKEEPSIE, N. Y.

FOR SALE

About 30,000 feet of glass in good condition, will sell at a low figure, or will lease to the right party, with privilege of buying. My object for selling is, I do not know anything about the business and can't hire men that do.

H. F. CRAWFORD
Montello Sta. Brockton, Mass.

FOR SALE—Special 18 x 18 and 16 x 24 double thick glass in "A" and "B" quality. Buy now and save money. Write PARSELSKY BROTHERS, INC., 60 Montrose Ave., Brooklyn, N. Y.

FOR SALE—7000, 16x24, double thick glass, 10c per light, F.O.B.; twenty lights per box. Address Frank M. Richardson, Littleton, N. H.

THE ONLY SYSTEM OF FORCED CIRCULATION

of hot water for greenhouse heating that has demonstrated its practicability, economy and perfection of action is the

CASTLE AUTOMATIC CIRCULATOR

All others are either superseded by the Castle Automatic, or are yet in the

EXPERIMENTAL STAGE

THE CASTLE BOILER

Our other speciality, is the best hot water heating Plate Boiler for Greenhouse purposes, on the market today.

Send for *Descriptive Catalogue and Testimonials from Florists Who Are Using One or Both.*

DO IT NOW! Mention Horticulture

**W. W. CASTLE CO., HEATING ENGINEERS
170 SUMMER ST., BOSTON**

"Revero" Garden Hose



LIGHT - STRONG - FLEXIBLE

STANDS ABUSE
BRAIDED MOULDED CONSTRUCTION



SEAMLESS THROUGHOUT
WON'T KINK



REVERO RUBBER CO.

BOSTON, MASS
BRANCHES
SAN FRANCISCO
PHILADELPHIA
PITTSBURG

NEW ORLEANS
ROSLANDORE

NEW YORK
CHICAGO

NEW ORLEANS
ROSLANDORE

PATENTS GRANTED.

- 921,019. Hot-Air Heating System. Robert C. Speer, St. Louis, Mo., assignor to Sarah B. Speer, St. Louis, Mo.
- 921,804. Grass Catcher. Joseph H. Coult, Fairmount, Minn.
- 921,917. Fruit Picker. Mary G. Troxell, Sunbury, Pa.
- 921,968. Hoe Attachment for Rakes. Patrick Fairfield, East Port Chester, Conn.
- 921,993. Transplanter. Ellsworth E. Husted, Newport, N. J.
- 922,178. Quack Grass Destroyer. Charles C. Nelson, Lafayette, Minn.

STANDARD FLOWER POTS

Packed in small crates, easy to handle.

	Price per crate		Price per crate
1500 9 in. pots in crate	\$1.88	144 6 in. pots in crate	\$3.16
1500 2 1/2 " " " "	5.25	120 7 " " " "	4.20
1000 4 1/2 " " " "	6.00	60 8 " " " "	3.00
1000 3 " " " "	5.00	48 9 in. pots in crate	\$3.60
800 3 1/2 " " " "	5.80	48 10 " " " "	4.80
500 4 " " " "	4.50	24 11 " " " "	3.60
450 4 1/2 " " " "	5.24	24 12 " " " "	4.80
320 5 " " " "	4.51	12 14 " " " "	4.80
210 5 1/2 " " " "	3.78	6 16 " " " "	4.50

Seed pans, same price as pots. Send for price list of Cylinders for Cut Flowers, Hanging Baskets, Lawn Vases, etc. Ten per cent. off for cash with order. Address **Hilfinger Bros., Pottery, Fort Edward, N.Y.** August Holker & Sons, Agts. 31 Barclay St., N. Y. City.

Standard Flower POTS

If your greenhouses are within 900 miles of the Capital, write us, we can save you money

W. H. ERNEST

28th and M Street WASHINGTON D. C.

Syracuse Red Pots

STANDARD SIZES

Florists, we will suit you as to quality and prices. Write for catalogue.

Syracuse Pottery Co., SYRACUSE, N. Y.

IMP SOAP SPRAY

THREE SUCCESSFUL YEARS

Outdoor or Indoor

ELM BEETLE OR
WHITE FLY

EASTERN CHEMICAL CO.
Pittsburg Street, Boston, Mass.



TARGET BRAND Weed Killer

Sold at retail by a thousand of seed houses and dealers. Special price in quantities to parks and cemeteries

TARGET BRAND, Box 732, Martinsburg, W. Va.

FOR "POT LUCK" TRY US...

HEWS STANDARD POTS

POT MAKERS FOR 140 YEARS

WORLD'S LARGEST MANUFACTURERS

WRITE FOR CATALOGUE AND DISCOUNTS

A. H. HEWS & CO., Inc.
CAMBRIDGE, MASS.

Pearson Street,
LONG ISLAND CITY, N. Y.

452-460 No. Branch St.,
CHICAGO, ILL.

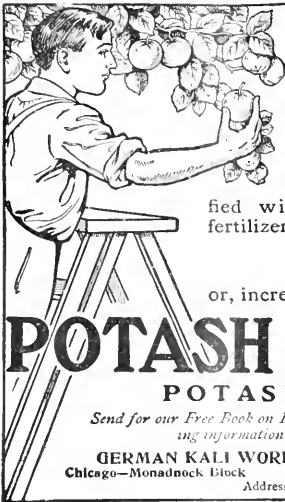

Flavor and Flesh

are the aim of the fruit grower. The flavor should be rich and the flesh firm and solid. To secure the best of both is the mark of the highest success in horticulture.

If you have not been satisfied with results heretofore, try a fertilizer with more

POTASH

or, increase the Potash in the low-grade goods by adding Sulfate of Potash or Muriate of Potash.

POTASH

POTASH IS PROFIT

Send for our Free Book on Fertilizing, prepared by experts and containing information indispensable to horticulturists.

GERMAN KALI WORKS, 93 Nassau Street, New York
Chicago—Monadnock Block Atlanta—Candler Building
Address Office Nearest You.

"Every Bug Has its Dose."

Insect-destroying preparations that do their work well and effectively are the cheapest. Bowker's Arsenate of Lead and Bowker's Pyrox are recognized standard insecticides and fungicides for both indoor and outdoor use. Bowker's Insect Emulsion destroys many kind of plant lice, black and green flies, etc. Call or send for catalogue.

BOWKER INSECTICIDE COMPANY
43 CHATHAM ST. BOSTON

An Absolute Success

in Killing Scale and All Other Insect Pests on Trees, Shrubs and Gard-n Plants, including the notorious

LACE FLY ON RHODODENDRONS without injury to the foliage.

WILSON'S PLANT OIL

Well Tested and Its Efficacy Fully Demonstrated

TRY IT!

Wilson Plant Oil & Fertilizer Co., Chatham, N. J.

For Trees, Plants, Shrubs and Flowers
— USE —

THE NIAGARA BRAND LIME SULPHUR SOLUTION

It destroys Scale Lice, Spiders and all forms of Aphides, AT THE SAME TIME Mildew, Blight, Rust and other Fungus difficulties.

Used in Winter or Summer — No other remedy has been so universally effective. Niagara Brand ARSENATE OF LEAD for chewing insects is equal to the best and better than the most. Ask about our Green House sorayer. Address —

NIAGARA SPRAYER CO., - - Middleport, N. Y.

KILMDEAD
The best of all the tobacco dusts for
Dusting or fumigating

25 lbs., \$1.00 100 lbs., \$3.00 1000 lbs., \$27.00
50 lbs., .75 500 lbs., 18.00 2000 lbs., 52.00

Swamp & Walter Co.
New York.



The Best Bug Killer and Bloom Saver

For PROOF Write to

P. R. Palethorpe Co.
OWENSBORO, KY.

COOPERS SPRAY FLUIDS

LATEST DISCOVERY

Progressive Growers Investigate

32 page Booklet of British, American and Canadian Testimony free for the asking

Eastern Agent - CYRIL FRANKLYN
62 Beaver St., New York, N. Y.

Sole Proprietors
WILLM COOPER & NEPHEWS
177 Illinois Street, CHICAGO

Which Spray Pump?

What shall you buy? Buy the Spray Pump that fully meets the demands of the Government Agricultural Scientists and all practical Fruit Growers. These pumps are widely known as

DEMING SPRAYERS and are made in 23 styles for use in small gardens or immense orchards. Write for our 1903 catalog with Spraying Chart. Add 4 cents postage and receive "Spraying for Profit," a useful guide book.

CHARLES J. JAGER CO.
281-285 Franklin St., Boston

SPRAYED

In writing to Advertisers kindly mention Horticulture

STANDARD PLATE GLASS CO.
 Manufacturers—Importers—Jobbers
 NOW IS THE TIME TO BUY
FRENCH OR AMERICAN GREENHOUSE GLASS
 LOWEST PRICES ON REQUEST
 26-30 Sudbury St. BOSTON, MASS. 61-63 Portland St.

GLASS Always Write Us Before Buying
SHARP, PARTRIDGE & CO.
 22nd and Lumber Streets, CHICAGO
 WE HAVE SOME SNAPS

BOSTON PLATE & WINDOW GLASS CO.
GREENHOUSE GLASS GERMAN AND AMERICAN
 261 to 287 A Street BOSTON 20 to 22 Canal Street

GLASS
 Greenhouse and Hot Bed
 SIZES OUR SPECIALTY
 IMMENSE STOCK
Plate and Window Glass
 Write for Our Prices
PARSHELSKY BROS., Inc.
 59 Montrose Ave., BROOKLYN, N. Y.

FOR SALE
GLASS New American natural glass made 10x12 C. double, \$1.75 per box; 8x10, 10x12 to 12x20, 14x16 to 14x20, R. double, \$1.92 per box; 16x16 and 16x18, R. double, at \$2.00 per box; and 16x20, 16x22, 12x24, R. double, \$2.08 per box; 16x24, R. double, \$2.13 per box. Discount in large quantities.
PIPE Good serviceable second-hand with good threads and a coupling with each length, no junk. 1 in., 3c.; 1 1/4 in., 4c.; 1 1/2 in., 5c.; 2 in., 6c.; 2 1/2 in., 10c.; 3 in., at 14c. and 4 in. at 19c. New 2 in. standard black, \$1.20. Old 1 in. greenhouse pipe, 14c. per foot; 4 in. boiler tubes, 7c. per foot.

We quote you above only a few of our prices. We manufacture and job in everything pertaining to greenhouses, both new and second hand. Get our prices before placing your orders.
METROPOLITAN MATERIAL CO.
 Greenhouse Wreckers
 1392-1402 Metropolitan Ave., Brooklyn, N. Y.

MASTICA
 FOR Greenhouse Glazing
USE IT NOW.
F. O. PIERCE CO.
 12 W. BROADWAY
 NEW YORK

Mastica is elastic and tenacious, admits of expansion and contraction. Putty becomes hard and brittle. Broken glass more easily removed without breaking of other glass as occurs with hard putty. Lasts longer than putty. Easy to apply.

A WIRELESS MESSAGE
 IF YOU WANT
 BUY FROM WHO RUNS THE IN THE YOU WILL WEAR CAUSED BY FROM GROWN IN
BIG RESULTS
 BUY YOUR BUILDING MATERIAL WOOD IRON GLASS FROM FOLEY
 PHIL FOLEY FACTORY CITY OF CHICAGO.
 SMILE PROFITS CROPS HOUSES
 (WESTERN, AUSTRIAN, AND CANADIAN) 237 N. W. 23rd ST. CHICAGO

PATENTS
 Trademarks and Copyrights
 Send your business direct to Washington. Saves time and insures better service. Personal attention guaranteed. Twenty-five years' active service. SPECIALTY: "Working on the Failure of Others."
SIGGERS & SIGGERS
 PATENT LAWYERS
 Box 9, National Union Building Washington, D. C.

The Advance Ventilating Apparatus
 THE ADVANCE MACHINE will take care of all the ventilating work that the shading pipe will carry well. We dare any other line to give you better, longer and easier service than we will. \$10.00 for the machine all complete, made of the very best material in a mechanical manner assures of long life and the most satisfactory service. Our shading pipe is the best grade, new, painted, straightened, drilled and furnished with our new couplings at 8c. for the double and 10c. for the single strength pipe. Give us a chance to show you what we can do.
The Advance Co.
 RICHMOND, IND.

The Payne Steel "T" Bar Greenhouses

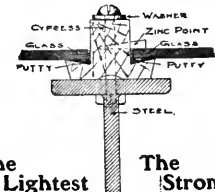

The Lightest The Strongest
 Half full size
 HOUSES of this type are constructed with both curved glass eaves and straight glass eaves. Least amount of shadow. Least amount of wood. No drip. Greatest durability.
JOHNA. PAYNE
 Greenhouse Designer and Builder
 260-274 Culver Avenue
Jersey City, N. J.

Everything for Greenhouse Building Write for information and prices.

 21 FOOT WIDE KING IRON FRAME GREENHOUSE
 In Widths from 14 feet 0 inches to 54 feet 0 inches. Without posts.
KING TRUSS SASH BAR HOUSES. IRON GUTTERS AND EAVES. IRON AND CYPRESS BENCHES. VENTILATING MACHINERY.
KING CONSTRUCTION CO.
 NORTH TONAWANDA, N. Y.

CYPRESS SASH BARS
 82 feet or longer
HOT BED SASH
PECKY CYPRESS BENCH LUMBER
GREENHOUSES
 ERECTED AND EQUIPPED COMPLETE IF DESIRED
 Write for Circular "D" and Erics
The A. T. STEARNS LUMBER CO.
 NEPONSET, BOSTON, MASS.

HOSE
CRESTLINE SPECIAL Garden Hose. Made in three different weights. A tough, durable hose that has the life in it. Every section guaranteed.
 Price with couplings: 5-ply 6-ply 7-ply
 1 1/2-in., per 50 ft. \$1.00 \$1.00 \$5.00 \$5.50
 1 1/2-in., per 100 ft. 7.75 9.75 10.75
 3/4-in., per 50 ft. 4.50 5.50 6.00
 3/4-in., per 100 ft. 8.75 10.75 11.75
 Immediate shipment. Express or freight.
THE CRESTLINE MFG. CO.
 Box 235, Crestline, O.

To the man who needs a Boiler

THE KROESCHELL BOILER

was installed to heat over six million (6,000,000) square feet of glass during the past three years.

Expressions from the men who know :

Used steam; was advised to change to your hot water boiler. Find it about half the work with your boiler. We would have no other.

Sternitzke Bros., Park Ridge, Ill. Have handled many greenhouse boilers of other makes, but Kroeschell beats them all. I get perfect circulation in 30 minutes.

Wm. Otto, Oshkosh, Wis. Former boiler, 16 horse-power steamer; as much difference as between day and night. Your boiler does not need recommendation. Will recommend itself wherever used.

Thos. F. Damerow, Grosse Pointe, Mich. Your boiler, in my estimation, is the best in use today. We have two of them.

Potter & Sons, Waukegan, Ill. When we rebuilt our plant, we were undecided whether to use your boiler or a cast iron boiler. We are satisfied we made no mistake in using Kroeschell.

Yeatman & Way, Kennett Square, Pa. Have fired greenhouse boilers since 1883, both steam and hot water. Yours suits me the best. I have two of your boilers. At one time I had two cast iron boilers working together and during a blizzard the rear section of one boiler gave out and the front section of the other sprung a crack a couple of months later. No more cast iron boilers for me. I came very close to freezing out in both instances.

G. M. Thost, DeSoto, Mo.

The Kroeschell Generator

prevents boiling over, cures sluggish circulation, saves fuel, smaller mains can be used, water can be heated to 240° without boiling, increases circulation, 3 to 5 times faster; no hot water system complete without it

HAVE YOU EVER INVESTIGATED

the one sure thing

KROESCHELL BOILERS

See the simplicity of construction. Plate material, NOT CAST IRON. Long fire travel, thin water ways. The best and the most heating surface in the world for the money.

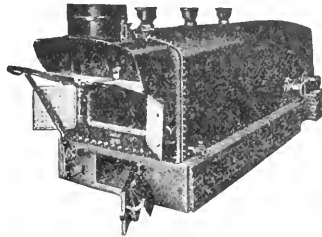

THE KROESCHELL BOILER will give you more heat with the same piping required by other boilers, and with less fuel.

Send for our catalogue.

Kroeschell Bros. Co.
35 Erie St., CHICAGO

THE KROESCHELL BOILER

replaced 1346 cast iron boilers in 1905, 1906, 1907, and many in 1908.

Expressions from the men who know :

We are very well pleased with your boiler. I have had fourteen years' experience in heating, six with gravity steam and eight with vacuum, but give me the hot water system for all purposes. Use me for references any time.

E. Lichtner & Son, Xenia, O. Have used upright boilers, tubular boilers, and cast iron boilers. Your boiler heats up better and easier than any boiler we have ever had anything to do with. If we ever buy another boiler, it will certainly be a Kroeschell.

Paule & Parlant, Washington C. H., O. I have fired boilers both here and in Europe for the last forty years. The Kroeschell is the best type of boiler I have ever used. I have two cast iron boilers, also a locomotive boiler coupled with yours, but did not need to use the cast iron boilers this winter. Your No. 7 boiler is rated at 15,000 sq. ft. of glass and carries 25,000 sq. ft. of glass until the outside temperature goes down to 10 deg. of frost. We have no trouble to keep temperatures in our houses with easy firing since we installed your boiler. The main flows and returns are heating our potting shed and packing room, which are not included in the amount of square feet of glass. From the boiler to the farthest end of our violet houses and return is 800 ft. and circulates very quickly.

The Safford Flower Shop, Wm. D. Safford, Pres. Poughkeepsie, N. Y.

The Kroeschell Piping System

is being installed by many progressive florists. 1 1/2, 2 or 2 1/2 in threaded pipe, or 4 in tubing is used. Boiler can be set on level with greenhouse walks. You do not need deep boiler pits.

COAL Pocahontas Smokeless Coal Blossburg Smokeless Coal

The above steam coals are peculiarly adapted to FLORISTS' use. Prominent features are HIGH EVAPORATION, LOW ASH, LOW SULPHUR, HIGH CARBON, and HIGH HEAT UNITS. Permit us to figure on your year's requirements, deliverable as called for.

CARGOES CONSTANTLY ARRIVING AT ALL NEW ENGLAND PORTS

The Bader Coal Company, F. B. LAYTON Gen'l Sales Agent

Telephone Fort Hill 2044 **Board of Trade Building, Boston, Mass.**

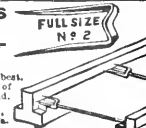
Holds Glass Firmly
See the Point 
PEERLESS
Glazing Points are the best. No rattle or rick. Box of 1,000 points 75 cts. postpaid.
HENRY A. DREER,
714 Chestnut St., PHILADELPHIA

GREENHOUSE CONSTRUCTION

LUMBER

John C. Moninger Co.

117 E. Blackhawk St., CHICAGO.

The FLORISTS' HAIL ASSOCIATION OF AMERICA, insurer of 29,000,000 sq. ft. of glass. For particulars address: John C. Esler, Sec'y, Saddle River, N. J.



Evans 20th Century Arm

Will not twist the shunting pipe. Three times the power of old style elbow arms. Sold only with Evans Challenge Machine.

Write for free Catalogue to **QUAKER CITY MACHINE CO.** Richmond, Ind.

In ordering goods please add "I saw it in HORTICULTURE."

In ordering goods please add "I saw it in HORTICULTURE."



THE WAY WE BUILD

Here is an octagonal palm house made with our proven Flat Iron Rafter Construction. Just notice how effectively all of the detail is worked out, and though not elaborate, it is undoubtedly pleasing. That passage at the left connects the palm house with the rest of the range.

An attractive, reliable, durable house—the kind we always build—send for our illustrated circular

Hitchings & Company

Designing & Sales Offices General Offices & Factory
 1170 Broadway, N. Y. Elizabeth, N. J.



Talk About Lightness, How Is This?

It is a north roof view of an L & B Sectional Iron Frame Shadeless Ridge House, 55 feet 6 inches wide and 300 feet long. Considering that this construction is not alone the lightest, but the most enduring, as its many years use has long since proven—you cannot afford to experiment with a construction that is only a few months old. Let someone else pay for the experiments.

LORD AND BURNHAM COMPANY,
 Irvington-on-Hudson, N. Y.
 New York — Boston — Philadelphia — Chicago

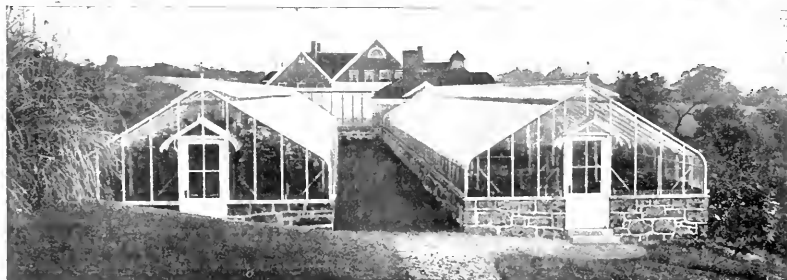

THE POINT IS THIS—WE ARE HAVING PRINTED A MOST BEAUTIFUL CATALOG OF U-BAR GREENHOUSES—IT IS GOING TO BE BY FAR THE FINEST

thing on greenhouses ever published. It is one of those catalogs that is not only illustrated in the finest kind of a way, but it tells you what you want to know, in just the way you want to know it, and gets at it quickly. Now this complete catalog will not be ready for a few more weeks, but rather than keep you waiting, we have had a very limited number of Advance Sheets of the first ninety pages printed, and bound up, ready to send to you. It is really the cream of the catalog.

If you write at once, mentioning the fact that you saw this mentioned in Horticulture you shall have one of the first copies that comes from the press, but don't wait and then blame us because all the special copies are gone.

U-BAR GREENHOUSES

PIERSON
 DESIGNERS AND BUILDERS



U-BAR CO.
 1 MADISON AVE. NEW YORK

HORTICULTURE

Vol. IX.

JUNE 5, 1909

No. 23

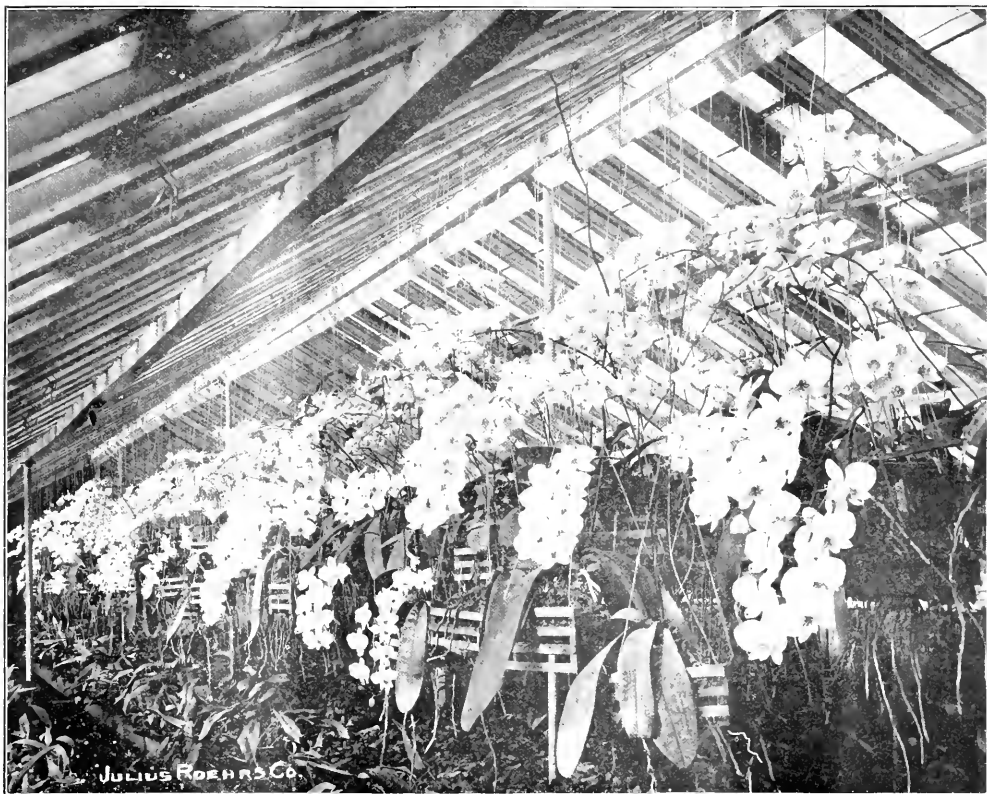

HOUSE OF PHALAENOPSES
At Rutherford, N. J.

*Devoted to the
FLORIST, PLANTSMAN,
LANDSCAPE GARDENER,
and
Kindred Interests*

*Published
EVERY SATURDAY
At 11 Hamilton Place,
BOSTON, MASS.
Subscription, \$1.00*

CHRYSANTHEMUMS

I have now ready 100,000 plants of 300 varieties, Large Flowered, Singles, Pompons, etc. These are fine stock from 2 1/4 inch pots.

All the standards such as Robinson, Bonnaffon, Duckham, Clay Frick, Beatrice May, Mrs. Partridge, Polly Rose in large quantities at

\$3 per 100, \$25 per 1000

Ralph Curtis, Marie Masse, Horace Martin and other new early kinds, \$10.00 per 100.

Write me what you want and see what I can do for you.

CHARLES H. TOTTY, MADISON, N. J.

CHRYSANTHEMUMS.

"Not small weak runty stock grown under benches, but the kind that brings back Dollars for Pennies."

WHITE: Earliest OctoberFrost (We have extra fine large stock of this variety), Mrs. Henry Robinson, Clemence Louise, Alice Byron, Timothy Eaton, Merry Christmas, White Bonnaffon.
YELLOW: Moorena, Halliday, Appleton, Boonefloo, Eaton, Chataqua Gold.
PINK: Maud Deao, Dr. Enguehardt.
RED: Intensity, Schrimpton

All these varieties, rooted cuttings \$2.00 per 100; \$20.00 per 1000. 2 1/2 in. \$3.00 per 100; \$25.00 per 1000.
Golden Wedding, R. C. \$3.00 per 100; \$27.50 per 1000. 2 1/2 in. \$4.00 per 100; \$35.00 per 1000.
Golden Glow, R. C. \$5.00 per 100. 2 1/2 inch \$6.00 per 100.

ROSES. 2 in. or 2 1/2 in. 3 in. or 3 1/2 in.
100 1000 100 1000
Americo Beauties... \$7.00 \$65.00 \$9.00 \$83.00
Killarney - Own roots \$6.00 \$55.00 7.50
Mrs. Potter Palmer... 5.00 45.00 6.50

Bridesmaids } 2 in. or 2 1/2 in.
100 1000
Richmond... } \$5.00 \$45.00
Katherine... } 5.00 45.00 \$6.50
Uncle John... } 4.00 35.00

POEHLMANN BROS. COMPANY, Morton Grove, Ill.

EARLY MUMS

Should be planted at once for best results. We have the following in quantity ready for immediate delivery. Also full quota of mid-season and late sorts for those ready to plant. Price on application.

EARLY

GLORY OF PACIFIC POLLY ROSE ROBERT HALLIDAY
IVORY GOLDEN GLOW OCTOBER FROST

Price \$3.00 per 100, \$25.00 per 1000.

PACIFIC SUPREME, \$4.00 per 100, \$35.00 per 1000.
VIRGINIA POEHLMANN, \$5.00 per 100.

Not less than 25 of a kind at 100, 250 at 1000 rate.

ELMER D. SMITH & CO., Adrian, Mich

CHRYSANTHEMUMS

Rooted Cuttings and Pot Plants

Write for list and prices. ALL OF THE BEST ONES.

S. J. REUTER & SON, WESTERLY, R. I.

Our New Carnation SHASTA

is always pure white, is always in bloom and is always high grade.

\$12.00 per 100, \$100.00 per 1000. Send Order now to
PATTEN & CO., Tewksbury, Mass. BAUR & SMITH, Indianapolis, Ind.

White Bonnaffon
The Chrysanthemum Every body Should Grow.
I have Rooted Cuttings, Cool Grown, Sturdy Stock, \$12.50 per 1000

H. L. CAMERON, North Cambridge, Mass.

THE BOSTON VIOLET

Unequaled for Productiveness, Beauty and Popularity.

In Crop from September to May.
Plants \$2.00 per doz. \$12.00 per 100, \$100.00 per 1000
Process of Wales \$15.00 per 1000.

WILLIAM SIM, Cliffondale, Mass.

CARNATIONS

Fine Healthy Stock From 2 inch Pots.
Per 100 Per 1000
Pres Seelye - - - \$6.00 \$50.00
White Enchantress, Beacon 4.50 40.00
Victory, Winsor, Melody, 4.00 35.00
Kingston Pel - - -
Dahelm, Lady Mountful, Mrs. Lawson, White Lawson, Red Lawson, Variegated Lawson 3.50 30.00

CHRYSANTHEMUMS

Rooted Cuttings
G. W. Childs, Miss Clay Frick, White Shaw, Early Snow, Mrs. Jas. Marshall, Flayer Weaver, The Harriott, Yellow Eaton, \$2.00 per 100, \$15.00 per 1000.
A. J. Ballour, Autumn Glory, Ada Spaulding, Dr. Enguehardt, Doro by Davens, Geo. Kaib, Glory of the Pacific, Harry Hay, H. W. Reiman, Ivory, Jeanne Nonin, J. E. Lager, J. H. Troy, J. K. Shaw, Maud Dean, Meta, Monrovia, Mrs. Jerome Jones, Plinnie Wanamaker, Mrs. Alice Byron, Mrs. Baer, Mrs. Robert Arthur, Major Bonnaffon, Mad F. Bergmann, Nagoya, Polly Rose, Robt. Halliday, Timothy Eaton, W. H. Lincoln, Wm. Duckham, etc., \$1.50 per 100.

Send for Catalogue of Roses, cwn root and grafted, and other miscellaneous stock.

WOOD BROTHERS FISHKILL, N. Y.

Send for our Preliminary List describing and quoting

Chrysanthemums and Carnations.

A fine lot of Carnation Cuttings ready now.

THE E. G. HILL CO., Richmond, Indiana.

MARY TOLMAN

A New Light Salmon Pink Carnation for 1910.

\$12.00 per 100, \$100.00 per 1000.

A. E. Hunt & Co., Evansville, Ill. Chicago Carnation Co., Joliet, Ill. Hunt Bros., - - Park Ridge, Ill.

CARNATIONS

F. DORNER & SONS CO. LaFayette, Ind.

SCOTT BROS.

Gloire De Lorraine Begonias From 2 1-4 and 3 1-2 inch pots, \$15.00 and \$25.00 per 100.

Elmsford Nurseries, Elmsford, N. Y.

Begonia Gloire de Lorraine

Leaf Stock, June Delivery. \$15 per 100, \$145 per 1000. In 2 1/2 inch pots. Stock guaranteed to be absolutely free from disease.

THOMAS ROLAND, NAHANT, MASS.

WHITE KILLARNEY

It is needless to say much about the value of this

NEW WHITE ROSE

its value is so well established. In support of this statement, we might say that we intend to plant not less than 20,000 for our own growing. We have a splendid stock of both grafted and own-root plants, which we can deliver immediately on receipt of order,—gilt-edged planting stock. We guarantee perfect satisfaction.

STRONG PLANTS, 2½ in. pots, own-root, \$30.00 per 100; 250 for \$70.00; \$250.00 per 1000.
GRAFTED PLANTS, \$35.00 per 100; 250 for \$82.50; \$300.00 per 1000.

HYDRANGEAS IN BUD AND BLOOM

We offer fine plants, well budded, just beginning to show color; in splendid shape for immediate use.
 6-in. pots, 4-5 blooms each, \$9.00 per dozen.

Large Plants in Tubs

We have a large stock of splendid plants grown in tubs and half-barrels for July and August flowering.
 Fine plants in tubs, \$2.00 each. Extra large plants in half-barrels, \$5.00 each.

A FEW SEASONABLE SPECIALTIES

BOXWOOD PYRAMIDAL. Fine plants 3 ft. high, \$2.00 each; 4 ft. high, \$3.00 each; 4½ ft. high, \$4.00 each.

RUBBER PLANTS (Ficus elastica). Very large, bushy plants in tubs 4 ft. high, fine for summer decoration, \$3.50 each; 6-in. pots, 3½ ft. high, \$9.00 per dozen.

PANDANUS VEITCHII. Fine plants, 6-in. pots, \$12.00 per dozen.

PHOENIX ROEBELENI. Extra fine plants, 5-in. pots, \$18.00 per dozen.

CROTONS. Strong plants, 3-in. pots, \$3.00 per dozen; 5-in. pots, \$6.00 per dozen; 6-in. pots, \$9.00 per dozen.

CANNAS. Beaute de Poltevine, Buttercup, Souv. d'Antoine Crozy, Pierson's Premier, Mlle. Berat, L. Patry, Florence Vauchan, etc.; Strong started plants, 3½-in. pots, \$6.00 per 100. Dormant roots, \$3.00 per 100, \$25.00 per 1,000.

CALADIUM ESCULENTUM. Started plants, \$6.00 per 100.

GERANIUMS. Double Gen. Grant. Extra fine plants, 3½-in. pots, \$8.00 per 100.

GERANIUMS. Assorted. 3½-in. pots, \$8.00 per 100.

VIOLA VARIEGATA. 4-in. pots, extra heavy, \$12.00 per 100.

NASTURTIUMS. 3-in. pots, \$4.00 per 100.

F. R. PIERSON CO., Tarrytown on-Hudson, NEW YORK

Fine Rubbers at 20c.

All well grown stock in first class condition

Rubbers, 4 inch	each	.20c
" 6 "		.25c
Vincas, 2 "		.02c
Plumosus, 4 "		.05c
" 3 year		.04c
Mums, cuttings		.02c
" Nonin, out of pots		.04c
Sprenger, 3 year		.04c

Cash with order or satisfactory references

WILLIAM C. SMITH
 Market and 61st Street
 Philadelphia, Pa.

5000 GOLDEN GLOW

2½ ready, \$35 per fl. R. C. \$27 per fl.
 2000 White Cloud and Pacific Supreme
 2½ inch, and R C prices as above
 Dorner's new Golden Eagle, \$10 per 100
 October Frost, Nonin, Touset, Enguehard, Golden Wedding, and all standard Chrysanthemums
 2½ inch, \$2.50 per 100, \$23 per fl., R. C. 15 less

I. M. RAYNER
GREENPORT, L. I. N. Y.
 Perles, Brides and Maids for Planting

1000 Brides and Maids, 3 inch strong, \$4.00
 1000 Perles, 3 inch, ready for shift, \$6.00
 Pittsburg Rose & Carnation Co., Gibsonia, P. O., Pa.

A. N. PIERSON, Inc., Cromwell, Conn.

WHITE KILLARNEY (Waban Strain)

GRAFTED STOCK	Doz.	100	250	500	1000	2500	5000
		\$6.00	\$35.00	\$82.50	\$150.00	\$300.00	\$687.50
						\$1,250.00	

MY MARYLAND GRAFTED... \$3.00 per doz., \$30.00 per 100, \$150.00 per 1000
OWN ROOT... 3.00 " " 10.00 " " 90.00 " "

STANDARD VARIETIES

Betty, Bon Silence, Bride, Bridesmaid, Cardinal, Echanter, Etoile de France, Etoile de Lyon, Franz Deegan, Gen. McArthur, Golden Gate, Hermosa, Ivory, Kaiserin Augusta Victoria, Kate Wootton, Killarney, La Detroit, Waman Cochey, Marchal Niel, Mme. Abel Chatenay, Mrs. Jardine, Mme. Hoste, Mrs. Paul Niehoff, Mrs. Pierpont Morgan, Mrs. Potter Palmer, Papa Gontier, Queen Beatrice, Rhea Reid, Richmond, Rosaline Orr English, Souv. du President Carnot, Souv. de Wootton, Uncle John, Wellatey, White Cockat. The above Grafted (selected plus \$) 20 cts. each, \$2.00 per doz., \$15.00 per 100, \$130.00 per 1000.

OWN ROOT ROSES

Killarney, Bride, Bridesmaid, Mme. Abel Chatenay, Ivory, Richmond, Mrs. Paul Niehoff, 2-1/2 pots, 75c per doz., \$3.50 per 100, \$34.00 per 1000. 2½-in. pots, \$1.00 per doz., \$6.00 per 100, \$50.00 per 1000.
 Queen Beatrice, Rhea Reid, Mrs. Jardine, Mrs. Potter Palmer, from 2½-in. pots, \$8.00 per 100, \$70.00 per 1000.

BEDDING PLANTS

COLEUS. Verschaffeltii, Golden Queen, Queen Victoria, Beckwith Gem, Firebrand, Lord Palmerston. Rooted Cuttings by express, \$9.99 per 100, \$5.00 per 1000. Out of 2½ in. pots in May, \$2.00 per 100, \$15.00 per 1000.
 Golden Bedder, Hero Messy, Pearl of Orange. Fancy Varieties. Twelve kinds out listed above, 75 cts. per 100, \$5.00 per 1000.
 AGERATUM, Stella Gorney, Princess Pauline. SALVIA, Splendens, Bonfire and Zurich. HELIOTROPE. Dark blue bedding varieties. GERMAN IVY. 75 cts. per 100, \$6.50 per 1000.
 ALTERNANHERA, Red and Yellow, 50c per 100, \$5.00 per 1000. From 2½ in. pots, \$2.00 per 100.
 SALLEROL. Rooted Cuttings, \$1.00 per 100, 2½ in. pots, \$2.50 per 100.
 CHRYSANTHEMUMS IN QUANTITY. Catalogue on Application.

GERANIUMS Aster Plants

Five Varieties, including Nutt, J. Doyle, Dbl. Gen. Grant, Dbl. Dryden, La Favorite, Heinrich, Richelle, J. P. Cleary, and others 3 in in assortment, \$3.50 per 100.

WM. SWAYNE, Kennett Sq., Pa.

Sample's, Vick's and Queen of the Market, grow from the best seed, fine plants, in White, Blue and Pink. \$2.50 per 1000; 5000 for \$10.00.
 TOMATOES, best var., \$1.50 per 1000.
 CAULIFLOWER, PEPPERS, EGG PLANTS, \$2.50 per 1000.
J. C. SCHMIDT, Bristol, Pa.

ORCHIDS!

It is no reason whatever why all of you grower experts do not try us and see by your own eyes which kind of handsome orchids we handle and at such low prices, but we call your attention giving three kinds in special sale:

C. Mossiae, imported plants, \$40.00 case containing 450 strong, healthy and well leaved.

C. Percivalliana, 9 to 12, \$1.00.

C. Gaskelliana, 9 to 12, \$1.25; no less than two new growth which we guarantee the flowers will pay price of plants, as they are visible in the sheath, and from 12 to 18, \$1.75; 18 to 25, \$2.50. The largest plants have 3 to 5 new growths.

We are true importers and need to be acquainted with all of you.

Labiata and C. Gigas Sanderiana and others shortly.

ORDONEZ BROS.,
Madison, N. J.

ORCHIDS

We are booking orders now for delivery early in the Spring on all commercial **CATTLEYS** and **NOVELTIES**. Our prices are right and our guarantee perfect. We sell only first-class goods.

CARRILLO & BALDWIN Secaucus N. J.
FRESH IMPORTED ORCHIDS.

Arrived in Splendid Condition: *Cattleya Trianae*, *Mossiae*, *Gigas*, *Skinnerii*, *Oncidium Splendidum*, *Ornithorhynchum*, *Wentworthianum*, *Phalaenopsis Schilleriana* and *Amabilis*, *Lycaste Skinnerii*, *Vanda Boxallii*, *Laelia Superbueus Odontoglossum grande*. Write for prices.

JOSEPH A. MANDA.
191 Valley Road West Orange, N. J.

IMPORTED ORCHIDS

Now Arriving

Julius Roehrs Co.
RUTHERFORD, N. J.

ORCHIDS

Largest Importers, Exporters, Growers and Hybridists in the World

Sander, St. Albans, England
and 235 Broadway, Room 1
NEW YORK CITY

ROSES

A SPECIALTY

The Dingee & Conard Co. West Grove PA.

JAPANESE
THE YOKOHAMA NURSERY CO.
31 BARCLAY STR. NEW YORK.
LILIES
PLANTS
BAMBOO STAKES

PHALAENOPSES AND VANDAS

Importations Received Every Two Months

Phalaenopsis Amabilis
Phalaenopsis Schilleriana
Phalaenopsis Sanderiana
Phalaenopsis Stuartiana

Vanda Sanderiana
Vanda Batemannii
Vanda Boxallii
Dendrobium Superbum

We also receive many other varieties of Orchids from the South Pacific and East Indies. We respectfully solicit your inquiry in this line.

MACRORIE - McLAREN COMPANY

721 Crocker Bldg., San Francisco, California, U. S. A.

LAGER & HURRELL ORCHIDS

Established and Fresh Imported. SUMMIT, N. J.

Fresh Stock Direct from Collectors ORCHIDS

CATTLEYS LABIATA, MENDELII, MOSSIAE, GIGAS, SPECIOSISSIMA, GIGAS SANDERIANA, CHRYSOTOXA, AUREA.

Ordering now insures prompt delivery. Send for prices.

C. L. FREEMAN, 388 APPLETON STREET, HOLYOKE, MASS.

Palms

Shrubs



Ferns

Perennials

Send for Our Catalogue.

The GEO. WITTBOLD CO., 1657 Buckingham Place, Chicago, Ill.

FERNS FOR DISHES,

Assorted Varieties
From 2 inch pots, \$3.50 per 100; \$30.00 per 1000

CASH WITH ORDER
2570 to 2606 W. Adams St., Chicago, Ill.

FRANK OECHSLIN

IPOMOEA NOCTIFLORA

Best pure white moonvine in the market, very fragrant and as big as a saucer. On this variety we have a world-wide reputation as growers and shippers for the last twenty years.

Price, 2 1/2 in. pots, \$5.00 per 100. 10,000 are now ready.

Godfrey Aschmann

1012 West Ontario St., Philadelphia, Pa.

NEPHROLEPIS MAGNIFICA

THE SENSATIONAL NOVELTY
Strong 2 1/2-in. stock, \$25.00 per 100.

WHITMANII

2 1/2 in., \$40.00 per 1000; 3 1/2 in., from Bench, \$8.00 per 100.

H. H. BARROWS & SON, WHITMAN, MASS.

ROBERT CRAIG CO.

ROSES, PALMS,

and Novelties in Decorative Plants

MARKET and 49th STREETS., PHILADELPHIA, PA.

PALMS AND FERNS DECORATIVE PLANTS

JOHN SCOTT

Rutland Road and E. 45th St.
Tel. 2890 Bedford BROOKLYN, N. Y.

JARDINIERE FERNS

IN BEST VARIETIES. VERY FINE STOCK.

\$3.50 per 100, \$30.00 per 1000

ROSE HILL NURSERIES

New Rochelle, N. Y.

Kentias, Arecas, Latanias, Cocos, Phoenix, Araucarias, Rubbers, Crotons, Pandanus, Asparagus, Ferns for Dishes. 200,000 Bedding Plants, also Rooted Cuttings of Coleus at lowest wholesale rates.

Orders taken for imported plants for fall delivery

A. LEUTHY & CO.

PERKINS ST. NURSERIES
ROSLINDALE, MASS.

Water in the Garden and Home Park



MAKING AN AQUATIC GARDEN

No one will deny that one may possess a garden beautiful without lakes, waterfalls and pools and fountains, but the generality of mankind have a preference for those which have some one of these pleasant adjuncts, as they add to the interest and the enjoyments of a country residence. In hilly and mountainous country there is usually the opportunity of making use of running water for supplying a lake with abundance, or making cascades, and by making devious stretches of comparatively still water on the level by means of suitable excavations. The water may take the form of a stream of varying breadth, furnished with gentle projections jutting out into the stream, and easy outline which when planted with trees, shrubs, and flowering, as well as ornamental leaved plants, afford the gardener facilities for adding interest and beauty to the banks. Such still or slowly moving streams afford admirable sites for patches of water lilies and other aquatic plants.

Before the site of a lake is fixed upon the nature of the soil ought to be ascertained, for if it allows water to percolate too freely, the bottom and sides would have to be made watertight by a six-inch layer of tenacious clay, well worked and beaten to a smooth surface, and carried rather higher than the proposed level of the water. Where no such operation is needed the banks under water and for 6 to 8 inches above it may be simply cased with stone or coarse gravel, so that the soil be not undermined by the action of the water. The outline of a lake will depend in some measure on the contour of the land, but is more pleasing to the eye if it be of a serpentine character with projections at long intervals on which trees and shrubs may be planted to add still more to its intricacy, and supply surprise views, and stations for rockwork, or for choice conifers, or flowering trees such as the catalpas, pavia, Paulownia, etc., and weeping willows.

The depth of a lake in a warm climate should not be less than 6 to 8 feet in the deeper part, or more than 2 feet near the banks if it is intended to plant aquatics, excepting such as are quite hardy, deeper water than this being too cold in the summer months for healthy development; moreover there is little chance of seeing the flowers of such plants when they are placed far distant from the banks. If a lake be less than 6 feet and the inflow meagre there is the risk of fermentation taking place in the warm months, especially after the lapse

of years, during which masses of leaves have been blown into it, and settled at the bottom.

In my next article I intend to give examples of planting the banks of lakes and streams; giving examples in England and Ireland, as well as on the continent of Europe.

Frederick Moore

British Horticulture

THE NEW EXHIBITION

The Imperial International exhibition which has this year taken the place of the Franco-British one at the Great White City at Shepherd's Bush was opened on May 20th. The site covers an area of 160 acres so that there is ample space available for the display of the nurserymen's art. Several of the leading firms have taken space in the grounds for bedding exhibits. Messrs. Waterer & Sons, of Bagshot, Surrey, who are noted on both sides of the Atlantic for their famous rhododendrons, have laid out several beds in a prominent position with some of the most brilliant varieties. The same firm are making their customary display this summer in an immense marquee in the Botanic Gardens at Regents' Park. In addition to the displays made by the firms the exhibition authorities have placed large orders with the trade for the supply of enormous quantities of bedding plants. The exhibition has thus proved a great advantage to the trade in bringing fresh business this season. The public are beginning to more fully appreciate the advantages of having the best music in the open air, amidst pleasant surroundings, an idea which has been borrowed from continental cities.

POPULAR PRIMULAS

A short distance from the mass of London's drab bricks and mortar there has lately been a welcome blaze of color furnished by some 16,000 Chinese primulas at a leading nursery. Special attention has in recent years been paid to this section of spring flowers by several firms, with the result that a high standard has been reached as regards brilliancy of tint, habit, and floriferousness. At the nursery referred to amongst the chief varieties are Holborn Coral, coral pink with yellow eyes; King Edward, pure white, dark green foliage; Holborn Salmon, salmon pink; Princess of Wales, white with carmine flake; Vivid, deep rich carmine; Snowflake, white, slightly tinged with pink; Prince of Wales, large salmon pink.

A SUGGESTED NATIONAL VEGETABLE SOCIETY

Although Britain is well supplied with special floral societies there is not one of a national character solely devoted to vegetables. There has from time to time been a suggestion made for supplying the omission. "The Garden" has lately had a further correspondence on this subject. Several leading experts express the opinion that there is an opening for a society of this kind in order that an increased attention might be given to vegetable culture by means of exhibitions and trials. For about three years there was a National Potato Society but the interest waned after the "boom" of big prices was over, and the organization dwindled and died from lack of sufficient financial support.

W. H. Adsett,

London, Eng.

HORTICULTURE

VOL. IX JUNE 5, 1909 NO. 23

PUBLISHED WEEKLY BY

HORTICULTURE PUBLISHING CO.
11 Hamilton Place, Boston, Mass.

Telephone, Oxford 292
WM. J. STEWART, Editor and Manager

SUBSCRIPTION PRICE

One Year, in Advance, \$1.00; To Foreign Countries, \$2.00; To Canada, \$1.50

ADVERTISING RATES

Per Inch, 30 Inches to page \$1.00.
 Respects to Contracts for consecutive insertions, as follows:
 One month (4 times) 5 per cent.; three months (12 times) 10 per cent.;
 six months (26 times) 20 per cent.; one year (52 times) 30 per cent.
 Page and half page spaces, special rates on application.

Entered as second-class matter December 8, 1904, at the Post Office at Boston, Mass., under the Act of Congress of March 3, 1879.

CONTENTS

	Page
COVER ILLUSTRATION—House of Phalaenopsis.	
WATER IN THE GARDEN AND HOME PARK—Fred- eric Moore—Illustrated.....	797
BRITISH HORTICULTURE—W. H. Adsett.....	797
NOTES FROM THE ARNOLD ARBORETUM—Alfred Rehder.....	799
NEW PLANTS AT THE ROYAL HORTICULTURAL SOCIETY—Frederick Moore.....	799
AMERICAN ASSOCIATION OF NURSERYMEN: Program of Rochester Convention—Portraits of Of- ficers.....	800-801
SPECIMEN DAVALLIAS—Vernon T. Sherwood.....	801
NEWS OF THE CLUBS AND SOCIETIES: Florists' Hail Association—Florists' Club of Wash- ington—Florists' Club of Philadelphia—American Peony Society—Royal Horticultural Society.....	802
Connecticut Horticultural Society—Pennsylvania Horticultural Society—Club and Society Notes.....	802
SEED TRADE: An Unwarranted Attack on the Canning Industry— Crop Prospects—The Conventions—Personal.....	804
American Seed Trade Association, Convention Pro- gram—Incorporated—Notes.....	806
OF INTEREST TO RETAIL FLORISTS: New Flower Stores—Business Changes.....	808
Flowers by Telegraph.....	809
FLOWER MARKET REPORTS: Boston, Detroit, Philadelphia.....	811
Chicago, New York.....	813
OBITUARY: John E. Andre—George W. Earl—Norman C. Cookson —George T. Waldbart—Mrs. Marie M. Cornell—Julius Friedlander—Edmund Hersey.....	820
MISCELLANEOUS: News Notes.....	801-818
Personal.....	801
Catalogues Received.....	806
Publications Received.....	806
Philadelphia Notes.....	809
Chicago Notes.....	809
Patents Granted.....	818
Greenhouses Building or Contemplated.....	819

The balance, \$9653 is distributed over the trans-Mississippi states of Nebraska, Iowa, Oklahoma, Kansas, Texas and South Dakota. The project of insurance of greenhouses against hail losses was one of the incentives in the organization of the Society of American Florists. It is to be noted that the main strength of the Hail Association is now in those sections where the S. A. F. has the least following and vice versa.

Relaxation well earned

The season for respite and recreation in all departments of horticultural activity is fast approaching. Memorial Day has passed, June floral festivities of various brands will shortly follow it; trees are in leaf and flower and the nurseryman's digging, and packing and planting for the spring of 1909 has already passed into history; counter trade, mail order trade and all other phases of the seedsman's calling have shrunk rapidly within the past few days; interest now turns to the outings and picnics, and the society conventions which, despite their flourish of business, are, after all, the real article in the picnic line for many. Next week the nurserymen start the series with their convention at Rochester—a town with more snap and ginger in it when it comes to jollification than any place of its size on the map; only a few days later the seedsman will gather at Niagara Falls, Ontario, where, if the experience of others who have tried it counts for anything, they will have the time of their lives; Florists' Club outings innumerable will punctuate July from start to finish and the climax of merry-making adroitly interwoven with the acquisition of serviceable knowledge, will be reached in the silver jubilee of the S. A. F. at Cincinnati in August. One needs only to read the names of the active participants in these merry yet industrious events to get a good line on the intellectual and progressive forces, the bone and sinew of present day horticulture. If you want to find out "who's who in horticulture" don't waste your time looking among the chronic stay-at-homes.

A manifest injustice

The attacks upon the canning industry which extended reference is made in our seed trade notes in this issue should be regarded with grave concern by seedsman, fruit growers and the horticultural profession in general. Unfortunately no distinction is made by the agitators and alarmists between the "canners" of fruit and vegetables and the products thereof and the "packers" of meats, fish, etc. As to the practices of the latter we have nothing to say at present but sterilization by heat is practically the universal custom in the fruit and vegetable canning business and it is nothing short of rascality to include, even by implication, these people in any denunciation or criticism that may, with or without reason, be made concerning the methods of meat preserving and thus mislead the public and tend to bring suspicion and great injury upon a reputable industry the products of which constitute one of the greatest blessings of modern civilization. The Pure Food Law is something we should all be grateful for and whoever is caught violating its provisions should be given the limit of punishment, whatever branch of food manufacturing or food preserving he may be identified with. Fresh fruit and vegetables need no chemical preservative. If the fruit has reached that condition where chemicals are needed to make it keep it should be destroyed, if not voluntarily then under compulsion. Regulations to this effect will not disturb the canners of garden products, please them rather, as any writer desiring to deal out unprejudiced information can readily ascertain by proper investigation.

The losses adjusted by Secretary Esler of the Florists' Hail Association between May 5 and June 1, 1909, amount to \$11,984. It is interesting to note the localities in which the greatest losses were sustained. None are reported from east of Indiana although it does not necessarily follow that there have been no losses in the east as the reports cover only those cases where hail insurance is carried. In Indiana the amount is \$8,559, in Illinois \$1,911, in Michigan \$171, in Wisconsin \$200, and in Missouri \$191, totaling \$1131 east of the Mississippi.

Notes from the Arnold Arboretum

Besides the Lilacs and Azaleas the Honeysuckles are now the most showy flowering shrubs at the Arnold Arboretum and particularly *Lonicera tatarica* and its crosses with *L. Morrowii* and *L. Ruprechtiana*, their flowers varying from pure white to deep pink. Another cross of more recent origin and apparently not yet known in American gardens is *Lonicera amoena*, a hybrid of *L. tatarica* and *L. Korolkovii* var. *floribunda* raised in Germany several years ago. A similar hybrid of nearly the same parentage, one of its parents being the true *L. Korolkovii*, instead of a variety of it, originated a few years ago at the Arnold Arboretum and produced last year for the first time its flowers in profusion; it was described recently by me as a new variety under the name *L. amoena* var. *Arnoldiana*. This is certainly the most graceful of all the hybrids and, though we have other graceful species, none of them combines an elegant habit with such a profusion of delicately tinted and rather large flowers. *Lonicera amoena* var. *Arnoldiana* is a rather dense bush with upright and spreading branches clothed with light bluish green foliage, the leaves being similar to those of *L. tatarica* but smaller and narrower. In June, when the flowers of *L. tatarica* and its other hybrids are passing away, its branches are covered with light pink flowers borne on long and slender stalks well above the bluish green foliage. The whole shrub has thus the appearance of an airy lightness and gracefulness very unlike any other of the hybrids of *L. tatarica*. It is not yet in trade and in fact not known outside of the Arnold Arboretum.

Among the *Diervillas* attention ought to be drawn to *Diervilla praecox* which is now in full bloom several weeks ahead of other species and varieties of this genus. *Diervilla praecox* is of comparatively recent introduction and apparently still little known in American gardens. It is a hardy shrub of upright vigorous habit with pubescent sharply toothed leaves. The flowers appear in great profusion surrounded by clusters of leaves along the branches of last year's growth; they are about one and three-quarters of an inch long and of pale purple color. One cannot deny that the color is not as beautiful as in many other varieties of *Diervilla*, but this drawback has been remedied by the new hybrids raised by Lemoine of Nancy who also introduced originally the species in question; they combine the early flowering time with flowers from delicate pink to carmine purple; the first named color shade is represented by the variety *Gracieux*, the latter by var. *Conquerant*.

Of the well known favorite shade and avenue tree *Jesulus carnea* (*A. rubicunda*) there is at present a variety in flower which seems to be still very little known though it surpasses the original *A. carnea* in beauty and originated about fifty years ago in France. It is *A. carnea* var. *Briotti* with deep red flowers, the two upper petals marked with an orange red blotch. The flowers are so much more brilliant than those of the common *A. carnea* that this variety deserves to be better known and more often planted.

Besides the Lilacs and the Azaleas which are now past

their prime the native and the Ghent Azaleas are now in bloom and the earliest of the *Rhododendrons* begin to unfold their flowers. As the latter have come well through the winter, they give every promise of a splendid show when they will be in full bloom.

Alfred Rehder.

New Plants at the Royal Horticultural Society

In addition to my previous list given in the issue of HORTICULTURE, May 29, there were the following: *Odontioda Vuylstekeae Crawshayanum* (O. Pescatorei x *Coehlioda Nozibiana*) shown on May 17 at the Vincent Square Hall, by DeB. Crawshaw, of Rosefield, Sevenoaks. The variety retains the fine shape of *Odont. Pescatorei*, but in color the flowers are of a glowing scarlet, the crest being of an orange color. The flower shows a variety of tints, but none of the spotting observed in *M. Vuylsteke's* form. The colors and markings are those most probable in such a cross as that given, so that its appearance was a surprise to the raiser.

RHODODENDRON SOULEI.—The society awarded a first-class certificate to this species from China and shown on this occasion by Messrs. J. Veitch & Sons of Chelsea. The comparatively large flowers have a bright suffusion of rose on a pale ground. The ovate cordate leaves are covered in the young state with a glaucous bloom, and are then of a red tinge, as are the young shoots, but subsequently the tinge becomes green. The flower for one-third of its depth is widely expanded, and has a diameter of 4 inches. The plant has proved hardy in England.

PRIMULA BULEYANA.—This plant was shown by Messrs. Bees, Ltd., Liverpool, at the meeting on May 18. Its tall stalks bear orange colored flowers in whorls; sometimes these will number three whorls. The calyx and upper parts of the flower stem are mealy, and the leaves resemble those of a polyanthus. The plant was found in China by Mr. G. Forrest, collector for Messrs. Bees, Ltd., who states that it is a moisture loving plant, growing to a height of 3 feet, and is found in colonies of several acres in extent.

TULIP THE PRESIDENT.—A new and striking variety of the late flowering or cottage tulip is *The President*, shown by Messrs. R. W. Wallace & Co., of Colchester. The bloom is of a very large size, in color a reddish orange, with a dark basal patch. An award of merit was bestowed upon it.

J. C. C. Hurst.

Mr. C. C. Hurst, a member of an English firm of wholesale seedsmen, had many interesting points to offer respecting Mendel's law and its application to horticulture before the members of the B. H. S. at a recent meeting. Recent experiments have shown, Mr. Hurst explained, that many simple characters in garden plants follow Mendel's laws. In many cases, however the Mendelian characters do not happen to correspond with the horticultural characters, and interesting complications then arise.

AMERICAN ASSOCIATION OF NURSERYMEN

The thirty-fourth annual convention of the American Association of Nurserymen will be held at Hotel Seneca, Rochester, N. Y., June 9, 10, and 11, 1909.

Program.

Much attention has been given to this matter of program by the officers. The aim has been to make it possible to combine business with pleasure in reasonable proportions. To that end arrangements have been made for one session daily. The hope is that members will all attend these sessions which will be interesting and ample time is thus given for social and business intercourse as well as for the special features provided by the Entertainment Committee. It will be therefore a courtesy toward those who have been working hard on this convention if all will be promptly on hand for these sessions and remain throughout.

Wednesday, June 9, 9 A. M.

Address of Welcome, Hon. H. H. Edgerton, Mayor of Rochester.

Response, George S. Jesselyn, Fredonia, N. Y.

President's Address, Charles J. Brown, Rochester, N. Y.

Report of Secretary, George C. Seager, Rochester, N. Y.

Report of Treasurer, C. L. Yates.

The President will announce the meeting of the newly elected state vice-presidents to be held Wednesday evening, 8 P. M., Assembly Hall. During the day (Wednesday) the members from each state are requested to get together and select their new vice-president, who will attend the Wednesday evening meeting which will consider the question of nominations and selection of place for next meeting in order to report on Thursday morning. In case but one representative from a state is in attendance he



CHARLES J. BROWN,
President.

will please consider himself vice-president and attend the meeting.

Report of Tariff Committee, Irving Rouse, Rochester, N. Y.

"Nurserymen Pulling Together a Little More," J. H. Dayton, Paineville, Ohio.

"What the Orchardist Expects from the Nurseryman," T. B. Wilson, Halls Corners, N. Y.

Report Transportation Committee, F. H. Stannard, Ottawa, Kan.

"Evergreen Conifers," Samuel C. Moon, Morrisville, Pa.

Appointment of Special Committees.

Wednesday, June 9, Afternoon.

A ride through Rochester streets and parks, as guests of Western New York Nurserymen.

Conveyances will be at the Hotel Seneca at two o'clock P. M. This is expected to be a most attractive feature of the convention. A band concert will be given in one of the parks. All Nurserymen and representatives of allied industries with their wives, children, sweethearts or friends invited. Give the Secretary names of your personal party early Wednesday morning so that proper arrangements can be made.

Wednesday, June 9, 8 P. M.

Meeting of State Vice-Presidents in assembly room to nominate officers and a place of meeting for the year 1910.

Thursday, June 10, 9 A. M.

Roll Call of State Vice-Presidents. Report of State Vice-Presidents. Elections of Officers. Selection of Next Place of Meeting.

"Our Department's Work," R. A. Pearson, Commissioner of Agriculture, Albany, N. Y.

"The Science Point of View," Prof. L. H. Bailey, Cornell University, Ithaca, N. Y.

This is the first time in several years it has been possible for Professor Bailey to be with the nurserymen. The committee is gratified to have been able to arrange for this meeting.

"Commercial Peach Orchards," L. A. Berckmans, Augusta, Ga.

"The Experiment Station and the Fruit Interests," Dr. W. H. Jordan, New York Agricultural Station, Geneva, N. Y.

"Relations Between the Grower and



GEORGE C. SEAGER,
Secretary.



CHARLES L. YATES,
Treasurer.

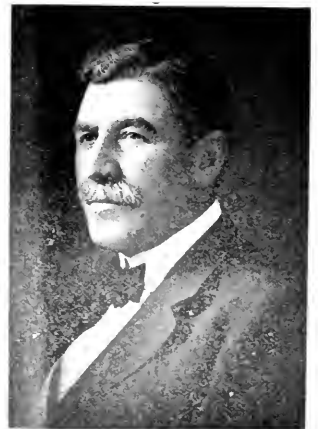

WILLIAM C. BARRY,
Ex-President.

the Reliable Nurseryman," R. S. Osborne, Rochester, N. Y.

Report of Legislative Committee, Wm. Pitkin, Rochester, N. Y.

Report of National Council of Horticulture Committee, C. J. Maloy, Rochester, N. Y.

Report of Exhibits Committee, T. B. Meehan, Dreshertown, Pa.

Report of Publicity Committee, J. M. Irvine, St. Joseph, Mo.

Report of Co-operation with Entomologists' Committee, Orlando Harrison, Berlin, Md.

Thursday, June 10, Afternoon.

At one o'clock P. M.—Reception and lunch for Ladies at Genesee Valley Club as guests of the Western New York Nurserymen. A committee to escort the ladies will be in the Hotel lobby at 12:45, noon.

At two o'clock P. M.—Annual meeting of American Protective Association, T. B. Meehan, Secretary, in the general assembly room.

At three P. M.—Annual meeting of the Retail Nurserymen's Association,

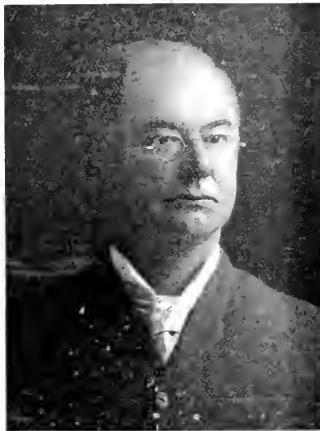

C. M. HOBBS
Vice-President.

Guy A. Bryant, Secretary, in general assembly room.

Thursday, June 10, Evening.

For the Ladies—Theatre party at the Lyceum Theatre adjoining the hotel, as guests of the Western New York Nurserymen. Members will kindly give names of their ladies to the Secretary by noon Thursday so arrangements can be made; also call on Secretary for ladies' tickets by 6 P. M., Thursday.

For the Men—As guests of the Western New York Nurserymen, a SMOKER will be given in the Masonic Temple auditorium, at eight P. M. "Something doing every minute," is the promise of those in charge.

Friday, June 11, 9 A. M.

Unfinished Business. Special Orders, if any. Final Resolutions.

It has been thought wise to leave Friday as much open as possible in order to give the nurserymen opportunity for business intercourse, for looking over the exhibits, visiting nurseries, etc.

SPECIMEN DAVALLIAS.

Editor Horticulture:

Dear Sir:—In regard to Mr. Pope's fine specimen of *Davallia filifera* illustrated in your issue of May 29, which I rather think to be *Davallia filifera* as evidenced by the photograph, *D. filifera* is rather more erect, and decidedly paler than its variety *plumosa*. Both form, however, excellent decorative subjects, and, as Mr. Pope states, the fronds are of great durability when cut. In Mrs. J. L. Gardner's collection there is a plant which just now measures five feet nine inches through, and I think that when it makes its second growth this measurement will be exceeded. In all probability had Mr. Pope's plant the rhizomes trained horizontally on the soil inside the pot or tub it would have formed during the period he has had it, an even larger piece than the specimen here, inasmuch as our piece was formed of three plants from four-inch pots purchased in the spring of 1905, being repotted twice in light soil since that time. The whole of the rhizomes are carefully kept on the surface of the soil, and no water is ever allowed to get on the foliage, otherwise discoloration soon takes place. I would be interested to know whether Mr. Pope has any other varieties of this genus, particularly *D. pallida*, usually known as *D. Mooreana*, a variety which a few years ago was largely used as an exhibition plant.

Yours very truly,
VERNON T. SHERWOOD.
Brookline, Mass.

NEWS NOTES.

Brooklyn, N. Y.—J. W. Merritt has opened a florists' supply house at 384 Jay St.

New Haven, Conn.—The Munro Co., florists, are putting up a barn and storehouse.

Sayre, Pa.—J. B. Knapp has the contract for the scenic garden work around the plant of the Sayre Electric Company.

Los Angeles, Calif.—T. Takahashi, proprietor of the New Yokohama Nursery, was severely injured on May 20 by a runaway horse.

Oskaloosa, Ia.—The Mahaska Nursery & Fruit Farm is the name under which A. Branson will carry on business on his recently acquired land here.

Dunkirk, N. Y.—Fire, supposed to have been caused by spontaneous combustion, on May 25, in the plant of the Lake Shore Seed Co., did about \$3,000 damage.

Far Rockaway.—Axel Lindstrom, a florist, has been awarded damages of \$2,000 by the New Jersey Telephone Company for the death of his son caused by dangling wires.—*Brooklyn, N. Y., Times.*

ALWAYS GOOD.

HORTICULTURE is always good and a welcome visitor. I wish it all kinds of success. Please find enclosed amount for renewal.

JOHN McL. CAMERON.
Buffalo, N. Y.

PERSONAL.

James Cottier of Hinchendon, Mass., is now with C. H. Hunt, Providence, R. I.

Joseph Le Clerc of Lexington, Ky., has accepted a position at Olympian Springs.

Donald Carmichael sailed from Boston on the Allan Line steamship for a visit to the land of heather, on May 28.

H. M. Mayer, horticulturist at Belle Isle, Detroit, is mentioned as the probable successor to William Dilger as superintendent of Belle Isle Park.

Messrs. Phil. Breitmeyer and J. F. Sullivan of Detroit are participating in the annual excursion of the Board of Commerce—a four days' water trip on the steamer Cleveland.

Mr. and Mrs. Fred C. Weber and their daughter Adele, and Mr. and Mrs.



C. J. MALOY
Chairman N. C. H. Committee.

Theodore Miller and their daughter Dora, all of St. Louis, Mo., will leave about June 15th, for New York from whence they take a steamer to spend the summer seeing the sights of Europe. Their return home will be about September 1st. They will miss the opportunity of seeing their many friends at the S. A. F. convention this year.

CAN'T DO WITHOUT IT.

Enclosed find one dollar to renew my subscription to HORTICULTURE. I am one of your first subscribers and am going to stay by you. Can't do without it. It is getting better and better with every issue.

Elkhart, Ind.

H. D. SEELE.

The Gardeners' and Florists' Club of Boston will have a field day at E. J. Shaylor's peony gardens, Wellesley Hills, on June 17.

NEWS OF THE CLUBS AND SOCIETIES

FLORISTS' HAIL ASSOCIATION OF AMERICA.

The Florists' Hail Association is a purely mutual, co-operative association, which was incorporated under the laws of New Jersey on June 1st, 1887. No agencies are established, and all business is transacted through the office of the secretary at Saddle River, N. J. Greenhouse glass is insured whether owned by market gardeners or florists, but loose sash not securely fastened against wind, are not insurable.

The basis of insurance is per square foot of glass, the rate of assessment being 8 cents per hundred square feet of single thick and 6 cents per hundred square feet of double thick glass. All members pay, upon joining or insuring additional glass, the sum of \$2.00 for the first 2,000 square feet of glass and 50 cents for each additional thousand square feet of glass. This goes into a separate fund known as the reserve fund which now amounts to \$21,000. The emergency fund is supplied by assessments levied at option of directors whenever such fund falls below 2 per cent of the fixed value of all risks; 19 assessments have been levied in 22 years.

In case of loss the insured receives 5 cents per square foot for single thick and 8 cents per square foot for double thick glass broken, in such ratio as the amount insured bears to the amount owned. Extra one-half an extra whole insurance is allowed, in which case the insured receives a proportionate increase in payment in case of loss.

FLORISTS' CLUB OF WASHINGTON.

The regularly monthly meeting of the Florists' Club of Washington was held on the evening of June 1st at 1214 F street. Owing to the absence of President Kramer, who was in New York, Vice-President Robertson presided. One new name was admitted to membership, viz., George J. Hess of Anacosta, D. C.

Tickets are out for the annual outing of the bowling team, which will be held this year at Chesapeake Beach on June 25th. Wm. F. Gude spoke earnestly in support of the bowling team and advocated that greater recognition be shown that organization. He also moved that the club re-adopt the plan of last summer and hold the summer meetings out-of-doors, first of which should be held at his home. This motion was unanimously accepted. After adjournment refreshments were served by Mr. Gude.

FLORISTS' CLUB OF PHILADELPHIA.

The June meeting held on the 1st inst. was slimly attended, coming so close on the Memorial Day rush and also on account of the street car strike. Even the essayist of the evening failed to put in an appearance. Mr. Lonsdale was to have read a paper on "Bedding Plans," and many came quite a distance to hear him and were correspondingly disappointed. Routine matters of the usual uninteresting kind occupied most of the time. No exhibits. The Lonsdale talk will be the feature of the July meeting.

AMERICAN PEONY SOCIETY

The seventh annual meeting and sixth annual exhibition of the society will be held June 11 and 12, '09, at the Cottage Gardens, Queens, N. Y., and all consignments of flowers for exhibition must be addressed to the Cottage Gardens Co., Queens, Long Island, N. Y.

Express charges on all exhibits must be prepaid, and should be so marked on the boxes, as no charges will be paid by the manager of the exhibition.

All entries must be sent direct to the manager of the exhibition, Mr. R. T. Brown, Cottage Gardens, Queens, N. Y., so as to reach him at least two days before the exhibition. While it is not wished to debar anyone who wishes to make an exhibit, compliance with this rule will greatly facilitate the work of arrangement. All entries not staged by 1 P. M., June 11, will be disqualified from any and all competition.

The society will furnish uniform cards for all exhibits entered in competition and any exhibit not so marked will not be judged in any of the classes.

The premium list includes classes for commercial and amateur exhibitors, with liberal prizes. Copies may be obtained from the secretary, A. H. Fewkes, Newton Highlands, Mass.

The meeting promises to be a very interesting one. Mr. Ward's extensive collection will be in fine condition and owing to the great number of varieties represented it will be worth travelling many miles to see.

All who can do so should send flowers for the exhibition as the facilities for keeping them until the time of the exhibition are of the best and they will be cared for by experienced men in charge.

In connection with the exhibition Mr. Ward wishes to have it distinctly understood that the Cottage Gardens Co. will not be a competitor in any of the classes.

Visitors can conveniently stay at any of the New York hotels, as Queens is situated within the limits of Greater New York, about eleven miles from Herald Square and can be easily reached by the subway connecting with trains every hour at the Flatbush Avenue Station, Brooklyn. Conveyances will meet all trains at Queens during the two days of the convention and lunch will be served to those present at the meeting.

The regular business meeting will be held at 3 P. M., on the first day, June 11.

Officers.

President, C. W. Ward, Queens, N. Y.

Vice-president, C. J. Maloy, Rochester, N. Y.

Treasurer, J. H. Humphreys, Germantown, Pa.

Secretary, A. H. Fewkes, Newton Highlands, Mass.

PEONY SOCIETY MEETING POSTPONED.

Owing to the prevailing cold weather of last week, it has been decided to postpone the meeting of the Peony Association until June 11th and 12th.

ROYAL HORTICULTURAL SOCIETY.

On the occasion of the meeting of this society on Tuesday, May 18, the hall at Vincent Square, Westminster, was, as on the previous meeting, packed to overflowing with plants and flowers in season. Only the orchids were missing, *Laelia purpurata* being the solitary exhibit—good examples in fine bloom.

Of new or rare plants the following were noted, viz., *Verbena Princess of Wales*, a deep blue variety having almost globular flower head; and King of Scarlets, of a very bright tint and the same kind of truss. Both make excellent plants for culture in pots or for bedding purposes. *Clorinda*, a geranium of a cerise red tint and having fragrant foliage the shape of an oak leaf, has a flower of 3 inches diameter. It was raised from two Cape species by the late Doctor Bonavia; plants that some nursery firms are trying to force into public favor, but not with much chance of success.

These exhibits came from H. B. May & Sons of Edmonton; M. H. Corveon of Geneva, the well known cultivator of Alpine plants, showed many rare plants, but I now only mention two which compelled attention—the scarlet flowering *Silene Virginicum*, and *Gentiana angulosa* of a tint of blue, like that of *G. verna*, but a better expanded flower. Messrs. Bunyard & Co. of Maidstone showed the showy *Statice Suworowi*, a plant with tall compound flowerstalks and violet pink flowers arranged on spikes, ranging from 3 inches to 12 inches in length; the poppy-like *Meconopsis integrifolia* with blooms of lemon yellow color and *Saxifraga McNabiana* producing pyramids of white blooms arranged in corymbs, a good subject for greenhouse decoration when grown in 3 inch pots. This should be a good market plant. Amos Perry of Enfield, Middlesex, was an exhibitor of various hybrids of iris raised by that famous cultivator of the genus, the late Sir Michael Foster. There were 1. *Vaga*, 1. *Kolkowi*, 1. *balkana*, 1. *Hungaria*, 1. *Calypso* and 1. *Andromache*, etc. The colors of the blooms were of various shades of blue and deep purple.

A number of Himalayan and other species of rhododendrons came from the gardens of Sir E. G. Lover, at Horsham, Sussex. I noted *Coombe Royal*, *Aucklandi*, *Kewensis*, *cinnabarina*—two plants of different shades of dull red, very distinct looking species, and not often met with in gardens.

Many plants of the Odier or spotted varieties of pelargoniums, very ornamental for greenhouse use, but which are greatly gone out of cultivation here, were shown by Heath & Son, of Cheltenham. Very good were the varieties, viz. *Vulcan*, *Marchand*, *Souvenir de Madame Royer*, *M. Gaston Alling*, and *Negress* a very dark colored pretty flower.

Some extremely large flowered annual chrysanthemums were shown by Mrs. Bischoffsheim, the best being *Morning Star*, the colors being lemon yellow, the disc of an orange color, with a bright yellow ring around it;

Rhododendrons

No Estate Complete Without Them.

We have the hardy ones in unlimited quantity. We can supply

The American Nursery Trade

with the quality and the sizes required.

Talk Now Before Stocks are Depleted.

JOHN WATERER & SONS, Ltd.

American Nursery, Bagshot, England.

Lord Beaconsfield, with smaller blooms, 4 inches in diameter, marked with rings of deep rosy purple and of yellow, and florets of a pale rose tint. Paul & Son, Cheshunt, had a new form of *Kerria Japonica* named *grandiflora flore pleno*. It greatly exceeds the old *K. Japonica* in the size of the bloom.

Tulips formed the chief attraction, and next came Rambler and other climbing roses.

FREDERICK MOORE.

CONNECTICUT HORTICULTURAL SOCIETY.

This society held its second semi-monthly meeting on the evening of May 28th, in Hartford, President Huss presiding. William E. Stewart, of New Britain, who was elected to membership, makes the 120th active member. John Gerard and Oscar F. Gritzmacher, both of New Britain, brought specimens of over two hundred varieties of pansy blooms. Mr. Gerard's collection was not for competition, and Mr. Gritzmacher received a vote of thanks of the society, on the recommendation of the judges, Messrs. Stewart, Zuger and Sperry. Mr. Gerard then gave a short, interesting address concerning the pansy, and he has promised to present a paper on the subject at some later time. He is a pansy specialist, and is looked upon hereabouts as an authority in pansy lore. J. A. Weber, gardener for Walter L. Goodwin, was awarded honorable mention for specimens of Early Snowball and Thorburn's Gilt Edge cauliflower, and a certificate of merit for an exhibition of splendid-looking mushrooms. At

the next meeting, on June 11th, arrangements will be made for the fall exhibitions of the society.

GEORGE W. SMITH, Sec.
Melrose, Conn.

PENNSYLVANIA HORTICULTURAL SOCIETY.

The peony show scheduled for the 27th of May proved a disappointment, flowers generally being more backward than expected. A good display of hardy perennials was in evidence. The Newbold estate sent a very fine collection of the latter, many of the specimens being rare and all the collection of unusual interest. Herman Van Goden, who had charge of this exhibit, deserves a word of praise for careful and correct labeling. Francis Canning, gardener for Samuel T. Bodine, also had a fine exhibit of perennials. S. Hammond from Ellison's, was the chief exhibitor for the salad prizes.

CLUB AND SOCIETY NOTES.

The Gardeners' and Florists' Club of Baltimore will hold their annual picnic at Avondale on July 14.

At the meeting of the New London County Horticultural Society at Norwich, Conn., on June 1, B. Hammond Tracy on the gladiolus and Mrs. E. M. Rogers on native orchids, were the speakers.

The Rose Festival at Portland, Ore., is to be held on June 8 and 9 and 75 silver cups are offered for amateurs. In the class for nurserymen, for exhibit of roses and shrubbery, the first prize is \$100, second \$60, third \$40.

The Florida Horticultural Society, at their meeting in Daytona, on May 20, elected the following officers: President, H. Harold Hume, of Glen St. Marys; vice-presidents, W. C. Temper, H. B. Stevens, B. F. Chilton; secretary, E. O. Painter, of Jacksonville; treasurer, W. B. Hart.

WOOD LABELS For Nurserymen and Florists

THE QUALITY THAT GIVES SATISFACTION

No orders too large for our capacity, or too small to receive our careful attention. Samples and Prices are at the command of a communication from you.

DAYTON FRUIT TREE LABEL CO.
SOUTH CANAL STREET, DAYTON, O.

Seed Trade

AMERICAN SEED TRADE ASSOCIATION.

Watson S. Woodruff, Orange, Conn., Pres.; J. C. Robinson, Waterloo, N.D., First Vice Pres.; C. E. Kennel, Cleveland, O., Sec'y and Treas. Twenty seventh annual convention June 22-24, 1909, at Clifton House, Niagara Falls, Ont.

WHOLESALE SEEDSMEN'S LEAGUE.

F. W. Bruggenbaf, Pres.; Burnet Lindseth, Sec'y.

An Unwarranted Attack Upon the Canning Industry.

It would be interesting to know what influences are behind the propaganda conducted by one William Wolff Smith against canned foods. Mr. Smith, presumably, is not conducting this attack for glory or amusement. He is known as a man whose services can be had to help secure the passage or repeal of legislative acts favorable to or inimical to any particular interests through the creating of public opinion against any measure he wishes repealed, and contra in favor of any enactment desired by him or those he represents. He seems to command a publicity bureau which he works assiduously. The writer recalls a specific instance of this kind, but for valid reasons will not mention it at this time. Probably Mr. Smith would object to being called a lobbyist, however.

Going back to the literature which he is disseminating, can it be that he is trying to create a public prejudice against canned foods in general, though possibly aiming to boost some brand in particular? There is a persistent rumor that a certain purveyor of canned foods has been back of the sensational and absolutely false statements appearing in certain yellow newspapers, and one or two more weighty periodicals, which have lent their space to the publication of these utterly ignorant and misleading if not malicious statements.

William Wolff Smith quoted Dr. Wiley against the use of benzoate of soda and plainly seeks to create the impression that it is used in practically all canned foods. He says: "It has been successfully used in ketchup, soups, preserves, apple-butter, soda water syrups, jellies, etc., and it is believed will replace boric acid in the embalming of roast beef, sausage both green and smoked, potted tongue, ham and chicken, etc." He mentions many other items including practically all pickles, jams and preserves, and says further that to the great preservative properties of this drug are we indebted for the wonderful state of preservation of the Egyptian mummies. He criticises the findings of the Remsen board, at the same time saying that during their investigations, "some symptoms were noticed that were not fully understood"; implying that the board were in doubt about the accuracy of their report.

Now, no one questions the preservative properties of benzoate of soda, and as to its harmful effects, authorities at East differ when it is used in very small quantities. William Wolff Smith says it can now be used all around in, plainly implying that it will be found in

large quantities, when as a matter of fact those who find its use necessary will reduce the quantity to the lowest minimum required. To what extent it is used in jellies, jams and preserves, if at all, the writer is unable to state positively, but as a general rule its use is limited to such condiments or other products as are not all consumed at once upon being opened, but which are used in small quantities only, and are expected to remain in edible condition for several days. As a well-nigh universal rule, all food products of fruits or vegetables hermetically sealed either in glass or tin are put up without benzoate of soda or any other preservative.

"The Journal of American Medical Association," is quoted in part as follows: "Benzoate of soda is incorporated in foods either to obviate the necessity of cleanliness in preparation, or to permit the use of inferior products. The use of sodium benzoate to preserve foodstuffs has proved unnecessary." If correctly quoted, here is a responsible—one might say authoritative journal—giving circulation to a most rash and unfounded statement, indicating either absolute ignorance or disregard of facts on the part of its author. It is not improbable that an occasional obscure canner may use unwholesome products and may operate under unsanitary conditions, but to indict all canners in this sweeping manner is rankly unjust, and somebody should be called to book.

It is strange how frequently Dr. Wiley is quoted, showing quite conclusively, it seems to the writer, that the Doctor's statements have created a most unfavorable impression in the past, whatever his intentions were, and his recent letter to Mr. Frost was only the amende honorable. By the way, Mr. William Wolff Smith and all other traducers of the canning industry are cordially invited to read this letter published herewith, and note what the chief authority for most of their misstatements and scurrilous abuses has to say as to the wholesomeness and freedom from preservatives of any kind, of practically all kinds of canned foodstuffs, excluding, of course, condiments. Thousands of experiments and years of experience have demonstrated most fully, that the only preservative required for such products is sterilization by heat, and it would be idiocy to go to the expense and trouble of adding drugs or chemicals. That preservatives and adulterants have been used more or less in the past is not denied, but it can be emphatically stated today that above 95 per cent. of all foods in tin or glass are free from preservatives or drugs of any kind.

Dr. Wiley's letter to Mr. Frost reads in full as follows:

Washington, D. C., May 1, 1909.
Mr. Walter A. Frost,
57 Wabash Ave., Chicago, Ill.

Dear Mr. Frost, I have often regretted the inadvertent injury which is done to the canned goods trade by enthusiastic, well-intentioned, and yet not fully informed writers, implying that canned goods, as such, are adulterated. I think I can safely say that, taking the whole matter of canned goods together, including fish, canned meats, canned vegetables, and canned fruits, only an extremely small percentage of them ever contain any added substances whatever, except food and perhaps a little salt or sugar. I think this fact ought to be well advertised and published.

Of course, I do not include in canned

goods, articles which have not been sterilized, for in such articles preservatives are often employed. I do not think the great canning trade should suffer because such an insignificant few persist in either using artificial color, artificial sweetener, or a chemical preservative.

Under the rules of the Department of Agriculture certain substances may be used in foods legally, provided their presence is plainly stated upon the label. Buyers of canned goods, therefore, have a certain method of protecting themselves in this matter, and that is to look at the label. When we consider the immense benefit of the canning industry to the consuming public, it appears to me that we ought to use every honorable endeavor to set the minds of the community right in regard to the composition of such articles. Of course, some canned goods are of better quality than others, that is a natural and necessary consequence; but the impression that some people obtain that all canned goods contain artificial colors, artificial sweeteners, and preservatives, is a most erroneous one and is harmful to the trade, inasmuch as you know, I believe in canned goods and in the canning process. I think it is a blessing, and a blessing which is not in disguise. I realize as well as anyone that public prejudice is difficult to control and to rectify, but I should like to do as much as I can to help this good trade along by appealing to the public not to condemn the whole trade because occasionally a sample may be found which is not in that state of purity which the public demands. Let the people give their confidence to the trade and let them eliminate those goods which they do not want to purchase, by inspection of the label.

If you think this letter will be of benefit to the trade, I shall be very glad to have you publish it. Respectfully,

F. W. WILEY.

In passing it may be pointed out that Mr. William Wolff Smith does not directly charge that all canned foods are "doped." He says, "it has been successfully used," and again, "it is believed it will replace boric acid," etc.

This is largely innuendo and implication, but it is probably quite as effective with the average reader as specific and direct charges.

Crop Prospects.

Weather conditions have greatly improved and crops are going into the ground rapidly with growing conditions about ideal. Peas are late, but there is ample time for corn, beans and all vine seeds, and there is hope for good crops of these, but peas are starting under more or less of a handicap, though with favorable conditions up to harvest, a good average crop may be looked for.

The Conventions.

Those contemplating attending the forthcoming seedsmen's convention should lose no time in making application for rooms, as with its regular patrons, the hotel will be well filled. Address "The Clifton," Niagara Falls, Ontario.

Atlantic City has been selected as the place for the next canners' convention. "The Randolph" is to be headquarters as in 1906. Something further may be said about both of these conventions in the near future.

Personal.

John Badger and wife of Gardena, Calif., sailed on the S. S. Carmania on May 22 for a European trip.

D. Hamilton and C. C. Massie of No. 7rup, King & Co., Minneapolis, Minn., sailed on the Baltic on the 26th ult. for Europe.

G. C. Eldering of W. J. Eldering & Son, Overton, Holland, will sail from New York on June 8 on the New Amsterdam.

JULIUS ROEHR'S CO., RUTHERFORD N. J.

Large stock of Bay Trees, Box Trees, Blue Spruce, Choice Evergreens, etc., all in finest condition.

Palms, Stove Plants, Begonias, Hydrangeas in all sizes and prices.

ORCHIDS

Fine assortment on hand of both newly imported and semi-established.

LET US QUOTE YOU PRICES.

Kentia Belmoreana

Delivery from now on	Per 1000	Per 100
Strong seedlings, ready to go in		
2 1/2 in. pots.....	\$25.00	\$3.00
2 1/4 inch plants, fine bushy stuff	75.00	8.00

Cocos Weddelliana

Per dozen	Per 100
Fine established healthy plants from 2 1/4 in. pots.....	\$90.00 \$10.00

Satisfaction Guaranteed.

O. V. ZANGEN, Seedsman, Hoboken, N. J.

HEACOCK'S PALMS

Kentia Belmoreana		
7-inch pots.....	32 to 34 inches high.....	\$2.50 each
7-inch pots.....	36 to 38 inches high.....	3.00 "
9-inch tub.....	42 to 48 inches high.....	5.00 "
Made up Kentia Forsteriana		
7-inch pots.....	34 to 36 inches high.....	\$2.50 each
7-inch pots.....	36 to 38 inches high.....	3.00 "
9-inch tub.....	42 to 48 inches high.....	5.00 "

Joseph Heacock Co., Wyncote, Pa

PEACOCK'S CELEBRATED NEW DAHLIAS JACK ROSE and other cut flower sorts.

SEND FOR CATALOG.

Peacock Dahlia Farms
Williamstown Junction, N. J.

The Northboro Dahlia and Gladiolus Gardens

Offer for Spring 1909
300 selected varieties of Dahlias and one and one half million large-flowering Gladioli in mixtures, in lots to suit. Send list of your wants. Catalogue free.

J. L. MOORE, Northboro, Mass

DAHLIAS.

Now is the time to place your order for bulbs which will assure you getting named varieties in any quantity; prompt delivery.

DAVID HERBERT & SON,
Successors to L. K. Peacock, Inc.
ATCO, N. J.

In ordering goods please add "I saw it in HORTICULTURE."

CANNAS

Strong plants from pots 25 leading varieties, \$5.00 per 100.
ESTATE OF DAVID FISHER, Woburn, Mass.

OFFERS ENOUGH.

Horticulture Publishing Company:
Gentlemen:—You may stop want ad. in your paper. I got offers and information enough.

Yours respectfully,
ED. HERRMANN.

Baltimore, Md.

GERANIUMS, DAHLIAS AND BEDDING PLANTS

We have one of the most complete collections of Geraniums in the country, containing every color and type found in the Geraniums. Every one of our 75 Standard Varieties at \$2.00 and \$3.00 per 100 are Bread and Butter Winners, and among our 34 New Varieties of special merit are some that are going to fix the standard in the future. Every one is a Gem, not high in price, only \$4.00 and \$6.00 per 100.

Our Novelties should, coming as they do from the leading introducers of the world, represent the highest development of Geraniums at the present time. A collection of 100 Varieties, our selection of 1907 and 1908 Novelties, will be sent for \$10.00.

Special Offer of 1000 good, strong plants from 2 in. pots, our selection of 20 distinct kinds from among our Standard and Newer Varieties, for \$15.00 cash. From 3 in. pots \$3.00 per 100, \$25.00 per 1000, in a good assortment.

CANNAS

Strong plants from 3 in. pots. J. D. Elsele, Egandale, Alphonse Bouvier, Mme. Crozy, and Florence Vaughan, \$4.00 per 100. Jean Tissot, President Myers, Louisiana, Pennsylvania, \$5.00 per 100.

DAHLIAS

We have one of the finest collections in the country of good distinct Commercial Varieties at \$2.00 per 100 and up for plants ready for shipment. Then we have Jack Rose, Virginia Maule, Big Chief, Rose Pink Century, Pringed 20th Century, Rebecca Mayhew, etc., at 50c. each, \$5.00 per doz., \$35.00 per 100. We will send 1000 in 20 good distinct Cut Flower Sorts, our selection, for \$18.50.

See issue of April 24th or Our Wholesale Catalogue for complete list of Bedding plants.

R. VINCENT, JR., & SONS CO., White Marsh, Md.

ROSE PLANTS

Fine, Strong, Healthy

3-inch pots	Per 100	Per 1000	2 1/2-inch pots	Per 100	Per 1000
American Beauty	\$7.00	\$65.00	American Beauty	\$5.50	\$50.00
Richmond	4.00	35.00	Richmond	3.00	25.00
Chatenay	4.00	35.00	Chatenay	3.00	25.00
Ivory	4.00	35.00	Ivory	3.00	25.00
Bride & Maid	4.50	40.00	Bride & Maid	3.50	30.00

Asp. Sprengeri, 4-in. pots, \$8.00 per 100.
Asp. Plumosus, 3-in. pots, 5.00 "
Smilax, 3-in. pots, 4.00 "

UNITED STATES CUT FLOWER CO., Elmira, N. Y.

American Grown Roses

Fruit and Ornamental Trees. Shrubs, Small Fruits, Clematis, Evergreens.

Write for Trade List.

W. & T. SMITH CO.

Geneva, N. Y.

Cannas

Dry roots: Italia, Cleveland, Austria, Egandale, Marlborough, America, Penna, Black Beauty, \$1.50 per 100, Kate Gray, mixed with red, \$1.25 per 100 Asparagus Sprengeri, 2 in., \$1.75, 3 in., \$4.00, 4 in., \$6.00 per 100. Francena miliv, 4 in., 10c. English Ivy, 2 in., \$2.00; R. C. 75c per 100. Rex Begonia, 2 in., 3c. J. H. DANN & SON, - WESTFIELD, N. Y.

Box Trees

and other EVERGREENS for Tubs and Boxes
Our Prices are Always Right—Catalog Free
THE NEW ENGLAND NURSERIES, INC.
BEDFORD, MASS.

Hardy Rhododendrons, Azaleas, Conifers, Clematis, H. P. Roses, Shrubs and Herbaceous Plants from our
HOLLAND NURSERIES
Prices Moderate

P. OUWERKERK, 216 Jane St., Westhoken Heights P. O. No. 1, Hoboken, N. J.

AMERICAN SEED TRADE ASSOCIATION.

Secretary C. E. Kendel announces that the Clifton Hotel, Niagara Falls, Ontario, has been selected as headquarters for the 27th annual convention, June 22-24.

A special rate has been obtained for the members as follows, all on the American plan, which includes the banquet on Wednesday evening as well as all other meals.

Room without bath, per person, \$4.00 per day.

Room with bath, one person, \$6.00 per day.

Room with bath, two in a room, \$5.00 each person per day.

Arrangements may be made with the customs authorities to allow automobiles to enter Canada for the three days' stay without paying the customary license.

Word has been received that at least one large grass seed dealer in Darmstadt will send a representative to the convention to meet the dealers on this side, ostensibly, the secretary has been led to believe, to confer on matters connected with this branch of the trade.

Several notable men connected in various capacities with horticulture have promised to address the association, chief among them, Prof. Liberty H. Bailey, of Cornell.

The subjects to be considered are vital and a large attendance is anticipated, especially with the meeting place so attractive and accessible. It is therefore advisable, while the hotel accommodations are ample, to secure rooms in advance.

The program is as follows:

Order of Business.

Reports of the Secretary and Treasurer—Election of Members—Reports of Committees—Reading of Communications—Unfinished Business—New Business—General Discussions—Annual Election and Installation of Officers. Opening Session, Tuesday, June 22, 10 A. M.

The National Organization of Seed Analysts. Its Purpose and Scope. By the President, Dr. E. H. Jenkins (Director Connecticut Experiment Station).

Root Crops. Prof. C. A. Zavitz (representing Ontario Agricultural College, Guelph, Ont.).

Seed Legislation. Its Uses and Abuses. Prof. L. H. Pammel (Iowa State College of Agriculture).

A Campaign for Rural Progress. Prof. Liberty H. Bailey (Director New York State College of Agriculture, at Cornell University).

The Deterioration of Types of Cabbage. J. M. Lupton, Mattituck, L. I., N. Y.

Color Photography. Illustrated with Views from Nature. J. Horace McFarland, Harrisburg, Pa.

Tuesday Evening, 8.45.

Concert by Clifton Hotel Orchestra, followed by informal dancing.

Wednesday Evening, 8 O'clock.

Banquet. A few five-minute Talks, followed by Mr. McFarland's Lecture on Color Photography.

Officers 1908-1909.

President, Watson S. Woodruff, Orange, Conn.

Reliable Flower Seeds

PRIMULA KEWENSIS
New Verbena Scented
YELLOW PRIMROSE

A cross between P. Floribunda and P. Verticillata, of strong, vigorous growth, producing numerous spikes, bearing four to six whorls of bloom, of large size, and of a clear, canary yellow color. Trade pkt. 50c.

WRITE FOR OUR WHOLESALE CATALOGUE.

HENRY F. MICHELL CO.,

1018 Market St., Phila.

First Vice-President, J. C. Robinson, Waterloo, Neb.

Second Vice-President, M. H. Durvey, New York.

Secretary-Treasurer, C. E. Kendel, Cleveland, O.

Assistant Secretary, Leonard H. Vaughan, Chicago.

Executive Committee.—George S. Green, Chicago; Howard M. Earl, Philadelphia; Chas. Dickinson, Chicago; Chas. N. Page, Des Moines, Ia.;

S. F. Willard, Wethersfield, Conn.

Membership Committee.—Albert McCullough, Cincinnati, O.; F. W. Bologiano, Washington, D. C.; Leonard H. Vaughan, Chicago, Ill.

INCORPORATED.

Norfolk, Va.—George Tait & Sons, to grow, buy and sell seeds; president, J. C. Tait; secretary and treasurer, Robert Tait; capital, \$100,000.

SEED TRADE NOTES.

Howard M. Earl left on his annual crop inspection tour west by way of New Orleans on the 3rd inst. Mr. Burpee starts a week later by a different route.

It is surprising how little is known of actual conditions by those connected more or less closely with the trade, and if one may judge by what he reads, some persons do not know that most contracts for future peas, beans, corn, and, in fact, most other seeds have long since been closed.

The Rontzahn Seed Co. of Arroyo Grande, Calif., report that, "crops in general with us are looking above the average. Especially is this true of sweet peas, nasturtiums and flower seeds in general. Lettuce, salsify, tomato and cucumber are good. Onion prospects about two-thirds of a crop. Pole beans in course of planting."

CATALOGUES RECEIVED.

J. F. Rosenfield, West Point, Neb.—Wholesale Price List of Peonies for Fall, 1909.

King Construction Co., North Tonawanda, N. Y.—Bulletin No. 25, describing their new iron-frame greenhouses. In it is given a description of the house in course of erection for the Florex Gardens, North Wales, Pa., 700 ft. in length and with the unprecedented width of 172 ft. This house covers about 3 acres of ground and is intended to hold 70,000 American Beauty plants, 135 tons of glass, over 10 miles of pipe for frame work, 10 miles of piping for heat, are other factors in the construction, and the beds, if put end to end, would be over six miles in length.

Giant Pansy Seeds

Representing seven of the best growers of Europe. Each color or stain packed separately. The proportion of light and dark is well blended.

Florist Collection—16 pkt. Hybrid Giants, 8 pkt. Giant Five Blotched, 8 oz. in each pkt.; in all, 24 pkts., weight 1 oz. \$7.96
Half Florist Collection—24 pkts., weight 1/2 oz. \$3.93
Amateur Collection—24 pkt., 500 seeds in each pkt., 12,000 seeds, \$2.50
Cottage Collection—12 pkt., 500 seeds in each pkt., 6,000 seeds, \$1.25
Mixture—extra fine, 1000 seeds, 25c
Exhibition Collection—4 pkt., 500 seeds in each pkt., 2000 seeds, \$1.00

Send for descriptive list of prize winners
JOHN GERARD, New Britain, Conn.

NEW CROP SEED

For Early Planting
THOMAS J. GREY CO.
2 SO. MARKET ST., EGSTON, MASS.

CAULIFLOWERS^S
ABBA**C**E^E
LILY OF THE VALLEY PIPS.
HJALMAR HARTMANN & CO.
Langangssraede 20,
COPENHAGEN, DENMARK.

PUBLICATIONS RECEIVED.

Annual Report of the Commissioners of Lincoln Park, Chicago, for the Year 1908—A volume of 90 pages, giving full details and statistics of park and boulevard extension and maintenance, illustrated with half-tone views, maps, diagrams, etc., and list of specimens in the zoological department.

The schedule of prizes for the annual June exhibition of Roses, Strawberries and Hardy Flowers by the Tarrytown Horticultural Society has been issued. The show will be held at the Young Men's Lyceum on the afternoon and evening of June 15. Copies of prize list may be obtained from secretary E. W. Neubrand, Tarrytown, N. Y.

VEGETABLE PLANTS

BETS: Crosby, Egyptian and Eclipse, \$1.25 per 1000.

CABBAGE: Field Crown, all leading varieties, \$1.00 per 100. 10,000 and over, 85c per 1000.

CELERY: White Plum, Golden Self Blanching and Giant Pascal, \$1.25 per 100.

EGG PLANT: N. Y. Improved and Black Beauty, \$1.00 per 1000.

LETTUCE: Big Boston, Boston Market, Tennis Ball and Grand Rapids, \$1.00 per 1000.

PEPPERS: Ruby King, Bull Nose, Sweet Mountain and Neapolitan, \$1.00 per 1000. Chinese Giant and Cavendish, 50c per 100.

CASH WITH ORDER

R. VINCENT, JR., & SONS CO.
White Marsh, Md.

Everything "For the Land's Sake."

The one firm in Boston where all good forms of plant food may be obtained, is the Bowker Fertilizer Company, opposite Faneuil Hall at 43 Chatham St. All greenhouse chemicals, Nitrate of Soda, Ground Bone, Potash Salts, Sheep Manure and Wood Ashes can there be had at first hands.

BOWKER FERTILIZER COMPANY

Everything "For the Land's Sake."

BEGONIAS TUBEROUS ROOTED

—ALSO—
GLOXINIAS, LILY OF VALLEY, SPIREA

Catalogues mailed free on application
Joseph Breck & Sons Corp.
47-54 NO. MARKET ST., BOSTON, MASS.

BULBS OF QUALITY

- | | |
|------------------------------------|--------|
| Begonias, Single, under color..... | \$2.75 |
| " Double " " " " " " " " " " | 5.00 |
| " Frieled " " " " " " " " " " | 10.00 |
| Gloxinas, under color..... | 4.00 |
| Pearl Tuberoses, \$7.00 thous..... | 1.00 |

Schlegel & Fottler Co.
26 & 27 So. Market St., BOSTON, MASS.

Burpee's Seeds
PHILADELPHIA

Blue List of Wholesale Prices mailed only to those who plant for profit

Ward's Lily Bulbs



Send for Catalogue
Ralph M. Ward & Co.
12 W. Broadway
NEW YORK

GEO. E. DOW
Designing and Illustrating
178 Washington St., Boston, Mass.
OUR SPECIALTY
Machine, Booklet, Advertising and Flower PHOTOGRAPHS

Primulas for Christmas

SOW SEED NOW

B's Matchless Giant, pure white; B's Matchless Giant, bluish white; B's Matchless Giant, rose; B's Matchless Giant, scarlet; B's Matchless Giant, royal blue; B's Matchless Giant, mixed. Each 1-2 trade packet, 60c; trade packet, \$1.00.

Primula obconica gigantea Kermesina, deep crimson. Primula obconica gigantea alba, pure white. Primula obconica gigantea lilacina, beautiful lilac. Primula obconica gigantea rosea, lovely pink. Primula obconica gigantea grandiflora, mixed, containing pure white to deep crimson.

Each of above 1-2 trade packet, 30c; trade packet, 50c.
Primula floribunda grandiflora (Buttercup) 1-2 trade packet, 1.30c; trade packet, 50c.
Forbesi (Baby Primrose). Trade packet, 25c; Primula Kewensis (Giant Buttercup) 1-2 trade packet, 60c; trade packet, \$1.00.

Seedsman
ARTHUR T. BODDINGTON, 34 2 W. 14th Street, New York

LEONARD SEED CO.

CONTRACT CROWERS AND WHOLESALE DEALERS

BEANS, PEAS, SWEET CORN, ONION, GARDEN SEEDS

ONION SETS 79 and 81
FLOWER SEEDS Get Our Prices E. KINZIE STREET, CHICAGO

Novelties and Crops For Inspection

The Routzahn Seed Co. Announce

That their Novelties consisting of many new and beautiful Spencer Type of Sweet Peas, Gorgeous Nasturtiums of Both Flower and Foliage, and other crops, will be ready for the inspection of the Trade from about June 15th to July 15th. A circular invitation is extended to all interested.

ROUTZAHN SEED CO., - ARROYO GRANDE, CALIFORNIA.

ESTABLISHED 1802



LILIUM HARRISII

True stock from most reliable growers

PURITY FREESIA

SEND FOR SPECIAL ADVANCE PRICES FOR EARLY ORDERS

J. M. THORBURN & CO.
33 Barclay Street
NEW YORK

Mignonette

FARQUHAR'S GIANT

Oz., 75c; 1-4 oz., 25c

R. & J. Farquhar & Co.

6 & 7 South Market Street
BOSTON, MASS.

SHEEP MANURE

IT'S STERILIZED

Free from Weed Seeds.

\$24.00 Ton;
\$7.00 quarter of Ton.

Wm. Elliott & Sons
42 Vesey St., New York

RELIABLE SEEDS—SOW NOW

PRIMULA OBCONICA GRANDIFLORA
1000 seeds Tr. pkt.
Blood red, fine seller.....\$1.60 .50
Real pink, fine for cut..... 1.00 .50
Pure white, fine for cut..... 1.00 .50
Compact, the potter..... 1.50 .50
Mixed Hybrids..... 1.00 .50
O. V. ZANGEN, - HOBOKEN, N. J

BRIDGEMAN'S SEED WAREHOUSE

RICKARDS BROS.

Props.

37 East 19th St., - NEW YORK CITY

STOCK SEED

FOR WINTER BLOOMING
Our strain of Double Branching Stocks is exceptionally true. About 90% Double Flowers.

In colors: -- 1/2 oz. .60 or.....\$4.00
Pure White 1/2 " .75 " " " " 5.00

H. E. FISKE SEED CO.
Faneuil Hall Square, BOSTON, MASS.

Winter-flowering SWEET PEAS

have been the best money-makers the past winter.
NEW PRICE LIST of those celebrated Sweet Pea seeds will be ready soon. Send for it to the editor.

Ant. C. Zvolanek, Bound Brook, N. J.

JOHN BREITMEYER'S SONS

Cor. Miami and Gratiot Aves.
DETROIT, MICH.

**Artistic Designs . . .
High Grade Cut Blooms**

We cover all Michigan points and good sections of Ohio, Indiana and Canada

WILLIAM J. SMYTH FLORIST

Cor. Michigan Ave. and 31st St., CHICAGO
We ship to all points in Illinois and Iowa.
Phones: Douglas 744, Douglas 523, Douglas 740

HAUSWIRTH THE FLORIST

Out of Town orders for Hospitals
Carefully filled.
**232 Michigan Ave.
CHICAGO**
AUDITORIUM ANNEX Tel. Harrison 585

SAMUEL MURRAY Florist

Coates House Conservatory
1017 BROADWAY, KANSAS CITY, MO.
Both 'Phones 2670 Main.



WASHINGTON,
D. C.

GUDE'S

The Far-Famed Flowers of TORONTO

Delivered on mail or telegraph order for any occasion, in any part of the Dominion.
JOHN H. DUNLOP,
96 Yonge St., - Toronto, Ont.

The Park Floral Co.

J. A. VALENTINE,
Pres.

DENVER, COLORADO

WILLIAM L. ROCK FLOWER CO. KANSAS CITY, - MO.

will carefully execute orders for Kansas City and any town in Missouri or Kansas.



Buffalo, N. Y.

W. J. PALMER & SON, 304 Main St.

Of Interest to Retail Florists

NEW FLOWER STORES.

McKeesport, Pa.—J. W. Butler, Fifth Ave.
Braceville, Ill.—Wm. Moran, Harris Building.
Bay City, Mich.—Schweirs & Potratz Floral Co.; So. Euclid Ave.

BUSINESS CHANGES.

Cleveland, O.—Mr. Davis has taken the Hoyt greenhouses this season.
North Wales, Pa.—Wm. Frost has purchased the nursery of T. N. Yates & Co.
St. Louis, Mo.—The Eggeling Floral Co. have removed all their green-

STEAMER DEPARTURES

Allan.	June 11
Laurentian, Boston-Glasgow.	June 11
American.	June 12
St. Paul, N. Y.-Shampton.	June 12
New York, N. Y.-Shampton.	June 12
Atlantic Transport.	June 12
Minnewaska, N. Y.-London.	June 12
Minneapolis, N. Y.-London.	June 12
Cunard.	June 12
Lusitania, N. Y.-Liverpool.	June 9
Saxonia, Boston-Liverpool.	June 15
Mauretania, N. Y.-Liverpool.	June 16
French Line.	June 19
La Provence, N. Y.-Havre.	June 19
La Savoie, N. Y.-Havre.	June 17
Hamburg-American.	June 19
Pres. Lincoln, N. Y.-Hamb'g.	June 9
Melita, N. Y.-Med. Forts.	June 10
Cincinnati, N. Y.-Hamburg.	June 12
Leyland Line.	June 12
Winifredian, Boston-Liv'pool.	June 9
North German Lloyd.	June 12
Kp. Wilhelm, N. Y.-Bremen.	June 8
Kp. Cecilia, N. Y.-Bremen.	June 15
White Star.	June 12
Oceania, N. Y.-Shampton.	June 9
Celtic, N. Y.-Liverpool.	June 12
Canopic, N. Y.-Med. Forts.	June 12
Canada, Montreal-Liverpool.	June 12
Red Star.	June 12
Kronland, N. Y.-Antwerp.	June 12

houses to Kinloch. The retail store will remain in its present location.

Ashtabula, O.—Mr. Good has purchased the interest of his partner in the business of Good & Bush, and will continue the business in his own name.

So. Manchester, Conn.—Mr. Nettleton has taken over his partner's interest in the North & Nettleton Greenhouses and will continue the business.

Cleveland, O.—F. C. Wittuhn has sold his greenhouses to C. B. Wilhelmly and will start in a new location across the street about September 1st.

Winston-Salem, N. C.—Martin McNulty, for many years manager of the company, has purchased the business of the Fallon Floral Co. \$15,000 is the price paid, it is said.

Cleveland, O.—Mr. Hoffman has bought the greenhouses of John Blechschmidt, and will carry on business there. Mr. Blechschmidt has moved into his new range.

Brooklyn.—M. D. Hanley, florist at 1285 Bedford Ave., has been indicted on a charge of presenting a fraudulent claim to an insurance company. —New York Herald.

ALEX. MCGONNELL

571 FIFTH AVENUE
NEW YORK CITY

Telegraphic orders forwarded to any part of the United States, Canada, and all principal cities of Europe. Orders transferred or entrusted by the trade to our selection for delivery on steamships or elsewhere receive special attention.

Telephone Calls, 487 and 488 38th St.
Cable Address, ALEXCONNELL

M. A. BOWE

In the Heart of New York City
**1294 Broadway
NEW YORK**
Tel. 2770, 38th St.
Our Motto—The Golden Rule

DAVID CLARKE'S SONS

Deliver orders from any part of the country to
New York City
Or OUT-GOING STEAMERS
Write or telegraph
2139-2141 Broadway, New York
Telephone 1554-1555 Columbus

YOUNG & NUGENT

42 West 28 St., NEW YORK
"FLOWERS BY TELEGRAPH"

ALBANY, N. Y.

EYRES

Flowers or Design Work

DELIVERED IN ALBANY AND VICINITY
ON TELEGRAPHIC ORDER.

11 NORTH PEARL ST., ALBANY, N. Y.

Flower Deliveries

in Brooklyn and other Long Island Points
New York City, New Jersey, etc. At Theaters,
Hotels, Steamers or Residences.

WILSON

Fulton St. and Greene Ave., Brooklyn, N. Y.

DANKER, Albany, N. Y.

ORDERS FOR

**Choice Flowers and
Floral Emblems**

FILLED PROMPTLY

Orders by Wire Receive Prompt and Careful Execution

J. Newman & Sons

Corporation

24 Tremont Street, BOSTON

Theater, Steamer and Funeral Flowers Our Specialty
We can refer to leading florists in all principal cities.
Established 1870.

LOUISVILLE, KY. JACOB SCHULZ, 550 South Fourth Ave.

WELLESLEY COLLEGE

Dana Hall, Walnut Hill and Rockledge, Mal
Schools. TAILBY, Wellesley, Mass.
Tel. Wellesley 441 and 5. Night 443.

ATLANTA FLORAL CO.

41 Peachtree Street, ATLANTA, GEORGIA

Money in June Is Easy Enough if You Make a Reach for It

Prepare for the Commencements and Graduations

Tens of thousands of graduates are expecting Floral Gifts from their friends. Art Baskets in Willow, Twigs and Bronze, Lace Bouquet Holders and other dainty receptacles can be sold by tens of thousands and if you show our goods specially prepared for this use, they will sell

LIKE HOT CAKES

Let us send you a list of them. Don't delay for we have some novelties that are Cracker-Jacks.

H. BAYERSDORFER & CO.,

1129 Arch St., Phila., Pa.

PHILADELPHIA NOTES.

Grandmother Lee, the dearly beloved of the Burion homestead at Chestnut Hill, is reported critically ill, June 1st.

C. F. Schermerhorn, assignee of Stern & Co., has sold the effects of the defunct concern to Joseph G. Neidinger.

Visitors this week: Parker Thayer Barnes, of Suburban Life, Harrisburg; P. Joseph Lynch, of Dingee & Conard Co., West Grove.

Mrs. C. P. Poryzees sailed from New York on the 2nd inst. for a trip to the old country. Mr. Poryzees intended to go along but had to change his plans at the last minute.

The monthly meeting of the Florists' Club, held on the 1st inst., was addressed by Edwin Lonsdale on "The Decoration of the Lawn." Mr. Lonsdale is an authority on this subject and we hope to be able to give his talk in full in an early issue.

Griffin Bros. the Frankford florists, have gone into orchid growing extensively. The department is under

the charge of the junior member of the firm, Bruce Griffin. All the leading commercial varieties are included in the collection which is one of the finest in this locality.

The new flower store on 13th street near Walnut is scheduled to open on the 10th inst. T. Nelson Geiger is the proprietor and manager and as chief assistants will have with him Wallace W. Faust and C. W. Moorby, both late of Graham's. The store is number 141 South 13th and is one of the series under the old Hotel Edouard. Roomy, central and will be handsomely fitted up.

A tie-up in the street car system here has hurt business considerably the past week—particularly Memorial Day, in the outlying sections where the cemeteries are located. Many timid devotees were afraid to travel. Business generally is being hurt by the blocking of transportation. Conditions do not seem to warrant a long duration to the struggle. There is a vast amount of idle labor around which is likely to prove the solvent.

Henry S. Pennock, accompanied by his father, Abram L. Pennock, and his mother arrived by the Savannah Line on June 1st from Jupiter, Fla., for a short sojourn at the old homestead in Lansdowne. This is the first time in four years that Henry S. Pennock has honored us with his presence, and we are all duly cognizant of the importance of the event. The change from the fragrance of the orange groves to the crisp atmosphere of the dogwood and "the gang" ought to be a delightful experience. Delaware County is "God's Country" after all.

CHICAGO NOTES.

Personal.

Jens Jensen has opened offices at 80 Steinway Hall, 17 Van Buren street, as a landscape architect.

A. H. Goodwin, vice-president of the W. W. Barnard Co., has returned from his six months' European trip.

Visitors.

A large number of growers and retailers have made the market during the past week. They found the Chicago men too busy to make note of their arrival, but among them were A. Peterson, Hoopstown, Ill.; Carl Hirsch, Hillsdale, Mich.; B. O'Neil, Elgin, Ill.; Chas. Trainer, South

Bend, Ind.; Wm. H. Fininger and Max Spanner, Toledo, Ohio; H. H. Fisher, Kalamazoo, Mich.; Gilbert H. Wild, Sarcoux, Mo.

"FLOWERS BY TELEGRAPH."

Leading Retail Florists Listed by Towns for Ready Reference.

- Denver, Colo.—Park Floral Co., 1706 Broadway.
- Washington D. C.—Gude Bros., 1214 F St.
- Atlanta, Ga.—Atlanta Floral Co., 41 Peach Tree St.
- Chicago—Hanswirth, "The Florist," 232 Michigan Ave.
- Chicago—William J. Smith, Michigan Ave. and 31st St.
- Chicago—George Whitbold Co., 1657-59 Buckingham Place.
- Louisville, Ky.—Jacob Schmitz, 550 South Fourth Ave.
- Boston—Thos. F. Galvin, 124 Tremont St.
- Boston—Edward MacMullin, 194 Boylston St.
- Boston—Hoffman, Florist, 59-61 Massachusetts Ave.
- Boston—J. Newman & Sons, Inc., 24 Tremont St.
- Boston—Julius A. Zinn, 2 Beacon St.
- Wellesley, Mass.—Tally.
- Detroit, Mich.—J. Breitmeyer's Sons, Miami and Gratiot Aves.
- Kansas City, Mo.—Samuel Murray, 1071 Broadway.
- Kansas City, Mo.—Wm. L. Rock Floral Co., 1146 Walnut St.
- Albany, N. Y.—H. G. Eyres, 11 N. Pearl St.
- Albany, N. Y.—F. A. Banker, 40 Malden Lane.
- New York—David Clarke's Sons, 2130-2141 Broadway.
- New York—Alex McConnell, 571 5th Ave.
- New York—Young & Nugent, 42 W. 28th St.
- New York—M. A. Rowe, 1294 Broadway.
- Brooklyn, N. Y.—Robert G. Wilson, Fulton St. and Greene Ave.
- Rutland, N. Y.—Palmer's, 204 Main St.
- Toronto, Can.—J. H. Dunlop, 96 Yonge St.

BOSTON'S BEST
In Quality and Design
Can be relied upon when you transfer your retail orders to

EDWARD MACMULKIN
194 Boylston Street, Boston

Send flower orders for delivery in
BOSTON
and all
NEW ENGLAND POINTS
THOS. F. GALVIN
124 Tremont St., Boston



TRANSFER
Your orders for flower or plant delivery in Eastern New England to
JULIUS A. ZINN,
2 Beacon St., Boston
FINE DESIGN WORK A SPECIALTY

THE BEST LETTERS

FOR **R** THOSE
FLORISTS' MADE
USE BY THE

Boston Florist Letter Co.
66 PEARL ST., BOSTON
N. F. McCARTHY, Mgr.

Order direct or buy from your local supply dealer. Insist on having the

BOSTON
Inscriptions, Emblems, etc., Always in Stock

Flower Market Reports.

As predicted in these columns, the Memorial Day trade of Boston far exceeded any previous record for this patriotic holiday.

1907 was the banner year heretofore but 1909 has left it far in the rear. The florist did business this time under the most favorable conditions of weather. Never was a more lovely day provided for any celebration at any time of the year and the cool pure air of the days preceding it made the handling of flowers an easy proposition for the wholesale shipper. The out of town demand was capped for in an orderly and expeditious manner, prices having been generally fixed two weeks previous and adhered to as a rule, something that is always desirable but not so easily done on other special occasions as is possible at Memorial Day.

Early reports indicate a greatly increased demand for our product for Decoration Day as compared with other years. The almost complete lack of out door flowers caused a heavy shortage in roses and carnations. Stock, snapdragon and cold frame tulips were most welcome substitutes. Some wholesalers were compelled to curtail shipping orders from 25 per cent to 30 per cent. The slight advance in prices for Decoration Day will drop away this week. A couple of days of good weather will bring a plentiful supply of first-class stock to this market.

Memorial week PHILADELPHIA trade on the whole was very satisfactory. An immense volume of

business was done, and prices held firm all along the line. There was no glut in any staple, and on one or two items, notably carnations and peonies, there was a distinct scarcity. The untoward weather held back peonies two or three days—just enough to make the flush of them miss the great occasion. Carnations were away up, bringing in some cases as high as six dollars, and putting them for the minute distinctly ahead of roses of similar quality. Roses were in fair supply—probably less than usual for the season—but prices remained normal, the demand not running specially on these. The lower priced grades of roses were the best sellers, as was to be expected in Memorial week business. The lily of the valley market was weaker than usual, for obvious reasons, and the same may be said of cattleyas and gardenias. These three latter items, however, will have hardened up by the time this appears in print, as the June bride will then be the star attraction in the social firmament. The sweet pea holds its own remarkably; quality good, demand good. Some good lilac sprays are coming in from northern and eastern points—notably Rhode Island. There are lots of snowflakes, mock orange,

iris, and other outdoor subjects around, but far less in volume than usual at this season. Many more peonies and carnations could have been sold Friday and Saturday if they had been in sight. Washington, D. C., reports that the usual Decoration Day rush for flowers of all kinds occupied the dealers Sunday and Monday. No trouble was experienced in selling any kind of a flower.



Cattleyas, Valley and Fragrant June Roses and Peonies for the Bride to Wear

We mention below a few of these and other specialties.

Order now and push them. No retailer should allow it to be said: "Asleep at the post."

- SWEET PEAS - Lavender, Pink, White and Flesh; 75c. to \$1.00. VALLEY - In unlimited quantities: \$3.00, \$4.00. CATTLEYA MOSSIAE - Per doz., \$6.00; per hundred \$50.00. GARDENIAS - Per doz., specials \$3.00; 1st, \$2.00. BEAUTIES - Specials per doz. \$3.00; per hundred \$20.00. RICHMOND, KILLARNEY (Pink and White), JARDINE, MARYLAND. KAISERINES, MAIDS, BRIDES. PAONIES - 1st quality, Pink and White mainly, \$3.00 per 100.

S. S. PENNOCK - MEEHAN CO. 1608-1620 Ludlow Street PHILADELPHIA, PA.

WHOLESALE FLOWER MARKETS. - PER 100 TO DEALERS ONLY.

Table with columns for CINCINNATI, DETROIT, BUFFALO, PITTSBURG and rows for ROSES, CARNATIONS, MISCELLANEOUS items like Cattleyas, Lilies, Gardenias, etc.

FORD BROTHERS

48 West 28th Street NEW YORK
FINE ROSES FANCY CARNATIONS
 A Full Line of All CUT FLOWERS
 Telephone, 3870 or 3871 Madison Square

H. E. FROMENT

Wholesale Commission Florist,
 Choice Cut Flowers,
 57 West 28th St. :: NEW YORK
 Telephones: 2200, 2201, Madison Square.

Alfred H. Langjahr

All choice cut-flowers in season. Send for quotations. Correspondence with shippers of first-class stock invited.
 55 West 28th Street, New York
 Telephones 4626-4627 Madison Square

Edward C. Horan
 Wholesale Florist

53 WEST 28th ST.
 Tel. 1462 Madison Square New York

JOHN YOUNG

WHOLESALE FLORIST
 Finest American Beauties and Carnations
 51 West 28 St. - NEW YORK

FRANK MILLANG

Wholesale Florist
 55-57 West 26th St., NEW YORK
 Shipments, any quantity, Wholesale Market Rates.

Greater New York Florists' Association, Inc.

Now Open for Cut Flower Consignments
 162 Livingston Street, BROOKLYN, N. Y.
 Geo. W. Crawbuck Telephone Connection
 Manager 3642-43 Main

Moore, Hentz & Nash

Wholesale Commission Florists
 55 and 57 West 26th Street
 Telephone No. 756 Madison Square New York

MILLANG BROS.

WHOLESALE COMMISSION FLORISTS
 41 West 28th Street
 Telephone 3860 Madison NEW YORK

WILLIAM H. KUEBLER

Brooklyn's Foremost and Best
 WHOLESALE COMMISSION HOUSE
 A First Class Market for all CUT FLOWERS
 28 Willoughby St., Brooklyn, N. Y.
 Tel. 4691 Main

JOHN I. RAYNOR
 Wholesale Commission Florist **SELLING AGENT FOR LARGEST GROWERS**
 A full line of Choice Cut Flower Stock for all purposes. Comprises every variety grown for New York market, at current prices
 TEL. 1998 MADISON SQUARE 49 West 28th St., New York City

Walter F. Sheridan
 Wholesale Commission Dealer in
CHOICE CUT FLOWERS
 39 West 28th Street, New York
 Telephone: 3532-3533 Madison Square

HEADQUARTERS FOR NOVELTIES
ORCHIDS A SPECIALTY
 THE HIGHEST GRADE OF **VALLEY** ALWAYS ON HAND
CARDENIAS, DAISIES, ROSES AND CARNATIONS
 Telephone
JAMES McMANUS, 759 Mad. St., 42 W. 28th St., New York

NEW YORK QUOTATIONS PER 100. To Dealers Only

ROSES AND CARNATIONS	Last Half of Week ending May 29 1909		First Half of Week beginning May 31 1909	
American Beauty, Fancy and Special.....	10.00	10 25.00	10.00	10 20.00
" " Extra.....	8.00	10 10.00	6.00	10 8.00
" " No. 1.....	4.00	10 6.00	4.00	10 5.00
" " Lower Grades.....	1.00	10 2.00	1.00	10 2.00
Bride, 'Hald, Golden Gate, Fancy and Special.....	2.00	10 6.00	2.00	10 4.00
" " Lower Grades.....	1.00	10 2.50	.50	10 1.00
Killarney, Fancy and Special.....	3.00	10 8.00	3.00	10 6.00
" " Lower Grades.....	1.00	10 2.00	.50	10 1.00
Richmond, Fancy and Special.....	3.00	10 8.00	3.00	10 6.00
" " Lower Grades.....	1.00	10 2.00	.50	10 1.00
Ty Maryland.....	1.00	10 6.00	.50	10 6.00
Carnations, Fancy and Novelties.....	2.00	10 5.00	2.00	10 3.00
" " Ordinary and White.....	1.00	10 2.00	1.00	10 2.00

Alexander J. Guttman
THE WHOLESALE FLORIST OF NEW YORK
 34 WEST 28th STREET
 PHONES. 1664-1665 MADISON SQUARE
ENOUGH SAID

CENTRALLY LOCATED, THE HUB OF THE FLOWER MARKET SECTION
CHARLES MILLANG
 Wholesale Florist
 444 Sixth Ave., NEW YORK
 Telephone 7062 Madison

GEORGE COTSONAS & CO.
 Wholesale and Retail Dealers in all kinds of **EVERGREENS**
 Fancy and Dagger Ferns
 Bronze and Green Galax
Main Store 50 W. 28 St.
 Phone 1202 Mad. Sq. New York

GROWERS' CUT FLOWER CO. CUT FLOWERS AT WHOLESALE
VIOLETS, CARNATIONS, ROSES ORCHIDS, CHRYSANTHEMUMS, LILIES
 Consignments Solicited. Shipments to Order, any Distance
 39 West 28th Street, Telephone 647 Madison Square NEW YORK
 J. J. COAN, Manager

Durand & Marohn
 MANUFACTURERS OF
All Kinds of Wire Work
 Florists' Wire Designs a Specialty
 24 Beaver St., ALBANY, N. Y.

Wired Toothpicks
 Manufactured by
W. J. COWEE, BERLIN, N. Y.
 50,000.....\$1.75; 50,000.....\$7.50. Sample free.
 For sale by dealers

NOTICE!

Manhattan Flower Market

Ship us some stock. We need a large supply of all kinds of flowers, **Roses, Carnations, Sweet Peas, Narcissus, Summer Stock, etc.**, for our new store. Reliability and responsibility first-class. Good prices and prompt returns, Good opportunity.

WHOLESALE FLORISTS
 46 W. 28th St., New York
 Telephone: 1016 Madison Sq.

WHOLESALE FLORISTS
 54 West 28th St.
 NEW YORK
 Telephone 8559 Madison Sq.

A. L. YOUNG & CO.

RECEIVERS & SHIPPERS OF CUT FLOWERS.
 CONSIGNMENTS SOLICITED.



REED & KELLER
 122 West 28th St., New York
Florists' Supplies

We manufacture all our Metal Designs, Baskets, Wire Work & Novelties and are dealers in Glassware Decorative Greens and Florists' Requisites

MICHIGAN CUT FLOWER EXCHANGE, Inc.
 WHOLESALE COMMISSION FLORISTS
 Consignments Solicited
Hardy Fancy Fern Our Specialty
 38-40 BROADWAY, DETROIT, MICH.

FOR FLORISTS' USE
 There's **NOTHING** as good as
MEYER'S SILKALINE
 Don't let them sell you anything else
JOHN C. MEYER & CO., Boston, Mass.

WILLIAM F. KASTING CO.
 WHOLESALE FLORISTS

383-387 Ellicott Street
BUFFALO, - N. Y.

ROBERT J. DYSART
 Public Accountant and Auditor
 Simple methods of correct accounting especially adapted for florists' use.
 Books Balanced and Adjusted
 Merchants Bank Building
 28 STATE STREET, - BOSTON
 Telephone, Main 58.

WHOLESALE COMMISSION J. K. ALLEN 106 W. 28th St. NEW YORK
 Open 6 a.m. Daily Tel. 167 Madison Sq.
 Shipments of Lily of the Valley Needed

Order by Name
Krick's Genuine Immortelle Letters, Etc.
 The Best and Cheapest. Accept no Substitute. Every Letter Marked
KRICK'S LETTERS
 1164-66 Greene Av., Brooklyn, N. Y.
 For Sale by all Supply Houses

FLOWER MARKET REPORTS.
 (Continued from page 812)

Business sprang with a CHICAGO tremendous bound from the depressed condition of the entire month to the most lively Memorial Day known in Chicago for many years. It was from one extreme to the other in so short a time that buyer and seller could scarcely understand each other and adjust themselves to the new conditions. It looks like the last blow to the hard times and florists should certainly now drop that expression when referring to their business. Trade began early Friday morning and when wholesalers sought to advise their customers to buy heavily some were inclined to be skeptical, but in a few hours these same ones were almost ready to beg for the flowers which then could not be bought. Buyers were anxious to fix prices for Saturday delivery, but generally no one would agree to it and Saturday found Friday's demand greatly exceeded. The greatest call was for red; the last to go was white, a complete change from a few years ago. Carnations can not be said to be equal to the demand and the Cape Jasmine was not at all abundant. Roses were more nearly equal in supply. The demand for flowers Sunday was increased by the fact that it was also Pentecostal

NEW YORK QUOTATIONS PER 100. To Dealers Only

MISCELLANEOUS	Last Half of Week ending May 29 1909		First Half of Week beginning May 31 1909	
	Low	High	Low	High
Cattleyas.....	20.00	to 35.00	30.00	to 57.00
Lilies.....	3.00	to 0.00	3.00	to 5.00
Lily of the Valley.....	.50	to 2.10	.50	to 2.00
Peonies.....	3. 0	to 6.20	2.00	to 6.00
Daisies.....	.25	to .50	.25	to .50
Stocks.....	1.00	to 2.00	1.00	to 2.10
Mignonette.....	.53	to 1.00	.53	to 1.00
Sweet Peas (per 100 bunches).....	1.00	to 5.10	1.00	to 5.00
Gardenias.....	2.00	to 12.00	8.00	to 25.00
Adiantum.....	.50	to 1.00	.50	to 1.00
Smiles.....	10.00	to 15.00	15.00	to 15.00
Asparagus Plumosus, strigis.....	20.00	to 30.00	20.00	to 33.00
" " & Spren. (100 bchs).....	12.00	to 25.00	15.00	to 25.00

Day, a coincidence that has not occurred for many years. Chicago florists are weary with their three and one-half days' incessant rush, but not so wearisomely weary as when they sat and waited for the business that did not come. Gladioli sold at \$1.50 per dozen on Saturday, but went slowly as compared with other flowers. Mignonette and marguerites also were in the less desirable class. Asparagus plumosa and Sprengerii did not move as fast as had been anticipated. Special reports from H. C. Blewitt of Des Plaines, a specialist in sweet peas, A. Meyer of Dalton, Anton Then, who had a big crop of red carnations on, Miss Tomner, who displayed the first nasturtiums of the season, Chas. Wiffin, who specializes in stocks (not the Wall street kind), E. H. Hunt Co., Bassett & Washburn, Percy Jones, J. A. Pudlong, Pochmann Bros., George Reinberg, John Kruchten, Zeck & Mann, C. W. McKellar, Miss Gunderberg, Bently & Carsworth and Weller Bros., are invariably to the effect that the quality of material on the market was far above the average and

that the sales were unprecedentedly and unexpectedly large. Memorial Day, while NEW YORK, a big occasion with the suburban and cemetery florists, has in the central flower districts of New York always fallen short of its importance elsewhere. The special demand, as a general rule, is for showy, low-priced material and enormous quantities are shipped to the wholesale markets where it is sold for what it will bring. Peonies were a strong feature this year, coming mostly from points further south. Carnations experienced a lively call and early in the game were held at stiff prices, which, however, had to break in the end. There were large receipts of roses, the lower grades finding most ready buyers. Lilies were plentiful and had to share in the general depression which white material experienced, the best demand being for bright colored stock. Orchids and similar choice goods were only in light request. The business this week, since the holiday shows improvement in this respect, however,

Buyer's Directory and Ready Reference Guide

Advertisements under this head, one cent a word. Initials count as words.

Display advertisers in this issue are also listed under this classification without charge. Reference to List of Advertisers will indicate the respective pages.

Buyers failing to find what they want in this list will confer a favor by writing us and we will try to put them in communication with reliable dealers.

ACCOUNTANT

R. J. Dyrart, 28 State St., Boston.
For page see List of Advertisers.

ALYSSUM

Dwarf Alyssum from 2 in. pots, at \$2.00 per 100, Jas. T. Baker, Bustleton, Philadelphia, Penn.

AMPELOPSIS.

Eastern Nurseries, Henry F. Dawson, Mgr., Ampelopsis Quincifolia, Jamaica Plain, Mass.

AQUATIC PLANTS

Aquarium plants the year round. Wholesale and retail. Send for price list. Schmid's Emporium of Pets, 712 12th Street, Washington, D. C.

AQUILEGIAS

Aquilegia. Geniole Coerulea, finest of all. Both plants and seeds from the heart of the Rockies. C. S. Harrison's Select Nursery, York, Neb.

ARAUCARIAS

A. Leuthy & Co., Perkins St. Nurseries, Roslindale, Mass.
For page see List of Advertisers.
Godfrey Aschmann, 1012 West Ontario St., Philadelphia, Pa.
For page see List of Advertisers
Bobbink & Atkins, Rutherford, N. J.

ASPARAGUS PLUMOSUS

William C. Smith, Market & 61st St., Philadelphia.
For page see List of Advertisers.
Asparagus Plumosus, 2½ in., \$3.00 per 100; Sprengeri seedlings, 600 per 100; 3 in., \$3.50 per 100. Edwin Bishop, Roslyn, Md.

ASPARAGUS SEED

Asparagus Plumosus Seed, fresh, lath-house grown, \$2.00 per 1000. Special price in quantities. Immediate delivery. Cash. Oak Grove Nurseries, Office, 404 North Los Angeles St., Los Angeles, Cal.

ASTERS.

J. C. Schmidt, Bristol, Pa.
For page see List of Advertisers.
Asters—Field grown. Trego, white, rose and shell pink, mixed; Rosbach's selected purple and lavender, mixed, white separate, \$2.50 per 100. For several years we have tried most of the new varieties offered with a view of securing an ideal florist's strain. Last season we acquired the Trego and found it the most satisfactory of them all. A. & G. Rosbach, Penberton, N. J.

AUTOMATIC CIRCULATOR

W. W. Castle Co., 170 Summer St., Boston.
For page see List of Advertisers.

AZALEAS

A. Leuthy & Co., Perkins St. Nurseries, Roslindale, Mass.
For page see List of Advertisers.
Godfrey Aschmann, 1012 W. Ontario St., Philadelphia.
For page see List of Advertisers.

BAMBOO CANES

Yokohama Nursery Co., 81 Barclay Street, New York
Bamboo Sticks, Colored Green.
For page see List of Advertisers.

BAY TREES.

Bobbink & Atkins, Rutherford, N. J.
3000 Bay and Box Trees in all sizes, Pyramid and Standards. Write for list. Julius Roehrs, Rutherford, N. J.

BEDDING PLANTS

J. E. Felthousen, Schenectady, N. Y.
A. Leuthy & Co., Perkins St. Nurseries, Roslindale, Mass.
For page see List of Advertisers.

G. Aschmann, 1012 W. Ontario St., Philadelphia, Pa.
For page see List of Advertisers.

R. Vincent, Jr. & Sons Co., White Marsh, Maryland.
For page see List of Advertisers.

J. C. Schmidt, Bristol, Pa.
For page see List of Advertisers.

Thomas Rohnd, Nahant, Mass.
Begonia Gloire De Lorraine.
For page see List of Advertisers.

S. V. Smith, 3223 Goodman St., Phila., Pa.
J. W. Adams & Co., Springfield, Mass.

BEGONIAS

Begonia Veeron and Luminosa, \$5.00, \$6.00 and \$7.00 per 100. Rose Hill Nurseries, New Rochelle, N. Y.

BEGONIA REX

J. H. Dann & Son, Westfield, N. Y.
For page see List of Advertisers.

BOILERS

"Brimham" Boilers made for greenhouse heating. Lord & Burham, 1133 Broadway, N. Y.

Krosschell Bros. Co., 35 Erie St., Chicago.
For page see List of Advertisers.

W. W. Castle Co., 170 Summer St., Boston.
The Castle Boiler.
For page see List of Advertisers.

BOOKS

Pronunciation of Plant Names, sent for 50 cents, postpaid, by HORTICULTURE. P. O. Box, 11 Hamilton Place, Boston.

BOXWOOD TREES

New England Nurseries, Inc., Bedford, Mass.
For page see List of Advertisers.
Bobbink & Atkins, Rutherford, N. J.

BUILDING MATERIAL

BUILDING MATERIAL of all description for All Cypress, Semi-Iron, Iron Frame or Truss Houses. Hot Bed Sash and Frames. Lord & Burham Co., 1133 Broadway, N. Y.

BULBS AND TUBERS

Joseph Breck & Sons, 47-54 N. Market St., Boston.
For page see List of Advertisers.

J. M. Thornburn & Co., 33 Barclay St., New York.
For page see List of Advertisers.

A. T. Boddington, 342 W. 14th St., N. Y.
For page see List of Advertisers.

Rickards Bros., 37 East 19th St., New York.
For page see List of Advertisers.

H. F. Mitchell Co., Philadelphia.
For page see List of Advertisers.

H. E. Fiske Seed Co., Faneuil Hall Sq., Boston.
For page see List of Advertisers.

T. J. Grey & Co., 32 and 33 So. Market St., Boston.
For page see List of Advertisers.

Yokohama Nursery Co., 81 Barclay St., New York.
For page see List of Advertisers.

BULBS AND TUBERS—Continued

Ralph M. Ward & Co., 12 W. Broadway, New York.
For page see List of Advertisers.

Schlegel & Fetter Co., 26 & 27 S. Market St., Boston.
Begonias, Gloxinias, Tuberoses.
For page see List of Advertisers.

COANNAS

R. Vincent, Jr. & Sons Co., White Marsh, Maryland.
For page see List of Advertisers.

Estate of David Fisher, Woburn, Mass.
For page see List of Advertisers.

J. H. Dann & Son, Westfield, N. Y.
For page see List of Advertisers.

J. W. Adams & Co., Springfield, Mass.

CARNATIONS

Baur & Smith, 38th & Seane St., Indianapolis, Ind.
Patten & Co., Tewksbury, Mass.
Carnation Shasta.
For page see List of Advertisers.

F. Dorner & Sons Co., Lafayette, Ind.
Carnations for Immediate Delivery.
For page see List of Advertisers.

Chicago Carnation Co., Joliet, Ill.
Mary Tolman.
For page see List of Advertisers.

Wood Bros., Fishkill, N. Y.
Carnations, Rooted Cuttings.
For page see List of Advertisers.

The E. G. Hill Co., Richmond, Ind.
Carnation Cuttings.
For page see List of Advertisers.

Poebmann Bros. Co., Morton Grove, Ill.
For page see List of Advertisers.

CHRYSANTHEMUMS

E. G. Hill Co., Richmond, Ind.
For page see List of Advertisers.

S. J. Reuter & Son, Westery, B. I.
For page see List of Advertisers.

C. H. Totty, Madison, N. J.
For page see List of Advertisers.

Wood Bros., Fishkill, N. Y.
Chrysanthemums Rooted Cuttings.
For page see List of Advertisers.

Scott Bros., Elmsford, N. Y.
Poebmann Bros. Co., Morton Grove, Ill.
For page see List of Advertisers.

Flener D. Smith & Co., Adrian, Mich.
Special Offer of commercial Chrysanthemums.
For page see List of Advertisers.

William Swayne, Kennett Square, Pa.
Rooted Cuttings.

H. L. Cameron, N. Cambridge, Mass.
White Bonafida.
For page see List of Advertisers.

William C. Smith, Market & 61st St., Philadelphia.
For page see List of Advertisers.

Chrysanthemums, good stocky cuttings from soil; all orders filled promptly.
White—Estelle, Opah, Oct. Frost, Ivory, C. Tonset, Mrs. Robinson.

Yellow—Monrovia, Cremo, J. Jones, Maj. Bonaffon.
Pink—Glory Pacific, Dr. Enguehard, Wm. Duckham, Minnie Bailey, Maud Dean.

Red—Black Hawk, Cullinford. Potted plants, 2½ in. above, \$2.00 per 100. Cash or C. O. D. D. H. Green, West Grove, Pa.

100 commercial varieties, including Pompon and Hairy, \$12.50 per 100. Satisfaction guaranteed. Wm. Ehmman, Jr., Corfu, N. Y.

For List of Advertisers See Page 819

CHRYSANTHEMUMS—Continued

Chrysanthemum Golden Glow from 2-14 in. pots, for early spring delivery, \$1.00 per doz., \$5.00 per 100, \$50.00 per 1000. Stock plants of Montmore, Oct. Frost, Crocus, Matchless, Lucy Devaux, Polly Rose and Holiday, \$1.00 per doz.; \$5.00 per 100. Peirce Bros., Waltham, Mass.

Herrington's book on the Chrysanthemum, mailed to your address for 50c., by Horticulture Publishing Co., 11 Hamilton Place, Boston.

Golden Glow and Pacific Supreme, R. C., \$2.75 per 100, prepaid; 1000 not prepaid, \$25; from 24 in. pots, \$3.50 per 100. Chas. Frost, Kenilworth, N. J.

COAL FOR GREENHOUSE USE

Bader Coal Co., Board of Trade Bldg., Boston.

COLEUS

J. E. Felthousen, Schenectady, N. Y.

A. Leathy & Co., Perkins St. Nurseries, Roslindale, Mass.
For page see List of Advertisers.

CONIFERS

John Waterer & Sons, Ltd., American Nursery, Baysshot, Eng.

Julius Roehrs Co., Rutherford, N. J.
For page see List of Advertisers.

OUT FLOWER BOXES.

Edward Folding Box Co., Philadelphia.
For page see List of Advertisers.

Folding out flower boxes, the best made write for list. Holton & Hunkel Co., Milwaukee, Wis.

DAHLIAS

David Hechert & Son, Atco, N. J.
For page see List of Advertisers.

J. L. Moore, Northboro, Mass.
For page see List of Advertisers.

Peacock Dahlia Farms, Williamstown Junction, N. J.
For page see List of Advertisers.

R. Vincent Jr. & Sons Co., White Marsh, Md.
For page see List of Advertisers.

DAHLIAS.

Geo. H. Walker, No. Dighton, Mass.
Wholesale and Retail.

*Send your name for my 1909 Catalog and Pocket Guide, ready to mail about Feb. 25th

Dahlias, divided roots, \$1.00 the doz., including such varieties as Thomas Parkin, Mrs. Roosevelt, Sony, de Gustave Dupon, Standard Bearer, Catherine Dyer, 20th Century, Gen. Buller, Dainty, Frank Smith, Lively, White Swan and 25 other sorts, all selected as good for cut flowers. A. & G. Rosbach, Pemberton, N. J.

DECORATIVE PLANTS

A. Leathy & Co., Perkins St. Nurseries, Roslindale, Mass.
Imported Plants for Fall Delivery.
For page see List of Advertisers.

Godfrey Aschmann, 1012 W. Ontario St., Phils., Pa.
For page see List of Advertisers.

Joseph Hancock Co., Wyncote, Pa.
For page see List of Advertisers.

The Geo. Wittbold Co., 1857 Buckingham Place, Chicago, Ill.
For page see List of Advertisers.

Robert Craig Co., Market and 49th Sts., Philadelphia, Pa.
For page see List of Advertisers.

EVERGREENS

New England Nurseries, Bedford, Mass.
For page see List of Advertisers.

American Nursery Co., 150 Broadway, N. Y.
Evergreens. Send 25 cents in stamps for complete work on propagating and growing Evergreens. C. S. Harrison's Select Nursery, York, Neb.

FERNS

A. Leathy & Co., Roslindale, Mass.
For page see List of Advertisers.

H. H. Barrows & Son, Whitman, Mass.
Nephrolepis Magnifica.
For page see List of Advertisers.

John Scott, Brooklyn, N. Y.
For page see List of Advertisers.

Frank Oechlein, 2570-2606 W. Adams St., Chicago.
Ferns for Dishes.
For page see List of Advertisers.

The Geo. Wittbold Co., 1857 Buckingham Place, Chicago, Ill.
For page see List of Advertisers.

Godfrey Aschmann, 1012 W. Ontario St., Philadelphia.
For page see List of Advertisers.

Jardiniere Ferns, 6-7 best varieties, \$3.50 per 100; \$30.00 per 1000. Rose Hill Nurseries, New Rochelle, N. Y.
For page see List of Advertisers.

Anderson's ferns for in and outdoors. Largest commercial collection in the country. Ask for descriptive catalogue. J. F. Anderson, Fern Specialist, Short Hills, N. J.

FERTILIZERS

Pauperized Manure Co., 31 Union Stock Yards, Chicago, Ill.

Wisard Brand Sheep and Shredded Cattle
For page see List of Advertisers.

Bowker Fertilizer Co., Boston, Mass.
All Forms of Plant Food at First Hand.
For page see List of Advertisers.

German Kall Works, 93 Nassau St., New York.
Potash Fertilizer.

Wm. Elliott & Sons, 42 Vesey St., New York.
Sheep Manure.
For page see List of Advertisers.

FLORAL PHOTOGRAPHS

Floral Photographs, Foley's, 226-228 12 Bowery, New York.

FLORISTS' LETTERS.

Boston Florist Letter Co., 66 Pearl St., Boston, Mass.
For page see List of Advertisers.

FLORISTS SUPPLIES

N. F. McCarthy & Co., 84 Hawley St., Boston.
For page see List of Advertisers.

H. M. Robinson & Co., 15 Province St. and 9 Chapman Pl., Boston, Mass.
For page see List of Advertisers.

Seed & Keller, 122 W. 23rd St., New York.
For page see List of Advertisers.

H. Bayerdorfer & Co., 1129 Arch St., Philadelphia.
For page see List of Advertisers.

W. C. Krick, 1164-66 Greene Av., Brooklyn, N. Y.
Immortelle Letters.

S. S. Pennock-Meehan Co., Philadelphia.
For page see List of Advertisers.

FLOWER POTS

W. H. Ernest, 28th and M Sts., Washington, D. C.
For page see List of Advertisers.

A. H. Hews & Co., Cambridge, Mass.
For page see List of Advertisers.

Hilfinger Bros., Ft. Edward, N. Y.
For page see List of Advertisers.

The Peters & Reed Pottery Co., Red pots, seed pans, etc.
Zanesville, O.

Syracuse Pottery Co., Syracuse, N. Y.
Syracuse Red Pots.
For page see List of Advertisers.

We make Standard Flower Pots, etc. Write us when in need.
Wilmer Cope & Bro.

Lincoln University, Chester Co., Pa.

FRUIT TREES

Dwarf Fruit Trees, by F. A. Waugh, mailed to your address for 55 cents by Horticulture Publishing Co., 11 Hamilton Place, Boston.

GALAX

Michigan Cut Flower Co., 38 and 40 Broadway, Detroit, Mich.

George Cotsanos & Co., 50 W. 28th St., New York.
For page see List of Advertisers.

The Kervan Co., 118 West 23rd St., M. Y.
Rice Bros., 115 N. 6th St., Minneapolis, Minn.
For page see List of Advertisers.

H. M. Robinson & Co., 15 Province St. and 9 Chapman Place, Boston.
For page see List of Advertisers.

GARDEN HOSE

Revere Rubber Co., Boston, Mass.
For page see List of Advertisers.

Crestline Mfg. Co., Crestline, O.
For page see List of Advertisers.

GERANIUMS

R. Vincent Jr. & Sons Co., White Marsh, Md.
New and Standard Varieties.
For page see List of Advertisers.

Godfrey Aschmann, Philadelphia, Pa.
For page see List of Advertisers.

Geraniums, large plants, bud and bloom, out of 3 1/2 in. pots. S. A. Nutt and others, \$7.00 per 100. Cash. Stephen Chase, Nashua, N. H.

Sallerol Geraniums, strong plants from 2 1/2-in. pots, \$2.50 per 100. J. B. Shurtleff & Son, Chishman Ave., Revere, Mass.

GLADIOLI

J. L. Moore, Northboro, Mass.
For page see List of Advertisers.

E. S. Miller, Wading River, N. Y.
For page see List of Advertisers.

GLASS

Boston Plate & Window Glass Co., Boston.
For page see List of Advertisers.

Standard Plate Glass Co., 29-30 Sudbury St., Boston.
For page see List of Advertisers.

Foley Mfg. Co., Western Ave., between 25th & 26th Sts., Chicago.
For page see List of Advertisers.

Sharp, Partridge & Co., 22d & Lumber St., Chicago.
For page see List of Advertisers.

Parshelsky Bros., Inc., 59 Montrose Av., Brooklyn, N. Y.
For page see List of Advertisers.

Metropolitan Material Co., 1392-1402 Metropolitan Ave., Brooklyn, N. Y.

Greenhouse glass, lowest prices. Johnson Glass Co., Hartford City, Ind.

Glass, High Grade, Double Thick Greenhouse Glass. Lord & Burnham, 1133 Broadway, N. Y.

GLAZING POINTS

H. A. Dreer, Philadelphia, Pa.
Peerless Glazing Point.
For page see List of Advertisers.

GLAZING POINTS, Lord & Burnham Special Glazing Points. Lord & Burnham, 1133 Broadway, N. Y.

GREENHOUSE BUILDING MATERIAL

Lord & Burnham Co., 1133 Broadway, New York.
For page see List of Advertisers.

Pierson U-Bar Co., 1 Madison Sq., N. Y.
For page see List of Advertisers.

A. T. Stearns Lumber Co., Neponset, Boston.
For page see List of Advertisers.

King Construction Co., N. Tonawanda, New York.
For page see List of Advertisers.

Hinchings & Co., 1170 Broadway, New York.
For page see List of Advertisers.

J. C. Moulnger Co., 117 East Blackhawk St., Chicago, Ill.
For page see List of Advertisers.

Foley Mfg. Co., Western Ave., between 25th & 26th Sts., Chicago.
For page see List of Advertisers.

S. Jacobs & Sons, 1350-63 Flushing Av., Brooklyn, N. Y.
For page see List of Advertisers.

In writing to Advertisers kindly mention Horticulture

GREENHOUSE CONSTRUCTION

GREENHOUSE CONSTRUCTION, Semi-Iron Greenhouse, New Truss Houses and Iron Frame Houses. Lord & Burnham, 1183 Broadway, N. Y.

J. A. Payne, 260-274 Culver Ave., Jersey City, N. J.
For page see List of Advertisers.

Foley Mfg. Co., Western Ave., between 25th & 26th Sts., Chicago.
For page see List of Advertisers.

Hitchhugs & Co., 1170 Broadway, New York.
For page see List of Advertisers.

GREENHOUSE HOSE

Revere Rubber Co., Boston, Mass.
Revere Hose.
For page see List of Advertisers.

GREENHOUSES FOR SALE

Thomas M. Lynch, 256 Main St., Poughkeepsie, N. Y.
For page see List of Advertisers.

GUTTERS

GUTTERS, Cast Iron Gutters, L. & B. Improved V Shaped Gutter with drip gutter attachment. Lord & Burnham, 1183 Broadway, N. Y.

HAIL INSURANCE

Florida's Hall Assn. of America.
J. G. Esler, Saddle River, N. J.
For page see List of Advertisers.

HARDY FERNS, MOSS AND GREENS

H. M. Robinson & Co., 15 Province St. and 9 Chapman Pl., Boston, Mass.
For page see List of Advertisers.

Michigan Cut Flower Exchange,
38 and 40 Broadway, Detroit, Mich.
For page see List of Advertisers.

George Cotsonas & Co., 60 W. 28th St., New York.
For page see List of Advertisers.

N. F. McCarthy & Co., 84 Hawley St., Boston.

The Kervan Co., 113 W. 28th St., N. Y.
McC Bros., 115 N. 6th St., Minneapolis, Minn.
For page see List of Advertisers.

HEATING APPARATUS

Lord & Burnham Co.,
1183 Broadway, New York.
For page see List of Advertisers.

Pierion U-Bar Co., 1 Madison Sq., N. Y.
For page see List of Advertisers.

John A. Payne, 260-274 Culver Ave., Jersey City, N. J.
For page see List of Advertisers.

Kroschel Bron. Co., 85 Erie St., Chicago.
For page see List of Advertisers.

HELP FURNISHED

Wm. H. Hambrick, 34 S. 7th St., Phila.
For page see List of Advertisers.

HERBACEOUS PERENNIALS

P. Ouwkerkerk, P. O. No. 1, Hoboken, N. J.
For page see List of Advertisers.

New England Nurseries, Bedford, Mass.
For page see List of Advertisers.

The Geo. Wittbold Co., 1657 Buckingham Place, Chicago.
For page see List of Advertisers.

HOLLYHOCKS

Hollyhocks, best single and double strains, plants to flower, \$5.00 per 100; \$75.00 per 1000. Rose Hill Nurseries, New Rochelle, N. Y.

HOT-BED SASH

The A. T. Stearns Lumber Co., Neponset, Mass.
For page see List of Advertisers.

Pierion U-Bar Co., 1 Madison Sq., N. Y.
For page see List of Advertisers.

Lord & Burnham Co., 1183 Broadway, N. Y.
For page see List of Advertisers.

Foley Mfg. Co., Western Ave., between 25th & 26th Sts., Chicago.

HYDRANGEAS.

The F. R. Pierson Co., Tarrytown-on-Hudson, N. Y.
For page see List of Advertisers.

Julius Roehrs Co., Rutherford, N. J.
For page see List of Advertisers.

INSECTICIDES.

Nicotinole kills all greenhouse pests.
F. R. Palethorpe Co.
Eleventh St., Owensboro, Ky.
For page see List of Advertisers.

Stump & Walter Co., 50 Barclay St., New York.
Kiln-dried Soap Dust.
For page see List of Advertisers.

Niagara Sprayer Co., Middleport, N. Y.
Niagara Brand.
For page see List of Advertisers.

Bowker Insecticide Co., Boston, Mass.
Insect Destroying Preparations.
For page see List of Advertisers.

Wm. Cooper & Nephews, 177 Illinois St., Chicago; **Cyril Funcklyn**, 62 Beaver St., New York, Agt.
V I Fluid.
For page see List of Advertisers.

Eastern Chemical Co., Pittsburg St., Boston.
"IMP" Soap Spray.
For page see List of Advertisers.

"The Fumigating Kind Tobacco Powder"—The first on the market and the kind used has so many imitations, has our guarantee tag of satisfaction or money back, and "The Moon Trade Mark" on every bag, \$3.00 per 100 lbs. The H. A. Stoothoff Co., Mount Vernon, N. Y., Makers and sellers.

JAPANESE PLANTS

Yokohama Nursery Co., 31 Barclay St., New York.
For page see List of Advertisers.

KENTIAS

Godfrey Aschmann,
1012 W. Ontario St., Phila., Pa.
For page see List of Advertisers.

A. Leuthy & Co., Roslindale, Mass.
For page see List of Advertisers.

Jos. Heacock Co., Wyncote, Pa.
Single and Made-Up Specimens.
For page see List of Advertisers.

O. V. Zangen, Hoboken, N. J.
For page see List of Advertisers.

LILY OF THE VALLEY PIPS
Hjalmar Hartmann & Co., Langangstraede 20, Copenhagen, Denmark.
For page see List of Advertisers.

MADEIRA VINES
E. S. Miller, Wading River, N. Y.
For page see List of Advertisers.

MASTICA

F. O. Pierce Co., 12 W. Broadway, New York.
For page see List of Advertisers.

MOON VINES

Godfrey Aschmann, Philadelphia, Pa.
For page see List of Advertisers.

Ipomea Grandiflora, extra strong, grown from seed, 2½ in., \$3.50 per 100; 3 in., \$5.00. **Edwin Bishop**, Roslyn, Md.

MYRTLE

Myrtle, blue for cemetery planting, \$2.00 per 100; \$17.50 per 1000. **Geo. A. Dhanau**, Sta. H., Cincinnati, Ohio.

NICO-FUME

Kentucky Tobacco Product Co., Louisville, Ky.
For page see List of Advertisers.

NURSERY STOCK

John Waterer & Sons, Ltd.,
American Nursery, Bagshot, England.
For page see List of Advertisers.

P. Ouwkerkerk, 216 Jane St., Weehawken, Helghts, N. J.
For page see List of Advertisers.

American Nursery Co., 150 Broadway, New York, N. Y.
W. & T. Smith Co., Geneva, N. Y.
For page see List of Advertisers.

NURSERY STOCK—Continued

Manual of the Trees of North America, by C. S. Sargent, mailed to your address for \$9.00, by Horticulture Publishing Co., 11 Hamilton Place, Boston.

TREES, SHRUBS, ROSES, EVERGREENS, PEONIES, HARDY PLANTS, BELLWANGER & BARRY, Rochester, N. Y.
New Hardy Shrub—Ruddelega variabilis Veltchil and Magnifica, the summer flowering Lilac, 50c. each; \$5.00 per doz., \$25.00 per 100. **Rose Hill Nurseries**, New Rochelle, N. Y.

Catalog now ready. Nursery grown evergreens, wedding white blue and ham lock, native trees and plants. **L. E. Williams**, Nottingham, N. H.

ORCHID PLANTS

Lager & Hurrell, Summit, N. J.
Fresh Imported and Established Orchids.
For page see List of Advertisers.

Snader, St. Albans, England,
Importers, Exporters, Growers, Hybridists.
For page see List of Advertisers.

Carillo & Baldwin, Seacaucus, N. J.
For page see List of Advertisers.

Joia A. Mandia, 191 Valley Road, W.
For page see List of Advertisers.

Ordenez Bros., Madison, N. J., Box 106.
Cutlera Mosses.
For page see List of Advertisers.

G. L. Freeman, 388 Appleton St., Holyoke, Mass.
Orchid Importations.
For page see List of Advertisers.

MacFlorie-McLaren Co., 721 Crucker Bldg., San Francisco, Cal.
Phalaenopsis and Vandas.
For page see List of Advertisers.

Largest stock in the country. Ask for prices. **Julius Roehrs**, Rutherford, N. J.

Native Orchids. **Hugo Kind**, Hammon-ton, N. J.

PAINT AND PUTTY

PAINT AND PUTTY: Ideal Greenhouse lead; Special Greenhouse Putty. **Lord & Burnham**, 1183 Broadway, N. Y.

PALMS

A. Leuthy & Co., Perkins St. Nurseries, Roslindale, Mass.
For page see List of Advertisers.

Robert Craig Co., Market and 49th Sts., Philadelphia, Pa.
For page see List of Advertisers.

Joseph Heacock Co., Wyncote, Pa.
Home-Grown Palms.
For page see List of Advertisers.

Geo. Wittbold Co., 1657 Buckingham Place, Chicago.
For page see List of Advertisers.

Julius Roehrs Co., Rutherford, N. J.
For page see List of Advertisers.

Ebbiuk & Atkins, Rutherford, N. J.
O. V. Zangen, Hoboken, N. J.
For page see List of Advertisers.

PANSY PLANTS.

J. C. Schmidt, Bristol, Pa.
For page see List of Advertisers.

Pansies, large, field grown, transplanted plants, very choice colors, \$10.00 per 1000. **Cash, Stephen Chase**, Nashua, N. H.

PATENTS

Siggers & Siggers, Washington, D. C.
For page see List of Advertisers.

PEAT

Orchid Peat and Moss always on hand. **Julius Roehrs Co.**, Rutherford, N. J.

PEONIES

Peonies only, by the wholesale—best 100 varieties. **J. F. Rosenfield**, Westpoint, Neb.

One of the finest collections in America. Send 25 cts. in stamps for new edition of Peony Manual. **C. S. Harrison's** Select Nursery, York, Neb.

PHLOXES

Seed 25 cts in stamps for Phlox Manual Fine mixed phloxes \$2.00 per 100. C. S. Harrison's Select Nursery, York, Neb.

Phlox, Hardy Perennial, best assorted varieties, strong plants, \$5.00 per 100; \$40.00 per 1000. Rose Hill Nurseries, New Rochelle, N. Y.

PHOTOGRAPHS: DESIGNING: ILLUSTRATING

Geo. E. Dow, 178 Washington St., Boston. For page see List of Advertisers.

PIPE AND FITTINGS

Foley Mfg. Co., between Western Ave. and 26th St., Chicago, Ill.

Kroeschell Bros. Co., 35 Erie St., Chicago. For page see List of Advertisers.

PIPE AND FITTINGS, Cast Iron and Wrought Pipe, Valves, Elbow, Pipe Hooks, Automatic Air Headers, etc. Lord & Burnham, 1133 Broadway, N. Y.

Metropolitan Ave. Co., 1392-1402 Metropolitan Ave., Brooklyn, N. Y.

PLANT STAKES

Seele's Tiesless Plant Stakes and Trellises. H. D. Seele & Sons, Elkhart, Ind.

POT HANGERS

Pot hangers, Kramer's \$1 doz. by exp., \$1.25 by mail. I. N. Kramer & Son, Cedar Rapids, Ia.

RAFFIA

Raffia (colored), 2) beautiful shades. Samples free. R. H. Comey Co., Camden, N. J.; 810 Washburn Ave., Chicago, Ill.

RHODODENDRONS

John Waterer & Sons, Ltd., American Nursery, Bagshot, England. For page see List of Advertisers.

P. Ouwkerk, Hoboken, N. J. For page see List of Advertisers.

ROSES

Robert Craig Co., Market and 49th Sts., Philadelphia, Pa.

For page see List of Advertisers. P. Ouwkerk, P. O. No. 1, Hoboken, N. J. For page see List of Advertisers.

The F. R. Plerson Co., Tarrytown-on-Hudson, N. Y. White Killarney. For page see List of Advertisers.

Dingee & Conard Co., West Grove, Pa. For page see List of Advertisers.

Scott Bros., Elmford, N. Y. Poehlmann Bros. Co., Morton Grove, Ill. For page see List of Advertisers.

A. N. Plerson, Cromwell, Conn. White Killarney, My Maryland, Rambler. For page see List of Advertisers.

U. S. Cut Flower Co., Elmira, N. Y. Rose Plants. For page see List of Advertisers.

W. & T. Smith Co., Geneva, N. Y. American Grown Roses. For page see List of Advertisers.

Pittsburgh Rose & Carnation Co., Gibsonia, Pa. For page see List of Advertisers.

Roses, Mails and Richmonds, strong 4 in stock, \$8.00 per 100. Rose Hill Nurseries, New Rochelle, N. Y.

The Rose, by H. B. Ellwanger; mailed for \$1.30 by Horticulture, 11 Hamilton Place, Boston.

Hand Book of Cultural Notes on Roses Under Glass, by F. P. Brigham, mailed to your address for 25c. by Horticulture Publishing Co., 11 Hamilton Place, Boston.

RUBBER PLANTS

William C. Smith, Marlet & 61st St., Philadelphia.

For page see List of Advertisers.

SEED GROWERS

Hjalmar Hartmann & Co., Cauliflower and Cabbage Seed. Langaastræde 20, Copenhagen, Denmark. For page see List of Advertisers.

SEEDS

T. J. Grey Co., 32 So. Market St., Boston. For page see List of Advertisers.

Joseph Breck & Sons, 51 and 52 N. Market St., Boston, Mass. For page see List of Advertisers.

W. Atlee Burpee & Co., Philadelphia. For page see List of Advertisers.

Arthur T. Boddington, 342 W. 14th St., New York. For page see List of Advertisers.

H. E. Flake Seed Co., Faneuil Hall Sq., Boston. For page see List of Advertisers.

Hjalmar Hartmann & Co., Langaastræde 20, Copenhagen, Denmark. For page see List of Advertisers.

Richard Bros., 37 E. 19th St., New York. For page see List of Advertisers.

R. & J. Farquhar & Co., 67 So. Market St., Boston. Mignonette Seed. For page see List of Advertisers.

H. F. Mitchell Co., 1018 Market St., Philadelphia. Primula Seed. For page see List of Advertisers.

J. M. Thorburn & Co., 33 Barclay St., N. Y. For page see List of Advertisers.

Leonard Seed Co., Chicago, Ill. For page see List of Advertisers.

Schlegel & Fottler Co., 26 & 27 S. Market St., Boston. For page see List of Advertisers.

O. V. Zangen, Hoboken, N. J. Florists' Spring Seeds. For page see List of Advertisers.

E. F. Winterson Co., Chicago. Seeds for Plantsmen, Nurserymen, Seeds men. For page see List of Advertisers.

Warren Shinn, Woodstock, N. J. Imperial Palmetto Asparagus Seed. A. C. Zvolanek, Bound Brook, N. J. Winter Flowering Sweet Peas. For page see List of Advertisers.

Seeds, Rocky Mountain Evergreen seeds in large or small quantities. C. S. Harrison's Select Nursery, York, Neb.

SHRUBS

The Geo. Wittbold Co., 1657 Buckingham Place, Chicago. For page see List of Advertisers.

SILKALINE

John C. Meyer & Co., Boston, Mass. For page see List of Advertisers.

SPHAGNUM MOSS

Live Sphagnum moss, orchid peat and orchid baskets always on hand. Lager & Hurrell, Summit, N. J.

SPRAYERS

Niagara Sprayer Co., Middleport, N. Y. For page see List of Advertisers.

Chas. J. Jager Co., Boston. Deming Spray Pump. For page see List of Advertisers.

STEAM TRAP

E. Hippard, Youngstown, O. For page see List of Advertisers.

STOVE PLANTS

Julius Rehrs Co., Rutherford, N. J. For page see List of Advertisers.

SULPHUR BURNER

Benj. Dorrance, Rose Growers, Dorrance, Pa. For page see List of Advertisers.

SWEET PEAS

A. C. Zvolanek, Bound Brook, N. J. Winter Flowering. For page see List of Advertisers.

VEGETABLE PLANTS

R. Vincent, Jr. & Sons Co., White Marsh, Md. For page see List of Advertisers.

VEGETABLE PLANTS—Continued

Vegetable plants now ready, all cold frame grown and hardened ready for outdoor planting. Cabbage, Charleston, Wakefield and Early Summer at \$2.00 per M, \$15.00 per 10,000. Egg Plants, Black Beauty and New York Skinless, \$1.50 per 100. Tomato plants, Earliana, Chalk's Jewell, June Plink and Allen's Best, \$1.00 per 100. \$6.00 per M. Cauliflower, Early Snowball, 75c per 100, \$4.00 per M. Pepper plants, Ruby King, 75c per 100, \$4.00 per M. Cash with order. All plants by express, receiver to pay charges. Address W. F. Allen, Salisbury, Md.

Tomatoes, Earliana, Chalks Jewell, Greater Baltimore, \$1.25 per 100. Transplanted Pepper and Egg plant, 50c per 100. Sweet Tomato plants, \$2.50 per 100. Cabbage, Jersey Wakefield, \$1.00 per 100. Edwin Bishop, Roslyn, Md.

VENTILATING APPARATUS

Pierson U-Bar Co., 1 Madison Sq., N. Y. For page see List of Advertisers.

Foley Mfg. Co., Western Ave., between 25th & 26th Sts., Chicago. For page see List of Advertisers.

John A. Payne, 260-274 Culver Ave., Jersey City, N. J. For page see List of Advertisers.

The Advance Co., Richmond, Ind. For page see List of Advertisers.

Quaker City Machine Co., Richmond, Ind. 2th Century Ventilating Arm. For page see List of Advertisers.

VENTILATING MACHINERY, New Model enclosed, self-rolling gear; Standard Model Open Gear. Lord & Burnham, 1133 Broadway, N. Y.

VERBENAS

J. C. Schmidt, Bristol, Pa. For page see List of Advertisers.

VIOLETS.

William Sim, Cliffdale, Mass. Boston and Princess of Wales Violets. For page see List of Advertisers.

1000 California Violets, \$1.00 per 100; good rooted divisions from cold frame. Allen Bros., Leominster, Mass.

Princess Violets, 2 1/2 in., \$2.00 per 100. Jas. T. Baker, Bustleton, Philadelphia, Pa.

VINCAS

William C. Smith, Market & 61st St., Philadelphia. For page see List of Advertisers.

WEED KILLER

The American Horticultural Distributing Co., Martinsburg, W. Va. Target Brand.

WILSON'S PLANT OIL

Wilson Plant Oil & Fertilizer Co., Chatham, N. J. For page see List of Advertisers.

WIRED TOOTHPICKS

W. J. Cowee, Berlin, N. Y. For page see List of Advertisers.

WIREWORK

Reed & Keller, 122 W. 25th St., N. Y. For page see List of Advertisers.

Dorand & Marlin, Albany, N. Y. For page see List of Advertisers.

Wirework. Write for our catalogue. Holton & Hunkeler Co., Milwaukee, Wis.

William E. Heischler's Wire Works, 38-40 Broadway, Detroit, Mich.

Wirework—Compare our prices with others. Scamton Florist Supply Co., 201 N. 7th St., S. Canton, Pa.

In writing to Advertisers kindly mention Horticulture

FOR "POT LUCK" TRY US...

HEWS STANDARD POTS

POT MAKERS FOR 140 YEARS
WORLDS LARGEST MANUFACTURERS
WRITE FOR CATALOGUE AND DISCOUNTS
**Pearson Street,
LONG ISLAND CITY, N. Y.**
**A. H. HEWS & CO., Inc.
CAMBRIDGE, MASS.**
**452-460 No. Branch St.,
CHICAGO, ILL.**
**WHOLESALE FLORISTS—
Boston**

- N. F. McCarthy & Co., 81 Hawley St., Boston.
For page see List of Advertisers.
- H. M. Robinson & Co., 15 Province St. and 9 Chapman Pl., Boston.
For page see List of Advertisers.
- Welch Bros., 226 Devonshire St., Boston.
For page see List of Advertisers.
- Tally, Wellesley, Mass.
For page see List of Advertisers.

Buffalo, N. Y.

- William F. Kesting Co., 383-85 Elliott St., Buffalo, N. Y.
For page see List of Advertisers.

Chicago

- Chas. W. McKeller, 51 Wabash Ave., Chicago.
For page see List of Advertisers.
- Peter Reinbold, 51 Wabash Ave., Chicago.
For page see List of Advertisers.
- E. F. Whitson Co., 45-49 Wabash Ave., Chicago.
For page see List of Advertisers.
- J. A. Budlong, 37-39 Randolph St., Chicago.
For page see List of Advertisers.
- Foehlmann Bros. Co., Morton Grove, Ill.
For page see List of Advertisers.

Cromwell, Conn.

- A. N. Pierson, Cromwell, Conn.
For page see List of Advertisers.

Detroit

- Michigan Cut Flower Exchange, 38 and 40 Broadway, Detroit, Mich.
For page see List of Advertisers.

Minneapolis

- Rice Bros., 115 N. 6th St., Minneapolis, Minn.
For page see List of Advertisers.

New York

- Ford Bros., 48 W. 28th St., New York.
For page see List of Advertisers.
- H. E. Fromont, 57 W. 28th St., New York.
For page see List of Advertisers.
- Alex. J. Guttman, 34 W. 28th St., New York.
For page see List of Advertisers.
- E. C. Horan, 55 W. 28th St., New York.
For page see List of Advertisers.
- A. H. Langjahr, 55 W. 28th St., New York.
For page see List of Advertisers.
- James McMinns, 42 W. 28th St., New York.
For page see List of Advertisers.
- John J. Rayner, 46 W. 28th St., New York.
For page see List of Advertisers.
- W. E. Sheridan, 59 W. 28th St., New York.
For page see List of Advertisers.
- Moore, Hertz & Nash, 55 and 57 W. 28th St., New York.
For page see List of Advertisers.
- Wm. H. Knobler, 28 Willoughby St., Brooklyn, N. Y.
For page see List of Advertisers.

**WHOLESALE FLORISTS—
New York—Continued**

- Milling Bros., 41 W. 28th St., New York.
For page see List of Advertisers.
- John Young, 51 W. 28th St., New York.
For page see List of Advertisers.
- Greater New York Florists' Association, 102 Livingston St., Brooklyn, N. Y.
For page see List of Advertisers.
- Frank Millang, 55-57 W. 26th St., New York.
For page see List of Advertisers.
- A. L. Young & Co., 54 W. 28th St., N. Y.
For page see List of Advertisers.
- Growers' Cut Flower Co., 39 W. 28th St., New York.
For page see List of Advertisers.
- Henshaw & Fearick, 44 W. 28th St., New York.

- J. K. Allen, 106 W. 28th St., New York.
For page see List of Advertisers.

- Charles Millang, 44 Sixth Ave., New York.
For page see List of Advertisers.

- Manhattan Flower Market, 46 W. 28th St., New York.
For page see List of Advertisers.

Philadelphia

- W. E. McKissick & Bros., 1619-1621 Raitstead St., Philadelphia, Pa.
For page see List of Advertisers.

- Leo Niessen Co., 1209 Arch St., Philadelphia, Pa.
For page see List of Advertisers.

- The S. S. Pennock-Meehan Co., 1608-18 Ludlow St., Philadelphia, Pa.
For page see List of Advertisers.

New Offers in This Issue.
GERANIUMS.

- William Swaine, Kennett Square, Pa.
For page see List of Advertisers.

GIANT PANSY SEEDS.

- John Gerard, New Britain, Conn.
For page see List of Advertisers.

LORRAINE BEGONIAS.

- Elmsford Nurseries, Elmsford, N. Y.
For page see List of Advertisers.

SLUG SHOT.

- Hammond's Paint & Slug Shot Works, Fishkill-on-Hudson, N. Y.
For page see List of Advertisers.

SOUTHERN HUCKLEBERRY BRANCHES.

- H. M. Robinson & Co., 12 Province St., Boston.
For page see List of Advertisers.

SPENCER TYPE SWEET PEAS, NASTURTIUMS, ETC.

- Routzahn Seed Co., Arroyo Grande, Calif.
For page see List of Advertisers.

WOOD LABELS FOR NURSERYMEN AND FLORISTS.

- Dayton Fruit Tree Label Co., So. Canal St., Dayton, O.
For page see List of Advertisers.

PATENTS GRANTED.

- 920,864. Lawn Sprinkler. John B. Gorrell, Kendallville, Ind., assignor of one-half to Hiram V. Gorrell, Kendallville, Ind.
- 922,515. Rake Attachment. William E. Riley, Saratoga Springs, N. Y.
- 922,529. Cutter for Raspberry and Similar Stalks. Marinus B. Sherman, Payette, Idaho.
- 922,664. Nozzle. George L. Burden, Sandusky, Ohio, assignor of one-half to Charles A. Craig, Sandusky, Ohio.
- 923,089. Folding Flower Stand. Frank C. Tedesco, Dickson City, Pa.

NEWS NOTES.

St. Louis, Mo.—J. S. Seketer has started in the wire design business at 202 N. 13th street.

Lincoln, Ill.—Otto Hembreiker has withdrawn from the partnership of the West End Greenhouses, and Hans Schmalz will continue the business.

The annual Rhododendron Show of the Massachusetts Horticultural Society will be held at Horticultural Hall, Boston, on Saturday and Sunday, June 5 and 6.

Kennicott Bros. of Chicago report having handled 60,000 dozen peonies in the three days of Memorial Day trade. A fine red glab-holis called Frances King, with four to five-foot stem, was a attraction at this place.

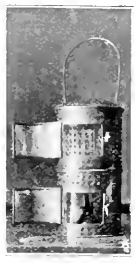

**THIS
KILLS
MILDEW
EVERY
TIME**

FOR PARTICULARS WRITE
**Benjamin Dorrance
ROSE GROWERS
Dorrancton, Penna.**

**Standard
Flower.. POTS**

If your greenhouse are within 100 miles of the Capital, write us, we can save you money

W. H. ERNEST

229 and M Street WASHINGTON D. C.

For List of Advertisers See Page 819

LIST OF ADVERTISERS

Page	Page
Advance, The Co. 823	Krick W. J. 814
Allen, J. K. 813	Kraeischel Bros. Co. 824
Angelo Nursery (Eng.) 803	Kuebler Wm. H. 812
Aschmann Godfrey. 806	Lager & Harrell 796
Atlanta Floral Co. 808	Langjahr, Alfred H. 812
Bambrick Thos. H. 819	Leonard Seed Co. 807
Barrows H. H. & Son. 796	Leathy A. & Co. 796
Bark & Smith. 808	Lord & Burnham Co. 824
Bassendorfer H. & Co. 800	Lynch Thos. M. 819
Boddington A. T. 807	MacMulklin E. A. 809
Boston Florist Letter Co. 796	MacRorie-McLaren Co. 812
Boston Plate and Window Glass Co. 822	Manda Jos. A. 790
Bowe, M. A. 808	Manhattan Flower Mkt. 813
Bowker Fertilizer Co. 817	McCarthy N. F. & Co. 813
Bowker Insecticide Co. 821	McConnell Alex. 808
Breck Joseph & Sons. 807	McKellar Charles W. & E. 810
Breitmeier's J. Sons. 808	McKissick, W. E. & Bros. 810
Bridgeman's Seed Warehouse. 807	McManus Jas. 814
Budlong, J. A. 808	Meyer J. C. & Co. 813
Burpee W. A. & Co. 807	Michell H. F. Co. 806
Cameron H. L. 794	Michigan Cut Flower Exchange. 813
Carrie & Salewiz. 796	Millang Bros. 812
Castle W. W. & Co. 822	Millang Charles. 812
C. J. & Co. Garzanti. 794	Millang Frank. 812
Clark's David, Sons. 818	Minner, J. C. 812
Coan J. J. 812	Moore, Hentz & Nash. 805
Cooper Wm. & Nep. 821	Moore, Hentz & Nash. 805
Consons Geo. & Co. 812	Murray Samuel. 818
Croce W. J. 812	New Eng. Nurseries. 805
Crout, Kolt. Co. 795	Newman J. & Sons. 808
Crawback Geo. W. 812	Niagara Sprayer Co. 821
Crawford H. F. 819	Niesse Len Co. 810
Crestline Mfg. Co. 822	Oechslin Fra. 796
Danfer F. A. 818	Ordewex Bros. 796
Dann J. H. & Son. 815	Ouzerkwerk P. 805
Dayton Fruit Tree Co. 803	Paletborpe P. R. Co. 821
Dege & Conrad Co. 796	Palmer W. J. & Son. 818
Dermer F. Sons & Co. 794	Park Floral Co. 821
Dorrance Benj. 818	Parfinsky Bros. 812
Dow Geo. E. 817	Patten & Co. 724
Dreer H. A. 822	Payne John A. 823
Dunlop John H. 808	Peacock Dahlia Farms. 805
Durand & Marohn. 812	Pennock-Meehan Co. 817
Jysant R. J. 813	Perkins St. Nurseries. 796
Eastern Chemical Co. 820	Pierce, F. O. Co. 793
Edwards Foidig. 802	Pierston, A. N. Inc. 745
Ellott Wm & S. 807	Pierston F. R. Co. 825
Elm City Nursery Co. 819	Pierston U Bar Co. 814
Elmsford Nurseries. 794	Pittsburg Rose & Car. 795
Esker J. G. 812	Porter Bros. 812
Ernest W. H. 818	Poehlman Bros. 805
Eyres. 808	704-2 0
Fahs R. D. & F. R. Co. 794	Pulverized Manure Co. 820
Fishar David, Est. of. 805	Quaker City Mach. Co. 823
Fiske H. E. Seed Co. 807	Rayner, I. M. 795
Foley Mfg. Co. 823	Kayser John L. 809
Ford Bros. 803	Reed & Keller. 813
Freeman G. L. 796	Reinberg Peter. 810
Front H. E. 812	Reuter S. J. & Son. Inc. 794
Galvin Thos. F. 809	Rice Bros. 810
Gerard, J. 806	Richardson H. M. & Co. 816
Greater N. Y. Florists' Association. 812	Rock Wm. L. Fls. Co. 808
Grey T. J. Co. 816	Rohls Julius Co. 795-805
Growers' Cut Flower Co. 812	Roland, Thomas. 794
Gude Bros. Co. 808	Rolker August & Sons. 822
Guttman Alex. J. 812	Rose Hill Nurseries. 807
Hall Asso. 823	Routznahn Seed Co. 807
Hammond Paint and Slug Shot Works. 821	Sander & Son. 796
Hannemann Hymn Co. 806	Schlegel & Fottler Co. 807
Hauswirth the Florist. 808	Schmid J. 803
Heacock Jos. Co. 805	Schulz Jacob. 807
Herbert David & Sons. 805	Scott Bros. 794
Hewes A. H. & Co. 818	Scott, John. 796
Hillinger Bros. 822	Sharr, Partridge & Co. 812
Hill, The E. G. Co. 794	Sherman W. P. 812
Hippard E. 823	Siggers & Siggers. 813
Hitchings & Co. 824	Sim, Wm. 794
Hoffman. 809	Situations & Wants. 819
Horan E. C. 812	Smith Chas. D. & Co. 794
Hunt A. E. & Co. 794	Smith W. T. 795
Hunt Bros. 794	Smith W. & C. 805
Janus, S. & Sons. 823	Smyth Wm. J. 812
Jager, Chas. J. Co. 821	Standard Fire Glass Co. 822
Kasting W. F. Co. 813	Stearns A. T. Lumber Co. 823
Kentucky Tobacco Co. 820	Stump & Walter Co. 821
King Cons. Co. 823	Swayne Wm. 795
	Syracuse Pottery Co. 822

Page	Page
United States Cut Flower Co. 803	Wilson Plant Oil and Fertilizer Co. 821
Valentine, J. A. 818	Winterson, E. F. Co. 812
Vincent K. J. & Sons. 805-805	Wood Bros. 794
	Yokohama Nursery Co. 813
	Young A. L. 813
	Young John. 812
	Young & Nugent. 818
Ward R. M. & Co. 807	Zangen O. V. 805-807
Water John & Sons. 803	Zinn Julius Ast. 803
Welch Bros. 810	Zvolanek A. G. 817
Wittbold Geo. Co. 798	
Wilson. 808	

GREENHOUSES BUILDING OR CONTEMPLATED.

New Haven, Conn.—House 34 x 135. Baltimore, Md.—H. J. Quick, one house.

Orlando, Fla.—L. Luther, range of houses.

Xenia, O.—J. J. Lampert, range of houses.

Plymouth, Mass.—C. T. Stevens, additions.

Montreal, Can.—A. Asselman, range 25 x 100.

Pittsfield, Mass.—A. N. Cooley, conservatory.

Lebanon, Mo.—Ernest Beck, house 27 x 175.

Rhinebeck, N. Y.—Frank Marquet, one house.

Cleveland, O.—M. L. Ruetenik, seven houses 30 x 190.

Cheyenne, Wyo.—C. H. Garwood, house 16 x 30.

Arlington Heights, Ill.—Emil Sigwalt, one house.

Walden, N. Y.—Walden Floral Co., range of houses.

Decatur, Ind.—Ernsberger Bros., range of houses.

Big Rapids, Mich.—Charles Buskirk, addition 18 x 72.

Platteville, Wis.—W. A. Schaefer, house, 26 x 100.

W. Norwood, N. J.—Herman Steinhoff, house 35 x 200.

Freeport, Ill.—Louis Bauscher, three houses 27 x 170 each.

Rogers Park, Ill.—Peter Rolling, four houses 25 x 150.

Neenah, Wis.—Louis Otto, three houses, each 23 x 130.

No. Cambridge, Mass.—John McKenzie, improvements.

Vincennes, Ind.—John G. Friez, seven houses 28 x 100 each.

Rochester, N. Y.—Frank Purcell, two rose houses, each 20 x 150.

Minneapolis, Minn.—Henry Bachmann, ten houses, each 20 x 120.

SITUATIONS WANTED

SITUATION WANTED—By all-round foreman; full charge of first-class place. Twenty years' experience. Roses, carnations, general greenhouse and nursery stock; landscape work. Permanent place only; would take interest in paying nursery or florist's establishment later. Total abstainer; married. References from present employer. Address Roses, 180 Grand St., Jersey City, N. J.

MISCELLANEOUS WANTS

WANTED TO BUY—Complete green house plants and all kinds of greenhouse material, to be taken down and removed at once. Terms cash. Address I. Snesser man, 229 Livingston St., Newark, N. J.

FOR SALE

FOR SALE—Two 7-section Weathered hot water boilers at a great reduction; good as new; will heat about 10,000 ft. glass. Inquire of Montrose Greenhouses, Montrose, Mass.

HELP WANTED

Wanted Nursery Foreman

Permanent position for right party. Must be well up on growing high grade ornamentals and a good handler of men.

Landscape Foreman

Experience in carrying out landscape work and familiar with ornamental stock

THE ELM CITY NURSE Y CO
NEW HAVEN, CONNECTICUT.

GOOD MEN

When you need good men, skilled or unskilled, Write:

THOS. H. BAMBRICK

34 South 7th Street Philadelphia

Help of all kinds, including that for Florists, Nurserymen, Seedsmen and the Horticultural trade generally.

WANTED—First-class plant grower to work under foreman; state age, experience and wages expected. Thomas Roland, Nantux, Mass.

FOR SALE

FOR SALE

THE GREENHOUSE PROPERTY, to close the ESTATE OF M. J. LYNCH, Deceased

The old established greenhouse property of the late M. J. Lynch, on the South Road, near the city of Poughkeepsie, N. Y., consisting of sixteen greenhouses, 3,000 square feet of glass with entire stock of Palms, Roses, Carnations, Bedding Plants, and all kinds of plants.

Eight-room Dwelling, with hot-water heating and slate roof, also,

Five-room Gardener's Cottage, adjoining Greenhouses.

Large, substantial Carriage House.

This is a valuable location, with ample water supply, adjoining Rural cemetery, on line of Wappingers trolley, one mile and a quarter from Court House.

For Particulars Apply

THOMAS M. LYNCH

256 Main St., POUGHKEEPSIE, N. Y.

FOR SALE

About 30,000 feet of glass in good condition, will sell at a low figure, or will lease to the right party, with privilege of buying. My object for selling is, I do not know anything about the business and can't hire men that do.

H. F. CRAWFORD
Montello St., Brockton, Mass.

FOR SALE—Five greenhouses, house, five rooms, improvements; barn, carriage house, sheds; all in good repair. One mile to depot, on main street; 20 minutes to Boston; five minutes to two lines of electric. Only florist in large town. Established twenty years. For further particulars address E. G. Blaney, Swampscott, Mass.

FOR SALE—Special 16 x 18 and 16 x 24 double thick glass in "A" and "B" qualities. Buy now and save money. Write PAULSHESKY BROTHERS, INC., 59 Montrose Ave., Brooklyn, N. Y.

Tobacco Paper		“NICO-FUME”	LIQUID
IS THE			
STRONGEST,		OVER 40% NICOTINE	
BEST PACKED,		By far the	
EASIEST APPLIED.		CHEAPEST.	
		JUST NOTE PRICE!	
24 sheets.....	\$ 0.75	Pint.....	\$ 1.50
144 sheets.....	3.50	½ Gallon.....	5.50
288 sheets.....	6.50	Gallon.....	10.50
1728 sheets.....	35.10	5 Gallons.....	47.25

**Furnishes the
Most Nicotine for the Money**

... Manufactured by ...
THE KENTUCKY TOBACCO PRODUCT CO., **Louisville, Ky.**

Obituary.

John E. Andre.

A prominent figure in the florist trade of Philadelphia passed away suddenly on the 28th ult. in the death of John E. Andre, of Doylestown, from peritonitis, superinduced by an operation for stomach trouble. Mr. Andre was a native of Detroit, Mich., and came to this vicinity from a rose growing establishment in Long Island to act as foreman for J. Y. Smith, of Doylestown, who was the first to make a success of rose growing in shallow elevated benches in this locality. This was in the early eighties. In 1888 Mr. Andre started for himself in Doylestown, and also reuted the old Smith establishment. He made a specialty of Hybrid Tea roses, in which he was very successful. His Brides and Bridesmaids had a more than local reputation. He also grew Beauties, smilax and mushrooms. In the latter he was one of the pioneers and grew same as an important crop for many years.

Mr. Andre was of a very genial disposition and had hosts of friends everywhere he was known. He leaves a widow and one son, the latter grown up and interested with his father in the business—which will in all likelihood be continued by the family. The funeral took place on the 30th ult. and was largely attended by members of the craft from Philadelphia and vicinity. Fred Ehret of Philadelphia, one of his oldest friends, was intrusted with the furnishing of many of the beautiful floral offerings which graced the last rites. Mr. Andre was a member of the Philadelphia Florists' Club, the Society of American Florists and other trade organizations—in most of which he took an active interest.

George W. Earl.

George W. Earl, Jr., son of the late G. W. Earl, well known in horticultural circles in Philadelphia, and brother of Howard M. Earl, manager for W. Atlee Burpee & Co., died suddenly at Wickford, R. I., on the 20th ult. The funeral took place with military honors at West Laurel Hill cemetery, Philadelphia, on the 24th ult., from his late residence at Bryn Mawr. Mr. Earl served in the Cuban and Philippine campaigns, retiring five years ago with the rank of second lieutenant. He was an author of marked ability and contributed many brilliant stories to the magazines. He

had been in poor health for the past two years and it was in hopes of recuperation that he had visited his friend John Kent Kane, who is building a summer residence on Narragansett Bay, and where he was suddenly stricken in the streets of Wickford and died shortly after being taken to the office of a resident physician. Mr. Earl was 49 years of age and unmarried.

Norman C. Cookson.

Cultivators of orchids will learn with great regret of the death of this enthusiastic orchid amateur, which occurred on May 15, at his residence, Oakwood Hall, Wylam on Tyne, Northumberland, England. The deceased commenced in 1880 the crossing of Calanthes, the finest of his earliest crosses being C. Cooksoni, C. Bryan, C. Clive, C. W. Murray and C. Alexanderi; the crosses Ruby, Angela and Chapmanii indicating the fine results that may be obtained by cross-breeding carried out with skill, for these flowers, although almost entirely of a ruby crimson color, were bred from the crimson eye of the otherwise white C. vestita. Mr. Cookson was very successful in raising hybrid Phaius, Dendrobiums, Cypripediums, Odontoglossums, Laelio-cattleyas and other species of great excellence and novel in form and coloring.

George T. Waldbart.

George T. Waldbart, youngest son of Alexander Waldbart, died after a lingering sickness on Friday morning May 28th, at the home of his parents, 3542 Lawton avenue, St. Louis. Both the young man and his father and his uncle, George Waldbart, are well-known in the trade, who extend their heartfelt sympathy. The funeral took place Saturday morning with many in the trade present and many beautiful floral pieces were sent.

Mrs. Marie M. Corneli.

Mrs. Marie M. Corneli, mother of Adolph and Den Corneli, members of the Schister-Corneli Seed Co., died on Wednesday, May 26, at her home, 3627 Easton avenue, St. Louis. The sons were well-known in local seed circles, also in the floral trade. Her funeral took place on Friday, May 28th. The many friends in the trade of the Council boys extend their sympathy in their hour of bereavement.

Julius Friedlander.

Julius Friedlander, son of the late Ludwig Friedlander, died on May 25,

WIZARD

TRADE BRAND MARK

MANURES

Dried, screened and packed in bags of 100 lbs. each.

PULVERIZED SHEEP MANURE
PURE — UNIFORM — RELIABLE

A strong and quick acting manure, highly recommended for carnations and chrysanthemums.

SHREDDED CATTLE MANURE
EASY TO HANDLE AND APPLY

Stronger and better in every way than rough manure. Lasts much longer on the benches. Unequaled for mulching and feeding roses, liquid manuring and mixing with bench and potting soil. Used by all the largest growers.

Ask Your Supply Man or Write Us for Circulars and Prices.

— THE —

Pulverized Manure Co.
31 Union Stock Yards, CHICAGO

IMP SOAP SPRAY

THREE SUCCESSFUL YEARS

Outdoor or Indoor

ELM BEETLE OR

WHITE FLY

EASTERN CHEMICAL CO.

Pittsburg Street, Boston, Mass.

at Bayonne, N. J., aged 56 years. Mr. Friedlander's father established a flower store at Broadway and 48th street, New York, in 1868 and the business has been carried on by Mrs. Friedlander, with whom Julius was associated, until last fall when the illness of the latter forced them to give it up.

Edmund Hersey.

Edmund Hersey, a native of Hingham, Mass., and for thirty-two years a member of the Massachusetts State Board of Agriculture, died in that town on May 25, at the age of 85.

SOLD BY SEED DEALERS IN USE FOR 29 YEARS



FOR PAMPHLET ON "BUGS AND BLIGHTS" WRITE TO

Hammond's Paint & Slug-Shot Works FISHKILL ON HUDSON
NEW YORK

An Absolute Success

in Killing Scale and All Other Insect Pests on Trees,
Shrubs and Garden Plants, including the notorious
LACE FLY ON RHODODENDRONS
without injury to the foliage.

WILSONS' PLANT OIL

Well Tested and Its Efficacy Fully Demonstrated
TRY IT!

Wilson Plant Oil & Fertilizer Co., Chatham, N. J.

For Trees, Plants, Shrubs and Flowers

— USE —

THE NIAGARA BRAND LIME SULPHUR SOLUTION

It destroys Scale Lice, Spiders and all forms of Aphides, AT THE SAME TIME Mildew, Blight, Rust and other Fungus difficulties.
Used in Winter or Summer. — No other remedy has been so universally effective.
Niagara Brand ARSENATE OF LEAD for chewing insects is equal to the best and better than the most.
Ask about our Green House sprayer. Address —

NIAGARA SPRAYER CO., - - Middleport, N. Y.

KILMDEAD
The best of all
the tobacco
dusts for
Dusting or
fumigating

25 lbs., \$1.00	100 lbs., \$ 3.00	1000 lbs., \$27.00
50 lbs., 1.75	500 lbs., 14.00	2000 lbs., 52.50

Stump & Walker Co.
50 Barclay St.,
New York.



The Best
Bug Killer and
Bloom Saver

For PROOF
Write to

P. R. Paethorpe Co.
OWENSBORO, KY.

"Every Bug Has His Dose."

Insect-destroying preparations that do their work well and effectively are the cheapest. Bowker's Arsenate of Lead and Bowker's Pyrox are recognized standard insecticides and fungicides for both indoor and outdoor use. Bowker's Insect Emulsion destroys many kind of plant lice, black and green flies, etc. Call or send for catalogue.

BOWKER INSECTICIDE COMPANY
43 CHATHAM ST. BOSTON



LATEST DISCOVERY

Progressive Growers Investigate

32 page Booklet of British, American and Canadian Testimony free for the asking

Eastern Agent - CYRIL FRANKLYN
62 Beaver St., New York, N. Y.

Sole Proprietors
WILLM COOPER & NEPHEWS
177 Illinois Street CHICAGO

Which Spray Pump

shall you buy? Buy the Spray Pump that fully meets the demands of the Government Agricultural Scientists and all practical Fruit Growers. These pumps are widely known as

DEMING SPRAYERS and are made in 23 styles for use in small gardens or immense orchards. Write for our 1909 catalog with Spraying Chart. Add 4 cents postage and receive "Spraying for Profit," a useful guide book.

CHARLES J. JAGER CO.
281-285 Franklin St., Boston



In ordering goods please add "I saw it in HORTICULTURE."

THE ONLY SYSTEM
OF
FORCED CIRCULATION

of hot water for greenhouse heating that has demonstrated its practicality, economy and perfection of action is the

CASTLE AUTOMATIC CIRCULATOR

All others are either superseded by the Castle Automatic, or are yet in the

EXPERIMENTAL STAGE

THE CASTLE BOILER

Our other specialty, is the best hot water heating Plate Boiler for Greenhouse purposes, on the market today.

Send for Descriptive Catalogue and Testimonials from Florists Who Are Using One or Both.

DO IT NOW! Mention Horticulture

W. W. CASTLE CO. HEATING ENGINEERS
177 SUMMER ST., BOSTON

"Revere" Garden Hose



LIGHT - STRONG - FLEXIBLE

STANDS ABUSE BRAIDED MOULDED CONSTRUCTION

WON'T KINK SEAMLESS THROUGHOUT

REVERE RUBBER CO.
BOSTON MASS
13 BANCROFTS
NEW YORK CHICAGO
SAN FRANCISCO PHILADELPHIA
MINNEAPOLIS PITTSBURG
NEW ORLEANS PORTLAND, ORE

GLASS
Greenhouse and Hot Bed
SIZES OUR SPECIALTY
IMMENSE STOCK
Plate and Window Glass
Write for Our Prices
PARSHELSKY BROS., Inc.
59 Montrose Ave., BROOKLYN, N. Y.

STANDARD PLATE GLASS CO.
Manufacturers—Importers—Jobbers
NOW IS THE TIME TO BUY
FRENCH OR AMERICAN GREENHOUSE GLASS
LOWEST PRICES ON REQUEST
26-30 Sudbury St. BOSTON, MASS. 61-63 Portland St.

STANDARD FLOWER POTS
Packed in small crates, easy to handle.

	Price per crate		Price per crate
1500 2 1/2 in. pots in crate	\$4.85	144 6 in. pots in crate	\$3.16
1500 2 3/4 " " "	5.25	120 7 " " "	4.20
1500 3 " " "	6.00	60 8 " " "	3.00
1000 3 " " "	5.00	HAND MADE	
800 3 1/2 " " "	5.80	48 9 in. pots in crate	\$3.60
300 4 " " "	4.50	45 10 " " "	4.80
450 4 1/2 " " "	5.74	24 12 " " "	4.80
300 5 " " "	4.51	12 14 " " "	4.80
210 5 1/2 " " "	3.78	6 16 " " "	4.50

Seed pans, same price as pots. Send for price list of Cylinders for Cut Flowers, Hanging Baskets, Lawn Vases, etc. Ten percent off for cash with order. Address **Hilfinger Bros., Pottery, Fort Edward, N. Y.** August Rolker & Sons, Agts. 31 Barclay St., N. Y. City

GLASS Always Write Us Before Buying
SHARP, PARTRIDGE & CO.
22nd and Lumber Streets, CHICAGO
WE HAVE SOME SNAPS

BOSTON PLATE & WINDOW GLASS CO.
GREENHOUSE GLASS GERMAN AND AMERICAN
261 to 287 A Street BOSTON 20 to 22 Canal Street

Syracuse Red Pots
STANDARD SIZES
Florists, we will suit you as to quality and prices. Write for catalogue.
Syracuse Pottery Co., SYRACUSE, N. Y.

Holds Glass Firmly
See the Point
PEELESS
Glassing Pottery are the best. No rubs or lifts. Box of 1000 points 75 cts. postpaid.
HENRY A. BREYER,
714 Chestnut St., Phila., Pa.

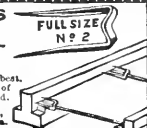

In ordering goods please add "I saw it in HORTICULTURE."

HOSE
CRESTLINE SPECIAL Garden Hose. Made in three different weights. A tough, durable hose that has the life in it. Every section guaranteed.

Price with couplings: 5-ply, 6-ply, 7-ply.

1/2 in., per 50 ft.	\$1.00	\$5.00	\$5.50
3/4 in., per 100 ft.	7.75	9.75	10.75
1 in., per 50 ft.	4.50	5.50	6.00
1 1/4 in., per 100 ft.	8.75	10.75	11.75

Immediate shipment. Express or freight.
THE CRESTLINE MFG. CO.
Box 233, Crestline, O.

Light
Graceful
Durable



22 ft. wide without columns

**Payne "T"
Bar Greenhouse**

any width and length. Every bar galvanized steel. Absolutely drip ss. No breakage of glass at eaves. Every kind of greenhouse construction. Estimates furnished

JOHN A. PAYNE

Designer and Builder

260-274 Culver Ave. Jersey City, N. J.

Everything for
Greenhouse
Building

Write for information and
prices

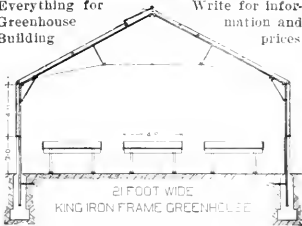

In Widths from 14 feet 0 inches to 54 feet 0 inches. Without posts.

**KING TRUSS SASH BAR HOUSES
IRON GUTTERS AND EAVES.
IRON AND CYPRESS BENCHES.
VENTILATING MACHINERY.**

**KING CONSTRUCTION CO.
NORTH TONAWANDA, N. Y.**

MASTICA
FOR Greenhouse Glazing
USE IT NOW.
F. O. PIERCE CO.
12 W. BROADWAY
NEW YORK

Mastica is elastic and tenacious, admits of expansion and contraction. Putty becomes hard and brittle. Broken glass more easily removed without breaking of other glass as occurs with hard putty. Lasts longer than putty. Easy to apply.

Evans 20th Century Arm

Will not twist the shafting pipe. Three times the power of old style elbow arms. Sold only with Evans Challenge Machine.

Write for free Catalogue to

**QUAKER CITY MACHINE CO.
Richmond, Ind.**



In ordering goods please add "I saw it in HORTICULTURE"

THE STANDARD STEAM TRAP

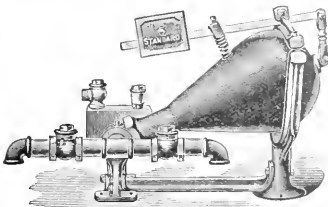

is acknowledged the best for the florist, because it is durable and does its work without trouble and annoyance, saving its cost by the economy in coal bills.

E. HIPPARD

YOUNGSTOWN, OHIO

S. JACOBS & SONS
1359-1363 Flushing Ave., BROOKLYN, N. Y.
MANUFACTURERS OF
GREENHOUSE MATERIAL - VENTILATING APPARATUS - PUTTY
ORDERERS IN **GREENHOUSE GLASS - BOILERS - PIPE - FITTINGS**
We carry on hand everything necessary for the complete Erecting, Heating, Ventilating or Repairing of Greenhouses. Let us quote you.

IF YOU WANT BIG RESULTS
BUY FROM WHO RUNS THE IN THE YOU WILL WEAR CAUSED BY FROM GROWN IN
PHIL FOLEY FACTORY CITY OF CHICAGO
SMILE PROFITS FROM CROPS HOUSES
A WIRELESS MESSAGE
BIBL YOUR BUILDING MATERIAL WOOD IRON GLASS PROFIT FOR



ECHOS FROM OUR CUSTOMERS.

"Both neat and mechanically made. Works with greatest ease."—Mich. "Your machine is a dandy."—Ohio. "It is ahead of anything here."—Mass. "Your machines are first class—do not wish for anything better."—Kas. "Machines work fine, will wait more."—Pa. "Your machine is a Joe dandy."—Mont. "Your machines are the only kind to have."—Ky. "Your machine for me every time."—W. Va. "Machines are working very satisfactorily."—Wis. "Work nicely and so easy to set up."—Minn. "Like the Advance better than any machine I have seen or used."—Iod. "Best machine on my place."—Neb. Free circulars and free estimates for the asking.

The ADVANCE CO., Richmond, Ind.

PATENTS
Trademarks and Copyrights
Send your business direct to Washington Saves time and insures better service Personal attention guaranteed. Twenty-five years' active service. SPECIALTY: "Working on the Failure of Others."
SIGGERS & SIGGERS
PATENT LAWYERS
Box 9, National Union Building Washington, D. C.

KROESCHELL BOILER



MADE OF FIRE BOX FLANGE PLATE
Can not Crack

Water Space in Front, Sides and Back
The Most Popular Boiler Made

SEND FOR CATALOGUE.

KROESCHELL BROS. CO.
35 Erie street, CHICAGO, ILL.

CYPRESS SASH BARS 32 feet or longer
HOT BED SASH
PECKY CYPRESS BENCH LUMBER

GREENHOUSES

ERECTED AND EQUIPPED COMPLETE IF DESIRED

Write for Circular "D" and Prices

The A. T. STUBBS LUMBER CO.
NEPONSET, BOSTON, MASS.

GREENHOUSE CONSTRUCTION LUMBER

John C. Moninger Co.

117 E. Blackhawk St., CHICAGO.

The FLORESTA'S HAIL ASSOCIATION OF AMERICA, insurer of 29,000,000 sq. ft. of glass. For particulars address

John C. Esler, Sully Saddle River, N. J.

In ordering goods please add "I saw it in HORTICULTURE."

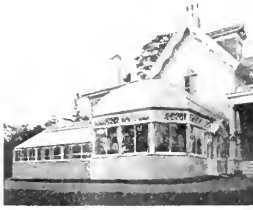

The Greenhouse Conservatory

This is a pleasing combination of a curvilinear conservatory and a straight roof greenhouse.

The conservatory opening out of the dining room, furnishes bright flowers the year round. The greenhouse opening into the conservatory, supplies it with plants and flowers, and also vegetables for the table.

Notice how excellently these buildings fit in with the style of the house itself. Our well known Flat Iron Rafter Construction makes the best of houses, and is light, strong and durable. Send for our interesting circular.

Hitchings & Company

Designing & Sales Offices General Offices & Factory
1170 Broadway, N. Y. Elizabeth, N. J.



Beyond All Doubt the Most Architectural and Ornamental of All Greenhouses

is the curvilinear type. For practical all around growing houses, whether for flowers, fruits or vegetables, they can't be beat. It is important, however, that they shall be the L. & B. Sectional Iron Frame Construction; that is, if you want lightness and durability combined.

LORD AND BURNHAM COMPANY,
Irvington-on-Hudson, N. Y.

New York — Boston — Philadelphia — Chicago



No Heavy Roof Supports. The U-Bar is the Rafter and Roof Bar in one. No House like it. The lightest and best. Patented.

Send for Catalog

PIERSON U-BAR CO.

U-Bar Greenhouses
1 Madison Avenue
NEW YORK

HORTICULTURE

Vol. IX.

JUNE 12, 1909

No. 24

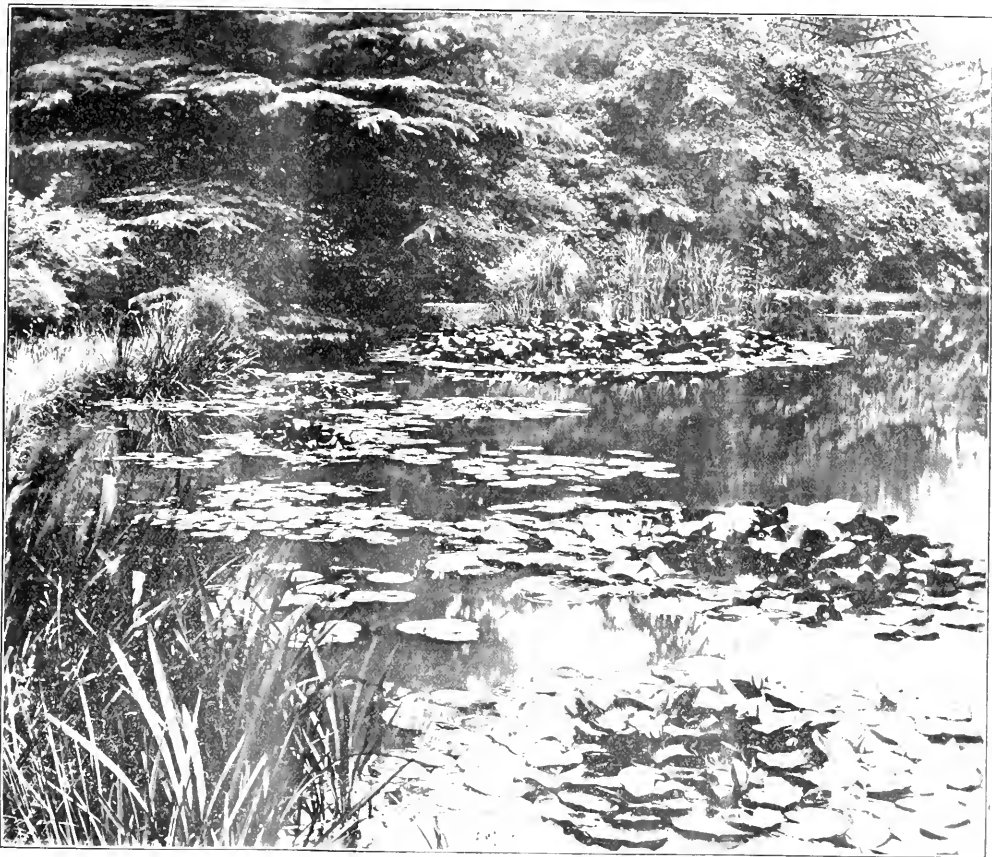

LILY LAKE

Gunnersbury House, England.



DEVOTED TO THE
FLORIST, PLANTSMAN, LANDSCAPE GARDENER AND KINDRED INTERESTS

PUBLISHED EVERY SATURDAY AT 11 HAMILTON PLACE, BOSTON, MASS.

SUBSCRIPTION, \$1.00 PER YEAR



JUN 14 1909

CHRYSANTHEMUMS.

"Not small weak runty stock grown under benches, but the kind that brings back Dollars for Pennies."

WHITE: Earliest October Frost (We have extra fine large stock of this variety), Mrs. Henry Robinson, Clementine Touset, Alice Byron, Timothy Eaton, Merry Christmas, White Bonafon.
YELLOW: Monrovia, Halliday, Appleton, Bonafon, Eaton, Chataqua Gold.
PINK: Maud Dean, Dr. Enguehardt.
RED: Intesity, Schrimpton.

All these varieties, rooted cuttings \$2.50 per 100; \$20.00 per 1000. 2 1/2 in. \$3.00 per 100; \$35.00 per 1000.
 Golden Wedding, R. C. \$3.00 per 100; \$37.50 per 1000. 2 1/2 in. \$4.00 per 100; \$35.00 per 1000.
 Golden Glow, R. C. \$5.00 per 100. 2 1/2 inch \$6.00 per 100.

ROSES.

	2 in. or 2 1/2 in.	3 in. or 3 1/2 in.		
	100	100	1000	1000
American Beauties....	\$7.00	\$65.00	\$9.00	\$85.00
Killarney—Own roots....	\$6.00	\$55.00	7.50	
Mrs. Potter Palmer.....	5.00	45.00	6.50	

Bridesmaids	2 in. or 2 1/2 in.	
Bridesmaid	100	1000
Richmond.....	\$5.00	\$45.00
Kaiserine.....	5.00	45.00
Uncle John.....	4.00	35.00

POEHLMANN BROS. COMPANY,

Morton Grove, Ill.

ROSES OWN ROOT

Bride, Maid, Killarney, Richmond, Perle, Chatenay, 4 in. stock, \$8.00 per 100; \$75.00 per 1000
 Mrs. Jardine, My Maryland, Rhea Reid, Beatrice, 4 inch, \$12.00 per 100.
 These are in splendid shape for immediate planting.
***MUMS??** Sure, lots of them yet. Standard kinds, \$3.00 per 100; \$25.00 per 1000
 Asparagus Plumosa and Sprengeri, year old plants from bench, \$8.00 per 100; \$75.00 per 1000.

CHARLES H. TOTTY, Madison, N. J.

CHRYSANTHEMUMS

FOR EVERY PURPOSE.

ELMER D. SMITH & CO., Adrian, Mich.

CHRYSANTHEMUMS

Rooted Cuttings and Pot Plants Write for list and prices.
S. J. REUTER & SON, WESTERLY, R. I.

Our New Carnation SHASTA

is always pure white, is always in bloom and is always high grade.

\$12.00 per 100, \$100.00 per 1000. Send Order now to
PATTEN & CO., Tewksbury, Mass. BAUR & SMITH, Indianapolis, Ind.

CARNATIONS

F. DORNER & SONS CO.
 LaFayette, Ind.

SCOTT BROS.

Gloire De Lorraine Begonias
 From 2 1-4 and 3 1-2 inch pots,
 \$15.00 and \$25.00 per 100.
 Elmsford Nurseries, Elmsford, N. Y.

Begonia Gloire de Lorraine

Leaf Stock, June Delivery, \$15 per 100,
 \$145 per 1000, from 2 1/2 in pots
 Stock guaranteed to be absolutely free from disease.

THOMAS ROLAND NAHANT, MASS.
 Perles, Brides and Maids for Planting

Per 100
 1000 Brides and Maids, 3 inch strong, \$4.00
 1000 Perles, 3 inch, ready for shift, \$6.00
 Pittsburg Rose & Carnation Co., Gibsonia, P. O., Pa.

MARY TOLMAN

A New Light Salmon Pink Carnation for 1910.

\$12.00 per 100. \$100.00 per 1000.

A. E. Hunt & Co., Evansville, Ill.
 Chicago Carnation Co., Joliet, Ill.
 Hunt Bros., - - Park Ridge, Ill.

Cannas

Dry roots: Italia, Cleveland, Austria, Egadale, Marlborough, America, Penna, Black Beauty, \$1.50 per 100. Kate Gray, mixed with red, \$1.25 per 100. Asparagus Sprengeri, 2 in., \$1.75, 3 in., \$4.00, 4 in., \$6.00 per 100. Dracaena indiv., 4 in., 10c. English Ivy, 2 in., \$2.00; R. C. 75c per 100. Rex Begonia, 2 in., 3c. **J. H. DANN & SON, - WESTFIELD, N. Y.**

In writing advertisers kindly mention HORTICULTURE.

Now Ready for Delivery NEW WINTER-FLOWERING BEGONIA

"PRESIDENT TAFT"

Awards Bronze Medal S. A. F., Chicago, Nov., 1908; Certificate of Merit by Pittsburg and Allegheny Florists and Horticultural Society, and New York Florists' and Gardeners' Club.

This beautiful winter-flowering Begonia originated in our Nurseries about 1870. It is stronger, sturdier and more beautiful than any of its predecessors. In color it is similar to Agatha; it is free and continuous flowering from November to April; each flower the size of a silver dollar. \$4.00 per dozen; \$25.00 per 100. Cash with order from unknown correspondents.

J. A. PETERSON
 McHenry Avenue, Westwood,
 Cincinnati, O.

CARNATIONS Fine Healthy Stock

From 2 inch Pots. Per 100 Per 1000
 Pres. Seelye - - - \$6.00 \$50.00
 White Enchantress, Beacon 4.50 40.00
 Victory, Winsor, Melody, 4.00 35.00
 Kingston Pet.
 Dabell, Lady Hountful, Mrs. Lawson, Variegated Lawson 3.50 30.00

CHRYSANTHEMUMS Rooted

Cuttings
 G. W. Childs, Miss Clay Frick, White Shaw, Early Snow, Mrs. Jas. Marshall, Flayer Weaver, The Harriott, Yellow Eaton, \$2.00 per 100, \$15.00 per 1000.
 A. J. Ballour, Autumn Glory, Ada Spaulding, Dr. Enguehardt, Doro by Devens, Geo. Kab. Glory of the Pacific, Harry Lay, H. W. Reiman, Ivory, Jeanne Nonin, J. E. Lager, J. H. Troy, J. K. Shaw, Inad Dean, Meta, Monrovia, Mrs. Jerome Jones, Minnie Wamaker, Mrs. Alice Byron, Mrs. Baer, Mrs. Robert Icarthur, Major Bonaffon, Mad E. Bergmann, Nagoya, Foily Rose, Robt. Heathday, Timothy Eaton, W. H. Lincoln, Wm. Duckham, etc., \$1.50 per 100.

Send for Catalogue of Roses, cwn root and grafted, and other miscellaneous stock.
WOOD BROTHERS
 FISHKILL, N. Y.

Send for our Preliminary List describing and quoting

Chrysanthemums and Carnations.

A fine lot of Carnation Cuttings ready now.

THE E. G. HILL CO.,
 Richmond, Indiana.

White Bonaffon

The Chrysanthemum Everybody Should Grow.
 I have Rooted Cuttings, Cool Growth, Sturdy Stock, \$12.50 per 1000
H. L. CAMERON,
 North Cambridge, Mass.

THE BOSTON VIOLET

Unequaled for Productiveness, Beauty and Popularity.
 In Crap from September to May.
 Plants \$2.00 per doz; \$74.00 per 1000; \$100.00 per 1000.
 Princess of Wales \$15.00 per 1000.
WILLIAM SIM, - Cliftondale, Mass.

WHITE KILLARNEY

It is needless to say much about the value of this

NEW WHITE ROSE

its value is so well established. In support of this statement, we might say that we intend to plant not less than 20,000 for our own growing. We have a splendid stock of both grafted and own-root plants, which we can deliver immediately on receipt of order,—gilt-edged planting stock. We guarantee perfect satisfaction.

STRONG PLANTS, 2 1/4 in. pots, own-root, \$30.00 per 100; 250 for \$70.00; \$250.00 per 1000.
GRAFTED PLANTS, \$35.00 per 100; 250 for \$82.50; \$300.00 per 1000.

HYDRANGEAS IN BUD AND BLOOM

We offer fine plants, well budded, just beginning to show color: in splendid shape for immediate use.
6-in. pots, 4-5 blooms each, \$9.00 per dozen.

Large Plants in Tubs

We have a large stock of splendid plants grown in tubs and half-barrels for July and August flowering.
Fine plants in tubs, \$2.00 each. Extra large plants in half-barrels, \$5.00 each.

A FEW SEASONABLE SPECIALTIES

BOXWOOD PYRAMIDAL. Fine plants 3 ft. high, \$2.00 each; 4 ft. high, \$3.00 each; 4 1/2 ft. high, \$4.00 each.

RUBBER PLANTS (Ficus elastica). Very large, bushy plants in tubs 4 ft. high, fine for summer decoration, \$3.50 each; 6-in. pots, 3 1/2 ft. high, \$9.00 per dozen.

ENGLISH IVY, 3 1/2-in. pots, \$12.00 per 100.

AMPELOPSIS VEITCHII. Strong plants, 4-in. pots, \$15.00 per 100.

PHOENIX ROEBELENI. Extra fine plants, 5-in. pots, \$18.00 per dozen.

CICUTONS. Strong plants, 3-in. pots, \$3.00 per dozen; 5-in. pots, \$6.00 per dozen; 6-in. pots, \$9.00 per dozen.

CANNAS. *Beaute de Poitevine, Buttercup, Souv. d'Antoine Crozy, Pierson's Premier, Mlle. Berat, L. Patry, Florence Vaughan, etc.* Strong started plants, 3 1/2-in. pots, \$6.00 per 100. Dormant roots, \$3.00 per 100, \$25.00 per 1,000.

CALADIUM ESCULENTUM. Started plants, \$6.00 per 100.

GERANIUMS, in bud and bloom. Double Gen. Grant. Extra fine plants, 3 1/2-in. pots, \$8.00 per 100.

GERANIUMS, in bud and bloom. Assorted. 3 1/2-in. pots, \$8.00 per 100.

VINCA VARIEGATA. 4-in. pots, \$10.00 per 100; extra heavy, \$16.00 per 100.

NASTURTIUMS. 3-in. pots, \$4.00 per 100.

F. R. PIERSON CO., Tarrytown-on-Hudson, NEW YORK

Fine Rubbers at 20c.

All well grown stock in first class condition

Rubbers, 4 inch	each	20c
" 6 "		25c
Vincas, 2 "		02c
Plumosas, 4 "		05c
" 3 year		04c
Mums, cuttings		02c
" Nonin, out of pots		04c
Sprengeri, 3 year		04c

Cash with order or satisfactory references

WILLIAM C. SMITH
 Market and 61st Street
 Philadelphia, - - Pa.

Last Call! Last Call!

For the NEW MUMS for EARLY PLANTING
10,000 Golden Glow, -1000 White Cloud
 1000 Pacific Supreme, all at \$5 per M., out of 2 1/2 inch; \$18 per M., strong R. C., 200 at M rate. Add 1/4 for 100 rate.
 \$8.000 October Frost, \$20 M. 2 1/2 inch; \$12 M R. C.

After June 15 VIRGINIA ROEHLIANN, \$4 per 100, 2 1/2 inch. Order NOW. LYNWOOD HALL, \$4 per 100.

1000 Golden Eagle—new yellow, \$3 per 100. All standards midseason and late \$20 per M., out 3 1/2 inch; \$12 per M. R. C. Ask for our quantity prices. Will not be beat out them.

I. M. RAYNOR, Greenport, N. Y.

A. N. PIERSON, Inc., Cromwell, Conn.

WHITE KILLARNEY (Waban Strain)

	Doz.	100	250	500	1000	2500	5000
GRAFTED STOCK.....	\$6.00	\$35.00	\$82.50	\$150.00	\$300.00	\$687.50	\$1,250.00

MY MARYLAND GRAFTED.....	\$3.00 per doz.,	\$30.00 per 100,	\$150.00 per 1000
OWN ROOT	2.00 "	10.00 "	90.00 "

STANDARD VARIETIES

Betty, Bon Silene, Bride, Bridesmaid, Cardinal, Enchanter, Etoile de France, Etoile de Lyon, Frenz Deegan, Gen. McArthur, Golden Gate, Hermosa, Ivory, Kaiserin Augusta Victoria, Kate Moulton, Killarney, La Detroit, Maman Cochet, Marechal Niel, Mme. Abel Chateauy, Mrs. Jardine, Mme. Hoste, Mrs. Paul Niehoff, Mrs. Pierpont Morgan, Mrs. Potter Palmer, Papa Gontier, Queen Beatrice, Rhea Reid, Richmond, Rosaline Orr English, Souv. du President Carnot, Souv. de Wootton, Uncle John, Wellesley, White Cochet. The above Grafted (selected plan s) 20 cts. each, \$2.00 per doz., \$15.00 per 100, \$120.00 per 1000.

OWN ROOT ROSES

Killarney, Bride, Bridesmaid, Mme. Abel Chateauy, Ivory, Richmond, Mrs. Paul Niehoff. 2-in. pots, 75c per doz., \$3.50 per 100, \$39.00 per 1000. 2 1/2-in. pots, \$1.00 per doz., \$6.00 per 100, \$50.00 per 1000.
 Queen Beatrice, Rhea Reid, Mrs. Jardine, Mrs. Potter Palmer, from 2 1/2-in. pots, \$8.00 per 100, \$70.00 per 1000.

BEDDING PLANTS

COLEUS. Verschaffeltii, Golden Queen, Queen Victoria, Beckwith Gem, Firebrand, Lord Palmerston. Rooted Cuttings by express, \$0.60 per 100, \$5.00 per 1000. Out of 2 1/2 in. pots in May, \$2.00 per 100, \$15.00 per 1000.
Golden Bedder, Hero Messy, Pearl of Orange, Faasy Varieties. Twelve kinds not listed above, 75 cts. per 100, \$5.00 per 1000.
AGERATUM, Stella Gurney, Princess Pauline. SALVIA, Splendens, Bonfire and Zurich.
HELIOTROPE. Dark blue bedding varieties. GERMAN IVY. 75 cts. per 100, \$6.00 per 1000.
ALTERNANTHERA (Red and Yellow), 50c per 100, \$5.00 per 1000. From 2 1/2 in pots, \$2.00 per 100.
SALLEROL. Rooted Cuttings, \$1.00 per 100, 2 1/2 in. pots, \$2.50 per 100.
CHRYSANTHEMUMS IN QUANTITY. Catalogue on Application.

GERANIUMS Aster Plants

Simple's, Vick's and Queco of the Market, grown from the best seed, fine plants, in White, Blue and Pink \$2.50 per 1000; 5000 for \$10.00
TOMATOES, best var., \$1.50 per 1000.
CALLIFLOWER, PEPPERS, EGG PLANTS, \$2.50 per 1000.
WM. SWAYNE, Kennett Sq., Pa. J. C. SCHMIDT, Bristol, Pa.

ORCHIDS!

It is no reason whatever why all of you grower experts do not try us and see by your own eyes which kind of handsome orchids we handle and at such low prices, but we call your attention giving three kinds in special sale:

C. Mossiae, imported plants, \$40.00 case containing 450 strong, healthy and well leaved.

C. Percivalliana, 7 to 12, \$3.00.

C. Gaskell na, 9 to 12, \$2.25; no less than two new growth which we guarantee the flowers will pay price of plants, as they are visible in the sheath, and from 12 to 18, \$1.75; 18 to 25, \$2.50. The largest plants have 3 to 5 new growths.

We are true importers and need to be acquainted with all of you.

Lablata and C. Gigas Sanderlana and others shortly.

ORDONEZ BROS., Madison, N. J.

ORCHIDS

We are booking orders now for delivery early in the Spring on all commercial CATTLEYSAS and NOVELTIES. Our prices are right and our guarantee perfect. We sell only first-class goods.

GARRILLO & BALDWIN Secaucus N. J. FRESH IMPORTED ORCHIDS.

Arrived in Splendid Condition: Cattleya Trianae, Mossiae, Gigas, Skinnerii, Oncidium Splendidum, Orlithorhynchum, Wentworthianum Phalaenopsis Schilleriana and Amabilis, Lycaste Skinnerii, Vanda Boxallii, Laelia Superbicus Odontoglossum grande. Write for prices.

JOSEPH A. MANDA

191 Valley Road West Orange, N. J.

IMPORTED ORCHIDS

Now Arriving

Julius Roehrs Co.
RUTHERFORD, N. J.

ORCHIDS

Largest Importers, Exporters, Growers and Hybridists in the World

Sander, St. Albans, England and 235 Broadway, Room 1 NEW YORK CITY

ROSES

A SPECIALTY

The Dingee & Conard Co. West Grove PA.

Kentia Belmoreana

Delivery from now on. Per 1000 Per 100

Strong seedlings, ready to go in 2 1/2 in. pots..... \$25.00 \$3.00
2 1/2 inch plants, fine bushy stuff 75.00 8.00

Cocos Weddelliana

Per 1000 Per 100

Fine established healthy plants from 2 1/2 in. pots..... \$90.00 \$10.00
Satisfaction Guaranteed.

O. V. ZANGEN, Seedsman, Hoboken, N. J.

JAPANESE NURSERY CO.
THE YOKOHAMA NURSERY CO.
31 BARCLAY STR. NEW YORK.
LILIES
PLANTS
BAMBOO STAKES

PHALAENOPSES AND VANDAS

Importations Received Every Two Months

Phalaenopsis Amabilis
Phalaenopsis Schilleriana
Phalaenopsis Sanderiana
Phalaenopsis Stuartiana

Vanda Sanderiana
Vanda Batemannii
Vanda Boxallii
Dendrobium Superbum

We also receive many other varieties of Orchids from the South Pacific and East Indies. We respectfully solicit your inquiry in this line.

MACRORIE - McLAREN COMPANY

721 Crocker Bldg., San Francisco, California, U. S. A.

LAGER & HURRELL ORCHIDS

Established and Fresh Imported. SUMMIT, N. J.

Palms



Ferns

Shrubs

Perennials

Send for Our Catalogue.

The GEO. WITTBOLD CO., 1657 Buckingham Place, Chicago, Ill.

FERNS FOR DISHES,

CASH WITH ORDER

2570 to 2606 W. Adams St., Chicago, Ill.

Assorted Varieties
From 2 inch pots, \$3.50 per 100; \$30.00 per 1000

FRANK OEGHSLIN

IPOMOEA NOCTIFLORA

Best pure white moonvine in the market, very fragrant and as big as a saucer. On this variety we have a worldwide reputation as growers and shippers for the last twenty years.

Price, 2 1/2 in. pots, \$5.00 per 100. 10,000 are now ready.

Godfrey Aschmann

1012 West Ontario St., Philadelphia, Pa.

Kentias, Arcas, Latanias, Cocos, Phoenix, Araucarias, Rubbers, Crotons, Pandanus, Asparagus, Ferns for Dishes. 200,000 Bedding Plants, also Rooted Cuttings of Coleus at lowest wholesale rates.

Orders taken for imported plants for fall delivery

A. LEUTHY & CO.

PERKINS ST. NURSERIES

ROSLINDALE, MASS.

In ordering goods please add "I saw it in HORTICULTURE."

CANNAS

Strong plants from pots 25 leading varieties, \$5.00 per 100.

ESTATE OF DAVID FISHER, Woburn, Mass.

NEPHROLEPIS MAGNIFICA

THE SENSATIONAL NOVELTY
Strong 2 1/2-in. stock, \$25.00 per 100.

WHITMANII

2 1/2 in., \$40.00 per 1000; 3 1/2 in., from Bench, \$8.00 per 100.

H. H. BARROWS & SON, WHITMAN, MASS.

ROBERT CRAIG CO.

ROSES, PALMS,

and Novelties in Decorative Plants

MARKET and 49th STREETS., PHILADELPHIA, PA.

PALMS AND FERNS DECORATIVE PLANTS

JOHN SCOTT

Rutland Road and E. 45th St. Tel. 8300 Bedford BROOKLYN, N. Y.

JARDINIERE FERNS

IN BEST VARIETIES. VERY FINE STOCK.

\$3.50 per 100, \$30.00 per 1000

ROSE HILL NURSERIES

New Rochelle, N. Y.

HEACOCK'S PALMS

Kentia Belmoreana

7-inch pots.....32 to 34 inches high.....\$2.50 each
7-inch pots.....36 to 38 inches high..... 3.00 "
9-inch tub.....44 to 48 inches high..... 5.00 "

Made up Kentia Forsteriana

7-inch pots.....34 to 36 inches high.....\$2.50 each
7-inch pots.....36 to 38 inches high..... 3.00 "
9-inch tub.....42 to 48 inches high..... 5.00 "

Joseph Heacock Co., Wyncote, Pa.

Schizanthus Wisetonensis as a Basket Plant



During my visit to the United States I noticed how well you grow the *Schizanthus Wisetonensis* but did not see any grown in baskets. The accompanying photograph of a plant grown by Mr. R. B. Leech, Woodhall Gardens, Dulwich, London, will convey some idea of what can be done with it in this way. The lasting quality of the flower also adds very greatly to its usefulness. The plant measured over two feet each way.

Har Barnard

Notes from the Arnold Arboretum

Several new species of *Deutzia* have in recent years been introduced from China, one of the handsomest on account of the purplish color of its flowers being the *Deutzia discolor* var. *purpurascens*. This species, however, has not proved hardy in this latitude, but some crosses raised by Lemoine between this species and *Deutzia parviflora* and *D. gracilis* seem to be fairly hardy here and have withstood the winter at the Arnold Arboretum. One of the handsomest of these hybrids is *Deutzia discolor* var. *floribunda* with rather large flowers about three-quarters of an inch in diameter arranged in dense clusters, carmine pink in bud and becoming nearly white with a slight blush when fully open. Very similar, but slightly more pinkish is *D. Lemoinei* var. *Fleurs de pommier* with slender branches covered their whole length with dense clusters of pinkish flowers. *Deutzia Lemoinei* var. *Boule rose* also has slightly pinkish flowers borne in dense clusters along the branches, and there are some other similar hybrids.

A very recently introduced species is *Deutzia Filmorinae* from southwestern China, a handsome apparently rather tall growing shrub with pure white flowers in large corymbs somewhat similar to those of *Deutzia parviflora*, but larger. The individual flowers measure more than three-quarters of an inch in diameter and are borne in large twenty to thirty five-flowered clusters. The oblong-lanceolate leaves are about two to four inches long and resemble those of *Deutzia crenata*, but have a whitish under side. It is yet too early to say much about its hardiness but it seems to be hardier than some of the other recently introduced Chinese species as *D. discolor*, *D. setchuensis* and *D. corymbiflora*.

One of the numerous forms of the Mock Oranges which merits to be better known and more planted on account of its early appearing flowers is the native *Philadelphus hirsutus*. It is perfectly hardy in this latitude, though its habitat is from Tennessee and North Carolina to Georgia and Alabama. It is the earliest of all the species to bloom and a handsome shrub with its slender branches studded their whole length with creamy white cup-shaped flowers. The individual scentless flowers are about one and a quarter inches in diameter and spring usually in short-stalked three-flowered clusters from the axillary buds of last year's branches. The leaves which are not yet fully developed while the shrub is in bloom, are rather small, three-nerved and grayish pubescent on the under side. Though this species is a very distinct one and easily recognized, it is not often found true to name in nurseries, usually other forms of this polymorphous genus are grown and sold as *P. hirsutus*.

The most attractive feature at the Arnold Arboretum is at present the *Rhododendrons* which will be in their prime the coming week and these in turn will be followed by the *Kalmias*.

Alfred Rehder

Thrifty French Nursery Practice

The French cultivator has a good knowledge of the right breakment of the soil with which he has to deal and, compared with his French neighbor, the West German has much to learn. The working of the soil goes hand in hand with its improvement. Throughout the year the workers by the piece are to be found in the nurseries; in winter they trench and dig and in summer hoe and chop up the weeds; and naturally the employer pays a wage upon which these people may live in comfort. In the spring when the despatch of goods has ceased, and in the quarters of young stuff earlier, the soil is broken with a three-tined "graft", as it would be called in Kent, and then hoed as soon as a weed shows itself. They do not wait till "goats fodder" can be made. As to manure, it is not so much of the dear stable manure that is used but rather waste from the kitchen of which every big town wants to rid itself, and which the gardener and farmer throws into a heap to decay. The dust and rubbish of the summer months, which contains but a small quantity of coal ashes, and therefore the more humus, are the most made use of. This is mixed with stable manure and cow dung to improve it. About Paris this rubbish is put at once on the land, crockery, metals, etc., picking out these latter, afterwards. This compost is not only a manure, but it helps to lighten heavy loamy soils.

HORTICULTURE

VOL. IX

JUNE 12, 1909

NO. 24

PUBLISHED WEEKLY BY
HORTICULTURE PUBLISHING CO.
 11 Hamilton Place, Boston, Mass.
 Telephone, Oxford 322
 WM. J. STEWART, Editor and Manager

SUBSCRIPTION PRICE

One Year, in advance, \$1.00; To Foreign Countries, \$1.00; To Canada, \$1.50

ADVERTISING RATES

Per Inch, 30 inches to page \$1.00
 Discounts on Contracts for consecutive insertions, as follows: . . .
 One month (4 times) 5 per cent.; three months (12 times) 10 per cent.;
 six months (24 times) 20 per cent.; one year (36 times) 30 per cent.
 Page and half page spaces, special rates on application.

Entered as second-class matter December 8, 1904, at the Post Office at Boston, Mass., under the Act of Congress of March 3, 1879.

CONTENTS

	Page
COVER ILLUSTRATION—Lily Lake.	
SCHIZANTHUS WISETONENSIS AS A BASKET PLANT—H. A. Barnard—Illustrated.	829
THRIFTY FRENCH NURSERY PRACTICE.	829
NOTES FROM THE ARNOLD ARBORETUM—Alfred Rehder	829
WATER SCENERY IN THE GARDEN—Frederick Moore	831
AMERICAN ASSOCIATION OF NURSEYMEN: Thirty-fourth Annual Convention—Wednesday Afternoon's Session.	832
Thursday Morning's Session—St. Louis Next Meeting Place	833
Thursday Evening—The Exhibition	852
NEWS OF THE CLUBS AND SOCIETIES: Horticultural Society of New York—Pittsburg Florists' and Gardeners' Club—Cincinnati and the S. A. F. Convention	833
Newport Horticultural Society—Chicago Florists' Club—Pennsylvania Horticultural Society—Proposed National Sweet Pea Society of America—Massachusetts Horticultural Society	834
Club and Society Notes	835
OBITUARY—Geo. Waldhart, Jr.—Wm. F. Andross—Dr. F. M. Hexamer	835
ROYAL HORTICULTURAL SOCIETY—Frederick Moore	836
CARE OF HARRISH BULBS—J. T. Butterworth	836
SEED TRADE: Canners' Convention—American Seed Trade Association—Onion Seed Crop—Notes	838
OF INTEREST TO RETAIL FLORISTS: Packing Flowers for Shipment, W. H. Long—Steamer Departures	840
New Flower Stores—Flowers by Telegraph	841
FLOWER MARKET REPORTS: Boston, Buffalo, Chicago, Detroit	843
Philadelphia, New York	845
Epsom Salts as a Fertilizer, Dudley M. Pray	852
MISCELLANEOUS: Personal	835
Catalogues Received	837
Incorporated	837
Chicago Personal and News Notes	841
Greenhouses Building or Contemplated	850
A Notable Publication	850
Business Changes	852
News Notes	852
French Bulbs Higher	852

gestions repeatedly urged in HORTICULTURE'S editorial columns and is undoubtedly due in part to the incentive afforded by the special features of the recent spring exhibition of the Massachusetts Horticultural Society in Boston which were so eminently successful. Rochester is to be congratulated for her enterprise and should the affair prove the success hoped for we may reasonably expect to see the flower show business take on renewed vitality all over the country and the revival will tend to enlist the participation of those elements in the profession that have hitherto almost invariably held aloof from any active interest in the exhibitions.

The communication from Vice-president The call Gillett in this issue reminds us that the date to duty for the 25th convention of the Society of American Florists at Cincinnati is drawing near and that it is fully time for those whose position, official or otherwise, endows them with the privileges and responsibilities of leadership to get busy in their respective fields and do their utmost to stir up interest in the Society and in the meeting. This gathering will present features of unique interest and the time is opportune for a reawakening of the spirit and personal enthusiasm which made the first convention the potential factor in the opening of a new era for American floriculture. To attain this the young generation to which the pioneers now give way must have the same quality of inspiration and loyalty, ever bearing in mind that something far more than the payment of membership fees and presence at a convention—commendable as these are—is essential if the grand old Society is to attain its best usefulness in the years to come. We have full confidence that the duty will be worthily performed.

Magnesium as a plant food The question of food is, and will continue to be in an increasing degree, of supreme importance in animal and vegetable life. Notwithstanding the vast amount of literature sent broadcast by the Department of Agriculture, experiment stations and agricultural colleges, erroneous conceptions regarding plant feeding and stimulation are very general and it must be acknowledged that among those growers who have had the benefit of extended experience the exact knowledge possessed concerning soil, contents and their functions in plant building is often of the crudest character. We commend to our readers the article on magnesium as a plant requirement, by Dudley M. Pray, which we publish in this issue. Mr. Pray is of the Eastern Chemical Company, whose fertilizer and insecticide preparations are regularly advertised in this paper. Mr. Pray has made the question of chemical fertilizers and their availability and comparative economy in plant stimulation his life study and previous articles from his pen have attracted widespread notice. It will be noted that he asks for experiences of others who have given attention to the magnesium subject. Our columns are open to any who may have anything to offer or are disposed to discuss or question.

Mention has been made in our news columns recently of the innovation planned by the florists of Rochester, N. Y., for the exhibition to be given in that city next fall. Briefly stated, the idea is to dispense with all tables and to substitute for the staging methods almost universally in vogue heretofore, artistic groupings on the floor. This is in harmony with sug-

A promising innovation

Water Scenery in the Garden

(See Cover Illustration.)

Having in my previous article given the methods of making a lake and supplying the water wherewith to fill it, its inflow and overflow, I will touch now upon the banks and adjacent area. The latter may perchance consist of land which has been under the plow; but in the first place a path for pedestrians if the lake or water course be but small in extent, will appear an essential feature, if not a necessary one. In that case a width of 5 feet would be required, and the path may in a general way follow the windings of the lake shore. These are however, details that admit of great diversity of treatment, depending on local conditions, the landscape views, and other things. If a lake be of great extent, as may be the case when an earthen dam built across a narrow natural hollow encloses a space of many acres, it may be advisable to make a road that may be driven over. Then the cost is so much greater, owing to the need of a foot-deep foundation of hard materials, as well as good sound coating of gravel or finely broken hard stone and a final layer of sifted gravel, seashell, or of sea sand. This last is excellent, surfacing material, as, by the use of the Dutch, or Planet hoes, and a freshening with sand once every fourth or fifth year the surface can be maintained in a presentable condition for any number of years, and afford pleasant walking, riding and driving. I am reminded of many miles of such roads on private estates which are still serviceable although they were made a hundred or more years ago.

As no piece of water can be considered perfect without trees and shrubs on its banks and for some considerable distance beyond these, we come to the point when the planter must be called into consultation, as to the species to be planted and in what manner—a very important matter. It may be stated as an axiom that on the south or sunny side on all land in the northern hemisphere, not much of anything higher in growth than 5 feet may be planted within fifty yards of the water. To do otherwise would be to darken the surface of the water, and thus render gloomy what should be kept cheerfully glistening and bright; and even on the west side the planting of anything that grows to a great height or any dense grouping should be avoided close to the bank, unless it be for the purpose of making "surprise" views, at certain parts. Coniferous plants, such as Thuja, Cupressus, Juniperus, Retinosporas, have good effects if planted in groups of one species, or of several; as these if set at distances of 4 to 5 feet asunder, make close masses in a few years.

Around large pieces of water say of fifty or more acres almost any kind of tree suitable to the climate may be planted in more or less proximity to the same with the certainty of the effects being desirable for either in summer, autumn or winter. Some may be chosen for their fine leaves and handsome flowers as Catalpa bignoniodes, and C. b. aurea for the sake mainly of its yel-

lowish leaves; B. speciosa, and, in the warmer states the Japanese B. Kaempferii; Paulownia imperialis, a species with very large leaves, and purple gloxinia-like flowers. Kolreuteria paniculata, Crataegus in many species and varieties—as C. Crusgalli, of which there are in the nurserymen's list some six or eight varieties, all desirable for flower or fruit: C. Douglasii, C. nigra, C. oxyacantha, especially the pink flowered varieties, and Paul's double-flowered, scarlet thorn; Robina hispida and R. h. macrophylla; Sophora Japonica, and S. J. pendula, a remarkable looking subject, very hardy and well adapted by its habit of growth for planting near the water; Hippophae rhamnoides femina and H. r. mascula, the former being covered with masses of orange red fruits in the autumn and winter months; the latter should be planted near it in order to secure a crop of fruits. Many of the maples are most desirable waterside plants including the Japanese species and their varieties where the climate favors. Acer platanoides laciniatum, A. p. Reitenbachii, A. p. Schwedleri, A. rubrum, A. saccharinum, A. tartaricum, A. colchicum aureum, A. c. rubrum, and A. striatum are capital picture trees, mostly growing of moderate dimensions in good soil, and they possess distinct characteristics in the form and color of their foliage. The Pavia, a subsection of Aesculus should not be omitted if space allows and P. macrostachya with its spikes of white flowers is an excellent subject as a bush of six to eight feet high for planting near the borders of a lake. Of the taller growing Pavia, I cannot write too highly of P. rubicunda, P. discolor, and P. rubra. The common horsechestnut in its several varieties looks well by the water. The alders should not be omitted, especially telling being the varieties of Alnus glutinosa which differ in the form and color of the leaves. They do best planted with their roots within reach of the water, and may be treated as trees with one stem, or as bushes, cut down to the ground after a few years growth. As solitary specimens—to be employed at rare intervals Fagus purpurea and F. p. pendula may be recommended for planting near to the water.

As suitable waterside trees the poplars have an acknowledged position, and for lakes of limited area Abele alba, A. argentea and A. Bolliana are among the smaller growing species; P. halsamifera and P. monilifera and the varieties of this last are more vigorous, and they reach very large sizes, too overpowering for any but the most spacious grounds. The oaks of North America offer in the splendid coloring of the foliage and their ample dimensions some of the finest material for waterside planting, very effective either placed singly or in groups of several trees; but they must have plenty of space in order to show their grand crowns to advantage.

J. Anderson Moore

London, Eng.

(To be continued)

AMERICAN ASSOCIATION OF NURSERYMEN

Thirty-Fourth Annual Convention, Rochester, N. Y.

The preeminence of Rochester as a convention centre, combined with its commanding position as the hub of the great nursery interests, proved a great attraction and drew together a most representative gathering of the nursery trade people of the continent. Remote and widely separated sections were well represented and the social and business advantages of the occasion were taken full advantage of by one of the most comprehensive and cosmopolitan audiences that ever congregated to listen to the opening addresses of a nurserymen's convention.

The lecture hall in the Seneca Hotel was well filled when at 10 a. m., June 9, one hour later than the program announcement, President Brown called the meeting to order and introduced Hon. H. H. Edgerton, Mayor of the

Rochester as a city and in the nurserymen's industry. He recommended the Rochester slogan, "Do it for Rochester" as worthy of adoption by every city and town. The spring of 1909, he acknowledged, had been a record breaker in the nursery trade, everything sold at good prices and stocks exhausted. He asserted that the nurserymen were following the most delightful avocation in the world, in daily contact with nature and those who love nature and advised the support and holding up of the hands of those who are interested in park and playground movements. As pertinent subjects he suggested the question of how much capital a nurseryman can afford to invest in land, whether he is not better equipped to carry land than the ordinary investor and advised the young men to keep on the alert for wise purchases of land.

The secretary, George C. Seager, then presented his report, showing receipts and disbursements, and was followed by the treasurer, Charles L. Yates, with a detailed report on similar lines, showing a balance of \$3853.00 in the treasury. Messrs. Hill, Harrison and Moon were appointed an auditing committee.

Irving Rouse, chairman of the Tariff Committee, was then called upon for a report. He intimated that, although much hard work had been done by the committee in connection with the tariff revision now under consideration at Washington, nothing definite had as yet been secured, although the paragraphs in the new schedule as at present accepted by the Senate Finance Committee, levying specific duties on various kinds of stocks, evergreen seedlings and roses, and 25 per cent. ad valorem on all other nursery or greenhouse stock, was now expected to stand and become law. A hearty vote of thanks was accorded this committee.

"Nurserymen Pulling Together a Little More," was the text for a very vigorous paper by J. H. Dayton, of the Storrs, Harrison Co., which came next on the programme. Mr. Dayton urged the need of a better business education for nurseryman, so that they would all realize that the percentage of actual cash cleaned up would be the only criterion of value of a sale of goods. He condemned the methods of price cutting, bargain sales and other depreciative resorts for disposing of stock, and advocated the bonfire as a preferable recourse. The questions of who should be entitled to the benefit of wholesale prices, the necessity of a better system of grading, etc., were referred to and their consideration with a spirit of fairness urged. It was an eloquent and practical paper and elicited tumultuous applause. T. B. Wilson was the next speaker, his subject being "The Relationship Between the Nurseryman and the Farmer or Fruit Grower." He advocated more education for the latter and more consideration by the former as the best means of remedy-

ing existing difficulties and misunderstandings. He emphatically condemned substitutions in filling orders and gave good reasons for his belief. The necessity of budding from prolific bearing stock of the best type of best varieties was strongly urged.

The report of the Transportation Committee by F. H. Stannard was next presented and the committee was accorded a vote of thanks for its successful efforts in having the objectionable "release clause" rescinded at the R. R. meeting in Mobile.

Prof. Wm. E. Alwood then gave a very interesting address on "The By-Products of Food," giving the results up to date of investigations being conducted by the U. S. Department of Agriculture in computing and ascertaining the comparative value of sugar



HENRY B. CHASE
Member Executive Committee.

City of Rochester, who incidentally complimenting the promptness displayed, extended in an informal way a hearty welcome and cordial greetings to the visitors, who, he said, represented the industry that has made Rochester famous. George S. Josselyn of Fredonia, responded on behalf of the Association. Being a man of a poetical turn of mind, his response was in verse, telling in a most impressive manner, how they "do it in Rochester" and reverting in plaintive strain as to how they "did it in Milwaukee." Many local and personal allusions, found favor with the audience which was not slow to "see the point."

President Charles J. Brown then made his address, speaking first as a Rochester man in recognition of the honor to his city which he recognized in this visit and then as representing the Association of which he is the chief official. He referred to the last meeting of the Association in Rochester, twenty-six years ago and called attention to the great walking which had taken place since that time in

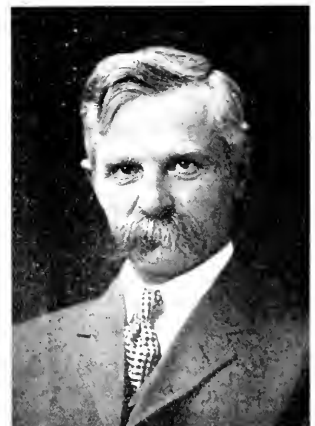

E. M. SHERMAN
Member Executive Committee.

and acid contents of fruit and explaining the necessity of having a well-defined standard to aim for in selecting and developing desirable qualities in varieties of grapes, apples, etc. Many questions were asked from the floor and a very interesting running debate was carried on.

Last on the forenoon program was a paper by S. C. Moon on Evergreen Conifers. It was just such a paper as might be expected from this eminent authority and was listened to with marked attention. In the remarks which followed, it was commented upon as touching on a phase of the nursery business hitherto rather neglected in the programs of the Association, and an innovation worthy of further attention.

Wednesday Afternoon Session.

Wednesday afternoon was devoted to a ride through Rochester streets and parks as guests of the Western New York Nurserymen. Tallyhoss and park wagons and phaetons in long array were required to accommodate the

News of the Clubs and Societies

550 guests who took advantage of this opportunity to view Rochester's charms, and the procession attracted plenty of attention as it wound its attenuated length along the residential avenues and through the park drives. Genesee Park was first visited and then Highland Park; the party being photographed in the rhododendron dell at the latter place, which is now in its full beauty. A special band concert was given at Highland Park, complimentary to the visitors.

Thursday Morning's Session—St. Louis the Next Meeting Place.

The convention assembled at ten o'clock. After the roll call of state vice-presidents their report was presented recommending St. Louis as the place for the convention next year. J. Horace McFarland, presented the claims of Harrisburg, Pa., in competition in an impressive address, and afterward withdrew for this year, substituting next year in advance. An amendment substituting Denver was defeated, and St. Louis was finally selected.

Election of Officers.

The nominations by state vice-presidents for officers for the coming year were supported by unanimous vote, and the following were declared elected: President, F. H. Stannard, Ottawa, Kansas; vice-president, W. P. Stark, Louisiana, Mo.; Secretary Seager and Treasurer Yates were re-elected. Messrs. J. H. Dayton, H. P. Chase, Irving Rouse, D. S. Lake, and Wau. Pitkin were appointed a committee to consider and make recommendations on matters presented in the paper by Mr. Dayton, on Wednesday. Dr. L. H. Bailey then presented his paper, "The Science Point of View," which we can safely characterize as the most remarkable address ever presented before a body of horticulturists in America. It elicited tumultuous applause from an audience which filled the hall. The next speaker was Dr. W. H. Jordan, who spoke extempore on the subject of "The Experiment Stations and Their Work." He gave interesting statistics of work done hitherto, and showed that the public prejudice and misunderstanding, which at first was encountered, had now given place to confidence and liberal support. The stations stand primarily for discovery of truth and should be given time and freedom to pursue this work with less demand for other public services with which they have been somewhat overburdened in the past.

R. S. Osborn then read a brief and practical paper on the relation of growers with retail dealers, calling attention to the mutual dependence of these two interests and desiring the sending of wholesale lists to consumers.

L. A. Berckmans then read a scholarly address on the commercial peach industry. William Pitkin reported for the legislative committee, and a vote was passed in accordance with his recommendations, giving the next committee discretionary power in following up proposed state legislation relative to inspection of foreign importations. The report of C. J. Maloy on the National Council of Horticulture was followed by a criticism by Col Watrous

(Continued on page 832)

THE HORTICULTURAL SOCIETY OF NEW YORK.

The summer exhibition of this society was held on June 5 and 6, and the experiment of holding it open on Sunday seemed to be appreciated, judging by the goodly number of flower lovers in attendance on that day. The unfavorable weather of the last ten days has retarded the development of peonies and roses; not an entry was made in the rose classes.

J. A. Manda received a bronze medal for Laelio-Cattleya Dominicana splendens and certificate of merit for Cattleya Mossiae variety. Julius Roehrs Co. received a special prize for cut orchid blooms and cultural certificate for Cattleya gigas. Miss B. Potter, gardener G. Wittlinger, special prize for plants of Crassula rosea and cultural certificate for Gladiolus Peach Blossom. Lager & Hurrell special prize for orchids.

In peonies the first prize for white, crimson, for the best collection of singles, and for the largest and finest collection, went to The F. R. Pierson Co.; first for light pink and for rose to Geo. H. Peterson.

For flowers of hardy shrubs and trees: E. H. Weatherbee, gardener Francis Milne, 1st; F. R. Pierson Co., 2nd. Rhododendrons and azaleas: F. R. Pierson Co., 1st; Theo. Havemeyer, gardener Albert Lahodney, 2d. Hardy herbaceous plants: Blue Hill Nurseries, 1st; Palisades Nursery, 2d. Irises: Theo. Havemeyer, 1st; Bobbink & Atkins, 2d.

PITTSBURG FLORISTS' AND GARDENERS' CLUB.

The meeting on June 1st did not have the large attendance or the "snap" that has characterized our meetings of late. Nevertheless, there was a quietly confident hope for the future, and assured feeling that the August vacation was going to materialize, for Decoration Day had put more money into the pockets than ever before, and though everybody was tired everybody was happy. When the picnic was broached it was quickly voted that a picnic be held in July, and E. C. Reineman, Jno. W. Jones, and W. A. Clarke were appointed a committee with full power to make arrangements and report at the next meeting. The chances are in favor of the selection of Rock Springs, from which resort a cordial letter of invitation was read.

The subject of the meeting was "Outdoor Roses and Peonies," with an exhibition of outdoor roses scheduled for the private gardeners, but the meeting was just a week too early for these flowers and none were exhibited.

Frank Crook, gardener for J. H. Park, showed a very fine specimen of Cattleya Mendellii with 36 blooms. Robert Lillie, gardener for Mr. Barnhart, showed a collection of rhododendron blooms, and Phipps Conservatories, Jno. W. Jones, foreman, showed a collection of German Iris, Helium Hoopesi and Heuchera sanguinea.

The subject for the July meeting will be, "Seasonable Flowers."

H. C. JOSLIN, Secretary.

CINCINNATI AND THE S. A. F. CONVENTION.

We are now on the eve of the battle. Twenty-four years ago the first meeting of the S. A. F. was held in Cincinnati, since which time as you all well know, the child has grown to an adult, and has assumed the roll of a National Society, under a charter of the United States Government. Again Cincinnati, The Queen City of the West, opens wide her arms and bids you welcome, not only the members who wear the rose leaf, but all florists, private gardeners or others who are in any way associated with the trade will be welcome. Come, you will not only see a fine city but you will see the largest gathering of florists that has ever congregated in one given place. At the same time at Horticultural Hall, Music Hall, you will find the largest and finest display of florists' requisites that you ever beheld. The meeting will also be a little out of the ordinary. On Thursday night the meeting will be turned over to the "Boys of Twenty-five Years Ago," and it will constitute a genuine love feast, and a review of the past twenty-five years; there will also be other new and interesting features of the meetings that I am not at liberty to note at this time; these features you will have to come and see for yourself.

The ladies will not lack for entertainment; they will be first upon the list! The sports are all being looked after by competent committees. The bowling alleys will be cleanliness itself and the choicest fabric will not get soiled. The President's reception will be a feature and many other comforts will be imparted to our guests.

The Cincinnati Florists' Society are working hard to get all details well in hand. The Souvenir Committee are promising us a work of art. Twenty-five hundred copies will be printed at the first issue. If you have not already sent in your advt., do so at once, to J. W. Rodgers, Park Department, City Hall, and your wants will have immediate attention. William Murphy is Superintendent of the Trade Exhibit, and his address is 311 Main St. He is now ready to book your order for space and will be pleased to mail you a diagram and all particulars upon application. Write him; it will be a pleasure for him to answer any and all questions.

Boys! Don't forget to write Captain Frank Dellar, Station F, Price Hill. He has charge of the ball games and is the man to write. C. E. Critchell is chairman of the bowling and shooting, and any information wanted will be cheerfully furnished. William Gardner is manager of the shooting department and his address is 128 East Third St. This contest will be pulled off at the Dayton, Ky., Gun Club, one of the finest in the country, so boys fetch your gun. Ed. Winterson of Chicago is chairman of the national sports committee, and should any public-spirited individual feel that he or they want to contribute a prize for either team or individual, he will certainly be pleased to hear from you at an early date.

Now, we expect to enroll a great

number of new members at this meeting and while we do not want or intend to bore you with the proposition, we feel that it is certainly an honor to be enrolled as a member of the S. A. F. and O. H., the only national horticultural society in our great country America.

The cost is very small in contrast to the good the Society is doing and the next twenty-five years will see a wonderful improvement, not only in flowers but in the Society as well. Make up your mind to join, but come and see, even if you don't join. It will set you to thinking, and lead you into channels that you have never thought of.

E. G. GILLETT.

Cincinnati, O.

NEWPORT HORTICULTURAL SOCIETY.

At a well attended meeting of this Society on June 8, a committee of arrangements was appointed to carry out the work connected with the Rose Show which is to be held the 23rd and 24th of this month. This Committee is headed Mr. James McLeish, who has successfully filled that position on many similar occasions. Messrs. Richard Gardner, Andrew S. Meikle and Alexander Fraser, were appointed judges for both exhibitions of the year. James Hooper, gardener for Mrs. T. K. Gibbs, had on exhibition some samples of a stem rot in peonies which gave him some trouble last year as well as this season. The samples resembled the decay often found in the stems of egg plants, and were examined and freely discussed by the many members present.

The committee appointed to provide seeds and plants for the public school gardens reported having supplied a large number of plants to the youthful competitors for prizes offered by this Society.

Much regret was expressed by the members that D. J. Coughlin, our recording secretary, was again in the hospital, this time for an operation for appendicitis performed on him a few days ago, but we are very pleased to hear that he is rapidly recovering and is likely to be with us soon again.

CHICAGO FLORISTS' CLUB.

The new by-laws were passed with some amendments at the regular meeting of the Club, June 5. One of the important changes is the addition of two members to the board of managers which heretofore has consisted of five only. The new members elected were F. F. Bentley and E. C. Amling. Another radical change was combining the offices of the two secretaries into one and raising the salary from ten to twenty-five dollars per year. The names of Louis Whiterson and Frank Johnson were proposed for this office and though both gentlemen declined one will probably be induced to accept.

At the bowling contest last week, cash prizes were won by E. Schultz, 1st; John Zerk, 2nd; Henry Krauchen, 3rd. A great deal of interest is shown by the club in the making up of the team for the convention. The record is now being kept for that event.

PENNSYLVANIA HORTICULTURAL SOCIETY.

Meeting of the Executive Council.

A special meeting of the executive council of this society was held on the 11th inst. to consider affairs in connection with the hall property. Among those present were Clement B. Newbold, Dr. Robert Huey, Sydney W. Keith, John W. Pepper, J. G. Casselt, C. Hartman Kuhn, Robert Craig, William Robertson, and David Rust. Mr. Keith reported on behalf of the trustees of the bond holding (or building syndicate) that the property had not proved a paying venture. The revenue from social affairs on which the syndicate counted for its income is becoming less every year on account of the competition of the newer hotels. During last year, with most economical management and nothing spent for repairs, a surplus of \$1800 only over running expenses was realized, and it requires \$6000 to pay the interest on the bonds. After some discussion the following resolutions were introduced and passed, and the secretary was authorized to call a special meeting of the society on June 15th, 3 p. m., to consider and act on same.

WHEREAS, In the judgment of the executive council of the Pennsylvania Horticultural Society it would be of advantage to said society for the property known as Horticultural Hall to be sold, and out of the proceeds of such sale for a sum to be set aside that may be sufficient to enable the holders of the trust certificates which were issued to raise the funds to erect the building, the balance to be applied to the furthering of the objects of the society, therefore

Resolved, That the president be requested to call a special meeting of the Pennsylvania Horticultural Society to consider this subject.

Resolved, That the society be recommended at such meeting to adopt the necessary resolutions to authorize such sale, the taking of any legal steps that may be necessary in order to perfect the title to said premises.

June Exhibition.

An exhibition of outdoor roses was held on the 8th inst. Some excellent stock was shown—although if the date had been a week later we think same would have been even better. In hybrid teas, class 11, Samuel Batchelor, gardener for Clement B. Newbold, took first with a well-grown and well-staged lot of twelve varieties. In class 12, lot called for 12 varieties, 3 each, Wm. Robertson, gardener for Jno. W. Pepper, was the leader. Class 13 was for 12 blooms of any variety of hybrid tea. The honor went to Tans. A. Archfield, superintendent for C. A. Grisson, for a fine lot of Killamey—although Wm. Robertson gave him a strong fight with a lot of the same variety with better color, although not quite so vigorous. Classes 14 and 15 were Hybrid Perpetuals, and here Robertson carried the day over Archfield. Benschki, Crawford, Hayward, Magna, Bruner and Jacqueminot were the most noticeable good things in these collections. Robertson also got the Huey first in collection of hybrid teas, this class being unlimited as to number of varieties. Mrs. James M. Rhodes exhibited an interesting collection of 12 vases of various classes. Dr. Robert Huey sent some of the latest Dickson productions, among them being: Harry Kirk, Geo. C. Ward, Lady Iva Bingham, Avoca and Dorothy Page Roberts. A well-grown

specimen of Baby Rambler in 8 inch pot came from the Pepper place; and from the same establishment a curious Anthurium sport—the upper part of the spathe green, the lower half red.

PROPOSED NATIONAL SWEET PEA SOCIETY OF AMERICA.

The above proposed society is now taking concrete form. The exhibition will be held in New York City about the middle of July, exact time and place to be stated later. The schedule is now in process of preparation. The following firms have already offered prizes to be competed for at the first annual exhibition as follows:

The Arthur T. Boddington Cup—Class A—for the largest collection of Sweet Peas.

The W. Atlee Burpee Cup—Class B—for the largest collection of Sweet Peas.

The Peter Henderson & Company Cup or its value—Class C—for the best 25 vases distinct varieties.

The W. W. Rawson Silver Medal—Class D—for the best 12 vases distinct varieties.

The Stump & Walter prize—Class E—\$10.00 in gold for the best 6 vases distinct varieties.

We would also suggest other classes as follows:

For the best single vases, distinct varieties and colors, first prize, \$5.00; second prize, \$3.00; third prize, \$2.00.

Perhaps you would like to offer a prize along these lines or make other suggestions.

Great interest is being taken in the vicinity and it will be a great boom for the Sweet Pea in this country and an organization of this kind is essential to promote the love for and interest in this popular flower.

I shall be glad to write you further and answer any questions.

HARRY A. BUNYARD,
Secretary pro tem.

MASSACHUSETTS HORTICULTURAL SOCIETY.

The annual free rhododendron show took place at Horticultural Hall, Boston, on Saturday and Sunday, June 5 and 6. Although rhododendrons are rather backward this year there was a good display by Walter Hunnewell, gardener T. D. Hatfield, also from Francis Skinner, gardener J. T. Kin-sella. Ghent and Mollis azaleas were shown in profusion by R. & J. Farquhar, & Co., W. Whitman, gardener Martin Sullivan, and others. German irises were staged by thousands and made a glorious sight. Among the contributors of irises were T. C. Thurlow & Co., W. Whitman, whose display won a bronze medal, and W. W. Rawson & Co., who showed a novelty—a German iris named Success, in which the standards open out flat, similarly to the Japanese species, *levigata*.

Bellevue Nurseries staged a beautiful collection of hardy herbaceous plants in flower in pots. Old Town Nurseries showed pyrethrum and centauras, Mrs. J. L. Gardner glonias, W. Whitman specimen zonal petargoniums, Mrs. Fred. Aver fuchsias and from F. J. Rea came Phlox divaricata var. Laphami, which received honorable mention. A bronze medal was awarded to Dr. C. G. Weid for a



THIRD ANNUAL SALE

IT WAS A SUCCESS LAST YEAR WHY NOT THIS?

AT HIGH NOON, JUNE 22

we will offer growers a combination of stock to grow on consisting of

ARECAS, PANDANUS, ARAUCARIAS, FERNS, DRACAENAS, SAGOS, ASPIDISTRAS, ARDISIAS

in quantities to suit all bidders. Do Not Fail to Attend.

WM. ELLIOTT & SONS

42 Vesey Street,

NEW YORK

pair of specimens of *Cypripedium Lawrenceanum* bearing upwards of thirty flowers each and Dr. Weld's gardener, Wm. Rust, was given a cultural certificate for some fine pots of *Hydrangea Otaksa*. W. J. Clemson, gardener O. Christenson, showed some finely grown vegetables, including forced cauliflowers.

The great feature of the exhibition was the group of hardy herbaceous plants and flowers by R. & J. Farquhar & Co., in competition for the special prize to be awarded next September to the leading winner in five exhibitions. This display covered 500 sq. ft. of floor space, and, arranged in a sloping rocky setting, was gorgeous in the extreme. A great many Alpine rocky subjects rarely seen in exhibitions were included. Hardy asters bloomed in small pots were among the unusual things for this time of year.

CLUB AND SOCIETY NOTES.

The second annual flower show at Bethlehem, Pa., was scheduled for June 9

The Massachusetts Horticultural Society will hold their rose and strawberry show on June 26, 27.

The rose and strawberry exhibition of the Tarrytown (N. Y.) Horticultural Society will be held on June 15.

At the meeting of the New York Florists' Club on Monday, June 14, there will be an exhibition of peonies and outdoor roses.

The first June exhibition of the Wor-

cester County Horticultural Society, Worcester, Mass., was held on June 3 with a good display of flowers but a small showing of vegetables. James P. Porter and C. P. Fish were the only exhibitors of peonies. Irises were shown in splendid variety and L. C. Midgeley had a fine showing of campanula.

PERSONAL.

James Aldous of Iowa City, Iowa, is planning a trip to England this month.

It is reported that George W. West, lily exporter of Bermuda, is critically ill.

A. A. Smith, who has been connected with W. J. Ritterskamp's establishment at Princeton, Ind., has gone on a visit to his home in Norway.

Mrs. Philip Light, who succeeded her late father Henry Burt, in the florist business at Syracuse, N. Y., was married on May 24 to F. H. Robinson.

Among the passengers on the New Amsterdam which sailed June 8, from New York, were P. Koster, G. C. Eldering, P. Onwerkerk, Jr., Jeanu Van Waverin and J. Ebbingse.

Governor Gillett has named H. P. Stabler of Yuba, C. O. Bocks, Cupertino, and A. T. Garey, Los Angeles, as horticultural commission examiners for the State of California. An examination will be held in every county in which a horticultural commission is to be established.

Obituary.

Dr. F. M. Hexamer.

Dr. F. M. Hexamer, for many years vice-president of the Horticultural Society of New York and organizer of the horticultural shows of the American Institute of New York, died at his home in Stamford, Conn., on May 29, at the age of 77. He was a native of Heidelberg, Germany. He has held respectively the positions of agricultural editor of the New York Tribune, editor of American Garden, and from 1886 until 1905 editor of the American Agriculturist for Orange Judd. On retiring from this latter position he assumed the care of the publication of the agricultural books of Orange Judd Co. He has suffered from neuralgic troubles for several years. Three sons survive him; one a medical doctor of Mt. Vernon, N. Y.; one a landscape gardener at Jamaica, N. Y., and one a veterinary surgeon at Stamford, Conn.

William F. Andross.

William F. Andross of South Windor, Conn., died on May 28 at the age of 59. He has held many positions of trust and at the time of his death was secretary of the Connecticut State Agricultural Society.

George Waldbart, Jr.

George Waldbart, Jr., son of Alexander Waldbart, died at his home in St. Louis, on May 28, after a lingering illness, at the age of 30.

ROYAL HORTICULTURAL SOCIETY.

Novelties at the Temple Show.

The great event of the year took place on May 25, 26 and 27, the first day being very discouraging for rain fell heavily in the morning, although the afternoon was sufficiently fine as to induce an enormous number of persons to visit the Inner Temple Gardens, in which the exhibition, by permission of the Benchers, was held for the twenty-second time. Orchids have for many years been the more interesting flowering plants, and it has been usual for many novelties of an extraordinary character to be first exhibited to the public in these gardens. This year there were few startling new species or hybrids although the space filled was as large as in former years. One of the finest orchids shown and the most striking was *Odontoglossum crispum* var. *Solum* shown by F. Sander & Sons, a creamy white flower of good size, having a rich claret colored lip, and a few spots on the sepals. It was first seen in 1907, but in that year the flowers were smaller. Placed near the apex of Messrs. Sander's group stood a splendid plant of *Cyrtopodium Saintlegerianum*, and arranged around it there were to be noted graceful sprays of *Odontioda Devassiana*, and good specimens of *Brasso-cattleyas*. There were also many cattleyas and *Laelio-cattleyas* including *Niobe*, with flesh pink flowers; the entirely white flowered *C. Dusseldorfei* Undine; *L. C. ammonier* Menley, a pretty flower of white, pink and purple; *Sophran-laelia Danae*, a handsome hybrid, of low growth, flowers pink and white; and *Miltonia Bleuana* Mrs. F. Sander, a white flower having lines of rose on the lip. A fine group of orchids was shown by F. M. Ogilvie, on which were observed several *Odontiodas*, viz., *Bradshawiae*, *O. Charlesworthii*, etc. This group contained *Trichopilla Backhousiana*, a striking white flowered variety, and a scarlet variety of *Odontioda Vuykstekeae*. Bull & Sons showed among their new plants *Odontoglossum-crispum* *Minora*, a white flower having purple blotches; *Odontioda chelseiensis* a white flower, having suffused blotches of a pinkish lilac tint. Armstrong & Brown had the following novelties: *Odontoglossum Armstrongia*, having white flowers that are regularly spotted with violet; among *Laelio cattleyas* a white variety named *Aphrodite alba* with a lip marked with a ruby tint; *Cattleya Skinneri* Temple's variety, the best colored variety of *C. Skinneri*. Charlesworth & Co. showed a grand group in the best position in the Marquee and out of the fine array of species and varieties secured a first class certificate each for *Laelio cattleya Eurylochus* and *Oncidium Charlesworthii*. The first named possesses well-shaped flowers of a bright orange tint shaded bronze, a lip of ruby and a yellow tube, and the latter is of the *On. crispum* type, doubtless, a natural hybrid. The sepals and petals are of chestnut brown tint, with waved cross lines and the lip is bright yellow at the base and at the front blotched with brown. *M. Chas. Vuyksteke* of Ghent, received a first class certificate for *Odontoglossum mirum* Emperor of India, white with dense purple blotches; *Od. Aglaon*, in form like *Od. Vuykstekeae*, with

handsome shield like lip of the latter species, flower white as regards the ground, the surface nearly covered with red-brown orange blotches and bright crimson in some parts, the lip of white with red-brown blotches; *Od. Princess Victoria Alexandra* with flowers of a claret color with a silvery edging.

Roses formed an important portion of the show and five varieties received awards of merit, viz.: *Rosa Wichuriana* *Cocquina* shown by W. Paul & Sons and *Hobbies*, Ltd. The plant has large trusses of single flowers much cupped in form, of a shade of pink tipped with rose. It is a variety of vigorous growth. *Rose Margaret* is a large H. T. of a delicate pink tint, shown by W. Paul & Sons. *Rose Mrs. Taft*, a *Polyantha* variety, produces bunches of double blossoms on rigid shoots; the color is a dark shade of pink. It was shown by Hugh Low & Co. *Rose Jessie*, shown by H. Merryweather & Sons, is a *Polyantha* variety of a crimson tint, dwarf, and not differing much from *Mad N. Levassieur*. *Rose American Pillar*, a variety having comparatively single flowers of large size, a fine subject for a pergola or as a pillar rose. The color is pink and the base of the bloom is white.

Begonia Pink Pearl, shown by Blackmore and Langdon, is a beautiful variety of a tender salmon rose color, of the type known as rose-centred.

FREDERICK MOORE,

London.

The Temple Gardens, where the Royal Horticultural Society held its annual show, have seen some famous gatherings in their day. As early as 1305 the gardens were the scene of a brilliant military spectacle. The news of Robert Bruce's rising had just reached London, and Edward I. resolved to knight the young men of birth who were going to quell it. The youths kept pious vigil all night in the Temple Church, and on the mor-

Violet Blue Rose

A Remarkable Novelty

THE NEW Rambler (Violet Blue), hailed by the German rose growers as the forerunner of a genuinely cornflower blue rose, is a seedling of *Crimson Rambler*, very vigorous and hardy.

For descriptions of this great novelty, as well as many others, send for Booklet.

Ellwanger & Barry

Mount Hope Nurseries

Rochester, N. Y.

row were duly knighted in such numbers that the trees had to be cut down to provide room for their tents and pavilions.

CARE OF HARRISII BULBS AFTER BLOOMING.

HORTICULTURE:

Please let me know how to keep *Lilium Harrisii* bulbs after bloom and *Calla* bulbs and oblige.

Yours truly,

E. C. P.

Lilium Harrisii bulbs after flowering should be thoroughly dried off (I do not recommend the refacing), and then planted in the ground where they will flower again during the month of August of the same year. Give slight protection during the winter in region of frost.

Calla bulbs after flowering during the winter must be thoroughly dried off until all foliage is gone; then store in a cool, dry place. *Calla* bulbs should be replanted after a rest of eight or ten weeks, for if allowed to remain longer they will commence to grow and thus ruin the bulbs.

I. T. BUTTERWORTH.

TREES, EVERGREENS, SHRUBS, VINES, PERENNIAL PLANTS, FRUIT, FRUITS, TRAINED FRUIT TREES, FOREIGN GRAPE VINES, HARDY RHODODENDRONS and R. MAXIMUM in quantity, per hundred or per thousand, very fine. Complete assortments: Careful grading: Low prices.

AMERICAN NURSERY COMPANY,

Sales Department, - - - - 150 BROADWAY, NEW YORK CITY.
 BLOODGOOD NURSERIES DEPT., - - - - Flushing, Long Island.
 F. & F. NURSERIES DEPT., - - - - Springfield, New Jersey.

JULIUS ROEHRS CO., RUTHERFORD N. J.

Large stock of Bay Trees, Box Trees, Blue Spruce, Choice Evergreens, etc., all in finest condition.

Palms, Stove Plants, Begonias, Hydrangeas in all sizes and prices.

ORCHIDS

Fine assortment on hand of both newly imported and semi-established.

LET US QUOTE YOU PRICES.

PEACOCK'S CELEBRATED NEW DAHLIAS

JACK ROSE and other cut flower sorts.

SEND FOR CATALOG.

Peacock Dahlia Farms
Williamstown Junction, N. J.

The Northboro Dahlia and Gladiolus Gardens

Offer for Spring 1909

300 selected varieties of Dahlias and one and one half million large-flowering Gladioli in mixtures, in lots to suit. Send list of your wants. Catalogue free.

J. L. MOORE, Northboro, Mass

DAHLIAS. Now is the time to place your order for bulbs which will assure you getting named varieties in any quantity; prompt delivery.

DAVID HERBERT & SON,
Successors to L. K. Peacock, Inc.
ATCO, N. J.

American Crown Roses

Fruit and Ornamental Trees. Shrubs, Small Fruits, Clematis, Evergreens.

Write for Trade List.

W. & T. SMITH CO.

Geneva, N. Y.

Box Trees

and other EVERGREENS for Tubs and Boxes

Our Prices are Always Right—Catalog Free

THE NEW ENGLAND NURSERIES, Inc.
BEDFORD, MASS.

Hardy Rhododendrons, Azaleas, Conifers, Clematis, H. P. Roses, Shrubs and Herbaceous Plants from our **HOLLAND NURSERIES**

Prices Moderate

P. OUWERKERK, 216 Jane St., Weehawken Heights P. O. No. 1, Hoboken, N. J.

CATALOGUES RECEIVED.

Union Nurseries, Ondenbosch, Holland—Trade List for 1909-1910.

New England Nurseries, Bedford, Mass.—New and Rare Things Worth While Planting; supplement to General Catalog.

INCORPORATED.

South Bend, Ind.—The Beyer Floral Co.; August F. L. M. P. O. H. H., R. A., Wm. R. and John F. Beyer; capital, \$40,000.

GERANIUMS, DAHLIAS AND BEDDING PLANTS

We have one of the most complete collections of Geraniums in the country, containing every color and type found in the Geraniums. Every one of our 75 Standard Varieties at \$2.00 and \$3.00 per 100 are Bread and Butter Winners, and among our 34 New Varieties of special merit are some that are going to fix the standard in the future. Every one is a Gem, not high in price, only \$4.00 and \$6.00 per 100.

Our Novelties should, coming as they do from the leading introducers of the world, represent the highest development of Geraniums at the present time. A collection of 100 Varieties, our selection of 1907 and 1908 Novelties, will be sent for \$10.00.

Special Offer of 1000 good, strong plants from 2 in. pots, our selection of 20 distinct kinds from among our Standard and Never Varieties, for \$15.00 cash. From 3 in. pots \$3.00 per 100, \$25.00 per 1000, in a good assortment.

CANNAS

Strong plants from 3 in. pots, J. D. Elsele, Egandale, Alphonse Bonvier, Mme. Crozy, and Florence Vaughan, \$4.00 per 100. Jean Tissot, President Myers, Louisiana, Pennsylvania, \$5.00 per 100.

DAHLIAS

We have one of the finest collections in the country of good distinct Commercial Varieties at \$2.00 per 100 and up for plants ready for shipment. Then we have Jack Rose, Virginia Maule, Big Chief, Rose Pink Century, Fringed 20th Century, Rebecca Mayhew, etc., at 50c. each, \$5.00 per doz., \$35.00 per 100. We will send 1000 in 20 good distinct Cut Flower Sorts, our selection, for \$18.50.

See issue of April 24th of Our Wholesale Catalogue for complete list of Bedding plants.

R. VINGENT, JR., & SONS CO., White Marsh, Md.

ROSE PLANTS

Fine, Strong, Healthy

3-Inch pots	Per 100	Per 1000	2½-Inch pots	Per 100	Per 1000
American Beauty	\$7.00	\$65.00	American Beauty	\$5.50	\$50.00
Richmond	4.00	35.00	Richmond	3.00	25.00
Chatenay	4.00	35.00	Chatenay	3.00	25.00
Ivory	4.00	35.00	Ivory	3.00	25.00
Bride & Maid	4.50	40.00	Bride & Maid	3.50	30.00
Asp. Sprengeri, 4-in. pots,	\$8.00 per 100.				
Asp. Plumosus, 3-in. pots,	5 00 "				
Smilax, 3-in. pots,	4 00 "				

UNITED STATES CUT FLOWER CO., Elmira, N. Y.

RHODODENDRONS, ANDROMEDAS, KALMIAS AND SPECIMEN EVERGREENS

JOHN WATERER & SONS, Ltd.

AMERICAN NURSERY

BAGSHOT - - - ENGLAND

Seed Trade

AMERICAN SEED TRADE ASSOCIATION.

Watson S. Woodruff, Orange, Conn., Pres.; J. C. Robinson, Waterloo, Neb., First Vice-Pres.; C. E. Kendall, Cleveland, O., Sec'y and Treas. Twenty-seventh annual convention June 22-24, 1909, at Clifton House, Niagara Falls, Ont.

WHOLESALE SEEDSMEN'S LEAGUE.

F. W. Bruggerhof, Pres.; Burnet Landreth, Sec'y.

Canners' Convention.

The publication of the report that Atlantic City has been selected as the place for the next Canners' convention has been held back for many weeks by HORTICULTURE as the members of the executive committee did not wish the fact made public until negotiations under way with the Hotel Association of Atlantic City were concluded.

Unless the Machinery and Supplies Association reverses itself there will be no exhibits at Atlantic City next winter. This question was put to the Association at its final meeting at Louisville last winter, and it was decided by an overwhelming majority to have no exhibits. A small minority objected and has been conducting a propaganda with the view of bringing about a reversal, but with little prospects of success. However, only accomplished facts are certainties, and the kickers will win out.

Back of this action of the Machinery and Supplies Association is a principle involved. For several years a small number of leading canners have without even submitting the proposition to a vote of their own association, levied special tax on all the association in the form of an admission fee to the Machinery Hall, and the Machinery and Supplies Association who paid for the hall, light, heat and were at heavy expense in fitting up attractive display booths, have been compelled to pay this tax into the treasury of the National Canners' Association to get into the building they had rented and to see their own show. The great expense of transporting heavy machinery back and forth, the cost of installing and operating the same, the booths and all other matters pertaining to the exhibits were to attract the canners, who were really the guests of the Machinery and Supplies Association, and they have resented the tax which has been levied upon them. When they entered a mild protest they were told, in effect, that they had no standing in court, that they were tolerated only during good behavior, and that they had better pay up and keep quiet. As most of them are largely, many of them entirely, dependent on the canners for business, they submitted, but being convinced that the comparatively few who have assumed control of the canners' organization do not represent the main body, they have decided to try it out, and make no exhibit in 1910, being satisfied that the machinery and supplies display are the great attraction to the large body of canners. Just so long as they are dependent on the canners for business they will have to accept their dictum, but the old say-

ing that nothing is ever settled until it is settled right, will be found to apply to this case as to all others.

About ten years ago the leaders of the Western Packers' Association voted to exclude the Machinery and Supplies Association from their conventions. How well they represented their associates the sequel proved. Their next annual convention was held at Chicago. At the same time the Atlantic States Packers' Association met in Buffalo and cordially invited the Machinery and Supply men to meet with them, an invitation the latter gladly accepted. The result was a veritable frost for the Chicago convention, not a corporal's guard aside from the leaders being present, while the Buffalo meeting was a grand success, members of the Western Association being present in large numbers. That ended the attempt of the Western Association to exclude the Machinery and Supply men while the leaders for the most part went into a state of "innocuous desuetude." Will history repeat itself?

American Seed Trade Association.

The forthcoming convention of the American Seed Trade Association, offers a very attractive program, and as the place for the meeting is one of the most attractive in the world, the attendance should be large. The New Clifton, which is to be headquarters, is one of the most up-to-date and best equipped hotels on the Continent, and with good weather the convention offers a most ideal outing. It will be the first real relaxation for many since last fall, and will be greatly appreciated. While the rates may at first thought seem high, it must be remembered that these rates include meals, and will in the end prove cheaper than either of the recent conventions at New York city or Detroit.

Onion Seed Crop.

Another week of splendid growing weather has advanced crop prospects greatly, and conditions at this time are most promising. Good crops, harvested under favorable conditions, are what both seed growers and seed merchants are earnestly hoping for. The reported shortage in the onion seed crop is rather good news than otherwise, as there is no single seed crop which is such a burden to carry when in surplus as onion seed. In money value it mounts into high figures rapidly, while deterioration is quite as rapid. A 50 per cent. crop means more actual clean profit to every one except the growers, than a full one, and even the growers are the gainers over a period of years. Short crops enable them to keep up their prices to good paying figures, while even a small surplus is almost invariably followed by reduced prices the following year.

Notes.

Fred H. Hunter has resigned his position as manager of the German Seed & Plant Co., Los Angeles, Cal., and will take a much needed rest.

The Iowa Seed Dealers' Association met at Des Moines on June 1. The Iowa seed law was discussed freely. Officers were elected as follows: President, C. N. Page; vice-president, Henry Field; secretary, B. H. Adams, Decorah; treasurer, J. T. Hamilton.

Seattle, Wash.—Frank Stevens is

TUBEROSES

Our Tuberoses Bulbs are all hand selected and are entirely reliable, blooming the first season. Mammoth Pearl, 1st size, \$7.50 per 1000.

GYGAS REVOLUTA

Strong Healthy Trunks.

\$7.50 per 100 Pounds
\$21.00 " 300 "

WRITE FOR OUR CATALOGUE.

HENRY F. MICHELL CO.

1018 Market St., Phila.

Giant Pansy Seeds

Representing seven of the best growers of Europe. Each color or strain packed separately. The proportion of light and dark is well blended.

Florist Collection—16 pkt. Hybrid Giants, 8 pkt. Giant Five Blotched, 1/2 oz. in each pkt.; in all, 24 pkts., weight 3 oz. \$7.50
Half Florist Collection—24 pkts., weight 1 1/2 oz. \$3.93
Amateur Collection—24 pkt., 500 seeds in each pkt., 12,000 seeds, \$2.50
Cottage Collection—12 pkt., 500 seeds in each pkt., 6,000 seeds, \$1.25
Mixture—extra fine, 1000 seeds, 250.
Exhibition Collection—4 pkt., 500 seeds in each pkt., 2,000 seeds, \$1.00

Send for descriptive list of prize winners.

JOHN GERARD, New Britain, Conn.

NEW CROP SEED

For Early Planting

THOMAS J. GREY CO.

2 SO. MARKET ST., BOSTON, MASS.

CALIFLOWERS
CABBAGE
LILY OF THE VALLEY PIPS.

HJALMAR HARTMANN & CO.

Langangsstraede 20,
COPENHAGEN, DENMARK.

manager of the new store opened by the Interlaken Nursery & Seed Co. in the public market.

Knoxville, Tenn.—J. W. Thompson, commissioner of agriculture, met the soilsmen of the city at the Imperial Hotel on June 1 to explain the new seed law which requires that all seeds must be tested and quality ascertained before sale. Prof. H. A. Morgan represented the experiment station at the meeting.

VEGETABLE PLANTS

BEEETS. Crosby, Egyptian and Eclipse, \$1.25 per 1000.

CABBAGE. Field Crown, all leading varieties, \$7.00 per 1000; 10,000 and over, \$50 per 1000.

CELERY. White Plume, Golden Self Blanching and Giant Pascal, \$1.25 per 1000.

EGG PLANT. N. Y. Improved and Black Beauty, \$3.00 per 1000.

LETTUCE. Big Boston, Boston Market, Tennis Ball and Grand Rapids, \$1.00 per 1000.

PEPPERS. Ruby King, Bull Nose, Sweet Mountain and Neapolitan, \$2.00 per 1000. Chinese Giant and Cayenne, 50c per 100.

CASH WITH ORDER

R. VINCENT, JR., & SONS CO.

White Marsh, Md.

Everything "For the Land's Sake."

The one firm in Boston where all good forms of plant food may be obtained, is the Bowker Fertilizer Company, opposite Faneuil Hall at 43 Chatham St. All greenhouse chemicals, Nitrate of Soda, Ground Bone, Potash Salts, Sheep Manure and Wood Ashes can there be had at first hands.

BOWKER FERTILIZER COMPANY

Everything "For the Land's Sake."

BEGONIAS TUBEROUS ROOTED
—ALSO—

GLOXINIAS, LILY OF VALLEY, SPIREA

Catalogues mailed free on application
Joseph Breck & Sons Corp.
47-54 NO. MARKET ST., BOSTON, MASS.

BULBS OF QUALITY

Begonias, Single, under color.....	100
" Double " " " " " " " " " "	\$2.75
" Fritted " " " " " " " " " "	5.00
Gloxinias, under color " " " " " "	10.00
Pearl Tuberoses, \$7.00 thous.	4.00
	1.00

Schlegel & Fottler Co.

26 & 27 So. Market St., BOSTON, MASS.

Burpee's Seeds

PHILADELPHIA

Blue List of Wholesale Prices mailed only to those who plant for profit

Ward's Lily Bulbs

Send for Catalogue



Ralph M. Ward & Co.
12 W. Broadway
NEW YORK

GEO. E. DOW
Designing and Illustrating

178 Washington St., Boston, Mass.
OUR SPECIALTY
Machine, Booklet, Advertising and Flower PHOTOGRAPHS

Primulas for Christmas

SOW SEED NOW

B's Matchless Giant, pure white; B's Matchless Giant, blush white; B's Matchless Giant, rose; B's Matchless Giant, scarlet; B's Matchless Giant, royal blue; B's Matchless Giant, mixed. Each 1-2 trade packet, 60c; trade packet, \$1.00.

Primula obconica gigantea Kermaia, deep crimson. Primula obconica gigantea alba, pure white. Primula obconica gigantea lilacea, beautiful lilac. Primula obconica gigantea rosea, lovely pink. Primula obconica gigantea grandiflora, mixed, containing pure white to deep crimson.

Each of above 1-2 trade packet, 30c; trade packet, 50c.
Primula floribunda grandiflora (Buttercup) 1-2 trade packet, 30c; trade packet, 50c.
Forbesi (Baby Primrose). 1-2 trade packet, 25c. Primula Kewensis (Giant Buttercup) 1-2 trade packet, 60c; trade packet, \$1.00.

ARTHUR T. BODDINGTON, Seedsman, 34 2 W. 14th Street, New York

LEONARD SEED CO.

CONTRACT GROWERS AND WHOLESALE DEALERS

BEANS, PEAS, SWEET CORN, ONION, GARDEN SEEDS

ONION SETS 79 and 81
FLOWER SEEDS Get Our Prices E. KINZIE STREET, CHICAGO

Novelties and Crops For Inspection
The Routzahn Seed Co. Announce

That their Novelties consisting of many new and beautiful Spencer Type of Sweet Peas, Gorgeous Nasturtiums of Both 1-2 lower and foliage, and other crops, will be ready for the inspection of the Trade from about June 15th to July 15th. A cordial invitation is extended to all interested.

ROUTZAHN SEED CO., - ARROYO GRANDE, CALIFORNIA.

ESTABLISHED 1802

Thorburn's
Bulbs

LILIUM HARRISII
PURITY FREESIA

True stock from most reliable growers

SEND FOR SPECIAL ADVANCE PRICES FOR EARLY ORDERS

J. M. THORBURN & CO.
33 Barclay Street
NEW YORK

Mignonette

FARQUHAR'S GIANT

Oz., 75c; 1-4 oz., 25c

R. & J. Farquhar & Co.

6 & 7 South Market Street
BOSTON, MASS.

SHEEP MANURE

IT'S STERILIZED

Free from Weed Seeds.
\$24.00 Ton;
\$7.00 quarter of Ton.

Wm. Elliott & Sons
42 Vesey St., New York

RELIABLE SEEDS—SOW NOW
PRIMULA OBCONICA GRANDIFLORA

Fluod red, fine seller.....	1000 seeds	Tr. pkt.
Real pink, fine for cut.....	\$1.50	\$0.50
Pure white, fine for cut.....	1.00	.50
Compacta, fine potter.....	1.50	.50
Mixed Hybrids.....	1.00	.50

O. V. ZANGEN, - HOBOKEN, N. J.

BRIDGEMAN'S SEED WAREHOUSE

RICKARDS BROS.

Props.

37 East 19th St., - NEW YORK CITY

STOCK SEED

FOR WINTER BLOOMING

Our strain of Double Branching Stocks is exceptionally true. About 90% Double Finera.

In colors: -- 1/4 oz. .60 or.....\$4.00

Pure White 1/4 " .75 "..... 5.00

H. E. FISKE SEED CO.
Faneuil Hall Square, BOSTON, MASS.

Winter-flowering SWEET PEAS

have been the best money-makers the past winter. NEW PRICE LIST of those celebrated Sweet Pea. Seeds will be ready soon. Send for it to the originator.

Ant. C. Zvolanek, Bound Brook, N. J.

JOHN BREITMEYER'S SONS

Cor. Miami and Gratiot Aves.
DETROIT, MICH.

Artistic Designs . . .
High Grade Cut Blooms

We cover all Michigan points and good sections of Ohio, Indiana and Canada

WILLIAM J. SMYTH FLORIST

Cor. Michigan Ave. and 31st St., CHICAGO
We ship to all points in Illinois and Iowa.
Phones: Douglas 744, Douglas 523, Douglas 740

HAUSWIRTH THE FLORIST

Out of Town orders for Hospitals
Carefully filled.
232 Michigan Ave.
CHICAGO
AUDITORIUM ANNEX Tel. Harrison 585

SAMUEL MURRAY Florist

Coates House Conservatory
1017 BROADWAY, KANSAS CITY, MO.
Both 'Phones 2670 Main.



WASHINGTON,
D. C.

GUDE'S

The Far-Famed Flowers of TORONTO

Delivered on mail or telegraph order for any occasion, in any part of the Dominion.
JOHN H. DUNLOP,
96 Yonge St., - Toronto, Ont.

The Park Floral Co.

J. A. VALENTINE,
Pres.

DENVER, COLORADO

WILLIAM L. ROCK FLOWER CO.

KANSAS CITY, - MO.
will carefully execute orders for Kansas City and any town in Missouri or Kansas.



Buffalo, N. Y.

W. J. PALMER & SON, 304 Main St.

Of Interest to Retail Florists

PACKING FLOWERS FOR SHIPMENT.

In packing flowers for shipment by express the following rules may with safety be adopted.

Cut flowers should be arranged in single layers with pounded ice closely packed along the entire length of the stems. In cold or warm weather air should be excluded from the blooms. To accomplish this end, old newspaper in quantity may be used as a lining to the box, the latter to be of wood. The newspapers will absorb the melted ice and prevent the leakage so noticeable in packages where ice is used without an absorbent of some sort. Paste-board boxes are apt to become moist-

STEAMER DEPARTURES		
American.		
New York, N. Y. - Southampton, June 10	St. Louis, N. Y. - Southampton, June 26	
Atlantic Transport.		
Minneapolis, N. Y. - London, June 19	Minnetonka, N. Y. - London, June 26	
Cunard.		
Saxonia, Boston - Liverpool, June 15	Mauretania, N. Y. - Liverpool, June 19	
Carnegie, N. Y. - Liverpool, June 19	French Line.	
La Savoie, N. Y. - Havre, June 17	La Lorraine, N. Y. - Havre, June 24	
Hamburg-American.		
Cincinnati, N. Y. - Hamburg, June 12	Blucher, N. Y. - Hamburg, June 16	
America, N. Y. - Hamburg, June 19	Leyland Line.	
Devonian, Boston - Liverpool, June 19	North German Lloyd.	
Kr. 'eille, N. Y. - Bremen, June 15	Ribassin, N. Y. - Bremen, June 19	
Kg. Albert, N. Y. - Mod. Prs., June 19	Red Star.	
Lapland, N. Y. - Antwerp, June 19	White Star.	
Trenton, N. Y. - Southampton, June 16	Baltic, N. Y. - Liverpool, June 19	
Laurentic, Montreal - Liverpool, June 19		

ened and in turn collapse before reaching their destination.

As the folds of paper left for covering the flowers are necessarily heavy, twine stretched from side to side and directly above the flowers may be used to prevent crushing. In every instance paraffine paper must be used next to the flowers, as any paper of a bibulous nature operates as a poultice when in direct contact with dampened vegetable matter and destroys its vitality. A wrapping of stout paper on outside of box is also serviceable, as it helps to preserve the ice.

In packing floral designs for shipment to any great distance, strong pasteboard boxes may be used, as no ice can be employed in such packing. With the exception of carnations, violets and orchids, a spray of cold water on the flowers will help greatly to sustain them. As with cut flowers strings should be drawn across the box to prevent the heavy weight of paper on inside of box crushing the floral part of the design.

W. H. LONG.

ALEX. McCONNELL

571 FIFTH AVENUE
NEW YORK CITY

Telegraphic orders forwarded to any part of the United States, Canada, and all principal cities of Europe. Orders transferred or intrusted by the trade to our selection for delivery on steamships or elsewhere receive special attention.

Telephone Calls, 487 and 488 38th St.
Cable Address, ALEXCONNELL

M. A. BOWE

In the Heart of New York City
1294 Broadway

NEW YORK
Tel. 2770, 38th St.
Our Motto—The Golden Rule

DAVID CLARKE'S SONS

Deliver orders from any part of the country to
New York City
Or OUT-GOING STEAMERS
Write or telegraph

2139-2141 Broadway, New York
Telephone 1552-1553 Columbus

YOUNG & NUGENT

42 West 28 St., NEW YORK
"FLOWERS BY TELEGRAPH"

ALBANY, N. Y.

EYRES

Flowers or Design Work

DELIVERED IN ALBANY AND VICINITY
ON TELEGRAPHIC ORDER.

11 NORTH PEARL ST., ALBANY, N. Y.

Flower Deliveries

In Brooklyn and other Long Island Points
New York City, New Jersey, etc. At Theaters,
Hotels, Steamers or Residences.

WILSON

Fulton St. and Greene Ave., Brooklyn, N. Y.

DANKER, Albany, N. Y.

ORDERS FOR

Choice Flowers and
Floral Emblems
FILLED PROMPTLY

Orders by Wire Receive Prompt and Careful Execution

J. Newman & Sons

Corporation
24 Tremont Street, BOSTON

Theater, Steamer and Funeral Flowers Our Specialty
We can refer to leading florists in all principal cities.
Established 1870.

LOUISVILLE, KY.

JACOB SCHULZ,
550 South Fourth Ave.

WELLESLEY COLLEGE

Dane Hall, Walnut Hill and Rockridge High
Schools. TALBY, Wellesley, Mass.
Tel. Wellesley 44-1 and 2. Night 44-3.

In ordering goods please add "I saw
it in HORTICULTURE."

YOU CAN'T LOSE US IN JUNE

Or Any Other Month in the Year

The Florist who Can't Show **Bayersdorfer & Co's** Fancy Goods to his Customers Every Day for the Next Month is shy on Enterprise and and will be shy on business he might have had. That's All. It's not too late, Write or Telegraph.

THE Florists' Supply House of America

H. BAYERSDORFER & CO., 1129 Arch St., Philadelphia, Pa.

CHICAGO PERSONAL AND NEWS NOTES.

E. B. Washburn is spending a week in New York.

O. P. Bassett is in West Baden, Ind., for a few days.

E. Wienhoeber has just returned from an eastern trip.

Uncle John Thorp is again able to be about after a prolonged illness.

Mrs. C. Frauenfelder, who has been ill for several months, remains about the same.

Chicago Visitors: P. N. Oberlin, Kenosha, Wis.; Edward Gullett, Lincoln, Ill.; A. C. Rott, of Joliet.

A. F. Longren has started on an extended trip for the E. H. Hunt Co., in the interest of their florists' supplies department.

George Fisher, buyer for H. A. Fisher Co., Kalamazoo, Mich., says trade there has been unusually good this spring.

Mrs. Margaret Port of Maywood has rented her greenhouses to Carl Smith,

BOSTON'S BEST
In Quality and Design

Can be relied upon when you transfer your retail orders to

EDWARD MACMULKIN
194 Boylston Street, Boston

Send flower orders for delivery in

BOSTON
and all
NEW ENGLAND POINTS
THOS. F. GALVIN
124 Tremont St., Boston



TRANSFER
Your orders for flower or plant delivery in Eastern New England to
JULIUS A. ZINN,
2 Beacon St., Boston
FINE DESIGN WORK A SPECIALTY

who will put the houses in first-class shape and push the business. Mrs. Port will continue the retail store on West Madison street for the present.

W. H. Gullett, senior member of the firm of Gullett & Son of Lincoln, Ill., was brought to Chicago for an operation last week. Reports from Mercy Hospital are that the patient is resting easily and a complete recovery is expected.

The Peony Market.

Among the peony growers who are heavy shippers to the Chicago cut flower markets are H. H. Fisher of Kalamazoo, Mich., and Gilbert H. Wild of Sarcoxia, Mo. The latter has twelve acres of peonies and gives his whole attention to this specialty. He has been in the business over fifteen years and his peonies go to all points. 6000 dozen came to Kennicott Bros. for Memorial Day. Mr. Wild is searching for a red that will come in in time for Memorial Day in Chicago. The reds that are the best for the more southern trade are not the varieties that will ship here at this time. Mr. Wild mentions as the most useful market varieties Festiva Maxima and Queen Victoria for white and L'Esperance, Delicatissimo and Dorchester for pink. Mr. Fisher grows Richardson's Rubra Superba for red and likes it, but Mr. Wild finds it a shy bloomer seeming to need the northern climate.

Among new varieties there is a deep red introduced by Rosenfeld which promises to be valuable. Felix Crousse is also a good red. Grace D. Bryan, also by Rosenfeld, now promises well. Emperor William is another red and a fair producer.

Peony growers have much to learn as to the great value of properly bunching peonies for shipping. Many are bunched irregularly and such stock sells much lower than that which has been carefully handled and evenly bunched—that is, with the flowers all on a level.

Among the Growers.

Florists handling leading stock have had one of the busiest weeks following Memorial Day they have ever known. The backward spring has prolonged this part of the trade and it will take another two weeks to finish up the stock. As most of the growers increase their output this year and it is all going to clean up, it must follow that the volume of business is larger than ever before.

NEW FLOWER STORES.

Owego, N. Y.—E. B. Snow, Broad St.

Marcus Hook, Pa.—William Williams, Market St.

Long Beach, Cal.—Gage, Florist (formerly The Fernery).

"FLOWERS BY TELEGRAPH"

Leading Retail Florists Listed by Towns for Ready Reference.

- Denver, Colo.—Park Floral Co., 1706 Broadway.
- Washington D. C.—Gude Bros., 1214 F St. Chicago—Hauswirth, "The Florist," 232 Michigan Ave.
- Chicago—William J. Smith, Michigan Ave. and 31st St.
- Chicago—George Wittbold Co., 1657-59 Buckingham Place.
- Louisville, Ky.—Jacob Schütz, 550 South Fourth Ave.
- Boston—Thos. F. Galvin, 124 Tremont St.
- Boston—Edward MacMulkin, 194 Boylston St.
- Boston—Hoffman, Florist, 59-61 Massachusetts Ave.
- Boston—J. Newman & Sons, Inc., 24 Tremont St.
- Boston—Julius A. Zinn, 2 Beacon St.
- Wellesley, Mass.—Talby.
- Detroit, Mich.—J. Breitmeyer's Sons, Miami and Gratiot Aves.
- Kansas City, Mo.—Samuel Murray, 1071 Broadway.
- Kansas City, Mo.—Wm. L. Rock Flower Co., 116 Walnut St.
- Albany, N. Y.—H. G. Eyres, 11 N. Pearl St.
- Albany, N. Y.—F. A. Danker, 40 Malden Lane.
- New York—David Clarke's Sons, 2139-2141 Broadway.
- New York—Alex. McConnell, 571 5th Ave.
- New York—Young & Nugent, 42 W. 25th St.
- New York—M. A. Bowe, 1294 Broadway.
- Brooklyn, N. Y.—Robert G. Wilson, Fulton St. and Greene Ave.
- Buffalo, N. Y.—Palmer's, 304 Main St.
- Toronto, Can.—J. H. Dunlop, 96 Yonge St.

THE BEST LETTERS

FOR THOSE
FLORISTS' MADE
USE OF BY THE



Boston Florist Letter Co.
66 PEARL ST., BOSTON
N. F. MCCARTHY, Mgr.

Order direct or buy from your local supply dealer. Insist on having the

BOSTON
Inscriptions, Emblems, etc., Always in Stock

BEAUTIES
Best \$3.00 per dozen. \$20.00 per 100.

S. PEAS
.75—\$1.00 per 100. \$6.00 per 1000.

FERNS
Note our price. \$1.00 per 1000.

THE LEO NIESSEN CO.
1209 Arch St., Philadelphia, Pa.
Open from 7 a. m. to 8 p. m.

To Cut Flower Growers and Retail Florists

IF YOU want to find a market for your product
want a regular or special supply of the product of the best growers

Consult the Advertisements on these Wholesale Flower Pages

The Advertisers Represented Here are the Leading Concerns in the Wholesale Flower Trade

NEW CROP KAIZERINS
\$4.00 to \$10.00 per 100

W. E. MCKISSICK & BROS.
WHOLESALE FLORISTS
1619-1621 RANSTEAD ST.
PHILADELPHIA

WELCH BROS.
AMERICAN BEAUTY, KILLARNEY, RICHMOND, MARYLAND AND ALL THE SUPERIOR ROSES, LILY OF THE VALLEY, CARNATIONS, ORCHIDS
BEST PRODUCED
226 Devonshire Street, Boston, Mass.

CUT FLOWER BOXES
EDWARDS FOLDING BOX CO
MANUFACTURERS
PHILADELPHIA, PA.

CHAS. W. MCKELLAR
51 WABASH AVE. CHICAGO

Western Headquarters for Choice Orchids
Valley, Roses and all Cut Flowers

PETER REINBERG
WHOLESALE
CUT FLOWERS
51 Wabash Av., Chicago, Ill

Long Distance Phone, Central 6004
WINTONSON'S SEED STORE
45-47-49 Wabash Ave., Chicago.
Seedsmen, Plantsmen, Nurserymen
Florists' Supplies

We can supply everything used by the Florist. SUPPLY CATALOG FREE. Correspondence solicited.

POEHLMANN BROS. CO.
33-35-37 Randolph St., - CHICAGO
CUT FLOWERS
Greenhouses, - Morton Grove, Ill.

Rice Brothers
115 N. 6th Street, MINNEAPOLIS, MINN.
WHOLESALE FLORISTS AND SUPPLIES
CUT FLOWERS received twice daily, and can fill your orders to your satisfaction. A complete line of Hardy Greens - WILD SMLAX, BOXWOOD, HARDY FANCY FERNS, GALAX LEAVES.
Write for quotations on large quantities.

WHOLESALE FLOWER MARKETS—TRADE PRICES—Per 100 TO DEALERS ONLY

	CHICAGO June 7		TWIN CITIES June 7		PHILA. June 7		BOSTON June 10	
ROSES								
Am. Beauty, Fancy and Special...	25.00	to 30.00	28.00	to 32.00	20.00	to 25.00	20.00	to 25.00
" Extra.....	20.00	to 25.00	20.00	to 25.00	12.00	to 15.00	12.00	to 15.00
" No. 1.....	10.00	to 15.00	10.00	to 15.00	8.00	to 10.00	4.00	to 8.00
" Lower grades.....	6.00	to 9.00	5.00	to 10.00	3.00	to 5.00	2.00	to 3.00
Bride, Maid, Golden Gate, F. & S.	4.00	to 8.00	6.00	to 8.00	5.00	to 8.00	1.00	to 6.00
" Lower grades.....	4.00	to 6.00	4.00	to 6.00	2.00	to 3.00	.50	to 1.00
Killarney, Fan, & Sp.....	6.00	to 10.00	6.00	to 10.00	5.00	to 8.00	6.00	to 8.00
" Lower grades.....	4.00	to 6.00	4.00	to 6.00	3.00	to 4.00	2.00	to 6.00
Richmond, Fancy & Special.....	9.00	to 10.00	6.00	to 10.00	8.00	to 10.00	8.00	to 10.00
" Lower grades.....	4.00	to 6.00	4.00	to 6.00	3.00	to 5.00	1.00	to 4.00
Chatenay.....	9.00	to 10.00	6.00	to 8.00	4.00	to 10.00	1.00	to 8.00
My Maryland.....	3.00	to 10.00	6.00	to 10.00
CARNATIONS								
Fancy and Red.....	3.00	to 3.00	3.00	to 4.00	2.00	to 4.00	.50	to 1.00
Ordinary and White.....	1.50	to 2.00	1.50	to 3.00	1.00	to 2.00	.25	to .50
MISCELLANEOUS								
Cattleyas.....	10.00	to 60.00	50.00	to 75.00	to 50.00	15.00	to 50.00
Lilies.....	10.00	to 12.00	10.00	to 12.50	8.00	to 10.00	5.00	to 6.00
Lily of the Valley.....	3.00	to 4.00	3.00	to 4.00	2.00	to 4.00	1.00	to 3.00
Mignonette.....	3.00	to 4.00	3.00	to 4.00	2.00	to 4.00	1.00	to 2.00
Sweet Peas.....	.50	to 1.00	.75	to 1.00	.30	to 1.00	.25	to .50
Gardenias.....	to 50.00	to 50.00	8.00	to 15.00	8.00	to 12.00
Peonies.....	3.00	to 6.00	5.00	to 6.00	2.00	to 5.00	4.00	to 6.00
Daisies.....	to 2.00	1.00	to 1.50	1.00	to 1.00	.50	to .75
Stocks.....	8.00	to 10.00	6.00	to 10.00	2.00	to 3.00	1.00	to 2.00
Snapdragon.....	8.00	to 12.00	6.00	to 10.00	3.00	to 8.00	2.00	to 4.00
Adonis.....	.75	to 1.00	1.00	to 1.50	1.00	to 1.50	.75	to 1.25
Smilax.....	15.00	to 25.00	15.00	to 20.00	15.00	to 20.00	12.00	to 15.00
Asparagus Plumosus, strings.....	40.00	to 60.00	30.00	to 50.00	35.00	to 50.00	35.00	to 50.00
" " & Sprea. (100 bchs.)	30.00	to 40.00	30.00	to 50.00	35.00	to 50.00	15.00	to 25.00

J.A. BUDLONG
37-39 Randolph Street, CHICAGO.
Roses and Carnations
A Specialty.....

WHOLESALE GROWER of **CUT FLOWERS**

HENRY M. ROBINSON & CO.
15 Province St. and 9 Chapin Place - BOSTON, MASS.
WHOLESALE COMMISSION FLORISTS
Hardy Cut Evergreens and Florists' Supplies
New Crop 0.25 per and Fancy Ferns \$2.00 per Thousand.

We have the stuff and can fill all orders, large or small
WE NEVER DISAPPOINT SATISFACTION GUARANTEED

Prices Quoted in these Columns are for Dealers Only.
When Writing to Advertisers Please Mention
HORTICULTURE.

In ordering goods please add "I saw it in HORTICULTURE."

Flower Market Reports.

BOSTON The market has fallen completely flat the last few days, bad weather and an over supply being the cause. Carnations are a drug on the market. It has been a long time since such a glut has been seen. Material of every description is piling up with little demand. American Beauties alone hold their own. Improved conditions are looked for soon, however, owing to graduations and June weddings.

Rather a little late on **BUFFALO** report of Memorial week's business; nevertheless trade was active throughout the week and prices on most lines were better than on previous years. The main flowers looked for were peonies which were not to be had, therefore the demand for carnations was stronger. A few cool days, with little or no sunshine previously, held this flower back and there could have been thousands more sold had they come in. Some very fine outdoor tulips, narcissus, iris, Persian and Alexander lilacs, dogwood, hly of the valley, deutzia and other stock were to be had which helped out in the right time. Roses were in demand and the weather being cool, there were but few complaints, especially on stock which was shipped. The shipping trade was large and the demand so great for carnations that a good many orders had to be turned away. Daisies, sweet peas and Loniflorums were in good supply and an exceptionally good Memorial week's trade was experienced by all.

On Monday last, trade was still booming and a fairly good cleaning up was had. Tuesday and Wednesday stock came in heavy with trade quiet; Thursday and Friday an abundance of everything and Saturday an over supply on all lines and prices exceedingly low, it being the case of wholesalers carrying all the stock. Bargain signs are again to be seen, but these helped but little to consume the enormous supply that was received during the week and if any weddings were on during this week it was not noticed at the wholesale houses. The few hot days no doubt were the cause of such an amount of stock, which could have been easily disposed of during Commencement week, had there been a way to receive it.

The market last week **CHICAGO** was very active. A slight lull followed Memorial Day, but the latter part of the week found trade lively and indications are for an unusually good June. Mr. Washburn calls attention to the fact that in this month, Monday, Tuesday, Wednesday and Thursday are the days demanding flowers for commencements while Friday and Saturday bring the wedding orders, these latter events being now week-end affairs rather than as formerly occurring on Wednesday. American Beauties are scarce just when they are needed most, but the throwing out of old plants is to blame for this. Monday's price kept to \$4.00 per dozen, and it is not expected to go lower on best stock for some time. Roses most in demand for school functions are the red and yellow varieties.

The few days of hot and damp weather have somewhat injured carnations and sweet peas at this writing are also showing the effects of the weather, which one day is cold and the next hot, while the rain comes in either case. There are just now no really good sweet peas, but the demand is active. Quantities of peonies are to be had and the quality generally is good. Lilies are selling well for weddings. Lilacs are here in profusion, but by the time outdoor stock is in the demand is about over. In greens there is a shortage, wedding orders requiring so much of both smilax and asparagus. New ferns are being received in large quantities from the South and are exceptionally good.

A decided change has **DETROIT** taken place in business as compared with last week, which in great part may be accounted for by Decoration Day. Some few stores report a brisk demand for wedding flowers, while some others hustled to finish outdoor planting orders. There was plenty of stock but of decidedly weak quality. The coming week will see things liven up again

VALLEY, BEAUTIES, PEONIES



The week's leaders. Buy liberally and push them. No retailer should allow it to be said: "Asleep at the post"!

Peonies

First Quality (a good proportion of pink and white varieties) **\$3.00 per 100**
Fancy and novelties **\$6.00 and \$8.00 per 100**

Beauties

Specials **\$3.00 per doz., \$20.00 per 100**
Other Grades **\$1.00 to \$2.00 per doz.**

Valley

The "come-again" kind. Best quality reaching this market. Unlimited quantity **\$3.00 and \$4.00 per 100**

SWEET PEAS

lavender, pink, white and flesh **50c and 75c per 100**

CATTLEYA MOSSIAE **\$6.00 per doz., \$40.00 per 100**

GLADIOLUS America, May, Bride, etc.

CENTAUREA, YELLOW DAISIES, NIMPHAEAS, HEMEROCALLIS, ISMENE, IRIS SYBRICA, and all seasonable staples at market prices. Write Us.

S. S. PENNOCK - MEEHAN CO.
The **WHOLESALE FLORISTS Philadelphia**

1608-1620 Ludlow Street Store closes 8 p. m.

with Commencements and weddings. We are all prepared for the final rush of the season and look forward to opportunities to make it a grand finish as a compensation for the somewhat quiet winter's trade. Mr. Michael Bloy inaugurated a 5 cent plant sale at his place of business and found it a very well-paying venture.

(Continued on page 845)

WHOLESALE FLOWER MARKETS.— TO DEALERS ONLY.

	CINCINNATI June 7		DETROIT June 7		BUFFALO June 7		PITTSBURG June 8	
ROSES								
Am. Beauty, Fan, and Sp.	20.00	25.00	20.00	25.00	20.00	25.00	20.00	25.00
" Extra	15.00	20.00	15.00	20.00	12.00	15.00	10.00	15.00
" No. 1	10.00	12.00	10.00	12.00	6.00	10.00	6.00	8.00
" Lower grades	4.00	6.00	5.00	8.00	2.00	4.00	2.00	4.00
Bride, "Maid, Golden Gate, F. & S.	5.00	6.00	4.00	6.00	6.00	8.00	6.00	8.00
" Low. gr.	3.00	4.00	3.00	4.00	2.00	4.00	2.00	4.00
Killarney, Fao. & Sp.	5.00	6.00	4.00	6.00	6.00	8.00	6.00	8.00
" Lower grades	3.00	4.00	3.00	4.00	2.00	4.00	2.00	4.00
Richmond, Fancy & Special	6.00	8.00	5.00	8.00	8.00	10.00	10.00	12.00
" Lower grades	3.00	4.00	3.00	5.00	2.00	4.00	2.00	6.00
Chateau	4.00	6.00	3.00	6.00	3.00	4.00	2.00	6.00
My Maryland
CARNATIONS								
Fancy and Novelties	2.00	3.00	2.00	3.00	2.00	2.50	1.50
Ordinary	1.00	1.50	1.00	2.00	1.00	2.00	1.00
MISCELLANEOUS								
Cattleyas	35.00	50.00	60.00	75.00	50.00	75.00
Lilies	8.00	10.00	12.50	15.00	8.00	15.00	12.00
Lily of the Valley	3.00	4.00	3.00	4.00	3.00	4.00	3.00	4.00
Mignonette	2.00	3.00	2.00	3.00	1.00	2.00	2.00	3.00
Sweet Peas	.50	.75	.50	.75	.50	1.00	.25	1.00
Geraniums	20.00	30.00	30.00
Peonies	4.00	6.00	5.00	8.00	2.00	5.00	3.00	6.00
Daisies	.50	1.00	.75	1.00	.75	1.50	.50	1.50
Stocks	3.00	4.00	2.00	4.00	1.00	1.50	1.00	3.00
Snapdragons	3.00	4.00	2.00	4.00	3.00	6.00
Adonis	1.00	1.00	1.50	.50	1.50	1.00	1.25
Smilax	10.00	12.00	15.00	15.00	15.00	20.00
Asparagus Plumosus, strings	40.00	50.00	20.00	30.00	50.00	60.00	30.00	50.00
" & Sprnc. (100 bchs.)	20.00	30.00	20.00	30.00	25.00	50.00	30.00	40.00

FORD BROTHERS

48 West 28th Street NEW YORK

FINE ROSES FANCY CARNATIONS

A Full Line of All CUT FLOWERS

Telephone, 3870 or 3871 Madison Square

H. E. FROMENT

Wholesale Commission Florist,
Choice Cut Flowers,

57 West 28th St. :: NEW YORK

Telephones: 2200, 2201, Madison Square.

Alfred H. Langjahr

All choice cut-flowers in season. Send for quotations. Correspondence with shippers of first-class stock invited.

55 West 28th Street, New York

Telephones 4626-4627 Madison Square

Edward C. Horan
Wholesale Florist

55 WEST 28th ST.

tel. 1462 Madison Square New York

PHILIP F. KESSLER

55 & 57 W. 26th St., New York.

CUT FLOWERS WHOLESALE

Open from 5 a. m. to 6 p. m. Sunday till 10 a. m.

FINEST LILIES IN THE MARKET.

Tel. 5243 and 2921 Madison Square.

JOHN YOUNG

WHOLESALE FLORIST

Finest American Beauties and Carnations

51 West 28 St. - NEW YORK

FRANK MILLANG

Wholesale Florist

55-57 West 26th St., NEW YORK

Shipments, any quantity. Wholesale Market Rates.

Greater New York Florists' Association, Inc.

Now Open for Cut Flower Consignments

162 Livingston Street, BROOKLYN, N. Y.

Geo. W. Crawbuck Telephone Connection
Manager 3642-43 Main

Moore, Hentz & Nash

Wholesale Commission Florists

55 and 57 West 26th Street

Telephone No. 756 Madison Square New York

MILLANG BROS.

WHOLESALE COMMISSION FLORISTS

41 West 28th Street

Telephone 3660 Madison 3661 NEW YORK

JOHN I. RAYNOR
Wholesale Commission Florist **SELLING AGENT FOR LARGEST CROWERS**
A full line of Choice Cut Flower Stock for all purposes. Comprises every variety grown in New York market, at current prices
TEL. 1998 MADISON SQUARE 49 West 28th St., New York City

Walter F. Sheridan
Wholesale Commission Dealer in
CHOICE CUT FLOWERS
39 West 28th Street, New York
Telephone: 3532-3533 Madison Square

HEADQUARTERS FOR NOVELTIES
ORCHIDS A SPECIALTY
THE HIGHEST GRADE OF **VALLEY** ALWAYS ON HAND
CARNEDIAS, DAISIES, ROSES AND CARNATIONS
JAMES McMANUS. Telephone 7653 Mad. Sq. 42 W. 28th St., New York

NEW YORK QUOTATIONS PER 100. To Dealers Only

	Last Half of Week ending June 5 1909		First Half of Week beginning June 7 1909	
ROSES AND CARNATIONS				
American Beauty, Fancy and Special.....	13.00	to 25.00	13.00	to 25.00
" " Extra.....	6.00	to 10.00	6.00	to 10.00
" " No. 1.....	4.00	to 5.00	4.00	to 5.00
" " Lower Grades.....	1.00	to 2.00	1.00	to 2.00
Bride, 'Haid, Golden Gate, Fancy and Special.....	2.00	to 4.00	2.00	to 4.00
" " Lower Grades.....	.50	to 1.00	.50	to 1.00
Killarney, Fancy and Special.....	3.00	to 6.00	3.00	to 6.00
" " Lower Grades.....	.50	to 1.00	.50	to 1.00
Richmond, Fancy and Special.....	3.00	to 6.00	3.00	to 6.00
" " Lower Grades.....	.50	to 1.00	.50	to 1.00
Chatenay.....	.50	to 6.00	.50	to 6.00
Ply Maryland.....	4.00	to 6.00	1.00	to 6.00
Carnations, Fancy and Novelties.....	2.00	to 3.00	2.00	to 3.00
" Ordinary and White.....	1.00	to 2.00	1.00	to 2.00

Alexander J. Guttman
THE WHOLESALE FLORIST OF NEW YORK
34 WEST 28th STREET
PHONES. 1664-1665 MADISON SQUARE
ENOUGH SAID

CENTRALLY LOCATED, THE HUB OF THE FLOWER MARKET SECTION
CHARLES MILLANG
Wholesale Florist
444 Sixth Ave., NEW YORK
Telephone 7062 Madison

GEORGE GOTSONAS & CO.
Wholesale and Retail Dealers in all kinds of **EVERGREENS**
Fancy and Dagger Ferns
Bronze and Green Galax
Main Store 50 W. 28 St.
Phone 1202 Mad. Sq. New York

GROWERS' CUT FLOWER CO. CUT FLOWERS AT WHOLESALE
VIOLETS, CARNATIONS, ROSES
ORCHIDS, CHRYSANTHEMUMS, LILIES
Consignments Solicited. Shipments to Order, any Distance
39 West 28th Street; Telephone 6271 Madison Square J. J. COAN, Manager NEW YORK

Durand & Marohn
MANUFACTURERS OF
All Kinds of Wire Work
Florists' Wire Designs a Specialty
24 Beaver St., ALBANY, N. Y.

WILLIAM H. KUEBLER
Brooklyn's Foremost and Best
WHOLESALE COMMISSION HOUSE
A First Class Market for all CUT FLOWERS
28 Willoughby St., Brooklyn, N. Y.
Tel. 4591 Main

NOTICE!

Manhattan Flower Market

Ship us some stock. We need a large supply of all kinds of flowers, **Roses, Carnations, Sweet Peas, Narcissus, Summer Stock, etc.**, for our new store. Reliability and responsibility first-class. Good prices and prompt returns, Good opportunity.

WHOLESALE FLORISTS
 46 W. 28th St., NEW YORK
 Telephone: 1016 Madison Sq.

WHOLESALE FLORISTS
 54 West 28th St.
 NEW YORK
 Telephone 3559 Madison Sq.

A. L. YOUNG & CO.

**RECEIVERS & SHIP-
 PERS OF CUT
 FLOWERS.**
 CONSIGNMENTS SOLICITED

REED & KELLER
 123 West 28th St., New York

Florists' Supplies

We manufacture all our
Metal Designs, Baskets, Wire Work & Novelties
 and are dealers in
 Glassware Decorative Greens and Florists' Requisites

MICHIGAN CUT FLOWER EXCHANGE, Inc.

WHOLESALE COMMISSION FLORISTS
 Consignments Solicited
Hardy Fancy Fern Our Specialty
 38-40 BROADWAY, DETROIT, MICH.

FOR FLORISTS' USE

There's **NOTHING** as good as

MEYER'S SILKALINE

Don't let them sell you anything else
JOHN C. MEYER & CO., Boston, Mass.

Order by Name



**Krick's Genuine Immortelle
 Letters, etc.**

The Best and Cheapest. Accept no
 Substitute. Every Letter Marked

KRICK'S LETTERS
 1164-66 Greene Av., Brooklyn, N. Y.
 For Sale by all Supply Houses

Wired Toothpicks

Manufactured by

W. J. COWEE, BERLIN, N. Y.

\$30,000....\$1.75; \$50,000....\$7.50. Sample free.
 For sale by dealers

FLOWER MARKET REPORTS.

(Continued from page 83)

Week of May
PHILADELPHIA 31st June 7th here
 was rather a dis-
 appointment. Trading started off quite
 briskly in the first day or two; but made
 a bad slump later. By Friday and
 Saturday there was a tremendous accumu-
 lation of flowers with demand at
 a very low ebb. Good sweet peas sold
 well; but there were enormous quanti-
 ties of inferior stock which would
 not go at all. Many of the sweet pea
 shipments opened up badly—appearing
 soft and watersoaked. Such stock may
 have looked all right to the grower
 when packing; but at destination
 proved quite unsaleable as a rule.
 Roses were altogether too plentiful.
 Carnations also suffered. The general
 demand was away below expectations
 and while the trolley strike undoubtedly
 hurt local conditions it could not be
 blamed for the lack of life in the ship-
 ping trade. Peonies as a rule were
 very good and were one of the most
 satisfactory items. While they did
 not bring high prices, there was no

WILLIAM F. KASTING CO.
 WHOLESALE FLORISTS

**383-387 Ellicott Street
 BUFFALO, - N. Y.**

ROBERT J. DYSART
 Public Accountant and Auditor
 Simple methods of correct accounting
 especially adapted for florists' use.
 Books Balanced and Adjusted
 Merchants Bank Building
 28 STATE STREET, - BOSTON
 Telephone, Main 58.



I KEEP OPEN HOUSE THIS SUMMER

For the Sale and Shipment of Flowers.
 Good Stock. Favorable Prices.

J. K. ALLEN

106 W. 28th St., New York.
 Tel. 167 Madison Sq.

Open 6 A. M. Daily.

NEW YORK QUOTATIONS PER 100. To Dealers Only

MISCELLANEOUS	Last Half of Week ending June 5 1909		First Half of Week beginning June 7 1909	
Cattleyas.....	15.00	to 50.00	15.00	to 50.00
Lilies.....	2.00	to 4.00	2.00	to 4.00
Lily of the Valley.....	.50	to 2.00	.50	to 2.00
Peonies.....	1.10	to 4.00	1.00	to 4.00
Daisies.....	.25	to .50	.25	to .50
Stocks.....	1.00	to 2.00	1.00	to 2.00
Mignonette.....	.50	to 1.00	.50	to 1.00
Sweet Peas (per 100 bunches).....	1.00	to 5.00	1.00	to 5.00
Gardenias.....	8.00	to 25.00	8.00	to 25.00
Adiantum.....	.50	to 1.00	.50	to 1.00
Smilax.....	10.00	to 15.00	10.00	to 15.00
Asparagus Plumosus, strings.....	20.00	to 30.00	20.00	to 30.00
" & Spreen. (100 bchs).....	15.00	to 25.00	15.00	to 25.00

great surplus and the tremendous sacrifices that were made in roses were conspicuous by their absence in peonies. Southern gardenias have made their appearance, which practically winds up the market for local greenhouse grown, for the time being. The June girl is using up lots of lily of the valley, which is generally of excellent quality at present. Gladiolus America is arriving, and is in grand shape. May and Bride gladioli are also to be seen in limited lots. Hemerocallis, yellow and orange; Iris sibirica; Gaillardia and Centaurea, are among the prominent outdoor items. Nymphaeas are to be seen in the wholesale market in spots; but these are not from local outdoor sources. Smilax is plentiful, also adiantum, plumosus and all other greens.

NEW YORK June has not shown any special activity thus far. Indeed, the state of business in the wholesale districts is unmistakably on the dull side and sales are effected only at sacrifice figures. Roses and carnations show plenty of evidence of the wear

and tear of the season, many of the roses being very inferior and often badly mildewed and the carnations running small and faded. Cattleyas are very plentiful and there are lots of low grade blooms among them which are practically unsaleable, although on fancy flowers of gigas top prices are generally maintained. The gardenia situation is peculiar at present. Southern outdoor blooms are being peddled by basketful on the streets, yet the price on the greenhouse product remains high for first quality but very few of that kind are seen, most of the stock being far inferior to the southern shipped and consequently unsaleable at any figure. Peonies are abundant, some of them being of superb quality. Corn flowers, stocks, gladioli, pyrethrums, irises, etc., are seen in quantities everywhere, sweet peas of every description and grade are crowding in and the first shipments of mountain laurel in bloom have begun to arrive. Lilies are experiencing a hard time, the receipts being far in excess of the normal requirements of this market.

Buyer's Directory and Ready Reference Guide

Advertisements under this head, one cent a word. Initials count as words.

Display advertisers in this issue are also listed under this classification without charge. Reference to List of Advertisers will indicate the respective pages.

Buyers failing to find what they want in this list will confer a favor by writing us and we will try to put them in communication with reliable dealers.

ACCOUNTANT

B. J. Dyarr, 28 State St., Boston.
For page see List of Advertisers.

AQUATIC PLANTS

Aquarium plants the year round. Wholesale and retail. Send for price list. Schmidt's Emporium of Pets, 712 12th Street, Washington, D. C.

AQUILEGIAS

Aquilegia. Genuine Coerulea, finest of all. Both plants and seeds from the heart of the Rockies. C. S. Harrison's Select Nursery, York, Neb.

ARAUCARIAS

A. Leuthy & Co., Perkins St. Nurseries, Roslindale, Mass.
For page see List of Advertisers.

Godfrey Aschmann, 1012 West Ontario St., Philadelphia, Pa.
For page see List of Advertisers.

ASPARAGUS PLUMOSUS

William C. Smith, Market & 61st St., Philadelphia.
For page see List of Advertisers.

ASPARAGUS SEED

Asparagus Plumosus Seed, fresh, late-harvest grown, \$1.75 per 1000. Special price in quantities. Immediate delivery. Cash. Oak Grove Nurseries, Office, 604 North Los Angeles St., Los Angeles, Cal.

ASTERS.

A. C. Schmidt, Bristol, Pa.
For page see List of Advertisers.
Asters—Field grown. Tzago, white, rose and shell pink, mixed; Rosbach's selected purple and lavender, mixed, white separate, \$2.50 per 1000. For several years we have tried most of the new varieties offered with a view of securing an ideal florist's strain. Last season we acquired the Tzago and found it the most satisfactory of them all. A. & G. Rosbach, Pennington, N. J.

AUTOMATIC CIRCULATOR

W. W. Castle Co., 170 Summer St., Boston.

AZALEAS

A. Leuthy & Co., Perkins St. Nurseries, Roslindale, Mass.
For page see List of Advertisers.
Godfrey Aschmann, 1012 W. Ontario St., Philadelphia.
For page see List of Advertisers.

BAMBOO CANES

Yokohama Nursery Co., 31 Barclay Street, New York.
Bamboo Sticks, Colored Green.
For page see List of Advertisers.

BAY TREES.

2000 Bay and Box Trees in all sizes, Pyramid and Standards. Write for list. Julius Roehrs, Rutherford, N. J.

BEDDING PLANTS

A. Leuthy & Co., Perkins St. Nurseries, Roslindale, Mass.
For page see List of Advertisers.
G. Aschmann, 1012 W. Ontario St., Philadelphia, Pa.
For page see List of Advertisers.
R. Vincent, Jr. & Sons Co., White Marsh, Maryland.
For page see List of Advertisers.
J. C. Schmidt, Bristol, Pa.
For page see List of Advertisers.
Thomas Roland, Nahant, Mass.
Begonia Gloire De Lorraine.
For page see List of Advertisers.

BEGONIAS

Elmsford Nurseries, Elmsford, N. Y.
Lorraine Begonias.
For page see List of Advertisers.

Begonia Gloire de Lorraine and Agatha, propagated from leaf cuttings, \$15.00 per 100; \$140.00 per 1000. Only good strong plants sent out. J. A. Peterson, McHenry Ave., Westwood, Cincinnati, O.

Begonia Veraou and Luminosa, \$5.00, \$6.00 and \$7.00 per 100. Rose Hill Nurseries, New Rochelle, N. Y.

BEGONIA REX

J. H. Dann & Son, Westfield, N. Y.
For page see List of Advertisers.

BOILERS

BOILERS. "Burnham" Boilers made for greenhouse heating. Lord & Burnham, 1133 Broadway, N. Y.

Kroeschel Bros. Co., 35 Erie St., Chicago.
For page see List of Advertisers.

W. W. Castle Co., 170 Summer St., Boston.
The Castle Boiler.

BOOKS

Pronunciation of Plant Names, sent for 50 cents, postpaid, by HORTICULTURE PUBL. CO., 11 Hamilton Place, Boston.

BOXWOOD TREES

New England Nurseries, Inc., Bedford, Mass.
For page see List of Advertisers.

Box Trees. Very complete assortment in various sizes of bush, pyramid and standard forms. State quantity and sizes wanted. Write for special prices. Wagner Park Conservatories, Sidney, Ohio.

BUILDING MATERIAL

BUILDING MATERIAL of all description for All Cypress, Semi-Iron, Iron Frame or Truss Houses. Hot Bed Sash and Frames. Lord & Burnham Co., 1133 Broadway, N. Y.

BULBS AND TUBERS

Joseph Breck & Sons, 47-54 N. Market St., Boston.
For page see List of Advertisers.

J. M. Thornburn & Co., 33 Barclay St., New York.
For page see List of Advertisers.

A. T. Boddington, 242 W. 14th St., N. Y.
For page see List of Advertisers.

Rickards Bros., 37 East 19th St., New York.
For page see List of Advertisers.

H. F. Mitchell Co., Philadelphia.
For page see List of Advertisers.

H. E. Plske Seed Co., Faneuil Hall Sq., Boston.
For page see List of Advertisers.

T. J. Gray & Co., 32 and 33 So. Market St., Boston.
For page see List of Advertisers.

Yokohama Nursery Co., 31 Barclay St., New York.
For page see List of Advertisers.

Ralph M. Ward & Co., 12 W. Broadway, New York.
For page see List of Advertisers.

Schlegel & Fottler Co., 28 & 27 S. Market St., Boston.
Begonias, Gloxinias, Tuberoses.

Begonias, Gloxinias, Tuberoses.
For page see List of Advertisers.

CANNAS

R. Vincent, Jr. & Sons Co., White Marsh, Maryland.
For page see List of Advertisers.

Estate of David Fisher, Woburn, Mass.
For page see List of Advertisers.

J. H. Dann & Son, Westfield, N. Y.
For page see List of Advertisers.

CARNATIONS

Baur & Smith, 38th & Senate Sts., Indianapolis, Ind.
Patten & Co., Tewksbury, Mass.
Carnation Shasta.
For page see List of Advertisers.

F. Dorrer & Sons Co., Lafayette, Ind.
Carnations for Immediate Delivery.
For page see List of Advertisers.

Chicago Carnation Co., Joliet, Ill.
Mary Tolman.
For page see List of Advertisers.

Wood Bros., Fishkill, N. Y.
Carnations, Rooted Cuttings.
For page see List of Advertisers.

The E. G. Hill Co., Richmond, Ind.
Carnation Cuttings.
For page see List of Advertisers.

Poehmann Bros. Co., Morton Grove, Ill.
For page see List of Advertisers.

CHRYSANTHEMUMS

E. G. Hill Co., Richmond, Ind.
For page see List of Advertisers.

S. J. Reuter & Son, Westery, R. I.
For page see List of Advertisers.

C. H. Totty, Madison, N. J.
For page see List of Advertisers.

Wood Bros., Fishkill, N. Y.
Chrysanthemums Rooted Cuttings.
For page see List of Advertisers.

Poehmann Bros. Co., Morton Grove, Ill.
For page see List of Advertisers.

Elmer D. Smith & Co., Adrian, Mich.
For page see List of Advertisers.

H. L. Cameron, N. Cambridge, Mass.
White Bononia.
For page see List of Advertisers.

William C. Smith, Market & 61st St., Philadelphia.
For page see List of Advertisers.

I. M. Raper, Greenport, L. I., N. Y.
For page see List of Advertisers.

100 commercial varieties, including Pompon and Hairy, \$12.50 per 100. Satisfaction guaranteed. Wm. Ehmann, Jr., Corfu, N. Y.

Chrysanthemum Golden Glow from 2 1/4 in. pots, for early spring delivery, \$1.00 per doz., \$6.00 per 100, \$50.00 per 1000. Stock plants of Montmore, Oct. Frost, Crocus, Matchless, Lucy Devaux, Polly Rose and Hilday, \$1.00 per doz., \$6.00 per 100. Peetre Bros., Waltham, Mass.

Chrysanthemums, good stocky cuttings from soil, all orders filled promptly; \$1.25 per 100; \$10.00 per 1000.
White—Estelle, Opah, Oct. Frost, Ivory, Polly Rose, C. Touset, Mrs. Robinson.
Yellow—Monrovia, Bue early, Wm. Jerome Jones, Maj. Bonaffon.
Pink—Glory Pacific, Dr. Euguehard, Wm. Duckham, Minnie Bailey.
Red—Hilday, Cullingford.

Potted plants of above, 2 1/4 in., \$2.00 per 100. Cash or C. O. D.

D. H. Green, West Grove, Penn.

75,000 transplanted chrysanthemum cuttings ready to bench: Opah, Kalb, Estelle, Pacific, Cerise, Yellow Jones, Monrovia, Whilday, Hilday, Bonaffon, Bailey \$1.25, 100; \$12.00, 1000. T. W. Baylis & Sons, West Grove, Pa.

For List of Advertisers See Page 851

CHRYSANTHEMUMS—Continued
Herrington's hook on the Chrysanthemum, mailed to your address for 50c. by Horticulture Publishing Co., 11 Hamilton Place, Boston.

Golden Glow and Pacific Supreme, R. C., \$2.75 per 100, prepaid; 1000 not prepaid, \$25; from 2 1/2 in. pots, \$3.75 per 100. Chas. Frost, Kenilworth, N. J.

COAL FOR GREENHOUSE USE
Bader Coal Co., Board of Trade Bldg., Boston.
For page see List of Advertisers.

COLEUS
A. Leuthy & Co., Perkins St. Nurseries, Roslindale, Mass.
For page see List of Advertisers.

CONIFERS
John Waterer & Sons, Ltd., American Nursery, Bagin, England.
For page see List of Advertisers.
Julius Boehrs Co., Rutherford, N. J.
For page see List of Advertisers.

CUT FLOWER BOXES.
Edwards Folding Box Co., Philadelphia.
For page see List of Advertisers.
Folding cut flower boxes, the best made. Write for list. Holton & Hunkel Co., Milwaukee, Wis.

DAHLIAS
David Herbert & Son, Atco, N. J.
For page see List of Advertisers.
J. L. Moore, Northboro, Mass.
For page see List of Advertisers.
Peacock Dahlia Farms, Williamstown Junction, N. J.
For page see List of Advertisers.
R. Vincent Jr. & Sons Co., White Marsh, Md.
For page see List of Advertisers.

DAHLIAS.
Geo. H. Walker, No. Dighton, Mass. Wholesale and Retail.
Send your name for my 1909 Catalog and Pocket Guide, ready to mail about Feb. 25th.

Dahlias, divided roots, \$1.00 the doz., including such varieties as Thomas Parkin, Mrs. Roosevelt, Souv. de Gustave Duzon, Standard Bearer, Catharine Duer, 20th Century, Gen. Buller, Dainty, Frank Smith, Lyonal, White Swan and 25 other sorts, all selected as good for cut flowers. A. & G. Rosbach, Pemberton, N. J.

DECORATIVE PLANTS
A. Leuthy & Co., Perkins St. Nurseries, Roslindale, Mass.
Imported Plants for Fall Delivery.
For page see List of Advertisers.
Godfrey Aschmann, 1012 W. Ontario St., Phila., Pa.
For page see List of Advertisers.
Joseph Heacock Co., Wyncote, Pa.
For page see List of Advertisers.

The Geo. Wittbold Co., 1057 Buckingham Place, Chicago, Ill.
For page see List of Advertisers.
Robert Craig Co., Market and 49th Sts., Philadelphia, Pa.
For page see List of Advertisers.

EVERGREENS
New England Nurseries, Bedford, Mass.
For page see List of Advertisers.
American Nursery Co., 150 Broadway, N. Y.
For page see List of Advertisers.

Evergreena. Send 25 cents in stamps for complete work on propagating and growing Evergreena. C. S. Harrison's Select Nursery, York, Neb.

FERNS
A. Leuthy & Co., Roslindale, Mass.
For page see List of Advertisers.
H. H. Barrows & Son, Whitman, Mass. Nephrolepis Magnifica.
For page see List of Advertisers.
John Scott, Brooklyn, N. Y.
For page see List of Advertisers.

FERNS—Continued
Frank Oechelb, 2570-2600 W. Adams St., Chicago.
Ferns for Dishes.
For page see List of Advertisers.
The Geo. Wittbold Co., 1057 Buckingham Place, Chicago, Ill.
For page see List of Advertisers.

Godfrey Aschmann, 1012 W. Ontario St., Philadelphia.
For page see List of Advertisers.
Jardiniere Ferns, 6-7 best varieties, \$3.50 per 100; \$30.00 per 1000. Rose Hill Nurseries, New Rochelle, N. Y.
For page see List of Advertisers.
Anderson's ferns for in and outdoors. Largest commercial collection in the country. Ask for descriptive catalogue. J. F. Anderson, Fern Specialist, Short Hills, N. J.

FERTILIZERS
Palverized Manure Co., 31 Union Stock Yards, Chicago, Ill.
Wisard Brand Sheep and Shredded Cattle Manure.
Bowker Fertilizer Co., Boston, Mass. All Forms of Plant Food at First Hands.
For page see List of Advertisers.
Wm. Elliott & Sons, 42 Vesey St., New York.
Sheep Manure.
For page see List of Advertisers.

FLORAL PHOTOGRAPHS
Floral Photographs, Foley's, 226-228 1-2 Bowery, New York.

FLORISTS' LETTERS.
Boston Florist Letter Co., 66 Pearl St., Boston, Mass.
For page see List of Advertisers.

FLORISTS SUPPLIES
N. F. McCarthy & Co., 84 Hawley St., Boston.
For page see List of Advertisers.

H. M. Robinson & Co., 15 Province St. and 9 Chapman Pl., Boston, Mass.
For page see List of Advertisers.
Reed & Keller, 122 W. 25th St., New York.
For page see List of Advertisers.
H. Bayersdorfer & Co., 1129 Arch St., Philadelphia.
For page see List of Advertisers.
W. C. Krick, 1164-66 Greene Av., Brooklyn, N. Y.
Immortelle Letters.
For page see List of Advertisers.
S. S. Pennock-Meehan Co., Philadelphia.
For page see List of Advertisers.

FLOWER POTS
W. H. Ernest, 25th and M Sts., Washington, D. C.
For page see List of Advertisers.
A. H. Hewa & Co., Cambridge, Mass.
For page see List of Advertisers.
Hilfinger Bros., Ft. Edward, N. Y.
For page see List of Advertisers.
The Peters & Reed Pottery Co., Red pots, seed pans, etc., Zanesville, O.
Syracuse Pottery Co., Syracuse, N. Y. Syracuse Red Pots.
We make Standard Flower Pots, etc. Write us when in need.
Wilmer Cope & Bro.
Lincoln University, Chester Co., Pa.

FRUIT TREES
Dwarf Fruit Trees, by F. A. Waugh, mailed to your address for 55 cents by Horticulture Publishing Co., 11 Hamilton Place, Boston.

GALAX
Michigan Cut Flower Co., 38 and 40 Broadway, Detroit, Mich.
For page see List of Advertisers.
George Colson & Co., 50 W. 28th St., New York.
For page see List of Advertisers.
Rice Bros., 115 N. 6th St., Minneapolis, Minn.
For page see List of Advertisers.
H. M. Robinson & Co., 15 Province St. and 9 Chapman Place, Boston.
For page see List of Advertisers.

GARDEN HOSE
Revere Rubber Co., Boston, Mass.
For page see List of Advertisers.
Crestline Mfg. Co., Crestline, O.
For page see List of Advertisers.

GERANIUMS
R. Vincent Jr. & Sons Co., White Marsh, Md.
New and Standard Varieties.
For page see List of Advertisers.
Godfrey Aschmann, Philadelphia, Pa.
For page see List of Advertisers.
William Swayne, Kennett Square, Pa.
For page see List of Advertisers.
2000 S. A. Nutt Geranium in bud and bloom, 3 1/2 in. and 4 in., \$5.00 per 100.
500 Ageratum, 2 1/2 in., \$3.00 per 100.
500 Lobelia, 1 1/2 in., \$2.00 per 100.
Harry E. Bloom, 1805 West 3rd St., Chester, Pa.

Geraniums, from 2 1/2 in. pots, \$2.75 per 100; 3 in. pots, \$4.50 per 100; 3 1/2 in. pots, \$6.00 per 100. Extra heavy well branched, from 4 in. pots, \$8.00 per 100. All plants are first-class; good tops. Cash with order, please. C. E. Merritt, Highland Mills, N. Y.
Salicoid Geraniums, strong plants from 2 1/2-in. pots, \$2.50 per 100. J. B. Shurtleff & Son, Cushman Ave., Revere, Mass.

GLADIOLI
J. L. Moore, Northboro, Mass.
For page see List of Advertisers.
E. S. Miller, Wading River, N. Y.
For page see List of Advertisers.

GLASS
Boston Plate & Window Glass Co., Boston.
For page see List of Advertisers.
Standard Plate Glass Co., 20-30 Sudbury St., Boston.
For page see List of Advertisers.
Foley Mfg. Co., Western Ave., between 25th & 26th Sts., Chicago.
For page see List of Advertisers.
Sharp, Partridge & Co., 22d & Lumber St., Chicago.
For page see List of Advertisers.
Parshefsky Bros., Inc., 59 Montrose Av., Brooklyn, N. Y.
For page see List of Advertisers.
Metropolitan Material Co., 1332-1402 Metropolitan Ave., Brooklyn, N. Y.
For page see List of Advertisers.
Greenhouse glass, lowest prices. Johnston Glass Co., Hartford City, Ind.
Glass, High Grade, Double Thick Greenhouse Glass. Lord & Burnham, 1133 Broadway, N. Y.

GLAZING POINTS
H. A. Dreer, Philadelphia, Pa.
Peerless Glazing Point.
For page see List of Advertisers.

GLAZING POINTS. Lord & Burnham Special Glazing Nails (Points). Lord & Burnham, 1133 Broadway, N. Y.

GREENHOUSE BUILDING MATERIAL
Lord & Burnham Co., 1133 Broadway, New York.
For page see List of Advertisers.

Pierson U-Bar Co., 1 Madison Sq., N. Y.
For page see List of Advertisers.
A. T. Stearns Lumber Co., Neponset, Boston.
For page see List of Advertisers.

King Construction Co., N. Tonawanda, New York.
For page see List of Advertisers.

Hitchings & Co., 1170 Broadway, New York.
For page see List of Advertisers.

J. C. Montger Co., 117 East Blackhawk St., Chicago, Ill.
For page see List of Advertisers.

Foley Mfg. Co., Western Ave., between 25th & 26th Sts., Chicago.
For page see List of Advertisers.

S. Jacobs & Sons, 1350-63 Flushing Ave., Brooklyn, N. Y.

In writing to Advertisers kindly mention Horticulture

GREENHOUSE CONSTRUCTION

GREENHOUSE CONSTRUCTION, Semi-Iron Greenhouse, New Truss Houses and Iron Frame Houses. Lord & Burnham, 1133 Broadway, N. Y.

J. A. Payne, 260-274 Culver Ave., Jersey City, N. J.
For page see List of Advertisers.

Foley Mfg. Co., Western Ave., between 26th & 26th Sts., Chicago.
For page see List of Advertisers.

Hitchings & Co., 1170 Broadway, New York.
For page see List of Advertisers.

GREENHOUSE HOSE

Revere Rubber Co., Boston, Mass.
Revere Hose.
For page see List of Advertisers.

GREENHOUSES FOR SALE

Thomas M. Lynch, 231 Main St., Poughkeepsie, N. Y.
For page see List of Advertisers.

GUTTERS

GUTTERS, Cast Iron Gutters, L & B Improved V Shaped Gutter with drip gutter attachment. Lord & Burnham, 1133 Broadway, N. Y.

HAIL INSURANCE

Florists' Hall Assn. of America.
J. G. Ealer, Saddle River, N. J.
For page see List of Advertisers.

HARDY FERNS, MOSS AND GREENS

H. M. Robinson & Co., 15 Province St. and 9 Chapman Pl., Boston, Mass.
For page see List of Advertisers.

Michigan Cut Flower Exchange, 38 and 40 Broadway, Detroit, Mich.
For page see List of Advertisers.

George Cotouan & Co., 50 W. 29th St., New York.
For page see List of Advertisers.

N. F. McCarthy & Co., 84 Hawley St., Boston.

McC Bros., 115 N. 6th St., Minneapolis, Minn.
For page see List of Advertisers.

HEATING APPARATUS

Lord & Burnham Co., 1133 Broadway, New York.
For page see List of Advertisers.

Pierston U-Bar Co., 1 Madison Sq., N. Y.
For page see List of Advertisers.

John A. Payne, 260-274 Culver Ave., Jersey City, N. J.
For page see List of Advertisers.

Kroeschell Bros. Co., 85 Erie St., Chicago.
For page see List of Advertisers.

HELP FURNISHED

Thos. H. Bambrick, 34 S. 7th St., Phila.
For page see List of Advertisers.

HERBACEOUS PERENNIALS

P. Ouwerkerk, P. O. No. 1, Hoboken, N. J.
For page see List of Advertisers.

New England Nurseries, Bedford, Mass.
For page see List of Advertisers.

The Geo. Wittbold Co., 1657 Buckingham Place, Chicago.
For page see List of Advertisers.

HOLLYHOCKS

Hollyhocks, best single and double strains, plants to flower, \$8.00 per 100; \$75.00 per 1000. Rose Hill Nurseries, New Rochelle, N. Y.

HOT-BED SASH

The A. T. Stearns Lumber Co., Neponset, Mass.
For page see List of Advertisers.

Pierston U-Bar Co., 1 Madison Sq., N. Y.
For page see List of Advertisers.

Lord & Burnham Co., 1133 Broadway, N. Y.
For page see List of Advertisers.

Foley Mfg. Co., Western Ave., between 26th & 26th Sts., Chicago.

HYDRANGEAS.

The F. R. Pierson Co., Barrytown-on-Hudson, N. Y.
For page see List of Advertisers.

Julius Roehrs Co., Rutherford, N. J.
For page see List of Advertisers.

INSECTICIDES.

Nicotinic kills all greenhouse pests.
F. R. Palethorpe Co., Eleventh St., Owensboro, Ky.
For page see List of Advertisers.

Stump & Walter Co., 50 Barclay St., New York.
Kilnseed Tobacco Dust.
For page see List of Advertisers.

Niagara Sprayer Co., Middleport, N. Y.
Niagara Brand.
For page see List of Advertisers.

Bowker Insecticide Co., Boston, Mass.
Insect Destroying Preparations.
For page see List of Advertisers.

Wm. Cooper & Nephews, 177 Illinois St., Chicago; Cyril Francklyn, 62 Beaver St., New York.
V 1 Fluid.
For page see List of Advertisers.

Eastern Chemical Co., Pittsburg St., Boston.
"IMP" Soap Spray.
For page see List of Advertisers.

Hammond's Paint & Slug Shot Works, Fishkill-on-Hudson, N. Y.
Slug Shot.
For page see List of Advertisers.

"The Fumigating Kind Tobacco Powder"—The first on the market and the kind used by so many imitators, has our guarantee tag of satisfaction or money back, and "The Moon Trade Mark" on every bag, \$3.00 per 100 lbs. The H. A. Stoothoff Co., Mount Vernon, N. Y., Makers and sellers.

JAPANESE PLANTS

Yokohama Nursery Co., 31 Barclay St., New York.
For page see List of Advertisers.

JERUSALEM CHERRIES

JERUSALEM CHERRIES. Fine strong stock, 2 1/2 in., \$2.50 per 100; \$18.00 per 1000. T. N. YATES CO., Mt. Airy, Phila., Pa.

KENTIAS

Godfrey Aschmann, 1012 W. Ontario St., Phila., Pa.
For page see List of Advertisers.

A. Leuthy & Co., Rosindale, Mass.
For page see List of Advertisers.

Jos. Heacock Co., Wyncote, Pa.
Single and Made-Up Specimens.
For page see List of Advertisers.

O. V. Zanzen, Hoboken, N. J.
For page see List of Advertisers.

LABELS

Dayton Fruit Tree Label Co., So. Canal St., Dayton, O.
Wood Labels for Nurserymen and Florists.
For page see List of Advertisers.

LILY OF THE VALLEY PIPS
Hjalmar Hartmann & Co., Langangstrade 20, Copenhagen, Denmark.
For page see List of Advertisers.

MASTICA

F. O. Pierce Co., 12 W. Broadway, New York.
For page see List of Advertisers.

MOON VINES

Godfrey Aschmann, Philadelphia, Pa.
For page see List of Advertisers.

MYRTLE

Myrtle, blue for cemetery planting, \$2.00 per 100; \$17.50 per 1000. Geo. A. Dhotau, Sta. H., Cincinnati, Ohio.

NICO-FUME

Kentucky Tobacco Product Co., Louisville, Ky.

NURSERY STOCK

John Waterer & Sons, Ltd., American Nursery, Bexshot, England.
For page see List of Advertisers.

NURSERY STOCK — Continued

P. Ouwerkerk, 216 Jane St., Weehawkes Heights, N. J.
For page see List of Advertisers.

American Nursery Co., 150 Broadway, New York, N. Y.
For page see List of Advertisers.

W. & T. Smith Co., Geneva, N. Y.
For page see List of Advertisers.

Manual of the Trees of North America, by C. S. Sargent, mailed to your address for \$5.00 by Horticulture Publishing Co., 15 Hamilton Place, Boston.

TREES, SHRUBS, ROSES, EVER GREENS, PEONIES, HARDY PLANTS, ELLWANGER & BARRY, Rochester, N. Y.

New Hardy Shrub—Buddleia variabilis Veitchii and Magnolia, the summer flowering Lilac, 50c. each; \$5.00 per doz.; \$25.00 per 100. Rose Hill Nurseries, New Rochelle, N. Y.

ORCHID PLANTS

Lager & Hurrell, Summit, N. J.
Fresh Imported and Established Orchids.
For page see List of Advertisers.

Stands, St. Albans, England.
Importers, Exporters, Growers, Hybridists.
For page see List of Advertisers.

Carrillo & Baldwin, Secaucus, N. J.
For page see List of Advertisers.

Jos. A. Manda, 191 Valley Road, W. Orange, N. J.
For page see List of Advertisers.

Ordonez Bros., Madison, N. J., Box 106
For page see List of Advertisers.

G. L. Freeman, 388 Appleton St., Holyoke, Mass.
Orchid Importations.

MacRorie-McLaren Co., 721 Crocker Bldg., San Francisco, Cal.
Phalaenopsis and Vandas.
For page see List of Advertisers.

Largest stock in the country. Ask for prices. Julius Roehrs, Rutherford, N. J.
Native Orchids, Ilugo Kind, Hammon-ton, N. J.

PAINT AND PUTTY

PAINT AND PUTTY: Ideal Greenhouse lead; Special Greenhouse Putty. Lord & Burnham, 1133 Broadway, N. Y.

PALMS

A. Leuthy & Co., Perkins St. Nurseries, Rosindale, Mass.
For page see List of Advertisers.

Robert Craig Co., Market and 49th Sts., Philadelphia, Pa.
For page see List of Advertisers.

Joseph Heacock Co., Wyncote, Pa.
Home-Grown Palms.
For page see List of Advertisers.

Geo. Wittbold Co., 1657 Buckingham Place, Chicago.
For page see List of Advertisers.

Julius Roehrs Co., Rutherford, N. J.
For page see List of Advertisers.

O. V. Zanzen, Hoboken, N. J.
For page see List of Advertisers.

PANSY PLANTS.

J. C. Schmidt, Bristol, Pa.
For page see List of Advertisers.

PANSY SEED

John Gerard, New Britain, Conn.
Giant Pansy Seed.
For page see List of Advertisers.

PATENTS

Siggers & Siggers, Washington, D. C.
For page see List of Advertisers.

PEAT

Orchid Peat and Moss always on hand
Julius Roehrs Co., Rutherford, N. J.

PEONIES

Peonies only, but the wholesale—best 100 varieties. J. F. Rosendahl, Westpoint, Nebr.

One of the finest collections in America. Send 25 cts. in stamps for new edition of Peony Manual. C. S. Harrison's Select Nursery, York, Neb.

For List of Advertisers See Page 851

PHLOXES

Send 25 cts in stamps for Phlox Manual Fine mixed phloxes \$2.00 per 100. C. R. Harrison's Select Nursery, York, Neb.

Phlox, Hardly Perennial, best assorted varieties, strong plants, \$5.00 per 100; \$40.00 per 1000. Rose Hill Nurseries, New Rochelle, N. Y.

PHOTOGRAPHS: DESIGNING: ILLUSTRATING

Geo. E. Dow, 178 Washington St., Boston. For page see List of Advertisers.

PIPE AND FITTINGS

Foley Mfg. Co., between Western Ave. and 26th St., Chicago, Ill.

Kroeschell Bros. Co., 35 Erie St., Chicago. For page see List of Advertisers.

PIPE AND FITTINGS. Cast Iron and Wrought Pipe, Valves, Elbows, Pipe Hooks, Automatic Air Headers, etc. Lord & Burnham, 1133 Broadway, N. Y.

Metropolitan Material Co., 1392-1402 Metropolitan Ave., Brooklyn, N. Y. For page see List of Advertisers.

PLANT STAKES

Seele's Tiesla Plant Stakes and Trellises. H. D. Seele & Sons, Elkhart, Ind.

POT HANGERS

Pot hangers, Kramer's \$1 doz. by exp. \$1.25 by mail. I. N. Kramer & Son, Cedar Rapids, Ia.

RHODODENDRONS

John Waterer & Sons, Ltd., American Nursery, Bagshot, England. For page see List of Advertisers.

P. Ouwerkerk, Hoboken, N. J. For page see List of Advertisers.

ROSES

Robert Craig Co., Market and 40th Sts., Philadelphia, Pa. For page see List of Advertisers.

P. Ouwerkerk, P. O. No. 1, Hoboken, N. J. For page see List of Advertisers.

The F. R. Pierson Co., Tarrytown-on-Hudson, N. Y. White Killarney. For page see List of Advertisers.

Dingee & Conard Co., West Grove, Pa. For page see List of Advertisers.

Poehlmann Bros. Co., Morton Grove, Ill. For page see List of Advertisers.

A. N. Pierson, Cromwell, Conn. White Killarney, My Maryland, Ramblers. For page see List of Advertisers.

U. S. Cut Flower Co., Elmira, N. Y. Rose Plants. For page see List of Advertisers.

W. & T. Smith Co., Geneva, N. Y. American Grown Roses. For page see List of Advertisers.

Pittsburgh Rose & Carnation Co., Gibsonia, Pa. For page see List of Advertisers.

Roses, Malds and Richmonds, strong 4 in. stock, \$8.00 per 100. Rose Hill Nurseries, New Rochelle, N. Y.

The Rose, by H. B. Ellwanger; mailed for \$1.30 by Horticulture, 11 Hamilton Place, Boston.

Hand Book of Cultural Notes on Roses Under Glass, by F. P. Brigham, mailed to your address for 25c. by Horticulture Publishing Co., 11 Hamilton Place, Boston.

RUBBER PLANTS

William C. Smith, Market & 61st St., Philadelphia. For page see List of Advertisers.

SEED GROWERS

Hjalmar Hartmann & Co., Cauliflower and Cabbage Seed.

Langangstræde 20, Copenhagen, Denmark. For page see List of Advertisers.

Routzahn Seed Co., Arroyo Grande, Calif. Spencer Type Sweet Peas, Nasturtiums, Etc. For page see List of Advertisers.

SEEDS

T. J. Grey Co., 32 So. Market St., Boston. For page see List of Advertisers.

Joseph Ereck & Sons, 51 and 52 N. Market St., Boston, Mass. For page see List of Advertisers.

W. Altee Burpee & Co., Philadelphia. For page see List of Advertisers.

Arthur T. Boddington, 342 W. 14th St., New York. For page see List of Advertisers.

H. E. Flake Seed Co., Faneull Hall Sq., Boston. For page see List of Advertisers.

Hjalmar Hartmann & Co., Langangstræde 20, Copenhagen, Denmark. Cauliflower and Cabbage Seed. For page see List of Advertisers.

Rickards Bros., 37 E. 19th St., New York. For page see List of Advertisers.

R. & J. Farquhar & Co., 67 So. Market St., Boston. Magnolia Seed. For page see List of Advertisers.

H. F. Michell Co., 1018 Market St., Phila. Primula Seed. For page see List of Advertisers.

J. M. Thorburn & Co., 33 Barclay St., N. Y. For page see List of Advertisers.

Leonard Seed Co., Chicago, Ill. For page see List of Advertisers.

Schlegel & Fottler Co., 26 & 27 S. Market St., Boston. For page see List of Advertisers.

O. V. Zangen, Hoboken, N. J. Florists' Spring Seeds. For page see List of Advertisers.

E. F. Whiterson Co., Chicago. Seeds for Plantamen, Nurserymen, Seedsmen. For page see List of Advertisers.

A. C. Zvolanek, Round Brook, N. J. Winter Flowering Sweet Peas. For page see List of Advertisers.

Seeds. Rocky Mountain Evergreen seeds in large or small quantities. C. S. Harrison's Select Nursery, York, Neb.

SHRUBS

The Geo. Wittbold Co., 1687 Buckingham Place, Chicago. For page see List of Advertisers.

SILKALINE

John C. Meyer & Co., Boston, Mass. For page see List of Advertisers.

SPHAGNUM MOSS

Live Sphagnum moss, orchid peat and orchid baskets always on hand. Lager & Hurrell, Summit, N. J.

SPRAYERS

Niagara Sprayer Co., Middleport, N. Y. For page see List of Advertisers.

Chas. J. Jager Co., Boston. Deming Spray Pump. For page see List of Advertisers.

STEAM TRAP

E. Hippard, Youngstown, O.

STOVE PLANTS

Jullus Roehrs Co., Rutherford, N. J. For page see List of Advertisers.

SULPHUR BURNER

Benj. Dorrance, Rose Growers, Dorrancton, Pa.

SWEET PEAS

A. C. Zvolanek, Round Brook, N. J. Winter Flowering. For page see List of Advertisers.

VEGETABLE PLANTS

R. Vincent, Jr. & Sons Co., White Marsh, Md. For page see List of Advertisers

VENTILATING APPARATUS

Piemont U-Bar Co., 1 Madison Sq., N. Y. For page see List of Advertisers.

Foley Mfg. Co., Western Ave., between 25th & 26th Sts., Chicago. For page see List of Advertisers.

John A. Payne, 260-274 Culver Ave., Jersey City, N. J. For page see List of Advertisers.

The Advance Co., Richmond, Ind. For page see List of Advertisers.

Quaker City Machine Co., Richmond, Ind. 20th Century Ventilating Arm. For page see List of Advertisers.

VENTILATING MACHINERY, New Model enclosed, self-oiling gear; Standard Model Open Gear. Lord & Burnham, 1133 Broadway, N. Y.

VERBENAS

J. C. Schmidt, Bristol, Pa. For page see List of Advertisers.

Lemon Verbena R. C., 75c. per 100, prepaid. Chas. Frost, Kenilworth, N. J.

VIOLETS.

William Slin, Cliftondale, Mass. Boston and Princess of Wales Violets. For page see List of Advertisers.

Marin Louise Violet plants, well rooted, grown on the benches, free from disease, selected stock, \$15.00 per 1000. Ready for immediate delivery. J. Vonder Linden, Rhinebeck, N. Y.

VINCAS

William C. Smith, Market & 61st St., Philadelphia. For page see List of Advertisers.

WILSON'S PLANT OIL

Wilson Plant Oil & Fertilizer Co., Chatham, N. J. For page see List of Advertisers.

WIRED TOOTHPICKS

W. J. Cowee, Berlin, N. Y. For page see List of Advertisers.

WIREWOK

Reed & Keller, 122 W. 25th St., N. Y. For page see List of Advertisers.

Durand & Marohn, Albany, N. Y. For page see List of Advertisers.

Wirework. Write for our catalogue. Holton & Hunkel Co., Milwaukee, Wis.

William E. Heilscher's Wire Works, 38-40 Broadway, Detroit, Mich.

Wirework—Compare our prices with others. Scranton Florist Supply Co., 201 N. 7th St., Scranton, Pa.

WHOLESALE FLORISTS

Boston

N. F. McCarthy & Co., 84 Hawley St., Boston. For page see List of Advertisers.

H. M. Robinson & Co., 15 Proville St. and 9 Chapman Pl., Boston. For page see List of Advertisers.

Welch Bros., 226 Devonshire St., Boston. For page see List of Advertisers.

Tally, Wellesley, Mass. For page see List of Advertisers.

Buffalo, N. Y.

William F. Kastner Co., 383-87 Elicott St., Buffalo, N. Y. For page see List of Advertisers.

Chicago

Chas. W. McKeller, 51 Wabash Ave., Chicago. For page see List of Advertisers.

Peter Reinberg, 51 Wabash Ave., Chicago. For page see List of Advertisers.

In writing to Advertisers kindly mention Horticulture

**WHOLESALE FLORISTS—
Chicago—Continued**

E. F. Wintercon Co., 45-49 Wabash Ave., Chicago.
For page see List of Advertisers.

J. A. Badlong, 37-39 Randolph St., Chicago.
For page see List of Advertisers.

Foehmann Bros. Co., Morton Grove, Ill.
For page see List of Advertisers.

Cromwell, Conn.

A. N. Pierson, Cromwell, Conn.
For page see List of Advertisers.

Detroit

Michigan Cut Flower Exchange, 38 and 40 Broadway, Detroit, Mich.
For page see List of Advertisers.

Minneapolis

Rice Bros., 115 N. 6th St., Minneapolis, Minn.
For page see List of Advertisers.

New York

Ford Bros., 48 W. 28th St., New York.
For page see List of Advertisers.

H. E. Froment, 57 W. 28th St., New York.
For page see List of Advertisers.

Alex. J. Guttman, 34 W. 28th St., New York.
For page see List of Advertisers.

E. C. Horan, 55 W. 28th St., New York.
For page see List of Advertisers.

A. H. Langjahr, 55 W. 28th St., New York.
For page see List of Advertisers.

James McMann, 42 W. 28th St., New York.
For page see List of Advertisers.

John I. Raynor, 49 W. 28th St., New York.
For page see List of Advertisers.

W. E. Sheridan, 39 W. 28th St., New York.
For page see List of Advertisers.

Moore, Hentz & Nash, 55 and 57 W. 26th St., New York.
For page see List of Advertisers.

Wm. H. Knebler, 28 Willoughby St., Brooklyn, N. Y.
For page see List of Advertisers.

Millang Bros., 41 W. 28th St., New York.
For page see List of Advertisers.

John Young, 51 W. 28th St., New York.
For page see List of Advertisers.

Greater New York Florists' Association, 162 Livingston St., Brooklyn, N. Y.
For page see List of Advertisers.

Frank Millang, 55-57 W. 26th St., New York.
For page see List of Advertisers.

A. L. Young & Co., 54 W. 28th St., N. Y.
For page see List of Advertisers.

Growers' Cut Flower Co., 39 W. 28th St., New York.
For page see List of Advertisers.

J. K. Allen, 166 W. 28th St., New York.
For page see List of Advertisers.

Charles Millang, 444 8th Ave., New York.
For page see List of Advertisers.

Manhattan Flower Market, 46 W. 28th St., New York.
For page see List of Advertisers.

Philadelphia

W. E. McKissick & Bros., 1619-1621 Ransford St., Philadelphia, Pa.
For page see List of Advertisers.

Leo Niessen Co., 1299 Arch St., Philadelphia, Pa.
For page see List of Advertisers.

The S. S. Pennock-Meehan Co., 1608-18 Ludlow St., Philadelphia, Pa.
For page see List of Advertisers.

New Offers in This Issue.

AUCTION SALE.

Wm. Elliott & Sons,
42 Vesey St., New York.
For page see List of Advertisers.

BEGONIA PRESIDENT TAFT, WINTER FLOWERING.

J. A. Peterson,
McHenry Av., Westwood, Cincinnati, O.
For page see List of Advertisers.

GLASS, PIPE, FITTINGS, FOR SALE.

Jacob Becker, Market & 52d Sts., Phila.
For page see List of Advertisers.

OPEN HOUSE ALL SUMMER.

J. K. Allen, 106 W. 28th St., New York.
For page see List of Advertisers.

ROBINSON BOILER FOR SALE.

Bennett Bros.,
41-51 Payne St., Lowell, Mass.
For page see List of Advertisers.

ROSES OWN ROOT: ASPARAGUS

PLUMOSA AND SPRENGERI.

Charles H. Totty, Madison, N. J.
For page see List of Advertisers.

VIOLET BLUE ROSE.

Ellwanger & Barry,
Mount Hope Nurseries, Rochester, N. Y.
For page see List of Advertisers.

WHOLESALE FLORIST.

Philip F. Kessler,
55 & 57 W. 26th St., New York.
For page see List of Advertisers.

GREENHOUSES BUILDING OR CONTEMPLATED.

Lowell, Mass.—H. L. Shedd, violet house.

Englehart, Ont.—D. Kerrigan, house 30 x 75.

Herrington, Kan.—Charles Rissman, conservatory.

St. Louis, Mo.—Paul Schneider, two carnation houses.

New Galilee, Pa.—Wm. Lauch, two carnation houses.

Stoneham, Mass.—A. S. Parker, two houses, each 200 feet.

Fishkill, N. Y.—G. W. Russell, two houses, each 20 x 120.

Allentown, Pa.—Ed. Kroninger, two houses, each 50 x 400.

Chatham, N. J.—G. F. Neipp, house 40x200, Kinga construction.

Rocky River, O.—Rocky River Greenhouse Co., eight houses 30 x 325.

Bensenville, Ill.—W. F. Dumtman, two violet houses, each 27 x 200.

Albuquerque, N. M.—Albuquerque Floral Co., two houses, 20 x 100, two houses 36 x 100 each.

La Fayette, Ind.—Experiment Station, lean-to conservatory 15 x 48, and even span connecting house 11 x 20.

Johnstown, Pa.—H. H. Mishler, two houses, one 40 x 125, one 12 x 60. D. Mishler, two houses, one 12 x 100, one 32 x 100.

Ithaca, N. Y.—Plans have been completed at Cornell University for the construction of three houses, one two stories high, of terra cotta blocks, with laboratories and work rooms.

The Board of General Appraisers has reversed Collector Loeb in his assessment of a 50 per cent. duty on wreaths composed of artificial flowers, and mounted on wire frames. Collector Loeb held that the articles should pay duty as "artificial flowers" with a tax of 50 per cent.

A NOTABLE PUBLICATION.

Catalogue Edition, No. 2 of the Pierson U-Bar Company has just been issued. It comprises 64 pages, size 9 1-2 x 12 inches, embracing the following topics: Why the U-Bar?—The U-Bar Described.—Other Things to Consider.—A Word About the Subjects.—The Subjects.—Workrooms and Their Equipment. The next section which will shortly follow will treat on Garden Frames and Sash.—Standard Greenhouse Sections.—interior Views. The third section, which will complete the work, will include: Side Wall Constructions.—Alternate Foundations.—Dome Construction.—Ridge and Furrow Construction.—Plant Tables and Beds.—Examples of Structural Details.—Distinctive Architectural Treatments.—Specification, Illustrative and Descriptive.—Estimates: How to Obtain Them. The text and illustrations are printed in "duo-tone" on dull surfaced paper and the effect is artistic in the fullest sense. A full page picture of the Brewster range, erected at New Haven last year, forms a striking frontispiece. The catalogue starts with an illustration of the simplest kind of a lean-to house and the subjects follow along gradually larger and larger until the largest and most luxurious structures are reached. Each subject has interesting descriptive text matter, also technical plan description with cross references to pertinent matter on other pages. The views are all those of standard sections and their various combinations, photographed from representative ranges erected up to the present time by this company. The technical plans, etc., are all drawn to a uniform scale and with such completeness of detail that full working plans might be prepared from them.

We have now said enough to indicate somewhat of the comprehensive character of this catalogue and great amount of work done in its compilation. Nothing in its line, remotely approaching it, has ever been put out. It contains a prodigious amount of valuable suggestion and information and cannot fail to exert a potent influence in its field.

STANDARD FLOWER POTS

Packed in small crates, easy to handle.

Price per crate		Price per crate	
1500 2 1/2 in. pots in crate	\$4.88	144 6 in. pots in crate	\$5.40
1500 2 1/2 " " " "	5.75	120 7 " " " "	4.20
1500 2 1/2 " " " "	6.00	60 8 " " " "	3.00
1000 3 " " " "	5.00	HAND MADE	
800 3 1/2 " " " "	5.80	48 9 in. pots in crate	\$2.60
500 4 " " " "	5.20	24 11 " " " "	3.60
450 4 1/2 " " " "	4.94	24 12 " " " "	4.80
300 5 " " " "	4.51	12 14 " " " "	4.80
210 5 1/2 " " " "	3.78	6 16 " " " "	4.50

Seed pans, same price as pots. Send for price list of Cylinders for Cut flowers, Hanging Baskets, Lawn Vases, etc. Ten per cent. off for cash with order. Address Hilfinger Bros., Pottery, Fort Edward, N. Y. Hilfinger & Sons, Agts. 31 Barclay St., N. Y. City.

Standard Flower . . . POTTS

If your greenhouses are within 500 miles of the Capital, write us, we can save you money
W. H. ERNEST
25th and M Street WASHINGTON D C

LIST OF ADVERTISERS

Advance, The Co.....855	Lager & Hurrell.....828
Allen J. K.....845	Langjahr, Alfred H.....844
American Nursery.....845	Leonard Seeds Co.....839
(Eng.).....837	Luthy A. & Co.....838
American Nursery Co836	Lord & Burnham Co.866
Aschmann Godfrey.....828	Lynch Thos. M.....851
Bader Coal Co.....855	MacMullin E. A.....841
Bambrick Thos. H.....851	MacRorie-McLareo Co.....828
Barrows H. H. & Son.....848	Maeda Jos. A.....828
Barron Smith.....845	Manhattan Flower Mkt.....845
Baversdorfer H. & Co.841	McCarthy N. E. & Co.....845
Becker Jacob.....851	McConnell Alex.....840
Beckett Bros. Co.....851	McKellar Charles W.842
Boddington A. T.....839	McKisick, W. E. & Bros.....842
Boston Florist Letter Co.....841	McManus Jas.....844
Botan Plate and Window Glass Co.....854	Metropolitan Material Co.....855
Bowe, M. A.....840	Meyer J. C. & Co.....848
Bowler Fertilizer Co.839	Michell H. F. Co.....838
Bowler Insecticide Co.....853	Michigan Cut Flower Exchange.....845
Breck Joseph & Sons839	Milling James.....844
Breitmeier's J. Sons840	Millang Charles.....844
Bridgman's Seed Warehouse.....839	Millang Frank.....844
Budlong J. A.....842	Moninger J. C.....855
Burpee W. A. & Co.....839	Moore, Hentz & Nash847
Cameron H. L.....826	Mt Hope Nurseries.....836
Carrillo & Watson828	Murray Samuel.....840
Chicago Carnation Co.....826	New Eng. Nurseries837
Clarke's David, Soos,820	Newman J. & Sons.....840
Cosa J. J.....844	Niagara Sprayer Co.851
Cooper Wm. & Nephews.....853	Niessen Leo Co.....842
Cotsonas Geo. & Co.744	Oechstin Frank.....828
Cowee W. J.....826	Ordonez Bros.....828
Craig, Robt. Co.....828	Ouwertkerk P.....837
Crawback Gen. W.....844	Palethorne P. R. Co.853
Crawford H. F.....851	Palmer W. J. & Son.....840
Cresline Mfg. Co.....854	Park Floral Co.....840
Danker F. A.....847	Parkeley Bros.....854
Dann J. B. & Son.....826	Patten & Co.....840
Dayley F. H.....851	Payne John A.....854
Diagee & Leonard Co.828	Peacock Dahlia Farms837
Dorner F. Sns & Co.846	Peacock-Mechan Co.....843
Dow Geo. E.....839	Perkins St Nurseries828
Dreer H. A.....854	Peterson J. A.....826
Dunkan John H.....840	Pierce, F. L.....825
Durand & Maroha.....844	Piersma, A. N., Inc.827
Dysart R. J.....845	Pierson F. R. Co.....827
Eastern Chemical Co.852	Pierson U Bar Co.856
Edwards Folding Box Co.....842	Pittsburg Rose & Carnation Co.....826
ElliotWm & Son835	Pochlmann Bros. Co.....826-842
Elwanger & Barry.....836	Quaker City Mach. Co.855
Elm City Nursery Co.851	Rayner, I. M.....827
Elmsford Nurseries.....826	Raynor John L.....844
Esler J. G.....854	Reed & Keller.....845
Ernest W. H.....826	Reinberg Peter.....842
Eyes.....840	Reuter S. J. & Son, Inc.826
Farouhar R. & J. & Co.839	Revere Rubber Co.....854
Fisher David, Eber.....828	Rice Bros.....842
Fiske H. E. Seed Co.....839	Rickards Bros.....839
Foley Mfg. Co.....855	Robinson H. M. & Co.822
Ford Bros.....844	Rock Wm. L. Flo. Co.840
Froment H. E.....844	Roehrs Julius Co.828-837
Galvin Thos. F.....841	Roland, Thomas.....826
Gardner J.....838	Rolker August & Son.....826
Greater N.Y. Florists' Association.....844	Rose Hill Nurseries.....828
Grey T. J. Co.....838	Routzaha Seed Co.....839
Growers' Cut Flower Co.....844	Sander & Son.....828
Gude Bros. Co.....840	Schlegel & Fottler Co.839
Guttman Alex. J.....844	Schmidt J. C.....827
Hall Asso.....855	Schulz Jacob.....840
Hammond Paint and Slug Shot Works.....853	Scott John.....828
Hartmann Hjalmar & Co.....838	Sharp, Partridge & Co.854
Hauswirth the Florist840	Sheridan W. F.....844
Heacock Jos. Co.....828	Siggers & Siggers.....855
Herbert David & Son.837	Sims, Wm.....826
Hewes H. & Co.....851	Smith Elmer D. & Co.826
Hilfinger.....850	Smith W. C.....827
Hill, The E. G. Co.....826	Smith W. & T. Co.....827
Hitchings & Co.....856	Sothworth Wm. J.....840
Hoffman.....855	Standard Plate Glass Co.....854
Horan E. C.....844	Stearns A. T. Lumber Co.....855
Huot A. E. & Co.....826	Stump & Walter Co.....853
Hunt Bros.....826	Swayne Wm.....827
Jager, Chas. J. Co.....853	Talhy.....840
Kasting W. F. Co.....845	Thorburn J. M. & Co.839
Kings, Co.....845	Totty Chas. H.....826
Kesler P. F.....824	United States Cut Flower Co.....837
Krick W. C.....845	Valentine, J. A.....840
Kroeschell Bros. Co.854	
Kuebler Wm H.....844	

Winterson, E. F. Co.....822	Wood Bros.....822
Yokohama Nursery Co8.8	Young A. L.....845
Young A. L.....845	Young John.....844
Young & Nugent.....840	Zvonek A. C.....839

FOR SALE THE ESTATE OF M. J. LYNCH, Deceased

The old established greenhouse property of the late M. J. Lynch, on the South Road, near the city of Poughkeepsie, N. Y., consisting of sixteen Greenhouses, 36,000 square feet of glass with entire stock of Palms, Roses, Carnations, Bedding Plants, and Plants of all kinds, etc.

Eight-room Dwelling, with hot-water heating and slate roof, also,

Five-room Gardener's Cottage, adjoining Greenhouses

Large, substantial Carriage House.

This is a valuable location, with ample water supply, adjoining Rural cemetery, on line of Wappingers trolley, one mile and a quarter from Court House.

For Particulars Apply
THOMAS M. LYNCH
256 Main St., Poughkeepsie, N. Y.

PEREMPTORY Sale of Glass, Pipe, Fittings, Etc.

Jacob Becker, Market and 52nd Sts., Phila., will sell at once all private sale: 1 house 20 ft. x 64 ft., 3 houses 120 ft. x 16 ft., 4 houses 80 ft. x 16 ft., to make room for stores and apartment houses. Must be sold at once. No reasonable offer refused. To be sold standing. Buyer must take down and remove. Hot water heating throughout.

FOR SALE

About 20,000 feet of glass in good condition, will sell at a low figure, or will license to the right party, with privilege of buying. My object for selling is, I do not know anything about the business and can't hire men that do.

H. F. CRAWFORD
Montello Sta. Brockton, Mass.

SECOND HAND BOILER

For sale, suitable for heating purposes. Robinson make. 4 1/2 x 15 ft. 64 tubes, 3 in. All trimmings and settings in good condition.

BENNETT BROS. CO , Lowell, Mass.

For Sale Greenhouse Property

Located at Somerset and Howard streets, North Plainfield, Somerset County, New Jersey. Dimensions 248 x 106 ft. Contains three green houses 20 x 175 ft., steel frames. Trolley lines pass property. Will sell cheap and on easy terms. For particulars apply to F. B. DAILEY, care F. BERG & CO., - Orange, N. J.

FOR SALE—Five greenhouses, house, five rooms, improvements; barn, carriage house, sheds; all in good repair. One minute to depot, on main street; 20 minutes to Boston; five minutes to two lines of electric. Only florist in large town. Established twenty years. For further particulars address E. G. Binney, Swampscott, Mass.

FOR SALE—Special 16 x 18 and 16 x 24 double thick glass in "A" and "B" qualities. Buy now and save money. Write PARHSELBY BROTHERS, INC., 59 Montrose Ave., Brooklyn, N. Y.

FOR SALE—Two 7 section Weathered hot water boilers at a great reduction; good as new; will heat about 10,000 ft. glass. Inquire of Montrose Greenhouses, Montrose, Mass.

FOR SALE. CHEAP—A good, second-hand Horizontal Tubular Steam Boiler, 85 H. V. Auburn Last Co., So. Framingham, Mass.

WANTS, FOR SALE, ETC.
Advertisements in this column one cent a word. Initials count as words. Cash with order. All correspondence addressed "care HORTICULTURE" should be sent to 11 Hamilton Place, Boston.

HELP WANTED

Wanted Nursery Foreman
Permanent position for right party. Must be well up on growing high grade ornamentals and a good handler of men.

Landscaper Foreman

Experience in carrying out landscape work and familiar with ornamental stock

THE ELM CITY NURSERY CO.
NEW HAVEN, CONNECTICUT.

GOOD MEN

When you need good men, skilled or unskilled, Write:

THOS. H. BAMBRICK

34 South 7th Street Philadelphia

Help of all kinds, including that for Florists, Nurserymen, Seedsmen and the Horticultural trade generally.

HORTICULTURE needs a wide-awake representative in every town in the land. Good commission paid on advertising and subscriptions. If you are ambitious, write for terms.

WANTED—First-class plant grower to work under foreman; state age, experience and wages expected. Thomas Roland, N. hant, Mass.

MISCELLANEOUS WANTS

WANTED TO BUY—Complete green house plants and all kinds of greenhouse material, to be taken down and removed at once. Terms cash. Address I. Sussnerman, 229 Livingston St., Newark, N. J.

WANTED—To lease, with privilege of buying, retail greenhouse establishment, with land, State size of houses, glass, terms, first letter GROWER, 150 Grand St., Jersey City, N. J.

WANTED—Second-hand hoes and bur-lap, any kind, any quantity, anywhere. Richmond Bar Co., Richmond, Va.

AMERICAN ASSOCIATION OF NURSERYMEN.

(Continued from page 839)

of the value of the council to the nurserymen and no action was taken. The reports of the Publicity Committee, by J. M. Irvine, and of Co-operation with Entomologists' Committee, by Orlando Harrison were presented and the latter committee was discharged.

Thursday Evening.

On Thursday evening the ladies attended the Lyceum Theatre as guests of the Western New York Nurserymen, and the men enjoyed the smoker in Masonic Temple auditorium. The promise of those in charge of "something doing every minute" was carried out to the letter.

THE EXHIBITION.

The catalogue and color plate men were well represented in the exhibition rooms, also the periodical department. HORTICULTURE'S issue for the current week was on display, also New Fruits. The McFarland Organizations made an extensive exhibit of the new French Autochrome color process. McMillan & Co. had Bailey's Cyclopaedia of Agriculture on view. B. G. Pratt Co. demonstrated the value of Sealecide to the nurseryman. Paul C. Koebler Co. showed their photo-gelatin color process. Color plates were also on view from Vredenburg Co., M. Bruns- wick & Co., Rochester Lithographing Co. and the Stecher Lithograph Co. Nathan R. Graves showed photograph illustrations for catalogue purposes. The Fruit Grower displayed examples of nursery catalogue printing. The National Nurseryman was, of course, in evidence. The Dayton Fruit Tree Label Company had an exhibit of their wares and did a well-deserved business. McHutchison & Co. showed raffia. John Charlton & Sons had a display of irises and peonies, also mammoth rhubarb. The Chas Nursery Co. showed "C. A. G., nurserymen's supplies; the Ohio Nursery and Supply Company, shipping tags and Clark Nursery Co., a nice exhibit of nuts.

In a room on the street floor of the hotel a number of exhibits, including the tree and plant groups, were placed. Here were Ellwanger & Barry, Dundee Nurseries and Jackson & Perkins Co., with general nursery stock; L. J. Farmer, strawberries; Thos. A. McBeth, Hydrangea arborescens sterilis; P. J. Berckmans Company, evergreens; Vincennes Nursery Co., cherry trees; C. M. Hooker & Son, Perfection currant; Perfection Planter Co., Perfection Planters; Niagara Sprayer Co., spraying machinery and solutions; Wm. Cooper & Nephews, tree spraying fluids; E. C. Brown Co., Auto Spray; Clinton Falls Nursery Co., soil firmer and trencher; C. Betscher, display of peonies; Stecker Lithographic Company. All reported a good line of sales.

BUSINESS CHANGES.

Oakland, Cal.—The Oakland Floral Co. has purchased the store of N. Rollert.

Sarcoux, Mo.—Sarcoux Nurseries and C. & M. Wild have united under the title of Wild Bros. Nursery Co.

San Diego, Cal.—E. S. Langford, formerly of the Oceanic Floral Co. has leased land in Grossman Park for commercial purposes.

EPSOM SALTS AS A FERTILIZER.

It will be a pleasure to elucidate somewhat the question raised by one of the readers of HORTICULTURE by the article "Planting for Winter Effect in the Northern States," written by Mr. Geo. E. McClure and published on page 482 of your paper, in which he says that to use Epsom salts in such planting assures success.

Most of us have a pretty good idea of what Epsom salts are, for as the veterinarian would say, they are good for "man or beast," and, without joking, this particular soluble chemical is widely used for mankind and likewise for almost all of our domestic animals and fowls. This chemical as ordinarily made is a white crystal substance containing 50 per cent water and something under 14 per cent of Magnesium, calculated as Oxide of Magnesium, which is the usual manner of calculation, just as Oxide of Potash is the way in which we calculate the amount of Potash in a substance.

This was first called Epsom from the springs at that place, and is an almost inevitable constituent of our mineral table and medicinal waters. This element is found in many rocks and thus it slowly gets into our wells and streams and finally finds its way into the ocean, where it is found in some quantity along with Mr. Jernege's gold and many other elements. As the great deposits of Potash and Magnesium salts in Germany were made from the ocean we can readily understand that here are enormous quantities of Potash and Magnesium mixed with other impurities.

Salts imported to this country which contain Magnesium are the Sulphate of Magnesium, also known as Keiserite, Kainit, Sylvanite, and the double Sulphate of Potash and Magnesia, and naturally small amounts are usually found in the Sulphate of Potash. All these salts may be included under the term of "Chemicals for agricultural purposes," but Magnesium is so widely distributed throughout the land that its presence by no means ends here, as plants almost invariably have it, getting it from the rocks through the water, and in turn nearly all animals have it in their composition, and thus in running through the list of ordinary fertilizers we find that Magnesium is noticed more by its absence than by its presence. It is thus found in blood, bone, fish and all the animal refuses which are used for manures. It is also found in Thomas slag and in hardwood ashes, always in the latter as almost no tree, bush or ordinary land vegetation is without its Magnesia. In fact, to a chemist Magnesium and Lime are dromions. They are always band in hand and are found almost everywhere in the vegetable world, although in the case of trees and the ordinary plants and vegetables, Lime is more abundant than Magnesium.

We do not commonly bear as much about Magnesium as we do about Nitrogen, Potash and Phosphoric Acid, because the amount of Magnesium is usually less than the amount of any of these (although it is often more than that of Phosphoric Acid) and because

it has been assumed that the three most essential elements to plant life that have to be supplied with most soils are Nitrogen, Phosphoric Acid and Potash, when as a matter of fact Magnesium may be just as important but is needed in smaller amounts, and is pretty widely distributed, so that in many cases Magnesium shortage may have been overlooked.

DUDLEY M. PRAY.

(To be continued)

NEWS NOTES.

Lewiston, Pa.—Herbert Bratton will start in the florist business here at an early date.

Marietta, O.—Walter Smith, florist, will move to the building on Putnam near Front street.

Dover, Del.—The failure of Wm. Schaffer & Son is reported; liabilities \$1,500; assets, none.

Jamestown, N. D.—A fire in the furnace room of the Wheeler Floral Co. caused a loss of \$2,000.

Newport, R. I.—Wadley & Smythe and Joseph G. Leikens have opened their stores here for the summer.

Springfield, Mass.—George and Frederick Miellez have opened an office at 85 Main street as advisory horticulturists.

Handsboro, Miss.—D. P. Magruder is starting a nursery here and will give special attention to the cultivation of oranges.

Adams, Mass.—Adolph Koch, florist, was thrown from his wagon while delivering stock on June 3, and received severe injuries.

Salem, O.—The Grandview Greenhouses of which Case & Weirick are proprietors, opened for business just before Memorial Day.

The baseball game between the employees of the retail and the wholesale florists of New York came off last Sunday at "The Oval." The retailers won.

Ernest Winkler, a florist employed at Crystal Farm, Gibsonia, Pa., was killed by a trolley car on June 1st, at Elfinwild.

FRENCH BULBS HIGHER.

Information from several exporters of Roman hyacinths and other French bulbs is to the effect that prices have materially advanced, especially on 12-15 and larger sizes, as a result of unfavorable weather last season. This is an unexpected turn as many dealers on this side looked for a decline.

Cold storage giganteum lily bulbs are, and have been for some weeks, scarce.

IMP SOAP SPRAY

THREE SUCCESSFUL YEARS

Outdoor or Indoor

ELM BEETLE OR

WHITE FLY

EASTERN CHEMICAL CO.

Pittsburg Street, Boston, Mass.

SOLD BY SEED DEALERS IN USE FOR 29 YEARS



FOR PAMPHLET ON "BUGS AND BLIGHTS" WRITE TO

Hammond's Paint & Slug-Shot Works FISHKILL ON HUDSON
NEW YORK

An Absolute Success

in Killing Scale and All Other Insect Pests on Trees, Shrubs and Garden Plants, including the notorious

LACE FLY ON RHODODENDRONS

without injury to the foliage.

WILSONS' PLANT OIL

Well Tested and Its Efficacy Fully Demonstrated

TRY IT!

Wilson Plant Oil & Fertilizer Co., Chatham, N. J.

For Trees, Plants, Shrubs and Flowers

USE

THE NIAGARA BRAND LIME SULPHUR SOLUTION

It destroys Scale Lice, Spiders and all forms of Aphides, AT THE SAME TIME Mildew, Blight, Rust and other Fungus difficulties.

Used in Winter or Summer — No other remedy has been so universally effective.

Niagara Brand ARSENATE OF LEAD for chewing insects is equal to the best and better than the most Ask about our Green House sprayer. Address —

NIAGARA SPRAYER CO., - - Middleport, N. Y.



The Best Bug Killer and Bloom Saver

For PROOF

Write to

P. R. Paethorpe Co. OWENSBORO, KY.

"Every Bug Has His Dose."

Insect-destroying preparations that do their work well and effectively are the cheapest. Bowker's Arsenate of Lead and Bowker's Pyrox are recognized standard insecticides and fungicides for both indoor and outdoor use. Bowker's Insect Emulsion destroys many kind of plant lice, black and green flies, etc. Call or send for catalogue.

BOWKER INSECTICIDE COMPANY
43 CHATHAM ST. BOSTON

COOPERS SPRAY FLUIDS

LATEST DISCOVERY

Progressive Growers Investigate

32 page Booklet of British, American and Canadian Testimony free for the asking

Eastern Agent - CYRIL FRANKLYN
62 Beaver St., New York, N. Y.

Sole Proprietors

WILLM COOPER & NEPHEWS
177 Illinois Street CHICAGO

Which Spray Pump

shall you buy? Buy the Spray Pump that fully meets the demands of the Government Agricultural Scientists and all practical Fruit Growers. These pumps are widely known as

DEMING SPRAYERS

and are made in 23 styles for use in small gardens or immense orchards. Write for our new catalog with Spraying Chart. Add 4 cents postage and receive "Spraying for Fruit," a useful guide book.

CHARLES J. JAGER CO.
281-285 Franklin St., Boston

SPRAYED

In ordering goods please add "I saw it in HORTICULTURE."



**80 REELS, 40,000 FEET
A DAILY SHIPMENT OF "REVERO GARDEN HOSE"**

Indestructible — Light — Strong — Flexible.
Wears longest, stands most abuse. Seamless, braided, moulded construction

ASK YOUR SUPPLY MAN FOR "REVERO"

PUT UP ON REELS IN 500 FT. LENGTHS

REVERE RUBBER COMPANY

Boston, New York, Philadelphia, Pittsburg, Chicago,
Minneapolis, New Orleans, San Francisco, Portland, Ore.

STANDARD PLATE GLASS CO.

Manufacturers—Importers—Jobbers

NOW IS THE TIME TO BUY

FRENCH OR AMERICAN GREENHOUSE GLASS

LOWEST PRICES ON REQUEST

26-30 Sudbury St. BOSTON, MASS. 61-63 Portland St.

GLASS Always Write Us Before Buying
SHARP, PARTRIDGE & CO.
22nd and Lumber Streets, CHICAGO
WE HAVE SOME SNAPS

BOSTON PLATE & WINDOW GLASS CO.

GREENHOUSE GLASS GERMAN AND AMERICAN

261 to 287 A Street BOSTON 20 to 22 Canal Street

**FOR "POT LUCK" TRY US...
HEWS STANDARD POTS**

POT MAKERS FOR 140 YEARS

WORLDS LARGEST MANUFACTURERS

WRITE FOR CATALOGUE AND DISCOUNTS

Pearson Street,
LONG ISLAND CITY, N. Y.

A. H. HEWS & CO., Inc.
CAMBRIDGE, MASS.

452-460 No. Branch St.,
CHICAGO, ILL.

**The Payne Steel
"T" Bar Greenhouses**

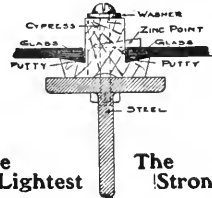

The Lightest The Strongest

Half full Size

HOUSES of this type are constructed with both curved glass eaves and straight glass eaves. Least amount of shadew. Least amount of wood. No drip. Greatest durability.

JOHNA. PAYNE

Greenhouse Designer and Builder

260-274 Culver Avenue

JERSEY CITY, N. J.

GLASS

Greenhouse and Hot Bed

SIZES OUR SPECIALTY IMMENSE STOCK

Plate and Window Glass

Write for Our Prices

PARSHESKY BROS., Inc.

69 Montrose Ave., BROOKLYN, N. Y.

HOSE

CRESTLINE SPECIAL Garden Hose. Made in three different weights. A tough, durable hose that has the life in it. Every section guaranteed.

Price with couplings:	5-ply.	6-ply.	7-ply.
1/2-in., per 50 ft.....	\$4.00	\$5.00	\$5.50
3/4-in., per 100 ft.....	7.75	9.75	10.75
1-in., per 50 ft.....	4.50	5.50	6.00
1 1/4-in., per 100 ft.....	8.75	10.75	11.75

Immediate shipment. Express or freight.
THE CRESTLINE MFG. CO.,
Box 233, Crestline, O.

Holds Glass Firmly See the Point #2 **FULL SIZE N° 2**
PEERLESS
Glazing Points are the best. No rubs or lifts. Box of 1,000 points 75 cts. postpaid.
HENRY A. DREER,
214 Chestnut St., Phila., Pa.

COAL Pocahontas Smokeless Coal Blossburg Smokeless Coal

The above steam coals are peculiarly adapted to FLORISTS' use. Prominent features are HIGH EVAPORATION, LOW ASH, LOW SULPHUR, HIGH CARBON, and HIGH HEAT UNITS. Permit us to figure on your year's requirements, deliverable as called for.

CARGOES CONSTANTLY ARRIVING AT ALL NEW ENGLAND PORTS

The Bader Coal Company, F. B. LAYTON
Gen'l Sales Agent
Telephone Fort Hill 2044 Board of Trade Building, Boston, Mass.

Everything for Greenhouse Building

Write for information and prices.

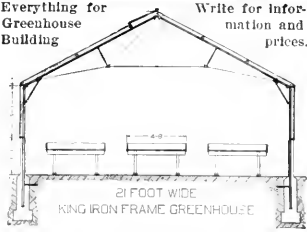

16 Widths from 14 feet 0 inches to 54 feet 0 inches. Without posts.

KING TRUSS SASH BAR HOUSES. IRON GUTTERS AND EAVES. IRON AND CYPRESS BENCHES. VENTILATING MACHINERY. KING CONSTRUCTION CO. NORTH TONAWANDA, N. Y.

FOR SALE

GLASS New American natural glass made, 10x12 C. double, \$1.75 per box; 8x10, 10x12 to 10x15 B. double, \$1.50 per box; 12x14 to 12x20, 14x16 to 14x20, B. double, \$1.92 per box; 10x16 and 10x18, B. double, at \$2.00 per box; and 10x21, 10x22, 12x24, B. double, \$2.08 per box; 16x24, B. double, \$2.13 per box. Discount in large quantities.

PIPE Good serviceable second-hand with good threads and a coupling with each length, no junk—1 in., 3/4 in., 1 1/2 in., 2 in., 2 1/2 in., 3 in., 4 in., 4 1/2 in., 5 in., 6 in., 6 1/2 in., 8 in., 10 in., 12 in., 14 in., and 4 in. at 19c. New 2 in. standard black, 8 1/2c. Old 4 in. greenhouse pipe, 14c. per foot; 4 in. boiler tubes, 7c. per foot.

We quote you above only a few of our prices. We manufacture and job in everything pertaining to greenhouses, both new and second-hand. Get our prices before placing your orders.

METROPOLITAN MATERIAL CO. Greenhouse Wreckers

1392-1402 Metropolitan Ave., Brooklyn, N. Y.



MASTICA FOR Greenhouse Glazing
USE IT NOW.
F. O. PIERCE CO.
12 W. BROADWAY
NEW YORK

Mastica is elastic and tenacious, admits of expansion and contraction. Putty becomes hard and brittle. Broken glass more easily removed without breaking of other glass as occurs with hard putty. Lasts longer than putty. Easy to apply.

In ordering goods please add "I saw it in HORTICULTURE."

IF YOU WANT **BIG RESULTS**

BUY FROM WHO RUNS THE IN THE BOX YOUR BUILDING MATERIAL WOOD IRON GLASS FROM FOLEY

PHIL FOLEY FACTORY CITY OF CHICAGO.

YOU WILL WEAR A SMILE CAUSED BY PROFITS FROM CROPS GROWN IN HOUSES

WESTERN, ADELAIDE AND APRILL AVE. CHICAGO. 25" TO 26" STD



ADVANCE VENTILATING APPARATUS

is the machine that does things in an easy way. Hence people have bought 68, 72, 74, 75, 76, 77, 78, 79, 80, 81, 82, 83, 84, 85, 86, 87, 88, 89, 90, 91, 92, 93, 94, 95, 96, 97, 98, 99, 100 of 11 each, 3 of 10 each, 3 of 9 each, 6 of 8 each, 3 of 7 each, 11 of 6 each, and scores of 2, 4 and 5 machines each, and who have had other makes of machines and know the difference. Give us a trial and you will then know why we please. Highest grade of material, ease of service, lasting and moderate prices brings us the business.

The ADVANCE CO., Richmond, Ind.

PATENTS

Trademarks and Copyrights

Send your business direct to Washington. Saves time and insures better service. Personal attention guaranteed. Twenty-five years' active service. SPECIALTY: "Working on the Failure of Others."

SIGGERS & SIGGERS
PATENT LAWYERS
Box 9, National Union Building
Washington, D. C.

The FLORISTS' HALL ASSOCIATION OF AMERICA, Insurer of 29,000,000 sq. ft. of glass. For particulars address: John C. Esler, Sec'y, Saddle River, N. J.

KROESCHELL BOILER



MADE OF FIRE BOX FLANGE PLATE Can not Crack

Water Space in Front, Sides and Back The Most Popular Boiler Made SEND FOR CATALOGUE.

KROESCHELL BROS. CO. 35 Erie street, CHICAGO, ILL.

CYPRESS SASH BARS 82 feet or longer
HOT BED SASH
PECKY CYPRESS BENCH LUMBER

GREENHOUSES

EREGED AND EQUIPPED COMPLETE IF DESIRED

Write for Circular "D" and Prices

The A. T. STEARNS LUMBER CO. NEPONSET, BOSTON, MASS.

GREENHOUSE CONSTRUCTION LUMBER

John C. Moninger Co. 117 E. Blackhawk St., CHICAGO.

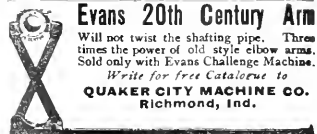

Evans 20th Century Arm
Will not twist the shunting pipe. Three times the power of old style elbow arms. Sold only with Evans Challenge Machine. Write for free Catalogue to QUAKER CITY MACHINE CO. Richmond, Ind.

In ordering goods please add "I saw it in HORTICULTURE."



An Ornamental Little Greenhouse Proposition

This little range with its curvilinear roof palm house and wings, nestles within the borders of a big city. It is built with our well known Flat Iron Rafter Construction, and is a constant source of pleasure and enjoyment to its owner.

We build greenhouses of any kind for any place. We want to do business with you. Write for our circular.

Hitchings & Company

Designing & Sales Offices General Offices & Factory
1170 Broadway, N. Y. Elizabeth, N. J.

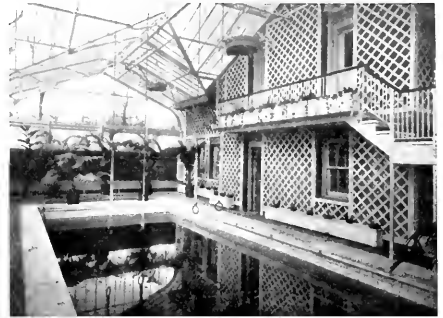

This is a Swimming Pool just to show you what a Beautiful Light Construction Our Sectional Iron Frame is. Can't be beat for Greenhouses.

LORD AND BURNHAM COMPANY,
Irvington-on-Hudson, N. Y.
New York — Boston — Philadelphia — Chicago



ABOUT THAT NEW CATALOG OF OURS

A year and a half is a long time to be getting out a catalog, but when you gardeners and superintendents see how complete it is in every detail — what an unusual collection of illustrations and practical plans are shown, and how beautifully it is printed, you will agree with us that it is worth all the time it has taken.

Rather than keep you waiting for the entire catalog we are binding up sections of advance

sheets as soon as they come from the press, and mailing out these sections separately. If you want to know why the U-Bar Greenhouses are the best houses built — the ideal construction for parks, private places and florists' show rooms — why no other concern can build a house that approaches them in lightness, attractiveness and durability, just send us your name and address, and let us know what you are thinking of building, and the first section of 64 pages will come to you by return mail.

U-BAR GREENHOUSES

PIERSON U-BAR CO.
DESIGNERS AND BUILDERS 1 MADISON AVE., NEW YORK



HORTICULTURE

Vol. IX.

JUNE 19, 1909

No. 25



AMERICAN ASSOCIATION OF NURSERYMEN
at Highland Park, Rochester, N. Y.



DEVOTED TO THE
FLORIST, PLANTSMAN, LANDSCAPE GARDENER AND KINDRED INTERESTS

PUBLISHED EVERY SATURDAY AT 11 HAMILTON PLACE, BOSTON, MASS.

SUBSCRIPTION, \$1.00 PER YEAR



JUN 21 1909

CHRYSANTHEMUMS.

"Not small weak runty stock grown under benches, but the kind that brings back Dollars for Pennies."

WHITE: Earliest October Frost (We have extra fine large stock of this variety), Mrs. Henry Robinson, Clemantine Touset, Alice Byron, Timothy Eaton, Merry Christmas, White Bonafino.
YELLOW: Munrovia, Hilliday, Appleton, Bonaffon, Eaton, Chataqua Gold.
PINK: Maud Dean, Dr. Enguehardt.
RED: Intensity, Schrimpton.

All these varieties, rooted cuttings \$2.50 per 100; \$20.00 per 1000, 3/4 in. \$3.00 per 100; \$25.00 per 1000.
 Golden Wedding, R. C. \$3.00 per 100; \$27.50 per 1000. 2 1/2 in. \$4.00 per 100; \$35.00 per 1000.
 Golden Glow, R. C. \$5.00 per 100. 3 1/2 inch \$6.00 per 100.

ROSES. 1 in. or 2 1/2 in. 3 in. or 3 1/2 in.
 American Beauties.....\$7.00 1000 \$15.00 100 \$25.00 1000
 Killarney—Own roots. \$6.00 \$15.00 7.50
 Mrs. Potter Palmer.....5.00 45.00 6.50

2 in. or 2 1/2 in.
 Bridesmaids } 100 1000
 Brides.....\$5.00 \$45.00
 Richmond.. }
 Kaiserine.....5.00 45.00 \$6.50
 Uncle John.....4.00 35.00

POEHLMANN BROS. COMPANY,

Morton Grove, Ill.

ROSES OWN ROOT

Bride, Maid, Killarney, Richmond, Perle, Chatenay, 4 in. stock, \$8.00 per 100; \$75.00 per 1000
 Mrs. Jardine, My Maryland, Rhea Reid, Beatrice, 4 inch, \$12.00 per 100.
 These are in splendid shape for immediate planting.
 'MUMS?? Sure, lots of them yet. Standard kinds, \$3.00 per 100; \$25.00 per 1000
 Asparagus Plumosa and Sprengeri, year old plants from bench, \$8.00 per 100; \$75.00 per 1000.

CHARLES H. TOTTY, Madison, N. J.

CHRYSANTHEMUMS

FOR EVERY PURPOSE.

ELMER D. SMITH & CO., Adrian, Mich.

CHRYSANTHEMUMS

Rooted Cuttings and Pot Plants

Write for list and prices.
 ALL OF THE BEST ONES.

S. J. REUTER & SON, WESTERLY, R. I.

Our New Carnation SHASTA

is always pure white, is always in bloom and is always high grade.

\$12.00 per 100, \$100.00 per 1000. Send Order now to
PATTEN & CO., Tewksbury, Mass. BAUR & SMITH, Indianapolis, Ind.

GARNATIONS

F. DORNER & SONS CO.

LaFayette, Ind.

SCOTT BROS.

Gloire De Lorraine Begonias
 From 2 1-4 and 3 1-2 inch pots,
\$15.00 and \$25.00 per 100.

Elmsford Nurseries, Elmsford, N. Y.

Begonia Gloire de Lorraine

Leaf Stock, June Delivery, \$15 per 100,
 \$145 per 1000, from 2 1/2 in. pots
 Stock guaranteed to be absolutely free from disease.

THOMAS ROLAND NAHANT, MASS.
 Perles, Brides and Maids for Planting"

Per 100
 1000 Brides and Maids, 3 inch strong, \$4.00
 1000 Perles, 3 inch, ready for shift, \$6.00
 Pittsburg Rose & Carnation Co., Gibsonia, P. O., Pa.

MARY TOLMAN

A New Light Salmon Pink Carnation for 1910.

\$12.00 per 100. \$100.00 per 1000.

A. E. Hunt & Co., Evansville, Ill.
Chicago Carnation Co., Joliet, Ill.
Hunt Bros., - - Park Ridge, Ill.

Cannas

Dry roots: Italia, Cleveland, Austria, Egandale, Marlborough, America, Penna, Black Beauty, \$1.50 per 100, Kate Gray, mixed with red, \$1.25 per 100. Asparagus Sprengeri, 2 in. \$1.75, 3 in., \$4.00, 4 in. \$6.00 per 100. Tracena mix, 4 in., 10c. English Ivy, 2 in., \$2.00; R. C. 75c per 100. Rex Begonia, 2 in., 3c.
J. N. DANN & SON, - WESTFIELD, N. Y.

In writing advertisers kindly mention HORTICULTURE.

Burnett Bros.

POT GROWN STRAWBERRIES
COLD STORAGE VALLEY
LILIAM HARRISH
FREESIA PURITY
 In Original Packages

Write for Midsummer Catalogue

BURNETT BROS.

72. CORTLAND ST., - NEW YORK

GARNATIONS Fine Healthy Stock From 2 Inch Pots.
 Per 100 Per 1000
 Pres. Seelye - - - \$6.00 \$50.00
 White Enchantress, Beacon 4.50 40.00
 Victory, Winsor, Melody,
 Kingston Pet. - - - 4.00 35.00
 Dahelm, Lady Bountiful, Mrs. Lawson, White Lawson, Red Lawson, Variegated Lawson 3.50 30.00

CHRYSANTHEMUMS Cuttings
 G. W. Childs, Miss Clay Frick, White Shaw, Early Snow, Mrs. Jas. Marshall, Flayer Weaver, The Harriott, Yellow Eaton, \$2.00 per 100, \$15.00 per 1000.
 A. J. Balfour, Autumn Glory, Ada Spaulding, Dr. Enguehardt, Dorothy Davens, Geo. Kalb, Glory of the Pacific, Harry Lay, H. W. Reiman, Ivory, Jeanne Nonin, J. E. Layer, J. N. Troy, J. K. Shaw, fluid Dean, Meta, Monrovia, Mrs. Jerome Jones, Plinnie Wamamaker, Mrs. Alice Byron, Mrs. Baer, Mrs. Robert McArthur, Major Bonaffon, fluid F. Bergmann, Nagoya, Polly Rose, Robt. Halliday, Timothy Eaton, W. H. Lincoln, Wm. Duckham, etc., \$1.50 per 100.

Send for Catalogue of Roses, cwn root and grafted, and other miscellaneous stock.

WOOD BROTHERS
FISHKILL, N. Y.

Send for our Preliminary List describing and quoting

Chrysanthemums and Carnations.

A fine lot of
Carnation Cuttings
 ready now.

THE E. G. HILL CO.,
 Richmond, Indiana.

White Bonaffon

The Chrysanthemum Everybody Should Grow.

I have Rooted Cuttings, Cool Grown, Sturdy Stock, \$12.50 per 1000

H. L. CAMERON,
 North Cambridge, Mass.

Aster Plants

Simplex, Vick's and Queen of the Market, grown from the best Seed, fine plants, in White, Blue and Pink \$2.50 per 100; 500 for \$10.00

TOMATOES, best var., \$1.50 per 100.
CARFLOWER, PEPPERS, EGG PLANTS, \$2.50 per 100.
J. C. SCHMIDT, Bristol, Pa.

WHITE KILLARNEY

It is needless to say much about the value of this

NEW WHITE ROSE

its value is so well established. In support of this statement, we might say that we intend to plant not less than 20,000 for our own growing. We have a splendid stock of both grafted and own-root plants, which we can deliver immediately on receipt of order,—gilt-edged planting stock. We guarantee perfect satisfaction.

STRONG PLANTS, 2 1/2 in. pots, own-root, \$30.00 per 100; 250 for \$70.00; \$250.00 per 1000.
GRAFTED PLANTS, \$35.00 per 100; 250 for \$82.50; \$300.00 per 1000.

SPECIMEN HYDRANGEAS

Large Plants Grown in Tubs and Half-Barrels for July and August Flowering

We make a specialty of these, and have a grand lot of plants in the finest possible condition. Our plants have never been so well budded as they are this season.

Fine plants in tubs, \$2.00 and \$3.00 each. Large plants in half-barrels, \$5.00 and \$7.50 each.

A FEW SEASONABLE SPECIALTIES

BOXWOOD PYRAMIDAL. Fine plants 3 ft. high, \$2.00 each; 4 ft. high, \$3.00 each; 4 1/2 ft. high, \$4.00 each.

RUBBER PLANTS (Ficus elastica). Very large, bushy plants in tubs 4 ft. high, fine for summer decoration, \$3.50 each.

PHOENIX ROEBELENI. Extra fine plants, 6-in. pots, \$18.00 per dozen.

CROTONS. Strong plants, 3-in. pots, \$3.00 per dozen; 5-in. pots, \$6.00 per dozen; 6-in. pots, \$9.00 per dozen.

CANNAS. Buttercup, Souv. d'Antoine Crozy, Pierson's Premier, Mlle. Berat, I. Patry, Florence Vaughan, etc. Strong started plants, 3 1/2-in. pots, \$5.00 per 100, \$49.00 per 1000; dormant roots, \$3.00 per 100, \$29.00 per 1000.

CALADIUM ESCULENTUM. Started plants, \$6.00 per 100.

CASTOR OIL BEANS (Ricinus). 2 1/2-in. pots, \$6.00 per 100.

MUSA ENSETTE (Abyssinian Banana). 8-in. pots, \$1.00 each.

GERANIUMS. Double Gen. Grant. Extra fine plants in bud and bloom, 3 1/2-in. pots, \$8.00 per 100.

GERANIUMS, assorted. In bud and bloom, 3 1/2-in. pots, \$6.00 per 100.

NASTURTIUMS, 3 1/2-in. pots, bushy, \$1.00 per 100.

ENGLISH IVY. 3 1/2-in. pots, \$12.00 per 100.

GERMAN IVY. 2 1/2-in. pots, \$3.00 per 100.

AMELOPSIS VEITCHII. Strong plants, 4-in. pots, \$15.00 per 100.

F. R. PIERSON CO., Tarrytown-on-Hudson, NEW YORK

Fine Rubbers at 20c.

All well grown stock in first class condition

Rubbers, 4 inch	each	20c
" 6 "		25c
Vincas, 2 "		02c
Piumosus, 4 "		05c
" 3 year		04c
Mums, cuttings		02c
" Nonin, out of pots		04c
Sprengeri, 3 year		04c

Cash with order or satisfactory references

WILLIAM C. SMITH

Market and 61st Street

Philadelphia, - - Pa.

Last Call! Last Call!

For the NEW MUMS for EARLY PLANTING
 10,000 Golden Glow,—1000 White Cloud
 1000 Pacific Supreme, all at \$25 per M.
 out of 2 1/2 inch; \$18 per M., strong R. C.,
 200 at M. rate. Add 1/4 for 100 rate,
 50,000 October Frost, \$30 M. 2 1/2 inch;
 \$12 M. R. C.

After June 15 VIRGINIA POEHLTANN, \$4
 per 100, 2 1/2 inch. Order NOW. LYNWOOD
 HALL, \$4 per 100.

1000 Golden Eagle—new yellow, \$5 per
 100. All standards midseason and late \$25
 per M. Out 3 1/2 inch; \$12 per M. R. C.
 Ask for our quantity prices. Will not be
 beat on them.

I. M. RAYNOR, Greenport, N. Y.

A. N. PIERSON, Inc., Gromwell, Conn.

WHITE KILLARNEY (Waban Strain)

	Doz.	100	250	500	1000	2500	5000
GRAFTED STOCK	\$6.00	\$55.00	\$82.50	\$150.00	\$300.00	\$687.50	\$1,280.00

MY MARYLAND GRAFTED... \$3.00 per doz., \$30.00 per 100, \$150.00 per 1000
 OWN ROOT " 2.00 " 10.00 " 90.00 "

STANDARD VARIETIES

Betty, Bon Silene, Bride, Bridesmaid, Cardinal, Enchanter, Etiole de France, Etiole de Lyon, Franz Deegan, Gen. McArthur, Golden Gate, Hermosa, Ivory, Kalverin Augusta Victoria, Kate Moulton, Killarney, La Detroit, Maman Cochet, Marechal Niel, Mme. Abel Chateauf, Mrs. Jardine, Mme. Hoste, Mrs. Paul Niehoff, Mrs. Pierpont Morgan, Mrs. Potter Palmer, Papa Gontier, Queen Bearrice, Rhea Reid, Richmond, Rosaline Orr English, Souv. du President Carnot, Souv. de Wootton, Uncle John, Wellseaiey, White Cochet. The above Grafted (selected plan \$) 20 cts. each, \$2.00 per doz., \$15.00 per 100, \$120.00 per 1000.

OWN ROOT ROSES

Killarney, Bride, Bridesmaid, Mme. Abel Chateauf, Ivory, Richmond, Mrs. Paul Niehoff. 2-in. pots, 75c per doz., \$3.50 per 100, \$30.00 per 1000. 2 1/2-in. pots, \$1.00 per doz., \$6.00 per 100, \$50.00 per 1000.
 Queen Bearrice, Rhea Reid, Mrs. Jardine, Mrs. Potter Palmer, from 2 1/2-in. pots, \$8.00 per 100, \$70.00 per 1000.

BEDDING PLANTS

COLEUS. Verschaffeltii, Golden Queen, Queen Victoria, Beckwith Gem, Firebrand, Lord Palmerston. Rooted Cuttings by express, \$0.63 per 100, \$5.00 per 1000. Out of 2 1/2 in. pots in May, \$2.00 per 100, \$15.00 per 1000.
 Golden Bedder, Hero, Messy, Pearl of Orange. Fancy Varieties. Twelve kinds not listed above, 75 cts. per 100, \$5.00 per 1000.
 AGERATUM. Stella Gurney, Princess Pauline. SALVIA. Splendens, Bonfire and Zurich.
 HELIOTROPE. Dark blue bedding varieties. GERMAN IVY. 75 cts. per 100, \$6.00 per 1000.
 ALTERNANTHERA. Red and Yellow, 50c per 100, \$5.00 per 1000. From 2 1/2 in pots, \$2.00 per 100.
 SALLEROL. Rooted Cuttings, \$1.00 per 100, 2 1/2 in. pots, \$2.50 per 1000.
 CHRYSANTHEMUMS IN QUANTITY. Catalogue on Application.

PEACOCK'S CELEBRATED
NEW DAHLIAS
 JACK ROSE and other cut flower
 sorts.

SEND FOR CATALOG.
 Peacock Dahlia Farms
 Williamstown Junction, N. J.

DAHLIAS. Now is the time to place your order for bulbs which will insure you getting named varieties in any quantity; prompt delivery.
DAVID HERBERT & SON,
 Successors to L. K. Peacock, Inc.
 ATCO, N. J.

ORCHIDS

The following freshly imported ORCHIDS have arrived in excellent condition. Prices here quoted are for this month only.

	Per doz.	Per 100
CATTLEYA Trianae , plants with 6 to 8 bulbs.....	\$15.00	\$100.00
Plants with 9 to 12 bulbs.....	20.00	150.00
Or in case lots of 400 bulbs, \$45.00.		
C. Percivaliana , plants with 10 to 12 bulbs.....	15.00	100.00
Or in case lots of 450 bulbs, \$48.00.		
C. Mossiae , fine early flowering type, exceptionally fine, strong stock. Plants with 6 to 8 bulbs.....	15.00	100.00
Plants with 9 to 12 bulbs.....	20.00	150.00
Or in case lots of 400 bulbs, \$48.00.		
C. Mendellii , plants with 6 to 8 bulbs.....	20.00	150.00
Plants with 9 to 12 bulbs.....	30.00	200.00
Or in case lots of 400 bulbs, \$75.00.		
C. Skinnerii , plants with 8 to 10 bulbs.....	15.00	
BRASSAYOLA Digbyana , plants with 5 to 6 bulbs, \$20.00 per 100; \$80.00 per 1000.		
Plants with 7 to 10 bulbs.....	12.00	
EPIDENDRUM Vitellium Majus , plants with 8 to 9 bulbs.....	7.50	50.00
LAELIA Superbiana , plants with 4 to 6 bulbs.....	24.00	
L. Anceps , plants with 8 to 9 bulbs.....	8.00	60.00
L. Anceps , plants with 10 to 12 bulbs.....	10.00	75.00
L. Anceps , plants with 13 to 15 bulbs.....	15.00	110.00
L. Autumnalis , plants with 5 to 6 bulbs.....	10.00	75.00
L. Autumnalis , plants with 7 to 9 bulbs.....	12.00	90.00
L. Albida , plants with 6 to 7 bulbs.....	7.50	50.00
L. Albida , plants with 8 to 10 bulbs.....	12.00	75.00
CHYSIS Species , A limited number only.		
Plants with 6 to 9 bulbs.....	9.00	
ONCIDIUM Varicosum Reeseri. All smaller sizes of these are sold. Those we offer are only extra strong plants, with 5 to 8 bulbs.....	24.00	175.00
O. Crispum , large plants only, with 7 to 8 bulbs.....	24.00	
With 9 to 11 bulbs.....	35.00	90.00
O. Forbesii , plants with 5 to 8 bulbs.....	20.00	
O. Sarcodes , plants with 5 to 8 bulbs.....	20.00	
O. Spicodidum , extra fine, even stock, with 4 to 5 heavy bulbs.....	\$18.00	\$125.00

	Per doz.	Per 100
O. Wentworthianum , plants with 6 to 10 bulbs.....	18.00	
ODONTOGLOSSUM Graade , extra fine plants, with 7 to 8 bulbs.....	18.00	
O. Crispum , Peck's type, plants with 4 to 5 bulbs.....	15.00	
With 6 to 7 bulbs.....	24.00	
MILTONIA Candida , superb plants, with 6 to 8 bulbs.....	15.00	100.00
With 9 to 12 bulbs.....	20.00	150.00
M. Spectabilis , fine plants, \$1.00, \$2.00 and \$3.00 each.		
M. Flavescens , fine plants, \$2.00 and \$3.00 each.		
ZYGOPETALUM Criaatum , a few nice plants, \$2.50 each.		
Z. Maxillare var. Gautieri on fern stumps, large clumps, \$5.00 and \$7.50 each.		
SCUTICARIA Steedii , fine plants, \$2.00 each.		
VANDA Cerealis , fine, well leaved plants, about 12 in. long.....	18.00	125.00
About 16 to 18 in. long.....	24.00	175.00
ONCIDIUM Incarvum , fine, well-leaved plants with 9 to 12 bulbs.....	12.00	90.00
DENDROBIUM Formosum Gligaeum . This is the finest lot of plants ever arrived here.		
Plants with 6 to 8 bulbs.....	18.00	125.00
Plants with 9 to 12 bulbs.....	30.00	200.00
Plants with 13 to 15 bulbs.....	36.00	275.00
Plants with 16 to 20 bulbs, \$5.00 each.		
D. Nobile , plants with 9 to 10 bulbs.....	12.00	90.00
Plant with 12 to 15 bulbs.....	18.00	125.00
Plants with 16 to 20 bulbs.....	24.00	
Plants with 21 to 25 bulbs.....	36.00	
Large specimens, \$5.00, \$7.50 and \$10.00 each.		

All of the above is in A 1 condition if anything does not prove to be as here represented, return at once at our expense. We also have a large stock of established orchids; also materials, such as selected orchid peat, live sphagnum moss and orchid baskets.

If you do not have our catalogue, write us.

LAGER & HURRELL, Orchid Growers and Importers, SUMMIT, N. J.

ORCHIDS

We are booking orders now for delivery early in the Spring on all commercial C.A.T. FLEYSAS and NOVELTIES. Our prices are right and our guarantee perfect. We sell only first-class goods

CARRILLO & BALDWIN Secaucus N. J. FRESH IMPORTED ORCHIDS.

Arrived in Splendid Condition: Cattleya Trianae, Mossiae, Gigas, Skinnerii, Oncidium Spicodidum, Ornithorhynchum, Wentworthianum Phalaenopsis Schilleriana and Amabilis, Lycaste Skinnerii, Vanda Boxallii, Laelia Superbiana Odontoglossum grande. Write for prices.

JOSEPH A. MANDA, 191 Valley Road West Orange, N. J.

IMPORTED ORCHIDS

Now Arriving
Julius Roehrs Co. RUTHERFORD, N. J.

ORCHIDS

Largest Importers, Exporters, Growers and Hybridists in the World
Sander, St. Albans, England and 235 Broadway, Room 1 NEW YORK CITY

ORCHIDS!

Most of our healthy established plants are sold. Many importations are nearly to be in.

ORDONEZ BROS. Madison, N. J.

JAPANESE NURSERY CO. NEW YORK
THE YOKOHAMA NURSERY CO. LILIES
31 BARCLAY STR. PLANTS
BAMBOO STAKES

PHALAENOPSES AND VANDAS

Importations Received Every Two Months

Phalaenopsis Amabilis	Vanda Sanderiana
Phalaenopsis Schilleriana	Vanda Batemannii
Phalaenopsis Sanderiana	Vanda Boxallii
Phalaenopsis Stuartiana	Dendrobium Superbum

We also receive many other varieties of Orchids from the South Pacific and East Indies. We respectfully solicit your inquiry in this line.

MACRORIE - McLAREN COMPANY

721 Crocker Bldg., San Francisco, California, U. S. A.

Palms
Shrubs
Ferns
Perennials

Wittbold FLORIST

Send for Our Catalogue.

The GEO. WITTOLD CO., 1657 Buckingham Place, Chicago, Ill.

FERNS FOR DISHES,

Assorted Varieties From 2 inch pots, \$3.50 per 100; \$30.00 per 1000
CASH WITH ORDER
2570 to 2606 W. Adams St., Chicago, Ill.

NEPHROLEPIS MAGNIFICA
THE SENSATIONAL NOVELTY
Strong 2½-in. stock, \$25.00 per 100.

WHITMANII
2½-in., \$40.00 per 1000; 3½-in., from Bench, \$8.00 per 100.

H. H. BARROWS & SON, WHITMAN, MASS.

FRANK OECHSLIN

PALMS AND FERNS
DECORATIVE PLANTS
JOHN SCOTT
Rutland Road and E. 45th St.
Tel. 5850 Bedford BROOKLYN, N. Y.

ROBERT CRAIG CO.
ROSES, PALMS,
and Novelties in Decorative Plants
MARKET and 49th STREETS., PHILADELPHIA, PA.

JARDINIERE FERNS
IN BEST VARIETIES. VERY FINE STOCK.
\$3.50 per 100, \$30.00 per 1000
ROSE HILL NURSERIES
New Rochelle, N. Y.

Water Scenery



AN AQUATIC POOL.

In continuation of my remarks on styles of tree and shrub planting in the vicinity of lakes or large areas it will be understood that only trees which have decided characteristics are mentioned. These consist of the pendulous, the horizontal branched, and the columnar or pyramidal in form, all of which have special effects in the landscape and contrast admirably with the horizontal plane of the water. According to fancy, they may in the case of the pendulous be planted in small groups or in a continuous line on portions of the banks, and so close to the water as in the course of years to hang over and into the water. Of such mention may be made of *Salix babylonica* (the common weeping willow), one of the most effective by reason of its pendulous shoots and a rapid grower. It is perfectly hardy in even the colder parts of North America, and it is not affected by any insects excepting the wood leopard moth, whose caterpillars bore galleries in the trunks of aged trees. It is, however, well to keep a sharp lookout for these and kill them by inserting a piece of stiff wire into the galleries, as if left to the woodpeckers ugly wounds are made by these birds in their efforts to reach them.

Other willows suitable as weeping trees are *S. Caprea pendula* (Kilmarnock weeping), and *S. regalis*, *syn.*, *S. alba argentea*. *Tamarix*, which when aged has a pendulous habit, looks well on the banks; and *T. gallica* and *T. germanica* are among the more effective species. Of the *Robinias*, *Pseudo-acacia Bessoniana*, *R. p. a. inermis* and *R. p. a. inermis foliis variegatis* are of value

when their shoots are left to grow to their natural length, so as to become pendulous. *Pyrus* of the apple and pear section, always beautiful in flower and in fruit, offer the weeping habit in *P. Malus Elise Rathke* and *P. salicifolia pendula*. Other *Pyrus* destitute of this habit of growth, yet desirable trees or half trees, are *P. coronaria*, *P. c. flore pleno*, *P. Malus Halleana*, *P. M. Scheideckerii*, *P. prunifolia*, *P. spectabilis*, etc. The Flowering Ash (*Ornus europea*) is a handsome pendulous tree when aged. *Laburnum vulgare* in its numerous varieties has the weeping habit in so far as its blossoms go. *Fraxinus excelsior pendula* and *F. oxyphylla pendula* and *Fagus purpurea pendula* are good waterside trees. As a small tree of great hardiness, of which the pendulous habit is a marked feature, *Cornus florida pendula* is a beautiful Dogwood worthy of a place near the water. *Cerasus* (cherry) *sinensis pendula rosca* is a beautiful half tree; *Celtis* (nettle tree) *occidentalis*, has a weeping habit, and it does well where its roots have access to water. The insignificant flowers are succeeded by small, black edible berries.

The trees with horizontal branches are mostly to be found among conifers. The silver firs (*Abies*), of great hardiness, are *A. concolor*, *A. c. Louriana*, *A. grandis*, *A. lasiocarpa*, *A. magnifica* and *A. nobilis*. The hemlock spruces as *A. Albertiana*, *A. A. aurea* and *A. Douglasii*, all have this habit when aged. *Pinus Strobus* is the most characteristic of all the conifers in the matter of habit.

Trees of columnar or pyramidal habit among deciduous species are plentiful among those of a hardy nature. Suitable positions may be found for them among masses of round-headed trees, in clumps of half a dozen specimens planted sufficiently wide as to afford full development without crowding and spoiling each other. *Betula fastigiata*, a form of the common birch, *Corylus Colurna*, *Ginkgo biloba*, *Populus Bollana*, *P. nigra pyramidalis*, *Quercus pedunculata fastigiata*, *Ulmus montana* (Wych Elm) *fastigiata*. Most conifers have this fastigiata form, and in the *Thuias*, *Cupressus*, *Juniperus*, *Taxus baccata* (Upright Irish), *Sciadopitys verticillata*, the hemlock, silver, and spruce firs we see it in the more pronounced manner. Not only do these species of conifers contrast and relieve the monotony of the round-headed deciduous trees, but when planted in conspicuous positions as solitary specimens, or in small groups or at bends and promontories of the banks, they attract the attention of the beholder, and add to the general effect. On the banks of large lakes the planting of flowering shrubs, excepting such as grow to large dimensions, is better omitted, the effect being to fritter the more noble arboreal, imposing features of the trees. In the background, or distant landscape, 100 yards or further from the water's edge, shrubs of any kind would be in their proper place, and quite admissible, more especially if paths led in their direction.

In my next article I will touch upon water in the home garden, and methods of decorating the adjacent area of land.

Jacobus Moore

London, Eng.

HORTICULTURE

VOL. IX

JUNE 19, 1909

NO. 25

PUBLISHED WEEKLY BY

HORTICULTURE PUBLISHING CO.
11 Hamilton Place, Boston, Mass.

Telephone, Oxford 292
WM. J. STEWART, Editor and Manager

SUBSCRIPTION PRICE

One Year, in advance, \$1.00; To Foreign Countries, \$2.00; To Canada, \$1.50

ADVERTISING RATES

Per Inch, 30 inches to page \$1.00.
Discounts on Contracts for consecutive insertions, as follows:
One month, 4 times 5 per cent.; three months 13 times 10 per cent.;
six months 26 times 20 per cent.; one year (52 times) 30 per cent.
Page and half page spaces, special rates on application.

Entered as second-class matter December 8, 1904, at the Post Office at Boston, Mass under the Act of Congress of March 3, 1879.

CONTENTS

	Page
COVER ILLUSTRATION—American Association of Nurserymen	
WATER SCENERY—Frederick Moore—Illustrated	861
NOTES FROM THE ARNOLD ARBORETUM—Alfred Rehder	863
SEASONABLE OBSERVATIONS BY A BOSTON GARDENER—Vernon T. Sherwood	863
NEWS OF THE CLUBS AND SOCIETIES:	
Gardeners' and Florists' Club of Boston—Lenox Horticultural Society—Cincinnati Florists' Society—Pennsylvania Horticultural Society—National Sweet Pea Society	864
American Society of Nurserymen, Illustrated—American Nurserymen's Protective Association—St. Louis Florist Club—Society of German Landscape Gardeners	865
American Peony Society Annual Meeting at Queens, Portrait C. W. Ward	866
New York Florists' Club	867
Connecticut Horticultural Society—Nassau County Horticultural Society	868
Engelman Botanical Club—Club and Society Notes	870
THE BEST PEONIES	867
OF INTEREST TO RETAIL FLORISTS—Up To Date Flower Baskets—Steamer Departures—New Flower Stores	872
Flowers by Telegraph	873
FLOWER MARKET REPORTS:	
Boston, Chicago, New York, Philadelphia	875
ABOUT SPECIMEN DAVALLIAS—M. J. Pope	882
EPSOM SALTS AS A FERTILIZER, II—Dudley M. Pray	884
OBITUARY—Charles Zuber—W. D. Chase	882
MISCELLANEOUS:	
Wm. Bull & Sons' Orchid Group at Temple Show—Illustration	867
During Recess	870
Dianthus Napoleon III—G. C. W.	870
Personal	870
Incorporated	870
Strawberries	870
Business Changes	870
Chicago Notes	873
Philadelphia Notes	877
Clarkias as Spring Bedders	882
News Notes	882
Indianapolis Notes	883
Florists' Trade in Winnipeg	883
Greenhouses Building or Contemplated	886
Patents Granted	886

by dozens or by hundreds, it is gorgeous; but when seen in rows five hundred feet long, of established plants, one variety to the row, it is dazzlingly splendid and impressive in a way that the smaller quantities never suggest and which no words can fittingly express. When privileged to see them thus, one is convinced of the fact that the peony's strongest vantage lies in generous massing of single colors, using the most distinct types of color, floriferousness and sturdiness. After gazing on such a picture and breathing the spice-laden perfumed air that floats afar from a peony field one finds little to interest in any cut-flower exhibit, however choice in selection and artistic in arrangement it may be. The rhododendron may shine resplendent in captivity indoors or under cover—the peony never.

The earnest plea of one of the speakers at the recent Nurserymen's Convention for more regular and stable market values on nursery stock generally, quickly struck a responsive chord in his audience and will undoubtedly find an equally appreciative reception wherever it may be read by a reputable member of the nursery trade. Inordinate price cutting is a most demoralizing evil, one of the worst consequences of which is its effect upon the public, and the public's estimate of the people engaged in the business affected and of the presumed profits it affords. The florist business has suffered much in the public eye in this regard, and it may be well to consider whether in the nursery industry as well as in that of the florist a valid reason for distrust may not be found in the excessive disparity existing between standard wholesale and retail price quotations. So wide a variance cannot fail to present a menace to desired stability, an ever-active source of uncertainty, a field for unsavory fluctuations, and a lure to unprincipled and unwelcome elements to intrude themselves. The suggestion that a remedy for the abuses complained of should be sought in the burning up of surplus stock will carry no weight. Human nature as it is constituted at this stage in its career is not built that way. The speaker said that the nurserymen invariably "show a spirit of fairness 'twixt one another until it comes to the disposal of their products." We might add—likewise until it comes to the burning up of their products. In looking for a practical solution it might be well to give thoughtful consideration to the question from the standpoint of the public, who are today taking more interest in the nurserymen's products than ever before in the history of the world, and in its relation to the still broader theme of the prosperity of the nursery trade as affected by the public's estimate of and consequent attitude towards the nursery trade. The ceaseless struggle between the forces working to extort the highest selling prices, regardless of cost of goods, and those aiming to sell at the lowest prices consistent with cost, probably dates back to the infancy of commercial activity, and what constitutes "price slashing" depends very much upon which side one's sympathies happen to lie.

It would be futile to attempt to convey in cold type to anyone who has never seen such a sight an adequate idea of the impression made by a vast field of ten acres of blooming peonies such as those who attended the meeting of the American Peony Society a few days ago were privileged to see at Queens, N. Y. The peony as a specimen bloom is lovely; in garden clumps, singly,

The peony at its best

Notes from the Arnold Arboretum

The native Highbush Cranberry is an often planted and familiar shrub, while its Asiatic representative, *Viburnum Sargentii*, seems still little known, though it is in several respects superior to the native species. It is of more upright and denser habit with handsome dark green foliage and with the sterile flowers somewhat larger and of a purer white, the color being the more striking, as the central fertile flowers have a darker hue on account of the purple color of the anthers. The purple color of the anthers is also one of the best characters to distinguish it from the native Highbush Cranberry. In its typical form *Viburnum Sargentii* has pubescent branches and leaves, but the variety *calvescens* has glabrous branches and leaves, like the native species. In one respect, however, in regard to the fruits, the common Highbush Cranberry is much superior to *Viburnum Sargentii* which has smaller fruits, not produced in great abundance and therefore the native species ought to be preferred for general planting, as the clusters of scarlet fruits are the chief ornamental features of this shrub and particularly attractive during the winter.

Some remarks on the proper botanical name for our native species seem not to be out of place here, though they are more of strictly botanical interest. Almost 150 years ago the famous English gardener Philipp Miller noticed that the American Highbush Cranberry then introduced into English gardens, was different from the European species and called it *Viburnum americanum*, but most botanists, united it again with *V. Opulus*. Nowadays, however, the tendency among botanists is to make nicer distinctions and to separate again the forms lumped together by the older botanists into large variable species. This modern tendency is also apparent in the latest edition of Gray's Manual where our plant is at least distinguished as a variety and is called *V. Opulus* var. *americanum*. At the Arnold Arboretum, however, we prefer to call it *V. americanum* and leave the name *V. Opulus* to the European species where it properly belongs. The horticultural difference between the two species is very slight; the European species is of a somewhat denser habit, but seems more likely to be infested and disfigured by aphides. The chief distinctive character is in the petioles which have a rather narrow channel and large glands at the base of the blade and in the longer peduncles and longer stamens.

Quite a number of new Chinese *Viburnums* have been introduced into cultivation during the last years, some evergreen and some deciduous. The evergreen ones as *Viburnum rhytidophyllum*, *V. propinquum*, *V. utile*, *V. Feitchii* and *V. buddifolium* seem unfortunately too tender for our climate, but some of them are worth trying in the southern states or in California, particularly *V. rhytidophyllum* which is of striking beauty with its large leaves from 4 to 8 inches long, dark green and lustrous above and yellowish white beneath, and the white flowers in large cluster followed in September by scarlet berries add considerably to its ornamental value. The deciduous species as *Viburnum foetidum* (*V. ceanothoides*), *V. corylifolium* and *V. betulifolium*, all similar to *Viburnum dilatatum* and *V. Wrightii*, are probably hardy, but it is still too early to pass definitely upon their hardiness and ornamental value.

Alfred Rehder.

Seasonable Observations by a Boston Gardener

In Mr. Moore's remarks upon the last meeting of the Royal Horticultural Society, London, he mentions the comparatively new scented geranium *Clorinda*, which in his view has not much chance of success in the public favor. As a matter of fact his own description of this variety, the very best of the scented type, precludes the necessity of being obliged to force it upon the public. A geranium of a cerise red tint and having fragrant foliage the shape of an oak leaf, has a flower of three inches in diameter, to which I append the fact that the flower is very similar to the Lady Washington type, but not striped. It is quite equal to an ordinary zonal with the additional advantage in being sweetly scented. It is of sufficient merit to have induced a florist from America to acquire a stock of it, and I have little doubt that when it finds its way to the exhibition tables here it will be looked upon as a decided acquisition. To Mr. H. B. May, who exhibited the above-mentioned plant, further credit is due for the cultivation of verbenas, varieties suitable for pot work, which include *Miss Willmott*, which I believe was the first to catch on and from a selling point of view is the best; *King of Scarlets* and *Princess of Wales*, a deep purple blue, the *King* not so flat in truss as *Miss Willmott*; *Queen of Whites* and the auricula-eyed *The Queen*, rosy pink, *Model*, *heliotrope*, *Adonis*, *scarlet*, *Vulcan*, *crimson*, *Admirable*, *claret*. The foregoing include an admirable range of shades, and grown four or five plants to the five-inch pot very rapidly make an excellent plant, although it should be borne in mind that they require to be pinched early and all points simultaneously to produce even growth.

It is interesting to note that the 22nd Temple Show, London, has gone on record as being the greatest ever, and I have no doubt but what your correspondent, Mr. Moore, will suitably comment upon it. What I wished to say is, why could not Boston have a similar summer show? A public spirited lady or gentleman, necessarily living near Boston, could possibly be induced to lend their grounds for this purpose. If this could be attained I would venture to state that if not in magnitude or number of exhibits as the London Show, the setting up would be far superior, inasmuch as the question of space is the greatest difficulty those on the other side have to contend against, exhibitors being approximately limited to about 25 per cent. of the space they apply for. I give the suggestion for what it is worth; the time must come, if indeed it is not already here, when the confines of the Horticultural Hall will not adequately stage intended exhibits.

Vernon G. Sherwood.

As is well known, the National Horticultural Society of France publishes a list of chrysanthemums, and their values, which for three years in succession have been brought before it. Recently, the following varieties have received the commendation of the society: *W. R. Church* (raiser Wells), *M. F.* and *S. Vallis* (Calvat), *Duchesse Orleans* (Chaubrier), *Dr. J. Roche* (Ragout), *Riverie* (Bonafous), *Mlle. Therese Mazier* (Mazier), *Princesse Alice de Monaco* (Nonin), *Baronne de Vinols* (Bruant), *Mme. Paolo Radaelli* (Calvat), *Mme. Gustave Henry* (Calvat).

NEWS OF THE CLUBS AND SOCIETIES

GARDENERS' AND FLORISTS' CLUB OF BOSTON.

A full attendance was had at the closing meeting of the season last Tuesday evening. There was no regular speaker or subject, but a big list of questions and miscellaneous topics of general interest and the meeting at no time lacked in liveliness. The question of the annual picnic brought out some amusing episodes and much oratory. After the dust had cleared away it was settled that 50 cents should be charged for men's tickets, women and children should be admitted free, the latter to include boys under 16 years, that there would be plenty of games and lots of prizes and that the time and place should be selected by the executive committee.

There was a splendid display of brilliant flowers on the exhibition stage. The committee, consisting of Wilfrid Wheeler, Kenneth Finlayson, M. A. Patten and J. F. Flood reported honorable mention for seedling peony Snowdrift from George Hollis; report of cultural merit to Eler Holmes for Killarney roses; vote of thanks to each of the following: Blue Hill Nurseries, collection of herbaceous perennials; Geo. Hollis, for ten varieties of peonies; Old Town Nurseries, herbaceous perennials; Wm. Thatcher, *Platyclinis filiformis*; J. W. Duncan, collection of hardy roses; R. & J. Farquhar & Co., herbaceous perennials; Duncan Finlayson, aquilegias; T. D. Hatfield, *Dimorphothea aurantiaca*; E. F. Dwyer & Son, collection of irises.

Briefly stated, the subjects variously discussed brought out the facts that *Rosa cinnamomea*, *blanda*, *altaica* and *lucida alba* are valuable roses for massing effects in borders, in addition to *rugosa*, *Wichuraiana* and *setigera*; that in selecting garden roses the *H. T.* are now indispensable; that the Dawson and Carmine Pillar are among the earliest blooming climbing roses and should be in every list; that *Vaporite* is a good insecticide for cut worms but must be put under surface of soil to be effective—in drills 2 in. deep and 3 in. apart was recommended; that cut worms will not touch violets or carnations that have been sprayed with Disparine; that Sulphonaphthol, half pint to 12 gals. of water is effective against red spider; that in spraying mixture for fruit trees it is judicious to have an excess of lime to neutralize the copper sulphate as a protection against burning the foliage; that *Anemone pap. alba*, *Phlox Miss Lingard*, *Achillea The Pearl*, *Campanula Medium* and *C. persiciflora*, *As-tille Gladstone*, *Coreopsis grandiflora*, also peonies, irises, *candidum lilies*, lily of the valley, *gypsophilas* and *tritomas* should be grown for their value as cut flowers by every florist having available ground.

On Thursday, the 17th, the club visited the peony gardens of E. J. Shaylor, where they found a gorgeous display of Mr. Shaylor's specialties—peonies—and were hospitably entertained by that gentleman.

LENOX HORTICULTURAL SOCIETY.

The regular meeting of this society was held June 5 and was largely attended. President A. Jenkins in the chair. Messrs. J. Cant, J. Green, W. McGregor and L. C. Peters were elected active members. An exhibit on which special praise was bestowed was a magnificent vase of extra fine varieties of *Odontoglossum crispum*, exhibited by A. J. Loveless. The flowers were remarkable for their size and substance, several of the spikes being fully three feet in length, and we question if a finer exhibit has ever been seen in Berkshire County. They were awarded the society's highest award—a first-class certificate and cultural commendation. Mr. Loveless gave a short talk on their culture which was greatly enjoyed. E. Jenkins was awarded a diploma for a fine vase of *Gladiolus Golden West*.

We were all pleased to welcome back George Foulsham, who has lately been appointed to take charge of Mr. W. B. O. Field's estate at Lenox, and he gave us an interesting description of his sojourn in Savannah, Ga., and also spoke of his recent visit to Messrs. Charlesworth's Orchid Nurseries, England.

The following firms have generously donated premiums to be competed for at the fall exhibition: A. T. Boddington, R. & J. Farquhar & Co., W. W. Rawson, Scott Bros., Bay State Nurseries, Pon Arbor Chemical Co., Pier-son U-Bar Co., Howard & Morrow, Hews & Co., Lager & Hurrell, Peter Henderson & Co., W. E. Marshall Co., Chas. H. Totty and Julius Roehrs Co.
GEORGE H. INSTONE,
Secretary.

CINCINNATI FLORISTS' SOCIETY.

Convention Preparations.

The annual meeting of the Cincinnati Florists' Society was called to order by President Peterson, Saturday evening, at 8:30 p. m., about 20 members being present. The finance committee reported favorable progress in getting in the money subscribed for the entertainment fund. Committee on sports reported progress and by the next regular meeting, which occurs July 10th, everything will be in readiness for the entertainment of the S. A. F. This being the annual meeting the election of officers was necessary, and resulted in the re-election of the present officials, viz.: J. A. Peterson, Pres.; C. E. Critchell, Vice-Pres.; Albert Sunderbruch, Secretary; D. Rusconi, Treasurer, and Gustave Adrian, Associate Director.

The members of the Cincinnati Florists' Society extend a very cordial invitation for all florists in the United States and Canada who possibly can so arrange to attend the Silver Jubilee of the "Mother Lodge," the S. A. F. We certainly extend to you the glad hand and bid you welcome. Those who have never visited Cincinnati will find a beautiful city whose suburbs are unequalled by any city in the United States. Come!

E. G. GILLET.

PENNSYLVANIA HORTICULTURAL SOCIETY.

The special meeting held on the 15th inst. to consider the advisability of selling the Hall property resulted in a vote entirely favorable to the bond-holding syndicate, who seemed to have their forces much better marshalled than the opposition. In fact, if it had not been for Joseph Heacock, it appeared that there was no opposition. Clement B. Newbold, the president of the society, was in the chair for the first time and his keen handling of any timid protests that arose, said much for his standing as a millionaire. Congressman Morrell and Dr. Mears also added their eloquence at critical points, and when the clinching of the nail was required George Vaux, a keen lawyer and one of the Schaffer trustees, made a speech. So that when a vote was taken it was a foregone conclusion. The disinterested members of the society hope that the end is not yet; but there seems very little hope for the ancient and honorable P. H. S. when their property is coveted by a lot of hungry capitalists. The beautiful building, the crowning masterpiece of the splendid artist, Frank Miles Day, seems in a fair way to be pulled down and be replaced by some soap-box hotel. The society may get a few dollars out of the wreck and can look for some other home. They will never get one anyway comparable as to location or beauty to the one they have this day been roped out of—with hardly a protest. The principal speakers before mentioned (excepting Mr. Heacock) seemed to think the P. H. S. stood condemned because it was not a money-making institution. Which shows that there is something fundamentally wrong in their conception of the functions of a horticultural society. They must be money mad.

NATIONAL SWEET PEA SOCIETY.

Harry A. Bunyard, secretary pro tem, sends the following list of additional prizes offered for the National Sweet Pea Society Exhibition:

Class F. Henry A. Dreer. \$10.00 in gold for the best ten vases of Sweet Peas Spencer or Unwin flowered in ten varieties.

Class G. Henry F. Mitchell Co. Largest and best vase Mixed Sweet Peas \$5.00.

Class H. W. A. Burpee. For the best vase of waved or Spencer type Sweet Peas introduced 1909. 1st, \$5.00. 2nd, \$3.00. 3rd, \$2.00.

Class I. J. M. Thorburn Co. For the best 15 vases Sweet Peas. 1st, \$10.00. 2nd, \$7.50. 3rd, \$2.50.

Class J. Watkins & Simpson, London, England. For the best 3 vases of Sweet Peas disseminated in 1909. 1st, \$5.00. 2nd, \$3.00. 3rd, \$2.00.

Class K. F. R. Pierson Co. Three vases Sweet Peas. Three distinct colors. 1st, \$5.00. 2nd, \$3.00. 3rd, \$2.00.

Class L. John Young. Best vase Sweet Peas, crimson. 1st, \$5.00. 2nd, \$2.00. 3rd, \$1.00.

Class M. Jerome B. Rice. Best vase Sweet Peas, white. 1st, \$3.00. 2nd, \$2.00. 3rd, \$1.00.

AMERICAN ASSOCIATION OF NURSERYMEN.

In our account of the proceedings at the annual convention in Rochester, N. Y., in last week's issue, we left the visiting nurserymen in Masonic Hall on the night of Thursday, 10th inst., up against the real thing in "smokers" as presented by the Rochester contingent. In an editorial note the previous week we remarked that the visiting nurserymen would find Rochester "a town with more snap and ginger in it when it comes to jollification than any place of its size on the map." We don't doubt that a practically unanimous endorsement of our statement would be forthcoming from all who attended that smoker. It certainly was a daisy and it speaks well for the staying powers of the aggre-

mittee who manouvered the affair consisted of E. S. Osborne, chairman; C. L. Yates, J. M. Pitkin, C. H. Vick, W. W. Wyman, O. G. Chase and E. O. Graham.

AMERICAN NURSERYMEN'S PROTECTIVE ASSOCIATION.

At the Rochester convention last week the American Nurserymen's Protective Association held its annual meeting and elected the following officers: President, J. W. Hill, Des Moines, Iowa; vice-president, W. F. Heikes, Huntsville, Ala.; secretary, Thomas B. Meehan, Dresher, Pa.; treasurer, Peter Youngers, Geneva, Neb.; executive committee, J. W. Hill, Chas. J. Brown, H. B. Chase, J. H. Dayton, D. S. Lake, E. R. Taylor, J. S. Kerr.

THE SOCIETY OF GERMAN LANDSCAPE GARDENERS.

On the 10th of May, last, a party of the members of the Society of German Landscape Gardeners, fatigued apparently by their exertions at the International Exhibition held in Berlin, and desirous of a change, paid a visit to the Royal Botanical Garden, and to the Schiller Park, now in course of formation, on May 17th, and on the 19th viewed the operations now in progress in Rathausplatz at Stiglitz. The visit to the Royal Botanical Gardens on May 10th took place under the friendly guidance of the oberinspektor, F. Ledien. The grounds which were first inspected showed, in spite of their very exposed position and need of shelter, great progress, the plantation



VISITING NURSERYMEN AMONG THE RHODODENDRONS
At Highland Park, Rochester, N. Y.

gation that they were able to turn out the next day, three hundred strong, for the special train to Newark as guests of the Jackson & Perkins Company and there traverse the company's 350 acre tract at Lyons and Newark, enjoy supper at Gardinere Hotel and return to Rochester at 10.45 p. m. without a grunt.

The ladies were being well cared for at theatre and luncheon by the local committees while the sterner sex were enjoying the smoker, the music, the vaudeville, moving pictures, etc., and chorusing themselves hoarse with Yip-I-Addy-I-Ay!, the Rhubarb song and "My Country, 'tis of Thee," under the leadership of the Rochester Male Quartette and with the assistance of the band. The com-

ST. LOUIS FLORIST CLUB.

The regular monthly meeting of this club was held on Thursday, June 10. Only twenty members showed up. The trustees reported that they had made all arrangements for the annual outing at Romona Park on the Suburban line, on Wednesday, July 21. They also reported that they had not as yet found a suitable meeting hall so it was decided to retain the old quarters for the summer. Treasurer Weber's report showed a healthy balance in the club's treasury. Trustee Smith announced that he had arranged with the Big Four R. R. for a special car for the convention at Cincinnati in August.

President Young urged a large attendance at the July meeting when nominations would take place.

of conifers more especially, which to some extent begin to assume their true characteristics, and must soon be transplanted at wider distances apart. The party then passed through the Japanese Magnolia Grove, and over the Primula field of the Himalaya, the Aubrietia lawns of the mountains of the Orient, and along the ridges of the Riesengebirges to the German plains of the lower lands. Everywhere was noted abundance of material to stimulate the observer; too much indeed to be more than alluded to in a notice of this kind. At the following meeting at Abrechtshof at Stiglitz an interesting discussion took place concerning the past Exhibition and the efforts put forth to create a central horticultural society.

F. MOORE.

AMERICAN PEONY SOCIETY.

The annual meeting and exhibition of this society was held at Cottage Gardens, Queens, N. Y., on Friday and Saturday, June 11 and 12. President Ward being unable to be present, Prof. Craig of Ithaca served as temporary chairman at the two meetings held Friday afternoon. Geo. C. Thurlow, Guy A. Bryant and A. H. Fewkes were appointed judges of the exhibition. Adjournment was made until Saturday and the visitors spent the afternoon in looking over and admiring the unprecedented display of peonies blooming in the fields of the Cottage Gardens Co.

Address of President C. W. Ward.

It is my extreme regret that I am compelled to announce my inability to be with our beloved society at the fourth annual meeting and to also announce that hereafter I shall be unable to take any active part or position with you or any other horticultural body. My connection with and labors among horticulturists have been most agreeable, pleasant and instructive and I would much like to continue them; but the condition of my health during the past year warns me that I must cut off all detail work possible and save my strength for tasks that I cannot avoid. I wish, however, to assure you all that my sympathy and support will always be heartily exerted in aiding all horticultural societies and clubs in America and other lands as well, in the grand works they have undertaken.

The work for which the Peony Society was organized to perform has been but fairly begun. Some errors and omissions have likely been made, but these should not discourage you all in continuing the work already planned nor in planning additional work that experience shows to be needful, but we all should rather work with renewed vigor and a determination to accomplish all that which we set out to accomplish.

Nomenclature: With the data at my command I am at this time unable to make many suggestions of value, but the work already mapped out should be continued to the end that American peony growers should have at least an authentic list of named varieties most desirable for general culture on our continent and that appropriate names should as far as practicable be eliminated from that list.

Your nomenclature committee should be composed of practical men who are willing and able to give it the necessary time, observation and attention.

Essays:—There should be provided at each annual meeting two or three able essayists, covering subjects of interest to peony growers, both amateurs and professional. Among the subjects that will likely prove of interest might be mentioned: Cultivation of the peony. Propagation of the peony. Organizing new varieties by cross fertilization. Commercial peony growing. The value of the peony for cut flowers. The peony for the amateur. The peony as a decorative plant. The use of the peony in landscape gardening. Peony colors—painting and shades of color that are not desirable and not worthy of cultivation. The peony at exhibitions illustrating best methods for keeping, shipping and staging peony blooms at exhibitions; and several other subjects that will suggest themselves as time passes.

The Cornell Experimental Plot: The Cornell experiment has not proved as successful as might be desired, owing very largely to the unsuitable nature of the soil and the lack of continued culture and fertilization, and the condition of the plants at the station is not such as to enable a correct study of the varieties, nor to enable one to judge as to the value of different varieties. Some means should be adopted to provide for proper culture, fertilization and favorable soil conditions, for until the peony can be described in fairly favorable conditions, the observations and the deductions therefrom will not likely prove of great general value.

Annual Exhibition: should be held in localities where an attractive and effective exhibition of peony blooms may be assured, and at such seasons as would enable nearby growers to stage the displays to good advantage.

Premiums:—Substantial premiums should be offered under such conditions as will

attract extensive entries and thereby assure the displays the rules and regulations should not be so technical or severe as to discourage or drive away exhibitors.

Introducing New Varieties: While the Society should encourage the growers of new varieties and give ample recognition to all improvements of merit, it should carefully avoid the endorsement of the commercial value of any new peony, and its awards should be of such a character as would prevent the use of the Society's name in advertising worthless varieties or varieties that may be practically duplicates of kinds already existing in commerce.

In conclusion I desire to express my great gratitude to the members of this Society for the uniform, kind and courteous treatment they have one and all accorded me, and for the generous assistance all have rendered the Society, as well as for the enthusiasm manifested in our work. I feel that I ought to apologize for the little time I have been able to devote to the duties of the office with which you have thrice honored me and to offer as the only explanation lack of sufficient strength to attend to them properly and at the same time care for the business duties which have crowded upon me and which could not be avoided. I feel certain that any one of your members whom you may choose as my successor will more ably fill the office than I have been able to do and that under his guidance our society will prosper and accomplish the needed work.



C. W. WARD

Honorary President of American Peony Society.

You all have my best wishes for success collectively and individually and I desire to express to each and everyone of you my warmest friendship and sincerest wishes for a long, successful and happy career.

Secretary's Report.

The present membership of the Society, not including four honorary members, is 54. We have lost during the year one member by death, Mr. E. V. Hallock, who joined the Society at the last meeting at Ithaca. Although his membership was of short duration his loss will be keenly felt, for his horticultural attainments and genial personality made him a most valued member.

The work of the Nomenclature committee is progressing. The peony catalogue published by Cornell University was issued early in the year and distributed to members. It contained the Critt essay on the peony and a partial descriptive list of varieties. This list forms the beginning of the official catalogue of the Society. In his introductory note Professor Craig says: "It is to be regarded as a preliminary step, and therefore subject to objection in the light of future experience." I will therefore say without other authority from the chairman of the Nomenclature committee that these descriptions are submitted to you for your approval or criticism, both as to method and accuracy. If they do not meet with your approval it is suggested

that your objections be communicated direct to Professor Craig or his representative, Mr. Leon D. Batchelor, as it is through a frank expression of opinion on these matters that the best results will be obtained.

In connection with the nomenclature work the question suggests itself to me whether as individual members we are doing all we can to further the work of the committee. It certainly is not enough for us to simply send our collections of roots to Cornell and expect the confusion to be straightened out by the committee there while we keep on selling and distributing doubtful varieties under the names we happen to have attached to them. We should cease being too confident of the accuracy of our own list of names unless we have taken extraordinary means for proving them to be correct.

For instance, if some of us have invested in the Early Alexandra Duff "gold brick" we should not pass it along as the true thing, but sell it upon its own merits if we are fortunate enough to have received one of the few good ones out of the dozen more varieties sent for it and solve the problem as one member at least has done, by advertising it as having been received for the true variety, but expressing a doubt of its accuracy while giving it full credit for quality. There are many other varieties of uncertain identity which should be treated in the same way and if we are to be consistent members of the American Peony Society some such course as the above should be followed.

Another matter which should receive attention at this meeting is the premium list on our exhibitions and the ways our means of providing for it. The exhibitions form an important adjunct to the meetings and some special provisions should be made whereby prizes can be offered and paid without making too heavy demands upon the treasury.

The exhibition at the last meeting at Ithaca was a fairly good one, but was made up principally of flowers cut from the test collections. T. C. Thurlow Co., West Newbury, Mass., and Professor A. P. Saunders, Clinton, N. Y., were the only other exhibitors and great credit is due them for making so good a showing of blooms. The former entered in the commercial, and the latter in the amateur classes.

A. H. FEWKES, Secretary.

The society reconvened at 11.30 a. m., Saturday. Many localities were placed in nomination for the next meeting and Messrs. A. H. Fewkes, R. T. Brown and W. A. Peterson were appointed a committee to select a suitable place. The Treasurer's report showed a balance on hand of \$456.89, a substantial increase since the last report. The membership is 55.

Officers were elected as follows: President, B. H. Farr, Reading, Pa.; vice-president, C. J. Maloy, Rochester, N. Y.; secretary, A. H. Fewkes, Newton Highlands, Mass.; treasurer, J. H. Humphreys; director to succeed Theodore Smith, Prof. A. P. Saunders of Hamilton College.

Prof. Craig and others spoke appreciatively of Mr. Ward's liberality and kindness and Messrs. Saunders, Batchelor and Bryant, who had been appointed a committee on resolutions, recommended a message of good wishes to Mr. Ward, which was carried. On recommendation of Prof. Craig, Mr. Ward was made honorary president of the society. L. D. Batchelor was elected an honorary member and resolutions of regret on the death of E. V. Hallock were adopted.

The judges report showed B. H. Farr winner of first in classes 1, 8, 9, and second in classes 2, 4, 5, 7. Geo. H. Peterson first in classes 2, 5, 7, and second in classes 1, 9. S. G. Harris first in classes 10, 11. The prizes in the amateur classes were all awarded to T. S. Havemeyer, gardener, A. Lahody. Special mention was made of collections by B. H. Farr and

G. H. Peterson, and irises and lilies by John Lewis Childs.

Important changes were decided upon in the classification for next year's schedule after considerable interesting debate.

After dinner speeches were made by the new president and Mr. Batchelor and by Nicholas Hallock, former owner of the tract now occupied by Cottage Gardens Co.

THE BEST PEONIES.

Mr. George C. Thurlow of Cherry Hill Nurseries, West Newbury, Mass., acceding to our request for a list of the most desirable varieties of peonies for effective garden display and for cut bloom writes as follows:

There are so many really good varieties that I doubt if two different growers could be found who would give the same list.

I have selected these varieties from a list which I had previously compiled and from notes which I made at Queens last week. In making these selections I am influenced by the following:

1st. Varieties which are very floriferous.

2nd. Varieties which have strong stems to support the flowers.

3rd. Varieties which will open readily during a rainy season. (Some really fine flowers will during a wet season become waterlogged and not open at all.)

4th. Varieties which are lasting as cut flowers.

5th. Varieties which in a mass planting will give a good color effect. The peony can be used for landscape work with good results, either among shrubbery or alone. Their foliage is good when they are out of blossom and some of the early flowering plants may be used with them, such as daffodils or narcissus.

There are a number of fine varieties which I do not include in this list, desirable for the grower who is getting a collection for study or for the value of the individual flower, such as some of the tri-color varieties or anemone flowered or single and semi-double. There are also some very fine new varieties which will probably prove ahead of some in the list given, but I have not as yet made enough study of them to really decide as to their relative value at the present time.

Best Double White or Cream.

Festiva Maxima, Duchess de Nemours (Calot), Mad. de Verneville, Couronne d'Or, Avalanche, Festiva, Mons. Dupont, Mad. Crousse, Baroness Schroeder, Marie Lemoine.

Best Flesh or Light Pink.

La Tulipe, Marguerite Gerard, Mad. Emile Lemoine, Germain Bigot, Mad. Emile Gallee Pottsi Alba, Grandiflora (Richardson), Euphemia.

Best Rose Pink.

L'Esperance, Modeste Guerin, Rosea Superba, Mad. Ducl, Mons. Jules Elie, La Coquette, Etta, Lamartine.

Best Red or Crimson.

Eduard Andre, Dr. Callot, Felix Crousse, Henry Demay, Louis Van Houtte, Thurlow's Double Red, Mons. Martin Cabuzac, Marechal MacMahon, Marechal Valliant, Plutarch.

NEW YORK FLORISTS' CLUB.

The last meeting of this club for the season was held on Monday evening, 14th instant, President Turner in the chair and fifty members present. There was no special topic for discussion but a great variety of important matters were brought up and it was late before the very interesting session came to a close. These topics we shall touch upon only briefly.

Resolutions were presented by Robert Schultz on the death of Herman Dreyer, and by W. E. Marshall on the death of John Scott. John Birnie reported for the Committee on plant market, speaking of the busy mornings and crowded streets and inadequate accommodations now obtained. Mr. Nugent reported that a promising proposition for desirable quarters for a general market had on investigation proved to be spurious. The old committee was discharged with thanks and a new committee consisting of A. L. Miller, A. Schultheis, H. C. Steinhoff, John Birnie and F. H.

Traendly was constituted with instructions to wait on the Board of Aldermen and present the needs of the plant growers.

The transportation committee reported on available trains and rates by various lines to the Cincinnati con-

Violet Blue Rose

A Remarkable Novelty

THE NEW Rambler (Violet Blue), hailed by the German rose growers as the forerunner of a genuinely cornflower blue rose, is a seedling of Crimson Rambler, very vigorous and hardy.

For descriptions of this great novelty, as well as many others, send for Booklet.

Ellwanger & Barry

Mount Hope Nurseries

Rochester, N. Y.



WM. BULL & SONS' ORCHID GROUP
at Temple Show, London.

HEACOCK'S KENTIAS



Our stock consists of healthy, HOME-GROWN WELL ESTABLISHED Plants.

Kentia Belmoreana

	Each.	Doz.
6-in. pot, 6 to 7 leaves, 22 to 24 in. high.....	\$1.00	\$12.00
6-in. pot, 6 to 7 leaves, 24 to 26 in. high.....	1.25	15.00
6-in. pot, 6 to 7 leaves, 26 to 28 in. high.....	1.50	18.00
9-in. tub, 6 to 7 leaves, 42 to 48 in. high.....	5.00	

Kentia Forsteriana

	Each.	Per doz.
6-in. pot, 5 to 6 leaves, 28 to 30 in. high.....	\$1.00	\$12.00
6-in. pot, 6 leaves, 30 to 32 in. high.....	1.25	15.00
9-in. pot, 6 leaves, 34 to 36 in. high.....	1.50	18.00

Made-up Kentia Forsteriana

9-in. tub, 4 plants, 42 to 48 in. high.....	\$ 4.00 each
12-in. tub, 4 plants, 6 feet high, heavy.....	15.00 each
12-in. tub, 4 plants, 6 to 8 feet high, heavy.....	20.00 each

Joseph Heacock Co., WYNCOTE, PA.

vention and were given full power to make official selection for the club members. The house committee was given a generous appropriation in this connection. Mr. Bunyard presented a spirited report on the program and souvenir book which will soon be ready. A nominating committee for officers for next year was appointed, consisting of Messrs. Weathered, Totty, Bunyard, Elliott, Manda and McManus. A committee consisting of Messrs. O'Mara, Hendrickson and W. A. Manda was constituted to prepare resolutions on the death of C. L. Allen. Secretary Young announced a lengthy list of new members.

State Vice-President Bunyard of the S. A. F., distributed membership application blanks for those who desired to join the national society. A discussion on the inadequate pay received by professional gardeners in the public parks as compared with the wages of ordinary laborers brought out some brilliant oratory, notably by Robert E. Berry.

The only exhibits were from W. A. Manda, who received cultural certificates for a number of fine hardy herbaceous plants.

CONNECTICUT HORTICULTURAL SOCIETY.

The first June meeting of this society was held on the 11th inst., at the County Building, Hartford, President John F. Berry occupying the chair. Much of the evening was spent in making plans for the fall exhibitions; and many of the rules of the New Haven County Horticultural Society, relating to exhibitions, were adopted for our

convenience. An arbitration committee, consisting of Messrs. Howard A. Pinney, Carl Peterson, and C. H. Sierman, was appointed for service at the fall exhibitions. The dahlia show is set for September 23d, at Unity Hall, Hartford, and the chrysanthemum show for November 4th and 5th, probably at Putnam Phalanx Hall, Hartford. A special feature of the evening was a beautiful collection of cut flowers, all hardy varieties, brought by Mr. Huss, who received a vote of thanks for his display. They included aquilegia, dianthus, heuchera, lychnis, campanula, poppy, phlox, pyrethrum, armeria, and lupinus. The next meeting of the society will be held June 25. GEORGE W. SMITH, Sec'y.

NASSAU COUNTY HORTICULTURAL SOCIETY.

This society held its regular monthly meeting in Pembroke Hall, Glen Cove, on the evening of June 9, with a small attendance, owing to the unpleasant weather. Vice-President Emslie occupies the chair during the absence of President Everett. A great deal of business was transacted. Final arrangements were made for the summer show, which is to be held in Pembroke Hall on June 23. This is the first time the society has held a summer show, and everything possible is being done to make it a success. They intend to hold it annually in future. Preliminaries were discussed regarding the dahlia and chrysanthemum shows. Mr. Dean, Glen Cove, offered a silver cup for the best collection of dahlias shown on long stems. His idea in offering the cup is to encourage the culture of the

dahlia as a cut flower. The fall exhibition is to be held the last week of October instead of the first week of November as formerly.

The monthly exhibits were as usual of a high order. The judges for the month were Messrs. Duthie, Garrett and Holloway. Their awards in the points competitions were: Paul Reul, lettuce, 912-3; H. Gaut, peony, 88 1-2; V. Cleres, tuberous begonia, 88 1-3; G. Wilson, roses (outdoor) 86 2-3. G. Wilson and P. Reul were awarded culture certificates for a collection of vegetables and three heads of lettuce respectively. Special attention was drawn to the fine cauliflower shown in G. Wilson's collection. On request, Mr. Wilson told briefly how it had been grown.

S. J. Trepas exhibited a yellow carnation seedling. V. Cleres was awarded honorable mention for an exhibit of May King lettuce. H. Turner, Castle Gould, Wm. Millar, Oyster Bay, and Wm. Marshall, Glen Cove, have been asked to officiate as judges at the rose show. J. Hearn, Roslyn, was elected to active membership.

WM. H. MACKENZIE, Cor. Sec.

Kentia Belmoreana

	Per 1000	Per 100
Delivery from now on.....		
Strong seedlings, ready to go in		
2 1/2 in. pot.....	\$25.00	\$3.00
3 1/2 inch plants, fine bushy stuff.....	75 00	8.00

Cocos Weddelliana

	Per 1000	Per 100
Fine established healthy plants		
from 2 1/2 in. pots.....	\$90.00	\$10.00
Satisfaction Guaranteed.		

O. V. ZANGEN, Seedsman, Hoboken, N. J.

IPOMOEA NOCTIFLORA

Best pure white moonvine in the market, very fragrant and as big as a saucer. On this variety we have a world-wide reputation as growers and shippers for the last twenty years.

Price, 2½ in. pots, \$5.00 per 100. 10,000 are now ready.

Godfrey Aschmann

1012 West Ontario St., Philadelphia, Pa.

Kentias, Arecas, Latanias, Cocos, Phoenix, Araucarias, Rubbers, Crotons, Pandanus, Asparagus, Ferns for Dishes. 200,000 Bedding Plants, also Rooted Cuttings of Coleus at lowest wholesale rates.

Orders taken for imported plants for fall delivery

A. LEUTHY & CO.

PERKINS ST. NURSERIES

ROSLINDALE, MASS.

WANTED

Cycas Revoluta

Nice specimens 4 ft. to 4½ ft. high. State price and size.

KNIGHT & STRUCK

11 Madison Ave.

NEW YORK CITY

ROSES

A SPECIALTY

The Dingee & Conard Co. West Grove PA.

ROSES

Strong, 3-inch, ready to bench stock own roots from grafted RICHMOND, CHATELAIN, BRIDE at 50¢ Cash.

FRANK F. CRUMP

Colorado Springs Colo.

THE BOSTON VIOLET

Unequaled for Productiveness, Beauty and Popularity.

In Crop from September to May. Plants \$3.00 per doz. \$12.00 per 100; \$16.00 per 1000. Princess of Wales \$15.00 per 1000.

WILLIAM SIM, Clifftondale, Mass.

In ordering goods please add "I saw it in HORTICULTURE."

CANNAS

Strong plants from pots 25 leading varieties, \$5.00 per 100.

ESTATE OF DAVID FISHER, Woburn, Mass.

GERANIUMS, DAHLIAS AND BEDDING PLANTS

We have one of the most complete collections of Geraniums in the country, containing every color and type found in the Geraniums. Every one of our 75 Standard Varieties at \$2.00 and \$3.00 per 100 are Bread and Butter Winners, and among our 34 New Varieties of special merit are some that are going to fix the standard in the future. Every one is a Gem, not high in price, only \$4.00 and \$6.00 per 100.

Our Novelties should, coming as they do from the leading introducers of the world, represent the highest development of Geraniums at the present time. A collection of 100 Varieties, our selection of 1907 and 1908 Novelties, will be sent for \$10.00.

Special Offer of 1000 good, strong plants from 2 in. pots, our selection of 20 distinct kinds from among our Standard and Newer Varieties, for \$15.00 cash. From 8 in. pots \$3.00 per 100, \$25.00 per 1000, in a good assortment.

CANNAS

Strong plants from 3 in. pots. J. D. Eisele, Eganale, Alphonse Rouvier, and Florence Vaughan, \$4.00 per 100. Jean Tissot, President Myers, Louisiana, Pennsylvania, \$5.00 per 100.

DAHLIAS

We have one of the finest collections in the country of good distinct Commercial Varieties at \$2.00 per 100 and up for plants ready for shipment. Then we have Jack Rose, Virginia Marie, Big Chief, Rose Pink Century, Fringed 20th Century, Rebecca Mayhew, etc., at 50¢ each, \$5.00 per doz., \$35.00 per 100. We will send 1000 in 20 good distinct Cut Flower Sorts, our selection, for \$15.50. See issue of April 24th of Our Wholesale Catalogue for complete list of Bedding plants.

R. VINCENT, JR., & SONS CO., White Marsh, Md.

A Grand Opportunity FIRST CLASS GOLD STORAGE VALLEY

in cases of 2500, \$20.00 per case; immediate delivery; address

Jacs Smits, Ltd., CARE OF Maltus & Ware

14 STONE STREET, NEW YORK

Catalogue of Nursery Stock furnished on application

JOHN WATERER & SON, Ltd.

American Nursery Bagshot, England

Are Specialists in the

REALLY HARDY VARIETIES

of Rhododendron Hybrids and in Select Varieties of Hardy Border Plants

Hardy Rhododendrons, Azaleas, Conifers, Clematis, H. P. Roses, Shrubs and Herbaceous Plants from our **HOLLAND NURSERIES**
Prices Moderate

P. OUWERKERK, 216 Jane St., Weehawken Heights P. O. No. 1, Hoboken, N. J.

The Northboro Dahlia and Gladiolus Gardens

Offer for Spring 1909 300 selected varieties of Dahlias and one and one half million large-flowering Gladioli in mixtures, in lots to suit. Send list of your wants. Catalogue free.

J. L. MOORE, Northboro, Mass

American Grown Roses

Fruit and Ornamental Trees, Shrubs, Small Fruits, Clematis, Evergreens.

Write for Trade List.

W. & T. SMITH CO.

Ceneva, N. Y.

Box Trees

and other **EVERGREENS** for Tubs and Boxes

Our Prices are Always Right—Catalog Free

THE NEW ENGLAND NURSERIES, Inc. BEDFORD, MASS.

ENGELMANN BOTANICAL CLUB.

The Engelmann Botanical Club of St. Louis held its regular monthly meeting on Monday night, June 14, in the rooms of the New Central High School Building. The interesting feature of the meeting was a paper read by Dr. S. M. Coulter of the Shaw school of Botany of Washington University on "The Relationship Between Physiographic Conditions of Plant Life." Other interesting discussions followed. The meeting was well attended. Secretary W. W. Ohlweider announced that this would be the last meeting of the club until September although there would be field meetings during the summer months.

The club has enjoyed a very successful season and all of its meetings have been well attended. The members are looking forward to interesting meetings for the coming fall and winter months.

CLUB AND SOCIETY NOTES.

The Nassau County Horticultural Society will hold their rose show on June 23.

The Newport (R. I.) Horticultural Society will hold their June exhibition on the 23rd and 24th inst.

The gold watch found by Wm. J. Stewart at Highland Park, Rochester, on the occasion of the visit of the Nursesmen's Association, has been restored to its owner, Mrs. E. Van Herff of Yonkers, N. Y.

The North Shore Horticultural Society will hold their rose show on June 30 and July 1 at Manchester, Mass. The numerous prizes, cups and medals that are offered are making this show of more than ordinary interest to those outside of the immediate territory.

DURING RECESS.

At the Astoria (L. I.) Florists' Bowling Club last Tuesday evening an interesting feature was the presentation of a fine ball to President W. H. Siebrecht in recognition of his many courtesies to the members and as a token of the esteem in which he is held by the florist fraternity. The speech of presentation was made in eloquent form by Alfred Blackwin. W. H. Siebrecht, jr., was not overlooked in the general round-up and was presented with a rattle in consideration of a recent youthful arrival at his home. The famous auto car is bespoken for a tour to Patchogue on Saturday, 19th, to inspect the establishment of Frank Niquet.

DIANTHUS NAPOLEON III.

A subscriber wishes to know where seeds of Dianthus Napoleon III can be purchased. This is a hybrid and does not produce seeds. Plants only. These can be procured from Drعر. In this connection one of the latifolius varieties (atrococcineus plenus) is an excellent companion to Napoleon III and seeds freely. It is a deep blood red, flowers all summer and is a splendid cut flower. Seeds can be purchased at 50 cents an ounce.

G. C. W.

PERSONAL.

Lebanon, Ore.—At the recent flower show G. L. Allen, florist, was one of the judges.

Dr. L. H. Bailey of Cornell will go abroad in October and expects to be absent about six months.

New Castle, Ind.—Peter Welland has taken charge of the greenhouses which he recently purchased from L. A. Jennings.

Joseph Street, foreman for C. A. Anderson, of Buffalo, N. Y., will sail with his wife on July 3 for a two months' stay in Germany.

J. H. Hadkinson and wife left Omaha last week for Tacoma, Wash., where he will enter on his duties as manager of the city parks.

Fall River, Mass.—William Byard, the local tree warden and florist, has been ill for several weeks and little hope for his recovery is now entertained.

W. H. Siebrecht, Sr., has bought a new place in Connecticut a few miles from Ossining, N. Y., consisting of six acres. He may erect greenhouses later, but his main object is for a home and to enjoy himself.

Ludwig Zimmer, florist, Biddle Market, St. Louis, will leave next week for a trip to Germany, where, at Hamburg, he will settle up an estate left by his father. Mrs. Zimmer will look after the business while he is away.

Visitors in St. Louis last week: Harry Balsey, Detroit, Mich.; G. Reising, of the L. Baumann Co., Chicago, offering florists' supplies; Simon Maloney, who represents the American Forestry Co., of Little Lake, Mich., soliciting Christmas green orders.

Robert Graham, a florist living at Carrollton, Mo., who was disappointed in love, tried to kill himself last week by swallowing a dozen grains of bichloride of mercury. He was taken to the city hospital in a serious condition but at last accounts was improving a little and may pull through.

INCORPORATED.

Knoxville, Tenn.—Standard Nursery Co.; N. W. Hale, W. P. Wilson, C. W. McCormick, S. J. Herrell; capital, \$35,000.

Brooklyn, N. Y.—The Broadway Floral Co., 1010 Broadway; Elias and Esther Freedman, Bessie Silverstein; capital, \$5,000.

Litchfield, Conn.—The Rosemere Nursery; president, W. T. Marsh; vice-president, Dr. J. L. Buel; secretary and treasurer, A. T. Bulkley; capital, \$10,000.

STRAWBERRIES.

Burnett Bros., 72 Cortlandt street, New York City, are ready to distribute their new catalogue of pot-grown strawberry plants. The list is strictly up-to-date and in it are carefully described the newest and best varieties of strawberries as grown by one of the leading specialists. All interested in strawberries should send for a copy.

The National Nurseryman distributed a very interesting and finely gotten up souvenir pamphlet at the Nurserymen's convention. Views in Rochester parks and nurseries with portraits of eminent men in the trade embellished the pages.

TUBEROSES

Our Tuberose Bulbs are all hand selected and are entirely reliable, blooming the first season. Mammoth Pearl, 1st size, \$7 50 per 1000.

CYGAS REVOLUTA

Strong Healthy Trunks.

\$7.50 per 100 Pounds

\$21.00 " 300 "

WRITE FOR OUR CATALOGUE.

HENRY F. MICHELL CO.

1018 Market St., Phila.

Giant Pansy Seeds

Representing seven of the best growers of Europe. Each color or strain packed separately. The proportion of light and dark is well blended.

Florist Collection—16 pkt. Hybrid Giants, 2 pkt. Giant Five Elotched, 1/2 oz. in each pkt. 12 all, 24 pkts., weight 3 oz. \$7.50

Half Florist Collection—24 pkts., weight 1 1/2 oz. \$3.93

Amateur Collection—24 pkt., 500 seeds in each pkt., 12,000 seeds. \$1.25

Cottage Collection—12 pkt., 500 seeds in each pkt., 6,000 seeds. \$1.25

Mixture—extra fine, 1000 seeds. \$50.

Exhibition Collection—4 pkt., 500 seeds in each pkt., 2,000 seeds. \$3.00

Send for descriptive list of prize winners

JOHN GERARD, New Britain, Conn.

BUSINESS CHANGES.

Sandusky, O.—D. R. White has purchased the Central greenhouses.

Montpelier, Vt.—R. Bannigan has purchased the Montpelier Greenhouses and will start in business on July 1. He has been a grower on the place for several years.

Auburn, Me.—Hugh Roak, who for several years has been engaged in the greenhouse business with his father, G. M. Roak, has purchased a farm in Vienna and removed there.

Bangor, Me.—Carl Beers has purchased the Winter Gardens from E. P. Lane and also the Mt. Hope Nurseries which he recently sold to Mr. Lane. Both places will be continued and Mr. Beers will give his personal attention to them.

Green Bay, Wis.—The Everett E. Clark Seed Co., of Milford, Conn., will build a three-story fireproof warehouse, equipped with all modern conveniences for handling seed peas and beans, on their recently acquired land here. We understand that E. L. Olmsted will take charge of the place.

VEGETABLE PLANTS

CABBAGE. Field Green, all leading varieties, \$1.00 per 1000, 10,000 and over, 85c per 1000.

CELEBY. White Plume, Golden Sell Blanching and Giant Pascal, \$1.00 per 1000.

EGG PLANT. N. Y. Improved and Black Beauty, \$3.00 per 1000.

LETTUCE. Big Boston, Boston Market, Tennis Ball and Grand Rapids, \$1.00 per 1000.

PEPPERS. Ruby King, Bull Nose, Sweet Mountain and Neapolitan, \$3.00 per 1000. Chinese Giant and Cayenne, 50c per 1000.

PARSLEY. \$1.25 per 1000.

CASH WITH ORDER

R. VINCENT, JR., & SONS CO.
White Marsh, Md.

Everything "For the Land's Sake."

The one firm in Boston where all good forms of plant food may be obtained, is the Bowker Fertilizer Company, opposite Faneuil Hall at 43 Chatham St. All greenhouse chemicals, Nitrate of Soda, Ground Bone, Potash Salts, Sheep Manure and Wood Ashes can there be had at first hands.

BOWKER FERTILIZER COMPANY

Everything "For the Land's Sake."

BEGONIAS TUBEROUS ROOTED

ALSO
GLOXINIAS, LILY OF VALLEY, SPIREA
Catalogues mailed free on application
Joseph Breck & Sons Corp.
47-54 NO. MARKET ST., BOSTON, MASS.

BULBS OF QUALITY

Begonias, Single, under color..... \$2.75
" Double " " 5.00
" Fritted " " 10.00
Gloxinias, under color..... 4.00
Pearl Tuberoses, \$7.00 tubous..... 1.00

Schlegel & Fottler Co.
26 & 27 So. Market St., BOSTON, MASS.

Burpee's Seeds

PHILADELPHIA
Blue List of Wholesale Prices mailed only to those who plant for profit

Ward's Lily Bulbs

Not how cheap, but how good.
Ralph M. Ward & Co.
12 W. Broadway, New York

GEO. E. DOW
Designing and Illustrating
178 Washington St., Boston, Mass.
OUR SPECIALTY
Machine, Booklet, Advertising and Flower
PHOTOGRAPHS

Primulas for Christmas

SOW SEED NOW

B's Matchless Giant, pure white; B's Matchless Giant, blush white; B's Matchless Giant, rose; B's Matchless Giant, scarlet; B's Matchless Giant, royal blue; B's Matchless Giant, mixed. Each 1-2 trade packet, 60c; trade packet, \$1.00.

Primula obconica gigantea kermesina, deep crimson. Primula obconica gigantea alba, pure white. Primula obconica gigantea hiacinta, beautiful lilac. Primula obconica gigantea rosea, lovely pink. Primula obconica gigantea grandiflora, mixed, containing pure white to deep crimson.

Each of above 1-2 trade packet, 30c; trade packet, 50c.
Primula floribunda grandiflora (buttercup) 1-2 trade packet, 30c; trade packet, 50c.
Forbesi (Baby Friesland). Trade packet, 25c. Primula kewensis (Giant Buttercup) 1-2 trade packet, 60c; trade packet, \$1.00.

ARTHUR T. BODDINGTON, 342 W. 14th Street, New York
Seedsman

LEONARD SEED CO.

CONTRACT CROWERS AND WHOLESALE DEALERS
BEANS, PEAS, SWEET CORN, ONION, GARDEN SEEDS
ONION SETS Get Our Prices 79 and 81
FLOWER SEEDS E. KINZIE STREET, CHICAGO

ESTABLISHED 1802

*Thorburn's
Bulbs*

**LILIAM HARRISII
PURITY FREESIA**

True stock from most reliable growers

SEND FOR SPECIAL ADVANCE PRICES FOR EARLY ORDERS

J. M. THORBURN & CO.
33 Barclay Street
NEW YORK

SHEEP MANURE

IT'S STERILIZED
Free from Weed seeds.
\$24.00 Ton;
\$7.00 quarter of ton.

Wm. Elliott & Sons
42 Vesey St., New York

RELIABLE SEEDS—SOW NOW

PRIMULA OBCONICA GRANDIFLORA
1000 seeds Tr. pt.
Blood red, fine seller..... \$1.50 .50
Real pink, fine for cut..... 1.00 .50
Pure white, fine for cut..... 1.00 .50
Compacta, fine potter..... 1.50 .50
Mixed Hybrids..... 1.00 .50
O. V. ZULGEN, - HOBOKEN, N. J.

CABBAGE
LILY OF THE VALLEY PIPS.
HJALMAR HARTMANN & CO.
Løngangsstræde 20,
COPENHAGEN, DENMARK.

Mignonette

**FARQUHAR'S
GIANT**

Oz., 75c; 1-4 oz., 25c

R. & J. Farquhar & Co.
6 & 7 South Market Street
BOSTON, MASS.

BRIDGEMAN'S SEED WAREHOUSE

RICKARDS BROS.

Props.
37 East 19th St., - NEW YORK CITY

**STOCK SEED
FOR WINTER BLOOMING**

Our strain of Double Branching Stocks is as exceptionally true. About 90% Double Flowers.

In colors: 1/4 oz. .60 oz. \$4.00
Pure White 1/4 .75 " 5.00

H. E. FISKE SEED CO.
Faneuil Hall Square, BOSTON, MASS.

**Winter-flowering
SWEET PEAS**

have been the best money-makers the past winter. New PRICE LIST of these celebrated Sweet Pea Seeds will be ready soon. Send for it to the originator

Ant. C. Zvelanek, Bound Brook, N. J.

NEW CROP SEED

For Early Planting
THOMAS J. GREY CO.
2 SO. MARKET ST., BOSTON, MASS.

**JOHN BREITMEYER'S
SONS**

Cor. Miami and Gratiot Aves.
DETROIT, MICH.

**Artistic Designs . . .
High Grade Cut Blooms**

We cover all Michigan points and good sections of Ohio, Indiana and Canada

**WILLIAM J. SMYTH
FLORIST**

Cor. Michigan Ave. and 31st St., CHICAGO

We ship to all points in Illinois and Iowa.
Phones: Douglas 744, Douglas 523, Douglas 740

**HAUSWIRTH THE
FLORIST**

Out of Town orders for Hospitals
Carefully filled.

**232 Michigan Ave.
CHICAGO**

AUDITORIUM ANNEX Tel. Harrison 686

**SAMUEL MURRAY
Florist**

Coates House Conservatory
1017 BROADWAY, KANSAS CITY, MO.

Both 'Phones 2670 Main.



**WASHINGTON,
D. C.**

GUDE'S

GUDE BROS. CO.
FLORISTS
1214 F ST NW
WASHINGTON, D.C.

The Far-Famed Flowers of
TORONTO

Delivered on mail or telegraph order for any occasion, in any part of the Dominion.

JOHN H. DUNLOP,
96 Yonge St., - Toronto, Ont.

The Park Floral Co.

J. A. VALENTINE,
Pres.

DENVER, COLORADO

**WILLIAM L. ROCK
FLOWER CO.**
KANSAS CITY, - MO.

will carefully execute orders for Kansas City and any town in Missouri or Kansas.



Palmer's

Buffalo, N. Y.

W. J. PALMER & SON, 304 Main St.

Of Interest to Retail Florists

UP-TO-DATE FLOWER BASKETS.

We have all seen flower baskets. Some of us have watched their development from year to year, from old brown willow, Swiss, plateau, white and gold, and grass trimmed straw, down to the present day artistic and dainty "creations," but never before this year's crop came in sight do we think anyone has seen such a variety and as many specially adapted to particular uses by reason of their color or trimming, the material of which they are composed, their shape or fitness to hold or conceal a vase, jar, flower pot or other receptacle. The values are equally diverse, and fine taste and proficiency are evident in the make-up of those intended for the flower buyers with scanty funds as

STEAMER DEPARTURES

Amudian, Boston-Glasgow... June 25	American.	
St. Louis, N. Y.-S'ampton... June 26	Philadelphia, N. Y.-S'ampton... July 3	
Atlantic Transport.		
Minnetonka, N. Y.-London... June 26	Mimichaba, N. Y.-London... July 3	
Cunard.		
Campania, N. Y.-Liverpool... June 23	Ivernia, Boston-Liverpool... June 29	
Lusitania, N. Y.-Liverpool... June 30	French Line.	
La Lorraine, N. Y.-Havre... June 24	La Provence, N. Y.-Havre... July 1	
Hamburg-American.		
Graf Waldersee, N. Y.-H'g... June 24	Cleveland, N. Y.-Hamburg... June 29	
Pres. Grant, N. Y.-Hamburg... June 30	Leyland Line.	
Canadian, Boston-Liverpool... July 7	North German Lloyd.	
K. W. der Grosse, N. Y.-H'm'd... June 23	Berlin, N. Y.-Med. Ports... June 26	
K. Wilhelm H., N. Y.-Bremen... June 29	White Star.	
Adriatic, N. Y.-S'ampton... June 23	Arctic, N. Y.-Liverpool... June 29	
Corie, N. Y.-Med. Ports... June 26	Cymic, Boston-Liverpool... June 26	
Romanic, Boston-Med. Ports... July 3		

well as those for the patron blessed with a plethoric purse. These reflections are inspired by a cursory look through the well-stocked warehouses of Bayerdorfer & Co., Philadelphia, who display for inspection a bewildering array of new home made and recently imported material, well fitted to inspire the heart of the florist who wishes to excel and knows the value of having a handy reserve of just such goods for various uses when a particular customer drives up to the office door.

- NEW FLOWER STORES.**
- Greenford, O.—M. C. Clay.
 - Easton, Pa.—Paul Kaffe, 3rd and Church streets.

Kansas City, Mo.—The Alpha Floral Co. celebrated their seventh anniversary as a business house on June 4 by giving a carnation to every caller at their store, 1105 Walnut Street.

ALEX. MCCONNELL

571 FIFTH AVENUE
NEW YORK CITY

Telegraphic orders forwarded to any part of the United States, Canada, and all principal cities of Europe. Orders transferred or intrusted by the trade to our selection for delivery on steamships or elsewhere receive special attention.

Telephone Calls, 487 and 488 38th St.
Cable Address, ALEXCONNELL

M. A. BOWE

In the Heart of New York City
1294 Broadway
NEW YORK

Our Motto—The Golden Rule

DAVID CLARKE'S SONS

Deliver orders from any part of the country to
New York City
Or OUT-GOING STEAMERS

Write or telegraph
2139-2141 Broadway, New York
Telephone 1552-1553 Columbus

YOUNG & NUGENT

42 West 28 St., NEW YORK
"FLOWERS BY TELEGRAPH"

ALBANY, N. Y.

EYRES

Flowers or Design Work

DELIVERED IN ALBANY AND VICINITY OF TELEGRAPHIC ORDER.

11 NORTH PEARL ST., ALBANY, N. Y.

Flower Deliveries

In Brooklyn and other Long Island Points
New York City, New Jersey, etc. At Theaters, Hotels, Steamers or Residences.

WILSON

Fulton St. and Greene Ave., Brooklyn, N. Y.

DANKER, Albany, N. Y.

ORDERS FOR
Choice Flowers and
Floral Emblems
FILLED PROMPTLY

Orders by Wire Receive Prompt and Careful Execution

J. Newman & Sons
Corporation

24 Tremont Street, BOSTON

Theater, Steamer and Funeral Flowers Our Specialty
We can refer to leading florists in all principal cities.
Established 1820.

LOUISVILLE, KY.

JACOB SCHULZ,
550 South Fourth Ave.

WELLESLEY COLLEGE
Dana Hall, Walnut Hill and Rockbridge Hall
Schools. TAIL BY, Wellesley, Mass.
Tel. Wellesley 44-1 and 2. Night 44-3.

In ordering goods please add "I saw It in HORTICULTURE."

YOU CAN'T LOSE US IN JUNE

Or Any Other Month in the Year

The Florist who Can't Show **Bayersdorfer & Co's** Fancy Goods to his Customers Every Day for the Next Month is shy on Enterprise and will be shy on business he might have had. That's All. It's not too late, Write or Telegraph.

THE Florists' Supply House of America

H. BAYERSDORFER & CO., 1129 Arch St., Philadelphia, Pa.

CHICAGO NOTES.

Action by the Flower Trade.

Chicago florists are making strenuous efforts to have the action taken by the board of education, three years ago rescinded.

The school board under the influence of Superintendent Cooley at that time placed an embargo on the giving of cut flowers to the graduates of the Chicago High Schools. This was a serious matter to the florist trade and the action was not submitted to gracefully, each year bringing it up afresh, but the board remained firm.

This year the matter has taken on a new aspect inasmuch as President Cooley is no longer in Chicago, having resigned his position during the early spring. At a meeting of the representative florists at Amling's Friday evening, a committee was appointed to confer with the school board at their next open meeting, June 16th. The committee represents the wholesale as well as the retail trade and consists of eleven members, as follows: F. F. Benthey, A. C. Amling, Phil.

Schupp, C. A. Samuelson, John Zeck, W. N. Rudd, J. C. Vaughan, G. C. Yarnell, A. Lang, J. B. Deamud and Peter Reinberg. From these F. F. Benthey and W. N. Rudd have been selected as speakers to plead for a return of the old days when the sweet girl graduate could close her school-days amid banks of flowers bestowed by admiring friends.

General News.

In the many new greenhouses now being erected in and about Chicago cement posts are quite generally used. Many florists are also trying the cement benches, and the results so far have been on the whole quite satisfactory. According to the E. H. Hunt Co., which specializes in this line, there is a saving in first cost of 25 per cent. They have a valuable little booklet out on this subject, free for the asking, and many dollars are to be saved by the man who reads it carefully.

Incongruous as it at first appears, it is a move in the right direction to have the unoccupied places in the Chicago stock yards embellished with flower beds and clumps of shrubbery. The planting began around the office, but has spread to the various parts of the grounds, and though for the benefit of the visitors it is to be expected that the workers in this gruesome place will appreciate the touch of beauty.

The parsy season is very backward. The cut flowers were not satisfactory this year and now the cold weather is greatly retarding the outdoor stock. Chas. Cassier of Maywood has completed the first two of his range of greenhouses.

Personal.

Visitors: W. W. Coles, Kokomo, Ind.; J. Northrup, Minneapolis, Minn.; Mr. Davis and Mr. Timme, Morristown, Ill.; C. P. Braslin, San Jose, Cal.; Frank Budlong, of J. A. Budlong's Sons' Co., Providence, R. I.; Mrs. A. L. Glaser, Dubuque, Iowa; Mr. Van Aken, Cold Water, Mich.

Miss Hertha Tonner has received word of the critical illness of her sister, Mrs. T. D. Cobb, in Los Angeles, Cal. Mrs. Cobb was for many years in Chicago and had a flower store at 33rd street and Cottage Grove avenue.

Springfield, O.—Samuel F. McGrew, receiver for the Fairview Floral Co., has asked permission to sell the property, as the business as carried on at present cannot be done at a profit.

"FLOWERS BY TELEGRAPH."

Leading Retail Florists Listed by Towns for Ready Reference.

- Denver, Colo.—Park Floral Co., 1706 Broadway.
- Washington D. C.—Gude Bros., 1214 F St.
- Chicago—Hauswirth, "The Florist," 232 Michigan Ave.
- Chicago—William J. Smith, Michigan Ave. and 31st St.
- Chicago—George Wittbold Co., 1657-59 Buckingham Place.
- Louisville, Ky.—Jacob Schulz, 550 South Fourth Ave.
- Boston—Thos. F. Galvin, 124 Tremont St.
- Boston—Edward MacMullin, 194 Boylston St.
- Boston—Hoffman, Florist, 59-61 Massachusetts Ave.
- Boston—J. Newman & Sons, Inc., 21 Tremont St.
- Boston—Julius A. Zinn, 2 Beacon St.
- Wellesley, Mass.—Tally.
- Detroit, Mich.—J. Breitmeyer's Sons, Miami and Gratiot Aves.
- Kansas City, Mo.—Samuel Murray, 1071 Broadway.
- Kansas City, Mo.—Wm. L. Rock Flower Co., 1136 Walnut St.
- Albany, N. Y.—H. G. Eyres, 11 N. Pearl St.
- Albany, N. Y.—F. A. Danker, 40 Malden Lane.
- New York—David Clarke's Sons, 2139-2141 Broadway.
- New York—Alex. McConnell, 571 5th Ave.
- New York—Young & Nugent, 42 W. 23th St.
- New York—M. A. Rowe, 1294 Broadway.
- Brooklyn, N. Y.—Robert G. Wilson, Fulton St. and Greene Ave.
- Buffalo, N. Y.—Palmer's, 304 Main St.
- Toronto, Can.—J. H. Dunlop, 96 Yonge St.

St. Louis, Mo.—The heavy rainfall on June 3 caused an overflow in the north and west parts of the city. John F. Quinn's florist establishment was invaded by a crowd of Italian laborers seeking shelter, and considerable damage done to his potted plants.

BOSTON'S BEST
In Quality and Design

Can be relied upon when you transfer your retail orders to

EDWARD MACMULKIN
194 Boylston Street, Boston

Send flower orders for delivery to
BOSTON
and all
NEW ENGLAND POINTS
THOS. F. GALVIN
124 Tremont St., Boston



TRANSFER
Your orders for flower or plant delivery in Eastern New England to
JULIUS A. ZINN,
2 Beacon St., Boston.
FINE DESIGN WORK A SPECIALTY

THE BEST LETTERS

FOR **R** THOSE
FLORISTS MADE
USE BY THE

Boston Florist Letter Co.
66 PEARL ST., BOSTON
N. F. MCCARTHY, Mgr.

Order direct or buy from your local supply dealer. Insist on having the
BOSTON
Inscriptions, Emblems, etc., Always in Stock

BEAUTIES
Best \$3.00 per dozen. \$20.00 per 100.

S. PEAS
.75-\$1.00 per 100. \$6.00 per 1000.

FERNS
Note our price. \$1.00 per 1000.

THE LEO NIESSEN CO.
1209 Arch St., Philadelphia, Pa.
Open from 7 a. m. to 8 p. m.

To Cut Flower Growers and Retail Florists

IF YOU

want to find a market for your product

want a regular or special supply of the product of the best growers

Consult the Advertisements on these Wholesale Flower Pages

The Advertisers Represented Here are the Leading Concerns in the Wholesale Flower Trade

NEW CROP KAIZERINS
\$4.00 to \$10.00 per 100

W. E. McKISSICK & BROS.
WHOLESALE FLORISTS
1619-1621 RANSTEAD ST.
PHILADELPHIA

WELCH BROS.

AMERICAN BEAUTY, KILLARNEY, RICHMOND, MARYLAND AND ALL THE SUPERIOR ROSES, LILY OF THE VALLEY, CARNATIONS, ORCHIDS

BEST PRODUCED

226 Devonshire Street, Boston, Mass.

CUT FLOWER BOXES
EDWARDS FOLDING BOX CO
MANUFACTURERS
PHILADELPHIA, PA.

WHOLESALE FLOWER MARKETS—TRADE PRICES—Per 100 TO DEALERS ONLY

	CHICAGO June 14		TWIN CITIES June 14		PHILA. June 15		BOSTON June 16	
ROSES								
Am. Beauty, Fancy and Special.....	25.00	to 30.00	28.00	to 38.00	12.50	to 25.00	26.00	to 25.00
" Extra.....	30.00	to 25.00	20.00	to 18.00	10.00	to 12.00	18.00	to 18.00
" No. 1.....	10.00	to 20.00	10.00	to 20.00	6.00	to 8.00	4.00	to 8.00
" Lower grades.....	6.00	to 9.00	5.00	to 10.00	to 4.00	2.00	to 3.00
Bride, 'Maid, Golden Gate, F. & S.....	6.00	to 8.00	6.00	to 8.00	4.50	to 6.00	1.00	to 6.00
" Lower grades.....	4.00	to 6.00	4.00	to 6.00	3.00	to 3.00	.50	to 3.00
Killarney, Fan, & Sp.....	6.00	to 10.00	6.00	to 10.00	8.00	to 10.00	6.00	to 8.00
" Lower grades.....	4.00	to 6.00	4.00	to 6.00	1.00	to 4.00	.50	to 6.00
Richmond, Fancy & Special.....	6.00	to 10.00	6.00	to 10.00	8.00	to 10.00	8.00	to 10.00
" Lower grades.....	4.00	to 6.00	4.00	to 6.00	1.00	to 4.00	.50	to 4.00
Chateaux.....	6.00	to 10.00	6.00	to 8.00	4.00	to 10.00	.50	to 8.00
My Maryland.....	to	to	2.00	to 8.00	.50	to 8.00
CARNATIONS								
Fancy.....	3.00	to 3.00	3.00	to 4.00	2.00	to 4.00	.50	to 1.00
Ordinary.....	1.50	to 2.00	1.50	to 3.00	1.50	to 1.00	.25	to .50
MISCELLANEOUS								
Carlays.....	10.00	to 60.00	50.00	to 75.00	40.00	to 50.00	30.00	to 40.00
Lilies.....	10.00	to 12.00	10.00	to 12.00	10.00	to 15.00	6.00	to 8.00
Lily of the Valley.....	3.00	to 4.00	3.00	to 4.00	3.00	to 4.00	1.00	to 3.00
Mignonette.....	3.00	to 4.00	3.00	to 4.00	2.00	to 4.00	1.00	to 2.00
Sweet Peas.....	.50	to 1.00	.75	to 1.00	.50	to .75	.25	to .50
Gardenias.....	to 50.00	to 50.00	10.00	to 12.50	8.00	to 12.00
Fennies.....	3.00	to 3.00	3.00	to 8.00	3.00	to 6.00	4.00	to 6.00
Daisies.....	to 2.00	1.00	to 1.50	.50	to 1.00	.50	to .75
Stocks.....	8.00	to 10.00	6.00	to 10.00	3.00	to 3.00	.75	to 1.00
Sandragon.....	8.00	to 12.00	6.00	to 10.00	3.50	to 8.00	2.00	to 4.00
Adiantum.....	.75	to 1.00	1.00	to 1.50	1.00	to 1.50	.75	to 1.25
Smilax.....	15.00	to 25.00	15.00	to 20.00	15.00	to 20.00	12.00	to 15.00
Asparagus Plumosus, strigos.....	40.00	to 60.00	30.00	to 50.00	35.00	to 50.00	25.00	to 30.00
" " & Spren. (red hchs.).....	30.00	to 40.00	30.00	to 50.00	35.00	to 50.00	15.00	to 25.50

CHAS. W. MCKELLAR
51 WABASH AVE., CHICAGO

Western Headquarters for Choice Orchids
Valley, Rose and all Cut Flowers

PETER REINBERG
WHOLESALE
CUT FLOWERS
51 Wabash Av., Chicago, Ill

Long Distance Phone, Central 6004
WINTERSON'S SEED STORE
45-47-49 Wabash Ave., Chicago.
Seedsmen, Plantsmen, Nurserymen
Florists' Supplies
We can supply everything used by the Florist. SUPPLY CATALOG FREE. Correspondence solicited.

POEHLMANN BROS. CO.
33-35-37 Randolph St., - CHICAGO
CUT FLOWERS

Greenhouses, - Morton Grove, Ill.
Rice Brothers
118 N. 6th Street, MINNEAPOLIS, MINN.
WHOLESALE FLORISTS and SUPPLIES
CUT FLOWERS received twice daily, and can fill your orders to your satisfaction. A complete line of Hardy Greens - WILD SMILAX, BOXWOOD, HARDY FANCY FERNS, GALAX LEAVES.
Write for quotations on large quantities.

J.A. BUDLONG
37-39 Randolph Street, CHICAGO.

Roses and Carnations
A Specialty.....

WHOLESALE GROWER of **CUT FLOWERS**



HENRY M. ROBINSON & CO.
15 Province St. and 9 Chepman Place - BOSTON, MASS.
WHOLESALE COMMISSION FLORISTS
Hardy Cut Evergreens and Florists' Supplies
New Crop Dagger and Fanc. Ferns \$2.00 per Thousand.
We have the stuff and can fill all orders, large or small.
WE NEVER DISAPPOINT SATISFACTION GUARANTEED



Prices Quoted in these Columns are for Dealers Only.
When Writing to Advertisers Please Mention
HORTICULTURE.

In ordering goods please add "I saw it in HORTICULTURE."

Flower Market Reports.

BOSTON

A very satisfactory activity is noticeable in the market, due to the graduation exercises in the many colleges, seminaries and other educational institutions in which New England abounds and which are an annual adjunct to the shipping trade of Boston. Outside of this special call, however, the demand seems to be very light in what may be designated the regular trade channels. Carnations are very abundant and as they only figure as one of many factors in the graduation demand the values, based upon the street call, are very low. On the other hand, Richmond, Killarney and Carnot roses are exceedingly popular with the debutantes and consequently are holding their own when of good quality. Sweet peas also enjoy a special popularity, but on account of recent damp, nuggy weather, are arriving in bad shape from growers who neglect necessary precautions in packing and only those that reach the consumer in crisp, dry condition get a look-in at the quoted prices. Cattleyas are plentiful and in very light demand. Stocks are in unwieldy supply also, and the market doesn't need them. Peonies are on the rising tide, magnificent in quality but facing trouble in a very few days. Lily of the valley is of nice finish and in fair request. In the entire list the most unfortunate item seems to be the Divine Flower just at present.

Prices are unchanged. The market was greatly depressed early last week but improved later, but is still unsatisfactory. Cold, damp weather prevails and carnations are suffering most, many being worthless. Roses are of fair quality but sales are slow. Peonies are the main stay of trade. Commencement orders are a great boon to those having shipping trade. Wedding calls are about as usual. Plant business is fine. It is predicted that the trade usually considered over in June will hold on well into July.

New York florists experienced an unsatisfactory week up to last Saturday and the early part of the present week has shown no appreciable improvement over its predecessor. Roses continue abundant and of variable quality. There is not much encouragement toward the production of high grade blooms, however, as under present conditions all have to be lumped in at bargain counter valuation and everything has to go. Carnations are even more unfortunate as to selling results and in the case of these also the extra goods get but little reward for being extra. Cattleyas continue in over-supply; there are many very inferior blooms in sight and, on the other hand, some gigas flowers of unexcelled beauty. Lily of the valley is abundant and selling somewhat better. Peonies are in the ascendant and will make the wholesalers' tables gorgeous for a few days more. The retail stores are satisfied with a vase or two of peonies, irises, oriental poppies or mock-orange for their window displays and the greenhouse industry profits little from this source at present. The mock-orange is seen in enormous quantities. Out-

door moss roses are also a feature just the now.

PHILADELPHIA

Trading was fairly brisk during the week (June 7th to 12th), especially towards the latter part, when a good many churches celebrated Children's Day, and used up large quantities of the lower-priced grades of flowers. The clean-up on Saturday was better than expected, and on the whole the situation wound up in fairly satisfactory shape. American Beauty roses continue plentiful, and of excellent quality, the growers now having their relay planning operations so well arranged that they have enough to supply all ordinary demands, no matter what the season. Liberty has the call over Richmond, the latter not being nearly as good a hot weather rose. Bridesmaids are showing the effects of the warm weather, and Jardine for the same reason is a negligible quantity. Killarney, Maryland and Kaiserin are all in excellent shape and are the leaders in their respective classes. Only a few of the carnation growers are able to send in first-class stock at present—the great majority of receipts show-



VALLEY, BEAUTIES, CATTLEYS,

The week's leaders. Buy liberally and push them. No retailer should allow it to be said: "Asleep at the post!"

Cattleyas

(Gaskelliana and others, now in season.)

\$7.50 per doz.

Beauties

Specials \$3.00 per doz.; \$20.00 per 100
Other Grades \$1.00 to \$2.00 per doz.

Valley

The "come-again" kind. Best quality reaching this market. Unlimited quantity
\$3.00 and \$4.00 per 100

SWEET PEAS

lavender, pink, white and flesh 50c and 75c per 100

CARNATIONS

Specials \$4.00, Fancies \$3.00, Second's \$2.00 per 100
Our Selection, good quality, in lots of 500 or over, at \$2.00 per 100

PLUMOSA STRINGS

Extra Heavy 50c each, \$40.00 per 100

S. S. PENNOCK - MEEHAN CO.
The WHOLESALE FLORISTS Philadelphia
1608-1620 Ludlow Street Store closes 6 p. m.
Washington Store, 1212 New York Ave.

ing the effects of the advancing season. The worst sufferer of all from the damp, warm weather is the sweet pea. There are very few local gardenias arriving—but the southern cut is very good and fills the gap nicely. Cattleyas are not nearly as plentiful, and have hardened in price. Mossiae is over, and Gaskelliana is now the leader.

WHOLESALE FLOWER MARKETS. PER 100. TO DEALERS ONLY.

	CINCINNATI June 14	DETROIT June 14	BUFFALO June 14	PITTSBURG June 14
ROSES				
Am. Beauty, Fac. and Sp.	20.00 to 25.00	20.00 to 25.00	20.00 to 25.00	20.00 to 25.00
" Extra	15.00 to 20.00	15.00 to 20.00	12.00 to 15.00	10.00 to 15.00
" No. 1	7.00 to 12.00	10.00 to 12.00	6.00 to 10.00	6.00 to 8.00
" Lower grades	4.00 to 6.00	4.00 to 8.00	2.00 to 4.00	2.00 to 4.00
Bride, "Maid, Golden Gate, F. & S.	5.00 to 6.00	5.00 to 6.00	5.00 to 8.00	6.00 to 8.00
" Low grades	3.00 to 4.00	3.00 to 4.00	2.00 to 4.00	2.00 to 4.00
Killarney, Fac. & Sp.	5.00 to 6.00	4.00 to 6.00	5.00 to 8.00	6.00 to 8.00
" Lower grades	3.00 to 4.00	3.00 to 4.00	2.00 to 4.00	2.00 to 4.00
Richmond, Fancy & Special	6.00 to 8.00	5.00 to 8.00	8.00 to 10.00	10.00 to 12.00
" Lower grades	3.00 to 4.00	3.00 to 5.00	2.00 to 4.00	2.00 to 6.00
Chatenay	4.00 to 6.00	3.00 to 6.00	3.00 to 4.00	2.00 to 6.00
My Maryland
CARNATIONS				
Fancy and Novelties	2.00 to 3.00	2.00 to 3.00	2.00 to 2.50 to 1.50
Ordinary	1.00 to 1.50	1.00 to 2.00	1.00 to 2.00 to 1.00
MISCELLANEOUS				
Cattleyas to 35.00 to 50.00 to 60.00 to 75.00
Lilies	8.00 to 10.00	12.50 to 15.00	8.00 to 15.00 to 12.00
Lily of the Valley	3.00 to 4.00	3.00 to 4.00	3.00 to 4.00	3.00 to 4.00
Mignonette	2.00 to 3.00	2.00 to 3.00	1.00 to 2.00	2.00 to 3.00
Sweet Peas	.50 to .75	.50 to .75	.50 to 1.00	.25 to 1.00
Gardenias to 20.00 to 30.00 to 40.00 to 50.00
Daisies	5.00 to 6.00	5.00 to 6.00	5.00 to 6.00	3.00 to 6.00
Stocks	5.00 to 1.00	7.50 to 1.00	7.50 to 1.50	5.00 to 1.50
Nonparings	3.00 to 4.00	2.00 to 4.00	1.00 to 1.50	1.00 to 3.00
Spidering	3.00 to 4.00	2.00 to 4.00 to 3.00	3.00 to 6.00
Adiantum	1.00 to 1.00	1.00 to 1.50	1.00 to 1.50	1.00 to 1.75
Smilax	10.00 to 15.00 to 15.00 to 15.00	15.00 to 20.00
Asparagus Plumosus, strings	40.00 to 50.00	20.00 to 30.00	50.00 to 60.00	30.00 to 50.00
" " & Sprea (100 bchs.)	20.00 to 30.00	20.00 to 30.00	25.00 to 50.00	30.00 to 40.00

FORD BROTHERS
 48 West 28th Street NEW YORK
FINE ROSES FANCY CARNATIONS
 A Full Line of All Cut FLOWERS
 Telephone, 3870 or 3871 Madison Square

H. E. FROMENT
 Wholesale Commission Florist,
 Choice Cut Flowers,
 57 West 28th St. :: NEW YORK
 Telephone: 2200, 2201, Madison Square.

Alfred H. Langjahr
 All choice cut-flowers in season. Send for quotations. Correspondence with shippers of first-class stock invited.
 55 West 28th Street, New York
 Telephone 4626-4627 Madison Square

Edward C. Horan
 Wholesale Florist
 53 WEST 28th ST.
 Tel. 1462 Madison Square New York

PHILIP F. KESSLER
 55 & 57 W. 26th St., New York.
CUT FLOWERS WHOLESALE
 Open from 5 a. m. to 6 p. m. Sunday till 10 a. m.
FINEST LILIES IN THE MARKET.
 Tel. 5243 and 5221 Madison Square.

JOHN YOUNG
WHOLESALE FLORIST
 Finest American Beauties and Carnations
 51 West 28 St. - NEW YORK

FRANK MILLANG
 Wholesale Florist
 55-57 West 26th St., NEW YORK
 Shipments, any quantity, Wholesale Market Rates.

Greater New York Florists' Association, Inc.
 Now Open for Cut Flower Consignments
 162 Livingston Street, BROOKLYN, N. Y.
 Geo. W. Crawbuck Telephone Connection
 Manager 3642-43 Main

Moore, Hentz & Nash
 Wholesale Commission Florists
 55 and 57 West 26th Street
 Telephone No. 756 Madison Square New York

MILLANG BROS.
 WHOLESALE COMMISSION FLORISTS
 41 West 28th Street
 Telephone 3860 3361 Madison NEW YORK

JOHN I. RAYNOR
 Wholesale Commission Florist **SELLING AGENT FOR LARGEST GROWERS**
 A full line of Choice Cut Flower Stock for all purposes. Comprises every variety grown for New York market, at current prices
 TEL. 1998 MADISON SQUARE 49 West 28th St., New York City

Walter F. Sheridan
 Wholesale Commission Dealer in
CHOICE CUT FLOWERS
 39 West 28th Street, New York
 Telephone: 3532-3533 Madison Square

HEADQUARTERS FOR NOVELTIES ORCHIDS A SPECIALTY
 THE HIGHEST GRADE OF VALLEY ALWAYS ON HAND
CARDENIAS, DAISIES, ROSES AND CARNATIONS
JAMES McMANUS, Telephone 753 Mad. Sq. 42 W. 28th St., New York

NEW YORK QUOTATIONS PER 100. To Dealers Only

ROSES AND CARNATIONS	Last Half of Week ending June 12 1909		First Half of Week beginning June 14 1909	
American Beauty, Fancy and Special.....	15.00	10 20.00	15.00	21.00
" " Extra.....	6.00	10 10.00	6.00	8 00
" " No. 1.....	4.00	10 5.00	3.00	10 5.00
" " Lower Grades.....	.50	10 2.00	.50	10 2.00
Bride, "Told, Golden Gate, Fancy and Special.....	2.00	10 4.00	4.00	10 6.00
" Lower Grades.....	.50	10 1.00	.50	10 2.00
Killarney, Fancy and Special.....	3.00	10 6.00	4.00	10 6.00
" Lower Grades.....	.50	10 1.00	.50	10 2.00
Richmond, Fancy and Special.....	3.00	10 6.00	4.00	10 6.00
" Lower Grades.....	.50	10 1.00	.50	10 1.00
Chatenay.....	.50	10 6.00	.50	10 6.00
Ty Maryland.....	.50	10 6.00	.50	10 6.00
Carnations, Fancy and Novelties.....	1.00	10 3.00	1.00	10 3.00
" Ordinary and White.....	.25	10 .50	.50	10 .75

Alexander J. Guttman
THE WHOLESALE FLORIST OF NEW YORK
 34 WEST 28th STREET
 PHONES. 1664-1665 MADISON SQUARE
ENOUGH SAID

CENTRALLY LOCATED, THE HUB OF THE FLOWER MARKET SECTION
CHARLES MILLANG
 Wholesale Florist
 444 Sixth Ave., NEW YORK
 Telephone 7062 Madison

GEORGE COTSONAS & CO.
 Wholesale and Retail Dealers in all kinds of **EVERGREENS**
 Fancy and Dagger Ferns
 Bronze and Green Galax
Main Store 50 W. 28 St.
 Phone 1202 Mad. Sq. New York

GROWERS' CUT FLOWER CO. CUT FLOWERS AT WHOLESALE
VIOLETS, CARNATIONS, ROSES ORCHIDS, CHRYSANTHEMUMS, LILIES
 Consignments Solicited, Shipments to Order, any Distance
 39 West 28th Street, Telephone 6327 Madison Square J. J. COAN, Manager NEW YORK

Durand & Marohn
 MANUFACTURERS OF
All Kinds of Wire Work
 Florists' Wire Designs a Specialty
 24 Beaver St., ALBANY, N. Y

WILLIAM H. KUEBLER
 Brooklyn's Foremost and Best
WHOLESALE COMMISSION HOUSE
 A First Class Market for all CUT FLOWERS
 28 Willoughby St., Brooklyn, N. Y.
 Tel. 4591 Main

NOTICE!

Manhattan Flower Market

WHOLESALE FLORISTS
46 W. 28th St., NEW YORK
Telephone: 1016 Madison Sq.

Ship us some stock. We need a large supply of all kinds of flowers, Roses, Carnations, Sweet Peas, Narcissus, Summer Stock, etc., for our new store. Reliability and responsibility first-class. Good prices and prompt returns, Good opportunity.

WHOLESALE FLORISTS
54 West 28th St.
NEW YORK
Telephone 3559 Madison Sq.

A. L. YOUNG & CO.

RECEIVERS & SHIP-
PERS OF CUT
FLOWERS.
CONSIGNMENTS SOLICITED.

REED & KELLER
123 West 28th St., New York
Florists' Supplies

Metal Designs, Baskets, Wire Work & Novelties
and are dealers in
Decorative Greens and Florists' Requisites

MICHIGAN CUT FLOWER
EXCHANGE, Inc.

WHOLESALE COMMISSION FLORISTS
Consignments Solicited
Hardy Fancy Fern Our Specialty
38-40 BROADWAY, DETROIT, MICH.

FOR FLORISTS' USE
There's NOTHING as good as
MEYER'S SILKALINE
Don't let them sell you anything else
JOHN C. MEYER & CO., Boston, Mass.

Krick's Genuine Immortelle
Letters, Etc.
The Best and Cheapest. Accept no
Substitute. Every Letter Marked
KRICK'S LETTERS
1164-66 Greene Av., Brooklyn, N. Y.
For Sale by all Supply Houses

Wired Toothpicks
Manufactured by
W. J. COWEE, BERLIN, N. Y.
\$1.75; \$0.00...\$7.50. Sample free.
For sale by dealers

WILLIAM F. KASTING CO.
WHOLESALE FLORISTS
383-387 Ellicott Street
BUFFALO, - N. Y.

ROBERT J. DYSART
Public Accountant and Auditor
Simple methods of correct accounting
especially adapted for florists' use.
Books Balanced and Adjusted
Merchants Bank Building
28 STATE STREET, - BOSTON
Telephone, Main 58.



I KEEP OPEN HOUSE THIS SUMMER
For the Sale and Shipment of Flowers.
Good Stock. Favorable Prices.

J. K. ALLEN 106 W. 28th St., New York
Tel. 167 Madison Sq.
Open 6 A. M. Daily.

Table with columns: MISCELLANEOUS, Last Half of Week ending June 12 1909, First Half of Week beginning June 14 1909. Rows include Cattleyas, Lilies, Lily of the Valley, Peonies, Daisies, Stocks, Mignonette, Sweet Peas, Gardenias, Adiantum, Semex, Asparagus Plumosus, etc.

PHILADELPHIA NOTES.
The Pennock-Meehan Co. will close
at 6 p. m. for the summer months,
commencing June 21st.

The sweet pea show will be held at
Horticultural Hall, Broad and Locust
street, Tuesday, June 29th, from 3 to
10 p. m.

Edwin Lonsdale, superintendent of
Gardens and Grounds at Girard Col-
lege, and Mrs. Lonsdale are contem-
plating a trip to Bermuda in the near
future.

Miss Elizabeth Burton, daughter of
John Burton, the well known rose
grower, of Chestnut Hill, graduated
with honors from Swarthmore College,
June 5th.

J. Max Nietschke, late of Hoffman's,
Boston, is now with Habermehl's Bel-
vue-Stratford establishment, doing the
debonair and handsome for the four
hundred of Philadelphia.

George D. Clark of Dreer's has a
good word to say for the latifolius
section of the Dianthus family. They

are very valuable as cut flowers. He
gives Dr. Van Fleet much credit for
good work in this connection.

Andrew Wilson and his plant oil
have been with us. He thinks the
Philadelphia gardeners are very
bright boys. That means some good
orders of course. The way has been
well paved for him in advance, as he
has been an intelligent and consistent
advertiser.

Ernst F. Hoehl, late of Madison, N.
J., is the lessee of the Bunting place at
55th and Elmwood avenue, and is
making a success of it. His special-
ties are sweet peas, Asparagus plumo-
sus, adiantum, mignonette, and daisies.
He will add pot plants to the list the
coming season.

The date for the Waretown opening
has just been announced by Commo-
dore Westcott. It will be Friday,
June 25. Who the lucky participants
will be is not yet known. The accom-
modations are limited to twenty,
and the outsiders—composed of a mil-
lion or so—are all putting on their
sweetest for the time being—when
the commodore is around. He'd in-

vide everybody if it were possible.
The commodore's heart is much big-
ger than his club house. What we
want is a few more club houses on
this lovely location. Come on you
tired western millionaire florists.
Lots of room. Buy a few acres.

Alfred E. Purk has built a seventy-
five thousand-dollar mansion at Jef-
ferson and Carlisle streets, and will
shortly add to it an eighteen thousand-
dollar conservatory and garage. Mr.
Burk is a leather merchant of this city
and is an orchid fancier like his
brother, Louis Burk, the wealthy pork
packer. Louis Burk resides at Olney
and conducts his private conservato-
ries there on a commercial basis under
the name of the Grovedale Nurseries.
He has a fine collection of orchids and
the estate also boasts one of the best
examples of Japanese gardening in this
vicinity. He is superintending the
work of laying out the grounds, and
building and stocking the conservatory
on his brother's new place as he per-
sonally takes great delight in this sort
of pastime. He is a member of the
Florists' Gun Club and the Horticul-
tural Society.

Buyer's Directory and Ready Reference Guide

Advertisements under this head, one cent a word. Initials count as words.

Display advertisers in this issue are also listed under this classification without charge. Reference to List of Advertisers will indicate the respective pages.

Buyers failing to find what they want in this list will confer a favor by writing us and we will try to put them in communication with reliable dealers.

ACQUINTANT

R. J. Dycart, 28 State St., Boston.
For page see List of Advertisers.

AQUATIC PLANTS

Aquarium plants the year round. Wholesale and retail. Send for price list. Schmidt's Emporium of Pets, 712 12th Street, Washington, D. C.

AQUELIAS

Aquelias. Genuine Corolla, finest of all. Both plants and seeds from the heart of the Rockies. C. S. Harrison's Select Nursery, York, Neb.

ARAUCARIAS

A. Leuthy & Co., Perkins St. Nurseries, Roslindale, Mass.
For page see List of Advertisers.
Geoffrey Aschmann, 1012 West Ontario St., Philadelphia, Pa.
For page see List of Advertisers.

ASPARAGUS PLUMOSUS

William C. Smith, Market & 61st St., Philadelphia, Pa.
For page see List of Advertisers.
Charles H. Totty, Madison N. J.
Asparagus Plumosa and Sprengeri.
For page see List of Advertisers.

ASPARAGUS SEED

Asparagus Plumosus Seed. Fresh, lathouse grown, \$1.75 per 1000. Special price in quantities. Immediate delivery. Cash. Oak Grove Nurseries, Office, 404 North Los Angeles St., Los Angeles, Cal.

ASTERS

J. C. Schmidt, Bristol, Pa.
For page see List of Advertisers.
Crego, the most of the Giant Comet asters, light pink and white, 50c. per 100; \$4.00 per 1000. Edward Harris, Cumberland, Md.

AUCTION SALE

Wm. Elliott & Sons,
42 Vesey St., New York.

AZALEAS

A. Leuthy & Co., Perkins St. Nurseries, Roslindale, Mass.
For page see List of Advertisers.
Geoffrey Aschmann, 1012 W. Ontario St., Philadelphia, Pa.
For page see List of Advertisers.

BAMBOO CANES

Yokohama Nursery Co., 31 Barclay Street, New York, N. Y.
Bamboo Sticks, Colored Green.
For page see List of Advertisers.

BAW TREES.

2000 Bay and Box Trees in all sizes. Standard and Standards. Write for list. Johns Rooters, Rotterdam, N. J.

BEDDING PLANTS

A. Leuthy & Co., Perkins St. Nurseries, Roslindale, Mass.
For page see List of Advertisers.
G. Aschmann, 1012 W. Ontario St., Philadelphia, Pa.
For page see List of Advertisers.
R. Vincent, Jr. & Sons Co., White Marsh, Maryland.
For page see List of Advertisers.
J. C. Schmidt, Bristol, Pa.
For page see List of Advertisers.
C. G. Daniels, Bingham, 3 in., \$2.00 per 100; 2 in., \$1.50 per 100. Ernest Harris, Johnson, N. Y.

BEGONIAS

Elmsford Nurseries, Elmsford, N. Y.
Lorraine Begonias.
For page see List of Advertisers.
Thomas Rohod, Sabant, Mass.
Begonia Gloire De Lorraine.
For page see List of Advertisers.

J. A. Peterson.
McHenry Ave., Westwood, Cincinnati, O.
Begonia President Taft. Winter Flowering.
Begonia Gloire de Lorraine and Agatha, propagated from leaf cuttings, \$15.00 per 100; \$140.00 per 1000. Only good strong plants sent out. J. A. Peterson, McHenry Ave., Westwood, Cincinnati, O.

Begonia Verona and Luminosa, \$5.00, \$6.00 and \$7.00 per 100. Rose Hill Nurseries, New Rochelle, N. Y.

Now ready for delivery, Begonia Gloire de Lorraine, strong, healthy stuff, all propagated from leaf cuttings, and ready for 3 and 4 inch pots; \$15.00 per 100, \$140.00 per 1000. New winter flowering Begonia "Pres. Taft." Awards—Bronze Medal, S. A. E. Chicago, Nov., 1908; certificate of Merit by Pittsburg and Allegheny Florists' Club, Newport, R. I., Horticultural Society, and New York Florists and Gardeners' Club. This beautiful winter-flowering Begonia originated in our nurseries about two years ago; it is stronger, sturdier and more beautiful than any of its predecessors. In color it is similar to Agatha; it is free and continuous flowering from November to April; each flower the size of a silver dollar. \$4.00 per dozen, \$25.00 per 100. Cash with order from unknown correspondents. J. A. Peterson, McHenry Ave., Westwood, Cincinnati, O.

BEGONIA REX

J. H. Dann & Son, Westfield, N. Y.
For page see List of Advertisers.

BOILERS

BOILERS. "Burnham" Boilers made for greenhouse heating. Lord & Burnham, 1133 Broadway, N. Y.
Kroeschell Bros. Co., 35 Erie St., Chicago.
For page see List of Advertisers.

BOOKS

Pronunciation of Plant Names, sent for 50 cents, postpaid, by HORTICULTURE PUBL. CO., 11 Hamilton Place, Boston.

BOXWOOD TREES

New England Nurseries, Inc., Bedford, Mass.
For page see List of Advertisers.

Box Trees. Very complete assortment in various sizes of bush, pyramidal and standard forms. State quantity and sizes wanted. Write for special prices. Wagner Park Conservatories, Sidney, Ohio.

BUILDING MATERIAL

BUILDING MATERIAL of all description for All Express, Sent Free, from Frames of Truss Houses, Hot Bed Sashes and Frames. Lord & Burnham Co., 1133 Broadway, N. Y.

BULBS AND TUBERS

Joseph Breck & Sons, 47-54 N. Market St., Boston.
For page see List of Advertisers.
J. M. Thorburn & Co., 33 Barclay St., New York.
For page see List of Advertisers.
A. T. Boddington, 342 W. 14th St., N. Y.
For page see List of Advertisers.
Richards Bros., 37 East 9th St., New York.
For page see List of Advertisers.
H. F. Mitchell Co., Philadelphia.
For page see List of Advertisers.

BULBS AND TUBERS — Continued

H. E. Fiske Seed Co., Panell Hall Sq., Boston.
For page see List of Advertisers.
T. J. Grey & Co., 32 and 33 So. Market St., Boston.
For page see List of Advertisers.
Yokohama Nursery Co., 31 Barclay St., New York.
For page see List of Advertisers.
Ralph M. Ward & Co., 12 W. Broadway, New York.
For page see List of Advertisers.
Schlegel & Futher Co., 26 & 27 S. Market St., Boston.
Begonias, Gloxinias, Tuberoses.
For page see List of Advertisers.

CANNAS

R. Vincent, Jr. & Sons Co., White Marsh, Maryland.
For page see List of Advertisers.
Estate of David Fisher, Woburn, Mass.
For page see List of Advertisers.
J. H. Dann & Son, Westfield, N. Y.
For page see List of Advertisers.

CARANIONS

Baur & Smith, 38th & Senate Sts., Indianapolis, Ind.
Patten & Co., Tewksbury, Mass.
Caranion Shasta.
For page see List of Advertisers.

F. Dornier & Sons Co., Lafayette, Ind.
Caranions for immediate delivery.
For page see List of Advertisers.
Chicago Caranion Co., Joliet, Ill.
Mary Tolman.
For page see List of Advertisers.
Wood Bros., Fishkill, N. Y.
Caranions. Rooted Cuttings.
For page see List of Advertisers.
The E. G. Hill Co., Richmond, Ind.
Caranion Cuttings.
For page see List of Advertisers.

Poehmann Bros. Co., Morton Grove, Ill.
For page see List of Advertisers.

CHRYSANTHEMUMS

E. G. Hill Co., Richmond, Ind.
For page see List of Advertisers.
S. J. Ruter & Son, Westery, R. I.
For page see List of Advertisers.
C. H. Totty, Madison, N. J.
For page see List of Advertisers.
Wood Bros., Fishkill, N. Y.
Chrysanthemums Rooted Cuttings.
For page see List of Advertisers.
Poehmann Bros. Co., Morton Grove, Ill.
For page see List of Advertisers.
Elmer D. Smith & Co., Adrian, Mich.
For page see List of Advertisers.
H. L. Cameron, N. Cambridge, Mass.
White Bonnaillon.
For page see List of Advertisers.
William C. Smith, Market & 61st St., Philadelphia.
For page see List of Advertisers.
L. M. Kayser, Groomport, L. I., N. Y.
For page see List of Advertisers.
75,000 transplanted chrysanthemum cuttings ready to bench: Oph, Kalb, Estelle, Pacific, Cremo, Yellow Jones, Monrovia, Whilidm, Halliday, Bonnaillon, Bailey, \$1.25, 100; \$12.00, 1000. T. W. Baylis & Sons, West Grove, Pa.
Herrington's book on the Chrysanthemum mailed to your address for 50c. by Horticulture Publishing Co., 11 Hamilton Place, Boston.

For List of Advertisers See Page 883

CHRYSANTHEMUMS—Continued

Chrysanthemums, good stocky cuttings from soil; all orders filled promptly; \$1.25 per 100; \$10.00 per 1000.
 White—Estelle, Opah, Oct. Frost, Ivory, Polly Rose, C. Touset, Mrs. Robinson.
 Yellow—Monrovia, fine early, Cremo, Jerome Jones, Maj. Bonnaffon.
 Pink—Glory Pacific, Dr. Eugenehard, Wm. Duckham, Minnie Bailey.
 Red—Black Hawk, Cullingfordi.
 Potted plants of above, 2 1/2 in., \$2.00 per 100. Cash or C. O. D.
 D. H. Green, West Grove, Penn.

Golden Glow and Pacific Supreme, R. C., \$2.75 per 100, prepaid; 1000 not prepaid, \$25; from 2 1/2 in. pots, \$3.50 per 100. Chas. Frost, Kenilworth, N. J.

57 VARIETIES

Best commercial mums, 2 1/2 in. pots, 3c. each. Gloria, 25c. Henry Trail, Frederick, Md.

COAL FOR GREENHOUSE USE

Bader Coal Co., Board of Trade Bldg., Boston.

COLEUS

A. Leuthy & Co., Perkins St. Nurseries, Roslindale, Mass.
 For page see List of Advertisers.

CONIFERS

John Waterer & Sons, Ltd., American Nursery, Bagshot, Eng.
 For page see List of Advertisers.
 Julius Roehrs Co., Rutherford, N. J.

CUT FLOWER BOXES.

Edwards-Folding Box Co., Philadelphia. For page see List of Advertisers.
 Folding cut flower boxes, the best made. Write for list. Bolton & Hunkel Co., Milwaukee, Wis.

DAHLIAS

David Herbert & Son, Atco, N. J. For page see List of Advertisers.
 J. L. Moore, Northboro, Mass. For page see List of Advertisers.
 Peacock Dahlia Farms, Williamstown Junction, N. J. For page see List of Advertisers.
 R. Vincent Jr. & Sons Co., White Marsh, Md. For page see List of Advertisers.

DAHLIAS

Geo. H. Walker, No. Dighton, Mass. Wholesale and Retail.
 Send your name for my 1909 Catalog and Pocket Guide, ready to mail about Feb. 25th.

DECORATIVE PLANTS

A. Leuthy & Co., Perkins St., Nurseries, Roslindale, Mass.
 Imported Plants for Fall Delivery. For page see List of Advertisers.
 Godfrey Aschmann, 1012 W. Ontario St., Philadelphia, Pa. For page see List of Advertisers.
 Joseph Hearock Co., Wynnton, Pa. For page see List of Advertisers.
 The Geo. Wittbold Co., 1637 Buckingham Place, Chicago, Ill. For page see List of Advertisers.
 Robert Craig Co., Market and 8th Sts., Philadelphia, Pa. For page see List of Advertisers.

EVERGREENS

New England Nurseries, Bedford, Mass. For page see List of Advertisers.
 American Nursery Co., 150 Broadway, N. Y. Evergreens. Send 25 cents in stamps for complete work on propagating and growing Evergreens. C. S. Harrison's Select Nursery, York, Neb.

FERNS

A. Leuthy & Co., Roslindale, Mass. For page see List of Advertisers.
 H. B. Barrows & Son, Widman, Mass. Nephrolepis, Marattiaceae. For page see List of Advertisers.
 John Scott, Brooklyn, N. Y. For page see List of Advertisers.

FERNS—Continued

Frank Oechslin, 2570-2906 W. Adams St., Chicago.
 Ferns for List of Dishes.
 For page see List of Advertisers.
 The Geo. Wittbold Co., 1637 Buckingham Place, Chicago, Ill.
 For page see List of Advertisers.
 Godfrey Aschmann, 1012 W. Ontario St., Philadelphia.
 For page see List of Advertisers.
 Jardiniere Ferns, 6-7 best varieties, \$3.50 per 100; \$30.00 per 1000. Rose Hill Nurseries, New Rochelle, N. Y.
 For page see List of Advertisers.

Anderson's ferns for in and outdoors. Largest commercial collection in the country. Ask for descriptive catalogue. J. E. Anderson, Fern Specialist, Short Hills, N. J.

FERTILIZERS

Pulverized Manure Co., 31 Union Stock Yards, Chicago, Ill.
 Wizard Brand Sheep and Shrodded Cattle Manure.
 Bowker Fertilizer Co., Boston, Mass. All Forms of Plant Food at First Hands. For page see List of Advertisers.
 Wm. Elliott & Sons, 42 Vesey St., New York. Sheep Manure. For page see List of Advertisers.

FLORAL PHOTOGRAPHS

Floral Photographs, Foley's, 226-228 1-2 Bovey, New York.

FLORISTS' LETTERS.

Boston Florist Letter Co., 68 Pearl St., Boston, Mass.
 For page see List of Advertisers.

FLORISTS SUPPLIES

N. E. McCarthy & Co., 84 Hawley St., Boston. For page see List of Advertisers.
 H. M. Robinson & Co., 15 Province St. and 9 Chatham Place, Boston, Mass. For page see List of Advertisers.
 Reed & Keller, 122 W. 25th St., New York. For page see List of Advertisers.
 H. Bayersdorfer & Co., 1129 Arch St., Philadelphia. For page see List of Advertisers.
 W. C. Krick, 1164-66 Greene Ave., Brooklyn, N. Y. Immortelle Letters. For page see List of Advertisers.
 S. S. Pennek-Meehan Co., Philadelphia. For page see List of Advertisers.

FLOWER POTS

W. H. Ernest, 28th and M Sts., Washington, D. C. For page see List of Advertisers.
 A. H. Hewes & Co., Cambridge, Mass. For page see List of Advertisers.
 Hiltner Bros., Ft. Edward, N. Y. For page see List of Advertisers.
 The Peters & Reed Pottery Co., Red Pots, Seed Pans, etc., Zanesville, O.
 We make Standard Flower Pots, etc. Write us when in need.
 Wilmar Cup & Pot, Lincoln University, Chester Co., Pa.

FRUIT TREES

Dwight Fruit Trees, by F. A. Waugh, mailed to your address for 25 cents by Horticulture Publishing Co., 11 Hamilton Place, Boston.

GALAX

Michigan Cut Flower Co., 38 and 40 Broadway, Detroit, Mich.
 For page see List of Advertisers.
 George Cotsouas & Co., 50 W. 28th St., New York. For page see List of Advertisers.
 Rice Bros., 115 N. 6th St., Minneapolis, Minn. For page see List of Advertisers.
 H. M. Robinson & Co., 15 Province St. and 9 Chatham Place, Boston. For page see List of Advertisers.

GARDEN HOSE

Revere Rubber Co., Boston, Mass. For page see List of Advertisers.
 Crestline Mfg. Co., Crestline, O.

GERANIUMS

R. Vincent, Jr. & Sons Co., White Marsh, Md.
 New and Standard Varieties. For page see List of Advertisers.
 Godfrey Aschmann, Philadelphia, Pa. For page see List of Advertisers.
 William Swayne, Kennett Square, Pa.
 Geraniums, from 2 1/2 in. pots, \$2.75 per 100; 3 in. pots, \$4.50 per 100; 3 1/2 in. pots, \$6.00 per 100. Extra heavy well branched, from 4 in. pots, \$8.00 per 100. All plants are first-class; good tops. Cash with order, please. C. E. Merritt, Highland Mills, N. Y.

GLADIOLI

J. L. Moore, Northboro, Mass. For page see List of Advertisers.

GLASS

Boston Plate & Window Glass Co., Boston. For page see List of Advertisers.
 Standard Plate Glass Co., 26-30 Sudbury St., Boston. For page see List of Advertisers.
 Foley Mfg. Co., Western Ave., between 25th & 26th Sts., Chicago. For page see List of Advertisers.
 Sharp, Partridge & Co., 224 & Lumber Sts., Chicago. For page see List of Advertisers.
 Parschelsky Bros., Inc., 75 Montrose Ave., Brooklyn, N. Y. For page see List of Advertisers.
 Metropolitan Material Co., 1392-1402 Metropolitan Ave., Brooklyn, N. Y. Greenhouse glass, lowest prices. Johnston Glass Co., Hartford City, Ind. Glass, High Grade, Double Thick Greenhouse Glass. Lord & Burnham, 1133 Broadway, N. Y.

GLAZING POINTS

H. A. Dmeer, Philadelphia, Pa. Perfect Glazing Point. For page see List of Advertisers.
 GLAZING POINTS, Lord & Burnham. Special Glazing Nails (Points), Lord & Burnham, 1133 Broadway, N. Y.

GREENHOUSE BUILDING MATERIAL

Lord & Burnham Co., 1133 Broadway, New York. For page see List of Advertisers.
 Pierson Lumber Co., 1 Madison St., N. Y. For page see List of Advertisers.
 A. T. Stearns Lumber Co., Neponset, Boston. For page see List of Advertisers.
 King Construction Co., N. Tonawanda, New York. For page see List of Advertisers.
 Hitchings & Co., 1170 Broadway, New York. For page see List of Advertisers.
 J. C. Moninger Co., 117 East Blackhawk St., Chicago, Ill. For page see List of Advertisers.
 Foley Mfg. Co., Western Ave., between 25th & 26th Sts., Chicago. For page see List of Advertisers.
 S. Jacobs & Sons, 1570-63 Flushing Ave., Brooklyn, N. Y. For page see List of Advertisers.

GREENHOUSE CONSTRUCTION
 GREENHOUSE CONSTRUCTION, Semi-Iron greenhouse, New Truss Houses and Iron Frame Houses, Lord & Burnham, 1133 Broadway, N. Y.
 J. A. Payne, 260-274 Culver Ave., Jersey City, N. J. For page see List of Advertisers.
 Foley Mfg. Co., Western Ave., between 25th & 26th Sts., Chicago. For page see List of Advertisers.
 Hitchings & Co., 1170 Broadway, New York. For page see List of Advertisers.

In writing to Advertisers kindly mention Horticulture

GREENHOUSE HOSE

Revere Rubber Co., Boston, Mass.
Revere Hose.
For page see List of Advertisers.

GUTTERS

GUTTERS, cast Iron Gutters, L. & B. Improved V-shaped Gutter with drip gutter attachment. Lord & Burnham, 1133 Broadway, N. Y.

HAIL INSURANCE

Florists' Hall Assn. of America.
J. G. Esler, Saddle River, N. J.
For page see List of Advertisers.

HARDY FERNS, MOSS AND GRENS

H. M. Robinson & Co., 15 Province St. and 9 Chapman Place, Boston, Mass.
For page see List of Advertisers.

Michigan Cut Flower Exchange, 38 and 30 Broadway, Detroit, Mich.
For page see List of Advertisers.

George Cotsonas & Co., 50 W. 28th St., New York.
For page see List of Advertisers.

N. F. McCarthy & Co., 84 Hawley St., Boston.
Rice Bros., 115 N. 6th St., Minneapolis, Minn.
For page see List of Advertisers.

HEATING APPARATUS

Lord & Burnham Co.,
1133 Broadway, New York.
For page see List of Advertisers.

Pierson U-Bar Co., 1 Madison Sq., N. Y.
For page see List of Advertisers.

John A. Payne, 260 27 Culver Ave., Jersey City, N. J.
For page see List of Advertisers.

Kroschell Bros. Co., 35 Erie St., Chicago.
For page see List of Advertisers.

HELP FURNISHED

Thos. H. Tambrick, 34 So. 7th St., Phila.
For page see List of Advertisers.

HERBACEOUS PERENNIALS

P. Ouwkerk, P. O. No. 1, Hoboken, N. J.
For page see List of Advertisers.

New England Nurseries, Bedford, Mass.
For page see List of Advertisers.

The Geo. Wittbold Co., 1637 Buckingham Place, Chicago.
For page see List of Advertisers.

HOLLYHOCKS

Hollyhocks, best single and double strains, plants to flower. \$8.00 per 100; \$75.00 per 1000. Rose Hill Nurseries, New Rochelle, N. Y.

HOT-BED SASH

The A. T. Stearns Lumber Co., Neponset, Mass.
For page see List of Advertisers.

Pierson U-Bar Co., 1 Madison Sq., N. Y.
For page see List of Advertisers.

Lord & Burnham Co., 1133 Broadway, N. Y.
For page see List of Advertisers.

Foley Mfg. Co., Western Ave., between 25th & 26th Sts., Chicago.

HYDRANGEAS.

The P. R. Pierson Co., Tarrytown-on-Hudson, N. Y.
For page see List of Advertisers.

Julius Roehrs Co., Rutherford, N. J.

INSECTICIDES.

Neotide kills all greenhouse pests.
P. R. Pierson Co.,
Eleventh St., Owensboro, Ky.
For page see List of Advertisers.

Stump & Waller Co., 50 Barclay St., New York.
Killed Tobacco Dust.
For page see List of Advertisers.

Niagara Sprayer Co., Middleport, N. Y.
Niagara Brand.
For page see List of Advertisers.

Bowker Insecticide Co., Boston, Mass.
Insect Destroying Preparations.
For page see List of Advertisers.

INSECTICIDES — Continued

Wm. Cooper & Nephews, 177 Illinois St., Chicago; Cyril Franchlyn, 62 Heaver St., New York, Agt.
Y I Fluid.
For page see List of Advertisers.

Eastern Chemical Co., Pittsburg St., Boston.
"IMI" Soap Spray.
For page see List of Advertisers.

Hammont's Paint & Slug Shot Works, Fishkill-on-Hudson, N. Y.
Slug Shot.
For page see List of Advertisers.

"The Fumigating Kind Tobacco Powder". The first on the market and the kind that has no many imitators, has our guaranteed tag of satisfaction or money back, and "The Moon Trade Mark" on every bag. \$3.00 per 100 lbs. The H. A. Stothoff Co., Mount Vernon, N. Y., makers and sellers.

JAPANESE PLANTS

Yokohama Nursery Co., 31 Barclay St., New York.
For page see List of Advertisers.

JERUSALEM CHERRIES

JERUSALEM CHERRIES—Fine strong stock, 2 1/2 in. \$2.50 per 100; \$18.00 per 1000. T. N. YATES CO., Mt. Airy, Phila., Pa.

KENTIAS

Godfrey Aschmann,
1012 W. Ontario St., Philadelphia, Pa.
For page see List of Advertisers.

A. Leuthy & Co., Roslindale, Mass.
For page see List of Advertisers.

Jos. Heacock Co., Wyncote, Pa.
Single and Made-Up Specimens.
For page see List of Advertisers.

O. V. Zangue, Hoboken, N. J.
For page see List of Advertisers.

LILY OF THE VALLEY PIPS

Hjalmar Hartmann & Co., Laugausstræde 20, Copenhagen, Denmark.
For page see List of Advertisers.

MASTICA

F. O. Pierce Co., 12 W. Broadway, New York.
For page see List of Advertisers.

MOON VINES

Godfrey Aschmann, Philadelphia, Pa.
For page see List of Advertisers.

MYRTLE

Myrtle, blue for cemetery planting. \$2.00 per 100; \$17.50 per 1000. Geo. A. Dionan, Station 11, Cincinnati, Ohio.

NICO-FUME

Kentucky Tobacco Product Co., Louisville, Ky.
For page see List of Advertisers.

NURSERY STOCK

John Waterer & Sons, Ltd., American Nursery, Bagshot, England.
For page see List of Advertisers.

P. Ouwkerk, 216 Jane St., Weehawken Heights, N. J.
For page see List of Advertisers.

American Nursery Co., 150 Broadway, New York, N. Y.

W. & T. Smith Co., Geneva, N. Y.
For page see List of Advertisers.

Manual of the Trees of North America, by C. S. Sargent, mailed to your address for \$6.00, by Horticulture Publishing Co., 11 Hamilton Place, Boston.

TREES, SHRUBS, ROSES, EVERGREENS, PEONIES, HARDY PLANTS, ELLWANGER & BARRY, Rochester, N. Y.

New Hardy Shrub—Buddleya varinabilis Vetchell and Magnolia, the summer flowering Lilac. 50c. each; \$5.00 per doz.; \$25.00 per 100. Rose Hill Nurseries, New Rochelle, N. Y.

ORCHID PLANTS

Lager & Hurrell, Summit, N. J.
Fresh Imported and Established Orchids.
For page see List of Advertisers.

Saunders, St. Albans, England.
Importers, Exporters, Growers, Hybridists.
For page see List of Advertisers.

Carrillo & Baldwin, Secaucus, N. J.
For page see List of Advertisers.

Jos. A. Manda, 191 Valley Road, West
For page see List of Advertisers.

Ordóñez Bros., Madison, N. J., Box 105.
Cattleya Mossiae.
For page see List of Advertisers.

MacKerrie-McLaren Co., 721 Crocker Bldg., San Francisco, Cal.
Philadelphus of Vandas.
For page see List of Advertisers.

Largest stock in the country. Ask for prices. Julius Roehrs, Rutherford, N. J.
Native Orchids. Hugo Kind, Hammo-ton, N. J.

PAINT AND PUTTY

PAINT AND PUTTY: Ideal Greenhouse Lead; Special Greenhouse Putty. Lord & Burnham, 1133 Broadway, N. Y.

PALMS

A. Leuthy & Co., Perkins St. Nurseries, Roslindale, Mass.
For page see List of Advertisers.

Robert Craig Co., Market and 49th Sts., Philadelphia, Pa.
For page see List of Advertisers.

Joseph Heacock Co., Wyncote, Pa.
Home-Grown Palms.
For page see List of Advertisers.

Geo. Wittbold Co., 1637 Buckingham Place, Chicago.
For page see List of Advertisers.

Julius Roehrs Co., Rutherford, N. J.
O. V. Zangue, Hoboken, N. J.
For page see List of Advertisers.

PANSY PLANTS.

J. C. Schmidt, Bristol, Pa.
For page see List of Advertisers.

PANSY SEED

John Gerard, New Britain, Conn.
Giant Pansy Seed.
For page see List of Advertisers.

PATENTS

Siggers & Siggers, Washington, D. C.
For page see List of Advertisers.

PEAT

Orchid Peat and Moss always on hand.
Julius Roehrs Co., Rutherford, N. J.

PEONIES

Peonies only, by the wholesale—best 100 varieties. J. F. Rosencfield, Westpoint, Nehr.

One of the finest collections in America. Send 25 cts. in stamps for new edition of Peony Manual. C. S. Harrison's Select Nursery, York, Neb.

PHLOXES

Send 25 cts. in stamps for Phlox Manual. Fine mixed phloxes, \$2.00 per 100. C. S. Harrison's Select Nursery, York, Neb.

Phlox, Hardy Perennial, best assorted varieties, strong plants, \$5.00 per 100; \$40.00 per 1000. Rose Hill Nurseries, New Rochelle, N. Y.

PHOTOGRAPHS; DESIGNING; ILLUSTRATING
Geo. E. Dow, 178 Washington St., Boston.
For page see List of Advertisers.

PIPE AND FITTINGS

Foley Mfg. Co., between Western Ave. and 29th St., Chicago, Ill.

Kroschell Bros. Co., 35 Erie St., Chicago.
For page see List of Advertisers.

PIPE AND FITTINGS—Cast Iron and Wrought Pipe, Valves, Elbows, Pipe Hooks, Automatic Air Headers, etc. Lord & Burnham, 1133 Broadway, N. Y.

Metropolitan Material Co., 1392-1402 Metropolitan Ave., Brooklyn, N. Y.

For List of Advertisers See Page 883

PLANT STAKES

Seel's Tiesless Plant Stakes and Trellises. H. P. Seel & Sons, Elkhart, Ind.

POT HANGERS

Pot hangers, Kramer's, \$1 doz. by exp. \$1.25 by mail. I. N. Kramer & Son, Cedar Rapids, Iowa.

PRIMULAS

Primula obovata grandiflora, Ronsdorfer Hybrid, the best strain in existence; compacta, Kennerly's Empresses, violacea gigantea and five other varieties; strong plants from 2 1/2 in. pots, \$3.00 per 100. Cash. Henry Schmidt, 408 Fulton St., Weehawken P. O., N. J.

RHODODENDRONS

John Waterer & Sons, Ltd., American Nursery, Bagshot, England. For page see List of Advertisers.
F. Ouwkerker, Hoboken, N. J. For page see List of Advertisers.

ROSES

Robert Craig Co., Market and 40th Sts., Philadelphia, Pa. For page see List of Advertisers.
P. Ouwkerker, P. O. No. 1, Hoboken, N. J. For page see List of Advertisers.

The F. R. Pierson Co., Tarrytown-on-Hudson, N. Y. White Killarney. For page see List of Advertisers.
Dingee & Conard Co., West Grove, Pa. For page see List of Advertisers.
Poehlmann Bros. Co., Morton Grove, Ill. For page see List of Advertisers.

A. N. Pierson, Cromwell, Conn. Walter Killarney, White Marsh, Md. For page see List of Advertisers.
U. S. Cut Flower Co., Elmira, N. Y. Rose Plants.

W. & T. Smith Co., Geneva, N. Y. American Grown Roses. For page see List of Advertisers.
Pittsburgh Rose & Carnation Co., Gibsonia, Pa. For page see List of Advertisers.

Elliwanger & Barry, Violet Blue Rose. Mount Hope Nurseries, Rochester, N. Y. For page see List of Advertisers.
Charles H. Tutty, Madison, N. J. For page see List of Advertisers.

Roses, Maids and Richmonds, strong 4 in. stock, \$8.00 per 100. Rose Hill Nurseries, New Rochelle, N. Y.
The Rose, by H. B. Elliwanger, mailed for \$1.30 by Horticulture, 11 Hamilton Place, Boston.

Hand Book of Cultural Notes on Roses Under Glass, by F. P. Brigham, mailed to your address for 25c., by Horticulture Publishing Co., 11 Hamilton Place, Boston.

RUBBER PLANTS

William C. Smith, Market & 61st St., Philadelphia. For page see List of Advertisers.

SEED GROWERS

Hjalmar Hartmann & Co. Cauliflower and Cabbage Seed. Langangstræde 20, Copenhagen, Denmark. For page see List of Advertisers.
Routzahn Seed Co., Arroyo Grande, Calif. Spencer Type Sweet Peas, Ninsturtius, Etc.

SEEDS

T. J. Grey Co., 32 So. Market St., Boston. For page see List of Advertisers.
Joseph Breck & Sons, 51 and 52 N. Market St., Boston, Mass. For page see List of Advertisers.

W. Atlee Burpee & Co., Philadelphia. For page see List of Advertisers.
Arthur T. Boddington, 312 W. 14th St., New York. For page see List of Advertisers.

H. E. Fiske Seed Co., Faneuil Hall Sq., Boston. For page see List of Advertisers.
Hjalmar Hartmann & Co., Langangstræde 20, Copenhagen, Denmark. Cauliflower and Cabbage Seed. For page see List of Advertisers.

SEEDS - Continued

Rickards Bros., 37 E. 19th St., New York. For page see List of Advertisers.
R. & J. Farquhar & Co., 67 So. Market St., Boston.

Mignonette Seed. For page see List of Advertisers.
H. F. Mitchell Co., 1018 Market St., Phila. Primula Seed. For page see List of Advertisers.

J. M. Thorburn & Co., 33 Barclay St., N. Y. For page see List of Advertisers.
Leonard Seed Co., Chicago, Ill. For page see List of Advertisers.

Schlegel & Fottler Co., 26 & 27 So. Market St., Boston. For page see List of Advertisers.
O. V. Zungen, Hoboken, N. J. Florists' Spring Seeds. For page see List of Advertisers.

E. F. Winterson Co., Chicago. Seeds for Plantations, Nurseriesmen, Seedsmen. For page see List of Advertisers.
A. C. Zvolanek, Bound Brook, N. J. Winter Flowering Sweet Peas. For page see List of Advertisers.

Seeds, Rocky Mountain Evergreen seeds in large or small quantities. C. S. Harrison's Select Nursery, York, Neb. For page see List of Advertisers.

SHRUBS

The George Withold Co., 1657 Buckingham Place, Chicago. For page see List of Advertisers.

SILKALINE

John C. Meyer & Co., Boston, Mass. For page see List of Advertisers.

SPHAGNUM MOSS

Live Sphagnum moss, orchid peat and orchid baskets always on hand. Lager & Hurrell, Summit, N. J.

SPRAYERS

Niagara Sprayer Co., Middleport, N. Y. For page see List of Advertisers.
Chas. J. Jager Co., Boston. Denning Spray Pump. For page see List of Advertisers.

STOVE PLANTS

Julius Roehrs Co., Rutherford, N. J.

SULPHUR BURNER

Benj. Dorrance, Rose Growers, Dorrance, Pa. For page see List of Advertisers.

SWEET PEAS

A. C. Zvolanek, Bound Brook, N. J. Winter Flowering. For page see List of Advertisers.

VEGETABLE PLANTS

R. Vincent, Jr., & Sons Co., White Marsh, Md. For page see List of Advertisers.

VENTILATING APPARATUS

Pieron U-Bar Co., 1 Madison Sq., N. Y. For page see List of Advertisers.
Foley Mfg. Co., Western Ave., between 25th & 26th Sts., Chicago. For page see List of Advertisers.

John A. Payne, 206-274 Culver Ave., Jersey City, N. J. For page see List of Advertisers.
The Advance Co., Richmond, Ind. For page see List of Advertisers.

Quaker City Machine Co., Richmond, Ind. 20th Century Ventilating Arm. For page see List of Advertisers.

VENTILATING MACHINERY, New Model enclosed, self-oiling gear, Standard Model Open Gear. Lord & Burnham, 1133 Broadway, N. Y.

VERBENAS

J. C. Schmidt, Bristol, Pa. For page see List of Advertisers.
Lemon Verberna R. C., 75c. per 100, prepaid. Chas. Frost, Kenilworth, N. J.

VIOLETS.

William Slim, Cliftondale, Mass. Boston and Princess of Wales Violas. For page see List of Advertisers.
Maria Louise Violet plants, well rooted, grown on tile benches, free from disease, selected stock, \$15.00 per 1000. Ready for immediate delivery. J. Vander Linden, Rhinebeck, N. Y.

VINCAS

William C. Smith, Market & 61st St., Philadelphia. For page see List of Advertisers.

WILSON'S PLANT OIL

Wilson Plant Oil & Fertilizer Co., Chatham, N. J. For page see List of Advertisers.

WIRED TOOTHPICKS

W. J. Cowee, Berlin, N. Y. For page see List of Advertisers.

WIREWORK

Reed & Keller, 122 W. 25th St., N. Y. For page see List of Advertisers.
Durand & Marohn, Albany, N. Y. For page see List of Advertisers.

Wirework, Write for our catalogue. Holton & Hinkel Co., Milwaukee, Wis. William E. Heilscher's Wire Works, 38-40 Broadway, Detroit, Mich.

Wirework—Compare our prices with others. Scranton Florist Supply Co., 201 N. 7th St., Scranton, Pa.

WHOLESALE FLORISTS

Boston

N. F. McCarthy & Co., 84 Hawley St., Boston. For page see List of Advertisers.
H. M. Robinson & Co., 15 Province St. and 9 Chapman Pl., Boston. For page see List of Advertisers.

Welch Bros., 226 Devonshire St., Boston. For page see List of Advertisers.
Tabby, Wellesley, Mass. For page see List of Advertisers.

Buffalo, N. Y.

William F. Kasting Co., 383-87 Ellicott St., Buffalo, N. Y. For page see List of Advertisers.

Chicago

Chas. W. McKeller, 51 Wabash Ave., Chicago. For page see List of Advertisers.
Peter Reiberg, 51 Wabash Ave., Chicago. For page see List of Advertisers.

E. F. Winterson Co., 45-49 Wabash Ave., Chicago. For page see List of Advertisers.

J. A. Biddling, 37-39 Randolph St., Chicago. For page see List of Advertisers.
Poehlmann Bros. Co., Morton Grove, Ill. For page see List of Advertisers.

Cromwell, Conn.

A. N. Pierson, Cromwell, Conn. For page see List of Advertisers.

Detroit

Michigan Cut Flower Exchange, 38 and 40 Broadway, Detroit, Mich. For page see List of Advertisers.

Minneapolis

Rice Bros., 115 N. 6th St., Minneapolis, Minn. For page see List of Advertisers.

New York

Ford Bros., 48 W. 28th St., New York. For page see List of Advertisers.
H. E. Froment, 57 W. 28th St., New York. For page see List of Advertisers.

Alex. J. Guttman, 34 W. 28th St., New York. For page see List of Advertisers.

In writing to Advertisers kindly mention Horticulture

WHOLESALE FLORISTS— New York—Continued

- E. C. Horan, 55 W. 28th St., New York.
For page see List of Advertisers.
- A. H. Langjahr, 55 W. 28th St., New York.
For page see List of Advertisers.
- James McManus, 42 W. 28th St., New York.
For page see List of Advertisers.
- John I. Kaynor, 49 W. 28th St., New York.
For page see List of Advertisers.
- W. F. Sheridan, 39 W. 28th St., New York.
For page see List of Advertisers.
- Moore, Heitz & Nash, 55 and 57 W. 26th St., New York.
For page see List of Advertisers.
- Wm. H. Kneider, 25 Willoughby St., Brooklyn, N. Y.
For page see List of Advertisers.
- Millang Bros., 41 W. 28th St., New York.
For page see List of Advertisers.
- John Young, 51 W. 28th St., New York.
For page see List of Advertisers.
- Greater New York Florists' Association,
162 Livingston St., Brooklyn, N. Y.
For page see List of Advertisers.
- Frank Millang, 55-57 W. 26th St., New York.
For page see List of Advertisers.
- Phillip F. Kessler, 55 & 57 W. 26th St., New York.
- A. L. Young & Co., 54 W. 28th St., N. Y.
For page see List of Advertisers.
- Growers' Cut Flower Co., 39 W. 28th St., New York.
For page see List of Advertisers.
- J. K. Allen, 105 W. 28th St., New York.
For page see List of Advertisers.
- Charles Millang, 444 Sixth Ave., New York.
For page see List of Advertisers.
- Manhattan Flower Market, 46 W. 28th St., New York.
For page see List of Advertisers.

Philadelphia

- W. E. McKissick & Bros., 1619-1621 Ransstead St., Philadelphia, Pa.
For page see List of Advertisers.
- Leo Niessen Co., 1299 Arch St., Philadelphia, Pa.
For page see List of Advertisers.
- The S. S. Pennock-Meehan Co., 1608-13 Ludlow St., Philadelphia, Pa.
For page see List of Advertisers.

New Offers in This Issue.

BOXWOODS, PALMS, CROTONS, MUSAS, ETC.

The F. R. Myerson Co., Tarrytown-on-Hudson, N. Y.
For page see List of Advertisers.

CATTLEYES; CARNATIONS; PLUMOSA STRINGS.

S. S. Pennock-Meehan Co., Philadelphia.
For page see List of Advertisers.

COLD STORAGE LILY OF THE VALLEY.

Jacobs Smits, Ltd., care Maltus & Ware, 14 Stone St., New York.
For page see List of Advertisers.

KENTIA BELMOREANA AND FORTERIANA.

Joseph Heacock Co., Wynonote, Pa.
For page see List of Advertisers.

ORCHIDS FRESH IMPORTED.

Lager & Hurrell Smunt, N. J.
For page see List of Advertisers.

PECKY CYPRESS.

The Foley Mfg. Co., 29th & Western Aves., Chicago, Ill.
For page see List of Advertisers.

POT GROWN STRAWBERRIES; FORCING BULBS.

Burnett Bros., 72 Cortlandt St., New York.
For page see List of Advertisers.

WANTED: CYCAS REVOLUTA.

Knight & Struck, 1 Madison Ave., New York.
For page see List of Advertisers.

ABOUT SPECIMEN DAVALLIAS.

Editor of HORTICULTURE:

It was with much interest I read Mr. Sherwood's note on specimen Davallias in your issue of June 5th and in reply would like to say the following:

In my article on the species in the issue of May 29th I should have said: It took more than two years to grow this fern to this size, instead of: "It takes more than two years," etc. The fact is, I did not try to see how big I could grow the fern, as it is now plenty big enough to suit our requirements. No doubt but what the plant could be as big again if we had followed the method advised by Mr. Sherwood, but it would then be too big for ordinary purposes in decorating and very awkward to handle. A plant in a 10-inch pot can easily be moved about and can be used to good advantage in decorating.

I am not prepared to say whether the plant here is *D. f. plumosa* or not, as I am not an authority on ferns, it is the only Davallia here outside of D. bullata.

(I can send a frond to Mr. Sherwood for comparison with his specimen.)

Our plant is watered overhead daily as it can not be avoided on account of the orchids which are suspended from the roof and which are syringed every bright day, but discoloration does not take place so easily, on account of the dense shade in which the plant has to grow. It is true, however, that the fronds will discolor quickly if watered overhead in strong light.

M. J. POPE.

Naugatuck, Conn.

CLARKIAS AS SPRING BEDDERS.

It is a great surprise to many cultivators that the various clarkias, easily managed plants of great floriferousness are so little cultivated for these purposes; and others. The best mode of growing these annuals is to sow the seed in the month of October, and place the pots 4 1-2 inches or 6 inches in diameter in a well ventilated, low house or cold pit from which frost can be excluded in the winter months; and when the seedlings have grown an inch or two, thin them out, leaving from 10 to 14 in each pot. Water should be afforded in moderation during the cold months, keeping the pots near the roof glass, and applying air during the warm parts of the day, tickling the soil to prevent it caking, and removing the weaker plants if there is a risk of their being crowded over much. When mild weather ensues in late spring the plants may be inured for a week or two to the open air gradually, and subsequently planted (without the pots) in prepared beds. They will make a pretty display in May and June. F. M.

As advertised in our issue of last week, the third big annual sale of decorative greenhouse stock by Wm. Elliott & Sons will take place at high noon Tuesday, June 22. Growers looking for such goods will find much in this anniversary event to interest them. It was a great success last year.

NEWS NOTES.

Des Moines, Ia.—The Lozier Floral Co. are to move into a new building at 410 East 6th street.

Greenfield, Mass.—P. E. Burt, florist, has secured a five-years' lease of the new building now being erected on Davis street.

Houston, Tex.—The Texas Nursery Co. has secured the order for the landscape work for improving the San Jacinto battle ground.

Easton, Pa.—D. B. Nevin succeeds to the business of A. L. Raub & Co., who failed recently. Mr. Nevin's "stands well" with the trade.

Baltimore, Md.—W. E. Burnham secured the contract for erecting the county agricultural school near Sparks. His bid was for \$16,873.

Colorado Springs, Col.—A terrific hail storm swept over this section on June 11 and the majority of the florists were sufferers to a greater or less degree.

Portland, Ore.—After being made the beneficiary of a bequest from C. E. Hoskins, valued at between \$20,000 and \$30,000, the Oregon Horticultural Society are in danger of losing it through a suit filed by the heirs of Mr. Hoskins, who were practically cut off in the will.

Brookline, Mass.—Holm Lea, Prof. C. S. Sargent's beautiful estate, was open to the public on June 12 and 13, according to yearly custom when the rhododendrons and azaleas are in bloom. Many thousands of visitors took advantage of the prized opportunity. The display this year has been exceptionally fine.

Providence, R. I.—Joseph Kopelman of J. Kopelman & Co., has purchased the range of greenhouses operated as the Rhode Island Greenhouses, containing about 50,000 feet of glass, and will move them from Pawtucket to Oaklawn. J. F. Barclay, who was formerly connected with the business, will have charge of the place when completed.

The dedication exercises of the Zabriskie playground at Jersey City, N. J., will take place on June 19. Rev. Dr. Lyman of Brooklyn will make the presentation address and Mayor Wittjen the address of acceptance. There will be competitive games, exhibition drills, etc., by the children. It is hoped that Mrs. Zabriskie will be present to distribute the prizes. The committee of arrangements is John T. Withers and M. R. Wise.

OBITUARY.

Charles Zuber.

Charles Zuber, youngest son of Vincent Zuber of Whitestone, N. Y., died at St. Catherine's Hospital on June 5 after a short illness. The young man was engaged with his father in business.

W. D. Chase.

Watson D. Chase of New London, Ohio, died on May 30, aged 61. He was senior member of the firm of W. D. Chase & Son and had been engaged in the florist and nursery business for thirty years.

LIST OF ADVERTISERS

Page	Page
Advance, The Co. 876	Langjahr, Alfred H. 876
Allen J. K. 877	Leonard Seed Co. 871
American Nursery (Engl.) 879	Leuthy A. & Co. 869
Aschmann Godfrey. 879	Lord & Furnham Co. 888
Bambrock Thos. H. 883	MacMulkin E. A. 873
Barrows H.H. & Son. 860	MacKorie-McLaren Co. 860
Baur & Smith. 858	Maltus & Ware. 869
Bayersdorfer H. Co. 873	Manoa Jos. A. 860
Bennett Bros. Co. 873	Manhattan Flower Mkt 877
Boddington A. T. 871	McCarthy N. F. & Co. 877
Boston Florist Letter 873	McConnell Alex. 877
Boston Plate and Win- dow Glass Co. 886	McKellar Charles W. 874
Bowe, M. A. 872	McKissick, W. E. & Bros. 874
Bowker Fertilizer Co. 871	McManus Jas. 876
Bowler Insecticide Co. 885	Meyer J. & Co. 877
Breck Joseph & Sons 871	Michell H. F. Co. 870
Breitmeier's J. Sons. 872	Michigan Cut Flower Exchange. 877
Bridgeman's Seed Warehouse. 871	Milburg Bros. 876
Budlong J. A. 874	Milang Charles. 876
Burtett Bros. 868	Milang Frank. 876
Burpee W. A. & Co. 871	Montager J. C. 887
Cameron H. L. 868	Moore, J. L. 877
Carrillo & Baldwin. 860	Moore, Henry & Nash 875
Chicago Carnation Co. 873	Mt Hope Nurseries. 867
Chapman David, Sons. 872	Murray Samuel. 872
Coan J. J. 876	New Eng. Nurseries. 869
Cooper Wm. & Nep- hews. 885	Newman J. & Sons. 872
Cotsonas Geo. & Co. 876	Niagara Sprayer Co. 885
Cywe W. J. 877	Nielsen Leo. Co. 874
Craig, Robt. Co. 876	Oechslin Frank. 860
Crawback Geo. W. 876	Ordoner Bros. 880
Crawford H. F. 883	Owenskerk P. 869
Crump Frank F. 879	Palethorpe P. R. Co. 883
Danker F. A. 872	Palmer W. J. & Son. 872
Dalton J. H. & Son. 872	Park Floral Co. 872
Dancy F. B. 883	Parshelsky Bros. 886
Dingee & Conrad Co. 880	Patten & Co. 874
Dorner F. Sons & Co. 868	Payne John A. 887
Dorrance Benn. 885	Peacock Dahlia Farms 859
Dow Geo. E. 871	Peacock-Meehan Co. 875
Dreer H. A. 867	Perkins St. Nurseries. 869
Dunlop John H. 872	Pierce, F. O. Co. 887
Durand & Maroh. 877	Pierson, A. N., Inc. 859
Dysart R. J. 877	Pierson F. K. Co. 880
Eastern Chemical Co. 884	Pierson U Bar Co. 888
Edwards Fording Box Co. 874	Pittsburg Rose & Car- nation Co. 888
Elliott Wm & Sons. 871	Poehlmann Bros. Co. 874
Ellwanger & Barry. 875	Pulverized Manure Co 884
Elmsford Nurseries. 858	Quaker City Mach. Co 887
Ester J. G. 887	Rayner, J. M. 859
Ernest W. H. 885	Raynor John I. 876
Ery T. J. Co. 872	Reber & Keller. 874
Fargusar R. & J. Co. 871	Reinberg Peter. 874
Fisher David, East of 860	Reuter S. J. & Son, Inc. 883
Fiske H. E. Seed Co. 871	Revere Rubber Co. 866
Foley Mfg. Co. 872	Rever Bros. 874
Foley Bros. 876	Richards Bros. 871
Froment H. E. 876	Robinson H. M. & Co. 874
Galvin Thos. F. 873	Rock Wm L. Flo. Co. 872
Gerard J. 870	Rochrs Julius Co. 869
Greater N.Y. Florists' Association. 876	Roland, Thomas. 868
Grey T. J. Co. 871	Rolker August & Sons 886
Growers' Cut Flower Co. 876	Rose Hill Nurseries. 860
Gude Bros. Co. 872	Sander & Son. 860
Gutman Alex. J. 876	Schlegel & Fottler Co. 871
Hall Assn. 887	Schmidt J. C. 868
Hammond Point and Slug Shot Works. 885	Schult Jacob. 859
Hartmann Hjalmar & Co. 872	Scott Bros. 868
Heaswith the Florist. 872	Scott, John. 860
Heacock Jos. Co. 868	Sharp, Partridge & Co 886
Herbert David & Son. 879	Sheridan W. J. 874
Hews A. H. & Co. 886	Smith W. & T. Co. 876
Hewes Flower Bros. 888	Smits, Jacs, Ltd. 869
Hill, The E. G. Co. 868	Smyth Wm. J. 872
Hitchings & Co. 886	Standard Plate Glass Co. 886
Hoffman 873	Stearns A.T. Lumber Co. 887
Horan E. C. Co. 876	Stupp & Walter Co. 883
Hunt A. E. & Co. 868	Tailly 887
Hunt Bros. 858	Thorburn J.M. & Co. 871
Jacobs S. & Sons. 877	Totty Chas. H. 885
Jager, Chas. J. Co. 855	Valentine, J. A. 872
Keatine W. F. Co. 877	Vincent R. J. & Sons, 862-870
Keatueky Tobacco Product Co. 884	Wants, For Sale, etc. 883
Kesler, E. F. 876	Ward R. M. & Co. 874
Kiss Co. 879	Waterer John & Sons. 869
Knight & Stack. 879	Welch Bros. 871
Krick W. C. 877	Whitford Geo. Co. 860
Kuehler Wm H. Co. 877	
Kuehler Wm H. Co. 876	
Lager & Hurrell. 860	

Page	Page
Wilson. 874	Young A. L. 877
Wilson Plant Oil and Fertilizer Co. 885	Young John. 876
Winterson E. F. Co. 874	Young & Nugent. 876
Wood Bros. 878	Zangen O. Y. 860-871
Yokohama Nursery Co 860	Zinn Julius A. 873
	Zvolanek A. C. 871

INDIANAPOLIS NOTES.

The bedding plant season is drawing to a close with very favorable comments from these interested. It is with difficulty that good stock can be obtained, as most of the growers are cleaned out. Owing to heavy rains and excellent weather, outside flowers and vegetation never looked better at this time of the year. There ought to be a plentiful supply of asters this fall, judging from the enormous quantity being planted.

The market in some lines has been very active since Memorial Day, weddings, school exercises and garden parties forming the outlet for the many flowers coming into the market. All kinds of flowers are plentiful and the prices have dropped away down. There is quite a crop of June weddings on but none of them very extensive. Smilax is in good demand and none too plentiful. There seems to be an abundance of wood ferns.

FLORISTS' TRADE IN WINNIPEG.

Reports from Winnipeg indicate that the demand for bedding stock is enormous, far and away ahead of previous year. Weather conditions are fine. The cut flower trade is good also, while wedding work is coming very fast, keeping all the florists in the city busy. The prospects are the best ever seen for a humming business all round this season. Lots of good stock on the market, with fair prices and good demand.

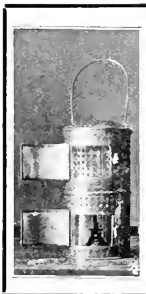

**THIS
KILLS
MILDEW
EVERY
TIME**

FOR PARTICULARS WRITE
**Benjamin Dorrance
ROSE GROWERS
Dorrancton, Penna.**

MISCELLANEOUS WANTS

WANTED TO BUY—Complete greenhouse plants and all kinds of greenhouse material to be taken down and removed at once. Terms cash. Address I. Sussengrnan, 229 Livingston St., Newark, N. J.

WANTED—To lease, with privilege of buying, retail greenhouse establishment, with land. State size of houses, glass, terms. First letter, GROWER, 180 Grand St., Jersey City, N. J.

WANTED—Second-hand bags and bur-lap, any kind, any quantity, anywhere. Richmond Bag Co., Richmond, Va.

HELP WANTED

GOOD MEN

When you need good men, skilled or unskilled, Write:

THOS. H. BAMBRICK

34 South 7th Street Philadelphia

Help of all kinds, including that for Florists, Nurserymen, Seedsmen and the Horticultural trade generally.

WANTED Assistant florist: must be careful at watering, tying and potting. Wages to start \$12.00 per week. Address, with copy of references, experience, etc., Plant Grower, care HORTICULTURE.

SITUATIONS WANTED

SITUATION WANTED—By single florist and gardener, 28, with 13 years' experience in and outdoors; sober, honest and industrious. State wages and particulars in first letter. Address Schroeder, care Cottage Hotel, Foutlyne, Va.

FOR SALE

FOR SALE

About 30,000 feet of glass in good condition, will sell at a low figure, or will lease to the right party, with privilege of buying. My object for selling is, I do not know anything about the business and can't hire men that do.

**H. F. CRAWFORD
Montello Sta. Brockton, Mass.**

SECOND HAND BOILER

For sale, suitable for heating purposes. Robinson make, 4 1/2 x 15 ft. 64 tubes, 3 in. All trimmings and settings in good condition.

BENNETT BROS. CO., Lowell, Mass.

For Sale Greenhouse Property

Located at Somerset and Howard streets, North Plainfield, Somerset County, New Jersey. Dimensions 248 x 106 ft. Contains three greenhouses 20 x 175 ft., steel frame. Trolley lines pass property. Will sell cheap and on easy terms. For particulars apply to **F. B. DAILEY, care F. EERG & CO., Orange, N. J.**

FOR SALE—Five greenhouses, boues, five rooms, improvements; barn, carriage house, sheds; all in good repair. One minute to depot, on main street; 20 minutes to Boston; five minutes to two lines of electric. Only florist in large town. Established twenty years. For further particulars address E. G. Blaney, Swampscott, Mass.

FOR SALE—Special 16 x 18 and 16 x 24 double thick glass in "A" and "B" qualities. Buy new and save money. Write **PARSHELSKY BROTHERS, INC., 58 Montrose Ave., Brooklyn, N. Y.**

FOR SALE, CHEAP—A good, second-hand Horizontal Tubular Steam Boiler, 85 H. P. Auburn Last Co., So. Framingham, Mass.

FOR SALE—18 section Weathered boiler in good condition; nearly new. N. F. McCarthy & Co., 84 Hawley St., Boston, Mass.

TO LET

TO LET—Three greenhouses, one 18x55, two 12x75 each; six and one-half miles from Boston market; all modern conveniences. Also lot of land for outside use. Terms reasonable to right party. Apply to Samuel Brown, 220 Beale St., Wollaston, Mass., N. Y., N. H. & H. R. R.

Tobacco Paper		"NICO-FUME"	LIQUID
IS THE			
STRONGEST,		OVER 40% NICOTINE	
BEST PACKED,		By far the	
EASIEST APPLIED.		CHEAPEST.	
		JUST NOTE PRICE!	
24 sheets.....	\$ 0.75	Pint.....	\$ 1.50
144 sheets.....	3.50	½ Gallon.....	5.50
288 sheets.....	6.50	Gallon.....	10.50
1728 sheets.....	35.10	5 Gallons.....	47.25

Furnishes the
Most Nicotine for the Money

... Manufactured by ...
THE KENTUCKY TOBACCO PRODUCT CO., Louisville, Ky.

EPSOM SALTS AS A FERTILIZER.

(Continued from page 520)

Magnesium is found in relatively large amounts in many of our root vegetables, as potatoes and beets. This question of Magnesium has received considerable attention at the hands of the sugar beet people, and the following is quoted from an abstract published by the American Chemical Society lately and concerns the work of F. Riganx, a French investigator:

"Jentle holds that a soil in a good state of fertility should contain 0.30 per cent. MgO. On this basis and as the result of numerous analyses of Belgian soils the conclusion follows that Belgian soils naturally deficient in this element have been further depleted of it. From a consideration of the ash analysis of various field crops, MgO is at least as important as the other elements of plant food, K₂O & P₂O₅. A number of field tests with sugar beets during the past ten years indicates that the yields are greater and that the sugar content is greater where MgO was used in the fertilizer than where it was omitted, or where no fertilizer was applied. Cereals and potatoes also gave better returns where MgO was present in the fertilizer.

Now, this is about sugar beets and not about shrubs and small trees of any kind, but from analyses made of evergreens and other trees we find that Magnesium is always found in the seed, leaf, bark and in the substance of the tree itself.

The character of Magnesium is part way between that of Lime and that of Potash or Soda. It appears probable that like Potash it is usually found in the soil and extracted therefrom by the plant roots, and that the particular form of soluble salt in which it was applied to the ground would not make much difference as far as its availability was concerned.

Without digging up all the work ever done on Magnesium it seems to the writer that nothing would be gained by applying amounts of Magnesium salts much larger than we would apply of Lime (with a mental reservation we will consider later). Like Lime, Magnesium may act indirectly and thus unlock plant foods.

Your inquirer seems to have the idea that Magnesium was of distinct disadvantage to plants. This idea is erroneous, although large quantities of any soluble salt in the soil would be disadvantageous and Magnesium is a very soluble salt and would without doubt get to the roots of the plant when other more insoluble salts, as those of Lime, would soon be fixed in the ground and could then do no further injury.

It might be interesting to note that in the so-called alkaline plains salts of Magnesium are almost always found, and Magnesium itself is an alkali not

so strong as Potash but partaking of that nature.

If your readers desire further information it would be a pleasure to quote more definitely the amounts of Magnesium in the various salts, or if they want Magnesium Sulphate (Kieserite), it may be had at about \$1.25 per 100 lbs., or the refined Epsom salts may be obtained at a little more or about \$1.50 per 100 lbs. Crude is quoted at \$20.00 per ton.

It would be very interesting for all of us if the sources of soluble chemicals would modestly state their experience with Magnesium, as I have no doubt that many of them will say they have tried and in many cases by overdoing it have had bad results, and on the other hand it would be of greatest interest to hear from those who have used very small amounts of this chemical and are convinced they have had good results.

Up to this time we have considered Magnesium entirely in the light of an element that gets in by the roots and, whether absolutely necessary or not, happens to be found in almost every part of almost every thing in the vegetable world, it being an element well nigh all-pervading. Just how far it may take the place of Lime or other elements is not entirely settled, but there is no doubt but that the amount of this element in the soil is seriously depleted by successive croppings and it is true that this has been recognized and that fertilizers containing Magnesium have been applied to offset this shortage.

Starting from the main idea of the rotation of crops there have been a good many reasons that we could advance to account for the success of some sort of rotation. Among other advantages that have been alleged is that of destroying or combating poisons left in the soil by previous crops and making new ones that would not increase the undesirability of the soil for other crops, in other words to destroy all poisons left in the soil from the presence of living plants. Now, there is no question whatever but that such poisons are left. They have been extracted by water, and other solvents, and considerable work has been done on them, and chemists have recognized among them many well-known poisons familiar to them under various guises. It has also been shown that many of these plant poisons may be rendered innocuous by certain chemicals, and among these are many of the soluble fertilizers as Nitrate of Soda and others. Although Magnesium has not been especially mentioned in this category it may be that this element (on account of its cheapness and its solu-

WIZARD

TRADE BRAND MARK

MANURES

Dried, screened and packed in bags of 100 lbs. each.

PULVERIZED SHEEP MANURE
PURE — UNIFORM — RELIABLE

A strong and quick acting manure, highly recommended for carnations and chrysanthemums.

SHREDDED CATTLE MANURE
EASY TO HANDLE AND APPLY

Stronger and better in every way than rough manure. Lasts much longer on the benches. Unequalled for mulching and feeding roses, liquid manuring and mixing with bench and potting soil. Used by all the largest growers.

Ask Your Supply Man or Write Us for Circulars and Prices.

— THE —

Pulverized Manure Co.
31 Union Stock Yards CHICAGO

IMP SOAP SPRAY

THREE SUCCESSFUL YEARS

Outdoor or Indoor

ELM BEETLE OR

WHITE FLY

EASTERN CHEMICAL CO.

Pittsburg Street, Boston, Mass.

bility, and the fact that it is a plant food) is desirable to apply in such quantities entirely apart from its use as an ordinary fertilizer.

The government has made geological surveys of most of the country and from this the content of Magnesium may be found without going to the expense of having the soil analyzed. In most cases where there is recourse to this survey and recourse to the State Experimental Station the question of the scarcity of Magnesium or otherwise, would be pretty well decided, except for a particular case, when the real experiment would be to have the plant or tree have its own say.

DUDLEY M. PRAY.

SOLD BY SEED DEALERS IN USE FOR 29 YEARS



FOR PAMPHLET ON "BUGS AND BLIGHTS" WRITE TO

Hammond's Paint & Slug-Shot Works FISHKILL ON HUDSON NEW YORK

"Every Bug Has His Dose."

Insect-destroying preparations that do their work well and effectively are the cheapest. Bowker's Arsenate of Lead and Bowker's Pyrox are recognized standard insecticides and fungicides for both indoor and outdoor use. Bowker's Insect Emulsion destroys many kind of plant lice, black and green flies, etc. Call or send for catalogue.

BOWKER INSECTICIDE COMPANY
43 CHATHAM ST. BOSTON

An Absolute Success

in Killing Scale and All Other Insect Pests on Trees, Shrubs and Garden Plants, including the notorious **LACE FLY ON RHODODENDRONS** without injury to the foliage.

WILSONS' PLANT OIL

Well Tested and Its Efficacy Fully Demonstrated
TRY IT!

Wilson Plant Oil & Fertilizer Co., Chatham, N. J.

For Trees, Plants, Shrubs and Flowers

USE

THE NIAGARA BRAND LIME SULPHUR SOLUTION

It destroys Scale Lice, Spiders and all forms of Aphides, AT THE SAME TIME Mildew, Blight, Rust and other Fungus difficulties.
Used in Winter or Summer. — No other remedy has been so universally effective.
Niagara Brand **ARSENATE OF LEAD** for chewing insects is equal to the best and better than the most.
Ask about our Green House sprayer. Address —

NIAGARA SPRAYER CO., - - Middleport, N. Y.

COOPERS SPRAY FLUIDS

LATEST DISCOVERY

Progressive Growers Investigate
32 page Booklet of British, American and Canadian Testimony free for the asking
Eastern Agent — **CYRIL FRANKLYN**
62 Beaver St., New York, N. Y.
Sole Proprietors
WILLM COOPER & NEPHEWS
177 Illinois Street CHICAGO

KILMDEAD
The best of all the tobacco dusts for
Dusting or fumigating

25 lbs., \$1.00	100 lbs., \$ 3.00	1000 lbs., \$27.00
50 lbs., 1.75	400 lbs., 14.00	2000 lbs., 52.00

Swamp & Walter Co.
50 Barclay St. New York.



The Best Bug Killer and Bloom Saver

For PROOF Write to

P. R. Palethorpe Co.
OWENSBORO, KY.

Which Spray Pump

Which shall you buy? Buy the Spray Pump that fully meets the demands of the Government, Agricultural Scientists and all practical Fruit Growers. These pumps are widely known as **DEMING SPRAYERS** and are made in 23 styles for use in small gardens or immense orchards. Write for our free catalogue with Spraying Chart. Add 4 cents post age and receive "Spraying for Profit," a useful guide book.
CHARLES J. JAGER CO.
281-285 Franklin St., Boston



In ordering goods please add "I saw it in HORTICULTURE."

GREENHOUSES BUILDING OR CONTEMPLATED.

- Essex, Conn.—C. G. Cheney, one house.
- Wendell, Ida.—Wm. S. Pew, one house.
- Barre, Vt.—Alex. Emslie, house, 20x100.
- Montreal, Can.—B. Asselman, house, 20x200.
- Kirkwood, Mo.—G. Edwards, four houses.
- Bluefield, Va.—Edward Schneider, one house.
- Xenia, O.—E. E. Lighthizer, one vegetable house.
- Xenia, O.—George C. Crane, one vegetable house.
- Stuyvesant Falls, N. Y.—John A. Dick, violet house.
- Brooklyn, N. Y.—George Schuneman, carnation house.

PATENTS GRANTED.

- 923,403. Lawn Mower. Charles L. Bergeman, Pottsville, Pa.
- 923,663. Attachment for Flower Pots and the Like. Martin C. A. C. Kroeger, Gerrards Cross, England.

GLASS
Greenhouse and Hot Bed

SIZES OUR SPECIALTY
IMMENSE STOCK
Plate and Window Glass
Write for Our Prices
PARSHELSKY BROS., Inc.
89 Montrose Ave., BROOKLYN, N. Y.

STANDARD FLOWER POTS

Packed in small crates, easy to handle.

Price per crate		Price per crate	
1500 2 in. pots in crate	\$4.88	144 6 in. pots in crate	\$3.16
1500 2 1/2 " " "	5.25	120 7 " " "	4.00
1500 3 " " "	6.00	60 8 " " "	3.00
HAND MADE			
1000 3 " " "	5.00	48 9 in. pots in crate	\$3.60
800 3 1/2 " " "	5.80	48 10 " " "	4.80
500 4 " " "	4.50	24 12 " " "	3.60
450 4 1/2 " " "	5.24	24 12 " " "	4.80
320 5 " " "	4.51	12 14 " " "	4.80
210 5 1/2 " " "	3.78	6 16 " " "	4.50

Seed pans, same price as pots. Send for price list of Cylinders for Cut Flowers, Hanging Baskets, Lawn Vases, etc. Ten per cent. off for cash with order. Address **Hilfinger Bros., Pottery, Fort Edward, N. Y.** August Rolker & Sons, Agts. 31 Barclay St., N. Y. City.

Standard Flower . . . POTTS

If your greenhouses are within 500 miles of the Capital, write us, we can save you money

W. H. ERNEST

29th and M Street WASHINGTON D. C.

REVERO
THE MODERN GARDEN HOSE
FOR LAWNS, GARDENS, GREENHOUSES, STABLES, ETC.

BRAIDED FABRIC, MOULDED CONSTRUCTION, SEAMLESS THROUGHOUT

LIGHT—STRONG—FLEXIBLE



OLD STYLE—READILY KINKS



REVERO—NON KINKING

Revero is furnished on Reels in Continuous Lengths up to 500 ft. Your Supply House can furnish "Revero."

Write for Catalog

REVERE RUBBER COMPANY
BOSTON, MASS.

- NEW YORK
- PHILADELPHIA
- PITTSBURG
- CHICAGO
- NEW ORLEANS
- MINNEAPOLIS
- SAN FRANCISCO
- PORTLAND, ORE.

STANDARD PLATE GLASS CO.

Manufacturers—Importers—Jobbers

NOW IS THE TIME TO BUY

FRENCH OR AMERICAN GREENHOUSE GLASS

LOWEST PRICES ON REQUEST

26-30 Sudbury St. BOSTON, MASS. 61-63 Portland St.

GLASS Always Write Us Before Buying
SHARP, PARTRIDGE & CO.
22nd and Lumber Streets, CHICAGO
WE HAVE SOME SNAPS

BOSTON PLATE & WINDOW GLASS CO.
GREENHOUSE GLASS GERMAN AND AMERICAN

261 to 287 A Street BOSTON 20 to 22 Canal Street

FOR "POT LUCK" TRY US...

HEWS STANDARD POTS

POT MAKERS FOR 140 YEARS

WORLD'S LARGEST MANUFACTURERS

WRITE FOR CATALOGUE AND DISCOUNTS

Pearson Street,
LONG ISLAND CITY, N. Y.

A. H. HEWS & CO., Inc.
CAMBRIDGE, MASS.

452-460 No. Branch St.,
CHICAGO, ILL.

Light
Graceful
Durable

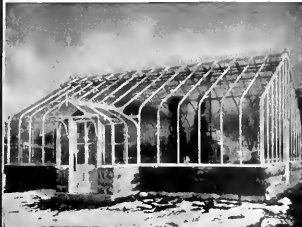
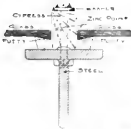

32 ft. wide without columns
**Payne "T"
Bar Greenhouse**

any width and length. Every bar galvanized steel. Absolutely dripless. No breakage of glass at eaves. Every kind of greenhouse construction. Estimates furnished.

JOHN A. PAYNE
Designer and Builder
260-274 Culver Ave. Jersey City, N. J.

Everything for
Greenhouse
Building

Write for information and prices

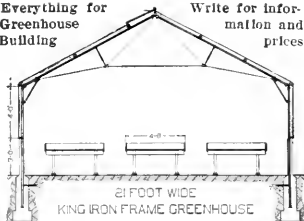

In Widths from 14 feet 0 inches to 54 feet 0 inches. Without posts.

**KING TRUSS SASH BAR HOUSES.
IRON GUTTERS AND EAVES
IRON AND CYPRESS BENCHES.
VENTILATING MACHINERY.
KING CONSTRUCTION CO.
NORTH TONAWANDA, N. Y.**

MASTICA
FOR Greenhouse Glazing
USE IT NOW.
F. O. PIERCE CO.
12 W. BROADWAY
NEW YORK

Mastica is elastic and tenacious, admits of expansion and contraction. Putty becomes hard and brittle. Broken glass more easily removed without breaking of other glass as occurs with hard putty. Lasts longer than putty. Easy to apply.

In ordering goods please add "I saw it in HORTICULTURE"

The FLORISTS' HALL ASSOCIATION OF AMERICA, insurer of 29,000,000 sq. ft. of glass. For particulars address: **John C. Esler, Inc., Saddle River, N. J.**

We can supply in any Size or Length and in Car Loads or any Quantity

PECKY CYPRESS

The Ideal Lumber for Greenhouse Benches

MOST LASTING - LEAST EXPENSIVE

When ordering your other building material it is wise to add enough Pecky Cypress to make the shipment a carload and so take advantage of lower carload freight rates.

— WRITE TO US FOR PRICES —

THE FOLEY MFG. CO., 26th & WESTERN AVES. **Chicago**

S. JACOBS & SONS
1350-1363 Flushing Ave., BROOKLYN, N. Y.

MANUFACTURERS OF

GREENHOUSE MATERIAL - VENTILATING APPARATUS - PUTTY
JOBBERS IN **GREENHOUSE GLASS - BOILERS - PIPE - FITTINGS**

We carry on hand everything necessary for the complete Erecting, Heating, Ventilating or Repairing of Greenhouses. Let us quote you.



**ADVANCE
VENTILATING
APPARATUS**

is a simple, neat and strong machine, made of the very best material, works very easy and any handy man can set it up quickly. One price to all. Get our net prices and do your figuring or get our estimate on what you need. We guarantee satisfaction. It has pleased all before you, certainly, we can please you too.

The Advance Co.
RICHMOND, IND.

PATENTS

Trademarks and Copyrights

Send your business direct to Washington. Saves time and insures better service. Personal attention guaranteed. Twenty-five years' active service. SPECIALTY: "Working on the Failure of Others."

SIGGERS & SIGGERS

PATENT LAWYERS

Box 9, National Union Building
Washington, D. C.

GREENHOUSE CONSTRUCTION LUMBER

John C. Moninger Co.
117 E. Blackhawk St., CHICAGO.

Holds Glass Firmly
See the Point
PEERLESS
Glazing Points are the best. No rights or lefts. Box of 1,000 points 75 cts. postpaid.
HENRY A. DREER,
714 Chestnut St., Phila., Pa.

KROESCHELL BOILER



MADE OF FIRE BOX FLANGE PLATE
Can not Crack.

Water Space in Front, Sides and Back
The Most Popular Boiler Made

SEND FOR CATALOGUE.

KROESCHELL BROS. CO.
35 Erie street, CHICAGO, ILL.

CYPRESS SASH BARS

32 feet or longer

HOT BED SASH

PECKY CYPRESS BENCH LUMBER

GREENHOUSES

ERECTED AND EQUIPPED COMPLETE IF DESIRED

Write for Circular "D" and Prices

The A. T. STEARNS LUMBER CO.
NEPONSET, BOSTON, MASS.



Evans 20th Century Arm

Will not twist the shafting pipe. Three times the power of old style elbow arms. Sold only with Evans Challenge Machine.

Write for free Catalogue to
QUAKER CITY MACHINE CO.
Richmond, Ind.

In ordering goods please add "I saw it in HORTICULTURE."

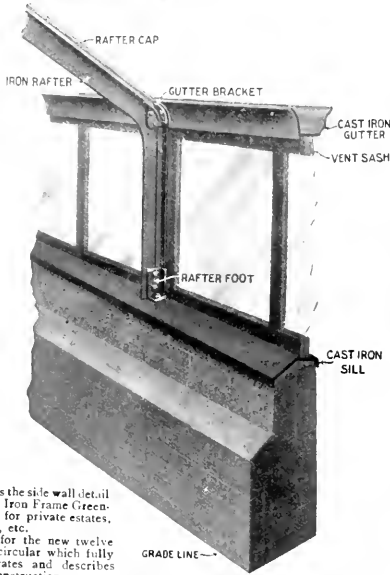

This is the side wall detail of our Iron Frame Greenhouse for private estates, parks, etc. Send for the new twelve page circular which fully illustrates and describes our construction.

GRADE LINE---

Hitchings & Company

Designing & Sales Offices 1170 Broadway, N. Y. General Offices & Factory Elizabeth, N. J.



The Longer Your Vines the More Your Fruit and Curvilinear Houses have the Longest Roof and the Best Curvilinear House is Our Sectional Iron Frame Construction.

LORD AND BURNHAM COMPANY,
Irvington-on-Hudson, N. Y.
New York — Boston — Philadelphia — Chicago

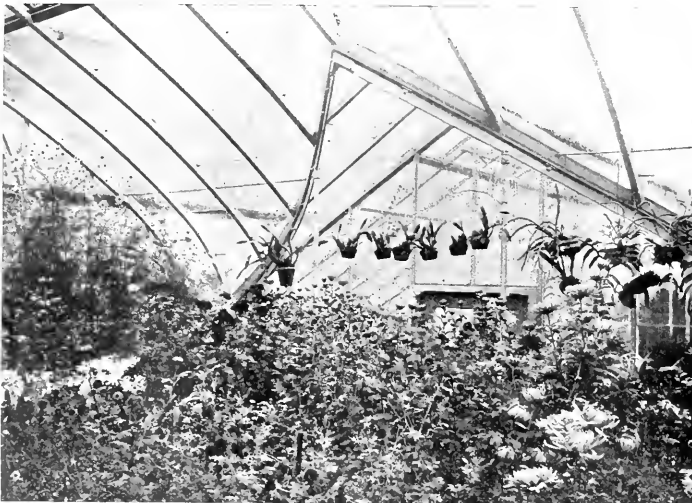

ABOUT THE WAY WE MAKE OUR ROOF CONNECTIONS

Everybody kicks against the heavy, ugly valleys necessary in the ordinary constructions. The U-Bar makes one that is clean cut, light and so skillfully handled that you scarcely notice it in the house. Other superior points of construction shown in the Advance Sheets of our new catalog which are now ready

PIERSON U-BAR COMPANY

NUMBER ONE MADISON AVE. N. Y.

HORTICULTURE

Vol. IX.

JUNE 26, 1909

No. 26



F. H. STANNARD.

President-elect American Association of Nurserymen.

DEVOTED TO THE
FLORIST, PLANTSMAN, LANDSCAPE GARDENER AND KINDRED INTERESTS
PUBLISHED EVERY SATURDAY AT 11 HAMILTON PLACE, BOSTON, MASS.
SUBSCRIPTION, \$1.00 PER YEAR



100,000 PEONIES

FOR FALL DELIVERY

All of the Leading Varieties from the Cottage Gardens' Famous Collection.

Our enormous stock enables us to send out tubers of the very highest quality, and in filling orders we use undivided roots only—assuring an abundance of flowers the first season. This year we offer one, two and three year plants.

WHOLESALE LIST NOW READY. SEND FOR A COPY.

Cottage Gardens Company, Inc.

QUEENS, LONG ISLAND, NEW YORK

CHRYSANTHEMUMS.

"Not small weak rusty stock grown under benches, but the kind that brings back Dollars for Pennies."

WHITE: Earliest October Frost (We have extra fine large stock of this variety), Mrs. Henry Robinson, Clementine Touset, Alice Byron, Timothy Eaton, Merry Christmas, White Bonafion.
YELLOW: Monrovia, Halliday, Appleton, Bonafion, Eaton, Chataquus Gold.
PINK: Maud Dean, Dr. Enguehardt.
RED: Intensity, Schrimpton.

All these varieties, rooted cuttings \$2.50 per 100; \$20.00 per 1000. 2 1/2 in. \$3.00 per 100; \$25.00 per 1000.
 Golden Wedding, R. C. \$3.00 per 100; \$27.50 per 1000. 2 1/2 in. \$4.00 per 100; \$35.00 per 1000.
 Golden Glow, R. C. \$5.00 per 100. 2 1/2 inch \$6.00 per 100.

ROSES.

2 in. or 2 1/2 in. 3 in or 3 1/2 in.
 100 1000 100 1000
 American Beauties... \$7.00 \$65.00 \$9.00 \$85.00
 Killarney—Own roots. \$6.00 \$55.00 7.50
 Mrs. Potter Palmer.....5.00 45.00 6.50

2 in. or 2 1/2 in.
 100 1000
 Bridesmaids } \$5.00 \$45.00
 Brides }
 Richmond .. }
 Knisternoe.....5.00 45.00 \$6.50
 Uncle John.....4.00 35.00

POEHLMANN BROS. COMPANY,

Morton Grove, Ill.

ROSES OWN ROOT

Bride, Maid, Richmond, Perle, Chatenay, 4 in. stock, \$8.00 per 100; \$75.00 per 1000.
 Mrs. Jardine, My Maryland, Rhea Reid, Beatrice, 4 inch, \$12.00 per 100
GRAFTED My Maryland, Golden Gate, Mrs. Jardine, Rhea Reid, \$20.00 per 100. Fine 4 inch stock.

These are in splendid shape for immediate planting.

'MUMS?? Sure, lots of them yet. Standard kinds, \$3.00 per 100; \$25.00 per 1000
 Asparagus Plumosa and Sprengerii, year old plants from bench, \$8.00 per 100; \$75.00 per 1000.

CHARLES H. TOTTY, Madison, N. J.

CHRYSANTHEMUMS

FOR EVERY PURPOSE.

ELMER D. SMITH & CO., Adrian, Mich.

OWN ROOT ROSES

Excellent stock. Ready for benching. Free from mildew and not pot bound.
KILLARNEY, RICHMOND, CHATENAY, MRS. POTTER PALMER, BRIDES, AND BRIDESMAIDS. 3 in. pots ready for 4 in, \$1.00 per hundred, \$10.00 per thousand.
BRIDES and BRIDESMAIDS. 2 1/2 in. pots, \$4.00 per hundred, \$35.00 per thousand.
S. J. REUTER & SON, Inc., Westerly, R. I.

CARNATIONS

F. DORNER & SONS CO.

LaFayette, Ind.

Cannas

Dry roots: Italia, Cleveland, Austria, Egadale, Mariborough, America, Penna, Black Beauty, \$1.50 per 100. Kate Gray, mixed with red, \$1.25 per 100. Asparagus Sprengerii, 2 in., \$1.75, 3 in., \$4.00, 4 in., \$6.00 per 100. Dracaena only, 4 in., 10c. English Ivy, 2 in., \$2.00; R. C. 75c per 100. Rex Begonia, 2 in., 3c.
J. H. DARN & SON, - WESTFIELD, N. Y.

In writing advertisers kindly mention HORTICULTURE.

SCOTT BROS.

Gloire De Lorraine Begonias
 From 2 1-4 and 3 1-2 inch pots, \$15.00 and \$25.00 per 100.

E'msford Nurseries, Elmsford, N. Y.

Begonia Gloire de Lorraine

Leaf Stock, June Delivery, \$15 per 100, \$145 per 1000 from 2 1/2 in pots
 Stock guaranteed to be absolutely free from disease.

THOMAS ROLAND NAHANT, MASS.

Send offer of Frank Sokol

Under Classification of Bedding Plants

Page 919 this issue

CARNATIONS

Fine Healthy Stock From 2 Inch Pots.
 Per 100 Per 1000
 Pres. Seelye - - - \$6.00 \$50.00
 White Enchantress, Beacon 4.50 40.00
 Victory, Winsor, Meleidy, Kingdon Pet - - - 4.00 35.00
 Daheim, Lady Bountiful, Mrs. Lawson, White Lawson, Red Lawson, Variegated Lawson 3.50 30.00

CHRYSANTHEMUMS

Rooted Cuttings
 G. W. Childs, Miss Clay Frick, White Shaw, Early Snow, Mrs. Jas. Parrish, Mayor Weaver, The Harriot, Yellow Eaton, \$2.00 per 100, \$15.00 per 1000.
 A. J. Bellour, Autumn Glory, Ada Spaulding, Dr. Enguehardt, Dorothy Devens, Geo. Kalb, Glory of the Pacific, Harry Pley, H. W. Reimen, Ivory, Jeanne Nonin, J. E. Lager, J. H. Troy, J. K. Shaw, Glad Dean, Meta, Monrovia, Mrs. Jerome Jones, Plante West, smaker, Mrs. Alice Byron, Mrs. Baer, Mrs. Robert McArthur, Major Bonnafion, Glad F. Bergmann, Nagoya, Polly Rose, Robt. Halliday, Timothy Eaton, W. H. Lincoln, Wm. Duckham, etc. \$1.50 per 100.
 Send for Catalogue of Roses, own root and grafted, and other miscellaneous stock.

WOOD BROTHERS FISHKILL, N. Y.

Send for our Preliminary List describing and quoting

Chrysanthemums and Carnations.

A fine lot of Carnation Cuttings ready now.

THE E. G. HILL CO.,
 Richmond, Indiana.

MARY TOLMAN

A New Light Salmon Pink Carnation for 1910.

\$12.00 per 100. \$100.00 per 1000.

A. E. Hunt & Co., Evansville, Ill.
Chicago Carnation Co., Joliet, Ill.
Hunt Bros., - - Park Ridge, Ill.

ROSES

A SPECIALTY

The Dingee & Conard Co. West Grove PA.

ROSES

Strong, 3-inch, ready to bench stock own roots from grafted RICHMOND, CHATENAY, BRIDE at 5c. Cash.

FRANK F. CRUMP
 Colorado Springs - - - Colo.

ASTER PLANTS.

Sampler Branching, Vicks and Queen of the Market fine plants grown from the best seed, 3 colors, \$2.00 per 1000; 5000 for \$10.00. Cabbage, Tomato and Celery Plants, all kinds, fine plants, \$1.00 per 100; \$5.00 per 1000. Peppers and Cauliflower. Best kinds, \$2.00 per 1000.

J. C. SCHMIDT, Bristol, Pa.

WHITE KILLARNEY

It is needless to say much about the value of this

NEW WHITE ROSE

its value is so well established. In support of this statement, we might say that we intend to plant not less than 20,000 for our own growing. We have a splendid stock of both grafted and own-root plants, which we can deliver immediately on receipt of order,—gilt-edged planting stock. We guarantee perfect satisfaction.

STRONG PLANTS. 2½ in. pots, own-root, \$30.00 per 100; 250 for \$70.00; \$250.00 per 1000.
GRAFTED PLANTS, \$35.00 per 100; 250 for \$82.50; \$300.00 per 1000.

SPECIMEN HYDRANGEAS

Large Plants Grown in Tubs and Half-Barrels for July and August Flowering

We make a specialty of these, and have a grand lot of plants in the finest possible condition. Our plants have never been so well budded as they are this season.

Fine plants in tubs, \$2.00 and \$3.00 each. Large plants in half-barrels, \$5.00 and \$7.50 each.

A FEW SEASONABLE SPECIALTIES

BOXWOOD PYRAMIDAL. Fine plants 3 ft. high, \$2.00 each; 4 ft. high, \$3.00 each; 4½ ft. high, \$4.00 each.

RUBBER PLANTS (Ficus elastica). Very large, bushy plants in tubs 4 ft. high, fine for summer decoration, \$3.50 each.

PHOENIX ROEBELENI. Extra fine plants, 5-in. pots, \$18.00 per dozen.

CROTONS. Strong plants, 3-in. pots, \$3.00 per dozen; 5-in. pots, \$6.00 per dozen; 6-in. pots, \$9.00 per dozen.

CANNAS. Buttercup, Sour, d'Antoine Crozy, Pierson's Premier, Mlle. Berat, L. Patry, Florence Vaughan, etc. Strong started plants, 3½-in. pots, \$5.00 per 100, \$30.00 per 1000; dormant roots, \$3.00 per 100, \$20.00 per 1000.

CALADIUM ESCULENTUM. Started plants, \$6.00 per 100.

CASTOR OIL BEANS (Ricinus). 3½-in. pots, \$6.00 per 100.

MUSA ENSETTE (Abyssinian Banana). 8-in. pots, \$1.00 each.

GERANIUMS. Double Gen. Grant. Extra fine plants in bud and bloom, 3½-in. pots, \$8.00 per 100.

GERANIUMS, assorted, in bud and bloom, 3½-in. pots, \$6.00 per 100.

NASTURTIUMS. 3½-in. pots, bushy, \$4.00 per 100.

ENGLISH IVY. 3½-in. pots, \$12.00 per 100.

GERMAN IVY. 2¼-in. pots, \$3.00 per 100.

AMPELOPSIS VEITCHII. Strong plants, 4-in. pots, \$15.00 per 100.

F. R. PIERSON CO., Tarrytown-on-Hudson, NEW YORK

Fine Rubbers at 20c.

All well grown stock in first class condition

Rubbers, 4 inch	each	.20c
" 6 "25c
Vincas, 2 "02c
Plumosa, 4 "05c
" 3 year04c
Mums, cuttings02c
" Nonin, out of pots.....		.04c
Sprenger, 3 year04c

Cash with order or satisfactory references

WILLIAM C. SMITH

Market and 61st Street

Philadelphia, - - Pa.

Last Call! Last Call!

For the NEW MUMS for EARLY PLANTING
 10,000 Golden Glow,—1000 White Cloud

1000 Pacific Supreme, all at \$25 per M, out of 2½ inch; \$18 per M, strong R. C., 200 at M rate. Add ½ for 100 rate, 50,000 October Frost, \$20 M. 2½ inch; \$12 M R. C.

After June 15 VIRGINIA PUEHLING, \$4 per 100, 2½ inch. Order NOW. LYNWOOD HALL, \$4 per 100.

1000 Golden Eagle—new yellow, \$5 per 100. All standards midseason and late \$20 per M, out 2½ inch; \$12 per M. R. C. Ask for our quantity prices. Will not be beat on them.

I. M. RAYNOR, Greenport, N. Y.

A. N. PIERSON, Inc., Cromwell, Conn.

WHITE KILLARNEY (Waban Strain)

GRAFTED STOCK.....	Doz.,	100	250	500	1000	2500	5000;
	\$6.00	\$35.00	\$82.50	\$150.00	\$300.00	\$657.50	\$1260.00

MY MARYLAND GRAFTED.....\$3.00 per doz., \$20.00 per 100, \$150.00 per 1000
 OWN ROOT .. 2.00 " " 10.00 " " 90.00 " "

STANDARD VARIETIES

Betty, Bon Silene, Bride, Bridesmaid, Cardinal, Enchanter, Etoile de France, Etoile de Lyon, Franz Deegan, Gen. McArthur, Golden Gate, Hermosa, Ivory, Kaiserin Augusta Victoria, Kate Moulton, Killarney, La Detroit, Maman Cochet, Marechal Niel, Mme. Abel Chateauy, Mrs. Jardine, Mme. Hoste, Mrs. Paul Niehoff, Mrs. Pierpont Morgan, Mrs. Potter Palmer, Papa Gontier, Queen Beatrice, Rhea Reid, Richmond, Rosaline Orr English, Souv. du President Carnot, Souv. de Wootton, Uncle John, Wellesley, White Cochet. The above Grafted (selected plan 5) 20 cts. each, \$2.00 per doz., \$15.00 per 100, \$120.00 per 1000.

OWN ROOT ROSES

Killarney, Bride, Bridesmaid, Mme. Abel Chateauy, Ivory, Richmond, Mrs. Paul Niehoff. 2-in. pots, 75c per doz., \$3.50 per 100, \$30.00 per 1000. 2½-in. pots, \$1.00 per doz., \$6.00 per 100, \$50.00 per 1000.
 Queen Beatrice, Rhea Reid, Mrs. Jardine, Mrs. Potter Palmer, from 2½-in. pots, \$8.00 per 100, \$70.00 per 1000.

BEDDING PLANTS

COLEUS. Verschollleitii, Golden Queen, Queen Victoria, Beckwith Gem, Firebrand, Lord Palmerston. Rooted Cuttings by express, \$0.60 per 100, \$5.00 per 1000. Out of 2½ in. pots in May, \$2.00 per 100, \$15.00 per 1000.
 Golden Bedder, Hero, Messy, Pearl of Orange. Fancy Varieties. Twelve kinds not listed above, 75 cts. per 100, \$5.00 per 1000.
 AGERATUM, Stella Gurney, Princess Pauline. SALVIA, Splendens, Bonlire and Zurich. HELIOTROPE. Dark blue bedding varieties. GERMAN IVY. 75 cts. per 100, \$6.00 per 1000.
 ALTERNANTHERA. (Red and Yellow), 50c per 100, \$5.00 per 1000. From 2½ in pots, \$2.00 per 100.
 SALLEROL, Rooted Cuttings, \$1.00 per 100, 2½ in. pots, \$2.50 per 100.
 CHRYSANTHEMUMS IN QUANTITY. Catalogue on Application.

PEACOCK'S CELEBRATED NEW DAHLIAS

JACK ROSE and other cut flower sorts.
 SEND FOR CATALOG.
 Peacock Dahlia Farms
 Williamstown Junction, N. J.

DAHLIAS.

Now is the time to place your order for bulbs which will insure you getting named varieties in any quantity; prompt delivery.
DAVID HERBERT & SON,
 Successors to L. K. Peacock, Inc.
 ATCO, N. J.

Dear Sir:

BUSH HILL PARK, ENFIELD, MDD'X, June, 1909

HUGH LOW & CO. Dissolved

In consequence of the voluntary Dissolution of my late Firm, I have much pleasure in informing you that I have taken over the Royal Nurseries with the greater part of the stock. These Nurseries were formed by me in 1831, under the instructions of my late Father, and since his death, I have taken an active part in the direction of the business.

The staff which is transferred, practically intact, includes such well-known men as my representatives — Mr. Harry A. Barnard, Mr. F. W. Ashton, and Mr. Laurence J. Cook. Mr. Edward Tack as Orchid Specialist and Grower, and Mr. M. C. Allwood, the enthusiastic Carnation Man. Messrs. Moore, Reid and Meades, amongst the Roses and Fruit Trees, and Mr. Phillips in the General Department.

I feel that with such men at my back, clients can rely upon the same care and attention being given to their business as under the old regime.

Esteeming your orders and enquiries, believe me to be always at your service as heretofore.

Please address all communications

Obediently yours,

STUART LOW & CO.,

Bush Hill Park, Enfield, Midd'x, England

STUART H. LOW

Araucarias OUR Specialty

Araucaria Robusta Compacta and **Excelsa**
Glauca, Specimen Plants, Spring 1909 importation, 7 inch pots, 25, 30, 35, 40 inches high, 6 years old, 8, 10 able for the veranda, porch or lawn, \$2.00, \$2.50, \$3.00 each, worth double that amount.
Same Varieties, April 1909 importation, 15-20-22 inches high, \$1.00, \$1.25, \$1.50.
Araucaria Excelsa, 5, 5 1/2, 6 inch pots, 2-3-4 years old, 100, 500, 600, 750, \$1.00.
Keatia Forsteriana, 6-7 inch pots, 25, 30, 40, 50 inches high, \$1.00, \$1.25, \$1.50, \$2.00, \$3.00 each.
Belmoreana, 6 inch pots, 5 to 6 leaves, \$1.00, \$1.25, \$1.50.
Cocos Weddiana, 3-4 inch, 150, 180, 250.
Adiantum Hybridum, valuable for fronds for cutting, big bushes suitable for 6, 7, 8 inch pots, 300, 400, 500.
Arcua lutescens, 4 inch, 250.
Begonia Gloire de Lorraine, 4 inch, 250.
Lonsdale light pink and the dark pink.
Sago palms, 100, per leaf.
 Cash with order please.

GODFREY ASCHMANN

Importer and Wholesale Grower of Pot Plants
 1012 W. Ontario St., PHILADELPHIA, PA.
 All goods must travel at purchaser's risk

Kentias, Arecas, Latanias, Cocos, Phoenix, Araucarias, Rubbers, Crotons, Pandanus, Asparagus, Ferns for Dishes. 200,000 Bedding Plants, also Rooted Cuttings of Coleus at lowest wholesale rates.

Orders taken for imported plants for fall delivery

A. LEUTHY & CO.

PERKINS ST. NURSERIES

ROSLINDALE, MASS.

Hardy Rhododendrons, Azaleas, Conifers, Clematis, H. P. Roses, Shrubs and Herbaceous Plants from our HOLLAND NURSERIES

Prices Moderate

P. OUWERKERK, 216 Jane St., Weehawken Heights, N. J.

American Grown Roses

Fruit and Ornamental Trees, Shrubs, Small Fruits, Clematis, Evergreens.

Write for Trade List.

W. & T. SMITH CO.

Geneva,

N. Y.

GERANIUMS

ARE OUR SPECIALTY

We are preparing to grow Geraniums on quite an extensive scale for next season; and claim to have the largest stock and most complete collection in the country, and are making very interesting **Special Prices for November and December delivery.** Write us about your probable requirement and we will convince you that it is more to your advantage to buy just the kinds you want in the fall than to bother with saving a few stock plants and working up stock yourself.

We have ready for shipment about 250,000 in 2 and 3 in. pots which would make fine stock for Fall and Christmas sales. **A splendid collection of Single for winter blooming at \$2.00 per 100; \$18.50 per 1000.**

If you want to stock up now we will send you 1000, 50 each of 20 good distinct kinds, our selection for \$18.50, which we are confident would please you in every way.

NOVELTIES

We now offer one each of 100 Varieties, 1907 and 1908 Novelties, good stocky plants from 3 in. pots for \$10.00. This collection should represent the highest development in Geraniums to date, as they come from the foremost introducers of the world.

Cash With Order

R. VINGENT, JR. & SONS CO., White Marsh, Md.

RHODODENDRONS, ANDROMEDAS, KALMIAS AND SPECIMEN EVERGREENS

JOHN WATERER & SONS, Ltd.

AMERICAN NURSERY

BAGSHOT - - - ENGLAND

TREES, EVERGREENS, SHRUBS, VINES, PERENNIAL PLANTS, FRUITS, TRAINED FRUIT TREES, FOREIGN GRAPE VINES, HARDY RHODODENDRONS and R. MAXIMUM in quantity, per hundred or per thousand, very fine. Complete assortments: Careful grading: Low prices.

AMERICAN NURSERY COMPANY,

Sales Department, - - - 150 BROADWAY, NEW YORK CITY.
 BLOODGOOD NURSERIES DEPT., - - - Flushing, Long Island.
 F. & F. NURSERIES DEPT., - - - Springfield, New Jersey.

Box Trees

and other **EVERGREENS** for **Tubs and Boxes**
 Our Prices are Always Right—Catalog Free
THE NEW ENGLAND NURSERIES, Inc.
 BEDFORD, MASS.

New Hybrid Calceolaria



The accompanying photograph is that of a new hybrid Calceolaria raised by Robert Shore, head gardener in the Botanical Department of the University of Cornell. Forty-five plants were obtained as a result of crossing a small shrubby variety, which originated as a chance seedling from seed supplied by the Peter Henderson Co. of New York, and a plant of the herbaceous type commonly grown in greenhouses.

A strange feature is the tallness of the hybrids, seeing that the parents are of dwarf habit. However, the tall character does not in any way detract from their beauty; rather it lends a charm which is not possessed by the parents. The flowers stand well up above the foliage and are beautifully mottled, the colors ranging through all the shades of yellow and bronze to a shade of purple,



the plant possessing the latter coloring being very distinct, and should it be reproduced from seed will undoubtedly prove a valuable acquisition as a greenhouse subject. In size, the flowers and leaves are intermediate between those of the parents, while the general habit of the plant is not unlike that of *C. kewensis*, although perhaps more graceful. An individual plant gives but a poor idea of the decorative value of the hybrid, which is seen to the best advantage when massed or grouped together with other ornamental plants.

Many beautiful hybrid plants have been raised by Mr. Shore, but being of a modest disposition very little has been heard of him as a hybridizer.

H J Moore

Crassula coccinea, Syn. Kalosanthes coccinea

This beautiful fleshy shrub is a native of Table Mountain, South Africa, and has been known to horticulturists for a great many years. As a young man in the old land I can remember seeing some magnificent specimens at exhibitions. Here around Boston I have seen very little of it and several well-known plantmen have told me it was a failure in this climate, which is certainly a very erroneous idea. As a summer flowering plant I don't know of anything that will more quickly attract attention and its bright scarlet flowers, lasting for over five weeks, make it very suitable for piazza decoration.

Crassulas are easily propagated. After the plants have finished flowering in July we take the stems and cut them into pieces about an inch and half long and insert in sand. They will root in about three weeks at that time of the year and each piece will break two or three eyes. In this age of hustle it takes a good deal of patience to wait for a single cutting to make a decent sized specimen. The quicker way is to prick the cuttings when rooted thickly into the desired size of pot; a ten-inch pot is what we generally use. Fill the pot full of a good rich open soil (the above size will hold about eighty cuttings), keep a little close for a day or two and set outdoors in the full sun as long as there is no frost.

In winter we keep them in the coolest end of a house where calceolarias and cinerarias are grown, the thermometer quite often being as low as 34 degrees. When the plant is about ten months old a few straggling flowers will set which we cut off. Right here I suppose it is where some get discouraged with the plant and give it up as being no good for this climate, but if kept for another season one will be rewarded with a plant about three feet high with two hundred or more flowers if grown in the above-mentioned pot.

If a dwarf plant is desired the following method will answer. After a plant has set for flower make cuttings of the shoots the required length and fill a pan of good sandy soil and set them in as thick as you can get them and put for three weeks in about sixty degrees of heat when they will be all rooted. Remove to a cool light house as soon as they are rooted and give a little weak liquid manure occasionally until they show color. They will flower beautifully although not so large as the older plant.

George F. Stewart.

West Medford, Mass.

HORTICULTURE

VOL. IX JUNE 26, 1909 NO. 26

PUBLISHED WEEKLY BY
HORTICULTURE PUBLISHING CO.
11 Hamilton Place, Boston, Mass.

Telephone, Oxford 22
WM. J. STEWART, Editor and Manager

SUBSCRIPTION PRICE
One Year, in advance, \$1.00; Ten Foreign Countries, \$2.00; To Canada, \$1.50
ADVERTISING RATES

Per Inch, 30 inches to page \$1.00.
Discounts on Contracts for consecutive insertions, as follows:
One month 4 times 5 per cent.; three months 13 times 10 per cent.;
six months 26 times 20 per cent.; one year 52 times 20 per cent.
Page and half page spaces, special rates on application.

Entered as second-class matter December 8, 1904, at the Post Office at Boston, Mass under the Act of Congress of March 3, 1879.

CONTENTS

	Page
COVER ILLUSTRATION—F. H. Stannard, Pres.-elect Amer. Asso. of Nurserymen.	
NEW HYBRID CALCEOLARIAS—H. J. Moore—Illustrated	893
CRASSULA COCCINEA, SYN. KALOSANTHES COCCINEA—George F. Stewart	893
NOTES FROM THE ARNOLD ARBORETUM—Alfred Rehder	895
EUROPEAN HORTICULTURE—Frederick Moore.....	895
AMERICAN SEED TRADE ASSOCIATION: Proceedings at Niagara Falls Meeting—President's Address—Reports of Officers and Committees—Reports on Seed Legislation—Officers Elected.....	896
National Association of Seed Analysts—Irrigation in the East.....	897
NEWS OF THE CLUBS AND SOCIETIES: Massachusetts Horticultural Society—Tarrytown Horticultural Society—Commercial Florists' Association of Rochester—Morris County Gardeners' and Florists' Society—New Jersey Floricultural Society—Postponement of Newport Show.....	898
Royal Horticultural Society, Frederick Moore—American Rose Society—Westchester Horticultural and Agricultural Society—Huntington Horticultural and Agricultural Society.....	899
Pennsylvania Horticultural Society—Park Superintendents Visit Boston—B. H. Farr, President-elect American Peony Society, portrait—Club and Society Notes	900
SEED TRADE: Bermuda Onion Seed Crop Prospects, F. C. Varela—The Corn Crop—Canning Peas—The Value of Experience	902
OF INTEREST TO RETAIL FLORISTS: Steamer Departures.....	904
Flowers by Telegraph.....	905
FLOWER MARKET REPORTS: Boston, Buffalo, Washington.....	907
Chicago, Indianapolis, New York.....	909
Philadelphia, Rochester.....	914
OPTIM'ARY: Mrs. T. D. Cobb—Mrs. Julia D. Stroud.....	914
A PEONY DAY.....	916
MISCELLANEOUS: St. Louis News.....	897
Rochester Personal and News Notes.....	897
Greenhouse Glass Drops in Tariff Schedule.....	899
Personal.....	900
Catalogues Received.....	902
Pansies at Pittsburgh.....	902
News Notes.....	904
Chicago Notes.....	905
Business Changes.....	897-914
Greenhouses Building or Contemplated.....	915
Patents Granted.....	915
Philadelphia Notes and Comments.....	916

Another mile stone With this issue closes Vol. IX of HORTICULTURE. It contains forty-eight pages more than the corresponding volume, first half of last year, necessitated by the very gratifying increase in advertising business. It is a matter of no small satisfaction to the publishers of

HORTICULTURE to note the increasing and steady growth of confidence in the paper as unquestionably indicated by the support accorded by the most reliable advertising houses. We believe this to be based upon real value as an advertising medium, due to the high character of the reading matter which we have been enabled to present, and we take pleasure in stating that still greater advancement on this line is assured for the immediate future. We realize that no better foundation can be laid for an effective advertising medium in the horticultural industries at their present stage of development than readable and instructive matter from the pens of the most advanced and representative men of today in the profession. We shall endeavor, as in the past, to steer clear of threadbare and overwritten subjects and aim for the best in up-to-date fields that have not been worn out.

“Time is a sort of river of passing events.” The change in the personnel of the old and world-renowned firm of Hugh Low & Co., which is announced in our advertising columns will doubtless prove of more than minor interest to many of our readers, for from this establishment have graduated a large number of our leading gardeners. In the early part of the last century it was already a power in the horticultural world—under the late Hugh Low whose enterprise brought to notice many varieties of Mexican plants, California conifera, New Holland species, Cape heaths, camellias, etc. When the reins were taken up by the late Stuart Henry Low orchids were a specialty and no corner of the world was exempt from his collectors, his brother Sir Hugh Low, Blunt, Boxall, Smith, Tucker, Bruckmuller, Lehmann, White, Currow and others all sending home large shipments of what are now the main occupants of our orchid houses and during his regime the glass at Clapton Nurseries was increased four-fold and the present Bush Hill Park Nursery was started with his son Stuart Henry in charge and assisted by his younger brother Edward V. Low who is well known personally among the trade in the United States.

A privilege and a recompense This week, from the Atlantic to the Pacific, the country is all aglow with the peony and the rose—than which Nature has given us no fairer benefaction. At sight of their splendor and scent of their perfume humanity is constrained to stop for a moment its strenuous rush and submit to the sway of the gentler emotions and the fierce struggle of traffic and speculation is temporarily forgotten in the contemplation of the garden glory. Nurseryman or florist, have you ever given a thought to the part you are privileged to perform in the great onward and upward march of refinement? To your industry and skill, perhaps more than to any other influence, is due the fact that the land is decked in such loveliness today. Eloquently these flowers are speaking in your behalf—better persuaders than all the pictures and agents and books. The pity is that so many who seek to sell these things to the people neglect to use the splendid means that is within their grasp, paying no more attention to the floral adornment of their homes or business premises than a bricklayer or sausage dealer might be expected to show. There is something radically wrong with the florist or nurseryman who fails to display his art in its most impressive possibilities in and around his place of business. The surroundings of the offices and work rooms of the men who deal in trees, plants and flowers should invariably set the standard of home adornment in the neighborhood.

Notes from the Arnold Arboretum

Though the number of *Spireas* cultivated in our gardens is by no means small, the new Chinese *Spirea Henryi* promises to be a valuable addition on account of its blooming so late for a species of the spring flowering group, its flowers appearing about the middle of June, when all the other hardy *Spireas* of this group have passed. The white flat flower clusters are produced in great abundance along the spreading branches of the previous year as in the other species of this particular group, while in the summer-flowering *Spireas* the flowers appear at the end of the usually wand-like shoots which gives them an entirely different and as a rule less graceful habit. *Spirea Henryi* is a compact shrub three feet in height or more with upright stems and spreading branches clothed with neat bright green foliage, the leaves being about an inch long or a little longer and oval to oblong in outline with a few teeth toward the apex. The white flowers appear in flat clusters about two inches in diameter along the whole length of last year's branches. As it has stood at the Arboretum the last two winters without being injured, it may be considered as hardy in this latitude. Two other species from China, *Spirea Veitchii* and *S. Wilsonii*, have not yet bloomed here, but to judge from herbarium specimens and descriptions they are very similar in habit and general appearance and probably as hardy as *S. Henryi*. It was a happy thought or may be unintentional to commemorate in the names of these three closely related species introduced recently from China the names of the three men who have been in recent years so successful in bringing to our knowledge as well as introducing into cultivation so many beautiful plants from China the flora of which seems unexpectedly rich and almost inexhaustible.

Among the Honeysuckles attention may be drawn to two recently introduced species which like the above mentioned *Spireas* are valuable on account of their blooming later than the other species in cultivation; these are *Lonicera deflexicalyx* and *L. leycesterioides*. The former is an upright shrub with long and slender arching or nearly pendulous branches studded with rather small two-lipped flowers about three-quarters of an inch in length, pale yellow when they open, but changing soon to almost golden yellow; they are borne on short stalks in the axils of the leaves which are about two inches long and lanceolate in outline. The berries which ripen in autumn are orange yellow. The other species *L. leycesterioides* has also yellow flowers of about the same size borne at the end of the branchlets in the axils of the upper leaves smaller than those of the preceding species and more ovate in outline. The berries are bright red but partly enclosed by an involucre formed of the bractlets. Both species seem to be perfectly hardy here and though not very showy, worth planting on account of their late flowers. Another comparatively new Honeysuckle, *Lonicera Altmanni* from Turkestan, is now very attractive with its numerous pea-sized twin berries of a bright scarlet color. It is an upright shrub three feet high or more with dull green rather small foliage and whitish not very showy flowers appearing early in May together with the leaves. It is perfectly hardy.

Alfred Rehder

European Horticulture

TUBEROUS BEGONIA GRAF ZEPPELIN

In recent years not much has been seen or heard of *Begonia Graf Zeppelin*, and it looks as if it had quite disappeared. It is not easy to find any plants prettier than this light brick-red colored begonia for a bed. It is the usual practice to propagate the plant by cuttings made from the young shoots, and by the leaf. Earthing-up is an advantageous method. For this purpose a few plants should be planted in frames rather wide apart; and when these mother plants have produced a number of shoots, the soil should be drawn over the tuber a few inches high, or it should be added from an outside source. In about three weeks the whole of the earthed-up shoots will have formed roots at the point where the earthing-up is closed. The rooted shoots may then be detached in such a way as not to make wounds in the tubers, and planted in pots of suitable sizes, in a mixture of two parts leaf soil, one part peat, and a good proportion of sharp-sand. This method of propagation may be carried out thrice during the course of the summer.

THE BOTANIC GARDEN, REGENTS PARK, LONDON

The Royal Botanic Garden has not been a financial success for many years past for the probable reason that it has not served any useful scientific purpose. The few shows held are not well patronized by the public, excepting always on the occasions when some special society, as the National Rose, decides to hold one there, when the highest in the land come in large numbers, or some ridiculous floral fete is being held. Now, the society is passing through a financial crisis. The debenture debt amounts to £30,000, and there are numerous creditors, the chief one being the office of Woods and Forests, to whom rent is owing. The matter was brought before a special meeting of the Fellows on Tuesday, May 25 last, and it was resolved almost unanimously that Fellows should give five guineas each to pay the debts and save the garden from going into liquidation. This decision was reported to a general meeting. Towards the end of last year a writ was hanging over the garden, and to prevent it being served Mr. C. Brinsley Morley, vice-president and treasurer, paid the money. After a stay in Germany he returned to London a few weeks ago to find another writ. Again he paid the money to save the garden. The sum required to place the society in a fair condition on January 1, 1910, was about £5000. He proposed that each Fellow should subscribe a minimum of three guineas; but an amendment that the subscription should be five guineas was carried, only three voting against it.

THE CANNA FAMILY (*Das Geschlecht der Cannas*)

In recent years M. Arpad Muhle, florist and nurseryman, Temesvar, Hungary, has proved himself to be the most successful raiser of new varieties of cannas. He has now brought out a brochure consisting of 118 pages, in which everything is stated that a cultivator and raiser of new cannas needs to know. Particular chapters deal with the crossing of varieties, natural and artificial propagation, cultivation and employment in the garden. The greater part of the contents of this pamphlet consists of a scrupulously worked out catalogue of the true species and large flowered varieties of cannas.

Sunderick Brown

AMERICAN SEED TRADE ASSOCIATION

Twenty-Seventh Annual Convention at Niagara Falls a Notable Event

Officers Elected

PRESIDENT, J. C. Robinson, Waterloo, Neb.; FIRST VICE-PRESIDENT, M. H. Duryea, New York; SECOND VICE-PRESIDENT, F. W. Bolgiano, Washington, D. C.; SECRETARY-TREASURER, C. E. Kendel, Cleveland, Ohio; ASSISTANT SECRETARY, Leonard H. Vaughan, Chicago.
EXECUTIVE COMMITTEE, W. S. Woodruff, Orange, Conn.; Geo. S. Green, Chicago; Alex. Forbes, New York; C. N. Page, Des Moines, Ia.

The twenty-seventh annual convention of the American Seed Trade Association convened at Clifton House, Niagara Falls, Ont., June 22, President Watson S. Woodruff, of Orange, Conn., in the chair. An address of welcome was made by Hon. R. P. Slater, Mayor of Niagara Falls, and was responded to by H. W. Wood, of Richmond, Va., in felicitous manner.

President's Address.

President Woodruff's annual message congratulated the membership upon a successful year in business, and said that the fact that so few failures occur in the seed business augurs well for the honesty and probity of the seedsmen. He referred feelingly to the loss which the association has suffered in the death of Warren W. Rawson, Boston, Mass.; S. W. Flower, Toledo, Ohio and C. L. Allen, Floral Park, N. Y., in the past year. Committee on obituary consisting of Messrs. C. H. Breck, W. T. Phillips and M. H. Duryea was appointed pursuant to this item. President Woodruff called attention to bills introduced in the legislatures of New Hampshire, Wyoming, North Carolina, North Dakota, Michigan, Missouri, New York, South Dakota, Wisconsin, Iowa, Rhode Island, Minnesota and Tennessee, during the 1909 sessions, and enacted in a number of these states, New Hampshire, Wyoming, North Carolina, Wisconsin and Tennessee. The committee of seven appointed last year to consider the question of unwise state legislation and federal legislation on the general subject of seeds has done able and conscientious work during the year, and has materially assisted to stem the tide of unwise legislation. In one state a license of \$25 yearly was established, which is doubtless unconstitutional. Several states have endeavored to establish arbitrary and unreasonable standards of purity and viability of seeds.

President Woodruff called attention to the large number of laws which have been introduced recently into state legislatures, the character of which is so severe as to be most alarming many of them containing absolutely impracticable provisions. In Europe such legislation is not attempted, but a safe and sane policy followed. The Kentucky Seed Act stands alone in American state legislation as adopting the reasonable pro-

vision as to intentional deception which characterizes the Seeds Act of Great Britain. In almost all the states there is no attempt to relieve the seedsmen from the rigors of the law in the case of an honest mistake. Owing to the difficulty of local seedsmen always being informed as to the legislation that is attempted, President Woodruff recommends the appointment of a special committee to look after the general work connected with seed legislation to have the benefit of legal advice from a regularly retained counsel. This recommendation was adopted by the association in convention. The Wholesale Seedsmen's League are to co-operate in the employment of the counsel.

President Woodruff further recommended that in future legislation, separate statutory provisions be made to cover sales of garden and flower seeds from those governing the sale of grass, clover and field seeds. This recommendation was also approved by the convention after it was favorably endorsed by the special committee appointed on President's address. President Woodruff passed a high encomium upon the work of J. C. Vaughan for his efficient work on the Committee on Tariff and Customs. The great and all-important question has been the matter of specific rather than ad valorem duties, and the Senate having approved the specific duties it now remains for the House to follow suit.

President Woodruff expressed the belief that the knell of low grade seeds is sounding through the land, and that seeds of high grade will command a much better price than formerly, and the cheap seeds go begging. Publicity is the cure for many of the evils that have confronted the seed business of recent years, and all seedsmen will lend their aid to the correction of any abuses that may creep in the trade most cheerfully.

President Woodruff paid his respects to the abuse of government free seeds and commented on the same in a forceful way, stating that the total expended by the government for free seed distribution, not over ten per cent of which were ever used for any useful purpose, from 1903 to 1909, inclusive, amounts to the sum of \$2,197,800; and next year each senator, member and delegate will be allowed 20,000 packages of vegetable seeds, and 2,000 packages of flower seeds. Small fractional currency for mailing purposes was favorably mentioned as a possible great aid to the mail order business.

President Woodruff referred to the subject of mutual insurance against fire by seedsmen, and recommended

that a standing committee of three be created to work out the whole subject to some conclusion for report to the next convention. He was informed that considerable saving had been effected by the hardware people in this way. With the recommendations that the Executive Committee and J. C. Vaughan be allowed their traveling expenses, and with a pronounced note of optimism for the future of the seed business, President Woodruff held up "Quality" as always and ever the watchword of the trade, and his belief that seedsmen of all others leave the world better than they find it, as they cause two blades of grass to grow where only one grew before.

The President's address was referred to a committee of five, Messrs. J. C. Robinson, Walter P. Stokes, C. H. Breck, Chas. Dickinson and Albert McCullough, who recommended concurrence in various recommendations. A vote of thanks was returned to the President for his able address on motion of Capt. Landreth.

Reports of Officers and Committees.

The report of Secretary-Treasurer Kendel showed the finances in good shape and membership increasing. New members elected were Kirby B. White, Detroit, Mich.; Cargill Elevator Co., Minneapolis, Minn.; Edwin C. Foltz, Louisville, Ky., and D. B. Gurney, Yankton, S. D. The Auditing Committee, F. W. Bolgiano, S. E. Briggs and Ben P. Corneli reported books in good shape and accounts correct; report accepted. Albert McCullough presented report of Delegates to National Board of Trade. Himself and W. Atlee Burpee had participated in important work on committees of the National Board of Trade, on postal and other matters of mutual interest to the two Associations. C. E. Kendel presented report of delegates to National Council of Horticulture, showing the great value of the work of the Council to the seed trade and horticultural interests. Report accepted.

Two Reports on Seed Legislation.

Geo. S. Green, chairman Committee on Seed Legislation, presented report of the committee referring to its general federal aspects, and Chas. N. Page, vice-chairman, presented a separate report referring to seed legislation in the various states and territories. Mr. Green's report favored laws to prevent the importation of adulterated and low grade seeds as for the general good of the trade and the public; he recommended the passage of a proposed bill carrying out this idea. With regard to absolute freedom from dod-

der in the minutest ratio he felt that a minimum percentage should be favored such as will not exclude commercially valuable seed in years when a sufficient supply cannot be obtained in this country. The European screenings should be excluded from this country. In regard to prohibited seeds a reasonable margin of tolerance should be shown. As to germination hard and fast rules should not be adopted. The methods of testing for germination are so variable and the results of tests vary so much in various hands that it is really unreasonable to try to enforce a criminal law, the punishment based on such evidence as can be possible with regard to germination of seeds. Seeds that are above a certain minimum standard should not have to be labelled, for while there are laws against burglary the seedsmen should not have to be compelled to tag himself as not a burglar. He deprecated the fact that much of the legislation seemed to be class in its nature in that it endeavored to exempt the farmer from the operation of the same law that was sought to be enforced as against the seedsmen. Chas. N. Page's report commented on the large amount of crude and ill-considered legislation that has been attempted, and gave an exhaustive review of the present condition of seed legislation in the various states. In many of the states legislation so drastic had been attempted that its effect would have been not only to knock all the seedsmen out of business but to absolutely render unsalable all the seeds produced in the states affected. In conclusion, he said that the American Seed Trade Association do not object to any reasonable sane national or state legislation affecting seeds. The Committee recommended that a committee of three be appointed to confer with a similar committee from the National Association of State Seed Analysts to agree if possible on the draft of a uniform state seed law to take the place of the many objectionable laws which now exist. This recommendation was concurred in, and also the recommendation by President Woodruff that in future statutory enactments separate provisions be inserted governing the sale of vegetable and flower seeds from those covering the sale of grass, clover and field seeds.

C. F. Wood, of the Committee on Weights and Measures, read a letter from F. Reichman and D. C. Palmer, Sub-committee of the Nat'l Conference of Weights and Measures, and same was fled without action at this time. The application of Linnaeus Allen to continue the membership of C. L. Allen, deceased, was favorably reported by the membership committee and concurred in.

National Association of Seed Analysts.

In the absence of the author Mr. F. C. Woodruff read the paper by the president of the National Organization of Seed Analysts, E. H. Jenkins, setting forth purposes and scope of his organization, to improve and unify present methods of seed testing and to work for more uniform and satisfactory laws regulating the sale of agricultural seeds. This work is being forced upon the attention of agricultural stations of the country by the

logic of events and from the side of the retail purchaser, and follows as a consequence of other kinds of control work which, state institutions are doing. Determinations as to species as labeled, whether relatively light or heavy, what percentage of foreign matter contained and percentage of pure seed capable of germinating are obviously of greatest value to the buyer. The results to be accomplished are similar in nature to what has been done in the past twenty-five years by the Association of Official Agricultural Chemists in securing accuracy and uniformity in fertilizers, etc. The association will welcome any facts or suggestions from American Seed Trade Association membership, and expresses cordial relations with them, and in no sense is the organization hostile to producers or dealers, but aims to foster fair trade and legitimate competition.

In the absence of the author Secretary Leland read the paper on Seed Legislation by Prof. Pammel, and on motion of Mr. C. F. Wood a special vote of thanks to Messrs Jenkins and Pammel was adopted, and 2,000 copies of Prof. Pammel's paper were ordered printed for distribution.

Irrigation of the East.

Capt. Burnett Landreth of Philadelphia read a paper on the application of irrigation to old eastern farms, and presented some of the difficulties that might confront the establishment of such at first because of riparian rights of farmers who would object to the water from any small stream being diverted by farmers above who might undertake to irrigate their own farms; therefore, farmers in the east will be dependent for such irrigation upon wells driven on their own farms unless they reside upon the banks of large rivers from which they can draw water without objection. He then presented the following resolution, which was adopted unanimously:

While the American Seed Trade Association heartily approves of the promotion by the United States Government of irrigation practices in the New West, the association is as firmly impressed with the belief that there is pressing room for some federal promotion of irrigation practices in the Old East; consequently I move that there be appointed a committee of three to urge upon the Secretary of Agriculture of the United States and the Agricultural Committees of the Senate and House such congressional legislation as will establish a national irrigation station near the city of Washington where may be assembled pumps, irrigating machinery and all appliances so that working processes may be shown as adapted to Eastern conditions.

The convention adjourned until Wednesday morning, the evening being occupied with social pleasures, concert and dance.

Closing proceedings of the Convention will appear in our Seed Trade columns next week.

Bay City, Mich.—The firm of Schweers & Potratz Floral Co. has dissolved and the business will be conducted hereafter by Carl B. Schweers.

ST. LOUIS NEWS.

The Henry Shaw Banquet.

The members of the St. Louis Florists' Club have all been extended an invitation to attend the Henry Shaw banquet given to gardeners, florists and nurserymen at noon, Thursday, July 1st, to take place in the open air at the Missouri Botanical Garden. This is the first time that this yearly banquet is given at the garden and in the open. Secretary Benizen of the Florists' Club was asked by Prof. Wm. Trelease to notify each member of the club, which he has done and it is hoped that the entire membership, which numbers nearly one hundred, will respond and spend a pleasant afternoon at the home of the late Henry Shaw, who in his will provided for these social entertainments yearly.

Personal.

A. W. Murray has moved from his old location, 2032 Eastern avenue, to Union and Page Boulevards.

John E. Guinn, who for many years was on Grand and Finney avenues, has moved around the corner to 3507 Finney avenue.

Miss Margaret Klickeukern and Miss Adele Brix, both daughters of well-known St. Louis florists, were married recently. Both husbands are outside of the trade.

Visitors in town last week were T. E. Waters, representing the A. L. Randall Co., Chicago; Mr. Guy M. Reburn, Chicago and F. H. Macke, traveling salesman for the Chicago Tin Foil Mfg. Co.

Walter Retzer, late vice-president of the St. Louis Seed Co., who resigned his position to take charge of a railroad in South America, has changed his mind about leaving St. Louis and has taken a position with Grimm & Corley on Cass avenue.

ROCHESTER PERSONAL AND NEWS NOTES.

Salter Bros. are contemplating rebuilding several of their houses.

H. Salmon, a newcomer at Mt. Hope Cemetery contemplates building a 30x150 ft. house, King construction.

F. Thoman is going to Europe for an extended trip through Holland and Belgium, to visit growers there.

J. B. Keller's Sons are having their store remodelled and, when completed, they will have a first-class floral emporium.

The firm of Croke Co. are building a propagating house, King construction, on Mt. Hope. The grower here is F. Scofield.

A number of new roses are being tried out by Mr. Ogston, gardener at the Kimball estate. A visit to this place is certainly of great interest to any florist.

BUSINESS CHANGES.

Sandusky, O.—D. R. White has taken the Central Greenhouses and is remodeling and improving them.

Eric, Pa.—R. Olsowski has bought the greenhouses of John Stelle, but will raise flowers in the place of vegetables.

Indianapolis, Ind.—The sons and daughter of Alfred Pahud have leased his greenhouses and propose to incorporate and carry on the business with Charles Pahud as manager.

NEWS OF THE CLUBS AND SOCIETIES

MASSACHUSETTS HORTICULTURAL SOCIETY.

Probably never has a finer display of peonies been shown at an unscheduled exhibition at Horticultural Hall than that which was given last Saturday. While the exhibition was unheralded, many visitors were attracted to the show, which was opened at 10 o'clock and closed at 2 p. m. No regular prizes were offered, but gratuities were awarded, the superior character of the exhibits demanding official recognition from the society. The small exhibition hall was used, and this was filled, peonies predominating, although there were other flowers, including irises, lilies, Kalmias, etc. The peonies made the show, however. William Whitman (gardener Martin Sullivan) was the leading exhibitor, with 105 vases of double peonies and nineteen vases of singles. Of the former, the Dean Hole, a pink, was one of the handsome, while the singles had their most attractive specimen in Lady Lillian Ogle. Moonstone, a red with yellow pistils was another handsome variety. These were displayed on a side table along the hall, and seventeen more vases were on a centre table. At the end were five vases of the pink and white Magnifica, the finest peony shown, from the same estate. On one of the centre tables Mrs. John L. Gardner, gardener William Thatcher, had twenty-five vases of peonies.

E. J. Shaylor, of Wellesley Farms, staged 117 varieties, one of the finest of which was the Lady Alexander Duff. T. C. Thurlow also had 117 vases of peonies. George Hollis showed fifteen varieties of new seedling peonies, including the Rev. L. W. Atwood, white; Seraph, light pink; Mrs. Josephine March, white and President C. W. Eliot, pink, none of which had ever before been exhibited.

TARRYTOWN HORTICULTURAL SOCIETY.

The June Flower Show was held on the 15th instant. The collection of roses exhibited by General McAlpin, gardener John Woodcock, was the most extensive that we have seen in this section. It contained over fifty varieties of H. P.'s, and forty varieties of H. T.'s. It was a grand collection, and shows that our rose collections generally are far too limited. "All of the varieties," Mr. Woodcock says, "are perfectly hardy, with the ordinary winter protection." We noted in his collection such sorts as, viz.: Tea, and H. T. Antoine Rivoire, Belle Siebrecht, Clothilde Souperit, Caroline Testout, Catherine Mermet, Gruss an Teplitz, Grace Darling, J. B. Clark, Kaiserin Aug. Victoria, Killarney, Konigen Carola, La Tosca, La France, La France (98), Cochet—White and Pink—Mrs. Cant, Mildred Grant, Mme. Chateaub. Mme. Hoste, Mme. Jules Grotz, Mme. Ravary, Prince de Bulgarie, President Carnot, Malmaison, Pierre Notting, Vicountess Folkestone, Clara Watson, Gustave Regis, Etoile de France, Mme. H. Leulot, Mme. Philip Rivoire, Reichthof Von Kottelstadt, Reine Inconstant, Mme. Helen Cawley, Le Innocence, Amateur Teyseur,

Augustine Guinoiseau, Apothica Gen'l Hofer, Rosomane Gravereaux, Etienne Levet, Gloire de Ducher, Reme, Caroline de Sachs, Ferdinand Jamine, Ellen Wilmot, Mme. C. de Luce, Mme. Jean Gihnot.

Amongst the H. P.'s we noted: Victor Hugo, R. Lambertin, Alsace Lorraine, Star of Waltham, La Rosier, Countess of Oxford, Jean Liebaud, Marquise Castelaire, Mme. G. Luizet, Gov. Wm. Wood, Ben Cant, Mrs. R. G. S. Crawford, Ulrich Bruaner, Pride of Waltham, Mrs. J. Laing, Marie Baumann, Druschki, Earnst Rohan, Marie Finger, Horace Vernet, Jacqu., Chas. Lefebvre, S. A. Rodocanachie, Eclair, and others. The rose collection from Mrs. Trevor was also good, and Miss Blanche Potter's Druschki was marvellous. Robert Angus had on exhibition a vase of *Chrysanthemum Golden Glow*.

The sweet peas were excellent, and competition keen. The most conspicuous sorts were: Satopian, Emily Henderson, First of All, Lady G. Hamilton, Helen Pierce, Janet, Lady Clarke, Royal Rose, Prince of Wales, Nora Unwin, and Mrs. Wilmot.

Mr. Nicols, gardener for Mrs. J. B. Trevor, says that he sows his sweet peas outdoors, from the 1st to the 5th of October, and protects them during the winter with small sashes, covered in hard weather with salt hay. He certainly gets fine results, and claims he got them earlier and finer than if sown indoors in February and planted out.

The collection of wild flowers by the school children was a great attraction. Annie Lee staged over fifty species and varieties, and Caroline Rosenstein had nearly as many; all were correctly named, and were in themselves an educational feature worth going to see. We noted amongst the hardy shrubs a nice vase of *Magnolia parviflora*, and one of *Pterostyrax lespidium*—both hardy here but very seldom met with. The exhibition was free to the public and from every standpoint was a grand success.

COMMERCIAL FLORISTS' ASSOCIATION OF ROCHESTER, N. Y.

At the meeting on Monday night, 14th inst., "Doing it for Rochester" was much in evidence. With President Vick in the chair, further plans for the fall show were discussed and the numerous attending members took the greatest interest in all proposals. There is no doubt, that this show is going to be "it" and several florists have already started preparations.

At this meeting the vice-president, A. H. Secker, handed in his resignation and it was received with expressions of regret by all present. Mr. Secker has always been the first to consider the association's welfare, and has given much of his time to same. On hearing that he has accepted a position in Philadelphia on the staff of the Florists' Exchange, congratulations were general and his many friends, both at Salter Bros., where he for two years was foreman, and outside the trade, have asked me to voice their good wishes for his future career.

A. FENDEL.

MORRIS COUNTY (N. J.) GARDENERS' AND FLORISTS' SOCIETY.

The society had to hustle to clear the table of all unfinished business at the regular June meeting as there will be no session until next September in accordance with custom. The 14th Annual Flower Show, as has been previously stated, is to be held October 27 and 28 in the assembly rooms, Madison, N. J. There are a number of attractive special prizes. Robt. D. Foote of Morristown, on whom we can always count, offers a special prize of \$25 for the best vase of 25 carnations, any variety, open to all (undisseminated varieties barred). This liberal prize ought to bring in many outside competitors, as it is a nice little scalp to hang on one's belt. Dr. D. H. McAlpin of Morris Plains, another enthusiastic friend of the society, offers a prize of \$25. What it goes for has not been decided upon yet. Still another friend offers a silver cup, value \$25, which also is to be placed. Another special of \$25 is offered for three vases of chrysanthemums, 6 flowers, varieties, O. H. Kahn, Merza and Wm. Duckham; 1st \$15; 2nd \$10. There are many more special prizes which will appear in the schedule. The show promises to be better than any of its predecessors as far as prizes go, and we hope that meritorious exhibits will not be lacking either, as it would be a great reflection on the club.

Florham Farms put up a fine show of peonies and gladioli as the evening's exhibit.

Arthur Herrington, always in our councils, was absent on account of a painful illness. He is past the acute stage and is expected to be around again soon.

EDW. REAGAN, Sec.

NEW JERSEY FLORICULTURAL SOCIETY.

The regular monthly meeting of the society was held on June 11 at their rooms in Orange when Rev. L. H. Lightfoot read a paper on the nomenclature of plants. The subject was handled in a practical and thorough manner and suggested many points for the interesting discussion that followed in which W. A. Manda led. The tendency of the times to multiply names was deplored and adherence to botanical names was favored.

In the floral display of which W. A. Manda and H. Halbig were judges for the evening, carnations, roses and peonies predominated. Fine lettuce and cucumbers were displayed by Samuel J. Wyatt, gardener for A. C. Van Gansbeck, whose name was placed in nomination for membership. The society adjourned for the usual summer recess.

J. B. DAVIS.

POSTPONEMENT OF NEWPORT SHOW.

On account of roses being late, the Newport Horticultural Society has postponed its Rose Show from June 23 and 24 to June 28 and 29, and a good exhibition is now fully expected.

ROYAL HORTICULTURAL SOCIETY.

Some New Plants.

On the occasion of the meeting of the various committees at the hall in Vincent Square on June 8, Messrs. J. Veitch & Sons contributed hybrids of Gesnera and Gloxinia, which exhibited many interesting additions to a class of stove plants possessing drooping flowers of a blue or purple coloring of much decorative value. These are derived from Gesnera Regina—a plant with blue, pendant blooms, and leaves with light colored veins and ribs. Sometimes this species was employed as the male, and sometimes as the female or seed-bearing parent, the crosses being made with different varieties of Gloxinias, Gloxinia Deva—a fine crimson flower—being apparently the more prepotent in the production of rich coloring in the hybrids.

Large flowered abutilons in yellow, crimson rose and white came from H. B. May. Mr. J. Douglas, the veteran carnation and auricula raiser, was to the fore with Dianthus hybrids of the garden pink and the Sweet William; very good in regard to form and bright of color. He also showed a cross with this last named plant and the old Uriah Pike carnation, the color of the flower being crimson with a purplish tint. It is a showy border plant. Stuart Low & Co., Ltd., showed a new hardy pink called Progress, and Louis Stuart carnation; and W. Cutbush & Son, Highgate, staged the new Lady Coventry of the Malmesion section, that received the Society's award of merit in May, last. The flower is large, in color scarlet with a suspicion of orange in it.

The Orchids.

Orchids were less numerously shown on this occasion, and but few awards were made. F. Sander & Co. showed among other things Cypripedium Gowernianum magnificum Schoefeld's var., with a flower of purple brown, tall growing and handsome; six plants of Laelio cattleya Canhamiana Rex; the bloom of opaque white, and lip of rich purple; Laelio cattleya Eudoxa, a cross between L. purpurata and C. Mendelli. J. Veitch & Sons showed Laelia Othone, an orange-colored flower; Disa Luna has bright rose pink flowers carried on stems 3 ft. high, and withal of much decorative value. In Charlesworth & Co.'s, Spathoglottis aenea Niwillardie attracted attention.

The following brief descriptions of remarkable species and varieties of orchids shown on this occasion will, no doubt, have interest for lovers of these plants:

Laelio cattleya Mikado—This is a hybrid, of unrecorded origin, shown by Lieut.-Col. Holford, and one of the most beautiful of its color. The flower is of a pleasing form, excelling in brightness, and of considerable size. Its lip is of good expanse, ruby-colored in the front, and possessing a yellow margin. A first-class certificate was awarded. The same exhibitor sent Cattleya Mossiae A. Dimmock, a beautiful variety of the C. Mossiae of the Reineckiana breed. The flower has wide petals and sepals of a bluish color; the lip is of the same color, only slightly paler at the base; the disc yellow,

and the white margin is crimped, and of much breadth—a special feature of the bloom. Laelio cattleya Feronia (C. Enid L.-C. Haroldiana) was shown by Sir Trevor Lawrence; a large showy flower, rivalling in size that of L.-C. Canhamiana. The lip is of a bright ruby tint; sepals and petals cream-colored, having a yellow tinge, the latter a pink suffusion. Odontoglossum amabile Fowlerianum, a hybrid with flowers of great width, and tinted with pink towards the margins, and the interior surface blotched with brown, whilst the front of the lip is white.

These last three received awards of merit. Cirrhopetalum vaginatum, and Angraecum expansum, from Sir T. Lawrence's garden, were awarded botanical certificates.

FREDERICK MOORE.

AMERICAN ROSE SOCIETY.

Several persons have advised that the last schedule of premiums be adhered to by the A. R. Society for the next Rose Exhibition to be held in New York City in March, 1910. President Poebmann has requested the committee which drew the last schedule to act, and if in their judgment it seems best, that the same be adopted and published without delay. The committee is composed of the following: Messrs. Robt. Simpson, Alex. Montgomery, John N. May, Frank R. Pierson and Benj. Hammond. Life certificates have been issued to Mrs. Gertrude M. Hubbard, who by unanimous vote at the Buffalo meeting was elected the first honorary life member, and to Peter Crowe of Utica. Treasurer Harry O. May reports that with all bills paid he has a net cash balance on hand.

There is one thing which surely should be done if the American Rose Society is to grow among amateurs, and that is to issue a special quarterly—something whereby the interest in the Association would be aroused in those who do not see our excellent trade papers. Two propositions have been submitted—one from the "Gardeners' Chronicle," the other from the "Garden Magazine." A general meeting of the Rose Society will be called during the session of the S. A. F. in Cincinnati. His Honor the Mayor of Detroit, Philip Berntmeyer, offers a cash prize of \$100 for the best collection of hardy outdoor roses, in pots or tubs, to be exhibited at the next annual Exhibition. The gentlemen who provided the promised contributions last November toward the prize fund of the Society have loyally redeemed their promises then made.

BENJAMIN HAMMOND, Sec'y.
Fishkill-on-Hudson, N. Y.

GREENHOUSE GLASS DROPS IN THE TARIFF SCHEDULE.

Amid the clash of interests in the U. S. Senate pertaining to tariff rates, the one large item of expenditure in all greenhouse construction—window glass—is affected. The Aldrich Committee refer the clause back with a much lower rate than existed under the present tariff.

Senator Elihu Root of New York, threw his powerful influence in favor of this action.

BENJAMIN HAMMOND,
Secretary Tariff Committee, S. A. F.

WESTCHESTER HORTICULTURAL AND AGRICULTURAL SOCIETY.

The exhibition of this Society took place in the Mount Kisco Opera House, Friday, Saturday and Sunday, June 18-20. There was a splendid display of roses, strawberries and perennial flowers. Mr. Spavins, the local florist, worked very hard to make the exhibition the success that it was and is entitled to great credit for his decoration of the exhibition hall. There was a particularly noteworthy display in the peony class, the first prize going to Mr. W. Cowdin, Matthew Tall, gardener; second prize to Mr. Clarence Whitman, W. Willis, gardener. The second prize exhibit was remarkable in that fifty varieties of the finest peonies were exhibited, all correctly named, but unfortunately, the flowers were a little past their best. A collection of pressed native flowers exhibited by Chas. Hilderbrandt, gardener to Senator Agnew, was of much interest. The awards were as follows:

Hardy Perpetual Roses—1st, Chas. Whitman, gardener W. Willis; 2nd, J. Borden Harriman, gardener M. J. O'Brien. Hybrid Teas—1st, Chas. Whitman, gardener W. Willis; 2nd, Moses Taylor, gardener R. W. Beatty; 3rd, Hon. Seth Low, gardener Hugh Birch. Vase of 12 Roses in Variety—1st, J. D. Laying, gardener David Francis. Vase of 12 Roses, White—1st, Col. Jay, gardener A. L. Marshall; 2nd, Hon. Seth Low, gardener Hugh Birch. Vase of 12 Crimson Roses—1st, Moses Taylor, gardener R. W. Beatty; 2nd, Col. Jay, gardener A. L. Marshall. Collection of Peonies—1st, W. Cowdin, gardener Matthew Tall; 2nd, Clarence Whitman, gardener W. Willis. The class for the best strawberries was won by the Hon. Seth Low, gardener Hugh Birch, and the second prize by M. B. Fuller, gardener J. Fiecht. Perennials—1st, J. Borden Harriman, gardener J. M. O'Brien; 2nd, Clarence Whitman, gardener W. Willis.

The Westchester County Horticultural and Agricultural Society is all alive. It will hold another exhibition in the autumn in addition to the Chrysanthemum Show. The work of the various members is increasing the interest of a great many amateurs in that locality.

The judges, who gave complete satisfaction, were Harry A. Bunyard of New York, and Robt. Angus of Tarrytown.

HUNTINGTON HORTICULTURAL AND AGRICULTURAL SOCIETY.

The annual Rose and Strawberry exhibition of the Huntington (N. Y.) Horticultural and Agricultural Society was held on June 15. The season was good for strawberries and brought out a fine display. Roses were also numerous and excellent. The Huntington Nursery Co. exhibited fifty varieties. The judges were Walter Riddell and John R. McCulloch.

On strawberries, Clinton Gilbert was awarded first for size, H. T. & A. H. Funnell for flavor and finish, H. Paulding for shipping, and John S. Baylis for collection of named varieties.

On roses, Walter Jennings, gardener Richard Cartwright, took first for pink, white, red and roses of any other color, also for 12 roses, assorted, collection of roses and vase of hardy flowers. W. J. Matheson, gardener Jas. Kirby, took first for collection of hardy flowers, sweet peas, carnations and collection of peonies.

ALL ABOARD

For the Ninth Annual Outing and Bean Feast of the

NEW YORK FLORISTS' CLUB

THURSDAY, JULY 1st, 1909.

\$300.00 in Prizes.

STEAMER LEAVES FOOT 31ST. ST., 10 A. M. SHARP.

For Souvenirs, List of Events and further particulars write to

HARRY A. BUNYARD, Chairman,

342 W. 14th St., New York

PENNSYLVANIA HORTICULTURAL SOCIETY.

Resolutions passed at special meeting, June 15th:

Whereas, The Executive Council of the Pennsylvania Horticultural Society has recommended that the Society adopt the necessary resolutions, to authorize the sale of the premises on the west side of Broad Street, south of Loenst Street, in the city of Philadelphia and known as Horticultural Hall. And

Whereas, in the judgment of the Society it will be to its advantage for said property to be sold, the net proceeds thereof, after paying off the trust certificates which were issued to raise funds to erect the building, to be invested and the income thereof to be applied to the furthering of the objects of the Society; therefore

Resolved, That the Pennsylvania Horticultural Society does hereby approve the sale of said premises and building at a price not less than \$500,000.

Resolved, That the officers and Executive Council of the Society be authorized to take all legal steps necessary to accomplish such sale and to perfecting the title to the premises.

Resolved, That the officers be and they are hereby authorized and directed to execute under the corporate seal of the Society such deeds or other writing as may be necessary to convey the title to the purchaser or purchasers thereof in fee simple.

Resolved, That the officers and Executive Council be authorized out of the proceeds of such sale to pay off the certificates issued to raise the funds to erect the building, provided the funds so paid shall in no case exceed the face of said certificates.

Resolved, That the President be authorized to appoint a committee of three to act in conjunction with the Trustees who now hold legal title to the property under deed of gift of Elizabeth Schaeffer in effecting such sale and the other necessary arrangements in connection therewith.

Resolved, That the expenses incident to such sale, etc., be chargeable to the proceeds thereof.

R. C. Lippincott, C. Hartman Kuhn, Sidney W. Keith, committee of the Pennsylvania Horticultural Society, to act with the trustees of the Schaeffer Deed of Gift:—George Vaux, Jr., Wm. Hacker, Robert Craig and the Girard Trust Co.

PARK SUPERINTENDENTS VISIT BOSTON.

Members of the Eastern Branch of the national association to the number of twenty visited Boston on June 18, and enjoyed an auto ride through some of the parkways and reservations. A short business session was held at the residence of Superintendent Pettigrew, where lunch was enjoyed, as guests of Mr. and Mrs. Pettigrew. Several invitations for the honor of the next meeting were extended.

The floral parade on June 11 was a leading feature of the carnival at San Mateo, Cal.

CLUB AND SOCIETY NOTES.

The Minnesota State Horticultural Society will hold their summer meeting on June 29 at the State Agricultural School, just when the strawberries will be at their best.

The Transportation Committee of the New York Florists' Club have decided to go by the New York Central to the Annual Convention at Cincinnati, but have not selected the train.

Bertrand H. Farr, president-elect of the American Peony Society, left

seam. The dates will be made known soon.

The Grand River Valley Horticultural Society met with W. K. and J. P. Munson of Grand Rapids, Mich., on June 15. Prof. Eustace of the Agricultural College, W. K. Munson and Mrs. Campbell were among the speakers.

The Dutchess County Horticultural Society (N. Y.) have decided on November 4 and 5 for their fall show. The June meeting was held on the 17th at Annandale, and the society was entertained by Miss C. C. Cruger of Barrytown.

The New Haven County Horticultural Society (Conn.) at their meeting on June 15 were addressed by Peter Zuger, head gardener of Elizabeth Park, Hartford, on roses. The subject was well covered and presented in an interesting manner, and at the close of the talk it was unanimously voted that the society should visit Elizabeth Park on June 28.

PERSONAL.

Mrs. T. H. Westwood of Boston, sailed on June 15 for Scotland.

John J. Dervan, of Orange, N. J., has taken a position with R. H. Hunt of Rochester, N. Y.

Visitors in Boston: Theodore Outerbridge, Sunnyslans, Bermuda; C. B. Weathered, New York.

Joseph Linfoot of Cincinnati, and Miss Isabella Ross of Walnut Hill, O., were married on June 12.

David Welch, of the firm of Welch Bros., the wholesale florists of Boston, sailed from New York on the Lusitania on June 30, for a short period of rest and recuperation, after a strenuous season in which his health has suffered somewhat from the strain.

Advices from Albany state that Elisha S. Miller of Wading River had been appointed by Governor Hughes as one of the trustees of the New York Agricultural Experiment Station. The Governor has made a good selection. Mr. Miller will prove a valuable assistant in this work, for he has had years of experience in experimental work on his own account.

HEACOCK'S PALMS

Kentia Belmoreana
 7-inch pots.....32 to 34 inches high.....\$2.50 each
 7-inch pots.....36 to 38 inches high..... 3.00
 9-inch tub.....42 to 48 inches high..... 5.00 "
 Made up Kentia Forsteriana
 7-inch pots.....34 to 36 inches high.....\$2.50 each
 7-inch pots.....36 to 38 inches high..... 3.00
 9-inch tub.....42 to 48 inches high..... 5.00 "
 Joseph Heacock Co., Wyncote, Pa.



B. H. FARR

President-elect American Peony Society.

Reading, Pa., on June 19 for Ithaca to meet with the Nomenclature Committee and study the peonies at the test plot at Cornell University.

The Worcester County Horticultural Society (Mass.) at the show on June 17 had but two entries of roses, neither of which was up to the usual standard. Peonies were in fine form and strawberries made a good showing.

The next event of interest with the Utica (N. Y.) Florists' Club will be a beefsteak supper in the woods at Ilion, early in July, on invitation of Theo. Schesch, who promises also a surprise for those who attend.

The executive committee of the St. Louis Horticultural Society has closed a contract with the Coliseum company to hold a fall flower show, combined with a pomological display at the Coli-

SPECIAL LOW PRICES

Purple Japan Maples

—HOME GROWN PLANTS—
SUPERIOR TO IMPORTED

From pots and tubs about 2 feet high with ball, ensuring perfect success in transplanting.—Can be shipped now at any time.

Price:—\$1.00 each; 10 for \$7.50; 25 for \$15.00; 100 for \$50.00; as long as stock lasts.

ELLWANGER & BARRY

Mount Hope Nurseries
ROCHESTER, - N. Y.

WANTED

Cycas Revoluta

Nice specimens 4 ft. to 4½ ft. high. State price and size.

KNIGHT & STRUCK

1 Madison Ave.
NEW YORK CITY

JARDINIERE FERNS

IN BEST VARIETIES. VERY FINE STOCK.

\$3.50 per 100, \$30.00 per 1000

ROSE HILL NURSERIES

New Rochelle, N. Y.

ROBERT CRAIG CO.

ROSES, PALMS,

and Novelties in Decorative Plants

MARKET and 49th STREETS., PHILADELPHIA, PA.

THE BOSTON VIOLET

Unequaled for Productiveness, Beauty and Popularity.

In Crop from September to May.
Plants \$2.00 per doz.; \$12.00 per 100; \$100.00 per 1000.
Princess of Wales \$15.00 per 1000.

WILLIAM SIM, - Cliftondale, Mass.

JAPANESE
THE YOKOHAMA NURSERY CO.
31 BARCLAY STR. NEW YORK.
LILIES
PLANTS
BAMBOO STAKES

A Grand Opportunity
FIRST CLASS COLD STORAGE VALLEY

in cases of 2500, \$20.00 per case; immediate delivery; address

Jacs Smits, Ltd., CARE OF Maltus & Ware

14 STONE STREET, NEW YORK

Catalogue of Nursery Stock furnished on application

Palms

Shrubs



Ferns

Perennials

Send for Our Catalogue.

The GEO. WITTBOLD CO., 1657 Buckingham Place, Chicago, Ill.

FERNS FOR DISHES,

Assorted Varieties
From 2 inch pots, \$3.50 per 100; \$30.00 per 1000

CASH WITH ORDER
2570 to 2606 W. Adams St., Chicago, Ill.

FRANK OECHSLIN

LAGER & HURRELL
ORCHIDS

Established and Fresh Imported. SUMMIT, N. J.

ORCHIDS

We are booking orders now for delivery early in the Spring on all commercial CATELEYS and NOVELTIES. Our prices are right and our guarantee perfect. We sell only first-class goods

CARRILLO & BALDWIN Secaucus N. J.

FRESH IMPORTED ORCHIDS.

Arrived in Splendid Condition: Cattleya Trianae, Mossiae, Gigas, Skinnerii, Oncidium Splendidum, Ornithorrhynchum, Wentworthianum, Phalaenopsis Schilleriana and Amabilis, Lycaste Skinnerii, Vanda Boxallii, Laelia Superbieus Odontoglossum grande. Write for prices.

JOSEPH A. MANDA.
191 Valley Road West Orange, N. J.

IMPORTED ORCHIDS

Now Arriving

Julius Roehrs Co.

RUTHERFORD, N. J.

ORCHIDS

Largest Importers, Exporters, Growers and Hybridists in the World
Sander, St. Albans, England
and 235 Broadway, Room 1
NEW YORK CITY

In ordering goods please add "I saw it in HORTICULTURE."

Kentia Belmoreana

Delivery from now on. Per 1000 Per 100
2½ inch plants, fine bushy stuff 75.00 8.00

Cocos Weddelliana

Per 1000 Per 100
Fine established healthy plants from 2½ in. pots. \$90.00 \$10.00

Satisfaction Guaranteed.

O. V. ZANGEN, Seedsman, Hoboken, N. J.

NEPHROLEPIS MAGNIFICA

THE SENSATIONAL NOVELTY
Strong 2½-in. stock, \$25.00 per 100.

WHITMANII

2½-in., \$40.00 per 1000; 3½-in., from Bench, \$8.00 per 100.

H. H. BARROWS & SON, WHITMAN, MASS.

PALMS AND FERNS

DECORATIVE PLANTS

JOHN SCOTT
Rutland Road and E. 45th St.
Tel. 5890 Bedford BROOKLYN, N. Y.

ORCHIDS!

Most of our healthy established plants are sold, many importations are nearly to be in.

ORDONEZ BROS.

Madison, - - - N. J.

Seed Trade

AMERICAN SEED TRADE ASSOCIATION.

Watson S. Woodruff, Orange, Conn., Pres.; J. C. Robinson, Waterloo, Neb., First Vice-Pres.; C. E. Kendel, Cleveland, O., Sec'y and Treas. Twenty-seventh annual convention June 22-24, 1909, at Clifton House, Niagara Falls, Ont.

WHOLESALE SEEDSMEN'S LEAGUE.

F. W. Bruggerhof, Pres.; Burnet Landreth, Sec'y.

Bermuda Onion Seed—Crop Prospects.

Some time ago I made a report on the probable yield this fall, and, whilst I surmised for only a fair return, other growers more sanguine than myself predicted a large crop on account of increase in the planting of onions. This fact could not bear any weight on the crop, since the over-planting was not the outcome of speculation, as it used to be done at other times, but the natural consequence of a greater demand for our seeds from the United States and other consuming markets. Thus the increased yield over 1908 is absorbed by further contract orders from different parts of the world and there will not be this year any surplus, particularly of "White," to meet orders coming at the eleventh hour.

From the impression that I have obtained in the different producing districts, I think that as the fields look up to this date and the average size of the heads bearing the seeds, the crop will not permit of filling the contract orders to their full extent, although it will come very near it.

The progress of the developing plants has been somewhat checked by a small touch of disease but the evil localized itself and the damage done was not so considerable as predicted by some growers. The rainfall has been this season very scanty, and plants, although looking pretty well developed, have not reached their full seed capacity.

If we are not visited by high winds between this and the full harvesting time, the crop may be said to be much more encouraging than last fall and a good seed, too.

The earlier seedsmen contract in advance the better chance they will stand of obtaining full delivery of their orders and the more satisfactory it will be for the growers here.

I would like to say for your readers' information that I have raised a White Bermuda seed which is earlier than the earliest onion known, and I will forward some of this to my friends in the United States.

The famous White Crystal Wax is becoming a great favorite onion in other markets and as the genuine selected seed is rather scarce, it is probable that before long the price will be raised from 50 to 75 cents per lb. It will be advisable if seedsmen inform their clients—the growers—of this possible event.

FEDERICO C. VARELA, Teneriffe (Canary Islands), May 29th, 1909.

The Corn Crop.

While the weather as a whole has been favorable for growing crops, corn has not advanced much. Nights have been cool as a rule, and on the night

of the 18th light frosts were general throughout central, western and northern New York. It is also reported from Michigan that frost was noticed early in the morning. It was heavy enough to cut down corn in many sections, but it will, no doubt, come up again. However, as the corn crop is backward quite generally, any event that will retard it still further gives cause for anxiety.

Canning Peas.

Peas are, as a rule, looking well in Michigan, but not so good in Wisconsin. The harvest is two months hence, however, and no one can say what it will be. Delaware, Maryland and Indiana have finished their canned pea packs. The Baltimore pack was about 60 per cent. of an average, but Maryland and Delaware, excluding Baltimore, were up to about the average for those states. New York and Wisconsin, which furnish fully 60 per cent. of all the canned peas, have not started, but New York will be in full swing on early peas—Alaskas—before July 1st. The crop is promising, but the acreage considerably reduced from last year.

The Wisconsin crop is nearly three weeks late, and it will be close to the middle of July before they are really busy. It is generally reported that the crop has suffered to some extent from excessive moisture, while the acreage, notwithstanding the new factories operating this year for the first time, will not exceed last year. More full and accurate information will be given in a week or two. It may be mentioned that 80 per cent. of the peas packed in Maryland, Delaware and Indiana are Alaskas.

The Value of Experience.

The graduation of the staff of the National Department of Agriculture into the seed business is a matter of general interest. These "Scientists" who were trying to regulate the seed business of the country have probably discovered how little they knew about it, and how poorly qualified they were for their more or less self-imposed task. Several of those remaining of more or less exalted station would be vastly more useful and less hostile to the trade with a few years' practical experience. Our California friends may feel inclined to offer them inducements. It would be quite fitting.

CATALOGUES RECEIVED.

Reade Manufacturing Company, New York—Folder of "Herbicide," the weed exterminator.

Liverpool Orchid and Nursery Co., Gateacre, England—Special Offer, No. 37, of Orchids.

M. Herb, Naples, Italy—General Catalogue of Bulbs and Seeds for Autumn Sowing. Text in English, German and French languages.

Van Heiningen Bros. & Co., Boskoop, Holland—General Trade Catalogue, 1909-10. Conifers, Rhododendrons and hardy material generally are listed in this useful catalogue. This firm purchased the stock of Parsons' Hardy Rhododendrons when the Kissena Nurseries discontinued and are now propagating them in Holland.

PRIMULA GHINENSIS

Michell's Prize Mixture contains only the finest sorts, beautifully fringed.

½ Tr. Pkt. 60c. 1 Tr. Pkt. \$1.00

PRIMULA

OBSCURA
GIANTEA
Lilac50c
Kermesina50c
Rosea50c
Mixed50c

Write for our Wholesale Catalogue. It will interest you.

HENRY F. MICHELL CO.

1018 Market St., Phila.

Giant Pansy Seeds

Representing seven of the best growers of Europe. Each color or strain packed separately. The proportion of light and dark is well blended.

Florist Collection—16 pkt. Hybrid Giants, 8 pkt. Giant Five Etched, 18 oz. in each pkt., in all, 24 pkts., weight 3 oz. \$7.36
Half Florist Collection—24 pkts., weight 1½ oz. \$4.93
Amateur Collection—24 pkt., 500 seeds in each pkt., 12,000 seeds, \$2.50
Cottage Collection—12 pkt., 500 seeds in each pkt., 6,000 seeds, \$1.25
Mixture—extra fine, 1000 seeds, 25c.
Exhibition Collection—4 pkt., 500 seeds in each pkt., 2000 seeds, \$1.00

Send for descriptive list of prize winners

JOHN GERARD, New Britain, Conn.

PANSIES AT PITTSBURGH.

The finest pansies ever seen in this district have just flowered in the Homewood Cemetery. The strain is particularly fine containing colors we have never seen elsewhere. We were told it is Mr. Allen's own. The size of the flowers and the vigor of the plants are remarkable. The seed is sown in July and the plants planted after the bulbs in October, and left all winter without protection. A pleasing effect was noticed where the crocus foliage had been allowed to remain amongst the pansies.

This cemetery is, in Mr. Allen's hands, becoming one of the most beautiful in western Pennsylvania. William Allen, late of Boston, is a stickler for order, and objectionable features common in most of our cemeteries are practically unknown here. We understand that to complete the equipment a range of Pierson U-Bar green-houses is soon to be erected.

A letter has been received by M. H. Dnyrea from Hon. Albert S. Callan, State Assemblyman of New York and maker of the Callan Pure Seed Bill, under date of June 11, advising that the Governor has not signed the bill, consequently no further legislation can be accomplished on same until both Houses meet next winter.

VEGETABLE PLANTS

CABBAGE. Field Grown, all leading varieties, \$1.00 per 1000. 10,000 and over, 75c per 1000.

CELERY. White Plume, Golden Self Blanching and Giant Pascal, \$1.00 per 1000.

EGG PLANT. N. Y. Improved and Black Beauty, \$3.00 per 1000.

LETTUCE. Big Boston, Boston Market, Tennis Ball and Grand Rapids, \$1.00 per 1000.

PEPPERS. Ruby King, Bull Nose, Sweet Mountain and Neapolitan, \$2.00 per 1000. Chinese Giant and Cayenne, 50c per 1000.

PARSLEY. \$1.25 per 1000.

CASH WITH ORDER

R. VINCENT, JR., & SONS CO.
White Marsh, Md.

Everything "For the Land's Sake."

The one firm in Boston where all good forms of plant food may be obtained, is the Bowker Fertilizer Company, opposite Faneuil Hall at 43 Chatham St. All greenhouse chemicals, Nitrate of Soda, Ground Bone, Potash Salts, Sheep Manure and Wood Ashes can there be had at first hands.

BOWKER FERTILIZER COMPANY

Everything "For the Land's Sake."

ORDER NOW
French and Dutch Bulbs

FOR FULL SHIPMENT
Wholesale Price List mailed to Florists on application.

Joseph Breck & Sons Corp.
47-54 NO. MARKET ST., BOSTON, MASS.

BULBS OF QUALITY

Begonias, Single, under color.....	100	\$2.75
" Double " " " " " " " " " "	5.00	
" Frilled " " " " " " " " " "	10.00	
Olexinias, under color.....	4.00	
Pearl Tuberoses, \$7.00 thous.....	1.00	

Schlegel & Fottler Co.
26 & 27 So. Market St., BOSTON, MASS.

Burpee's Seeds
PHILADELPHIA

Blue List of Wholesale Prices mailed only to those who plant for profit

Ward's Lily Bulbs



Not how cheap, but how good.
Ralph M. Ward & Co.
12 W. Broadway, New York

GEO. E. DOW
Designing and Illustrating
178 Washington St., Boston, Mass.
OUR SPECIALTY
Machine, Booklet, Advertising and Flower PHOTOGRAPHS

Primulas for Christmas

SOW SEED NOW

B's Matchless Giant, pure white; B's Matchless Giant, blush white; B's Matchless Giant, rose; B's Matchless Giant, scarlet; B's Matchless Giant, royal blue; B's Matchless Giant, mixed. Each 1-2 trade packet, 60c; trade packet, \$1.00.

Primula obconica gigantea Kermealna, deep crimson. Primula obconica gigantea alba, pure white. Primula obconica gigantea Ilacina, beautiful lilac. Primula obconica gigantea rosea, lovely pink. Primula obconica gigantea grandiflora, mixed, containing pure white to deep crimson.

Each of above 1-2 trade packet, 30c; trade packet, 50c.
Primula floribunda grandiflora (buttercup) 1-2 trade packet, 30c; trade packet, 50c.
Forbesi (Baby Primrose). Trade packet, 25c. Primula Kevenisi (Giant Buttercup) 1-2 trade packet, 60c; trade packet, \$1.00.

ARTHUR T. BODDINGTON, Seedsman
342 W. 14th Street, New York

LEONARD SEED CO.

CONTRACT GROWERS AND WHOLESALE DEALERS
BEANS, PEAS, SWEET CORN, ONION, GARDEN SEEDS
ONION SETS **Get Our Prices** 79 and 81
FLOWER SEEDS **E. KINZIE STREET, CHICAGO**

ESTABLISHED 1802

Thorburn's
Bulbs

LILIUM HARRISII

True stock from most reliable growers

PURITY FREESIA

SEND FOR SPECIAL ADVANCE PRICES FOR EARLY ORDERS

J. M. THORBURN & CO.
33 Barclay Street
NEW YORK

Mum Canes

What you want now
7 to 8 ft. \$7.00 1000

Wm. Elliott & Sons
42 Vesey St., New York

RELIABLE SEEDS—SOW NOW
PRIMULA OBCONICA GRANDIFLORA

	1000 seeds	Tr. pkt.
Blood red, fine seller.....	\$1.50	\$0.50
Real pink, fine for cut.....	1.00	.80
Pure white, fine for cut.....	1.00	.80
Compacta, fine potter.....	1.50	.80
Mixed Hybrids.....	1.00	.80
O. V. ZANGEN, - HOBOKEN, N. J.		

CABBAGE SEED
LILY OF THE VALLEY PIPS.
HJALMAR HARTMANN & CO.
Langangsstraede 20,
COPENHAGEN, DENMARK.

Mignonette

FARQUHAR'S GIANT

Oz., 75c; 1-4 oz., 25c

R. & J. Farquhar & Co.

6 & 7 South Market Street
BOSTON, MASS.

BRIDGEMAN'S SEED WAREHOUSE

RICKARDS BROS.

Props.

37 East 19th St., - NEW YORK CITY

STOCK SEED

FOR WINTER BLOOMING
Our strain of Double Branching Stocks is exceptionally true. About 90% Double Flowers.
In colors: 1/4 oz. .60 oz. \$4.00
Pure White 1/4 " .75 " 3.00

H. E. FISKE SEED CO.
Faneuil Hall Square, BOSTON, MASS.

Winter-flowering SWEET PEAS

have been the best money-makers the past winter.
NEW PRICE LIST of those celebrated Sweet Pea Seeds will be ready soon. Send for it to the originator.

Ant. C. Zvolanek, Bound Brook, N. J.

NEW CROP SEED

For Early Planting
THOMAS J. GREY CO.
2 SO. MARKET ST., BOSTON, MASS.

**JOHN BREITMEYER'S
SONS**

Cor. Miami and Gratiot Aves.
DETROIT, MICH.

**Artistic Designs . . .
High Grade Cut Blooms**

We cover all Michigan points and good sections of Ohio, Indiana and Canada

**WILLIAM J. SMYTH
FLORIST**

Cor. Michigan Ave. and 31st St., CHICAGO

We ship to all points in Illinois and Iowa.

Phones: Douglas 744, Douglas 523, Douglas 740

**HAUSWIRTH THE
FLORIST**

Out of Town orders for Hospitals
Carefully filled.

**232 Michigan Ave.
CHICAGO**

AUDITORIUM ANNEX Tel. Harrison 585

**SAMUEL MURRAY
Florist**

Coates House Conservatory

1017 BROADWAY, KANSAS CITY, MO.

Both 'Phones 2670 Main.



WASHINGTON,
D. C.

GUDE'S

The Far-Famed Flowers of
TORONTO

Delivered on mail or telegraph order for any occasion, in any part of the Dominion.

JOHN H. DUNLOP,
96 Yonge St., - Toronto, Ont.

The Park Floral Co.

J. A. VALENTINE,
Pres.

DENVER, COLORADO

**WILLIAM L. ROCK
FLOWER CO.**

KANSAS CITY, - MO.

will carefully execute orders for Kansas City and any town in Missouri or Kansas.



Buffalo, N. Y.

N. J. PALMER & SON, 304 Main St.

Of Interest to Retail Florists

Milford, Conn. Cornell & Co., the Danbury florists, have closed their branch store.

Hornell, N. Y.—Fire damaged the store of Walbridge & Co. to the extent of \$500 on June 5.

Bar Harbor, Me.—The Mt. Desert Nurseries extended their store on May 31 for the summer. O. P. McDonald is in charge.

Columbus, O.—Mrs. E. M. Krauss will close her store as her lease has expired, and will later announce her new location.

John Robertson of 1108 Connecticut avenue, N. W., Washington, D. C., will have to move his store by July 1st. The entire row of houses which he rents will be torn down.

STEAMER DEPARTURES

Allen.	Boston-Glasgow.	July 9
Laurentian.	Boston.	July 9
American.		
Philadelphia.	N. Y.-Sampton.	July 3
St. Paul.	N. Y.-Sampton.	July 19
Atlantic Transport.		
Minnehaha.	N. Y.-London.	July 3
Minnewaska.	N. Y.-London.	July 10
Cunard.		
Lashania.	N. Y.-Liverpool.	June 30
Corinthia.	N. Y.-Liverpool.	July 3
Londonia.	N. Y.-Liverpool.	July 7
Saxonia.	Boston-Liverpool.	July 13
French Line.		
La Provence.	N. Y.-Havre.	July 1
La Savoie.	N. Y.-Havre.	July 8
Hamburg-American.		
Prinz Gert.	N. Y.-Hamburg.	June 30
K. Aug. Witt.	N. Y.-Hamburg.	July 3
Prinzessin.	N. Y.-Hamburg.	July 7
Leyland Line.		
Canadian.	Boston-Liverpool.	July 7
North German Lloyd.		
K. Wilhelm.	N. Y.-Hamburg.	June 29
Gloria.	Washington N. Y.-Hamburg.	July 7
K. Wilhelm.	N. Y.-Hamburg.	July 10
K. Louise.	N. Y.-Hamburg.	July 19
White Star.		
Majestic.	N. Y.-Sampton.	June 30
Celtic.	N. Y.-Liverpool.	July 3
Romania.	Boston-Med. Pts.	July 3
Megantic.	Montreal-L. Pool.	July 3

NEWS NOTES.

Cincinnati, O.—The greenhouse in the rear of the residence of Mrs. J. H. Perkins, Hyde Park, was destroyed by fire on June 12. It was thought to be the work of a firebug.

Springfield, O.—Reeser & Youngstrand have started in business at Johnson avenue and Clay street. Harry C. Reeser is the moving spirit. They have four greenhouses.

Philadelphia, Pa.—Alfred Driver, referee in bankruptcy, announces that the first meeting of the creditors of Joseph Stern, trading as J. Stern & Co., will be held at his office, 505 Chestnut street, on July 2, at ten o'clock.

Lewiston, Me.—Ernest Saunders has had his old house torn down and a new one to be built on the same site. It will have a model office building. Foundations for a boiler house, 30x40, of concrete, are laid and a 100 ft. chimney will be added.

ALEX. McCONNELL

571 FIFTH AVENUE
NEW YORK CITY

Telegraphic orders forwarded to any part of the United States, Canada, and all principal cities of Europe. Orders transferred or intrusted by the trade to our selection for delivery on steamships or elsewhere receive special attention.

Telephone Calls, 487 and 488 38th St.
Cable Address, ALEXCONNELL

M. A. BO

In the Heart of New York City
**1294 Broadway
NEW YORK**

Our Motto—The Golden Rule

DAVID CLARKE'S SONS

Deliver orders from any part of the country to
New York City
Or OUT-GOING STEAMERS

Write or telegraph

2139-2141 Broadway, New York
Telephone 1552-1553 Columbus

YOUNG & NUGENT

42 West 28 St., NEW YORK

"FLOWERS BY TELEGRAPH"

ALBANY, N. Y.

EYRES

Flowers or Design Work

DELIVERED IN ALBANY AND VICINITY
ON TELEGRAPHIC ORDER.

11 NORTH PEARL ST., ALBANY, N. Y.

Flower Deliveries

In Brooklyn and other Long Island Points
New York City, New Jersey, etc. At Theaters
Hotels, Steamers or Residences.

WILSON

Felton St. and Greene Ave., Brooklyn, N. Y.

DANKER, Albany, N. Y.

ORDERS FOR
**Choice Flowers and
Floral Emblems**
FILLED PROMPTLY

Orders by Wire Receive Prompt and Careful Execution

J. Newman & Sons
Corporation

24 Tremont Street, BOSTON

Theater, Steamer and Funeral Flowers Our Specialty
We can refer to leading florists in all principal cities.
Established 1870.

LOUISVILLE, KY.

JACOB SCHULZ,
550 South Fourth Ave.

WELLESLEY COLLEGE

Dana Hall, Walnut Hill and Rockridge Hall
Schools. TAILBY, Wellesley, MASS.
Tel. Wellesley 44-1 and 2. Night 44-3.

In ordering goods please add "I saw it in HORTICULTURE."

YOU CAN'T LOSE US IN JULY

Or Any Other Month in the Year

The Florist who Can't Show **Bayersdorfer & Co's** Fancy Goods to his Customers Every Day of Every Month is shy on Enterprise and will be **shy on business** he might have had. **That's All.** And **Don't Forget** that there are not and never have been **Wheat Sheaves** as good as ours. We use only the finest material made up in the best manner and are the **largest dealers in Wheat Sheaves in the United States.** It's not too late, Write or Telegraph.

THE Florists' Supply House of America

H. BAYERSDORFER & CO., 1129 Arch St., Philadelphia, Pa.

CHICAGO NOTES.

This is peony week in Chicago. This popular flower has been in the market now for many weeks, coming as it does in great quantities from the South, but when the Northern stock is in it has not lost any of its popularity, but rather otherwise. People are even more ready to welcome the home-grown article. Shipping is now in the opposite direction and the Northern growers find a market in the South. The season seems to have been a successful one, but reports will be more definite in another week. Carson, Pierie, Scott & Co. had their large department store decorated with thousands of peonies last week and the effect was enjoyed by their patrons, many of whom tried to purchase, thinking so many flowers could only be for sale.

Serious Accident.

Wm. J. Smyth was seriously injured in a peculiar automobile accident Sun-

day, June 20th, at his summer home at Lake Marie, Ill., about fifty miles from Chicago. Mr. Smyth was preparing to take Mrs. Smyth for a ride and was standing beside the machine. In clanking it he caused the machine to run over himself, causing internal injuries of a very serious nature. Mrs. Smyth summoned a physician who hastened the injured man to St. Luke's Hospital, where an operation followed in the hopes of saving his life. At this writing his condition is very serious. Mr. Smyth is one of Chicago's best known retail florists on the South Side.

Flowers at Commencements.

The subject of the use or non-use of flowers at commencements in the Chicago high schools was not brought up at the meeting of the Board of Education as expected on the 16th. A special committee was appointed, however, consisting of members of the board to look into the matter and report at the meeting on June 24th.

Personal.

Uncle John Thorpe has again been under the physician's care during the past week.

Supt. West of Lincoln Park, who has been absent on account of illness is again at his post of duty.

W. W. Barnard is now considered as safely past the danger line. He has a carbuncle near the base of the brain and an operation at the hospital was necessary to prevent blood poisoning.

Frank Ben leaves this week for an extended trip east. He will visit Washington, Philadelphia, New York, Atlantic City and other eastern cities, spending the greater portion of his time with his parents at Philadelphia.

F. H. Henry, of Henry & Lee, New York, was in Chicago last week, accompanied by his wife and daughter. They are on their way to Japan, where they will spend the summer and Mr. Henry will combine business with pleasure, making a tour of the world before they return home.

Other visitors were: W. A. Hartman, South Haven, Mich., and J. G. Crozier, Cedar Rapids, Iowa.

Denver, Colo. At the last meeting of the State Horticultural Board D. R. Stoller was elected to succeed Martha Shute as secretary. Thurston White of Canon City was elected president.

"FLOWERS BY TELEGRAPH"

Leading Retail Florists Listed by Towns for Ready Reference.

- Denver, Colo.—Park Floral Co., 1706 Broadway.
- Washington D. C.—Gude Bros., 1214 F St.
- Chicago—Hanswirth, "The Florist," 232 Michigan Ave.
- Chicago—William J. Smith, Michigan Ave. and 31st St.
- Chicago—George Wittbold Co., 1657-59 Buckingham Place.
- Leitchville, Ky.—Jacob Schulz, 550 South Fourth Ave.
- Boston—Thos. F. Galvin, 124 Tremont St.
- Boston—Edward MacMulkln, 194 Boylston St.
- Boston—Hoffman, Florist, 59-61 Massachusetts Ave.
- Boston—J. Newman & Sons, Inc., 24 Tremont St.
- Boston—Julius A. Zinn, 2 Beacon St.
- Wellesley, Mass.—Tallyb.
- Detroit, Mich.—J. Breitmeyer's Sons, Miami and Gratiot Aves.
- Kansas City, Mo.—Samuel Murray, 1071 Broadway.
- Kansas City, Mo.—Wm. L. Rock Flower Co., 1116 Walnut St.
- Albany, N. Y.—H. G. Eyres, 11 N. Pearl St.
- Albany, N. Y.—F. A. Danker, 40 Malden Lane.
- New York—David Clarke's Sons, 2139-2141 Broadway.
- New York—Alex. McConnell, 571 5th Ave.
- New York—Young & Ngent, 42 W. 28th St.
- New York—M. A. Bowe, 1294 Broadway.
- Brooklyn, N. Y.—Robert G. Wilson, Fulton St. and Greene Ave.
- Buffalo, N. Y.—Palmer's, 304 Main St.
- Toronto, Can.—J. H. Dnnlop, 96 Younge St.

The Rhode Island Horticultural Society will hold a dahlia show in September and a chrysanthemum show on November 12 and 13. Secretary C. W. Smith has already prepared the premium list.

BOSTON'S BEST

In Quality and Design

Can be relied upon when you transfer your retail orders to

EDWARD MACMULKIN
194 Boylston Street, Boston

Send flower orders for delivery in

BOSTON

and all

NEW ENGLAND POINTS

THOS. F. CALVIN
124 Tremont St., Boston



TRANSFER

Your orders for flower or plant delivery in Eastern New England to

JULIUS A. ZINN,
2 Beacon St., Boston
FINE DESIGN WORK A SPECIALTY

THE BEST LETTERS

FOR
FLORISTS'
USE



THOSE
MADE
BY THE

Boston Florist Letter Co.

66 PEARL ST., BOSTON

N. F. McCARTHY, Mgr.

Order direct or buy from your local supply dealer. Insist on having the

BOSTON

Inscriptions, Emblems, etc., Always in Stock

Big Value in
SPHAGNUM MOSS

6 Lge 5 Bbls Bales for \$10.00

Single Bale \$2.00

THE LEO NIESSEN CO.

1209 Arch St., Philadelphia, Pa.

Please Note: We now close at 6 p. m.

To Cut Flower Growers and Retail Florists

IF YOU

want to find a market for your product

want a regular or special supply of the product of the best growers

Consult the Advertisements on these Wholesale Flower Pages

The Advertisers Represented Here are the Leading Concerns in the Wholesale Flower Trade

CUT EASTER LILIES

Extra Fine

\$1.50 per doz. \$10.00 per 100

Can furnish in quantity

W. E. McKISSICK & BROS., Wholesale Florists
1619-1621 Ranstead St., Philadelphia

CUT FLOWER BOXES
EDWARDS FOLDING BOX CO
MANUFACTURERS
PHILADELPHIA, PA.

CHAS. W. MCKELLAR

51 WABASH AVE., CHICAGO

Western Headquarters for Choice Orchids
Valley, Roses and all Cut Flowers

PETER REINBERG
WHOLESALE

CUT FLOWERS

51 Wabash Av., Chicago, Ill.

Long Distance Phone, Central 6004

WINTERSON'S SEED STORE
45-47-49 Wabash Ave., Chicago.

Seedsmen, Plantmen, Nurserymen
Florists' Supplies

We can supply everything used by the Florist. SUPPLY CATALOG FREE. Correspondence solicited.

POEHLMANN BROS. CO.

33-35-37 Randolph St., - CHICAGO

CUT FLOWERS

Greenhouses, - Morton Grove, Ill.

Rice Brothers

115 N. 6th Street, MINNEAPOLIS, MINN.
WHOLESALE FLORISTS AND SUPPLIES

CUT FLOWERS received twice daily, and can fill your orders to your satisfaction. A complete line of Hardy Greens - WILD SMILAX, BOXWOOD, HARDY FANCY FERNS, GALAX LEAVES. Write for quotations on large quantities.

In ordering goods please add "I saw it in HORTICULTURE."

WELCH BROS.

AMERICAN BEAUTY, KILLARNEY, RICHMOND, MARYLAND AND ALL THE SUPERIOR ROSES, LILY OF THE VALLEY, CARNATIONS, ORCHIDS
BEST PRODUCED

226 Devonshire Street, Boston, Mass.

WHOLESALE FLOWER MARKETS—TRADE PRICES—Per 100 TO DEALERS ONLY

	CHICAGO June 21	TWIN CITIES June 21	PHILA. June 21	BOSTON June 24
ROSES				
Am. Beauty, Fancy and Special.....	25.00 to 30.00	25.00 to 30.00	25.00 to 30.00	25.00 to 30.00
" Extra.....	20.00 to 25.00	20.00 to 25.00	20.00 to 25.00	20.00 to 25.00
" No. 1.....	15.00 to 20.00	15.00 to 20.00	15.00 to 20.00	15.00 to 20.00
" Lower grades.....	4.00 to 8.00	5.00 to 10.00	4.00 to 8.00	4.00 to 8.00
Bride, "Maid, Golden Gate, F. & S.....	6.00 to 8.00	6.00 to 8.00	6.00 to 8.00	6.00 to 8.00
" Lower grades.....	3.00 to 5.00	4.00 to 6.00	3.00 to 5.00	3.00 to 5.00
Killarney, Fan, & Sp.....	6.00 to 10.00	6.00 to 10.00	6.00 to 10.00	6.00 to 10.00
" Lower grades.....	3.00 to 5.00	4.00 to 6.00	3.00 to 5.00	3.00 to 5.00
Richmond, Fancy & Special.....	8.00 to 10.00	8.00 to 10.00	8.00 to 10.00	8.00 to 10.00
" Lower grades.....	3.00 to 5.00	4.00 to 6.00	3.00 to 5.00	3.00 to 5.00
Chatenay.....	5.00 to 10.00	4.00 to 7.00	4.00 to 8.00	5.00 to 6.00
My Maryland.....	4.00 to 12.00	4.00 to 8.00	5.00 to 8.00
CARNATIONS				
Fancy.....	1.50 to 2.00	2.00 to 3.00	3.00 to 4.00	1.00 to 2.00
Ordinary.....	.50 to 1.00	1.00 to 2.00	1.50 to 2.00	.50 to 1.00
MISCELLANEOUS				
Cattleyas.....	10.00 to 50.00	10.00 to 60.00	50.00 to 60.00	10.00 to 40.00
Lilacs.....	6.00 to 8.00	10.00 to 12.50	10.00 to 12.50	6.00 to 8.00
Lily of the Valley.....	3.00 to 4.00	3.00 to 4.00	3.00 to 4.00	1.00 to 3.00
Mignonette.....	1.00 to 6.00	4.00 to 4.00	3.00 to 4.00	1.00 to 3.00
Sweet Peas.....	.50 to 1.00	.75 to 1.25	.50 to .75	.35 to .50
Gardenias.....	50.00 to 10.00	12.50 to 15.00
Peonies.....	5.00 to 6.00	5.00 to 8.00	2.00 to 6.00	2.00 to 4.00
Daisies.....	1.00 to 1.75	.75 to 1.00	.50 to .75
Stocks.....	8.00 to 10.00	.75 to .50	.75 to 1.00
Snaptagon.....	4.00 to 5.00	8.00 to 10.00	3.00 to 8.00	2.00 to 4.00
Adiantum.....	.75 to 1.00	1.00 to 1.50	1.00 to 1.50	.75 to 1.25
Smilax.....	15.00 to 20.00	15.00 to 20.00	12.50 to 15.00	15.00 to 15.00
Asparagus Plumosus, stragg.....	40.00 to 50.00	30.00 to 50.00	35.00 to 50.00	45.00 to 50.00
" " & Sprea. (100 bchs.).....	30.00 to 40.00	30.00 to 50.00	35.00 to 50.00	15.00 to 25.00

J.A. BUDLONG
37-39 Randolph Street, CHICAGO.

Roses and Carnations
A Specialty.....
WHOLESALE GROWER of **CUT FLOWERS**

HENRY M. ROBINSON & CO.
15 Province St. and 9 Chapman Place - BOSTON, MASS.

WHOLESALE COMMISSION FLORISTS
Hardy Cut Evergreens and Florists' Supplies

New Crop Dagger and Fancy Ferns \$2.00 per Thousand.
We have the stuff and can fill all orders, large or small
WE NEVER DISAPPOINT SATISFACTION GUARANTEED

Prices Quoted in these Columns are for Dealers Only.
When Writing to Advertisers Please Mention
HORTICULTURE.

ATTENTION! Plant and Flower Growers

If you are rebuilding, remodeling or adding more glass, don't fail to inquire into the merits of the

CASTLE SYSTEM

THE CASTLE BOILER is the best hot water heating Plate Boiler for Greenhouse purposes on the market today.

The Only System of Forced Circulation

of hot water for greenhouse heating that has demonstrated its practicability, economy and perfection of action is the

CASTLE AUTOMATIC CIRCULATOR

All others are either superseded by the Castle Automatic, or are yet in the experimental stage.

Send for Descriptive Catalogue and Testimonials from Florists Who Are Using One or Both.

DO IT NOW! Mention Horticulture
HEATING ENGINEERS
W. W. Castle Co. 170 Summer St., Boston



SPECIAL RIBBONS AT SPECIAL PRICES

Just the thing for Weddings and Commencements

All quotations are per piece of 10 yards unless otherwise noted.

The week's leaders. Buy liberally and push them. No retailer should allow it to be said: "Asleep at the post!"

Pattern Orchid

We have a special shade in this pattern for "Lily of the Valley." It is a Beautiful Two Tone Silvery Green Satin Taffeta. Very stylish and can be used for all occasions.

No. 7 Price \$.65 No. 40 Price \$1.65
No. 100 Price \$2.75

Pattern 848

Gauze Ribbon for Shower Effects.

No. 2 Price \$3.00 No. 3 Price \$.85

NOTE—The No. 2 width we offer in box lots of 60 pieces at \$.25 piece—will assort colors.

Pattern Killarney

For the Killarney Rose—Two Tone Satin Taffeta.

No. 7 Price \$.65 No. 60 Price \$2.35
No. 16 " 1.15 No. 100 " 2.75
No. 22 " 1.35 No. 150 " 3.50
No. 40 " 1.65

Pattern Supreme

In this Pattern we have Combination Shadings for Flesh Color and Lavender Sweet Pea. Also Orchid Shades—two widths only.

No. 7 Price \$.65 No. 9 Price \$.85

S. S. PENNOCK - MEEHAN CO.
The WHOLESALE FLORISTS Philadelphia
1608-1620 Ludlow Street Store closes 6 p. m.
Washington Store, 1212 New York Ave.

Flower Market Reports.

BOSTON

There is a good demand for certain lines of flowers this week and buyers will take nothing else. The favored items are American Beauty, Richmond and Carnot roses, orchids and Lily of the valley. Outside of these the traveling is very hard, especially for peonies, stocks, candytuft and sweet peas, all of which are a drug and many of which are unsalable. Add also carnations to the list of "under dogs." Of these there are no first quality flowers coming in and some of them are so loaded with red spider and other creatures that it is almost a question as to which—carnations or bugs—is the chief article of merchandise and which is the "by-product" of the growers' labors.

The situation in the BUFFALO flower market has improved considerably for the past two weeks. Only certain lines of stock are in demand and only the best of it can be used, and the balance drags along from day to day making the wholesaler feel uneasy most of the time. Owing to the warm weather roses and carnations are decreasing in size. Beauties are of only fair quality. Richmonds good, Kaisersins, Carnots, La Detroits are of excellent quality but not any too plentiful, while ordinary Bridesmaids and Brides of poor, mildewed quality, are overplentiful. The outdoor material has come on abundantly and has had a fair demand at moderate price. Sweet peas and lilies of the valley have had

the call. While the outdoor peas are not of the best as yet, the indoor have brought good value and clean sales daily. Weddings, graduations and other social gaieties are in order for the balance of the month and should the severe warm weather hold off for a while it may give the wholesaler a chance to send out satisfactory returns. Greens of all kinds including new fancy ferns are to be had in quantity.

Business above the WASHINGTON average here. There have been an unusual number of June weddings, likewise of funerals. Pond lilies are unusually fine and plentiful. Carnations have kept much above the average in quality, due to the absence of hot weather. Out-door sweet peas are practically ruined by the rain and there is a great scarcity of same. Green not any too plentiful.

WHOLESALE FLOWER MARKETS. — PER 100. — TO DEALERS ONLY.

	CINCINNATI June 22	DETROIT June 21	BUFFALO June 21	PITTSBURG June 23
ROSES				
Ams. Beauty, Fan, 2nd Sp.....	20.00 to 25.00	20.00 to 25.50	20.00 to 25.00	20.00 to 25.00
" Exire	15.00 to 20.00	15.00 to 20.00	12.00 to 15.00	10.00 to 15.00
" No. 1.....	10.00 to 12.00	10.00 to 12.00	6.00 to 10.00	6.00 to 8.00
" Lower grades.....	4.00 to 6.00	4.00 to 6.00	2.00 to 4.00	2.00 to 4.00
Bride, 'Maid, Golden Gate, F. & S.	4.00 to 6.00	4.00 to 6.00	2.00 to 4.00	2.00 to 4.00
" Low gr.....	3.00 to 4.00	3.00 to 4.00	2.00 to 3.00	2.00 to 3.00
Killarney, Fan, & Sp.....	5.00 to 6.00	4.00 to 6.00	6.00 to 8.00	6.00 to 8.00
" Lower grades.....	3.00 to 4.00	3.00 to 4.00	2.00 to 3.00	2.00 to 3.00
Richmond, Fancy & Special.....	6.00 to 8.00	5.00 to 6.00	8.00 to 10.00	8.00 to 10.00
" Lower grades.....	3.00 to 5.00	3.00 to 5.00	2.00 to 4.00	2.00 to 4.00
Chetyay.....	4.00 to 6.00	3.00 to 5.00	6.00 to 8.00	6.00 to 8.00
My Maryland.....	4.00 to 6.00	3.00 to 5.00	6.00 to 8.00	6.00 to 8.00
CARNATIONS				
Fancy and Novelties.....	2.00 to 3.00	2.00 to 3.00	2.00 to 3.00	2.00 to 3.00
Ordinary.....	1.00 to 1.50	1.00 to 2.00	1.00 to 2.00	.75 to 1.00
MISCELLANEOUS				
Cattleyas.....	35.00 to 40.00	50.00 to 60.00	75.00 to 80.00
Lilies.....	10.00 to 12.00	12.50 to 15.00	8.00 to 10.00	10.00 to 12.00
Lily of the Valley.....	3.00 to 4.00	3.00 to 4.00	3.00 to 4.00	3.00 to 4.00
Nigouette.....	3.00 to 3.00	3.00 to 3.00	3.00 to 3.00	3.00 to 3.00
Sweet Peas.....
Gardeasies.....
Peonies.....	4.00 to 6.00	5.00 to 7.00	8.00 to 10.00	10.00 to 12.00
Daisies.....
Stocks.....
Snapdragon.....
Adonis.....
Sanitas.....
Asparagus.....
Asparagus Plumose, strings.....
" " & Spren. (too bchs.).....

FORD BROTHERS
 48 West 28th Street NEW YORK
FINE ROSES FANCY CARNATIONS
 A Full Line of All CUT FLOWERS
 Telephone, 3870 or 3871 Madison Square

H. E. FROMENT
 Wholesale Commission Florist,
 Choice Cut Flowers,
 57 West 28th St. :: NEW YORK
 Telephones: 2200, 2201, Madison Square.

Alfred H. Langjahr
 All choice cut-flowers in season. Send for quotations. Correspondence with shippers of first-class stock invited.
 55 West 28th Street, New York
 Telephones 4626-4627 Madison Square

Edward C. Horan
 Wholesale Florist
 55 WEST 28th ST.

Tel. 1462 Madison Square New York
 1463

PHILIP F. KESSLER
 55 & 57 W. 26th St., New York.
CUT FLOWERS WHOLESALE
 Open from 5 a. m. to 6 p. m. Sunday till 10 a. m.
FINEST LILIES IN THE MARKET.
 Tel. 5243 and 2921 Madison Square.

JOHN YOUNG
WHOLESALE FLORIST
 Finest American Beauties and Carnations

51 West 28 St. - NEW YORK
FRANK MILLANG
 Wholesale Florist
 55-57 West 26th St., NEW YORK
 Shipments, any quantity, Wholesale Market Rates.

Greater New York Florists' Association, Inc.
 Now Open for Cut Flower Consignments
 162 Livingston Street, BROOKLYN, N. Y.
 Geo. W. Crawbuck Telephone Connection
 Manager 3642-43 Main

Moore, Hentz & Nash
 Wholesale Commission Florists
 55 and 57 West 26th Street
 Telephone No. 756
 Madison Square New York

MILLANG BROS.
 WHOLESALE COMMISSION FLORISTS
 41 West 28th Street
 Telephone 3860 Madison
 3861 NEW YORK

JOHN I. RAYNOR
Wholesale Commission Florist SELLING AGENT FOR LARGEST GROWERS
 A full line of Choice Cut Flower Stock for all purposes. Completes every variety grown for New York market, at current prices
 TEL. 1998 MADISON SQUARE 49 West 28th St., New York City

Walter F. Sheridan
 Wholesale Commission Dealer in
CHOICE CUT FLOWERS
 39 West 28th Street, New York
 Telephone: 3532-3533 Madison Square

HEADQUARTERS FOR NOVELTIES
ORCHIDS A SPECIALTY
 THE HIGHEST GRADE OF VALLEY ALWAYS ON HAND
 GARDENIAS, DAISIES, ROSES AND CARNATIONS
JAMES McMANUS, Telephone 769 Wad. Sq. 42 W. 28th St., New York

NEW YORK QUOTATIONS PER 100. To Dealers Only

ROSES AND CARNATIONS	Last Half of Week ending June 19 1909		First Half of Week beginning June 21 1909	
American Beauty, Fancy and Special.....	15.00	to 20.00	8.00	to 15.00
" " Extra.....	5.00	to 8.00	5.00	to 8.00
" " No. 1.....	2.00	to 5.00	2.00	to 4.00
" " Lower Grades.....	.50	to 1.00	to .50
Bride, "Ald, Golden Gate, Fancy and Special.....	2.00	to 4.00	2.00	to 4.00
" " Lower Grades.....	.50	to 1.00	to .50
Killarney, Fancy and Special.....	2.00	to 6.00	3.00	to 6.00
" " Lower Grades.....	.50	to 1.00	to .50
Richmond, Fancy and Special.....	2.00	to 6.00	3.00	to 5.00
" " Lower Grades.....	.50	to 1.00	to .50
Chateau.....	.50	to 5.00	.50	to 5.00
Ply Maryland.....	.50	to 5.00	.50	to 5.00
Carnations, Fancy and Novelties.....	1.00	to 2.00	1.00	to 2.00
" Ordinary and White.....	.25	to .50	to .50

Alexander J. Guttman
THE WHOLESALE FLORIST OF NEW YORK
 34 WEST 28th STREET
 PHONES. 1664-1665 MADISON SQUARE
ENOUGH SAID

CENTRALLY LOCATED, THE HUB OF THE FLOWER MARKET SECTION
CHARLES MILLANG
 Wholesale Florist
 444 Sixth Ave., NEW YORK
 Telephone 7062 Madison

GEORGE COTSONAS & CO.
 Wholesale and Retail Dealers in all kinds of **EVERGREENS**
 Fancy and Dagger Ferns
 Bronze and Green Galax
Main Store 50 W. 28 St.
 Phone 1202 Mad. Sq. New York

GROWERS' CUT FLOWER CO. CUT FLOWERS AT WHOLESALE
VIOLETS, CARNATIONS, ROSES ORCHIDS, CHRYSANTHEMUMS, LILIES
 Consignments Solicited. Shipments to Order, any Distance
 Telephone 757 Madison Square
39 West 28th Street, J. J. COAN, Manager NEW YORK

Durand & Marohn
 MANUFACTURERS OF
All Kinds of Wire Work
 Florists' Wire Designs a Specialty
 24 Beaver St., ALBANY, N. Y.

WILLIAM H. KUEBLER
 Brooklyn's Foremost and Best
WHOLESALE COMMISSION HOUSE
 A First Class Market for all CUT FLOWERS
 28 Willoughby St., Brooklyn, N. Y.
 Tel. 4591 Main

NOTICE!

Manhattan Flower Market

WHOLESALE FLORISTS
 46 W. 28th St., NEW YORK
 Telephone: 1016 Madison Sq.

Ship us some stock. We need a large supply of all kinds of flowers, **Roses, Carnations, Sweet Peas, Narcissus, Summer Stock, etc.**, for our new store. Reliability and responsibility first-class. Good prices and prompt returns, Good opportunity.

WHOLESALE FLORISTS
 54 West 28th St.
 NEW YORK
 Telephone 3559 Madison Sq.

A. L. YOUNG & CO.

RECEIVERS & SHIPPERS OF CUT FLOWERS.
CONSIGNMENTS SOLICITED.

REED & KELLER
 122 West 28th St., New York
Florists' Supplies
 We manufacture all our Metal Designs, Baskets, Wire Work & Novelties and are dealers in Glassware Decorative Greens and Florists' Requisites

WILLIAM F. KASTING CO.
 WHOLESALE FLORISTS
 383-387 Ellicott Street
BUFFALO, - N. Y.



MICHIGAN CUT FLOWER EXCHANGE, Inc.
 WHOLESALE COMMISSION FLORISTS
 Consignments Solicited
Hardy Fancy Fern Our Specialty
38-40 BROADWAY, DETROIT, MICH.

ROBERT J. DYSART
 Public Accountant and Auditor
 Simple methods of correct accounting especially adapted for florists' use.
 Books Balanced and Adjusted
 Merchants Bank Building
28 STATE STREET, - BOSTON
 Telephone, Main 58.

FOR FLORISTS' USE
 There's **NOTHING** as good as **MEYER'S SILKALINE**
 Don't let them sell you anything else
JOHN C. MEYER & CO., Boston, Mass.

I KEEP OPEN HOUSE THIS SUMMER

For the Sale and Shipment of Flowers.
 Good Stock. Favorable Prices.

J. K. ALLEN 106 W. 28th St., New York
 Tel. 167 Madison Sq.
 Open 6 A. M. Daily.

Order by Name
Krick's Genuine Immortelle Letters, Etc.
 The Best and Cheapest. Accept no Substitute. Every Letter Marked
KRICK'S LETTERS
 1164-66 Greene Av., Brooklyn, N. Y.
 For Sale by all Supply Houses

NEW YORK QUOTATIONS PER 100. To Dealers Only

MISCELLANEOUS

	Last Half of Week ending June 19 1909	First Half of Week beginning June 21 1909
Cattleyas.....	15.00 to 35.00	10.00 to 35.00
Lilacs.....	2.00 to 4.00	2.00 to 3.00
Lily of the Valley.....	1.00 to 5.00	.50 to 3.00
Peonies.....	1.00 to 4.00	1.00 to 3.00
Daisies (per bunch).....	.10 to .15	.10 to .15
Stocks (per bunch).....	.45 to .10	.45 to .10
Sweet Peas (per 100 bunches).....	2.00 to 8.00	2.00 to 8.00
Gardenias.....	2.00 to 25.00	5.00 to 20.00
Adiantum.....	.50 to .75	.50 to .75
Smilax.....	2.00 to 12.00	8.00 to 12.00
Asparagus Plumosus, strings.....	20.00 to 30.00	20.00 to 30.00
" " & Spreu. (100 bchs).....	15.00 to 25.00	10.00 to 25.00

Wired Toothpicks
 Manufactured by
W. J. COWEE, BERLIN, N. Y.
 \$3,000,000.....\$1.75; 50,000,000.....\$7.50. Sample free.
 For sale by dealers

FLOWER MARKET REPORTS.
 (Continued from page 907)

CHICAGO
 The past week was a most uneventful one in the eyes of most of the florists, wholesale or retail. The plant men are the only ones who did not feel the reaction after the unusually brisk Memorial Day trade. Various theories have been advanced to account for the extreme dullness of the month of June but none of them seem wholly satisfactory. The fact remains that flowers are not selling as they should at this season of the year, except with florists who have a large shipping trade. Kaiserin and Carnot roses are getting into fine shape now. Carnations are hardly worth considering so light is the demand. Ferns have taken a big drop and are now selling at less than one-half the price they brought two weeks ago, the price at that time being abnormally high. Most of the florists report their sales as comparing well with one year ago notwithstanding the low prices. Florists are preparing to close at 5 p. m.

during July and August, and an effort is being made to close Sundays also. And why should not the florist who has worked hard all the week rest as most of the world does on Sunday?

INDIANAPOLIS
 Business has been moving along very quietly the past week, but it is pretty generally conceded that present conditions are an improvement over those of a year ago. Though June weddings and commencements have not greatly enriched the florists they have helped some. At present the market is weak with falling prices. Much inferior rose stock is coming in. American Beauty and Killarney are the best grade of roses at the present time. Carnations are in fair condition and moving nicely. There is not much of a variety of stock but abundance of the kinds at hand. Calla season is about over but Harrisii lilies are very much in evidence. Iris, Shasta daisies, corn flowers, larkspur, Coreopsis and stocks furnish diversion from the blossoms generally seen. Peony season is over

and cold storage stock is being used. Bedding plants have had a big run this season and stock is now pretty well cleaned up. Vines and good geraniums are almost impossible to obtain at the present time. Hardy cut ferns are good property and meet a good demand as well as asparagus and other greens.

NEW YORK
 Hot weather, abundance of stock of all kinds and very little business is the discouraging condition we are facing now. Roses and carnations are showing the effect of the high temperature. The usual spurt incident to the school closings has not materialized as yet. Everything is cheap and not all of the stock can be moved except at ruinous prices. Lilies are particularly plentiful. Some improvement is hoped for before the end of the week, but it would require considerable of a demand to consume the material now coming into the market at even fair figures.

(Continued on page 912)

Buyer's Directory and Ready Reference Guide

Advertisements under this head, one cent a word. Initials count as words.

Display advertisers in this issue are also listed under this classification without charge. Reference to List of Advertisers will indicate the respective pages.

Buyers falling to find what they want in this list will confer a favor by writing us and we will try to put them in communication with reliable dealers.

ACCOUNTANT

R. J. Dyrant, 28 State St., Boston.
For page see List of Advertisers.

AQUATIC PLANTS

Aquarium plants the year round. Wholesale and retail. Send for price list. Schmid's Emporium of Pets, 712 12th Street, Washington, D. C.

AQUILEGIAS

Aquilegia Genuine Coriacea, finest of all. Both plants and seeds from the heart of the Rockies. C. S. Harrison's Select Nursery, York, Neb.

ARAUCARIAS

A. Leuthy & Co., Perkins St. Nurseries, Roslindale, Mass.

For page see List of Advertisers.
Godfrey Aschmann, 1012 West Ontario St., Philadelphia, Pa.
For page see List of Advertisers.

ASPARAGUS PLUMOSUS

William C. Smith, Market & 61st St., Philadelphia.

For page see List of Advertisers.
Charles H. Totty, Madison N. J.
Asparagus Plumosus and Sprenger.
For page see List of Advertisers.

ASPARAGUS SEED

Asparagus Plumosus Seed, fresh, lath-house grown, \$1.75 per 1000. Special price in quantities. Immediate delivery. Cash. Oak Grove Nurseries, Office, 404 North Los Angeles St., Los Angeles, Cal.

ASTERS

I. C. Schmidt, Bristol, Pa.
For page see List of Advertisers.

Credo, the best of all, colors light pink and white. Trive to clean out, \$2.50 per 1000. Edward Harris, Cumberland, Md.

BAMBOO CANES

Yokohama Nursery Co., 31 Barclay Street, New York.

Bamboo Sticks, Colored Green.
For page see List of Advertisers.

BAY TREES.

2000 Bay and Box Trees in all sizes, Pyramid and Standards, Write for list. Julius Koehrs, Rutherford, N. J.

BEGONIAS

Elmsford Nurseries, Elmsford, N. Y.
Lorraine Begonia.

For page see List of Advertisers.
Thomas Roland, Nahant, Mass.
Begonia Gloire De Lorraine.
For page see List of Advertisers.

Now ready for delivery, Begonia Gloire de Lorraine, strong, healthy stuff, all propagated from leaf cuttings, and ready for 3 and 4 inch pots; \$15.00 per 100, \$140.00 per 1000. New winter-flowering Begonia Pres. Tuff. Awards—Bronze Medal S. A. F., Chicago, Nov. 1908; Certificate of Merit by Pittsburg and All-England Florists' Club, Newport, R. I., Horticultural Society, and New York Florists' and Gardeners' Club. This beautiful winter-flowering Begonia originated in our nurseries about two years ago; it is stronger, sturdier and more beautiful than any of its predecessors. In color it is similar to Azalea; it is free and continuous throughout from November to April; each flower the size of a silver dollar. \$4.00 per dozen, \$25.00 per 100. Cash with order from unknown correspondents. J. A. Peterson, McHenry Ave., Westwood, Cincinnati, O.

BEDDING PLANTS

A. Leuthy & Co., Perkins St. Nurseries, Roslindale, Mass.
For page see List of Advertisers.

G. Aschmann, 1012 W. Ontario St., Philadelphia, Pa.
For page see List of Advertisers.

R. Vincent, Jr. & Sons Co., White Marsh, Maryland.
For page see List of Advertisers.

Geraniums, Buchner, 3 in., \$3.00 per 100; Coleus, 2 in., \$1.50 per 100. Ernest Harris, Dolansau, N. Y.

NORTHERN FLORISTS' NOTICE! I have a splendid stock of the following in right condition for this late season. The prices quoted are strictly cash: Ageratum, blue, 3 in., \$2.50 per 100, cash. Alternanthera, red and yellow, 2 in., \$1.50 per 100. Begonia Vernon, pink and white, 3 in., \$2.50 per 100. Centaurea Gymnocarpa, 2 in., \$1.50 per 100. Camas Muscicola (bronze), and a yellow-flowering French canna (green), 3 1/2 in., \$5.00 per 100. Cobaea scandens, 3 1/2 in., \$5.00 per 100. Coleus, assorted colors, 2 in., \$1.50 per 100. Fuchsias, single and double, mixed, 2 1/2 in., \$3.00 per 100. Geranium, Pique, Jamin, Viand and La Favorite, 2 1/2 in., \$5.00 per 100. Heliotropes, 3 1/2 in., \$5.00 per 100. Baisles, (Paris) white, 3 in., \$2.50 per 100. Ivy, Parlor (for Geranium), 3 in., \$2.50 per 100. Lobelias, 2 1/2 in., \$2.00 per 100. Petunias, single, finest mixture, 2 1/2 and 3 in., \$2.00 per 100. Salvia Bonthe, 2 1/2 in., \$2.00; 3 1/2 in., \$4.00 per 100. Verbenas, Vaughan's best mixture, 2 1/2 in., \$2.00 per 100. T. SOKOL, Worcester, Mass.

BEGONIA EX

J. H. Dann & Son, Westfield, N. Y.
For page see List of Advertisers.

BOILERS

BOILERS. "Burnham" Boilers made for greenhouse heating. Lord & Burnham, 1133 Broadway, N. Y.

Kroeschell Bros. Co., 35 Erie St., Chicago.
For page see List of Advertisers.

BOOKS

Pronunciation of Plant Names, sent for 50 cents, postpaid, by HORTICULTURE PUBL. CO., 11 Hamilton Place, Boston.

BOXWOOD TREES

New England Nurseries, Inc., Bedford, Mass.

For page see List of Advertisers.
The F. R. Pierson Co., Tarrytown-on-Hudson, N. Y.
For page see List of Advertisers.

BUILDING MATERIAL

BUILDING MATERIAL of all description for All Cypress, Semi-iron, Iron Frame or Truss Houses, Hot Bed Sash and Frames, Lord & Burnham Co., 1133 Broadway, N. Y.

BULBS AND TUBERS

Joseph Breeck & Sons, 47 1/2 N. Market St., Boston.
For page see List of Advertisers.

J. M. Thornburn & Co., 33 Barclay St., New York.
For page see List of Advertisers.

A. T. Roddington, 342 W. 14th St., N. Y.
For page see List of Advertisers.
Rickards Bros., 37 East 19th St., New York.
For page see List of Advertisers.

H. F. Michell Co., Philadelphia.
For page see List of Advertisers.
H. E. Fiske Seed Co., Fauvel Hall Sq., Boston.
For page see List of Advertisers.

BULBS AND TUBERS—Continued

T. J. Grey & Co., 32 and 33 So. Market St., Boston.
For page see List of Advertisers.

Yokohama Nursery Co., 31 Barclay St., New York.
For page see List of Advertisers.

Ralph M. Ward & Co., 12 W. Broadway, New York.
For page see List of Advertisers.

Schlegel & Fother Co., 26 & 27 S. Market St., Boston.

Begonias, Gloxinias, Tuberoses.
For page see List of Advertisers.
Jaes Smits, Ltd., care Maitus & Ware, 14 Stone St., New York.
Cold Storage Lily of the Valley.
For page see List of Advertisers.
Burnett Bros., 72 Corlandt St., New York.
Foreign Bulbs.

CAANAS

R. Vincent, Jr. & Sons Co., White Marsh, Maryland.

The F. R. Pierson Co., Tarrytown-on-Hudson, N. Y.
For page see List of Advertisers.

Estate of David Fisher, Woburn, Mass.
For page see List of Advertisers.
J. H. Dann & Son, Westfield, N. Y.
For page see List of Advertisers.

CARNATIONS

Baur & Smith, 38th & Senate Sts., Indianapolis, Ind.

Patten & Co., Tewksbury, Mass.
Carnation Shasta.

F. Dorner & Sons Co., Lafayette, Ind.
Carnations for immediate delivery.
For page see List of Advertisers.

Chicago Carnation Co., Joliet, Ill.
Mary Tolman.
For page see List of Advertisers.

Wood Bros., Fishkill, N. Y.
Carnations, Rooted Cuttings.
For page see List of Advertisers.

The E. G. Hill Co., Richmond, Ind.
Carnation Cuttings.
For page see List of Advertisers.

Poehlmann Bros. Co., Morton Grove, Ill.
For page see List of Advertisers.

CHRYSANTHEMUMS

E. G. Hill Co., Richmond, Ind.
For page see List of Advertisers.

S. J. Renter & Son, Westley, E. I.
For page see List of Advertisers.

C. H. Totty, Madison, N. J.
For page see List of Advertisers.

Wood Bros., Fishkill, N. Y.
Chrysanthemums Rooted Cuttings.
For page see List of Advertisers.

Poehlmann Bros. Co., Morton Grove, Ill.
For page see List of Advertisers.

Elmer D. Smith & Co., Adrian, Mich.
For page see List of Advertisers.

H. L. Cameron, N. Cambridge, Mass.
White Bonaffon.

William C. Smith, Market & 61st St., Philadelphia.
For page see List of Advertisers.

I. M. Rayner, Greenport, L. I., N. Y.
For page see List of Advertisers.

75,000 transplanted chrysanthemum cuttings ready to bench: Opah, Kalb, Estelle, Pacific, Creno, Yellow Jones, Monroya, Whildid, Haiday, Bonaffon, Bailey, \$1.25, 100; \$12.00, 1000. T. W. Bayla & Sons, West Grove, Pa.

Herrington's book on the Chrysanthemum mailed to your address for 50c, by Horticulture Publishing Co., 11 Hamilton Place, Boston.

For List of Advertisers See Page 915

CHRYSANTHEMUMS—Continued

Chrysanthemums, good stock cuttings from soil; all orders filled promptly; \$1.25 per 100; \$10.00 per 1000.
 White—Estelle, Opal, Oct. Frost, Ivory, Polly Rose, C. Tonslet, Mrs. Robinson.
 Yellow—Morrovia fine early, Crema, Jerome Jones, Maj. Bonaffon.
 Pink—Gloria Pacific, Dr. Enguehard, Wm. Duckham, Minnie Bailey.
 Red—Black Hawk, Cullington.
 Potted plants of above, 2 1/2 in., \$2.00 per 100, Cash or C. O. D.
 D. H. Green, West Grove, Penn.

Golden Glow and Pacific Supreme, R. C., \$2.75 per 100, prepaid; 1000 not prepaid, \$25; from 2 1/2 in. pots, \$3.50 per 100. Chas. Frost, Kenilworth, N. J.

57 VARIETIES.

Best commercial mums, 2 1/2 in. pots, 3c. each. Gloria, 25c. Henry Trull, Frederick, Md.

Chrysanthemums. For sale, cheap for cash, 3000 plants in 2 1/2 in. pots, and 2000 in 3 inch. Leading varieties. Fine stock. Samuel Kinder, Bristol, R. I.

COAL FOR GREENHOUSE USE

Bader Coal Co., Board of Trade Bldg., Boston.
 For page see List of Advertisers.

COLEUS

A. Leuthy & Co., Perkins St. Nurseries, Roslindale, Mass.
 For page see List of Advertisers.

CONIFERS

John Waterer & Sons, Ltd., American Nursery, Bagshot, Eng.
 For page see List of Advertisers.

CROTONS

The F. R. Pierson Co., Tarrytown-on-Hudson, N. Y.
 For page see List of Advertisers.

CUT FLOWER BOXES.

Edwards Folding Box Co., Philadelphia.
 For page see List of Advertisers.

Folding cut flower boxes, the best made. Write for list. Holton & Hunkel Co., Milwaukee, Wis.

CYCAS REVOLUTA WANTED

Kuight & Struck, 1 Madison Av., New York.
 For page see List of Advertisers.

DAHLIAS

David Herbert & Son, Atco, N. J.
 For page see List of Advertisers.

J. L. Moore, Northboro, Mass.

Peacock Dahlia Farms, Williamstown Junction, N. J.
 For page see List of Advertisers.

R. Vincent Jr. & Sons Co., White Marsh, Md.

DAHLIAS.

Geo. H. Walker, No. Dighton, Mass. Wholesale and Retail.
 Send your name for my 1906 Catalog and Pocket Guide, ready to mail about Feb. 25th.

Willmore's Dahlia Manual will be mailed for twenty-five cents by HORTICULTURE PUBLISHING COMPANY, 11 Hamilton Place, Boston.

DECORATIVE PLANTS

A. Leuthy & Co., Perkins St., Nurseries, Roslindale, Mass.
 Imported Plants for Fall Delivery.
 For page see List of Advertisers.

Godfrey Aschmann, 1012 W. Ontario St., Philadelphia, Pa.
 For page see List of Advertisers.

Joseph Hancock Co., Wyncote, Pa.
 For page see List of Advertisers.

The Geo. Wittbold Co., 1657 Buckingham Place, Chicago, Ill.
 For page see List of Advertisers.

Robert Craig Co., Market and 49th Sts., Philadelphia, Pa.
 For page see List of Advertisers.

EVERGREENS

New England Nurseries, Bedford, Mass.
 For page see List of Advertisers.
 American Nursery Co., 150 Broadway, N. Y.
 For page see List of Advertisers.

Evergreens. Send 25 cents in stamps for complete work on propagating and growing Evergreens. C. S. Harrison's Select Nursery, York, Neb.

FERNS

A. Leuthy & Co., Roslindale, Mass.
 For page see List of Advertisers.
 H. H. Barrows & Son, Whitman, Mass.
 Nephrolepis Magnifica.
 For page see List of Advertisers.
 John Scott, Brooklyn, N. Y.
 For page see List of Advertisers.

Frank Ochslin, 2570-2606 W. Adams St., Chicago.
 Ferns for Dishes.
 For page see List of Advertisers.

The Geo. Wittbold Co., 1657 Buckingham Place, Chicago, Ill.
 For page see List of Advertisers.

Godfrey Aschmann, 1012 W. Ontario St., Philadelphia.
 For page see List of Advertisers.

Jardinere Ferns, 6-7 best varieties, \$3.50 per 100; \$30.00 per 1000. Rose Hill Nurseries, New Rochelle, N. Y.
 For page see List of Advertisers.
 Anderson's ferns for in and outdoors. Largest commercial collection in the country. Ask for descriptive catalogue. J. F. Anderson, Fern Specialist, Short Hills, N. J.

FERTILIZERS

Universalized Manure Co., 31 Union Stock Yards, Chicago, Ill.
 Wizard Brand Sheep and Shredded Cattle Manure.

Bowker Fertilizer Co., Boston, Mass. All Forms of Plant Food at First Hands.
 For page see List of Advertisers.

Wm. Elliott & Sons, 42 Vesey St., New York.
 Sheep Manure.

FLORAL PHOTOGRAPHS

Floral Photographs. Foley's, 226-228 1-2 Bowery, New York.

FLORISTS' LETTERS.

Boston Florist Letter Co., 66 Pearl St., Boston, Mass.
 For page see List of Advertisers.

W. C. Krick, 1164-66 Greene Ave., Brooklyn, N. Y.
 Immortelle Letters.
 For page see List of Advertisers.

FLORISTS SUPPLIES

N. F. McCarthy & Co., 84 Hawley St., Boston.
 For page see List of Advertisers.

H. M. Robinson & Co., 15 Province St. and 9 Chapman Place, Boston, Mass.
 For page see List of Advertisers.

Reed & Keller, 122 W. 25th St., New York.
 For page see List of Advertisers.

H. Bayersdorfer & Co., 1129 Arch St., Philadelphia.
 For page see List of Advertisers.

S. S. Pennock-Mechan Co., Philadelphia.
 For page see List of Advertisers.

FLOWER POTS

W. H. Ernest, 28th and M Sts., Washington, D. C.
 For page see List of Advertisers.

A. H. Hews & Co., Cambridge, Mass.
 For page see List of Advertisers.

Hillinger Bros., Ft. Edward, N. Y.
 For page see List of Advertisers.

The Peters & Reed Pottery Co., Red Pots, Seed Pans, etc., Zanesville, O.

We make Standard Flower Pots, etc. Write us when in need.
 Whimper Cope & Bro.
 Lincoln University, Chester Co., Pa.

FRUIT TREES

Dwarf Fruit Trees, by F. A. Wauhan, mailed to your address for 55 cents by Horticulture Publishing Co., 11 Hamilton Place, Boston.

GALAX

Michigan Cut Flower Co., 35 and 40 Broadway, Detroit, Mich.
 For page see List of Advertisers.

George Cotsonas & Co., 50 W. 25th St., New York.
 For page see List of Advertisers.

Rice Bros., 115 N. 6th St., Minneapolis, Minn.
 For page see List of Advertisers.

H. M. Robinson & Co., 15 Province St. and 9 Chapman Place, Boston.
 For page see List of Advertisers.

GARDEN HOSE

Revere Rubber Co., Boston, Mass.
 For page see List of Advertisers.

GERANIUMS

R. Vincent, Jr. & Sons Co., White Marsh, Md.
 New and Standard Varieties.
 For page see List of Advertisers.

Godfrey Aschmann, Philadelphia, Pa.
 For page see List of Advertisers.

GLADIOLI

J. L. Moore, Northboro, Mass.
 For page see List of Advertisers.

GLASS

Boston Plate & Window Glass Co., Boston.
 For page see List of Advertisers.

Standard Plate Glass Co., 26-30 Sudbury St., Boston.
 For page see List of Advertisers.

Foley Mfg. Co., Western Ave., between 25th & 26th Sts., Chicago.
 For page see List of Advertisers.

Sharp, Partridge & Co., 22d & Lumber Sts., Chicago.
 For page see List of Advertisers.

Parsehelsky Bros., Inc., 59 Montrose Ave., Brooklyn, N. Y.
 For page see List of Advertisers.

Metropolitan Material Co., 1392-1402 Metropolitan Ave., Brooklyn, N. Y.
 For page see List of Advertisers.

Greenhouse glass, lowest prices. Johnston Glass Co., Hartford City, Ind.

Glass, High Grade, Double Thick Greenhouse Glass. Lord & Burnham, 1133 Broadway, N. Y.

GLAZING POINTS

H. A. Dreer, Philadelphia, Pa.
 Peerless Glazing Point.
 For page see List of Advertisers.

GLAZING POINTS, Lord & Burnham. Special Glazing Nails (Points). Lord & Burnham, 1133 Broadway, N. Y.

GREENHOUSE BUILDING MATERIAL

Lord & Burnham Co., 1133 Broadway, New York.
 For page see List of Advertisers.

Pierson U-Bar Co., 1 Madison Sq., N. Y.
 For page see List of Advertisers.

A. T. Stearns Lumber Co., Nepouset, Boston.
 For page see List of Advertisers.

King Construction Co., N. Tonawanda, New York.
 For page see List of Advertisers.

Hitchings & Co., 1170 Broadway, New York.
 For page see List of Advertisers.

J. C. Moulting Co., 117 East Blackhawk St., Chicago, Ill.
 For page see List of Advertisers.

Foley Mfg. Co., Western Ave., between 25th & 26th Sts., Chicago.
 For page see List of Advertisers.

S. Jacobs & Sons, 1259-63 Flushing Ave., Brooklyn, N. Y.

In writing to Advertisers kindly mention Horticulture

GREENHOUSE CONSTRUCTION

GREENHOUSE CONSTRUCTION, Semi-Iron Greenhouse, New Truss Houses and Iron Frame Houses. Lord & Burnham, 1133 Broadway, N. Y.

J. A. Payne, 260-274 Culver Ave., Jersey City, N. J.

Foley Mfg. Co., Western Ave., between 25th & 26th Sts., Chicago.

For page see List of Advertisers.

Hitchings & Co., 1170 Broadway, New York. For page see List of Advertisers.

GREENHOUSE HOSE

Revere Rubber Co., Boston, Mass. Revere Hose.

For page see List of Advertisers.

GUTTERS

GUTTERS, Cast Iron Gutters, L. & B. Improved V Shaped Gutter with drip gutter attachment. Lord & Burnham, 1133 Broadway, N. Y.

HAIL INSURANCE

Florists' Hall Asso. of America, J. G. Esler, Saddle River, N. J.

For page see List of Advertisers.

HARDY FERNS, MOSS AND GREENS

H. M. Robinson & Co., 15 Province St. and 9 Chapman Place, Boston, Mass.

For page see List of Advertisers.

Michigan Cut Flower Exchange, 38 and 39 Broadway, Detroit, Mich.

For page see List of Advertisers.

George Cotsonas & Co., 50 W. 28th St., New York.

For page see List of Advertisers.

Rice Bros., 115 N. 6th St., Minneapolis, Minn.

For page see List of Advertisers.

HEATING APPARATUS

Lord & Burnham Co., 1133 Broadway, New York.

For page see List of Advertisers.

Person U-Bar Co., 1 Madison Sq., N. Y.

For page see List of Advertisers.

John A. Payne, 260-274 Culver Ave., Jersey City, N. J.

Kroeschell Bros. Co., 35 Erie St., Chicago.

For page see List of Advertisers.

HELP FURNISHED

Thos. H. Fambrik, 31 So. 7th St., Phila.

For page see List of Advertisers.

HERBACEOUS PERENNIALS

P. Ouwerkerk, P. O. No. 1, Hoboken, N. J.

For page see List of Advertisers.

New England Nurseries, Bedford, Mass.

For page see List of Advertisers.

The Geo. Witthold Co., 1657 Buckingham Place, Chicago.

For page see List of Advertisers.

HOT-BED SASH

The A. T. Stearns Lumber Co., Nepouset, Mass.

For page see List of Advertisers.

Person U-Bar Co., 1 Madison Sq., N. Y.

For page see List of Advertisers.

Lord & Burnham Co., 1133 Broadway, N. Y.

For page see List of Advertisers.

Foley Mfg. Co., Western Ave., between 25th & 26th Sts., Chicago.

HYDRANGEAS.

The F. R. Pierson Co., Tarrytown-on-Hudson, N. Y.

For page see List of Advertisers.

INSECTICIDES.

Nitocitide kills all greenhouse pests. P. R. Palethorpe Co., Eleventh St., Owensboro, Ky.

For page see List of Advertisers.

Stump & Walser Co., 50 Barclay St., New York.

For page see List of Advertisers.

Kiln-dried Tobacco Dust.

For page see List of Advertisers.

Niagara Sprayer Co., Middleport, N. Y. Niagara Brand.

For page see List of Advertisers.

INSECTICIDES — Continued

Bowker Insecticide Co., Boston, Mass. Insect Destroying Preparations.

For page see List of Advertisers.

Wm. Cooper & Nephews, 177 Illinois St., Chicago; Cyril Brooklyn, 62 Beaver St., New York, Agt.

For page see List of Advertisers.

Y I Fluid.

Eastern Chemical Co., Pittsburg St., Boston.

For page see List of Advertisers.

Hammond's Paint & Slug Shot Works, Fishkill-on-Hudson, N. Y.

For page see List of Advertisers.

"The Fumigating Kind Tobacco Powder"

The first on the market and the kind that has so many imitators, has our guarantee tag of satisfaction or money back, and "The Moon Trade Mark" on every bag. \$2.00 per 100 lbs. The H. A. Stoothoff Co., Mount Vernon, N. Y., makers and sellers.

JAPANESE PLANTS

Yokohama Nursery Co., 31 Barclay St., New York.

For page see List of Advertisers.

KENTIAS

Godfrey Aschmann, 1012 W. Ontario St., Philadelphia, Pa.

For page see List of Advertisers.

A. Leuthy & Co., Rosindale, Mass.

For page see List of Advertisers.

Jos. Heacock Co., Wyncoke, Pa. Single and Made-Up Specimens.

For page see List of Advertisers.

O. V. Zangen, Hoboken, N. J.

For page see List of Advertisers.

LILY OF THE VALLEY PIPS

Hjalmar Hartmann & Co., Langangstraede 20, Copenhagen, Denmark.

For page see List of Advertisers.

MASTICA

F. O. Pierce Co., 12 W. Broadway, New York.

For page see List of Advertisers.

MOON VINES

Godfrey Aschmann, Philadelphia, Pa.

For page see List of Advertisers.

MUSAS

The F. R. Pierson Co., Tarrytown-on-Hudson, N. Y.

For page see List of Advertisers.

MYRTLE

Myrtle, blue for cemetery planting, \$2.00 per 100; \$17.50 per 1000. Geo. A. Dhonau, Station H., Cincinnati, Ohio.

NICO-FUME

Kentucky Tobacco Product Co., Louisville, Ky.

NURSERY STOCK

John Waterer & Sons, Ltd., American Nursery, Bagshot, England.

For page see List of Advertisers.

P. Ouwerkerk, 216 Jane St., Weehawken Heights, N. J.

For page see List of Advertisers.

American Nursery Co., 150 Broadway, New York, N. Y.

For page see List of Advertisers.

W. & T. Smith Co., Geneva, N. Y.

For page see List of Advertisers.

Manual of the Trees of North America, by C. S. Sargent, mailed to your address for \$6.00, by Horticulture Publishing Co., 11 Hamilton Place, Boston.

TREES, SHRUBS, ROSES, EVERGREENS, PEONIES, HARDY PLANTS, ELLWANGER & BARRY, Rochester, N. Y.

ORCHID PLANTS

Lager & Hurrell, Summit, N. J. Fresh Imported and Established Orchids.

For page see List of Advertisers.

Sander, St. Albans, England.

Importers, Exporters, Growers, Hybridists. For page see List of Advertisers.

Carrillo & Baldwin, Secaucus, N. J.

For page see List of Advertisers.

Jos. A. Manda, 191 Valley Road, West Orange, N. J.

For page see List of Advertisers.

Ordonez Bros., Madison, N. J., Box 105.

For page see List of Advertisers.

MacRorie-McLaren Co., 721 Crocker Bldg., San Francisco, Cal.

Phalaenopsis and Vandas.

Largest stock in the country. Ask for prices. Julius Rechs, Rutherford, N. J.

Native Orchids. Hugo Kind, Hammon-ton, N. J.

PAINT AND PUTTY

PAINT AND PUTTY: Ideal Greenhouse Lead; Special Greenhouse Putty. Lord & Burnham, 1133 Broadway, N. Y.

PALMS

A. Leuthy & Co., Perkins St. Nurseries, Rosindale, Mass.

For page see List of Advertisers.

Robert Craig Co., Market and 49th Sts., Philadelphia, Pa.

For page see List of Advertisers.

Joseph Heacock Co., Wyncoke, Pa.

For page see List of Advertisers.

Geo. Witthold Co., 1657 Buckingham Place, Chicago.

For page see List of Advertisers.

O. V. Zangen, Hoboken, N. J.

For page see List of Advertisers.

PANSY SEED

John Gerard, New Britain, Conn. Giant Pansy Seed.

For page see List of Advertisers.

PATENTS

Siggers & Siggers, Washington, D. C.

For page see List of Advertisers.

PEAT

Orchid Peat and Moss always on hand. Julius Rechs Co., Rutherford, N. J.

PEONIES

Peonies only, by the wholesale—best 100 varieties. J. F. Rosenfield, Westpoint, Nehr.

One of the finest collections in America. Send 25 cts. in stamps for new edition of Peony Manual. C. S. Harrison's Select Nursery, York, Neb.

PHLOXES

Send 25 cts. in stamps for Phlox Manual. Fine mixed phloxes, \$2.00 per 100. C. S. Harrison's Select Nursery, York, Neb.

PHOTOGRAPHS: DESIGNING: ILLUSTRATING

Geo. E. Dow, 178 Washington St., Boston. For page see List of Advertisers.

PIPE AND FITTINGS

Foley Mfg. Co., between Western Ave. and 26th St., Chicago, Ill.

For page see List of Advertisers.

Kroeschell Bros. Co., 35 Erie St., Chicago.

For page see List of Advertisers.

PIPE AND FITTINGS. Cast Iron and Wrought Pipe, Valves, Elbows, Pipe Hooks, Automatic Air Headers, etc. Lord & Burnham, 1133 Broadway, N. Y.

Metropolitan Material Co., 1362-1402 Metropolitan Ave., Brooklyn, N. Y.

For page see List of Advertisers.

PLANT STAKES

Seele's Tless Plant Stakes and Trellises. H. D. Seele & Sons, Elkhart, Ind.

POT HANGERS

Pot hangers. Kramer's, \$1 doz. by exp., \$1.25 by mail. I. N. Kramer & Son, Cedar Rapids, Iowa.

For List of Advertisers See Page 915

PRIMULAS

Primula obconica grandiflora, Rousdorfer Hybrids, the best strain in existence; compact, Kernessia, purpurescens, violacea, glauca and five other varieties; strong plants from 2 1/2 in. pots, \$3.00 per 100. Cash. Henry Schmidt, 408 Fulton St., Weehawken P. O., N. J.

RHODODENDRONS

John Waterer & Sons, Ltd., American Nursery, Bagshot, England. For page see List of Advertisers.
P. Ouwerkerk, Hoboken, N. J. For page see List of Advertisers.

ROSES

Robert Craig Co., Market and 49th Sts., Philadelphia, Pa. For page see List of Advertisers.
P. Ouwerkerk, P. O. No. 1, Hoboken, N. J. For page see List of Advertisers.
The F. R. Pierson Co., Tarrytown-on-Hudson, N. Y., White Killarney. For page see List of Advertisers.
Dingee & Conard Co., West Grove, Pa. For page see List of Advertisers.
Poehlmann Bros. Co., Morton Grove, Ill. For page see List of Advertisers.
A. N. Pierson, Cromwell, Conn.
White Killarney, Ny Maryland, Rambler. For page see List of Advertisers.
W. & T. Smith Co., Geevea, N. Y., American Grown Roses. For page see List of Advertisers.
Pittsburgh Rose & Carnation Co., Gibsonia, Pa.
Ellwanger & Barry, Violet Blue Rose.
Mount Hope Nurseries, Rochester, N. Y.
Charles H. Totty, Madison, N. J. For page see List of Advertisers.
Roses, Maids and Richmonds, strong 4 in. stock, \$8.00 per 100. Rose Hill Nurseries, New Rochelle, N. Y.
The Rose, by H. B. Ellwanger, mailed for \$1.30 by Horticulture, 11 Hamilton Place, Boston.
Hand Book of Cultural Notes on Roses Under Glass, by F. P. Brigham, mailed to your address for 25c, by Horticulture Publishing Co., 11 Hamilton Place, Boston.
Roses, Maids and Richmonds, strong 4 in. stock, \$8.00 per 100. American Beauties, 3 in. pots, \$7.00 per 100; 3 1/2 in. pots, \$8.00 per 100. Rose Hill Nurseries, New Rochelle, N. Y.

RUBBER PLANTS

William C. Smith, Market & 61st St., Philadelphia. For page see List of Advertisers.

SEED GROWERS

Hjalmar Hartmann & Co., Cauliflower and Cabbage Seed, Langensgade 20, Copenhagen, Denmark. For page see List of Advertisers.

SEEDS

T. J. Grey Co., 32 So. Market St., Boston. For page see List of Advertisers.
Joseph Breck & Sons, 51 and 52 N. Market St., Boston, Mass. For page see List of Advertisers.
W. Atlee Burpee & Co., Philadelphia. For page see List of Advertisers.
Arthur T. Boddington, 342 W. 14th St., New York. For page see List of Advertisers.
H. E. Fiske Seed Co., Faneuil Hall Sq., Boston. For page see List of Advertisers.
Hjalmar Hartmann & Co., Langensgade 20, Copenhagen, Denmark. Cauliflower and Cabbage Seed. For page see List of Advertisers.
Rickards Bros., 37 E. 19th St., New York. For page see List of Advertisers.
R. & J. Farquhar & Co., 67 So. Market St., Boston. Michigan Seed. For page see List of Advertisers.
H. F. Mitchell Co., 1018 Market St., Phila. Pennsylvania Seed. For page see List of Advertisers.

SEEDS - Continued

J. M. Thorburn & Co., 33 Bareilly St., N. Y. For page see List of Advertisers.
Leonard Seed Co., Chicago, Ill. For page see List of Advertisers.
Schlegel & Pottery Co., 25 & 27 So. Market St., Boston. For page see List of Advertisers.
O. V. Ziegen, Hoboken, N. J., Florists' Spring Seeds. For page see List of Advertisers.
E. F. Winterson Co., Chicago. Seeds for Plantations, Nurserymen, Seedsmen. For page see List of Advertisers.
A. C. Zvolanek, Bound Brook, N. J., Winter Flowering Sweet Peas. For page see List of Advertisers.
Seeds, Rocky Mountain Evergreen seeds in large or small quantities, C. S. Harrison's Select Nursery, York, Neb.

SHRUBS

The George Wittbold Co., 1657 Buckingham Place, Chicago. For page see List of Advertisers.

SILKALINE

John C. Meyer & Co., Boston, Mass. For page see List of Advertisers.

SPHAGNUM MOSS

Live Sphagnum moss, orchid peat and orchid baskets always on hand. Lager & Hurrell, Summit, N. J.

SPRAYERS

Nagara Sprayer Co., Middleport, N. Y. For page see List of Advertisers.
Chas. J. Jager Co., Boston. Densling Spray Pump. For page see List of Advertisers.

STRAWBERRY PLANTS

Burnett Bros., 72 Cortlandt St., New York. For page see List of Advertisers.

SULPHUR BURNER

Benj. Dorrance, Rose Growers, Dorrance, Pa.

SWEET PEAS

A. C. Zvolanek, Bound Brook, N. J., Winter Flowering. For page see List of Advertisers.

VEGETABLE PLANTS

R. Vincent, Jr., & Sons Co., White Marsh, Md. For page see List of Advertisers.
J. C. Schmidt, Bristol, Pa. For page see List of Advertisers.
500,000 Cabbage, Fine, stocky, field-grown plants from best strains of seed, ready to set out from now to August. Early Summer, Allhead, Succession. All Seasons, Brunswick, Flat Dutch, Drumhead, Danish Ballhead, Surehead, Warren. Carefully packed and delivered at any American Express office in New England, transportation charges prepaid by me. 500 \$1.25; 1000 \$2. Write for special prices on larger lots. Cash with order. L. W. Goodell, Pansy Park Dwight P. O., Mass.

VENTILATING APPARATUS

Pierson U-Bar Co., 1 Madison Sq., N. Y. For page see List of Advertisers.
Foley Mfg. Co., Western Ave., between 25th & 26th Sts., Chicago. For page see List of Advertisers.
John A. Payne, 260-274 Culver Ave., Jersey City, N. J.
The Advance Co., Richmond, Ind. For page see List of Advertisers.
Quaker City Machine Co., Richmond, Ind., 20th Century Ventilating Arm. For page see List of Advertisers.

VENTILATING MACHINERY. New Model enclosed, self-oiling gear; Standard Model Open Gear. Lord & Burnham, 1133 Broadway, N. Y.

VERBENAS

Lemon Verbena, C. C., 75c. per 100, prepaid. Chas. Frost, Kentworth, N. J.

VIOLETS.

William Sim, Cliftondale, Mass. Boston and Princess of Wales Violets. For page see List of Advertisers.
Maria Louise Violet plants, well rooted, grown on tile benches, free from disease, selected stock, \$15.00 per 1000. Ready for immediate delivery. J. Vouder Linden, Rhinebeck, N. Y.

VINGAS

William C. Smith, Market & 61st St., Philadelphia. For page see List of Advertisers.

WILSON'S PLANT OIL

Wilson Plant Oil & Fertilizer Co., Chatham, N. J.

WIRED TOOTHPICKS

W. J. Cowee, Berlin, N. Y. For page see List of Advertisers.

WIREWORK

Reed & Keller, 122 W. 25th St., N. Y. For page see List of Advertisers.
Durand & Marohn, Albany, N. Y. For page see List of Advertisers.
Wirework. Write for our catalogue. Holton & Hunsel Co., Milwaukee, Wis.
William E. Heischer's Wire Works, 38-40 Broadway, Detroit, Mich.
Wirework—Compare our prices with others. Scranton Florist Supply Co., 201 N. 7th St., Scranton, Pa.

WHOLESALE FLORISTS

Boston

N. F. McCarthy & Co., 84 Hawley St., Boston. For page see List of Advertisers.
H. M. Robinson & Co., 15 Province St. and 9 Chapman Pl., Boston. For page see List of Advertisers.
Welch Bros., 226 Devonshire St., Boston. For page see List of Advertisers.
Tally, Wellesley, Mass. For page see List of Advertisers.

Buffalo, N. Y.

William F. Kasting Co., 383-87 Ellicott St., Buffalo, N. Y. For page see List of Advertisers.

Chicago

Chas. W. McKeller, 51 Wabash Ave., Chicago. For page see List of Advertisers.
Peter Reinberg, 51 Wabash Ave., Chicago. For page see List of Advertisers.
E. F. Winterson Co., 45-49 Wabash Ave., Chicago. For page see List of Advertisers.
J. A. Budlong, 37-39 Randolph St., Chicago. For page see List of Advertisers.
Poehlmann Bros. Co., Morton Grove, Ill. For page see List of Advertisers.

Cromwell, Conn.

A. N. Pierson, Cromwell, Conn. For page see List of Advertisers.

Detroit

Michigan Cut Flower Exchange, 38 and 40 Broadway, Detroit, Mich. For page see List of Advertisers.

Minneapolis

Rice Bros., 115 N. 6th St., Minneapolis, Minn. For page see List of Advertisers.

New York

Ford Bros., 48 W. 28th St., New York. For page see List of Advertisers.
H. E. Froment, 57 W. 28th St., New York. For page see List of Advertisers.
Alex. J. Guttmann, 34 W. 28th St., New York. For page see List of Advertisers.

In writing to Advertisers kindly mention Horticulture

**WHOLESALE FLORISTS—
New York—Continued**

- E. C. Moran, 55 W. 28th St., New York.
For page see List of Advertisers.
- A. H. Langjahr, 55 W. 28th St., New York.
For page see List of Advertisers.
- James McManis, 42 W. 28th St., New York.
For page see List of Advertisers.
- John J. Raynor, 49 W. 28th St., New York.
For page see List of Advertisers.
- W. F. Sheridan, 39 W. 28th St., New York.
For page see List of Advertisers.
- Moore, Bentz & Nash, 55 and 57 W. 26th St., New York.
For page see List of Advertisers.
- Wm. H. Kuebler, 28 Willoughby St., Brooklyn, N. Y.
For page see List of Advertisers.
- Millang Bros., 41 W. 28th St., New York.
For page see List of Advertisers.
- John Young, 51 W. 28th St., New York.
For page see List of Advertisers.
- Greater New York Florists' Association, 162 Livingston St., Brooklyn, N. Y.
For page see List of Advertisers.
- Frank Millang, 55-57 W. 26th St., New York.
For page see List of Advertisers.
- Phillip F. Kessler, 55 & 57 W. 26th St., New York.
For page see List of Advertisers.
- A. L. Young & Co., 54 W. 28th St., N. Y.
For page see List of Advertisers.
- Growers' Cut Flower Co., 39 W. 28th St., New York.
For page see List of Advertisers.
- J. K. Allen, 105 W. 28th St., New York.
For page see List of Advertisers.
- Charles Millang, 444 Sixth Ave., New York.
For page see List of Advertisers.
- Manhattan Flower Market, 46 W. 28th St., New York.
For page see List of Advertisers.

Philadelphia

- W. E. McKissick & Bros., 1619-1621 Ransford St., Philadelphia, Pa.
For page see List of Advertisers.
- Leo Niessen Co., 1269 Arch St., Philadelphia, Pa.
For page see List of Advertisers.
- The S. S. Pennock-Medhan Co., 1608-18 Ludlow St., Philadelphia, Pa.
For page see List of Advertisers.

New Offers in This Issue.

- ARAUCARIAS, PALMS, SAGOS, ADANTUM, LORRAINE BEGONIAS.**
Godfrey Aschmann, Philadelphia, Pa.
For page see List of Advertisers.

ANNOUNCEMENT OF CHANGE IN FIRM NAME.

- Stuart Low & Co., Bush Hill Park, Enfield, Middlesex, Eng.
For page see List of Advertisers.

BEDDING PLANTS.

- F. Sokol, Worcester, Mass.
For page see List of Advertisers.

DUTCH AND FRENCH BULBS.

- Joseph Brock & Sons, 47-54 N. Market St., Boston.
For page see List of Advertisers.

GERANIUMS FOR NOVEMBER AND DECEMBER DELIVERY.

- R. Vincent, Jr. & Sons Co., White Marsh, Md.
For page see List of Advertisers.

'MUM CANES.

- Wm. Elliott & Sons, 42 Vesey St., New York.
For page see List of Advertisers.

NEW YORK FLORISTS' CLUB OUTING.

- H. A. Burdard, 312 W. 14th St., New York.
For page see List of Advertisers.

OWN ROOT ROSES.

- S. J. Reed & Son, Westley, R. I.
For page see List of Advertisers.

NEW OFFERS—Continued

PURPLE JAPAN MAPLES.

- Ellwanger & Barry, Rochester, N. Y.
For page see List of Advertisers.

PRIMULA CHINENSIS, OBCONICA GRANDIFLORA.

- H. T. Mitchell Co., 1018 Market St., Phila.
For page see List of Advertisers.

PEONIES FOR FALL DELIVERY.

- Cottage Gardens Co., Inc., Queens, L. I., N. Y.
For page see List of Advertisers.

PULLMAN'S INSECT AND WORM DESTROYER; NICOTINE.

- Phila. Insecticide Co., 617 Main St., Germantown, Pa.
For page see List of Advertisers.

ROSES.

- Frank P. Crump, Colorado Springs, Colo.
For page see List of Advertisers.

RIBBONS, SPECIAL PRICES.

- S. S. Pennock-Medhan Co., Philadelphia.
For page see List of Advertisers.

THE CASTLE HEATING SPECIALTIES.

- The W. W. Castle Co., 170 Summer St., Boston.
For page see List of Advertisers.

WHEAT SHEAVES OF SUPERIOR QUALITY.

- H. Bayersdorfer & Co., 1129 Arch St., Philadelphia.
For page see List of Advertisers.

OBITUARY.

Mrs. T. D. Cobb.

Mrs. T. D. Cobb, formerly Miss Emma Tonner, passed away at a hospital in Los Angeles, Cal, June 18th, after six weeks' of typhoid fever. Mrs. Cobb was a Chicago girl who had grown up closely connected with the florists' business and for several years conducted a retail store on Cottage Grove avenue. Her father, who died ten years ago, was a landscape gardener and laid out some of the Chicago parks. One sister, Bertha Tonner, is in the Flower Growers' Market and another is at the head of the Randall Supply Department. Another sister, also a florist, went to be with Mrs. Cobb during her last illness and telegraphed the sad news to her mother and sisters in Chicago. The deceased leaves a husband and three small children, one of whom is also suffering with typhoid.

Mrs. Julia D. Stroud.

Mrs. Julia Darling Stroud, widow of William C. Stroud, who was a member of the Baldwin Locomotive Works firm of Philadelphia at the time of his death eighteen years ago, died at her home at Overbrook, Pa., on the 16th inst. Mrs. Stroud had been ill for three years. She is survived by one son, Edward A. Stroud, and a daughter, Mrs. Westray Ladd. Edward A. Stroud has made a name for himself in commercial horticulture, especially in carnation culture, and owns two establishments, one at Overbrook, Pa., the other at Stratford, Pa. We extend our sympathy to Mr. Stroud in his bereavement.

FLOWER MARKET REPORTS.

(Continued from page 910)

PHILADELPHIA Stock dropped off a little both in quantity and quality

last week, but demand was fairly good as there were a great many weddings, commencements and other social functions. American Beauty roses are still plentiful but not quite so gilt edge in quality as they were. Eastern grown Killarneys have the call over local stock for the present on account of the difference in season; but this will probably not last very long. Bride roses suffer badly from the weather and are coming in very poor. Bridesmaids hold their own better, and Killarneys are fine. The few growers who took good care of their plants as to watering and keeping down red spider at the waning of the season, are reaping their reward now. Many just let their stock go as it pleased, and the results in poor quality and little for it are very apparent. Lily of the valley was in normal supply but the demand was unusually brisk so it looked at times as if there might be a scarcity, but this was not really so. Only southern gardenias now—no local coming in. Catechins are in satisfactory supply and meet with ready market at good prices. Sweet peas were in short supply and poor last week on account of rain. They show up better at this writing. Mostly outdoor stock arriving. Japanese irises have made their advent. Gladioli—varieties like Shakespeare, May, America, are in evidence—also fine gallardia and snapdragon.

ROCHESTER FLOWER AND PLANT TRADE.

Although the spring rush is over here, florists are still busy selling and they are unanimous that the spring, 1909, has been one of the best. The public seems to act on the motto, "Do it for Rochester," and along the residential streets beautiful beds and window boxes abound. The result of this extra beautification and expenditure is that several firms contemplate extensions or re-building. It is to be hoped that Rochester will continue to suffer with "geraniumitis." Local florists all report an unusual demand, not only for bedding plants, but for chrysanthemums and Nephrolepis Scottian, the latter being all cleaned out.

BUSINESS CHANGES.

Racine, Wis.—R. J. Mohr has sold out his florist business on Wisconsin street.

Andover, O.—Grant Chase has purchased the greenhouse business of Mrs. R. A. Pardee.

Evanston, Ill.—Frank Kadlec, nurseryman of Chicago, has taken up his residence here.

Rochester, N. Y.—The Webb Floral Co. is the new title of the former A. J. Webb Co., florists at 133 Saratoga avenue.

Monticello, Ind.—The Reynolds property on South Illinois street has been sold to F. Switzer, who will carry on the florist business.

LIST OF ADVERTISERS

<p>Page Advance, The Co., 909 Allen J. K., 909 American Nursery (Eng.), 893 American Nursery Co., 893 Aschinano Godfrey, 893 Bader Coal Co., 919 Samsky Thos., 915 Barrows H. H. & Son, 901 Bayersdorfer H. & Co., 905 Bennett Bros. Co., 915 Boddington A. T., 903 Boston Florist Letter Co., 905 Boston Plate and Dow Glass Co., 913 Bowe, M. A., 903 Bowker Fertilizer Co., 904 Bowker Insecticides Co., 916 Breck Joseph & Sons, 903 Brimmey's J. Sons, 904 Buckingham S., 903 Warehouse, 903 Budlong J. A., 906 Bunyard H. A., 906 Burpee W. A. & Co., 903 Carrillo & Baldwin, 901 Castle Co. W. W., 917 Chicago Carnation Co., 906 Clark's David Sons, 904 Coan J. J., 908 Cooper Wm. & Nephews, 907 Cottons Geo. & Co., 917 Cottage Gardens Co., 890 Cowee W. J., 909 Craig, Robt. Co., 901 Crawford Geo. W., 908 Crawford H. F., 905 Crump Frank F., 890 Danker F. A., 904 Dau J. H. & Son, 890 Dailley F. B., 905 Diuge & Conard Co., 890 Dorner F. Sons & Co., 890 Dow Geo. E., 903 Dreer H. A., 919 Dunlop John H., 904 Durand & Marohoe, 908 Dysart R. J., 909 Eastern Chemical Co., 917 Edwards Folding Box Co., 906 Elliot Wm & Sons, 903 Eilwanger & Barry, 901 Elmsford Nurseries, 890 Esler J. G., 901 Ernest W. H., 903 Eyes, 903 Farquhar R. & J. Co., 903 Flske H. E. Seed Co., 903 Foley Mfg. Co., 910 Ford Bros., 908 Fronment H. E., 908 Galvin Thos. F., 905 Gerard J., 903 Greater N. Y. Florists Association, 908 Grey T. J. Co., 903 Growers' Cut Flower Co., 903 Guth Bros. Co., 904 Gutman Alex. J., 908 Hall Assn., 919 Hastmann Hjalmar & Co., 913 Hauswirth the Florist, 904 Heacock Jos. Co., 900 Herbert David & Son, 905 Hews A. H. & Co., 918 Hilfinger Bros., 918 Hill, The E. G. Co., 890 Hitchings & Co., 909 Hoffman, 905 Horan E. C. & Co., 890 Hunt A. E. & Co., 890 Hunt Bros., 909 Jaeger, Chas. J. Co., 917 Valentine, W. F. Co., 909 Kessler P. F., 908 Kim Oms Co., 919 Knight & Strick, 900 Knick W. C., 909 Kreschell Bros., 901 Kuebler Wm. H., 908 Lager & Hurrell, 901</p>	<p>Page Langjahr, Alfred H., 908 Leonard Seed Co., 908 Leuthy A. & Co., 892 Lori & Burnham Co., 900 Low Stuart H., 897 MacMullen E. A., 905 Mellus & Ware, 901 Manda Jos. A., 901 Mahataha Flower Mkt., 909 McCarthy N. F. & Co., 909 McConnell Alex., 904 McKellar Charles W., 906 McKissick, W. E. & Bros., 906 McManus Jas., 908 Metropolitan Material Co., 918 Meyer J. C. & Co., 909 Michell H. F. Co., 902 Michigan Cut Flower Exchange, 909 Milling Bros., 908 Millang Charles, 908 Millang Frank, 908 Montinger J. C. Co., 908 Moore, Heitz & Nash, 908 Mt Hope Nurseries, 901 Murray Samuel, 904 New Eng. Nurseries, 892 Newman J. & Sons, 904 N. Y. Florists Club, 900 Niagara Sprayer Co., 906 Niessen Leo. Co., 906 Oechlin Frank, 901 Ordozker Bros., 892 Ouwertkerk P., 908 Paltheorpe P. R. Co., 917 Palmer W. J. & Son, 904 Park Florist Co., 904 Parselsky Bros., 918 Peacock Dahlia Farms, 891 Peacock-Meehan Co., 907 Perkins St. Nurseries, 892 Pilsa Insecticide Co., 917 Pierce, F. O. Co., 919 Pierson, A. N., Inc., 919 Pierson F. R. Co., 891 Pierson U Bar Co., 902 Pochlmann Bros. Co., 906 Quaker City Mach. Co., 919 Rayner, I. M., 901 Reyer, John, 908 Reed & Keller, 909 Reubner Peter, 906 Reuter S. J. & Son, Inc., 890 Revers Rubber Co., 918 Rice Bros., 908 Rickards Bros., 901 Robison H. M. & Co., 906 Rock W. L. Co., 904 Roehrs Julius Co., 901 Roland, Thomas, 890 Rolkner August & Sons, 818 Rose Hill Nurseries, 901 Sander & Son, 901 Schlegel & Fottler Co., 903 Schmidt J. C., 904 Schulz Jacob, 901 Scott Bros., 893 Scott, John, 901 Sharp Partridge & Co., 908 Sheridan W. F., 908 Siggers & Siggers, 919 Sim, Wm., 901 Smith Elmer D. & Co., 891 Smith W. G. & Co., 894 Smith W. & T. Co., 904 Smits, Jacs, Ltd., 901 Smyth Wm. J., 904 Skoll F., 909 Standard Plate Glass Co., 918 Stearns A. T. Lumber Co., 919 Stump & Walter Co., 917 Syracuse Pottery Co., 918 Tailly, 904 Thorburn J. M. & Co., 903 Totty Chas. H., 890 Valentine, I. A., 904 Vincent R. Jr. & Sons, 897 Wants, For Sale, etc., 913 Ward R. M. & Co., 903 Waterer John & Sons, 892 Welch Bros., 906 Withold Geo. Co., 901</p>	<p>Page Wilson, 904 Winterson, E. F. Co., 906 Wood Bros., 890 Yokohama Nursery Co., 901 Young A. L., 909 Young John, 908 Young & Nugent, 904 Zaegen O. V., 901 Zino Julius A., 903 Zvolnaek A. C., 903</p>	<p>GREENHOUSES BUILDING OR CON-TEMPLATED. Lee, Mass.—James A. Rice, one house. Monticello, Ind.—Floyd Switzer, one house. Springfield, Mass.—J. A. Rice, one house. Springfield, O.—G. Schneider, two houses. Evansville, Ind.—O. S. Smith, two houses. E. Rochester, N. H.—E. A. Corson, one house. Gloversville, N. Y.—R. E. Loeben, one house. Mansfield, Mass.—W. Holmes, two houses, 25x200. Holly, Mich.—H. J. Green, improving and enlarging. Niles, Calif.—California Nursery Co., house, 15x100. Ashtabula, O.—Roger Griswold, twelve houses, each 300 ft. Gibsonia, Pa.—Pittsburg Rose & Carnation Co., house, 50x400. E. W. Fengar is adding five new houses of King construction, to his existing range of carnation houses at Irvington, N. J., and contemplates a still further extension in the fall. The heating will be done by Hitchings & Co. Two of the largest size Castle Automatic Circulators have been contracted for, Mr. Fengar asserts, after a thorough investigation of all the circulators, pumps and other devices for forced circulation of hot water that are on the market, none of which in his observations can compare in practical utility with the "Automatic."</p> <p>PATENTS GRANTED. 923,921. Tile Greenhouse Bench. Byron P. Wise, Cleveland, O. 924,318. Cutter for Lawn Mowers. Adelbert B. Case, Springfield, Mass. 924,392. Weed Cutter. Joseph J. Smith, Woodburn, Ore. 924,498. Weed Destroyer and Gatherer. Benjamin Pomije, New Prague, Minn.</p> <p>TO LET TO LET—Three greenhouses, one 18x85, two 16x75 each; six and one-half miles from Boston market; all modern conveniences. Also lot of land for outside use. Terms reasonable to right party. Apply to Samuel Brown, 220 Beale St., Wollaston, Mass., N. Y., N. H. & H. R. R.</p> <p>MISCELLANEOUS WANTS WANTED TO BUY—Complete green house plants and all kinds of greenhouse material, to be taken down and removed at once. Terms cash. Address L. Sussner- man, 220 Livingston St., Newark, N. J. WANTED—Second-hand bags and bur-lap, any kind, any quantity, anywhere. Richmond Bag Co., Richmond, Va.</p>
--	--	--	--

HELP WANTED

GOOD MEN

When you need good men, skilled or unskilled, Write:

THOS. H. BAMBRICK

34 South 7th Street Philadelphia

Help of all kinds, including that for Florists, Nurserymen, Seedsmen and the Horticultural trade generally.

WANTED—Assistant florist; must be careful at watering, tying and potting. Wages, to start, \$12.00 per week. Address, with copy of references, experience, etc., Plant Grower, care HORTICULTURE.

SITUATIONS WANTED

SITUATION WANTED—By intelligent young German, 27, sturdy, of good character and ability, to learn American nursery trade. Good propagator, grafter. Five years' experience in German nurseries. Speaks and writes English fluently. State wants and particulars in first letter. R. S., care HORTICULTURE.

FOR SALE

FOR SALE

About 20,000 feet of glass in good condition, will sell at a low figure, or will lease to the right party, with privilege of buying. My object for selling is, I do not know anything about the business and can't hire men that do.

H. F. CRAWFORD
Montello Sta. Brockton, Mass.

SECOND HAND BOILER

For sale, suitable for heating purposes. Robinson make. 42 x 15 ft. 64 tubes. 8 in. All trimmings and settings in good condition.

BENNETT BROS. CO., Lowell, Mass.

For Sale Greenhouse Property

Located at Somerset and Howard streets, North Plainfield, Somerset County, New Jersey. Dimensions 248 x 106 ft. Contains three green houses 20 x 175 ft., steel frame. Trolley lines pass property. Will sell cheap and on easy terms. For particulars apply to

F. B. DAILEY, care F. EERG & CO., - Orange, N. J.

FOR SALE—Five greenhouses, bone, five rooms, improvements; barn, carriage house, sheds; all in good repair. One minute to depot, on main street; 20 minutes to Boston; five minutes to two lines of electric. Only florist in large town. Established twenty years. For further particulars address E. G. Blaney, Swampscott, Mass.

FOR SALE—Special 16 x 18 and 16 x 24 double thick glass in "A" and "B" qualities. Buy now and save money. Write PAISHEYSKY, BROTHERS, INC., 59 Montrose Ave., Brooklyn, N. Y.

FOR SALE, CHEAP—A good, second-hand Horizontal Tubular Steam Boiler, 85 H. P. Auburn Last Co., So. Framingham, Mass.

FOR SALE—Three thousand lights, 16x 21, double thick glass, 20 lights per box, 100 per light. F. O. B. Littleton. Frank M. Richardson, Littleton, N. H.

A PEONY DAY.

Reposing in simple rural dignity on the crest of a richly wooded eminence in one of the loveliest sections of eastern Massachusetts, overlooking the valley of the winding Charles river and a verdant clad landscape of rare beauty, far removed from the disturbance of train or trolley car, is the home of one of the best known and best informed peony specialists of our day, E. J. Shaylor. Skirting the grounds adjoining the broad piazzas just now are great masses of rich color and the air is redolent with the incomparable aroma from the peony fields where this peony enthusiast spends most of his waking hours and if he should ever be accused of sleeping with his beloved plants I question whether he would not plead guilty.

To this enchanted spot, a few days ago, came a delegation from the Gardeners' and Florists' Club of Boston and spent an afternoon of rare enjoyment in inspecting the flowers, inhaling the country air, admiring the view and enjoying the unconventional hospitality of a host and hostess who are excellent exponents of the art of making visitors feel at home and it may be recorded as having been one of the best field days the club has ever had.

There are larger peony fields than Mr. Shaylor's but it is a question whether there are any where can be seen more new varieties or a better selection of the really distinct and high-class varieties. There are many seedlings but only one has been named thus far, *Georgianna Shaylor*, and none of the others will be given a name unless they demonstrate some special distinction or quality as compared with existing varieties. *Georgianna Shaylor* has developed quite noticeably since it was certificated last year by the Massachusetts Horticultural Society. It is a broad petalled soft pink, than which there is nothing in the whole list more promising.

Some time ago when Mr. Shaylor had a controversy as to the identity of the much-lauded *Lady Alexander Duff*, Messrs. Kelway sent him, under the label of "*Lady Alexander Duff, True*," a plant which has now flowered and proves to be both lovely and distinct, unquestionably different from any variety Mr. Shaylor has ever seen. It bears some resemblance to *Germaine Bigot* but the stigma is pink in *Duff* whereas in *Bigot* it is crimson.

Improvement in the peony follows the line of the broad petalled type. *Mme. Savrean* by *Brochet* is a remarkably handsome flower. This variety has not yet been put on the market in America. It is creamy white with petals of great substance, foliage and stem remarkably sturdy. *Le Cygne* is one of *Lemoine's* new ones, a pale yellow and *Prime Vere* is another from the same raiser. Both are very promising, but as they were only received last fall their full character has not yet been developed as it takes at least three years after division before a fair estimate of a variety can be made. Of *Dessert's* novelties very few have even bloomed this year. One of them, *Madeline Gauthier*, has flowered and is a creamy, single pink with bright yellow at the tips.

Mr. Shaylor has proved *Pottii Alba* sold by some nurserymen to be quite other than *Engelm. Verdun*. It

is a noble variety with broad softly flushed petals. *Kelway's Summer Day* is very close to *Festiva Maxima* in every respect.

Mr. Shaylor pronounces the lists of the most useful varieties as given by Geo. C. Thurlow in last week's issue of *HORTICULTURE* to be about as good as anyone could name. Among the most impressive varieties in his own collections are *Mons. Dupont*, a very symmetrical creamy white with petals occasionally red tipped; *Mme. Lantie Lemoine*, an exquisite flower, pink in centre, with strong upright habit; *Theresa*, a beautiful soft pink flower with broad cupped petals; *Marie Crousse*, similar in color; *Asa Gray*, pink uniquely veined and pencilled with darker pink; *James Kelway*, an enormous white with very leathery foliage; *Avalanche*, very handsome white with crimson-tipped cupped petals; *Rosa Bonheur*, one of *Dessert's*, a late blooming, tall, deep pink; *Aulph Rosseau*, one of the best of the reds, not the darkest but a tall erwer and sure bloomer. Among Mr. Shaylor's seedlings one or two very promising reds are under watch.

PHILADELPHIA NOTES AND COMMENTS.

The Leo Niessen Co. will commence the 6 p. m. early closing for the summer on Monday, June 23th.

Marguerite II, the new yacht being built by Blatz of Kensington, for A. B. Cartledge of Pennock Bros., will be launched in the near future.

Miss Marguerite Harris, daughter of William K. Harris, with a party of friends sailed from New York on the 16th inst. for a European tour.

John McIntyre has treated himself to a new office, nicely fitted up and will prove a great comfort in the conduct of his rapidly extending business.

Frank Bennett, of Bordentown, N. J., will take a trip to Europe in the near future, and among other points of interest will visit his old home in England.

William Warner Harper cordially invites visitors to Andorra Nurseries, City Line and Wissahickon Drive, Chestnut Hill, to view their magnificent collection of Japanese Irises, which are now at their best.

George Anderson had to go to Jenkintown last week to answer a charge of auto speeding. The defendant knew very well they had the wrong man on their list as his wagon had not been cut of the garage on the date specified. Still, it was some satisfaction to go up and get a smile at the expense of the Montgomery County authorities.

Louis and Charles Berger, scions of the well-known family of florists of that name in Germantown, have started in the insecticide business under the title of the Philadelphia Insecticide Co., at 6117 Germantown avenue. Their new insect powder is highly spoken of by those who have tried it. They are also offering nicotine of their own manufacture at very reasonable prices.

Robert Kift has purchased the property at 1821 Chestnut street, one block

"Every Bug Has his Dose."

Insect-destroying preparations that do their work well and effectively are the cheapest. Bowker's Arsenate of Lead and Bowker's Pyrox are recognized standard insecticides and fungicides for both indoor and outdoor use. Bowker's Insect Emulsion destroys many kind of plant lice, black and green flies, etc. Call or send for catalogue.

BOWKER INSECTICIDE COMPANY
43 CHATHAM ST. BOSTON

west of his present location. The price stated is fifty-five thousand dollars. The building is profitably rented at present, but is intended in the near future for the new Kilt flower store and office building. This should prove a profitable investment as real estate values are rapidly advancing in the neighborhood.

William Falck, of the Pennock Bros.' establishment, will be given a farewell dinner at Boothby's on Saturday evening, 26th inst., by his store associates. Mr. Falck will shortly sail for the other side and will locate with his brother, who is in business in Copenhagen, Denmark. Good wishes from the many friends he has made in Philadelphia during the past fifteen years go with him.

Commencing last Monday, June 21st, the McKissick flower market closes for the summer at 6 p. m., daily. To accommodate out-of-town customers, they have arranged to keep the store open for two hours each Sunday morning from 9 to 11. It is seldom we see such Kaiserin roses as those they had on sale there last Saturday. *Centaura Imperialis*, the first of the season, and a fine assortment of gladioli were also conspicuous features.

"Make your garden glad," is the happy slogan and trade-mark of the E. Winterson Co., Chicago. Why didn't I think of that! They are branching out and are now seedsmen, plantsmen, and nurserymen—besides being large commission handlers of cut flowers and florists' supplies. Their catalogue is original and it will pay

Pullman's Insect and Worm Destroyer

Kills Worms and Ants in ground. Kills Cut Worm. Kills All Kinds Insects. Acts as a Fertilizer to ground

This powder is put up in packages from 1lb. to 100lbs. Full directions and testimonials in each package.

PRICE: 1 lb., 20c.; 5 lbs., 35c.; 10 lbs., 65c.; 25 lbs., \$1.50; 50 lbs., \$2.25; 100 lbs., \$5.00.

SALESMEN WANTED EVERYWHERE

Made by

PHILADELPHIA INSECTICIDE CO.

6117 MAIN STREET, CERMANTOWN, PHILADELPHIA

Nicotine

Kills Thrip, Red Spider, Black Fly, Aphis, Green Fly and other Greenhouse Pests

This solution is put up in

1-8 pt. at 25c.	1 pt. at \$1.40
1-4 pt. at 50c.	1 qt. at 2.75
1-2 pt. at 90c.	1-2 gal. at 5.00
5 gals. at \$40.00	

For Trees, Plants, Shrubs and Flowers

THE NIAGARA BRAND LIME SULPHUR SOLUTION

It destroys Scale Lice, Spiders and all forms of Aphides, AT THE SAME TIME Mildew, Blight, Rust and other Fungus difficulties. Used in Winter or Summer. — No other remedy has been so universally effective. Niagara Brand ARSENATE OF LEAD for chewing insects is equal to the best and better than the most. Ask about our Green House sprayer. Address —

NIAGARA SPRAYER CO., - - Middleport, N. Y.

IMP SOAP SPRAY

THREE SUCCESSFUL YEARS

Outdoor or Indoor

ELM BEETLE OR WHITE FLY

EASTERN CHEMICAL CO.
Pittsburg Street, Boston, Mass.

KILMDEAD
The best of all the tobacco dusts for Dusting or fumigating

Stump & Walker Co. 50 Barclay St., New York.

25 lbs., \$1.00 100 lbs., \$ 3.00 1000 lbs., \$27.00
60 lbs., 1.75 500 lbs., 14.00 2000 lbs., 52.50

COOPERS SPRAY FLUIDS

LATEST DISCOVERY

Progressive Growers Investigate
32 page Booklet of British, American and Canadian Testimony free for the asking

Eastern Agent - CYRIL FRANKLYN
62 Beaver St., New York, N. Y.

Sole Proprietors
WILLM COOPER & NEPHEWS
177 Illinois Street CHICAGO



The Best Bug Killer and Bloom Saver

For PROOF Write to

P. R. Paethorpe Co.
OWENSBORO, KY.

anyone to get a copy. Write for it. Philadelphia is a long way from Chicago, but it seems short when we have HORTICULTURE to carry messages between us. Besides, Ed. Winterston is well known to us in the Quaker City and we all think a lot of him.

John H. Dodds, superintendent of the Wenamaker estate at Jenkintown, will sail on the S. S. Baltic, July 17th, for a visit to the famous county seats and public gardens in England, France and Germany, not excepting a glimpse at his native town of Hawick, Scotland, where many memories of wonderful things—wooden-legged hens, jail doors two miles wide, Scots' Greys, strong blacksmiths and so forth, remain to be revived or dispelled. If he should happen into Jedburgh (the late William Elliott's burg) we advise him to keep his hand in his pouch. They'll get it there, unless his purse has a severe attack of lock-jaw.

William F. Kasting of Buffalo, and F. H. Cordes of Tonawanda, N. Y., attended the convention of the Credit Men's Association in Philadelphia,

June 15 to 18. Among other places of interest visited was Girard College, the pilots in that case being David Rust and G. C. Watson. Mr. Lonsdale had many interesting things to show horticulturally—not the least being the splendid hedging in which his new crotons, Robert Craig and Edwin Lonsdale, form conspicuous features.

A trellis line of the various species of rambler roses proved an engrossing attraction. Particularly noticeable was the desirability of the Farquhar for its fine color and vigorous free blooming habit. It is also considerably earlier than its great rival, Dorothy Perkins. Juanita, although a fine thing, is completely eclipsed as to distinctiveness in color when viewed from a short distance and compared with its companion, Newport Fairy. The more we see of Hiawatha the more lovely and desirable it appears. A discussion on the hardness of the gladioli formed an interesting interlude in the personally conducted tour.

Mr. Kasting and friends were hospitably entertained by E. J. Pancourt of Pennock-Meehan Co. on the 16th inst.

Which Spray Pump

shall you buy? Buy the Spray Pump that fully meets the demands of the Government Agricultural Scientists and all practical Fruit Growers. These pumps are widely known as

DEMING SPRAYERS
and are made in 22 styles for use in small gardens or immense orchards.

Write for our 1909 catalog with spraying chart. Add 4 cents postage and receive "Spraying for Profit," a useful guide book.

CHARLES J. JAGER CO.
281-285 Franklin St., Boston

In ordering goods please add "I saw it in HORTICULTURE."

FOR SALE

GLASS New American natural glass made, 10x12 C. double, \$1.75 per box; 8x10, 10x12 to 10x15 B. double, \$1.65 per box; 12x14 to 12x20, 14x16 to 14x20, B. double, \$1.92 per box; 16x16 and 16x18, B. double, at \$2.00 per box; and 16x20, 16x22, 12x24, B. double, \$2.08 per box; 16x24, B. double, \$2.18 per box. Discount in large quantities.

PIPE Good serviceable second-hand with each length, no junk—1 in., 3/4 in., 1 1/2 in., 2 in., 2 1/2 in., 3 in., 3 1/2 in., at 14c. and 4 in. at 19c. New 2 in. standard black, 8 1/2c. Old 4 in. greenhouse pipe, 14c. per foot; 4 in. boiler tubes, 7c. per foot.

We quote you above only a few of our prices. We manufacture and job in everything pertaining to greenhouses, both new and second-hand. Get our prices before placing your orders.

METROPOLITAN MATERIAL CO.
Greenhouse Wreckers

1392-1402 Metropolitan Ave., Brooklyn, N. Y.

GLASS
Greenhouse and Hot Bed

SIZES OUR SPECIALTY
IMMENSE STOCK

Plate and Window Glass

Write for Our Prices

PARSHELSKY BROS., Inc.
59 Montrose Ave., BROOKLYN, N. Y.

In ordering goods please add "I saw it in HORTICULTURE."

STANDARD FLOWER POTS

Packed in small crates, easy to handle.

Price per crate	Price per crate
1500 9 in. pots in crate \$4.88	144 6 in. pots in crate \$3.16
1500 2 1/2 " " " 5.25	120 7 " " " 4.20
1500 2 1/2 " " " 6.00	60 8 " " " 3.00
HAND MADE	
1000 3 " " " 5.00	48 9 in. pots in crate \$3.60
800 3 1/2 " " " 5.80	48 10 " " " 4.80
500 4 " " " 4.50	24 11 " " " 3.60
435 4 1/2 " " " 5.54	24 12 " " " 4.80
320 5 " " " 4.51	12 14 " " " 4.80
210 5 1/2 " " " 3.78	6 16 " " " 4.50

Seed pans, same price as pots. Send for price list of Cylinders for Cut flowers, Hanging Baskets, Lawn Vases, etc. Ten per cent. off for cash with order. Address Hilfinger Bros., Pottery, Fort Edward, N.Y. August Folker & Sons, Agts. 31 Barclay St., N. Y. City.

Syracuse Red Pots

ALL THE STANDARD SIZES

It will soon be time to order large pots for fall potting. We have a full line of the best.

Syracuse Pottery Co., SYRACUSE, N. Y.

Standard Flower . . . POTTS

If your greenhouses are within 500 miles of the Capital, write us, we can save you money.

W. H. ERNEST

29th and M Street WASHINGTON D. C.

FOR "POT LUCK" TRY US... HEWS STANDARD POTTS

POT MAKERS FOR 140 YEARS

WORLD'S LARGEST MANUFACTURERS

WRITE FOR CATALOGUE AND DISCOUNTS

Pearson Street,
LONG ISLAND CITY, N. Y.

A. H. HEWS & CO., Inc.
CAMBRIDGE, MASS.

452-460 No. Branch St.,
CHICAGO, ILL.

REVERO

THE MODERN GARDEN HOSE
FOR LAWNS, GARDENS, GREENHOUSES, STABLES, ETC.

BRAIDED FABRIC, MOULDED CONSTRUCTION, SEAMLESS THROUGHOUT

LIGHT—STRONG—FLEXIBLE

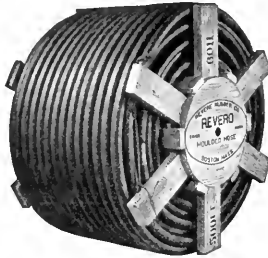

OLD STYLE—READILY KINKS



REVERO—NON KINKING

Revero is Furnished on Reels in Continuous Lengths up to 500 ft. Your Supply House can furnish "Revero."

Write for Catalog

REVERE RUBBER COMPANY
BOSTON, MASS.

NEW YORK
NEW ORLEANS

PHILADELPHIA
MINNEAPOLIS

PITTSBURG
SAN FRANCISCO

CHICAGO
PORTLAND, ORE.

STANDARD PLATE GLASS CO.

Manufacturers—Importers—Jobbers

NOW IS THE TIME TO BUY

FRENCH OR AMERICAN GREENHOUSE GLASS

LOWEST PRICES ON REQUEST

26-30 Sudbury St.

BOSTON, MASS.

61-63 Portland St.

GLASS Always Write Us Before Buying SHARP, PARTRIDGE & CO. 22nd and Lumber Streets, CHICAGO WE HAVE SOME SNAPS

BOSTON PLATE & WINDOW GLASS CO. GREENHOUSE GLASS GERMAN AND AMERICAN

261 to 287 A Street

BOSTON

20 to 22 Canal Street

COAL Pocahontas Smokeless Coal Blossburg Smokeless Coal

The above steam coals are peculiarly adapted to FLORISTS' use. Prominent features are HIGH EVAPORATION, LOW ASH, LOW SULPHUR, HIGH CARBON, and HIGH HEAT UNITS. Permit us to figure on your year's requirements, deliverable as called for.

CARCOES CONSTANTLY ARRIVING AT ALL NEW ENGLAND PORTS

The Bader Coal Company, F. B. LAYTON Gen'l Sales Agent

Telephone Fort Hill 2044

Board of Trade Building, Boston, Mass.

KROESCHELL BOILER

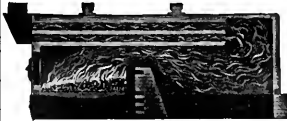

MADE OF FIRE BOX FLANGE PLATE
Can not Crack

Water Space In Front, Sides and Back
The Most Popular Boiler Made

SEND FOR CATALOGUE.

KROESCHELL BROS. CO.
35 Erie Street, CHICAGO, ILL.

CYPRESS SASH BARS
82 feet or longer
HOT BED SASH
PECKY CYPRESS BENCH LUMBER

GREENHOUSES
ERECTED AND EQUIPPED COMPLETE IF DESIRED

Write for Circular "D" and Prices

The A. T. STEARNS LUMBER CO.
NEPONSET, BOSTON, MASS.



Evans 20th Century Arm

Will not twist the shafting pipe. Three times the power of old style elbow arms. Sold only with Evans Challenge Machine

Write for free Catalogue to
QUAKER CITY MACHINE CO.
Richmond, Ind.

Holds Glass Firmly
See the Point

FULL SIZE
No. 2

PEERLESS

Glaszing Points are the best. No flights or jets. Box of 1,000 points 75 cts. postpaid.

HENRY A. DRAPER,
314 Chestnut St., PHILA., PA.

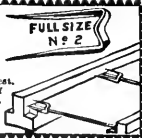

We can supply in any Size or Length and in Car Loads or any Quantity

PECKY CYPRESS

The Ideal Lumber for Greenhouse Benches

MOST LASTING—LEAST EXPENSIVE

When ordering your other building material it is wise to add enough Pecky Cypress to make the shipment a carlot and so take advantage of lower carload freight rates.

— WRITE TO US FOR PRICES —

THE FOLEY MFG. CO., 26th & WESTERN AVES. **Chicago**

ADVANCE VENTILATING APPARATUS



Why do we keep spreading and growing? We use the very best material in our line. It is built right, gives the best of service, lasts, one price to all, together with ease of erection and operation, no repairs, and a square deal. Will send machine with arms and hangers on trial to any responsible florist where we have no machine at work. Will place it against any machine on the market and let you decide. Free circular.

The Advance Co.
RICHMOND, IND.

Everything for Greenhouse Building

Write for Information and prices

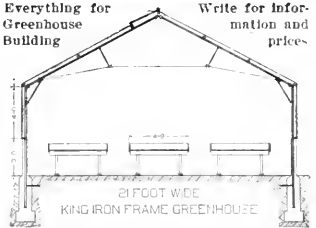

10 Widths from 14 feet 0 inches to 54 feet 0 inches. Without posts.

KING TRUSS SASH BAR HOUSES.
IRON GUTTERS AND EAVES.
IRON AND CYPRESS BENCHES.
VENTILATING MACHINERY.

KING CONSTRUCTION CO.
NORTH TONAWANDA, N. Y.

PATENTS

Trademarks and Copyrights

Send your business direct to Washington. Saves time and insures better service. Personal attention guaranteed. Twenty-five years' active service. SPECIALTY: "Working on the Failure of Others."

SIGGERS & SIGGERS

PATENT LAWYERS

Box 9, National Union Building
Washington, D. C.

GREENHOUSE CONSTRUCTION LUMBER

John C. Moninger Co.

117 E. Blackhawk St., CHICAGO.

MASTICA

FOR ²/₂ Greenhouse Glazing

USE IT NOW.

F. O. PIERCE CO.
12 W. BROADWAY
NEW YORK

Mastica is elastic and tenacious, admits of expansion and contraction. Putty becomes hard and brittle. Broken glass more easily removed without breaking of other glass as occurs with hard putty. Lasts longer than putty. Easy to apply.

The FLORISTS' HALL ASSOCIATION OF AMERICA, insurer of 29,000,000 sq. ft. of glass. For particulars address:

John C. Esler, Sec'y, Saddle River, N. J.

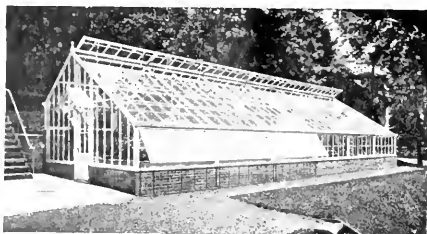

Satisfactory Dealing

It is one thing to get estimates and to place your order. It's another thing to know that after you have given the word to go ahead, that the work *will go ahead*. No cluttering up of the premises for an indefinite period, waiting for material that isn't ready — when we start, we finish.

Hitchings & Company

Designing & Sales Offices General Offices & Factory
 1170 Broadway, N. Y. Elizabeth, N. J.



A Curvilinear Palm House and Wings make a Good Combination — that is, if it is Built with Our Sectional Iron Frame Construction — this is.

LORD AND BURNHAM COMPANY,
 Irvington-on-Hudson, N. Y.
 New York — Boston — Philadelphia — Chicago

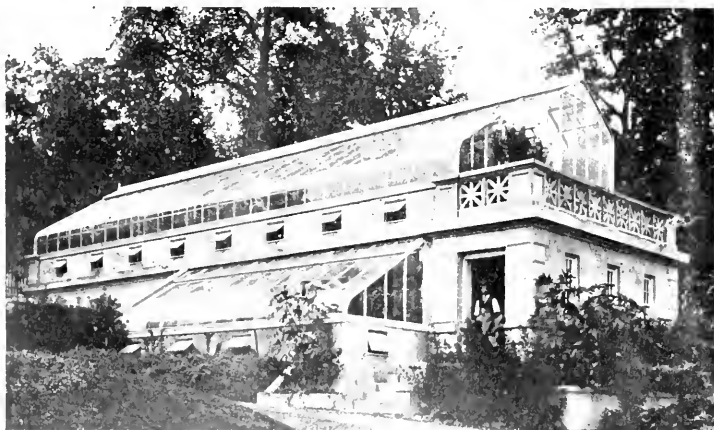

WHAT DO YOU THINK ABOUT THIS?

The architect of the great Metropolitan Tower, designed this house for a steep hillside location at Montclair, N. J. It is results likethis that the U-Bar Construction makes possible. Architects recognize the U-Bar's superiority in both attractiveness and durability. Gardeners, whether they have a U-Bar house or not, admit it is the best growing house. Advance sheets of our new catalog now ready.

U-BAR GREENHOUSES

PIERSON
 DESIGNERS AND BUILDERS



U-BAR CO.
 1 MADISON AVE. NEW YORK



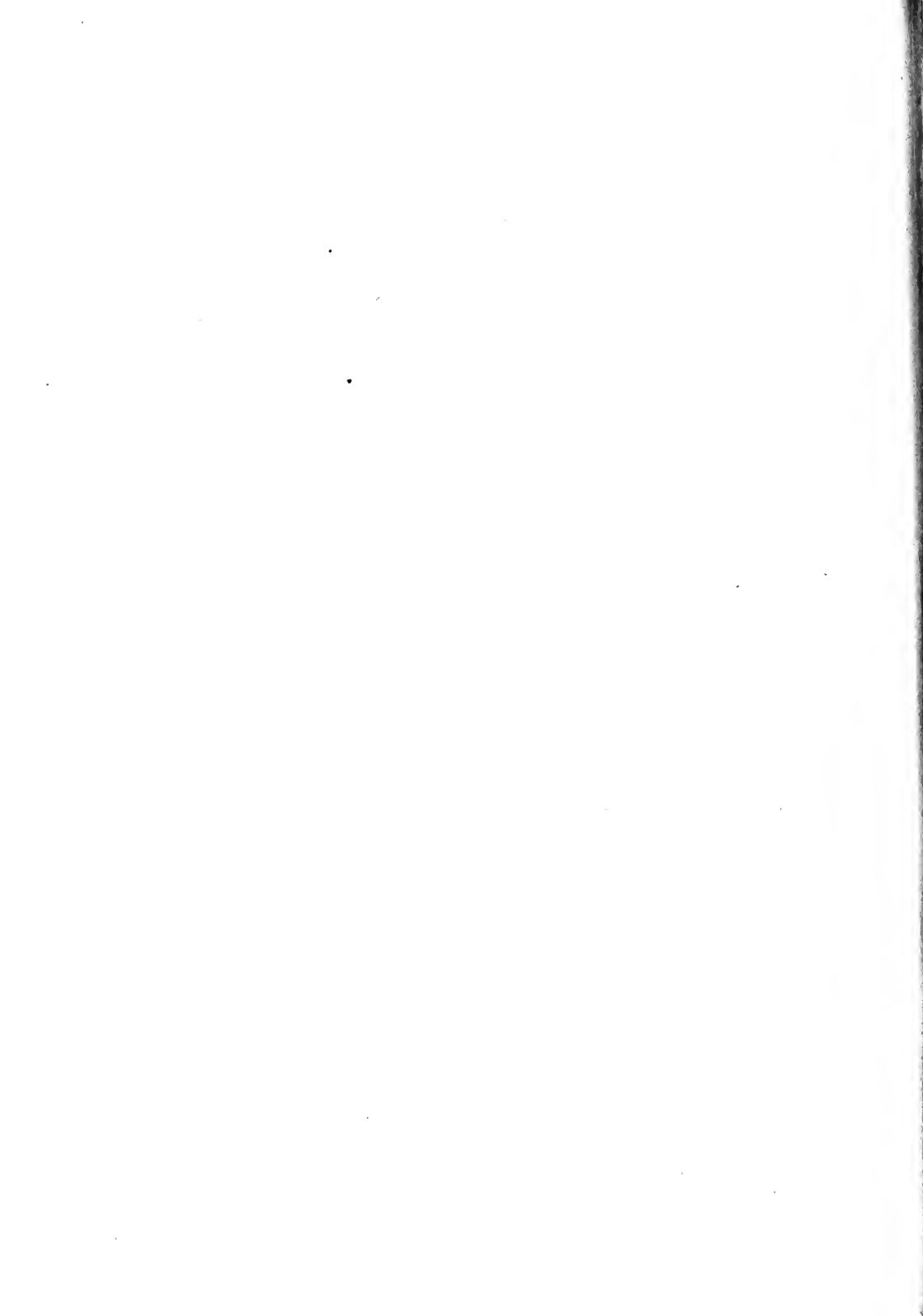

New York Botanical Garden Library



3 5185 00256 8994

