

California Academy of Sciences

RECEIVED BY PURCHASE

Beal

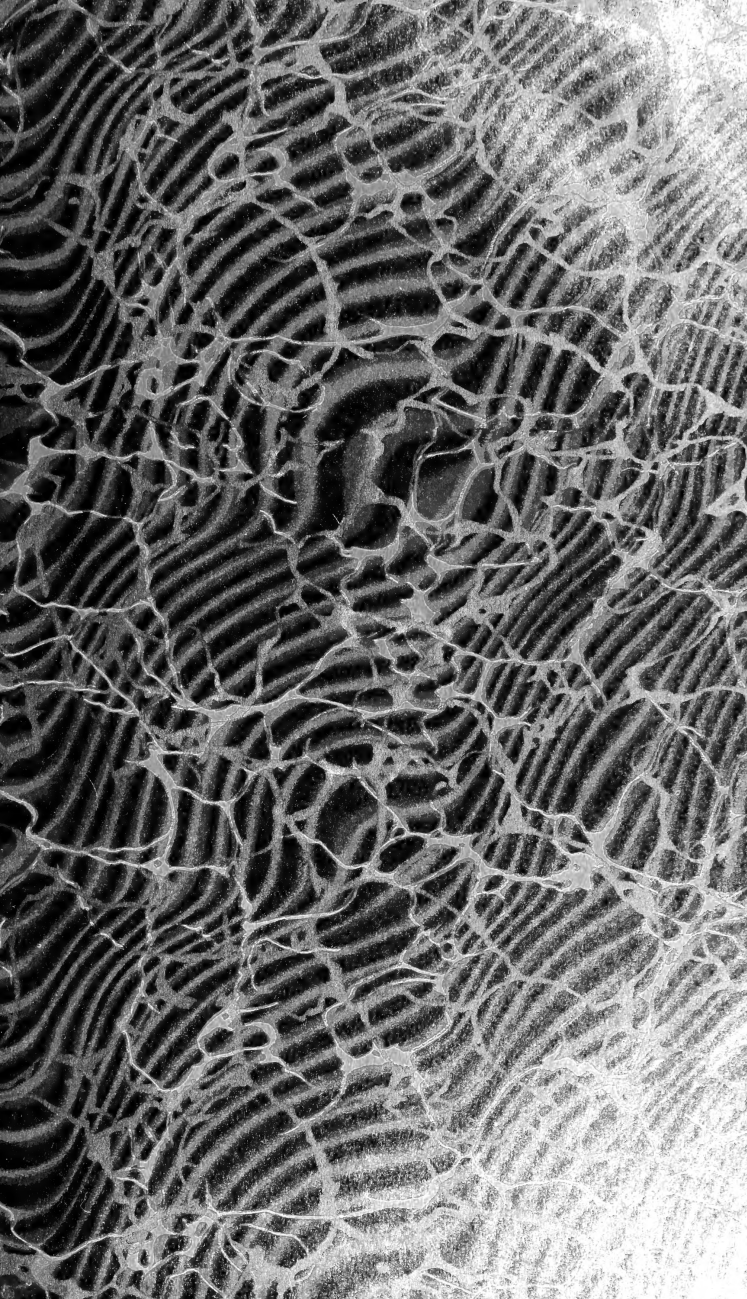

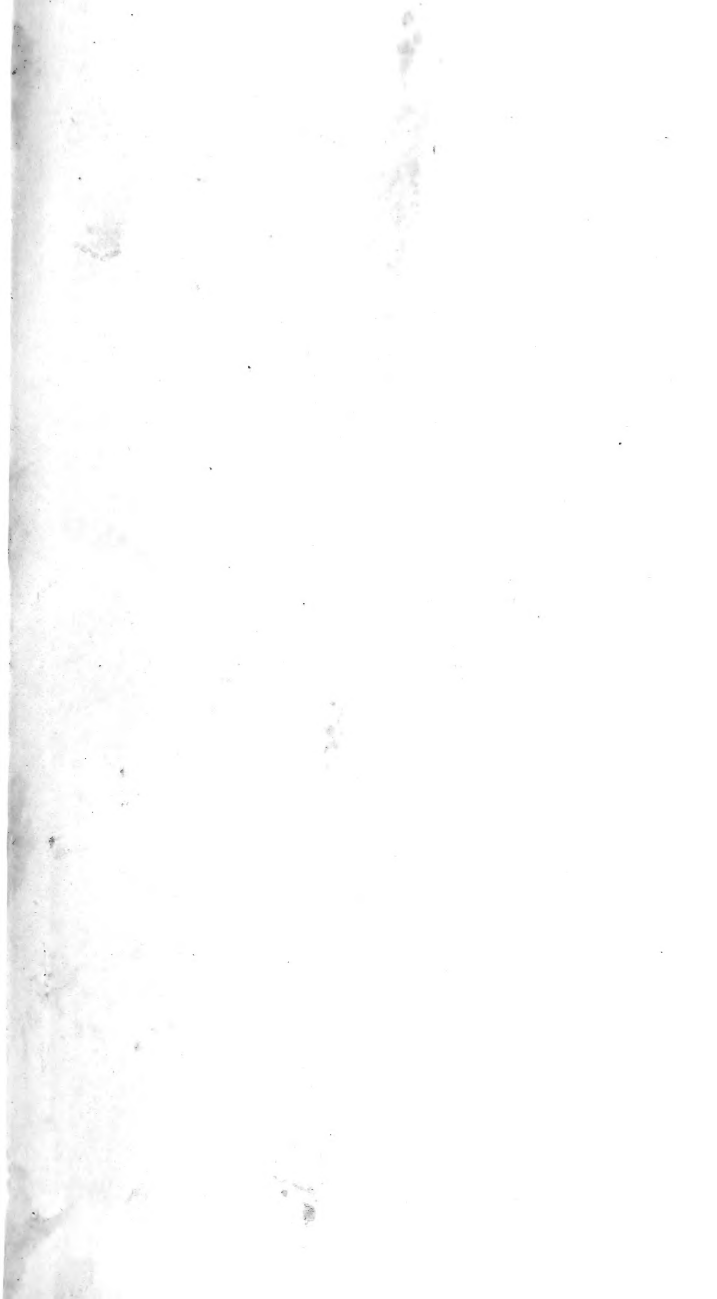



VIEW OF THE UNIVERSITY OF CHICAGO



HORTUS WOBURNENSIS,
A
Descriptive Catalogue
of upwards of Six Thousand Ornamental Plants,
(Cultivated at Woburn Abbey.)

With numerous illustrative plans for the erection of
FORCING HOUSES, GREEN HOUSES &c.



AND
an account of their management throughout the year
By **JAMES FORBES, A.L.S.C.M.H.S. &c.**
Gardener to his Grace the Duke of Bedford, K. G.

LONDON,

JAMES RIDGWAY, PICCADILLY.

1833.

1087.

TO
HIS GRACE THE DUKE OF BEDFORD, K.G. F.L.S.
&c. &c. &c.

MY LORD DUKE,

To no individual could the following pages be inscribed with so perfect a propriety, as to one who takes so great a pleasure in encouraging the efforts of science in general, and in patronizing in particular those discoveries in Botany and improvements in Horticulture, which have engaged so large a portion of your Grace's personal attention; and this persuasion is much increased, by the consideration, that no one can, at the same time, feel a greater interest in the introduction of new and valuable plants to his collections, than the Duke of Bedford.

I beg, therefore, with all humility and respect, to dedicate the "Hortus Woburnensis" to your Grace; and, at the same time, to return my grateful acknowledgments for the access kindly granted me to the numerous splendid Botanical Works in the Libraries at Woburn Abbey, which have been of infinite assistance to me in identifying many of the Plants enumerated in the following Catalogue.

I have the honour to be,

My Lord Duke,

Your Grace's

Most Obliged, and very Obedient Servant,

JAMES FORBES.

Woburn Abbey Gardens,

July, 1833.

P R E F A C E.

AFTER the numerous and important Works that have already appeared on the Physiology of the Vegetable Kingdom, from so many eminent and scientific writers, whose elaborate descriptions, accurate delineations of the Plants cultivated in our British Gardens, and mass of general information on the various branches of Horticulture, which are so justly appreciated, it might appear presumptuous in one, who has been much more accustomed to the pruning knife than the pen, to attempt a compilation on the same subjects. But every practical observer, however humble, may have it in his power to communicate some new or valuable information, unattained by others; and, hence, my Essay will not want an excuse in the minds of the candid and intelligent.

I am, indeed, fully conscious of my own inability, and the difficulty of communicating the minutæ of the various operations and treatments necessary for bringing to perfection the numerous productions of the Garden, and have, therefore, to claim the indulgence of the Public, whilst attempting to detail, in the succeeding pages, the course of culture which I have practically found the most suitable for the growth of the different subjects enumerated in the following Work.

I was first prompted to the undertaking by the inconvenience that I have frequently experienced in the nomenclature of our Plants, as arranged in the various Catalogues, the Authors of which have generally left their names unaccompanied with any discriminative remarks relative to their most essential *generic* and *specific* characters, which might enable us, in some degree, to ascertain their identity. Much merit is undoubtedly due to the late Mr. Donn, for his excellent arrangement of the Plants in the "*Hortus Cantabrigiensis*," which contains much useful information in a small compass, and has established a basis for the nomenclature that is most practicable for general utility. In "*Sweet's Hortus Britannicus*" we have an extensive collection of Plants, arranged with the colour of flower of each species, and references to the Botanical Works in which they are figured or described, &c., which tend considerably to enhance its value. We have, again, in "*Loudon's Hortus Britannicus*," much valuable information conveyed to us within a limited space; much of which is, by ingenious signs, adapted by that indefatigable Author for indication of the different habits of the Plants. But the above-mentioned Catalogues are all deficient, in not giving the *generic* and *specific* characters, which are essential for discriminating one plant from another.

There are, unquestionably, many other elementary Works that contain numerous illustrations and details on the natural affinities of Plants; but these books are generally confined to the hands of the few, and scarcely within the reach of the operative Gardener; they are, moreover, chiefly confined to particular branches of the science; and no individual work that has yet appeared, to my knowledge, combines within itself, in my estima-

tion, the separate subjects of Horticulture and Botany, which now deservedly engage so much attention. It, therefore, appeared to me, that a work, comprising, in abbreviated terms, the *generic* and *specific* character of the most interesting Plants for cultivation, and, at the same time, combining the most essential subjects of Horticulture, would not be unacceptable to the young Gardener, and Amateur in gardening; as we may safely say, that no science has been more encouraged or improved, or has, consequently, made a more rapid progress to perfection, during the last half century, than those of Botany and Horticulture. In short, the taste for these pursuits is now happily pervading all ranks of society: for whilst we see, on the one hand, the *Peer* and *Peeress* anxiously introducing into their Stoves and Greenhouses the numerous new exotics, watching the progressive development of their beautiful flowers and foliage, and directing the various improvements of the garden, we may observe, on the other, the humble cottager, and the manufacturer, devoting his leisure hours to the cultivation of his flowers and vegetables.

The first part of the Work contains a descriptive Catalogue, in abbreviated terms, of the *generic* and *specific* character of upwards of 6,000 plants, such as are best adapted for the Greenhouse, Plant Stove, or decoration of the Pleasure Ground, or such as appear the most interesting to the Botanist and Amateur in the British Flower Garden; the descriptions of which, although much compressed by being confined within a small compass, will render considerable assistance in the identifying of the numerous *genera* and *species*. These distinguishing peculiarities will, it is hoped, characterise the arrangement of the Plants in this work, from those of any other

Catalogue. The accompanying *Glossary* will elucidate the various abbreviations in the Catalogue part of the Work. The second part comprises the plans of the Parterres, Pleasure Grounds, Greenhouses, Plant Stove, Heathery, and other erections, with a description of the different subjects enumerated, the soil, and the general management best adapted for the growth of the Cape, Botany Bay, and other exotic Plants. The third part is confined to the plans and details relative to the Kitchen Garden department, with lists of the fruits cultivated; and comprises numerous designs for the erection of Forcing-Houses, Culinary Pits, &c. with an account of the materials best adapted for their erection, and mode of heating by Hot-water pipes, &c.; and lastly, the general routine of culture pursued, throughout the year, in the Forcing Department.

Much, if any success, that may have attended my practice, must be attributed to the very liberal assistance afforded me by His Grace the Duke of Bedford, who has been always anxious to have the various Horticultural improvements introduced, and their efficiency put to the test, in the Woburn Abbey Gardens.

I venture to hope, that the details and numerous illustrations will be of some assistance to the Noblemen and Gentlemen who have improvements in contemplation, and even be of some service to those who have already carried them into effect.

SUBSCRIBERS.

- His Grace the Duke of Bedford, K.G. F.L.S. &c. &c. (3 copies, large paper.)
- His Grace the Duke of Northumberland, K.G. (2 copies.)
- His Grace the Duke of Devonshire, K.G. (large paper, coloured.)
- Her Grace the Duchess of Atholl, (large paper, coloured.)
- The Most Noble the Marchioness of Cornwallis, (2 copies, large paper.)
- The Right Honourable Earl Spencer, K.G.
- The Right Honourable the Earl of Bradford.
- The Right Honourable the Earl of Clancarty.
- The Right Honourable the Earl of Essex.
- The Right Honourable Earl De Grey.
- The Right Honourable the Earl of Carlisle.
- The Right Honourable Lord Southampton, (large paper, coloured.)
- The Right Honourable General Lord Lynedoch, (large paper, coloured.)
- The Right Honourable the Countess Dowager of Bradford.
- The Right Honourable the Viscount Clive.
- The Right Honourable Lord Grey, *of Groby*, (large paper, coloured.)
- The Right Honourable Lord Gray, *Kinfauns Castle, Perth*.
- The Right Honourable Lord Chief Commissioner Adam, Blair-Adam.
- The Lady Elizabeth Harcourt.
- The Lady Charlotte Palmer, *of Ladbroke*.
- The Honourable G. G. Osborne.
- The Honourable Mrs. Cockayne, *Northampton*, (large paper, coloured.)

Sir Oswald Mosley, Bart. M.P.
 Sir R. G. Russell, Bart. M.P.
 Sir G. Staunton, Bart. M.P.
 Sir R. Frankland, Bart. M.P.
 Sir John Malcolm, Bart. (large paper, coloured.)
 Sir W. Wake, Bart. *Courteen Hall*, (large paper, coloured.)

Adam, W. G. Esq. 14, *Berkeley Square*, (3 copies, large paper.)
 Abercrombie, Mr. Gardener to Henry Seymour, Esq. *Woburn*.
 Anderson, Mr. W. *Royal Gardens, Kew*.
 Arnold, Mr. Erneste, *Dresden*.
 Aspin, J. Esq. *Newington Green*.
 Atkins, Mr. Nurseryman, *Northampton*, (2 copies, large paper.)

Baird, Rev. J. *Cranfield*.
 Banks, Mr. P. *Woburn Abbey Gardens*.
 Barrow, Mr. Hot Water Pipe Manufacturer, &c. *East Street, Manchester Square, London*.
 Barrow, Mr. Gardener to the Right Honourable the Earl of Harrington.
 Barwell, Mr. *Eagle Foundry, Northampton*, (large paper, coloured.)
 Baxter, Mr. J. *Lewes*.
 Bayley, E. C. Esq.
 Belshes, John Murray, Esq. *Invermay*, (large paper, coloured.)
 Berkeley, C. P. Esq. *Cotterstock Hall*, (large paper, coloured.)
 Bevos, Mr. George, *Syon Gardens*.
 Bow, Mr. William, *Manchester*.
 Boylan, Mr. M. Gardener to the Earl of Kenmore, *Killarney, Ireland*.
 Bright, John, Esq. *Brixton Hill*.
 Brooks, Thomas, Esq. *Flitwick*, (2 copies.)
 Brodie, Mr. Gardener to His Grace the Archbishop of York.
 Brown, Mr. Gardener to His Grace the Duke of Buckingham.
 Broughton, Rev. T. Delves, Bletchley Rectory, *Fenny Stratford*.
 Bruce, Mr. J. Gardener to R. Roe, Esq. *Sans Souci*.

- Burn, Mr. Gardener to the Most Noble the Marquess of Ailesbury, (large paper, coloured.)
- Caie, Mr. J. *Woburn Abbey Gardens.*
- Chantrey, John, Esq. *Chelsea*, (large paper, coloured.)
- Charlwood, Mr. Seedsman, *Covent Garden.*
- Coke, T. W. Esq, M.P. *Holkham*, (large paper, coloured.)
- Cooke, Hamilton, Esq. *Carr House, Doncaster*, (large paper, coloured.)
- Crocker, Mr. *Woburn.*
- Cullis, Mr. Nurseryman, &c. *Leamington Spa*, (3 copies, 1 large paper, coloured, 1 large paper, and 1 demy.)
- Cuthill, Mr. Gardener.
- Daniells, Thomas, Esq. *Berkhampstead.*
- Dall, Mr. Gardener to the Right Hon. Earl of Hardwicke, *Wimpole House.*
- Darby, Francis, Esq. *Colebrook Dale.*
- Davies, Mr. E. *Dulwich Hill.*
- Dickson, Mr. Gardener to Alexander Stewart, Esq.
- Dickson and Turnbull, Messrs. Nurserymen, *Perth.*
- Dillon, J. D. Esq. *Water End, Dursley*, (large paper, coloured.)
- Dixon, Mr. Seedsman, *Hull.*
- Dodds, Mr. J.
- Duncombe, P. P. Duncombe, Esq. *Brickhill Manor.*
- Duncan, Mr. Gardener to W. Whitbread, Esq. M.P.
- Edmunds, Mrs. *Torrington Square.*
- Edwards, Mr. John, *Oxford*, (large paper.)
- Emerson, A. L. M.D. *Parliament Street.*
- Emery, Mrs. *St. Neots.*
- Evans, Mr. Richard, *Swansea.*
- Fielding, H. B. Esq. *Shodday Lodge, Lancaster*, (large paper, coloured.)
- Fletcher, Rev. Charles, *Southwell.*
- Forrester, Mr. Gardener to His Grace the Duke of Bedford, *Endsleigh.*

Forrest, Mr. Gardener to His Grace the Duke of Northumberland.

Fort, John, Esq. *Read Hall, Lancashire*, (large paper, coloured.)

Foy, Mr. at *Mr. Lee's Nursery*.

Francis, Mr. Nurseryman, *Hertford*.

Fraser, James, Esq. Landscape Gardener, &c. *Ireland*.

Gibbs, Messrs. Seedsman, *Piccadilly*.

Gordon, W. Esq.

Grant, John, Esq. *Leighton Buzzard*.

Grant, Mr. Gardener to Charles Pulland, Esq. *Bray Head, Ireland*.

Greaves, John, Esq. *Bradford, near Warwick*.

Harcourt, G. V. Esq. M.P. *Nuneham Courtney*.

Harding, G. P. Esq. *Lambeth*.

Harrison, R. Esq. *Wolverton House*, (large paper, coloured.)

Hayter, George, Esq. 9, *Stratford Place*.

Hewlett, Mr. T. B. *Northampton*, (large paper.)

Hickling, Mr. J. *Northampton*.

Hooker, Dr. Professor of Botany, *Glasgow*, (2 copies, 1 large paper.)

Hosea, Mr. Gardener to General Lord Lynedoch.

Humphrey, Mr. A. Gardener to Sir John Nicholl.

Hungerford, H. H. Esq. *Dingley Park*, (large paper, coloured.)

Inglis, Miss Louisa, *Milton Bryant*.

Ireland, Mr. Forester to His Grace the Duke of Bedford.

Jephson, H. M.D. *Leamington*, (large paper, coloured.)

Johnston, Mr. A. Gardener to the Right Honourable the Earl of Clancarty.

Kennedy, T. F. Esq. M.P.

Kerr, Mrs. *Northampton*, (large paper, coloured.)

- Lawson and Son, Messrs. Nurserymen, *Edinburgh*.
- Leigh, Chandos, Esq. *Stoneleigh Abbey, Warwickshire*.
- Lenigan, James, Esq. *Castle Fogerty, Tipperary, Ireland*.
- Lindsey, Mr. Gardener to His Grace the Duke of Devonshire,
(large paper, coloured.)
- Linnwood, J. Esq. *Birmingham*.
- Loudon, Mr. Edwin, *Syon Gardens*.
- Low, Mr. Nurseryman, *Clapton*.
- Lucas, S. T. Esq. *Baron Down, Delverton*.
- Lucas, C. E. M.D. *Hatfield*.
- Mackay, J. T. Esq. *Cottage Terrace, Dublin*, (large paper, coloured.)
- Mackay, Mr. Alexander, *Woburn Abbey Gardens*.
- Mackie, Mrs. *Norwich Nursery*.
- Malcolm, Mr. Nurseryman, *Kensington*.
- Mansfield, Rev. W. *Milton Bryant*.
- Matheson, Mr. J. Gardener, *Hibernian School, Phoenix Park, Dublin*.
- Mc Donald, Mr. John, Gardener to the Right Honourable Lord Carteret.
- Mc Gregor, Mr. J. Gardener to His Grace the Archbishop of Tuam.
- Mc Lean, Mr. Forester to the Right Honourable Viscount Powerscourt.
- Miller, Mr. R. Gardener to the Right Honourable the Earl of Shrewsbury, *Alton Towers*.
- Moffatt, Mr. Gardener to His Grace the Duke of Newcastle.
- Muirhead, Mr. Gardener, *Invermay*.
- Niven, Mr. Gardener to the Chief Secretary, *Phoenix Park, Dublin*.
- Noes, Mr. Gardener to F. Pym, Esq.
- Orman, R. H. Esq. *Ipswich*, (large paper, coloured.)
- Osborn, George, Esq. *Northampton*, (large paper, coloured.)

- Paul, Mr. Nurseryman, *Cheshunt*, (2 copies, large paper.)
 Pease, Hannah, *Darlington*.
 Penrose, Charles, Esq. M.R.C.S. *Brickhill*.
 Perrott, T. Esq. *Sandford Park, Enstone*.
 Phillips, Mr. James, *Syon Gardens*.
 Phillips, Mr. Gardener to R. Trevor, Esq. *Tingrith House*.
 Pigott, J. H. Smyth, Esq.
 Praed, Mrs. *Tyringham House*.
 Pullen, Mr. Henry, *Syon Gardens*.
 Pullock, Matthew, Esq. *Oatlands, near Dublin*.
- Radcliffe Library, *Oxford*.
 Ramsay, Mr. John, *Dropmore Gardens*.
 Reddall, R. A. Esq. *Woburn*.
 Ripon, John, Esq. (large paper, coloured.)
 Robson, Mr. Gardener to His Excellency the Lord Lieutenant of
 Ireland.
 Ross, Mr. Gardener to the Right Honourable Viscount Powers-
 court.
 Ross, Mr. Gardener, *Dunkeld House*, (2 copies.)
 Rotherham, Mr. *Coventry*.
 Russell, John, Esq. M.P. *Upton*, (2 copies, 1 large paper, co-
 loured.)
 Russell, Mr. M. *College Botanic Garden, Dublin*.
- Sanders, Mr. James, Gardener to His Grace the Duke of Bed-
 ford, *Campden Hill*.
 Seymour, Henry, Esq. *Woburn*.
 Smith, Mr. D. *Botanic Garden, Hull*.
 Smyth, W. F. Esq. *Little Houghton*, (large paper, coloured.)
 Sowerby, Mr. Robert, *Hackness Gardens*, (2 copies.)
 Strachan, J. M. Esq.
- Tagg, Mr. Nurseryman, *Oxford*.
 Taylor, Mr. John, *Syon Gardens*.
 Taylor, Mr. Gardener to the Most Noble the Marquis of Tavistock.

Templeton, Mr. James, *Syon Gardens*.

Thane, W. Esq. *Russell Place*.

Thompson, Mr. J. *Colosseum*.

Tilling, Mr. *Chelsea*, (large paper, coloured.)

Trevor, R. Esq. *Tingrith House*, (large paper, coloured.)

Turner, W. Esq. *Reigate*.

Vivian, Rev. C. *Pasley, Wellingborough*, (large paper, coloured.)

Way, Albert, Esq.

Weddell, Mr. 14, *Prospect Row, Walworth*.

Weeks, Mr. Hothouse Builder, &c. *Chelsea*.

Wetherall, Mrs. *Newton Longueville*.

Whitbread, W. H. Esq. M.P. (large paper, coloured.)

Whitbread, Mrs. *Southill*, (large paper, coloured.)

Whittaker, Mr.

Wiffen, J. H. Esq. M.R.S.L. *Froxfield*.

Wilkie, Mr. W. Under Ranger, &c. *Phoenix Park, Dublin*.

Young, Mr. W. Gardener to the Right Honourable the Earl of
Enniskillen.

BOOKS

IN THE

LIBRARIES OF WOBURN ABBEY,

Consulted, or referred to throughout the Work.

- A.F.B. Abbot's Flora Bedfordiensis.
A.H. Andrews' Heaths.
A.B.R. ——— Botanist's Repository.
- B.C. Loddiges's Botanical Cabinet.
Br.F. British Flora, by Dr. Hooker, 1st and 2nd Editions.
B.F.G. Sweet's British Flower Garden, 1st and 2nd Series.
B.M. Curtis's Botanical Magazine.
Brookshaw's Pomona Britannica, or Fruit Repository.
B.P. Brown's Prodrômus Floræ Novæ Hollandiæ.
Bryant's Flora Diætetica, or History of Esculent Plants.
Botany of Captain Beechey's Voyage, by Dr. Hooker, and G. W. Arnott, Esq.
B.R. Botanical Register, by Dr. Lindley.
- Darwin's Phytologia, or the Philosophy of Agriculture and Gardening.
Description Botanique, Du Chiranthodendron.
DC. Decandolle; Astragalogia.
——— Prodrômus Systematis Naturalis Regni Vegetabilis.
- E.B. Smith's English Botany.
Ex.B. Exotic Botany, by Sir J. E. Smith.
E.Fl. English Flora, by Sir James Smith.
- F.D. Flora Danica.
F.G. Flora Græca.
F.I. Flora Indica.
F.P. Flora Peruviana.

- Flora Londinensis, or Plants growing in the Environs of London.
 Flore des Antilles, par Tussac.
 Flore Portugaise, par Hofmansegg.
- Fl.L. Flora Laponica; Linnæus.
 Fl.Sc. Flora Scotica, by Dr. Hooker.
 Fl.B.A. Flora Boreali Americana, by Professor Hooker.
- H.Ex.F. Exotic Flora, by Professor Hooker.
 H.Ic.F. Hooker and Greville's Icones Filicum.
 H.E.W. Hortus Ericæus Woburnensis.
 H.G.W. Hortus Gramineus Woburnensis.
 H.K. Hortus Kewensis.
 Hortus Malabaricus.
 H.T. Horticultural Transactions.
 H.M. Hooker's Miscellany.
 Heritier's Plants.
 Humboldt; Monographie de Melastomes.
 ———— Mimoses et autres Pl. Legumineuses.
 ———— et Bonpland; Nova Genera et Species Plantarum.
 ———— ————— Plantas Equinoxiales.
- J.Ic. Jacquin's Icones Plantarum Rariorum.
 ———— Hortus Botanicus Vindoboniensis.
 ———— Plantarum Rariorum Horti Cæsarii Schœnbrunensis.
 ———— Fragmenta Botanica.
 J.S. ———— Stapeliæ.
- Knapp's British Grasses.
 Kæmpfer; Icones selectæ Plantarum quas in Japonia collegit.
- L.P. Lambert's Description of the Genus Pinus.
 Labillardierre; Nova Hollandiæ Plantarum Specimen.
- L.R. Lindley's Rosarum Monographia.
 ———— Orchideous Plants.
- L.T. Transactions of the Linnæan Society.
 Loudon's Encyclopædia of Plants.
 ———— Hortus Britannicus.
- L. Linnæus Species Plantarum.
- Miller's Gardeners' and Botanists' Dictionary.
 ———— Figures of Plants described in his Gardeners' Dictionary.
 ———— Sexual System of Linnæus.
- Mx. Michaux; Flora Boreali Americana.

Fl.R. Nodder and Martyn's Flora Rustica.

Per. Persoon's Synopsis.

Plantes de La France, par Sainte-Hilaire.

Plantes usuelles Indigenes ou Exotiques, par Rocquer.

Pomona Austriaca.

Ph. Pursh's Flora Americæ.

Redouté; Les Liliacees.

———— La Botanique de J. J. Rousseau.

———— et Decandolle; Plantes Grasses.

Rees' Cyclopaedia.

Raii Historia Plantarum.

Rox. Roxburgh, Plants of the Coast of Coromandel.

R.S. Roscoe's Scitamineæ.

S.W. Salictum Woburnense.

Sw.C. Sweet's Cistineæ.

S.F.A. ——— Flora Australasica.

S.G. ——— Geraniaceæ.

———— Hortus Britannicus.

Thornton's Illustration of the Sexual System of Linnaeus.

V.Ch. Ventenat; Choix de Plantes.

Wall. Wallich; Plantes Rarioræ Asiaticæ.

Waldstein's Hungarian Plants.

Woodville's Medical Botany.

W. Willdenow; Hortus Berolinensis.

W.en. ———, Enumeratio Plantarum Horti Bot. Berolinensis.

Wend. Wendland's Ericarum Icones et descriptiones.

GLOSSARY

Of abbreviated Terms, used in the Generic and Specific Descriptions of the Plants throughout the Work.

<p>H.A. Hardy Annual, that requires to be sown yearly in the open ground.</p> <p>H.B. Hardy Biennial, Plants whose duration is seldom more than two years.</p> <p>H.p. Hardy Herbaceous Perennial, whose stems die down in Winter, but pushes anew in Spring.</p> <p>H.S. Hardy Shrub, or small Tree.</p> <p>H.T. Hardy Tree, which attains a considerable height.</p> <p>F.A. Frame Annual, that which requires to be kept in a Frame, or covered with a mat in Winter.</p> <p>F.B. Frame Biennial.</p> <p>F.p. Frame Perennial.</p> <p>F.S. Frame Shrub.</p> <p>F.T. Frame Tree, that requires to be covered with a mat in Winter.</p>	<p>G.A. Greenhouse Annual, that which requires the protection of a Greenhouse in Winter.</p> <p>G.B. Greenhouse Biennial.</p> <p>G.p. Greenhouse Perennial.</p> <p>G.S. Greenhouse Shrub.</p> <p>G.T. Greenhouse Tree.</p> <p>S.A. Stove Annual Plants, which require to be kept in a Stove or Hothouse in Winter.</p> <p>S.B. Stove Biennial.</p> <p>S.p. Stove Perennial.</p> <p>S.S. Stove Shrub.</p> <p>S.T. Stove Tree.</p> <p>D.S.S. Dry Stove Shrub, Annual, Biennial, &c. plants that require but little water.</p> <p>D.G.S. Dry Greenhouse Shrub.</p> <p>C.B.S. Cape of Good Hope.</p> <p>N.S.W. New South Wales.</p>
--	---

Explanation of the Abbreviations used in the line of Italics for the Colour of the Flower.

<p><i>bh.</i> bluish.</p> <p><i>bl.</i> blue.</p> <p><i>bk.</i> black.</p> <p><i>br.</i> brown.</p> <p><i>car.</i> carnea, or flesh-coloured.</p> <p><i>cr.</i> crimson.</p> <p><i>co.</i> copper.</p> <p><i>da.</i> dark.</p> <p><i>fl.</i> flesh-coloured.</p> <p><i>gr.</i> green.</p> <p><i>li.</i> lilac.</p> <p><i>or.</i> orange.</p> <p><i>pa.</i> pale.</p>	<p><i>pu.</i> purple.</p> <p><i>pk.</i> pink.</p> <p><i>ro.</i> rose.</p> <p><i>re.</i> red.</p> <p><i>sa.</i> salmon-coloured.</p> <p><i>sc.</i> scarlet.</p> <p><i>sp.</i> spotted.</p> <p><i>st.</i> striped.</p> <p><i>wh.</i> white.</p> <p><i>ye.</i> yellow.</p> <p><i>var.</i> variegated.</p> <p><i>ve.</i> velvet.</p> <p><i>vi.</i> violet.</p>
--	--

<p><i>cl.</i> climber.</p> <p><i>cr.</i> creeper.</p> <p><i>w.</i> water.</p>	
---	--

- Abort.* abortion, abortive, or barren.
ab. above.
acer. acerose, or needle-pointed.
acic. acicular, or needle-shaped.
acinacif. acinaciform, or scimitar-shaped.
acul. aculeate, or prickly.
acum. acuminate, or taper-pointed.
acut.-ang. acute-angular, or sharp-angled.
acut. acute.
adn. adnate, or adhering to any thing.
adul. adult, or full grown.
æurugin. æruginous, having a colour like verdigris.
agglom. agglomerated, or crouded together.
aggr. aggregate, or heaped together.
alt. alternate.
alveol. alveolate, or honeycomb-like.
ament. amentum, or catkin.
ampl. amplexicaul, or stem-clasping.
androg. androgynous, or producing male and female sexes on the same plants.
angu. angular, or angled.
annulat. annulation, or circles.
antherif. antheriferous, or bearing anthers.
apet. apetalous, or without petals.
ap. apex, the summit.
apicu. apiculate, or having a little point.
appr. appressed, or placed close against some other thing.
approx. approximated, or near together.
apter. apterous, or without wings.
aqu. aquatic, or growing in water.
arbor. arboreus, or a tree.
arbores. arborescent, or shrubby.
arcu. arcuate, or curved.
avill. arillous.
arist. aristate, or bearded.
artic. articulate, or jointed.
ascen. ascending.
ascig. ascigerous, or acid.
ussur. assurgent, or ascending upwards.
atten. attenuated.
aur. auriculated, or eared.
axill. axillary.
Bacc. baccate, or berried.
beard. bearded.
beardl. beardless.
ben. beneath.
bicusp. bicuspidate, or with two points.
biden. bidented, or double-toothed.
bifar. bifarious, or two-rowed.
bif. bifid, or two-cleft.
biglan. biglandular, or double glanded.
bilab. bilabiate, or with two lips.
bin. binate, or in two's.
bine. binerved, or two-nerved.
bipart. biparite, or two-parted.
bipinn. bipinnate, or twice pinnate.
bipinnatif. bipinnatifid, or twice pinnatifid.
bisacc. bisaccate, two pouches or bags.
biscut. biscutate, or like 2 bucklers.
bitern. biternate, or twice divided in three.
bivalv. bivalved, or two-valved.
blist. blistered, or with blisters on the surface.
brach. brachiate, or having arms or small branches.
bract. bracteate, furnished with small leaves or bractæe.
brist. bristles, or strong hairs.
bulb. bulbiferous, or bulb-bearing.
Caduc. caducous, soon falling off.
cæs. cæsious, or grey.
cæsp. cæspitose, or growing in tufts.
calc. calcarate, or spurred.
calceif. calceiform, or shoe-shaped.
cal. calyx, or flower cup.
calyp. calyptra, or covering.
camp. campanulate, or bell-shaped.
canal. canaliculate, or channelled.
canes. canescent, hoary, or whitish.
capill. capillary, or very slender.
cap. capitae, or headed.
caps. capsule, or seed vessel.
capit. capitulis, or small heads.
carin. carinate, or keel-shaped.
carn. carnose, or fleshy.
carp. carpilla, or the small parts of a compound fruit.
cart. cartilaginous, or gristly.
catk. catkin.
caud. caudate, or tailed.
caules. caulescent.
cell. cellular, or of cells.
cer. cernuous, or drooping.
cil. ciliated, or of hairs.
ciner. cinereous, grey, or ash-coloured.
circin. circinate, or curled.
cirrh. cirriferous, or bearing tendrils.
clam. clammy, or viscid.
clav. clavate, or club-shaped.
coh. cohering, or connected.
colum. columnar, like columns.
com. comose.
comp. complicate, or folded together.
compl. complanate.
compo. compound, or several together.
compr. compressed, or pressed together.
conc. concave, or hollow.
conf. confluent, running into one another.
conic. conical, or cone-shaped.
conj. conjugate, or united in pairs.
conn. connate, or joined together at the base.
const. constricted, or contracted.
conver. converging, or approaching together.
conv. convex.
convol. convolute, or rolled together.
cord. cordate, or heart-shaped.
coriac. coriaceous, or leathery.
cor. corolla.
corn. cornute, or horned.
coro. corona, or crown.
corrug. corrugated, or wrinkled.
cortic. cortical, or bark.
cory. corymbose.
cost. costæ, or ribs.
cost. costate, or ribbed.
coty. cotyledons, or seed leaves.
cren. crenate, or notched.
cris. crisped, or curled.
crucif. cruciform, or like a cross.
crust. crustaceous, or hard shelly.
cuc. cucullate, or hooded.
cul. culm, or stem of grass.
cult. cultrate, or knife-shaped.
cun. cuneate, or wedge-shaped.
cuspid. cuspidate, or pointed like a spur.

- cyath.* cyathiform, or cup-shaped.
cyl. cylindrical, or cylinder-shaped.
cymb. cymbiform, or boat-shaped.
cym. cymose, or flowering in cymes.
- Decan.* decandrous, or having ten stamens.
decid. deciduous, or falling off.
declin. declinate, or declining downwards.
decomp. decomposed, such as twice pinnated.
decorti. decorticated, or stripped of the bark.
decum. decumbent, or laying down.
decurr. decurrent, or running down.
decuss. decussate, or to cross each other.
defl. deflexed, or turned downwards.
dehis. dehiscent, or gaping.
delt. deltoid, or three-sided.
den. dentate, or toothed.
dentic. denticulate, or finely toothed.
dentif. dentiform, or tooth-shaped.
depen. dependant, hanging down.
depr. depressed, or pressing downwards.
diand. diandrous, or having two stamens.
dich. dichotomous, or forked.
dicocc. dicoccous, or having two nuts.
didy. didymous, or two united.
didyn. didynamous, or two long and two short.
diff. difformed, or of two forms.
diffu. diffused, or scattered.
dig. digitate, or fingered.
digy. digynous, or of two styles.
dimid. dimidiate, or divided in two halves.
diœc. diœcious, plants with female flowers on one plant, and male on another.
disco. discoid, or tubular florets.
dissep. dissepiment, or partitions of the seed vessels.
dist. distichous, or two-rowed.
divar. divaricate.
dodec. dodecandrous, or having 12 stamens.
dolabr. dolabriform, or hatchet-shaped.
dors. dorsal, growing on the bark.
dru. drupe, or a kind of fruit.
- Echin.* echinate, or prickly like a hedgehog.
elas. elastic.
ellip. elliptic.
elon. elongated, or lengthened.
emarg. emarginate, or notched at the apex.
ensif. ensiform, or sword-shaped.
ent. entire.
epider. epidermis, or outer bark.
equid. equidistant, or equally distant.
equil. equilateral, or of equal sides.
equit. equitant, or when the edges of the leaves overlap each other alternately.
- erect.* erect.
erod. eroded, or bitten.
eros. erose, or gnawed.
evol. evolved, or unfolded.
exse. exserted, or projecting beyond any thing.
exsic. exsiccated, or dried up.
- Falc.* falcate, or sickle-shaped.
farin. farinaceous, or flowery.
fusci. fasciculate, or in parcels, or bundles.
- fast.* fastigate.
fav. favose, or pitted.
feath. feathery.
ferru. ferruginous, or iron-coloured.
fil. filaments, or stamens.
fibr. fibrous, or of fibres.
filif. filiform, thread-shaped.
fimb. fimbriate, or fringed.
fistu. fistulous, or hollow.
flabell. flabelliform.
flac. flaccid, or feeble.
flex. flexible, or pliable.
flexu. flexuose.
fl. flower.
floscu. flosculous, or having compound flowers.
foliac. foliaceous, or having the form of leaves.
follic. follicle, or a kind of seed vessel.
foots. footstalks.
form. fornicate, or arched.
fring. fringed.
fron. frond, leaves of ferns or palms.
fruct. fructification, or parts composing the flower and fruit.
frut. frutescent, or shrubby.
ful. fulvous, or tawny.
fung. fungous, or mushrooms, &c.
furc. furcate, or forked.
fusc. fuscous, or dark brown.
fusif. fusiform, or spindle-shaped.
- Gal.* galeate, or helmet-shaped.
gem. geminate, or in two's.
germ. germen.
gibb. gibbous, or swelling.
glab. glabrous, or smooth.
glad. gladiate, shaped like a straight sword.
glan. glandular, or having glands.
glau. glaucous, or bluish hoary-coloured.
glob. globose, or globular.
glom. glomerate, or heaped together.
glum. glume, or glumaceous like grasses.
glut. glutinous.
gran. granular, or covered with grains.
gro. groved, or furrowed.
gyna. gynandrous, or having the stamens and styles united in one body.
gyr. gyrose, or turned round.
- Hast.* hastate, or halbert-shaped.
helm. helmet.
herbac. herbaceous, or plants whose stems die down to the ground annually.
herm. hermaphrodite, or of both sexes.
hexa. hexagonal, or of 6 sides.
hexand. hexandrous, having 6 stamens.
hexang. hexangular, or 6-angled.
hexap. hexapetalous, having 6 petals.
hirs. hirsute, or hairy.
hisp. hispid, rough, with stiff hairs.
hoar. hoary, covered with white down.
hood. hooded, or hollowed out.
hus. husks, or envelopes of the flowers of fruit.
hyb. hybrid, or mule.
hypocr. hypocrateriform, or salver-shaped.
hypog. hypogynous, placed under the ovary.
hypop. hypophyllous, or under the leaf.

- Imbr.* imbricate, or tiled.
incis. incised, or cut.
incras. incrassated, or thickening.
incur. incurved, or bending inwards.
indeh. indehiscent.
indig. indigenous, native of a country.
infl. inflated.
inflx. inflexed, or curved inwards.
inflor. inflorescence, or mode of flowering.
infund. infundibuliform, or funnel-shaped.
inter. internodes, or space between the joints.
inve. inverse, or inverted.
invol. involucre, or small leaves that surround the flower.
invol. involute, or rolled inwards.
- Labell.** labellum, or front lip or segment of an orchideous plant.
lacin. laciniate, or divided into segments.
lac. lacinia, or segments.
lact. lactescent, or milky.
lacun. lacunose, or covered with small pits.
laevig. lævigated, or smooth.
lam. lamina.
lanc. lanceolate, or spear-shaped.
lat. lateral, or inclined to one side.
lax. loose.
leaf. leaflets, the parts of compound leaves.
leg. legume, or pod.
lent. lenticula, or little lentil.
lentif. lentiform.
lepr. leprous, or spotted.
lig. ligulate, or strap-shaped.
lin. linear, or when both sides are parallel.
ling. linguiform, or tongue-shaped.
lip. lipped.
lob. lobes.
locul. loculaments, or partitions of the seed vessel.
loment. lomentaceous.
lor. lorate, or strap-shaped.
luc. lucid, or shining.
lun. lunate, or half-moon-shaped.
lur. lurid.
lyr. lyrate, or lyre-shaped.
- Marg.** marginate.
med. medulla, or pith.
mellif. melliferous, or honey-bearing.
memb. membranaceous.
micac. micaceous, or glittering.
midr. midrib, or vein that passes in the middle of a leaf.
mitr. mitriform, or formed like a mitre.
monud. monadelphous, or having the stamens united into one set.
monan. monandrous, or of 1 stamen.
monilif. moniliform, or necklace-formed.
monocot. monocotyledons, or having 1 seed leaf.
monœc. monœcious.
monop. monopetalous, having 1 petal.
monos. monosepalous, having 1 sepal.
mucr. mucronate, or sharp-pointed.
multif. multifarious, numerous.
multi. multipartite, many-parted.
multipl. multiplex, multiplied.
mur. muricated, or covered with sharp points.
- Nar.* navicular, or boat-shaped.
- nectarif.* nectariferous, or honey-bearing.
nect. nectary.
nerv. nervose, or nerved.
neut. neuter, neither male nor female.
nodd. nodding, or drooping.
nodo. nodose, or joints.
nucl. nucleus, or kernel.
- Obcor.* obcordate, or inversely heart-shaped.
obl. oblong.
obov. obovate, or inversely ovate.
obt. obtuse, or blunt.
occid. occidentalis, or western.
ochr. ochraceous, or yellowish.
octan. octandrous, having 8 stamens.
octogy. octogynous, having 8 styles.
offic. officinal.
oleag. oleaginous, or oily.
opp. opposite.
operc. opercular, or having a lid.
orbic. orbicular, or roundish.
orif. orifice, or opening.
ov. ovate, or egg-shaped.
ovar. ovary, or seed vessel.
- Pal.* palate, or mouth of gaping flower.
paleac. paleaceous, or chaffy.
palm. palmate, or resembling a hand.
pand. panduriform, or fiddle-shaped.
pani. panicle, or loose spiked.
papil. papilionaceous, or butterfly-like.
papill. papillose, or small glands, or like nipples.
pap. pappus, or downy.
pat. patent, or spreading.
patul. patulous, a little spreading.
pect. pectinate, or comb-like.
pedatif. pedatifid, or cut into lobes.
pedic. pedicellate, or small footstalks.
pedu. peduncle footstalks.
pell. pellucid, shining.
pell. peltate.
penc. pencilled, or marked with lines.
pend. pendulous, or drooping.
pentag. pentagonal, or having 5 angles.
pentagy. pentagynous, having 5 styles.
pent. pentandrous, having 5 stamens.
pentap. pentapetalous, having 5 petals.
peren. perennial, of many years duration.
perf. perfoliate, when the stem runs through the leaf.
- perianth.* perianthium, or envelope that surrounds the flower.
peric. pericarp, or seed vessel.
perigy. perigynous, inserted in the calyx.
persis. persistent, not falling of.
petalo. petaloid, like a petal.
pet. petals.
petio. petioles, or footstalks.
pilif. piliferous, or bearing hairs.
pil. pilose, a little hairy.
pinnæ. segments of a pinnated leaf.
pinnatisect. pinnatisectis.
pinnatif. pinnatifid, or cut into lobes nearly to the midrib.
pisif. pisiform, or pea-shaped.
 pist. pistillum.
plie. plicate, or plaited.
plu. plumose, or feathery.
pluril. plurilocular, having many cells.

- polyan.* polyandrous, having many stamens.
polygy. polygynous, having many styles.
polyp. polypetalous, having many petals.
polys. polysperma, having many seeds.
pom. pomum, an apple.
por. pores.
precoc. precocity, ripe sooner than usual.
prolif. prolific, or profligate.
prop. propendant, or hanging forwards.
pubes. pubescent, or downy.
pulvi. pulvinate, or cushion-shaped.
punctif. punctiform, formed like points.
pung. pungent, or prickly.
pust. pustules, or pimples.
pyrif. pyriform, or pear-shaped.
- Quad.* quadrangular, or 4-angled.
quadri-fu. quadrifarous, in 4 rows.
quadrif. quadrifid, 4-cleft.
quat. quaternate, in fours.
quin. quinate, in fives.
quinq. quinquifid, 5-cleft.
- Racem.* racemose, or flowering in racemes.
rad. radiate.
radic. radical, proceeding from the root.
rad. radius, or rayed.
ram. ramose, or branchy.
recep. receptacle, or part of fructification
 which supports the other part of it.
rect. rectangular, or right angled.
recurv. recurved, or bent backward.
refl. reflexed, or bent backward.
renif. reniform, or kidney-shaped.
rep. repand.
repl. replicate, folded back.
resup. resupinate.
retic. reticulate, like a net.
retu. retuse, or blunt.
revol. revolute, rolled back.
rhomb. rhomboid, or like a rhombus.
rig. rigid, or stiff.
ring. ringent, or gaping.
rot. rotate.
rotun. rotund, or roundish.
rug. rugose, rough or wrinkled.
runc. runcinate.
- Sac.* saccate, having a bag, or pouch.
sagit. sagittate, or arrow-shaped.
sam. samara, seed vessel.
sarm. sarmentose, or producing runners.
scabr. scabrous, rough.
scal. scales.
scari. scarioso, or scarious.
scp. scape, or stem bearing the flowers.
scrob. scrobiculate, of little hollows.
secun. secund, arranged on 1 side.
seg. segments, or parts of the leaves or
 flowers.
sep. sepals, segments of the calyx.
sept. septa, the divisions of the interior of
 the fruit.
serr. serrated, or sawed.
serrul. serrulate, finely sawed.
sess. sessile, or having no footstalks.
setac. setaceous, or bristly-like.
setæ. bristles.
- seto.* setose, covered with bristles.
sili. silicle, or round pod, or pouch.
siliq. siliqua, a long pod.
sinu. sinuate, or bending in and out.
smth. smooth.
sobol. soboliferous, or producing young plants.
sori. the patches of fructification on the back
 of the fronds of ferns, &c.
- spa.* spadix, a spike.
spath. spathaceous, having a spatha.
spat. spatulate.
sphace. sphacelate, or withered.
sphae. sphaerical, or round like a sphere.
spk. spike.
spinif. spiniform, formed like a spine.
spin. spinous, spiny.
spir. spiral.
spr. spreading.
spur. spurious.
spu. spurs.
squamif. squamiform, like scales.
squar. squarrose.
stam. stamen, or male part of the flower.
staminif. staminiferous, bearing stamens.
stand. standard, upper segment of the pea
 blossomed flowers.
- stell.* stellate, or star-like.
ster. sterile, or barren.
stig. stigma, the female part of the flower.
stimu. stimuli, stinging hairs.
stipit. stipitate, or having a short stalk.
stip. stipulæ, or small scales at the base of
 the leaves.
- stolonif.* stoloniferous, having creeping roots.
striat. striated, or furrowed.
strig. strigose, having hairs.
strum. strumose, or strumous.
sty. style.
- sub-dent.* } a little dented, or heart-shaped.
sub-cord. }
- succul.* succulent, or fleshy.
subul. subulate, or awl-shaped.
suffr. suffruticose, or shrubby.
sulc. sulcate, or furrowed.
surc. surculi, or young shoots.
sut. suture.
syng. syngenesious.
- Tend.* tendrils.
ter. terete, taper or round.
term. terminal, or ending at the top.
tern. ternate, or growing in three's.
testac. testaceous, or having a shell.
tetrach. tetrachotomus, or 4-forked.
tetr. tetrandrous, or having 4 stamens.
tetrap. tetrapetalous, having 4 petals.
tetras. tetrasepalous, having 4 sepals.
tetrasp. tetraspermous, having 4 seeds.
thalam. thalamas.
thec. thecæ, having a case.
thyr. thyrses, or a dense panicle.
tom. tomentose, or densely hairy.
toro. torose, uneven.
tort. tortuose, twisted.
trapez. trapeziform, trapezium-shaped.
trian. triandrous, having 3 stamens.
trich. trichotomus, 3-forked.
tricus. tricuspidate, or 3-pointed
trifar. trifarious, arranged in 3 ways.

<i>trif.</i>	trifid, 3 cleft.	<i>upp.</i>	upper.
<i>tril.</i>	triloculare, 3-celled.	<i>urc.</i>	urceolate, or pitcher-shaped.
<i>trip.</i>	tripetalous, 3 petals.	<i>utr.</i>	utriculate, or having little bladders.
<i>tripetal.</i>	tripetaloid, 3 petal-like.		
<i>triqu.</i>	triquetrous, or 3-sided.	<i>Val.</i>	valved, or valves.
<i>trisect.</i>	trisetus, or thrice cut.	<i>var.</i>	variegated.
<i>trop.</i>	tropical, a native of the torrid zone.	<i>vaul.</i>	vaulted.
<i>trunc.</i>	truncate, or as if cut off at apex.	<i>vent.</i>	ventricose, or inflated.
<i>tuberc.</i>	tuberculous.	<i>vernac.</i>	vernacular, or native.
<i>tuber.</i>	tuberous, having fleshy round roots.	<i>ver.</i>	vernal, or spring.
<i>tub.</i>	tubular.	<i>vers.</i>	versatile, swinging on a stalk.
<i>tum.</i>	tumid, or swelling.	<i>vert.</i>	verticillate, or in whorls.
<i>tunic.</i>	tunicated, or coated.	<i>vertil.</i>	vertilinear, or in a straight line.
<i>turb.</i>	turbinate.	<i>vesic.</i>	vesicatories, blistering.
<i>turg.</i>	turgid, or swollen.	<i>vex.</i>	vexillum, the upper petal of a pea blossomed flower.
<i>Umb.</i>	umbellate, or having umbels.	<i>vill.</i>	villous, shaggy, or hairy.
<i>unar.</i>	unarmed, or without prickles.	<i>vire.</i>	virescent, or green.
<i>uncin.</i>	uncinate, or hooked.	<i>virg.</i>	virgate, or twiggy.
<i>undul.</i>	undulate, or waved.	<i>visc.</i>	viscid, or clammy.
<i>ungui.</i>	unguiculated, or having a short unguis.	<i>vivip.</i>	viviparous, or producing young plants in place of flowers or seeds.
<i>ung.</i>	unguis, the lower or taper part of a petal.	<i>vulvif.</i>	vulviform, like a cleft, whose edges project.
<i>unil.</i>	unilateral, or 1-sided.		
<i>uniloc.</i>	uniloculare, or 1-celled.	<i>Whor.</i>	whorls, or the leaves inserted round the stem.
<i>unit.</i>	united.		
<i>unisex.</i>	unisexual, of 1 sex.		

CONTENTS.

	Page.
DEDICATION	i
PREFACE	iii
LIST OF SUBSCRIBERS	vii
BOTANICAL WORKS, &c. REFERRED TO	xv
GLOSSARY	xix

PART I. CATALOGUE OF PLANTS.

CLASSES of Plants.

MONANDRIA	1
DIANDRIA	3
TRIANDRIA	10
TETRANDRIA	21
PENTANDRIA	29
HEXANDRIA	59
HEPTANDRIA	72
OCTANDRIA	73
ENNEANDRIA	89
DECANDRIA	90
DODECANDRIA	105
ICOSANDRIA	108
POLYANDRIA	121
DIDYNAMIA	131
TETRADYNAMIA	142
MONADELPHIA	147
DIADELPHIA	162
POLYADELPHIA	173
SYNGENESIA	176
GYNANDRIA	197
MONŒCIA	203
DICŒCIA	213

CONTENTS.

	Page.
POLYGAMIA	222
CRYPTOGAMIA	225
ADDENDA	231

PART II. PLEASURE GROUND, &c.

Pleasure Ground	233
Flower Gardens	242
Parterres	245
Construction of the Greenhouse	248
Management of the Greenhouse and Conservatory	249
Construction of the Plant Stove	261
Management of Hothouse Plants	264
Management of the Heaths	271
Propagation of the Heaths	278
Hardy Heath Garden	282
Menagerie	285
Children's Gardens	287
The Evergreens	289
Aspley Cottage	293

PART III. KITCHEN GARDEN DEPARTMENT.

General Plan of the Kitchen Garden	297
Materials for Hothouse Roofs	310
On Heating Hothouses with Hot-Water	261, 328, 376
Construction of and Management of the Peach-House	333
Construction and Management of the Vinery	350
Management of the Fig-House	373
Construction of and Management of the Pinery	376
On the Pine Pits	398
On the Melon Pits	402, 404
Culture of the Melon	405
Culture of the Cucumber	409
Forcing Mushrooms	415
Forcing of the Strawberry	426
Forcing of French, or Kidney Beans	428
Management of the Cherry-House	423
Forcing of Rhubarb	431
Forcing the Potatoe	433
Forcing Asparagus	436
Forcing Sea Kale	439

Directions to the Binder for placing the Plates.

View of Woburn Abbey, to face Title Page	1
Engraved Title, with Vignette of the Principal Entrance to the Abbey ..	1
General Plan of the Pleasure Ground	233
Her Grace's Flower Garden, &c.	242
The Parterres	245
Plan and Elevation of the Greenhouse	248
The Plant Stove, &c.	261
The Heath-House	271
Parterres for Hardy Heaths	282
Menagerie	285
Menagerie Entrances	286
Children's Gardens	287
The Evergreens	289
Henry the Seventh's Cottage	293
Labyrinths	296
General Plan of the Kitchen Garden	297
Plan and Elevation of the Hothouses, &c. &c.	300
Materials for Hothouse Roofs, (Plate No. 18.)	322
Sections of Forcing Houses, (Plate No. 19.)	333
Plan, Elevation, &c. of the Pine-House	376
Pine Pit	398
Succession Pine Pit	399
Early Forcing Pit	402
Later Forcing Pit	404
Mushroom-House	415
Hot Wall	420

CLASS 1. ORDER 1.

MONANDRIA MONOGYNIA. STAMEN 1. STYLE 1.

Systematic Name.	English Name.	Form of Leaves, &c.	Col. of Flow.	Month of Fl.	Native Country.	Yr. of Intro.	Soil and Propagation.
CA'NNA, INDIAN SHOT. <i>Cal. of 3 leaves. Cor. of 6 petals. Sty. club-shap. Stig. obtuse. Cap. muric.</i>							
coccínea. B.M.	scarlet.	ov. inn. limb of cor. trif.	sc.	1. 12.	W. Ind.	1731.	S. \mathfrak{P} . Sandy loam.
díscolor. B.R.	crimson-leaved.	ov. obl. spa. 3-4-in. long.	sc.	8. 10.	Trinidad.	1827.	S. \mathfrak{P} . Seeds, or
edúlis. B.R.	eatable.	ov. obl.; st. col. at base.	rd.	6. 10.	Peru.	1820.	S. \mathfrak{P} . offsets.
gláúca. L.	glaucous.	ellip. lin. glau. ben.	yel.	1. 12.	S. Amer.	1732.	S. \mathfrak{P} . ———
iridiflóra. B.M.	nodding-flow'd.	ov. acum. pet. notched.	cr.	—	Peru.	1816.	S. \mathfrak{P} . ———
Índica. Rosc.	Indian.	acum. nerv. smooth.	rd.	—	W. Ind.	1570.	S. \mathfrak{P} . ———
Lambertiána. B.M.	Mr. Lambert's.	obl. lanc. acute.	sc.	5. 8.	Trinidad.	1818.	S. \mathfrak{P} . ———
lútea. B.M.	yellow.	ellip. glau. smooth.	yel.	1. 12.	S. Amer.	1629.	S. \mathfrak{P} . ———

[1-seed.

MARA'NTA, ARROW-ROOT. *Cal. 3 leav. Cor. 3-par. Sty. pet.-like. Stig. 3-sid. Nec. 3 fid. Cap. 1-cel.*

arundinácea. B.M.	Índian.	ov. lanc. hairy ben.	wh.	7. 8.	S. Amer.	1732.	S. \mathfrak{P} . Light loam.
angustifólia. B.M.	narrow-leav'd.	lanc. narr. smooth.	lil.	—	W. Ind.	1820.	S. \mathfrak{P} . parting
bícolor. B.R.	two-coloured.	ov. subro. rusty & red ben.	wh.	1. 12.	S. Amer.	1823.	S. \mathfrak{P} . roots.

RENEA'LMIA, RENEA'LMIA. *Perian. of 1-leaf. 2-3-toothed. Cor. 3-part. Cap. 3-furrow. Nec. obl.*

exaltáta. Rosc.	tubular-flowg.	alt. remot. scap. sheath.	rd.	7. 8.	Demerar.	1820.	S. \mathfrak{P} . Loam & peat.
<i>Alpínia tubuláta.</i> B.R.							offsets.
fasciculáta. Rosc.	clustered.	alt. lanc. bract. sess.	wh. yel.	—	—	1828.	S. \mathfrak{P} . ———
grandiflóra. B.F.G.	large-flowered.	lin. nerv. sheath at base.	wh.	4. 7.	N. Holl.	1822.	G. \mathfrak{P} . ———

PHRY'NIUM, PHRY'NIUM. *Cal. of 3 leav. Cor. of 3 equal pet. Sty. united to the Cor. Cap. of 3-cells.*

capitátum. w.	headed.	ov. smth. ent.; fl. cap.	wh.	5. 9.	E. Ind.	1820.	S. \mathfrak{P} . Sandy loam.
comósúm. Rosc.	tufted.	elon. ov. 2 ft. long. smth.	yel.	6. 8.	Trinidad.	1812.	S. \mathfrak{P} . parting
colorátum. B.M.	colored-spiked.	obl. lanc. smth.	yel.	—	Brazil.	1828.	S. \mathfrak{P} . roots.
flavéscens. Swt.	yellowish.	obl. acum. smth. glau.	yel.	6. 8.	—	1823.	S. \mathfrak{P} . ———

Calathéa flavéscens. B.R.

lúteum. Swt.	yellow-bracted.	stm. knot. smth.; sp. ter.	wh.	6. 7.	Caraccas.	1809.	S. \mathfrak{P} . ———
--------------	-----------------	----------------------------	-----	-------	-----------	-------	-------------------------

Maránta lútea. B.M.

Zebrium. Rosc.	Zebra plant.	ov. obl. pur. ben.	pur.	4. 7.	Brazils.	1815.	S. \mathfrak{P} . ———
----------------	--------------	--------------------	------	-------	----------	-------	-------------------------

THA'LIA, THA'LIA. *Cal. of 3 leav. pet. 5. Sty. depr. Stig. depr. & gaping. Nect. concave. Drupe 1-cel.*

dealbáta. B.M.	mealy.	ov. apex. revol. smooth.	wh.	7. 9.	Carolina.	1791.	G. w. \mathfrak{P} . Strong loam. seeds or offsets.
----------------	--------	--------------------------	-----	-------	-----------	-------	---

Systematic Name.	English Name.	Form of Leaves, &c.	Col. of Month of Flow.	Native Country.	Yr. of Intro.	Soil and Propagation.
HEDY'CHIUM, GARLAND. <i>Fl. cal. of 1 leaf, dbl. 5-part. Cor. limbs 3-part. Sty. large. Nec. 2-cleft.</i>						
coccineum. B.R.	scarlet-flower'g.	ensif. glau. ben. bas. atte. sc.	5. 12.	Nepaul.	1818.	S. β . Light rich
coronarium. B.M.	sweet-scented.	lan. ellip. apex elon. silk.	wh. 7. 9.	E. Ind.	1793.	S. β . soil, parting
elátum. B.R.	tall.	obl. lanc. smooth.	p. r. 1. 12.	—	1818.	S. β . of roots.
flávum. B.M.	yellow.	ellip. brd; lip of fl. retuse.	yel. 6. 11.	—	1818.	S. β . —
Gardnerianum. B.R.	Gardner's.	spike many-fl.; lip bifid.	yel. 7. 9.	Nepaul.	—	S. β . —
ROSCOE'EA, ROSCO'EA. <i>Cor. outer limb 3-part. inner 2-lip. Anth. 2-lob. incurved, surrounding the Sty.</i>						
capitata. L.T.	headed.	smth. spike cap. many-fl. pur.	7. 9.	Nepaul.	1819.	S. β . Loam & peat.
purpúrea. Ex. Bot.	purple.	ov. acum. smooth. vagin. pur.	7. 8.	—	1820.	S. β . offsets.
spicata. L.T.	spiked.	lan. smth.; spike many-fl. pur.	—	—	1821.	S. β . —
ALPINIA, ALPINIA. <i>Cal. 3-tooth. tubular. Cor. 3-parted, in. limb of 1 lip. Nec. 2-lip. low. lip spread.</i>						
auriculata. Rosc.	eared.	alt. lanc. ciliat. ro. ye. pend.	4. 5.	E. Ind.	1814.	S. β . Sandy loam.
calcarata. A. rep.	upright flowg.	lanc. ensif.; spike. erect. red-or.	9.	—	1800.	S. β . parting
cérnua. B.M.	drooping.	lan. acum. smth. den.	wh. pu. 4. 6.	—	1790.	S. β . roots.
diffissa. Rose.	two-cleft.	lanc.; spike. many-fl.	yel. pu. 5.	—	1818.	S. β . —
nútans. Rosc.	nodding.	alt. sheath. smth.	pk. yel. 4. 6.	—	1792.	S. β . —
racemosa. Rosc.	racemed.	obl. acum. smth.	wh. 7. 9.	W. Ind.	1752.	S. β . —
KÄMPFERIA, KÄMPFERIA. <i>Cal. minute. Cor. tubel long & slen. limb 6-par. Anth. 2-lob. Stig. 2-l.</i>						
Galanga. w.	officinal.	broadly ov. pale ben.	pu. wh. 6. 9.	E. Ind.	1724.	S. β . Sandy loam
marginata. Rosc.	red-margined,	broadly ov. gl. & dow. ben.	pu. —	—	1820.	S. β . & peat, slips
Roscoeana. B.R.	Roscoe's.	binate. orbic. variega.	wh. 4. 7.	Ava.	1828.	S. β . from roots.
AMOMUM, AMOMUM. <i>Cal. 3-cleft. Cor. of 3 unequal spreading petals, the inner of 1-lip. Anth. 2-lob.</i>						
grandiflorum. Ex. B.	large-flowd.	ellip. lanc. acute.	wh. 6. 7.	Sier. Leon.	1795.	S. β . Sandy loam.
subulatum. F.I.	awl-shaped.	lanc. subul. smth.	yel. 5. 7.	E. Ind.	1819.	S. β . divid. roots.
ZINGIBER, GINGER. <i>Calyx of 1 leaf. Cor. 4-5-cleft. Filaments extended beyond the 2 anthers.</i>						
officinale. Rosc.	officinal.	lin. lanc. smooth.	red. 6. 8.	E. Ind.	1605.	S. β . Peat & loam.
roseum. Rosc.	rosy.	ov. short stalks. lanc.	rd. yel. —	—	1822.	S. β . parting
Zerumbet. Ex. B.	broad-leaved.	sess. lanc. smooth.	yel. gr. 9. 11.	—	1690.	S. β . roots.
CURCUMA, CURCUMA. <i>Cal. 2-cleft. Cor. limb 3-4-par. Anth. dbl. Cap. 2-cell. Seeds numerous.</i>						
ærginosa. Rosc.	verdigrease.	lanc. ser. midrib. pur.	rose. 4. 8.	E. Ind.	1807.	S. β . Peat & loam.
longa. w.	long-rooted.	broadly lan. ner. smth.	pk. 6. 7.	—	1759.	S. β . parting roots.
COSTUS, COSTUS. <i>Cal. 3-part. gibb. Cor. gaping, 3-cleft, inner limb split. Nect. 2-par. Seeds nak.</i>						
arábicus. L.T.	Arabian.	smooth. ellip. lanc.	wh. 8.	Arabia.	1752.	S. β . Peat & loam.
cylíndricus. Rosc.	cylindr. spiked.	alter. lanc. obt. ciliat.	yel. 5. 9.	Brazil.	1822.	S. β . offsets
Pisónis. B.R.						
comósus. L.T.	comose.	ob. ov. pube.; spk. como. rd. y.	6.	Caraccas.	—	S. β . —
Alpinia comosa. Jacq.						
speciosus. F.I.	shewy.	silky. ben. ent. nerv.	wh. 8. 9.	W. Ind.	1794.	S. β . —
spicatus. Rosc.	spike flowg.	lan. smth.; stem cylin.	yel. 6.	S. Amer.	1793.	S. β . —

Systematic Name.	English Name.	Form of Leaves, &c.	Col. of Flow.	Month of Fl.	Native Country.	Yr. of Introd.	Soil and Propagation.
LOPEZIA, LOPEZIA.	<i>Cal. 4 leav. Cor. of unequal pet. Fil. 2, one pet.-shap. Cap. 4-cell. & many-seed.</i>						
coronáta. H.K.	crowned.	alt. op. ov. ver. ellip. den.	pur. 7. 10.	Mexico.	1805.	H. A.	Light loam.
racemósa. B.M.	racemed.	alt. ov. atten. serr.	red. 8. 10.	—	1792.	G. B.	seeds.
BOERHAAVIA, HOGWEED.	<i>Cal. of 1 leaf, inclosing the seed. Cor. plaited on one end of the calyx.</i>						
viscósá, Lag.	clammy.	ov. acut. vill. sub-repand.	sc. 4. 8.	Peru.	1821.	S. P.	Peat & loam cuttings.
SALICORNIA, JOINTED GLASS-WORT.	<i>Cal. swelling, undivid. Cor. 0. Sta. 1 or 2. Anth. 2-lob.</i>						
arábica. w.	Arabia.	alt. sheath. obt.	gr. 8. 9.	Arabia.	1758.	G. S.	Light soil.
fruticósá. E. B.	shrubby.	st. shrub. ar.; sp. sess. obt.	gr. —	Britain.	...	H. S.	cuttings, or
herbáceá. E. B.	marsh.	st. her. art. comp. emar.	gr. —	—	...	H. A.	seeds.
procúbens. E. B.	procumbent.	st. proc. joints obconic.	gr. —	England.	...	H. A.	—
rádicans. G. B.	creeping.	st. herb. proc. art.; sp. obl.	gr. —	Britain.	...	H. P.	—
HIPPURIS, MARE'S-TAIL.	<i>Cal. aborder scarcely discern. Cor. 0. Sty. awl-shap. Sti. sim. Seed ov. na.</i>						
vulgáris. E. Fl.	common.	in whorls. lin. smooth.	red. 5.	Britain.	...	H. w. P.	—
							[Stigma 2.]
ZOSTERA, GRASS-WRACK.	<i>Cal. 0. Cor. 0. Spad. lin flat, with many fls. An. sess. of 1 cell. Ger. round.</i>						
marína. E. Fl.	common.	ent. 3-rib.; stem comp.	gr. 8. 9.	Britain.	...	H. P.	Mud. seeds, & slips of roots.

ORDER II.

DIGYNIA. PISTILS 2.

CALLITRICHE, WATER STAR-WORT.	<i>Cal. 0. Pet. 2 obl. acu. opposite, equal. Anth. 2-lob. Germ.</i>						
autumnális. E. Fl.	Autumnal.	lin. 1-ribb. floating.	wh. 6. 10.	Britain.	...	H. w. A.	Mud.
vérna. E. Fl.	spring.	obo. 3-ribb. smth. axill.	wh. 4. 10.	—	...	H. A.	seed.
CORISPERMUM, TICK-SEED.	<i>Calyx 2-parted. Corolla 0. Seed solitary, oval, convex, plane.</i>						
hyssopifólium. L.	hyssop-leaved.	lin. nerveless.	wh. 7.	Europe.	1739.	H. A.	Light soil.
intermédiúm. R. s.	intermediate.	mucr.; stem vill.	wh. 7. 9.	Prussia.	1822.	H. A.	seeds.
BLITUM, STRAWBERRY-BLITE.	<i>Calyx 3-parted. Cor. 0. Seed 1, enveloped in a berried calyx.</i>						
capitátum. L.	headed.	triang. tooth.; sp. term.	5. 9.	Austria.	1633.	H. A.	Sandy soil.
virgátum. B. M.	twiggy.	trian. den.; spik. lat. scat.	—	S. Europ.	1650.	H. A.	seeds.

CLASS II. ORDER I.

DIANDRIA MONOGYNIA. STAMENS 2. PISTIL 1.

LIGUSTRUM, PRIVET.	<i>Cal. tubular, 4-cleft. Cor. 4-part. Ger. ov. Sty. short. Ber. of 2 cells, & 4 seeds.</i>						
lúcidum. R. s.	shining.	ov. ellip. smth. shin. abov.	wh. 6. 7.	China.	1794.	F. S.	Peat & loam.
vulgáre. R. s.	common.	lanc. acute. smooth.	wh. 6. 9.	Britain.	...	H. S.	cuttings.

DIANDRIA MONOGYNIA.

Systematic Name	English Name.	Form of Leaves, &c.	Col. of Flow.	Month of Fl.	Native Country.	Yr. of Introd.	Soil and Propagation.
FRA'XINUS, ASH-TREE. <i>Cal. wantg. or deep. 4-cleft. Cor. 0, or in 4 deep seg. Cap. compr. with 1 or 2 seeds.</i>							
americana. s.s.	American.	obl. ent. shin. glauc.	gr.	4. 6.	N. Amer.	1723.	H. C. Strong loam.
acuminata. s.s.	acuminate.	obl. serr. acum. glac. ent.	gr.	—	—	—	H. C. seeds, bud-
excelsior. E. Fl.	common.	in 5 or 6 pairs, ov. lan. serr.	gr.	—	Britain.	H. C. ting, or
<i>péndula.</i>	<i>weeping.</i>		gr.	—	—	H. C. grafting.
ellíptica. s.s.	elliptic-leaved.	in 3 prs. hair. be. lea. ob. to.	gr.	—	N. Amer.	1824.	H. C. —
heterophylla. E. Fl.	single-leaved.	4-5 inches long, serr.	gr.	—	England.	H. C. —
juglandifolia. s.s.	Walnut-leaved.	ov. serr. stalk. glau. ben.	gr.	—	N. Amer.	1783.	H. C. —
longifolia. s.s.	long-leaved.	ov. lanc. acum. serr.	gr.	—	—	1825.	H. C. —
macrophylla.	large-leaved.	ov. serr. smth. dark gr.	gr.	—	—	1823.	H. C. —
nigra. s.s.	black.	in 3 pairs, obl. acut. dent.	gr.	—	N. Amer.	1818.	H. C. —
pubescens. s.s.	downy.	ellip. ov. ser. stalk downy.	gr.	5. 6.	—	1783.	H. C. —
sambucifolia. s.s.	Sambucus-lvd.	sess. ov. lanc. serr. shin.	gr.	—	—	1800.	H. C. —
CHIONANTHUS, FRINGE-TREE. <i>Cal. 0. Cor. 4-parted, segments very long. Drupe with 1 seed.</i>							
axillaris. B.P.	axillary.	obl. ellip. acute.	wh.	5. 7.	N. Holl.	1810.	G. S. Loam & peat.
virginica. w.	smooth-leaved.	acute, smooth.	wh.	—	N. Amer.	1736.	H. C. cuttings.
NYCTANTHES, NYCTANTHES. <i>Cal. 0. Cor. saliv.-shap. 4-part. Seg. emar. Cap. of 2 cells. Seed 1.</i>							
árbor-trístis. B.R.	square-stalked.	ov. acute; stem 4-sided.	wh.	6. 9.	E. Ind.	1781.	S. S. Loam & peat, cuttings.
OLEA, OLIVE. <i>Cor. 4-cleft, segments somewhat ovate. Drupe single seeded.</i>							
americana. s.s.	American.	ellip. lanc. ent. smth.	wh.	6.	N. Amer.	1758.	G. S. Loam & peat.
angustifolia. Swt.	narrow-leaved.	lin. lanc. ent.	wh.	—	—	—	cuttings in sand, under
<i>Phillyrea angustifolia. s.s.</i>							
capensis. B.R.	leathery-leaved.	ovate, entire.	wh.	6. 9.	C. B. S.	1730.	G. S. a hand-
excelsa. s.s.	tall.	ellip. acute, smooth.	wh.	5. 6.	Madeira.	1784.	G. S. glass.
europæa. s.s.	European.	lanceolate, entire.	wh.	6. 8.	S. Europ.	1570.	G. S. —
1. latifolia.	<i>broad-leaved.</i>		wh.	—	—	—	G. S. —
2. buxifolia.	<i>Box-leaved.</i>		wh.	—	—	—	G. S. —
3. obliqua.	<i>oblique-leaved.</i>		wh.	—	—	—	G. S. —
fragrans. B.M.	fragrant.	lanceolate, serrate.	wh.	6. 8.	China.	1771.	G. S. —
latifolia. R.S.	broad-leaved.	ov. cord. serr. smooth.	wh.	—	S. Europ.	1597.	H. S. —
<i>Phillyrea latifolia. L.</i>							
mèdia. R.S.	twiggy.	obl. lanc. 3-nerv. ent.	wh.	—	—	—	H. S. —
1. Buxifolia.	<i>Box-leaved.</i>		wh.	—	—	—	H. S. —
<i>Phillyrea mèdia. L.</i>							
oleæfolia. R.S.	Olive-leaved.	ob. lan. nearly ent. base att.	wh.	—	—	—	H. S. —
<i>Phillyrea oleæfolia. H.K.</i>							
undulata. B.C.	wavy-leaved.	obl. acum. undul.	wh. yel.	—	C. B. S.	1829.	G. S. —
JASMINUM, JASMINE. <i>Cal. 5 or 8 cleft. Cor. campa. limb 5-8-cleft. Berry of 2 divis. Seed solitary.</i>							
azòricum. B.R.	Azorian.	op. ter. leaf. ov. sub. cord.	yel.	4. 11.	Madeira.	1724.	G. S. cl. Loam & peat.
auriculatum. B.R.	auricled.	ternate, opposite.	wh.	5. 9.	E. Ind.	1790.	G. S. cl. cuttings in
fruticans. B.M.	yellow.	alt. tern. leaf. obo. obt.	yel.	4. 9.	S. Europ.	1570.	H. S. sand, roots
gracile. A.R.	slender.	opp. ovate, elliptic.	wh.	1. 12.	Norf. Isl.	1791.	G. S. cl. freely un-
grandiflorum. B.R.	large-flowered.	opp. pinn. leaf. ob.	wh.	6. 10.	E. Ind.	1629.	G. S. cl. der a hand-
hùmile. B.M.	Italian.	alt. ac. ter. pin.; bran. ang.	yel.	6. 8.	S. Europ.	1656.	H. S. glass.
hirsutum. L.	hairy.	ov. cord. opp. pubes.	wh.	—	E. Ind.	1759.	G. S. —
odoratissimum. E.M.	sweet-scented.	alt. obt. tern. pinn.	yel.	5. 10.	Madeira.	—	G. S. —
officinale. B.M.	common.	opp. pinn. leaf. acum.	wh.	6. 10.	E. Ind.	1548.	H. S. cl. —
pubigerum. D.P.	pubescent.	leaf. ov. uneq. at base.	ye.	3. 8.	Nepaul.	1828.	H. S. cl. —

Systematic Name.	English Name.	Form of Leaves, &c.	Col. of Flow.	Month of Fl.	Native Country.	Yr. of Introd.	Soil and Propagation.
paniculatum. B.R.	panicked.	tern. leaf. ov. obt. acum.	wh.	2. 11.	China.	1812.	S. S. cl. ———
revolutum. B.R.	revolute.	ov. lanc. in 3 pairs.	yel.	—	Nepaul.	—	H. S. cl. ———
Sambac. B.R.	single Arabian.	op. elli. ov. subc.; bran. pu.	wh.	—	E. Ind.	1665.	S. S. cl. ———
	<i>flore pleno.</i>	<i>double flowering.</i>					
undulatum. B.R.	wave-leaved.	cord. obl. shin. wavy.	wh.	2. 6.	—	1812.	S. S. cl. ———

[with 1 seed in each.

CIRCEA, ENCHANTER'S NIGHT-SHADE. Cal. in 2 seg. tubu. at the base. Pet. 2, obo. Cap. of 2 cells,

alpina. E. Fl.	Alpine.	cord. dent. shin.	wh.	6. 8.	Britain.	...	H. P. Light loam.
lutetiãna. E. Fl.	common.	ov. dent. downy.	wh. or redd.	—	—	...	H. P. part. roots.

[many seeds.

VERONICA, SPEEDWELL. Cal. of 4 uneq. seg. Cor. wheel-shap. 4-part. Ger. comp. Cap. of 2 cells, with

alpina. E. Fl.	Alpine.	ov. smooth. serr.	bl.	5. 6.	Scotland.	...	H. P. Sandy loam,
azúrea. R.S.	sky blue.	lin. lanc. serr.	bl.	6. 9.	1818.	H. P. or mixed
agréstis. E. Fl.	field.	ov. serr. flower-leaves alt.	bl.	1. 12.	Britain.	...	H. A. with peat.
Anagállis. E. Fl.	narrow.	lan. ser. acut.; st. erect.	bl.	6. 8.	—	...	H. w. P. seeds, or part-
angustifolia. S.S.	long-leaved.	opp. lin. acute, serr.	bl.	7. 9.	Siberia.	1823.	H. P. ing roots.
aph'ylla. R.S.	naked-stalked.	round, oblong.	bl.	5. 6.	Italy.	1775.	H. P. ———
bellidioides. R.S.	daisy-leaved.	ovate, serr. rough.	bl.	6. 7.	Switzer.	1775.	H. P. ———
Clúsi. R.S.	Clusius's.	ov. tooth. upp. lan. stalk.	bl.	7. 9.	N. Europ.	1824.	H. P. ———
crenulata. R.S.	notch-flowered.	tern. opp. obl. lanc.	bl.	—	S. Europ.	1804.	H. P. ———
decussata. R.S.	cross-leaved.	ellip. ent.; stem shrub.	wh.	6. 8.	Falkl. Isl.	1776.	F. S. ———
digitata. R.S.	digitate.	digitate, part.; stem erect.	wh.	4. 5.	Spain.	1805.	H. A. ———
élegans. R.S.	elegant.	ov. obl. cren. stalk.	ros.	7. 9.	Italy.	1822.	H. P. ———
fruticulosa. R.S.	flesh-coloured.	ellip. lanc. serr.	pur.	6. 8.	Scotland.	...	H. S. ———
filiformis. S.S.	thready-stalk'd.	cord. cren.	bl.	5.	Levant.	1780.	H. A. ———
gentianifolia.	Gentian-leaved.	ellip. lan. ser. low. smth.	pa. bl.	5. 6.	—	1748.	H. P. ———

Veronica gentianoides. B. M.

glábra. R.S.	smooth.	tern. opp. subcord. lanc.		7. 9.	S. Europ.	1804.	H. P. ———
hederifolia. E. Fl.	Ivy-leaved.	cor. slight. hairy, 5-lob.	pa. bl.	3. 10.	Britain.	...	H. A. ———
hirsuta. B. Fl.	hairy.	ellip. lanc. serr. stalk.	pa.	4. 7.	Scotland.	...	H. P. ———
incana. R.S.	hoary.	lanc. opp. cren. pub.	bl.	7. 9.	Russia.	1759.	H. P. ———
incisa. R.S.	cut-leaved.	lanc. pinnatif. smooth.	bl.	6. 8.	Siberia.	1779.	H. P. ———
longifolia. R.S.	long-leaved.	lanc. acum. serr.	bl.	7. 9.	S. Europ.	1731.	H. P. ———
latifolia. B. F. G.	broad-leaved.	cord. sess. obt. serr.	bl.	6. 7.	Austria.	1748.	H. P. ———
maritima. R.S.	sea.	cord. lanc. tern. serr.	bl.	7. 9.	S. Europ.	1570.	H. P. ———
montana. E. Fl.	mountain.	ov. ser. shin.; stem hairy.	pa.	—	Britain.	...	H. P. ———
multifida. B. M.	multifid.	binpinnatif. seg. lan. lin.	bl.	6. 8.	Siberia.	1748.	H. P. ———
neglecta. B. F. G.	neglected.	lanc. acut. ser. base ent.	bl.	7. 9.	—	1797.	H. P. ———
pinnata. R.S.	pinnate.	lin. pintf. crowd. leaf. filif.	bl.	6. 8.	—	1776.	H. P. ———
paniculata. R.S.	panicked.	lan. tern. ser.; stem ascen.	bl.	—	Tartary.	1797.	H. P. ———
pectinata. R.S.	pectinated.	pectin. ser. obl.; stem pros.	bl.	—	Levant.	1820.	H. P. ———
perfoliata. B. P.	perfoliate.	ov. acum. decuss. en. perf.	pu.	—	N. S. W.	1815.	G. P. ———
saxatilis. E. Fl.	blue rock.	ellip. serr. in the middle.	bl.	6. 7.	Scotland.	...	H. P. ———
scutellata. E. Fl.	narrow-leaved.	lin. slight. tooth. Racem. al.	bl.	—	Britain.	...	H. w. P. ———
spicata. E. Fl.	spiked.	obl. opp. lower obov.	bl.	7. 9.	England.	...	H. P. ———
triphyllos. W.	three-leaved.	dig. part. low. ent.; st. spr.	bl.	4. 5.	Britain.	...	H. A. ———
Teucrium. B. C.	saw-leaved.	ov. rug. dent.; stem vill.	bl.	6. 8.	Europe.	1596.	H. P. ———
vérna. E. Fl.	spring.	pinnatif. upp. lanc.	pa. bl.	4. 5.	Britain.	...	H. A. ———
virginica. W.	Virginian.	4-5-together, lanc. ov.	wh.	—	Virginia.	1714.	H. P. ———

Systematic Name.	English Name.	Form of Leaves, &c.	Col. of Flow.	Month of Fl.	Native Country.	Yr. of Introd.	Soil and Propagation.
PINGUICULA, BUTTER-WORT. <i>Cal. 5-clef. Cor. of 1 pet. ring. spur. Cap. of 1 cell, with many seeds.</i>							
alpina. E. Fl.	Alpine.	Nec. con. sca. vil. Cap. glo. wh.	4.	Europe.	1794.	H. w. P.	Peat & moss.
edéntula. H. E. F.	toothless.	Cor. 5-lo. Nec. sub. recur. yel.	4. 5.	N. Amer.	1821.	H. w. P.	seeds, or
grandiflora. E. Fl.	large-flowered.	Nect. acut. Pet. 5-lob. pa. bl.	5. 6.	Ireland.	...	H. w. P.	offsets.
lusitánica. E. Fl.	pale.	ret. vein. Nec. obt.; sca. vil. li.	6. 7.	Britain.	...	H. w. P.	—
lútea. B. R.	yellow.	Cor. lips dent. Nec. sub. ye.	—	Carolina.	1816.	H. w. P.	—
vulgáris. E. Fl.	common.	Nect. acut. Cor. in 5 seg. st.	5.	Britain.	...	H. w. P.	—
UTRICULARIA, BLADDER-WORT. <i>Cal. of 2 leaves. Cor. ring. up. lip obt. Ger. round. Stig. of 2 lips.</i>							
intermédia. E. Fl.	intermediate.	forked, lin. acut. seg. flat. yel.	7.	Ireland.	...	H. P.	Peat, and
minor. E. Fl.	lesser.	trip.; spurkeel. lips undiv. ye.	—	Britain.	...	H. P.	plunged in
vulgáris. E. Fl.	common.	3 pinnatif. alt. up. lip ent. yel.	—	—	...	H. P.	water. offsets.
LEMNA, DUCK-WEED. <i>Cal. of 1 leaf. Cor. 0. Ger. super. ova. Stig. obt. Cap. of 1 cell, with 1 seed.</i>							
gíbba. E. Fl.	gibbous.	obo. conv. abov. reti. ben. wh.	6. 7.	Britain.	...	H. w. A.	Mud.
minor. E. Fl.	lesser.	ellip. obo. flat on both sid. wh.	—	—	...	H. w. A.	seeds.
LYCOPUS, GIPSY-WORT. <i>Cal. tub. 5-part. Cor. tub. 4-cleft. Ger. 4-cleft. Stig. cloven. Seeds 4, 4-sid.</i>							
europæus. E. Fl.	common.	obl. lan. ser. low. pinnatif. wh.	7. 8.	Britain.	...	H. P.	Light loam.
exaltátus. Fl. Gr.	tall.	pinnatif. at base. lob. tooth. wh.	—	Italy.	1739.	H. P.	Seeds, or di-
intermédius.	intermediate.	ovate, pubes. pinnatif. wh.	—	Europe.	1816.	H. P.	viding the
virginicus. R. S.	Virginian.	lan. ser. base ent. narr. wh.	8. 9.	N. Amer.	1760.	H. P.	roots.
SALVIA, SAGE or CLARY. <i>Cal. tub. with 2 uneq. lips. Cor. rin. Ger. 4-cleft. Sty. cur. Stig. clov. Seeds 4.</i>							
africana. R. S.	African.	ser. round base trun. down. bl.	4. 6.	C. B. S.	1731.	G. S. h.	Sandy loam.
ægyptiaca. R. S.	Egyptian.	lanc. dent. ciliat. wh.	6. 7.	Egypt.	1770.	H. A.	Seeds, or
azúrea. B. M.	blue-flowered.	lin. lanc. serr. bl.	8. 9.	Carolina.	1806.	F. P.	cuttings, of
amœna. B. R.	Caribbean.	obl. ov. rug. serr. bl.	9. 12.	W. Ind.	1793.	S. S.	many sorts,
aúrea. B. M.	golden.	ent. round. trun. at base. br.	4. 11.	C. B. S.	1731.	G. S.	will root
amplexicaulis. R. S.	stem-clasping.	cord. lanc. unequal. li.	7. 9.	Levant.	1813.	H. P.	freely in san-
bícolor. B. M.	two-coloured.	cor. obl. multif. hairy. bl. ye.	6. 7.	Barbary.	1793.	H. P.	dy loam.
bullata. W.	blistered.	cord. obl. crenu. red.	7. 8.	Spain.	1804.	H. P.	—
bracteata. B. M.	large-bracted.	pinn. hairy. ov. acum. li.	6. 8.	Syria.	1788.	G. S.	—
betonicaefolia. R. S.	Betony-leaved.	cord. lanc. uneq. cren. bl.	—	Russia.	1804.	H. P.	—
crética. R. S.	Cretan.	lin. lanc. pubes. vi.	—	Crete.	1760.	F. S.	—
coccinea. R. S.	scarlet.	cord. acut. toment. sc.	4. 10.	S. Amer.	1774.	G. S.	—
campéstris. R. S.	field.	cor. obl. rep. cren. pub. bl.	6. 7.	Tauria.	1813.	H. P.	—
Chamædryoides. B. M.	Germander-lk.	ov. cren. hairy, ben. red.	6. 9.	Mexico.	1795.	G. S.	—
crassifolia. B. M.	thick-leaved.	cor. lob. acut. hoary, ben. bl.	—	Barbary.	1804.	F. S.	—
Forsköhlhii. B. M.	Forsköhl's.	lyr. auric. pub.; st. nr. nak. bl.	—	Levant.	1800.	H. P.	—
fúlgens. B. R.	Cardinal.	rug. cord. ov. cren. hairy. sc.	1. 12.	Mexico.	1827.	G. S.	—
foliosa. B. R.	leafy.	subcor. at base, ov. ser. acu. bl.	8. 9.	—	1830.	H. A.	—
glutinosa. R. S.	glutinous.	cord. sagitt. serr. acum. st.	6. 9.	Europe.	1596.	H. P.	—
Horminum. R. S.	Annual, Clary.	obt. cren. Bract. col'd. par.	—	S. Europ.	—	H. A.	—
índica. B. M.	Indian.	cor. sid. lo. whorl. subnak. bl. w.	5. 7.	India.	1731.	H. P.	—
involutáta. B. M.	involute.	cor. ov. acum. serr. smth. sc.	8. 11.	Mexico.	1825.	G. P.	—
mexicana. R. S.	Mexican.	ov. acum. serr. bl.	5. 7.	—	1724.	G. S.	—
nubicola. B. F. G.	Nepaul.	last. ov. obl. rug. cren. ye. spot.	—	Nepaul.	1823.	H. P.	—
phlomisoides. R. S.	Phlomis-like.	lan. nearly ent.; st. wooll. pu.	—	Spain.	1815.	H. B.	—
pseudococcinea. B. M.	hairy-stalked.	ov. cor. obl. cren. pubes. sc.	—	S. Amer.	1797.	S. S.	—

Systematic Name.	English Name.	Form of Leaves, &c.	Col. of Flow.	Month of Fl.	Native Country.	Yr. of Introd.	Soil and Propagation.
<i>pratensis</i> . E. E.	meadow.	cor. obl. cren. up.; st. clasp.	bl.	5. 11.	England.	H. β . ———
<i>spléndens</i> . B. R.	splendid.	ov. lanc. serr. smooth.	sc.	8. 3.	Brazil.	1823.	S. ξ . ———
<i>Spielmanni</i> . R. S.	Spielman's.	obl. cord. dent.	bl.	6. 7.	Caucasus.	1813.	H. β . ———
<i>Sclárea</i> . R. S.	common Clary.	cord. obl. rugos. serr.	bl.	7. 9.	Italy.	1562.	H. β . ———
<i>Simsiána</i> . B. R.	Sims's.	ov. rugos. cren. repand.	bl.	7.	Russia.	1820.	H. β . ———
<i>sylvéstris</i> . R. S.	wood.	cor. lan. und. bis. Bract. col.	bl.	6. 9.	Germ.	1759.	H. β . ———
<i>tingitána</i> . R. S.	Tangier.	cord. obl. rugos. dent.	st.	7.	Barbary.	1796.	G. ξ . ———
<i>variegáta</i> . R. S.	variegated.	cord. obl. rug. dent.	bl. wh.	6. 8.	Hungary.	1814.	H. β . ———
<i>verticilláta</i> . R. S.	whorl-flowered.	cor. cren. den. whls. subna.	li.	6. 11.	German.	1650.	H. β . ———
<i>verbenáca</i> . E. Fl.	wild Clary.	serr. sinuat. smooth.	bl.	6. 7.	Britain.	H. β . ———

AUDIBERTIA, AUDIBERTIA. *Cal.* 2-lip. up. subentire, low. bifid. *Cor.* 2-lip. up. bifid. lower trifid.
incána. B. R. hoary. obov. obt. ent. hoary. *pa. bl.* 6. Colomb. 1826. H. ξ . Peat & loam cuttings.

[*Stig.* 2-lob. *Caps.* 2-celled.

GRATIOLA, HEDGE-HYSSOP. *Cal.* of 7 lea. *Cor.* 4 part. irregu. resupinate. *Fil.* 4, 2 of them sterile.

<i>officinális</i> . R. S.	official.	lanc. serr. 3-nerved.	wh.	6. 8.	Europe.	1568.	H. β . Light loam.
<i>virginica</i> . R. S.	Virginian.	obov. lanc. dent. smth.	st.	8.	Virginia.	1759.	H. β . parting the
<i>quadridentáta</i> . Ph.	four-toothed.	lin. lanc. acut. 4-dent.	st.	6. 8.	N. Amer.	1826.	H. β . roots.

[*Cap.* 2-valv. 2-cell.

SCHIZANTHUS, SCHIZANTHUS. *Cal.* 5-cleft. *Cor.* 2-lip. recur. up. lip 5-part. low. 3-par. *Fil.* 4, 2 ster.

<i>Hookéri</i> .	Dr. Hooker's.	pinnati. or bipinn. seg. ent. ro.	6. 7.	Chile.	1830.	H. β . Light rich	
<i>pinnátus</i> . H. E. F.	pinnate.	pinn. leaf. pinnatif.	li. pu.	7. 10.	Chile.	1823.	H. β . loam.
<i>pórrigens</i> . H. E. F.	spreading.	pinn.; stem spread. vil.	w. pu.	—	—	—	H. β . seeds.

JUSTYCIA, JUSTYCIA. *Cal.* 5-part. *Cor.* irregu. 2-lip. lower part. *Anth.* 2-cell. *Cap.* of 2 cells, & 2 valves.

<i>eocínea</i> . B. M.	scarlet.	ellip. smth. spik. termin.	sc.	12. 4.	S. Amer.	1770.	S. ξ . Loam & peat.
<i>carnea</i> . B. R.	flesh-coloured.	ov. lan. acum. cren. smth.	fl.	8. 9.	Rio Janie.	1830.	S. ξ . cuttings root
<i>carthaginénsis</i> . B. R.	Carthaginean.	ov. ellip. acut. nerv.	pur.	6. 7.	Carthage.	1792.	S. ξ . freely in a
<i>calycotricha</i> . B. M.	yellow-flowered.	opp. cord. ov. repand.	yel.	3. 4.	Brazil.	1825.	S. ξ . little bot-
<i>lúcida</i> . B. M.	shining.	ellip. blistered, shin.	sc.	7. 8.	W. Ind.	1795.	S. ξ . tom heat.
<i>nítida</i> . A. R.	glossy.	lan. ell. acu. at bth. ends.	w. sp.	3. 9.	—	1790.	S. ξ . ———
<i>nodósa</i> . B. R.	swollen-jointed.	ov. acum. smth. serrul.	cr. pu.	8. 10.	Brazil.	1826.	S. ξ . ———
<i>nasúta</i> . B. M.	white-flowering.	lanc. ovate, entire.	wh.	2. 10.	E. Ind.	1790.	S. ξ . ———
<i>pícta</i> . R. S.	painted.	ov. lanc. varieg. ent.	sc.	7. 8.	—	1780.	S. ξ . ———
<i>paniculáta</i> . R. S.	panicled.	lanc. nearly sess.	ros.	—	—	1811.	S. β . ———
<i>quadrífida</i> . R. S.	quadrifid.	linear, lanceolate.	sc.	3. 9.	Mexico.	1795.	S. ξ . ———
<i>speciósa</i> . B. M.	purple-flowered.	opp. smth. ov. subcren.	pur.	1. 12.	E. Ind.	1824.	S. β . ———
<i>secúnda</i> . B. M.	side-flowering.	ov. obl. acum. ent.	sc.	—	—	1793.	S. ξ . ———
<i>ventricósa</i> . B. M.	ventricose.	obl. ov. ent. smooth.	wh. rd.	—	China.	1825.	S. ξ . ———

CALCEOLARIA, SLIPPER-WORT. *Cal.* 4-parted. *Cor.* 2-lipp. inflated. *Cap.* of 2 cells, & 4 valves.

<i>arachnoídea</i> . B. M.	cobweb.	obl. dent. lingul. woolly.	pur.	6. 10.	Chile.	1827.	F. β . Peat & loam.
<i>angustifolia</i> . B. M.	narrow-leaved.	ov. obl. biser. pub. shin. at.	yel.	—	—	1822.	G. ξ . many of this
<i>ascéndens</i> . B. R.	dwarf-shrubby.	ov. stalk. rugos. dent. pub.	yel.	6. 9.	—	1826.	G. ξ . tribe per-
<i>bícolor</i> . B. M.	two-coloured.	ov. cor. rugos. pubes. dent.	yel.	7. 10.	—	—	G. ξ . feet seeds,
<i>corymbósa</i> . B. R.	corymbose.	ov. cren. the under cord.	yel.	4. 8.	—	1823.	G. β . when the stig.
<i>diffúsa</i> . B. R.	spreading.	cord. ov. opp. serr. rug.	yel.	—	—	—	G. β . mas are ferti-
<i>Fothergillii</i> . B. M.	Fothergill's.	ov. spat. ent. toment.	pur.	5. 8.	Falkl. Isl.	1777.	G. β . lized with the
<i>Herbertiána</i> . B. R.	Mr. Herbert's.	obl. rug. cren. pub.	yel.	6. 8.	Chile.	1828.	G. β . pollen, while
<i>hybrída</i> .	hybrid.	obov. ellip. den. retic. vill.	br.	—	—	—	G. β . the plants are

DIANDRIA MONOGYNIA.

Systematic Name.	English Name.	Form of Leaves, &c.	Col. of Flow.	Month of Fl.	Native Country.	Yr. of Introd.	Soil and Propagation.
integrifolia. B.R.	entire-leaved.	lanc. rug. tooth.	yel.	6. 8.	Chile.	1823.	G. S. <i>in bloom.</i>
purpurea. B.M.	purple-flower'd.	rug. hairy, spath. serr.	pur.	6. 10.	—	1826.	S. P. <i>The shrubby</i>
pinnata. B.M.	pinnate.	pinnatif. upp. pinn.	st.	7. 9.	Peru.	1773.	H. A. <i>species will</i>
plantaginea. E.M.	Plantain-leaved.	about 4 in. long, rho. ell. ser.	ye.	—	Chile.	1826.	F. P. <i>readily be in-</i>
polifolia. B.M.	white-leaved.	spa. ell. canes. wool. wrink.	ye.	—	—	—	G. P. <i>creased from</i>
rugosa. Ex. Fl.	rugose.	lanc. dent. rug.	yel.	6. 8.	—	1823.	G. S. <i>young cut-</i>
thyrsiflora. B.M.	tufted-flowered.	opp. lin. serr. smooth.	yel.	—	—	1827.	G. S. <i>tings, placed</i>
Youngii. B.R.	Mr. Young's.	ellip. cren. pubes.	yel. br.	6.	—	1830.	G. P. <i>under a hand- glass.</i>

WULFENIA, WULFENIA. *Cal. 5-part. Cor. ring. up. lip entire, short, cren. lower 3-cleft, mouth bearded.*

Carinthiaca. B.F.G. Carinthian. obov. obt. cren. smth. *bl.* 6. 9. Carinth. 1817. H. P. *Peat & loam. seeds, or parting the root.*

ERANTHEMUM, ERANTHEMUM. *Cal. 5-cleft. Cor. 5-part. the tube curv. in the mid. Cap. many-seed.*

bicolor. B.M. two-coloured. ov. acum. repand. *wh. pu.* 6. 9. Philippin. 1802. S. S. *Peat & loam.*

pulchellum. A.R. showy. ov. acum. nerv. *bl.* 1. 10. E. Ind. 1796. S. S. *cuttings.*

Justicia nervosa. B.M. strictum. B.R. upright. ov. lanc. crenul. opp. *bl.* 3. 4. Nepaul. 1818. S. S. —

[*ster. Seeds 2.*

STACHYTA'RPHETA, BASTARD-VERVAIN. *Cal. tub. 4-tooth. Cor. salver-shap. 5-cleft. Fil. 4, 2-*

indica. R.S. Indian. lanc. obl. dent. *vi.* 8. 9. Ceylon. 1733. S. A. *Peat & loam.*

mutabilis. R.S. changeable. ov. ser. rug.; *stem hoary. ros.* 3. 9. S. Amer. 1801. S. S. *seed,*

urticifolia. B.M. nettle-leaved. ov. lanc. serr. *bl.* — — — — — S. S. *cuttings.*

MONARDA, MONARDA. *Cal. striated, 5-cleft. Cor. ringent, helmet linear. Seeds naked.*

altissima. R.S. tall. ov. acum. base round. *li.* 7. 9. N. Amer. 1818. H. P. *Sandy loam.*

clinopodia. Ph. wild Basil-leav'd. ov. obl. lan. ser.; *st. smth. y. pu.* 7. — — — 1771. H. P. *parting the*

didyma. B.M. Oswego-tea. ov. cord. acum. serr. rug. *sc.* 6. 8. — — — 1752. H. P. *roots.*

fistulosa. R.S. fistulose. ov. acum. pub.; *stems smth. pu.* — — — — — 1656. H. P. — — —

media. B.F.G. purple-bracted. cor. ov. acum. serr. rug. *pur.* — — — — — ... H. P. — — —

purpurea. B.M. purple. ov. obl. acut. serr. *cr.* — — — — — 1789. H. P. — — —

punctata. B.R. dotted. lan. obl. ser. smth.; *st. vil. y. re.* 6. 10. — — — 1714. H. P. — — —

rugosa. B.M. rugose. ov. subcor. acut. ser. smth. *wh.* 7. 9. — — — 1761. H. P. — — —

Russelliana. B.M. Russell's. ov. acum. serr. *wh. re.* 6. 8. — — — 1823. H. P. — — —

ROSMARINUS, ROSEMARY. *Cal. 2-lipped. Cor. ringent, helmet bifid. Stam. curved. Seeds naked.*

chilensis. R.S. Chile. stalked, lin. lanc. *wh.* 7. Chile. 1795. G. S. *Light soil.*

officinalis. R.S. common. lin. sess. whit. ben. *pa. bl.* 1. 4. S. Europ. 1548. H. S. *cuttings.*

DIDYMOCA'RPUS, DIDYMOCA'RPUS. *Cal. 5-part. unequal. Cor. tubu. ventr. limb 5-lob. Style comp.*

Rexii. B.M. Cape. ov. obl. cren. rug. vill. *bl.* 2. 10. C. B. S. 1824. S. P. *Sandy loam and peat. seeds.*

GALIPEA, GALIPEA. *Cal. campa. 5-tooth. Cor. of 5 lin. petals. Germ. 5, 3-sided. Style 5, & Stig. 5.*

odoratissima. B.R. sweet-scented. obo. obt. ent. smth. *fl.* 6. RioJanei. — — — *Peat & loam. cuttings.*

ACÆNA, ACÆNA. *Cal. of 2 scales. Cor. of 4 5 petals. Stam. 2-4. Caps. 1-2, single-seeded.*

argentea. Fl. per. silvery. ov. obl. serr. silky, ben. *gr.* 5. 6. S. Amer. 1823. F. S. *Loam & peat-*

ascendens. Vahl. ascending. leaf. obo. obl. serr. *gr.* — — — Magellan. 1823. H. P. *cuttings ta-*

lucida. Vahl. shining. 3-5-part. seg. lin. vil. ben. *gr.* — — — Falkl. Isl. 1777. H. P. *ken off at a*

Systematic Name.	English Name.	Form of Leaves, &c.	Col. of Flow.	Month of Fl.	Native Country.	Yr. of Introd.	Soil and Propagation.
latebrósa. D.C.	hairy-leaved.	leaf. obl. ent. vill.	gr.	4. 6.	C. B. S.	1774.	G. \mathfrak{P} . joints.
lavigáta. H.K.	smooth.	leaf. ov. cren. smooth.	gr.	6. 8.	Magellan.	1790.	H. \mathfrak{P} . ———
ovalifólia. Fl. per.	oval-leaved.	obl. wedge-sh. silky, ben.	gr.	5. 6.	Peru.	1802.	F. \mathfrak{P} . ———
pinnatifída. D.C.	pinnatifid.	lin. lanc. pinnatif. vill.	gr.	4. 6.	Chile.	1823.	G. \mathfrak{P} . ———
sanguisórbæ. Lam.	Burnet-leaved.	leaf. obov. dent. silky.	gr.	6.	N. Zeal.	1796.	H. \mathfrak{P} . ———
COLLINSÓNIA, COLLINSÓNIA. Cal. parted. Cor. multifid, in the under lip. Stamens 2-4. Seeds 4.							
canadénsis. L.	Nettle-leaved.	ov. cor. smth.; stem smth.	yel.	8. 10.	N. Amer.	1735.	H. \mathfrak{P} . Peat & loam.
scabriúscula. H.K.	rough-stalked.	ov. cor. pilose.; st. rough.	yel.	—	Florida.	1776.	H. \mathfrak{P} . divid. plants.
PIMELEA, PIMELEA. Cal. 0. Involucrum 4-leaved. Cor. 4-cleft. Stigma capitate.							
diosmæfólia. B.C.	Diosma-leaved	decuss. obl. smth. ent.	ros.	—	N. Holl.	1830.	G. \mathfrak{S} . Peat & loam.
drupácea. B.C.	fleshy-fruited.	ov. obl. pubes. ben.	wh.	4. 8.	V. Die. Is.	1820.	G. \mathfrak{S} . cuttings in
decussáta. B.M.	decussate.	opp. ellip. smooth, ent.	pi.	—	N. S. W.	1823.	G. \mathfrak{S} . sand will
glauca. L.T.	glaucous-leav'd.	ellip. ent. smooth, glau.	wh.	2. 8.	—	1822.	G. \mathfrak{S} . root freely.
incána. B.P.	hoary.	lin. ell. op. hair. be. sh. ab.	st.	4. 8.	V. Diem.	1826.	G. \mathfrak{S} . ———
linifólia. B.M.	flax-leaved.	lin. lanc. 1-nerved.	wh.	—	N. S. W.	1793.	G. \mathfrak{S} . ———
pauciflóra. B.C.	few-flowered.	lin. lanc. smooth.	yel.	3. 9.	V. Die. Is.	1812.	G. \mathfrak{S} . ———
rósea. B.M.	rose-coloured.	opp. lin. smooth, ent.	pi.	—	N. Holl.	1800.	G. \mathfrak{S} . ———
GUNNERA, GUNNERA. Cal. 2-toothed. Cor. 0. Style 2 cleft. Seed single.							
Perpénsa. B.M.	common.	cord. ren. flat, cren. scp. sm. fl. pur.	6. 8.	C. B. S.	1688.		F. \mathfrak{P} . Peat & loam. dividing at the root.
FONTANE'SIA, FONTANE'SIA. Cal. 4-parted. Cor. of 2 petals. Caps. 2-celled, 1 seed in each.							
phillyræoides. w.	Phillyrea-leav'd.	lin. smooth. entire.	wh.	6. 8.	Syria.	1787.	H. \mathfrak{S} . Garden soil. cuttings, or layers.
LINOCTERA, LINOCTERA. Cal. 4-toothed. Cor. with 4 petals. Berry 2-celled.							
compácta. B.P.	Caribbean.	ellip. lanc. Racem. comp.	wh.	—	W. Ind.	1793.	S. \mathfrak{S} . Peat & loam. cuttings.
CLADIUM, TWIG-RUSH. Cor. 0. Spik. imb. Glum. chaf. Sty. capill. Stig. from 2-4. Drup. ov. of 1 cell.							
Mariscus. E. Fl.	prickly.	keel. serr. acum.; st. artic. bl.	—	—	England.	—	H. w. \mathfrak{P} . Peat & loam. seeds, or parting roots.
CATA'LPA, CATA'LPA. Cal. 2-parted. Cor. 5-cleft, irregular. Caps. 2-celled.							
longíssima. H.K.	wave-leaved.	obl. undul. smooth.	wh. pu.	—	W. Ind.	1777.	S. \mathfrak{S} . Garden loam.
syringifólia. B.M.	common.	cord. ent. smooth.	wh.	6. 8.	N. Amer.	1726.	H. \mathfrak{S} . seeds, or cuttings of root.

ORDER II.

DIGYNIA. STYLES 2.

[Seed 1:

ANTHOXANTHUM, VERNAL-GRASS. Cal. glu. of 2 val. 1-fl. Cor. of 2 eq. val. aw. Sty. shor. Stig. ercc.							
amárum. R.S.	bitter.	smth. glau. Panic. spik. sh.	7.	S. Europ.	1810.	H. \mathfrak{P} .	Light loam.
ovátum. R.S.	ovate.	ciliat. ; spikes ov.	—	Spain.	1824.	H. \mathfrak{P} .	seeds, or di-
*odorátum. E. Fl.	sweet-scented.	flat, hairy, panic.; sp. ov. obl.	5.	Britain.	—	H. \mathfrak{P} .	viding at root.

* This is an excellent grass for permanent pastures, when intermixed with other species.

ORDER III.

TRIGYNIA. STYLES 3.

Systematic Name.	English Name.	Form of Leaves, &c.	Col. of Flow.	Month of Fl.	Native Country.	Yr. of Introd.	Soil and Propagation.
<i>PIPER, PEPPER. Cal. 0. Cor. 0. Berry single seeded. Spadix simp. covered with flow. bearing scales.</i>							
alátum. P.s.	winged.	obl. lanc. atten. 5-nerv.	gr.	—	W. Ind.	1812.	S. S. Loam & peat.
adúncum. w.	hooked.	ellip. rough, uneq. at base.	gr.	—	Jamaica.	1784.	S. S. cuttings, or
Bétle. w.	Betle.	cord. ov. entire, smth.	gr.	—	E. Ind.	1804.	S. S. suckers.
coriáceum. B.C.	leathery-leav'd.	lanc. point, coriac.	gr.	7. 8.	—	1815.	S. S. —
incánium. B.C.	hoary.	alt. orbic. ov. hairy.	gr.	—	Brazil.	—	S. S. —
geniculátum. w.	jointed.	ell. obl. many-nerv. uneq. at ba.	—	—	W. Ind.	1826.	S. S. —
macrophyllum. w.	large-leaved.	ov. obl. many-nerv. smth.	gr.	—	—	1810.	S. S. —
nítidum. R.S.	shining.	ellip. lanc. smth. dott.	wh.	5. 6.	Jamaica.	1793.	S. S. —
nígrum. w.	black.	ov. acum. 7-nerv. coriac.	gr.	—	E. Ind.	1798.	S. S. —
plantagíneum. R.S.	Plantain-leav'd.	ellip. acum. ent.	gr.	—	W. Ind.	1820.	S. S. —
<i>medium. Jacq.</i>							
sérpens. R.S.	trailing.	tern. ellip. vill.	gr.	6. 7.	Jamaica.	—	S. S. —
unguiculátum. R.S.	claw-pointed.	ellip. lanc. glau.	gr.	—	Peru.	1822.	S. S. —
<i>glaucescens. Jacq.</i>							

CLASS III. ORDER I.

TRIANDRIA MONOGYNIA. STAMENS 3. STYLE 1.

<i>COMOCLA'DIA, MAIDEN PLUM. Cal. 3-pa. Pet. 3, lar. than the cal. Dru. 3-spot. at the end. Nut 1. seed 1.</i>							
integrifólia. w.	entire-leav'd.	pin. leafl. ov. lanc. en.	wh.	7. 9.	Jamaica.	1778.	S. S. Loam & peat. cuttings.
<i>GNEORUM, WIDOW-WAIL. Cal. 3-4-tooth. Pet. 3-4 equal. Stam. 3-4. Stig. 3-fid. Drup. 3-4-clus.</i>							
trícóccum. L.	three-grained.	smooth, lanc. obov. axil. yel.	4. 9.	S. Europ.	1793.	G. S.	Sandy soil. cutt. or seeds.
<i>COMMELINA, COMMELINA. Cal. of 3 leav. Pet. 3. Fil. 3-4-ster. Cap. 2-3-cell. Seeds attach. to the val.</i>							
africána. B.M.	African.	lanc. sess.; stem decum.	yel.	5. 10.	Africa.	1759.	G. S. Sandy loam
caléstis. w.	sky blue.	sess. obl. und. smth.	bl.	7. 10.	Mexico.	1813.	G. S. and peat.
deficiéns. B.M.	deficient.	lanc. ent. smooth.	bl.	10.	Brazil.	1825.	S. S. cuttings.
tuberósa. B.R.	tuberous-root'd.	ov. lanc. sess. ciliat.	bl.	7. 9.	—	1732.	H. S. —
<i>TRITONIA, TRITONIA. Spath. 2-valv. Cor. tubular, limb 6-parted, nearly equal. Stig. 3-spread.</i>							
Capénsis. B.M.	Cape.	Spatha. lanc. pointed.	str.	8. 10.	C. B. S.	1811.	F. S. Sandy loam.
miniáta. H.K.	late-flowered.	ensif. smth. spatha, spik.	yel.	8.	—	1795.	F. S. dividing at
refrácta. B.R.	reflexed.	lin. ensif.; spikes reflex.	yel.	5. 6.	—	1815.	F. S. root.
<i>WITSE'NIA, WITSE'NIA. Spath. 0. Cor. tubu. limb 6-part. Stig. emarg. or sub-3-fid. Caps. 3-cell.</i>							
corymbósa. H.K.	corymbose.	in two rows, smooth.	bl.	4. 9.	C. B. S.	1803.	G. S. Loam & peat. part. at roots.

TRIANDRIA MONOGYNIA.

11

Systematic Name.	English Name.	Form of Leaves, &c.	Col. of Flow.	Month of Fl.	Native Country.	Yr. of Introd.	Soil and Propagation.	
WATSONIA, WATSONIA. <i>Spath. 2-val. Cor. tub. limb 6-part. Stig. 3-fid. recur. Cap. of many seeds.</i>								
aletróides. H.K.	Aletris-like.	lin. nerv. fl. recur.	ros.	5. 7.	C. B. S.	1774.	F. \mathcal{P} . Peat & loam.	
húmilis. H.K.	dwarf.	lin. ensif. vill.	red.	— — —	— — —	1754.	F. \mathcal{P} . offsets.	
punctáta. B.R.	dotted-flower'd.	lin. nar. smooth.	pur.	4. 5.	— — —	1800.	F. \mathcal{P} . — — —	
róseo-álba. B.M.	two-coloured.	lin. ensif. smooth.	pk.	7. 8.	— — —	1795.	F. \mathcal{P} . — — —	
ARISTEA, ARISTEA. <i>Cor. tubu. short. Pet. 6, regular. Stig. simple, obtuse. Cap. 3-celled.</i>								
cyánea. H.K.	blue-flowered.	ensif. smth. spatha. part.	bl.	4. 6.	C. B. S.	1759.	G. \mathcal{P} . Loam & peat.	
pusilla. B.M.	flat-stemmed.	lin. lanc. falcate.	bl.	6. 7.	— — —	1806.	G. \mathcal{P} . div. at root.	
ANTHOLYZA, ANTHOLYZA. <i>Spath. 2-valv. Cor. tubul. limb ringent, ovate, lanceolate. Stig. 3.</i>								
æthiópica. B.M.	Flag-leaved.	ensif. attenuat. nerv.	sc. or.	1. 4.	C. B. S.	1759.	F. \mathcal{P} . Peat & loam. offsets.	
MORÆA, MORÆA. <i>Cor. of 6-petals, spreading. Stig. 3-6. Cap. oblong, many-seeded.</i>								
lúrida. B.R.	lurid.	in 3's. lin.; stem single.	cr.	6. 7.	C. B. S.	1817.	F. \mathcal{P} . Loam & peat.	
Tenoreána. B.F.G.	Tenore's.	in 2's. smooth. nerv.	bl.	— —	Naples.	1824.	F. \mathcal{P} . part. at roots.	
WACHENDORFIA, WACHENDORFIA. <i>Cor. 6-parted, irregular. Caps. 3-celled. Seeds 1.</i>								
thyrsiflora. w.	tall-flowered.	ensif. smooth, ribb.	plie.	yel.	5. 6.	C. B. S.	1759.	G. \mathcal{P} . Loam & peat. offsets.
MA'RICA, MA'RICA. <i>Cor. of 6-petals, the 3 upper largest. Stig. petal-like, 3-fid. Caps. 3 celled.</i>								
ánceps. B.M.	two-edged.	scap. 2-edged, simp. smth.	bl.	7.	N. Amer.	1693.	H. \mathcal{P} . Loam and	
cerúlea. B.R.	blue.	4-6 feet high, smooth.	bl.	4. 10.	Brazil.	1810.	S. \mathcal{P} . leaf mould.	
semi-apérta. B.C.	half-open.	lin. lanc. nerv.	yel.	— — —	— — —	1820.	S. \mathcal{P} . dividing	
Sabíni. H.T.	Mr. Sabine's.	ensif. smth. ent.	bl.	9. 10.	St. Thom.	1822.	S. \mathcal{P} . plants.	
BRODIÆA, BRODIÆA. <i>Perianth. tubu. 6-part. petal-like. Sty. filif. Stig. 3-fid. Caps. 3-celled.</i>								
grandiflora. B.R.	large-flowered.	lin. acum. chann.	bl.	6.	Georgia.	1806.	G. \mathcal{P} . Loam & leaf mould. offsets.	
GLADIO'LUS, CORN-FLAG. <i>Spath. 2-3-valved. Cor. tubular, 6-parted. Legume ovate, lanceolate.</i>								
alátus. B.M.	winged-flow'd.	ensif. rigid, plicate, pub.	sc. y.	5. 6.	C. B. S.	1796.	F. \mathcal{P} . Loam and	
angústus. H.K.	narrow-leav'd.	lin. ribbed, smooth.	st. re.	— — —	— — —	1757.	F. \mathcal{P} . peat mixed.	
brevifólius. H.K.	short-leaved.	lin. compr. pubes.	fl.	3. 5.	— — —	1802.	F. \mathcal{P} . offsets from	
commúnis. H.K.	common.	ensif. nerv.; spik. 1-sid.	red.	6. 7.	S. Europ.	1596.	F. \mathcal{P} . bulbs.	
Colvillii. B.F.G.	Colvill's.	lin. ensif. glau. nerv.	red.	—	—	1824.	F. \mathcal{P} . — — —	
cardínalis. B.M.	superb.	ensif. smth.; spike 1-sid.	sc.	7. 8.	C. B. S.	1789.	F. \mathcal{P} . — — —	
cárneus. B.M.	flesh-coloured.	ensif. striat. smooth.	car.	5. 6.	— — —	1796.	F. \mathcal{P} . — — —	
dèbilis. B.M.	weak.	lin. elong. flat.	wh. pu.	4. 5.	— — —	1822.	F. \mathcal{P} . — — —	
floribúndus. H.K.	many-flowered.	lanc. ensif. nerv.	pk. wh.	5. 7.	— — —	1788.	F. \mathcal{P} . — — —	
grácilis. H.K.	slender.	lin. sheath. ribb.	pa. bl.	4. 5.	— — —	1800.	F. \mathcal{P} . — — —	
hirsútus. H.K.	hairy.	lin. ensif. downy.	ros.	4. 6.	— — —	1795.	F. \mathcal{P} . — — —	
Milléri. B.M.	Miller's.	lin. ribb. sheath. spott.	wh. pu.	4. 5.	— — —	1751.	F. \mathcal{P} . — — —	
psittacinus.	Parrot.	ensif. equitant. acum.	or. rd.	6. 7.	1829.	F. \mathcal{P} . — — —	
recurvus. B.M.	recurved.	lin. ribb. sheath. spott.	pu. y.	— — —	— — —	1758.	F. \mathcal{P} . — — —	
trístis. B.M.	dark.	lin. 3-nerv. 4-sided.	st. br.	5. 6.	— — —	1745.	F. \mathcal{P} . — — —	
viperátus. B.M.	viper.	ensif. glau. ner. distich.	gr. pu.	— — —	— — —	1787.	F. \mathcal{P} . — — —	
versícólor. H.K.	various-color'd.	lin. ensif. 3-nerv.	gr. red.	— — —	— — —	1794.	F. \mathcal{P} . — — —	
Watsonius. B.M.	Watson's.	lin. ensif. 3-ribb.	sc.	4. 5.	— — —	1791.	F. \mathcal{P} . — — —	

Systematic Name.	English Name.	Form of Leaves, &c.	Col. of Flow.	Month of Fl.	Native Country.	Yr. of Introd.	Soil and Propagation.
ANISANTHUS, ANISANTHUS. <i>Spatha 2-valved. Perianth, tubular, limb 6-part. Caps. 3-angular.</i>							
Cunônia. B.F.G.	scarlet.	ensif. lin. smooth.	sc.	5. 6.	C. B. S.	1756.	F. \mathfrak{P} . Sandy loam
spléndens. B.F.G.	splendid.	lin. ensif. smooth.	sc.	— — —	— — —	1825.	F. \mathfrak{P} . and peat. offsets.
BABIANA, BABIANA. <i>Spatha 3-valved, inner 2-parted. Cor. tubular, limb 6-cleft. Stig. 3.</i>							
dística. B.M.	two-ranked.	plaited, vill. rigid.	bl.	6. 7.	C. B. S.	1774.	F. \mathfrak{P} . Peat and loam.
ríngens. H.K.	gaping-flower'd.	smooth, lin. ensif.	pur.	5. 6.	— — —	1806.	F. \mathfrak{P} . offsets.
Thunbérghii. H.K.	many-spiked.	vill. Cor. ring.	pur.	— — —	— — —	1774.	F. \mathfrak{P} . offsets.
SPARAXIS, SPARAXIS. <i>Spatha 2-valved, jagged. Cor. tubular. Stig. 3, recurved. Caps. oblong.</i>							
bulbifera. H.K.	bulb-bearing.	Cor. limb regu. seg. ov. yel.	5. 6.	C. B. S.	— — —	1758.	F. \mathfrak{P} . Loam & peat.
versicolor. E.F.G.	various-color'd.	ensif. stria. disti.; sp. 3-4-fl. pu.	— — —	— — —	— — —	1811.	F. \mathfrak{P} . offsets.
SYNNOTIA, SYNNOTIA. <i>Perianth, 6-parted, ringent. Stam. 3. Stig. 3, apex fringed.</i>							
bicolor. B.M.	two-coloured.	Spat. spot. cor. limb cleft. y. bl.	3. 4.	C. B. S.	— — —	1786.	F. \mathfrak{P} . Sandy loam.
variegata. B.F.G.	variegated-flow.	distich. ensif. obliq. smth.	vio.	4. 6.	— — —	1825.	F. \mathfrak{P} . offsets.
HESPERANTHA, EVENING-FLOWER. <i>Spath. 2-valv. Cor. tubu. limb equal, 6-part. Stig. 3-clo.</i>							
falcata. B.M.	sickle-leaved.	falc. smooth, nerv.	wh. br.	4. 5.	C. B. S.	1787.	F. \mathfrak{P} . Sandy loam
graminifolia. B.M.	Grass-leaved.	lin.; stem smooth.	wh. br.	8. 9.	— — —	1808.	F. \mathfrak{P} . and peat.
pilosa. B.M.	hairy.	lin. hairy.; st. smth.	wh. br.	4. 5.	— — —	1811.	F. \mathfrak{P} . offsets.
IXIA, IXIA. <i>Spatha 2-3-valved. Cor. tubular, slender, limb equal. Stig. 3, recurved. Caps. globose.</i>							
aúlica. B.M.	rose-coloured.	ensif. nerv. smooth.	pk.	4. 5.	C. B. S.	1774.	F. \mathfrak{P} . Sandy loam
capitata. B.R.	headed.	lin. ensif.; fl. in spik. wh. bk.	5. 6.	— — —	— — —	1780.	F. \mathfrak{P} . and peat.
crispa. H.K.	curled.	lin. curled, smth.	ros.	4. 5.	— — —	1787.	F. \mathfrak{P} . offsets from
cónica. B.M.	Orange-color'd.	ensif. smth. limb spott.	or.	— — —	— — —	1757.	F. \mathfrak{P} . the bulbs.
hybrida. B.M.	spurious.	slen.; Racem. many-fl. w. ros.	— — —	— — —	— — —	—	F. \mathfrak{P} . — — —
leucántha. B.M.	white-flowered.	lin. ensif. obliq.	wh.	5. 8.	— — —	1799.	F. \mathfrak{P} . — — —
maculata. B.R.	spotted.	ensif. smooth. spott.	var.	5. 6.	— — —	1780.	F. \mathfrak{P} . — — —
reflexa. A.B.R.	reflex-flower'd.	ensif. smooth.	red.	6.	— — —	—	F. \mathfrak{P} . — — —
viridiflora. B.R.	green-flower'd.	lin. striat.	gr.	5. 6.	— — —	1780.	F. \mathfrak{P} . — — —
SISYRINCHIUM, SISYRINCHIUM. <i>Cor. of 6 petals. Stam. united at base. Ger. rounded, 3-sided.</i>							
bermudiánum. w.	Iris-leaved.	ensif. lin.; stem 2 edged.	bl.	5. 7.	Bermud.	1752.	G. \mathfrak{P} . Sandy loam.
californicum. H.K.	yellow.	lin. flat; scape simp.	yel.	6. 9.	Californ.	1796.	F. \mathfrak{P} . and peat.
latifolium. B.M.	plaited.	lin. lan. plic.; scp. 2 edged.	w.	6. 8.	W. Ind.	1737.	S. \mathfrak{P} . dividing at
pedunculatum. B.M.	long-stalked.	lin. ensif.; stem round.	yel.	— — —	Chile.	1827.	G. \mathfrak{P} . root.
striatum. B.M.	streaked.	lin. lanc.; scape 2-sided.	yel.	5. 9.	Mexico.	1788.	F. \mathfrak{P} . — — —
ORTHOSANTHUS, ORTHOSANTHUS. <i>Per. pet.-like, salv.-shap. 6-part. Sta. 3. Cap. obl. 3-sid.</i>							
multiflorus. S.F.A.	many-flowered.	lin. ensif. striat. smooth.	bl.	5. 7.	N. Holl.	1825.	G. \mathfrak{P} . Peat & loam. part. at root.
VALERIANA, VALERIAN. <i>Cor. of 1-tubu. petal 5-cleft. Germ. elliptic, obl. of 1-cell. Seed compr.</i>							
céltica. w.	celtic.	ov. obl. obt. ent. upp. lin. str.	6. 7.	Switzer.	— — —	1740.	H. \mathfrak{P} . Sandy loam.
dioica. E.Fl.	diœcious.	ov.; stem ones pinnatif. bh.	5. 7.	Britain.	H. \mathfrak{P} . dividing at
elongata. R.S.	clongated.	cord.; st. ones sess. cord. str.	6. 7.	Austria.	— — —	1812.	H. \mathfrak{P} . roots, or
montana. E.C.	Mountain.	ov. obl. dent. upp. acut. bh.	— — —	Switzer.	— — —	1748.	H. \mathfrak{P} . seeds.
officinalis. E.B.	great-wild.	lanc. serr. upp. pinn. bh.	— — —	Britain.	H. \mathfrak{P} . — — —

Systematic Name.	English Name.	Form of Leaves, &c.	Col. of Flow.	Month of Fl.	Native Country.	Yr. of Introd.	Soil and Propagation.
Phù. R.S.	Garden.	ent.; stem ones pinn.	wh.	5. 7.	Germany.	1597.	H. β . ———
pyrenæica. E.B.	heart-leaved.	cord. serr. upp. pinn.	ros.	5. 6.	Scotland.	H. β . ———
rùbra. E.Fl.	red.	ov. lanc. sub. ent.	red.	6. 10.	England.	H. β . ———

[3-sided, 3-furrowed,

STREPTANTHERA, STREPTANTHERA. *Spatha 2 valved. Perianth. 6-parted, rotate. Ovarium*

cùprea. B.F.G.	copper-color'd.	ens. striat.; sep. 2-4 fld. y.c.	6. 7.	C. B. S.	1825.	F. β .	Sandy loam.
élegans. B.F.G.	elegant.	ens. obt. nerv.; scp. 1-2-fld. w. y.	—	—	—	F. β .	offsets.

VALERIANELLA, VALERIANELLA. *Cal. minute. Cor. of 1-petal, 5-cleft, regular. Caps. 3-cell'd.*

dentàta. DC.	oval-fruited.	lin.; st. smth.; caps. ov. pur.	4. 8.	Britain.	H. α .	Sandy soil.
<i>Valeriána dentàta. E.B.</i>							
olitària. DC.	Lamb's-Lettuc.	lin. obt.; caps. infl. pale bl.	—	Britain.	H. α .	Seeds.
<i>Valeriána locústa. E.B.</i>							

CROCUS, CROCUS. *Cal. tubular, 1-flowered. Cor. 6 equal segments. Capsule 3-celled.*

biflòrus. H.K.	two-flowered.	longer than the flowers.	wh.	2. 3.	Crimea.	1629.	H. β . Sandy loam.
nudiflòrus. E.K.	naked.	stig. 3seg. tu. cor. 1ft. long. vi.	10. 11.	England.	H. β .	offsets from
susiánus. H.K.	Cloth of Gold.	segm. of cor. revol. ye. pur.	2. 3.	Turkey.	1609.	H. β .	bulbs.
satùrus. E.Fl.	saffron.	stig. 3-lin. notch. segm. pur.	9. 10.	England.	H. β .	—
sulphùreus. H.K.	sulphur-color'd.	stig. proj. beyond ant. yel.	2. 3.	S. Europ.	1629.	H. β .	—
serotinus. H.K.	late-flowered.	appear with flwrs. stig. div. rio.	9. 11.	—	—	H. β .	—
vèrnus. E.Fl.	spring.	stig. 3-jagged lobes. pur. wh.	2. 4.	England.	H. β .	—

TRICHONEMA, TRICHONEMA. *Cal. of 2 leafy valves. Cor. 6-parted. Stigma deeply divided.*

Bulbocòidium. E.Fl.	channel-leav'd.	lin. chann. 3-4 inch long. pur.	3. 4.	S. Europ.	1739.	H. β .	Light loam.
caulèscens. B.M.	caulescent.	furrowed. smth. lin. yel.	6. 7.	C. B. S.	1810.	H. β .	offsets.
ròseum. B.M.	Rose-coloured.	filif.; scapes 1-flower'd. pk.	—	—	1808.	F. β .	—

[rowed. Stigmas 3-equal.

IRIS, FLOWER-DE-LUCE. *Cal. of 2 leafy valves. Cor. of 6 unequal segments. Germen oblong, 3-fur-*

aphylla. B.M.	naked-stalked.	ens. smth.; scp. many-fl. p. w.	5. 6.	Dauria.	1748.	H. β .	Sandy loam.
arenària. B.R.	sand.	ensif.; scape 2-flower'd. yel.	—	Hungary.	1802.	F. β .	divided at
biflòra. R.S.	two-flowered.	ensif. short; scp. 3-fld. vi. pu.	4. 9.	S. Europ.	1596.	H. β .	the roots.
crisàta. B.M.	crested.	scp. 1-fld.; long as leaves. bl. y.	5.	N. Amer.	1756.	H. β .	—
dichòtoma. B.R.	forked.	ensif. smth.; scp. 2-4-fld. pur.	6. 8.	Dauria.	1784.	H. β .	—
fætidissima. E.Fl.	stinking.	ensif.; stem angled. pur.	6.	Britain.	H. β .	—
florentina. w.	Florentine.	ensif. smth.; scp. 2-fld. wh.	5. 6.	S. Europ.	1596.	H. β .	—
fùlva. B.M.	copper-colour'd.	ensif. smooth. cop.	6. 7.	N. Amer.	1812.	H. β .	—
fimbriàta. v.	fimbriated.	ensif. smth.; scp. many-fld. bl.	5. 6.	China.	1792.	H. β .	—
flavissima. w.	bright-yellow.	ensif. smth.; scp. 2-fld. yel.	—	Siberia.	1814.	H. β .	—
graminea. B.M.	Grass-leaved.	lin. smth.; scp. 2-fld. p. bl.	6.	Austria.	1597.	H. β .	—
germànica. H.K.	German.	ensif. smth.; scp. many-fl. bl.	5. 6.	German.	1572.	H. β .	—
lusitànica. H.K.	Portuguese.	chann.; scape 2-fld. yel.	4. 5.	Portug.	1596.	H. β .	—
lutèscens. w.	pale-yellow.	ensif.; scape 1-flower'd. yel.	—	German.	1748.	H. β .	—
nepalènsis. B.F.G.	Nepaul.	lin. ensif. nerv. li.	6. 7.	Nepaul.	1824.	H. β .	—
ochroleuca. B.M.	sulphur-color'd.	ensif. striat.; scp. 3-fld. str.	7.	Levant.	1757.	H. β .	—
Pseudò-àcorus. E.Fl.	yellow-water.	ensif. ribb.; cor. naked. ye.	6.	Britain.	H. β .	—

SCHÆNUS, BOG-RUSH. *Spike of 1-3-flow. Cor. 0. Glumes 2 ranked. Style simple at base. Stigm. 3.*

nìgricans. E.Fl.	black.	st. naked, head roundish.	7.	Britain.	H. w. β .	Loam. parting at roots.
------------------	--------	---------------------------	----	----------	------	-----------------	-------------------------

Systematic Name.	English Name.	Form of Leaves, &c.	Col. of Flow.	Month of Fl.	Native of Fl. Country.	Yr. of Introd.	Soil and Propagation.
RHYNCHO'SPORA, RYNCHO'SPORA. <i>Spike of few flowers. Cor. 0. Glume imb. concave. Fil. 1-3.</i>							
álba. E.Fl.	white.	taper.lin.; sp.slend. in a cory.	8.	Britain.	...	H.w. \mathfrak{P} .	Peat & loam.
fúscá. E.Fl.	brown.	filif.; brist. 3-6. glume shin. br.	—	—	...	H.w. \mathfrak{P} .	parting at root.
CYPERUS, CYPERUS. <i>Spike of many fl. Cor. 0. Glu. imbr. Style simple at the base. Stigma 2-3.</i>							
fúscus. E.Fl.	brown.	stem triang.; sp. crowded.	7.	9. England.	H. \mathfrak{A} .	Sandy soil.
lóngus. E.Fl.	sweet.	st. 3-sided; sp. alt. 5-6 tog.	7.	—	...	H.w. \mathfrak{P} .	Seed, or divided plant.
SCIRPUS, CLUB-RUSH. <i>Spike of many flowers. Cor. 0. Fil. flat. Style divid. Stigma 2-3, downy.</i>							
cæspitósus. E.Fl.	scaly-stalked.	st. striat.naked; sp. red.sol.	7.	Britain.	...	H.w. \mathfrak{P} .	Loam and peat.
caricínus. E.Fl.	compressed.	lin.flat; sp. aggr. many-fl'd.	—	—	...	H.w. \mathfrak{P} .	peat.
carinátus. E.Fl.	blunt-edged.	st. triang.naked; sp.ov.num.	7.	8. —	...	H.w. \mathfrak{P} .	dividing
glaucus. E.Fl.	glaucous.	st. glauc. naked; sp. croud.	—	—	...	H.w. \mathfrak{P} .	plants at
lacústris. E.Fl.	Bull-rush.	1 or 2 at base; pan.cym.; sp.ov.	7.	—	...	H.w. \mathfrak{P} .	root.
marítimus. E.Fl.	salt-marsh.	st. triang.; sp. ov. croud.	7.	9. —	...	H.w. \mathfrak{P} .	—
pauciflórus. E.Fl.	few-flowered.	sp. of few flowers; glu. obt.	8.	—	...	H.w. \mathfrak{P} .	—
rúfus. E.Fl.	brown.	chann.smth.; sp. aggr. few-fl.	6.	7. —	...	H.w. \mathfrak{P} .	—
sylváticus. E.Fl.	wood.	keel'd; st. triang.; sp. aggr.	7.	9. —	...	H.w. \mathfrak{P} .	—
tríquetér. E.Fl.	triangular.	st. triang. naked; sp. lateral.	8.	—	...	H.w. \mathfrak{P} .	—
ELEO'CHARIS, ELEO'CHARIS. <i>Cor. 0. Germ. compr. Sty. dilat. at base. Stig. 2-3. Seed crowded.</i>							
aciculáris. E.Fl.	least spike rush.	st. 4-sided, smth.; sp. 5-6 fl.	7.	8. Britain.	...	H.w. \mathfrak{P} .	Peat and loam.
flúitans. Br.Fl.	floating.	awl-shap. keel'd; sp. few fl.	—	—	...	H.w. \mathfrak{P} .	loam.
multicáulis. E.Fl.	many-stalked.	st. round, 1-2 shths. at base.	6.	7. —	...	H.w. \mathfrak{P} .	parting at
palústris. E.Fl.	creeping.	sp. $\frac{1}{2}$ in. long, acute; stig. 2.	—	—	...	H.w. \mathfrak{P} .	root.
<i>[obovate. Style 1. Stigmas 3, downy.</i>							
ERIO'PHORUM, COTTON-GRASS. <i>Spike of many flowers. Glume imbricated. Cor. 0. Germen</i>							
angustifólium. E.Fl.	narrow-leaved.	lin. triang.; glume pointed.	4.	5. Britain.	...	H.w. \mathfrak{P} .	Loam and peat.
alpínum. B.Fl.	Alpine.	chann.; st. triang.; sp.ov. ob.	—	Scotland.	...	H.w. \mathfrak{P} .	peat.
capitátum. E.Fl.	round headed.	lin. awl-sh.; st. round; gl. rib.	8.	9. —	...	H.w. \mathfrak{P} .	dividing at
grácile. E.Fl.	slender.	lin. trian.; st. slightly so; sp. 3-4.	7.	8. —	...	H.w. \mathfrak{P} .	root.
pubéscens. E.Fl.	downy-stalked.	lanc.flat; sp. from 2 to 8 or 9.	4.	5. Britain.	...	H.w. \mathfrak{P} .	—
polystáchion. E.Fl.	broad-leaved.	lanc.flat; sp. stalks smth.	4.	—	...	H.w. \mathfrak{P} .	—
vaginátum. E.Fl.	hare's-tail.	st. joint triang. obov.; sp.ov. 3.	4.	—	...	H.w. \mathfrak{P} .	—
NARDUS, MAT-GRASS. <i>Cal. 0. Cor. of 2 concave valves. Germ. obl. Style 1. Stigma feathery.</i>							
strícta. B.Fl.	common.	st. & lvs. furr.; sp. sing. many-fl.	6.	7. Britain.	...	H.w. \mathfrak{P} .	Sandy soil. parting plant.

ORDER II.

DIGYNIA. STYLES 2.

<i>[thery. Seeds ovate.</i>							
PHA'LARIS, CANARY-GRASS. <i>Cal. 1-flowered. Cor. of 3 valves. Styles short. Stigmas long, fea-</i>							
arundinácea. B.Fl.	Reed.	Panic; erect. flor. clust.	7.	8. Britain.	...	H. \mathfrak{P} .	Seeds.
aquática.	water.	Panic; sp.obl.ov. Glu.tooth.	6.	7. Egypt	1778.	H. \mathfrak{A} .	Sandy soil.

Systematic Name.	English Name.	Form of Leaves, &c.	Co. of Flow.	Month of Fl.	Native Country.	Yr. of Introd.	Soil and Propagation.
bulbósa.	bulbous.	Pan.beardl.; sp. round.	—	Spain.	1824.	H. P.	Seeds.
canariénsis. B.Fl.	manured.	Panic. ov. like a spike.	6.	8.	Britain.	H. A. —
paradóxa. R.S.	paradoxical.	Panic.; spike round, bristly.	6.	7.	S. Europ.	1824.	H. A. —
seminéutra. R.S.	half-barren.	Panic.diff.Glum.acute.	—	—	Hungary.	1813.	H. P. —

[roundish. Styles spr. Stigma feathery.

PHLEUM, CAT'S-TAIL-GRASS. Cal. of 2 nearly equal valves. Cor. of 2 unequal valves. Germen

alpinum. E.Fl.	Alpine.	Pan.sp.ov.obl.Cal.fring.	7.	Scotland.	H. P.	Light loam.
arenarium. E.F.	sea.	sp.ov.lanc.obt.Cal.glu.fr.	6.	7.	Britain.	H. A. Seeds, or
ásperum. B.Fl.	rough.	Panic.round.Cal.glu.mucl.	7.	—	H. A.	division of
Bæhméri. E.F.	purple-stalked.	Panic.cylind.lob.glu.lin.	7.	9.	England.	H. P. plant.
Michélli. B.Fl.	Michelian.	Pan.sp.1-3-in.long.Cal.gl.lan.	6.	7.	Scotland.	H. P. —
* pratense. B.Fl.	Timothy-grass.	Cal. glu. trun. awn.	6.	Britain.	H. P.	—
1 minor.	lesser.	—	—	—	H. P.	—
2 major.	greater.	—	—	—	H. P.	—

[Style short. Stigma downy.

KNAPPIA, KNA'PPIA. Cal. 2, nearly equal concave valves. Cor. 2, unequal valves. Germen small.

agrostídea. E.Fl.	early.	stem trian.; sp.of 6to10fl.	3.	7.	Wales.	H. A. Sandy soil. Seeds.
-------------------	--------	-----------------------------	----	----	--------	------	--------------------------

[feathery. Seed loose.

POLYPOGON, BEARD-GRASS. Cal. of 2 valves, awned. Cor. of 2 valves. Style short. Stigma

littoralis. B.Fl.	perennial.	rough; st.smth.decum.Pa.lob.	8.	Britain.	H. P.	Sandy loam.
monspeliénsis. B.Fl.	annual.	acut.striat.Panic.silky like.	7.	8.	—	H. A. Seeds, or di-vid. plant.

[united. Stigma spreading. Seed ovate, smooth.

ALOPECU'RIS, FOX-TAIL-GRASS. Cal. of 2 acute valves. Cor. of 1 valve awned at the base. Style

alpinus. B.Fl.	Alpine.	lin. Cal. glum.fring.3-ribb.	5.	6.	Scotland.	H. P. Light soil.
agrésis. B.Fl.	slender.	sp.slen.cal.glum.unit.atbase.	7.	8.	Britain.	H. A. Seeds, or
bulbósus. E.Fl.	bulbous.	striat.con.; sp.rac.Cal.gl.lin.	6.	—	H. P.	parting roots
fúlvus. E.Fl.	Orange-spiked.	sp.3-in.long, pan.Cal.gl.unit.	7.	—	H. w. P.	—
geniculátus. B.Fl.	jointed.	sp.1½in.long, pan.Cal.gl.un.	5.	8.	—	H. w. P. —
* praténsis. E.B.	meadow.	gl.; st.erec.smth.Cor.of 5ribs.	5.	—	H. P.	—
utriculátus. Fl.Gr.	bladdered.	Rac.; sp.ov.Glu.hairy at keel.	7.	8.	Italy.	1777.	H. P. —

[at each end. Style short. Stigma feathery.

AGROS'TIS, BENT-GRASS. Cal. of 2 acute, awnless, valves. Cor. of 2 unequal valves. Anthers divided

álba. H.G.W.	white.	Pa.br.his.out.val.of Cor.5-n.	8.	9.	Britain.	H. P. Sandy loam. Seeds, or
purpuráscens, purpurascens.	—	—	—	—	—	—	—
canína. B.Fl.	brown.	Pan.br.erect,spr.Ca.va.une.	6.	7.	Britain.	H. P. parting
retrofrácta. W.en.	retrofracted.	Panic.spread.Paleæ hairy.	8.	9.	N.Holl.	1806.	H. P. plant.
setácea. E.B.	bristly.	Pan.dens.Cal.va.une.lanc.	—	—	Britain.	H. P. —
spíca-vénti. Br.Fl.	windward-spik.	Pan.spr.val.une.rough.	6.	7.	—	H. A. —
* stolonífera. E.B.	creeping.	Pan.cont.clust.Glu.pub.	—	—	H. P.	—
1 angustifólia.	narrow-leaved.	—	—	—	H. P.	—
2 aristáta. H.G.W.	awned.	—	—	—	H. P.	—
3 * latifólia.	broad-leaved.	—	—	—	H. P.	—
4 nemorális.	grove.	—	—	—	H. P.	—
5 palustris.	marsh.	—	—	—	H. P.	—
vulgáris. E.B.	common.	Pan.spr.out-val.cor.3-n.	6.	7.	—	H. P. —

Those marked with an Asterisk, are recommended by Mr. Sinclair, in his "Hortus Gramineus Woburnensis," as the grasses best adapted for permanent pastures, and containing the greatest quantity of nutritive matter.

Systematic Name.	English Name.	Form of Leaves, &c.	Col. of Flow.	Month of Native Fl. Country.	Yr. of Introd.	Soil and Propagation.
TRICHODIUM, WINTER-GREEN-GRASS. <i>Glu. 2-valv. 1-fl. Palea beard, shorter than glumes.</i>						
alpinum.	alpine.	rough on both sid.	Cal. ov.	7.	Europe.	1821. H. P. Light loam.
rúbrum.	red.	glau.	Pan. obl. in clus.	7. 8.	—	H. P. seeds.
[valves. Germen ovate. Style distinct.						
CYNODON, DOG'S TOOTH-GRASS. <i>Cal. of 2 keeled awnless valves. Cor. of 2 unequal, compressed</i>						
Dáctylon. E. Fl.	creeping.	taper. rib. glau.; sp. 4-5-toge.		7. 8.	England. H. P. Sandy loam.
lineáris. W. en.	linear-leaved.	sp. digit. 4; Glum. erect.		—	E. Ind. S. P. seeds.
[ments longer than the glume.						
DIGITARIA, FINGER-GRASS. <i>Cal. of 2-3 unequal awnless valves. Cor. of 2 unequal valves. Fila-</i>						
sanguinális. E. Fl.	Cock's-foot.	hairy; sp. 3-8 alt. in pairs.		8.	Britain. H. A. Light soil.
villósa. P. s.	villous.	sheat. hairy; sp. many-setac.		—	N. Amer.	1781. H. A. seeds.
[acute valves. Style awl shaped. Stigma short tuft.						
PANICUM, PANICK-GRASS. <i>Cal. of 2 unequal ribbed valves. Cor. of the perfect floret of 2 unequal</i>						
clandestinum. w.	hidden-flow'd.	st. dich. Panic. of few flowers.		7.	N. Amer.	1802. H. P. Loam.
latifólium. w.	broad-leaved.	ov. lan. amp. Panic. spread.		8. 9.	—	1765. H. P. seed.
Crus-gállí. B. Fl.	loose.	lanc. Panic. bristly, awned.		7. 8.	England. H. A. —
CATABRO'SA, WHORL-GRASS. <i>Cal. of 2-val. obt. Cor. 2-val. ribbed, trunc. awnless, nearly equal.</i>						
aquática. B. Fl.	water.	flat. Panic. spread, awnless.		—	Britain. H. w. P. —
[notched. Style short. Stigma large.						
AIRA, HAIR-GRASS. <i>Cal. of 2 keeled valves. Cor. of 2 oblong valves. Nect. a cloven scale. Anthers</i>						
álba.	white.	lin. Panic. spread. awnd.		5. 6.	Spain.	1829. H. P. Loamy soil.
alpína. B. Fl.	Alpine.	awl-shap. inv. Pan. erect. awn.		—	Scotland. H. P. seeds, or
caespitósa. E. B.	turfy.	flat. fur. Sti. often clo. Pan. sp.		8.	Britain. H. P. dividing
canéscens. Br. Fl.	grey.	tri. Pan. 1-2 in. long. aw. cl. sh.		7. 8.	— H. P. plants.
caryophýllea. B. Fl.	silvery.	Pan. spr. 3-fork. florets short.		—	— H. A. —
flexuósa. Br. Fl.	wavy.	glau. Pan. spr.; fl. awnless.		—	— H. P. —
præcox. Br. Fl.	early.	Pan. few-fl'd. awn-twisted.		5. 6.	— H. A. —
[each floret. Style short. Stigma large, feathery.						
HOLCUS, SOFT-GRASS. <i>Cal. of 2 unequal awnless valves. Cor. of 2 unequal valves. Filaments 3 in</i>						
*avenáceus. E. B.	Oat-like.	Cal. smth. barr.; fl. awn. fer. sli.		6. 7.	Britain. H. P. Sandy loam.
*lanátus. B. Fl.	meadow.	down. on both sid. Cal. woolly.		—	— H. P. seeds.
móllis. E. Fl.	soft.	slig. dow. Cal. ner. sm.; fl. aw.		7. 8.	— H. P. —
[Germen round. Style long. Stigma short.						
MELICA, MELIC-GRASS. <i>Cal. of 2-concave, awnless, ribbed valves. Cor. of 2 unequal oblong valves.</i>						
altíssima. Hos. gr.	tall.	Pan. bran.; sp. 3-flower'd.		7. 8.	Siberia.	1770. H. P. Light loam.
Baubíni. W. en.	Italian.	spik. 3-flower'd. Pan. spr.		6. 7.	Italy.	1806. H. P. seeds.
ciliáta. w.	ciliated.	Pan. equal; spik. erect.		7.	Europe.	1771. H. P. —
caerúlea. B. Fl.	purple.	acu. rough. Pa. obl. erect.		8.	Britain. H. P. —
nútans. E. Fl.	mountain.	Pan. rac. droop. Stip. short.		6. 7.	— H. P. —
pyramidális.	pyramidal.	spik. droop. glauc. acute.		—	Barbary.	1804. H. P. —
uniflóra. E. Fl.	wood.	Pa. droop. to 1-sid.; sp. erect. ov.		5. 6.	Britain. H. P. —
SETARIA, SETARIA. <i>Panicle in a close round spike. Cal. 2-valved, 2-flowered. Florets 1-2-valved.</i>						
glaúca. Host. Gr.	glaucous.	Rac.; sp. Inv. 2-flow'd. hairy.		7. 8.	S. Europ. H. A. Light loam.
goniculáta. R. s.	jointed.	sp. elon. cyl. Inv. 2-fl'd. brist.		7.	1805.	H. A. seeds.
itàlica. R. s.	Italian.	spik. comp.; spikel. heap.		8.	India.	1816. H. A. —

Panicum italicum. Host. gr.

Systematic Name.	English Name.	Form of Leaves, &c.	Col. of Flow.	Month of Fl.	Native Country.	Yr. of Introd.	Soil and Propagation.
sericea. R.S.	silky.	flat; sp. round.	Inv. vil. 1-fl'd.	5. 8.	W. Ind.	— H. A.	—
viridis. Br. Fl.	green.	Panic. ; spik.	Invol. bristly.	7. 9.	Britain.	— H. P.	—
<i>Panicum viride.</i> E. B.							
verticillata. Br. Fl.	rough.	Pan. ; sp. & lob.	Inv. brist.	8. 9.	—	— H. A.	—
<i>Panicum verticillatum.</i> E. B.							

[Style a little united. Stigma long, downy.

SESLERIA, MOOR-GRASS. Cal. of 2 equal valves, containing 2-3 perfect florets. Germs small.

cærúlea. B. Fl.	blue.	rec. str. 1-rib. ; sp. obl. imbr.	4. 5.	Britain.	H. P.	Sandy soil.
elongata. Host.	long-spiked.	spik. 3-fl'd. out. palea 3-5 bear.	—	German.	1805.	H. P.	parting
tenuifolia. R.S.	slender-leaved.	Pan. clustered.	—	S. Europ.	1818.	H. P.	plants.

[florets, 3 in each barren one.

HIERO'CHLOE, HOLY-GRASS. Cal. of 2 unequal keeled valves. Cor. of 2 valves. Fil. 2 in perfect

borealis. B. Fl.	Northern.	flat, edg. rough, Pa. erect. sec.	5. 6.	Scotland.	H. P.	—
<i>Holcus odoratus.</i> L.							
frágans.	fragrant.	lin. nerv. Pan. clust.	—	N. Amer.	1777.	H. P.	—

[Stig. spreading.

GLYCERIA, SWEET-GRASS. Cor. of 2 uneq. valves. Fil. longer than the cor. Ger. ovate. Style dist.

aquática. E. Fl.	reedy.	1-rib. lin. spik. of 5-10 flor.	7.	Britain.	H. w. P.	Loam. seeds, or
<i>Poa aquática.</i> E. B.							
flúitans. E. Fl.	floating.	Pan. obl. erect. flor. num. 7-rib.	5. 8.	—	H. w. P.	parting plants.
<i>Poa flúitans.</i> E. B.							
dístans. E. Fl.	reflexed.	Pan. branc. flor. 5, obt. 5-ribb.	7.	—	H. w. P.	—
<i>Poa distans.</i> E. B.							
marítima. E. Fl.	sea.	inv. acut. flor. 5, slight. 5-ribb.	—	—	H. w. P.	—
<i>Poa marítima.</i> E. B.							
procúbens. E. Fl.	procumbent.	flat, rough, sm. ben. flo. 5; 5-rib. 7. 8.	—	—	H. A.	—
<i>Poa procúbens.</i> E. B.							
rígida. E. Fl.	hard.	Pan. lanc. 2 rank. flor. 7.	6. 7.	—	H. A.	—
<i>Poa rígida.</i>							

[Seed elliptic, oblong.

POA, MEADOW-GRASS. Cal. of 2 uneq. awnl. keel. valves. Ger. ovate. Style short. Stig. feathery.

alpína. B. Fl.	Alpine.	spik. cor. 4-5-fl'd. Glu. keel'd.	6. 7.	Scotland.	H. P.	Light loam.
* angustifolia. DC.	narrow-leaved.	Pan. diffuse, spikel 4-flow'd.	—	—	H. P.	seeds, or
* ánnua. B. Fl.	annual.	spikel. ov. 5-flow'd. fl. 5-ribb.	1. 12.	Britain.	H. A.	parting
bulbósa. E. Fl.	bulbous.	ser. spikel. 4-flow'd. Stip. lan.	5. 6.	—	H. P.	plants.
cær'sia. E. B.	sea-green.	spikel. ov. 5-flow'd. Glu. lan.	—	—	H. P.	—
comprésa. E. Fl.	flat-stemmed.	fla. stalk. Ca. gl. 3-ri. fl. 3	8 or 9.	6. 8.	—	H. P.	—
festucæfórmis.	Fescue-like.	lin. nerv. Pan. clust.	—	Dalmatia.	1800.	H. P.	—
glauca. E. B.	glaucous.	lin. flat, 1-ribb. ; fl. 2-5.	6. 7.	Britain.	H. P.	—
láxa. w.	wavy.	Pan. droop. spik. 3-fl'd. St. lan.	7.	Scotland.	H. P.	—
* nemoralis. w.	wood.	Panic. spread. ; fl. 3-5 ribb.	6.	Hungar.	1824.	H. P.	—
* nervata. w.	nerved.	spikel. ov. 5-flow. ; stem furr.	6. 7.	N. Amer.	1812.	H. P.	—
* pratensis. B. Fl.	smooth-stalked.	Pan. spr. spikel. 4-fl. ; fl. 5-rib.	5. 6.	Britain.	H. P.	—
* trivialis. E. B.	roughish.	spikel. 3-fl. ; flor. lan. 5-ribb.	6. 8.	—	H. P.	—

TRIO'DIA, HEATH-GRASS. Cor. orbicular, slight. ribb. with 2 uneq. concave val. Ger. flat. Seed ov.

decúbens. R. Br.	decumbent.	lin. smth. glau. Stip. hair. ; fl. 4.	7. 8.	Britain.	H. P.	—
<i>Poa decúbens.</i> L.							

TRIANDRIA DIGYNIA.

Systematic Name.	English Name.	Form of Leaves, &c.	Col. of Month of Flow.	Native Country.	Yr. of Introd.	Soil and Propagation.
BRIZA, QUAKING-GRASS. <i>Cal. of 2 obt. valv. Cor. 2 awnl. valv. Nect. a clov. scale. Ger. ov. Seed flat.</i>						
mínor. B.Fl.	small.	spik. trian. 7-fl.; stip. lanc.	7.	England.	H. A. Sandy soil.
média. B.Fl.	common.	spik. ovat. 7-flow.; stip. obt.	5. 6.	Britain.	H. P. seeds.
máxima. R.S.	great-spiked.	pan. nodd.; spik. cord. 13-17-fl.	6. 7.	S. Europ.	1633.	H. A. ———
DA'CTYLIS, COCK'S-FOOT-GRASS. <i>Cal. of 2 comp. valves. Cor. awned, keeled, [Seed loose, oblong, inner valve folded.]</i>						
cynosuróides.	Dog's tailed.	elong. glauc. spik. alt.	6. 8.	E. Ind.	1823.	S. P. Light loam.
* glomeráta. E.Fl.	rough.	lin. acu.; pan. alt. branc.; fl. cr.	6. 7.	Britain.	H. P. seeds, or
glaucescens.	glaucous.	Pan. clust. valv. awn.	—	Switz.	1818.	H. P. dividing
hispánica. W.en.	Spanish.	pan. 1-sid.; spik. 3-flow'd.	—	Spain.	1814.	H. P. plants.
littorális.	shore.	Pan. clust. fl. awn.	—	S. Europ.	1816.	H. P. ———
SPARTINA, CORD-GRASS. <i>Cal. 1-flow. Cor. 2, lanc. awnless valves. Style united. Stig. slender. [Seed oblong, compressed.]</i>						
stricta. E.Fl.	twin-spiked.	keel'd. chann.; spik. 2-3-erect.	8.	Britain.	H. P. ———
CYNOSURUS, DOG'S-TAIL-GRASS. <i>Cal. of 2 equal 1-ribb. awn. valves. Cor. of 2 uneq. lanc. valves. [Seeds furrowed.]</i>						
* cristátus. E.B.	crested.	sp. erect. lin. 2-in. lon.; stip. shor.	8.	Britain.	H. P. Sandy loam.
echinátus. E.B.	rough.	spike ov.; spikel. awned.	—	—	H. A. seeds.
erucæfórmis. H.G.W.	linear-spiked.	spik. comp.; spiklts. scatt.	—	Germany.	H. P. ———
FESTUCA, FESCUE-GRASS. <i>Cal. of 2 conc. valves. Cor. of 2 uneq. conc. valves. Sty. short. Stig. feat.</i>						
bromoídes. E.B.	barren.	pan. racem.; fl. tapering.	7.	Britain.	H. A. Sandy loam.
calamária. B.Fl.	reed.	lin. ere. stri. 6-18 in. lon.; fl. 2-5.	7. 8.	—	H. P. parting at
Cámbrica. H.G.W.	Welsh.	flat.; pan. obl.; spikel. awl-sh.	—	—	H. P. root, or
* duriúscula. B.Fl.	hard.	com. acut.; stip. clov.; fl. long.	6. 7.	—	H. P. seeds.
dumetórum. H.G.W.	pubescent.	filif. panic.; spike pub.	—	Europ.	H. P. ———
elátior. B.Fl.	tall.	lin. lan.; pa. droop.; fl. num.	—	—	H. P. ———
<i>β fertilis.</i> H.G.W.	<i>fertile.</i>	pan. lax.; spikel. 5-flower'd.	—	Germany.	H. P. ———
flavescens. DC.	yellowish.	pan. spr.; sp. obl. ou. val. of gl. cil.	—	Switzerl.	1818.	H. P. ———
<i>β sterilis.</i>	<i>barren.</i>	—	—	—	H. P. ———
* glábra. H.G.W.	smooth.	pan. bran. com.; spikel. 4-6-fl.	—	Britain.	H. P. ———
glaúca. P.S.	glaucous.	awl-sh.; spikel. 5-fl. sub-bear.	6.	S. Europ.	H. P. ———
loliácea. B.Fl.	spiked.	li. flat.; sp. 2ran. droop.; fl. 10-12	6. 7.	Britain.	H. P. ———
Myúrus. B.Fl.	wall.	awl-sh.; pa. dr.; flo. taper. at top.	6.	—	H. A. ———
ovína. E.Fl.	sheeps.	lin. fold; pan. erect; flo. 4-5-aw.	—	—	H. P. ———
<i>β hordeiformis.</i> H.G.W.	<i>long-awn'd.</i>	—	—	—	H. P. ———
pannónica. R.S.	Hungarian.	pan. obl.; spikel. 7-fl. hairy.	6. 7.	Hungary.	1823.	H. P. ———
* praténsis. B.Fl.	meadow.	pan. nearly erect.; spikl. com.	—	Britain.	H. P. ———
pinnátum. E.F.	heath.	smth.; sp. erect. 2ran. aw. shor.	6. 8.	England.	H. P. ———
rúbra. H.Fl.Sc.	creeping.	inv. down. obo.; flor. long.	7.	Britain.	H. P. ———
sylvaticum. E.F.	wood.	hair; sp. droop. aw. lon. than gl.	6. 8.	—	H. P. ———
uniglúmis. B.Fl.	single-husked.	pan. erect.; flor. tap. comp. awn.	6. 7.	—	H. A. ———
vivípara. E.Fl.	viviparous.	inv. smth.; flor. com. keel. awnl.	6.	—	H. P. ———
BROMUS, BROME-GRASS. <i>Spikel. imbr. with perfect florets. Cor. of 2 conc. valves, a little ribbed.</i>						
arvénsis. B.Fl.	field.	many-rib. hair; pa. droo. 1/2 who.	6. 8.	Britain.	H. P. Loam.
ásper. B.Fl.	rough.	a ft. lon. pan. droop. 1ft. in len.	7.	—	H. P. seed, or
diándrus. B.Fl.	wall.	pan. erect; spikl. erect.; fl. 2-ri.	6. 8.	—	H. A. parting
erctus. E.Fl.	upright.	nar. frin.; pan. erect; flo. 8-imb.	6.	—	H. P. roots.

TRIANDRIA DIGYNIA.

19

Systematic Name.	English Name.	Form of Leaves, &c.	Col. of Flow.	Month of Fl.	Native Country.	Yr. of Introd.	Soil and Propagation
<i>gigánteus</i> . B.Fl.	tall.	lin. lan.; pan. droop. to 1 side.	5. 7.	Britain.	H. P.	—
<i>móllis</i> . E.Fl.	soft.	<i>spikl.</i> ov. com.; <i>fl.</i> imbr. 5-10.	—	—	H. P.	—
<i>montánus</i> . R.S.	mountain.	pan. nod.; <i>spikl.</i> comp. nak.	7. 8.	Switzerl.	1827.	H. P.	—
<i>racemósus</i> . B.Fl.	smooth.	pan. erect.; <i>spikl.</i> ov. smth. imb.	6. 8.	England.	H. A.	—
<i>secalinus</i> . B.Fl.	smooth-rye.	pan. spr.; <i>spikl.</i> ob.; <i>fl.</i> 10, sm.	—	—	H. A.	—
<i>squarrósus</i> . B.Fl.	corn.	pan. droop.; <i>spikel.</i> ov. lanc.	—	—	H. P.	—
<i>stérilis</i> . E.Fl.	barren.	pan. droop.; <i>spikel.</i> lin. lanc.	6. 7.	Britain.	H. A.	—
<i>velutinus</i> . E.Fl.	downy-rye.	<i>spikel.</i> ov. obl.; <i>fl.</i> 10-15.	6. 8.	—	H. A.	—
AVENA, OAT-GRASS. <i>Cal. of 2 awn. valves. Cor. of 2 uneq. valves. Ger. obt. Sty. short. Stig. feuth.</i>							
<i>alpina</i> . E.Fl.	Alpine.	<i>spikel.</i> 5-6-flowered.	6.	Britain.	H. P.	Sandy loam.
* <i>flavescens</i> . B.Fl.	yellow.	pan. lax.; <i>spikel.</i> 3-flow'd.	—	—	H. P.	seeds.
<i>fátua</i> . B.F.	wild.	<i>spikel.</i> droop.; <i>flor.</i> 3-rough.	8.	Britain.	H. A.	—
<i>pubescens</i> . E.Fl.	pubescent.	pan. erect.; <i>spikel.</i> 3-flow'd.	—	—	H. P.	—
<i>púmila</i> .	dwarf.	awl-sh. stm. ang; pan. clos.	5. 6.	Africa.	1824.	H. P.	—
* <i>praténsis</i> . B.F.	narrow-leaved.	rac. erect.; <i>spikl.</i> of 3-5 flor.	6. 7.	—	H. P.	—
<i>panicúlmus</i> . B.Fl.	flat-stemmed.	<i>spikel.</i> lin. obl. of 5-7 florets.	—	—	H. P.	—
<i>strigósa</i> . E.B.	bristle-pointed.	pan. erect.; <i>flor.</i> with long awn.	7. 8.	—	—	H. A.	—
TRISE'TUM, TRISE'TUM. <i>Glumes longer than the florets, 2-7-flowered. Under Paleæ with 2 bristles.</i>							
<i>airoídes</i> . Host. Gr.	Aira-like.	<i>pa. spi.</i> ; beard refl. lon. than gl.	—	Switzerl.	1800.	H. A.	Loam.
<i>Pensylvánicum</i> . R.S.	Pennsylvanian.	pan. slen.; <i>glu.</i> 2-fl'd.; seed vill.	—	N. Amer.	1785.	H. A.	seeds.
<i>Loeflingiánum</i> . R.S.	Loefling's.	pan. 1-sid. <i>spikel.</i> 2-fl'd.	—	S. Europ.	1770.	H. A.	—
ERAGRO'STIS, LIVE-GRASS. <i>Panic. compound. Glume 4-10-flowered. Seed loose, 2-horned.</i>							
<i>capilláris</i> . Lk.	capillary.	pan. lax. spread. capillary.	—	N. Amer.	1781.	H. A.	Sandy soil.
<i>Póa capilláris</i> . R.S.							seeds.
<i>cynosuroídes</i> . R.S.	Dog's-tail.	Pan. clust. valv. awn.	8.	Egypt.	1824.	H. A.	—
<i>Póa cynosuroides</i> . W.							
<i>purpuráscens</i> . R.S.	purple.	pan. erect; fl. stalks stiff.	7. 8.	1822.	H. A.	—
<i>pilósa</i> . Host. Gr.	hairy.	pan. equal; <i>spikel.</i> 7-fl'd.	—	Italy.	1804.	H. A.	—
<i>tenélla</i> . R.S.	slender.	pan. whorl; florets 6-fl'd.	—	E. Ind.	1781.	S. A.	—
PA'SPALUM, PA'SPALUM. <i>Glume 2-valved, 1-flowered. Seed coated with the Paleæ.</i>							
<i>disséctum</i> . L.	dissected.	<i>sp.</i> alt. fl. alt. apex pil.	6. 7.	America.	1822.	H. A.	Sandy loam.
<i>plicátum</i> . Mich.	plaited.	<i>sp.</i> alt. erect; <i>glume</i> ov.	—	—	H. A.	seeds, or
<i>serotínium</i> . R.S.	decumbent.	<i>sp.</i> 5-tog.; <i>glumes</i> ellip. lanc.	—	N. Amer.	1804.	H. P.	parting at
<i>villósum</i> . Pers.	villous.	<i>sp.</i> alt. sec. fl. vill. secund.	7. 8.	Asia.	1824.	G. A.	roots.
MILÍUM, MILLET-GRASS. <i>Calyx 2-valved, flat, acute, longer than the Corolla.</i>							
<i>effúsum</i> . E.B.	common.	pan. umbell.; <i>glume</i> 1-fring.	6. 7.	Britain.	H. P.	Sandy soil.
<i>multiflórum</i> . H.G.	many-flow'r'd.	many-fl'd.; pan. spr. fl. beard.	—	S. Europ.	1778.	H. P.	dividing
<i>paradóxum</i> . W.	black-seeded.	pan. few fl'd.; <i>gl.</i> 3 or more ner.	—	France.	1771.	H. A.	plant.
GASTRIDÍUM, GASTRIDÍUM. <i>Cal. 2-valv. acute, ventric. Cor. of 2 valv. outer with a dorsal awn.</i>							
<i>lendígerum</i> . B.Fl.	awned.	cal. valves lanc. awn long.	6. 7.	Britain.	H. P.	Sandy soil.
<i>Milium lendigerum</i> . E.Fl.							part. plant.
BRACHYPO'DIUM, BROME-GRASS. <i>Spikel. alt. Cal. 2-valv. many-fl'd. Cor. 2-valv. outer awned.</i>							
<i>ásperum</i> . R.S.	rough.	<i>sp.</i> 2 rank. hairy awns short.	6. 8.	Spain.	1818.	H. A.	Light soil.
<i>mexicánum</i> .	Mexican.	<i>sp.</i> droop.; awns long. than fl.	—	Mexico.	—	H. A.	dividing
<i>Festuca mexicana</i> . R.S.							plant.

TRIANDRIA DIGYNIA.

Systematic Name.	English Name.	Form of Leaves, &c.	Col. of Flow.	Month of Fl.	Native Country.	Yr. of Introd.	Soil and Propagation.
<i>SECALE, RYE. Glumes awl-shaped, oppos. ent. shorter than the florets, under flor. fertile, up. abortive.</i>							
cereale. w.	common.	gl. beard.; <i>pal.</i> smth. den. at ap.	7.	Crimea.	—	—	H. A. Sandy soil.
fragile. Bieb.	brittle.	broad, lin. glauc. ben.	6. 7.	Tauria.	1816.	—	H. B. seeds, or
orientale. w.	hairy-spiked.	gl. 4.; <i>palca</i> beard.; <i>stm.</i> proc.	7.	Levant.	1807.	—	H. B. part. plant.
<i>MUHLENBERGIA, MUHLENBERGIA. Glume 2-valved, valves small fring. Scales ovate, trunc.</i>							
diffusa. R.S.	spreading.	lin. smth.; <i>panic.</i> compr.	6.	N. Amer.	1816.	—	H. B. Light soil. part. plant.
<i>UNTOLA, SEA-SIDE OAT. Spikel. comp. Flor. imbr. in 2 rows. Glu. 3-20-fl'd. short. than the flor.</i>							
distichophylla. R.S.	two-ranked.	awl-sh.; <i>sp.</i> 5-9-fl'd. smth.	6. 7.	N. Amer.	1789.	—	H. B. Sandy loam.
paniculata. L.	panicked.	<i>sp.</i> sub-sess.; <i>glu.</i> many-valv.	—	—	1793.	—	H. B. parting at
latifolia. Mx.	broad-leav'd.	<i>pan.</i> lax.; <i>sp.</i> ov.; <i>gl.</i> 3-valv.	—	—	1809.	—	H. B. root.
spicata. L.	spiked.	invol. rigid.; <i>panic.</i> spik.	7.	—	1790.	—	H. B. —
<i>SACCHARUM, SUGAR-CANE. Glu. 2-valv. 2-fl'd. lower flower neuter, up. hermaphr. with 2 palea.</i>							
officinarum. w.	common.	flat nerv.; fl. panicked.	4. 5.	India.	1597.	—	S. B. Loam & peat. part. plant.
							[<i>Stig.</i> feathery.
<i>TRITICUM, WHEAT. Cal. of 2 oppos. valv. solitary, many-fl'd. Cor. of 2 valv. Ger. turbin. Sty. short.</i>							
aestivum. H.Gr.	summer.	<i>sp.</i> compr. beard.; <i>gl.</i> gibb.	6. 7.	Baschkiros	—	H. A. Light loam.
giganteum. R.S.	gigantic.	nerv.; <i>sp.</i> lanc. 8-flow'd.	—	S. Europ.	1805.	—	H. B. seeds, or
hybernium. H.Gr.	Lammas.	<i>sp.</i> compr. beard.; <i>gl.</i> gib.	—	—	H. B. parting
juncum. E.B.	rushy.	invol. acut.; <i>sp.</i> alt.; <i>fl.</i> 5.	—	England.	—	H. B. roots.
Spelta. w.	spelt.	<i>sp.</i> 3-flowered; <i>glume</i> ov.	—	—	H. A. —
turgidum. w.	turgid.	<i>sp.</i> 4-flowered, imbric. pub.	4.	—	H. A. —
<i>STIPA, FEATHER-GRASS. Cal. of 2 lax point. valv. Cor. of 2 valv. Ger. obl. Sty. distin. Stig. round.</i>							
junceae. Fl.Gr.	rush-leaved.	filif. convol.; <i>panic.</i> elong.	7. 8.	France.	1772.	—	H. B. Peat soil.
pennata. E.Fl.	common.	filif. grooved; awns feather.	—	Britain.	—	H. B. part. roots.
							[<i>Sty.</i> short. <i>Stig.</i> crowded.
<i>LAGURUS, HARE'S-TAIL-GRASS. Cal. of 2 awned valves. Cor. of 2 unequal valves. Germ. oblong.</i>							
ovatus. E.B.	ovate.	lanc. down. ribb. und.	6.	Guernsey.	—	H. A. Garden loam. seeds.
							[<i>long.</i> <i>Seed</i> pointed at each end.
<i>ARUNDO, REED-GRASS. Cal. of 2 lanceolate, keeled, awnless valves. Cor. of 2 valves. Germen ob-</i>							
Dónax. H.G.W.	manured.	<i>st.</i> woody at base; <i>gl.</i> 3-5-fl.	7. 8.	S. Europ.	1648.	—	H. B. Common soil.
epigjos. E.Fl.	wood.	lin. lanc. <i>Panic.</i> ; <i>gl.</i> acum.	—	Britain.	—	H. B. seeds.
Phragmites. B.Fl.	common.	ribbed, brd.; <i>gl.</i> 3-5-fl.	4.	—	—	H. B. —
stricta. E.Fl.	upright.	lin. pan. er. 2-4 ln. long; <i>cal.</i> gl.	6.	Germany.	1813.	—	H. B. —
<i>LOLIUM, DARNEL. Cal. of 1 valve, opposite the stalk. Cor. 2 valves. Ger. obt. Sty. short. Stig. oblong.</i>							
arvense. E.B.	beardless.	<i>sp.</i> nearly beardless.	7.	England.	—	H. A. Common soil.
*perenne. E.Fl.	Rye grass.	<i>sp.</i> beardless; <i>spklt.</i> long.	5. 6.	Britain.	—	H. B. seeds.
1. Russellianum. H.G.W.	Bedford.	—	—	—	—	H. B. —
2. Whitworthii. H.G.W.	Whitworth's.	—	—	—	—	H. B. —
3. Stickneyanum. H.G.W.	Stickney's.	—	—	—	—	H. B. —
4. paniculatum.	panicked.	—	—	—	—	H. B. —
temulentum. E.Fl.	bearded.	<i>sp.</i> bearded; <i>cal.</i> rough.	7. 8.	—	—	H. A. —

Systematic English Form of Col. of Month Native Yr. of Soil and Name. Name. Leaves, &c. Flow. of Fl. Country. Introd. Propagation.

ROTTBO'ELLIA, ROTTBO'ELLIA. *Cal. of 2 val. Cor. in perfect flor. of 2 acu. val. which are nearly eqv. incurvata.* E.B. sea side. *sp. round, awl-sh.; cal. 2-valv.* 7. Britain. . . . H. A. Sandy soil. seeds.

HORDEUM, BARLEY. *Cal. 2-valv. 1-flower. Out. valve of Cor. awned, concave, inner inflex. pointed.*

bulbòsum. Fl. Gr. bulbous. lin. flat; *sp. 2-3 in.* 2 rank. 7. 8. S. Europ. 1770. H. P. Light loam.
 hexástichon. R. S. winter. fl. herm. bearded, seeds 6 ro. ———— Levant. ———— H. A. seeds, or
 jubàtum. R. S. long-bearded. beards bristly, very long. ———— N. Amer. 1782. H. B. parting roots
 murinum. E. Fl. wall. lin. flat; *sp. 2-3 in. long, 2 rank.* 4. 8. Britain. ———— H. A. ————
 *pratense. E. Fl. meadow. narr.; *sp. 2 in. long; cal. valve.* ———— ———— H. P. ————

[Ger. crowned. Sty. short. Stig. spread.

ELYMUS, LYME-GRASS. *Cal. of 2 valves, aggregate, with 2 or more florets. Cor. of 2 uneq. valves.*

arenarius. E. Fl. sea. *cal. invol.; sp. erect; spklt. dou* 4. 6. Britain. . . . H. P. Rich loam.
 canadensis. R. S. Canadian. flat; *sp. nodd.; spklt. 6 fld.* 7. 8. N. Amer. 1699. H. P. seeds, or
 Càput-Medusæ. R. S. Portuguese. *spklt. 2-fld.; Invol. bristly.* ———— Portugal. 1784. H. A. dividing at
 europæus. E. Fl. wood. *spklt. tern. 1-2 fld.; fl. awn'd.* 6. 7. England. . . . H. P. the roots.
 geniculatus. E. Fl. pendulous. *spklt. 2; cal. valves smth.* ———— ———— H. P. ————
 hy'strix. H. G. W. Porcupine. *sp. erect; spikelets spread.* 7. 8. Levant. 1770. H. A. ————
 striatus. R. S. striated. flat; *spikelets 2-flowered.* 6. 7. N. Amer. 1790. H. P. ————
 sibericus. R. S. Siberian. *sp. pend.; spklt. 2 together.* ———— Siberia. 1758. H. P. ————
 tener. R. S. tender. flat; *spklt. 3-flowd. beard.* ———— ———— 1801. H. P. ————

ORDER III.

TRIGYNIA. STYLES 3.

MON'TIA, BLINKS. *Cal. of 2 conc. leav. Cor. of 1 pet. 5-clef. Ger. 3-lob. Sty. short. Stig. 3. Caps. of 1 cell.*

fontána. E. Fl. water. opp. ellip. lanc. ent. wh. 4. 6. Britain. . . . H. A. Light loam. seeds.

[Caps. of 1 cell. Seeds peltate, round.

HOLO'STEUM, JAGGED-CHICKWEED. *Cal. of 5 ov. conc. leaves. Pet. 5. Fil. 3, or more. Sty. 3.*

umbellatum. E. Fl. umbelled. ov. ellip. acut. wh. 7. 8. England. . . . H. A. Sandy loam. seeds.

[Seeds kidney-shaped.

POLYCA'RPON, ALL-SEED. *Cal. of 5 keeled leaves. Pet. 5. Filam. 3-5. Anth. 2-lob. Caps. of 1 cell.*

tetraphyllum. E. Fl. four-leaved. ob. ent. smth. stlk. g.w. 5. 8. England. . . . H. A. Peat & loam. seeds.

CLASS IV. ORDER I.

TETRANDRIA MONOGYNIA. STAMENS 4. PISTIL 1.

ISOPO'GON, ISOPO'GON. *Perianth. 4-cleft. Sty. deciduous. Stig. cylind. Nect. sess. ventricose.*

anéthiifolius. L. T. Dill-leaved. pinn. & bipinn. groov'd ab. wh. 3. 6. N. S. W. 1796. G. S. Peat & loam.
 attenuatus. L. T. attenuate. elong. obl. mucr. atten. wh. 5. 6. N. Holl. 1824. G. S. cuttings in
 formósus. B. R. handsome. bipinn. sub. trit. seg. hairy. li. 3. 6. ———— 1805. G. S. sand, under

Systematic Name.	English Name.	Form of Leaves, &c.	Col. of Flower.	Month of Fl.	Native Country.	Yr. of Introd.	Soil and Propagation.
longifolius. B.R.	long-leaved.	lin. lingul. atten. at base.	yel.	5. 6.	—	1820.	G. S. a bell-glass.
trilobus. L.T.	three-lobed.	cuneat. flat, 3-lobed.	pa.	—	—	1803.	G. S. —

PROTEA, PROTEA. Cal. 0. Cor. 4-cleft. *Tips linear, inserted into the petals. Seeds solitary.*

acerosa. B.R.	Pine-leaved.	slender, subul. smooth.	cr.	3. 5.	C. B. S.	1803.	G. S. Peat & loam.
acaulis. L.T.	stemless.	obl. smooth; st. decumb.	br.	5. 9.	—	1802.	G. S. cuttings,
coronata. A.B.R.	crown-flow'd.	lanc. obliq. edges downy.	sc.	5. 6.	—	1800.	G. S. under a bell-
canaliculata. A.B.R.	channel-lv'd.	lin. acut. incurv. rigid.	pk.	2. 12.	—	—	G. S. glass in sand,
cynaroides. B.M.	Artichoke-lv'd.	nearly round smth. stlk.	red.	3. 11.	—	1774.	G. S. will root
cordata. A.R.	heart-leaved.	cord. smooth, ent.	cr.	3. 5.	—	1790.	G. S. freely, if
formosa. B.M.	shewy.	lanc. down.; stem vill.	sc.	5. 6.	—	1789.	G. S. kept free
grandiflora. B.M.	great-flowered.	obl. round, smooth.	ros. wh.	—	—	1787.	G. S. from damp.
humilis. A.R.	low-flowering.	lin. acut. silky.	pur.	6. 8.	—	1802.	G. S. —
longiflora. B.M.	long-flowered.	sess. cord. ov. obl. br. down. st.	1. 4.	—	—	1795.	G. S. —
mellifera. A.B.R.	honey-bearing.	lanc. ellip. smooth.	ros. wh.	5. 12.	—	1774.	G. S. —
magnifica. A.R.	magnificent.	large, elli. wavy, sl. pub.	pk.	3. 6.	—	1789.	G. S. —
mucronifolia. A.R.	mucronate-lv'd.	lin. lanc. mucr. glau.	wh. ros.	7. 12.	—	1803.	G. S. —
neriifolia. B.R.	Oleander-lv'd.	lin. lingul. pub. at base.	pur.	2. 4.	—	1806.	G. S. —
pulchella. A.B.R.	wave-leaved.	lanc. undul. shin.	pur.	3. 8.	—	1795.	G. S. —
speciosa. A.B.R.	shewy.	lanc. obliq. undul. pilos.	w. yel.	3. 6.	—	1786.	G. S. —

HA'KEA, HA'KEA. Cal. imbricated, of many leaves. Cor. of 4 petals. Capsule of 2 valves.

acicularis. L.T.	needle-leav'd.	lin. smth. a little furrow'd.	w.	5. 6.	N. S. W.	1790.	G. S. Sandy loam
angustifolia. L.T.	narrow-leav'd.	lin. lan. ent.	wh.	4. 8.	N. Holl.	1824.	G. S. and peat.
amplexicaulis. L.T.	stem-clasping.	sinuat. dent. base cord.	wh.	6. 7.	—	1803.	G. S. cuttings in
cinerea. L.T.	hoary-leaved.	lin. lanc. ent. 3-nerved.	wh.	—	—	—	G. S. sand, under
ceratophylla. L.T.	horn-leaved.	lin. bipinnatif.	wh.	6. 8.	—	—	G. S. a glass.
elliptica. L.T.	elliptic.	ov. ellip. ent. 5-nerv.	wh.	—	—	1794.	G. S. —
illicifolia. L.T.	Holly-leaved.	ov. sinuate. dent.	wh.	7. 9.	—	1803.	G. S. —
linearis. L.T.	linear-leaved.	lin. lanc. alt. spiny.	wh.	4. 8.	—	1824.	G. S. —
microcarpa. B.R.	small-fruited.	filif. flat.	wh.	—	V. Diem.	1818.	G. S. —
nitida. B.M.	shining.	lanc. attenuate at base.	wh.	6. 8.	N. Holl.	1803.	G. S. —
pugioniformis. L.T.	dagger-fruited.	alt. round. acute.	wh.	5. 6.	N. S. W.	1796.	G. S. —
saligna. L.T.	Willow-leaved.	elong. lanc. ent. smooth.	wh.	4. 7.	N. Holl.	1791.	G. S. —

CEPHALANTHUS, BUTTON-WOOD. Cal. 4-tooth. Cor. tubu. limb 4-cleft. Sty. long. Stig. capit.

occidentalis. L.	American.	opp. tern. ov. acum.	wh.	6. 8.	N. Amer.	1765.	S. S. —
------------------	-----------	----------------------	-----	-------	----------	-------	---------

GLOBULARIA, GLOBULARIA. Common. Cal. imb. proper tubu. Cor. up. lip bif. un. trif. Recep. chaf.

cordifolia. B.F.G.	heart-leaved.	smth. cord. apex. 3-dent.	bl.	5. 7.	Germany.	1633.	H. P. Loam & peat.
longifolia. B.R.	long-leaved.	lin. lanc. ent. smooth.	bl.	—	Madeira.	1775.	G. S. cuttings, or
nudicaulis. R.S.	naked-stalked.	lanc. ent. smooth.	bl.	—	Germany.	1629.	H. P. dividing the
vulgaris. B.F.G.	common.	obov. 3-dent. upper lanc.	bl.	—	Europe.	1640.	H. P. plants at the root.

CURTYSIA, HASSAGAY-TREE. Cal. 4-part. Cor. of 4 pet. obt. Stig. 4-lobed. Drupe ovate, 1-celled.

faginea. DC.	Beech-leaved.	opp. ellip. lanc. dent. smth.	w.	6. 7.	C. B. S.	1775.	G. S. Peat & loam. cuttings.
--------------	---------------	-------------------------------	----	-------	----------	-------	---------------------------------

ELEAGNUS, OLEASTER. Cal. 4-8-parted, campan. Cor. 0. Sty. short. Berry 1-seeded.

angustifolia. B.R.	narrow-leaved.	lanc. alt. silvery, spott.	yel.	6. 8.	S. Europ.	1633.	H. S. Loam & peat.
argentea. Ph.	silvery.	obl. silv. acute at both ends.	w.	—	N. Amer.	1813.	H. S. cuttings, or
orientalis. R.S.	oriental.	obl. ov. pubes.	wh.	—	Levant.	1748.	G. S. layers.

Systematic Name.	English Name.	Form of Leaves, &c.	Col. of Flow.	Month of Fl.	Native Country.	Yr. of Introd.	Soil and Propagation.
CHLORANTHUS, CHLORANTHUS. <i>Cal. 0. Cor. with 3 lobed petals. Berry single-seeded.</i>							
inconspicuus. R.S.	trailing.	ellip. smooth, dent.	st. 1. 9.	China.	1781.	G. S.	Peat & loam, cuttings.
RIVINA, RIVINA. <i>Cal. 0. Cor. of 4 petals. Stamens 4 to 12. Berry 1-seeded. Seed lentiform.</i>							
humilis. B.M.	dwarf.	ellip. pubes.; stem vill.	wh. 1. 10.	W. Ind.	1699.	S. S.	Sandy loam
octandra. B.S.	climbing.	fl. from 8-12 stamens.	wh. 6.	—	1752.	S. S.	and peat, cutt. & seeds.
SANTALUM, SANDAL-WOOD. <i>Cal. 4-dented. Cor. of 4 petals, with 4 glands. Berry single-seeded.</i>							
album. w.	white.	obl. lanc. ent.	yel. pur. . . .	E. Ind.	1804.	S. S.	Cutt. or seed.
myrtifolium. Rox.	myrtle-leaved.	opp. ellip. lanc. ent.	li. . . .	—	1819.	S. S.	peat & loam.
POTHOS, POTHOS. <i>Spatha 1-leaved. Spadix cylind. simple. Cal. 0. Petals 4. Berry 2-seeded.</i>							
acaulis. R.S.	stemless.	lanc. ent. smooth.	gr. 4. 6.	W. Ind.	1804.	S. P.	Loam & peat.
lanceolata. R.S.	spear-leaved.	lanc. ent. 3-nerved.	vio. 4. 7.	Barbad.	1790.	S. P.	parting at
sagittata. B.M.	arrow-leaved.	cord. sagitt. acute.	gr. br. 8.	W. Ind.	1794.	S. P.	root.
violacea. B.C.	blue-fruited.	ov. cord. ent. smooth.	gr. 4. 6.	Jamaica.	—	S. P.	—
SIDERODENDRON, IRON-TREE. <i>Cal. 4-toothed. Cor. tubular. Berry 2-celled. Seeds solitary.</i>							
triflorum. s.s.	three-flowered.	ell. lanc. elong. br. 4-corn'd. pk.	8.	W. Ind.	1793.	S. S.	Peat & loam, cuttings.
CALLICARPA, CALLICARPA. <i>Cal. minute 4-tooth. Cor. short, funnel-shaped. Stam. 4, exerted.</i>							
cana. R.S.	hoary.	ov. lanc. serr. pubes. ben. li.	6.	E. Ind.	1790.	S. S.	Sandy loam.
longifolia. B.R.	long-leaved.	lanc. ac. upper half serr. w. p.	6. 8.	China.	1822.	G. S.	cuttings.
rubella. B.R.	pink-flowered.	sess. obov. ac. cord. pub. ros.	6.	—	—	G. S.	—
LUDWIGIA, LUDWIGIA. <i>Cal. 4-parted. Cor. 4 petals, or 0. Caps. 4-cornered, 4-celled.</i>							
alternifolia. w.	alternate-lv'd.	lanc. alt. hoary ben.	yel. 6. 7.	Virginia.	1752.	H. P.	Peat soil.
hirsuta. Ph.	hairy.	alt. lanc.; fl. axill. solit.	yel. —	N. Amer.	1812.	H. P.	parting plant at root.
TELOPEA, TELOPEA. <i>Cal. irregu. 4-tooth. on one side, irregu. on the other. Ger. stalk. many-seed.</i>							
speciosissima. B.M.	splendid.	wedge-sh. obl. tooth. smth. cr.	5. 7.	N. S. W.	1789.	G. S.	Peat & loam, cuttings.
PERSOONIA, PERSOONIA. <i>Cal. 0. Cor. 4-cleft, glands 4 at the base, of the seed vessel. Caps. 1-seed.</i>							
linearis. B.M.	linear-leaved.	lin. obl. vill. mucron.	yel. 7. 8.	N. S. W.	1794.	G. S.	Loam & peat.
lanceolata. B.R.	lance-shaded.	lanc. acute, smooth.	yel. 6. 7.	N. Holl.	1791.	G. S.	cuttings.
pinifolia. L.T.	Pine-leaved.	lax. filif. smooth.	yel. —	N. S. W.	1818.	G. S.	—
LAMBERTIA, LAMBERTIA. <i>Cor. tubular, 4-cleft. Recep. flat, naked. Follicle 1-celled.</i>							
echinata. B.R.	hedge-hog.	lin. smth. apex 3-lob. spin. ro.	6. 8.	N. Holl.	1824.	G. S.	Sandy loam
formosa. B.K.	shewy.	lin. lanc. cusp. edges revol. ro.	—	N. S. W.	1788.	G. S.	& peat, cutt.
GREVILLEA, GREVILLEA. <i>Cor. irregular. Pet. 4, revolute, hairy on the inside. Ger. orate.</i>							
acanthifolia. B.M.	Acanthus-lv'd.	pinn. smth. lobes 3fid. spin. g.	5. 8.	N. Holl.	1823.	G. S.	Peat & loam.
buxifolia. B.R.	Box-leaved.	ellip. scab. ben. dot. above. pk.	2. 9.	N. S. W.	1790.	G. S.	cuttings under a glass,
Baueri. L.T.	Bauer's.	obl. mucr. sess. pubes. bh.	4. 8.	—	1823.	G. S.	in sand, or
concinna. L.T.	pretty.	pinnat. or 2 or 3 forked. st. ro.	3. 8.	N. Holl.	1824.	G. S.	mixture of
Caleyi. Br.P.S.	Blechnum-lv'd.	pinn. segm. lin. obl. pub. br. pu.	6.	N. S. W.	1829.	G. S.	—

Systematic Name.	English Name.	Form of Leaves, &c.	Col. of Month of Flow.	Native of Fl. Country.	Yr. of Introd.	Soil and Propagation.
juniperina. B.C.	Juniper-like.	subul.; br. vill.	gr. st. 4. 5.	—	1821.	G. S. peat, will
linearis. L.P.	linear-leaved.	lin. pub. old ones smth.	corn. 4. 9.	—	1790.	G. S. readily
mucronulata. L.T.	mucronate.	obov. obt. mucr.	gr. wh. —	—	1809.	G. S. strike root.
planifolia. B.C.	flat-leaved.	lin. acut. flat. nerved.	red. —	—	—	G. S. —
punica. B.R.	scarlet.	ellip. obl. mucr. edges rec.	sc. —	—	1822.	G. S. —
rosmarinifolia.	Rosemary-iv'd.	lin. lanc. ent. silky ben.	r. yel. 4. 5.	—	1824.	G. S. —

LOMATIA, LOMATIA. Cal. irregu. Seg. distinct, 1-sid. Glands 3 on one side. Ger. stalk. many-seed.

longifolia. B.R.	long-leaved.	lin. lanc. smooth, serr.	wh. 5. 8.	N. S. W.	1816.	G. S. Sandy loam
silaifolia. B.M.	cut-leaved.	bipinnatif. smth. seg. lan.	wh. 6. 7.	—	1792.	G. S. & peat, cutt.

LEUCOSPERMUM, LEUCOSPERMUM. Involu. imbr. Cal. labiate, 3 of the seg. cohering at base.

candicans. B.R.	white.	lin. wedge-sh. flat, 3-5thd.	or. 8. 9.	C. B. S.	1790.	G. S. Light loam.
ellipticum. B.R.	elliptic.	ellip. obl. 3-4-toothed.	yel. 5. 8.	—	1803.	G. S. cuttings, in
formosum. B.R.	shewy.	ellip.; bract. spat. fringed.	yel. 6. 9.	—	1794.	G. S. a mixture of
grandiflorum. L.T.	large-flowered.	obl. lanc. 3-toothed.	yel. 5. 7.	—	1800.	G. S. sand & peat.

BA'NKZIA, BA'NKZIA. Cal. 4-parted. Cor. of 1 petal. Stam. in limb of corolla. Caps. 2-valved, seeded.

æmula. B.R.	Rival.	lin. elong. serr. smth. ben.	st. 1. 6.	N. S. W.	1788.	G. S. Peat, and
attenuata. L.T.	smooth-flow'd.	elong. lin. trunc. serr.	st. 1. 10.	N. Holl.	1794.	G. S. sandy loam.
collina. L.T.	hill.	lin. prickly toothed.	st. 12. 5.	N. S. W.	1810.	G. S. cuttings,
coccinea. L.T.	scarlet.	alt. obov. tooth. trunc.	sc. 7. 11.	N. Holl.	1803.	G. S. in sand, un-
dentata. L.T.	dented.	obl. dent. teeth spiny.	st. 1. 6.	—	1822.	S. S. der a glass,
ericifolia. B.M.	Heath-leaved.	lin. trunc. emarg. smth.	yel. 1. 12.	N. S. W.	1788.	G. S. will strike
grandis. L.T.	great-flow'd.	pinnatif. lobes ov. 3-ang.	st. 5. 8.	N. Holl.	1794.	G. S. root.
integrifolia. B.M.	entire-leaved.	vertic. obl. lanc. mucr.	yel. —	N. S. W.	1798.	G. S. —
latifolia. L.T.	broad-leaved.	obo. obl. sp. ser. hairy ben.	gr. —	—	1802.	G. S. —
littoralis. L.T.	shore.	lin. elong. dent. spiny.	yel. —	—	1803.	G. S. —
marcescens. B.M.	marcescent.	wedge-sh. trunc. dent. ser.	gr. —	N. Holl.	1794.	G. S. —
media. B.M.	intermediate.	lin. dent. atten. at base.	gr. —	—	—	G. S. —
marginata. B.M.	various-leaved.	linc. trunc. marg. revol.	gr. —	N. S. W.	1804.	G. S. —
occidentalis. R. Br.	west-coast.	lin. prick. dent.	yel. —	N. Holl.	1803.	G. S. —
pulchella. L.T.	small-flow'd.	ent. acerose.	st. 2. 8.	—	—	G. S. —
paludosa. B.R.	marsh.	vertic. obl. cuneat. serr.	st. 1. 4.	N. S. W.	1805.	G. S. —
quercifolia. B.R.	Oak-leaved.	obl. subcun. smth. serr.	st. 3. 4.	—	—	G. S. —
repens. L.T.	creeping.	pinn. lob. toot.; st. creepg.	st. 5. 8.	N. Holl.	1803.	G. S. —
spinulosa. A. Rep.	spiny.	lin. acut. revol. serr.	yel. 12. 5.	N. S. W.	1788.	G. S. —
serrata. L.T.	saw-leaved.	lin. attenuat. serr.	st. 7. 9.	—	—	G. S. —
speciosa. L.T.	shewy.	pinnatif. lobes 3-ang.	wh. 5. 8.	N. Holl.	1805.	G. S. —
verticillata. L.T.	whorl-leaved.	obl. obt. lingul. wh. ben.	st. 7. 11.	—	1794.	G. S. —

DRYANDRA, DRYANDRA. Perian. 4-parted. Stamens 4, inserted in the hollow part of the lacinae. [Ovary of 2 cells,

armata. L.T.	acute-leaved.	pinnatif. lobes 3-angul.	yel. 1. 12.	—	1803.	G. S. Sandy loam
floribunda. B.M.	many-flowered.	wedge-sh. ent. ser. at apex.	yel. —	—	—	G. S. and peat.
formosa. L.T.	handsome.	elong. lin. pinnat. wh. ben.	or. —	—	—	G. S. cuttings, in
longifolia. L.T.	long-leaved.	lin. pinn. acute, tom. ben.	yel. —	—	1805.	G. S. sand, undera
nervosa. S.F.A.	nerved-leaved.	pinn. lobes lanc. ac. dow.	yel. 3. 12.	—	—	G. S. hand-glass.
nivea. L.T.	white.	pinn. lob. 3-ang. edge rec.	yel. 7. 9.	—	1803.	G. S. —
plumosa. R. Br.	feathery.	lin. pinn. pub. ap. lob. not.	yel. —	—	—	G. S. —
tenuifolia. L.T.	slender-leaved.	lin. pinn. trunc. wh. pub.	yel. 3. 5.	—	—	G. S. —

Systematic Name.	English Name.	Form of Leaves, &c.	Col. of Flow.	Month of Fl.	Native Country.	Yr. of Introd.	Soil and Propagation.
HEMICLIDIA, HEMICLIDIA. <i>Inco. imb. Perian. 4-part. regular. Ovary 1-cell. Fruit open, at apex.</i>							
Baxteri. R.Br.	Baxter's.	pinn. lob. spiny; wh. ben.	yel.	8. 9.	N. Holl.	1830.	G. \mathfrak{S} . Peat & loam. cuttings.
PTHELIA, SHRUBBY TREFOIL. <i>Calyx 4-parted. Petals 4-coriaceous. Stigmas 2. Seed solitary.</i>							
trifoliata. DC.	three-leaved.	tern. ov. ent. smth.	gr. wh.	6. 7.	N. Amer.	1704.	H. \mathfrak{S} . Sandy soil. seed, or layers.
CORNUS, DOG-WOOD. <i>Cal. 4-toothed. Cor. of 4 petals. Germ. orbicular, compr. Nut obl. 2-celled.</i>							
alternifolia. R.S.	alternate-l'd.	alt. ov. acut. white ben.	wh.	9.	N. Amer.	1760.	H. \mathfrak{S} . Light loam.
alba. R.S.	white.	ov. acut. pubes. wh. ben.	wh.	6. 9.	Siberia.	1741.	H. \mathfrak{S} . cuttings.
canadensis. B.M.	Canadian.	about 6 in whorls, ellip. ob. wh.	wh.	6. 8.	Canada.	1774.	H. \mathfrak{P} . ———
mascula. R.S.	Cornelian Cher.	ellip. smooth.	yel.	2. 4.	Europe.	1596.	H. \mathfrak{S} . ———
paniculata. R.S.	panicled.	ov. acum. smth. wh. ben.	wh.	6. 7.	N. Amer.	1758.	H. \mathfrak{S} . ———
snecica. B.Fl.	dwarf.	opp. ovat. smooth.	pur.	4.	Britain.	H. \mathfrak{P} . ———
sanguinea. E.Fl.	common.	ov. pubes. cyme flat.	wh.	6. 7.	———	H. \mathfrak{S} . ———
β . variegata.	variegated.						
CISSUS, CISSUS. <i>Calyx 4-toothed. Petals 4, reflexed. Berry 2-celled, 1-2 or 4-seeded.</i>							
quinquefolia. B.M.	five-leaved.	quin. leaf. acum. stalk'd.	gr.	5. 9.	Brazil.	1822.	S. \mathfrak{S} . cl. Sandy soil.
trifoliata. DC.	three-leaved.	tern. round, hairy.	red.	6. 8.	Jamaica.	1739.	S. \mathfrak{S} . cl. cuttings, un-
vitifolia. DC.	Vine-leaved.	cord. rounded, dent. vill.	red.	7. 8.	India.	1772.	S. \mathfrak{S} . cl. der a glass, in a little heat.
FRASERA, FRASERA. <i>Cal. 4-parted. Cor. 4-cleft, longer than the calyx. Caps. compr. 1-cell. 2-valv.</i>							
carolinensis. P.S.	Carolina.	lanc. smth. ent. opp. vert.	yel.	7. 8.	N. Amer.	1795.	H. \mathfrak{B} . Peat & loam. seeds, or off's. from root.
BU'DDLEA, BU'DDLEA. <i>Cal. 4-parted. Cor. 4-toothed. Caps. 2-celled, 2-furrowed. Seeds many.</i>							
connata. B.M.	connate-leaved.	lanc. serr. pubes. ben.	yel.	6.	Peru.	1826.	G. \mathfrak{S} . Peat, & gar-
globosa. B.M.	round-headed.	lanc. acum. cren. hairy.	yel.	5. 7.	Chile.	1774.	H. \mathfrak{S} . den loam.
heterophylla. B.R.	various-leaved.	cord. obl. acum. dent. vill.	yel.	——	S. Amer.	1826.	S. \mathfrak{S} . cuttings.
salvifolia. S.S.	sage-leaved.	cordate. lanc. cren. rug.	w. cr.	8. 7.	C. B. S.	1760.	G. \mathfrak{S} . ———
BLÆRIA, BLÆRIA. <i>Cal. 4-parted. Cor. 4-cleft. Stam. inserted in the receptacle. Caps. 4-celled.</i>							
ericoides. S.S.	heath-leaved.	4-obl. imbr. pilose.	pur.	8. 10.	C. B. S.	1774.	G. \mathfrak{S} . Sandy peat. cuttings.
MITCHELLA, MITCHELLA. <i>Cal. 2, on 1 ovar. 4-clef. Cor. fun.-sh. hair. within. Stig. 4. Ber. bif. 4-seed.</i>							
repens. L.	creeping.	renif. smth. ent. opp.	wh.	6.	N. Amer.	1761.	H. \mathfrak{S} . Peat soil. part. at roots, or lay.
PENÆA, PENÆA. <i>Cal. of 2 leaves. Cor. compan. the limb 4-part. Caps. 4-sid. 4-cell. & 2 seeds in each.</i>							
imbricata. B.M.	imbricated.	rhomb. ov. acute, ent.	ros.	4. 6.	C. B. S.	1823.	G. \mathfrak{S} . Peat & loam.
mucronata. R.S.	mucronate-l'd.	cord. acum. smth. mucr.	red.	5. 7.	———	1787.	G. \mathfrak{S} . cuttings, in
squamosa. B.R.	scaly.	decuss. flat. obov.	ros.	——	———	——	G. \mathfrak{S} . sand.
ZIERIA, ZIERIA. <i>Calyx. 4-cleft. Petals 4. Stamens 4. Style 1. Stigma 4-lobed. Capsule 4-celled.</i>							
Smithii. B.M.	Smith's.	tern. lanc. flat. acute, dott. wh.	wh.	4. 7.	N. S. W.	1808.	G. \mathfrak{S} . Peat & loam. cuttings.

Systematic Name.	English Name.	Form of Leaves, &c.	Col. of Flow.	Month of Fl.	Native Country.	Yr. of Introd.	Soil and Propagation.
IXORA, IXORA. <i>Cal. 4-toothed. Cor. of 1 petal, funnel-shaped, limb 4-parted. Berry 4-celled.</i>							
barbáta. B.M.	bearded.	opp. obl. ov. ent.	wh.	6. 8.	E. Indies.	1822.	S. S. Loam & peat.
Bandhúca. B.R.	bushy.	opp. ov. amplex. obt.	sc.	7. 8.	—	1815.	S. S. cuttings, un-
coccínea. B.M.	scarlet.	sess. ellip. obt. mucr.	sc.	4. 8.	—	1690.	S. S. der a hand-
cuncifólia. B.R.	wedge-leav'd.	broadly lanc. cuneat.	wh.	6.	—	1820.	S. S. glass, will
crocáta. B.R.	saffron-color'd.	ov. lanc. atten.	sn.	—	China.	—	S. S. strike root
grandiflóra. B.R.	great-flowered.	sess. obl. cord. ent.	sc.	7. 9.	E. Indies.	1814.	S. S. freely.
BOUVA'RDIA, BOUVA'RDIA. <i>Cal. 4-parted, lobes linear. Cor. funnel-shaped, limb 4-cleft.</i>							
triphyl'la. B.R.	three-leaved.	lanc. tern. obl.	sc.	4. 11.	Mexico.	1794.	G. S. Peat & loam.
versicolor. B.R.	various-color'd.	opp. lanc. ciliat.	red. yel.	7. 1.	S. Amer.	1824.	S. S. cutt. or slips of roots, strike freely und. a glass.
HOUSTONIA, HOUSTONIA. <i>Cal. 4-tooth. Cor. funnel-shaped, 4-tooth. Stig. bifid. Caps. 2-celled.</i>							
cœrúlea. B.M.	blue-flowered.	spath. upper. oppo. lanc.	bl.	5. 8.	N. Amer.	1785.	H. B. Peat soil.
longifólia. B.M.	long-leaved.	lin. obl. pubes. opp.	pa. pur.	—	—	1829.	H. B. offsets from
purpúrea. R.S.	purple.	sess. ov. lanc.	pur.	—	—	1800.	H. B. the root.
serpyllifólia. B.M.	Thyme-leaved.	round, ov. or spath. hairy.	wh.	—	—	1827.	H. B. —
CATESBÆA, LILY-THORN. <i>Cal. 4-tooth. Cor. funnel-shap. limb 4-lob. Stig. bifid. Berr. 2-celled.</i>							
latifólia. B.R.	broad-leaved.	ov. or obov. obt. entire.	wh.	6. 7.	W. Ind.	1818.	S. S. Loam & peat.
parviflóra. S.S.	small-flowered.	ov. subrot. mucro.	wh.	7. 10.	—	1810.	S. S. cuttings.
spinósa. B.M.	thorny.	ov. acut. at both ends.	wh.	5. 9.	Provi. I.	1726.	S. S. —
STRUTHIOLA, STRUTHIOLA. <i>Cal. of 2 leav. Cor. tubu. 4-clef. Nect. of 8 glan. Seed 1. Ber. like.</i>							
ciliáta. A.R.	ciliated.	lanc. mucr. cili. concav.	wh.	5. 7.	C. B. S.	1779.	G. S. Sandy peat.
erécta. W.	upright.	lin. smth.; br. 4-sided.	wh.	4. 8.	—	1798.	G. S. cuttings,
juniperína. R.S.	Juniper-like.	lin. acut. spread.	wh.	—	—	1758.	G. S. in sand.
imbricáta. A.R.	imbricated.	ov. crowd. edges ciliat.	yel.	—	—	1794.	G. S. —
ováta. A. Rep.	oval-leaved.	ov. smth.; br. smth. rug.	wh.	—	—	1792.	G. S. —
virgáta. H.K.	twiggy.	lanc.; br. pubes.	red.	—	—	1779.	G. S. —
DIPSACUS, TEASEL. <i>Cal. double, undivided. Cor. of 1 pet. tubular, 4-5-part. Seed solitary, angular.</i>							
fullónum. E. Fl.	Fuller's.	sess. serr. ribs prickly.	li.	7.	Britain.	...	H. B. Garden soil.
pilósus. E. Fl.	small.	tern. ov. acut. serr. stalk.	w.	8.	—	...	H. B. seeds.
sylvéstris. E. Fl.	wild.	opp. serr. Invol. inflex. pur.	7.	—	—	...	H. B. —
SCABIOSA, SCABIOUS. <i>Cal. many-fl'd. Cor. of each of 1 pet. from 4 to 5 cleft. Fil. 4, spr. Seed nak.</i>							
arvénsis. E. Fl.	field.	ent. pinn. cut.; stm. bristly. pu.	7. 10.	Britain.	...	H. B. Sandy loam.	
atropurpúrea. B.M.	dark-purple.	lanc. ov. lyrate.	d. pur.	7. 9.	E. Indies.	1629.	H. B. seeds, or
Candóllii. DC.	Candolle's.	lin. ent. smth.	pur. wh.	—	—	1831.	H. B. parting
graminifólia. B.R.	grass-leaved.	lin. ent. silky.	bl.	6.	Switzerl.	1683.	H. B. plants.
succísa. E. Fl.	Devil's-bit.	lanc. ov. pubes. upp. lin.	vi.	8. 10.	Britain.	...	H. B. —
Webbiána. B.R.	Webb's.	subrot. cun. cren. upp. pinn.	7. 8.	Levant.	1820.	H. B. —	
KNAUTIA, KNAUTIA. <i>Involucrum of many leaves. Cor. 4-5-parted. Receptacle naked.</i>							
orientális. R.S.	oriental.	obl. ent. involuc. 5-10-ly'd. r.	6. 9.	Levant.	1713.	H. A. Sandy loam.	
propóntica. W.	purple-flow'd.	pinnatif. upp. lanc.	pur.	—	—	1768.	H. B. seeds.
SHERA'RDIA, SHERA'RDIA. <i>Cal. of 1 leaf, 6-cleft. Cor. of 1 petal, from 3-4-cleft. Seeds 2, naked.</i>							
arvénsis. B. Fl.	field-madder.	6 in a whorl. obov. acut.	yel.	4. 9.	Britain.	...	H. A. Garden soil. seeds.

Systematic Name.	English Name.	Form of Leaves, &c.	Col. of Flow.	Month of Fl.	Native Country.	Yr. of Introd.	Soil and Propagation.
ASPERULA, WOODROOF. <i>Cal. 4-parted. Cor. of 1 pet. wheel-shap. 4-cleft. Fil. awl-sha. Anth. 2-cell.</i>							
<i>cynánchia.</i> B.Fl.	small.	4 in a whorl. lin. upp. uneq. <i>bl.</i>	7.	England.	H. \mathfrak{P} .	<i>Light loam.</i>
<i>odoráta.</i> E.Fl.	sweet-scented.	8 in a whorl. ellip. lanc. <i>wh.</i>	5. 6.	Britain.	H. \mathfrak{P} .	<i>parting of</i>
<i>taurína.</i> R.S.	broad-leaved.	4 ov. lanc.	<i>li.</i> 4. 6.	Italy.	1739.	H. \mathfrak{P} .	<i>roots.</i>
<i>tinctória.</i> R.S.	narrow-leaved.	lin. the lower in 7's.	<i>bh.</i> 6. 7.	Europe.	1764.	H. \mathfrak{P} .	—
GALIMUM, BEDSTRAW. <i>Cal. 4-tooth. Cor. of 1 pet. wheel-shap. 4-cleft. Fil. awl-shap. Anth. 2-cell.</i>							
<i>Aparíne.</i> E.B.	Goose-grass.	6-8 in a whorl. lanc. rug. <i>wh.</i>	5. 9.	Britain.	H. \mathfrak{A} .	<i>Light soil.</i>
<i>ánglicum.</i> E.B.	wall.	6 in a whorl. lanc. fring. <i>g. yel.</i>	6. 7.	England.	H. \mathfrak{A} .	<i>parting</i>
<i>aristátum.</i> S.S.	bearded.	6 in a whorl. stalk. lanc. <i>wh.</i>	7. 8.	Scotland.	H. \mathfrak{P} .	<i>roots.</i>
<i>boreále.</i> E.B.	cross-leaved.	4 in a whorl. ov. 3-5 ribb. <i>wh.</i>	—	Britain.	H. \mathfrak{P} .	<i>or seeds.</i>
<i>cinereum.</i> E.Fl.	grey.	6-8 in a whorl. lin. smth. <i>wh.</i>	—	Scotland.	H. \mathfrak{P} .	—
<i>cruciátum.</i> E.Fl.	cross-wort.	4 in a whorl. ov. hairy. <i>yel.</i>	5. 6.	Britain.	H. \mathfrak{P} .	—
<i>Mollúgo.</i> E.Fl.	great-hedge.	8 in a whorl. ellip. point. <i>wh.</i>	8.	—	H. \mathfrak{P} .	—
<i>pusillum.</i> E.Fl.	least mountain.	8 in a whorl. lin. lanc. ent. <i>wh.</i>	—	England.	H. \mathfrak{P} .	—
<i>saxátile.</i> B.Fl.	smooth Heath.	6 in a whorl. obov. <i>wh.</i>	—	Britain.	H. \mathfrak{P} .	—
<i>trícórne.</i> E.Fl.	three-flow'd.	8 in a whorl. lanc. fl. 3's. <i>wh.</i>	7.	—	H. \mathfrak{A} .	—
RUBIA, MADDER. <i>Cor. of 1 pet. bell-shaped, 4 or 5 toothed. Ger. of 2 lobes. Sty. cloven. Stig. capit.</i>							
<i>peregrína.</i> E.Fl.	wild.	4-6 in a whorl. lanc. shin. <i>y.g.</i>	7.	England.	H. \mathfrak{P} .	<i>Sandy loam.</i>
<i>tinctórum.</i> L.	Dyer's.	lanc. in 6's. upp. in 4's. <i>asper. y.</i>	6.	S. Europ.	1596.	H. \mathfrak{P} .	<i>part. plants.</i>
EXACUM, GENTIANELLA. <i>Cal. of 1 leaf, 4-cleft. Cor. of 1 pet. 4-cleft. Caps. of 2 valves, many-seed.</i>							
<i>filifórme.</i> E.Fl.	least.	sess. lin. lanc. 1-ribb.	<i>yel.</i> 6. 7.	Britain.	—	H. \mathfrak{A} .	<i>Light loam.</i>
<i>viscósium.</i> Sm.	clammy.	obl. amplex. nerv.	<i>yel.</i> —	Canaries.	1781.	G. \mathfrak{B} .	<i>seed, or divid. plants.</i>
SPERMACO'CE, SPERMACO'CE. <i>Cal. minute, edge 4-tooth. Cor. of 1 pet. funnel-shap. Caps. 2-cell.</i>							
<i>Fischèri.</i> Lk.	Fischer's.	ent. acut. pub.; <i>stm. ang. w.</i>	7. 8.	Jamaica.	1820.	S. \mathfrak{A} .	<i>Loam and</i>
<i>mucronáta.</i>	mucronate.	obt. mucr. rough.	<i>wh.</i> 6. 7.	—	1822.	S. \mathfrak{P} .	<i>peat.</i>
<i>rúbra.</i> S.S.	red.	ov. upper 4 together.	<i>pk.</i> 7. 8.	S. Amer.	1760.	S. \mathfrak{B} .	<i>cuttings, or</i>
<i>strícta.</i> L.	upright.	lin. lanc. lined.	<i>wh.</i> 6. 7.	E. Ind.	1820.	G. \mathfrak{B} .	<i>parting</i>
<i>suffrutícósa.</i> Jacq.	shrubby.	ov. acum.; <i>stem</i> 4 corn.	<i>bh.</i> 7. 8.	1824.	S. \mathfrak{S} .	<i>plants.</i>
RHOPA'LA, RHOPA'LA. <i>Cal. 4-leaved, segm. recurved. Scales 4. Ovary 2-seeded. Follicle 1-celled.</i>							
<i>dentáta.</i> R.Br.	dented.	alt. ov. lanc. dent.	<i>gr.</i> 5. 8.	Guiana.	1802.	S. \mathfrak{S} .	<i>Peat & loam.</i>
<i>sessilifólia.</i> R.Br.	sessile-leaved.	cuneat. obl. ent. in 4's.	<i>gr.</i> — —	—	1803.	S. \mathfrak{S} .	<i>cuttings.</i>
PLANTA'GO, PLANTAIN. <i>Cal. of 1 leaf, 4-part. Cor. of 1 petal, 4-cleft, tubular. Ger. of 2-4-cells.</i>							
<i>alpína.</i> R.S.	Alpine.	lin. flat; <i>spike</i> obl.	<i>li.</i> 6. 7.	S. Europ.	1774.	H. \mathfrak{P} .	<i>Sandy soil.</i>
<i>altíssima.</i> R.S.	tall.	lanc. dent. smth. 5-nerv. <i>wh.</i>	—	Italy.	—	H. \mathfrak{P} .	<i>seeds, or</i>
<i>Bellárdi.</i> Fl.Gr.	Bellard's.	lin. lanc.; <i>spike</i> ov. <i>gr. wh.</i>	—	S. Europ.	1797.	H. \mathfrak{A} .	<i>parting</i>
<i>Corónopus.</i> E.Fl.	Buck's-horn.	lin. pinnatif.	<i>gr.</i> 4. 9.	Britain.	H. \mathfrak{A} .	<i>plants.</i>
<i>C'ynops.</i> R.S.	shrubby.	filif. ent. erect.	<i>gr.</i> 5. 8.	S. Europ.	1596.	H. \mathfrak{S} .	—
<i>marítima.</i> R.S.	sea.	lin. chann. ent.	<i>gr.</i> 7.	Britain.	—	H. \mathfrak{P} .	—
HEDYOTIS, HEDYOTIS. <i>Cal. 4-parted. Cor. tubular, 4-toothed. Caps. 2-celled, many-seeded.</i>							
<i>campanulifóra.</i> B.M.	Bell-flow'd.	ov. obt. opp. hairy.	<i>bl.</i> —	Brazil.	1825.	S. \mathfrak{P} .	—
[1 cell. Seeds many.]							
CENTUNCULUS, BASTARD-PIMPERNAL. <i>Cal. 4-part. Cor. of 1 leaf, 4-part, tubular. Caps. of</i>							
<i>minimus.</i> E.Fl.	small.	alt. ov. smooth.	<i>axill. red.</i> 6. 7.	Britain.	H. \mathfrak{A} .	<i>Seeds.</i>

Systematic Name.	English Name.	Form of Leaves, &c.	Col. of Flow.	Month of Fl.	Native Country.	Yr. of Introd.	Soil and Propagation.
SANGUISORBA, BURNET. <i>Cal. of 1 leaf, 4-clef. Cor. 0. Fil. nearly as long as the cal. elast. Ger. 4-sid.</i>							
canadensis. w.	Canadian.	pinn.; spikes round, long.	w.	7. 9.	Canadian.	1633.	H. P. Light soil.
mèdia. E. Fl.	oblong.	spikes round; cal. fring.	wh.	—	—	1785.	H. P. Seeds, or
officinális. B. Fl.	great.	cord. serr. pinn.; sp. ov.	pur.	6. 8.	Britain.	H. P. part. plants.
[Pod of 1 cell. Seeds many.]							
EPIMEDIUM, BARREN-WORT. <i>Cal. of 4 leaves, concave. Cor. of 4 petals. Nect. 4, 1 on each petal.</i>							
alpinum. E. Fl.	Alpine.	tritern. leaf. cord. serr.	red.	4. 5.	England.	H. P. Light loam, divid. plant.
PARIETARIA, WALL-PELLITORY. <i>Cal. of 1 leaf, 4-clef. Cor. 0. Fil. clas. Ger. ov. Sty. erect. Sti. tuft.</i>							
officinális. E. Fl.	common.	ov. lanc. alt. 3-nerv.	pur.	5. 6.	Britain.	H. P. Sandy loam, divid. plant.
ALCHEMILLA, LADY'S MANTLE. <i>Cal. of 1 leaf, tub. 8-cleft. Cor. 0. Fil. awl-shap. short. Seed 1-2 nak.</i>							
alpina. E. Fl.	Alpine.	digit. serr. silky ben.	gr.	7.	Britain.	H. P. Light soil.
arvensis. E. Fl.	field; or Parsley Pier.	trif. alt. ent.	gr.	4. 6.	—	H. A. part. plants,
pentaphylla. DC.	five-leaved.	quin. leaf.	gr.	7.	Switzerl.	1784.	H. P. or seeds.

ORDER II.

DIGYNIA. STYLES 2.

BUFFONIA, BUFFONIA. <i>Cal. of 4 equal leaves. Petals 4. Filam. awl-shaped. Ger. compr. Sty. 2.</i>							
tenuifolia. E. Fl.	slender.	awl-sh. spread. 3-ribb.	wh.	6.	Britain.	H. A. Sandy soil, seeds.
HAMAMELIS, WITCH-HAZEL. <i>Cal. of 4 lobes. Petals 4. Fil. short. Anth. 2-celled. Caps. 2-celled.</i>							
virginica. B. C.	Virginian.	broadly ellip. serrate.	yel.	5. 11.	N. Amer.	1736.	H. S. Sandy loam, cuttings.
HYPECOUM, HYPECOUM. <i>Sepals 2, lanceolate. Petals 4, unequal, the 2 exter. 3-lobed. Pod flat.</i>							
erectum. DC.	erect.	pinn. leaf. bipinnatif.	yel.	5.	Siberia.	1759.	H. B. Sandy soil.
pendulum. w.	pendulous.	Pods knotty pend. 2 inn. pet	—	—	S. France.	1640.	H. A. seeds.
procumbens. DC.	procumbent.	pinn. multipart. glau.	yel.	6.	Europe.	1596.	H. A. —
ILEX, HOLLY. <i>Cal. of 1 leaf, 4-cleft. Cor. wheel-shap. of 4 pet. Ger. roundish. Sty. 0. Stig. 4, obtuse.</i>							
Aquifolium. E. B.	common.	ov. acut. spiny.	wh.	4. 6.	Britain.	H. S. Sandy loam.
1. heterophylla.	various-leaved.	wh.	—	—	H. S. grafting,
2. recurva.	recurved.	wh.	—	—	H. S. cuttings,
3. crassifolia.	thick-leaved.	wh.	—	—	H. S. or seeds.
4. alba marginata.	white-edged.	wh.	—	—	H. S. —
5. ferox.	hedgchog.	wh.	—	—	H. S. —
6. aurea marginata.	gold-edged.	wh.	—	—	H. S. —
7. flava.	yellow-fruited.	wh.	—	—	H. S. —
8. echinata.	hedgchog.	wh.	—	—	H. S. —
angustifolia. DC.	narrow-leaved.	lin. lanc. serr.	wh.	5. 6.	N. Amer.	1806.	F. S. —

Systematic Name.	English Name.	Form of Leaves, &c.	Col. of Flow.	Month of Fl.	Native Country.	Yr. of Introd.	Soil and Propagation.
chinénsis. DC.	Chinese.	ov. obl. sub-tooth.	wh.	7.	China.	1814.	G. S. ———
Cassine. DC.	broad-leaved.	ov. lanc. serr. flat.	wh.	8.	Carolina.	1726.	F. S. ———
Dahoon. DC.	Dahoon.	lanc. ellip. nearly ent.	wh.	5. 6.	———	———	F. S. ———
myrtifolia. DC.	Myrtle-leaved.	alt. remote lin. lanc.	wh.	7. 8.	W. Indies.	1806.	S. S. ———
opaca. DC.	Carolina.	ov. acut. spiny.	wh.	5. 6.	Carolina.	1744.	F. S. ———
Perádo. DC.	thick-leaved.	ov. ent. shin.	wh.	4. 5.	Madeira.	1760.	F. S. ———
salicifolia. Jacq.	Willow-leaved.	elong. lanc. dent.	wh.	5. 6.	Mauritius.	1818.	S. S. ———
Vomitória. H.K.	emetic.	alt. obl. serr. cren.	wh.	7. 8.	Florida.	1700.	F. S. ———

POTAMOGETON, POND-WEED. Cal. 0. Cor. of 4 incurved petals. Germ. 4, ov. Stig. obt. Seeds 4.

crispum. B.Fl.	curled.	lin. lanc. serr. 3-nerv.	br.	6. 7.	Britain.	H.w. P. Mud and
gramineum. E.B.	Grass-leaved.	alt. lin. 3 inch long.	br.	7. 8.	———	H.w. P. sand,
lucens. E.B.	shining.	ellip. lanc. 4 inch. long.	gr.	6. 7.	———	H.w. P. in ponds.
lanceolatum. E.B.	lanceolate.	lanc. flat. ent.	br.	7. 8.	England.	H.w. P. ———
nátans. E.B.	broad-leaved.	alt. obl. lin. upp. opp.	gr.	8.	Britain.	H.w. P. ———
perfoliatum. E.Fl.	perfoliate.	cord. amplex. 7-nerv.	br.	———	———	H.w. P. ———

RUPPIA, RUPPIA. Cal. 0. Cor. 0. Anth. 4 sess. 4-sid. Ger. 4-5. Sty. 0. Stig. obt. Seeds 4, naked.

marítima. E.Fl.	sea.	alt. lin. setac.	br.	7.	Britain.	H.w. P. Strong loam.
-----------------	------	------------------	-----	----	----------	------	----------------------

SAGINA, PEARL-WORT. Cal. of 4 conc. leav. Pet. 4. Ger. ov. Sty. short. Stig. downy. Cap. of 1 cell.

marítima. E.Fl.	sea.	obt. fleshy stm. er. sm. pet. 0.w.	7.	Ireland.	H. A. Sandy soil.	seeds.
-----------------	------	------------------------------------	----	----------	------	-------------------	--------

RADIO'LA, RADIO'LA. Cal. of 1 leaf, in 12 segments. Petals 4. Caps. of 8 cells, and 8 valves.

millegrána. E.Fl.	all-seed.	sess. ov. 3-ribb.	wh.	6. 7.	Britain.	H. A. Sandy soil.	seeds.
-------------------	-----------	-------------------	-----	-------	----------	------	-------------------	--------

TILLÆA, TILLÆA. Cal. of 3-4 leaves. Pet. 3-4. Nect. 0. Fil. 3-4, awl-shap. Ger. 3-4. Stig. obtuse.

muscosa. Br.Fl.	mossy.	opp. ov. obt. smth.	wh.	———	Britain.	H. A. Sandy soil.	seeds.
-----------------	--------	---------------------	-----	-----	----------	------	-------------------	--------

CLASS V. ORDER I.

PENTANDRIA MONOGYNIA. STAMENS 5. PISTIL 1.

ANCHUSA, ALKANET. Cal. of 1 leaf, 5-parted. Cor. of 1 pet. funn-sha. 5-cleft, & obt. Seeds concave.

officinális. B.Fl.	common.	lanc. narr. ; spk. imbr. pur.	6.10.	Britain.	H. P. Light loam.
sempervirens. E.Fl.	evergreen.	ov. strig. Pedun. axill.	bl. 5. 7.	———	H. P. div. at root.

CYNOGLOSSUM, HOUND'S-TONGUE. Cal. 5-cleft. Cor. of 1 pet. of 5 round. seg. Ger. 4. Seeds 4.

officinále. B.Fl.	common.	ellip. lanc. pub. upp. sess. cr.	6. 7.	Britain.	H. B. Sandy soil.
sylvaticum. B.Fl.	green-leaved.	ov. lanc. scabr. sub. hairy. pu.	———	———	H. B. cuttings, or div. at root.

PULMONARIA, LUNG-WORT. Cal. 5-angl. 5-cleft. Cor. funnel-shap. Ger. vill. Seeds 4, orbicular.

angustifolia. B.Fl.	narrow-leaved.	lanc. scabr. upp. sess.	4. 5.	Britain.	H. P. Light loam.
azúra. s.s.	sky-blue.	obl. lanc. acum. hisp.	bl. 4. 6.	Poland.	1823.	H. P. part. roots.

Systematic Name.	English Name.	Form of Leaves, &c.	Col. of Fl.	Month of Native Fl. Country.	Yr. of Introd.	Soil and Propagation.
<i>lanceolata</i> . P.H.	lance-leaved.	lanc. stalk. upp. lin. obl.	pur.	—	Louisiana. 1813.	H. P. ———
<i>mollis</i> . B.B.	soft.	ov. sess. ent.; <i>stm.</i> hairy. <i>pu. bl.</i>	4.	5.	N. Amer. 1816.	H. P. ———
<i>virginica</i> . w.	Virginian.	ov. ellip. upp. obov. lanc.	<i>bl.</i>	3. 5.	— 1699.	H. P. ———
LITHOSPERMUM, GROMWELL. <i>Cal. in 5 deep segments. Cor. funnel-shaped. Stig. notched.</i>						
<i>maritimum</i> . E. Fl. sea.		ov. glau. apex recurv.	<i>pur.</i>	6. 7.	Britain.	... H. P. Sandy loam, seeds, or
<i>Pulmonaria maritima</i> . E. B.						H. P. div. at root.
<i>purpuro-cœruleum</i> . E. B.	purple.	alt. lanc. acut. pil.	<i>pur.</i>	4.	—	... H. P. div. at root.
SYMPHYTUM, COMFREY. <i>Cal. 5-parted. Cor. bell-shaped, with 5 shallow segments. Germ. 4.</i>						
<i>officinale</i> . E. Fl. common.		ov. lanc. wavy, marg. rou. <i>y. w.</i>	5. 7.	Britain.	... H. P. Light loam.	
<i>tuberosum</i> . E. Fl. tuberous.		ov. obl. upp. lvs. in 2's. opp. <i>y.</i>	5. 10.	Scotland.	... H. P. part. plant.	
BORAGO, BORAGE. <i>Cal. 5-parted. Cor. wheel-shaped, the limb in 5 deep seg. Ger. 4. Seeds 4, ovate.</i>						
<i>orientalis</i> . w.	Oriental.	cord. rug. hairy.	<i>bl.</i>	3. 5.	Turkey. 1752.	H. P. Sandy soil.
<i>officinale</i> . E. B.	common.	ov. rough, hairy.	<i>bl.</i>	—	Britain.	... H. A. seeds, or [dividing plant.]
ASPERU'GO, MADWORT. <i>Cal. of 1 leaf, 5-part. Cor. funn.-sha. 5-part, nearly closed by 5 conv. valves.</i>						
<i>procumbens</i> . B. Fl. German.		obl. lanc. roug.; <i>stm.</i> proc.	<i>bl.</i>	4. 5.	Britain.	... H. A. Sandy loam. seeds.
LYCO'PSIS, BUGLOSS. <i>Cal. 5-cle. Cor. of 1 pet. fun.-sh. 5-par. Ger. 4. Sty. thread-sh. Sti. notch. Seeds 4.</i>						
<i>arvensis</i> . E. Fl. small.		lanc. dent. recurv. hisp.	<i>bl.</i>	5. 8.	Britain.	... H. A. Sandy soil. seeds.
E'CHIUM, VIPER'S-BUGLOSS. <i>Cal. of 1 leaf, 5-parted. Cor. bell-shap. 5-parted. Ger. 4. Sty. often [hairy. Stig. deeply cloven.]</i>						
<i>argenteum</i> . w.	silvery.	lanc. silky, vill.	<i>bl.</i>	6. 7.	C. B. S. 1789.	G. S. Loam, & leaf
<i>australe</i> . w.	oval-leaved.	ov. tubercul. hairy.	<i>pur.</i>	8.	S. Europ. 1824.	H. A. mould, or peat
<i>candicans</i> . w.	hoary-tree.	lanc. nerv. hoary.	<i>bl.</i>	5. 6.	Madeira. 1777.	G. S. cuttings,
<i>creticum</i> . w.	Cretan.	obl. lanc. hispid.	<i>red.</i>	7. 9.	Levant. 1683.	H. A. or seeds.
<i>fruticosum</i> . w.	shrubby.	lanc. base attenuat. vill.	<i>pk.</i>	5. 6.	C. B. S. 1759.	G. S. ———
<i>fastuosum</i> . H. K.	fastuous.	lanc. nerv.; <i>br.</i> silky.	<i>pur.</i>	4. 8.	Canaries. 1779.	G. S. ———
<i>grandiflorum</i> . B. R.	large-flow'd.	lanc. amplex. hisp. abov. <i>ros.</i>	6. 7.	Madeira. 1787.	G. S. ———	
<i>giganteum</i> . w.	gigantic.	lanc. base attenuat. pil. <i>wh.</i>	7. 11.	Canaries. 1779.	G. S. ———	
<i>glabrum</i> . w.	smooth.	lanc. smth. edges rough. <i>wh.</i>	5. 6.	C. B. S. 1791.	G. S. ———	
<i>italicum</i> . w.	white.	lin. lanc. white, hairy. <i>wh.</i>	7.	Jersey.	— H. B. ———	
<i>parviflorum</i> . H. K.	small-flowered.	ov. obl.; <i>stm.</i> erect, fork. <i>bl.</i>	7. 8.	Barbary. 1798.	H. A. ———	
<i>violaceum</i> . w.	Violet-flow'd.	ell. lan. Tube short. than cal. <i>b.</i>	—	Austria. 1658.	H. B. ———	
CERINTHE, HONEY-WORT. <i>Cal. parted. Cor. tubular, ventri. limb 5-cleft. Nuts 2, each 2-celled.</i>						
<i>major</i> . w.	great.	ellip. smth. obt.	<i>yel.</i>	7. 8.	S. France. 1596.	H. A. Light loam.
<i>minor</i> . w.	small.	amplex. ent. smth.	<i>yel.</i>	6. 10.	Austria. 1570.	H. A. seeds.
<i>maculata</i> . w.	spotted.	amplex. ent. spath. <i>yel. red.</i>	6. 7.	S. France. 1804.	H. B. ———	
NAUCLEA, NAUCLEA. <i>Cal. campan. 5-parted. Cor. funnel-shap. 5-lobed. Caps. 2-celled, 2-valved.</i>						
<i>Adina</i> . B. R.	Myrtle-leaved.	lanc. smth. opp.	<i>wh.</i>	—	China. 1804.	G. S. Loam, & leaf
<i>Cadamba</i> . Ros.	broad-leaved.	broadly ell. subp. ner. und. or.	—	E. Indies. 1823.	S. S. mould. cutt.	

Systematic Name.	English Name.	Form of Leaves, &c.	Col. of Fl.	Month of Fl.	Native Country.	Yr. of Intro.	Soil and Propagation.
[roundish. Seed 4.]							
MYOSOTIS, SCORPION-GRASS. <i>Cal. 5-part. half way down. Cor. salver-shaped. 5-cleft. Ger. 4.</i>							
alpéstris. B.Fl.	rock.	ov. obt. stalk. hair.	bl.	6. 7.	Scotland.	H. P. Loam & peat. dividing
rupicola. E.B.							
palústris. E.Fl.	Forget-me-not.	sess. obl. 1-2 inch long.	bl.	4. 8.	Britain.	H. P. at root.
sylvática. R.S.	wood.	obl. obt. obov. fring.	bl. yel.	— — —	— — —	H. P. — — —
nána. w.	dwarf.	obl. lan. vill.; stm. few-fl.	bl.	6. 8.	Europe.	H. P. — — —
[each stone having 2 seeds.]							
TOURNEFORTIA, TOURNEFORTIA. <i>Cal. 5-part. Cor. salver-shap. Stig. peltate. Ber. 2-stoned.</i>							
fruticósa. B.R.	sweet-scented.	elong. lanc. hisp.	yel. gr.	6. 7.	Canaries.	1800.	G. S. Loam & peat.
laurifólia.	laurel-leaved.	ov. obl. acut. smth.	yel.	—	Porto Rico.	1819.	S. S. cl. cuttings.
volúbilis. w.	climbing.	ov. acum. smth.; stm. twin.	gr.	7. 8.	Jamaica.	1752.	G. S. cl. — — —
CORDIA, CORDIA. <i>Perianth. of 1-leaf, tubular, toothed at the apex. Cor. funnel-shaped, 4-5-cleft.</i>							
Geraschánthus. w.	Spanish-elm.	lanc. ov. scabr.	pk.	6.	W. Ind.	1789.	S. S. Sandy loam,
Sebesténa. B.M.	rough-leaved.	ov. obl. scabr.	or.	6. 8.	— — —	1728.	S. S. & leaf mould. cuttings.
PYXIDANTHERA, PYXIDANTHERA. <i>Cal. 5-parted. Cor. campanulate, 5-cleft.</i>							
barbuláta. Mich.	bearded.	wedge-sh. lanc. acut.	wh.	7.	Carolina.	1806.	F. P. Peat & loam. parting at root.
DEERINGIA, DEERINGIA. <i>Perianth. 5-part. Sta. 5, opp. the seg. Sty. 3-part. Stig. obt. Ber. 3-lob.</i>							
celosióides. B.M.	Celosia-like.	alt. ov. acum. ent.	wh.	8. 10.	E. Ind.	1804.	S. S. Peat & loam. cutt. or seeds.
HELICONIA, WILD PLANTAIN. <i>Cal. 0. Pet. 3, obl. Nect. of 2 pieces. Caps. obl. 2-celled. Seed 1.</i>							
Bíhai. w.	Bihai.	stalk. obl. ent. erect.	or.	7. 8.	W. Ind.	1786.	S. P. Peat & loam. seeds, or div. plant.
CAMPANULA, BELL-FLOWER. <i>Cal. of 5-deep seg. Cor. bell-sha. Ger. ang. Sty. fili. Sti. 2 or 3-cleft.</i>							
Alpína. R.S.	Alpine.	lanc. serr. upp. sess.	bl.	6. 7.	Italy.	1823.	H. P. Light loam.
aggregáta. R.S.	crowded.	sess. wavy, lanc. dent.	pu. bl.	7. 9.	Bavaria.	1824.	H. P. seeds, or
azúrea. B.M.	azure.	ov. obl. sess. serr.	bl.	6. 7.	Switzerl.	1778.	H. P. parting at
barbáta. B.M.	bearded.	lanc. cren. ; stm. pubes. li. bl.	— — —	— — —	Italy.	1752.	H. P. the roots.
Bellárdi. R.S.	Bellarde's.	ellip. lanc. dent. stalk.	bl.	6. 9.	— — —	1813.	H. P. — — —
bononiénsis. R.S.	panicked.	sess. ov. lanc. scabr. ben.	bl.	9. 10.	— — —	1773.	H. P. — — —
carpáthica. R.S.	Carpathian.	cord. serr. stalk. smth.	bl.	6. 8.	Car. Alps.	1774.	H. P. — — —
capénsis. R.S.	Cape.	lanc. dent. hispid.	bl.	6. 9.	C. B. S.	1803.	G. S. — — —
caucásica. R.S.	Caucasian.	obov. undul. scabr.	bl.	7. 8.	Caucasus.	1804.	H. P. — — —
dichótoma. E.F.G.	Forked.	sess. ov. dent. hairy.	bl.	— — —	Levant.	1827.	H. A. — — —
excísa. B.C.	bitter.	obl. upp. lin.	bl.	5. 6.	Switzerl.	1816.	H. P. — — —
glomeráta. E.Fl.	clustered.	ov. cren. hairy, upp. amp. x. pu.	5. 9.	— — —	Britain.	H. P. — — —
hederácea. E.Fl.	Ivy-leaved.	cord. smth. angul. pur.	bl.	5. 6.	England.	H. P. — — —
latifólia. E.Fl.	broad-leaved.	ov. lanc. cren. rough.	bl.	7.	Britain.	H. P. — — —
lactiflóra. B.R.	milk-white.	ov. lanc. serr. ; stm. hisp.	wh.	7. 9.	Caucasus.	1814.	H. P. — — —
linifólia. R.S.	Flax-leaved.	obov. r. upp. lin. lanc. dent.	bl.	6. 9.	Sweden.	1816.	H. P. — — —
Médiúm. R.S.	Canterbury-bell.	lanc. serr. sess. 3-nerv.	wh.	— — —	Germany.	1597.	H. B. — — —
pyramidális. R.S.	Pyramidal.	ov. lanc. smth.	bl.	6. 7.	Carniola.	— — —	H. P. — — —
1. alba.	white-flowered.						
2. cærúlea.	blue-flowered.						

Systematic Name.	English Name.	Form of Leaves, &c.	Col. of Flow.	Month of Native Fl. of Country.	Yr. of Introd.	Soil and Propagation.
púmila. B.R.	dwarf.	stalk. ov. cren.	bl. wh.	6. 9. Switzerl.	H. P. ———
patúla. E. Fl.	spreading.	ellip. lanc. cren. rough.	bl.	7. 8. Britain.	H. P. ———
púlla. B.M.	dark-flowered.	smth. cren. dent. fring.	dk. bl.	6. 7. Austria.	H. P. ———
púsilla. R.S.	small.	cord. lob. smth. up. ell. den.	bl.	— Eur. Alps.	H. P. ———
persicifólia. Fl. D.	Peach-leaved.	obov. upp. lin. lanc. serr.	bl.	7. 9. Europe.	1596.	H. P. ———
1. álba.	white-flowered.	wh.	— — — —	H. P. ———
2. cœrúlea.	blue-flowered.	bl.	— — — —	H. P. ———
3. álbo-flore-pleno.	double-white.	wh.	— — — —	H. P. ———
punctáta. B.M.	dotted-flow'd.	ov. lanc. serr. hairy.	yel.	5. 6. Siberia.	1813.	H. P. ———
Rapúnculus. E. Fl.	Rampion.	obov. cren. opp. lanc.	bl.	7. 8. Britain.	H. P. ———
rapunculoides. E. Fl.	creeping.	cord. lanc. cren. rough.	pu. bl.	— England.	H. P. ———
speciósá. B.M.	showy.	ov. cord. stalk. upp. sess.	pu.	5. 9. Siberia.	1818.	H. P. ———
Scheuchzéri. B.C.	Scheuchzer's.	ellip. lanc. serr. hairy.	bl.	6. 9. Alps. Eur.	1813.	H. P. ———
Trachélium. E.B.	Nettle-leaved.	cord. lanc. serr.; stem. ang.	bl.	— Britain.	H. P. ———
versicolor. R.S.	various-col'd.	cord. ov. undul. serr.	bl.	— Greece.	1788.	H. P. ———

WAHLENBERGIA, WAHLENBERGIA. Cal. of 5-linear seg. Cor. bell-sha. limb 5-lob. Stig. 3-fid.

grandiflora. Schr. large-flowered. tern. ob. lan. ser.; st. 1-fl. pu. bl. 6. 7. Siberia. 1782. H. P. Sandy loam. div. at root.

Campánula grandiflora. E.M.

ADENO'PHORA, ADENO'PHORA. Cal. 5-part. Cor. campan. 5-cleft. Caps. 3-celled, 3-valved.

coronopifólia. B.F.G.	Bucks-hn-lv'd.	ov. dent. upp. lanc.	bl.	6. 7. Dahuria.	1822.	H. P. Light loam.
denticuláta. B.F.G.	tooth-leaved.	cord. upp. ov. lan. pub. den.	bl.	— — — —	—	H. P. seeds, or di-
intermédia. B. Fl. G.	Intermediate.	cord. dent. upp. lanc.	bl.	7. 8. Siberia.	1820.	H. P. viding at
marsupiiflora. B.F.G.	bellied.	stalk. serr. lower cord.	bl.	— — — —	1818.	H. P. root.
Campánula coronáta. B.R.						
stylósa. B.F.G.	long-styled.	alt. obov. sinuat. upp. ov.	bl.	6. 7. — — —	1820.	H. P. ———

PHYTE'UMA, RAMPION. Cal. 5-part. Cor. wheel-sha. 5-cleft. Caps. of 2 or 3 cells. Stig. 2 or 3-cleft.

comósa. Wul.	comose.	dent. lower cord.	dk. bl.	— Austria.	1752.	H. P. Sandy loam
hemisph'érica. W.	linear-leaved.	lin. nearly ent.	bl.	— Switzerl.	—	H. P. and peat.
orbiculáre. E. Fl.	round-headed.	ellip. lanc. smth. cren.	bl.	6. 8. England.	H. P. dividing at
Scheuchzéri. B.M.	Scheuchzer's.	lin. lanc. serr. stalk.	bl.	6. 7. Switzerl.	1815.	H. P. the root, or
spicáta. Fl. D.	spiked.	cor. doubly-tooth.; st. hair. st.	—	— Europe.	1597.	H. P. seeds.
scorzonericifólium. B.M.	Scorzonera-ld.	lin. lanc. chann. serr.	bl.	7. 8. — — —	1817.	H. P.

LOBE'LIA, LOBE'LIA. Cal. 5-cleft. Cor. irregu. 5-part. Ger. acute. Stig. hairy. Caps. of 2 or 3 cells.

am'æna. R.S.	beautiful blue.	broad, lanc. serr.	bl.	6. 9. N. Amer.	1812.	H. P. Sandy loam,
argúta. B.R.	fine-toothed.	lin. lanc. serr. smth.	yel.	8. 9. Chili.	1823.	S. P. and leaf
assúrgens. A. rep.	assurgent.	lanc. serr. decurr.	pur.	— W. Ind.	1787.	S. S. mould, cut-
bícolor. B.M.	two-coloured.	obl. dent. pubes.	pur. bl.	— C. B. S.	1795.	H. A. tings, or
bellidifólia. W.	Daisy-leaved.	ov. dent. hairy.	bl.	5. 7. — — —	1790.	G. P. dividing at
corymbósa. B.M.	Corymbose-fl'g.	ov. orbic. upp. lin. serr.	wh.	6. 8. — — —	1825.	G. P. the roots.
cardinális. B.M.	Cardinal-flow.	broadly-lanc. serr.	sc.	5. 10. Virginia.	1629.	F. P. ———
cœrúlea. B.M.	b'ue-flowered.	lanc. dent. pinnatif. pub.	bl.	6. 7. C. B. S.	1823.	G. S. ———
coronopifólia. B.M.	Bucks-hn-lv'd.	lanc. dent. pedun. long.	bl.	— — — —	1752.	G. P. ———
Dortmánná. E. Fl.	Water.	lin. ent. obt.	bl.	7. 8. Britain.	H. w. P. ———
decúrrens.	winged-stem'd.	ov. lanc. serr.	pur.	9. Chili.	1829.	F. P. ———
Erinus. E.M.	ascending.	lanc. dent.; stem flexu.	bl.	— C. B. S.	—	H. P. ———
erinóides. W.	trailing.	obl. dent.; stem trailing.	bl.	— — — —	1759.	G. S. ———
fúlgens. B.R.	fulgent.	lanc. tooth. revol.; st. pub.	sc.	5. 9. Mexico.	1809.	F. P. ———

Systematic Name.	English Name.	Form of Leaves, &c.	Col. of Flow.	Month of Fl.	Native Country.	Yr. of Introd.	Soil and Propagation.
grácilis. B.M.	slender.	ov. ent. ; stem divid.	bl.	7. 9.	N. S. W.	1801.	G. A. ———
goodenioides. H. K.	Goodenia-like.	obl. obt. low. sp. all nearly ent.	—	—	N. Amer.	1799.	H. P. ———
hirsúta. W.	hairy.	ov. tooth. ; st. hairy, prostr.	bl.	5. 8.	C. B. S.	1759.	G. P. ———
ilicifólia. B.M.	Holly-leaved.	ov. undul. dent.	wh. pur.	5. 9.	—	1815.	G. P. ———
lútea. W.	yellow.	lanc. serr. ; st. procumb.	yel.	6. 9.	—	1774.	G. P. ———
lineáris. R. S.	linear-leaved.	lin. smth. ent.	bl.	—	—	1791.	G. S. ———
minúta. B.M.	small.	spat. ent. smth. und.	bh.	—	—	1772.	G. P. ———
pinifólia. A. rep.	Pine-leaved.	lin. crowd. ent.	bl.	5. 9.	—	1752.	G. P. ———
procúbens.	procumbent.	spat. tooth. upp. lanc. smth.	bl.	7. 8.	—	1830.	G. A. ———
purpuráscens. B. P.	purplish.	ov. lanc. ent. serr.	pur.	6. 8.	N. S. W.	1809.	G. P. ———
robústa. B.M.	thick-stemmed.	obo. lan. acum. serr. smth.	pu.	—	Hayti.	1830.	G. P. ———
siphilítica. B. R.	blue Cardinal.	ov. obl. acut. serr.	bl.	9. 10.	Virginia.	1665.	H. P. ———
senecioides. B.M.	blue pedunculat.	lanc. lin. pinnatif.	bl.	6. 7.	N. S. W.	1824.	G. S. ———
surinaménsis. A. B. R.	shrubby.	obl. smth. serr.	red.	1. 7.	W. Ind.	1786.	S. S. ———
Túpa. B.M.	Mullein-ly'd.	ov. obl. acum. downy.	red.	9. 10.	Peru.	1824.	F. P. ———
tyrianthina.	violet-coloured.	obl. smth. serr. up. lan. cil.	vio.	8. 9.	1830.	F. P. ———
úrens. E. Fl.	acid.	dent. obov. upp. lanc. sess.	pu.	6. 7.	England.	H. P. ———
unidentáta. B.M.	one-toothed.	lanc. opp. smth. 1-tooth.	bl.	—	C. B. S.	1794.	G. P. ———
variifólia. B.M.	various-leaved.	lin. dent.	yel.	—	—	1812.	G. P. ———

IPOM'OPSIS, IPOM'OPSIS. Cal. 5-parted, lobes acute. Cor. campanulate, limb 5-cleft.

élegans. Ex. B. elegant. pinnatif. fleshy, lobes lin. sc. 6. 7. Carolina. 1726. G. B. Loam, and
Cántua coronopifolia. A. R. leaf mould. seeds.

IMP'ATIENS, BALSAM. Cal. of 2 leaves. Cor. irregu. of 5 uneq. petals. Caps. of 5 cells, and 5 valves.

biflóra. B. F. G. two-flowered. ov. serr. pedun. 2-fld. or. 6. 9. N. Amer. H. A. Sandy loam.
Nôli-me-tângere. E. Fl. Touch me not. alt. ellip. serr. stalk. yel. — England. H. A. seeds.
parviflóra. D. C. small-flowered. ov. acum. serr. yel. — Russia. 1828. H. A. ———

SAM'OLUS, BROOK-WEED. Cal. of 1 leaf, 5-clef. Cor. funn-sha. 5-clef. Caps. of 1 cell, with 5 recur. valv.

Valerándi. E. B. water Pimpernel. ov. obt. ent. smth. wh. 7. 8. Britain. H. P. Sandy loam.
 divid. at root.

ERYTHRÆA, CENTAURY. Cal. 5-clef. Cor. salver-sha. 5-part. Ger. comp. Caps. 2-cell. of 2 valves.

aggregáta. B. F. G. aggregate. spath. obt. opp. ent. 1-ner. pk. 3. 10. Germany. 1824. H. P. Sandy loam.
Centaúrium. E. B. common. ov. lanc. 3-ribb. smth. ros. 7. 9. Britain. H. A. seeds.
latifólia. s. s. broad-leaved. ellip. 5-7-ribb.; st. m. 3-clft. ros. — Lancash. H. A. ———
littorális. E. B. dwarf-tufted. lin. obov. obt. ros. — Britain. H. A. ———
marítima. F. gr. sea. obl. lanc. ; stem forked. yel. — S. Europ. 1777. H. A. ———
pulchélla. E. Fl. dwarf branched. obl. ent. smth. ; st. ang. pk. 9. 10. England. H. A. ———

CHIRONIA, CHIRONIA. Cal. 5-parted. Cor. rotate, of 5 petals. Caps. 2-celled.

angustifólia. B. M. narrow-leaved. lin. spread. Cor. clammy. red. 6. 9. C. B. S. 1800. G. S. Loam & peat.
baccífera. B. M. berry-bearing. lin. lanc. smth. ; st. m. shrubby. pk. 6. 7. — 1759. G. S. cuttings.
decussáta. B. M. cross-leaved. obl. lin. decus. ; st. shr. hai. ros. — 1789. G. S. ———
frutésdens. B. M. shrubby. lanc. hairy ; st. shrubby. ros. 6. 9. — 1756. G. S. ———
jasmínoides. B. R. Jasmine-like. opp. lanc. ent. pk. 4. 7. — — G. S. ———
linóides. B. M. flax-leaved. opp. lin. smth. ros. — — 1787. G. S. ———

SPIGELIA, WORM-GRASS. Cal. 5-part. Cor. funnel-sha. limb 5-cleft. Caps. 2, 2-cell. and 4-valved.

marylándica. B. M. perennial. opp. ov. smth. ent. red. 7. 8. N. Amer. 1694. H. P. Loam & peat.
 divid. at root.

Systematic Name.	English Name.	Form of Leaves, &c.	Col. of Flow.	Month of Fl.	Native Country.	Yr. of Intro.	Soil and Propagation.
CLAYTONIA, CLAYTONIA. <i>Cal. 2-valv. Cor. of 5-pet. Stig. 3-fid. Caps. 1-cell. 3-valv. & 3-seed.</i>							
alsinoides. B.M.	Chickweed-like.	spatul. ovate, ent. smth.	wh.	3. 6.	Noot. Sou.	1794.	H. A. Peat, and a
caroliniana. B.F.G.	spatula-leaved.	spath. ent. smth. 3-nerv.	car.	—	N. Amer.	1789.	H. P. little loam.
grandiflora. B.F.G.	large-flowered.	lin. lanc. attenuat.	pk.	—	—	—	H. P. seeds, or
perfoliata. B.M.	perfoliate-lv'd.	ov. rhomb. upp. connate.	wh.	5. 9.	—	1794.	H. A. offsets from
sibirica. B.M.	Siberian.	ov. smth. nerv. ent.	ros.	—	Siberia.	1768.	H. A. base of plant.
virginiana. B.M.	virginican.	ellip. ent. smth. Pet. notch.	v.	3. 5.	N. Amer.	1748.	H. P. —
[Sty. twisted near the base.]							
ERPELION, SPURLESS VIOLET. <i>Cal. 5-part. Cor. of 5-pet. the lower much the largest. Ger. 3 sid.</i>							
reniforme. B.F.G.	kidney-shaped.	renif. smth. dent.	bl.	3. 5.	N. S. W.	1823.	F. P. Sandy loam, [& leaf mould. cuttings, or part. plants.]
VIOLA, VIOLET. <i>Cal. of 5 equal leaves. Cor. of 5 unequal petals, spurred. Caps. of 1 cell, and 3 valves.</i>							
biflora. w.	two-flowered.	renif. serr. ; stip. ent.	yel.	8. 10.	Europe.	1752.	H. P. Sandy loam,
calcarata. w.	spurred.	ov. ; stip. tooth.	bl.	3. 6.	—	—	H. P. & leaf mould.
canadensis. w.	Canada.	cord. hast. serr. large.	wh. red.	5. 7.	N. Amer.	1783.	H. P. cuttings, or
cornuta. B.M.	horned.	cord. cren. ; st. 3-cornered.	bl.	5. 6.	Pyrenees.	1776.	H. P. part. plants.
flavicornis. E. Fl.	dwarf-yellow.	cord. alt. rigid. smth.	bl.	—	Britain.	—	H. P. —
grandiflora. L.	great-flowered.	obl. ; stip. pinnatif.	yel.	—	Switzerl.	—	H. P. —
hirta. E.B.	hairy.	cor. hairy. cren. ; stip. lan. den.	yel.	5. 8.	England.	—	H. P. —
lutea. E.B.	yellow.	obl. cren. fring. ; stip. pal.	yel.	—	Britain.	—	H. P. —
lactea. E.B.	cream-coloured.	ov. lanc. cren. ; stip. jagg.	wh.	—	England.	—	H. P. —
montana. B.M.	mountain.	cord. upp. ov. acut.	bl.	—	Europe.	1683.	H. P. —
odorata. w.	sweet-scented.	cord. nearly smooth.	vio.	3. 10.	Britain.	—	H. P. —
1. alba.	white-flowered.	wh.	—	—	—	H. P. —
2. alba plena.	double-white.	wh.	—	—	—	H. P. —
3. caerulea.	blue.	bl.	—	—	—	H. P. —
4. caerulea plena.	double-blue.	bl.	—	—	—	H. P. —
5. pallido plena.	Neapolitan.	pa. bl.	—	—	—	H. P. —
6. purpurea.	purple.	pur.	—	—	—	H. P. —
7. purpureo plena.	double-purple.	pur.	—	—	—	H. P. —
palustris. E. Fl.	marsh.	kidney-sh. smth. veiny	ben. b.	5. 6.	—	—	H. P. —
pedata. DC.	pedate-leaved.	many-parted. seg. lin. lan.	pu.	5. 8.	N. Amer.	1759.	H. P. —
palmata. B.M.	palmate.	hast. lob. palm. pubes.	bl.	5. 7.	Virginia.	1752.	H. P. —
præmorsa. B.R.	bitten-rooted.	ov. obl. cucull. dent.	yel.	—	—	1827.	H. P. —
papilionacea. Ph.	variegated.	cord. cren. a little hairy.	bl.	—	—	1800.	H. P. —
pinnata. w.	wing-leaved.	pinn. multipart. seg. lob.	pur.	—	Europe.	1752.	H. P. —
striata. w.	streaked.	ov. cord. acum. pubes.	yel.	6. 8.	N. Amer.	1772.	H. P. —
tricolor. E.B.	three-coloured.	obl. cren. alt. ; stip. pinn. br. yel.	4. 11.	—	Britain.	—	H. P. —
uniflora. w.	one-flowered.	renif. upp. ov. acum. dent.	yel.	6. 7.	Siberia.	1774.	H. P. —
VERBASCUM, MULLEIN. <i>Cal. of 5 equal seg. Cor. wheel-sha. 5-cleft. Caps. ov. of 2 cells, & 2 valves.</i>							
Blattaria. E. Fl.	moth.	shin. serr. smth. amplex.	yel.	7. 9.	Britain.	—	H. B. Sandy loam.
Boerhavia. w.	annual.	lyrate, sess. upp. obl. serr.	yel.	—	S. Europ.	1731.	H. A. seeds, or di-
cupreum. B.M.	copper-colored.	cord. ov. rugos. cren. wooll.	co.	5. 8.	Hybrid.	1798.	H. P. vid. plant.
ferrugineum. B.R.	rusty.	ov. cord. rug. cren. hairy.	pur.	—	S. Europ.	1683.	H. P. —
formosum. B.R.	Fischers.	obl. sinuat. base cord.	yel. pur.	7. 8.	Russia.	1814.	H. P. —
Lychnitis. E. Fl.	white.	cren. ell. obl. downy	ben. yel.	6. 8.	Britain.	—	H. B. —
nigrum. w.	dark.	cord. obl. undul. cren. pub. y.	—	—	England.	—	H. P. —
pulverulentum. E.B.	powdered.	obl. finely serr. woolly.	yel.	—	—	—	H. B. —
phœniceum. B.M.	purple-flow'd.	ov. cren. naked.	pur.	5. 8.	S. Europ.	1596.	H. P. —
virgatum. E. Fl.	large-flowered.	ov. lanc. dent. upp. sess.	yel.	8.	Britain.	—	H. B. —

Systematic Name.	English Name.	Form of Leaves, &c.	Col. of Flow.	Month of Fl.	Native Country.	Yr. of Introd.	Soil and Propagation.
NEMO'PHILA, NEMO'PHILA. <i>Cal. 10-cleft. Cor. camp. 5-lobed, lobes notch. Nect. 10. Ger. hairy.</i>							
phacelioides. B.M.	Phacelia-like.	pinnatif. segm. obl. ciliat.	bl.	6. 9.	N.Amer.	1822.	H. A. Garden loam, seeds.
DATU'RA, THORN-APPLE. <i>Cal. 5-tooth. Cor. funnel-sha. with 5 pointed equal lobes. Ger. of 4 cells.</i>							
ceratocáula. R.S.	horn-stemmed.	ov. lanc. undul. hairy.	wh. pur.	8. 9.	Cuba.	1805.	H. A. Sandy soil.
fastuósa. W.	purple.	ov. angul.	vio.	6. 9.	Egypt.	1629.	H. A. seeds.
Métel. B.B.	downy.	cord. sub-ent. pubes.	wh. —	—	Asia.	1596.	H. A. —
Stramónium. E.Fl.	common.	ov. sinuat. smth.	wh.	7. 10.	England.	—	H. A. —
HYOSCYAMUS, HENBANE. <i>Cal. of 1 leaf, with 5 equal seg. Cor. funn-sha. 5-part. Caps. of 2 cells.</i>							
álbus. W.	white.	stalk. sinuat. obt.	st. pur.	7. 8.	Greece.	1570.	H. A. Sandy loam
aúreus. W.	golden.	stalk. dent. acut.	yel. pur.	3. 10.	Levant.	1640.	G. S. and peat.
níger. B.Fl.	common.	amplex. sinuat. downy.	yel. bk.	6. 7.	Britain.	—	H. B. seeds, or
physaloides. B.M.	purple-flow'd.	alt. ov. acut. smth.	pur.	3. 4.	Siberia.	1777.	H. B. cuttings.
[Seeds kidney-shaped.]							
MANDRAGO'RA, MANDRAKE. <i>Cal. of 1 leaf, 5-part. Cor. of 1 petal, bell-shap. 5-clef. Berr. of 1 cell.</i>							
pr'æcox. B.F.G.	early.	obl. lanc. obt. und. vill.	yel.	4. 5.	Switzerl.	1819.	H. B. Peat & loam, div. plants.
<i>Atropa, Mandragóra, L.</i>							
CA'PSICUM, CA'PSICUM. <i>Cal. 5-cleft. Cor. rotat. 5-parted. Berry juiceless.</i>							
baccátum. W.	Bird-pepper.	ellip. lanc.; stem shrubby.	wh.	6. 9.	W. Ind.	1731.	S. S. Loam & leaf
cerasifórme. W.	Cherry-pepper.	Fr. ob'; stem shrubby.	st.	5. 8.	—	1759.	S. S. mould.
frutésceus. W.	shrubby.	Fr. glob.; stem erect.	wh.	6. 9.	India.	1656.	S. S. seeds.
péndulum. W.en.	pendulous.	Fr. obl.; stem shrubby.	wh.	4. 7.	1804.	S. S. —
CORTU'SA, BEAR'S-EAR SANICLE. <i>Cor. rotat. Stig. capitate. Caps. 1-celled, oblong.</i>							
Mathioli. B.M.	short-calyx'd.	cord. lob. serr. pubes.	li.	4. 6.	Austria.	1596.	H. B. Sandy loam [and peat. seeds, or dividing at root.]
DODEC'ATHEON, AMERICAN COWSLIP. <i>Cal. 5-cle. Cor. of 5 pet. inser. in tub. of cal. Caps. obl. 1-cel.</i>							
mêadia. B.M.	Mead's.	obl. smth. dent.	li.	—	Virginia.	1774.	H. B. Peat & loam. [parting at root, or seeds.]
<i>β. albiflora. white flowering.</i>							
SOLDANE'LLA, SOLDANE'LLA. <i>Cal. 5-parted, segm. lanceol. Cor. camp. Caps. obl. Seeds many.</i>							
alpina. B.M.	Alpine.	orbic. smth. ent.	bl.	4.	Switzerl.	1656.	H. B. Light loam
montána. B.F.G.	mountain.	renif. undul. cren.	bl.	—	Bohemia.	1816.	H. B. and peat. seeds, or di-
<i>Clusii. B.R.</i>							
miníma. B.F.G.	least.	orbic. cren.; scapes pub.	p. bl.	4. 5.	Carp. Mo.	1820.	H. B. vid. at root.
pusilla. B.F.G.	lesser.	rot. cord. subrep. cren.	p. bl.	—	S. Europ.	1824.	H. B. —
SPRENGE'LIA, SPRENGE'LIA. <i>Cal. 5-part. imbri. Cor. 5-cleft. Stam. inser. in the recep. Caps. 5.</i>							
incarnáta. B.M.	flesh-coloured.	ov. acum.	pk.	—	N. S. W.	1793.	G. S. Peat & loam, cuttings.
ANDERS'ONIA, ANDERS'ONIA. <i>Cal. 5-part. col. Cor. the length of calyx, limb bearded at the base.</i>							
sprengelioides. B.M.	Sprengelia-like.	ov. acum. spread.	pk.	5.	N. Holl.	1803.	G. S. Peat & loam, cuttings.
EP'ACRIS, EP'ACRIS. <i>Cal. 5-part. Cor. tubu. limb 5-cleft. Ger. smth. beset with 5 scales. Stig. 5-lob.</i>							
liosmæfólia.	Diosma-leaved.	ellip. smth. ent.	wh.	4. 5.	N. Holl.	1830.	G. S. Sandy loam
grandiflora. B.M.	crimson-flow'd.	ov. acum. mucr.	cr.	1. 6.	N. S. W.	1803.	G. S. and peat.

Systematic Name.	English Name.	Form of Leaves, &c.	Col. of Flow.	Month of Fl.	Native Country.	Yr. of Intro.	Soil and Propagation.
<i>impréssa</i> . S.F.A.	elegant.	sess. lanc. acut. mucr.	ros.	5. 8.	V. Diem.	1824.	G. S. cuttings, or
<i>microphylla</i> . B.P.	small-leaved.	cucull. acut. spread.	wh.	5. 6.	N. S. W.	1817.	G. S. seeds.
<i>obtusifolia</i> . Ex.B.	obtuse-leaved.	lanc. imbric.	wh.	4. 5.	—	1804.	G. S. —
<i>purpurascens</i> . B.P.	purple-flow'd.	cuc. nearly sess. apex rec.	li.	1. 3.	—	1803.	G. S. —
<i>pungens</i> . B.M.							
<i>pulchella</i> . B.C.	handsome.	cord. imbr. rigid.	wh.	4. 6.	—	1804.	G. S. —
<i>patula</i> .	spreading.	sess. ov. or triang. mucr.	wh.	—	—	1829.	G. S. —
LYSIN'EMA, LYSIN'EMA. Cal. coloured. Bract. numer. Cor. salver-sha. often 5-part. the seg. beardl.							
<i>pungens</i> . B.P.	pungent.	ov. ac. cord. smth. ent. rec.	wh.	4. 5.	N. S. W.	1804.	G. S. Peat & loam. seeds, or
<i>Epacris attenuata</i> . B.C.							G. S. cuttings.
<i>roseum</i> . B.C.	rose-coloured.	ov. acum. mucr.	ros.	—	—	—	G. S. —
STENANTH'ERA, STENANTH'ERA. Cal. 5-parted. Cor. tubular, limb 5-parted. Ger. 5-celled.							
<i>pinifolia</i> . B.R.	Pine-leaved.	accr. pub. edges revol.	gr. sc.	5. 7.	N. S. W.	1811.	G. S. Loam & peat. cuttings.
ASTROL'OMA, ASTROL'OMA. Cal. of 4, or somet. more bract. Cor. ventr. with 5 bundles of hairs insid.							
<i>humifusum</i> . B.M.	Juniper-leaved.	lanc. lin. convex. ciliat.	sc.	5. 8.	—	1807.	G. S. Peat & loam. cuttings.
STYPHELIA, STYPHELIA. Cal. parted. Cor. tubu. 5-cleft, limb revol. Fil. exerted. Ger. 5-celled.							
<i>longifolia</i> . B.R.	long-leaved.	lanc. atten. at end. smth.	gr.	4. 6.	—	—	G. S. Sandy loam
<i>l'æta</i> . B.P.	fruitful.	ov. ellip.	gr.	—	—	1822.	G. S. and peat.
<i>triflora</i> . B.M.	three-flow'd.	obl. lanc. flat. glau.	cr. gr.	5. 8.	—	1796.	G. S. cuttings.
<i>viridiflora</i> . B.P.	green-flowered.	obov. obl. sess. mucr.	gr.	4. 6.	—	1791.	G. S. —
PLUMBA'GO, LEAD-WORT. Cal. 5-angled. Cor. of 5 pet. funnel-shap. Stig. 5-cleft. Seed single, obl.							
<i>capensis</i> . B.R.	Cape.	obov. obt. smth. scab. ben. p. b.	9. 10.	C. B. S.	—	1818.	S. S. Loam, & leaf
<i>rosea</i> . B.M.	Rose-coloured.	ov. smth. slightly tooth.	ros.	3. 7.	E. Ind.	1777.	S. S. mould.
<i>zeylanica</i> . W.	Ceylon.	ov. smth. ent. stalked.	wh.	4. 8.	—	1731.	S. S. cuttings.
[hairy, 1-celled. Seeds 5, compr.							
SPERMAD'ICTYON, SPERMAD'ICTYON. Cor. funnel-shap. limb 5-lob. Stig. 5-cleft. Caps. obl.							
<i>azureum</i> .	azure-flowered.	obl. lanc. ent. acum.	p. bl.	2. 4.	Nepal.	1827.	S. S. Cuttings.
<i>suaevolens</i> . B.R.	sweet-scented.	opp. ellip. lanc. smth. ent.	wh.	8. 9.	India.	1816.	S. S. —
BEAUM'ONTIA, BEAUM'ONTIA. Cal. of 5 leaves. Cor. funnel-shaped, limb 5-lobed. Ger. round.							
<i>grandiflora</i> . B.R.	large-flowered.	opp. obl. obt. downy ben.	wh.	6.	E. Ind.	1812.	S. S. cl. Loam, & leaf
<i>longifolia</i> . Lod.	long-leaved.	lanc. obl.	wh.	—	—	1818.	S. S. cl. mould. cutt.
IPOM'ÆA, IPOM'ÆA. Cal. 5-part. nak. Cor. campan. 5-plicate. Caps. 2-3-celled, with 2 seeds in each.							
<i>bignonioides</i> . B.M.	trumpet-flow'd.	3-lobed, base, cord.	d. pur.	7. 8.	Cayenne.	1823.	S. S. cl. Sandy loam,
<i>cœrulea</i> . B.R.	blue.	cord. 3-lobed. vill.	bl.	6. 8.	E. Ind.	1815.	S. S. cl. and leaf
<i>grandiflora</i> . A. rep.	large-flowered.	cord. ov. obt. ent.	wh.	9.	—	1802.	S. S. cl. nould.
<i>insignis</i> . A.R.	magnificent.	palm. 5-lob. up. ov. or. cord.	p.	6. 8.	E. Ind.	1814.	S. S. cl. cuttings, or
<i>Jalapa</i> . B.M.	Jalap.	cord. ent. lob. plicate.	ros.	—	S. Amer.	1733.	S. S. cl. seeds.
<i>latiflora</i> . B.R.	broad-flowered.	cord. smth. pedun. 3-fld.	wh.	8. 9.	E. Ind.	...	S. S. cl. —
<i>latifolia</i> . B.R.	broad-leaved.	cord. smth. acum.	wh.	—	W. Ind.	1811.	S. S. cl. —
<i>mutabilis</i> . B.R.	changeable.	cord. ent. ov. 3-lob. pubes.	bl.	5. 8.	S. Amer.	1812.	S. S. cl. —
<i>maritima</i> . B.R.	sea.	orb. ent. deep. notched at apex.	—	—	N. Holl.	1770.	S. S. —
<i>platensis</i> . B.R.	Plata.	palm. 7-lob. obl.	p. pur.	6. 9.	—	1817.	S. S. cl. —

Systematic Name.	English Name.	Form of Leaves, &c.	Col. of Flow.	Month of Fl.	Native Country.	Yr. of Introd.	Soil and Propagation.		
péndula. B.R.	pendulous.	quinat. digit. leafl. lanc.	pur.	5.	N. S. W.	1808.	G. S. cl. ———		
paniculáta. B.R.	panicked.	palm. lobes 7. lanc. ent.	pur.	6.	E. Ind.	1779.	S. S. cl. ———		
Quamócilit. B.M.	wing-leaved.	pinn. leafl. filif.	red.	——	——	1629.	S. P. cl. ———		
setósa. B.R.	bristly-stalked.	cord. 3-lob. lobes dent.	pur.	9.	Brazil.	1817.	S. S. cl. ———		
sanguínea. B.R.	blood-flowered.	palm. 7-lob. segm. lanc.	sc.	——	W. Ind.	1812.	S. S. cl. ———		
sagittifólia. B.R.	Catesby's.	obl. sagitt. smth.	p. ros.	6.	9.	Carolina.	1819.	G. P. cl. ———	
tuberósa. B.R.	tuberous.	palm. lobes 7. lanc.	st. pur.	——	W. Ind.	1731.	S. P. cl. ———		
trilóba. L.	three-lobed.	cord. 3-lobed.	——	vi.	6.	7.	——	1752.	S. A. cl. ———

ARGYREIA, ARGYREIA. Cal. of 5 leaves. Cor. campan. funnel-shaped. Ger. 2-4-celled, with 1 seed.

cuneáta. B.R.	wedge-leaved.	obov. notch. silky.	d. pur.	9.	10.	E. Ind.	1817.	S. S. cl. Loam & peat.
<i>Ipom'ea atrosanguinea.</i> B.M.								cuttings.
spléndens. B.M.	splendid.	ov. ent. smth. ab. silky ben.	pk.	——	——	1814.	S. S. cl.	——
<i>Lettsómia spléndens.</i> F.I.								
speciôsa.	shewy.	cord. ent. ac. silky. silv. ben.	p. 7.	8.	——	1778.	S. S. cl.	——
<i>Ipom'ea speciôsa.</i> B.M.								

RETZIA, RETZIA. Cor. cylindrical, villous. Stig. bifid. Caps. 2-celled, many-seeded.

spicáta.	spiked.	in 4's. lin. sess. erect.	br.	5.	6.	C. B. S.	G. S. ———
----------	---------	---------------------------	-----	----	----	----------	------	-----------

ROE'LLA, ROE'LLA. Cal. 5-parted. Cor. funnel-shaped, limb 5-lobed, spreading. Caps. 2-celled.

ciliáta. B.M.	ciliated.	lin. erect. vill.	bl. wh.	6.	8.	——	1774.	G. S. Peat & loam.
decúrrens. W.	decurrent.	lanc. ciliat. ent. decurrent.	bl.	7.	9.	——	1787.	H. A. seeds or
squarrósa. L.	trailing.	ov. recurv. smth. tooth.	bl.	——	——	——	——	G. P. cuttings.

VE'STIA, VE'STIA. Cal. camp. 5-toothed. Cor. funnel-shaped, limb 5-cleft. Caps. 2-celled, 4-valved.

lycióides. B.R.	Box-thorn-like.	lanc. ent. smooth.	yel.	6.	Chili.	1815.	G. S. Peat & loam.	cuttings.
-----------------	-----------------	--------------------	------	----	--------	-------	--------------------	-----------

COB'EA, COB'EA. Cal. 5-cleft, campanulate. Cor. bell-shaped, 5-lobed. Caps. 3-5-celled.

scándens. B.M.	climbing.	pinn. leafl. obl. ov. smth.	bl.	5.	9.	Mexico.	1792.	G. S. cl. Loam & leaf mould. cutt. or seeds.
----------------	-----------	-----------------------------	-----	----	----	---------	-------	--

[Caps. 3-celled.

TRACH'ELIUM, THROAT-WORT. Cal. 5-cleft. Cor. fun. sha. Sty. longer than stam. Stig. globos.

cœrúleum. B.R.	blue.	ov. ellip. serr. smth.	bl.	7.	8.	Italy.	1640.	H. B. Peat & loam.
diffúsum. L.	shrubby.	awl-shap. smth. ent.	bl.	——	——	C. B. S.	1787.	G. S. cuttings, or slips from root.

PHLO'X, PHLO'X. Cal. tubu. 5-tooth. Cor. of 5 petals, salver-shap. tube curv. Stig. 3-fid. Caps. 3-cell.

ame'na. B.M.	Fraser's hairy.	ov. lanc. hairy.	ros.	6.	7.	N. Amer.	1809.	H. P. Loam & leaf
aristáta. B.C.	awned.	ov. awl-shap. fringed.	wh.	4.	Carolina.	——	F. S.	mould. cut-
acumináta. B.M.	cross-leaved.	ov. acum. decuss. pub. ben. pu.	5.	8.	N. Amer.	1812.	H. P.	tings, or di-
corymbósa. B.F.G.	corymbose-fl'd.	obl. lan. und. ac. pub. ben. p. li.	6.	10.	——	1824.	H. P.	viding the
cordáta. B.F.G.	heart-leaved.	obl. cord. acum. smth.	pur.	6.	9.	Carolina.	1826.	H. P. roots, will
Carolina. B.M.	rough-stalked.	sess. lanc. smth.	red. pur.	7.	9.	N. Amer.	1728.	H. P. readily en-
canadáensis. B.F.G.	Canadian.	ov. upp. lanc. edges ciliat.	bl.	5.	7.	Canada.	1826.	H. P. crease this
divaricáta. B.M.	early-flowering.	ov. lanc. alt.	pa. bl.	4.	6.	N. Amer.	1746.	H. P. beautiful
glabérrima. W.	smooth.	lin. lanc. smth. upp. opp.	red.	6.	8.	——	1725.	H. P. tribe of
intermédia. B.C.	intermediate.	opp. lan. smth.	pur.	——	——	——	H. P. plants, which
Listoniána.	Lady Liston's.	ellip. elong. up. opp. sess.	pk.	——	——	1816.	H. P.	are a great
maculáta. B.M.	spotted-stalked.	ov. acum. ent.	pur.	7.	8.	——	1740.	H. P. acquisition

Systematic Name.	English Name.	Form of Leaves, &c.	Col. of Flow.	Month of Fl.	Native Country.	Yr. of Introd.	Soil and Propagation.
nivalis. B.C.	white-flowering.	awl-sh. cil. in fascic.	wh.	4. 6.	—	1820.	H. S. to the flower
odorata. B.F.G.	sweet-scented.	acum. smth. upp. ov. cord.	red.	—	—	1824.	H. P. garden.
ovata. B.M.	oval-leaved.	ov. ent. smth.	pur.	6. 8.	—	1759.	H. P. —
pyramidalis. H.K.	pyramidal.	cord. obl. sess. smth.	car.	7. 9.	—	1800.	H. P. —
paniculata. L.	panicled.	lanc. smth. flat.	pur.	9. 10.	—	1732.	H. P. —
penduliflora. B.F.G.	Nodding-fl'd.	obl. lanc. acum. upp. cord.	pur.	—	—	1824.	H. P. —
rosea.	rosy.	obov. ent. smth.	ros.	—	—	1830.	H. P. —
reflexa. B.F.G.	reflexed-leaved.	opp. lin. lanc. up. cord. acut. p.	—	—	—	1824.	H. P. —
Shepherdii.	Shepherd's.	lin. lanc. ent. smth.	pur.	—	Hybrid.	—	H. P. —
speciosa. B.R.	shewy.	lin. acum. ciliat.	ros.	5. 7.	N. Amer.	1827.	H. P. —
suffruticosa. B.R.	shining-leaved.	lan. acut.; st. thr. at base.	d.p.	1.	—	1790.	H. P. —
subulata. B.M.	awl-leaved.	lin. cil. awl-shaped.	pk.	4. 6.	—	1786.	H. S. —
setacea. B.M.	fine-leaved.	cil. lin. lanc.	pk.	4. 5.	—	—	H. S. —
stolonifera. H.K.	creeping.	opp. obov. ent. subcili.	bl.	6. 9.	—	1800.	H. P. —
tardiflora.	late-flowering.	lanc. smth. ent.	wh.	—	—	—	H. P. —
verna.	spring.	obov. ent. smth.	pk.	3. 4.	Hybrid.	1828.	H. P. —
Wheeleriána. B.F.G.	Wheeler's.	ov. ent. smth. upp. lin.	pur.	—	—	1824.	H. P. —

GOODE'NIA, GOODE'NIA. Cal. 5-part. Cor. 5-cleft, labiate. Caps. 1-2-cell, 2-valved, many-seeded.

gracilis. B.C.	slender.	sub-lin. smth.; stem vill.	yel.	8.	N. Holl.	1822.	G. P. Sandy loam
hederacea. Sm.	Ivy-leaved.	cord. lobed, smooth.	yel.	6. 7.	—	1824.	G. P. and peat.
grandiflora. B.M.	large-flowered.	lyr. serr. upp. obov.	yel.	6. 9.	N. S.W.	1802.	G. S. cuttings.
ovata. A.Rep.	oval-leaved	ov. acut. tooth. or serr. smth.	—	—	—	1793.	G. S. —

ANAG'ALLIS, PIMPERNEL. Cal. of 5 deep seg. Cor. wheel-sha. 5-part. Caps. of 1 cell. Seed numerous.

cærulea. B.Fl.	blue.	ov. sess. dott. ben.; st. erect.	bl.	6. 9.	Britain.	...	H. A. Sandy loam
grandiflora.	great-flowered.	ov. sess. smth.	pk.	5. 7.	E. Ind.	1824.	H. A. and peat.
indica. B.F.G.	Indian.	ov. sess. ent. dott. ben.	bl.	6. 9.	Nepal.	—	H. S. seeds, or
Monelli. B.M.	blue Italian.	ov. smth. opp.	bl.	5. 9.	Italy.	1648.	G. P. cuttings.
tenella. Br.Fl.	Bog.	roundish, smth.; st. creep.	pk.	7. 8.	Britain.	...	H. P. —
Webbiána.	Mr. Webb's.	ov. ellip. smth. ent.	bl.	6. 7.	C. B. S.	1830.	G. P. —

[with 10 valves.

LYSIM'ACHIA, LOOSE-STRIPE. Cal. 5-parted. Cor. of 1 petal, 5-cleft, wheel-shap. Caps. of 1 cell,

angustifolia. R.S.	narrow-leaved.	opp. long. lin. vertic.	yel.	7. 9.	N. Amer.	1803.	H. P. Sandy loam
ciliata. R.S.	ciliated.	opp. ov. cord.	yel.	6. 8.	—	1732.	H. P. and leaf
Ephemerum. B.M.	Willow-leaved.	lin. lanc. sess. smth.	wh.	7. 9.	Spain.	1730.	H. P. mould, part-
Nummularia. E.Fl.	creeping.	subcord. obt. undul.	yel.	6. 7.	Britain.	...	H. P. ing at roots.
nemorum. E.Fl.	wood.	ov. acut. opp.; st. creep.	yel.	5. 7.	—	...	H. P. —
quadrifolia. R.S.	four-leaved.	sess. quatern. ov. acum.	yel.	7. 8.	N. Amer.	1798.	H. P. —
stricta. B.M.	upright.	sess. lanc. Racem. term.	yel.	—	—	1781.	H. P. —
thyrsiflora. E.B.	tufted.	opp. lanc. sess. ent.	yel.	5. 7.	England.	...	H. P. —
vulgaris. E.Fl.	common.	ov. lanc. acut.	yel.	7. 9.	Britain.	...	H. P. —

PRIMULA, PRIMROSE. Cal. of 1 leaf, 5-toothed. Cor. salver-shaped, 5-parted. Caps. of 1 cell.

cortusoides. B.M.	Cortusa-leaved.	cord. lob. vill. serr.	red.	5. 7.	Siberia.	1794.	H. P. Rich loam &
dentiflora. A.Rep.	tooth-flowered.	cord. cren. lob. rugose.	red.	—	—	...	H. P. leaf mould.
farinosa. Br.Fl.	Birds-eye.	obov. lanc. mealy.	li. pur.	4. 7.	Britain.	...	H. P. seeds, or di-
glaucescens. B.F.G.	glaucous.	obl. lanc. sess. rigid.	li.	—	Switzerl.	1826.	H. P. viding at
integrifolia. B.M.	entire-leaved.	ellip. nearly ent.	pk.	6. 7.	Pyrenees.	—	H. P. the root.
intermedia. B.M.	intermediate.	ov. lanc. cren.	pur.	5. 6.	Davuria.	1806.	H. P. —
longifolia. B.M.	long-leaved.	obl. spatul. tooth.	li.	4. 5.	Levant.	1790.	H. P. —

PENTANDRIA MONOGYNIA.

Systematic Name.	English Name.	Form of Leaves, &c.	Col. of Flow.	Month of Fl.	Native Country.	Yr. of Introd.	Soil and Propagation.
nivalis.	white.	lanc. flat. tooth. smth.	wh.	4. 6.	Davuria.	1790.	H. ♂. ———
scôtica. B.Fl.	Scotch.	obov.lanc.dent.nearly.	bl.pu.	7.	Scotland.	...	H. ♂. ———
sinénsis. Lind.	Chinese.	cord. lob. serr. pubes.	pk.	1. 10.	China.	1820.	G. ♂. ———
β alba.	white-flowering.	wh.	—	—	—	G. ♂. ———
verticillâta. B.M.	whorl-leaved.	erect. obl. acut. serr.	yel.	7. 8.	Egypt.	1826.	H. ♂. ———
villôsa. R.S.	villous.	ov.obl.serr. flat, vill.	red.pur.	4. 6.	S.Europ.	1768.	H. ♂. ———

C'YCLAMEN, C'YCLAMEN. Cal. in 5 segm. Cor. of 1 petal, wheel-shaped, 5-parted. Caps. of 1 cell.

côum. B.M.	round-leaved.	orbic. cord. ent.	red.	1. 4.	S. Eur.	1596.	H. ♂. Sandy loam,
europæ'um. L.	European.	cord. orbic. cren. dent.	pk.	—	Switzerl.	—	F. ♂. and leaf
hederæfôlium. E.Fl.	Ivy-leaved.	cord. dent. varieg.	wh.	6. 8.	Britain.	...	H. ♂. mould-seeds.
pérsicum. B.R.	Persian.	cord. renif. cren.	wh.	2. 4.	Cyprus.	1731.	G. ♂. ———
repândum. B.F.G.	angular-leaved.	cord. repand. dent.	sc.	6. 7.	Greece.	1816.	H. ♂. ———

MENY'ANTHES, BUCK-BEAN. Cal. in 5-segm. Cor. funnel-shap. limb 5-parted. Caps. of 1 cell.

trifoliâta. E.Fl.	three-leaved.	tern. smth. obov.	flesh-col.	6. 7.	Britain.	...	H. w. ♂. Mud in ponds, parting roots.
-------------------	---------------	-------------------	------------	-------	----------	-----	---------------------------------------

VILL'ARSIA, VILL'ARSIA. Cal. 5-parted. Cor. rotate, ciliated at limb. Caps. 1-celled.

nymphæoïdes. Br.Fl.	Nymphæ-lik.	cord. undul. floating.	yel.	6. 7.	England.	—	H. w. ♂. Mud in ponds, parting roots.
---------------------	-------------	------------------------	------	-------	----------	---	---------------------------------------

Menyanthes nymphoides. E.B.

[Stig. ent. Caps. of 1 cell, 5 valves.

HOTT'ONIA, FEATHER-FOIL. Cal. 5-cleft. Cor. salver-shaped, 5-parted. Ger. round. Style short.

palústris. E.Fl.	Water.	crowd. 3-4 inch. long.	pk.	7. 8.	England.	H. w. ♂. Mud in water, part. at the root.
------------------	--------	------------------------	-----	-------	----------	------	---

AZ'ALEA, AZ'ALEA. Cal. of 1 leaf, 5-parted. Cor. bell-shaped, 5-cleft. Caps. 2-3-celled, 2-3-valved.

bicolor. Ph.	two-coloured.	obl. slightly pubes.	st.	5. 6.	N. Amer.	1734.	H. ♂. This beautiful
calendulácea. Mx.	yellow.	obl. lanc. pubes.	yel.	—	—	—	H. ♂. ful tribe of
1. erócea.	saffron-coloured.	sn.	—	—	—	H. ♂. plants will
2. cúprea.	copper-coloured.	co.	—	—	—	H. ♂. grow freely,
3. flámmea.	flame-coloured.	co.ye.	—	—	1812.	H. ♂. if planted in
4. ignéscens.	fiery-flowered.	co.ye.	—	—	—	H. ♂. a mixture of
5. grandiflôra.	large-flowered.	or.	—	—	1806.	H. ♂. sandy peat
6. triúmphans.	triumphant.	co.ye.	—	—	1812.	H. ♂. and light
canéscens. Mx.	canescent.	lanc. slightly pube. ben.	va.	—	—	—	H. ♂. maiden loam.
glâuca. Ph.	glaucous dwarf.	obl. lass. smth.	wh.	6.	—	1784.	H. ♂. They are
índica. B.M.	Indian.	ellip. lanc. hairy.	va.	3. 5.	China.	1808.	G. ♂. easily en-
1. álba.	white-flowered.	wh.	—	—	1819.	G. ♂. creased by
2. puníceá.	red-flowered.	pi.	—	—	1808.	G. ♂. layers, and
3. phæníceá.	purple-flowered.	pu.	—	—	1824.	G. ♂. also by seeds,
4. purpúrea-pléna.	double-purple.	pu.	—	—	1819.	G. ♂. sown in
nudiflôra. L.	naked-flower'd.	obl. atten. at base, cil.	va.	5. 6.	N. Amer.	1734.	H. ♂. spring.
1. álba-pléna.	double-white.	wh.	—	—	H. ♂. ———
2. coccínea.	scarlet.	sc.	—	—	—	H. ♂. ———
3. blánda.	blush-flowered.	bh.	—	—	—	H. ♂. ———
4. cárnea.	pale-red.	fl.	—	—	—	H. ♂. ———
5. críspa.	curled.	bh.	—	—	—	H. ♂. ———
6. discolor.	two-coloured.	re.wh.	—	—	—	H. ♂. ———
7. flórida.	many-flowered.	bh.	—	—	—	H. ♂. ———
8. globôsa.	globose.	bh.	—	—	—	H. ♂. ———

PENTANDRIA MONOGYNIA.

Systematic Name.	English Name.	Form of Leaves, &c.	Co. of Month of Flow. of Fl.	Native Country.	Yr. of Introd.	Soil and Propagation.
9. <i>incarnáta</i> .	<i>flesh-coloured.</i>	<i>fl.</i> — — — —	— — — —	— — — —	H. Sp. — — — —
10. <i>mirábilis</i> .	<i>wonderful.</i>	<i>re.</i> — — — —	— — — —	— — — —	H. Sp. — — — —
11. <i>pállida</i> .	<i>pale-flowered.</i>	<i>li. wh.</i> — — — —	— — — —	— — — —	H. Sp. — — — —
12. <i>papilionácea</i> .	<i>butterfly.</i>	<i>fl.</i> — — — —	— — — —	— — — —	H. Sp. — — — —
13. <i>purpúrea</i> .	<i>purple.</i>	<i>pu.</i> — — — —	— — — —	— — — —	H. Sp. — — — —
14. <i>rósea</i> .	<i>rosy.</i>	<i>ro.</i> — — — —	— — — —	— — — —	H. Sp. — — — —
15. <i>rubéscens</i> .	<i>reddish.</i>	<i>pi.</i> — — — —	— — — —	— — — —	H. Sp. — — — —
16. <i>rútilans</i> .	<i>deep red.</i>	<i>re.</i> — — — —	— — — —	— — — —	H. Sp. — — — —
<i>nítida</i> . B. R.	<i>shining.</i>	<i>lanc. mucr. coriac. shin.</i>	<i>wh. 6. 7.</i>	— — — —	1812.	H. Sp. — — — —
<i>procumbens</i> . B. F.	<i>procumbent.</i>	<i>opp. smth. revol. stm. cr. car.</i>	— — — —	Britain.	H. Sp. — — — —
<i>pontica</i> . L.	<i>yellow.</i>	<i>lanc. obl. atten. at base.</i>	<i>yel.</i> — — — —	Turkey.	1793.	H. Sp. — — — —
1. <i>albiflora</i> .	<i>white-flowered.</i>	<i>wh.</i> — — — —	— — — —	H. Sp. — — — —
2. <i>cúprea</i> .	<i>copper-coloured.</i>	<i>co.</i> — — — —	— — — —	H. Sp. — — — —
3. <i>crocea</i> .	<i>saffron.</i>	<i>pa. y.</i> — — — —	— — — —	H. Sp. — — — —
4. <i>gláuca</i> .	<i>glaucous.</i>	<i>pa.</i> — — — —	— — — —	H. Sp. — — — —
5. <i>pállida</i> .	<i>pale-yellow.</i>	<i>pa.</i> — — — —	— — — —	H. Sp. — — — —
6. <i>tricolor</i> .	<i>three-coloured.</i>	<i>st.</i> — — — —	— — — —	H. Sp. — — — —
<i>sinénsis</i> . B. F. G.	<i>Chinese.</i>	<i>lanc. obl. pubes.</i>	<i>yel. 3. 6.</i>	China.	1824.	H. Sp. — — — —
<i>viscósá</i> .	<i>viscid.</i>	<i>lanc. nerv. hairy.</i>	<i>wh. 7. 8.</i>	N. Amer.	1734.	H. Sp. — — — —
1. <i>críspa</i> .	<i>curled.</i>	<i>wh.</i> — — — —	— — — —	— — — —	H. Sp. — — — —
2. <i>præ'cox</i> .	<i>early.</i>	<i>st.</i> — — — —	— — — —	— — — —	H. Sp. — — — —
3. <i>rubéscens</i> .	<i>reddish-flow'r'd.</i>	<i>re.</i> — — — —	— — — —	— — — —	H. Sp. — — — —

NOLA'NA, NOLA'NA. Cal. 5-parted. Cor. campan. limb 10-lobed. Germ. 20.

<i>prostráta</i> . B. M.	<i>trailing.</i>	<i>ov. ellip. smooth, ent.</i>	<i>bl. 7. 9.</i>	Peru.	1761.	H. Sp. <i>Sandy soil.</i>
<i>paradóxa</i> . B. R.	<i>cluster-fruited.</i>	<i>ovate, obtuse, pilose.</i>	<i>bl.</i> — — — —	Chili.	1822.	H. Sp. <i>seeds.</i>

[Caps. 1-celled, 4-seeded.

CALYSTEGIA, CALYSTEGIA. Brac. 2. Cal. 5-part. Cor. camp. limb 5-lobed. Stam. 5, nearly equal.

<i>renifórmis</i> . B. F. G.	<i>kidney-leaved.</i>	<i>renif. subrepand. cren.</i>	<i>fl. 6. 7.</i>	N. Holl.	1817.	H. Sp. — — — —
------------------------------	-----------------------	--------------------------------	------------------	----------	-------	----------------

[with 1-2 seeds in each.

CONVOLVULUS, BIND-WEED. Cal. 5-cleft. Cor. bell-shaped, plaited. Stig. 2. Caps. of 2-3-cells,

<i>arvénsis</i> . Br. Fl.	<i>small.</i>	<i>sagitt. acut. Pedun. 1-fl. ros. 6. 9.</i>	— — — —	Britain.	H. Sp. <i>cl. Sandy loam</i>
<i>althæoídes</i> . Fl. Gr.	<i>Athea-leaved.</i>	<i>cord. sin. silk. lob. repand. pk.</i>	— — — —	Levant.	1597.	F. Sp. <i>cl. and peat.</i>
<i>bryoniaefólius</i> . B. M.	<i>Bryony-ly'd.</i>	<i>palm. 7-lobed, hispid. pk. 7. 8.</i>	— — — —	China.	1802.	G. Sp. <i>cl. seeds or</i>
<i>chínénsis</i> . B. R.	<i>Chinese.</i>	<i>hast. auric. obt. ent. pur. or.</i>	— — — —	— — — —	1817.	G. Sp. <i>cl. cuttings.</i>
<i>cándicans</i> . B. M.	<i>hoary.</i>	<i>cord. acum. ent.</i>	— — — —	E. Ind.	1818.	S. Sp. <i>cl. some of the</i>
<i>Cneórum</i> . B. M.	<i>silvery-leaved.</i>	<i>lanc. hairy.</i>	<i>bh. 5. 9.</i>	Levant.	1640.	G. Sp. <i>species of</i>
<i>canariénsis</i> . B. M.	<i>Canary.</i>	<i>cord. pubes.; stm. vill.</i>	<i>pk. 6. 9.</i>	Canaries.	1690.	G. Sp. <i>cl. this genus</i>
<i>dahúricus</i> . B. M.	<i>Dahurian.</i>	<i>obl. cord. smth. hairy, ben. ro.</i>	— — — —	Dahuria.	1823.	H. Sp. <i>cl. secured best</i>
<i>lineátus</i> . Fl. Gr.	<i>lined.</i>	<i>lanc. silky, stalk.</i>	<i>bh. 6. 7.</i>	S. Europ.	1714.	H. Sp. <i>by cuttings</i>
<i>ochráceus</i> . B. R.	<i>yellow.</i>	<i>cord. ent. pilose.</i>	<i>yel. 8.</i>	Guinea.	1825.	S. Sp. <i>cl. of the root.</i>
<i>pudibándus</i> . B. R.	<i>various-leaved.</i>	<i>cord. 3-lobed, smooth.</i>	<i>ros.</i> — — — —	S. Amer.	— — — —	S. Sp. <i>cl. — — — —</i>
<i>Soldanélla</i> . E. Fl.	<i>sea.</i>	<i>angu. kid. sh.; stm. creep. pu. 6. 7.</i>	— — — —	Britain.	H. Sp. — — — —
<i>scrobiculátus</i> . B. R.	<i>pitted.</i>	<i>cor. 3-lo. smth. sid. lo. obl. p. bl.</i>	— — — —	America.	1825.	H. Sp. — — — —

[of 3 cells, and 3 valves.

POLEMONIUM, JACOB'S LADDER. Cal. cup-shaped, 5-cleft. Cor. wheel-shaped, 5-cleft. Caps.

<i>cæruleum</i> . E. Fl.	<i>blue. Greek-valerian. pinn. smooth.</i>	<i>bl. or wh. 6.</i>	— — — —	Britain.	H. Sp. <i>Sandy loam.</i>
<i>húmile</i> . B. R.	<i>dwarf.</i>	<i>pinn. leaf. obov. pubes. bl.</i>	— — — —	N. Amer.	1827.	H. Sp. <i>seed, or di-</i>
<i>sibíricum</i> . B. F. G.	<i>Siberian.</i>	<i>bipin. pubes. leaf. lin. wh.</i>	— — — —	Siberia.	1800.	H. Sp. <i>vid. at roots.</i>

Systematic Name.	English Name.	Form of Leaves, &c.	Col. of Flow.	Month of Fl.	Native Country.	Yr. of Intro.	Soil and Propagation.
[<i>Sty. erect. Stig. cloven.</i>]							
JASIONE, SHEEPS-BIT.	<i>Cal. 5-cleft. Cor. wheel-shaped, 5-parted. Anthers combined at the base.</i>						
montàna. E.B.	common.	lin. wavy, hairy.	bl. 6. 7.	Britain.	H. A.	Light soil.
perènnis. B.R.	perennial.	lin. flat, obtuse.	bl. —	France.	1787.	H. B.	seeds.
[<i>Sty. erect. Stig. cloven.</i>]							
G'ILIA, G'ILIA.	<i>Cal. 5-part. Cor. funnel-shap. 5-cleft. Style 3-fid. Caps. 3-cell. with 1-2 seeds in each.</i>						
capitàta. B.M.	round-headed.	bipinnatif. seg. lin. ent.	bl. —	America.	1826.	H. A.	Sandy soil.
inconspícua. B.M.	small-flowered.	pinnatif. low. bipinnatif.	bl. —	—	—	H. A.	seeds.
grácilis. B.M.	slender.	lin. obl. obt. lower spath.	ros. —	N. Amer.	1827.	S. B.	—
[<i>segm. Ger. 2. Sty. 1. Apex dilated.</i>]							
STROPH'ANTHUS, STROPH'ANTHUS.	<i>Cal. camp. limb 5-cleft. Cor. funnel-shap. of 5 long lin.</i>						
dichótamus. DC.	forked.	ellip. muc. acum. smth. ent. y.	4.	China.	1818.	S. S.	Rich loam. cuttings.
[<i>Caps. 2-celled, ovate, dotted.</i>]							
NIEREMBERGIA, NIEREMBERGIA.	<i>Cal. tubu. 5-cleft. Cor. on a long tube, limb 5-lobed, plicate.</i>						
grácilis. B.M.	slender.	lin. subspath. pubes. wh. pu. 6. 7.	B. Ayres.	1829.	G. B.	Peat & loam.	
[<i>Sty. purple. Stig. sub-2-lobed.</i>]							
HELIOTROPIUM, HELIOTROPE.	<i>Cal. 5-clef. Cor. salver-sha. 5-clef. plicate. Stig. peltate. Nuts 4.</i>						
corymósus. B.M.	corymbose.	obl. lanc. rug. pub.	li. 6. 9.	Peru.	1808.	G. B.	Sandy loam
oblongifólium. Lk.	oblong-leaved.	obl. obt. ent. sub-hairy.	wh. —	S. Europ.	1824.	G. A. &	leaf mould.
peruvíanum. W.	Peruvian.	ov. lanc. rug. pubes.	li. 6. 10.	Peru.	1757.	G. B.	cuttings.
parviflórum. L.	small-flowered.	ov. rug. opp. alt. scabr.	wh. 6. 7.	W. Ind.	1732.	S. B.	—
[<i>Sty. purple. Stig. sub-2-lobed.</i>]							
LUBINIA, LUBINIA.	<i>Cal. 5-parted. Cor. funnel-shaped, limb 5-cleft. Stam. exert. Ger. ov. smooth.</i>						
atropurpúrea. B. F. G.	dark-purple.	obl. lanc. spath. dott.	d. pu. 7. 8.	C. B. S.	1823.	G. B.	Loam & peat. parting roots or cutt.
[<i>Sty. purple. Stig. sub-2-lobed.</i>]							
SOLLY'A, SOLLY'A.	<i>Cal. 5-part. Pet. 5, spread, bell-shap. Anth. sagitte. Ovary 2-celled, many-seeded.</i>						
heterophýlla. E. R.	various-leaved.	alt. ov. lanc. serr. upp. ent. bl.	7.	N. Holl.	1829.	G. S. cr.	Sandy loam and leaf mould. cutt.
[<i>Sty. purple. Stig. sub-2-lobed.</i>]							
LECHENAULTIA, LECHENAULTIA.	<i>Cal. 5-cleft. Cor. tube split at apex, limb 2-lipp. Caps. 2-cell.</i>						
formósa. B. P.	handsome.	lin. recurv. smooth.	sc. 6. 10.	—	1823.	G. S.	Peat & loam. cuttings.
[<i>Sty. purple. Stig. sub-2-lobed.</i>]							
ILLECEBRUM, KNOT-GRASS.	<i>Cal. of 5 leaves. Cor. 0. Caps. pointed at each end, of 1 cell, with 1 seed.</i>						
verticillátum. E. Fl.	whorled.	ov. acute.	wh. or red.	6.	England.	H. A. Loam & peat. seeds.
[<i>Sty. purple. Stig. sub-2-lobed.</i>]							
GLA'UX, SEA-MILKWORT.	<i>Cal. 5-parted. Cor. 0. Caps. of 1 cell, and 5 valves. Seeds 5, roundish.</i>						
marítima. E. Fl.	common.	opp. ov. smth. ent. sess.	ros. 5. 6.	Britain.	H. B.	Sandy loam and peat. divid. roots.
[<i>Sty. purple. Stig. sub-2-lobed.</i>]							
THESIUM, BASTARD-TOADFLAX.	<i>Cal. of 1 leaf, 5-part. half way down. Cor. 0. Ger. rib. Stig. clov.</i>						
linophýllum. E. Fl.	flax-leaved.	lin. lanc. smooth.	gr. 6. 7.	England.	H. B.	Sandy loam. parting plant.
[<i>Sty. purple. Stig. sub-2-lobed.</i>]							
VYNCA, PERIWINKLE.	<i>Cal. of 1 leaf, in 5 segm. Cor. salver-shap. 5-cleft. Ger. 2. Seeds several.</i>						
herbácea. B. R.	herbaceous.	obl. lanc. edges ciliat.	bl. 6. 7.	Hungary.	1816.	H. B.	Light loam.
mínor. E. Fl.	lesser.	ellip. lanc. smooth.	vi. 3. 9.	Britain.	H. S. cr.	part. roots.
1. fol. argenteo.	silver-striped.	vi. —	—	H. S. cr.	—

Systematic Name.	English Name.	Form of Leaves, &c.	Col. of Flow.	Month of Fl.	Native Country.	Yr. of Introd.	Soil and Propagation.
2. <i>fol. aureo.</i>	<i>gold-striped.</i>	vi.	—	—	H. S. cr. —
3. <i>álba.</i>	<i>white flowered.</i>	wh.	—	—	H. S. cr. —
4. <i>fl. plèno.</i>	<i>double-flowered.</i>	vi.	—	—	H. S. cr. —
májor. E. Fl.	<i>greater.</i>	ov. ciliat. ; stems erect.	bl.	—	England.	H. S. —
<i>variègàta.</i>	<i>variegated.</i>						

ARETIA, ARETIA. *Cal. 5-part. Cor. salver-shaped, contracted at the orifice. Stig. globose.*

<i>alpina.</i> w.	Alpine.	lin. vill. ; scapes 1-fl'd.	pk.	5. 6.	Switzerl.	1775.	H. P. Sandy loam
<i>pubèscens.</i> B. C.	downy.	ov. ellip. pubes.	wh.	—	—	1820.	H. P. and peat.
<i>Vitaliána.</i> B. C.	grass-leaved.	smth.abov.;stm.branch.	yel.	—	Pyren.	1787.	H. P. divid.root.

ANDROS'ACE, ANDROS'ACE. *Cal. 4-cleft. Cor. salver-shaped. Stig. globular. Caps. 1-celled.*

<i>carinàta.</i> B. F. G.	keeled.	ov. lanc. acut. ciliat.	wh. yel.	3. 4.	America.	1828.	H. P. Light loam
<i>cárnea.</i> B. C.	flesh-coloured.	lin. subul. ciliat.	ros.	7. 8.	Switzerl.	1768.	H. P. and peat.
<i>Chamæjásme.</i> B. C.	grass-leaved.	lanc. nearly ent. ciliat.	bh.	6. 7.	Austria.	—	H. P. seeds, or
<i>coronopifólia.</i> A. R.	Buck's-horn-l'd.	lin. lanc. dent.!	wh.	—	Siberia.	1806.	H. P. parting at
<i>láctea.</i> B. M.	white-flowered.	lin. shin. ciliat. at apex.	wh.	6. 8.	—	1752.	H. P. roots.
<i>máxima.</i> R. S.	large.	ovate, oblong, villous.	wh.	3. 6.	Austria.	1597.	H. A. —
<i>septentrionalis.</i> B. M.	tooth-leaved.	lanc. tooth. atten. at base.	wh.	4. 5.	Russia.	1755.	H. A. —

EUONYMUS, SPINDLE-TREE. *Cal. of 5 concave segm. Pet. 5. Caps. of 5 cells & 5 valves. Seeds 1.*

<i>americánus.</i> DC.	American.	ellip. lanc. serr.	st.	6.	N. Amer.	1683.	H. S. Garden soil.
<i>angustifólius.</i> DC.	narrow-leaved.	obl. lin. ellip.	st.	—	Georgia.	1806.	H. S. seeds, or
<i>atropurpúreus.</i> DC.	dark purple.	lanc. serr. ; stem smth.	d. pu.	—	N. Amer.	1756.	H. S. cuttings.
<i>europæus.</i> E. B.	common.	ov. serr. ; Br. angul.	gr. wh.	5. 6.	Britain.	H. S. put in, in
<i>Hamiltoniánus.</i> Wal.	Hamilton's.	ellip. obl. smooth.	wh.	3. 4.	Nepal.	1825.	H. S. autumn, will
<i>latifólius.</i> DC.	broad-leaved.	ellip. acum. serr.	gr.	5. 6.	S. Europ.	1730.	H. S. strike root.
<i>verrucósus.</i> DC.	warty.	ov. serr. ; stem warty.	pur.	—	Austria.	1763.	H. S. —

RIBES, CURRANT & GOOSEBERRY. *Cal. in 5 segm. Pet. 5, obtuse. Ber. globu. with many seeds.*

<i>alpinum.</i> E. Fl.	tasteless.	3-lob. shin. ben. st. erect.	gr.	4. 5.	Britain.	H. S. Garden loam.
<i>aúrcum.</i> B. R.	yellow-flower'd.	ov. 3-lob. smth. dent.	yel.	—	Missouri.	1812.	H. S. cuttings, or seeds.
<i>a. fructu-albo.</i>	<i>white-fruited.</i>						
<i>β. fructu-rubro.</i>	<i>red-fruited.</i>						
<i>floridum.</i> DC.	Pensylvanian.	3-lob. dent. smth. acut.	st.	4. 5.	N. Amer.	1729.	H. S. —
<i>petræum.</i> E. B.	rock.	alt. 5-lob. down. ben.	red.	—	England.	H. S. —
<i>rúbrum.</i> E. B.	red.	3-5-lobed. obt. pub.	st.	—	Britain.	H. S. —
<i>sanguineum.</i> B. R.	purple-flower'd.	cord. sub. 5-lob. serr.	pur.	—	N. Amer.	1820.	H. S. —
<i>spicátum.</i> E. Fl.	Acid mountain.	subcord. rotund. 3-5-lob.	br.	—	England.	H. S. —
<i>triflórum.</i> B. C.	three-flowered.	3-5-lob. dent. smth. ent.	br.	—	N. Amer.	1812.	H. S. —

HE'DERA, IVY. *Cal. of 5 teeth. Pet. 5, altern. with the calyx. Berry globu. of 1 cell. Seeds from 3 to 5.*

<i>Hélix.</i> E. Fl.	common.	ov. 3-5-lobed.	gr.	9. 10.	Britain.	H. S. cl. Garden soil.
<i>fol. argenteo.</i>	<i>silver-striped.</i>	gr.	—	—	H. S. cl. cuttings.

RHA'MNUS, BUCK-THORN. *Cal. funnel-sha. generally 5-cleft. Pet. 5, or none. Berry of 2-3, or 4 cells.*

<i>alnifólius.</i> w.	Alder-leaved.	ov. acum. serrul. smth.	gr.	5.	N. Amer.	1778.	H. S. Loam. seeds,
<i>cathárticus.</i> E. Fl.	purging.	ov. serr. smooth. decid.	ye. gr.	5. 6.	England.	H. S. or cuttings.
<i>crenulátus.</i> w.	crenate.	obl. obt. serr. smth.	gr.	3.	Teneriffe.	1778.	G. S. —
<i>Frángula.</i> E. B.	Berry-bearing.	ent. smth. alt. ellip.	wh.	4. 5.	Britain.	H. S. —
<i>latifólius.</i> w.	broad-leaved.	ellip. acum. ent.	wh.	7.	Azores.	1778.	H. S. —

Systematic Name.	English Name.	Form of Leaves, &c.	Col. of Flow.	Month of Fl.	Native Country.	Yr. of Introd.	Soil and Propagation.
púmilus. w.	dwarf.	ov. serr. smooth.	wh.	—	Europe.	1752.	H. S. —
prinoïdes. w.	winter-berry.	ld. ov. lanc. acum. shin. serr.	gr.	8. 9.	C. B. S.	1778.	G. S. —

NICOTIANA, TOBACCO. Cal. 5-parted. Cor. funnel-shaped, limb plicate. Caps. 2-celled, 2-valved.

glutinósa.	glutinous.	cord. ov. und. ent. pub. red. gr.	7. 9.	Peru.	1759.	H. S.	Strong loam.
Langsdórfii. B.M.	Langsdorff's.	ov. lanc. vill.	gr. ye.	8.	Chile.	1819.	H. S. seeds.
noctiflóra. B.M.	night-flowering.	lan. und. lower obl.	wh.	—	S. Amer.	1826.	F. P. —

SOLANUM, NIGHTSHADE. Cal. 5-part. Cor. wheel-shap. in 5 segm. Berry of 2 cells. Seeds many.

auriculátum. w.	ear-leaved.	ov. acum. downy, ent.	vio. . . .	Madagas.	1773.	S. S.	Loam & leaf
atrosanguíneum. Sck.	dark-crimson.	lobed, spiny.	cr. 6. 7.	W. Ind.	1827.	S. S.	mould. seeds,
coriáceum. B.M.	coriaceous.	obl. ent. shin. coriac.	bl. 7. 8.	Mexico.	1820.	S. S.	or cuttings.
crassifólium.	thick-leaved.	ov. ent. sinuat. angled, hairy.	—	1829.	S. S.	—
corymbósum. w.	corymbose.	ov. lanc. acut.	vio. —	Peru.	1786.	S. P.	—
gigantéum. w.	gigantic.	lanc. acut. downy ben. wh.	xio. 6. 7.	C. B. S.	1792.	G. S.	—
índicum. w.	Indian.	wedg. sh. ang. sub. vill. ent. bl.	7.	India.	1732.	S. S.	—
macrocarpon. w.	large-fruited.	cuneat. repand. smth.	bl. 4. 9.	Peru.	1759.	S. S.	—
pyracánthum. Ex. B.	Orange-colo'd.	obl. acut. dent.	pu. 8. 9.	Madagas.	1789.	S. S.	—
quiténse. B.M.	angular-leaved.	sub. cord. sinuat. ang. pub.	w. —	Peru.	1825.	S. S.	—
Seafortiánium. B. rep. L.	Seafort's.	pinn. und.	car. —	Barbad.	1804.	S. S. cl.	—
tomentósum. w.	woolly.	cord. obliq. repand.	bl. —	S. Amer.	1662.	S. S.	—

[Seeds many.]

LONICERA, FLY-HONEY-SUCKLE. Cal. of 5 seg. Cor. of 1 leaf, tubu. 5-cleft. Ber. of 1 or more cells.

flexuósa. B.R.	flexuose.	ov. ent. smth.	wh. —	China.	1806.	H. S. cl.	Sandy loam.
hirsúta. B.M.	hairy.	ov. ellip. pub. glau. ben.	yel. 6. 7.	N. Amer.	1819.	H. S.	cuttings.
involutáta. B.R.	involucrad.	ellip. obl. obt. pilos. ben.	yel. —	—	1824.	H. S.	—
japónica. B.R.	red-flowered.	ov. ent. gr. pubes.	red. —	China.	1806.	F. S. cl.	—
Periclymenum. B. Fl.	common.	ov. obt. base attenuat.	st. 6. 8.	Britain.	H. S. cl.	—
1. álba.	white.	wh. —	—	—	H. S. cl.	—
2. flava.	yellow.	yel. —	—	—	H. S. cl.	—
3. rúbra.	red.	red. —	—	—	H. S. cl.	—
quercifólia.	Oak-leaved.	st. —	—	—	H. S. cl.	—
tatárica. L.	Tartarian.	cord. ov. ent. acut.	ros. 4. 5.	Tartary.	1752.	H. S.	—
Xylóstem. E. Fl.	upright-fly.	ov. acum. ent.	yel. 6. 7.	England.	H. S.	—

CAPRIFOLIUM, HONEY-SUCKLE. Cal. 4-5-tooth, or ent. Cor. 5-clef. tubu. Ber. 3-cell, many-seed.

flávu. B.M.	yellow.	ov. glau. upp. perfol.	yel. 5. 6.	Carolina.	1810.	G. S. cl.	Sandy soil.
Lonicéra fláva.							cuttings.
italícum. E.B.	early.	obl. acut. shin. perfol.	pa. yel. —	England.	H. S. cl.	—
rúbrum.	red.	red. —	Italy.	—	H. S. cl.	—
Lonicéra Caprifólium. E.B.							
impléxum. R.S.	Minorca.	glau. obl. sub. perfol.	pa. 6. 9.	Minorca.	1772.	H. S.	—
longiflórum. B.R.	long-leaved.	obl. lanc. smooth.	st. —	China.	1816.	F. S. cl.	—
occidentále. B.R.	North-west.	ov. smth. glau. edges cil.	or. —	N. Amer.	1829.	H. S. cl.	—
sempervirens. B.M.	Trumpet.	obl. glau. shin. upp. perfol.	sc. 5. 8.	—	1656.	H. S. cl.	—

ELAEODENDRUM, OLIVE-WOOD. Cal. 5-10-cleft. Cor. 5-part. petals concave. Nectary 2-3-celled.

austrále. DC.	thick-leaved.	obl. lanc. dent. leathery.	wh. —	N. S. W.	1796.	G. S.	Peat & loam.
crocéum. DC.	Cape Holly.	obl. serr. prickly.	wh. —	C. B. S.	1794.	G. S.	cuttings.

Ilex crocea, w.

Systematic Name.	English Name.	Form of Leaves, &c.	Col. of Flow.	Month Native of Fl. Country.	Yr. of Introd.	Soil and Propagation.
JACQUINIA, JACQUINIA. <i>Cal. of 5 leaves. Cor. camp. limb 10-cleft. Berry 1-celled, 1-seeded.</i>						
armillaris.	obtusely-leaved.	wedge-sh. smth.	wh.	6. 7. W. Ind.	1768.	S. S. Peat & loam. cuttings in sand.
LUCULIA, LUCULIA. <i>Cal. of 5 sepals. Cor. funnel-shap. limb 5-part. Stig. 2, fleshy. Berry 2-celled.</i>						
gratissima. B. F. G.	fragrant.	ellip. acum. opp. ent. large. pk.	6.	9. Nepaul.	1816.	G. S. ———
ZIZYPHUS, ZIZYPHUS. <i>Cal. spread. 5-part. Petals 5. Sty. 2-3. Berry 2-celled, 2-seeded, rarely 3.</i>						
mucronata. W. en.	mucronate.	cord. ov. mucr. cren. smth.	st.	5. C. B. S.	1820.	G. S. Loam, peat,
Spina Christi. R. S.	Christ's-thorn.	ov. obt. dent. smth: spiny.	st.	8. 9. Egypt.	G. S. & leaf mould. cuttings.
CELASTRUS, STAFF-TREE. <i>Cal. 5-lob. minu. Pet. 5. Stam. 5. Stig. 2-3. Caps. 2-3-valv. Seed sing.</i>						
buxifolius. B. M.	Box-leaved.	lanc. obov. obt. serr. smth.	wh.	5. 6. C. B. S.	1752.	G. S. Loam & leaf
cassinoides. DC.	crenated.	ov. acut. serr.	wh.	9. Canaries.	1779.	G. S. mould. cutt.
lucidus. DC.	shining.	ov. marginate, shin.	wh.	4. 9. C. B. S.	1722.	G. S. ———
tricuspidatus. DC.	three-pointed.	alt. obl. ov. obt. ent.	wh.	5. 6. ———	1816.	G. S. ———
<i>Cassine lavigata. Lam.</i>						
CEAN'OTHUS, CEAN'OTHUS. <i>Cal. camp. 5-parted. Petals 5, or none. Style 2-3. Berry 3-celled.</i>						
americanus. B. M.	New Jersey tea.	ov. acum. serr. pubes.	wh.	8. 9. N. Amer.	1713.	H. S. Sandy loam,
azureus. B. R.	azure-flowered.	ov. obl. scabr. serr. hairy.	bl.	4. N. Spain.	1818.	G. S. & peat. cutt.
africanus. W.	African.	lanc. obt. serr. smth.	st.	3. 4. C. B. S.	1812.	G. S. ———
[Caps. of 3 divisions.]						
POMADERRIS, POMADERRIS. <i>Cal. 5-parted. Petals 5, conc. or none. Sty. short, 3-sided. Stig. 3.</i>						
apétala. DC.	petal-less.	ov. lanc. acum. serr.	br.	5. 6. N. Holl.	1803.	G. S. Sandy loam,
elliptica. A. rep.	elliptic-leaved.	ellip. obt. upp. smth.	yel.	—————	1805.	G. S. & peat. cutt.
lanigera. A. R.	woolly.	obl. lanc. ent. woolly ben.	yel.	—————	1806.	G. S. ———
<i>Ceanothus lanigera. A. rep.</i>						
LASIOP'ETALUM, LASIOP'ETALUM. <i>Cal. of 5 leaves. Petals 5. Filaments 5. Germ. 1-3-celled.</i>						
corylifolium.	Hazel-leaved.	cord. ov. serr. hairy.	wh.	3. 5. N. Holl.	1830.	G. S. Sandy loam,
ferrugineum. B. R.	rusty.	lin. shin. abov. rusty ben.	wh.	4. 8. ———	1791.	G. S. & peat. cutt.
parviflorum. DC.	small-flowered.	lin. lanc. ent.	wh.	—————	1810.	G. S. ———
THOMA'SIA, THOMA'SIA. <i>Cal. permanent. Pet. 5, minute. Fil. unit. at base. Anth. opening laterally.</i>						
dumosa.	bushy.	ov. ellip. dent. wrink. abov.	4.	9. N. Holl.	1829.	G. S. Sandy loam
purpurea. DC.	purple.	lin. ellip. ent.	pur.	4. 8. ———	1803.	G. S. and peat. cuttings.
<i>Lasiopétalum purpureum. B. M.</i>						
quercifolia. DC.	Oak-leaved.	3-lob. hairy.	pur.	—————	—————	G. S. ———
<i>Lasiopétalum quercifolium. B. M.</i>						
solanæca. DC.	Solanum-like.	cord. lob. hairy, rusty ben.	pu.	—————	—————	G. S. ———
<i>Lasiopétalum solanæcum. B. M.</i>						
STA'AVIA, STA'AVIA. <i>Cal. 5-lobed. Petals 5. Stam. inserted in the calyx. Caps. 2-celled, 2-seeded.</i>						
radiata. DC.	rayed.	lan. 3-sided; Br. vill.	wh.	—————	C. B. S.	1787. G. S. Peat & loam. cuttings.
DIOSMA, DIOSMA. <i>Cal. 5-parted. Cor. of 5 equal petals. Stamens 5.</i>						
ambigua. B. C.	ambiguous.	lin. lan. acum. cil.	wh.	4. 5. C. B. S.	1824.	G. S. Loam & peat.
cupressina. B. C.	cypress-leaved.	obl. lanc. keeled.	wh.	6. 8. ———	1790.	G. S. cuttings.

Systematic Name.	English Name.	Form of Leaves, &c.	Col. of Flow.	Month of Fl.	Native Country.	Yr. of Introd.	Soil and Propagation.
capitata. DC.	headed.	3-sided, obt. vill.	wh.	—	C. B. S.	—	G. S. —
ericoïdes. DC.	Heath-like.	3-sided, obt. smth. dott.	wh.	4. 8.	—	1756.	G. S. —
hirsûta. DC.	hairy.	lin. mucr. vill. hairy.	wh.	—	—	1731.	G. S. —
imbricatâ.	imbricated.	ov. acum. imbr. dott. ciliat.	li.	—	—	1774.	G. S. —
lanceolatâ. B. R.	lance-leaved.	ellip. obt. fring.; Br. vill.	ros.	—	—	—	G. S. —
oppositifolia. Thun.	opposite-leaved.	opp. 3-sided, obt. ciliat.	wh.	—	—	1752.	G. S. —

AGATH'OSMA, AGATH'OSMA. Cal. in 6 lin. seg. Cor. of 10 uneq. pet. insert. in the cal. Nect. 5-lob.

Cerefolium. s. s.	Chervil-scented.	imbr. lanc. ciliat.	wh.	4. 6.	C. B. S.	1790.	G. S. Peat & loam.
ciliatâ. s. s.	ciliated.	lanc. ciliat. acum.	li.	—	—	G. S. cuttings.

Diòsma ciliatâ.

hispidâ. w.	hispid.	3-sid. obt. dott.	vio.	6. 8.	—	1786.	G. S. —
-------------	---------	-------------------	------	-------	---	-------	---------

ADEN'ANDRA, ADEN'ANDRA. Cal. 5-part. Petals 5, inserted in calyx. Stam. 10, 5 of them sterile.

acuminatâ. B. C.	acuminate-l'd.	ov. cord. acum. ciliat.	wh.	4. 8.	C. B. S.	1812.	G. S. Loam & peat.
<i>Diòsma acuminatâ.</i>	B. C. ?						cuttings.

am'œna.	charming.	ov. smth. dot. mar. rev. wh. ros.	—	—	—	1798.	G. S. —
---------	-----------	-----------------------------------	---	---	---	-------	---------

Diòsma am'œna. B. C.

frâgrans.	sweet-scented.	ov. obl. obt. gland. dent.	ros.	5. 6.	—	—	G. S. —
-----------	----------------	----------------------------	------	-------	---	---	---------

Diòsma frâgrans. B. M.

BR'UNIA, BR'UNIA. Cal. 5-tooth. Pet. 5. Fil. inserted in the claws of pet. Stig. bifid. Caps. 2-celled.

abrotanoïdes. B. C.	Southernwood-l.	lin. lanc. reflex.	wh.	—	C. B. S.	1787.	G. S. Sandy loam,
ericoïdes. B. M.	Heath-leaved.	lin. acut. 3-sided.	wh.	8. 9.	—	1812.	G. S. and peat.
imbricatâ.	imbricated.	cord. ov. smth.	wh.	—	—	1801.	G. S. cuttings.
lanuginôsa. DC.	woolly.	half round, vill.	wh.	—	—	1774.	G. S. —

BILLARDIERA, APPLE-BERRY. Cal. in 5 segments. Petals 5. Berry many-seeded.

longiflora. B. M.	long-flowered.	obl. lin. ent.	st.	6. 9.	V. Diem.	1810.	G. S. cl. Sandy loam,
mutabilis. B. M.	changeable.	lin. lanc. ent.	pur.	—	N. S. W.	1795.	G. S. cl. and peat.
rosmarinifolia. DC.	Rosemary-l'd.	lin. edges revol. smth.	...	—	—	1830.	G. S. cl. cuttings.
scândens. DC.	climbing.	ov. lanc. slightly vill.	yel.	6. 9.	—	1790.	G. S. cl. —

ESCALL'ONIA, ESCALL'ONIA. Cal. 5-cleft. Petals 5. Stig. 2-lobed. Caps. imperfectly 2-celled.

floribunda.	many-flowered.	ellip. lanc. serr. smth.	red.	—	N. Gran.	1827.	G. S. —
glandulôsa. B. Fl. G.	glandular.	obl. ellip. acu. rigid, smth.	wh.	8. 9.	Chile.	1826.	G. S. Loam, and
rûbra. B. M.	red.	obov. lanc. acut. serr.	red.	8. 10.	—	—	G. S. peat. cutt.

PITT'OSPORUM, PITT'OSPORUM. Cal. of 5 leav. Pet. 5, connected in a tube. Caps. many-seeded.

coriâceum. A. rep.	leathery-leav'd.	obov. obt. smth. coriac. gr. yel.	5.	Madeira.	1787.	G. S. Loam, and	
ferrugineum. B. M.	rusty-leaved.	ellip. acu. rusty down. ben. st.	—	Guinea.	—	G. S. leaf mould.	
revolutum. H. K.	revolute.	opp. ellip. obt. pubes. ben. yel.	—	N. S. W.	1795.	G. S. cuttings.	
Tobira. DC.	glossy-leaved.	obov. retuse, smth.	wh.	3. 9.	China.	1804.	G. S. —
tomentosum.	woolly-leaved.	obo. obl. ferru. downy ben. yel.	—	N. Holl.	1824.	G. S. —	
undulatum. DC.	wave-leaved.	ov. lanc. undul. smth.	wh.	—	N. S. W.	1789.	G. S. —

GAL'X, GAL'X. Cal. of 5 leaves. Cor. of 5 pet. salver-shap. Caps. 3-celled, 3-valved. Nect. tubular.

aphylla. B. M.	heart-leaved.	cord. orbic. serr. gland. bh.	6. 7.	N. Amer.	1786.	H. P. Peat, dividing at the root.
----------------	---------------	-------------------------------	-------	----------	-------	-----------------------------------

Systematic Name.	English Name.	Form of Leaves, &c.	Col. of Flow.	Month of Fl.	Native Country.	Yr. of Introd.	Soil and Propagation.
MANG'IFERA, MANGO-TREE. <i>Cal. 5-part. decidu. Pet. 5. Stam. 5. Sty. 1. Ber. comp. Seed ova.</i>							
índica. B.M.	Indian.	obl. lanc. smth.	yel.	6. 9.	E. Ind.	1690.	S. S. Loam & peat cuttings.
'ITEA, 'ITEA. <i>Cal. 5-cleft. Cor. of 5 pet. inser. in the cal. reflex. Caps. 2-cell. and 2-valv. Stig. cap. 2-lob.</i>							
virgínica. B.M.	Virginian.	obl. serr. smth.	wh.	—	N. Amer.	1744.	H. S. Peat, layers.
BURSA'RIA, BURSA'RIA. <i>Cal. 5-toothed. Petals 5. Stam. 5. Caps. compressed, obcordate, 2-celled.</i>							
spínòsa. DC.	thorny.	obov. notch. smth. spiny.	wh.	9. 12.	N. S. W.	1793.	G. S. Peat & loam cuttings.
<i>'Itea spinòsa. A. B. R.</i>							
STRELITZIA, STRELITZIA. <i>Spath. of 1 leaf. Cor. irreg. Pet. 3. lanc. Nect. 3-lob. Caps. of 3 cells.</i>							
angustifólia. H. K.	narrow-leaved.	lanc. smth.	yel. blue.	5. 6.	C. B. S.	1778.	S. P. Sandy loam
parvifólia. H. K.	small-leaved.	li. lan. leaf-stlk long.	yel. blue.	5. 7.	—	1796.	S. P. & leaf mould.
reginæ. H. K.	Canna-leaved.	elli. smth. paral. ribs.	yel. blue.	4. 5.	—	1773.	S. P. suckers from root.
CEL'OSIA, COCK'S-COMB. <i>Cal. of 3 leaves. Cor. of 5 pet. Sty. 2-3-cleft. Caps. opening horizontally.</i>							
cristáta. R. S.	common.	ov. obl. acum.	red.	6. 9.	Asia.	1570.	S. A. Light loam.
coccínea. R. S.	scarlet.	ov. erect; stm. furrowed.	sc.	—	China.	1597.	S. A. seeds.
ACHYR'ANTHES, ACHYR'ANTHES. <i>Cal. of 5 leaves. Cor. 0. Stig. 2-cleft. Seed solitary.</i>							
argénteá. R. S.	silvery.	ov. orbic. acum. silve. ben. ros.	sc.	5. 9.	Sicily.	1713.	H. S. Sandy loam.
pórrigens. B. M.	scarlet.	ellip. ent. obt. opp.	sc.	4. 8.	Peru.	1802.	G. S. cuttings, or seeds.
PARON'YCHIA, PARON'YCHIA. <i>Cal. 5-part. Pet. 5, lin. Sta. 5. Sty. 1. Stig. 2. Caps. 5-val. 1-seed.</i>							
capitáta. DC.	capitate.	keel'd, obl. apex. cilia. pub. w.	6. 8.	Spain.	1683.	H. P. Loam & peat cutt. or seeds.	
<i>Illæcebrum capitátum. L.</i>							
hispánica.	Spanish.	smth.; stm. procumb.	wh.	—	—	—	H. P. —
pubéscens. R. S.	pubescent.	ellip. obt. pubes.	wh.	—	S. Franc.	1818.	H. P. —
polygonifólia. DC.	Polygonum-l'd.	obl. lin. smth. acut.	wh.	6. 7.	Dauphin.	1816.	H. P. —
GELS'EMIUM, GELS'EMIUM. <i>Cal. 5-tooth. Cor. funnel-shap. limb 5-lobed. Caps. compr. 2-seeded.</i>							
sempervirens. H. K.	ever-green.	lanc. smth.	yel.	—	N. Amer.	1640.	G. S. cl. Peat & loam cuttings.
ARDU'INA, ARDU'INA. <i>Cal. 5. Cor. funnel shaped. Stig. bifid. Berry 2-celled. Seed 1.</i>							
bispínòsa. S. S.	two-spined.	cord. ov. mucr. shin. smth.	wh.	4. 5.	C. B. S.	1760.	G. S. Loam & peat cuttings.
C'ERBERA, C'ERBERA. <i>Cal. 5-part. Cor. fun.-sha. limb 5-part. Sty. 1. Stig. 2-lob. Drup. 2-cell. 2-seed.</i>							
Ahoúai. B. M.	oval-leaved.	ov. obl. ent. smth.	yel.	6. 7.	Brazil.	1739.	S. S. Peat & loam.
fruticósa. B. R.	Rose-flowered.	opp. broad, lanc. ent.	ros.	5. 6.	Pegu.	1817.	S. S. cuttings.
Mánghas. L. T.	blunt-leaved.	alt. lanc. smth.	wh.	6. 9.	E. Ind.	1759.	S. S. —
Thevétia. B. M.	linear-leaved.	long, lin. crowded.	yel.	6. 7.	S. Amer.	1735.	S. S. —
Táughin. B. M.	poison-nut.	lanc. elong. atten. at base.	ros.	—	Madag.	1826.	S. S. —
TABERNÆMONTA'NA, TABERNÆMONTA'NA. <i>Cal. 5-part. Cor. salr.-sha. Sta. inclu. Anth. sagit.</i>							
citrifólia. R. S.	Citron-leaved.	ov. smth. ent. fl. in umbels. st.	5. 8.	Jamaica.	1784.	S. S. Loam & peat.	
coronária. L. T.	broad-leaved.	ov. lanc. smth.	wh.	6. 7.	E. Ind.	1710.	S. S. cuttings.

Systematic Name.	English Name.	Form of Leaves, &c.	Col. of Flow.	Month of Fl.	Native Country.	Yr. of Introd.	Soil and Propagation.
gratissima. B.R.	fragrant.	opp.obl.lanc.und.smth.	wh.	—	—	1824.	S.S. ———
laurifolia. B.R.	Laurel-leaved.	opp.ov.obt.ent.smth.	wh.	5.	W. Ind.	1768.	S.S. ———
PLUM'ERIA, PLUM'ERIA. Cal. 5-cleft. Cor. funnel-shap. limb 5-parted, with oblique ovate segm.							
bicolor. B.R.	two-coloured.	obl.acum.ent.smth.	wh.yel.	6. 9.	S.Amer.	1815.	S.S. Loam & leaf
rùbra. B.R.	red.	ov.obl.ent.smth.	ros.yel.	7. 8.	Jamaica.	1690.	S.S. mould. cutt.
tricolor. B.R.	three-coloured.	obl.acut.at both ends.	wh.ros.	6. 9.	S.Amer.	1815.	S.S. placed in pots, with all their leaves on, will strike root freely, but they must be kept in a dry state.
NERIUM, OLEANDER. Cal. 5-part. Cor. salver-shap. Anth. sagitt. fixed by the middle to the stig.							
odòrum. R.S.	sweet-scented.	lin.lanc.smth.	ros.	6. 9.	E. Ind.	1683.	S.S. Loam & leaf
	fl. pleno.	double-flow'ring.					mould. cutt.
Oleánder. R.S.	common.	lanc.lin.tern.smth.	ros.	—	S.Europ.	1596.	G.S. ———
álba.	white.						
TRISTA'NIA, TRISTA'NIA. Cal. 5-parted, permanent. Petals 5. Caps. 3-celled, many-seeded.							
confërta. DC.	Pittosporum-l'd.alt.	lanc.ellip.acut.	yel.	7. 9.	N.S.W.	1805.	G.S. Sandy loam
neriifolia. DC.	Nerium-leaved.	lin.lan.smth.ent.	yel.	—	—	1804.	G.S. & peat. cutt.
PSYCH'OTRIA, PSYCH'OTRIA. Cal. 5-tooth. Cor. tubular, 5-cleft. Berry small, subrotund, 2-seed.							
elliptica. B.R.	elliptical-leaved.	opp.ellip.lan.ent.smth.	gr.w.	2. 6.	Brazil.	1820.	S.S. Sandy loam & peat. cutt.
WRIGHTIA, WRIGHTIA. Cal. 5-lob. Cor. salver-sha. 5-cleft, spreading, with 5 fleshy 3-lobed scales.							
coccinea. B.M.	scarlet.	ov.lanc.smth.ent.acum.	sc.	6. 8.	E. Indies.	—	S.S. Loam & leaf mould. cutt.
MELOD'INUS, MELOD'INUS. Cal. 5-part. Cor. of 5 pet. Berry 2-cell. and many-seed. Ger. smth.							
monogynus. B.R.	one-styled.	ov.obl.acum.ent.	wh.	4. 8.	—	1816.	S.S.cl. Peat & loam. cutt. in sand.
PET'UNIA, PET'UNIA. Cal. 5-tooth. Cor. large, 5-lob. Stig. capit. subbilob. Caps. 2-cell. and 2-seed.							
nyctaginiflora. B.M.	large-flowered.	ov.obl.pubes.	wh.	6. 8.	S.Amer.	1824.	G.ß. Loam & leaf mould. cutt. or seeds.
ECHITES, ECHITES. Cal. 5-part. Cor. funnel-shap. limb 5-part. Caps. long, 1-celled, and 1-valved.							
nütans. B.M.	nodding.	ov.acum.ent.smth.	yel.	6. 9.	W.Ind.	1820.	S.S.cl. Loam & peat.
suberecta. B.M.	Savanna-flow.	ov.obt.mucl.	yel.	6. 8.	—	1759.	S.S.cl. cutt.
COLLOMIA, COLLOMIA. Cal. 5-part. glandu. Cor. salver-shap. limb 5-cleft. Caps. 3-cell. Seed solita.							
grandiflora. B.R.	large-flowered.	obl.lanc.ent.shin.	bf.	6. 7.	N.Amer.	1827.	H.ß. Loam & peat.
heterophylla. B.R.	various-leaved.	pinnatif.acute.vill.	pk.	5. 8.	—	—	H.ß. seeds.
linearis. B.R.	linear-leaved.	alt.sess.ov.lanc.smth.	fl.	6. 7.	—	—	H.ß. ———
SOLANDRA, SOLANDRA. Cal. 5-cleft. Cor. funnel-shap. limb reflexed. Berry 4-celled, many-seeded.							
grandiflora. L.	large-flowered.	ellip.lan.ent.smth.	yel.	7.	Jamaica.	1781.	S.S.cl. Sandy loam
viridiflora. B.M.	green-flow'r'd.	lanc.ellip.ent.smth.	gr.	5. 6.	Brazil.	1816.	S.S. & leaf mould. cuttings.
BRE'XIA, BRE'XIA. Cal. of 5 obtuse leaves. Petals 5, ovate, spreading. Filam. dilated at the base.							
madagascariensis. B.R.	Madagascar.	obl.lanc.ent.elong.	wh.	7. 8.	Madagas.	1815.	S.S. Peat & loam.
pinosa. B.M.	prickly.	lan.mucl.spiny,elong.	wh.	—	—	1815.	S.S. cuttings.

Systematic Name.	English Name.	Form of Leaves, &c.	Col. of Flow.	Month of Fl.	Native Country.	Yr. of Intro.	Soil and Propagation.
<i>EU'TOCA, EU'TOCA.</i>		<i>Cal. 5-part. Cor. campan. limb 5-lobed. Sty. hairy, bifid. Caps. many-seeded.</i>					
multiflora. B.R.	many-flowered.	lin. rough, lower trip.	pur.	5. 6.	N.Amer.	1826.	H. A. Sandy loam. seeds.
<i>ABR'ONIA, ABR'ONIA.</i>		<i>Perianth. salver-shap. limb 5-part. Stam. unequal. Stig. villous on one side.</i>					
mellifera. B.M.	honey-smelling.	ov. long, stalked, ent. smth.	w.	6. 8.	N.Amer.	1826.	H. A. Light loam. seeds.
<i>BURCHELLIA, BURCHELLIA.</i>		<i>Cal. 5-cleft. Cor. funn.-shap. limb 5-part. Berr. 2-cell. many-seed.</i>					
capensis. B.R.	Cape.	cord. obl. opp.	sc.	3. 6.	C. B. S.	1818.	G. S. Loam & peat. cuttings.
<i>APOCYNUM, DOG'S-BANE.</i>		<i>Cor. cum. Glan. 5, alter. with the sta. Sty. 0. Stig. broad. Follic. lin. androsæmifolium. B.M. Tutsan-l'd. ov. smth. on both sides. ros. 7. 8. N.Amer. 1688. H. P. Sandy soil & hypericifolium. Pers. Hypericum-l. obl. cord. smth. wh. ——— 1758. H. S. peat. divid. at root.</i>					
							[Ger. 4-celled, with 1 seed in each. Sty. half bifid.]
<i>EHR'ETIA, EHR'ETIA.</i>		<i>Cal. 5-cleft. Cor. of 1 petal, rotate, 5-parted. segments recurved. Sty. half bifid.</i>					
serrata. B.R.	serrated.	obl. lanc. serr. smth. acut.	wh.	8. E. Ind.	1823.	S. S. Loam & peat.	
tinifolia. L.	Tinus-leaved.	ov. obl. ent. smth.	wh.	6. 7.	Jamaica.	1734.	S. S. cuttings.
<i>HOV'ENIA, HOV'ENIA.</i>		<i>Cal. 5-cleft. Pet. 5, convolut. Sty. 1. Stig. 3. Caps. 3-cell. 3-valv. & 3-seed.</i>					
dulcis. B.M.	sweet.	ov. acum. serr. glau. ben.	gr.	4. 6.	China.	1812.	G. S. Peat & loam. cuttings.
<i>MUSS'ÆNDA, MUSS'ÆNDA.</i>		<i>Cal. of lin. seg. Cor. with long tub. limb 5-par. Caps. ov. 2-cell. many-seed.</i>					
frondosa. B.R.	frondose.	opp. ov. lanc. acu. vill.	yel.	6.	S. Ceylon.	1815.	S. S. Loam & peat. cuttings.
							[Caps. 2-celled. Seeds angular.]
<i>LISIA'NTHUS, LISIA'NTHUS.</i>		<i>Cal. 5-cleft. camp. Cor. funnel-shap. 5-lobed. Stam. 5. Anth. sagit.</i>					
longifolius. B.R.	long-leaved.	opp. lanc. acut. pub. ent.	yel.	7. 8.	Jamaica.	1793.	S. S. Sandy loam and peat. cutt.
<i>VELL'EIA, VELL'EIA.</i>		<i>Cal. of 3-5 leaves. Cor. spurred at the base. Sty. ent. Caps. 2-cell. Seed compr.</i>					
lyrata. B.R.	lyrate-leaved.	spath. lyr. den. att. at base.	yel.	—	N. Holl.	1819.	G. S. Sandy loam
paradoxa. B.R.	paradoxical.	lyrate, obt. dent. pubes.	yel.	—	—	1824.	G. P. & peat. cutt. or divid. plant.
<i>OPLOTHE'CA, OPLOTHE'CA.</i>		<i>Cal. tubu. 5-parted, white & woolly. Nect. tubu. 5-toothed. Ger. orate.</i>					
floridana. B.M.	Florida.	lanc. opp. undul. pubes.	wh.	8. 9.	N.Amer.	1824.	H. P. Peat & loam. seeds, or divid. plant.
<i>CO'RIS, CO'RIS.</i>		<i>Cal. ventricose, 5-toothed. Cor. of 1 petal, 5-cleft. irregu. Caps. 5-valved, seeds many.</i>					
monspelienſis. B.M.	Montpelier.	lin. alt. scattered.	bl. pur.	6. 7.	S. Europ.	—	G. B. Loam & peat. cuttings.
<i>TRIO'STEUM, FEVER-WORT.</i>		<i>Cal. 5-part. lobes linear. Cor. tubul. 5-lob. Stam. 5. Berry 3-celled</i>					
angustifolium. L.	narrow-leaved.	ov. lanc. ent.	yel.	—	N.Amer.	1699.	H. P. Sandy loam
perfoliatum. L.	perfoliate.	perfol. ov. acum.	pur.	—	—	1730.	H. P. cuttings, or divid. root.

Systematic Name. English Name. Form of Leaves, &c. Col. of Flow. Month of Fl. Native Country. Yr. of Introd. Soil and Propagation.

RAMONDA, RAMONDA. *Cal. 5-parted. Cor. of 5 petals, rotate. Caps. of 1 cell, with many seeds.*
 pyrenáica. W.en. Borage-leaved. ellip. rug. cren. tern. *bl. 5. 6. Pyrenees. 1731. H. P. Peat & loam. seed, or parting at the root.*
Verbascum Myconi. Linn.

TE'CTONA, TEAK-WOOD. *Cal. campan. 5-6-lobed. Cor. funnel-shaped, 5-6-part. Drupe 3-4-celled.*
 grándis. L. great. obov. scabr. ent. wh. ben. *wh. 6. 7. E. Ind. 1777. S. S. Cuttings.*

A'CHRAS, A'CHRAS. *Cal. 5-6-parted. Cor. 5-cleft. Fruit 1-celled. Seed single.*
 Sapóta. L. common. ov. lanc. smth. *wh. 8. 9. S. Amer. 1731. S. S. Peat & loam. cuttings.*

CHRYSOPHYLLUM, STAR-APPLE. *Cal. 5-clef. Cor. camp. 5-clef. Ber. 10-cell. with 1 seed in each.*
 argéntem. Jac. silvery. ov. falc. downy, shin. ben. *wh. 7. Martinico. 1758. S. S. Loam & peat.*
 Caimito. L. broad-leaved. ov. striat. shin. downy ben. *w. 5. 6. W. Ind. 1737. S. S. cuttings.*

SIDER' OXYLON, IRON-WOOD. *Cal. 5-tooth. Cor. rotate, 5-cleft. Nect. of 5 scales. Drupe 5-seed.*
 inérme. L. smooth. obov. smth. *wh. 7. C. B. S. 1692. G. S. Loam & peat. cuttings.*

ARDISIA, ARDISIA. *Cal. 5-parted. Cor. salver-shaped, limb reflexed. Stig. 1. Drupe 1-seeded.*
 élegans. A. B. R. elegant. lan. cren. shin. edges, rev. *pk. 7. 8. E. Ind. 1809. S. S. Loam, peat, crenuláta. B. M. crenate. ellip. revol. smth. cren. red. 6. 9. W. Ind. — S. S. & leaf mould. coloráta. B. C. red-flowered. obl. ent. smth. shin. ros. 7. 8. E. Ind. 1816. S. S. cutt. or seeds. punctáta. B. R. dotted. lanc. coriac. sinuat. pk. 6. 8. China. 1823. S. S. — paniculáta. B. M. panicked. cuneat. obl. ent. glau. ros. — E. Ind. 1818. S. S. —*

LIGHTFOOTIA, LIGHTFOOTIA. *Sep. 5. Pet. 5, closed by stam. bear. val. Stig. 3-5-clef. Caps. 3-5-cell.*
 subuláta. w. awl-leaved. subul. Pet. linear. *bl. 8. C. B. S. 1787. G. P. Sandy loam*
 tenélla. B. C. slender. in clusters, awl-sh. recurv. *bl. 6. 7. — 1822. G. P. & peat. cutt.*

SCÆVOLA, SCÆVOLA. *Cal. 5-lob. Cor. of 1 pet. tubu. limb 5-cleft. Nect. 2-celled. Drupe single-seed.*
 crassifólia. B. P. thick-leaved. obo. smt. flesh. slight. tooth. *bl. 8. 9. N. Holl. 1815. G. S. Peat & loam.*
 microcárpa. B. P. small-fruited. alt. obov. smth. tooth. *bl. 6. 9. N. S. W. 1790. G. P. cuttings.*
 Kœnigii. B. M. Kœnig's. obo. alt. ent. smth. *pa. re. — N. Holl. 1824. G. S. —*

GARDENIA, GARDENIA. *Cal. 5-7 clef. Cor. funnel-shaped, 5-9-parted. Stig. bifid. Berry 2-5-celled.*
 angustifólia. B. C. narrow-leaved. ellip. lanc. smth. ent. *wh. 7. China. 1820. S. S. Loam & peat.*
 am'œna. B. R. Chinese. ov. acut. smth.; spin. axi. re. w. *6. 8. — 1810. S. S. cuttings, in campanuláta. Rox. bell-flowered. lanc. acum. smth. st. 8. E. Ind. 1812. S. S. a little heat, flórida. B. R. Cape Jasmine. ellip. both ends acute. wh. 7. 9. China. 1754. S. S. will root flore pléno. double-flowered. — — — S. S. freely. grandiflóra. R. S. large-flowered. lanc. shin. wh. — — — 1816. S. S. — propínqua. B. R. allied. ov. cord. und. acum. smth. wh. 7. E. Ind. 1823. S. S. — rádicans. B. R. rooting. lanc. smth.; stm creep. wh. 4. 6. — 1804. G. S. —*

OXY'ANTHUS, OXY'ANTHUS. *Cal. 5-tooth. Cor. with along tub. 5-lob. Fil. 5. Sty. filif. Ber. 2-sell.*
 speciósus. DC. tube-flowered. ellip. pubes. *wh. 7. S. Leon. 1789. S. S. Peat & loam. cuttings.*

HAME'LLIA, HAME'LLIA. *Cal. 5-lob. Cor. tubul. 5-sided, limb 5-lobed. Stig. 5-sid. Berry 5-celled.*
 patens. Ex. B. spreading. tern. ov. obl. vill. *sc. 7. 8. W. Ind. 1759. S. S. Loam & peat.*
 ventricósa. B. R. ventricose. tern. or quater. lanc. shin. *yel. — — — 1788. S. S. cuttings.*

Systematic Name.	English Name.	Form of Leaves, &c.	Col. of Flow.	Month of Fl.	Native Country.	Yr. of Introd.	Soil and Propagation.
RANDIA, RANDIA. Cal. 5-parted. Cor. salver-shaped, 5-lobed. Stig. 2, thick. Berry 2-celled.							
longiflora. Sal.	long-flowered.	lanc. obl. flat.	wh.	8. 9.	E. Ind.	1818.	S. S. Sandy loam & peat. cutt.
<i>Gardënia multiflora.</i> w.							
RONDELETIA, RONDELETIA. Cal. 4-5-cleft, lob. lin. acu. Cor. 4-5-lob. Stig. bifid. Caps. 4-valc.							
americana. L.	American.	lanc. both ends acum. smth. w.	8. 9.	W. Ind.	1752.	S. S.	Peat & loam. cuttings.
SERISSA, SERISSA. Cal. 5-parted, limbs obov. Cor. funnel-shap. 5-lob. Berry 2-celled, & 2-seeded.							
fœtida. B.M.	Japanese.	ellip. obov. ent. smth. wh. pk.	5. 8.	Japan.	1787.	G. S.	Loam & leaf mould. cutt.
<i>ß. flora-plëna.</i> double-flowering.							
SYMPHORIA, ST. PETER'S-WORT. Cal. limbs small, 4-5-toothed. Cor. 4-5-lobed. Ger. 4-celled.							
glaucescens. DC.	glaucous.	ellip. acut. smth. glau.	wh.	8.	N. Amer.	1830.	H. S. Loam & peat.
racemosa. Ph.	Snow Berry.	ellip. mucr. ent.	pk. 6. 9.	—	—	1817.	H. S. cuttings.
ASCLEPIAS, SWALLOW-WORT. Cal. 5-clef. Cor. 5-part. Poll. masses fixed by a fine end. Stig. depr.							
amœna. R.S.	oval-leaved.	ov. ent. pilose, ben.	pur. 7. 8.	—	—	1732.	H. P. Sandy loam
curassavica. B.R.	Curassavian.	lanc. smth. shin.	sc. 6. 10.	—	—	1692.	S. P. and peat.
decumbens. B.M.	decumbent.	obl. obt. mucr. hairy ben.	sc. 7. 9.	—	—	1731.	H. P. parting
incarnata. B.R.	flesh-coloured.	lanc. woolly.	pur. — — —	—	—	1710.	H. P. roots, or
pulchra. B.F.G.	pretty.	opp. obl. cord. hairy.	pur. — — —	—	—	—	H. P. seeds.
purpurascens. R.S.	purple-flow'rd.	ov. vill. ben.	pur. — — —	—	—	1732.	H. P. —
salicifolia. B.C.	Willow-leaved.	opp. lin. ent. smth.	wh. pk. —	—	S. Amer.	1816.	G. P. —
tuberosa. B.R.	tuberous.	alt. lin. lanc. hairy.	or. —	—	N. Amer.	1690.	H. P. —
virgata.	twiggy.	lin. lanc. acut. pubes. ben.	pk. —	—	Mexico.	1804.	H. P. —
variegata. B.M.	variegated.	ov. rug. glau.	wh. red. 7. 8.	—	Florida.	1597.	H. P. —
verticillata. w.	whorl-leaved.	vertic. lin. edges revol.	gr. pu. —	—	N. Amer.	1759.	H. P. —
CYNA'NCHUM, CYNA'NCHUM. Cor. rotate, 5-parted. Stig. acute. Pollen masses inflated.							
acutum. Fl. Gr.	acute-leaved.	cord. obl. smth.	wh.	7.	Europe.	1596.	H. P. cl. Light loam.
crassifolium. R.S.	thick-leaved.	cord. ov. fleshy, smth.	gr. 6. 9.	—	C. B. S.	1816.	G. S. cl. dividing
undatum. A. rep.	waved.	cord. obl. obt. apex acum.	gr. 6. 7.	—	E. Ind.	1803.	S. S. cl. roots,
Vincetoxicum. Fl. D. officinal.		ov. acum. edges ciliat.	wh. 5. 8.	—	Europe.	1596.	H. P. or by seeds.
viridiflorum. B.M.	green-flowered.	cord. ov. acum.	gr. red. 10. 12.	—	E. Ind.	1814.	S. S. cl. —
GOMPHOCARPUS, GOMPHOCARPUS. Cal. 5-part. Cor. of 5 pet. Poll. masses comp. Seeds comose.							
arborascens. R.S.	broad-leaved.	ov. obl. smth.	wh. 1. 2.	—	C. B. S.	1714.	G. S. Sandy loam
fruticosus. B.M.	Willow-leaved.	lin. lanc. smth.	wh. 6. 9.	—	—	—	G. S. & peat. cutt.
PERIPL'OCA, PERIPL'OCA. Cal. parted. Cor. rotate, 5-cleft. Nect. 5-cleft. Stig. 5-sided.							
græca. B.R.	common.	ov. ellip. ent. smth.	pur. 7. 8.	—	Syria.	1597.	H. S. cl. Loam & peat.
lævigata. R.S.	smooth.	obl. lanc. veiny, smth.	yel. 6. 8.	—	Canaries.	1779.	G. S. cl. cuttings.
HOYA, HO'YA. Pollen masses fixed by the base, compressed. Follicles smooth. Seeds comose.							
carnosa. B.R.	fleshy.	ov. ellip. ent.	wh. 7. 10.	—	China.	1802.	G. S. cl. Sandy loam
pallida. B.R.	pale-flowered.	ov. lanc. acum. ent.	wh. pk. 6. 7.	—	—	—	G. S. cl. & peat. cutt.
PERGULARIA, PERGULARIA. Cal. 5-cleft. Cor. salver-shap. limb 5-part. Stig. obt. Seeds comose.							
minor. B.M.	small.	cord. obtuse, pointed.	st. 6. 7.	—	E. Ind.	1790.	S. S. cl. Loam & peat.
odoratissima. B.M.	sweet-scented.	cord. acum. downy.	yel. 5. 8.	—	—	1784.	S. S. cl. cuttings.
sanguinolenta. B.M.	bloody-juiced.	ov. lan. smth. stalked.	yel. 8. 9.	—	S. Leon.	—	S. S. cl. —

Systematic Name.	English Name.	Form of Leaves, &c.	Col. of Flow.	Month of Fl.	Native Country.	Yr. of Introd.	Soil and Propagation.
------------------	---------------	---------------------	---------------	--------------	-----------------	----------------	-----------------------

GONOLOBUS, GONOLOBUS. *Cor. rotate, 5-cleft. Anthers opening crossways. Stig. flat.*

diadematus. B.R.	red-crowned.	obl. ellip. lanc. cord.	st.	9.10.	Mexico.	1812.S.S.	cl. Sandy loam
niger. B.M.	dark-flowered.	cord.obl.undul.pube.	blk.pu.	8. 9.	— — —	1825.S.S.	cl. & peat. cult.
viridiflorus. B.R.	green-flowered.	cord. ov. acum. smth.	gr.	— — —	S. Amer.	— S.S.	cl. — — —

STAPELIA, STAPELIA. *Cor. 5-cleft, wheel-shap. fleshy. Pollen masses fixed by the base. Stig. obt.*

acuminata. R.S.	acuminate.	Br. 4 angled, dent.	d.pur.	7. 9.	C. B. S.	1795.D.S.	S. Sandy loam
concinna. R.S.	spruce.	Br.4-sid.smth.ang.dent.	br.	6. 8.	— — —	— D.S.	S. and brick
grandiflora. R.S.	tufted.	Br. proc. 4-cor.teethac.	pur.	— — —	— — —	1790.D.S.	S. rubbish. cut-
Gordóni.	great-flowered.	Br. 4-sided, club-sh.	d.pur.	9.12.	— — —	— D.S.	S. tings will
Gordóni.	Gordon's.	Br. roun. tuber. spin.	br.	— — —	— — —	— D.S.	S. readily strike
glauca. W.en.	glaucous.	Br. square, ang. round.	re.p.	6. 9.	— — —	1710.D.S.	S. root, if dried
hirsuta. R.S.	hairy.	Br. prickly; fl. flat, hairy.	d.p.	6. 8.	— — —	— D.S.	S. a few days
hamata. R.S.	hooked.	Br. tooth.; fl. flat, ciliat.	pu.re.	6. 9.	— — —	1805. D.S.	S. before plant-
incarnata. W.	flesh-coloured.	Br. erect. square, dent.	car.	— — —	— — —	1793. D.S.	S. ing.
lucida. R.S.	shining.	Br. squ. velv. teeth. erect.	pu.	6. 8.	— — —	1821. S.S.	S. — — —

SALSOLA, SALTWORT. *Cal. of 1 leaf, 5-clef. Cor. 0. Ger. round. Sty. 2 or 3, unit. at the base. Caps. of 1 cel.*

Kali. E.Fl.	prickly.	awl.sh.rou.prick.;stm.an.	g.	7. 8.	Britain.	H.A. Sandy soil seeds.
-------------	----------	---------------------------	----	-------	----------	------	------------------------

ULMUS, ELM. *Cal. of 1 leaf, 4-5 or 6-cleft. Cor. 0. Caps. compr. of 1 cell. Seed solitary, round. compr.*

americana. W.	American.	pubes. acum. serr.	gr.	4. 5.	N. Amer.	1752.	H.C. Strong loam.
campéstris. E.Fl.	common.	bi-serr. 2-inch. long, 1-br.	pu.	— — —	Britain.	H.C. seeds or lay-
carpinifolia.	Hornbeam-l'd.	ov. acut. cren. cord. at base.	g.	— — —	Siberia.	1776.	H.C. ers, and
crispa. W.	curled-leaved.	bi-serr. downy, ben.	bl.	— — —	N. Amer.	— — —	H.C. grafting.
glabra. E.B.	smth-l.or Wych-Elm.	ov. lan. smth. serr. uneq.	pu.	3. 4.	Britain.	H.C. — — —
májor. E.B.	Dutch Cork-bark.	ov. acu. scabr. above, pub.	br.	— — —	— — —	H.C. — — —
montana. E.B.	broad-leaved.	obo. point, serr. dow. ben.	gr.	4. 5.	— — —	H.C. — — —
microphylla. P.S.	small-leaved.	ov. lanc. small, cut, serr.	br.	— — —	Siberia.	1776.	H.S. — — —
péndula. W.en.	pendulous.	doubly serr. uneq. at base.	gr.	— — —	N. Amer.	— — —	H.C. — — —
suberosa. E.B.	common.	nearly orbic. cord. bi-serr.	pu.	3. 4.	Britain.	H.C. — — —
stricta. Lind.	upright.	obov. point. smth. shin. above.	5. 6.	— — —	— — —	H.C. — — —

CU'SCUTA, DODDER. *Cal. cup-shap. 4-5-part. Cor. of 1 pet. 4-5-part. Filam. 4 or 5. Caps. of 2 cells.*

Epithymum. B.Fl.	lesser.	stm. twin. round other pl.	wh.	7.10.	Britain.	H.P. cl. Sandy peat.
europæa. E.Fl.	greater.	stm. fili. twin. on other pl.	w.re.	8. 9.	England.	H.A. cl. seeds.

SWERTIA, FELWORT. *Cal. of 1 leaf, 5-part. Cor. wheel-shap. 5-part. Nec. 10, 2 at the base of each pet.*

Michauxiana. R.S.	American.	ov. smth; Br. shorter.	gr.y.	7. 8.	N. Amer.	1824.	H.B. Loam & peat.
perennis. E.Fl.	marsh.	ov. attenuat. nerv.	br.pur.	— — —	England.	H.P. divid. roots.

HEUCHERA, ALLUM-ROOT. *Cal. 5-tooth. Pet. 5, insert. in cal. Stam. 5. Caps. 2-cell. many-seed.*

americana. L.	American.	7-lob. tooth. roughish.	pur.	5. 7.	N. Amer.	1656.	H.P. Light loam
micrantha. B.R.	small-flowered.	cord. orbic. cren. sub. 5-lo.	gr.	— — —	— — —	1827.	H.P. and peat.
Richardsonia.	Richardson's.	orbic. lob. dent. subcil.	gr.	— — —	— — —	— — —	H.P. divid. roots.
villôsa. Ph.	villous.	acutely lobed, vill.	pk.	— — —	— — —	1812.	H.P. — — —

MICROLO'MA, MICROLO'MA. *Cor. tubular, inflated. Anth. sagitt. Pollen masses compr. pendulous.*

sagittatum. H.K.	arrow-leaved.	opp. sagitt. pubes.	sc.	7. 8.	C. B. S.	1775.G.	S. cl. Sandy loam & peat. cult.
------------------	---------------	---------------------	-----	-------	----------	---------	---------------------------------

PENTANDRIA DIGYNIA.

Systematic Name.	English Name.	Form of Leaves, &c.	Col. of Flow.	Month of Fl.	Native Country.	Yr. of Introd.	Soil and Propagation.
CUSSONIA, CUSSONIA. <i>Cal. 5-7-toothed. Petals 5-7. Style 2-3. Fruit 2-3-celled.</i>							
spicàta. w.	spiked.	palm. leafl. acut. ent.	gr.	8.10.	C. B. S.	1789.	G. S. Loam & peat.
thyrsiflora. w.	Thyrse-flow'r'd.	pal. seg. obt. trun. 3-dent.	gr.	—	—	1795.	G. S. cuttings.
HERNARIÀ, RUPTURE-WORT. <i>Cal. of 5 deep seg. Cor. 0. Fil. 5, awl-sha. Caps. of 1 cell. Seed sing.</i>							
alpina. DC.	Alpine.	obo. acut. smth. edges cili.	gr.	7. 8.	S. Europ.	1816.	H. P. Light loam
glàbra. E. Fl.	smooth.	opp. ellip. fring.	gr.	7.	England.	H. P. and peat.
hirsùta. B. Fl.	hairy.	ov. hairy, opp.; stm. proc.	gr.	7. 8.	—	H. P. seeds, or cutt.
CHENOPODIUM, GOOSE-FOOT. <i>Cal. of 1 leaf, conc. 5-cleft. Cor. 0. Ger. orbicu. Sty. short. Stig. obt.</i>							
botryoides. E. B.	many-spiked.	triang. slightly toothed.	red.	6. 8.	Britain.	H. A. Sandy loam.
ficifolium. E. B.	Fig-leaved.	sinuat. jagged, hast.	gr.	8. 9.	England.	H. A. seeds.
fruticòsum. R. S.	shrubby.	fleshy, round, obt. imbri.	gr.	—	—	H. S. —
<i>Salsòla fruticòsa. E. Fl.</i>							
glàucum. E. Fl.	Oak-leaved.	obl. tooth. glau. mealy. ben.	gr.	7. 8.	England.	H. A. —
muràle. E. Fl.	nettle-leaved.	ov. dent. acut. shin.	gr.	8. 9.	—	H. A. —
maritimum. E. Fl.	sea.	alt. smth. awl-sheath.	gr.	8.	—	H. A. —
polyspèrmum. E. Fl.	round-leaved.	ov. obt. ent.	gr.	7. 8.	—	H. A. —
rùbrum. E. Fl.	red.	trian. atten. at bas. ser. sin. re.	gr.	8. 9.	—	H. A. —
ùrbicum. E. Fl.	upright.	large, triang. acut. dent.	gr.	8.	—	H. A. —
BETA, BEET. <i>Cal. in 5 deep segments. Cor. 0. Ger. depressed. Style 2 or 3. Stig. acute.</i>							
maritima. E. Fl.	sea.	ov. ent. wavy; stm. proc.	gr.	6. 8.	Britain.	H. P. Sandy loam. seeds.
GENTIANA, GENTIAN. <i>Cal. in 4 or 5 seg. Cor. tubu. 4 or 5-clef. Caps. of 2 valv. & 1 cell. Seeds many.</i>							
alpina. B. C.	Alpine.	sess. ov. ent. smth.	bl.	5. 7.	Switzerl.	1818.	H. P. Sandy loam
acaùlis. E. Fl.	dwarf.	ellip. lanc. acut.; stm. 4-sid.	bl.	3. 5.	Wales.	H. P. and peat.
Amarélla. R. S.	Autumnal.	sess. ov. 3-ribb. acut. publ.	bl.	8.	Britain.	H. P. dividing at
asclepiadéa. B. M.	swallow-wort-ld.	amplex. ov. lanc.	bl.	7. 8.	Austria.	1629.	H. P. the root, or
bavàrica. L.	Bavarian.	spat. ent.; stm. elong. 1-fl.	bl.	—	German.	1775.	H. P. seeds.
Catesbæi. A. Rep.	Catesby's.	opp. tern. lanc. smth.	bl.	6. 7.	N. Amer.	1776.	H. P. —
cruciàta. R. S.	cross-leaved.	decuss. connat. sheath.	bl.	7. 8.	Austria.	1596.	H. P. —
crinìta. B. F. G.	jagged-flower'd.	lanc. acut; Cor. quadrif.	bl.	—	N. Amer.	1804.	H. P. —
intermèdia. B. M.	intermediate.	obl. obov. 3-nerved.	bl.	8. 9.	—	1820.	H. P. —
incarnàta. B. M.	flesh-coloured.	ov.; Fl's in clusters, carn.	—	—	—	1812.	H. P. —
lútea. R. S.	yellow.	ov. nerv. elong.	yel.	6. 7.	Alps Eur.	1596.	H. P. —
ochroleúca. B. R.	Pale-white.	opp. ov. lanc. smooth.	wh.	8. 9.	N. Amer.	1803.	H. P. —
Pneumonánthe. E. Fl.	marsh.	lin. lanc. obt.	bl.	9.10.	England.	H. P. —
pùmila. L.	dwarf.	spat. ent. smth.	bl.	—	Switzerl.	1817.	H. P. —
septémfida. B. M.	crested.	cruciat; Cor. 5-7-cleft.	bl.	6. 7.	Levant.	1804.	H. P. —
Saponària. B. M.	barrel-flowered.	ov. lanc.; Cor. 10-cleft.	bl.	9.10.	N. Amer.	1776.	H. P. —
vèrna. E. B.	spring.	ov. acut. crowd.	bl.	4. 5.	England.	H. P. —
uniflòra.	one-flowered.	ov. lanc. ent. acute.	vi.	6. 7.	Canaries.	1828.	H. P. —
ERYNGIUM, ERYNGO. <i>Flow. aggreg. Cal. of each of 5 equ. lves. Pet. 5, equ. undiv. Fruit ov. bristly.</i>							
amethy'stinum. s. s.	amethystine.	pinnatif. lobes spiny, ent.	bl.	7. 8.	Syria.	1648.	H. P. Sandy loam.
alpinum. B. M.	Alpine.	cord. serr. upp. palm. ciliat.	bl.	8. 9.	Switzerl.	1597.	H. P. seeds, or
Bourgàti. s. s.	cut-leaved.	orbic. 3-part. segm. pinnat.	bl.	6. 9.	S. France.	1731.	H. P. part. roots.
campèstre. B. Fl.	field.	ampl. low. 2-3-pinnatif.	wh.	—	Britain.	H. P. —
maritimum. B. Fl.	sea.	round, plait. spiny.	bl.	8. 9.	—	H. P. —
plànum. s. s.	flat-leaved.	ov. cren. flat.	bl.	—	Europe.	1596.	H. P. —

Systematic Name.	English Name.	Form of Leaves, &c.	Col. of Flow.	Month of Fl.	Native Country.	Yr. of Introd.	Soil and Propagation.
ECHIN'OPHORA, PRICKLY-SAMPHIRE.	<i>Cal. of 5 rigid leaves. Pet. obov. uneq. Fruit ov. Seed 1.</i>						
spinosa. E.Fl.	sea-parsnip.	bipinnat.segm.awl-sh.spi. w.	7.	England.	H. P.	Sandy soil. seeds.
DA'UCUS, CARROT.	<i>Cal. small. Pet. 5-obo. Fruit ellip. obl. Seeds with 4 rows of prickles, rough, & flat.</i>						
maritimus. E.Fl.	sea.	tripin.leafl.pinnat.fleshy.ro. 6. 7.	—	H. B.	Sandy loam. seeds.	
SANICULA, SANICLE.	<i>Cal. acu. 5-l'd. Pet. 5, nearl. equ. in the barren flor. Ger. round, bris. Seeds 2.</i>						
europ'ea. B.Fl.	wood.	palm. lobes trif. serr.	wh. —	Britain.	H. P.	Light loam.
Marilandica. s.s.	Maryland.	digit. leaf. obl. serr.	wh. —	N.Amer.	1765.	H. P.	or part. root.
CA'UCALIS, BUR-PARSLEY.	<i>Cal. of 5 leaves, uneq. Pet. 5, obo. Seeds with 4 rows of hooked prickles.</i>						
mauritanica. L.	Mauritanian.	bipinnatif.segm.lin.lan. wh.	6.	Mauritan.	1818.	H. A.	Sandy soil. seeds.
BU'BON, BU'BON.	<i>Involucre of many leaves. Fruit ovate, 5-ribbed, villous, compressed.</i>						
Gálbanum. dc.	Lovage-leaved.	triter.leaf.ov.cuneif.ser.gr.y. 8. 9.	C. B. S.	—	G. P.	—	—
TORILIS, HEDGE-PARSLEY.	<i>Cal. short, nearly equ. of 5 leaves. Pet. 5, obo. Fruit rib. Seeds rib.</i>						
Anthriscus. E.Fl.	upright.	bipinn.leafl.pinnat.ser.w.or. 7. 8.	Britain.	H. A.	Sandy soil. seeds.	
HARRIS'ONIA, HARRIS'ONIA.	<i>Cal. 5-part. Cor. flesh. limb 5-tooth, the seg. acu. obliq. Pol. masses 2.</i>						
loniceroides. B.M.	Honey-suckle-lk. opp. decuss. ellip. cord. red. —	Brazil.	1827.	S. S.	cl. Peat & loam. young cutt. will easily strike root in sand.		
SCA'NDIX, SHEPHERD'S-NEEDLE.	<i>Cal. uneq. undiv. Ger. comp. Sty. short. Stig. obt. Fruit ribb.</i>						
pinnatifida.	cut-leaved.	decomp. pinnatif. smth. wh. —	Persia.	1805.	H. A.	Seeds.	
CHEROPHYLLUM, CHERVIL.	<i>Cal. 0. Pet. 5, uneq. obo. Ger. smth. Sty. short. Stig. 1. Fru. smth.</i>						
Claytóni. Ph.	sweet-rooted.	biter.pube.;stm.joints tum. w. —	N.Amer.	1806.	H. P.	Sandy loam.	
temuléntum. E.Fl.	rough.	twice pinn. leafl. lobed. wh. —	Britain.	H. B.	seeds.	
MYRRHIS, CICELY.	<i>Cal. 0. Pet. rather uneq. obov. Ger. furrow. & smth. Sty. awl-shap. Stig. capit.</i>						
odorata. E.Fl.	sweet-scented.	tripinn.leafl.lanc.cut.ser. w. 5. 6. —	H. P.	Gard. loam. seeds.		
FER'ULA, FER'ULA.	<i>Involucre various. Fruit ovate, flatly compressed with 3 obtuse dorsal ribs.</i>						
pérsica. A.rep.	Persian.	leafl. multif. decurr. yel. 7. 8.	Persia.	1782.	H. P.	Gard. loam. seeds.	
LIGUSTICUM, LOVAGE.	<i>Cal. of 5 leaves. Petals 5. Filam. shorter than the corolla. Sty. angular.</i>						
cornubiense. L.	Cornish.	bi. or tripin. leafl. wedge-sh. w. 6. 7.	Britain.	H. P.	Sandy soil.	
scóticum. E.Fl.	Scottish.	biter. leafl. broad, acut. ser. w. — — —	H. P.	seeds.		
BUPLEURUM, HARE'S-EAR.	<i>Cal. 0. Pet. 5, equ. Fil. longer than the cor. Ger. furr. Seeds 5-ribb.</i>						
angulòsum. w.	angular.	amplex. cord. lanc. st. 5. 7.	Switzerl.	1759.	H. P.	Sandy loam.	
caricifolium. w.	Carex-leaved.	lin. attenuated at base. st. — — —	1824.	H. P.	seeds.		
graminifolium. s.s.	grass-leaved.	lin. smth. Invol. 3-5-lv'd. st. — — —	1768.	H. P.	—		
longifolium. s.s.	long-leaved.	ov. obl.;stm. leaves amplex. st. — — —	1713.	H. P.	—		

Systematic Name.	English Name.	Form of Leaves, &c.	Col. of Flow.	Month of Fl.	Native Country.	Yr. of Introd.	Soil and Propagation.
<i>Odontites</i> . E.B.	narrow-leaved.	lin.lan. acut. 1-2 inch.l.	buff.	7.	England.	1713.	H. A. ———
<i>rotundifolium</i> . E.Fl.	common.	ov. perfol. glan. alt.	yel.	6. 7.	———	H. A. ———
<i>tenuissimum</i> . E.Fl.	slender.	lin. lanc. 3-ribb. glau.	yel.	7. 8.	———	H. A. ———
PEUCEDA'NUM, SULPHUR-WORT. <i>Cal. of 5 teeth. Pet. 5, obovate. Filam. longer than corolla.</i>							
<i>aúrea</i> . E.R.	Golden-flow'd.	leafl. pinnatif. segm. lin.	yel.	6.	Canaries.	1779.	G. B. Light loam.
<i>officinále</i> . E.Fl.	Hog's-fennel.	leafl. tern. lin. lanc. 3-rib.	yel.	5. 7.	England.	H. P. seeds.
<i>Ostrúthium</i> .	great.	bitern. leafl. 2-3 in. long.	wh.	———	Scotland.	H. P. ———
<i>Imperatöria Ostrúthium</i> . E.B.							
TORD'YLIUM, HART-WORT. <i>Cal. of 5 leaves. Pet. 5, obov. Ger. ov. bristly. Sty. swelling at base.</i>							
<i>máximum</i> . E.Fl.	great.	pinn. leafl. lanc. serr.	red.	6. 7.	England.	H. A. Sandy soil.
<i>officinále</i> . E.Fl.	small.	pinn. leafl. ov. lob. notch.	wh.	7.	———	H. A. seeds.
HYDROCO'TYLE, WHITE-ROT. <i>Cal. 0. Pet. 5, equ. Ger. round, smth. ribb. Fr. hollow at the sides.</i>							
<i>vulgáris</i> . E.Fl.	common.	orbic. peltate, cren.	wh.	5. 6.	Britain.	H. w. P. Peat. divid. at the roots.
LASERPITIUM, LASER-WORT. <i>Cal. 5-toothed. Pet. 5, obovate, notched. Fruit compr. oblong.</i>							
<i>aquilegífolium</i> . w.	Columbine-ly'd.	2-3-ter. seg. ov. cord. dent. w.	5.	Austria.	1796.	H. P.	Sandy loam.
<i>glábrum</i> . DC.	smooth.	bipinnat. seg. cord. dent. pu.	6.	———	1824.	H. P.	seeds.
ATHAMA'NTA, STONE-PARSLEY. <i>Cal. of 5 leaves. Pet. 5, obo. Ger. downy, furro. Seed 5-ribbed.</i>							
<i>Matthióli</i> . DC.	fine-leaved.	pinnatisest. segm. lin.	wh.	6. 7.	Carniola.	1802.	H. P. Sandy loam. seeds.
ME'UM, FENNEL. <i>Cal. 0. Pet. 5, obov. apex inflexed. Ger. striated. Sty. recurv. Fruit ellip. oblong.</i>							
<i>athamánticum</i> . E.Fl.	Bald-money.	bipinn. leafl. opp. multif.	yel.	4. 6.	Britain.	H. P. Light soil.
<i>Fœniculum</i> . L.	common Fennel.	tripinn. leafl. awl-sh.	yel.	———	———	H. P. seeds, or part. roots.
CORIA'NDRUM, CORIANDER. <i>Cal. of 5 broad uneq. leav. Pet. 5. Fruit smth. ribless. Seeds conc.</i>							
<i>sativum</i> . E.Fl.	common.	bipinn. upp. lvs. lin. segm.	wh.	6.	England.	H. A. Sandy loam. seeds.
ÆTHU'SA, FOOL'S-PARSLEY. <i>Cal. of 5 small leaves. Pet. 5-lob. Ger. ov. furro. Seeds ov. 5-ribbed.</i>							
<i>Cynápium</i> . E.B.	lesser Hemlock.	bipinn. segm. lanc.	wh.	7. 9.	Britain.	H. A. Sandy loam. seeds.
SMY'RNium, ALEXANDER'S. <i>Cal. of 5 small leaves. Pet. 5, equ. Ger. angu. & furr. Seeds 3-ribbed.</i>							
<i>Olusàtrum</i> . E.Fl.	common.	bitern. upp. tern. leafl. ser.	st.	5. 6.	———	H. B. Light loam. seeds.
C'ONIUM, HEMLOCK. <i>Cal. obsolete. Pet. 5, obov. Ger. wrinkled. Fruit ovate, 10-ribbed.</i>							
<i>maculátum</i> . E.Fl.	common.	Leafl. ov. pinnat.; stm. spot. w.	6. 7.	———	———	H. B. Sandy loam. seeds.
ARCHANGE'LICA, ARCHANGE'LICA. <i>Cal. 5-toothed. Pet. ellip. incurv. Fruit a little compressed.</i>							
<i>officinális</i> . DC.	garden.	bipinn. leafl. ov. smth.	wh.	6. 8.	England.	H. B. Garden soil. seeds.
<i>Angelica Archangélica</i> . E.B.							
CRITHMUM, SAMPHIRE. <i>Cal. of 5 small conc. leaves. Pet. 5, incurv. Ger. furrowed. Seeds 5-ribb.</i>							
<i>marítimum</i> . E.Fl.	sea.	bitern. leafl. lanc. fleshy.	yel.	7. 9.	Britain.	H. P. Sandy loam. seeds, or part. root.

Systematic Name.	English Name.	Form of Leaves, &c.	Col. of Flow.	Month of Fl.	Native Country.	Yr. of Intro.	Soil and Propagation.
------------------	---------------	---------------------	---------------	--------------	-----------------	---------------	-----------------------

S'IUM, WATER-PARSNEP. *Cal. of 5 small leav. Pet. 5, equ. obo. Ger. striat. Fr. ov. fur. Seed 5-rib.*
angustifolium. E.Fl. narrow-lv'd. pinn. leaf. uneq. lob. serr. wh. 7. 8. Britain. . . . H.w. \mathfrak{P} . Mud. seeds.
latifolium. E.Fl. broad-leaved. pinn. leaf. obl. lanc. wh. — — — — H. \mathfrak{P} . — —

S'ISON, HONE-WORT. *Cal. 5 clef. blunt. tooth. Pet. 5, equ. obo. point. Ger. ov. Sty. shor. Seed 3-rib.*
Amomum. E.Fl. Hedge. pin. smth. gr. upp. ter. 3-lob. y. 8. 9. — — . . . H. \mathfrak{A} . Light loam. seeds.

PIMPIN'ELLA, BURNET-SAXIFRAGE. *Cal. 0. Pet. 5, equal, obov. Ger. smooth. Fruit ov. ribb.* [Style as long as the fruit.
magna. E.Fl. greater. pinn. leaf. ov. serr. wh. 5. 8. England. . . . H. \mathfrak{P} . Sandy loam.
Saxifraga. B.Fl. common. pin. leaf. ellip. serr. up. bip. w. — — Britain. . . . H. \mathfrak{P} . seeds.

SE'SELI, SE'SELI. *Invol. of many leaves. Cal. 5, dentic. Pet. obcord. Fruit obl. with reflexed styles.*
gummiferum. Ex. B. gummy. tripart. glau. leaf. trifid. yel. — — Crimea. 1710. H. \mathfrak{B} . Sandy loam.
Libanotis. B.Fl. mountain. bipinnatif. segm. lanc. acut. — — Britain. . . . H. \mathfrak{P} . — —
Athamanta Libanotis. L.

ENA'NTHE, WATER-DROP-WORT. *Cal. of 5 large unequal leaves. Pet. 5, obov. Ger. furrowed.* [Seeds ovate, slightly furrowed.
apiifolia. s.s. Parsley-leaved. tripinn. upp. pinn. wh. 5. 8. Portugal. 1806. H. \mathfrak{P} . Sandy soil,
peucedanifolia. s.s. Sulphur-wort. pinn. leaf. lin. acut. red. 6. 9. S. Europ. 1820. H.w. \mathfrak{P} . or in mud.
pimpinelloides. E.Fl. Burnet Saxifrage. bipinn. leaf. ellip. carn. — — England. . . . H.w. \mathfrak{P} . seeds, or part. roots.

TRACHYME'NE, TRACHYME'NE. *Involucre of many leaves. Cor. of 5 equal, obtuse, entire, petals.* [Stam. exerted. Stig. obtuse.
cerulea. B.R. blue-flowered. 3-part. segm. 3-lob. en. pub. bl. — — N. Holl. — — H. \mathfrak{A} . — —

CEROPE'GIA, CEROPE'GIA. *Cal. of 5 linear leaves. Cor. tube club-shap. limb 5-lobed. Pollen masses* [ova. obt. Stig. 5-cornered.
elegans. B.M. beautiful. obl. acut. opp. — — Calcutta. 1828. S. \mathfrak{S} . cl. — —

AMMI, BISHOP'S-WEED. *Cal. of 5 leaves. Pet. obovate, notched. Fruit compressed, oblong.*
najus. Fl. Gr. great. pinnatif. opp. lobes ser. wh. 6. 7. Europe. — — H. \mathfrak{A} . Sandy loam. seeds.

BRACHYST'ELMA, BRACHYST'ELMA. *Cal. 5-parted. Cor. campanulate, 5-lobed.*
rispium. B.M. crisped-leaved. ellip. lanc. opp. glandul. br. gr. — — C. B. S. 1829. G. \mathfrak{P} . — —
patulatum. B.R. spatulate-lv'd. spat. ob. sub-rep. pilo. dull pu. — — — — 1826. G. \mathfrak{P} . — —

CRYPTOSTE'GIA, CRYPTOSTE'GIA. *Cal. of 5 leaves. Cor. funnel-shaped, limb 5-parted. Scales 5.* [Ger. 2. Style 2.
randiflora. B.R. large-flowered. opp. ellip. obl. ent. ros. 6. 8. E. Ind. — — S. \mathfrak{S} . cl. Sandy loam and peat. cutt. under a hand glass, in a little heat, will strike root.

ORDER III.

TRIGYNIA. STYLES 3.

Systematic Name.	English Name.	Form of Leaves, &c.	Col. of Flow.	Month of Fl.	Native Country.	Yr. of Introd.	Soil and Propagation.
VIBURNUM, GUELDER-ROSE. <i>Cal. 5-clef. Cor. of 1 pet. 5-lob. Ger. comp. Sty. 0. Stig. 3. Seed 1.</i>							
<i>acerifolium</i> . R.S.	Maple-leaved.	cord.ov.often 3-lob.ser.	wh.	6. 7.	N.Amer.	1736.	H.S. Sandy loam.
<i>cassinoides</i> . R.S.	thick-leaved.	ov. lanc. cren. smth.	wh.	—	—	1761.	H.S. cuttings or layers.
<i>dentatum</i> . R.S.	tooth-leaved.	ov. serr. smth.	wh.	—	—	1736.	H.S. layers.
<i>Lantana</i> . E.Fl.	Way-faring-tree.	cord. serr. pubes.	wh.	5. 6.	Britain.	...	H.S. —
<i>O'pulus</i> . E.Fl.	common.	3-lob. serr. decid.	wh.	—	—	...	H.S. —
<i>odoratissimum</i> . B.R.	sweet-scented.	ellip. obl. opp. smth.	wh.	—	China.	1818.	F.S. —
<i>pubescens</i> . R.S.	downy.	ov. acum. serr. vill. ben.	wh.	6. 7.	N.Amer.	—	H.S. —
<i>rugosum</i> . B.R.	rugose-leaved.	ov. rug. hairy, ben.	wh.	4. 5.	Canaries.	1796.	H.S. —
<i>Tinus</i> . B.M.	Laurustinus.	ov. obl. ent.	wh.	12. 4.	S.Europ.	1596.	H.S. —
1. <i>hirtum</i> .	<i>hairy</i>	wh.	—	—	—	H.S. —
2. <i>lucidum</i> .	<i>shining</i>	wh.	—	—	—	H.S. —
3. <i>fol. argentea</i> .	<i>silvery-leaved</i>	wh.	—	—	—	H.S. —
SAMBU'CUS, ELDER. <i>Cal. 5-part. Cor. 5-cleft. Fila. as long as the petals. Berry of 1 cell. Seeds 3.</i>							
<i>canadensis</i> .	Canada.	pinnatif. segm. ov. obl.	wh.	6. 8.	N.Amer.	1761.	H.S. Sandy loam.
<i>racemosa</i> . R.S.	raceme-flow'g.	pinnatif. segm. obl. acum.	st.	5. 6.	S.Europ.	1596.	H.S. seeds or cult.
CORRIGI'OLA, STRAP-WORT. <i>Cal. 5-part. obov. conc. Pet. 5, obovate. Style 3. Seed 1, 3-angled.</i>							
<i>littoralis</i> . E.Fl.	sand.	lin. lanc. ent. glau.	wh.	—	England.	H.P. Light soil, seeds.
STAPHYLEA, BLADDER-NUT. <i>Cal. 5-part. conc. Pet. 5. Ger. 2, or cleft. Sty. 2 or 3. Caps. 2 or 3.</i>							
<i>pinnata</i> . E.Fl.	common.	pinn. opp. leaf. ov. serr. gr. ye.	4. 6.	—	—	H.S. Gard. loam.
<i>trifolia</i> . DC.	three-leaved.	tern. ov. serr.	wh.	5. 6.	N.Amer.	1640.	H.S. seeds or cult.
TAMARIX, TAMARICK. <i>Cal. of 5 seg. Pet. 5, obo. Ger. ov. Sty. 0. Stig. 3. Caps. of 1 cell & 3 valves.</i>							
<i>gállica</i> . E.Fl.	French.	lan. acut. smth. sp. at base.	red.	7. 8.	England.	H.S. Sandy soil, cuttings.
MYRICA'RIA, MYRICA'RIA. <i>Cal. 5-parted. Pet. 5. Sty. 0. Stam. short. Stig. capitate.</i>							
<i>germánica</i> . DC.	German.	lin. lan. sess.	pk.	6. 9.	German.	1582.	H.S. Light loam, cuttings.
<i>Tamarix germánica</i> . L.							
TURNE'RA, TURNE'RA. <i>Cal. funnel-shap. 5-cleft. Cor. of 5 pet. Stig. multifid. Caps. 1-celled, 3-valv.</i>							
<i>trioniflora</i> . DC.	Ketmia-flow'd.	ov. ellip. acut. at both ends.	y.	—	Trinidad.	1812.	S.S. Loam & peat, cuttings.
RH'US, SUMACH. <i>Cal. 5-parted, Pet. 5, ovate, spread. Style 3. Stig. 3. Drupe 1-celled, 1-2 or 3-seed.</i>							
<i>Búcku Amélia</i> . Wall.	Walnut-ldv.	large, rugose, downy.	gr. yel.	—	Nepal.	1823.	G.S. Peat, loam,
<i>Cotinus</i> . R.S.	Venice.	obov. entire, smth.	gr.	7. 8.	S.Europ.	1656.	H.S. & leaf mould.
<i>javánica</i> . R.S.	Java.	pinn. ov. acum. serr.	wh.	—	Java.	1799.	S.S. cuttings.
<i>juglandifolia</i> . D.P.	Walnut-leaved.	pinn. leaf. 11-15 pairs, obl. gr.	—	—	S.Amer.	1826.	G.S. —
<i>lúcida</i> . DC.	shining.	palm. leaf. obov. obt. ent.	gr.	—	C. B. S.	1697.	G.S. —

Systematic Name.	English Name.	Form of Leaves, &c.	Col. of Flow.	Month of Fl.	Native Country.	Yr. of Introd.	Soil and Propagation.
parviflora. DC.	small-flowered.	palm.tern.leaf.obo.cren.	gr.	7. 8.	Nepaul.	1824.	G. S. ———
tomentosa. R.S.	hairy.	palm.tern.leaf.ellip serr.	gr.	—	C. B. S.	1691.	G. S. ———
typhina. L.	Virginian.	pinn.leaf.lanc.acum.ser.	pu.	—	N.Amer.	1629.	H. S. ———
Toxicodendron. DC.	Poison Oak.	pinn. leaf. ent. pubes.	wh.	—	—	1640.	H. S. cl. ———

CASSINE, CASSINE. Cal. 5-part. Pet. 5-spread. Ger. 1. Style 0. Stig. 3. Drupe 3-celled, 3-seed.
 capensis. DC. Cape. ov. retuse, cren. flat. wh. — C. B. S. 1629. G. S. Loam & peat.
 Colpoón. w. Colpoon-tree. ovate, ent. serr. at base. wh. — — — — 1791. G. S. cuttings.
 Maurocènia. DC. Hottentot-cherry. sess. obov. ent. smth. wh. — — — — 1690. G. S. ———

SPATHELIA, MOUNTAIN-PRIDE. Cal. 5-part. col'd. Cor. of 5 pet. Fil. short. Caps. obl. 3-sided.
 simplèx. B.R. Sumach-leaved. pinn. ov. dent. br.pur. . . . Jamaica. 1788. G. S. Peat & loam. cuttings.

BASELLA, MALABAR NIGHTSHADE. Cal. 0. Cor. 7-cleft, becom. a berr. the 2 opp. seg. the largest.
 alba. R.S. white. ov. undul. Pedun. long. wh. 7.11. E. Ind. 1688. S. B. cl. Loam & peat.
 cordifolia. R.S. heart leaved. cord. rounded, smth. pk. — — — — 1802. S. B. cl. cutt. or seeds.
 rubra. R.S. red-flowered. flat, pedun.; simple. pk. 7. 9. — — — — 1731. S. B. cl. ———

PORTULACARIA, PURSLANE-TREE. Cal. of 2 leaves. Cor. of 5 pet. Seed 1-winged, & 3-cornered.
 afra. DC. African. opp. round. fleshy, smth. ros. 7.10. Africa. 1732. D. G. S. Loam & peat. cutt. or seeds.

ORDER IV.

TETRAGYNIA. STYLES 4.

[Caps. of 4 cells.
PARNASSIA, GRASS OF PARNASSUS. Cal. of 1 leaf, 5-part. Pet. 5 conca. Nect. of 5 fleshy scales.
 asarifolia. DC. Asarum-leaved. renif. upp. cord. orbic. wh. 8. 9. N.Amer. 1812. H. P. Peat & loam
 caroliniana. E.M. Carolina. orbic. upp. ovate. wh. 5. 6. Carolina. 1802. H. P. suits them
 palustris. E. Fl. marsh. cord. smth. acut. wh. 7. 8. Britain. . . . H. P. best, when the pots are placed in a little water. divid. roots, or seeds.

ORDER V.

PENTAGYNIA. STYLES 5.

ATICE, THRIFT. Cal. funnel-shaped, undivided. Pet. 5. Caps. of 1 cell, & 1 valce. Seed solitary.
 pina. Alpine. lin. flat, acute, edges mem. vio. 5. 8. Carinthia. . . . H. P. Loam & leaf
 enticulata. toothed. lin. flat, denticulate. fl. — Italy. 1816. H. P. mould.
 marginata. W.en. emarginate. spatul. notched. bl. 5. 7. Gibraltar. . . . F. P. cuttings, or
 tifolia w. broad-leaved. pubes. scape panic. li. — Portugal. 1740. H. P. part. roots.
 nuata. B.M. scollop-leaved. lyr. sinuat. upp. lin. bl. ye. — Levant. 1629. F. P. ———

Systematic Name.	English Name.	Form of Leaves, &c.	Col. of Flow.	Month of Fl.	Native Country.	Yr. of Introd.	Soil and Propagation.
<i>TAXANTHEMA, SEA-LAVENDER. Cal. tubular, 5-toothed. Cor. of 5 petals, notched.</i>							
bellidifolia. Fl.Gr.	Daisy-leaved.	obov. spat. ent.	blue.	—	Greece.	1823.	G. \mathfrak{P} . Light rich
Limonium. R.S.	blue-spiked.	ellip. obl. mucr. 1-ribb.	blue.	5. 9.	England.	...	H. \mathfrak{P} . loam. part- ing roots.
<i>Staticè Limonium. E.B.</i>							
macrophylla. s.s.	large-leaved.	lanc. mucr. glauc.	bl.wh.	5. 6.	Canaries.	1816.	F. \mathfrak{P} . —
reticulata. R.S.	matted.	spathul. ent. stalk dott.	pur.	7. 8.	England.	...	H. \mathfrak{P} . —
<i>Staticè reticulata. E.B.</i>							
speciosa. B.F.G.	Plantain-ly'd.	obov. casp. mucr.	ros.	8. 9.	Russia.	1776.	H. \mathfrak{P} . —
<i>Staticè speciosa. E.M.</i>							
spicata. R.S.	spiked.	sinuate. pinn.	wh.	6. 9.	Caucas.	1828.	H. \mathfrak{A} . —
tatarica. L.	Tartarian.	lanc. obov. undul. mucr.	pk.	—	Russia.	1731.	H. \mathfrak{P} . —
Wildenowiana. R.S.	Wildenow's.	spathul. point. glau. 3-ribb. vi.	—	—	S. Fran.	1804.	H. \mathfrak{P} . —
<i>Staticè spathulata. W.en.</i>							
<i>LINUM, FLAX. Cal. 5 parted. Pet. 5, obtuse. Filam. 5. Anth. arrow-shaped. Caps. sub-5-angled.</i>							
angustifolium. H.K.	narrow-leaved.	lin. lanc. 3-5-nerved.	blue.	7. 8.	England.	...	H. \mathfrak{P} . Loam & peat.
ascyrifolium. H.K.	blue and white.	cord. ovate. pubes.	wh.bl.	—	Portug.	1800.	H. \mathfrak{P} . parting
alpinum. w.	Alpine.	lin. awl-sh.; stm. decum. bl.	—	—	Austria.	1739.	H. \mathfrak{P} . roots, seeds;
arboresum. w.	tree.	obov. or wedge-sh. smth.	yel.	5. 9.	Candia.	1788.	G. \mathfrak{S} . or cuttings.
africanum. E.M.	African.	lin. lanc. alt.	yel.	6. 8.	C. B. S.	1771.	G. \mathfrak{S} . —
maritimum. L.	sea.	alt. lanc. 3-nerv.	yel.	8. 9.	S. Europ.	1596.	H. \mathfrak{P} . —
mexicanum. B.R.	Mexican.	ov. obl. acut. scatt.	yel.	—	Mexico.	1827.	F. \mathfrak{P} . —
sibiricum. B.R.	Siberian.	lin. acut. spread.	blue.	7. 8.	Siberia.	1775.	H. \mathfrak{P} . —
trigynum. E.M.	three-styled.	alt. ellip. both ends acum.	yel.	1. 10.	E. Ind.	1799.	G. \mathfrak{S} . —
venustum. A.B.R.	graceful.	ov. acut. 5-7-nerved.	pk.	6. 7.	Caucasus.	1807.	H. \mathfrak{P} . —
<i>SIBBALDIA, SIBBALDIA. Cal. in 10 segments. Pet. 5, obovate. Ger. 5, seldom 10. Seeds 5, smooth.</i>							
procumbens. E.Fl.	procumbent.	ter. leaf. 3-dent. wedge-sh.	y.	6. 8.	Britain.	...	H. \mathfrak{P} . Sandy loam. part. plant.
<i>ARALIA, ARALIA. Cal. short, dented. Pet. 5. Stam. 5. Style 5, spreading. Berry 5-celled.</i>							
capitata. Pers.	headed.	ellip. ent. simple.	gr.	8.	W. Ind.	1777.	S. \mathfrak{S} . Loam & peat.
nudicaulis. s.s.	naked-stalked.	3-fid. pinnat. seg. 5-ov. ser. w.	—	—	N. Amer.	1731.	H. \mathfrak{P} . cutt. from
racemosa. s.s.	berry-bearing.	decompound, segm. ov. ser. w.	—	—	—	1658.	H. \mathfrak{P} . root or lay.
spinosa. s.s.	Angelica-tree.	pinnatif. segm. ov. serr. smth.	—	—	Virginia.	1688.	H. \mathfrak{S} . —
<i>CRASSULA, CRASSULA. Cal. of 5 leaves. Pet. 5, recurved. Stam. 5. Styles 5. Caps. 5.</i>							
arborescens. B.M.	tree.	orbic. glau. dott. fleshy.	pk.	7.	C. B. S.	1730.	G. \mathfrak{S} . Loam & peat.
cordata. DC.	heart-leaved.	cord. obt. ent. stalk.	ros.	5.	—	1774.	G. \mathfrak{S} . cuttings.
ciliata. w.	ciliated.	opp. ov. flat, fring.	yel.	7.	—	1732.	G. \mathfrak{S} . —
imbricata. H.K.	imbricated.	ov. acut. smth.	wh.	6. 7.	—	1760.	G. \mathfrak{S} . —
lactea. B.M.	white.	ov. connat. atten. at base. w.	—	9.	—	1774.	G. \mathfrak{S} . —
orbicularis. H.S.	orbicular-ly'd.	obl. obt. fring.	bh.	6. 7.	—	1731.	G. \mathfrak{P} . —
obliqua. E.M.	oblique.	obliq. ent. acut.	red.	4. 5.	—	1759.	G. \mathfrak{S} . —
perfoliata. Pers.	perfoliate.	awl-sh. connat. conv. glau.	va.	7. 8.	—	1725.	G. \mathfrak{S} . —
<i>MAHERNIA, MAHERNIA. Cal. 5-toothed. Petals 5. Nect. 5. Caps. 5-celled, 5-valved.</i>							
grandiflora. DC.	large flowered.	cuneat. lanc. dent. pubes.	sc.	5. 8.	—	1791.	G. \mathfrak{S} . Loam & peat
incisa. DC.	cut-leaved.	pinn. lob. scabr.	wh. yel.	7. 9.	—	1792.	G. \mathfrak{S} . cuttings.
bipinnata. DC.	wing-leaved.	bipinn. lob. lin. smth.	red.	6. 8.	—	1752.	G. \mathfrak{S} . —
<i>pinnata. B.M.</i>							

ORDER VI.

HEXAGYNIA. STYLES 6.

Systematic Name.	English Name.	Form of Leaves, &c.	Co. of Month Native Flow. of Fl. Country.	Yr. of Introd.	Soil and Propagation.
[shaped. Caps. of 3 valves, with many seeds.					
<i>DRO'SERA, SUN-DEW.</i> Cal. 5-parted. Pet. 5. Fil. 5-8. Ger. roundish. Sty. 6-8, simple. Stig. club.					
ánglica. E.B.	great.	lin.spath.obt.hairy,gland.	w. 8. 9. Britain.	... H.w.Þ.	Peat soil.
filifórmis. Ph.	thready-ly'd.	filif. very long.	pur. 5. 6. N.Amer.	1811. H.w.Þ.	divid. at root.
longifólia. E.B.	long-leaved.	obov. petioles naked.	wh. 8. 9. England.	... H.w.Þ.	—
rotundifólia. E.Fl.	round-leaved.	orb.con.obt.pu.glan.hair.	w. — Britain.	... H.w.Þ.	—

ORDER VII.

POLYGYNIA. STYLES MANY.

<i>MYOSU'RUS, MOUSE-TAIL.</i> Cal. 5-part. Pet. 5, very small. Fil. 5, or more. Ger. numer. Seeds nak.					
mínimus. E.Fl.	common.	li.fleshy,1-rib.1-2-in.long.	y. 8. 9. Britain.	... H.Æ.	Sandy peat. seeds.
<i>XANTHORH'ZA, YELLOW-ROOT.</i> Cal. 0. Pet. 5. Nect. 5-stalked. Caps. 5, 1-seeded.					
paifólia. B.M.	parsley-leaved.	compound. serr. smth.	gr. 3. 4. N.Amer.	1766. H.Æ.	Sandy loam. cuttings.

CLASS VI. ORDER I.

HEXANDRIA MONOGYNIA. STAMENS 6. STYLE 1.

<i>AMARY'LLIS, AMARY'LLIS.</i> Cor. of 6 petals, irregu. Filam. inserted into the throat of the tube.					
aúlica. B.R.	Mr. Woodford's.lora.	elong. atten. at 2 ends.	sc. 5. 8. Brazil.	1810.	S.Þ. Sandy loam,
Belladónna. w.	Belladonna Lily.	ligul. stalks many-fl'd.	car. 6. 8. W.Ind.	1712.	S.Þ. peat, & leaf
crocáta. B.R.	saffron-colored.	ensif. smth.	sn. 4. 6. —	1810.	S.Þ. mould. The
calyptráta. B.R.	green-flowered.	spread. lan. acut. chan.	gr.y. 5. 8. —	1816.	S.Þ. bulbs should
equèstris. B.M.	Barbadoes Lily.	Tube fring. 2-3-flowered.	sc. 7.10. —	1710.	S.Þ. be kept in a
fúlgida. B.R.	fulgid.	obl. lanc. smth.	sc. 1.12. Brazil.	1810.	S.Þ. dry state un-
intermédia. B.R.	intermediate.	lin. smth.; spatha 3-fl'd.	red. 1.10. —	1827.	S.Þ. til they be-
latifólia. w.	broad-leaved.	obl.lanc.; spath.many-fl'd.	w. 4. 5. E. Ind.	1806.	S.Þ. gin to shew
pulverulénta. B.R.	powdery.	long, strap-shaped.	or. 4. 8. Brazil.	1819.	S.Þ. flower, when
psittacína. B.R.	parrot-like.	lanc. obt. acum. glau.	gr.cr. 1.12. —	1816.	S.Þ. they must
reginá. B.M.	Mexican Lily.	lorate, acum. rib. keel'd.	sc. 5. 7. S.Amer.	1725.	S.Þ. be rcotted
reticuláta. B.M.	netted-veined.	lorat.obl.7-9inch.long.	li.cr. 4. 5. Brazil.	1777.	S.Þ. in fresh soil.
Solándraeflóra. Lindl.	Solandra-fl'd.	Fls.with nearly regul.limb.	st. 4. 6. S.Amer.	1820.	S.Þ. They are
pectábilis. A.rep.	waved-leaved.	broadly awl-sh. serrul.	w.pu. 6. S. Leon.	1810.	S.Þ. readily in-
pléndens.	splendid.	linear, narrow.	wh.sc. — Spofforth.	1819.	S.Þ. creased by
					offsets from the bulb.

Systematic Name.	English Name.	Form of Leaves, &c.	Col. of Flower.	Month of Fl.	Native Country.	Yr. of Introd.	Soil and Propagation.
TUPISTRA, TUPISTRA. <i>Perianth. campan. 6-part. Anth. 6, sessile. Ger. round. Stig. peltate.</i>							
nútans. B.M.	drooping,	2-3ft.long,obo.lan.striat.y.b.	10.	E.	Ind.	1822.	S. \mathfrak{P} . Sandy loam,
squálda. B.R.	grey-flowered.	lanc. atten. at base, nerv.gr.	4.	Amboy.	1810.		S. \mathfrak{P} . & leaf mould. offsets.
STERNBERGIA, STERNBERGIA. <i>Flow. vertical, funnel-shaped, limb erect. Stam. declinate.</i>							
lútea. B.R.	yellow.	many-keel'd.scap.2-edged.y.9.10.	S.	Europ.	1596.		S. \mathfrak{P} . Peat & loam. offsets.
<i>Amaryllis lútea. B.M.</i>							
HABRANTHUS, HABRANTHUS. <i>Perian. of 6 leaves, flat, obov. Ger. 3-cell. & 3-valv. many-seeded.</i>							
advéna. B.M.	streaked.	lin. ligul. invol. glau.	std. —	S.	Amer.	1807.	S. \mathfrak{P} . Sandy loam & peat. off-
<i>Amaryllis advéna. B.R.</i>							
Andersonii. B.F.G.	Anderson's.	lin. obt. glau. striat.	yel. — — —	1829.			S. \mathfrak{P} . sets from the
róseus. B.F.G.	rose-coloured.	long, lin. apex obt.	ros. — — —	Chiloe.	—		S. \mathfrak{P} . bulb.
CURCULIGO, CURCULIGO. <i>Cor. salver-shap. 6-parted. Caps. 3-celled, with several seeds in each.</i>							
latifólia. H.K.	broad-leaved.	ellip. lanc. acum.	yel. 5. 8.	PooloPin.	1804.		S. \mathfrak{P} . Peat & loam.
recurváta. B.R.	recurved.	ellip. lanc. recurv. plic.	yel. . . .	Bengal.	1805.		S. \mathfrak{P} . offsets from the bulb.
PHYCELLA, PHYCELLA. <i>Cor. campan. segm. convolute. Ger. 3-sided. Stig. apex fringed.</i>							
cyrtanthoides. Lindl.	Cyrtanthus-lk.	gr. lorate, obt.	cr. 6. 8.	Chile.	1821.		G. \mathfrak{P} . Loam & leaf
I'gnea. Lind.	fiery.	distich. lin. obt. glau.	sc. 11.	— — —	1824.		G. \mathfrak{P} mould. off-sets.
<i>Amaryllis i'gnea. Lind.</i>							
GRIFFINIA, GRIFFINIA. <i>Spath. 2-valv. Cor. funnel-shap. limb 5-cleft. Ger. obl. 3-cell. Seeds obo.</i>							
hyacinthína. B.R.	largest.	ov. obl. flat, retic.	vio. 6. 9.	Brazil.	1815.		S. \mathfrak{P} . Sandy loam
intermédia. B.R.	intermediate.	ov. ellip. ent. retic.	vio. 7. 8.	— — —	1823.		S. \mathfrak{P} . and peat.
parviflóra. B.R.	small-flowered.	ov. lanc. smth. ent.	p.vio. 5. 7.	S.Amer.	1820.		S. \mathfrak{P} . offsets from the bulb.
PANCRATIUM, PANCRATIUM. <i>Cor. fun.-shap. limb 6-part. Nec. 1-2-clef. with the Stam. fix'd on it.</i>							
amænum. B.M.	handsome.	elong. smth. lanc.	wh. 5. 9.	W. Ind.	—		S. \mathfrak{P} . Loam & peat.
Amáncaes. B.R.	Golden.	elong. lanc. chann.	yel. 6. 7.	Peru.	1804.		S. \mathfrak{P} . offsets from
australásicum. B.R.	Australian.	petiolate, orbic. ent.	wh. 5.	N. S. W.	—		S. \mathfrak{P} . the bulb, or
amboinénsé. B.M.	heart-leaved.	cord. ov. acut.	wh. 5. 8.	E. Ind.	1759.		S. \mathfrak{P} . seeds.
marítimum. B.R.	sea-daffodil.	lin. ; spath. many-flow'd.	wh. 5. 7.	S. Europ.	1597.		G. \mathfrak{P} . — — —
declinátum. B.C.	declined.	ligul. smth.	wh. 5. 9.	Brazil.		S. \mathfrak{P} . — — —
frágrans. B.C.	fragrant.	ellip. elong. smth.	wh. — — —	W. Ind.	1819.		S. \mathfrak{P} . — — —
mexicánum. B.R.	Mexican.	lanc. lin. apex. elong.	wh. 8.	Mexico.	1824.		G. \mathfrak{P} . — — —
ovátum. B.R.	oval-leaved.	striat. narr. many-fl'd.	wh. — — —	W. Ind.		S. \mathfrak{P} . — — —
rotátum. B.M.	large-crowned.	lin. obt. 2 or many-fl'd.	wh. 7. 9.	Carolina.	1803.		G. \mathfrak{P} . — — —
TRADESCANTIA, SPIDER-WORT. <i>Perianth. 6-part. the 3 inner leaves petal-like. Caps. 3-celled.</i>							
crássula. B.M.	thick-leaved.	obl. smth. sheath. at base.	wh. 5. 8.	Brazil.	1825.		S. \mathfrak{P} . Loam & leaf
discolor. H.K.	various-col'd.	lanc. smth. red ben.	wh. 4. 9.	S. Amer.	1783.		S. \mathfrak{P} . mould. divid-
fuscáta. B.R.	browned.	ellip. acum. pubes.	blue. 9. 10.	— — —	1820.		S. \mathfrak{P} . ing plant at
rósea. B.C.	rose-coloured.	lin. keel'd, chan. obo. dott.	ros. 5. 10.	Carolina.	1802.		H. \mathfrak{P} . root.
undáta. S.S.	wave-leaved.	ov. und. pilose, abov.	vio. 8. 9.	Trinidad.	1819.		S. \mathfrak{P} . — — —
PHORMIUM, FLAX-LILY. <i>Sepals 6, the 3 inner longest. Caps. oblong, 3-cornered. Seeds compr.</i>							
tenax. W.	tough.	distich. smth. ent.	gr. wh. 6.	N. Zeala.	1788.		H. \mathfrak{P} . Rich loam. offsets.

Systematic Name.	English Name.	Form of Leaves, &c.	Col. of Flow.	Month of Fl.	Native Country.	Yr. of Introd.	Soil and Propagation.
CAMA'SSIA, QUAMASH. <i>Perian. spread. 6-leaved. Fil. smth. Stig. 3-dent. Caps. 3-celled & 3-valved.</i>							
esculénta. B.R.	eatable.	lin. acum. chann. curv.	bl.	6. 7.	N. Amer.	1828.	H. \mathfrak{P} . Loam & peat. divid. plant.
CONANTHERA, CONANTHERA. <i>Cor. of 6 reflexed petals, fringed. Caps. 3-celled, 3-valved.</i>							
bifólia. B.M.	two-leaved.	lin. lanc. smth. ped. 2-fl'd.	bl.	6.	Chile.	1823.	G. \mathfrak{P} . Loam & peat.
campanuláta. B.M.	bell-flowered.	lin. lanc. fl. spr.	bl.	3. 4.	—	—	G. \mathfrak{P} . divi. at roots.
CUMMINGIA, CUMMINGIA. <i>Perianth. campan. limb 6-cleft, decidu. Ger. 3-celled. Stig. dotted.</i>							
trimaculáta. B.F.G.	three-spotted.	lin. chann. nerv. recurv.	bl.	—	—	—	Peat & loam. divid. at roots.
CHARLWOODIA, CHARLWOODIA. <i>Perianth. 6-part. petal like. Sty. 3-sid. Caps. 3-celled, 3-valv.</i>							
congéstá. S.F.A.	crowded.	amplex. elong. lanc. serr.	pu.	3.	N. Holl.	1822.	S. \mathfrak{S} . Loam & leaf mould. cutt.
CYCLOBOTHRA, CYCLOBOTHRA. <i>Perian. 6-part. pet. like. Sta. 6. Ger. smth. obl. 3-sid. 3-furr.</i>							
purpúrea. B.F.G.	purple.	lanc. elong. acum. glau. gr. pu.		9.	Mexico.	1827.	H. \mathfrak{P} . Sandy loam. offsets.
UVULARIA, UVULARIA. <i>Cor. of 6 petals, erect. Filam. short. Caps. compressed, 3-cornered.</i>							
chinénsis. B.M.	Chinese.	ov. lanc. stalk.	br. pu.	6. 11.	China.	1801.	F. \mathfrak{P} . Sandy loam
grandiflóra. Ex. B.	large-flowered.	obl. perfol. acut.	yel.	5. 6.	N. Amer.	1802.	H. \mathfrak{P} . and peat.
perfoliáta. Ex. B.	perfoliate.	ov. perfol. smth.	gr. yel.	—	—	1710.	H. \mathfrak{P} . divid. at root.
SANSEVIERA, SANSEVIERA. <i>Cor. of 1 pet. limb in 6 div. rev. Fil. inser. in the limb. Berr. of 1 seed.</i>							
cárnea. A. rep.	flesh-coloured.	2-rank. lanc. ensif. smth.	car.	3. 6.	China.	1792.	H. \mathfrak{P} . Loam & peat.
longiflóra. B.M.	long-flowered.	lanc. acum. 3-nerv.	gr.	7. 8.	S. \mathfrak{P} . divid. at root.
Zeyláncia. B.R.	Ceylon.	obl. lanc. acut. macul.	wh.	6. 11.	Ceylon.	1731.	S. \mathfrak{P} . —
MASSONIA, MASSONIA. <i>Cor. 6-parted. Filam. sessile. Caps. 3-winged, 3-celled.</i>							
angustifólia. B.M.	narrow-leaved.	obl. erect, lanc.	wh.	3. 4.	C. B. S.	1774.	G. \mathfrak{P} . Sandy loam,
ensifólia. B.M.	trumpet-flow'd.	2 opp. lanc.	pk.	9. 2.	—	1790.	G. \mathfrak{P} . & peat. seeds
grandiflóra. B.R.	large-flowered.	sub-rot. obl. fleshy.	wh.	1. 4.	—	1825.	G. \mathfrak{P} . or offsets
muricáta. B.M.	prickly-leaved.	sub-rot. smth. ape. prickly.	w.	4. 5.	—	1790.	G. \mathfrak{P} . from bulbs.
ASPHODELUS, ASPHODEL. <i>Cor. 6-parted, spreading. Six valves covering the Germens.</i>							
álbus. w.	white.	lin. keel-sh.	wh.	5. 7.	S. Europ.	H. \mathfrak{P} . Sandy loam.
lútens. B.M.	yellow.	3-sided, striat.	yel.	5. 6.	Sicily.	1596.	H. \mathfrak{P} . divid. at root.
ramósus. B.M.	branched.	ensif. keel.	wh.	5. 7.	S. Europ.	1551.	H. \mathfrak{P} . —
DIANELLA, DIANELLA. <i>Cor. 6-part. equal. Filam. curv. Berry round, 3-celled, many-seeded.</i>							
cærúlea. B.M.	blue.	lin. lanc. distich. spiny.	blue.	5. 8.	N. S.W.	1783.	F. \mathfrak{P} . Peat & loam.
ensifólia. B.M.	sword-leaved.	lin. lanc. keel'd, smth.	blue.	8.	E. Ind.	1731.	S. \mathfrak{P} . seeds, or
longifólia. B.R.	long-leaved.	lin. ensif. elong.	blue.	—	N. Holl.	1822.	G. \mathfrak{P} . part. at root.
revolúta. R.B.	few-flowered.	lin. erect, edges revol.	blue.	5. 8.	N. S.W.	1820.	F. \mathfrak{P} . —
DRI'MIA, DRI'MIA. <i>Perianth. 6-parted, campanulate, limb reflexed. Caps. 3-celled.</i>							
altíssima. B.M.	tall.	ov. erect; Bractes hooked.	w.	8. 9.	C. B. S.	1791.	F. \mathfrak{P} . Sandy loam
acumináta. B.C.	sharp-leaved.	ov. acum. varieg.	g. br.	—	—	1800.	F. \mathfrak{P} . & leaf mould.
villósa. B.R.	villous.	obl. undul. glau.	gr.	5. 6.	—	1826.	F. \mathfrak{P} . seeds, or off-sets from the bulb.

Systematic Name.	English Name.	Form of Leaves, &c.	Col. of Flow.	Month of Fl.	Native Country.	Yr. of Introd.	Soil and Propagation.
MUSCA'RIA, GRAPE HYACINTH. <i>Perian. pet.-like, ov. infla. 6-tooth. Caps. 3-sid. Cells of 2 seeds.</i>							
botryoides. B.M.	blue.	lin. erect, chann.	var.	4. 5.	Italy.	1596.	H. P. Sandy loam.
glaucum. B.R.	glaucous-leav'd.	acum. glau. smth. flat.	p.gr.	—	Persia.	1825.	H. P. offsets from
macrocarpum. B.F.G.	large-capsul'd.	lan. elong. glau.	bl. & yel.	—	Turkey.	1812.	H. P. the bulb.
LACHENALIA, LACHENALIA. <i>Cor. cylind. 6-lobed, the outer segm. shortest. Caps. 3-cell. 3-valv.</i>							
bifolia. B.M.	two-leaved.	lanc. erect, uneq.	ros.wh.	3. 4.	C. B. S.	1813.	G. P. Loam & peat
fragrans. R.R.	sweet-scented.	2-ov. obl. smth.	ros.	3. 5.	—	1798.	G. P. or leaf mould
pustulata. A.rep.	rough-leaved.	in pairs, lin. lanc.	wh.gr.	1. 4.	—	1790.	G. P. mixed. seeds
rosea. B.R.	rose-coloured.	2-lanc. lin. obt.	ros.	4. 5.	—	1800.	G. P. or offsets
tricolor. B.M.	three-coloured.	2-lanc. spott. ent.	yel.red.gr.	—	—	1774.	G. P. from the
unifolia. B.M.	one-leaved.	single, lin. lanc.	blue.red.	3. 4.	—	1795.	G. P. bulb.
DRACÆNA, DRAGON-TREE. <i>Cor. salver-shap. 6-parted. Stig. 3-fid. Berry 3-celled, single seeded.</i>							
Dráco. L.	common.	fleshy, apex spiny.	wh.	6. 7.	E. Ind.	1649.	S. S. Sandy loam
férrea. B.M.	purple.	lanc. smth. purp.	wh.	3. 4.	China.	1791.	S. S. & leaf mould.
fragrans. B.M.	sweet-scented.	broadly lanc. smth.	wh.	2. 5.	Africa.	1768.	S. S. cuttings.
stricta. B.M.	upright.	lin. lanc. cuspid. ent.	lil.	4. 5.	NewZeal.	1820.	S. S. —
ALSTRÆMERIA, ALSTRÆMERIA. <i>Perianth. of 6 segm. campan. Caps. 3-celled, many-seeded.</i>							
acutifolia. B.M.	acute-leaved.	lanc. acum. downy ben.	or.	9.10.	S.Amer.	1829.	F. P. Sandy loam
Ligtú. B.M.	Ligtú.	spat. obl. smth.	sc.	3. 4.	Peru.	1776.	S. P. & turfy peat.
ováta. B.C.	oval-leaved.	obl.acum.alt.4-5in.long.	sc.	6. 9.	—	1824.	H. P. seeds, or di-
pelegrina. B.M.	spotted-flow'd.	twisted, lin. lanc.	red.bh.	—	—	1753.	G. P. dividing at the
psittacina.	Parrot-like.	obl. lanc. acut. nerv.	sc.gr.	—	Mexico.	1829.	G. P. root. several
pulchella. B.M.	handsome.	obov. spat. ciliat.	red.yel.	—	Chili.	1822.	H. P. of these spec-
<i>ies will flower freely, if planted out in a sheltered border.</i>							
YU'CCA, ADAM'S NEEDLE. <i>Cor. campanulate, 6-cleft. Ger. 3-sided. Caps. 3-celled.</i>							
angustifolia. B.M.	narrow-leaved.	long, lin. glau. mucr.	gr.	7. 8.	Missouri.	1811.	H. S. Rich sandy
aloifolia. L.	Aloe-leaved.	lanc. smth. convolute.	w.gr.	8. 9.	S.Amer.	1696.	G. S. loam. suckers
filamentosa. B.M.	thready.	lanc. serr. smth.	wh.	7.10.	Virginia.	1675.	H. P. from root.
glauca. B.M.	glaucous-leav'd.	lanc. glau. ent.	yel.	7. 8.	Carolina.	1812.	H. P. —
gloriosa. B.M.	superb.	lanc. ent. broad.	wh.	8.10.	America.	1596.	H. S. —
glaucescens. B.F.G.	glaucous.	lin. lanc. ent.	gr.wh.	7. 8.	N.Amer.	1819.	H. P. —
AGAVE, AGAVE. <i>Cal. 0. Cor. funn.-shap. 6-part. Sty. long. than the fila. Caps. 3-cell. Seeds many.</i>							
americana. B.R.	common.	ov. lanc. dent. spiny.	gr.	8.10.	S.Amer.	1640.	G. S. Rich loam.
virginica. B.M.	Virginian.	lanc. rigid, dent. cil.	gr.yel.	9.	N.Amer.	1765.	F. P. suckers from root.
CYANELLA, CYANELLA. <i>Perianth. of 6 petals. Stam. 6, united at the base into a fleshy cup.</i>							
lineata. B.T.	lined.	ensif. erect, acum.	ros.	4. 8.	C. B. S.	1816.	F. P. Sandy loam
odoratissima. B.R.							& peat. seeds or offsets from the bulb.
DIPHYLLIA, DIPHYLLIA. <i>Cal. of 3 leaves, deciduous. Cor. of 6 petals. Berr. 1-cell. Seeds 2-3.</i>							
cymosa. B.M.	blue-berried.	palm. angul. serr.	wh.	5. 6.	N.Amer.	1812.	H. P. Sandy loam & leaf mould. dividing at root.
ORONTIUM, ORONTIUM. <i>Spadix round, with many florets. Cor. 6-parted. Sty. 0. Caps. 3-celled.</i>							
aquaticum. Ex.F.	aquatic.	ov. lanc. veiny.	st.	6.	—	1775.	H. v. P. Sandy loam.
japonicum. B.M.	Japan.	ensif. veiny.	yel.	1. 4.	Japan.	1788.	H. P. part. at root.

Systematic Name.	English Name.	Form of Leaves, &c.	Col. of Flower.	Month of Fl.	Native Country.	Yr. of Intro.	Soil and Propagation.
<i>ALET'RIS, ALET'RIS.</i> Cor. funnel-shap. wrinkled. Stam. inserted into the base of segm. Caps. 3-cell'd.							
aùrea. Ph.	golden.	broad, lanc. mucr.	yel.	7. 8.	N. Amer.	1811.	H. β . Sandy loam
farinòsa. B.M.	Colic-root.	lanc. ensif. acut.	wh.	6.	—	1768.	H. β . & peat. off-sets from root.
<i>TRITOMA, TRITOMA.</i> Cor. 6-toothed. Stam. inserted in the receptacle. Caps. 3-celled.							
uvària. B.M.	great.	ensif. keel & edge rough.	or.	8. 9.	C. B. S.	1707.	H. β . Sandy loam. offsets from root.
<i>VELTHEIMIA, VELTH'EIMIA.</i> Cor. tubular, 6-toothed. Stam. inserted in the tube. Caps. 1-seeded.							
viridifòlia. B.M.	green flowered.	lanc. plic. undul. obt.	sc. or.	11. 4.	—	1768.	G. β . Loam & leaf mould. offsets from bulb.
<i>EUCOMIS, EUCOMIS.</i> Cor. 6-parted, persistent. Filam. united at the base of the corolla.							
purpureocàulis. A. Rep.	purple-stk'd.	orbic. spatul. scape thick.	gr.	4.	C. B. S.	1794.	G. β . Peat & loam,
undulàta. H.K.	wave-leaved.	ov. obl. undul. spread.	g. w.	3. 5.	—	1760.	G. β . with leaf mould. offsets from bulb.
<i>LILIUM, LILY.</i> Cor. campanulate, 6-parted. Caps. valves connected by a mesh of hairs.							
bulbiferum. B.M.	bulb-bearing.	scatt. 3-nerv.	or.	6. 7.	Italy.	1596.	H. β . Light rich
chalcédonicum. B.M.	scar. Martagan.	lin. lanc. scatt.	sc.	—	Levant.	—	H. β . loam. offsets
càndidum. B.M.	white.	lan. scatt. base attenuat.	wh.	—	—	—	H. β . from bulb.
Catesb'æi. B.M.	Catesby's.	lin. lanc. scatt.	sc. yel.	7. 9.	Carolina.	1787.	H. β . —
japònicum. B.M.	Japan.	scatt. lanc. smth.	wh.	7. 8.	Japan.	1804.	H. β . —
longiflòrum. R.S.	long-flowered.	lanc. scatt.	wh.	7. 9.	—	1819.	H. β . —
Mártagan. w.	Turk's-cap.	verticill. ov. lanc.	var.	6. 7.	Germany.	1596.	H. β . —
spectabile. B.F.G.	showy.	tern. lin. lanc. sub-3 nerv.	or.	6. 9.	Siberia.	1754.	H. β . —
tigrinum. B.M.	tiger spotted.	sess. 5-ner. up. cord. ov.	or. bh.	7. 9.	China.	1804.	H. β . —
<i>ERYTHRO'NIUM, DOG'S-TOOTH VIOLET.</i> Perianth. of 6-leaves, petal-like. Sty. 3-sid. Seed ov.							
americànum. B.M.	American.	ov. ellip. smth.	yel.	4. 5.	N. Amer.	1665.	H. β . Sandy peat &
Déns-cànis. w.	common.	ov. 3-nerv. smth. spott.	pur.	3. 4.	Europe.	1596.	H. β . loam. offsets
β albiflòrum.	white-flowered.	wh.	—	—	—	H. β . from root.
<i>SOWERB'ÆA, SOWERB'ÆA.</i> Invol. 6-leaved. Cor. of 6-pet. Caps. 3-sided, 3-celled. Seeds angular.							
júncea. A. B.R.	rush-leaved.	long, cylind. acut.	p. bl.	5. 7.	N. S.W.	1792.	G. β . Peat & sandy loam. divid. at root.
<i>EUCRO'SIA, EUCRO'SIA.</i> Cor. limb 6-parted. Filam. twice the length of corol. Ger. 3-sided, 3-celled.							
bícolor. B.R.	two-coloured.	lanc. ent. spatha 4-fl'd. or.	red.	4. 5.	S. Amer.	1816.	S. β . Peat & loam.
<i>CRINUM, CRINUM.</i> Cor. tubular, limb 6-parted, nearly equal. Ger. 3-celled, many-seeded.							
americànum. B.M.	American.	striat. umbelless. many-fl.	w.	7. 8.	—	1752.	S. β . Loam, and a
amœ'num. K.R.	shewy.	narr. edges nearly smth.	wh.	4. 8.	E. Ind.	1810.	S. β . mixture of
augústum. B.M.	stately.	many, lanc. edges smth.	w. p.	—	Mauritius.	1819.	S. β . well decom-
amàbile. B.M.	beautiful.	3-feet long, smth.	red. wh.	1. 12.	Sumatra.	1810.	S. β . posed tree
bracteàtum. B.R.	bracteated.	obl. lanc. apex obt.	wh.	6. 8.	Mauritius.	—	S. β . leaves. This
capense. B.M.	Cape.	elong. chann. glau.	wh.	7. 9.	C. B. S.	1752.	H. β . throws out
Careyànum. B.M.	Dr. Carey's.	lorate, und. 2 feet long.	wh.	6. 7.	Mauritius.	1821.	S. β . offsets from
canaliculàtum. K.R.	channelled.	lorate, edges smth.	wh.	4. 8.	E. Ind.	1810.	S. β . their bulbs,
erubescens. B.M.	blush-flowered.	lan. lor. edges ciliat. den. re. w.	6. 8.	S. Amer.	1789.	S. β . by which	

Systematic Name.	English Name.	Form of Leaves, &c.	Col. of Flow.	Month of Fl.	Native Country.	Yr. of Introd.	Soil and Propagation.
elegans. B.M.	elegant.	lor. lanc. 3-4 feet long.	wh.	8. 9.	E. Ind.	1823.	S. \mathcal{P} . means they
gigánteum. A.R.	Gigantic.	flaccid, undul.	wh.	7. 8.	S. Leone.	1792.	S. \mathcal{P} . are easily increased.
<i>Amaryllis gigánteum</i> . B.M.							
hùmile. B.M.	humble.	acut. margins flat.	wh.	4. 8.	E. Ind.	1816.	S. \mathcal{P} . ———
prócerum. B.M.	tall.	4-5 feet long, 6-in. broad.	w.p.	7. 8.	Pegu.	1822.	S. \mathcal{P} . ———
plicátum. B.R.	plaited.	plaited, backwards.	wh.	6. 8.	China.	1823.	G. \mathcal{P} . ———
sumatránium. B.R.	Sumatra.	lorate, lin. lanc. serr.	wh.	—	Sumatra.	1810.	S. \mathcal{P} . ———

BRUNSVIGIA, BRUNSVIGIA. Cor. 6-parted. Caps. turbinate, 3-winged, many-seeded.

grandiflora. B.R.	large-flowered.	ligul. falc. erect.	car.	8. 9.	C. B. S.	1827.	F. \mathcal{P} . Sandy loam
Josephina. B.R.	Josephine's.	elon. spread. erect, glau.	sc.	6. 8.	—	1814.	F. \mathcal{P} . and peat.
multiflora. B.M.	many-flowered.	linquif. smth.	sc. gr.	—	—	1752.	F. \mathcal{P} . offsets from
mínor. B.R.	small.	3 or 4. obl. spread.	pk.	—	—	1774.	F. \mathcal{P} . bulbs.
toxicaria. B.R.	Poison bulb.	lorate, acum. obliq. glau. pk.	—	—	—	—	—

[Stig. convol. Ger. 3-celled.

BILLBERGIA, BILLBERGIA. Cal. 3-parted. Pet. 3. Stam. inserted in the base of the perianthium.

cruenta. B.M.	blood-stained.	conv. 1-2 ft. long. imb. ser. bl.	l.	4. 6.	Brazil.	1824.	S. \mathcal{P} . Sandy loam
fasciata. B.R.	banded.	recurv. spiny, serr. glau.	blue.	8. 10.	—	1825.	S. \mathcal{P} . & leaf mould.
iridifolia. B.R.	drooping.	lanc. ensif. und. spiny. bl. yel.	sc. 3. 5. R.	Janeiro.	1826.	S. \mathcal{P} . suckers.	
pyramidális.	pyramidal.	lanc. dent. spiny.	sc. 2. 4.	—	—	—	S. \mathcal{P} . ———

Bromelia nudicaulis. B.R.

DORYANTHES, DORYANTHES. Cal. 6-parted, decidu. Cor. 6-cleft. Fil. awl-shap. Sty. 3-furr.

excelsa. B.M.	tall.	lin. lanc. acut.	sc.	7. 10.	N.S.W.	1800.	G. \mathcal{S} . Loam & peat. suckers.
---------------	-------	------------------	-----	--------	--------	-------	--

BLANFORDIA, BLANFORDIA. Cor. tub. limb 6-lob. Stam. inser. on the tube. Ger. stalk. Sty. awl-sha.

grandiflora. B.R.	great-flowered.	lin. elong. chann. keel. sc. yel.	7. 8.	—	—	1824.	G. \mathcal{P} . Sandy loam.
nobilis. B.R.	noble.	lin. narr.; Bract. short. than fl.	—	—	—	1803.	G. \mathcal{P} . offsets.

AGAPANTHUS, AFRICAN LILY. Cor. funnel-shaped, 6-parted, regular. Stam. declinate.

præcox. W.en.	early.	lin.; Pedun. twice as long as c. 1. 4.	C. B. S.	—	—	G. \mathcal{P} . Rich loam.
umbellatus. B.M.	large-flowered.	lin. smth. fl. umbel'd.	blue.	8. 2.	—	1692.	G. \mathcal{P} . divid. at root.

[Caps. of 3 cells, and 3 valves.

NARCISSUS, NARCISSUS. Cal. 0. Pet. 6, attached to the nectary. Filam. insert. in tube of nectary.

biflorus. B.M.	two-flowered.	acut. keel. edges inflex. yel.	5. 4.	—	England.	H. \mathcal{P} . Sandy loam.
Bulbocodium. B.M.	Hoop-petticoat.	awl-sh.; Crown trunc.	yel.	3. 4.	S. Europ.	1629.	H. \mathcal{P} . offsets from
incomparabilis. B.M.	Butter & Eggs.	flat; Crowns campa.	yel.	4. 5.	Portugal.	—	H. \mathcal{P} . roots.
Jonquilla. B.M.	Jonquil.	awl-sha.; spatha. 1-3 fl'd.	ye.	—	Spain.	1596.	H. \mathcal{P} . ———
máior. B.M.	large.	glau. twisted.	yel.	3. 4.	—	1629.	H. \mathcal{P} . ———
poéticus. L.	Poetic.	keel. 12-18 inch. long.	wh.	4.	Greece.	1620.	H. \mathcal{P} . ———
pseudo-narcissus. E.H.	Daffodil.	erect. 1 foot long, glau.	yel.	3. 4.	England.	H. \mathcal{P} . ———

CYRTANTHUS, CYRTANTHUS. Cal. 0. Cor. tubular, cernuous, limb 6-cleft, equal. Stam. short.

cárneus. B.R.	flesh-coloured.	erect, long. obt. glau.	car.	8. 9.	C. B. S.	1829.	G. \mathcal{P} . Sandy loam
collinus. B.R.	hill.	3 lin. glau. chann.	sc.	5. 8.	—	1816.	G. \mathcal{P} . & turfy peat.
odorus. B.R.	sweet-scented.	2-3 lin. lorate, umbel 4 fld.	sc.	7. 8.	—	1818.	G. \mathcal{P} . seeds, or offs.
spirális. B.R.	spiral-leaved.	spir. ligul. glau.	sc.	—	—	1790.	G. \mathcal{P} . from bulbs.

Systematic Name.	English Name.	Form of Leaves, &c.	Col. of Flow.	Month of Fl.	Native Country.	Yr. of Introd.	Soil and Propagation.
LEUCOJUM, SNOW-FLAKE. <i>Cal. 0. Cor. of 6 pet. bell-sh. Caps. turb. of 3 cells, & 3 valv. Seeds globo.</i>							
æstivum. B.M.	summer.	lin. obt. 1-2 feet long.	wh.	4. 5.	England.	H. P. Light rich
autumnale. B.M.	autumnal.	<i>Spatha</i> of 1 leaf, 2-fl'd.	bh.	9.	Portugal.	1629.	H. P. loam. offsets
vérnum. B.M.	spring.	lin. smth.; <i>spath.</i> 1-fl'd.	wh.	2. 4.	Germany.	1596.	H. P. from bulb.
ZEPHYRANTHES, ZEPHYRANTHES. <i>Peria. tubu. 6-par. Sty. declin. Stig. 3-lob. Caps. 3-cell.</i>							
carinata. B.R.	keel'd-leaved.	lin. acut. falcate.	ros.	6. 8.	Mexico.	1824.	F. P. Sandy soil.
rosea. B.R.	rose-flowered.	lin. ent. smth.	ros.	—	Havanna.	1823.	F. P. offsets from bulb.
ALLIUM, GARLICK. <i>Cal. 0. Pet. 6, ovate, regul. Ger. angul. Sty. angul. Caps. 3-celled, & 3-valved.</i>							
Ampeloprasum. E. Fl.	great round-h. dent. edges scabr.		pa.	7. 8.	England.	H. P. Sandy loam.
arenarium. E. Fl.	sand.	lin. flat, sheaths cylin.	red.	6. 8.	Britain.	H. P. offsets from
angulosum. G. D.	angular-scaped.	lin. chann.	pur.	6. 7.	Siberia.	1739.	H. P. bulbs.
albidum. G. D.	white.	lin. scape 4-corner.	wh.	6. 8.	Caucasus.	1823.	H. P. ———
Cowaní. B. R.	Cowan's.	lanc. acum. ciliat. sheath.	wh.	5.	Chile.	1824.	F. P. ———
carinata. E. Fl.	mountain.	lin. keel. concave above.	yel.	5. 6.	England.	H. P. ———
Möly. B.M.	large-yellow.	sess. lanc.; <i>scape</i> naked.	yel.	6.	S. Europ.	1604.	H. P. ———
neapolitanum. B. F. G.	Neapolitan.	lin. lanc. chann.	wh.	4. 5.	Italy.	1824.	F. P. ———
oleraceum. E. Fl.	streaked.	lin. cylind. tubul. rough.	yel.	7.	England.	H. P. ———
Schœnoprasum. B.	Chive.	awl-sh. cyl. glau. smth. pu.	ros.	5. 6.	Britain.	H. P. ———
ursinum. E. Fl.	broad-leaved.	ov. lanc. stalk. smth. ent.	wh.	4. 5.	—	H. P. ———
[Caps. of 3 cells, and 3 valves.							
ORNITHOGALUM, STAR OF BETHLEHEM. <i>Cal. 0. Pet. 6, lance-shap. Filam. dilat. at the base.</i>							
aureum. B.M.	golden.	lanc. dent.	yel.	6. 7.	C. B. S.	1790.	F. P. Sandy soil.
corymbosum.	corymb-flow'r'd. ligul. elong. chann. obov.		wh.	—	Chile.	1822.	H. P. offsets from
elatum. A. B. R.	tall.	lanc. smth.	wh.	—	Egypt.	1804.	H. P. bulbs.
latifolium. B. M.	broad-leaved.	lanc.; <i>Raceme</i> long.	wh.	—	—	1629.	H. P. ———
nütans. E. Fl.	drooping.	lin. 12-18 inch. long.	wh.	4. 5.	Britain.	H. P. ———
pyrenaicum. E. Fl.	Pyrenean.	lin. acum. chann. smth.	gr.	6. 7.	England.	H. P. ———
revolutum.	revolute-flow'd.	lin. lanc. chann.	wh.	—	C. B. S.	1795.	F. P. ———
virens. B. R.	greenish.	lin. lanc. many flower'd.	gr.	—	—	1823.	F. P. ———
HEMEROCALLIS, DAY-LILY. <i>Cal. 0. Cor. 6-part. Fil. awl-shap. Anth. obl. Caps. 3-sid. & 3-cell.</i>							
cœrulea. B.M.	blue-flowered.	cord. smth. stalk.	blue.	6. 8.	Japan.	1790.	H. P. Sandy loam.
flava. B.M.	yellow.	lin. keeled.	yel.	6. 7.	Siberia.	1596.	H. P. divid. roots.
fúlva. B.M.	copper-colored.	lin. keel'd, 3inn. pet. wavy.	ful.	6. 8.	Levant.	—	H. P. ———
anceæfolia. B. C.	lance-leaved.	lanc. undul. acum.	lil.	—	Japan.	1829.	H. P. ———
SCILLA, SQUILL. <i>Cal. 0. Pet. 6, ovate, obl. Filam. half the length of the pets. Caps. of 3 cells, & 3 valv.</i>							
autumnalis. E. Fl.	autumnal.	lin. chann. glau. smth.	ros.	8.	England.	H. P. Light sandy
amœna. B.M.	nodding.	<i>Scape</i> angu.; <i>Ped.</i> alt. short. bl.	3. 4.	Levant.	1596.	H. P. loam. offsets	
bifolia. E. B.	two-leaved.	lin. lanc. conc. obt.	bl.	2. 4.	England.	H. P. from bulb.
brevisfolia. R. S.	short-leaved.	shorter than <i>scape</i> .	pk.	1. 3.	C. B. S.	1822.	F. P. ———
campanulata. B. M.	bell-flowered.	lanc.; <i>Raceme</i> many-fl'd.	bl.	5. 6.	Spain.	1633.	H. P. ———
hyacinthoides. B. M.	Hyacinth-like.	lanc.; <i>Raceme</i> many-fl'd.	bl.	8.	Madeira.	1585.	H. P. ———
non-scripta. L. en.	Hare-bell.	lin. 6-parted.		3. 6.	Britain.	H. P. ———
nütans. E. B.							
sibirica. A. rep.	Siberian.	stalks 2-flowered, striated.	bl.	—	Siberia.	1796.	H. P. ———
serena. E. Fl.	spring.	lin. chann. acut.	blue.	4. 5.	—	H. P. ———

Systematic Name.	English Name.	Form of Leaves, &c.	Col. of Flow.	Month of Nat. of Fl. Country.	Yr. of Introd.	Soil and Propagation.
[Seeds in 2 rows. Caps. of 3 cells, & 3 valv.						
FRITILLA'RIA, FRITILLARY. Cal. 0. Cor. bell-shap. of 6 petals. Ger. 3-sid. Caps. of 3 cells, & 3 valv.						
Imperiàlis. w.	Imperial.	lanc. obl. crowd.	yel.	3. 4. Persia.	1596.	H. β . Sandy loam.
Meleàgris. E. Fl.	common.	alt. lin. lanc. glau.	pur. wh.	3. 5. Britain.	H. β . offsets from
oblíqua. B. M.	oblique-leaved.	glau. crowd. oblig.	pur.	4. Caucasus.	H. β . bulbs.
pyrenàica. B. M.	cluster-flowered.	opp. upp. alt. lin.	pur.	5. 6. S. Europe.	H. β . ———
T'ULIPA, T'ULIP. Cal. 0. Cor. bell-sh. of 6 conc. pets. Ger. with blunt angles. Caps. of 3 cells, & 3 valves.						
Bonarotiana.	Bonarata's.	elong. undul. glau.	r. var.	5. Italy.	1828.	H. β . Rich sandy
biflora. B. R.	two-flowered.	lin. awl-shap.	wh. vi. yel.	4. Russia.	1806.	H. β . loam. en-
Celsiana. B. M.	Cell's.	lanc. ov. convol.	yel. red.	6. 7. Levant.	H. β . creased by
montana. B. R.	Mountain.	obl. lanc. acum. chan.	cr. —	Persia.	1826.	H. β . offsets from
óculis-sólis. s. s.	Agen.	ov. lanc. ciliat. glau.	sc. ve.	4. S. Europ.	1816.	H. β . the bulb. The
præcox.	early.	ov. lanc. und. pubes.	sc. ve. —	Persia.	1826.	H. β . choice sorts
sylvêstris. E. B.	wild.	lin. lanc. ent.	yel.	4. 5. England.	H. β . should be ta-
túrcaica. B. F. G.	Florentine.	lanc. acut. chann. glau.	yel. —	H. β . ken up when they are done flowering, and replanted in October, or November.
HYACINTHUS, HYACINTH. Cor. of 1 petal, in 6 segm. Ger. with 3 angles. Caps. 3-celled.						
amethýstinus. B. F. G.	Spanish.	6-7 ligul. chann.	blue.	4. 5. S. Europ.	1759.	H. β . Rich sandy
orientális. E. R.	oriental.	lin. chann. smth.	blue.	3. 4. Levant.	1596.	H. β . loam & leaf mould, offsets from the bulbs.
CALOSTE'MMA, CALOSTE'MMA. Cor. fun.-sha. limb 6-part. Nect. 12-dented. Ger. 1-cell. 2-3-seed.						
luteum. B. R.	yellow.	lorate, lin. smth.	yel.	8. 9. N. Holl.	1819.	F. β . Sandy loam
purpúreum. B. R.	purple.	narr. lin. obt.	pur.	— — — —	—	F. β . & peat. seeds.
ANTHERICUM, SPIDER-WORT. Cal. 0. Pet. 6. Fil. thread-sh. Ger. of 3 angl. Caps. of 3 cells, & 3 valv.						
serotinum. E. Fl.	late-flowering.	half round, upp. ones dil. at bas.	6.	Britain.	—	H. β . Light loam. offsets.
BULBINE, BULBINE. Cor. 6-parted, spreading. Filam. smooth. Caps. ovate. Seeds angular.						
aloïdes. R. S.	Aloe-leaved.	lingul. lanc. fleshy.	yel.	— C. B. S.	1732.	G. β . Sandy loam. seeds, or cutt
<i>Anthericum aloïdes.</i> B. M.						
HYPOXIS, HYPOXIS. Cal. 0. Cor. of 6 pets. Anth. 3 times as long as the filam. Sty. 3-sided.						
obtusa. B. R.	obtuse.	lin. lanc. the outer twisted.	y. — — —	— — —	1816.	F. β . Sandy loam
stellipilis. B. R.	starry-furred.	awl-sh. 3-sid. white, hairy.	y. — — —	— — —	1821.	F. β . & leaf mould seeds, or offsets from the bulb
NARTHECIUM, BOG-ASPHODEL. Cal. 0. Pet. 6-ribb. Fil. woolly. Caps. 3-furr. 3 cells, & 3 valves						
americánum. B. M.	American.	lin.; Bructes uneq.	yel.	7. 8. N. Amer.	1811.	H. β . Light loam
ossifragrum. E. Fl.	Lancashire.	lanc. ribb. 2-ranked.	yel.	— Britain.	H. β . divid. at root
[Caps. 3-sided, & 3-valved Ger. 3-sid. Stig. 3-angl						
DICHORISA'NDRA, DICHORISA'NDRA. Cal. of 3 leaves, conc. Pet. 3. Ger. 3-sid. Stig. 3-angl						
oxypétala. B. M.	sharp-petaled.	alt. ellip. ent. striated.	pur.	6. 8. Brazil.	1825.	S. β . Loam & peat
thyrsiflora. B. R.	Thyrsé-flower'd.	elong. lanc. ent.	blue.	— — —	1822.	S. β . cuttings, o part. at roots
[globular, of 3 cells. Seeds 2 in each						
CONVALLA'RIA, SOLOMON'S SEAL. Cor. bell-shap. 6-part. Ger. roundish. Stig. triang. Berr						
bifolia.	two-leaved.	cord. ov. ent. smth.	wh.	5. 6. N. Europ.	1596.	H. β . Light loam
majális. E. Fl.	Lily of the Valley.	ov. lanc. smth.	wh.	— Britain.	H. β . divid. roots

Systematic Name.	English Name.	Form of Leaves, &c.	Col. of Flow.	Month of Fl.	Native Country.	Yr. of Introd.	Soil and Propagation.
multiflora. B.Fl.	many-flowered.	plex. alt. ov. ellip.	wh.	5. 6.	Britain. H. P.	—
polygonatum. E.Fl.	common.	alt. plex. ellip. plaited.	w.	—	England. H. P.	—
racemosa.	racemed.	ellip. lanc. ribb. pubes. ben. w.	—	—	N. Amer.	1640. H. P.	—
verticillata. E.Fl.	whorl-leaved.	lin. lanc. whorl. glau.	wh.	—	Scotland. H. P.	—

ASPARAGUS, ASPARAGUS. Cal. 0. Cor. 6-par. perm. Ber. of 3 cells. Stig. 3. Seeds 1 or 2 in each cell.

capensis. s. s.	Cape.	setace. spin. quater.	4. 5.	C. B. S.	1691.	G. S.	Sandy loam.
scandens. w.	climbing.	lanc. falcate; stm. climb.	—	—	—	1795. G. S.	cl. seeds, cutt. or part. roots.

A'CORUS, SWEET-FLAG. Cor. of 6 concave petals. Ger. sessile. Stig. 3-lob. Caps. triang. of 3 cells.

Calamas. E. Fl.	common.	erect, 2-3 feet long, smth. gr.	6. 7.	Britain. H. w. P.	Loam, part.
gramineus. H. K.	Grass-leaved.	lin. smth. ent.	gr. 2.	China.	1786. H. w. P.	ing roots.

[with many seeds.

FRANKENIA, SEA-HEATH. Cal. of 1 leaf, with 5 acute teeth. Pet. 5. Ger. 3-furrow. Caps. of 1 cell.

laevis. E. Fl.	smooth.	li. revo. smth. cilia. at base. car.	7. 8.	England. H. P.	Loam & peat.
pulverulenta. E. Fl.	powdered.	obo. ob. smth. downy. ben. re.	—	— H. P.	seeds, or cutt.
pauciflora. B. M.	few-flowered.	lin. obt. canes. edges revol. ros.	—	N. Holl.	1825. G. S.	—

[Seeds 3 in each.

LUZULA, WOOD-RUSH. Cal. of 6 obl. leaves. Ger. of 1 cell. Stig. 3, downy. Caps. of 1 cell, & 3 valves.

arcuata. B. Fl.	curved.	lin. chan. hairy; Panic.	3-5 fl.	—	Scotland. H. P.	Loam, seeds,
campestris. Br. Fl.	field.	flat, hairy; Panic.	3-4 clust. bl.	4. 5.	— H. P.	or dividing
Forsteri. E. Fl.	Forster's.	hairy; Panic. cymose.	bl. 5. 6.	England. H. P.	at roots.	
pilosa. B. Fl.	hairy.	pilose; Peduncles 1-flow'd. bl.	3. 5.	Britain. H. P.	—	
sylvatica. E. Fl.	wood.	stri. shin. hairy; Ped. elon. bl. w.	—	— H. P.	—	
spicata. B. Fl.	spiked.	chann.; Panic. lob. droop. br.	—	Scotland. H. P.	—	

JUNCUS, RUSH. Cal. of 6 perm. leav. Cor. 0. Fil. shor. Ant. of 2 cells. Ger. trian. Stig. 3. Caps. of 3 cells.

acutus. E. Fl.	sharp.	stm. nak. acut.; Pan. agg. g. br.	7. 8.	Britain. H. P.	Sandy soil
arcticus. E. F.	Arctic.	stm. erect, smth.; Pani. da. br.	—	Scotland. H. P.	or peat, for
acutiflorus. B. Fl.	sharp-flowered.	stm. arti. comp.; Pani. fork. g.	6. 7.	Britain. H. P.	the dwarf
bufonius. E. F.	Toad.	filif. angu. seta.; Pani. fork. pa.	6. 8.	— H. P.	sorts. Seeds,
biglumis. E. Fl.	two-flowered.	lin. awl-sh. compr. br.	8.	Scotland. H. P.	or dividing
castaneus. B. F.	clustered.	keeled, flat, chann. above. br.	7.	— H. P.	roots.
capitatus. B. F.	headed.	filif. chann. above. br. gr.	5. 7.	Britain. H. P.	—
compressus. B. F.	round-fruited.	lin. chann.; stm. compr. gr. br.	6. 7.	— H. P.	—
conglomeratus. B. F.	common.	stm. nak. stria.; Pani. glob. br.	—	— H. P.	—
effusus. E. F.	soft.	Panic. spread. gr.	5. 8.	— H. P.	—
filiformis. B. F.	least.	stm. nak. filii.; Pani. of few fl. g.	8.	— H. P.	—
glaucus. B. Fl.	glaucous-leaved.	stm. glau. striat.; Pani. ere. br.	7. 8.	— H. P.	—
ampocarpus. B. F.	shining-fruited.	art. comp.; Pan. 4-6 or 8-fl. br.	—	— H. P.	—
naritimus. E. F.	sea.	stem nak.; Panic. comp. br.	8.	— H. P.	—
obtusiflorus. B. F.	obtuse-flower'd.	lvs. & stem joint. round. bh.	7. 8.	— H. P.	—
quarrus. B. F.	moss.	chann.; Panic. elong. br.	6. 8.	— H. P.	—
subverticillatus. w.	whorl-headed.	setaceous, jointed. br.	7. 8.	— H. P.	—
rigidus. E. F.	three-flowered.	lin. awl-sh. chann. br.	7.	— H. P.	—
rifidus. B. F.	three-leaved.	stm. naked, sheaths fring. br.	7. 8.	Scotland. H. P.	—
liginosus. E. F.	little-bulbous.	bristly, knotty. br.	—	Britain. H. P.	—

P'EPPLIS, PURSLANE. Cal. bell-shap. of 6 seg. Pet. 6, obo. Ger. furr. Caps. of 2 cells, with many seeds.

P'ortula. E. Fl.	water.	opp. obo. smth. stm. creep. red.	7. 9.	— H. P.	Sandy soil.
------------------	--------	----------------------------------	-------	---	------------	-------------

Systematic Name.	English Name.	Form of Leaves, &c.	Col. of Flow.	Month of Fl.	Native Country.	Yr. of Intro.	Soil and Propagation.
<i>MUSA, PLANTAIN-TREE.</i> Cor. of 2 petals. 1 erect, 5 tooth. the other conc. Berr. obl. 3-corn. many-seed.							
coccinea. A.R.	scarlet.	obl. ent. 2-3-feet long.	sc.12.3.		China.	1792.	S.S. Rich loam.
rosacea. B.R.	rose-coloured.	with parallel veins.	ros. 3. 6.		Mauriti.	1818.	S.S. suckers from root.
							[Berry of 1 cell, with 2 seeds.
<i>BERBERIS, BARBERRY.</i> Cal. of 6 conc. leaves. Pet. 6. Ger. superior, ellip. obl. Sty. 0. Stig. singl.							
aquifolia. B.R.	Holly-leaved.	pinn. 2-4 pairs, ov. lan. dent. y.	4. 5.		N. Amer.	1824.	H.S. Garden loam
sinensis. DC.	Chinese.	obl. ob. ent. ov. a little tooth. y.	4. 6.		China.	1800.	H.S. seeds, layers,
canadensis. DC.	Canadian.	obo. tooth. Prickl. in threes. y.	—		Canada.	1759.	H.S. or cuttings.
glumacea. DC.	glumaceous.	pinn. leaf. obl. lan. dent. spin.	4. 5.		N. Amer.	1827.	H.S. ———
pinnata. B.R.	pinnate.	pinn. leaf. ov. dent. spiny. yel.	4.		—	1820.	H.S. ———
repens. B.R.	creeping.	pin. leaf. ov. subr. spin. den. y.	—		—	1822.	H.S. ———
<i>PITCAIRNIA, PITCAIRNIA.</i> Cal. of 3 leaves. Pet. 3, strap-shaped. Stig. 3. Caps. 3-celled.							
angustifolia. B.M.	narrow-leaved.	erect, narr. lorate, spiny.	sc.12.1.		S. Cruz.	1777.	S.P. Sandy loam
bromeliæfolia. B.M.	scarlet.	ciliat. spiny, apex elong.	sc. 6. 8.		Jamaica.	1781.	S.P. and leaf
flammea. B.R.	flame-coloured.	lanc. ent. acum.	sc. —		Brazil.	1823.	S.P. mould. suck-
furfuracea. B.M.	mealy.	dent. spiny, lanc. smth. abo. ro.	7. 9.		S. Amer.	1818.	S.P. ers from root.
<i>PONTEDEIRA, PONTEDEIRA.</i> Cor. ring. 6-part. Stam. inser. in the tube, 3 short, & 3 long. Stig. cap.							
angustifolia. Ph.	narrow-leaved.	long, triang. base trun. cor.	bl. 6. 8.		N. Amer.	1806.	H.w.P. Rich loam, in
azurea. B.M.	large-flowered.	cord. ent. smth.	pur. —		Jamaica.	1822.	S.w.P. water. di-
cordata. Ph.	heart-leaved.	cord. obl. smth.	bl. —		N. Amer.	1759.	H.w.P. viding roots.
dilatata. A.B.R.	dilated.	sagitt. obt. or. acute.	bl. 5.		E. Ind.	1806.	S.w.P. ———
<i>TILLANDSIA, TILLANDSIA.</i> Cal. 3-parted. Cor. 3-cleft, campan. Caps. 1-3-celled.							
lingulata. s.s.	tongue-leaved.	lanc. lingul. ent.	yel. 6. 7.		Jamaica.	1776.	S.P. Sandy loam
psittacina. B.M.	Parrot-like.	lin. ligul. ent. acut.	yel.pk. —		Brazil.	1827.	S.P. and leaf
rosea.	rose-coloured.	ligul. acum. serr. spread.	ros. —		—	1829.	S.P. mould. suck-
stricta. B.R.	erect.	lanc. acum. convex canesc. bl.	11.		—	1810.	S.P. ers from root.
<i>BROMELIA, PINE-APPLE.</i> Cal. 3-par. Pet. 3, with a honey-bear. scale at base of each pet. Ber. 3-cell.							
Pinguin. s.s.	broad-leaved.	ciliat. spin. mucr.	red. 3. 4.		W. Ind.	1699.	S.S. Sandy loam
sylvestris. B.M.	wild.	spiny, apex. elong.	cr. 7. 8.		S. Amer.	1820.	S.P. & leaf mould.
Zebrina. B.M.	Zebra-streaked.	chann. obt. dent. spiny.	yel. 6. 7.		—	1825.	S.P. suckers from the roots.
<i>HÆMANTHUS, BLOOD-FLOWER.</i> Invol. of many leaves. Cor. 6-parted. Berry 3-celled.							
coccineus. B.M.	scarlet.	lingul. flat, smth.	sc. 8.10.		C. B. S.	1629.	F.P. Sandy loam
carneus. B.R.	flesh-coloured.	2, rotun. ov. pilose, opp. car.	6. 8.		—	1819.	F.P. and peat.
coarctatus. B.R.	close-umbelled.	2, ellip. point. flat, smth.	sc. 2. 3.		—	1795.	F.P. offsets from
multiflorus. B.M.	many-flowered.	ellip. lanc. undul.	sc. 5. 9.		S. Leone.	1783.	S.P. bulbs.
puniceus. B.M.	wave-leaved.	obl. ellip. acut.	sc. —		C. B. S.	1722.	G.P. ———
pubeszens. B.R.	downy.	obl. lanc. hairy.	wh. 8. 9.		—	1774.	F.P. ———
<i>A'LOE, A'LOE.</i> Cor. tubul. limb 6-parted. Filam. inserted in the recep. Caps. 3-celled, many-seeded.							
arborescens. B.M.	tree.	amplex. edges reflex. spin.	sc.11.3.		C. B. S.	1731.	G.S. Sandy loam
africana. B.M.	African.	ensif. glau.	yel. 7.		—	—	G.S. and lime
acuminata. B.M.	acuminate-l'd.	acum. glau. prickly.	sc. yel. 3. 6.		—	1795.	G.S. rubbish.
acinacifolia. H.R.	Seymitar-leaf'd.	in 2 ro. erect. spr. spott.	sc. gr. —		—	1818.	G.S. suckers.

Systematic Name.	English Name.	Form of Leaves, &c.	Col. of Flow.	Month of Fl.	Native Country.	Yr. of Introd.	Soil and Propagation.
brevifolia. H.S.	short-leaved.	glau. edges spiny.	sc.gr.	6. 8.	C. B. S.	1731.	G. S. ———
imbricata. B.M.	imbricated.	mucr. erect. shin.	st.	5. 6.	————	————	G. S. ———
intermedia. Haw.	intermediate.	bifarious, ensif.	gr.	————	————	1790.	G. S. ———
lingua. B.M.	tongue-leaved.	lingul. spott. serr.	ro.w.g.	6. 8.	————	1759.	G. S. ———
microcantha. B.M.	small spined.	lin.lanc.chann.spott.	red.gr.	7. 8.	————	1819.	G. S. ———
maculata. B.M.	spotted.	linguif. smth.	ro.gr.	————	————	1759.	G. S. ———
mitræformis. H.S.	Mitre.	thick edges, spiny.	sc.	8.	————	1732.	G. S. ———
plicatilis. B.M.	Fan.	distich. linguif. smth.	red.gr.	6. 7.	Africa.	1723.	G. S. ———
pentagona. E.M.	five-sided.	5 far. and spiral, smth.	gr.	————	C. B. S.	1731.	G. S. ———
spicata. H.	spike-flowered.	ensif.spott.edges.spiny.	w.g.	4. 6.	————	1795.	G. S. ———
striata. H.S.	streaked.	glau. striat. sub dent.	re.gr.	6. 8.	————	————	G. S. ———
variegata. B.M.	Partridge-breast.	trifar. angled, varieg.	sc.gr.	3. 8.	————	1720.	G. S. ———
<i>BUONAPARTEA, BUONAPARTEA. Cal. of 2 leav. Cor. of 3 convol. pet. Sty. 3-corn. Caps. 3-cell.</i>							
junceæ. R.P.	Rush-leaved.	numer.recurv.awl-sh.rig.	bl.	7. 9.	Peru.	1800.	S. P. Sandy peat.
<i>COSSIGNEA, COSSIGNEA. Cal. 5-parted. Cor. of 4-5 petals. Caps. 3-celled, opening at apex.</i>							
borbónica. DC.	Bourbon.	pinn. ov. lanc. notch.	wh.	————	Mauriti.	1824.	G. S. Sandy peat & loam. cutt.
<i>PRINOS, WINTER-BERRY. Cal. 6-parted. Cor. of 1 petal, rotate. Berry 6-seeded.</i>							
ambiguus. DC.	Carolina.	ov. acum. decid. smth.	wh.	7. 8.	N.Amer.	1812.	H. S. Sandy loam.
glaber. DC.	evergreen.	cuneat. lanc. smth. shin.	wh.	————	————	1759.	H. S. layers, or
laevigatus. DC.	smooth.	lan.serr.acum.smth.decid.w.	————	————	————	1812.	H. S. seeds.
nitidus. DC.	shining.	obl. ov. serr. shin.	w.	————	————	1829.	H. S. ———
prunifolius. D.F.	Prunus-leav'd.	ellip. lanc. serr.	wh.	6. 7.	————	1820.	G. S. ———
<i>NANDINA, NANDINA. Cal. 6-cleft, imbricated. Pet. 6. concave. Berry 1-celled, 2-seeded.</i>							
doméstica. B.M.	garden.	Leaf. lanc. tern.	wh.	————	China.	1804.	G. S. Loam & peat. cutt. with their leaves not shortened, will strike root.
<i>CANARINA, CANARINA. Cal. 6-leav. Cor. 6-cleft, campan. Stig. 6. Caps. 6-celled, many-seeded.</i>							
campánula. L.	Canary.	stalk. hast. dent.	or.	1. 3.	Canaries.	1696.	G. P. Loam & peat. cuttings.
<i>BAMBU'SA, BAMBOO-CANE. Scales 3, covering the 5-flow. spikelets. Glume 2-valved. Sty. bifid.</i>							
arundinácea. W.	common.	ov. lanc. ent.		6. 7.	India.	1790.	S. S. Sandy loam. offsets.

ORDER II.

DIGYNIA. STYLES 2.

<i>FAL'KIA, FAL'KIA. Cal. of 1 leaf, 5-angled. Cor. of 1 petal, tubular, margins 5-lobed. Ger. 4, pubes.</i>							
épens. A.rep.	creeping.	cord. ent. fleshy.	wh.	5. 8.	C. B. S.	1774.	G. S. Loam & peat. part. roots, or cutt.
<i>ATRAPH'AXIS, ATRAPH'AXIS. Cal. of 2 leaves. Cor. of 2 pet. sinuate. Stig. capit. Seed single.</i>							
nduláta. L.	wave-leaved.	ellip. undul. smth.	gr.	5. 7.	————	1732.	G. S. Sandy loam. cuttings.

Systematic Name.	English Name.	Form of Leaves, &c.	Col. of Flow.	Month Native of Fl. Country.	Yr. of Introd.	Soil and Propagation.
<i>RICHARDSONIA</i> , <i>RICHARDSONIA</i> .		<i>Cal. 4-7-part. Cor. funn.-shap. limb 3-5-lob. Stig. 3-4-cleft.</i>				
<i>scábra</i> . B.F.G.	rough.	ov. lanc. acut. edges scabr.	w.	9. 10. America.	1812.	H. \mathfrak{A} . Peat & loam. seeds.
<i>OX'YRIA</i> , <i>MOUNTAIN-SORREL</i> .		<i>Cal. of 2 oppo. leaves. Pet. 2. Ger. clov. at the summit. Seed 1, nak.</i>				
<i>reniformis</i> . E.B.	kidney-shaped.	kidney-sh. stalk. wavy.	gr.	6. 7. Britain.	...	H. \mathfrak{B} . Sandy loam. seeds, or part. roots.
<i>BARBACE'NIA</i> , <i>BARBACE'NIA</i> .		<i>Cor. of 6-pet. united into a tube at the base. Filam. bifid.</i>				
<i>purpúrea</i> . B.M.	purple.	lin. acum. teeth spiny.	pur.	— Brazil.	1825.	S. \mathfrak{S} . Loam & peat. seeds, or divid. plant.

ORDER III.

TRIGYNIA. STYLES 3.

<i>NOLINA</i> , <i>NOLINA</i> .		<i>Cor. 6-parted, spread. Sty. short. Caps. 3-cornered, 3-celled. Seeds solitary.</i>				
<i>georgiána</i> . Mx.	Georgian.	elong. lin. acum.	wh.	7. 8. Georgia.	1812.	H. \mathfrak{B} . Sandy loam. divid. plant.
<i>RUMEX</i> , <i>DOCK</i> & <i>SORREL</i> .		<i>Cal. of 3 obtuse leaves. Pet. 3. Ger. triangular. Seed 1, naked, 3-angl.</i>				
<i>Hydrolápathum</i> . E.B.	great-water.	lanc. smth. acut. ent.	gr.	7. 8. Britain.	...	H. w. \mathfrak{B} . Sandy loam.
<i>marítimus</i> . E.Fl.	golden.	lin. lanc. acut. ent.	yel.	— — —	...	H. \mathfrak{B} . seeds, or cut-
<i>obtusifólius</i> . E.Fl.	broad-leaved.	cord. obl. obt. cren.	gr.	6. 8. —	...	H. \mathfrak{B} . tings from
<i>sanguíneus</i> . E.Fl.	bloody-veined.	lanc. cord. acut. curi'd.	gr.	6. 7. England.	...	H. \mathfrak{B} . root.
<i>TOFFELDIA</i> , <i>SCOTTISH ASPHODEL</i> .		<i>Cal. 3-cleft. Pet. 6, conc. Ger. 3, with 3 styles. Caps. 3, each</i>				
<i>palústris</i> . E.Fl.	marsh.	lan. ribb. incurv. 2-rank.	w. y.	7. 8. Britain.	...	H. \mathfrak{B} . Peat soil. divid. root.
<i>SCHEUCHZERIA</i> , <i>SCHEUCHZERIA</i> .		<i>Cal. 0. Pet. 6, recur. Ger. 3. Sty. 0. Stig. obt. Caps. 3, infla.</i>				
<i>palústris</i> . E.Fl.	marsh.	a't. slender, semicylind.	gr.	5. 6. England.	...	H. w. \mathfrak{B} . Peat & loam. in water seeds.
<i>TRIGLOCHIN</i> , <i>ARROW-GRASS</i> .		<i>Cal. of 3 conc. leav. Pet. 3. Fil. shor. Ger. 3 or 6, fur. Sty. 0. Sti. 3 or 6.</i>				
<i>marítimum</i> . E.Fl.	sea.	semicylind. fleshy.	5.	8. Britain.	...	H. w. \mathfrak{B} . Mud in
<i>palústris</i> . E.Fl.	marsh.	lin. chann. smth. 2-rank.	re. g.	— — —	...	H. w. \mathfrak{B} . water. seeds, part. roots.
<i>C'OLCHICUM</i> , <i>MEADOW-SAFFRON</i> .		<i>Cal. 0. Cor. of 1 pet. in 6 deep seg. Caps. 3-cell. Seeds globos.</i>				
<i>arenárium</i> .	sand.	lin. chann. erect.	pur.	9. 10. Hungary.	1816.	H. \mathfrak{B} . Light loam.
<i>autumnále</i> . E.Fl.	common.	lanc. erect, smth.	pur.	— Britain.	...	H. \mathfrak{B} . seeds, or off-
<i>byzantínium</i> . B.M.	broad-leaved.	obl. ov. broad.	pur.	— Levant.	1629.	H. \mathfrak{B} . sets from
<i>crociflórum</i> . B.M.	Crocus-flower'd.	lanc. smth.; spathafew-fld.	pu.	— — —	...	H. \mathfrak{B} . bulb.
<i>MEDEO'LA</i> , <i>MEDEO'LA</i> .		<i>Cal. 0. Cor. 6-parted, revolute. Berry 3-seeded.</i>				
<i>virginica</i> . L.	Indian Cucumb. in whorls.		gr.	6. Virginia.	1759.	H. \mathfrak{B} . Sandy loam. divid. roots.

Systematic Name.	English Name.	Form of Leaves, &c.	Col. of Flower.	Month of Fl.	Native Country.	Yr. of Introd.	Soil and Propagation.
<i>MYRSIPHYLLUM, MYRSIPHYLLUM.</i> Cor. of 6 pet. revol. Sty. 3. Ber. 3 cell. cells with 2 seeds.							
asparagoides. W. en. Asparagus-like. ov. alt. obliq. sub-cord. wh. 10. 3. C. B. S. 1702. G. S. cl. Sandy loam. Medeóla asparagoides. cuttings.							
<i>CALOCHORTUS, CALOCHORTUS.</i> Cal. of 3 leav. Pet. 3-col. Sty. 3, short. Stig. recu. Caps. 3-cel. macrocápus. B. R. long-fruited. ensif. glau. sheath. pur. 6. Columb. 1826. H. P. Peat & loam. offsets.							
<i>TRILLIUM, TRILLIUM.</i> Cal. of 3 leaves. Cor. of 3 petals, spreading. Berry 3-celled, many-seeded.							
cérnum. B. M.	drooping.	ov. smth. narr. at base.	wh. 4. 5.	N. Amer.	1758.	H. P.	Sandy loam
díscol. B. M.	two-coloured.	sess. ov. acut. blotched.	gr. 6.	—	—	H. P.	and peat.
erythrocarpon. B. M.	blood-stained.	cord. ov. smth. ent.	red. 5. 6.	—	1811.	H. P.	seeds, or di-
eréctum. W.	erect.	tern. ov. ent. smth.	d. pur. 4. 5.	—	1759.	H. P.	viding the
séssile. B. M.	sessile flowering, broadly ov.		d. pur. —	—	—	H. P.	root.
<i>HELONIAS, HELONIAS.</i> Cal. 0. Cor. 6-parted. Sty. 3. Stig. recurved. Caps. 3-celled.							
bulláta. B. M.	spear-leaved.	lanc. ensif. smth.	pur. —	N. Amer.	1758.	H. P.	Loam & peat.
erythrospérma. B. M.	channel-leav'd. long, lin. smth.		gr. 6.	—	1770.	H. P.	part. root.
<i>XEROPHYLLUM, XEROPHYLLUM.</i> Flow. 6-parted. Stig. 3, obl. sess. Caps. 3-celled, 2-seeded.							
gramíneum. Nut. grass.		lin. grassy; Panic, loose.	wh. 5. 6.	—	1812.	H. P.	Peat & loam. part. roots.
<i>Helónias gramínea.</i> B. M.							
<i>APONOGETON, APONOGETON.</i> Cal. 0. Cor. 0. Catkin composed of scales. Caps. 4, 3-seeded.							
distáchyon. B. M.	broad-leaved.	ellip. obl. smth. ent.	wh. 5. 7.	C. B. S.	1788.	G. w. P.	Peat & loam
monostáchyon. B. rep.	spiked.	ov. cord. spike simple.	wh. 8. 10.	E. Ind.	1803.	S. w. P.	in water. offsets from bulb.

ORDER IV.

HEXAGYNIA. STYLES 6.

<i>ACTINOCARPUS, ACTINOCARPUS.</i> Cal. of 3 leaves. Pet. 3. Ger. 6-8, united at base, 2-seeded.							
Damasónium. B. F. common.		cord. obl. smth.	wh. 6. 8.	England.	...	H. w. P.	Loam & peat, in water. seeds.
<i>Alisma Damasónium.</i> E. B.							

ORDER V.

POLYGYNIA. STYLES MANY.

<i>ALISMA, WATER-PLANTAIN.</i> Cal. of 3 leaves. Pet. 3, decid. Caps. in a cluster, distinct, 1-seeded.							
nátans. E. Fl.	floating.	ellip. obt.; Pedunc. sing.	wh. 7. 8.	Wales.	...	H. w. P.	Peat & loam
Plantágo. E. Fl.	great-water.	ellip. ov. smth.	wh. —	Britain.	...	H. w. P.	in water.
ranunculoídes. E. Fl. lesser.		lin. lanc.	wh. 8.	—	...	H. w. P.	seeds, or part. roots.

CLASS VII. ORDER I.

HEPTANDRIA MONOGYNIA. STAMENS 7. STYLE 1.

Systematic Name.	English Name.	Form of Leaves, &c.	Col. of Flow.	Month of Fl.	Native Country.	Yr. of Introd.	Soil and Propagation.
<i>JONE'SIA, JONE'SIA.</i> Cal. coloured, funnel-shaped. Cor. 0. Legume compressed, 4-8-seeded.							
Asóca. B.M.	wing-leaved.	pinn. leaf. ov. opp. glau.	or.	4. 6.	E. Ind.	1796.	S. S. Sandy loam and peat. cutt.
[segm. Caps. of 1 cell, & 7 valves. Seeds angular.							
<i>TRIENTALIS, CHICKWEED WINTER-GREEN.</i> Cal. of 7 leaves. Cor. wheel-shap. in 7 deep equ.							
americàna. Ph.	American.	lanc. acum. obliq.	wh.	7. 8.	N. Amer.	1816.	H. P. Light loam
europ'æa. E.Fl.	European.	obov. obt. obl. sub. serr.	wh.	5. 6.	Britain.	H. P. and peat. divid. at root.
<i>DIS'ANDRA, DIS'ANDRA.</i> Cal. 7-parted. Cor. rotate, 7-cleft. Caps. 2-celled, many-seeded.							
prostràta. B.M.	trailing.	renif. cren.	yel.	5. 8.	Madeira.	1771.	G. P. Loam & peat. part. at root.
<i>PIS'ONIA, PIS'ONIA.</i> Cal. campanulate, 5-parted. Cor. 0. Berry 1-celled, single-seeded.							
frágrans. s.s.	fragrant.	opp. acum. smth. fleshy.	gr.	4. 9.	1825.	S. S. Loam & peat.
grándis. B.P.	superb.	obl. acum. smth.	wh.	—	N. Holl.	1805.	G. S. cuttings.
obovàta. L.en.	obovate.	obov. acut. opp. ent. smth.	gr.	—	S. Amer.	1820.	S. S. ———
<i>ÆSCULUS, HORSE-CHESNUT.</i> Cal. cam. of 1 leaf. Pet. 4-5. Sta. recur. Caps. 3-cell. Seeds large.							
cárnea. E.R.	flesh-coloured.	quinate. obl. acum. serr.	carn.	—	H. C. Sandy loam.
glàbra. DC.	smooth.	pinn. leaf. 5-smth.	gr. yel.	5. 6.	N. Amer.	1812.	H. C. grafting,
húmilis. B.R.	dwarf.	stalk. lanc. serr. quinate.	sc.	—	—	H. S. budding, or
Hippocástanum. DC. common.		pinn. leaf. 7-obov. acut. dent.	4. 5.	Asia.	1629.		H. C. layers for the
neglécta. B.R.	dingy-flowered.	5-lanc. serr. smth. ben.	yel.	—	N. Amer.	H. C. dwarf specie.
<i>P'AVIA, BUCK'S-EYE-TREE.</i> Cal. tubu. Cor. of 4 erect, narrow, petals. Caps. smooth. Stam. erect.							
fláva. DC.	yellow-flowered.	quinate. pub. at rib, ben.	yel.	—	—	1764.	H. C. Same treat-
macrostáchya. DC.	long-spiked.	quinate. leaf. lanc.	wh.	7. 8.	—	1786.	H. S. ment as last genera.
<i>Æsculus parviflora.</i> H. K.							
rúbra. DC.	red-flowered.	5-ellip. obl. serr.	sc.	5. 6.	—	1711.	H. C. ———
<i>Æsculus Pàvia.</i> B. C.							
<i>DRACO'NTIUM, DRAGON.</i> Spath. cymbiform. Cal. 0. Pet. 5. Spadix covered.							
polyphy'llum. B.R.	purple-stalked.	pedate, segm. pinnatif.	d. pu.	3. 6.	India.	1759.	S. P. Light rich loam. part. root
<i>C'ALLA, C'ALLA.</i> Spath. ovate. Spadix covered. Cor. and Cal. wanting.							
æthiópica. B.M.	Ethiopian.	cord. sagitt. smth. shin.	wh.	1. 5.	C. B. S.	1731.	G. P. Rich loam suckers.

ORDER II.

DIGYNIA. STYLES 2.

Systematic Name.	English Name.	Form of Leaves, &c.	Col. of Flow.	Month of Fl.	Native Country.	Yr. of Introd.	Soil and Propagation.
<i>LYMEUM, LYMEUM.</i> Cal. of 5 leaves. Pet. 5, equal. Caps. globose, 2-celled.							
<i>africanum.</i> L.	African.	obl. lanc. ent.	wh.	6. 7.	C. B. S.	1774.	G. β . Sandy loam and peat. divid. at root.

ORDER III.

TETRAGYNIA. STYLES 4.

<i>SAURURUS, LIZARD'S-TAIL.</i> Cal. a catkin of single-fl'd. scales. Cor. 0. Ger. 4. Berr. 4, 1-seeded.							
<i>chinensis.</i>	Chinese.	cord. ov. acum. shin.	wh.	8. 10.	China.	1822.	F. w. β . Strong loam
<i>cérnuus.</i> w.	drooping.	cord. alt. ent. smth.	wh.	8. 9.	Virginia.	1759.	H. w. β . in water. seeds, or part. roots.

ORDER IV.

HEPTAGYNIA. STYLES 7.

<i>SEPTAS, SEPTAS.</i> Cal. 7-left. Cor. of 7 peta's. Caps. 7, single-seeded.							
<i>apénsis.</i> DC.	Cape.	connate, eren. orbic.	wh.	8. 9.	C. B. S.	1774.	G. β . Sandy loam and peat. divid. at root.

CLASS VIII. ORDER I.

OCTANDRIA MONOGYNIA. STAMENS 8. STYLE 1.

<i>ENOTHE'RA, EVENING-PRIMROSE.</i> Cal. decid. 4-clef. Pet. 4, obo. Ger. obl. Stig. 4. Cap. 4-cell.							
<i>caulis.</i> B. R.	stemless.	pinn. terminal, lob. dent.	w. r.	6. 7.	Chile.	1822.	H. β . Sandy loam
<i>isóloba.</i> B. F. G.	unequal-lobed.	ell. obov. pub. upp. pinnati.	w.	6.	—	1828.	H. β . β leaf mould.
<i>énnis.</i> DC.	common.	ov. lanc. tooth.; stm. rough.	ye.	6. 9.	N. Amer.	1629.	H. β . seeds, or cut-
<i>uciata.</i>	cross-leaved.	ellip. lanc. smth.	st.	6. 10.	—	1821.	H. β . tings; some
<i>espitosa.</i> B. M.	tufted.	lanc. ent. dent.	wh.	6. 7.	—	1811.	H. β . of the species
<i>rymbosa.</i> DC.	corymböse-fl'g.	lanc. dent. smth.; stm. twist.	y.	7. 10.	1826.	H. β . will bear di-
<i>cúmbens.</i> B. R.	decumbent.	ov. lanc. glau. pubes.	pur.	—	N. Amer.	1827.	H. β . dividing at the
<i>asèri.</i> B. M.	Fraser's.	ov. denticul.; stm. pubes.	yel.	5. 10.	—	1811.	H. β . root.

Systematic Name.	English Name.	Form of Leaves, &c.	Col. of Flow.	Month of Fl.	Native Country.	Yr. of Introd.	Soil and Propagation.
glauca. B.M.	glaucous.	ov. dent. glau.	yel.	5. 10.	N. Amer.	1737.	H. P. ———
grandiflora. B.M.	great-flowered.	ov. lanc. dent.	yel.	6. 8.	———	1778.	H. A. ———
longiflora. DC.	long-flowered.	dent.; <i>stm.</i> hairy.	yel.	7. 9.	B. Ayres.	1776.	H. B. ———
Lindleyana. B. Fl. G. Lindley's.		lanc. ellip. smth. ent.	pur.	6. 12.	N. Amer.	1827.	H. A. ———
missouriensis. B.M.	Missouri.	lanc. gland. dent.	yel.	6. 8.	———	1811.	H. P. ———
macrocarpa. B. F. G.	large-capsuled.	lanc. dent. notch.	yel.	———	———	———	H. P. ———
nocturna. DC.	night-smelling.	lanc. serr.	pur.	4. 8.	C. B. S.	1790.	G. B. ———
odorata. B.M.	sweet-scented.	lin. undul. lanc. dent.	yel.	———	Patagon.	———	H. P. ———
pallida. B.R.	pale-stemmed.	lin. lanc. dent. or. ent.	wh. pk.	———	N. Amer.	1827.	H. P. ———
pumila. B.M.	dwarf.	obl. lanc. ent.	yel.	5. 9.	———	1757.	H. P. ———
parviflora. DC.	small-flowered.	ov. lanc.; <i>stm.</i> sub-vill.	yel.	6. 8.	———	———	H. B. ———
Romanzovii. B.R.	Romanzow's.	lanc. alt. ent. recurv.	viol.	———	———	1817.	H. A. ———
rosea. B.M.	rose-coloured.	ov. dent. lower lyrate.	ros.	5. 8.	Peru.	1783.	F. P. ———
rosea-alba.	red and white.	lanc. ent. smth. obt.	ros. wh.	———	Nepaul.	1827.	H. A. ———
serotina. B. F. G.	late-flowering.	lanc. smth. dentic.	yel.	7. 10.	N. Amer.	1820.	H. S. ———
serrulata. S.S.	saw-leaved.	lin. lanc. sub-pubes. ben.	yel.	5. 6.	———	1824.	H. P. ———
speciosa. B. F. G.	shewy.	lanc. tooth. & atten. at base. w.	6. 8.	Louisian.	1821.	H. P. ———	
taraxacifolia. B. F. G.	Dandelion-l'd.	pinnatif. lyrate, pubes.	w. pk.	———	Ch. le.	1823.	H. P. ———
tenella. B.M.	slender.	lin. lanc. sess. glau.	pur.	6. 7.	———	———	H. A. ———

[Seeds feathery.]

EPILOBIUM, WILLOW-HERB. *Cal.* 4-part. *Cor.* of 4 pet. clov. *Caps.* 4-sided, with 4 cells & 4 valves.

alpinum. E. Fl.	Alpine.	elli. lan. obt. smth. ent. ov.	ros.	6.	Britain.	H. P. Light loam.
angustifolium. Br. Fl.	French Willow.	lin. lanc. smooth.	pk.	———	———	H. P. seeds, or
alsinifolium. E. Fl.	Chickweed-lv'd.	ova. acum. smth. shin.	wh.	———	———	H. P. part. at roots.
angustissimum. H. K.	narrowest-l'd.	lin. ent. smooth.	pu. pk.	———	Alps. Eu.	1775.	H. P. ———
Dodonæi.	Dodoens's.	lin. denticul. smth.	pu. pk.	———	France.	1700.	H. P. ———
hirsutum. E. Fl.	hairy.	ov. lanc. serr. hairy.	pu. pk.	———	Britain.	H. P. ———
montanum. E. Fl.	mountain.	lanc. dent.; <i>stems</i> smth.	li.	7. 8.	———	H. P. ———
parviflorum. E. B.	small-flowered.	sess. lan. down. slight. tooth.	y.	———	———	H. P. ———
roseum. E. B.	pale.	ov. lanc. tooth.; <i>stm.</i> 4-sid.	ros.	———	———	H. P. ———
tetragonum. E. Fl.	square-stalked.	lanc. sess. tooth. alt.	pur.	———	———	H. P. ———

[Caps. of 1 cell, and 2 valves]

CHLORA, YELLOW-WORT. *Cal.* of 6-8 leaves. *Cor.* salver-shaped, 6-8-cleft. *Ger.* oblong. *Stig.* 2

perfoliata. E. Fl.	perfoliate.	perf. acut. smth. glau.	yel.	6. 7.	———	H. A. Sandy loam seeds.
--------------------	-------------	-------------------------	------	-------	-----	------	-------------------------

RH'EXIA, RH'EXIA. *Cal.* tubular, ovate, ventricose, limb 4-cleft. *Pet.* 4, obovate. *Caps.* 4-celled.

ciliosa. B. F. G.	ciliated.	ov. acu. 3-ner. edg. ciliat.	pur.	6. 8.	N. Amer.	1812.	H. P. Loam & peat
mariana. DC.	Maryland.	lanc. acute, 3-nerv.	li.	———	———	1759.	H. P. parting root
virginica. B.M.	Virginian.	sess. ov. lan. cilia. serr.	pur.	———	———	———	H. P. ———
versicolor. B.R.	changeable.	ov. obl. serrul. 5-nerv.	fl.	———	Brazil.	1825.	S. S. ———

GA'URA, GA'URA. *Cal.* 3-4-cleft. *Cor.* of 3-4 petals. *Filam.* 6-8. *Ger.* of 1 cell.

biennis. B.M.	biennial.	obl. lanc. acut. dent.	w. red.	8. 10.	N. Amer.	1762.	H. B. Rich light
coccinea. DC.	scarlet.	lin. lanc. dent. hairy.	sc.	———	Louisian.	1811.	H. P. loam. seeds.

TROPÆOLUM, INDIAN CRESS. *Cal.* 5-part. *spurr.* at the base. *Cor.* of 5 petals. *Ger.* smooth, 3-lobed

peregrinum. B.R.	strange.	sub-pelt. 5-7-lob. smth.	yel.	6. 7.	Peru.	1810.	S. P. Sandy loam
tricolorum. B. F. G.	three-coloured.	pelt. segm. 6-7 obov. ent. or.	———	———	Chile.	1828.	H. P. divid. roots or seeds.

Systematic Name.	English Name.	Form of Leaves, &c.	Col. of Flow.	Month of Fl.	Native Country.	Yr. of Introd.	Soil and Propagation.
------------------	---------------	---------------------	---------------	--------------	-----------------	----------------	-----------------------

JEFFERSONIA, JEFFERSONIA. *Cal. 5-part. colo. Cor. of 8 petals. Caps. obo. 1-celled, many-seeded.*
diph'ylla. DC. two-leaved. on long stalk. bina. reni. smth. w. 5. N. Amer. 1792. H. β . Sandy loam and peat. seeds, or part. roots.

EUPHORIA, EUPHORIA. *Cal. 5-tooth. Pet. 5, reflexed. Stam. 6-8. Stig. 2. Caps. 1-celled.*
Longana. DC. Longan. pinn.; *Pan. lax.* wh. 5, 6. China. 1786. S. ξ . Loam & peat. cuttings.
Dimocarpus Longan. Lou.

ROXBURGHIA, ROXBURGHIA. *Cal. of 4 leaves. Cor. of 4 petals. Caps. 1-celled, 2-valv. many-seed.*
viridiflora. Ex. B. elliptic-leaved. cord. stalk. *yel. pur.* — E. Ind. 1803. S. β cl. Peat & loam. part. root.
gloriosa. B. M.

MICHAUXIA, MICHAUXIA. *Cal. 8-10-cleft. Cor. rota. 8-10-cleft. Stam. 8 or 10. Caps. 8-10-cell.*
avigata. B. R. smooth. obl. lan. den. pil.; *stm. smth. w.* 8, 9. Persia. 1820. F. β . —

GRISLEA, GRISLEA. *Cal. tubular, 4-6-toothed. Pet. 4-6. Sty. filiform. Caps. globular.*
omentosa. B. R. hairy. ov. sess. hairy under. *red. 5. 12.* E. Ind. 1804. S. ξ . Loam & peat. cuttings.

CLARKIA, CLARKIA. *Cal. 4-cleft, tubul. Cor. of 4 petals. Pet. 3-lobed. Filam. 4. Caps. of 4 cells.*
ulchella. B. R. beautiful. lin. alt. ent. smth. *pur.* — N. Amer. 1827. H. α . Sandy loam. seeds.
 β . albiflora. white-flowered.

BORONIA, BORONIA. *Cal. of 4 leaves. Cor. of 4 equal petals. Stam. bearded. Ger. 4. Caps. 2-valved.*
lata. winged-leaved. pin. leaf. ellip. cren. edg. rev. — H. Holl. 1825. G. ξ . Sandy loam,
enticulata. B. R. tooth leaved. lin. dentic. retuse. *pk.* — — — 1823. G. ξ . & peat.
innata. B. M. pinnate leaved. pinn. leaf. opp. lin. smth. *pk. 2. 5.* N. S. W. 1794. G. ξ . cuttings.
errulata. B. R. saw-leaved. trapezif. acut. serrul. *ros.* — — — 1816. G. ξ . —

FUCHSIA, FUCHSIA. *Cal. 4-parted, coloured. Cor. of 4 petals. Berr. of 4 cells, with many seeds.*
borascens. B. R. shrubby. tern. ov. obl. ent. smth. *pk. 6. 10.* Mexico. 1823. G. ξ . Loam & leaf
occinea. B. M. scarlet. opp. ov. dent. *sc. 5. 8.* Chile. 1788. F. ξ . mould. cutt.
corticata. B. R. changeable. alt. ov. lanc. acum. dent. *vio. 6. 4.* N. Zeal. 1821. G. ξ . —
racilis. B. R. slender. opp. lanc. pubes. *sc. 5. 6.* Mexico. 1822. F. ξ . —
cioides. B. M. Box-thorn-l'd. ov. ent. opp. *pur. 4. 10.* Chile. 1796. G. ξ . —
microphylla. E. F. G. small-leaved. opp. ellip. dent. *red.* — Mexico. 1827. F. ξ . —
acrostemma. DC. large-crowned. in 3-whorls, ov. dent. *sc. 5. 8.* Chile. 1823. G. ξ . —
viriflora. B. R. small-flowered. ov. obt. ent. concave. *sc.* — Mexico. 1824. F. ξ . —
acillaris. B. R. globe-flow'd. opp. serr. obl. ov. cord. *sc. 5. 9.* — 1830. G. ξ . —
ymifolia. B. R. thyme-leaved. ov. acut. ent. or sub-dent. *sc. 6.* — 1827. G. ξ . —

ÆCKIA, BÆCKIA. *Cal. 5-cleft, permanent. Pets. 5. Stam. 5-10, short. Caps. 2-5-celled.*
amphorata. B. M. fragrant. obov. lanc. obt. imbr. *wh. 7. 8.* N. S. W. 1820. G. ξ . Sandy loam,
lifolia. DC. Flax-leaved. lin. mucr. smth. *wh. 6. 8.* — 1820. G. ξ & leaf mould.
lifolia. Pine-leaved. long, lin. acum. *vio.* — — 1829. G. ξ . cuttings.
gata. B. M. twiggy. lin. smth. ent. *wh. 8. 10.* — 1806. G. ξ . —

KOELRUTERIA, KOELRUTERIA. *Cal. of 5 leaves. Pets. 4, irreg. Nect. scales 4. Caps. 3-sided.*
paniculata. B. R. panicled. pinn. leaf. ov. obl. lanc. den. *y. 7. 8.* China. 1763. H. ξ . Sandy loam. layers, or cuttings of roots.

Systematic Name.	English Name.	Form of Leaves, &c.	Col. of Flow.	Month of Fl.	Native Country.	Yr. of Introd.	Soil and Propagation.
DODONÆA, DODONÆA. <i>Cal. 4-parted. Cor. 0. Sty. filiform. Caps. 2-3-celled. Seeds 2.</i>							
attenuata. B.M.	attenuated.	lin. spat. rig. edg. rev. den.	g.	7. 8.	N. S.W.	1824.	G. S. <i>Loam & peat.</i>
oblongifolia. B.R.	oblong-leaved.	obl. ob. muc. en. or sub-den. p.g.	—	—	N. Holl.	1816.	G. S. <i>cuttings.</i>
DA'PHNE, DA'PHNE. <i>Cal. tubular, 4-parted, coloured. Cor. 0. Berr. of 1 cell, with 1 seed.</i>							
alpina. B.C.	alpine.	lanc. obt. downy ben.	wh.	5. 7.	Italy.	1759.	H. S. <i>Sandy loam</i>
altaica. B.M.	Altaic.	obl. lanc. obt. base atten.	wh.	4. 5.	Siberia.	1796.	H. S. <i>and peat.</i>
Cneorum. B.M.	trailing.	obov. lanc. mucr. ent.	pk.	4. 9.	Austria.	1752.	H. S. <i>grafting on</i>
collina. B.M.	hairy.	obl. obo. smth. abo. vill. ben.	re.	1. 6.	Italy.	—	H. S. <i>the common</i>
hybrida. B.R.	hybrid.	ov. ellip. smth.	ros.	—	Hybrid.	1826.	F. S. <i>spurge lau-</i>
laureola. E.B.	spurge-laurel.	lanc. obov. smth. ent.	yel.	1. 3.	Britain.	...	H. S. <i>rel, which</i>
mezereum. E.B.	Mezereon.	lanc. smth. decid.	red.	2. 4.	England.	...	H. S. <i>may be rais'd</i>
β album.	white-flowered.						by seeds.
napolitana. B.C.	Neapolitan.	obov. ent. apex notched.	re.	1. 6.	Italy.	1823.	H. S. —
odora. B.M.	sweet-scented.	lanc. obl. ent. smth.	p.wh.	1. 3.	China.	1771.	G. S. —
pontica. B.M.	Pontic.	obov. ent. smth. shin.	g.yel.	4. 5.	Pontus.	1759.	H. S. —
Tárton-ráira. W.	silvery-leaved.	obov. ellip. silky.	st.	5. 7.	France.	1640.	H. S. —
A'CER, MAPLE. <i>Cal. 5-clef. Pet. 5. Ger. of 2 lob. Sty. longish. Stig. 2-3. Caps. 2 or 3 wing. Seeds 1-2.</i>							
campêtre. E.B.	common.	5-lob. obt. cut. serr.	gr.	5. 6.	Britain.	—	H. C. <i>Light loam.</i>
créticum. L.	Cretan.	cunea. at base, acu. 3-lo.	g.y.	—	Levant.	1752.	H. S. <i>cuttings, ta-</i>
eriocarpum. DC.	Sir C. Wager's.	pal. 5-lob. dent. smth. glau.	st.	4. 5.	N. Amer.	1725.	H. C. <i>ken off at a</i>
heterophyllum. W.	evergreen.	ov. ent. green, smth.	gr.	5. 6.	Levant.	1759.	H. C. <i>joint, and</i>
sempervirens. L.							planted in a
macrophyllum. Ph.	large-leaved.	digit. 5-lob. lobes dent.	gr.	—	N. Amer.	1826.	H. C. <i>shaded situ-</i>
nigrum. Mx.	black.	sinuat. cord. pubes. ben.		4.	—	1812.	H. C. <i>ation, will</i>
oblongum.	oblong-leaved.	ov. obl. ent. smth. shin.	gr.	7. 8.	Nepaul.	1820.	H. C. <i>strike root.</i>
obtusatum.	blunt-leaved.	cor. orbi. 5-lo. lobe. den. gr. ye.	—	—	Hungary.	1825.	H. S. —
palmatum. DC.	palmete-leav'd.	pal. 5-7 cleft, lobes obl. ser. st.	g.	4. 5.	—	—	H. S. —
rubrum.	red.	cor. palm. cut, dent.	gr.	—	N. Amer.	1656.	H. C. —
Pseudo-platanus. E.B.	Sycamore.	5-lob. unequally serr.	gr.	—	Britain.	...	H. C. —
fol. argenteo.	silvery-leaved.						—
saccharinum. DC.	sugar.	cor. pal. 5-lo. smt. glau. den. st.	—	—	N. Amer.	1735.	H. C. —
VACCINIUM, WHORTLE-BERRY. <i>Cal. of 1 leaf, 4-clef. Cor. bell-sh. 4-part. Ber. 4-cell. Seeds ang.</i>							
amœnum. B.R.	broad-leaved.	obl. acut. ent. smth.	wh.	5. 6.	—	1765.	H. S. <i>Sandy loam,</i>
angustifolium. W.	narrow-leaved.	lanc. acum.	red.wh.	4. 5.	—	1776.	H. S. <i>& peat. lay-</i>
arboreum.	tree.	ov. obov. acut. serrul.	wh. red.	5. 9.	—	1765.	H. S. <i>ers, or cut-</i>
buxifolium. B.M.	Box-leaved.	obov. cren. smth.	wh. red.	5. 6.	—	1794.	H. S. <i>tings, under</i>
corymbosum. W.	corymbose.	obl. smth. acut.	wh.	6. 7.	—	1806.	H. S. <i>a hand-glass.</i>
crassifolium. A. rep.	thick-leaved.	ov. serr. rigid.	red.	—	—	1787.	F. S. <i>will strike</i>
dumosum. B.M.	bushy.	obov. obl. ent.	wh.	—	—	1774.	H. S. <i>root.</i>
fuscatum. B.R.	cluster-flower'd.	obl. acut. serr. smth.	wh. red.	—	—	1778.	H. S. —
ligustrinum. W.	privet-leaved.	lanc. serr. pubes.	pur. red.	—	—	...	H. S. —
myrtifolium.	Myrtle-leaved.	ov. shin. smth.	pk.	—	—	1812.	F. S. —
nitidum. S.S.	shining.	obov. ellip. serr. smth.	pk. red.	—	—	1794.	F. S. —
ovatum. B.R.	ovate-leaved.	ov. serr. smth. shin.	bh.	—	—	1827.	H. S. —
Vitis Idæa. E.B.	Cow-berry.	obov. revol. sub-tooth.	car.	—	Britain.	...	H. S. —
CORRÆA, CORRÆA. <i>Cal. 4-toothed. Cor. of 1 petal, 4-cleft. Caps. 4-celled, and 4-valved.</i>							
alba. B. Rep.	white.	ov. hairy, ent.	wh.	4. 7.	N. S.W.	1793.	G. S. <i>Sandy loam</i>
pulchella. B.R.	pretty.	opp. ov. obl. und.	pk.	11. 5.	N. Holl.	1824.	G. S. <i>and peat.</i>

Systematic Name.	English Name.	Form of Leaves, &c.	Col. of Flow.	Month of Fl.	Native Country.	Yr. of Introd.	Soil and Propagation.
speciosa. B. Rep.	shewy.	ov. obl. scabr. rusty ben.	red.	11. 5.	N. S. W.	1806.	G. S. cuttings.
virens. B. R.	green-flowered.	ov. obl. cord.	gr.	—	—	1800.	G. S. —
GNIDIA, GNIDIA. Cal. parted. Cor. funnel-shaped, limb 4-cleft. Nut a little drupaceous.							
imbricata. L.	imbricated.	obl. silky.	st.	4. 6.	—	1822.	G. S. Loam & peat.
laevigata. Thunb.	smooth.	opp. smth. ovate.	pa. yel.	—	—	—	G. S. cuttings.
oppositifolia. B. M.	opposite.	ov. lanc. pubes.	yel.	5. 7.	—	1783.	G. S. —
pinifolia. B. M.	Pine-leaved.	3-sided, mucr.	wh.	5. 6.	—	1768.	G. S. —
sericea. B. Rep.	silky.	opp. ov. obt. toment.	pa. yel.	5. 7.	—	1786.	G. S. —
tomentosa. L.	hairy.	opp. decus. ellip. ner. hairy.	y.	—	—	1822.	G. S. —
PASSERINA, PASSERINA. Cal. 0. Cor. 4-cleft. Sty. thread-shaped. Nut 1, coated.							
grandiflora. B. M.	great-flowered.	obl. acut. concave.	wh.	5. 6.	C. B. S.	1789.	G. S. Loam & peat.
hirsuta. W.	hairy.	ov. ellip. fleshy, hairy.	yel.	—	—	—	G. S. cuttings.
laxa. B. C.	lax.	ov. lanc. scatt.	wh.	6. 7.	—	1804.	G. S. —
LACHNÆA, LACHNÆA. Cal. 0. Cor. 4-cleft. Filam. elongated, unequal. Seed 1. Berry-like.							
conglomerata. L.	clustered.	lin. awl-sh. smth. imbric.	wh.	6. 7.	C. B. S.	1773.	G. S. Loam & peat.
purpurea. B. M.	purple.	imbric. 3-sid. obt. smth.	pur.	5. 7.	—	1830.	G. S. cuttings.
BLIGHIA, AKEE-TREE. Cal. 5-parted. Cor. of 5 petals. Style short. Stig. 3.							
sapida. H. K.	Ash-leaved.	in 3 or 4 pairs, ov. lanc. vein. w.	7. 9.	Africa.	1723.	S. S.	Sandy loam & peat cutt.
DYRCA, LEATHER-WOOD. Cal. 0. Cor. funnel-shap. limb slightly dent. Ger. smth. 1-celled, 1-seed.							
palustris. B. R.	marsh.	ellip. obl. ent. vill. ben.	yel.	3. 4.	Virginia.	1750.	H. S. Peat soil. layers.
CALLUNA, LING. Cal. double, each of 4 fringed leaves. Cor. bell-sh. 4-cleft. Caps. of 4 cells, & 2 valves.							
vulgaris. B. Fl.	common.	opp. 2 spurs at the base.	pk.	6. 8.	Britain.	H. S. Sandy peat.
1. alba.	white.	wh.	—	—	H. S. cuttings, or
2. carnea.	flesh-coloured.	car.	—	—	H. S. layers.
3. coccinea.	scarlet.	sc.	—	—	H. S. —
4. decumbens.	decumbent.	red.	—	—	H. S. —
5. flore pleno.	double-flower'g.	pk.	—	—	H. S. —
6. spicata.	spiked.	red.	—	—	H. S. —
7. tomentosa.	tomentose.	red.	—	—	H. S. —
8. variegata.	variegated.	red.	—	—	H. S. —
9. spuria.	spurious.	red.	—	—	H. S. —
10. aurea.	golden-striped.	pk.	—	—	H. S. —
11. prostrata.	prostrate.	wh.	—	—	H. S. —
*ERICA, HEATH. Cal. of 4 perman. leav. Cor. of 1 leaf, 4-clef. Caps. of 4 cells & 4 valve. with num. seeds.							
absinthoides. H. K.	wormwood-like.	4, ciliat. Sty. excl. Anth. incl.	pac. glob.	3. 6.	C. B. S.	1792.	G. S.
actæa. H. E. W.	cluster-leaved.	3, in a whorl smth. Sty. excl. An. i. w. bell-sh.	5. 6.	—	—	1822.	G. S.
acuta. A. H.	acute-leaved.	4, smth. Sty. & Anth. incl.	red. ov. vent.	5. 7.	—	1799.	G. S.

* The soil best adapted for the growth of this beautiful tribe of plants, is a black sandy peat, taken from the surface of a common, where the *Calluna vulgaris*, or *Ling*, is growing spontaneously; and if not naturally of a sandy texture, it should be rendered so, by the incorporation of a portion of sharp pit sand. All the species of the genus *Erica*, (with very few exceptions,) are readily increased by cuttings and of the young wood. These should be taken off, when the shoots appear rather of a firm texture; and a

Systematic Name.	English Name.	No. of Leaves in a whorl.	Col. & Form of Flower.	Month of Fl.	Native Country.	Yr. of Introd.	
<i>acutanguláris</i> . L. C.	acute-angled.	3, smth. Sty. & Anth. excl.	red. bell-sh.	5. 8.	C. B. S.	1823.	G. Sp.
<i>acumináta</i> . A. H.	pointed-leaved.	4, smth. Sty. excl. Anth. incl.	pk. tub.	5. 6.	—	1798.	G. Sp.
<i>aggregáta</i> . H. E. W.	aggregate-fl'd.	4, vill. Anth. incl. Sty. excl.	pur. red. glob.	5. 8.	—	1810.	G. Sp.
<i>Aitoniana</i> . A. H.	Mr. Aiton's.	3, smth. Anth. incl. Sty. excl.	wh. red. tub.	6. 9.	—	1790.	G. Sp.
<i>álbens</i> . H. K.	white.	3, smth. 3-sid. Sty. & Anth. incl.	wh. glob.	3. 8.	—	1789.	G. Sp.
<i>alopeuroídes</i> . B. C.	Fox-tail-like.	3-4, ciliat. Sty. & Anth. excl.	pur. red. ov.	5. 8.	—	1812.	G. Sp.
<i>ampullácea</i> . H. E.	flask-flower'd.	4, reflex. fring. Sty. excl. Ant. inc.	r. flask-sh.	6. 8.	—	1790.	G. Sp.
<i>ampullaceoides</i> . H. E. W.	ampulla. -li.	4, ciliat. Sty. excl. Anth. incl. r. g. y. flask-sh.		5. 7.	—	1800.	G. Sp.
<i>amé'na</i> . H. K.	feathery.	4, vill. Sty. & Anth. incl.	pur. bell-sh.	3. 7.	—	1795.	G. Sp.
<i>plumósa</i> . A. H.							
<i>andromedæflóra</i> . B. M.	Andromeda-fl.	3, smth. awl-sh. Sty. & Anth. incl.	pk. glob.	3. 6.	—	1803.	G. Sp.
<i>β. rubra</i> .	red-flowering.	red. glob.	—	—	—	G. Sp.
<i>árdens</i> . B. R.	fiery red.	3, smth. Sty. & Anth. incl.	red. glob.	4. 6.	—	1800.	G. Sp.
<i>arbúscula</i> . B. C.	little tree.	4, smth. Sty. excl. Anth. incl.	pk. ov.	4. 8.	—	1818.	G. Sp.
<i>Archeriana</i> . A. H.	Lady Archer's.	6, serr. ciliat. Anth. incl. Sty. excl.	red. tub.	8. 11.	—	1796.	G. Sp.
<i>aristáta</i> . A. H.	awned.	4-5, reflex. Sty. & Anth. incl.	pur. red. tub.	3. 8.	—	1801.	G. Sp.
<i>aristélla</i> . H. E. W.	slender-awned.	3, ciliat. Sty. & Anth. incl.	red. pur. tub.	6. 7.	—	1806.	G. Sp.
<i>aristáta minor</i> . Hortul.							
<i>arbórea</i> . H. E. W.	tree.	3, smth. Sty. excl. Anth. incl.	wh. bell-sh.	2. 6.	S. Europ.	1658.	H. Sp.
<i>1. squarrósa</i> .	scaly.	wh. bell-sh.	—	—	—	H. Sp.
<i>2. stylósa</i> .	long-styled.	wh.	—	—	—	H. Sp.
<i>argentiflóra</i> . A. H.	silvery-flower'd.	6, smth. Sty. excl. Anth. incl.	wh. cyl.	4. 6.	C. B. S.	1816.	G. Sp.
<i>articuláris</i> . H. E. W.	articulate.	3, smth. Sty. & Anth. excl.	red. bell-sh.	—	—	G. Sp.
<i>arbutiflóra</i> . H. E. W.	Arbutus-flow'd.	3, smth. Sty. & Anth. incl.	wh. glob.	—	—	1774.	G. Sp.
<i>triflóra</i> . A. H.							
<i>assúrgens</i> . H. E. W.	assurgent.	3, vill. Sty. & Anth. incl.	wh. bell-sh.	5. 8.	—	1810.	G. Sp.
<i>áspera</i> . H. E. W.	rough-leaved.	4, prickly, Sty. & Anth. incl.	yel. obl.	5. 6.	—	1802.	G. Sp.
<i>aúrea</i> . A. H.	golden-flower'd.	6, smth. Sty. excl. Anth. incl.	yel. cyl.	7. 9.	—	1799.	G. Sp.
<i>austrális</i> . A. H.	Spanish.	4, smth. Sty. excl. Anth. incl.	red. bell-sh.	4. 7.	Spain.	1769.	G. Sp.
<i>Bandónia</i> . A. H.	Coun. Bandon's.	3, smth. Sty. excl. Anth. incl.	bh. tub.	5. 8.	C. B. S.	1816.	G. Sp.
<i>báccans</i> . A. H.	berry-like.	4, smth. Sty. & Anth. incl.	red. pur. glob.	4. 7.	—	1774.	G. Sp.
<i>Banksia</i> . A. H.	Sir J. Banks's.	3, smth. Sty. & Anth. excl.	gr. yel. cyl.	2. 7.	—	1787.	G. Sp.
<i>álba</i> .	white-flowered.	wh. cyl.	2. 5.	—	—	G. Sp.
<i>barbáta</i> . A. H.	bearded.	4, vill. Sty. excl. An. sub-incl. w. y. pitch-sh.		5. 8.	—	1799.	G. Sp.
<i>β. májor</i> .	large-bearded.	w. red. pitch-sh.	—	—	—	G. Sp.
<i>Beaumóntia</i> . A. H.	Mrs. Beaumont's.	4, smth. Sty. excl. Anth. incl.	pk. wh. glob.	6. 8.	—	1820.	G. Sp.
<i>Bedfordiana</i> . G. Don.	Duke of Bedf. 3, ciliat. Sty. sub-excl. Anth. incl.		p. wh. cyl.	4. 9.	—	1800.	G. Sp.
<i>Linnæa supérba</i> . A. H.							

small portion of the lower end should be carefully divested of the leaves, so as not to injure the shoot, which must be cleared of the foliage, to such length as may appear necessary, to insert the cutting in the soil, of a sufficient depth only for its steady fixtore. The pots intended for the cuttings, should be previously prepared, and filled to within a couple of inches of the rim, with the drainage; and have a layer of the fibrous parts of the soil placed over the broken crocks, which will prevent the sand, wherewith the remaining space is filled up, from being washed away; and will, also, afford nourishment to many of the young roots that will penetrate through the sand. Sharp pit sand is the most suitable for facilitating the propagation, which, however, should be well washed, and cleared from all filth, and ferruginous matter. The pots of cuttings will require to be covered with glasses, and placed where they can be shaded from the effects of the mid-day sun. For further particulars of management, &c. see the description of the Heathery.

Systematic Name.	English Name.	No. of Leaves in a whorl.	Col. & Form of Flower.	Month of Fl.	Native Country.	Yr. of Introd.	
Bergiana. B.C.	Bergius's.	4, ciliat. Sty. & Anth. incl.	red.glob. 4. 8.	C. B. S.	1787.	G. ♂.	
<i>quadriflora</i> . A.H.							
bicolor. A.H.	two-coloured.	4, vill. Sty. excl. Anth. incl.	red.gr.cyl. 8. 3.	— —	1790.	G. ♂.	
biflora. H.E.W.	two-flowered.	2, smth. Sty. excl. Anth. incl.	wh. bell-sh. 5. 8.	— —	1820.	G. ♂.	
blanda. A.H.	charming.	6, smth. Sty. excl. Anth. incl.	pk. tub. 4. 9.	— —	1800.	G. ♂.	
Blandfordiana. B.M. D. of Marlboro's.		4, smth. Sty. sub-excl. Anth. incl.	yel. glob. 3. 6.	— —	1803.	G. ♂.	
blæria. H.E.W.	glomerate.	4, vill. Sty. & Anth. excl.	wh. bell-sh. —	— —	G. ♂.	
β rubra.	red-flowering.	— —	— —	G. ♂.	
Bonplandiana. B.M. Bonpland's.		4, smth. Sty. & Anth. incl.	or.glob. —	— —	1816.	G. ♂.	
Bowiana. B.C.	Bowie's.	4, glau. smth. Sty. & Anth. incl.	wh. tub. obl. 3. 9.	— —	—	G. ♂.	
<i>Baueria</i> . A.H.							
bruniades. A.H.	Brunia-like.	3, vill. Sty. & Anth. excl.	pur. red. glob. 4. 7.	— —	1790.	G. ♂.	
Broadleyana. A.H.	Broadley's.	3, smth. Sty. excl. Anth. incl.	pur. red. 5. 7.	— —	1810.	G. ♂.	
brevifolia.	short-leaved.	7, smth.	G. ♂.	
bucciniflora. B.M.	Trumpet-fl'd.	3, smth. Sty. excl. Anth. incl.	pur. red. 5. 9.	— —	1816.	G. ♂.	
cåffra. B.C.	Caffrean.	4, nearl. smth. Sty. exc. Ant. incl.	w. bell-sh. 8. 10.	— —	1774.	G. ♂.	
<i>spicata</i> . spike-flowering.							
callosa. Wend. H.	callous.	3, smth. Sty. excl. Anth. incl.	red. bell-sh. —	— —	—	G. ♂.	
calycina. H.E.W.	calycine.	3, smth. Sty. excl. Anth. incl.	pur. r. ov. vent. 6. 9.	— —	1799.	G. ♂.	
<i>måjor</i> . large-flowering.							
campanulata. H.K.	bell-flowering.	3, smth. Sty. & Anth. incl.	yel. bell-sh. 4. 8.	— —	1791.	G. ♂.	
canaliculata. H.K.	channelled.	3, smth. Sty. excl. Anth. incl.	pur. bell-sh. 8. 2.	— —	1799.	G. ♂.	
canescens. H.E.W.	canescent.	4, vill. Sty. & Anth. excl.	re. or. club-sh. 5. 8.	— —	—	G. ♂.	
<i>non eriocéphala</i> . A.H.							
capitata. A.H.	downy-headed.	3, vill. Sty. sub-excl. Anth. incl.	yel. gr. glob. 3. 7.	— —	1774.	G. ♂.	
carinata. B.C.	keeled.	5, smth. Sty. sub-excl. Anth. incl.	red. cyl. 6. 9.	— —	1806.	G. ♂.	
carnea. L.	flesh-coloured.	4, smth. Stig. & Anth. excl.	car. ov. obl. 1. 8.	German.	1763.	H. ♂.	
<i>β herbæua</i> . herbaceous.							
carneola. H.E.W.	fle-h-tinged.	3, smth. Sty. sub-ex. Anth. inc.	p. red. ov. obl. 5. 8.	C. B. S.	1816.	G. ♂.	
caesia. Wend. H.	grey.	3, smth. Sty. & Anth. excl.	w. bell-sh. —	— —	—	
Celsiana. A.H.	Cels's.	3, Sty. excl. Anth. incl.	r. pur. bell-sh. 4. 7.	— —	1820.	G. ♂.	
cerinthoides. B.M.	Honeywort.	5-6, pubes. Sty. & Anth. incl.	red. obl. 5. 9.	— —	1774.	G. ♂.	
1. <i>måjor</i> . large. red. obl. — — — — 1800. G. ♂.							
2. <i>minor</i> . small. red. obl. — — — — — G. ♂.							
3. <i>nåna</i> . dwarf. red. obl. — — — — — G. ♂.							
cérnuu. H.K.	drooping.	3-4, smth. Sty. & Anth. incl.	p. red. glob. ov. 8. 12.	— —	1791.	G. ♂.	
ciliata.	ciliated-leaved.	3, ciliate. Sty. & Anth. incl.	p. red. bell-sh. 5. 8.	— —	1830.	G. ♂.	
ciliaris. B.M.	ciliated.	3, ciliat. Sty. excl. Anth. incl.	pk. ovate. 7. 9.	Britain.	H. ♂.	
cinerea. E.B.	fine-leaved.	3, smth. Sty. excl. Anth. incl.	pur. ov. 6. 9.	— —	H. ♂.	
1. <i>ålba</i> . white-flowered. wh. — — — — H. ♂.							
2. <i>atropurpårea</i> . dark-purple. d. pur. ov. — — — — H. ♂.							
3. <i>råbra</i> . red. red. ov. — — — — H. ♂.							
cistifolia. H.E.W.	Cistus-leaved.	4, ciliat. Sty. & Anth. excl.	wh. bell-sh. 5. 8.	C. B. S.	1799.	G. ♂.	
<i>barbåta</i> . β <i>minor</i> . A.H.							
clavæflora. H.K.	club-flowered.	4-5, smth. Sty. excl. Anth. incl.	gr. club-sh. 8. 10.	— —	—	G. ♂.	
<i>sessiliflora</i> . A.H. non L.							
clavata. A.H.	clubbed.	3, smth. Sty. & Anth. excl.	gr. club-sh. —	— —	1812.	G. ♂.	
Cliffordiana. H.E.W. L. de Clifford's.		4, smth. Sty. & Anth. incl.	wh. tub. 4. 5.	— —	—	G. ♂.	
coccinea. A.H.	scarlet.	6, inc. smth. Sty. excl. Ant. sub-excl.	sc. cyl. 1. 12.	— —	1783.	G. ♂.	
cólorans. H.E.W.	changing-col'd.	4, vill. Sty. sub-exc. Ant. incl.	w. re. club-sh. 1. 6.	— —	1812.	G. ♂.	
comosa. H.K.	tufted.	4, smth. Sty. & Anth. incl.	re. w. ov. vent. 4. 8.	— —	1787.	G. ♂.	
1. <i>ålba</i> . white-flowering. wh. ov. vent. — — — — — G. ♂.							
2. <i>råbra</i> . red-flowering. red. ov. vent. — — — — 1787. G. ♂.							

Systematic Name.	English Name.	No. of Leaves in a whorl.	Col. & Form of Flower.	Month of Fl.	Native Country.	Yr. of Introd.	
complanáta. H. E. W.	flat flowered.	3, smth. Sty. & Anth. incl.	red. w. bell-sh.	4. 8.	C. B. S.	1821.	G. G.
Comptoniána. A. H.	M. of Northamp.	3, smth. Sty. & Anth. incl.	red. pitch-sh.	—	—	1820.	G. G.
concáva. B. C.	concave.	3, smth. Sty. & Anth. excl.	pur. bell-sh.	2. 5.	—	1898.	G. G.
conférta. B. C.	crowded-flow'd.	4, smth. Sty. & Anth. excl.	wh. glob.	10. 2.	—	1800.	G. G.
cónica. B. C.	conical.	5, smth. Sty. sub-excl. Anth. incl.	re. bell-sh.	5. 8.	—	1820.	G. G.
congésa. Wend. E.	cluster-flower'd.	5, ciliat. Sty. excl. Anth. incl.	wh. bell-sh.	—	—	1812.	G. G.
concína. A. H.	blush.	6, nearly smth. Sty. & Anth. excl.	bh. cyl.	7. 10.	—	1773.	G. G.
constántia. H. E. W.	constant-flow'd.	3, smth. Sty. & Anth. excl.	wh. bell-sh.	5. 8.	—	1810.	G. G.
conspícua. H. K.	conspicuous.	4, smth. Sty. & Anth. excl.	yel. club-sh.	—	—	1774.	G. G.
cordáta. A. H.	heart-leaved.	3, ciliat. Sty. & Anth. excl.	wh. bell-sh.	4. 7.	—	1799.	G. G.
coronáta. A. H.	coronate-fl'd.	8, smth. obt. Sty. & Anth. incl.	red. gr. cyl.	4. 5.	—	1787.	G. G.
<i>fasciculáris. H. K. radiiflóra. L. T.</i>							
corifólia. H. E. W.	coris-leaved.	4, smth. Sty. & Anth. incl.	wh. ov.	2. 5.	—	1821.	G. G.
costáta. A. H.	ribbed-flower'd.	3, smth. Sty. sub-excl. Anth. incl.	re. gr. tub.	2. 6.	—	1795.	G. G.
<i>β</i> <i>superba.</i>	<i>superb.</i>	bh. tub.	4. 5.	—	1820.	G. G.
Coventryána. B. C.	Lad. Coventry's.	4, nearly smth. Sty. & Anth. incl.	ros. tub.	5. 6.	—	1808.	G. G.
crináta. B. C.	long-haired.	3-4, hairy. Sty. & Anth. incl.	pur. red. cyl.	—	—	1825.	G. G.
cruénta. A. H.	bloody-flower'd.	3, smth. Sty. excl. Anth. sub-excl.	red. tub.	9. 5.	—	1774.	G. G.
crucifórmis. A. H.	cross-like.	4, smth. Sty. & Anth. incl.	yel. jar-sh.	6. 7.	—	1800.	G. G.
crassifólia. A. H.	thick leaved.	3, smth. glau. Sty. sub-ex. An. inc.	ro. bel-sh.	5. 6.	—	1826.	G. G.
cúbica. A. H.	cube-flowered.	4-5, smth. Sty. excl. Anth. incl.	re. bell-sh.	4. 7.	—	1790.	G. G.
<i>mínor.</i>	<i>lesser.</i>	red. bell-sh.	—	—	—	G. G.
Cushiniána. Lee.	Cushin's.	3, smth. Sty. excl. Anth. incl.	pk. bell-sh.	7. 10.	—	1816.	G. G.
curviflóra. A. H.	curve-flowered.	4, smth. Sty. & Anth. excl.	yel. cyl.	—	—	1774.	G. G.
1. <i>aurántia.</i>	<i>orange.</i>	or. cyl.	—	—	—	G. G.
2. <i>rúbra.</i>	<i>red.</i>	red. cyl.	—	—	—	G. G.
cupressína. H. E. W.	Cypress-like.	4, smth. Sty. & Anth. incl.	p. red. glob.	4. 6.	—	1800.	G. G.
cylíndrica. H. E. W.	cylindrical-fl'd.	4, pubes. Sty. excl. Anth. incl.	pur. red. cyl.	3. 5.	—	1810.	G. G.
daphnæflóra. B. C.	Daphne-flow'd.	4, smth. Sty. & Anth. incl.	bh. ov. acute.	4. 5.	—	1791.	G. G.
daphnóides. B. C.	Daphne-like.	4, smth. Sty. excl. Anth. incl.	ros. ov. vent.	—	—	—	G. G.
decóra. A. H.	graceful.	6, smth. Sty. & Anth. incl.	red. bell-sh.	11. 1.	—	1790.	G. G.
declináta. H. E. W.	declinate.	4, smth. Sty. excl. Anth. incl.	pur. bell-sh.	9. 10.	—	1820.	G. G.
defléxa. H. E. W.	deflex-flower'd.	3, smth. Sty. excl. Anth. incl.	wh. bell-sh.	5. 8.	—	1812.	G. G.
demíssa. H. E. W.	dwarf.	3, smth. Sty. & Anth. excl.	gr. yel. cyl.	—	—	1810.	G. G.
dénsa. A. H.	dense.	3, smth. Sty. & Anth. incl.	bh. cyl.	—	—	—	G. G.
denticuláta. H. E. W.	tooth-cupped.	4, smth. Sty. excl. Anth. incl.	yel. wh. glob.	3. 8.	—	1811.	G. G.
<i>β</i> <i>moscháta.</i>	<i>musk-scented.</i>	yel. wh. glob.	—	—	—	G. G.
depréssa. A. H.	depressed.	4, smth. Sty. excl. Anth. incl.	yel. cyl.	6. 8.	—	1789.	G. G.
Dickensoniána. B. C.	Mr. Dickenson's.	3, smth. Sty. & Anth. incl.	yel. cyl.	8. 5.	—	1819.	G. G.
díscolor. A. H.	discoloured.	3, smth. Sty. excl. Anth. incl.	bh. cyl.	10. 3.	—	1788.	G. G.
divaricáta. H. E. W.	various-growing.	3, smth. slen. Sty. sub-ex. Ant. in. ex.	w. bell-sh.	4. 5.	—	1800.	G. G.
<i>tenuis.</i>	<i>Salisb.</i>	—	—	—	—	—
droseróides. A. H.	Sun-dew-like.	alt. vill. Sty. excl. Anth. incl.	pur. glob.	7. 10.	—	1812.	G. G.
Douglassii.	Lady Douglass's.	4-5, smth. Sty. & Anth. incl.	car. cyl.	6. 7.	—	1830.	G. G.
<i>impúlsa.</i>	<i>Roll.</i>	—	—	—	—	—
echiiflóra. A. H.	Echium-flow'd.	5-6, smth. Sty. excl. Anth. incl.	red. tub.	2. 7.	—	1798.	G. G.
1. <i>purpúrea.</i>	<i>purple.</i>	pur. tub.	—	—	1812.	G. G.
2. <i>superba.</i>	<i>superb.</i>	sc. tub.	—	—	1825.	G. G.
eláta. H. K.	tall.	4-5, smth. Sty. & Anth. excl.	yel. tub.	7. 9.	—	1790.	G. G.
élegans. B. M.	elegant.	3, smth. Sty. & Anth. incl.	pk. vent.	11. 5.	—	1799.	G. G.
emargináta. A. H.	hairy-cupped.	3, smth. Sty. excl. Anth. incl.	wh. bell-sh.	6. 10.	—	1800.	G. G.
empetrifólia. B. M.	crowberry-fl'd.	7, pilos. Sty. excl. Anth. incl.	red. ov.	4. 7.	—	1774.	G. G.
empetroídes. A. H.	cranberry-fl'd.	6, pub. Sty. excl. Anth. incl.	pk. ov.	5. 8.	—	1788.	G. G.

Systematic Name.	English Name.	No. of Leaves in a whorl.	Col.&Form of Flower.	Month of Fl.	Native Country.	Yr. of Introd.
epistómia. B.C.	spout-flowered.	4, smth. Sty. & Anth. incl.	yel. obl.	5. 8.	C. B. S.	1800. G. 99.
erubéscens. A.H.	reddish-flow'd.	4, vill. Sty. excl. Anth. incl.	bh. cyl.	3. 8.	—	— G. 99.
eriocéphala. B.C.	woolly-headed.	3, vill. Sty. &c. excl.	pk.wh.ov.glob.	6. 8.	—	1816. G. 99.
Ewerána. H.K.	Ewer's.	3, smth. Sty. excl. An. incl.	re.g. club-sh.	7. 11.	—	1793. G. 99.
1. glábra,	smooth-leaved.	re.g. club-sh.	—	—	— G. 99.
2. pilósa,	pilose-leaved.	re.g. club-sh.	—	—	— G. 99.
exímia. B.C.	choice.	3, cil. Sty. & Anth. incl.	pk.gr.obl.	3. 9.	—	1811. G. 99.
exsérta. L.C.	exserted.	3, smth. Sty. & Anth. excl.	wh. bell-sh.	—	—	1820. G. 99.
exsúrgens. A.H.	quiver-formed.	4, smth. Sty. excl. Anth. incl.	or.re. cyl.	1. 12.	—	1792. G. 99.
β grandiflóra.	large-flowered.	or.re. cyl.	—	—	—
exsúdans. B.C.	perspiring.	4, vill. Sty. & Anth. excl.	pk. obl.	8. 10.	—	1810. G. 99.
expánsa.	expanded.	3-4, smth. Sty. & Anth. excl.	sc.	3. 9.	—	1811. G. 99.
expósita. B.C.	exposed.	4, vill. Sty. excl. Anth. incl.	pu.re. cyl.	8. 9.	—	1820. G. 99.
fastigiáta. H.E.W.	crowded-flow'd.	4, smth. Sty. & Anth. incl.	blh. vent.	2. 7.	—	1792. G. 99.
ferrugínea. A.H.	rusty.	4, pilose. Sty. & Anth. incl.	blh. tub.	5. 7.	—	1798. G. 99.
fí'bula. L.en.	button-flow'r'd.	4, smth. Sty. excl. Anth. incl.	re. glob.	5. 6.	—	1812. G. 99.
filamentósa. H.K.	long-peduncled.	6, smth. Sty. excl. Anth. incl.	re. bell-sh.	1. 12.	—	1800. G. 99.
filifórmis. L.T.	filiform.	3, vill. Sty. & Anth. incl.	red.	2. 5.	— G. 99.
fimbriáta. A.H.	fringed.	3, edg. cilia. Sty. & Anth. incl.	re. glob.	3. 7.	—	1800. G. 99.
fláccida. L.en.	flaccid.	3, vill. Sty. excl. Anth. incl.	wh. glob.	7. 11.	—	1810. G. 99.
lanáta. A.H.						
flagellifórmis. A.H.	whipcord-like.	3, smth. Sty. & Anth. incl.	re. vent.	—	—	1812. G. 99.
láva. H.K.	yellow.	3, smth. Sty. excl. Anth. sub-excl.	ye. ov.	9. 4.	—	1795. G. 99.
flammea. A.H.	flame-coloured.	4, smth. Sty. & Anth. excl.	ye. tub.	10. 5.	—	1798. G. 99.
lexicáulis. H.K.	crooked-stalk.	4, cilia. Sty. sub-excl. An. incl.	red. ov.	5. 1.	—	1800. G. 99.
glandulósa. A.H.	nec aliorum.					
flexuósa. H.K.	flexuose.	3, smth. Sty. & Anth. excl.	wh. bell-sh.	4. 7.	—	1792. G. 99.
flórida. H.E.W.	florid.	4, vill. Sty. & Anth. incl.	pu. bell-sh.	5. 8.	—	1803. G. 99.
β moscháta.	musk-scented.					
loribúnda. H.E.W.	many-flower'd.	3, smth. Sty. excl. Anth. incl.	lil. bell-sh.	11. 3.	—	1800. G. 99.
foliácea. A.H.	foliaceous.	4, smth. Sty. & Anth. incl.	yel. cyl.	5. 7.	—	1822. G. 99.
folliculáris. H.K.	yellow-pencil'd.	3, smth. Sty. & Anth. excl.	yel. club-sh.	2. 7.	—	1794. G. 99.
Peticeriána. A.H.						
ormósa. H.E.W.	shewy.	7-8, smth. Sty. & Anth. excl.	red. cyl.	3. 8.	—	1795. G. 99.
1. álba.	white-flowering.	wh. cyl.	—	—	— G. 99.
2. rúbra.	red-flowering.	red. cyl.	—	—	— G. 99.
rágrans. B.M.	fragrant.	3, smth. Sty. & Anth. excl.	lil. bell-sh.	3. 7.	—	1803. G. 99.
urfurósa. H.K.	columnar-threaded.	3, smth. Sty. & Anth. excl.	red. tub.	8. 12.	—	1789. G. 99.
monadélpha. A.H.						
élida. H.K.	green-verticillate.	4-6, smth. Sty. & Anth. incl.	gr. cyl.	4. 7.	—	1790. G. 99.
emmifera. B.M.	jewel-like.	4-5, pubes. Sty. & Anth.	pu. red. cyl.	7. 10.	—	1802. G. 99.
lomeráta. A.H.	glomerate-fl'g.	3, smth. Sty. excl. Anth. incl.	lil. bell-sh.	7. 9.	—	1812. G. 99.
lobósa. A.H.	globose.	3, smth. Sty. & Anth. incl.	red. glob.	—	—	1789. G. 99.
láuca. A.H.	glaucous-leav'd.	3, glau. sm. Sty. & An. inc.	pu. ven. cone-sh.	5. 8.	—	1792. G. 99.
fordónia.	Duchs. of Bedford's.	3, smth. Sty. & Anth. incl.	wh. glob.	—	—	1830. G. 99.
rácilis. H.K.	slender.	4, smth. Sty. & Anth. incl.	red. glob.	2. 6.	—	1794. G. 99.
randiflóra. A.H.	large-flower'd.	4, smth. Sty. & Anth. excl.	yel. or. cyl.	5. 9.	—	1775. G. 99.
1. humilis.	dwarf.	yel. or. cyl.	—	— G. 99.
2. supérba.	superb.	yel. or. cyl.	—	— G. 99.
randinósa. B.C.	hailstone-like.	3, smth. Sty. & Anth. incl.	wh. glob.	—	—	1820. G. 99.
alicácaba. A.H.	bladder-flow'd.	3, smth. Sty. & Anth. incl.	wh. yel. vent.	5. 8.	—	1780. G. 99.
Hartnellii.	Hartnell's.	4, pubes. Sty. & Anth. incl.	red. pur. cyl.	5. 6.	—	1826. G. 99.

Systematic Name.	English Name.	No. of Leaves in a whorl.	Col.&Form of Flower.	Month of Fl.	Native Country.	Yr. of Introd.	
Hibbertiána. A.H.	Mr. Hibbert's	6, smth.	Sty.&Anth.excl.	cr.gr.cyl. 6.	9. C. B. S.	1800.	G. 99.
hírta. H.E.W.	hairy-leaved.	3, hairy.	Sty.excl. Anth.incl.	red.gr.cyl. 4.	7. ———	1795.	G. 99.
hispidula. W.	bristly-stemm'd.	3, revol.	Sty.excl. Anth.incl.	pa.re.glob. 6.	8. ———	1791.	G. 99.
hispidá. A.H.	hispid.	4, hisp.	Sty.&Anth.excl.	pu.red.glob. 7.	9. ———	—	G. 99.
horizontalis. A.H.	horizontal-l'd.	4, smth.	Sty.&Anth.excl.	wh.ov. —	—	1800.	G. 99.
Humeána. B.C.	Sir A. Hume's	3-4, smth.	Sty.excl. Anth.incl.	pk.vent. 5.	7. ———	1808.	G. 99.
hyacinthoides. A.H.	hyacinth-flow'd.	4, smth.	Sty.excl. Anth.incl.	pk.vent. 6.	8. ———	1798.	G. 99.
hy'brida. H.E.W.	hybrid.	4, ciliat.	Sty.excl. Anth.incl.	pu.re.cyl.	—	—	—
ignéscens. H.K.	fiery.	4, smth.	Sty.&Anth.excl.	red.or.cyl. 3.	7. ———	1792.	G. 99.
imbecilla. H.E.W.	feeble.	4, smth.	Sty.&Anth.incl.	pk.obl.bell-sh. 6.	7. ———	1793.	G. 99.
imbricáta. B.C.	imbricated.	3, smth.	Sty.&Anth.excl.	wh.ov. 5.	8. ———	1796.	G. 99.
incána. Wend.	hoary.	4, hoary.	Sty.excl. Anth.incl.	re.wh.ov. —	—	1816.	G. 99.
incarnáta. A.H.	flesh-coloured.	4, smth.	Sty.excl. Anth.incl.	car.glob. —	—	1791.	G. 99.
infláta. W.	inflated.	3-4, ciliat.	Sty.&Anth.incl.	ros.vent. 5.	9. ———	1800.	G. 99.
infundibulifórmis. B.C.	funnel-fl'd.	3, smth.	Sty.&Anth.incl.	ro.wh.fun.-sh. —	—	1812.	G. 99.
intertéxta. B.C.	interwoven.	3, vill.	Sty.excl. An.sub.incl.	w.bell-sh. —	—	1810.	G. 99.
insúlsa. H.E.W.	ungraceful.	3, smth.	Sty.excl. An.incl.	ye.gr.cyl. 6.	7. ———	—	G. 99.
Irbyána. A.H.	Irby's	3, smth.	Sty.excl. An.incl.	blh.cyl.ven. 6.	10. ———	1800.	G. 99.
jasminifóra. A.H.	Jasmine-flow'd.	3, near.	smth.recu. Sty.&An.in.	w.cyl.ve. —	—	1794.	G. 99.
Juliána. B.C.	Julian's	4, smth.	Sty.excl. An.incl.	pu.re.ov.ven. 5.	10. ———	1812.	G. 99.
lachneáfólia. B.C.	Lachnæa-leav'd.	3, imb.	powd'y. Sty.excl. An.incl.	wh.ov. 5.	7. ———	1793.	G. 99.
lactifóra. B.C.	milk-coloured.	3, smth.	Sty.&Anth.incl.	wh.ov. —	—	1816.	G. 99.
læ'vis. A.H.	smooth.	4, smth.	Sty.&Anth.incl.	wh.bell-sh. 3.	6. ———	1790.	G. 99.
β álba.	white-flowering.	wh.bell-sh. —	—	—	G. 99.
Lambertiána. A.H.	Mr. Lambert's	3, smth.	Sty.excl. Anth.incl.	p.red.glob. 5.	8. ———	1800.	G. 99.
lanáta. Wend.	woolly.	4, woolly.	Sty.excl. Anth.incl.	or.y.tub. 4.	5. ———	1775.	G. 99.
lanuginósa. A.H.	brown woolly.	3, ciliat.	Sty.&Anth.incl.	br.ov. 9.	1. ———	1803.	G. 99.
laterális. A.H.	side-flowering.	4, smth.	Sty.excl. Anth.incl.	red.glob. 3.	7. ———	1791.	G. 99.
latifólia. A.H.	broad-leaved.	3, vill.	Sty.&Anth.incl.	red.glob. 5.	8. ———	1800.	G. 99.
Lawsóni. B.M.	Sir W. Lawson's	4, smth.	Sty.&Anth.incl.	red.cyl. 4.	7. ———	1802.	G. 99.
láxa. A.H.	loose-flowered.	3, smth.	Sty.excl. Anth.incl.	lil.bell-sh. 9.	2. ———	1800.	G. 99.
Lécána. A.H.	Mr. Lee's	6, smth.	Sty.excl. Anth.incl.	yel.tub. 8.	1. ———	1788.	G. 99.
leucántha. L.en.	white-blossom'd.	3, smth.	Sty.&Anth.incl.	wh.pitcher-sh. 1.	5. ———	1803.	G. 99.
leucánthéra. A.H. non L.
leucánthéra. W.	white-flowered.	3, smth.	Sty.sub-ex. Anth.incl.	w.bell-sh. 2.	6. ———	—	G. 99.
Linnæána. H.K.	Linnæus's	4, vill.	Sty.&Anth.incl.	pur.wh.cyl. 1.	5. ———	1790.	G. 99.
Linnæoídes. H.E.W.	Linnæa-like.	4, vill.	Sty.&Anth.incl.	pu.re.wh.cyl. —	—	1812.	G. 99.
hírsúta. B.C.
longiflóra. B.C.	long-flowered.	4-5, smth.	Sty.&Anth.excl.	yel.cyl. 4.	8. ———	G. 99.
longipedunculáta. B.C.	long-pedunc.	3, vill.	Sty.&Anth.excl.	pu.red.ov. 3.	8. ———	1818.	G. 99.
lúcida. A.H.	shining.	3, smth.	Sty.excl. Anth.incl.	pk.bell-sh. 4.	1. ———	1800.	G. 99.
lútea. A.H.	yellow.	2, opp.	smth. Sty.&Anth.incl.	ye.bell-sh. 2.	5. ———	1774.	G. 99.
β álba.	white-flowered.	wh.bell-sh. —	—	G. 99.
magnífica. A.H.	magnificent.	3, smth.	Sty.sub-ex. An.incl.	ros.ov. 4.	8. ———	1816.	G. 99.
mammósa. W.	nipple.	4, smth.	Sty.&Anth.incl.	pu.red.cyl. 7.	10. ———	1762.	G. 99.
1. pállida.	pale.	pa.cyl. —	—	—	G. 99.
2. purpúrea.	purple.	pur.cyl. —	—	—	G. 99.
margaritácea. H.K.	pearl-flowered.	4, smth.	Sty.excl. An.incl.	wh.bell-sh. 5.	9. ———	1775.	G. 99.
marifólia. A.H.	Marum-leaved.	3, ov.	pub. Sty.excl. An.incl.	wh.sub glob. 5.	7. ———	1773.	G. 99.
Massóni. H.K.	Masson's	4-5, hair.	Sty.excl. An.incl.	or.g.club-sh. 7.	10. ———	1762.	G. 99.
β rúbra.	red.	red.club-sh. —	—	1830.	G. 99.
mediterránea. B.M.	Mediterranean.	4, smth.	Sty.&Anth.excl.	red.ov. 3.	5. Portug.&Ireland.	H. 99.	

Systematic Name.	English Name.	No. of Leaves in a whorl.	Col.&Form of Flower.	Month of Fl.	Native Country.	Yr.of Introd.	
melanthéra. B.C.	dark-anthered.	3, smth. Sty.&Anth.excl.	lil.bell-sh.	6. 8.	C. B. S.	1803.	G. 99.
melástoma. A.H.	black-mouthed.	3, ciliat. Sty.&Anth.excl.	yel.cone-sh.	4. 7.	—	1795.	G. 99.
melliféra. H.E.W.	honey-bearing.	3, smth. Sty.&Anth.excl.	pur.bell-sh.	—	—	1816.	G. 99.
metulæflóra. H.K.	nine-pin-flow'd.	4-5, smth. Sty.&Anth.incl.	red.obl.tub.	6. 8.	—	1798.	G. 99.
β bicolor.	two-coloured.						
minutæflóra. A.H.	minute-flower'd.	4, smth. Sty.excl. Anth.incl.	pur.bell-sh.	5. 7.	—	1822.	G. 99.
mirábilis. A.H.	admirable.	4, smth. Sty.&Anth.incl.	ros.wh.vent.	3. 8.	—	—	G. 99.
modésta. H.E.W.	modest.	4, vill. Sty.&Anth.incl.	blh.glob.	—	—	—	G. 99.
móllis. A.H.	soft.	4, vill. Sty.&Anth.incl.	pur.glob.	4.10.	—	1816.	G. 99.
monadélpha. B.M.	monadelphous.	3, smth. Sty.&Anth.excl.	wh.p.cyl.	5. 7.	—	1789.	G. 99.
Bánksia β purpúrea. A.H.							
Monsónia. B.M.	Lady Monson's.	3, smth. Sty.sub-ex. An.incl.	wh.obl.	4. 9.	—	1787.	G. 99.
montána. H.E.W.	mountain.	3, smth. Sty.&Anth.incl.	wh.bell-sh.	—	—	1816.	G. 99.
moscháta. A.H.	musk.	3, whitish. Sty.excl. An.incl.	pk.bell-sh.	5. 7.	—	1805.	G. 99.
mucósa. H.K.	mucons.	4, smth. Sty.&Anth.incl.	pu.red.glob.	2. 4.	—	1787.	G. 99.
mucosoides. B.C.	mucous-like.	3-4, smth. Sty.&Anth.incl.	pur.glob.	3. 4.	—	1800.	G. 99.
mucronáta. A.H.	mucronate.	3, smth. Sty.excl. Anth.incl.	car.bell-sh.	4. 8.	—	1812.	G. 99.
multiflóra. A.H.	many-flowered.	4, smth. Sty.&Anth.excl.	p.re.bell-sh.	6.11.	France.	1731.	H. 99.
múndula. B.C.	neat.	4, vill. Sty.&Anth.incl.	pk.vent.	3. 8.	C. B. S.	1816.	G. 99.
Muscári. A.H.	musk.	4, smth. Sty.&Anth.incl.	st.yel.vent.	—	—	1790.	G. 99.
mutábilis. A.H.	changeable.	3-4, ciliat. Sty.&Anth.excl.	red.tub.	2.10.	—	1798.	G. 99.
nidulária. B.C.	nest-like-flow'g.	4, smth. Sty.excl. Anth.incl.	wh.bell-sh.	5. 8.	—	1816.	G. 99.
nígrita. A.H.	black-tipped.	3, smth. Sty.&Anth.excl.	wh.bell-sh.	3. 7.	—	1790.	G. 99.
nítida. H.K.	glossy.	3, smth. Sty.excl. Anth.incl.	wh.glob.	7.10.	—	1800.	G. 99.
nítens. H.E.W.	garnished.	4, pilo. Sty.excl. An.incl.	pu.gr.club-sh.	6. 9.	—	1810.	G. 99.
Nívéní. H.K.	Niven's.	3, ciliat. Sty.&Anth.excl.	red.cyl.	2. 7.	—	1799.	G. 99.
nívea. H.E.W.	white-flowered.	3, smth. Sty.excl. Anth.incl.	wh.bell-sh.	5. 9.	—	1816.	G. 99.
holæflóra. L.T.	bell-shaped.	3, smth. Sty.excl. Anth.incl.	wh.bell-sh.	2. 5.	—	—	G. 99.
rudiflóra. w.	naked-flowered.	3, ciliat. Sty.&Anth.excl.	red.ov.cyl.	7. 8.	—	1783.	G. 99.
1. glábra.	smooth.	red.ov.cyl.	—	—	—	G. 99.
2. hirsúta.	hairy.	red.ov.cyl.	—	—	—	G. 99.
obbáta. A.H.	bottle-shaped.	4, pilo. Sty.excl. An.incl.	re.w.glo.vent.	4. 7.	—	1796.	G. 99.
β umbelláta.	unbel-flow'd.	re.w glo.vent.	—	—	—	G. 99.
oblónga. H.E.W.	oblong-flower'd.	4, vill. Sty.&Anth.incl.	red.pur.obl.	—	—	—	G. 99.
oblíqua. A.H.	oblique-leaved.	4, smth. Sty.&Anth.incl.	pur. glob.	8.10.	—	1789.	G. 99.
obtúsa. B.C.	obtuse-leaved.	3, smth. Sty.&Anth.incl.	pk.bell-sh.	5. 8.	—	1816.	G. 99.
odoráta. A.H.	odorate.	4, clammy. Sty.excl. An.incl.	wh.bell-sh.	4. 7.	—	1804.	G. 99.
ollula. A.H.	close-mouthed.	4, smth. Sty.&Anth.incl.	p.re.ov.glob.	—	—	1812.	G. 99.
Onosmæflóra. L.T.	Onosma-flow'd.	6, smth. Sty.sub-ex. An.incl.	yel.cyl.	9. 5.	—	1789.	G. 99.
glutinósa. A.H.							
ppositifólia. A.H.	opposite.	2, smth. Sty.&Anth.incl.	wh.pitcher-sh.	3. 5.	—	1804.	G. 99.
1. áiba.	white-flowered.	wh.	—	—	—	G. 99.
2. rúbra.	red-flowered.	red.	—	—	—	G. 99.
váta. B.C.	ovate.	4, vill. Sty.&Anth.incl.	pur.ov.	2. 5.	—	1791.	G. 99.
strína. B.C.	purple.	5-6, smth. Sty.excl. Anth.incl.	pk.cyl.	6.11.	—	1820.	G. 99.
állens. A.H.	pale.	3, vill. Sty.excl. Anth.incl.	wh.yel.	3. 8.	—	1812.	G. 99.
alástris. A.H.	marsh.	4, pub. Sty.excl. Anth.incl.	blh.bell-sh.	5.10.	—	1799.	G. 99.
aniculáta. B.C.	panicled.	3, smth. Sty.&Anth.incl.	pur.ov.vent.	2. 8.	—	1774.	G. 99.
Parmentíera. B.C.	Parmentier's.	4, smth. Sty.excl. Anth.	pu.re.ov.cyl.	5. 8.	—	1816.	G. 99.
β rósea.	rose-coloured.	ros.ov.cyl.	—	—	—	G. 99.
arvíflóra. L.T.	small fl'd.-down.	3, vill. Sty.&Anth.incl.	p.red.bell-sh.	3. 9.	—	1790.	G. 99.
aténs. A.H.	spreading.	3, cil. Sty.excl. An.sub-ex.	pu.bell-sh.	3. 6.	—	1800.	G. 99.

Systematic Name.	English Name.	No. of Leaves in a whorl.	Col. & Form of Flower.	Month of Fl.	Native Country.	Yr. of Introd.	
Patersóni, H.K.	Paterson's.	4, smth. Sty. sub-excl.	An. incl. <i>ye. cyl.</i>	3. 8.	C. B. S.	1791.	G. sp.
β <i>máior</i> .	<i>large</i> .						
Patersonia coccínea, H.E.W.	Patersonia-lik.	5-6, smth. Sty. ex.	An. incl. <i>or. red. cyl.</i>	4. 8.	—	1800.	G. sp.
<i>Patersónia coccínea</i> , A.H.							
pedunculáta, A.H.	peduncled.	4, pilose. Sty. & Anth. incl.	<i>red. bell-sh.</i>	5. 9.	—	—	G. sp.
pellúcida, A.H.	pellucid.	4, hairy. Sty. & Anth. incl.	<i>wh. tub.</i>	10. 6.	—	—	G. sp.
β <i>rábra</i> .	<i>red</i> .					1806.	G. sp.
peltáta, A.H.	peltate-stigm'd.	3, smth. Sty. & Anth. excl.	<i>pu. gr. bell-sh.</i>	4. 8.	—	1804.	G. sp.
péndula, B.C.	pendulous.	4, smth. Sty. & Anth. incl.	<i>pur. ov. glob.</i>	7. 8.	—	1791.	G. sp.
penicilláta, A.H.	pencilled.	3, smth. Sty. & Anth. excl.	<i>pur. cone-sh.</i>	4. 7.	—	1774.	G. sp.
persolúta, B.M.	garland.	4, smth. Sty. & Anth. incl.	<i>red. bell-sh.</i>	2. 5.	—	—	G. sp.
β <i>álba</i> .	<i>white-flowered</i> .						
perláta, H.E.W.	full-flowered.	4, smth. Sty. & Anth. excl.	<i>pur. red. glob.</i>	3. 8.	—	1810.	G. sp.
perspícua, H.K.	clear-flowered.	3, vill. Sty. sub-excl.	Anth. incl. <i>wh. cyl.</i>	3. 6.	—	1790.	G. sp.
β <i>nána</i> .	<i>dwarf</i> .						
perspicuoides, H.E.W.	perspicua-lik.	4, vill. Sty. & Anth. incl.	<i>p. red. cyl.</i>	5. 6.	—	1800.	G. sp.
petioláta, A.H.	rosemary-leav'd.	3, smth. Sty. & Anth. excl.	<i>wh. bell-sh.</i>	3. 7.	—	1774.	G. sp.
Petiveriána, H.K.	Petiver's.	3, smth. Sty. & Anth. excl.	<i>yel. club-sh.</i>	—	—	—	G. sp.
β <i>aurántia</i> , A.H.	<i>orange-fl'd</i> .						
Peziza, B.C.	woolly-flower'd.	3, smth. Sty. & Anth. incl.	<i>wh. glob.</i>	5. 8.	—	G. sp.
<i>nivális</i> , A.H.							
phylicoides, W.	Phylica-like.	3, smth. Sty. & Anth. incl.	<i>w. pitcher-sh.</i>	4. 7.	—	1800.	G. sp.
physódes, H.K.	bird-lime.	4, smth. Sty. & Anth. incl.	<i>wh. ov. glob.</i>	3. 7.	—	1788.	G. sp.
pícta, B.C.	painted.	4, vill. Sty. & Anth. excl.	<i>wh. yel. cyl.</i>	—	—	1800.	G. sp.
pilósa, B.C.	pilose.	3-4, pilose. Sty. & Anth. excl.	<i>gr. ye. bell-sh.</i>	—	—	—	G. sp.
piluláris, B.C.	pill-flowered.	3, smth. Sty. & Anth. incl.	<i>wh. glob.</i>	3. 5.	—	1820.	G. sp.
pinea, s.s.	Pine-like.	6, smth. Sty. excl. Anth. incl.	<i>wh. cyl.</i>	4. 5.	—	1790.	G. sp.
1. <i>favoides</i> .	<i>honeycomb-like</i>	<i>pa. red. cyl.</i>	—	—	1829.	G. sp.
2. <i>purpúrea</i> , L.C.	<i>purple-flower'd</i>	<i>pur. cyl.</i>	—	—	1806.	G. sp.
3. <i>pulchélla</i> .	<i>pretty</i>	<i>red. cyl.</i>	—	—	1828.	G. sp.
pinifólia, A.H.	Pine.	6-8, sub-pubes. Sty. excl. Anth. incl.	<i>w. cyl.</i>	6. 12.	—	—	G. sp.
1. <i>coccínea</i> .	<i>scarlet-flower'd</i>	<i>sc. cyl.</i>	—	—	—	G. sp.
2. <i>discolor</i> .	<i>two-coloured</i>	<i>red. wh. cyl.</i>	—	—	1820.	G. sp.
3. <i>spirális</i> .	<i>spiral-leaved</i>	<i>wh. pur. cyl.</i>	—	—	—	G. sp.
planifólia, A.H.	flat-leaved.	3, vill. Sty. & Anth. excl.	<i>pur. pitcher-sh.</i>	—	—	—	G. sp.
Plukenetiána, H.K.	Plukenet's.	3, smth. Sty. & Anth. incl.	<i>sc. or. cone-sh.</i>	4. 7.	—	1774.	G. sp.
1. <i>álbens</i> , A.H.	<i>white-flowered</i>	<i>yel. wh. cone-sh.</i>	—	—	—	G. sp.
2. <i>pállida</i> .	<i>pale-flowered</i>	<i>pale. cone-sh.</i>	—	—	—	G. sp.
præ'cox, B.C.	early dwarf.	3-4, ciliat. Sty. excl. Anth. sub-excl.	<i>pu. glo.</i>	2. 5.	—	1805.	G. sp.
præ'gnans, A.H.	swelled-neath.	4, ciliat. Sty. & Anth. incl.	<i>bh. vent.</i>	5. 7.	—	1796.	G. sp.
β <i>coccínea</i> .	<i>scarlet</i>	<i>sc. vent.</i>	—	—	—	G. sp.
præ'stans, A.H.	excelling.	4, smth. Sty. excl. Anth. incl.	<i>wh. vent.</i>	—	—	—	G. sp.
primuloides, A.H.	Primula-flow'd.	5, smth. Sty. excl. Anth. incl.	<i>red. ov.</i>	4. 7.	—	1802.	G. sp.
princeps, A.H.	princely.	4, ciliat. Sty. & Anth. incl.	<i>pk. vent.</i>	—	—	1800.	G. sp.
β <i>cárnea</i> .	<i>flesh-coloured</i>					
procumbens, H.E.W.	procumbent.	3, vill. Sty. & Anth. excl.	<i>p. red. glob.</i>	—	—	1816.	G. sp.
propéndens, B.M.	pendent.	4, pubes. Sty. excl. Anth. incl.	<i>pur. bell-sh.</i>	7. 8.	—	1800.	G. sp.
pubéscens, H.K.	downy.	4, pubes. Sty. & Anth. incl.	<i>p. red. glob.</i>	2. 12.	—	1790.	G. sp.
1. <i>máior</i> .	<i>larger</i> .						
2. <i>mínor</i> .	<i>smaller</i> .						
3. <i>vérna</i> .	<i>spring</i> .						
pulchélla, W.	neat.	3, smth. Sty. & Anth. incl.	<i>red. glob.</i>	3. 8.	—	1812.	G. sp.

Systematic Name.	English Name.	No. of Leaves in a whorl.	Col.&Form of Flower.	Month of Fl.	Native Country.	Yr. of Introd.	
pulvérulenta. B.C.	powdery.	3, white.	Sty. & Anth. incl.	wh.ov.	3. 8.	C. B. S.	1820. G. ♂.
púmila. A.H.	dwarf.	3, smth.	Sty. & Anth. incl.	car. cyl.	— — — —	— — — —	1812. G. ♂.
púra. B.C.	clear.	3, smth.	Sty. & Anth. excl.	wh.pk.glob.	— — — —	— — — —	G. ♂.
purpúrea. A.H.	purple-flower'd.	6-7, smth.	Sty. & Anth. excl.	pur.cyl.	1. 12.	— — — —	1789. G. ♂.
pyramidális. B.M.	pyramidal.	4, smth.	Sty. sub-excl. An. incl.	bh. bell-sh.	6. 7.	— — — — G. ♂.
pyrolæflóra. L.T.	pyrola-flower'd.	3, smth.	Sty. & Anth. incl.	wh.glob.	5. 7.	— — — —	1790. G. ♂.
andromedæflóra álba. A.H.							
pygmæ'a. H.E.W.	dwarf-purple.	3, smth.	Sty. & Anth. incl.	pur. bell-sh.	7. 10.	— — — —	1806. G. ♂.
quadranguláris. A.H.	square-tubed.	numer.	smth. Sty. & Anth. incl.	car. wh. tub.	5. 8.	— — — —	1812. G. ♂.
erósa. B.C.							
radiáta. A.H.	rayed.	4, smth.	Sty. excl. Anth. incl.	red. cyl.	8. 11.	— — — —	1798. G. ♂.
β discolor.	two-coloured.	wh. red. cyl.	— — — —	— — — —	1820. G. ♂.
racemifera. A.H.	compact-flow'd.	6, smth.	Sty. & Anth. incl.	pur. glob.	4. 6.	— — — —	1803. G. ♂.
ramentácea. H.K.	slend.-branch'd.	4, smth.	Sty. sub-excl. Anth. incl.	pur. glob.	7. 12.	— — — —	1786. G. ♂.
recurváta. B.C.	recurved-flow'd.	6, smth.	Sty. excl. Anth. incl.	wh. ov. obl.	5. 8.	— — — —	1812. G. ♂.
refléxa. H.E.W.	reflexed.	3, smth.	Sty. excl. Anth. incl.	wh. glob. vent.	— — — —	— — — — G. ♂.
β rábra.	red-flowered.	red. glob. vent.	— — — —	— — — — G. ♂.
refúlgens. A.H.	refulgent.	4, smth.	Sty. excl. Anth. incl.	ros. gr. cyl.	5. 9.	— — — —	1816. G. ♂.
regériminans. A.H.	twice-flowering.	4, smth.	Sty. & Anth. incl.	lil. bell-sh.	5. 8.	— — — —	1791. G. ♂.
β álba.	white-flowered.	wh. bell-sh.	— — — —	— — — —	G. ♂.
retórta. H.K.	recurved-leav'd.	4, ciliat.	Sty. excl. Anth. incl.	pur. red. tub.	— — — —	— — — —	1787. G. ♂.
rígida. B.C.	rigid.	3-4, rigid.	Sty. & Anth. incl.	pk. wh. cyl.	— — — —	— — — —	1820. G. ♂.
Rollissónia. H.E.W.	Rollisson's.	10, recurv.	smth. Sty. & Anth. incl.	r. bh. tub.	— — — —	— — — —	1823. G. ♂.
rósea. A.H.	rose-coloured.	5-6, sub-ciliat.	Sty. excl. Anth. incl.	ros. cyl.	6. 10.	— — — —	1798. G. ♂.
róstella. H.E.W.	small-beaked.	3, Sty. & Anth. excl.		wh. ov. glob.	4. 6.	— — — —	1810. G. ♂.
rubélla. B.M.	reddish.	3, smth.	Sty. & Anth. incl.	red. ov. vent.	5. 8.	— — — —	1812. G. ♂.
rúbens. A.H.	red-flowered.	4, smth.	Sty. excl. Anth. incl.	pur. red. glob.	6. 9.	— — — —	1798. G. ♂.
rúbida. B.C.	red-calyxed.	4, smth.	Sty. & Anth. incl.	red. v. obl.	— — — —	— — — —	1825. G. ♂.
rúber-cályx. A.H.	rúbra sepála.	Swt.					
rugósa. A.H.	wrinkled-flow'd.	3-4, smth.	Sty. & Anth. excl.	red. tub.	— — — —	— — — —	1812. G. ♂.
rupéstris. A.H.	rock.	3, smth.	Sty. sub-excl. Anth. incl.	w. bell-sh.	— — — —	— — — —	1789. G. ♂.
Russeliána. A.H.	D. of Bedford's.	4, smth.	Sty. & Anth. incl.	ros. ov. glob.	6. 9.	— — — —	1824. G. ♂.
Sainsburyána. A.H.	Sainsbury's.	3, smth.	Sty. & Anth. incl.	pk. ov. obl.	7. 9.	— — — —	1804. G. ♂.
Salisburyána. A.H.	Salisbury's.	6-8, Sty. excl.	Anth. incl.	sc. club-sh.	5. 9.	— — — —	1815. G. ♂.
sanguínea. B.C.	bloody.	4, smth.	Sty. excl. Anth. sub-excl.	cr. cyl.	3. 8.	— — — — G. ♂.
Savileána. B.C.	C. of Scarboro'.	4, nearl.	smth. Sty. & Anth. incl.	re. glob. obl.	6. 7.	— — — —	1800. G. ♂.
scabriúscula. B.C.	roughish.	4, vill.	Sty. & Anth. incl.	wh. ov.	— — — —	— — — —	1810. G. ♂.
scariósa. B.C.	scariose.	3, smth.	muc. sub-excl. Ant. incl.	w. bell-sh.	— — — —	— — — —	G. ♂.
Schöllii. B.C.	Scholl's.	2, smth.	Sty. & Anth. incl.	pur. bell-sh.	5. 9.	— — — —	1790. G. ♂.
scopária. W.	broom.	3, smth.	Sty. & Anth. incl.	gr. bell-sh.	4. 5.	S. Europ.	1770. H. ♂.
β mínima.	lesser.						
Sebanæoides.	Seban-like.	crowd.	smth. Sty. & Anth. excl.	w. ov. small.	— — — —	C. B. S.	1830. G. ♂.
Sebána. A.H.	Seba's.	3, smth.	Sty. & Anth. excl.	red. cyl. curv.	3. 6.	— — — —	1774. G. ♂.
1. lútea.	yellow-flowered.	yel. cyl. curv.	— — — —	— — — —	G. ♂.
2. mínor.	lesser.	or. cyl. curv.	— — — —	— — — —	G. ♂.
serpyllifólia. B.C.	Serpyllum-lv'd.	3, vill.	Sty. excl. Anth. incl.	lil. bell-sh.	5. 8.	— — — —	1812. G. ♂.
serratifólia. A.H.	saw-leaved.	4, rigid.	Sty. excl. Anth. sub-excl.	gr. ye. cyl.	8. 12.	— — — —	1790. G. ♂.
serruláta. H.E.W.	serrulate-leav'd.	2-4, serrul.	Sty. excl. Anth. incl.	yel. bell-sh.	6. 8.	— — — —	1814. G. ♂.
setácea. A.H.	bristly-leaved.	3, bristly.	Sty. excl. Anth. incl.	blh. glob.	2. 8.	— — — —	1796. G. ♂.
sexfária. A.H.	six-angled.	3, smth.	Sty. & Anth. excl.	wh. ov.	5. 8.	— — — —	1774. G. ♂.
Shannoniána. A.H.	Earl Shannon's.	3, ciliat.	Sty. & Anth. incl.	blh. vent.	6. 7.	— — — —	1800. G. ♂.
Smithiána. H.E.W.	Sir J. E. Smith's.	4, smth.	Sty. & Anth. incl.	red. glob.	3. 7.	— — — —	1810. G. ♂.

Systematic Name.	English Name.	No. of Leaves in a whorl.	Col.&Form of Flower.	Month of Fl.	Native Country.	Yr.of Introd.	
socciflora. L.T.	green-pencilled.	3, smth. Sty. & Anth. excl.	gr.yel.	4. 5.	C. B. S.	1799.	G. ♀♀.
Solándri. A.H.	Solander's.	4-5, hair. Sty. exc. An. sub-inc.	pur.r.be.-sh.	3. 9.	—	1800.	G. ♀♀.
sórdida. H.K.	sordid-flow'g.	4, vill. Sty. & Anth. excl.	or.cyl.	8. 5.	—	1790.	G. ♀♀.
spársa. B.C.	scattered.	3, smth. Sty. & Anth. excl.	red.bell-sh.	3. 8.	—	1800.	G. ♀♀.
speciósá. A.H.	shewy.	3, near. smth. Sty. excl. Anth. incl.	re.gr.cyl.	6. 9.	—	—	G. ♀♀.
spicáta. A.H.	spiked.	6, smth. Sty. & Anth. incl.	gr.wh.cyl.	1. 12.	—	1789.	G. ♀♀.
spumósá. B.C.	spumous.	3, smth. Sty. & Anth. excl.	pur.re.bell-sh.	5. 8.	—	1786.	G. ♀♀.
spléndens. W.	splendid.	4, vill. Sty. excl. Anth. incl.	sc.ov.cyl.	4. 9.	—	1792.	G. ♀♀.
spúria. A.H.	spurious.	4, ciliat. Sty. excl. Anth. incl.	pk.cyl.	4. 8.	—	1796.	G. ♀♀.
β pállida.	pale-flowering.	p.pk.cyl.	—	—	—	G. ♀♀.
squamósá. A.H.	scaly-cupped.	4, smth. Sty. & Anth. incl.	pur.red.glob.	4. 6.	—	1794.	G. ♀♀.
stelláta. B.C.	starry.	4, crowd. vill. Sty. & Anth. excl.	wh.bell-sh.	6. 9.	—	1806.	G. ♀♀.
solandroides. A.H.							
stellifera. B.C.	star-bearing.	4, pilose. Sty. excl. Anth. incl.	bh.ov.vent.	4. 8.	—	—	G. ♀♀.
strícta. A.H.	upright.	4, smth. Sty. sub-excl. Anth. incl.	pur.re.ov.	8. 11.	S. Europ.	1765.	H. ♀♀.
struthioláflóra. H.E.W.	struthiola-fl.	3, smth. Sty. & Anth. incl.	wh.	5. 8.	C. B. S.	1812.	G. ♀♀.
sulphúrea. B.M.	sulphur-color'd.	4, vill. Sty. excl. Anth. incl.	yel.cyl.	3. 5.	—	—	G. ♀♀.
suaveólens. A.H.	sweet-scented.	5-6, smth. Sty. & Anth.	pa.pur.cyl.	5. 11.	—	1828.	G. ♀♀.
Swainsoniána. A.H.	Swainson's.	5-6, smth. Sty. & Anth. sub-incl.	pk.cyl.	6. 7.	—	1810.	G. ♀♀.
taxifólia. A.H.	yew-leaved.	3, smth. Sty. & Anth. incl.	pa.red.ov.	7. 11.	—	1758.	G. ♀♀.
Templéa. A.H.	Lady Temple's.	6, pub. Sty. & Anth. incl.	ros.tub.vent.	5. 8.	—	1820.	G. ♀♀.
tenélla. A.H.	delicate.	4, smth. Sty. & Anth. incl.	red.vent.	8. 5.	—	1791.	G. ♀♀.
tenuiflóra. A.H.	slender-flow'r'd.	3, smth. Sty. & Anth. incl.	wh.tub.	4. 6.	—	1800.	G. ♀♀.
β látea.	yellow-flower'd.	yel.tub.	—	—	—	G. ♀♀.
tétrágona. A.H.	square-flower'd.	3, smth. Sty. excl. Anth. incl.	yel.pitcher-sh.	7. 9.	—	1789.	G. ♀♀.
Tétrálix. E.B.	cross-leaved.	4, ciliat. Sty. excl. Anth. incl.	lil.ov.glob.	6. 8.	Britain.	H. ♀♀.
1. álba.	white-flowered.	wh.ov.glob.	—	—	H. ♀♀.
2. rúbra.	red-flowered.	red.ov.glob.	—	—	H. ♀♀.
Thalictriflóra. B.C.	meadow-rue-fl'd.	3, smth. Sty. & Anth. excl.	yel.wh.	5. 9.	C. B. S.	1810.	G. ♀♀.
staminea. A.H. ?							
Thunbérghii. B.M.	Thunberg's.	3, smth. Sty. sub-ex. An. in.	or.glob.bell-sh.	5. 8.	—	1794.	G. ♀♀.
thymifólia. A.H.	Thyme-leaved.	3, ciliat. Sty. excl. Anth. incl.	red.glob.	—	—	1789.	G. ♀♀.
tiaráflóra. A.H.	turban-flow'd.	3, rigid. Sty. & Anth. excl.	car.turban-sh.	—	—	1800.	G. ♀♀.
togáta. B.M.	large-cupped.	2, smth. Sty. & Anth. incl.	red.ov.vent.	6. 8.	—	1812.	G. ♀♀.
togatoides.	togata-like.	2-3, smth. Sty. sub-ex. An. incl.	pk.ov.ven.	4. 6.	—	G. ♀♀.
transpárens. H.E.W.	transparent.	3, smth. Sty. & Anth. incl.	pur.tub.	5. 8.	—	1800.	G. ♀♀.
tríceps. B.C.	three-headed.	3, smth. Sty. & Anth. excl.	wh.ov.	—	—	1809.	G. ♀♀.
trícolor. H.E.W.	three-coloured.	3-4, ciliat. Sty. & An. excl.	re.g.ye.ov.obl.	6. 9.	—	1803.	G. ♀♀.
1. dumósá.	bushy.	re.p.g.ye.ov.obl.	6. 7.	—	—	G. ♀♀.
2. májor.	large.	p.re.gr.yel.obl.infl.	—	—	1824.	G. ♀♀.
3. mínor.	small.	p.red.gr.vent.infl.	—	—	1803.	G. ♀♀.
triúmphans. B.C.	triumphant.	3, ciliat. Sty. & Anth. incl.	wh.ov.infl.	5. 10.	—	1812.	G. ♀♀.
tróssula. B.C.	neat.	4, smth. Sty. & Anth. incl.	wh.ov.vent.	—	—	—	G. ♀♀.
β rúbra.	red-flowered.	red.ov.vent.	—	—	—	G. ♀♀.
tubiflóra. A.H.	tube-flowered.	4, ciliat. Sty. excl. An. sub-ex.	pu.re.cyl.	4. 7.	—	1775.	G. ♀♀.
tubiúscula. B.C.	small-tubed.	4, vill. Sty. & Anth. incl.	red.pur.tub.	—	—	1822.	G. ♀♀.
túrgida. Len.	turgid.	3, smth. Sty. & Anth. incl.	pk.ov.vent.	—	—	1800.	G. ♀♀.
taxifólia β májor. A.H.							
umbelláta. A.H.	umbelled.	3, smth. Sty. & Anth. excl.	red.flask-sh.	5. 7.	Portugal.	1782.	H. ♀♀.
unduláta. A.H.	waved-flowered.	3, smth. Sty. excl. Anth. incl.	re.flask-sh.	5. 8.	C. B. S.	1828.	G. ♀♀.
urcoláris. H.K.	pitcher-flower'd.	3, ciliat. Sty. & Anth. incl.	wh.pitcher-sh.	5. 7.	—	1778.	G. ♀♀.

Systematic Name.	English Name.	No. of Leaves in a whorl.	Col.&Form of Flower.	Month of Fl.	Native Country.	Yr. of Introd.
vágans. H.K.	Cornish.	4-5, smth. Sty.&Anth.excl.	wh.bell-sh.	7. 8.	Cornwall. H. \mathcal{S} .
1. álba.	white-flowered.	wh.bell-sh.	4. 8. H. \mathcal{S} .
2. rúbra.	red-flowered.	red.bell-sh. H. \mathcal{S} .
3. pállida.	pale-flowered.	pale,bell-sh. H. \mathcal{S} .
4. tenélla.	dwarf.	wh.bell-sh. H. \mathcal{S} .
vária. B.C.	variable.	3, smth. Sty.excl. Anth.incl.	red,bell-sh.	5. 8.	C. B. S.	1820. G. \mathcal{S} .
ventricósa. B.M.	Porcelain.	4, ciliat. Sty.&Anth.incl.	bh.vent.	4. 9.	1787. G. \mathcal{S} .
1. álba.	white-flowered.	wh.vent. G. \mathcal{S} .
2. coccínea.	scarlet-flower'd.	sc.vent. G. \mathcal{S} .
3. cárnea.	flesh-coloured.	fl.vent. G. \mathcal{S} .
4. supérba.	superb.	p.red.vent. G. \mathcal{S} .
5. stellífera.	starry.	p.red.vent. G. \mathcal{S} .
versicolor. A.H.	various-colored.	3, smth. Sty.excl. An.incl.	sc.or.tub.cyl.	11.5.	1790. G. \mathcal{S} .
venústa. H.E.W.	graceful.	4, Sty.&Anth.incl.	wh.yel.ov.vent.	6. 8. G. \mathcal{S} .
verecúnda. B.C.	blushing.	5, near.smth. Sty.&Anth.incl.	pk.bh.cyl.	1820. G. \mathcal{S} .
vernális. B.C.	spring-flowering.	3, smth. Sty.excl. Anth.incl.	car.bell-sh.	3. 4. G. \mathcal{S} .
vernís. A.H.	varnished.	3, smth. Sty.&Anth.incl.	or.gr.glob.ov.	3. 9.	1803. G. \mathcal{S} .
1. longiflóra.	long-flowered.	or.gr.glob.ov. G. \mathcal{S} .
2. rúbra.	red-flowered.	or.re.glob.ov. G. \mathcal{S} .
verticilláta. A.H.	whorled.	4, smth. Sty.&Anth.incl.	red.cyl.	7.10.	1774. G. \mathcal{S} .
vestíta. H.K.	tremulous.	6-8, smth. Sty.excl. Anth.incl.	var.cyl.	1.12.	1789. G. \mathcal{S} .
1. álba.	white.	wh.cyl. G. \mathcal{S} .
2. coccínea.	scarlet.	sc.cyl. G. \mathcal{S} .
3. incarnáta.	flesh-coloured.	fl.cyl. G. \mathcal{S} .
4. fúlgida.	bright red.	red.cyl. G. \mathcal{S} .
5. lútea.	yellow.	yel.cyl. G. \mathcal{S} .
6. purpúrea.	purple-flower'd.	pur.cyl. G. \mathcal{S} .
7. rósea.	rose-coloured.	ros.cyl. G. \mathcal{S} .
viridipurpúrea. W.	green & purple.	3, smth. Sty.ex. Anth.incl.	p.gr.bell-sh.	5. 8.	Portugal. H. \mathcal{S} .
villósa. A.H.	villous-leaved.	3, vill. Sty.&Anth.excl.	wh.pitcher-sh.	2. 6.	1800. G. \mathcal{S} .
viridescens. A.H.	greenish-flow'g.	4, vill. Sty.excl. An.incl.	gr.cyl.club-sh.	1. 6. G. \mathcal{S} .
viridis. A.H.	green.	6, nearlismth. Sty.excl. An.incl.	gr.cyl.	5. 8.	1800. G. \mathcal{S} .
viridiflóra. A.H.	dark-green-fl'd.	3, smth. Sty.&Anth.excl.	gr.cyl.club-sh.	1820. G. \mathcal{S} .
virgíneo-rúbra.	Maiden's-blush.	4, smth. Sty.excl. Anth.incl.	pk.cyl.	3. 9. G. \mathcal{S} .
víscaria. H.K.	clammy.	4, smth. Sty.&Anth.incl.	lil.bell-sh.	3. 7.	1774. G. \mathcal{S} .
Walkeríana. B.C.	Walker's.	4, smth. Sty.&Anth.incl.	red.ov.vent.	6. 8.	1806. G. \mathcal{S} .

Walkéria rúbra. A.H.

[*Stig.* 4-5-notched.

<i>MENZIE'SIA, MENZIE'SIA.</i>	<i>Cal.</i> 4-5-cleft. <i>Cor.</i> of 1 pet. 4-5-part. <i>Fil.</i> 8 or 10. <i>Ger. furr.</i> <i>Sty.</i> angu.
cærúlea. E.Fl.	Scottish. lin.obt.crowd.1-rib.den. p.b. 6. 7. Scotland. H. \mathcal{S} . <i>Sandy peat.</i>
ferrugínea. s.s.	rusty-flowered. obov. lanc. cop. 5. 6. N.Amer. 1811. H. \mathcal{S} . <i>seeds, layers,</i>
globuláris. s.s.	globe-flowered. elli.lan.hair.abo.glaug.be.cop. 1806. H. \mathcal{S} . <i>or cuttings,</i>
polifólia. E.Fl.	Irish. ov. wh.ben.; stem vill. pu.re. 6. 9. Ireland. H. \mathcal{S} . <i>under a</i>
1. angustifólia.	narrow-leaved. pur. H. \mathcal{S} . <i>hand-glass.</i>
2. latifólia.	broad-leaved. pur. H. \mathcal{S}
3. nána.	dwarf. pu.re. H. \mathcal{S}

COMBRETUM, COMBRETUM. *Cal.* 4-lobed, deciduous. *Pet.* 4. *Stam.* 8, in 2 rows.

comósum. DC.	comose. op.obl.acu.ent.sub-cor. sc. 7. 8. S.Leone. 1821. S. \mathcal{S} . cl. <i>Sandy loam</i>
grandifórum. B.M.	large-flowered. opp. ov. obl. sub-cord. sc. 1824. G. \mathcal{S} . cl. <i>and peat.</i>

cuttings.

Systematic Name.	English Name.	Form of Leaves, &c.	Col. of Month Native Flow. of Fl. Country.	Yr. of Introd.	Soil and Propagation.
[with many seeds.]					
<i>FRANCO'A, FRANCO'A.</i>	<i>Cal. 4-cleft, equ. Pet. 4. Stam. 8, fertil. & 8 very short, abor. Caps. 4-5-cell.</i>				
<i>appendiculata.</i>	<i>B.F.G. naked-stk'd. lyr. serr. pub. und.</i>	<i>car. —</i>	<i>S. Amer. 1828.</i>	<i>H. P.</i>	<i>Peat & loam. seeds, & part. roots.</i>

ORDER III.

TRIGYNIA STYLES 3.

POLYGONUM, PERSICARIA. *Cal. in 4 deep segm. Cor. 0. Film. from 5 to 8. Sty. 3. Seed 1, nak.*

<i>amphibium.</i>	<i>E.B. Amphibious.</i>	<i>ov. lanc. acut.</i>	<i>crim. — — — —</i>	<i>....</i>	<i>H. P.</i>	<i>Sandy loam.</i>
<i>Bistorta.</i>	<i>E. Fl. great Bistort.</i>	<i>ov. obt. glau. wavy.</i>	<i>pk. 5. 9. — — — —</i>	<i>....</i>	<i>H. P.</i>	<i>seeds.</i>
<i>Convólulus.</i>	<i>E. Fl. climbing.</i>	<i>alt. cord. sagitt. ent.</i>	<i>gr. wh. — — — —</i>	<i>— — — —</i>	<i>H. A. cl.</i>	<i>— — — —</i>
<i>emarginatum.</i>	<i>B. R. notch-fruited.</i>	<i>cord. sagitt. ent.</i>	<i>pk. 5. 9. China.</i>	<i>1796.</i>	<i>H. A.</i>	<i>— — — —</i>
<i>Fagopyrum.</i>	<i>E. Fl. Buck-wheat.</i>	<i>cord. sagitt. ent.</i>	<i>pk. 7. 8. England.</i>	<i>....</i>	<i>H. A.</i>	<i>— — — —</i>
<i>Hydropiper.</i>	<i>E. Fl. biting.</i>	<i>lanc. wavy. shin.</i>	<i>gr. — — Britain.</i>	<i>....</i>	<i>H. A.</i>	<i>— — — —</i>
<i>lapathifolium.</i>	<i>E. Fl. pale-flowered.</i>	<i>ov. lanc. marg. rough.</i>	<i>red. 7. 10. — — — —</i>	<i>....</i>	<i>H. A.</i>	<i>— — — —</i>
<i>minus.</i>	<i>E. Fl. small.</i>	<i>lin. lanc. flat, smth.</i>	<i>p. red. — — England.</i>	<i>....</i>	<i>H. A.</i>	<i>— — — —</i>

COCCOLO'BA, SEA-SIDE-GRAPE. *Perianth. 5-part. colored. Cor. 0. Berry ovate, single-seeded.*

<i>latifolia.</i>	<i>s.s. broad-leaved.</i>	<i>cord. orbic. ent.</i>	<i>wh.</i>	<i>S. Amer. 1812.</i>	<i>S. S.</i>	<i>Sandy loam.</i>
<i>pubescens.</i>	<i>s.s. pubescent.</i>	<i>orbic. pubes. rugos.</i>	<i>wh.</i>	<i>W. Ind. 1690.</i>	<i>S. S. &</i>	<i>leaf mould.</i>
<i>uvifera.</i>	<i>L. round-leaved.</i>	<i>cord. orbic. obt. smth.</i>	<i>w. gr. 8. — — — —</i>	<i>— — — —</i>	<i>S. S.</i>	<i>cuttings, in sand, with the leaves left on, will strike root.</i>

SAPI'NDUS, SOAP-BERRY. *Cal. of 4 leaves. Cor. of 4 petals. Caps. fleshy, ventricose.*

<i>Saponaria.</i>	<i>DC. common.</i>	<i>pinn. leafl. obl. lanc.</i>	<i>wh. 7. 9. W. Ind.</i>	<i>1697.</i>	<i>S. S.</i>	<i>Loam & peat. cuttings.</i>
-------------------	--------------------	--------------------------------	--------------------------	--------------	--------------	-----------------------------------

PAULL'INIA, PAULL'INIA. *Cal. 5-part. Pet. 4. Nect. 4, uneq. Caps. 3-sided, 3-celled, sing.-seed.*

<i>pinnata.</i>	<i>DC. wing-leaved.</i>	<i>pin. leafl. obl. obt. ser. acu. wh.</i>	<i>7. 9. S. Amer.</i>	<i>1752.</i>	<i>S. S. cl.</i>	<i>Light loam.</i>
<i>polyphylla.</i>	<i>DC. Supple Jack.</i>	<i>leafl. ov. cuneat. apex cren. w.</i>	<i>6. 8. — — — —</i>	<i>1739.</i>	<i>S. S. cl.</i>	<i>cuttings.</i>

ORDER IV.

TETRAGYNIA. STYLES 4.

[Seeds many.]						
<i>PARIS, HERB-PARIS.</i>	<i>Cal. of 4 leaves. Cor. of 4 pets. Ger. 4, furr. Sty. 4. Berr. 4-angled, of 4 cells.</i>					
<i>quadrifolia.</i>	<i>B. Fl. four-leaved.</i>	<i>elli. acu. 4 in a whor. g. w. or re.</i>	<i>5. 6. England.</i>	<i>....</i>	<i>H. P.</i>	<i>Sandy loam. seeds, or parting roots.</i>
[cell. Seeds 4.]						
<i>AD' OXA, MOSCHATELL.</i>	<i>Cal. of 2 or 3 leaves. Cor. wheel-shaped, 4 or 5-cleft. Sty. 4 or 5. Berr. of 1</i>					
<i>Moschatellina.</i>	<i>B. Fl. tuberous.</i>	<i>lob. tritern. upp. tern.</i>	<i>gr. 3. 5. Britain.</i>	<i>....</i>	<i>H. P.</i>	<i>Light loam. seeds, or parting roots.</i>

Systematic Name.	English Name.	Form of Leaves, &c.	Col. of Flow.	Month of Fl.	Native Country.	Yr. of Introd.	Soil and Propagation.
[Seeds numerous, furrowed.]							
<i>ELATINE, WATER-WORT.</i>		<i>Cal. of 3 to 4 concave leaves.</i>	<i>Pet. 3-4.</i>	<i>Ger. round.</i>	<i>Sty. 3 to 4, short.</i>		
tripétala. E.Fl.	three-petaled.	opp. ellip. ent. 1-ribb.	red.	7. 8.	Britain.	...	H. P. Light soil, seeds, or parting plants.
<i>BRYOPHYLLUM, BRYOPHYLLUM.</i>		<i>Cal. of 4 leaves. Cor. of 4 petals, cylindrical. Seeds many.</i>					
calycinum. B.M.	large-cupped.	ov. crenat. smth.	br. 4. 7.	Mauritius.	1800.	G. S.	Loam & leaf mould, cuttings, or the leaves will strike root readily.
<i>FORSK'OHLEA, FORSK'OHLEA.</i>		<i>Cal. of 4 leaves. Cor. of 8 spath. pets. Seeds 4, enveloped in wool.</i>					
tenacissima. w.	clammy.	ellip. serr. unarmed.	gr. 6. 8.	Egypt.	1767.	H. A.	---

CLASS IX. ORDER I.

ENNEANDRIA MONOGYNIA. STAMENS 9. STYLE 1.

<i>ANACARDIUM, CASHEW-NUT.</i>		<i>Cal. 5-parted. Cor. of 5 petals. Nut kidney-shaped.</i>					
occidentale. DC.	common.	ov. obt. notched.	yel. gr. 6. 7.	India.	1599.	S. S.	---
[4-cell. Stig. lob. Ber. naked.]							
<i>TETRANTHERA, TETRANTHERA.</i>		<i>Fl. dioica. Invo. 4-5-leav. deci. Peria. 4-6-par. Sta. 6-15. Anth.</i>					
laurifolia. B.R.	laurel-leaved.	obo. obl. ent. smth. above.	gr. 5. 6.	China.	1822.	G. S.	---
<i>L'AURUS, LAUREL.</i>		<i>Cal. 0. Cor. 6-parted. Inner filam. glandular. Ber. dry, single-seeded.</i>					
Benzóin. w.	Benjamin-tree.	ovate, acute at ends.	gr. ye. 4. 5.	N. Amer.	1765.	G. S.	Loam & peat.
Borbônia. w.	broad-leaved.	lanc. ent. shin.	gr. yel. 4. 6.	S. Amer.	1739.	F. S.	cuttings, in
Cinnamômum. B.M.	Cinnamon-tree.	ov. obl. 3-nerv.	gr. 5. 9.	E. Ind.	1768.	S. S.	sand, und. a
Camphora. B.M.	Camphire-tree.	ovate, lanc. 3-nerv.	wh. 3. 6.	Japan.	1727.	G. S.	hand-glass,
Cássia. B.M.	Cassia.	ov. lanc. acut. 3-nerv.	gr. 5. 9.	Ceylon.	1763.	S. S.	will root
obtilis. Fl. Gr.	sweet-bay.	lanc. shin. veiny.	gr. yel. 4. 5.	S. Europ.	1561.	H. S.	freely, when
1. undulata.	wave-leaved.	H. S.	kept free
2. salicifolia.	Willow-leaved.	H. S.	from damp.
Sassafras. w.	Sassafras-tree.	3-lobed, ent.	gr. yel. 5. 6.	N. Amer.	1633.	H. S.	---

ORDER II.

TRIGYNIA. STYLES 3.

<i>RHEUM, RHUBARB.</i>		<i>Cal. 0. Cor. 6-cleft, persistent. Nut 1, 3-cornered.</i>					
compactum. w.	thick-leaved.	obt. lobed, dent. smth.	wh. 5. 6.	Tartary.	1758.	H. P.	Rich sandy
almatum. w.	palmate-leaved.	palm. acut. rough.	wh. 4. 5.	China.	1763.	H. P.	loam.
rhaponticum. w.	common.	obt. smth. veins hairy.	wh. 5. 6.	Asia.	1573.	H. P.	seeds, or part-
undulatum. w.	waved-leaved.	vill. wavy, footstalks flat.	wh. —	China.	1734.	H. P.	ing roots.

ORDER III.

HEXAGYNIA. STYLES 6.

Systematic Name.	English Name.	Form of Leaves, &c.	Col. of Flow.	Month of Fl.	Native Country.	Yr. of Introd.	Soil and Propagation.
[Caps. 6, with many seeds.							
<i>BUTOMUS, FLOWERING-RUSH.</i> Cal. 0. Pet. 6, concave. Germ. 6, each with an elongated style.							
umbellatus. B.Fl. umbelled.		lin. triang. upp. round.	ros. —		Britain.	... H.w. 18.	Loam. divid. plants.

CLASS X. ORDER I.

DECANDRIA MONOGYNIA. STAMENS 10. STYLES 2.

[Caps. 5-celled. Seeds comp.							
<i>RHODOENDRON, RHODOENDRON.</i> Cal. 5-parted. Cor. campanulate, limb 5-lob. Stam. 10.							
album. B.F.G.	white-flowered.	ellip. rigid, rusty ben.	wh.	5. 6.	Nepal.	1818.	F.S. Sandy loam & peat, mixed, will grow most
arborescens. Hort.	maximum album. Ph.	ellip. lan. silvery ben.	sc.	Nepaul.	1820.	F.S. ed, will grow most
β roseum.	rose-coloured.	F.S. grow most
Alta-clerense. B.R.	Highclere.	ellip. lanc.	sc.	5. 6.	Hybrid.	H.S. of the species of this
azaleoides. B.rep.	Azalea-like.	ellip. lanc. smth. decid.	pk.	6. 7.	H.S. cies of this
Chamaecistus. L.	Thyme-leaved.	ellip. dent. cil. gland.	pk.w.	6.	Austria.	1786.	H.S. genus to
cinnamomeum.	Cinnamon.	ellip. obl. smth.	pur.	—	Nepaul.	1820.	F.S. great per-
caucasicum.	Caucasian.	elli. lan. down. ben. scab.	ro.w.	8.	Caucasus.	1803.	H.S. ffection; they
Catawbiense. B.M.	Catawba.	ov. obl. obt. smth. dott. ben.	ro.	6. 8.	N. Amer.	1809.	H.S. however ge-
camtschaticum.	Kamtschatka.	ellip. cil. nerv.	pk.	Kamtsch.	1802.	H.S. nerally suc-
chrysanthum.	yellow-flower'd.	obl. smth. abov. scab. ben.	ye.	6. 7.	Siberia.	1796.	H.S. ceed best in
Catesbaei.	Catesby's.	ellip. obl. smth.	pale pur.	5. 6.	N. Amer.	1810.	H.S. peat soil;
dauricum. L.	Daurian.	ellip. smth. ent.	pa. pu.	3. 11.	Siberia.	1780.	H.S. but when
1. atrovirens.	dark-green.	pur.	—	—	H.S. this mould
2. altaicum.	Altaic.	pur.	..	Altaic.	H.S. is difficult to
ferrugineum. L.	rusty-leaved.	ellip. smth. ferrug. ben.	sc.	5. 6.	Switzerl.	1752.	H.S. be procured,
Farrerae. B.F.G.	Mrs. Farrer's.	obt. ov. hair. on both sid.	ros.	6. 7.	—	1829.	H.S. they may be
fragrans.	sweet-scented.	ellip. obv. ent. smth.	—	—	1828.	H.S. grown to a
hirsutum. L.	hairy.	ellip. hairy, obt. dott. ben.	ros.	5. 6.	—	1656.	H.S. large size, in
foliis variegatis.	variegated.	ros.	—	—	1800.	H.S. light sandy
hybridum. B.R.	Herbert's-hybrid.	ov. glau. coriac.	vil.	6. 7.	H.S. loam. They
lapponicum. s.s.	Lapland.	ellip. obl. obt. dott.	sc.	3. 4.	Lapland.	1810.	F.S. are readily
Morterii. B.F.G.	Morter's.	ellip. obl. smth. acut. shin.	ye.	—	—	1818.	H.S. increased by
myrtifolium. E.C.	Myrtle-leaved.	elli. 1-½-inch. dott. edg. cil.	pk.	5. 6.	Gibralt.	1763.	H.S. seeds, or lay-
maximum. B.M.	large.	obl. smth. shin. nerv.	bh.	6. 8.	N. Amer.	1736.	H.S. ers.
purpureum.	purple-flowered.	pur.	—	—	H.S. —
Knightianum.	Mr. Knight's.	ellip. rigid, rusty, ben.	wh. y.	—	Nepal.	1828.	F.S. —
obtusum.	obtuse.	ellip. obt. shin.	vil.	—	Hybrid.	H.S. —
punctatum. B.rep.	dotted-leaved.	ellip. obl. smth. dott.	vil.	6. 7.	N. Amer.	1786.	H.S. —

Systematic Name.	English Name.	Form of Leaves, &c.	Col. of Flow.	Month of Fl.	Native Country.	Yr. of Introd.	Soil and Propagation.
pávilum.	dwarf.	ellip. smth. nearl. l. in. long.		6. 7.	Nepal.	1829.	H. S.
prunifólium.	Plum-leaved.	ellip. lanc. shin. smth.	ros.	5. 6.	—	—	H. S.
pónticum. L.	Pontic.	ellip. lanc. smth.	pur.	6.	Gibraltar.	1763.	H. S.
1. angustifólium.	narrow-leaved.	pur.	6.	Gardens.	H. S.
2. álbium.	white-flowered.	wh.	—	—	H. S.
3. cóncolor.	self-coloured.	—	—	—	H. S.
4. contórtum.	twisted-petaled.	pur.	—	—	H. S.
5. cassinifólium.	Cassine-leaved.	pur.	—	—	H. S.
6. crispum.	curl'd-leaved.	pur.	—	—	H. S.
7. Daphnoides.	Daphne-like.	lil.	—	—	H. S.
8. frondósum.	leafy.	pur.	—	—	H. S.
9. fóliis-argéntis.	silver-leaved.	lil.	—	—	H. S.
10. fóliis-aúreis.	golden-leaved.	lil.	—	—	H. S.
11. flore pleno.	double flowering.	pur.	—	—	H. S.
12. floribúndum.	many-flowered.	lil.	—	—	H. S.
13. grandiflórum.	large-flowered.	lil.	—	—	H. S.
14. glomerátum.	glomerate.	lil.	—	—	H. S.
15. intermédiu.	intermediate.	pur.	—	—	H. S.
16. kalmiánum.	Kalmia-leaved.	pur.	—	—	H. S.
17. macrophy'llum.	large-leaved.	pur.	—	—	H. S.
18. magnoliáfólium.	Magnolia-l'd.	lil.	—	—	H. S.
19. marginátum.	silver-edged.	lil.	—	—	H. S.
20. nepaléense.	Nepaul.	pur.	—	Nepaul.	1767.	H. S.
21. obtusifólium.	obtuse-leaved.	pur.	—	Gardens.	H. S.
22. ovátum.	oval-leaved.	pur.	—	—	H. S.
23. róseum.	rose-flowered.	ros.	—	—	H. S.
24. rotundifólium.	round-leaved.	lil.	—	—	H. S.
25. salicifólium.	Willow-leaved.	pur.	—	—	H. S.
Russeliánum.	Russell's.	obl.elli. coriac. down. ben.	sc.	4. 6.	Hybrid.	1830.	H. S.
míthii.	Smith's.	lanc. elong. alt. reti.	ro. pu.	—	—	—	H. S.
GUAFACUM, LIGNUM-VITÆ-TREE. Cal. 5-part. uneq. Cor. of 5 equ. pets. Caps. angu. 2-5-celled.							
arbóreum. DC.	tree.	7-14 pairs. lea. ov. obl. obt.	bh.	7. 9.	W. Ind.	1694.	S. S. Sandy loam, & leaf mould.
Zygophy'llum.	arbóreum Jac.	& leaf mould.
ficinále. L.	officinal.	pin. lea. of 2 or 3 pairs, obt.	bh.	—	1794.	S. S. cuttings.
HEY'NEA, HEY'NEA. Cal. 5-toothed. Pet. 5. Ovary 2-celled. Caps. 2-valved, 1-celled, single-seeded.							
cinquejuga. Rox.	five-paired.	pinn. leafl. ov. ellip.	wh.	W. Ind.	1821.	S. S. Sandy loam
ijuga. B.M.	three-paired.	pinn. leafl. ellip. lanc.	wh.	9.	Nepaul.	1812.	S. S. & peat. cutt.
AGONIA, FAGONIA. Cal. of 5 leav. Cor. of 5 heart-shap. pets. Caps. 5-cell. 10-valv. Cells. 1-seeded.							
ética. L.	Cretan.	pinn. leafl. lanc. smth.	pur.	6. 8.	Candia.	1739.	G. S. Peat & loam.
utinósa. DC.	glutinous.	tern. leafl. obov. mucr.	red.	5. 8.	Egypt.	1820.	G. S. cuttings.
ÆMATOXYLON, LOGWOOD. Cal. 5-cleft. Pet. 5. Caps. 1-celled, 2-valved.							
mpечиánum. L.	Campechy.	pinn. leafl. obcord.	yel.	S. Amer.	1724.	S. S. Loam & peat. cuttings.
YMENEA, LOCUST-TREE. Cal. 5-part. Cor. of 5 nearly equ. pets. Legu. large, dila. Pulp mealy.							
úrbaril. L.	Courbaril.	bin. leafl. uneq. at base.	pk.	W. Ind.	1688.	S. S. Peat & loam. cuttings.

Systematic Name.	English Name.	Form of Leaves, &c.	Col. of Flow.	Month of Fl.	Native Country.	Yr. of Introd.	Soil and Propagation.
CHLOROXYLON, CHLOROXYLON. <i>Cal. 5-cleft. Cor. of 5 petals. Caps. 3-celled, 3-valved.</i>							
Swieténia. DC.	Van Swieten's.	pinn. leaf. ov. glau. obt.	wh.	...	E. Ind.	1820.	S. $\frac{S}{S}$. Loam & peat cuttings.
<i>Swieténia chloróxylon.</i> Rox.							
HORKE'LIA, HORKE'LIA. <i>Cal. camp. of 5 small & 5 large teeth. Pet. 5. Recep. con. Ger. ov. orbic.</i>							
congésta. B.M.		crowded-flow'd. pinn. leaf. obl. cunea.	wh.	8.	N. Amer.	1826.	H. $\frac{P}{P}$. Sandy loam. part. plants.
GARU'GA, GARU'GA. <i>Cal. camp. 5-cleft. Pet. 5. equal. Stig. 5-lob. Drupe with 2-5 single-seed. nuts.</i>							
pinnáta. Rox.	wing-leaved.	pinn. leaf. lanc. serr.	yel.	...	E. Ind.	1808.	S. $\frac{S}{S}$. Loam & peat cuttings.
BERGE'RA, BERGE'RA. <i>Cal. 5-parted. Cor. of 5 petals. Ovary 2-celled. Ber. often 1-celled, & 1-seeded.</i>							
integerrima. DC.	entire-leaved.	pinn. leaf. ent.	wh.	5. 6.	W. Ind.	1823.	S. $\frac{S}{S}$. Peat & loam cuttings.
MORINGA, HORSERADISH-TREE. <i>Cal. of nearly equ. leaves. Pet. 5. Legu. siliqua-like, 3-valved.</i>							
pterygospérma. DC.	winged-seeded.	bipin. leaf. ellip. orbic.	yel.	...	E. Ind.	1759.	S. $\frac{S}{S}$. Peat & loam cuttings.
<i>Hyperanthera Moringa.</i> Vahl.							
GETO'NIA, GETO'NIA. <i>Cal. of 5 leav. Cor. of 5 pet. Sta. 10. 5 alter. broad. & inser. in the orif. of the cal.</i>							
floribúnda. Rox.	bundle-flow'd.	ov. opp. ent. acute.	yel. gr.	...	E. Ind.	1815.	S. $\frac{S}{S}$. Loam & peat.
nútax. Rox.	nodding.	ov. acum. smth. abo. pub. ben.	...	---	---	1816.	S. $\frac{S}{S}$. cuttings.
LYO'NIA, LYO'NIA. <i>Cal. 5-lobed. Cor. globular, 5-lobed at the apex. Caps. 5-6-celled.</i>							
ferrugínea. Nut.	ferruginous.	ellip. ent. rust. & meal. ben. w.	6. 7.	N. Amer.	1784.	H. $\frac{S}{S}$. Sandy loam and peat.	
<i>Andrómeda ferrugínea.</i> Walt.							
multiflóra. Wat.	many-flowered.	lanc. pilose beneath.	wh.	7.	---	...	H. $\frac{S}{S}$. layers.
paniculáta. Nut.	panicled.	ov. ent. shin. Br. 3-corn.	wh.	---	---	1748.	H. $\frac{S}{S}$. ---
<i>Andrómeda paniculáta.</i> L.							
[Caps. 3-4-winged, 3-celled.							
MYLOCA'RYUM, BUCK-WHEAT-TREE. <i>Cal. 5-dented. Cor. of 5 petals. Stig. sessile, 3-sided.</i>							
ligustrínium. w.	Privet-like.	cuneat. lanc. acut.	wh.	6.	Georgia.	...	F. $\frac{S}{S}$. Peat & loam cuttings.
HARDWICKIA, HARDWICKIA. <i>Cal. 4-5-clef. Cor. 0. Sty. shor. Stig. pel. Legu. lan. 1-cell. 1-seed.</i>							
bináta. Rox.	binate.	in 2's. lea. op. semi-cor. 3-n. y.	...	E. Ind.	1820.	S. $\frac{S}{S}$. Loam & peat.	
pinnáta. Rox.	pinnate.	pin. leaf. alt. ov. lan. acum. ye.	...	---	---	1818.	S. $\frac{S}{S}$. cuttings.
PARKINS'ONIA, PARKINSO'NIA. <i>Cal. 5-clef. Cor. of 5 pet. und. ones renif. Sty. 0. Leg. neckl-sha.</i>							
aculeáta. L.	prickly.	pinn. leaf. ov. ent.	yel.	...	W. Ind.	1739.	S. $\frac{S}{S}$. Sandy loam cuttings.
ATALANTIA, ATALANTIA. <i>Cal. 4-5-part. Pet. 4-5. Stam. unit. at base. Ber. 4-celled, 4-seeded.</i>							
monophýlla. DC.	one-leaved.	ov. obl. apex notched.	wh.	6. 8.	E. Ind.	1777.	S. $\frac{S}{S}$. Loam & leaf mould. cutt.
<i>Limónia monophýllum.</i> Rox.							
AMMY'RSINE, AMMYRSINE. <i>Cal. 5-part. Cor. of 5 petals. Stam. Caps. 5-cell. open. at base.</i>							
buxifólia. Ph.	Box-leaved.	ov. convex, smth. shin.	wh.	5. 6.	Carolina.	1736.	H. $\frac{S}{S}$. Sandy loam and peat.
<i>Léduum buxifolium.</i> L.							

Systematic Name.	English Name.	Form of Leaves, &c.	Col. of Flow.	Month of Fl.	Native Country.	Yr. of Introd.	Soil and Propagation.
thymifolia.	Thyme-leaved.	ellip. shin. not convex.	wh.	5. 6.	Carolina.	H. ♂. layers.
<i>Léduum thymifolium</i> . Hort.							
LEDUM, LEDUM. Cal. 5-parted. Cor. of 5 petals, equal. Caps. of 5 cells, bursting at the base.							
latifolium. B.C.	broad-leaved.	obl. edges rev. down. ben.	w.	4. 5.	N. Amer.	1763.	H. ♂. Sandy loam,
palustre. B. Fl.	marsh.	lin. rev. down. rust. ben.	wh.	—	Ireland.	H. ♂. or peat.
β decumbens.	decumbent.	wh.	—	H. ♂. seeds, or lay.
KALMIA, KALMIA. Cal. 5-parted. Cor. salver-shaped, limb 5-cornered, Caps. 5-celled.							
angustifolia. B.M.	narrow-leaved.	lanc. ent. smth.	red.	5. 7.	N. Amer.	1736.	H. ♂. Peat, or san-
1. variegata.	variegated l'd.	red.	—	—	—	H. ♂. dy loam and
2. pumila.	dwarf.	red.	—	—	—	H. ♂. peat, mixed.
3. rosea.	rose-coloured.	rose.	—	—	—	H. ♂. seeds, or
4. rubra.	red.	red.	—	—	—	H. ♂. layers.
glauca. B.M.	glaucous.	op. obl. glau. edg. rev.	red.	4. 5.	—	1767.	H. ♂. —
latifolia. B.M.	broad-leaved.	ellip. smth. ent.	wh.	5. 7.	—	1734.	H. ♂. —
β salicifolia.	Willow-leaved.
nitida.	shining-leaved.	ov. ent. shin. sub-cord.	pur.	6. 7.	—	1829.	H. ♂. —
GAULTHERIA, GAULTHERIA. Cal. 5-parted. Cor. ovate, 5-toothed at the apex. Caps. 5-celled.							
procumbens. B. rep.	procumbent.	ellip. smth. shin. serr.	bh.	7. 9.	N. Amer.	1762.	H. ♂. Peat. layers,
Shallon. B.C.	Shallon.	cor. ov. acut. serr.	bh.	5. 6.	—	1827.	H. ♂. or dividing at the root.
EPIGÆA, EPIGÆA. Cal. 5-part. Cor. salver-shap. tubu. at the base, limb 5-cleft. Stig. 5, indented.							
repens. B.R.	creeping.	cord. ov. ent.	wh.	7. 8.	N. Amer.	1736.	H. ♂. Peat. seeds, or layers.
RHODO'RA, RHODO'RA. Cal. 5-toothed. Pet. 3. Stam. declinate. Caps. 5-celled.							
canadensis. B.M.	Canadian.	ellip. lanc. pubes. glau.	pu.	6. 7.	N. Amer.	1767.	H. ♂. Peat, or sandy loam. layers, or seeds.
MELIA, BEAD-TREE. Cal. 5-parted. Pet. 5, oblong, lin. Stig. 5-angled. Ber. ovate, 5-celled, 1-seed.							
Azedarach.	common.	bipinn. cut.	lil.	6. 8.	Syria.	1656.	G. ♂. Sandy loam.
sempervirens. B.R.	evergreen.	pinn. leafl. rugos. dent.	lil.	8. 9.	W. Ind.	—	S. ♂. seeds, or cutt.
D' AIS, D' AIS. Involu. of 4-5 leaves. Cor. 4-5-cleft. Stig. capitate. Ber. 1-seeded.							
cotinifolia. B.M.	Cotinus-leaved.	obov. obt. ent. smth.	pk.	6. 7.	C. B. S.	1776.	G. ♂. Peat, loam, and leaf mould. cuttings, under a glass.
TRIBULUS, CALTROPS. Cal. of 5 leaves. Pet. 5, spread. Sty. 0. Caps. 5, spiny, many-seeded.							
cistoides. B.R.	Cistus-flowered.	in 8 pairs, lea. obl. obt. silk.	ye.	5. 7.	S. Amer.	1752.	S. ♂. Sandy loam, and leaf mould. cuttings.
ERIOSTEMON, ERIOSTEMON. Cal. 5-part. Pet. 5. Film. hairy. Ger. 5-lobed, dotted with glands.							
salicifolium. B.M.	Willow-leaved.	lin. lanc. ent. smth.	yel.	4. 6.	N. S. W.	1822.	G. ♂. Light loam and peat. cuttings.
JUSSIEUA, JUSSIEUA. Cal. 4-6-part. lobes acu. Cor. of 4-5 pets. Caps. 4-5-cell. Seeds many, minu.							
erecta. L.	erect.	lanc. both ends acum.	yel.	7. 10.	S. Amer.	1739.	S. w. ♂. Light loam.
grandiflora. B.M.	large-flowered.	obl. lanc. pubes.	yel.	—	Carolina.	1812.	G. w. ♂. cuttings, or
scabra. DC.	rough.	obl. pilose, scabr. ben.	yel.	—	Brazil.	1816.	S. w. ♂. part. roots.

Systematic Name.	English Name.	Form of Leaves, &c.	Col. of Month Native Flow. of Fl. Country.	Yr. of Intro.	Soil and Propagation.
CO'OKIA, WAMPEE-TREE. <i>Cal.</i> 5-parted. <i>Pet.</i> villous, navicular. <i>Ber.</i> 5-celled.					
punctáta. B.R.	dotted.	ov. dotted, acum. smth.	wh. 5. 7. China.	1795.	S. S. Loam, peat, and leaf mould, cuttings, in sand.
EKEBERGIA, EKEBERGIA. <i>Cal.</i> 4-toothed. <i>Pet.</i> 4. <i>Stig.</i> capitate. <i>Ber.</i> globose, 5-seeded.					
capénsis. DC.	Cape.	pin. leaf. elli. acum. smth.	wh. 7. 8. C. B. S.	1789.	G. S. Sandy loam
indica.	Indian.	pin. leaf. ov. ell. apex den.	w. — E. Ind.	1830.	S. S. & peat. cutt.
ARTHROSTEMMA, ARTHROSTEMMA. <i>Cal.</i> camp. 4-lob. <i>Pet.</i> 4. <i>Filam.</i> smooth. <i>Caps.</i> 4-celled.					
nítida. B.M.	shining.	ov. acut. serrul. hisp.	lil. 6. 7. B. Ayres.	1829.	G. P. Loam & peat. dividing plants.
LASIA'NDRA, LASIA'NDRA. <i>Cal.</i> 5-lob. acum. <i>Pet.</i> 5 obov. <i>Caps.</i> 5-celled. <i>Seeds</i> often 7-angled.					
argénteá. DC.	silvery-leaved.	ov. op. cor. vill. ; Br. 4-sid.	bl. 4. 8. Brazil.	1818.	S. S. Sandy loam & leaf mould, cuttings.
<i>Rhexia holocericea.</i> B.R.					
PLEROMA, PLEROMA. <i>Cal.</i> 5-lobed. <i>Pet.</i> 5, obovate. <i>Filam.</i> smooth. <i>Caps.</i> 5-celled.					
heteromállum. D.D.	woolly-leaved.	ov. cord. woolly ben.	bl. 4. 8. Brazil.	1820.	S. S. Sandy loam & leaf mould,
<i>Melástoma heteromálla.</i>					
vimíneum. DC.	slender.	ov. lanc. acut. wh. ben.	vi. — — — —	— — — —	S. S. mixed with peat. cutt.
<i>Rhexia vimínea.</i>					
MELA'STOMA, MELA'STOMA. <i>Cal.</i> 5-part. <i>Pet.</i> 5, inser. in the cal. <i>Ber.</i> of 5 cells, with many seeds.					
cándida.	white-flowered.	ov. ellip. 7-nerv. silky.	wh. 6. 7. E. Ind.	1822.	S. S. Peat, loam,
granulôsa. B.R.	granular.	ov. lan. acum. shi. abo. vil. ben.	— — — — Brazil.	— — — —	S. S. & leaf mould,
malabáthrica. B.R.	bristly.	ellip. obl. rough.	pur. 1. 8. — — — —	1793.	S. S. mixed.
sanguínea. B.M.	bloody.	ov. lanc. acum. 5-nerv.	pk. 6. China.	1818.	S. S. cuttings.
trinèrvis. w.	three-nerved.	ov. smth. veiny, edg. cil.	wh. 7. Jamaica.	1795.	S. S. — — — —
villôsa. B.M.	villous.	ov. acut. ent. vill. 5-nerv.	pk. 5. 6.	1820.	S. S. — — — —
OSBE'CKIA, OSBE'CKIA. <i>Cal.</i> 4-5-lob. cilia. <i>Pet.</i> 4-5, obo. <i>Sta.</i> 8-10, 5 of them short. <i>Caps.</i> 4-5-celled.					
glomeráta. B.M.	glomerate.	ov. lanc. 3-nerv. ent. hisp.	ros. . . . Trinidad.	— — — —	S. S. Sandy loam
stelláta.	starred.	lanc. obl. acum. 5-nerv.	yel. 6. 8. Ceylon.	1820.	S. S. and peat.
zeyláncia.	Ceylon.	ov. lanc. reflex. 3-nerv.	pk. 7. 8. Nepal.	1799.	S. S. cuttings.
QUISQUA'LIS, QUISQUA'LIS. <i>Cal.</i> 5-cleft, decid. <i>Pet.</i> 5, oblong. <i>Ber.</i> 5-sided, with 1 seed.					
indica. B.M.	Indian.	ov. or sub-cord. pub.	cr. 5. 8. China.	1815.	S. S. Loam & peat. cuttings.
THERMO'PSIS, THERMO'PSIS. <i>Cal.</i> camp. 4-5-cleft. <i>Pet.</i> 5, nearly equal. <i>Legu.</i> comp. many-seeded.					
fabáceá. B.R.	Bean-leaved.	3-5 lea. obl. obt. down. ben. ye.	6. 7. Kamtsch.	1824.	H. P. Light loam. parting plants.
DIONÆ'A, DIONÆ'A. <i>Cal.</i> of 5 leav. <i>Cor.</i> of 5 pets. <i>Stig.</i> fimb. <i>Caps.</i> 1-celled, swelling, many-seeded.					
Muscípula. B.M.	Venus's Fly-trp. folding, edges bristly.	wh. 7. 8. Carolina.	1768.	G. P. Peat, and the pots well drained with moss, and placed in a larger sized pot, inserted in a pan of water. Increased by seeds, or parting roots.	
HÍPTAGE, HÍPTAGE. <i>Cal.</i> 5-parted, with 5 glands at the base. <i>Pet.</i> fringed.					
Madablôta. DC.	clustered.	ov. lanc. acum.	wh. . . . E. Ind.	1796.	S. S. Loam & leaf mould.
<i>Gavtnéra racemôsa.</i> B. rep.					

Systematic Name.	English Name.	Form of Leaves, &c.	Col. of Flow.	Month of Pl.	Native Country.	Yr. of Introd.	Soil and Propagation.
obtusifolia, DC.	blunt-leaved.	obov. obt. mucr.	wh.	China.	1822.	S. S. cuttings.
<i>Gartnera obtusifolia</i> , H.B.							

BUNCHO'SIA, BUNCHO'SIA. Cal. 5-part. base glan. Fil. uni. at base. Sty. 1, simp. or 2-3-clef. at apex.

cornifolia, DC.	Cornus-leaved.	ellip. acum. silvery.	wh.	—	S. Amer.	1820.	S. S. Sandy loam
glandulosa, DC.	glandular.	ov. ellip. acum. smth.	yel.	—	Antilles.	1804.	S. S. & peat. cutt.

POIVREA, POIVREA. Cal. camp. 5-tooth. decid. Cor. of 5 pets. Sta. 10, exser. Seeds sing. 5-angled.

alternifolia, DC.	alternate-lv'd.	ellip. obl. obt. smth.	wh.	6. 7.	S. Amer.	1826.	S. S. cl. Loam and
coccinea, DC.	scarlet-flow'd.	opp. ov. obl. acut.	sc.	7. 8.	Madagas.	1818.	S. S. cl. leaf mould. cuttings.
<i>Combrétum purpureum</i> , B.R.							

ANDROMEDA, ANDROMEDA. Cal. 5-cleft. Cor. bell-sha. 5-part. Caps. of 5 cells, ang. Seeds num.

acuminata, E.X.B.	acuminated.	ov. lanc. unite. serr.	wh.	8. 9.	N. Amer.	1765.	H. S. Sandy loam
axillaris, W.	axillary-flow'g.	ov. acut. serr. axil.	wh.	5. 9.	—	—	H. S. or peat.
<i>β. angustifolia</i> , narrow-leaved. wh. — — — — H. S. Seeds or							
arborea, E.M.	tree.	ellip. acum. tooth.	wh.	8. 9.	—	1752.	H. S. layers.
buxifolia, B.M.	Box-leaved.	cord. ov. ent. mucr.	cr.	—	Mauritiu.	1822.	H. S. —
calyculata, W.	various-leaved.	ov. dott. slightly serr.	wh.	4.	Russia.	1748.	H. S. —
1. <i>angustifolia</i> , narrow-leaved. wh. — — — — H. S. —							
2. <i>latifolia</i> , broad-leaved. wh. — — — — H. S. —							
3. <i>nana</i> , dwarf. wh. — — — — H. S. —							
Catesbyi, B.M.	Catesby's	ov. lanc. finely. serr.	wh.	6. 7.	N. Amer.	1793.	H. S. —
coriacea, B.M.	thick-leaved.	ov. ent. shin. coriac.	pk.	6. 9.	—	1765.	H. S. —
floribunda, B.M.	many-flowered.	obl. ov. acut. serrul.	wh.	5. 6.	Georgia.	1812.	H. S. —
hypnoides, B.M.	hypnum-like.	imbr. awl-sh. erect. ciliat.	wh.	—	Canada.	1826.	H. S. —
mariana, L.	Maryland.	ov. obl. ent. ; Pedun. aggr.	bh.	5. 8.	N. Amer.	1736.	H. S. —
polifolia, E.B.	marsh.	alt. lanc. revol. glau.	blush.	5. 9.	Britain.	H. S. —
<i>β. angustifolia</i> , narrow-leaved. wh. — — — — H. S. —							
racemosa, W.	raceme-flow'd.	obl. lanc. serr.	wh.	8.	N. Amer.	1736.	H. S. —
speciosa, Ph.	shewy.	ov. serr. shin.	wh.	5. 8.	Carolina.	1800.	H. S. —
1. <i>glauca</i> , glaucous-leaved. wh. — — — — H. S. —							
2. <i>pulverulenta</i> , powdered-lv'd. wh. — — — — H. S. —							
tetragona, B.M.	four-sided.	imbr. ov. ellip. sagitt.	bh.	4. 5.	N. Amer.	1827.	H. S. —

[Ber. of 5 cells.

ARBUTUS, STRAWBERRY-TREE. Cal. 5-cleft. Cor. ov. 5-part. Fila. half the length of the corolla.

alpina, E.Fl.	black Bear-ber.	obov. rugg. serr. reticul.	wh.	4. 5.	Scotland.	H. S. Sandy loam
Andrachne, s.s.	oriental.	ov. ellip. ent. serr. smth.	wh.	3. 4.	Levant.	1724.	F. S. and peat.
canariensis, B.M.	Canary.	obl. lan. serr.	wh. gr.	—	Canaries.	1796.	G. S. seeds, layers,
mucronata, B.M.	sharp-pointed.	ov. cuspid. dent. serr. shin.	wh.	—	N. Amer.	1828.	F. S. or enarch-
serratifolia, B.C.	saw-leaved.	lanc. serr. wavy.	wh. gr.	—	G. S. ing.
Unedo, E.Fl.	common.	obl. lanc. serr. smth.	wh. red.	—	Ireland.	H. S. —
1. <i>crispa</i> , cur'd-leaved. wh. — — — — H. S. —							
2. <i>integrifolia</i> , entire-leaved. wh. — — — — H. S. —							
3. <i>angustifolia</i> , narrow-leaved. wh. — — — — H. S. —							
4. <i>rubra</i> , red-flowering. red. — — — — H. S. —							
5. <i>salicifolia</i> , Willow-leaved. wh. — — — — H. S. —							
ibirica.	Siberian.	obov. ent. notch. smth.	—	—	Siberia.	1825.	H. S. —
uva-ursi, E.Fl.	red Bear-berry.	obov. ent. obt.	ros. col.	4. 5.	Britain.	H. S. —

RYROLA, WINTER-GREEN. Cal. 5-part. Cor. of 5 round, conc. pet. Caps. of 5 ang. 5 cells, & 5 valv.

sarifolia, Ph.	Asarum-leaved.	renif. smth.	st.	6. 7.	N. Amer.	1822.	H. D. Sandy peat.
media, E.Fl.	intermediate.	ov. orbic. cren. shin.	wh.	—	England.	H. D. seeds, or

Systematic Name.	English Name.	Form of Leaves, &c.	Col. of Flow.	Month of Fl.	Native Country.	Yr. of Introd.	Soil and Propagation.
minor. Br. Fl.	lesser.	ellip. orbic. cren.	pink.	6. 7.	Britain.	...	H. P. part. roots.
rotundifolia. E. Fl.	round-leaved.	obov. round. cren. shin.	wh.	—	—	...	H. P. —
secunda. Br. Fl.	side-flowering.	ov. acut. serr.	wh.	—	—	...	H. P. —
uniflora. E. Fl.	single-flowered.	orbic. acut. serr.	wh.	—	—	...	H. P. —

QUIVISA, QUIVISA. Cal. 4-5-tooth. Pet. 4-5, short. Caps. 4-5-celled, cells 2-seeded.

heterophylla. DC. various-leaved. alt. obov. sinuat. dent. wh. — Maurit. 1821. S. S. Peat & loam. cuttings.

MONOTROPA, BIRD'S-NEST. Cal. 0. Cor. of 8-10 pet. Fil. 8-10. Ger. with 4 or 5 fur. Seeds num.

Hypopitys. E. Fl. yellow. Stm. 6-9-in. high. scal. ov. yel. 8. 9. Britain. ... H. P. —

[Caps. 5-celled, many-seeded.]
SWIETENIA, MAHOGANY-TREE. Cal. 4-5-cleft, decid. Pets. 4-5. Sta. 8-10. Sty. 1. Stig. capit.

Mahogoni. L. common. in 4 pairs. leaf. ov. lanc. wh. — W. Ind. 1734. S. S. Loam & peat. cuttings.

ENKIA'NTHUS, ENKIA'NTHUS. Cal. 5-part. Cor. camp. 5-cleft, nect. 5. Caps. 5-celled.

quinqueflorus. B. R. five-flowered. ell. acu. at both ends smth. re. 7. China. 1812. G. S. Peat & loam.

reticulatus. B. R. netted-leaved. obl. obo. acu. at both ends. re. 4. 5. — 1822. G. S. cuttings.

MURRAYA, MURRAYA. Cal. 5-part. Cor. camp. Stam. 10. Ber. 2-celled, single-seeded.

exotica. B. R. Ash-leaved. pinn. leaf. ov. ent. smth. wh. 8. 9. E. Ind. 1771. S. S. Sandy loam

paniculata. H. E. F. panicled. pin. leaf. ov. acum. ent. wh. — — 1823. S. S. & peat. cutt.

CROWEA, CROWEA. Cal. 3-part. Pets. 5. Stam. 10. Caps. 5-celled, 5-valved. Seeds solitary.

saligna. B. M. Willow-leaved. lanc. ent. smth. pi. 8. 12. N. S. W. 1790. G. S. Loam & peat. cuttings.

MIRBELIA, MIRBELIA. Cal. of 2 lips, 5-toothed. Vexil. obcord. Legu. 2-celled, & 2-seeded.

Baxteri. B. R. Baxter's. opp. obl. cre. muc. silk. yel. red. 6. N. Holl. 1830. G. S. Sandy loam

dilatata. B. R. wedge-leaved. cunif. apex dilated 3-5 fid. pu. 5. 9. — 1803. G. S. and peat.

grandiflora. B. M. large-flowered. alt. ov. lanc. yel. red. 5. 6. N. S. W. 1823. G. S. cuttings.

speciosa. shewy. lin. acut. edges. revol. pur. — — 1824. G. S. —

BAUHINIA, MOUNTAIN-EBONY. Cal. 5-cleft. Pet. 5, obl. Sta. 10, unit. Legu. 1-cell. many-seed.

Lamarkiana. DC. Lamark's. cor. smth. abo. pub. ben. wh. — S. Amer. 1818. S. S. Sandy peat

porrecta. B. M. smooth-leaved. cord. ov. 3-4 nerv. wh. — W. Ind. 1737. S. S. and loam.

pubescens. DC. pubescent. cor. pub. ben. lea. ov. 4-ner. — Jamaica. 1823. S. S. cuttings, or

retusa. Rox. retuse-leaved. cor. 5-ner. apex notched. — E. Ind. 1820. S. S. seeds.

tomentosa. L. hairy. ov. obt. hairy. 3-4-nerv. st. — E. Ind. 1808. S. S. —

EUCHILUS, EUCHILUS. Cal. bilab. 5-cleft. Sty. awl-shap. Stig. simple. Ger. 2-seeded.

obcordatus. B. C. obcordate-lv'd. wedge-shap. vill. unde. ye. pu. 4. 5. N. Holl. 1803. G. S. Sandy loam and peat. cuttings.

JACKSONIA, JACKSONIA. Cal. 5-part. equ. Pet. decid. Ger. 2-seeded. Sty. filiform.

reticulata. DC. reticulate. lanc. pung. reticul. yel. 5. 8. N. S. W. 1822. G. S. Light loam

Daviesia reticulata, Sm.

spinosa. R. Br. spiny. Br. spiny. angul. forked. 4. 9. N. Holl. 1803. G. S. cuttings.

PODALYRIA, PODALYRIA. Cal. 5-cleft, uneq. Cor. papilionacea. Legu. vent. many-seeded.

buxifolia. B. R. Box-leaved. ov. flat, muc. silky ben. pur. 5. 9. C. B. S. 1790. G. S. Peat & loam

styracifolia. B. M. Storax-leaved. ov. ellip. retic.; Br. angu. fl. 5. 6. N. Holl. — Seeds, or cuttings.

Systematic Name.	English Name.	Form of Leaves, &c.	Col. of Flow.	Month of Fl.	Native Country.	Yr. of Introd.	Soil and Propagation.
A'OTUS, A'OTUS. <i>Cal. 5-parted, bilabiate. Style filif. Germen 2-seeded. Legume 2-valved.</i>							
villōsa. B.M.	villous.	ov. ellip. rough above.	yel.	4. 6.	V. Die. Is.	1790.	G. S. Loam & peat.
virgāta. DC.	twiggy.	tuberculated, rough.	yel.	— — —	— — —	1824.	G. S. cuttings.
EUTAXIA, EUTAXIA. <i>Cal. 2-tipped, upper emarginate, lower 3-cleft. Standard; a little broader [than long.]</i>							
Baxteri.	Baxter's.	obo. lan. muc. ent. smth.	yel.	4. 5.	N. Holl.	1829.	G. S. Peat & loam.
myrtifolia. B.M.	Myrtle-leaved.	lanc. obov. mucr.	yel.	8. 9.	— — —	1803.	G. S. cuttings.
pungens. Swt.	pungent-leaved.	ver. acicu. smth. edg. rev.	yel.	— — —	— — —	1825.	G. S. — — —
DILLWYNIA, DILLWYNIA. <i>Cal. 5-cleft. Petals insert. in the tube of the Calyx. Capsule 2-seeded.</i>							
floribunda. Ex. B.	many-flowered.	awl-shap. muc. rough.	yel.	4. 8.	N. S. W.	1794.	G. S. Loam & peat.
glaberrima. B.M.	smooth.	filif. smth. erect.	yel.	— — —	— — —	1800.	G. S. cuttings.
juniperina. B.C.	Juniper-leaved.	filif. spread. acut.	yel.	4. 5.	— — —	1818.	G. S. — — —
parvifolia. B.M.	small-leaved.	short, spread. decuss.	yel.	6. 7.	— — —	1800.	G. S. — — —
DAVIESIA, DAVIESIA. <i>Cal. angular, 5-toothed. Cor. keel shorter than vexillum. Germen of 2 [seeds, stalked.]</i>							
alata. B.R.	winged.	stems erect. spread. leafis.	yel.	4. 5.	N. Holl.	1818.	G. S. Sandy loam
acicularis. B.C.	needle-leaved.	lin. marg. revol. dent.	yel.	6. 8.	N. S. W.	1804.	G. S. and peat.
cordata. B.R.	cordate-leaved.	cord. acum. ampl. smth.	yel.	— — —	N. Holl.	1824.	G. S. cuttings, or
corymbosa. Sm.	corymb-flow'd.	lin. oblong, acute.	yel.	5. 9.	N. S. W.	1804.	G. S. seeds.
glauca. B.C.	glaucous.	lin. lanc. glau.	yel.	— — —	— — —	1812.	G. S. — — —
linearis.	linear-leaved.	lin. ent. smooth.	yel.	— — —	— — —	1825.	G. S. — — —
ulicina. B.C.	Furze-like.	lin. lan.; Br. spin. spread.	yel.	— — —	— — —	1792.	G. S. — — —
PULTENÆA, PULTENÆA. <i>Cal. 5-parted, lobes equal. Style awl-shaped. Capsule sessile, 2-seeded.</i>							
biloba. B.C.	two-lobed.	wedg.-sh. ap. 2-lo. silk. ben. y.	yel.	4. 5.	N. Holl.	1818.	G. S. Sandy loam
candida. B.C.	white-leaved.	lin. ciliat. in clusters.	yel.	— — —	— — —	1824.	G. S. & peat. cut-
lentata. DC.	toothed.	lin. tubercu. smth.	yel.	— — —	— — —	1830.	G. S. tings under
laphnoides. B.M.	Daphne-leaved.	obov. obl. smth. point.	yel.	6. 7.	N. S. W.	1792.	G. S. a bell-glass.
læxilis. Sm.	fragrant.	obo. lin. glau. smth. muc.	yel.	5. 6.	— — —	1801.	G. S. in sand, will
paleacea. B.M.	chaffy.	lin. smth. apex point.	yel.	4. 7.	— — —	1789.	G. S. strike freely.
pedunculata. B.M.	pedunculated.	lin. lanc. flat, hairy.	yel.	— — —	— — —	1824.	G. S. The plants
retusa. B.R.	retuse-leaved.	lin. retuse, smth. flat.	yel.	4. 5.	— — —	1789.	G. S. frequently
stricta. B.M.	upright.	ellip. obov. mucr. smth.	yel.	— — —	— — —	1803.	G. S. ripen seeds.
enuifolia. B.M.	slender-leaved.	lin. awl-shap. hairy.	yel.	— — —	N. Holl.	1818.	G. S. — — —
SPHEROLOBIUM, SPHEROLOBIUM. <i>Cal. 5-part. 2-tipped. Legume round, 1-2-seed. pedicel.</i>							
limineum. B.M.	yellow-flow'd.	lin. ent. smth. sess. point. ye. pu.	ye.	5. 9.	N. S. W.	1802.	G. S. Loam & peat. seeds, or cuttings.
GASTROLOBIUM, GASTROLOBIUM. <i>Cal. 2-tipped, 5-parted. Petals nearly equal. Germen [2-seeded, stalked.]</i>							
lobum. B.R.	two-lobed.	wedge-sh. retu. emar. bilo.	ye.	4. 5.	N. Holl.	1803.	G. S. Sandy loam and peat. seeds, or cuttings.
ODOLOBIUM, PODOLOBIUM. <i>Cal. bilabiate, 5-parted, upper lobe bifid, under 3-parted. Ger- [men of 4 seeds.]</i>							
aurophyllum. B.R.	pungent-ly'd.	opp. rig. trif. spiny.	yel.	3. 4.	N. S. W.	1821.	G. S. Sandy loam
lobatum. B.M.	three-lobed.	opp. dent. spiny, sub-3-lo.	yel.	4. 8.	— — —	1791.	G. S. and peat. cuttings, or seeds.
XYLOBIUM, OXYLOBIUM. <i>Cal. 5-parted. Cor. keel compr. Legume nearly sessi. with many seeds.</i>							
borscens. B.R.	tall.	lin. lanc. edges recurv.	yel.	5. 6.	V. Dic. Isl.	1805.	G. S. Light loam

Systematic Name.	English Name.	Form of Leaves, &c.	Col. of Flow.	Month of Native Fl. Country.	Yr. of Introd.	Soil and Propagation.
cordifolium. B. rep.	heart-leaved.	ov. cord. pilose.	sc.	4. 9. N. S. W.	1807.	G. S. & peat. seeds.
obtusifolium.	obtuse-leaved.	obl. lin. obt. downy ben.	sc.	— N. Holl.	1825.	G. S. or cuttings.
retusum. B. R.	retuse-leaved.	ov. obl. retuse.	or.	4. 5. —	1822.	G. S. in sand, un-

[der a hand-glass, will strike root.

[of many seeds.

GOMPHOLOBIUM, GOMPHOLOBIUM. Cal. 5-parted, nearly equal. Stigma simple. Legume

glabratum. DC.	smooth.	pinn. in 3 pairs, leaf. lin.	yel.	4. 9. N. Holl.	1824.	G. S. Peat & loam.
grandiflorum. B. R.	great-flowered.	lin. acute.	yel.	3. 9. N. S. W.	1803.	G. S. seeds, or
Knightsianum. B. R.	Mr. Knight's.	tern. pin. leaf. obov.	pk.	8. —	1830.	G. S. cuttings.
maculatum.	spotted.	lin. tern. smth.	yel.	— —	G. S. —

[pressed keel.

BRACHYSEMA, BRACHYSEMA. Cal. 5-parted, a little unequal. Standard shorter than the com-

latifolium. B. R.	broad-leaved.	ov. flat, ent.	sc.	4. 7. N. Holl.	1803.	G. S. cl. Peat & loam.
undulatum. B. R.	waved-leaved.	ellip. wavy, silky ben.	p. ye.	2. 7. —	1820.	G. S. cl. cuttings.

[sule of many seeds.

CHORIZEMA, CHORIZEMA. Cal. 5-parted. Cor. of 3 petals. Keel shorter than the wings. Cap-

Henchmannii. B. R.	Mr. Henchmann's.	acicul. hairy.	sc.	— N. Holl.	1825.	G. S. Peat & loam.
ilicifolia.	Holly-leaved.	obl. prickly; ; Stip. minu.	ye.	3. 10. —	1803.	G. S. cuttings, or
nana. B. M.	dwarf.	sinuat. dent. spiny.	ye.	red. —	—	G. S. seeds.
rhombea. R. B.	few-flowered.	ellip. mucr. hair; ; stm. twin. y.	4. 6. —	—	—	G. S. —

[stalked, many seeded.

CALLISTACHYS, CALLISTACHYS. Cal. bilabiate, upper lip bifid, under 3-parted. Legume

lanceolata. B. R.	spear-leaved.	opp. lanc. acum.	yel.	6. 8. —	1815.	G. S. Loam & leaf
ovata. B. M.	oval-leaved.	obov. mucr. tern.	yel.	— — —	—	G. S. mould. cutt.

VIRGILIA, VIRGILIA. Cal. 5-parted. Cor. of 5 petals. Legume compressed, many seeded.

aurea. Lam.	yellow.	pinn. leaf. opp. ov. obt.	yel.	7. Abyssi.	1777.	G. S. Loam & leaf
capensis. B. M.	Cape.	pinn; ; leaf. lanc. mucr. pube.	7. 8. C. B. S.	1767.	G. S. mould. cutt.	

[many seeds.

BAPTISIA, BAPTISIA. Cal. 4-5-cleft. Petals nearly equal. Legume ventricose, pediculate, with

australis. B. M.	blue-flowered.	pinn. smth; ; leaf. obl. obt. blue.	6. 7. N. Amer.	1758.	H. P. Sandy loam.	
exaltata. B. F. G.	tall.	tern. leaf. lanc. obov.	blue. —	—	1812.	H. P. Seeds, or di-
nepalensis. Ex. Fl.	Nepaul.	tern; ; leaf. ellip. lanc.	yel.	6. —	1819.	G. S. viding at
perfoliata. H. K.	perfoliate.	orbic. perfol. ent. smth.	yel.	7. —	1732.	F. P. the roots.
villosa. DC.	villous.	nrly sess. pub. upp. lan. obt. st.	—	—	1811.	H. P. —

EDWARDSIA, EDWARDSIA. Cal. oblique, 5-dent. Petals 5. Filam. 10. Legume of 1 cell & 2 valves.

chrysophylla. B. R.	golden-leaved.	pinn. lfl. obv. obt. ellip. pilo.	y.	— S. Isla.	F. S. Loam & peat.
grandiflora. B. M.	large-flowered.	pinn. leaf. 17-21. obl. lin.	yel.	3. 6. N. Zeal.	1772.	F. S. cuttings.
microphylla. B. M.	small-leaved.	Leaf. 33-41. obov. vill.	yel.	— — —	—	F. S. —

SAMYDA, SAMYDA. Cal. 5-cleft, coloured. Cor. 9. Capsule round, 4-furrowed, 1-celled.

serrulata. L.	saw-leaved.	ov. obl. serr.	scar.	7. 8. W. Ind.	1723.	S. S. Peat & loam. cuttings.
---------------	-------------	----------------	-------	---------------	-------	------------------------------

SOPHORA, SOPHORA. Cal. 5-dented, campanulate at base. Legume necklace-shaped, many-seeded.

alopocuroides. L.	Fox-tail.	pinn. lfl. 15-25. obl. silky.	wh.	7. 8. Levant.	1731.	H. P. Peat & loam.
japonica. B. R.	Japanese.	Leaf. 11-13. obl. ov. act. sm. w.	8. 9. Japan.	1753.	H. C. cuttings.	
tomentosa. L.	downy.	Leaf. 15-19. ov. obt. hairy.	yel.	— E. Ind.	1690.	S. S. —
velutina. B. R.	velvetty.	pinn; ; leaf. ellip. mucr.	pur.	6. 7. Nepaul.	1824.	G. S. —

DECANDRIA MONOGYNIA.

99

Systematic Name.	English Name.	Form of Leaves, &c.	Col. of Flow.	Month of Fl.	Native Country.	Yr. of Introd.	Soil and Propagation.
[pressed, many seeded.]							
CERCIS, JUDAS-TREE.		<i>Cal. 5-toothed. Petals 5, compressed. Stamens 10, unequal.</i>					<i>Legume compressed.</i>
<i>canadensis</i> . L.	Canadian.	acum. cord. smth.	ros.	5. 6.	N. Amer.	1730.	H. ♂. Sandy loam.
<i>Siliquastrum</i> . B.M.	European.	obt. smth. ent.	ros.	—	S. Europ.	1596.	H. ♂. seeds or laye.
[Germen stalked. 3 inferior longest.]							
CA'SSIA, CA'SSIA.		<i>Cal. of 5 leaves. Cor. of 5 petals. Stamens 10, unequal, the</i>					<i>3 inferior longest.</i>
<i>arborescens</i> . DC.	tree.	in two pairs. obl. vill.	yel.	6. 8.	N. Spain.	1826.	S. ♂. Loam & leaf
<i>australis</i> . B.M.	Southern.	pinn. leaf. obl. obt.	yel.	—	N. Holl.	1824.	G. ♂. mou'd. cutt.
<i>atomaria</i> . L.	woolly-leaved.	Leaf. in 5-pairs ov. hairy.	yel.	3. 8.	S. Amer.	1822.	S. ♂. ———
<i>Barclayana</i> . Swt.	Barclay's.	pinn. leaf. opp. lin. lanc.	yel.	—	N. Holl.	1827.	G. ♂. ———
<i>bicapsularis</i> . L.	two-capsuled.	Leaf. in 3-pairs, obov. smth.	yel.	5. 6.	W. Ind.	1730.	S. ♂. ———
<i>biflora</i> . B.R.	two-flowered.	Leaf. 6-8 pairs, ov. obl.	yel.	12. 4.	—	1766.	S. ♂. ———
<i>bacillaris</i> . DC.	four-leaved.	bijug. ov. oblig.	yel.	3. 4.	Surinam.	1818.	S. ♂. ———
<i>Cathartocarpus Bacillus</i> . B.R.							———
<i>floribunda</i> .	many-flowered.	Leaf. in 3-5 pairs, obl. lanc. ye.	yel.	5. 8.	N. Spain.	1822.	S. ♂. ———
<i>Herbertiana</i> .	Mr. Herbert's.	pinn. leaf. lanc. obov.	yel.	—	Barbade.	1821.	S. ♂. ———
<i>purpurea</i> .	purple.	in 5 pairs, ov. lan.	yel.	—	E. Ind.	1823.	S. ♂. ———
<i>ruscifolia</i> .	Ruscus-leaved.	Leaf. in 6 pairs, ov. lan.	yel.	5. 7.	Caracus.	1816.	G. ♂. ———
<i>tipulacea</i> . H.K.	large stipuled.	Leaf. in 8 pairs, ov. lan. sm. ye.	yel.	—	Chile.	1786.	S. ♂. ———
<i>Tora</i> . L.	Tora.	in 3 pairs, obov. obt.	yel.	—	E. Ind.	1693.	S. ♂. ———
[about 4 inches long.]							
POINCIA'NA, POINCIA'NA.		<i>Cal. leaves 5. Petals 5, stalked, crenate. Legume compressed, 2-valved,</i>					
<i>égia</i> . B.M.	superb.	bipinn. leaf. ov. obl.	red.	Madaga.	1827.	S. ♂. Loam & peat cuttings.
[Legume compressed.]							
MESALPINA, BRASILETTO.		<i>Cal. of 5 leaves, unequal. Petals 5. Filaments villous at the base.</i>					
<i>acullata</i> .	hooded.	pinn.; leaf. ov. ellip. smth.	yel.	—	E. Ind.	1832.	S. ♂. Peat & loam.
<i>simosoides</i> . Lam.	Mimosa-leaved.	pin.; leaf. 8-12 pairs, obl. obt. y.	yel.	—	—	1806.	S. ♂. cuttings.
<i>nuga</i> . H.K.	Nuga.	Leaf. 2-3 pairs, ov. acut.	yel.	—	—	1801.	S. ♂. ———
CH'OTIA, SCH'OTIA.		<i>Cal. coloured, of 5 leaves. Petals 5. Filaments 10, smooth. Style filiform.</i>					
<i>eciösa</i> . B.R.	small-leaved.	Leaf. 7-10 pairs, ov. lanc.	cr.	7. 12.	C. B. S.	1759.	G. ♂. Loam & peat.
<i>amarindifolia</i> . B.M.	Tamarind-ld.	Leaf. 8-10 pairs, ov. obt.	cr.	5. 9.	—	1795.	G. ♂. cuttings.
YGOPHYLLUM, BEAN CAPPER.		<i>Cal. of 5 leaves. Pet. 5. Caps. obl. 5-sided, 5-cell'd, & 5-valv'd.</i>					
<i>bum</i> . L.	white.	in 2's. leaf. round. fleshy.	w.	10. 11.	Egypt.	1770.	G. ♂. Loam & leaf
<i>orgsäna</i> . L.	four-leaved.	in 2's. leaf. obov. stalk.	yel.	5. 7.	C. B. S.	1732.	G. ♂. mould. cut-
<i>sessilifolium</i> . B.M.	sessile-leaved.	conjug. sess. leaf. ov.	yel.	7. 8.	—	1713.	G. ♂. tings.
ICTA'MNUS, FRAXINELLA.		<i>Cal. 5-leaved, decidu. Cor. of 5-clawed petals, unequal. Caps. 5, united.</i>					
<i>gustifolia</i> . M.D.	narrow-leaved.	pinn. leaf. obl. lan. ser. dot.	pu.	6. 7.	Siberia.	1829.	H. ♂. Light loam.
<i>pa</i> . L. en.	white.	pinn. leaf. ov. serr.	wh.	—	S. Europ.	1596.	H. ♂. seeds, or
<i>fraxinella</i> . Pers.	red.	pinn. leaf. ov. serr.	red.	—	—	—	H. ♂. part. root.
[2-valved cleft. Caps. 5-celled, opening at the angles.]							
CHIMA'PHILA, CHIMA'PHILA.		<i>Cal. 5-parted. Petals 5. Stigma sessile. Anthers opening by a</i>					
<i>maculata</i> . B.M.	spotted.	lanc. remotely serr. varieg. w.	w.	7.	N. Amer.	1752.	H. ♂. Peat soil.
<i>Py'rola maculata</i> . w.							cuttings, seeds, or
<i>umbellata</i> . s.s.	umbelled.	cuneat. lanc. acut. serr.	gr. w.	6. 8.	—	—	H. ♂. part. plants.
<i>Py'rola umbellata</i> . B.M.							

ORDER II.

DIGYNIA. STYLES 2.

Systematic Name.	English Name.	Form of Leaves, &c.	Col. of Month Native Flow. of Fl. Country.	Yr. of Introd.	Soil and Propagation.
CUNONIA, CUNONIA. <i>Cal. 5-parted, lobes often articulated. Petals obt. altern. with the calyx lobes.</i>					
capensis. B.R.	Cape.	pinn.; leaf, obl. coriac. serr.	w. 5. 7. C.B.S.	1816.	G. S. Peat and loam. cutt.
HYDRANGEA, HYDRANGEA. <i>Cal. 5-parted. Cor. of 5 equal petals. Stam. 10. Sty. 2. Caps. 2-cell'd.</i>					
arboréscens. B.M.	tree.	ov. subcord. upp. lanc. den.	w. 7. 8. Virginia.	1736.	H. S. Loam & peat.
cordata. Ph.	heart-leaved.	ov. cor. acu. dent. sm. ben.	wh. — Carolina.	1806.	H. S. cuttings, or
horténsis. B.M.	changeable.	ov. dent. acut. pk. or blue.	4. 9. China.	1788.	H. S. suckers from
quercifolia. B.M.	Oak-leaved.	ov. sinu. lob. den. pilo. ben.	wh. 6. 9. Florida.	1803.	H. S. the root.
radiata. w.	rayerd.	ov. acum. den. white, ben.	wh. 7. 8. Carolina.	1786.	H. S. —
[many seeded.]					
TELLIMA, TELLIMA. <i>Cal. 5-toothed. Petals 5, jagged. Style 2. Stigma angular. Capsule 1-celled,</i>					
grandiflora. B.R.	large-flowered.	cord. lob. dent. pilose.	re. st. 5. N. Amer.	1826.	H. P. Sandy soil. seeds, or parting root.
[Capsule 1-celled, 2-valved, valves unequal.]					
TIARELLA, TIARELLA. <i>Cal. 5-parted. Petals 5, inserted in the calyx, entire. Stamens 10. Style 2.</i>					
cordifolia. B.M.	heart-leaved.	cord. acut. lob. dent.	wh. 4. 5. N. Amer.	1731.	H. P. Sandy soil
Menziesii. Ph.	Menzies's.	ov. cord. acu. lob. dent.	wh. — — — —	1812.	H. P. and peat.
trifoliata. Ph.	three-leaved.	tern. leaf. narr. serr. pil.	wh. — — — —	1826.	H. P. dividing at root.
MITELLA, MITELLA. <i>Cal. campanul. 5-lobed. Pet. 5-toothed. Caps. 1-celled, with 2 equal valves.</i>					
cordifolia. w.	heart-leaved.	cord. 3-lob. dent.	wh. 4. 5. N. Amer.	1812.	H. P. Light loam
diphylla. B.R.	two-leaved.	cord. lob. serr. hairy.	wh. — — — —	1731.	H. P. and peat.
nuda. w.	naked.	renif. lob. obt.	wh. 6. 8. — — — —	—	H. P. dividing at
prostrata.	prostrate.	alt. cord. rotund.	wh. 5. 6. — — — —	1812.	H. P. root.
pentandra. B.M.	five-stamened.	cord. lob. cren.	wh. — — — —	1827.	H. P. —
GYPSOPHILA, GYPSOPHILA. <i>Cal. of 1 leaf, campanulate. Petals 5. Cap. globose, 1-celled.</i>					
arenaria. DC.	sand.	lin. fleshy, smth. flat.	wh. 7. 8. Hungary.	1801.	H. P. Sandy loam
dubia. DC.	doubtful.	lin. thick. sm. Pet. notch.	wh. 5. 9.	1815.	H. P. cuttings.
prostrata. B.M.	creeping.	lin. lanc. smth.; stem prost. bh.	7. 9. Sibera.	1759.	H. P. —
saxifraga. DC.	small.	lin. rigid.; stem erect. stiff. bh.	7. 8. Germany.	1774.	H. P. —
[of 1-cell. Seeds many]					
DIAANTHUS, PINK. <i>Cal. tubular, 5-toothed. Petals 5-notched. Germen on short stalks. Capsule</i>					
Arméria. E.B.	Deptford.	awl-shap. flow. loose bun.	red. 7. 9. England.	H. S. Sandy loam
alpinus. DC.	alpine.	lanc. smth.; stem 1-fl'd.	red. 5. 6. Austria.	1759.	H. P. and leaf
alpéstris. DC.	field.	lin. lanc. smth.	red. 7. 8. Tauria.	1820.	H. P. mould.
arbúscula. B.R.	shrubby.	lanc. smth. ent.	pur. red. 6. 7. China.	1824.	H. S. seeds, or cut
barbátus. B.M.	bearded.	lanc. flowers in cluster.	pk. 6. 7. Germany.	1753.	H. P. tings under hand-glasse
β. flore pleno.	double-flowering.				

Systematic Name.	English Name.	Form of Leaves, &c.	Col. of Flow.	Month of Fl. Country.	Yr. of Introd.	Soil and Propagation.
Balbásii. B.F.G.	Balbis's.	opp. lanc. lin. acut.	red.	6. 7. Genoa.	1827.	H. P. will root
bicolor. DC.	two-coloured.	awl-shap. pubes.	wh. p.	6. 8. Tauria.	1818.	H. P. freely.
Caryophyllus. E. Fl.	Clove.	lin. chan. dent. at base.	wh. pur.	— England.	H. P. —
β. flore pleno.	Carnation.	—	—	H. P. —
fruticosus.	tree.	—	—	H. S. —
cæsius. Br. Fl.	mountain.	lin. lanc. margin rough.	ros.	6. 7. Britain.	H. P. —
collinus.	hill.	lin. lanc. Flow. in clusters.	wh.	7. 9. Hungary.	1800.	H. P. —
campéstris. DC.	field.	awl-shap. ; stm. hairy.	w. re.	7. 8. Tauria.	1815.	H. P. —
deltóides. E. Fl.	maiden.	lin. lan. down. ; stms. decum. ro.	6. 10.	Britain.	H. P. —
fimbriátus. B.M.	fringed.	awl-sh. rough ; stm. sub. shr. lil.	6. 8.	Iberia.	1802.	H. S. —
Fischèri. B.F.G.	Fischer's.	opp. lanc. acut. glau. 1-ner.	li.	— Russia.	1826.	H. P. —
gláucus. E. Fl.	glauous-iv'd.	glau. the lower obl. obt.	wh.	6. 10. Britain.	H. P. —
gigánteus.	gigantic.	broad. lin. acut. smth.	sc.	— Bulgaria.	1827.	H. P. —
latifólius. DC.	broad-leaved.	obl. lanc. 3-nerv.	red.	5. 11.	H. P. —
petræus. DC.	rock.	awl-shap. ent. smth. nerv.	pk.	7. 8. Hungary.	1804.	H. P. —
próliifer. E.B.	proliferous.	lin. lanc. serrul.	pk.	— England.	H. P. —
pubescens.	pubescent.	opp. striat. apex. subul.	red.	—	1829.	H. P. —
supérbus. DC.	superb.	lin. awl-sh. ; stm. many fl'd.	w.	7. 9. Europe.	1596.	H. P. —
serotinus. DC.	late-flowering.	glau. lin. awl-shap.	wh. pk.	7. 8. Hungary.	1804.	H. P. —
Sternbèrgii. DC.	Sternberg's.	lin. ; stm. 2-fl'd. petals serr.	re.	—	1825.	F. P. —

[calyx. Capsule of 1 cell. Filaments as long as the

SAPONARIA, SOAPWORT.	Cal. of 1 leaf. 5-toothed. Petals 5, obtuse.					
glutinosa. B.M.	clammy.	opp. ov. the upper cord.	re.	5. 7. Tauria.	1823.	H. P. Sandy loam.
lutea. DC.	yellow.	crow ; stm. leaves op. li. lan. y.	6. 8.	Switzerl.	1804.	H. P. parting at
ocymóides. B.M.	Basil-leaved.	ov. lanc. smth. 1-nerved.	red.	5. 7. Europe.	1768.	H. P. the root, or cuttings.

[with 2 styles. Capsule of 2 beaks.

SAXIFRAGA, SAXIFRAGE.	Cal. in 5 segments. Petals 5. Filaments 10, awl-shaped. Germen					
aizóides. L.T.	yellow.	alt. lin. fring. fleshy.	yel.	7. 8. Britain.	H. P. Sandy loam
affinis. L.T.	involute.	5-cleft, upp. 3-cleft.	wh.	6. 7. Ireland.	H. P. and peat.
Aizoön. L.T.	large-margined.	lingu. with cartilag. teeth.	wh.	5. 7. Pyren.	1731.	H. P. dividing the
Androsæca. L.T.	Androsace-iv'd.	lan. obt. hairy ; stm. 2-fl'd.	wh.	5. 6. Switzerl.	1792.	H. P. plants at the
áspera. L.T.	rough.	lanc. alt. ciliated.	wh.	8. —	1752.	H. P. roots.
cæspitosa. E.B.	tufted.	crowd. 3-5 parted.	wh.	5. 6. Wales.	H. P. —
cérnua. E.E.	drooping.	renif. palmate, upp. trifid.	wh.	7. Scotland.	H. P. —
ceratophylla. L.T.	shining-calyx'd.	3 lob. lobes cut, seg. falcate.	w.	5. 6. Spain.	1804.	H. P. —
denudata. L.T.	smooth.	5-c'eft. segm. lin.	wh.	6. Scotland.	H. P. —
elongella. L.T.	long-stalked.	lower leaves 3-5 cleft.	wh.	5. 6. —	H. P. —
granulata. E. Fl.	white-meadow.	lob. kidney-shap. hairy.	wh.	5. Britain.	H. P. —
Gèum. E. Fl.	kidney-leaved.	orbi. or kidney-sh. cren.	w. re.	6. 7. Ireland.	H. P. —
Hírculus. E. Fl.	yellow-marsh.	alt. lanc. smth. ent.	yel.	8. England.	H. P. —
hirsuta.	hairy.	ov. cord. at base, serr.	car.	5. 6. Ireland.	H. P. —
hirta. L.T.	rough.	3-5 cleft, hairy, lob. ellip.	wh.	—	H. P. —
hypnoídes. E. Fl.	Ladies Cushion.	lin. ent. 3-fid.	wh.	4. 6. Britain.	H. P. —
incurvifolia. E.F.	incurve-leaved.	5-cleft, palm.	wh.	6. Ireland.	H. P. —
ætevírens. E. Fl.	bright green.	3-5-cleft, segm. lin.	wh.	5. 6. Scotland.	H. P. —
muscoídes. L.T.	mossy.	obl. obt. 3-fid. ; stm. 2-fid.	w. y.	— England.	H. P. —
nivális. L.T.	clustered.	orbi. obov. serr. ent. at base.	w.	6. 7. Britain.	H. P. —
oppositifolia. E. Fl.	opposite-leaved.	opp. imbr. ov.	pur.	3. 4. —	H. P. —

Systematic Name.	English Name.	Form of Leaves, &c.	Col. of Flow.	Month of Fl.	Native Country.	Yr. of Introd.	Soil and Propagation.
pedatífida. E.Fl.	pedatifid.	in 3 lin. segm. pub.	wh.	5. 6.	Scotland. H. P.	—
platypétala. L.T.	broad-petal'd.	3-5-cleft, hairy.	wh.	6.	— H. P.	—
pygm'æa. E.B.	dwarf.	lin.lanc.ent.or trifid.	wh.	5. 6.	— H. P.	—
retùsa. L.T.	retuse-leaved.	imbr.opp.3-sided, acut.	r.pu.	3. 4.	Pyrenees. H. P.	—
rivulàris. E.B.	Brook.	palm.; stem sing.2-flid.	wh.	—	Scotland. H. A.	—
stellàris.	starry.	wedge-sh.angul.serr.	wh.	6. 7.	Britain. H. P.	—
tridactylites.	Rue-leaved.	wedge-sh.3-5-cleft.	bh.	3. 5.	— H. A.	—

[Filaments 8-10. Capsule of 1 cell and 2 valves.

Cal. coloured of 1 leaf, 4 or 5 parted. Cor. 0.

alternifòlium. E.Fl.	alternate-lv'd.renif. lob. hairy.	yel.	4. 5.	Britain H. P.	Sandy loam.
oppositifòlium. E.Fl.	opposite-lv'd.opp.cord.orbic.lob.	yel.	—	— H. P.	part. roots.

[Capsule oval, of 1 cell, and 2 seeds.

SCLERANTHUS, KNAWEI. Cal. 5-parted, ribbed at the base. Cor. 0. Filaments from 5 to 10.

perennis. E.Fl.	perennial.	lin.awl-sh.curv.crowd.	8. 9.	— H. P.	Light sandy loam. seeds.
-----------------	------------	------------------------	-------	---	------------	--------------------------

ORDER III.

TRIGYNIA. STYLES 3.

[Seeds many, kidney-shaped.

SILENE, CATCHFLY. Cal. angular, 5-cleft. Petals 5, as long as the calyx. Capsule slightly 3-celled.

ánglica. E.Fl.	English.	lan.lowerobov.acut.ent.w.re.	6. 7.	England. H. A.	Rich light
Arméria. DC.	common.	ov. obl. sess. glau.	pur. 7. 9.	— H. A.	soil. seeds or
acúnis. E.Fl.	moss Campion.	opp.lin.acut.fring.	ros. 6. 8.	Britain. H. P.	cuttings.
compácta. DC.	compact.	cord.ov.smth.glau.	scar.	—	Russia. 1816.	H. A.
cònica. E.B.	striated.	sess.lin.lanc.acut.	pur. 6. 7.	England. H. A.	—
laciniàta. B.R.	cut-flowered.	lanc. acut. pubes.	sc.	7.	Mexico. H. P.
marítima. E.B.	sea.	lanc.smth.; stm.spread.	wh. 8. 9.	Britain. H. P.	—
noctiflòra. E.F.	night-flowering.	large; stem erect, branch.	7.	England. H. A.	—
nútans. E.B.	Nottingham.	ellip.lanc.down.fl. droop.	wh. 6. 7.	— H. P.	—
pennsylvànica. B.R.	Pennsylvanian.	lin. lanc. cuneat.	pk. 6. 8.	America. 1806.	H. P.	—
pusilla.	dwarf.	spat. pubes.	wh. 6. 7.	Hungary. 1804.	H. P.	—
quinquevùnera. E.B.	variegated.	lanc.obt.; stem hairy.	6. 8.	England. H. A.	—

[of 1 cell, and 6 valves.

STELLARIA, STITCHWORT. Cal. 5-parted, concave. Cor. of 5 cloven petals. Nect. 5 glands. Caps.

cerastoides. E.B.	Alpine.	ellip. lanc. pubes.	wh. 6. 8.	Scotland. H. P.	Sandy loam
gláuca. E.B.	glaucous.	lin. lanc. glau.	wh. 5. 9.	Britain. H. P.	and peat.
gramínea. E.B.	lesser.	lan.acu.en.about1in.long.w.	4. 6.	— H. P.	dividing
holóstea. E.Fl.	greater.	lanc. serrul. glau.	wh.	— H. P.	plants.
némorum. E.Fl.	wood.	cord.stalk.upp.sess.ov.	wh.	— H. P.	—
scapígera. E.B.	many-stalked.	lin.lanc.margin rough.	wh.	—	Scotland. H. P.

[of 1 cell, and 3 valves, rarely 6.

ARENARIA, SANDWORT. Cal of 5 pointed leaves. Pet. 5, undivided. Nect. 5 or 10 glands. Caps.

baleárica. DC.	Majorca.	ov.stalk.vill.pedun.elong. w.	3. 9.	Majorca. 1787.	H. P.	Sandy soil.
ciliàta. E.Fl.	ciliated.	spat.scab.;stm.pro.downy.w.	—	Ireland. H. P.	seeds, or

Systematic Name.	English Name.	Form of Leaves, &c.	Col. of Flow.	Month of Fl.	Native Country.	Yr. of Introd.	Soil and Propagation.
fastigiáta. B.Fl.	level-topped.	awl-sh.3-ribb.at base.	wh.	5. 6.	Scotland.	H.Á. parting plants.
peploídes.	common.	fleshy,ov.acut.ent.smth.	wh.	5. 7.	Britain.	H.Á. plants.
rúbra. B.Fl.	red.	lin.awl-sh.; stm.procum.	red.	6. 9.	—	H.Á. —
serpyllifólia. E.Fl.	Thyme-leaved.	ov.acut.sess.ciliat.nerv.	wh.	—	—	H.Á. —
trinérvia. DC.	Plantain-leav'd.	ov.acut.ciliat.nerv.	wh.	5. 6.	—	H.Á. —
tenuifólia. E.Fl.	slender.	awl-sh.; stm.forked.	wh.	6. 9.	England.	H.Á. —
vérna. E.Fl.	spring.	awl-sh. acut. smth.	wh.	4. 9.	Britain.	H.Á. —

[cell, and 3 valves. Seeds angular.

CHERLERIA, CHERLERIA. Cal. of 5 concave leaves. Cor. 0. Nect. 5 cloven glands. Caps. of 1 sodoídes. E.Fl. mossy. lin.awl-sh.a little vill. *yel.gr.* 8. 9. Britain. H.Á. Sandy soil.

THRYALLIS, THRYALLIS. Cal. 5-cleft, unequal. Pet. 5, on long claws. Germ. 3-celled. Sty. 3.

brachystáchys. B.R. short-spiked. ov.lan.glau.above,wh.ben.y. 8. 9. Brazil. 1823. S.Á. *cl.* Sandy loam. cuttings.

BRUNNICHIA, BRUNNICHIA. Cal. 5-cleft, ventricose. Cor. 0. Caps. 3-cornered, 1-cell. 1-seed. cirrhósa. s.s. Carolina. cord. sagitt. smth. *gr.* — Carolina. 1787. G. Á. *cl.* Loam and peat. cuttings.

BANISTERIA, BANISTERIA. Cal. 5-parted. Pet. rounded. Filam. awl-shaped, united at base.

Humboldtiana. DC. Humboldt's. ov. cord. pubes. *yel.* S. Amer. 1826. S. Á. *cl.* Loam & peat.
 laurifólia. B.R. bay-leaved. ov.obl.acut.smth. *yel.* 8. 9. Jamaica. 1733. S. Á. *cl.* cuttings.
 nítida. shining. ellip. acum. shin. *yel.* — Brazil. 1809. S. Á. *cl.* —
 spléndens. DC. splendid. cord. renif. smth. dent. *yel.* S. Amer. 1812. S. Á. *cl.* —

[Stig. very small.

MALPIGHIA, BARBADOES-CHERRY. Cal. of 5 leaves. Pet. 5, roundish. Filam. united. Sty. 3.

angustifólia. B.C. narrow-leaved. lin. lanc. hisp. *lil.* 7. 9. W. Ind. 1777. S. Á. Sandy loam
 coccifera. B.R. kermes Oak-ld. ov. tooth. spiny. *lil.* S. Amer. 1733. S. Á. and peat.
 fucáta. B.R. painted. ellip. shin. hairy ben. *lil.* 3. 8. W. Ind. 1814. S. Á. cuttings.
 úcida. B.M. shining. obov.cuneif.ent.smth. *pk.* 5. 8. E. Ind. 1759. S. Á. —
 úrens. B.R. stinging. obl.opp.prickly ben. *ros.* 8. 9. S. Amer. 1737. S. Á. —

[Drupe 3-celled, and 3-seeded.

BYRSONIMA, BYRSONIMA. Cal. 5-parted. Pet. clawed. Stam. united at the base. Sty. 3.

chrysophýlla. DC. golden-leaved. obl.silky, rusty ben. *yel.* 8. Orinoco. 1823. S. Á. Peat & loam.
 legans. DC. elegant. obl. lanc. smth. *car.* — Guiana. 1827. S. Á. cuttings.

ORDER V.

PENTAGYNIA. STYLES 5.

VERRHO'A, AVERRHO'A. Sep. 5. Pet. 5, spread. Stam. insert. in a rectangle? Apple 5-cornered.

ilimbi. L. Bilimbi-tree. pinn.leaff.ov.lanc.smth. *st.* 8. 9. E. Indies. 1791. S. Á. Peat & loam.
 arambóla. DC. Carambola-tree. pinn.leaff.ov.unequal. *s.* — — 1793. S. Á. cuttings.

OTYLEDON, NAVEL-WORT. Cal. 5-parted. Cor. bell-shaped, 5-cleft. Germ. 5. Sty. 5. Caps. 5.

trúscans. B.M. shining. cunea.obl.acum.fleshy.or.re. 6. C. B. S. 1818. G. Á. Sandy loam.
 urvilfóra. curve-flowered. semi-cylind.scatt.smth. *yel.* 10. — — G. Á. *cutt.* dried a

Systematic Name.	English Name.	Form of Leaves, &c.	Col. of Flow.	Month Native of Fl. Country.	Yr. of Intro.	Soil and Propagation.
decussata. B.R.	cross-leaved.	opp. decuss. fleshy, glau.	red.	8. 9. C. B. S.	1819.	G.S. few days before
hemisphærica.	thick-leaved.	half orbic. flat, dott. obov.	vi.	6. 7. —	1731.	G.S. fore planted,
lutea. E.Fl.	yellow.	dent. a little peltate.	yel.	— England.	H.P. will readily
Umbilicus. B.F. Wall. Penny-wort.		orbic. pelt. cren.	gr.yel.	— Britain.	H.P. strike root, or divid. plant.

[compressed. Seeds many notched scale. Capsule 5,

SEDUM, STONE-CROP. Cal. deeply 5-cleft. Petals 5. Nectary a small						
ánglicum. DC.	English.	ov. fleshy, smth. alt.	wh.	8. 9. England.	H.P. Sandy loam.
álbum. E.B.	white.	obl. cylind. sess. smth.	wh.	6. 8. —	H.P. dividing
Anacampseros. DC.	evergreen.	cuncif. nearly sess.	pur.	— France.	1596.	H.P. roots.
dasyllyllum. E.B.	thick-leaved.	opp. ov. fleshy, sess.	wh. red.	6. 7. England.	H.P. —
Forsterianum. H.K. Mr. Forster's.		subul. spread.	yel.	— Wales.	H.P. —
glaucum. DC.	glaucous-leav'd.	awl-sh. glau. scattered.	yel.	— Hungary.	1816.	H.B. —
reflexum. E.B.	reflex-leaved.	subul. lower ones recurve.	yel.	— Britain.	H.P. —
rupéstre. E.B.	rock.	subul. scatt. glau.	yel.	— England.	H.P. —
sexangulare. E.Fl.	insipid.	in 6-7 rows, cylind. fleshy.	yel.	—	H.P. —
Telèphium. E.B.	Orpine.	flat. serr. smth.	pur.	8. 9. Britain.	H.P. —
villosum. E.Fl.	villous.	obl. flat, above.	ros.	—	H.P. —

[Scales 5, obtuse.

ECHEVERIA, ECHEVERIA. Cal. 5-parted. Petals 5. Stamens 10, shorter than the petals.						
coccinea. DC.	scarlet.	obov. fleshy, acut.	sc.	— Mexico.	1816. D.G.S.	Sandy loam. cuttings.
Cotyledon coccinea. B.M.						
gibbiflora. DC.	gibbous-flow'd.	cuncif. acut. mucr.	or.	—	1826. D.G.S.	—
grandiflora.	large-flowered.	thick, spiny.	or.	—	—	D.G.S. —

[Capsule with 5 cells, and 5 angles.

O'XALIS, WOOD SORREL. Cal. 5-parted. Petals 5. Germen 5-angled. Style 5. Stigma downy.						
americana. DC.	American.	tern. leaf. obcord. downy.	wh.	4. 5. N. Amer.	H.P. Sandy loam
crenata. DC.	crenate petal'd.	tern. pubes. leaf. obcord.	yel.	— Peru.	1829.	G.P. and leaf
corniculata. E.B.	yellow.	alt. ov. opp. stalk.	yel.	5. 8. Britain.	H.P. mould, seeds,
Déppii. B.F.G.	Deppe's.	quatern. obcord. pilose.	sc.	— Mexico.	1827.	G.P. or offsets
fúlgida. B.R.	crimson.	sess. tern. vill.	cr.	9. 10. C. B. S.	G.P. from the
rúsea. B.M.	rose-coloured.	tern. leaf. obcord. hairy.	ros.	3. 4. Chile.	1826.	G.P. bulbs.
stricta. DC.	upright.	Leaf. obcord. Umbels 2-fl. y.	6. 9. N. Amer.	1658.	H.P.	—
violacea. DC.	violet-coloured.	tern. obcord. smth.	li. pur.	5. 6. —	1772.	H.P. —

[of 1, 3, or 5 cells. Seeds roundish.

LYCHNIS, CAMPION. Cal. of 1-leaf, oblong, 5-toothed. Petals 5. Germen ovate. Style 5. Capsule						
coronata. B.M.	Chinese.	ov. acum. smth.	sc.	6. 9. China.	1774.	H.P. Light loam.
fúlgens. DC.	fulgent.	opp. ov. ellip. rough, hairy.	sc.	9. Siberia.	1819.	H.P. slips from roots or cuttings.

[5 valves. Seeds many, kidney shaped.

AGROSTEMMA, COCKLE. Cal. ribbed, 5-toothed. Cor. of 5 obtuse petals. Capsule of 1 cell and						
alpina.	Alpine.	lin. lanc. smth.	rose.	— Scotland.	H.P. Sandy loam. seeds, or
Lychnis alpina.						
diöica. DC.	red or white.	ov. acut. downy.	wh.	— Britain.	H.P. parting at roots.
Lychnis dioica.						
suécica. B.C.	Swedish.	lin. dott. upp. opp.	red.	— Sweden.	H.P. —

[ments 10, 5, or 4. Capsule of 1 cell.

CERASTIUM, MOUSE-EAR CHICKWEED. Cal. of 5 acute leaves. Petals 5, cloven. Fila-						
alpium DC.	Alpine.	ellip. ov. smth. or sub-pubs.	w.	6. 7. Britain.	H.P. Sandy loam.
arvénse. E.B.	field.	lin. lanc. obt. pub.	wh.	5. 6. Hungary.	H.P. seeds or di-
aquaticum. E.B.	water.	cord. acut. upp. sess. hairy.	w.	— Britain.	H.P. viding at the
latifolium. E.B.	broad-leaved.	ellip. obt. pub.	wh.	6. 7. —	H.P. roots.

Systematic Name.	English Name.	Form of Leaves, &c.	Col. of Flow.	Month of Fl.	Native Country.	Yr. of Introd.	Soil and Propagation.
<i>SPERGULA, SPURRY.</i>	<i>Cal. of 5 ov. obt. leaves. Pet. 5, conc. Ger. ov. Sty. 5. Caps. of 1 cell, & 5 valv.</i>						
nodosa. E.Fl.	knotted.	opp.awl-shap.smth.	wh.	8. 9.	Britain.	H. P. Sandy loam.
saginoïdes. E.Fl.	smooth.	opp.awl-sh.smth.lit.acut.wh.	7. 9.	Scotland.	H. P.	seeds, or
subulata. B.Fl.	fringed.	opp.awl-shap.ciliat.	wh.	6. 8.	Britain.	H. P. parting at roots.

CLASS XI.

DODECANDRIA. Stamens 12.

ORDER I.

MONOGYNIA. STYLE 1.

<i>A'SARUM, ASARABACCA.</i>	<i>Cal. bell-sh. 3-cleft, col. Cor. 0. Ger. infer. Stig. 6-clef. Caps. of 6 cells.</i>						
arifolium. H.E.Fl.	Arum-leaved.	cord. hast. smth.	pur.	5. 6.	Carolina.	1818.	H. P. Loam & peat.
canadense. B.F.G.	Canadian.	cor.renif.sub.pub.above.	pu.	4. 7.	Canada.	1713.	H. P. dividing at
europæum. E.Fl.	common.	renif. shin. obt.	pur.	5.	England.	H. P. root.
virginicum. B.F.G.	Virginican.	orbic.cord.obt.ent.	pur.	—	Virginia.	1759.	H. P. ———
<i>MACLEAYA, MACLE'AYA.</i>	<i>Cal. of 2-coloured deciduous leaves. Ger. compressed, spathulate.</i>						
cordata. R.Br.	cordate.	cord.lobed.dent.glauc.ben.w.	—	—	China.	1795.	H. P. ———
<i>Bocconia cordata. L.</i>							
<i>LYTHRUM, LYTHRUM.</i>	<i>Cal. stria. with 12 teeth. Pet. 6, wav. Fil. 12. Caps. of 2 cells. Seeds min.</i>						
alatum. B.M.	winged.	opp. ov. obl.	pur.	5. 11.	N. Amer.	1812.	F. P. Light loam.
diffusum. B.F.G.	spreading.	opp. lanc. smth.	pur.	7. 9.	—	1822.	H. P. cuttings, or
Græfferi. DC.	Græffer's.	alt. lin. lanc.	pur.	—	S. Europ.	1825.	H. A. dividing at
hyssopifolium. E.B.	Hyssop-leaved.	alt. lin. lanc. obt.	li.	8.	England.	H. A. root.
strictum.	upright.	ov.opp.ent. ; stm.4-sided.	pu.	6.	1830.	H. P. ———
Salicaria. E.B.	common.	opp. lanc. ent.	pur.	7. 8.	Britain.	H. w. P. ———
virgatum. B.M.	twiggly.	alt. lin. lanc. obt.	pur.	6. 9.	Europe.	1766.	H. P. ———
<i>HELMIA, HELMIA.</i>	<i>Bract. 2. Cal. camp. 6-cleft. Pet. 6. Stam. 12. Ger. sessile, 4-celled.</i>						
salicifolia. Lk.	Willow-leaved.	opp. or tern. lin. lanc.	yel.	—	Mexico.	1821.	F. S. ———
<i>TALYNUM, TALYNUM.</i>	<i>Cal. of 2 small leaves. Cor. of 5 pets. Caps. ovate, 3-valved.</i>						
patens. DC.	spreading.	ov. lanc. sess. smth.	red.	8. 10.	S. Amer.	1776.	S. B. Peat & loam. cuttings.
<i>BLA'KEA, BLA'KEA.</i>	<i>Cal. camp. 6-lobed. Pets. 6. Caps. 6-celled. Seed ovate, angular.</i>						
trinervia. DC.	three-nerved.	ov. obl. smth. shin.	ros.	6. 7.	Jamaica.	1789.	S. S. Loam & peat. cuttings.
<i>HALESIA, SNOW-DROP-TREE.</i>	<i>Cal. 4-toothed. Cor. 4-parted. Nect. 4-sided, 2-seeded.</i>						
etraptera. B.M.	four-winged.	ov. acum. serr.	wh.	4. 5.	Carolina.	1756.	H. S. Light loam. layers, or cuttings of the root.
<i>ARISTOT'ELIA, ARISTOT'ELIA.</i>	<i>Sepals 5. Pet. 5. Sty. trifid. Ber. 3-celled. Seeds 2.</i>						
lâcqui. L.	shining-leaved.	opp. ov. serr. shin.	wh.	4. 5.	Chile.	1773.	H. S. ———
fol. varigatis.	variegated-l'd.	H. S. ———

Systematic Name.	English Name.	Form of Leaves, &c.	Col. of Month Flow.	Native of Fl. Country.	Yr. of Introd.	Soil and Propagation.
<i>CUPHEA, CUPHEA.</i> Cal. 6-12-toothed. Pet. 6, inserted in calyx. Caps. 1-celled.						
Llávea. B.R.	two-petaled.	ov. lanc. ent. acut.	d.pur. 4. 5.	Mexico.	1829.	F. P. Peat & loam.
Melvilla. B.R.	Melville's.	lanc. roug. atten.	sc.gr. 6. 9.	Guiana.	1822.	S. S. cuttings.
procumbens. B.R.	procumbent.	ov.lanc.hairy; Br.proc.	pk. —	Mexico.	1816.	H. A. —
<i>HUDS'ONIA, HUDS'ONIA.</i> Cal. tub. 5-par. Pet. 5. Fil. thread-sh. Caps. 1-cell. 3-valv. with 1-3 seeds.						
ericoides. w.	Heath-leaved.	lin.awl-sh.imbr.pilose.	yel. —	N. Amer.	1805.	F. S. Sand, loam,
tomentosa. Swt.C.	downy.	ov.obl.acut.closel.imb.hai.y.	— — —	— — —	1826.	G. S. and peat cuttings.
<i>CO'DON, CO'DON.</i> Perianth. of 1 leaf, limb 12-cleft. Caps. 2-celled, seed roundish.						
Royeni. w.	Royen's.	alt.cord.ov.spiny.	red.wh.	9. C. B. S.	1801.	G. B. Peat & loam cuttings.
<i>PORTULA'CA, PURSLANE.</i> Cal. 2-part. Pet. 5. Stam. shorter than pet. Caps. 1-celled, many-seed.						
foliosa. B.R.	leafy.	awl-sh. smth. ent.	yel. 6. 8.	Guinea.	1822.	S. P. Sandy loam,
Gilliésii. B.M.	Dr. Gillies'.	cyind.obliq.compr.	pur. —	Mendoza.	1829.	G. P. & brick rub-
pilosa. B.R.	hairy.	awl-sh.axillary,pilose.	ros. —	W. Ind.	1690.	S. S. bish. cutt.
<i>TRIUMFETTA, TRIUMFETTA.</i> Cal. of 5 leaves. Cor. of 5 petals. Caps. prickly.						
ánua. B.M.	annual.	ov. acum. serr.	yel. 8. 9.	Java.	1760.	S. A. Sandy loam
Láppula. L.	small Burr.	cord.orbic.dent.vill.	yel.gr. —	Jamaica.	1739.	S. S. & peat.
oblongata. DC.	oblong-leaved.	obl.serr.5-nerv.hairy.	yel. 7. 8.	Nepaul.	1823.	S. B. cuttings, or
ovata. DC.	oval-leaved.	ov. dent. vill.	... —	Brazil.	1829.	S. S. seeds.
<i>HELIOCARPUS, HELIOCARPUS.</i> Cal. of 4 leav. Pet. 4. Sty. 1, bifid. Caps. comp. 2-cell. & 2-seed.						
americana. DC.	American.	cord.3-lob.serr.smth.	wh. 6. 8.	V. Cruz.	1733.	S. S. Loam & peat cuttings.

ORDER II.

DIGYNIA. STYLES 2.

<i>CALLICOMA, CALLICOMA.</i> Cal. 4-5-part. Pet. 0. Stam. 8-10, insert. in the calyx. Ger. villous.						
serratifolia. A.R.	saw-leaved.	obl. lanc. serr.	yel. 5. 8.	N. S. W.	1793.	G. S. Peat & loam cuttings.
<i>AGRIMONIA, AGRIMONY.</i> Cal. 5-part. Pet. 5, notch. Fila. from 7 to 20. Ger. 2-3. Sty. as long as [the stamens. Stig. undivided.						
Eupatoria. E.B.	common.	pinn. leaf. ov. obl.	yel. 6. 7.	Britain.	H. P. Sandy soil seeds.

ORDER III.

TRIGYNIA. STYLES 3.

<i>RESEDA, ROCKET.</i> Cal. in 6-7 seg. Pet. from 3 to 6. Fil. 11-15. Ger. ang. Sty. 3. Caps. of 1 cell.						
álba. s.s.	white.	pinn. leaf. ellip.	wh. 5. 10.	S. Europ.	1596.	H. B. Light loam.
bipinnata. s.s.	bipinnate-1v'd.	bipinnatif.rough.	wh. 6. 8.	Spain.	1816.	G. S. seeds.

Systematic Name.	English Name.	Form of Leaves, &c.	Col. of Flow.	Month of Fl.	Native Country.	Yr. of Introd.	Soil and Propagation.
Lutëola. E. Fl.	Dyer's-weed.	lanc. ent. 1-tooth, at base.	st. 6.	7.	Britain.	H. A. ———
lutea. E. Fl.	base-rocket.	trifid, lower pinnatifid.	yel. 7.	8.	Britain.	H. B. ———
odorata. B. M.	Mignonette.	ent. 3-lobed, smth.	st. 6.	12.	Egypt.	1752.	H. A. ———
<i>β. frutescens.</i>	<i>tree.</i>						————

ORDER IV.

TETRAGYNIA. STYLES 4.

CALLIGONUM, CALLIGONUM. Cal. 5-cleft. Cor. 0. Fil. 12-16, unit. at base. Ger. 4-cor. Sty 4.

Pallásia. H. K. Pallas's. Fruit wing, wings dent, gr. w. — Cas. Sea. 1780. H. S. Sandy loam.

ORDER V.

PENTAGYNIA. STYLES 5.

BLACKWELLIA, BLACKWELLIA. Cal. many-parted. Cor. of 15 ptes. Stam. 12-15. Caps. of 1 cell, [many-seeded.
 integrifolia. Lam. entire-leaved. ov. obt. entire. wh. 6. 7. Madagas. 1823. S. S. ———

GASTONIA, GASTONIA. Cal. near. ent. plait. Pet. 6, soon falling off. Stam. 5-9. Sty. often parted [at apex. Caps. 10-12-celled.
 palmata. B. R. palmate. cord. serr. 7-lobed. wh. gr. 2. 3. Chitta-gong. 1818. S. S. ———

ORDER VI.

HEXAGYNIA. STYLES 6.

CEPHALOTUS, CEPHALOTUS. Cal. 5-clef. hairy, seg. ov. Pet. 0. Fil. 12. Ger. ov. smth. 1-seeded.
 collicularis. DC. pitcher-plant. ellip. ent. petiol. pur. crow. w. N. Holl. 1822. G. P. Sandy peat, offsets, or seeds.

ORDER VII.

DODECAGYNIA. STYLES 12.

EMPERVIVUM, HOUSELEEK. Cal. of 1 leaf, in 6 to 12 conc. segm. Ptes. from 6 to 12. Caps. 12. [Seeds numerous.
 bóreum. B. R. tree. cuneif. smth. ciliat. yel. 3. 10. Levant. 1640. G. S. Sandy soil, cuttings, or
β. variegatum. striped-leaved.
 utinosum. B. R. glutinous. cuneif. obt. ciliat. viscid. yel. 7. 8. Madeira. 1777. G. S. parting at
 rtum. DC. hairy. ellip. lanc. hairy. st. 6. 7. Italy. H. P. root.
 mithii. B. M. Smith's. ellip. curv. yel. 7. 8. Canaries. 1815. G. S. ———
 ctórum. E. B. common. obl. fleshy, fring. ros. 7. Britain. H. P. ———

CLASS XII.

ICOSANDRIA. *Stamens 20, or more, inserted on the Calyx.*

ORDER I.

MONOGYNIA. STYLE I.

Systematic Name.	English Name.	Form of Leaves, &c.	Col. of Flow.	Month of Fl.	Native Country.	Yr. of Introd.	Soil and Propagation.
MAMMILLA'RIA, MAMMILLA'RIA. <i>Cal. 5-6-lob. adher. to ova. Pet. 5-6. Stig. 5-7-clef. rad. Ber. smth.</i>							
coccinea.	scarlet-flow'd.	Stem globul. spiny.	sc. . . .	Chile.	1827.	S. S.	Sandy loam,
coronária. DC.	the great.	Stem simp. cylin. spiny.	sc. 6. 8.	Mexico.	1820.	S. S.	mixed with
glomeráta. DC.	glomerate.	Stem tuft. warts glau. pub. re. . . .	St. Domin.	1825.	S. S.	a little brick	
geminispina. DC.	twin-spined.	Stem colum. warts small. re. 6. 8.	Mexico.	1823.	S. S.	rubbish, is	
lanífera. DC.	wool-bearing.	Stem sim. ro. obo. war. woolly.	— — — —	— — — —	— — — —	S. S.	the soil best
magnimámma. DC.	large-beaded.	Stem sub-glob. war. loose. re. — — — —	— — — —	— — — —	— — — —	S. S.	adapted for
<i>the growth of this genus, and other tribes belonging to the Cactea. They require but little water, & may be readily increased by seeds, or cuttings.</i>							
MELOCA'CTUS, MELON-THISTLE. <i>Cal. 5-6-lob. petal-like. Pet. 5-6. Stig. 5, radiate. Ber. smth.</i>							
commúnis. DC.	Turk's Cap.	Stem ov. orb. 12-18-ang. spi. r. 7. 8.	W. Ind.	1688.	S. S.	— — — —	
macracánthus. DC.	large-spined.	Stem round. 14-ang. spin. re. — — — —	S. Amer.	1820.	S. S.	— — — —	
pyramidális. DC.	pyramidal.	Stem 17-ang. ribs obl. spin. . . .	Curassao.	1824.	S. S.	— — — —	
placentifórmis. DC.	black-spined.	Stem roun. depr. 12-14-an. re. 7. 9.	Brazil.	— — — —	S. S.	— — — —	
<i>Cactus melocactus. Bes.</i>							
Sellówii. DC.	Sellow's.	Stem glo. rib. 10-acu. prick. 7. . . .	M. Video.	1826.	S. S.	— — — —	
ECHINOCA'CTUS, ECHINOCA'CTUS. <i>Sep. num. imbr. the exterior invol. petal-like. Ber. scaly.</i>							
acuátus. DC.	sharp-ribbed.	Stem sub-glo. glau. ribs 20. . . .	M. Video.	1826.	S. S.	— — — —	
crispátus. DC.	curl-ribbed.	Stem obo. ape. retu. ribs und. — — — —	Mexico.	— — — —	S. S.	— — — —	
gladiátus. DC.	sword-spined.	Stem ov. obl. glau. ribs 14-22. . . .	— — — —	— — — —	S. S.	— — — —	
latispínus. H. P.	flat-spined.	Stem depr. with 21 ang. spi. pu. . . .	— — — —	1823.	S. S.	— — — —	
orthacánthus. DC.	straight-spined.	Stem depr. ribs 18, obt. awl. 7. . . .	M. Video.	1828.	S. S.	— — — —	
Ottónis. B. M.	Mr. Otto's.	Stem 3-4-in. high. orb. 12-ang. y. . . .	Brazil.	1829.	S. S.	— — — —	
parvispínus. DC.	small-spined.	Stem sub-glo. ribs 15-comp. . . .	S. Amer.	1815.	S. S.	— — — —	
CE'REUS, CE'REUS. <i>Sep. imbric. numerous, crowded in a long tube. Ber. tuberculate.</i>							
albispínus. DC.	white-spined.	Stem erect. 9-10-ang. ribs obt. . . .	S. Amer.	1822.	S. S.	Sandy loam	
aúreus. DC.	golden-spined.	Stem erect. 7-8-ang. spi. elong. . . .	— — — —	1825.	S. S.	& peat, mixed	
coccíneus. DC.	scarlet-flow'd.	Stem elon. articu. 3-ang. sc. . . .	Brazil.	1828.	S. S.	with brick	
chiloénsis. DC.	ten-angled.	Stem ov. erect. with 10 obt. ang. . . .	Chile.	1825.	S. S.	rubbish.	
flavispínus. DC.	yellow-spined.	Stem erect, 8-10-angul. . . .	S. Amer.	1822.	S. S.	They are	
flagellifórmis. DC.	creeping.	Stem 10-ang. war. crowd. spi. 3. 6.	Peru.	1690.	S. S.	easily pro-	
grandiflórus. DC.	night-flowered.	Stem 5-6-ang. bristl. 5-6. y. w. 6. 8.	Jamaica.	1700.	S. S.	pagated by	
horizontális.	horizontal.	Bran. cyl. artic. spiny. . . .	Chile.	1828.	S. S.	cuttings; &	
phyllanthóides. DC.	rosy-flowered.	Bran. ensif. com. obo. den. pk. 5. 8.	Mexico.	1816.	S. S.	several hy-	
<i>Cactus speciosus. B. R.</i>							
speciosíssimus. DC.	beautiful.	Bran. erect. 3-4-sid. ang. den. 6. 9.	— — — —	— — — —	S. S.	ties are fre-	
<i>Cactus speciosissimus. B. R.</i>							
<i>quently rais-</i>							

Systematic Name.	English Name.	Form of Leaves, &c.	Col. of Flow.	Month of Fl.	Native Country.	Yr. of Introd.	Soil and Propagation.
<i>truncátus</i> . DC.	truncated.	<i>Bran.</i> joint. obl. truncate.	cr.	7. 11.	Brazil.	1818.	S. <i>Sp.</i> ed by seeds.
<i>Cactus truncátus</i> . B.M.							
<i>trípteris</i> . DC.	broad-lobed.	<i>Bran.</i> erect. artic. 3-4 ang.	1827.	S. <i>Sp.</i> ———
<i>trianguláris</i> . DC.	great triangular.	<i>Bran.</i> 3-sid. creep. prick. 4. w.	7.	8.	W. Ind.	1690.	S. <i>Sp.</i> ———
<i>trigónus</i> . DC.	small triangular.	<i>Bran.</i> creep. 3-sid. prick. 5-7.	—	—	—	1809.	S. <i>Sp.</i> ———
OPUNTIA, INDIAN FIG. <i>Sep.</i> num. pet.-like, obov. <i>Stig.</i> erect, thick. <i>Ber.</i> ovate, tuberculate.							
<i>crássa</i> . DC.	thick-lobed.	<i>Stem</i> erect. joint. ov. obl.	yel.	6. 9.	Mexico.	1817.	G. <i>Sp.</i> ———
<i>cochinillifera</i> . DC.	Cochineal.	<i>Stem</i> erect. joints ov. obl.	red.	7. 9.	S. Amer.	1688.	S. <i>Sp.</i> ———
<i>Cactus cochinillifer</i> . B.M.							
<i>feróx</i> . DC.	ferocious.	Joints obl. elon. prickly.	yel.	—	—	1817.	S. <i>Sp.</i> ———
<i>Ficus Indicæ</i> . DC.	Indian Fig.	Joints ov. obl. prickly.	yel.	6. 7.	—	1731.	S. <i>Sp.</i> ———
<i>inérmis</i> . DC.	uprt. spineless.	Joints ov. ellip. fleshy.	yel.	7. 9.	Chile.	1796.	S. <i>Sp.</i> ———
<i>lanceoláta</i> . Haw.	spear-leaved.	3 lines long. Joints lan.	yel.	—	—	—	S. <i>Sp.</i> ———
<i>rubéscens</i> . DC.	red-stemmed.	<i>Stems</i> erect. Joints. elon. com.	—	—	Brazil.	1828.	S. <i>Sp.</i> ———
<i>spinossíma</i> . DC.	cluster-spined.	Joints obl. spines num.	—	7.	Jamaica.	1732.	S. <i>Sp.</i> ———
<i>tomentósa</i> . DC.	wooly-branch'd.	<i>Stem</i> erect. down. Joints com.	—	S. Amer.	1824.	S. <i>Sp.</i> ———
PERE'SKIA, PERE'SKIA. <i>Sep.</i> many, filiform. <i>Cor.</i> rotate. <i>Sty.</i> filiform. <i>Ber.</i> globose.							
<i>grandifólia</i> . DC.	large-leaved.	obl. lanc. dotted.	—	6.	Brazil.	1818.	S. <i>Sp.</i> ———
<i>portulacæfólia</i> . DC.	Purslane-1v'd.	obov. cuneat. prickly.	pur.	6. 7.	W. Ind.	1820.	S. <i>Sp.</i> ———
<i>rotundifólia</i> . DC.	round-leaved.	sub-orbi. mucr. prick. ax. y. sc.	—	—	Mexico.	1829.	S. <i>Sp.</i> ———
RHIPSALIS, RHIPSALIS. <i>Cal.</i> limb 3-6-part. <i>Pet.</i> 6, oblong. <i>Stam.</i> 12-18. <i>Stig.</i> 3-6, spreading.							
<i>fasciculáta</i> . DC.	clustered.	<i>Bran.</i> round, crowd. pen.	—	—	S. Amer.	1800.	S. <i>Sp.</i> ———
PRUNUS, PLUM. <i>Cal.</i> bell-sh. 5-cleft. <i>Cor.</i> of 5 conc. pet. <i>Drupe</i> slight. <i>sulc.</i> at the marg. with 1 cell.							
<i>cándicans</i> . B.R.	snowy.	ellip. obl. serr.	wh.	6.	—	1825.	H. <i>Sp.</i> ———
<i>caroliniana</i> .	Carolinian.	ov. lanc. serr.	wh.	—	Carolina.	1759.	H. <i>Sp.</i> ———
<i>Cérusus</i> . Br. Fl.	common Cherry.	ov. lanc. serr. glandular.	wh.	—	Britain.	H. <i>Sp.</i> ———
<i>insitítia</i> . E. Fl.	Bullace-tree.	ov. lanc. serr. downy.	wh.	4. —	—	H. <i>Sp.</i> ———
<i>Laurocérusus</i> .	common Laurel.	ellip. serr. shin.	wh.	4. 5.	Levant.	1629.	H. <i>Sp.</i> ———
<i>fol. variegáta</i> .	variegated-1v'd.	wh.	—	—	H. <i>Sp.</i> ———
<i>angustifólia</i> .	narrow-leaved.	wh.	—	—	H. <i>Sp.</i> ———
<i>Pádus</i> . B. Fl.	Bird-Cherry.	obo. serr. smth. glau. ben.	wh.	5.	Britain.	H. <i>Sp.</i> ———
CARYOPHYLLUS, CLOVE-SPICE. <i>Cal.</i> 4-part. <i>Pet.</i> 4. <i>Ger.</i> obl. cylin. 2-cell. <i>Ber.</i> ellip. of 1 seed.							
<i>aromáticus</i> . B.M.	aromatic.	opp. ov. lan. shin. ent. smth. w.	—	—	Molucca.	1797.	S. <i>Sp.</i> Peat & loam, cuttings.
BARTONIA, BARTONIA. <i>Cal.</i> 5-cleft. <i>Pet.</i> many. <i>Caps.</i> 1-celled at the end, with 3-5 lid-like valves.							
<i>ornáta</i> . DC.	naked-seeded.	alt. semi-amp. obl. up. cut. de.	6.	9.	Missouri.	1811.	F. <i>Sp.</i> Sandy loam. seeds.
<i>decapetala</i> . B.M.							
AMYGDALUS, ALMOND. <i>Cal.</i> 5-cleft. <i>Pet.</i> 5. <i>Drupe</i> , a nut perforated on its surface.							
<i>communis</i> . DC.	Sweet-Almond.	ov. serr. glandular.	pk.	3. 4.	Barbary.	1548.	H. <i>Sp.</i> Sandy loam.
<i>nána</i> . B.M.	dwarf.	ov. serr. base attenuat.	pk.	—	Russia.	1683.	H. <i>Sp.</i> budding on
<i>orientális</i> .	silvery-leaved.	lanc. silvery, ent.	ros.	—	Levant.	1756.	H. <i>Sp.</i> the bitter Almond, or Plum stocks.
PUNICA, POMEGRANATE. <i>Cal.</i> 5-cleft. <i>Pet.</i> 5. <i>Ber.</i> many-celled, many-seeded.							
<i>Granátum</i> . w.	common.	lanc. ent. smth.	sc.	6. 9.	S. Europ.	1548.	H. <i>Sp.</i> Loam, and
<i>l. álba</i> .	white.	wh.	—	China.	H. <i>Sp.</i> leaf mould.

Systematic Name.	English Name.	Form of Leaves, &c.	Col. of Flow.	Month of Fl.	Native Country.	Yr. of Intro.	Soil and Propagation.
2. <i>pleno</i> .	<i>double-flowered</i>	sc.	6. 9.	S. Europ.	H. <i>cuttings, or</i>
3. <i>flava</i> .	<i>yellow-flowered</i>	yel.	— —	— —	H. <i>layers.</i>
<i>nana</i> . w.	<i>dwarf</i> .	lin. ent. smth.	red.	8. 9.	S. Amer.	1723.	F. <i>—</i>

PSIDIUM, GUAVA. *Cal. 5-part. Pet. 5. Stam. many. Sty. filiform. Stig. capit. Ber. many-seeded.*

<i>cordatum</i> . B.M.	heart-leaved.	cord sub-rotun. sub-amp.	w.	5. 6.	W. Ind.	1811.	S. <i>Loam & peat.</i>
<i>Cattleianum</i> . DC.	Mr. Cattle's.	obov. ent. smth. shin.	wh.	— —	Brazil.	1816.	S. <i>cuttings, or</i>
<i>polycarpon</i> . B.R.	many-fruited.	ov. obl. acut. sub-cren.	wh.	— —	Trinidad.	1809.	S. <i>layers.</i>
<i>pyriferrum</i> . B.R.	Pear-fruited.	ov. ellip. smth. ent.	wh.	6. 7.	W. Ind.	1656.	S. <i>—</i>

EUGENIA, EUGENIA. *Cal. superior, 4-parted. Cor. 4 petals. Ber. of 1 cell. Seed solitary.*

<i>amplexicaulis</i> . B.R.	stem-clasping.	ov. obl. lanc. smth. ent.	wh.	6. 7.	E. Ind.	1823.	S. <i>Peat & loam.</i>
<i>disticha</i> . DC.	globe-berried.	distich. ov. lan. acu. smth.	wh.	4. 8.	Jamaica.	1793.	S. <i>cuttings.</i>
<i>Myrtus disticha.</i>							
<i>myrtifolia</i> . B.R.	myrtle-leaved.	ellip. ent. smth.	wh.	— —	N. Holl.	1818.	G. <i>—</i>
<i>Pimenta</i> . DC.	Allspice-tree.	ov. obl. smth. shin.	wh.	5. 8.	W. Ind.	1723.	S. <i>—</i>
<i>Myrtus Pimenta.</i> B.M.							

ACMENA, ACMENA. *Cal. 5 cleft, limb truncate. Pet. 5, small. Sty. short. Ber. globose, 1-seeded.*

<i>elliptica</i> . DC.	elliptic-leaved.	ent. ellip. acum. smth.	wh.	6. 9.	N.S.W.	1790.	G. <i>Loam & peat.</i>
							<i>cuttings.</i>
<i>Eugenia elliptica.</i> B.M.							

JAMBO'SA, JAMBO'SA. *Cal. 4-part. lobes rounded. Pet. 4. Sty. filif. Stig. acute. Fruit 1-2-seeded.*

<i>purpurascens</i> . DC.	purple-flow'd.	opp. alt. ov. apex acut.	pu. re.	6. 9.	W. Ind.	1768.	S. <i>Sandy loam</i>
							<i>and peat.</i>
<i>Eugenia malacensis.</i> Ex.B.							
<i>vulgaris</i> . DC.	narrow-leaved.	ellip. lanc. smth.	st.	8.	E. Ind.	—	S. <i>cuttings.</i>
<i>Eugenia Jambos.</i> B.M.							

EUCALYPTUS, EUCALYPTUS. *Cal. trunc. Pet. 0. Filam. num. Caps. 3-4-celled, many-seeded.*

<i>corymbosa</i> . DC.	corymbose.	lanc. attenuat. coriac.	wh.	8. 9.	N.S.W.	1788.	G. <i>Sandy loam</i>
<i>glauca</i> . DC.	glaucous.	glau. powd. opp. upp. alt.	wh.	— —	— —	1820.	G. <i>and peat.</i>
<i>longifolia</i> . DC.	long-leaved.	lin. lanc. ent.	wh.	6. 7.	N.S.W.	1818.	G. <i>cuttings.</i>
<i>piperita</i> . DC.	Pepperm.-tree.	lanc. acum. coriac.	wh.	7. 8.	— —	1788.	G. <i>—</i>
<i>pulverulenta</i> . B.M.	powdered.	opp. ov. orbic. cord. glau.	wh.	6. 8.	— —	1816.	G. <i>—</i>
<i>robusta</i> . DC.	brown gum-tree.	ovate. acum. ent.	wh.	8. 9.	— —	1794.	G. <i>—</i>
<i>resinifera</i> . B.R.	resinous.	ov. lanc. acum. ent.	wh.	— —	— —	1798.	G. <i>—</i>

MYRTUS, MYRTLE. *Cal. 5-parted. Pet. 5, rarely 4. Ber. 2 to 3-celled.*

<i>communis</i> . DC.	common.	ov. lanc. acute.	wh.	6. 7.	S. Europ.	1597.	F. <i>Loam & leaf</i>
							<i>mould.</i>
1. <i>baetica</i> .	<i>Orange-leaved.</i>	wh.	— —	— —	—	F. <i>cuttings.</i>
2. <i>fl. pleno</i> .	<i>double-flowered.</i>	wh.	— —	— —	—	F. <i>—</i>
3. <i>latifolia</i> .	<i>broad-leaved.</i>	wh.	— —	— —	—	F. <i>—</i>
4. <i>Thymifolia</i> .	<i>Thyme-leaved.</i>	wh.	— —	— —	—	F. <i>—</i>
<i>tomentosa</i> . B.M.	woolly-leaved.	ov. pubes. 3-nerved.	—	—	China.	1776.	G. <i>—</i>

LEPTOSPERMUM, LEPTOSPERMUM. *Cal. 5-part. lobes 3-ang. Pet. 5. Stam. 20 30. Caps. 4-5-*

<i>baccatum</i> . DC.	berry-fruited.	lin. lan. 1-nerv. base 3 ner.	wh.	6. 7.	N.S.W.	1790.	G. <i>Peat & loam.</i>
<i>grandiflorum</i> . B.C.	large-flowered.	ov. lanc. mucr.	wh.	— —	— —	1816.	G. <i>cuttings.</i>
<i>juniperinum</i> . DC.	Juniper-leaved.	lin. lan. 1-ner.; Br. silky.	wh.	— —	— —	1790.	G. <i>—</i>
<i>myrtifolium</i> . DC.	Myrtle-leaved.	obov. obl. 3-nerv. dott.	yel.	— —	N. Holl.	1827.	G. <i>—</i>
<i>marginatum</i> . DC.	marginated.	obov. obl. ciliat. 3-nerv.	wh.	6. 7.	— —	1820.	G. <i>—</i>

[*celled. Seed oblong, small.*

Systematic Name.	English Name.	Form of Leaves, &c.	Col. of Flow.	Month of Fl.	Native Country.	Yr. of Introd.	Soil and Propagation.
obovatum. Sw.F.A.	obovate-lv'd.	obov.smth.notch.dott.	wh.	6. 7.	N.S.W.	1823.	G. ♀. ———
pubescens. w.	pubescent.	obliq. lanc. obl. hairy.	wh.	— — —	— — —	1774.	G. ♀. ———
parvifolium. DC.	small-leaved.	obov. smth. nerveless.	wh.	— — —	— — —	1795.	G. ♀. ———
scoparium. A.R.	N. Zealand Tea.	ov. acut. sub-3-nerv.	wh.	— —	N. Zeal.	1772.	G. ♀. ———
triloculare. DC.	trilocular.	lin. dott. ciliat.	wh.	— —	N.S.W.	1816.	G. ♀. ———
thymifolium.	Thyme-leaved.	lin. ellip. smth.	wh.	5. 6.	— — —	1826.	G. ♀. ———

CALYTRIX, CALYTRIX. *Cal. 5-parted. Pet. 5, deciduous. Ger. 1-celled, 2-seeded.*

glabra. B.R.	smooth-leaved.	lin. imbric. dott. gland.	wh.	4. 6.	N.S.W.	1818.	G. ♀. ———
--------------	----------------	---------------------------	-----	-------	--------	-------	-----------

METROSIDE'ROS, METROSIDE'ROS. *Cal. 6-part. Stam. 20-30. Caps. 2-3-celled, many-seeded.*

angustifolia. DC.	narrow-leaved.	opp. lin. lanc. smth.	wh.	5. 6.	C.B.S.	1818.	G. ♀. Sandy peat
ericifolia.	Heath-leaved.	alt. lin. imbric. pilose.	N.Holl.	1829.	G. ♀. and loam.
verus. Lind.	true Iron-wood.	opp.ov.lanc.acum.smth.	ye.	3. 6.	E.Ind.	1819.	S. ♀. cuttings.

CALLISTE'MON, CALLISTE'MON. *Cal. 5-part. lob. obt. Pet. 5. Sty. thread-sh. Stig. cap. Cap. 3-cell.*

lanceolatum. DC.	spear-leaved.	lanc. mucr. attenuat.	sc.	6. 9.	N.S.W.	1788.	G. ♀. Sandy loam and peat.
<i>Metrosideros citrina. B.M.</i>							
pinifolium. DC.	Pine-leaved.	lin. filif. rigid. mucr.	gr.	6. 7.	— — —	1806.	G. ♀. cuttings.
rigidum. B.R.	rigid.	lin. lanc. mucr. acute.	sc.	4. 5.	— — —	1800.	G. ♀. ———
salignum. DC.	Willow-leaved.	lanc. mucr. acum.	st.	— — —	— — —	1778.	G. ♀. ———
speciosum. Swt.	splendid.	lanc. mucr. flat.	sc.	3. 6.	— — —	1823.	G. ♀. ———
<i>Metrosideros speciosus. B.M.</i>							

ANG'OPHORA, ANG'OPHORA. *Cal. 5-tooth. Pet. 5. Sty. filiform. Caps. 3-celled. 3-valved.*

cordifolia. DC.	hispid.	ov.cord.sess.; Br.smth.	wh.	— —	N.S.W.	1789.	G. ♀. Sandy loam & peat, cutt.
<i>Metrosideros hispida. Ex.B.</i>							

FABRICIA, FABRICIA. *Cal. campa. 5-cleft. Pet. 5. Stam. numerous. Caps. of many cells.*

nyrtifolia. DC.	Myrtle-leaved.	alt. obov. glau. silky.	wh.	...	N.S.W.	1803.	G. ♀. ———
-----------------	----------------	-------------------------	-----	-----	--------	-------	-----------

ORDER II.

DI-PENTAGYNIA. STYLES 2-5.

HESEMBRYANTHEMUM, FIG MARYGOLD. *Cal. 5-part. Pet. nume. lin. Caps. generally 5-cell.*

cutum. Haw.	acute-leaved.	half cylind. acut.	pur.	4.10.	C.B.S.	1793.	G. ♀. Sandy soil,
acéps. Haw.	two-edged.	acinacif. 3-cor.; Br. 2-edg.		9.10.	— — —	1811.	G. ♀. mixed with
oides. Haw.	aloe-like.	half round, ent.	ye.	— — —	— — —	1816.	G. ♀. a little lime
bidum. B.M.	white.	awl-sh. obt. threaded.	ye.	7. 8.	— — —	1714.	G. ♀. rubbish, is
arantium. Haw.	Orange-flow'd.	obt. three-sid. comp.	ye.	6. 9.	— — —	1793.	G. ♀. best adapted
luncum. Haw.	hook-leaved.	semi-cylind. crowd.acum.	li.	— — —	— — —	1795.	G. ♀. for the cul-
ascendens. Haw.	ascending.	tongue-shap. obt.	ye.	9.10.	— — —	...	G. ♀. ture of this
cinaciforme. L.	cymeter-leav'd.	opp. comp. three-sid.	re.	— — —	— — —	1714.	G. ♀. curious tribe
areum. L.	golden.	cylind. three-sid. glau.	ye.	3. 9.	— — —	1750.	G. ♀. of plants,
itoni. Jac.	Aiton's.	opp. ov. spathul.	ros.	6. 9.	— — —	1823.	G. ♀. many of
arbatum. L.	trailing-bear'd.	spread; sub-obov.	pur.	— — —	— — —	1793.	G. ♀. which pro-
fidum. Haw.	bifid.	awl-shap. glau. obt.	ye.	10.	— — —	1795.	G. ♀. duce shewy

Systematic Name.	English Name.	Form of Leaves, &c.	Col. of Flower.	Month of Fl.	Native Country.	Yr. of Intro.	Soil and Propagation.	
blándum. Haw.	fair-flowered.	compr. 3-sid.;	<i>Br.</i>	num. <i>re. w.</i>	6. C.B.S.	1816.	G. S. flowers,	
bracteátum. Haw.	double-bracted.	three-sid.;	<i>stem</i>	erect.	<i>re.</i> 7. 8.	—	1774. G. S. when turned	
brevifólium. Н. К.	short-leaved.	cylind. spread.	obt.	<i>rub.</i> 6. 9.	—	1777.	G. S. out in the	
caninum. Haw.	dog's-chop.	glau. keel-sh.	three-sid.	<i>ye.</i> 9. 10.	—	1717.	G. S. flower bor-	
capitátum. Haw.	headed.	alt. glau.	three-sid.	<i>ye.</i> 6. 9.	—	—	G. S. ders during	
coccíneum. Haw.	scarlet.	3-sid. compr.	glau. obt.	<i>sc.</i> 5. 9.	—	1696.	G. S. the summer	
croceum.	saffron-flow'r'd.	crowd. glau.	half round.	<i>sn.</i> —	—	1816.	G. S. months.	
curvifólium. w.	curve-leaved.	distant, curv.		<i>rub.</i> 9.	—	1799.	G. S. They are	
cylíndricum. Haw.	cylindrical.	3-sid. sub-glau.	dott.	<i>re.</i> 9. 10.	—	1792.	G. S. readily in-	
cymbifórmе. Haw.	boat-shaped.	spread. glau.	3-sid.	<i>re.</i> —	—	1793.	G. S. creased by	
deflexum. Н. К.	deflexed.	three-sid. glau.	rough.	<i>pu.</i> 7. 9.	—	1774.	G. S. cuttings.	
deltóides. Haw.	deltoid.	three-sid. glau.	crowd.	<i>li.</i> 5.	—	1731.	G. S. —	
dolabrifórmе. Haw.	hatchet-leaved.	hatchet-sh. dott.	glau.	<i>ye.</i> —	—	1705.	G. S. —	
diffórmе. Haw.	deformed.	obliq. half cylind.		<i>ye.</i> 8. 9.	—	1732.	G. S. —	
echinátum. Н. К.	Hedge-hog.	obl. ov. three-sided.		<i>ye.</i> —	—	1774.	G. S. —	
emarginátum. L.	emarginate.	three-sid. glau.	rough.	<i>vio.</i> 6. 9.	—	1732.	G. S. —	
expánsum. L.	House-leek-l'd.	remote, opp. ov. lanc.		<i>ye.</i> 8. 9.	—	1705.	G. S. —	
fí'ssum. Haw.	cleft.	half round, equal, obt.	glau.	—	—	1776.	G. S. —	
falcátum. L.	falcate-leaved.	compr. three-sid. glau.		<i>ros.</i> 6. 9.	—	1727.	G. S. —	
fastigiátum. Haw.	clustered.	reflex. awl-sh. glau.		<i>bi.</i> 8. 9.	—	1794.	G. S. —	
filamentósum. Haw.	thready.	compr. 3-sided. thick.		<i>ros.</i> 9.	—	1732.	G. S. —	
flicaulè. Haw.	thread-stalked.	crowd. semi-cylind. acum.	<i>re.</i>	10. —	—	1800.	G. S. —	
floribándum. Haw.	many-flower'd.	sub-cylind. incurv.	obt.	<i>car.</i> 5. 9.	—	1704.	G. S. —	
formósum. Haw.	handsome.	three-sid.;	<i>stem</i>	shrubb.	<i>re.</i> 9.	—	1820.	G. S. —
glomerátum. L.	clustered.	obt. 3-corn. glau.		<i>red.</i> 6. 9.	—	1732.	G. S. —	
glaucéscens. Haw.	glaucous.	incurv. 3-sid. glau.		<i>pur.</i> 8.	N. Holl.	1804.	G. S. —	
geminátum. Haw.	twin.	<i>Br.</i> fork. Lvs. conn. 3-sid.	<i>re.</i>	—	C.B.S.	1792.	G. S. —	
geminifórum.	twin-flowered.	opp. connate, dott.		<i>pur.</i> —	—	1819.	G. S. —	
Hawórhii. Don.	Haworth's.	crowd. cylind. compr.		<i>pur.</i> 1. 6.	—	1793.	G. S. —	
hy'bridum. Haw.	hybrid.	ent. 3-sided.		<i>yel.</i> —	—	—	G. S. —	
incúrvum. Haw.	incurved.	compr. 3-corn. glau.		<i>li.</i> 6.	—	1802.	G. S. —	
imbricatúм. Н. К.	imbricated.	conn. sheath. glau. 3-sid.		<i>wh.</i> 8.	—	1792.	G. S. —	
linguæfórmе. Haw.	tongue-formed.	thick, uneq. tongue-sh.		<i>yel.</i> 3. 10.	—	1804.	G. S. —	
lóngum. Haw.	long tongue.	elong. shin. tongue-sh.		<i>yel.</i> 9.	—	1725.	G. S. —	
lácerum.	purple-serrated.	3-sid. acut. compr. glau.		<i>ros.</i> —	—	1792.	G. S. —	
minútum. Haw.	least.	<i>Stem</i> obconic. smth. glau.		<i>re.</i> 9. 10.	—	1795.	G. S. —	
mínimum. Haw.	small.	<i>Stem</i> obconic. glau. spott.		<i>ye.</i> —	—	1766.	G. S. —	
máximum. Haw.	large-leaved.	3 sid. glau. semi-amplex.		<i>ros.</i> 3. 9.	—	1787.	G. S. —	
microph'yllum. Haw.	small-leav'd.	connate, 3-sid. dott.		<i>ros.</i> 5.	—	1795.	G. S. —	
multiflórum. Haw.	many-flowered.	connate, vagin. glau.		<i>wh.</i> 8. 9.	—	1792.	G. S. —	
muricatúм. Haw.	muricated.	crowd. deltoid. glau.		<i>li.</i> 5.	—	1731.	G. S. —	
murinum. Н. П.	mouse-chop.	dent. ciliat. dott.		<i>yel.</i> 5. 7.	—	1790.	G. S. —	
mutábilе. Haw.	changeable.	3-sid. dott.;	<i>Br.</i> 2-edg.	<i>w. ro.</i> 8. 9.	—	1792.	G. S. —	
noctiflórum. L.	night-flow'ring.	roundish. glau.		<i>ro. wh.</i> —	—	1714.	G. S. —	
nitídum. Haw.	shining.	half-cylind. blistered.		<i>yel.</i> —	—	1790.	G. S. —	
perfoliátum. Mil.	perfoliate-l'd.	connate, sheath, decurr.		<i>ros.</i> 6. 9.	—	1714.	G. S. —	
pulchéllum. Haw.	handsome.	acute, 3-cornered.		<i>pk.</i> 4.	—	1793.	G. S. —	
parviflórum. Haw.	small-flowered.	half inch long, sub-erect.		<i>wh.</i> 6. 9.	—	1800.	G. S. —	
quadrifídum. Haw.	quadrid.	hoary, glau. obt. spott.		<i>yel.</i> 10.	—	1795.	G. S. —	
radiátum. Haw.	rayed.	glau. apex, attenuat.		<i>red.</i> 11.	—	1732.	G. S. —	
rígídum. Haw.	rigid.	conn. sheath. 3 lines long.		<i>wh.</i> 8. 9.	—	1793.	G. S. —	
rubricaulè. Haw.	red-stalked.	compr. 3-cornered.		<i>pk.</i> 10. 11.	—	1802.	G. S. —	

Systematic Name.	English Name.	Form of Leaves, &c.	Col. of Flow.	Month of Fl.	Native Country.	Yr. of Introd.	Soil and Propagation.
serratum. L.	serrated.	opp. distinct, 3-sid.	yel.	6. 7.	C. B. S.	1707.	G. sp. ———
speciosum. Haw.	shewy.	semi-cylind. awl-sh.	sc.	5. 9.	———	1793.	G. sp. ———
spectabile. Haw.	splendid.	glau. 3-sid.	pur.	———	———	1787.	G. sp. ———
taurinum. Haw.	Bull's-horn.	bifarious, obliq. crossed.	yel.	9. 10.	———	1795.	G. sp. ———
tigrinum. Haw.	Tiger-chap.	cord. ov. marbl. with wh.	yel.	———	———	1790.	G. sp. ———
tortuosum. L.	twisted.	obl. ov. connate.	p. ye.	6. 9.	———	1705.	G. sp. ———
tuberosum. L.	tuberous-root'd.	3-cornered, comp. recur.	co.	———	———	1714.	G. sp. ———
variabile. Haw.	variable.	3-cornered, comp. glau.	yel.	———	———	1796.	G. sp. ———
violaceum. DC.	violet-coloured.	comp. 3-cornered, glau.	pur.	———	———	1820.	G. sp. ———
viride. Haw.	green.	ent. smth. hook. backw.	li.	8.	———	1792.	G. sp. ———
umbellatum. Haw.	umbelled.	orbic. glau. dott.	wh.	6. 9.	———	1727.	G. sp. ———
uncinatum. Haw.	lesser-perfoliate.	connate, sheath. dott.	pur.	9.	———	1725.	G. sp. ———

SPIRÆA, SPIRÆA. Cal. 5-part. Pet. 5, roundish. Ger. generally 5. Caps. 5, each of 2 valves, & 1 cell.

Bélla. B.R.	red-flowered.	alt. ov. serr.	pk.	5. 6.	Nepaul.	1818.	H. sp. Sandy loam.
Filapéndula. E.B.	drop-wort.	pinn. leaf. serr. smth.	yel. wh.	6. 8.	Britain.	H. sp. divid. roots.
Hypericifolia. w.	Hypericum-l'd.	spat. ent. smth.	wh.	4. 5.	N. Amer.	1640.	H. sp. layers, or
lobata. DC.	lobe-leaved.	pinn. smth. odd. lea. 7-lob.	ro.	7. 8.	———	1765.	H. sp. cuttings.
lævigata. DC.	smooth-leaved.	lanc. ent. sess. smth.	wh.	4. 6.	Siberia.	1774.	H. sp. ———
salicifolia. E. Fl.	Willow-leaved.	ellip. lanc. serr. smth.	ros.	6. 8.	Britain.	H. sp. ———
trilobata. DC.	three-lobed.	sub-cord. lob. dent.	wh.	5.	Siberia.	1801.	H. sp. ———

GILLENIA, GILLENIA. Cal. campan. 5-parted. Pet. 5, linear, large. Caps. 5-celled.

trifoliata. DC.	three-leaved.	tern. lanc. serr. stip. lin.	bh.	6. 8.	N. Amer.	1713.	H. sp. Light loam. divid. roots.
-----------------	---------------	------------------------------	-----	-------	----------	-------	----------------------------------

Spiræa trifoliata. B.M.

WALDSTEINIA, WALDSTEINIA. Cal. 10-cleft. Pet. 5. Sty. cub-shaped. Seeds 2, obovate.

geoides. B.C.	Avens-like.	3-5-lob. cut, dent.	yel.	6. 7.	Hungary.	1894.	H. sp. Loam & peat. part. roots.
---------------	-------------	---------------------	------	-------	----------	-------	----------------------------------

PYRUS, PYRUS. Cal. in 5 deep seg. Pet. 5, conc. Apple with 2 to 5, 2-valved caps. Seeds 2 in each cell.

A'ria. E. Fl.	white beam-tree.	ov. cut. serr. downy ben.	wh.	5. 6.	Britain.	H. sp. Garden soil.
aucuparia. E.B.	Mountain Ash.	pinn. serr. smth.	wh.	———	———	H. sp. seeds, or
angustifolia. DC.	narrow-leaved.	lanc. obl. dent. serr. shin.	bh.	———	N. Amer.	1750.	H. sp. grafting.
coronaria. B.R.	sweet-scented.	cord. angul. serr. smth.	pk.	5.	Virginia.	1724.	H. sp. ———
communis. E. Fl.	wild Pear.	ov. serr. smth.	wh.	4.	England.	H. sp. ———
fol. variegata.	variegated-l'd.	———	———	———	———	———	———
domestica. E.F.	true Service-tree.	pinn. downy, serr.	———	———	———	H. sp. ———
orbifunda. B.R.	many-flower'd.	obov. lanc. sharply cren.	wh.	6.	China.	1818.	H. sp. ———
randifolia.	large-leaved.	obl. obov. smth. serrul.	wh.	4. 5.	N. Amer.	H. sp. ———
lalus. E.B.	Apple-tree.	ov. acut. serr.	wh. re.	———	Britain.	H. sp. ———
fol. variegata.	variegated-l'd.	———	———	———	———	———	———
epalensis.	Nepaul.	ov. acum. serr. shin.	wh.	5. 6.	Nepaul.	1820.	H. sp. ———
ræcox.	early.	ov. lanc. serr.	bh.	———	Russia.	1784.	H. sp. ———
innatifida. E.B.	bastard service.	pinnatif. serr. down. ben.	wh.	———	England.	H. sp. ———
nénsis. B.R.	Chinese.	cord. serr. shin. jun. pub.	wh.	———	China.	1823.	H. sp. ———
ouria. B.R.	hybrid.	pin. in 3prs. lea. ov. cren.	pk. w.	5. 6.	N. Amer.	1800.	H. sp. ———
licifolia. B.R.	Willow-leaved.	lin. lanc. serr. downy.	wh.	———	Siberia.	1780.	H. sp. ———
rectabilis. DC.	Chinese Apple.	ov. obl. serr.	wh.	———	China.	———	H. sp. ———
rminalis. DC.	wild service.	cord. lob. serr. smth.	wh.	4. 5.	England.	H. sp. ———

Systematic Name.	English Name.	Form of Leaves, &c.	Col. of Flow.	Month of Fl.	Native Country.	Yr. of Introd.	Soil and Propagation.
CYDONIA, QUINCE. <i>Cal. 5-parted. Pet. 5, rounded. Sty. 5. Pomum 5-celled, and many-seeded.</i>							
japónica.	Japan.	ov.sub-cuneat.cren.serr.	sc.	12.1.	Japan.	1796.	H. S. ———
<i>Py'rus japónica.</i>							
β álba.	white-flowered.	wh.	H. S. ———
CRATÆGUS, HAWTHORN. <i>Cal. 5-cleft. Pet. 5, spread, orbic. Ovary 2-5-celled. Sty. 1-5, smth.</i>							
apiifolia. Mx.	Parsley-leaved.	delt.cut-lob.lobes dent.	wh.	5. 6.	N.Amer.	1812.	H. C. Sandy loam.
Azorulus. L.	Azorole.	cunea.pub.trif.lob.dent.	wh.	——	S.Europ.	1640.	H. C. grafting, or
Crús-gállí. L.	Cockspur.	obov.cuneif.smth.shin.	wh.	——	N.Amer.	1691.	H. C. seeds sown
1. <i>salicifolia.</i> <i>Willow-leaved.</i> wh. ——— H. C. in spring.							
2. <i>spléndid.</i> wh. ——— H. C. ———							
coccinea. L.	scarlet.	ov.cord.angul.ent.smth.	wh.	4. 5.	——	1683.	H. C. ———
cordáta. Mil.	heart-leaved.	cord.ov.angul.ent.smth.	wh.	5.	——	1738.	H. C. ———
ellíptica. H. K.	elliptic.	ellip.uneq. serr. smth.	wh.	——	N.Amer.	1765.	H. C. ———
eriocárpa. Lind.	woolly-fruited.	obt. 3-lob. serr. smth.	wh.	5. 6.	Britain.	H. C. ———
fláva. H. K.	yellow.	obo.cuneif.sub-lob.serr.	wh.	5.	N.Amer.	1724.	H. C. ———
glandulosa. W.	glandular.	obo.cunea.ang.smth.shin.	w.	——	——	1750.	H. C. ———
heterophýlla. B. R.	various-leaved.	lan.cunea.ape.den.pinn.	wh.	——	——	1816.	H. C. ———
latifolia. Pers.	broad-leaved.	obov.uneq.serr.subplic.	wh.	——	——	1820.	H. C. ———
laciniáta. DC.	fringed.	pin.ent.hair.lob.obl.den.	wh.	——	Sicily.	1816.	H. C. ———
lúcida. Mil.	shining.	lan.serr.shin.pale ben.	wh.	——	N.Amer.	H. C. ———
melanocárpa. DC.	black-berried.	sub-trif. serr.	wh.	——	Tauria.	1820.	H. C. ———
mexicána. DC.	Mexican.	ov.acut. serr. at apex.	wh.	——	Mexico.	1823.	F. C. ———
monógynia. W.	one-styled.	acut.sub-trif.serr.smth.	wh.	——	Siberia.	H. C. ———
ovalifolia. DC.	oval-leaved.	ov.serr.pilo.shin.abov.	wh.	——	N.Amer.	1810.	H. C. ———
odoratíssima. B. R.	sweet-scented.	pinnatif.vill.seg.3-fid.	wh.	——	Crimea.	H. C. ———
pyrifolia. H. K.	Pyrus-leaved.	ov.ellip.ent.ser.sub-hair.	wh.	6.	N.Amer.	1765.	H. C. ———
parvifolia. H. K.	small-leaved.	obov. cuneif. serr. pub.	wh.	5. 6.	——	1704.	H. C. ———
punctáta. H. K.	dotted-fruited.	obov. cuneif. smth. serr.	wh.	5.	——	1746.	H. C. ———
Pyracántha. Pers.	evergreen-thor.	ov. lanc. crin. shin.	wh.	——	S.Europ.	1629.	H. S. ———
tanacetifolia. Pers.	Tanzy-leaved.	pinn.ent.hair.lob.dent.	wh.	5. 6.	Greece.	1789.	H. C. ———
PHOTYNIA, PHOTYNIA. <i>Cal. 5-tooth. Cor. of 5 reflexed pets. Ovary vill. 2-celled. Sty. 2, smooth.</i>							
arbutifolia. E. R.	Arbutus-leaved.	obl. lanc. acut. serr.	wh.	7. 8.	Californ.	1796.	F. C. Sandy loam and peat.
<i>Cratægus arbutifolia.</i>							
serruláta. Lind.	serrulate-l'd.	obl. acut. serr. smth.	wh.	4. 7.	China.	1804.	F. C. layers, or grafting.
<i>Cratægus glábra. Thun.</i>							
M'ESPILUS, MEDLAR. <i>Cal. superior, of 1 leaf, conc. in 5 seg. Pet. 5, orbic. conc. Sty. 2-5, smooth.</i>							
germánica. B. Fl.	common.	lanc. alt. sub-downy.	wh.	5. 7.	England.	H. C. Sandy loam
prunifolia.	Plum-leaved.	ellip.lanc.serr.pub.ben.	wh.	5. 6.	N.Amer.	1812.	H. S. seeds, or
Smíthii. DC.	Sir J. E. Smith's.	obl.sub-trilob.serr.pub.	wh.	——	1800.	H. C. grafting.
COTONEA'STER, COTONEA'STER. <i>Cal. turbin. bluntly 5-tooth. Pet. 5, short, erect. Sty. smth.</i>							
acumináta. DC.	pointed-leaved.	ov. acum. pilose.	wh.	5.	Nepaul.	1820.	H. S. Sandy loam
frigidá. B. R.	mountain.	ov. lanc. pubes. ben.	wh.	——	——	1823.	H. S. budding, o
vulgáris. DC.	common.	ov.ent.acut.downy ben.	wh.	4. 5.	Europe.	1660.	H. S. grafting.
<i>Méspilus cotoneáster. L.</i>							
AMELA'NCHIER, AMELA'NCHIER. <i>Cal. 5-cleft. Pet. 5, lanc. Pomum 3-5-celled. Seeds 3-5.</i>							
sanguínea. DC.	red-wooded.	rotund,obl.shortly serr.	wh.	4. 5.	N.Amer.	1800.	H. S. Sandy loam
vulgáris. DC.	common.	ov.obt.orbic.downy ben.	wh.	——	S.Europ.	1596.	H. S. layers, o
<i>Méspilus Amelánchier. L.</i>							

Systematic Name.	English Name.	Form of Leaves, &c.	Col. of Month Native Flow. of Fl. Country.	Yr. of Introd.	Soil and Propagation.
<i>PURSHIA</i> , <i>PURSHIA</i> .		<i>Cal.</i> 5-cleft, lobes obtuse.	<i>Pet.</i> 5, orbic.	<i>Carp.</i> 1-2, ovate, oblong, pubescent.	
tridentáta. DC.	three-toothed.	cuneat. glau. apex 3, den.	ye. . . . N. Amer.	1826.	H. S. ———

ORDER III.

POLYGYNIA. STYLES MANY.

GEUM, *AVENS*. *Cal.* in 10 deep segm. *Pet.* 5, rounded. *Seeds* ovate, with a hooked tail.

álbum. DC.	white.	pinnatif. upp. tern.	wh. 7. 8. N. Amer.	1730.	H. P. Light loam.
intermédium. W.	intermediate.	pinnatif. lobes ov. serr.	yel. 5. 8. S. Europ.	1794.	H. P. seeds, or
macrophyllum. DC.	large-leaved.	pinn. upp. leaf. 3-lob.	yel. 6. 7. Kamsch.	1804.	H. P. divid. roots.
Quéllyon. B.F.G.	scarlet.	lyrate, upp. 3-lobed.	sc. ——— Chile.	1826.	H. P. ———
<i>coccineum</i> . B.R.					
rivále. E. Fl.	water.	pinn. lyrate, upp. tern.	pur. 6. Britain.	H. P. ———
strictum. W.	upright.	pinn. leaf. cut.	st. 5. 6. N. Amer.	1778.	H. P. ———

SIEVERSIA, *SIEVERSIA*. *Cal.* 10-cleft, segm. unequal. *Pet.* 5, oblong. *Ger.* hairy. *Stig.* obtuse.

Péckii. B.M.	Mr. Peck's.	lyr. pin. up. lea. renif. cord.	ye. 6. 8. N. Amer.	1826.	H. P. Light loam.
triflóra. B.M.	three-flower'd.	pinn. hairy.	pu. wh. ——— ———	—	H. P. seeds, or divid. at root.

DRYAS, *DRYAS*. *Cal.* 8-10-cleft. *Pet.* 8, occasionally 10. *Seeds* obovate, hairy.

Drummondii. B.M.	Drummond's.	ellip. cren. downy.	yel. N. Amer.	1827.	H. P. Sandy loam
integrifolia. H. Ex.	Fl. entire-1v'd.	ov. tooth. at base, wh. ben.	wh. 6. 8. Greenla.	1824.	F. P. & peat, seeds,
octopétala. E. B.	white.	ov. ellip. serr. down. ben.	wh. 7. 8. Britain.	H. P. or divid. root.

CALYCANTHUS, *ALLSPICE*. *Perian.* many-part. *Stam.* uneq. falling off. *Ger.* many, ov. 1-celled.

flóridus. B.M.	Carolina.	opp. ov. ent. pub. ben.	dull re. 5. 8. Carolina.	1726.	H. S. Sandy loam
lævigátus. B.R.	dark-flowered.	obl. acum. glau. smth.	d. pu. ——— ———	1806.	H. S. & peat. layers.

CHIMONA'NTHUS, *CHIMONA'NTHUS*. *Cal.* imb. lobes ov. obt. *Sta.* equ. 5 out. fertile, & all persist.

frágrans. DC.	fragrant.	ov. lauc. smth.	yel. 2. 12. Japan.	1766.	H. S. Sandy loam & peat. layers.
<i>Calycanthus pr'æcox</i> . B.M.					

ROSA, *ROSE*. *Cal.* 5-cleft. *Pet.* 5, obov. *Filam.* shorter than the petals. *Ger.* nume. with 1 style to each.

arvénsis. E. Fl.	creeping.	pin. lea. 5-7-ellip. obl. ser. smt.	6. 8. Britain.	H. S. cr. Rich loam
1. Andersónii.	Anderson's.	bh. ——— ———	H. S. cl. is the most
2. scándens.	Ayrshire.	wh. ——— ———	H. S. cl. suitable soil
3. flóre. pléno.	double-flow'ring.	wh. ——— ———	H. S. cl. for the
4. fl. pléno odoràta.	sweet-scent'd.	wh. 6. 7. ———	H. S. cl. growth of
5. fl. pléno rósea.	dbl. rose-flow'g.	ros. ——— ———	H. S. cl. this beauti-
ciculáris. L.R.	grey Siberian.	Leaf. glau. rug. convex.	ros. 5. 6. Siberica.	—	H. P. ful & nume-
pína. B.R.	Alpine.	Leaf. 5-11 prs. obo. biser.	re. 6. 7. Europe.	1683.	H. P. rous tribe of
borréri. E. Fl.	Borrer's.	Leaf. 7, ov. acut. biserr.	car. 4. 8. Britain.	H. S. plants, whose
boursoulti.	Boursoult's.	Leaf. 5-7, ellip. ser. smth.	ros. 4. 7. Hybrid.	1821.	H. S. cl. species and
β álba.	white-flower'ng.				varieties are

Systematic Name.	English Name.	Form of Leaves, &c.	Col. of Flow.	Month of Fl.	Native Country.	Yr. of Introd.	Soil and Propagation.	
Bánkásiæ. L.R.	Sir J. Bank's.	Leafl. ellip. lanc. 3-5, ser.	wh.	7. 8.	China.	1807. H. §. cl.	now exten-	
β lútea.	yellow.	yel.	— —	— —	1823. H. §. cl.	sively culti-	
berberifólia.	Berberry-l'd.	ellip. serr.; Br. prickly.	yel.	6. 7.	Persia.	1790. H. §.	vated in al-	
Lôwea berberifólia. B.R.							most every	
bractæata.	Macartney.	Leafl. 5-9, obo. serr. shiu.	wh.	—	China.	1795. H. §. cl.	garden.	
bractéscens. L.T.	bracteated.	Leafl. ellip. acut. hair. serr.	w.	6. 7.	Lancash.	H. §.	They are	
cæ'sia. E. Fl.	glaucous leav'd.	Leafl. 5-7, ellip. acu. down. ben.	—	—	Scotland.	H. §.	readily in-	
carolina. L.R.	Caroline.	Leafl. 5-9, lanc. obov. serr.	re.	—	N. Amer. 1726.	H. §.	creased by	
canina. L.T.	dog.	Leafl. 5-7, ellip. serr.	bh.	—	Britain.	H. §.	layers, or	
cinnamómea. E.B.	Cinnamon.	Leafl. 5-7, lanc. obl. serr. glau.	5.	—	England.	H. §.	budding on	
caucásica.	Caucasian.	Leafl. 5, ov. roun. twice ser. bh.	6. 7.	—	Caucas. 1793.	H. §.	each other;	
centifólia. L.R.	Province.	Leafl. 5-7, ov. edges gland.	ro.	8. 9.	—	1596.	H. §.	new varie-
1. muscôsa.	single-moss.	ros.	—	—	H. §.	ties are also
2. multipléx.	double-moss.	ros.	—	—	H. §.	very fre-
3. albiflora.	white-moss.	wh.	—	—	H. §.	quently ob-
Doniána. L.T.	Don's.	Leafl. 7-9, ellip. biserr. hair.	w.	5. 6.	Britain.	H. §.	tained from	
damascéna. L.R.	red damask.	Leafl. 5-7, ov. rigid. prick.	red.	6. 7.	Syria. 1575.	H. §.	seeds.	
dumétorum. L.T.	bushy.	Leafl. 7, ellip. serr. shin.	bh.	—	England.	H. §.	—	
Dicksoniána. E. Fl.	Dickson's.	Leafl. 5-7, ellip. serr. pub.	bh.	—	—	H. §.	—
Forstéri. E. Fl.	Forster's.	Leafl. 5-7, ellip. acu. ser. smth.	6. 7.	—	—	H. §.	—
fraxinifólia. L.R.	Ash-leaved.	Leafl. 5-7, ellip. den. smth.	re.	5. 6.	Newfoun. 1773.	H. §.	—	
férox. L.R.	hedge-hog.	Leafl. 3-5, ellip. serr.	pur.	6.	Caucas. 1796.	H. §.	—	
gráciлис. L.T.	tall bristly.	Leafl. 7-9, ellip. biser. pub.	ro.	6. 7.	Britain.	H. §.	—	
gállica.	official.	Leafl. 5-7, ov. lanc. rigid.	red.	—	Europe. 1596.	H. §.	—	
grandiflora. Lind.	large-flower'd.	Leafl. flat. serr. smth.	wh.	5. 6.	Siberia. 1818.	H. §.	—	
Grevillii.	Greville's.	Leafl. 5-7, serr. smth. ro. bh.	—	—	China.	H. §. cl.	—	
gemélla. w.	twin-flowering.	Leafl. obl. acut. fruit glo.	re.	8. 9.	N. Amer. 1800.	H. §.	—	
hibérnica.	Irish.	Leafl. 5-7, glau. abo. hair. ben.	6. 10.	—	Ireland.	H. §.	—	
índica. w.	common China.	Leafl. 3-5, ov. acum. shin. ser. fl.	1. 12.	—	China. 1789.	H. §.	—	
1. centifolia.	large-double.	pk.	—	—	H. §.	—
2. minor.	small-China.	pk.	—	—	H. §.	—
3. purpúrea.	purple China.	pur.	—	—	H. §.	—
involuta.	prickly.	Leafl. 5-9, ellip. smth. abo. hair.	6. 7.	—	Hebrides.	H. §.	—	
kamchática.	Kamtschatka.	Leafl. 5-9, obl. obt. serr.	pur.	7. 9.	Kamtsch. 1802.	H. §.	—	
Lawranceána. B.R.	Miss Lawrance's.	Leafl. ov. acut. finely serr.	re.	1. 12.	China. 1810.	F. §.	—	
lúcida. w.	shining.	Leafl. 5-9, ellip. lanc. serr.	re.	6. 9.	N. Amer. 1773.	H. §.	—	
Lindléyi.	Mr. Lindley's.	Leafl. 5-7, obl. undul. glau.	ro.	7. 8.	—	1726.	H. §.	—
lútea. B.M.	yellow.	Leafl. 5-7, ellip. serr. conc.	ye.	6.	German. 1596.	H. §.	—	
micrántha. L.T.	small-flowered.	Leafl. ov. twice serr. hairy.	re.	6. 7.	England.	H. §.	—	
microcárpa.	small-fruited.	Leafl. 3-4, lanc. shin.	wh.	5. 10.	China. 1822.	F. §. cl.	—	
moscháta.	musk-scented.	Leafl. 5-7, lanc. smth.	wh.	8.	Africa. 1596.	H. §.	—	
1. arbórea.	tree.	—	Persia. 1824.	H. §.	—	
2. flóre-pléno.	double-flow'ring.	wh.	7. 9.	Barbary. 1596.	H. §.	—	
multiflora. w.	many-flowered.	Leafl. 5-7, ov. lanc. soft.	pk.	6. 7.	China. 1804.	H. §. cl.	—	
1. álba.	white-flowered.	wh.	6. 8.	—	1810.	H. §. cl.	
2. rósea.	common.	ros.	—	—	H. §. cl.	
nítida.	shining.	Leafl. 5-9, lanc. smth.	red.	6. 9.	N. Amer. 1773.	H. §. cl.	—	
Noissetiána. B.R.	Noisset's.	Leafl. ov. serr.	bh.	5. 11.	Hybrid. 1816.	H. §.	—	
1. grandiflora.	large-flowered.	bh.	—	—	1827.	H. §.	
2. purpúrea.	purple.	pur.	—	—	1823.	H. §.	
nívea. B.R.	snow-white.	Leafl. tern. shin. smth.	wh.	8.	Hybrid. 1823.	H. §.	—	

Systematic Name.	English Name.	Form of Leaves, &c.	Col. of Flow.	Month of Fl.	Native Country.	Yr. of Introd.	Soil and Propagation.
odorata.	sweet-scented.	Leaf. ov. serr. smth.	pa.	2.12.	China.	1810.	H. S. ———
1. flavescens.	yellow-China.	yel.	——	——	1823.	H. S. ———
2. coccinea.	scarlet.	sc.	——	——	1828.	H. S. ———
parviflora.	small-flowered.	Leaf. 5-9, lanc. smth. serr.	bh.	8. 9.	N. Amer.	1724.	H. S. ———
rúgo.	wrinkled.	Leaf. 5, ov. serr. smth.	——	——	1829.	H. S. ———
Russelliana. Sincl.	Ldy. G. Russell.	Leaf. 5-7, ellip. serr. glau. y. w.	6.	8.	Britain.	H. S. cl. ———
<i>Double hip.</i> Hort.							
rubilla.	red-fruited.	Leaf. 7-11, ellip. obt. ser. smth.	7.	——	England.	H. S. ———
rubiginosa.	Sweetbriar.	Leaf. 5-7, ellip. acut. biser. pk.	5.	6.	Britain.	H. S. ———
rubrifolia.	Rubus-leaved.	Leaf. 5-7, ov. lanc. dent.	re.	6.	S. Europ.	H. S. ———
Sabini. L.T.	Sabine's.	Leaf. 5-7, or 9, ellip. biser. ro.	——	——	Britain.	H. S. ———
sarmentacea. L.T.	trailing.	Leaf. 5-7, ov. acut. biser. smth.	6.	8.	——	H. S. ———
spinossissima.	Burnet.	Leaf. 7-9, or more, orb. ser. w.	6.	7.	——	H. S. ———
subglobosa.	round-headed.	Leaf. 5-7, ellip. biser. down.	——	——	——	H. S. ———
systyla.	close-styled.	Leaf. 5-7, ellip. smth. abo. ser.	——	——	——	H. S. ———
sempervirens.	ever-flowering.	Leaf. ov. lanc. cren. ser.	cri.	12.1.	China.	1789.	F. S. ———
1. atrorubens.	double-red.	d.r.	——	F. S. ———
2. fragrans.	fragrant.	pu.	——	F. S. ———
sempervirens. w.	evergreen.	in 5-7 pairs, prickl. falc.	wh.	5. 9.	S. Europ.	1629.	H. S. cl. ———
scabriuscula. L.T.	roughish.	Leaf. ov. hairy ben.	bh.	6. 7.	Britain.	H. S. ———
scipium.	small-leaved.	Leaf. 7, lan. acu. biser. hair. w.	——	——	France.	H. S. ———
sinica. Lind. R.	3-leaved China.	tern. leaf. ov. lanc. serr.	wh.	6. 8.	China.	1759.	F. S. ———
sulphurea. H. K.	double-yellow.	Leaf. 5-7, glau. flat.	yel.	7.	Levant.	1629.	H. S. ———
stricta. L. R.	upright.	Leaf. 7-9, ov. obt. Fr. pend. ro.	6.	8.	N. Amer.	1726.	H. S. ———
tomentosa. L. T.	downy.	Leaf. 5-7, ellip. biser. hoar. re.	5.	8.	Britain.	H. S. ———
turbinata. H. T.	turbinate.	Leaf. 5-7, ov. cor. ser. vill. ben.	6.	9.	Europe.	1629.	H. S. ———
villosa.	villous.	Leaf. 5-7, ellip. biser. vill.	pk.	6. 7.	Britain.	H. S. ———
Wilsoni. B. Fl.	Wilson's.	Leaf. 7-9, ov. obt. pub. ser. pk.	——	——	——	H. S. ———
Woodsi. Lind.	Wood's.	Leaf. obl. obt. glau. smth.	red.	6. 7.	N. Amer.	1815.	H. S. ———

Garden Varieties.	Garden Varieties.	Garden Varieties.	Garden Varieties.
I. GALLICA.	Flemish.	Pyramidal.	Petite Holland.
Admirable.	Grand Monarque.	Roi de France.	Persian.
Amaranth.	Grand Sultan.	Roi de Pourpres.	Pourpree Amiable.
Atlas.	Incomparable.	Sanspareil. cl.	Provins common.
Beaute rouge.	Infernal.	Sultan.	—— cabbage.
Belle violette.	Josephine.	Trafalgar.	—— white.
Blue.	La Dauphin.	Triumphant.	—— blush.
Blush, hundred leaved.	Malabar.	Tuscany.	—— damask. cl.
Brussels.	Mignonne. cl.	Victory.	—— invincible.
Carmine.	—— blush. cl.	——	—— semi-double.
—— brillante.	—— red. cl.	——	Superb carmine.
Carnation.	—— semi-double. cl.	——	Syren.
Changeable.	Mogul.	II. CENTIFOLIA.	Versailles.
Cramoise grand.	Nonpareil.	Aurora.	Vilmorin.
Damask black. cl.	Nonsuch.	Blush Cabbage.	Centifolia muscosa.
Double velvet.	Official carmine.	Bourbon.	Blush moss.
Duchess d'Orleans.	Orleans.	Cluster. cl.	Common moss.
Dutch, hundred leaved.	Paradise.	Duchess de Berri.	Royal moss.
Enfant de France.	Poppy.	Duchess de Angouleme.	Scarlet moss.
Flanders.	Portland.	Grand Provins.	Striped moss.
	Proserpine.		Shailer's white moss.

Garden Varieties.	Garden Varieties.	Garden Varieties.	Garden Varieties.
Centifolia Pomponia. Mignonne charmante. Pomponne. St. Francis. Spong's. —————	V. RUBIGINOSA. Double mossy Sweet- briar. <i>cl.</i> Double red Sweet- briar. <i>cl.</i> Evergreen Sweetbriar. <i>cl.</i> Eglantine Sweetbriar. <i>cl.</i> Iver Cottage Briar. Maiden Sweetbriar. <i>cl.</i> Monstrous Sweetbriar. <i>cl.</i> Royal Sweetbriar. <i>cl.</i> Scarlet Sweetbriar. <i>cl.</i> —————	Arcadian. Armenian. Assyrian. Augusta. Bellona. Berkshire. Blondine. Blush velvet. Bold. Bourbon. Brabant. Bucephalus. Calypso. Carthaginian. Castile. Ceris. Chance. Cleopatra. <i>cl.</i> Cossack. Crimson. Danish. Darling. Derby. Diadem. Dedo. Discolor. Duc de Brabant. Duke of Clarence. Durham. Etna. Euphrosyne. <i>cl.</i> Favourite. Felix. Floribunda. Franckfort. Frizzled. Gascony. Genoese. Globe. Grand Mogul. Helena. Hertford. Isabella. Jersey. Justica. Julian. King Agrippa. La Moderne. Lancaster. Leander. Lee's Perpetual.	Lodoiska. Luxemburg. Magdalen. Margareta. Marseilles. Minerva. Montpelier. <i>cl.</i> Narbonne. Nassau. Niobe. Oliver. Olympic. Orient. Parnassus. Palestine. Pegasus. Penelope. <i>cl.</i> Pomegranate. Portobello. Pope's Cluster. Prince Regent. Princess Charlotte. Raphael. Ratisbon. Red Provins. Rosabel. Rosanna. Ruby. St. Catharine. St. George. St. Patrick. Sarmatian. Seville. Shylock. Silenus. Southampton. Striped Provins. Sulphurea. ————— minor. Tangiers. Theseus. Triton. Turban. Venusta. Victoria. Wellington. Yorkshire Provins. —————
III. DAMASCENA. Argentea. Blush, monthly. <i>cl.</i> ————— Damask. <i>cl.</i> Brunswick. Egyptian. Goliath. Grand Monarque. Incomparable. Parnassus. Perpetual. Prolific. Red damask. <i>cl.</i> Red monthly. <i>cl.</i> Red Belgic. Swiss. Valiant. White Damask. <i>cl.</i> ————— Monthly. <i>cl.</i> York and Lancaster. Zealand. ————— —————	VI. INDICA ET SEMPER-FLORENS. Atronigra. Carnescens. Cucullata. Elegans. Florida. Gigantea. Lie. de vin. <i>cl.</i> Lucida. Major. Monstrosa. Moonshine. Nigra. Sanguinea. Sans epines. <i>cl.</i> Thisbe. Veloutee. —————		
IV. ALBA. Agate. ————— magnifique. Belle aurore. ————— Henrietta. Bonquet Blanc. Cœlestiæ. Double white Blush. Duc d'York. Grand cuisse d'Nymph. Great Maiden Blush. Joanne d'Arc. Muscat rouge. Nova cœlestis. Small Maiden's Blush. ————— —————	VII. VARIOUS GARDEN ROSES. Abundant. Achilles. Adelina. Adonis. Aimable violette. Ajax. Albaniam. Alba nova cœlestis. Amazon. Andalusian.		

New Garden Varieties of the Spinosissima, in the Rosarium Scoticum.

Double Red.	Duchess of Gloucester.	Eliza.	Jason.
— Blush.	Sylvia.	Pythagorus.	Europa.
— Ladies' Blush.	Lady Jane Montgomery.	Dunsinnaine.	Ferchard.
— White.	Celisia.	Herodotus.	Apis.
— Velvet.	Lady Castle Coote.	Euipidus.	Cornelius.
— Pale Yellow.	Lady H. Dalrymple.	Mrs. Smythe.	Lady M. Thriepand.
— Light Red.	Proteus.	Benmore.	Countess of Kinnoull.
— Large Blush.	Phæton.	Socrates.	Maldevin.
— Purple.	Lady Banks.	Barnum.	Triumphant.
— Marbled.	Orpucus.	Plato.	Seneca.
Single Velvet.	Mrs. Hooker.	Caroline.	Leda.
Double Provins.	Phocion.	Mrs. Trotter.	Lomond.
— Rayed.	Dwarf Bicolor.	Mrs. Hunter.	Lady Baird.
— De Meaux.	Bellona.	Cupid.	Lady Rollo.
— Miss Dunbar.	Hercules.	Mrs. Moray.	Duchess of Bedford.
Queen of Scots.	Sillyla.	Josephus.	Lady L. Grant.
Princess.	Althea.	Argus.	Nicoles.
King of Scots.	Jangthea.	Mrs. Watson.	Miss Moray.
Duchess of Argyle.	Appelis.	Mrs. Ross.	Horace.
Hector.	Jugurtha.	Charlotte.	Mrs. Oliphant.
Mr. Walker.	Hector.	Demosthenes.	Pliny.
Lady Stewart.	Agrippa.	Margaret.	Amberchelet.
Austin.	Hecuba.	Comus.	Ambrosea.
Duchess of Hamilton.	Aristides.	Julia.	Iris.
— of Glasgow.	Pomona.	Burns.	Jupiter.
Lady Blantyre.	Alimina.	Lord Gray.	Aurea.
Countess of Glasgow.	Diana.	Donald.	Cleo.
James.	Sappho.	Ferney.	Solvatius.
Agricola.	Scotia.	Diogenes.	Lucus.
Exonia.	Artenesia.	Mrs. Maule.	Mrs. Maxton.
Mr. Aiton.	Mrs. M'Lean.	Euginius.	Argo.
Lady Crompton.	Cyrene.	Collina.	Achaius.
Paris.	Mrs. Aiton.	Hebe.	Medusa.
Saxonia.	Lady Moncrieff.	Fergus.	Mrs. Stewart.
Mr. Robertson.	Mrs. Pearson.	Dougara.	Tacitus.
Serjia.	Ajax.	Countess of Mansfield.	Dougal.
Juba.	Transparent.	Leucretius.	Mrs. Balfour.
Phyllis.	Mrs. Campbell.	Constantine.	Medas.
Phœdia.	Antioch.	Robina.	Plutarch.
Numa.	Lord Lynedoch.	Lady Dundas.	Alpine.
Formosa.	Mrs. Hamilton.	Lady Willoughby.	Mrs. M. Stirling.
Mrs. Bailie.	Eribus.	Congall.	Miss Grant.
Aurora.	Priam.	Cicero.	Mary Stewart.
Princess Elizabeth.	Mrs. Richardson.	Lady C. Drummond.	Miss Drummond.
Acis.	Mrs. Nairne.	Concordia.	Juvinial.
Countess of Dunmore.	Æsop.	Lethe.	Miss Thriepand.
Sabina.	Sappho.	Mordac.	Carna.
Lady Clive.	Homer.	Amphitrite.	Atlas.
Alexandria.	Isabella.	Countess of Breadalbane.	Bacchus.
Lady Herriot Thynne.	Maria.	Kennet.	Casandra.
Palestine.	Mrs. M'Donald.	Acastus.	Indulphus.
Marchioness of Bute.	Pindar.	Damon.	Miss Norton.

Systematic Name.	English Name.	Form of Leaves, &c.	Col. of Month Native Flow. of Fl. Country.	Yr. of Introd.	Soil and Propagation.
<i>New Garden Varieties of the Spinossissima, in the Rosarium Scoticum.</i>					
Miss Richardson.	Alexander.	Captain.			Telemachus.
Duchess of Buccleuch.	Miss Thomson.	Pan.			Mrs. Hay.
Lady M. Murray.	Amiable.	Parnassus.			Major.
Miss M'Lean.	Minerva.	Macbeth.			Mrs. Allan.
Marcus.	Neptune.	Dryden.			Mogul.
Hero.	Knox.	Miss Martin.			Lady Ramsay.
Fame.	Pallas.	Triton.			Viscountess Strathallan.
Castor.	Lady Menzies.	Lady E. M'Gregor.			Admirable.
Bacon.	David.	Priam.			Ulyssis.
Edgar.	Miss Campbell.	Thespes.			Virgilia.
Mercury.	Miss Paton.	Ruby.			Spencer.
Niobe.	Miss Stewart.	Cardinal.			Shakespeare.
Lady Duncan.	Baliol.	Mrs. Murray.			Amelia.
Mars.	Buchanan.	Mrs. Craigie.			Regent.
Nero.	Marchioness of Abercorn.				

RUBUS, BRAMBLE. Cal. in 5 deep seg. Pet. 5. Ger. crowd. Ber. comp. Seeds soli. keel'd & wrinkl.

affinis. E.Fl.	related.	tern. 5-lob. leaf. cord. ov.	wh. 6. 9.	Britain.	H. S.	Sandy loam
arcticus. E.Fl.	Arctic.	tern. smth. bluntly serr.	ros. 5. 8.	Scotland.	H. P.	& leaf mould
caesius. E.Fl.	Dew-berry.	tern. ov. hairy und. oft. lob.	w. 6. 7.	Britain.	H. S.	layers, or
Chamæmorus. E. B.	Cloud-berry.	cord. plaited, 5-lob. serr.	wh. — — —	H. P.	parting at
corylifolius. E. B.	Hazel-leaved.	3-5-cord. ov. hairy.	wh. 7. — — —	H. S.	roots.
β flore-pleno.	double-flow'g.		wh. — — —	H. S.	— — —
canadense. DC.	Canadian.	digit. leaf. lanc. smth.	wh. 6. 7.	N. Amer.	1811.	H. S.	— — —
fruticosus. E.Fl.	shrubby.	3-5-lob. leaf. ov. obl. down.	fl. 6. 9.	Britain.	H. S.	— — —
glandulosus.	glandular.	tern. leaf. orbic. ov. serr.	7. 8.	— — —	H. S.	— — —
Idæus. B.Fl.	Raspberry.	pinn. of 3 or 4 ov. leaf. serr.	w. 5. 6.	Britain.	H. S.	— — —
leucostachys. s. s.	white-spiked.	quinnate, ov. obl. hairy.	wh. 7. 8.	— — —	H. S.	— — —
nitidus. E.Fl.	shining.	tern. leaf. ov. shin. smth.	bh. — — —	H. S.	— — —
odoratus. B.M.	sweet-scented.	5-lob. tooth.	red. 6. 7.	N. Amer.	1827.	H. S.	— — —
pauciflorus. B.R.	few-flowered.	pinn. leaf. 5-7-obl. plic. pil. pu.	— — —	Nepaul.	1818.	H. S.	— — —
plicatus. E.Fl.	plaited.	tern. leaf. cord. ov.	wh. 7.	Britain.	H. S.	— — —
reflexus. B.M.	reflexed.	cord. obl. lob. pilose.	wh. 6. 7.	China.	1818.	G. S. cl.	— — —
rhamnifolius. B.Fl.	Buck-thorn-l'd.	digit. orbic. serr. leaf. w. or pu.	7. 8.	Britain.	H. S.	— — —
saxatilis. E.Fl.	stone.	Leaf. 3, downy, serr. gr. wh.	6.	— — —	H. P.	— — —
suberectus. E.Fl.	upright.	pinn. hairy, upp. tern.	wh. 6. 9.	— — —	H. S.	— — —
spectabilis. DC.	shewy.	tern. palm. leaf. ov. serr.	pur. — — —	Columb.	1827.	H. S.	— — —

FRAGARIA, STRAWBERRY. Cal. 10-cleft. Pet. 5. Ger. nume. with as many styles. Seeds naked.

indica. B.R.	yellow-flow'r'd.	tern. leaf. ov. serr.	yel. 5. 10.	Nepaul.	1805.	H. P.	Light loam.
virginiana. DC.	scarlet.	smth. serr. acum.	wh. 4. 6.	N. Amer.	1629.	H. P.	seeds, or runners.

POTENTILLA, CINQUE-FOIL. Cal. 10-parted. Pet. 4-5. Ber. consisting of many small nuts.

alba. E.Fl.	white.	quin. apex. serr.	wh. 7. 8.	Wales.	H. P.	Sandy loam
alpestris. E.Fl.	Orange-Alpine.	5-wedge-sh. hairy, upp. cut. y.	— — —	Scotland.	H. P.	and peat.
atrosanguinea. B. F. G.	dark-crimson.	tern. leaf. ellip. serr. vill. d. re.	6. 9.	Nepaul.	1820.	H. P.	seeds, or
Clusiana. B.M.	Clusius's.	quin. apex. serr.	wh. 7. 8.	S. Europ.	1806.	H. P.	part. roots.
Còmarum. DC.	marsh.	Leaf. 7-ellip. lanc. serr. pu.	6. 7.	Britain.	H. P.	— — —
Còmarum palustre. E.Fl.							

Systematic Name.	English Name.	Form of Leaves, &c.	Col. of Flow.	Month of Fl.	Native Country.	Yr. of Introd.	Soil and Propagation.
<i>Fragariastrum</i> . B. Fl.	Strawberry-ld.	ter. leaf. orb. obo. ser. hair.	w.	3. 4.	Britain	H. P. ———
<i>fruticosa</i> . E. B.	shrubby.	pinn. obl. ent. hairy.	yel.	6. 8.	—	H. S. ———
<i>gracilis</i> . B. M.	slender.	tern. leaf. 3-4-inch long.	yel.	—	N. Amer.	1827.	H. P. ———
<i>grandiflora</i> . B. M.	great-flowered.	tern. dent. pilose.	yel.	6. 7.	Siberia.	1640.	H. P. ———
<i>laciniosa</i> . B. R.	jagged-leaved.	segm. 7, obl. lacin. pinnatif.	ye.	—	Hungary.	1819.	H. P. ———
<i>nepalensis</i> . H. Ex. Fl.	Nepal.	quin.; <i>stm.</i> ones tern. serr.	pu.	6. 9.	Nepal.	1822.	H. P. ———
<i>nivea</i> . DC.	white-leaved.	leaf. ov. serr. wh. ben.	yel.	5. 6.	America.	1816.	H. P. ———
<i>opaca</i> . DC.	saw-leaved.	5-7, lin. cuneat. dent.	yel.	6. 7.	Scotland.	H. P. ———
<i>rupéstris</i> . B. Fl.	rock.	pin. wedge-sh. ov. ser. hair.	w.	5. 9.	England.	H. P. ———
<i>Russelliana</i> . B. F. G.	Russell's.	3-4, or 5, leaf. obov. ser. pil.	sc.	—	Hybrid.	1827.	H. P. ———
<i>spléndens</i> . B. F. G.	splendid.	pinn. leaf. silky, tooth.	wh.	—	Nepaul.	1818.	H. P. ———
<i>tridentata</i> . E. Fl.	three-toothed.	tern. leaf. obl.	wh.	5. 6.	Scotland.	H. P. ———
<i>vérna</i> . E. Fl.	spring.	5; leaf. obo. serr. edg. hair.	y.	3. 5.	Britain.	H. P. ———

TORMENTILLA, TORMENTIL. *Cal.* 8-cleft. *Pet.* 4, obov. *Ger.* 8, with 8 styles. *S. eds* ov. smooth.
réptans. E. Fl. trailing. tern. stalked, leaf. 3-5, obo. y. 6. 8. Britain. H. P. Sandy loam. seeds.

DALIBARDA, DALIBARDA. *Cal.* 5-6-part. lobes dentic. *Pet.* 5. *Sty.* 5, very long, deciduous.
répens. DC. violet-leaved. simple, cord. serr. wh. 5. 6. N. Amer. 1768. H. P. Loam & peat. divid. roots.
violæoides. M.

COMAROPSIS, COMAROPSIS. *Cal.* tube turb. 5-cleft. *Pet.* 5. *Stam.* many. *Sty.* filiform, elong.
Doniána. DC. Don's. ter. leaf. wedge-shap. ser. ye. 5. 6. ——— 1803. H. P. Loam & peat. part. roots.
Dalibárda Fragarioides. B. M.

CLASS XIII. ORDER I.

POLYANDRIA MONOGYNIA. STAMENS MANY. STYLE 1.

ARGEMONE, ARGEMONE. *Cal.* of 3 leaves. *Cor.* of 6 pets. *Ger.* ov. 4-celled. *Seeds* numerous.

<i>albiflora</i> . B. M.	white-flowered.	amplex. lobes spiny.	wh.	6. 7.	Louisian.	1820.	H. P. Sandy soil.
<i>randiflora</i> . B. R.	large-flowered.	obl. pinnatif. spott.	wh.	—	Mexico.	1827.	H. P. seeds.
<i>mexicana</i> . B. R.	Mexican.	spiny, dent. spott.	yel.	—	—	1592.	H. A. ———

LETTSOMIA, LETTSOMIA. *Cal.* of 5 leaves. *Pet.* 5. *Sty.* short. *Stig.* 3-5. *Ber.* 3-5-celled.

<i>mentosa</i> . DC.	woolly.	lanc. ent. silky ben.	Peru.	1820.	S. S. Light soil and leaf mould, cuttings.
----------------------	---------	-----------------------	------	-------	-------	--

[many cells. *Seeds* round.

LYMPHÆA, WHITE WATER-LILY. *Cal.* of 4 large leaves. *Pet.* numer. attached to the ger. *Ber.* of

<i>alba</i> . E. Fl.	white.	cord. ent. smth. float.	wh.	6. 7.	Britain.	H. w. P. Strong loam,
<i>erulea</i> . DC.	blue.	pelt. sub-ent. smth. base 2-lob.	6. 9.	Egypt.	1812.	S. w. P. or mud, in	
<i>otus</i> . DC.	Egyptian.	pelt. sharply serr. pub.	wh.	—	—	1802.	S. w. P. ponds. seeds
<i>orata</i> . B. M.	sweet-scented.	cord. ent. und. nerv.	wh.	7.	N. Amer.	1786.	H. w. P. or divid. at
<i>bra</i> . B. M.	red.	sub-orbic. ent. smth.	red.	7. 8.	E. Ind.	1803.	S. w. P. the roots.

UPHAR, YELLOW WATER-LILY. *Cal.* of 5-6 conc. leaves. *Pet.* num. furr. & honey-bear. at the back.

<i>vena</i> . DC.	stripe-flowered.	cord. erect, lob. divaric.	yel.	7. 8.	N. Amer.	1772.	H. w. P. Loam, seeds,
-------------------	------------------	----------------------------	------	-------	----------	-------	-----------------------

Systematic Name.	English Name.	Form of Leaves, &c.	Col. of Flow.	Month Native of Fl. Country.	Yr. of Intro.	Soil and Propagation.
púmila. E.Fl.	least.	cord. lobes remote.	yel. 7. 8.	Scotland.	...	H.w. β . or parting
lútea. E.Fl.	common.	cord. lobes approxim.	yel. 6. 7.	Britain.	...	H.w. β . at roots.
<i>SANGUINARIA, PUCCOON.</i> Cal. 2-leaved. Pet. 8-12. Stam. 21. Stig. 2. Caps. oblong, 2-valved.						
canadénsis. B.M.	Canad.-Blood-wor.	renif. smth.	wh. 3. 4.	N.Amer.	1680.	H. β . Sandy loam
grandiflora. B.F.G.	large-flowered.	renif. sub-7-lob. glau.	wh. 4. 5.	—	1812.	H. β . & leaf mould, parting at the root.
<i>SARRACENIA, SIDE-SADDLE-FLOWER.</i> Cal. doubl. of 3-5 leaves. Cor. of 5 pet. Caps. 5-celled.						
fláva. B.M.	yellow.	ent. tubu. valv. contract.	yel. 6. 7.	N.Amer.	1752.	H. β . Peat.
purpúrea. B.M.	purple.	cucul. vent. arch.	pur. — — —	—	1640.	H. β . parting at
variolaris. B.M.	hook-leaved.	elong. apex tubular.	gr.yel. — — —	—	1803.	H. β . roots.
[5-celled, and 2 seeds.						
<i>SPARRMA'NNIA, SPARRMA'NNIA.</i> Cal. of 4 leaves. Pet. 4, rounded. Stam. many. Caps. 5-angled.						
africána. B.M.	African.	cord. lob. serr. pubes.	wh. 3. 7.	C.B.S.	1790.	G. \mathfrak{S} . Light loam and leaf mould. cuttings.
[Ber. of 1 cell. Seeds in 2 rows.						
<i>ACT'ÆA, BANE-BERRIES.</i> Cal. of 4 concave leaves. Cor. of 4 petals. Ger. ovate. Sty. 0. Stig. round.						
álba. Mill.	white-berried.	bi-tritern.; leaf. ov. lan. serr.	4. 6.	N.Amer.	...	H. β . Garden soil.
spicáta. DC.	Herb-Christoph.	tritern.; leaf. ov. serr. cut.	w. — —	Britain.	...	H. β . seeds, or dividing at root.
<i>HUNNEMA'NNIA, HUNNEMA'NNIA.</i> Cal. of 2 leaves. Pet. 4. Stig. pelt. 4, sulc. 4-lo. Caps. 10-rib.						
fumarifolia. B.F.G.	Fumitory-l'd.	tritern. glau.; leaf. lin.	yel. 7. 10.	Mexico.	1827.	H. \mathfrak{S} . Light loam. seeds.
<i>CHELIDO'NIUM, CELANDINE.</i> Cal. infer. 2-cleft. Pet. 4, equ. Pods of 2 or 3 cells. Seeds dotted.						
grandiflorum. DC.	large-flowered.	pinn. seg. dent. lob.	yel. 4. 10.	Dahuria.	1823.	H. β . Common soil.
május. E.Fl.	common.	5-lob. lobes lin. acut.	yel. — —	Britain.	...	H. β . seeds.
<i>ESCHSCHO'LTZIA, ESCHSCHO'LTZIA.</i> Cal. of 1 leaf. Cor. of 4 pets. obov. Caps. round, 10-ribb.						
californica. B.R.	Menzies'.	glau. bipinnatifid.	yel. 7. 10.	Californ.	1826.	H. β . Garden loam. seeds.
[Stig. 2-3-cleft. Pod of 2 or 3 cells.						
<i>GL'AUCIUM, HORNED-POPPY.</i> Cal. of 2 oblong leaves. Pet. 4, unequal. Ger. rounded. Style 0.						
fúlrum. B.F.G.	Orange-color'd.	pinn. upp. ampl. cord.	or. 8. 9.	S.Europ.	1802.	H. β . Sandy soil.
flávum. E.Fl.	yellow.	pinnatif. lyrate, hairy.	yel. 6. 10.	Britain.	...	H. \mathfrak{B} . seeds.
lúteum. H.K.						
phæníceum. H.K.	scarlet.	obl. hair.; stem pinnatif. scar.	6. 7.	England.	...	H. \mathfrak{A} . ———
violáceum. E.B.	Violet.	bipinn. seg. lin. scabr.	bl. 5. 7.	—	...	H. \mathfrak{A} . ———
<i>CALANDRI'NIA, CALANDRI'NIA.</i> Cal. 2-part. Pet. 3-5. Sty. short. Caps. obl. 1-celled, many-seed.						
grandiflora. B.R.	large-flowered.	rhomboid, acut. glau.	ros. 6. 9.	Chile.	1826.	G. β . Sandy peat and loam. cuttings.
[1 cell. Seeds kidney-shaped.						
<i>PAPA'VER, POPPY.</i> Cal. of 2 ovate leaves. Pet. 4, uneq. Ger. oblong. Sty. 0. Stig. peltate. Caps. of						
Argemone. E.Fl.	long rough-head.	bipinn. segm. lanc.	sc. 6. 7.	Britain.	...	H. \mathfrak{A} . Sandy loam.
alpínum. B.F.G.	Alpine.	bipinnate, smooth.	wh. — —	Austria.	1759.	H. β . seeds.
bracteatum. DC.	bracted.	pinn. part. hairy.	red. 5. 8.	Caucas.	1821.	H. β . ———

Systematic Name.	English Name.	Form of Leaves, &c.	Col. of Flow.	Month of Fl.	Native Country.	Yr. of Introd.	Soil and Propagation.
cámbrium. E.Fl.	yellow.	pinn. ent.	yel.	5. 8.	Wales.	H. D. ———
dübium. E.Fl.	long smth.-head.	pinn. part. lobes dent.	re.	—	Britain.	H. A. ———
floribúndum. B.R.	many-flowered.	pinn. upp. pinnatif.	re.	—	Levant.	1815.	H. B. ———
hy'bridum. E.Fl.	hybrid.	bipinn. seg. lin. revol.	sc.	—	England.	H. A. ———
nudicáule. B.Fl.	naked-stalked.	pinnatif. segm. tooth.	yel.	—	Siberia.	1730.	H. D. ———
orientále. B.M.	oriental.	pinn. part. hairy, serr.	red.	5. 6.	N.S.W.	1714.	H. D. ———
somníferum. DC.	white.	ampl. glau. wavy, notch.	bl. w.	7. 8.	England.	H. A. ———

PODOPHYLLUM, DUCK'S-FOOT. *Cal. of 3 leaves, decid. Cor. of 6 to 9 pets. Ber. ovate, of 1 cell.*

peltátum. B.M.	peltate.	pelt. lob. serr. smth. retic.	wh.	7.	N. Amer.	1664.	H. D. Sandy loam, seeds, or divid. at root.
----------------	----------	-------------------------------	-----	----	----------	-------	---

[1 or 2 seeds in each.

TILIA, LIME-TREE. *Cal. 5-part. conc. Cor. of 5 obov. pet. Ger. orbic. Stig. 5-ang. Caps. of 5 cells,*

glábra. DC.	broad-leaved.	cord. serr. smth.	wh.	6. 7.	N. Amer.	1752.	H. C. Common loam.
-------------	---------------	-------------------	-----	-------	----------	-------	--------------------

americana. L.							
---------------	--	--	--	--	--	--	--

heterophylla. DC.	white-leaved.	cor. sub-sinu. den. wh. ben.	w.	6. 8.	—	—	H. C. layers.
-------------------	---------------	------------------------------	----	-------	---	---	---------------

álba. Mich.							
intermédiá. DC.	intermediate.	3-4-inch long, serr. cord.	gr.	8. 9.	Britain.	H. C. ———

europæa. E. B.							
----------------	--	--	--	--	--	--	--

microphylla. DC.	small-leaved.	orbic. cord. smth. above.	wh.	—	—	H. C. ———
------------------	---------------	---------------------------	-----	---	---	------	-----------

parcifolia. E. B.							
-------------------	--	--	--	--	--	--	--

platyphylla. DC.	broad-leaved.	cord. acum. serr. hairy.	wh.	6. 7.	—	H. C. ———
------------------	---------------	--------------------------	-----	-------	---	------	-----------

grandifolia. Ehrh.							
pubéscens. DC.	downy.	cor. trunc. obliq. serr. pub.	w.	7. 8.	N. Amer.	1726.	H. C. ———

B'IXA, B'IXA. *Cal. of 5 leaves. Pet. 5, obovate. Caps. 1-celled, 2-valved. Seeds 8-10.*

Orellána. B.M.	Orellana.	cord. ov. ent. smth.	ros.	5. 8.	S. Amer.	1690.	S. S. Sandy loam and leaf mould, cuttings.
----------------	-----------	----------------------	------	-------	----------	-------	--

GREWIA, GREWIA. *Cal. 5-part. Pet. 5. Stam. nume. Sty. 1. Stig. 4-lob. Nuts 2-celled, & 2-seed.*

bícolor. DC.	two-coloured.	serr. ov. obl. hoary ben.	wh.	—	Senegal.	1822.	S. S. Sandy loam
--------------	---------------	---------------------------	-----	---	----------	-------	------------------

ovalifolia. DC.	oval-leaved.	ov. cren. smth. apex atten. wh.	E. Ind.	1818.	S. S. and peat.	
-----------------	--------------	---------------------------------	------	---------	-------	-----------------	--

occidentális. B.M.	Elm-leaved.	ov. obt. dent. smth.	pur.	7. 9.	C. B. S.	1690.	G. S. cuttings.
--------------------	-------------	----------------------	------	-------	----------	-------	-----------------

oppositifolia. DC.	opposite-leaved.	ov. acum. dent. scabr.	pur.	—	Nepaul.	1818.	S. S. ———
--------------------	------------------	------------------------	------	---	---------	-------	-----------

tíliafolia. DC.	Lime-tree-l'd.	cord. round. smth. serr.	wh.	E. Ind.	1812.	S. S. ———
-----------------	----------------	--------------------------	-----	------	---------	-------	-----------

umbelláta. DC.	umbel-flower'g.	ellip. dent. smth.	pur.	7. 9.	—	1818.	S. S. ———
----------------	-----------------	--------------------	------	-------	---	-------	-----------

MAMM'EA, MAMM'EA. *Cal. of 2 leaves, colo. Pet. 4. Filam. numerous. Stig. capitate. Seeds 2-4.*

americana. DC.	American.	obov. obt. ent.	wh.	6. 8.	S. Amer.	1737.	S. S. Sandy loam
----------------	-----------	-----------------	-----	-------	----------	-------	------------------

emargináta. DC.	emarginate.	obov. obt. apex notch.	—	—	Mexico.	1830.	S. S. and peat. cuttings, under a glass, in sand, will strike freely.
-----------------	-------------	------------------------	---	---	---------	-------	---

LAGERSTR'ÆMIA, LAGERSTR'ÆMIA. *Cal. 6-part. Pet. 6-claw. Stam. 18-30. Caps. 3-6-celled.*

indica. B.M.	Indian.	subrot. ov. acut. smth.	red.	8. 10.	China.	1759.	F. S. Light loam
--------------	---------	-------------------------	------	--------	--------	-------	------------------

Reginæ. DC.	oblong-leaved.	obl. smooth.	ros.	—	E. Ind.	1792.	S. S. & leaf mould.
-------------	----------------	--------------	------	---	---------	-------	---------------------

CAPP'ARIS, CAPER. *Cal. 4-parted. Pet. 4, obovate. Stam. long & numerous. Siliq. stalked.*

acumináta. B.R.	acuminate.	ov. lanc. acum. smth.	wh.	6. 7.	E. Ind.	1821.	S. S. ———
-----------------	------------	-----------------------	-----	-------	---------	-------	-----------

[with a curled nut.

ELÆOC'ARPUS, ELÆOC'ARPUS. *Cal. 5-parted. Pet. 5, their apex torn. Anth. 2-valved. Drupe*

y'aneus. B.M.	blue-fruited.	obl. lanc. serr. reticul.	wh.	6. 8.	N. Holl.	1803.	G. S. Peat & loam
---------------	---------------	---------------------------	-----	-------	----------	-------	-------------------

Systematic Name.	English Name.	Form of Leaves, &c.	Col. of Flow. of Fl.	Month Native Country.	Yr. of Introd.	Soil and Propagation.
<i>integrifolius</i> . DC.	entire-leaved.	ov. obl. obt. ent.	...	Maurit.	1830.	S. S. cuttings.
<i>serratus</i> . DC.	serrated.	lanc. ellip. serr.	pur.	6. 8. E. Ind.	1774.	S. S. —

[irregular, numerous.

C'ISTUS, C'ISTUS. Cal. of 5 leaves. Pet. 5, equal. Ger. round. Caps. of various cells & valves. Seeds

<i>álbídus</i> . DC.	white.	sess. obl. ellip. hairy.	ros.	5. 9. S. Europ.	1640.	H. S. Loam & peat.
<i>Clúsi</i> . Sw. C.	Clusius's.	lin. 3-nerv. marg. revol.	wh.	6. 8. Spain.	—	H. S. or leaf mould.
<i>florentinus</i> . DC.	Florentine.	lanc. rugose, reticul.	wh.	— Italy.	—	H. S. cuttings.
<i>hirsútus</i> . Sw. C.	hairy.	ov. obl. obt. hairy.	wh.	— Spain.	1656.	H. S. —
<i>incánus</i> . Sw. C.	hoary-leaved.	spathul. hairy, rugose.	lil.	— S. Europ.	1596.	F. S. —
<i>laurifólus</i> . Sw. C.	Laurel-leaved.	ov. lan. 3-ner. smth. down.	ben.	— — —	1731.	H. S. —
<i>ladaniferus</i> . DC.	flat-leaved gum.	lin. lanc. smth.	wh.	— Spain.	1629.	F. S. —
<i>populifólus</i> . Sw. C.	Poplar-leaved.	cord. acum. smth.	wh.	5. 6. —	1656.	H. S. —
<i>parviflórus</i> . Sw. C.	small-flowered.	ov. acut. downy.	li.	6. 8. Levant.	1821.	F. S. —
<i>purpúreus</i> . DC.	purple.	obl. lanc. acum. rugose.	pur.	— — —	—	F. S. —
<i>undulátus</i> . Sw. C.	wavy.	sess. lin. obl. lanc. undul.	pur.	5. 8. S. Europ.	—	H. S. —
<i>vaginátus</i> . DC.	sheathing.	lanc. acut. hairy, 3-nerv.	ros.	4. 8. Teneriff.	1779.	F. S. —
<i>villósus</i> . Sw. C.	villous.	round, ov. rugose, hairy.	pur.	— S. Europ.	1640.	F. S. —

[Caps. 3-valved.

HELIANTHEMUM, SUN-ROSE. Cal. of 5 leaves, 3 of them equ. the 2 exter. leaves very small. Pet. 5.

<i>Andersóni</i> . Sw. C.	Anderson's.	opp. obl. lanc. pubes.	yel.	5. 10. Hybrid.	1827.	H. S. Loam, peat,
<i>alyssóides</i> . DC.	Alyssum-like.	sess. obl. ov. hairy.	yel.	6. 8. S. Europ.	—	F. S. and leaf
<i>alpéstre</i> . Sw. C.	Alpine.	obl. ellip. nearly smth.	yel.	— Europe.	1816.	H. S. mould.
<i>Barreliéri</i> . DC.	Barrelier's.	lin. obl. opp. pubes.	yel.	— Italy.	1822.	F. S. layers, or
<i>barbátum</i> . Sw. C.	bearded.	opp. ellip. obt. hair. on both	sid.	5. 10. S. Europ.	1820.	H. S. cuttings, un-
<i>cânun</i> . DC.	hoary.	obov. hairy; stem pilos.	yel.	6. 7. Europe.	1772.	F. S. der a hand-
<i>confértum</i> . DC.	crowded.	lanc. ellip. obt. toment.	yel.	— Teneriff.	—	F. S. glass.
<i>cándidum</i> . Sw. C.	white.	opp. lan. obo. spott. canes.	ye.	— Spain.	1822.	F. S. —
<i>eriocáulon</i> . DC.	woolly-stalked.	opp. obl. lin. hairy.	yel.	— — —	1823.	H. S. —
<i>ericóides</i> . DC.	Heath-leaved.	alt. imbr. half round.	yel.	— S. Europ.	—	F. S. —
<i>ellípticum</i> . Sw. C.	elliptic-leaved.	opp. ellip. downy.	st.	— Levant.	1827.	F. S. —
<i>formósum</i> . DC.	beautiful.	obov. lanc. opp. vill.	yel.	5. 7. Portug.	1780.	F. S. —

Cistus formósus. B. M. 264.

<i>grandiflórum</i> . DC.	large-flowered.	obl. hairy, stipul. ciliat.	yel.	6. 7. Pyrenees.	1800.	H. S. —
<i>guttátum</i> . DC.	spotted-flow'r'd.	opp. sess. obl. lin. hairy.	yel.	— England.	...	H. S. —
<i>glomerátum</i> . DC.	cluster-flow'r'd.	lanc. obl. hairy.	yel.	— N. Spain.	1723.	F. S. —
<i>ledifólum</i> . Sw. C.	Ledum-leaved.	opp. obl. den. smth. up. alt.	st.	— England.	...	H. S. —
<i>lanceolátum</i> . Sw. C.	lance-leaved.	opp. lanc. acut. hairy.	wh.	—	H. S. —
<i>mutábile</i> . Sw. C.	changeable.	flat. ov. obl. hairy ben.	p. re.	6. 8. Spain.	1795.	H. S. —
<i>obsúrnum</i> . Pers.	obscure.	edges revol.	yel.	5. 8. Europ.	1816.	H. S. —
<i>procumbens</i> . Sw. C.	procumbent.	alt. lin. pilose.	yel.	6. 7. S. Europ.	...	F. S. —
<i>Tuberária</i> . Sw. C.	Plantain-leav'd.	ov. obl. 3-nerv. hairy.	yel.	— — —	1752.	F. S. —
<i>venústum</i> . Sw. C.	charming.	lin. lanc. vill. in pairs.	sc.	— — —	1800.	H. S. —

PRO'CKIA, PRO'CKIA. Cal. permanent, 3-5-parted. Cor. 0. Stam. numerous. Stig. entire.

<i>Crúcis</i> . B. R.	Santa Cruz.	cord. ov. dent. pubes.	yel.	7. 8. S. Cruz.	1822.	S. S. Loam & peat.
-----------------------	-------------	------------------------	------	----------------	-------	--------------------

cuttings, not quite ripened, will root readily, if planted in pots of sand, under a hand-glass, on heat.

ORDER II.

DIGYNIA. STYLES 2.

Systematic Name.	English Name.	Form of Leaves, &c.	Col. of Flow.	Month of Fl.	Native Country.	Yr. of Introd.	Soil and Propagation.
<i>BAUERA, BAUERA.</i> Cal. 7-9-parted, lobes lin. Pet. 7-9-decid. Caps. 2-3 celled, 2-3-valved.							
humilis. B.C.	dwarf.	leafl.obl.cren ; Br.pub. red.	8.12.	N.S.W.	1804.	G.S.	Peat & loam.
rubiaefolia. B.M.	Madder-leaved.	ellip.den.smth.6 in a whor.sc.	—	—	1793.	G.S.	cuttings.
<i>FOTHERGILLA, FOTHERGILLA.</i> Cal. campan. 5-7-toothed. Pet. 0. Caps. 2-celled, 1-seeded.							
alnifolia. B.M.	obtuse leaved.	obov. alt. smth.	wh. 4. 6.	N.Amer.	1765.	H.S.	Peat. layers.

ORDER III.

TRIGYNIA. STYLES 3.

<i>HOMALIMUM, HOMALIMUM.</i> Cal. 6-7-part. Cor. of 6-7 pets. Stam. num. Caps. 1-celled, many-seeded.							
racemòsum. w.	racemed.	ellip.obl.acum.ser.smth.	wh. 5. 7.	W.Ind.	1816.	S.S.	Loam & peat. cuttings.

ORDER IV.

PENTAGYNIA. STYLES 2-5.

<i>PÆONIA, PÆONY.</i> Cal. 5-part. conc. Pet. 5. Filam. nume. Anth. of 4 cells. Caps. from 2, 4, 5, or more.							
albiflora. L.T.	white-flowered.	part. smth.seg.ov.lanc.	wh. 5. 6.	Siberia.	1784.	H.P.	Rich loam.
1. candida.	pale-flowered.	wh. —	—	H.P.	seeds, or di-
2. tartarica.	Tartarian.	bh. —	Tartary.	H.P.	viding at
3. sibirica.	Siberian.	wh. —	Siberia.	H.P.	root.
4. rubescens.	rubescent.	bh. —	H.P.	—
5. Hámii.	Hume's.	red. —	China.	1810.	H.P.	—
6. frágrans.	fragrant.	red. —	—	1805.	H.P.	—
7. véstalis.	virgin.	wh. —	Siberia.	1784.	H.P.	—
8. Whitleji.	Whitley's.	wh. —	China.	1800.	H.P.	—
9. uniflora.	single-flowered.	wh. —	H.P.	—
anámalá. B.M.	jagged-leaved.	pinn.lobes ov.lanc.smth.	pk. —	Siberia.	1788.	H.P.	—
crética. B.R.	Cretan.	bitern.glau.pub.chann.	ros. —	Crete.	H.P.	—
corállina. E.Fl.	entire-leaved.	bitern. leafl. ellip. ent.	cr. —	England.	H.P.	—
lecóra. L.T.	comely.	3-part. segm. obl. obt.	red. —	Turkey.	H.P.	—
1. Pallásii.	Pallas's.	pur. —	H.P.	—
2. latifolia.	broad-leaved.	pur. —	H.P.	—
3. pr'æcox.	early.	pur. —	H.P.	—
aybrida. DC.	hybrid.	multip.seg.lin.smth.acum.sc.	5.	Caucasus.	1812.	H.P.	—
úmilis. B.M.	dwarf.	leafl. 3-part. lanc. vill.	pk. 5. 6.	Spain.	1633.	H.P.	—

Systematic Name.	English Name.	Form of Leaves, &c.	Col. of Flow.	Month of Fl.	Native Country.	Yr. of Introd.	Soil and Propagation.
lobàta. B.F.G.	lobe-leaved.	tern.leafl.pinn.seg.3-lob.	sc.	5. 6.	Portugal.	1821.	H. β . ———
móllis. B.R.	soft.	leafl. ov. lanc. lob.	red.	5.	Siberia.	H. β . ———
Montán. A.B.R.	Chinese-tree.	obl. ov. glau.	pk.	4. 6.	China.	1789.	H. β . ———
1. <i>Bánksii.</i>	<i>Banks's.</i>	pk.	— — — — —	— — — — —	— — — — —	H. β . ———
2. <i>papaverácea.</i>	<i>Poppy-flowered.</i>	wh.	— — — — —	— — — — —	— — — — —	H. β . ———
3. <i>rósea.</i>	<i>rose-coloured.</i>	pk.	— — — — —	— — — — —	H. β . ———
officinális. L.T.	official.	leafl. smth. seg. ov. lan.	va.	5. 6.	Europe.	1648.	H. β . ———
1. <i>rósea.</i>	<i>rose-coloured.</i>	ros.	— — — — —	H. β . ———
2. <i>blándá.</i>	<i>bland.</i>	pk.	— — — — —	H. β . ———
3. <i>rúbra.</i>	<i>red.</i>	red.	— — — — —	H. β . ———
4. <i>Sabíni.</i>	<i>Sabine's.</i>	sc.	— — — — —	H. β . ———
5. <i>atrorúbens.</i>	<i>dark red.</i>	d.p.	— — — — —	H. β . ———
6. <i>purpúreus.</i>	<i>purple.</i>	pur.	— — — — —	H. β . ———
7. <i>carnescens.</i>	<i>carnescent.</i>	wh.	— — — — —	H. β . ———
peregrína. L.T.	Turkish.	3-part.seg.ent.ov.lanc.	red.	— — — — —	Levant.	1588.	H. β . ———
1. <i>compácta.</i>	<i>compact.</i>	pk.	— — — — —	H. β . ———
2. <i>Grevillii.</i>	<i>Greville's.</i>	pk.	— — — — —	H. β . ———
paradóxa. L.T.	paradoxical.	many-part. obt. und.	pk.	— — — — —	Levant.	H. β . ———
1. <i>fmbriáta.</i>	<i>fringed.</i>	pk.	— — — — —	H. β . ———
2. <i>simpliciflóra.</i>	<i>single-flowered.</i>	re.	— — — — —	H. β . ———
3. <i>acumináta.</i>	<i>acuminate.</i>	ro.	— — — — —	H. β . ———
púbens. B.M.	downy.	bitern.leafl.lan.pub.ben.	sc.	— — — — —	1821.	H. β . ———
Rússi. B.F.G.	crimson.	tern.leafl.pinn.pubes.	cr.	— — — — —	Sicily.	— — — — —	H. β . ———
tenuifólia. B.M.	slender-leaved.	smth.many-part.lobes.lin.	cr.	— — — — —	Siberia.	1765.	H. β . ———
villósa. B.F.G.	villous.	tritern.upp.tern.glau.vill.	w.	— — — — —	S.Europ.	1816.	H. β . ———
variabilis.	changeable.	leafl.lanc.smth.	r.wh.	— — — — —	1829.	H. β . ———

DELPHINIUM, LARKSPUR. *Cal. 0. Pet. 5, uneq. the up. tub. & spurr. Nect. divid. Ger. 1-3 or 5, ov.*

alpínium.	Alpine.	palm. lobes lanc.	bl.	6. 7.	Hungary.	1816.	H. β . <i>Light loam.</i>
azúreum. DC.	blue-flowered.	3-5-part. multif.lob.lin.	bl.	— — — — —	Carolina.	1805.	H. β . <i>dividing at</i>
chinéense. B.C.	Chinese.	palm. segm. lanc.	d.bl.	6. 9.	China.	1818.	H. β . <i>the roots.</i>
consólida. E.Fl.	field.	sess.in many seg.3-clef.acut.	6. 7.	England.	H. β . <i>seeds.</i>
cuneátum. B.R.	Wolga.	5-7-lob.base.cun.lob.acut.	bl.	7. 8.	Wolga.	1815.	H. β . ———
díscolor.	two-coloured.	palm. leafl. vill.	vi.	— — — — —	Siberia.	1819.	H. β . ———
grandiflórum. DC.	great-flowered.	palm. multif. lobes lin.	bl.	6. 9.	— — — — —	1741.	H. β . ———
1. <i>ábum.</i>	<i>white.</i>	wh.	— — — — —	China.	1816.	H. β . ———
2. <i>flóre-pléno.</i>	<i>double-flower'd.</i>	bl.	— — — — —	— — — — —	— — — — —	H. β . ———
montánium. DC.	Mountain.	pubes. 5-lobed, cut.	bl.	7. 9.	Pyrenee.	1819.	H. β . ———
Menziésii. B.R.	Mrs. Menzies'.	5-part. lobes trif. lin.	pur.bl.	6. 7.	N.Amer.	1826.	H. β . ———
speciósum. DC.	shewy.	5-lob. pub. lobes serr.	bl.	7. 8.	Caucasus.	1817.	H. β . ———

ACONITUM, WOLF'S-BANE. *Cal. 0. Pet. 5, upp. 1-headed. Nect. 2, recurv. Ger. 3-4, or 5, oblong.*

ábum. H.K.	white.	3-5-part. lobes 3-fid.tooth.	w.	7. 8.	Levant.	1752.	H. β . <i>Light loam.</i>
Ánthora. w.	wholesome.	multif. segm. lin. acut.	st.	6. 8.	Pyrenee.	1596.	H. β . <i>dividing at</i>
biflórum. Fish.	two-flowered.	5-part.on long stalks, segm.p.	Siberia.	1807.	H. β . <i>the root.</i>	
barbátum.	bearded.	palm. 5-part.segm.lin.fur.	bl.	6. 7.	— — — — —	— — — — —	H. β . <i>seeds.</i>
Napéllus. w.	common.	5-cleft, segm. lin. furrow.	bl.	— — — — —	Europe.	1596.	H. β . ———
ochroleúcum. B.M.	pale yellow.	palm. 5-lob. pubes.	yel.	6. 9.	Caucasus.	1794.	H. β . ———
paniculátum. B.C.	panicked.	Br. twisted, flexuose.	bl.	— — — — —	Switzerl.	H. β . ———
speciósum.	shewy.	lobed. Pan. lax.	bl.	7. 8.	1804.	H. β . ———

Systematic Name.	English Name.	Form of Leaves, &c.	Col. of Flow.	Month of Fl.	Native Country.	Yr. of Introd.	Soil and Propagation.
HIBBERTIA, HIBBERTIA. <i>Cal. of 5 leaves. Pet. 5, decidu. Caps. numer. often 1-2-seeded.</i>							
dentáta. DC.	toothed-leaved.	obl. acum. smth. dent.	yel.	1. 8.	N. Holla.	1814. G. S. cl.	Sandy loam
grossulariæfólia. DC.	Gooseberry-p'd. orbic. cren. dent. smth.	yel.	3. 8.	—	—	1803. G. S. cl. & peat.	cuttings will
crenátá. A. R.							strike root
pedunculátá. DC.	long-pedicled.	lin. obt. edges revol.	yel.	5. 8.	N. S. W.	1822. G. S.	readily under
volúbilis. DC.	twining.	obov. lanc. sub-ent. pub.	yel.	5. 10.	—	1796. G. S. cl.	a hand-glass, in the same kind of soil.

AQUILE'GIA, COLUMBINE. *Cal. 0. Pet. 5, equal. Nect. 5. Ger. 5. Sty. 5, with simple stigmas.*

alpína. B. F. G.	Alpine.	multif. lobes lin.	bl.	5. 6.	Switzerl.	1731. H. P.	Sandy soil
atropurpúrea. B. R.	purple-flower'd.	on long stalks leaf. wedge-sh.	wh.	4. 5.	Siberia.	... H. P.	and leaf
canadénsis. B. M.	Canadian.	parted, segm. 3-part.	red.	5. 6.	N. Amer.	1640. H. P.	mould, seeds.
Garnieriana. B. F. G.	Miss Garnier's.	ter. seg. 3-part. ob. den. pu. gr.	—	—	Hybrid.	1830. H. P.	—
glandulósa. B. F. G.	glandular.	bitern. leaf. bifid, or 3-fid.	bl.	—	Altay.	1818. H. P.	—
sibírica. DC.	Siberian.	bit. up. ter. smth. seg. dent.	bl.	—	Siberia.	1806. H. P.	—

CIMICIFUGA, BUG-WORT. *Cal. 4-5-parted. Pet. 4-8. Caps. 1-5, oblong, many-seeded.*

cordifólia. B. M.	heart-leaved.	bitern. leaf. cord. lob. serr.	w.	6. 7.	Carolina.	1812. H. P.	Sandy loam
palmáta. B. M.	palmate.	large, palm. serr.	wh.	7. 8.	—	—	H. P. & leaf mould.
							seeds, or parting roots.

[Ber. with 6, or more cells.

STRATIO'NES, WATER-SOLDIER. *Cal. of 1 leaf, tubul. 3-part. Cor. of 3 pets. Ger. triang. Sty. 6.*

loídes. E. Fl.	Water Aloe.	sword-sh. triang. serr.	wh.	6. 7.	England.	... H. w. P.	mud in ponds, parting at root.
----------------	-------------	-------------------------	-----	-------	----------	--------------	--------------------------------

ORDER V.

POLYGYNIA. STYLES MANY.

ANEMO'NE, ANEMO'NE. *Cal. 0. Sep. from 5-15, imbric. Ger. nume. Sty. short. Seeds pointed.*

pennína. E. Fl.	blue mountain.	tritem. segm. lanc. dent.	bl.	3. 4.	England.	... H. P.	Light loam
lba. B. M.	white.	tern. 5-part. apex dent.	wh.	4. 5.	Dahuria.	1818. H. P. &	leaf mould.
piifólia.	Parsley-leaved.	tern. vill. leaf. pinnatif.	yel.	6. 7.	Europe.	... H. P.	seeds, or
oronária. B. M.	poppy.	tern. segm. multif.	pur.	1. 12.	Levant.	1596. H. P.	parting at
Halléri. W. en.	Haller's.	pinnatis. vill. seg. 3-part.	pur.	4. 5.	Switzerl.	1816. H. P.	root.
emorósa. E. Fl.	wood.	tern. segm. trif. dent.	wh.	3. 5.	Britain.	... H. P.	—
fl. pléno.	double-flower'g.						—
avonína. DC.	acute-petaled.	3-part. lobes wedge-sh.	re.	4. 5.	Levant.	... H. P.	—
fl. pléno.	double-flower'g.						—
raténsis.	meadow.	pinn. segm. part. lin. d. pur.		5.	German.	1731. H. P.	—
almáta. B. R.	palmate.	orbic. cord. 3-lob. cren. vill.	y.	5. 6.	Portugal.	1597. H. P.	—
ulsatílla. L.	Pasque-flower.	pinn. segm. multif.	pur.	4. 5.	England.	... H. P.	—
munculoídes. E. Fl.	yellow wood.	quin. leaf. trif.	yel.	3. 4.	—	... H. P.	—
lvéstris. B. M.	snow-drop.	3-part. trif. dent.	wh.	4. 5.	Europe.	1596. H. P.	—
elláta. DC.	star.	3-part. lob. cun. ent. den. p. br.	—	—	Italy.	—	H. P.
horténsis. B. M.							—
ifólia. DC.	three-leaved.	tern. segm. ov. lanc.	pur.	—	France.	1597. H. P.	—
tifólia. B. R.	Vine-leaved.	orbic. cord. 5-7-lob. serr.	wh.	—	Nepal.	1827. H. P.	—

Systematic Name.	English Name.	Form of Leaves, &c.	Col. of Flow.	Month of Fl.	Native Country.	Yr. of Introd.	Soil and Propagation.
HEPÁTICA, HEPÁTICA. <i>Invol. 3-leaved, 1-flow'd. Sep. 6-9, petal-like, arranged in 2-3 rows.</i>							
americana. DC.	American.	cord. 3-lob. lobes ent.	bl.	2. 4.	N. Amer.	1800.	H. P. Sandy loam.
angulosa. DC.	angulose.	palm. 5-lob. serr.	bl.	— — —	— — —	1816.	H. P. parting roots.
acutiloba. DC.	acute-lobed.	cord. lob. lobes ent. acut.	bl.	— — —	— — —	1818.	H. P. roots.
triloba. DC.	three-lobed.	cord. lobes ov. acut.	bl.	— — —	Europe.	1573.	H. P. — — —
<i>Anemone Hepatica, L.</i>							
flóre pléno.	double-flower'g.	red.	— — —	H. P. — — —
fl. pléno. cærul.	double-blue-fl'g.	bl.	— — —	H. P. — — —
álba.	white.	wh.	— — —	H. P. — — —
CLEMATIS, VIRGIN'S BOWER. <i>Cal. 0. Pet. 4-8, regu. Ger. ov. sess. Sty. elong. Seeds comp. num.</i>							
angustifolia. DC.	narrow-leaved.	pinn. segm. lin. lanc.	wh.	5. 9.	Siberia.	1787.	H. P. Sandy loam.
austríaca. H. K.	Alpine.	bitern. segm. ov. lanc. serr.	bl.	— — —	Austria.	1792.	H. S. cl. seeds, layers, or cuttings.
<i>Atragene alpina, DC.</i>							
calycina. B. M.	Minorca.	tern. segm. cut, dent.	st.	12. 3.	Minorca.	1783.	H. S. cl. — — —
cordifolia.	heart-leaved.	cord. ent. ciliat.	pur.	1829.	H. S. cl. — — —
cirrósá. DC.	evergreen.	ov. sub-cord. dent.	pur.	3. 4.	S. Europ.	1596.	H. S. cl. — — —
críspsa. B. M.	curled-flow'd.	ent. 3-lob. acut.	pu.	7. 9.	N. Amer.	1726.	H. S. cl. — — —
dióíca. DC.	Jamaica.	tern. segm. ov. cord. smth.	wh.	5. 6.	Jamaica.	1733.	S. S. cl. — — —
florida. B. M.	large.	tern. segm. ov. acut. ent.	wh.	4. 9.	Japan.	1776.	H. S. cl. — — —
fl. pléno.	double-flower'g.
integrifolia. L.	entire-leaved.	opp. ellip. lanc.	bl.	6. 8.	Hungary.	1596.	H. P. — — —
parviflora. DC.	small-flowered.	pinn. seg. smth. ent. 3-lob.	wh.	— — —	1822.	H. S. cl. — — —
reticulata. DC.	netted.	smth. with 3 lob. ov. en. seg. pu.	6. 9.	N. Amer.	1812.	H. S. cl. — — —	
virginiana. DC.	Virginian.	tern. segm. cord. acut.	wh.	6. 8.	— — —	1767.	H. S. cl. — — —
Viticélla. B. M.	purple.	en. ov. decom. ter. seg. ent. pu.	6. 9.	Spain.	1569.	H. S. cl. — — —	
1. álba.	white-flowered.	wh.	— — —	H. S. cl. — — —
2. cærulea.	blue.	bl.	— — —	H. S. cl. — — —
Vitálba. E. B.	Traveller's joy.	pinn. segm. ov. lanc. dent.	wh.	7. 9.	England.	H. S. cl. — — —
ADO'NIS, ADO'NIS. <i>Cal. of 5 concave leaves. Pet. 5-15. Nect. 0. Seeds numerous, angular, naked.</i>							
autumnális. E. Fl.	Pheasant's-eye.	sess. tripinnatif. segm. lin.	sc.	5. 10.	Britain.	H. A. Sandy soil.
flámmea. DC.	Flame-colour'd.	bipinn. segm. lin.	fl.	6. 7.	Austria.	1800.	H. A. seeds.
vernális. B. M.	perennial.	sheath. sess. multif.	yel.	3. 4.	Europe.	1629.	H. P. — — —
[Seeds furrowed.]							
THALICTRUM, MEADOW-RUE. <i>Cal. 0. Pet. 4-5, conc. imbric. Ger. striat. Sty. 0. Stig. downy.</i>							
anemónídes. DC.	Anemone-like.	bitern. upp. simp. vertici.	wh.	4. 8.	N. Amer.	1768.	H. P. Sandy loam & leaf mould.
<i>Anemone thalictroides, W.</i>							
alpinum. E. B.	Alpine.	biter.; leaf. orbi. cren. glau. w.	5. 6.	Britain.	H. P. dividing at roots.	
angustifolium. DC.	narrow-leaved.	Leaf. lin. lanc. ent.	yel.	6. 7.	Germany.	1739.	H. P. roots.
aquilegífolium. DC.	Columbine-1v'd.	Leaf. flat, 3-lob. obt.	l. pu.	5. 7.	Europe.	1731.	H. P. — — —
elátum. DC.	tall.	Leaf. smth. ov. subc. trifid. ye.	6. 8.	Hungary.	1794.	H. P. — — —	
flávum. E. Fl.	common.	bipinn.; leaf. obov. trifid.	yel.	5. 7.	Britain.	H. P. — — —
galíoides. DC.	sweet scented.	Leaf. lin. narr. ent.	yel.	— — —	Europe.	1816.	H. P. — — —
gláucum. DC.	glaucous-leav'd.	Leaf. subc. ov. glau. 3-fid.	ye.	6. 7.	S. Europ.	1798.	H. P. — — —
úcidum. DC.	shining.	Leaf. lin. lanc. ent.	yel.	5. 7.	Spain.	1739.	H. P. — — —
nájus. E. Fl.	large.	tripi.; leaf. trif. dent. glau.	pu.	6. 8.	England.	H. P. — — —
nínus. B. Fl.	lesser.	bipinn.; leaf. tern. trif. glau. y.	6. 7.	Britain.	H. P. — — —	
ugósúm. DC.	rugose.	segm. ov. sub-cord. glauc.	ye.	7.	N. Amer.	1774.	H. P. — — —

Systematic Name.	English Name.	Form of Leaves, &c.	Col. of Flow.	Month of Fl.	Native Country.	Yr. of Introd.	Soil and Propagation.
------------------	---------------	---------------------	---------------	--------------	-----------------	----------------	-----------------------

[berried, with a deciduous style.

KNOWLTONIA, KNOWLTONIA. Cal. 5-parted. Pet. 5-15, with a naked claw. Grains 1-seeded.

<i>rigida</i> . DC.	rigid.	bitern.seg.sub-cor.smth.	gr. 3. 5.	C. B. S.	1780.	G. P.	Loam & peat.
<i>vesicatoria</i> . B.M.	blistering.	bitern.seg.sub-cor.smth.	gr. 2. 4.	—	1691.	G. P.	dividing roots, or seeds.

ISOPYRUM, ISOPYRUM. Cal. 5-part. Pet. 5, equal. Caps. sessile, 1-celled, many-seeded.

<i>fumarioides</i> . DC.	Fumitory-like.	Leaf. acut.;	Caps. 10-20.	wh. 6. 7.	Siberia.	1741.	H. A.	Sandy loam.
<i>thalictroides</i> . DC.	Meadow Rue-ld.	pinn. leaf. cord. lob. dent.	wh. 3. 4.	Italy.	1759.	H. P.	seeds, or parting roots.	

TROLLIUS, GLOBE-FLOWER. Cal. 0. Pet. from 5 to 15. Nect. 5-10. Ger. sessile. Sty. 0.

<i>americanus</i> . B.M.	American.	quin. segm. serr.	yel. 5. 7.	N. Amer.	1805.	H. P.	Light loam.
<i>europaeus</i> . E. Fl.	mountain.	in 5 segm. cut and serr.	yel. 5. 6.	Britain.	H. P.	part. roots.

[each petal. Seeds numerous, naked.

RANUNCULUS, CROW-FOOT. Cal. of 5 ov. segm. Pet. 5, rarely 8 or 10. Nect. a pore at the base of

<i>alpestris</i> . E. Fl.	Alpine.	cord. smth. 3-lob. upp. lanc. w.	6. 8.	Scotland.	H. P.	Light sandy
<i>auricomus</i> . B. F.	wood.	renif. 3-5-lob. up. in lin. seg. y.	3. 5.	—	H. P.	loam. seeds,
<i>amplexicaulis</i> . B. M.	amplex.	ov. lanc. amplex.	wh. 4. 5.	Pyrenee.	1633.	H. P.	or offsets
<i>bulbosus</i> . E. Fl.	bulbous.	trifid, segm. cut.	yel. 4. 6.	Britain.	H. A.	from roots.
<i>creticus</i> . W.	Cretan.	cord. orbic. dent.	yel. —	Candia.	1658.	H. P.	—
<i>flammula</i> . E. Fl.	Less. spear-wort.	ov. lanc. upp. lin. serr.	yel. 6. 9.	Britain.	H. W. P.	—
<i>graminea</i> . E. Fl.	Grass-leaved.	lin. lanc. ent. glauc. striat.	yel. 4. 6.	Wales.	H. P.	—
<i>hederaceus</i> . E. B.	Ivy-leaved.	orbic. renif. 3-5-lob.	wh. 5. 6.	Britain.	H. W. P.	—
<i>lingua</i> . E. Fl.	great spear-wort.	sess. lanc. serrul.	yel. 6. 8.	—	H. W. P.	—
<i>parviflorus</i> . E. Fl.	small-flowered.	orbic. ov. cord. upp. 3-lob. y.	5. 6.	England.	H. A.	—
<i>parnassifolius</i> . DC.	Parnassia-iv'd.	sub-cor. smth. upp. ov. lan. w.	6. 7.	Pyrenee.	1769.	H. P.	—
<i>scleratus</i> . E. B.	Celery-leaved.	palm. smth. upp. in 3 lin. seg. y.	5. 8.	Britain.	H. W. A.	—
<i>Thora</i> . DC.	Kidney-leaved.	smth. cren. renif.	yel. 5. 6.	Alps. Eur.	1710.	H. P.	—

HELLEBORUS, HELLEBORE. Cal. 0. Pet. 5, obt. & conc. Ger. from 3 to 10. Sty. awl-shaped.

<i>alutetorum</i> . B. F. G.	bushy.	smth. peda. upp. nearl. sess. g.	3. 4.	Hungary.	1817.	H. P.	Sandy loam.
<i>foetidus</i> . E. Fl.	stinking.	peda. of 7-9. lan. serr. leaf. gr.	2. 4.	England.	H. P.	dividing
<i>lividus</i> . B. M.	smooth.	thrice cut, smth. glauc. pur.	1. 5.	Corsica.	1710.	H. P.	roots.
<i>niger</i> . DC.	Christmas-Rose.	pedate, smth.	pk. 1. 3.	Europe.	1596.	H. P.	—
<i>viridis</i> . En. B.	green.	digit. segm. lin. lanc. serr.	gr. 4. 6.	Britain.	H. P.	—

CALTHA, MARSH MARYGOLD. Cal. 0. Pet. 5, or more. Nect. 0. Ger. 5 to 10, compressed.

<i>palustris</i> . E. Fl.	marsh.	cord. cren. smth.	yel. 3. 5.	Britain.	H. W. P.	Loam. slips
<i>radicans</i> . Br. Fl.	creeping.	3-angul. cord. serr. cren.	yel. —	Scotland.	H. W. P.	at the roots.
<i>sagittata</i> .	sagittate-leaf'd.	sagitt. auricul. smth.	America.	1829.	H. W. P.	—

ERA'NTHIS, WINTER ACONITE. Invol. cut into many segm. Sep. 5-8, coloured. Pet. 6-8.

<i>hyemalis</i> . B. M.	common.	leaf. ell. lan. serr. at apex.	yel. 1. 3.	Europe.	1596.	H. P.	Sandy loam. parting roots.
-------------------------	---------	--------------------------------	------------	---------	-------	-------	----------------------------

COPTIS, COPTIS. Cal. 5-part. coloured. Pet. small. Stan. 20 to 25. Caps. 6-10, ov. obl. 4-6-seeded.

<i>trifolia</i> . B. C.	three-leaved.	trifid, segm. obov. dent.	wh. 6. 7.	N. Amer.	1782.	H. P.	Peat soil. seeds, or parting the root.
-------------------------	---------------	---------------------------	-----------	----------	-------	-------	--

HYDROPELTIS, HYDROPELTIS. Cal. 3-4-part. Pet. 3-4. Seeds in a pendul. ov. round, capsule.

<i>purpurea</i> . B. M.	purple.	peltate, smth. ent.	pur. 7. 8.	N. Amer.	1798.	F. W. P.	Loam & leaf mould. parting at root.
-------------------------	---------	---------------------	------------	----------	-------	----------	-------------------------------------

Systematic Name.	English Name.	Form of Leaves, &c.	Col. of Flow.	Month of Fl.	Native Country.	Yr. of Introd.	Soil and Propagation.
NELUMBIUM, SACRED BEAN. <i>Cal.</i> 4-5-leaved. <i>Pet.</i> numerous. <i>Fruit</i> turbinate.							
luteum. DC.	yellow.	pelt. smth.;			N. Amer.	1810.	F. w. β . Rich loam.
speciosum. B.M.	shewy.	pelt. smth.;			India.	1787.	S. w. β . seeds, or dividing at the roots.
ILLICIUM, ILLICIUM. <i>Cal.</i> 3-6-parted. <i>Pet.</i> 27. <i>Caps.</i> many in a circle, 2-valved, 1-seeded.							
floridanum. B.M.	red-flowered.	ellip. smth.	red. pur.	4. 6.	Florida.	1766.	F. S. Loam & leaf
parviflorum. DC.	small-flowered.	ellip. smth. ent.	yel.	— — —	— — —	1790.	F. S. mould. cutt.
LIRIODENDRON, TULIP-TREE. <i>Cal.</i> of 3 leaves. <i>Pet.</i> 6. <i>Caps.</i> 1-2-seeded.							
tulipifera. B.M.	common.	trunc. 4-lob. smth. glauc.	yel.	6. 7.	N. Amer.	1663.	H. C. Sandy loam. seeds.
MAGN'OLIA, MAGN'OLIA. <i>Cal.</i> 5-leaved. <i>Pet.</i> 6-9. <i>Caps.</i> 2-valved, 1-2-seeded.							
acuminata. B.M.	acuminated.	ov. obl. acum. pubes.	pa.	5. 7.	N. Amer.	1736.	H. S. Loam & peat.
auriculata. B.M.	ear-leaved.	obov. cord. smth. glauc.	wh.	4. 5.	— — —	1786.	H. C. seeds, or laying
conspicua. B.M.	Youlan.	obo. acum. decid. junr. pub. w.	2. 5.	China.	1789.	H. S. ers; the latter is the most	
Yulan. DC.							
cordata. B.R.	heart-leaved.	cord. a little hairy ben. ent.	ye.	6. 7.	N. Amer.	1801.	H. S. general prac-
fuscata. B.M.	brown-stalked.	ellip. obl. acut.	br.	4. 6.	China.	1789.	G. S. tice for ob-
grandiflora. DC.	Laurel-leaved.	ov. obl. shin. rusty ben.	wh.	6. 10.	Carolina.	1734.	H. S. taining
1. ferruginea.	rusty-leaved.	wh.	— — —	H. S. plants of this	
2. obtusifolia.	obtuse-leaved.	wh.	— — —	H. S. genus; but	
3. obovata.	obovate-leaved.	wh.	— — —	H. S. the shoots,	
glauca. DC.	glaucous-leav'd.	ellip. obt. glau.	wh.	6. 9.	N. Amer.	1688.	H. S. when layed,
macrophylla. B.M.	long-leaved.	obl. obo. base cor. glau. und. w.	6. 7.	— — —	1800.	H. S. should not	
obovata. DC.	obovate-leaved.	ellip. obov. smth.	pk. wh.	4. 6.	China.	1790.	H. S. be divested
pumila. B.M.	dwarf.	ellip. acum. glauc. smth.	wh.	1. 12.	— — —	1786.	G. S. of their fo-
Soulangeana. B.F.G.	Soulange Bodin's.	obov. acum. pubes.	wh.	2. 5.	Hybrid.	1826.	H. S. liage.
Thompsoniana.	Thompson's.	ellip. obl. smth.	wh.	— — —	1818.	H. S. — — —	
tripetala. W.	three-petaled.	obl. obov. acut. smth.	wh.	5. 6.	N. Amer.	1752.	H. S. — — —
ANO'NA, CUSTARD-APPLE. <i>Cal.</i> 3-parted, lobes concave. <i>Pet.</i> 6, thick. <i>Ber.</i> pulpy, many-celled.							
Cherimolia. DC.	Cherimolli.	ov. lanc. silky ben.	wh.	7. 8.	S. Amer.	1739.	S. S. Loam & leaf mould.
tripetala. B.M.							
laurifolia. B.R.	Laurel-leaved.	ov. lanc. smth. ent.	yel.	6. 8.	W. Ind.	1824.	S. S. cuttings.
squamosa. B.M.	scaly.	obl. acut. undul. alt. smth.	gr.	— — —	S. Amer.	1731.	S. S. — — —
triloba.	trifid-fruited.	obov. ell. ent. glau.	p. p.	— — —	N. Amer.	1736.	H. S. — — —
GUATTERIA, GUATTERIA. <i>Cal.</i> 3-parted. <i>Pet.</i> 6, ov. or obov. <i>Berr.</i> ov. 1-celled, 1-seeded.							
rufa. B.R.	brown-leav'd.	ov. acum. cord.	pur.	5. 8.	India.	1820.	S. S. Loam & peat. cuttings.
ARTAB'OTRYS, ARTAB'OTRYS. <i>Cal.</i> 3-parted. <i>Pet.</i> 6. <i>Stam.</i> numerous. <i>Berr.</i> 2-seeded.							
odoratissimus. B.R.	fragrant.	obl. lanc. smth. ent.	b.	6. 7.	China.	1758.	S. S. cl. Loam & leaf mould. cuttings.

CLASS XIV.

DIDYNAMIA. *Stamens 4, 2 long, and 2 short.*

ORDER I.

GYMNOSPERMIA. SEEDS 4, NAKED.

STACHYS, WOUNDWORT. *Cal. tub. of 5 teeth. Cor. ring. vault. notch. low. 3-lob. the later. ones reflex.*

angustifolia.	narrow-leaved.	op.lin.pinn.up.lin.ent.	pk. 6.	Tauria.	1823.	H. P.	Light loam.
ambigua. E.Fl.	ambiguous.	obl.cord.at base.serr.	red. 6. 7.	Britain.	H. P.	dividing
arenaria.	purple-flower'd.	obl.lanc.serrul.	pur. —	Levant.	1824.	H. P.	roots.
coccinea. B.M.	scarlet.	cord.ov.obl.cren.	sc. —	S.Amer.	1798.	F. S.	—
áspera. Mx.	rough.	lanc.sharply serr.	pur. —	N.Amer.	1816.	H. P.	—
germánica. E.Fl.	downy.	ov.acut.cren.silky.	pur. —	England.	H. P.	—
lanata. s.s.	woolly.	obl.lanc.woolly.	pur. —	Siberia.	1782.	H. P.	—
palústris. E.Fl.	marsh.	lin.lanc.half amplex.	pur. 8.	Britain.	H. P.	—
sibírica. B.F.G.	Siberian.	cord.ov.obl.serr.hairy.	li. 6. 8.	Siberia.	1822.	H. P.	—
sylvática. E.B.	Hedge.	cord.acut.serr.	red. —	Britain.	H. P.	—

SPHA'CELE, SPHA'CELE. *Cal. camp. 5-dent. Cor. bilab. upp. lip notch. low. 3-fid. reflex. Stig. bif.*

Lindlèyi. B.M.	Lindley's.	ov.hast.sagit.cren.hairy.	li. —	Valpairo.	1825.	G. S.	—
<i>Stachys Sálviz.</i> Lind. B.R.							

LEONURUS, MOTHER-WORT. *Cal. 5-angl. 5-toothed. Cor. ring. upper lip conc. lower reflexed, in*

Cardiaca. E.Fl.	common.	lanc. 3-lob. upp. ent.	li.wh. 7. 8.	Britain.	H. P.	Sandy loam.
heterophyllus.	various-leav'd.	cor.cre.lo.or 3-par.up.lin.pk.	—	Brazils.	1824.	H. A.	seeds, or
supinus. s.s.	procumbent.	5-lobed, lobes tooth.	wh. 6. 8.	—	1816.	H. P.	parting
sibíricus. B.F.G.	Siberian.	3-part. seg. cleft, obt.	pur. —	—	1759.	H. B.	roots.

[3 deep equal lobes.

CLINOPO'DIUM, WILD BASIL. *Cal. many-ribbed, 2-lipped, upper 3-cleft, lower 2-parted. Cor. ring.*

egyptiacum. s.s.	Egyptian.	smooth, nearly ent.	pur. 6.	S. Egypt.	1759.	H. P.	Light loam.
vulgare. E.Fl.	common.	ov. serr. hairy.	pur. —	Britain.	H. P.	seeds, or dividing roots.

[upper lip clov. lower in 3 segm.

ORIGANUM, MARJORAM. *Cal. ribbl. 1 or 2-lipp. Cor. ring. the upp. lip notch. low. in 3 deep equ. lob.*

Dictamnus. B.M.	Dittany of Crete.	ov. orbic. downy.	li. 6. 9.	Candia.	1551.	F. S.	Light soil &
Tournefortii. Fl.Gr.	Tournefort's.	ov.orbic.ent.; spi.4-sid.	ros. 8. 9.	Amorgos.	1788.	F. S.	leaf mould.
vulgare. E.Fl.	common.	ov. ent. or serrul.	pur. 6.10.	Britain.	H. P.	cutt. or seeds.

[notched, lower 3-lobed.

THYMUS, THYME. *Cal. many-ribbed, 2-lipped, the upper with 3 teeth, lower 2-tooth. upper lip of corolla*

nontanus. s.s.	Mountain.	ov. obt. entire.	li. 6. 7.	Hungary.	1800.	H. S.	Sandy loam. cuttings.
----------------	-----------	------------------	-----------	----------	-------	-------	-----------------------

LAMIUM, DEAD-NETTLE. *Cal. tubu. 5-tooth. Cor. ring. up. lip vault. low. obo. notch. Seeds 4, trian.*

album. E.B.	white.	cord. serr. hairy.	wh. 4. 9.	Britain.	H. P.	Light loam.
plexicaule. E.Fl.	great henbit.	cord.obt.deep.cren.amp.	ro. 5. 7.	—	H. A.	parting the
ncisum. E.Fl.	cut-leaved.	cord. deeply cut, cren.	red. —	England.	H. A.	roots.

Systematic Name.	English Name.	Form of Leaves, &c.	Col. of Flow.	Month of Fl.	Native Country.	Yr. of Intro.	Soil and Propagation.
maculatum. E.B.	spotted.	cord. acut. serr. spott.	cr.	4. 5.	Britain.	H. P. ———
purpureum. E.Fl.	purple.	cord. obt. cren. hairy.	pur.	2. 8.	————	H. A. ———
rugosum. Fl.Gr.	rugged.	ov. serr. pilose.	pur.	7. 8.	Italy.	1766.	H. P. ———

GALEOPSIS, HEMP-NETTLE. *Cal. 5-tooth. Cor. ring. up. lip vault. low. with 2 prominences.*

Ladanum. E.B.	red.	lanc. serr. hairy.	pur.	7. 9.	Britain.	H. A. Sandy loam.
Tetrahit. E.B.	common.	ov. acut. ser. hairy.	pu. or w.	————	————	H. A. seeds.
villösa. E.Fl.	downy.	ov. lanc. serr. downy.	yel.	————	————	H. A. ———

GALEOBDOLON, WEASEL-SNOOT. *Cal. bell-shap. 5-tooth. Cor. the length of the calyx, upper lip [entire, under in 3 acute undivid. segm.]*

luteum. E.B.	yellow.	ov. acut. serr. hairy.	yel.	5. 6.	Britain.	H. P. Light loam. parting roots.
--------------	---------	------------------------	------	-------	----------	------	----------------------------------

BETONICA, BETONY. *Cal. of 5 nearly equal teeth. Cor. ring. upper lip entire, lower longer, in 3 deep [segments. Ger. 4-lobed.]*

incana. s.s.	hoary.	ov. serr.; helmet bifid.	yel.	6. 7.	Italy.	1759.	H. P. Sandy loam.
grandiflora. B.M.	great-flowered.	ov. cord. tooth. hairy.	pur.	————	Siberia.	1800.	H. P. parting
officinalis. E.Fl.	wood.	oblon. serr.	cr.	————	Britain.	H. P. roots.

BALLOTA, BLACK-HOREHOUND. *Cal. with 10 furrows, 5 angles, & 5 teeth, upper lip of cor. notch. [lower lip 3-lobed, the middle one cloven.]*

alba. E.Fl.	white.	cord. serr. ent.	wh.	7. 9.	Britain.	H. P. Light soil.
nigra. E.Fl.	black stinking.	ov. cren. serr.	pur.	————	————	H. P. seeds, or dividing roots.

MARRUBIUM, WHITE-HOREHOUND. *Cal. funnel-shaped, 10-furrowed, & 5-toothed, upper lip of [cor. in 2 acute lobes, lower reflex. in 3 lobes.]*

vulgare. E.Fl.	common.	ov. serr. woolly.	wh.	7. 9.	Britain.	H. P. Sandy loam. cuttings, or parting roots.
----------------	---------	-------------------	-----	-------	----------	------	---

MELITTIS, BASTARD-BALM. *Cal. bell-shaped, variously lobed. Cor. ringent, upper lip entire, lower [3-lobed, the middle one obovate.]*

grandiflora. s.s.	great-flowered.	ov. obl. serr.	wh. vi.	6. 8.	England.	H. P. Sandy loam.
Melissophyllum. s.s.	common.	ov. obl. serr.	var. pur.	————	————	H. P. divid. roots.

SCUTELLARIA, SKULL-CAP. *Cal. tub. 4-lob. Cor. rin. up. lip 3-clef. low. the same. Ger. 4-lo. Seeds 4.*

alpina. B.F.G.	Alpine.	opp. cord. cut, cren. serr.	bl.	6. 10.	Hungar.	1752.	H. P. Sandy loam.
altaica. B.F.G.	Altay.	ov. obt. cut, dent.	bl. wh.	7. 10.	Siberia.	1816.	H. P. part. roots.
altissima. B.M.	tall.	cord. obl. acum. serr.	d. pu.	————	Levant.	1731.	H. P. or seeds.
Columnnae. B.F.G.	Columnna's.	cord. obl. serr. pubes.	pur.	6. 8.	Italy.	1806.	H. P. ———
galericulata. E.B.	common.	lanc. cren. veiny, obt.	bl.	————	Britain.	H. P. ———
grandiflora. B.M.	large-flowered.	cord. cut, pub. cren.	re. ye.	————	Siberia.	1804.	H. P. ———
minor. E.Fl.	lesser.	obl. ov. cord. at base.	pk.	7. 8.	————	H. P. ———
serrata. A.B.R.	saw-leaved.	opp. ov. serr.	bl.	6. 9.	N. Amer.	1800.	H. P. ———

PRUNELLA, SELF-HEAL. *Cal. bell-shap. 2-lipped, the upper 3-toothed, lower of 2 segm. Cor. ring. [lower lip in 3 crenate lobes.]*

grandiflora. B.M.	great-flowered.	obl. ov. dent. stalk.	bl.	7. 9.	Austria.	1596.	H. P. Light loam.
pennsylvanica. s.s.	Pennsylvanian.	ov. lanc. dent.	bl.	————	N. Amer.	1801.	H. A. part. roots.
vulgaris. E.Fl.	common.	obl. ov. dent.	pur.	————	Britain.	H. P. or seeds.
β variegata.	variegated.	————	————	————	H. P. ———

Systematic Name.	English Name.	Form of Leaves, &c.	Col. of Flow.	Month of Fl. Country.	Yr. of Introd.	Soil and Propagation.
------------------	---------------	---------------------	---------------	-----------------------	----------------	-----------------------

PHLO'MIS, PHLO'MIS. Cal. 5-angl. 5-tooth. Cor. helmet compr. Keel notched. Seeds bearded.

floccosa. B.R.	flocculent.	cord. obl. woolly.	yel.	8.11. Egypt.	1828.	F. S. Sandy loam.
pungens. w.	pungent-bract'd.	obl. lanc. apex serr.	pur.	8. Persia.	1818.	F. P. cuttings.
tuberosa. B.M.	tuberous.	cord. obl. dent. scabr.	pur.	— Siberia.	1759.	H. P. —

LAVA'NDULA, LAVENDER. Cal. ovate, dented. Cor. resupinate. Stam. within the tube.

dentata. B.M.	tooth-leaved.	sess. lin. pinn.	bl.	6. 9. Spain.	1597.	G. S. Sandy loam.
pinnata. B.M.	pinnate-leaved.	pinn. leaf. pinnatif.	bl.	4. 8. Madeira.	1787.	G. S. cuttings.
spica. s.s.	common.	sess. lanc. lin. edg. revol.	bl.	7. 9. S. Europ.	1568.	H. S. —
β álba.	white-flowered.	wh.	— — —	—	H. S. —

ELSHO'LTZIA, ELSHO'LTZIA. Cal. 5-tooth. tubul. Cor. upper lip 4-toothed, under entire.

cristata. B.M.	crested.	ov. ellip. serr.	lil.	5. 7. Siberia.	1789.	H. A. Light soil seeds.
----------------	----------	------------------	------	----------------	-------	-------------------------

BYSTROPOGAN, BYSTROPOGAN. Cal. 5-part. throat bearded. Cor. upper lip bifid, under 3-fid.

organifolius. w.	entire-leaved.	ov. ent. wh. ben.	lil.	7. 8. Teneriff.	1815.	G. S. Loam & leaf
punctatum. w.	dotted.	ov. dent. smth.	pk.	— Madeira.	1775.	G. S. mould. cutt.

LEONOTIS, LION'S-TAIL. Cal. stria. 6-10-tooth. Cor. an inch long, upp. lip elong. ent. lower 3-fid.

intermedia. B.R.	intermediate.	ov. cord. acum. tooth.	or.	9.10. S. Africa.	1823.	G. S. Peat & loam.
Leonurus. B.M.	narrow-leaved.	lanc. serr.	or.	10.12. C.B.S.	1712.	G. S. cuttings.
nepetifolia. B.R.	Catmint-leav'd.	cord. elong. acut. cren.	or.	9.10. E. Ind.	1788.	S. A. —

DRACOCEPHALUM, DRAGON'S-HEAD. Cal. bilabiate, tubular. Cor. of 2 lips, notched.

argunense. B.F.G.	Fischer's.	lin. lanc. obt. ent.	bl.	7. 9. Siberia.	1822.	H. P. Light loam.
altaense. B.F.G.	Betony-leaved.	cord. obl. obt. den. up. amp.	bl.	— Georgia.	1787.	H. P. dividing
canescens. B.F.G.	hoary.	opp. obl. obt. hoary.	bl.	7. 8. Levant.	1711.	H. A. roots.
lenticulatum. B.M.	Carolina.	lanc. smth. denticul.	str.	8. 9. Carolina.	1789.	H. P. —
grandiflorum. s.s.	great-flowered.	obl. obt. dent.	bl.	6. 9. Siberia.	1759.	H. A. —
nutans. B.R.	nodding.	obl. obt. und. 3-nerv. pub.	bl.	— — —	1823.	H. P. —
Ruyschiana. Fl.D.	Hyssop-leaved.	lanc. ent. point.	bl.	— N. Europ.	1699.	H. P. —
ibricum. B.M.	Siberian.	cord. lanc. acum. serr.	bl.	— Siberia.	1760.	H. P. —
peciosum. B.F.G.	beautiful.	sess. lanc. serr. base ent.	pk.	— — —	1822.	H. P. —
virginianum. B.M.	Virginian.	lin. lanc. serr	red.	— N. Amer.	1683.	H. P. —

OCYMYM, BASIL. Cal. bilabiate, upper lip orbicular, lower 4-cleft. Cor. resupinate.

ebrifugum. B.R.	Fever-wort.	ov. ellip. cren. opp.	gr. wh.	6.10. S. Leone.	1821.	S. A. Loam & peat.
grandiflorum. s.s.	great-flowered.	ov. serr.; stem shrubby.	wh.	9. Abyssin.	1802.	G. S. seeds, or
minimum. s.s.	blush.	ov. ent.	wh.	9.10. Ceylon.	1573.	H. A. cuttings.

PROSTRANTHERA, PROSTRANTHERA. Cal. 2-lipp. obt. Cor. ring. middle segm. of lip 2-lobed.

iolacea. B.R.	violet-colour'd.	ov. stalk. lob. pubes.	bl.	4. 6. N.S.W.	1823.	G. S. Peat & loam cuttings.
---------------	------------------	------------------------	-----	--------------	-------	-----------------------------

[upper 2-lobed, under 3-lobed.

HORMNUM, HORMNUM. Cal. bilabi. 3-tooth. the upper lip entire, the lower bifid. Cor. 2-lipped,

pyrenaicum. B.F.G.	Pyrenean.	ov. round, cren. dent. da. bl.	6. 7. Pyrenees.	1820.	H. P. Light loam. dividing roots.
--------------------	-----------	--------------------------------	-----------------	-------	-----------------------------------

Systematic Name.	English Name.	Form of Leaves, &c.	Col. of Flow.	Month of Fl.	Native Country.	Yr. of Introd.	Soil and Propagation.
[3-lobed, middle lobe bifid.]							
PLECTRA'NTHUS, PLECTRA'NTHUS. <i>Cal. 2-lipped, gibbous at the base. Cor. ringent, upper lip</i>							
Forskóhlæi.	Forskohl's.	ov. rug. footstalks decur.	bl.	9.10.	Abyssin.	1806.	S. S. ———
NE'PETA, CAT-MINT. <i>Cal. with 5 acu. teeth. Cor. ring. with the up. lip a little clov. lower nume. notch.</i>							
Catária. E. Fl.	common.	cord. downy, bluntly serr.	wh.	7. 9.	Britain.	H. P. Light loam.
grandiflóra. s. s.	great-flower'd.	ov. lanc. pubes.	bl.	—	Caucas.	1806.	H. P. parting
Mussíni. B. M.	scolloped-lv'd.	cord. cren. rough, down.	bl.	5. 8.	Siberia.	1804.	H. P. roots.
violácea. s. s.	Violet-colour'd.	cord. stalk. nearly sess.	vio.	7. 9.	Spain.	1723.	H. P. ———
ME'NTHA, MINT. <i>Cal. 5-tooth. Cor. fun.-sh. 4-par. Ger. 4-lo. Sty. long. than the cor. Stig. 2. Seeds 4.</i>							
acutifólia. E. B.	acute-leaved.	ov. lan. acu. ent. at each end.	pu.	9.	England.	H. w. P. Light loam.
agréstis. E. Fl.	rugged-field.	sub-cord. rugos. serr.	li.	7. 8.	Britain.	H. P. dividing
arvénsis. E. Fl.	corn.	ellip. obt. serr. hairy.	bl.	—	—	H. P. roots.
citráta. E. Fl.	Bergamot.	ellip. obt. serr. smth.	pur.	—	England.	H. P. ———
géntilis. B. Fl.	bushy.	ov. serr. dott.	pur.	—	Britain.	H. w. P. ———
grácilis. E. Fl.	narr. w-leaved.	lanc. acut. serr. hairy.	pur.	—	—	H. w. P. ———
hirsúta. E. B.	hairy.	ov. serr. pubes. stalk.	bl.	—	—	H. w. P. ———
rotundifólia. E. Fl.	round-leaved.	ellip. obt. serr. wrink.	pur.	8. 9.	—	H. P. ———
rúbra. B. Fl.	red.	ov. cut serr. nearly smth.	red.	—	—	H. w. P. ———
sylvéstris. E. Fl.	Horse-mint.	sess. ov. obl. serr. hairy.	pur.	7. 8.	—	H. P. ———
virídís. E. Fl.	Spear-mint.	sess. lanc. smth. serr.	pur.	—	—	H. P. ———
verticilláta. B. M.	whorled.	lin. lanc. serr. upp. quat.	lil.	—	Nepal.	1828.	G. P. ———
PERILO'MIA, PERILO'MIA. <i>Cal. camp. 2-lipp. Cor. tubu. arch. 2-lipp. upper lip notch. lower 3-fid.</i>							
ocymóides. B. R.	Basil-like.	ov. acut. opp. cren.	pk.	8. 9.	Peru.	—	F. P. ———
A'JUGA, BUGLE. <i>Cal. 5-part. Cor. ring. upper lip notched, under 3-lobed. Ger. of 4 lobes. Seeds 4.</i>							
álpina. B. Fl.	Alpine.	obl. tooth. smth. upp. ov.	bl.	5. 7.	England.	H. P. Sandy loam.
Chamæ'pitys. E. B.	ground Pine.	tripart. segm. lin. ent.	yel.	4. 7.	—	H. S. part. roots.
genevénsis. L.	Geneva.	—	—	5. 6.	Switzerl.	1656.	H. P. ———
pyramidális. B. Fl.	Pyramidal.	obo. cre. obt. 2-3-in. lon. bl. pu.	4. 7.	Britain.	H. P. ———	
réptans. E. Fl.	creeping.	obo. serr. veiny, upp. sess.	bl.	5. 6.	—	H. P. ———
[Ger. 4-cleft. Seeds 4, wrinkled.]							
TEU'CRIMUM, GERMANDER. <i>Cal. bell-shap. 5-cleft. Cor. ring. upper lip in 2 lateral lobes, lower in 3.</i>							
betónicum. B. M.	hoary.	lanc. cren. downy.	pur.	7.	Madeira.	1775.	G. S. Sandy loam.
Chamæ'drys. E. B.	wall.	ov. cut, serr. stalk.	cr.	5. 8.	England.	H. P. cuttings, or
hyrcánicum. L.	Betony-leaf'd.	cord. obl. obt. cren.	pur.	8. 9.	Persia.	1763.	H. P. part. roots.
lúcidum. s. s.	shining.	ov. serr. smooth.	red.	6. 9.	S. Europ.	1730.	H. P. ———
multiflórum. Fl. Gr.	many-flower'd.	ov. dent.	pur.	7. 9.	Spain.	1731.	H. P. ———
Márum. s. s.	Cat Thyme.	ov. acut. ent. downy ben.	pur.	—	—	1640.	F. S. ———
orchidéum. B. R.	Orchis-flow'r'd.	obl. obt. ent. 3-lob.	ye. red.	—	Chile.	1826.	H. P. ———
scórdium. E. Fl.	water.	obl. sess. dow. stron. ser. pa. pu.	—	—	England.	H. w. P. ———

ORDER II.

ANGIOSPERMIA. SEEDS ENCLOSED IN A CAPSULE.

VERBENA, VERVAIN. <i>Cal. tubul. 5-tooth. Cor. in 5 uneq. seg. Fil. 4, in some species 2. Seeds 2-4.</i>							
Aublétia. B. M.	rose.	ov. cut, serr.	pur.	6. 8.	N. Amer.	1774.	F. S. Loam & ley
aláta. B. F. G.	winged-stalk'd.	lanc. serr. 3-nerv. rug.	pur.	5. 8.	M. Video.	1827.	G. P. moul'd. cut-

Systematic Name.	English Name.	Form of Leaves, &c.	Col. of Flower.	Month of Fl.	Native Country.	Yr. of Introd.	Soil and Propagation.
bracteôsa. B.M.	long-bracted.	jagg.; <i>stm.</i> decum. hair.	<i>pur.</i>	7.	Mexico.	1812.	H. P. <i>tings, and</i>
caroliniana. s.s.	Carolina.	obl. obov. serr.	<i>red.</i>	6. 9.	N. Amer.	1732.	H. P. <i>divid. roots.</i>
chamædryfolia. B.F.G.	scarlet-fl'd.	ellip. lanc. tooth. hairy.	<i>sc.</i>	5. 9.	B. Ayres.	1827.	F. P. ———
<i>melindres.</i> B.R.							
Lamberti. B.M.	Lambert's.	obl. cut, dent. apex ent.	<i>pur.</i>	6. 9.	Peru.	1816.	F. P. ———
pulchella. B.F.G.	pretty.	opp. 3-part. pinnatif. hair.	<i>li.</i>	—	B. Ayres.	1827.	F. P. ———
triphy'lla. B.M.	three-leaved.	lin. lanc.	<i>li.</i>	—	Chile.	1784.	G. S. ———
venosa.	nerved.	ellip. lan. sub-cor. op. pub.	<i>pu.</i>	—	—	1829.	G. P. ———

JACARA'NDA, JACARA'NDA. *Cal.* 5-tooth. *Cor.* camp. limb bilabiate. *Caps.* 2-celled. *Seed* winged.

bahamensis. B.M.	Bahamia.	pinn. leaf. ellip. mucr.	<i>bl.</i>	7. 8.	Bahamas.	1724.	G. S. ———
mimosifolia. B.M.	Mimosa-leaved.	pinn. leaf. pub. mucr.	<i>bl.</i>	4. 5.	Brazil.	1818.	S. S. ———
filicifolia. D.D.	Fern-leaved.	pinn. leaf. opp. pub.	<i>vio.</i>	—	S. Amer.	1823.	S. S. ———
tomentosa. B.R.	tomentose.	bipinn. leaf. ov. acut. hair.	<i>pu.</i>	—	Brazil.	1824.	S. S. ———

[3-fid. *Ger.* 4-lobed, 4-celled, 4-seeded.

HOLMSKIO'LDIA, HOLMSKIO'LDIA. *Cal.* camp. slightly 5-lob. *Cor.* ring. upper lip 2-lobed, lower

sanguinea. H.K.	crimson.	op. cor. ser. acum. sub. pub. sc.	China.	1796.	S. S. ———
-----------------	----------	-----------------------------------	------	--------	-------	-----------

SELA'GO, SELA'GO. *Cal.* camp. 3-5-toothed. *Cor.* tubul. 4-5-lobed. *Caps.* 2-celled, single-seeded.

corymbosa. s.s.	fine-leaved.	filif. smooth, crowd.	<i>wh.</i>	7. 9.	C. B. S.	1699.	G. S. <i>Peat & loam.</i>
fasciculata. B.R.	cluster-flow'd.	obov. dent. smth.	<i>bl.</i>	6. 7.	—	1774.	G. S. <i>cuttings.</i>
Gillii. B.M.	Dr. Gill's.	lin. obl. smth. ent.	<i>ros.</i>	—	—	1830.	G. S. ———

ANTHOCE'RCIS, ANTHOCE'RCIS. *Cal.* 5-tooth. *Cor.* camp. limb 5-parted, equal. *Caps.* 2-celled.

viscosa. B.M.	clammy.	alt. obov. dott. gland.	<i>wh.</i>	4. 6.	N. Holl.	1823.	G. S. <i>Loam & peat. cuttings.</i>
---------------	---------	-------------------------	------------	-------	----------	-------	---

[*segm.* *Ger.* globular, of 3 cells.

LINN'ÆA, LINN'ÆA. *Cal.* double, of 4 leaves, the 2 exterior large & concave. *Cor.* bell-shap. in 5 deep

americana. E.Fl.	American.	op. orbi. cren. pil. shin.	<i>ros.</i>	7. 8.	America.	1800.	H. P. <i>Peat & loam.</i>
borealis. E.Fl.	Northern.	opp. ov. cren.; <i>stms.</i> trail.	<i>ro.</i>	—	Britain.	H. P. <i>cutt. or layer.</i>

SIBTHORPIA, SIBTHORPIA. *Cal.* 5-par. *Cor.* somew. wheel-sh. 5 cleft. *Caps.* obo. of 2 cells, & 2 val.

europ'æa. E.Fl.	Cornish-money.	orbic. renif. cren.	<i>wh.</i>	—	—	H. P. <i>Loam & peat. divid. at root.</i>
-----------------	----------------	---------------------	------------	---	---	------	---

LIMOSELLA, MUDWORT. *Cal.* of 5 deep seg. *Cor.* bell-shap. 5-cleft. *Caps.* ov. of 2 cells, & 2 valves.

aquatica. E.B.	common.	lanc. spath. obt. smth.	<i>car.</i>	7. 9.	—	H. A. <i>Seeds.</i>
----------------	---------	-------------------------	-------------	-------	---	------	---------------------

OROBAN'CHE, BROOM-RAPE. *Cal.* 2-col. leaves. *Cor.* ring. upper lip notch, lower in 3 wavy lobes.

ærulea. E.Fl.	purple.	<i>Stem</i> simp.; <i>Sty.</i> downy.	<i>bl.</i>	7.	—	H. P. <i>Loam & peat.</i>
lätior. E.Fl.	tall.	<i>Stems</i> sim.; <i>sta.</i> down.; <i>sty.</i> sm. br.	—	—	—	H. P. <i>offsets from roots.</i>
håjor. E.B.	greater.	<i>Stem</i> scal. tumid at base. <i>br.</i> pu.	6. 7.	—	—	—
hånor. Br.Fl.	lesser.	<i>Stem</i> simp.; <i>cor.</i> 4-cleft. <i>y.w.</i>	7. 8.	—	—	H. P. ———
ùbra. E.Fl.	red.	<i>Stems</i> sim. und. lip of cor. 3-cl. r.	—	—	Ireland.	H. P. ———
amosa. E.B.	branching.	<i>Stem</i> branc. up. lip of cor. clo. b.	—	—	Britain.	H. P. ———

ERINUS, ERINUS. *Cal.* of 5 leaves. *Cor.* 5-tooth. limbs equal, the lobes notch. *Caps.* 2-celled.

pinus. B.M.	Alpine.	spath. smth. apex serr.	<i>pur.</i>	3. 4.	Pyrenee.	1739.	H. P. <i>Loam & peat.</i>
ispànicus. P.S.	hairy-leaved.	spath. serr. hairy.	<i>pur.</i>	—	Spain.	—	H. P. <i>seeds, or dividing at roots.</i>

Systematic Name. English Name. Form of Leaves, &c. Col. of Flow. Month of Fl. Native Country. Yr. of Introd. Soil and Propagation.

RUELLIA, RUELLIA. *Cal. 5-cleft. Cor. camp. the limb 5-lobed. Caps. attenuated at both ends.*

anisophylla. H. E. F.	unequal-leaved. ov. acum. serr.	bl. 9. 4. E. Indies.	1823.	S. S.	Loam & leaf
ciliata. S. S.	ciliated. ent. cord. or ciliat.	li. 7. 8.	— 1806.	S. S.	mould. cutt.
formosa. B. M.	splendid. ent. ov. downy, stalk.	sc. 6. 9. Brazil.	1808.	S. S.	—
Sabiniæna. B. R.	Mr. Sabine's. ov. lanc. dent. smth.	vio. — E. Indies.	1827.	S. S.	—

BARLERIA, BARLERIA. *Cal. 4-part. Cor. . Caps. 4-angul. 2-celled, 2-valved, elastic. Seeds 2.*

buxifolia. S. S.	Box-leaved. subtrotund. ent.	bl. 6. 7. — —	1763.	S. S.	Peat & loam.
crisata. B. M.	crested. ellip. lanc. pubes.	pur. 8. 9. Mauritiu.	1796.	S. S.	—
lupulina. B. R.	Hop-flowered. lin. lanc. ent. smth.	yel. 4. 9. — —	1828.	S. S.	—
mitis. B. R.	yellow thornless. opp. ellip. lanc. hairy.	yel. — E. Ind.	1816.	S. S.	—
Prionitis. S. S.	thorny. ov. lanc. ent.	yel. ? 7. 8. — —	1759.	S. S.	—

GLOXINIA, GLOXINIA. *Cal. of 5 leaves. Cor. campanul. the limb oblique, 5-lobed. Caps. 1-cell'd.*

caulescens. B. R.	caulescent. ov. obt. cren. hairy.	d. pur. — Pernam.	1820.	S. P.	Peat & loam.
hirsuta. B. R.	hairy. ov. round, rug. hisp. cren.	bl. 5. 8. Brazil.	1825.	S. P.	dividing at
maculata. B. M.	spotted. cord. cren. rug.; stm. spott.	pu. 7. 10. S. Amer.	1739.	S. P.	the root, or
speciosa. B. R.	shewy. ellip. obl. cren. hairy.	bl. 6. 11. Brazil.	1815.	S. P.	offsets.

GESNERIA, GESNERIA. *Cal. 5-part. Cor. campanulate, 5-lobed. Ger. downy, with 4 yel. glands.*

aggregata. B. R.	cluster-flow'r'd. ov. obl. rugos. cren.	sc. 6. 10. — —	1816.	S. P.	Loam & leaf
bulbosa. B. R.	bulbous. ov. ellip. pubes. serr.	sc. 5. 8. — —	—	S. P.	mould. cutt.
Douglasiæ. B. R.	Mr. Douglas's. ov. cren. ciliat.	pk. — — — —	1825.	S. S.	—
macrostachya. B. R.	large-spiked. opp. ov. cord. cren.	pk. spot. — R. Janeiro.	—	S. P.	—
pendulina. B. R.	drooping-flow'r'd. opp. ov. obl. pubes. cren.	sc. — — — —	—	S. P.	—
tomentosa. B. M.	hairy. ov. lanc. cren.	gr. pu. — S. Amer.	1752.	S. S.	—

[into 5 spreading lobes.

THUNBERGIA, THUNBERGIA. *Cal. of 2 cordate, 3-nerved, leaflets. Cor. of 1 petal, limb divided*

alata. B. M.	winged. cord. sag. pubes. stlks. wing. y.	1. 12. Zanzeba.	1825.	S. S.	cl. Peat & loam.
angulata. H. E. F.	angulated. sagitt. acut. ent. smth.	bl. 5. 8. Mauritiu.	1824.	S. S.	cl. cuttings.
coccinea. H. E. F.	scarlet-flow'r'd. ov. sag. smth. blunt. tooth.	sc. 6. 2. Nepal.	—	S. S.	cl. —
fragrans. B. M.	sweet-scented. cord. acum. base ang. dent. w.	5. 9. E. Indies.	1796.	S. S.	cl. —
grandiflora. B. R.	large-flowered. opp. angul. cord.	bl. 3. 8. — —	1822.	S. S.	cl. —

ACANTHUS, BEAR'S BREECH. *Cal. 4-parted. Cor. labiate, under lip 3-lobed. Anthers villous.*

mollis. w.	soft-leaved. sinuat. unarmed, smth.	wh. 7. 9. Italy.	1548.	H. P.	Sandy loam.
spinosus. B. M.	prickly-leaved. pinn. spiny.	wh. — S. Europ.	1629.	H. P.	divid. roots.

[Stam. 5, four fertile, and 1 sterile.

SALPIGLOSSIS, SALPIGLOSSIS. *Cal. 5-angled, 5-cleft. Cor. funnel-shaped, limb 5-lobed.*

atropurpurea. B. M.	dark-purple. ellip. obl. sinuat. opp. lanc. pu.	— Chile.	1826.	F. P.	Loam & peat.
Barclayana. B. F. G.	Mr. Barclay's. obl. obt. sinuat. upp. lin. pur. y.	4. 5. — —	1829.	F. P.	seeds.
picta. B. F. G.	painted. ov. obl. sinuat. dent. wh. bl.	— — — —	1826.	F. P.	—
integri-folia. B. M.	entire-leaved. ov. lanc. atten. at base. cri. pu.	8. B. Ayres.	1830.	F. P.	—

BIGNONIA, TRUMPET FLOWER. *Cal. campanulate entire. Cor. 5-cleft. Capsule 2-celled.*

Cherère. B. R.	various-leaved. ter. leaf. subc. obl. smth. or. sc.	— Guiana.	1820.	S. S.	cl. Loam & peat.
Chamberlaynii. B. M.	Chamberlayne's. binate. leaf. ov. acum. yel.	6. 8. S. Amer.	1818.	S. S.	cl. cuttings.
apreolata. B. M.	four-leaved. conjug. leaf. ov. cord. ye. pu.	— N. Amer.	1710.	H. S.	cl. or layers.
Colei. B. M.	General Cole's. tern. verti. pinn. leaf. ellip. sc.	— — — —	1829.	H. S.	cl. —
randifolia. B. M.	gigantic-leaved. conjug. leaf. ov. obl. & smth. y.	4. 7. S. Amer.	1816.	S. S.	cl. —

Systematic Name.	English Name.	Form of Leaves, &c.	Col. of Flow.	Month of Fl.	Native Country.	Yr. of Introd.	S. & C.	Soil and Propagation.
pállida. B.R.	pale-flowered.	opp. obl. obt. cord.	wh.	7. 8.	S. Amer.	1823.	S. S.	—
Telfáiríe. B.M.	Mrs. Telfair's.	opp. pinn. leaf. ov. obl. shi. pk.	3. 4.	Madagas.	1831.	S. S. cl.	—	—
venústa. B.R.	comely.	tern. leaf. ov. obl. acum.	or.	9. 12.	—	1816.	S. S. cl.	—
viridiflora. B.R.	Green-flower'd.	quin. leaf. lanc. ent.	gr.	—	S. Amer.	1823.	S. S. cl.	—
[2-celled, 2-valved.								
CROSSA'NDRA, CROSS'ANDRA. Cal. 5-parted, unequal. Cor. labiate. Anthers 1-celled. Capsule								
undulæfólia. B.M.	wave-leaved.	in 4's. ov. lanc. undul.	sc.	6. 1.	E. Indies.	1800.	S. S.	Peat & loam. cuttings.
[Germ. 4-celled.								
STENOCHILUS, STENOCH'ILUS. Cal. 5-parted. Cor. ringent, upper lip 4-cleft, under deflexed.								
gláber. B.M.	smooth-leaved.	ellip. lanc. smth. nearl. ent.	sc.	1. 12.	N. Holl.	1803.	G. S.	Loam & peat.
maculátus. B.R.	spotted-flow'd.	ligul. lanc. ent.	sc. spot.	—	N. S. W.	1820.	G. S.	cuttings.
viscósus. B.M.	clammy.	alt. ov. lanc. glutin. sub-ser.	y.	7. 9.	—	1825.	G. S.	—
[lobed. Germ. 1-celled, many-seeded.								
ECCREMOCAR'PUS, ECCREMOCAR'PUS. Cal. campanulate, 5-parted. Cor. tubular, limb 5-								
scáber. B.R.	rough-fruited.	pinn.; leaf. cord. obliq. ser. or.	—	—	—	1824.	G. S. cl.	Loam & leaf mould. seeds, or cutt.
[with 2-celled nuts.								
MYOP'ORUM, MYOP'ORUM. Cal. 5-parted. Cor. campanulate, limb 5-parted. Drupe 1 2-seeded,								
acminátum. B.P.	acuminate.	lanc. acum. Br. smth.	wh.	5.	N. S. W.	1812.	S. S.	Peat & loam.
débile. B.M.	procumbent.	ellip. lanc. apex. dent.	ros.	—	—	1793.	G. S.	cuttings.
ellípticum. B.M.	elliptic-leaved.	ellip. obt. mucr. smth.	wh.	1. 3.	—	1789.	G. S.	—
parvifólium. B.M.	small-leaved.	lin. obt. apex. dent.	wh.	3. 9.	N. Holl.	1803.	G. S.	—
BA'RTSIA, BA'RTSIA. Cal. tubular, 4-cleft. Cor. ringent, upper lip entire, lower in 3 deep lobes.								
alpina. Br. Fl.	Alpine.	opp. cord. ov. serr.	pur.	7. 8.	Britain.	H. A.	Sandy loam.
Odontites. E. Fl.	red.	lanc. serr. upp. alt.	red. pu.	—	—	H. A.	seeds.
viscósá. E. Fl.	yellow-viscid.	lanc. serr. upp. alt. downy.	y.	—	—	H. A.	—
[3 obovate lobes. Germ. orate.								
EUPHRASIA, EYE-BRIGHT. Cal. ribbed, 4-cleft. Cor. ringent, the upper lip notched, lower in								
alpina. Lam.	Alpine.	lanc. dent. setaceo.	pur.	7. 9.	S. Europ.	1823.	H. A.	Sandy soil.
linifólia. L.	Flax-leaved.	lin. ent.	li.	—	S. France.	—	H. A.	seeds.
lútea. L.	yellow.	lin. serr. upp. ent.	ye.	—	S. Europ.	1816.	H. A.	—
[under 3-cleft. Capsule of 2 cells, seeds compressed.								
RHINA'NTHUS, YELLOW RATTLE. Cal. 4-toothed. Cor. with a hooded, cloven, upper tip, the								
máior. E. Fl.	large.	lin. lanc. serr.	pur.	6. 8.	England.	H. A.	Light loam. seeds.
[lip, under 3-parted.								
MELAMP'YRUM, COW-WHEAT. Cal. of 4 unequal segments. Cor. gaping, with a notched upper								
arvénsé. E. B.	purple.	lanc. margins rough, downy.	—	—	—	H. A.	Sandy loam.
praténsé. E. B.	common.	lanc. pointed, smth. ent.	ye.	—	Britain.	H. A.	seeds.
sylváticum. E. Fl.	wood.	lanc. ent. in pairs.	ye.	7. 8.	—	H. A.	—
[lip. Nectary a fleshy gland. Capsule of 1 cell.								
LATHR'E'A, TOOTH-WORT. Cal. bell shaped, 4-parted. Cor. with a vaulted, cloven, or entire upper								
squamária. L.	greater.	ov. thick, ent. smth. axill.	pu.	4.	Britain.	H. P.	Peat & loam. roots parted, will form young plants.

Didynamia Angiosperma.

139

Systematic Name.	English Name.	Form of Leaves, &c.	Col. of Flow.	Month of Fl.	Native Country.	Yr. of Introd.	Soil and Propagation.
[notched, lower of 3 lobes.]							
PEDICULARIS, LOUSE-WORT. Cal. in 5 or 2, jagged segments. Cor. ringent, upper lip vaulted,							
canadensis. B.F.G.	Canadian.	lanc. pinnatif. dent. hairy.	y.	7. 8.	N. Amer.	1800.	H. P. Peat. seeds,
incarnata. s.s.	flesh-coloured.	pinnat. leaf. lin. lanc. dent. car.	6. 7.		Austria.	1796.	H. P. or slips from
syriaca. E. Fl.	dwarf red.	alt. bipinnatif. lobes serr.	rose.	5. 7.	Britain.	...	H. P. the root.
[sule of 2 cells, and 2 valves.]							
SCROPHULARIA, FIG-WORT. Cal. 5 unequal segments. Cor. tubular, 5-parted, recolute. Cap-							
aquatica. E. Fl.	water.	cord. smth. obt. serr.	pu. gr.	— — —	— — —	...	H. P. Light loam.
scordonia. E. B.	Balm-leaved.	cord. downy, bi-serr.	pur.	6. 9.	— — —	...	H. P. seeds, or
vernalis. B. Fl.	yellow.	cord. serr. downy, upp. alt.	y.	3. 5.	— — —	...	H. P. cuttings.
[sule of 2 cells.]							
APHELANDRA, APHELANDRA. Cal. 5-parted, unequal. Cor. 2-lipped. Anthers 1-celled. Cap-							
cristata. B. M.	dense-spiked.	ellip. obl. acum. ent.	sc.	6. 9.	W. Indies.	1733.	S. S. Loam & peat. cuttings under a glass.
[at the base behind. Capsule of 2 cells.]							
ANTIRRHINUM, SNAP-DRAGON. Cal. 5-parted. Cor. ringent, closed with a palate, or gibbous							
angustifolium.	narrow-leaved.		red.	—	Italy.	1818.	H. P. Light loam.
najus.	greater.	alt. lanc. upp. opp. ent. smth. re.	6. 8.		England.	...	H. P. seeds, or cuttings.
β alba.	white.						
Drontium. E. Fl.	lesser.	alt. lin. lanc. axill.	ros.	7. 9.	Britain.	...	H. A. ———
LINARIA, TOAD FLAX. Cal. 5-parted. Cor. spurred at the base. Capsule ventricose, 2-celled.							
ymbalaria. Br. Fl.	Ivy-leaved.	cor. al. 5-lo. smth.; stm. crep. pu	5. 11.		England.	...	H. P. Light loam.
minor. s.s.	little erect.	lanc. lin. obt. downy. pur.	ye.	6. 11.	— — —	...	H. A. seeds.
Antirrhinum minus. E. B.							
repens. B. Fl.	creeping.	in whorls, or opp. glau. lin. bl. y.	7. 10.		— — —	...	H. P. ———
pura. s.s.	round-leaved.	ov. down. alt.; stm. procu. y. vi.	7. 9.		— — —	...	H. A. ———
Antirrhinum spurium. E. B.							
vulgaris. Br. Fl.	common.	lin. lanc. acut.	ye.	6. 9.	— — —	...	H. P. ———
Antirrhinum vulgare. E. Fl.							
[of 2 cells, and 2 valves.]							
DIGITALIS, FOX-GLOVE. Cal. 5-parted. Cor. bell-shaped, limb in 4 unequal segments. Capsule							
urea. s.s.	golden.	Cor. lip ov. 3-dent.	or.	7. 8.	Greece.	1815.	H. P. Sandy loam.
ambigua. B. R.	ambiguous.	ov. lanc. tooth. nerv.	ye.	—	Switzerl.	1596.	H. P. seeds, or
erruginea. s.s.	rusty.	obl. obt. smth. sess.	br.	—	Italy.	1597.	H. P. slips, taken
tea. s.s.	yellow.	lanc. lin. smth.	ye.	—	France.	1629.	H. P. off at the
cinerea. B. R.	cut-leaved.	lanc. acum. smth. cut. ye. br.	6. 8.		Malaga.	1826.	H. P. roots.
nata. B. F. G.	woolly-leaved.	obl. lanc. acut.	bh.	—	Hungary.	1789.	H. P. ———
obscura. B. M.	Willow-leaved.	lin. lanc. smth. ent.	or.	7. 8.	Spain.	1778.	H. P. ———
viriflora. s.s.	small-flowered.	sess. lin. lanc. ent.	br. y.	—	Hungary.	1798.	H. P. ———
mentosa. B. M.	hairy-leaved.	obl. alt. serr. downy.	pur.	6. 8.	Portugal.	1820.	H. P. ———
DALMANIA, ADAMIA. Cal. limb 5-tooth. Pet. 5. Stig. club-shap. 2-lobed. Berry 5-celled, many-seed.							
lancea. B. M.	blue.	opp. obl. lanc. acum. serr. pur.	—	—	E. Indies.	1829.	S. S. ———
[1-celled, many-seeded.]							
COLUMNEA, COLUMNEA. Cal. 5-parted. Cor. tubular, limb bilabiate, lower lip 3-fid. Capsule							
insuta. B. M.	hairy.	ov. acut. cren. serr. hairy.	sc.	—	Jamaica.	1780.	S. S. Sandy loam
indens. B. M.	climbing.	ov. acut. ent. vill.	ros.	—	W. Ind.	1759.	S. S. cl. & peat. cutt.

Systematic Name.	English Name.	Form of Leaves, &c.	Col. of Flow.	Month of Fl.	Native Country.	Yr. of Intro.	Soil and Propagation.
<i>BROWALLIA, BROWALLIA. Cal. 5-toothed. Cor. closed by the prominent orifice. Caps. 1-celled.</i>							
<i>eláta. L.</i>	tall.	ov. serr.		bl. 6. 8.	Peru.	1768.	G. A. Rich loam.
<i>grandiflora. B.M.</i>	large-flowered.	ov. acum. smth. shin.	<i>pa.lil.</i>	—	W. Ind.	—	G. S. seeds.
[2-celled, 2-valved, many-seeded.							
<i>FRANCISEA, FRANCISEA. Cal. campanulate, 5-dent. Cor. salver-shaped, limb 5-parted. Capsule</i>							
<i>Hopeana. B.M.</i>	Mrs. Hope's.	obl. lanc. alt. smth.		bl. —	Brazil.	1826.	S. S. —
<i>SPIELMANNIA, SPIELMANNIA. Cal. 5-part. limb of Cor. 5-cleft. Drupe with 2-cell'd warted nut.</i>							
<i>africana. B.M.</i>	African.	ov. ellip. tooth.		wh. 2. 11.	C. B. S.	1710.	G. S. Loam & leaf mould. cuttings.
<i>LANTA'NA, LANTA'NA. Cal. 4-toothed. Cor. 4-part. Stigma hooked backwards with a 2-cell'd nut.</i>							
<i>aculeata. B.M.</i>	prickly.	ov. sub-cord. soft ben.		yel. 4. 11.	W. Ind.	1692.	S. S. Loam & leaf
<i>braziliensis. Lk.</i>	Brazilian.	ov. serr. sess. pubes.		wh.	Brazils.	1823.	S. S. mould.
<i>fucata. B.R.</i>	painted.	ov. rugose, cren. pubes.		ros. 5. 6.	—	—	S. S. cuttings.
<i>involuta. s.s.</i>	round-leaved.	opp. tern. obo. obt. down.		li. 5. 7.	—	1690.	S. S. —
<i>nivea. B.M.</i>	snowy white.	ov. ser. rough.; sm. prick.		wh. 7. 9.	E. Ind.	1810.	S. S. —
<i>odorata. s.s.</i>	sweet-scented.	opp. tern. ellip. rugose.		wh. 5. 11.	W. Ind.	1758.	S. S. —
<i>salviaefolia. w.</i>	sage-leaved.	ov. op. hoar. ben. rough abo.		r. —	C. B. S.	1823.	S. S. —
[other two simple.							
<i>GMEI'NA, GMEI'NA. Cal. 4-toothed. Cor. campanulate, limb 4-cleft, 2 of the anthers bifid, the</i>							
<i>parviflora. P.S.</i>	small-flowered.	obov. sub-trif. simple.		or. —	E. Ind.	1817.	S. S. Loam & peat. cuttings.
[3-fid. Capsule 2-celled.							
<i>CASTILLE'JA, CASTILLE'JA. Cal. upper lip bifid, under wanting. Cor. 2-lipped, the lower lip</i>							
<i>coccinea. B.R.</i>	scarlet.	obl. lanc. trifid. pilose.		or. 7. 9.	N. Amer.	1787.	H. A. Loam & peat. seeds and
<i>Bartsia coccinea. w.</i>							seeds and cuttings.
<i>integrifolia. s.s.</i>	entire-leaved.	lin. lanc. entire.		wh. —	S. Amer.	1825.	G. S. cuttings.
[Drupe 2-seeded, nuts 2-celled.							
<i>CITHAR'EXYLUM, FIDDLE-WOOD. Cal. 5-toothed, campanulate. Cor. funnel-shaped, rotate.</i>							
<i>pentandrum. s.s.</i>	pentandrous.	ov. obl. tooth. pubes.		wh. 6. 8.	Portoric.	1815.	S. S. Loam & peat. cuttings, under a hand glass, in heat.
[Caps. 4-celled.							
<i>MARTYNIA, MARTYNIA. Cal. of 5 leaves, unequal. Cor. ventricose, limb 5-lobed, nearly equal.</i>							
<i>áltea. B.R.</i>	yellow.	cord. orbic. dent. pub.		yel. —	S. Amer.	1824.	H. A. Loam & peat. seeds.
<i>VITEX, CHASTE-TREE. Cal. 5-toothed. Cor. limb 5-6-cleft. Drupe single-seeded, with a 4-cell'd nut.</i>							
<i>altissima. s.s.</i>	tall.	tern. ent. ov. acum.		vi. . . .	Ceylon.	1802.	S. S. Loam & leaf
<i>Ágnus-Cástus. w.</i>	common.	in 5's-7's, digit. lanc.		wh. 9.	Sicily.	1570.	H. S. mould.
<i>Negúndo. B.M.</i>	quadrangular.	digit. quinate, ov. lan. ent.		wh. 6. 8.	E. Ind.	1759.	S. S. cuttings.
[Germ. 5-winged, 1-celled.							
<i>SINNINGIA, SINNINGIA. Cal. tubular, 5-angled, limb 5-cleft. Cor. sub-2-lipped, funnel-shaped.</i>							
<i>Helléria.</i>	Heller's.	ov. stalk. dent. pub. ye. spott.		8. 9.	Brazils.	1825.	S. S. Sandy loam
<i>villósa. B.R.</i>	villous.	stalked, ov. cord. cren.		yel. 6. 8.	—	1826.	S. S. & leaf mould.
<i>velutina.</i>	velvety.	ov. ellip. pubes.		yel. —	—	1827.	S. cuttings.

Systematic Name.	English Name.	Form of Leaves, &c.	Col. of Flow.	Month of Fl.	Native Country.	Yr. of Intro.	Soil and Propagation.
[stalked, 2-celled, and 2 seeds in each.							
<i>GEISSOMERIA, GEISSOMERIA.</i> Cal. of 5 leaves. Cor. tubular, limb erect, 4-cleft. Germans							
longiflora. B.R.	long-flowered.	op.ov.ellip.und.smth.abo.sc.	8.	9.	Brazils.	1829.	S.S. ———
<i>CLERODENDRUM, CLERODENDRUM.</i> Cal. 5-tooth. Cor. cylind. limb 5-parted, spreading.							
fragrans. s.s.	fragrant.	sub-cord.serr.tooth.pub.wh.	12.8.		China.	1790.	S.S. Loam, peat,
fortunatum. s.s.	spear-leaved.	lanc. entire.	wh.	7. 8.	E.Ind.	1784.	S.S. & leaf mould,
inerm. s.s.	smooth.	ov. ent. shining.	wh.	8.11.	———	1692.	S.S. mixed. cut-
lividum. B.R.	discoloured.	obl.den.acum.at both ends.p.	8.10.		China.	1824.	S.S. tings, under
macrophyllum. B.M.	large-leaved.	ov. acum. serr. hairy.	bl.	8. 9.	Maurit.	1822.	S.S. a hand glass,
nudans. B.M.	nodding.	op. or tern. obl. acum. ent. wh.		Nepaul.	1825.	S.S. in a moist
paniculatum. B.R.	panicled.	cord. 5-lob. dent. un.	sc.	7.10.	Java.	1809.	S.S. heat, will
pyramidale. A.B.R.	pyramidal.	cor. 5-lob. edge wav. ent.	or.		Is. Penang.	———	S.S. root freely.
[lip. Caps. 2-seeded.							
<i>HEBENSTRÆITIA, HEBENSTRÆITIA.</i> Cal. Spatheaceous. Cor. tubular, with a 4-cleft upper							
aurea. A.Rep.	golden.	lin. ent. obt. smth.	yel.	5. 6.	C. B. S.	1792.	G.S. Peat & loam.
chamædryfolia. L.en.	chamædry's-l.	obl.lanc.serr.hair.at bas.	wh.	5.11.	———	1816.	G.S. cuttings.
dentata. w.	dented.	lin. ent. dent. smth.	wh.	———	———	1739.	G.A. ———
tenuifolia. H.H.	slender-leaved.	lin. lanc.	wh.	5.11.	———	1826.	G.B. ———
[sule 2-celled, 2-valved.							
<i>TORENIA, TORENIA.</i> Cal. tubular, 5-toothed. Cor. ringent, upper lip 2-lobed, under 3-lobed. Cap-							
scabra. B.M.	rough.	ov. lanc. serr. scabr.	bl.	———	N.Holl.	1830.	G.P. ———
<i>BONTIA, BONTIA.</i> Cal. 5-parted. Cor. tubul. 2-lipped, lower 3-cleft, revolute. Drupe 1-seed. ovate.							
daphnoïdes. s.s.	Barbadoes.	lanc. altern.	yel.	6.	W.Ind.	1690.	S.S. Loam & leaf mould. cuttings.
<i>PENTSTEMON, PENTSTEMON.</i> Cal. of 5 leaves Cor. bilab. ventric. the filam. longest, & bearded.							
atropurpureum.	dark-purple.	lanc. atten. serr. smth.	d. pu.	3. 9.	Mexico.	1824.	H.S. Loam & leaf
angustifolium. B.R.	narrow-leav'd.	ov. lan. smth. sharp. serru.	ro.	5. 8.	———	1827.	H.P. mould. seeds,
acuminatum. B.R.	pointed-leav'd.	ov. obl. ent. upp. cord.	pur.	———	N.Amer.	———	H.P. cuttings, or
confertum. B.R.	cluster-flow'd.	lanc. ent. smth. upp. ov.	yel.	7. 9.	———	———	H.P. part. roots.
campanulatum. B.M.	bell-flowered.	lanc. acum. serr.	l. pur.	3.10.	Mexico.	1794.	F.S. For the in-
Digitalis. B.M.	Fox-glove-like.	amplex. lanc. serr.	wh.	6. 8.	Arkansa.	1824.	H.P. introduction of
diffusum. B.M.	spreading.	cord. deeply tooth. smth.	pu.	6.10.	Columbi.	1827.	H.P. this beauti-
deustum. B.R.	parched.	ov. obl. serr. upp. obl. sess.	pu.	7. 9.	N.Amer.	———	H.P. ful tribe,
glaucum. B.R.	glaucous.	ell. lan. dent. up. ov. lan. ser. li.	———	———	———	———	H.P. which adds
glandulosum. B.R.	glandular.	ov. dent. upp. amplex. acu. pu.	———	———	———	———	H.P. such a very
ovatum. B.M.	oval-leaved.	ov. cor. den. upp. opp. pub.	bl.	6. 8.	———	1826.	H.P. interesting
pruinosum. B.R.	blue-flower'd.	ent. ell. stalk. up. sess. den.	bl.	———	———	1827.	H.P. feature to the
pulchellum. B.R.	pretty.	lin. lanc. serr.	pk. pu.	———	———	———	H.P. flower gar-
Richardsonii. B.R.	Richardson's.	ov. acum. pinnatif.	pur.	7.10.	———	1825.	H.P. den, we are
speciosum. B.R.	shewy.	spath. lanc. ent. undul.	bl.	———	———	1827.	H.P. indebted to
Scoulerii. B.R.	Dr. Scouler's.	obov. lanc. serr. upp. ent.	pur.	5. 7.	———	———	H.P. Mr. D.
venustum. B.R.	pretty.	sess. ov. lanc. dent. smth.	pur.	7. 9.	———	———	H.P. Douglas,
whose botanical discoveries have so much enriched our flower borders.							
<i>CHELO'NE, CHELO'NE.</i> Cal 5-parted. Cor. ringent. Capsules 2-cell'd, 2-valved. Seeds numerous.							
barbata. B.R.	bearded.	opp. obo. lanc. ent. smth.	sc.	6. 9.	Mexico.	1794.	H.P. Light rich
glabra. L.	smooth.	opp. lanc. obl. serr.	wh.	8.10.	N.Amer.	1730.	H.P. loam. cut-

Systematic Name.	English Name.	Form of Leaves, &c.	Col. of Flow.	Month of Fl.	Native Country.	Yr. of Introd.	Soil and Propagation.
<i>Lyoni</i> . Ph.	Lyon's.	cord. ovate, opp. serr.	re. pu.	7. 9.	N. Amer.	1812.	H. β . <i>tings, or</i>
<i>nemorosa</i> . B.R.	grove.	ov. acum. nerv. serr.	pur.	—	—	1827.	H. β . <i>slips from</i>
<i>obliqua</i> . B.R.	oblique-leav'd.	opp. ov. lanc. serr.	red.	8. 10.	—	1752.	H. β . <i>the roots.</i>
TREVIRA'NA, TREVIRA'NA. <i>Cal. of 5 acute leaves. Cor. funn.-shap. limb 5-lob. Caps. half 2-cell.</i>							
<i>coccinea</i> . W.en.	scarlet.	tern. ov. ellip serr. hairy.	sc.	—	Jamaica.	1778.	S. β . <i>Loam & leaf mould. divid. roots.</i>
<i>Cyrtilla pulchella</i> . B.M.							
MELIANTHUS, HONEY-FLOWER. <i>Cal. 5-part. unequal. Pet. 5. Stam. 4. Sty. 1. Stig. 4-cleft.</i>							
<i>mâjor</i> . B.R.	greater.	pinn. serr. smooth.	br.	5. 7.	C. B. S.	1688.	G. \mathfrak{S} . <i>Loam & peat.</i>
<i>minor</i> . B.M.	lesser.	hoary, upp. smth. serr.	br.	8.	—	1696.	G. \mathfrak{S} . <i>cuttings.</i>
TEEDIA, TEEDIA. <i>Cal. 5-part. Cor. 5-cleft, obtuse, tubul. at base. Berry of 2 cells, with many seeds.</i>							
<i>lucida</i> . s.s.	shining-leaved.	ov. lanc. serr. smth.	pur.	4. 7.	—	1774.	G. \mathfrak{S} . <i>Peat & loam. cuttings, or</i>
<i>Capraria lucida</i> . w.							<i>cuttings, or</i>
<i>pubescens</i> . B.R.	pubescent.	op. ov. lan. pub. on both sid. pk.	—	—	—	1816.	G. \mathfrak{S} . <i>seed.</i>
ANGELO'NIA, ANGELO'NIA. <i>Cal. 5-part. equal. Cor. bilab. upper lip in 4 segm. under 1, elongated.</i>							
<i>salicariæfolia</i> . B.M.	salicaria-leav'd.	opp. sess. ov. lanc. serr.	vi.	7. 10.	S. Amer.	1818.	S. \mathfrak{S} . <i>Loam & leaf mould. cuttings.</i>

CLASS XV.

TETRADYNAMIA. STAMENS 6; 4 long, and 2 short.

ORDER I.

SILICULOSA. *Seeds in a short Pod, or Pouch.*

<i>VELLA, CRESS-ROCKET.</i>	<i>Cal. of 4 leaves, equal at the base. Pet. obovate. Pouch ovate. Style di-</i>						
<i>annua</i> . E. Fl.	annual.	bipinn. segm. lin. obt.	yel.	6. 7.	England.	H. \mathfrak{A} . <i>Light soil. seeds.</i>
[<i>lated. Seeds few in each cell, pendulous.</i>]							
<i>SUBULARIA, AWL-WORT.</i>	<i>Cal. of 4 concave leaves. Pet. 4, obovate. Pouch compressed, of 2 cells.</i>						
<i>aquatica</i> . B. Fl.	water.	awl-shap. 1-2-inch long.	wh.	7.	Britain.	H. w. \mathfrak{A} . <i>Mud. seeds.</i>
[<i>Seeds 4 or more in each cell.</i>]							
<i>DRABA, WHITLOW-GRASS.</i>	<i>Cal. leaves ovate, and concave. Pet. either notched, cloven, or entire.</i>						
<i>aizoïdes</i> . E. B.	yellow-Alpine.	lanc. obt.; Recl. ciliat.	yel.	2. 4.	Wales.	H. β . <i>Sandy loam.</i>
<i>aurea</i> . B.M.	golden.	ov. lan. dent. acut. pub.	yel.	—	N. Amer.	1824.	H. \mathfrak{B} . <i>seeds, or</i>
<i>hirta</i> . DC.	hairy.	lan. obt. slightly tooth.	wh.	5. 7.	Lapland.	H. β . <i>part. roots.</i>
<i>incana</i> . E. B.	hoary.	ellip. lanc. tooth. hoary.	wh.	—	Britain.	H. \mathfrak{B} . <i>—</i>
<i>murâlis</i> . E. Fl.	speedwell-lv'd.	ov. tooth. amplex. hairy.	wh.	4. 5.	England.	H. \mathfrak{A} . <i>—</i>

TETRADYNAMIA SILICULOSA.

143

Systematic Name.	English Name.	Form of Leaves, &c.	Col. of Flow.	Month of Fl.	Native Country.	Yr. of Introd.	Soil and Propagation.
[from 2 to 4 seeds in each cell.							
ALYSSUM, MADWORT. <i>Cal. equal at the base. Pet. obovate. Silicle, orbicular, of 2 cells, and</i>							
incanum. w.	hoary.	lan. hoar. ent.; stem erect.	wh.	6. 8.	Europe.	1640.	H. B. Sandy loam.
montanum. DC.	mountain.	obov. upp. obl. sub. hoary.	yel.	5. 8.	German.	1733.	H. P. seeds, or
olympicum.	Mt. Olympus.	obov. spath. smth.	yel.	—	Greece.	1800.	H. P. cuttings.
saxatile. B. M.	rock.	obov. lanc. vill. tooth.	yel.	4. 5.	Russia.	1710.	H. P. —
tortuosum. DC.	twisted.	lan. hoar.; stem twist. spr.	yel.	6. 7.	Hungary.	1804.	H. S. —
[cells, with numerous seeds in each cell.							
CAMELINA, GOLD OF PLEASURE. <i>Cal. leaves elliptic, oblong. Pet. undivided. Pouch of 2</i>							
sativa. E. B.	cultivated.	altern. lanc. sagitt.	yel.	5. 7.	Britain.	...	H. A. Light loam. seeds.
[shaped valves. Seeds 1 in each cell.							
LEPIDIUM, PEPPERWORT. <i>Pet. obovate, equal. Pouch compressed, with 2 cells, and 2 keel-</i>							
campêtre. B. Fl.	common.	obov. opp. sess. sagitt. den. wh.	wh.	6. 7.	Britain.	...	H. A. Light loam.
latifolium. E. B.	broad-leaved.	ovat. lanc. serr.	wh.	—	—	...	H. P. seeds.
ruderale. E. B.	narrow-leav'd.	pinnatif. seg. lin. tooth.	wh.	—	—	...	H. A. —
[densely downy. Stig. pubes. capitate.							
SCHIVERE'CKIA, SCHIVERE'CKIA. <i>Cal. lax. and concave. Pet. obovate, entire. Silicle ovate,</i>							
podolica. DC.	canescent.	obl. dent. obt. upp. sess.	wh.	—	Podolia.	1821.	H. P. —
[nearly entire, of 2 cells, and 2 or more seeds in each.							
HUTCHINSLA, HUTCHINSLA. <i>Cal. concave, deciduous. Pet. obov. Germ. compressed. Pouch</i>							
petræa. B. Fl.	rock.	pin. ent. lea. elli. obl. ent.	wh.	3. 5.	England.	...	H. B. Loam & peat.
stylösa. E. M.	sweet-scented.	obo. obl. sub. ent. upp. obl.	pu.	—	Naples.	1826.	H. P. cuttings.
[nate, of 2 cells, and 2 seeds in each cell.							
TEESDALIA, TEESDALIA. <i>Cal. equal at the base. Germ. 2-lobed. Stig. sessile. Silicle emargin-</i>							
nudicaulis. E. B.	naked-stalked.	lyrate, ov. pinnatif.	wh.	5. 7.	England.	...	H. A. Sandy loam. seeds.
[Silicle of 2 cells, with several seeds in each.							
THLASPI, SHEPHERD'S PURSE. <i>Cal. of 4 concave spreading leaves. Pet. notched, or entire.</i>							
arvensé. E. Fl.	corn Penny Cress.	obl. tooth. smth. upp. ampl.	w.	—	Britain.	...	H. A. Light soil.
alpêtre. DC.	Alpine.	nearly ent. upp. obl. ampl.	w.	—	England.	...	H. P. seeds.
perfoliatum. DC.	perfoliate.	ov. obt. up. cor. tooth. smth.	w.	—	—	...	H. A. —
[licle, elliptical, rugged, of 2 cells, and many seeds.							
COCHLEARIA, SCURVY-GRASS. <i>Cal. concave, about half the length of the obovate Petals. Si-</i>							
anglica. B. F.	English.	ov. ent. upp. sess. lan. tooth.	w.	—	—	...	H. A. —
danica. E. Fl.	Danish.	trian. 3-lob. ent. cor. at bas.	w.	5. 6.	Britain.	...	H. A. —
grœnlandica. B. Fl.	Greenland.	renif. fleshy, ent. upp. obl.	wh.	—	Scotland.	...	H. P. —
integri-folia. DC.	entire-leaved.	ov. stalk. ent. up. lan. near. sess.	—	—	Siberia.	1822.	H. B. —
pyrenæica. DC.	Pyrenean.	cor. renif. ent. up. ov. den.	wh.	—	Pyrenees.	1820.	H. B. —
[cloven, with 2 cells, and 2 keeled valves. Seeds 1 in each cell.							
BERIS, CANDY-TUFT. <i>Pet. 2, obovate, unequal. Germ. notched, compressed. Pouch obovate,</i>							
maritima. E. Fl.	bitter.	lanc. acute, dent.	wh.	6. 8.	England.	...	H. A. Light loam.
gibraltaria. B. M.	Gibraltar.	wedge-sh. obt. apex den.	wh.	5. 6.	Gibraltar.	1732.	G. S. cuttings.
impervirens. Fl. Gr.	evergreen.	spath. obt. ent. smth.	wh.	4. 6.	Crete.	1731.	H. S. —
nanca. B. M.	dwarf.	spath. obt. ent. sub. fleshy.	wh.	4. 5.	Dauphin.	1822.	H. B. —

Systematic Name.	English Name.	Form of Leaves, &c.	Col. of Flow.	Month of Fl.	Native Country.	Yr. of Introd.	Soil and Propagation.
saxátillis. DC.	rock.	lin. ent. sub-fleshy.	wh.	4. 5.	S. Europ.	1739.	H. S. —
Tenoreána. B.M.	Tenore's.	obov. dent. atten. at bas.	wh.	6. 7.	Italy.	1824.	H. S. —
<i>ISA'TIS, WOAD.</i> Cal. coloured. Pet. entire. Silicle obt. entire, of 1 cell, and 2 valves. Seeds solitary.							
alpína. DC.	Alpine.	ov. ampl. ; Silicl. ov. obl.	yel.	—	Italy.	1800.	H. P. Loam & peat.
tinctória. E.B.	Dyer's.	obl. cren. ; stem-lvs. sagitt.	ye.	—	England.	...	H. B. cuttings.
<i>CA'KILE, SEA-ROCKET.</i> Cal. deciduous. Pet. spreading. Silicle of 2 articulations, of 1 cell, valve- marítima. E.Fl. purple. pinnatif. flesh. den. glau. pur. 6. 9. Britain. ... H. A. Sandy loam, seeds, or cuttings. [less. Seed solitary.							
<i>CRA'MBE, SEA-KALE.</i> Cal. nearly equal at the base. Pouch with 2 joints and 1 cell, without valves. [Seed solitary.							
cordifólia. DC.	heart-leaved.	cord. dent. upp. ov. smth.	wh.	6. 7.	Caucasu.	1828.	H. P. Rich loam.
marítima. E.B.	sea.	sub-orbic. sinua. den. glau.	w.	5. 6.	Britain.	...	H. P. seeds, or parting roots.
<i>FARSE'TIA, FARSE'TIA.</i> Cal. bisaccate at base, ovate, or orbicular, with flat valves. Seed winged.							
lunarióides. B.M.	Lunaria-like.	spath. upp. obl. obt. hoar.	yel.	4. 5.	Archipel.	1731.	F. P. —
<i>AUBRIE'TIA, AUBRIE'TIA.</i> Cal. bisaccate at base. Pet. entire. Silicle oblong, valves convex.							
deltóidea. DC.	deltoid.	obo. lan. tooth. pub. ;	Ped. lon.	3. 5.	Levant.	1710.	H. P. Light loam, cuttings,
<i>Farsétia deltoidea.</i> H. K.							
purpúrea. DC.	purple.	spat. obt. pub. ;	Ped. short. pu.	3. 6.	Greece.	1820.	H. P. seeds, or parting roots.
<i>VESICA'RIA, VESICA'RIA.</i> Cal. 4-cleft. Pet. entire. Silicle globose, inflated with hemispherical [valves. Seeds above 8.							
ártica. B.M.	arctic.	spat. tap. at bas. hairs min.	ye.	8. 9.	Greenla.	1826.	H. P. Sandy loam.
crética. DC.	Cretan.	obl. ent. rep. undu. wh. hair.	y.	5. 8.	Crete.	1739.	H. P. seeds, or
ntriculâta. DC.	bladdered.	obl. ent. smth. lower ciliat.	ye.	4. 6.	Levant.	—	H. P. cuttings.

ORDER II.

SILIQUOSA. Seeds in a Siliqua, or long narrow Pod.

<i>DENTA'RIA, CORAL-WORT.</i> Petals shorter than the calyx. Siliqua lance shaped, with flat valves. [Seeds ovate.							
bulbífera. E.B.	bulbiferous.	pinn. upper lanc. serr.	pur.	5. 6.	England.	...	H. P. Sandy loam
diph'ylla. DC.	two-leaved.	1-2 alt. 3-fid. segm. ov. lanc. w.	6. 7.	N. Amer.	1806.	H. P.	and peat.
digitâta. B.M.	fingered.	in 5's. digit. leaf. ellip. lan. pu.	—	Switzerl.	1656.	H. P.	seeds, or dividing at root.
<i>CARD'AMINE, LADIES'-SMOCK.</i> Cal. unequal at the base, the 2 shortest filaments glandular at [the base. Siliqua sessile, linear.							
amára. B.F.	bitter.	pinnatisect. upp. dent.	wh.	5. 6.	Britain.	...	H. w. P. Light loam.
asarifólia. B.M.	Asarum-leaved.	cord. orbic. sinuat. dent.	wh.	6. 7.	Italy.	1710.	H. w. P. seeds, or
bellidifólia. Br.Fl.	Daisy-leaved.	ov. wavy, ent. smth.	wh.	5. 7.	Scotland.	...	H. P. part. roots.
hirsûta. E.B.	hairy.	pinnatif. segm. round.	wh.	12.1.	Britain.	...	H. A. —

Systematic Name.	English Name.	Form of Leaves, &c.	Col. of Month Native Flow. of FL. Country.	Yr. of Introd.	Soil and Propagation.
impatiens. E.Fl.	Impatient.	pinn. leaf. lanc. ent.	wh. 5. 6. Britain. H. A.	—
trifolia. B.M.	three-leaved.	smth. 3-fid. segm. dent.	wh. 4. 5. Europe.	1629. H. w. P.	—
Thalictróides. DC.	Thalictrum-lv'd.	pinnatif. segm. 3-lob.	wh. 6. 7. Switzerl.	1824. H. B.	—

NASTURTIUM, CRESS. *Cal. equal at the base. Pet. obov. Siliq. rounded, valves ribless. Seeds flat.*

sylyvestre. E.Fl.	creeping.	pinn. leaf. lanc. serr.	yel. 7. 9. Britain. H. w. P.	Light loam.
terrestre. E.B.	annual.	pinnatif. tooth. smth.	yel. — — — — H. w. P.	seeds, or dividing roots.

SISYMBRIUM, HEDGE-MUSTARD. *Cal. spread. conc. Pet. obt. Ger. sess. Pod round. or angul.*

acutángulum. DC.	acute-angled.	runcinate. upp. pinnatif.	yel. — — Pyrenée.	1791. H. B.	Sandy loam.
dentátum. All.	dentated.	spat. dent. scab. hairy.	wh. — — Taurie.	1822. H. P.	seeds.
Yrio. E.Fl.	London Rocket.	runcinate. dent. smth.	yel. — — England. H. A.	—
integrifólium. L.	entire-leaved.	lin. ent. Br. glandular. w. pu.	— — — — Siberia.	1822. H. B.	—
Sophia. E.B.	fine-leaved.	bipinnatif. hairy segm. lin. ye.	— — — — Britain. H. A.	—

[*Siliq. 4, edged. Seeds in 1 row.*

BARBAREA, WINTER-CRESS. *Cal. erect. Filam. awl-shaped, with glands between the shorter ones.*

præcox. E.Fl.	early.	lyrate, upp. pinnatif.	yel. 5. 10. England. H. P.	Sandy soil. cuttings.
---------------	--------	------------------------	----------------------	------------	-----------------------

HELIO'PHILA, HELIO'PHILA. *Cal. 4-cleft, equal at the base. Siliq. elongated, entire.*

digitata. B.R.	finger-leaved.	digit. ov. ent.	bl. 6. 9. C. B. S.	1819. H. A.	Light soil.
stricta. B.M.	upright.	pinn. dent. hairy.	bl. — — — —	1824. H. A.	—

ERYSIMUM, TREACLE-MUSTARD. *Cal. col. Pet. obo. obl. Pod sess. 4-sid. Stig. capit. notched.*

cheiranthóides. E.B.	worm-seed.	lanc. dent. hairy.	yel. 6. 9. Britain. H. A.	Sandy loam.
orientále. B.F.	Hare's-ear.	ellip. cord. amplex. smth.	w. — — — — H. P.	seeds.

ALLIA'RIA, ALLIA'RIA. *Cal. lax. Siliq. round, 4-cornered, with prominent nerves.*

brachycárpa. DC.	short-podded.	ovate, orbic.	wh. — — Iberia.	1827. H. P.	—
officinális. DC.	garlick-scented.	cord. dent. acut.	wh. 6. 7. Britain. H. P.	—

Ery'simum Alliária. E.B.

[*spreading. Seeds in 1 row.*

CHEIRA'NTHUS, WALL-FLOWER. *Cal. closed. Pet. notch. Siliq. compr. Sty. short. Stig. 2-lob.*

alpínus. DC.	Alpine.	dent. lanc. pubes.	yel. 6. 7. Norway.	1823. H. P.	Light loam.
Chéiri. Br.Fl.	common.	lanc. acut. hoary ben.	yel. — — Britain. H. P.	cuttings, or seeds.
fruticulósus. E.B.					
nutábilis. B.R.	changeable.	lin. lanc. acum. serr.	pu. 3. 4. Madeira.	1777. F. S.	—

MATHIOLA, STOCK. *Cal. clos. compr. Fil. with a nect. gland at the base of, 2 short. Pod roun. Sti. of 2 lob.*

ncána. E.B.	hoary.	lanc. obt. ent. hoary.	pu. 6. England. H. S.	Light loam.
1. coccínea.	scarlet.	sc. — — — — H. S.	cuttings, or
2. álba.	white.	wh. — — — — H. S.	seeds.
3. purpúrea.	purple.	pu. — — — — H. S.	—
lábra. DC.	smooth.	lanc. smth.; stm. erect.	wh. 6. 9. H. S.	—
1. álba.	white.	wh. — — — — H. S.	—
2. fl. pléno.	double-flow'ring.	var. — — — — H. S.	—
inuáta. E.B.	great sea.	sinuat. downy, upp. ent.	pu. — — England. H. B.	—
ricuspidáta. B.F.G.	three-forked.	pinnatif. sinuat. hairy.	pu. 8. 9. Barbary.	1789. H. A.	—

ORDER III.

PENTANDRIA. STAMENS 5.

Systematic Name.	English Name.	Form of Leaves, &c.	Col. of Flow.	Month of Fl.	Native Country.	Yr. of Introd.	Soil and Propagation.
[many-seeded, 5-celled, 5-valved.]							
HERMA'NNIA, HERMA'NNIA. <i>Cal. camp. 5-part. Pet. 5. Stam. 5. Sty. 5. Caps. 5-celled, 5-valved.</i>							
althæifólia. B.M.	Altæa-leaved.	ov. plic. cren. hairy.	yel.	3. 7.	C.B.S.	1728.	G. S. Loam & leaf
alnifólia. B.M.	Elder-leaved.	obov. cren. emarg. smth.	yel.	2. 5.	—	—	G. S. mould.
coronopifólia. DC.	Buck's-horn-l'd.	lin. pinnatif. smth.	yel.	6. 8.	—	1818.	G. S. cuttings.
denudáta. DC.	smooth.	lanc. acut. smth. serr.	yel.	5. 7.	—	1774.	G. S. —
decumbens. DC.	decumbent.	obl. tooth. pubes.	yel.	4. 6.	—	1818.	G. S. —
filifólia. DC.	thread-leaved.	lin. 3-corn. edges rough.	or.	5. 8.	—	1816.	G. S. —
flámmea. B.M.	flame-colour'd.	cuneif. lan. trunc. apex den.	re.	11. 12.	—	1794.	G. S. —
glandulósa. DC.	glandular.	ov. cren. pubes. gland.	yel.	5. 8.	—	1820.	G. S. —
plicáta. DC.	plicate.	sub-cord. ov. dent. hairy.	yel.	11. 12.	—	1774.	G. S. —
OCHRO'MA, OCHRO'MA. <i>Cal. 5-dent. 3 of the lobes rounded, & 2 acute. Pet. 5. Stig. 5. Seeds oblong.</i>							
tomentósa. DC.	woolly-leaved.	cord. 3-lob. rep. hairy.	wh.	7. 8.	S. Amer.	1816.	S. S. —
WALTHERIA, WALTHERIA. <i>Cal. double, outer 3-leaf. Pet. 5. Sty. 1. Caps. 1-cell. 2-valv. 1-seed.</i>							
americána. DC.	American.	ov. plic. dent. hairy.	yel.	5. 10.	S. Amer.	1691.	S. S. Loam & peat.
elliptica. DC.	elliptic-leaved.	ellip. lan. plic. dent. hair.	yel.	6. 8.	E. Ind.	1812.	S. S. cuttings.
PASSIFLO'RA, PASSION-FLOWER. <i>Cal. 5-part. col. Pet. 5, or none, inser. in the cal. Fruit fleshy.</i>							
aláta. B.M.	wing-stalked.	sub-cord. ov. acut. smth.	ri.	4. 8.	E. Ind.	1772.	S. S. cl. Sandy loam
álbida. B.R.	white.	subrotun. cor. ent. Stip lan. w.	7. 11.	Brazil.	1816.	S. S. cl. and peat.	
angustifólia. B.R.	narrow-leaved.	pelt. ov. upp. lan. 2-3-lob.	gr.	5. 9.	W. Ind.	1773.	S. S. cl. cuttings un-
adiantifólia. B.R.	Adiantum-l'd.	3-lob. smth. alt.	or.	6. 10.	Norf. Isl.	1792.	G. S. cl. der a hand-
ciliáta. B.M.	ciliated.	cord. 3-fid. lobes ciliat.	w. ro.	7. 9.	Jamaica.	1783.	S. S. cl. glass, in a
Colvillii. DC.	Colvill's.	palm. 5-part. lobes serr.	vio.	—	Hybrid.	1823.	S. S. cl. little bottom
cœrúlea. DC.	common.	5-part. lobes obl. ent.	wh. bl.	7. 8.	Brazil.	1699.	H. S. cl. heat, will
hirsúta. DC.	hairy.	3-fid. 5-nerv. lobes ov.	gr.	9. 9.	W. Ind.	1690.	S. S. cl. strike root.
holosericea. B.R.	silky-leaved.	ov. 3-lob. dent.	st.	5. 8.	V. Cruz.	1733.	S. S. cl. —
laurifólia. F.R.	Laurel-leaved.	ov. obl. ent.	vio.	6. 7.	W. Ind.	1690.	S. S. cl. —
lunáta. Sm.	crescent-leaved.	pub. base ov. ap. lun. trunc.	ri.	6. 8.	—	1733.	S. S. cl. —
liguláris. B.M.	ample-leaved.	cord. ent. smth. acum.	vio.	9.	Peru.	1822.	S. S. cl. —
malifórmis. B.R.	Apple-fruited.	ov. cord. acum. ent.	vio.	7. 11.	W. Ind.	1731.	S. S. cl. —
picturáta. B.R.	Newmann's.	pelt. orbic. 3-lob. 2-col'd.	vio.	—	Brazil.	1823.	S. S. cl. —
palmáta. Link.	palmate.	5-par. palm. ser. Invo. 3-l'd.	w.	—	—	1818.	S. S. cl. —
peltáta. B.R.	peltate.	pelt. 3-lob. pubes.	st.	8. 9.	W. Ind.	1778.	S. S. cl. —
perfoliáta. W.	perfoliate-l'd.	cord. obt. 2-lob. upp. amp.	pu.	7. 8.	—	—	S. S. cl. —
quadranguláris. B.R.	square-stalk'd.	smth. cord. ov. acum.	vio.	8. 9.	Jamaica.	1768.	S. S. cl. —
racemósa. B.R.	raceme-flow'ng.	sub-pelt. smth. 3-lob.	re. pu.	1. 12.	Brazil.	1816.	S. S. cl. —
<i>β princéps.</i>	chief.	sc.	6. 10.	Hybrid.	S. S. cl. —
rúbra. DC.	red-fruited.	cord. 2-lob. acut. pubes.	fl.	4. 9.	W. Ind.	1806.	S. S. cl. —
serratifólia. B.M.	saw-leaved.	ov. lanc. serr. pubes.	pur.	5. 10.	—	1779.	S. S. cl. —
suberosa. DC.	Cork-barked.	ov. cord. or 3-lob. smth.	wh.	6. 9.	—	1759.	S. S. cl. —

Systematic Name.	English Name.	Form of Leaves, &c.	Col. of Flow.	Month of Fl.	Native Country.	Yr. of Introd.	Soil and Propagation.
[Stig. 1. Caps. 5. Seeds 1 or 2.							
<i>ERODIUM, HERON'S-BILL.</i> Cal. of 5 concave leaves. Pet. 5, obovate. Nect. 5 glands. Ger. 5, furr.							
<i>crassifolium.</i> DC.	thick-leaved.	pinnatif. lobes lin.	li.	3. 8.	Cyprus.	1788.	G. S. Sandy loam,
<i>cicutarium.</i> E. B.	Hemlock-l'd.	pinn. leaf. sess. pinnatif.	pu.	4. 9.	Britain.	H. A. & leaf mould.
<i>Goussonii.</i> Sw. G.	Gousson's.	cord. obt. tooth.	li.	5. 8.	Naples.	1822.	H. P. cuttings of
<i>incarnatum.</i> Sw. G.	flesh-coloured.	cor. lob. wedge-sh. 3-tooth.	fl.	5. 7.	C. B. S.	1787.	G. S. roots,
<i>moschatum.</i> E. Fl.	musky.	pinn. leaf. ov. uneq. cut.	ro.	—	England.	H. A. or seeds.
<i>maritimum.</i> Br. Fl.	sea.	cord. lob. cren. pubes.	p. re.	5. 9.	—	H. P. —

ORDER IV.

HEPTANDRIA. STYLES 7.

PELARGONIUM, STORK'S-BILL. Cal. 5-parted. Pet. 5, unequal. Filam. 10.

<i>ardens.</i> Sw. G.	glowing.	vill. cord. ov. obl. 3-6-lob.	sc.	3. 8.	Hybrid.	1810.	G. S. The nume-
<i>adulterinum.</i> Sw. G.	hoary-trifid.	cor. obt. 3-lo. und. vill. soft.	pu.	4. 6.	C. B. S.	1785.	G. S. rous species
<i>acetabulosum.</i> Sw. G.	saucer-leaved.	cor. reni. sub-5-lo. und. den.	p.	4. 10.	Hybrid.	1827.	G. S. & varieties
<i>acetosum.</i> B. M.	Sorrel-leaved.	obov. smth. cren. fleshy.	ro. w.	—	C. B. S.	1710.	G. S. of the Gera-
<i>asperifolium.</i> Sw. G.	rough-leaved.	cor. lob. acut. und. hairy.	red.	5. 9.	Hybrid.	1807.	G. S. niaceæ, may
<i>augustum.</i> DC.	August.	sub-cor. 5-lob. sub-vill.	bh.	4. 8.	—	1809.	G. S. begrown suc-
<i>β coccinea.</i>	scarlet.	sc.	—	—	1831.	G. S. cessfully in
<i>affluens.</i> Sw. G.	numerous-fl'd.	cord. 3-lob. dent. hairy.	li.	5. 10.	—	1821.	G. S. a mixture of
<i>alchimilloides.</i> DC.	mantle-leaved.	cord. 5-lob. palm. vill.	wh.	—	C. B. S.	1693.	G. P. sandy loam, &
<i>atrofusum.</i> Sw. G.	dark-brown.	deeply 3-lob. den. hairy.	d. pu.	—	Hybrid.	1818.	G. S. leaf mould;
<i>amœnum.</i> Sw. G.	delightful.	pinnatisect. vil. seg. op. alt. obt.	4. 8.	—	—	1821.	G. S. about half &
<i>aurantiacum.</i> Sw. G.	Orange-col'd.	cord. lob. dent. vill.	or.	—	—	—	G. S. half, well in-
<i>atropurpurea.</i> Sw. G.	dark-purple.	trunc. sub-cord. lob. dent.	pu.	5. 10.	—	1822.	G. S. corporated
<i>angulosum.</i> DC.	Marshmallow-ld.	5-lob. dent. pubes.	pu.	7. 9.	C. B. S.	1794.	G. S. together,
<i>acutidentatum.</i> Sw. G.	acute-tooth'd.	cord. 5-7-lob. dent. smth.	sa.	5. 10.	Hybrid.	1827.	G. S. previous to
<i>æmulum.</i> Sw. G.	rival.	cor. re. sub-lo. den. Stip. lan.	pu.	—	—	1824.	G. S. using.
<i>acutilobum.</i> Sw. G.	acute-lobed.	obl. lanc. serr. smth.	wh.	—	—	1822.	G. S. This tribe
<i>argutum.</i> Sw. G.	sharp-toothed.	cord. lob. dent. smth.	sc.	—	—	1824.	G. S. of plants is
<i>auriculatum.</i>	ear-leaved.	obl. lanc. acum. hairy.	re. w.	—	—	G. S. easily propa-
<i>atrovirens.</i> Sw. G.	dark-green-l'd.	cor. acu. 5-lo. smth. und.	bh. pu.	—	—	1827.	G. S. gated by cut-
<i>atrorubens.</i> C. C.	dark-red.	cord. lob. serr.	da. red.	4. 8.	—	1822.	G. S. tings, which
<i>anacampton.</i> Sw. G.	recurv.-calyx'd.	cor. acu. 5-lo. und. den.	re. ve.	—	—	1827.	G. S. generally
<i>anisodonton.</i> Sw. G.	unequal-tooth'd.	cor. cucull. acu. den. pilo.	pu.	4. 10.	—	1825.	G. S. succeed best
<i>Abercorniæ.</i>	March. of Abercorn's.	cord. lob. serr. vill.	d. red.	—	—	1832.	G. S. by being put
<i>annesleyanum.</i> Sw. G.	Miss Annesley's.	cor. 7-9-lo. den. pilo.	re. ve.	5. 10.	—	1828.	G. S. in about Ju-
<i>ardescens.</i> Sw. G.	burnished.	cor. acu. lob. cut. den. pub.	cr.	4. 8.	—	1822.	G. S. ly, in an open
<i>acerifolium.</i> DC.	Maple-leaved.	ent. at base, apex palm.	5-lob.	4. 6.	C. B. S.	1784.	G. S. border,
<i>affine.</i> Sw. G.	related.	cor. und. lob. rig. den. pilo.	sc.	4. 10.	Hybrid.	1822.	G. S. where they
<i>Atkinsianum.</i> Sw. G.	Mr. Atkins's.	cor. 5-7-lo. curl'd. und.	bh. pu.	5. 10.	—	1828.	G. S. can be shaded
<i>adventitum.</i> Sw. G.	adventitious.	cor. renif. 5-7-lob. smth.	pu. v.	—	—	1826.	G. S. from the ef-
<i>Avronianum.</i> Sw. G.	Avron's.	3-part. pinnatif. vill.	sc.	—	—	1823.	G. S. fects of the
<i>altum.</i> Sw. G.	tall upright.	cor. und. sub-tri. many-den.	r.	4. 9.	—	1827.	G. S. mid-day sun,
<i>abutifolides.</i> Sw. G.	A batillon-like.	cor. acu. 7-9-lob. den. pub.	pu.	—	—	1820.	G. S. until they be-
<i>Allenii.</i> Sw. G.	Allen's.	cord. 3-lob. dent. pub.	da. re.	4. 10.	—	—	G. S. gin to calice,
<i>anthriscifolium.</i> Sw. G.	Anthriscus-l'd.	hairy, leaf. pinn.	sc.	7. 9.	—	—	G. S. or make

Systematic Name.	English Name.	Form of Leaves, &c.	Col. of Flow.	Month of Fl.	Native Country.	Yr. of Introd.	Soil and Propagation.
anómalum. Sw.G.	anomalus.	sub-cor.ov.sub-5-lo.ser.	pk.	4. 8.	Hybrid.	1822.	G. <i>g.</i> roots; they
aceroides. Sw.G.	Acer-leaved.	cor.5-7-lo.acu.tooth.pub.	fl.	4. 9.	—	—	G. <i>g.</i> should be ta-
Barringtóniæ. Dc.	Barrington's.	ren.den.obt.cucull.pilo.	pu.	4.10.	C. B. S.	1824.	G. <i>g.</i> ken up in
Broughtóniæ. Sw.G. Ly.	Broughton's.	ren.cor.5-lob.und.den.vill.	sc.	4. 8.	Hybrid.	1822.	G. <i>g.</i> September,
bícolor.	two-coloured.	cor.trif.und.obt.den.hair.da.	7. 8.	—	—	1788.	G. <i>g.</i> or beginning
Boylæa. Sw.G.	Count. of Cork's.	sub.rot.up.rhom.sub-5-lo.w.	5.10.	—	—	1810.	G. <i>g.</i> of October,
blándum.	blush-flowered.	cord. 5-lob. dent. pub.	bh.	—	—	1816.	G. <i>g.</i> and potted,
Brównii. Sw.G.	Brown's.	5-lo.acu.den.bas.sub-cun.d.b.	—	—	—	1827.	G. <i>g.</i> when they
Boléyniæ.	Anne Boleyne.	cord.lob.serr.sub-vill.	ros.	—	—	1829.	G. <i>g.</i> will make
Barclayánum. Sw.G. Mr.	Barclay's.	cor.5-lob.acut.ent.hairy.	sc.	—	—	1824.	G. <i>g.</i> handsome
Breesiánum. Sw.G.	Breese's.	cor.ov.obt.5-lo.edg.und.den.	4. 8.	—	—	1818.	G. <i>g.</i> bushy plants
Blandfordiánum. Sw.G.	Blandford's.	palm.7-lo.vill.seg.pinn.	bh.	1.12.	—	1812.	G. <i>g.</i> for flower-
betulinum. Dc.	Birch-leaved.	ov.ser.smth. Stip.ov.lan.	pu.	5.10.	C. B. S.	1759.	G. <i>g.</i> ing the ensu-
Beaufortiánum. Sw.G.	Beaufort's.	acu.5-lo.ser.up.bas.cucul.	li.	5. 8.	—	—	G. <i>g.</i> ing Spring.
Bishóppæ. Sw.G.	Mrs. Bishopp's.	cor.5-7-lo.obt.und.cren.	sc.	4.10.	Hybrid.	1822.	G. <i>g.</i> As there
Baileyánum. Sw.G.	Bailey's.	reni.trun.at.bas.dent.vill.	w.	5.10.	—	1819.	G. <i>g.</i> appears, in
Byroniánum.	Lord Byron's.	renif. dent. vill.	d.pu.	—	—	1829.	G. <i>g.</i> the Horticul-
Brightiánum. Sw.G.	Miss Bright's.	3-lob. serr. pubes.	wh.	—	—	1823.	G. <i>g.</i> tural Regis-
bipinnatífídum. Sw.G.	bipinnatifid.	bipinn.scabr.pub.seg.lin.	pu.	4.11.	—	1827.	G. <i>g.</i> ster, No. 3, a
Bluntiánum. Sw.G.	Miss Blunt's.	cor.7-9-lo.und.edg.fring.	sc.	5.10.	—	1828.	G. <i>g.</i> very useful
Burnettiánum. Sw.G.	Miss Burnett's.	cor.acut.5-lob.dent.	d.re.	4.10.	—	1826.	G. <i>g.</i> Paper, by
Belladóña. Sw.G.	Painted Lady.	flat.ov.acut.smth.serr.	bh.	5.10.	—	1823.	G. <i>g.</i> Mr. George
bryoniæfólium. Sw.G.	Bryony-l'd.	cor.5-lo.den.slight.hair.	bh.	—	—	1824.	G. <i>g.</i> Harrison,
biflórum. Sw.G.	two-flowered.	cor.orbi.acut.dent.pub.	wh.	—	—	1822.	G. <i>g.</i> jun., on the
basílico. Sw.G.	Princely.	cor.orb.den.pilo.on both sid.	5. 9.	—	—	1824.	G. <i>g.</i> propagation
Barnardiánum. Sw.G.	Barnard's.	3-clef.acu.smth.glaud.den.	sc.	5.10.	—	1820.	G. <i>g.</i> and manage-
Beadónia. Sw.G.	Mrs. Beadon's.	cunea.3-lo.cren.obt.hair.pu.	—	—	—	1815.	G. <i>g.</i> ment of the
cóncolor. s.g.	self-coloured.	cor.5-lo.und.soft. Stip.cor.re.	4. 8.	—	—	1820.	G. <i>g.</i> Geraniaceæ,
Codríngtónii.	Adm. Codrington's.	cord. serr. vill.	wh.p.	—	—	1828.	G. <i>g.</i> for keeping
cruéntum. s.g.	blood-red.	pinn.laciniat.pilo.dent.	cr.	—	—	1822.	G. <i>g.</i> up a succes-
Carólinum. s.g.	Queen Caroline.	cord.sub-lob.vill.serr.	li.wh.	—	—	1828.	G. <i>g.</i> sion of their
corúscans. s.g.	shining.	cor.lob.den.pub.on both sid.	r.5.10.	—	—	1821.	G. <i>g.</i> flowers
concínnum. s.g.	comely.	und. dent. trif. smth.	red.	—	—	1819.	G. <i>g.</i> throughout
cucullátum. Dc.	hooded.	renif. cuc. dent. pub.	pur.	4.10.	C. B. S.	1690.	G. <i>g.</i> the season,
cordátum. Dc.	heart-leaved.	cor.acu.den.flat.pub.ben.	pu.	3. 8.	—	1774.	G. <i>g.</i> at the Earl of
Colvállii. Sw.G.	Colvill's.	cor.renif.7-lob.und.den.	sc.	4. 8.	Hybrid.	1820.	G. <i>g.</i> Egremont's,
Cornvállii.	Ld. Cornwallis's.	cor.und.sub-pub.serr.	li.vel.	—	—	1830.	G. <i>g.</i> Petworth
Cummíngiæ. Sw.G. Ly.	Cumming's.	cor.acu.5-7-lo.cucul.den.	re.	4. 9.	—	1827.	G. <i>g.</i> House, I
cómpptum. Sw.G.	decked.	orb.ren.lo.acu.smth.abo.	pk.	3.10.	—	1810.	G. <i>g.</i> shall, I trust,
Clintónia. Sw.G.	D. of Newcastle's.	cord. 5-lob. und. shin.	re.	—	—	1827.	G. <i>g.</i> be pardoned
Cantabrigiense.	D. of Cambridge's.	renif. dent. vill.	d.re.	4. 9.	—	1830.	G. <i>g.</i> in repeating
capítatum.	rose-scented.	cord. lob. soft, vill. dent.	li.	4. 8.	C. B. S.	1690.	G. <i>g.</i> a part of his
carnósum.	fleshy.	sinu.pinn.smth.thick, seg.obl.	—	—	—	...	G. <i>g.</i> observations.
cándidum.	fair-flowered.	cor.3-lob.obt.den.canes.	wh.	5.10.	Hybrid.	1818.	G. <i>g.</i> " In Au-
Comptóniæ. Ly.	Northampton's.	flat.cunea.ov.cord.3-lob.	li.	—	—	—	G. <i>g.</i> gust, cut-
Coúttsiæ. Sw.G.	Mrs. Coult's.	cord. 3-lob. dent. pubes.	sa.	—	—	1822.	G. <i>g.</i> tings are ta-
ConquæstorStróudii. Stroud's	Conqueror.	cord. serr. vill.	sc.vel.	—	—	1830.	G. <i>g.</i> ken off the
chrysanthemifólium. Sw.G.	Chrysan.-fl.	cor. pinn. seg. cren.	sc.	4. 10.	—	1821.	G. <i>g.</i> old plants,
compáctum. Sw.G.	compact.	cunea.cut,lob.den.hair.	bh.re.	5.10.	—	1828.	G. <i>g.</i> choosing
cordifórme. Sw.G.	heart-shaped.	cor.ov.und.den.smth.	bh.pu.	—	—	1827.	G. <i>g.</i> such as have
calamistrátum. Sw.G.	curled-lobed.	cord.7-9-lob.cren.vill.	pu.	4. 8.	—	1828.	G. <i>g.</i> the young
contíguum. Sw.G.	contiguous.	cor.5-lob.vill.on both sid.	sc.	5.10.	—	—	G. <i>g.</i> wood tolera- bly perfect-

Systematic Name.	English Name.	Form of Leaves, &c.	Col. of Flow.	Month of Fl.	Native Country.	Yr. of Introd.	Soil and Propagation.
conchylátum.	Sw.G. violet purple.	cord. renif. pilos. dent.	vi. vel.	5. 10.	Hybrid.	1828.	G. ♀. ed; they are
Colley'anum.	Sw.G. Colley's.	cor. renif. cucull. vill. den.	pu.	—	—	—	G. ♀. cut off about
Chandléri.	Chandler's-purp.	cord. sinuat. cil.	pu.	—	—	—	G. ♀. 6 inch. long,
clathrátum.	Sw.G. burred-petaled.	cor. cucul. sub-3-lo. smth.	pk. v.	—	—	1827.	G. ♀. and close un-
commixtum.	Sw.G. mingled.	cord. 3-lob. dent. hairy.	re. vel.	—	—	—	G. ♀. der a joint;
chelidoniifólium.	Sw.G. Chelido.-ld.	cord. obt. 3-part. dent.	or.	4. 9.	—	1825.	G. ♀. & each cut-
chenopodiifólium.	Sw.G. Goose-foot-l'd.	cor. ov. sinuat. lob.	pk.	—	—	—	G. ♀. ting is put
cratægifólium.	Sw.G. Hawthorn-l'd.	renif. 3-lo. flat, dent. smth.	re.	5. 10.	—	1824.	G. ♀. into a small
coitophýllum.	Sw.G. hollow-leaved.	cor. acu. cucul. den. smth.	re.	—	—	1827.	G. ♀. pot, 2 inches
callistón.	Sw.G. graceful.	cor. pal. 7-9-lo. und. hair.	sal.	5. 9.	C. B. S.	—	G. ♀. wide, by 2 &
clárum.	Sw.G. clear white.	cor. 5-7-lo. und. tooth. pilo.	u.	5. 10.	Hybrid.	1826.	G. ♀. a half deep.
cuneifórum.	Sw.G. wedge-petaled.	cor. rug. lob. dent. pilo.	sc.	5. 9.	—	1825.	G. ♀. The pots are
carbasinum.	Sw.G. linen-flowered.	cor. flat, pal. 7-lo. hair. den.	sc.	3. 8.	—	1827.	G. ♀. filled with a
chærophyllum.	Sw.G. Cow-Parsley-l'd.	pinn. seg. ent. pub.	cr.	4. 8.	—	1822.	G. ♀. compost, con-
cartilagineum.	Sw.G. hoary-tooth'd.	orbi. cor. 3-lob. dent. plic.	re.	5. 10.	—	1824.	G. ♀. sisting of, 1
campylosépalon.	Sw.G. refl.-calyx.	cor. ren. sub-lo. den. glossy.	pu.	—	—	—	G. ♀. half of vege-
cosmiánum.	Sw.G. perfumed.	5-7-lo. und. plic. rig. den.	wh.	—	—	1821.	G. ♀. table mould,
conclásum.	Sw.G. shut-petaled.	pinnatif. hairy, dent.	d. red.	4. 10.	—	1823.	G. ♀. 1 half decay-
concrétum.	Sw.G. compounded.	cor. vill. 5-lob. und. dent.	sc.	4. 9.	—	1827.	G. ♀. ed leaves, 1
Charlwoódii.	Sw.G. Mr. Charlwood's.	cor. deeply lob. canes.	d. sc.	—	—	—	G. ♀. third of peat,
calocephalon.	Sw.G. pretty-headed.	flat, cor. 7-lob. hairy, den.	bh.	4. 8.	—	1820.	G. ♀. & 1 sixth of
Darnleyánum.	Sw.G. E. of Darnley's.	cord. acut. und. vill.	cr.	5. 10.	—	1826.	G. ♀. fine white
diversifólium.	Sw.G. different-ld.	cord. dent. vill.	pk. red.	6.	—	1794.	G. ♀. sand. Pre-
Dennisiánum.	Sw.G. Dennis's.	cor. reni. acu. und. dent.	pu.	4. 10.	—	1819.	G. ♀. vious to fill-
Daveyánum.	Sw.G. Davey's.	cor. ren. und. 5-lo. den. vill.	sc.	—	—	—	G. ♀. ing the pots,
divèrgens.	Sw.G. spreading-pet'd.	cor. acu. 5-7-lo. den. und. sm. li.	—	—	—	1826.	G. ♀. the compost
Dobreeánum.	Sw.G. Mrs. Dobree's.	pub. cor. obl. sinua. 5-7-lo.	sc.	—	—	1818.	G. ♀. is well mix-
Debúrghæ.	Sw.G. Mrs. Deburgh's.	cor. obt. 5-7-lob. und. den.	sc.	4. 9.	—	1827.	G. ♀. ed together.
diffórme.	Sw.G. various-leaved.	den. cor. ov. cunea. at ba.	bh.	5. 10.	—	—	G. ♀. The cuttings
dædánum.	Sw.G. various-col'd.	cord. und. 3-lob. hairy.	pk.	—	—	—	G. ♀. are inserted
dissímile.	Sw.G. dissimilar-lv'd.	ren. 5-lo. und. den. sm. re. li. ve.	—	—	—	1823.	G. ♀. by making a
Drákeæ.	Sw.G. Mrs. Drake's.	cor. ren. 3-5-lo. vill.	cr. v.	—	—	—	G. ♀. hole in the
depéndens.	Sw.G. pendant-petal'd.	3-lo. trun. at bas. hair. den.	w.	—	—	1823.	G. ♀. centre, and
dimacriafórum.	Sw.G. Dimacria-fl.	lac. in. pin. seg. den. 3-tooth.	sc.	4. 8.	—	1822.	G. ♀. after placing
elegántia.	elegant.	cor. serr. sub-und. smth.	pk. pu.	—	—	—	G. ♀. them in, the
eriosépalon.	Sw.G. woolly-calyxed.	cor. acu. 3-5-lob. den. vill.	bh.	—	—	1826.	G. ♀. hole is filled
extipulátum.	DC. soft trifid-lv'd.	trun. cor. 3-lo. den. wooll.	bh.	5. 10.	C. B. S.	1799.	G. ♀. up with white
eriocáuton.	Sw.G. woolly-stalked.	cor. 5-lob. plic. rug. dent.	sc.	4. 9.	Hybrid.	1820.	G. ♀. sand; the
erubéscens.	erubescens.	lob. den. vill. round at bas.	pk.	—	—	—	G. ♀. soil is then
eriphórum.	Sw.G. wool-bearing.	cor. rig. 5-lob. und. curl.	sc. re.	5. 10.	—	1828.	G. ♀. pressed close
exquisítum.	Sw.G. dainty-flw'd.	cor. 3-5-lob. hairy, den.	w. pu.	—	—	1824.	G. ♀. to each cut-
exornátum.	Sw.G. adorned.	orb. ren. und. den. bas. & ru. w.	—	—	—	1820.	G. ♀. ting, & they
erátinum.	Sw.G. lovely.	cor. acu. sub-tri. pub. den.	sc.	—	—	1827.	G. ♀. are watered;
fastuósum.	Sw.G. fastuous.	cor. 5-lob. smth. sub-pilo.	re. v.	—	—	1828.	G. ♀. they are then
Footiánum.	Ly. Harrington's.	cor. serr. lob.	pk.	—	—	1829.	G. ♀. plunged in a
fúlgidum.	DC. Celandine-lv'd.	trisect. seg. sess. ent. den.	sc.	3. 10.	C. B. S.	1823.	G. ♀. hot-bed
flámmeum.	flame-col'd.	cor. lob. pub.	sc.	4. 10.	Hybrid.	1822.	G. ♀. frame; no
flexuósum.	Sw.G. bent-stalked.	cord. ov. dent. hairy.	sc.	3. 10.	—	1821.	G. ♀. air is admit-
flæccidum.	Sw.G. flaccid-petaled.	cor. lob. und. hairy, den.	d. re.	4. 9.	—	1826.	G. ♀. ted for sece-
Foljámbeæ.	Sw.G. Mrs. Foljambe's.	cor. lob. und. den. pub.	re. pu.	5. 10.	—	1825.	G. ♀. ral days, but
fuscátum.	dark-marked.	flat. cor. sub-3 lob. den. vill.	ro.	—	—	1812.	G. ♀. they are
Fáirliæ.	Sw.G. Mrs. Fairlie's.	renif. 3-lob. und. dent.	ros.	—	—	1821.	G. ♀. shaded when

Systematic Name.	English Name.	Form of Leaves, &c.	Col. of Month of Flow.	Native of Fl. Country.	Yr. of Introd.	Soil and Propagation.
Fauxiæ.	Miss F. Faux's.	renif. serr. vill.	pk.st.	Hybrid.	1830.	G. S. requisite; as
Forsterianum.	Forster's.	cord. und. serr. pilose.	wh. vel.	—	1831.	G. S. soon as the
fiágrans. Sw. G.	burning.	cor. 3-lo. orb. vill. den. rug.	sc. 4. 9.	—	1827.	G. S. cuttings
flocósum. Sw. G.	nappy.	cor. 3-par. und. den. vill.	cr. —	—	1821.	G. S. push, air is
flabellifólium. Sw. G.	fan-leaved.	ren. den. vill. on both sid.	std. 5. 10.	—	1828.	G. S. admitted
Gordóniæ.	Duch. of Bedford's.	cor. lob. serr. vill.	d. pu.	—	1831.	G. S. freely. In 4
grandiflórum. DC.	great-flowered.	glau. smth. palm. 5-lob.	wh. —	C. B. S.	1794.	G. S. or 5 weeks,
gibbósum. DC.	knotted-stalked.	tern. glau. smth.	gr. —	—	1712.	G. S. these cut-
gigánteum.	gigantic.	renif. serr. und. vill.	pk. pu.	—	...	G. S. tings are re-
Gowéri. Sw. G.	Mr. L. Gower's.	cord. acut. lob. dent. vill.	pk. 5. 8.	Hybrid.	1825.	G. S. moved into
β <i>supérbum.</i>	<i>superb.</i>					larger pots,
Gloriánum. Sw. G.	Q. of Portugal's.	cor. 7-9-lo. und. hair. cren. cr. v	5. 10.	—	1828.	G. S. about 5 inch.
gravóloens. DC.	odour of Rose.	palm. 7-lob.	li. 3. 7.	C. B. S.	1774.	G. S. wide, by 6
β <i>variegata.</i>	<i>variegated-ly'd.</i>					deep; the
glaucifólium. Sw. G.	Glaucium-ly'd. tern.	pinnatif. glau.	da. 5. 10.	Hybrid.	1821.	G. S. same kind of
glabrécens. Sw. G.	smoothish-ly'd.	cord. renif. smth. dent.	w. pu.	—	1824.	G. S. compost is
grandidentátum. Sw. G.	large-tooth.	large, flabellif. dent.	w. pu.	—	1823.	G. S. used as be-
Gurneyánum. Sw. G.	Mr. Gurney's.	cune. 3-5-lo. den. smth.	d. re.	—	1826.	G. S. fore; the
Graftóniæ.	Duke of Grafton's.	cord. renif. serr. vill.	pk. vel.	—	1830.	G. S. plants are
gráphicum. Sw. G.	written-petaled.	ren. sub-3-lo. flat. den. hair. pu.	4. 6.	—	1826.	G. S. then plac'd in
Hilliánum. Sw. G.	Hill's.	cor. den. smth. sub-lob.	w. pu. 5. 10.	—	1828.	G. S. a cool frame,
Húmei. s. c.	Sir. A. Hume's.	ren. 5-lo. und. den. pub. da. re.	4. 10.	—	1824.	G. S. or removed
Hollandiánum.	Lord Holland's.	renif. serr. vill.	re. pk.	—	...	G. S. into the
Hoaréánum. Sw. G.	Fair Rosamond.	cor. ov. lo. rig. smt. den.	bh. pu. 5. 10.	—	1818.	G. S. Greenhouse,
Husseyánum. Sw. G.	Lady Hussey's.	cord. 5-lob. dent.	pur. 4. 8.	—	—	G. S. where they
heteromállum. Sw. G.	soft-leaved.	cor. ren. 5-7-lob. den. vill.	re. 4. 10.	—	1823.	G. S. will come in-
hæmastíctum. Sw. G.	blood-spotted.	cor. acu. 5-7-lob. und. den.	bh. 5. 10.	—	1827.	G. S. to bloom, ear-
Hammersléiæ. Sw. G.	Mrs. Hammersley's.	cor. ren. lob. den.	bh. 4. 9.	—	1822.	G. S. ly in March
heterotríchum. s. c.	unequal-hair'd.	cor. sub-5-lob. vill. den.	d. re.	—	1823.	G. S. following.
heracleifólium. Sw. G.	Heracleum-ld. obl. lacin. upp. pinnatif.	br. 5. 10.	C. B. S.	1820.	G. S. "About the	
Harewódiæ. Sw. G.	Ly. Harewood's.	cor. lo. smth. den. edg. cil. d. re.	—	Hybrid.	1826.	G. S. end of Sep-
instrátum. Sw. G.	spread.-spotted.	renif. dent. 5-lob. hair.	w. vel.	—	1828.	G. S. tember, ano-
inscúlpum. Sw. G.	engraved-petal'd.	cor. renif. dent. pilos.	li. pu.	—	—	G. S. ther succes-
implicátum. Sw. G.	implicated.	orb. renif. soft. pilos. den.	pu.	—	1827.	G. S. sion of cut-
involverátum. Sw. G.	large-bracted.	cord. rig. angul. dent.	va.	—	—	G. S. tings is put
β <i>máximum.</i>	<i>largest-flow'd.</i>					in, & treated
ignéscens. Sw. G.	fiery-flowered.	cor. 3-lob. seg. sid. 1's. bif.	sc. 5. 9.	—	1812.	G. S. as the others
1. <i>májor.</i>	<i>large-flowered.</i>	sc.	—	...	G. S. were; but
2. <i>minor.</i>	<i>small-flowered.</i>	sc.	—	...	G. S. when the
imperiale. Sw. G.	imperial.	cord. renif. 5-lob.	d. re. 4. 10.	—	1826.	G. S. plants are
icónicum. Sw. G.	figured.	cor. sub-5-lob. den. cil.	sc. bk. 5. 10.	—	1828.	G. S. about 10 in.
insígnitum. Sw. G.	marked-flow'd.	cord. lob. dent. pub.	d. sc. 4. 10.	—	1823.	G. S. high, the ends
incarnátum. Sw. G.	pale-flesh-col'd.	cor. 3-5-lob. den. hairy.	fl.	—	1821.	G. S. of the shoots
incanécens. Sw. G.	whitish-ly'd.	cor. 5-lo. den. canes. pub.	pu. 6. 12.	—	—	G. S. are pinched
intertéxtum. Sw. G.	interwoven.	ov. obt. lacinat. or tern.	sc. 4. 8.	—	1822.	G. S. off; this
inscriptum. Sw. G.	scribbled.	cord. sub-lob. und. den.	std. 5. 10.	—	—	G. S. causes them
jatrophæfólium. DC.	Jatropha-ly'd.	palm. smth. lob. lanc. pinn.	fl. 4. 9.	—	1820.	G. S. to push a
Jenkinsóni. Sw. G.	Jenkinson's.	cor. lo. den. upp. ov. acu.	d. bh. 5. 10.	—	—	G. S. number of la-
Kíngii. Sw. G.	Mr. King's.	cor. trif. vill. seg. 3-lob. den. sc.	3. 12.	—	1822.	G. S. teral branch-
Knípæa. Sw. G.	Mr. Knipe's.	cor. sub-lo. den. rug. pilos.	li. 4. 10.	—	1826.	G. S. es, & makes
Kenríckæ. Sw. G.	Mrs. Kenrick's.	cor. 7-lo. canes. hair. den. re. re.	5. 10.	—	1828.	G. S. the plants
latidentátum. Sw. G.	broad-toothed.	cor. 5-7-lob. dent. pubes.	sc. 4. 9.	—	1827.	G. S. bushy; these

Systematic Name.	English Name.	Form of Leaves, &c.	Col. of Flow.	Month of Fl.	Native Country.	Yr. of Introd.	Soil and Propagation.
lanceolatum.	lance-leaved.	lanc. smth. ent.	wh.	6. 8.	C. B. S.	1775.	G. ♀. flower early
lasiocaulon. Sw.G.	villous-stalked.	cord. lob. und. dent.	bh.	4. 10.	Hybrid.	1826.	G. ♀. in May.
laxiflorum. Sw.G.	spread-umbell'd.	cor. 5-lo. und. den. smth. rig. sc.	5. 9.	—	—	1822.	G. ♀. "Early in
lucidum. Sw.G.	glossy-leaved.	cor. 5-lob. den. shin. abov.	bh.	5. 10.	—	1826.	G. ♀. January, a
latilobum. Sw.G.	broad-lobed.	flat, 5-7-lob. dent. pubes.	sc.	3. 9.	—	1823.	G. ♀. third stock
Londonianum. Sw.G. Mr. Loudon's.		cor. acu. many-lob. den.	d. sc.	5. 9.	—	1827.	G. ♀. of cuttings
laxulum. Sw.G.	loose-umbell'd.	ren. cor. 3-lo. und. pil. den. re. r. 5. 10.	—	—	—	1828.	G. ♀. is put in ;
Littleanum. Sw.G. Little's.		cor. renif. sub-5-lo. den.	pu. li.	—	—	1827.	G. ♀. these are,
lanosum. Sw.G.	wool-bearing.	cord. flat, densely wooll.	li. ve.	—	—	1828.	G. ♀. also, stopped
laetum. Sw.G.	genteel.	cor. 3-lo. hair. shin. den.	pk. pu.	—	—	1827.	G. ♀. at 10 inches
Leghkeckæ. Sw.G. Mrs. Leghkeck's.		cor. 5-7-lo. und. den. pub.	sc.	4. 9.	—	1826.	G. ♀. high. The
lasiophyllum. Sw.G. woolly div. -lv'd.		cord. pinn. lobes ent.	sa.	—	—	1825.	G. ♀. plants are
Lawranceanum. Sw.G. Mrs. Kears's.		cor. sub-7-lo. cre. hair.	d. pu.	5. 10.	—	1824.	G. ♀. kept in a cool
Lacóniæ. Sw.G. Lady Lacon's.		rough, sub-3-lo. den. hair. d. sc.	4. 9.	—	—	1826.	G. ♀. and airy si-
lomonium. Sw.G.	Lemon-scented.	cor. 3-5-lob. crisp. den.	pu.	4. 8.	—	1823.	G. ♀. tuation, from
Lousadianum. Sw.G. Miss Lousada's.		cord. 3-lob. seg. lob. den.	bh.	5. 10.	—	1819.	G. ♀. the first of
latifolium. Sw.G.	broad-leaved.	renif. large dent. pilos.	red.	—	—	1824.	G. ♀. May to July,
lèpidum. Sw.G.	pretty.	cord. 5-lob. und. hairy.	li.	—	—	1822.	G. ♀. and are then
labyrinthicum.	labyrinth-mark'd.	pinn. ellip. pub.	std.	5.	—	—	G. ♀. taken into
Moreanum. Sw.G. More's Victory.		cor. pinnatif. hairy. den.	sc.	5. 9.	—	1823.	G. ♀. the houses to
magnifolium. Sw.G.	very large-lv'd.	cor. ren. sub-5-lo. den. hair. re.	4. 9.	—	—	1827.	G. ♀. bloom, which
Murrayanum. Sw.G. Ld. J. Murray's.		cor. 5-lob. und. den. hair.	bh.	4. 8.	—	1818.	G. ♀. they will do,
β superbum.	superb.	sc.	—	—	G. ♀. to the end of
mixtum. Sw.G.	mixed.	cor. 5-lo. und. plic. den. rig.	bh.	5. 8.	C. B. S.	1819.	G. ♀. September.
Mattocksianum. Sw.G. Mrs. Sweet's.		3-lob. hair. lob. acut. den.	wh.	5. 10.	Hybrid.	1823.	G. ♀. "In March,
modestum. Sw.G.	modest.	cor. 3-lob. und. den. hair.	bh.	—	—	1822.	G. ♀. a fourth lot
melissinum. Sw.G.	Balm-scented.	cord. 5-lob. und. dent.	da.	4. 8.	—	1818.	G. ♀. of cuttings
melanostictum. Sw.G.	large-spotted.	cord. sub-5-lob. den. vill.	li.	5. 10.	—	1827.	G. ♀. is put in ;
mündulum. Sw.G.	Spruce.	pinn. canes. leaf. 2-3-clef.	sc.	3. 10.	—	1823.	G. ♀. these, after
macranthos. Sw.G.	large-flow'd.	renif. 5-lob. dent. hair.	wh.	5. 10.	—	1821.	G. ♀. being stop-
malancholicum. Sw.G.	dark-edged.	cor. 5-lob. und. den. vill.	sc. re.	—	—	1827.	G. ♀. ped, will
malacophyllum. Sw.G.	soft-leaved.	orb. renif. und. den. hair.	pu.	—	—	1825.	G. ♀. push shoots,
magnistipulatum. Sw.G.	large-stipuled.	pinnatif. pilose.	sc.	—	—	—	G. ♀. which, when
mirabile. Sw.G.	admirable.	cord. 3-lob. dent. hair.	li. ve.	—	—	1827.	G. ♀. they have got
malachrafolium. Sw.G. Malachra-ld.		cor. ren. or sub-5-lob. vill.	re.	4. 9.	—	—	G. ♀. 6 inch. long,
mollifolium. Sw.G.	soft-leaved.	ren. acu. 5-lo. pilo. soft.	pk. ve.	5. 10.	—	—	G. ♀. are also stop-
Milleri.	Mr. Miller's.	cord. 5-lob. dent. vill.	red.	—	—	1824.	G. ♀. ped. These
megalanthum. Sw.G.	grand-flow'd.	orb. ren. und. sm. abo. den.	re.	—	—	1826.	G. ♀. plants are
megaleion. Sw.G.	magnificent.	cor. acu. sub-7-lo. sm. den.	sc.	—	—	—	G. ♀. kept in a
multiradiatum. Sw.G.	many-rayed.	pin. seg. pinnatif. obl. den.	da.	6. 10.	C. B. S.	1818.	G. ♀. cool, airy si-
mucronatum. Sw.G.	mucronate.	cor. 5-lob. deeply tooth. smth.	—	—	Hybrid.	1823.	G. ♀. tuation, from
megalostictum.	large-marked.	orb. renif. und. dent. vill. d. pu.	—	—	—	1824.	G. ♀. the end of
nervosum. Sw.G.	strong-nerved.	ren. 5-lo. conc. den. pub. pk. re.	—	—	—	—	G. ♀. May, to Sep-
norfordium.	Norford's.	cord. lob. serr. vill.	pk.	—	—	1830.	G. ♀. tember, and
nubilum. Sw.G.	clouded.	cor. 5-7-lo. acu. flat, den.	d. bl.	5. 10.	—	1827.	G. ♀. are then ta-
nütans. Sw.G.	nodding-flow'd.	cor. palm. 7-lo. und. den. pil.	sc.	—	—	—	G. ♀. ken into the
nodosum. Sw.G.	knotted-stalked.	pinnatif. upp. pinn. alt.	cr. re.	4. 11.	—	1824.	G. ♀. houses, and
notatum. Sw.G.	marked-petaled.	cor. acu. 3-lo. scabr. den.	pu.	5. 10.	—	1821.	G. ♀. will bloom
Nairnii. Sw.G.	Nairn's.	cord. 5-lob. und. dent.	d. re.	—	—	1825.	G. ♀. till Decem-
Newshamianum. Sw.G. Miss Newsham's.		cor. 3-lob. dent. hairy. bh.	—	—	—	1821.	G. ♀. ber, or later.
nänum. Sw.G.	pigmy.	cor. 3-lo. obtuse. den. hair.	sc.	5. 9.	—	1820.	G. ♀. —
obcordatum. Sw.G.	obcord-petaled.	cord. obl. 7-lob. hairy.	sc.	—	—	1823.	G. ♀. —

Systematic Name.	English Name.	Form of Leaves, &c.	Col. of Month of Fl.	Native Country.	Yr. of Introd.	Soil and Propagation
Obrienianum.	Sw.G. Miss O'Brien's.	cor. renif. cucull. vill. den.	bh. 5. 9.	Hybrid.	1827.	G. sp. ———
obtusidentatum.	Sw.G. blunt-tooth'd.	cor. lob. cucull. und. den.	sc. 5. 10.	———	1828.	G. sp. ———
politum.	Sw.G. polished.	renif. 3-5-lo. und. hair.	bh. re. ———	———	1827.	G. sp. ———
præclarum.	Sw.G. clear-coloured.	cor. ov. acut. lob. den.	wh. pu. ———	———	———	G. sp. ———
Peytoniæ.	Sw.G. Lady Peyton's.	cord. renif. 7-9-lob.	re. ve. ———	———	———	G. sp. ———
pûrum.	Sw.G. pure-white.	cord. dent. rigid. pubes.	wh. ———	———	1824.	G. sp. ———
porphy'reon.	Sw.G. bright-purple.	cor. renif. sub-5-lob. hair.	pu. ———	———	1828.	G. sp. ———
psilophyllum.	Sw.G. smooth-lv'd.	cor. renif. lob. den. smth.	red. ———	———	1825.	G. sp. ———
pulcherrimum.	Sw.G. beautiful.	ren. trun. at bas. sub-lo. den. p.	———	C. B. S.	1819.	G. sp. ———
<i>β superbum. superb.</i>						
pavonium.	Sw.G. Peacock-spott'd.	cord. 5-lob. dent. pub.	red. 4. 9.	Hybrid.	———	G. sp. ———
Princeanum.	Sw.G. Prince's.	cor. deep. lob. pub. den.	wh. 5. 10.	———	1827.	G. sp. ———
Pullaceum.	Sw.G. dark-brown.	cor. ov. acu. sub-5-lo. den. pil.	———	———	———	G. sp. ———
paucidentatum.	Sw.G. distant-tooth.	cord. 3-lob. und. dent.	pu. ———	———	1821.	G. sp. ———
plectophyllum.	Sw.G. plaited.	cord. 7-9-lob. dent.	d. sc. 4. 9.	———	1826.	G. sp. ———
Prestonii.	Preston's.	renif. dent. lob. vill.	pk. re. 6.	———	1829.	G. sp. ———
Potteri.	Sw.G. Potter's.	cor. trif. seg. lob. den. hair.	st. 6. 9.	———	1822.	G. sp. ———
<i>β superbum. superb.</i>						
poculifolium.	Sw.G. cup-leaved.	orb. ren. cucull. den. vill.	pu. 4. 10.	———	1826.	G. sp. ———
Peëlii.	Sir Robert Peel's.	cord. lob. vill.	d. pu. ———	———	1829.	G. sp. ———
principissæ.	Sw.G. Prin. Charlotte's.	cor. ren. sub-lob. den. hair.	pu. ———	———	1810.	G. sp. ———
Palkii.	Sw.G. Mr. Palk's.	flat. cor. 3-lob. den. hair.	cr. 1. 12.	———	1822.	G. sp. ———
platypetalon.	Sw.G. broad-pl.	cor. lob. den. upp. cuneat.	wh. 5. 10.	———	1812.	G. sp. ———
picturatum.	Sw.G. pictured.	cord. 3-lob. den. hairy.	d. bh. ———	———	1827.	G. sp. ———
platanifolium.	Sw.G. Plane-leaved.	cord. acut. 5-lob. serr.	li. ———	———	1824.	G. sp. ———
pûlchrum.	Sw.G. gay.	renif. slightly lob. dent.	pu. ———	———	1820.	G. sp. ———
perâmplum.	Sw.G. very large-fl'd.	orbic. renif. dent. smth.	li. ———	———	1826.	G. sp. ———
pallidulum.	Sw.G. pale-pink.	cord. vill. 3-5-lob. acut.	pk. ———	———	1828.	G. sp. ———
pentastictum.	Sw.G. five-marked.	pinnatif. tern. hair. dent.	bh. ———	———	1824.	G. sp. ———
papyraceum.	Sw.G. Paper-white.	cuneat. 5-7-lob. und. den.	wh. ———	———	1827.	G. sp. ———
Percyanum.	D. of Northumb.	cord. lob. dent. vill.	d. re. ———	———	1829.	G. sp. ———
phœniceum.	Sw.G. reddish-purple.	orb. ren. und. rig. den. vill.	d. re. 4. 12.	———	1824.	G. sp. ———
pyrethriifolium.	Sw.G. Feverfew-ld.	cor. palm. bipinnatif. hair.	sc. 5. 9.	———	1821.	G. sp. ———
pectinifolium.	Sw.G. Scallop-shell-ld.	renif. 3-lob. plicate.	li. 5. 10.	———	1820.	G. sp. ———
polytrichum.	Sw.G. many-haired.	cord. 5-7-lob. pilose. den.	wh. ———	———	1823.	G. sp. ———
pedicellatum.	Sw.G. long-pediced.	cord. 5-7-lob. smth. dent.	vi. ———	C. B. S.	1822.	G. sp. ———
Queenii.	Queen's.	cor. 5-6-lob. und. vill. den.	sc. ———	Hybrid.	1830.	G. sp. ———
quercifolium.	dc. Oak-leaved.	cor. pinnatif. lob. obt. cren.	bh. 3. 8.	C. B. S.	1774.	G. sp. ———
<i>β superbum. superb.</i>						
quinquevulnerum.	s. g. dark-flow'd.	tern. bipinn. seg. lin. den.	da. 5. 10.	Hybrid.	1796.	G. sp. ———
quadriflorum.	Sw.G. four-flowered.	cord. 3-part. rug. pubes.	or. 4. 9.	———	1824.	G. sp. ———
rutaceum.	Sw.G. Rue-like.	pinn. glau. leaf. pinnatif.	da. 5. 10.	———	1823.	G. sp. ———
Rollisonii.	Sw.G. Rollison's.	ren. 3-5-lo. den. und. pub.	d. r. ———	———	1826.	G. sp. ———
ramigerum.	Sw.G. branch-veined.	cord. acut. 3-lob. den. cil.	sc. 1. 12.	———	———	G. sp. ———
rubescens.	Sw.G. Ly. Liverpool's.	cord. 5-lob. und. soft.	red. 4. 9.	———	1819.	G. sp. ———
rhodopetalon.	Sw.G. rosy-petaled.	cor. 5-7-lo. und. den. smth.	ro. 5. 10.	———	1826.	G. sp. ———
recurvifolium.	Sw.G. recurved-lv'd.	cord. acut. lob. dent. vill.	wh. ———	———	1825.	G. sp. ———
règium.	Sw.G. Kingly.	cor. acut. den. 5-lob. pilo.	sc. 4. 10.	———	1826.	G. sp. ———
rotundilobum.	Sw.G. round-lobed.	cor. 5-lob. den. soft. vill.	sc. 3. 9.	———	1823.	G. sp. ———
Russellianum.	Sw.G. Russell's.	cord. acut. 5-lob. und.	sc. 4. 9.	———	1826.	G. sp. ———
RéxSandvichiarum.	K. of the Sandw. Isles.	cor. near. smth.	d. bh. ———	———	1829.	G. sp. ———
Richianum.	Sw.G. Mr. Rich's.	cord. 5-lob. und. dent.	bh. 5. 10.	———	1826.	G. sp. ———

Systematic Name.	English Name.	Form of Leaves, &c.	Col. of Flow.	Month of Fl.	Native Country.	Yr. of Introd.	Soil and Propagation.
recurvatum, Sw.G.	recurv.-petal'd.	flat, cor. obl. 3-5-lo.	den. pub. w.	7.	Hybrid.	1828.	G. ♀
ringens.	ringent-flow'd.	pinnatif. seg. dent.	pubes.	sc. 3. 10.	—	1823.	G. ♀
Regina Scótica.	Mry. Q. of Scot's.	cord. und. serr.	vill.	sc. ve.	—	1830.	G. ♀
Southcotéanum, Sw.G.	Miss Southcote's.	cor. 5-lo. plait.	den. vill.	sc. 4. 9.	—	1826.	G. ♀
Smithii, s.G.	Smith's.	cord. und. serr.	re.	—	—	1819.	G. ♀
suffusum, Sw.G.	suffused.	orb. cor. sub-5-lo.	und. den. pk. 5. 10.	—	—	1827.	G. ♀
sphærocéphalon, Sw.G.	round-head.	cord. sinuat. lob.	—	sc. 5. 9.	—	1824.	G. ♀
solúbile, Sw.G.	dissolvable-col'd.	orbi. reni. conc. den. pilo.	pu.	5. 10.	—	1818.	G. ♀
schizapétalon, Sw.G.	divid.-petaled.	tern. trif. obl. obt. hairy.	y. br.	6. 10.	C. B. S.	1821.	G. ♀
Seymóiriae, Sw.G.	Mrs. Seymour's.	cor. 3-lob. und.	den. pilo.	pu. 5. 10.	Hybrid.	1819.	G. ♀
spectabile, Sw.G.	shewy.	cor. und. sub-lo.	deep. den. pub.	4. 9.	—	1821.	G. ♀
saturatum, Sw.G.	saturated.	5-lo. und. acu. sharp.	tooth. d. r.	4. 10.	—	1827.	G. ♀
Stewartii, Sw.G.	Mrs. Stewart's.	cor. 5-lo. und. obt.	den. vill. d. s.	4. 9.	—	1825.	G. ♀
Scarboróvia, Sw.G.	Ly. Scarboro's.	deep. 3-lo. smth.	den. rig. d. li.	5. 10.	—	1817.	G. ♀
striatum, Sw.G.	streak-flowered.	cord. 5-lob. dent.	pubes.	bh. 3. 8.	—	1818.	G. ♀
sanguineum, Sw.G.	crimson.	smth. apex recur.	seg. den. cr.	4. 8.	C. B. S.	1819.	G. ♀
speculum, Sw.G.	Looking-Glass.	orb. ren. sub-cucul.	den. pil. cr.	5. 10.	Hybrid.	1827.	G. ♀
succulentum, Sw.G.	succulent-lv'd.	cor. 3-lo. flat.	den. fring. sc. ve.	—	—	—	G. ♀
Scóttii, Sw.G.	Sir C. Scott's.	cor. 5-lo. und. plic.	hair. den. sc.	3. 9.	—	1822.	G. ♀
Saundersii, Sw.G.	Saunder's.	trun. 3 lo. flat, sm.	abo. den. pu.	5. 10.	—	1821.	G. ♀
salebrósum, Sw.G.	rugged-leaved.	cor. 5-lob. trun. obt.	rug. d. pu.	—	—	1824.	G. ♀
signatum, Sw.G.	marked.	cor. obl. acut. 5-7-lo.	pub. re.	4. 10.	—	1822.	G. ♀
Stamfordiæne.	Lady Stamford's.	cord. serr. smth.	wh. st.	—	—	—	G. ♀
Sweetianum, Sw.G.	Sweet's.	cord. lob. very soft.	cr. ve.	5. 10.	—	1829.	G. ♀
inctum, Sw.G.	stained.	cor. acu. 5-7-lo.	hair. den. w. p.	—	—	1826.	G. ♀
Fibbitsianum, Sw.G.	Mr. Tibbit's.	cor. 3-lob. und.	vill. dent.	sc. 4. 9.	—	1821.	G. ♀
orefactum, Sw.G.	burnt-petaled.	cor. obt. 5-7-lo.	pub. dent.	da. 4. 8.	—	1822.	G. ♀
ranslúens, Sw.G.	transparent.	cord. und. 7-lo.	dent. hair.	sc. 4. 9.	—	1826.	G. ♀
ortúsum, Sw.G.	twoisted-petaled.	cor. sub-7-lo. flat.	und. den. li.	3. 8.	C. B. S.	—	G. ♀
ryanthinum, Sw.G.	twisted-purple.	cor. 5-lo. flat.	den. hairy.	pu. 5. 10.	Hybrid.	1820.	G. ♀
Thynneæ, Sw.G.	Lady Bath's.	renif. 3-lob. flat.	rig. den. pu.	—	—	1815.	G. ♀
ursinum, Sw.G.	shaggy-calyxed.	cor. acu. densely haired.	re.	—	—	1828.	G. ♀
undulæflórum, Sw.G.	wave-flow'd.	cor. 5-lo. acut.	den. pilos.	bh.	—	1824.	G. ♀
urbánum, Sw.G.	home-bred.	orbic. renif. den. hairy.	pk.	—	—	1828.	G. ♀
villósum, Sw.G.	villous.	orb. trun. at base.	den. vill. pu.	—	—	1824.	G. ♀
eníferum, Sw.G.	veined-petaled.	ov. cor. und. den. pilos.	std.	4. 10.	—	1825.	G. ♀
iscosissimum, Sw.G.	viscous.	palm. 5-7-lob. seg.	lanc. bh.	3. 8.	C. B. S.	1820.	G. ♀
Victória, Sw.G.	Prin. Victoria's.	renif. deeply 3-lob.	dent. sc.	6. 10.	Hybrid.	1826.	G. ♀
estifium, Sw.G.	clothed.	renif. dent. soft, hairy.	wh.	5. 10.	—	1827.	G. ♀
estrisianum, Sw.G.	Madm. Vestris's.	cord. lob. serr. vill.	li. ve.	—	—	1830.	G. ♀
Veitchianum, Sw.G.	Veitch's.	ren. sub-5-lob.	rug. pilo. pu.	—	—	1827.	G. ♀
olatiflorum, Sw.G.	flying-flow'd.	3-part. pub. seg. dent.	sc.	4. 8.	—	1823.	G. ♀
erecúndum, Sw.G.	blushing.	cor. den. 5-lob. pub.	flesh. pk.	5. 10.	—	1824.	G. ♀
enústum, Sw.G.	comely-flow'd.	renif. sub-lob. den. hairy.	bh.	—	—	1822.	G. ♀
Vatsónia, Sw.G.	Watson's.	cor. orbic. lob. den. cren.	pu.	7. 11.	—	1812.	G. ♀
Vellsianum, Sw.G.	Wells's.	cor. 5-lob. obt. den. pilo.	sc.	3. 8.	—	1822.	G. ♀
óungii, Sw.G.	Young's.	cor. 3-lo. flat.	den. hairy. w. ve.	5. 10.	—	1820.	G. ♀
eatmannianum, Sw.G.	Miss Yeatman's.	reni. sub-5-lo. pilo.	pu. ve.	—	—	1827.	G. ♀
arbúrgíi, Sw.G.	Ld. Yarborough's.	cord. cucull. vill. dent.	re.	—	—	1830.	G. ♀
ngiberinum, Sw.G.	Ginger-scent'd.	renif. 5-lob. dent. hairy.	bh.	4. 7.	—	1826.	G. ♀

Systematic Name.	English Name.	Form of Leaves, &c.	Col. of Month Flow. of Fl.	Native Country.	Yr. of Intro.	Soil and Propagation.
Aurora.	Duchess of Wellington.	Lady Mansfield.				Princess Augusta.
Brown's Lady Gore.	Duke Nicolas.	Lady Bagot.				Palus.
Blue formosum.	De Vere.	Lady Maryborough.				Queen of Wirtemburgh.
Basilisk.	Devonia.	Lady Wriothesley Russell.				Reuben Apsley.
Belvidera.	Effie Deans.	Lord Combermere.				Russell's Queen Adelaide.
Bathsheba.	Fanny Kemble.	Lord Brougham.				Robinson Crusoe.
Countess of Plymouth.	Fair Helen.	Lord Cochrane.				Rosa brillante.
Cyrella.	General Riego.	Lady Georgiana Russell.				Sydney.
Dennis's King William.	Harlequin.	Lady Grenville.				Sophonium.
—— Queen Adelaide.	Imperatrice.	Lady Ravensworth.				Tippoo Saib.
Duchess of Clarence.	Juliet.	Marmion.				Turner's Queen Adelaide.
—— of St. Alban's.	John Bull.	Nimrod.				Venus.

PHYMATANTHUS, PHYMATANTHUS. *Cal. 5-part. Pet. uneq. Stam. short.* [sterile 5, and erect, 5 fertile, recurved, tricolor. Sw.G. three-coloured. lan.cut,or tooth.vill.caues.w. 6.10. C. B. S. 1791. G. S. ———

CAMP'YLIA, CAMP'YLIA. *Cor. of 5 uneq. pets. 2 upp. ones orbi. Filam. 10. Ger. vill. Stig. 5, reflex.*
élegans. Sw.G. elegant. obl.ellip.und.serr.silky. *bh.* 6. 9. Hybrid. 1822. G. S. Sandy loam,
holosericea. Sw.G. silky-leaved. ov.orb.hair.on both.sid.den. 4. 9. ——— 1820. G. S. & leaf mould.
verbasciflora. Sw.G. Verbascum-fld. orbic. und. den. downy. *li.* 6. 9. C. B. S. 1811. G. S. cuttings,
variegata. Sw.G. variegated. ov.und.den.apex.trun. *va.* 4. 9. Hybrid. 1823. G. S. or seeds.

SEYMOURIA, SEYMOURIA. *Cal. 5-clef. seg. lin. Pet. 2, lanc. notch. at ape. refl. Fil. 5. Stig. 5, revo.*
asarifolia. Sw.G. Asarum-leaved. orb.cor.obt.ent.ciliat. *d.pu.* 11. 2. C. B. S. 1821. G. P. ———

HOA'REA, HOA'REA. *Cal. 5-cleft. Pet. 5, the 2 upp. lanc. Fil. 10, united, 5-ster. & 5-ferti. Stig. 5.*
atrosanguinea. Sw.G. dk. crim.-col'd. pinn.leafl.opp.ov.alt.cil. *cr.* 4. 8. Hybrid. 1822. G. P. ———
Colvillii. Sw.G. Colvill's. tern.pinnati.hair.lea.2-lo. *cr.* ——— 1823. G. P. ———
carinata. Sw.G. boat-flowered. bipinn.hair.leafl.pinnatif. *ye.* 5. 8. C. B. S. 1812. G. P. ———
coluteæfolia. Sw.G. Colutea-lv'd. ov. obt. hair. upp. pinn. *cr.* 4. 8. Hybrid. 1823. G. P. ———
rosea. Sw.G. rose-coloured. lacin.lob.obt.dent.pub. *ro.* ——— C. B. S. 1792. G. P. ———

JENKINSONIA, JENKINSONIA. *Cal. 5-cleft. Pet. 4, the 2 upper ones twice the size of the under.* [Filam. 10. Stig. 5.

quinata. Sw.G. quinate-leaved. alt.5-par.upp.lea.3-den. *st.* 5. 6. C. B. S. 1793. G. S. ———
Synnotii. Sw.G. Mr. Synnot's. ter.pinnatif.pilo.seg.den. *pu.* 6. 8. ——— 1825. G. P. ———
tetragona. Sw.G. square-stalked. cor.renif.5-lob.den.hair. *li.* 5. 8. ——— 1774. G. S. cl. ———

CIC'ONIUM, CIC'ONIUM. *Cal. 5-cleft. Pet. 5, uneq. Stam. erect, 6-7 of them bearing anth. Ger. vill.*
Fothergillii. Sw.G. Fothergill's. renif.5-lob.cren.downy. *sc.* 5. 10. C. B. S. G. S. ———

ORDER V.

OCTANDRIA. STAMENS 8.

Systematic Name.	English Name.	Form of Leaves, &c.	Col. of Flow.	Month of Fl.	Native Country.	Yr. of Introd.	Soil and Propagation.
<i>AITONIA</i> , <i>AITONIA</i> .	<i>Cal. 4-parted. Pet. 4. Sty. 1. Berr. 4-sided, of 1 cell, many-seeded.</i>						
<i>capensis</i> . B.M.	Cape.	in clusters, lan. smth.	pk.	5.	C. B. S.	1774.	G. Σ . Sandy loam and peat. cuttings.

ORDER VI.

DECANDRIA. STAMENS 10.

<i>CANAV'ALIA</i> , <i>CANAV'ALIA</i> .	<i>Cal. tubul. 2-tipped. Vexill. large wing stalked, obl. Legu. compr.</i>						
<i>bonariensis</i> . B.R.	Buenos Ayres.	pinn. leaf. ov. obt. smth.	pu.	7. 8.	B. Ayres.	1826.	G. Σ . cl. ———
[Fruit beaked, of 5 capsu. each tipp. with a long naked awn.]							
<i>GERANIUM</i> , <i>CRANE'S-BILL</i> .	<i>Cal. of 5 conc. leav. Pet. 5, equ. Nect. 5 glands. Fil. unit. at the base.</i>						
<i>aconitifolium</i> . DC.	Aconite-leaved.	pelt. 7-part. lobes cut.	wh.	6. 8.	Switzerl.	1775.	H. Φ . Sandy soil.
<i>angulatum</i> . DC.	angular-stalked.	7-lob. seg. ov. lob. dent.	std.	————	————	1789.	H. Φ . seeds, or
<i>argenteum</i> . Sw.G.	silvery.	5-7-part. lob. 3-fid. silky.	bh.	6. 7.	S. Europ.	1669.	H. Φ . parting at
<i>anemonifolium</i> . DC.	Anemone-lv'd.	palm. seg. bipinnatif. smth.	pu.	5. 8.	Canaries.	1778.	G. Σ . the root.
<i>columbinum</i> . E. Fl.	long-stalked.	5-part. lob. in many seg.	li.	6. 7.	Britain.	H. Φ . ———
<i>disséctum</i> . Br. Fl.	jagged-leaved.	5-part. lob. trif. hairy.	li.	5. 7.	————	H. Φ . ———
<i>ibericum</i> . DC.	Iberian.	5-7-part. lobes ent.	bl.	6. 9.	Iberia.	1802.	H. Φ . ———
<i>lucidum</i> . E. B.	shining.	renif. 5-lob. trif. smth.	ro.	5. 8.	Britain.	H. Φ . ———
<i>molle</i> . E. Fl.	soft.	orb. many-lob. downy.	re. pu.	4. 8.	————	H. Φ . ———
<i>maculatum</i> . DC.	spotted.	3-5-part. cut, dent.	bh.	5. 8.	N. Amer.	1774.	H. Φ . ———
<i>nodosum</i> . E. Fl.	knotty.	opp. 3-5-lob. acut. serr.	pu.	5. 10.	Britain.	H. Φ . ———
<i>ph'æum</i> . E. B.	dusky.	palm. 3-7-lob. serr. down.	pu.	4. 6.	————	H. Φ . ———
<i>pratense</i> . DC.	crow-foot-lv'd.	pinnatif. lobes multipart.	bl.	5. 7.	————	H. Φ . ———
<i>pyrenæicum</i> . E. B.	mountain.	ren. lo. seg. obl. trif. den.	pu.	5. 8.	————	H. Φ . ———
<i>pusillum</i> . E. B.	small-flowered.	ren. palm. lob. trif. downy.	pu.	————	————	H. Φ . ———
<i>rotundifolium</i> . E. Fl.	round-leaved.	ren. down. cut.	<i>Pedun. 2-fl. cr.</i>	6. 7.	————	H. Φ . ———
<i>sylvaticum</i> . E. Fl.	wood.	7-lob. cut & serr. hairy.	pu.	5. 6.	————	H. Φ . ———
<i>sanguineum</i> . E. B.	bloody.	opp. orb. 6-7-lo. seg. trif.	cr.	6. 9.	————	H. Φ . ———
<i>Wallichianum</i> . Swt.	Wallich's.	5-lob. seg. 3-lob. den. vill.	ro.	————	Nepaul.	1820.	H. Φ . ———

BROWNIA, *BROWNIA*. *Cal. bifid, tubul. Cor. double, outer 5-cleft, inner of 5 petals.*

<i>coccinea</i> . DC.	scarlet-flow'd.	pinn. lea. ov. ent. Br. smth. sc.	7. 8.	W. Ind.	1793.	S. Σ . Loam & peat. cuttings.
-----------------------	-----------------	-----------------------------------	-------	---------	-------	--------------------------------------

ORDER VII.

DODECANDRIA. STAMENS FROM 12 TO 20.

Systematic Name.	English Name.	Form of Leaves, &c.	Col. of Flow.	Month of Fl.	Native Country.	Yr. of Introd.	Soil and Propagation.
[Caps. 5, 2-celled, many-seeded.							
<i>DOMBE'YA, DOMBE'YA.</i> Cal. 5-parted. Involu. of 3 leaves. Pet. 5. Stam. 15-20, 5 of them sterile.							
angulàta. B.M.	angular-leaved.	cor.acum.serr.smth.	pub.	ro.	4. 7. Maurit.	1826.	S. $\frac{S}{S}$. Loam, peat,
ferrugínea. DC.	rusty.	ov.obl.7-ner.sub.cor.pel.ach.	—	—	—	1815.	S. $\frac{S}{S}$. & leaf mould.
tomentòsa. DC.	hairy.	cor.subrot.acum.ner.cren.	Madagas.	1831.	S. $\frac{S}{S}$. cuttings.
<i>HELICTERES, SCREW-TREE.</i> Cal. tub. 3-5-cle. Cor. of 5 pet. Sty. sub-5-cle. Caps. 5-cell. many-seed.							
Isòra. DC.	nut-leaved.	corr. ellip. serr. scab. pub.	sc.	6. 7. E. Ind.	1733.	S. $\frac{S}{S}$.	—
lanceolàta. DC.	spear-leaved.	lanc. acum. ent.	pu.	—	—	1823.	S. $\frac{S}{S}$. —
<i>PTEROSPERMUM, PTEROSPERMUM.</i> Cal. 5-par. Pet. 5. Sta. 20, 5 of which are ster. Caps. 5-cell.							
acerifòlium. B.M.	Maple-leaved.	cord. obt. dent.	wh.	7. 9. E. Ind.	1790.	S. $\frac{S}{S}$.	Loam & peat.
suberifòlium. B.M.	cork-leaved.	obl. acum. apex dent.	wh.	—	—	1783.	S. $\frac{S}{S}$. cuttings.
semisagittàtum. DC.	half-sagittate.	obl. ent. cord.	wh.	—	—	1818.	S. $\frac{S}{S}$. —
<i>PENTAP'ETES, PENTAP'ETES.</i> Cal. dbl. outer 3-leav. Pet. 5. Sty. 5-tooth. Caps. 5-cell. many-seed.							
ovàta. DC.	oval-leaved.	ov. serr. pubes.	sc.	6. 9. N. Spain.	1805.	S. $\frac{S}{S}$.	Sandy loam
phænicea. B.R.	scarlet-flowered.	alt. lan. cren. apex atten.	sc.	7. 8. India.	1690.	S. $\frac{S}{S}$.	and peat. cuttings.
<i>MONS'ONIA, MONS'ONIA.</i> Cal. of 5 equal leaves. Pet. 5. Stam. 15, united at the base.							
speciosa. B.M.	large-flowered.	palm. 5-part. lob. bipinn.	pu.	5. 6. C. B. S.	1774.	G. $\frac{P}{S}$.	Loam & peat.
spinosa.	spiny.	ov. mucr. ent.	yel.	—	—	1790.	G. $\frac{S}{S}$. cuttings.
<i>ASTRAP'EA, ASTRAP'EA.</i> Invol. of many leaves. Cal. 5-parted. Pet. 5. Flow. umbellate.							
Wallichii. B.R.	Wallich's.	cor. den. stip. ov. acum.	sc.	12. 1. Maurit.	1820.	S. $\frac{S}{S}$.	Loam & leaf
viscosa.	clammy.	cord. angul. pubes. serr.	Madagas.	1823.	S. $\frac{S}{S}$. mould.
cuttings, in a little bottom heat, will soon strike root.							

ORDER VIII.

POLYANDRIA. STAMENS MANY.

<i>SIDA, SIDA.</i> Cal. naked, 5-parted, angular. Sty. multifid. Caps. many, 1 or 3-seeded.							
álba. DC.	white-flowered.	obl. ov. sub-cord. dent.	wh.	6. 7. E. Ind.	1732.	S. $\frac{A}{S}$.	Loam & leaf
acuta. DC.	acute-leaved.	lin. lanc. serr.	p. yel.	—	—	1827.	S. $\frac{S}{S}$. mould.
bracteolàta. DC.	bracteolate.	ov. lan. acum. den. smth.	yel.	6. 9. S. Amer.	1818.	S. $\frac{S}{S}$.	seeds, or cut-
carpinifòlia. DC.	Hornbeam-lv'd.	ov. obl. bi-serr.	yel.	7. 9. Canaries.	1774.	G. $\frac{S}{S}$.	tings.
compréssa. DC.	compressed.	ov. lan. acum. den.	Br. com. ye.	6. 8. Nepal.	1823.	G. $\frac{P}{S}$.	—
capénsis.	Cape.	ovat. lanc. dent.	ye. C. B. S.	G. $\frac{S}{S}$.	—
dioíca. DC.	rough.	palm. 7-lob. rough.	wh.	8. 9. Virginia.	1759.	H. $\frac{P}{S}$.	—
grandifòlia. B.R.	large-leaved.	cor. orbic. smth. soft.	yel.	9. 10.	1816.	S. $\frac{S}{S}$.	—
malvæflòra. B.R.	Mallow-flow'd.	7-9-lob. base truncate.	wh.	—	Columb.	1826.	H. $\frac{P}{S}$. —

MONADELPHIA POLYANDRIA.

159

Systematic Name.	English Name.	Form of Leaves, &c.	Col. of Flow.	Month of Fl.	Native Country.	Yr. of Introd.	Soil and Propagation.
Nap'æa. DC.	smooth.	palm. 5-lob. smth.	wh.	8. 9.	Virginia.	1748.	H. ♀. ———
parvifolia.	small-leaved.	ov. lanc. hoary.	Is. Bourbon.	1829.	S. ♀. ———

PALAVIA, PALAVIA. Cal. naked, 5-parted. Caps. generally 1-seeded, crowded.

malvæfolia. DC.	Mallow-leaved.	ov. stalk. ; stem prostrate.	pu.	6. 8.	Lima.	1794.	H. ♀. Sandy loam.
rhombifolia. B. R.	Rhomb-leaved.	lob. cren. pilose.	ros.	—	—	1830.	H. ♀. seeds.

ALTHÆA, MARSH-MALLOW. Out. Cal. in 9 seg. Pet. 5, obo. Caps. whorl. of 1 cell. Seeds 1, kid.-sh.

cannabinâ. DC.	Hemp-leaved.	palm. down. ben. up. 3-fid.	ro.	6. 7.	S. Europ.	1597.	H. ♀. Sandy loam.
officinâlis. E. Fl.	common.	cord. 5-lob. downy, serr.	ro.	7. 8.	Britain.	...	H. ♀. seeds.
rôsea. DC.	Holly-hock.	cor. 5-7-ang. rug. cren.	ro.	—	China.	1573.	H. ♀. ———

MALVA, MALLOW. Cal. dbl. out. of 3 leav. inn. of 1 leaf, 5-clef. Pet. 5, obo. Cap. compr. Seeds kid.-sh.

Alcêa. B. M.	Vervain.	angul. upp. 5-part. cut.	pi.	7. 10.	Europe.	1597.	H. ♀. Light loam.
borbônica. DC.	Bourbon.	ovate, acut. dent. pubes.		7. 8.	Maurit.	1816.	S. ♀. seeds.
caroliniana. DC.	Carolina.	palm. 5-lob. cut, dent.	re.	6. 7.	Carolina.	1723.	H. ♀. ———
calycina. B. R.	broad-cupped.	cord. cren. hispid.	ros.		C. B. S.	1812.	G. ♀. ———
crispa. DC.	curled.	angul. den. crisp. smth.	bh.	—	Syria.	1573.	H. ♀. ———
capensis. B. R.	Cape.	5-lo. pub. den. upp. 3-lo. w. pk.	—		C. B. S.	1713.	G. ♀. ———
frâgrans. B. R.	fragrant.	cor. 5-7-lo. cren. rug.	sc.	—	—	1759.	G. ♀. ———
Munroana. B. R.	Mr. Munro's.	cord. lob. rough.	salm.	—	Columb.	1828.	H. ♀. ———
miniata. DC.	vermilion-fl'd.	ov. cord. sub-3-lob.	sc.	7. 8.	—	1798.	H. ♀. ———
Morénii. B. M.	Moreni's.	cord. 5-lob. cut, serr. cren.	pi.		Italy.	1824.	H. ♀. ———
mauritiâna. DC.	Ivy-leaved.	5-lo. obt. rug. den. sub-pil.	sc. pu	9.	S. Europ.	1768.	H. ♀. ———
moschata. E. B.	musk.	renif. in 5-7 cut lobes.	ro.	7. 8.	Britain.	...	H. ♀. ———
rotundifolia. E. Fl.	round-leaved.	orbic. cord. 5-lob.	li.	6. 9.	—	...	H. ♀. ———
sylvêstris. E. Fl.	common.	in 7 acut. lobes, down. serr. pu.	—	—	—	...	H. ♀. ———
stipulæca. DC.	large-stipuled.	3-lo. ent. upp. multif. den.	pu.	6. 8.	Spain.	1815.	H. ♀. ———
trifida. DC.	trifid.	3-part. lob. 3-fid. lin. obt.	bl.	—	—	—	H. ♀. ———

[1 cell, & 2 valves. Seeds kidney-shaped.

LAVATE'RA, LAVATE'RA. Outer Cal. 3-lobed, inner divided in 5 lobes. Pet. 5. Caps. 7-14 each, of

arborea. E. Fl.	Tree Mallow.	7-angl. downy, plaited.	pu. ro.	7. 10.	Britain.	...	H. ♀. Sandy loam.
hispida. B. M.	hairy.	5-lob. dent. upp. 3-lob.	pur.	7. 9.	Barbary.	1804.	H. ♀. seeds, or
thuringiaca. B. M.	large-flowered.	angul. hairy, upp. 3-lob.	pu.	—	German.	1731.	H. ♀. cuttings.
triloba. B. R.	three-lobed.	sub-cord. sub-3-lob. cren.	ro.	—	Spain.	1759.	G. ♀. ———

M'ALOPE, M'ALOPE. Invol. of 3 leaves. Cal. 5-parted. Caps. crowded, 1-seeded.

trifida. B. F. G.	trifid.	trif. den. smth. lob. acum.	re.	7. 8.	Barbary.	1808.	H. ♀. Sandy loam. seeds.
-------------------	---------	-----------------------------	-----	-------	----------	-------	-----------------------------

GOSSYPIUM, COTTON-TREE. Cal. 5-tooth. Invol. 3-part. Caps. 3-5 cells, & many seeds.

arboreum. DC.	tree.	palm. 5-lob. lobes lan.	ye. pu.	7. 8.	E. Ind.	1694.	S. ♀. Loam & leaf mould. seeds, or cuttings.
---------------	-------	-------------------------	---------	-------	---------	-------	---

RU'IZIA, RU'IZIA. Cal. 5-part. Invol. 3-leaved. Pet. 5. Stam. united. Caps. 5-celled, many-seeded.

variabilis. DC.	various-leaved.	palmatif. upp. palm.	wh.	5. 6.	Bourbon.	1792.	S. ♀. Loam & peat. cuttings.
-----------------	-----------------	----------------------	-----	-------	----------	-------	---------------------------------

UR'ENA, UR'ENA. Cal. double, exterior 5-parted. Caps. of 5 cells, and 1 seed.

multifida. DC.	multifid.	ov. multif. dent. pubes.	yel.	10. 1.	Maurit.	1817.	S. ♀. Loam & leaf mould. seeds, or cuttings.
----------------	-----------	--------------------------	------	--------	---------	-------	---

Systematic Name.	English Name.	Form of Leaves, &c.	Col. of Flow.	Month of Fl.	Native Country.	Yr. of Introd.	Soil and Propagation.
KITAIBE' LIA, KITAIBE' LIA. <i>Cal. double, outer 7-9-part. Caps. crowded in a 5-lobed head. Seed 1.</i>							
vitifolia. B.M.	vine-leaved.	5-lob. acute, dent.	wh.	7. 9.	Hungar.	1801.	H. \mathfrak{P} . Loam. seeds.
MAL'ACHRA, MAL'ACHRA. <i>Invol. 3-6-leav. Cal. 5-part. Cor. funn.-sh. limb 5-cleft. Stig. 10-cleft.</i>							
fasciata. B.R.	rough-piled.	cor. rotund. lob.; stem vill.	ro.	8. 9.	Caracas.	1820.	S. \mathfrak{A} . Light loam. seeds.
PAVONIA, PAVONIA. <i>Cal. double, of 5-15 leaves. Stig. 10. Caps. 5, 2-valved, and 1-seeded.</i>							
coccinea. DC.	scarlet.	cord. 3-lob. serr.	sc.	7. 8.	St. Dom.	1816.	S. \mathfrak{S} . Loam & leaf
spinifixa. B.R.	prickly-seeded.	ov. cord. acum. serr.	yel.	—	W. Ind.	1778.	S. \mathfrak{S} . mould. cutt.
ACHA'NIA, ACHA'NIA. <i>Cal. dbl. outer of many leaves. Cor. convol. Stig. 10. Berr. 5-cell. 5-seeded.</i>							
Malvaviscus. L.	smooth-leaved.	cor. 3-5-lo. acum. scab.	sc.	1. 12.	Jamaica.	1714.	S. \mathfrak{S} . Sandy loam
mollis. H.K.	woolly.	cor. 3-lob. acum. down.	sc.	—	México.	1780.	S. \mathfrak{S} . and leaf
pilosa. B.C.	hairy.	cord. cren. Br. hairy.	red.	8. 9.	Jamaica.	—	S. \mathfrak{S} . mould. cutt.
STU'ARTIA, STU'ARTIA. <i>Cal. 5-part. Pet. 5. Stig. somewhat 5-lobed. Caps. 5-valv. cells 1-2-seeded.</i>							
virginica. DC.	Virginian.	ellip. smth. abo. serr.	wh.	5. 8.	N. Amer.	1742.	H. \mathfrak{S} . Loam & leaf
<i>Malachodéndron. L.</i>							mould. cuttings, or layers.
GORDO'NIA, GORDO'NIA. <i>Cal. of 5 leav. Pet. 5. Sty. 1. Stig. 5. Caps. of 5 cells, 5 valv. & 2 seeds.</i>							
Lasiánthus. B.M.	smooth.	obl. coriac. smth. serr.	wh.	8. 11.	N. Amer.	1739.	H. \mathfrak{S} . Loam & peat.
pubescens. W.	pubescent.	obov. obl. smth. under.	wh.	—	—	1774.	H. \mathfrak{S} . layers, or cuttings, under a hand-glass.
HIBISCUS, HIBISCUS. <i>Cal. double, outer of many leaves. Stig. 5. Caps. 5-celled, many-seeded.</i>							
acerifolius. DC.	Maple-leaved.	cord. 5-lob. hairy.	va.	3. 6.	China.	1798.	G. \mathfrak{S} . Loam & peat.
Abelmóschus. L.	Musk Okro.	sub-pelt. cor. 7-ang. serr.	ye.	7. 9.	India.	1640.	S. \mathfrak{S} . seeds, or
digitatus. B.R.	fingered.	digit. leaf. 5-lanc. serr.	ye. re.	—	Brazil.	1818.	S. \mathfrak{A} . cuttings.
ficulneus. L.	Fig-leaved.	palm. 5-lo. lob. obl. den.	st.	6. 7.	Ceylon.	1732.	S. \mathfrak{S} . —
heterophyllus. Rox.	various-lev'd.	lin. lanc. acum. serr.	w. p.	8. 9.	N. S. W.	1808.	G. \mathfrak{S} . —
moscheutos. L.	musky.	ov. acum. dent.	wh.	8. 10.	N. Amer.	1820.	H. w. \mathfrak{P} . —
mutabilis. B.R.	changeable.	cor. angul. 5-lob. acum.	va.	10. 12.	E. Ind.	1690.	S. \mathfrak{S} . —
militaris. DC.	military.	cord. hast. 3-lob. serr.	wh. pk.	8. 9.	America.	1804.	G. w. \mathfrak{P} . —
macrophyllus. Rox.	large-leaved.	cord. acum. cren. 9-nerv.	yel.	7. 8.	—	1820.	S. \mathfrak{S} . —
palustris. L.	marsh.	ov. dent. sub-trilob. down.	pu.	7. 9.	N. Amer.	1759.	H. w. \mathfrak{P} . —
pedunculatus. DC.	peduncled.	alt. 3-5-lo. bas. cor. hairy.	ro.	—	C. B. S.	1812.	G. \mathfrak{S} . —
roseus. DC.	rose coloured.	ov. cor. den. hair. ben.	ro.	—	S. Europ.	1824.	H. w. \mathfrak{P} . —
Rosa sinensis. B.M.	China Rose.	ov. acum. smth. dent.	sc.	7. 8.	E. Ind.	1731.	S. \mathfrak{S} . —
1. β rubro-plenus.	double-red.	sc.	—	—	—	S. \mathfrak{S} . —
2. flavo-plenus.	double-buff.	cop.	—	—	—	S. \mathfrak{S} . —
racemosus. B.R.	Nepal.	cor. lobate, serr. hairy.	ye. pu.	—	Nepaul.	1824.	G. \mathfrak{S} . —
syriacus. L.	Althæa-frutex.	wedge-sh. ov. 3-lob. den.	va.	8. 9.	Syria.	1596.	H. \mathfrak{S} . —
1. purpureus.	purple.	pu.	—	—	—	H. \mathfrak{S} . —
2. albus.	white.	wh.	—	—	—	H. \mathfrak{S} . —
3. variegatus.	variegated.	sc. wh.	—	—	—	H. \mathfrak{S} . —
splendens. B.M.	splendid.	palm. 3-5-lo. lobes lanc.	pk.	6. 7.	N. Holl.	1828.	S. \mathfrak{S} . —
tiliaceus. B.R.	Lime-tree-lev'd.	cord. acum. cren.	yel.	7. 8.	E. Ind.	1739.	S. \mathfrak{S} . —
violaceus.	violet-coloured.	ov. lob. serr. pubes.	ro. ci.	—	Calcutta.	1830.	S. \mathfrak{S} . —

Systematic Name.	English Name.	Form of Leaves, &c.	Col. of Flow.	Month of Fl.	Native Country.	Yr. of Introd.	Soil and Propagation.
<i>CAMELLIA, CAMELLIA.</i> Cal. imbricated, many-leaved, the inner leaves the largest. Pet. obov.							
japónica.	common.	ov.acum.serr.	re.	4.	6.	China.	1739. G. ♀.
1. álba.	white.	wh.	5.	4.	—	—	... G. ♀. The soil that appears best
2. atrorúbens.	dark-red.	d.red.	—	—	—	—	... G. ♀. adapted for the growth of this
3. anemoniflora.	anemone-flow'd.	wh.	—	—	—	—	... G. ♀. beautiful tribe of plants, is the
4. Aitóni.	Mr. Aiton's.	red.	2.	4.	—	—	... G. ♀. top sward of a pasture that con-
5. anemoniflorarub.	red Waratah.	red.	—	—	—	—	... G. ♀. sists of a sandy yellow loam,
6. Byronii.	Lord Byron's.	ros.	—	—	—	—	... G. ♀. which should be well chopped
7. blánda.	blush Waratah.	bh.	—	—	—	—	... G. ♀. up with the spade, and incorpo-
8. bicolor.	two-coloured.	ro.wh.	—	—	—	—	... G. ♀. rated with about one fourth of
9. Bedfordiána.	Dk. of Bedford's.	wh.	—	—	—	—	... G. ♀. sandy peat, and one fourth of
10. cárnea.	flesh-coloured.	car.	—	—	—	—	... G. ♀. leafmould, and to be frequently
11. Chandléri.	Chandler's.	st.	—	—	—	—	... G. ♀. turned and mixed together for
12. Clivéana.	Lady H. Clive's.	red.	—	—	—	—	... G. ♀. six months previous to using.
13. crassinérvic.	thick-nerved.	red.	—	—	—	—	... G. ♀. When the plants are young,
14. crásceus.	single pale-red.	p.red.	—	—	—	—	... G. ♀. they require frequent shiftings,
15. coccínea.	scarlet.	sc.	—	—	—	—	... G. ♀. so as to prevent their roots
16. compácta.	compact-flow'd.	wh.	—	—	—	—	... G. ♀. from getting matted in the pots,
17. corállina.	coral-flowered.	sc.	—	—	—	—	... G. ♀. which would obstruct the free
18. conchiflora.	shell-flowered.	red.	—	—	—	—	... G. ♀. penetration of the water
19. Dianthiflora.	Carnation-fl'd.	red.	—	—	—	—	... G. ♀. through the ball of mould, and
20. eclipsis.	Press's Eclipse.	red.	—	—	—	—	... G. ♀. without a due proportion of
21. expánsa.	expanded.	red.	—	—	—	—	... G. ♀. heat and moisture in the grow-
22. Epsoménsis.	Young's semi-dbl.	red.	—	—	—	—	... G. ♀. ing season, the plants will be-
23. exímia.	choice red.	red.	—	—	—	—	... G. ♀. come stunted and unhealthy.
24. flavéscens.	buff.	wh.	—	—	—	—	... G. ♀. The most suitable season for
25. fimbriáta.	fringed.	wh.	—	—	—	—	... G. ♀. shifting the <i>Camellieæ</i> , is in
26. flórida.	cluster-flowered.	red.	—	—	—	—	... G. ♀. March, or April, when the plants
27. Hibbértia.	Mr. Hibbert's.	red.	—	—	—	—	... G. ♀. have done flowering; when they
28. imbricáta.	imbricated.	red.	—	—	—	—	... G. ♀. should, afterwards, have a slight
29. insignis.	splendid.	sc.	—	—	—	—	... G. ♀. degree of artificial heat applied
30. Knightii.	Mr. Knight's.	sc.	—	—	—	—	... G. ♀. to them, which will encourage
31. lácida.	shining.	red.	—	—	—	—	... G. ♀. the growth of the young shoots,
32. longifolia.	long-leaved.	red.	—	—	—	—	... G. ♀. and better enable them to form
33. lútea álba.	pale-yellow.	pa.yel.	—	—	—	—	... G. ♀. their flower-buds. The foliage
34. myrtifolia.	myrtle-leaved.	pk.	—	—	—	—	... G. ♀. should be frequently syringed
35. pæoniflora.	Pæony-flow'd.	bh.	—	—	—	—	... G. ♀. with soft water, and kept clear
36. punctáta.	dotted-flowered.	red.	—	—	—	—	... G. ♀. from all filth and dust; but care
37. Pércycæ.	D's. of Northumb.	sc.	—	—	—	—	... G. ♀. must be taken not to saturate the
38. princéps.	carmine.	bh.	—	—	—	—	... G. ♀. soil too much about their roots.
39. Pompónia.	Kew Blush.	red.	—	—	—	—	... G. ♀. All the species and varieties of
40. Róssii.	Ross's.	red.	—	—	—	—	... G. ♀. this <i>genus</i> may be increased by
41. rúbropléna.	double-red.	red.	—	—	—	—	... G. ♀. layers, grafting, or inarching
42. radiáta.	single-rayed.	red.	—	—	—	—	... G. ♀. them on the common stocks; or
43. refléxa.	reflex-petaled.	cr.	—	—	—	—	... G. ♀. by cuttings, taken off at a joint,
44. spléndens.	Allnut's superb.	re.	—	—	—	—	... G. ♀. when the young shoots are ri-
45. variegáta.	double-striped.	bh.	—	—	—	—	... G. ♀. pened, and inserted in sand,
46. Welbánkii.	Welbank's.	wh.	—	—	—	—	... G. ♀. under hand-glasses. Most of
47. Wiltóniæ.	Lady Wilton's.	ra.	—	—	—	—	... G. ♀. the species and varieties of the

Camellieæ are well adapted to be grown in airy rooms, where they will freely expand their beautiful blossoms.

Systematic Name.	English Name.	Form of Leaves, &c.	Col. of Flow.	Month of Fl.	Native Country.	Yr. of Introd.	Soil and Propagation.
oleífera. B.C.	oleiferous.	ov. ellip. serr.	wh.	5. 7.	China.	1819.	G. S. ———
reticulàta. B.R.	reticulated.	ov. serr. shin.	red.	4. 6.	————	1824.	G. S. ———
sasánqua. B.R.	Lady Banks's.	ellip. smth. serr.	wh.	2. 10.	————	1811.	G. S. ———
<i>flóre-pléno.</i>	<i>double-flow'g.</i>	ros.	——	——	G. S. ———
<i>THEA, TEA.</i> Cal. of 5-6 leaves. Pet. 6-9, somewhat united at the base. Ger. ov. pub. 3-celled.							
Bohèa. L.	Bohea.	ellip. obl. shin.	wh.	8. 12.	China.	1768.	G. S. ———
viridis. L.	green.	ellip. lanc. flat.	wh.	2. 10.	————	——	G. S. ———
<i>ADANSO'NIA, ADANSO'NIA.</i> Cal. sing. decid. Cor. of 5 pet. Sty. elong. Caps. 10-cell. many-seed.							
digitàta. B.M.	digitate-leaved.	quin. leaf. ellip. smth.	wh.	6.	Senegal.	1724.	S. S. Rich loam. cuttings.
<i>NUTTA'LLIA, NUTTA'LLIA.</i> Cal. 5-cleft. Cor. of 5 pet. Caps. about 12, collected in a whorl.							
digitàta. B.M.	digitate-leaved.	sub-pelt. seg. lin. smth.	pu.	6.	S. N. Amer.	1824.	H. P. ———
<i>CAROLINEA, CAROLINEA.</i> Cal. sub-trun. Fil. spread. Sty. elon. Stig. 6. Caps. 1-cell. many-seed.							
álba. B.C.	white.	digit. lea. 5-elli. obl. smth.	wh.	7. 8.	Brazil.	1817.	S. S. Sandy loam
insígnis. w.	great-flowered.	leaf. 5-7, obov. obl. smth.	red.	——	W. Ind.	1796.	S. S. and peat.
mínor. B.M.	lesser.	leaf. 7, ellip. obl. acute.	wh.	——	Guiana.	1798.	S. S. cuttings.

CLASS XVII.

DIADELPHIA. *Stamens combined in 2 parcels.*

ORDER I.

PENTANDRIA. STAMENS 5.

PETALOSTE'MUM, PETALOSTE'MUM. Cal. 5-cleft. Pet. 5. Legu. inclosed by the calyx. Seed 1. violáceum. purple. pinn. leaf. in 2 pairs. lin. vi. pu. 7. 9. Missouri. 1811. H. P. Sandy loam.

ORDER II.

HEXANDRIA. STAMENS 6.

FUMA'RIA, FUMITORY. Cal. of 2 leav. Cor. ring. Pet. 4, with a flat, obt. notch. upp. lip. Ger. compr. [Stig. 2-lobed.

capreolàta. E.B.	ramping.	bipinn. leaf. wedge-sh.	wh.	Britain.	H. A. Sandy loam.
enneaphýla. L.	nine-leaved.	leaf. ov. orbic.	p.yel.	Spain.	H. P. seeds.
parvisfóra. E.B.	small-flowered.	leaf. lin. chann.	pk.	Britain.	H. A. ———

CORYD'ALIS, CORYD'ALIS. Cal. of 2 leaves. Pet. 4. Pod 2-valved, compr. with many seeds.

claviculàta. E.B.	white-climbing.	pinn. leaf. ellip. glau.	wh.	6. 7.	Britain.	H. A. Sandy loam.
angustifólia. DC.	narrow leaved.	bitern. seg. lin. Brac. serr. pu.	——	——	Iberia.	1819.	H. P. seeds.

Systematic Name.	English Name.	Form of Leaves, &c.	Col. of Flow.	Month Native of Fl. Country.	Yr. of Introd.	Soil and Propagation
exímia. B.R.	choice.	bipinn. leaf. pinnatif.	car.	6. 7. N.Amer.	1812.	H. P. ———
formôsa. B.M.	blush.	pinnatif. glauc.	car.	————	1796.	H. P. ———
lûtea. E.B.	yellow.	bipinn. leaf. wedge-sh. trif. y.	4. 8.	Britain.	H. P. ———
nóbilis. B.M.	great-flowered.	bipinn. lea. 3-par. cut. glau.	ye.	5. 7. Siberia.	1783.	H. P. ———
pauciflôra. Pers.	few-flowered.	bitern. leaf. 3-part.	pu.	————	1823.	H. P. ———
sólida. E.Fl.	solid-rooted.	bitern. leaf. obl. glau.	pu.	— — Britain.	H. P. ———

ORDER III.

OCTANDRIA. STAMENS 8.

[and 2 valves. Seed 1.

POLYGALA, MILK-WORT. Cal. 5-part. Pet. unit, with the fila. the upp. deeply clov. Caps. of 2 cells

acuminâta.	acuminate-lv'd.	opp. sess. ov. acum. smth.	pu.	4. 9. S. Amer.	1827.	G. S. Loam and
attenuâta. B.C.	attenuated.	opp. cord. acum.	pu.	— — C. B. S.	1823.	G. S. peat.
Burmânni. DC.	Burmânn's.	lin. obt. Br. pubes.	pur.	————	1800.	G. S. cuttings, in
bracteolâta. B.M.	spear-leaved.	lin. lanc. smth.	pur.	5. 10. C. B. S.	1713.	G. S. sand, under
Chamæbûxus. B.M.	Box-leaved.	obl. lanc. muc. Br. creep.	yel.	5. 6. Europe.	1658.	H. S. a glass, will
cordifôlia. B.M.	heart-leaved.	op. cor. acum. Br. roun. sm. pu.	3. 8. C. B. S.	1791.	G. S. root freely.	
húmilis. B.C.	dwarf.	ov. lanc. imbr.	pk.	5. 8. ———	1817.	G. S. ———
ligulâris. B.R.	strap-leaved.	lin. ligul. smth.	pur.	————	1820.	G. S. ———
latifôlia. B.R.	broad-leaved.	ov. rhomb. decuss. glau.	pur.	3. 9. ———	—	G. S. ———
lûtea. w.	yellow.	obl. lanc. acu.	yel.	— N. Amer.	1739.	H. A. ———
myrtifôlia. B.R.	myrtle-leaved.	obt. obov. obl. mucr.	pur.	5. 8. C. B. S.	1707.	G. S. ———
oppositifôlia. B.R.	opposite-leaved.	opp. ov. acut. smth.	pur.	————	1790.	G. S. ———
paniculâta. B.R.	panicked.	lin. lanc. scatt.	p. pu.	— Jamaica.	1822.	S. A. ———
paucifôlia. B.M.	few-leaved.	ov. acut. at both ends, shin. pu.	— N. Amer.	1791.	H. P. ———	
rubélla. Ph.	pale-red.	lanc. lin. mucr.	ros.	6. 7. ———	1828.	H. P. ———
speciôsa. B.M.	shewy.	obl. wedge-sh. obt. upp. lin. pu.	5. 10. C. B. S.	1814.	G. S. ———	
stipulâcea. B.M.	large-stipuled.	in 3-4's, lin. cyl. acut.	pur.	————	1801.	G. S. ———
teretifôlia. B. rep.	round-leaved.	lin. obt. falcate.	pur.	5. 8. ———	1791.	G. S. ———
vulgâris. E.F.	common.	lin. lan.; stm. cr. bh. pu. pk. orw.	— Britain.	H. P. ———	

MO'NNINA, MO'NNINA. Cal. of 5 leaves. Pet. 5, unit. at base. Fil. incurv. hairy. Ger. obl. Stig. obt. obtusifôlia. DC. obtuse-leaved. obl. obov. obt. sub-pub. pu. 6. 7. Lima. 1830. G. S. ———

ORDER IV.

DECANDRIA. STAMENS 10.

[Legu. flat, of 1 cell, & 2 valves.

SP'ARTIUM, BROOM. Cal. 5-toothed, cup-shaped. Pet. 5, standard obovate. Filam. 10. Stig. hairy.

júnceum. w.	Spanish.	lan. ent. Br. opp. round.	yel.	7. 9. S. Europ.	1548.	H. S. ———
fl. pléno.	double-flowered.					————

Systematic Name.	English Name.	Form of Leaves, &c.	Col. of Flow.	Month of Fl.	Native Country.	Yr. of Introd.	Soil and Propagation.
LESSE'RTIA, LESSE'RTIA. <i>Cal. 5-part. Vexill. spreading. Keel obt. Stig. capit. Sty. bearded.</i>							
fruticosa. B.R.	shrubby.	5-6 pairs, lin. obt.	pur.	7. 8.	C. B. S.	1826.	G. A. ———
pálchra. B.M.	pretty.	in 7 prs. leaf. ov. acu. smth. re.	—	—	—	1817.	G. A. ———
GENISTA, GREEN-WEED. <i>Cal. 5-clef. tubu. Pet. 5. Stand. obl. & reflex. Fil. in 2 sets. Leg. turg.</i>							
ánglica. E. Fl.	petty-whin.	ov. lanc. ent. smth.	yel.	5. 6.	Britain.	...	H. S. Sandy loam.
canariénsis. L.	Canary.	tern. obl. mucr. vill.	yel.	—	Canaries.	1656.	G. S. seeds,
cándicans. L.	white.	tern. obov. pubes.	yel.	4. 7.	Spain.	1735.	H. S. or layers.
decúmbens. B.C.	trailing.	lanc. obt. silky.	yel.	5. 6.	France.	1755.	H. S. ———
diffusa. w.	diffuse.	lanc. smth. sub-cil.	yel.	—	Italy.	1816.	H. S. ———
hispánica. B.C.	Spanish.	lin. spiny. Br. pubes.	yel.	—	Spain.	1759.	H. S. ———
monospérnum.	single-seeded.	lanc. silky. Br. striat.	wh.	6. 7.	S. Europ.	1690.	F. S. ———
<i>Spártium, monospérnum. L.</i>							
ovata.	oval-leaved.	ov. obl. pods hairy.	yel.	6. 8.	Hungary.	1816.	H. S. ———
procúmbens. B.R.	procumbent.	lanc. acut. silky ben.	yel.	—	—	—	H. S. ———
pilosa. E. B.	hairy-green-weed.	obov. lanc. hairy.	yel.	5. 6.	Britain.	...	H. S. ———
sagittális. En. Fl.	jointed.	ov. lan. hairy; stem creep.	yel.	—	German.	1570.	H. S. ———
sericea.	silky.	lin. lanc. silky.	yel.	—	Austria.	1812.	H. S. ———
tinctória. Br. Fl.	dyers.	lanc. smth. marg. ciliat.	yel.	6. 8.	Britain.	...	H. S. ———
tríquetra. H. K.	three-sided.	ov. lanc. vill.	yel.	5. 6.	Corsica.	1770.	H. S. ———
U'LEX, FURZE. <i>Cal. of 2 conc. leav. 5-tooth. Cor. of 5 pet. Fil. in 2 sets. Leg. of 1 cell. Seeds 6 to 8, ang.</i>							
europæus. E. Fl.	common.	lanc. lin. Br. vill.	yel.	4. 5.	Britain.	...	H. S. ———
plenus.	double-flow'g.	yel.	—	—	...	H. S. ———
hibérnica.	Irish.	lin. lanc.; stems erect.	yel.	8. 12.	Ireland.	...	H. S. ———
nánus. E. B.	dwarf.	lin. awl-sh. Brac. minute.	yel.	—	Britain.	...	H. S. ———
ONONIS, REST-HARROW. <i>Cal. tub. in 5 deep seg. Cor. of 5 pets. Leg. sess. of 1 cell, & 2 clas. valves.</i>							
arvensis. E. Fl.	common.	alt. ellip. roug. serr. at apex. ro.	6. 8.	Britain.	...	H. S. Sandy soil.	
críspa. L.	crisped-leaved.	tern. subrot. dent. pub.	yel.	—	Spain.	1739.	F. S. seeds,
fruticosa. B.M.	shrubby.	tern. sess. lanc. serr.	red.	5. 6.	S. Europ.	1680.	H. S. or parting
pedunculáris. B.R.	peduncled.	obov. dent. recur. pub. wh. pk.	4.	Teneriffe.	...	F. S. roots.	
rotundifolia. B.M.	round-leaved.	tern. ov. dent.	red.	—	Switzerl.	1570.	H. S. ———
spinosa. E. Fl.	spiny.	tern. obl. bas. wedge-sh.	red.	6. 8.	Britain.	...	H. S. ———
[and 2 valves. Seeds 1-3, kidney-shaped.							
ANTHYLLIS, KIDNEY-VETCH. <i>Cal. 5-tooth. Pet. 5. Fil. 10. Ger. obl. Stig. obt. Legu. of 1 cell,</i>							
montana. B.C.	mountain.	pinn. leaf. ov. obl. pub.	ros.	6. 7.	Europe.	1759.	H. S. Light loam.
Vulneraria. E. Fl.	Ladies'-finger.	pinn. upper large.	yel.	5. 8.	Britain.	...	H. S. seeds.
[Legu. linear, of 1 cell, & 2 rigid valves.							
OROBUS, BITTER-VETCH. <i>Cal. 5-parted. Cor. of 5 pets. Standard obov. Ger. oblong. Sty. cylind.</i>							
álbus. B. F. G.	white.	in 3 prs. leaf. lin. mucr.	wh.	5. 6.	Austria.	1794.	H. S. Sandy loam.
angustifolius. L.	narrow-leaved.	in 2-3 prs. leaf. ensif. acut. v.	—	—	Siberia.	1766.	H. S. seeds,
Fischeri. B.C.	Dr. Fischer's.	lin. smth. in pairs.	pur.	—	Russia.	...	H. S. or parting
hirsutus. B.M.	hairy.	pinn. leaf. ov. acut.	vio.	6. 7.	Levant.	1818.	H. S. roots.
luteus. B.C.	yellow.	3-5 prs. leaf. ellip. lan. glau. y.	—	—	Siberia.	1759.	H. S. ———
sylvaticus. E. Fl.	wood.	pin. in 7-10 pr. of ov. lea. pu. w.	5. 7.	Britain.	...	H. S. ———	
tuberosus. E. Fl.	tuberous.	pinn. leaf. lanc. glau.	pur.	—	—	...	H. S. ———
vérnus. B.M.	spring.	in 3 prs. leaf. lan. acum.	pur.	3. 4.	Europe.	1629.	H. S. ———
variegatus.	variegated.	in 2-3 prs. lea. ov. acum. pil. pu.	Italy.	1821.	H. S. ———		

Systematic Name.	English Name.	Form of Leaves, &c.	Col. of Flow.	Month of Fl.	Native Country.	Yr. of Introd.	Soil and Propagation.
[Ger. compr. <i>Sty.</i> flattened. <i>Legu.</i> of 1 cell, & 2 valves. <i>Pet.</i> 5. <i>Standard</i> obov. with reflexed margins.							
<i>LATHYRUS</i> , <i>LATHYRUS</i> .		<i>Cal.</i> of 5 unequal segmen.					
<i>Aphaca</i> . B.Fl.	yel.vetchling.	<i>Stem</i> erect, leafless.		st. 6. 7.	England.	H. A. <i>Light soil.</i>
<i>californicus</i> . B.R.	Californian.	in 4-5 pairs, leaf. ellip.	pur.	—	N.Amer.	1826.	H. B. <i>seeds, or di-</i>
<i>grandiflorus</i> . B.M.	great-flowered.	in 3 pairs, leaf. ov. obt.	pur.	—	Italy.	1814.	H. B. <i>viding roots,</i>
<i>hirsutus</i> . B.M.	hairy-podded.	Tendrils with 2 lan. leaf.	va.	7.	Britain.	H. A. ———
<i>latifolius</i> . L.	broad-leaved.	Tendrils with 2 ellip. leaf.	ro.	7. 9.	—	H. B. ———
<i>Nissolia</i> . E.Fl.	crimson.	lin. lanc. Stip. awl-sh.	cr.	5.	—	H. A. ———
<i>odoratus</i> . E.M.	Sweet-pea.	pinn. leaf. ov. mucr.	va.	6. 8.	Sicily.	1760.	H. A. ———
<i>pratensis</i> . E.B.	meadow.	Tendrils with 2 lan. leaf.	ye.	—	Britain.	H. B. ———
<i>palustris</i> . B.R.	marsh.	Tendr. with 2-3 prs. elli. lea.	b.	—	—	H. B. ———
<i>sylvestris</i> . E.B.	Everlasting-pea.	Tend. with 2 lanc. leaf.	pu. v.	7. 9.	—	H. B. ———
<i>sativus</i> . B.M.	chickling-vetch.	pinn. leaf. lin. obl.	wh.	6. 7.	S.Europ.	1640.	H. A. ———
<i>venosus</i> . B.Fl.G.	veined.	pinn. leaf. ov. obt. mucr.	pur.	—	N.Amer.	1823.	H. B. ———

[*Sty.* bearded beneath the stigma.

[<i>Sty.</i> bearded beneath the stigma. <i>Cal.</i> tubu. of 5 uneq. seg. <i>Cor.</i> of 5 pets. <i>Standard</i> ov. with deflex. sides. <i>Ger.</i> compr.							
<i>Vicia</i> , <i>VETCH</i> .		<i>Cal.</i> tubu. of 5 uneq. seg.					
<i>angustifolia</i> . B.F.	narrow-leaved.	pin. leaf. lin. low. 1's obo.	pu.	5. 6.	Britain.	H. A. <i>Sandy loam.</i>
<i>atropurpurea</i> . B.R.	dark-purple.	pinn. leaf. lin. lanc. mucr.	pu.	—	Levant.	1773.	H. A. <i>seeds, or</i>
<i>Cracca</i> . E.Fl.	tufted.	pinn. leaf. lanc. hairy.	pu. bl.	6. 8.	Britain.	H. B. <i>parting</i>
<i>hybrida</i> . E.Fl.	hairy-flowered.	pinn. leaf. obl. hairy.	yel.	—	—	H. B. <i>roots.</i>
<i>ævigata</i> . E.Fl.	smooth-podded.	Leaf. ellip. obt. smth.	pu. bl.	7. 8.	—	H. B. ———
<i>athyroides</i> . E.B.	spring.	Leaf. ellip. hairy.	pur.	4. 6.	—	H. A. ———
<i>utea</i> . E.Fl.	yellow.	Leaf. ellip. hairy ben.	yel.	—	—	H. B. ———
<i>atiba</i> . E.B.	common.	Lea. elli. 6-10, opp. ov. alt. p. bl.	5. 6.	—	—	H. A. ———
<i>epium</i> . B.Fl.	common-bush.	Leaf. ov. hairy.	pu. bl.	—	—	H. B. ———
<i>ylvatica</i> . E.Fl.	wood.	Lea. elli. acu. Stip. den.	w. vi.	7. 8.	—	H. B. ———

[over on the outside.

[over on the outside. <i>ERVUM</i> , <i>TARE</i> . <i>Cal.</i> 5-part. <i>Pet.</i> 5. <i>Standard</i> obov. slightly reflex. <i>Ger.</i> obl. <i>Stig.</i> capita. downy all							
<i>hisperrimum</i> . Rox.	two-seeded.	pinn. leaf. lin. lan. downy.	li.	6. 7.	E. Ind.	1824.	H. A. <i>Sandy soil.</i>
<i>hirsutum</i> . E.F.	hairy.	pinn. leaf. obl. trunc.	pu. bl.	—	Britain.	H. A. <i>seeds.</i>
<i>tetraspermum</i> . L.	four-seeded.	Leaf. obl. obt.	pu. gr.	—	—	H. A. ———

[close single-seeded joints.

[close single-seeded joints. <i>ORNITHOPUS</i> , <i>BIRD'S-FOOT</i> . <i>Cal.</i> with 5 nearly equal teeth. <i>Cor.</i> of 5 pets. <i>Legu.</i> curved, of many							
<i>compressus</i> . L.	compressed.	pinn. leaf. compr. vill.	yel.	6. 7.	S.Europ.	1730.	H. A. <i>Light loam.</i>
<i>repens</i> . B.Fl.	common.	alt. pin. lea. elli. hair.	w. re. st.	5. 8.	Britain.	H. A. <i>seeds.</i>

ASTROL'OBium, *ASTROL'OBium*. *Cal.* 5-tooth. *Cor.* keel. compr. *Legu.* round, articulate.

<i>repandum</i> . DC.	repand.	ov. notch. upp. pinn.	yel.	6. 7.	Barbary.	1805.	H. A. <i>Sandy soil.</i>
<i>Ornithopus repandum</i> . Lam.							<i>seeds.</i>
<i>scorpioides</i> . DC.	Purslane-lv'd.	tern. leaf. small, round.	yel.	—	S.Europ.	1596.	H. A. ———
<i>Ornithopus scorpioides</i> . L.							

[jointed. *Seed* oblong, curved.

[jointed. <i>Seed</i> oblong, curved. <i>HIPPOCREPIS</i> , <i>HORSE-SHOE-VETCH</i> . <i>Cal.</i> bell-shaped, 5-cleft. <i>Cor.</i> of 5 pets. <i>Legu.</i> incurved.							
<i>olearica</i> . B.M.	shrubby.	pinn. leaf. ellip. hairy.	yel.	5. 6.	Minorca.	1776.	F. S. <i>Light loam.</i>
<i>omosa</i> . E.B.	tufted.	Leaf. 7-12. obo. hair. ben.	p. ye. 4.	8.	England.	H. B. <i>seeds, or</i>
<i>ultisiliquosa</i> . L.	many-podded.	pinn. pods stalk. clust.	yel.	7. 8.	S.Europ.	1683.	H. A. <i>cuttings.</i>

ESM'ODIUM, *DESM'ODIUM*. *Cal.* 4-cleft, opp. *Cor.* vexill. erect, notched. *Ger.* linear, hairy.

<i>odium</i> . B.M.	doubtful.	tern. leaf. obov. pubes.	ros.	6. 7.	Nepaul.	1823.	S. S. <i>Sandy loam.</i>
<i>grans</i> . DC.	whirling-plant.	tern. ov. lanc. obt.	re.	7. 8.	E. Ind.	1775.	S. B. <i>cuttings.</i>
<i>Hedysaran gygrans</i> . L.							

Systematic Name.	English Name.	Form of Leaves, &c.	Col. of Flow.	Month of Fl.	Native Country.	Yr. of Intro.	Soil and Propagation.
latifolium.	broad-leaved.	cord.orbic.pub.ben.	pu.	6.	China.	1818.	S. S. ———
nütans. B.M.	drooping.	tern. leaf. undul. rotun.	bl.	—	E. Ind.	1823.	S. S. ———

CYTISUS, CYTISUS. Cal. 2-lipp. lower lip 3-fid. Keel obtuse. Legu. compressed,

biflorus.	two-flowered.	tern. leaf. obl. elli. silk. ben. y.	6.	7.	Hungar.	1760.	H. S. ———
multiflorus. B.R.	many-flowered.	tern. leaf. obl. bas. atten.	yel.	—	Europe.	1800.	H. S. ———
nigricans. E.R.	dark-podded.	tern. leaf. ellip. pilos.	yel.	—	Austria.	1730.	H. S. ———

[Legu. of 1 or more single seeded joints.

HEDY'SARUM, HEDY'SARUM. Cal. 5-part. Pet. 5. Keel obtuse. Ger. compr. Sty. curved upwards.

alpinum. B.R.	Alpine.	pinn. ov. lanc. smth.	pu.	6.	7.	Siberia.	1798.	H. P. Rich sandy
coronarium. L.	French-Honeysuck.	Leaf. in 3-5 pairs, elli. pub. re.	—	—	Italy.	1596.	H. B. loam.	
elongatum. Fis.	elongated.	pinn. leaf. ellip.	pur.	—	Russia.	1823.	H. P. seeds, or	
grandiflorum.	large-flowered.	pinn. leaf. ellip. silky.	st.	—	Iberia.	1820.	H. P. parting	
obscurum. B.M.	creeping-root'd.	Leaf. 5-9 pairs, ov. smth.	pu.	—	Europe.	1640.	H. P. roots.	
roseum. B.M.	rose-coloured.	Leaf. 6-8 prs. obl. lan. vill. ro.	—	—	Siberia.	1803.	H. P. ———	

[gibbous. Seeds kidney-shaped.

ASTRAGALUS, MILK-VETCH. Cal. of 5 sharp teeth. Pet. 5. Standard the longest. Legu. 2-celled,

alopuroides. L.	Foxtail-like.	Leaf. ov. lanc. pubes.	yel.	6.	7.	Siberia.	1737.	H. P. Sandy loam.
aristatus.	awned.	Leaf. 6-9 prs. obl. mucr. pil. w.	—	—	Pyrenee.	1791.	H. S. seeds.	
Cicer. L.	bladdered.	Leaf. 10-13 prs. ellip. obl.	yel.	—	Europe.	1570.	H. P. ———	
capitatus. L.	headed.	Leaf. notch. pedunc. elon.	st.	7.	8.	Levant.	1759.	H. P. ———
glycyphyllos. E. Fl.	Wild Liquorice.	a span long, of 9-11 ov. leaf. ye.	—	—	Britain.	...	H. P. ———	
galegiformis. L.	Goat's-Rue-l'd.	Lea. 12-13 prs. ell. obt.; stm. er. y.	—	—	Siberia.	1729.	H. P. ———	
hypoglottis. E. B.	purple-mountain.	Leaf. notch. hairy.	pu. bl.	6.	7.	Britain.	...	H. P. ———
leontinus. B. C.	Lion's-tail.	Leaf. ellip. obt. 6-8 prs.	pu.	5.	6.	Austria.	1816.	H. P. ———
succulentus. B. R.	succulent.	Leaf. 10-12 prs. obl. obt.	p.	—	N. Amer.	1827.	H. P. ———	
Tragacantha. L.	Goat's-Thorn.	Lea. ellip. hoar. ped. 4-fl'd. w.	5.	7.	S. Europ.	...	H. S. ———	
tenuifolius.	slender-leaved.	pinn. leaf. lin. lanc. pub.	pu.	—	Siberia.	1780.	H. P. ———	
vulpinus. w.	Fox-tail.	Leaf. obo. obt. notch. down. y.	—	—	—	1815.	H. P. ———	

[Seeds 1, or more, smooth.

TRIFOLIUM, TREFOIL. Cal. 5-toothed. Pet. 4, united at the base. Legu. of 1 cell } 1 valve, deciduous.

arvense. L.	Hare's-foot.	Lea. lin. obo. serru. at apex. w.	7.	8.	Britain.	...	H. A. Sandy loam.
filiforme. E. B.	slender.	Leaf. obov. dent.	yel.	5.	7.	—	H. A. seeds.
fragiferum. E. F.	strawberry-head'd.	Leaf. obov. dent.	ros.	7.	8.	—	H. P. ———
glomeratum. E. B.	round-headed.	Leaf. obov. dent.	ros.	6.	—	—	H. A. ———
maritimum. E. B.	sea.	obov. notch. dent. hairy.	p. re.	—	—	—	H. A. ———
medium. E. Fl.	zig-zag.	Leaf. ellip. marg. cilia.	re. pu.	6.	7.	—	H. P. ———
minus. H. K.	lesser.	Leaf. obov. smth. dent.	yel.	—	—	—	H. A. ———
ochroleucum. L.	sulphur-color'd.	Leaf. ellip. ent. hairy.	st.	—	—	—	H. P. ———
pratense. E. B.	common-purple.	Leaf. ellip. acut. ent.	pur.	5.	9.	—	H. P. ———
procumbens. B. M.	Hop.	Leaf. obov. notch. den. sm. ye.	6.	7.	—	—	H. A. ———
repens. E. Fl.	Dutch-clover.	Leaf. obov. dent. smth.	wh.	5.	9.	—	H. P. ———
scabrum. E. Fl.	rough.	Leaf. obo. cor. hair. dent.	wh.	5.	6.	—	H. A. ———
striatum. E. Fl.	soft-knotted.	Leaf. obo. dent. down.	ros.	6.	—	—	H. A. ———
suffocatum. E. B.	suffocated.	Lea. wedge sh. smth. den.	pk.	—	—	—	H. A. ———
subterraneum. E. B.	subterraneous.	Leaf. obo. hairy, ent.	wh.	—	—	—	H. A. ———

[and 2 valves, cylindrical seeds.

LOTUS, BIRD'S-FOOT-TREFOIL. Cal. tubu. with 5 nearly equ. teeth. Cor. of 5 petals. Legu. of 1 cell,

angustissimus. L.	narrow-podded. ov. lanc. glau. hairy.	yel.	7.	8.	Britain.	...	H. B. Loam and
corniculatus.	common.	Leaf. obov.	yel.	—	—	...	H. P. peat.

Systematic Name.	English Name.	Form of Leaves, &c.	Col. of Flow.	Month of Fl.	Native Country.	Yr. of Introd.	Soil and Propagation.
créticus. L.	silver-leaved.	pinn. leafl. silky.	yel.	6. 9.	Levant.	1680.	G. S. cuttings,
Forsteri.	Forster's.	Leafl. lanc. glau. hair.	yel.	6.	Britain.	H. P. or seeds.
<i>decumbens.</i> Forst.							
glaucus. H. K.	glaucous-leaved.	Lea. sub-cuni. hoar. pods sm. y. 6. 8.	Madeira.	1777.	G. B.
jacobæus. W.	dark-flow'd.	Leafl. obo. spat. sub. silky.	da.	1. 12. C. Verd Is.	1714.	G. S.
microphyllus. B. M.	small-leaved.	tern. leafl. ellip. pilose.	ros.	7. 8. C. B. S.	1826.	G. S.
májor. E. B.	greater.	Leafl. obov. fringed.	yel.	—	Britain.	H. P. —
pinnátus. B. M.	pinnate-leaved.	pinn. leafl. obl. smth.	yel.	—	N. Amer.	1823.	H. P. —

DORY'CNium, DORY'CNium. Cal. bila. 5-tooth. Filam. awl-shap. Legu. turgid, 1-2-seeded.

argenteum.	silvery.	pinn. leafl. lin. lan. Stip. lin. ye.	6. 9.	Egypt.	1825.	H. S.	Sandy loam,
parviflorum.	small-flowered.	Leafl. lanc. Stip. ov.	yel.	—	S. Europ.	1824.	H. A. cuttings.
sericeum. Ph.	silky.	Leafl. tern. obl. silky.	bh.	—	—	1820.	H. S. —

Lótus seríceus. Ph.

CARMICHÆLIA, CARMICHÆLIA. Cal. 5-den. cup-sh. Cor. vex. broad. than long. Ger. lin. 5-6-seed.

austrális. B. R.	southern.	pin. or tern. old stm. leafles. pu.	3. 5.	N. Zeal.	1822.	G. S.
------------------	-----------	-------------------------------------	-------	----------	-------	-------	------

[1 cell, & 2 valves. Seeds smooth.

MEDICAGO, MEDICK. Cal. tubul. with 5 teeth. Pet. 5, decid. Ger. stalked. Legu. compr. falcate, of

arborea. W.	tree.	tern. leafl. obo. cord. ent.	yel.	5. 11.	Italy.	1596.	F. S. Sandy loam.
aculeata. W.	spiny.	rhomb. obov. dent.	ye.	6. 8.	S. Europ.	1802.	H. A. seeds, and
falcata. L.	yellow-sickle.	Leafl. obov. obl. dent.	yel.	7.	Britain.	H. P. cuttings.
lupulina. L.	black.	Leafl. orb. obo. smth. serr.	ye.	5. 8.	—	H. B. —
maculata. E. Fl.	spotted.	Leafl. obov. spott. dent.	yel.	5. 6.	—	H. A. —
mínima. E. Fl.	least.	Leafl. obov. dent. hairy.	yel.	—	England.	H. A. —
sativa. E. Fl.	purple.	Leafl. obl. serr. silky.	pu.	6. 7.	—	H. P. —

B'UTEA, B'UTEA. Cal. campan. 5-toothed, vexill. lanceolate. Legu. compressed, 1-seeded.

superba. Rox.	superb.	pinn. leafl. subrotun. obt. sc.	E. Ind.	1798.	S. S.	Loam & peat.
frondosa.	small-leaved.	pin. lea. obt. notch. silk. ben. re.	—	1801.	S. S.	cuttings.

ERYTHRINA, CORAL-TREE. Cal. 2-lipp. tubul. Vexill. long, lanc. Legu. of 2 valves, & many seeds.

Crista-gálii. L.	Cockscomb.	pinn. leafl. ov. smth.	red.	3. 7.	Brazil.	1771.	H. S. Loam, & leaf
carnea. B. R.	flesh-coloured.	ov. rhomb. acute, smth.	fl.	5.	V. Cruz.	1733.	G. S. mould.
caffra. B. R.	Cape.	pin. leafl. ov. obt. acum. sm. sc.	—	C. B. S.	1816.	S. C.	cuttings, in
herbacea. DC.	herbaceous.	Leafl. smth. rhomb.	sc.	6. 9.	S. Caroli.	1724.	G. P. sand, with-
ncána. W. en.	hoary.	rhomb. smth. Racem. elon.	sc.	—	E. Ind.	1820.	S. S. out being di-
aurifolia. B. F. G.	Laurel-leaved.	tern. leafl. ov. obl. acum.	sc.	—	Brazil.	H. S. vested of
poianthes. B. R.	naked-flow'ring.	tern. leafl. ov. pubes.	sc.	3. 4.	Caracas.	1826.	S. S. their leaves.
peciosa. DC.	shewy.	pin. leafl. ov. sub-trilob. acum.	—	W. Ind.	1805.	S. S.	The plants

will flower freely, if kept in a dry state, in Winter, and plunged in a little moist heat when the flower-buds begin to show; they may afterwards be turned out in the open border, where they will make a fine appearance.

DALBERGIA, DALBERGIA. Cal. 5-toothed, campan. Stam. 8-10. Legu. compress. 1-2-seeded.

atifolia. Rox.	broad-leaved.	pin. lea. 3-5-alt. notch. sm. abo. w. . .	E. Ind.	1811.	S. S.	Loam & peat.
candens. Rox.	climbing.	Lea. 9-11 pr. elli. obl. smth. ro. . . .	—	—	S. S.	cuttings.
sissoo. Rox.	Sissoo.	pin. lea. 5-alt. obo. pub. ben. w. . . .	—	—	1820.	S. S. —
olúbilis. Rox.	twining.	Leafl. 11, ov. mucr. smth. wh. . . .	—	—	1818.	S. S. —

Systematic Name.	English Name.	Form of Leaves, &c.	Col. of Flower.	Month of Fl.	Native Country.	Yr. of Introd.	Soil and Propagation.
PRIESTLE'YA, PRIESTLE'YA. <i>Cal. 5-parted. Cor. smooth. Legu. sess. compr. with 4-6 se. ds.</i>							
ericafolia. DC.	Heath-leaved.	lin. lanc. edges revol.	wh. pu.	4. 8.	C. B. S.	1812.	G. S. Loam & peat. cuttings.
<i>Borbônia ericafolia. L.</i>							
hirsuta. DC.	hairy.	obov. obl. smth. Br. hair.	— — —	— — —	— — —	1792.	G. S. — — —
lavigata. DC.	smooth.	obl. lin. acute.	yel.	7. 8.	— — —	1790.	G. S. — — —
BORBO'NIA, BORBO'NIA. <i>Cal. 5-parted, spiny. Cor. villous. Legu. linear, compr. seeds numerous.</i>							
cordata. DC.	heart-leaved.	cor. ent. smth. Br. hair.	yel.	6. 8.	C. B. S.	1759.	G. S. Sandy loam
lanceolata. L.	lanceolate.	lanc. ent. nerv.	yel.	— — —	— — —	1752.	G. S. and peat.
parviflora. DC.	small-flowered.	cord. dent. nerv.	yel.	— — —	— — —	1821.	G. S. cuttings.
ruscifolia. B.M.	ruscus-leaved.	cord. slightly ciliat.	yel.	— — —	— — —	1816.	G. S. — — —
LEBE'CKIA, LEBE'CKIA. <i>Cal. 5-cleft, lobes acute. Filam. all united. Legu. round, many-seeded.</i>							
cytisoides. Thun.	Cytisus-leaved.	tern. leaf. lin. obl. pubes.	yel.	— — —	C. B. S.	1774.	G. S. Peat & loam.
sub-nuda. DC.	sub-naked.	nearly smth. lin. decid.	yel.	— — —	— — —	1824.	G. S. cuttings.
PLATYLOBIUM, FLAT-PEA. <i>Cal. 2-lipp. the upper lip bifid, obtuse. Legu. compr. many-seeded.</i>							
formosum. B.M.	large-flowered.	ov. sub-cord.	yel.	6. 8.	N. S. W.	1790.	G. S. Peat & loam.
parviflorum. B.M.	small-flowered.	ov. smth. ent.	yel.	5. 9.	— — —	1792.	G. S. cuttings.
triangulare. B.M.	triangular.	deltoid, sub-hastate.	yel.	— — —	V. Die. Is.	1805.	G. S. — — —
ASPA'LATHUS, ASPA'LATHUS. <i>Cal. 5-part. lobes near. equ. Vexill. stalk. Legu. obl. about 2-seed.</i>							
argentea. L.	silvery.	tern. ov. both sides silky.	yel.	7. 8.	C. B. S.	1759.	G. S. Peat & loam.
crassifolius. A. rep.	thick-leaved.	in clusters, cylind. smth.	yel.	6.	— — —	1800.	G. S. cuttings.
ericifolia. L.	Heath-leaved.	crowded, filif. obt. vill.	yel.	— — —	— — —	1780.	G. S. — — —
mucronata. L.	thorny-branch'd.	tern. lanc. obt.	yel.	6. 7.	— — —	1796.	G. S. — — —
uniflora. B.M.	one-flowered.	in clusters, filif. acut. smth.	yel.	7. 8.	— — —	1812.	G. S. — — —
BOSSIÆ'A, BOSSIÆ'A. <i>Cal. 2-lipped, upper lip largest, & bifid. Legu. compressed, many-seeded.</i>							
cinerea. B.R.	sharp-leaved.	ov. lanc. pubes. ben.	pu. ye.	4. 7.	N. Holl.	1803.	G. S. Loam, peat,
cordifolia.	heart-leaved.	cord. acut. mucr. spiny.	yel.	6.	— — —	1824.	G. S. and leaf
heterophylla. B.M.	various-leaved.	obov. lin. lanc.	yel.	5. 12.	N. S. W.	1792.	G. S. mould.
linophylla. B.M.	narrow-leaved.	lin. margins recurved.	yel.	7. 9.	N. Holl.	1803.	G. S. cuttings, or
lenticularis. DC.	orbicular-leaf'd.	orb. smth. Br. roun. oft. spi. y.	5. 7.	N. S. W.	1822.	G. S. seeds.	
microphylla. B.C.	small-leaved.	obcor. wedge-sh. smth.	yel.	5. 8.	— — —	1803.	G. S. — — —
rufa. DC.	red-flowered.	Br. compl. lin. leafless, keel,	pil. 6. 9.	N. Holl.	— — —	G. S. — — —	
rhombifolia. DC.	Rhomb-leaved.	rhomb. orb. glau. mucr.	yel.	— — —	N. S. W.	1822.	G. S. — — —
scelopendria. B.R.	Plank-plant.	Br. smth. lin. leafless, den.	ye.	5. 7.	— — —	1792.	G. S. — — —
PLAGIOLOBUM, PLAGIOLOBUM. <i>Cal. bilab. upp. lip retu. und. 3-part. Legu. ventri. 2-seeded.</i>							
chorizemæfolium. Sal.	Chorizema-l'd.	obl. lanc. sinuat. spiny.	bl.	3. 5.	N. Holl.	1826.	G. S. Loam & peat.
ilicifolium. S.F.A.	Holly-leaved.	ov. ellip. sinua. spiny.	bl.	— — —	— — —	1824.	G. S. cuttings.
H'OVEA, H'OVEA. <i>Cal. bilab. upper lip half bifid. Stam. all united. Legu. sess. rounded, 2 seeded.</i>							
Célsi. B.R.	Cels's.	lanc. sub-rhomb. apex obt.	bl.	3. 4.	N. Holl.	1824.	G. S. Sandy loam
longifolia. B.R.	long-leaved.	lin. elong. opp.	bl.	6. 9.	N. S. W.	1805.	G. S. and peat.
linearis. B.R.	linear-leaved.	lin. mucron. hairy.	bl.	3. 7.	— — —	1796.	G. S. cuttings, or
latifolia. L.B.C.	broad-leaved.	ellip. obl. notch. smth.	bl.	— — —	— — —	1817.	G. S. seeds.
lanceolata. B.M.	spear-leaved.	lanc. point. pubes.	bl.	— — —	— — —	1805.	G. S. — — —
purpurea. Swt.	purple-flower'd.	lin. obl. downy, ben.	pur.	— — —	— — —	1820.	G. S. — — —
pannosa. B.M.	rusty-leaved.	lin. obl. obt. ent. smth. abo.	pu.	— — —	— — —	1824.	G. S. — — —

Systematic Name.	English Name.	Form of Leaves, &c.	Col. of Flow.	Month of Fl.	Native Country.	Yr. of Introd.	Soil and Propagation.
------------------	---------------	---------------------	---------------	--------------	-----------------	----------------	-----------------------

CROTALARIA, CROTALARIA. Cal. 5-lo. Cor. wing-cord. Filam. united. Legu. twrg. infla. stalk.

júncea. A. rep.	rushy-stalked.	lanc. sess. smth.	yel.	3. 7.	Malabar.	1700.	S. A. Sandy loam,
incána. B. R.	hoary-leaved.	tern. ovate, vill.	yel.	6. 7.	W. Ind.	1714.	S. A. peat, and
laburnifólia. L.	Laburnum-l'd.	Leafl. ov. acut. smth.	yel.	7. 9.	E. Ind.	1739.	S. B. leaf mould.
ovális. B. M.	oval-leaved.	ov. sub-sess. hairy.	yel.	—	N. Amer.	1827.	H. A. seeds, or
purpúrea. B. R.	purple.	obo. retuse, sub-emarg.	pur.	3. 5.	C. B. S.	1790.	G. S. cuttings.
pulchérriima. B. M.	pretty.	obov. lanc. silky ben.	yel.	5. 9.	E. Ind.	1814.	S. P. —
retúsa. B. M.	retuse-leaved.	obl. cuneif. retuse.	yel.	—	Mexico.	1731.	S. A. —
tenuifólia. B. R.	narrow-leaved.	lin. acut. silky.	yel.	—	—	1818.	S. A. —
vitellína. B. R.	yolk of egg.	tern. pub. leafl. ov. lan.	ye. vi.	—	Brazils.	1819.	S. S. —

TEMPLET'ONIA, TEMPLET'ONIA. Cal. 5-tooth. Keel obl. Stam. unit. Legu. compr. many-seeded.

gláuca. B. M.	glaucous-leaved.	obov. cuneate, glau.	sc.	3. 6.	N. Holl.	1803.	G. S. Loam & peat.
retúsa. B. R.	retuse.	wedge-sh. ent. smth.	cr.	—	—	—	G. S. cuttings.

GALA'CTIA, GALA'CTIA. Brac. 2. Cal. 4-dent. Cor. of 5 pets. Stig. obt. Legu. round. Seed round.

péndula. B. R.	pendulous.	tern. leafl. ov. smth. mucr.	pk.	—	Jamaica.	1794.	S. S. cl. —
----------------	------------	------------------------------	-----	---	----------	-------	-------------

GO'ODIA, GO'ODIA. Cal. 2-lipped, the upper half bifid, acute. Legu. compr. stalked.

lotifólia. B. M.	smooth.	tern. leafl. obov. smth.	yel.	4. 7.	V. Die. Is.	1793.	G. S. Loam & peat.
pubéscens. B. M.	downy.	obov. cuneate, pubes.	re. ye.	—	—	1805.	G. S. seeds, or cutt.

LODDIG'ESIA, LODDIG'ESIA. Cal. 5-toothed. Vexil. shorter than the keel. Ger. oblong, compr.

oxalidifólia. B. M.	Oxalis-leaved.	tern. obov. mucr.	yel.	5. 9.	C. B. S.	1802.	G. S. Sandy loam and peat. cuttings.
---------------------	----------------	-------------------	------	-------	----------	-------	--------------------------------------

SCOT'TIA, SCOT'TIA. Cal. imbr. 5-tooth. Pet. 5. Stam. 10, smth. Sty. filif. Legu. compr. Seeds 3-4.

angustifólia. B. R.	narrow-leaved.	lin. obl. dent.	br.	6. 8.	N. Holl.	1825.	G. S. Sandy loam
dentáta. B. R.	dented-leaved.	opp. cord. dent. smth.	re. gr.	6. 9.	—	1803.	G. S. & peat. cutt.

CLIT'ORIA, CLIT'ORIA. Cal. 5-parted. Vexill. large, spreading. Legu. linear, compressed.

arboréscens. L.	shrubby.	Leafl. 3 pairs. ellip.	pu.	8.	Trinidad.	1804.	S. S. Loam & peat.
Plumièri. B. R.	Plumier's.	tern. leafl. ov. obl. acum. w. pu.	pu.	9. 11.	W. Ind.	1815.	S. S. cl. seeds, or cutt.
Fernátea. B. M.	wing-leaved.	Leafl. 2-3 prs. ov. Stip. awl-sh.	7. 8.	E. Ind.	1739.	S. S. cl. tings, under	
virginiána. B. R.	Virginian.	ov. obl. smth. sub-rug.	pur.	—	America.	1732.	G. P. cl. a hand glass, will strike freely.

GLY'CINA, GLY'CINA. Cal. 2-lipped, 5-cleft. Cor. vexill. oblong-obcordate, apex bifid.

Comptoniána. B. R.	Ly. Northampton's.	tern. leafl. ov. cord.	pur.	—	N. Holl.	1803.	G. S. cl. —
Vicentína. B. R.	St. Vincent's.	obov. mucr. smth.	yel.	—	W. Ind.	1823.	S. P. —

WISTE'RIA, WISTE'RIA. Cal. 2-lipp. upp. 2, low. 3-part. Legu. lin. compr. many-seeded, 1-celled.

rutéscens. DC.	shrubby.	pinn. leafl. ov. ellip.	bl.	—	N. Amer.	1724.	H. S. cl. Loam & leaf mould.
Gly'cine frutéscens. L.							
hinénsis. DC.	Chinese.	pinn. leafl. ov. acum. pub. p. bl.	—	—	China.	1818.	H. S. cl. cuttings, or layers.
Gly'cine sinénsis. B. R.							

KENNE'DYA, KENNE'DYA. Cal. 2-lipped, upper 2-tooth. under 3-dented. Legu. linear, compr.

ordáta. B. R.	heart-leaved.	cord. ov. ent. smth.	pur.	—	N. Holl.	1824.	G. S. cl. Sandy loam
occínea.	scarlet.	tern. obov. Stip. lanc.	sc.	5. 8.	—	1803.	G. S. cl. and peat.
ilatáta. B. R.	dilated.	tern. ov. obt. silky.	sc.	4. 5.	—	1830.	G. S. cl. cuttings.

Systematic Name.	English Name.	Form of Leaves, &c.	Col. of Flow.	Month of Fl.	Native Country.	Yr. of Intro.	Soil and Propagation.
inophylla. B.R.	close-headed.	tern. cunea. mucr. silk.	sc.	4. 5.	N. Holl.	1825. G. S. cl.	———
monophylla. B.M.	one-leaved.	pinn. leaf. smth. sub-cor.	vi.	3. 6.	N. S. W.	1790. G. S. cl.	———
ovata. B.M.	oval-leaved.	Leaf. ov. acut. Stip. lanc.	pu.	———	———	1820. G. S. cl.	———

D'OLICHOS, D'OLICHOS. *Cal. campan. 5-toothed. Vexill. oblong. Legu. linear, compressed.*

angulosus. DC.	angular.	pinn. leaf. 2-lobed.	yel.	6. 8.	N. Amer.	1820. H. A. cl.	Loam & leaf
hirsutus. DC.	hairy.	Leaf. ov. acut. hairy.	pur.	6.	China.	1802. G. S. cl.	mould.
lignosus. DC.	woody.	Leaf. ov. acut. smth.	ros.	7. 8.	E. Ind.	1776. G. S. cl.	seeds, or
Láblab. L.	common.	Leaf. ov. ent.	pur.	———	———	S. A. cl.	cuttings.

PSOPHOCARPUS, PSOPHOCARPUS. *Cal. bilab. uneq. Cor. vexil. round, refl. Legu. obl. 7-8-seed.*

tetragonolobus. DC.	square-podded.	pinn. leaf. tern.	bl.	9. 11.	Maurit.	1816.	S. A. Sandy loam & peat, cutt.
<i>Dolichos tetragonolobus.</i> L.							

A'PIOS, A'PIOS. *Cal. 5-toothed. Stam. diadelphia. Legu. of 2 cells, many-seeded.*

tuberosa. B.M.	tuberous-root'd.	pinn. leaf. ov. smth.	pur.	———	N. Amer.	1640. H. P. cl.	———
----------------	------------------	-----------------------	------	-----	----------	-----------------	-----

LUPINUS, LUPINE. *Cal. bilabiate. Cor. papilionacea. Legu. torulose, compressed.*

arboreus. B.M.	tree.	Leaf. lan. lin. acut. pub.	yel.	7. 9.	S. Amer.	1793.	H. S. Loam & leaf
Cruckshánkia. B.M.	Mr. Cruckshank's.	Leaf. 7-9, obl. obt.	pu. ye.	———	Peru.	1829.	H. P. mould.
laxiflorus. B.R.	loose-flow'ring.	Leaf. lin. lanc. 7-9.	bl.	8. 10.	Columb.	1827.	H. P. seeds, or
mutabilis. B.F.G.	changeable-col.	Leaf. 7-9, obl. lan. pub. ben. w.	———	———	Begota.	1825.	H. P. parting the
nootkaténsis. B.M.	yellow.	Leaf. obov. obl. hairy.	bl. ye.	6. 8.	Noot. Soun.	1794.	H. P. plants at
ornatus. B.R.	sky-blue.	digit. leaf. lin. lan. silky.	bl.	5. 11.	Columb.	1827.	H. P. the root.
pulchellus. B.F.G.	pretty.	alt. leaf. obl. lanc. mucr. pub.	———	———	Mexico.	1828.	F. P. ——
perennis. B.M.	perennial.	Leaf. obl. mucr. vill.	pur.	5. 8.	N. Amer.	1658.	F. P. ——
polyphyllus. B.R.	many-leaved.	lanc. ent. vill. ben.	pu. bl.	———	Columb.	1827.	H. P. ——
plumosus. B.R.	feathery.	pinn. leaf. 5-7-lanc. silk.	bl.	5. 11.	———	———	H. P. ——
Sabiánus. B.M.	Mr. Sabine's.	Leaf. 9-12, lanc. silky.	yel.	———	N. Amer.	H. P. ——
versicolor. B.F.G.	various-color'd.	Leaf. 6-9, spath. lanc. obt.	bl.	6. 9.	Mexico.	1828.	H. S. ——

PHASEOLUS, PHASEOLUS. *Cal. campan. bilab. upper lip 2-dented, under 3-toothed. Legu. 1-seed.*

caracalla. B.R.	twisted-flow'd.	tern. leaf. ov. rhomb.	pu. ye.	———	India.	1690. S. P. cl.	Sandy loam
farinosus. L.	mealy.	Leaf. ov. rhom. sub-trilob. ro.	7. 8.	E. Ind.	1759. S. P. cl.		and leaf
multiflorus. W.	many-flowered.	Leaf. ov. acum.	sc.	———	S. Amer.	1633. H. P. cl.	mould.
semierectus. B.R.	dark-red.	tern. leaf. ov. ent.	re.	———	———	1732. S. A. cl.	cuttings,
triflorus. Roth.	three-lobed.	pin. side 1's 2-lo. ter. 3-lo.	pu.	———	E. Ind.	1777. S. A.	or seeds.
vulgaris. L.	common.	Leaf. ov. acum.	wh.	6. 9.	———	1597. H. A. cl.	———

LIPARIA, LIPARIA. *Cal. 5-parted. Cor. smth. vexillum, oblong. Legu. ovate, compressed.*

sphaerica. B.M.	round-headed.	lanc. nerv. smth.	ye.	7. 8.	C. B. S.	1794.	G. S. Peat & loam.
sericea. L.	silky.	ov. vill. downy.	yel.	———	———	———	G. S. cuttings.
tomentosa. Thun.	downy.	lanc. ent. downy.	yel.	———	———	1812.	G. S. ——
vestita. B.M.	concave-leaved.	ov. conc. pub. ben.	yel.	———	———	1800.	G. S. ——

[celled, and single-seeded.

GEOFFROYA, BASTARD CABBAGE-TREE. *Cal. 5-part. Cor. papilionacea. Legu. drupacea, 1-*

supérba.	superb.	pinn. leaf. 13-17, obl. obt.	yel.	S. Amer.	1830.	S. S. Loam & peat.
spinosa. Jac.	spiny.	pin. lea. 13-15, obl. obt. sm.	st.	8. 9.	———	1823.	S. S. cuttings.
violacea. Pers.	violet-coloured.	pinn. ov. obl. notch.	vi.	7. 6.	Guiana.	1827.	S. S. ——

Systematic Name.	English Name.	Form of Leaves, &c.	Col. of Flow.	Month of Fl.	Native Country.	Yr. of Introd.	Soil and Propagation.
CORONILLA, CORONILLA. <i>Cal. 5-part. Vexill. hardly longer than the wings. Legu. jointed.</i>							
E'merus. B.M.	Scorpion-senna.	Leaf. 5-7 pr. obo.	Ped. 3-fl. y.	4. 6.	France.	1596.	H. S. Loam & leaf
glauca. B.M.	glaucous.	Leaf. 5-7, obo. obt. glau.	umb.	9. 5.	—	1722.	F. S. mould.
ibérica. B.C.	Iberian.	pinn. leaf. wedge-sh. cil.	ye.	—	Iberia.	1818.	H. P. cuttings.
júncea. DC.	rush-like.	Leaf. 3-7 prs. lin. obl. obt.	yel.	6. 8.	France.	1656.	F. S. —
valentina. B.M.	nine-leaved.	Leaf. 5-9 prs. obo. glau.	yel.	2. 6.	S. Europ.	1596.	F. S. —
varia. B.M.	various.	Leaf. 9-13 prs. obl. mucr.	pu.	6. 11.	Europe.	1597.	H. P. —
COLUTEA, BLADDER-SENNA. <i>Cal. 5-tooth. Carina obt. Sty. bearded. Stig. capit. Legu. inflat.</i>							
arboréscens. B.M.	common.	ellip. retuse.	yel.	6. 8.	S. Europ.	1568.	H. S. Sandy loam.
cruenta. H.K.	oriental.	Leaf. obov. emarg. glau.	re.	—	Levant.	1710.	H. S. cuttings.
Haléppica. DC.	Pocock's.	Leaf. ellip. obt. mucr.	yel.	5. 10.	—	1752.	H. S. —
	<i>Pocockii. H.K.</i>						
AMPHODUS, AMPHODUS. <i>Cal. bila. upp. lip 2-den. low. 3-lo. Cor. vexil. refl. Leg. comp. many-seed.</i>							
ovatus. B.R.	ovate-leaved.	tern. leaf. ov. obt. hairy.	d. pu.	3. 4.	Trinidad.	1824.	S. S. cl. —
SUTHERLANDIA, SUTHERLANDIA. <i>Cal. 5-tooth. Cor. keel, obl. wings short. Legu. inflated.</i>							
frutéscent. B.M.	shrubby.	pinn. leaf. ellip. silky ben.	sc.	6. 9.	C. B. S.	1683.	F. S. Light loam and leaf mould. cuttings, or seeds.
SWAINSONIA, SWAINSONIA. <i>Cal. 5-tooth. Carina obt. Sty. bearded. Legu. inflated, turgid.</i>							
coronillifolia. B.M.	Coronilla-lv'd.	of 9-11 pairs, ov. obt.	pu.	7. 8.	N. S. W.	1802.	G. S. —
galegifolia. B.M.	red-flowered.	9 pairs, ov. emarg.	sc.	—	—	1800.	G. S. —
CARAGANA, CARAGANA. <i>Cal. tubul. 5-tooth. Sty. snth. Legu. sessile, compr. Seeds numerous.</i>							
arboréscens. DC.	common.	pin. lea. 6-8 prs. ov. obl. vill.	ye.	4. 6.	Siberia.	1752.	H. S. Sandy loam.
frutéscent. DC.	shrubby.	pin. leaf. 2 prs. obo. mucr.	yel.	—	—	—	H. S. grafting, or
grandiflora. DC.	large-flowered.	bijugis obl. cuneat. pub.	yel.	—	Iberia.	1822.	H. S. budding or
microphylla. DC.	small-leaved.	Leaf. 6-7 prs. retuse, wh.	yel.	—	Siberia.	1816.	H. S. the arbores-
spinosa. DC.	thorny.	Leaf. 2-4 prs. lin. cun. smt.	ye.	—	—	1775.	H. S. cens, or seeds or layers.
ROBINIA, ROBINIA. <i>Cal. 5-tooth. 2 upp. shortest. Sty. bearded. Legu. compr. near. sess. many-seed.</i>							
hispida. B.M.	Rose-acacia.	pinn. leaf. obov.	ros.	5. 9.	Carolina.	1743.	H. S. Sandy loam.
	<i>β rósea.</i>	<i>upright.</i>	ros.	—	—	H. S. seeds, layers,
Pseudacacia. L.	common.	pinn. leaf. ov.	wh.	5. 6.	N. Amer.	1640.	H. C. budding, or
	<i>β inermis.</i>	<i>smooth.</i>	wh.	—	H. C. grafting.
viscosa. B.M.	clammy.	ov. Br. clammy.	wh. re.	6. 8.	—	1797.	H. C. —
HALLIA, HALLIA. <i>Cal. 5-cleft, segm. nearly equal. Legu. compr. of 2 valves, and 1 seed.</i>							
cordata. DC.	heart-leaved.	cord. ov. hairy. Stip. ov.	pu.	6. 9.	C. B. S.	1787.	G. S. Sandy loam
imbricata. B.M.	imbricated.	cord. acut. convol. imbr.	pu.	—	—	1812.	G. S. & peat. cutt.
SMITHIA, SMITHIA. <i>Cal. 2-parted. Filam. divided in 2 equal parcels. Legu. jointed, plaited.</i>							
sensitiva. H.K.	annual.	pinn. Racem. few-fl'd.	yel.	7. 10.	E. Ind.	1785.	S. A. —
PSORALEA, PSORALEA. <i>Cal. 5-parted the length of the pod. Legu. 1-seeded, valveless.</i>							
aphylla. B.M.	leafless.	tern. leaf. lin. lanc.	bl.	8. 10.	C. B. S.	1790.	G. S. Sandy loam
aculeata. B.M.	prickly.	tern. leaf. wedg.-sh. recur.	bl.	5. 9.	—	1774.	G. S. and leaf
bituminosa. L.	bituminous.	pinn. leaf. ov. lanc.	bl.	—	Italy.	1570.	F. S. mou'd.

Systematic Name.	English Name.	Form of Leaves, &c.	Col. of Flow.	Month of Fl.	Native Country.	Yr. of Introd.	Soil and Propagation.
bracteata. B.M.	bracteated.	ter.lea.wedg.-sh.shin.dott.bl.5.	9.	C. B. S.	1731.	G. S.	cuttings,
glandulosa. DC.	glandular.	tern.leafl.ov.lanc.acum.	bl. —	Peru.	1770.	G. S.	under a
Onobrychis. B.R.	rough-podded.	tern.leafl.ov.lan.sub-pub.pu.	—	N.Amer.	1818.	H. S.	glass, will
pinnata. B.R.	wing-leaved.	pinn. leafl. lin.	bl. 5. 7.	C. B. S.	1690.	G. S.	strike freely.
pubescens. B.R.	pubescent.	tern.leafl.ov.obl.ent.	bl. 6.	Lima.	1823.	G. B.	—
spicata. B.R.	spiked.	tern.leafl.obo.obl.dott.bl.u.	7. 8.	C. B. S.	1774.	G. S.	—
tenuifolia. DC.	slender-leaved.	Leafl. lin. lanc. mucr.	bl. 6. 7.	—	1793.	G. S.	—

[upper suture turned inwards.

OXYTROPIS, OXYTROPIS. Cal. 5-tooth. Cor. keel, mucr. Legu. 2-celled, or half 2-celled, with the
Lambertii. B.M. Lambert's. pinn.leafl.ellip.lanc.acut. bl. 6. 8. Missouri. 1811. S. P. Loam & peat. cuttings.

SESBANIA, SESBANIA. Cal. campan. 5-toothed. Vexillum, round, notched. Legu. elongated.

affinis. DC.	likened.	pinn.leafl.obl.lin.obt.	yel. 5. 8.	E. Ind.	1822.	S. B.	Loam & peat.
picta. B.R.	spotted.	pinn.leafl.lin.obt.mucr.	yel. 4. 9.	W. Ind.	—	S. S.	cuttings.
paludosa. DC.	marsh.	Leafl.obl.-lin.10-20 prs.	ye. —	E. Ind.	1810.	S. A.	—
pubescens. DC.	pubescent.	Leafl. obl.-lin. 20 pairs.	ye. —	—	1830.	S. B.	—

GALEGA, GOAT'S-RUE. Cal. 5-tooth. Vexill. obov. obl. Legu. with oblique streaks, round.

biloba.	two-lobed.	pin.lea.obl.pub.apex 2-lo.	bl. 5. 6.	—	1823.	H. P.	Rich loam.
officinalis. L.	officinal.	Leafl.lanc.mucr.smth.	pu. 6. 9.	Spain.	1568.	H. P.	seeds, or
1. alba.	white.	wh. —	—	—	H. P.	dividing
2. caerulea.	blue.	bl. —	—	—	H. P.	roots.
grandiflora. B.R.	large-flowered.	pinn. leafl. obl. mucr.	pu. —	C. B. S.	1774.	H. P.	—
persica. B.F.G.	Persian.	pinn.leafl.ov.obl.mucr.	wh. —	Persia.	1816.	H. P.	—

GLYCYRRHIZA, LIQUORICE. Cal. nak. bilab. 5-tooth. Vexill. ova. lanc. Legu. compr. 1-4-seeded.

glabra. L.	smooth.	Leafl.ov.retuse,glandul.	pu. 7. 9.	S.Europ.	1562.	H. P.	Rich loam.
glandulifera.	glandulous.	Leafl.obl.lanc.gland.pub.pu.	6. 8.	Hungary.	1805.	H. P.	seeds, or part.
hirsuta. L.	hairy.	Leafl.obl.lan. Legu.hair.	li. —	Levant.	1739.	H. P.	at the roots.

TRIGONELLA, FENUGREEK. Cal. campanulate, 5-parted. Legu. oblong, compressed.

ruthenica. L.	small.	Leafl. lanc. obt. serr.	yel. 5. 7.	Siberia.	1741.	H. P.	Sandy loam.
tenuis. DC.	slender.	Leafl.obov.cord.serrul.	yel. 6. 8.	Tiflin.	1818.	H. A.	part. roots, or seeds.

ÆSCHYNO' MENE, ÆSCHYNO' MENE. Cal. bilab. 5-part. upp. lip 2-tooth. Legu. jointed, compr.

aspera. DC.	rough-stemmed.	pinn. leafl. lin. obt.	yel. 6. 7.	E. Ind.	1759.	S. A.	Loam & leaf
sensitiva. DC.	sensitive.	Leafl. lin. 16-20 pairs.	wh. 5. 8.	W. Ind.	1733.	S. S.	mould. cutt.

FLEMINGIA, FLEMINGIA. Cal. acut. 5-cleft. Vexill. striat. Legu. sess. ov. turgid, 2-valv. 2-seed.

congesta. Rox.	crowded.	Leafl.lan.sid.1's 2-nerv.	re. 7. 9.	E. Ind.	1802.	S. S.	Loam & peat.
nana. Rox.	dwarf.	Leafl.obov.foots.winged.	re. —	—	1804.	S. S.	cuttings.
strobilifera. B.R.	Beech-leaved.	ov. obl. cord. vill.	gr.wh. —	—	1787.	S. S.	—

INDIGO'FERA, INDIGO. Cal. 5-part. lobes acute. Vexill. notched. Legu. 4-sided, & many-seeded.

australis. B.C.	Botany Bay.	pinn.leafl.ellip.obt.smth.	ro. 3. 6.	N.S.W.	1790.	G. S.	Loam & leaf
am'cua. H.K.	scarlet-flow'r'd.	Leafl. 3, ov. mucr. hairy.	sc. —	C. B. S.	1774.	G. S.	mould.
atropurpurea. DC.	dark-purple.	in 5 prs. leafl. ellip.obt.	pu. 7. 8.	Nepaul.	1820.	S. S.	cuttings.
cytisoïdes. B.M.	Cytisus-like.	pinn. leafl. obl. mucr.	pu. —	C. B. S.	1774.	G. S.	—
denudata. B.C.	smooth-leaved.	Leafl. 3, obcord. obov.	pu. 5. 7.	—	1790.	G. S.	—

Systematic Name.	English Name.	Form of Leaves, &c.	Col. of Flow.	Month of Fl.	Native Country.	Yr. of Introd.	Soil and Propagation.
endecaphylla. B. R.	eleven-leaved.	pinn. leaf. obl. smth. muc.	re.	7.	9. Guinea.	1822.	S. A. ———
incana. B. R.	hoary.	Leaf. ter. orb. obo. down.	r. p.	5.	7. C. B. S.	1812.	G. S. ———
spinosa.	spiny.	in 3's, lea. obo. stip. needle-sh.		4.	8. Arabia.	1822.	S. S. ———
[of 1 cell, & 2 valves. Seeds several.							
PISUM, PEA.	<i>Cal. cup-shap. 5-cleft. Pet. 5, obo. notch. Ger. compr. Sty. triang. Stig. downy. Legu.</i>						
americanum. DC.	American.	lan. acu. dent. upp. sagit.	pu.	7.	8. America.	H. A. Sandy loam.
maritimum. E. B.	sea.	alt. sess. pin. glau.; stm. ang. p.	—		England.	H. P. seed, or parting the root.
DA'LEA, DA'LEA.	<i>Cal. 5-parted. Stam. 10, united. Legu. ovate, 1-seeded, shorter than the calyx.</i>						
aurea. DC.	golden.	Leaf. in 4 prs. obo. hair.	yel.	—	Louisian.	1811.	H. P. Sandy loam.
Cliffortiãna. W.	Vera Cruz.	in 6 pairs, lin. retuse.	bl.	—	V. Cruz.	1737.	H. A. seeds, or dividing the root.
LUPINA'STER, BASTARD-LUPINE.	<i>Cal. campan. 5-tooth. Stig. hooked. Legu. round, many-seed.</i>						
pentaphyllus. B. M.	five-leaved.	quinate. sess.		red.	7. 8. Siberia.	1741.	H. P. Light rich loam. seeds, or parting roots.
AMORPHA, BASTARD-INDIGO.	<i>Cal. 5-dent. Cor. vexill. obo. conc. Legu. compr. 1-cell, & 2-seed.</i>						
reticulosa. L.	shrubby.	pinn. leaf. ell. obl.	bl.	—	Carolina.	1724.	H. S. ———
fragrans. B. F. G.	fragrant.	pin. leaf. ellip. obl. mucr. pub.	—		N. Amer.	1812.	H. P. ———

CLASS XVIII.

POLYADELPHIA. Filaments united in several parcels.

ORDER I.

DECANDRIA. Stamens 10, united into separate sets.

[Nect. with 5 horns.							
THEOBRO'MA, THEOBRO'MA.	<i>Cal. of 5 leav. Pet. 5-fornic. Stam. 5, each with 2 anth. Stig. 5-clef.</i>						
Cacáo. W.	smooth-leaved.	ov. obl. ent. smth.	cr.	—	S. Amer.	1739.	S. S. Sandy peat
Guianensis. W.	woolly-leaved.	acum. repand. dent. down. br.	—		Guiana.	1803.	S. S. and loam. cuttings.
ABRO'MA, ABRO'MA.	<i>Cal. 5-part. Pet. 5. Stam. 10-cleft. Caps. 5-celled, & 5-winged.</i>						
ugústa. L.	maple-leaved.	cord. lob. serr. smth.	pu.	8.	E. Ind.	1770.	S. S. Sandy loam
astuósa. H. K.	prickly-stalked.	cor. lob. serr. pub. ben.	pu.	5.	8. N. S. W.	1800.	S. S. and peat. cuttings.

ORDER II.

POLYANDRIA. STAMENS NUMEROUS.

MELALEU'CA, MELALEU'CA.	<i>Cal. 5-part. Pet. 5. Sty. short. Stig. capit. Caps. 3-cell, many-seed.</i>						
milláris. B. R.	pale-flowered.	alt. lin. awl-shap.	wh.	6.	8. N. S. W.	1789.	G. S. Sandy loam
lycína. H. K.	permanent-cal.	opp. ov. lanc.	wh.	—	N. Holl.	1803.	G. S. and peat.

Systematic Name.	English Name.	Form of Leaves, &c.	Col. of Flow.	Month of Fl.	Native Country.	Yr. of Intro.	Soil and Propagation
dēnsa. H.K.	dense-leaved.	tern. opp. obov. smth.	pu.	6. 8.	N.Holl.	1804.	G. S. cuttings,
decussāta. H.K.	decussate.	opp. decus. ov. lanc.	li.	6. 9.	—	1803.	G. S. under a glass
ericifōlia. Ex.B.	heath-leaved.	alt. lin. awl-shap.	wh.	7. 9.	N.S.W.	1788.	G. S. in sand, will
fimbriata.	finged.	opp. ellip. smth.	wh.pk.	—	N. Holl.	1817.	G. S. readily
fūlgens. B.R.	splendid.	opp. lanc. lin. acut.	sc.	6. 8.	—	1803.	G. S. strike root.
genistifōlia. Ex.B.	Genista-leaved.	alt. lin. lanc.	wh.	4. 6.	—	1793.	G. S. —
globifera. H.K.	Globe-fruited.	alt. obl. 5-nerv.	wh.	7. 9.	—	1803.	G. S. —
hypericifōlia. H.K.	Hypericum-l'd.	opp. decuss. ellip.	sc.	—	N.S.W.	1792.	G. S. —
incāna. B.R.	hoary.	tern. lanc. lin.	wh.y.	—	—	1812.	G. S. —
Leucadēndron. L.	Cajuputi-tree.	alt. lanc. acum.	wh.	—	E. Ind.	1796.	S. S. —
linarifōlia. Ex.B.	toad-flax-lv'd.	opp. lanc. lin.	wh.	5. 7.	N.S.W.	1793.	G. S. —
sqúamea. DC.	scaly.	ov. lanc. acut. 3-nerv.	pu.	6. 8.	V.D.Isl.	1805.	G. S. —
thymifōlia. B.M.	Thyme-leaved.	opp. lanc. nerveless.	pu.	6. 9.	N.S.W.	1792.	G. S. —

BEAUFORTIA, BEAUFORTIA. Cal. 5-part. lobes acut. Pet. 5. Caps. 3-celled. Stig. filiform.

decussāta. B.M.	decussate.	opp. decus. ov.	sc.	3. 8.	N. Holl.	1803.	G. S. —
spārsa.	scattered.	ov. many-nerv. scatt.	sc.	—	—	—	G. S. —

CALOTHA'MNUS, CALOTHA'MNUS. Cal. 4-5-tooth. persist. Pet. 4-5. Caps. 3-cell. many-seeded.

clavāta. B.C.	club-flowered.	lin. vill. flat.	sc.	1.12.	—	1826.	G. S. Peat & loam.
grācilis. DC.	slender.	elongated, smth.	sc.	—	—	1803.	G. S. cuttings.
quadrifida. B.M.	four-cleft.	obl. smth. lin.	sc.	—	—	—	G. S. —
villōsa. B.R.	hairy.	lin. vill. cyl.	sc.	—	—	—	G. S. —
longifolius.	long-leaved.	above a ft. long, smth.	G. S. —

[Sty. short. Stig. 5-lob. Ber. 5-celled. Seeds 5.

XANTHOCHY'MUS, XANTHOCHY'MUS. Cal. 5-parted, imbric. Pet. 5, ovate, round. Stam. 15-20.

dūlcis. B.M.	sweet-fruited.	opp.obl.acum.smth.ent. y.st.	—	—	E. Ind.	1820.	S. S. Loam & leaf
ovalifolius. Rox.	oval-leaved.	ov. obt. smth.	yel.	—	—	1796.	S. S. mould.
pictōrius.	painter's.	obl. smth.	yel.	—	—	1824.	S. S. cuttings.

CANDO'LLA, CANDO'LLA. Cal. 5-part. Pet. 5. Stam. in 5 bundles. Caps. 3-celled, 2-seeded.

cuneāta. B.M.	wedge-shaped.	obo.cunea.sub-den.smth.	ye.	5. 8.	N. Holl.	1823.	G. S. —
---------------	---------------	-------------------------	-----	-------	----------	-------	---------

EUDE'SMIA, EUDE'SMIA. Cal. tubul. 4-dented. Pet. 4, decidu. concave. Caps. 4-celled, many-seeded.

tetragōna.	square-stalked.	obl.lan.decuss.powdery.	ye.	6. 8.	—	1814.	G. S. —
------------	-----------------	-------------------------	-----	-------	---	-------	---------

SIMPLOCOS, SIMPLOCOS. Cal. 5-cleft. Pet. 5-8. Stam. united. Caps. 5-celled.

sīnica. B.R.	Chinese.	ellip.lanc.downy,serr.	wh.	6. 7.	China.	1822.	G. S. —
tinctōria.	Dyer's.	glau. shin. ell. obl.	yel.	—	Carolina.	1780.	G. S. —

CITRUS, ORANGE-TREE. Cal. 5-cleft. Pet. 5, obl. Filam. spread. Ber. 9-18-celled. Pulp soft.

aurāntium. DC.	Sweet Orange.	ov. lanc. acum. smth.	wh.	5. 7.	Asia.	1695.	G. S. Rich sandy
buxifōlia. DC.	Box-leaved.	ov. ret. flo. racemed.	wh.	—	China.	1789.	G. S. loam, mixed
decumāna. DC.	shaddock.	obt. emarg. Frt. large.	wh.	—	—	1724.	G. S. with rotten
Limōnium. DC.	Lemon.	obl.acut.tooth.Frt.glob.	wh.	—	Asia.	1648.	G. S. dung & leaf
Limétto. DC.	Lime.	ov. serr. round.	wh.	—	—	—	G. S. mould. The
Médica. DC.	Citron.	obl. acut. Frt. obl.	wh.	—	—	1805.	G. S. pots and tubs
nóbilis. B.Rep.	mandarin.	ov. ellip. smth. ent.	wh.	—	China.	—	G. S. should be
trifoliātus. P.S.	three-leaved.	tern. ov. ellip.	wh.	—	—	1800.	G. S. well drained,

and the plants should not have too much water when in a dormant state. They are freely increased by budding or ingrafting on the common stocks.

Systematic Name.	English Name.	Form of Leaves, &c.	Col. of Flow.	Month of Fl.	Native Country.	Yr. of Introd.	Soil and Propagation.
ASCYRUM, ASCYRUM. <i>Cal. 4-leaved. Pet. 4. Stam. many. Sty. 1-3. Caps. 1-celled, & 3-valved.</i>							
amplexiçaulè.	Ph. stem-clasping.	ov. cord. crisp.	yel.	7. 9.	N. Amer.	1823.	G. S. Sandy loam
Crux-Andræ.	Ph. St. Andrew's Cross.	ov. lin. obt.	yel.	7.	—	1825.	G. S. and peat.
hypericoïdes.	Ph. Hypericum-l'd.	obl. lin. obt. 2-glands.	yel.	7. 9.	—	1759.	G. S. cuttings.
humilum.	Ph. dwarf.	ov. obt. clustered.	yel.	6. 8.	—	1806.	G. P. —
stans.	DC. large-flowered.	ov. ellip. obt. glau.	yel.	7. 9.	—	—	G. S. —
LOA'SA, LOA'SA. <i>Cal. 5-part. Pet. 5. Stam. many. Sty. 3-fid. at apex. Caps. 1-celled, & 3-valved.</i>							
grandiflora.	DC. great-flowered.	opp. upp. alt. 5-lob.	yel.	7. 10.	Caracas.	1825.	H. A. Peat & loam.
hispidà.	B. M. hispid.	alt. bipinnatif.	yel.	6. 7.	Lima.	1829.	F. A. seeds.
incana.	B. R. hoary.	ov. acut. serr. hisp.	wh.	—	Peru.	—	F. A. —
nitida.	B. R. shining.	opp. cord. 5-7-lob.	yel.	—	Chili.	1822.	H. A. —
Placei.	B. R. Place's.	ov. smth.	yel.	—	—	1824.	H. A. —
volubilis.	DC. twining.	alt. opp. lob. lin. obt.	yel.	—	—	—	H. A. —
HYPERICUM, ST. JOHN'S WORT. <i>Cal. 5-part. Pet. 5. Stam. many. Sty. 5. Caps. membr.</i>							
angulosum.	DC. angular.	ov. ampl. acut.	yel.	6. 7.	N. Amer.	1812.	H. P. The nume-
Androsæmum.	E. B. Tutsan.	ampl. acut. lanc. ov.	yel.	—	Britain.	...	H. P. rous species
Ascyron.	DC. St. Peter's-wort.	ampl. lanc. acut.	yel.	6. 9.	Siberia.	1774.	H. P. in this ge-
macnum.	DC. shewy.	obl. ellip. acut.	yel.	7. 8.	Carolina.	1812.	H. P. nus may be
ascyroïdes.	w. ascyron-like.	obl. lanc. acut.	yel.	6. 7.	N. Amer.	—	H. P. increased by
egyptiacum.	L. Egyptian.	sess. decuss. ellip. ent.	yel.	—	Egypt.	1787.	G. S. cuttings, and
arbatum.	En. B. bearded.	obl. lanc. amplex. dott.	yel.	6. 10.	Scotland.	...	H. P. the parting
baleàricum.	L. balearic.	ov. obt. sub-plex. warty. ye.	3. 9.	Majorca.	1714.		G. S. of the plants
cordifolium.	heart-leaved.	ov. cord. amplex. dott.	yel.	...	Nepal.	1825.	G. S. at the roots
alycinum.	E. B. large-calyxed.	ov. coriac. dott. shining.	yel.	6. 10.	Ireland.	...	H. S. of those that
chinense.	DC. Chinese.	ellip. obt. Pedun. 2-bract'd. y.	3. 9.	China.	1753.		G. S. are of peren-
<i>monogynum. L.</i>							
Coris.	B. M. Coris-leaved.	lin. verticill. edges revol.	yel.	5. 9.	Levant.	1640.	G. S. tion.
crispum.	L. curled-leaved.	sess. lanc. base undul. sinua. y.	7. 8.	Greece.	1688.		F. P. —
dubitum.	E. Fl. doubtful.	ellip. ov. obt.	yel.	—	Britain.	...	H. P. —
dentatum.	toothed.	ampl. sub-obt. obl. shin. dott. y.	6. 10.	Mediterr.	1820.		H. P. —
elatum.	H. K. tall.	ov. obl. acut. edges sub-rev. y.	7. 8.	N. Amer.	1762.		H. S. —
lodes.	L. marsh.	subrot. ov. sess. upp. notch. ye.	—	Britain.	...		H. P. —
empetrifolium.	w. Empetrum-l'd.	tern. lin. edges revol.	yel.	5. 9.	Levant.	1640.	F. S. —
ericoides.	L. Heath-like.	round, acute, dott. glau.	yel.	6. 7.	Spain.	1821.	F. S. —
horibundum.	H. K. many-flowered.	lanc. sess. dott. numer.	yel.	8.	Madeira.	1799.	G. S. —
oliolum.	H. K. shining.	ov. obl. sess. slightly perfor. y.	—	Azores.	1778.		G. S. —
randifolium.	great-leaved.	ov. obl. cord. amplex.	yel.	7. 8.	Teneriffe.	1818.	G. S. —
laucum.	glaucous.	cord. amplex. obt. glau.	yel.	—	N. Amer.	1812.	F. S. —
glandulosum.	glandular.	ellip. lanc. acut. edges glan. y.	5. 8.	Madeira.	1777.		G. S. —
umifasum.	E. Fl. trailing.	obl. obt. dott.	yel.	7. 8.	Britain.	...	H. P. —
irsutum.	B. Fl. hairy.	ov. obl. nerv. shin. dott.	yel.	6. 7.	—	...	H. P. —
Kalmianum.	Kalm's.	lin. lanc.; stem 4-sided.	yel.	—	N. Amer.	1759.	H. S. —
myrtifolium.	myrtle-leaved.	ov. cord. amplex. edges rev. y.	7. 8.	—	—	1818.	H. P. —
maculatum.	spotted.	amplex. ov. obl.	yel.	—	—	1789.	H. P. —
montanum.	E. Fl. mountain.	ov. obt. amplex. shin. dott.	yel.	—	Britain.	...	H. P. —
nudiflorum.	Mx. naked-flowered.	ov. obl. obt. dott.	yel.	9. 10.	N. Amer.	1811.	F. S. —
Olympicum.	B. M. Olympian.	ellip. ov. sub-obt. shin. dott. y.	7. 9.	Levant.	1706.		H. S. —
punctatum.	Lam. dotted.	ov. lanc. sub-acut. amplex. ye.	6. 7.	N. Amer.	1823.		H. S. —
ulchrum.	L. fair.	amplex. cord. obt. shin. dott. y.	7.	Britain.	...		H. P. —

Systematic Name.	English Name.	Form of Leaves, &c.	Col. of Flow.	Month of Fl.	Native Country.	Yr. of Introd.	Soil and Propagation
perfoliatum.	perfoliate.	amplex. ov.; fl. 3-sty.	yel.	7. 8.	Italy.	1785.	H. \mathfrak{P} . ———
perforatum. L.	perforated.	ov. ellip. obt. shin. dott.	yel.	—	Britain.	H. \mathfrak{P} . ———
quadrangulum. L.	square-stalked.	ov. obt. shin. dott.	yel.	—	—	H. \mathfrak{P} . ———
rosmarinifolium. Lan.	Rosemary-l'd.	obt. ov. amplex. edges rev.	ye.	6. 8.	Carolina.	1812.	F. \mathfrak{S} . ———
simplex. Mx.	simple.	obl.; stem chann. pubes.	yel.	7. 8.	N. Amer.	1826.	H. \mathfrak{A} . ———
serpyllifolium.	Thyme-leaved.	ov. obt. edges revol.	yel.	—	Levant.	1688.	H. \mathfrak{S} . ———
triplinerve.	three-nerved.	lin. spread. obt. edges revol.	y.	7.	N. Amer.	1821.	H. \mathfrak{P} . ———
tomentosum. L.	woolly.	ov. obt. sub-plex. dott.	yel.	7. 9.	S. Europ.	1648.	F. \mathfrak{P} . ———
virginicum. L.	Virginian.	obl. obt. sub-plex.	red.	—	N. Amer.	1800.	H. \mathfrak{P} . ———

CLASS XIX.

SYNGENESIA. *Anthers united into a tube; Flowers compound.*

ORDER I.

AQUALIS. Florets of the disk and ray, all hermaphrodite.

TRAGOPOGON, GOATS-BEARD. *Cal. sim. of several equ. scal. Recep. nak. Papp. feathery, stalked.*

floccosus.	woolly.	lin. chann. stem ones revol.	ye.	5. 6.	Hungary.	1816.	H. \mathfrak{B} . Light loam.
pratensis. E. B.	yellow.	alt. ent. smth. acum.	yel.	—	Britain.	H. \mathfrak{B} . seeds.
porrifolius. E. B.	purple.	undiv. straight, acum.	pur.	—	England.	H. \mathfrak{B} . ———

P'ICRIS, P'ICRIS. *Cal. dbl. the inn. equ. Cor. compound, imbr. florets 5-tooth. Rec. dott. Papp. feath.*

asplenioides. w.	Asplenium-l'd.	obl. lanc. sinuat. pinnatif.	yel.	7. 8.	Barbary.	1803.	H. \mathfrak{A} . Sandy soil.
hieracioides. E. B.	Hawk-weed.	amplex. lanc. dent.	yel.	—	England.	H. \mathfrak{A} . seeds.

HELMINTHIA, OX-TONGUE. *Invol. dbl. exter. 8-leav. inn. of 5 leaves. Recep. nak. Papp. feathery.*

echioides. w.	bristly.	lanc. wavy, upper amplex.	y.	6. 7.	Britain.	H. \mathfrak{A} . Sandy loam. seeds.
---------------	----------	---------------------------	----	-------	----------	------	--

Picris echioides. E. B.

SONCHUS, SOW-THISTLE. *Cal. imbr. Cor. imbr. Flor. mucr. with 4 or 5 teeth. Down simp. sess.*

alpinus. E. B.	blue-flowered.	lyr. sagitt. dent. smth.	bl.	8. 9.	Britain.	H. \mathfrak{P} . Light soil.
arvensis. E. Fl.	corn.	obl. lanc. dent. cord. at base.	y.	7. 9.	—	H. \mathfrak{P} . seeds.
acuminatus. Ph.	taper-pointed.	runcin. upp. ov. acum.	bl.	8. 9.	N. Amer.	1812.	H. \mathfrak{B} . ———
squarrosus. Dc.	shrubby.	lanc. runcin.; stm. shrubby.	y.	—	Madeira.	1777.	G. \mathfrak{S} . ———
<i>fruticosus. L.</i>							—————
Oleraceus. E. Fl.	common.	amplex. obl. lanc. dent.	bl.	6. 8.	Britain.	H. \mathfrak{A} . ———
palustris. E. Fl.	marsh.	pinnatif. sagitt. at base.	yel.	7. 9.	—	H. \mathfrak{P} . ———

[*furrowed. Recep. naked. Down stalked.*

LACTUCA, LETTUCE. *Cal. imbr. Scales membr. at the mar. Cor. imbr. Flor. with 4 or 5 teeth. Seeds*

murâlis. D. D.	wall.	runcin. amplex. dent.	yel.	7.	Britain.	H. \mathfrak{P} . Light loam. seeds.
----------------	-------	-----------------------	------	----	----------	------	--

Prenanthes murâlis. E. B.

Scarîola. E. B.	prickly.	pinnatif. amplex. dent.	yel.	7. 8.	—	H. \mathfrak{B} . ———
saligna. E. B.	least.	lin. pinnatif. dent.	yel.	—	England.	H. \mathfrak{B} . ———

Systematic Name.	English Name.	Form of Leaves, &c.	Col. of Flow.	Month of Fl.	Native Country.	Yr. of Intro.	Soil and Propagation.
[Recep. naked.]							
PRENANTHES, WALL-LETTUCE. <i>Cal. dbl. Cor. compo. of a few ligul. 4 or 5-tooth. flor. Papp. sess.</i>							
cordata.	heart-leaved.	cord. dented, ciliat.	pa. y.	7. 8.	N. Amer.	1816.	H. P. Light soil.
purpurea. w.	purple.	obl. lanc. cord. dent. glau.	pur.	7. 9.	Germany.	1658.	H. P. seeds.
LEONTODON, DANDELION. <i>Cal. dbl. imb. Cor. of man. ligu. abrupt, 5-tooth. flor. Papp. stalk. sin.</i>							
palustre.	marsh.	sinuat. dent. smth.	yel.	6. 7.	Britain.	H. P. Sandy soil. seeds.
APA'RGIA, HAWKBIT. <i>Cal. imbr. dbl. Cor. of many ligu. 5-tooth. flor. Papp. sess. feath. Recep. nak.</i>							
alpina.	Alpine.	lanc. obl. smth.	yel.	5. 6.	Austria.	1816.	H. P. Sandy loam.
autumnalis. Br. Fl.	autumnal.	lanc. dent. nearly smth.	yel.	8.	Britain.	H. P. seeds.
hispid.	hispid.	runcin. hisp. obl.	yel.	7. 9.	—	H. P. —
Taraxaci. E. B.	Dandelion-l'd.	lanc. runcin. smth. dent.	yel.	8.	—	H. P. —
CR'EPIS, HAWK'S-BEARD. <i>Cal. dbl. Cor. of many perf. ligul. 5-tooth. flor. Papp. sess. Recep. rough.</i>							
biennis. E. B.	biennial.	runcin. pinnatif. lobes dent.	y.	6. 8.	—	H. B. Sandy soil.
fœtida. E. B.	stinking.	runcin. pinnatif. hairy.	st.	6. 7.	—	H. B. seeds.
macrorhiza. B. M.	large-rooted.	obl. dent. coriac.	yel.	—	Madeira.	1829.	F. P. —
pulchra. E. B.	small-flowered.	obov. dent. upp. sess. ampl.	y.	6. 9.	Scotland.	H. A. —
tectorum. E. B.	smooth.	runcin. smth. upp. amplex.	y.	—	Britain.	H. A. —
[or sessile. Recep. chaffy.]							
HYPOCHÆRIS, CAT'S-EAR. <i>Cal. imbr. Cor. imb. of many ligu. 5-tooth. flor. Papp. feathery, stalk.</i>							
glabra. E. B.	smooth.	ligulate, tooth. upp. alt.	yel.	7. 8.	—	H. A. Sandy soil.
maculata. E. B.	spotted.	obov. obl. undivid. dent.	yel.	6. 7.	—	seeds.
radicata. E. B.	long-rooted.	runcin. obt. rough.	yel.	6. 9.	—	H. P. —
[Recep. naked.]							
LAPSANA, NIPPLE-WORT. <i>Cal. dbl. the inn. with channell. scal. Cor. of several broad. 5-tooth. flor.</i>							
communis. B. Fl.	common.	ov. angul. dent.	yel.	6. 7.	—	H. A. Light loam.
pusilla. Br. Fl.	dwarf.	obov. obl. tooth.	yel.	—	—	H. A. seeds.
[5-sided. Papp. sessile.]							
CICHO'RORIUM, SUCCORY. <i>Cal. double. Cor. of about 20 ligul. abrupt, 5-tooth. florets. Seed somewhat</i>							
Intybus. E. B.	wild.	runcin. tooth. rough.	bl.	6. 8.	—	H. P. Sandy loam. seeds.
[Down bristly. Recep. chaffy.]							
ARCTIUM, BURDOCK. <i>Cal. glob. scales spinous, hook'd. Cor. of many tubul. florets, their limb 5-part.</i>							
Bardana. E. B.	woolly-headed.	cord. stalk. ent.	pur.	7. 8.	—	H. B. Light loam. seeds.
STE'VIA, STE'VIA. <i>Invol. cylindrical. Recep. naked. Papp. paleaceous. Flor. of 5 pets.</i>							
Eupatoria. B. M.	entire-leaved.	sess. obl. lanc. serrul.	ros. wh.	7. 9.	Mexico.	1798.	F. P. Sandy loam
hyssopifolia. B. M.	Hyssop-leaved.	obl. obov. ent.	wh.	8. 9.	—	F. P. and peat.
ivafolia. W. en.	Ivy-leaved.	lanc. stalk. serr. 3-nerv.	wh.	7. 9.	—	1816.	F. P. dividing
purpurea. B. R.	purple.	lanc. obt. serr.	pur.	8. 9.	—	1812.	H. P. roots.
salicifolia. W.	Willow-leaved.	lanc. attenuat. at both ends.	w.	7. 9.	—	1803.	F. P. —
serrata. W.	saw-leaved.	lin. serr. scatt.	wh.	—	—	1799.	F. P. —
LI'ATRIS, LI'ATRIS. <i>Cal. oblong, imbric. Papp. plumose. Recep. naked, dott. Seeds striat. hairy.</i>							
elegans. B. R.	elegant.	lin. falcate, dott. rong.	pur.	9. 10.	N. Amer.	1787.	H. P. Loam & leaf
villosa. B. R.	hairy-leaved.	lin. pilose, gland.	pur.	10.	—	1783.	H. P. mould.

Systematic Name.	English Name.	Form of Leaves, &c.	Col. of Flow.	Month of Fl.	Native Country.	Yr. of Introd.	Soil and Propagation.
scariósa. B.R.	large-flowered.	lan. atten. smth. edge.	scab. pu.	9. 10.	N. Amer.	1739.	H. P. seeds, or
sphæroidea. B. Fl. G.	globular-cupp.	flat, lanc. upp. lin.	lanc. pur.	8. 10.	—	1817.	H. P. parting
spicâta. B. Fl. G.	long-spiked.	lin. sess. smth. dott.	pur.	—	—	1732.	H. P. roots.
squarrósa. w.	squarrose.	lin. rough, pubes. ben.	pur.	9. 10.	—	—	H. P. —
<i>AGERATUM, AGERATUM. Invol. double. Recep. naked. Papp. with somewhat 5-awned paleæ.</i>							
cælestinum. B.M.	blue.	ov. acut. serr. pubes.	bl.	7. 9.	S. Amer.	1800.	G. S. Light loam
conyzoides. w.	hairy.	ov. sub-cord.; stm. pilose.	bl.	7. 8.	America.	1714.	H. A. and peat.
latifolium. w.	broad-leaved.	ov. base wedge-shaped.	wh.	—	Peru.	1800.	H. A. seeds.
<i>ERYTHROLÆNA, ERYTHROLÆNA. Invol. conical. Scales lanc. Recep. conv. pilo. Papp. sess.</i>							
conspicua. B.M.	conspicuous.	alt. sess. pinnatif. spiny.	yel.	—	Mexico.	1825.	H. B. Light loam and leaf mould. cuttings.
<i>SCOLYMUS, GOLDEN THISTLE. Cal. imbricated, spiny. Recep. paleaceous. Papp. naked.</i>							
hispánicus.	perennial.	scabr. decurr. hairy.	yel.	7. 9.	S. Europ.	1658.	H. P. Sandy soil.
maculâtus. Fl. Gr.	spotted.	scabr. dent.	yel.	7. 8.	—	1633.	H. A. seeds.
<i>CATANANCHE, CATANANCHE. Cal. imbricated, scaly. Recep. paleaceous. Papp. chaff. 5-l'd.</i>							
cærulea. Fl. Gr.	blue.	lin. bipinnatif. at base. vill.	bl.	7. 10.	—	1596.	H. P. Light loam
bicolor.	two-coloured.	lin. lanc. nerv.	wh. bl.	—	—	1830.	H. P. and peat.
lutea. B.M.	yellow.	lanc. dent. 3-nerv.	yel.	6. 7.	Candia.	1640.	H. A. seeds.
<i>CYNARA, ARTICHOKE. Invol. imbr. Scales fleshy, spiny, emarg. Papp. sessile, feathery.</i>							
Cardúnculus. B.M.	Cardoon.	decurr. pinnatif. white.	bl.	8. 9.	—	1658.	H. P. Garden loam.
hórrida. Fl. Gr.	hoary.	pinnatif. downy ben. spin. pu.	—	—	Madeira.	1778.	G. P. suckers from
húmillis. w.	dwarf.	pinnatif. downy ben. spiny. bl.	7. 8.	Spain.	1613.	H. P.	root.
<i>STOBÆA, STOBÆA. Cal. imbric. Scales dented, spiny. Recep. hispid. Papp. paleaceous.</i>							
pinnâta. B.M.	Carthamus-like.	pinnatif. hairy segm. lin.	yel.	1. 12.	C. B. S.	1812.	G. S. Sandy loam and peat. cuttings.
<i>CARTHAMUS, CARTHAMUS. Cal. of many leaves, imbricated. Recep. chaffy. Papp. chaffy.</i>							
tinctórius. B.R.	Dyer's.	ov. dent. spiny.	or.	6. 7.	Egypt.	1551.	H. A. Light loam. seeds.
<i>ONOBROMA, ONOBROMA. Invol. ventric. outer scales spiny. Recep. chaffy. Papp. setaceous, rigid.</i>							
arboréscens. Spr.	tree.	ensif. sinuat. dent.	yel.	7. 8.	Spain.	1731.	F. S. Sandy loam. cuttings, or
<i>Cárthamus arboréscens. L.</i>							
cærulea.	blue.	ov. lanc. spiny, dent.	bl.	6. 7.	—	1640.	H. P. parting roots.
<i>Cárthamus cæruleus. L.</i>							
salicifolium. L. en.	Willow-leaved.	lan. serrat. spiny, hairy.	st.	8.	Madeira.	1784.	G. S. —
<i>Cárthamus salicifolius. w.</i>							
<i>VERNONIA, VERNONIA. Cal. imbricated. Papp. double, outer paleaceous. Recep. naked.</i>							
axilliflora. B.R.	axillary-flow'd.	ov. acut. pilose, undul.	pur.	—	Brazils.	1829.	F. P. Light loam.
angustifolia. Ph.	narrow-leaved.	lin. sub-ent.	pur.	9. 11.	N. Amer.	1817.	H. P. parting
acutifolia. B.M.	acute-leaved.	lin. lanc. attenu. sub-dent.	pu.	—	Brazil.	—	roots.
præalta. w.	tall.	lanc. acut. serr. pubes.	pu.	—	—	1732.	H. P. —
sericea. B.R.	silky.	lin. lanc. silky ben.	pur.	9. 1.	—	1818.	S. S. —

Systematic Name.	English Name.	Form of Leaves, &c.	Col. of Flow.	Month of Fl.	Native Country.	Yr. of Introd.	Soil and Propagation.
[Recep. hairy.]							
CNICUS, PLUME-THISTLE. <i>Cal. tum. Scales spin. Cor. flor. of 5 lin. segm. Seeds obor. Papp. sess.</i>							
ambiguus.	ambiguous.	obl.acum.sinu.spin.vill.ben.	7. 8.	S.	Europ.	1823.	H. 5. Sandy loam.
áfer. B.M.	Barbary.	sess.lanc.spiny,hairy ben.pu.	6. 7.	Barbary.	1800.	H. 5.	seeds, or
arvensis. Br.Fl.	creeping.	pinnatif.alt.nearl.smth.spin.	7.	Britain.	H. 3.	parting at
acaülis. Br.Fl.	dwarf.	pinnat.smth.segm pal.spiny.	7. 8.	—	H. 3.	root.
erióphorus. E.Fl.	woolly-headed.	sess.pinn.spin.wh.dow.ben.	—	—	H. 3.	—
Forstéri. E.Fl.	Mr. Forster's.	pinnatif.spiny,down.ben. cr.	6. 8.	—	H. 3.	—
heterophyllus. E.Fl.	melancholy.	lanc.dent.laciniat.vill.ben.	6.10.	—	H. 3.	—
lanceolatus. Br.Fl.	spear-leaved.	pinnatif.spiny,cotto.ben. cr.	6. 9.	—	H. 3.	—
palustris. Br.Fl.	smooth.	pinnatif.tooth.rough,spin.cr.	7. 8.	—	H. 3.	—
pratensis. Br.Fl.	meadow.	sess.lan.cotto.ben.prickl.pu.	6. 7.	—	H. 3.	—
[sess. Recep. fleshy.]							
ONÓPORDUM, COTTON-THISTLE. <i>Cal. swelling, the scales spread. and spinous. Ger. obor. Down</i>							
Acánthium. E.B.	common.	obl.ov.sinuat.woolly. blue re.	7. 8.	—	H. 3.	Light loam.
illyricum. w.	Illyrian.	sinuat.downy,tooth.spin. pu.	—	S.	Europ.	1648.	H. 3. seeds.
TROXIMON, TROXIMON. <i>Cal. obl. imbri. Recep. naked. Papp. sessile, hairy.</i>							
glaucum. B.M.	glaucous.	lin. lanc. glau.	yel.	—	N.	Amer.	1811. H. 3. Light rich soil, seeds.
CARLINA, CARLINE-THISTLE. <i>Cal. tum. col. Cor. flor. equ. limb 5-part. Recep. chaff. Papp. feath.</i>							
acaülis. w.	stemless.	pinnat.nak.seg.dent.spin. w.	6.	Italy.	1640.	H. 3.	Rich loam.
símplex.	single-flowered.	pinnatif. scaly.	wh. 6. 7.	Hungary.	1816.	H. 3.	seeds.
vulgáris. E.B.	common.	lanc.sinuat.wavy,spiny. red.	5. 9.	Britain.	H. 3.	—
[more long awns. Recep. chaffy.]							
BIDENS, BUR-MARIGOLD. <i>Cal. of several conc. scales. Flor. of the cor. equ. 5-cleft. Seeds with 2 or</i>							
cérnua. E.Fl.	nodding.	lanc. serr. smth.	gr.yel. 7. 9.	—	H. 3.	Sandy loam.
prócera. B.M.	Mr. Lambert's.	bi-tripart. segm. lin.	yel. 9. 7.	S.	Amer.	1818.	H. 3. seeds.
tripartíta. E.Fl.	three-parted.	tripart. leaf. lanc. serr.	yel. 7. 9.	Britain.	H. 3.	—
EUPATORIUM, HEMP-AGRIMONY. <i>Cal. imb. Scal. unarm. Cor. of a few funn.-sh. fl. Recep. nak.</i>							
cannabínium. E.B.	common.	opp.3-5-partit.serr.downy.p.	7.10.	—	H. 3.	Sandy loam.
purpureum. w.	purple.	quaternis.ov.lanc.serr. pur.	8. 9.	N.	Amer.	1640.	H. 3. dividing
perfoliátum. w.	perfoliate.	connate, perfol. obl.	wh. 8.10.	—	1669.	H. 3.	root.
trifoliátum. w.	three-leaved.	tern.ov.attenuated,serr. wh.	—	—	1768.	H. 3.	—
[Recep. naked.]							
CHRYSO'COMA, GOLDYLOCKS. <i>Cal. imbr. Scal. pointed. Cor. of seve. level-top'd flor. Down sess.</i>							
diffóra. w.	two-flowered.	lanc. 3-nerv. dott.	bl. 8. 9.	Siberia.	1741.	H. 3.	Light loam.
Comaúrea. L.	shrubby.	lin. smth. acut. decurr.	yel.	C. B. S.	1748.	G. 5.	dividing at
Linosýris. E.Fl.	Flax-leaved.	lin. smth. ent.	yel. 9.10.	Britain.	H. 3.	root.
villósa. w.	villous.	lanc. vill.	yel. 8. 9.	Hungary.	1799.	H. 3.	—
[Papp. 0. Recep. chaffy.]							
DI'OTIS, COTTON-WEED. <i>Cal. imbr. Cor. of many level-topped flore. their limb 5-cleft, base 2-spurr.</i>							
narítima. Br.Fl.	sea.	sess.obl.flat,cren.cottony.ye.	—	Britain.	..	H. 3.	—
GEROP'OGON, OLD MAN'S BEARD. <i>Cal. of many leaves. Recep. chaffy. Peric. of ray 5-awned.</i>							
gláber. B.M.	smooth.	lin. ent. smth.	pk. 7. 8.	Italy.	1704.	H. 3.	Sandy soil, seeds.

Systematic Name.	English Name.	Form of Leaves, &c.	Col. of Flow.	Month of Fl.	Native Country.	Yr. of Introd.	Soil and Propagation.
SCORZONERA, VIPER'S-GRASS. <i>Cal. imbricated. Recep. naked. Papp. feathery.</i>							
angustifolia. w.	narrow-leaved.	awl-sh. ent.	yel. pur.	6. 8.	S. Europ.	1759.	H. P. Light rich
glastifolia. w.	Woad-leaved.	lin. lanc. acum. smth.	yel.	6. 9.	German.	1816.	H. P. loam. seeds, or dividing at roots.
ANDRYALA, ANDRYALA. <i>Cal. many-parted. Recep. villous. Papp. simple, sessile.</i>							
lanata. w.	woolly.	ov. obl. vill.	ye.	5. 6.	S. Europ.	1732.	H. P. Sandy loam.
nigricans. w.	dark-flowered.	pinnatif. lyrate.	yel.	6. 8.	Barbary.	1804.	H. A. part. roots.
HYOSERIS, SWINE'S SUCCORY. <i>Recep. naked. Papp. dbl. out. capillary, inn. paleaceous, awned.</i>							
lucida. w.	shining.	lyrate, runci. smth. fleshy.	ye.	—	Levant.	1770.	H. P. Light rich
radiata. w.	starry.	lyrate, runcin. smth. dent.	yel.	6. 7.	S. Europ.	1640.	H. P. soil. dividing root, or seeds.
[Stig. truncate.]							
AMMOBIUM, AMMOBIUM. <i>Invol. imbric. white. Flor. tubul. 5-cleft. Rays 0. Stam. 5. Sty. smth.</i>							
alatum. B. M.	winged-stalked.	lanc. elong. undul. ent. hair. y.	ye.	8. 9.	N. S. W.	1822.	H. P. —
[Recep. nearly naked.]							
HIERACIUM, HAWK-WEED. <i>Cal. ov. imbr. Cor. of many linear, ligul. 5-tooth. florets. Down sess.</i>							
alpinum. E. B.	Alpine.	obl. nearly ent. hairy.	yel.	7. 8.	Britain.	H. P. Sandy loam.
aurantiacum. E. B.	Orange.	ellip. acut. ent. hairy.	yel.	6. 7.	Scotland.	H. P. parting at
Auricula. E. B.	Orange-mouse.	lanc. acut. hairy.	yel.	7. 8.	England.	H. P. root, or seed
cerinthoides. E. B.	Honey-wort-ld.	ellip. obov. dent. hairy.	yel.	8.	Scotland.	H. P. —
denticulatum. E. B.	small-toothed.	ellip. lanc. dent. smth.	yel.	7. 8.	—	H. P. —
dubium. E. B.	branching.	ellip. lanc. hairy, glau.	yel.	—	Britain.	H. P. —
Halleri. B. F.	Hallerian.	obl. lanc. dent. opp. cord.	yel.	—	—	H. P. —
Lawsöni. E. B.	glaucous.	ov. lanc. dent. spotted.	yel.	6. 7.	—	H. P. —
maculatum. E. B.	spotted.	ov. lanc. dent. spotted.	yel.	7. 8.	England.	H. P. —
mölle. E. B.	soft.	lanc. dent. hairy, amplex.	ye.	—	Scotland.	H. P. —
mürdum. E. B.	broad-leaved.	ov. dent. at base, hairy.	yel.	7.	Britain.	H. P. —
Pilosella. E. B.	common.	ov. ent. hairy.	st.	5. 7.	—	H. P. —
prenanthoides. E. B.	rough-border'd.	lanc. cord. ample. dent. pub.	yel.	6. 9.	Scotland.	H. P. —
pulmonarium. E. B.	Lung-wort-ly'd.	lanc. sinuat. dent.	yel.	7. 8.	—	H. P. —
sabaudum. E. B.	shrubby broad-l.	ov. lanc. dent. half amplex.	y.	—	Britain.	H. P. —
sylvaticum. E. B.	wood.	ov. lanc. downy ben.	yel.	8.	—	H. P. —
umbellatum. E. B.	narrow-leaved.	sess. lin. dent.	yel.	8. 9.	—	H. P. —
SERRATULA, SAW-WORT. <i>Cal. cyl. Cor. compo. flor. fun.-sh. limb 5-clef. Papp. sess. Recep. chaff.</i>							
alpina. E. B.	Alpine.	lanc. tooth. cottony ben. pk. bl.	yel.	7. 8.	Britain.	H. P. Loam & clay
pulchella. B. M.	purple-scaled.	pinnatif. decurr. rough.	pur.	6. 7.	Siberia.	1823.	H. P. mould. part
quinquefolia. H. K.	five-leaved.	pinn. serr.; Ped. 1-fl'd.	pu.	—	Persia.	1804.	H. P. root, or seed
[sess. Recep. hairy]							
CA'RDUUS, THISTLE. <i>Cal. imbr. swelling. Scales spiny. Cor. of many funnel-shap. florets. Down</i>							
acanthoides. E. B.	welted.	decurr. sinuat. pinnatif. spin.	—	—	Britain.	H. A. Light loam
alatus. B. F. G.	wing-stalked.	cord. dent. hair. npp. lanc.	pu.	6. 8.	1812.	H. B. seeds.
crassifolius.	thick-leaved.	obl. spin. tooth. glau. smth.	pu.	7.	1805.	H. P. —
marianus. L.	milk-thistle.	amplex. undul. spiny.	pur.	—	Britain.	H. B. —
nütans. E. B.	musk.	lanc. sinuat. spiny.	pur.	7. 8.	—	H. A. —
pannonicus. L.	Hungarian.	ent. ciliat.	p.	—	Hungary.	1810.	H. P. —
simplex. E. M.	one-flowered.	pinnatif. lobes distant.	pur.	—	Caucasus.	1817.	H. P. —

Serratula simplex.

Systematic Name.	English Name.	Form of Leaves, &c.	Col. of Month Native Flow. of Fl. Country.	Yr. of Introd.	Soil and Propagation.
<i>tinctórius</i> , D.P.	common.	pinnatif. serr.	pur. 7. 10. Britain.	... H. P.	—
[Recep. honey-comb. fringed.]					
<i>Serrátula tinctória</i> , E.B.					—
<i>tenuiflórus</i> , E.B.	slender-flow'd.	decurr. sinuat. cotton. ben.	li. 6. 7. —	... H. A.	—
[Recep. honey-comb. fringed.]					
<i>NO'CCA</i> , <i>NO'CCA</i> .	Brac. 6-8.	Invol. of 1 leaf, tubul.	Flor. tubul. 5-cleft, hermaph.	Anth. tooth. at base.	
<i>latifólia</i> , B. F. G.	broad-leaved.	opp. obl. acum. ampl. serr. wh.	— Mexico.	1826. F. S.	—
[Papp. chaffy.]					
<i>AMPHE'REPHIS</i> , <i>AMPHE'REPHIS</i> .	Invol. of many leaves, imbr.	Flor. tubul. 5-cleft.	Recep. naked.		
<i>intermédia</i> , L. en.	intermediate.	ov. obl. serr. pubes.	bl. 5. 6. Brazil.	1822. F. A.	—
<i>MIKA'NIA</i> , <i>MIKA'NIA</i> .	Recep. naked.	Papp. plumose.	Cal. 4-6-leaved, & 4-6-flowered.		
<i>Houstóni</i> , w.	Houston's.	ov. ent.; stem climb.	wh. 7. 8. Jamaica.	1783. S. S.	Loam & peat. cuttings.
<i>SPILA'NTHEIS</i> , <i>SPILA'NTHEIS</i> .	Cal. nearly equ. imbr.	Recep. chaffy.	Papp. awned.	Seed compr.	
<i>álba</i> , w.	white-flower'd.	alt. ov. repand.; stm. branc. w.	5. 6. Peru.	—	—
<i>PLATY'PTERIS</i> , <i>PLATY'PTERIS</i> .	Invol. of many leaves, imbr. squarr.	Recep. convex, chaffy.			
<i>crocáta</i> , k. s.	saffron-color'd.	opp. ent. hairy, decurr.	yel. 1. 6. Mexico.	1812. S. P.	Light soil. cuttings.
<i>Spilánthes crocáta</i> , B. M.					
<i>CAC'ALIA</i> , <i>CAC'ALIA</i> .	Cal. cylindrical.	Recep. naked.	Papp. pilose.	Anth. awnl.	Sty. 2-lob.
<i>cordifólia</i> , k. s.	heart-leaved.	ov. cord. serr.	yel. 8. —	1825. F. P.	Sandy loam.
<i>hastáta</i> , w.	hastate.	stalk. 3-lob. hast. serr.	wh. 8. 10. Siberia.	1789. H. P.	parting
<i>ovális</i> , w.	oval-leaved.	ov. repand. cren. pubes.	yel. 9. 5. E. Indies.	1804. S. S.	roots.
<i>sarracènia</i> , w.	creeping-rooted.	sess. obl. lanc. serr.	st. 8. 10. France.	1772. H. P.	—
<i>suavèolens</i> , w.	sweet-scented.	stalk. hast. sagitt. serr.	wh. — N. Amer.	1752. H. P.	—
<i>sagittata</i> , w.	sagittate.	sagitt. dent. lower ob. ov. pu.	— Java.	1823. S. A.	—
<i>H'UMEA</i> , <i>H'UMEA</i> .	Invol. imbric.	Recep. glandular.	Flor. about 3, tubular.	Anth. awned.	Papp. 0.
<i>élegans</i> , H. K.	elegant.	ampl. ellip. obl. acut.	red. 6. 10. N. S. W.	1800. G. S.	Sandy loam. seeds.
<i>TARCHONA'NTHUS</i> , <i>AFRICAN FLEA-BANE</i> .	Cal. somewhat 7-toothed.	Recep. villous.			
<i>camphorátus</i> , w.	shrubby.	obl. ent. downy ben.	yel. — C. B. S.	1690. G. S.	Loam & peat
<i>dentátus</i> , w.	dented.	obl. dent. hairy ben.	yel. — —	1816. G. S.	mould. cutt.
<i>PENTZIA</i> , <i>PENTZIA</i> .	Invol. imbricated.	Recep. naked.	Papp. a torn rim.		
<i>flabellifórmis</i> , w.	fan-leaved.	deltoid, apex. serr.	yel. 5. 6. —	1774. G. S.	Loam & peat. cuttings.
<i>ATHANA'SIA</i> , <i>ATHANA'SIA</i> .	Cal. imbricated.	Recep. chaffy.	Papp. short and chaffy.		
<i>capitáta</i> , w.	headed.	ov. vill. Heads nearly sess.	yel. 1. 8. C. B. S.	—	G. S. Loam & peat.
<i>pectináta</i> , w.	pectinated.	pinn. leaf. lin. smth.	yel. 5. 6. —	—	G. S. cuttings.
<i>virgáta</i> , w.	twiggy.	pinnatif. ent. upp. 3-5-dent. y.	7. 6. —	1815. G. S.	—
<i>BALSAM'ITA</i> , <i>COSTMARY</i> .	Cal. imbricated, round.	Recep. naked.	Papp. none.		
<i>ageratifólia</i> , w.	Ageratum-lv'd.	obov. serr. sess.	yel. gr. 6. 10. Candia.	1605. G. S.	Peat & loam.
<i>grandiflóra</i> .	large-flowered.	obov. serr. upp. lanc.	yel. — Algiers.	1821. F. S.	cuttings.

ORDER II.

POLYGAMIA SUPERFLUA. *Florets of the disk hermaphrodite, those of the ray with pistils only.*

Systematic Name.	English Name.	Form of Leaves, &c.	Col. of Flow.	Month of Fl.	Native Country.	Yr. of Introd.	Soil and Propagation.
[5-cleft, those of the ray subulate, entire. Cor. compound. Flor. of the disk tubul.							
ARTEMISIA, WORM-WOOD. <i>Cal. imbr. Scales rounded.</i>							
argentea. w.	silvery.	bipinnatif. silky wh.	yel.	6. 7.	Madeira.	1777.	G. S. Sandy loam.
cœrulæscens. E. Fl.	bluish Mugwort.	lanc. ent. hoary, upp. obl.	yel.	6. 10.	England.	H. S. seeds, or
gállica. E. Fl.	upright-flow'd.	bipinn. upp. pinn. lin. hoar.	br.	8. 9.	Britain.	H. P. cuttings.
glaûca. w.	glaucous.	pinn. glau. pubes. leaf. lin.	gr.	6. 8.	Siberia.	1806.	H. P. ———
glaciâlis. w.	silky.	palm. multif. silky wh.	yel. gr.	7. 8.	Switzerl.	1739.	H. P. ———
marítima. E. Fl.	sea.	pinnat. down. upp. lin. ent.	br.	8. 9.	Britain.	H. P. ———
[5-cleft, those of the ray 3-cleft. Recep. naked.							
TANACETUM, TANSY. <i>Cal. hemisph. Flor. of the disk 5-cleft, those of the ray 3-cleft.</i>							
argenteum. w.	silvery.	pinn. leaf. lanc. silky.	yel.	5. 9.	Levant.	1812.	H. P. Light loam.
incanum. w.	hoary.	pinn. leaf. digit. hoary.	yel.	— — —	— — —	1827.	H. P. divid. root.
[awl-shap. Papp. feathery. Recep. naked.							
GNAPHALIUM, CUDWEED. <i>Cal. imbr. Scales coloured. Flor. of the disk 5-cleft, those of the ray</i>							
arenarium. B. M.	sand.	lanc. obt. downy.	yel.	6. 8.	S. Europ.	1728.	H. P. Sandy loam.
apiculatum. B. R.	New Holland.	sub-spath. downy, apex smth.	— — —	— — —	V. D. Isl.	1804.	G. S. seeds, or
crassifolium.	thick leaved.	lanc. leathery, downy.	yel.	— — —	C. B. S.	1816.	G. S. dividing at
congestum. B. R.	crowded.	lin. lanc. 3-nerv. vill.	car.	— — —	— — —	1791.	G. S. root.
ericoides. B. M.	Heath-leaved.	sess. lin. recur.	pk.	4. 8.	— — —	1774.	G. S. ———
gállicum. E. B.	narrow-leaved.	lin. acum. vill.	st.	6. 8.	England.	H. A. ———
germanicum. E. B.	German.	lanc. downy, wavy.	yel.	— — —	Britain.	H. A. ———
grandiflorum. w.	large-flowered.	amplex. ov. obl. vill. abov.	wh.	— — —	C. B. S.	1731.	G. S. ———
luteo-âlbum. w.	yellow.	wh. lin. obl. woolly, alt.	yel.	7. 8.	Britain.	H. A. ———
margaritaceum. w.	pearly.	lin. lanc. acut. cottony.	wh.	— — —	— — —	H. P. ———
mînimum. B. F.	least.	lanc. acut. cottony.	st.	— — —	Britain.	H. A. ———
supinum. E. Fl.	dwarf.	lin. lanc. cotton. on both sides.	6. 7.	— — —	Scotland.	H. P. ———
sylvaticum. E. B.	wood.	lin. lanc. downy.	yel.	8. 9.	Britain.	H. P. ———
[5-cleft, those of the ray 3-cleft. Recep. naked. Papp. feathery.							
ELICHRYSUM, ELICHRYSUM. <i>Invol. imbric. Recep. naked. Papp. feathery.</i>							
argenteum. B. R.	silvery.	obl. silky, recurv.	wh.	6. 9.	C. B. S.	1800.	G. S. Sandy loam
fasciculatum. A. R.	crowded-leaved.	lin. round, vill. above.	ra.	3. 9.	— — —	1799.	G. S. and peat.
<i>β rubrum.</i>	<i>red.</i>	— — —	red.	— — —	— — —	G. S. cuttings,
fûlgidum. B. M.	great-yellow.	ellip. amplex. ent. downy.	yel.	2. 10.	— — —	1774.	G. P. under a bell-
herbaceum. A. R.	shining-flow'd.	amplex. obl. revol.	yel.	7. 9.	— — —	1802.	G. P. glass in sand.
incanum. B. M.	hoary-leaved.	long, lin. acut. downy.	yel.	— — —	V. D. Isl.	1828.	G. S. ———
imbricatum. w.	imbricated.	obl. lanc. silky, imbr.	ro.	— — —	C. B. S.	1816.	G. S. ———
proliferum. B. R.	prolific.	ov. smth. convex. imbr.	pur.	5. 11.	— — —	1789.	G. S. ———
sesamoides. w.	superb.	acerose, lin. downy abov.	pu.	4. 6.	— — —	1739.	G. S. ———
<i>β major.</i>	<i>greater.</i>	— — —	— — —	— — —	— — —	— — —	— — —
speciosissimum. w.	shewy.	sess. obov. lan. 3-nerv. woolly.	7. 9.	— — —	— — —	1691.	G. S. ———
spectabile. B. C.	shewy.	lin. subul. imbric.	pur.	6. 9.	— — —	1812.	G. S. ———

Systematic Name.	English Name.	Form of Leaves, &c.	Col. of Month of Flow.	Native of Fl. Country.	Yr. of Introd.	Soil and Propagation.
XERA'NTHEMUM, XERA'NTHEMUM. <i>Cal. imbricated. Recep. chaffy. Papp. 5.</i>						
ánnuum. w.	annual.	lan.lin.ent.scales of invo.	scar. 7. 8.	S. Europ.	1570.	H. A. Sandy loam.
1. álba.	white-flowered.	wh. — — —	— — —	— — —	H. A. seeds.
2. rósea.	red-flowered.	ros. — — —	— — —	— — —	H. A. — — —
BA'CCHARIS, BA'CCHARIS. <i>Cal. ov. imbric. cylind. Recep. naked. Papp. pilose.</i>						
angustifólia.	narrow-leaved.	lin. ent. smth.	wh. 7. 9.	N. Amer.	1812.	G. S. Sandy loam.
halmifólia. w.	Groundsel-tree.	obov. notch. cren.	wh. 10. 11.	— — —	1683.	H. S. cutt. or layer.
GRINDELIA, GRINDELIA. <i>Invol. imbric. Recep. naked. Papp. bristly, deciduous.</i>						
angustifólia.	narrow-leaved.	spathul. upp. lin. obl. serr.	yel. 6. 9	Mexico.	1822.	F. S. Sandy soil & glutinosa. B. R.
glutinosa. B. R.	glutinous.	ov. obl. serr.	yel. 1. 12.	— — —	1803.	F. S. leaf mould. cuttings.
Dónia. glutinosa. R. Br.						
inulóides. B. R.	Inula-like.	obl. lanc. serr. at apex.	yel. 6. 9.	— — —	1813.	F. S. — — —
NE'JA, NE'JA. <i>Invol. imbr. Recep. dotted. Papp. double. Flor. of the disk tubular, 5-toothed.</i>						
grácilis. B. F. G.	slender-leaved.	lin. fring. with long hairs.	ye. — — —	— — —	1828.	F. S. Loam & peat. cuttings.
A'RNICA, A'RNICA. <i>Cal. leaves equal. Flor. of ray with 5-sterile filam. Recep. naked. Papp. simple.</i>						
Dorónicum. w.	Alpine.	obl. dent. hairy.	yel. 7. 8.	Austria.	1816.	H. B. Loam & peat.
montána. B. M.	mountain.	ov. ent. upp. opp. lanc.	yel. — — —	Europe.	1731.	H. B. divid. root.
BELLIUM, BELLIUM. <i>Cal. leaves equal. Recep. naked. Papp. awned. Peric. conical.</i>						
minútum. w.	dwarf.	spath. ent. nearly smth.	w. pk. 6. 10.	Levant.	1772.	H. B. Loam & peat. divid. root.
						[tubular, 5-toothed.
DIPLOCOMA, DIPLOCOMA. <i>Invol. of many leaves, imbrica. Recep. honey-combed. Flor. of the disk</i>						
villósa. B. F. G.	villous.	ov. obl. or dent. hairy.	yel. — — —	Mexico.	1827.	F. B. Sandy loam. seeds, or parting root.
TAGETES, TAGETES. <i>Invol. tubul. toothed. Flor. of the disk tubular, 5-cleft. Recep. naked.</i>						
flórida. B. F. G.	gay-flowering.	opp. amplex. obl. lanc. serr.	ye. — — —	— — —	1827.	F. B. Light loam.
lúcida. w.	shining.	lanc. serr. ; stem angul.	yel. 7. 11.	— — —	1798.	F. B. divid. root.
micrántha. w.	small-flowered.	pinn. leaf. lin. ent.	yel. 8. 10.	— — —	1822.	H. A. — — —
HELIOPSIS, HELIOPSIS. <i>Invol. imbric. Recep. conical, paleaceous. Pericar. 4-sid. Papp. 0.</i>						
canéscens. B. R.	canescent.	ov. cord. vill. cren.	yel. — — —	S. Amer.	1820.	H. B. Sandy loam. divid. root.
LEYSE'RA, LEYSE'RA. <i>Cal. scaly. Recep. a little paleaceous. Papp. paleaceous, of the disk feath.</i>						
squarrósa.	squarrose.	filif. hairy.	or. 7. 9.	C. B. S.	1815.	G. S. — — —
						[disk 5-toothed.
ERIOPHYLLUM, ERIOPHYLLUM. <i>Invol. of 1 leaf, campan. 8-toothed. Flor. of the ray 8, of the</i>						
lanátum.	woolly.	decurr. pinnat. upp. 3-part.	y. — — —	N. Amer.	1827.	H. B. Loam & peat. dividing roots, or sced.
cáspitòsum. B. R.						
ZIN'NIA, ZIN'NIA. <i>Cal. ov. imbric. Recep. chaffy. Papp. awned. Flor. of the ray 5, entire.</i>						
hy'brida. B. M.	large-flowered.	cord. sess. 5-nerv.	cr. — — —	Mexico.	1818.	H. A. Light loam
multiflora. B. M.	many-flowered.	opp. ov. lanc.	red. yel. 6. 10.	N. Amer.	1770.	H. A. & leaf mould.

Systematic Name.	English Name.	Form of Leaves, &c.	Col. of Flow.	Month of Fl.	Native Country.	Yr. of Introd.	Soil and Propagation.
pauciflora. w.	few-flowered.	opp. cord. lanc.	yel.	7. 8.	Peru.	1753.	H. A. seeds.
tenniflora. B.M.	slender-flow'd.	opp. cord. lanc.	red.	—	Mexico.	1799.	H. A. ———
verticillata. w.	whorl-leaved.	sess. ov. lanc.	sc.	—	—	1789.	H. A. ———
violacea. B.R.	purple.	ov. acut. sess. apex serr.	pur.	7. 10.	—	1796.	H. A. ———
β coccinea.	scarlet.	sc.	—	—	1829.	H. A. ———

BALBISIA, BALBISIA. Cal. of 8 leaves. Cor. rays 3-fid. Recep. chaffy. Papp. sess. feathery.

elongata. w. elongated. opp. ov. nearly equal. st. 7. 8. ——— 1804. H. A. ———

BOLTONIA, BOLTONIA. Recep. hemisph. Cal. imbricated. Papp. dented, awned.

asteroides. B.M. Star-wort-fl'd. lanc. ent. smth. wh. 8. 10. N. Amer. 1758. H. B. Light loam.

glatifolia. B.M. glaucous-leaved. serr. glau. lanc. pur. 9. ——— ——— H. B. divid. root.

ANTENNARIA, ANTENNARIA. Invol. imbri. coloured. Anth. spurred at base.

dioica. L.T. red-flowered. Low leaves obov. wh. ben. w. 5. 7. Britain. H. B. Sandy loam.

Gnaphalium dioicum. E.B.

dividing at

plantaginifolia. L.T. Plantain-leav'd. obov. nerv. wh. dioc. 6. 7. Virginia. 1759. H. B. root.

Gnaphalium plantaginifolium. w.

ASTELMA, ASTELMA. Invol. imbric. with scarios scales. Papp. feathery, sess. Recep. naked.

eximium. B.R. giant. sess. ov. crowd. erect. red. 6. 9. C. B. S. 1793. G. S. Sandy loam

Gnaphalium eximium. A.R.

and peat.

modestum. modest. alt. lin. chann. downy. yel. ——— ——— 1824. G. S. seeds, or

Gnaphalium modestum. B.M.

cuttings.

[ray 2-cleft. Recep. naked.

CONYZA, SPIKENARD. Cal. with acu. rigid scales. Flor. of the disk funnel-shap. 5-cleft, those of the

bifrons. w. oval-leaved. amplex. obl. serr. rugos. st. 8. 9. N. Amer. 1739. H. B. Sandy loam.

squarrosa. E.B. Plowman's. ov. lanc. cren. downy. yel. 7. 8. Britain. H. B. seeds, or

verbascifolia. w. Mullein-leaved. ov. cren. obt. hairy. yel. 6. 7. Candia. 1714. F. S. part. at root-

[toothed. Papp. sess. Recep. naked.

ERIGERON, FLEA-BANE. Cal. imbr. Flor. of the disk 5-cleft, those of the radius entire, or slightly

acris. E.B. blue. sess. lanc. ent. hairy. ye. pur. 7. 8. Britain. H. B. Sandy loam.

asteroides. L.en. Aster-like. spath. smth. dott. upp. lin. wh. ——— ——— 1812. H. B. seeds, or

alpinus. E.Fl. Alpine. sess. lan. ent. hair. on both sid. pu. 7. Scotland. H. B. parting at

bellidifolius. Daisy-leaved. obov. serr. upp. lanc. ent. lil. 8. 9. N. Amer. 1790. H. B. root.

canadensis. E.B. Canada. lin. lanc. ciliat. wh. ——— ——— ——— ——— ——— H. A. ———

caucasicus. M.B. large-flowered. obl. ent. upp. cord. ov. pur. 7. 8. Caucasus. 1820. H. B. ———

glabellus. B.M. smooth-leaved. lan. ent. smth. edges ciliat. pu. ——— N. Amer. 1827. H. B. ———

uniflorus. E.Fl. Pale-rayed. sess. lanc. ent. hairy. *li. 8. 9. Scotland. H. B. ———

Villarsii. w. Villar's. sess. scabr. lanc. tooth. pu. 7. 8. Piedmo. 1804. H. B. ———

[the ray ligulate, short. Papp. sess.

TUSSILA'GO, COLT'S-FOOT. Cal. simp. from 15 to 20 equ. scales. Flor. of the disk 5-cleft, those of

alpina. B.M. Alpine. renif. tooth. smth. pur. 3. 5. Austria. 1710. H. B. Loam & peat.

fragrans. B.M. sweet-scented. orbi. cor. tooth. down. ben. bh. 1. 3. Italy. 1806. H. B. divid. root.

[ray slightly toothed. Pappus sessile, roughish.

SENECIO GROUNDSEL, or RAGWORT. Cal. double. Florets of the disk 5 parted, those of the

aquaticus. E.B. marsh. obov. upp. lyrate, serr. yel. 5. 7. Britain. H. B. Sandy loam.

abrotanifolius. w. South-wood-l'd. pinn. multifid. segm. lin. smth. 7. 10. S. Europ. 1640. H. B. dividing at

coriaceus. w. leathery-leav'd. lanc. serr. downy ben. yel. 7. 8. Levant. 1788. H. B. roots, or

Systematic Name.	English Name.	Form of Leaves, &c.	Col. of Flow.	Month of Fl.	Native Country.	Yr. of Introd.	Soil and Propagation.
<i>Doronicum</i> . w.	Leopard's-banel.	ent. serr. vill.	yel.	7. 9.	S. Europ.	1705.	H. β . seeds.
<i>Elegans</i> . w.	elegant.	pinnatif. pilose, viscid.	re. wh.	6. 8.	C. B. S.	1700.	H. α . ———
<i>lividus</i> . E. B.	green-scaled.	amplex. lanc. tooth.	yel.	7. 8.	Britain.	H. α . ———
<i>lilacinus</i> . B. R.	Lilac-color'd.	ov. lanc. semi-amplex. dent. li.	—	—	C. B. S.	1826.	G. β . ———
<i>paludosus</i> . w.	Bird's-tongue.	lanc. serr. woolly ben.	yel.	6. 8.	England.	H. β . ———
<i>Pseudo-China</i> . w.	China-root.	sinuat. cut. two-coloured. pu.	—	—	China.	1732.	G. β . ———
<i>speciosus</i> . B. R.	shewy.	sinuat. lob. dent. hairy.	red.	7. 8.	—	1789.	G. β . ———
<i>tenuifolius</i> . E. Fl.	hoary.	alt. pinnatif. downy ben.	yel.	—	Britain.	H. β . ———
<i>venustus</i> . B. R.	handsome.	pinnatif. segm. lin. dent.	red.	5. 11.	C. B. S.	1774.	G. β . ———
PYRETHRUM, FEVERFEW. <i>Cal. hemisp. Flor. of the disk with 5 equ. segm. those of the ray 3-tooth.</i>							
<i>alpinum</i> . w.	Alpine.	pinnatif. dent. upp. lin. ent. w.	wh.	7. 8.	Switzerl.	1759.	H. β . Sandy loam.
<i>diversifolium</i> . B. M.	hairy.	pinnatif. cut. hairy.	wh.	—	N. Holl.	1823.	G. β . parting
<i>inodorum</i> . E. Fl.	Scentl.-Mayweed.	sess. pin. seg. acut. smth.	y.	8. 9.	Britain.	—	H. β . roots, or seed.
<i>fl. pléno.</i>	<i>double-flower'g.</i>						
<i>maritimum</i> . w.	sea.	sess. bipinn. seg. obt.	wh. yel.	6. 10.	—	H. β . ———
<i>Parthénium</i> . w.	common.	bipinn. segm. ov.	wh. yel.	6. 9.	—	H. β . ———
<i>β flore-pléno.</i>							
<i>roseum</i> .	rose-coloured.	pinn. smth. leaf. bipinn.	rose.	6.	Caucasus.	1826.	H. β . ———
<i>uliginosum</i> . B. M.	marsh.	lanc. deepl. serr.; stm. erect. w.	wh. yel.	7. 9.	Hungary.	1816.	H. β . ———
GALINS'OGEA, GALINS'OGEA. <i>Invol. imbr. Flor. of the disk tubu. 5-tooth. hermaph. Sty. smooth.</i>							
<i>trilobata</i> . B. F. G.	three-lobed.	obl. lanc. dent. hast. 3-lob.	yel.	5. 7.	Peru.	1797.	H. α . Light loam. seed.
[those of the rays 3-toothed.]							
MATRIC'ARIA, WILD-CHAMOMILE. <i>Cal. nearly flat, imbr. Cor. radiant. Flor. of the disk 5-part.</i>							
<i>Chamomilla</i> . E. Fl.	common.	bipinnatif. segm. lin. smth.	ye.	—	Britain.	H. α . Light loam. seed.
SANVITALIA, SANVITALIA. <i>Cal. round. Cor. radiate. Flor. of the disk tubu. limb 5-parted.</i>							
<i>procumbens</i> . B. R.	trailing.	opp. ov. upp. alt. hairy.	yel.	7. 8.	Mexico.	1798.	H. α . Sandy soil. seeds.
ANTHEMIS, CHAMOMILE. <i>Cal. hemisph. scales nearly equal. Recep. chaffy, convex.</i>							
<i>arvensis</i> . E. Fl.	corn.	bipinnat. segm. lin. pube. y. w.	y.	6. 8.	Britain.	H. α . Light soil.
<i>apiifolia</i> . B. R.	Parsley-leaved.	pinnatif. smth. lobes 3-fid.	w.	8. 9.	1764.	H. β . seed, or
<i>Cötula</i> . w.	stinking.	bipinnat. smth. segm. flat. y. w.	y.	6. 9.	Britain.	H. α . parting root.
<i>maritima</i> . E. Fl.	sea.	bipinnat. hairy. dott. flesh.	y.	7. 8.	England.	H. α . ———
<i>inctoria</i> . E. B.	Ox-eye.	bipinnat. serr. hairy above. ye.	6. 11.	Britain.	H. β . ———	
ACHILLE'A, YARROW. <i>Cal. ov. imbr. uneq. Flor. of the disk 5-parted. Down none.</i>							
<i>Ageratum</i> . w.	Sweet Maudlin.	obl. obt. serr. smth.	yel.	8. 10.	S. Europ.	1570.	H. β . Light loam.
<i>bratanifolia</i> . w.	Southernw.-l'd.	bipinn. pubes. segm. lin. yel.	6. 8.	Levant.	1739.	H. β . parting root.	
<i>splenifolia</i> . P. S.	Rose-coloured.	bipinn. segm. ov. obt. serr. ros.	—	—	N. Amer.	1803.	H. β . ———
<i>diserrata</i> . M. B.	two-toothed.	lin. lanc. acum. finely serr.	w.	7. 9.	Iberia.	1825.	H. β . ———
<i>grandiflora</i> . M. B.	great-flowered.	lin. acut. smth. serrul.	wh.	7. 8.	Caucasus.	1815.	H. β . ———
<i>lillefolium</i> . B. Fl.	common-Milfoil.	bipinnatif. segm. tooth.	ye.	6. 10.	Britain.	H. β . ———
<i>ptarmica</i> . E. Fl.	Sneeze-wort.	lin. lanc. serr.	wh.	7. 11.	—	H. β . ———
<i>errata</i> . w.	serrated.	lin. lanc. downy, serr.	ye. wh.	8. 9.	—	H. β . ———
<i>omentosa</i> . B. M.	downy.	bipinnat. woolly, segm. lin.	ye.	5. 10.	—	H. β . ———
PODOLE'PIS, PODOLE'PIS. <i>Invol. imbr. Recep. naked. Papp. sess. pilo. Flor. of the disk 5-tooth.</i>							
<i>racilis</i> . B. F. G.	slender.	ov. obl. 3-ner. upp. lan. amp. li.	—	—	N. Holl.	1827.	H. β . Loam & leaf mould. seeds.

Systematic Name.	English Name.	Form of Leaves, &c.	Col. of Flow.	Month of Fl.	Native Country.	Yr. of Introd.	Soil and Propagation
[entire, or 3-fid							
ADENOTRICHIA, ADENOTRICHIA. Invol. dbl. of many leaves. Recep. nak. Flor. of the ray ligul							
amplexicaulis. B.R.	stem-clasping.	ov. amplex. pinnatif.	yel.	—	Chili.	1826.	F. ♂. Sandy loam seeds, or parting roots
GERBERIA, GERBERIA. Invol. imbr. scales lanc. Recep. flat. Flor. of the rays 3-toothed.							
crenata. B.R.	crenate-leaved.	obo.cren.smth.scap.1-fl'd.pu.4.	8.	C. B. S.	1820.	G. ♂.	Loam & peat seeds, or dividing root
LEPTOSTELMA, LEPTOSTELMA. Invol. equ. round. Recep. conv. Flor. of the disk hermaph.							
maximum. D.D.	gigantic.	elong.lan.den.upp.cor.lan.w.	—	—	Mexico.	1828.	H. ♂. Sandy loam and leaf mould.
[combed. Papp. feathery.							
ATHRIXIA, ATHRIXIA. Cal. oblong, of many leaves, imbr. Flor. of the ray few, 2-lobed. Recep. honey-							
capensis. B.R.	Cape.	lin.awl-sh.rig.cotton.ben. re.	6.	7.	C. B. S.	1821.	G. ♂. Seeds, or parting roots.
CENTROCLINIUM, CENTROCLINIUM. Invol. imb. Flor. of the disk tub. 5-den. of the ray 3-den.							
apressum. B.M.	close-press'd-scal'd.lanc. ent. wh. ben.	ros. 3. 9.	Peru.	1829.	S. ♂.	—	—
reflexum. B.M.	reflexed-scaled. ov.lanc.den.wooll.ben.pu.re.	—	—	—	S. ♂.	—	—
[5-dented. Recep. epalium.							
MA'DIA, MA'DIA. Invol. of many leaves. Flor. of the rays 8-12-ligu. those of the disk hermaph. tubular,							
elegans. B.R.	elegant.	obt.sess.lin.lanc.pubes.	yel.	—	N.Amer.	1831.	H. ♂. —
HELENIUM, HELENIUM. Invol. simp. Recep. nak. Papp. 5-awn. Flor. of the ray half trifid.							
autumnale. w.	Autumnal-fl'g.	lanc. serr. smth.	yel.	8.10.	—	1729.	H. ♂. Sandy loam.
quadridentatum. B.R.	four-tooth'd.	pinnatif. upp. lanc. ent.	ye.	5.10.	Louisian.	1790.	H. ♂. dividid. root.
KAULFUSSIA, KAULFUSSIA. Cal. simpl. leaf. equal. Cor. rayed. Recep. nak. conc. Papp. bristl.							
amelloides. B.R.	blue-flowered.	alt. sess. lanc. dent.	blue.	6. 7.	C. B. S.	1819.	H. ♂. Sandy loam seeds.
PASCALIA, PASCALIA. Invo. of many lin. leav. Rec. chaff. Seeds a ripe berr. Papp. tooth. edg. thin.							
glauca. A.B.R.	glaucous-leaved.opp.	3-nerv. glau. dent.	yel.	6. 8.	Chili.	1799.	H. ♂. Loam & peat cuttings.
[radius from 5 to 10, ligul. 3-cleft							
SOLID'AGA, GOLDEN-ROD. Cal. imbr. scales pointed. Flor. of the disk tubular, 5-parted, those of the							
ambigua. w.	ambiguous.	obl. lanc. serr. pilose.	yel.	7. 8.	1759.	H. ♂. Sandy loam.
aspera. w.	rough.	ov.sub-ellip.scabr.serr.	yel.	9.	N.Amer.	1732.	H. ♂. dividing at
axillaris. Ph.	axillary-flow'd.	lanc. serr. smth.	yel.	8.10.	—	1811.	H. ♂. the root.
caesia. w.	Maryland.	lanc. smth.; stem erect.	yel.	9.10.	—	1732.	H. ♂. —
cambrica. w.	Welsh.	wedge-sh. lanc. downy.	yel.	7. 8.	Wales.	—	H. ♂. —
elliptica. w.	oval-leaved.	ellip. serr. flat.	yel.	8. 9.	N.Amer.	1759.	H. ♂. —
gigantea. w.	gigantic.	lanc. serr. edges rough.	yel.	—	—	1758.	H. ♂. —
lanceolata. B.M.	Tarragon-l'd.	lin. lan. ent. 3-nerv.	yel.	—	—	—	H. ♂. —
minuta. B.C.	least.	lanc. acut. serr. smth.	yel.	7. 8.	Pyreee.	1772.	H. ♂. —
pátula. w.	spreading.	ellip. spath. serr. smth.	yel.	9.10.	N.Amer.	1805.	H. ♂. —
petiolaris. w.	late-flowered.	stalk. ellip. rough.	yel.	10.12.	—	1758.	H. ♂. —
rugosa. Ph.	wrinkled-l'd.	lanc.serr.scabr.rugose.	yel.	8. 9.	—	1732.	H. ♂. —
reflexa. w.	reflexed.	lanc.serr.reflex.rough.	yel.	—	—	1758.	H. ♂. —

Systematic Name.	English Name.	Form of Leaves, &c.	Col. of Flow.	Month of Native Country.	Yr. of Introd.	Soil and Propagation.
speciosa.	shewy.	lanc. serr. smth.	yel.	9.10.	N. Amer.	1812. H. P. ———
stricta. w.	upright.	lanc. ent. smth. low. serr.	yel.	9.	——	1758. H. P. ———
Virgaurea. E. Fl.	common.	ellip. upp. lanc. serr.	yel.	7. 9.	Britain. H. P. ———

[the rays linear, 3-toothed.

TNULA, ELECAMPANE, & FLEA-BANE. *Cal. imbr. Flor. of the disk with 5 equal segm. those of*

britannica. Fl. D.	creeping-root'd.	ampl. lanc. base serr. pilo.	yel.	——	German.	1759. H. . Light loam
crithimoides. B. Fl.	Samphire-l'd.	lin. fleshy, 3-cuspid.	yel.	8. 9.	England. H. . & leaf mould.
ensifolia. w.	Sword-leaved.	sess. smth. lin. acum.	yel.	7. 9.	Austria.	1793. H. . dividing the
glandulosa. w.	glandular.	obl. sess. serr. gland.	yel.	7. 8.	Georgia.	1804. H. . roots.
grandiflora. w.	great-flowered.	lanc. sess. hairy serr.	yel.	——	Caucasus.	1825. H. P. ———
Helénium. E. B.	Elecampane.	ov. ampl. tooth. downy.	yel.	——	Britain. H. . ———
mariana. w.	American.	obl. lanc. sess. ent. mucr.	yel.	——	America.	1742. H. ———
salicina. Fl. D.	Willow-leaved.	lanc. recurv. serr. scabr.	yel.	8. 9.	N. Europ.	1648. H. P. ———
squarrosa. Fl. Gr.	scaly.	ov. rigid, sess. serrul.	yel.	7. 9.	S. Europ.	1768. H. P. ———
Vaillantii. w.	Vaillant's.	lanc. obl. serr. hairy.	yel.	6. 8.	France.	1739. H. P. ———

PULICARIA, FLEA-WORT. *Invol. imbr. scales linear. Recep. naked. Papp. compound.*

vulgàris.	small.	ampl. undul.; stem prost.	yel.	8. 9.	England.	—— H. A. Sandy soil.
<i>Tnula Pulicaria.</i>	E. B.					

CINERARIA, FLEA-WORT. *Cal. simp. scal. equ. Flor. of the disk perfect, 5-cleft. Seeds 4-sid. stria.*

aurantiaca. B. F. G.	Orange-colored.	ellip. lanc. repand. dent.	or.	5. 7.	Switzerl.	1818. H. P. Loam & leaf
cruenta. B. M.	bloody.	cor. ang. dent. purpl. ben.	pu.	2. 5.	Canaries.	1777. G. P. mould. cut-
campéstris. w.	field.	ellip. den. upp. lan. cottony.	y.	5.10.	N. Europ. H. P. tings or divi-
petasites. B. M.	Butter Bur-l'd.	sub-orbic. undul. lob. pub.	yel.	12.2.	Mexico.	1812. G. S. ding roots.
sibirica. B. M.	Siberian.	cord. obt. dent.	yel.	6. 8.	Siberia.	1784. H. P. ———
speciosa. B. R.	shewy.	renif. acum. cren.	yel.	——	——	1818. H. P. ———

[Papp. sessile.

DORONICUM, LEOPARD'S-BANE. *Cal. a double row of equal scales. Flor. of the ray 3 to 5-tooth.*

altáicum. w.	Siberian.	obo. spath. upp. ampl. den.	ye.	——	——	1783. H. P. Light loam.
Pardaliánches. E. B.	great.	cord. tooth. upp. ampl.	yel.	5.	Britain. H. P. part. roots.
plantagineum. w.	Plaintain-leav'd.	ov. acut. sub-dent.	yel.	5. 6.	S. Europ.	1570. H. P. ———

[Seed obovate.

BELLIS, DAISY. *Cal. scales equ. in 2 rows. Flor. of the disk 5-cleft, those of the radius notch. Down 0.*

graminea.	grass-like.	lin. ent.; stem 1-flow'd.	y. w.	5. 7.	V. Diem. H. P. Loam & pent.
integrifolia.	entire-leaved.	ov. lanc. ent.	w. ye.	——	N. Amer. H. P. divid. at root.

MUTISIA, MUTISIA. *Invol. imbr. Flow. of disk hermaphr. tubular, 5-dented. Recep. naked.*

speciosa. B. M.	handsome.	pinn. leaf. ov. lanc. acut.	pur.	8.	R. Janeiro.	—— S. S. cl. ———
-----------------	-----------	-----------------------------	------	----	-------------	------------------

[hermaph. of the ray ligul. Recep. chaffy.

SIEGESBECKIA, SIEGESBECKIA. *Invol. double, outer of 5 linear leaves. Flor. of the disk tubul.*

droseroides. B. F. G.	sun-dew-like.	opp. rhomb. ov. ampl.	yel.	8. 9.	Mexico.	1825. F. P. ———
-----------------------	---------------	-----------------------	------	-------	---------	-----------------

[Recep. honey-combed.

CALLISTEMA, CHINA-ASTER. *Cal. of many leaves. Flor. of the disk 5-cleft, those of the ray ligul.*

horténsis.	garden.	ov. dent. ciliated.	va.	7. 9.	China.	1731. H. A. Sandy loam
1. carúlea.	blue.	——	——	——	H. A. and leaf
2. álba.	white.	——	——	——	H. A. mould.
3. rúbra.	red.	——	——	——	H. A. seeds,

Systematic Name.	English Name.	Form of Leaves, &c.	Col. of Flow.	Month of Fl.	Native Country.	Yr. of Introd.	Soil and Propagation.
4. <i>multipléx.</i>	<i>double-flowered.</i>*	7.	9.	China.	1731.	H.Æ. —
5. <i>variegata.</i>	<i>variegated.</i>	—	—	—	—	H.Æ. —
6. <i>versicolor.</i>	<i>red and white.</i>	—	—	—	—	H.Æ. —

[Down sess. Recep. naked.]

A'STER, STAR-WORT. *Cal. imbr. Flor. of the disk tubul. 5-cleft, those of the ray 3-cleft. Seeds obov.*

<i>alpínus.</i> B.M.	Alpine.	lanc.ent.smth.low.spath.	<i>pu.</i>	5.	8.	Alps.Eur.	1658.	H.Æ. Sandy soil.
<i>ácris.</i> w.	acid.	lin.lanc.ent.	<i>bl.</i>	8.	9.	S.Europ.	1731.	H.Æ. The most of
<i>æstívus.</i> w.	summer.	lin.lanc.ent.amplex.	<i>bl.</i>	7.	8.	N.Amer.	1776.	H.Æ. the species of
<i>adulterínus.</i> w.	bastard.	ellip.lan.smth.slight.den.	<i>bl.</i>	8.10.	—	—	—	H.Æ. this genus
* <i>Andersónii.</i>	Anderson's.	lanc.smth.serr.	<i>bl.</i>	9.	—	—	—	H.Æ. are readily
<i>Améllus.</i> B.R.	Italian.	obl.lanc.ent.pub.scabr.	<i>bl.</i>	8.	9.	Italy.	1596.	H.Æ. increased by
<i>argophýllus.</i> B.M.	Musk-scented.	ov.lanc.dent.silky.	<i>ye.bl.</i>	5.	7.	V.Dic.Isl.	1804.	G.Æ. parting the
<i>amplexicaúlis.</i> w.	stem-clasping.	ov.obl.cord.ampl.serr.	<i>bl.</i>	9.11.	—	N.Amer.	—	H.Æ. plants at the
<i>alwarténsis.</i> B.M.	fine-rayed.	ov.ent.base atten.	<i>pur.</i>	7.	8.	Caucasus.	—	H.Æ. root, or from
<i>acuminátus.</i> B.M.	acuminate.	ov.lanc.acum.serr.	<i>wh.</i>	8.10.	—	N.Amer.	1806.	H.Æ. seeds. Those
<i>aculeátus.</i>	prickly.	lin.prickl.abo.edges revol.	<i>v.</i>	—	—	V.Dic.Isl.	1818.	G.Æ. marked G.Æ.
<i>angustifólius.</i> w.	narrow-leaved.	lin.acut.hoary.	<i>bl.</i>	5.	7.	C. B. S.	1804.	G.Æ. are propa-
<i>álbus.</i> w.	white-flowering.	ellip.lanc.serr.	<i>wh.</i>	—	—	N.Amer.	1799.	H.Æ. gated by cut-
<i>Aitónii.</i>	Mr. Aiton's.	ellip.lanc.ent.obt.smth.	<i>bl.</i>	—	—	—	—	H.Æ. tings.
<i>ardéne.</i>	bright.	lanc. 3-4 inch long.	<i>bl.</i>	—	—	—	—	H.Æ. —
<i>angústus.</i>	narrow-leaved.	lanc.tooth.3-4 inch.long.	<i>wh.</i>	—	—	—	—	H.Æ. —
<i>bellidifórus.</i> w.	Daisy-flowered.	ampl.lin.lan.marg.rough.	<i>li.</i>	9.10.	—	N.Amer.	—	H.Æ. —
<i>Bórreri.</i>	Borrrer's.	lanc. remotely serr.	<i>wh.</i>	—	—	—	—	H.Æ. —
<i>bupleuroides.</i>	Bupleurum-like.	ov.lanc.ent.smth.	<i>bl.lil.</i>	—	—	—	—	H.Æ. —
<i>blándus.</i> Ph.	charming.	lanc.serr.smth.	<i>bl.</i>	10.11.	—	N.Amer.	1800.	H.Æ. —
<i>biflórus.</i> Bieb.	two-flowered.	sess.lanc.serr.rough.	<i>v.</i>	—	—	Caucasus.	1820.	H.Æ. —
<i>corymbósus.</i> w.	corymbose-fl'g.	cord.ov.serr.long stalk.	<i>wh.</i>	9.	—	N.Amer.	1765.	H.Æ. —
<i>cornifólius.</i> w.	Cornus-ly'd.	obl.acum.ov.ent.	<i>wh.</i>	6.11.	—	—	—	H.Æ. —
<i>concínus.</i> w.	neat.	lanc.serr.smth.	<i>bl.</i>	9.10.	—	N.Amer.	1800.	H.Æ. —
<i>cánus.</i> w.	hoary-leaved.	lin.lanc.ent.3-nerv.pub.	<i>bl.</i>	8.	9.	Hungary.	1816.	H.Æ. —
* <i>cæspitósus.</i>	tufty.	ellip.lanc.tooth.	<i>pur.</i>	—	—	—	—	H.Æ. —
<i>cordifólius.</i> w.	heart-leaved.	cord.serr.stalk.	<i>li.</i>	7.	8.	N.Amer.	1759.	H.Æ. —
* <i>Dónii.</i>	Don's.	4-5 in.long.lan.acum.serr.	<i>bl.</i>	—	—	—	—	H.Æ. —
<i>dumósus.</i> w.	bushy.	lin.ent.smth.4-5 in.long.	<i>p.w.</i>	9.10.	—	—	—	H.Æ. —
<i>diffúsus.</i> w.	diffuse.	ellip.lanc.serr.smth.	<i>wh.re.</i>	—	—	—	—	H.Æ. —
<i>divérgens.</i> w.	spreadingdow'y.	ellip.lan.serr.smt.upp.lin.lan.	—	—	—	—	—	H.Æ. —
<i>demissus.</i>	bushy.	lin.smth.sub-dent.	<i>wh.</i>	—	—	—	—	H.Æ. —
<i>dracunculóides.</i> w.	Tarragon-like.	lin.lanc.serr.smth.	<i>wh.</i>	—	—	—	—	H.Æ. —
<i>eréctus.</i>	upright.	lan.tooth.smth.; <i>stm.cil.p.li.</i>	—	—	—	—	—	H.Æ. —
<i>élegans.</i> w.	elegant.	ellip.lanc.dent.	<i>bl.</i>	8.10.	—	—	—	H.Æ. —
<i>éminens.</i> w.	eminent.	lin.lanc.acum.	<i>li.</i>	9.11.	—	N.Amer.	—	H.Æ. —
<i>ericóides.</i> w.	Heath-leaved.	lin.ent.smth. <i>Br.lvs.crowd.w.</i>	<i>9.</i>	—	—	—	—	H.Æ. —
<i>Forstéri.</i> Borr.	Forster's.	ampl.near.ent.lan.smth.	<i>li.</i>	—	—	—	—	H.Æ. —
<i>floribúndus.</i> w.	many-flowered.	amp.lanc.lower serr.	<i>li.</i>	9.10.	—	—	—	H.Æ. —
<i>frágilis.</i> w.	fragile.	lin.lanc.ent.underserr.	<i>wh.</i>	9.	—	—	—	H.Æ. —
* <i>Fischéri.</i>	Fischer's.	lan.den.roug.5-inch.long.	<i>w.</i>	—	—	—	—	H.Æ. —

* Those species marked with an *asterisk* are designated by the nomenclature of Edward Foster, Esq. F.R.S. F.L.S. &c., who kindly furnished me with the entire collection from his Garden at Hale End, where he grows one of the most extensive collections of Asters, as well as other hardy and herbaceous plants, that is to be found in the Kingdom.

Systematic Name.	English Name.	Form of Leaves, &c.	Col. of Flow.	Month of Fl.	Native Country.	Yr. of Introd.	Soil and Propagation.	
foliósus.	leafy.	lan.sub-ser.upp.lin.ent.	<i>pa.li.</i>	9.	N. Amer.	1800.	H. \mathcal{P} .	
glaucus.	glaucous.	ellip. lanc. ent.	glau.	<i>bl.</i>	9.11.	—	1823.	H. \mathcal{P} .
gravéolens.	strong-scented.	ellip. lanc.		<i>bl.</i>	—	Arkansa.	1825.	H. \mathcal{P} .
graminifólius.	grass-leaved.	lin. smth. erect.		<i>pa.p.</i>	—	—	—	H. \mathcal{P} .
grandiflórus. w.	great-flowered.	lin. ent. acut. rig. ampl.		<i>bl.</i>	10.11.	N. Amer.	1720.	H. \mathcal{P} .
*hybérnus.	Irish.	lin.lan.smth.ent.4-5 in.long.		<i>wh.</i>	—	—	—	H. \mathcal{P} .
hyssopifólius. w.	Hyssop-leaved.	lin. ent. dott. smth.		<i>li.</i>	9.10.	—	1683.	H. \mathcal{P} .
*Hunnemánni.	Mr.Hunnemann's.	lanc. dent. smth.		<i>pur.</i>	—	—	—	H. \mathcal{P} .
Hookérii.	Dr. Hooker's.	lin. ent. smth.		<i>wh.</i>	—	—	—	H. \mathcal{P} .
lánceus. w.	slender-stalked.	lin.lanc.smth.low.serr.		<i>wh.</i>	—	—	1758.	H. \mathcal{P} .
lánceolátus. w.	lance-leaved.	5-6 inch.long,lanc.dent.		<i>wh.</i>	8.11.	—	1811.	H. \mathcal{P} .
Milléri.	smooth.	obl.ent.shin.ampl.sub-ser.li.		<i>li.</i>	9.10.	—	1753.	H. \mathcal{P} .
longifólius. w.	long-leaved.	lin.lan.smth.seldom tooth.		<i>w.</i>	10.	—	1798.	H. \mathcal{P} .
*lividus.	livid.	lanc. tooth. smth.		<i>pu.li.</i>	9.	—	—	H. \mathcal{P} .
lájus. w.	loose-stalked.	spat.upp.lin.lan.den.smt.		<i>p.p.</i>	9.11.	—	—	H. \mathcal{P} .
lævigátus. w.	smooth.	lanc. serr. smth. ampl.		<i>li.</i>	—	—	1794.	H. \mathcal{P} .
Milléri.	Miller's.	semi-ampl.lan.smth.den.		<i>bl.</i>	—	—	—	H. \mathcal{P} .
*Macleaii.	Maclea's.	lan.smth.tooth.in the mid.		<i>pu.</i>	—	—	—	H. \mathcal{P} .
mutábilis. w.	changeable.	elli.lan.ser.amp.upp.ent.		<i>bl.</i>	9.10.	N. Amer.	1710.	H. \mathcal{P} .
multiflórus. w.	many-flowered.	lin. smth. ent.		<i>wh.</i>	—	—	1732.	H. \mathcal{P} .
míser. w.	meagre-flow'd.	lanc. serr. sess. smth.		<i>wh.</i>	—	—	1579.	H. \mathcal{P} .
macrophyllus. w.	large-leaved.	cord. serr. rough.		<i>bl.wh.</i>	7. 9.	—	1739.	H. \mathcal{P} .
Nóva-Bélgii.	New York.	lan.5-6 in.lan.den.in mid.		<i>bl.</i>	9.10.	—	1710.	H. \mathcal{P} .
Nóva-A'ngliæ. w.	New England.	lin.lan.ampl.pub.ent.;stm.		<i>pil.</i>	—	—	—	H. \mathcal{P} .
nemorális. H.K.	wood.	lin. lanc. rough.		<i>li.</i>	8. 9.	—	1778.	H. \mathcal{P} .
Nóva-Scótiæ.	New Scotland.	lin. lanc. alt. ent. smth.		<i>li.</i>	9.	—	—	H. \mathcal{P} .
*Ottónis.	Otto's.	ellip. lanc. dent.		<i>bl.</i>	—	—	—	H. \mathcal{P} .
paniculátus. w.	panicle-flow'g.	cord.ov.lanc.serr.smth.		<i>wh.</i>	9.10.	—	1640.	H. \mathcal{P} .
pendúlus. w.	pendulous-fl'g.	broadly ellip.lan.den.smt.		<i>bl.</i>	—	—	—	H. \mathcal{P} .
puníceus. w.	scarlet-stalked.	lanc. serr. ampl. scabr.		<i>li.</i>	7.10.	—	1710.	H. \mathcal{P} .
polítus.	polished.	lan.smth.glau.sub-serr.		<i>pu.</i>	—	—	—	H. \mathcal{P} .
*Pseúdo-dumósus.	Bastard-bushy.	lin. ent. smth.		<i>wh.</i>	—	—	—	H. \mathcal{P} .
*Pseúdo-diffúsus.	Bastard-spread.	ellip.lan.serr.scabr.		<i>wh.pu.</i>	—	—	—	H. \mathcal{P} .
præ'cox. w.	early-flowering.	lan.den.smth.4 in.long.		<i>bl.</i>	7. 8.	—	1800.	H. \mathcal{P} .
preanthóides. w.	Prenanthes-like.	spath. lanc. serr.; stm.		<i>pil.bl.</i>	9.11.	—	1817.	H. \mathcal{P} .
pannónicus. w.	Hungarian.	lin.lan.ent.edges rough.		<i>vi.</i>	7. 8.	Hungary.	1815.	H. \mathcal{P} .
pulchéllus. w.	pretty.	spath. upp. lin. lanc.		<i>red.</i>	5. 8.	Armenia.	1818.	H. \mathcal{P} .
punctátus. w.	dotted.	lin. acum. dott. 3-nerv.		<i>vi.</i>	8. 9.	Hungary.	1815.	H. \mathcal{P} .
polyphyllus. w.	many-leaved.	lin. smth. ent.		<i>wh.</i>	8.10.	N. Amer.	—	H. \mathcal{P} .
pállens. w.	pale-flowered.	obl. lanc. serr. smth.		<i>li.</i>	9.10.	—	—	H. \mathcal{P} .
refléxus. B.M.	reflex-leaved.	ov.imb.recur.cilia.serr.		<i>re.w.</i>	2. 9.	C. B. S.	1759.	G. \mathcal{S} .
rivuláris.	river.	lan.remote. tooth.smth.		<i>p.pu.</i>	—	—	—	H. \mathcal{P} .
rubicúndus.	red-stalked.	ov.lan.remotely serr.sm.		<i>li.</i>	9.	—	—	H. \mathcal{P} .
rúber.	red-flowered.	ov.lan.ampl.scabr.ent.		<i>red.</i>	9.10.	—	—	H. \mathcal{P} .
reticulátus. Ph.	netted-leaved.	obl. lanc. acut. hoary.		<i>wh.</i>	8.11.	N. Amer.	1812.	H. \mathcal{P} .
*spathulátus.	spathulate.	lan. serr. smth.		<i>bl.</i>	—	—	—	H. \mathcal{P} .
seríceus. w.	silky-leaved.	obl. lanc. sess. silky.		<i>bl.</i>	—	Missouri.	1802.	G. \mathcal{S} .
*Solándri.	Solander's.	cord. acum. serr.		<i>wh.</i>	9.	—	—	H. \mathcal{P} .
símplex. w.	single-stalked.	lin. lanc. serr.		<i>pa.wh.</i>	—	N. Amer.	—	H. \mathcal{P} .
salicifólius. w.	Willow-leaved.	lin.lan.5-6 in.long.smth.		<i>li.</i>	9.10.	—	1760.	H. \mathcal{P} .
spùrius.	spurious.	ampl.ov.lanc.edges cil.		<i>p.bl.</i>	10.	—	—	H. \mathcal{P} .
squarrósus. w.	ragged.	ov. acum. ent. hairy.		<i>bl.</i>	6. 7.	—	1801.	H. \mathcal{P} .

Systematic Name.	English Name.	Form of Leaves, &c.	Col. of Flow.	Month of Fl.	Native Country.	Yr. of Introd.	Soil and Propagation.
spectabilis. w.	shewy.	lanc. serr. ; stem hairy.	bl.	8. 9.	N. Amer.	1777.	H. ♂. ———
serotinus. w.	late-flowering.	sess. ellip. lanc. remo. serr.	bl. li.	9. 11.	—	—	H. ♂. ———
sparsiflorus. w.	scattered-flow'g.	lin. awl-sh. reflex. smth.	wh.	—	—	1798.	H. ♂. ———
sagittifolius. w.	Arrow-leaved.	cord. sagitt. acum. serr.	bl.	7. 9.	—	1818.	H. ♂. ———
strictus. Ph.	upright-dwarf.	lin. lanc. rough.	vi.	9. 11.	—	1806.	H. ♂. ———
sibiricus. w.	Siberian.	ampl. serr. lanc. pilose.	pur.	7. 9.	Siberia.	1768.	H. ♂. ———
thyrsiflorus.	thyrs-flow'g.	lin. lanc. nearly ent.	wh.	—	H. ♂. ———
Tripólium. E. Fl.	sea.	lin. lanc. ent.	car.	8. 9.	Britain.	H. ♂. ———
Tradescánti. w.	Michaelm. Daisy.	lanc. serr. smth.	wh.	7. 9.	N. Amer.	1633.	H. ♂. ———
tenuifolius. w.	slender-leaved.	lin. ent. smth.	wh.	9. 10.	—	1725.	H. ♂. ———
tardiflorus. w.	late-flowering.	sess. lanc. serr. smth.	pur.	7. 9.	—	1775.	H. ♂. ———
tomentosus. w.	downy-leaved.	ov. serr. downy.	wh.	5. 7.	N. S. W.	1798.	G. ♂. ———
versicolor. w.	various-color'd.	ampl. broad. lanc. ser. smth.	vi.	8. 9.	N. Amer.	1790.	H. ♂. ———
villosus. w.	villous-leaved.	lin. filif. vill.; stm. shrub.	li.	5. 7.	C. B. S.	1812.	G. ♂. ———
*vagas.	spreading.	ampl. lanc. smth. dent.	li.	—	H. ♂. ———
*Wildenóvii.	Wildenow's.	cor. ov. deep. serr. upp. lanc.	li.	—	H. ♂. ———

[the ray 3-cleft, ligulate.

DIPLOSTE'PHIUM, DIPLOSTE'PHIUM. Cal. imbricate. Flor. of the disk tubul. 5-cleft. Flor. of

linariifolium.	toad-flax-iv'd.	lin. mucr. rough.	pur.	9. 10.	N. Amer.	1699.	H. ♂. ———
<i>Aster linariifolius.</i> w.							
linifolium.	Flax-leaved.	lin. ent. scabr. 1 inch long.	wh.	7. 8.	—	1739.	H. ♂. ———
<i>Aster linifolius.</i> w.							
Amygdalinum.	Almond-leaved.	lan. wrinkl. edges ciliat.	p. wh.	7. 9.	—	1759.	H. ♂. ———
<i>Aster umbellatus.</i> w.							

***GEORGINA, GEORGINA.** Cal. double, outer reflexed ; inner of 8 leaves. Recept. chaffy. Papp. 0.

variabilis. w.	variable.	pinn. leaf. ov. serr.	va.	6. 11.	Mexico.	1789.	H. ♂. ———
<i>Dáhlia supérftua.</i> H. K.							

Garden Varieties.

Garden Varieties.

Garden Varieties.

I. WHITE.

II. WHITE, SPOTTED WITH RED.

IV. LILAC.

	Height in Feet.		Height in Feet.		Height in Feet.
Alba multiflora	3 - 4	Dwarf Blush White	2 - 3	Daphne	1 - 2
Albinia	3 - 4	Nymphæiflora	3 - 4	Landgravine	3 - 4
Blanch Fleur	3 - 4	Marchioness of Tavistock	2 - 3	Lady of the Lake	3 - 4
French Fleur	2 - 3	—	—	Lilia pumila	2 - 3
Inwood's White	3 - 4	III. BLUSH.		Lady Rachel Russell	3 - 4
King of the Whites	3 - 4	Maid of Kent	3 - 4	Queen of Scots	3 - 4
Mountain of Snow	4 - 5	Miss Turner	3 - 4	Royal Lilac	3 - 4
Lady Eliz. Harcourt	4 - 5	Rosea alba	2 - 3	Theodore	3 - 4
				Trevoriana	3 - 4

* The soil best adapted for the growth of these beautiful and numerous varieties of flowers, is a yellow rich loam ; if recently taken from a pasture, so much the better. They are all readily increased by parting the preceding year's roots ; but the most general and successful method, is, by subjecting these roots to a little artificial heat in March or April ; this will induce them to push out young shoots, which should be taken off when they are from three to four inches long, and put into pots in a mixture of sandy loam and leaf mould, and then placed in a hot-bed, where a gentle heat should be kept until they have made good roots, when they may be taken out and placed in a cold frame, and gradually exposed to the external atmosphere, previous to their being planted out in the flower border about the middle of May. They will thus produce an abundance of flowers in Autumn, which will continue to ornament the flower garden until they are destroyed by the frost.

Garden Varieties.

Garden Varieties.

Garden Varieties.

V. ROSE, OR PINK.

	Height in Feet.
Duchess of Wellington ..	4 - 5
Duke of York	4 - 5
King of the Roses	4 - 5
Lady Grenville	3 - 4
Maid of Belle Vue	4 - 5
Miss Pelham	2 - 3
Miss Wright	4 - 5
Russelliana	3 - 4

ORANGE.

	Height in Feet.
Duke of Grafton	5 - 6
General Lafayette	4 - 5
Globe Orange	4 - 5
Lady Osborne	3 - 4
Lord Lyndhurst	3 - 4
Pizarro	2 - 3
Von Weber	3 - 4

XII. DARK MAROON, PUCE,
AND BLOOD COLOUR.

	Height in Feet.
Achates	3 - 4
Black Turban	5 - 6
Countess of Craven	1 - 2
Dawson's Victory	4 - 5
Seymouriana	
Douglas's Achilles	3 - 4
———— decora	4 - 5
Hall's Mogul	3 - 4
Involuta purpurea	3 - 4
Marchioness of Abercorn	2 - 3
Bedfordiana	6 - 7
Premier	4 - 5
Smith's Brunswick	2 - 3
———— Paul Pry	5 - 6
Wellington	4 - 5
Wells' William the Fourth	5 - 6
———— Pulla	2 - 3
———— Eminent	2 - 3
———— Stephenia	2 - 3
———— Lord Winchelsea	4 - 5
———— Mount Vesuvius	2 - 3
Wheeler's Turk	3 - 4
Xenophon, or Flower Ball	3 - 4

VI. GARDEN VARIETIES.

Sussex Maid	3 - 4
Wells' Amanda	3 - 4
———— Beauty of Flora ..	4 - 5
———— Densa	1 - 2
———— Diffusa	3 - 4
———— Robusta	3 - 4
———— Triumph Royal ..	3 - 4
Wednall's Queen of Roses	2 - 3
York and Lancaster ..	4 - 5

X. PURPLE.

Lady Holland	4 - 5
Atropurpurea	3 - 4
———— superba ..	3 - 4
———— speciosa ..	4 - 5
Bella	2 - 3
Barret's Susanna	4 - 5
Beauty in the Bush	1 - 2
Brewer's Cambr. Surprise	5 - 6
Commoda	2 - 3
Compacta	2 - 3
Homer	2 - 3
Kentish Hero	2 - 3
Lady Blake	2 - 3
Lady Farnborough	3 - 4
Leopold the First	4 - 5
Lord Cochrane	3 - 4
Lady Aberdeen	4 - 5
Maid of Orleans	3 - 4
Plant's purpurea perfecta	3 - 4
Queen of Wirtemberg ..	3 - 4
Suttonia superb	3 - 4
Stanhopeæ	3 - 4
Wells' Juno	1 - 2
———— Sir J. Copley ..	2 - 3
———— Man of Kent	3 - 4
Zelinda	1 - 2

VII. YELLOW.

Bright Yellow	4 - 5
Dwarf Golden Yellow ..	2 - 3
Reine de Jaune	4 - 5
Squib's Pure Yellow	3 - 4
Sulphurea Grandiflora ..	2 - 4

VIII. BUFF AND SALMON.

Anna Maria	2 - 3
Gris de Lin	3 - 4
Maid of St. Leonard's ..	3 - 4
Paris	3 - 4
Wells' Jupiter	6 - 7

IX. ORANGE.

Aurantia pallida	3 - 4
———— speciosa	5 - 6
———— superba	3 - 4
Duchess of Bedford	1 - 2

XI. SHADED ROSE, SHADED
PURPLE.

Colville's perfecta	4 - 5
Douglas's Augusta	5 - 6
Lord Farnborough	6 - 7
Perfecta of Sussex	3 - 4
Princess Augusta	3 - 4
Rob Roy	3 - 4
Tricolor	5 - 6

XIII. SCARLET.

Barret's William IV	4 - 3
Beauty of Hackney	2 - 3
Beauty of Cheshunt	4 - 5
Columbine	3 - 4
Coccinea superba	5 - 6
———— speciosissima ..	3 - 4
Countess of Liverpool ..	6 - 7
Douglas's Splendida	4 - 5
England's Defiance	4 - 5
Eximia	4 - 5
Electa	3 - 4
Lord John Russell, su- perb ball	3 - 4
Marshall's Prince George	3 - 4
Mount Etna	5 - 6
Read's Lord Neville	3 - 4
Smith's Queen Adelaide	3 - 4
———— Waterloo	4 - 5
Scarlet Turban	5 - 6
———— Ranunculus, extra fine	2 - 3
Veitch's Beauty of Devon	4 - 5
Lady William Russell	3 - 4

Systematic Name.	English Name.	Form of Leaves, &c.	Col. of Flow.	Month of Fl.	Native Country.	Yr. of Introd.	Soil and Propagation.
Garden Varieties.		Garden Varieties.			Garden Varieties.		
XIV. RED.				XVI. CRIMSON.			
	Height in Feet.		Height in Feet.			Height in Feet.	
Barnardiæ	4 - 5	Cicero	4 - 5	Wells' minima		1 - 2	
Beauty of England	5 - 6	Crimson Turban	3 - 4	William the Conqueror		4 - 5	
— of Hertford	4 - 5	Coronation	3 - 4	Lady Georgiana Russell		3 - 4	
Claudius Cæsar	3 - 4	Dennis's Invincible	3 - 4				
Excelsa	4 - 5	Fulgida perfecta	3 - 4				
Humilis	1 - 2	— superb	4 - 5				
Lady Sydney	4 - 5	Foster's Incomparable	4 - 5				
Mr. Hutchinson	3 - 4	Grandeur Superbe	3 - 4				
Marshall's Queen Adelaide	3 - 4	Galanthus	4 - 5				
— William the Fourth	3 - 4	Hon. Mrs. Petre	3 - 4				
Rosette	3 - 4	Inwood's crimson multiflora	2 - 3				
Talavera	2 - 3	Lady Grantham	4 - 5				
		Lindleyana	4 - 5				
		Minerva	3 - 4				
		Mundula	2 - 3				
		Marquis of Hertford	3 - 4				
		Nutter's Apollo	4 - 5				
		Paul's Rival	3 - 4				
		— Crimson Turban	3 - 4				
		Sowerby	3 - 4				
		Summit of Perfection	3 - 4				
		Wells' Aurora	5 - 6				
		— Bellona	3 - 4				
XV. RUBY COLOURED.				XVII. ANEMONE FLOWERED.			
British Hero	5 - 6			Painted Lady		3 - 4	
Dennisii	4 - 5			Sweet scabious flowered		3 - 4	
Inwood's Donna Maria	3 - 4						
Rudhall Venus	3 - 4						
Sans Rivale	4 - 5						
Young's Triumph	7 - 8						
XVII. GLOBE flowered crimson and scarlet.							
				Crimson		4 - 5	
				— bonnet		4 - 5	
				— dark		2 - 3	
				Neat Crimson		3 - 4	
				Lord Russell		3 - 4	
CHRYSA'NTHEMUM, CHRYSA'NTHEMUM. Invol. imbricated. Recept. naked. Pappus none.							
argenteum. w.	silvery.	bipinn. leaf. acut. ent.	7. 8.	Levant.	1731.	H. P.	Sandy loam
atrátum. w.	fleshy-leaved.	wedge-sh. obl. serrul. wh.	—	Austria.	—	H. P.	& leaf mould.
graminifolium. w.	grass-leaved.	lin. nearly entire.	6. 7.	Mont Pel.	1739.	H. P.	part. at roots
sinense.	Sabine's-Chinese.	pinnatif. dent. glau. var.	9. 11.	China.	1790.	H. P.	or cuttings.
1. purpureum.	old purple.		10. 12.			H. P.	
2. variabile.	changeable-white.					H. P.	
3. tubulosum, album.	quilled-white.					H. P.	
4. superbum.	superb-white.					H. P.	
5. tessellatum.	tasselled-white.					H. P.	
6. tubulosum, luteum.	quilled-yellow.					H. P.	
7. sulphureum.	straw-coloured.					H. P.	
8. aurea.	golden-yellow.					H. P.	
9. discolor.	large lilac.					H. P.	
10. Lilacinum.	pink, or lilac.					H. P.	
11. cupreum.	buff, or copper-coloured.					H. P.	
12. fulcum.	Spanish brown.					H. P.	
13. flammum.	quilled flame-yellow.					H. P.	
14. tubulosum roseum.	quilled pink.					H. P.	
15. atropurpureum.	large quilled-orange.					H. P.	
16. expansum.	expanded light purple.					H. P.	
17. purpurascens.	quilled light purple.					H. P.	
18. involutum.	curled-lilac.					H. P.	
19. fasciculatum.	superb clustered-yellow.					H. P.	

Systematic Name.	English Name.	Form of Leaves, &c.	Col. of Flow.	Month of Fl.	Native Country.	Yr. of Introd.	Soil and Propagation.
20. <i>tubulosum carneum</i> .		semi-double quilled-pink.	10.12.	China.	1790.	H. P.	—
21. <i>album semi-duplex</i> .		semi-double quilled-white.	—	—	—	H. P.	—
22. <i>tubulosum auranteum</i> .		semi-double quilled-orange.	—	—	—	H. P.	—
23. <i>serotinum</i> .		late pale-purple.	—	—	—	H. P.	—
24. <i>salmoneum</i> .		quilled salmon-coloured.	—	—	—	H. P.	—
25. <i>parvulum</i> .		small-yellow.	—	—	—	H. P.	—
26. <i>papyraceum</i> .		paper-white.	—	—	—	H. P.	—
27. <i>pallidum</i> .		late pale-pink.	—	—	—	H. P.	—
28. <i>chrysocomum</i> .		tasselled-yellow.	—	—	—	H. P.	—
29. <i>Waratah</i> .		yellow-waratah.	—	—	—	H. P.	—
30. <i>Sabini</i> .		golden-lotus.	—	—	—	H. P.	—
31. <i>chryseides</i> .		double Indian-yellow.	—	—	—	H. P.	—
32. <i>Parkii</i> .		Park's small-yellow.	—	—	—	H. P.	—
33. <i>pallens</i> .		semi-dbl. quill, pale-orange.	—	—	—	H. P.	—
34. <i>stramineum</i> .		pale-buff.	—	—	—	H. P.	—
35. <i>mutabile</i> .		changeable pale-buff.	—	—	—	H. P.	—
36. <i>bicolor</i> .		two-coloured incurved.	—	—	—	H. P.	—
37. <i>versicolor</i> .		two-coloured red.	—	—	—	H. P.	—
38. <i>stellatum</i> .		starry-purple.	—	—	—	H. P.	—
39. <i>ornatum</i> .		tasselled-lilac.	—	—	—	H. P.	—
40. <i>fulvescens</i> .		brown-purple.	—	—	—	H. P.	—
41. <i>verecundum</i> .		early-blush.	—	—	—	H. P.	—
42. <i>blandum</i> .		blush.	—	—	—	H. P.	—
43. <i>leucanthum</i> .		double Indian-white.	—	—	—	H. P.	—

RELHANIA, RELHANIA. *Cal. obl. turbin. imbr. Flor. of the disk androgynous, of the ray female.*

pungens. B. R. prickly. lanc. pung. hairy. *yel. 6. 8. C. B. S. 1820. G. S. Loam & peat cuttings.*

VERBESINA, VERBESINA. *Cal. double. Recep. paleaceous. Papp. awned. Flor. of the ray 5.*

alata. B. M. wing-stalked. alt. undul. obt. decurr. *or. 5. 10. S. Amer. 1699. G. P. Light rich*
serrata. w. saw-leaved. opp. ov. lanc. serr. rug. *yel. 7. 10. Mexico. 1803. G. P. loam. cut-*
sativa. B. M. Oil-seed. opp. cord. lanc. ampl. serr. *yel. 8. 9. E. Ind. 1806. S. A. tings & seeds.*
virginica. w. Virginian. alt. lanc. serr. *wh. 7. 9. N. Amer. 1812. H. P. —*

BUPHTHALMUM, OX-EYE. *Cal. imbric. Recep. paleaceous. Papp. an obsolete rim, 4-dented.*

arborescens. w. tree. opp. lanc. ent. smth. *yel. 5. 7. S. Amer. 1699. G. S. Sandy soil.*
cordifolium. w. heart-leaved. cord. serr. upp. ov. *yel. 6. 8. Hungary. 1739. H. P. divid. root.*
salicifolium. w. Willow-leaved. alt. lanc. serr. vill. *yel. 6. 10. Austria. 1759. H. P. —*
sericeum. B. M. silky-leaved. opp. spath. obl. silky. *yel. 5. 7. Canaries. 1779. G. S. —*

ORDER III.

FRUSTRANEA. *Florets of the disk fertile, those of the ray neuter.*

HELIAANTHUS, SUN-FLOWER. *Invol. imbric. scaly. Recep. paleaceous, plane. Papp. 2-leaved.*

altissimus. w. tall. alt. ov. lanc. serr. *yel. 7. 9. N. Amer. 1731. H. P. Sandy loam.*
angustifolius. B. M. narrow-leaved. alt. lin. edges revol. *yel. 9. 10. — 1789. H. P. seeds, or*
atrorubens. w. dark-eyed. spath. ov. cren. scabr. *ye. pu. 7. 10. — 1732. H. P. parting*

Systematic Name.	English Name.	Form of Leaves, &c.	Col. of Flow.	Month of Fl.	Native Country.	Yr. of Introd.	Soil and Propagation.
diffusus. E.M.	spreading.	ov. obl. rigid; stem hisp.	yel.	7.10.	N. Amer.	1812.	H. P. roots.
decapetalus. w.	ten-petaled.	ov. acum. serr.	yel.	8.11.	—	1759.	H. P. —
linearis. B.R.	linear-leaved.	lin. acut. ent. hispid.	yel.	8.10.	Mexico.	1823.	H. P. —
Jenticularis. B.R.	freckled.	ov. acum. serr. hispid.	yel.	8.	N. Amer.	1827.	H. P. —
petiolaris. B. Fl. G.	long-petioled.	ov. alt. dent. scabr. 3-nerv.	yel.	—	Arkansa.	1826.	H. P. —
pubescens. B.M.	pubescent.	opp. semi-ampl. ov. lan. ser.	ye.	7.10.	N. Amer.	1795.	H. P. —
macrophyllus. w.	large-leaved.	ov. acum. 3-nerv. serr.	yel.	8.10.	—	1800.	H. P. —
multiflorus. E.M.	many-flowered.	cord. upp. ov. 3-nerv. scabr.	ye.	—	—	1597.	H. P. —
tuberosus. w.	tuberous.	cord. ov. upp. alt.	yel.	9.10.	Brazil.	1617.	H. P. —

[disk tubular, 5-toothed.

CENTROCARPHA, CENTROCARPHA. *Invol. of many leaves. Flor. of the ray ligulate, those of the grandiflora.* large-flowered. elong. ov. dent. hairy. yel. — N. Amer. 1830. H. P. Garden soil. seeds.

COREOPSIS, COREOPSIS. *Invol. dbl. each of many leaves. Recep. paleaceous. Papp. 2-horned.*

aurea. B.R.	golden.	tripar. ser. up. trif. lan. lin.	ye.	8.9.	—	1795.	H. P. Sandy soil.
auriculata. w.	ear-leaved.	subsess. ov. lan. ent. up. ter.	ye.	8.10.	—	1699.	H. P. seeds, or
grandiflora.	large-flowered.	opp. smth. upp. tern.	ye.	8.9.	—	1826.	H. P. dividing
lanceolata. w.	spear-leaved.	lanc. smth. ent.	yel.	7.9.	Carolina.	1724.	H. P. roots.
tripteris. Ph.	three-leaved.	lanc. ent. pinn. upp. tern.	yel.	8.10.	N. Amer.	1737.	H. P. —
tinctoria. E.M.	two-coloured.	opp. pinn. leaf. ov. alt.	ye. pu.	6.10.	Arkansa.	1823.	H. P. —
verticillata. w.	whorl-leaved.	tern. in whorls, pinn.	yel.	7.10.	N. Amer.	1759.	H. P. —

RUDBECKIA, RUDBECKIA. *Invol. scaly. Recep. palea, conical. Papp. with a 4-toothed rim.*

amplexifolia. Ph.	stem-clasping.	obl. lanc. cord. ampl. serr.	yel.	7.8.	Louisian.	1793.	H. P. Light rich
columnaris. E.M.	high-crown'd.	pinnatif. cut, segm. lin.	yel.	8.9.	N. Amer.	1811.	H. P. loam. seeds,
fulgida. H.K.	small hairy.	obl. lanc. dent. hispid.	yel.	7.8.	—	1760.	H. P. or parting
hirta.	hairy.	spath. serr. hairy.	yel.	6.11.	—	1714.	H. P. at root.
laevigata. Ph.	smooth-stem'd.	ov. lanc. acum. ent.	yel.	7.8.	Georgia.	1812.	H. P. —
laciniata. Ph.	jagged.	pinn. segm. 3-lob. upp. ov.	ye.	7.9.	N. Amer.	1640.	H. P. —
pinnata. B. F. G.	wing-leaved.	pinn. under bipart.	yel.	8.9.	—	1813.	H. P. —
triloba. E.M.	three-lobed.	tripart. upp. lanc.	yel.	—	—	1699.	H. P. —

ECHINACEA, ECHINACEA. *Invol. of many leaves. Recep. chaffy. Flor. of disk hermaph.*

heterophylla. B. F. G.	various-ly'd.	alt. obl. acu. pandurif. ser.	pu.	9.10.	Mexico.	1828.	H. P. Sandy loam
purpurea. D. D.	purple.	ov. dent. upp. lanc. ov.	pu.	7.10.	N. Amer.	1699.	H. P. and peat. seeds, or
Rudbeckia purpurea. E.M.	late-flowered.	elong. ov. dent. rough.	red.	8.10.	—	1816.	H. P. parting roots.
Rudbeckia serotina. B. F. G.							

[Recep. bristly. Papp. pilose.

PLECTOCOPHALUS, PLECTOCOPHALUS. *Invol. imbr. globos. Flor. of the disk tubul. 5-parted.*

americanus. D. D.	American.	obl. ent. alt. sess. mucr.	pu. r.	—	N. Amer.	H. P. —
-------------------	-----------	----------------------------	--------	---	----------	------	---------

ENCELIA, ENCELIA. *Invol. of many leaves, imbr. Flor. of the disk tubular. Papp. none.*

canescens. B.R.	hoary.	ov. 3-nerv. alt. hairy.	yel.	7.9.	Mexico.	1786.	G. S. Sandy soil. cuttings.
-----------------	--------	-------------------------	------	------	---------	-------	-----------------------------

GYMNOLOMA, GYMNOLOMA. *Invol. of many leaves. Recep. convex, paleaceous. Papp. 0.*

maculata. B.R.	spotted-stalked.	ov. lanc. serr. opp.	yel.	6.9.	S. Amer.	1822.	H. S. —
----------------	------------------	----------------------	------	------	----------	-------	---------

TITHONIA, TITHONIA. *Invol. globose. Recep. convex, scaly. Papp. paleaceous, 5-leaved.*

tagetiflora. R.R.	Saffron-color'd.	ov. lanc. smth. cren.	yel.	8.9.	W. Ind.	1821.	S. P. —
-------------------	------------------	-----------------------	------	------	---------	-------	---------

Systematic Name.	English Name.	Form of Leaves, &c.	Col. of Flow.	Month of Fl.	Native Country.	Yr. of Introd.	Soil and Propagation.
[ray funnel-shaped, abortive.							
CENTAUREA, KNAPWEED. Cal. imbr. Cor. compound. Flor. of the disk perfect, tubul. those of the							
argentea. w.	silvery.	downy, lower pinn.	yel.	7. 8.	Candia.	1739.	F. S. Light loam.
atropurpurea. w.	dark-purple.	bipinnatif. segm. lin.	pur.	6. 8.	Hungary.	1802.	H. P. dividing at
cruenta. W.en.	obovate-leaved.	obov. tooth. stalk.	pur.	—	S. Europ.	1816.	H. P. roots, or
Calcitrapa. E. B.	common.	pinnatif. spiny, dent.	pur.	7. 9.	Britain.	H. A. seeds.
Fischèri. W.en.	Fischer's.	obl. lanc. vill. ent.	pur.	6. 7.	Siberia.	1816.	H. P. ———
glastifolia. B. M.	Woad-leaved.	ent. decurr.	yel.	6. 9.	—	1731.	H. P. ———
Isnardi. L.	Jersey-star-thist.	lyrate, roug. tooth. ampl.	pu.	7. 8.	Jersey.	H. P. ———
Jacea. E. B.	Brown.	lin. lanc. lower obov. dent.	pu.	7. 9.	England.	H. P. ———
nitens. w.	shining.	pinn. leaf. lin. mucr.	pur.	7. 8.	Caucasus.	1823.	H. A. ———
suaveolens.	sweet Sultan.	lyrate, pinnatif. dent.	yel.	7. 10.	Levant.	1683.	H. A. ———
scabiösa. B. Fl.	greater.	pinnatif. segm. lanc. roug.	cr.	6. 8.	Britain.	H. P. ———
sulphurea.	sulphur-color'd.	lanc. decurr. roug. dent.	st.	—	Podolia.	1815.	H. A. ———
solstitialis. E. Fl.	yellow.	lyrate, lobes alt.	yel.	7. 8.	England.	H. A. ———

GAZA'NIA, GAZA'NIA. Invol. of 1 leaf, the tube naked, or covered with leaf. Recep. nak. Papp. chaffy.
 rigens. B. M. great-flowered. lan. pinnat. whit. down ben. y. 5. 9. C. B. S. 1755. G. S. Leaf mould & loam. cuttings.

BERCKHE'YA, BERCKHE'YA. Cal. imbr. Ray of cor. hermaph. Recep. chaffy. Papp. chaffy.
 cuneata. w. wedge-shaped. alt. obl. wedg.-sh. den. spin. vill. 6. 8. ——— 1812. G. S. Sandy loam
 grandiflora. B. M. great-flowered. opp. lan. 3-ner. spin. dent. ye. ——— ——— G. S. & leaf mould.
 uniflora. w. single-flowered. alt. lanc. spiny, downy ben. ye. 6. 8. ——— 1815. G. S. cuttings.

GAILLA'RDIA, GAILLA'RDIA. Invol. imbr. with many linear leaves. Recep. palea, roundish.
 aristata. B. R. long-awned. spath. dent. upp. obl. ent. yel. 7. 10. N. Amer. 1812. H. P. Sandy loam
 bicolor. B. M. two-coloured. lin. lanc. ent. hairy. yel. red. ——— Carolina. 1787. H. P. & leaf mould.
 seeds, or parting roots.

CO'SMEA, CO'SMEA. Cal. double, 8-parted. Recep. chaffy. Papp. 2-4-awned. Seeds 4-sided.
 bipinnata. B. M. fine-leaved. bipinn. leaf. lin. subul. ros. 10. 11. Mexico. 1804. G. P. Sandy loam &
 parviflora. w. small-flowered. bipinn. leaf. filif. wh. ——— ——— 1806. H. A. leaf mould.

ORDER IV.

POLYGAMIA NECESSARIA. Florets of the disk with stamens only, those of the ray with pistils.

SILPHIUM, SILPHIUM. Cal. scaly, of many leaves. Recep. chaffy. Papp. notch. Seeds obcor. compr.
 atropurpureum. w. purple-stalked. dent.; stem round. d. pur. 7. 10. N. Amer. 1812. H. P. Sandy loam.
 connatum. w. round-stalked. opp. sess. perfol. yel. ——— ——— 1765. H. P. dividing
 laciniatum. w. jagged-leaved. pinnatif. ent.; stem hairy. yel. 7. 9. ——— 1781. H. A. root.
 trifoliatum. w. three-leaved. tern. ov. dent.; stem 6-sided. y. 7. 10. ——— 1755. H. P. ———

POLY'MNIA, POLY'MNIA. Cal. dbl. outer 4-5-leaved, inner 10-leaved. Recep. chaffy. Papp. none.
 Uvedalia. w. broad-leaved. 3-lobed, acut. lobes angul. ye. 8. 10. ——— 1699. H. P. Light loam.
 parting root.

Systematic Name.	English Name.	Form of Leaves, &c.	Col. of Flow.	Month of Fl.	Native Country.	Yr. of Introd.	Soil and Propagation.
ARCTOTIS, ARCTOTIS. <i>Cal. imbricated. Recep. bristly. Papp. chaffy. Peric. 2-furr. at back.</i>							
acaülis. B.R.	dwarf.	lyrate, dent. pubes.	yel.	4. 7.	C. B. S.	1759.	G. P . Sandy loam.
speciosa. B.M.	shewy.	lyrate, pinnatif. hoary ben.	ye.	6. 8.	— —	1812.	G. P . cuttings, or
tricolor. B.R.	three-coloured.	lyrate, repand.	7-nerv. pu. w.	5. 7.	— —	1794.	G. P . part. at root.
CHAPTA'LIA, CHAPTA'LIA. <i>Recep. nak. Papp. capill. Flor. of the ray deform. those of the disk bilab.</i>							
tomentosa.	woolly.	ov. obl. ent. silvery ben.	bh.	5. 6.	N. Amer.	1806.	H. P . Light soil. dividing at roots.
CALE'NDULA, MARYGOLD. <i>Cal. of many leaves, equal. Recep. naked. Papp. none.</i>							
denticulata.	tooth-leaved.	lanc. acut. smth. dent.	yel.	6. 8.	Barbary.	1821.	F. S . Loam & leaf
graminifolia. B.R.	grass-leaved.	lin. nearly ent.	wh. pu.	5. 6.	C. B. S.	1731.	G. P . mould. cut-
Tragus. B.M.	white-flowered.	lin. dent. pilose.	wh.	— —	— —	1774.	G. S . tings, or parting roots.
OSTEOSPERMUM, OSTEOSPERMUM. <i>Cal. of many leaves. Recep. nak. Papp. none. Seed round.</i>							
ilicifolium. w.	Holly-leaved.	obl. dent. angul. scabr.	yel.	7. 8	— —	1816.	G. S . Loam & leaf
spinosum. H.K.	spiny.	obov. serr. pubes.; Br. spin.	y.	2. 10.	— —	1700.	G. S . mould. cutt.
OTHONNA, RAG-WORT. <i>Cal. many-parted. Recep. naked. Papp. a little villous.</i>							
Athanasia. w.	Athanasia-like.	pinn. filif.	yel.	11. 12.	— —	1795.	G. S . Loam & leaf
Cheirifolia. B.R.	Stock-leaved.	alt. spath. lanc. 3-nerv. ent.	ye.	4. 6.	Barbary.	1752.	H. S . mould.
coronopifolia. w.	Buck's-horn-lv'd.	lanc. ent. upp. sinuat. dent.	ye.	7. 9.	C. B. S.	1731.	G. S . cuttings.
ericoides. w.	Heath-leaved.	lin. needle-shaped.	yel.	7. 8.	— —	1815.	G. S . — —
GYMNO'STYLES, GYMNO'STYLES. <i>Cal. of many leaves. Recep. minu. a little vill. Peric. compr.</i>							
anthemifolia.	Chamomile-lv'd.	pinn. leaf. lin. acut.	gr.	4. 12.	S. Amer.	1812.	H. A . Sandy loam. seeds.
FLAVE'RIA, FLAVE'RIA. <i>Partial Invo. 2-5-l'd. 2-5-fl'd. comm. cal. imbr. tubu. Papp. none. Rec. nak.</i>							
angustifolia.	narrow-leaved.	lin. acut. apex serr.	yel.	8. 10.	Mexico.	1825.	H. P . Light loam.
Contra'y'erba. B.M.	broad-leaved.	lanc. 3-nerv. mucr. serr.	yel.	7. 9.	Peru.	1794.	S. B . seeds, or parting roots.

ORDER V.

POLYGAMIA SEGREGATA. *Plants with several flowers, either simple, or compound, but with united tubular anthers, and each floret having its own calyx, and all included in one general involucreum.*

Æ'DERA, Æ'DERA. *Cal. many-flowered. Cor. tubular, hermaphr. Recep. chaffy. Papp. chaffy.*

prolifera. B.M. prolific-flow'g. ov. lanc. ciliat. recurv. yel. 5. 6. C. B. S. 1789. G. S . Loam & peat. cuttings.

CASSI'NIA, CASSI'NIA. *Invol. 4-leaved. Flor. hermaphr. Recep. naked. Papp. chaffy.*

aurea. B.R. yellow-flow'd. lin. lanc. smth. gland. ben. y. 4. 6. N. S. W. 1821. G. S . Peat & loam.

spectabilis. B.R. shewy. lanc. decurr. woolly ben. st. 5. 10. N. Holl. — G. B . cutt. or seeds.

Systematic Name.	English Name.	Form of Leaves, &c.	Col. of Flow.	Month of Fl.	Native Country.	Yr. of Introd.	Soil and Propagation.
<i>ECHINOPS, GLOBE-THISTLE. Cal. of 1 flower. Cor. tubular, hermaphr. Recep. bristly.</i>							
<i>bannáticus.</i>	Hungarian.	pinnatif. spiny, down.	<i>wh.</i>	8. 9.	Hungary.	1828.	H. P. Sandy loam.
<i>Dahúricus.</i>	Dahurian.	pinnatif. spin. downy	<i>ben.</i>	7. 8.	Persia.	—	H. P. parting
<i>hórridus.</i>	horrid.	pinnatif. spin. down.	<i>wh.</i>	—	—	1817.	H. P. roots.
<i>Rítro. B.M.</i>	small.	pinnatif. smth.	<i>bl.</i>	—	Europe.	1570.	H. P. —
<i>spinósus. Fl.Gr.</i>	horny-headed.	pinnatif. spiny.	<i>wh.</i>	—	Egypt.	1597.	H. P. —
<i>strictus. B.M.</i>	upright.	pinnatif. toothed, spiny.	<i>bl.</i>	7. 8.	Russia.	1821.	H. P. —

CLASS XX.

GYNANDRIA. *Stamens fixed upon the style, or column, above the germen.*

ORDER I.

MONANDRIA. STAMEN 1.

							[Anth. of 2 cells.
<i>O'RCHIS, O'RCHIS. Cal. of 3 ovate, concave, ribb. leaves. Cor. ring. Pet. 2. Nect. with a spur behind.</i>							
<i>fúscá. Br.Fl.</i>	great brown.	Lip 3-par. dott.;	<i>Brac. ver. sh.</i>	5. 6.	England.	H. P. Peat & loam,
<i>hircína. Br.Fl.</i>	Lizard.	Lip 3-par. spur shor. con. dbl.		6. 7.	—	H. P. or mixed
<i>latifólia. E.Fl.</i>	broad-leaved.	ov. acum. not spott.	<i>pur.</i>	—	Britain.	H. P. with a little
<i>longicórnu. B.F.G.</i>	long flat-spurr.	lanc. obt. Labellum 3-lob.	<i>pu.</i>	4. 5.	Barbary.	1815.	H. P. leaf mould,
<i>maculáta. E.Fl.</i>	spotted.	lanc. spott. lip 3-lob.	<i>w. or pu.</i>	6. 7.	Britain.	H. P. or chalk.
<i>máscula. Br.Fl.</i>	early-purple.	ellip. lanc. shin.	<i>pur.</i>	4. 5.	—	H. P. seeds, or
<i>militáris. Br.Fl.</i>	Military.	obl. acut. lip 3-lob.	<i>pur.</i>	5. 6.	Switzerl.	1825.	H. P. slips, taken
<i>Mórió. E.Fl.</i>	green-winged.	lanc. glau. not spott.	<i>pur.</i>	—	Britain.	H. P. off at roots.
<i>pyramidális. E.Fl.</i>	pyramidal.	lanc. chann. acum.	<i>pur.</i>	6. 7.	—	H. P. —
<i>papilionácea. B.R.</i>	Butterfly.	obl. ensif. obt. spic. 5-7-fid.	<i>pu.</i>	—	Naples.	1788.	H. P. —
<i>spectábilis. B.C.</i>	remarkable.	obov. obl. smth.	<i>wh. pu.</i>	—	N. Amer.	1817.	H. P. —
<i>tephrosánthos. Br.Fl.</i>	Monk. Orchis.	spic. shor. conic. Lip 3-par.	<i>pa.</i>	5. 6.	England.	H. P. —
<i>ustuláta. En.Fl.</i>	dwf. dk. winged.	lanc. acut. not spott.	<i>pur.</i>	—	—	H. P. —

CYRTOPODIUM, CYRTOPODIUM. Pet. 5. Labell. 3-lob. connec. with a joint. Poll. masses 2, bilo.

<i>Andersónii. R.Br.</i>	Anderson's.	lanc. elong. 3-nerv. 3-fid.	<i>ye.</i>	5. 8.	W. Ind.	1804.	S. P. —
<i>Woodfórdii. B.M.</i>	Woodford's.	lanc. elong. Lip ventric.	<i>pu.</i>	10.	Brazil.	1814.	S. P. —

SARCA'NTHUS, SARCA'NTHUS. Cor. of 5 pets. upp. 3, obl. the 2 lower half heart-shap. Labell. conc.

<i>guttátus. B.R.</i>	spotted-flow'd.	lin. chann. imbric. recur. <i>re. w.</i>		4.	E. Indies.	—	S. P. —
<i>rostrátus. B.R.</i>	rostrate.	lanc. flat, sub-recurv. <i>y. re. gr.</i>		11.	China.	1819.	S. P. —

GYMNADE'NIA, GYMNADE'NIA. Cor. ring. Lip spurr. at base beneath. Glands approximate.

<i>conópsea. B.Fl.</i>	fragrant.	bulb palm. Lip trifid, ent.	<i>ro.</i>	6. 7.	Britain.	H. P. Loam & peat.
<i>O'rchis conópsea.</i>							slips of the roots, or seeds.

Systematic Name.	English Name.	Form of Leaves, &c.	Col. of Flow.	Month of Fl.	Native Country.	Yr. of Introd.	Soil and Propagation.	
BRA'SSIA, BRA'SSIA. <i>Labell. undivid. Pet. spread, distinct. Column erect. Poll. masses 2.</i>								
caudáta. B.R.	long-tailed.	2, obl. erec. smth. ner. <i>gr. y. re.</i>	6. 7.	W.	Ind.	1823.	S. \mathfrak{P} . ———	
maculáta.	spotted.	lanc. nerv. Sep. spread. <i>ye. re.</i>	—	Jamaica.	1806.	S. \mathfrak{P} .	———	
CALANTHE, CALANTHE. <i>Perianth. spread. Lip spur. lob. unit. with the column. Poll. mass. 8.</i>								
veratrifolia.	plaited-leaved.	lanc. nerv. spik. many-fl'd. <i>wh.</i>	—	E. Ind.	1819.	S. \mathfrak{P} .	———	
HABENARIA, HABENARIA. <i>Cor. gaping, of 3-5 pets. Glands of the stalk of pollen masses naked.</i>								
álbida. B. Fl.	white-flow'd.	obl. stria. spur. obt. Lip 3-clef. —	—	Britain.	...	H. \mathfrak{P} .	Sandy mould	
bifolia. Br. Fl.	two-leaved.	obl. smth. Lip lin. ent. <i>wh.</i>	—	—	...	H. \mathfrak{P} .	and peat.	
fimbriáta. B. R.	fringed.	alt. sess. obl. ent. keel. <i>bl.</i>	—	N. Amer.	1777.	H. \mathfrak{P} .	seeds, or part-	
lácera. B. C.	torn.	Spik. obl. Lip 3-clef. seg. dig. —	—	—	1818.	H. \mathfrak{P} .	ing roots.	
tridentáta. H. E. F.	three-toothed.	Lip ov. blunt. 3-tooth. spur. <i>w.</i>	5. 6.	Canada.	1819.	H. \mathfrak{P} .	———	
[Caps. furrowed.								
A'CERAS, MAN-ORCHIS. <i>Cal. 3 ov. conc. leaves. Pet. 2, as long as the calyx. Nect. spurless, 4-lobed.</i>								
anthropóphora. E. Fl.	green.	Lip 3-part. long. than germ. <i>gr.</i>	6.	England.	...	H. \mathfrak{P} .	Loam & peat, seeds, or parting roots.	
[Caps. triang. Seeds many.								
HERM'INIUM, MUSK-ORCHIS. <i>Cal. of 3 ovate, spread leaves. Pet. 2 3-lobed. Nect. spurless, 3-lob.</i>								
Monórchis. E. Fl.	green.	2, lanc. alt. acut. conc. <i>gr.</i>	6. 7.	—	...	H. \mathfrak{P} .	Peat & loam, seeds, or slips of roots.	
'Ophrys Monórchis. L.								
OPHRYS, 'OPHRYS. <i>Cal. 3 spread. ribb. leav. Pet. 2, ent. Nec. conc. spur. variously lob. Caps. ribb.</i>								
apifera. B. Fl.	bee.	Lip refl. about as long as cal. <i>pu. y.</i>	—	—	...	H. \mathfrak{P} .	Loam & peat,	
aranifera. B. Fl.	spider.	hairy, round, 4-lobed. <i>gr.</i>	4. 5.	—	...	H. \mathfrak{P} .	mixed with	
atráta. B. R.	dark-flowered.	ov. lanc. glau. flat. <i>d. pur.</i>	—	Rome.	1825.	H. \mathfrak{P} .	a little leaf	
lútea. H. E. Fl.	yellow-flow'd.	ov. sess. acut. sin. ent. <i>yel.</i>	—	S. Europ.	1821.	H. \mathfrak{P} .	mould, or chalk, seeds, or parting roots.	
BON'ATEA, BON'ATEA. <i>Cor. of 5 pets. ring. upper pet. vaulted. Labell. fleshy, unequally 5-parted.</i>								
speciósá. B. M.	shewy.	ov. und. smt. abo. rust. spot. <i>g w.</i>	8.	C. B. S.	1820.	S. \mathfrak{P} .	———	
RENANTHERA, RENANTHERA. <i>Pet. spread. 3 lower lin. 2 low, much larger & undul. Poll. mass. 2.</i>								
coccínea. B. R.	scarlet.	lin. obl. notch. <i>sc.</i>	3. 5.	China.	1816.	S. \mathfrak{S} .	Loam & peat.	
GOODYERA, GOODYERA. <i>Cal. of 3 ov. col. leav. Pet. half ov. Nec. spur. Ger. incur. Seeds minú.</i>								
díscoló. B. R.	two-coloured.	ov. obl. ent. pur. ben. <i>wh.</i>	11. 12.	S. Amer.	1815.	S. \mathfrak{P} .	Loam & peat.	
pubéscens. H. K.	downy.	ov. acut. retic. <i>wh.</i>	7.	N. Amer.	1802.	H. \mathfrak{P} .	suckers from	
prócera. H. E. Fl.	Nepaul.	lanc. smth. ent. <i>wh.</i>	6. 7.	Nepaul.	1821.	S. \mathfrak{P} .	root.	
Néóttia prócera. B. R.							———	
répens. E. Fl.	creeping.	ov. smth. obt. <i>wh.</i>	7. 8.	Scotland.	...	H. \mathfrak{P} .	———	
PRESC'OTIA, PRESC'OTIA. <i>Perian. spread. 2 upp. sepals unit. at base. Lip cucull. entire, fleshy.</i>								
plantaginifolia. H. Ex. Fl.	Plant. lvd. obl. flat, nerv.		<i>gr.</i>	4. 8.	Brazil.	1822.	S. \mathfrak{P} .	———
CATTLE'YA, CATTLE'YA. <i>Perian. spreading. Lip sessile, cucullate. Poll. masses 4, in 2 pairs.</i>								
críspa. B. R.	curled-petal'd.	obl. lanc. notch. <i>wh. pur.</i>	8.	Trinidad.	1820.	S. \mathfrak{P} .	Light turf	
Forbésii. B. R.	Forbes's.	obt. obl. flat. <i>yel.</i>	7. 8.	Brazil.	1823.	S. \mathfrak{P} .	peat. This	
guttáta. B. R.	spotted.	obl. conc. ap. notch. obli. <i>g. pu.</i>	8.	——	1828.	S. \mathfrak{P} .	beautiful or-	

Systematic Name.	English Name.	Form of Leaves, &c.	Col. of Flow.	Month of Native Fl. Country.	Yr. of Introd.	Soil and Propagation.	
<i>intermedia</i> . B.M.	middle-sized.	ov. lingul. fleshy, ent.	ros.	4.	Rio Jan. 1824.	S. S. chideous ge-	
<i>Loddigésii</i> . Lind.	Loddiges'.	ellip. ent. Lip 3-lobed.	vio.	—	S. Amer. 1815.	S. P. nus will thrive well by having their roots wrapped up in moss, and tied to the stems of other woody plants.	
STANHOPEA, STANHOPEA. <i>Perian. spread. refl. Pet. unif. Colum. pet.-like, notch. Anth. 2-cell.</i>							
<i>ebúrnea</i> . B.R.	Ivory-lipped.	ellip. obl. plicate.	wh. spott.	6.	Rio Jan.	S. P. ———	
RODRIGUEZIA, RODRIGUEZIA. <i>Perianth. of 4 leaves, ring. Labell. separate. Colum. 2-toothed.</i>							
<i>lanceolata</i> . B.C.	spear-leaved.	lanc. ent. smth.	pk.	—	Trinidad 1824.	S. P. Turfy peat	
<i>secúnda</i> . B.R.	side-flowering.	obl. lanc. apex obliq. notch.	re.	6.12.	S. Amer. 1819.	S. P. and moss. dividing at root.	
BRASSAVOLA, BRASSAVOLA. <i>Perian. 5-par. Labell. 3-lob. side lob. ov. centre 1 obo. Poll. mass. 8.</i>							
<i>élegans</i> . B.M.	elegant.	lin. awl-sh. chan. abo. smth.	ro.	Antigua.	S. P. ———	
<i>tuberculáta</i> . B.M.	tuberculated.	cyl. awl-sh. smth.;	stms. arti. w. y.	6.	Brazil. 1828.	S. P. ———	
SERAPIAS, SERAPIAS. <i>Fl. rin. Colum. point. Lip spur. Poll. mass. fix'd to a gland incl. in 1 pouch.</i>							
<i>cordigera</i> . A.R.	heart-lipped.	ensif. smth. Lip 3-part.	pur.	5. 6.	S. Europ. 1806.	F. P. Sandy loam.	
<i>Língua</i> . H. Ex. F.	tongue-lipped.	lan. ensif. Lip 3-part. mid. lo. r.	—	—	1781.	F. b. P. seeds, or parting at roots.	
D'ISA, D'ISA. <i>Perian. spread. Inner sepals united to the column. Lip spurless. Flow. ringent.</i>							
<i>cornúta</i> . w.	horned.	spur defl. inn. sep. 2-tooth.	bh.	6. 7.	C. B. S. 1805.	F. P. Sandy loam	
<i>grandiflora</i> . B.R.	large-flowered.	lanc. acum. sheath.	sc.	7. 8.	—	1823.	F. P. and peat.
<i>graminifolia</i> . s. s.	blue.	filif.; spur obtuse.	bl.	6. 7.	—	1822.	F. P. dividing at
<i>prasináta</i> . B.R.	green-flowered.	spur obl. keel'd. Lip lin. acut.	—	—	—	1815.	F. P. root.
CATASETUM, CATASETUM. <i>Perianth. erect. Labell. concave. Sepals deformed.</i>							
<i>crístátum</i> . B.R.	crested.	ellip. lan. Lab. arti. crest. gr. y.	8. 9.	Brazil.	1824.	S. P. Turfy peat.	
<i>Claveríngi</i> . B.R.	Capt. Clavering's.	lanc. smth. alt. distant.	y. pu.	8.12.	—	1823.	S. P. dividing at
<i>tridentátum</i> . B.M.	three-toothed.	6-10 inch. long, lanc. keel.	ye.	—	Trinidad.	—	S. P. root.
POGONIA, POGONIA. <i>Lip sessile, hooded, crest. inside. Ova. 3-corner. Sepals 5, without glands.</i>							
<i>ophioglósoides</i> . B.R.	Adder's-tongue.	Leaf of scap. & bractea ellip.	6. 7.	N. Amer.	1816.	H. P. Sandy loam	
<i>péndula</i> . B.R.	pendulous.	ov. amplex.; stem angul.	pk.	—	—	1824.	H. P. and peat. offsets from bulbs.
EULOPHIA, EULOPHIA. <i>Pet. 5, distinct, spread. Labell. artic. at the base. Poll. masses 2, & 2-lob.</i>							
<i>guinénsis</i> . B.R.	Guinea.	lanc. acum. nerv.	pk.	—	S. Leone. 1822.	S. P. Sandy peat.	
<i>streptopétala</i> . B.M.	twisted-petal'd.	1 foot long, plic. lin. lanc.	yel.	—	C. B. S. 1822.	S. P. part. at root.	
BLEETIA, BLEETIA. <i>Lip sess. cucullate. Pet. 5, distinct. Colum. separate. Poll. masses 8 or 4, & 2-lob.</i>							
<i>flórida</i> . B.R.	pallid.	ensif.; Sep. obl. lan. obt. sprea.	3. 9.	W. Ind.	1786.	S. P. Sandy loam	
<i>hyacínthina</i> . B.M.	hyacinthine.	ensif. Lip spur. Poll. mass. 4.	—	China.	1802.	G. P. and peat.	
<i>Tankervíllæ</i> . B.M.	Ly. Tankerville's.	ov. lanc. nerv.	wh.	3. 4.	—	1778.	S. P. dividing at
<i>Woodfórdii</i> . B.M.	Woodford's.	spott. lanc. pli.	ye. or.	—	Trinidad. 1820.	S. P. roots.	
<i>verecúnda</i> . B.R.	tall.	ensif. smth. nerv.	pur.	9.10.	W. Ind. 1733.	S. P. ———	
ORNITHIDIUM, ORNITHIDIUM. <i>Sep. conniving. Lip hood. Poll. masses 4, furrowed at base.</i>							
<i>coccíneum</i> . H. E. Fl. scarlet.		long. flow. axill.; stm. bulbif. sc.	1.12.	—	—	1790.	S. P. Turfy peat, or moss,
<i>Cymbídium coccíneum</i> . B.M.							in cocoa nut shells. dividing at the joints of shoots.

Systematic Name.	English Name.	Form of Leaves, &c.	Col. of Flow.	Month of Fl.	Native Country.	Yr. of Introd.	Soil and Propagation.
<i>VA'NDA, VA'NDA.</i> Cor. of 5 petals. Lamina 3-lob. at apex. Colum. obtuse. Poll. masses 2.							
Roxbúrhíi.	Roxburgh's.	obl.obli.sm.apex 3-den.w.pu.	1.12.	China.	1810.	S.ϕ.	—
[and 3 angles. Seeds small.							
<i>NE'OTTIA, LADIES'-TRACES.</i> Cal. 3 concave leaves. Pet. 2. Nect. flat, spurless. Caps. of 3 furrows.							
aphýlla. B.M.	leafless.	Brac. lin. lan. pubes.	re.gr.	—	Trinidad.	1826.	S.ϕ. Sandy loam
cérnua. H.K.	nodding.	lanc. 3-nerv. sheath.	wh.	8.10.	N.Amer.	1796.	H.ϕ. and peat.
grandiflora. B.M.	large-flowered.	lin. obl. glau. striat.	gr.	—	Brazil.	1825.	S.ϕ. seeds, or dis-
spirális. E.Fl.	sweet.	ov. acut. glau.	gr.wh.	8. 9.	Britain.	...	H.ϕ. viding roots.
'Ophrys. spirális. E.B.							—
speciosa. H.E.Fl.	shewy.	ov. lanc. ent. smth.	sc.	5. 6.	W. Ind.	1790.	S.ϕ. —
[Pollen masses 2.							
<i>CORYA'NTHEs, CORYA'NTHEs.</i> Pet. 3, spread. refl. Colum. round, 2-toothed at base. Apex trunc.							
maculáta. B.M.	spotted-lipped.	lan.ner. Rac.many-fl'd.y.pu.6. 7.		Demerara.	1828.	S.ϕ.	—
<i>CÆL'OGYNE, CÆL'OGYNE.</i> Cor. spreading. Labell. sessile, convolute. Pet. short, limb 3-lobed.							
fimbriáta. B.R.	fringed.	binate, obl. lanc.	st.	9.	China.	1824.	S.ϕ. Peat & loam.
maculáta.	spotted.	lanc. plicat. 3-nerv.	st. ...		Brazil.	1831.	S.ϕ. parting at
	shining-leaved.	obl. lanc. shin.	yel. ...		E. Ind.	1822.	S.ϕ. roots.
Wallíchiana.	Dr. Wallich's.	lanc. coloured.	pur. ...		Brazil.	1831.	S.ϕ. —
[swelling at the base, contracted in the middle.							
<i>EPIPA'CTIS, HELLEBORINE.</i> Cal. 3 ovate equal leaves. Pet. 2, the length of the calyx. Nect. spur.							
ensifolia. E.Fl.	narrow-leaved.	lanc. acum. alt.	wh.	6.	Britain.	...	H.ϕ. Peat & loam.
grandiflora. B.Fl.	large-flowered.	ellip. lanc. sess.	wh.	—	—	...	H.ϕ. dividing
latifolia. B.Fl.	broad-leaved.	ov. amplex. plait.	gr.pur.	7. 8.	—	...	H.ϕ. roots.
palústris. En.Fl.	marsh.	lanc. amplex. smth.	wh.	—	—	...	H.ϕ. —
purpuráta. E.Fl.	purple-leaved.	ov.lanc.pur.upp.lin.lan.y.gr.		8.	England.	...	H.ϕ. —
rúbra. En.Fl.	purple.	lanc. erect. Lipacute.	pur.	6. 7.	—	...	H.ϕ. —
[2 or 4-lobed, Caps. ribbed. Seeds small.							
<i>LISTE'RA, TWAY-BLADE.</i> Cal. of 3 spreading leaves. Pet. 2, spreading. Nect. nearly flat, spurless,							
cordáta. B.Fl.	heart-leaved.	opp.cord.; stm.angul. gr.br.	—	—	Britain.	...	H.ϕ. Light loam
ováta. En.Fl.	common.	ov. ellip. opp.	ye.gr.	5. 6.	—	...	H.ϕ. and peat.
Nidus-Avis. E.Fl.	Bird's-nest.	stm.cloth.with whitish scal.br.	—	—	—	...	H.ϕ. part. roots.
[Masses of pollen 4, placed on the stigma.							
<i>MAL'AXIS, BOG-ORCHIS.</i> Cal. of 3 oblong leaves. Nect. spurless, concave at the base. Anth. 2-celled.							
liliiifolia. B.M.	Lily-leaved.	2,ov.lanc.scap.3-sided. pa.bl.	—	—	N.Amer.	1758.	H.ϕ. Loam & peat.
paludosa. B.Fl.	least.	4-5,spath.conc.apex roug. gr.	7.	—	England.	...	H.ϕ. seeds, or off-sets from roots.
[Caps. ellip. oblong. Seeds small.							
<i>CORALLORRH'IZA, CORAL-ROOT.</i> Cal. of 3 lanceo. leaves. Nect. spurless, the lip slightly 3-lobed.							
innáta. E.Fl.	spurless.	ov.scal.lan.;stm.6-12in.high.	6. 7.	—	Scotland.	...	H.ϕ. Loam & peat. seeds, or slips from roots.
<i>DENDR'OBIMUM, DENDR'OBIMUM.</i> Lip spurless, artic. with the colum. Poll. masses 4, parallel.							
'æmulum. B.M.	small-clustered.	ov.obl.ent. Race.term. g.re.	—	—	N. S. W.	1823.	G.ϕ. Sandy peat.
cucullátum. B.M.	hooded.	lanc. acum. ent.	bh.	3. 5.	E. Ind.	1815.	S.ϕ. dividing at
linguifórme. Sm.E.B.	tongue-l'd.	sess. ov. ligul.	w.st.	6. 8.	N. S. W.	1810.	G.ϕ. roots.
monilifórme. B.R.	Neckl.-stem'd.	obl. obliq. notch. obt.	ros.	—	China.	1822.	S.ϕ. —

Systematic Name.	English Name.	Form of Leaves, &c.	Col. of Flow.	Month of Fl.	Native Country.	Yr. of Intro.	Soil and Propagation.
speciosum. Sm. E. B.	shewy.	ov. obl.; stem erect.	Sep. obl. pu.	—	N. S. W.	1801.	G. P.
secundum. B. R.	one-sided.	obl. obliq. smth.	yel.	—	Sumatra.	1828.	S. S.
squalens. B. R.	dingy-coloured.	lanc. plic. sub-3-nerv.	y. br.	6. 7.	Rio Jan.	1822.	S. P.

EPIDENDRUM, EPIDENDRUM. *Colum. united with the claw of the lip. Poll. masses 4.*

anceps.	two-edged.	lin. lanc. smth.	gr.	8. 10.	W. Ind.	1820.	S. P. Turfy peat,
cochleatum. W.	shell-flowered.	binate, obl. smth. striat.	d. pu.	—	—	—	S. P. or moss, in
cuspidatum. B. R.	pointed.	in 3's, erect, coriac.	yel.	6. 10.	—	1808.	S. P. cocou-nuts,
ciliare. B. R.	fringed.	keel. obl. obt.	wh.	—	—	1790.	S. P. & arranged
ensifolia. B. M.	sword-leaved.	ensif. smth. Pet. lanc.	y. gr.	—	China.	1780.	S. P. on a stump
fragrans. B. M.	sweet-scented.	lan. Scap. many-fl.	Lip cor. y. g.	10.	W. Ind.	1778.	S. P. of a tree.
nudans. H. E. Fl.	nodding.	ov. lan. ampl. Lip 3-lob.	gr.	6. 7.	—	1794.	S. P. parting at
umbellatum. B. R.	umbelled.	obl. somewhat notch.	gr.	—	Jamaica.	1793.	S. P. roots.

VANILLA, VANILLA. *Cal. of 5 leaves, spreading. Lip unite. l at base with colum. Caps. fleshy.*

aromatica. H. K.	aromatic.	ov. obl. nerv.	wh.	6. 8.	S. Amer.	1739.	S. P. Sandy peat.
planifolia. A. R.	fragrant.	obl. lanc. flat, sub-striat.	wh.	4. 6.	W. Ind.	1800.	S. S. slips of roots.

ONCIDIUM, ONCIDIUM. *Lip expan. lob. Pet. spread. Colum. wing. Poll. masses 2, & 2-lob. behind.*

altissimum. W.	tall.	Sep. 5, lon. than lip. Scp. pan. y. 8. 9.	—	—	—	1793.	S. P. Turfy peat.
bicornutum. B. M.	two-horned.	bina. lin. lan. coria.	ye. spott.	—	Brazil.	1830.	S. P. part. roots.
livaricatum. B. M.	spreading.	thick, fleshy, ov. obt. muc.	ye.	—	—	1826.	S. P.
Papilio. B. M.	Butterfly.	ov. ent. spott. spread.	ye. pu.	4. 6.	Trinidad.	1823.	S. P.
viridum. B. R.	lurid.	ellip. obl. acut.	gr. spott.	3. 4.	—	1818.	S. P.
pubes. B. R.	Olive-green.	lanc. nerv. solit. plait.	br. re.	—	Brazil.	1824.	S. P.

FERNANDE'SIA, FERNANDE'SIA. *Lip erect. 3-lo. tuber. Colum. wing. Anth. 2-cell. Poll. mass. 2.*

elegans. B. C.	beautiful.	ranked, ov. obl. obt.	yel.	—	Trinidad.	1822.	S. P.
Lockhartia elegans. B. M.							

GONGORA, GONGORA. *Pet. 3, spread. the 2 inn. smallest. Colum. elon. Labell. stalk. Poll. mass. 2.*

speciosa. B. M.	shewy.	2, lin. lan. subplic. bas. atten. y.	—	—	Brazil.	1827.	S. P. Sandy peat.
viridi-purpurea.	green-purple.	lan. acum. Labell. elon. g. pu.	—	—	—	—	S. P. part. roots.

MAXILLARIA, MAXILLARIA. *Perian. spread. resupin. Colum. pubes. Poll. mass. 2, cleft at back.*

Barringtonia. B. R.	large-flowered.	sub-tern. obl. nerv.	gr.	6. 8.	W. Ind.	1790.	S. P. Peat & loam.
Harrisonia. B. M.	Mrs. Harrison's.	solit. lanc. plic.	yel. br.	—	Brazil.	1820.	S. P. sec. ls. & slips
Parkeria. B. M.	Parker's.	lan. lingul. Brac. imbr. w. pu.	—	—	W. Ind.	1826.	S. P. from roots.
racemosa. B. M.	raceme-flower'g.	lanc. 3-nerv. reflex.	ye.	—	Brazil.	—	S. P.
tetragona. B. R.	four-cornered.	obl. lanc. plic. solitary. g. pu.	—	—	—	1827.	S. P.

ZYGOPETALUM, ZYGOPETALUM. *Pet. equ. unit. at base. Lip notch. at apex. Colum. half round.*

Mackayia. B. M.	Mr. Mackay's.	lin. lanc. striat.	gr. bl.	—	—	1825.	S. P. Peat & loam.
rostratum. B. M.	rostrate.	distich. lanc. striat.	gr. br.	—	Demerar.	—	seeds, or parting roots.

SATYRIUM, SATYRIUM. *Perian. ring. of 5 leaf. Labell. large, keel'd at the back. Ger. 6, ribbe l.*

coriifolium. B. F. G.	leather-leaved.	ov. acut. cren. upp.	yel.	5. 6.	C. B. S.	1819.	F. P. Sandy peat
carneum. B. M.	flesh-coloured.	orbic. nerv. red at apex.	car.	7. 9.	—	1828.	F. P. and loam. parting roots, or seeds.

ORDER II.

DIANDRIA. STAMENS 2.

Systematic Name.	English Name.	Form of Leaves, &c.	Col. of Flow.	Month of Fl.	Native Country.	Yr. of Introd.	Soil and Propagation
[Nect. spurless, inflated. Cor. of 2 wavy petals.]							
<i>CYPRIFE'DIUM, LADIES'-SLIPPER. Cal. of 3 spreading coloured leaves. Cor. of 2 wavy petals.</i>							
Calcéolus. E. Fl.	common.	ov. alt. ampl. downy.	yel.	5. 7.	England.	H. P. Light loam
húmîle. B. F. G.	dwarf.	obl. ov. vill. on both sid.	pu.	—	N. Amer.	1786.	H. P. and peat.
macránthos. B. M.	large-flowered.	ov. atten. at base, striat.	pu.	—	Siberia.	1829.	H. P. dividing
pubéscens. B. F. G.	pubescent.	alt. sess. ov. obl. pubes.	yel.	—	N. Amer.	1790.	H. P. roots,
parviflôrum. B. F. G.	small-flowered.	ov. lanc. downy.	yel.	—	—	1759.	H. P. or seeds.
spectábîle. B. C.	white-petaled.	ov. ampl. acut. plic.	wh.	6. 7.	—	1731.	H. P. —
venústum. B. R.	spotted-leaved.	lanc. obl. chann. spott.	pu. gr.	7. 10.	Nepaul.	1816.	S. P. —
ventricósum. B. F. G.	ventricose-fl'd.	ov. pubes. ampl.	pur.	—	Siberia.	1829.	H. S. —

STYLIDIUM, STYLIDIUM. Cal. 2-lobed. Cor. irreg. 5-cleft. Anth. 2-lobed. Caps. 2-celled.

adnátum. B. R.	adnate.	lin. marg. revol.; stm. stria. pk.	5. 10.	N. Holl.	1824.	G. S. Peat & loam.	
fruticôsum.	shrubby.	lin. decurr. smth.	wh.	—	1803.	G. S. cuttings, or	
fasciculátum. B. R.	fascicled.	lin. acut. spik. pedun.	wh. pk.	—	1831.	G. A. seeds.	
graminifôlium. B. R.	grass-leaved.	lin. lanc. dent. rigid.	ros.	4. 8.	N. S. W.	1803.	G. P. —
hirsútum. B. M.	hairy.	lin. edges revol. Sep. hair.	ro.	6.	N. Holl.	1831.	G. S. —
laricifôlium. B. R.	fine-leaved.	lin. sess. pilose.	ros.	5. 10.	—	1818.	G. S. —
scándens. B. M.	climbing.	lin. chann. mucr. whorl.	ros.	—	—	1803.	G. S. —

ORDER III.

HEXANDRIA. STAMENS 6.

[Caps. of 6 cells, and 6 valves.]							
<i>ARISTOLO'CHIA, BIRTH-WORT. Cal. of 1 leaf, tubul. Cor. 0. Ger. angul. Sty. short. Stig. 6-lob.</i>							
arboréscens. W.	tree.	cord. lanc. smth. ent.	pu. ye.	6. 7.	America.	1737.	G. S. Light loam.
Clemátis. E. B.	common.	cord. ent. coriac.	p. ye.	5. 8.	England.	H. P. layers, or
caudáta.	livid-flowered.	renif. 3-lob. upp. 3-part.	br.	—	Brazil.	1828.	S. S. cl. dividing at
glaúca. B. M.	glaucous.	cord. ov. obl. glauc.	yel.	6. 8.	Barbary.	1785.	G. S. cl. the roots.
labiôsa.	great-lipped.	orbic. renif. cord. amp. p. gr. y.	—	—	Brazil.	1821.	G. S. cl. —
sempervirens. B. M.	evergreen.	cord. obl. acum.	pur.	5. 6.	Candia.	1727.	G. S. cl. —
Sípho. B. M.	broad-leaved.	cord. acut. smth. ent.	bh.	6. 7.	N. Amer.	1763.	H. S. cl. —
tomentósa. B. M.	downy.	stalk. cord. downy ben.	yel.	—	—	1799.	H. S. cl. —
trilobáta. B. R.	three-lobed.	cor. 3-lob. smth. lob. obt.	y. br.	—	Surinam.	1823.	S. S. cl. —

CLASS XXI.

MONŒCIA. *Stamens & Styles in separate flowers on the same plant.*

ORDER I.

MONANDRIA. STAMEN 1.

Systematic Name.	English Name.	Form of Leaves, &c.	Col. of Flow.	Month of Fl.	Native Country.	Yr. of Introd.	Soil and Propagation.
[by many barren florets. Nect. 4 or 5.							
<i>EUPHORBIA, SPURGE.</i> Cal. 0. Cor. 0. Invol. swelling, of many spread. leaves. Flor. 1, surrounded							
<i>amygdaloides.</i> E. Fl.	Almond-leav'd.	obov. lanc. hairy ben.	st.	4. 6.	England.	...	H. ♂. Sandy loam
<i>cotinifolia.</i> H. E. F.	Cotinus-leaved.	opp. subtun. notch. ent.	wh.	6. 7.	S. Amer.	1690.	S. ♀. and peat.
<i>Characias.</i> E. Fl.	upright.	lanc. downy, ent.	ye. pu.	4. 6.	England.	...	H. ♂. cuttings, or
<i>Cyparissias.</i> E. B.	Cypress.	lin. ent. smth.	yel.	5. 7.	—	...	H. ♂. offsets.
<i>exigua.</i> E. Fl.	dwarf.	lin. lanc. smth. often trunc.	gr.	—	Britain.	...	H. ♂. —
<i>enneagona.</i> Haw.	nine-angled.	Stem 9-angl. prick.	Br. pend.	6. 9.	C. B. S.	1790.	G. ♀. —
<i>esula.</i> B. F.	leafy.	obl. lanc. ent.	gr.	5. 6.	Britain.	...	H. ♂. —
<i>hiberna.</i> E. Fl.	Irish.	obt. sess. ent. 2-3-in. long.	yel.	6. 7.	Ireland.	...	H. ♂. —
<i>Humboldtii.</i> W. en.	Humboldt's.	ov. obl. acut. ent. smth.	wh.	7. 8.	S. Amer.	1809.	S. ♂. —
<i>Lathy'ris.</i> E. B.	Caper.	opp. 4-ranked, cord. at bas.	gr.	6. 9.	England.	...	H. ♂. —
<i>meloformis.</i> A. R.	Melon-like.	Stem glob. leafles. angl.	yel.	5. 7.	C. B. S.	1774.	G. ♀. —
<i>neriefolia.</i> DC.	Oleander-l'd.	obl.; stem angu. warted.	red.	—	India.	1690.	S. ♀. —
<i>paralias.</i> E. Fl.	sea.	obov. ellip. obl. imbric.	yel.	—	England.	...	H. ♂. —
<i>portlandica.</i> E. B.	Portland.	lin. obov. smth. spread.	yel.	6. 7.	Britain.	...	H. ♂. —
<i>punica.</i> B. M.	scarlet-flower'd.	lanc. cuneat. glauc.	sc.	1. 9.	Jamaica.	1778.	S. ♀. —
<i>plendens.</i> B. M.	shewy.	obl. spath. mucr. ent. smth.	sc.	6.	Madagas.	1826.	S. ♀. —
<i>trigona.</i> Haw.	three-sided.	Stem. erect. prickl. joint.	gr.	4.	E. Ind.	1768.	S. ♀. —
<i>uralensis.</i> Fish.	Ural.	lin. acum. smth. ent.	y. wh.	7. 8.	Ural.	1821.	H. ♂. —

ARTOCARPUS, BREAD-FRUIT. *Male, a cylin. catkin. Pet. 2. Fila, long as corol. Female cal. 0.*

<i>neisa.</i> w.	true.	1-2 or 3 ft. long, ov. alt. lob. gr.	—	S. Sea Isl.	1793.	S. ♀. —
<i>integrifolia.</i> B. M.	entire-leaved.	obo. obl. smt. ent. scab. ben. g.	—	E. Ind.	1778.	S. ♀. —

[ovate. Cor. 0.

CASUARINA, CASUARINA. *Mas. catkin filif. Cal. 2-valv. Cor. 0. Fem. catking lobu. Cal. scale*

<i>list'yla.</i> w.	two-styled.	Bran. erect. round, joint. br. re.	8.	N. S. W.	1812.	G. ♀. —
<i>equisetifolia.</i> w.	Horse-tail.	Bran. round, flacc. joint. br. re.	—	S. Sea Isl.	1793.	S. ♀. —
<i>nodiflora.</i> w.	knott-flowered.	Bran. 4-sided, jointed. br. re.	—	—	1818.	S. ♀. —
<i>quadri-valvis.</i> P. S.	four-valved.	Jun. bran. flacc. joint. br. re.	—	N. Holl.	1812.	G. ♀. —
<i>torulosa.</i> w.	cork-barked.	Dioecious branchl. flacc. br. re.	—	N. S. W.	1772.	G. ♀. —

ORDER II.

TRIANDRIA. STAMENS 2-3.

TYPHA, CAT'S-TAIL. *Catkins hairy, in round crowd. spik. Anth. 3, unit. into 1 filam. Seed stalked.*

<i>angustifolia.</i> E. F.	narrow-leaved.	lin. chann. above.	br.	6. 7.	Britain.	...	H. w. ♂. —
<i>atifolia.</i> E. Fl.	broad-leaved.	lin. ent. tapering.	br.	—	—	...	H. w. ♂. —

Systematic Name.	English Name.	Form of Leaves, &c.	Col. of Flow.	Month of Fl.	Native Country.	Yr. of Intro.	Soil and Propagation
[Stig. 1, rarely 2.							
<i>SPARGANIUM, BUR-REED.</i> Flow. collec. in round dense heads. Cal. of 3 leaves. Cor. 0. Ger. ovate.							
nátans. Br. Fl.	floating.	lin. shin. flat.	wh.	6. 7.	England.	H. w. β . ———
ramòsum. E. F.	branched.	trian. at base, sides conc.	wh.	—	Britain.	H. w. β . ———
símplex. E. B.	unbranched.	trian. at base, sides flat.	wh.	—	—	H. w. β . ———
[in barren. Cor. of 1 leaf.							
<i>CAREX, CAREX.</i> Catkin imbric. Cal. of barren fl. a lance-shap. scale. Cor. 0. Fert. fl. Cal. same as							
acúta. B. Fl.	slender-spiked.	broad, roug.	Fr. ell. stig. 2. bl.	—	—	H. w. β . Sandy soil,
ampullácea. B. Fl.	slender-beaked.	glau. acut.	Fr. inflat.	st. 5. 6.	—	H. β . and peat.
angustifólia. E. Fl.	narrow-leaved.	lin. chann. acut.	Fr. ov.	br.	—	H. β . This nume-
arenária. E. Fl.	sand.	flat. Stem angu.	spik. obl.	br. 6. 7.	Britain.	H. β . rous tribe of
atráta. E. Fl.	black.	broad, erec. stria.	Fr. comp. bk.	—	—	H. β . Granina, are
axilláris. E. Fl.	axillary.	Spikl. sess. remo.	Fr. ov.	br. 5. 6.	England.	H. β . readily in-
binérvís. E. Fl.	green-ribbed.	shea. clon. fert. spik. remo.	bk.	6.	Britain.	H. β . creased by
capítosa. E. Fl.	tufted-bog.	lin. erect, sheaths 0.	Fr. tria.	gr. 5. 6.	—	H. β . parting at
capilláris. B. Fl.	capillary.	half as lon. as the stem.	Fr. tria.	—	—	H. β . the root, and
clandestína. E. Fl.	dwarf-silvery.	chann. rig.	Fr. obo. trian.	wh. 5.	—	H. β . many of them
cúrta. B. Fl.	white.	Spikl. 6, ellip. alt.	Fr. ellip. w.	6.	—	H. β . perfect seeds,
Davalliána. E. Fl.	Davall's.	Spik. simp.	Fr. ov. trian.	br.	—	H. β . whereby they
depauperáta. B. Fl.	starved-wood.	roug. on edg.	Fr. trian. sm. g.	6. 7.	—	H. β . may be sown
digitáta. B. Fl.	fingered.	Fert. spik. 3-in. lon.	Fr. down.	5. 6.	England.	H. β . in Spring.
dióica. B. Fl.	diœcious.	Keel sm. Stip. abrupt.	Stig. 2.	—	Britain.	H. β . ———
dístans. B. Fl.	loose.	flat, lan. Catkins ellip.	br. 6. 7.	—	—	H. β . ———
divísa. B. Fl.	bracteated.	lin. sheath. Stm. trian.	Fr. ang. 5. 7.	—	—	H. β . ———
divúlva. E. Fl.	divulsa.	Spik. clon. 11½-in. lon.	Fr. ov. w.	5.	—	H. β . ———
elongáta. E. Fl.	elongated.	long, chann.	br. gr. 5. 6.	England.	—	H. β . ———
exténsa. E. Fl.	long-bracted.	lin. chann. fert. spik. sess.	gr. 6.	Britain.	—	H. β . ———
filifórmis. B. Fl.	slender-leav'd.	lin. smt. chan. Spik. ov.	Fr. rib. 6. 7.	—	—	H. β . ———
Fraseriana. H. K.	Fraser's.	obl. lan. smth. edges roug.	w. 4. 6.	N. Amer.	1809.	H. β . ———
fláva. B. Fl.	yellow.	ribb. broad. Stm. trian. smt. ye.	5. 6.	Britain.	—	H. β . ———
fúlva. E. Fl.	tawny.	flat, lan. fert. spik. obl. remo.	br. 6. 7.	—	—	H. β . ———
hírta. B. Fl.	hairy.	erect, hairy. Stm. 2 ft. high.	br.	—	—	H. β . ———
incúrva. E. Fl.	curved.	lin. acut. chann. Fr. ov.	br. 7. 8.	Scotland.	—	H. β . ———
intermédia. B. Fl.	soft brown.	Stem trian. Spik. obl. crowd. b	5. 7.	Britain.	—	H. β . ———
lævigáta. E. Fl.	smooth-stalked.	erec. stria. Catkins cylin.	gr. 5. 6.	—	—	H. β . ———
limósa. B. Fl.	green.	narr. fertile. Spik. obl. pen. ye.	6.	—	—	H. β . ———
Mielichóferi. B. Fl.	loose-spiked.	flat, smth. Fert. spik. remo. g.	6. 7.	Scotland.	—	H. β . ———
muricáta. B. Fl.	greater prickly.	Spikl. 8-10, sess. Fr. ov.	br. 5. 6.	Britain.	—	H. β . ———
Oedéri. E. Fl.	Oederian.	Sheath shor. fert. catk. roun.	6. 7.	England.	—	H. β . ———
ovális. B. Fl.	oval-spiked.	Stm. 1 ft. high. trian. Spik. 6. g.	—	Britain.	—	H. β . ———
pallescens. B. Fl.	pale.	Shea. scarcl. any. fert. spik. obl.	—	—	—	H. β . ———
paludósa. E. Fl.	lesser.	broad, roug. Fr. ov. trian. bk.	—	—	—	H. w. β . ———
panicéa. B. Fl.	pink-leaved.	glau. roug. Fr. smth. bk.	—	—	—	H. β . ———
paniculáta. E. Fl.	great-panicled.	Stm. 2-3 ft. high, 3-ang. Fr. ov.	—	England.	—	H. β . ———
pauciflóra. E. Fl.	few-flowered.	2-3-sheath. chann. abov. st.	6.	Britain.	—	H. β . ———
péndula. B. Fl.	pendulous.	larg. fert. spik. lon. pen. smt. g.	—	—	—	H. β . ———
phœostáchya. B. Fl.	sh.-brown-spik.	Sh. shor. than flow.-stalks.	br.	—	Scotland.	H. β . ———
pilulífera. E. Fl.	round-headed.	Fr. trian. downy.	br. 4. 5.	Britain.	—	H. β . ———
præcox. B. Fl.	vernal.	keel. roug. ribb. Catk. ellip. st.	—	—	—	H. β . ———
Pseudo-cypérus. E. Fl.	Bast.-cyperus.	Stm. trian. roug. fer. cat. pen.	—	—	—	H. β . ———
pulicáris. B. Fl.	Flea.	trian. Cat. slen. fl. in up. ½ barr.	—	—	—	H. β . ———

Systematic Name.	English Name.	Form of Leaves, &c.	Col. of Flow.	Month of Fl.	Native of Country.	Yr. of Introd.	Soil and Propagation.
púlla. E.Fl.	russet.	Sh.0.fert.spik.ov.obt.	Fr.ell.	4. 5.	Scotland.	H.ϕ. ———
rariflóra. E.Fl.	loose-flowered.	Fer.catk.lax.pend.	Fr.obo.b.	—	—	H.ϕ. ———
remóta. E.Fl.	remote.	Stm.1ft.high.Spikl.remov.	w.	—	Britain.	H.ϕ. ———
recúrva. B.Fl.	glaucous.	broad,acu.fert.catk.cyl.pen.	—	—	—	H.ϕ. ———
rígida. E.Fl.	rigid.	short.than.stems.lin.lan.	bk.	—	—	H.ϕ. ———
ripária. E.Fl.	great-common.	broad,roug.	Spik.erec.	bk.	—	H.w.ϕ. ———
secalina.	Rye.	lin.flat,fert.catk.cyl.	br.	—	Europe.	1820.	H.ϕ. ———
strícta. E.Fl.	straight-leaf'd.	erec.short.than.stem.	Fr.elli.	—	Britain.	H.ϕ. ———
stelluláta. E.Fl.	little-prickly.	Spikl. 3-4, alt.	Fr.ov.	br.	—	H.ϕ. ———
speirostáchya. B.Fl.	dense short-spi.	Stem trian.smth.	Fr.ov.	trian.	—	H.ϕ. ———
stíctocárpa. B.Fl.	dotted.	erec.lin.lan.flat.	Fr.obo.	br.	Scotland.	H.ϕ. ———
strígósa. B.Fl.	loose.	large glau.fert.catk.droop.	g.	—	—	H.ϕ. ———
sylvática. E.Fl.	pendulous-wood.	Stm.smth.trian.	Fr.ov.	gr.	Britain.	H.ϕ. ———
tenélla. E.Fl.	slender-headed.	Spikl.3,remot.	Fr.ellip.	br.	Scotland.	H.ϕ. ———
teretíuscula. B.Fl.	lesser-panicled.	Stm.1-½ft.high.	Fr.smt.ribb.	—	Britain.	H.ϕ. ———
tomentósa. E.Fl.	downy-fruited.	Stm.trian.	Fr.round,down.	g.	—	H.ϕ. ———
ustuláta. B.Fl.	scorched Alpine.	Stm.3-4-in.high.	Fr.trian.	bk.	Scotland.	H.ϕ. ———
vesicária. E.Fl.	short-spiked.	Stm. 2 ft. high.	Fr.ov.	bk.	Britain.	H.ϕ. ———
vulpína. B.Fl.	great prick.-spi.	Stm.2 ft.high, trian.	Fr.rib.g.	—	—	H.ϕ. ———

[outer scale. Cor. 0. Seed 1, naked,

KOBRESIA, KOBRESIA. Cal. of barr. fl. a slightly concave scale. Cor. 0. Fila. 3. Fert. fl. Cal. an caricína. w. compound-head. lin. Spik. 3 or 4, alt. gr. — Britain. H.ϕ. ———

COMPTONIA, COMPTONIA. Male catkin. Cor. of 2 pet. Fem. cor. of 6 pet. Sty. 2. Nut ovate.

asplenifólia. Fern-leaved. obl. lanc. sinuat. br. 3. 4. N.Amer. 1714. H.ϕ. ———

HERNAN'DIA, JACK-IN-A-BOX. Mas. cal. 3-part. Cor. of 3 pet. Fem. cal. trunc. ent. Cor. of 6 pet.

sonóra. w. peltate-leaved. pelt. smth. wh. — W.Ind. 1693. S.ϕ. ———

[Cone ovate.

CUNNINGHAMIA, CUNNINGHAMIA. Mas. catkin scales imbric. Fem. catkin obov. scales imbric.

lanceoláta. B.M. lance-leaved. lin. lanc. cuspid. vill. ye. — China. 1804. H.ϕ. ———

ORDER III.

TETRANDRIA. STAMENS 4.

AUCUBA, AUCUBA. Male cal. 4-tooth. Pet. 4. Fem. cal. 4-tooth. Pet. 4. Sty. short. Nut ovate.

javónica. L. Japan. ellip. lanc. blotch. pu. — Japan. 1783. H.ϕ. ———

[Cor. 3-cleft. Nect. of 1 cell, single-seeded.

LITTORE'LLA, SHORE-WEED. Cal. of the barr. flor. 4 or. leaves. Pet. 1-4-cleft. Cal. of fert. flor. 0.

lacústris. Plantain. lin. chann. ent. 3-4 in. long. gr. 6. Britain. H.ϕ. ———

[Seed single-polished.

URTICA, NETTLE. Barr. flor. Cal. of 4 concave leaves. Pet. 0. Fert. fl. Cal. 2 unequal leaves. Cor. 0.

baccífera. B.Rep. berry-bearing. alt. cord. dent. prick. gr. S.Amer. 1793. S.ϕ. Sandy loam.

cannabína. w. Hemp-leaved. opp. 3-part. ent. pinnatif. gr. 6. 7. Siberia. 1749. H.ϕ. cuttings, or

ciliáta. w. ciliated. opp. obl. 3-nerv. serr. gr. — Jamaica. 1815. S.ϕ. seeds,

pilulífera. E.Fl. Roman. opp. ov. serr. gr. — England. H.ϕ. ———

Systematic Name.	English Name.	Form of Leaves, &c.	Col. of Flow.	Month Native of Fl. Country.	Yr. of Introd.	Soil and Propagation.
MORUS, MULBERRY. <i>Male catkin. Cal. 4-part. Cor. 0. Fem. cal. of 4 leaves. Cor. 0. Sty. 2.</i>						
álba. w.	white.	cord. ov. lob. serr.	gr.	6. China.	1596.	H. S. Loam.
rúbra.	red.	cord. ov. acum. 3-lob. serr.	gr. —	N. Amer.	1629.	H. C. cuttings.
[<i>of fert. fl. 2-flowered. Cor. 0.</i>]						
ALNUS, ALDER. <i>Barr. fl. an imbr. catkin. Cal. a wedge-shap. scale, 3-flower. Cor. 4-cleft. Cal. scale</i>						
cordáta.	heart-leaved.	cord. ent. acum. shin. abo.	gr.	7. Naples.	1820.	H. S. Sandy soil.
glutinosa.	common.	orbic. lob. serr.	wh. —	Britain.	H. C. cuttings, or
1. laciniáta.	jagged-leaved.	gr. —	—	H. C. seeds.
2. quercifolia.	Oak-leaved.	gr. —	—	H. S. —
serruláta.	saw-leaved.	obov. acum. serr.	gr. —	N. Amer.	H. C. —
[<i>leaves. Pet. 3. Cap. 3-celled, & 3-valved. Pet. 2. Fila. 4. Fert. fl. Cal. of 4 obtuse</i>]						
BUXUS, BOX-TREE. <i>Barren fl. Cal. of 3-coloured leaves. Pet. 2. Fila. 4. Fert. fl. Cal. of 4 obtuse</i>						
baleárica. w.	Minorca.	obl. shin. smth.	yel. —	Minorca.	1780.	H. S. —
sempervirens.	E. Fl. common.	ov. obl. obt. shin.	yel. 3. 4.	England.	H. S. —
1. angustifolia.	narrow-leaved.	yel. —	—	H. S. —
2. variegata.	variegated.	yel. —	—	H. S. —
[<i>Caps. 3-celled. Seeds 2.</i>]						
PACHYSA'NDRA, PACHYSA'NDRA. <i>Masc. cal. of 4 leaves. Cor. 0. Fem. cal. of 4 leaves. Sty. 3.</i>						
coriácea.	H. Ex. F. coriaceous.	ov. lanc. acum. nerv.	wh. 5. 6.	Nepaul.	1820.	G. S. Sandy loom
procumbens.	н.к. trailing.	ov. dent. stalk.	bh. 6. 7.	N. Amer.	1800.	H. P. and peat. cutt. or divid. plants.

ORDER IV.

PENTANDRIA. STAMENS 5.

[<i>of 2 leaves, with 2 flowers. Cor. 0.</i>]						
XANTHIUM, BUR-WEED. <i>Barr. fl. comm. Cal. imbric. Cor. of 1 pet. funnel-shap. 5-cleft. Fert. fl.</i>						
strumárium. w.	broad-leaved.	cord. lob. 2-serr. 3-nerv.	gr.	8. England.	H. A. —
spinósum. w.	spiny.	3-lob. spines ternate.	gr. 7. 8.	S. Europ.	1713.	H. A. —
[<i>3-celled, many-seeded.</i>]						
LU'FFA, LU'FFA. <i>Male cal. 5-parted. Pet. 5. Fem. cal. & cor. the same. Stig. 3-4. Pepo 10-furrowed.</i>						
fœ'tida. B. M.	stinking.	cord. lob. serr.	yel.	6. E. Ind.	1812.	F. A. cl. —
NEPHELIUM, NEPHELIUM. <i>Male cal. 5-tooth. Cor. 0. Fem. cal. 4-clef. Cor. 0. Ger. 2. Drup. 1-seed.</i>						
lappáceum. w.	Bur-seeded.	pinn. alt.	wh.	E. Ind.	1809.	S. S. —
[<i>Sty. 3. Caps. of 1 cell, & 1 seed.</i>]						
AMARA'NTHUS, AMARANTH. <i>Barren fl. Cal. of 3 or 5 leaves. Cor. 0. Fert. the same. Ger. ovate.</i>						
bícolor. w.	two-coloured.	ov. acum. obt. color'd.	st. 7. 8.	E. Ind.	1802.	H. A. Rich loam.
Blítum. w.	wild.	ov. retuse. Stm. diffuse.	gr. —	England.	H. A. seeds.
caudátus. w.	Love-lies-bleed.	ov. lanc. serr.	red. —	E. Ind.	1596.	H. A. —
hypochondríacus. w.	Prince's-feath.	obl. lanc. mucr.	red. —	Virginia.	1684.	H. A. —
oleráceus. w.	eatable.	obl. rug. notch. obt.	li. —	E. Ind.	1764.	H. A. —
paniculátus. w.	panicked.	ov. lanc. Br. pubes.	red. —	N. Amer.	1798.	H. A. —

Systematic Name.	English Name.	Form of Leaves, &c.	Col. of Flow.	Month of Fl.	Native Country.	Yr. of Introd.	Soil and Propagation.
[<i>Sty.</i> 3-fid. <i>Berr.</i> many-seeded.]							
<i>BRY'ONIA</i> , <i>BRYONY</i> .	<i>Barren fl.</i>	<i>Cal.</i> 5-parted.	<i>Cor.</i> 5-cleft.	<i>Fert. fl.</i>	<i>Cal.</i> 5-toothed.	<i>Cor.</i> 5-parted.	
<i>álba</i> .	white.	cord. 5-lob. den. dott. scabr.	<i>w.</i>	6. 7.	Europe.	1807. H. <i>P.</i>	<i>cl.</i> Sandy soil.
<i>dioíca</i> . E. F.	red-berried.	palm. roug. on both sides.	<i>wh.</i>	—	Britain.	... H. <i>P.</i>	<i>cl.</i> cuttings, or
<i>epigæ'a</i> .	umbel-flow'd.	3-lob. dent. asper.	<i>st.</i>	... E. Ind.	1815. G. <i>P.</i>	<i>cl.</i>	<i>part. plants.</i>
<i>grándis</i> .	great-flowered.	cord. angul. dott.	<i>red.</i>	6. 8.	—	1783. S. <i>P.</i>	<i>cl.</i> —
<i>scábra</i> .	rough.	cord. dent. scabr. pilose.	<i>st.</i>	8. 9. C. B. S.	1774. G. <i>P.</i>	<i>G.</i>	—
<i>villósa</i> . B. R.	shaggy.	semi-cor. slightly den. vill.	<i>ye.</i>	—	—	1830. G. <i>P.</i>	—

ORDER V.

HEXANDRIA. STAMENS 6.

[<i>Ger.</i> 2 or 3-lobed. <i>Caps.</i> of 2 or 3 cells.]							
<i>ERIOCAULON</i> , <i>PIPE-WORT</i> .	<i>Barren fl.</i>	<i>Cal.</i> 0.	<i>Pet.</i> 1, 6 or 4-cleft.	<i>Fert. fl.</i>	<i>Pet.</i> 6 or 4-ovovate.		
<i>decanguláre</i> . L.	ten-angled.	subu. chan. smt.	<i>Scap.</i> 10-ang. <i>w.</i>	8.	N. Amer.	1825. H. <i>w.</i>	<i>P.</i> Sandy peat.
<i>septanguláre</i> . E. Fl.	jointed.	smt. awl-sh.	<i>Stm.</i> 7-ang. <i>w. pu.</i>	—	Scotland.	... H. <i>w.</i>	<i>P.</i> div. at root.
[<i>Ger.</i> 2 or 3-lobed. <i>Caps.</i> of 2 or 3 cells.]							
<i>COCOS</i> , <i>COCOA-NUT-TREE</i> .	<i>Male cal.</i> 3-leaved.	<i>Pet.</i> 3.	<i>Fem. cal.</i> 2-leaved.	<i>Pet.</i> 6.	<i>Sty.</i> 0.		
<i>nucífera</i> . w.	common.	<i>Fronspinn.</i> leaf. ensif.	<i>st.</i>	... E. Ind.	1690.	S. <i>S.</i>	—
<i>GUETTARDA</i> , <i>GUETTARDA</i> .	<i>Cal.</i> 4-tooth.	<i>Cor.</i> salver-shap. tube cylin.	<i>lobes</i> 4-9-obl.	<i>Ber.</i> 4-9-cell.			
<i>speciósa</i> . B. R.	showy-flow'd.	ov. or sub-cor. ent. pub. ben. <i>w.</i>	8.	Madagas.	1823.	S. <i>S.</i>	—
<i>SAGUS</i> , <i>SAGO-PALM</i> .	<i>Male cal.</i> of 3 leaves.	<i>Cor.</i> 0.	<i>Fem. cal.</i> 3-leav.	<i>Cor.</i> 0.	<i>Sty.</i> short.	<i>Stig.</i> simp.	
<i>vinífera</i> .	prickly.	<i>Fronspinn.</i> leaf. spiny.	<i>st.</i>	... Africa.	1820.	S. <i>S.</i>	—

ORDER VI.

POLYANDRIA. STAMENS MANY.

[<i>short.</i> <i>Stigma</i> oblique.]							
<i>CERATOPHYLLUM</i> , <i>HORNWORT</i> .	<i>Cal.</i> many cleft.	<i>Cor.</i> 0.	<i>Stam.</i> 16-20.	<i>Ger.</i> ovate, compr.	<i>Sty.</i>		
<i>demérsun</i> . E. Fl.	common.	in whorls, 2 or 3 forked.	<i>gr.</i>	—	Britain.	... H. <i>w.</i>	<i>P.</i> —
[<i>Stig.</i> 4, downy.]							
<i>MYRIOPHYLLUM</i> , <i>WATER-MILFOIL</i> .	<i>Barr. fl.</i>	<i>Cal.</i> of 4 leaves.	<i>Pet.</i> 4.	<i>Fert.</i> the same.	<i>Ger.</i> 4.		
<i>spicátum</i> . E. Fl.	spiked.	4, in a whorl, pinnatif.	<i>red.</i>	—	Britain.	... H. <i>w.</i>	<i>P.</i> —
[<i>Sty.</i> short. <i>Seeds</i> obovate.]							
<i>SAGITTARIA</i> , <i>ARROW-HEAD</i> .	<i>Barr. fl.</i>	<i>Cal.</i> 3 conc. leaves.	<i>Pet.</i> 3.	<i>Fert. fl.</i> the same.	<i>Ger.</i> nume.		
<i>gramínea</i> . w.	grass-leaved.	lin. lanc. smth.	<i>wh.</i>	6. 7.	Carolina.	1812. H. <i>w.</i>	<i>P.</i> Sandy loam
<i>latifólia</i> .	broad-leaved.	ov. acut. sagitt.	<i>wh.</i>	—	N. Amer.	1816. H. <i>w.</i>	<i>P.</i> and peat.
<i>sagittifólia</i> . E. Fl.	common.	sagitt. ent. smth.	<i>wh.</i>	—	England.	... H. <i>w.</i>	<i>P.</i> part. plants.
<i>flóre-pléno</i> .	double-flow'ring.	<i>wh.</i>	—	—	... H. <i>w.</i>	<i>P.</i> —
<i>sinénsis</i> . B. M.	Chinese.	sagitt. 3-lob. nerv.	<i>wh.</i>	8. 9.	China.	1812. G. <i>w.</i>	<i>P.</i> —

Systematic Name.	English Name.	Form of Leaves, &c.	Col. of Flow.	Month of Country.	Native Country.	Yr. of Intro.	Soil and Propagation
[dense ring, sess. Berr. of 1 ell. Seeds several							
<i>A'RUM, A'RUM. Cal. of 1 sheathing leaf, convolute at the base. Cor. 0. Filam. numer. Ger. forming c</i>							
bulbiferum. B.M.	bulb-bearing.	decompound, bulbifer.	pa.	5.	Bengal.	1813.	S. \mathbb{P} . Sandy loam
crinitum. B.R.	hairy.	ped. ent. spadix round.	d. pur.	3. 4.	Minorca.	1777.	F. \mathbb{P} . and leaf
Dracónitium. w.	Dragon.	pedate, leaf. lanc. obl. ent.	gr.	6. 7.	N. Amer.	1759.	H. \mathbb{P} . mould. divi
flagellifórmé. B.C.	whip-lash.	ov. ent. or 3-lob.	pur.	5.	E. Ind.	1824.	S. \mathbb{P} . ding plants
maculátum. E.B.	Cuckow-pint.	hastate, acut. spott.	p. gr.	5. 7.	Britain.	H. \mathbb{P} . at roots.
macrorhízon. w.	long-rooted.	cord. hast. large.	gr.	E. Ind.	1803.	S. \mathbb{P} . ———	
orixénsis. B.R.	Orixion.	tern. vein. two-colored.	pur.	8. 10.	———	1802.	S. \mathbb{P} . ———
sagittifólium. Lk.	sagittate-lv'd.	sagitt. acut. base round.	wh.	———	———	1824.	S. \mathbb{P} . ———
triphyl'ium. w.	three-leaved.	tern. ent. sid. uneq. spath.	br.	5. 6.	N. Amer.	1664.	H. \mathbb{P} . ———
trilobátum. w.	three-lobed.	3-lob. sagitt.	pur.	———	Ceylon.	1714.	S. \mathbb{P} . ———
[the same. Cor. 4-cleft. Ger. 2-celled.							
<i>POTERIUM, BURNET. Barr. fl. Cal. of 3-coloured leaves. Cor. of 1 tubul. petal. 4-cleft. Fert. fl. cal.</i>							
polygámum. w.	Hungarian.	pin. leaf. serr. stem angul.	pu.	7. 8.	Hungary.	1803.	H. \mathbb{P} . Sandy soil.
spinósum. w.	prickly.	pinn. Br. vill. angul.	wh.	4. 8.	Levant.	1595.	G. \mathbb{S} . seeds, or
sanguisórbæ. w.	common.	pinn. leaf. ov. serr.	pur.	7.	England.	H. \mathbb{P} . divid. plants.
<i>CALA'DIUM, CALA'DIUM. Mas. cal. 0. Cor. 0. Anth. pelt. Fem. cal. 0. Cor. 0. Berr. 1-cell. 2-seed.</i>							
bícolor. B.M.	two-coloured.	pelt. cord. sagitt.	wh.	6. 7.	Brazil.	1773.	S. \mathbb{P} . Loam & leaf
odórum. B.R.	sweet-scented.	cord. ent. on long stalks.	gr.	3.	E. Ind.	1818.	S. \mathbb{P} . mould. cutt.
virgínicum. H. E. F.	Virginian.	hast. cord. acut.	st.	6. 7.	N. Amer.	1759.	H. \mathbb{P} . or parting plants.
<i>A'rum Virgínicum. w.</i>							
<i>BEGO'NIA, BEGO'NIA. Male cal. 0. Cor. 0. Fem. pet. 4-6. Sty. 3-bifid. Caps. 3-angl. & 3-celled.</i>							
acumináta. w.	acuminate-lv'd.	semi-cord. acum. hisp.	wh.	5. 12.	Jamaica.	1790.	F. \mathbb{S} . Sandy loam
argyrostígma. B.R.	silver-spotted.	semic. alt. cren. smth. spott.	w.	7. 10.	Brazil.	1819.	S. \mathbb{S} . and leaf
dichótoma. w.	forked.	uneq. cord. ang. smth.	wh.	7. 8.	Caracas.	1810.	S. \mathbb{S} . mould. cut-
díscolor. H. K.	two-coloured.	ang. serr. crim. ben.	wh.	5. 9.	China.	1804.	S. \mathbb{S} . tings, or
dipétala. B.M.	two-petaled.	semi-cord. acu. serr. spott.	pk.	4. 9.	Bombay.	1826.	S. \mathbb{S} . parting
hirsúta. w.	hairy.	half-cord. 2-serr. hairy.	wh.	5. 6.	W. Ind.	1789.	S. \mathbb{S} . plants at
pícta. B.M.	painted.	cord. acum. hisp. serr. spot.	pk.	9.	Nepaul.	1818.	S. \mathbb{S} . roots.
nítida. w.	shining.	cord. smth. dent. shin.	bh.	5. 12.	Jamaica.	1777.	S. \mathbb{S} . ———
ulmifólia. w.	Elm-leaved.	hisp. on both sid. uneq. obl.	bh.	5. 6.	S. Amer.	1820.	S. \mathbb{S} . ———
unduláta. B.M.	wave-leaved.	alt. distich. cord. und. ent.	wh.	6. 7.	Brazil.	———	S. \mathbb{S} . ———
[of 1 leaf, 6-cleft. Cor. 0. Nut 1-cell.							
<i>QUERCUS, OAK. Barr. fl. in a lax catkin. Cal. a scale 4-5-cleft. Cor. 0. Fert. fl. Cal. double, inner</i>							
álba. w.	white.	obl. pinna. sinuat. pub. ben.	ye.	5. 6.	N. Amer.	1724.	H. \mathbb{C} . The soil best
aquática. Mx.	water.	obov. cuneat. ent. smth. y. gr.	———	———	———	1723.	H. \mathbb{C} . adapted for
ambígua. Mx.	doubtful.	sinuat. smth. lobes acut. y. gr.	———	N. Amer.	1800.	H. \mathbb{C} . the growth	
Ægilops. w.	Velanida.	ov. obl. sinuat. w. pub. ben. y. gr.	———	S. Europ.	1731.	H. \mathbb{C} . of the Ame-	
Banistéri. Mx.	Banister's.	obov. cuneat. 3-5-lob. y. gr.	———	N. Amer.	1800.	H. \mathbb{S} . rican species	
Ballóta. w.	Barbary.	ellip. serr. hairy ben. y. gr.	———	Barbary.	1818.	H. \mathbb{S} . of this orna-	
Catesb'ái. w.	Catesbæ's.	narr. at base palm. lob. y. gr.	5. 6.	N. Amer.	1820.	H. \mathbb{S} . mental Ge-	
cinérea. Mx.	Ash-coloured.	lanc. obl. acut. ent. pubes. ben.	———	———	1789.	H. \mathbb{C} . nera, is a	
coccífera. w.	Kermes.	cor. obl. dent. spin. smth. y. gr.	———	S. Franc.	1683.	H. \mathbb{S} . mixture of	
coccínea. Ph.	scarlet.	obl. sinuat. smth. y. gr.	———	N. Amer.	1691.	H. \mathbb{C} . sandy loam	
E'sculus. w.	Italian.	ov. obl. sinua. smth. lobes angl.	———	S. Europ.	1739.	H. \mathbb{C} . and leaf	
falcáta. Mx.	Spanish.	stalk. base obt. palm. lob. y. gr.	5.	N. Amer.	1763.	H. \mathbb{C} . mould. The	
ferrúginea. Mx.	rusty.	dilat. at apex, sub-3-lob. pow.	———	———	1749.	H. \mathbb{S} . species may	

Systematic Name.	English Name.	Form of Leaves, &c.	Col. of Flow.	Month of Fl.	Native Country.	Yr. of Intro.	Soil and Propagation.
gramuntia. w.	Holly-leav'd.	ov. cord. spiny, dent.	ye.gr.	6.	S. Franc.	1730.	H. S. be all in-
imbricaria. Mx.	tiled.	ov. obl. ent. shin.	ye.gr.	5. 6.	N. Amer.	1786.	H. C. creased by
flex. w.	evergreen.	ov. obl. serr. wh. ben.	ye.gr.	—	S. Franc.	1581.	H. S. grafting or
1. crispa.	curled-leaved.	ye.gr.	—	—	—	H. S. encarching on
2. integrifolia.	entire-leaved.	ye.gr.	—	—	—	H. S. the common
3. longifolia.	long-leaved.	ye.gr.	—	—	—	H. S. Oak; but
4. serratifolia.	saw-leaved.	ye.gr.	—	—	—	H. S. they are more
aurifolia. w.	Laurel-leaved.	obl. ent. smth.	ye.gr.	5.	N. Amer.	1786.	H. C. frequently
utea. w.	yellow-leaved.	obo. ent. sub-cor. ye. hair. ben.	—	—	Mexico.	1825.	H. C. raised from
yrata.	lyrate-leaved.	lyr. sinuat. smth. lob. acut. y.g.	—	—	N. Amer.	1786.	H. C. seeds, in-
auguinosa. D.P.	Nepaul.	obl. gland. lanug.	ye.gr.	—	Nepaul.	1818.	G. C. ported from
Leucombeana.	Leucombe's.	ob. sinuat. lobed.	ye.gr.	5.	Levant.	...	H. C. America.
macrocarpa. Ph.	large-fruited.	obl. sinuat. pubes. lob. obl. y.g.	—	—	N. Amer.	1800.	H. C. —
Michauxii.	white-swamp.	obl. obov. pubes. ben.	y.g.	—	—	1812.	H. C. —
montana. Ph.	rock-Chesnut.	obov. acut. wh. & hair. ben. ye.	—	—	—	1800.	H. C. —
nigra. Ph.	black.	sub-cor. wedge-sh. smth. ye.g.	—	—	—	1739.	H. S. —
obtusiloba. Mx.	obtuse-lobed.	sinuat. pubes. lobes obt. ye.gr.	—	—	—	1819.	H. C. —
palustris. Mich.	marsh.	deepl. sinuat. smth. lobe. acut.	—	—	—	1800.	H. C. —
Phellos. w.	Willow-leaved.	lin. lanc. ent. smth.	ye.gr.	5. 6.	N. Amer.	1723.	H. C. —
Prinus. w.	Chesnut-leav'd.	obov. acut. dent. pubes. ye.gr.	—	—	—	1730.	H. C. —
Robur. B.F.	common.	alt. obl. sinuat. lobes obt. ye.gr.	4. 5.	Britain.	...	H. C. —	
rubra. Ph.	red.	obl. obt. sinuat. smth. ye.gr.	5.	N. Amer.	1759.	H. C. —	
sessiliflora. B.Fl.	sessile-fruited.	obl. obov. deepl. sinuat. ye.gr.	—	—	Britain.	...	H. C. —
inctoria. Ph.	black.	obov. obl. sinuat. pubes. ye.gr.	5.	N. Amer.	1800.	H. C. —	
virgens. Ph.	green.	lanc. ent. edges revol. ye.gr.	—	—	—	1739.	H. C. —

FA'GUS, BEECH. Barr. fl. a catk. Cal. in 5 or 6 seg. Cor. 0. Fert. fl. Cal. dbl. the out. in 4-5 or 6 seg.

erruginea. w.	ferruginous.	ov. acum. downy ben.	ye.gr.	5. 6.	N. Amer.	1796.	H. C. Strong loam.
ylvatica. E.B.	common Beech.	ov. smth. dent.	ye.gr.	4. 5.	Britain.	...	H. C. seeds, or
β asplenifolia.	Fern-leaved.						grafting.

[Cal. a peltate, 3-lobed, 3-flowered scale. Cor. 0.

BETULA, BIRCH. Barr. fl. Catk. imbr. Scal. concave. Cor. 0. Filam. 10-12. Fert. fl. Catk. cylind.

alba. w.	white.	ov. acum. serr.	gr.	4. 6.	Britain.	...	H. C. —
excelsa. w.	tall.	acut. serr.	gr.	5.	N. Amer.	1767.	H. C. —
utea. Mx.	yellow.	ov. acut. serr.	gr.	—	—	1816.	H. C. —
nana. E.B.	dwarf.	orbic. cren. retic. ben.	gr.	—	Scotland.	...	H. S. —

[scales in deep segments. Cor. 0. Sty. 2.

CARPINUS, HORNBEAM. Barr. fl. Catk. with round. conc. sing. flow'd. scal. Cor. 0. Fert. fl. The

americana. w.	American.	ov. serr. scales of Cones 3-par.	3. 5.	N. Amer.	1812.	H. C. Sandy loam.	
Bétulus. w.	common.	cord. acut. biserr.	gr.	—	Britain.	...	H. C. cuttings, or
1. variegata.	variegated.	gr.	—	—	...	H. C. seeds.
2. quercifolia.	Oak-leaved.	gr.	—	—	...	H. C. —

[Cal. of 1 leaf, divid. inner obsolete. Cor. 0.

CORYLUS, HASEL-NUT. Barr. fl. Catk. imbr. scal. 1-fl'd. 3-cl'ft. Cor. 0. Fila. 8, or more. Fert. fl.

Avellana. E.Fl.	common.	cord. acum. serr.	ye.red.	2. 4.	Britain.	...	H. C. —
americana. w.	American.	cord. orbic. acum.	st.red.	3. 4.	N. Amer.	1798.	H. C. —

O'STRYA, HOP-HORNBEAM. Catkin imbric. Fem. one naked. Caps. inflat. 1-seeded.

vulgáris. L.	common.	ov. acut. serr.	gr.	5.	Italy.	1724.	H. C. —
virginica. w.	Virginian.	obl. ov. acut. serr.	gr.	—	N. Amer.	1692.	H. C. —

Systematic Name.	English Name.	Form of Leaves, &c.	Col. of Month of Flow.	Native Country.	Yr. of Introd.	Soil and Propagation.
PLATANUS, PLANE-TREE. <i>Catk. round. Fem. cal. of many leav. Cor. 0. Stig. recur. Seeds round.</i>						
acerifolia. w.	Maple-leaved.	cord. 5-lob. dent.	gr. 4. 5.	Levant.	1724.	H. C. Sandy loam,
cuneata. w.	wave-leaved.	3-5-lob. dent.	gr. — — —	— — —	1739.	H. C. layers,
orientalis. L.	Oriental.	5-lob. palm. segm. lanc.	gr. — — —	— — —	1548.	H. C. seeds, or
occidentalis. L.	American.	5-angled, lobes dent.	gr. — — —	N. Amer.	1640.	H. C. grafting
LIQUIDAMBAR, LIQUIDAMBAR. <i>Male catk. con. Inv. 4-leav. Fem. catk. glob. Cal. of 1 leaf, 2-fl.</i>						
styraciflua. L.	Sweet-Gum-fl'g. palm.	lob. vill.	gr. wh. 3. 4.	— — —	1683.	H. C. — — —
[Drupe 3-seeded.						
SALISBURIA, SALISBURIA. <i>Catk. naked. Male cal. 0. Cor. 0. Anth. imbrica. Fem. cal. 4-cleft.</i>						
adiantifolia. Sm.	Maiden-hair-fl'd. wedge-sh.	lob. at apex.	g. st. 4. 5.	Japan.	1754.	H. S. Sandy soil, cuttings.
CARYOTA, CARYOTA. <i>Male cal. 3-leav. Cor. of 3 pets. Fem. cal. 3 cor. the same. Ber. 1-cell. 2-seed.</i>						
urens.	horn-leaved.	bipin. leaf. wedge-sh. obli. st.	E. Ind.	1798.	S. S. Loam & peat.	
JUGLANS, WALNUT. <i>Male catk. imbr. Cor. 6-part. Fem. cal. 4-cleft. Cor. 4-par. Sty. 2. Nut furr.</i>						
alba. w.	white.	pinn. leaf. lanc. serr.	gr. 4. 5.	N. Amer.	1629.	H. C. Sandy loam,
regia. w.	common.	ov. smth. serr.	gr. — — —	Persia.	1562.	H. C. layers, or
sulcata.	channelled.	pinn. leaf. lanc. serr.	gr. — — —	N. Amer.	1804.	H. C. seeds.
nigra. L.	black.	pinn. leaf. serr. ov. acum. gr.	— — —	— — —	1629.	H. C. — — —

ORDER VII.

MONADELPHIA. *Stamens united into one set.*

[imbric. catk. its scales 2-flow'd.						
<i>PINUS, PINE, or FIR. Barr. fl. in a racemose catk. Cal. 0. Cor. 0. Stam. nume. Fert. fl. with an ov.</i>						
A'bies. w.	Norway Spruce.	solitary, 4-sided.	ye. 4.	N. Europ.	1548.	H. C. Sandy loam.
adunca.	crooked.	lin. hooked.	ye. 5. 6.	— — —	1822.	H. C. seeds,
Balsamea. w.	Balm-of-Gilead.	solitary, notch. pectin.	ye. 5.	N. Amer.	1696.	H. C. or cuttings.
Banksiana.	Hudson's-Bay.	in 2's, obliq.	ye. 5. 6.	Huds.-Ba.	1785.	H. C. — — —
Clanbrassiliana.	Ld. Clanbrasil's.	lin. flat, mucr. shin.	ye. 5.	N. Amer.	1810.	H. S. — — —
canadensis. L. P.	Hemlock Spruce.	solitary, flat, dent.	ye. — — —	— — —	H. C. — — —
Cembra.	Siberian.	in 5's. Cones ov. obt.	ye. — — —	Siberia.	1746.	H. C. — — —
Dicksoniana.	Mr. Dickson's.	5's, lin. glau. angl.	Nepaul.	1827.	H. C. — — —
Douglasii.	Douglas's.	lin. flat, glau. ben.	ye. — — —	N. Amer.	1827.	H. C. — — —
excelsa. L. P.	tall.	in 5's, slend. leaves; Cones pen.	— — —	Nepal.	1823.	H. C. — — —
Fraseri. Ph.	Double-Balsam.	lin. flat, apex notch.	ye. — — —	Pensylva.	1811.	H. C. — — —
Gerardi.	Gerard's.	needle-sh. glau.	ye. 5. 6.	Nepal.	1824.	H. C. — — —
halepensis. w.	Aleppo.	in 2's, slen. Cones ov.	ye. 5.	Levant.	1688.	H. C. — — —
inops. Ph.	Jersey.	in 2's. Cones obl. ov.	ye. — — —	N. Amer.	1739.	H. C. — — —
intermedia.	intermediate.	in clusters, lin.	ye. 3. 4.	Altays.	1828.	H. C. — — —
Laricio. L. P.	Corsican.	in 2's, long; Cone ov.	ye. re. 4. 5.	Corsica.	1814.	H. C. — — —
Lambertiána. Doug.	Lambert's.	quin. 3-sided, mucr.	ye. 4.	Californi.	1827.	H. C. — — —
maritima. w.	maritime.	in 2's, slender; Cones ov.	ye. 5. 6.	S. Europ.	1759.	H. C. — — —
nigra. Ph.	Black Spruce.	single, 4-sided, erect.	ye. 5.	N. Amer.	1700.	H. C. — — —
Nova-Zelandica.	New Zealand.	in 2's, flat on the inn. sid.	ye.	N. Zeal.	1825.	H. C. — — —

Systematic Name.	English Name.	Form of Leaves, &c.	Col. of Flow.	Month of Native Fl.	Yr. of Country.	Yr. of Introd.	Soil and Propagation.
balustris. Ph.	marsh.	long, lin. lanc.	ye.	5. 6.	N. Zeal.	1730.	H. T. ———
Píchta. Fis.	Fischer's.	lin. flat. apex notch.	yel.	5.	Altay.	1824.	H. T. ———
Pumilio. w.	Mugho.	in 2's. Cones ov. erect.	yel.	4. 5.	Carniola.	1779.	H. T. ———
Pínea. w.	Stone.	in 2's. Cones obt. ov.	yel.	5.	S. Europ.	1548.	H. T. ———
Ponderosa. D.	ponderous.	in 3's, elong.	yel.	5. 6.	N. Amer.	1827.	H. T. ———
Picea. w.	Silver Fir.	solit. flat, notch. Con. obt.	yel.	5.	German.	1603.	H. T. ———
Pináster. w.	cluster.	in 2's, elon. Cones ov. sess.	yel.	4. 5.	S. Europ.	1596.	H. T. ———
Púngens. Ph.	pungent.	in 2's, short, acut.	yel.	—	N. Amer.	1804.	H. T. ———
esinosa.	Pitch.	in 2's. Cones ov.	yel.	5.	—	1756.	H. T. ———
fgensis.	Rigo.	in 2's, lin. obliq.	yel.	S. Europ.	1824.	H. T. ———
ígida.	rigid.	tern. Cones ov.	yel.	5. 6.	N. Amer.	1739.	H. T. ———
úbra. Ph.	Red Spruce.	sing. awl-sh. Cones ov. obt.	yel.	5.	—	1755.	H. T. ———
erotina. Ph.	late.	tern. elong. Cones ov. obt.	yel.	5. 6.	—	1713.	H. T. ———
ibérica.	Siberian.	lin. flat, lau. ben.	yel.	—	Siberia.	1823.	H. T. ———
tróbus. w.	Weymouth.	quin. slen. Cones pend.	yel.	4.	N. Amer.	1705.	H. T. ———
pectábilis. D. P.	purple-coned.	lin. sing. flat, apex notch.	yel.	5.	Nepal.	1825.	H. T. ———
ylvéstris.	Scotch.	in 2's, rigid, glau.	yel.	—	Scotland.	H. T. ———
'a'da. Ph.	Frankincence.	elong. Cones ov. 4-in. lon.	yel.	—	N. Amer.	1713.	H. T. ———
axifólia. Ph.	Yew-leaved.	single, flat, erect.	yel.	—	—	1822.	H. T. ———
ncináta. DC.	hooked-leaved.	in 2's, elon. Cones ov. obl.	yel.	—	Pyreee.	1820.	H. T. ———
ariábilis.	variable-leav'd.	2-3. Cones ovate.	yel.	—	N. Amer.	1739.	H. T. ———

'ARIX, LARCH. Male anth. 2-celled. Fem. scales imbr. in round cone. Stig. cupped, glandular.

uropæa.	European.	crowd. dec. Con. ov. obl.	ye. re.	3. 4.	German.	1629.	H. T. ———
Pinus Lárix.							
icrocárpa. w.	red.	crowd. decid.	ye. re.	5.	N. Amer.	1760.	H. T. ———
éndula.	black.	in clusters, lin. glau.	ye. re.	—	—	1739.	H. T. ———

'EDRUS, CEDAR. Cones turbin. ov. Scales lamellif. Seed small, cuneate, coat coria.

eadára. Rox.	Deodara.	inclus. acu. 3-sid. Con. ov. obt.		5.	Nepal.	1822.	H. T. ———
ibani.	Cedar of Lebanon.	lin. acer. crowd. Cone ov.	yel.	—	Levant.	1683.	H. T. ———
Pinus Cédrus.							

'RECA, CABBAGE-TREE. Male cal. 3-part. Pet. 3. Stam. 6. Fem. nect. 6-toothed. Sty. 3, short.

úmilis. w.	dwarf.	Fron. pin. lea. cunea. trun.	st.	E. Ind.	1814.	S. S. ———
erácea. w.	esulent.	Fron. pinn. leaf. lin. acut.	st.	W. Ind.	1656.	S. S. ———

'ATROPHA, PHYSIC-NUT. Cal. 5-par. Masc. Sta. 10. Fem. Ger. 1. Sty. 3. Stig. 3. Cap. 3-seed.

úrcas. L.	angular-leaved.	cord. angul.	gr.	5. 8.	S. Amer.	1731.	S. S. Peat & loam.
ssypifólia. L.	cotton-leaved.	cord. 5-lob. serr. cil.	sc.	—	W. Ind.	1690.	S. S. cuttings.
erbácea. L.	herbaceous.	3-lob. Stem herbac.	wh.	V. Cruz.	1756.	S. S. ———
ánihot. L.	Cassava.	5-lob. segm.	gr.	7. 8.	S. Amer.	1739.	S. S. ———
ultif'da. L.	multifid.	multipart. segm. pinn.	sc.	—	1696.	S. S. ———
ens. L.	stinging.	cord. 5-lob. ent.	wh.	5. 7.	Brazil.	1690.	S. S. ———

ROTON, CROTON. Male cal. 5-tooth. Cor. of 5 pet. Fem. cal. 5-leav. Cor. 0. Sty. 3-fid. Cap. 3-cell.

mentósum. Lk.	downy.	orb. cor. obt. down. ben.	w. gr.	7. 8.	E. Ind.	1823.	S. S. Sandy loam &
riegátum. w.	variegated.	lan. smth. ent. varieg.	gr.	6. 9.	—	1804.	S. S. peat, cutt.

ODIÆUM, CODIÆUM. Masc. cal. 5-clef. Pet. 5. Sta. man. Fem. cal. 5-clef. Pet. 0. Stig. 3. Ger. 0.

ctum. B.M.	painted.	cord. obl. varieg. shin.	gr.	7. 9.	E. Ind.	1820.	S. S. ———
Cróton píctum. B.C.							

Systematic Name.	English Name.	Form of Leaves, &c.	Col. of Flow.	Month of Fl.	Native Country.	Yr. of Intro.	Soil and Propagation
R'ICINUS, PALMA-CHRISTI. Male cal. 5-part. Fem. cal. 3-part. Sty. 3-fid. Caps. 3-cell. & 3-seed.							
commúnis. w.	Castor-oil-plant. palm.	pelt. segm. lanc.	gr.	7. 8.	E. Ind.	1548.	H. A. Rich loam
inermis. w.	smooth-capsul'd. pelt. palm.	lobesserr.	pur.	—	—	1758.	G. S. seeds & cut
[1-celled nu							
PODOCA'RPUS, PODOCA'RPUS. Male cal. leaf. of the bud imbr. Anth. 2-celled. Fem. catk. an o							
elongátus. p. s.	African.	lanc. Br. whorled.	yel.	5. 7.	China.	1774.	H. S. Sandy loa
macrophy'llus.	long-leaved.	lanc. remote.	yel.	7. 8.	—	1804.	G. S. and peat.
nucifera.	Nut-bearing.	sing. lin. cuspid.	yel.	2. 4.	—	1764.	G. S. cuttings.
PHYLLA'NTHUS, PHYLLA'NTHUS. Male cal. 5-6-part. Fem. fl. the same. Sty. 3. Caps. 3-cell.							
polyphy'llus. w.	many-leaved.	pinn. florifer. leaf. lin.	gr.	7. 9.	E. Ind.	1805.	S. S. —
turbinátus. B. M.	turbinate.	alt. ov. orbic. ent.	gr.	—	China.	...	S. S. —
]Caps. 3-celle							
STILLINGIA, STILLINGIA. Male cal. round, many-fl'd. Cor. tubul. Fem. cal. 1-fl'd. Sty. 3-bifid.							
ligustrína. w.	Privet-leaved.	lanc. ent. atten. at ends.	st.	7. 8.	N. Amer.	1822.	G. S. —
STERCULIA, STERCULIA. Cal. 5-6-parted. Cor. 0. Nect. 5-6-toothed. Caps. 5, of 1 cell.							
Balánghas. DC.	Crown-flow'd.	ov. alt. stalk. ent. smth.	gr. ye.	6. 8.	E. Ind.	1787.	S. S. Sandy loa
platanifólia. w.	Plane-tree-l'd.	palm. 5-lobed.	gr.	7.	China.	1757.	G. S. and leaf
versicolor.	changeable.	digit. leaf. 5, obl. hairy.	re. ye.	—	E. Ind.	1829.	S. S. mould.
Tragacántha. B. R.	Tragacanth-tree.	obl. cuspid. ent. apex 3-fid.	st.	5. 6.	S. Leon.	1822.	S. S. cuttings.
[barren. Sty. 3-clef							
CUCUMIS, CUCUMBER. Mas. cal. 5-toothed. Cor. 5-parted. Stam. 3. Fert. cal. & cor. the same as i							
Angúria. w.	round-prickly.	palm. sinuat. Fr. echin.	ye.	7. 9.	Jamaica.	1692.	H. A. —
THU'JA, ARBOR-VITÆ. Male cal. imbr. Cal. a scale. Fem. cal. scale 2-fl'd. Cor. 0. Nect. 1.							
articuláta.	jointed.	imbr. lan. acu. Br. compr.	yel.	2. 5.	Barbary.	1815.	F. S. —
cupressóides. L.	African.	imbr. obl. Br. round.	yel.	—	C. B. S.	1797.	G. S. —
occidentális. w.	American.	imbr. ov. tub. Br. 2-edg.	yel.	5.	N. Amer.	1596.	H. S. —
orientális. L.	Chinese.	imbr. in 4 rows, ov. rhomb.	yel.	2. 3.	China.	1752.	H. S. —
CUPRE'SSUS, CYPRESS. Male catk. imbr. Cal. a scale. Cor. 0. Fem. cal. scale 1-fl'd. Cor. 0. Stig. 3.							
dísticha. L.	deciduous.	2-ranked, lin. spread.	yel.	4. 5.	America.	1640.	H. T. Sandy loa
péndula. Th.	pendulous.	imbric. glau. keeled.	yel.	—	Japan.	1818.	F. S. cuttings,
sempervirens. w.	evergreen.	imbric. obt. convex.	yel.	—	Candia.	1541.	H. S. or seeds.
β stricta.	upright.						—
thyóides. L.	white Cedar.	ov. imbric. Br. compr.	yel.	—	N. Amer.	1736.	H. S. —
[Caps. 2-celled, with 1 seed in each							
OMALA'NTHUS, OMALA'NTHUS. Mas. perian. 2-lob. Stam. 3-6, united at base. Fem. sty. 2-par							
populifólia. B. M.	Poplar-leaved.	alt. rhomb. ov. ent. smth.	wh.	6.	N. Holl.	1825.	G. S. —

CLASS XXII.

DICECIA. *Stamens & Pistils in separate flowers, & on different plants.*

ORDER I.

MONANDRIA. STAMEN 1.

Systematic Name.	English Name.	Form of Leaves, &c.	Col. of Flow.	Month of Fl.	Native Country.	Yr. of Introd.	Soil and Propagation.
[<i>Drupe simple, or compound.</i>							
PANDA'NUS, SCREW-PINE. <i>Male cal. 0. Cor. 0. Anth. cuspidate. Fem. cal. and cor. 0. Sty. bifid.</i>							
amaryllifolius. Rox.	Amaryllis-l'd.	lanc. ent.	wh.	E.	Ind.	1820.	S. T. Rich sandy
odoratissimus. w.	sweetest-scented.	lin. lanc. spiny.	wh.	—	—	1771.	S. T. loam, cutt.

ORDER II.

DIANDRIA. STAMENS 2.

[*Caps. 1-cell. 2-valv. Stig. 2. Seeds comose.*]

SALIX, WILLOW. *Male fl. Scales of the catk. 1-fl'd, imbr. Stam. 1-5. Fem. fl. Scales 1-fl'd, imbric.*

acuminata. E.B.	large-leaved.	obl. lan. glau. pub. ben.	Ger. hairy.	gr. ye.	4.	Britain.	H. S.
adscendens. E.B.	ascending.	elli. sub-ent. glau. silk. ben.	Ger. pub.	g. ye.	4. 5.	England.	H. S.
ægyptiaca.	Egyptian.	ellip. dent. obl. glau. & hairy ben.	g. ye.	—	—	Egypt.	G. S.
alaternoides. s.w.	Alaternus-l'd.	ellip. lanc. serr. silky.	Ger. silky.	gr. ye.	—	Switzerl.	1824.	H. S.
álba. E.B.	common white.	ellip. lanc. serr. silky.	Ger. smth.	gr. ye.	—	Britain.	1813.	H. T.
alpína.	Alpine.	obov. ellip. ent. glau. hairy ben.	gr. ye.	—	—	—	H. S.
amœ'na. Borr. Mss.	pleasant.	ellip. lanc. glauc. smth. serr.	g. ye.	—	—	—	H. S.
ambigua. B.F.	ambiguous.	obov. sub-serr. pub.	Ger. silky.	gr. ye.	4.	—	H. S.
amygdalina. E.B.	Almond-leaf'd.	ov. serr. smth. branch furr.	Ger. smth.	g. ye.	—	—	H. T.
Andersoniana. E. Fl.	green-mountain.	ellip. acut. glau. ben.	Ger. smth.	gr. ye.	4. 5.	Scotland.	H. S.
annularis. s.w.	ring-leaved.	lan. acum. ser. curl'd. sm. glau.	Ger. sm. g. y.	4.	1823.	H. T.
Ansoniana. s.w.	Anson's.	ellip. acu. serr. glau. sub-hair. ben.	Ger. pub.	3. 4.	—	Switzerl.	1824.	H. S.
aquatica. E. Fl.	water.	obo. elli. ser. down. & sub-glau. ben.	Ger. sil. y.	4.	—	Britain.	H. T.
angustifolia. B.F.	narrow-leaved.	lin. lan. acut. glau. ben. sub-silky.	Ger. silk.	—	—	Scotland.	H. S.
arbuscula. E. Fl.								
arenaria. E.B.	downy-mountain.	ov. acut. sub-ent. down. ben.	Ger. vill.	g. ye.	5. 6.	—	H. S.
argentea. E.B.	silky-silvery.	ellip. ent. apex recurv. silk. ben.	Ger. silk. y.	5.	—	Britain.	H. S.
arbuscula. s.w. 275.	Little-tree.	ellip. lanc. serr. smth. abo.	Ger. silk.	g. y.	—	Switzerl.	1828.	H. S.
atropurpurea. s.w. dk.	purp.-bran.	ov. serr. glau. & sub-hairy ben.	gr. ye.	4.	—	—	1824.	H. T.
atrovirens. s.w.	dark-green.	ov. acu. sub-cor. serr. nearl. smth.	Ger. vill.	—	—	—	—	H. S.
aurita. E. Fl.	round-eared.	serr. obov. obt. hairy.	Ger. silky.	gr. ye.	4. 5.	Europe.	1820.	H. T.
australis. s.w.	southern.	elli. acu. serr. glau. sub-hair.	Ger. smth. g. y.	—	—	Switzerl.	1824.	H. S.
babylonica. Willd.	weeping.	lanc. acum. serr. glau.	Ger. smth.	gr. st.	4.	Levant.	1692.	H. T.
berberifolia. s.w.	Barberry-l'd.	obo. smth. shin. deeply serr.	Ger. smth. g. y.	—	—	Davuria.	1824.	H. S.
bicolor. Ehrh.	two-coloured.	ellip. glau. pubes. nearly entire.	gr. ye.	5.	—	Hercynia.	1820.	H. S.
Bonplandiana. s.w.	Bonpland's.	lin. lanc. dent. smth. glau.	Ger. smth.	br.	4. 5.	Mexico.	1821.	G. S.
Borreriana. E. Fl.	dark-upright.	lanc. serr. smth. glau.	Ger. smth.	gr. st.	5.	Scotland.	H. S.
candida. s.w.	white.	lin. lanc. vill. on both sides.	r. st.	4. 5.	—	N. Amer.	1811.	H. S.

Systematic Name.	English Name.	Form of Leaves, &c.	Col. of Flow.	Month of Fl.	Native Country.	Yr. of Intro.
càprea. E. B.	great round-l'd.	ov. serr. vill. ben. <i>Ger.</i> silky.	<i>gr. ye.</i>	4. 5.	Britain. H. \mathcal{C} .
carináta. E. B.	folded-leaved.	ov. dent. smth. <i>Ger.</i> sess. vill.	<i>gr. ye.</i>	—	Scotland. H. \mathcal{S} .
carpinifolia. s. w.	horn-beam-l'd.	ov. acu. serr. sub-hair. <i>Ger.</i> smth.	<i>gr. ye.</i>	3. 4.	Switzerl.	1824. H. \mathcal{C} .
cinérea. E. Fl.	grey-Sallow.	obov. lanc. serr. vill. <i>Ger.</i> hairy.	<i>gr. ye.</i>	5.	Britain. H. \mathcal{C} .
<i>β variegata. s. w.</i>	<i>variegated-l'd.</i>	<i>gr. ye.</i>	—	— H. \mathcal{C} .
cœrúlea. E. B.	blue.	lanc. serr. gland. silky. <i>Ger.</i> vill.	<i>gr. ye.</i>	4. 5.	England. H. \mathcal{C} .
conformis. s. w.	uniform-leaved.	lanc. serr. smth. glauc. <i>Ger.</i> vill.	<i>gr. ye.</i>	2. 3.	Russia.	1818. H. \mathcal{S} .
cordáta. s. w.	heart-shaped.	ov. lan. cord. at bas. serr. <i>Ger.</i> smth.	<i>gr. ye.</i>	4. 5.	N. Amer.	1811. H. \mathcal{S} .
cordifolia. s. w.	heart-leaved.	ov. acut. ent. cord. at base.	<i>gr. ye.</i>	—	—	— H. \mathcal{S} .
coriácea. s. w.	coriaceous-l'd.	ellip. obov. dent. pubes. <i>Ger.</i> vill.	<i>gr. ye.</i>	3.	Switzerl.	1822. H. \mathcal{C} .
cotinifolia. E. B.	Quince-leav'd.	ellip. orbic. dent. glauc. pub. <i>Ger.</i> vill.	<i>gr. ye.</i>	4.	Britain.	1820. H. \mathcal{S} .
crassifolia. s. w.	thick-leaved.	ov. ellip. serr. pubes. <i>Ger.</i> smth.	<i>gr. ye.</i>	4. 5. H. \mathcal{S} .
críspa. s. w.	crisped-leaved.	ov. lanc. crisped, glauc. retic.	<i>gr. st.</i>	3. H. \mathcal{S} .
Croweána. E. Fl.	Mr. Crowe's.	ellip. serr. smth. glauc. <i>Ger.</i> vill.	<i>gr. ye.</i>	4. 5.	England. H. \mathcal{S} .
damascéna. s. w.	Damson-leav'd.	ellip. serr. glauc. sub-hairy. <i>Ger.</i> smth.	<i>gr. ye.</i>	3. 4.	Switzerl.	1821. H. \mathcal{C} .
Davalliána. Br. Fl.	Davallian.	obo. lan. serr. smth. glauc. <i>Ger.</i> vill.	<i>br. st.</i>	4.	Scotland. H. \mathcal{S} .
decipiens. E. B.	white Welsh.	lanc. serr. smth. <i>Ger.</i> smth.	<i>gr. ye.</i>	5.	England. H. \mathcal{C} .
decumbens. s. w.	decumbent.	lin. lan. sub-dent. silky. <i>Ger.</i> vill.	<i>gr. ye.</i>	—	Switzerl.	1823. H. \mathcal{S} .
Dicksoniána. E. B.	broad-l'd.-mount.	ellip. acut. dent. glauc. <i>Ger.</i> vill.	<i>gr. ye.</i>	—	Scotland. H. \mathcal{S} .
díscolor. s. w.	two-coloured.	ov. lanc. serr. smth. glauc. <i>Ger.</i> vill.	<i>gr. ye.</i>	4.	N. Amer.	1811. H. \mathcal{S} .
Doniána. Br. Fl.	rusty-branched.	obov. lanc. serr. pubes. <i>Ger.</i> silky.	<i>gr. ye.</i>	4. 5.	Scotland. H. \mathcal{S} .
dúra. s. w.	hardy.	ellip. dent. glauc. pubes.	<i>gr. ye.</i>	—	Switzerl.	1824. H. \mathcal{C} .
elaëgnifolia. s. w.	elaëgnus-lv'd.	ov. ellip. woolly. <i>Ger.</i> vill.	<i>gr. ye.</i>	4. 8.	—	1823. H. \mathcal{S} .
falcáta. s. w.	sickle-leaved.	lin. lanc. serr. smth.	<i>gr. ye.</i>	4. 5.	N. Amer.	1811. H. \mathcal{S} .
ferrugínea. s. w.	ferruginous.	obov. lanc. vill. <i>Ger.</i> silky.	<i>br. st.</i>	4.	Britain. H. \mathcal{C} .
fírma. s. w.	firm-leaved.	ellip. obt. serr. glauc. <i>Ger.</i> sub-vill.	<i>gr. ye.</i>	3. 4.	Switzerl.	1824. H. \mathcal{C} .
floribúnda. s. w.	many-flow'r'd.	ellip. serr. shin. smth. glauc.	<i>gr. ye.</i>	4. 7.	Britain. H. \mathcal{S} .
Forbyána. E. Fl.	fine-bask. Osier.	lanc. obo. serr. smth. glauc. <i>Ger.</i> vill.	<i>gr. ye.</i>	4.	England. H. \mathcal{S} .
Forsteriána. E. Fl.	glaucous-mount.	ellip. obl. acut. pubes. <i>Ger.</i> vill.	<i>gr. ye.</i>	4. 5.	Scotland. H. \mathcal{S} .
frágilis. E. Fl.	crack.	ov. lan. point. serr. smth. <i>Ger.</i> smth.	<i>gr. ye.</i>	—	Britain. H. \mathcal{C} .
fúsa. E. B.	brownish-dwarf.	elli. obl. acut. glauc. silk. <i>Ger.</i> sub-vill.	<i>gr. st.</i>	5.	— H. \mathcal{S} .
gemináta. s. w.	twin-flowering.	obov. lanc. serr. pubes.	<i>gr. ye.</i>	3.	— H. \mathcal{S} .
glauca. E. Fl.	glaucous-leav'd.	ellip. lan. woolly. sub-ent. <i>Ger.</i> vill.	<i>gr. ye.</i>	5.	Scotland. H. \mathcal{S} .
Grisónénsis. s. w.	Grison-Sallow.	ellip. lan. nearly smth. serr. <i>Ger.</i> vill.	<i>gr. ye.</i>	3. 4.	Grisons.	1820. H. \mathcal{C} .
grisophýlla. s. w.	grey-head.-Sall.	ellip. acut. dent. vill. ben.	<i>gr. ye.</i>	4.	Switzerl.	1824. H. \mathcal{C} .
hastáta. s. w.	halberd-leaved.	ov. sub-cord. smth. serr. <i>Ger.</i> smth.	<i>gr. ye.</i>	5.	Lapland.	1780. H. \mathcal{S} .
Hélix. E. B.	rose.	obl. lanc. serr. smth. <i>Ger.</i> vill.	<i>gr. ye.</i>	3. 4.	Britain. H. \mathcal{S} .
herbácea. E. B.	least.	orbic. cren. shin. smth. <i>Ger.</i> smth.	<i>gr. ye.</i>	6.	— H. \mathcal{S} .
hírta. Br. Fl.	hairy-bran.-Sall.	ellip. cord. cren. downy. <i>Ger.</i> vill.	<i>gr. ye.</i>	4. 5.	England. H. \mathcal{C} .
Hoffmanniána. B. Fl.	Hoffman's.	ov. obl. serr. smth. <i>Ger.</i> smth.	<i>gr. ye.</i>	5.	— H. \mathcal{C} .
holoseríceá. w.	silky-leaved.	lanc. flat, vill. <i>Ger.</i> silk.	<i>g. ye.</i>	—	Switzerl. H. \mathcal{C} .
<i>Micheliána. s. w.</i>						
Houstoniána. s. w.	Houston's.	lin. lanc. serr. smth. <i>Ger.</i> smth.	<i>gr. ye.</i>	4. 5.	America.	1812. H. \mathcal{S} .
Humboldtiana. s. w.	Humboldt's.	lin. acum. serr. smth. <i>Ger.</i> smth.	<i>bl.</i>	Peru.	1821. G. \mathcal{S} .
helvética. s. w.	Swiss.	ov. acu. serr. glauc. vill. ben. <i>Ger.</i> silk.	<i>gr. ye.</i>	4. 8.	Switzerl.	1824. H. \mathcal{C} .
incána. s. w.	hoary-leaved.	lin. acut. serr. vill.	<i>gr. ye.</i>	4.	Europe.	1820. H. \mathcal{S} .
incanescens. s. w.	whitish-l'd.-Sall.	ellip. obov. serr. pub. <i>Ger.</i> downy.	<i>gr. ye.</i>	3. 4.	Switzerl.	1823. H. \mathcal{C} .
incubácea. s. w.	trailing-silky.	elli. lan. glauc. & silk. ben. <i>Ger.</i> vill.	<i>bh. ye.</i>	5.	Britain.	1775. H. \mathcal{S} .
Kitaibeliána. s. w.	Kitaibel's.	obov. smth. ent. notch. <i>Ger.</i> smth.	<i>gr. ye.</i>	4. 8.	Carpath.	1816. H. \mathcal{S} .
lacústris. s. w.	lake-Sallow.	ellip. serr. vill. glauc. <i>Ger.</i> smth.	<i>gr. ye.</i>	3.	Switzerl.	1824. H. \mathcal{S} .
Lambertiána. E. Fl.	Lambert's.	lanc. serr. smth. <i>Ger.</i> pubes. sess.	<i>gr. ye.</i>	3. 4.	England. H. \mathcal{S} .
lanáta. Br. Fl.	woolly broad-l'd.	orbic. ov. hairy. glauc. <i>Ger.</i> smth.	<i>gr. ye.</i>	3. 4.	Scotland.	1823. H. \mathcal{S} .

Systematic Name.	English Name.	Form of Leaves, &c.	Col. of Flow.	Month of Fl.	Native Country.	Yr. of Introd.	
<i>laurina</i> . Br. Fl.	shin. dark-green.	ellip. obl. acut. serr. <i>Ger.</i> silky.	<i>gr. ye.</i>	4. 5.	England.	H. ♀.
<i>bicolor</i> . E. Fl.							
<i>lanceolata</i> . E. Fl.	sharp-leaved.	lanc. serr. smth. <i>Ger.</i> smth.	<i>gr. ye.</i>	—	—	H. ♀.
<i>Lappónum</i> . s. w.	Lapland.	ellip. lanc. woolly. <i>Ger.</i> vill.	<i>gr. ye.</i>	4.	Lapland.	H. ♀.
<i>latifolia</i> . s. w.	broad-leaved.	broadly ellip. dent. <i>Ger.</i> silky.	<i>gr. ye.</i>	3.	Switzerl.	1824.	H. ♀.
<i>linearis</i> . s. w.	linear-leaved.	lin. vill. dent.	<i>br. st.</i>	4. 5.	—	1820.	H. ♀.
<i>lúcida</i> . s. w.	shining-leaved.	ov. serr. smth. shin.	<i>gr. ye.</i>	5.	N. Amer.	1811.	H. ♀.
<i>Lyóni</i> . s. w.	Lyon's.	lanc. elong. smth. serr. shin.	<i>gr. ye.</i>	4. 5.	Switzerl.	1816.	H. ♀.
<i>macrostipulacea</i> . s. w.	large-stipul'd.	ellip. lanc. serr. glau. <i>Ger.</i> smth.	<i>gr. ye.</i>	—	—	1822.	H. ♀.
<i>mayifolia</i> . E. Fl.	apple-leaved.	ellip. und. smth. glau. <i>Ger.</i> smth.	<i>gr. ye.</i>	4.	England.	H. ♀.
<i>Meyeriana</i> . s. w.	Meyer's.	ov. ellip. smth. shin. serr.	<i>g. st.</i>	4. 5.	German.	1823.	H. ♀.
<i>Woolgariana</i> . Br. Fl.	Woolgar's.	obov. lanc. serr. smth. <i>Ger.</i> vill.	<i>gr. ye.</i>	4.	Switzerl.	1822.	H. ♀.
<i>monandra</i> . Hoff.							
<i>montana</i> . s. w.	mountain.	lanc. smth. glau. hairy, ben. <i>Ger.</i> smth.	<i>g. y.</i>	3. 4.	Europe.	H. ♀.
<i>Monspelienfis</i> . s. w.	Montpelier's.	ellip. lanc. smth. shin. serr.	<i>gr. ye.</i>	5. 6.	Montpeli.	H. ♀.
<i>Muhlenbergiana</i> .	Muhlenberg's.	lanc. sub-ent. vill.	<i>gr. ye.</i>	4. 5.	N. Amer.	H. ♀.
<i>mutabilis</i> . s. w.	changeable.	ellip. serr. pubes. glau. <i>Ger.</i> vill.	<i>re. ye.</i>	4.	Switzerl.	1811.	H. ♀.
<i>myrsinifles</i> . E. B.	green whorl-l'd.	ellip. serr. smth. <i>Ger.</i> vill.	<i>gr. ye.</i>	3. 4.	Scotland.	1824.	H. ♀.
<i>myrtilloides</i> . s. w.	bilberry-leav'd.	ellip. ent. smth. glau. <i>Ger.</i> vill.	<i>gr. ye.</i>	4. 6.	—	H. ♀.
<i>nigra</i> . s. w.	dark American.	ov. lanc. serr. smth. <i>Ger.</i> smth.	<i>br. ye.</i>	4. 8.	N. Amer.	1772.	H. ♀.
<i>nigricans</i> . Br. Fl.	dark broad-l'd.	ellip. lanc. acut. cren. smth. <i>Ger.</i> vill.	<i>gr. ye.</i>	5.	England.	1811.	H. ♀.
<i>nifens</i> . Br. Fl.	shining-leaved.	ellip. acut. serr. shin. glau.	<i>gr. ye.</i>	4.	—	H. ♀.
<i>obovata</i> . s. w.	obovate-leaved.	obov. ent. silky, ben. smth. above.	<i>gr. ye.</i>	4. 5.	Scotland.	H. ♀.
<i>oleifolia</i> . E. B.	olive-leaved.	obov. lanc. dent. <i>Ger.</i> downy.	<i>gr. ye.</i>	3.	Britain.	H. ♀.
<i>pállida</i> . s. w.	pale.	obov. lanc. serr. vill. <i>Ger.</i> silky.	<i>gr. ye.</i>	5.	Switzerl.	1824.	H. ♀.
<i>pannosa</i> . s. w.	cloth-leaved.	ellip. obov. serr. vill. <i>Ger.</i> silky.	<i>gr. ye.</i>	4. 5.	—	—	H. ♀.
<i>parvifolia</i> . E. Fl.	small-leaved.	ellip. sub-ent. glau. silky. <i>Ger.</i> vill.	<i>gr. ye.</i>	—	England.	H. ♀.
<i>pátens</i> . s. w.	spread-branch.	ellip. acut. smth. glau. <i>Ger.</i> vill.	<i>gr. ye.</i>	5. 8.	H. ♀.
<i>Pennsylvánica</i> . s. w.	Pennsylvanian.	lanc. serr. silky, silvery.	<i>gr. ye.</i>	3. 4.	Pennsyl.	1811.	H. ♀.
<i>pentandra</i> . E. B.	bay-leaved.	ov. acut. cren. shin. gland. <i>Ger.</i> smth.	<i>gr. ye.</i>	5. 6.	Britain.	H. ♀.
<i>petraea</i> . s. w.	rook-swallow.	ellip. obl. serr. sub-hairy. <i>Ger.</i> smth.	<i>gr. ye.</i>	4.	—	H. ♀.
<i>petiolaris</i> . Br. Fl.	dark long-lv'd.	lanc. serr. smth. glau. <i>Ger.</i> vill.	<i>br. st.</i>	—	N. Amer.	H. ♀.
<i>phylicifolia</i> . E. Fl.	Tea-leaved.	ellip. lanc. serr. wavy. glau. <i>Ger.</i> vill.	<i>gr. ye.</i>	5.	Scotland.	H. ♀.
<i>poláris</i> . s. w.	polar.	orbic. serr. smth. shin. glau. <i>Ger.</i> silky. <i>gr. y.</i>	4. 7.	Lapland.	1824.	H. ♀.
<i>Pomeránica</i> . s. w.	Pomeranian.	lanc. serr. glau. smth. <i>Ger.</i> smth.	<i>gr. ye.</i>	3. 5.	Pomera.	1816.	H. ♀.
<i>Pontederána</i> . s. w.	Pontederá's.	ellip. serr. smth. glau. <i>Ger.</i> vill.	<i>gr. ye.</i>	5.	German.	1818.	H. ♀.
<i>præcox</i> . s. w.	early-flowering.	broad. lanc. serr. glau. smth. <i>Ger.</i> smth.	<i>g. y.</i>	2. 3.	Europe.	H. ♀.
<i>prinoides</i> . s. w.	winter berry-l'd.	ov. obl. serr. glau. smth. <i>Ger.</i> vill.	<i>gr. ye.</i>	3. 4.	N. Amer.	1811.	H. ♀.
<i>prostrata</i> . E. Fl.	early-prostrate.	ellip. obl. dent. glau. silky. <i>Ger.</i> vill.	<i>gr. ye.</i>	5.	Britain.	H. ♀.
<i>proteafolia</i> . s. w.	protea-leaved.	ellip. ent. vill. <i>Ger.</i> silky.	<i>gr. ye.</i>	4. 5.	Switzerl.	1820.	H. ♀.
<i>procumbens</i> . s. w.	procumbent.	ellip. orbic. serr. smth. shin. <i>Ger.</i> vill.	<i>gr. ye.</i>	5.	Scotland.	H. ♀.
<i>propinqua</i> . E. B.	flat-leaved.	ellip. cren. sub-pub. <i>Ger.</i> silk. at apex.	<i>g. y.</i>	—	—	H. ♀.
<i>prunifolia</i> . E. Fl.	plum-leaved.	ov. serr. smth. glau. <i>Ger.</i> vill.	<i>gr. ye.</i>	4. 5.	Scotland.	H. ♀.
<i>purpúrea</i> . E. Fl.	bitter-purple.	obo. lanc. serr. smth. <i>Ger.</i> vill.	<i>gr. ye.</i>	3.	England.	H. ♀.
<i>Phillyræfolia</i> . E. B.	Phillyrea-l'd.	ellip. lanc. acut. at each end. <i>Ger.</i> smth.	<i>g. y.</i>	—	—	H. ♀.
<i>ramifúsa</i> . s. w.	brown-branch'd.	ellip. acut. serr. shin. smth. glau.	<i>gr. ye.</i>	4. 7.	Britain.	H. ♀.
<i>refléxa</i> . s. w.	reflexed-flow'd.	lanc. dent. old leaves glau. & smth. <i>Ger.</i> vill.	3.	H. ♀.
<i>répens</i> . E. B.	common dwarf.	ellip. lanc. glau. silky. <i>Ger.</i> vill.	<i>br. ye.</i>	5.	Britain.	H. ♀.
<i>reticulata</i> . E. Fl.	wrinkled.	orbic. obt. ent. glau. reticul. <i>Ger.</i> vill.	<i>re.</i>	6. 7.	—	H. ♀.
<i>retúsa</i> . s. w.	blunt-leaved.	obov. ent. smth. shin. <i>Ger.</i> smth.	<i>gr. ye.</i>	4. 8.	Italy.	1763.	H. ♀.
<i>rígida</i> . s. w.	stiff-leaved.	ellip. lanc. rigid. smth. <i>Ger.</i> smth.	<i>gr. ye.</i>	4. 5.	N. Amer.	1811.	H. ♀.
<i>rivuláris</i> . s. w.	river.	ellip. smth. glau. pubes. <i>Ger.</i> sub-vill.	<i>gr. ye.</i>	5.	Switzerl.	1824.	H. ♀.

Systematic Name.	English Name.	Form of Leaves, &c.	Col. of Flow.	Month of Fl.	Native Country.	Yr. of Introd.
rosmarinifolia. Br. Fl.	Rosemary-ld.	lin. lanc. ent. silky.	Ger. silky.	gr. ye. 4. 5.	Britain. H. S.
rotundata. s. w.	round-leaved.	orbic. serr. glau. sub-hairy.	Ger. smth.	g. y. —	Switzerl.	1824. H. C.
rubra. Br. Fl.	green-leaved.	lin. lanc. serr. smth.	Ger. silky.	gr. ye. —	England. H. S.
rupestrís. Br. Fl.	silky-rock.	obov. acut. serr. pubes.	Ger. vill.	gr. ye. 4.	Scotland. H. S.
Russelliána. E. B.	Bedford.	lanc. serr. smth.	Ger. smth.	gr. ye. 4. 5.	England. H. C.
Schleicheriána. s. w.	Schleicher's.	ellip. lanc. serr. glau. pubes.	Ger. smth.	g. y. —	Switzerl.	1824. H. C.
sericea. s. w.	silky-leaved.	ellip. lanc. silky.	Ger. vill.	wh. ye. 5.	Alps Eur.	1816. H. S.
serpyllifolia. s. w.	Thyme-leaved.	ov. lanc. acut. ent. smth.	Ger. smth.	gr. ye. 4. 8.	Switzerl.	1818. H. S.
Smithiána. Br. Fl.	silky-leaved.	lanc. acut. dent. downy.	Ger. silky.	gr. ye. 3. 4.	England. H. S.
sordida. s. w.	sordid.	ellip. lanc. serr. pubes.	glau.	g. st. 4.	Switzerl.	1820. H. C.
sphacelata. Br. Fl.	withered point'd.	ellip. obov. ent. serr. down.	Ger. vill.	gr. ye. 4. 5.	Scotland. H. C.
stipularis. Br. Fl.	auricled.	lanc. cren. wavy. pubes.	Ger. vill.	gr. ye. 3.	Britain. H. C.
strépida. s. w.	creaking.	obov. ellip. glau. dent. pubes.	Ger. vill.	g. y. 3. 4.	Switzerl.	1820. H. C.
Stuatiána. E. B.	small-leaved.	ov. lanc. acut. silky.	Ger. vill.	w. ye. 7. 8.	Scotland. H. S.
sub-alpína. s. w.	sub-alpine.	ellip. lanc. sub-ent. vill. & white.		gr. ye. 4. 5.	Switzerl.	1824. H. S.
tenuifolia. E. Fl.	thin-leaved.	ellip. acut. serr. smth. glau.	Ger. vill.	gr. ye. 5. 6.	Britain. H. S.
tetrápila. E. Fl.	four-ranked.	ellip. obl. serr. glau.	Ger. smth.	gr. ye. 4.	Scotland.	— H. S.
tetrasperma. s. w.	four-seeded.	obl. lanc. serr. smth. glau.	Ger. smth.	g. y. —	E. Ind.	1796. S. S.
tenuior. E. B.	slenderer.	obo. lan. acut. cren. smth. glau.	Ger. vill. g. y. —		Britain. H. S.
triándra. Br. Fl.	long-ld. triandro.	lin. obl. lanc. serr. smth.	Ger. smth.	gr. ye. 5. 8.	— H. S.
trístis. s. w.	dark.	lin. lanc. ent. smth. obov. pubes. ben.		gr. ye. 3. 4.	N. Amer.	1765. H. S.
ulmifolia. s. w.	elm-leaved.	ov. ellip. serr. glau. pubes.	Ger. smth.	gr. ye. 4.	Switzerl.	1820. H. C.
undulata. s. w.	wave-leaved.	lin. lanc. acum. smth. serr.	Ger. sub-vill. g. y. 4. 5.		German.	1819. H. S.
Uva-úrsi.	dark American.	spatul. obov. ent. smth.	Ger. smth.	gr. ye. —	Labrado.	1811. H. S.
vacciniifolia. E. B.	bilberry-leav'd.	ov. lanc. serr. smth. glau.	Ger. silky. gr. y. —		Scotland. H. S.
vaudénsis. s. w.	vaudois-Sallow.	ellip. serr. vill. glau. pubes.	Ger. vill.	gr. ye. 3. 4.	Switzerl.	1824. H. S.
venulosa. Br. Fl.	veiny-leaved.	ov. serr. smth. glau.	Ger. vill.	gr. ye. 4. 5.	Scotland. H. S.
versicolor. s. w.	various-color'd.	ellip. sub-dent. glau. pub.	Ger. silky. g. y. —		Switzerl.	1822. H. S.
Villarsiana. s. w.	Villar's.	ellip. apex. acut. smth. serr.	Ger. smth.	g. y. 5. 6.	S. France.	1818. H. S.
villósa. s. w.	villous-leaved.	obov. lanc. vill. serr.	Ger. silky.	gr. ye. 4. 5.	H. S.
viminális.	common.	lin. silky. wavy.	Ger. vill.	gr. ye. —	Britain. H. S.
violácea. An. Rep.	violet-coloured.	lin. lanc. smth. serr. glau.		gr. ye. 3. 4.	Russia. H. S.
viréscens. s. w.	verdant-Osier.	lin. smth. serr.	Ger. smth.	gr. ye. 4. 5.	Switzerl.	1823. H. S.
virgáta. s. w.	twiggy.	lin. lanc. smth. serr.		gr. ye. 5. 6.	H. S.
vitellina. Br. Fl.	golden-Osier.	lanc. acut. serr. smth. glau.	Ger. smth.	gr. ye. 3. 5.	England. H. C.
Weigeliána. s. w.	Weigelian.	ellip. smth. glau. serr.	Ger. vill.	gr. ye. 2. 3.	Silesia.	1820. H. S.
Willdenowiána. s. w.	Willdenow's.	ellip. lanc. dent. glau.	Ger. vill.	gr. ye. 4. 8.	H. S.
Wulfeniána. s. w.	Wulfen's.	ellip. serr. smth. sub-cord.	Ger. smth.	gr. ye. 4. 5.	Scotland. H. S.

ORDER III.

TRIANDRIA. STAMENS 3.

[Pet. 3. Berr. of 1 cell, with 9 seeds.

EMPETRUM, CROWBERRY. Barr. fl. Cal. 3-cleft. Cor. of 3 petals. Fila. 3-9. Fert. fl. Cal. 3-cleft.

álbum. w. white-berried. lin. edges revol. rough above. 4. 6. Portugal. 1774. H. S. Sandy peat.
 nígrum. E. Fl. black. lin. obl. margins recurv. gr. 4. 5. Britain. H. S. cutt. or lay.

Systematic Name.	English Name.	Form of Leaves, &c.	Col. of Month Native Flow. of Fl. Country.	Yr. of Introd.	Soil and Propagation.
[<i>Cor. 0. Nect. tubu. Berr. of 3 cells, & 2 seeds in each. Cal. of 6 uneq. leaves. Cor. 0. Fert. fl. Cal. of 6 leaves.</i>]					
RUSCUS, BUTCHER'S-BROOM. <i>Barr. fl. Cal. of 6 uneq. leaves. Cor. 0. Fert. fl. Cal. of 6 leaves.</i>					
aculeátus. B.F.	common.	ov. acut. obliq.	wh. 12.6. England.	H. S. Sandy Loam.
andrógynus.	climbing.	ov. acum. smth. ent.	yel. 4. 5. Canaries.	1713.	G. S. cl. cuttings.
Hypophyllum. w.	thick-leaved.	ov. ent. smth.	gr. yel. 5. 6. Italy.	1648.	H. S. ———
racemósus. w.	Alexand.-laurel.	ov. lanc. Raceme terminal.	gr. y. 6. Portugal.	1713.	H. S. ———
STILA'GO, STILA'GO. <i>Male cal. tubu. 3-4-tooth. Cor. 0. Stam. 2-3. Fem. 2-bifid. Drupe 1-seeded.</i>					
Búnus. w.	Laurel-leaved.	ellip. smth.	gr. 8.10. E. Indies.	1757.	S. S. Sandy loam
diándra. w.	diandrous.	ellip. ent. smth.	gr. ———	1800.	S. S. & peat. cutt.
WILLDENO'VIA, WILLDENO'VIA. <i>Male cal. of man. glum. Cor. of 6 pet. Fem. cal. cor. & nec. the same.</i>					
téres. w.	round-stalked.	Bran. round, smth.	br. 6. 8. C. B. S.	1790.	F. J. ———
ELEGIA, ELEGIA. <i>Male cal. of 6 glumes. Cor. 0. Fem. the same. Sty. 3. Caps. 6-celled.</i>					
racemósa.	racemed.	Stem chann. spath. ov. obt.	br. 4. 6. ———	1804.	F. J. ———
PHENIX, DATE-PALM. <i>Male cal. 3-part. Pet. 3. Fem. flow. the same. Sty. 1. Drupe ov. obl.</i>					
acáulis. Rotb.	stemless.	Fronds pinn. pinnæ lin. ensif.	st. E. Ind.	1820.	S. S. Loam & peat.
dactylífera. w.	common.	Fronds pinn. leaf. lin. lanc. st.	Levant. 1597.	G. S. ———
farínífera. w.	small.	Fronds pinn. leaf. lin. subu. st.	E. Ind. 1800.	S. S. ———

ORDER IV.

TETRANDRIA. STAMENS 4.

[<i>Pet. 4. Berr. of 1 cell, with 1 heart-shaped seed.</i>]					
VISCUM, MISSELTOE. <i>Barr. fl. Cal. 0. Cor. of 1 pet. 4-cleft. Stam. 4. Fert. fl. Cal. a slight border.</i>					
álbum. E.F.	common-white.	lanc. obt.; stm. forked.	ye. 5. England.	H. S. ———
[<i>of 1 cell, with 1-furrowed seed.</i>]					
HIPP'OPHAE, SEA BUCK-THORN. <i>Barr. fl. Cal. 2-cleft. Cor. 0. Fert. fl. Cal. clov. Cor. 0. Ber.</i>					
canadénsis. Nutt.	Canadian.	lin. lanc. smth. above.	gr. 4. 5. N. Amer.	1759.	H. S. ———
rhamnóides. B.F.	common.	lin. lanc. silvery ben.	gr. ———	England.
[<i>the catk. conc. Berr. of 1 cell, & 1 seed.</i>]					
MYRICA, CANDLEBERRY-MYRTLE. <i>Barr. fl. Catk. imbr. Scales conc. Cor. 0. Fert. fl. Scal. of</i>					
cerífera. w.	common.	obl. base attenuat. apex serr.	5. 6. N. Amer.	1699.	H. S. Sandy loam.
cordifólia.	heart-leaved.	sess. cord. serr.	br. 5. 7. C. B. S.	1759.	G. S. cuttings.
Gále. w.	Sweet-Gale.	lanc. serr. alt. smth.	br. 5. Britain.	H. S. ———
quercifólia.	Oak-leaved.	obl. opp. sinuat.	br. 6. 7. C. B. S.	1752.	G. S. ———
MACLU'RA, MACLU'RA. <i>Male catk. Cal. 4-cleft. Cor. 0. Sty. filiform, villous.</i>					
aurantiaca. L.P.	Osage Apple.	ov. ent. Br. spiny.	gr. 6. Missouri.	1824.	H. S. ———
BRUCEA, BRUCEA. <i>Male cal. 4-part. Pet. 4. Nect. 4-lob. Fem. caps. 4, single-seeded.</i>					
ferrugínea. w.	Ash-leaved.	pinn. leaf. ov. ellip.	st. 4. 5. Abyssini.	1775.	S. S. ———

DIECIA TETRANDRIA.

Systematic Name.	English Name.	Form of Leaves, &c.	Col. of Month Native Flow. of Fl. Country.	Yr. of Introd.	Soil and Propagator
<i>A'ULAX, A'ULAX. Male fl. racem. Cal. 0. Pet. 4. Fem. fl. Stig. obliq. Nut ventric. bearded.</i>					
pinifolia. R.Br.	pine-leaved.	filiform, chann. smth.	ye. 7. 9. C. B. S.	1780.	G. S. Sandy peat
umbellata. B.Br.	umbelled.	lin. flat, spatul.	ye. 6. 8. ———	1774.	G. S. & loam. cutt
[Seed-vessel single-seeded]					
<i>LEUCADE'NDRON, LEUCADE'NDRON. Male fl. capitate. Cal. 0. Pet. 4. Fem. fl. Stig. obliqua.</i>					
argenteum.	Silver-tree.	lanc. silky. Br. vill.	ye. 6. 7. ———	1693.	G. S. Sandy loam
buxifolium.	Box-leaved.	ov. lanc. old ones smooth.	ye. 6. 8. ———	1812.	G. S. and peat.
decurrens. L.T.	decurrent.	spat. lanc. concave.	ye. ———	——	G. S. cuttings.
grandiflorum. L.T.	large-flowered.	lanc. obl. smooth.	ye. 4. 6. ———	1789.	G. S. ———
plumosum.	feathery.	lin. lanc. obliq. smth.	ye. 6. 8. ———	1790.	G. S. ———
strictum. L.T.	upright.	lin. lanc. mucr.	yel. 4. 6. ———	G. S. ———

ORDER V.

PENTANDRIA. STAMENS 5.

<i>HUMULUS, HOP. Barr. fl. Cal. of 5 conc. leaves. Cor. 0. Filam. 5. Fert. fl. Catk. imbr. Cal. scales</i>					
Lupulus. w.	common.	3-5-lob. serr. rough.	ye. 6. 8. Britain.	H. P. cl. ———
[seeded.]					
<i>PISTA'CIA, MASTICK-TREE. Mas. cal. 5-dent. Cor. 0. Fem. cal. 3-fid. Cor. 0. Sty. 3. Berr. single-</i>					
Lentiscus.	common.	pinn. leaf. lanc. ent. smth.	pk. 5. 6. Africa.	1664.	S. S. ———
<i>ZANTHOXY'LUM, TOOTH-ACHE-TREE. Male cal. 5-part. Fem. sty. 5. Caps. 3-5, single-seed.</i>					
Clava-Herculis. w.	Lentiscus-l'd.	pinn. leaf. ov. acum.	wh. 4. 5. W. Ind.	1739.	S. S. Loam & peat.
fraxineum. w.	common.	pinn. leaf. ov. slightly serr.	gr. 3. 4. N. Amer.	1759.	H. S. cuttings.
nitidum. B.M.	shining.	pinn. leaf. obl. gland. serr.	pk. 5. China.	1822.	G. S. ———

ORDER VI.

HEXANDRIA. STAMENS 6.

<i>TAMUS, BLACK-BRYONY. Barr. fl. Cal. 0. Cor. 6-part. Stam. 6. Fert. fl. Cal. 0. Cor. in 6 segm.</i>					
communis. E. Fl.	common.	cord. ent. smth. shin. gr. wh.	5. 8. England.	H. P. ———
[hairy. Seeds reniform.]					
<i>COCCULUS, COCCULUS. Male cal. of 6 leaves. Cor. of 6 pets. Fem. cal. & cor. the same. Fr. densely</i>					
palmatus. B.M.	Palmate-leav'd.	cor. 5-7-lob. pil. lob. ent. lan. gr.	E. Ind.	S. S. cl. ———
<i>SM'LAX, SM'LAX. Masc. cal. of 6 leaves. Cor. 0. Fem. cal. of 6 leaves. Cor. 0. Sty. 3. Berr. 3-cell.</i>					
aspera. w.	rough-Bindwood.	cord. hast. dent. lan. wh. gr.	9. S. Europ.	1648.	H. S. cl. Sandy loam
australis.	oblong.	obl. acut. 5-nerv. smth. ro. gr.	5. 7. N. S. W.	1815.	G. S. cl. & leaf mould.
herbacea. B.M.	herbaceous.	ov. acum. 7-nerv.	gr. 7. N. Amer.	1669.	H. P. cl. parting
glyciphy'lla.	Botany Bay-Tea.	obl. lanc. 3-nerv. glau. wh. gr.	5. 6. N. S. W.	1815.	H. S. cl. plants, or

Systematic Name.	English Name.	Form of Leaves, &c.	Col. of Flow.	Month of Fl.	Native Country.	Yr. of Introd.	Soil and Propagation.
gláuca. B.M.	glaucous.	orbic. ov. mucr. glau.	wh.	5.	7. N.Amer.	1811. H. S. cl.	cuttings.
Sarsaparilla. w.	Medicinal.	ov. lanc. cuspid, glau.	w. gr.	7.	8. ———	1664. H. S. cl.	———
DIOSCO'RIA, DIOSCO'RIA. Male cal. 6-part. Cor. 0. Fem. sty. 3. Caps. 3-cell. compr. Seeds 2.							
aculeáta. w.	prickly.	cord. orbic. 7-nerv.	gr.	7.	9. E. Ind.	1803. S. P. cl.	Sandy soil.
bulbífera. w.	bulb-bearing.	cord. ov. acum.; stm. bulbi. gr.	——	——	——	1692. S. P. cl.	cuttings, or
satíva. w.	common.	cord. ov. cuspid.	gr.	——	W. Ind.	1733. S. P. cl.	part. roots,
villósa. w.	villous.	opp. cord. acum. vill.	re. gr.	8.	N.Amer.	1732. H. P. cl.	———
MA'BA, MA'BA. Male cal. 3-cleft. Cor. tubu. 3-fid. Fem. drupe 2-celled, cells 2-seeded.							
buxifólia. Roxb.	Box-leaved.	obov. ent. fl. hexand.	wh.	E. Ind.	1810. S. S.	———

ORDER VII.

OCTANDRIA. STAMENS 8.

[Catk. as in barren. Caps. of 1 cell, & 2 valves.

POPULUS, POPLAR. Barr. fl. Catk. many-flow. Cal. a 1-fl'd. torn scal. Cor. of 1 pet. turbi. Fert. fl.

lba. w.	Abele-tree.	cord. lob. dent. wh. ben.	fl.	3.	4. Britain.	H. T. Sandy loam.
nguláta. w.	Carolina.	cord. angul. acum. tooth. fl.	3.	Carolina.	1738.	H. T.	layers, or
alsamífera. w.	Tacamahac.	ov. acum. serr. wh. ben.	fl.	——	N.Amer.	1692.	H. T. cuttings.
ándicans. w.	white.	orb. ang. rep. tooth. hoar. ben.	——	——	——	1772.	H. T. ——
anáscens. w.	grey.	orbic. wavy, tooth. downy ben.	3.	4. England.	H. T.	——
ilatáta. w.	Lombardy.	deltoid, acum. serr. smth.	sc.	5. Italy.	1758.	H. T.	——
r'æca. w.	Athenian.	ov. orbic. serr. smth.	fl.	3.	4. Archipel.	1799.	H. T. ——
nonífera. w.	neckl.-bearing.	sub-cord. serr. smth.	fl.	3.	5. Canada.	1772.	H. T. ——
nígra. w.	black.	deltoid, serr. smth.	fl.	3.	4. Britain.	H. T. ——
rémula. E. Fl.	Aspen.	orbi. dent. smth. on both sides.	——	——	H. T.	——

[Pet. 4. Caps. 4, of 1 cell, & many seeds.

RHODIOLA, ROSE-ROOT. Barr. fl. Cal. 4-parted. Pet. 4. Nect. 4. Filam. 8. Fert. fl. Cal. 4-cleft.

ósea. E. Fl.	common.	obov. imbric. glau. dent. ye.	5.	7. ———	H. P.	Sandy loam, slips from root.
--------------	---------	-------------------------------	----	--------	------	-------	------------------------------

ORDER VIII.

ENNEANDRIA. STAMENS 9.

[the same. Caps. of 2 lobes & 2 elast. cells. Seed 1.

MERCURIA' LIS, MERCURY. Barr. fl. Cal. 3-cleft. Cor. 0. Stam. from 9 to 12. Fert. fl. Cal. & cor.

nnua. E. Fl.	annual.	ov. lanc. smth. serr.	gr.	7.	9. ———	H. A. ——
omentósa. L.	woolly.	obl. hairy, apex serr.	gr.	——	Spain.	1640.	H. S. ——

[same as in the barren. Caps. of 6 cells. Seeds numer.

HYDRO'CHARIS, FROG-BIT. Barr. fl. Cal. 3 deep segm. Pet. 3. Filam. 9. Fert. fl. Cal. & pet. the

lórsus-ránæ. B. Fl.	common.	renif. obt. purp. ben.	wh.	6.	7. Britain.	H. w. P. ——
---------------------	---------	------------------------	-----	----	-------------	------	-------------

ORDER IX.

DECANDRIA. STAMENS 10.

Systematic Name.	English Name.	Form of Leaves, &c.	Col. of Flow.	Month of Fl. Country.	Yr. of Introd.	Soil and Propagation.
<i>CA'RICA, PAPA-W-TREE. Cal. 5-tooth. Mas. cor. funnel-shap. Fem. cor. 5-part. Stig. 5.</i>						
Papáya. B.R.	common.	palm. 7-part. segm. obl. sinuat.	7.	8. India.	1690.	S. S. Loam & peat.
cauliflora. w.	stem-flowering.	palm. 5-lob. midd. lobes sinuat.	6.	8. Caracas.	1806.	S. S. cuttings
microcarpa. w.	small-fruited.	3-5-part. midd. lob. 3-part. w.	—	—	—	S. S. under glass.
<i>GYMNOCLADUS, GYMNOCLADUS. Male cal. 5-toothed. Pet. 5. Fem. sty. 1. Legu. 1-celled.</i>						
canadensis. w.	Canadian.	bipinn. leaf. ellip. ov.	wh. 5.	6. N. Amer.	1748.	H. C. —
<i>SCHINUS, SCHINUS. Male cal. 5-cleft. Pet. 5. Fem. flowers the same. Berr. 3-celled.</i>						
dentata. H. K.	toothed-leaved.	ellip. dent. smth.	wh. —	—	1795.	G. S. Sandy loam
molle. w.	soft.	pinn. leaf. ellip. serr.	wh. 7.	8. Peru.	1597.	G. S. & peat. cutt.
<i>CORIA'RIA, CORIA'RIA. Cal. 5-part. Cor. 0. Anth. bifid. Sty. 0. Caps. 5, single-seeded.</i>						
myrtifolia. w.	Myrtle-leaved.	ov. lanc. smth.	gr. 5.	8. S. Europ.	1629.	H. S. Sandy loam.
sarmentosa. B. M.	running.	cor. ov. acum. ent. 5-nerv.	gr. 7.	9. N. Zeala.	1820.	G. P. cuttings.

ORDER X.

DODECANDRIA. STAMENS 12, OR MORE.

<i>MENISPERMUM, MOON-SEED. Mas. cal. of 2 leaves. Pet. 4. Fem. cor. Stam. 8, sterile. Ger. 2-3.</i>						
canadensis. w.	Canadian.	pelt. cord. angul. smth.	ye. 6.	7. N. Amer.	1691.	H. S. cl. Sandy soil.
Virginicum. w.	Virginian.	pelt. cord. lob.	gr. ye. —	—	1732.	H. S. cl. cuttings, or parting roots.
<i>EU'CLEA, EU'CLEA. Male cal. 5-part. Cor. 5-cleft. Fem. sty. 2. Caps. 3-cornered, 3-celled.</i>						
undulata.	wave-leaved.	obov. undul.	wh. 6.	10. C. B. S.	1794.	G. S. Loam & peat. cuttings.

ORDER XI.

ICOSANDRIA. Stamens numerous, inserted in the calyx.

<i>FLACOURTIA, FLACOURTIA. Male cal. 5-par. Cor. 0. Sta. nume. Fem. stig. sess. Ber. many-cell.</i>						
sápida. w.	Esculent.	ellip. obt. serr. repand.	wh. 6.	7. E. Ind.	1800.	S. S. Peat & loam. cuttings.
<i>ROTTLE'RA, ROTTLE'RA. Male cal. 2-part. Cor. 0. Fem. cal. 4-dent. Sty. 3. Caps. 3-cell. & 3-seed.</i>						
tinctória. Roxb.	dyers.	alt. obl. ellip.	gr. 7.	8. —	181	S. S. —

ORDER XII.

POLYANDRIA. *Stamens numerous, inserted in the Receptacle.*

Systematic Name.	English Name.	Form of Leaves, &c.	Col. of Flow.	Month of Fl.	Native Country.	Yr. of Introd.	Soil and Propagation.
CLIFFORTIA, CLIFFORTIA. <i>Cal. 3-cleft. Pet. 0. Stam. numerous. Stig. bearded, elong.</i>							
ericifolia. w.	Heath-leaved.	lin. sulcate, smth. crowd.	st. 7. 9.	C. B. S.	1799.	G. S.	Sandy loam
ilicifolia. w.	Holly-leaved.	subrot. ellip. amplex.	st. 5. 9.	—	1714.	G. S.	and peat.
obcordata. w.	obcordate-l'd.	obcor. the low. subrot. elli.	st. 6. 8.	—	1790.	G. S.	cuttings.
trifoliata. w.	three-leaved.	tern. lanc. ent. pilose.	st. 4. 7.	—	1752.	G. S.	—
CYCAS, CYCAS. <i>Male catk. imbr. Cal. a spath. scale. Cor. 0. Fem. spadix 2-sid. ensif. compr.</i>							
circinalis.	broad-leaved.	Fronds pin. leaf. lin. lanc. flat.	5. 6.	E. Ind.	1700.	S. S.	—
revoluta. B.M.	narrow-leaved.	Fronds pin. leaf. lin. mucr. br.	7. 8.	China.	1737.	S. S.	—
[Ger. 2. Sty. 0. Berr. 2, 1-seeded.]							
ZAMIA, ZAMIA. <i>Male catk. like a cone. Cal. an obovate scale. Cor. 0. Fert. cal. scale peltate. Cor. 0.</i>							
débilis. w.	long-leaved.	Fronde pin. leaf. lanc. acut. br.	6. 8.	W. Ind.	1777.	S. S.	Loam & peat.
furfuracea.	broad-leaved.	leaf. lanc. serr.	br. 7. 8.	—	1691.	S. S.	suckers from
horrída. w.	gray.	leaf. lanc. acut.	br. 6. 8.	C. B. S.	1800.	G. S.	base of plants.
integrifolia. B.R.	entire-leaved.	leaf. lanc. apex serr.	br. —	W. Ind.	1768.	S. S.	—
spiralis. w.	spiral.	leaf. 30-40 prs. apex 3-5-den.	7. 8.	N. S.W.	1796.	G. P.	—

ORDER XIII.

MONADELPHIA. *Stamens united into one set.*

[Cal. 3-cleft. Pet. 3. Berr. 3-seeded.]							
JUNIPERUS, JUNIPER. <i>Barr. fl. Catk. imbr. with 3 rows of somewhat pelt. scales. Cor. 0. Fert. fl.</i>							
communis.	common.	3 in a whorl, lin. glau.	yel. 5. 6.	Britain.	...	H. S.	Sandy soil.
chinensis. w.	Chinese.	decurr. crowd. upper tern.	ye. —	China.	1804.	H. S.	cuttings, or
excelsa. w.	tall.	opp. obt. gland.	yel. —	Siberia.	1806.	H. S.	seeds.
virginiana. w.	red Cedar.	tern. young leaves imbric.	ye. —	N. Amer.	1664.	H. S.	—
[Seed 1, enveloped in the pulpy calyx.]							
TA'XUS, YEW. <i>Barr. fl. Cal. 0. Cor. 0. Filam. numer. Anth. pelta. Fert. fl. Cal. cup-shaped. Cor. 0.</i>							
baccata. E. Fl.	common.	distich. lin. smth.	yel. 2. 4.	Britain.	...	H. T.	Sandy soil.
β hibernica.	Irish.	yel. —	Ireland.	...	H. T.	cutt. or seeds.
ARAUCARIA, ARAUCARIA. <i>Male catk. imbric. Anth. 10-12. Fem. cal. scale lanc. Sty. 0.</i>							
braziliána.	Brazilian.	imbr. lan. mucr. glau.	ye.	Brazil.	1819.	H. S.	Loam & peat.
Cunninghámii.	Cunningham's.	needle-sh. mucr.	ye.	N. Holl.	1824.	F. S.	cuttings, or
excelsa. H. K.	Norf.-Isl.-Pine.	closely imbr. inflex. point.	ye.	Norf. Isl.	1793.	G. T.	seeds.
imbricata. w.	imbricated.	imbric. ov. lanc. mucr.	ye.	Chile.	1796.	H. T.	—
[Caps. 4-celled, many-seeded.]							
NEPENTHES, PITCHER-PLANT. <i>Cal. 4-cleft, spreading, coloured inside. Cor. 0. Stig. pelt. sess.</i>							
distillatória. w.	cylindrical.	sess. flat. Pitcher's cylind. gr.	4. 5.	Ceylon.	1789.	S. P.	Sandy peat. seeds.

Systematic Name.	English Name.	Form of Leaves, &c.	Col. of Month Flow.	Native of Fl. Country.	Yr. of Introd.	Soil and Propagation
<i>EPHEDRA, EPHEDRA. Male cal. 2-cleft. Stam. 7. Fem. cal. 2-parted.</i>						
distáchya. w.	great.	Br. with 2 toothed joints.	6. 7.	France.	1570.	H. S. ———

ORDER XIV.

GYNANDRIA. *Stamens inserted on the Germen, or Style.**CLU'YTIA, CLU'YTIA. Mas. cal. 5-parted. Pet. 5. Fem. sty. 3. Caps. 3-celled. Seed single.*

alaternóides. w.	narrow-leaved.	lin. lanc. acut. sess.	wh. 12. 3.	C. B. S.	1692.	G. S. Loam & leaf
collina. w.	hill.	ellip. obl. retuse, smth. shin. st. . . .	E. Ind.	1807.	S. S.	mould.
daphnoídes. w.	Daphne-like.	obov. ellip. mucr. smth.	wh. 5. 6.	C. B. S.	1731.	G. S. cuttings.
tomentósa. w.	tomentose.	ellip. obt. both sides hairy. st. 4. 6.	———	1812.	G. S.	———

CLASS XXIII.

POLYGAMIA. *Stamens and Pistils on the same, or different flowers; and, also, on the same, or separate plants.*

ORDER I.

MONÆCIA. *Flowers different on the same plant.*

							[Cor. 0. Filam. 0. Seed 1, compr.
							Sty. clov. Seed 1. Fert. fl. Cal. 2 cleft.
<i>A'TRIPLEX, ORACHE. Unit. fl. Cal. 5-part. Cor. 0. Stam. 5.</i>							
angustifólia. E. Fl.	narrow-leaved.	lanc. ent. lower 3-lobed.	gr. 6. 8.	Britain.	H. A. Light loam.	
erécta. E. Fl.	upright.	ov. lanc. powdery.	gr. 8.	England.	H. A. seeds.	
laciniáta. E. Fl.	frosted-sea.	ov. deltoid. tooth.	gr. 7. 8.	Britain.	H. A. ———	
littorális. E. Fl.	Grass-leaved.	lin. obl. ent. dent.	gr. 8. 9.	———	H. A. ———	
pátula. E. Fl.	spreading.	triang. hast. smth. dent.	gr. 6. 9.	———	H. A. ———	
portulacóides. E. Fl.	Sea Purslane.	opp. obov. lanc. ent. smth.	gr. 7. 8.	———	H. S. ———	
pedunculáta. E. Fl.	pedunculated.	obov. lanc. ent.	gr. 7. 9.	England.	H. A. ———	

I'NGA, I'NGA. Cal. tubul. Cor. regul. Legu. of many cells. Cells single-seeded.

álba. DC.	white.	in 3 pairs, leaf. obl. smth.	wh. 7. 8.	Cayenne.	1804.	S. S. Sandy soil
anómala. Kth.	anomalous.	pinn. 15-17 pairs, leaf. lin.	———	Mexico.	1769.	S. S. and peat.
<i>Acácia grandiflóra. w.</i>						
dúlcis. DC.	sweet.	pinn. leaf. obl. mucr.	5. 7.	E. Ind.	1800.	S. S. ———
Houstonei. DC.	Houston's.	in 6-7 pairs, leaf. obliq.	wh. 9. 11.	V. Cruz.	1729.	S. S. ———
mellifera. DC.	honey-bearing.	in 2 pairs, half-obov.	wh. 4. 6.	Arabia.	1826.	S. S. ———
purpúrea. DC.	purple.	conj. pinn. leaf. obov.	pur. 3. 5.	W. Ind.	1733.	S. S. ———

MIMO'SA, MIMO'SA. Hermaph. cal. 5-toothed. Cor. 0, or 5-tooth. Male cal. & cor. the same. Pod sepa-

asperáta. DC.	rough.	bipinn. pinn. 8-12 pairs, leaf.	6. 7.	———	1822.	S. S. ———
púdice. w.	Humble-plant.	digit. pinn.; stm. prickly.	wh. 4. 9.	Brazil.	1638.	S. S. ———
sensitiva. w.	Sensitive-plant.	pin. leaf. half ov. hairy be. pk.	———	1648.	S. S. ———	

Systematic Name.	English Name.	Form of Leaves, &c.	Col. of Flower.	Month of Fl.	Native Country.	Yr. of Introd.	Soil and Propagation.
<i>ACA'CIA, ACA'CIA. Hermaph. cal. 5-tooth. Cor. of 5 pcts. Stam. numer. Legu. 2-valved.</i>							
armata. H.K.	armed.	sess. ent. ov. obliq.	yel.	4. 6.	N. Holl.	1893.	G. sp. Light sandy
álba.	white.	bipin. wings 7-10 pairs.	w.	E. Ind.	1828.	S. sp. soil & peat.
affinis. Swt.	kindred.	bipinn. leaf. lin. glau.	yel.	8. 9.	N. Holl.	1822.	G. sp. The most of
áspera.	rough.	ov. ellip. prickly.	y.	— — — —	— — — —	1824.	G. sp. the species of
álbida. B.R.	whitish-leaved.	Leaf. 8-10-pairs, lin. acut.	yel.	Peru.	— — — —	G. sp. this inte-
angustifolia. B.C.	narrow-leaved.	lin. mucr. base attenuat.	st.	2. 6.	N. S. W.	1790.	G. sp. resting tribe
alata. H.K.	wing-stalked.	Br. winged 2 ways, prick.	yel.	4. 7.	N. Holl.	1803.	G. sp. of plants, are
Brównii. DC.	Brown's.	lin. subul. mucr. pung.	st.	3. 6.	N. S. W.	1796.	G. sp. freely in- creased by
<i>Aciculis, H.K.</i>							
biflora. H.K.	two-flowered.	triang. 1-nerv.	ye.	— — — —	N. Holl.	1803.	G. sp. cuttings, un-
ciliata. H.K.	ciliated.	bipin. wings 3-4 pairs, leaf. 13	S. Amer.	1823.	S. sp. der a glass,
calamifolia. B.R.	bodkin-leaved.	filif. compr.; Br. smth.	yel.	1. 12.	N. S. W.	1822.	G. sp. or by seeds,
cornigera. W.	Cuckold-tree.	bipinn. spines united.	y.	5. 6.	S. Amer.	1692.	S. sp. soun in
decipiens. H.K.	paradoxical.	triang. trapezif. mucr.	yel.	3. 6.	N. Holl.	1803.	G. sp. spring.
discolor. W.	two-coloured.	bipinn. in 6 pairs.	yel.	— — — —	— — — —	1788.	G. sp. — — — —
decurrens. W.	decurrent.	pinn. wings 9-11 pairs, leaf. y.	— — — —	— — — —	N. S. W.	1790.	G. sp. — — — —
diffusa. B.R.	diffuse.	lin. 1-nerv. apex obliq.	y.	3. 6.	— — — —	1822.	G. sp. — — — —
falcata. W.	sickle-leaved.	obl. falcate, acut. 1-nerv.	yel.	5. 6.	— — — —	1790.	G. sp. — — — —
Julibrissin.	smooth.	bipinn. leaf. of 8-12 pairs.	w.	9. 11.	Levant.	1745.	H. sp. — — — —
juniperina. W.	Juniper-leaved.	lin. mucr. pung.	st.	3. 6.	N. S. W.	1790.	G. sp. — — — —
lophantha. W.	two-spiked.	bipinn. in 7-9-12 pairs.	st.	11. 4.	N. Holl.	1803.	G. sp. — — — —
linarifolia.	linear-leaved.	lin. flat, smth.	yel.	5. 6.	— — — —	1828.	G. sp. — — — —
linifolia. B.M.	Flax-leaved.	lin. erect, mucr.; spic. glob.	ye.	2. 6.	N. S. W.	1790.	G. sp. — — — —
lunata. DC.	Lunate-leaved.	falcate. obl. lunat. glau.	yel.	3. 6.	V. D. Isl.	1816.	G. sp. — — — —
leprosa. B.R.	Leprous.	lin. lanc. sub-falcate, spott.	ye.	— — — —	N. S. W.	1824.	G. sp. — — — —
longifolia. W.	long-leaved.	lin. lanc. 3-nerv. ent.	ye.	— — — —	— — — —	1792.	G. sp. — — — —
Lambertiána. B.R.	Lambert's.	pinn. wings 2-3 pairs.	pu.	7. 9.	Mexico.	1820.	G. sp. — — — —
melanoxylon. B.M.	black-wooded.	obl. lanc. ent. sub-falcate.	yel.	4. 6.	V. D. Isl.	1808.	G. sp. — — — —
marginata. H.K.	marginate-l'd.	elong. lanc. 1-nerv.	yel.	— — — —	N. S. W.	1803.	G. sp. — — — —
myrtifolia. W.	Myrtle-leaved.	alt. obl. lanc. ent.	yel.	2. 5.	— — — —	1789.	G. sp. — — — —
mucronata. B.M.	mucronate-l'd.	lin. spath. apex. obliq. mucr. y.	9. 1. — — — —	— — — —	— — — —	1812.	G. sp. — — — —
mollis. DC.	soft.	pinn. 8-18 pairs, leaf. 30-40-l	4. 7. — — — —	— — — —	— — — —	1818.	G. sp. — — — —
nigricans. B.M.	dark.	bipinn. partial of 2 pairs.	yel.	5. 7.	N. Holl.	1803.	G. sp. — — — —
Oxycédrus. Swt. Au.	sharp-point'd.	vertic. lanc. lin. sess.	yel.	4. 6.	N. S. W.	1824.	G. sp. — — — —
ornithophora.	bird-leaved.	alt. sess. obl. lan. unc. at base.	y.	— — — —	— — — —	1825.	G. sp. — — — —
pubescens. B.M.	downy.	wings 3-10 pairs, leaf. 6-18 p.	3. 6. — — — —	— — — —	— — — —	1790.	G. sp. — — — —
pulchella. H.K.	shewy.	Leaf. 5-7 pairs, obl. obov.	ye.	4. 7.	N. Holl.	1803.	G. sp. — — — —
quadranguláris. B.M.	square-stalk'd.	quinquij. leaf. lin. acut. cili. uc.	5. 7.	1816.	S. sp. — — — —
rutæfolia.	Rue-leaved.	pinn. leaf. unequal.	ye.	— — — —	N. Holl.	1810.	G. sp. — — — —
stricta. W.	upright.	lin. base atten. apex orbic.	ye.	2. 5.	N. S. W.	1790.	G. sp. — — — —
suavæolens. B.C.	sweet-scented.	lin. acut. ent.	yel.	2. 6.	— — — —	— — — —	G. sp. — — — —
trinervata. Sieb.	three-nerved.	lin. mucr. 3-nerv.	yel.	4. 6.	— — — —	1823.	G. sp. — — — —
taxifolia.	Yew-leaved.	vertic. tern. lanc.	yel.	3. 6.	— — — —	1817.	G. sp. — — — —
undulata. B.R.	wave-leaved.	lan. und. mucr.; spin. in 2's.	yel.	— — — —	— — — —	1824.	G. sp. — — — —
uncinata. B.R.	hook-leaved.	ov. obl. obliq. und. mucr.	yel.	9. 1.	N. Holl.	1823.	G. sp. — — — —
verticillata. W.	whorl-leaved.	lin. mucr. pung.	yel.	3. 5.	V. D. Isl.	1780.	G. sp. — — — —
vestita. B.R.	Cunningham's.	half-ellip. lanc. hairy.	yel.	2. 6.	N. Holl.	1820.	G. sp. — — — —
<i>BRIDE'LIA, BRIDE'LIA. Male cal. 5-part. Cor. of 5 pcts. Fem. flow. the same. Berr. 2-seeded.</i>							
montana. W.	Mountain.	obov. ellip. smth.	st.	7. 9.	E. Ind.	1825.	S. sp. Sandy peat
spinosa. W.	spiny.	ov. ent. acut. smth.	st.	— — — —	1823.	S. sp. & loam, cutt.

Systematic Name.	English Name.	Form of Leaves, &c.	Col. of Flow.	Month of Fl.	Native Country.	Yr. of Introd.	Soil and Propagation.
TERMIN'ALIA, TERMIN'ALIA. <i>Hermaph. cal. 5-clef. Cor. stam. 10. Male cal. & cor. the same.</i>							
angustifolia. w.	narrow-leaved.	lin.lanc.repan.down.ben.	w.	5.	E.Ind.	1692.	S.℄. Sandy loam
moluccana. w.	Molucca.	obov. ent. smth.	wh.	...	Moluccas.	1816.	S.℄. & peat. cutt.
CELTIS, NETTLE-TREE. <i>Hermaph. cal. 5-part. Cor. 0. Stam. 5. Sty. 2. Male cal. 6-part. Stam. 6.</i>							
australis. L.	European.	obl. lanc. finely serr.	gr.	5.	S.Europ.	1799.	H.℄. Sandy loam.
occidentalis. L.	American.	ov.acum.serr.hairy ben.	gr.	4.	N.Amer.	1656.	H.℄. layers.
pumila. Ph.	dwarf.	ov.acum.serr. base uneq.	gr.	5.	---	1812.	H.℄. ---
sinensis. Pers.	Chinese.	ov. acum. serr. smth.	gr.	...	China.	1820.	H.℄. ---
[Male cal. 0. Pet. 6. Ger. 0.]							
VERA'TRUM, VERA'TRUM. <i>Hermaph. cal. 0. Cor. of 6 pets. Stam. 6. Ger. 3. Caps. 3, many-seed.</i>							
album. w.	white.	ellip.nerv. Race.panic.	wh.	6.	S.Europ.	1548.	H.℄. Loam & peat.
parviflorum. w.	small-flowered.	ellip. Race.panic.	gr.	7.	N.Amer.	1809.	H.℄. dividing at
viride. w.	green.	ellip.obt.nerv. Race.pan.gr.	---	---	---	1742.	H.℄. root.
RHAGO'DIA, RHAGO'DIA. <i>Hermaph. cal. 5-cleft. Cor. 0. Stam. 5. Male cal. & cor. the same.</i>							
hastata. r.	halbert-leaved.	rhom.hast.opp.ent.smth.	gr.	6.	N. S.W.	1803.	G.℄. ---
AILANTHUS, AILANTHUS. <i>Male cal. 5-par. Pet. 5. Fem. cal. & cor. the same. Ger. 3-5. Caps. 1-seed.</i>							
glandulosa. w.	Chinese.	pinn.leafl.glan.den.at bas.g.	8.	E. Ind.	1800.	1800.	H.℄. Sandy loam, cuttings.
CLU'SIA, BALSAM-TREE. <i>Cal. conc. 4-6 leaves. Pet. 4-5, or 6. Filam. many. Caps. furrowed.</i>							
alba. w.	white.	obov. obt. veinless.	wh.	7.	S. Amer.	1752.	S.℄. Sandy soil,
flava. w.	yellow.	obov. ent. smth.	yel.	9.	Jamaica.	1759.	S.℄. and leaf
rosea. w.	rose-coloured.	obov. obt. smth.	ros.	7.	8. America.	1692.	S.℄. mould. cutt.

ORDER II.

DIECIA. *Stamens & Pistils on separate flowers, & on different plants.*

[3-seeded. Male cal. 3-part. Pet. 3.]							
CHAMÆROPS, CHAMÆROPS. <i>Hermaph. cal. 3-parted. Cor. of 3 petals. Stam. 6. Pist. 6. Drupe</i>							
humilis. w.	dwarf.	Fronspalm.plic.spin.	st.	2.	3. S.Europ.	1731.	G.℄. Peat & loam.
Palmétto. w.	smooth-stalk'd.	Fronspalm.stalk.unarm.	st.	...	Carolina.	1812.	G.℄. suckers.
CERATONIA, CAROB-TREE. <i>Cal. 5-part. Cor. 0. Stam. 5. Sty. filif. Legu. leathery.</i>							
siliqua. B.rep.	St. John's Bread.	3-6 pairs, leafl. ellip.	gr.	9.10.	Levant.	1570.	G.℄. ---
[3 pets. Fem. cal. 5 leaves. Cor. of 5 pets.]							
GLEDITSCHIA, GLEDITSCHIA. <i>Hermaph. cal. 4-cleft. Cor. of 3 pet. Male cal. of 3 leaves. Cor. of</i>							
sinensis. P.s.	Chinese.	pinn. leafl. ellip.	gr.	6.	8. China.	1774.	H.℄. Sandy loam.
triacanthos. Ph.	Hon.-Locust-tree.	leafl.lin.obt. Br.spiny.	gr.	---	N.Amer.	1700.	H.℄. cuttings.
DIOSPYROS, DATE-PLUM. <i>Male cal. 4-6-cleft. Cor. 4-6-part. Fem. sty. 4-cleft. Ber. 8-12-seed.</i>							
discolor. w.	Mabola-fruit.	obl.acut.silk.glau.ben.	gr.	...	Philippin.	1823.	G.℄. Sandy loam.
Embryopteris. B.R.	glutiniferous.	ov. obl. lanc. ent. smth.	gr.	5.	8. E. Ind.	1796.	S.℄. cuttings.

Systematic Name.	English Name.	Form of Leaves, &c.	Col. of Flow.	Month of Fl.	Native Country.	Yr. of Introd.	Soil and Propagation.
montana. w.	mountain.	obl. acut. smth.	wh.	6. 8.	E. Ind.	1819.	S. S. ———
Mabóla. B. R.	Mabola-tree.	obl. alt. und. ent. silk.	ye. gr.	—	Phill. Isl.	1822.	S. S. ———
pubescens. Ph.	pubescent.	lin. lanc. pubes.	pa. ye.	4. 5.	N. Amer.	1812.	H. S. ———
virginiána. w.	Virginian.	ov. obt. smth. shin.	pa. ye.	5. 6.	—	1629.	H. S. ———

MYRSINE, MYRSINE. Cal. 5-tooth. Cor. half 5-cleft. Drupe with a solit. seed. Nect. 5-celled.

africana. w.	African.	obov. ellip. serr.	gr. pu.	3. 5.	C. B. S.	1691.	G. S. Sandy loam.
retusa. w.	retuse-leaved.	obov. retuse, dent.	gr. pu.	6.	Azores.	1778.	G. S. cuttings.

NYSSA, TUPELO. Hermaph. cal. 5-part. Cor. 0. Sty. 1. Male cal. & cor. the same. Stam. 10.

cándicans. w.	white.	obl. ent. wh. ben.	gr. . . .	N. Amer.	1812.	H. S. Sandy loam
integri-folia.	entire-leaved.	ellip. obov. ent. vill.	gr. . . .	—	—	H. S. & peat. cutt.
tomentosa. w.	downy.	obl. acum. serr.	gr. . . .	Carolina.	1812.	H. S. or layers.

PA'NAX, PA'NAX. Cal. 5-tooth. Pet. 5. Sty. 2-3, short. Ger. fleshy, compr. 2-celled.

aculeatum. w.	prickly.	pinn. leaf. 3, ov. smth.	wh.	11.	China.	1773.	S. S. Peat and
fruticosum. w.	shrubby.	supradecom. tooth. ciliat.	gr.	8. 9.	Ternate.	1800.	S. S. sandy loam.
trifolium. w.	three-leaved.	tern. or quin. leaf. ov. serr. w.	5. 6.	N. Amer.	1759.	H. S. cuttings.	
tomentosum. DC.	hairy.	digit. leaf. obl. lanc. ent.	w. . . .	Nepal.	—	H. S. ———	

BURSE'RA, BURSE'RA. Cal. 3-5-part. Pet. 3-5, spreading. Stam. 6-8. Ger. ov. 3-celled.

gummifera. w.	Jamaica.	pinn. leaf. ov. acut.	wh.	5. 7.	W. Ind.	1690.	S. S. ———
---------------	----------	-----------------------	-----	-------	---------	-------	-----------

FIGUS, FIG-TREE. Male cal. 3-part. Fem. cal. 5-part. Sty. 1. Recep. fleshy.

aquática. w.	aquatic.	obl. 3-lob. sinuat.	gr.	4.	E. Ind.	1758.	S. S. Loam and
bengalénsis. w.	Bengal.	ov. ent. obt.	gr.	4. 5.	—	1690.	S. S. leaf mould.
benjamína. w.	oval-leaved.	ellip. obl. ent.	gr.	5. 6.	—	1757.	S. S. cuttings.
cordata. w.	heart-leaved.	ov. lanc. ent. base cord.	gr.	8.	C. B. S.	1802.	S. S. ———
coriácea. w.	leathery-leav'd.	obl. base cord. atten.	gr.	3. 6.	E. Ind.	1772.	S. S. ———
elástica. Rox.	elastic-gum.	ellip. smth. ent.	gr.	—	—	1815.	S. S. ———
índica. w.	Banyan-tree.	ov. acum. ent.	gr.	—	—	1759.	S. S. ———
nítida. w.	shining.	obov. ent. shin.	gr.	1. 4.	—	1786.	S. S. ———
religiosa. w.	Poplar-leaved.	cord. ov. acum.	gr.	8.	—	1731.	S. S. ———

[turgid, spiny.

ARCTOPUS, ARCTOPUS. Male invol. of 5 leaves. Fem. invol. of 4 leaves. Cor. of 5 petals. Fruit ovate, echinatus. B. R. prickly. cunea, ov. lacin. or trif. spin. g. . . . C. B. S. 1774. G. S. ———

CLASS XXIV.

CRYPTOGAMIA. Stamens and Pistil concealed, so as not to be distinguished with any certainty.

ORDER I.

FILICES. Fructification only of one kind upon the same species.

[valves. Seeds small.

POLYPO'DIUM, POLYPODY. Caps. in round masses on the back of the frond, each of 1 cell, and 2 equ.

aúreum. w.	golden.	pinnat. glau. segm. lan. ent.	y. 3. 4.	W. Ind.	1742.	S. S. Sandy loam	
asplenifolium. L.	Asplenium-l'd.	pinnatif. segm. half ov.	yel.	7.	Martinic.	1790.	S. S. and peat,

Systematic Name.	English Name.	Form of Leaves, &c.	Col. of Flow.	Month of Fl.	Native Country.	Yr. of Introd.	Soil and Propagation	
crassifolium. L.	thick-leaved.	obl.smth.ent.; <i>Sori</i> in row. <i>y.</i>	8.	9.	W. Ind.	1816.	S. \mathcal{P} . mixed, will	
calcàreum. B.Fl.	rigid.	tern.bipin.segm.nearl.ent. <i>y.</i>	8.	Britain.	H. \mathcal{P} .	grow this	
Dryopteris. L.	slen.-3-branch.	tern. bipinn. leaf. serr. <i>yel.</i>	6.	9.	— — — —	H. \mathcal{P} . family of	
decumànum. w.	tall.	pinnat.glauc.leaf.lan.serr. <i>ye.</i>	8.	Brazil.	1820.	S. \mathcal{P} . plants. They	
effusum. Swz.	spreading.	tripinn. pinnulæ pinnatif. <i>y.</i>	10.	Jamaica.	1769.	S. \mathcal{P} . are readily	
fraxinifolium. Jac.	Ash-leaved.	pinn. leaf. lanc. wavy. <i>yel.</i>	8.	Caracas.	1822.	S. \mathcal{P} . increased by	
irioides.	Iris-leaved.	ensif. ent. smth. shin. <i>yel.</i>	—	E. Ind.	1824.	S. \mathcal{P} . parting at	
juglandifolium.	Juglan-leaved.	pinn. leaf. lanc.	<i>yel.</i>	5.	8.	S. Amer.	1822.	S. \mathcal{P} . the roots, and
lycopodioides. L.	club-moss.	lanc.ent.smth.; <i>stm.</i> creep. <i>ye.</i>	7.	W. Ind.	1793.	S. \mathcal{P} . by seeds.	
phæmatodes. w.	red.	3-lob.pinnat.leaf.lan.opp. <i>y.</i>	—	— — — —	1816.	S. \mathcal{P} .	
Phegopteris. B. Fl.	pale-mountain.	bipinnatif. lob. lin. lanc. <i>yel.</i>	—	—	Britain.	H. \mathcal{P} .	
Phyllitidis. L.	Hart's-tongue.	lanc. smth.; <i>Sori</i> in 2 rows. <i>y.</i>	—	—	W. Ind.	1793.	S. \mathcal{P} .	
pubescens. H. Ic. F.	pubescent.	pectin.segm.opp.lin.obl. <i>yel.</i>	—	—	Bonareæ.	S. \mathcal{P} .	
pectinatum. w.	comb-leaved.	pinnat.segm.lan.lin. erect. <i>y.</i>	7.	9.	W. Ind.	1793.	S. \mathcal{P} .	
quercifolium. L.	Oak-leaved.	ov. sinuat. fert. pinnatif. <i>yel.</i>	9.	E. Ind.	1824.	S. \mathcal{P} .	
scolopendrioides. L.	Scolopendrum-lk.	obl.lanc.sinuat.pinnat. <i>ye.</i>	7.	8.	Jamaica.	—	S. \mathcal{P} .	
sérpens. w.	gliding.	obl. ent. fert. lin. lanc. <i>yel.</i>	5.	6.	W. Ind.	1822.	S. \mathcal{P} .	
vulgàre. B. Fl.	common.	pinnatif.lob.lin.obl.serr. <i>yel.</i>	5.	10.	Britain.	H. \mathcal{P} .	
<i>β càmbricum.</i>	<i>Welsh.</i> <i>yel.</i>	—	—	— — — —	H. \mathcal{P} .	

[centre, separating all round.

ASPIDIUM, SHIELD-FERN. Caps. in orbic. masses. Cover nearly round, or kidney-shap. fixed by the

aculeatum. B. Fl.	prickly.	bipinn.leaf. ov. serr. obliq. <i>br.</i>	6.	8.	Britain.	H. \mathcal{P} . Sandy peat
auriculatum. Swz.	eared.	pinn. leaf. falc. lanc. <i>br.</i>	7.	E. Ind.	1798.	S. \mathcal{P} . and loam, the
angulare. B. Fl.	angular-leaved.	bipinn.leaf. ov. obt. fring. <i>br.</i>	—	—	Hungary.	1819.	H. \mathcal{P} . same as in
bulbiferum. Swz.	bulbiferous.	pinn. segm. obl. serr. <i>br.</i>	7.	8.	N. Amer.	1638.	H. \mathcal{P} . the last Ge-
cristatum. E. Fl.	crested.	pinn. sub cord. obl. pinnat. <i>br.</i>	6.	8.	Britain.	H. \mathcal{P} . nus.
dentatum. B. Fl.	toothed.	pinn. pinnæ. ov. obl. pinnat. <i>br.</i>	7.	Scotland.	H. \mathcal{P} .
dumetorum. B. Fl.	thicket.	bipinn. leaf. pinnatif. <i>br.</i>	—	—	— — — —	H. \mathcal{P} .
dilatatum. E. F.	broad sharp-tooth.	bipinn. pinnæ. obl. pinn. <i>br.</i>	6.	8.	Britain.	H. \mathcal{P} .
exaltatum. Swz.	lofty.	pinn. pinnæ. cord. sub-falc. <i>br.</i>	7.	Jamaica.	1793.	S. \mathcal{P} .
glandulosum.	glandular.	pinn. leaf. obl. lanc. cren. <i>br.</i>	6.	— — — —	S. \mathcal{P} .
irriguum.	brook.	pinn. lanc. <i>br.</i>	6.	7.	Britain.	H. \mathcal{P} .
Lonchitis.	rough.	lin. lan. pinn. leaf. alt. acut. <i>br.</i>	5.	8.	— — — —	H. \mathcal{P} .
lobatum. B. Fl.	close-leaved.	bipinn. leaf. ov. obt. serr. <i>br.</i>	6.	8.	— — — —	H. \mathcal{P} .
Oreopteris. Swz.	Heath.	bipinn. leaf. pinnatif. ent. <i>br.</i>	7.	— — — —	H. \mathcal{P} .
Singaporiànum. H. Ic. F.	Singapore.	simple, broadly lanc. ent. <i>br.</i>	Singapore.	S. \mathcal{P} .
spinulosum. B. Fl.	prickly-toothed.	bipinn. leaf. obl. pinnatif. <i>br.</i>	6.	8.	Britain.	H. \mathcal{P} .
Thelypteris. B. Fl.	marsh.	pinn. leaf. lin. lanc. pinnat. <i>br.</i>	7.	8.	— — — —	H. \mathcal{P} .

[side of the sorus.

CISTOPTERIS, BLADDER-FERN. Sori roundish. Invol. inser. by its broad cucul. base at the under

alpina. B. F.	Alpine.	tripinn. leaf. pinnatif. <i>br.</i>	—	—	— — — —	H. \mathcal{P} .
<i>Cystea régia.</i> E. T.							
dentata. E. Fl.	toothed.	bipinn. leaf. ov. dent. <i>br.</i>	—	—	— — — —	H. \mathcal{P} .
<i>Cystea dentata.</i> E. B.							
frágilis. B. T.	brittle.	bipinn. leaf. pinnatif. serr. <i>br.</i>	—	—	— — — —	H. \mathcal{P} .
<i>Cystea frágilis.</i> E. F.							

[broadest at the base.

ASPLENIUM, SPLEEN-WORT. Caps. in numer. linear masses, bound by a jointed ring. Cover linear,

alternifolium. B. Fl.	alternate-ly'd.	pinn. leaf. alt. cuneat. dent. <i>br.</i>	6.	10.	Scotland.	H. \mathcal{P} . Sandy loam
Adiantum-nigrum. B. Fl.	black Maiden-hair.	tripinn. deltoid. leaf.	4.	9.	Britain.	H. \mathcal{P} . and peat,

Systematic Name.	English Name.	Form of Leaves, &c.	Col. of Flow.	Month of Fl.	Native Country.	Yr. of Introd.	Soil and Propagation.
alatum.	winged.	lanc. pinn. leaf. obl. serr.	br.	4. 9.	Jamaica.	—	S. \mathcal{P} . <i>dividing the</i>
Douglásii.	Douglas's.	ov. cord. acum. ent.	br.	—	N. Amer.	—	H. \mathcal{P} . <i>plants at the</i>
Filix-fémina. B.F.	female.	lanc. bipin. pinnul. lin. ser.	br.	7. 8.	Britain.	...	H. \mathcal{P} . <i>roots, or</i>
fontánium. B.F.	smooth.	bipinn. lin. lanc. leaf. obo.	br.	6. 8.	England.	...	H. \mathcal{P} . <i>sowing seeds.</i>
<i>Aspidium fontánium. E.B.</i>							
lanceolatum. B.F.	green-lanceolate.	lan. bipinn. leaf. obo. den.	br.	6. 9.	England.	...	H. \mathcal{P} . ———
marinum. E.Fl.	sea.	pinn. leaf. obt. obl. serr.	br.	6. 10.	Britain.	...	H. \mathcal{P} . ———
Nídus. B.M.	Bird's-nest.	nearly sess. lanc. ent. smth.	br.	8.	E. Ind.	1820.	S. \mathcal{P} . ———
Ruta-murària. B.Fl.	wall-rue.	bipinn. leaf. obov. tooth.	br.	6. 10.	Britain.	...	H. \mathcal{P} . ———
septentrionale. B.Fl.	forked.	3-cleft, lea. alt. lin. 3-tooth.	br.	—	—	...	H. \mathcal{P} . ———
Trichómanes. B.Fl.	Maiden-hair.	pinn. leaf. obl. cren.	br.	5. 10.	—	...	H. \mathcal{P} . ———
viride. E.Fl.	green-Maiden-hair.	pinn. leaf. ov. cren.	br.	6. 9.	—	...	H. \mathcal{P} . ———

GRAMMITIS, GRAMMITIS. *Sori obl. nearly linear, straight, scattered. Invol. none.*

céterach. B.Fl.	scaly.	pinnatif. segm. ov. obt.	br.	—	—	...	H. \mathcal{P} . ———
decúrrens. H.Ic.F.	decurrent.	pinnatif. segm. lanc. ent.	br.	—	Indies.	...	S. \mathcal{P} . ———

[*other. Seeds minute.*

SCOLOPE'NDRIUM, HART'S-TONGUE. *Caps. lin. between 2 parallel veins. Invol. folding over each*

vulgáre. B.Fl.	common.	obl. cord. at base.	br.	—	Britain.	...	H. \mathcal{P} . ———
----------------	---------	---------------------	-----	---	----------	-----	------------------------

BLE'CHNUM, HARD-FERN. *Caps. parallel on each of the midr. of the frond. Inv. open. towards the rib.*

austrále. L.	Cape.	pinn. pinnæ. lin. lan. edges scb.	3. 9.	C. B. S.	1691.	G. \mathcal{P} . <i>Sandy loam</i>	
boreále. B.Fl.	Northern.	pectin. leaf. lin. ent. smth.	br.	—	Britain.	...	H. \mathcal{P} . <i>and peat.</i>
longifólium. B.M.	long-leaved.	pinn. pinnæ. lin. lanc.	br.	—	Trinidad.	—	S. \mathcal{P} . <i>part. at root.</i>

PARK'ERIA, PARK'ERIA. *Caps. scattered, sessile. Semena large, 3-sided, and striated.*

pteroides. H.Ic.F.	Pteris-like.	sterile, frond pinnat.	br.	8.	Essequibo.	1825.	S. \mathcal{P} . ———
--------------------	--------------	------------------------	-----	----	------------	-------	------------------------

PT'ERIS, BRAKE. *Caps. close to the marg. of the fert. frond. Invol. from the inflex. marg. of the frond.*

atropurpúrea. L.	dark-purple.	bipinn. leaf. lanc.; stm. pube.	8. 9.	N. Amer.	1770.	H. \mathcal{P} . <i>Loam and</i>	
biauríta. H.Ic.F.	two-eared.	pin. leaf. lan. blunt. ser. st.	br.	5. 7.	W. Ind.	1824.	S. \mathcal{P} . <i>sandy peat.</i>
crética. L.	Canadian.	pinn. segm. lan. serr. at bas.	br.	7. 8.	Candia.	1818.	G. \mathcal{P} . <i>dividing</i>
denticuláta. H.Ic.F.	toothed.	dent. pinn. seg. decur. sub-op.	5. 8.	Brazil.	1824.	S. \mathcal{P} . <i>plants at the</i>	
longifólia. L.	long-leaved.	pinn. segm. lin. cord. at base.	8. 9.	W. Ind.	1770.	S. \mathcal{P} . <i>roots, or by</i>	
palμάta. w.	palmate.	5-lob. Lobes pinnat. segm. lin.	6. 8.	—	1823.	S. \mathcal{P} . <i>seeds.</i>	
Plumiérii. w.	Plumier's.	pinn. leaf. opp. pinnat. st.	br.	7.	S. Amer.	1818.	S. \mathcal{P} . ———

ADI'ANTUM, MAIDEN-HAIR. *Mass. of caps. round, marg. at the back of the frond. Covers brown, flat.*

Capillus-Vénéris. B.F.	true.	bipinn. leaf. alt. wedge-sh.	br.	5. 9.	Britain.	...	H. \mathcal{P} . <i>Sandy peat</i>
chilense. H.Ic.F.	Chinese.	tripinn. leaf. renif.	br.	—	Peru.	...	G. \mathcal{P} . <i>and loam</i>
cuneátum. H.Ic.F.	wedge-shaped.	tripinn. segm. 3-4-lob. at apex.	8.	Brazil.	1820.	G. \mathcal{P} . <i>mixed.</i>	
macrophyllum. H.Ic.F.	large-l'd.	pinn. leaf. opp. sub-falc. serr.	7. 8.	Jamaica.	1793.	S. \mathcal{P} . <i>see's, and</i>	
pedátum. L.	pedate.	ped. leaf. pinn. segm. obl.	br.	8. 9.	N. Amer.	1640.	H. \mathcal{P} . <i>parting at</i>
renifórmé. L.	kidney-shaped.	orbic. renif. cren.	br.	6. 9.	Madeira.	1699.	G. \mathcal{P} . <i>the roots.</i>
serrulátum. L.	serrulate.	bipinn. segm. lanc. serrul.	br.	8.	Jamaica.	1823.	S. \mathcal{P} . ———
ténerum. Swz.	tender.	twice comp. pinnulæ rhomb.	br.	7.	—	1793.	S. \mathcal{P} . ———
trapezifórmé. L.	rhomb-leaved.	twice com. pinnulæ rhom.	br.	6. 7.	Britain.	...	H. \mathcal{P} . ———

LINDSÆ'A, LINDSÆ'A. *Sori lin. parallel with the marg. Invol. arising from the tops of the veins.*

polymórpha.	multiform.	segm. ov. obl. flabellif.	br.	—	E. Ind.	...	S. \mathcal{P} . ———
-------------	------------	---------------------------	-----	---	---------	-----	------------------------

Systematic Name.	English Name.	Form of Leaves, &c.	Col. of Flow.	Month of Fl.	Native Country.	Yr. of Introd.	Soil and Propagation.
[roundish. Seeds kidney-shaped.]							
<i>WOODSIA</i> , <i>WOODSIA</i> .							
hyperborea. B.Fl.	round-leaved.	pinn.leaf.ov.pinnatif. br.ye.	7.	9.	Scotland.	H. P. ———
<i>NOTHOCLÆNA</i> , <i>NOTHOCLÆNA</i> .							
ténera. B.M.	thin-leaved.	tripinn. leaf. ellip. obt. br.	—	—	Mendoza.	1828.	S. P. ———
<i>ACROSTICHUM</i> , <i>ACROSTICHUM</i> .							
alcicôrne. B.P.	Elk's-horn.	ster. fronds renif. lob. ent. fert.	8.10.	N. S.W.	1808.		G. P. Loam and
flagelliferum.	whip-like.	pinn. leaf. lanc. 5-9.	br.	—	E. Ind.	1828.	S. P. sandy peat.
villôsum. H.Ic.F.	villous.	simple, obl. lanc. acum.	br.	5.	8. Jamaica.	S. P. seeds, or dividing at root.
<i>HEMIONITIS</i> , <i>HEMIONITIS</i> .							
cordata. H.Ic.F.	heart-shaped.	frond cord. obl. fert. sub. br.	—	—	W. Ind.	S. P. ———
<i>GYMNOGRAMMA</i> , <i>GYMNOGRAMMA</i> .							
cheilanthoides. H.Ic.F.	cheilanth-l.	pinn. segm. sub-pinnatif. br.	—	—	I. Tristan.	S. P. Sandy peat & subglandulosa. H.Ic.F. glandular. segm. pinnatif. pubes. br. — N. S. W. S. P. loam, parting at roots.
<i>DANÆA</i> , <i>DANÆA</i> .							
elliptica. H.Ic.F.	elliptica.	pinn. leaf. ellip. obl. acum. br.	—	—	Jamaica.	S. P. ———
nodosa. H.Ic.F.	knotted.	pinn. leaf. obl. lanc. acum. ent.	—	—	Caracas.	S. P. ———
[shaped, opening outwards.]							
<i>TRICHOMANES</i> , <i>BRISTLE-FERN</i> .							
Bojéri. H.Ic.F.	Bojer's.	flabellif. apex lob.	br. y.	—	Mauritius.	S. P. ———
brevisétum. H.K.	short-styled.	tripinnatif. segm. lin. ent.	b. y.	5.	6. Britain.	H. P. ———
floribundum.	many-flow'r'd.	pinn. segm. lanc. serr.	br.	—	Trinidad.	S. P. ———
crispum. H.Ic.F.	curled.	pinnatif. segm. obl.	br.	—	Jamaica.	S. P. ———
<i>HYMENOPHYLLUM</i> , <i>FILMY-FERN</i> .							
tunbridgense. B.Fl.	Tunbridge.	bipinnatif. smth. segm. tooth.	—	—	Britain.	H. P. ———
<i>LYGODIUM</i> , <i>LYGODIUM</i> .							
dichotomum.	forked.	conjug. leaf. bi-tripart.	br.	—	P. of W. Isl.	..	S. P. ———
scândens. B.C.	climbing.	pinn. in pairs.	br. yel.	5.	9. E. Ind.	1793.	S. P. ———
<i>SCHIZÆA</i> , <i>SCHIZÆA</i> .							
dichótoma.	forked.	fork. segm. lin. attenuat. at ap.	—	—	Indies.	S. P. ———
rupéstris. B.P.	rock.	lin. flat, ent.	br.	6.	7. N. Holl.	1822.	G. P. ———
<i>GLEICHENIA</i> , <i>GLEICHENIA</i> .							
immérsa. H.Ic.F.	bedded.	dichot. segm. lin. rust. ben. br.	—	—	Brazil.	S. P. ———
Hermánii. H.Ic.F.	Herman's.	lanc. pinnatif. smth. glau.	br.	—	—	1820.	S. P. ———
<i>OSMUNDA</i> , <i>OSMUND-ROYAL</i> .							
cinnamómea. L.	Cinnamon.	pinn. steril. bipinnat. segm. ov.	6.	N. Amer.	1772.		H. P. ———
Claytoniána. L.	Clayton's.	bipinnatif. rusty, down. br. ye.	8.	—	—	—	H. P. ———
regális. E.Fl.	common.	bipinn. leaf. obl. ent.	br. ye.	7.	8. Britain.	H. P. ———

Systematic Name.	English Name.	Form of Leaves, &c.	Col. of Flow.	Month of Fl.	Native Country.	Yr. of Introd.	Soil and Propagation.
<i>ONOCLEA, ONOCLEA. Sori glob. inser. upon colum. recep. Ind. dbl. comm. placed on edge of pinnul.</i>							
<i>sensibilis. L.</i>	sensitive.	pinn. leafl. lanc. ent.	br.	8.	Virginia.	1799.	H.P. ———
<i>BOTRYCHIUM, MOON-WORT. Caps. sess. on a branch, stalk. near. roun. Inv. none. Seeds very min.</i>							
<i>daucifolium.</i>	Carrot-leaved.	delt. tern. leafl. bipinnatif.	br.	—	N. Amer.	H.P. ———
<i>lunaria. B. Fl.</i>	common.	solitary, pinn. leafl. jun. br. ye.	5.	6.	Britain.	H.P. ———
<i>virginicum. Swz.</i>	Virginian.	tern. 3-parted, bipinnatif.	br.	8.	N. Amer.	1790.	H.P. ———
<i>OPHIOGLOSSUM, ADDER'S-TONGUE. Caps. on a 2-rank. spik. 1-cell. & 2-valv. Cov. 0. Seeds num.</i>							
<i>vulgatum. B. Fl.</i>	common.	ov. obt. spikd, stalked.	br.	5.	6.	Britain. H.P. ———
<i>DEPARIA, DEPARIA. Sori in globular masses on the teeth of the margins of the fronds.</i>							
<i>Macraei. H. Ic. F.</i>	Macrae's.	pinn. leafl. lanc. lin. dent.	br.	—	I. Ohwyee.	S.P. ———

ORDER II.

EQUISETACEÆ. *Fructification, terminal, amentaceous. Stem leafless. Branches whorled, jointed.*

<i>[flam. with 4 anth. Seeds infold. by 4 spir.]</i>							
<i>EQUISETUM, HORSE-TAIL. Catk. termin. consist. of many stalk. pelt. scales. Seeds infold. by 4 spir.</i>							
<i>fluviatile. E. Fl.</i>	great-water.	Ster. stms. with man. angul.	br.	4.	8.	Britain. H.P. ———
<i>hyemale. E. Fl.</i>	shave-grass.	Stm. nak. striat. sheaths whit.	7.	8.	—	H.P. ———
<i>palustre. E. Fl.</i>	marsh.	Stm. furr. of 7-8-angles, whor.	6.	7.	—	H.P. ———
<i>sylvaticum. E. Fl.</i>	wood.	Stm. erect, smth. with man. w.	4.	5.	—	H.P. ———
<i>variegatum. E. Fl.</i>	variegated.	Stm. nak. rough, decumb.	4-8-6.	7.	Scotland.	H.P. ———

ORDER III.

LYCOPODINEÆ. *Fructif. axillary, sessile, at the base of the leaves, or of the bractææ. Caps. of 2 kinds, 1-3-celled, 2-3-valved, granules numerous, minute.*

<i>LYCOPodium, CLUB-MOSS. Caps. 1-cell. axil. sess. compr. from 1-3 valves. Seeds chaffy, minu.</i>							
<i>alpinum. E. Fl.</i>	Savin-leaved.	in 4 rows, acut. keel'd.	br.	8.	Britain.	H.P. ———
<i>annotinum. E. Fl.</i>	interrupted.	in 5 rows, lin. lanc. acut.	br.	6.	8.	—	H.P. ———
<i>alopencuroides. L.</i>	Fox-tail-like.	lin. subul. tooth. at base.	br.	8.	N. Amer.	1816.	H.P. ———
<i>atro-viride. H. Ic. F.</i>	dark-green.	ov. bifar. horizon. ent. or ser.	b.	—	E. Ind.	S.P. ———
<i>inundatum. B. Fl.</i>	marsh.	lin. lanc. acut.; stm. depress.	br.	6.	7.	Britain. H.w.P. ———
<i>Selaginoides. B. Fl.</i>	prickly.	lanc. ciliat. dent.	br.	8.	—	H.P. ———
<i>Selago. B. Fl.</i>	Fir-like.	in 8 rows, lanc.; stm. erect.	br.	—	—	H.P. ———
<i>serratum. H. Ic. F.</i>	serrated.	lanc. serr. scatter.	br.	—	Japan.	G.P. ———

ORDER IV.

MARSILEACEÆ. *Fructif. radical, spherical, coriaceous, 1 or many-celled.*

Systematic Name.	English Name.	Form of Leaves, &c.	Col. of Flow.	Month of Fl.	Native Country.	Yr. of Introd.	Soil and Propagation.
[coated, roundish, oblong.]							
<i>PILULARIA, PILL-WORT.</i>	<i>Common receptacle of 4 cells, concealing the barren & fertile florets. Seeds</i>						
<i>globulifera.</i> B.Fl.	creeping.	erect, awl-sh. smth.	br.	6, 9.	Britain.	... H.w. P.	—
<i>ISOETES, QUILL-WORT.</i>	<i>Com. recep. of 1 cell at the base of the frond. Seeds angu. combin. 3 together.</i>						
<i>lacustris.</i> B.Fl.	marsh.	awl-sh. 4-angul.	br.	—	—	... H.w. P.	—
<i>MARSILEA, MARSILEA.</i>	<i>Invol. sub-ov. clausum, many-celled, cells in 2 rows, androgynous.</i>						
<i>quadrifolia.</i> L.	four-leaved.	obov. cun. ent. smth.	—	—	S. Europ.	1820. H.w. P.	—

ADDENDA ET CORRIGENDA.

DIANDRIA MONOGYNIA.

Systematic Name.	English Name.	Form of Leaves, &c.	Col. of Flow.	Month of Fl.	Native Country.	Yr. of Introd.	Soil and Propagation.
SA'LZIA.							
angustifolia.	narrow-leaved.	lin. smth. dent.	bl.	8. 9.	Mexico.	1831.	H. \mathfrak{P} . ———
Grahámi.	Dr. Graham's.	ov. cord. cren. pub.	sc.	— — —	— — —	1830.	F. \mathfrak{P} . ———
CALCEOLA'RIA.							
Atkinsiána. B.F.G.	Mr. Atkins's.	spath. dent. rug.	re. ye.	6. 8.	Hybrid.	1830.	F. \mathfrak{P} . ———
Martineauæ. B.F.G.	Miss Martineau's.	ov. obt. dent. hairy.	ye. re.	— — —	— — —	1829.	F. \mathfrak{P} . ———
péndula. B.F.G.	drooping-flow'd.	obov. obl. serr. pilose.	ye. re.	—	Chiloe.	—	F. \mathfrak{P} . ———

TETRANDRIA MONOGYNIA.

PO'THOS.							
digitáta. Jac.	digitate.	auricul. 7-9-lob.	pur.	Caracas.	1823.	S. \mathfrak{S} . ———

ORDER III.

TETRAGYNIA. STYLES 4.

Omitted at Page 28, where it should have stood at the head of the Genus ILEX.

PENTANDRIA MONOGYNIA.

RÍBES.							
speciósium. B.F.G.	shewy.	ov. sub-rot. cut, lob.	sc.	4. 5.	N. Amer.	1829.	H. \mathfrak{S} . ———
SAMO'LUS.							
littoralis. B.C.	sea-side.	lan. spat. alt. smth.	wh.	8. 9.	N. S. W.	1806.	G. \mathfrak{P} . ———
ESCALLO'NIA.							
montevideńsis.	Monte Video.	ellip. obl. serr. smth.	wh.	8.	M. Video.	1827.	G. \mathfrak{S} . ———
viscósa.	viscous.	ellip. serr. und.	wh.	Mendoza.	1829.	G. \mathfrak{S} . ———
EUO'NYMUS.							
náuus.	dwarf.	lin. smth. edges serr. revol.	st.	5. 7.	Caucasus.	1829.	H. \mathfrak{S} . ———
obovátus.	obovate-leaved.	obov. ell. serr. smth.	gr.	6. 7.	N. Amer.	1823.	H. \mathfrak{S} . ———
STRELITZIA.							
húmilis.	humble.	ov. ellip. sub-convolute.	y. bl.	2. 4.	C. B. S.	S. \mathfrak{P} . ———

OCTANDRIA MONOGYNIA.

Systematic Name.	English Name.	Form of Leaves, &c.	Col. of Month of Flow.	Native Country.	Yr. of Introd.	Soil and Propagation.
MENZIE'SIA.						
empetrifolia.	B.M. Crowberry-l'd.	lin. serrul. smth.	re. pur. 8. 9.	N.Amer.	1810.	H. S. Sandy peat and loam. cutt.
FUCHSIA.						
globosa.	globose-fl'd.	ov. cord. serr.	cr. pur. 6. 9.	Hybrid.	1830.	G. S. ———
BÆCKIA.						
saxicola.	B.M. stony.	imbric. obov. dott.	ros. 3. 4.	N.Holl.	1822.	G. S. ———
CHLO'RA.						
serotina.	late-flowering.	opp. ellip. glau.	yel. 11.	1832.	H. B. ———

DECANDRIA MONOGYNIA.

CHORIZE'MA.						
ovatum.	B.R. ovate-leaved.	ov. acum. ciliat.	re. 6. 7.	N.Holl.	1831.	G. S. ———
triangulare.	B.R. triangular-l'd.	pinnatif. spiny.	sc. ———	———	———	G. S. ———
A'RBUS.						
rigida.	rigid.	ov. ellip. mucr. dent. smth.	1830.	H. S. ———
RHODO'ENDRON.						
pictum.	painted.	ellip. lanc. sub-ferr. ben. sp.	Hybrid.	H. S.	———
Smithii.	Smith's.	ellip. lanc. smth.	———	1826.	H. S. ———

ICOSANDRIA DI-PENTAGYNIA.

COTONEA'STER.						
microphylla.	small-leaved.	obov. ent. vill. ben.	wh. 4. 6.	Nepaul.	1820.	H. S. ———

TETRADYNAMIA SILIQUOSA.

A'RABIS.						
crispata.	DC. curled-leaved.	spat. ellip. smth. dent.	wh. 3. 4.	Carniola.	1816.	H. B. ———
lasioloba.	DC. woolly-podded.	pinnatif. vill.	wh. 5. 7.	Mexico.	1824.	H. B. ———

MONADELPHIA PENTANDRIA.

TACSO'NIA. TACSO'NIA. <i>Invol. 3-part. Perianth. col'd. of 10 leaves. Stam. 5, unit. in a long tube.</i>						
grandiflora.	large-flowered.	3-part. seg. serr. lan. smth. car.	8.	1830.	G. S. cl.	———
pinnatifida.	pinnate-stip.	3-part. pube. segm. ill. ser. pa.	———	Chile.	1828.	F. S. cl. ———

ERRATA.

At Page 10, for "Trigynia Monogynia," read "Diandria Trigynia."

At — 50, add "ORDER II. DIGYNIA. Styles 2," which should stand at the head of the Genus *ASCLEPIAS*.

At — 58, for "paiifolia," read "apiifolia."

At — 150, in the first line from the top, for "anomalus," read "anomalous."



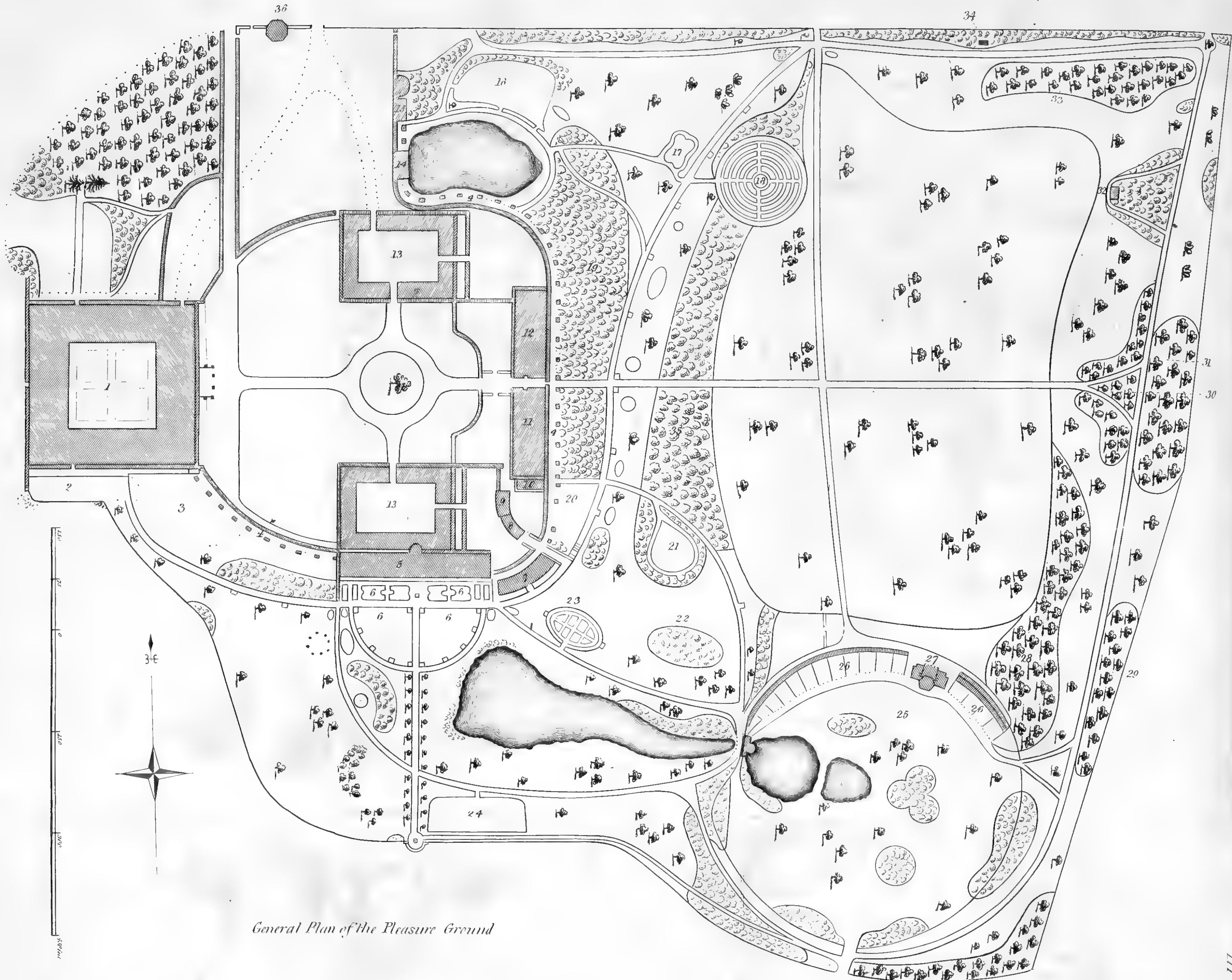

General Plan of the Pleasure Ground

THE PLEASURE GROUND.

THE annexed Plate, No. 3, will illustrate the general arrangement of the Pleasure Ground, &c. which are attached to the Abbey and its various out-buildings.

The Pleasure Grounds, or Flower Gardens, should always be formed so that a portion of them may come in connection with a part of the mansion, to secure a free communication betwixt the two, uninterrupted by roads or other intervening obstacles. In wet, or showery weather, a great distance is exceedingly inconvenient. It is very generally admitted, that but few grounds have been laid out with more taste and judgment, for convenience, privacy, variation of surface, and scenery, than those at Woburn Abbey. The accompanying Plate, No. 1, represents the *site* of the Abbey, which forms a quadrangle, 235 feet in length on each side. On the south, a *Terrace* has been raised by the present Duke, which is divided from the Park simply by an iron railing: at the extremity of this *Terrace* various beds are formed, enclosed with iron and basket

edgings, wherein are planted the different sorts of herbaceous and bulbous plants that are requisite for keeping up a display of flowers, in view from the *Libraries* and *South Drawing-room*. These beds, and Terrace, are separated from the Duchess's Private Garden by an iron railing and small gate, which opens into Her Grace's Garden, whereby a promenade of 235 feet in length, of a flagged *terrace*, is formed. An entrance from the private apartments opens into the Duchess's Garden, from which commences a covered walk, leading to the *Sculpture Gallery*. This building was originally erected for a Greenhouse, but it has been converted into a Gallery by the present Duke, the dimensions of which (including the two *Temples*) are 204 feet in length, 25 in breadth, and 23 feet high; the centre is about 30 feet, the dome of which is supported by eight magnificent antique marble columns. The floor is partly inlaid, on each side the centre walk, with handsome marble from His Grace's estates in Devonshire. This Gallery is considered to contain the richest private collection of marbles, and other antique sculpture in the kingdom; amongst which are the celebrated *Graces*, executed by *Canova*, at Rome, expressly for His Grace.

The Greenhouse is connected with the Gallery by a passage, whose walls are ornamented by various pieces of sculpture. A covered walk leads from the Greenhouse to the Heathery, Camellia-house, Geranium-house, and Stoves, &c. the walls of which have been tastefully painted in *fresco*, with flowers, and a landscape, by *A. Aglio*. The covered walk

is now repeated from the Sculpture Gallery, by the back of the Greenhouse, under the Heathery, towards the *Riding-house* and *Tennis-court*, which forms a range of building of about 240 feet in length, by 50 in breadth. This walk extends as far as the Duchess's *Chinese Dairy* and the Game Larder. The whole length of the covered walk measures 1342 feet, and forms an admirable promenade at any season, or in any weather. The roof rests on one side against the adjacent buildings, and is supported, on the side next to the Pleasure Ground, by columns, that are placed about five feet apart, and against which various species of hardy creepers are trained.

The *Chinese Dairy* is of an octagonal form, and contains a great variety of valuable old China. The floor and slabs are of different varieties of marble.

The windows are all beautifully painted with Chinese figures and various fancy birds; these, as well as the *Portico*, which surrounds three sides of the Dairy and Lantern, are also painted in the Chinese style, and the whole forms a very interesting feature in the Pleasure Ground. A small piece of water comes close to the base of the *Portico*, supplies the Dairy, and gives a highly picturesque effect to this part of the grounds. The banks, by the margins of the water, are planted with Aucubus, Rhododendrons, Azalias, China Roses, Hydrangea, and other species that are natives of China, in order that they may correspond with the Chinese style of the building. Adjoining, are, also, the Children's Gardens, with various Arbours, &c.; but as a separate plan, and description of these will appear in

another part of this Work, it will be unnecessary to notice them further here.

In proceeding with a brief description of the Grounds, we shall begin at the south front, or Terrace, and make a few observations on the most interesting parts that will not be further illustrated by other plates. The main walk, which sweeps round the greater part of the Pleasure Ground, is nearly two miles in length; it commences at the South Terrace, and winds along between the parterres in the front of the Sculpture Gallery and Greenhouse: opposite to the latter, No. 23, is the *Rosarium Britannicum*, formed by His Grace in 1830; it contains all the different species and varieties of *British Roses*, the entrance to which consists of an *iron trellis arch*, covered with climbing Roses; there is also a trellis along one of the sides, for training the creeping species to, terminated at each end by an ornamental stone *vase*; the other side is enclosed by a hedge formed of Scotch Roses. At the east end of the Greenhouse we ascend by a flight of steps that is necessary for the connection of the walk, and which continues by the Heathery and Hardy-heath Garden, and from thence sweeps along by the American Bank, Willow Garden, and Rock-work, towards the top of the Pleasure Ground: along the edges of this walk are placed a number of handsome stone vases, as is indicated by the square blocks on the plan.

The American Banks cover upwards of an acre of ground, the whole being richly planted with the numerous species and varieties of Rhododendrons,

Azalias, &c. Along the centre are planted various sorts of the Holly, always pleasingly conspicuous by its glossy foliage. Opposite to this Bank is the collection of *Pines* and other *genera*, belonging to the CONIFERÆ tribe, amongst which may be seen the *Pinus Douglasii*, *Lambertiana*, *Ponderosa*, *Gerardi*, and *Araucaria*, *imbricata*, *brasiliانا*, *Cedrus Deodara*, &c. &c. Adjoining the collection of *Pines* is situated the *Salictum*, consisting of the most numerous species and varieties of *Salices* in Britain: a splendid work on this *genus* was printed in 1829, by His Grace, for private distribution, illustrated by coloured plates of all the different species that were then in this collection, both foreign and indigenous.

The larger growing kinds are planted round the outer beds, or circles of this grove, and the small, or dwarf species, occupy the centre circles. The whole is enclosed by a Holly-hedge, with the exception of the entrance, which is formed by an iron arch *trellis*, intertwined with some of the more flexible *salices*. Opposite to the Willow Garden is a large mass of Rock-work, lately formed, and planted with a choice collection of the hardy alpine plants: upon the left of this, rises another bank of Rock-work, wherein exists a very complete *Rosarium Scoticum*, approached by a similar iron arch *trellis*, containing all the numerous varieties of the Scotch Rose, raised by Messrs. Dickson and Turnbull, whose Nursery, at Perth, has been so long celebrated for this Rose, as well as for their very extensive collection of other ornamental plants.

The entrance is covered with the different varieties of the Ayrshire Rose that were raised by Mr. Smith, the well-known *Botanist*, whose extensive collection at Monkwood, near Ayr, has long ranked amongst the first in the kingdom. Along the top of the Rock-bank is planted a row of the *Pyrus Japonica*, whose scarlet blossoms are so brilliant in the early Spring, or at whatever period they expand their flowers. The plants are all trained to a neat iron trellising, which separates them from the American plants, by which the rock-work is backed. At a short distance from the Willow Garden is a clump of Cedars, one of which measures 62 feet in length of clear straight timber, and is 10 feet in girth at 6 feet from the ground. This tree is upwards of 80 feet in height, and is certainly one of the handsomest timber trees of the kind in the country, or the author has ever met with. In a clump, towards the top of the Pleasure Ground, is a collection of American Oaks, terminated by a very fine Oak Tree. From this part of the grounds there is a beautiful view of nearly twenty miles extent, finely varied with wood, hill, dale, and other elements of the Picturesque. Hence, the walk winds towards the Menagerie, passing through different clumps of Forest Trees that have been lately introduced in this part of the grounds; with the species of each *genus* grouped together, whereby they are much more readily distinguished from each other, than they can be when planted promiscuously. A very complete Arboretum, surrounding the extremity of the grounds, will thus,

in a few years be formed;* such kinds, only, as are most conspicuous and interesting, have been selected for the more public situations. The natural arrangements, therefore, have not been strictly adhered to. The walk next forms a sweep round the rustic paling of the Menagerie, and thus branches into another, which conducts from the Sculpture Gallery, by the Grass Garden to the Labyrinth, which is now forming, with a Chinese temple in the centre; and, lastly, to the private entrance of the Heathery. The straight walk in front of the Sculpture Gallery, is terminated by a vase, by Kent, and a semicircular stone seat, surmounted by a balustrade. An avenue of Standard Roses ornaments the margins of this walk; adjacent to the seat is the HORTUS GRAMINEUS, No. 40, which contains 400 species of *Gramineæ*, as well as a number of species of the *Leguminosæ*, or Vetch tribe, so nutritious for the feeding of cattle. The different species in this Grass Garden, have each a square space of ground allotted to them, bordered with cast iron edgings; gravel walks intervene betwixt

* The most complete Arboretum, containing the best private collection of hardy trees and shrubs that the Author has seen, is, undoubtedly, at Flitwick House, in Bedfordshire, the seat of Thomas Brooks, Esq. a gentleman, who is devotedly attached to horticultural improvements, is an excellent *scientific Botanist*, and has arranged all his plants in the *Arboretum*, according to the natural system of Jussieu. Mr. Brooks's garden and grounds are kept up almost in unique neatness, and display a rich collection of Botany Bay and Tropical plants, all in a high state of cultivation; a collection which is daily increasing by the introduction of new plants.

the beds. The whole compartment is enclosed by a Hornbeam-hedge, bordered with Moss Roses; the garden was designed and executed by Mr. Sinclair, F.L.S. H.S., then His Grace's Gardener, the well-known author of that valuable work, "*Hortus Gramineus Woburnensis*," which contains the result of many years' laborious analysis on his part, and which is, therefore, a great acquisition to every agriculturist. In conclusion, we must not omit to mention that another walk, springing from the Greenhouse, conducts the visitor close by the Rosarium Britannicum, and its adjoining sheet of water, to the MENAGERIE. This interesting department occupies above two acres of ground, and consists of a rustic cottage, and various wired compartments, for the different fowls and animals which it contains; but as these buildings form the subject of a distinct plate and description, it is unnecessary to particularise them further in this place.

REFERENCE TO THE GENERAL PLAN OF THE
PLEASURE GROUND.

1. Abbey.
2. Parterres in front of the Libraries.
3. Her Grace's Private Flower Garden.
4. Covered Walk.
5. Sculpture Gallery.
6. Parterres in front of the Sculpture Gallery.
7. Greenhouse.
8. Camellia House.

9. Greenhouse for *Pelargonix*.
10. Plant Stove.
11. Riding House.
12. Tennis Court.
13. Stable Courts.
14. Chinese Dairy.
15. Larders.
16. Children's Gardens.
17. Rock Work.
18. Willow Garden.
19. American Bank.
20. Hardy Heath Garden.
21. Site for Heaths when out of Doors.
22. Collection of Hollies.
23. Rosarium Britannicum.
24. Grass Garden.
25. Menagerie.
26. Wired Compartments of Ditto.
27. Keeper's Apartments, Canary Room, &c.
28. Alders and Birches.
29. Poplars.
30. Species of Ash Trees.
31. Elms.
32. Temple and Platanus's.
33. American Oaks.
34. Arbour.
35. Different Species of the Genus *Pinus*.
36. Porter's Lodge.

THE FLOWER GARDENS.

The accompanying Plate, No. 4, is a representation of a Flower Garden, wherein are cultivated various species of flowering plants and bulbs, in order to preserve as constant a succession of blossom in front of the Libraries, as the season will admit. The entire row of hexagon beds in the centre, is enclosed with a stone curb, on which are inserted wrought iron basket edgings, which rise together with the stone-work about 9 inches above the gravel. The other smaller, or semi-hexagonal beds, have all simple cast iron edgings. The intervening space is kept neatly gravelled, which extends to the outer line of the Terrace, which is on an elevation about 10 feet above the Park level, towards which it is faced with rusticated stone-work, corresponding in character with the basement story of the Abbey. The west end of the Terrace is enclosed with a balustrade, and the south side by a handsome gilt trellis, which extends nearly as far as the Library, when it connects with an iron fence, that branches off around half the circuit of the Pleasure Ground.

The wide space that intervenes between the Library windows, and the line next to the flower-beds, consists of a flag pavement, which furnishes at all seasons a dry and clean promenade.

The Flower Garden, No. 2, opposite to these private apartments, was laid out according to the taste-

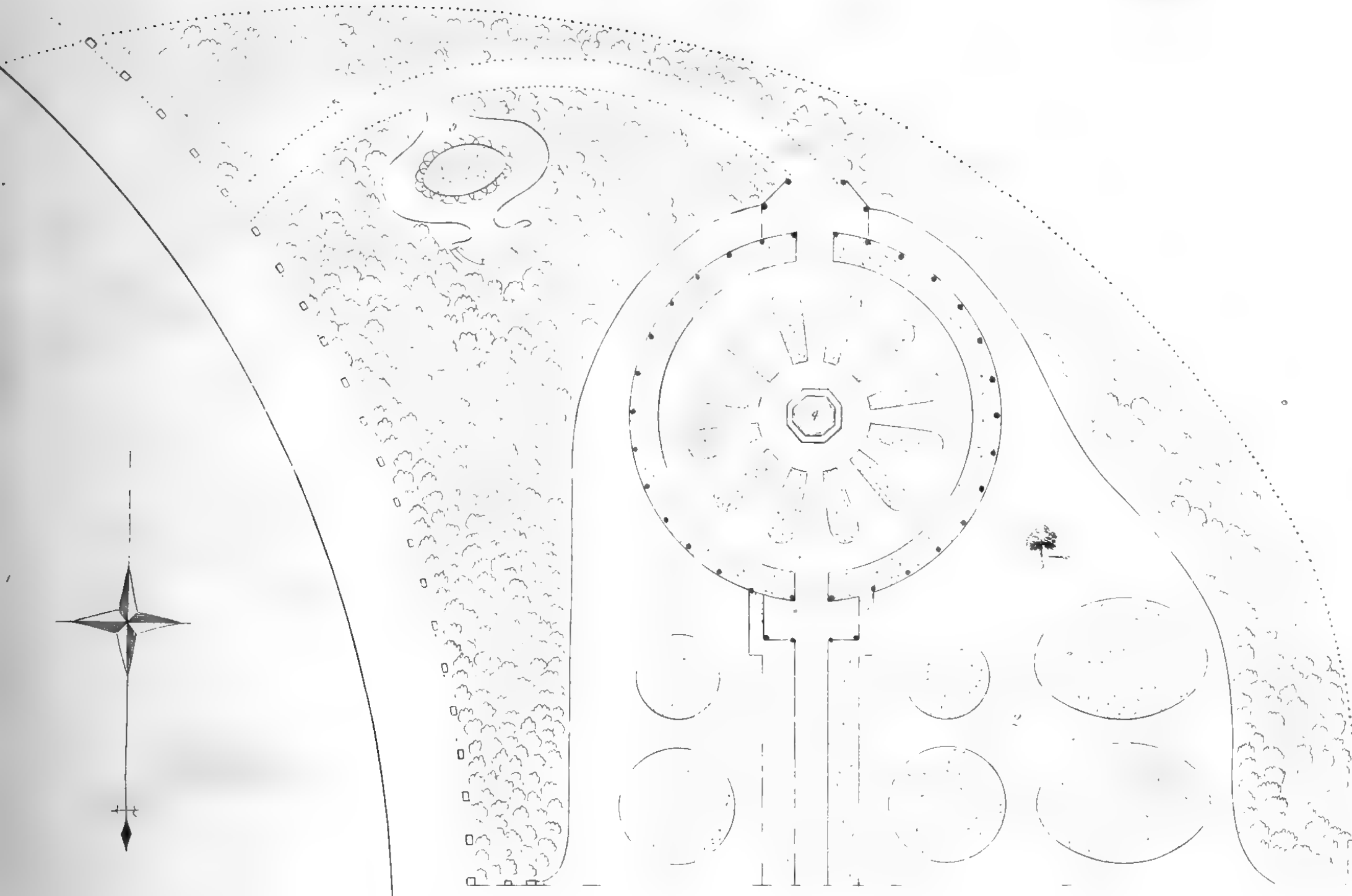
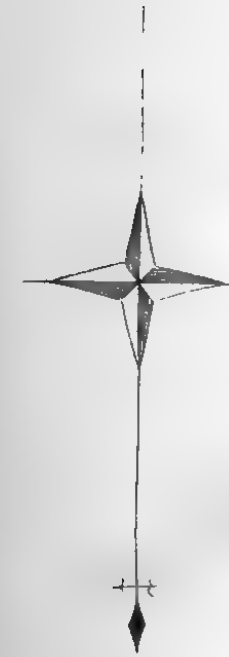

Her Grace's Flower-Garden, in front of the Private Apartments.

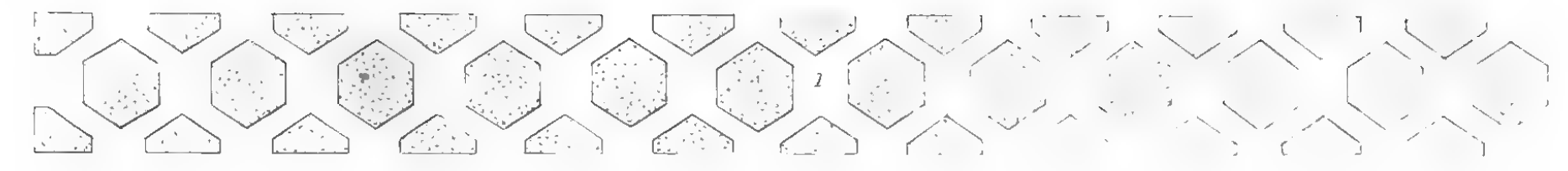

Parterres in front of the Library.



ful suggestions of Her Grace the Duchess of Bedford, who also planted the double-flowering Thorn, No. 3, which has now shot up to the height of 16 feet, the distinguishing peculiarity of which is, its forming a very close and complete arbour, full 45 feet in circumference. The lower branches being trained close to the ground, the tree is regularly kept clipped, with an arched entrance formed in the centre, and an aperture on each side for arboreal windows.

The circular and oval beds in this garden, are filled, in the Summer season, with the different species and varieties of Geraniums, grouped together, clumps of Heliotropes, and other choice flowering plants; and in the Winter season they are stocked with Wall Flowers, and other Evergreens. The borders, on each side of the straight walks, are also planted with Geraniums, and a selection of the most showy Herbaceous and Annual plants.

Around the exterior circle, iron arches are formed, for training the various kinds of climbing Roses on; the border consists of Roses, and Lilies of the Valley, intermixed. The inner beds are solely allotted for Roses. In the centre, No. 4, is a handsome fountain, which supplies this garden with water. The exterior borders are all richly planted with various species of American shrubs, in which the Magnolia, Calycanthus, Azalia, Kalmia, and Rhododendron, are, in the Spring time, floridly conspicuous. Leading out of the Rosarium, an iron-arched trellising is continued to the Piazza, covered with creepers; and, adjacent to it, No. 5, is Her Grace's Private Arbour, formed of open wood-work, intertwined with

Climbers, with an oval flower-bed in front, surrounded with a basket edging. This garden is enclosed by an invisible iron railing, which is concealed by the Evergreen-shrubs that surround the whole space.

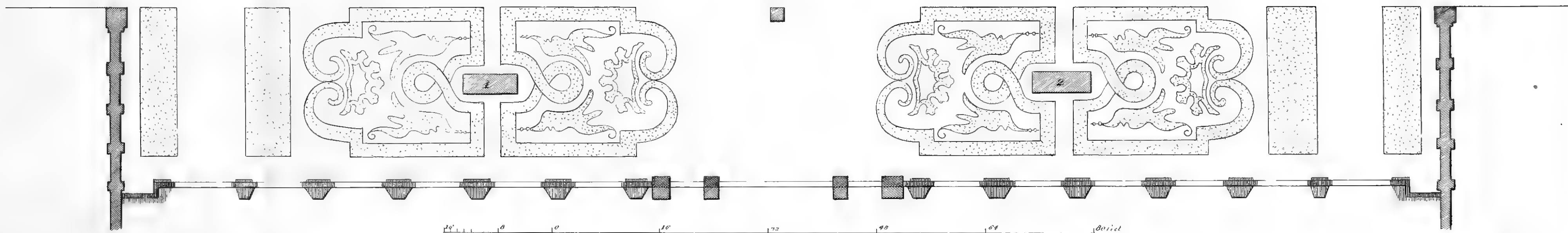
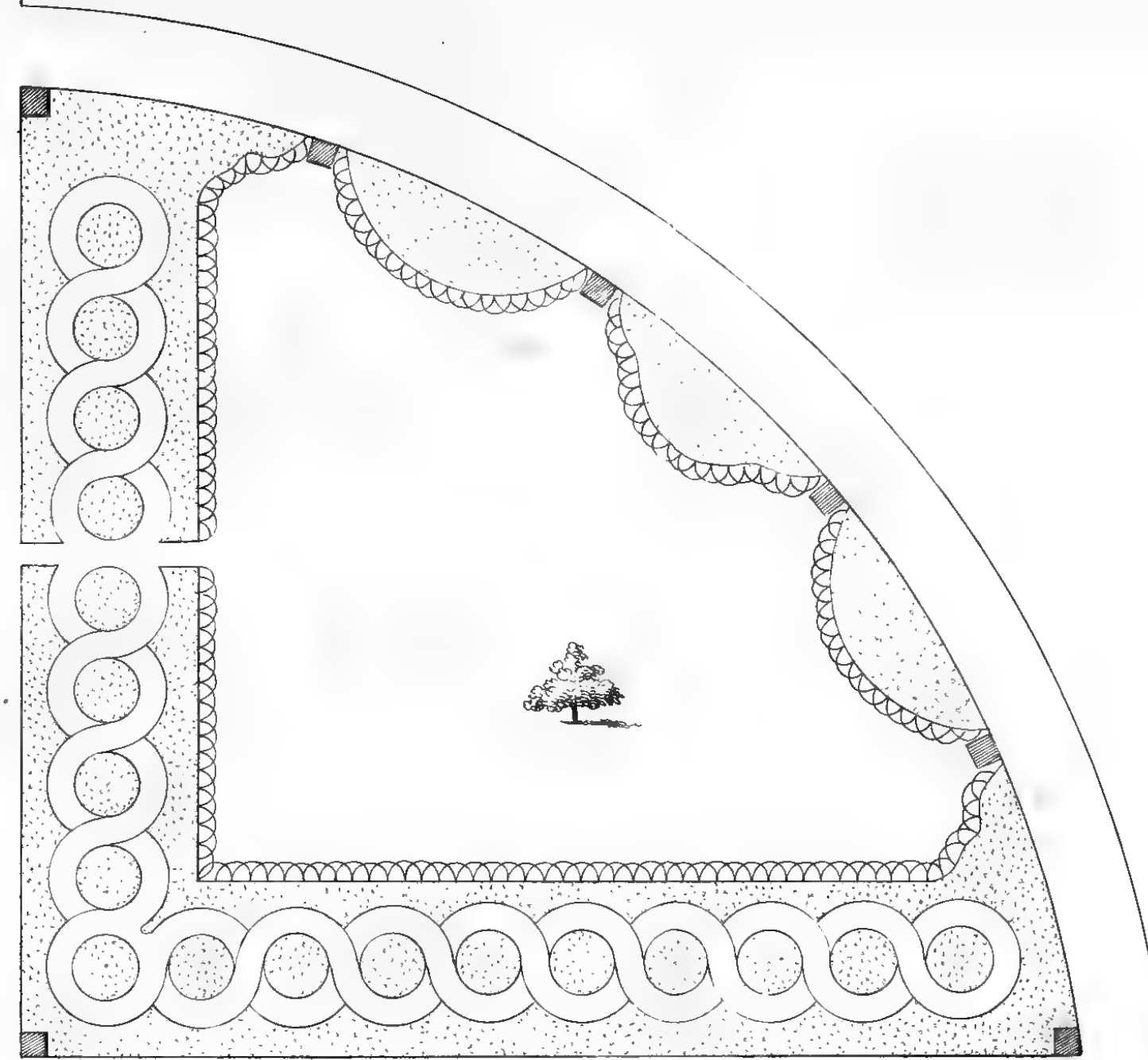
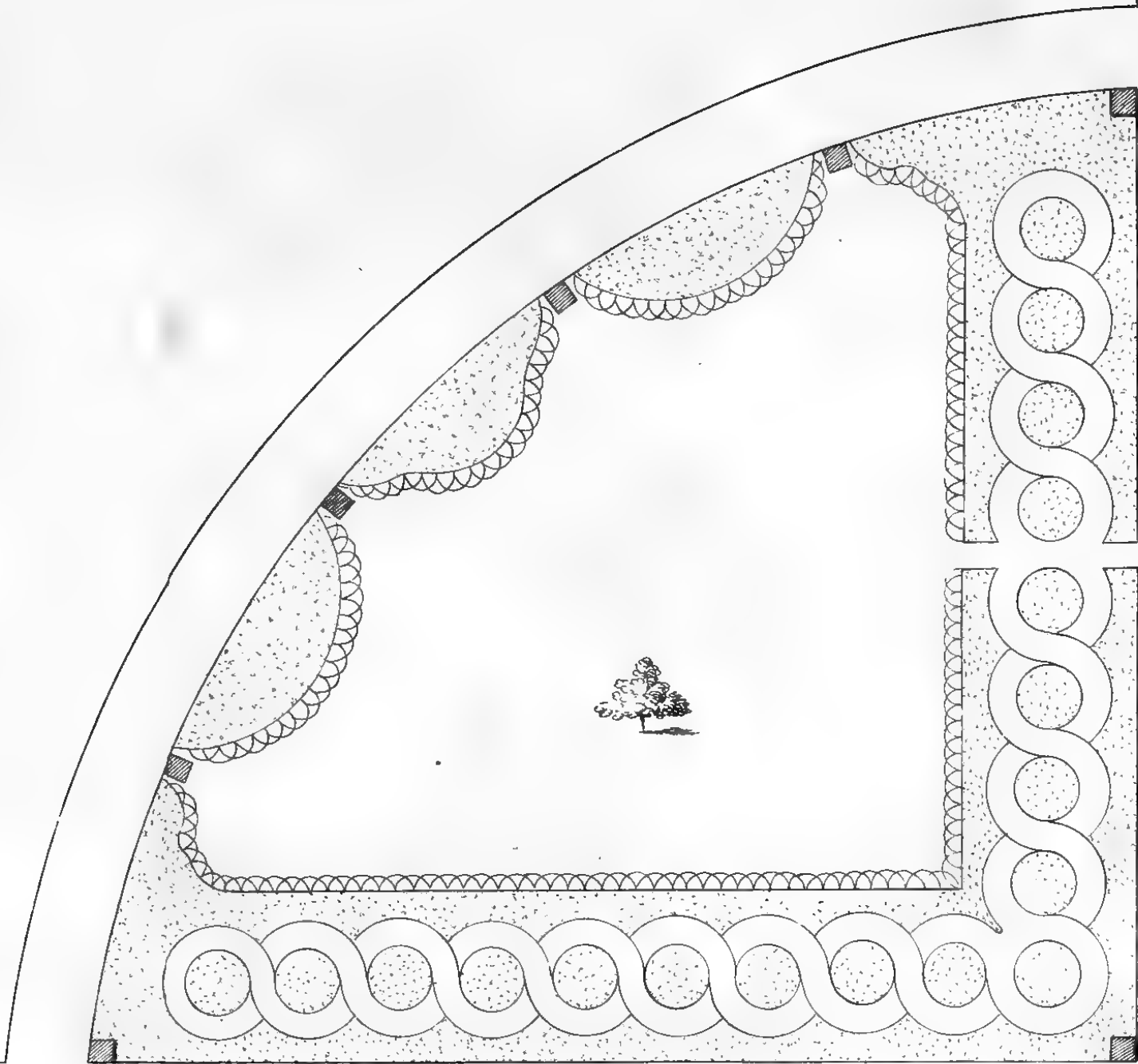

Porticoes in front of the Sculpture Gallery.



THE PARTERRES.

The annexed Plate, No. 5, is a representation of the Parterres situate in front of the Sculpture Gallery, which form an appropriate and interesting feature in this part of the Grounds. The variety and intricacy of these beds are much admired, more especially as they display a rich collection of herbaceous and annual plants, which keep up a mass of bloom throughout the greater part of the year. These beds and flower borders are all edged with box, and the intervening walks covered with fine sand, which gives them a peculiarly neat and original appearance. No. 1 and 2, represent the site of two fine bronze casts, by Westmacott, of the *Dying* and *Fighting Gladiators*, which are elevated on granite pedestals. The Parterres are terminated by a handsome balustrade wall, on which are placed copies of antique vases. Various descriptions of ornamental vases are also arranged along the edges of the walks, which are indicated by the square blocks in the plate: the basket work, also, shewn in the plan, consists of strong wire, and forms a very appropriate edging to the borders. These Parterres were laid out, and executed, from the drawings of Her Grace the Duchess of Bedford, and are extremely well adapted for the display of the various flowers, throughout their different stages of blooming, at the different periods of the year. The succession of flowers is

kept up by the Anemone, Tulip, Crocus, and other early blooming sorts; and is continued through the Summer months, by having recourse to frequent sowings of annuals from February, to the end of June; the kinds best adapted for Autumn flowering, are selected for the last sowings, which, together with the late blowing perennial kinds, Chrysanthemums, and a collection of Georginas,* or *Dahlias*,

* For the introduction into this country of this truly eminent and popular plant, whose beautiful blossoms so richly decorate the flower borders in the Autumn months, the British Horticulturists are indebted to Lady Holland; and, through her Ladyship's kindness, we are enabled to give the following interesting account of its native country, and the year it was introduced into our British Gardens.

In 1804, when Lord and Lady Holland were in Spain, the Abbe Cavanilles, Professor of Botany at Madrid, who had published 2 Volumes on Statistics, and the Natural History of Valencia, besides several Botanical works, gave Lady Holland some roots of the *Dahlia*, lately arrived in Spain from America; her Ladyship sent them to Mr. Buonauti, the Librarian at Holland House; under his superintendence they were planted, and flowered that year, in the gardens there. Mr. Buonauti made some mystery, for a time, of his manner of propagating them; but Lord Holland insisted upon his giving roots of the plants to Messrs. Lee and Kennedy, and others; they then became very common, and were much improved by culture. Lady Holland was not, at first, aware that the colours of the flowers ever varied; for those raised the first year, were all of a pale purple, or lilac hue, and all single flowers; the next year, many, of various colours, were produced at Holland House, and at St. Anne's Hill;† and it was not long before Messrs. Lee and Kennedy found the means of raising double flowers from those roots. It is supposed that it originally came from *Mexico*, not *Peru*.

They were named *Dahlia*, from the Swedish Professor *Dahl*,

† The Seat of the Right Honourable C. J. Fox.

with their numerous flowers, prolong the beauty of the borders, until the frost sets in. The finest collection of Georginas, as well as Pelargoniums, that I have seen in Bedfordshire, all cultivated in the highest state of perfection, is, unquestionably, in the Garden of Henry Seymour, Esq. at Woburn. It formerly abounded in numerous species of rare Cape and Tropical plants, which were cultivated by the late Honourable Mrs. Seymour, whose scientific knowledge, Mr. Sweet has commemorated in the Genus *Seymouria*. The Garden laid out by this Lady, is the most admirable little design of the kind that I have ever seen; the disposition of the various flower beds, and different pieces of rock-work, connected with trellising, and iron arches, are so judiciously arranged, that, I trust, it will be long preserved as a perfect model, on a small scale, of English Gardening, in the nineteenth century.

who first published an account of this plant; (the genus was, also, named by Willdenow *Georgina*, in compliment to J. G. Georgi, a Russian Botanist, as the name *Dahlia* was previously occupied by a different plant.)

They were, at first, supposed, in Spain, to be an esculent vegetable; but it is now believed that the root is unfit for the table.

CONSTRUCTION OF THE GREENHOUSE.

The accompanying Plan and Elevation represent a Greenhouse, built from the designs of Sir Jeffrey Wyattville. This house is about 85 feet long, 20 feet wide, and 25 feet high; the front and back of a gentle curve, so as to come in connection with the Sculpture Gallery, and Heathery, which buildings it adjoins. The front and ends of this house consist of cut stone piers, which are carried up, at 9 feet apart, to the height of 16 feet; from whence spring a stone blocking and cornice, that is raised about four feet above the level of the top of the lights. The front sashes are made in two tiers; the upper ones two feet long, whereby they open in the centre, and fold backwards to each side. The lower windows are eight feet high, and come close to the floor of the house; they also fold back to the outside: and being hinged on both sides, at the width of one foot six inches, leave a space of four feet in each, to throw open for the admission of air. The top consists of a spawn roof, with glazed lights on each side, which are fixtures, and not moved, except when taken off entirely, in the Summer season, for exposing the Orange Trees, Camellias, and other large plants, to the full benefit of the nightly dews, and external atmosphere; as, by opening the sashes in front, and taking off the roof lights, the plants are nearly as much exposed to the weather, standing in

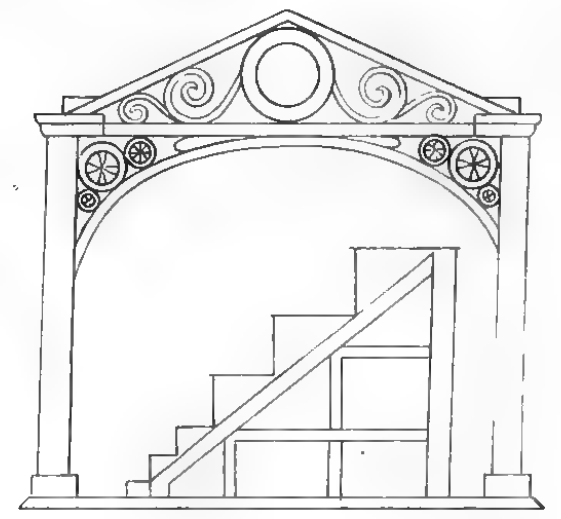
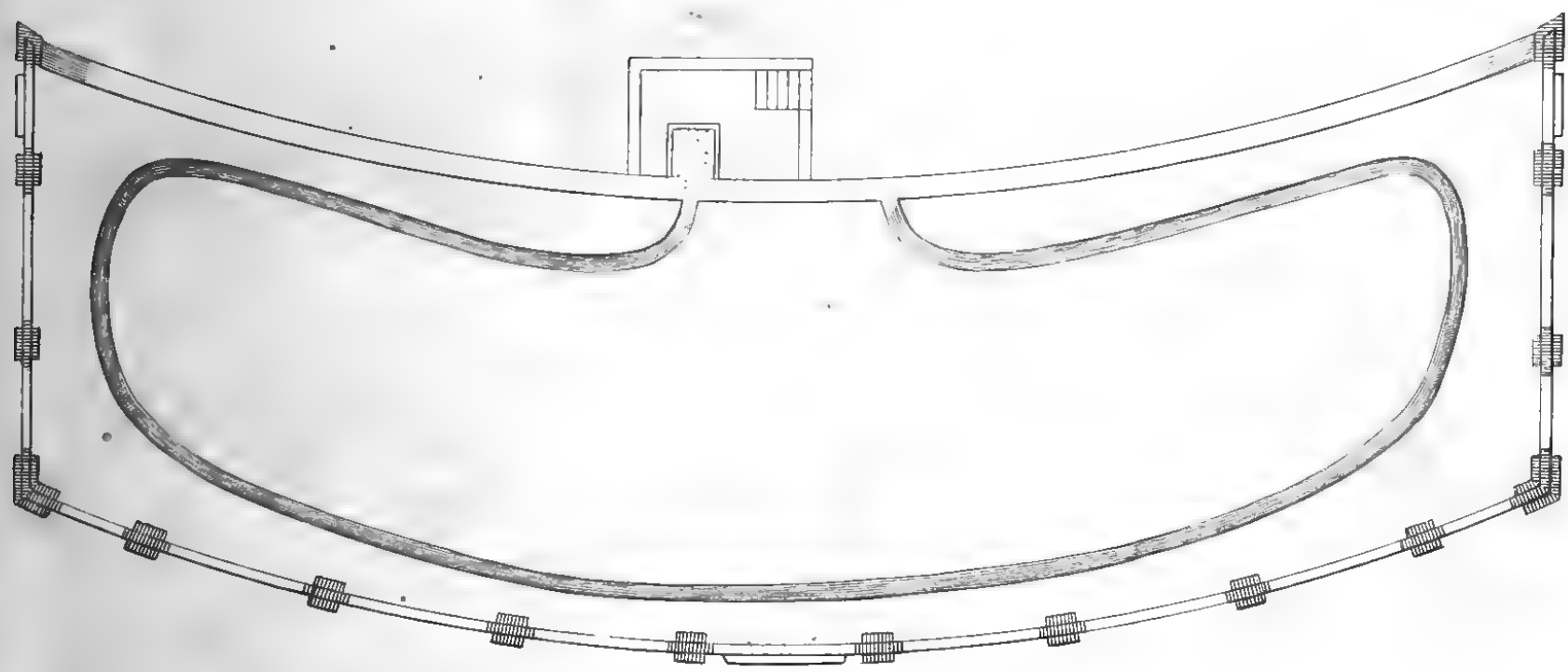
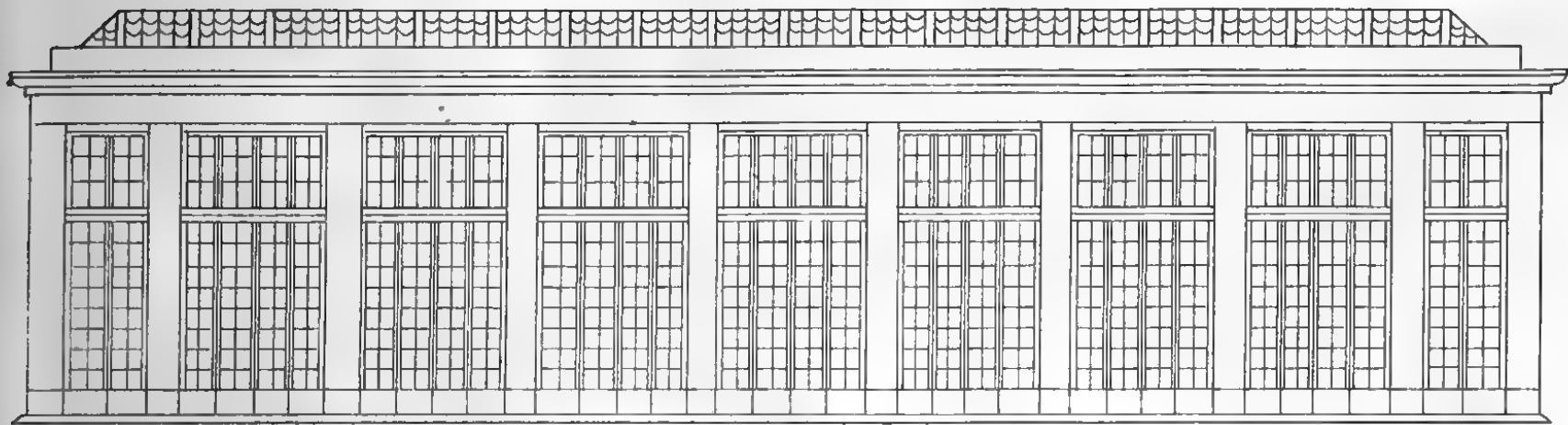

Ground Plan, Front Elevation, and Section of the Green house.



this Greenhouse, as if removed out of doors. The front windows are all composed of wood, as well as the roof sashes and rafters; the latter are, however, of very slight dimensions, and are supported by strong cast iron scrolls, as is represented in the section. The floor of this house is inlaid with octagon tiles; and the flues which warm it are carried round the front, under the tiles, where apertures are left at different spaces, so as to allow the heat to ascend amongst the plants. The stage is constructed of different heights, in order to suit the large boxes which the Orange Trees, Camellias, &c. necessarily require; the smallest plants being arranged along the front, or lower part of the stage. In the recesses of the windows, there is a small circular stand placed in each, which is about two feet wide at bottom, and gradually terminates at top to a 6-inch shelf. This stand consists of four rows of shelves, and was constructed according to the plan and directions of the Duchess of Bedford, with whom the idea first originated. These stands are very useful for holding a selection of the various small plants that are too delicate to be intermixed with the more robust growing kinds.

MANAGEMENT OF THE GREENHOUSE AND
CONSERVATORY.

The general management of the Greenhouse and Conservatory is so similar, that it might be considered superfluous to treat separately of the two,

especially as no deviation whatever takes place between the plants in both, so far as regards soil, temperature, and propagation.

The plants, cultivated in both departments, are principally natives of the Cape, Japan, New Holland, or some other equally temperate climate, and may, therefore, all be treated as Greenhouse plants.

In the erection of a Greenhouse and Conservatory, the form of the house is not of so much importance, providing it be placed so as to have the full benefit of the early morning and mid-day sun, in the Winter and Spring months, which is so essential to the welfare and health of the plants. It is, therefore, necessary, that these buildings should be so constructed as to admit of a large portion of light and ventilation, the two most essential requisites in such structures. The sashes should, consequently, be so arranged, that a large quantity of air may have access to circulate in all parts of the house.

It is, likewise, very desirable that the house should be furnished with the proper means of increasing the temperature in severe weather; and whether heated by steam, hot-water pipes, or flues, they should be constructed of such magnitude, and so devised, that the heat given out from them will be sufficient for expelling the frost in very severe weather, as well as for quickly raising the temperature of the house, which is often absolutely necessary, when the cold or frost sets in suddenly in the evenings, as this frequently becomes so intense, that, otherwise, many of the more tender species would be hurt before morning. And although many of the

Cape, and New Holland plants, will bear several degrees of frost without injury, there are other species of less hardy constitution, that would suffer severely by being exposed to the same degree of cold. It is, therefore, advisable to guard against any bad effects, by having recourse, in time, to the aid of the furnace. We must, however, observe, that the less any artificial heat is applied to the Greenhouse and Conservatory, the more beneficial it will be to the plants; and that fire-heat should never be resorted to, except in frosty weather, or when it is very cold and wet; then a little heat is necessary to dry up the damp, which is frequently very injurious to the more delicate plants. If the frost is simply expelled, it will be sufficient, and the atmosphere of the house should not be permitted to exceed 36 degrees, by artificial heat; as, if the plants are preserved from frost and damp, the more healthy and hardy they will be. During wet and frosty weather, the plants should have but little or no water, as many of the species suffer materially by being kept too moist, when they are in a dormant state. The entire collection should be frequently examined; and only such as appear in absolute want of water should have any given to them, and that in very moderate quantities, until they again appear in a state of activity, when they will require to be more bountifully supplied; but the operator must be guided in administering this element, according to the action of the plant, and state of the weather. Such species as are dormant, and those that are unhealthy, will require to be kept rather

dry, and should not be allowed to suffer from too much moisture. By the beginning or middle of March, the atmosphere will, in general, be getting more congenial to vegetation, when the plants may have occasional syringings over head, in order to refresh and clean their foliage from the dust that may have accumulated on them, during the suspension of the syringe or engine. The advantage of a fine morning should be taken for performing the watering, in order that the house may be immediately ventilated, so that the damp may be dried up before evening, which will prevent any of the tender shoots from being chilled; but as the season advances, and the nights become warm, the engine may be more freely applied, and the water administered in the evenings, in order that the plants may have time to refresh themselves with the moisture, during the night, and before the return of the scorching effects of the sun, the ensuing day.

When the weather begins to get warm in Spring, a little air should be let in, during the nights, to both the Greenhouse and Conservatory; and as the external atmosphere increases in mildness, the admission of air should be increased accordingly; as a large current of this element, circulating through the house at all favourable opportunities, will keep the plants from being drawn up into a weak or languid state, and getting naked at the bottom; consequently, air should only be excluded in frosty or severe cold weather. If the lights are only opened for a few hours, in the early part of the day, and again shut up early in the afternoon, it will be very

beneficial to the plants, particularly in the Winter season, when this element cannot be admitted in such large portions as would otherwise be desirable, owing to the cold and changeable state of the atmosphere. The plants should be also frequently looked over, and divested of all the decayed leaves and shoots that may appear, and the surface of the mould, in their pots, stirred up, and kept free from moss or weeds, which would soon accumulate. Many of the plants will require a little fresh soil added to the surface of what they are already growing in, which should be as near to the quality of that they were previously potted with as can be procured. By the end of February many of the plants will be beginning to grow ; these should, therefore, be examined ; and such as appear to require fresh potting, should now be shifted into fresh loam, and into such sized pots as the size and strength of the plants may require. In most establishments, it is desirable to keep the plants in small pots, so that they may not occupy too great a space on the stage ; the potting should, therefore, be regulated according to the size of plants wished for, and such pots be used as appear consistent with their health and flowering. As all the species do not begin to grow at the same time, they should be carefully examined, and shifted into fresh loam as they appear to require it. Some of the rapidly growing kinds will want to be shifted oftener than those of less luxuriant habits ; they should, therefore, be treated accordingly : but keeping in view the size, or space, the plants are wished to occupy, as, if encouraged by frequent additions of

fresh soil, they will reach a much greater size than when confined to small pots, which is, however, the most general practice, these being more convenient for the Greenhouse stage. The operation of re-potting may be performed, with great success, any time from February to September, but not later in the season than the middle of the latter month, as it is very desirable that the plants should have time before Winter to establish themselves in the pots. The seedlings, or other young plants, will require to be two or three times shifted in, the course of the season, according to their growth, which is always our best guide.

The soil in which Greenhouse and Conservatory plants seem most to delight, is sandy loam from a pasture, consisting of the top sward, which should be chopped up finely amongst it with the spade, but not sifted, as the roots will make a rapid progress through these fibrous particles. This loam should be mixed, previous to using, with one-third of sandy peat, and about a fourth of well decomposed leaf-mould; and if not naturally of a light sandy texture, it should be rendered so, by adding a portion of sharp pit sand to it: these ingredients being well incorporated together, the mould will be fit for using; but observe, never to use it in potting, except when in a rather dry state; and for preserving it from getting too wet, a shed should be devoted for this purpose, and a quantity of soil always kept in readiness. About the middle, or latter end of May, the plants may be removed from the Greenhouse to their Summer station, out of

doors, which should be situated so as that they will be partially shaded from the scorching effects of the mid-day sun, and be sheltered from the high winds, but placed where they will have the full benefit of the morning and evening sun. In this situation they may remain to the middle of September, if the weather is at all favourable; but, if otherwise, they must be taken in earlier, to prevent the soil about their roots becoming sodden with too much wet.

While the plants are out of doors, they must be regularly attended to with water in dry weather, and their pots kept from weeds, or moss; and when they are going to be removed back to the Greenhouse, they should be all properly cleaned, and such as require fresh staking, be neatly done, so that they may have a fair appearance when placed on the stage; which should be arranged according to the size of the plants, always observing to have the small ones on the front of the stage.

The Greenhouse should have full ventilation every night after the plants are put in, whilst the weather continues favourable; which should be reduced, gradually, as the state of the atmosphere may indicate, and render necessary. Those plants that are planted out in the Conservatory borders, and that cannot be exposed to the external atmosphere, in the Summer months, should have as much air given them as the house is capable of admitting, and be frequently refreshed, by syringing with water overhead, in the evening, when the weather is warm;

but when it begins to get cold, the morning is the more suitable time for this operation.

The borders in which the plants are growing, will also require to be plentifully supplied with water, during the growing season; but little of this element will be wanted when the plants are in a state of inaction, as the body of soil they are planted in, will, generally, then contain a sufficiency of moisture for their nourishment. The surface of these borders should be frequently stirred up, and kept clear of weeds, or moss, which would otherwise soon make their unsightly appearance. The plants must, also, be kept all neatly staked up, and the creepers tied to the trellising.

Many of the rampant growing kinds would soon so far encroach on those of a more delicate habit, as, in a short time, to smother them up; they should, therefore, be kept in due bounds with the knife, and not allowed to stifle or injure those adjoining them, of a less robust nature. I should, however, recommend the *Conservatory* borders to be divided into several compartments, in order that such species as bear a relative affinity with each other in growth, may be planted together; thus forming a clump of the beautiful varieties of the *Camellieæ*, one for the splendid genus *Ericææ*, another for the *Geraniaceæ*, as also for the *Proteaceæ*, and so on, for some of the equally grand and interesting species of other *genera*; observing to plant the larger growing sorts in the centre, or back of the house, and arranging the clumps, so as to have the most delicate and valuable kinds towards the best situation of the

house, in order that they may have the full benefit of the sun, and light ; allotting thus separate spaces for the growth of the different and most ornamental families of plants, the compartments can be filled with such soils as are most appropriate and congenial to the growth of the species they are intended to be planted with, and be made the means of preventing the robust growing kinds from over-shading or injuring the more valuable and delicate species, as is frequently the case, when they are intermixed promiscuously in the house.

The propagation of Greenhouse and Conservatory plants, will require to be performed at various periods throughout the year, as the cuttings should be put in according as they appear in a fit state ; that is, when the young shoots begin to assume a brownish colour, and are getting of a rather firm texture, as many of the sorts are liable to damp, or rot off, when the wood is soft and young ; but, previously to the preparing of the cuttings, there should be a pot, or deep pan, got in readiness, well drained, and filled with the soil, or sand, as the nature of the plant may require. The hard woody kinds will strike root best in sharp sand, while the soft, or herbaceous-like sorts, will root freely in a mixture of sand and loam. There should, also, be got in readiness, the frame, for the sowing of the tropical seeds, &c., into which such sorts as require a little bottom heat may be plunged, as soon as they are put into the cutting pots. Those species which are put in early in Spring, will succeed better, by the assistance of a gentle heat applied around the pots ; but

when the season is more advanced, they will readily strike root without it.

In the preparing of the cuttings, care must be taken not to injure the bark in the removal of the leaves, which should be cut close off to the wood, as far as is necessary for that part of the cutting to be inserted in the soil; none of the upper leaves ought to be shortened or removed, and not planted deeper in the soil than is requisite for the fastening of the cuttings; when they are put in, a little water should be given, to settle the soil or sand more firmly about them. As soon as the wet has evaporated from their leaves, they should be removed to the propagating frame, and if covered with bell or hand glasses, the surer, in general, will the success be, although many of the sorts will strike very freely without them, provided they are not exposed to too much air, and are shaded from the effects of the mid-day sun. The cutting pots will require to be frequently examined, and not permitted to become either too wet or too dry, but kept in a medium, vegetating state of moisture. The glasses will require occasional wiping, to prevent the damp from injuring or rotting the leaves of the cuttings. As soon as the cuttings have struck root, and begin to grow, they ought to be immediately potted off into small sized pots, and re-placed in a frame, when they can be gradually hardened and acclimated to the temperature of the Greenhouse, previous to their removal to that department. There are, however, many species of plants that we cannot propagate by cuttings of their branches, and we are, consequently,

obliged to have recourse to other means of propagation to increase the stock, such as by grafting, budding, laying, inarching, and the saving of seeds. The most natural and successful method of procuring plants, is, unquestionably, by seeds; but as many of our most valuable sorts do not flower in this country, no seeds can ever be obtained in this case. There are, likewise, several kinds that can be readily increased by cuttings off the root, which will not propagate from the shoots, or produce seeds freely. When, however, a collection of seeds can be procured from abroad, in a recent state, there is a great chance of obtaining new or rare plants; a portion of such should be sown immediately on their arrival, as many of them will be found to vegetate when first received, that would not if kept to the ensuing Spring. Those from a tropical country will require a moderate bottom heat to assist their germination.

Seeds from New Holland, the Cape, and other mild climates, will vegetate readily by being placed in a cold frame, or in a cool shaded part of the Greenhouse, and kept regularly supplied with due proportions of water, so that the soil in which they are sown may be kept in a moist vegetating state. The Greenhouse plants, as well as all other scarce sorts which have flowered during the season, should be carefully examined, to see if they have perfected their seeds, when a collection of all the most valuable species should be gathered, as they ripen, and laid up until the following February, when a general sowing should be made. The seed pots ought to be well drained with broken crocks, or

small stones, or cinders, and then the remaining space be filled up with light sandy loam and peat, well incorporated together, and finely sifted for the small seeds. As all the sorts will not vegetate at the same time, some of them will make their appearance in the course of a few weeks, whilst others may remain dormant for nearly two years, and afterwards vegetate; we must, therefore, never be too hasty in throwing away the seed pots, until we are thoroughly convinced that there is no chance of any of the remaining seeds coming up. As soon as the seedling plants appear above ground, they should be carefully watered with a fine rose on the watering pot; and when they get a little advanced in their growth, potted off into small sized pots, and replaced in a frame, where they can be shaded and attended with water until they get established in their pots, and are hardened by degrees to the temperature of the Greenhouse, to which they should be removed. Such plants as appear to be drawn up weakly, should have their tops pinched off, which will induce them to shoot into handsome bushy plants.

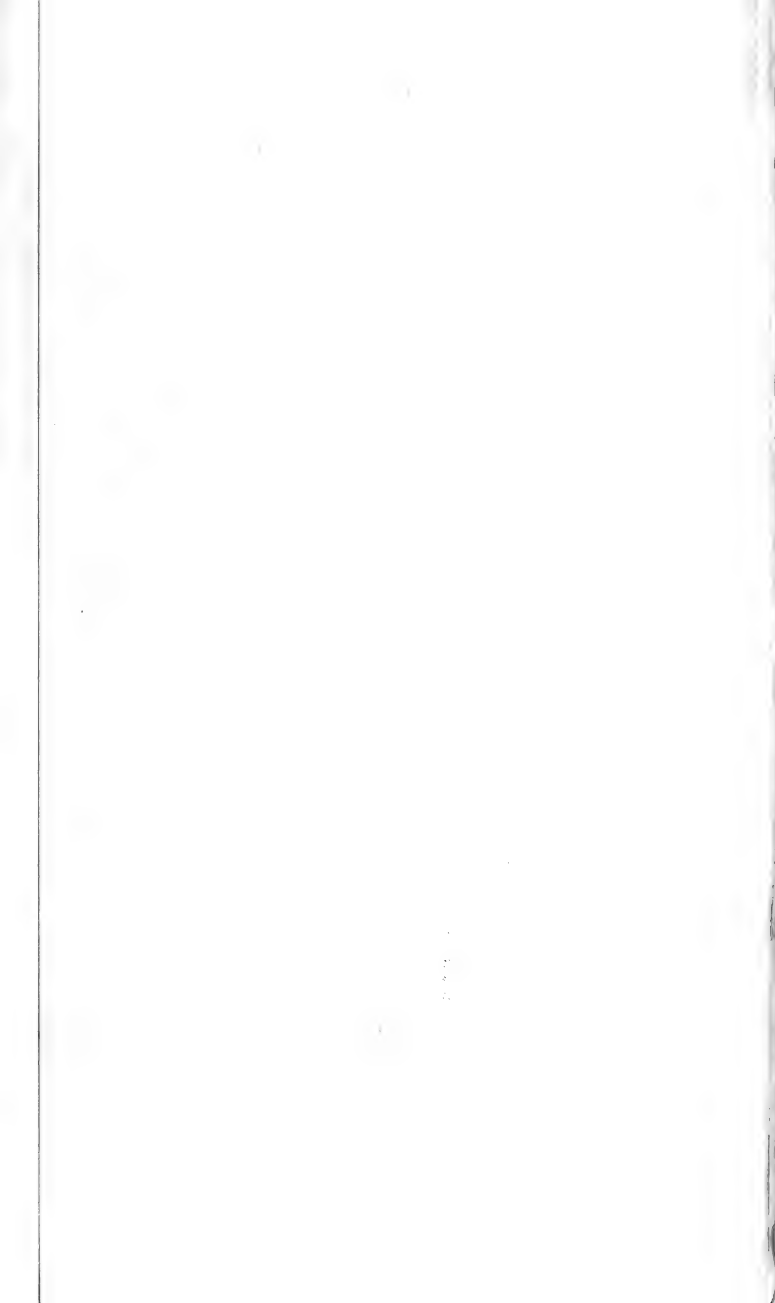

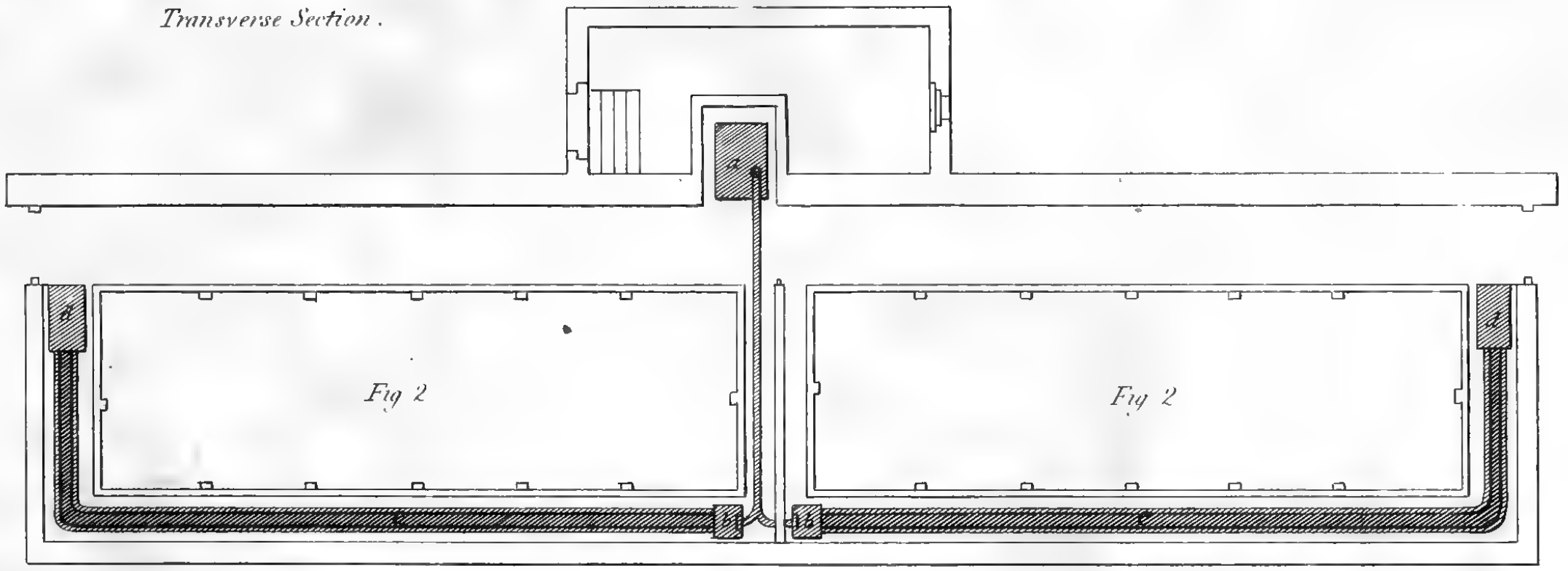
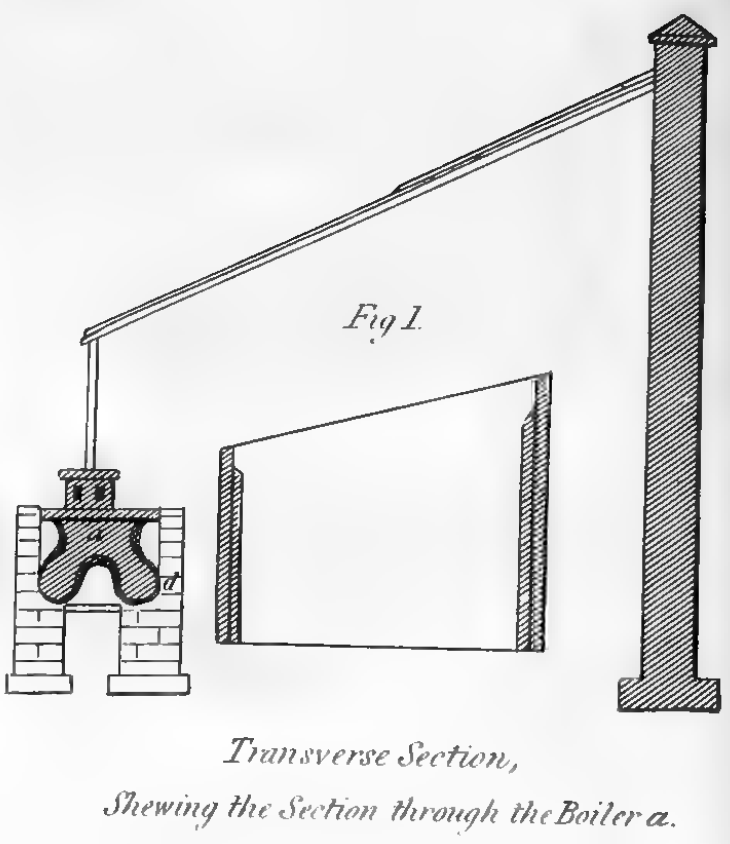
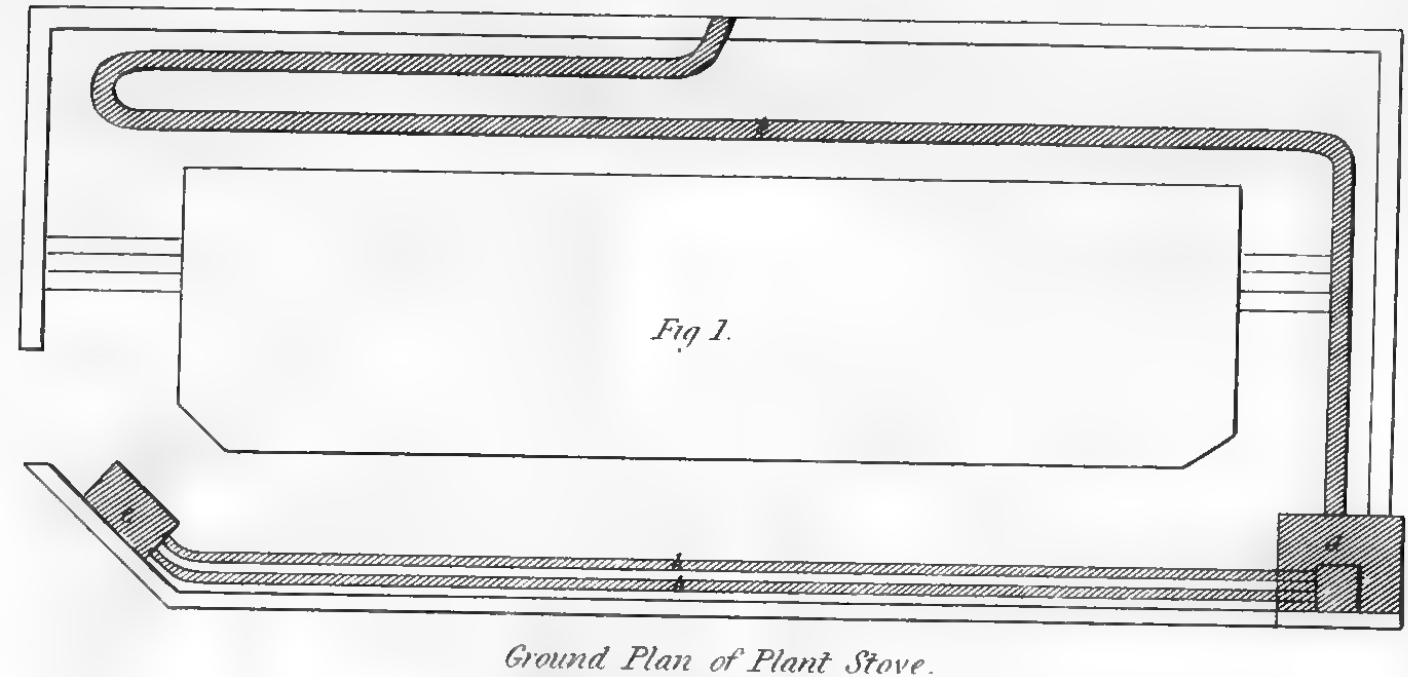
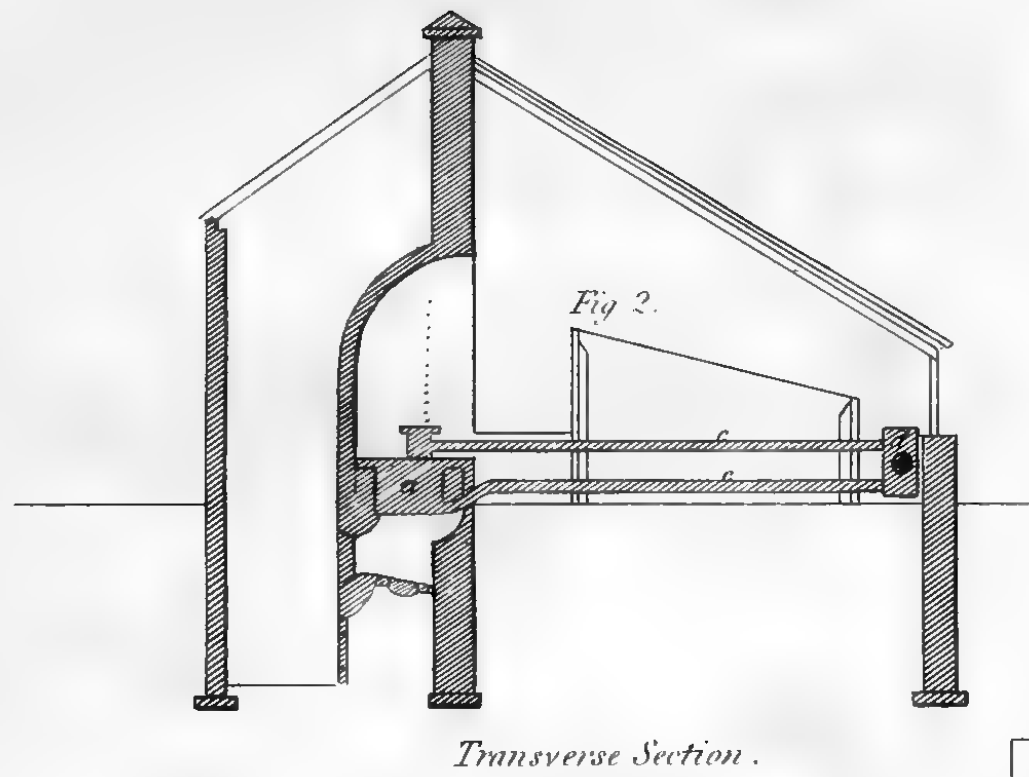

CONSTRUCTION OF THE PLANT STOVE.

The structure of a Stove, for the growth of *tropical* plants, may be of various dimensions and form, according to the taste of the proprietor, and size of the plants that are intended to be cultivated. In some cases, a collection of small bushy plants is preferred to those of a larger size; but where large flowering specimens are preferred, a lofty house should be erected, to allow them plenty of room for the free development of their flowers and foliage.

The accompanying Plate, Fig. 1, represents the ground plan and section of the Plant Stove here; the length of which is about 40 feet; height, at the back wall, 14 feet; and width, 15 feet; along the centre of which is a pit 8 feet in breadth, for holding either tan or tree leaves, for the placing of the plants on. This pit is generally filled every Autumn with the leaves recently fallen from the trees; and after they have heated and subsided a little in the pit, their surface is trod firmly, and then covered over with sand for the plants to stand on, whereby their roots are cherished through the Winter months by the gentle warmth produced by the fermenting leaves.

This house is heated by hot water, lately introduced; the pipes run close to the front wall, as is indicated in the plan, Fig. 1. In this department

are three pipes, in communication with the boiler *a*, and reservoir *c*; that is, two upper pipes, nine inches broad, and two and a half deep, placed on an edge, and running parallel to each other, and one circular return pipe, which is about four inches in diameter, and returns directly under the two flat ones, and thus conducts the water from the reservoir back into the boiler, close to the bottom of which it enters. This boiler consists of a concave bottom and steam-tight top; its length is two feet two inches by two feet two inches in width, and it is fixed in a niche in the front of the end wall of the house, and attended from the shed, wherein is placed the furnace for the heathery. The advantage of having the fire placed in the front, here, exists in the facility of getting the smoke conveyed into the old flue *e*, that runs along the back path of the house, and tends considerably to keep up the temperature, inasmuch as the heat that is conducted along it penetrates through the tiles into the house, which, otherwise, would be wasted by passing up the chimney. The principal advantage, apparently, of having the two flat pipes on an edge, in *lieu* of one of larger dimensions, consists in their exposing a greater surface of heated metal to the house, whereby its temperature is raised more expeditiously.

These pipes and boiler, were erected by the Messrs. Barwell and Co., of the Eagle Foundry, Northampton, whose *iron castings*, and workmanship, have been acknowledged to be superior to those of many other recent erections, and who are now extensively employed in the manufacture of the

hot water apparatus, not merely for horticultural purposes, but for conducting that element into more extensive buildings, where its application has been found to give very general satisfaction.

The plan and section, represented in this Plate, Fig. 2, is a Pinery, heated with one boiler, by Barwell and Co., who have introduced very simple and effectual valve cisterns *b b*, whereby the water can be turned off at either, or both divisions at pleasure. The boiler *a*, is placed in a niche in the back-wall, a pipe proceeds from it to the valve cisterns *b b*, which communicate with the pipes *c c*, that convey the water to the reservoirs *d d*, at the extremities of the house. Messrs. Barwell and Co. have introduced these valve cisterns in the heating of several forcing-houses for Lord Melbourne, and other Noblemen, as well as in the range of hot-houses in the Garden of R. Trevor, Esq. of Tingrith, Bedfordshire, who is devotedly attached to horticultural pursuits and rural improvements,* having lately formed an extensive sheet of water, whose margins are richly ornamented with hardy flowering shrubs, &c.

* The Author cannot let slip this opportunity of noticing the admirable neatness in which the Gardens at Tingrith are kept; they do infinite credit to the industry and attention of the gardener, Mr. Phillips. One of the finest horticultural sights I ever saw, was the flowering here of that noble plant, the *Bignonia venusta*, which is trained along the back of the Pine Stove; and, in November last, was brilliant, with an absolutely inconceivable multitude of blossoms.

MANAGEMENT OF HOTHOUSE PLANTS.

The house intended for the growth of stove, or tropical plants, should be constructed so as to give a proper command of artificial heat in the Winter season, when a high temperature is requisite for the preservation of the plants. These, being natives of warm climates, require a strong degree of heat, to induce them to grow and flourish in the confined apartments that are allotted for their cultivation.

The thermometer ought to be regulated, mornings and evenings, in this department, from 60 to 70 degrees; otherwise, the cold cutting winds that generally pass between the laps of the panes of glass, will prove very injurious to the tender shoots and foliage of many of these exotics. When the atmosphere of the stove increases to 70 degrees by the influence of sun-heat, a little air should be admitted in the middle of the day, but taken away again early in the afternoon, so that the house may be shut up warm from the effects of the sun, which is more advisable than having recourse to strong fires for the purpose; and as the use of the bark bed is now becoming very generally exploded, for the cultivation of tropical plants, a higher degree of temperature is necessary for the health and preservation of these; but, as many of the tender exotics will succeed better by having a slight degree of bottom heat at their roots, this may be successfully supplied

to them, by filling the bed, or pit, with fresh tree-leaves, or tan, every Autumn, and covering the surface over with sand or coal ashes, for the pots to stand on; when these should be arranged according to their different sizes, without plunging, as the heat arising from the fermenting substances will increase the temperature of the house, and produce a mild congenial heat to the roots of the plants, which will greatly facilitate the growth of the more tender species. The pots remaining unplunged on the bark bed, will not be so subject to have their roots injured with worms, which is always the case when plunged in the bed, and which are very pernicious to the young roots. During the Winter months, when there is but little sun to dry up the moisture, great care must be taken not to give any of the plants too much water; it is preferable to give them little, and frequently, as they may appear to require it, than to deluge the pots with too much moisture, in their quiescent state. When the flues, or hot water pipes, are pretty warm, the pouring of water on them will produce a fine steam, very beneficial to the plants, and also obnoxious to the insects, whose depredations should always be kept in subjection. When the *Aphis*, or green fly, infests the young shoots, recourse must be had to fumigation with leaf tobacco, which appears the most effectual remedy for their suppression. The advantage of a mild, or rather calm evening, should be taken, and the houses well filled with the fumigating bellows, which will instantly destroy these noxious depredators. The plants will require to

be well syringed the following morning, in order to displace any of the fly that may cling to the foliage; and if they do not appear all to be destroyed, a repetition of fumigation should be resorted to the ensuing evening, which will effectually clear the plants of these insects. When the weather is at all favourable, the syringe should be frequently applied in the evening, and the house shut up warm; this moist heat will, in general, keep the red spider under, especially in the early part of the season: but if this intruder begins to get a-head, a little sulphur, sprinkled over the hot pipes, or flues, will keep them in abeyance. The white mealy bug and scale are more difficult agents to get rid of, and require to be brushed off as soon as they begin to appear; otherwise they will become very troublesome. Frequent fumigations of tobacco will, also, considerably check their progress.

The soil that appears most appropriate for the growth of the greater portion of Stove Plants, is sandy loam, consisting of the sward from a pasture, which should be thrown into a heap, to decompose and pulverize for a short time previous to using; to which a portion of peat soil, mixed with it, will be a suitable compost for the growth of most tropical plants. When there is a scarcity of peat, a mixture of decomposed tree-leaves may be applied in its stead, with great advantage. Should the soil not be of a naturally sandy quality, a little sand should be intermixed, so as to render it light, and free for the roots to run in.

The plants should be all examined in March, or

April; and such as appear to be in want of fresh pots, should be shifted into others, a size larger; but the operation of shifting, and size of the pots, should be regulated according to the state of the plants. The more luxuriantly inclined species will require a larger supply of nourishment than those of less delicate habit, and may, therefore, be admitted into larger sized pots without injury, whilst the more delicate growing sorts must not be over-potted; rather repeat this operation, as the roots appear to fill the pots, than put them into too large sized pots at once. The pots that are used for this purpose must be well drained with small pieces of potsherds, or any other material that will permit a free passage for the superfluous moisture. There should be placed next to the drainage a little of the rough fibrous substance that is collected from the soil, which will admit of a ready penetration of the water through it, and prevent the mould in the pots becoming too much saturated with wet; as nothing is more injurious to the tender roots than to have the soil soured about them when in a dormant state. During the course of the season, they will require to be frequently examined; and such as appear to have out-grown their pots, to be removed into larger ones; as, also, any that are in an unhealthy state should be shook out of the pot, and the roots examined; and such as appear in a decayed state, cut away, and the plant fresh potted; but observing, in these instances, to use rather small pots than large ones. In Autumn, the whole stock should be carefully looked over; and those that appear too much con-

fined, for want of pot room, may be re-potted into larger sized ones ; care, however, should be taken not to disturb or injure the roots at this advanced season. During the Summer months, and growing season, they should be well supplied with water, and frequently syringed over their foliage, and the borders and footpaths, &c. kept in a moist state, particularly in hot weather, which will be very conducive to the health and vigour of the plants. The atmosphere of the house will require to be duly attended to, and the thermometer regulated mornings and evenings, at 65 degrees, which may be allowed to vary from 90 to 100 degrees, by the influence of sun heat.

Most sorts of tropical plants are increased, either by cuttings, seeds, or dividing at the root, whence offsets of the *Orchideæ* and *Cryptogamia* genus are procured ; and when those throw out such suckers, or side offsets, we have a plant supplied with roots immediately, which may be, at once, potted, and treated accordingly. I may, however, observe, that these suckers, or offsets, should be allowed to form good roots before they are taken from the mother plant, which will the better secure their future success. The hard woody kinds may be propagated by cuttings, which will root freely, in most instances, when planted in sharp sand, and placed in a shaded situation of the stove, or in any other apartment where they can be shaded from the effects of the mid-day sun ; as a small pit or frame is generally appropriated for this purpose, which can readily be shaded by throw-

ing a mat over the lights while the cuttings are striking root ; some of the species will require a slight degree of bottom heat, to induce them to throw out young roots. The most suitable season for the propagating of tropical plants, is from January to July ; but many of the kinds may be put into the cutting pots at any period of the year, providing that the young shoots are in a proper state, as some species require the wood to be ripened and firm before they are put in ; whilst others may be increased when the shoots have grown only sufficiently long for the cutting. In stripping the foliage from the shoot, care must be taken not to injure the bark, and not to clear away more of the leaves than are necessary for the insertion of the lower end of the cutting in the soil or sand in the pot, where they are all inserted ; a gentle watering should be given, to settle the soil about them, and the pots then covered with hand-glasses until the cuttings begin to grow, and throw out young roots, when a little air may be given, to prevent their being drawn up in a weak state. The sand, or mould, in which they are planted, must not be saturated too much with water, otherwise it will rot the cuttings.

When the plants have struck root, they should be immediately potted off in small sized pots, and placed in a slight hot-bed for a few days, and kept shaded from the effects of the mid-day sun until they have got a little established, when they may be removed with safety to the stove. Seeds that have been received from abroad, should be imme-

diately sown, without waiting for the return of the Spring season, as many of them will vegetate, if put in the soil as soon as received, that would remain dormant if kept for any length of time out of the seed pot. There should be a slight hot-bed prepared for plunging the pots in as soon as the seeds are sown, as a gentle heat will cause them to vegetate sooner than if they are kept without bottom heat. Such seeds as have been collected in the stove, through the Summer months, should be sown in February or March, which is the best season for a general sowing. As soon as the seedlings appear to be of a sufficient size for potting off, they should be put in small pots, but preserving as much of the soil and young fibres to the plant as can possibly be had. The young plants, after potting, should be re-placed in a gentle hot-bed, and kept shaded for a few days, until they begin to grow, when they may be removed to the stove; many of the seedlings, as well as those raised from cuttings, will naturally be drawn up in a weak state, for the want of a sufficiency of air while they are in a tender state; these, therefore, should have their tops pinched off, which will strengthen them, and induce the plants to form a bushy appearance.



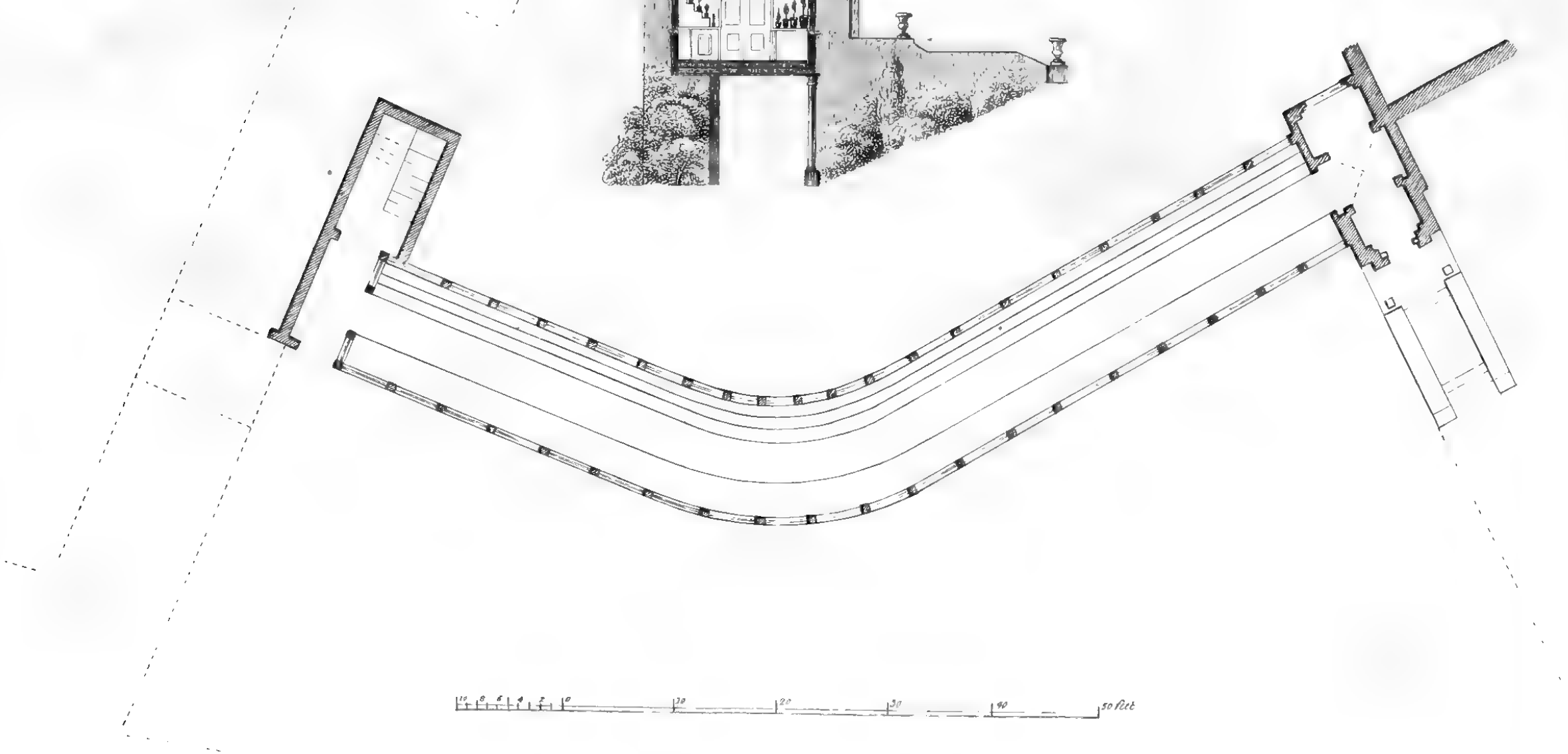
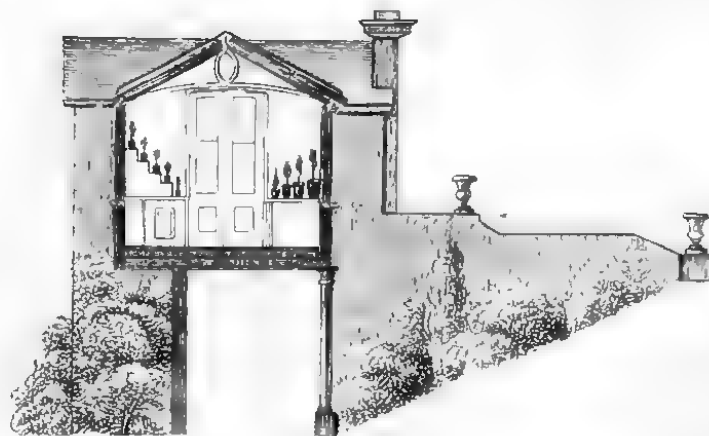
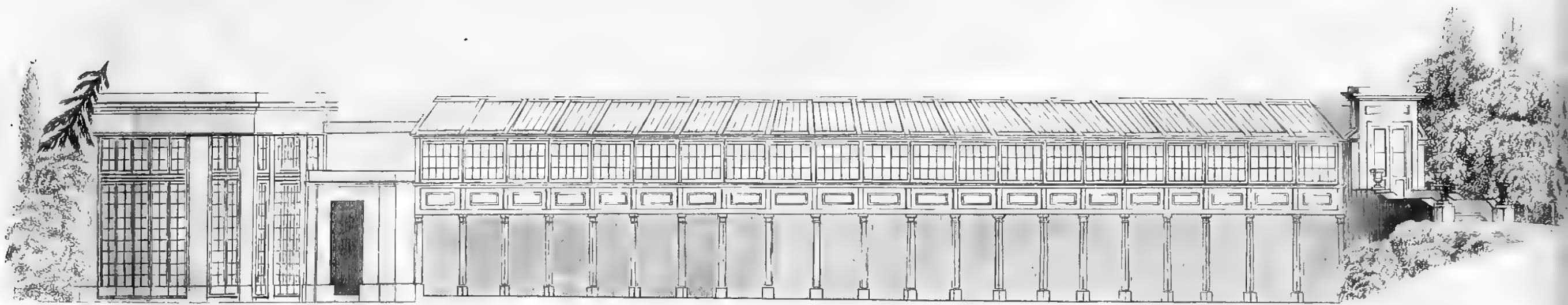

10 0 10 20 30 40 50 feet

Plan Elevation and Section of the Heath House.

MANAGEMENT OF THE HEATHS.

The annexed Plate represents the Ground Plan, Elevation, and Section of the Heathery, which was erected from the designs of Sir Jeffry Wyatville, a plan of which was engraved for the "Hortus Ericæus Woburnensis," printed by His Grace the Duke of Bedford, in 1825, for private distribution. I shall take the liberty of quoting the following passage from His Grace's Introduction to the "Hortus Ericæus."

"It is universally acknowledged, that the *genus* comprised in the following Catalogue requires a free exposure to the influence of light and air; and I, therefore, suggested a due attention to a circumstance of so much importance to my architect, Sir Jeffry Wyatville, who gave me a plan for a Heath-house, elevated considerably above the level of the ground, by being erected over a covered walk within the Pleasure Ground, which leads to the various offices, and other buildings connected with the establishment, lighted from both sides, as well as from the roof, and affording a fuller exposure of both light and air than could have been possibly obtained by any other means. I have found this Heath-house admirably adapted to its purpose, and have annexed a plan of it to the Catalogue."

This Heathery is above 100 feet in length, by 12 feet wide, and 9 feet high, to the centre or ridge of the roof. The stages for the plants are arranged

along each side of the house ; the one at the back consists of five tiers of shelves formed with about two and a half-inch boards ; and the other, along the front, is simply a platform, which is constructed of nearly the same sized boards, with apertures betwixt them, in order to carry off the wet from the pots, and to admit a free circulation of air amongst them.

This Heath-house is terminated by a small ante-room, as indicated by the Ground Plan ; and in the niche in the wall there is a very large and brilliant mirror, which reflects the greater part of the house ; and the deception is so great, that the visitor frequently walks up close to the glass before he is aware of its existence : the effect produced by the reflection of the numerous flowers, with their various colours, is extremely elegant.

The window facing the door of the ante-room, opening into the Pleasure Ground, is of an oval form, the margins of which are ornamented by 20 circular groups of different species of *Ericææ* ; and in the centre is a group of various kinds, represented in a basket ; consequently, there are about 50 of the most beautiful flowering species painted on this window, which was executed by Mr. Andrews, and so accurately done, that they can scarcely be distinguished from living plants. The recesses are fitted up with shelves, in which are placed the splendid works of Mr. Andrews, on the *Ericææ*, and various other botanical works. This house is entirely devoted to the collection of Cape Heaths, respecting which the able conductor of the "Gardener's Magazine" observes, vol. 1. p. 336, "Of what other

genus can it be said, that every species, without exception, is beautiful throughout the year, and of every period of its growth, in flower, or out of flower, and of every size and age? Suppose an individual had the penance imposed on him, of being forbidden to cultivate more than one genus of ornamental plants, is there a genus he could make choice of at all to be compared to *Ericææ*, perpetually green, perpetually in flower, of all colours, of all sizes, and of many shapes?"

Notwithstanding, however, all the beautiful and attractive qualities of this genus, its cultivation is still very limited, and not followed to the extent which it so deservedly ought to be: this may, perhaps, be occasioned by the supposition that various species of *Ericææ* are much more difficult in management than other Cape plants, natives of the same climate. They certainly require a little more delicacy in their general treatment, than most other Botany Bay or Cape plants; but they may be grown to great perfection, with very little more care than is necessary for a collection of *Pelargonia*, and at even less expense, as the same degree of artificial heat that is requisite for the preservation of the *Geraniaceæ*, in the Winter season, would be injurious to the *Ericææ*. Cape Heaths will bear a degree of frost and cold with impunity, that would be quite destructive to the whole collection of *Pelargoniæ*. In short, most of the species and varieties of the genus *Ericææ* may be successfully preserved throughout the Winter months, in pits, or frames, constructed similarly to those erected for the growth of the melon or

cucumber, if the lights of such frames or pits be well covered with bass mats. In frosty weather they should, also, be kept as free from damp as possible, and the lights opened at all favourable opportunities, which will facilitate its evaporation, and admit, at the same time, a free circulation of air into the pit, that will be very beneficial to the plants; as the more air they are exposed to, when not of a very wet or frosty nature, the more healthy and vigorous they will grow. The Heath-house will but seldom require any fire heat; which should never be applied, except in frosty or a continuation of cold wet weather, when a little is necessary to expel the damps, and prevent the plants from being injured by the frost. Although the *Ericææ* will bear a much greater degree of frost than most Cape plants, yet a little artificial heat is often necessary, in the Winter season, for their preservation, which should be but as sparingly supplied as the external state of the atmosphere will admit. If the thermometer, in the *Heathery*, does not fall below 25 degrees, during the night, the plants will not sustain any injury for the want of artificial heat.

Although the Heath-house here is considerably elevated above the ground level, and very much exposed, I have never observed any of the plants injured by it, except a few of the tender shoots next to the glass. It is, however, advisable, when the thermometer continues to fall more than five degrees under the freezing point, within the house, to have recourse to the aid of the furnace, observing, however, to apply no more fire heat than is absolutely necessary for

keeping out the frost, as the cooler the plants are kept through the Winter, and preserved from frost, the more healthy they will grow.

The Heathery should likewise have large portions of air admitted daily, to be only excluded in severe frosty weather, when the plants will require to be kept rather in a dry state, and but small portions of water given at once; they should be looked over daily, in case any of them are getting too dry, when a little water will be necessary. In mild weather, they will require to be more liberally supplied, and should have occasional syringings over their foliage; and as the season advances, this element must be more bountifully supplied, particularly in dry hot weather, when they should be syringed over head in the mornings and evenings, as well as large portions given at the roots.

About the latter end of May, or beginning of June, the plants may be turned out of doors, and placed in a situation where they can have the benefit of the morning and evening sun, but sheltered from the westerly winds, and scorching effects of the sun's rays, in the middle of the day; and arranged so, as that a free circulation of air can readily pass amongst the whole collection, which will prevent their being drawn up in a weak or languid state, as is frequently the case when crowded. The scarcer, and more delicate growing sorts, should be placed in a pit or frame, where they can also be shaded from the mid-day sun, (by throwing a thin mat over the frame,) and protected from heavy rains. If the Autumn months are at all favourable, the

plants may be left out of doors, until the middle or latter end of October, when they should be all cleaned and replaced in the Heath-house ; but if the season is wet, they will require to be taken into the house earlier, in order that they may be protected from the heavy rains, which would saturate the soil about their roots, and be injurious to the plants. When the Heaths are taken into the Heathery or Greenhouse, they should have as large a portion of air given to them as the house will admit of, both night and day, which should never be excluded, except in frosty, or cold and wet weather, when the Heathery should be shut up at night, but reopened, if only for a couple of hours, in the middle of the day.

The soil most suitable for the cultivation of Cape Heaths, consists of a black sandy peat, that is naturally intermixed with about one fourth of white sandy particles, which is frequently found on commons, where the common Heath or Ling is growing ; the top spit of which should not be taken off deeper than the soil appears of a free silicious texture. The turfy, or swardy surface, should be all carted along with it to the compost yard, and thrown up in a heap, to decompose and pulverise for two or three months, when the soil will be fit for use. The plants that have overgrown their pots, may be shifted into larger ones, any time from February to August, or otherwise, after they have done flowering, or previous to their coming into flower. If the operation be carefully performed, it is immaterial at what particular season. The balls of mould should not

be reduced, and as few of the roots injured by it as possible, observing only to loosen the small fibres a little at the bottom and sides of the pots, which will induce them to strike freer into the fresh soil. There should, also, be plenty of drainage placed in the bottom of the pots, in order to carry off any superfluous moisture; and over the drainage a layer of the fibrous particles, sifted out of the soil, should be placed, which will also facilitate the carrying off the superabundant water. Mr. M'Nab, Superintendent of the Royal Botanic Gardens at Edinburgh, has lately published a small treatise on the General Treatment of the Cape Heaths, which contains the most valuable instructions that have ever yet appeared in print on the subject, and ought to be in the hands of every cultivator or admirer of *Ericææ*; it is rendered doubly valuable by its coming from the pen of one who is generally known to be one of the best practical *Botanists*, and most successful cultivators in Britain, and whose Heaths are actually grown to the size of small *trees*, and many of them all covered, from the edge of the pot to the extremity of the plants, with beautiful blossoms.

Mr. M'Nab recommends to be mixed along with the soil, "a quantity of coarse free-stone, broken into pieces, from an inch to four or five inches diameter; of those I always introduce a quantity among the fresh earth, as it is put in. This I consider of great advantage to all sorts of Heaths; but more particularly so to those that may have been shifted into a much larger pot or tub at once, than it had been grown in before, or in what I would call biennial, or triennial shifting."

PROPAGATION.

Cape Heaths being of much shorter duration than most other Cape plants, it is necessary to have constant recourse to propagation, in order to keep up the collection, which should be increased by cuttings, and seeds, the latter forming the only means of procuring new varieties ; they should be both introduced direct from the Cape, and saved from those plants that perfect their seeds in the Heathery or Greenhouse, in this country, collected as they ripen, and a general sowing made in the ensuing February, or March. The pots intended for the seeds should be filled about half full with the drainage, and the remaining space with the soil, which should be intermixed, so as it may consist of half peat and half sand, finely sifted, for the depositing of the seeds, and rendered perfectly level, when the seeds may be sown, but observing not to bury them too deep in the soil ; a very slight covering will be quite sufficient. In short, if they are merely covered, it will be all that is necessary. After the seeds are committed to the soil, they should have a gentle sprinkling of water, to settle the soil about them, which must always be given to the seed-pot, by a very fine rose on the watering pot. The seed-pots should then be placed in a cool frame, when they can be shaded from the mid-day sun, and the soil in the pots kept in a moist and vegetating state. As soon as any of the seeds begin to vegetate, and make their appearance through the soil, a little air ought to be given, which will prevent the

young plants from being drawn up weakly, and damping off. When the seedling plants have attained the height of two to three inches, they should be put into small sized pots, in the same soil as was mentioned for the sowing of the seeds in ; five or six plants may be placed round the edges of each pot, which should be again re-placed in the frame, and kept shaded, until they begin to strike root in the fresh soil, when they may be gradually exposed to the sun and air ; and after they appear to have got well rooted, and are growing freely, they should be put out singly into small sized pots, with as much of the soil attached to the young fibres as possible. When the plants are young, they will require to be frequently shifted ; but this operation must be regulated according to their growth, and as they fill their pots with young roots.

But the most general method of increasing the Heath in this country, is, by propagating from cuttings of the young shoots, which should be taken off when the wood becomes of a firm texture, when it will not be so liable to be injured by damp, as is frequently the case when put into the cutting pot in a tender state. The best season for putting in Heath cuttings, is from March to July ; but the operator must be guided in this by the state of the shoots which are intended for this purpose. In fact, most of the species will strike root if put in at any period of the year, providing the cuttings are taken off when in a fit state. To procure shoots of the less free growing sorts, they may be assisted by placing the plants in a little artificial heat, at the

early part of the season, which will be the means of furnishing good cuttings ; when they should be carefully stripped of their leaves to about half the length of the cutting, with a sharp knife or scissors, and the end cut clean across. They will then be ready for inserting into the cuttings pot, that should be previously prepared, and filled within a couple of inches of the rim with the drainage ; and then have a layer of the fibrous parts of the soil placed over the crocks, when the remaining space should be filled up with sharp pit sand, well washed, and cleared from all earthy matter, &c. The sand should, lastly, be well watered, and made perfectly firm and level, when it will be fit for the reception of the cuttings, which should not be inserted deeper in the sand than is necessary for the fixture of them, to avoid being displaced in the watering, which should be liberally supplied while they are striking root.

Many of the sorts will have formed good roots in the course of eight or ten weeks, whilst others will require as many months. In Autumn and Spring, the cuttings should be placed in a shaded part of the stove ; but, in the Summer season, they will succeed equally well in a cold frame, shaded from the mid-day sun. Mr. Muirhead, a very successful propagator of the *Ericææ*, formerly plunged his pots in coal ashes, behind a north wall, in the Summer season, where they were covered with hand-glasses, and removed in Autumn to the Pine stove. The cuttings will, in general, strike root more readily by being covered with bell-glasses,

the size of which should be regulated by the pots, and be occasionally wiped, when there appears an accumulation of moisture on their inner surface; but these glasses may consist of those with holes in their tops, which will permit the moisture to evaporate, and prevent it, in a great measure, from injuring the cuttings. Mr. M'Nab, however, and the Messrs. Loddiges, both consider these glasses unnecessary, except for a few sorts. When the cuttings begin to grow freely, it is generally a sure sign of their having made roots; they should then be taken carefully out, and put into the smallest sized pots that are made, placing four or five round the sides of each, and then placed under a hand-glass, and shaded, until they begin to make young roots in the fresh soil, when they may be gradually exposed to the sun and air; and when they appear to be of sufficient strength, and their roots well established in the soil, they should be planted singly into small pots, and afterwards treated in every respect the same as was mentioned for the seedlings.

The culture of the *Ericææ* is rendered more easy by their being seldom attacked with insects; the green fly will occasionally infest some of the plants, but it is easily eradicated by fumigation, or by dipping the infected shoots into a decoction of tobacco-water; some of the species are, also, subject to mildew; but this is likewise readily subdued, by dusting a little sulphur over the affected parts; the most effectual preventive for the latter disease, however, is a free circulation of air amongst the plants.

HARDY HEATH GARDEN.

The accompanying Plate is a representation of the Hardy Heath Garden, which contains the different species and varieties of such *Ericææ* as will stand the severity of our climate throughout the Winter months. These parterres were designed and prepared by my predecessor, Mr. Sinclair, and they are found to be well adapted for the purpose. Each species, or variety, is confined to separate beds, which are all edged with the *Calluna vulgaris*, and *Erica tetralix*; and so disposed, that the tallest growing kinds are arranged towards the centre of the parterre, whilst the whole are so intermixed, in point of colour, as to produce the most lively contrast possible. It hence becomes an interesting spot, at all seasons of the year, as there are always some of the sorts expanding their beautiful blossoms.* During the Summer months, many of the duplicates from the Heath-house, are turned out of their pots, and planted in this compartment, where they generally flower, grow vigorously, and form themselves into handsome bushy plants, the scarcest and tenderest kinds of which are taken up in Autumn, repotted, and replaced in the Heathery. Many of the species that are natives of the Cape of Good

* I may justly say, that there can scarcely be a greater acquisition to a Flower Garden than such a collection of Hardy Heaths.

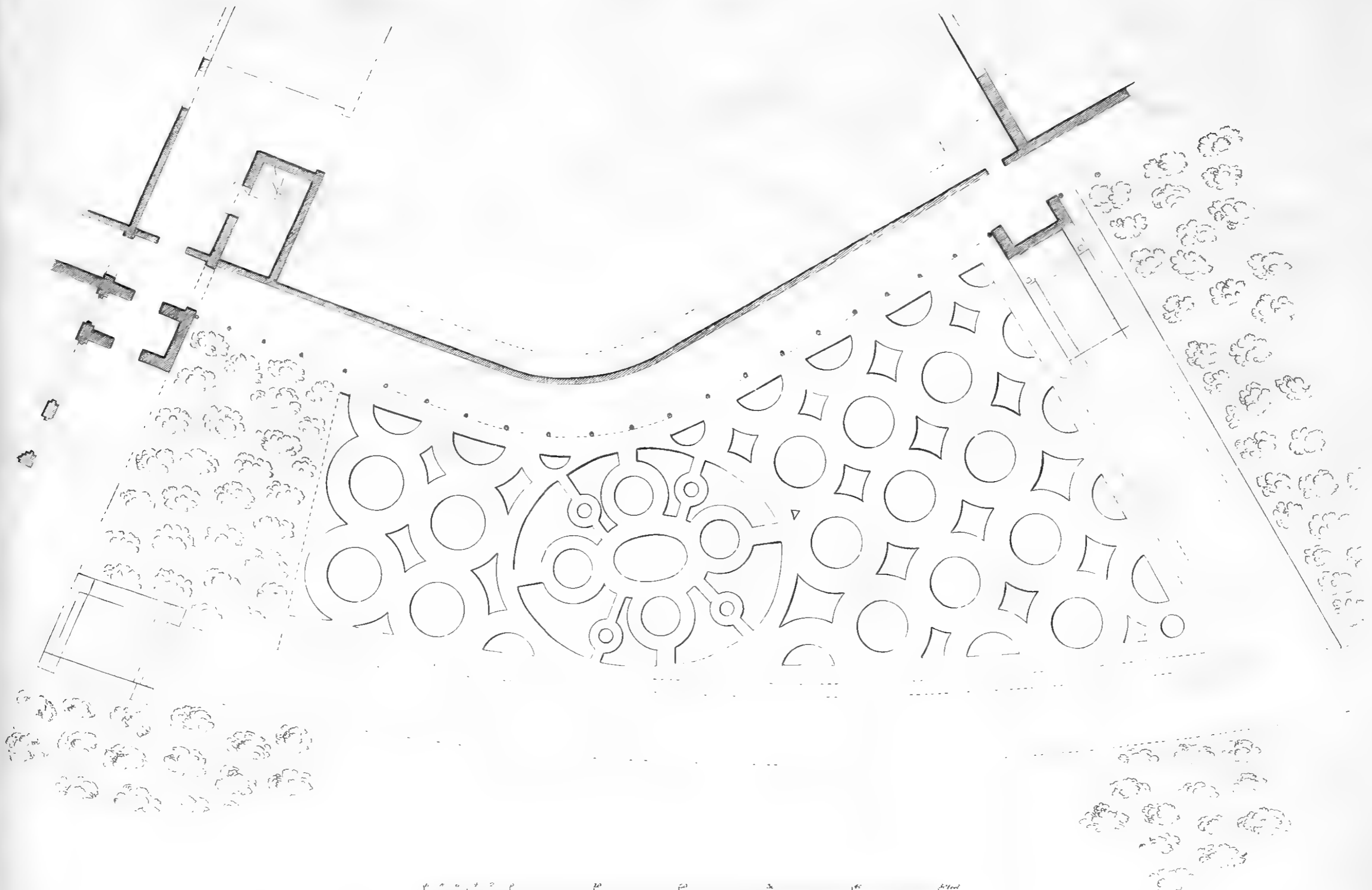

Plan of the Parterre for hardy Herbs.

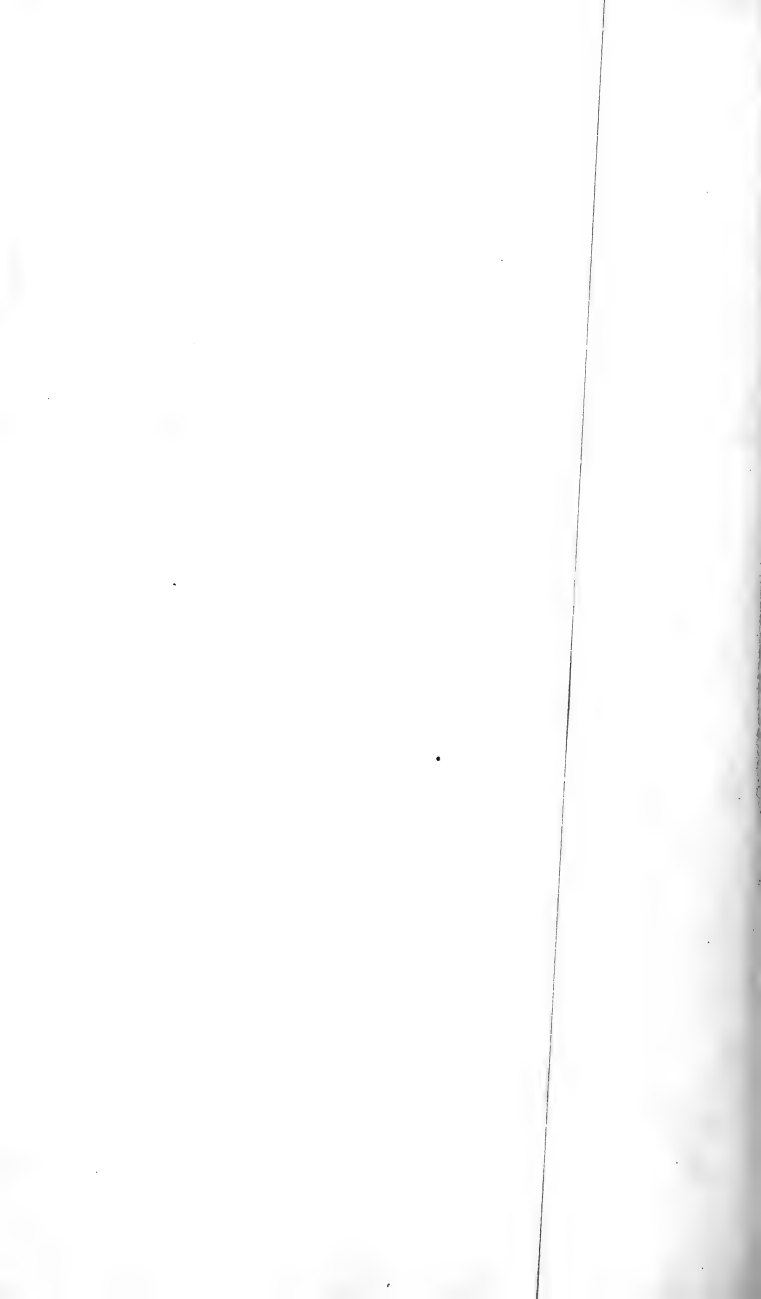

Hope, will stand nine or ten degrees of frost, in this situation; and very probably, by further experience, we may meet with some sorts that will stand the severity of our Winter months altogether. The *Erica actæa*, *triflora*, and *floribunda*, have stood out of doors here, through the last two years, without being in the least degree injured by the frost.

The last two Winters were, undoubtedly, very favourable for their preservation; the thermometer, in this quarter, not indicating more than 14 degrees of frost.

The following is a list of the species that are cultivated in this Garden:—

ERICA.

arborea.

1 *stylosa*.2 *squarrosa*.

Australis.

actæa.*carnea*.1 *herbacea*.*ciliaris*.*cinerea*.1 *alba*.2 *atropurpurea*.3 *rubra*.*floribunda*.

Mediterranea.

multiflora; this requires the protection of a mat in Winter.

scoparia.1 *minima*.*stricta*.*tetralix*.1 *alba*.2 *rubra*.

umbellata; this also requires to be protected in Winter.

viridipurpurea.*vagans*.1 *alba*.2 *rubra*.3 *pallida*.4 *tenella*.

CALLUNA.

vulgaris.1 *alba*.2 *aurea*.3 *carnea*.4 *coccinea*.5 *decumbens*.6 *flore pleno*.7 *prostrata*.8 *spicata*.9 *spuria*.

10 *tomentosa*.

11 *variegata*.

EMPETRUM.

nigrum.

scoticum.

MENZIESIA.

cærulea.

empetrifolia.

polifolia.

1 *angustifolia*.

2 *latifolia*.

3 *nana*.

HUDSONIA.

ericoides.

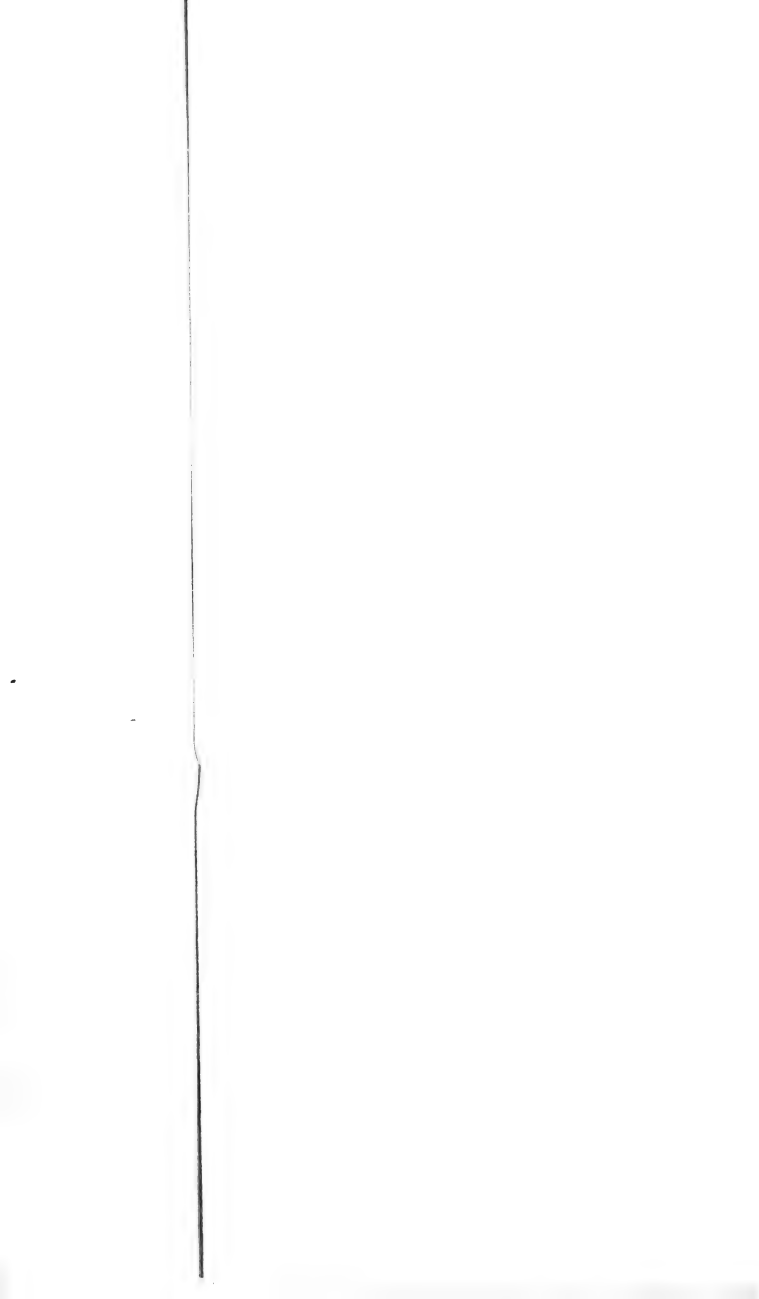

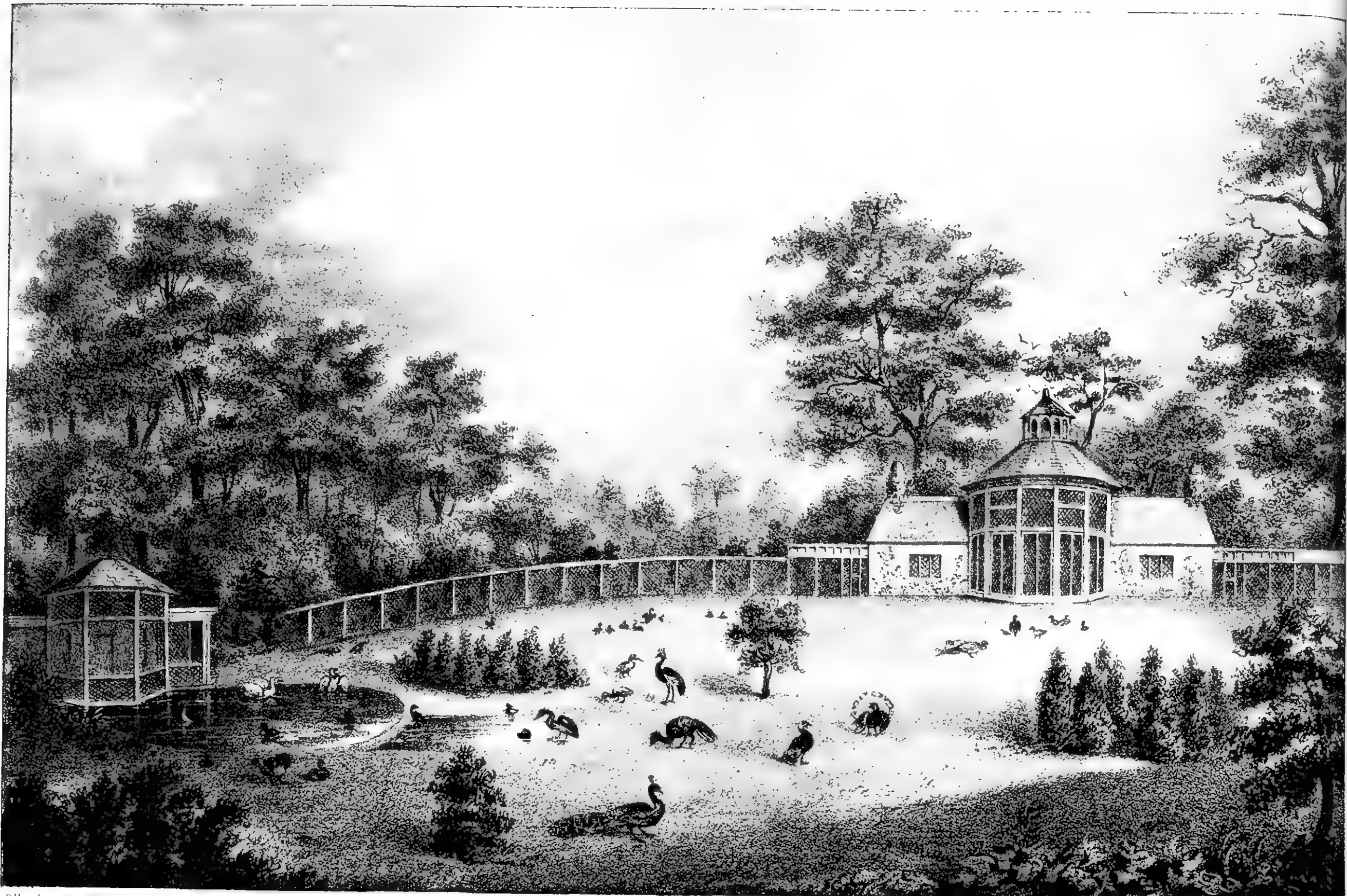

(Facing page)

MENAGERIE.

The annexed Plates, No. 10 and 11, are perspective views of the different erections connected with the Menagerie, and its entrance. These buildings were erected from the designs of Mr. Repton, and consist of numerous wired compartments, for separating the various birds and animals: they are constructed against the wall which forms the north side of the enclosure; the rest being surrounded with a high rustic fence, (against which, as well as in the centre of the wired compartments, and also interspersed through the interior of the ground,) are clumps of evergreen shrubs, for affording shelter to the pheasants, &c. The lower part of the centre, or octagonal building, is devoted to a collection of Canaries, and other small birds, which build their nests in the various apertures that are formed around the walls of this apartment. The upper half of the building consists of a very complete Pigeon-house, which is occupied by a numerous collection of the most curious varieties of these birds.

The wings, on each side of the octagons, constitute the Keeper's apartments, which are entered by a portico, on the north side, formed with rustic posts, &c. In the recess of the portico are placed, in glass cases, two *Antelopes*, that died about two years ago. The space occupied by the Menagerie covers nearly two acres of ground, in an angle of

the **Pleasure Ground**: the principal entrance to this interesting spot opens from one of the main walks, and consists of a handsome architectural stone structure: See fig. 1, on the following Plate 11. The interior side, see fig. 2, facing the *Menagerie*, is of a hexagonal form, and constructed with rough wood, so as to correspond with the other *Sylvan* erections.

For the accurate delineation of Plate 10, I am indebted to Mr. G. P. Harding, of *Hercules Buildings*, Lambeth, whose indisputable talent, as a miniature copyist of our old portraits, &c. deserves to be much more generally known, and more extensively encouraged.

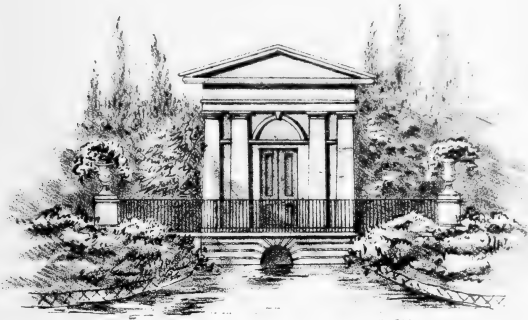

Fig. 1. Temple of the Sun.

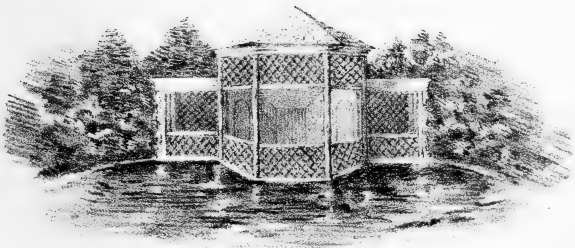
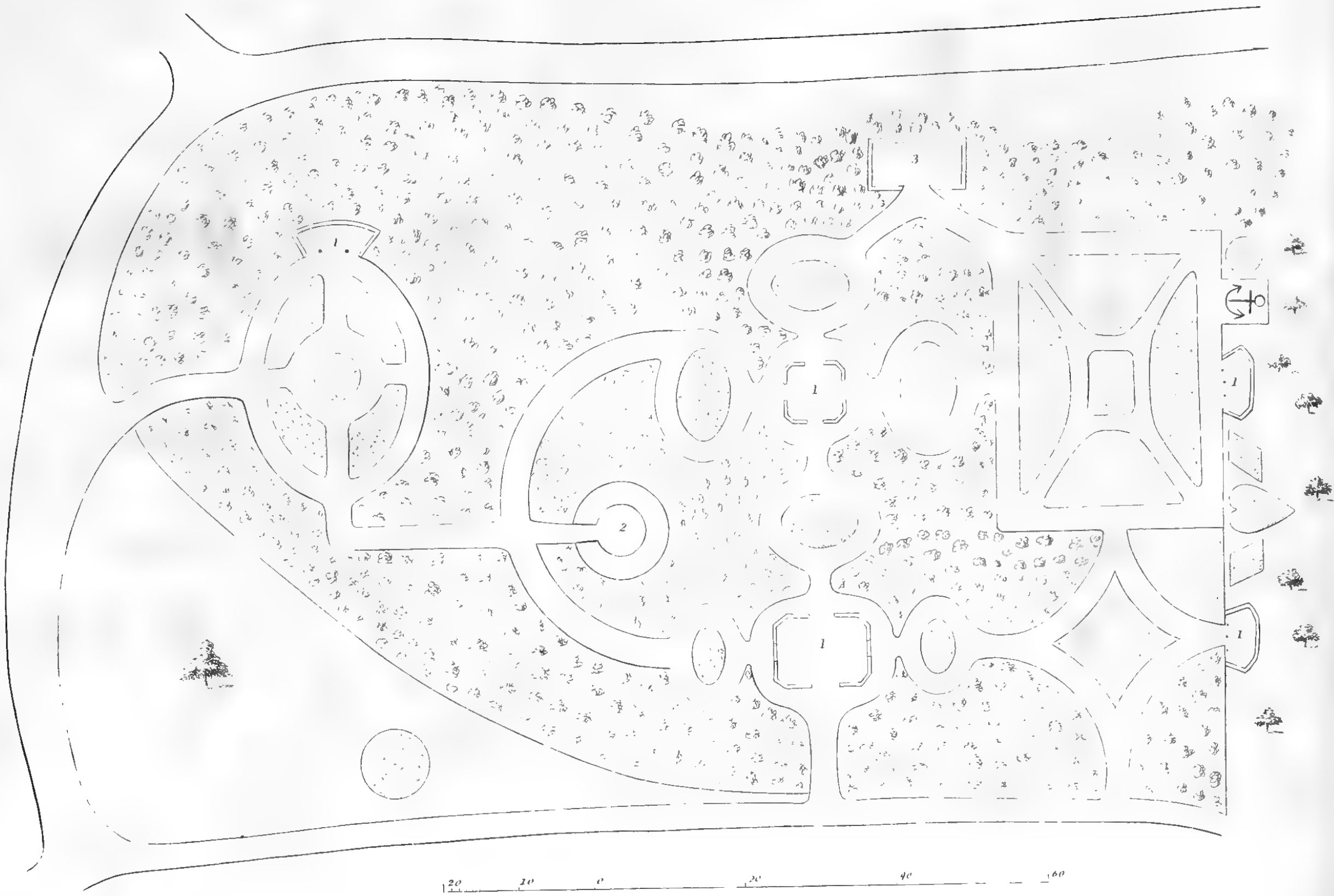

Fig. 2. Hexagonal Gazebo.



Gardens of the Children when young, designed by Mr Repton.

CHILDREN'S GARDENS.

The annexed Plate is a representation of the Ground Plan of the Children's Gardens, which were executed from the designs of the late Mr. Repton.

The different *Arbours* that are dispersed throughout these parterres, indicate to whom the adjoining flower-bed belongs, by having the name of its owner attached to the front of the *Arbour*; which is also covered with various sorts of creepers. The circular figure, with a walk leading from it to the oval, is a representation of the Ground Plan of the *Grotto*, which is built of different flints and stones, with walks leading around the right and left, and running into each other at the top, where there is an octagon platform, about eight feet square, encircled by an iron railing, for the training of creepers, which chiefly cover the exterior sides of the walls. The inside of the *Grotto* walls are inlaid with various shells, as well as the ceiling. At the entrances to, and junction of most of the walks, leading from the different divisions in these Gardens, are arched *trellis's*, which, together with the various *Arbours*, give this spot an interesting and picturesque appearance at all seasons of the year. The borders that surround these Gardens are thickly

planted with different kinds of evergreens, such as *Arbutus*'s, *Rhododendrons*, *Aucubas*, the *Laurustinus*, &c. &c. with each sort grouped together, so as to heighten the contrast of the foliage.



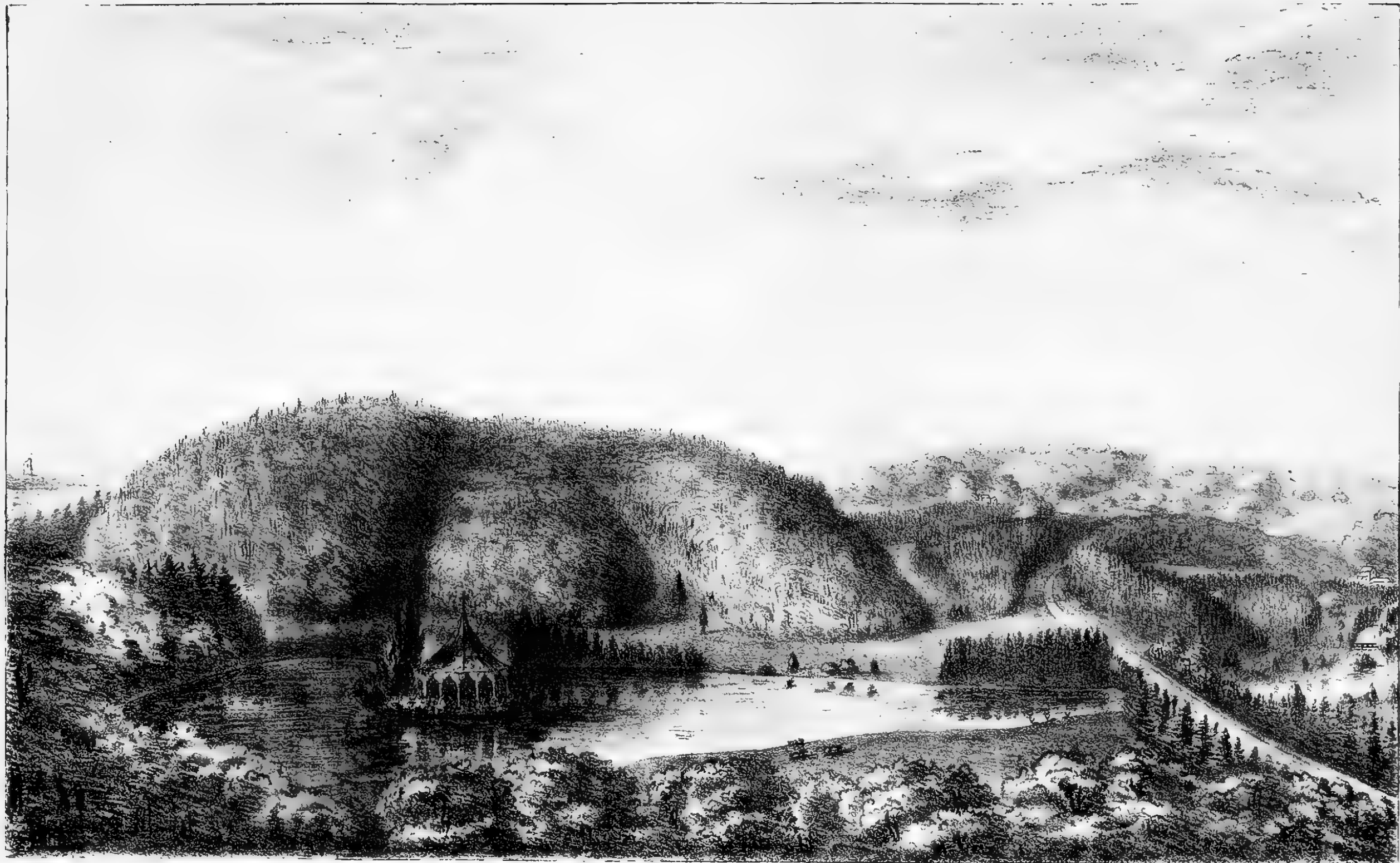

PLATE 100

TRAVELER POND, THE CHINESE TEMPLE, & EVERGREENS

TO THE WEST OF CHANGHAI

THE EVERGREENS.

The annexed Plate represents a bird's eye view, taken from the top of Woburn Church Steeple, of the fore-ground of about 100 acres of richly wooded Evergreens, planted by John, Duke of Bedford, in 1742. The inequality and variation of surface, together with the different species of trees and shrubs with which it is decorated, and the extensive sheet of water in the face of it, render this one of the most interesting and picturesque landscapes in the county; and one that is very generally acknowledged to be but seldom equalled by any thing of the kind that is to be met with elsewhere. For the different views of this landscape, we are indebted to the late Mr. Repton, who suggested various improvements, and superintended the execution with that taste and judgment which he was universally admitted to possess, and which caused him to be distinguished as the very first English Landscape Gardener of his day.

While we have here, on the summit of the rising ground, several thousand full grown Scotch Firs, many of them measuring 65 feet in height, and 7 to 8 feet in circumference, we have, also, these environed with fine specimens of the Spruce Fir; and the *Pinus Pinaster* has, in several instances, attained the height of 70 feet, and upwards of 12 feet in girth, at seven feet from the ground. There

are, also, some trees of the Weymouth Pine, (*Pinus Strobus*,) whose height are above 74 feet, and 11 feet in girth. In the front ground of these large trees, we have the numerous varieties of *Hollies*, *Evergreen Oaks*, *Arbutuses*, *Rhododendrons*, *Cypresses*, and other species of Evergreen Shrubs, &c. growing in great perfection. There are, also, several trees of the *Quercus Ilex* (Evergreen Oak,) 45 feet high, and 9 feet in circumference. Again, in the undulations and openings, we have the magnificent Cedar of Lebanon, and several single trees, and clumps of the genus *Pinus*, such as the *Pinus cembra*, *halapensis*, *inops*, *pinaster*, &c. all growing in great luxuriance and beauty. In a recess, near the commencement of the main ride, is a clump of four Cedars, which cover nearly a rood of ground, and are 70 feet high; the trunks, at six feet from the ground, measure 17 feet in circumference. As the Evergreens extend towards the North East, in a circuitous direction, for nearly two miles in length, we meet with the Silver Fir, of great magnitude, and the *Holly*, which forms a hedge of 500 yards in extent, of 45 feet in height; some are nearly six feet in girth. There are, also, several very fine specimens of the Hemlock Spruce in this part, and an abundance of the *Arbutus uva-ursi*, flourishing on the banks, in the shade of the trees.

Throughout these Grounds are formed spacious walks and rides, whose margins are richly decorated with evergreen and flowering Shrubs; and at various openings, towards the South, are large clumps of different varieties of *Rhododendrons*, which have

attained upwards of eight feet in height in the natural soil. This consists of a light yellow sandy loam, free from any kind of peat, in which American, and other flowering plants, flourish in equal luxuriance, which renders this an ornamental and interesting part at all seasons of the year; it may be very justly termed the Winter Gardens. The sheets of water, which are represented in the sketch, form a pleasing feature to the adjoining scenery; their margins being diversified by the Weeping Ash, Willow, and clumps of other appropriate trees, shrubs, &c. In the centre of the broadest part of the lower lake, is a handsome Turkish Chiosk, surrounded by Poplars, Rhododendrons, and other Evergreens; and, at the nearest extremity, a Viaduct, which connects the upper sheet of water with the lower, they being on two different levels. Over this Viaduct, the public road passes from Woburn, through the centre of the Park, to the Abbey, and neighbouring villages. At the Woburn entrance is the commencement of an handsome avenue, of about 60 feet in width: this avenue passes through a part of the Evergreens, and is lined with Cedars, Hollies, Spruces, Evergreen Oaks, &c. &c. and extends, from the Park-Gate towards the Abbey, above half a mile in length, where it terminates with a plain Doric-lodge.

The upper piece of water, which is of a circuitous form, embraces a small circular Island, in the centre, which is planted with low shrubs, where the Rhododendrons are most conspicuous, the reflection of whose flowers in the water produces a most pleasing

effect. This sheet of water is, also, connected with another of less extent, by a small foot-bridge. There are no less than twelve different pieces upon other levels, extending altogether above a mile in length, one of the uppermost of which passes in view of the principal rooms of the Abbey. This is the most extensive sheet, covering above twelve acres of ground; its form and size were much improved by Mr. Repton, in order to render it picturesque from the chief point of view. The more circuitous and ragged the boundaries of a lake are, the more pleasing and attractive it will always be to the eye.

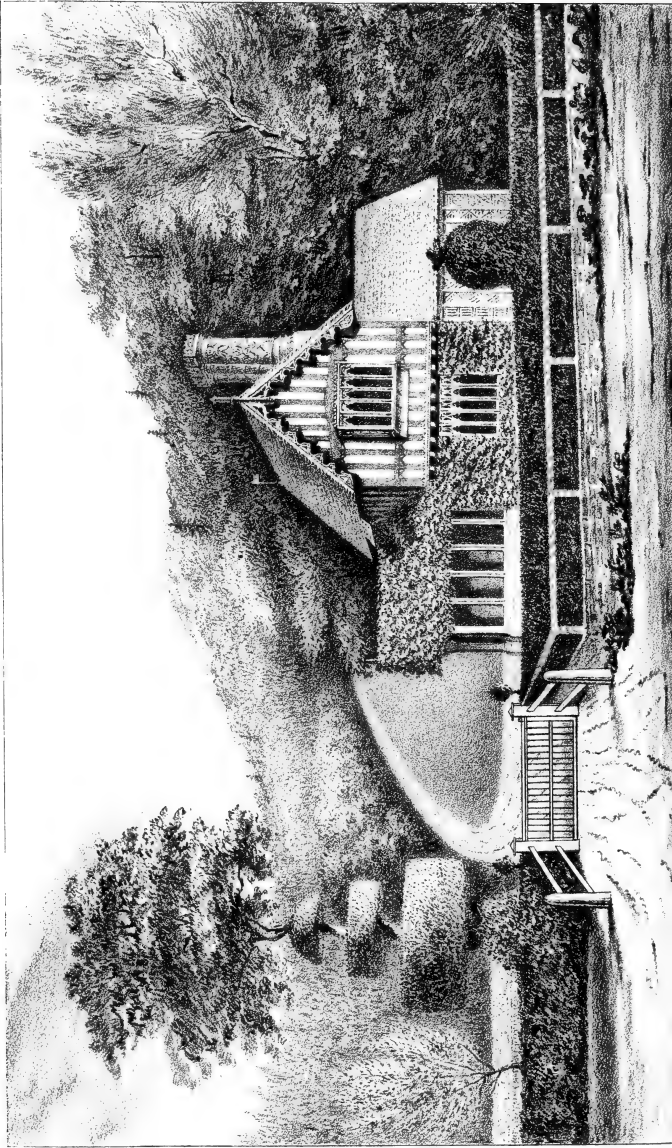

ASPLEY COTTAGE.

“ It has, of late,” says Mr. Repton,* in reference to this subject, “ become a common practice to erect Cottages, and small houses, in a style called Gothic, for which there is no authority in the ancient remains of the 15th and 16th centuries.” As a contrast to these, and for the sake of preserving a genuine specimen of that kind of architecture which prevailed from 1450 to 1550, the Timber Cottage, at the extremity of Aspley Wood, has been erected in the years 1810 and 1811; and by order of His Grace the Duke of Bedford, the strictest attention has been given to the detail, as will appear from the authorities subjoined.

“ Few buildings of this early date remain entire; the general plan of this Cottage is, therefore, not taken from any individual specimen, but the parts are copied from the most perfect fragments of the kind, some of which have since been destroyed.

“ It may, perhaps, be objected, that this Cottage is too small for a Mansion, and too richly ornamented for the habitation of a Labourer; but such was often the style of old Manor Houses, whose dimensions did not exceed those of this building, which is quite as large as the old Farm House at Stone Wall, near Penshurst, in Kent, where an

* From a M.S. Volume, on Improvements Proposed at Woburn Park.

ancestor of the Woodgate family resided, when he served the office of High Sheriff for that County. Specimens of Timber Houses are every year becoming more rare, not only from the decay of the materials, but from the prevailing rage for what is called improvement, by exchanging old forms for new. It is, however, worthy of remark, that the timbers of many of these buildings, which have been exposed to the weather above three centuries, appear never to have been painted.

AUTHORITIES.

“ The lower story is of stone. This hint is taken from a building near Eltham Palace, in Kent, except that the windows are here of oak, instead of stone, which was not uncommon, both in buildings of stone and also of brick, as at Wolterton Manor House, and Carhow Priory, in Norfolk.

“ Stone, and even brick corbels, supporting beams, may be seen at Lynn Regis, and at Ely.

“ The brick nogging, between the timbers, is copied from a curious specimen at Lynn Regis, built in the reign of Edward IV.

“ The hint of upright timbers, ornamented with small tracery, over the centre building, was taken from a house near Kelvedon, in Essex, very lately destroyed ; but a similar building is still remaining in the Market Place of Newark, Nottinghamshire.

“ The gable board is copied from a house at St. Edmunds Bury, but is not uncommon. The pinnacles, being the parts most exposed to the weather,

few specimens in wood are now to be found: the only one perfect in oak, is at Shrewsbury; but this form is common in brick and stone gables.

“ The vane, or square flag, is copied from one at Hornchurch, in Essex.

“ The projecting bow window is taken from one at Norwich; but the tracery is not uncommon; a specimen of it in oak still remains at Knowl, in Kent. The tracery of the lower window is copied from a Timber House, at Coventry, and is, also, not uncommon, such forms being preferred to those more rare or fanciful.

“ The general outline of all the windows is taken from an earlier date than the end of the reign of Henry VIII.; before, they were divided by a cross bar, which did not prevail in wood till the reign of Edward VI., Elizabeth, and the 17th century.

“ The design for the porch is from various specimens of open porches, and particularly the cloisters of several alms houses, of which a fragment remains at Clapton, near Lea Bridge.

“ The door is after one remaining at Sudbury, in Suffolk; and the handle did belong to the Vestry Door of Sall Church, in Norfolk.

“ The ornamented shafts of the chimnies are taken from some of those which are in perfect preservation at Wolterton Manor House, near Bانشam, in Norfolk, of which very curious building there are now four large plates engraving for the Society of Antiquaries, from drawings by my son, Mr. S. A. Repton, F.A.S.; to whose spirit of enquiry, and knowledge in this style of architecture, the erection

of this singular building has been solely committed, and it is hoped will remain a curious record, when time shall have destroyed those specimens from which the original hints have been selected.

“ The garden, to accord with the style of the Cottage, is proposed to be unlike modern landscape gardening; but as no specimens exist of such gardens, or even the fence by which they were inclosed, the rail in front is copied from one in an old painting of Henry VIII., in the Council Room of the Antiquarian Society; and the clipt hedges, mazes, and parterres, are taken from prints of Hans Holbein, and various pictures of the same date.

“ Among the flowers preserved in very old Gardens, are still to be found the following, which have, therefore, been particularly chosen—viz. Rosemary, Columbine, Crowfoot, Clove-Pinks, Marigold, Double-Daisy, Monkshood, Southernwood, Pansies, White Rose, Yellow Lillies, Turk’s Cap, &c.”

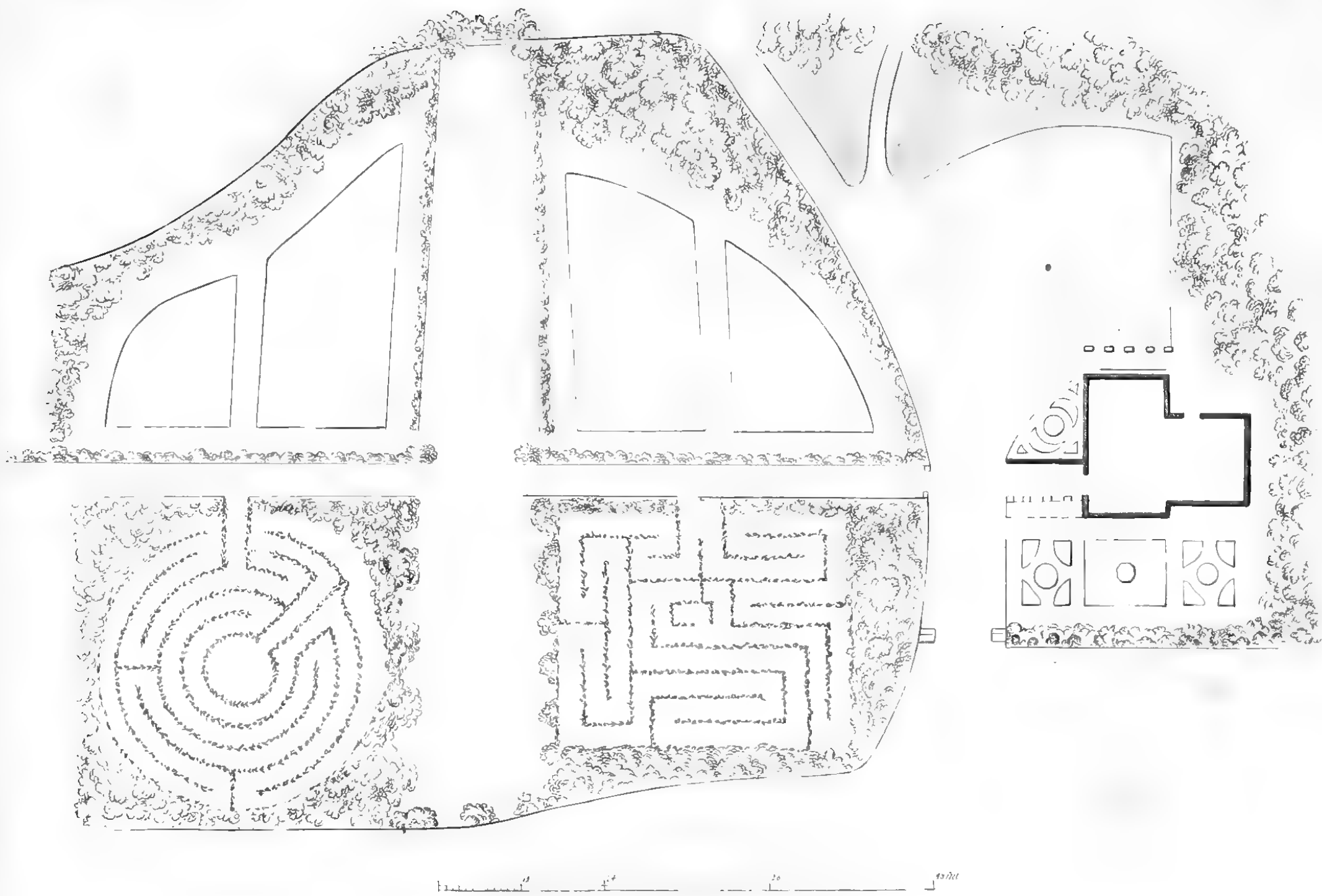

Labyrinths at Aspley Wood.

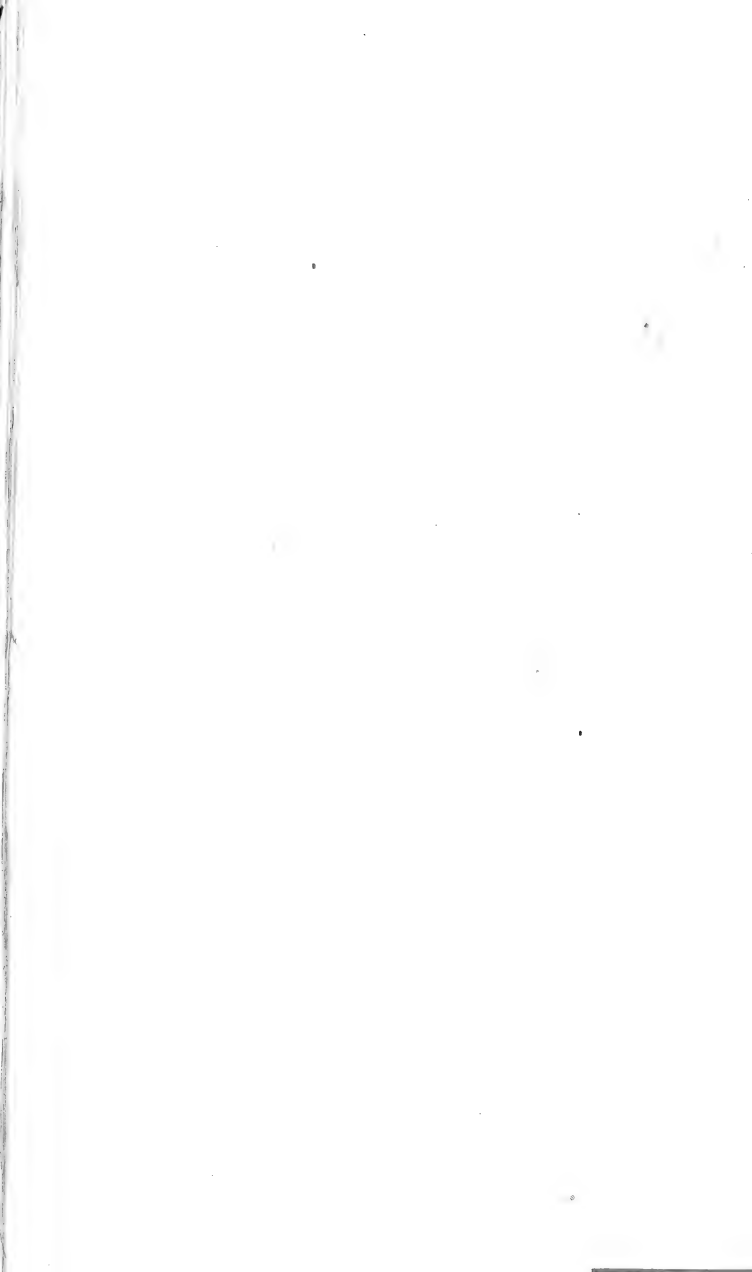

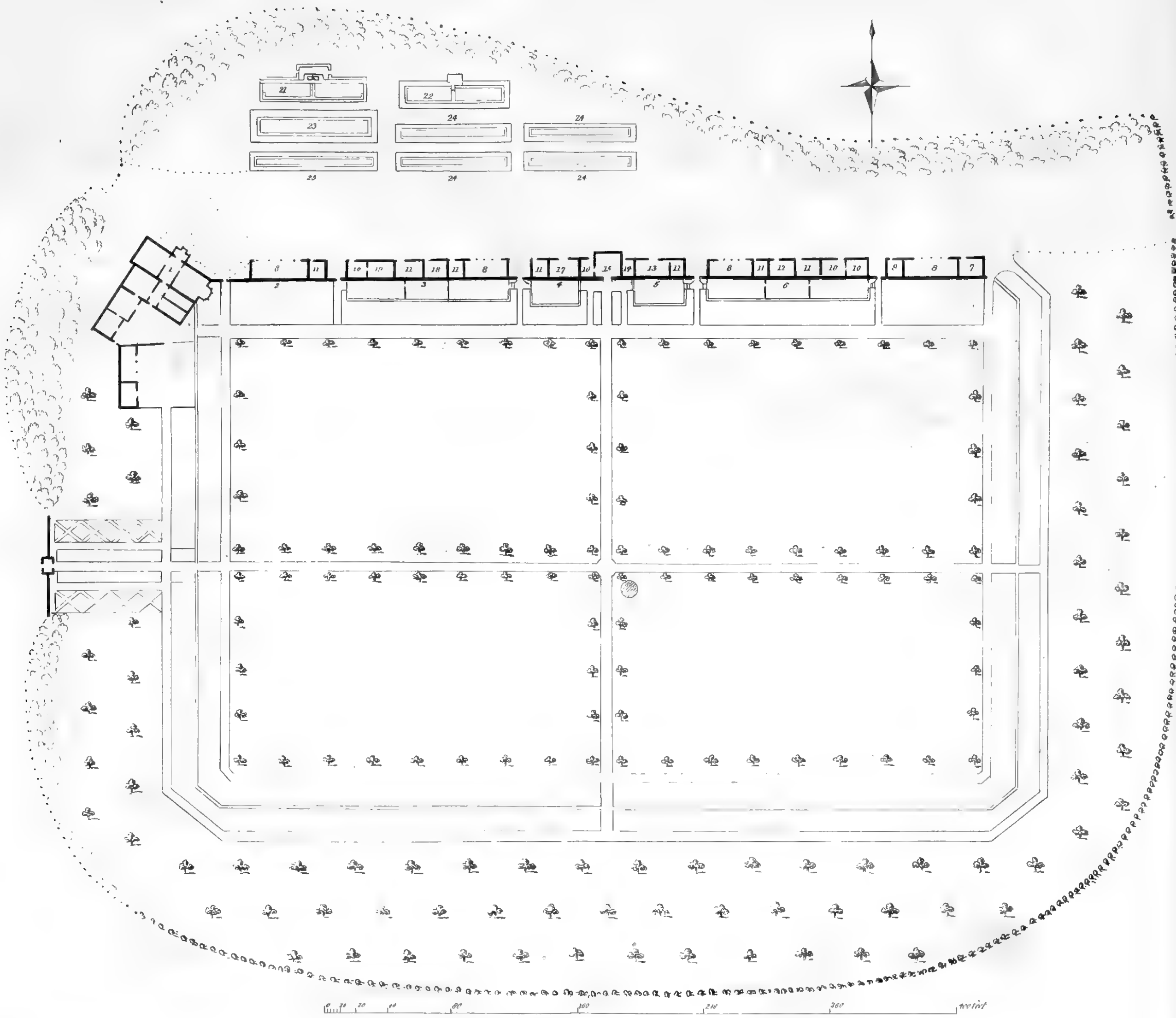

General Plan of the Kitchen Gardens.

KITCHEN GARDEN.

In the choice of the site for the Kitchen Garden, the situation, if possible, should be selected where it may be sheltered by plantations, or other adjoining scenery, from the high cutting winds, which are very destructive to the early crops, as well as to the fruit blossoms.

The site that appears most suitable for a Kitchen Garden, is on the declivity of an eminence, or rising ground, where it slopes towards the South; and if it can be formed with about one foot of a fall in thirty, and so as to have a gentle inclination towards the East, say about one foot in every hundred feet in length, the crops will have the better advantage of the morning sun in the Spring months. The annexed Plate will illustrate the general arrangement of the Kitchen Garden here, which was executed from the designs of William Atkinson, Esq., of Grove End, St. John's Wood, whose extensive experience in the various kinds of horticultural erections has been very generally acknowledged, as giving great satisfaction.

This Garden consists of a parallelogram, which is the most convenient form for cropping, and for affording a greater portion of South aspect for the finer wall fruits. The space enclosed within the walls contains about four English acres of ground; it is surrounded by a broad slip, which, being planted

with a selection of the best sorts of *pears* and *apples*, as standards, gives the exterior of the Garden the appearance of an *Orchard*.

On referring to the Plate, it will be perceived that the range of *Forcing-houses* is erected against the South side of the North wall of the Garden, and that the Coal Sheds, Furnaces, and other necessary appendages, are placed behind, where the fires are attended to, and the ashes, and other unsightly objects, are not in view from the principal walks of the Garden. The Pit, or what is more generally called the Melon Ground, is also arranged in the space behind the Hot-houses, and comprises three ranges of Pits, two of which extend to about half the length of the Garden, and are principally occupied with a succession of pines, melons, cucumbers, &c. all heated by dung linings applied round the Pits. The two back Pits, No. 21, and 22, are both heated by hot water, and are chiefly filled with the fruiting Pine Plants, and with Grape Vines, along the top of No. 21. The intervening spaces betwixt these ranges of Pits, are all paved with brick, which renders the Melon Ground always dry, and more easily cleaned from the frequent quantities of dung, &c. that is necessarily deposited between the Pits, in the renewing and taking out of the spent dung in the linings, &c. In the range of back Sheds, are situated the Apple Chambers and Seed Room, and other requisite compartments. In the centre of the range, No. 15, is an apartment fitted up for the entertainment of company in the fruit season; the ceiling of this room is ornamented by several kinds

of birds, and the floor is inlaid with different kinds of oak.

On the walls are hung two magnificent fruit pieces, painted by G. Lance, Esq. whose accuracy in the delineation of fruits is universally admired.

The interior of the Garden is divided into four quarters, each of which is surrounded by a row of standard fruit trees, planted along the flower borders. By thus confining the trees to the borders, the quarters are left free from their shade, and enabled to produce vegetables of a better quality. The shoots of the trees being all trained in the weeping or French form, which they call the "*Quenouille*," they do not shade, or but little injure the flowers or crops adjoining the borders. This method of training the shoots has also the advantage of checking the flow of sap, and throwing the trees, at a much earlier period, into a bearing state, than if they were permitted to grow in their natural form. In the centre of the Garden, where the walks cross each other, is an iron *cupola*, which is covered with creepers, and forms a pleasing object to the eye from the different parts of the Garden.

The principal entrance to the Garden is situated opposite to the centre of the West wall; its being in the most direct line from the Abbey, renders it the most suitable site for it, as the ground opposite the centre of the South wall, (which would, else, be the more appropriate space for the entrance, as commanding the best view of the Hot-houses,) falls much too rapidly into a hollow, which continues, for a considerable distance, on each side, opposite

the centre door, to admit of its being placed there. The main entrance is about 80 feet from the West wall; it consists of a handsome architectural building, and is connected with the Garden by a neat iron arch trellissing, that measures 80 feet in length, 8 feet wide, and about 12 feet in height, and is covered with different kinds of creepers, which have a very beautiful appearance when in flower. But to give the reader a fuller idea of this erection, I have given a perspective view of it on the following plate. At each end of the entrance wall commences an iron railing, which encloses all the West boundary of the Garden; the South and East sides being enclosed by a hedge, which is also protected from the *deer* by an oak fence. The North side is bounded by a sunk fence, with an iron railing along the top of it. This Garden is well sheltered, on every side, by plantations, which occupy the rising ground around the space enclosed, which falls both towards the South and East.

REFERENCE TO THE ANNEXED AND FOLLOWING
PLATES.

1. Ground Plan of Gardener's House.
2. Hot-wall.
3. Range of Peach-houses.
4. Citron and Lemon-house.
5. Fig-house.
6. Range of Vineries.
7. Room for Workmen.



View of the Gardeners House



View of the Garden Entrance



South East View of the Gardeners House

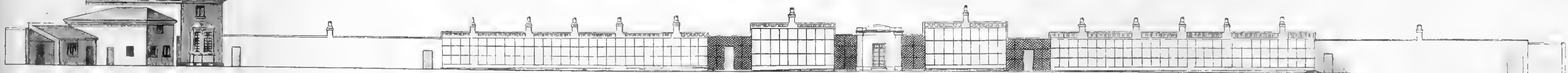

Front Elevation of the Hot-houses &c

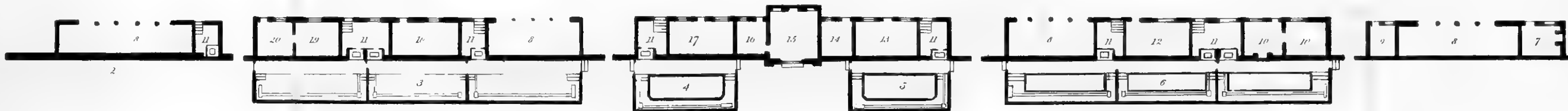

Ground Plan of the Hot-houses back-sheds &c.



8. Open Sheds, for Mould, Flower Pots, &c.
 9. Tool-house.
 10. Foreman's Rooms.
 11. Fire-place Sheds.
 12. Onion-room.
 13. Root-house.
 14. Store-room.
 15. Room for Company to take fruit in.
 16. Waiting-room, for ditto.
 17. Room for Dessert, Apples, &c.
 18. Room for Kitchen Apples.
 19. Seed-room.
 20. Office.
 21. Pinery for fruiting Pines.
 22. Pine Pits, for ditto.
 23. Succession Pine Pits.
 24. Pits for young Pines, Melons, Cucumbers, &c.
 25. Pits for early Melons, Cucumbers, &c.
-

The following are lists of the different varieties of fruits cultivated in the Gardens at Woburn Abbey.

APRICOTS.

Breda.	Peach Apricot.
Brussels.	Red Masculine.
Hemskirke.	Roman.
Large Early.	Royal.
Moorpark.	Turkey.
Orange.	

PEARS.

	Time when fit for use.	
Ambrette d'Hiver	Nov.—Jan.	<i>Dessert.</i>
Angelique de Bordeaux	Feb.—April.	————
Angleterre	Oct.	————
Angelique de Rome	Dec.—March.	————
Aston Town	Oct.	————
August Muscat	Aug.	————
Autumn Bergamot	Oct.	————
Ambrosia	Sept.	————
Autumn Colmar	Oct.	————
Belle Lucrative	Oct.	————
Belmont	Nov.	————
Bellissime d'Hiver	Nov.—April.	<i>Kitchen.</i>
Bergamotte de Hollande ..	March.—June.	<i>Dessert.</i>
———— Cadette	Oct.	————
———— de Soulers	Jan.—March.	————
———— Rouge	Sept.	————
Beurré Diel	Oct.—Nov.	————
———— Rance	Dec.—April.	————
———— Easter	Jan.—March.	————
———— Spence		————
Bezy de Caissoy	Nov.—March.	————
Bishop's Thumb	Oct.	————
Black Worcester	Nov.—Feb.	<i>Kitchen.</i>
Brown Beurré	Oct.—Nov.	<i>Dessert.</i>
Catillac	Dec.—April.	————
Chaumontel	Nov.—Jan.	————
Chaptal	Dec.—April.	<i>Kitchen.</i>
Comte de Lamy	Oct.	<i>Dessert.</i>
Colmar	Nov.—Jan.	————
———— Early	Oct.—Nov.	————
———— Autumn	Jan.	————
Crasanne	Nov.—Dec.	————
———— Winter	Jan.	————
Citron des Carmes	July.	————
Darimont	Sept.—Oct.	————
D'Auch	Nov.—Jan.	————
De Candolle	Sept.	————
Delices d'Hardenpont	Oct.	————
Damas	Nov.—Dec.	————

PEARS.

	Time when fit for use.	<i>Dessert.</i>
Dillen	Oct.—Nov.	————
Double d'Automne	Nov.—Dec.	————
Duchesse d'Angoulême	Oct.—Nov.	————
Dowler's Seedling	Nov.—Feb.	————
Early Bergamot	Aug. Sept.	————
Elton	Sept.	————
Eastnor Castle	Jan.—April.	————
Etranglee	Nov.—May.	————
Flemish Beauty	Oct.—Nov.	————
Famenga	Sept.	————
Forelle	Nov.—Jan.	————
Franc Réal d'E'té	Sept.	————
Gansel's Bergamot	Nov.—Dec.	————
Gendeseim	Sept.—Oct.	————
German Muscat	March.—May.	————
Gilogil	Dec.—April.	————
Glout Morceau	Nov.—Feb.	————
Great Blanquette	Aug.	————
Green Pear of Yair	Aug.—Sept.	————
—— Chisel	Aug.	————
—— Sylvange	Oct.—Dec.	————
Grey Doyenné	Oct.—Nov.	————
Grumkower	Nov.—Dec.	————
Hacon's Incomparable	Nov.—Dec.	————
Hessel	Oct.—Dec.	————
Henry the Fourth	Sept.—Oct.	————
Holmer	March.—May.	————
Incommunicable	Oct.	————
Jalousie	Oct.—Nov.	————
Jargonelle	Aug.	————
Kuiser	Oct.—Nov.	————
Lammas	Aug.	————
Lansac	Nov.—Dec.	————
Lent St. Germain	March.—April.	————
London Sugar	July.—Aug.	————
Longueville	Sept.	————
Long stalked Blanquet	July.—Aug.	————
Louise Bonne	Nov.—Dec.	————
Marceux	July.	————
Mansuette	Sept.	————
Marie Louise	Oct.—Nov.	————
Marquise	Oct.—Nov.	————
Martin Sec	Nov. Jan.	————

PEARS.

	Time when fit for use.	
Martin Sire	Dec.—Feb.	<i>Dessert.</i>
Merveille d'Hiver	Nov.—Dec.	————
Messire Jean	Oct.—Nov.	————
Monarch	Jan.	————
Moor-fowl Egg	Sept.—Oct.	————
Muscat Early	July.	————
Musk Summer Bonchretien	Sept.	————
Naples	Jan.—April.	————
Napoleon	Nov.	————
Neill	Sept.—Oct.	————
Ne plus Meuris	Nov.—March.	————
Nelis, Winter	Dec.—Jan.	————
Oak-leaved Imperial	Jan.—May.	————
Orange Tulipee	Sept.	————
Passe Colmar	Dec.—Jan.	————
Passans de Portugal	Aug.—Sept.	————
Pastorale	Nov.—March.	————
Passe Madeleine	Aug.	<i>Kitchen.</i>
Poire de Jardin	Dec.—Jan.	<i>Dessert.</i>
— de Vitrier	Nov.—Dec.	————
— Figue	Oct.—Nov.	————
Pour's Castle	Oct.	————
Princess of Orange	Oct.	————
Prince's	Aug.	————
Riche	Oct.—Jan.	————
Royale d'Hiver	Dec.—Feb.	————
Sabine	Nov.—Jan.	————
St. Augustin	Dec.—Feb.	————
St. Germain	Nov.—Jan.	————
St. Père	Feb.—May.	<i>Kitchen.</i>
Seckle	Oct.	<i>Dessert.</i>
Seigneur d'E'té	Sept.	————
Spanish Bonchretien	Nov.—Dec.	————
St. Germain, Uvedales	Jan.—April.	<i>Kitchen.</i>
Summer Bergamot	Sept.	<i>Dessert.</i>
— Rose	Aug.	————
— Bonchretien	Sept.	————
Swan's Egg	Sept.—Oct.	————
Swiss Bergamot	Sept.—Oct.	————
Tresor	Dec.—March.	<i>Kitchen.</i>
Thomson's	Nov.	<i>Dessert.</i>
Urbaniste	Sept.—Oct.	————
Vallée Franche	Aug.—Sept.	————

PEARS.

	Time when fit for use.	
White Doyenné	Sept.—Oct.	<i>Dessert.</i>
Williams's Bonchretien	Aug.—Sept.	————
Windsor	Aug.—Sept.	————
Winter Bonchretien	Jan.—Feb.	————
Winter Rousselet	Jan.—March.	————
Yute	Sept.	————

APPLES.

Acklam's Russet	Nov.—Feb.	<i>Dessert.</i>
Adams's Pearmain	Nov.—Feb.	————
Alfriston	Nov.—April.	<i>Culinary.</i>
Ashmead's Kernel	Nov.—May.	<i>Dessert.</i>
Astrachan White	Aug.—Sept.	————
Baltimore		
Baxter's Pearmain	Nov.—March.	<i>Culinary.</i>
Beachamwell Seedling	Nov.—April.	<i>Dessert.</i>
Beauty of Kent	Oct.—Dec.	————
Bedfordshire Foundling	Nov.—Jan.	<i>Culinary.</i>
Belvoir Pippin	Nov.—Dec.	<i>Dessert.</i>
Benwell's Pearmain	Oct.—Dec.	————
Best-Poole	Jan.—April.	<i>Dessert & Cul.</i>
Biggs's Nonesuch	Oct.—Dec.	<i>Culinary.</i>
Blenheim Pippin	Nov.—March.	<i>Dessert.</i>
Bossum Apple	Nov.—March.	<i>Culinary.</i>
Bowyer's Russet	Sept.—Nov.	<i>Dessert.</i>
Braddick's Nonpareil	Oct.—Dec.	————
Breedon Pippin	Nov.—Jan.	————
Brickley Seedling	Dec.—May.	————
Bringewood Seed Pippin	Dec.—May.	————
Borsdorff, or Queen's Apple	Nov.—Feb.	————
Calville Blanche d'Hiver	Dec.—March.	<i>Culinary.</i>
—— Malingre	Jan.—April.	————
—— Rouge, or Winter	Nov.—Feb.	————
—— Red		
Canadian Reinette	Dec.—March.	<i>Dessert.</i>
Caroline	Nov.—Feb.	<i>Culinary.</i>
Claygate Pearmain	Nov.—Feb.	<i>Dessert.</i>
Cockle Pippin	Nov.—May.	<i>Dessert & Cul.</i>
Codlin Winter	Aug.—Nov.	<i>Culinary.</i>
Crofton Scarlet	Aug.—Sept.	<i>Dessert.</i>
Cole Apple	Sept.—Dec.	<i>Dessert.</i>

APPLES.

	Time when fit for use.	
Colonel Harbord's Pippin	Nov.—March.	<i>Culinary.</i>
Cornish Aromatic	Nov.—Feb.	<i>Dessert.</i>
Cornish July Flower	Nov.—April.	————
Court of Wick Pippin	Oct.—April.	————
Cray Pippin	Oct.—Nov.	————
Darlington Pippin	Oct.—Jan.	————
Dowell's Pippin	————	————
Downton Pippin	————	————
Dredge's Fame	Oct.—March.	<i>Culinary.</i>
——— White Lily	Nov.—March.	<i>Dessert.</i>
Dumelow's Seedling	Nov.—April.	<i>Culinary.</i>
Dutch Mignonne	Nov.—June.	<i>Dessert.</i>
Early Nonpareil	Oct.—Nov.	————
Easter Pippin } French Crab }	Nov.	<i>Culinary.</i>
Emperor Alexander	Oct.—Dec.	<i>Dessert.</i>
Eyer's Greening	Nov.—Feb.	<i>Culinary.</i>
Franklin's Golden Pippin	Oct.—Jan.	<i>Dessert.</i>
Fulwood Apple	Nov.—April.	<i>Culinary.</i>
Golden Harvey	Dec.—June.	<i>Dessert.</i>
——— Noble	Nov.—March.	<i>Culinary.</i>
——— Pippin	Oct.—Dec.	<i>Dessert.</i>
Gravenstein Apple	Oct.—Dec.	————
Hanwell Souring	Oct.—May.	<i>Culinary.</i>
Hawthornden	Sept.—Dec.	————
Hubbard's Pearmain	Oct.—March.	<i>Dessert.</i>
Irish Peach Apple	August.	————
Jubilee Pippin	Oct.—Jan.	<i>Dessert & Cul.</i>
Juneating	July.—August.	<i>Dessert.</i>
Kentish Pippin	Oct.—Jan.	<i>Culinary.</i>
Keswick Codlin	Sept.—Nov.	————
King of the Pippins	Nov.—Dec.	<i>Dessert.</i>
Kirke's Lord Nelson	Nov.—Jan.	<i>Culinary.</i>
Lamb Abbey Pearmain	Dec.—March.	<i>Dessert.</i>
Lemon Pippin	Oct.—March.	<i>Culinary.</i>
Lucombe's Seedling	Oct.—Feb.	————
Mank's Codling	Nov.—Dec.	————
Margil Apple	Nov.—March.	<i>Dessert.</i>
Martin Nonpareil	Dec.—May.	————
Newtown Spitzenberg	Nov.—Feb.	————
New York Pippin	Nov.—April.	————
Nonesuch Apple	Sept.—Dec.	<i>Culinary.</i>
Norfolk Beaufin	Nov.—May.	————

APPLES.

	Time when fit for use.	
Norfolk Paradise	Oct.—March.	<i>Dessert.</i>
Northern Greening	Nov.—April.	<i>Culinary.</i>
Old Nonpareil	Dec.—March.	<i>Dessert.</i>
Old Royal Russet	Nov.—April.	<i>Culinary.</i>
Oxnead Pearmain	————	<i>Dessert.</i>
Padley's Pippin	Nov.—Dec.	————
Pile's Russet	March.—April.	<i>Cul. & Dessert.</i>
Pine-Apple Russet	Sept.—Oct.	<i>Dessert.</i>
Pomme Grise	Oct.—March.	————
Pomme de Deux Ans.	Sept.—Jan.	————
Red Astracan	August.	————
Red Quarrenden	August.—Sept.	————
Ribston Pippin	Oct.—April.	————
Scarlet Nonpareil	Nov.—March.	————
Spice Apple	Nov.—Feb.	————
Stone Pippin	Nov.—July.	<i>Cul. & Dessert.</i>
Summer Brooding	Oct.—Nov.	<i>Culinary.</i>
Sweeney Nonpareil	Nov.—March.	<i>Dessert.</i>
Sykehouse Russet	Dec.—March.	<i>Dessert</i>
Transparent Codlin	Sept.—Nov.	<i>Culinary.</i>
Waltham Abbey Seedling ..	Oct.—Jan.	<i>Dessert & Cul.</i>
Wheeler's Russet	Nov.—April.	————
White Cockle Pippin	Nov.—May.	————
Whitmore's Pippin	Nov.—Jan.	————
Winter Colman	Nov.—March.	<i>Culinary.</i>
Winter Majetin	————	————
Winter Queening	————	————
Winter Red Calville	————	————
—— White Calville	Dec.—March.	————
Wyken Pippin	Oct.—Jan.	<i>Dessert.</i>
Yellow Ingestrie	Oct.—Nov.	————
Yorkshire Greening	Nov.—April.	<i>Culinary.</i>

PLUMS.

Blue Gage.	Goliath.
Bullace Yellow.	Garlick's Early.
Coe's Golden Drop.	White Gage.
Damson, White.	Green Gage.
Damson, Black.	Imperatrice, Blue.
Diaper.	———— Downton.
Drap d'Or.	Imperial Diadem.
Fotheringham.	Jaune Hâtive.

PLUMS.

Kirke's.	Purple Gage.
La Délicieuse.	Perdrigon, Red.
La Royale.	Red Magnum Bonum.
Maitre Claude.	Reine Claude Violette.
Mirabelle.	Royale de Tours.
Monsieur Hâtif.	St. Catharine.
Morocco.	Washington.
Nectarine Plum.	Wentworth.
Orleans, Wilmot's New Early.	White Bullace.
Orleans.	White Imperatrice.
Perdrigon, Blue.	White Magnum Bonum.
Prune Damson.	Winesour.
Peter's Large Yellow.	Yellow Gage.

CHERRIES.

Ambrée.	Bleeding Heart.
Archduke.	Elton.
Belle de Choisy.	Kentish.
Bigarreau.	Knight's Early Black.
Black Eagle.	May Duke.
Black Heart.	Morello.

RASPBERRIES.

Antwerp, late Bearing.	Double Bearing.
Antwerp, Red.	Prolific Early.
Antwerp, Yellow.	Williams's Preserving.
Barnet.	Wilmot's Early Red.

GOOSEBERRIES.

REDS.	Smolensko.
Crown Bob.	Sportsman.
Champagne.	Top Sawyer.
Foxhunter.	Warrington, Red.
Highwayman.	Whipper-in.
Huntsman.	Yaxley Hero.
Lancashire Lad.	YELLOWS.
Old Rough Red.	Amber, Early.
Roaring Lion.	Brandy Yellow.
Rough Robin.	Golden Drop.

GOOSEBERRIES.

Golden Orange.	Southwell Hero.
Great Gunner.	Troubler.
Nelson's Waves.	Willow.
Regulator.	Wistaston Hero.
Rockwood.	WHITES.
Sovereign.	Bonny Lass.
Viper.	Governess.
Willow.	Lady Delamore.
GREENS.	Lancashire Lass.
Anchor.	Queen Caroline.
Elijah.	Thrasher.
Favourite.	Toper.
Green Gage.	Wellington's Glory.
Greenwood.	White Eagle.
Joke.	——— Lion.
Lord Crewe.	——— Rock.
Ocean.	Whitesmith.

CURRANTS.

Common Black.	White Chrystal.
Champagne.	White Dutch.
Red Dutch.	

STRAWBERRIES.

American Scarlet.	Knight's Large Scarlet.
Autumn Scarlet.	Morrisania Scarlet.
Bath Scarlet.	Myatt's Pine Apple.
Black Roseberry.	Nairn's Scarlet.
Blood Pine.	Oblong Scarlet.
Bostock.	Old Pine.
Carolina.	Old Scarlet.
Clustered Scarlet.	Pitmaston Black.
Common Hautbois.	——— Black Scarlet.
Downton.	Prolific Hautbois.
Dutch.	Red Alpine.
Dwarf White Carolina.	——— Chili.
Elton Seedling.	Roseberry.
Granstone Scarlet.	Round White Carolina.
Green Alpine.	Scarlet Cluster.
Garnstone Scarlet.	Scone Scarlet.
Glazed Pine.	True Chili.
Grove End Scarlet.	White Alpine.
Hudson's Bay Scarlet.	——— Wood.
Keen's Imperial.	Wilmot's late Scarlet.
——— Seedling.	Wilmot's Superb.

MATERIALS BEST ADAPTED FOR HOT- HOUSE ROOFS.

Of what materials the construction of Hot-House Roofs may most suitably be made, is a subject that has occupied, of late, the anxious attention of many horticulturists; and various and conflicting have their opinions been, insomuch that it would be a matter of serious difficulty for a person to come to a satisfactory conclusion which material bears the preference.

Let us commence *ab-ovo*. During the last half century, the authors of all the numerous improvements that have been adopted, in the formation, &c. of these structures, have principally had in view such inventions as would tend to admit the greatest portion of sun and light to the trees or plants, in the ungenial days of Winter and of Spring. Since it has been generally acknowledged, and is now established, that sun and light are amongst the first and most essential requisites for early forcing, several schemes have been resorted to, for their more unrestrained admission; such, for instance, as a reduction of the substance of materials in the wood houses, to within half the size of what prevailed with our antique forefathers, as also by the introduction of metallic substances.

It has, however, been stated by many, that the latter materials are unfit for Hot-House Roofs; as

being conductors of heat and cold, they render the houses additionally cold in Winter, and too hot in Summer. This objection is certainly applicable to wrought iron and cast metal bars, in some degree, as they are both formed of a solid bar, and are, in consequence, unquestionably conductors of heat and cold. But this objection, I shall hereafter prove, may be sufficiently guarded against.

Cast iron sashes have, likewise, been introduced for the roofs ; but from their ponderous weight, and brittle nature, they have not been found very appropriate.

In short, I conceive, that cast iron is the worst material possible for the sash bars or astragals, as they are very liable to snap in two, in the giving or taking away the air ; and, in most cases, they cannot be repaired without re-casting the entire sash ; and this, in the forcing season, might be attended with considerable loss.

The wrought iron curvilinear bars have, also, been of late years extensively used in the construction of roofs ; especially in plant structures, for which they are certainly well calculated, as they form an elegant and light roof, and can be erected at a much less expense, than rafters and sliding sashes. Messrs. Loddiges, of the Hackney Nursery, as well as Mr. Knight, of the Exotic Nursery, Chelsea, alike prefer this material to any other ; and in both establishments there has been a large curvilinear house for a number of years. Yet, however applicable the curvilinear roofs may be for plants, I do not consider them so well adapted for Forcing-Houses, as the

roofs are necessarily fixed, and are, in consequence, often very deficient in power of ventilation; air being, in most cases, only admitted by having ventilators in the back and front walls, which has frequently proved inefficient for modification of the temperature in hot weather. This defect is now, however, principally removed, by having parts of the roof and ends so constructed, as to admit a free circulation of air, which will certainly obviate that difficulty.

But the principal objection that I have against using the wrought iron sash bar in forcing-houses, is its attractive qualities, which allow the heat and cold to pass rapidly through it. Wrought iron is, also, very liable to corrode, much more so than cast metal, of which all who have had any experience of the two must be fully aware.

In the construction of the Forcing-House Roofs, cast iron rafters, wall plates, &c. wrought iron sash frames, and copper bars, have been extensively used; they are considered by many the most durable materials that can possibly be introduced; and when properly executed, I should imagine that a roof of this description cannot be surpassed by any other for durability, the admission of sun and light, and elegance of appearance. The annexed Plate, No. 18, will illustrate the materials of which the Forcing-Houses, at Woburn, are constructed. They are raised on somewhat a different principle from any that I have yet treated of; that is, with a combination of the several materials. In this range, the rafters, standards, spouts, and sills, where strength

is required, are of cast metal: the lights are composed of wood rims, and copper bars; over the rafters is a wood coping, which prevents the wet getting in between the tiles and rafters, and, likewise, lessens the external action of the atmosphere: the same effect is produced within, by the new contrivance of a safety water gutter, composed of wood, and lined with lead, and screwed on the lower part of the rafters, which is an invention of Mr. Jones, and of real importance, as it prevents any of the water that collects on the lower part of the rafters from falling on the foliage, at the same time, that it gives them a neat appearance.

The sash bars, or astragals of the lights, Fig. 3, consist of sheet copper, the lower side of which is hollow; a circumstance which, as Mr. Atkinson has justly observed, obviates every objection that attaches to wrought iron, or cast metal ones, of being conductors of heat and cold. This tube, by being always full of air, transforms the bars into non-conductors.

Hot-Houses, constructed with these materials, and in this manner, I consider preferable for every practicable purpose, for durability, neatness, admission of sun and light, and as non-conductors, to any other description of house that I have yet seen.

The lights of the forcing range are all glazed with crown glass, seven by seven inch squares. See Fig 2. There is one improvement of peculiar importance, introduced by Mr. Jones in the glazing of these houses, which deserves to be more generally adopted than it has yet been, as it is the most effectual pre-

ventative for the breakage of glass that has ever come under my observation. The panes are all bedded on a small stripe of solid lead, which is rabbitted on both sides, so as to fit the thickness of the glass, and which prevents it from slipping out of its proper place. The small aperture left in the centre is to carry off the moisture and foul air that collect within the house.

It has, however, been asserted by many, that metallic substances are less durable than wood in Hot-House Roofs, however well executed. Now this is an assertion, which I really consider too preposterous to require any refutation. In the name of common sense, I would inquire, what, *primâ facie*, can render metal materials less durable in Hot-House Roofs than in other buildings, where we meet with fragments still remaining, that have been in use for centuries; and the same material is introduced daily by all the eminent architects of the age, in the execution of the various buildings which they design, and which they intend shall stand for ages.

In arguing this question, it is unfair to bring the durability of wood houses, erected in the present day, with those constructed even thirty years ago, as the subject of comparison. Nobody would think, in the present day, of shutting out, by the monstrous bars, then in use, the sun and light. We must take modern wood structures for the standard, and modern metal ones; and as it is obvious in these, that the wood materials of the roofs have been reduced to nearly half the substance of those erected forty years ago, their strength and durability must, of

necessity, be proportionably decreased. In addition to this disadvantage, it must not be forgotten, that, of late years, the atmosphere of Forcing-Houses, &c. is constantly kept infinitely more humid, than formerly was the case, so that the roofs, being perpetually exposed to artificial heats and damp internally, and to the very frequent changes of the weather externally, they are subject to every destructive influence, which must operate more rapidly on the wood, and the injurious effects of which can only be partially stayed by the frequent and expensive application of paints.

Metallic roofs are, however, represented to be subject, in an extraordinary degree, to contraction and expansion, and, consequently, liable to break much more glass than wooden ones. As regards these shews of objections, I can confidently assert, that I have not yet, during the five years that the houses have been erected, observed one pane of glass broke in the whole range of metallic houses here, either by expansion or contraction; and further, that, during the severe frost, in the Winter of 1829, when the thermometer indicated 29 degrees of frost, not a pane of glass was broke by it in the metallic range, where we had upwards of 200 squares cracked in the range of wood houses. I, however, do not mean to imply that this number of squares was broken in consequence of the houses being constructed with wood; it might be, and undoubtedly was, in fact, occasioned by imperfect glazing; but the fact will show how ridiculous it is to impute a greater breakage of glass to the use of metal materials. In

short, it is my own opinion, as well as that of many others, that this climate will never, from either heat or cold, expand or contract the copper bars, to such a degree, as to cause breakage of glass. The Messrs. Jones and Co., the manufacturers of our houses, are so decidedly convinced of the fallacy of this argument to the point in question, that I cannot avoid extracting the following passage from their agreement of contract, which, I think, is sufficient to set this question at complete rest. "The houses," says the document, "shall be constructed, and finished in a better and more durable manner than any yet erected in *England*. In proof of which, we hereby engage and bind ourselves to supply all the glass which may be broken by frost, expansion, or contraction, or from whatever cause, excepting hail or accidents, during the space of fourteen years, for the sum of 40s. per annum; and should any part of the frame-work, sashes, or bars, give way, during the said space of fourteen years, from the time of erection, we hereby engage to repair them at our own expense. In short, at the expiration of fourteen years, the houses shall be left by us as good as when first erected."

Now, where, I would ask, shall we find a manufacturer of wood houses engaging to repair, in the like manner, all the breakages, and to leave the houses *at the expiration of fourteen years as good as new*? The truth is, we have many instances of wood roofs being entirely worn out, in the space of from 14 to 20 years; and we will cite, for instance, the range of this description in His Grace the Duke of Northum-

berland's Garden, at Sion House, which was, in fact, totally unfit for horticultural purposes at the end of seven years, in consequence of the dry rot. There was, also, an extensive range in the Royal Gardens, at Kensington, most substantially erected, about 16 years ago, of which the greater portion of the sashes and rafters is now in a decayed and mouldering state.

As regards the painting of metallic roofs, &c. it has been asserted by several, that these roofs require much more paint than wooden ones : unquestionably the wrought iron bars will require it more frequently than those constructed of other materials ; but their dimension being also much smaller than that of wood houses, the less portion of paint will be consumed to cover them, as, undoubtedly, less time is required to lay it on. The following abstract, from Messrs. Jones's agreement, will be, also, a sufficient answer, I presume, to the objection as to painting : " With respect to keeping the houses in paint, the inside of the copper bars would not require it at all in any length of time, or number of years ; and, therefore, we engage to paint the outside, the frame-work, &c. and the rims of the lights, every three or four years, as it might be wished for, at not exceeding two-thirds of the expense which would be necessary for a range of wood houses of equal extent."

The inside of the copper bars, in the Forcing-Houses here, has not yet been painted, neither does it appear to require it. In many of the compartments, the bars are as bright and clean as when first erected ; and the copper never being subject

to corrode, paint will not add one day to its durability. It has been asserted, that although copper is not liable to corrode, its verdigrease is pernicious to vegetation. But when we take into consideration the extreme smallness of the bars and surface that the water can accumulate upon, that it can never collect and remain, for so long a time, on so slight a substance, as to become impregnated with the copper, no injurious effects to vegetation can reasonably be anticipated. In fact, I have not yet been able to discern any drip or moisture falling from the bars.

It has again been objected, that copper bars are unfit for Hot-House Roofs, as being liable to bend, to the great damage of the glass, &c. under even a shower of snow. In reply to this, I will refer to the Winters of 1830, and 1831, when, it must be readily admitted, we had much heavier falls of snow than have been known for the previous twenty years. In this part of the country there was snow, during 1830-1, from a foot to fifteen inches in thickness, lying on the Hot-House Roofs, yet I can confidently assert, that neither was a single pane of glass broken, nor a bar bent by its accumulated pressure, although many of them are nearly 11 feet in length. Hence, as these were sufficiently strong to resist so heavy a weight, we may naturally suppose they are capable of standing against all ordinary chances of destructive wind and weather. In short, I conceive, copper is the best material that possibly can be used for the bars, where smallness of substance and durability are re-

quired. It is, also, a great preservation to the glass, owing to its non-absorbing qualities, an advantage which wood does not possess. The oil from the putty is never abstracted from it by metal substances, as it is in wood, consequently the putty remains sound on the copper rabbits, and prevents the glass being shaken out; while, as soon as the oil is absorbed from it by the wood bars, the putty scales off, and away goes the glass to destruction.

RAFTERS, &c.

Where strength again is requisite, as in the Rafters, Standards, &c. I am decidedly of opinion that cast metal is the best material for this purpose, as it is not subject to swag by weight, nor so liable to corrode and exfoliate as wrought iron.

SASH FRAMES.

The frames of the lights may be either made of wrought iron or wood; for this purpose, I certainly prefer the latter material, as it renders the sashes much lighter, and easier moved up or down, than those with iron rims. They are, also, easily repaired; and, by having a few of the different lengths of the copper bars as a reserve, an entire light might be got ready for re-glazing in much less than half the time that would be requisite to prepare a wooden sash. Although the wooden rims are not so durable as those composed of metal, new frames can be readily substituted as required.

COMPARATIVE COST.

It is objected that metallic houses are much more expensive, at first cost, than wooden ones; unquestionably, a superior article is always higher than an inferior one; but, in the erection of a range of Hot-Houses, I do not consider the difference of expense such as should deter any Nobleman or Gentleman from adopting the former, in preference to the latter, especially if durability and elegance of appearance be any object of consideration. Wood houses, constructed with green, or unseasoned timber, and inferior workmanship, may, undoubtedly, be put up at a very trifling expense indeed, as well as metallic roofs of slight materials, and imperfect workmanship. The principal advantages which metallic roofs, when properly executed, have, in my opinion, over wooden ones, is their decidedly greater durability, and the admission of more sun and light to the plants in the Winter and Spring months. The durability of metallic substances in Hot-House Roofs, is, in fact, no theoretic question; it has been proved, beyond a doubt, in practice. There are, at present, in the Woburn Gardens, 12 large lights, each consisting of 45 feet of glass, in the form of inverted vases, which were originally made for the forcing of Vines; and the whole have been constantly exposed to the weather for nearly forty years; the bars of these lights are composed of copper; and, during that period, they have not had above three coats of paint, and are still

as sound as when first executed, although of but very slight manufacture, in comparison to the bars constructed in the present day.

There are, also, in the Gardens here, cast iron rafters, and wall-plates, that have now, for nearly twenty years, been used in a couple of Pine pits, still as sound as when first cast. The lights of these pits are constructed of wood, and have been, for several years past, constantly under the necessity of having some part or other renewed: these are heated with dung, and, also, with hot water; so that either, or both heats, may be applied at pleasure. The steam, arising from the fermenting substancer, is very detrimental to the wood, whilst its pernicious effects do not injure the metal in the slightest degrees. In short, I should recommend cast metal rafters, and wall-plates, in all pits that are heated with dung.

Various other instances, in proof of the durability of metallic roofs, might be referred to, from works that were executed from thirty to forty years ago. The numerous objections that have been raised against metallic Hot-Houses, have been principally advanced by those who never had them under their own immediate charge, or by those who have had the cast metal, or the sashes whose bars were composed of the *sheet iron*, and enveloped in a thin bit of copper. But, in justice to the public, the opponents of the metallic roofs would but act fairly to state the exact materials of which the houses that they cite are constructed.

Mr. M'Intosh, an excellent scientific and practical

Gardener, expressly says, in that valuable work, "the Practical Gardener," lately published, vol. 1, page 553,—“Trellissing is now universally made of wire, as being lighter, stronger, and more durable than wood, and capable of being put up at much less expense.” It is evident, from the above paragraph, that Mr. M'Intosh considers even *wire* more durable and stronger than wood. Now, when this Author is convinced of the superiority of a material that is so very liable to corrode, being preferable to wood, in the erection of the trellissing, where strength and durability are so requisite for the support of trees and fruit, which rest, in most instances, entirely upon it, I am at a loss to divine how the opponents of metallic roofs can assert that this material is injurious to vegetation, in consequence of its corroding qualities. Surely, fruit, foliage, and shoots, would be as much injured by the wrought iron or wire trellissing, with which they are constantly in contact, and which are so very subject to corrode, as they possibly can be by metallic roofs.

The trellissing is, unquestionably, the first part of the structure that is likely to give way, when composed of wood, in consequence of the pressure it has to resist, and owing to its being kept almost constantly in a damp state, by the frequent syringings of the trees, &c., which soon rot the wood-work.

Fig. 1.

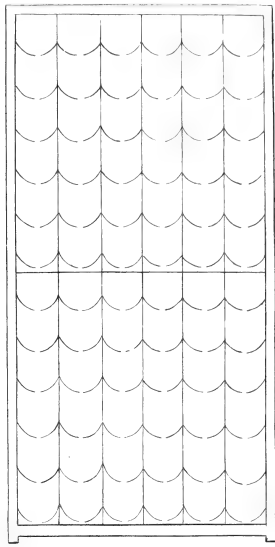
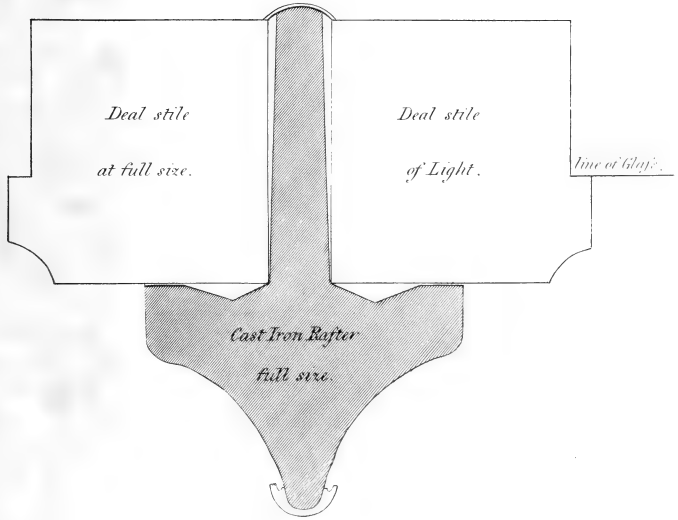

Fig. 3.



Copper Bar
at full size.

Fig. 2.



ON HEATING HOT-HOUSES, &c. WITH HOT WATER.

Amongst the numerous improvements that have been lately introduced in horticultural erections, the apparatus best calculated for heating them forms one of no small importance. Since the successful application of steam and hot water for this purpose, the old brick flues are falling rapidly out of repute; and we may look forward to no very distant period to see these smoke-flues totally expelled from the Gardens, and only used as conductors of the smoke, or in conjunction with the hot water pipes, for economizing fuel and heat. Steam, which is of rather a recent introduction, is not likely to become very generally applied to the heating of Hot-Houses, in consequence of the great expense attending its first application, and the subsequently greater consumption of fuel. The expense, at the first erection, is considerably more than that of flues, or hot water pipes; consequently, the steam apparatus has been but seldom introduced, except in large establishments, and for the heating of extensive ranges, for which it is unquestionably well adapted, and is perfectly efficacious in the most severe weather, to keep up, to convey to a great distance, and give out, in equality, the requisite degree of heat, through the various compartments in which it is introduced. The system of heating by hot water

is, however, of a still more recent invention ; and for its successful application to horticultural buildings, we are indebted to William Atkinson, Esq. who has devoted much time and attention to the constructing and heating of Hot-Houses. This Gentleman, being much attached to horticultural pursuits, has erected in his own Garden, at Grove End, St. John's Wood, several extensive ranges of Hot-Houses, whereby he is enabled to prove the efficiency of his experiments, at the same time that he gratifies his taste.

The simplicity of the hot water apparatus, combined with the steady and congenial heat produced from it, will always render this mode of heating Hot-Houses the most appropriate for general purposes; in short, I scarcely think it is likely to be ever superseded by any other application, of whatever form or construction. There is, no doubt, but that time will suggest various alterations in the boilers and pipes ; but the application of the water is not likely to be dispensed with, as it must be generally acknowledged, that the heat produced by hot water is more congenial to vegetation, and of a less arid nature than that given out from smoke flues, or the steam apparatus. The principal advantages that the hot water pipes have over the two latter methods, are their longer retention of heat, less consumption of fuel, and their requiring much less attendance. I may, however, here observe, that, notwithstanding the above advantages, several complaints have already appeared against this system, occasioned, no doubt, by constructing the pipes, &c. on an erroneous principle. Every practical Gardener will admit, that

the most essential requisite in the heating of Hot-Houses, &c. is to have the apparatus constructed upon such principles, as will, in severe weather, give a perfect command of the internal atmosphere of the compartment in which it is introduced, and which shall retain the heat to a sufficient degree, with the least attendance and consumption of fuel. I shall, hereafter, prove that nothing has yet been invented to surpass, or even equal the hot water system, for the above mentioned purposes, when properly executed. There have been, however, several theoretical schemes resorted to in the formation of the pipes, &c. upon a very mistaken notion, as, for instance, that of constructing the pipes of such shallow dimensions as to contain scarcely any room for holding a body of water. The object of the inventor was to increase the temperature of the house rapidly; but he omitted to take into due consideration what was necessary to retain the heat afterwards, and, hence, the failure.

But if the pipes, &c. are properly constructed, I will maintain that the temperature of a house can be both more quickly raised, and longer retained, than was ever the case with smoke flues. In the Forcing-Houses at Woburn we can heat a compartment, in which the *boiler* and pipes together, contain 112 imperial gallons of water, to 132 degrees in the boiler, in forty minutes from the lighting of the fire, and to 152 degrees in one hour; and that without consuming more than three-fourths of a bushel of coal. When water is heated to 152 degrees, it was considered by the late Mr. Tredgold, and others,

more ready in giving out its caloric than when at a higher degree.

In another house here, the boiler, pipes, and reservoir contain 190 gallons. The boiler has been filled when the water was at 45 degrees, the fire lighted, and in the space of one hour the temperature of this quantity of water has been raised to 110 degrees in the boiler, and to 98 degrees in the reservoir, which is 50 feet distant from the boiler, the fuel consumed being only half a bushel of coal. In the course of two hours, the water in the boiler was increased to 138 degrees, and, in three hours, its temperature to 166 degrees. The fuel required for raising it to the last mentioned degree, was simply one bushel, which would be sufficient to keep an ordinary sized house for 24 hours, in the severest weather, when once set a-going. The thermometer in the reservoir indicated 12 degrees of a lower temperature than that in the boiler, which may be readily accounted for, by being fifty feet apart, and farther from the immediate action of the fire. The advantages which these large pipes have over those of less dimensions, is, that when the great body of water is once heated in them, they will retain it for a number of hours, without requiring any additional fuel supplied to the boiler, or attendance; whereas, the shallow pipes, if not constantly attended to, and the fire kept plying under the boiler, will soon become cold. It must, therefore, be obvious, that the small, or shallow pipes, require a far greater attendance, and infinitely more fuel, than those of more capacious dimensions.

The size of the boiler, pipes, &c. should always be

regulated according to the area of the house, or number of cubical feet of air which it may contain, and the degree of heat it may be necessary to keep up in the severe Winter months. It is advisable to arrange the pipes, &c., so that they will have a perfect command of the internal atmosphere, when the external may even indicate from 25 degrees to 28 degrees of frost; we may calculate on this climate's not much exceeding the latter point, and but seldom indicating that degree; but in the Winter of 1830, the frost was so intense for several miles round this neighbourhood, that the thermometer in several places stood within three degrees of *Zero*, on the mornings of the 19th of January, and 5th of February.

To guard, therefore, against any failure or risk in these extreme cases, the pipes, &c. should be made and arranged, so as to contain a large body of water, and of heated surface to the house, as already observed; the more capacious these are, the higher the temperature will be increased, and the longer will the caloric be retained. The general size of the boiler and reservoir, in the Forcing-Houses at Woburn, is about two feet long, and 20 inches deep, and about 18 inches wide. The return pipe is 4 inches in diameter, and the upper, or conducting pipe, measures 12 inches over, by 4 deep, and contains double the quantity of water that the lower pipe does, and gives out a much greater degree of heat, and is sufficient to keep up a high state of temperature in any ordinary sized Forcing-House. The

largest compartment here allotted to the boiler and these sized pipes, contains about 5,060 cubical feet of air, and 1,080 superficial feet of glass, which is more than we generally find heated by a single fire or flue in a Forcing-House, and is more than I should recommend to be heated by the same sized boiler, and pipes, for early forcing ; and when such houses are intended for early crops, they should have a larger surface of pipes, or otherwise the flue ought to be carried along the back wall or footpath, which will have a considerable tendency to increase the temperature, with the same consumption of fuel. But, in the houses here, the flues are carried nearly perpendicular from the boiler, and, in consequence, a portion of the heat escapes out at the chimney tops, that would otherwise be saved, if conducted along the back path or wall.

The most suitable sized house, in my opinion, for very early forcing, and to be heated only with one fire, with the boiler, pipes, &c. of the dimensions above specified, should not have to heat a greater area than 3,000 or 3,500 feet of air. The smaller the house is for this purpose, the greater command there will be in severe weather, and the less fuel required for the maturity of the earliest crop. It is more advisable to begin forcing in the smaller compartments, and to leave those of larger dimensions to follow in succession, when the season is more favourable to vegetation, and when there is less risk in having a full crop, particularly of stone fruit.

In the setting of the boiler, &c. much depends on the rapidity of heating the water, as when the fire that plies under and around the boiler has not a proper draft, a considerable time must elapse before the water in the reservoir, at the extremity of the house, is warmed. The boiler, reservoir, and pipes, should be always, when practicable, as near on a level as possible, which will cause the hot water to flow more rapidly to the extremity of the house into the reservoir, whence it returns through the lower pipe into the bottom of the boiler, where it again becomes heated; and the hottest particles, being the lightest, ascend to the surface, and are propelled along the upper pipe, forcing the colder element before the warmer body into the lower pipe, and so again into the bottom of the boiler. Thus the circulation is continued while there is any fire under the boiler; and the heat remaining in the brick work after the fire is burned out, will be sufficient to retain the heat in the boiler, pipes, &c. for many hours.

The Plate, No. 20, will illustrate the principle on which the boilers, pipes, and reservoirs, are erected. The boiler (A,) is placed in a niche of the back wall, and can be attended to from the sheds behind, where the fire is supplied to it. The pipes (C,) that proceed horizontally from the boiler to the front of the house, are circular, and of four inches diameter; the upper one enters the boiler within two inches of the top, and the lower about two from the bottom. These pipes are con-

nected by a box, twenty inches by ten, which is constructed so as to connect the pipes that run parallel with the front of the house, and are joined to the oblong reservoir (D,) at the furthest or coldest end of the house. The upper pipe is twelve inches broad, the margins of which are raised, so as to hold water on its surface for creating a steam in the house; it also gives out a much greater quantity of caloric than the round ones. The reservoir, containing a large body of hot water, keeps that part within a few degrees of the same temperature as that at which the boiler is placed. When the water, in the latter, is at 200 degrees, the thermometer in the reservoir generally stands about 12 degrees lower, while the fire is plying; but, in the mornings, they are both of nearly an equal temperature, and the atmosphere of the house, at both ends, is within five or six degrees of each other, even when the boiler and reservoir are 50 feet apart. The boiler is furnished with a wooden cover, which fits into a grooved frame of the same material surrounding it, and prevents any evaporation or steam, except at pleasure. The cover of the reservoir is of cast metal, and may be taken off when requisite, either for the admission of steam, the adding of water, or emptying of the pipes, &c. Water should never be allowed to remain in the pipes in the Winter season, when not at work, as it will be liable to be frozen, to expand, and burst them. There appears to be various opinions relative to the boiler best suited for the speedy action of the fire; but there can be no doubt,

that that which is attended with the least labour and *consumption* of fuel must always bear the preference.

The square boilers possess the advantage of simplicity, and of ready access in getting them cleaned, to prevent an incrustation settling on the inner side of the bottom, which frequently occurs where the sediment of the water is not removed, and which renders the bottom liable to be burned out of them, as the water within is prevented from coming in contact with the part immediately on which the fire plays. When the pipes and boilers cannot be placed on a level, as is sometimes the case, and when the former have to be carried over the door, or to dip under it, it is necessary to have steam-tight boilers for forcing the water along the different levels; but the reservoir cover should be left unscrewed, in order that a little steam may evaporate out by the edges of the cover, which will prevent any collection or explosion of the steam; but the less complicated the apparatus is, the more efficacious it will generally be found, as well as the least expensive.

Since the preceding observations went to press, I have had an opportunity of seeing Mr. Weeks's newly invented *boiler*, &c. which, in my opinion, is the most economical and complete apparatus for the heating of Hot-Houses, &c. that I have seen. This boiler consists of several hollow bars, or pipes, connected together in the shape of an oblong square, which are kept full of water, and form the furnace that the fire rests on, that immediately warms

the pipes, and causes the water to flow, and circulate rapidly from one extremity of the house to the other, keeping up a steady heat with a trifling consumption of fuel. But I shall be able to speak more decidedly on this subject hereafter, as Mr. Weeks is preparing a *boiler*, &c. of this description, for the Gardens at Woburn Abbey.

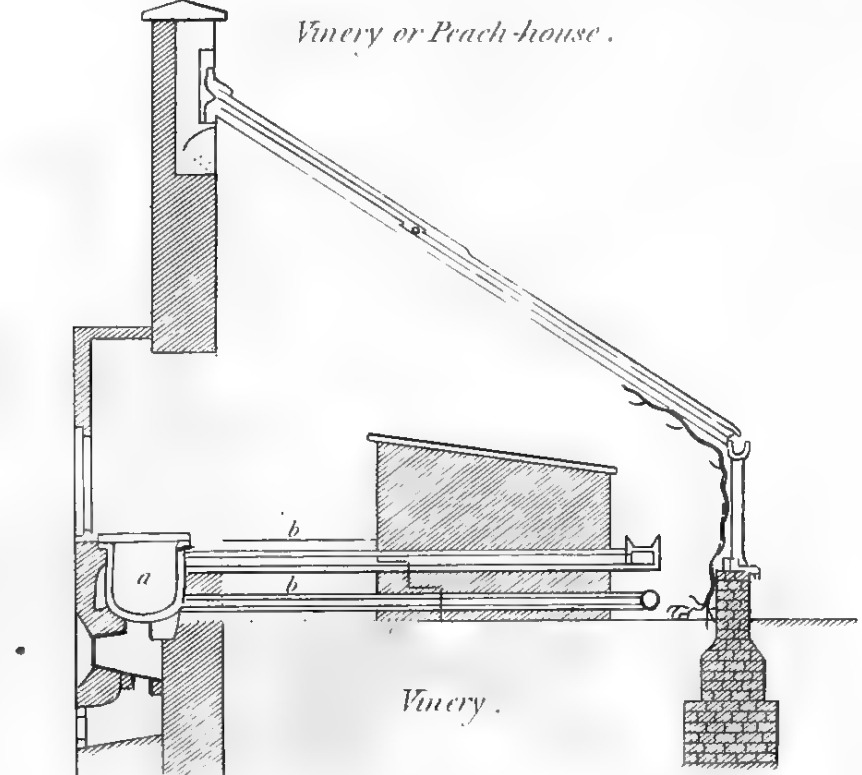
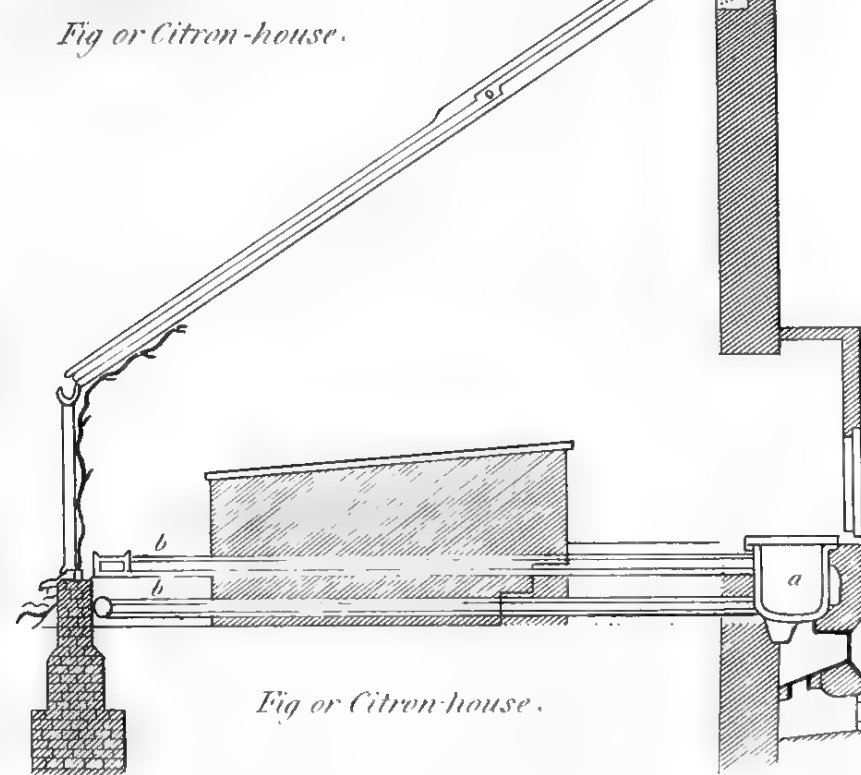
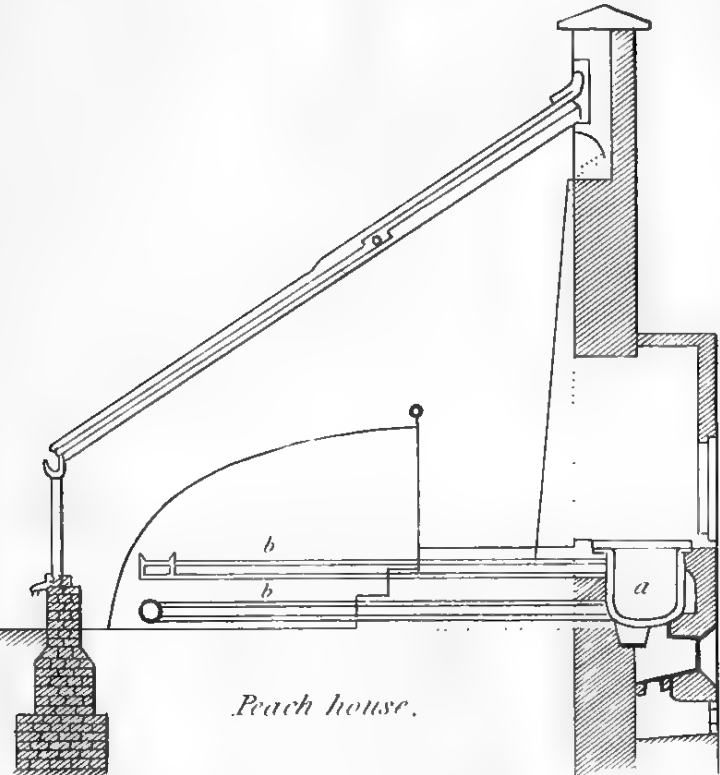
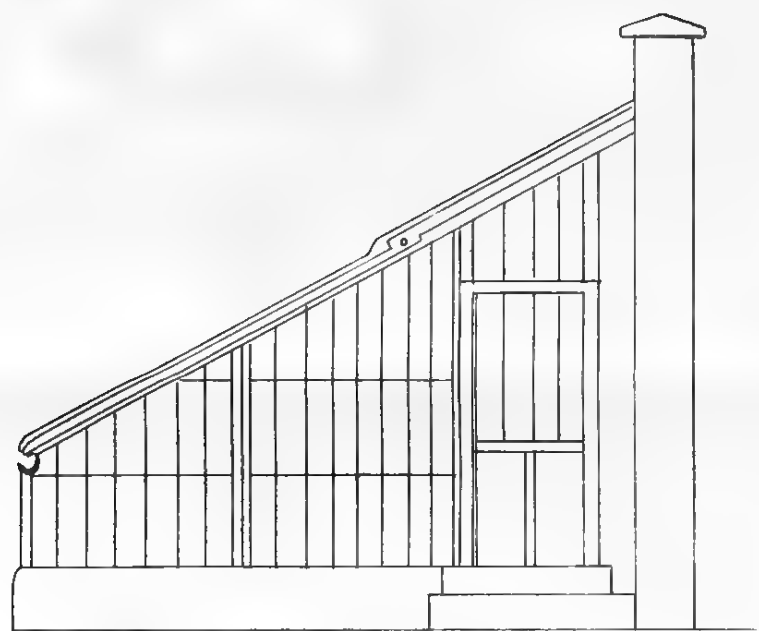
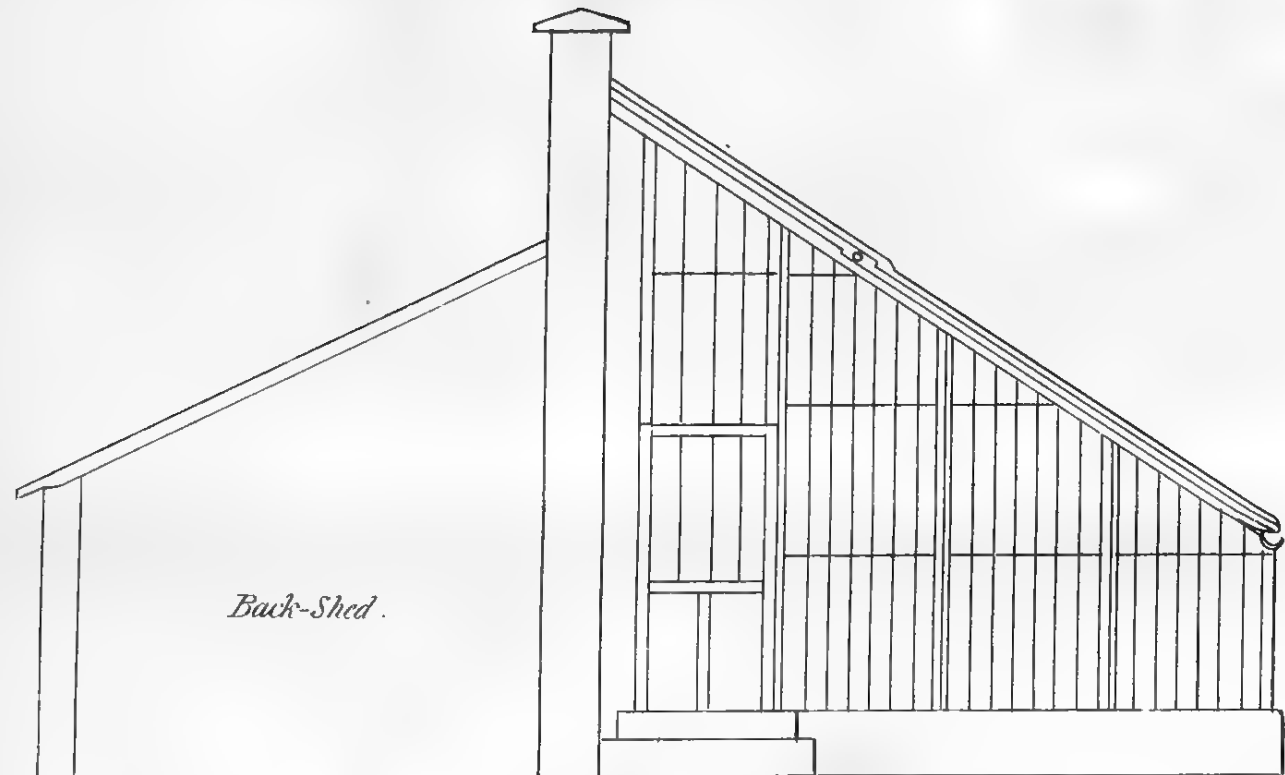

End Elevations and Sections of the Fruit-houses.

CONSTRUCTION OF THE PEACH-HOUSE.

The range of Peach-Houses here, is placed to an *angle* of 30 degrees, and is 102 feet long, and divided into different lengths; the middle division, intended for the earliest forcing, is 28 feet long; the end compartments are 35 and 39 feet long; the width of the house is 12 feet in the clear; and the height of the back wall is 10 feet from the floor level to the top of the rafter. The front sashes, and parapet wall, are three feet nine inches from the ground level to the top of the spout, or water gutter, as illustrated in the section. (See Plate 19.) The *spout* serves both as a plate for the support of the rafters, as well as for conveying the water that falls on the roof. There are also small *piers* of brick-work carried up from the foundation of the front wall, for the support of the table trellising, which springs from within 12 inches of the wall; this space is reserved for the planting of the trees within the houses. Their roots extend under the arches of the parapet wall, to the exterior border, which is raised about one foot above the level of the adjoining ground. The hot-water pipes are also supported on pillars, and run parallel to the front wall, at two feet distance, under the table trellising, to the extremity of the compartment. The boiler is placed in a niche of the back wall, and is attended from the sheds behind, where the furnaces are supplied with fuel. The

back trellising springs from within nine inches of the back wall, and goes up in a sloping position, as shewn in the section ; the whole trellis being composed of iron rods, and the meshes left about six inches wide. The roof ends, and front lights of these houses, are all constructed with cast iron rafters and wall plates ; the sashes, with wooden frames, and copper bars, as illustrated in Plate 18, and glazed with crown glass, by which, in a roof of this kind, more *sun* and *light* are admitted in March, when they are so essential to early forcing, than one composed of wood, will admit in April.

PEACH-HOUSE BORDERS.

Having already given a description of the construction, and the materials used in the erection of the Forcing-Houses here, I will now proceed by making a few brief remarks on the formation of the border, which is of no small importance to the future success of the Peach and Nectarine. Although these trees will grow, and even produce fruit in various soils, for a few years, they are, unquestionably, more subject to mildews, cankers, and other diseases, in some soils, than in others, and, consequently, of less duration. It is, therefore, a matter of some consideration to select such soils as are most congenial to the health and preservation of the trees, as I have frequently met with instances of their being worn out, and under the necessity of being cleared away, and replanted with others, where they should have only been in their prime and

full bearing state, in consequence of the border not being properly prepared when they were first planted. The soil that appears to me the most suitable, is the top spit of a pasture, which consists of a yellow loam, rather strong in quality than of too sandy a nature. Whilst the Peach-House was erecting here, a large quantity of this mould was drawn contiguous to the building, and incorporated with about one-fourth good decomposed stable dung, which was turned over once a month, for three months previously to using.

As soon as the houses were finished, the interior and exterior borders were excavated to the depth of three feet six inches, and about twenty-five feet in width, measuring from the back wall; but allowing two feet of a fall from back to front: along the edge of the walk, parallel to the house, a large drain was formed for carrying off the water that might collect on the border; the bottom of the drain was kept about eight inches lower than the bottom of the border, which consists of a strong retentive blue clay, and, by being bevelled off from back to front, the water passes readily into the drain, and keeps the border free from wet.

Immediately over the substratum, about six inches of brick bats, and rough lime rubbish, were laid, and then the remaining three feet filled up with the compost previously prepared; but keeping the whole from 10 to 12 inches higher than the ground or floor level, as an allowance for subsiding. The soil should be firmly trod in betwixt the piers of the front wall, or any other interstices, when it cannot

be kept above the ground level, that the roots may not become too deeply buried in the ground when it settles. It, perhaps, may be necessary to observe, that the mould should be rather in a dry state when put into the excavated border, and this operation should be performed in dry weather.

PLANTING THE PEACH-HOUSE.

The planting of the trees took place here, about a month after the filling up of the border; but keeping them about six inches above the surface of the then ground level, in order that they might not be lower than the floor level of the house, when the soil had subsided.

The next thing for consideration, is the selection of the trees for planting the houses with, which is a matter of no small importance, as many disappointments often originate through trees being received from the Nurserymen under erroneous names; consequently, such errors cannot be detected before they have produced fruit; it is, therefore, more advisable to fruit the trees on the open walls, previously to removing them to the Peach-House, when it can be conveniently done.

In the selection of the trees here, a collection was procured from the Nursery, the Spring previously to their being planted in the houses, a number of which had been two, and some three years trained: immediately on their arrival, they were all put into large sized pots, and plunged in the ground against a South wall, where they were trained during the

Summer months, and kept well supplied with water in dry weather.

The limiting the roots to a small portion of nourishment, at this stage, I conceive to be of infinite advantage for the future success of the trees, as it lessens their tendency to luxuriance, and causes them to produce kind-bearing wood, at once, without having recourse to that degree of lopping which would otherwise be necessary to procure a supply of shoots in young trees. There is another advantage in potting the trees, viz. that they may be removed, at any season, without sustaining the least injury, as their roots will, in a very short time, become matted round the edges of the pots; thus they can be turned out, and planted, without receiving the smallest check. The distances the Peach-Trees are planted at, should be regulated according to the length of the house, and proportion of trellising they are intended to fill: in low narrow houses, they will require to be placed further asunder than in houses of larger dimensions. The dwarfs may be from nine to twelve feet apart; but planting a rider betwixt every two such trees; which will furnish the top part of the wall or trellising. These standards, or riders, are generally cut away as the dwarfs advance, and furnish the lower part of the trellis; but this operation should be dispensed with, at least until such time as the trees have all produced fruit, and it can be ascertained whether that of the dwarfs, or riders, is of the best quality: then, if the latter proves superior to the former, they should be cut away, and the lower branches of the rider trained in a pendulous

form, which will soon furnish the under part of the trellis, and form a handsome tree. I am inclined to think, that if this mode of training were more in general practice, with regard to riders, the spaces assigned for their extension could be kept better supplied with young bearing wood, and the tree possess a more regular equilibrium of branches than we frequently meet with in old trees, that are trained as dwarfs, in consequence of the space of wall, or trellis they have to extend over, and which generally causes that part of the tree, next the stem, to be furnished with strong wood, that is necessary for the support of the smaller bearing shoots.

PRUNING, &C. OF THE PEACH TREE.

The durability of the Peach and Nectarine, and, I may assert, every other stone-fruit-bearing tree, that is cultivated in this country, depends more on the system of pruning to which they are subjected, than to any other cause; and when this operation is not performed with discrimination, the bad effects will soon shew themselves, and leave the greater part of the wall, or trellis, furnished only with strong barren wood, unfit for any thing but the fire: therefore, to keep a stock of trees in a healthy fruit-bearing state, the knife should be judiciously used in the pruning season. It may, however, be necessary to commence by stating, that, after the first year's pruning, the bud or graft of all trees that are intended to be trained, should be cut back to within a couple of eyes of the stock, which will cause strong laterals to be pro-

duced ; and these, the second season, must be again shortened to the length of three or four inches, in order to induce a sufficient number of young shoots to burst out, so that the tree may be regularly formed at this stage of growth, and that no part of the wall, or trellis, may be left without a prospect of young shoots appearing from the centre, or such parts of the trees most contiguous to the vacant spaces ; observing to keep the Summer shoots regularly laid in, and choosing such as are neither in a weak, nor in a too vigorous state, except where a supply of wood is wanted, when the luxuriant ones may be left until the ensuing pruning season, when they should be shortened, to furnish a sufficient number of laterals, to fill up the blank spaces of the wall or trellis.

The third year, the trees will not require to be so much cut in, and may be left from six to nine inches long, if they are of a strong growth, as we must now try to induce a supply of fruit-bearing wood ; and as the Peach Tree generally produces its fruit from the preceding year's shoots, much attention is required to keep the wall, or trellising, regularly furnished with bearing wood, and to replace the naked shoots that will have to be removed every year.

The beauty of a well managed tree, is in its having the wall, or trellising, regularly covered with bearing wood, which can only be done by keeping a good supply of young shoots, and thinning out the old and unproductive ones, as soon as they appear naked. Those that are of last Summer's growth, and in a vigorous state, should be shortened, when there is a

deficiency of wood, in order that they may produce a supply for the ensuing year's crop ; but such as are intended for this purpose, are often too luxuriant for bearing fruit, in consequence of the shoot's being too much cut in, which should, therefore, be left from eighteen inches to two feet long, according to their strength. If left above two feet, it is apt to leave the lower part of the branch naked and unsightly. It is, however, more advisable to cut rather too long than too short, when the trees have a propensity to luxuriance ; and if any of the bottom eyes remain dormant, when wood is wanted, the shoot should be again shortened, which will cause the lower parts to push, and produce kinder wood than appears at the extremity of the branch. The shoots that are of a medium size, and full of flower buds, may be laid in at full length, from two to three inches apart, shortening only the leading ones ; but always observing to cut a little above a wood bud, otherwise the fruit will but seldom come to maturity, for the want of a leader to draw up the nourishment. The trees will require to be frequently examined in the Summer months, and divested of the supernumerary and fore-right shoots. The form that is generally adapted for training the Peach Tree, and other stone fruits, is the fan-form, which appears to me preferable to any other ; but much nicety is required in giving an equal distribution of the leading or main branches, and to place them so as to be free from all bends, and that the younger shoots may be arranged, without having a confused or crowded appearance.

FORCING OF THE PEACH TREE.

The season for commencing the forcing of the Peach-House, must be regulated according to the time ripe fruit is wanted at the table, with due respect to such a season as that the trees will sustain the least injury by it.

When this fruit is wanted at a very early period, there should be a small compartment devoted solely to this purpose. In a narrow house, or pit, of limited dimensions, the fruit could be brought to maturity with a much less consumption of fuel or dung, than would be necessary for its preservation in a house of greater extent. The Peach Tree may be also successfully forced in pots; and by placing them at different periods in the Pinery, or any other forcing department, they will come in at an early season.

Where there is not an extensive range of the Peach-Houses to follow each other in rotation, the beginning of February is a very good time to commence forcing for a general crop. The Peach-Houses here, were all planted in the month of October, with the trees grown on the premises, and in pots, as already noticed; these, having formed handsome heads of very fine bearing wood, required but little cutting or thinning out, and shewed a strong disposition for fruit. The house was got in readiness, and the fires lighted about the middle of January, when they were gradually excited into blossom, the temperature, however, being kept as low as

possible until the fruit was all set, when it was raised to 60 degrees, with fire heat, and from 70 to 80 degrees by the influence of the sun, always admitting a large portion of air, which was very beneficial to the young shoots. The trees being kept well supplied with water, and free from insects, and the young shoots regularly tied to the trellising, a crop of high-flavoured fruit was ripened by the first week of July, a period of little more than eight months from the planting of the trees to the gathering of the fruit; when, if the same aged trees had been planted, without confining their roots, a period of, at least, from two to three years would have elapsed before a crop of fruit would have been produced, and then, very probably, not half the quantity that was brought to perfection here the first season. The trees having made, likewise, an abundant supply of bearing wood, they were pruned, and the house prepared by the middle of December, to commence forcing for a crop the second year. The fire was again set to work, on the 20th of December, daily admitting a large portion of air, and keeping the temperature in a low state, which brought the sap slowly into motion, and caused the buds to swell and expand stronger than if kept in a high state of excitement. In early forcing of every description, it is more advisable to begin with the lowest state of atmosphere that the weather will permit of, and gradually to advance, rather than to commence too high. Nicol offers a very judicious remark on this subject, "A word to the novice in forcing:—Be diffident, and drive too slow, rather

than too fast. Most new beginners, in this business, make haste to outdo, or eclipse their neighbours; and drive on at a pace they cannot long keep up, but founder their steed, and stop short by the way."

During the first fortnight after the fires were lighted, the thermometer was kept, as near as possible, to 40 degrees, allowing an advance, during the day, by artificial heat, of from 8 to 10 degrees. The fires at night should be regularly attended to, about 10 o'clock, in severe weather; and if the state of the house appears to be rather low, a little fuel must be added, so that the thermometer may not indicate above 8 or 10 degrees of a fall the next morning.

From the time the buds begin to swell, until they are fully expanded, one degree of advance may be allowed daily, till the thermometer is raised to 60 degrees, which temperature the house should be regulated at while the fruit is setting; it may afterwards be increased to 65 degrees, and allowing from 10 to 15 degrees of an advance with sun heat, observe to give free admission of air, to prevent the shoots being drawn in a weak or languid state. The trees must be kept syringed every evening after the fruit is set, which will, in a great measure, keep the red spider within bounds; but when the green fly makes its appearance, recourse must be had to fumigation. The mildew, which is generally very injurious to the tender foliage, must not be permitted to get a-head, but be suppressed, as soon as the least appears, by dusting, or rubbing the parts infected over with sulphur. As more fruit

generally sets than would be prudent to leave on the trees, they must be gone frequently over, and thinned, before they arrive at the period of stoning, only leaving a few more than what is intended to be ultimately left for a crop, in case of any dropping off while in the act of stoning, which, when this is accomplished, may be displaced. The young wood being kept regularly thinned out, and a good supply laid in, for the ensuing year's crop, and the trees kept free from insects, they will require little more attention than a free supply of water and air, until the fruit be gathered, which will be about the third week in May.

Having thus mentioned the course of culture that was followed here towards the Peach-Tree, the two years after planting, I will now proceed to make a few observations relative to their management the following seasons, which was pursued, in order to obtain ripe fruit early in May. The same treatment being applicable to all established trees, may be adopted with success, where Peaches are wanted for the table at an early period of the year; and, likewise, without the trees sustaining any injury by it.

To begin, therefore, with the excitement of the trees. The Peach-House was closed up at night the 1st of December; the pruning and re-tying to the trellising was then immediately commenced, as well as the syringing of the house, which was done in the morning, and a free admission of air given throughout the day; the border being slightly forked over, watered, and every thing got in readiness by the 12th of December, when the fire was first

lighted to the boiler. The temperature of the house was now kept up by fire heat for the remaining part of the month, betwixt 42 and 45 degrees, allowing 10 degrees of an advance during the day.

By the 1st of January, the flower-buds were beginning to swell, when the temperature was increased from 45 to 50 degrees in the evenings, and not permitted to exceed 60 degrees in the day, by the influence of the sun: thus endeavouring to keep the atmosphere of the house in a low vegetating state, with a view of strengthening the blossoms, and enabling the organs of fructification to perform their functions of impregnation, without which the blossoms would prove abortive.

About the middle of the month, the trees were in full bloom in every part of the house, when the temperature was regulated betwixt 55 and 60 degrees at night, but admitting a large portion of air at all favourable opportunities in the day. A free circulation of this element is of infinite importance, in assisting the dispersion of the pollen to the female parts of the flowers. As soon as the blossom buds begin to expand, the syringing of the trees must be dispensed with; but the humidity of the house kept up, by pouring water in the morning and evening on the pipes, and by occasionally sprinkling the borders and foot-path; the exhalation that will arise from these resources will prove very beneficial to the setting of the fruit. When the corolla, or petals, begin to drop, and the young fruit appears about the size of full grown peas, the syringe should be again resumed, but the water thrown, so as rather to

resemble a fine dew for the first few days, until the fruit is all finally beginning to swell, when it may be given with considerable force, in order to clear the trees of the decayed blossoms, and, likewise, the suppression of the red spider, which will now be making its appearance; and if not checked, while in an early stage, they will materially injure the tender foliage. These depredators, therefore, should be kept in subjection as long as possible, by the frequent application of the syringe or engine. It must, likewise, be observed, that the water applied at this season ought to have the chill taken off, and not be given in large quantities at a time, to sour and saturate the borders, which would prove injurious to the trees, and cause much of the tender fruit to drop. The trees should be syringed every evening, but taking care that the water be applied in various directions, so as to displace any of the insects that may be in embryo at the back of the leaf. If syringing, once a day, appears insufficient for subduing the red spider, a gentle sprinkling of sulphur over the hot pipes will have this desired effect.

When the young fruit has attained the size of full grown peas, they should have a slight thinning; but this must be cautiously performed at the present stage of growth, only displacing the weakest, and singling out such as have set two or three together, rather leaving a superabundance, the first going over, than thinning too freely, as many of the small fruit will be liable to fall off; consequently, this operation should rather be frequently performed, according to the swelling of the fruit, and, finally, when begin-

ning to stone, as many of the sorts are subject to drop off at this stage of growth. As soon as the wood buds have pushed about an inch in length, the trees should be looked over, and all the superfluous and foreright shoots, cut or rubbed off, only leaving those that are in the best position for laying into the trellising, and most contiguous to the empty space or vacancies that may occur, by the removal of old wood at the pruning season.

Some discrimination is necessary, at this time, for the selection of such shoots as are most likely to be of the kindest growth, for producing a crop the ensuing year. It is, also, more advisable to lay in a greater number than will be ultimately wanted, in order to give an opportunity of choosing and distinguishing those that are most likely to produce a crop of fruit the foregoing year; they should, however, be thinned out before the fruit begins to stone, which will give a free admission of light and air to the remaining shoots, and add considerably to the nourishment of the fruit. Such trees as have a propensity to make strong wood, may have a greater quantity of young shoots laid in, than those which show a disposition for fruit, which will lessen their state of luxuriance, and bring them into a bearing state. By the beginning of March, the weather, we may naturally suppose, will be much milder and more congenial to vegetation than was experienced through the two preceding months; consequently, the atmosphere of the Peach-House may be again raised to 65 degrees, with fire heat in the evenings, and

allowing from 10 to 15 degrees of an advance, by the reflection and effect of the sun through the day ; but air should be always admitted, as soon as the range of the thermometer is increased from 8 to 10 degrees above the temperature that the house is regulated at by fire heat ; this should be attended to particularly at an early period of the forcing, to prevent either the flower, or wood buds, being forced out in a weak state. About the middle, and latter end of March, the Peaches will be stoning, when they should again be looked over, and thinned to regular distances, say from six to seven inches apart. If the tree is in a vigorous state of growth, a more abundant crop may be taken from it ; and when producing healthy shoots, the quantity of fruit should be proportioned accordingly. The use of the syringe, or engine, must be daily applied, and the borders occasionally watered throughout the whole process of the forcing season. After the fruit is stoned, and beginning to take their second swelling, the temperature of the house may then be increased to 70 degrees, by fire heat, and permitted to get as high as 90 or 95 degrees, with the sun heat ; but, in the latter case, there should be a free circulation of air admitted, which will prevent the trees from sustaining any injury by so high a temperature. In following the above mentioned treatment, I have been enabled to gather ripe *Peaches* on the 12th day of May, for the last two seasons, and the trees have retained their usual vigour ; and are, at present, (March,) covered with an excellent crop of fruit,

which, I expect, will be ripe earlier than they were in the preceding seasons. For successional crops, the other compartments are excited in rotation, allowing from three to four weeks apart between the exciting of the different divisions, which will keep a supply of this fruit from May, until it ripens on the open walls.

PEACHES CULTIVATED.

Acton Scot.	Montaubon.
Barrington.	Neil's Early Purple.
Belle Chevreuse.	Noblesse.
Bourdine.	Old Newington.
Catharine.	Purple Alberge.
Chancellor.	Red Magdalen.
Double Montagne.	Rosanna.
Double Swalsh.	Royal Charlotte.
Early Admirable.	Royal George.
Early Vineyard.	Royal George Mignonne.
Galande.	Royal Kensington.
Grosse Mignonne.	Smith's Newington.
Hemskirke.	Superb Royal.
Late Admirable.	Têton de Venus.
Madeleine de Courson.	Vanguard.
Millet's Mignonne.	White Magdalen.
Monstrous Pavie.	White Nutmeg.

NECTARINES.

Aromatic.	Murrey.
Brinion.	Neat's White.
Common Elruge.	Ord's New.
Duc du Telliers.	Red Roman.
Early Newington.	Scarlet Newington.
Italian.	Violette Hâve.

CONSTRUCTION OF THE VINERY.

The Vinery here forms a range of about 102 feet in length, which is divided into three divisions, of 39 feet, 35 feet, and 28 feet each ; the smallest being the central compartment, and intended for early forcing ; its being sheltered by the other two divisions, less fuel is required to heat it in severe weather. The back wall of this range is about 10 feet high from the floor level to the top of the rafter. The front wall, which consists principally of piers that are carried up from the foundation at three feet six inches apart to the ground level where they are connected together by a flag-stone, about two inches thick, and extends from pier to pier, in order that the roots may not be too deeply buried in the border, which is frequently the case when these arches are formed with brick-work. Above the ground-line, or flag-stone, 15 inches of brick-work are carried up, for the wall-plate or sill to rest on, that receives the front lights, which, together with the wall, leaves the front of the Vinery about three feet nine inches high above the ground level of the border.

There are, also, piers built in the interior, for the support of the hot-water pipes, which are arranged parallel to the front wall, about 20 inches distance ; a space reserved for planting the *Vines* in, which are placed close to the wall, and their roots extend

under the pipes, and also through the *arches*, to the exterior borders. The interior width of the house is 12 feet in the clear; a pit is formed in it, for forming a bed of leaves, or dung, to produce a moist heat, for the assistance of the breaking of the Vine-buds. These pits, when filled with fermenting substances, are very useful for the accelerating Strawberries, French Beans, *Figs*, or even the Pine Apple, any of which may be brought to perfection in this department without injuring the Grapes. The roof of this range is also constructed with cast-metal, copper, and wood, as illustrated in Plate 18. The rafters, wall-plates, and spouting, are all cast-metal. The frames of the lights are composed of wood, and the *Astragals*, or small *bars*, of copper, which combination of materials forms a very durable, light, and elegant roof. The front sashes are all made to open outwards, which is done by means of a pivot, and fastened on the outside by a key, so as to prevent their being blown open by the wind, or without the latch-key. The lower *tier* of roof lights are all fixtures, and only every alternate sash in the upper range is made to run, in order to admit air. There is, also, a ventilator placed under every alternate or fixed sash of the top *tier*, which communicates with the openings in the top of the wall, whereby a free currency of air may be admitted into the house in wet weather, without sliding down any of the sashes. In short, a free circulation of this element may be, at all times, admitted, by opening these ventilators, and the front lights, which, except in very sultry weather, will be

sufficient to keep the temperature of the *Vinery* as low as it may be required.

Each of the moveable lights is furnished with a chain and small *wind*, which draws them up with the greatest facility. The trellising is of wrought-iron bar, and consists of about one quarter of an inch in diameter, and is placed within nine inches of the glass at the front, or lower end of the rafter, and about twelve inches from it at the top.

Each division is supplied with a separate boiler, &c. which are fixed in a niche in the back-wall, as indicated in Plate 17; and the pipes proceed across the ends of the houses, under the floor level, to the front, where they run parallel to the front wall, and are connected with the reservoir, at the extremity of the house.

ON THE CULTIVATION OF THE VINE.

I. FORMATION OF THE BORDERS.

In the preparation of the *Vinery* borders, much of our future success will depend. They should be, in the first place, rendered perfectly dry, and formed, so that no stagnant water will lodge on the sub-soil. In the formation of the *Vine* borders at Woburn, the ground was excavated to the depth of nearly four feet, and about 25 feet in width, allowing about two feet of a fall from back to front, in order that the wet might have a rapid descent into a drain

which runs at the extremity of the border, parallel to the houses. The bottom of the drain is kept nearly eight inches lower than the floor of the border; thus, with a few cross drains, which lead from the foundation of the Vineries, it prevents any water settling on the sub-stratum, which, being of a stiff blue clay, surely would be impervious. When the floor was properly drained and formed, about seven inches of brick-bats, and coarse lime rubbish, was laid for the foundation of the border materials, and over this was placed a layer of thick sods, with the grassy side downwards. The remaining space was then filled up with good hasel loam, rather of a sandy nature, which had been about three months from the common, and two or three times turned over, with the turf or sward chopped up amongst it. To this compost were added one-fourth of good decomposed stable dung, and one-fourth of decayed tree leaves, that were reduced to rough garden mould. These ingredients were well incorporated; and frequent sprinklings of lime rubbish, from an old building, was intermixed with them. The whole being put into the excavated space in a rough state, during the month of October, was left to decompose for a couple of months, when it was again turned over, for the purpose of exposing the decomposing matter to the action of the weather, and meliorate such parts as were in a crude state. When the borders were filled to their proper level, there was about three feet in depth of prepared soil for the roots to run in, under which, I believe, the Vine will but seldom penetrate in quest of nourishment, provided it has a

free scope for the roots to extend themselves in the width of the border, which should not be less than from 25 to 30 feet. It must be observed, that advantage of dry weather should be always taken in filling up the borders, and that the soil may be put in when it is rather of a dry texture, and free from wet.

2. PLANTING.

It may be necessary to observe, that, when planting Vines, particular care should be taken in keeping their roots as near to the surface of the border as possible, which may be done by raising the spaces intended for the plants eight or nine inches above the border level, as the decomposing substances are sure to subside, and often leave the roots too deeply buried in the ground, which is very pernicious to the future progress of the Vine, therefore an allowance for settlement should always be kept in view when planting.

Should the Vines that are intended for the houses, be grown in pots, and on the premises, they may be planted at any period of the year, only taking care not to injure the young fibres in turning them out, and carefully protecting them from frost or too much wet during the Winter season. The Vineries at Woburn, being built with the front wall on arches, the Vine stems are confined to the interior of the houses, and require no protection from the frost in Winter, as the glass is quite sufficient for this purpose. The greater part of the Vines were planted about the beginning of October ; and the space be-

twixt the front wall and hot-water pipes, where the Vines are planted, had a covering of three inches of half decayed dung put over it, on the first symptoms of frost, to preserve the young fibres from any check, while in a dormant state. About the first of March, the dung was removed, and the space forked over, and from two to three inches of leaf-mould laid over the surface, which added considerable nourishment to the young roots that were now in a vegetating state. The exterior border, that had been laid up in ridges, in order to pulverize by the frost, was now levelled down; and the remaining rafters, still unoccupied with Vines, were planted about the middle of March; it would be difficult to say, whether those planted in Autumn, or in Spring, are now the best plants. The former had certainly the superiority over the latter, in their first year's growth; which would arise from the roots having got hold of the ground before the Winter set in, and not meeting with any check, until the sap was again in motion. The distance Vines are generally planted apart: the common rule is, to place one to every rafter, which will be more than sufficient for narrow houses, particularly for the growth of the Black Hamburgh, Syracuse, Black Damascus, the White Alicant, and several others of the large growing kinds, which require a great length of rafter for their development. It is, however, more advisable, when planting Vineries, to put in a greater number of plants than are intended permanently to remain, in order to have some to choose from, in case any failures should occur, or any of the sorts prove of an inferior

quality when fruiting. We often see very fine crops of Grapes produced from a single Vine, that occupies half a dozen, or more rafters; but the principal objection in allowing such an extent to one Vine, will be the limited variety of Grapes that can be grown even in a large extent of glass, and when variety of fruit is an object of consideration; the crop produced from Vines planted from two to three feet apart will be equally good, provided they have a sufficient length of rafter for extending themselves upon. Two of the most successful cultivators of the Vine that I have yet observed, are Mr. M'Arthur, late gardener to A. Baring, Esq., at the Grange; and, also, Mr. Baily, late gardener to Earl Spencer, at Althorp; in both instances, the Vines were planted from two to four feet apart. I believe the former were not above two feet, and the latter with a single Vine confined to each rafter. I had the pleasure of seeing both Vineries within a few days of each other, and I should have some difficulty in deciding which bore the preference. In both cases, the houses are entirely constructed with metal roofs, &c. The length of the rafter in those at the Grange, is nearly 20 feet, and in that at Althorp 23 feet 6 inches. Some attention should be paid to the planting of the Vines, in order that the early ripening sorts may be placed at the warmest end of the house, where the flues, or hot-water pipes, enter, which will bring these sorts in earlier, and lengthen the season of the fruit; as, by having the late growing kinds placed at the coldest end of the house, they will be considerably longer in ripening their fruit, than those that

are of an earlier disposition, and in a warmer situation.

Some regard should, likewise, be had to the arranging of the large or luxuriant growing kinds, which ought to be placed all next each other; as, if they are planted promiscuously among the Frontignacs, and those of less robust habits, the larger sorts will deprive the latter of a great portion of their nourishment, and consequently lessen the size and quantity of the fruit.

3. MANAGEMENT.

Having made these cursory observations on the formation of the border, and the putting of the plants in their permanent stations, I will proceed with a few remarks on their subsequent treatment. The first Spring, before the buds begin to swell, or the sap flow, the Vines should be headed down to a couple of eyes; and that which appears to push the strongest, to be selected, and trained singly up the rafter; the others to be displaced, as one shoot will be sufficient; but it must be kept carefully tied to the trellising, divested of the tendrils that may appear, and the top of the shoot preserved from being broke or injured in any way, to deter its growth. Great care is also necessary, in keeping them regularly trained to the trellis as they advance, and guarding against the shoots being injured by too tight-tying, which is frequently the case, in consequence of the rapid swelling of the young wood; therefore, the Vines should be often examined, and

sufficient room left in the ties to prevent them from injury. If the plants are kept well supplied with water in dry weather, and plenty of air admitted, to prevent their being drawn up in a weak state, they will make a vigorous growth, the first season, and many will, in all probability, reach the top of the rafters. If the shoots appear not perfectly ripened by the end of September, or beginning of October, a gentle fire heat should be applied during the nights, to forward the perfection of the wood, which may be continued until the bottom leaves become of a yellow hue, and the lower part of the shoot, for the length of six or eight feet, be of a brownish colour, and feel of a firm texture. As that length of Vine will be much more than is required to be left the ensuing year, when the wood appears to be thoroughly ripened, the fires should be dispensed with, as well as the quantity of water, which should be but sparingly given while the fibres are in a state of inactivity. About the middle of December, the borders had a covering of half decayed dung and leaves put on, so as to prevent the frost from injuring any of the young fibres that had reached through the arches into the exterior border, which was again trenched over the following March, and the rotten leaves intermixed with it; care being taken not to encroach on the fibres that had extended beyond the arches, rather leaving a space unturned, than injuring the roots. The great advantage derived in turning the borders, is rendering the soil loose and free for the roots to run in; but this must not be practised after the first year's growth, as the second

season many of the leading roots will have extended over a considerable portion of the border, and should not meet with any check in their progress.

In the month of January, the plants were all headed down again, leaving them from 6 to 12 inches long, according to the strength of the Vines. The pits in the interior of the houses were now filled with tree leaves, for the purpose of forcing Strawberries and Kidney-beans, which were placed on the fermenting substances about the middle of February, when slight fires were commenced with, in order to promote the growth of these plants, and likewise to assist the starting of the Vine buds. By this artificial heat, the eyes began to push vigorously, when they were again cut out, leaving only that which appeared the most prominent and best calculated for a leading shoot, as only one shoot was permitted to grow in those divisions that were intended for spur pruning. In the other divisions, three shoots were selected at the bottom of the trellis; the centre one was conducted under the rafter, and allowed to run to the top of the house. The two side ones were, however, stopped, when they had pushed, the one about nine inches and the other two feet in length, in order to strengthen them for a supply of wood the ensuing year. Several of the strongest Vines shewed fruit the second year, which was all cut off, with the exception of a single bunch, merely to ascertain the quality of the fruit. The temperature of the house was kept in a low humid state during the two first months, not letting the thermometer exceed 55 degrees with fire heat, nor 70 from the influence of the

sun. But as the season advances, the weather will become more congenial to vegetation, and the atmosphere of the Vinery may be allowed to get as high as 80 degrees in sunshine, admitting large portions of air before the mercury gets to 70 degrees, which will prevent the plants from being drawn in a weakly or languid state. As the shoots proceed in growth, they must be kept well syringed over the foliage, and the interior and exterior borders liberally supplied with water; as the roots will have made considerable progress, they must be abundantly supplied with this element, which will greatly add to the health and vigour of the plant, the shoots being kept regularly tied to the trellis, as they advance in growth; but observing still to allow plenty of room for the swelling of the young wood in the tying, which, otherwise, would materially injure the shoot. The laterals, or side-shoots, that proceed from the young wood, should be pinched off, and likewise the tendrils, as they appear; the upper one may be left as a leader, in case of any accident happening to the leading shoot. Thus, keeping the Vines well supplied with light, heat, air, and water, and free from insects, many of them produced shoots, in their second year's growth, above 30 feet in length, and 2 inches in circumference; and having the advantage of a little artificial heat, in the Spring months, it promoted the maturity of the wood at an early period in Autumn, which may be easily ascertained by the falling of the leaves, and brown colour of the shoot. The operation of pruning was now performed in November, in order that the wounds might be

healed before the sap was again put in motion ; the Vine is very subject to bleed at the wounds when in a vegetating state. As it was now intended that a crop of fruit should be obtained the third season, the shoots were laid in at a considerable length, from 8 to 12 feet long, according to the strength of the plant, which is the best criterion to go by. The Vines in the division that were not intended for spur pruning, were left of three different lengths, the leading shoot from 8 to 10 feet, and the two side ones from 6 to 12 inches, leaving the weakest always the shortest, which will cause it to push with more vigour, and it being from the main or leading shoot that we are to expect a crop of fruit from this next year. The lower or side shoots should be cut sufficiently back, to induce them to throw out a supply of strong wood for producing a crop of fruit, the foregoing season. Those intended for spur pruning, and to be confined solely under the rafter, were kept to a single stem, and left about half the length of the rafter. The principal advantage, I conceive, derived by this form of training, is a greater portion of light and air, admitted into the house, for the benefit of the articles that are forced in the pits under the Vines. I also consider, that Vines, whose side shoots are shortened back to a single eye of the last year's growth, will break with more regularity at an early period of the season, than those that are left at a considerable length. It frequently happens with long shoots, that there is only a few buds at the extremity which push, consequently the lower part remains naked and unproductive ; this often

occurs in early forcing. The third year, the first Vinery here was got in readiness in December, by having the interior pits filled with leaves, which produce a beneficial heat, and steam for the breaking of the buds, when in a fermenting state. About the first of January, fire was commenced, but the temperature kept about 50 degrees during the first eight days, and plenty of air daily admitted, to prevent the atmosphere rising above 60 degrees in the day; the Vines were syringed every evening, and laid in a horizontal position, in order to induce the luxuriant shoots to burst freely, which, by keeping the house in a humid state by frequent syringing, and steaming from the water thrown morning and evening on the hot-water pipes, the buds soon began to swell, and to push regularly from the top to the bottom of the Vine, when the shoots were replaced under the rafter, as before. The temperature of the house was kept about 60 degrees until the buds had all expanded, when it was gradually increased to 65 degrees, and regulated to this heat every evening, until the buds were all fully developed, allowing about 12 degrees of an advance, with sun-heat, in the middle of the day. The temperature was now daily raised a degree, in order to have the atmosphere of the Vinery about 70 degrees, by the time the bunches were beginning to expand into flower, at which period a close moist heat was kept up, and the thermometer regulated, as near as possible to 73 degrees in the evenings, and from 80 degrees to 85 degrees in the day. The humidity of the house was sustained by pouring water on the pipes and footpaths every

morning and evening, which produced a steam in the Vinery, highly beneficial to the setting of the young fruit. The syringe, or engine, must be discontinued as soon as any of the bunches appear in bloom, and not again resumed until the fruit is set, when it should be applied with considerable force every evening, in order to keep the red spider in subjection, which will be making its appearance. The borders should, also, be now more abundantly supplied with water, and water thrown over the pipes and footpaths morning and evening. The Vine being a gross feeder, imbibes a greater degree of nourishment than most other plants; the roots were plentifully supplied with the water which had drained from the dung pits, and had been collected in a large reservoir, which affords a sufficient supply for the trees and plants throughout the Summer months. I must, however, observe, that none of the fruit, or foliage, is ever syringed with any thing but pure water, and this, when applied at an early season, has always the cold air taken off it, so as to be nearly of the same temperature with the house. As the fermenting substances in the pits will produce a considerable vapour, a free circulation of air should be daily admitted by letting down the ventilators in the back wall a few inches, and opening the front sashes; a small proportion of air, particularly in cold weather, will be quite sufficient whilst the Vines are in bloom, as this fruit sets much better in a high moist atmosphere than it does in a low dry one; but as soon as they are done flowering, large portions of air should be given, to invigorate the growth of the

young shoots, as it is from these that we must, at this period, make our selection, for producing a crop the ensuing year ; therefore, the shoot that appears to be the most vigorous should be chosen, and kept regularly tied to the trellising, and divested of the tendrils. The one, at the extremity, may be left, in case of accident occurring to the top of the leading shoot, which should be carefully preserved, if possible, as no subsequent leader it will form will be equal to the first. The side shoots which have shown fruit, were gone over, and also divested of tendrils, and stopped at the first joint above the bunch, which operation is performed by pinching off the young shoot. In short, the greater part of the Summer pruning of the Vines may be effected without using the knife ; in a similar manner, they will require to be frequently examined, and divested of all superfluous shoots and laterals that are not requisite for the nourishment of the fruit, and for providing a supply for the succeeding year's crop, which, at this time, should be chosen, and laid in so as to keep the trellis furnished with young bearing wood, but without creating too much confusion amongst the shoots, or shade to the Grapes. When the berries have attained the size of small peas, they should be gone over, and thinned out ; but this operation must be performed with some nicety, with a pair of sharp-pointed scissors ; all the deformed and smallest berries ought to be cut out, and such as appear crowded towards the centre of the bunch, so as to leave the remaining ones free from each other, and to allow room for their swelling, and that a free circulation

of air may pass among the berries, which will, in a great measure, prevent their getting mouldy, or rotting in cloudy damp weather. The thinning, however, must not be done all at one time; the bunches should also be examined two or three times before the fruit is beginning to colour, and those berries that appear too close together, removed, so as to allow room for the remaining ones to hang quite free and detached. Care should also be taken not to prick any of the berries that are intended to be left in the bunches with the point of the scissors. The large growing kinds should have their shoulders suspended to the trellis by matting; which will keep them free from the lower part of the bunch, and admit of more air to the berries, which is so essential for their swelling to perfection. Those shoots that were stopped at the joint above the fruit, will be throwing out laterals; these may be permitted to grow a few joints, and then pinched back to the first, and kept shortened so as to prevent their depriving the fruit, or young wood destined for next year's crop, of any portion of their nourishment. When the Grapes begin to shew the least symptoms of changing their colour, the steaming and watering of the house is abandoned, as, likewise, the supply to the roots; which, if liberally applied during their previous growth, the borders will be sufficiently moist to sustain. But if the border within the house, where the Vines are planted, appears dry, which will very likely be occasioned by the hot-water pipes that run close by that space, it must be watered, yet sparingly, as too much moisture, when the fruit is

ripening, would be injurious to its flavour ; therefore, the atmosphere of the house should be kept in as dry a state as possible, to enhance the flavour of the fruit. Should any insects be still in existence, they ought to be destroyed before the berries begin to colour ; but if the syringe or engine has been applied every evening with considerable force, until this period, little of the red spider will remain ; and it is but seldom the Vines are attacked by much of the green fly ; they are, however, more subject to the depredations of thrips, which, if not checked in their first progress, will commit sad devastations on the foliage ; therefore, recourse must be had to fumigation, which will readily suppress these destructive agents. If any of the red spider makes its appearance, slight sprinklings of sulphur over the hot-pipes will subdue them. When the fruit is colouring, they should be exposed as much as possible to the sun and light ; but cautiously observing not to deprive the Vine of its leaves for this purpose, which might promote the maturity of the Grape before it was perfectly coloured, only removing a few of such leaves as appear crowded and to overshadow the bunches. When ripe Grapes are wanted at an early period of the year, the exciting of the Vine should be commenced with early in October ; and by pursuing a similar routine of culture, ripe fruit may be obtained early in April ; but they should not be forced at such a season, until the Vines are fully established, when they will stand early acceleration without injury. The compartment intended for a late crop, should be planted with the latest growing

sorts, and the Vines exposed to the external atmosphere until the eyes begin to burst, when they should then be put under the glass, but daily exposed to as much air as the house will admit of, until the bunches are beginning to shew, when they will require to be kept rather close for the setting of the fruit.

LIST OF GRAPES.

Black Damascus.	Purple Frontignac.
Black Frontignac.	Red Frontignac.
Black Tripoli.	Red Syracuse.
Black Hamburgh.	Red Hamburgh.
Black Lombardy, or West St. Peter's.	Red Muscadel.
Black Muscadine.	Royal Muscadine.
Black Prince.	Saint Peter's.
Black Lisbon.	Syrian.
Black Esperione.	Tokay.
Black Frankendale.	White Frontignac.
Grove End Sweet-water.	White Muscat of Alexandria.
Poonah.	White Sweet-water.

 THE PROPAGATION OF THE VINE.

The Vine may be increased in various ways, by seeds, layers, grafting, and cuttings; but the most usual method of propagating the plant, is, by cuttings, formed from a single eye of the preceding year's wood, which should always be selected from the shoots that are of the earliest growth, and appear to be of the firmest texture, and best ripened; such,

also, as are not of too gross a substance; for the more luxuriant growing ones are generally very pithy, and, consequently, far less suitable than those of a less vigorous nature and compact wood.

Shoots that appear of a moderate size, and beset with bold prominent buds, are the most proper for selection; they should be chosen when the Vines are pruned from the kinds that are most approved, and the ends inserted in mould, and kept in a dry airy situation, until February, or the beginning of March, when they should be placed in a hot-bed, previously prepared for their reception.

In the preparing of the cuttings, leave but as little of the old wood attached to the eye as possible, paring it away close to the bud, on both sides; observing not to encroach on the eye, and that it may not be above an inch in length, (including the bud,) when completed. The underside of the shoot may be also reduced, which will leave still less of the old wood, whilst the plants will succeed equally well, and ultimately root much better, than if left of a greater length.

The practice of propagating Vines from long shoots containing several eyes, is now but seldom adopted, as those that are raised with the smallest portion of the mother plant attached to them are uniformly found to succeed the best. When the eyes or cuttings are all prepared, they should be inserted in pots, filled with leaf-mould and sandy loam; four or five cuttings will be quite sufficient to put in one pot, as, if crowded, their roots will become entangled, and will be more liable to be injured in the re-

potting. They should have nearly half an inch of the soil put over them as a covering, and be placed at regular distances around the edges of the pots, which will enable each to be removed, when necessary, with a little ball of earth attached to its roots. As soon as they are potted, a sprinkling of water should be given, to settle the soil about them, and the pots then plunged in the hot-bed previously made for their reception.

The temperature of the frame may be regulated at from 55 to 60 degrees; but fresh air should be admitted daily in great abundance, particularly when the buds begin to swell, which will prevent the young shoots from being drawn up in a weak or languid state. The atmosphere of the bed will require to be kept up by external linings of fresh dung, until the nights begin to get warm; and the mould, in the pots, kept in a moderate state of moisture by occasional watering.

When the plants have advanced in growth from 8 to 10 inches, they should be removed into single pots, with great care, lest the tender shoots, or young roots be injured in the operation. When re-potted, they must be re-plunged in the hot-bed, and frequently supplied with water and liquid manure, which will greatly invigorate their growth, and induce them to make good roots before Winter, at which season they will require to be carefully protected from frost as well as from too much wet. The plants thus raised, will be ready to plant out with advantage the ensuing Spring, where they may be intended to perfect their fruit. Those

that are wished to be kept as a reserve stock, should be headed down to a couple of eyes, and re-potted in larger sized pots, until required for planting out; but if they are not wanted before the plants are above two or three years old, it will be more advisable to throw them away, and propagate young ones instead. As plants of one or two years' growth generally succeed better than those of a more advanced age, I have frequently planted them out from the cutting pot in the middle of Summer, the same season they were raised; and have invariably found such as I have turned out, at this stage of growth, to surpass those that I have reserved until the ensuing Spring.

The increasing of the Vine, by grafting, is sometimes advantageously adopted, where there are old established plants in the house, whose fruit is of an inferior quality; or when it appears desirable to grow several kinds of Grapes on the same Vine. The size of the fruit, of the small and delicate growing kinds, is also often much improved by being ingrafted on stocks of a more robust nature. The Black Hamburgh, Black Damascus, Syrian, and White Nice, are very suitable subjects for forming a conjunction with the Frontignacs, Muscats, White Muscadine, Sweet-Water, and other small growing sorts.

The best season for performing the operation is, when the Vines are in a dormant state, and two or three weeks previous to their being excited into vegetation. Those shoots that are of a moderate size and firm texture should likewise be chosen, and

the operation performed with great nicety. The clay that surrounds the graft should be enveloped in moss, and that kept in a moist state by occasional watering with the syringe, until the union is fully accomplished.

The propagation of the Vine, by layers, which was the most general practice formerly, is now but seldom resorted to, in consequence of plants raised this way being found much inferior to those raised from eyes, or buds. This method, therefore, of late years, has become very justly abandoned; as plants, raised by layers, although very strong and shewy the first season, generally produce long jointed wood, are less prolific, and later in coming into a bearing state, and seldom make such good roots for their support, as those increased by eyes, or seeds.

The raising of Vines from seed is the only way of obtaining new varieties, which may still be increased to a much greater extent, and the quality of many of the kinds of fruit much improved, by being impregnated with the pollen from other approved sorts. This may be effected by placing the shoots of two or three of such kinds as generally burst into flower about the same time, in such a position as to allow of their bunches being brought in contact with each other when they are in bloom. The farina of the different varieties becoming thus intermixed, we may naturally expect from the result an improved variety of fruit. When the berries appear to be fully formed, the shoots should be again removed to their former position, and the bunches carefully thinned and tied up, so as that the fruit

may have the full benefit of the sun for its maturity. It should be permitted to hang on the Vine until perfectly ripened, and the seed appear of a dark brown colour, when it should be separated from the pulp or berry, dried in an airy place, and carefully preserved until the return of the growing season. From the middle of February, to the beginning of March, we may consider the most congenial season for sowing such seeds. About the latter end of February, a few large pans, from five to six inches in depth, should be filled with sandy loam and leaf-mould, and the seeds deposited in them, from three to four inches apart, and then placed in a hot-bed, of a moderate temperature, which will greatly facilitate the vegetation of the seed. As soon as the plants appear to have advanced four or five inches in growth, they will require to be placed singly into pots about five or six inches in diameter, and again plunged into the hot-bed, and carefully supplied with water and a free admission of air. Much care should be taken not to injure their tender roots, in removing them from the seed pans, but to preserve as much of the soil around the small fibres as possible. When the plants have filled their pots with fresh roots, they should be again shifted into others of a larger size, and treated in every other respect as was specified for cuttings, only observing not to plant out any of the sorts in the houses, until their fruit has been ascertained and approved of.

MANAGEMENT OF THE FIG TREE.

The Fig tree, being a native of a warm climate, requires to be protected in this country from the Winter frosts, for the preservation of the young fruit and branches. When planted out of doors, the shoots should be either enveloped in hay or straw bands, or thatched over with broom or fir branches; and thus many of the sorts will bring their fruit to a high state of perfection, when planted against a South wall.

But when ripe Figs are wanted at table at an *early* period of the year, it is necessary to accelerate them by artificial heat, either in one of the Forcing-Houses, or in a separate compartment by themselves.

Plate 19 will illustrate the end, elevation, and section of the Fig-House, at Woburn Abbey; which structure is also adapted for producing a crop of Grapes, that may be either excited at the same time as the Fig tree, or separately. As the front lights, and wall plates of this house, are so constructed as to admit the Vines being taken out of doors, and exposed to the external atmosphere, until it may be wished to accelerate them, the Vines are planted on the outside of the front wall, and introduced close under the sill, which is formed into separate lengths, for the convenience of being removed, in order to give facility for the Vines being taken out and into the house at pleasure, when one Vine is confined to each rafter, where they produce an excellent crop of Grapes, without injuring the Figs. Along the centre of the house is a pit four feet deep, by eight feet

wide, for the formation of a bed of leaves, or any other fermenting substances that will produce a mild bottom heat, wherein the plants are plunged, and from which their roots will make a rapid progress, and derive much nourishment.

It will be necessary to have a large stock of plants of such kinds as are best adapted for early forcing, for many of the sorts are liable to cast their first crop when accelerated by artificial heat. It is, however, considered by some *Horticulturists*, that cutting off a portion of the roots round the ball of earth, will prevent the Fig tree from losing its fruit; this mode of treatment I have frequently resorted to, but could never observe any beneficial effects arising from it, in practice, as many of the sorts will drop their fruit when excited at an early period, treat them as you will. As soon as the violent heating of the bed has subsided, the pots should be plunged to the rims, and regularly supplied with water at the roots, as well as frequently syringed overhead. The temperature of the house may be commenced with at 50 degrees, and gradually increased to 75 degrees by the time the fruit is swelling off, which, if excited early in January, will be beginning to swell and ripen early in April, when a succession may be continued to the latter end of the season, from the same plants, by keeping them regularly supplied with heat and moisture. Many of the sorts will succeed well, if potted in large pots, and kept at the temperature of the Pine Stove, and placed in pans of water, where they will have a regular supply of moisture at their roots. There is a Fig tree in the

Woburn Garden, that was planted out in a corner of the Pine-House, about three years ago, which has annually produced, and brought to perfection, nine successive crops, and is at this time covered with an abundant shew of healthy Figs. The soil that they appear to grow and flourish in best, is a mixture of sandy loam and leaf-mould, intermixed with one-fourth of good rotten dung.

LIST OF FIGS CULTIVATED.

Angelique.	Marseilles.
Black Genoa.	Minion.
Black Ischia.	Naples Black.
Black Italian.	Nerii.
Brown Turkey.	Pregussata.
Brunswick.	Purple Genoa.
Chesnut, or Brown Ischia.	Small Blue.
Green Ischia.	Small Brown Ischia.
Large Blue.	Small Early White.
Large White.	Small Green.
Large White Genoa.	Violette.
Long Brown Naples.	Yellow Ischia.
Malta.	

CONSTRUCTION OF THE PINERY.

The annexed Ground Plan, Elevations, and Section, (Plate 20,) will illustrate the principle upon which the Pine-House is erected. It is executed from the designs of W. Atkinson, Esq. This house is 65 feet long, and 13 feet wide, in the clear; and is divided into two divisions. The sashes and rafters are wood, and fixtures; consequently air is admitted by the ventilators D. D., that are placed in the top of the back wall, and along the centre of the front wall, which, together with opening the doors, will admit a sufficiency of air in the Summer season, for the Pine Apple. The house is heated by hot water, with separate boilers and pipes to each division; the boilers A. A. are placed in a recess about the centre of the back wall, the dimensions of which are two feet six inches long, one foot six inches wide, and one foot eight inches deep, of an oblong square. There are two pipes B. B. (see Section,) attached to each boiler, one near the top, and the other at the bottom; the upper pipe is round, until it reaches the front of the house, when it forms a square of 12 inches broad by four inches in diameter; the lower pipe is circular, and four inches in diameter. These pipes convey the water from the boilers across the ends, and along the front of the house to the reservoirs D. D., (see Ground Plan,) which are of the same dimensions as the boilers, and are

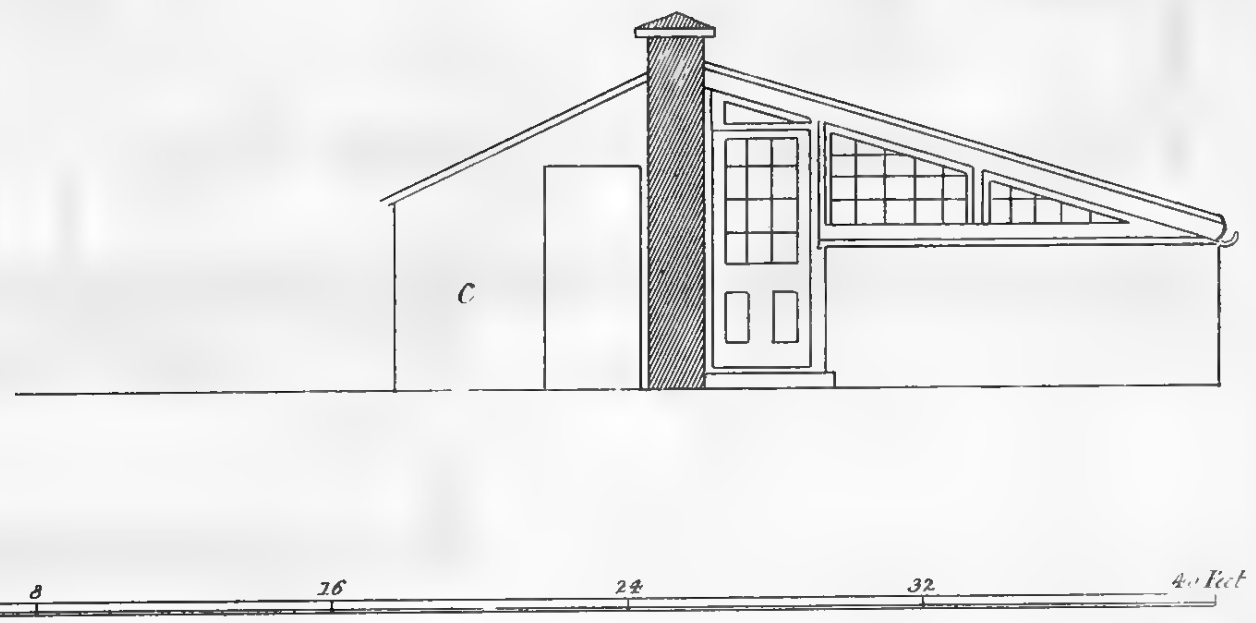
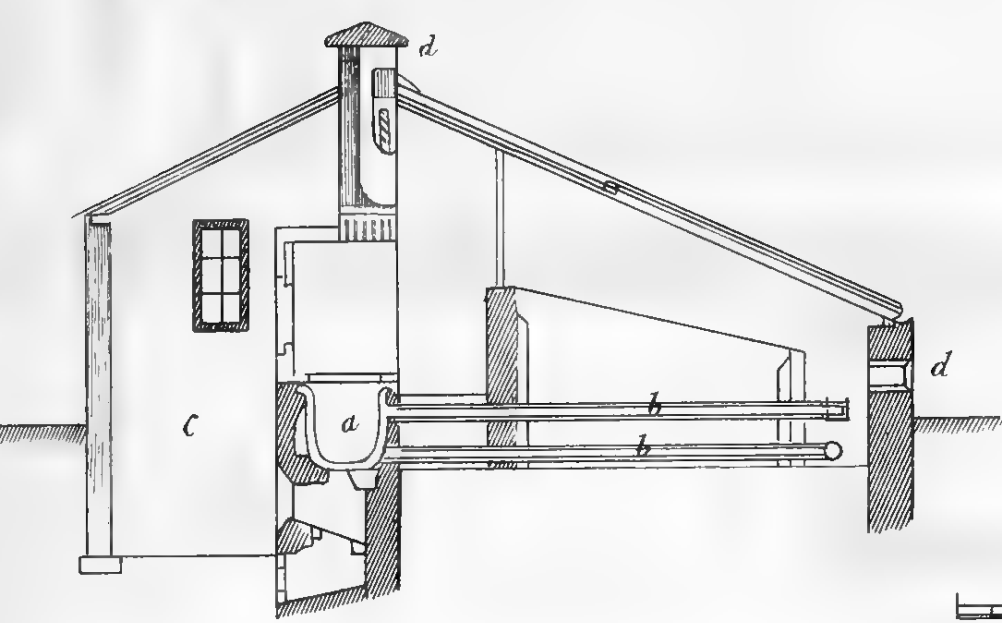
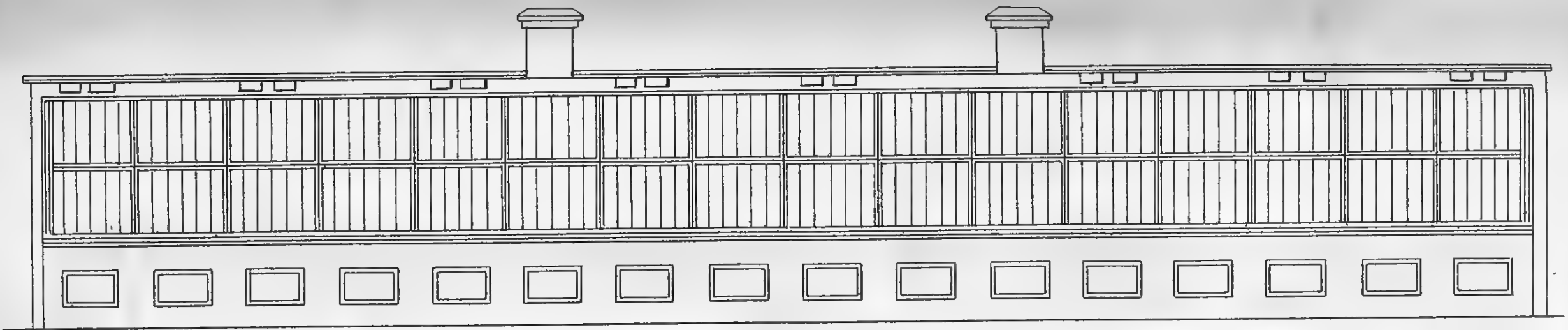

Elevations and Sections of the Pinery.

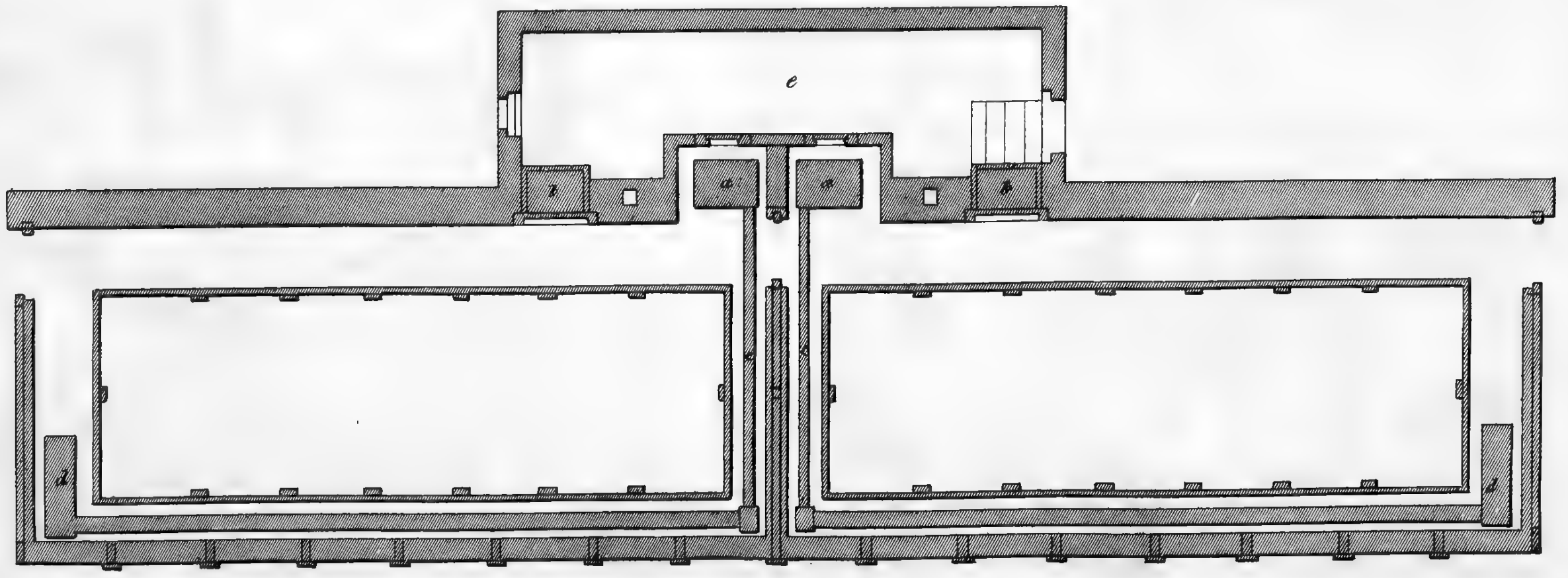

Ground Plan of the Pinery.

filled with water, flowing from the boiler, as the pipes, reservoirs, and boilers, are placed all on the same level, and filled about equally, within half an inch of the top, so as to allow room for circulating the heat regularly from one end of the house to the other.

When the fires are lighted under the boilers, the water, as soon as it begins to get hot, immediately ascends to the top of the boiler, and flows along the upper pipe, to the reservoirs, when it forces the cold before it in the under pipe back into the bottom of the boiler. The circulation of water is continued from one extremity of the house to the other; the hottest passing rapidly along the upper pipe, and the coldest returning through the lower one, back into the boiler, which will soon heat the pipes so as to raise the atmosphere of the house, in the severest weather, from 75 to 80 degrees, and that when we have had 28 degrees of frost. These houses, or compartments, are capable of containing 70 fruiting Pine plants each; the atmosphere of the house may be kept regularly from 60 to 65 degrees, in the severest weather, without consuming more than three-fourths of a bushel of coals to each division; or a bushel and a half to the two compartments. The fermenting leaves in the pits also assist in keeping up this temperature. The pipes, boilers, and reservoirs in each, contain about 140 gallons of water; when the fires are first lighted to the Pinery, the furnaces, &c. being then cold and damp, it takes about an hour to heat the water to 130 degrees; but when it is once heated, after the first night, it may be raised to the same

temperature in 20 minutes; as, from the volume contained in the apparatus, it will retain its heat for nearly 24 hours, consequently the water is about milk-warm when the fires are lighted in the afternoons. In the Winter of 1829, which was the severest season in this part of the country within my remembrance, the self-registering thermometers indicated 28 degrees of frost, two different nights that season; which afforded ample means of ascertaining the power of the hot-water; and as both divisions of the Pinery were then at work, the fires were made up both nights, at five o'clock in the evening; one of the compartments was regulated at eight o'clock, at 70 degrees, and the other at 60 degrees; the dampers were then shut close, so as to confine the heat around the boilers, and prevent it from escaping out of the chimney, but no fresh fuel was added after five in the evening; the next morning, at eight o'clock, the division that was left at 70 degrees the previous night, had lost 10 degrees; and the other, that was regulated at 60 degrees, only 5 degrees during the night. This lapse of 15 hours, without any fresh fuel being added, and that when we had 28 degrees of frost, is a sufficient proof that the hot-water has adequate power to answer all horticultural purposes in the most inclement season, when the apparatus is properly constructed, and is of a sufficient magnitude for giving out caloric, according to the size or area of the house which it is intended to heat. The furnaces are attended from the shed behind E., in which is also placed cisterns B.B., for supplying the houses with water.

ON THE CULTIVATION OF THE PINE APPLE PLANT.

The crowns and suckers being the first formation of the Pine Apple Plant, I will begin by stating the course of culture which I have followed with them, through the different stages of their growth, in order to bring the plants to the best degree of strength, for producing good-sized fruit. As soon as the fruit is cut, the greater portion of the old leaves is cleared away, close to the stem of the old plants, in order to admit the sun and air for the perfecting of the suckers, which are permitted to grow until there are a sufficiency of crowns and suckers collected for filling a two or three-light pit. In June, or July, according as the fruit has been cut, a bed of well-tempered dung or leaves is prepared, and the largest of the suckers taken off, and potted into pots of from four to five inches diameter, which are filled with leaf-mould, well incorporated with sandy loam. Before the suckers are potted, they are left in a warm situation for a few days to dry, and some of the lower leaves divested from the part that is to be inserted into the soil: those that appear perfectly ripened, and are of a firm texture, and of a brownish colour at the bottom, and separate easily from the mother plant, are immediately potted, and succeed as well as those laid up to dry. When the crowns are returned, they are likewise dried previous to planting, and a few of the leaves are removed from their base. When the bed appears to be of a

mild and congenial temperature, about six inches of leaf-mould are spread over its surface, and the pots are plunged therein along the back of the pit; the crowns, and small suckers, are planted in the leaf-mould, on the surface of the bed, towards the front of the pit, observing always to keep the largest at the back, and placing them at such distances apart as the size of the suckers and crowns will admit, but so as not to be too crowded. After they are all arranged, a syringing with soft water is freely given, in order to settle the leaf-mould, and clear the plants from any dust which they have collected. The atmosphere of the pit is now kept from 80 to 100 degrees, and neither air nor water given, until they begin to emit fresh roots, when these elements are gradually increased, and freely administered as the plants expand in the herb. While they are striking root, the pits are covered daily a few hours with thin or old bass mats, which lessen the effects of the mid-day sun. The moisture arising from the bed and external dung linings, will afford considerable nourishment to the plants whilst rooting; but they are afterwards copiously syringed over head, and liquid manure supplied to the roots, which invigorates their growth; and the temperature of the pit is kept up to nearly 80 degrees during the night, and from 95 to 100 degrees in the middle of the day, when sunshine excites the plants into a rapid growing state. About the first week of September the supplies of water are begun to be decreased, as well as the temperature of the pit. The nights at this time getting rather cold and damp, it is more advi-

sable to reduce the internal atmosphere of the pits, somewhat in proportion to the external air, than to force the plant forward too much against nature. By the latter end of September, or beginning of October, the plants will have filled their pots with good roots, when they are shifted into larger sized pots: as those that were planted on the surface of the bed will also have made a rapid growth. The largest are now potted with as much of the leaf-mould as remains attached to their roots, and the remainder of the pots filled up with the composition previously prepared for the Pine. Those crowns and suckers that are now potted, are all put into the succession department, in order to make room for the crowns and suckers that still remain unplanted, which are put in the nursing bed, along with those still remaining in the leaf-mould, and are left to grow there till the middle of March. Every precaution is taken, at this time, not to injure the young roots, in potting, or with too much bottom heat, as, if hurt at this late period of the season, they will not push out fresh ones freely before the return of Spring. The pits are now covered at night with bass mats, and the thermometer kept as near to 65 degrees as possible, and from 70 to 75 degrees in the day, with the influence of the sun. As the season advances, the proportion of water is diminished, and the syringing over head dispensed with about the latter end of October. In the first or second week in November, or as soon as a sufficient quantity of fresh Oak-tree leaves can be procured, the plants, in the succession department, are re-

moved, and all the old and exhausted leaves thrown out of the pit, when the fresh ones are now substituted, well trod, and raised so that the plants can merely stand on the surface of the bed, without the lights breaking or injuring their leaves when put on. The pots must not be plunged at this time, as the violent heating of the new leaves would materially injure the roots; and if hurt at this period, it will prove very injurious to the plants, as they will be in a great measure destitute of roots to support them, until the return of the growing season, when they will push out fresh ones.

A considerable saving of materials and labour is gained by putting in and forming the bed in the pit with the new leaves, as soon as they fall from the trees, which prevents them from being scattered about the ground through the Winter, and their substances partially exhausted before they are formed into a bed for the reception of the plants; and, consequently, their heating qualities not lost, by being collected in a large body, and allowed to ferment out of doors, as is the general practice. But when they are made up into a bed, while in a recent state, the heat arising from them, during the severest parts of the season when they are fermenting, will considerably increase the temperature within the pits, and render requisite a less consumption of dung for linings, than would otherwise be called for to keep up the atmosphere for the preservation of the plants. The crowns and suckers rooting in the nursing bed, are to be duly attended to, by giving air, by frequent turning and adding

fresh dung and leaves to the linings, in order to keep up the thermometer during the nights to about 65 degrees, at which temperature the succession pit is regulated, as near as possible, throughout the Winter; although, in very severe weather, the thermometer often falls under 60 degrees. During the day, the influence of the sun will have but very little power in raising the internal atmosphere of the bed; but, notwithstanding, a portion of fresh air is daily admitted, often merely for a few minutes, in order that it may displace the foul or stagnant air that may have collected from the fermenting substances. The plants will require scarcely any water during the three Winter months; they should, however, be looked over occasionally; and any that appear in a dry state, should have a little water given; but the cold or frosty temperature must be taken off previously to the watering of the plants. About the middle of March, there is a general shifting of the plants, and renewing of the beds in the pits; but before this operation is commenced, a quantity of the prepared soil is got in readiness, and frequently turned in an open shed to dry, and, likewise, a quantity of bones is broken to small pieces, for the purpose of putting into the bottom of the pots for drainage, which are placed about one inch thick for the small plants, and about two inches for the large or fruiting sized ones. The young roots seem to derive much nourishment from the broken bones, and are found entwined round them to a greater extent than round any other substance used for carrying off the superfluous moisture. When the pots and these materials are all got

in readiness, the selection of a fine day is taken for the removal of the plants, which are carefully tied up, as they are taken out of the pits, with strings of matting, to prevent their leaves being broke or bruised in the shifting. The plants are now shook clean out of the mould in which they were previously potted, and, the decayed roots being cut clean away, re-potted into similar sized pots. This clearing away the exhausted mould and decayed roots, will materially invigorate the growth of the plants; although giving them a partial check in the first instance, they will afterwards make a more rapid progress than if the old roots and soil had not been removed. While the operation of potting is proceeding with, the leaves in the pits, whose heat has, by this time, considerably subsided, as also the height of the bed, are turned over, and a supply of fresh leaves added, but kept towards the bottom of the pit, and the fermented ones turned to the top, for the plants to be plunged amongst. According as the potting is proceeded with, the largest of the plants are selected, and arranged towards the back of the pit, keeping still the lowest and smallest for the front: the pots are now plunged to the rims in the bed. Those crowns and suckers that have been growing in the nursing pit through the Winter, are taken and potted, and placed in the succession pit with the others. It may be necessary to observe, that, in potting, the mould should not be pressed very hard about the plants, particularly if it is in a damp state, as it would subject the soil to become too hard and binding for the free emission of the young roots.

When the plants are all potted, and re-plunged, the pit is kept close shut up until they begin to make fresh roots, which will be in the course of 10 or 12 days, at this season, if there is a good heat in the bed; the lights may be opened for a few minutes, about twice a week, to let any stagnant air pass off that has collected. The plants are also shaded from the mid-day sun whilst rooting, and no water given until they are established in the mould, which will be sufficiently moist at this season for them to throw out roots in, and it is more advisable to give rather too little than too much when the plants are in a dormant state, and not fit to absorb it. When the plants have thrown out a few roots, a little water is given, and also a small portion of air; and according as they proceed in growth, and the season advances, these elements are gradually increased, and frequent syringings over the leaves are had recourse to, as well as occasional waterings with liquid manure at the roots. The temperature of the pit is increased to 70 degrees during the nights, and allowed to vary from 80 to 90 degrees in sunshine. The dung linings are regularly attended to, and fresh dung added, to keep up the heat to the above degree in the bed. By the middle of June, these plants will have made a rapid progress, and have filled their pots with roots; and require now to be shifted into larger sized ones; but very carefully, least the leaves, or roots, in the re-potting, be broken or injured. The bed is likewise turned over, so as to renew the heat, which is kept very moderate at this season. The Pine appears to grow

and flourish most luxuriantly when the bottom heat is regulated to about milk-warm temperature, or little more. When the pots have been all again plunged to the rims in the bed of leaves, the pits are shaded for a few days from the violence of the mid-day sun; and when the plants have begun to throw out fresh roots in the new soil, they are kept well supplied with liquid manure, and more frequently watered over the leaves, particularly in hot sultry weather.

The season is, in general, getting warm and favourable for vegetation, by the months of May or June; the atmosphere of the pits will, in all probability, be kept during the nights, from the effects of the external dung linings, above 70 degrees, without having recourse to the covering of bass-matts; these may, therefore, at this period, be dispensed with, due attention being paid, however, to the state of the weather, and the internal atmosphere of the bed. The thermometer, during the day, in hot sunshine, often varies from 90 to 100 degrees, and upwards; but when the mercury exceeds the latter point, large admissions of air must be given, and the plants kept in a humid state, by syringing over their leaves in the morning and evening, which will induce an exhalation to arise from the surface of the bed of fermenting substances, that is very conducive to the health and vigour of the plants. If duly supplied thus with regular proportions of heat, water, and air, the Pines will have made a rapid progress in their growth, and many of them will be in a sufficient state of strength by October, for producing good fruit the ensuing

season. The Antigua, Jamaica Sugar-loaf, Providence, and several other of the large growing kinds, as well as the late planted crowns and suckers of the Queen's, will, however, require the cultivation of another season, to bring the plants to that degree of strength, which is requisite for the production of good sized fruit. These are, therefore, selected; and such as appear to have out-grown their pots, are shifted into others, a size larger, and re-plunged in the succession pits, which should be turned over while the operation of re-potting is proceeding with; so that the plants may be all again arranged in the bed the same day they are taken out of it. It is, however, necessary to observe, that a very mild bottom heat only should be continued at this late period of the Summer; as, if the roots be now injured, they will not freely produce fresh ones before the return of the growing season.

In October, as the nights are generally becoming cold and damp, the pits will require to have their coverings resumed, and the temperature gradually reduced to about 65 degrees, mornings and evenings. The syringing over the leaves is also dispensed with at this season, and less supplies of water given to the roots, as the evaporation, arising from the bed of fermenting substances and dung linings, will keep the herb in a state of moisture during the Winter months. About the first or second week in November, or as soon as a sufficient quantity of fresh tree leaves can be procured, those that have been in use the past season, and which will now be much exhausted by the constant damp they are subject to, proceeding

from the dung linings; these will require to be cleared out of the pits, and those that were recently collected substituted in their place. As soon as the heat begins to rise amongst the fresh leaves, they should be turned over, and trod as compactly together as possible, and the surface levelled for the plants to stand upon, observing, that the pots must not be plunged at this period, otherwise the violent heating of the new leaves will materially injure the roots, and be very prejudicial to the plants during the Winter season, while they are in a dormant state. The Pines should be placed on the surface of the bed, at such distances as the size of plants will admit of; they may be pretty closely packed together at this period, but should not be too crowded. When the plants are all arranged, the same temperature and culture, as was recommended through the preceding season, is applicable to the ensuing year's treatment. The plants should be again disrooted about the middle or latter end of March, and a similar course of culture adapted through the Summer months, which will bring them to a sufficient degree of forwardness and strength, to be placed in their fruiting sized pots by the middle of September.

It is, however, very desirable to have a succession of fruit in the latter end of the season, as well as in the early part; therefore, to provide for this, at the Spring shifting, a number of the strongest of the plants are selected from the pits, and shifted into larger sized pots than they have been previously growing in, and any decayed roots that may appear are cut clean away; the young fibres are carefully

singled out, and a few of the bottom leaves stripped off, so as to encourage fresh roots from that part of the stem : the upper surface of the ball of mould is also reduced; and the plants, thus prepared, are carefully re-potted into fresh soil, and again placed in the succession pits, and are kept in a moist growing heat until July, when they are removed into the fruiting department, in the room of those whose fruit has been previously cut. They are now kept well supplied with heat and water, and generally perfect their fruit at the latter end of the season.

MANAGEMENT OF THE FRUITING PINE PLANTS.

Those Pine plants that are intended for the principal crop the ensuing year, are generally shifted in the latter end of September or beginning of October, into such sized pots as the size and strength of the plant may require ; these pots vary from 12 to 14 inches in diameter, and about the same dimensions in depth. About two inches of broken bones are put in the bottom of the pots for drainage, and then the Pines are carefully transferred into the larger sized ones, with their balls of earth entire, which should not be reduced at this shifting; but the interstices betwixt them and the side of the pots, are filled up with the fresh soil, which has been previously prepared. Whilst the shifting of the plants is proceeding with, the bed of leaves is

turned over to about half its depth, and got in readiness for the reception of the plants, which are again plunged in this bed, that still retains a moderate heat, very beneficial to the roots, as facilitating their striking into the fresh loam. As one of the fruiting compartments here is always occupied at this season by the late fruit, the plants intended for it are again placed in the succession pit, until November; but those brought into the fruiting house in October are kept in a humid state, by pouring water on the paths and hot-water pipes, &c. and the temperature is regulated at 65 degrees, mornings and evenings; and from 75 to 80 through the day, by the influence of the sun. The supplies of water to the roots must now be proportionably decreased, according to the state of the external atmosphere.

About the beginning of November, when the Oak-tree leaves can be procured in abundance, the plants are again taken out of the beds, and the pits cleared of all the decayed leaves, and re-filled with fresh ones; those from the Oak-tree are, unquestionably, the best for this purpose, and will retain their heat, when kept free from too much damp, for upwards of two years, by having a few fresh ones intermixed with them. In the Fruiting Pineries here, there is, at present, a quantity of these leaves, which has been in use for three seasons. In filling the pits in the Pineries, the old and recent leaves should be well mixed and turned together, and the bed trod as firmly as they will admit, and raised as high as will merely allow the plants to stand on its surface with-

out their foliage being broke or injured with the glass. The pots must not be plunged at this time, but only set on the top of the bed, before Spring, when the violent heating will have subsided. They should be arranged from 20 to 24 inches apart, observing to place always the tallest plants at the back of the pit, and the lower ones next to the front.

During the Winter months, the temperature in the house is regulated from 65 to 70 degrees by fire heat, and allowed to vary from 75 to 80 degrees with sun heat, but admitting a free circulation of fresh air at all favourable opportunities, although it be only for a very short time, in severe frosty weather.

The plants will require little or no water from November to February, while they are in an inactive state; yet they should be occasionally examined; and such as appear to be getting dry, have a little aired water supplied to their roots.

By the month of February, the heat and bed will both have subsided; the pots are, therefore, at this period, placed level, and the spaces betwixt them filled up with fresh leaves, when the bed will retain its heat sufficient for the maturity of the fruit. A few of the lower leaves are stripped off the plants in February, and the pots re-surfaced with fresh soil, as an inducement for the production of young roots from that part of the stem whence the leaves were divested, which will greatly nourish and accelerate the growth and maturity of the fruit. Should any of the plants appear loose, or in too small pots, they should be shifted into others at this time. In

some cases, it is necessary to form a kind of bason round the edges of the pot, by placing a piece of thin turf, and filling it up by fresh soil, but leaving a sufficient space for holding water, so that it may not run over the surface of the mould without penetrating to the roots of the plants.

As many of the plants will be shewing fruit in February, the atmosphere of the house is increased to 70 degrees by fire heat, and from 80 to 85 degrees with sun heat; the Pines are now occasionally syringed over their leaves as the season advances; and water that has been well impregnated with pigeon and deer dung is applied to their roots; but duly observing that the chill is taken off the water used.

The hot-water pipes, and footpaths, are frequently sprinkled with this element, which creates an exhalation that is very beneficial to the vegetating fruit. As the season advances in warmth, the thermometer is gradually increased, until it will stand about 75 degrees in the evenings, by fire heat, and from 80 to 90 degrees in the day by the influence of the sun.

By the month of May, the fruit will be swelling apace, and should be supported by sticks placed in the pots, to which the crowns and stems of the fruit are to be tied. The plants, at this season, are bountifully supplied with liquid manure at the roots, and frequently syringed over their foliage, as they have now to support their suckers, as well as fruit; consequently, they require a greater portion of nourishment, and always appear to flourish more luxuriantly when grown in a humid atmosphere than if kept in

a dry heat. A moist heat is very beneficial for the suppression of insects, and, at the same time, congenial to the health and vigour of the plants. About the middle of this month, the weather will, in all probability, be sufficiently warm for dispensing with the fires in this department. As many of the sorts, particularly the Queen's, will throw up more suckers than should be allowed to remain, especially when larger sized fruit is the principal object in view, all should be destroyed, except two or three of the most promising ones, for a succession of young plants. During the months of June and July, much of the fruit will be fast approaching to a state of maturity, and will require to be bountifully supplied with water in its stage of swelling; but this element must be supplied according to the state of the plants, and as they appear to absorb it. In hot sultry weather they will require more than in dull cloudy seasons. Air must be freely admitted throughout the greater part of the day, and the thermometer may be allowed to vary from 90 to 100 or 110 degrees by the influence of the sun; but when it ranges with the latter point, a large admission of air should be in circulation through the house. As soon as the fruit begins to assume a different colour, it is an indication of its being nearly ripe; the quantity of water should now be gradually reduced; and should be entirely dispensed with before it is quite ripe, which will enhance its flavour. The flavour is often, however, much deteriorated by being too long cut before using. Nicol very

justly observes, "that if Pines are not cut before they are fully coloured, that is, just when the fruit is of a greenish yellow, or straw colour, they fall off greatly in flavour and richness; and that sharp luscious taste, so much admired, becomes insipid." This fruit is frequently retarded for a considerable time, by the removing of the plants to a cool airy situation, just as the Pines begin to colour, whereby they will retain their flavour longer than if separated from the plants; but this should only be resorted to when it is necessary to prolong their ripening for any particular occasion. As the Pines are cut from the mother plant, the greater portion of the old leaves should be cleared away from the stems, to allow a free circulation of air and sun to the suckers, which will considerably promote their maturity: these may be left attached to the stem, until the greater portion of the first crop or succession of fruit is cut, when it will be necessary to remove the stools, in order to make room for those plants in the succession pits that are intended for a supply of fruit in Autumn.

When all the old stools are cleared out of this department, and such fruit as is still remaining unripe removed, the bed of leaves will require to be turned over previous to plunging the plants in it, which will then maintain a sufficient heat for the maturity of the fruit. The plants thus removed, and such as are in a forward state, should be selected and replunged at one end of the Pinery, where their places may, as their fruit is cut, be readily got at to place succeeding plants in. The tem-

perature of the house must now be continued from 70 to 75 degrees in the evenings, and from 80 to 90 degrees in the day. When the thermometer falls under 70 degrees during the night, recourse should be had to a little fire heat, to increase the atmosphere to the degree required, which will promote the swelling and maturity of the fruit. The plants should, also, be regularly supplied with liquid manure at the roots, and a humid congenial heat be kept up in the house, by which means good sized fruit will be produced for the table during the months of November and December, when it is frequently in great requisition; especially as there is a scarcity of other fruits at this season. They are, however, considered inferior in flavour to those that have the full benefit of the Midsummer sun. Some kinds, such as the Blood-Red, St. Vincent, Enville's, &c. are more appropriate for late forcing than some other kinds. The Queen Pine seldom swells its fruit well in the Winter months, and requires a high degree of temperature to bring it to perfection. This Pine, as well as most of the other varieties, may be brought to maturity without the aid of fire heat; but the temperature of the compartments in which it is grown must be kept to the degree of heat necessary, by the application of strong dung linings round the exterior of the structures. This mode of heating is frequently attended with more trouble and expense than fire heat, especially when there is a scarcity of dung, &c. for this purpose.

The Pine plants that are grown in a moist dung heat, are not so subject to be attacked by insects, as

when they are cultivated in a dry atmosphere; the effluvia arising from the fermenting materials is very prejudicial to these depredators.*

• The insects to which the Pine plants are most liable, are, the mealy bug, and white scale.

The numerous recipes that have been published for the destruction of these agents, have, in many instances, proved ultimately inefficacious, and, when not repeatedly applied, the insects will commit considerable devastation both on fruit and foliage. I shall merely quote those receipts which I have found, from practice, the most effectual for eradicating these depredators. Mr. McMurtrie, who is a successful cultivator of the Pine, recommends, "simply, equal proportions of soot and flour of sulphur, with a little pounded camphor added, in the proportion of one-half to two pounds of the mixture of soot and sulphur, to be dusted all over the plants after having been washed with a lotion of soft soap and water, say, one pound of soft soap, dissolved in two gallons of water;" and adds, "I am of opinion the camphor might be omitted altogether." It is, however, necessary to observe, that this mixture of soot and sulphur must not be too freely applied, otherwise it will injure the leaves.

Griffin's recipe is, "To one gallon of soft rain water add eight ounces of soft green soap, one ounce of tobacco, and three table spoonfuls of turpentine; stir and mix them well together in a watering pot, and let them stand a day or two. When you are going to use this mixture, stir and mix it well again, then strain it through a thin cloth. If the fruit only be infested, dash the mixture over the crown and fruit with a squirt, until it be all fairly wet, and that which runs down the stems of the fruit will kill all the insects that are amongst the bottom of the leaves. When young plants are infested, take them out of their pots, and shaking all the earth from their roots, tying the leaves of the largest plants together, plunge them into the above mixture, keeping every part covered for the space of five minutes, then take them out and set them on a clean place, with their tops declining downwards, for the mixture to drain out of their centre. When the plants are

dry, put them in smaller pots than before, and plunge them into the bark bed."

Baldwin says, "Take horse dung from the stable, the fresher the better, sufficient to make up a hot bed three feet high, to receive a melon frame three feet deep at the back; put on the frame and lights immediately, and cover the whole with mats, to bring up the heat. When the bed is at the strongest heat, take some faggots, open them, and spread the sticks over the surface of the bed on the dung, so as to keep the plants from being scorched; set the plants or suckers bottom uppermost on the sticks; shut down the lights quite close, and cover them over well with double mats, to keep in the steam; let the plants remain in this state one hour, then take them out and wash them in a tub of cold water previously brought to the bed; then set them in a dry place, with their tops downwards, to drain, and afterwards plant them."

The soil in which the Pine plant will grow rapidly, is the top spit of a pasture that consists of a yellow loam, with the sward chopped up amongst it. To this one-fourth of good rotten stable dung, and about the same proportion of decomposed leaf mould; that produced from the Oak-tree leaves is the best; these should be all well intermixed together, and frequently turned over previously to using.

LIST OF PINE APPLES.

Anson's Queen.	New Black Jamaica.
Black Antigua.	Otaheite.
Black Jamaica.	Queen.
Blood Red.	Ripley Queen.
Brown leaved Sugar Loaf.	Russian Globe.
Brown Sugar Loaf.	Russian Cockscomb.
Enville.	Saint Vincent's.
Globe.	Silver Striped Queen.
Green Providence.	Striped leaved Sugar Loaf.
Green Antigua.	Surinam.
Havannah.	Trinidad.
Lemon Queen.	White Providence.
Montserrat.	

PINE PIT.

The accompanying Plate, No. 21, represents the Ground Plan, Elevation, and Cross Section, through the boiler of a Pine Pit. This structure is heated with hot-water, and also by external dung linings, whereby a moist or dry heat can be kept up at pleasure, as the state of the plants may require it. This pit is about 70 feet long, and divided into two divisions, and heated by one *boiler*, whereby either Figs or *Grape Vines* in pots, may be accelerated in one of the compartments, when not wanted for Pines. The Pines which shew their fruit at a late period of the year, are generally matured in this Pine pit, as, being of small dimensions, less fuel is requisite for keeping up the temperature in the Winter months. There is, also, a lining of dung and leaves applied around the walls, and the combination of a dry and moist heat prevents the plants from being scorched with fire heat, when the pit is kept at a high degree of temperature. The linings also throw a heat into the bed of leaves in which the *Pines* are plunged, and continue a regular bottom heat in the pit, until the fruit is ripened off, which renders it unnecessary to remove or disturb the plants for the renewing of the bed, as the warmth produced from the effects of the external linings will be quite sufficient for the maturity of the fruit.

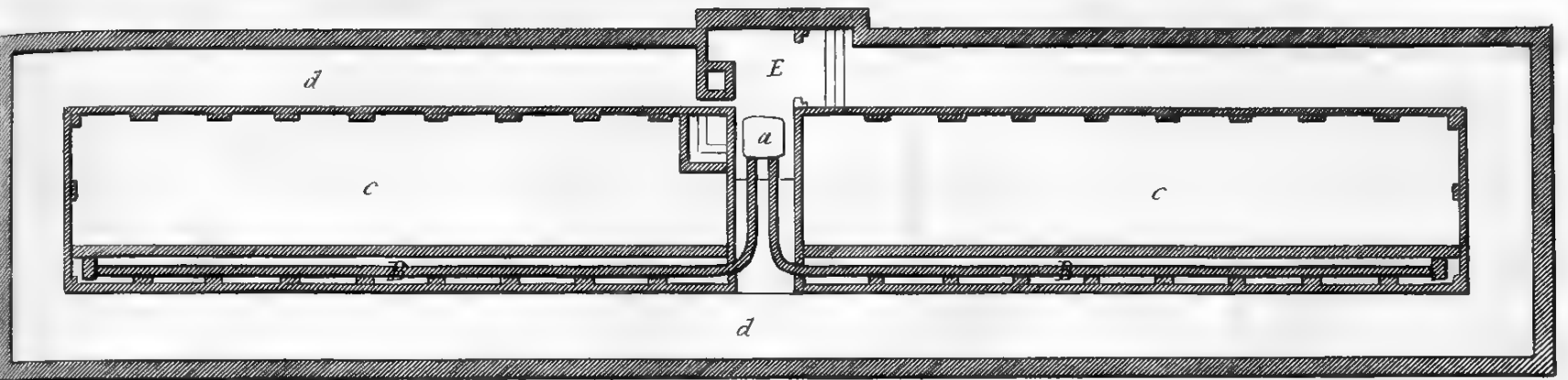
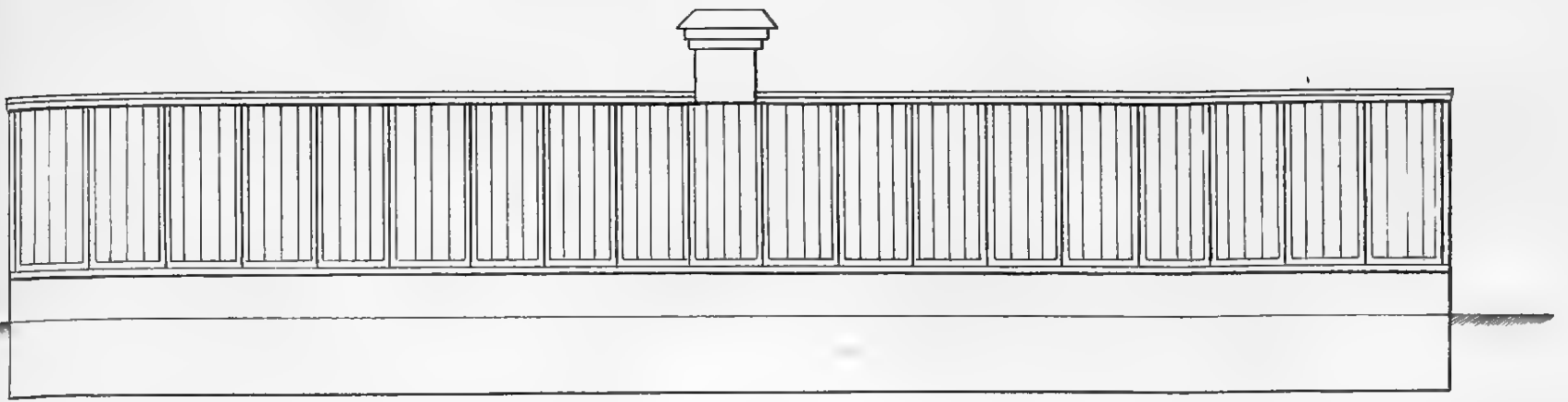

Ground Plan and Elevation of Pine Pit

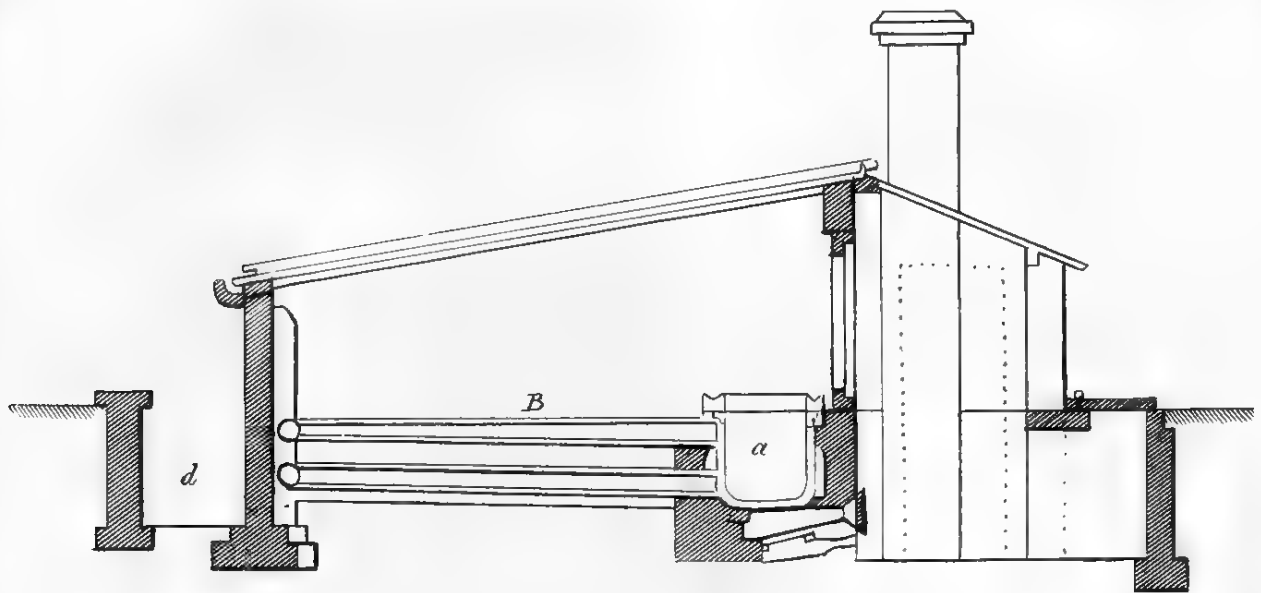

Transverse Section through Boiler &c.



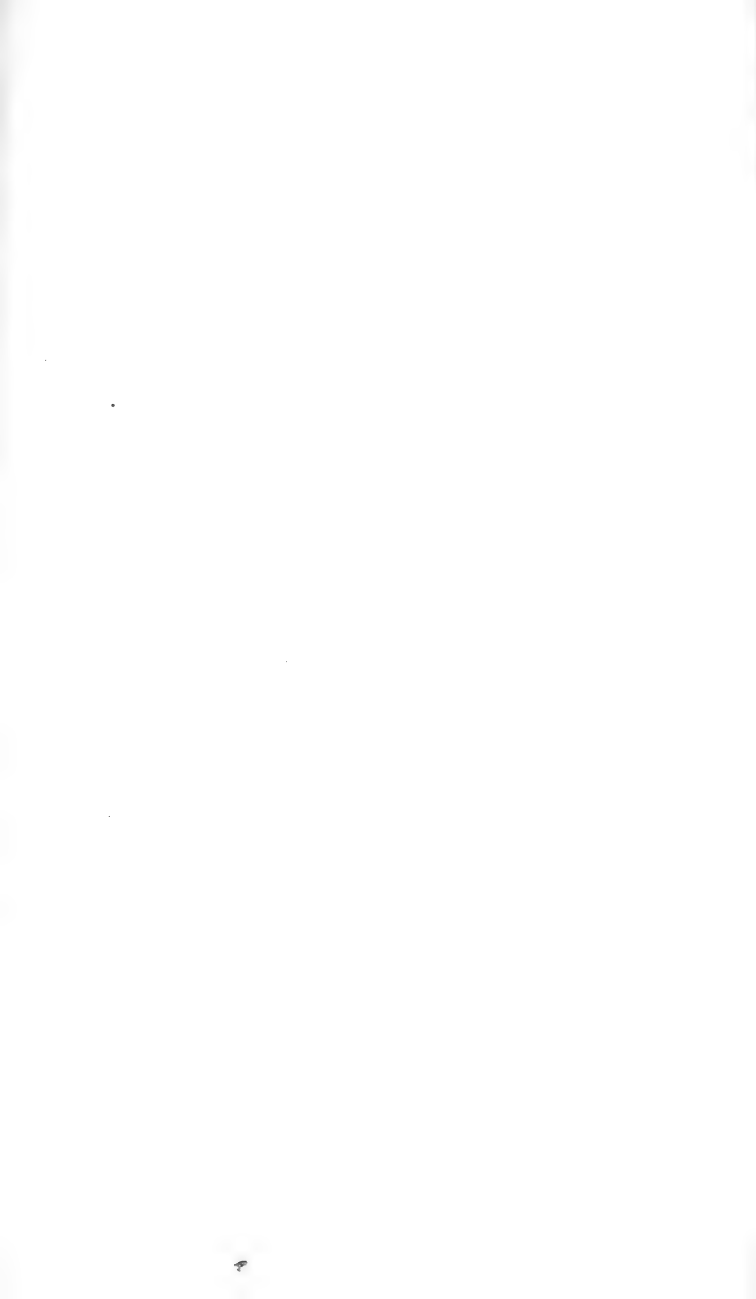

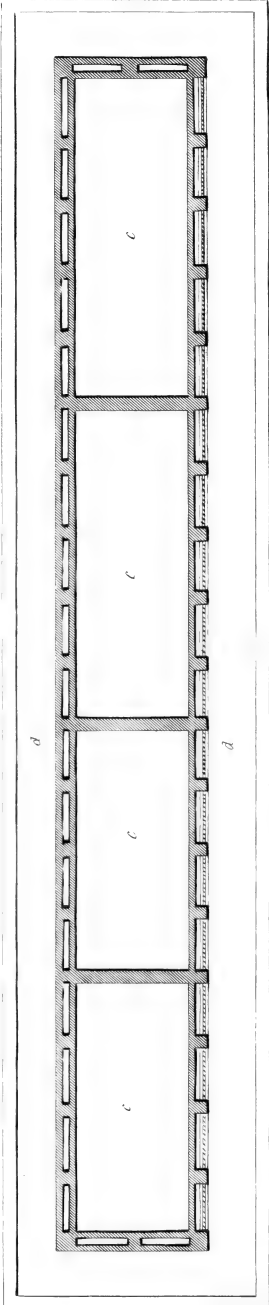
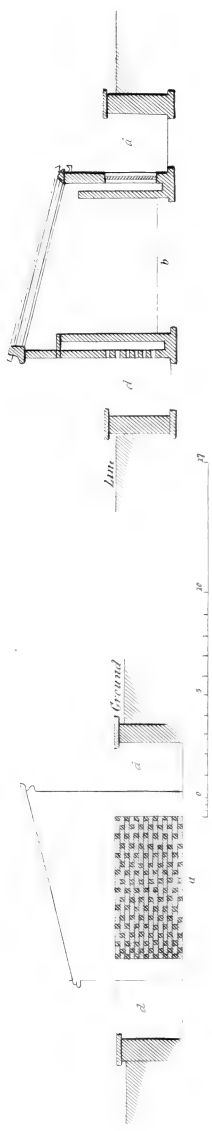

Ground Plan, End Elevation, and Cross Section of the Succession Pine Pits.

SUCCESSION PINE PIT.

The annexed Plate, No. 22, is a representation of the Ground Plan and Sections of the succession Pine Pit, which was erected from the designs of W. Atkinson, Esq., who has the merit of being the first that constructed pits on this principle of double walls, with a cavity between them, of four-inch brick work.

The back and ends are built in the honeycomb manner, and have an inner four-inch wall carried up from the floor level, to within two feet of the top; betwixt these walls there is a vacuum left from the bottom, which is covered over at the top with a thin slate, with apertures in it for the admission of steam, that is communicated from the dung linings through the pigeon hole work, in the back wall. The apertures in the slates are furnished with small plugs, whereby the steam can be excluded when in a rancid state, and admitted at pleasure. These walls are connected together by 14-inch piers, that are built up at four feet apart, which strengthens the back wall of the pit, and is a support for the rafters, which come over the centre of each. The top of the cavity being covered over, forms a very useful shelf for placing pots of strawberries on, or any other dwarf-growing plant, which it may seem desirable to accelerate by artificial heat. The front wall is, also, of a hollow, with 14-inch brick piers ;

the inner one is carried up to within a foot of the level for the wall plate, and a cavity of four inches left betwixt the two, which is left open at top. The centre of the external wall between the piers, is formed into pannels, with thin tiles placed on the edge, (and set in cement,) in order that the heat produced from the dung linings may penetrate rapidly through them into the vacuity, when it ascends and warms the atmosphere of the pit with dry heated air, free from all the obnoxious effluvia that arises from dung when applied in a recent state. This cavity is a very advantageous contrivance, as it prevents, also, much of the moisture, accruing from the fermenting materials, getting into the pit; a too great degree of which is often very injurious to the plants in the Winter season, particularly if the atmosphere of the pit is not kept in a warm and congenial state. This is often a matter of some difficulty, from the sudden changes of the weather, especially in large establishments, where there is a large supply of accelerated vegetables required, and various other articles, whose growth is promoted by dung heat; which renders the consumption of this material of no small importance. The pit is about 70 feet long, 6 feet 9 inches in the clear inside measure from the two interior walls; the back wall is eight feet high; the front five feet; the entire pit is sunk three feet under the ground level, and is surrounded by an external dung pit, where the linings are applied, of about two and a half feet wide. The exterior wall of this pit consists of nine-inch brick work, which is carried up to the ground level, and there coped with a three

inch thick plank of Oak, and about 12 inches wide, which preserves the brick work from being injured by the removal or wheeling in the dung. The rafters, wall plates, and sashes of the roof of this building, are all composed of wood, and it is furnished with a water gutter in front, which is a most essential requisite for carrying off the roof water, and preventing its falling on and chilling the dung. The length of the pit is divided into four compartments, so as to suit the different sizes or kinds of Pine plants, which it may be considered necessary to keep separate. It is well adapted for the growth of the Pine in its early stage of growth; and if supplied with a hot-water pipe, would answer every purpose that could be desired for bringing what is justly called "*the king of fruits*" to perfection, and in as good a state as it can be brought to, in what is generally termed the fruiting house. The pipes might, also, be constructed so as to heat only one or more divisions at a time, or the whole, as might be found necessary, by placing a small reservoir at the extremity of each compartment, where the water might be stopped with valves, and let on at pleasure, which is a very simple and efficacious mode of applying the heat to the different departments. The black Antigua's, Jamaica's, Providence's, and such as are rather impatient of cold, could thus be kept in one division, and supplied with a little fire heat, when necessary.

EARLY FORCING PIT.

The accompanying Ground Plan and Section, No. 23, represent the construction of the Early Forcing Pit, which is well adapted for growing early Melons, Cucumbers, and young Pine plants. This pit is also the invention of Mr. Atkinson, and was erected from his designs; it differs only from the succession Pine pit by its having no double wall or cavity at the back, and being of less dimensions in width. The back wall consists of four-inch brick work, with brick on the edge; at every four feet distance, nine-inch piers are carried up, to strengthen it, and for a support to the rafters, which are placed over the centre of each pier. The middle of the wall between the piers is open brick work, similar to the exterior wall of the pit last described, as well as the ends. The front consists of a double wall, with a cavity between them, which is left open at top. The exterior wall is also formed with pannels of one inch and a half thick tiles in the centre, which are placed on the edge, and bedded in cement. The heat of the dung, applied to these thin tiles, readily penetrates through them, and ascends rapidly up the cavity when there is nothing to obstruct its passage, and thus warms the atmosphere of the pit.

For every practicable purpose of early forcing, I consider this far preferable to any other that I have yet seen heated with dung linings; there being only

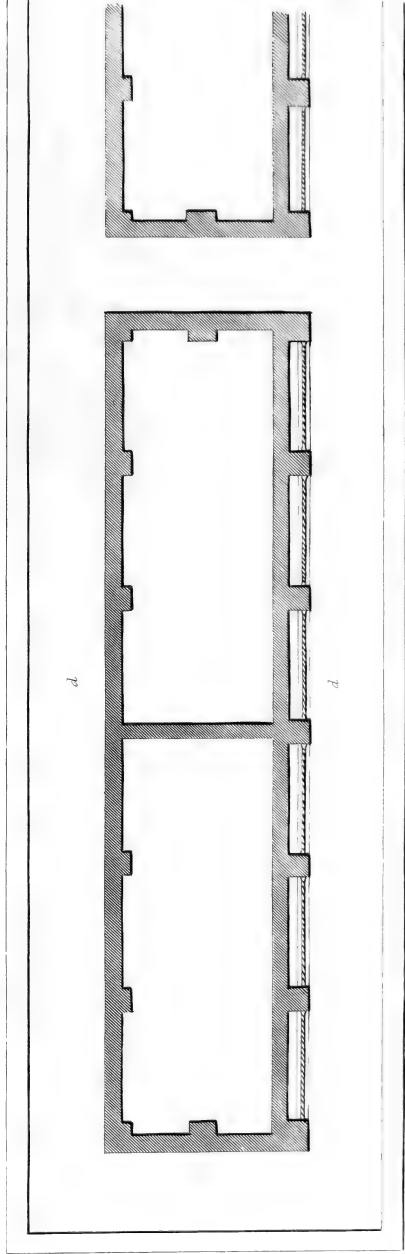
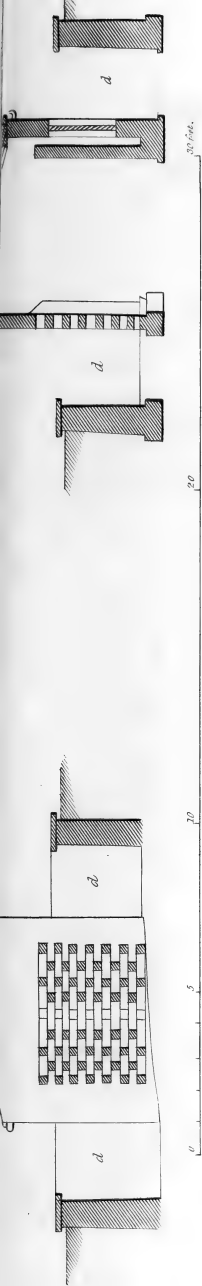

Ground Plan, End Elevation, and Section of the Early Eving III.

a four-inch wall at the back, the heat of the dung, applied outside, is readily communicated to the bed in which the plants are growing, which keeps a regular bottom heat at their roots. When the rancidity of the dung linings has evaporated, a few holes may be made by a round piece of wood, sharpened at the end, so as to pass more freely through the bed of leaves, or other materials, close to the back wall, which will supply the atmosphere of the pit with a moist heat, when it may appear desirable. This pit is also surrounded by a dung pit two feet wide, and sunk about three feet under the ground level, as will be seen by the Sections.

LATER FORCING PIT.

The prefixed Plate, No. 24, is illustrative of the principle and construction of the pit intended for forcing Melons, Cucumbers, &c. at a more advanced period of the year, when a greater degree of moisture is essential to the well-being of the plants than is necessary at an early period. This pit is constructed with four-inch brick work all round, and with nine inch piers, at four feet apart, in order to strengthen the walls. The walls also along the centre, together with the back, front, and end walls, to the depth of two feet, are honey-combed, similar to the back of the two last mentioned pits, which will be seen by the annexed Section.

This pit is also well adapted for the growth of young Pine plants in the Summer months; the exterior walls being honey-combed all round, admit rather more moisture in the Winter season, than those which are furnished with a cavity in front; but in other respects they are equally serviceable. This pit is six feet six inches wide, seven feet deep at the back, and five feet deep in front; and is divided at every three or four sashes in breadth into compartments, to suit the different succession of Melons, Cucumbers, &c., and to keep the various kinds in separate divisions.

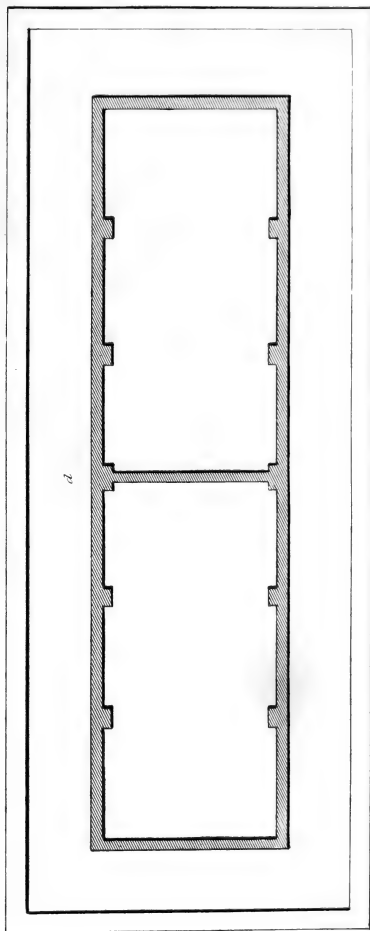
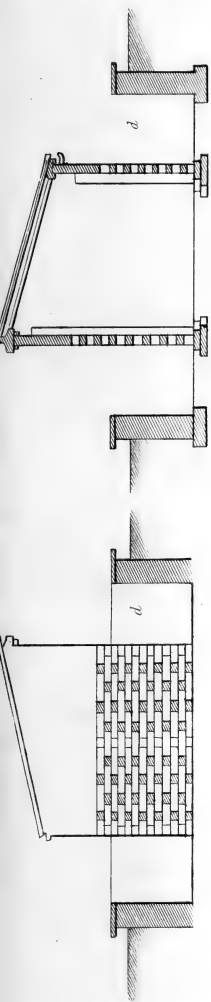

Circular Plan, End Elevation, and Cross-Section of the Lateral-Firing Pit.

CULTURE OF THE MELON.

The Melon and Cucumber plants, bearing a strong analogy to each other in their growth, require but little variation in their general treatment. The former being of a less robust nature, it is with more difficulty that a stock of healthy plants can be procured in the gloomy Winter months; frequent sowings are consequently made at various periods in January and February, in order to secure a stock of plants, which should be raised in a seed bed previously prepared for the Cucumber. When the plants have attained the height of two to three inches, with their seed leaves almost fully developed, they should be pricked out into pots about four inches diameter, placing three in each, as some of them will be liable to damp off; but when the season is more advanced, two plants in a pot will be sufficient. When the first or second rough leaf bursts forth, the plants should be stopped at the first or second joint, which will be the means of strengthening them, and induce lateral branches to push out from the centre of the plant. While they are nursing in the seed bed, the department in which they are intended to produce their fruit must be got in readiness, and prepared according to the directions specified for the Cucumber beds; and when the burning heat has subsided, the mould may be spread over the surface of the bed, and frequently

turned for a few days, so as that every part may become dry, and get into a warm congenial state for the reception of the plants. The soil that appears best adapted for the growth of the Melon, is the top spit (with the sward intermixed with it) of a pasture, that consists of rather a strong yellow loam, a few months previously prepared, well chopped up, and turned two or three times before it is used.

When the soil in the frames is thoroughly warmed through, and collected into hills under each light, the plants may be put in, turning them carefully out of their pots, and keeping them as close to the glass, in the first instance, as they will admit, as the fermenting substance will soon subside; and if not well prepared and trodden, it would leave the plants at too great a distance from the glass. After planting, a little aired water is given, to settle the soil about the roots. The lights must be now well covered during the nights, and the temperature in the frames not permitted to fall below 66 degrees with artificial heat, and from 80 to 85 degrees with sun heat; but when air can be freely admitted, the temperature may be increased 8 or 10 degrees. The exterior linings of dung must be well attended to, so as not to let the heat get too much exhausted before they are renewed with additional dung. A little fresh air should be given at all favourable opportunities, and the interior of the frame kept in a sweet and healthy state, otherwise the plants will make but little progress.

When their Vines begin to extend themselves, they must be kept pegged down to the surface, and

a little fresh soil added progressively to the hills, before the entire bed is moulded over to the depth of a foot or fourteen inches, which will be of sufficient thickness for the nourishment of the Melon plant. It is necessary, also, to be careful in watering the Melon; as if much is given close to its stems, it will be subject to canker and rot off before the crop of fruit is ripened; therefore the water should rather be applied to the extremities of the roots than to the centre. Care should likewise be taken not to injure or break the foliage, and to avoid wetting the incipient fruit and blossoms as much as possible. In short, while the fruit is setting, water should be almost suspended. At an early period of the year the impregnation should be assisted, as will be directed for the *Cucumber*. The Melon, being a plant rather impatient of much lopping, the Vines should be spread out thinly at the first arranging of the shoots, and the knife but sparingly used until the first crop is ripened off, only thinning out the weaker and unproductive Vines. But as soon as the fruit is gathered, it should have a thorough pruning, cutting away all the weak and unhealthy shoots, and shortening back those that are to remain to the most promising joints, which will push out strongly, and may produce as good or even a better second crop than the first. The heat of the beds will require to be kept up, by the exterior linings of dung, until Midsummer, when, if the weather is at all favourable, the effects of the sun will keep the internal atmosphere of the beds sufficiently high, and the linings may

be dispensed with. For succession crops, there must be additional beds prepared monthly, until the middle of June, when the last planting may be made for the latest crop of Melons ; the beds that are prepared in the latter months, will not require to be so strongly built as those which were made up at an earlier period of the year.

VARIETIES CULTIVATED.

Early Cantaloup.	Silver Rock.
Netted Ditto.	Romana.
Orange Ditto.	Smooth scarlet-fleshed.
Black Rock.	Green-fleshed.
Dutch Ditto.	George the Fourth.
Scarlet Ditto.	Valencia.

MANAGEMENT OF THE CUCUMBER PLANT.

The cultivation of the Cucumber, at an early period of the year, is attended with considerable risk and difficulty, especially when grown on dung beds, as the steam and moisture, arising from the dung, are very liable to damp and injure the tender plants; particularly when the weather continues, for any length of time, in such an unfavourable state as to prevent a free circulation of air being admitted into the frame.

When this fruit is wanted at an early period, the seed should be sown the latter end of November, or beginning of December.

Previous to sowing it there should be a one or two light box or pit prepared, in thickness of not less than four to five feet of well concocted dung, or leaves and dung mixed; these ingredients should be two or three times turned together previous to using, and allowed to ferment for about three weeks before it is made up into a bed, which will then become sweetened, and will retain the heat much longer than if made up in a recent state. When the bed is composed to the depth above specified, the lights should be kept close shut up two or three days, to assist in drawing up the heat, which will soon arise, when plenty of air must be admitted, to allow the rank

effluvia from the bed to pass away. As soon as the violent heat has subsided, the bed may be moulded over to the depth of three or four inches, and the seeds sown in pots from four to five inches diameter, and plunged in the mould about half way to the rims. In the course of a few days, after the seeds are sown, the cotyledons of the plants will begin to make their appearance; and when these are fully expanded, and the plants about two inches high, it will be time to remove them into other pots, by placing three plants in each, and giving a gentle watering, with water of the temperature of the bed, to settle the soil about the roots.

Much care and attention are required at this critical season, to prevent the plants from damping off; and the linings round the beds will require frequent turnings and additions of fresh dung, to prevent the heat from declining, which would, otherwise, soon become not of a sufficient warmth for the plants. The fruiting bed should also be got in readiness, and made according to the directions above-mentioned at this wintry period of the year. It is very desirable to have a strong body of the fermenting materials together, for the purpose of keeping up a good heat throughout the severest months; but as the season gets advanced, the beds may be prepared of less thickness than that specified. When the first, or second rough leaf makes its appearance on the seedling plant, it will be time to begin to prepare and mould the beds upon which they are destined to produce their fruit. The soil should be collected under each light to the depth of 12 inches, and

formed into round hills ; the top of which should be kept, at the first formation, pretty near the glass, as they will be sure to subside. The mould in which the Cucumber will grow freely and produce fruit, is one-half of maiden loam, one-fourth leaf mould, and one-fourth of decomposed good stable dung, which ingredients should be well incorporated together previous to using, and spread over the surface of the bed for a few days, before gathered into hills for the reception of the plants. As soon as the mould is in a warm and congenial state, the plants may be removed from the seed bed and committed to their final situation, placing three plants in each hill ; they should likewise have a little water to settle the soil about their tender fibres, which should be given of the same temperature with the atmosphere of the frame, as water, at this season, without the cold air being taken off, would chill and injure the plants. During the Winter months, the Cucumber requires a higher temperature for its preservation than even the Pine Apple ; consequently the atmosphere in the Cucumber frames should not be allowed to fall under 70 degrees, and should be permitted to get as high as 80 or 85 degrees by sun heat. The external dung linings will require to be frequently turned, and fresh dung added to renew the heat. Air should likewise be admitted at all favourable opportunities ; in short, even in the most severe weather, a little ought to be given daily, which will increase the vigour and health of the plants, as nothing is more pernicious to their growth than being shut up for any continued time without it. When

the *dung* that is applied to the exterior of the pits is in a rank state, it will sometimes appear necessary to leave the lights a little tilted behind during the night, so as to allow the steam that may collect in the frame to pass away. The ends of the mats must, however, be lapped over the apertures thus left, otherwise the frosty winds will be liable to injure the plants. When the weather is very severe, the beds or pits should be covered early in the afternoon with two or three tiers of mats, and not uncovered before nine o'clock in the morning. When the fruit blossoms begin to make their appearance, it will be necessary to assist nature at an early period of the year, by taking off the male flower, and inserting its anthers into the fertile blossom, when it is fully expanded, as the limited admission of air that is given in the Winter season is not sufficient for the dispersion of the pollen for impregnation, without which the fruit will not swell; but at a more advanced period of the year, the current of air, and the bees that generally frequent the Cucumber and Melon bed, are the best and most natural sources of fertilization. As the plants advance in growth, they should be regularly pegged down to the surface of the bed, also gradually adding mould to their hills, until the entire bed is covered over to the depth of a foot or 14 inches. Occasional waterings will be required, but care must be taken not to give them in such quantities as will sour and saturate the soil. The dung linings which surround the bed will also require to be frequently attended to and renewed, in order to keep up the requisite degree of heat

amongst the plants. Should there have been a favourable portion of sun throughout the month of February, the plants will then be shewing fruit, and will be fit for cutting by the beginning or middle of the ensuing month. When a large supply of this fruit is wanted, a succession of crops will require to be kept up, by ridging out young plants every month or six weeks till June, when the plants put out on the ridges, for prickly Cucumbers, will keep up a supply until they are destroyed by the frost.

The Plants in the frames will require to be looked often over in the course of the season, and thinned out by removing such superfluous and decayed shoots as may appear; they will also require large supplies of water throughout the Summer months; by all which processes they may be kept in a productive state for eight or nine months in the year.

Cucumbers may be also successfully grown and brought to perfection in the Winter months, on the back flue or front curb of a Pine stove, or in any other compartment in which the temperature is kept from 68 to 70 or 75 degrees; and when the plants can be placed so as to receive the full benefit of the sun and light in the gloomy months. The most successful cultivator of this fruit, at an early period, that I have yet seen, is Mr. Forrest, at Sion Gardens, who grows it in great perfection in the Winter season, and who has got a particular sort of Cucumber, that he calls the Sion Free-Bearer, which is well adapted for Winter culture, and produces fruit in great abundance in the Pine stoves, from November, until the other sorts come in, in the regular

frames. The seeds of this kind are sown in August, and nursed in small pots until fit for planting out, when the plants are placed in boxes about two feet long, and which are made so as to stand on the top of the back flue of the Pine stove, where they are placed. There is also a trellising for training them, formed over the back path of the Pine house, where the plants are exposed to the greatest degree of heat and light in the house. This method appears to be the most simple and effectual for procuring a crop of Cucumbers in the Winter season, that I have ever seen. It is a plan that has been long pursued by Mr. Aiton, in the Royal Gardens, although not, perhaps, with the same degree of success; the stove in these gardens being not so well adapted for the culture of this plant as those at Sion, which have also the advantage of a steam boiler, whereby the house can be at pleasure filled with vapour, which is known to be most conducive to the health and vigour of the Cucumber plants.

CUCUMBERS CULTIVATED.

Lancashire Prize-Fighter.
 White Turkey.
 Green Turkey.

Superlative.
 Early Short Prickly.
 Sion Free-Bearer.

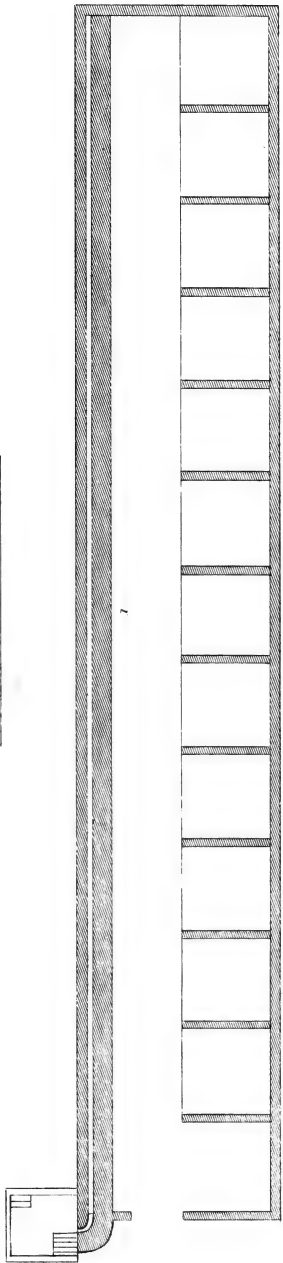
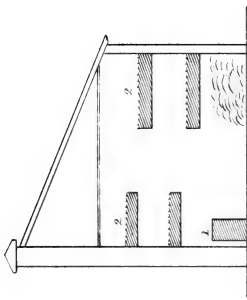

Mushroom House.

CULTURE OF THE MUSHROOM.

The Mushroom being in great demand throughout the greater part of the year, for various culinary purposes, it is necessary to have recourse to artificial means for prolonging its season, and to bring it to perfection in every month of the year.

Various methods are adopted for the cultivation of this vegetable, such as growing it on shelves, boxes, and ridges, &c. of well prepared and fermented dung out of doors, which most unquestionably produces Mushrooms of a superior quality to those grown in the German method. When Mushrooms are to be grown on ridges out of doors, it is necessary to have the beds of a sufficient thickness, say, four feet in the centre, if formed sloping to both sides; but if made against a wall, four feet at the back and gradually sloped to the ground level, will contain a considerable body of materials for retaining the heat, and affording nourishment to the Mushrooms. As soon as the heat of the bed is ascertained to be of a moderate temperature, the surface should be levelled, and about two inches of dry light loam put over it, and the spawn inserted through the mould, or placed on the dung previously. It will be advisable not to spawn and mould the entire surface at once, in case of the bed heating and injuring the spawn; the space of two or three feet from the top may be left for a few days, to allow

the steam and heat to evaporate. The bed must be carefully protected from the inclemency of the weather, and regularly covered with straw or litter, and bass mats. Mushrooms are more frequently grown in sheds, where they can be protected from the frost and wet, on ridges prepared similar to what I have described, and which should, also, have a little straw or short hay spread over their surface. To detail, however, all the various ways of cultivating this vegetable, would be a tedious undertaking.

The accompanying Plate, No. 25, represents the Ground Plan and Section of the Mushroom-House at Woburn Abbey, which is similar to what is generally used in Germany for the culture of this vegetable; it was introduced into this country by Mr. Oldacre, Gardener to the late Sir Joseph Banks, and is, undoubtedly, the most successful means of bringing the Mushroom to perfection during the Winter months.

The dimensions of this house are 70 feet long, and 10 feet in width, inside measure: the height of the front wall is about eight feet, and that of the back 12 feet high. In this house there are rows of beds along the front wall, which are about four feet square each; the partitions which divide the beds in the length, consist of brick work, and the shelves are supported by cast metal bars. There are also two tiers of beds that run along the back, as is indicated in the section, which are supported by cast metal bars, similar to those of the front; along the floor of this house, immediately under the first tier of shelves, a quantity of dung or leaves is introduced, which

assists in keeping up a moist heat in this department, and renders less fuel necessary.

The materials most generally used for the formation of the beds, for producing the best crop of Mushrooms, are horse droppings, and short litter recent from the stables; to these may be added a small portion of sandy loam, which will the better cement the other materials together. The Mushrooms will, however, succeed very well without any mixture of mould through the beds, if they have a sufficient body put over the surface for them to vegetate and run amongst. The droppings that are intended for forming the receptacle for the spawn, should be collected fresh from the stables, together with about one-fourth of the shortest litter; these ingredients must be spread on the floor of the house for a few days to dry, before they are made up into a bed; if the house is of too limited dimensions to admit of the droppings being spread on it, a shed or any other airy and convenient place will do as well, so that the moisture may evaporate before the materials are formed into a bed. When the ingredients appear to be in a moderately dry state they may be formed into a bed, observing to beat them as compactly together as possible, to the thickness of eight inches; a mallet should be used for this purpose, in order that every part of the beds may be rendered into a compact solid substance. These beds should not be made of a greater thickness than that specified, otherwise they will be subject to a strong fermentation, which will partly rot the materials, and render them less congenial to the vegetation of the spawn.

If, again, they are made up of much less substance, the body will be too slight for affording that degree of nourishment requisite for the maturity of the Mushroom. When the beds appear a little more than milk warm, which may be ascertained by thrusting watch sticks in them, (or placing a thermometer in the dung,) and when this indicates from 80 to 90 degrees, the beds should be again beat, so that every part may be made as compact and solid as it will admit; it is upon the solidity of the materials, and proper fermentation, that our success of a crop depends. The beds must not, therefore, be permitted to heat violently; but as soon as at the degrees above-mentioned, there should be a number of holes, about three inches in diameter and from seven to nine inches apart, made all over the surface of the beds. These holes will be the means of tempering the bed, and preventing the too strong fermentation taking place, which would render the beds unproductive; they are likewise intended for depositing the spawn, which may be put in three or four days after they are made, providing the temperature does not exceed 80 or 90 degrees; the spawning of the beds should be performed when the heat is on the decline—as if done when in a strong degree of fermentation, the spawn would be injured, and rendered abortive. This operation must likewise not be deferred until the heat is too much subsided, otherwise there will not be that congenial degree of temperature necessary for the production of a crop. When the beds appear in a proper state for spawning, the holes previously made in them should be well crammed

with the spawn, and their surface levelled, and left in this state until the spawn is beginning to vegetate, when they should be covered all over with light dry sandy loam, to the depth of two inches ; should the surface of the beds appear to get rather too dry for the running of the spawn freely in, a sprinkling of water should be given occasionally ; but observe not to give much at a time, in case of saturating or rotting the spawn. The Mushrooms will generally begin to make their appearance in the course of seven or eight weeks after the spawn is deposited in the beds, and will continue to produce good crops for several weeks ; the successions must be kept up by the making of fresh beds as they appear to be required, which will prolong the season of this vegetable from November, until they can be procured in the open air.

HOT WALL.

The accompanying Plate, No. 26, represents the Ground Plan of a wall, heated by Hot-water; the pipes are introduced along a cavity, that commences within a few inches of the bottom of the wall, and is continued to the top, but is connected by piers, that are carried up about four feet apart, which unite the back and front of the wall together, and render it, although hollow, equal to a solid one in strength; they are also found more economical in erection, as there is a considerable saving of materials.

In this structure, the *boiler* is also placed in the shed behind, where the fire is attended to, and the two pipes proceed one directly under the other, along the cavity to the extremity of the wall, where they are connected to an oblong square box, into which the water flows from the upper pipe, and returns to the boiler by the under one; and whilst any heat is continued in the furnace, the water will flow and circulate from one extremity of the wall to the other. The caloric given out from the pipes, produces a gentle heat in the brick wall against which the trees are planted, and the warmth given out from the bricks protects the blossoms from being injured by the frosts. It is, however, necessary to have a strong fire applied under the *boiler* from the time the blossoms begin to expand, until the fruit is set, and beginning to swell off, as the

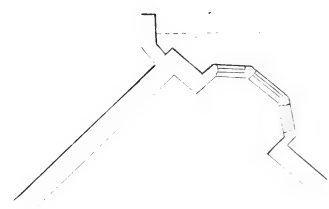
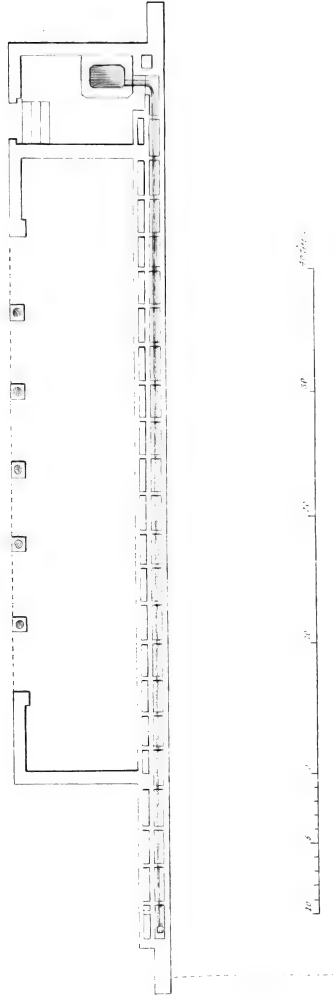

Plan of Hot-wall, & Back-shed.

hot-water pipes require to be kept constantly hot, in order to produce a gentle warmth in the brick work.

I am, however, inclined to think, that frame-work, with rafters, placed against a wall, and made as the Melon lights, or any other not in use, if applied for a few weeks, when not wanted for the early crops, would be attended with much less expense, and generally more successful than heating by hot-water. The pipes, &c. at first erection, will cost nearly as much as the frame-work, and there is, also, an annual expense for fuel, which, in this part of the country, where coals generally cost about 1s. 8d. per bushel, soon amounts to a considerable sum; but by having frame-work, and applying the late Melon and Cucumber pit lights, while the trees are in blossom, fire, and hot-water pipes will be unnecessary, as the fruit will be sufficiently forwarded by the influence of the sun, by the time the lights are wanted for the late crops of Melon or Cucumber. The young wood, in Autumn, if not perfectly ripened, may be also matured by adopting such spare lights as will fit the rafters and frame-work for a few weeks, as the effects of the sun through the glass will be sufficient for the perfecting of these shoots.

This wall is chiefly occupied by *Apricots*, and *Cherry trees*; and by applying artificial heat as soon as the flower buds begin to expand, the fruit is accelerated at a much earlier period. This hot-wall appears well adapted for the exciting and forwarding the Cherry at an early period; as being protected

from the frost by the heat in the brick work, and fully exposed to the influence of the sun and air, (a free exposure of which is necessary for the setting of the fruit,) it sets and swells off in great abundance.

CULTURE OF THE CHERRY.

It is universally acknowledged, that of all fruits accelerated by the aid of artificial heat, that of the Cherry is the most difficult, particularly at an early season, as the tender blossoms are very liable to drop off without setting their fruit, which is generally occasioned by the imperfect impregnation of the parts of fructification; therefore, when a supply of this fruit is wanted at the table, at an early season, there should be a large stock of trees kept in large pots or boxes, and grown on the premises for a year or two previous to placing them in the Forcing Houses, in order that they may get their roots well established in the pots or tubs, which should then be plunged in rotten leaf mould, and kept regularly supplied with water during the Summer months, in which situation they are left until wanted to be brought into the Cherry House, which is generally about the 1st of February, when the first set of trees is introduced; and for a succession of fruit there are other sets of trees brought in, about three weeks afterwards, and so on, until all that are intended to be forced through the early part of the season are introduced, bringing in only about a dozen and a half at a time; and those first excited will generally have ripened their fruit by the latter end of April, when

they are removed, to make room for the last succession. In the centre of the Cherry House here, is a pit about four feet deep, which is filled with tree leaves, for the plunging of the pots amongst; but there is very little bottom heat admitted to the roots of the trees.

The temperature of the house is afterwards kept very low, to correspond as nearly with the external atmosphere as possible, in order to strengthen the flower buds; but when they begin to expand, it is necessary to increase the temperature, so as to prevent their receiving any check from a too sudden transition of cold to heat, when the weather is so changeable in the early part of the season. When the fire is first lighted, the thermometer is regulated in the evenings to about 45 degrees, and not allowed to exceed 55 degrees in the day, for the first fortnight, allowing a large portion of air at all favourable opportunities, and keeping the trees well syringed with water, until their blossom is expanding, when the syringe is dispensed with, and the atmosphere of the house kept in a humid state, by pouring water on the hot-water pipes and foot-paths. From the time the flower bud begins to expand, the temperature is gradually increased, until it is raised to 60 degrees in the evenings, and about 65 degrees throughout the day, at which heat the house is continued till the setting of the fruit is over, when it is increased to from 60 to 65 degrees; but, by this time, the external state of the air will correspond, in some measure, more nearly with the atmosphere of

the house, which will, consequently, admit of a large portion of air through the day, keeping the thermometer five or seven degrees higher by the influence of the sun than it is regulated at in the evenings by artificial heat.

FORCING OF STRAWBERRIES.

The fruit of the Strawberry may be successfully brought to perfection at an early season, by placing a number of these plants in any of the forcing houses, where they can have a free circulation of air and light, and can be kept well supplied with water, as they appear to require it. They may also be grown and fruited, in small pits, heated with hot water. The pits might be adapted, with advantage, for the growth of the *Melon* or *Cucumber*, during the Summer months, after the Strawberry forcing is over.

But those forcing houses that are constructed with upright or front lights, are well adapted for producing an early crop of Strawberries ; and a succession of this fruit may be kept up by placing a row of their pots along the front of the house, as near to the glass as possible, where they will have the full benefit of the sun and light. A regular succession of plants should be placed in each compartment, according as artificial heat is applied for the acceleration of the other fruits, which will bring the Strawberry to perfection, without any additional expense for fuel. A constant supply may thus be obtained from the beginning of March, until the regular fruiting season in the open ground.

The principal point in Strawberry forcing is, to have a large stock of well prepared plants, that have

been potted, and whose roots have become well established in their pots, the previous Autumn; a supply, therefore, must be provided as soon as the runners have formed tolerably good roots, which they generally will have done by the month of July. They should be taken from the parent plant, and the strongest planted three in a pot, in good light rich loam. Pots from eight to nine inches in diameter, with a proportionate depth, will be a very suitable size for this purpose. As soon as potted, they should have a good watering, and be then plunged in old tan, or decayed leaves, in an open situation, and shaded from the effects of the mid-day sun, until they have taken root. They should be regularly supplied with water, and kept free from weeds; and should any flowers appear on any of the plants in Autumn, they should be pinched off. In this situation they may be left to remain, until the frost sets in, when they may be removed to a cold pit, or frame, or otherwise preserved from the severity of the frost by a covering of long straw, which will protect them, and prevent the pots from being broken, which frequently occurs by the expansion of the mould in the pots, in frosty weather. The number of plants required to be potted, must be regulated according to the family demand for this fruit, and the means for accelerating them. The kinds of Strawberries that appear most appropriate for early forcing, are, *Keen's Seedling*, *Bath*, and *Grove End Scarlet*, the *Roseberry*, and *Alpines* when raised from seed.

FRENCH BEANS.

The Kidney Bean, as a culinary vegetable, is in much demand in most families ; but by its being a native of a tropical climate, it requires a high temperature to bring it to perfection at an early season. It is most generally and successfully cultivated in the Pine Stove, the atmosphere of which appears congenial for its growth and maturity in the Winter months.

French Beans may be likewise forwarded and brought to perfection in small pits heated with hot-water ; and in pits, where the temperature is kept up by external linings of dung ; but when there is room on the back flues, or front curbs of the bark bed in the Pine Stove, they will be accelerated with less expense and trouble by growing them in pots, and placing them on the stone curbs or back flues ; a large supply may thus be regularly grown, and continued during the Winter season in this department, without increasing the consumption of fuel, or applying linings of dung, which must be resorted to, if grown in a pit separately.

About the middle of December, two or three large pans, about six inches deep, should be filled with light rich mould, that has been well incorporated with rotten dung ; these pans should be thickly set with the Beans, placing them quite close together, as, if old seed, many of them will not vegetate ;

there should be about two inches of the same mould put over them as a covering, when they may be placed in the most convenient or vacant space in the Pine Stove. If the pans are not very large, they may be plunged betwixt the Pine plants in the front row of the pit, where they will have a slight degree of bottom heat, which will induce them to vegetate more readily.

When the plants have attained four or five inches in height, they should be transplanted into pots about nine or ten inches in diameter, and about the same dimensions in depth, filling the pots only half full, or little more, when the plants are first put in them; the remaining space to be filled up when they have grown a few inches beyond the rims of the pots, which will serve as a moulding, and a support to their stems, when at a more advanced stage of growth. In removing the plants from the seed pan, great care must be taken not to injure any of the roots; but endeavour must be had to remove them with as much of the mould attached as possible, which will, in a great measure, secure them from receiving any serious check in the transplanting. Three plants will be sufficient to put into one pot, which should have, immediately after their insertion, a little water given them, to settle the soil about the roots; the water should be of the same temperature as the atmosphere of the house, and frequently applied when they are in a growing state; but observing not to keep them too wet, in case of their damping off, when they are in rather a tender state, particularly during the severity of the Winter

months. The pots should be placed in such a situation as to secure as much of sun and air as possible, in order to strengthen the plants, and prevent their being drawn up in a weak or sickly state, and rendered unproductive. Frequent syringings will be necessary over their foliage, in order to suppress the thrips and red spider, which often make great havock amongst the leaves, particularly the latter insect, which is, however, easily destroyed by frequent syringings, or by sprinkling a little sulphur on the flues or pipes, when hot, which will effectually eradicate this depredator for a time. The thrips will require to be suppressed by fumigations of tobacco; but when the atmosphere of the Pinery is kept in a humid state, these intruders are not so troublesome as when a dry high temperature is kept up. As soon as the plants appear in flower, they should be bountifully supplied at the root with water that has been well impregnated with animal or pigeon dung, which will greatly invigorate their growth, and prolong their bearing.

FORCING OF RHUBARB.

The stalk of Rhubarb being an excellent esculent for making tarts when blanched, this vegetable is extensively cultivated for the purpose in most families ; and there are few tables at which this is not a favourite dish, in the early part of the season. Rhubarb is likewise a vegetable that can be brought to perfection by artificial means, with less trouble and expense than most vegetables that are accelerated, as heat and moisture are the most essential necessities for the invigoration and maturity of this plant, sun and light not being requisite for its growth ; as, in short, the foot-stalks and leaves will grow and develop as strongly by being excluded totally from the light. A large supply of Rhubarb may be continued from December, until its season is over in the natural ground. Therefore, to accelerate this herb, the roots should be taken carefully up, and packed closely together in boxes, from two to three feet long, and from a foot to 18 inches wide, and about the same proportion in depth. The interstices between the roots should be filled with sandy loam, which should be washed in amongst them by a good watering, and then placed along the top of one of the hot-water pipes or flues, in any of the forcing-houses that are at work, or in the Mushroom-House. The plants should be well supplied with water, and as soon as the buds begin to vegetate, a box should

be inverted over them, to exclude the light, and to blanch the foot-stalks, &c. One or two of these boxes, filled and put into any of the Forcing Departments, at different periods, will produce a large supply and succession of this vegetable, until it appears in the open ground.

Where there are no Hot-Houses, this plant may also be accelerated in the natural ground by placing boxes over the roots, and covering them with hot-dung or leaves, or a mixture of each, which will soon produce a sufficient heat to excite the herb into a vegetating state.

Rhubarb may likewise be successfully grown on beds, such as those described for the acceleration of Asparagus, Sea-Kale, &c., and excited at an early period with linings of dung, or leaves, applied between the beds, when the roots will produce large crops annually, without injury. Those grown in boxes should be fresh planted every year with plants from one to two years old; and as soon as the crop of leaves is over, these roots should be again divided and planted in the open ground, when they will get established, and be again fit for forcing. When a large supply of this vegetable is in demand, a little seed should be sown annually, to keep up a good stock of young plants for acceleration.

FORCING THE POTATOE.

New Potatoes being, at an early period of the year, a favourite luxury, are, naturally, then in much repute. This root is most generally accelerated by prepared beds of fermenting substances, such as dung or leaves, or a mixture of both; either will form very suitable beds. If dung is used, it will be necessary to have it turned several times before it is made up, in order to allow the rank steam to evaporate, and the violence of the heat to subside; but if leaves only are used, as is the case here, they may be formed into a bed at once, as the evaporation arising from them will not injure the Potatoe sets. When Potatoe beds are made up in January, they should consist in thickness of three feet, at least, as it is necessary to have a good body of dung or leaves together, in order to retain the heat through the severity of the Winter, although a very low temperature will be quite sufficient for bringing the Potatoe to perfection: it is necessary to protect them from cold and frost, of which it is very impatient. As soon as the temperature of the bed is ascertained to be of a mild heat, the surface should be well trod and levelled, and have from four to five inches of light sandy dry soil spread over it; this soil should be well incorporated with rotten dung or leaf mould. While the dung or the leaves are getting in readiness, the Potatoes should be cut, and the roots

placed in a situation to dry previous to their being inserted in the mould, or they may be accelerated in one of the Forcing-Houses, or other frames at work, in flower pots or boxes, and transplanted into hot beds prepared for their reception, as soon as they appear in a fit state to receive them. The plants, or sets, should be placed in rows from 10 to 12 inches apart, and from four to five inches in the rows.

When the bed is completed, if planted with Potatoes previously excited, a little aired water should be given to settle the soil around their roots. But when the sets are inserted in the ground, without being previously forced, no water will be necessary, as the steam and moisture arising from the bed will be quite sufficient. The lights must be carefully covered with bass mats during the night, but a large admission of air allowed daily, when the weather will permit. Should the heat of the bed decline before the crop is nearly matured, an application of dung must be had to the linings, which will infuse a fresh heat in the bed, and promote the growth of the Potatoes. The internal atmosphere should be kept from 50 to 60 degrees. When the stalks have advanced in growth from six to eight inches, an additional supply of mould should be carefully put in betwixt the rows, as a landing for them. As the stalk proceeds in growth, and the weather becomes warm, water may be more freely administered, regulating the supply to the condition of the bed, which must always be kept in a moist vegetating state. Potatoes are often success-

fully brought to perfection by forming a bed, and enclosing its sides to keep in the mould with stakes, enveloped with hay or straw bands; and covering the surface over with straw and mats, to protect it from the wet and frost; which practice, if commenced in January, and carefully attended to in severe weather, will answer perfectly well, and the fruit be ready about May; as early nearly, as if accelerated under glass.

SEA-KALE, OR ASPARAGUS BEDS.

The beds for forcing these favourite vegetables may be constructed any length, and from three to four feet wide, which should be formed by building two parallel walls of open brick work, and to consist of four-inch work, with nine-inch piers, at five or six feet apart, to give durability to the thinner brick work. These walls should be about three feet high; if the substratum is of a dry nature, they may be sunk entirely under the ground level; but, if otherwise, a foot of the walls should be raised above the ground, and that space filled up with light sandy loam and leaf mould, for the plants to grow in. The top of the walls should have a coping of wood, to prevent the brick work from being displaced, or injured, by the frost or wet. The spaces between the beds are filled with leaves and dung mixed, or either material will answer, if a sufficient body is applied, which will produce a heat through the open brick work, into the beds, so as to promote the acce-

leration of the plants. These beds should be covered with wood covers, made with a rise in the centre, in order to throw off the rain water that falls ; or they may be covered with mats and hoops ; but the former is the more durable method.

ASPARAGUS.

This favourite vegetable is justly considered as one of great luxury during the Winter months. The acceleration of it, by artificial heat, in order to produce it in perfection at an early period of the season, is now very generally resorted to. By these means, a supply of it may be continued, from the beginning of December, (or earlier,) until the time when it appears in the open ground in its natural state.

The most general method of exciting this plant, is by forming beds of well prepared dung, or a mixture of leaves and dung. Either of these materials, separately, will form very suitable beds, if previously well prepared. The dung, or leaves, should first be thrown in a heap, and frequently turned over for a fortnight or so, in order that it may be well fermented, and that the rankness of the steam may fully evaporate. When the materials appear well fermented, and sweated, they will be fit for formation into a bed ; which should be made for an early crop, to the thickness of three or four feet, in order that it may return a steady heat through the severity of the Winter. Where the bed

is not formed within the pits erected for the Melon or Cucumber plants, it should be made to fit a three light Melon or Cucumber frame, and this put on, as soon as it is made up, in order to preserve the bed from getting wet; and to draw up the heat, by keeping the lights shut close for a few days. But as soon as the heat arises, the light must be removed every fine day; and if wet, a large admission of air be given by tilting up the sashes, so as to allow the rank steam to escape. When the heat has subsided, and the bed appears of a moderate temperature, it should be well trod and levelled, and then about two inches of dry loam spread regularly over the surface. After the bed is thus prepared, and the heat well regulated, a fine dry day should be chosen for taking up the plants. The Asparagus which has produced the strongest, and most vigorous shoots, the preceding Summer, should be selected for this purpose. Their age is of little consequence, providing they are strong and healthy; they should, however, not be less than three or four years previously established. The roots must be very carefully taken up, injuring but as few of the small fibres as possible; neither should they be exposed to the weather but as little as circumstances will admit. They should be immediately carried to the bed, and packed closely together, regularly over its surface; observing to keep the crowns as near to a level as possible, and sprinkling a little fine dry mould over them as you proceed, to fill up the spaces amongst the roots; when the bed is thus finished, and the soil used is very dry, a slight watering may

be given, which will settle it more compactly amongst the fibres. The surface may then be left in this state, until the buds are beginning to vegetate, when it will require to be covered with light dry loam, to the depth of four inches. The lights should be slid down every fine day; and if the heat appears too violent for the roots, they may be removed entirely in the day time, and left partly open at night, which will allow the heat to escape. A very moderate temperature will be quite sufficient for accelerating this vegetable; and if the atmosphere of the pit or frame is kept from 50 to 54 degrees during the night, and from 60 to 65 in the day by sunshine, it will be quite as high as is necessary.

As soon as the buds begin to make their appearance through the soil, a large admission of fresh air must be daily given, in order to prevent the shoots from being drawn up weakly, and to give a colour and flavour to the grass. The lights should likewise be covered at night with bass mats, and carefully preserved from frost, lest it might injure the tender shoots. When the grass appears to have advanced in growth four or five inches above the surface of the bed, it will be in a fit state for cutting, which should be carefully performed, so as not to injure any of the buds that are still concealed under the surface. The soil should be cleared away close to the shoots, and then cut as low as the roots will admit.

SEA-KALE.

This is reckoned one of the most valuable esculent vegetables that is indigenous to Britain, that we have got; and when accelerated by artificial heat, it is considered by many to be equal, or but little inferior to the *Asparagus*. The shoots of the Sea-Kale, when blanched, are extremely useful in Culinary dishes, during the Winter months, and are, at that period of the year, a luxury at table.

Various methods have, in consequence, been resorted to for bringing it to perfection at an early season, when there is a scarcity of other vegetables. But the more general and equally successful mode adapted for its cultivation, is by covering the beds or ridges on which the Sea-Kale is growing in the natural ground, with hot stable dung, or a mixture of dung and tree leaves. The beds selected for this purpose, should consist of strong crowns, whose roots have got well established in the ground. Those crowns that were planted the preceding Spring, if well supplied with water in dry weather, while striking root, will be fit for accelerating the ensuing Winter.

The decayed leaves and stems of the plants should be all cleared away, and the surface of the beds stirred up and cleared from weeds and filth; and then a covering of old tan, leaf-mould, or coal ashes, spread over them; then over each crown

place a large flower pot, or such pots as are generally made purposely for the blanching of the Sea-Kale. The holes in the pots must be all stopped, in order that the steam arising from the fermenting substances, may not get in to injure the tender shoots, when they are in a growing state. As soon as the plants are covered with the pots, a layer of the fermenting materials should be spread all over the bed, to the depth of from 15 to 20 inches, which thickness should be regulated according to the state of the weather; but observing, not to make the bed too strong, in case of injuring the crop, or drawing up the shoots in a weak state. If a temperature around the plants of from 55 to 60 degrees can be kept, it will be quite sufficient for bringing this vegetable to perfection, in the course of about three weeks after the beds are made up; and which may be had at the table in December; and its season prolonged until they appear in the open ground; and if covered with coal ashes, or turf-mould, it will considerably tend to blanch the shoots, and accelerate their growth.

INDEX GENERUM.

	Page.		Page.	
Argyreia	37	Natural Order.		
Argemone	121	Convolvulaceæ.	123	Bixineæ.
Aristolochia	203	Papaveraceæ.	179	Compositæ.
Arthrostemma	94	Asarineæ.	45	Pittosporææ.
Artocarpus	203	Melastomaceæ.	136, 137	Bigoniaceæ.
Ardisia	49	Urticeæ.	64	Asphodéleæ.
Arãlia	58	Myrsineæ.	3	Chenopodeæ.
Aster	188, 190	Araliaceæ.	105	Melastomaceæ.
Astéma	184	Compositæ.	64	Hemerocallideæ.
Astragalus	166		107	Homalideæ.
Astrolobium	165		199	Orchideæ.
Aspalathus	168	Leguminosæ.	227	Filices.
Aspidium	220		25	Ericææ.
Asplénium	226	Filices.	77	Sapindaceæ.
Asphodelus	61		168	Leguminosæ.
Asparagus	67	Asphodéleæ.	168	
Asperula	27	Rubiaceæ.	184	Compositæ.
A'sarum	105	Asarineæ.	—	Chenopodeæ.
Asey'rum	175	Hypericineæ.	198	Orchideæ.
Astroloma	36	Epacrideæ.	229	Filices.
Astrap'æa	158	Buttneriaceæ.	26	Rubiaceæ.
Asclépias	50	Asclepiadeæ.	30	Boragineæ.
Asperugo	30	Boragineæ.	75	Rutaceæ.
Atragène	128	Ranunculaceæ.	105	Papaveraceæ.
Athanásia	181	Compositæ.	141	Myoporineæ.
Athrixia	186	Umbelliferaæ.	3	Nyctagineæ.
Athamánta	54, 55	Aurantiaceæ.	217	Terebinthaceæ.
Atalántia	92	Solaneæ.	55	Asclepiadeæ.
A'tropa	35	Polygoneæ.	157	Leguminosæ.
Atraphaxis	69	Chenopodeæ.	98	Scrophularineæ.
A'triplex	222	Labiataæ.	140	Crassulaceæ.
Audibértia	7	Lorántheæ.	89	Cruciferaæ.
Aúcuba	205	Cruciferaæ.	146	Bromiaceæ.
Aubriétia	144	Tiliaceæ.	45	Hemerocallideæ.
Aublétia	—	Proteaceæ.	11	
Aúlix	218	Gramineæ.	198	Orchideæ.
Avèna	19	Balsamineæ.	199	Stackhouseæ.
Averrhòæ	103	Ericææ.	47	
Azáleæ	39	Hypoxideæ.	18	Gramineæ.
Barbacénia	70	Labiataæ.	19	
Ballòta	132	Leguminosæ.	18	
Baptístia	98	Irídeæ.	64, 68	Bromeliaceæ.
Bauhínia	96	Chenopodeæ.	64	Amaryllideæ.
Babiána	12	Proteaceæ.	103	Polygoneæ.
Basélla	57	Malpighiaceæ.	207	Cucurbitaceæ.
Bánskia	24	Cunoniaceæ.	223	Euphorbiaceæ.
Banístéria	103	Scrophularineæ.	167	Leguminosæ.
Bauçera	125	Acanthaceæ.	95	Malpighiaceæ.
Bártsia	138, 140	Cruciferaæ.	25	Scrophularineæ.
Barléria	137	Compositæ.	193	Compositæ.
Barbarça	145		48	Rubiaceæ.
Báçcharis	183		206	Euphorbiaceæ.
Balsamíta	181	Gramineæ.	28	Caryophyllææ.
Balbisia	184	Loaseæ.	53	Umbelliferaæ.
Bambúsa	69	Myrtaceæ.	53	
Bartónia	109	Apocineæ.	69	Bromeliaceæ.
Ba'çkia	75, 232	Labiataæ.	66	Asphodéleæ.
Beaufórtia	174	Aurantiaceæ.	90	Butomeæ.
Beaumóntia	36	Compositæ.	225	Terebinthaceæ.
Betónica	132		46	Pittosporææ.
Bergèra	92	Chenopodeæ.	133	Labiataæ.
Béllis	187	Umbelliferaæ.	103	Malpighiaceæ.
Béllium	183		123	Capparideæ.
Berckhéya	195	Compositæ.	9	Bigoniaceæ.
Béta	52		33	
Berberis	68	Chenopodeæ.	66	Amaryllideæ.
Begónia	208	Berberideæ.	198	Orchideæ.
Bétula	209	Begoniaceæ.	198	
		Betulineæ.	199	
			199	

INDEX GENERUM.

	Page.	Natural Order.		Page.	Natural Order.			
Callistemon	111	} <i>Myrtaceæ.</i>	Centroclivium	186	} <i>Compositæ.</i>			
Calothamnus	174		Centaurea	195				
Calytrix	111		Centrocarpha	194				
Caryophyllus	109		Celastrus	44		} <i>Celastrineæ.</i>		
Camphorosma	—		Cercis	99				
Caprifolium	43		<i>Caprifoliaceæ.</i>	224		} <i>Leguminosæ.</i>		
Caryocar	147		<i>Rhizoboleæ.</i>	108				
Calathæa	1		} <i>Canneæ.</i>	Ceanothus		44	<i>Cactæ.</i>	
Cánna	1			<i>Huloragææ.</i>		Celosia	46	<i>Rhâmneæ.</i>
Callitriche	3		} <i>Scrophularineæ.</i>	Cérbera		46	<i>Amaranthæceæ.</i>	
Castilleja	140	<i>Rubiaceæ.</i>		Ceratophyllum	207	<i>Apocineæ.</i>		
Calceolaria	7, 231	<i>Solanææ.</i>		Cerastium	104	<i>Ceratophylleæ.</i>		
Capraria	142	} <i>Compôsitaæ.</i>		Cerátunculus	27	<i>Caryophylleæ.</i>		
Catesbæa	26			<i>Umbelliferaæ.</i>	Céltis	224	<i>Primulæceæ.</i>	
Cápsicum	35	<i>Bombacææ.</i>		Cerínthe	30	<i>Urticeæ.</i>		
Carlina	179	<i>Cupuliferaæ.</i>		Cephalótus	107	<i>Boraginææ.</i>		
Catanánche	178	<i>Celastrineæ.</i>		Ceropégia	55	<i>Rosæceæ.</i>		
Cælestina	—	} <i>Compôsitaæ.</i>		Charlóodia	61	<i>Asclepiadææ.</i>		
Cárthamus	178			<i>Aroideæ.</i>	Chelone	141	<i>Asphodéleæ.</i>	
Cacalia	181		<i>Ericææ.</i>	Chrysocoma	179	<i>Scrophularineæ.</i>		
Callistemma	187		} <i>Compôsitaæ.</i>	Chrysanthemum	192	} <i>Compôsitaæ.</i>		
Carlowizia	—			<i>Umbelliferaæ.</i>	Chaptalia		196	
Caléndula	196			<i>Bombacææ.</i>	Chærophyllum		53	
Cassinia	196			<i>Cupuliferaæ.</i>	Chionanthus		4	<i>Umbelliferaæ.</i>
Cárduus	180			<i>Celastrineæ.</i>	Chimáphila		99	<i>Oleinaæ.</i>
Caúcalis	53			} <i>Compôsitaæ.</i>	Chorizema		98, 232	<i>Ericææ.</i>
Carolinea	162				<i>Aroideæ.</i>		Choiránthus	145
Castanea	—	<i>Ericææ.</i>			Chloróxyton		92	<i>Cruciferaæ.</i>
Cassine	44, 57	} <i>Compôsitaæ.</i>			Chloránthus		23	<i>Cedréleæ.</i>
Cállá	72				<i>Umbelliferaæ.</i>		Chirónia	33
Caládium	208		<i>Bombacææ.</i>		} <i>Gentiánaæ.</i>	Chlora	74, 232	
Candóllea	174		<i>Cupuliferaæ.</i>			Chimonánthus	115	
Calluna	77		<i>Celastrineæ.</i>		Chrysophyllum	49	<i>Calycántheæ.</i>	
Callistachys	98		<i>Aroideæ.</i>		Chenopodium	52	<i>Sapótææ.</i>	
Cássia	99		<i>Ericææ.</i>		Cherlèria	103	<i>Chenopólææ.</i>	
Cæsalpínia	99		} <i>Compôsitaæ.</i>	Chelidonium	102	<i>Caryophylleæ.</i>		
Carmichælia	167			<i>Umbelliferaæ.</i>	Chrysosplénium	102	<i>Saxifragææ.</i>	
Caragána	171			<i>Bombacææ.</i>	Chelidonium	122	<i>Papaveraceæ.</i>	
Canavália	157	<i>Cupuliferaæ.</i>		Chamærops	224	<i>Palmææ.</i>		
Cathartocarpus	99	<i>Celastrineæ.</i>		Chára	—	<i>Charæceæ.</i>		
Calligonum	107	<i>Aroideæ.</i>		Cichórium	177	} <i>Compôsitaæ.</i>		
Callicoma	106	<i>Ericææ.</i>		Cineraria	187			
Cactus	108, 109	} <i>Compôsitaæ.</i>		Cistóptis	226	} <i>Filices.</i>		
Calycánthus	115			<i>Polygónææ.</i>	Cy'stea		226	
Cáltha	129			<i>Cunoniaceææ.</i>	Cimicífuga		127	<i>Ranunculæceæ.</i>
Cakile	144		<i>Cactææ.</i>	Cistus	124		<i>Cistineææ.</i>	
Camelina	143		<i>Calycántheææ.</i>	Císsus	25		<i>Ampelidææ.</i>	
Cardamine	144		<i>Ranunculæceæ.</i>	Circæa	5		<i>Onagrariaæ.</i>	
Camèllia	161		} <i>Compôsitaæ.</i>	Citharèxylum	140		<i>Verbenæceæ.</i>	
Calandrinia	122			<i>Cruciferaæ.</i>	Citrus		174	<i>Aurantiaæceæ.</i>
Càrex	204			<i>Camellidææ.</i>	Cicónium		156	<i>Geraniæceæ.</i>
Cárpinus	209			<i>Portulacææ.</i>	Clinopódium		131	<i>Labiataæ.</i>
Caryôta	210	<i>Cyperæceæ.</i>		Clématis	128	<i>Ranunculæceæ.</i>		
Camássia	61	<i>Betulineææ.</i>		Claytónia	34	<i>Portulacææ.</i>		
Calochórtus	71	<i>Palmææ.</i>		Clerodéndrum	141	<i>Verbenæceæ.</i>		
Cárica	220	<i>Asphodéleææ.</i>		Cleome	146	<i>Capparidææ.</i>		
Campanula	31, 32	<i>Tulipacææ.</i>		Clárkia	75	<i>Onagrariaæ.</i>		
Canarina	69	<i>Cucurbitacææ.</i>		Cládium	9	<i>Cyperæceæ.</i>		
Cánnabis	—	} <i>Compôsitaæ.</i>	Clúsia	224	<i>Guttiferaæ.</i>			
Callicarpa	23		<i>Campanulæceææ.</i>	Cluy'tia	222	<i>Euphorbiæceæ.</i>		
Calystégia	40		<i>Urticeææ.</i>	Cliffórtia	221	<i>Rosæceæ.</i>		
Campy'lia	156		<i>Verbenæceææ.</i>	Cnicus	179	<i>Compôsitaæ.</i>		
Casuarina	203		<i>Convolvulæceææ.</i>	Cneórum	10	<i>Pteleacææ.</i>		
Catabrosa	16		<i>Geraniæceææ.</i>	Collinsónia	9	<i>Labiataæ.</i>		
Cephalánthus	22		<i>Amentacæææ.</i>	Corallorhiza	200	} <i>Orchidææ.</i>		
Cédrus	211		<i>Gramineææ.</i>	Coryánthes	200			
Célsia	136		<i>Rubiæceææ.</i>	Caclogyne	200			
			<i>Coniferaææ.</i>	Códon	106	<i>Solanæææ.</i>		
		<i>Solanæææ.</i>						

INDEX GENERUM.

	Page.		Page.
Echites	47	Natural Order.	
E'chium	30	<i>Apocínea.</i>	
E'chinops	197	<i>Boraginéa.</i>	
Echinácea	194	<i>Compòsita.</i>	
Echinocactus	108	<i>Cáctea.</i>	
Echinóphora	53	<i>Umbellifera.</i>	
Echremocárpus	138	<i>Bignoniácea.</i>	
Eceveria	104	<i>Crassulácea.</i>	
Edwárdsia	98	<i>Leguminósa.</i>	
Ehrétia	48	<i>Boraginéa.</i>	
Ekebergia	94	<i>Meliácea.</i>	
Elich'ysum	182	<i>Compòsita.</i>	
Elaeocárpus	123	<i>Elaeocarpea.</i>	
Eishóltzia	133	<i>Labiatá.</i>	
Elegia	217	<i>Restiácea.</i>	
Elátine	89	<i>Caryophyllea.</i>	
Eleócharis	14	<i>Gramínea.</i>	
E'lymus	21	<i>Elagnéa.</i>	
Eláagnus	22	<i>Celastrínea.</i>	
Elaeodéndrum	43	<i>Empetréa.</i>	
E'mpetrum	216	<i>Compòsita.</i>	
Encelia	194	<i>Ericéa.</i>	
Enkiánthus	96	<i>Orchídea.</i>	
Epig'aea	93	<i>Epacrídea.</i>	
Epipáctis	200	<i>Coníferá.</i>	
Epidéndrum	201	<i>Berberidéa.</i>	
Epácris	35, 36	<i>Onagrárica.</i>	
Ephédra	222	<i>Equisetácea.</i>	
Epimédium	28	<i>Compòsita.</i>	
Epilóbium	74	<i>Leguminósa.</i>	
Equisetum	229	<i>Restiácea.</i>	
Erythrol'æna	178	<i>Geraniácea.</i>	
Erigeron	184	<i>Ericéa.</i>	
Eriophyllum	183	<i>Acanthácea.</i>	
E'ryum	165	<i>Cyperácea.</i>	
Erythrina	167	<i>Gramínea.</i>	
Eriocáñlon	207	<i>Gentiána.</i>	
Eródium	149	<i>Umbellifera.</i>	
Erica . . 77, 78, 79, 80, 81, 82		<i>Tulipácea.</i>	
Eránthemum	8	<i>Ranunculácea.</i>	
Erióphorum	14	<i>Scrophularínea.</i>	
Eragróstis	19	<i>Crucifera.</i>	
Erythr'æa	33	<i>Violariéa.</i>	
Eryngium	52	<i>Rutácea.</i>	
Erythronium	63	<i>Papaverácea.</i>	
Eránthis	129	<i>Escallónícea.</i>	
Erinus	135	<i>Compòsita.</i>	
Ery'simum	145	<i>Leguminósa.</i>	
Erpétion	34	<i>Amaryllídea.</i>	
Eriostémon	93	<i>Celastrínea.</i>	
Eschschóltzia	122	<i>Asphodílea.</i>	
Escallónia	45, 231	<i>Scrophularínea.</i>	
Eupatòrium	179	<i>Euphorbiácea.</i>	
Eutáxia	97	<i>Sapindácea.</i>	
Euchilus	96	<i>Hydrophylléa.</i>	
Eucrosia	63	<i>Myrtácea.</i>	
Euonymus	42, 43	<i>Orchídea.</i>	
Eucomis	63	<i>Gentiána.</i>	
Euphrásia	138	<i>Rosácea.</i>	
Eucléa	220	<i>Serophularínea.</i>	
Euphórbia	203	<i>Gesnèrea.</i>	
Euphòria	75	<i>Geraniácea.</i>	
Eütoca	48	<i>Combretácea.</i>	
Eugénia	110	<i>Acanthácea.</i>	
Encaly'ptus	110	<i>Spirácea.</i>	
Eudésmia	144	<i>Polemoniácea.</i>	
Eulophia	199	<i>Leguminósa.</i>	
E'xacum	27	<i>Fílices.</i>	
		<i>Gesnèrea.</i>	
		<i>Iridéa.</i>	
		<i>Gramínea.</i>	
		<i>Globulárica.</i>	
		<i>Plantaginéa.</i>	
		<i>Papaverácea.</i>	
Farsétia	144	<i>Crucifera.</i>	
Fálkia	69	<i>Convolvulácea.</i>	
Fágus	209	<i>Cupulifera.</i>	
Fabricia	111	<i>Myrtácea.</i>	
Fagónia	92	<i>Zygophy'llea.</i>	
Ferrária	147	<i>Iridéa.</i>	
Férula	53	<i>Umbellifera.</i>	
Fernandésia	201	<i>Orchídea.</i>	
Festúca	18, 19	<i>Gramínea.</i>	
Ficus	225	<i>Urticéa.</i>	
Flacóurtia	220	<i>Flacóurtiána.</i>	
Flemingia	172	<i>Leguminósa.</i>	
Flavéria	196	<i>Compòsita.</i>	
Forsköhlea	89	<i>Urticéa.</i>	
Fothergilla	125	<i>Hamamelídea.</i>	
Fontancésia	9	<i>Oleína.</i>	
Francíscea	140	<i>Solána.</i>	
Frásera	25	<i>Gentiána.</i>	
Fráxinus	4	<i>Oleína.</i>	
Fragária	120	<i>Rosácea.</i>	
Fritillária	66	<i>Tulipícea.</i>	
Francóia	88	<i>Galacína.</i>	
Frankénia	67	<i>Frankeniácea.</i>	
Fúchsia	75, 232	<i>Onagrárica.</i>	
Fumária	162	<i>Fumáriácea.</i>	
Galeobdolon	132	<i>Labiatá.</i>	
Galeopsis	132	<i>Malpighiácea.</i>	
Gærtnéra	94, 95	<i>Rubiácea.</i>	
Gáñium	27	<i>Burserácea.</i>	
Gardénia	49, 50	<i>Galacína.</i>	
Garuga	92	<i>Onagrárica.</i>	
Gáñax	45	<i>Rutácea.</i>	
Gáúra	74	<i>Gramínea.</i>	
Galípea	8	<i>Compòsita.</i>	
Gastrídium	19	<i>Ericéa.</i>	
Gazánia	195	<i>Araliácea.</i>	
Galinsógea	185	<i>Leguminósa.</i>	
Gaillárdia	195	<i>Geraniácea.</i>	
Gaithéria	93	<i>Rosácea.</i>	
Gastónia	107	<i>Serophularínea.</i>	
Galactia	169	<i>Gesnèrea.</i>	
Galéga	172	<i>Geraniácea.</i>	
Gastrolóbium	97	<i>Combretácea.</i>	
Genista	164	<i>Acanthácea.</i>	
Geoffröya	170	<i>Spirácea.</i>	
Gerbéra	186	<i>Polemoniácea.</i>	
Geropógon	179	<i>Leguminósa.</i>	
Georgina	190	<i>Fílices.</i>	
Gelsémium	46	<i>Gesnèrea.</i>	
Gentiána	52	<i>Iridéa.</i>	
Géum	115	<i>Gramínea.</i>	
Gerárdia	136	<i>Globulárica.</i>	
Gesnèria	137	<i>Plantaginéa.</i>	
Geránium	157	<i>Papaverácea.</i>	
Getonia	92		
Geissomèria	141		
Gillènia	113		
Gilia	41		
Glycine	169		
Glycyrrhiza	172		
Gledítschia	224		
Gleichènia	228		
Gloxínia	137		
Gladíolus	11		
Glycèria	17		
Globulária	22		
Gláñx	41		
Gláñcium	122		

INDEX GENERUM.

	Page.		Page.	
Gmelina	140	Natural Order.		
Gnaphalium ..	182, 184	<i>Verbenaceæ.</i>	Hemerocallis	65
Gnidia	77	<i>Compositæ.</i>	Hemionitis	228
Gompholobium	98	<i>Thymelææ.</i>	Heuchera	51
Goödia	169	<i>Leguminosæ.</i>	Hiptage	94
Gossypium	159	<i>Malvaceæ.</i>	Hibbertia	127
Goodenia	38	<i>Goodeniææ.</i>	Hippocrepis ..	165, 166
Gomphocarpus	50	<i>Asclepiadææ.</i>	Hieracium	180
Gonolobus	51	<i>Ternstræmiæææ.</i>	Hippuris	3
Gordonia	160	<i>Orchidææ.</i>	Hieróchloa	17
Gongora	201	<i>Amaryllidææ.</i>	Hibiscus	160
Goodyera	198	<i>Compositæ.</i>	Hippophae	217
Griffinia	60	<i>Tiliæææ.</i>	Höya	50
Grindelia	183	<i>Scrophularinææ.</i>	Hoærea	156
Grèwia	123	<i>Filices.</i>	Hövea	168
Gratiola	7	<i>Lythrarieææ.</i>	Horkelia	92
Grammitis	227	<i>Proteæææ.</i>	Hösta	136
Grisea	75	<i>Rubiæææ.</i>	Holmskiöldia ..	135
Grevillea	23	<i>Anonæææ.</i>	Hovènia	48
Guettarda	207	<i>Zygophyllææ.</i>	Homalium	125
Guatteria	130	<i>Urticææ.</i>	Hördeum	21
Guaiaecum	91	<i>Compositæ.</i>	Hölcus	16, 17
Gunnera	9	<i>Leguminosæ.</i>	Horminum	133
Gymnostyles	196	<i>Filices.</i>	Houstonia	26
Gymnoloma	194	<i>Caryophyllææ.</i>	Holosteum	21
Gymnocladus	220	<i>Amaryllidææ.</i>	Hottönia	39
Gymnogramma	228	<i>Asclepiadææ.</i>	Hümea	181
Gypsophila	100	<i>Styracineææ.</i>	Hudsonia	106
Gymnadènia	197	<i>Hamamelidææ.</i>	Hutchinsia	143
Habenaria	198	<i>Rubiæææ.</i>	Hümulus	218
Hæmáanthus	68	<i>Leguminosæ.</i>	Hunnemannia ..	122
Habránthus	60	<i>Orchidææ.</i>	Hypëcom	28
Harrisonia	53	<i>Amaryllidææ.</i>	Hyperanthéra ..	92
Halësia	105	<i>Asclepiadææ.</i>	Hymenæa	91
Hamamélis	28	<i>Styracineææ.</i>	Hydrocotyle	54
Hamèllia	49	<i>Hamamelidææ.</i>	Hyöseris	180
Hæmatöxylon	91	<i>Rubiæææ.</i>	Hypochæris	177
Hállia	171	<i>Leguminosææ.</i>	Hydropeltis	129
Hardwíckia	92	<i>Proteæææ.</i>	Hyacínthus	66
Hákea	22	<i>Rubiæææ.</i>	Hyoscýamus	35
Hemiclidia	25	<i>Leguminosææ.</i>	Hypëricum	175
Hedyötis	27	<i>Proteæææ.</i>	Hypóxis	66
Hedy'sarum ..	165, 166	<i>Rubiæææ.</i>	Hydrängea	100
Hedy'chium	2	<i>Leguminosææ.</i>	Hydrocháris ..	219
Hédera	42	<i>Scitamíneææ.</i>	Hymenophyllum ..	228
Herniária	52	<i>Araliæææ.</i>	Ibèris	143
Heliánthemum	124	<i>Paronychieææ.</i>	Ilex	28, 43
Heimia	105	<i>Cistineææ.</i>	Illicium	130
Helicteres	158	<i>Lythrarieææ.</i>	Illécebrum	41, 46
Hepática	128	<i>Bombicæææ.</i>	Imperatoriá	54
Helléborus	129	<i>Ranunculæææ.</i>	Impatiens	33
Hebenstrèitia	141	<i>Selagineææ.</i>	Ínga	222
Helónias	71	<i>Selagineææ.</i>	Indigöfera	172
Helicónia	31	<i>Melanthidæææ.</i>	I'nula	187
Hermánnia	148	<i>Musicæææ.</i>	Ipom'æa	36, 37
Heliánthus	193	<i>Buttneriæææ.</i>	Ipomöpsis	33
Helminthia	176	<i>Compositææ.</i>	Iris	13
Heliöpsis	183	<i>Orchidæææ.</i>	Isátes	144
Helénium	186	<i>Meliæææ.</i>	Isopögon	21
Hernínium	198	<i>Tiliæææ.</i>	Isop'yrum	129
Hey'nea	91	<i>Cruciferææ.</i>	Isöetes	230
Heliocárpus	106	<i>Laurineææ.</i>	I'tea	46
Heliöphila	145	<i>Boragineææ.</i>	I'xia	12
Hésperis	146	<i>Irideææ.</i>	Ixöra	26
Hernándia	205		Jatröpha	211
Heliotrópium	41		Jasminum	4
Herbértia	147		Jacksónia	96
Hesperántha	12		Jasiöne	41
			Jacquinia	44

	Page.		Page.	
		<i>Hemerocallidææ.</i>		
		<i>Filices.</i>		
		<i>Saxifragææ.</i>		
		<i>Malpighiæææ.</i>		
		<i>Dillenæææ.</i>		
		<i>Leguminosææ.</i>		
		<i>Compositææ.</i>		
		<i>Haloragéææ.</i>		
		<i>Gramineææ.</i>		
		<i>Malvæææ.</i>		
		<i>Elæagnæææ.</i>		
		<i>Asclepiadæææ.</i>		
		<i>Geraniæææ.</i>		
		<i>Leguminosææ.</i>		
		<i>Rosáceææ.</i>		
		<i>Verbenæææ.</i>		
		<i>Rhamnæææ.</i>		
		<i>Homalínæææ.</i>		
		<i>Gramineææ.</i>		
		<i>Labiæææ.</i>		
		<i>Gentiæææ.</i>		
		<i>Caryophyllæææ.</i>		
		<i>Primulæææ.</i>		
		<i>Compositææ.</i>		
		<i>Cistineæææ.</i>		
		<i>Cruciferææ.</i>		
		<i>Urticæææ.</i>		
		<i>Papaveræææ.</i>		
		<i>Leguminosææ.</i>		
		<i>Umbelliferææ.</i>		
		<i>Compositææ.</i>		
		<i>Podophyllæææ.</i>		
		<i>Asphodéleææ.</i>		
		<i>Solanæææ.</i>		
		<i>Hypericinéææ.</i>		
		<i>Hypoxidæææ.</i>		
		<i>Saxifragæææ.</i>		
		<i>Hydrocharidæææ.</i>		
		<i>Filices.</i>		
		<i>Cruciferææ.</i>		
		<i>Celastrineææ.</i>		
		<i>Wintéæææ.</i>		
		<i>Paronychieææ.</i>		
		<i>Umbelliferæææ.</i>		
		<i>Balsaminæææ.</i>		
		<i>Leguminosææ.</i>		
		<i>Compositææ.</i>		
		<i>Convolvulæææ.</i>		
		<i>Polemoniæææ.</i>		
		<i>Irideæææ.</i>		
		<i>Cruciferæææ.</i>		
		<i>Proteææææ.</i>		
		<i>Ranunculææææ.</i>		
		<i>Marsilææææ.</i>		
		<i>Ericææææ.</i>		
		<i>Irideææææ.</i>		
		<i>Rubiæææææ.</i>		
		<i>Euphorbiææææ.</i>		
		<i>Jasminææææ.</i>		
		<i>Leguminosæææ.</i>		
		<i>Campanulææææ.</i>		
		<i>Myrsinææææ.</i>		

INDEX GENERUM.

	Page.		Page.	
Melástoma	94	Natural Order.		
Mélia	93	<i>Melastomácea.</i>	Núphar	121
Metrosidéros	111	<i>Meliácea.</i>	Nymphæa	121
Melaleúca	173	<i>Myrtácea.</i>	Nyctánthes	4
Méspilus	114	<i>Pomácea.</i>	Ny'ssa	225
Mesembryánthemum	111	<i>Ficoídea.</i>	O'cymum	133
Meliánthus	142	<i>Zygoph'yllæa.</i>	Ochróma	148
Medicágo	167	<i>Leguminósa.</i>	Ædèra	196
Menispermum	220	<i>Menispermácea.</i>	Ænothèra	73
Mercurialis	219	<i>Euphorbiácea.</i>	Ænánthe	55
Melodinus	47	<i>Apocínea.</i>	'Olea	4
Melocáctus	108	<i>Cáctea.</i>	Omálánthus	212
Michaúxia	75	<i>Campanulácea.</i>	Onónis	164
Mímulus	136	<i>Scrophularínea.</i>	Onopórdum	179
Mikània	181	<i>Composita.</i>	Onobróma	178
Milium	19	<i>Gramínea.</i>	Oncídium	201
Mimósa	222	<i>Leguminósa.</i>	Onoclèa	229
Mirbèlia	96	<i>Asclepiádea.</i>	Ophioglóssum	229
Microlóma	51	<i>Saxifrágea.</i>	Opúntia	169
Mitèlla	100	<i>Rubiácea.</i>	Oplothéca	48
Mitchèlla	25	<i>Labiàta.</i>	O'phrys	197, 198, 200
Monárda	8	<i>Crucifera.</i>	O'rchis	197
Moricándia	146	<i>Ericæa.</i>	Ornithídium	199
Monotrópa	96	<i>Urtícea.</i>	Origanum	131
Mórus	206	<i>Leguminósa.</i>	O'robis	164
Moringa	92	<i>Portulácea.</i>	Ornithópús	162
Móntia	21	<i>Polygálea.</i>	Ornithógalum	65
Monóina	163	<i>Iridæa.</i>	Oróntium	62
Mora'a	11	<i>Geraniácea.</i>	Orthrosánthus	12
Monsónia	158	<i>Composita.</i>	Orobánche	135
Mutisia	187	<i>Gramínea.</i>	Osmúnda	228
Muhlenbèrgia	20	<i>Musácea.</i>	Osbéckia	94
Mùsa	68	<i>Aurantíacea.</i>	Ostry'a	209
Murràya	96	<i>Rubiácea.</i>	Osteospermum	196
Muss'ænda	48	<i>Asphodèlea.</i>	Othónna	196
Muscári	62	<i>Umbellifera.</i>	Oxylobium	97
Myrsiphyllum	71	<i>Ericæa.</i>	Oxytrópis	172
Myrrhis	53	<i>Myrtácea.</i>	Oxyánthus	49
Mylocáryum	92	<i>Tamariscínea.</i>	Oxyria	70
Myrtus	110	<i>Myoporínea.</i>	Oxális	104
Myricária	56	<i>Halorágæa.</i>	Pæónia	125
Myopórum	138	<i>Boragínea.</i>	Pachysándra	206
Myriophyllum	207	<i>Myrsínea.</i>	Papáver	122
Myosóthys	31	<i>Myricea.</i>	Pandárus	213
Myrsine	225	<i>Ranunculácea.</i>	Pánicum	16, 17
Myrica	217	<i>Gramínea.</i>	Páspalum	19
Myósurus	5	<i>Amaryllidæa.</i>	Pánax	225
Nárdus	14	<i>Berberidæa.</i>	Parietária	28
Narcissus	64	<i>Crucifera.</i>	Parony'chia	46
Nandína	69	<i>Rubiácea.</i>	Parkéria	227
Nastúrtium	145	<i>Júncea.</i>	Pascálla	186
Nauclèa	30	<i>Labiàta.</i>	Parnássia	57
Narthécium	66	<i>Apocínea.</i>	Pancrátium	60
Népeta	134	<i>Sapindácea.</i>	Passerína	77
Nérium	47	<i>Orchídea.</i>	Paullínia	88
Nephélium	206	<i>Nymphæácea.</i>	Páris	88
Neóttia	198, 200	<i>Hydrophy'llæa.</i>	Pávia	72
Nelumbium	130	<i>Cytínea.</i>	Passiflora	141
Nemóphila	35	<i>Composita.</i>	Patersónia	147
Nepénthes	221	<i>Solánaea.</i>	Palávia	158
Nèja	183	<i>Filices.</i>	Pavónia	159
Nicotiána	43	<i>Solánaea.</i>	Parkinsonia	92
Nierembèrgia	41	<i>Melanthácea.</i>	Petúnia	47
Nothocl'æna	228	<i>Composita.</i>	Peucedanum	54
Nolana	40	<i>Malvácea.</i>	Peréskia	109
Nolina	70		Pen'æa	25
Nócca	181		Periplóca	50
Nuttállia	162		Pergulária	50
			Pèplis	67

Natural Order.	
<i>Nymphæácea.</i>	
<i>Jasminæa.</i>	
<i>Santalácea.</i>	
<i>Labiàta.</i>	
<i>Bombácea.</i>	
<i>Composita.</i>	
<i>Onagrária.</i>	
<i>Umbellifera.</i>	
<i>Oleína.</i>	
<i>Euphorbiácea.</i>	
<i>Leguminósa.</i>	
<i>Composita.</i>	
<i>Orchídea.</i>	
<i>Filices.</i>	
<i>Cáctea.</i>	
<i>Amaryllidæa.</i>	
<i>Orchídea.</i>	
<i>Labiàta.</i>	
<i>Leguminósa.</i>	
<i>Asphodèlea.</i>	
<i>Aroidæa.</i>	
<i>Iridæa.</i>	
<i>Orobánchea.</i>	
<i>Filices.</i>	
<i>Melastomácea.</i>	
<i>Betulínea.</i>	
<i>Composita.</i>	
<i>Leguminósa.</i>	
<i>Rubiácea.</i>	
<i>Polygónea.</i>	
<i>Oxalidæa.</i>	
<i>Ranunculácea.</i>	
<i>Euphorbiácea.</i>	
<i>Papaverácea.</i>	
<i>Pandínea.</i>	
<i>Gramínea.</i>	
<i>Araliácea.</i>	
<i>Urtícea.</i>	
<i>Parony'chiæa.</i>	
<i>Filices.</i>	
<i>Composita.</i>	
<i>Droserácea.</i>	
<i>Amaryllidæa.</i>	
<i>Thymelæ'a.</i>	
<i>Sapindácea.</i>	
<i>Smilácea.</i>	
<i>Hippocastánaea.</i>	
<i>Passiflora.</i>	
<i>Iridæa.</i>	
<i>Malvácea.</i>	
<i>Leguminósa.</i>	
<i>Solánaea.</i>	
<i>Umbellifera.</i>	
<i>Cáctea.</i>	
<i>Penácea.</i>	
<i>Asclepiádea.</i>	
<i>Lythráriæa.</i>	

INDEX GENERUM.

	Page.	Natural Order.		Page.	Natural Order.
Pediculàris ..	139	} <i>Scrophulariàcea.</i>	Priestlòya	168	<i>Leguminòsea.</i>
Pentstémón ..	141		Prescòtia	198	<i>Orchidea.</i>
Persoònia	23	<i>Proteaàcea.</i>	Prenánthes ..	176, 177	<i>Compòsita.</i>
Pelargòonium	149	<i>Geraniàcea.</i>	Prunella	132	} <i>Labiàta.</i>
Pentápètes ..	158	<i>Butneriàcea.</i>	Prostanthèra	133	
Petalostèmum ..	162	<i>Leguminòsea.</i>	Pròckia	124	<i>Bixiàcea.</i>
Péntzia ..	181	<i>Compòsita.</i>	Prùnus	109	<i>Amygdalinea.</i>
Perilòmia ..	134	<i>Labiàta.</i>	Prìnus	69	<i>Celastrinea.</i>
Phyllánthus ..	212	<i>Euphorbiàcea.</i>	Primula	38	<i>Primulàcea.</i>
Phàlaris	14	} <i>Graminea.</i>	Pròtea	22	<i>Proteaàcea.</i>
Phlèum	15		<i>Amaryllideà.</i>	Psoràlea	171
Phycèlla	60	<i>Geraniàcea.</i>	Psophocàrpus ..	170	
Phymatánthus ..	156	<i>Leguminòsea.</i>	Psidium	109	<i>Myrtàcea.</i>
Phaseòlus ..	170	<i>Càncea.</i>	Psychòtria	47	<i>Rubiàcea.</i>
Phry'nium	1	<i>Oleina.</i>	Pterospèrmum ..	158	<i>Butnerià. ca.</i>
Philly'rea ..	4	<i>Campanulàcea.</i>	Ptèris	227	<i>Filices.</i>
Phyteuma	32	<i>Asphodèleà.</i>	Ptelea	25	<i>Pteleàcea.</i>
Phòrmium	60	<i>Palmèa.</i>	Pulten'aea	97	<i>Leguminòsea.</i>
Ph'œnix	217	<i>Polemoniàcea.</i>	Pulicària	187	<i>Compòsita.</i>
Phlòx	37	<i>Labiàta.</i>	Pulmonària ..	29	<i>Boraginea.</i>
Phlòmis	133	<i>Pomàcea.</i>	Púrshia	115	<i>Spiràcea.</i>
Photinia ..	114	<i>Umbellifera.</i>	Pùnica	129	<i>Granàtea.</i>
Pimpinèlla ..	55	<i>Thymelà'ca.</i>	Pyrethrum	185	<i>Compòsita.</i>
Pimelèa	9	<i>Leguminòsea.</i>	Pyxidanthèra ..	31	} <i>Erica.</i>
Pisum	123	<i>Compòsita.</i>	Py'rola	95	
Picris	176	<i>Piperàcea.</i>	P'yrus	113, 114	<i>Pomàcea.</i>
Piper	10	<i>Bromeliàcea.</i>	Quércus	208	<i>Cupulifera.</i>
Pitcairnia	68	<i>Terebinthàcea.</i>	Quivisia	96	<i>Meliàcea.</i>
Pistàcia	218	<i>Nyctaginea.</i>	Quisqualis	94	<i>Combretàcea.</i>
Pisonia	72	<i>Pittospòrea.</i>	Ràphanus	146	<i>Crucifera.</i>
Pittòsporum	45	<i>Marsilèa.</i>	Ramònda	49	<i>Solànea.</i>
Pilulària	230	<i>Conifera.</i>	Radiola	29	<i>Linea.</i>
Pinus	210, 211	<i>Lentibularia.</i>	Ràndia	50	<i>Rubiàcea.</i>
Pinguicula	6	<i>Leguminòsea.</i>	Ranúnculus	129	<i>Ranunculàcea.</i>
Platylòbium	168	} <i>Compòsita.</i>	Rétzia	37	<i>Convolvulàcea.</i>
Plagiolòbium ..	168		<i>Plumbaginèa.</i>	Reseda	106
Plectocéphalus ..	194	<i>Apocinea.</i>	Relhània	193	<i>Compòsita.</i>
Platy'ptèris	181	<i>Platàcea.</i>	Renanthèra	198	<i>Orchidea.</i>
Plumbàgo	36	<i>Plantaginea.</i>	Renealmia	1	<i>Scitaminea.</i>
Plumèria	47	<i>Labiàta.</i>	Rhámnus	42	<i>Rhámnea.</i>
Plátanus	210	<i>Melastomàcea.</i>	Rhopàla	27	<i>Proteaàcea.</i>
Plantàgo	27	<i>Podophyllea.</i>	Rhùs	56	<i>Cassurica.</i>
Plectránthus ..	134	} <i>Graminea.</i>	Rhodòra	93	} <i>Erica.</i>
Pleròma	94		<i>Paronychéa.</i>	Rhododéndron ..	
Podophy'llum ..	123	<i>Leguminòsea.</i>	Rhinánthus	138	<i>Scrophulariàcea.</i>
Polypògon	15	} <i>Compòsita.</i>	Rhippsalis	10	<i>Càtea.</i>
Pòa	17, 19		<i>Polemoniàcea.</i>	Rhodiola	219
Polycàrpon	21	<i>Conifera.</i>	Rhagòdia	224	<i>Chenopòdea.</i>
Podaly'ria	96	<i>Fluviàles.</i>	Rhéxia	74, 94	<i>Melastomàcea.</i>
Podolòbium	97	<i>Rhámnea.</i>	Rhéum	89	<i>Polygònea.</i>
Poinciàna	99	<i>Pontedèrea.</i>	Rìvina	23	<i>Phytolàcea.</i>
Poly'mnia	195	<i>Polygònea.</i>	Rìbes	42, 231	<i>Grossularica.</i>
Podòlepis	185	<i>Orchidea.</i>	Rícinus	212	<i>Euphorbiàcea.</i>
Polemoniùm	40	<i>Polygàlea.</i>	Rìchardsonia ...	70	<i>Spermacècea.</i>
Podocàrpus	212	<i>Salicea.</i>	Ròxbùrgia	75	<i>Asphodèlea.</i>
Potamogeton ..	29	<i>Filices.</i>	Rondelétia	50	<i>Rubiàcea.</i>
Pomadèrris	44	} <i>Portulàcea.</i>	Roscòea	2	<i>Scitaminea.</i>
Pontedèria	68		<i>Rosàcea.</i>	Rodriguèzia	199
Poly'gonum	88	<i>Rosàcea.</i>	Rottlèra	220	<i>Euphorbiàcea.</i>
Pogònia	199	<i>Aroidea.</i>	Rosmarinus	8	<i>Labiàta.</i>
Poly'gala	163		Rottboèllia	21	<i>Graminea.</i>
Popùlus	219		Roèlla	37	<i>Campanulàcea.</i>
Polypòdium	225		Ròsa	115	<i>Rosàcea.</i>
Portulàca	106		Robìnia	171	<i>Leguminòsea.</i>
Portulacària	57		Rùppia	29	<i>Fluviàles.</i>
Potentilla	120		Rùbia	27	<i>Rubiàcea.</i>
Potèrium	208		Russèlia	136	<i>Scrophulariàcea.</i>
Pòivrea	95		Rùbus	120	<i>Rosàcea.</i>
Pòthos	23		Ruèllia	137	<i>Acanthàcea.</i>

INDEX GENERUM.

	Page.		Page.	
Rudbékcia	194	Natural Order.		
Rúscus	217	<i>Compositæ.</i>	Siegesbéckia	187
Rúmex	70	<i>Smilacææ.</i>	Sibthórpa	135
Ruízia	159	<i>Polygonææ.</i>	Sideróxylon	49
Rhynchóspora	14	<i>Buttneriæææ.</i>	Sisyrrinchium	12
Sanguinária	122	<i>Cyperæææ.</i>	Sida	159
Sansevièra	61	<i>Papaveræææ.</i>	Sievérsia	115
Sálix	213	<i>Hemerocallidææ.</i>	Sibbáldia	58
Salicórnia	3	<i>Salicinææ.</i>	Silène	102
Salsòla	51, 52	<i>Chenopòdeææ.</i>	Sinningia	140
Sanvitália	185	<i>Compositæ.</i>	Sium	55
Sálvia	6, 231	<i>Labiataæ.</i>	Sison	55
Saturèja	—	<i>Santalacææ.</i>	Sinápis	146
Sántalum	23	<i>Rosacææ.</i>	Sisy'mbrium	145
Sanguisórbá	28	<i>Caryophyllææ.</i>	Smy'rnium	54
Sagina	29	<i>Primulacææ.</i>	Smithia	171
Saponária	101	<i>Piperacææ.</i>	Smilax	218
Samòlus	33, 231	<i>Caprifoliæææ.</i>	Soldanèlla	35
Saurúrus	73	<i>Sapindacææ.</i>	Sònchus	176
Sambúcus	56	<i>Sarraceniææ.</i>	Solidágo	186
Sapíndus	88	<i>Palmææ.</i>	Sowerb'æa	63
Sarracénia	122	<i>Saxifragææ.</i>	Sophòra	98
Sápus	207	<i>Orchidææ.</i>	Sólyta	41
Saxífraga	101	<i>Alismacææ.</i>	Solánium	43
Saty'rium	201	<i>Coniferææ.</i>	Solándra	47
Sarcánthus	197	<i>Umbelliferææ.</i>	<i>Spatalánthus</i>	147
Sagittária	207	<i>Graminææ.</i>	Spérgula	105
Salisbúria	210	<i>Solânææ.</i>	Spartina	18
Sanícula	53	<i>Samy'dææ.</i>	Spermadictyon	36
Sáccharum	20	<i>Labiataæ.</i>	Spilánthus	181
Salpiglóssis	137	<i>Cyperæææ.</i>	Sphærolòbium	97
Sam'ya	98	<i>Dipsacææ.</i>	Spártium	163, 164
Scutellária	132	<i>Umbelliferææ.</i>	Sparrmánnia	122
Sch'ænus	13	<i>Cruciferææ.</i>	Spermacòce	27
Scirpus	14	<i>Compositæ.</i>	Spargànium	204
Scabiòsa	26	<i>Goodenòviææ.</i>	Sparáxis	12
Scándix	53	<i>Asphodéleææ.</i>	Spigèlia	33
Schiveréckia	143	<i>Leguminòsææ.</i>	Sprenghèlia	35
Scorzonèra	180	<i>Pavonychéææ.</i>	Spir'æa	113
Scólymus	178	<i>Terebinthacææ.</i>	Spielmánnia	140
Sc'ævola	49	<i>Filices.</i>	Spathèlia	57
Scilla	65	<i>Juncaginéææ.</i>	Sphácele	131
Schòtia	99	<i>Scrophularinææ.</i>	Stáchys	131
Scóttia	169	<i>Geraniacææ.</i>	Stellária	102
Scleránthus	102	<i>Orchidææ.</i>	Stipa	20
Schinus	220	<i>Graminææ.</i>	Stanhòpea	199
Scolopendrium	227	<i>Rubiacææ.</i>	St'æbe	178
Schizæ'a	228	<i>Umbelliferææ.</i>	Stèvia	177
Scheuchzèria	70	<i>Cruciferææ.</i>	Streptanthèra	13
Scrophulária	139	<i>Compositæ.</i>	Styphèlia	36
Schizánthus	7	<i>Goodenòviææ.</i>	Stenanthèra	36
Seymóúria	156	<i>Asphodéleææ.</i>	Staphylèa	56
Serâpias	199	<i>Leguminòsææ.</i>	Stachytárfpheta	8
Sesleria	17	<i>Pavonychéææ.</i>	Stillíngia	212
Setária	16	<i>Terebinthacææ.</i>	Stáavia	44
Secàle	20	<i>Filices.</i>	Strelitzla	46, 231
Serissa	50	<i>Juncaginéææ.</i>	Stapèlia	51
Séseli	55	<i>Scrophularinææ.</i>	Státice	57, 58
Séptas	73	<i>Geraniacææ.</i>	Stratiòtes	127
Sédum	104	<i>Orchidææ.</i>	Stenochilus	138
Sempervivum	107	<i>Graminææ.</i>	Struthiola	26
Selágo	135	<i>Rubiacææ.</i>	Stuártia	160
Senebièra	—	<i>Umbelliferææ.</i>	Stylidium	202
Serrátula	180	<i>Cruciferææ.</i>	Stílagó	217
Senécio	184	<i>Compositæ.</i>	Sterculia	212
Sesbània	172	<i>Leguminòsææ.</i>	Sternbèrgia	60
Sherárdia	26	<i>Rubiacææ.</i>	Strophánthus	41
Siderodéndron	23	<i>Umbelliferææ.</i>	Subulária	142
Silphium	195	<i>Compositæ.</i>	Swértia	51
			Swietènia	92, 96

INDEX GENERUM.

	Page.	Natural Order.		Page.	Natural Order.
Symphytum ..	30	<i>Boraginææ.</i>	Triumfetta	106	<i>Tiliacææ.</i>
Symphoria	50	<i>Caprifoliacææ.</i>	Tropæolum	74	<i>Tropæoleææ.</i>
Synnötia ..	12	<i>Irîdææ.</i>	Trichomanes	228	<i>Filices.</i>
Tamarîndus	147	<i>Leguminosææ.</i>	Tradescantia	60	<i>Commelinææ.</i>
Tacsônia	232	<i>Passiflorææ.</i>	Tribulus	93	<i>Zygophylleææ.</i>
Tabernaemontana	46	<i>Apocînææ.</i>	Tussilago	184	<i>Compositææ.</i>
Tarchonanthus ..	181	<i>Compositææ.</i>	Turnera	56	<i>Turneracææ.</i>
Tanacetum	182		<i>Plumbaginææ.</i>	Turritia	146
Tagetes	183	<i>Coniferææ.</i>	Tapistra	60	<i>Aroideææ.</i>
Taxantheme	58	<i>Tamcææ.</i>	Tulipa	66	<i>Tulipicææ.</i>
Taxus	221	<i>Portulacææ.</i>	Typha	203	<i>Typhînææ.</i>
Tamus	218	<i>Tamariscinææ.</i>	Ulmus	51	<i>Urticææ.</i>
Talinum	105	<i>Leguminosææ.</i>	Ulex	164	<i>Leguminosææ.</i>
Tamarix	56	<i>Verbenacææ.</i>	Uniola	20	<i>Graminææ.</i>
Templetônia	169	<i>Proteacææ.</i>	Urtica	205	<i>Urticææ.</i>
Tectona	49	<i>Ficoideææ.</i>	Urera	159	<i>Malvacææ.</i>
Telopœa	23	<i>Bignoniacææ.</i>	Utricularia	6	<i>Lentibulariææ.</i>
Tetragônia	—	<i>Combretacææ.</i>	Uvularia	62	<i>Melanthacææ.</i>
Tégoma	136	<i>Labiataæ.</i>	Valeriana	12, 13	<i>Valerianææ.</i>
Terminalia	224	<i>Scrophularinææ.</i>	Valerianella	13	
Teucrium	134	<i>Laurinaæ.</i>	Vaccinium	76	<i>Vaccinææ.</i>
Tœdia	142	<i>Cruciferææ.</i>	Vanilla	201	<i>Orchideææ.</i>
Tetranthera	89	<i>Saxifragææ.</i>	Vánia	200	
Teesdalia	143	<i>Leguminosææ.</i>	Vestia	37	<i>Solanææ.</i>
Téllima	100	<i>Camelliææ.</i>	Verbascum	34, 49	
Thermopsis	94	<i>Coniferææ.</i>	Veltheimia	63	<i>Hemerocallideææ.</i>
Thœa	162	<i>Cinnææ.</i>	Verbena	134	<i>Verbenacææ.</i>
Thûja	212	<i>Ranunculacææ.</i>	Vesicaria	144	<i>Cruciferææ.</i>
Thàlia	1	<i>Labiataæ.</i>	Vèlla	142	
Thalictrum ..	128	<i>Acanthacææ.</i>	Verónica	5	<i>Scrophularinææ.</i>
Thymus	131	<i>Cruciferææ.</i>	Verbesina	193	<i>Compositææ.</i>
Thunbergia	137	<i>Malpighiacææ.</i>	Vernonia	178	
Thlâspi	143	<i>Buttneriacææ.</i>	Verratum	224	<i>Melanthacææ.</i>
Thryallis	103	<i>Santalacææ.</i>	Vellèia	48	<i>Goodeniææ.</i>
Theobrôma	173	<i>Bromeliacææ.</i>	Villarsia	39	<i>Gentiânææ.</i>
Thomasia	44	<i>Tiliacææ.</i>	Vitex	140	<i>Verbenacææ.</i>
Thesium	41	<i>Tiliacææ.</i>	Viburnum	56	<i>Caprifoliacææ.</i>
Tillandsia	68	<i>Saxifragææ.</i>	Viscum	217	<i>Loranthææ.</i>
Tilia	123	<i>Irîdææ.</i>	Virgilia	98	<i>Leguminosææ.</i>
Tiarèlla	100	<i>Crassulacææ.</i>	Vicia	165	
Tigrîdia	147	<i>Compositææ.</i>	Vinca	41	<i>Apocînææ.</i>
Tillæa	29	<i>Scrophularinææ.</i>	Viola	34	<i>Violariææ.</i>
Tithônia	194	<i>Boraginææ.</i>	Watsonia	11	<i>Irîdææ.</i>
Torènia	141	<i>Umbelliferææ.</i>	Waldsteinia	113	<i>Rosacææ.</i>
Tournefortia	31	<i>Melanthacææ.</i>	Wahlenbergia ..	32	<i>Campanulacææ.</i>
Torilis	53	<i>Rosacææ.</i>	Waltheria	148	<i>Buttneriacææ.</i>
Tordylium	54	<i>Leguminosææ.</i>	Wachendorfia ..	11	<i>Hamodoracææ.</i>
Tofieldia	70	<i>Compositææ.</i>	Witsenia	10	<i>Irîdææ.</i>
Tormentilla	121	<i>Ranunculacææ.</i>	Willdenovia	217	<i>Restiacææ.</i>
Trifolium	166	<i>Scrophularinææ.</i>	Wistèria	169	<i>Leguminosææ.</i>
Trigonèlla	172	<i>Irîdææ.</i>	Woodia	228	<i>Filices.</i>
Tróximon	179	<i>Umbelliferææ.</i>	Wrightia	47	<i>Apocînææ.</i>
Tragopogon	176	<i>Melanthacææ.</i>	Wulfenia	8	<i>Scrophularinææ.</i>
Trólium	129	<i>Rosacææ.</i>	Xanthium	206	<i>Compositææ.</i>
Trevirana	142	<i>Leguminosææ.</i>	Xanthochymus ..	174	<i>Guttiferææ.</i>
Trichonema	13	<i>Compositææ.</i>	Xanthorhiza	58	<i>Ranunculacææ.</i>
Tritônia	10	<i>Ranunculacææ.</i>	Xeranthemum	183	<i>Compositææ.</i>
Trachymene	55	<i>Scrophularinææ.</i>	Xerophyllum	71	<i>Melanthacææ.</i>
Triodia	17	<i>Irîdææ.</i>	Yucca	62	<i>Tulipicææ.</i>
Trisetum	19	<i>Umbelliferææ.</i>	Zamia	221	<i>Cycadææ.</i>
Triticum	20	<i>Graminææ.</i>	Zanthoxylum ..	218	<i>Rutacææ.</i>
Trichodium	16	<i>Campanulacææ.</i>	Zephyranthes	65	<i>Amaryllidææ.</i>
Trachelium	37	<i>Caprifoliacææ.</i>	Zièria	25	<i>Rutacææ.</i>
Triosteum	48	<i>Hemerocallideææ.</i>	Zinnia	183	<i>Compositææ.</i>
Tritoma	63	<i>Myrtacææ.</i>	Zingiber	2	<i>Scitamineææ.</i>
Tristània	47	<i>Juncaginææ.</i>	Zizyphus	44	<i>Rhamnææ.</i>
Triglochim	70	<i>Smilacææ.</i>	Zostera	3	<i>Fluciales.</i>
Trillium	71	<i>Primulacææ.</i>	Zygophyllum ..	91, 99	<i>Zygophylleææ.</i>
Trientalis	72		Zygopetalum	291	<i>Orchideææ.</i>

ENGLISH INDEX.

	Page.		Page.		Page.
Abbey	233	Barberry	68	Bryony	207
Abele-tree	219	Barbadoes Cherry	103	Buck's Eye-tree	72
Adder's Tongue	199, 229	Bastard Pimpernel	27	Buck-bean	39
Adam's Needle	62	Bastard Cabbage-tree	170	Buck Wheat-tree	92
African Fleabane	181	Bastard Service	113	Buck-thorn	42
African Lily	64	Bald Money	54	Buck's-horn Plantain	27
Agrimony	106	Beard-grass	15	Buck Wheat	88
Akee-tree	77	Bear-berry, black	95	Bugloss	30
Alder	206	Bear's-breech	137	Bugle	134
Alexandrian Laurel	217	Bead-tree	93	Bugwort	127
Alexanders	54	Bear's-ear Sanicle	35	Bullace-tree	109
Alum-root	51	Bed-straw	27	Bullrush	14
Allseed	21, 29	Beech-tree	209	Bur-weed	206
Allspice	115	Beet	52	Burnet	28, 208
Allspice-tree	110	Bell-flower	31	Burnet Saxifrage	55
Alkanet	29	Belladonna Lily	59	Bur-parsley	53
Almond	109	Benjamin-tree	89	Butcher's-Broom	217
Althaea-frutex	160	Bean-caper	99	Butter-nut	147
Amaranth	206	Bent-grass	15	Bur-reed	204
American Cowslip	35	Bergamot	134	Butter and Eggs	64
Angelica-tree	58	Betony	132	Burdock	177
Apple-tree	113, 305	Bilimbi-tree	103	Butter-wort	6
Apricots, varieties of	301	Bindweed	40	Bur Marigold	179
Apple Berry	45	Bitter Vetch	164	Button-wood	22
Arbor-vitæ	212	Birch-tree	209	Cabbage	146
Arrow-grass	70	Bird Cherry	109	Cabbage-tree	211
Arrow-head	207	Bird's-eye Primrose	38	Cajuputi-tree	174
Arrow-root	1	Bird's-foot	165	Calathian Violet	—
Artichoke	178	Bird's-foot Trefoil	166	Calpoon-tree	57
Ash-tree	4	Birth-wort	202	Caltrops	93
Asparagus Beds, formation of	435	Bird's Pepper	35	Camphor-tree	89
Asparagus	67	Bird's-nest	96, 200	Campion	104
—, Forcing of	436	Bishop's-weed	55	Canary-grass	14
Aspen	219	Blood-flower	68	Candleberry Myrtle	217
Asphodel	61	Bladder-wort	6	Candytuft	143
Aspley Cottage	293	Blinks	21	Canterbury-bells	31
— wood	—	Black Spruce	210	Cape Jasmine	49
Asarabacca	105	Bladder Fern	226	Caper	123
Avens	115	Bladder-nut	56	Cape Bignonia	136
Awl-wort	142	Black Horehound	132	Carambola-tree	103
Azarole	114	Black Bryony	218	Cardinal Flower	32
Balm of Gilead	210	Bladder Senna	171	Cardoon	178
Balsam	33	Blood-wort	122	Carline Thistle	179
Balsam-tree	224	Bog Asphodel	66	Carnation	101
Bamboo Cane	69	Bog-rush	13	Carrot	53
Bane-berries	122	Bog Orchis	200	Carob-tree	224
Banyan-tree	225	Borage	30	Cashew Nut	89
Barley	21	Box-tree	206	Castor-Oil-plant	212
Barren-wort	28	Botany-bay Tea	218	Catchfly	162
Bastard Vervain	8	Brake	227	Cat's-tail	293
Basil	133	Bramble	120	Cat Mint	134
Bastard Toad-flax	41	Bread-fruit	203	Cat Thyme	134
Bastard Balm	132	Brome-grass	19	Cat's-ear	177
Bastard Indigo	173	Brook-weed	33	Cat's-tail-grass	15
Barbadoes Lily	59	Broom Rape	135	Cedar of Lebanon	211
Bastard Lupine	173	Brasillito	99	Celandine	122
		Broom	163	Centauy	33

ENGLISH INDEX.

	Page.		Page.		Page.
Chamomile	185	Cudweed	182	Fig-house	
Chaste-tree	140	Custard Apple	130	————, Construction of	373
Cherry-tree	109	Cucumber Pits	404	————, End Elevation of	333
————, varieties of ..	308	————, Construc-		————, Section of	
————, Forcing of ..	423	tion of	—	Figwort	39
Chervil	53	————, Management		Filmy Fern	23
Cherry Pepper	35	of	409	Finger-grass	16
Chesnut Oak	209	————, Varieties of ..	414	Fiorin-grass	15
Chickweed Winter-green	72	Current's	42, 309	Fir-tree	210
Chinese Apple	113	Cypress	212	Flat Pea	168
Chinese Temple	239	Daffodil	64	Flax	58
Chickling Vetch	165	Dahoon Holly	29	Flax Lily	60
China Aster	187	Day Lily	65	Flea-bane	184, 187
Children's Gardens	287	Daisy	187	Flower-de-luce	13
Chive	65	Darnel	20	Flower Gardens	242
Christmas Rose	129	Dandelion	177	Pleawort	187
Christ's Thorn	44	Dame's Violet	146	Flowering Raspberry ..	—
China Rose	160	Date Palm	217	Flowering Rush	90
Cicely	53	Date Plum	224	Fly Honeysuckle	43
Cinnamon-tree	89	Dead Nettle	131	Forget-me-not	31
Cinquefoil	120	Devil's-bit	26	Forcing Pits	402, 404
Citron, Management of ..	173	Deptford Pink	100	Fool's Parsley	54
Citron House	300	Dewberry	120	Fox Glove	139
————, End Eleva-	333	Dittany of Crete	131	Foxtail-grass	15
tion of		Dock	79	Fraxinella	99
————, Section of	—	Dodder	51	French Honeysuckle	166
Clary	6	Dog's-chop	112	French Willow	74
Clove	101	Dog's-tail-grass	18	Fringe-tree	4
Cloud Berry	120	Dog's-tooth-grass	16	Fritillary	66
Clove-spice	109	Dog's-tooth Violet	63	Frog-bit	219
Club Moss	229	Dogwood	25	Furze	164
Club-rush	14	Dog's-bane	48	Fumitory	162
Cockscomb	46	Dragon	72	Garden Entrance	300
Cock's-foot-grass	18	Dragon's-head	133	Gardener's House	300
Cockspur Thorn	114	Dragon-tree	62	Garland Flower	2
Cockle	104	Dropwort	113	Garlic	65
Cocoa-nut-tree	207	Dutch Clover	166	Gentianella	27
Coltsfoot	184	Duckweed	6	Gentian	52
Colic-root	63	Duck's-foot	123	General Plan of the Plea-	
Colpoon-tree	57	Dyers' Green-weed	164	sure Ground	233
Columbine	127	Dyers'-weed	107	Gipsey-wort	6
Comfrey	30	Elder	56	Ginger	2
Conservatory Plants, &c.	249	Elecampane	187	Germander	134
Compost	—	Elm-tree	51	Glasswort	3
Copper-bars	317	Elk's-horn	228	Globe Flower	129
Coral-tree	167	Enchanter's Nightshade ..	5	Globe Thistle	197
Cord-grass	18	Eryngo	52	Goat's-beard	176
Coriander	54	Evening Flower	12	Goat's-rue	172
Cornelian Cherry	25	Evening Primrose	73	Goat's Thorn	166
Corn Flag	11	Evergreens, View of	289	Gold of Pleasure	143
Coral-root	200	Evergreen Thorn	114	Golden-locks	179
Cornish Money-wort ..	135	Everlasting Pea	165	Golden-rod	186
Costmary	181	Eye-bright	138	Golden Saxifrage	102
Cotton-weed	179	Feather-foil	39	Golden Thistle	178
Cotton-grass	14	Feather-grass	20	Gooseberry's	42, 308
Cotton Thistle	179	Felwort	51	Goose-foot	52
Cotton-tree	159	Fennel	54	Goose-grass	27
Coral-wort	144	Fenugreek	172	Grass of Parnassus	57
Cow Berry	76	Fescue-grass	18	Grape Vine	352
Cress	145	Fever-few	185	————, Management	
Cow Wheat	138	Fever-wort	48, 133	of	357
Cress Rocket	142	Field Madder	26	————, Varieties of ..	367
Cranberry	—	Fig Marigold	111	Grape Hyacinth	62
Crane's Bill	157	Fiddle-wood	140	Great Burnet	—
Crocus	13	Fig-tree	225	Grass-wrack	3
Crow-foot	129	————, Varieties of ..	375	Greek Valerian	40
Crow Berry	216	————, Forcing of ..	373	Green Man Orchis	198
Cuckold-tree	223			Green-weed	164

ENGLISH INDEX.

	Page.		Page.
Gronwell	30	Hornbeam	209
Greenhouse	248	Hornwort	207
———, Construction of	—	Horse-tail	229
Greenhouse Plants	249	Horse-mint	134
———, Manage-		Hottentot Cherry	57
ment of	—	Hound's-tongue	29
———, Propaga-		Horse-shoe Vetch	165
tion of	257	Horse Chesnut	72
Groundsel-tree	183	Hothouses	300
Groundsel	184	———, Materials for	
Guelder Rose	56	erecting of	310
Guava	110	———, Heating of	323
Hassagay-tree	22	Hot Wall	420
Hare's-ear	53	Horse-raddish-tree	92
Hare's-foot	166	Houseleek	107
Hawkweed	176, 180	Humble Plant	222
Hawk's-beard	177	Hyacinth	66
Hawthorn	114	Indian Cress	74
Hawkbit	177	Indian Fig	109
Hair-grass	16	Indigo	172
Hardy Heath Garden	282	Indian Cucumber	70
Hare-bell	65	Indian Shot	1
Hard Fern	227	Insects, destruction of	396
Hair's-tail-grass	20	Irish Heath	87
Hart-wort	54	Iron-wood	49
Hart's-tongue	227	Iron-tree	23
Hazel-nut	209	Ivy	42
Heath-grass	17	Jagged Chickweed	21
Heath	77	Jacob's Ladder	40
———, Management of	273	Jack-in-a-box	205
———, Propagation of	278	Jasmine	4
Heath-house	271	Jerusalem Sage	
———, Elevation of	—	Jonquil	64
———, Section of	—	Juniper	221
———, Construction of	—	Judas-tree	99
Hedge Parsley	53	Kitchen Gardens	297
Hedge Hyssop	7	———, General	
Heliotrope	41	Plan of	297
Henry the VIIIth's Cottage	293	Kidney Vetch	164
Hedge Mustard	145	Kidney Bean	429
Hemp Nettle	132	———, Forcing	—
Helleborine	200	Knapweed	195
Henbane	35	Knawel	102
Hemp Agrimony	179	Knot-grass	41
Herb Paris	88	Ladies' Traces	200
Hellebore	129	Ladies' Cushion	101
Hemlock	54	Lady's Mantle	28
Hemlock Spruce	210	Ladies' Smock	144
Herb Christopher	122	Ladies' Slipper	202
Heron's-bill	149	Ladies' Finger	164
Her Grace's Flower Gar-		Lamb's Lettuce	13
den	242	Larkspur	126
Holly	28	Larch	211
Hollyhock	159	Laserwort	54
Holy-grass	17	Laurel	89, 109
Honey-wort	30	Laurestine	56
Honey Locust-tree	224	Lavender	133
Honey-flower	142	Labyrinth	296
Honeysuckle	43	Leadwort	36
Horned Poppy	122	Leatherwood	77
Hoop Petticoat	64	Lemon-tree	174
Hop	218	———, Cultivation of	—
Hog-weed	3	Leopard's-bane	187
Hog's-fennell	54	Lettuce	176
Hop Hornbeam	209	Lily-thorn	26
Hone-wort	55	Lily	63
Horehound	132	Lily of the Valley	66
		Lion's-tail	133
		Lignum Vita-tree	91
		Lime	174
		Lizard's-tail	73
		Lime-tree	123
		Ling	77
		Liquorice	172
		Live-grass	19
		Loose-strife	38
		Louse-wort	139
		Logwood	91
		Locust-tree	91
		Love Apple	—
		London Rocket	145
		Lovage	53
		Love-lies-bleeding	206
		Lupine	170
		Lung-wort	29
		Lyme-grass	21
		Mabolo-tree	224, 225
		Maiden-hair	227
		Maiden Plum	10
		Madder	27
		Madwort	30, 143
		Malabar-Nightshade	57
		Mahogany-tree	96
		Mallow	159
		Mango-tree	46
		Mandrake	35
		Man-Orchis	198
		Maple	76
		Mare's-tail	3
		Marjoram	131
		Marsh Marygold	129
		Marsh Cinquefoil	120
		Marsh Mallow	159
		Marygold	196
		Mastick-tree	218
		Mat-grass	14
		Meadow Grass	17
		Meadow Rue	128
		Meadow Saffron	70
		Medick	167
		Medlar	114
		Me'ic-grass	16
		Melon Pit, Construction of	402
		Melon, Management of	405
		———, Varieties of	408
		Melon Thistle	108
		Menagerie, View of	285
		———, Entrances	286
		Mercury	219
		Mexican Lily	59
		Mezereon	76
		Michaelmas Daisy	190
		Milfoil	185
		Milk-wort	163
		Milk Vetch	166
		Millet grass	19
		Mignonette	107
		Mint	134
		Misseltoe	217
		Monkey-flower	136
		Monk Orchis	197
		Moonsseed	220
		Mountain Sorrel	70
		Moschatel	68
		Mountain Pride	57
		Mountain Ash	113

ENGLISH INDEX.

	Page.		Page.		Page.
Moor-grass	17	Pepper	10	Sage	6
Moonwort	229	Pepper-wort	143	Sandwort	102
Mountain Ebony	96	Periwinkle	41	Sago Palm	207
Mother-wort	131	Petty-whin	164	Sawwort	180
Moss Campion	102	Persicaria	88	Saltwort	51
Mouse-ear Chickweed ..	104	Pheasant's-eye	128	Sandal-wood	23
Mouse-tail	59	Physic-nut	211	Sassafras-tree	89
Mudwort	135	Pill-wort	230	Sacred Bean	130
Mushroom House	415	Pink	100	St. John's Bread	224
—————, Manage-		Pimpernel	38	St. John's Wort	175
ment of	—	Pine Apple	68	St. Peter's Wort	50, 175
Mugwort	182	—————, Varieties of ..	397	Sampshire	54
Mustard	146	—————, Forcing of ..	389	Symore	76
Mulberry	206	Pine Stove	—	Saxifrage	101
Mullein	34	—————, Construction of ..	376	Screw-tree	158
Musk Orchis	198	Pine Pit	398	Screw-pine	213
Musk Okro	160	Pine-tree	210	Scabious	28
Myrtle	119	Pipe-wort	207	Scottish Asphodel	70
Navel-wort	103	Pitcher-plant	107, 221	Scorpion-grass	31
Nectarine	—	Plane-tree	210	Scorpion-senna	171
—————, Varieties of ..	349	Plank-plant	168	Scurvy-grass	143
Nettle	205	Plantain	27	Sea Daffodil	60
Nipple-wort	177	Plant Stove	261	Sea Heath	67
Nettle-tree	224	Plantain-tree	68	Sea Kale Beds, Formation	
New Jersey Tea	44	Plum-tree	109	of	435
New Zealand Tea	111	—————, Varieties of ..	307	—————, Forcing of	439
Nightshade	43	Plume Thistle	179	Sea Rocket	144
Norfolk Island Pine	221	Ploughman's Spikenard ..	184	Sea Purslane	222
Norway Spruce	210	Pomegranate	109	Sea Milkwort	41
Oak	208	Pondweed	29	Sea Buckthorn	217
Oat-grass	19	Poplar	219	Sea Lavender	58
Oleander	47	Poison Oak	57	Sea Parsnip	53
Oleaster	22	Potatoe, Forcing of	433	Sea-side Oat	20
Olive	4	Poison-bulb	64	Sea-side Grape	88
Olive-wood	43	Poppy	122	Self-heal	132
Old-man's-beard	179	Polypody	225	Service-tree	113
Orange-tree	174	Primrose	38	Sensitive Plant	222
Orphine	104	Prince's-feather	206	Shallon	93
Orache	222	Prickly Samphire	53	Shrubby trefoil	25
Osmund Royal	228	Privet	3	Sheep's-bit	41
Oswego Tea	8	Pucoon	122	Shepherd's Needle	53
Osage Apple	217	Purslane-tree	57	Shepherd's Purse	143
Ox-eye	193	Purslane	67, 106	Shaddock	174
Ox-tongue	176	Quamash	61	Shield Fern	226
Pæony	125	Quill-wort	230	Silver-tree	218
Papaw-tree	220	Quince	114	Side-saddle-flower	122
Palma Christi	212	Quaking-grass	18	Silver Fir	211
Panic-grass	16	Rampion	32	Skull-cap	132
Passion-flower	148	Radish	146	Slipperwort	7
Parsley Piert	28	Ragwort	196	Snap Dragon	139
Parterres	245	Raspberry's	120, 308	Sneeze-wort	185
Pasque-flower	127	Red Cedar	221	Snow-berry	50
Pea	173	Reed-grass	20	Snowdrop-tree	105
Peach-tree	338	Red Spruce	211	Snow-flake	65
—————, Borders for ..	334	Restharrow	164	Soft Grass	16
—————, Varieties of ..	349	Rhubarb	89	Solomon's Seal	66
—————, Forcing of	341	—————, Forcing of	431	Sorrel	70
Peach House Planting ..	336	Ribbon-flower	147	Soap-berry	88
—————, Construction		Rocket	106	Soap-wort	101
of	333	Rock Cress	146	Sow Thistle	176
—————, Section of ..	—	Rose	115	Spanish Elm	31
—————, End Eleva-		Rose Acacia	171	Spawn for Mushroom Beds	419
tion of	333	Rose-root	219	Speedwell	5
Pear-tree	—	Rosemary	8	Spear-mint	134
—————, Varieties of ..	302	Rupture-wort	52	Spider-wort	60, 66
Pearl-wort	29	Rush	67	Spikenard	184
Penny-wort	104	Rye	20	Spindle-tree	42
Peppermint-tree	110	Rye-grass	20	Spleen-wort	226

ENGLISH INDEX.

	Page.		Page.
Spurry	105	Thorn Apple	35
Spurge	203	Thistle	180
Spurge Laurel	76	Thrift	57
Spurless Violet	34	Throat-wort	37
Squill	65	Tick-seed	3
Staff-tree	44	Tiger-flower	147
Star Apple	49	Timothy-grass	15
Star of Bethlehem	65	Tobacco	43
Star-wort	188	Tooth-wort	138
Stitch-wort	102	Tormentil	121
Stone-crop	101	Toothache-tree	218
Stove Plants	264	Toad Flax	139
Management	—	Touch-me-not	33
of	—	Tower Mustard	146
Stone Parsley	54	Traveller's Joy	128
Stock	145	Tree Mallow	159
Stork's-bill	149	Trefoil	166
Strap-wort	56	Treacle Mustard	145
Strawberry-blite	3	Tropical Plants, Treatment	264
Strawberry	120	of	264
Forcing of	426	Trumpet-flower	137
Varieties of	309	Tulip	66
Strawberry-tree	95	Tulip-tree	130
St. Andrew's Cross	175	Tupelo	225
Succory	177	Turk's-cap	63
Sulphur-wort	54	Turnip	146
Succession Pine Pits	399	Twig-rush	9
Succession Pines	379	Tway-blade	200
Sugar Cane	20	Valerian	12
Sumach	56	Venus's Fly-trap	94
Sundew	59	Vetch	165
Supple Jack	88	Vinery Borders	352
Sun-flower	193	Vinery, Construction of	350
Sun-rose	124	End Elevation of	333
Sweet Flag	67	Section of	—
Sweet Pea	165	Vine, Varieties of	367
Sweet Orange	174	Propagation of	367
Sweet Sultan	195	Management of	357
Sweet Gale	217	Vernal-grass	9
Sweet-grass	17	Vervain	134
Sweet Bay	89	Viper's-grass	180
Swallow-wort	50	Viper's Bugloss	30
Swine's Succory	180	Violet	34
Tamarind-tree	147	Virgin's Bower	128
Tamarisk	56	Wall Cress	146
Tare	165	Wall Lettuce	177
Tansy	182	Wall-flower	145
Teak-wood	49	Wall Penny-wort	104
Teasel	26	Wall Pellitory	28
Tea-tree	162	Wall Rue	227
Thyme	131	Walnut-tree	210
		Wampee-tree	94
		Waratah Camellia	161
		Water Plantain	71
		Water Soldier	127
		Water Starwort	3
		Water Dropwort	55
		Water Lily	121
		Water Milfoil	207
		Water Melon	1
		Water Aloe	127
		Water-wort	89
		Water Parsnep	55
		Wayfaring-tree	56
		Weasel Snout	132
		Whorl-grass	16
		Wheat	20
		Whirling Plant	165
		White-rot	54
		Whitlow-grass	142
		White Horehound	132
		Whortle-berry	76
		Wild Liquorice	166
		Wild Basil	131
		Wild Chamomile	185
		Wild Pear	113
		Wild Plantain	31
		Widow Wail	10
		Winter Aconite	129
		Willow	213
		Willow-herb	74
		Winter-green	95
		Winter-cress	145
		Winter-berry	69
		Winter-green-grass	16
		Witch Hazel	28
		Woburn Abbey, View of	1
		Wormwood	182
		Worm-grass	33
		Wolf's-bane	126
		Wood-rush	67
		Woad	144
		Woundwort	131
		Woodsorrel	104
		Woodroof	27
		Wych Elm	51
		Yarrow	185
		Yellow-root	59
		Yellow-rattle	138
		Yellow-wort	74
		Yew-tree	221
		Zebra-plant	1



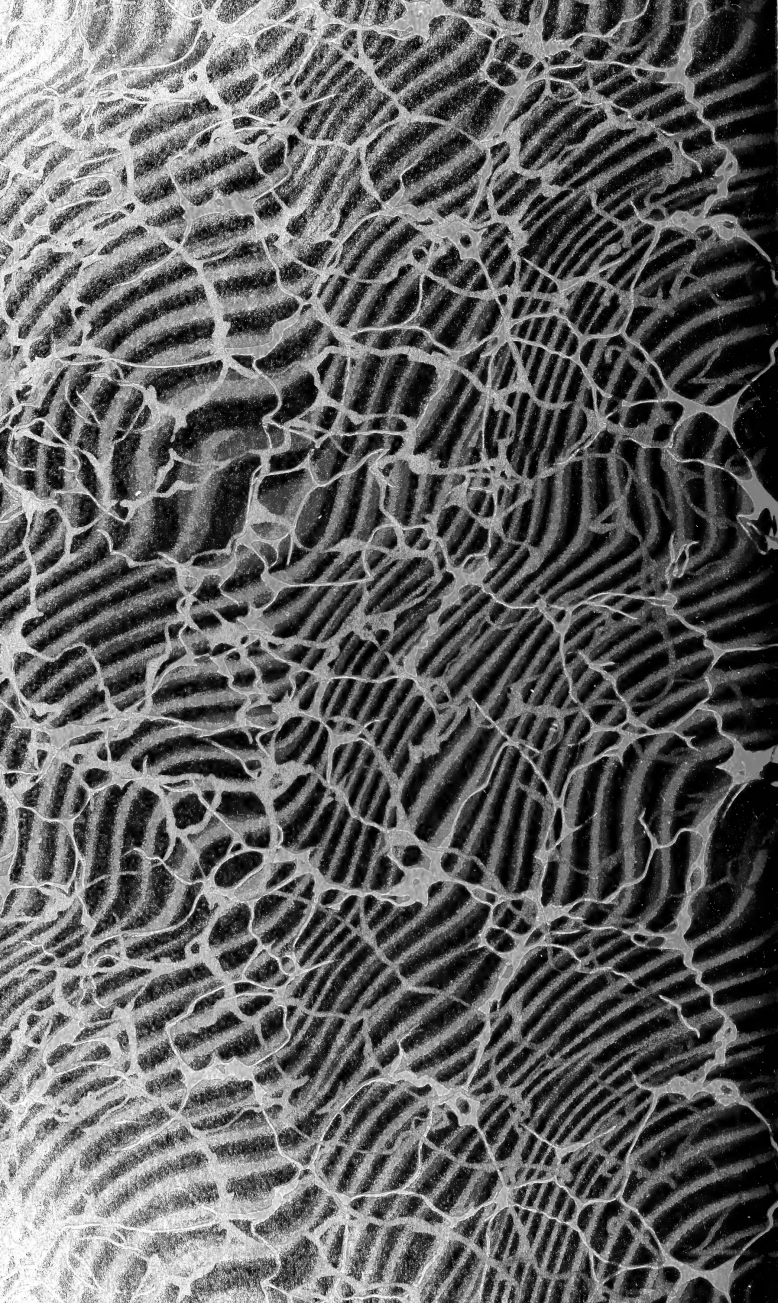



CALIF ACAD OF SCIENCES LIBRARY



3 1853 00051 4633