

UNIVERSITY OF
ILLINOIS LIBRARY
AT URBANA-CHAMPAIGN
NATURAL HIST. SURVEY

Digitized by the Internet Archive
in 2011 with funding from
University of Illinois Urbana-Champaign

6c
.39
62
p.6

HOW TO COLLECT AND PRESERVE INSECTS

H. H. ROSS



ILLINOIS STATE NATURAL HISTORY SURVEY
NATURAL HISTORY SURVEY LIBRARY
MAR 39



STATE OF ILLINOIS
DEPARTMENT OF REGISTRATION AND EDUCATION

HOW TO COLLECT AND PRESERVE INSECTS

H. H. ROSS



Printed by Authority of the State of Illinois

NATURAL HISTORY SURVEY DIVISION

Harlow B. Mills, Chief

Circular 39

Urbana

July, 1962

(Sixth Printing, With Alterations)

NATURAL
HISTORY SURVEY
LIBRARY

4 1962

BOARD OF NATURAL RESOURCES AND CONSERVATION

WILLIAM SYLVESTER WHITE, *Chairman*; A. E. EMERSON, Ph.D., *Biology*; WALTER H. NEWHOUSE, Ph.D., *Geology*; ROGER ADAMS, Ph.D., D.Sc., *Chemistry*; ROBERT H. ANDERSON, B.S.C.E., *Engineering*; CHARLES E. OLMSTED, Ph.D., *Forestry*; W. L. EVERITT, E.E., Ph.D., *Representing the President of the University of Illinois*; DELYTE W. MORRIS, Ph.D., *President of Southern Illinois University*

NATURAL HISTORY SURVEY DIVISION, Urbana, Illinois

SCIENTIFIC AND TECHNICAL STAFF

HARLOW B. MILLS, Ph.D., *Chief*

BESSIE B. EAST, M.S., *Assistant to the Chief*

Section of Economic Entomology

GEORGE C. DECKER, Ph.D., *Principal Scientist and Head*
 J. H. BIGGER, M.S., *Entomologist*
 L. L. ENGLISH, Ph.D., *Entomologist*
 W. H. LUCKMANN, Ph.D., *Entomologist*
 WILLIS N. BRUCE, Ph.D., *Entomologist*
 JOHN P. KRAMER, Ph.D., *Associate Entomologist*
 RICHARD J. DYSART, Ph.D., *Associate Entomologist*
 RONALD H. MEYER, M.S., *Assistant Entomologist*
 WILLIAM C. MOYE, M.S., *Assistant Entomologist*
 JAMES W. SANFORD, B.S., *Technical Assistant*
 EARL STADELBACHER, B.S., *Technical Assistant*
 SUE E. WATKINS, *Technical Assistant*
 H. B. PETTY, Ph.D., *Extension Specialist in Entomology**
 STEVENSON MOORE, III, Ph.D., *Extension Specialist in Entomology**
 CLARENCE E. WHITE, B.S., *Instructor in Entomology Extension**
 COSTAS KOUSKOLEKAS, M.S., *Research Assistant**
 VICTOR T. WILLIAMS, B.S., *Research Assistant**

Section of Faunistic Surveys and Insect Identification

H. H. ROSS, Ph.D., *Principal Scientist and Head*
 MILTON W. SANDERSON, Ph.D., *Taxonomist*
 LEWIS J. STANNARD, JR., Ph.D., *Taxonomist*
 PHILIP W. SMITH, Ph.D., *Associate Taxonomist*
 LEONOKA K. GLOYD, M.S., *Assistant Taxonomist*
 H. B. CUNNINGHAM, Ph.D., *Assistant Taxonomist*
 RUTH P. CASH, *Technical Assistant*
 JOHN M. KINGSOLVER, Ph.D., *Research Associate**
 JOHN D. UNZICKER, B.S., *Research Assistant**
 TALAAAT K. MITRI, M.S., *Research Assistant**

Section of Aquatic Biology

GEORGE W. BENNETT, Ph.D., *Aquatic Biologist and Head*
 WILLIAM C. STARRETT, Ph.D., *Aquatic Biologist*
 R. W. LARIMORE, Ph.D., *Aquatic Biologist*
 DAVID H. BUCK, Ph.D., *Associate Aquatic Biologist*
 ROBERT C. HILTBIRAN, Ph.D., *Associate Biochemist*
 DONALD F. HANSEN, Ph.D., *Associate Aquatic Biologist*
 WILLIAM F. CHILDERS, M.S., *Assistant Aquatic Biologist*
 MICHAEL G. JOHNSON, *Biochemical Assistant*
 MARYFRAN MARTIN, *Technical Assistant*
 ROBERT D. CROMPTON, *Field Assistant*
 MICHAEL J. DUEVER, *Field Assistant*
 CHARLES F. THOITS, III, A.B., *Research Associate**
 ROLLIN D. ANDREWS, III, B.S., *Field Assistant**
 LESLIE L. LAYTON, *Field Assistant**

CONSULTANTS: HERPETOLOGY, HOBART M. SMITH, Ph.D., *Professor of Zoology, University of Illinois*; PARASITOLOGY, NORMAN D. LEVINE, Ph.D., *Professor of Veterinary Parasitology and of Veterinary Research, University of Illinois*; WILDLIFE RESEARCH, WILLARD D. KLIMSTRA, Ph.D., *Professor of Zoology and Director of Co-operative Wildlife Research, Southern Illinois University*; STATISTICS, HORACE W. NORTON, Ph.D., *Professor of Agricultural Statistics Design and Analysis, University of Illinois*.

*Employed on co-operative projects with one of several agencies: University of Illinois, Illinois Agricultural Extension Service, Illinois Department of Conservation, National Science Foundation, United States Department of Agriculture, United States Fish and Wildlife Service, United States Public Health Service, and others.

Section of Applied Botany and Plant Pathology

J. CEDRIC CARTER, Ph.D., *Plant Pathologist and Head*
 J. L. FORSBERG, Ph.D., *Plant Pathologist*
 G. H. BOEWE, M.S., *Associate Plant Pathologist*
 ROBERT A. EVERS, Ph.D., *Associate Botanist*
 ROBERT DAN NEELY, Ph.D., *Associate Plant Pathologist*
 E. B. HIMELICK, Ph.D., *Associate Plant Pathologist*
 WALTER HARTSTIRN, Ph.D., *Assistant Plant Pathologist*
 D. F. SCHOENEWEISS, Ph.D., *Assistant Plant Pathologist*
 ANNE ROBINSON, M.A., *Technical Assistant*

Section of Wildlife Research

THOMAS G. SCOTT, Ph.D., *Wildlife Specialist and Head*
 RALPH E. YEATTER, Ph.D., *Wildlife Specialist*
 F. C. BELLROSE, B.S., *Wildlife Specialist*
 H. C. HANSON, Ph.D., *Associate Wildlife Specialist*
 RICHARD R. GRABER, Ph.D., *Associate Wildlife Specialist*
 GLEN C. SANDERSON, Ph.D., *Associate Wildlife Specialist*
 RONALD F. LABISKY, M.S., *Associate Wildlife Specialist*
 MARJORIE J. SCHLATTER, *Technical Assistant*
 RICHARD BARTHOLOMEW, B.S., *Technical Assistant*
 HOWARD CRUM, JR., *Field Assistant*
 JACK A. ELLIS, M.S., *Project Leader**
 BOBBIE JOE VERTS, M.S., *Project Leader**
 RALPH J. ELLIS, M.S., *Project Leader**
 WILLIAM L. ANDERSON, B.S., *Assistant Project Leader**
 JAMES A. HARPER, M.S., *Assistant Project Leader**
 DAVID A. CASTEEL, B.S., *Assistant Project Leader**
 GERALD G. MONTGOMERY, M.S., *Research Associate**
 JOHN E. WARNOCK, M.S., *Research Associate**
 DUANE E. NEWMAN, M.S., *Research Associate**
 WILLIAM R. EDWARDS, M.S., *Research Associate**
 P. J. RAO, B.V.Sc., M.A., *Research Assistant**
 RICHARD W. LUTZ, M.W.M., *Research Assistant**
 GEORGE B. JOSELYN, M.S., *Research Assistant**
 RICHARD D. ANDREWS, M.S., *Field Mammalogist**
 GERALD L. STORM, M.S., *Field Ecologist**
 KEITH P. DAUPHIN, *Assistant Laboratory Attendant**

Section of Publications and Public Relations

JAMES S. AYARS, B.S., *Technical Editor and Head*
 BLANCHE P. YOUNG, B.A., *Assistant Technical Editor*
 ANNE RUTH DREYFUSS, M.A., *Assistant Technical Editor*
 WILMER D. ZEHR, *Assistant Technical Photographer*

Technical Library

RUTH R. WARRICK, B.S., B.S.L.S., *Technical Librarian*
 DORIS F. DODDS, B.A., M.S.L.S., *Technical Librarian*

This paper is a contribution from the Section of Faunistic Surveys and Insect Identification.

570 Nat. Hist. Surv.
 Il. 6c
 no. 39
 1962
 6006

CONTENTS

| | |
|--|-----------------------|
| Where to Collect..... | 1 |
| What to Use..... | 2 |
| Nets..... | 3 |
| Killing Bottles..... | 6 |
| Aspirators or Suckers..... | 9 |
| Sifter..... | 12 |
| Berlese Funnel..... | 12 |
| Equipment for Collecting Aquatic Insects..... | 16 |
| How to Handle Unmounted Specimens..... | 17 |
| Temporary Cases..... | 17 |
| Relaxing Boxes and Jars..... | 19 |
| How to Mount and Preserve Specimens..... | 20 |
| Preservation by Pinning..... | 20 |
| Spreading Board for Moths and Butterflies..... | 24 |
| Preservation in Fluid..... | 26 |
| How to Label the Specimens..... | 26 |
| Housing the Collection Permanently..... | 27 |
| Insect Boxes..... | 27 |
| Precaution Against Pests..... | 27 |
| The Insect World..... | 28 |
| How to Identify Specimens..... | 34 |
| Synopsis of Illinois Insect Orders..... | 35 |
| Primitive Wingless Insects..... | 35 |
| Diplura, 36 | Collembola, 36 |
| Protura, 36 | Microcoryphia, 36 |
| Primitive Winged Insects..... | 38 |
| Ephemeroptera, 38 | Thysanura, 38 |
| Folding-Wing Insects..... | 40 |
| Cursoria, 42 | Phthiraptera, 45 |
| Isoptera, 43 | Mallophaga, 47 |
| Orthoptera, 43 | Anoplura, 47 |
| Dermaptera, 44 | Thysanoptera, 47 |
| Plecoptera, 45 | Hemiptera, 48 |
| Zoraptera, 45 | Megaloptera, 52 |
| Corrodentia, 45 | Neuroptera, 52 |
| Coleoptera, 53 | Siphonaptera, 61 |
| Hymenoptera, 54 | |
| Mecoptera, 55 | |
| Trichoptera, 57 | |
| Lepidoptera, 58 | |
| Diptera, 60 | |
| Chilopoda, 67 | |
| Relatives of Insects..... | 62 |
| Isopoda, 62 | Pseudoscorpionida, 64 |
| Amphipoda, 62 | Phalangida, 64 |
| Scorpionida, 64 | Araneida, 65 |
| Acarina, 65 | |
| Diplopoda, 66 | |
| Chilopoda, 67 | |
| The State Insect Collection..... | 67 |
| Reports on Illinois Insects..... | 69 |
| Useful Books..... | 70 |
| How to Ship Specimens..... | 70 |
| Where to Buy Supplies..... | 71 |



Illinois streams are a source of many insects of interest to the amateur collector. Shown here is the Salt Fork River, south of Oakwood.

HOW TO COLLECT AND PRESERVE INSECTS'

H. H. ROSS

WITH rather simple equipment, the amateur as well as the trained entomologist can make a worthwhile collection of insects.

The making of such a collection may have educational and recreational as well as scientific values. Developing this hobby is one of the finest ways for students, especially those in agricultural districts, to become acquainted with the large number of injurious and beneficial insects that they encounter about the home and in the fields. High school classes in biology find excellent laboratory material in the many insects available for rearing and study. Both old and young collectors find a great deal of pleasure in working with the showy and beautiful insects, such as beetles, moths, and butterflies; the satisfaction derived comes both from having relaxation from the day's work and from making real contributions to scientific knowledge. Many entomological museums welcome the opportunity to examine carefully prepared and labeled collections. These collections supply distribution records for insect species, in addition to other information of value to technical entomologists. Also, the amateur collector profits from his contact with specialists who can help him identify his specimens and advise him at any stage of his work.

It is hoped that this circular will show how easy it is to make a start in insect collecting and will give the student helpful ideas on how and where to begin.

WHERE TO COLLECT

In late spring, in summer, and in early fall, insects are very abundant in fields and woods, and large numbers of them may be caught by sweeping through the grass and branches with a strong insect net. Flowers of all descriptions are favorite visiting places of many bees, flies, beetles, and other insects, and will afford good collecting. Woods along the banks of streams, open glades in deep woods, and brush along forest edges offer some of the best opportunities for collecting by the sweeping method.

In early spring, when insects can be taken only sparingly in the open, the collector frequently finds sheltered hollows where they may

be caught in large numbers. A certain kind of insect may live only on a certain kind of plant, and to obtain the insect the collector must search or sweep the plant, called the host plant.

Many obscure places harbor insects seldom found elsewhere. Among these are leaf mold and debris on the surface of the soil, particularly in woods; rotten logs and stumps, which should be turned over to reveal insects that hide under or around them, and then carefully searched or torn apart for others that live inside; in, under, and around dead animals; under boards and stones.

Trees sometimes yield valuable specimens. If part of a tree, under which has been spread a large white sheet, is struck with a heavy, padded stick, many insects, such as weevils, will fall to the sheet and "play possum." They can be picked off quite easily.

Lights attract large numbers of certain nocturnal insects, such as June beetles and many kinds of moths; at night these insects may be collected at street or porch lights, on windows and screens of lighted rooms, or at light traps put up especially to attract them. Swarms of aquatic insects come to street lights of towns along rivers, sometimes in such numbers as to pile up in a crawling mass under each light. Collecting at this source is best on warm, cloudy nights; wind or cold keeps most nocturnal insects fairly inactive. Different species of moths and beetles visit the lights in different seasons so that collecting by this method alone yields many kinds of insects.

Insects that live in the water may be collected with heavy dip nets swept through the water at various levels and through the mud and debris at the bottom. In shallow water, many insects will be found if stones and logs are turned over and leaf tufts pulled apart.

In winter, insect galls or cocoons may be gathered. If these are placed in jars with cheesecloth covers tied over them, kept in a warm room, but away from radiators and all intense heat, many insects will emerge from them before spring.

WHAT TO USE

For making even a fairly large insect collection, only a small amount of equipment is required. A net and killing bottle are essential, and good work may be done with these alone. A greater variety of insects may be collected and with better results if a few more items are added to the list. Here is an outfit that will be found very satisfactory in the field.

1. A strong beating net for general sweeping and an additional light net to be used for moths and butterflies.

2. Killing bottles, several small and one or two large ones.
3. A pair of flexible forceps, 10 to 12 centimeters (about 4 to 5 inches) long, with slender prongs.
4. One or two camel's-hair brushes for picking up minute insects.
5. A few vials or small bottles containing fluid preservative.
6. Folded papers for butterflies.
7. A few small tins or boxes lined with cellucotton.

These items may be purchased from commercial supply houses such as those listed on page 71. Many items, however, may be made by the collector at nominal cost.

Nets

Nets are the most important items in the collecting kit of the entomologist. For this reason nets should be rigidly constructed and handled with care.

Construction.—Nets may easily be made at home. The necessary parts are a handle, a loop or ring to be attached to it, and a cloth bag to be hung from the loop, figs. 1 and 2. The handle should be strong and fairly light. At the net end, fig. 1*a*, a groove is cut down each side to receive the arms of the loop. The grooves are as deep as the thickness of the wire used in the loop; one groove is 3 inches long and the other 2½ inches; and each ends in a hole through the handle at right angles to the length.

The loop, fig. 1*b*, is made of steel wire, preferably three-eighths-inch piano wire, which if bent by rough usage springs back into shape and will stand a great deal of hard wear. The wire is shaped, as the figure shows, to form a loop with two straight arms, the tips of which are bent at right angles toward each other. The arms and hooks thus formed must be exactly long enough to fit along the grooves and into the holes in the handle. After the bag or net has been attached to the loop, and the wire has been fitted to the handle, the joint may either be wrapped tightly with wire, fig. 1*c*, or bound by a metal cylinder or ferrule slipped over the arms of the loop, fig. 1*d*.

The bag, about twice as long as the diameter of the loop, should be tapered at the bottom. It is made from four pieces of cloth, each cut in the shape of fig. 2*a*, and a narrow strip or band of stout muslin or light canvas, 2*b*, which is to bind the bag to the wire loop. The four pieces are sewed together to form a cone-shaped bag, and one edge of the band is sewed to the top edge of the bag.

The bag may be attached to the wire loop in either of two ways. The band may be folded over the loop and sewed so that the attachment is permanent; or it may be folded over, sewed, and then slipped on the loop before the latter is fastened to the handle. In the latter

case the bag must be open along one seam just below the handle a sufficient distance to allow the band to slip on and around the loop; this vent may be closed with a string lacing after the net is on the loop, and the whole fastened to the handle. A combination of this arrangement with a ferrule binding the loop to the handle is most

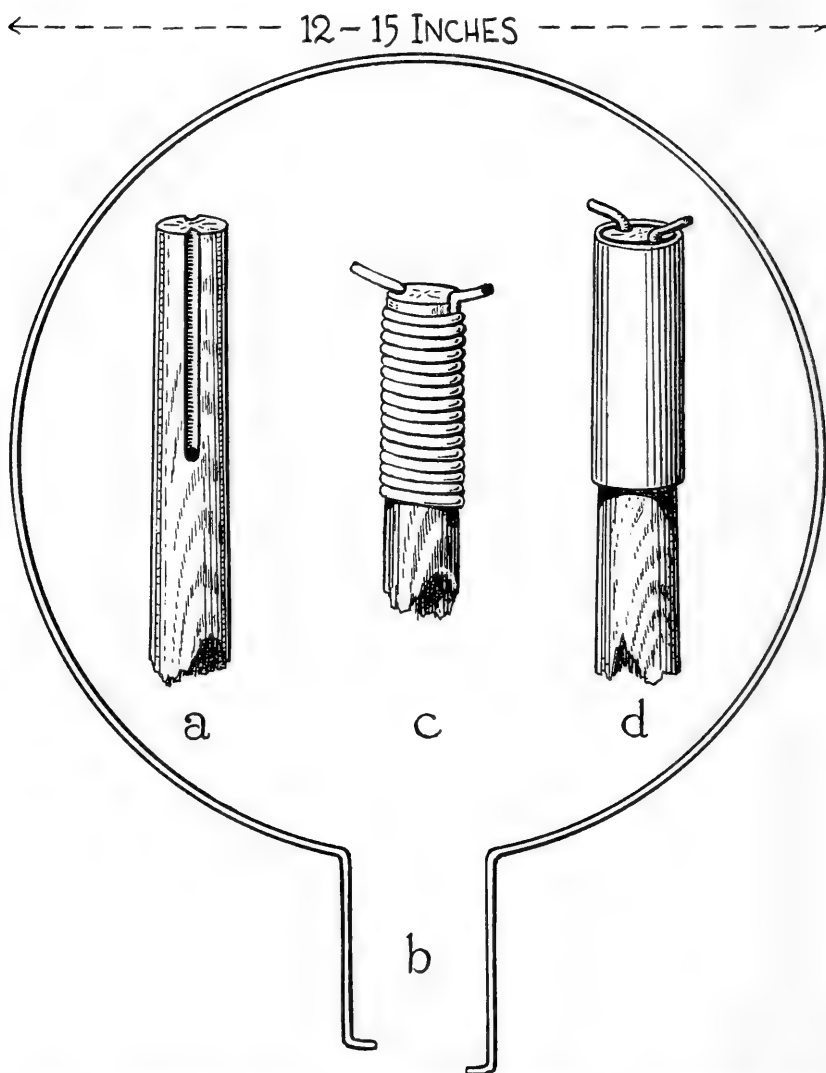

Fig. 1.—Net loop and handle. The short grooves cut opposite each other at the small end of the handle, *a*, end in holes through the handle that receive the hooks of the loop arms, *b*. The loop may be permanently bound to the handle with wire, *c*, or a removable joint may be effected with a metal ferrule that can be slipped up and down, *d*.

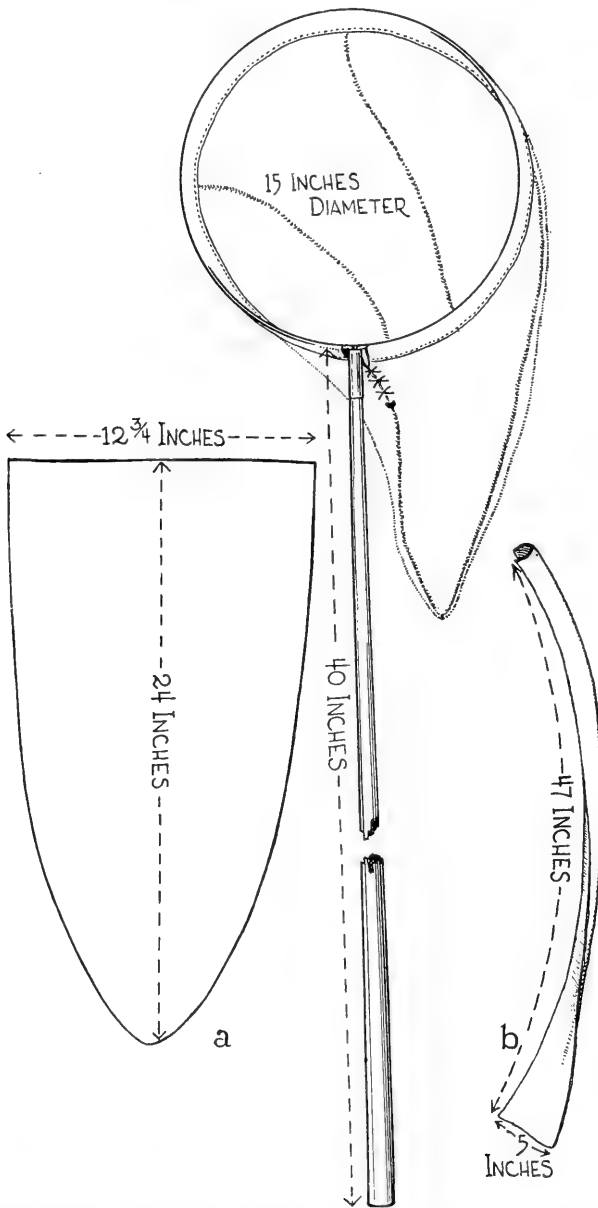

Fig. 2.—Bag and completed net. The bag is cut from four pieces shaped as in *a*, and the top edge of the bag is bound with a narrow strip of stout muslin or light canvas, *b*, by means of which the bag is attached to the loop. After the bag is on the loop, the back vent may be closed with a string lacing, as shown in the figure. This closing, which keeps the back of the net from gaping, prevents the escape of the most active insects through the back opening. The handle pictured here is a removable type, fig. 1*d*.

convenient, for it allows the bag to be removed at will and a lighter or heavier one substituted according to the needs of the collector.

General Purpose Net.—Loop, heavy wire, 12 inches in diameter; bag, strong unbleached muslin or light duck, 20 to 24 inches long; handle, hardwood stick, 24 to 30 inches long.

Butterfly Net.—As above but with a longer handle and a bag of good quality marquisette or fine nylon netting.

Combination Net.—A net that includes the features and uses of the two nets described above and is a better collecting instrument may be conveniently made instead, although at slightly higher cost because of the better materials. Its loop, of 7½ gauge (three-eighths inch) piano wire, is 15 inches in diameter and allows a greater area to be covered with each sweep. The bag, of finest bolter's silk or best quality marquisette, is 24 inches long and serves equally well for the capture of delicate insects and for beating. The handle, of straight-grained hickory or ash, is 40 inches long and permits the collector to cover greater areas in sweeping. If a cheaper net is desired, one of unbleached muslin will be satisfactory for general use.

Care and Use.—All nets are easily ripped and for this reason should be kept away from barbed wire and from thorny trees, such as locust and red haw. Also, they should be kept dry. Moisture rots the fabric, making it more easily torn. Most insects caught in a net while it is wet are unfit for a collection.

Flowers, herbs, and boughs should be swept with a sidewise motion. A sidewise sweep will collect more insects than an upward or downward sweep and at the same time mutilate less. If care is taken not to damage flowers or foliage, the same patch of plants may be visited several times with profit. The contents of the bag should be removed after every few sweeps or strokes. This practice will prevent damage to the insects caused by being jostled about in the net with a large amount of debris.

Killing Bottles

The best killing agents for use in bottles are either potassium cyanide or calcium cyanide. These compounds give a concentration of deadly fumes sufficient to kill most insects in a very short time, which is desirable. Generally, two sizes of bottles are used, and in either of them one of these cyanides may give good results. Only a small supply should be purchased at a time, as they deteriorate rapidly.

Construction.—A pyrex glass test tube or strong ring-necked vial, about three-quarters inch wide and 4 to 6 inches long, makes a good cyanide bottle of the smaller size, fig. 3. Put about three-quarters inch of granular potassium cyanide or calcium cyanide flakes in the

tube or vial. Cover with a tight plug of cellucotton, on top of which put one or two loose plugs. Instead of cellucotton, you may use sawdust and a plaster of Paris batter. In the latter case, cover the cyanide with one-quarter inch of sawdust and over it pour one-quarter inch

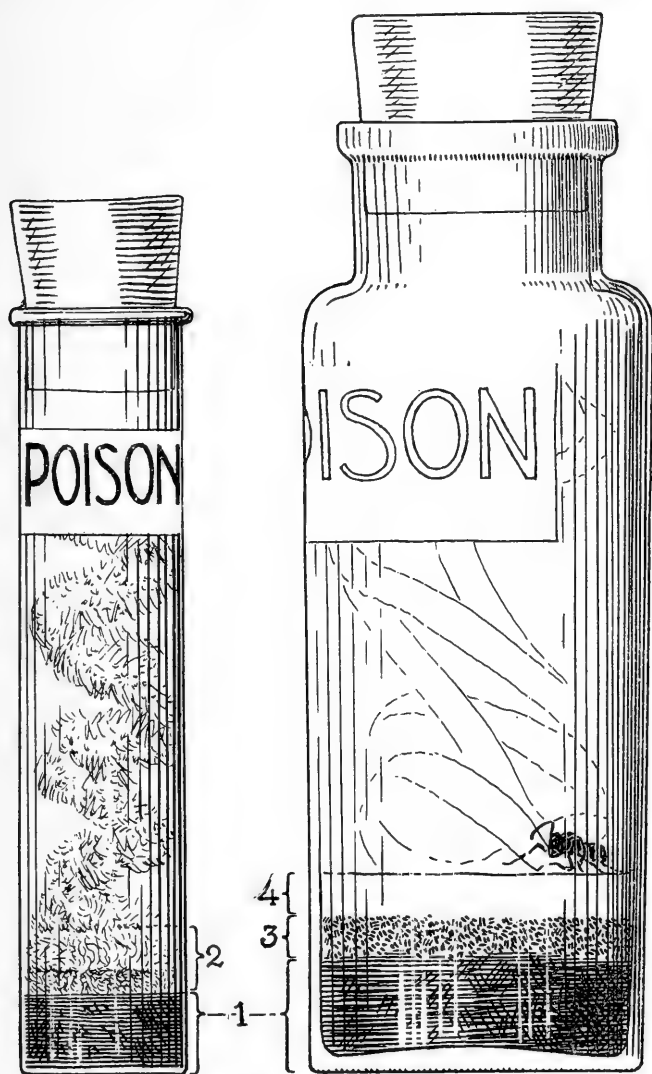

Fig. 3.—Cyanide killing bottles. The lethal chemical, 1, is potassium cyanide or calcium cyanide and is covered with a layer of cellucotton, 2, or sawdust, 3, and plaster of Paris, 4. The rest of the bottle is filled with soft, loosely crumpled, lint-free paper, which should be changed whenever it gets damp. The bottles should be tightly corked and labeled POISON. The collector should *not* test their strength by smelling.

of newly mixed, thick batter of plaster of Paris and water. Allow the batter to harden for a few hours; then keep the bottle tightly corked except when it is being used.

The larger cyanide bottle, fig. 3, which should be sturdy, may range in capacity from one-half pint to a quart. *In the larger bottle, the cyanide should always have the plaster of Paris covering.* The layer of sawdust and plaster should be a little thicker than that for the smaller bottle.

Care and Use.—Label all killing bottles and other containers of cyanide conspicuously with the word **POISON**; keep them tightly corked and away from children or adults who do not realize the extreme deadliness of the compounds. *Never test the strength of a killing bottle by taking the cork out and smelling the contents.* As an added precaution and safeguard to the collector, tape the bottom of the cyanide bottle to protect it against breakage.

The bottle should be almost entirely filled with loosely crumpled, soft paper, which should be changed whenever it gets damp. This paper will help keep the specimens from rubbing against each other inside the bottle and thereby being damaged.

Each collector should have several cyanide bottles and follow carefully these practices.

1. Transfer insects from net to bottle by holding the uncorked bottle in a fold or corner of the net and crowding one or more of the specimens into it, or "running" the open bottle up the side of the net beneath the specimen or specimens. Most insects can be maneuvered into the bottle easily and the opening temporarily closed by the thumb, or the stopper can be put on. In obstinate cases, it may be desirable to stopper the bottle through the cloth of the net until the specimen is stupefied, after which the insect will drop to the bottom of the bottle.

2. Keep small, delicate insects in a bottle by themselves. Such insects as large beetles are apt to mutilate small flies and other delicate insects in the same bottle.

3. Keep a special bottle for moths and butterflies. When these die they shed large quantities of scales, which stick to and partially spoil other insects.

4. Keep the inside of the bottle dry. Cyanide bottles "sweat"; that is, moisture both from the insects and the plaster condenses on the inside of the bottle. Moisture will mat the hair and appendages of insects and discolor the bodies. Do not crowd the bottle with large insects, especially juicy ones like grasshoppers. Change the paper frequently. Wipe out the bottle with paper or cloth, which should be carefully disposed of in such a way that it cannot poison persons or

pets. Keep the killing chemical out of cuts and mouth. Wash hands with care after handling the chemical.

5. Take insects out of the bottles soon after they are dead. Cyanide fumes quickly turn many yellows to red or orange, and also make small specimens brittle so that legs and other parts break off easily.

6. Empty the insects out of the bottles before they have accumulated in a ball at the bottom. To do so will prevent damage to the smaller specimens and discoloration due to "sweating."

7. Dispose of a cyanide bottle when it will no longer kill insects quickly. Substitute a fresh bottle and you will save time in the field. Be sure to dispose of old bottles in such a way that their deadly contents are out of reach of children and pets.

Aspirators or Suckers

Small, rapidly moving insects, such as leafhoppers, diminutive beetles, and flies, may be collected by using an aspirator or sucker, figs. 4 and 5.

Construction.—An aspirator can be made from a capsule vial (available from a drugstore) or from a piece of glass tubing. A small olive bottle may be substituted for the vial.

The following items are needed for the vial aspirator, fig. 4: a vial, $1\frac{1}{4}$ inches in diameter and 3 or more inches long, a two-hole rubber stopper with openings to fit one-fourth-inch diameter glass tubing, 16 inches of one-fourth-inch diameter glass tubing, rubber tubing 24 inches long to fit over the glass tubing, a small metal file (the triangular type is best), a small piece of cheesecloth, some string, and a bunsen burner. Construct the vial aspirator according to the following directions and as shown in fig. 4.

1. Cut the glass tubing into three pieces, 3 inches, 8 inches, and 5 inches in length. To cut the tubing, score it with an edge of the metal file; then hold the tubing with both hands so that the thumb of each hand is on the side of the tubing opposite to the scored mark; break the tubing away from the body by exerting pressure with the thumbs.

2. Make a slight bend in the center of the 8-inch piece of tubing and a right angle bend in the 5-inch piece, as follows: hold one piece of glass tubing with both hands and place the center of it in the blue flame of the bunsen burner; rotate the tubing slowly. When the glass glows yellow, it begins to soften. Bend the tubing to the desired angle. Then quickly withdraw the tubing from the flame.

3. Heat one end of the 8-inch piece of glass tubing in the bunsen burner, slowly rotating the tubing so that the sharp edges melt

slightly and round out; then allow the tubing to cool. Heat one end of the 3-inch tubing in the same manner. Smooth the remaining rough edges of the glass tubing by heating them slightly.

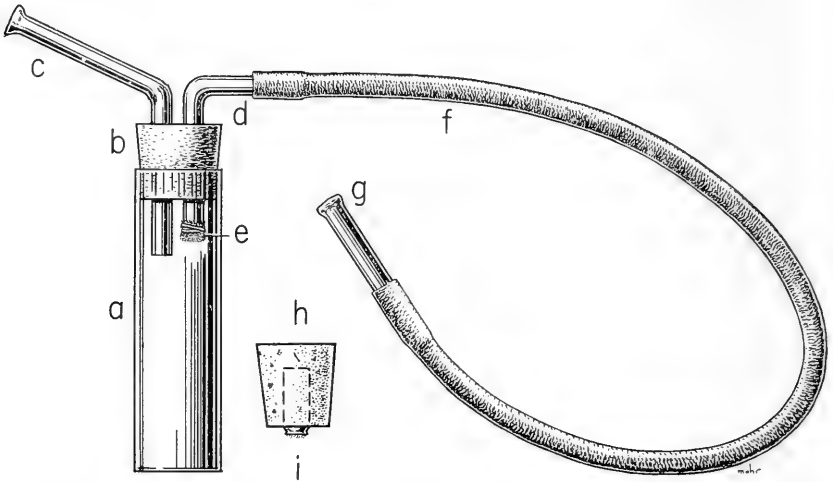

Fig. 4.—Vial type of aspirator or sucker. End *g* is placed in the mouth; *c* is used to pick up the insects. Shown also is a cyanide cork, *h-i*, which is used to kill insects in the aspirator.

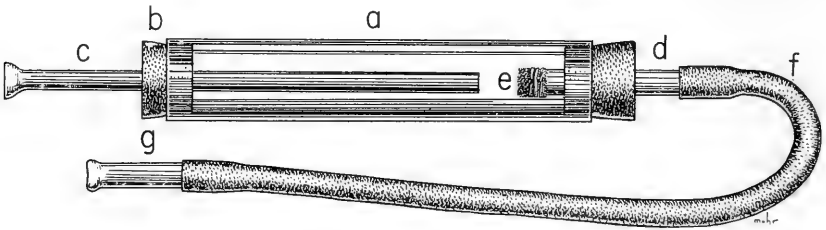

Fig. 5.—Tubing type of aspirator. Parts for this aspirator should be compared with equivalent parts for the aspirator shown in fig. 4. Noted especially should be the position of the glass tube, *c*, and the length of the rubber tube, *f*.

4. Insert the 8-inch and 5-inch pieces of glass tubing into the rubber stopper. The longer piece, fig. 4*c*, should project about 1½ inches into the vial. The shorter piece, fig. 4*d*, should project about three-fourths inch.

5. Over one end of the 5-inch piece of glass tubing, fig. 4*e*, tie two thicknesses of cheesecloth securely with string.

6. Over the other end of the 5-inch piece, slip one end of the rubber tubing, fig. 4*f*.

7. Into the other end of the rubber tubing slip the 3-inch piece of glass tubing, fig. 4*g*, so that the rounded end of glass is exposed.

8. Complete the assembly of the aspirator by placing the rubber stopper snugly into the vial. The vial aspirator is now ready for use.

If a piece of glass tubing $1\frac{1}{4}$ inches in diameter and 8 inches long is available, then a tube aspirator can be made, fig. 5. In making a tube aspirator, use two one-hole rubber stoppers, 5*b*. Cut the pieces of glass tubing as shown in fig. 5*c*, 5*e*, and 5*g*. Using a piece of rubber tubing, 5*f*, complete the minor details as described for the vial aspirator, not forgetting the cheesecloth, 5*e*, and assemble the parts as shown in fig. 5.

Use and Care.—To catch an insect with the aspirator shown in fig. 4 or fig. 5, put end piece, *g*, in your mouth, grasp the vial or tube, *a*, in your dexterous hand, aim the intake tube, *c*, at the insect and almost touching it; suck suddenly and hard. The air current pulls the insect in; the insect usually does not find its way into the intake tube to crawl out. The cheesecloth, *e*, prevents the insect from being sucked into your mouth.

To kill insects in the aspirator, use a small cyanide bottle, 4*i*, which is inserted in a cork, 4*h*, that has been partially bored through to receive it. This cork should be the exact size of the vial or tube for which it is intended.

To use the cyanide cork with the vial aspirator shown in fig. 4, simply exchange the corks. If the glass tube aspirator is used, plug

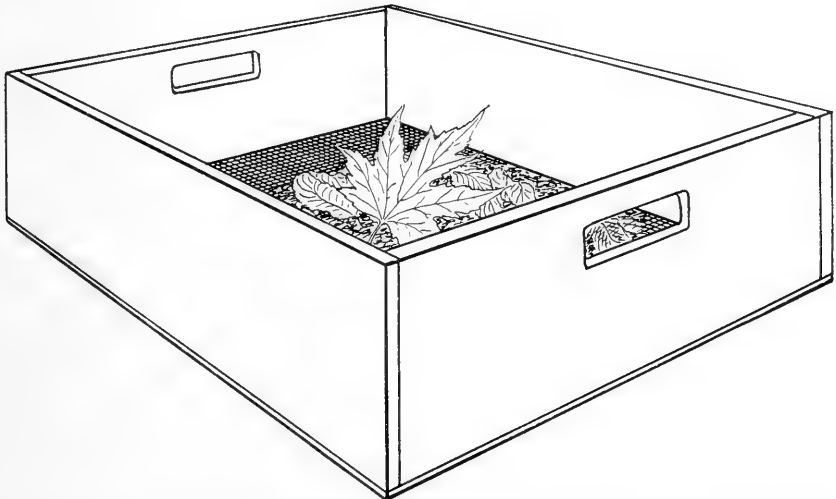

Fig. 6.—Sifter with hand grips. Debris containing insects is sifted over a piece of white oilcloth. The sifter, not more than half full, is shaken gently at first and then violently. Finally the debris that cannot be shaken through the sifter is emptied on the oilcloth, and specimens too large to go through the mesh of the sifter are captured. Patience is required to get the best results with the sifter, which provides one of the best methods for winter collecting.

the intake tube, 5c, with a tapered paper plug or a leaf, jar the insects away from the stopper at the opposite end, remove this stopper cautiously, and quickly insert in its place the cyanide cork. When the specimens are stupefied, they may be transferred to another bottle.

The cyanide corks are highly poisonous. Between times of use with an aspirator, keep each of these corks inserted tightly in a bottle or vial labeled "POISON," as in fig. 3.

Sifter

Perhaps no special collecting method results in more interesting, rare, and diverse kinds of insects than that involved in sifting rotten logs, leaf mold, and other forest and prairie ground cover. To do this type of collecting, provide yourself with the following:

1. A stout sifting sieve about 12 by 12 inches and 4 to 6 inches deep, fig. 6. The bottom may be wire screen of any desired mesh; usually 8, 10, or 12 meshes to the inch give good results.

2. A sturdy piece of white oilcloth about 18 inches or 2 feet square.

3. Collecting equipment, including an aspirator, camel's-hair brush, forceps, vials, and killing bottle.

Material such as leaf mold is placed in the sieve and this is shaken over the white oilcloth, which has been spread on a level spot on the ground. The small insects fall on the cloth and can be picked up with the aspirator or the camel's-hair brush. Many insects feign death when they fall to the oilcloth and they are difficult to detect in the bits of sifted material until they "revive" and start to move.

In late fall and winter, sifting provides one of the most profitable types of collecting; in any season, it will turn up such things as rare spiders and beetles. Sifting is most successful for finding large, active insects. For small, slow-moving forms, Berlese funnels offer a better collecting method.

Berlese Funnel

When you are wandering through woods or fields, do you realize that you are stepping on more insects than you ever see? The ground cover and soil are inhabited by a vast assemblage of little animals that are seldom seen by the casual collector. Because many of these animals are exceedingly minute, they are difficult to see and collect by ordinary methods.

Construction.—The most efficient method for collecting this fauna is by the use of Berlese funnels, named after the Italian entomologist Berlese (pronounced Bur-lazy), who first used them extensively. A Berlese funnel is a very simple apparatus, consisting of a fairly long

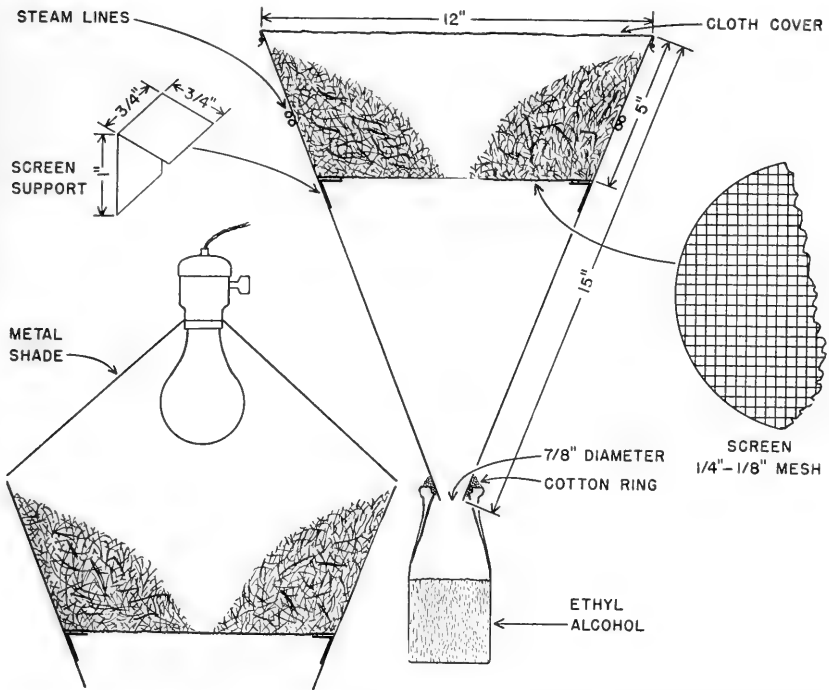

Fig. 7.—Diagrammatic cross section of a Berlese funnel. The central figure shows an arrangement for a steam coil, the lower left for an electric light.

funnel, suspended wide end up, with a screen placed about a third of the way down the funnel; heat is applied either around the upper portion or over the top of the funnel, and a container of preservative, preferably 80 per cent ethyl alcohol, is placed at the small bottom opening. Leaf mold or other material is placed on the screen, the heat source is turned on, and soon the animals begin to leave the drying sample and migrate downward, dropping into the preservative.

Fig. 7 illustrates a funnel that has proved very satisfactory; it is 15 inches from top to bottom, and the top has a diameter of 12 inches. The bottom opening, seven-eighths inch in diameter, fits into the mouth of the bottle containing the preservative. Three angled brackets or hangers are soldered inside the funnel to provide a rest for the screen, which is made of quarter-inch or eighth-inch mesh hardware cloth; the mesh used depends upon the type of sample. A battery of several funnels in a rack, fig. 8, will allow the collector to sample several kinds of material at the same time.

If steam is used as a source of heat, the small copper lines that conduct it act as a partial support for the funnel by encircling it about

halfway between the screen and the top; a piece of cloth is tied tightly over the top of the funnel to prevent the upward escape of animals. If an electric light is used for heating, it should be hung directly over the center of the funnel, no cloth should be tied over the top, and the light should have a reflector nearly as wide as the top of the funnel.

Care must be taken not to heat the sample too rapidly. Otherwise, either moisture will condense in the lower part of the funnel and trap many of the animals working their way toward the bottom, or the heat will kill many of the organisms before they have an opportunity



Fig. 8.—Berlese funnel in position on rack. Each funnel rests inside a double ring of copper tubing (visible at extreme lower left), through which live steam flows. The steam produces heat that dries out the sample of leaf mold in the funnel and drives animals into a bottle of preservative below. Cotton or a small rag is tamped between the end of the funnel and the mouth of the bottle to prevent escape of specimens.

to move out of the sample. An application of heat sufficient to dry the sample in 4 or 5 days is usually satisfactory.

The Berlese funnel is extremely useful for collecting many groups of beetles (particularly Staphylinidae), thrips, springtails, many groups of parasitic Hymenoptera, ants, mites, pseudoscorpions, millipedes, centipedes, and a wide range of other minute animals that live in soil, surface cover, logs, or bark.

Collecting Berlese Samples.—Many different habitats and microhabitats provide good samples for the Berlese funnel. You will find that, for general collecting, various types of ground cover are excellent; for leaf mold samples, scrape off and discard the dry surface leaves and scoop up the lower, rotted layers of leaves together with an inch or two of the adjacent soil. You may encounter especially good samples where leaves have blown in along the edge of a log. In such a situation, take some of the log bark with the sample. Collect rotten log samples in large hunks and break them up just before putting them in the funnel. From either standing stumps or fallen logs in which the wood is still too hard to break up, collect the loose bark, as it is often quite productive. Frequently, if you roll a log over, you may find animal runs under it; the debris and earth under and around these runs, together with animal nests, frequently give unusual catches, such as larvae and adults of fleas and rare ticks. Especially productive are samples taken from the interior of a standing hollow tree; from the bottom of the hollow you can scoop out a foot or more of fine, rotten, woody material rich in rare insects.

Certain items placed in the funnel may produce distinctive and unusual catches. Recently deserted birds' nests will give mites and, frequently, rare beetles, flies, and their larvae; mature or overmature mushrooms and bracket fungi are often rich in beetles, thrips, and maggots; bark of living trees may produce unusual thrips, springtails, and psocids; debris from aquatic habitats and from the wet edges of ponds and tiny streams may be productive of rare aquatic and semiaquatic forms. Moss is a good source of peculiar species of springtails, thrips, and beetles; the moss should be rolled up carefully while being transported.

Handling Berlese Collections.—In the field, put samples of leaf mold or other material in tightly woven cloth bags or strong paper bags for transportation. It is convenient to have small paper bags for mushrooms, nests, and other small items, and larger bags for ground cover, moss, and the like. When collecting ground cover and similar material, put in each bag enough of a sample so that it will not shake around loosely, but do not pack it tightly. Be sure that samples do not overheat while being transported.

Samples may be collected at any season. If collected during warm weather, they should be taken to a laboratory and placed in the funnels within a day or two; otherwise, considerable loss of population occurs within the samples. If collected during cold weather, they may be kept in cold storage for a week or two with little loss of fauna.

In putting material in the funnel, lay it carefully on the screen to a depth of a few inches. Moss and sod should be placed upside down in a single layer on the screen. In the case of dense material, pile the sample chiefly around the sides of the funnel and leave an opening in the middle, as shown in fig. 7. After the funnel is loaded, place it in the rack, put the bottle of preservative under it, and apply the heat.

By substituting a different kind of collecting bottle at the bottom of the funnel, you may obtain live material for rearing. The exact changes necessary to obtain live material will depend upon your ingenuity and the type of material you desire.

Equipment for Collecting Aquatic Insects

Hundreds of different kinds of insects are aquatic and offer rich collecting possibilities. In all instances, the immature stage lives in water, but in most of them the adult stage emerges on land or flies in the air. For this reason several types of collecting are needed to obtain a good sampling of aquatic insects.

Night Collecting of Adult Insects.—Collecting at lights on warm, cloudy nights, or warm nights without moonlight, gives best results. Two simple methods are as follows:

Drive your car to a spot overlooking a stream or lake and turn on the bright lights. Into a shallow pan, such as a pie pan, pour enough alcohol to cover the bottom with one-eighth to one-fourth inch of fluid. Hold the pan directly under a headlight. If aquatic insects are on the wing, they will come to the light and eventually drop in the fluid, which traps them. With a small piece of wet cardboard, you can scrape the entire insect contents of the pan into a small bottle of alcohol, which you should then label, giving date, name of collector, and location.

Lights in signs and store windows (especially blue neon signs) near fresh water attract large numbers of aquatic insects. You may capture an insect easily by dipping an index finger in a bottle of alcohol, "scooping up" the insect rapidly on the wet surface, and then dipping it in the bottle. An aspirator also can be used with success.

Day Collecting of Adult Insects.—During the day, aquatic insects frequently rest on or under bridges, window ledges, and similar places, and show a preference for dense trees in shaded situations.

They are especially numerous in those spots where the heavily leaved branches hang low over the water and form humid, protected areas in the heat of the day. Here sweeping with a stout and fairly wide-mouthed net is very effective. Aquatic insects may often be picked off stones in such places, especially early in the season.

Collecting Larvae.—Practically every stream or lake has some aquatic insect larvae which may be collected by various methods, some simple and others requiring specialized and complicated apparatus. For general collecting, the following suggestions may be of value:

1. Look under logs and stones. Search out crevices in them; some insects hide away and demand of the collector a keen and careful search.

2. Tear apart bunches of leaves, roots, and other debris that may have piled up in front of a rock or log, or that may have accumulated at the end of a root or branch dangling in the water.

3. Pick out bunches of aquatic plants and search through them carefully.

4. Sift mud, sand, or gravel taken from the bottom of a lake or stream. Remember that some insects build cases in which they hide when disturbed. It takes a practiced eye to see a motionless case. After an insect has dried out a little, it partially emerges from the case and drags it along in search of water; moving in this way, it is easy to see.

HOW TO HANDLE UNMOUNTED SPECIMENS

Soon after insects are killed they dry out, become very brittle, and are damaged easily. Small, fragile insects especially are susceptible to breakage and, when dry, break up readily into fragments. Hard-shelled insects, such as beetles, may appear to be sufficiently durable to withstand handling when dry, but even these insects have fragile legs, antennae, and other parts which snap off readily when handled dry. Newly killed material should be either mounted or put in temporary storage before it has dried out. If collected material dries out before it can be mounted or stored, it should be relaxed by special techniques so that the specimens can again be handled without danger of breakage.

Temporary Cases

If it is not convenient to mount the specimens when they are taken from the killing bottle, the moths and butterflies should be put in *papers* and other insects in cellulocotton.

Papers are simply rectangular strips of paper of convenient size folded as in fig. 9. A moth or butterfly, with its wings folded, is placed in a paper, the edges of which are then crimped over to lock it shut.

For insects other than moths or butterflies, cardboard pillboxes containing cellucotton make good temporary housing, fig. 10. A layer of cellucotton is laid in the bottom, a layer of insects placed on it, and another layer of cellucotton placed over the insects. The lid should fit fairly snugly over all. Cigar boxes and other boxes of like size also may be used in the same way.

Great care must be taken that sufficient cellucotton is put in the box to take up all moisture in the insect bodies. If the specimens are large, they should be allowed to dry moderately uncovered before being placed in cellucotton in storage containers. If insects become damp in the containers they quickly mold or rot. The containers

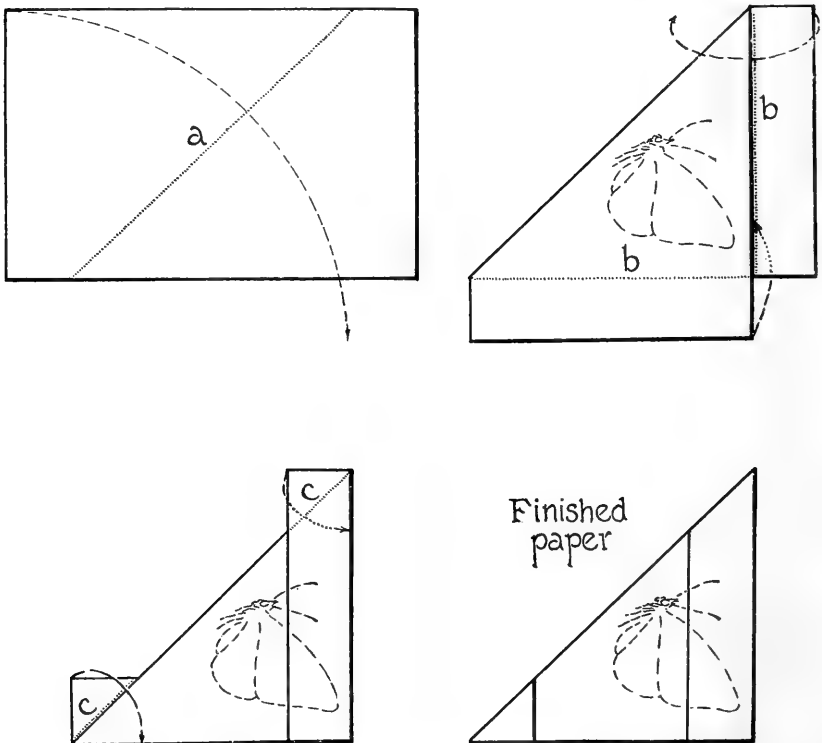

Fig. 9.—Papers. These are temporary means of keeping dragonflies, moths, butterflies, and small insects of other kinds until they can be relaxed and mounted. A rectangular piece of paper, of a size suited to the insect it is to contain, is folded along the dotted lines and in the directions indicated by arrows, as shown in *a*, *b*, and *c*.

should be wood or cardboard boxes, for they will not sweat, as will a metal box. The insects should be packed tightly enough to prevent their rolling around and breaking.

Relaxing Boxes and Jars

At any desired time the dry specimens may be relaxed and mounted. A relaxing box or jar is easily made. In the bottom of a wide-mouthed jar with a screw-on lid, put an inch or two of clean

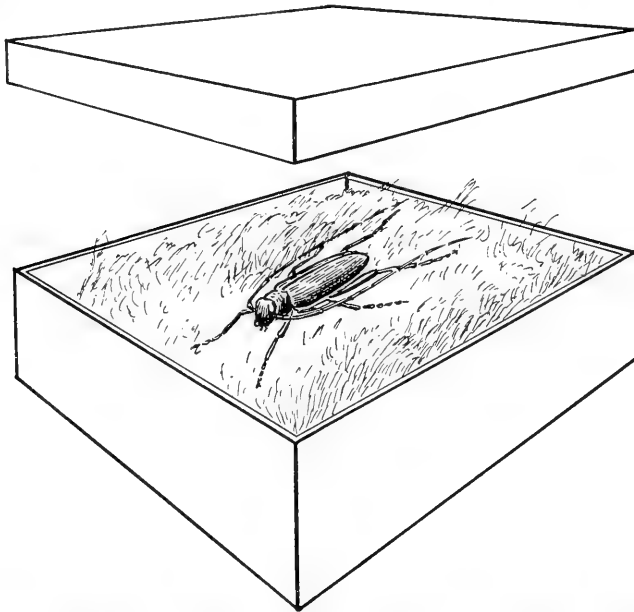

Fig. 10.—Pillbox for temporary storage of insects. Enough cotton packing is placed in the box to keep the specimen from rattling about but not so much that it crushes the specimen.

sand; saturate the sand with water containing a small amount of phenol (carbolic acid) and place over it a piece of cork, cardboard, or wood cut to fit the jar. Place the dry specimens on the cork or other material, and cover the jar tightly with the screw-on lid. The lid must be practically airtight. In a day or two the specimens will be soft and pliable enough for pinning or spreading, the next steps toward permanent arrangement of the collection.

The relaxer will sweat if kept in too hot a room and will spoil the specimens. Also, the insects will be spoiled if left in the relaxer too long. The correct length of time varies with each relaxer and can be learned only by experience.

HOW TO MOUNT AND PRESERVE SPECIMENS

Most adult insects in collections are mounted on pins. Most medium-sized to large insects, such as grasshoppers, butterflies, moths, flies, bees, and many beetles should be pinned directly through the body from top to bottom. Many small insects, such as leafhoppers, plant bugs, small beetles, and the like, should be glued on card points. Immature insects and the adults of some groups are best preserved in fluid.

Preservation by Pinning

Hard-bodied insects, such as beetles, flies, and wasps, are preserved as dry specimens on pins better than in fluid. The pinned specimens are more convenient to study and they retain their natural coloring better. Flies and butterflies are covered with hairs or scales that clot or break off if the specimens are preserved in fluid, and for this reason they should be pinned.

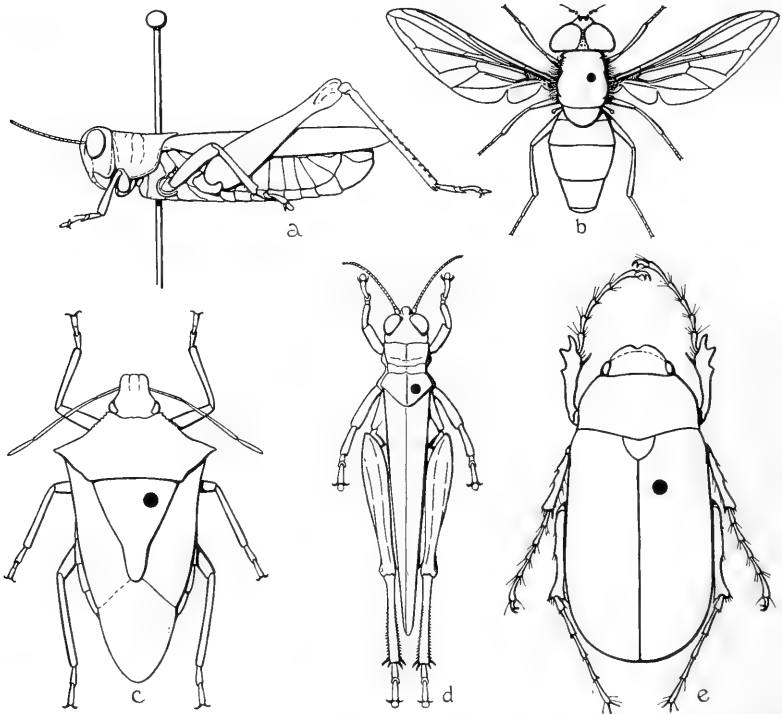

Fig. 11.—Pinning. Medium- to hard-shelled insects are mounted by being pinned through the body in the manner shown at *a*. The black spots show the location of the pin in the case of bees, flies, and wasps, *b*; stink bugs, *c*; grasshoppers, *d*; and beetles, *e*.

Common household pins are too thick and short for pinning insects. Longer, slender pins called insect pins are necessary and may be purchased from various supply houses. They should be of spring steel; a brass pin will corrode and be destroyed by acids in the insect's body. The pins are available in numbered sizes, of which 1, 2, 3, and 4 will be found of most general use, and sizes 0 and 00 of advantage in special cases.

Medium to Large Insects.—Medium to large hard-shelled insects such as moths, beetles, flies, bees, and wasps, should be pinned vertically through the body, fig. 11*a*. It is essential that the pin pass through a fairly solid part of the body, and, to insure this, the following standard procedures should be adopted:

1. Bees, wasps, flies.—Pin through thorax between bases of front wings slightly to right of middle line, fig. 11*b*.
2. Stink bugs.—Pin just to right of middle line of the scutellum or large triangle between the bases of the front wings, fig. 11*c*.
3. Grasshoppers.—Pin through back part of prothorax (the saddle behind the head) just to right of middle line, fig. 11*d*.

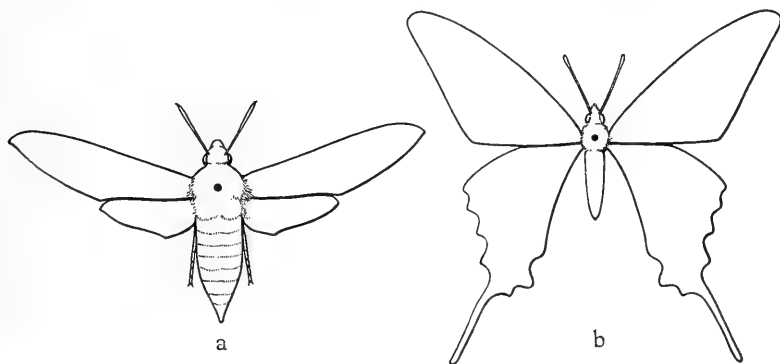

Fig. 12.—Pinning. Moths, *a*, and butterflies, *b*, are pinned through the center of the thorax (instead of to the right of the median line) between the bases of the front wings.

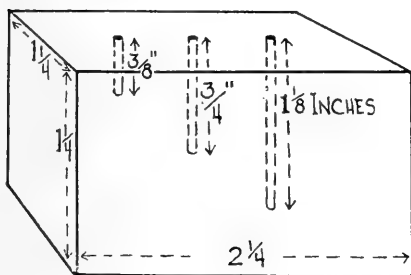

Fig. 13.—Pinning block. The block is $1\frac{1}{4} \times 1\frac{1}{4} \times 2\frac{1}{4}$ inches, with holes drilled to the depths shown and having diameters only slightly greater than the largest pin that will be used. A specimen is pinned and the pin inserted into one of the holes until the pin touches bottom; thus, insects may be pinned uniformly at a desired height.

4. Beetles.—Pin near front margin of right wing cover near middle line, fig. 11e.

5. Moths, butterflies, dragonflies, damselflies.—Pin through the center of the thorax between the bases of the front wings, fig. 12.

The insect should be pushed about three-quarters of the distance up the pin, but not so close to the top that no room is left for easy handling of the pin with the fingers. It is well to have all insects the same distance from the top of the pin. To insure a uniform distance, the collector should use a pinning block. This is a small piece

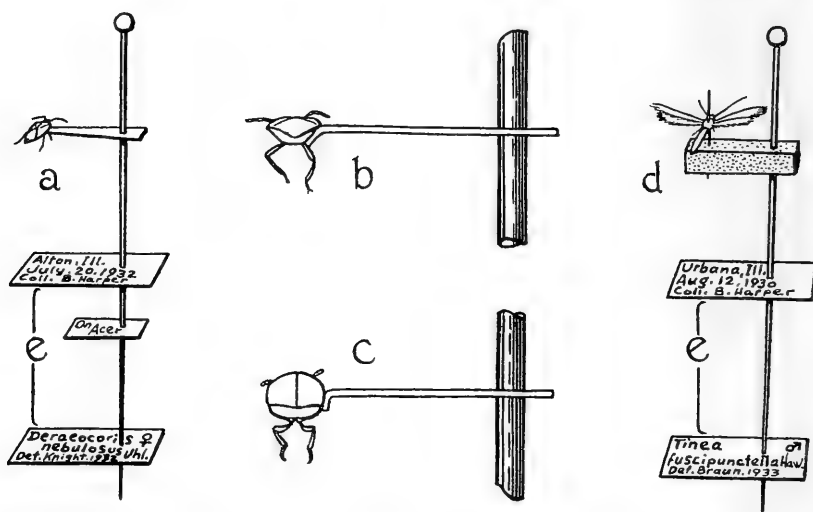

Fig. 14.—Pinning small insects and labeling. The insect may be glued to a card point, *a*, which has been crimped to meet the right side of the body, *b*, *c*; or it may be pinned with a minuten pin, *d*, to a piece of cork or pith, which in turn is regularly pinned. All pinned insects should be labeled, as at *e*. In the case of some small insects, such as tiny moths, the minuten pin may be run down through the body and then into the cork; in the case of others, such as mosquitoes, it is often desirable to run the minuten pin up through the cork first and then impale the specimen on the point of the pin.

of wood or metal usually in the form shown in fig. 13, into the top of which are drilled holes slightly larger than the pin diameters. Such a block may be fashioned of wood with holes made by small nails and covered with a cardboard rectangle through which have been stabbed holes the exact size of those in the wood. The depths of the holes in the block should be three-eighths inch, three-quarters inch, and $1\frac{1}{8}$ inches, respectively. To use the block, pin the insect and insert the pin into whichever hole allows the specimen to be pushed up the pin and still leave room, allowing for the thickness of the insect's body, for handling at the top.

Tiny Insects.—Very small insects should be mounted on card points or on minuten pins. Regular pins would break too many of the insects' body parts.

Card points are small triangles of cardboard or plastic pinned through one of the sides and crimped over at the opposite apex; a spot of strong glue is put on the angled tip, and the right side of the insect is pressed against the glued surface, fig. 14. The slant of the crimp depends on the angle of the insect's side; the desired product is the insect mounted with its top surface horizontal and its head forward; legs, wings, and antennae should be in view and as little of the body as possible hidden by the glue or card point. Very little glue should be used; a small amount holds well and gives a better specimen for study than a large amount. The points may be cut uniformly with a hand punch, and they should be about three-eighths inch long. Good material for making these points is 2-ply Bristol board.

Minuten pins are short, extremely delicate steel pins, fig. 14*d*. One of these is thrust through the body of the insect and into a small

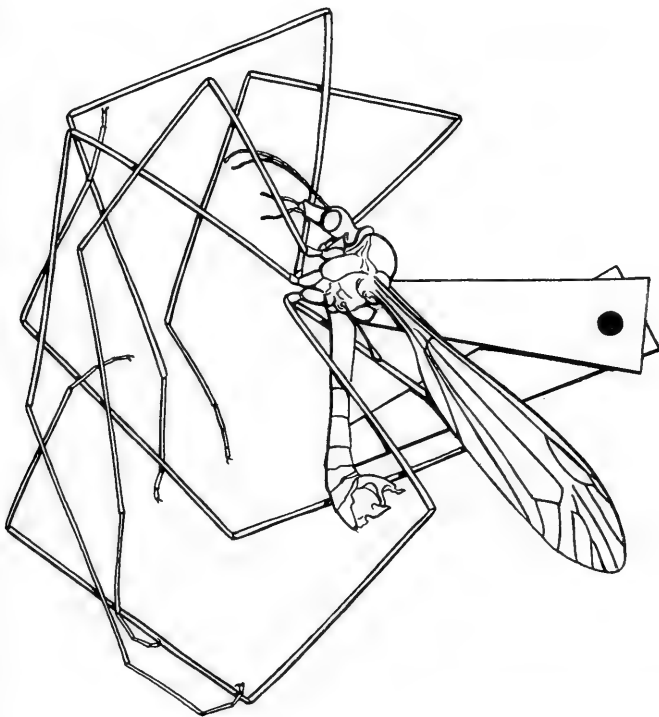

Fig. 15.—Pinning crane flies. Because of their unwieldy legs, these insects should have a double card point mount, and the legs should be kept away from the pin so that they will not be broken in handling.

piece of cork, pith, or similar substance, which is in turn pinned in the regular way a card point is. This method is especially desirable for tiny moths.

Insects Hard to Pin.—Wasps, lacewings, damselflies, and similar insects have an abdomen that sags readily when the specimen is killed and pinned. This unwanted drooping can be prevented in three simple ways. (1) Stick the pinned insect on a vertical surface of a block so that the body by its own weight dries in normal position. (2) Pin the insect on a horizontal surface and run a stiff paper on the pin beneath the body in such a way as to support it in a natural position until the insect dries. (3) Brace the abdomen by crossing two pins beneath it and thrusting them into the block, allowing the specimen to dry in the angle of the cross.

Crane flies are unwieldy and so are best pinned on a double card point mount, fig. 15. The legs should be directed away from the pin to avoid breakage in handling.

Spreading Board for Moths and Butterflies

Moths and butterflies should have their wings spread before being put into the collection. To do this well, it is necessary to have spreading boards that are accurately made but that are not necessarily complicated or expensive.

Construction.—A convenient board for medium-sized insects can be made at home of the following materials:

- 1.—A hardwood base, 4 x 12 x $\frac{1}{4}$ inch.
- 2.—Two hardwood end pieces, 4 x $\frac{3}{4}$ x $\frac{1}{2}$ inch.
- 3.—Two softwood top pieces, $1\frac{7}{8}$ x 12 x $\frac{1}{2}$ inch, with the top surface planed at an angle, so that the thickness at one edge is $\frac{1}{2}$ inch and at the other $\frac{3}{8}$ inch.
- 4.—Two flat cork pieces 1 x 11 x $\frac{3}{16}$ inch.

Nail the top pieces to the ends so that the slanting surfaces of the tops are uppermost and the narrower edges parallel and one-quarter inch apart, fig. 16. Glue one strip of cork beneath the top pieces, covering the opening between and fitting snugly at each end. Glue the other cork piece flat to the upper side of the base, lengthwise along the middle, and extending to within one-half inch of each end. Finally, nail the base across the bottoms of the end pieces, so that the two corks face each other.

Use.—Before spreading the specimen, relax it as described under "Relaxing Boxes and Jars." Then pin it, keeping in mind fig. 12 and the directions given under "Preservation by Pinning." Thrust the pin, with the insect on it, through the upper cork of the board and into the cork on the base. Insert the insect body in the groove so that

the wing bases are level with the near edge of each top piece. Hold the wings at the top level by two narrow strips of paper and pull them forward until the hind margin of the front wing is at right angles to the body axis, and the front margin of the hind wing is just under the front wing, fig. 16. Pin the wings temporarily in this position by inserting a pin, size 0 or 00, near the front margin at the base of each wing. When the wings on both sides of the insect are thus adjusted, lay strong pieces of paper over them and pin them down securely with large pins inserted close to the wings but not through them. Here you may use large common pins, but still better are the large-headed dressmaker's pins about $1\frac{1}{4}$ inches long. Finally, remove the original adjusting pins and put the specimen in a dry, pest-proof container for 2 or 3 weeks. It will then have set sufficiently to be removed from the board.

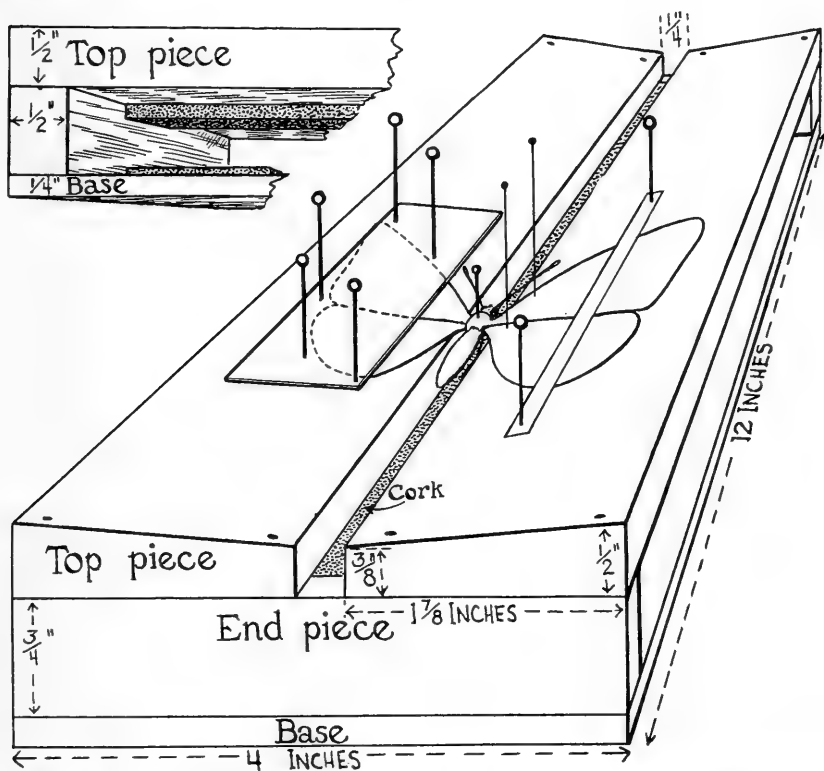

Fig. 16.—Spreading board for moths and butterflies. The insect is pinned with its body in the groove and, temporarily, with all its wings drawn forward and pinned as shown for the right wings. Then all wings are pinned as shown for the left wings, and the insect is allowed to dry. The inset shows a view of spreading board construction. The top pieces of the board must be smooth and of soft wood. First grade pine is satisfactory.

For good results, spreading boards with grooves of various widths are necessary; a specimen should be spread on a board with a groove that fits the body. The width of the top pieces should vary to accommodate different wingspreads. The slope of the top pieces should be about as described.

Preservation in Fluid

Caterpillars and other immature stages of insects should be preserved in 80 per cent grain alcohol. Caterpillars, grubs, and maggots should first be heated 5 to 10 minutes in water just at the boiling point. This treatment sterilizes the specimens and prevents their discoloration by bacteria in the digestive system.

Many soft-bodied adult insects, including bristletails, springtails, stoneflies, and caddisflies, also should be preserved in fluid. If pinned, they shrivel to such an extent that few identifying characters can be seen. The preserving fluid in the vials in which insects have been placed should be changed at the end of the first day or two.

Some hard-shelled insects may be preserved in fluid. Ants and beetles may be thus treated temporarily and later pinned and dried.

HOW TO LABEL THE SPECIMENS

To be useful to the entomologist and others interested in the scientific relations of insects, as well as to furnish the collector with a complete record of his hours in the field and make more valuable the work he has already accomplished, the specimens should be labeled. The important information to be put on the label of each specimen is the locality and date of capture, but greater scientific value will be attached to the specimen by adding the name of the collector and the host on which the insect was found, or the particular habitat in which the insect was caught.

Labels should be made of a good grade of white paper stiff enough to stay flat when pierced and pushed up the pins. A very satisfactory high quality paper is available under the name "substance 36 ledger." The labels may be printed by hand with a crow-quill pen and black India ink, or they may be purchased completely or partially printed from a biological supply house. They should be as small as possible and of nearly uniform size. They should be pushed up the pins, fig. 14, not too near the specimens, and they should project from the pins in the same direction as the specimens. To keep the labels small, yet to include all desirable information, it is often well to record the locality, collection date, and collector on one label, and the host plant or other pertinent information on a second label, fig. 14.

When the specimen is identified, its name should be recorded on still another label, which should be kept low on the pin. Sample identification labels are illustrated by the bottom labels in fig. 14.

HOUSING THE COLLECTION PERMANENTLY

After the specimens have been pinned and labeled, they should be housed in boxes or cases having a soft bottom or inner layer that will allow easy pinning. Such housing not only insures the safety of the collection but makes for easily handled units once the specimens have been named.

Insect Boxes

Several satisfactory types of boxes for housing insect specimens may be bought from commercial supply companies. These are usually much better than boxes of home construction, being more nearly dustproof and pestproof. Homemade boxes, however, are quite practical for the beginning collector, due to their ease of construction and extremely low cost. Cigar boxes 2 inches deep or more make ideal insect boxes if a layer of cork or balsa wood or two layers of soft, corrugated cardboard are glued in the bottom. Other wooden or cardboard boxes may be provided with such a bottom pinning surface and used for storing specimens. Boxes of this type, however, afford the specimens no protection against pests, and great care must be exercised in keeping the boxes fumigated.

Manufactured boxes, cabinets, and cases may be selected from catalogs that various scientific supply firms send free upon application.

Precaution Against Pests

Certain insects, such as flour beetles and carpet beetles, feed upon dried insects, and unless precautions are taken these may entirely destroy a collection. To guard against them, various chemical repellents may be placed in the boxes containing specimens. Naphthalene, of which ordinary mothballs are composed, is one of the best repellents. A few mothballs may be put in a cloth bag pinned securely in one corner of the box, or the heads of common pins may be inserted into naphthalene mothballs, and the points stuck in the corners of the box, fig. 17.

Naphthalene is chiefly repellent in action; its odor keeps out pests, but, if they are already in the specimen boxes, naphthalene will usually not kill these pests, and some other substance must be used.

Paradichlorobenzene, called PDB, is a good fumigant to use on pests in the collection. It should be used in a nearly airtight container,

such as a tight trunk, bin, or case, at the rate of 1 pound of PDB to 25 cubic feet of space. The boxes of specimens, with lids open or re-

Fig. 17.—A naphthalene mothball mounted on a common pin. It serves as a repellent to keep away from the collection live insects that might cause damage. To insert the pin, stick the point in a cork, heat the head in a flame, and then push the head into a mothball. The pin will melt its way into the naphthalene, which will cool and harden again almost immediately.



moved, should be placed in the container, the fumigant scattered or spread on a piece of cloth or paper above them, and the container sealed for about a week.

THE INSECT WORLD

When the insects have been collected, mounted or preserved, and labeled, the next step is to identify or name them. This is no easy task, because there are so many different kinds of insects. In the whole world there are well over 1 million different kinds and in Illinois alone probably 20,000 different kinds.

The identification of insects is simplified somewhat by the fact that many species are closely related and can be classified into a number of major groups. Insects as a whole constitute what is called a *class* of animals, the Insecta. The crabs, shrimps, and their allies constitute a class called the Crustacea; the snakes, turtles, lizards, and their allies constitute another class called the Reptilia; and so on. The entire insect class is divided into *orders*, such as the Coleoptera, or beetles, the Diptera, or flies, and the Siphonaptera, or fleas. Each of these orders may contain several dozen to 25,000 different kinds of insects in North America alone. These orders are divided into *families*, each of which may contain one species to many thousands of species. The family names always end in *-idae*, as in Pentatomidae, the name for the stink bugs. The families are divided into *genera* (the plural for genus), and the various *species* (the word is the same for both singular and plural) or kinds are placed in the genera.

The house fly bears the name *Musca domestica* Linnaeus; this means that the species name is *domestica*, that the name was first applied to the species by Carolus Linnaeus (known as the describer

of the insect or the author of the name), and that the species *domestica* is in the genus *Musca*. The genus *Musca* belongs to the family Muscidae, which, in turn, belongs to the order Diptera of the class Insecta.

Scientists may decide that a certain species belongs in another genus. When the species is transferred from the genus in which it was originally described to another genus, the name of the author is placed in parentheses. For example, the chinch bug was originally described by Thomas Say in the genus *Lygaeus* and had the name *Lygaeus leucopterus* Say. Later the species *leucopterus* was transferred to the genus *Blissus*, and Say's name was placed in parentheses, thus: *Blissus leucopterus* (Say).

In the process of growth, insects go through a series of interesting stages. When the immature insect reaches a certain size, its outside skin covering or cuticle will not stretch further and the insect then acquires a larger cuticle by a process called *molting*.

Molting consists of a definite sequence of steps: (1) A goodly portion of the inside layer of the cuticle is dissolved by special glands situated among cells immediately below the cuticle; (2) the cells under the cuticle then exude material which forms a new cuticle beneath what is left of the old cuticle; (3) when the new cuticle is completely formed, the insect breaks a slit in the old cuticle, crawls out of it, and leaves it behind in the form of a cast skin; (4) the insect goes through many contortions, during which the soft parts of the new cuticle are stretched to a larger size than the corresponding parts of the old one; (5) the cuticle becomes set and unstretchable almost immediately, and the insect resumes its normal activities. During the molting process, the hard plates of each new cuticle are formed a size larger than the corresponding parts of the old cuticle, and the soft parts are stretched a size larger than the old. When the insect resumes its normal activities immediately after a molt, the soft parts of the cuticle fall into a large number of pleats or folds between the hard parts. As the insect grows larger following a molt, the body can lengthen by the unfolding of these pleated areas.

The stages of the insect between molts are called *instars*. Among the different orders of insects the number of instars in the life history may vary, and various instars may have different forms. These characteristics of molting and instars are therefore important items in the classification of insects.

The insect orders are arranged in a classification based on the sequence in which the orders are believed to have evolved, fig. 18. Measured by geological time, insects are among the oldest of land animals, having first evolved from an earlier, centipede-like ancestor

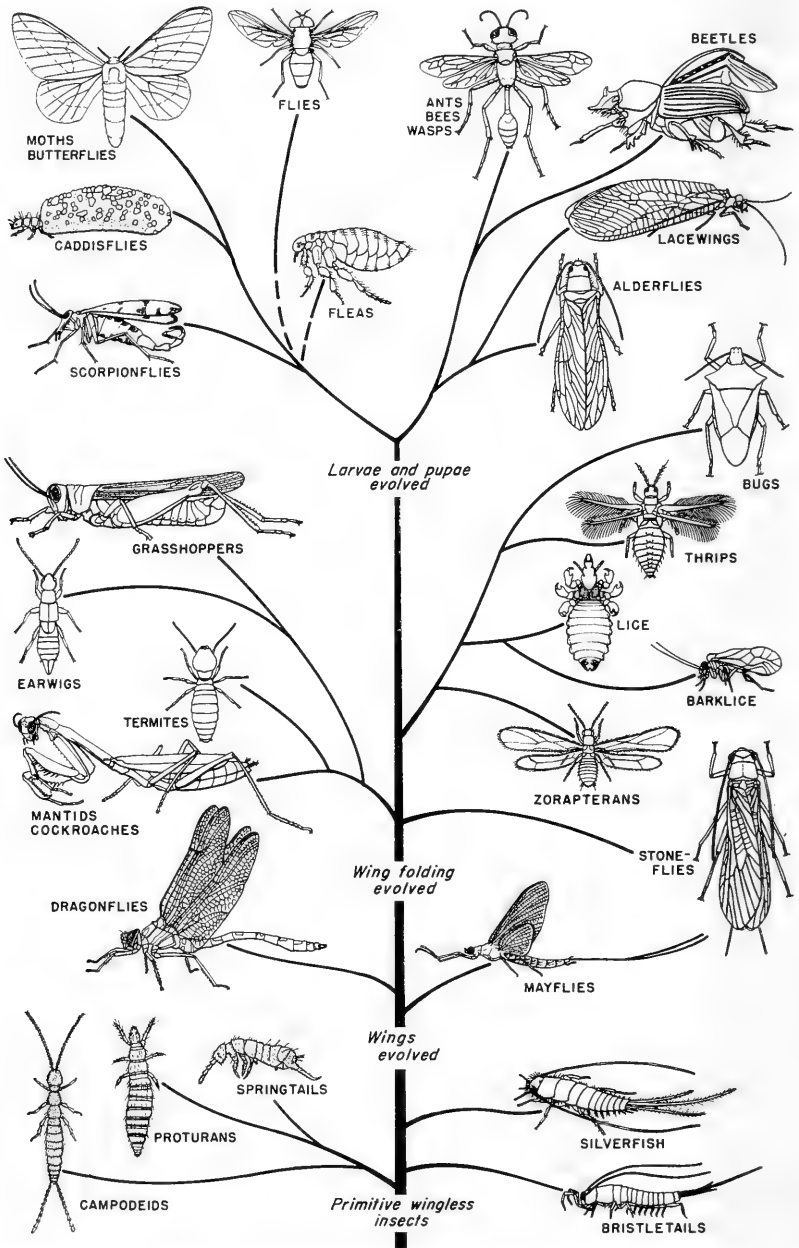

Fig. 18.—A family tree representing current ideas of how the orders of insects evolved. The early, primitive orders are at the bottom of the tree and the later, more highly specialized orders at the top. It is customary to list the orders of insects in this sequence, from primitive to specialized.

about 400 million years ago. The first insects had no wings and differed from the many-legged centipede-like creatures of that time chiefly in having only three pairs of functional legs. The legs were situated on the three segments immediately behind the head; the three distinctive segments are together called the *thorax*. The part of the body behind the thorax is called the *abdomen*. In contrast to this arrangement, a centipede has a pair of legs on each of its many segments for the whole length of the body. The slow evolutionary

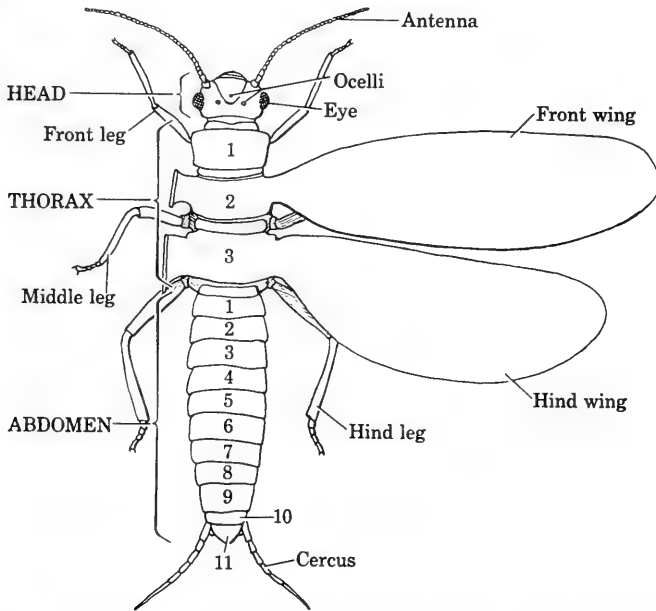

Fig. 19.—Diagram of a typical adult winged insect. This illustrates many of the parts that are useful in identifying these creatures. (Drawing adapted from R. E. Snodgrass.)

change from such a many-legged ancestral form to a typical insect undoubtedly occurred by a gradual enlargement and strengthening of the front three pairs of legs and a reduction of the legs posterior to these. Evidence supporting this idea is found in insect embryos, which normally have rudimentary leg structures on the abdominal segments, and in some of the extremely primitive insects, which have rudimentary legs called styli on some segments of the abdomen. The result of this evolutionary development is a body having the front part, the thorax, specialized for locomotion and the back part, the abdomen, serving chiefly as a container for the vital organs, such as those of the digestive and reproductive systems.

Five existing orders of insects, all found in Illinois, are representative of the primeval wingless insects. In all five, the individual molts at intervals, even after becoming adult and sexually mature, and the old and young are extremely similar. Three of the primitive orders, the campodeids, proturans, and springtails, belong to a specialized early branch of the insect family tree, fig. 18, in which the cheeks have grown forward to form a pouch surrounding the mouthparts. In the other two primitive orders, the bristletails and silverfish, the mouthparts are in a normally exposed condition, but the legs are larger and the insects are rapid runners.

From one of these ancestral, silverfish-like insects arose a form in which wings evolved. In birds and bats, the wings are converted front legs with membranes or feathers attached to form planing or flying surfaces. In insects, on the other hand, the wings are outgrowths of the edge of the body where the sides and top come together, fig. 19. The wings probably began as side flanges of the thorax and permitted a certain amount of planing. Whatever their origin, two pairs of flying wings did evolve, one pair on the second and another on the third segment of the thorax.

In the early winged forms, the wings could not be folded back in repose over the body, but were held out from the sides like airplane wings or together above the body like sails. Two living orders of insects represent this type, the mayflies and the dragonflies. In both of these, as in other winged insects, the wings form as small pads during the early stages of the individual; then at a final molt they are unfolded as functional units. In the mayflies, one more molt occurs after the wings are formed; in this molt the old outside covering of the wings is shed along with that of the rest of the insect. In all other winged insects no molt occurs after the wings are formed and the individual becomes sexually mature.

Insects having erect, nonfolding wings were abundant some 300 million years ago. Fossil remains of many of these early forms have been found in the Mazon Creek area in Illinois, fig. 20.

From one of these early winged types a form evolved in which the wings could be folded compactly over the body; this form gave rise to a great many of our present-day insects. In the first insects that evolved from this form the wing pads of the immature stages, called nymphs, grew as external and often inconspicuous flaps held close to the body. These primitive insects comprise three distinctive groups, characterized mainly by differences in leg and body structure. One group contains the cockroaches, grasshoppers, and their allies; the second includes only the stoneflies; and the third group includes the barklice, true lice, bugs, and their allies.

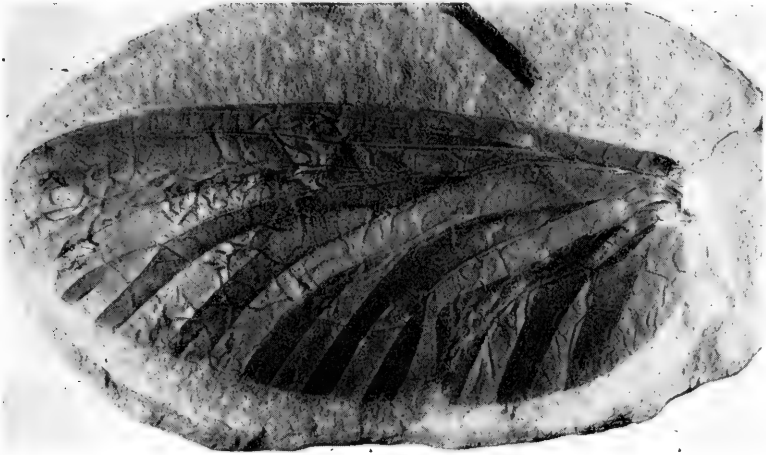

Fig. 20.—An insect fossil from an iron nodule or concretion found at Mazon Creek, Illinois; hind leg of an ancestral mayfly, *Lithoneura mirifica* Carpenter. Actual length of wing about one-half inch. This fossil represents an insect which lived during the Pennsylvanian period, about 250 million years ago. (Photograph courtesy of Illinois State Museum.)

One of the primitive lines of wing-folding insects, possibly an offshoot from the base of the barklouse-bug line, evolved into a distinctly different type in which the wing pads of the immature stages developed internally and appeared as external pads only in the stage before the adult form. The type was characterized by a marked difference of appearance between the various stages of the life history; these stages have been given distinctive names. The first immature stage, which is without external wing pads, is called a *larva*; the single stage with the external wing pads is called the *pupa*; and the final winged, sexually mature stage is called the *adult*. The larva is essentially a growing stage, the pupa is a quiescent stage of internal reorganization, and the adult is the *egg*-producing stage. This type of insect gradually gave rise to the orders which now contain the largest number of species, including the beetles, moths, and flies. In many lines of this neuropteroid branch, as it is called, the larva has become adapted to a mode of life quite different from that of the adult. Many fly larvae, for example, live in rotting organic material or live as parasites within the tissues of other kinds of insects, whereas the adult flies often feed at flowers on pollen and nectar, visiting the site of the larval habitat only to lay eggs. As a result of this type of evolution, members of the neuropteroid orders exhibit many bizarre and complicated life histories.

Occasionally certain groups of winged insects evolved new types which had small wings or were wingless. The new types resulted be-

cause the groups were subjected to environmental situations where wings were of little survival value. Within the groups, individuals with smaller wings were favored; they survived and reproduced in greater numbers than other individuals. Over many generations then, the wings in some groups became very small or were entirely lost. Sometimes this loss of wings occurred in all the adult forms, as in the fleas. Individuals of only one sex may be wingless, as are the females of two Illinois moths, one of which produces bagworms and the other cankerworms. In two groups, the termites and the ants, a wingless worker or soldier caste is produced; in these groups the normal adults which swarm and reproduce are fully winged. These winged forms establish new colonies.

Wings were lost in the evolutionary development of two insect groups that became parasites of warm-blooded animals, both birds and mammals. Each of these insect groups developed into a large, distinctive order. One order, the true lice, evolved from the barklice, and the other, the fleas, evolved possibly from a primeval fly group. Although these two orders, the lice and the fleas, are without wings, the structure of their bodies and their life histories provide adequate testimony of their evolutionary affinities.

The following synopsis of Illinois insects treats the various kinds in the sequence in which we believe they evolved, from the extremely primitive bristletails to the highly specialized flies.

HOW TO IDENTIFY SPECIMENS

As an aid to the beginner in making preliminary identification of his specimens and also as an aid in arranging his collection, a short descriptive synopsis of the orders of living insects is given below. In this description are noted the most distinctive features of the common insects occurring in Illinois. There are rare and obscure forms, seldom met by the collector, that require a more technical key for their identification; for these the collector will need to consult some of the more nearly complete books listed on page 70. The collector will find, however, that this synopsis will afford a beginning for his classification of the common forms.

Various characters are used to identify an insect to family, genus, and species. Among these characters are the antennae, wings (if present), legs, and mouthparts. Frequently important for identification are such minute details as hair or scales covering the body or wings and the texture of these parts. In most cases good microscopic equipment is necessary to see clearly the characters used in the diagnosis of insects.

SYNOPSIS OF ILLINOIS INSECT ORDERS

Of the 28 orders of insects recognized in North America, 26 have been collected in Illinois. The two orders not found here are the Embioptera or webspinners, a tropical and subtropical order, and the Raphidiodea or snakeflies, which occur in the western mountainous region of the continent.

The Illinois fauna thus contains a remarkable variety of insects, including forms such as the bristletails, mayflies, and cockroaches, which are practically "living fossils" of insects that lived hundreds of millions of years ago.

Primitive Wingless Insects

Only five orders of primitive wingless insects are known; species of each order occur in Illinois. These orders represent the stages in insect evolution before wings had appeared.

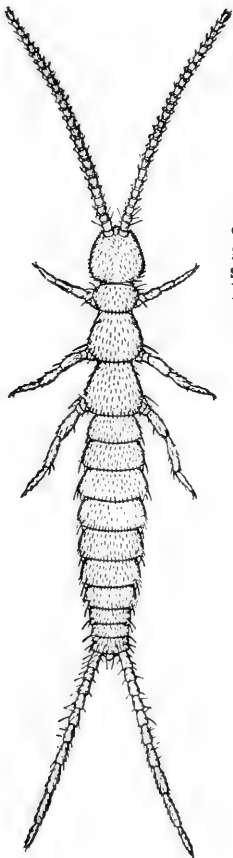

Fig. 21 (left).—Diplura. A campodeid belonging to the genus *Campodea*, found under stones in moist places. Actual length of adult about 0.1 inch. (Drawing from E. O. Essig.)

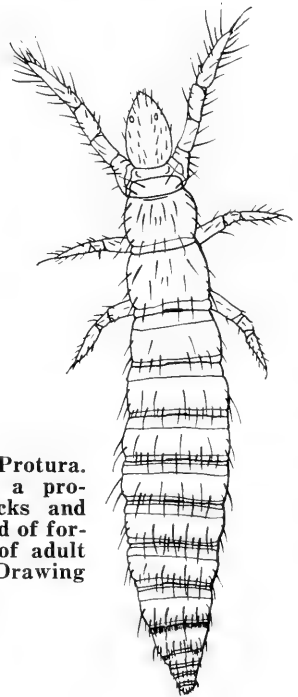

Fig. 22 (right).—Protura. *Acerentulus barberi*, a proturan found on sticks and leaves in the leaf mold of forests. Actual length of adult about 0.02 inch. (Drawing from H. E. Ewing.)

Diplura Small, wingless, fragile, blind, whitish insects that
 Campodeids, run fairly rapidly. They have long antennae and
 Japygids either two fairly long tails or a pair of forceps-
 like structures at the end of the abdomen. They
 are terrestrial and are found chiefly under stones in humid and shady
 situations. Fig. 21 shows a common campodeid, a species of *Campodea*,
 occurring commonly in Illinois.

The Diplura feed on fungi and other soil microorganisms. Although they are found most frequently under stones, they live also in the soil and in matted leaves or duff on the floor of woods. About a dozen species of Diplura occur in Illinois.

Protura Minute, wingless, blind insects that never grow to
 Proturans more than 0.05 inch long. They have no antennae
 and use the front legs to some extent for feeling.
 They are terrestrial and are found inhabiting dead twigs and leaves
 on the forest floor. Fig. 22 shows *Acerentulus barberi* Ewing, a member
 of a genus which occurs in many localities in Illinois. Only a few species
 of proturans have been taken in the state.

Collembola Small, wingless insects that jump and crawl when
 Springtails disturbed. They have short antennae and usually
 a springing structure on the under side near the
 posterior end of the body. They live in moist places and are abundant
 under leaf mold and similar material. Illustrated in fig. 23 is *Achorutes*
armatus Nicolet, which often becomes a major pest in mushroom cel-
 lars and greenhouses.

About a hundred different species of Collembola occur in Illinois; they include some of our smallest insects. A few never grow longer than 0.007 inch; the largest approach half an inch in length. These hardy animals are active all year and are surprisingly resistant to cold. Certain species occur on snow in winter. In Illinois a small, bluish gray species, *Podura aquatica* Linnaeus, is found on the surface of still water at the margins of ponds and small streams.

Microcoryphia Wingless, somewhat cylindrical insects that run
 Bristletails and jump with extreme rapidity. They have long
 antennae and three long tails. The under side of
 the abdomen bears several pairs of short projections called styli, which
 are vestiges of abdominal legs. Bristletails live in rocky places or in
 ground cover. A type occurring in some parts of Illinois is shown in
 fig. 24. It often occurs on rocky exposures, where it resembles the
 lichens and is difficult to detect.

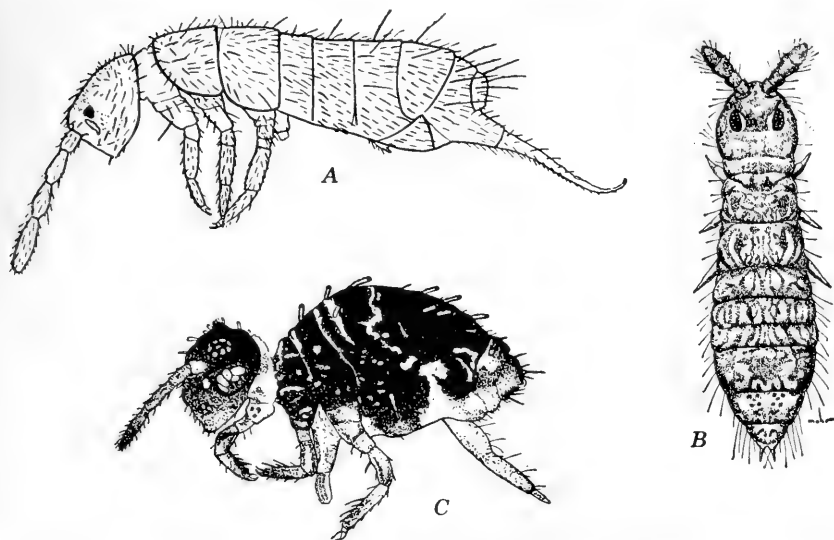

Fig. 23.—Collembola. *A*, *Isotoma andrei*; *B*, *Achorutes armatus*; *C*, *Neosminthurus clavatus*. *A* and *C* are found in woodland leaf molds; *B* is frequently abundant in commercial mushroom cellars. Actual length of adults ranges from 0.03 to 0.05 inch. (Drawings *A* and *C* after Harlow B. Mills.)

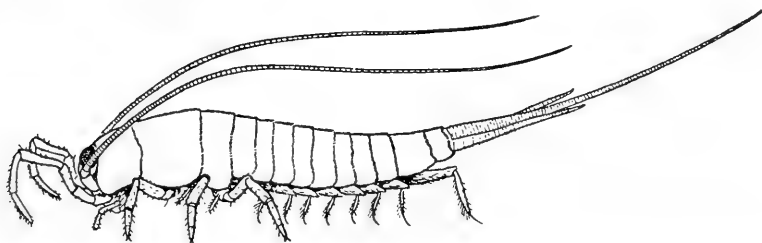

Fig. 24.—Microcoryphia. A bristletail belonging to the genus *Machilis*, often found on lichen-covered, shaded rocks. Actual length including tail is sometimes 0.5 inch. (Drawing after R. E. Snodgrass.)

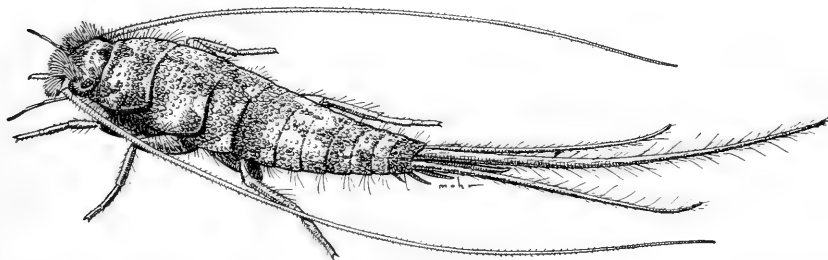

Fig. 25.—Thysanura. *Thermobia domestica*, a common silverfish. Actual length about 0.3 inch.

Thysanura Wingless, flat insects that run rapidly. They have long antennae and three long tails. They are terrestrial and are commonly found in dwellings.

Silverfish

Fig. 25 shows one of the common silverfish, *Thermobia domestica* (Packard); it frequently eats book bindings and other starchy materials. Some out-of-door rare forms live in the soil and are seldom collected.

Primitive Winged Insects

The primitive winged insects cannot fold their wings, which in repose are held erect over the body or straight out from the sides, as illustrated in figs. 26 and 29. Although many types of these insects lived in bygone ages, only two orders have survived to the present. Both occur abundantly in Illinois.

Ephemeroptera A group of insects in which the nymphs or young live in streams and lakes; the adults are found along the edges of the streams or lakes from

Mayflies

which they have emerged. Mayflies are unique in that the full-grown nymphs molt into winged insects that are not quite mature and that molt again, usually the next day, when they emerge as fully mature adults. The nymphs are varied in shape and have short antennae, long legs, which are often flattened, and three tails at the end of the body. The adult flies have very long front legs, short antennae, practically no mouthparts, usually two pairs of wings, and two or three long tails. When a mayfly is at rest, the wings are held together above the body. *Hexagenia limbata* (Serville), figs. 26 and 27, is one of the very common Illinois mayflies and is an important factor in the food economy of many fish.

Mayflies, formerly called Plectoptera, together with stoneflies, caddisflies, and midges, constitute a very large portion of the life of our lakes and streams; all four groups are important as fish food.

Odonata Another order in which the nymphs develop in streams, lakes, or ponds, and in which the adults are aerial. The nymphs have short antennae, long legs, and either a stout body with no tail, as in

Dragonflies,

Damselflies

Anax junius (Drury), fig. 28 (dragonfly nymph), or a slender body with three large leaflike gills projecting from the end of the body (damselfly nymph). A most distinctive feature of this order is an extensile, highly modified lower lip that fits like a mask over the face of a nymph. The lower lip is hinged to extend forward and seize the small animals upon which the nymph lives. The adults are large, often

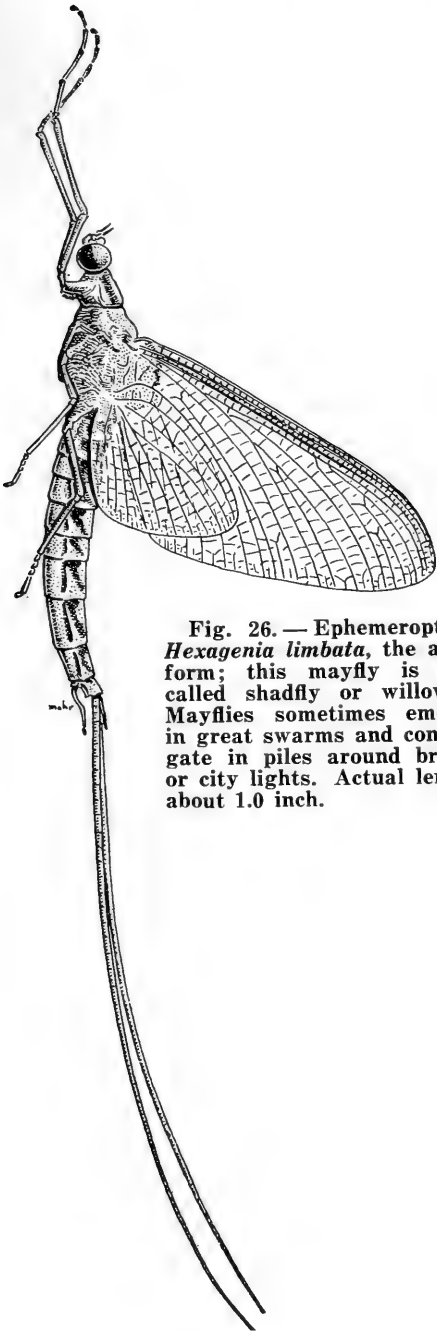

Fig. 26. — Ephemeroptera. *Hexagenia limbata*, the adult form; this mayfly is also called shadfly or willowfly. Mayflies sometimes emerge in great swarms and congregate in piles around bridge or city lights. Actual length about 1.0 inch.

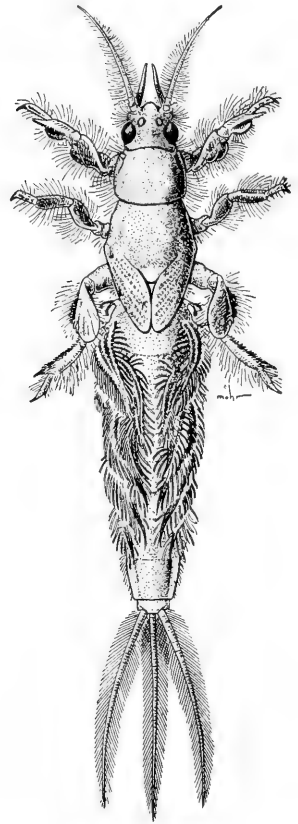

Fig. 27. — Ephemeroptera. *Hexagenia limbata*, the nymphal form of the mayfly in fig. 26; in this stage the mayfly lives in water, emerging when full grown. Actual length about 1.0 inch.

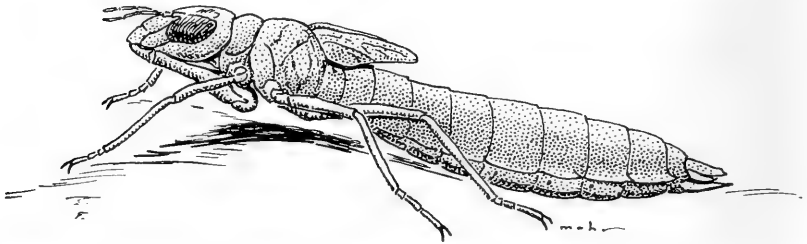

Fig. 28.—Odonata. Nymph of *Anax junius*, a dragonfly widely distributed in Illinois. Actual length of full-grown nymph about 2.3 inches. (Drawing courtesy of C. O. Mohr.)

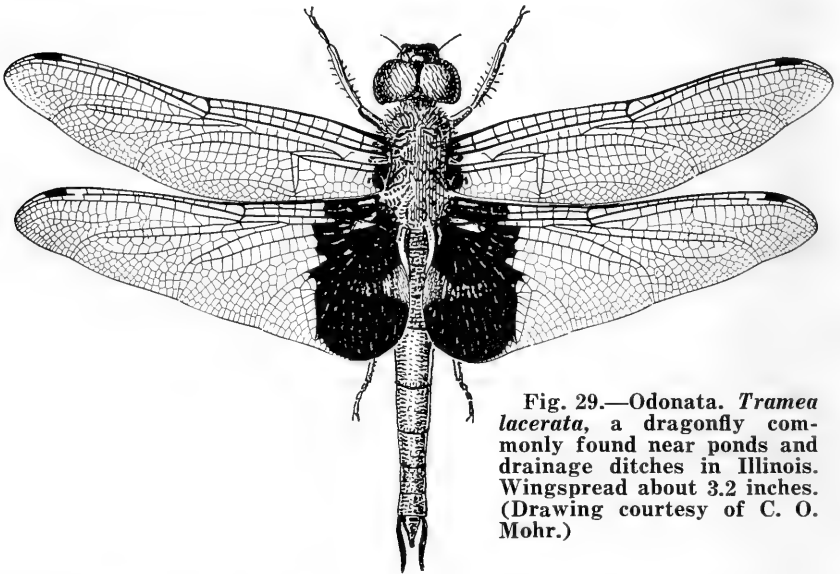

Fig. 29.—Odonata. *Tramea lacerata*, a dragonfly commonly found near ponds and drainage ditches in Illinois. Wingspread about 3.2 inches. (Drawing courtesy of C. O. Mohr.)

beautifully colored, as is the *Tramea lacerata* Hagen, fig. 29. They have chewing mouthparts and two pairs of large wings, very finely and intricately netted with veins.

The order is divided into two types; the adult flies are told apart as follows:

- Body stout, wings broad at base, the front and hind wings different in shape. Strong fliers. Dragonflies.....Suborder **Anisoptera**
- Body slender, wings narrowed at base, the front and hind wings similar in shape. Weaker fliers than dragonflies but nonetheless elusive. DamselfliesSuborder **Zygoptera**

Folding-Wing Insects

Almost all insects in this category can fold their wings in repose back over their bodies, as illustrated in fig. 31. A few kinds, notably some of the moths and butterflies, have lost this wing action and in

repose hold their wings erect. In some of these kinds, the male is winged and the female is wingless; in others, certain generations may be wingless and others winged; and, in still others, the species may be wingless in all stages. No members of the orders of folding-wing insects molt after becoming winged or sexually mature.

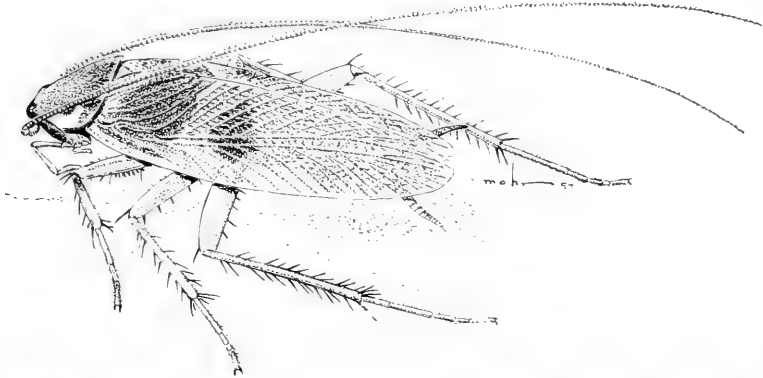

Fig. 30.—Cursoria. *Supella supellectilium*, the brown-banded cockroach. Actual length about 0.6 inch. (Drawing courtesy of C. O. Mohr.)

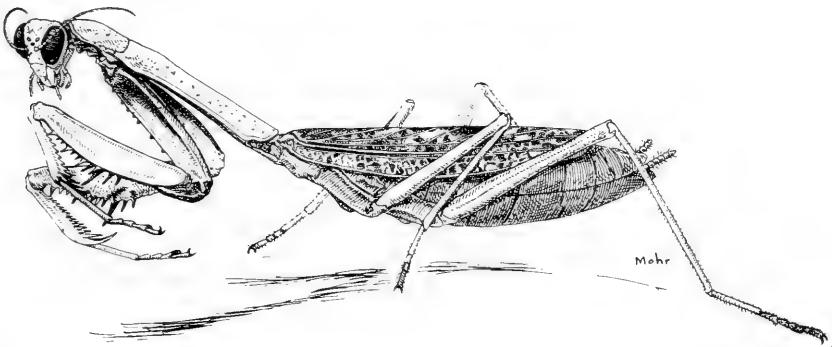

Fig. 31.—Cursoria. *Stagmomantis carolina*, a praying mantis. Common in southern and central Illinois. Actual length of adult about 1.5 to 2.0 inches.

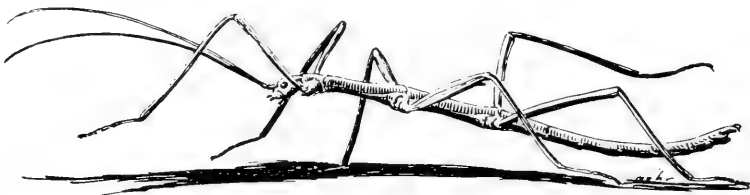

Fig. 32.—Cursoria. *Diaperomera femorata*, a walking stick insect. This insect lacks wings. Actual length about 3.0 inches. (Drawing courtesy of C. O. Mohr.)

Cursoria

Cockroaches,
Mantids,
Walkingsticks

An order that includes three groups of terrestrial insects, each group markedly different in appearance from the others: (1) rapidly running insects usually having two pairs of wings, each with a dense network of fine veins, the front pair of wings thick and leathery, fig. 30 (cockroaches); (2) winged insects having long, grasping front legs, fig. 31 (praying mantids); and long, wingless insects resembling sticks, fig. 32 (walking sticks). The mouthparts are fitted for chewing. The young look and act like the adults except that they do not have wings. The cockroaches are omnivorous, feeding chiefly on organic foods rich in carbohydrates, or on fungus growth. Cockroaches are among our most persistent indoor pests, eating a wide variety of domestic foods. The praying mantids feed on other insects, which they capture in their enlarged front legs. The walkingsticks eat leaves. The cockroaches and mantids lay eggs that are glued together and form pods or capsules, each containing 30 or more eggs. The walkingsticks lay their eggs singly.

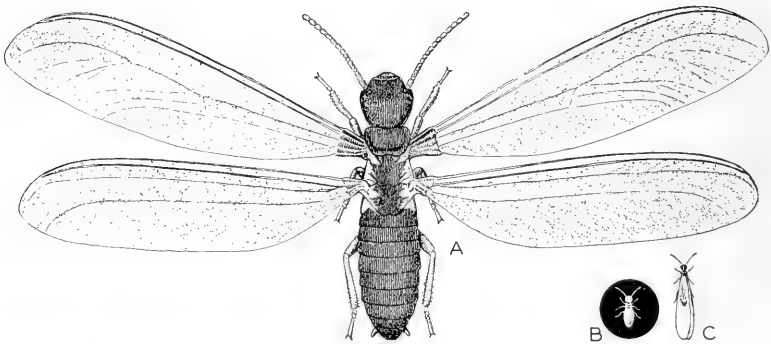

Fig. 33.—Isoptera. *Reticulitermes flavipes*, the commonest kind of termite found in Illinois: *A*, first form queen with wings spread, many times natural size (this is the form that lays eggs); *B*, worker nymph, natural size; *C*, first form queen, approximately natural size, with wings placed in their natural resting position. (Drawing courtesy of C. O. Mohr.)

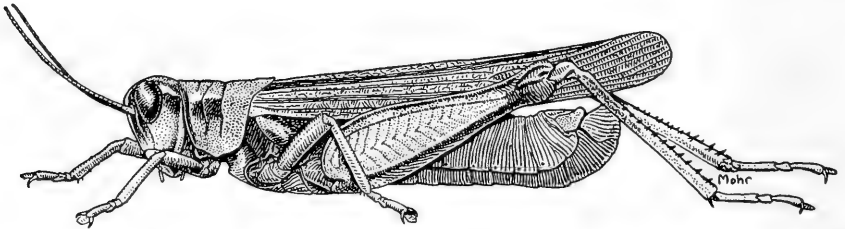

Fig. 34.—Orthoptera. *Melanoplus bilituratus*, the migratory locust, a common Illinois grasshopper. Actual length about 1.0 inch.

Isoptera

Fragile or soft insects with chewing mouthparts.

Termites

The mating forms are dark brown and have two similar pairs of wings; both pairs are delicate and

have a fine network of veins. The workers are white and soft bodied. Termites, which live in colonies in wood, are also called "white ants," although they are not true ants. The common native species in Illinois is *Reticulitermes flavipes* (Kollar), fig. 33, which lives in rotten logs and is destructive to buildings of wooden construction throughout Illinois; it is most destructive in the southern part of the state.

Orthoptera

Terrestrial insects usually with two pairs of

Grasshoppers,

wings, each wing with a very fine, dense network of veins, the front pair thick and leathery, the

Crickets

hind pair delicate and fanlike. The mouthparts, fitted for chewing, have stout mandibles. The young look and act like

the adults but do not have wings. This order includes all the grass-

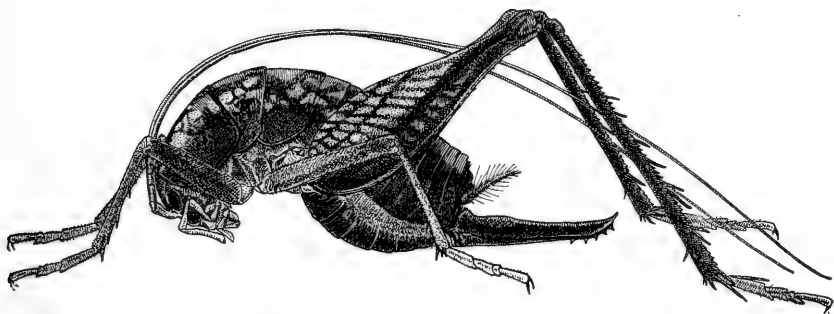
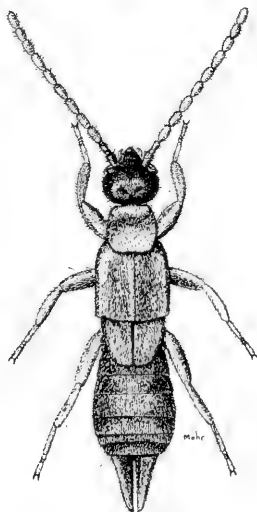

Fig. 35 (above).—Orthoptera. *Ceuthophilus maculatus*, a wingless cave cricket. Crickets of this kind are found in caves, under rocks, and in basements. Actual length about 1.0 inch.

Fig. 36 (right).—Dermaptera. *Labia minor*, an earwig frequently abundant in Illinois. Actual length of adult about 0.2 inch.



hoppers, crickets, and katydids. Fig. 34 shows the migratory locust or grasshopper, *Melanoplus bilituratus* (Walker). Adults of several of the groups of Orthoptera never develop wings. These include such odd forms as the cave crickets, exemplified by *Ceuthophilus maculatus* (Harris), fig. 35.

Dermaptera

Earwigs

Insects with two pairs of wings, the front pair forming short, hard covers, the second pair large, membranous, many-veined, and in repose folded intricately beneath the front pair. The abdomen ends in a pair of pincer-like structures. A common Illinois form is *Labia minor* (Linnaeus), shown in fig. 36. Of the half-dozen species known from Illinois, all but one were originally from Europe or Asia. Earwig females lay eggs in chambers in the ground and guard them.

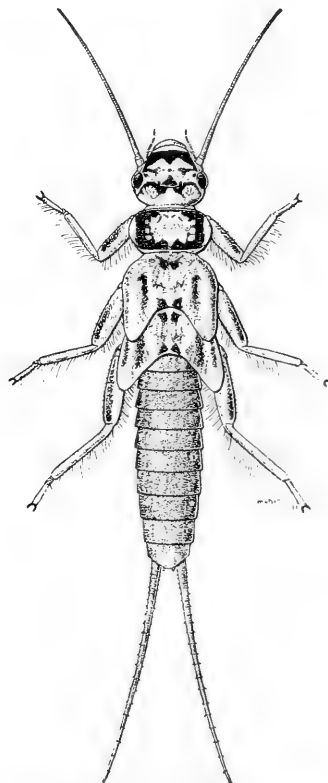
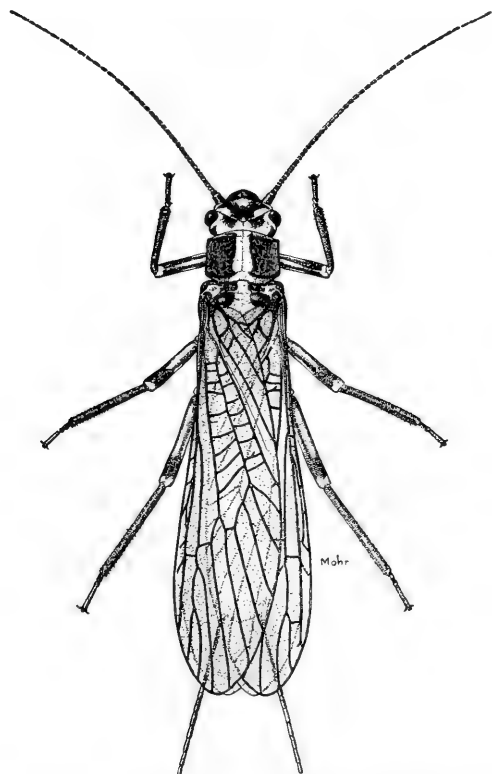

Fig. 37.—Plecoptera. *Isoperla confusa*, one of the typical stoneflies found in Illinois; adult form. Actual length about 0.8 inch. Illinois stoneflies range in length from 0.25 inch to 1.5 inches.

Fig. 38.—Plecoptera. *Isoperla confusa*; the nymph of the species shown in fig. 37. The nymph lives in streams. Actual length about 0.6 inch.

Plecoptera Insects that pass the young or nymphal stage in
 Stoneflies streams. They have slender, soft bodies and long
 tails; they move about rapidly. The adults are
 terrestrial in habit and occur along streams. In most species, the
 adults have two pairs of wings that are folded flat over the back; the
 number of crossveins varies from many to few. The antennae are
 long; the mouthparts are of the chewing type but greatly reduced. Of
 exceptional interest are stonefly adults that emerge in winter and are
 active from November through March. The winter forms can often
 be collected on bridges. Figs. 37 and 38 illustrate a spring species,
Isoperla confusa Frison.

Zoraptera Small, whitish insects, about a twelfth of an inch
 Zorapterans long, that run rapidly. They live in small colonies
 in rotting sawdust, in rotten logs, and under the
 bark of stumps. They have fairly long antennae, chewing mouthparts,
 and a pair of short, inconspicuous tails. Most members of a colony
 are wingless, but occasionally there occurs a darker specimen having
 two pairs of wings. These wings have only a few veins. In Illinois
 only a single rare species has been found; it is called *Zorotypus hub-*
bardi Caudell, fig. 39.

Corrodentia Small, rounded or flattened insects, rarely a quar-
 Booklice, ter-inch long, usually about 0.13 inch. In many
 Barklice species, adults have two pairs of wings, which
 have only a few zigzagging veins. Winged forms,
 such as *Psocus striatus* Walker, fig. 40, are found in crevices of bark
 and on dead leaves. Common species found in houses and on stored
 grain are usually wingless and louselike, similar in general appearance
 to fig. 41. Corrodentia eat fungus growth on bark, dead leaves, moldy
 grain, damp books, and similar materials. Some of the outdoor species
 become very abundant on drying corn leaves during autumn and may
 breed in immense numbers. They do little harm, feeding chiefly on
 fungus strands.

Phthiraptera Wingless, blind, flattened insects with short an-
 Chewing Lice, tennae, short legs, inconspicuous mouthparts, and
 Sucking Lice no tails on the posterior end of body. They are
 found exclusively on the bodies of birds and other
 warm-blooded animals. The young have the same general shape and
 habits as the adults and are found with them. Illinois species of lice
 belong to two distinct suborders, which may be differentiated through
 use of the following key:

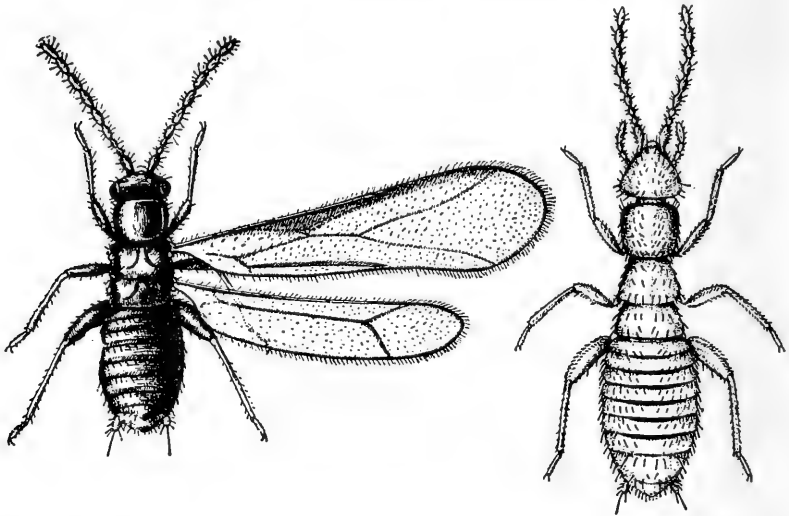

Fig. 39.—Zoraptera. *Zorotypus hubbardi*, the only zorapteron recorded from Illinois. The specimen on the left is a winged adult female; the specimen on the right is a wingless adult female. Actual length of adults about 0.08 inch.

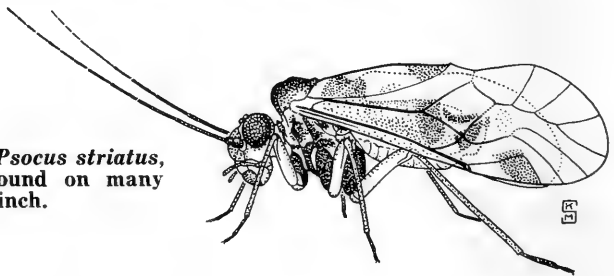

Fig. 40.—Corrodentia. *Psocus striatus*, a common bark louse found on many trees. Actual length 0.2 inch.

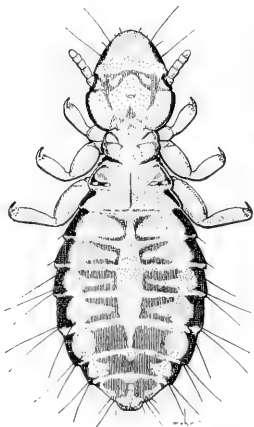
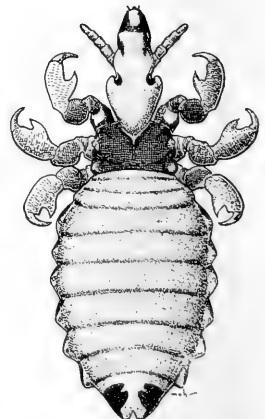

Fig. 41 (left).—Phthiraptera. Suborder Mallophaga. *Cuculotogaster heterographus*, a chewing louse found on the heads of poultry. Actual length about 0.1 inch.

Fig. 42 (right).—Phthiraptera. Suborder Anoplura. *Haematopinus asini*, the blood-sucking horse louse. Actual length 0.1 inch.



Legs fitted for running, as in fig. 41, without large pincers at their ends; mouthparts situated near the middle of under side of the head and fitted for chewing. Occurring on birds and mammals. The chewing lice Suborder **Mallophaga**

Legs fitted for clinging to hairs, each leg ending in a large pincer, as in fig. 42; mouthparts retracted within head, consisting of a set of thin, needle-like parts fitted for sucking blood. Normally occurring only on mammals. The sucking lice Suborder **Anoplura**

Suborder Mallophaga.—Individuals of many species of chewing lice move about with considerable rapidity. Many of them are very prettily banded and colored, as is the chicken head louse, *Cuclotogaster*

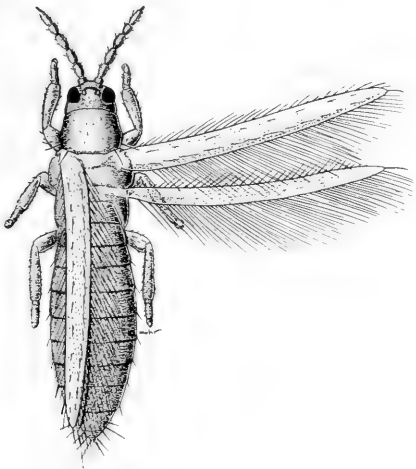

Fig. 43.—Thysanoptera. *Thrips tabaci*, onion thrips. Actual length less than 0.1 inch.

heterographus (Nitzsch), fig. 41. Anyone who has worked with domestic fowls or animals has seen members of this order scurrying among the feathers or hair. These insects feed on what they can chew from the surface of the skin and in some cases are known to injure their hosts.

Suborder Anoplura.—The sucking lice are sluggish insects that usually cling to hairs. Human lice are often found clinging to clothing. Various species occur on native and domestic species of mammals in Illinois. Fig. 42 shows the horse louse, *Haematopinus asini* (Linnaeus).

Thysanoptera

Thrips

Small, active insects, usually about 0.1 inch long, rarely a quarter-inch long, very slender, usually each with two pairs of narrow wings and with

the under side of the head forming a sharp, conelike sucking structure. Each wing has a long fringe on the hind margin; each front wing may have one or two veins running the length of the wing. The young of these insects are somewhat similar to the adults but are softer

bodied. Fig. 43 shows an adult of *Thrips tabaci* Lindeman, the onion thrips. Thrips suck the juice from plants. Because of their minute size, they are seldom noticed, but they can be collected in large numbers from blossoms of almost any plant. A few species of thrips, such as the onion thrips and the privet thrips, attack agricultural or horticultural plants and inflict considerable damage. A few species occasionally bite human beings.

Hemiptera

True Bugs and
Their Allies

Insects usually with two pairs of wings and with the mouthparts formed for sucking. The order contains two distinct suborders, the Heteroptera and the Homoptera. All species of Hemiptera in

North America fall readily into one suborder or the other, but certain species in other parts of the world are intermediate between the two suborders.

In the suborder Heteroptera, containing the stink bugs, the chinch bugs, and their allies, the beak is attached to the under side of the front part of the head; the base of the front pair of wings is hardened, and only the apical portion is membranous or delicate; the entire hind pair is delicate. In repose, the wings are folded over and flat against the body, the hind pair underneath. These characters are shown in fig. 44, which pictures a stink bug belonging to the family Pentatomidae. The young have the same general appearance and habits as the adults, but they lack wings. This suborder includes many common kinds, such as the water bugs, the water striders (these seldom develop wings even in the adult stage), the ambush bugs, and the lace bugs, as well as the stink bugs and the chinch bugs. The chief

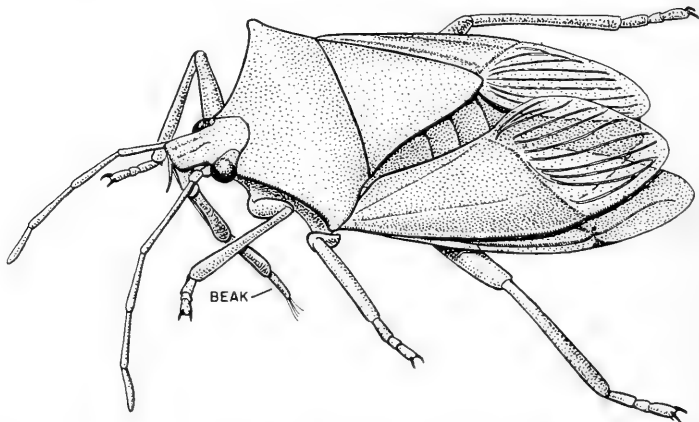

Fig. 44.—Hemiptera. A typical stink bug of the family Pentatomidae, showing attachment of beak and arrangement of wings. Actual length about 0.4 inch.

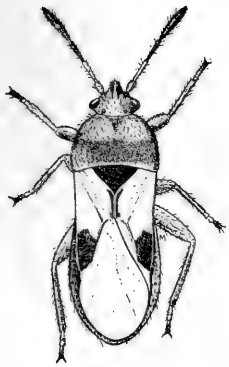

Fig. 45 (left).—Hemiptera. *Blissus leucopterus*, the chinch bug. Actual length about 0.1 inch.

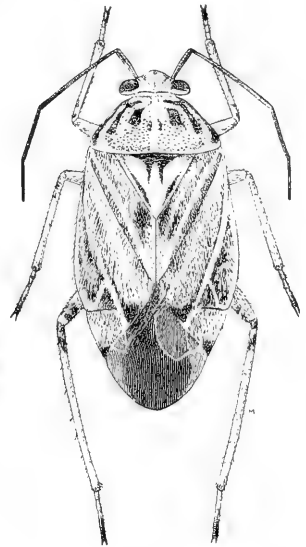

Fig. 46 (right).—Hemiptera. *Lygus lineolaris*, the tarnished plant bug. Actual length about 0.2 inch.

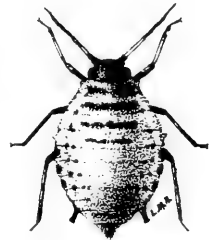
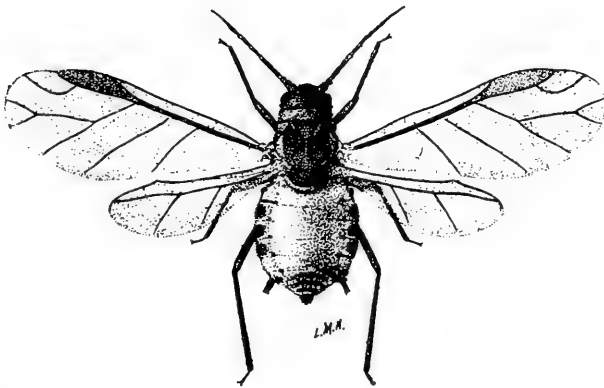

Fig. 47.—Hemiptera. *Anuraphis maidiradicis*, the corn root aphid. The form at the left is the winged form; that at the right is the wingless form. All of the plant lice have these two forms. This species, as well as other kinds of plant lice, is frequently attended by ants, which feed on the honeydew produced by the aphids. Actual length less than 0.1 inch.

pest of this group is the chinch bug, *Blissus leucopterus* (Say), fig. 45. Other pests include many kinds of plant bugs, of which *Lygus lineolaris* (Beauvois) is shown in fig. 46. The bed bugs, another group never developing functional wings, also belong in this suborder.

Members of one family, the Reduviidae or assassin bugs, prey on other insects. A few species called kissing bugs, some of them an inch long, occasionally attack people, inflicting an extremely painful bite and causing considerable bleeding.

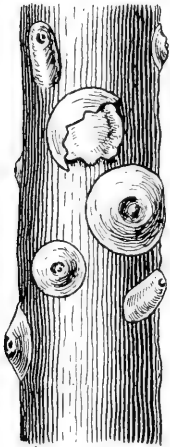

Fig. 48 (left). — Hemiptera. *Aspidiotus perniciosus*, the destructive San Jose scale. The scale is cut away on upper specimen to show insect proper beneath. Diameter less than 0.1 inch.

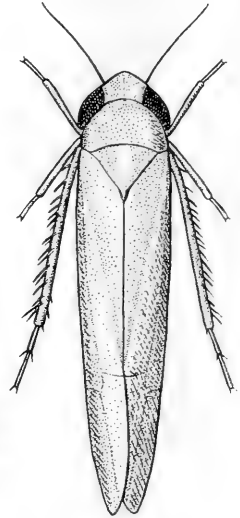

Fig. 49 (right). — Hemiptera. *Empoasca fabae*, the potato leafhopper. This species is pale green. Some species are distinguished by bright red or yellow markings. Actual length about 0.1 inch.

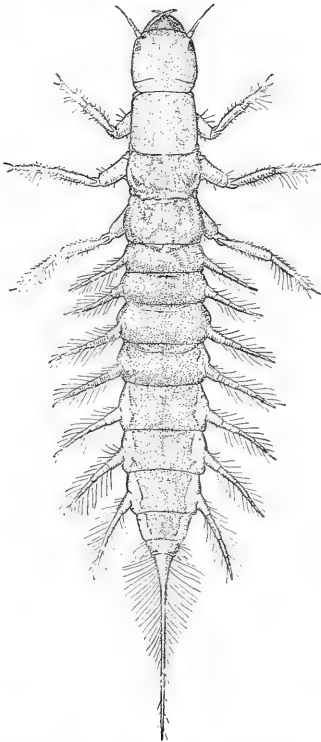

Fig. 50.—Megaloptera. The larva of a species of *Sialis*, an alderfly. This form is aquatic. Actual length 0.7 inch.

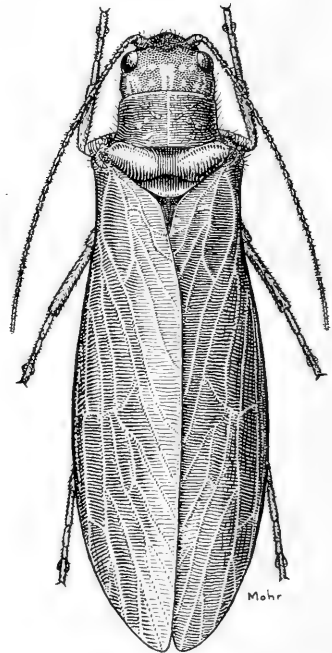

Fig. 51.—Megaloptera. The adult of *Sialis mohri*, an alderfly. Other members of this order reach a length of 1 or 2 inches. They are mostly black, black and white, or mottled gray in color. Actual length 0.5 inch.

The suborder Homoptera contains the cicadas, aphids, and their allies. All these insects have sucking mouthparts, but in each the beak is attached at the back of the head instead of the front of the head as in the suborder Heteroptera. In many species of the Homoptera, each individual has two pairs of wings, both of which are membranous. Probably as many species are without wings, however, as with them. The nymphs are in most respects similar to the adults. Sexual characters, and in some forms wings, gradually develop as the insects approach the adult state, when development is complete.

This suborder contains a large number of economic pests, including scale insects and leafhoppers, as well as many aphids. In many species of aphids each insect has a pair of tubular structures near the end of its body; these are called cornicles and can be seen in fig.

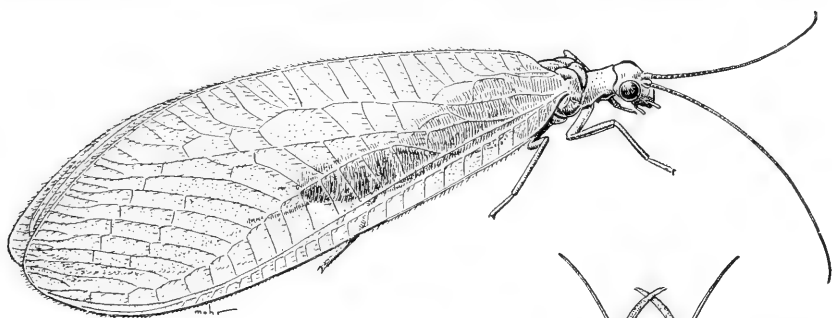

Fig. 52 (above).—Neuroptera. *Chrysopa nigricornis*, a green lacewing. When handled, members of this genus give out a very penetrating and disagreeable odor. Actual length 0.6 inch.

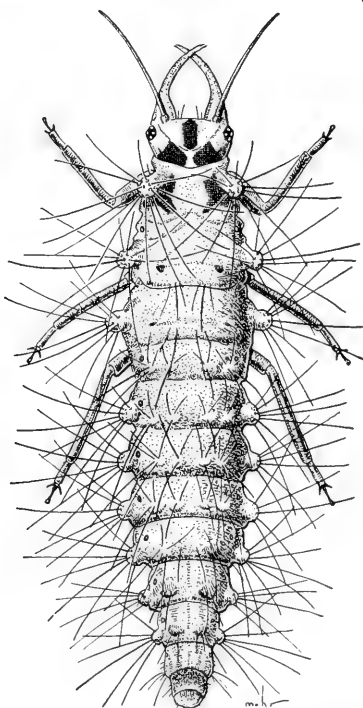

Fig. 53 (right).—Neuroptera. A larva of the genus *Chrysopa*. This form uses the long jaws to impale aphids and suck their body juices. Actual length 0.5 inch.

47, showing the corn root aphid, *Anuraphis maidiradicis* (Forbes). In most species of scale insects each individual produces a tough scale, which covers and protects its delicate body, as in fig. 48, showing the destructive San Jose scale, *Aspidiotus perniciosus* Comstock. Leafhoppers of many kinds, such as *Empoasca fabae* (Harris), fig. 49, are among the destructive pests of beans, potatoes, grapes, apples, and other plants. The treehoppers, spittlebugs, and lanternflies also belong to this suborder.

Megaloptera

Alderflies,
Dobsonflies

In this and in the following orders of insects, the life history includes four distinct stages, the egg, the larva, the pupa, and the adult. In the Megaloptera, which include alderflies and dobsonflies, the larvae are caterpillar-like or grublike, and the pupae represent a transformation stage in which the tissues of the larvae are converted to those of the adults. The larvae never have external wing pads; in winged species, these pads first appear externally in the pupae. The adults have long antennae, two similar pairs of net-veined wings, and chewing mouthparts. They are moderately strong fliers. The larvae, fig. 50, live in streams and lakes; when fully grown they migrate to dry land and pupate in the ground or under the bark of rotten logs.

Typical of the appearance of Illinois alderflies is the adult of *Sialis mohri* Ross, shown in fig. 51. Well known to the fisherman is the hellgrammite, the tough, ferocious, leathery larva found under rocks in streams and prized for bait. This larva matures into the large dobsonfly, *Corydalus cornutus* (Linnaeus), which often attains a wingspread of 4 inches.

Neuroptera

Lacewings and
Their Allies

Insects with two pairs of wings, both pairs about the same size and shape and intricately netted with veins; antennae long and slender, mouthparts fitted for chewing, posterior end of body without tails. The green lacewings, including *Chrysopa nigricornis* Burmeister, fig. 52, are our commonest members of this order. The young or larvae of this order are entirely unlike the adults and are somewhat grublike in form. The aphid lion, the interesting larva of *Chrysopa*, fig. 53, is frequently collected by the sweeping method. Another interesting larva of this order is the doodlebug or ant lion, of Huckleberry Finn fame. The adult insects that mature from these ant lion larvae are very similar in appearance to the chrysopids or lacewings. The larva of each of these insects sinks its long, sharp, curved mandibles into the body of its prey and sucks out the body juices. The female *Chrysopa* has the curious habit of forming a long, slender

stalk under each egg; the bottom of the stalk is fastened to the upper side of a leaf. The stalks are thought to have the effect of keeping the first larvae of a hatch from devouring the eggs placed nearby.

When the larva is mature, it spins a globular, silken cocoon or cell around itself and in this changes into the pupal, or quiescent, stage. While the pupa itself does not appear active, within it the larval tissues are reorganized into the structures of the adult, and the final growth of the wings and reproductive organs occurs. When this change is completed, the adult insect emerges from the cocoon.

Coleoptera

Beetles,
Weevils

Insects with two pairs of wings, the second pair delicate and folded under the first pair, which are hard and thickened and folded back against the body, touching each other along the midline to

form a hard shell, as shown in *Copris minutus* (Drury), fig. 54. The upper wings are not used for locomotion, but form part of the body armor and are called *elytra*. In most beetles they cover the entire posterior part of the body; in many others they are abbreviated and cover only part of the abdomen. The immature stages of the beetles

Fig. 54.—Coleoptera. *Copris minutus*, one of the scarab beetles. The drawing shows one of the elytra upraised and illustrates the method of folding the hind pair of wings under the elytra. Actual length 0.4 inch.

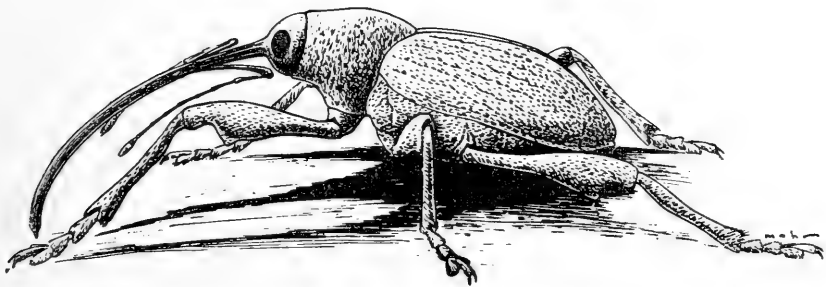
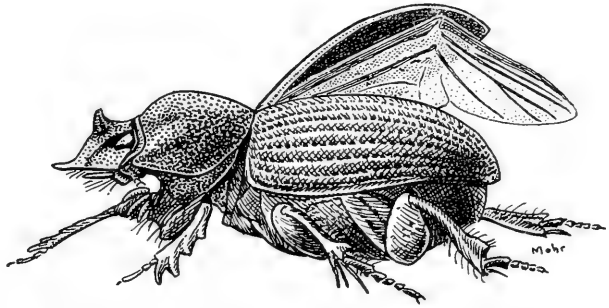

Fig. 55.—Coleoptera. A weevil belonging to the genus *Curculio*, which feeds on nuts and acorns. In this genus the beak is exceptionally long. In most of the Illinois weevils the beak is shorter and stouter. Actual length 0.4 inch.

are wormlike or grublike and have a great variety of food habits. Some of them defoliate plants, others attack roots, and still others feed on other insects.

A great many of the serious insect pests, including kinds that attack field crops, stored products, and household goods, are beetles. Beetles of one group having the front of the head produced into a snoutlike structure, as in the genus *Curculio*, fig. 55, are called weevils or snout beetles. This group has maggot-like larvae and contains many of our worst pests, such as the plum curculio, cotton boll weevil, alfalfa weevil, and clover weevil. Bizarre and striking forms occur in many beetle groups, notably among the scarab and long-horn beetles. The largest in Illinois is the rhinoceros beetle, *Dynastes tityus* (Linnaeus); the males (one shown on the cover of this circular) have long projections on both head and thorax; the larvae live in rotten wood.

Tree-boring beetle larvae are destructive to many orchard, ornamental, and native trees. These include chiefly the round-headed borers, adults of which are long-horn beetles; flat-headed borers, adults of which are metallic wood borers; and engraver or shot-hole types, adults of which are small and bullet shaped and are called bark beetles.

In a few families of beetles, both the adults and larvae are fitted for aquatic life. Well known among these are the shining whirligig beetles.

Hymenoptera

| | |
|--------------------------------------|--|
| Bees, Wasps, Ants, Sawflies | Insects typically with two pairs of wings; antennae of various lengths; chewing mouthparts; without tails. A typical member of this group is the wasp <i>Vespa maculata</i> (Linnaeus), fig. 56. Many adult members of the group are atypical in that they lack wings; these include all the true ants, fig. 57, which are without wings except for the sexual forms produced at the time of the nuptial flights. Forms of one species, <i>Lasius interjectus</i> Mayr, are shown in fig. 58. The wings, when developed, are without scales; the venation is much less extensive than in the Neuroptera; and the hind wings differ in shape and size from the front wings. The young stages of the Hymenoptera are caterpillar-like or grublike, entirely different from the adults. |
|--------------------------------------|--|

This very large order includes such well-known forms as the bees, as well as the wasps and the ants, mentioned above. In addition, it includes the sawflies, whose caterpillar-like larvae are extensive defoliators of a large number of native and cultivated plants and shrubs; the large and varied groups of parasitic wasps that exert great influence in the natural control of a tremendous number of other insects; and a large number of gall-making wasps, whose galls are

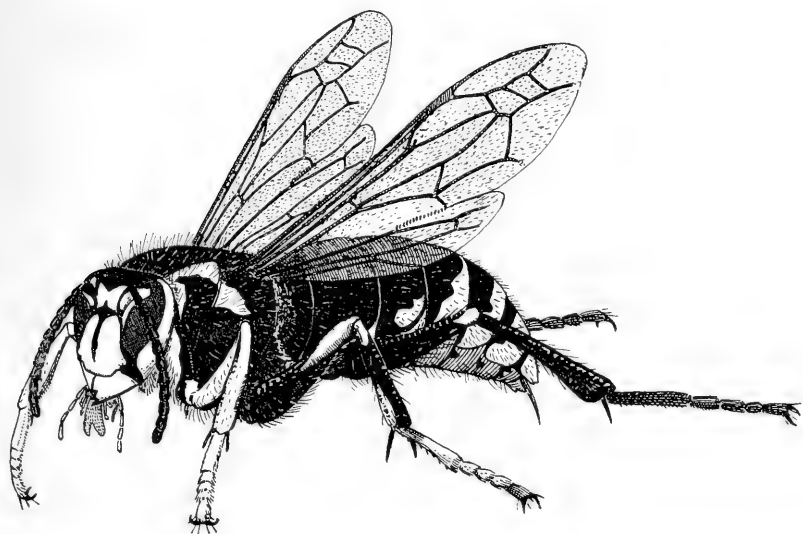

Fig. 56.—Hymenoptera. *Vespula maculata*, the common bald-faced hornet. Actual length 0.8 inch.

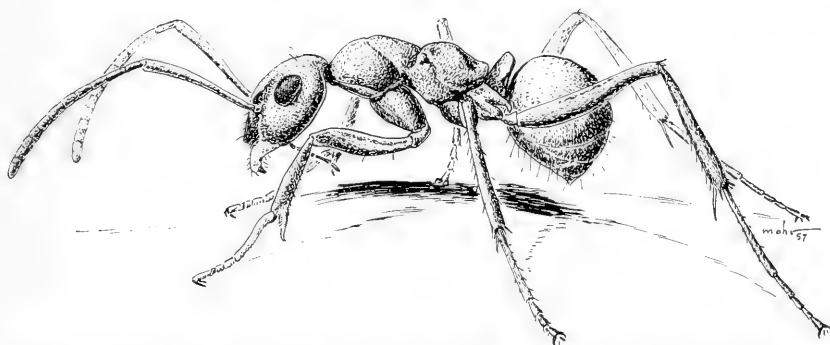

Fig. 57.—Hymenoptera. A worker ant belonging to the genus *Formica*. This form lacks wings. Actual length 0.3 inch.

especially conspicuous on oak trees. A parasitic wasp of the genus *Opius* is shown in fig. 59. The parasitic wasps are extremely diverse in size, shape, and habits. They range in size between 0.02 and 2.0 inches.

Mecoptera

Scorpionflies

Insects typically with two similar pairs of delicate wings, each wing with a network of veins. In repose the wings are laid either tentlike over the back or almost flat. The mouthparts are fitted for chewing and usually are lengthened into a beaklike structure, as in *Panorpa chelata* Car-

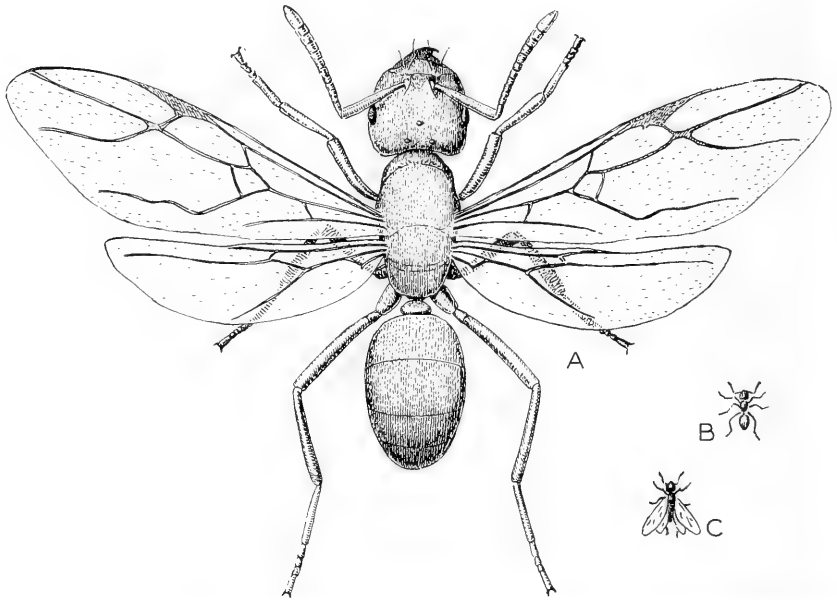

Fig. 58.—Hymenoptera. *Lasius interjectus*, a harmless winged ant, the yellow ant, with which the winged termite is often confused: *A*, queen with wings spread, many times natural size; *B*, worker ant, natural size; *C*, queen, approximately natural size, with wings partially closed and as usually seen. Ant has a narrower waist and shorter wings than termite. Actual length of queen about 0.3 inch.

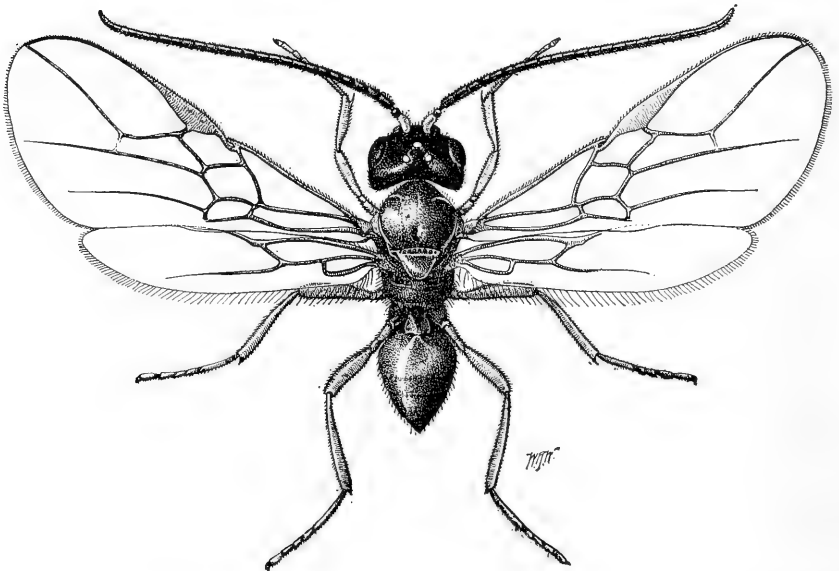

Fig. 59.—Hymenoptera. A parasitic wasp, *Opus*, sp. Actual length 0.1 inch. (Drawing from U. S. D. A.)

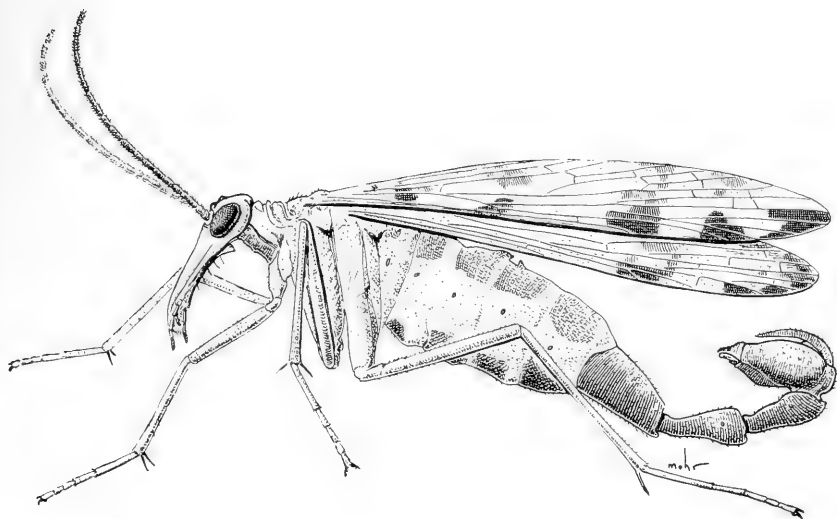

Fig. 60.—Mecoptera. *Panorpa chelata*, one of about 15 Illinois species of scorpionflies. Only the male has the “scorpion” tail. Actual length of insect about 0.5 inch.

penter, fig. 60. The larvae, seldom found, live in damp woods. The adults of most winged species occurring in Illinois are about 0.5 inch long. They are active in early summer in shady woods, flying through the undergrowth. Adults of the genus *Boreus* are smaller and they have very short, veinless wings. They emerge in the winter and early spring; these little metallic black insects often hop around on late winter snow. In certain genera, the adult male genitalia form a bulb-like structure at the end of the body, as in fig. 60. This structure is harmless but, because it resembles a scorpion’s sting, insects of these genera are given the name scorpionflies.

Trichoptera

Caddisflies

Insects with two pairs of wings, poorly developed mouthparts of the chewing type, and long antennae; without tails on the posterior end of the body.

In repose, the wings are held rooflike over the body and have only a moderate number of longitudinal veins, which are not connected by crossveins into any resemblance of a network. Neither body nor wings are covered with scales. The larvae are wormlike and they live in streams, ponds, and lakes. Many of them build cases of sticks, stones, or sand and move about with only the front end of the body protruding from the case. When disturbed, the larvae withdraw completely into the cases and are then very difficult to see. The adult fly and larva of *Rhyacophila fenestra* Ross illustrate this order, figs. 61 and 62. In

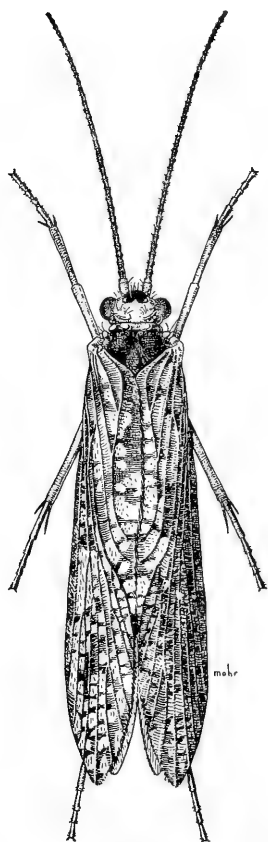

Fig. 61.—Trichoptera. *Rhyacophila fenestra*; the adult form of this caddisfly is shown here. Actual length about 0.4 inch.

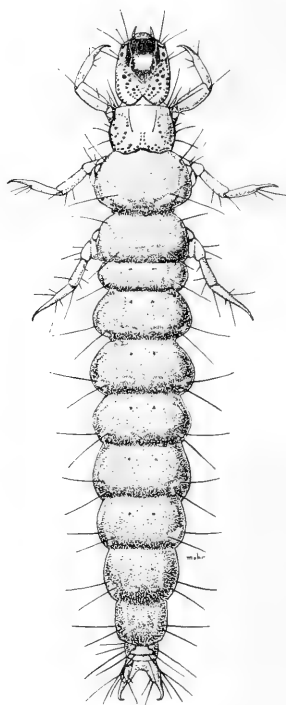

Fig. 62.—Trichoptera. *Rhyacophila fenestra*; the larva, shown here, is aquatic and builds no case. The larvae of some other kinds of caddisflies live in cases made of sticks and stones.

many aquatic situations, caddisflies are the predominant small animal life and are an important factor in fish food economy. Also, they are stream pollution indicators.

Lepidoptera

Butterflies,
Moths

Insects typically with two pairs of wings, with long antennae, and with mouthparts forming a long sucking tube. The body and wings are covered with a dense mass of scales, which are characteristic of this order, fig. 63. The young are known as caterpillars

or grubs. The larval stage in this order is well exemplified by the fairly smooth, cylindrical caterpillar of the fall armyworm, *Laphygma frugiperda* (Smith), fig. 64. Some other larvae are hairy; still others are sluglike.

Fig. 63.—Lepidoptera. A typical moth, showing scales on wings and body, and sucking tube, which is coiled up under the head when not in use. Species of this order occurring in Illinois include specimens that vary in size from 0.1 inch to several inches. The largest of these insects have a wingspread of over 5 inches.

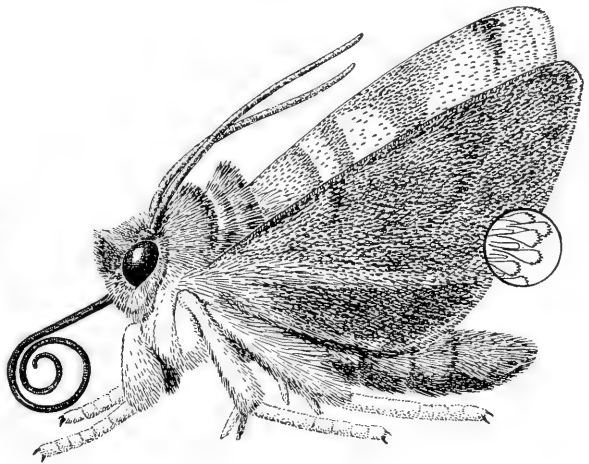

To this order belong not only a very large number of species, but also a very large number that are especially injurious to agriculture. These include such species as the codling moth, cabbage moth, butterflies, the entire cutworm group, and a host of others. In addition, the various clothes moths, which are a constant source of loss to householders, and various species of meal moths, which cause tremendous damage to stored grain every year, are members of this order.

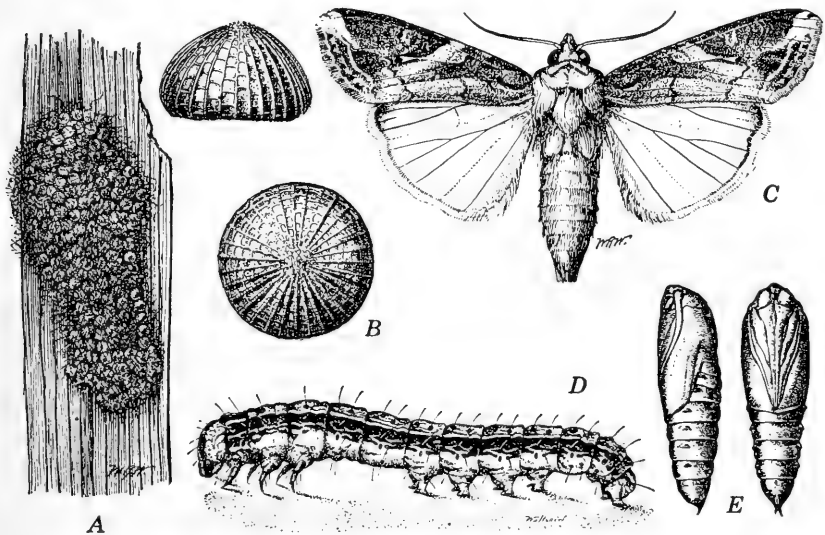

Fig. 64.—Lepidoptera. *Laphygma frugiperda*, the fall armyworm: A, egg mass on leaf; B, top and side view of individual eggs; C, adult; D, larva; E, pupae. Wing span of adult about 1.5 inches. (Drawing from U. S. D. A.)

In one group of moths, there are clear "windows" on the wings, but these are always surrounded by areas or lines of scales. A few species of the Lepidoptera are very odd in having wingless females. Examples are the bagworms and some of the cankerworms. In these species, however, the body of the female is densely clothed with scales, which will serve to identify her as one of the Lepidoptera.

The habits of Lepidoptera larvae are very diverse. Most of these larvae are leaf eaters, but some bore into trunks of trees and stems of herbaceous plants. Some of the small ones mine within leaf tissue, others live in the ground, where they eat roots, and a few are aquatic, living in clear, rapidly flowing streams.

Diptera

Flies,
Mosquitoes,
and Their
Allies

Insects with only one pair of wings, each wing with a limited number of veins. Other characters of the order, including antennae and mouthparts, are extremely varied. Most immature stages are wormlike or maggot-like. They live in protected situations, such as within the tissues of a plant in water, in leaf mold, or in the tissues of animals. A typical life cycle is that shown for the house fly, *Musca domestica* Linnaeus, fig. 65. The ubiquitous house fly is undoubtedly the best known representative of this order. It is also one of the most persistent and dangerous insect pests, being a possible carrier of many diseases.

Mosquitoes, punkies, black flies, and horse flies are likewise well known members of this order. In addition to economic forms, the order Diptera includes midges, crane flies, bee flies, robber flies, bluebottle flies, and a great assortment of other kinds of insects. Interesting are the bee flies, which mimic other insects such as honey bees, bumble

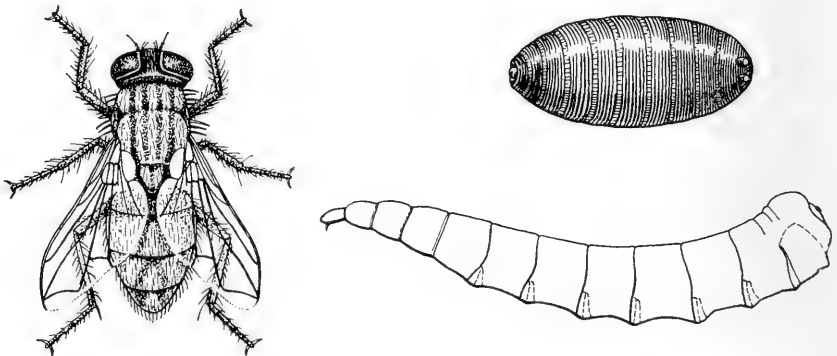

Fig. 65.—Diptera. *Musca domestica*, the house fly. The fly has only a single pair of wings; the pale, maggot-like larva is without legs; the darker, egg-shaped puparium contains the pupal or quiescent stage. Length of adult 0.2 inch. (Drawing by Alice Ann Prickett.)

bees, and wasps to an extent that wins them immunity from the attention of many beginning collectors.

Siphonaptera

Fleas Wingless insects that evolved from folding-wing insects; conspicuously flattened from side to side; with stout spiny legs, and with numerous spines over the body; without conspicuous antennae or tails or a forked posterior appendage like that of the springtails; usually hard; ranging in color from yellowish brown to almost black.

The human flea, *Pulex irritans* Linnaeus, and a widespread Illinois rat flea, *Nosopsyllus fasciatus* (Bosc), are shown in fig. 66.

All the fleas, which feed on the blood of birds and other animals, have sucking mouthparts. They are powerful jumpers. The young stages are slender, white larvae, fig. 67, which live in the nests of various animals; these larvae are seldom collected. The fleas are found on the animals themselves or around their nests. Several species of fleas, including the cat and dog flea, the human flea, and the rat fleas, attack man. One of the rat fleas, *Xenopsylla cheopis* (Rothschild) is the common transmitter of the organism causing bubonic plague.

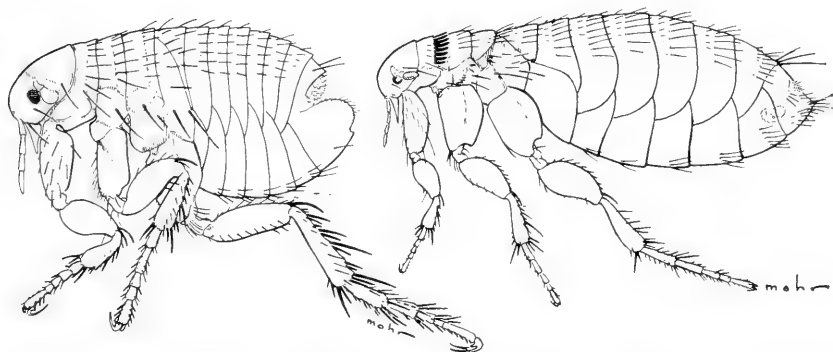

Fig. 66.—Siphonaptera. *Pulex irritans*, human flea (left), and *Nosopsyllus fasciatus*, one of the rat fleas. Actual length of body about 0.1 inch.

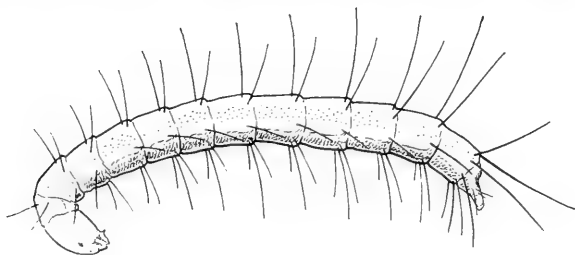

Fig. 67.—Siphonaptera. Larva of flea found in mouse nest. Length about 0.12 inch.

RELATIVES OF INSECTS

There are many small animals that belong to the same general group as insects and that are frequently collected with them. Spiders, centipedes, and amphipods are a few of many examples of such animals. Together with insects, they form the animal phylum called Arthropoda, characterized by having segmented bodies and jointed legs. A brief description is included here of the common groups of these insect relatives found in Illinois.

Isopoda

Sowbugs,
Pillbugs

Convex, many-legged animals having conspicuous antennae; several of the posterior segments short and joined rather closely to form an abdomen. Of the Illinois forms, about one-half are aquatic, living in streams and ponds. The others live in terrestrial situations that are humid and dark. They are frequently found under boards and in soil in greenhouses. One species of this group is *Armadillidium vulgare* (Latreille), fig. 68, which possesses the ability to curl up in a hard shell-like ball when disturbed. The isopods, relatives of crabs, shrimps, and crayfish, belong to the general group known as crustaceans. The crustacean groups are abundant in the ocean. In past geologic ages, the early ancestors of such predominantly terrestrial groups as insects and spiders resembled ancestors of the present crustacean marine forms.

Amphipoda

Small Water
Shrimps

Humpbacked, many-legged crustaceans, fig. 69, that are, unlike the isopods, flattened from side to side like the fleas. They are all aquatic but are seldom found swimming in open water; they prefer to live in tangled masses of vegetation, under stones or logs, and among debris in the very shallow water where it touches the bank.

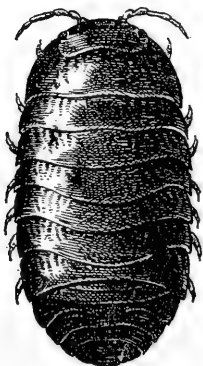

Fig. 68.—Isopoda. *Armadillidium vulgare*, a common pillbug or sowbug (two views). Actual length 0.3 inch. (Drawings from U.S.D.A.)

These little shrimps are never more than about one-half inch long and are frequently collected in large numbers along with aquatic beetles. As is the case with the aquatic sowbugs, certain species of amphipod shrimps occur in subterranean water sources and frequently are found in wells. Most of these species are blind.

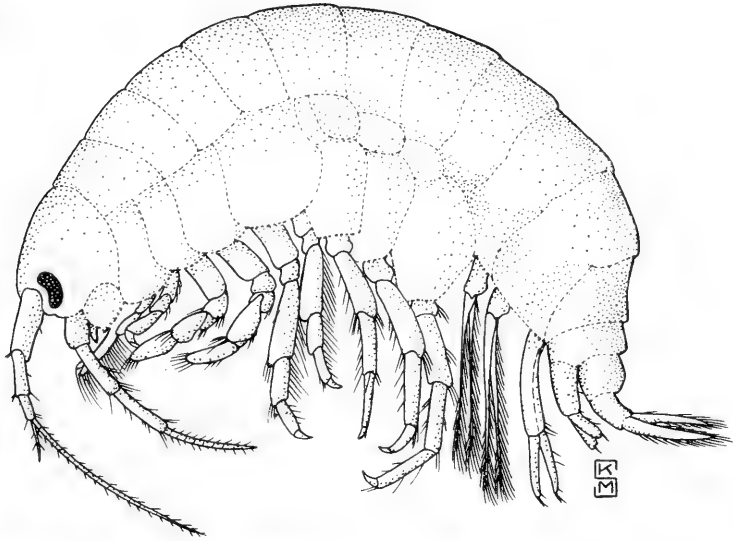

Fig. 69.—Amphipoda. *Gammarus* sp., a common small water shrimp. Actual length 0.4 inch.

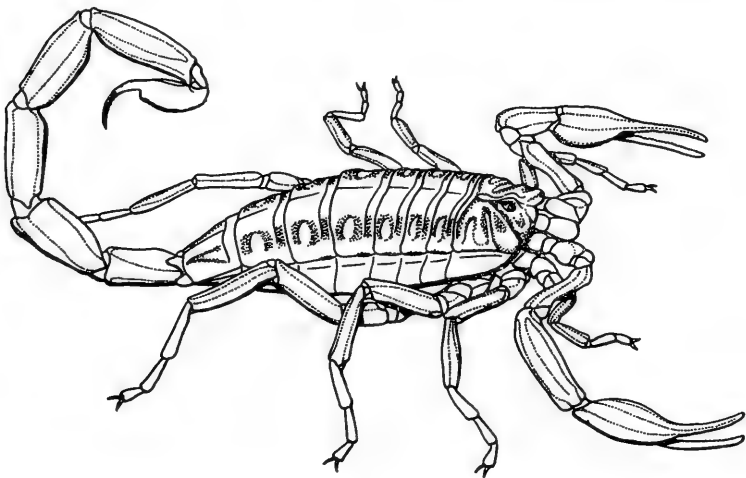

Fig. 70.—Scorpionida. *Centruroides vittatus*, the only scorpion known to occur in Illinois. Actual length 2.0 inches. (Drawing by Alice Ann Prickett.)

Scorpionida

Scorpions

Animals belonging to the spider group; characterized by a pair of stout pincers at the end of each front leg and a long tail-like extension of the abdomen ending in a sharp sting, as in *Centruroides vittatus* (Say), fig. 70. They have fairly long bodies and five pairs of legs each, including the chelate pair. During the day they live under stones and bark, moving about at night in search of insects and other small organisms on which they prey. Many species occur in the Southwest; the range of one of these extends as far northeastward as southwestern Illinois.

Pseudoscorpionida

Pseudoscorpions

Animals belonging to the spider group; characterized by a pair of stout pincers at the end of the front legs, as in *Larca granulata* (Banks), fig. 71. They have short, stout bodies, each with five pairs of legs including the chelate front pair, but unlike the true scorpions they

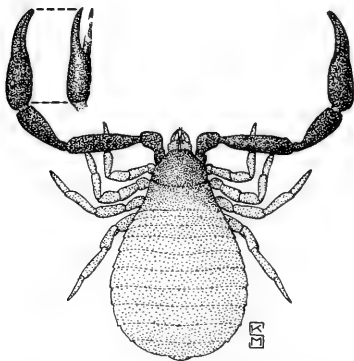

Fig. 71.—Pseudoscorpionida. *Larca granulata*, a native Illinois pseudoscorpion. Actual length 0.1 inch.

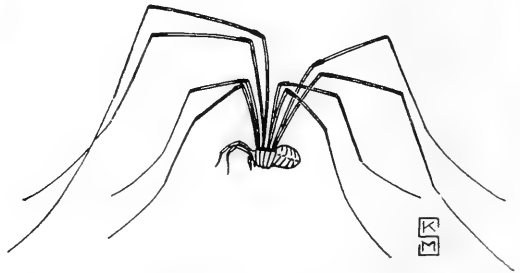

Fig. 72.—Phalangida. A common harvestman or daddy longlegs. Actual length of body 0.3 inch.

have no tails or stings. The pseudoscorpions are sometimes found indoors in old books, looking for their prey of small insects. They occur in greater numbers in wooded areas.

Phalangida

Daddy Longlegs,
Harvestmen

Spider-like forms, each animal with a short, round body and four pairs of walking legs that in most species are very long, fig. 72. They occur chiefly in woods and may be found in numbers walking over foliage and logs; they are often found on bluffs and in shady places. They feed on decaying humus. A few Illinois forms that occur chiefly on bark have considerably shorter legs than the species that range more widely.

Araneida

Spiders

Varied and well-known animals, each with four pairs of walking legs and a body divided into a cephalothorax (which combines the head and thorax) and abdomen. The spiders present a tremendous variety of shapes, some being round and fat, like the black widow, *Latrodectus mactans* (Fabricius), fig. 73, others being long and slender, mimicking ants. Others are crablike in shape; some that are long and slender are extremely rapid in their movements. Spiders appear practically everywhere. Certain species are domestic and are found only in houses. In Illinois the only poisonous species of any importance are the black widow spider, which is found in a variety of situations, and the recluse spider, *Loxosceles reclusa* Gertsch & Mulaik, which has been found in house basements in southern Illinois.

Acarina

Ticks,

Mites

Animals somewhat like the spiders but having no marked division between the cephalothorax and the abdomen. Each adult has four pairs of walking legs, although an individual of the very young stages has only three pairs. The mites are generally very minute and seldom are seen by the beginning collector. They vary greatly in general appearance. Many species are extremely destructive to stored produce, to live domestic animals, and to many groups of plants. Adults of the harvest mite and early stages of the chigger mite attack man persistently.

Ticks are larger than mites. All the species feed on warm-blooded animals, including birds and mammals. The commonest Illinois tick is *Dermacentor variabilis* (Say), fig. 74, which transmits the organism



Fig. 73.—Araneida. *Latrodectus mactans*, the black widow spider. Actual length of body 0.4 inch.

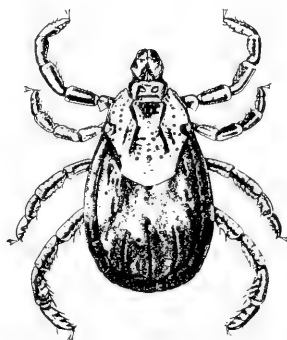

Fig. 74.—Acarina. *Dermacentor variabilis*, the common dog tick of Illinois and vector of Rocky Mountain spotted fever. When engorged, the tick looks like a red berry. Actual length 0.2 inch. (Drawing from U. S. D. A.)

causing the often fatal disease called Rocky Mountain spotted fever. Although this disease occurs only infrequently in Illinois, hikers and others exposed to ticks on excursions into the out-of-doors should carefully examine their clothing and bodies and promptly remove any ticks they find.

Diplopoda

Millipedes

Elongate animals each having a distinct head and a long, many-segmented body with two pairs of legs on every segment. The commonest Illinois representative is the large *Parajulus impressus* (Say), fig. 75, a

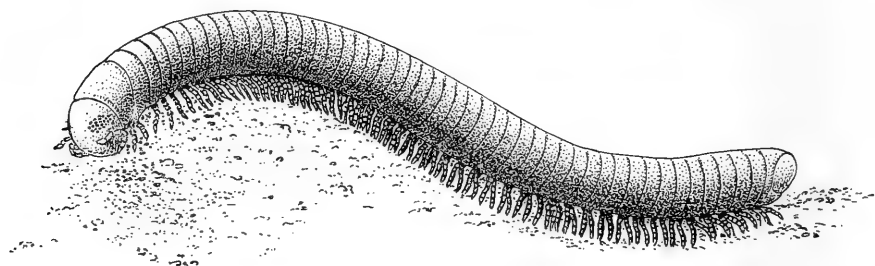

Fig. 75.—Diplopoda. *Parajulus impressus*, a common Illinois millipede. Actual length 1.5 inches.

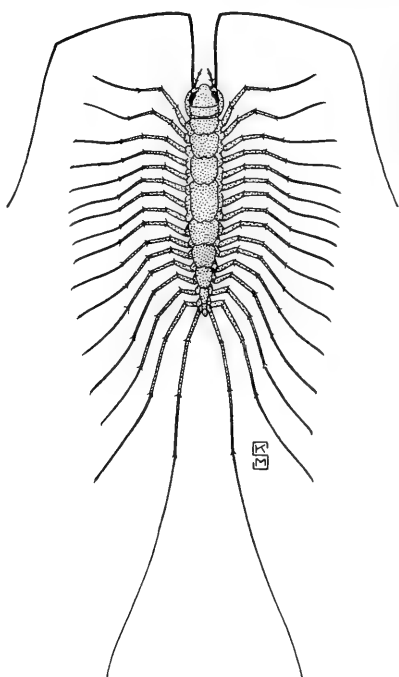

Fig. 76 (left).—Chilopoda. *Scutigera forceps*, the house centipede, commonly found in dark basements. Actual length of body 1.0 inch.

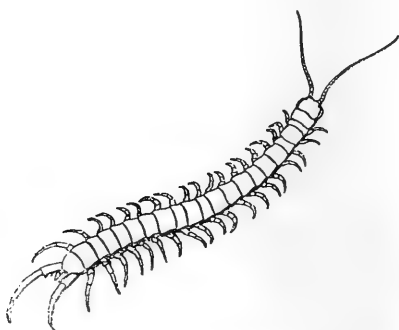

Fig. 77 (above).—Chilopoda. A common type of woodland centipede found in leaf mold and rotten logs. Actual length 1.0 inch. (Drawing from R. E. Snodgrass.)

robust, cylindrical, reddish species commonly found in rotten logs or moist leaf mold. Most species feed on decaying vegetable matter. A few occasionally do considerable damage in greenhouses.

Chilopoda

Centipedes

Elongate animals, similar in general appearance to the millipedes but with only one pair of legs on each body segment. Many species are predacious, feeding on insects and other small animals in rotten logs and humus. Most familiar to the city dweller is the house centipede, *Scutigera forceps* Rafinesque, fig. 76; this is a common inhabitant of dark places in houses, where it runs about with incredible speed in search of the small insects upon which it feeds. Other species may be encountered under boards and stones in gardens, fig. 77. Some Illinois centipedes found in woody or rocky situations are 2 inches or more long. No chilopod group in this state is dangerous to human beings, but to the south occur centipedes nearly a foot long that may inflict serious bites.

THE STATE INSECT COLLECTION

Illinois is one of the very few states that maintain a large research insect collection. This collection is under the care and guidance of the Section of Faunistic Surveys and Insect Identification of the Illinois Natural History Survey. It is housed in the west part of the



Fig. 78.—The Natural Resources Building. This building, on the campus of the University of Illinois, is the home of the Illinois Natural History Survey and houses the state insect collection on the second floor of the west wing. (Photograph from Illinois Geological Survey.)

fireproof Natural Resources Building on the University of Illinois campus at Urbana, fig. 78. Begun about 1880, the collection has grown steadily until now it is the most extensive representative collection of the insect fauna of any state in the nation. The collection consists of over 5,500,000 specimens of insects housed in steel cabinets, fig. 79. The pinned collection includes about 750,000 specimens in trays. The collection preserved in alcohol contains over 3,500,000 insects includ-



Fig. 79.—A view of the main insect collection room of the Illinois Natural History Survey. In the steel cabinets and hardwood trays shown here are arranged pinned insect specimens. Similar cabinets contain material in liquid preservative. Adjoining this collection room are offices and laboratories of the Section of Faunistic Surveys and Insect Identification, where records of insect distribution and habits are kept on file.

ing not only a great number of valuable adult insects but also a very useful collection of immature insects. The slide collection contains nearly 250,000 specimens mounted as permanent microscopic preparations. The papered and boxed material comprises more than 1,000,000 specimens of dried insects.

The most important use of the collection is for identification of insects known to damage crops, stored grains, and household articles, or to threaten human health. Important also is its use as a storehouse of information regarding the ecology, host relationships, and distribution of Illinois insects.

So large is the field of insect classification that many important gaps exist in our knowledge of the Illinois fauna. For maximum

usefulness, the collection should contain a complete representation of the Illinois insect fauna, supplemented with as much additional North American material as can be obtained. This additional comparison material is frequently necessary to evaluate correctly the species occurring in the state. It is estimated that there are about 20,000 different species of insects in Illinois and 150,000 in North America. The collection contains representatives of over 15,000 Illinois species, and a great many other North American species useful as comparison material in the identification of Illinois forms.

Gifts to the collection of well-prepared material are greatly appreciated. Many of those already received have made vital contributions to the collection and added valuable records to the Natural History Survey files of insect distribution.

REPORTS ON ILLINOIS INSECTS

As a result of the accumulation of material and information in the faunistic collection, the Illinois Natural History Survey has published a number of reports dealing with various groups of insects and other animals in Illinois; other reports in this series are being prepared or planned. These reports are designed primarily for use of the advanced student in zoology and entomology. They contain information regarding the characteristics, habits, and distribution of the various species in the state, keys for their identification, and illustrations to assist in diagnosis of the structures used in identification. Because of their great abundance in both species and numbers, and their importance as pests, insects have been studied extensively and much has been written about them.

The following reports of Illinois insects and their relatives have been published in the *Bulletin* series of the Illinois Natural History Survey. Those marked "out of print" are unavailable at the Survey, but may be consulted at libraries or obtained from book dealers. Reports followed by prices can be obtained by sending an order together with the proper remittance to the Illinois Natural History Survey, Urbana, Illinois. Checks and money orders should be made payable to the State Treasurer of Illinois.

The Oribatoidea of Illinois [Mites], by Henry E. Ewing. Out of print.

The Chironomidae, or Midges, of Illinois, by J. R. Malloch. Out of print.

A Preliminary Classification of Diptera, by J. R. Malloch. Out of print.

The North American Species of the Genus *Tiphia* [Wasps], by J. R. Malloch. Out of print.

The Pentatomoidea of Illinois [Stink Bugs], by Charles Arthur Hart. Out of print.

Forest Insects in Illinois: I. The Subfamily Ochthiphilinae (Diptera, Family Agromyzidae), by J. R. Malloch. Out of print.

Fall and Winter Stoneflies, or Plecoptera, of Illinois, by Theodore H. Frison. Out of print.

The Plant Lice, or Aphididae, of Illinois, by Frederick C. Hottes and Theodore H. Frison. Out of print.

The Dermaptera and Orthoptera of Illinois, by Morgan Hebard. \$1.00.

The Stoneflies, or Plecoptera, of Illinois, by T. H. Frison. \$1.25.
Nearctic Alder Flies of the Genus *Sialis* (Megaloptera, Sialidae), by H. H. Ross. Out of print.

The Plant Bugs, or Miridae, of Illinois, by Harry H. Knight. \$1.25.

Studies of North American Plecoptera, With Special Reference to the Fauna of Illinois, by T. H. Frison. \$1.00.

The Caddis Flies, or Trichoptera, of Illinois, by Herbert H. Ross. Out of print.

The Mosquitoes of Illinois (Diptera, Culicidae), by Herbert H. Ross. Out of print.

The Leafhoppers, or Cicadellidae, of Illinois, by D. M. DeLong. \$1.25.

The Pseudoscorpions of Illinois, by C. Clayton Hoff. 50 cents.

The Mayflies, or Ephemeroptera, of Illinois, by B. D. Burks. \$1.25.

USEFUL BOOKS

A considerable number of books can be of great help to the beginner in naming his specimens. The following are perhaps the most easily used. Others are being published from time to time.

An Introduction to Entomology, by J. H. Comstock. The Comstock Publishing Company, Ithaca, N. Y.

The Butterfly Book, by W. J. Holland. Doubleday, Doran & Company, Garden City, N. Y.

The Moth Book, by W. J. Holland. Doubleday, Page & Company, Garden City, N. Y. Out of print, but may be obtained from secondhand book dealers.

How to Know the Insects, by H. E. Jaques. H. E. Jaques, 709 North Main Street, Mount Pleasant, Iowa.

Insects: A Guide to Familiar American Insects, by Herbert S. Zim and Clarence Cottam. Simon and Schuster, Inc., Rockefeller Center, New York 20, N. Y.

Field Book of Ponds and Streams, by Ann Haven Morgan. G. P. Putnam's Sons, New York, N. Y.

The Insect Guide, by Ralph B. Swain. Doubleday & Company, Inc., Garden City, N. Y.

College Entomology, by E. O. Essig. The Macmillan Company, New York, N. Y.

Entomology for Introductory Courses, by Robert Matheson. The Comstock Publishing Company, Ithaca, N. Y.

A Textbook of Entomology, by Herbert H. Ross. John Wiley & Sons, Inc., 440 Park Avenue South, New York, N. Y.

HOW TO SHIP SPECIMENS

Specimens which the collector is unable to name may be sent to specialists or entomological museums for identification. Names and addresses of specialists can be furnished by agricultural agents, teachers, or museum curators. The arrangements under which these

specialists will undertake the work vary, but experts often will study well preserved and labeled collections in return for duplicate specimens which they may keep. However, the identification of many insects is so difficult and laborious that rapid service is not always to be expected by collectors sending in material.

Specimens need special preparation and care to guard against breakage if they are to be shipped to a specialist.

See that all pins used in mounting specimens are thrust securely into the cork on the bottom of the box. Thrust extra pins of the same height in each corner, and over the whole lay a piece of thin cardboard that has been cut to fit the inside of the box snugly; then place over this a layer of cotton wool or cellucotton thick enough to press firmly against the cardboard when the top is closed. Wrap the box in paper and then pack it in a larger box, protected on all sides by a layer of excelsior or crumpled paper at least 2 inches thick.

WHERE TO BUY SUPPLIES

The following list, by no means complete, contains names and addresses of companies that furnish entomological supplies. Most of these companies will send catalogs and price lists on request.

American Optical Company, Scientific Instrument Division, Box A, Buffalo 15, N. Y.

Bausch and Lomb Optical Company, Rochester 2, N. Y.

Central Scientific Company, 1700 Irving Park Road, Chicago 13, Illinois.

General Biological Supply House, Inc., 8200 South Hoyne Avenue, Chicago 20, Illinois.

E. H. Sargent and Company, 4647 West Foster Avenue, Chicago 30, Illinois.

Ward's Natural Science Establishment, Inc., P. O. Box 1749, Rochester 3, N. Y.



HECKMAN
BINDERY INC.



MAY 95

Bound -To -Please® N. MANCHESTER,
INDIANA 46962

UNIVERSITY OF ILLINOIS-URBANA



3 0112 018415429