

Fig. No. 70.

A
PRACTICAL
MANUAL-
TRAINING
AID.



HOW TO TEACH

Paper-Folding & Cutting.



MACLEOD.



MARCH BROTHERS,
Publishers,
LEBANON, OHIO.

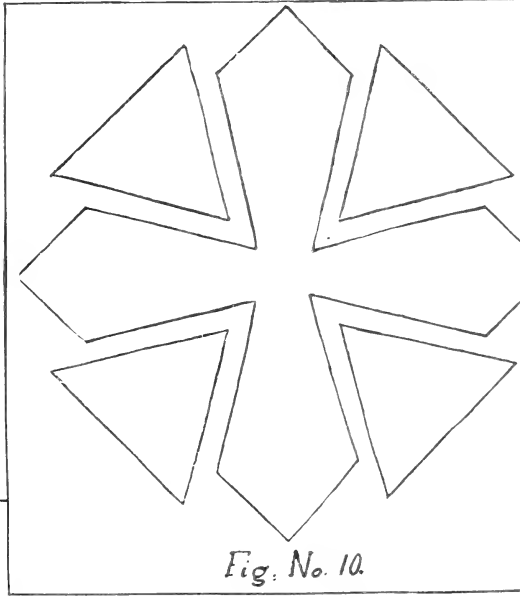

Fig. No. 10.

LB
1542
L5

LIBRARY OF CONGRESS.

~~2.1515~~
Chap. Copyright No.

Shelf L5

UNITED STATES OF AMERICA.

MANUAL-TRAINING SERIES, No. 2

HOW TO TEACH PAPER-FOLDING AND CUTTING

A PRACTICAL MANUAL-TRAINING AID

BY MACLEOD,

Author of "Lessons on Common Minerals," "Talks about Common Things," "Practical Drill Problems," "Reproduction Stories," "Composition Outlines."



LEBANON, OHIO

March Brothers, Publishers

1892

112
111
110
109
108
107
106
105
104
103
102
101
100
99
98
97
96
95
94
93
92
91
90
89
88
87
86
85
84
83
82
81
80
79
78
77
76
75
74
73
72
71
70
69
68
67
66
65
64
63
62
61
60
59
58
57
56
55
54
53
52
51
50
49
48
47
46
45
44
43
42
41
40
39
38
37
36
35
34
33
32
31
30
29
28
27
26
25
24
23
22
21
20
19
18
17
16
15
14
13
12
11
10
9
8
7
6
5
4
3
2
1

COPYRIGHT 1892 BY MARCH BROTHERS.

Electrotyped, printed, and bound by
C. J. KREHBIEL & CO.
CINCINNATI.

PREFACE.

THE author of this little book has endeavored to present in a brief and simple manner the development of that portion of Manual Training which is usually designated as "Paper-Folding and Cutting." Great care has been taken in the arrangement of topics so that they may come in natural succession, gradually increasing in difficulty and awakening by their variety an ever new interest in the minds of the pupils. The illustrations, plentiful as they are, should not be considered as *all* that are necessary or desirable. They are given merely as samples of *what may be done*, and, as is stated more than once in the text of this volume, pupils should be encouraged after a little instruction to form their own designs.

The benefits derived from this branch of Manual Training are manifold. Neatness and accuracy are developed in the mere *manual* operations, that is, the *cutting* and *pasting*, while the *designing*

calls into action a knowledge of drawing, love of color and arrangement, and a cultivation of originality not to be surpassed by any other branch of school work. The first step in this study—simple grouping of plane figures—forms one of the class of occupations for little fingers, so much in vogue at the present time, known as “Busy Work.” The solid forms illustrated and explained in the latter chapters will be found to form a useful basis both for solid geometry and modeling in clay or wax.

Although originally intended as a guide for teachers, the subject is treated in such a simple manner, and there is such a total lack of technical terms, that the book may be placed in the hands of pupils of average intelligence, and its instructions be understood and applied by them without difficulty.

MACLEOD.

PAPER-FOLDING AND CUTTING.

CHAPTER I.

NECESSARY IMPLEMENTS.

IN order to have neat, accurate work, it is imperative that each pupil be supplied with the necessary helps, such as pencils, rulers, scissors, paper, paste, etc.

The scissors should be about five inches long, and the pencil medium hard, and sharpened to a fine point. A ruler with a beveled edge is the most satisfactory. Various kinds of glue and mucilage are used for paper designs, but the writer, after numerous experiments, decided that home-made paste of flour and water answered the purpose better than anything else. Each pupil should be provided with a clean rag with which to press the cut designs after pasting.

The art of folding and cutting paper can be taught and learned just as well with the coarsest wrapping

paper as with paper of beautiful colors, but as the taste of the pupils is to be cultivated quite as much as skill in cutting, it is advisable to have the paper as pretty as can be obtained.

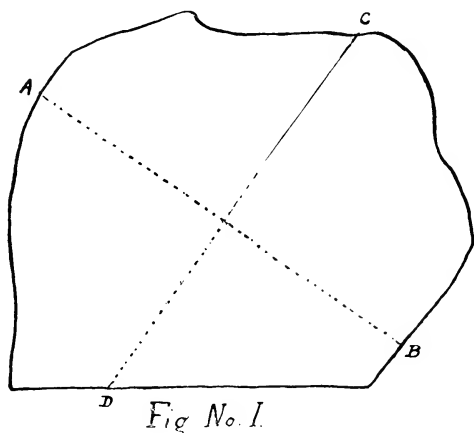

THE SQUARE.

The square is taken as a basis for all the simplest designs. Squares of paper are furnished to the schools in many cities, and they can be bought at a reasonable price at stationers. They are sold in packages of one thousand, various colors represented in each package. A four-inch square is a convenient size for designs.

For the benefit of those who can not obtain these squares, the following simple method of folding and

cutting a square is given. A piece of paper of any shape may be used. Fold twice as represented in the dotted lines A-B and C-D in figure No. 1, and the paper will assume the form shown in figure No. 2. Fold again as indicated in this figure by the dotted line E-F, and we have the paper in the shape repre-

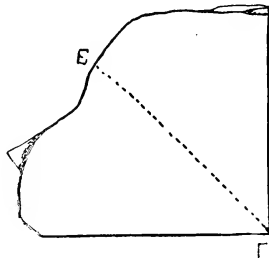

Fig. No. 2.

sented in figure No. 3. At the line H-K fold the paper over evenly, making a right angle with the line X-Y. This completes the folding, and if you cut through the line H-K and open the paper, a square will be the result. The size of the square is determined by the distance from K to Y. For instance, if that measurement is two inches, you will have a four-inch square.

FOLDING AND CUTTING.

It will be readily seen that the accuracy displayed in the folding and cutting is a very important matter.

A few general hints may be found useful. Do *not* fold the paper in the air, but lay it on a desk or table, or any solid surface. Fold *from* the body and not towards it. Press the folded paper evenly with the thumb and forefinger. In cutting take long, deep incisions, and not short, *jerky* ones. The latter

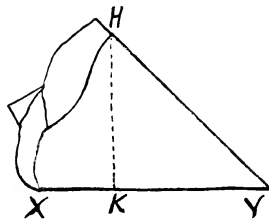

Fig. No. 3.

method produces an uneven edge, but if the scissors are held firmly over the line to be cut, and as much of the cutting performed with one closing of the scissors as is possible, an even edge will be the result.

ARRANGEMENT OF DESIGNS.

The portion of this work requiring the most delicate handling is the pasting of the design upon the paper or cardboard used as a background. A very little paste will go a long way, and as much as would cover a silver quarter of a dollar will be sufficient for the usual-sized design. The end of the

forefinger surpasses a brush as a means of applying the paste. The design should be carefully placed in position, and then one piece of it at a time taken up and a *thin* coating of the paste put on the under surface of it. It must then be placed in position again and pressed for a few seconds with the clean

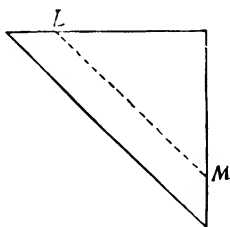

Fig. No. 4.

rag ready for that purpose. Each section of the design should be treated in the same manner

COLORS.

At first it is wise to use but one color in the design, with white as a background. Later, as the pupils grow more expert in designing, two or more colors may be used. Such combinations as purple and red, blue and green, etc., should, of course, not be allowed, and the children should be shown combinations producing a pleasing effect. Pale tints on a dark background, and *vice versa*, are very pretty.

CHAPTER II.

SIMPLE DESIGNS.

IN figure No. 5 is shown a design which is obtained by one cut of the scissors. The square, which is used as a basis for all the designs in this article, is folded twice diagonally and then once more, bringing the longest folded sides together. Compare your folded paper with figure No. 4. Now draw a line parallel to the longest folded side, as represented by the dotted line L-M. Cut through this line and you will then have five pieces of paper, which may be arranged to form the design illustrated in figure No. 5. A little variety in the arrangement of the four small sections of the design will produce the designs represented by figures Nos. 6, 7, and 8.

Another design may be produced by one cut of the scissors by folding the square as directed for the designs just illustrated, but instead of cutting parallel to the folded side, cut obliquely, as shown by the dotted line O-P in figure No. 9. Five pieces are again the result, a cross and four triangles. Arrange the latter around the cross as in diagram No. 10, and a very effective design is formed.

Another design may be made by the arrangement shown in illustration No. 11. These triangles may also be placed in positions similar to those in the

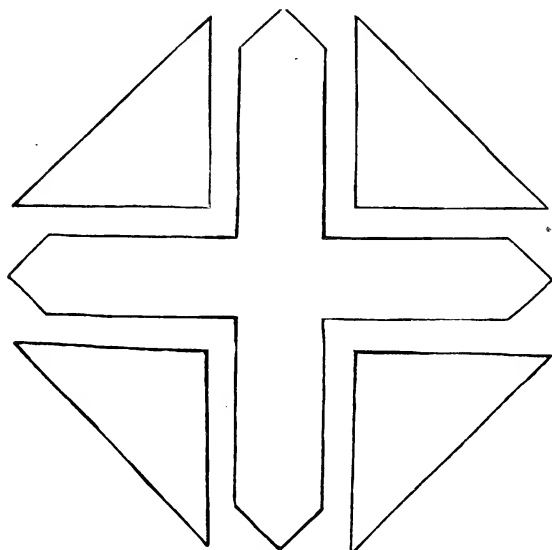

Fig. No. 5.

designs represented by figures Nos. 8 and 9. Still another design can be made by folding the paper as described, but the cutting must be parallel to the *short* folded side as indicated by the line R-S, in figure No. 12. After cutting, there is a cross and four small squares. These may be arranged as in diagram No. 13; while by placing them as shown in figure No. 14, a design of equal taste is formed.

In illustration No. 15, the square is represented as folded three times as in the previous designs. The line-for cutting reaches from the angle A to the mid-

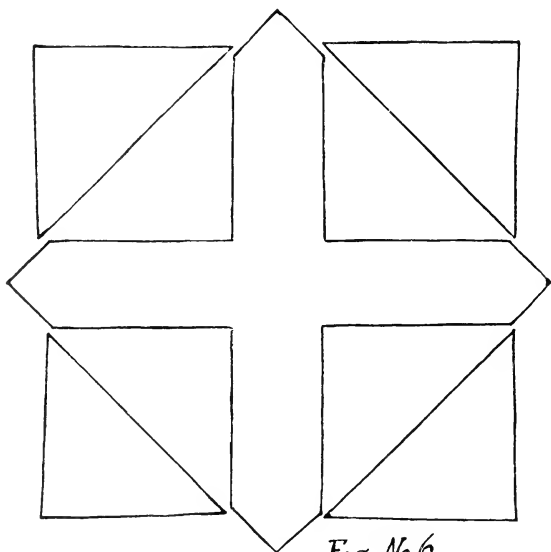

Fig. No. 6.

dle of the short folded side. The four triangles which we have after cutting may be arranged around the central portion of the square in the styles shown in figures Nos. 16 and 17.

It would require unlimited space to illustrate the numerous designs that can be made from a square, folded as mentioned and cut but once. One more lesson, however, is advisable, in order to explain

figure No. 18. An octagon is obtained by this cutting, and as, in a little while, designs, having this figure as a basis, will be illustrated, it is necessary to

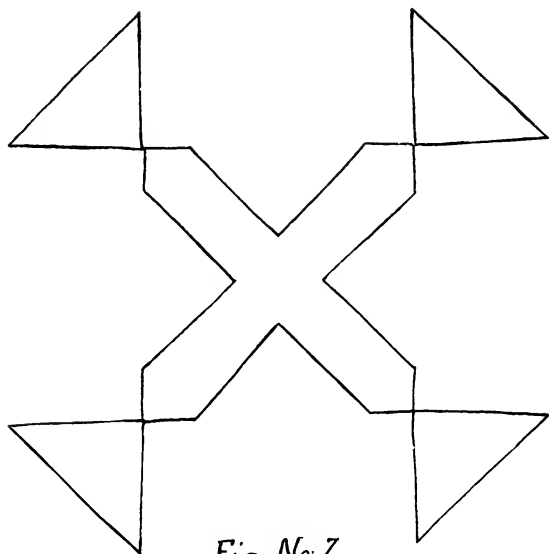

Fig. No. 7.

explain how the octagon can be obtained in a very simple manner. The line A-C is drawn from one folded side to the other so that the distance from A to B will be the same as from C to B. The octagon can be cut just as easily from any shaped piece of paper, no matter how irregular. Figure No. 19 shows a pretty combination of the octagon and small pieces resulting from cutting a square as directed.

LINES AND ANGLES.

It must be remembered that although paper-folding and cutting are so-called *manual training* exer-

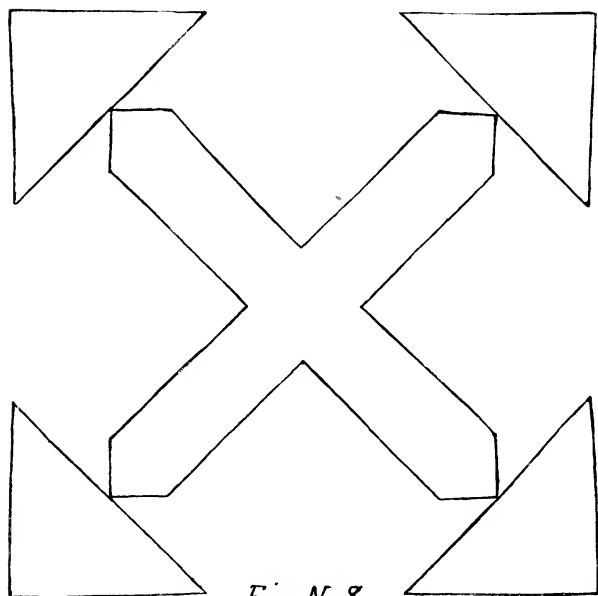

Fig. No. 8.

cises, that is, *hand training*, the brain is not allowed to be idle during these exercises. Short talks about lines, angles, and plane figures, should form a part of every lesson. This can be done from the very beginning. The square can be explained, and the children

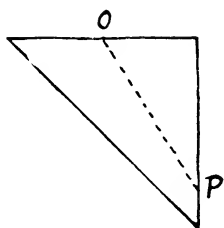

Fig. No. 9

taught that its four corners are called *right angles*. After folding three times a three-sided figure is

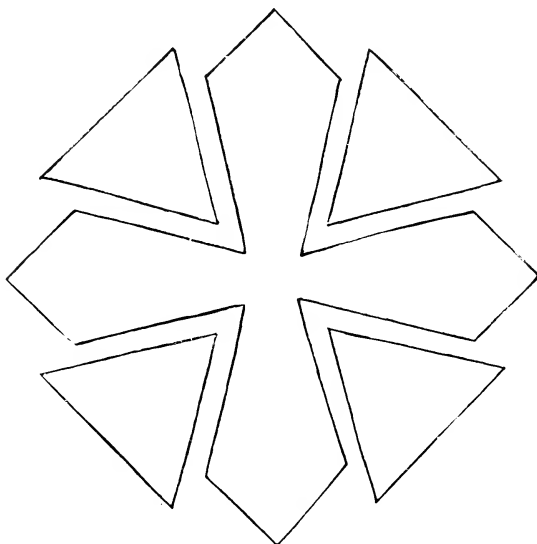

Fig. No. 10

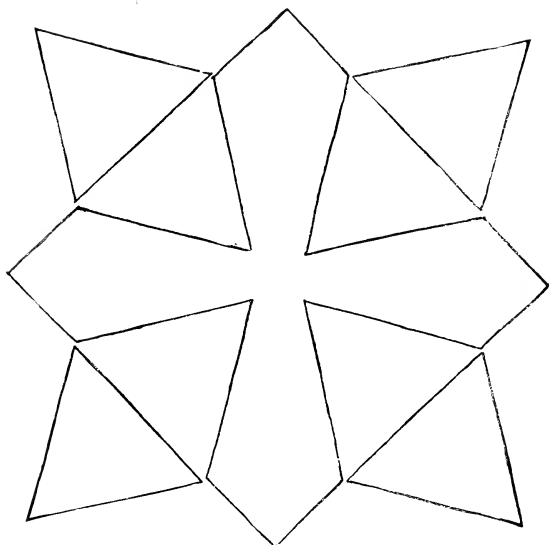

Fig. No. 11

obtained. Here teach the term *triangle*, and explain that as one of the angles is a right angle, the

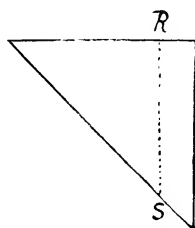

Fig. No. 12

triangle receives the name *right-angled triangle*. Various styles of triangles are seen in the different

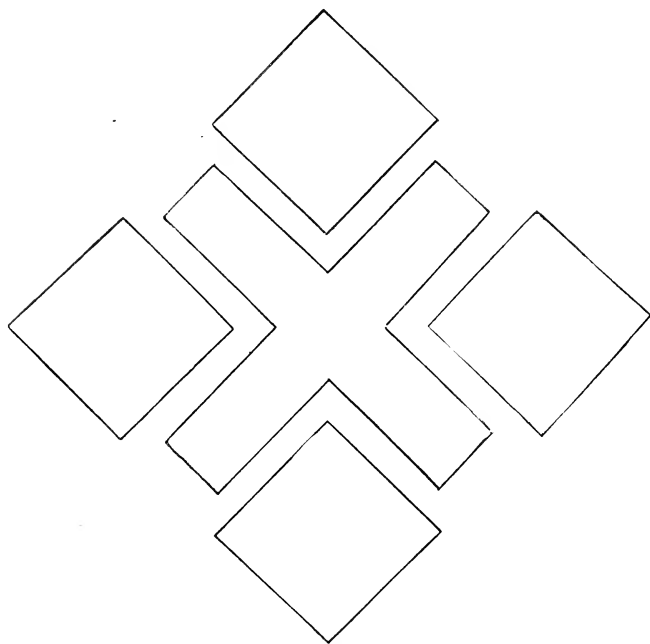
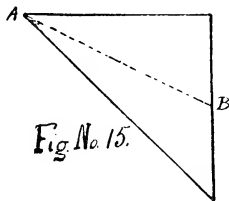
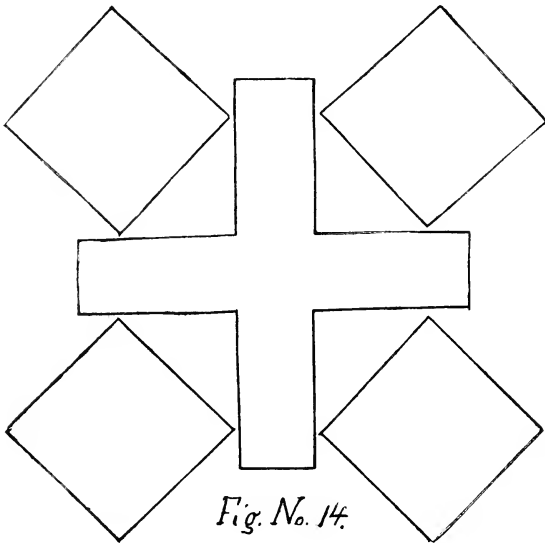

Fig. No. 13

designs, and the terms *acute* and *obtuse* may be used to designate the angles in them. In talking of drawing the lines, use the terms *oblique*, *vertical*, and *perpendicular* until the children can distinguish them at a glance. In figure No. 18 a chance occurs to teach the term octagon, also the *isosceles* triangle, as seen

in A-B-C. Show that such a triangle has *two equal* sides, and state that if all three sides were the same



length, the triangle would be *equilateral*. When you have cut and opened the octagon, let the pupils count the number of triangles forming it.

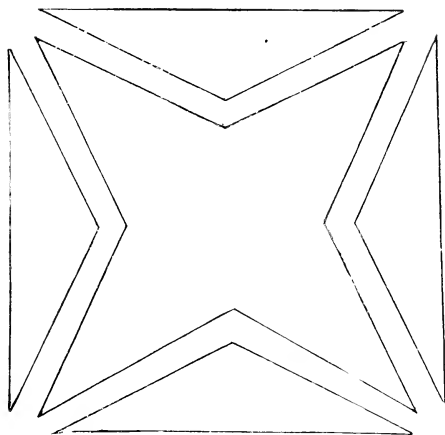

Fig. No. 16

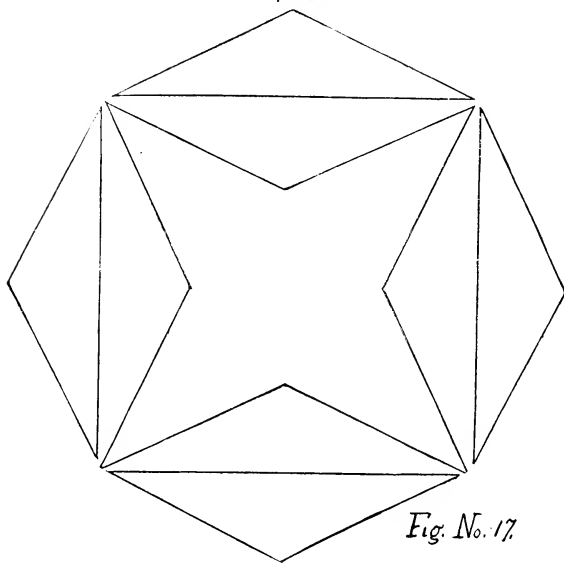
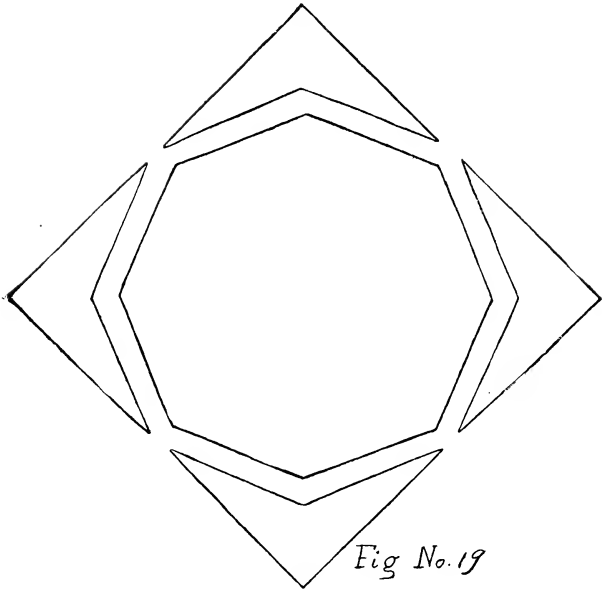
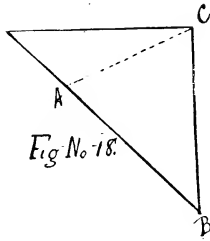

Fig. No. 17



CHAPTER III.

DESIGNS FORMED BY CUTTING TWICE.

BY folding the paper as in the former designs, and making two cuts with the scissors, a variety of elaborate designs can be formed, a few of which will be illustrated here. In figure No. 20, the line D-E

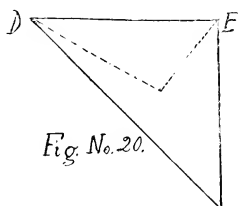

represents the edge of the square. By cutting as indicated by the dotted line, a design like that shown in figure No. 21 may be formed. The eight small triangles may be arranged around the center piece in at least half a dozen different ways, in each case forming a pretty design. Illustration No. 22 shows another manner of cutting twice. F-H is the edge of the paper and G is midway between these two points. Four squares, four triangles, and a star-shaped centerpiece result from these cuts.

Two designs formed from these pieces are shown in illustrations Nos. 23 and 24. Ingenious pupils will find many different ways of arranging the squares and triangles. The line I-K in figure No. 25 indi-

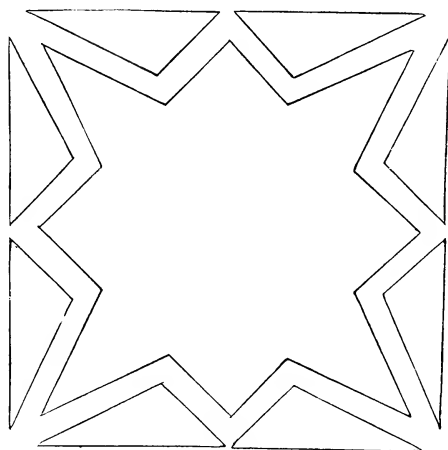

Fig. No. 21

cates the edge of the paper, and the dotted line shows that an acute angle is to be cut out of the folded paper. As a result we have a peculiar shaped center-piece and eight small triangles. The latter may be arranged in many ways, one arrangement being shown in figure No. 26.

A pretty and effective arrangement is shown in figure No. 28. By turning the triangles around another effect is produced.

No. 28 also shows two cuts, starting from the edge of the paper L-M and forming an acute angle. The triangles resulting from this cutting, eight in number, are so irregular that to have a satisfactory design they must be used in pairs.

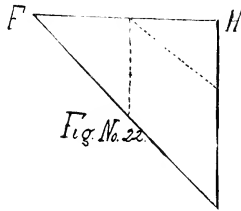

Fig. No. 22

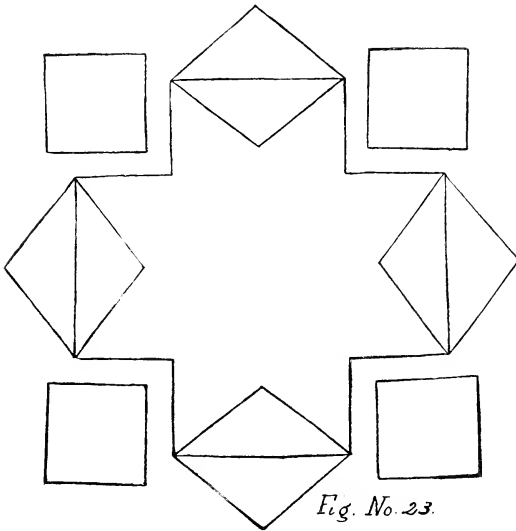
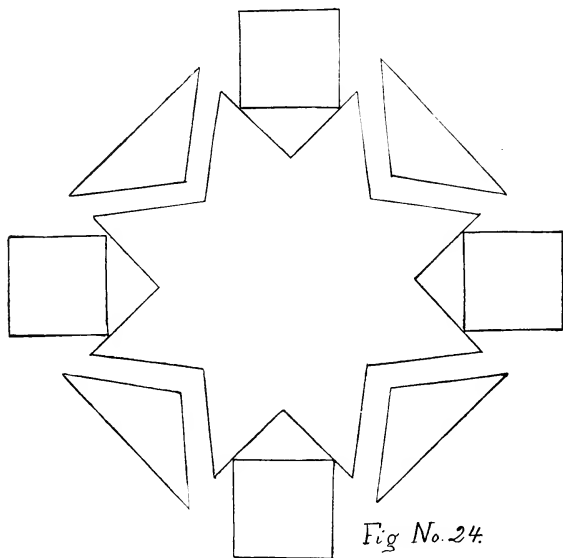

Fig. No. 23

MEASUREMENT.

Many pupils are extremely awkward in using the ruler. They do not place it correctly on their draw-



ings and fail to make a straight line. In cutting the folded paper it is absolutely necessary, in order to

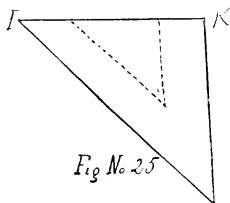

have a neat and perfect figure, that the lines should be accurately drawn. Small, fractional measurements

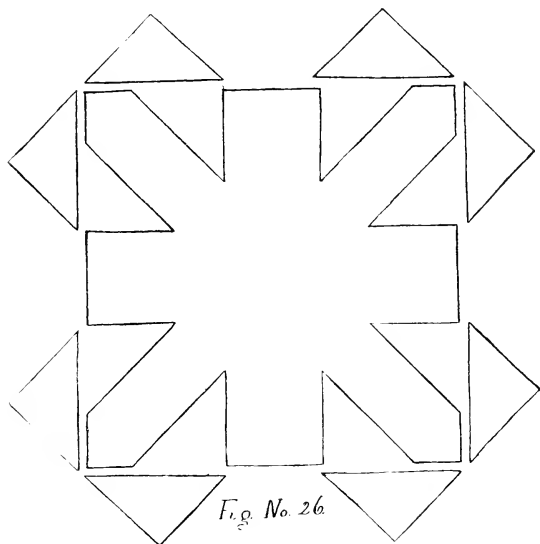

also puzzle young pupils. They should be shown how to draw lines whose lengths are estimated in quarters or eighths of an inch.

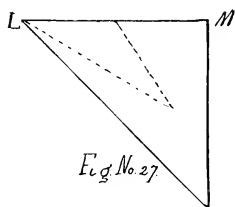

Little more need be said about folding and cutting designs in which *straight* cuts are made. A couple of designs are here shown in which three cuts have been made. Figure No. 29 shows the folded

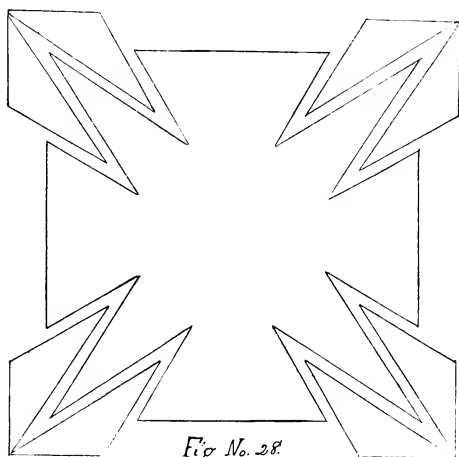

paper, the dotted lines indicating the lines for cutting. In figure No. 30 we have the paper opened and arranged in a pleasing design. Several different ways of placing the small pieces of paper are allowable, and it is a good idea to let the pupils exercise their own taste in the matter. The vacant space in the center of the design may be left as it is, so that the background will show through, or the small piece of paper which has been cut from it may be cut into some fanciful shape and placed in the center of the

space. In figure No. 31 three cuts are made as shown by the dotted lines. Figure No. 32 illustrates a simple arrangement of the pieces resulting from this style of cutting.

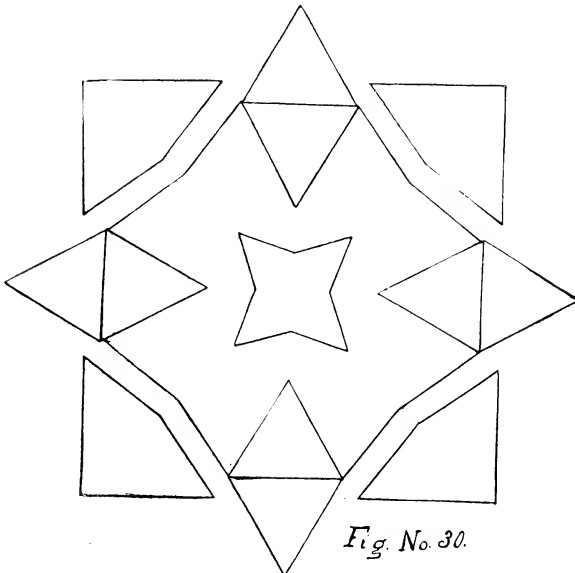
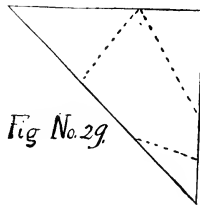

CURVED LINES.

“Curved is the line of beauty,” some one has written, and the truth of the statement is demonstrated in paper-cutting designs. A true eye and a steady

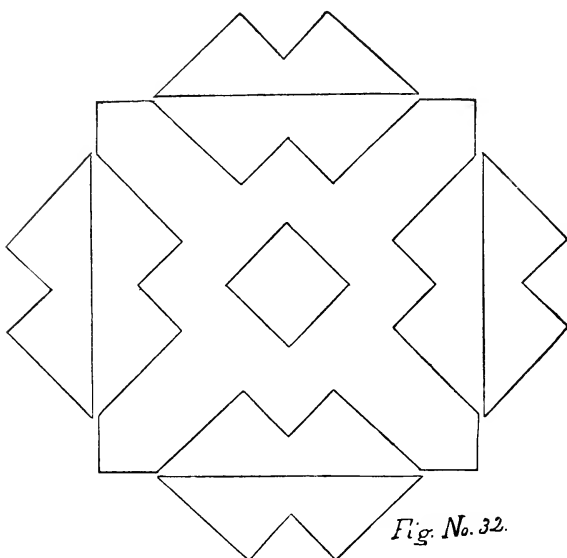
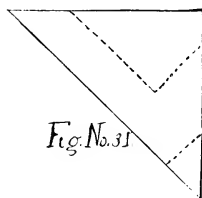

hand are necessary to draw and cut such lines. The compass may be used to advantage in many designs presenting curved lines. Figure No. 33 represents

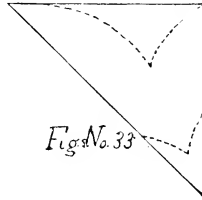

the paper square folded as for previous designs. Carefully draw lines such as are indicated by the dotted lines in this figure, and then cut slowly through the lines. A long, sharp cut, such as was advised in

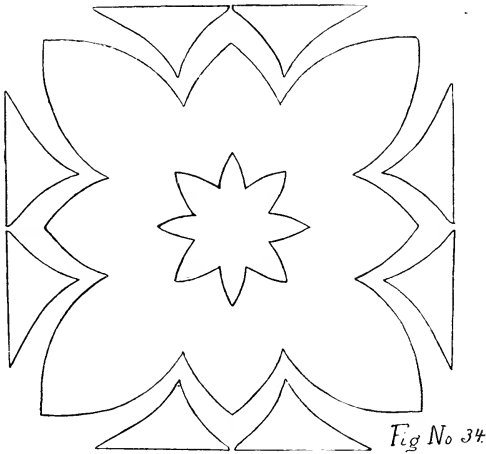

designs with straight lines, can not now be used. The scissors should not be removed from the paper until the entire curve is cut. Turn the paper slowly until

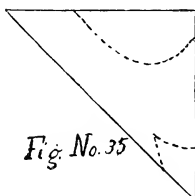

Fig. No. 35

each portion of the line to be cut comes under the edge of the scissors. Considerable practice will be

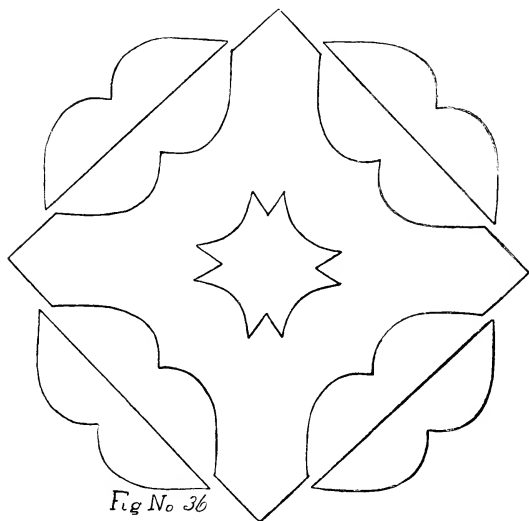

Fig No 36

necessary before curved lines can be accurately cut by the pupils.

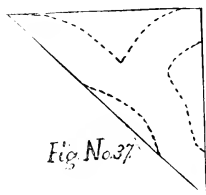

Fig. No. 37

Figure No. 34 represents a design made by cutting as shown in figure No. 33. Here the center space is left vacant, but the paper cut from this space may

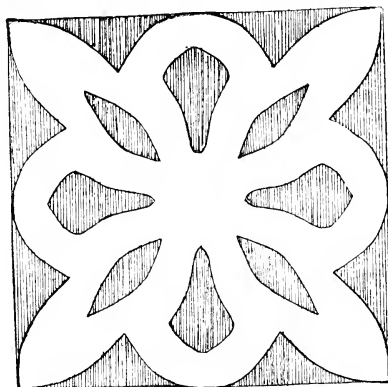

Fig. No. 38

be cut into a circle and inserted in the center with pretty effect. A simple combination of curved lines is shown in figure No. 35. A design representing one

arrangement of the papers from this cutting may be seen in figure No. 36. The small pieces may be turned so that the curved sides face the centerpiece, and quite a different effect will be produced.

A more complicated style of drawing and cutting is illustrated in figure No. 37, being difficult cutting, but the pasting more simple, as the small pieces may be discarded. Through the open spaces in this design the background shows plainly. In figure No. 38 the design is pasted first onto a four-inch square of a color that will combine well with the cut paper, and then the whole figure is pasted onto a larger sheet of white drawing-paper. Quite an elaborate effect is thus obtained in a simple manner.

CHAPTER IV.

COLOR COMBINATIONS.

UNTIL this stage of designing is reached, it is advisable to use but one color for the cut designs, with white as a background. Now, to vary the exercise, the following method might be adopted: retain

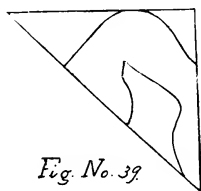
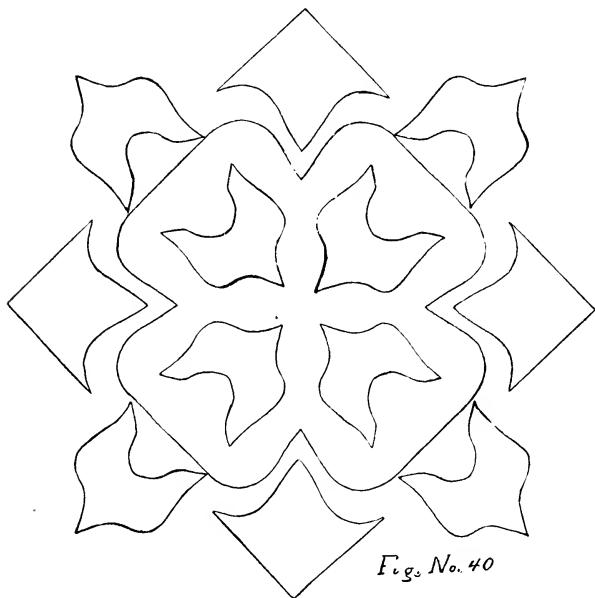

Fig. No. 32

the white as a background, but allow the pupils to exchange the small pieces of the designs with one another. Be sure, however, that they exchange all pieces of similar size and shape for others all of the same color. If there are four small triangles and a centerpiece, the centerpiece should be one color and the four small pieces should all be of the same color, and of a color that will combine well with the centerpiece. For instance, in figure No. 34, the background might be white, the large portion of the design a pale

green color, and the eight little triangular pieces of a pale pink or some color that will harmonize prettily with the green.



New interest will be added to the lessons by this little change of programme, and at the same time the tastes of the pupils will be cultivated. A little talk about *primary* and *secondary* colors will be instructive and in order, while these color combinations are being made.

In figure No. 39 we have a drawing, which, when cut and opened, can be so placed as to make very

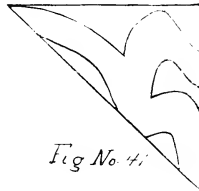

Fig No. 41

elaborate designs. Figure No. 40 illustrates one arrangement. The placing of the small pieces of

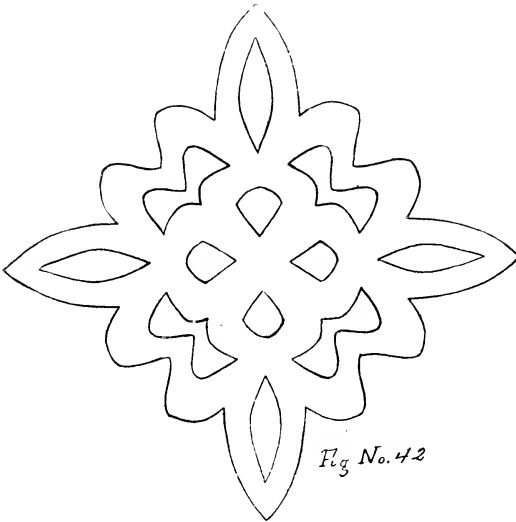

Fig No. 42

paper may be reversed and another pretty design will be the result. If desired, some of the small pieces

may be discarded. The plan of exchanging papers, advised in the last lesson, will be found very satis-

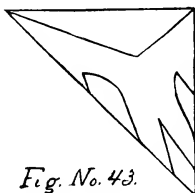

Fig. No. 43.

factory in this design. Three colors may be used, the centerpiece being of one color, four small pieces

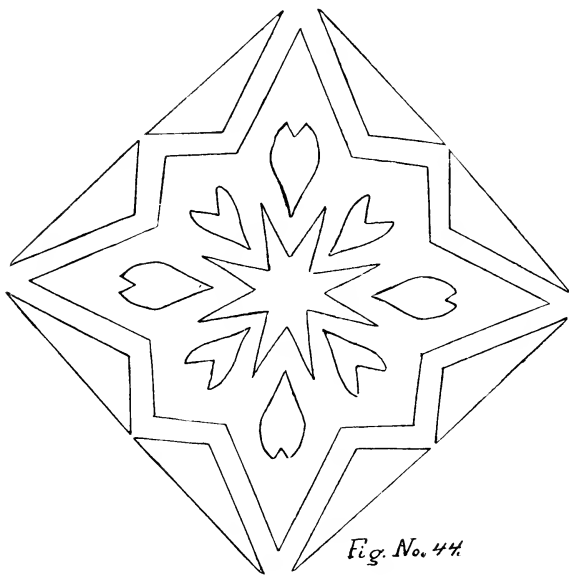

Fig. No. 44.

of similar shape of another color and the four remaining pieces of a third color. Figure No. 41 shows a

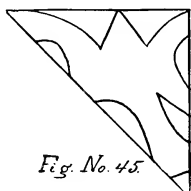

Fig. No. 45.

combination of curved cuts. If the small pieces are discarded and the elaborately cut centerpiece is

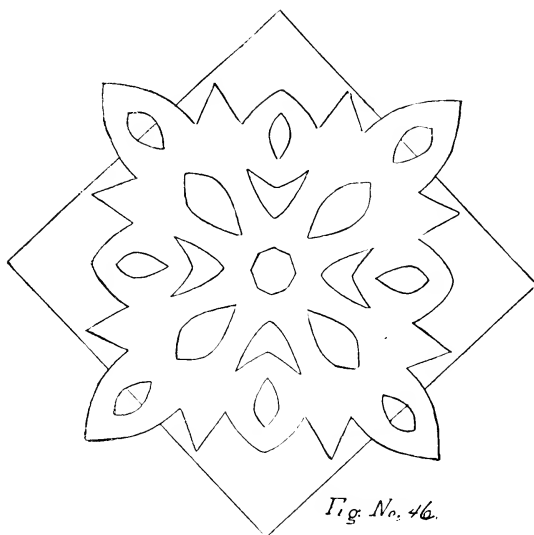
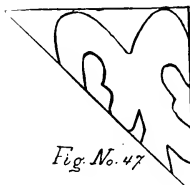

Fig. No. 46.

arranged over a contrasting color, a pleasing effect will be produced. Arranged simply on a white back-

ground, it has the appearance indicated by illustration No. 42. Straight cuts and curves both appear in figure No. 43. It is advisable to use the small tri-



angles resulting from these cuts, as a much more elaborate design can thus be formed. An easy arrangement of these triangles is shown in figure No.

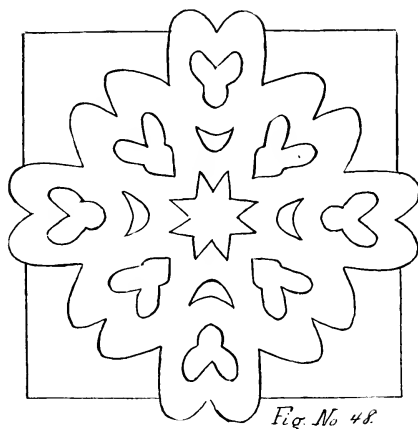

44. The triangles can be arranged in many ways. A small star or circle placed in the center of the design, where the background shows, will add greatly

to the effect. Another combination of straight and curved lines is shown in figure No. 45. Opened and arranged as in illustration No. 46, with a four-inch square of another color placed under it, and then the whole design pasted on white paper, a very beautiful figure is produced. Call the attention of the pupils to the small octagon in the center of the figure.

Rather complicated cutting is represented in figure No. 47. By easy degrees the pupil has been led to that point where he can without hesitation make a multiplicity of cuts. It is suggested that this design also be placed over a square of a contrasting color as represented in figure No. 48.

CHAPTER V.

ORIGINAL DESIGNS.

BY this time pupils possessing an atom of originality will be anxious to try a design "all their own," as they say, and I should counsel the teacher to indulge this desire. All children do not possess the

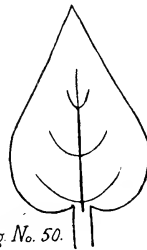
*Fig No. 49**Fig No. 50.*

same artistic taste and skill, therefore when their originality has full play the results obtained from different pupils will vary greatly. Some scholars can produce designs of great beauty with apparent ease, while others, after steady work and patient plodding, have nothing to offer but commonplace lines and angles that recall the first lessons on this subject.

SHOW-WORK.

As an incentive to the pupils and an encouragement in their artistic labors, it is an excellent plan to

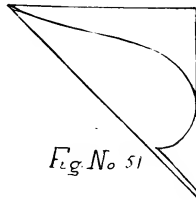

select a few designs at the end of each lesson and keep them as samples of the work done. They may

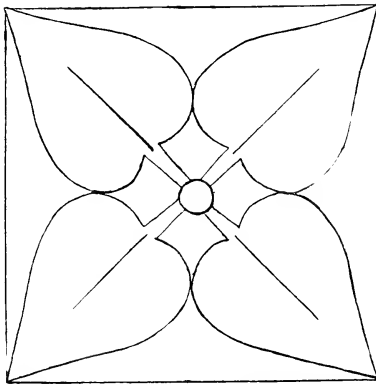

be used to decorate the walls of the class-room, or arranged in a scrap-book. I would suggest that the

naturally dull pupil should be occasionally encouraged by having his conscientious efforts (even if plain and unattractive in effect) selected and placed among the designs reserved for special inspection.

LEAF DESIGNS.

The teacher can now make use to some extent of the lessons in free-hand drawing. Conventionalized

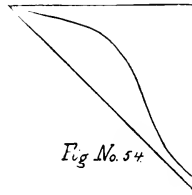

leaves and flowers have probably formed a portion of the free-hand instruction, and these same leaves and flowers may be cut from folded paper and formed into pretty designs. Illustration No. 49 represents a lilac leaf, true to nature, and the same leaf conventionalized is shown in figure No. 50. Explain right here the difference between a natural leaf and a conventional one. As both sides of a conventional leaf are exactly the same, the folded paper is so arranged that a drawing of but one half of the leaf is made. See figure No. 51 in which the same lilac leaf is used, half of it being outlined. The paper is folded as in

all preceding lessons, and the midrib of the leaf is placed on the longest side of the folded triangle. The stems all point toward the center of the paper. Care must be exercised not to cut through the stems by

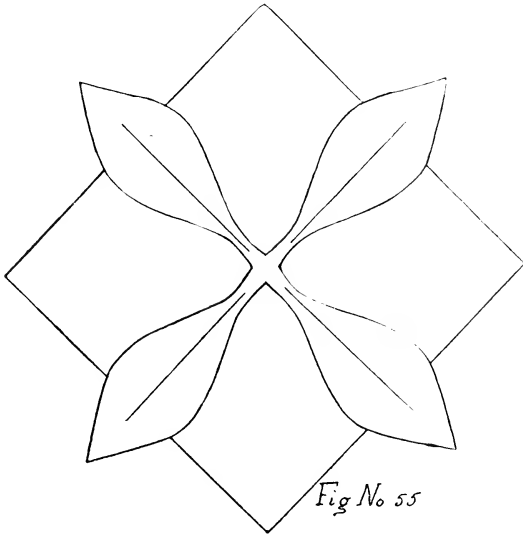
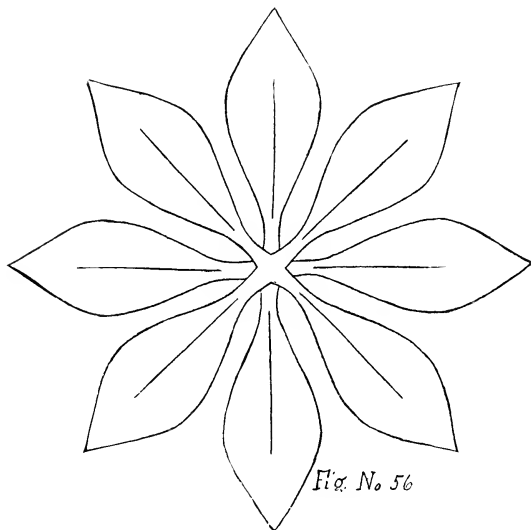

Fig No 55

mistake. Opened and arranged upon a square of paper of a harmonizing color, the design appears as represented in figure No. 52. If the stems are weak in the center where the paper has been folded so many times, a small circle, such as is shown in this figure, or a star or square may be placed in the center of the design. It will serve the twofold purpose of hiding the creases in the stems and adding to the

beauty of the design. Another simple leaf is shown in figure No. 53 which, when drawn on folded paper for cutting, appears as indicated in illustration No. 54.



Opened and placed over a square of a contrasting color, it forms the design seen in figure No. 55. The square of paper placed under the leaves may, if preferred, be arranged in a similar position to that in the former design, with the corners beneath the tips of the leaves. The elaborate design pictured in figure No. 56 is obtained in a very simple manner. It consists of two squares of paper of different colors, folded and cut as shown in figure No. 54, and then one

paper placed above the other in such a manner that all eight leaves can be seen. In delicate tints that form a pleasing combination, and with white as a background, the result is very effective. The veining of the leaves is a matter that depends upon the individual taste of each teacher. In the designs pictured here the principal vein is drawn, but it may be omitted, or *all* the veins may be drawn.

CHAPTER VI.

LEAF DESIGNS.

IN figure No. 57 we have a more difficult leaf. Arranged on the folded paper as explained in the previous lesson, it is represented in figure No. 58. A

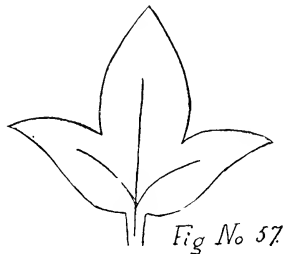

pretty design formed of these leaves is shown in the next drawing. A square of paper of a contrasting color is placed under the leaves as a background. In all leaf designs great care must be exercised in cutting and pasting the stems, which are so slender and have so many creases that they are easily torn. The ivy leaf represented in the next figure, No. 60, will be found both simple and graceful for designing purposes. Draw as illustrated in figure No. 61, having

the points of the leaves touch the edges of the folded paper. In cut No. 62 we have one arrangement of

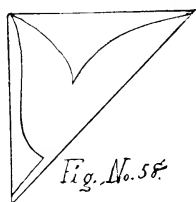

ivy leaves. Here, again, a square of another color is used as background. The square may be placed in

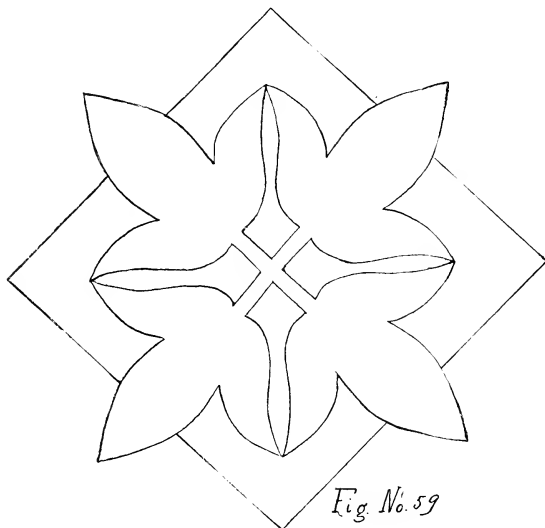

the same position as in the previous design if so desired. A conventionalized maple leaf next claims

our attention. See figure No. 63. It is so pretty in itself and is made up of such graceful curves that a design formed of such leaves can not help but be pleasing. Draw as indicated in figure No. 64. Illus-

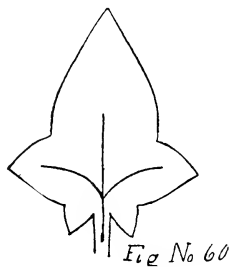

tration No. 65 shows the leaves unfolded and spread in position. No additional decoration is needed. Figure No. 66 represents a leaf of the oxalis, which from its peculiar shape is very effective as a basis for

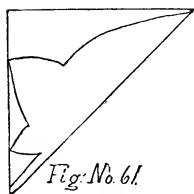

ornamental designs. The long stems may be shortened by drawing at their base as shown in figure No. 67 and when opened a pretty centerpiece will appear which will add greatly to the beauty of the design.

Figure No. 68 shows the design formed from this drawing. In this design, as in all the others here

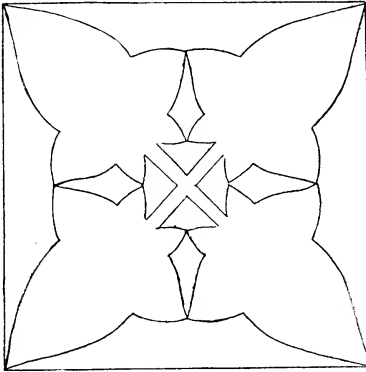

Fig No. 62.

shown, a contrasting square of paper used as a background will add much to the general effect. A combination of leaves is shown in the next design.

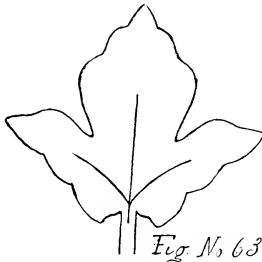

Fig No. 63

The necessity for careful drawing and cutting is greatly increased but the appearance when completed

compensates for the extra trouble. But one style of leaf is used in the design, one leaf being consider-

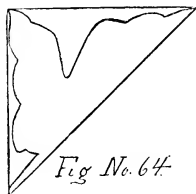

Fig. No. 64

ably smaller than the other. See figure No. 69.

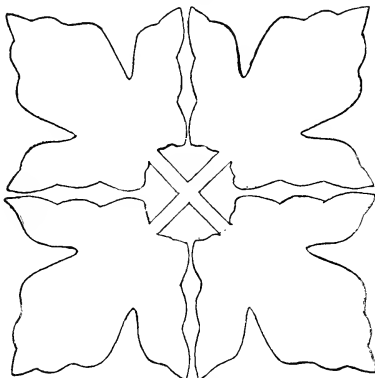

Fig. No. 65

When opened and pasted as illustrated in figure No.

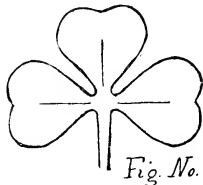

Fig. No. 66

70, this design is very elaborate and looks even more

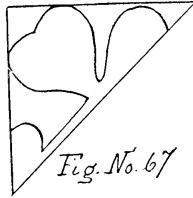

Fig. No. 67

difficult than it really is. If eight leaves of the same

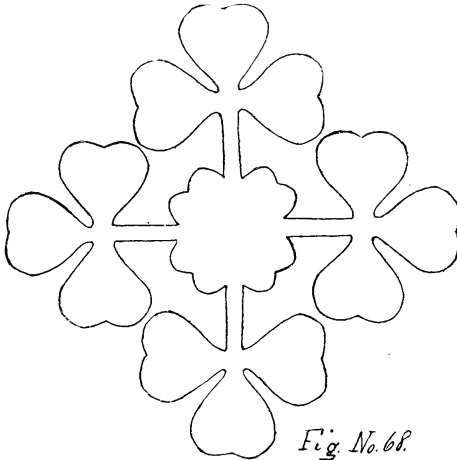

Fig. No. 68

size are desired, draw one on the folded paper as

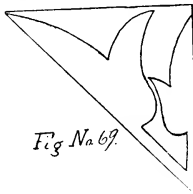
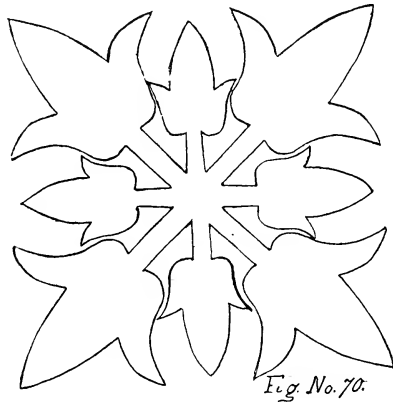
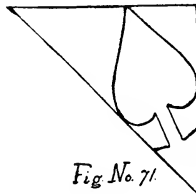

Fig. No. 69

shown in figure No. 71. When opened the leaves will form a circle as represented in the next design. The long, delicate stems are shortened by drawing the centerpiece as indicated in the illustration.



If a circle of darker color be placed under the leaves a very showy effect is produced, as shown in figure No. 73.



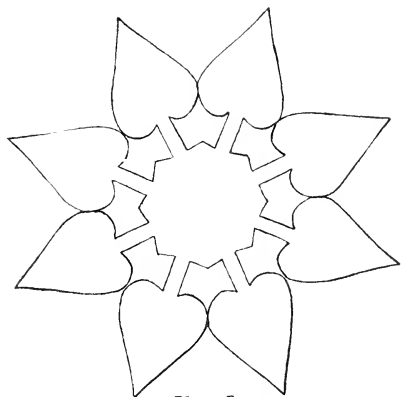

Fig No 72

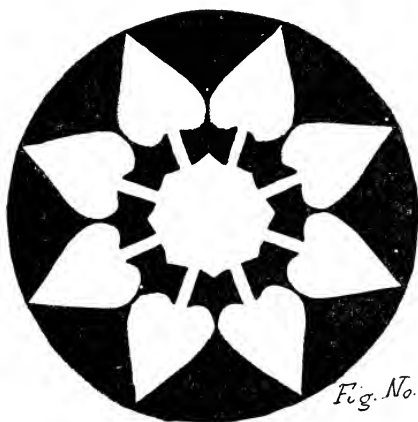
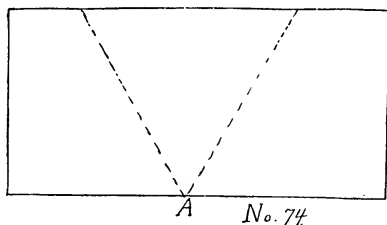

Fig. No. 73.

CHAPTER VII.

POLYGONS.

IN all the previous designs illustrated in these lessons on folding and cutting paper, the square has been used as a basis. This was considered wise for several reasons. Squares are simple to cut and easily fold-



ed, and above all other considerations, was the one that, in many cities where such work is desired in the schools, colored paper, cut in squares of a convenient size, could be obtained. It is time now, however, to consider plane figures having more than four sides. One, the octagon, has already been shown, and an explanation given how the figure may be easily cut. We will now take the pentagon, hexagon, and heptagon. Explain to the pupils the derivations and meanings of these words so that they will thoroughly understand what you are talking about.

These figures can be cut from paper of any size or shape, but for convenience we will first cut them from the squares, such as we have been using all along. For

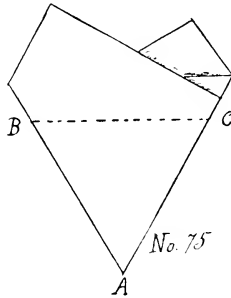

the hexagon, fold the paper once across, as shown in figure No. 74. Then with the folded side down, from the center *A*, fold the paper as illustrated by the dotted lines in this drawing. Fold the paper carefully, and

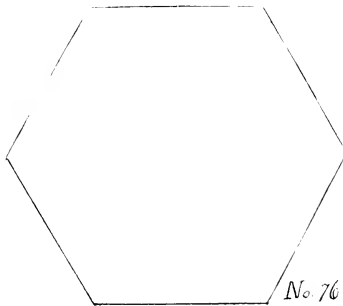

do not press it down firmly until you have divided the folded oblong into three exactly equal parts. Much precision is necessary, and there should be no

undue haste. No. 75 represents the folded paper. Now draw the line B-C, forming an isosceles triangle; that is, B-A is the same length as C-A. Cut through

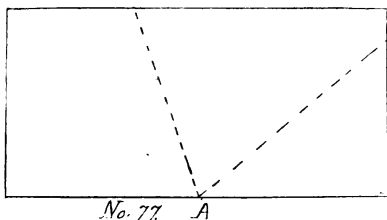

this dotted line and open the paper. Illustration No. 76 shows the result of our folding and cutting, a perfect six-sided figure, or *hexagon*. For the pentagon, even greater care is necessary, for instead of folding into equal parts, we fold so as to have two equal parts, and a part equal to half of one of these sections.

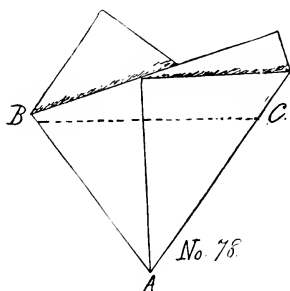

Fold the squares as for the hexagon (see figure No. 77), and then double the paper over until it presents the appearance shown in figure No. 78. Form the isosceles triangle as in the previous polygon by drawing

through B-C. Opening the folded paper, a pentagon appears as represented in figure No.79. Similar folding is required to cut the heptagon. Three equal

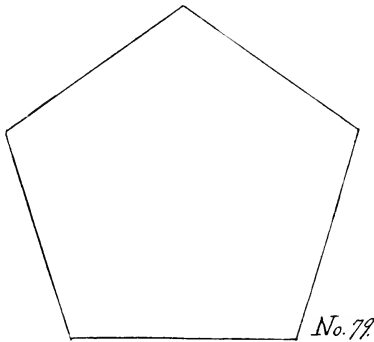

sections are folded and then a portion equal to half of one of these parts. Figure No. 80 shows the direction of the folds, and figure No. 81 the appearance of the paper when folded. Cut through the line B-C.

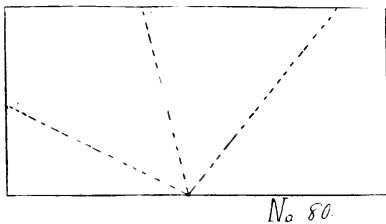
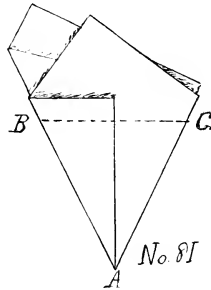

Illustration No. 82 shows the result. In all probability many trials will be needed before perfect polygons will be cut. The eye must be trained. After

practicing with the squares, take irregular-shaped pieces of paper and fold and cut them.



POLYGONS AS A BASIS FOR DESIGNS.

Very beautiful designs can be formed from these polygons. It will be readily seen that anything drawn on one of the folded triangles forming the

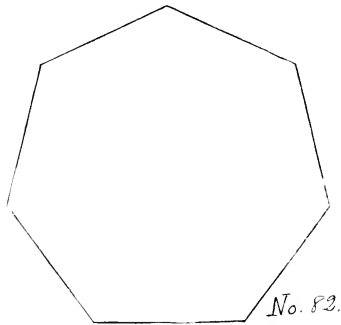

polygons, will be repeated on the other triangles when the design is cut. Figure No. 83 shows a simple design based upon the pentagon. The same orna-

mental drawing appears five times. In figure 84 a more elaborate design is shown, cut from the hexagon, and in illustration No. 85 the heptagon was the basis.

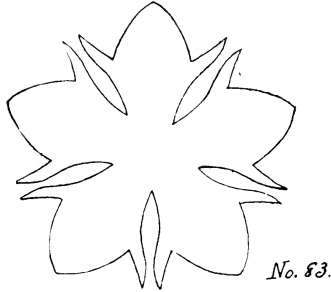

These polygons afford a large field for the originality of the pupils. Church and cathedral windows are often designed from these shapes, and an intelligent

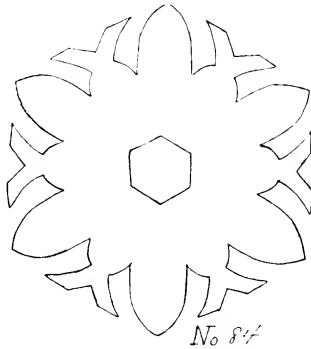

child may get pretty ideas from them. Figure No.86 shows the folded hexagon with very simple drawing upon it, composed entirely of straight lines. When

cut and arranged as in figure No. 87, a very effective design is formed. A circle, cut from paper of contrasting color and placed under any designs formed from these polygons, adds much to the appearance.

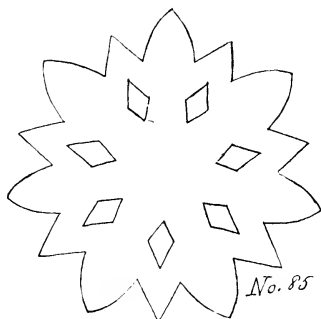

As far as possible the teacher should work with the pupils. He should have a larger square of paper and fold and cut it in plain view of the scholars. If the blackboard be moistened by passing a damp sponge over it, and the paper design pressed into the dampen-

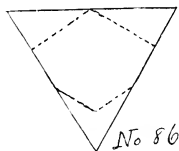

ed surface, it will adhere for quite a while. Occasionally allow a pupil to arrange a design on the board and it will stimulate the whole class to greater efforts. Again, I repeat, do not have this lesson too entirely

manual or “*of the hand,*” but make the brains do their share of the work. Have all the terms used during the lesson defined and thoroughly understood. Dis-

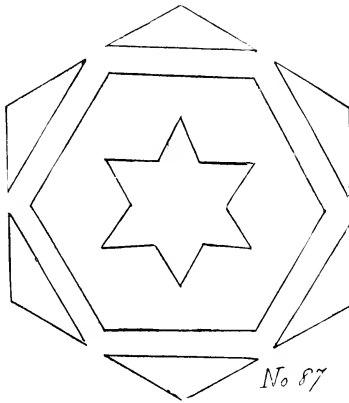

cuss lines and angles at length, and lead the pupils to make comparisons between the different polygons. When the latter are irregular and out of proportion, do not indicate the incorrect places, but make the pupils find them. The leaf designs used for the squares in a former lesson will be particularly graceful in designs based upon these polygons. For instance, the ivy or maple leaf, repeated six times as it would be in a hexagon, the stems meeting in the center, would form an elaborate figure.

CHAPTER VIII.

BORDERS.

THE subject of paper-cutting, as far as squares and polygons are concerned, is by no means exhausted; in fact, it may be said to be *inexhaustible*, but if the teacher has carefully read and applied the

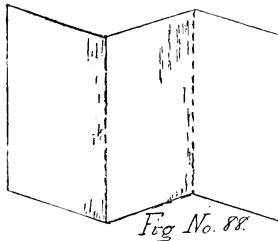

Fig. No. 88.

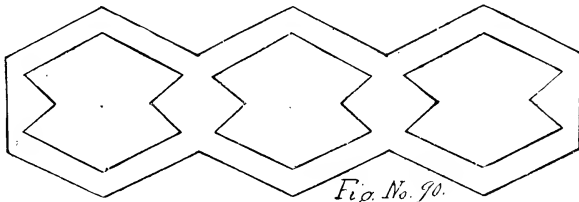

Fig. No. 87.

preceding chapters he will be able to continue giving lessons of the style without any special directions.

It is therefore unnecessary to take up any more space on the same figures. We will now consider *borders*, and if my experience in teaching is repeated, the pupils will hail the change with delight. A good size for decorative borders is six by two inches, and before the fancy work is commenced the paper should be cut into slips of said size. For most bor-

ders it is prettier to fold the paper into six divisions, each an inch wide. First fold the slips of paper in half, so that it measures three by two inches. Now you must, by carefully measuring with the eyes and fingers, fold this into three parts. Fold in accordion



style as shown in No. 88, for if you fold one division in and the others around it, the inner division will be slightly smaller than the others. By folding as represented, pleating it in fact, all the divisions will



be the same size. Figure No. 89 represents the folded paper, with a simple design drawn upon it. The drawing is made up entirely of straight lines, and will be found simple and useful to a beginner. In figure No. 90 the open paper is shown. With a background

of a contrasting color the appearance is much improved.

A combination of straight and curved lines is shown in illustration No. 91, and 92 shows the opened



Fig. No. 92.

paper. A strip of dark paper, six inches long and two inches wide, is placed under the cut work, and in this way a very showy effect is produced. Careful drawing is required for the next design, but the result is well worth the trouble. Curved lines alone are used. See figure No. 93. The border resulting from



Fig. No. 93.

drawing and cutting as indicated is remarkably pretty and will be found to be a favorite with most pupils. In illustration No. 94 this border is shown. It would be advisable to practice drawing and cutting borders

no more difficult than this for several lessons. The pupils' originality should be allowed full play, and many of the designs given for squares may be adapted to borders. A difficult design is illustrated in

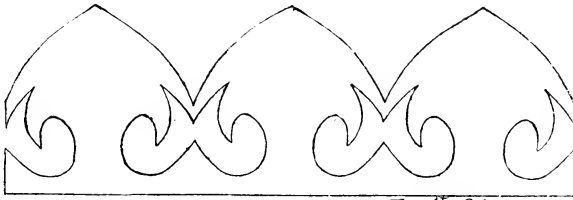

Fig. No. 94.

figure No. 95, the result of cutting as shown by the dotted lines being the elaborate border represented by figure No. 96.

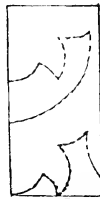
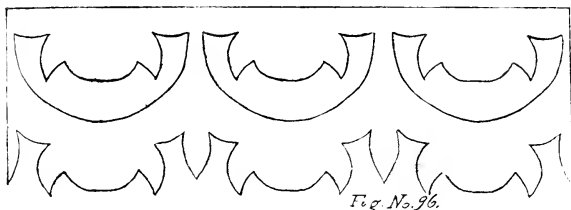

Fig. No. 95.

LEAVES FOR BORDERS.

We can now make use of leaves for decorative borders and find them quite as attractive as in former designs. A conventional leaf is used as the basis of the next design, with a small ornamental figure as connecting link between the leaves. See figure No.

97. Right here I must caution both teacher and pupils not to forget the connecting links between the



principal figures of the design, or the amusing experience of a certain city pupil may be repeated.

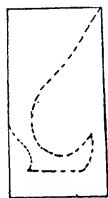

Fig. No. 97.

The pupil carefully drew and cut an elaborate design. He opened the paper with considerable pride, expect-

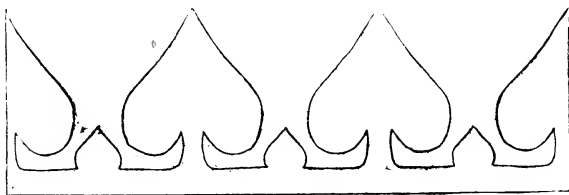

Fig. No. 98.

ing to be highly complimented for his skill, when to

his consternation he found that instead of a border he had only a number of pretty figures. There must

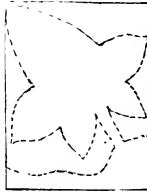

Fig No. 98

always be some portion of the design which runs the entire length of the border. It need be nothing but

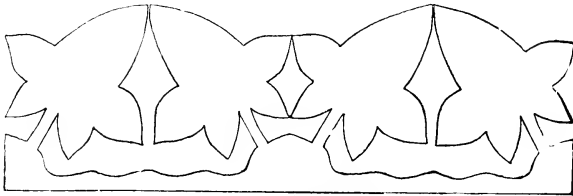

Fig No. 100

a straight band, or the severity may be broken as in the figure under discussion. The effect may be observed in figure No. 98. Unconventional leaves, or

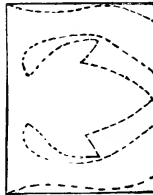

Fig No. 101

leaves coming naturally, may be used for borders. The ivy-leaf is a general favorite, and may be drawn as shown in representation No. 99. In this case the paper is folded in four equal parts, each space for the leaf being two by one and a half inches. A curved

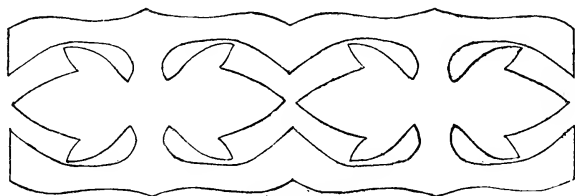

Fig. No. 102.

line runs from leaf to leaf. In figure No. 100 the elaborate border formed of these leaves is shown.

Fold the paper in the same way and draw a leaf crosswise as shown in figure No. 101, and an odd and pretty effect will be produced. The border thus formed is shown in figure No. 102. These leaf designs will be greatly beautified by placing dark slips of paper under them so that the edges of the leaf will stand out in bold relief. Taking these designs as models, and using different leaves, a great variety of borders may be cut. The leaves of the oxalis and maple, illustrated in a former chapter, will be found graceful in border designs. Variety may be produced by folding the slips of paper in a more or less number of parts. For class-room decoration an oblong of

paper of a deep tint, with cut borders placed one under the other at equal distances, forms a pretty wall ornamentation, and serves at the same time as a sample of the pupils' taste and skill in paper-cutting.

CHAPTER IX.

SOLIDS.

LEAVING the ornamental squares, polygons, and borders, we now take quite an important step forward in our paper-folding and cutting. We will develop in paper numerous solid, geometrical forms. The implements necessary are pencil, compass, ruler,

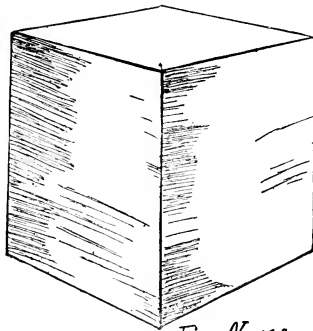

and stiff, white drawing-paper. Also the best paste that can be obtained. In all lessons relating to the cutting of paper so as to make solid forms the form itself should be before the class as a model. These

forms may be bought, made of wood, at reasonable prices, or the pupils may make their own models of

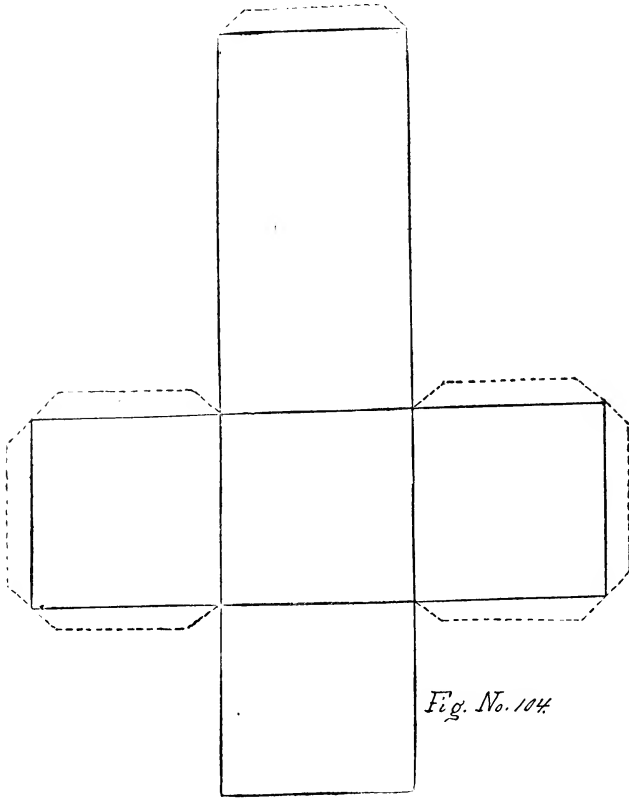

Fig. No. 104

clay, clay-modeling being a portion of manual training that usually either precedes or accompanies paper-cutting. Before any drawing is commenced the

pupils should be led by skillful questioning to form ideas of how the drawings should be arranged. For instance, take a cube as model. (See figure No. 103.)

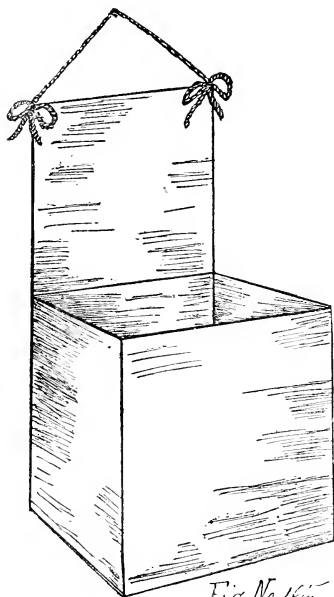

Fig. No. 105.

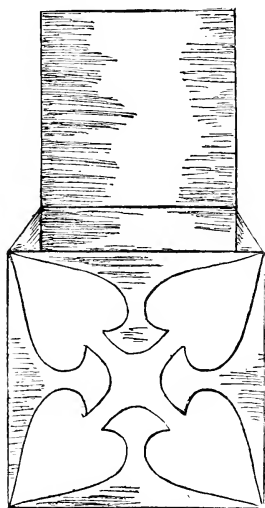

Fig. No. 106.

Questions—"How many faces has it? What is the shape of each face? How many angles altogether? What kind of angles?"

Then place the cube on one of its faces and turn it until it has stood on four faces in succession, that is, turn it as you would a wheel. These four faces will be seen to be in a straight line. Let the pupils then

draw four equal squares in a row, as shown in figure No. 104. A two-inch square is a convenient size. Now examine the model again and call the attention of the pupils to the position of the remaining square faces and then complete the plan, as seen in No. 104.

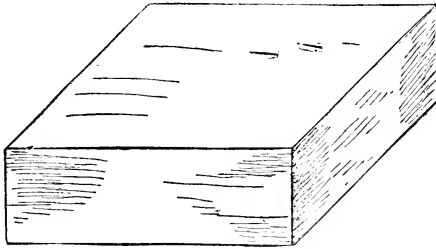
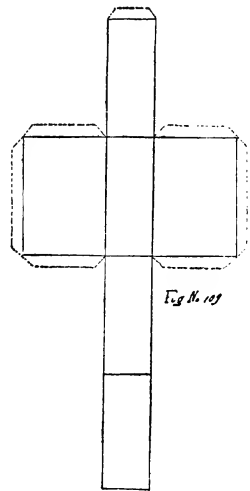
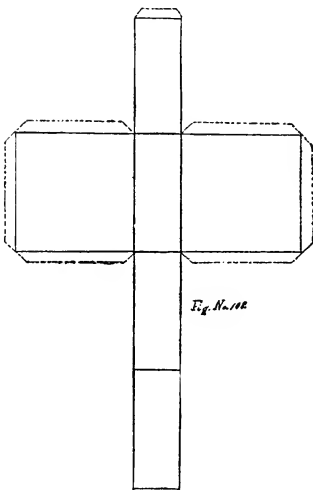

Fig. No. 104.

The little flaps indicated by the dotted lines are to hold the paste when the paper cube is cut and folded. In folding, keep one square entirely free of paste and fold all the others, keeping the thumb and finger pressed against the edges to be pasted. The finishing requires great delicacy of touch. Haste is to be avoided. Do not squeeze the figure or it will collapse. In fact, the writer might fill a column with "Don'ts," but the intelligent teacher will in one lesson learn what to do and what to avoid in this department of paper-folding. Do not expect many perfect figures at first. The development of these forms is by no means easy, and practice and patience will be necessary before success will be acquired. The wall-pocket

represented in figure No. 105, and the box shown in figure No. 106, are modifications of the cube. In the latter figure the front of the box is ornamented with a cut design in colored paper. From the cube to the box form shown in illustration No. 107 is an easy step. By turning the model the pupils may be led to see that the four narrow sides form a continuous line, and the position of the squares forming the top and bottom of the box will be readily understood. The plan is shown in figure No. 108. In this case the top and bottom were two-and one-half-inch squares and the sides were an inch high. A plan for an oblong box is shown in next figure, No. 109.

PRISMS.



The square prism, being an elongated cube, would naturally follow here. The four oblong faces (see figure No. 110) will be seen to be in a straight line,

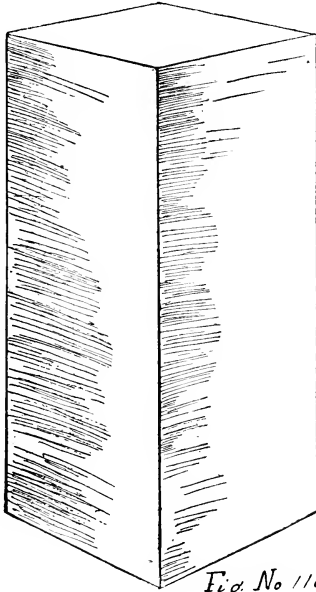
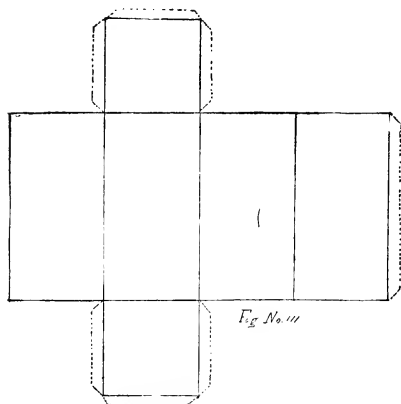

Fig. No. 110.

and must be drawn as shown in illustration No. 111. The squares are next drawn, and the plan is complete. The same directions that were given for pasting the cube will apply to the prism. The box shown in figure No. 112 is made by leaving one of the oblong faces of the prism open. See if the pupils can form anything else from the prism.



THE TRIANGULAR PRISM.

Place a triangular prism before the pupils (see figure No. 113), side by side with the square prism, and let them tell the points of resemblance and difference, viz: Its sides are oblongs. It is tall and slender. The oblongs are in a row. It only has three faces. The bases are triangles, not squares.

Draw the oblong sides, and from the opposite ends of one of the sides draw the triangles forming the bases. To draw the triangle accurately and quickly, use the compass.

Take the corners of each end of one of the faces as a center, in turn, and with the width of the oblong as a radius describe arcs as shown in figure No. 114. Complete the triangles by drawing straight lines from

the corners of the oblongs selected, to the intersection of arcs. Draw flaps for pasting, as indicated by the

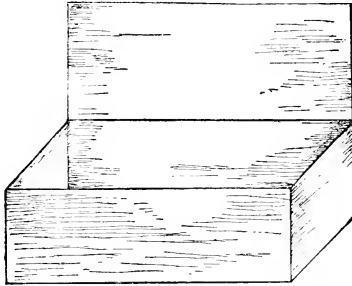

Fig. No. 112.

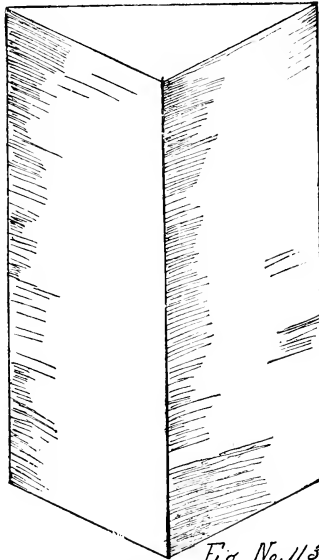
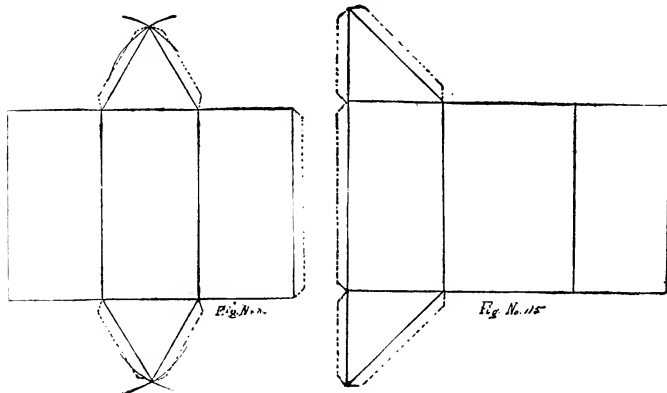
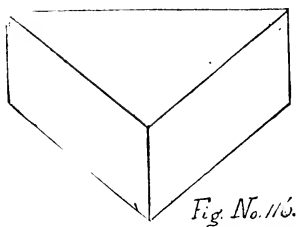

Fig. No. 113.

dotted lines. As all three sides of these triangular bases are equal, the prism may be described as an "equilateral triangular prism." All triangular prisms



are not necessarily equilateral. The triangles may be right-angled, isosceles, or irregular. In each case the three sides of the prism will be oblongs, but not



prisms of the same size. Each of the three sides of the triangular bases must have an oblong that will agree with it in width. Examine figure No. 115, and

no further explanation will be needed. The plan for a right-angled triangular prism is here shown. Two of the sides of the triangle are equal, the third side

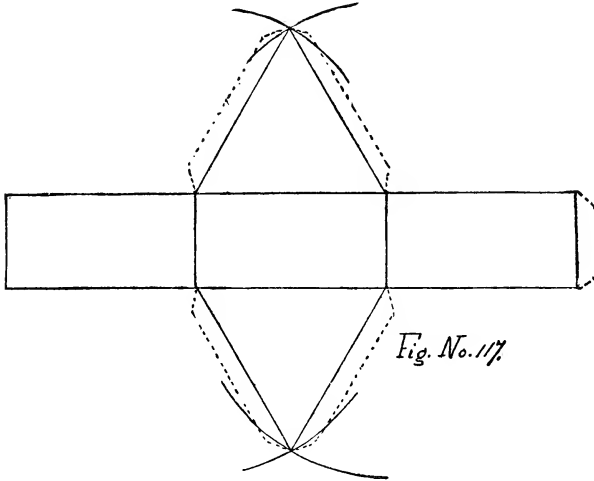

being considerably longer. The faces of the prism must correspond in width with the lengths of the sides of the triangle. A modification of the triangular prism is shown in the triangular box represented in figure No. 116. The sides are an inch high, and the plan is shown in figure No. 117.

CHAPTER X.

SOLID FORMS.

FROM prisms to pyramids is a natural and simple step. In figure No. 118 we have a representation of a square pyramid. Place your model of this form side by side with the square prism, already discussed, and let the pupils name the points common to each, also the respects in which the models differ. They will observe that each of the models has a square base and four sides, but in the case of the prism these four sides are oblongs, while in the pyramid they are triangles, joined so as to form a common vertex. In drawing the plan on paper it will, therefore, be understood that there must be four triangles, equal in all respects, and one square which serves as the base. The preliminary steps for drawing the plan of *any* pyramid are shown in figure No. 119. The straight line A-B is first drawn, the length of the sides of the pyramid. Then with a radius equal to the length of the line describe an arc of considerable length, as shown by C-D. Examine illustration No. 120 and you will see what the next steps are. Decide how wide the triangular sides of the pyramid are to be at

their bases and arrange your compass so as to have a radius of the desired length. With this radius place your compass on B and draw arcs cutting C-D. From these points of intersection as centers, and with the

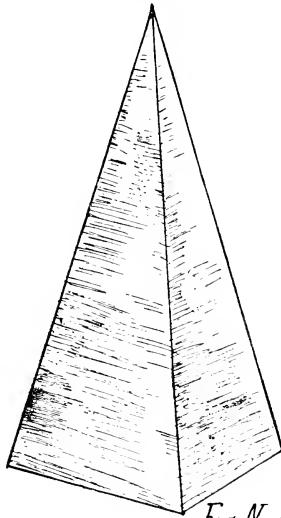
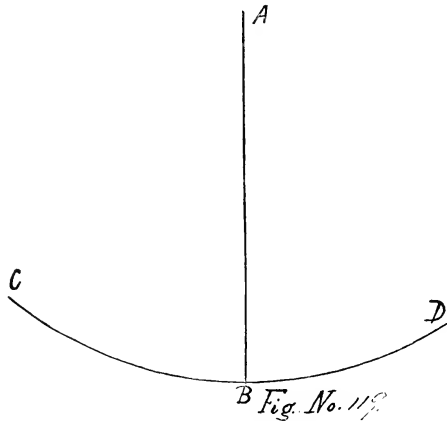

Fig. No. 118.

same radius, draw two more arcs and connect the points so formed by straight lines with point A. Draw straight lines from point to point for the bases of the triangles, and you then have the plan for the four sides of your pyramid. For the base of the pyramid select the base of either triangle and erect thereon a square. Draw the narrow edges for pasting, and cut and paste as in previous forms. Pyr-

amids may have any number of sides, but in all cases the manner of proceeding is the same. In No. 121 is shown the diagram of a triangular prism. Three triangles form the sides, and an equilateral triangle the base. To draw the equilateral triangle, use the



compass as directed in the last lesson for the triangular prism. It is a good idea in studying the formation of pyramids to always compare each pyramid with a prism having a corresponding number of sides. The hexagonal pyramid is shown in No. 122. Six equal triangles form the sides, and the hexagon, a plane figure having six equal sides, forms the base. As this is the first time we have been required to draw a hexagon it will be in order to give a short and simple method for this drawing. Draw a straight line as shown in the next illustration, and with half

the length of this line as a radius draw a circle. With the *same* radius, and each end of the line as a center in turn, cut the circumference on each side as indicated in figure No. 123. Connect the points of inter-

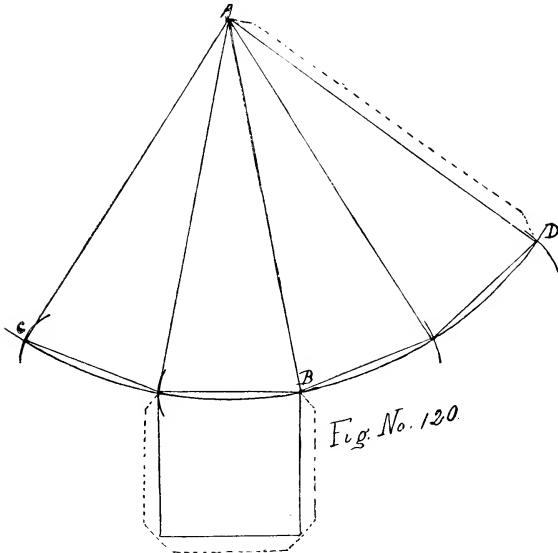

section by straight lines and a perfect hexagon will be the result. In representation No. 124 the plan for the hexagonal pyramid is to be seen. Six triangles are drawn with a common vertex, and the base of one of them forms one of the sides of the hexagon for the base of the pyramid. The hexagon is drawn in the manner just described. To find the point which is to be used as the center of the circle, proceed as if

you were drawing an equilateral triangle. (*See previous chapter.*) Then take the intersection of arcs as a central point, and the length of the bases of the triangles as a radius.

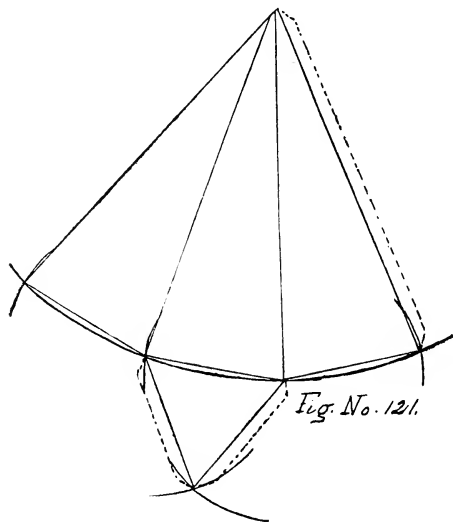

When the triangles forming the sides and base of a triangular pyramid are all equilateral, the pyramid is called an *equilateral triangular pyramid*. See figure No. 125. The next figure shows the plan for this solid. It is very simple, and requires no special explanation. Draw the large triangle first, then arrange your compass so as to have a radius equal to half of one of the sides of this large triangle, and *do not* change the radius until the figure is complete.

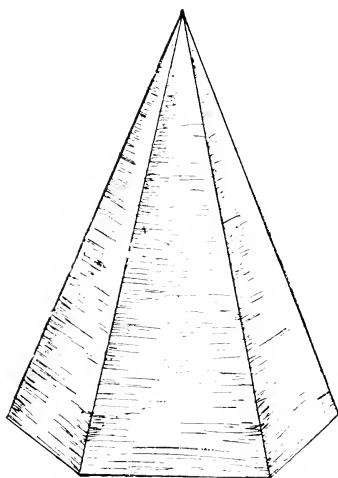

Fig. No. 122

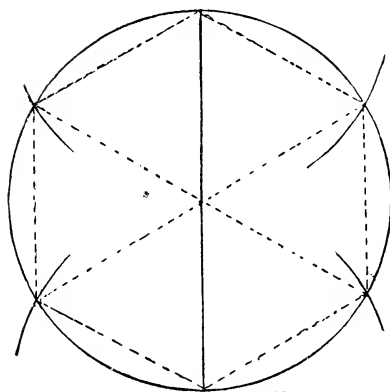
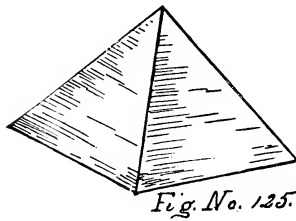
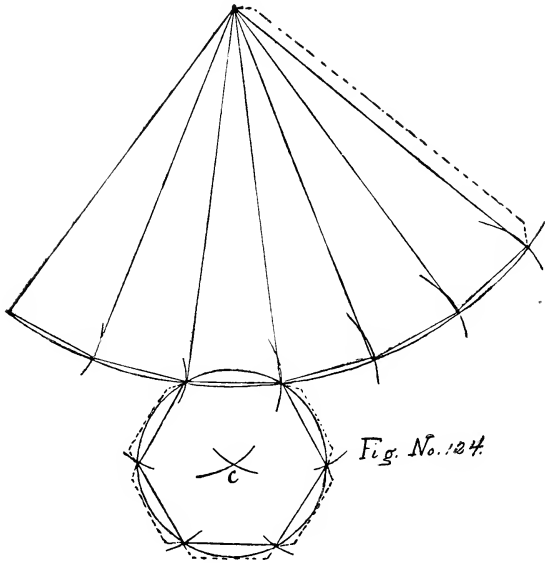

Fig. No. 123



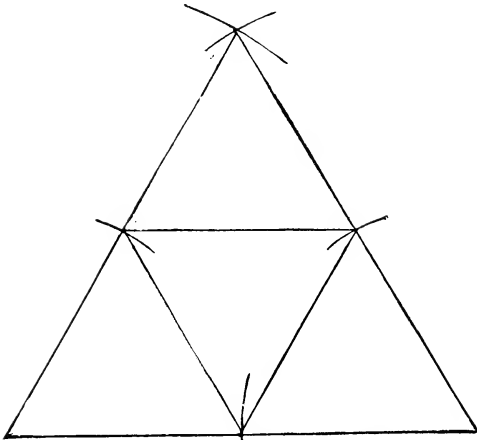

Fig. No. 126.

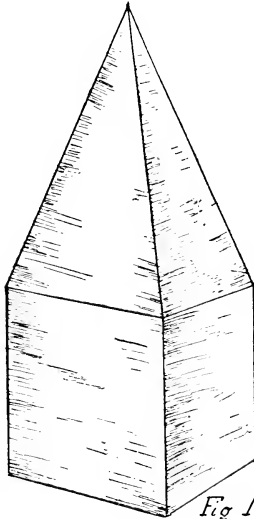
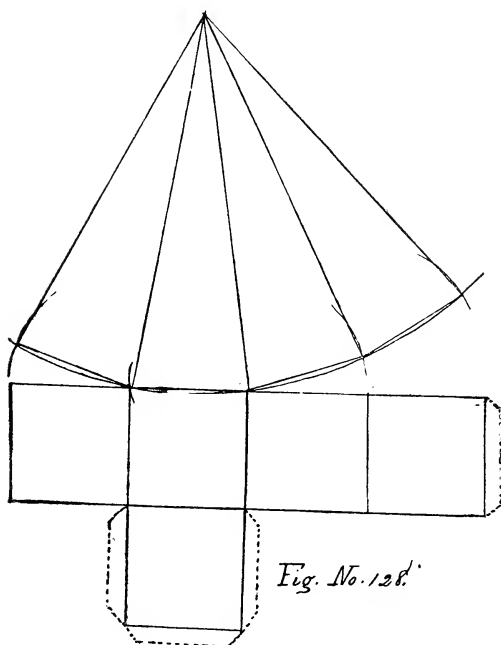

Fig. No. 127



COMBINATIONS OF SOLID FORMS.

From the explanations given for prisms and pyramids up to this time, the teacher will be able to advance, making these forms with any number of sides. By combining prisms, cubes, and pyramids, very pretty forms can be obtained. In illustration No. 127 is shown a cube and square pyramid combined, the result being very effective. The next figure represents

the plan for such a form combination. If, in place of the cube, you draw the plan for a square prism you

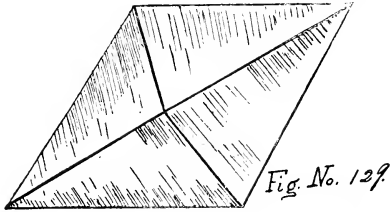

will have still another combination. Also you may omit the odd square at the lower part of the plan for

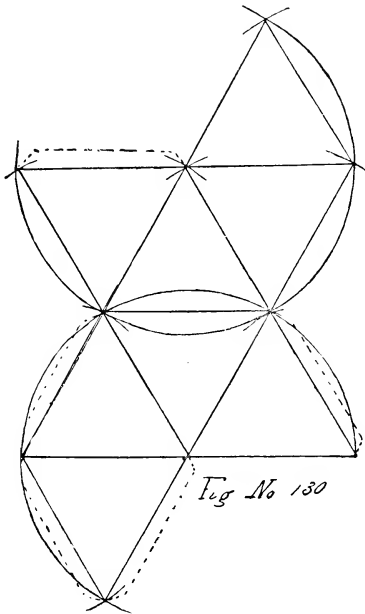

the cube, and instead draw another plan for a square pyramid. When folded you will have a handsome figure, which looks more difficult than it is in reality

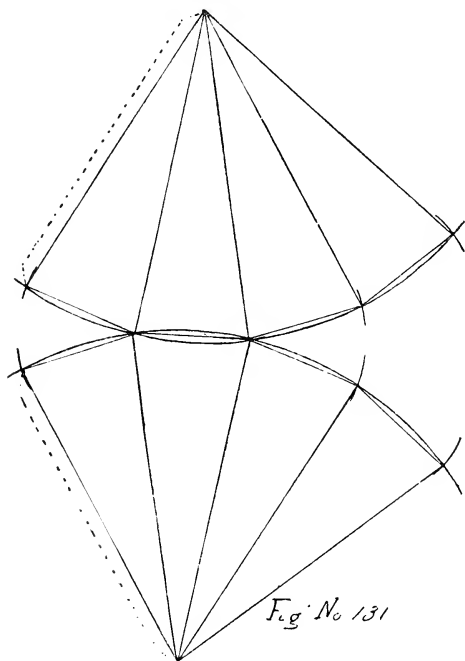

—a cube connecting two square pyramids. A solid which has eight equal faces, each face an equilateral triangle, is called an *octahedron*. Such a solid is represented in figure No. 129, and the plan is shown in the next figure. Eight equilateral triangles are drawn, two of them being joined at their bases. Draw

the flaps for pasting as indicated by the dotted lines. In No. 131 is the plan for a solid with eight triangu-

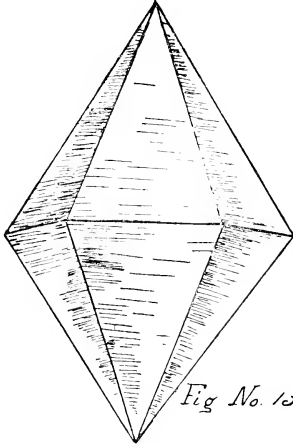

Fig No. 132.

lar faces, the triangles being isosceles, *not* equilateral. By using plan No. 130, and prolonging the arcs in which each set of four triangles is drawn, until the

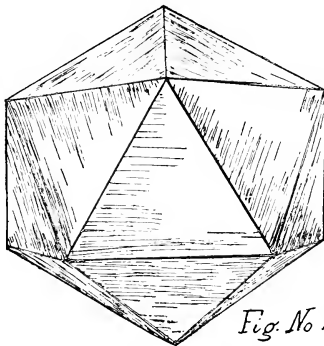

Fig. No 133.

circle is complete, also completing the hexagon in each circle, you will have altogether twelve equilateral triangles. These triangles, cut and pasted, will

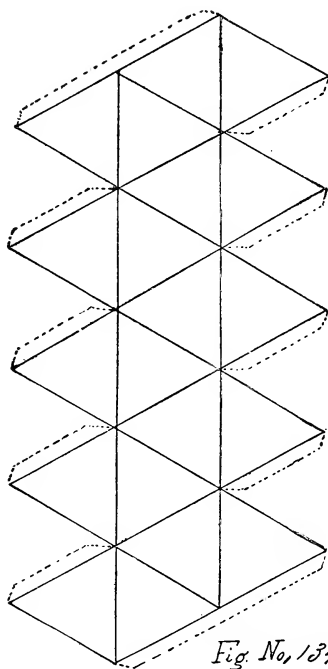

Fig. No. 134.

form a solid, such as is shown in figure No. 132. This solid is known as a *dodecahedron*. A twenty-sided solid is illustrated in No. 133. Each of the sides is an equilateral triangle, and the plan for drawing, cutting, and folding is represented in the next figure.

FRUSTUMS.

If the upper part of a pyramid is cut off, the portion remaining is called a *frustum*. In figures Nos.

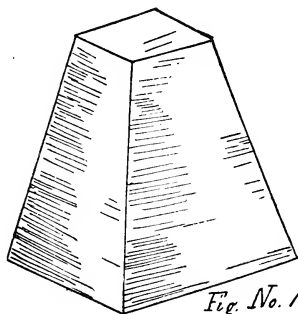

Fig. No. 135

135 and 136 are represented respectively frustums of a square prism and a hexagonal prism. The upper

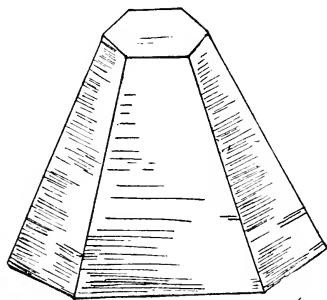
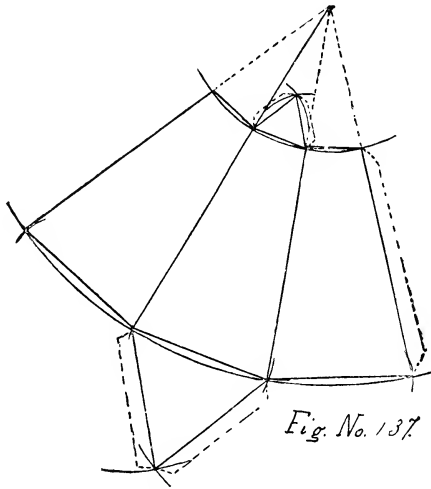

Fig. No. 136

face of a frustum is the same shape as the base of the pyramid, but, as a matter of course, is smaller. The

nearer the top of the pyramid the cutting is made, the smaller is the upper face. By examining the diagram shown in figure No. 137 you will see how frustums are drawn on paper for the purpose of fold-



ing and pasting. Proceed as if to draw a pyramid. Draw an arc the distance from the vertex that you desire the frustum to be cut. Draw straight lines as shown, which form the upper edges of the new figure, and draw the upper face projecting from one of these edges. The diagram illustrated here will fold into a frustum of a triangular pyramid.

