





9  
a2

x<sup>0</sup>  
TH  
7597  
A11  
1891



Digitized by the Internet Archive  
in 2010 with funding from  
Lyrasis Members and Sloan Foundation



## WORKS OF THE A. A. GRIFFING IRON COMPANY,

JERSEY CITY, N. J., U. S. A.

Junction New York & Newark Branch of Central Railroad of New Jersey, and Morris Canal.

LIBRARY

OCT 7 1949

U.S. PATENT OFFICE

1899

**ILLUSTRATED**

**CATALOGUE**

AND

PRICE LISTS OF

**BUNNY PATENT RADIATORS**

MADE BY

**A. A. Griffing Iron Co.**

461 COMMUNIPAW AVE. JERSEY CITY N.J.

THOS. H. WILLIAMS, Pres.      Branch Office 130 DEARBORN ST. CHICAGO ILL.

JAS. L. OGDEN, Vice Pres.      INTER OCEAN BUILDING

JOHN N. MATLOCK, M.E. GENERAL Supt.      NEW YORK OFFICE 106 LIBERTY ST.

SAM'L D. TOMPKINS, TREAS.      JAS. L. OGDEN JR. SECY.      PHILA. OFFICE, BUILDERS EXCH. 18 TO 24 S 7<sup>TH</sup> ST.

TH  
7480  
G8  
1891



ENTERED ACCORDING TO ACT OF CONGRESS, JAN. 1, IN THE YEAR 1891,  
BY A. A. GRIFFING IRON CO.,  
IN THE OFFICE OF THE LIBRARIAN OF CONGRESS, AT WASHINGTON, D. C.



CANCELLED

LIBRARY

OCT 7 1949

U S PATENT OFFICE

CONTENTS.

Angle Indirect, - - - - -	99, 100, 101	Hot Closet Dining Room Radiator, -	32 <sup>1</sup> / <sub>2</sub> , 44, 45, 46, 47, 48, 49
Announcement, - - - - -	6	Hot Water vs. Hot Air, - - - - -	17, 18, 19
Baker Automatic Air Valves, - - - - -	111	Indirect Radiators, - - - - -	96 to 107
Base, full size of Bundy, - - - - -	73	Japan. Bundy, - - - - -	115
Bay Window Defiance, - - - - -	88, 89	Marble Tops, - - - - -	118, 119, 120
Box Base Direct Indirect, - - - - -	50, 51	Measurements and Tapping, - - - - -	72
Brass Screens, - - - - -	54, 55, 56	Meigs, M. C., Report, - - - - -	124
Brass Screens, List, - - - - -	57	One Row Bundy, - - - - -	20, 21, 28, 29, 58, 61, 63, 66, 82, 83
Bronzing Liquid and Powder, - - - - -	114	Perfect Indirect, - - - - -	105, 106
Bundy Loop Wrench, - - - - -	112	Pet Cocks, Bundy, - - - - -	112
Ceiling Plates, - - - - -	117	Plates, Floor and Ceiling, - - - - -	117
Circular Radiators, - - - - -	34, 35, 38, 39	Pyro Radiator, - - - - -	76, 80, 80 <sup>1</sup> / <sub>2</sub> , 81, 82, 83
Climax Indirect, - - - - -	102, 103, 104	Pyro Wall, - - - - -	82, 83, 96 <sup>1</sup> / <sub>2</sub>
Code, Telegraph, - - - - -	8, 9, 10, 11, 12, 13, 14, 15, 16	Renaissance Radiators, - - - - -	48 <sup>1</sup> / <sub>2</sub> , 58 to 67
Column, - - - - -	36, 37, 38, 39	References, - - - - -	125
Corner, - - - - -	40, 41, 42, 43	Rochester Radiators, - - - - -	92, 93
Defiance Window, - - - - -	86, 87, 88, 89	Special Notice, - - - - -	7
Dining Room Hot Closet, - - - - -	32 <sup>1</sup> / <sub>2</sub> , 44, 45, 46, 47, 48, 49	Stairway Radiators, - - - - -	53
Direct Indirect Box Base, - - - - -	50, 51	Standard Bundy Loop, - - - - -	68, 69
Elite Radiator, Bundy, - - - - -	64 <sup>1</sup> / <sub>2</sub> , 76, 78, 79, 113	Steam and Hot Water vs. Hot Air, - - - - -	17, 18, 19
Emery, Chas., E. M. E. Report, - - - - -	121, 122, 123	Telegraph Code, - - - - -	8 to 16
Enlarged Bundy Loop, - - - - -	69	Thompson Loop, - - - - -	74, 75
Enamel, Bundy, - - - - -	115	Two Row Bundy, - - - - -	16 <sup>1</sup> / <sub>2</sub> , 22, 23, 30, 31, 59, 62, 64, 67
Eureka Indirect, - - - - -	107	Three Row Bundy, - - - - -	24, 25, 32, 33, 60 65
Eureka Window Indirect, - - - - -	108	Top Fret Work, Ornamental, - - - - -	73
Extended Surface Bundy Loop, - - - - -	70, 71	Top, Marble, - - - - -	118, 119, 120
Extended Surface Horizontal Indirect, - - - - -	98, 99	Triumph Radiator, - - - - -	77, 84, 85
Floor Plates, Bundy, - - - - -	117	Valves, Air, - - - - -	111, 112
Four Row Bundy, - - - - -	26, 27	Valves, Bundy Loop, - - - - -	109, 110
Flower City, - - - - -	99, 91	Wrench, Bundy Loop, - - - - -	112
Horizontal Bundy Indirect, - - - - -	96, 97, 98		

10/1149 - Shift - 710WS074 + 710WS074



67132

# ANNOUNCEMENT.

# IN

COMPILING OUR CATALOGUE FOR 1890-91, we have embodied therein a complete and comprehensive description of all our Radiators up to date of issue, interspersing, now and then, data pertinent to the subject of heating which we believe will prove of interest and value to any one who may read same.

## Improvements and New Designs.

We have made improvements in some of our Radiators, and brought out many new designs and now feel, more than ever before, that we make the largest and best assortment of Steam and Hot Water Radiators to be found anywhere. Our variety comprises over seven thousand different styles and sizes and of any one size, say 36 square feet of Heating Surface, we make over 300 different styles. Please to bear in mind that we manufacture nothing but Radiators and their immediate appurtenances, and so aim, and believe we have a right to claim that

**We make everything in Steam and Hot Water Radiators.**

Our extensive variety comprises a full line of Radiators having a Base and Top, Base and no top, Top and no Base, no Base nor Top, plain or nickel plated Top, Marble Top, Radiators with Arabesque (*Moorish*) Design, Renaissance Design, or plain, as the exigencies of the case may demand.

## Quality, High and Low Grade.

By the use of a special mixture of iron we are able to produce goods of the highest possible grade, close grain and strong, homogeneous and highly effective. In all fair and impartial tests of Radiators the Bundy has shown a superiority of from 10 to 60 per cent., and in 200 such tests by Mr. Chas. E. Emery, M. E., the Bundy Radiator showed an average superiority of 19.17 per cent. as reported by him. Our Hot Blast Furnaces are a special pattern designed by us and used exclusively in our business. Our goods have a larger percentage of carbon than any other, and while this adds to their cost of production, it makes them practically non-rustable and more effective as Radiators of heat.

## Over Twenty-five Million Square Feet of Bundy Radiators now in Use.

The universal adoption of the Bundy Radiator during the past ten years, or since its introduction attests more strongly than can anything else to its great superiority. During this time over 25,000 of the largest and best buildings in the world have been equipped with them, and we are continually receiving letters from users of our goods stating that they have never given them the slightest trouble or cost one cent for repairs. Other Radiators may appear cheaper for the reason that they cost a trifle less at first, but subsequent cost of repairs to correct defects soon more than make up this difference. An inferior Radiator may do fairly well when new, but the test comes after years of service. The Bundy Radiator has been in use for a long term of years and has never once failed to give satisfaction when set to place by a practical man.

## Less Fuel is Required Where the Bundy Radiator is Used.

This one item alone represents a saving to the user that pays a larger percentage on the investment than can be found any where, not taking into account the many other advantages also secured, long life of apparatus, noiseless operation, uniform, pleasant and healthful, no repairs or trouble of any description.

## Jersey City has Better Shipping Facilities than any other point in the Country.

Not even the great metropolis is so favorably located as Jersey City in point of shipping facilities. Its water frontage on the Hudson River and New York Bay, gives ready communication with every seaport of the commercial world. With all principal railroads terminating within its borders, it is linked with every city in the country. The result is that lower rates of freight and more prompt deliveries are secured from this point, than from any other in the United States.

## Large Stock, Prompt Shipment and Satisfaction Guaranteed.

Large quantities of regular goods we keep constantly in stock and can meet any demands promptly that may be made on us. We aim to please our customers in every conceivable way, for as we only manufacture Radiators and their immediate appliances we must satisfy a customer or lose his trade altogether.

We thank our many customers and friends for their liberal use of our goods in the past, and shall endeavor, by keeping up our present high standard of production and giving careful attention to all orders to merit a continuance of their esteemed trade and patronage.

**A. A. GRIFFING IRON CO.,**  
**Jersey City, New York, Chicago, Philadelphia.**



## SPECIAL NOTICE.

.....

IN ORDER TO SAVE CONSIDERABLE CORRESPONDENCE REGARDING RESPONSIBILITY OF SHIPPER,  
 CARRIER AND CONSIGNEE FOR LOSS OF AND DAMAGE TO GOODS, ETC., WE WOULD  
 CALL THE ATTENTION OF OUR CUSTOMERS TO THE FOLLOWING:

.....



SOON as goods are delivered in good order and condition in Jersey City or New York, and a receipt taken for same, our responsibility ceases. Should the Transportation Company insist on our signing a release or other document in reference to their liability, we must comply; this will not, however, in any way affect the right of the consignee (who is the real owner) to recover damages for any carelessness or negligence on the part of the carrier. It should be distinctly understood that we, as shippers, have no legal claim on the goods after they are delivered to the Transportation Company properly consigned, as the ownership has passed from us to the consignee. We will, however, endeavor to assist customers in getting claims adjusted.

We make a great variety of Radiators, and many different sizes, and have a great many customers. Hence it is absolutely impossible to remember what kind of Radiator, size, and style of tapping each particular customer may use.

To avoid mistakes in ordering, we would respectfully request our patrons to specify figure and size in our book. All Regular Steam Radiators are tapped 1" x 3/4" Right Hand, unless otherwise specified.

All Regular Hot Water Radiators are tapped 1 1/4" x 1 1/4" Right Hand, unless otherwise specified.

All measurements in this book are as accurately given as it is possible to get them, but as foundry castings vary in size, even when taken from the same pattern, a fact which all practical men, especially foundrymen understand and appreciate, we wish to state, that we do not hold ourselves liable for damages when the dimensions of the goods vary somewhat from those given. They are the average dimensions and we do not think that users will experience any difficulty in following them.

All claims for corrections or deductions must be made within ten days after receipt of goods.

Terms, Cash in Thirty days unless otherwise agreed upon.

Customers will protect their interests by examining goods to see that they have not been damaged in transit, before signing receipts for them.

Boxing and crating, when required, charged for at cost.

No goods insured, unless so ordered.

Full instructions as to making and shipping, must accompany each order. Where no instructions are given, all goods will be made in the regular way and shipped by the most expeditious route.

Permission must be received from us before any goods can be returned; and unless other arrangements are made, the party returning must in all cases pay freight and expenses, and be responsible for any damage to the goods until same are received by us.

As all parts of the "BUNDY" Radiator are interchangeable, to substitute a loop, base or top, or even change the height of a Radiator, it is not necessary to return the Radiator to our Works, as such change can be made at the building, by giving exact size when ordering required part.

All correspondence relating to business should be addressed to

**A. A. GRIFFING IRON CO.,**  
 454 Communipaw Ave., Jersey City, N. J.

## CODE FOR CORRESPONDENCE.



WITH a view of reducing the expense of telegraphing and facilitating the transaction of business between us, we have completed the following very complete Cipher Code. It will be found that a variety of questions and answers can be sent by means of this Cipher, and a very little practice will demonstrate its great convenience.

Please observe the following in writing a Cipher message :

**FIRST. Begin every Cipher word with a Capital letter.**

**SECOND. Whenever a blank occurs in a sentence, the word or words supplying such blank must follow the Cipher word of the sentence.**

### SAMPLE MESSAGE.

**IN PLAIN LANGUAGE, 38 WORDS.**

Ship via Star Union Line two three by twelve, four two by twenty, ten one by eighteen, all extended surface forty-two inches high, tapped one and one-quarter by one inch left hand iron tops, opposite ends.

**IN CIPHER, 13 WORDS.**

Hyena two Cattle, four Cargo, ten Calico, all Crumble Dotage Frantic Cupola Future.

**TELEGRAPH ADDRESS :**

**GRIFFING IRON WORKS, JERSEY CITY.**

**CABLE ADDRESS :**

**BUNDY, JERSEY CITY.**



NUMBER OR QUANTITY.

ABAPT.....	21	ACCELERATE.....	77	ADMITTED.....	245	AIRGUN.....	925	ANTIPHONE.....	6300
ABANDON.....	22	ACCESSION.....	78	ADMITTING.....	270	AIRHOLE.....	950	ANTIPHONY.....	6400
ABANDONED.....	23	ACCENT.....	79	ADMONISH.....	275	AIRTIGHT.....	975	ANTIPODE.....	6500
ABATEMENT.....	24	ACCIDENT.....	80	ADOPTED.....	280	ALABASTER.....	1000	ANTIPOPE.....	6600
ABBEY.....	25	ACCLAIM.....	81	ADORE.....	285	ALACK.....	1100	ANTIQUARY.....	6700
ABBOT.....	26	ACCLIMATE.....	82	ADORING.....	290	ALACRITY.....	1200	ANTIQUATE.....	6800
ABBREVIATE.....	27	ACCORD.....	83	ADROIT.....	295	ALARKBELL.....	1300	ANTIQUE.....	6900
ABDICATE.....	28	ACCORDANT.....	84	ADROITLY.....	300	ALARMED.....	1400	ANTIQUITY.....	7000
ABDOMEN.....	29	ACCORDION.....	85	ADULT.....	305	ALARMING.....	1500	ANTISEPTIC.....	7100
ABDOMINAL.....	30	ACCOST.....	86	ADVENT.....	310	ALBATROSS.....	1600	ANTHLER.....	7200
ABEYANCE.....	31	ACCOUNT.....	87	ADVENTURE.....	315	ALBEIT.....	1700	ANVIL.....	7300
ABHOR.....	32	ACCROACH.....	88	ADVERT.....	320	ALBIN.....	1800	ANXIETY.....	7400
ABIDE.....	33	ACCURUE.....	89	ADVERTISE.....	325	ALBION.....	1900	ANXIOUS.....	7500
ABIDING.....	34	ACCURATE.....	90	ADVOCATE.....	330	ALBUM.....	2000	AORTA.....	7600
ABILITY.....	35	ACCUSE.....	91	AFFABLE.....	335	ALBUMEN.....	2100	APARTMENT.....	7700
ABNORMAL.....	36	ACCUSING.....	92	AFFAIR.....	340	ALCHEMIST.....	2200	APATHY.....	7800
ABOARD.....	37	ACCUSTOM.....	93	AFFECTING.....	345	ALCOHOL.....	2300	APERTURE.....	7900
ABODANCE.....	38	ACHIEVE.....	94	AFFIDAVIT.....	350	ALDERMAN.....	2400	APEX.....	8000
ABODING.....	39	ACHIEVING.....	95	AFFINITY.....	355	ALERT.....	2500	APHELION.....	8100
ABOLISH.....	40	ACONITE.....	96	AFFIX.....	360	ALIEN.....	2600	APOLLO.....	8200
ABOLISHER.....	41	ACORNS.....	97	AFFIXING.....	365	ALIGNMENT.....	2700	APOLOGIZE.....	8300
ABOLITION.....	42	ACQUAINT.....	98	AFFLICT.....	370	ALLOT.....	2800	APOLOGY.....	8400
ABOMINABLE.....	43	ACQUIRE.....	99	AFFLICTION.....	375	ALLOW.....	2900	APOSTLE.....	8500
ABOMINATE.....	44	ACQUIT.....	100	AFFLUENT.....	380	ALLOY.....	3000	APPARATUS.....	8600
ABORIGINEAL.....	45	ACRID.....	105	AFFORD.....	385	ALLUDE.....	3100	APPAREL.....	8700
ABRASION.....	46	ACRIMONY.....	110	AFFORDING.....	390	ALLURE.....	3200	APPARENT.....	8800
ABRUPT.....	47	ACTION.....	115	AFFRAY.....	395	ALLUSION.....	3300	APPARTITION.....	8900
ABRUPTLY.....	48	ACTIVELY.....	120	AFFRIGHT.....	400	ALMANAC.....	3400	APPEAL.....	9000
ABCESS.....	49	ACTOR.....	125	AFFRONT.....	405	ALMOND.....	3500	APPEAR.....	9100
ABSCOND.....	50	ACTUAL.....	130	AFFIRE.....	410	ALOFT.....	3600	APPEARANCE.....	9200
ABSENCE.....	51	ACTUARY.....	135	AFFRAID.....	415	ALPHABET.....	3700	APPEASE.....	9300
ABSENT.....	52	ACTUATE.....	140	AFRICA.....	420	ALTAR.....	3800	APPELLANT.....	9400
ABSENTEE.....	53	ACUTE.....	145	AFTERCLAP.....	425	ALTERNATE.....	3900	APPEND.....	9500
ABSENTER.....	54	ACUTELY.....	150	AFTERNOON.....	430	ALUM.....	4000	APPENDAGE.....	9600
ABSOLUTE.....	55	ACUTENESS.....	155	AFTERWARD.....	435	ALUMINATE.....	4100	APPENDANT.....	9700
ABSOLUTELY.....	56	ADAGE.....	160	AGAINST.....	440	AMALGAM.....	4200	APPENDIX.....	9800
ABSORB.....	57	ADAMANT.....	165	AGENCY.....	445	AMASS.....	4300	APPERTAIN.....	9900
ABSORBING.....	58	ADAPT.....	170	AGGRESSOR.....	450	AMATEUR.....	4400	APPETITE.....	10000
ABSORBENT.....	59	ADAPTING.....	175	AGGRIEVE.....	455	AMATIVE.....	4500	APPETIZER.....	15000
ABSTAIN.....	60	ADDICT.....	180	AGHAST.....	500	AMAZEMENT.....	4600	APPLAUD.....	20000
ABSTAINER.....	61	ADDITION.....	185	AGILE.....	525	AMAZON.....	4700	APPLAUSE.....	25000
ABSTAINING.....	62	ADDRESS.....	190	AGILITY.....	550	AMBER.....	4800	APPLE.....	30000
ABSTINENCE.....	63	ADHERE.....	195	AGITATE.....	575	AMEND.....	4900	APPLEJACK.....	35000
ABSTRACT.....	64	ADHERENT.....	200	AGITATING.....	600	AMERICAN.....	5000	APPLEJOHN.....	40000
ABSURD.....	65	ADHESION.....	205	AGITATIVE.....	625	AMUCK.....	5100	APPLEPIE.....	45000
ABSURDITY.....	66	ADHESIVE.....	210	AGITATOR.....	650	AMULET.....	5200	APPLETREE.....	50000
ABSURDLY.....	67	ADJACENT.....	215	AGONIZE.....	675	ANALYST.....	5300	APPLIANCE.....	55000
ABUNDANCE.....	68	ADJECTIVE.....	220	AGONIZING.....	700	ANCHOR.....	5400	APPLICABLE.....	60000
ABUNDANT.....	69	ADJOIN.....	225	AGONY.....	725	ANDIRON.....	5500	APPLICANT.....	65000
ABUSE.....	70	ADJURE.....	230	AGREE.....	750	ANECDOTE.....	5600	APPLY.....	70000
ABUSED.....	71	ADJUST.....	235	AGREEABLE.....	775	ANIMATE.....	5700	APPOINT.....	75000
ABUSING.....	72	ADMIRABLE.....	240	AGREEING.....	800	ANNOIT.....	5800	APPOINTEE.....	80000
ABUSIVE.....	73	ADMIRAL.....	245	AIDANCE.....	825	ANTIDATE.....	5900	APPRAISE.....	85000
ABYSS.....	74	ADMIRE.....	250	AIDLESS.....	850	ANTHEM.....	6000	APPRECIATE.....	90000
ACADEMIC.....	75	ADMIRING.....	255	AIMLESS.....	875	ANTIC.....	6100	APPREHEND.....	95000
ACADEMY.....	76	ADMIT.....	260	AIMLESSLY.....	900	ANTI-PATHY.....	6200	APPRENTICE.....	100000



## STYLES OF RADIATORS.

NO OF SECTIONS.	ELITE.	TRIUMPH.	CLIMAX.	PERFECT.	SECTIONS - - RADIATORS.
1	BABY	BEAD	BLACKBIRD	BOY	50 BRACELET
2	BACHELOR	BEAM	BLACKMAIL	BOYLIKE	75 BRADAWL
3	BACKBITER	BEAUTY	BLAMABLE	BOYHOOD	100 BRAZEN
4	BACKBOARD	BEAUTIFUL	BLAMEFUL	BOYISH	200 BREAKFAST
5	BACKGROUND	BECALM	BLANKET	BOYISHLY	300 BREWERY
6	BACKWARD	BECOME	BLEAK	BOYISHNESS	400 BRICKLAYER
7	BAGPIPE	BEDDING	BLEND	BOYSPLAY	500 BRICKWORK
8	BALANCE	BEDECK	BLISS	BRACE	600 BRIGHTLY
9	BALCONY	BEDMAKER	BLOCKADE	BRACER	700 BRIMSTONE
10	BALDPATE	BEDTIME	BLOCKHOUSE	BRACING	800 BUCKSKIN
11	BALE	BEDWORK	BLOCKHEAD	BRACKET	900 BUCKHORN
12	BALLAST	BEFALL	BLOODSHED	BRACKETING	1000 BULLETIN
13	BALLOT	BEFOOL	BLOOM	BRACKISH	1100 BULLOCK
14	BANDAGE	BEFRIEND	BLOSSOM	BRAD	1200 BULLSEYE
15	BANDANA	BEGUILE	BLUEBELL	BRAG	1300 BULRUSH
16	BANDBOX	BEHAVE	BLUEBOOK	BRAGGED	1400 BULWARK
17	BANNER	BEHEAD	BOARD	BRAGGING	1500 BUMBLEBEE
18	BANQUET	BEHAVIOR	BOARDING	BRAGGART	1600 BUNDLE
19	BAPTISM	BELLOWS	BOASTFUL	BRAGLESS	1700 BUNGLER
20	BAREFOOT	BELOVED	BOATMAN	BRAID	1800 BUNION
21	BARGAIN	BEREAVE	BOBTAIL	BRAIDING	1900 BUNTING
22	BARLEY	BESTOW	BOLDFACE	BRAIN	2000 BURDEN
23	BARLEYCORN	BETRAY	BOMBARD	BRAINED	3000 BURDEN SOME
24	BARONET	BETIDE	BOOKFUL	BRAINLESS	4000 BUREAU
25	BARRACK	BETROTH	BOOTJACK	BRAKE	5000 BURGLAR
26	BARRIER	BETWIXT	BOUQUET	BRAKEMAN	6000 BURLESQUE
27	BARRISTER	BEWAIL	BOTANY	BRAMBLE	7000 BUSHEL
28	BASEMENT	BEWARE	BONEDUST	BRAMBLING	8000 BUTTERFLY
29	BAYONET	BEWILDER	BOUNDLESS	BRAN	9000 BYLAW
30	BAYTREE	BEWITCH	BOXWOOD	BRANCH	10000 BYWORD

ONE RCW.	TWO ROW.	THREE ROW.	FOUR ROW.	FIVE AND SIX ROW.
CABBAGE.....1 x 3	CAMERA.....2 x 3	CARVING.....3 x 3	CAVERN.....4 x 3	CIDER.....5 x 3
ABIN.....1 x 4	CAMPAIGN.....2 x 4	CASCADE.....3 x 4	CAVITY.....4 x 4	CINNAMON.....5 x 4
CABLE.....1 x 5	CAMPHOR.....2 x 5	CASINO.....3 x 5	CEDAR.....4 x 5	CITIZEN.....5 x 5
CABOOSE.....1 x 6	CANARY.....2 x 6	CASKET.....3 x 6	CENTURY.....4 x 6	CIVIL.....5 x 6
CACKLE.....1 x 7	CANDLE.....2 x 7	CASTOR.....3 x 7	CHAINING.....4 x 7	CLATTER.....5 x 7
CACTUS.....1 x 8	CANKER.....2 x 8	CASTLE.....3 x 8	CHARITY.....4 x 8	CLERGY.....5 x 8
CADAVER.....1 x 9	CANNIBAL.....2 x 9	CATACOMB.....3 x 9	CHATTEL.....4 x 9	CLINCH.....5 x 9
CADENCE.....1 x 10	CANOPY.....2 x 10	CATARACT.....3 x 10	CHECKMATE.....4 x 10	CLINKER.....5 x 10
CADET.....1 x 11	CANYAS.....2 x 11	CATNIP.....3 x 11	CHERRY.....4 x 11	CLOAK.....6 x 3
CAGE.....1 x 12	CAPITAL.....2 x 12	CAULLE.....3 x 12	CHIEF.....4 x 12	CLOUD.....6 x 4
CALAMITY.....1 x 13	CAPSTAN.....2 x 13	CAUCUS.....3 x 13	CHILD.....4 x 13	CLOVER.....6 x 5
CALCIUM.....1 x 14	CARAVAN.....2 x 14	CAVALRY.....3 x 14	CHIMNEY.....4 x 14	COBBLER.....6 x 6
CALDRON.....1 x 15	CARBOY.....2 x 15		CHINESE.....4 x 15	COCKNEY.....6 x 7
CALENDAR.....1 x 16	CARCASS.....2 x 16		CHURCH.....4 x 16	CODICIL.....6 x 8
CALICO.....1 x 18	CARDINAL.....2 x 18			COFFIN.....6 x 9
CALLOUS.....1 x 20	CARGO.....2 x 20			COLLUSION.....6 x 10
CALMNESS.....1 x 22	CARPET.....2 x 22			
CALOMEL.....1 x 24	CARRIAGE.....2 x 24			
CAMEL.....1 x 26	CARTOON.....2 x 26			

CIRCULARS.	CORNERS AND COLUMNS.	MISCELLANEOUS	MISCELLANEOUS.
COMBUSTION 10 Circular.	COMPOSE..... 10 Corner.	COTTAGE... Dining Room Hot Closet.	CRUMBLE... Extended Surface.
COMEDIAN... 15 Circular.	CONCERT..... 15 Corner.	COURTSHIP... Window.	CRYSTAL... Enlarged Surface.
COMFORT... 20 Circular.	CONFISCATE... 20 Corner.	COURAGE... Horizontal Indirect.	CULPRIT... Hot Water.
COMICAL... 26 Circular.	CONFLICT..... 25 Corner.	CRAPE..... Angle Indirect.	CUPID..... Marble Binder.
COMPANION... 34 Circular.	CONFORM..... 28 Corner.	CRAVAT... Angle Pin Indirect.	CUPOLA... Iron Tops.
COMPARISON... 50 Circular.	CONQUEST... 26 Column.	CRIBBAGE... Golds Pin Indirect.	CURATE... Brass Screen.
COMPASS... 72 Circular.	CONVULSION... 34 Column.	CRICKET... Direct Indirect.	CURFEW... Bronzed.
COMPLEX... 74 Circular.	CORDAGE... 50 Column.	CRUSH..... Box Base.	CURRENT... Renaissance with Pillars.
COMPLEXION 142 Column		CRUMB..... Baker Air Valve.	CUSHION... Renaissance without Pillars.



HEIGHT FROM FLOOR TO TOP OF SCREEN.

DAGGER.....10'	DAYLIGHT.....15'	DEFEND.....26'	DIGEST.....34'	DOVETAIL.....45'
DAISY.....11'	DAZZLE.....19'	DEGRADE.....27'	DIRK.....35'	
DAMAGE.....12'	DEACON.....20'	DEMOLISH.....28'	DISH.....36'	
DAMPER.....13'	DEAFEN.....21'	DENTAL.....29'	DOCK.....37'	
DAMSEL.....14'	DEBATE.....22'	DEPART.....30'	DOG.....38'	
DARKEN.....15'	DECLARE.....23'	DEPRIVE.....31'	DOLPHIN.....39'	
DARLING.....16'	DECOY.....24'	DESTROY.....32'	DOMAIN.....40'	
DATE.....17'	DEFAULT.....25'	DENTER.....33'	DOTAGE.....42'	

TAPPING.

RIGHT HAND.	RIGHT HAND.	LEFT HAND.	LEFT HAND.
EGOTIST..... $\frac{3}{4}$ × $\frac{3}{4}$ '	EMPIRE.....1 $\frac{1}{4}$ × $\frac{3}{4}$ '	FABLE..... $\frac{3}{4}$ × $\frac{3}{4}$ '	FORGERY.....1 $\frac{1}{4}$ " × $\frac{3}{4}$ "
ELASTIC..... $\frac{3}{4}$ × $\frac{3}{4}$ '	EMPTY.....1 $\frac{1}{4}$ × 1'	FACULTY..... $\frac{3}{4}$ × $\frac{1}{2}$ '	FRANTIC.....1 $\frac{1}{4}$ " × 1"
ELDER.....1' × $\frac{3}{4}$ '	ENGINE.....1 $\frac{1}{4}$ × 1 $\frac{1}{4}$ '	FAIRY.....1' × $\frac{3}{4}$ '	FURNACE.....1 $\frac{1}{4}$ " × 1 $\frac{1}{4}$ "
ELEGANT.....1'	ENGRAVE.....1 $\frac{1}{2}$ '	FASHION.....1'	FURNITURE.....1 $\frac{1}{2}$ '
ELOPE.....1' > 1'	ENGROSS.....1 $\frac{1}{2}$ × 1'	FETLOCK.....1' × 1'	FURROW.....1 $\frac{1}{2}$ " × 1"
EMBARK.....1 $\frac{1}{4}$ '	ENIGMA.....2'	FLOWER.....1 $\frac{1}{4}$ '	FURTIVE.....2'
FURY..... Same End		FUTILE..... Feed in Top.	
FUTURE..... Opposite End.		FUTURITY..... Feed in Base.	

REFERRING TO FIG.

YOUR ILLUSTRATED CATALOGUE

1 GABBLE	13 $\frac{1}{2}$ GIRDLE	30 GRAPHIC	44 $\frac{1}{4}$ GULLED	61 GURGLING
2 GAINFUL	14 GIRLHOOD	31 GRATUITY	44 $\frac{1}{2}$ GULLING	62 GUSH
3 GAITER	14 $\frac{1}{2}$ GIZZARD	32 GRAVEL	44 $\frac{1}{4}$ GULLER	63 GUSHING
4 GALLOW	15 GLADSOME	33 GROUP	45 GULLERY	64 GUST
5 GALVANIC	16 GLANDERS	34 GRUDGE	45 $\frac{1}{2}$ GULLET	65 GUSTY
6 GAMBLER	17 GLENDALE	35 GRUMBLE	46 GULLISH	66 GUT
7 GAMESTER	18 GLIMMER	36 GRUNT	47 GULLY	67 GUTTED
8 GARBAGE	19 GLISTEN	37 GUANO	48 GULP	68 GUTTER
8 $\frac{1}{2}$ GARDEN	19 $\frac{1}{2}$ GLOBULAR	38 GUARDIAN	49 GUM	69 GUTTERING
9 GARLIC	19 $\frac{3}{4}$ GLOMERATE	39 GUIDANCE	50 GUMMED	70 GUTTERAL
10 GAUDY	20 GLORIFY	39 $\frac{1}{2}$ GUIDING	51 GUMMING	71 GUY
10 $\frac{1}{4}$ GAUNFLET	21 GLOSSARY	40 GUILD	52 GUMMINESS	72 GUZZLE
10 $\frac{1}{2}$ GELATINE	22 GLUTTON	40 $\frac{1}{2}$ GUILLE	43 GUMMY	73 GUZZLER
10 $\frac{3}{4}$ GENIUS	23 GLYCERINE	41 GUILLOTINE	54 GUMPTION	74 GYMNASIUM
11 GENTEEL	24 GOBLET	41 $\frac{1}{2}$ GUILTY	55 GUN	75 GYMNAST
11 $\frac{1}{2}$ GEOLOGY	25 GOLDEN	42 GUINEA	56 GUNNAGE	76 GYPSUM
12 GHOST	26 GOSPEL	42 $\frac{1}{2}$ GULF	57 GUNNER	77 GYPSY
12 $\frac{1}{2}$ GIGANTIC	27 GOVERNNESS	43 GUITAR	58 GUNNERY	
12 $\frac{3}{4}$ GIMCRACK	28 GRACEFUL	43 $\frac{1}{2}$ GULL	59 GUNNING	
13 GIPSY	29 GRADUATE	44 GULLEF	60 GURGLES	

ORDERS AND SHIPMENTS.

HABIT.... Answer how soon can ship.....	HANDCUFF..Advices in regard to order ...too late, it wa <sup>s</sup> shipped.....
HACKNEY...Can ship at once if tapping is 1' × $\frac{3}{4}$ " R. H.	HANDSOME..When will order No ...be shipped?
HADDOCK...Ship immediately.	HANGMAN...If you have shipped our order of....please send tracer as we need it badly.
HAGGARD...Send shipping directions.	HANKER...Omit....from our order of.....
HALIBUT...Will send directions by mail.	HAPPY.....Omit....from our order No.....
HALLOW...Have you shipped our order of.....?	HATCHET...Substitute on our order of...in place of.....
HALTER... Your order was shipped.....	HATCHWAY..Add to our order No.....
HAMLET...Your order will be shipped....	HATEFUL...Duplicate order No.....
HAMMER...Add to our order of.....	
HAMMOCK...If you have not shipped order of...hold for further advices.	

CAN SHIP ORDER IN \_\_\_\_\_ DAYS FROM RECEIPT.

1 HATRED	6 HAWTHORN	11 HEADLONG	16 HELLISH	21 HERRING
2 HAUGHTY	7 HAZARD	12 HEAP	17 HEMLOCK	
3 HAUNTED	8 HAZEL	13 HEARSE	18 HERALD	
4 HAVOCK	9 HEADLESS	14 HEATHEN	19 HERESY	
5 HAWK	10 HEADWAY	15 HEBREW	20 HERO	



## Shipping Line.

SHIP VIA.
HEXAGON.....Anchor Line.
HIDEOUS.....A. T. & S. Fe R. R.
HIGGLE.....Antwerp.
HIGHLAND.....Boat.
HIGHWAY.....Balt. & O. R. R.
HILARITY.....Blue Line.
HILLOCK.....Bristol.
HINDER.....Bordeaux.
HINT.....Continental Line.
HIRELING.....Ches. & Ohio R. R.
HISSING.....Chi. & N. W. R. R.
HISTORY.....Chi., Bur. & Quincy R. R.
HIVE.....Chi., Mil. & St. Paul R. R.
HOARD.....Clyde Line.
HOBART.....Charleston Steamer.
HOBBY.....Chi., R. I. & Pac. R. R.
HOBBLE.....Canada Southern.
HOBSON.....Del., Lack. & Western.
HOCK.....Empire Line.
HOGGISH.....Ere Desp.
HOLIDAY.....Erie R. R.
HOLINESS.....Express.
HOLLAND.....Fast Freight.
HOMAGE.....First Steamer.
HOMELESS.....Globe Line.
HOMESICK.....Gt. West. Desp.
HOMICIDE.....Glasgow.

SHIP VIA.
HONEST.....Hoosac Tunnel.
HOODWINK.....Hull.
HOPEFUL.....Havre.
HOPPER.....Hamburg.
HORNET.....Kenawha Desp.
HORIZON.....Lackawanna Line.
HORRID.....Lehigh Valley R. R.
HOSPITAL.....Liverpool.
HOTHOUSE.....London.
HOUND.....Metropolitan Line.
HOSE.....Mer. Desp.
HOWLING.....Mallory Line.
HUCKSTER.....Morgan Line.
HUMANITY.....N. V. C. & H. R. R. R.
HUMBLE.....N. Y., N. H. & H. R. R.
HUMBUG.....Norwich Line.
HUMORIST.....N. Y., S. & Western R. R.
HUNGRY.....N. J. C. R. R.
HUNTSMAN.....Old Dominion Line.
HURDLE.....Penna. R. R.
HUSBAND.....Phila. & Reading R. R.
HUSKY.....Red Line.
HIVENA.....Star Union Line.
HYPOCRITE.....Traders' Desp.
HYPHEN.....Texas Steamer.
HYSTERIC.....Union Pac.
HYSON.....West Shore R. R.

## Prices and Quotations.

IDEAL.....Quote lowest price on.....  
 IDIOT.....Quote lowest price f. o. b. on.....  
 IGNOBLE.....This price for immediate acceptance.  
 ILLEGAL.....Our offer of.....withdrawn.  
 ILLUSION.....Carload lots.  
 IMBECILE.....All prices withdrawn as previously quoted.

IMBIBE.....Less than car load lots.  
 IMITATE.....With freight allowance to.....  
 IMMERGE.....With.....freight allowance.  
 IMMODEST.....If.....writes for prices quote.....  
 IMMORAL.....What price shall we quote.....

### Quote Lowest Price on..... Loops.

100 IMPACT	600 IMPLICATE	1,200 INDICATE	3,000 INHABIT
200 IMPARTIAL	700 INCLINE	1,500 INDULGE	3,500 INHALE
300 IMPATIENT	800 INCOME	1,800 INFAMY	4,000 INSAPE
400 IMPEACH	900 INCUBATE	2,000 INFIDEL	4,500 INSECT
500 IMPERIAL	1,000 INDELIBLE	2,500 INFLATE	5,000 IRRITATE

100 JABBER..... .25	100 JACKAL..... .25	100 JACKDAW..... .25	100 JACKET..... .25
100 JACOBITE..... .25	100 JALAP..... .25	100 JANITOR..... .25	100 JAPAN..... .25
100 JASPER..... .25	100 JAUNDICE..... .25	100 JEALOUS..... .25	100 JELLY..... .25
100 JEOPARD..... .25	100 JERK..... .25	100 JESUIT..... .25	100 JEWELL..... .25
100 JIG..... .25	100 JINGLE..... .25	100 JOCKEY..... .25	100 JOINER..... .25
100 JOKE..... .25	100 JOURNAL..... .27 1/2	100 JOURNEY..... .27 1/2	100 JOY..... .27 1/2
100 JUBILANT..... .27 1/2	100 JUDGMENT..... .27 1/2	100 JUG..... .27 1/2	100 JUICE..... .27 1/2
100 JUMBLE..... .27 1/2	100 JUMP..... .27 1/2	100 JUNCTION..... .27 1/2	100 JUNIOR..... .27 1/2
100 JUNIPER..... .27 1/2	100 JURIST..... .27 1/2	100 JUSTICE..... .27 1/2	



Prices and Quotations—Continued.

WILL QUOTE				WILL QUOTE				
F. O. B.				F. O. B.				
	Discount per cent.	Equivalent.	Net.		Discount per cent.	Equivalent.	Net.	
JUSTIFY.....	27½	7½ and 10	.3664	LEARNED.....	35	and 10	.415	.585
JUVENILE.....	27½ and 10		.3475	LEASE.....	35	10 and 2½	.4266	.5704
KANGAROO.....	27½	10 and 2½	.3638	LEATHER.....	35	10 and 5	.44425	.55575
KEEL.....	27½	10 and 5	.3801	LEAVEN.....	35	10 and 7½	.4580	.5411
KEEPER.....	27½	10 and 7½	.3965	LECTURE.....	35	10 and 10	.4735	.5265
KEG.....	27½	10 and 10	.41275	LEGACY.....	37½		.375	.625
KENNEL.....	30		.30	LEGAL.....	37½ and 2½		.3906	.6004
KETTLE.....	30	and 2½	.3175	LEGATION.....	37½	2½ and 2½	.4059	.5941
KEYHOLE.....	30	2½ and 2½	.3346	LEGION.....	37½	2½ and 5	.4211	.5789
KEYSTONE.....	30	2½ and 5	.3516	LEGISLATE.....	37½	2½ and 7½	.4363	.5637
KICK.....	30	2½ and 7½	.3687	LEISURE.....	37½	2½ and 10	.4516	.5484
KIDNAP.....	30	2½ and 10	.38575	LEMON.....	37½ and 5		.40625	.59375
KIDNEY.....	30	and 5	.335	LEPROSY.....	37½	5 and 2½	.4211	.5789
KINDLE.....	30	5 and 2½	.3516	LETHARGY.....	37½	5 and 5	.4359	.5641
KINDNESS.....	30	5 and 5	.36825	LETTUCE.....	37½	5 and 7½	.4508	.5492
KING.....	30	5 and 7½	.3849	LEVITY.....	37½	5 and 10	.4656	.5344
KISS.....	30	5 and 10	.4015	LEWDNESS.....	37½ and 7½		.4219	.5781
KIT.....	30	and 7½	.3525	LEXICON.....	37½	7½ and 2½	.4363	.5637
KITCHEN.....	30	7½ and 2½	.3687	LIBEL.....	37½	7½ and 5	.4508	.5492
KITE.....	30	7½ and 5	.3849	LIBERAL.....	37½	7½ and 7½	.4652	.5348
KNAPSACK.....	30	7½ and 7½	.4009	LIBRARY.....	37½	7½ and 10	.4797	.5203
KNAVE.....	30	7½ and 10	.41725	LIFELESS.....	37½ and 10		.4375	.5625
KNEE.....	30	and 10	.37	LIGAMENT.....	37½	10 and 2½	.4516	.5484
KNELL.....	30	10 and 2½	.38575	LIGHTNING.....	37½	10 and 5	.4656	.5344
KNIFE.....	30	10 and 5	.4016	LIMBER.....	37½	10 and 7½	.4797	.5203
KNOCK.....	30	10 and 7½	.41725	LIMPID.....	37½	10 and 10	.49375	.50625
LABEL.....	30	10 and 10	.433	LINGUISTI.....	40		.40	.60
LACKEY.....	32½		.325	LION.....	40	and 2½	.415	.585
LADDER.....	32½ and 2½		.3419	LIQUOR.....	40	2½ and 2½	.4296	.5704
LADLE.....	32½	2½ and 2½	.3583	LITANY.....	40	2½ and 5	.44425	.55575
LAG.....	32½	2½ and 5	.3748	LITIGATE.....	40	2½ and 7½	.4589	.5411
LAKE.....	32½	2½ and 7½	.3912	LITTER.....	40	2½ and 10	.4735	.5265
LAMB.....	32½	2½ and 10	.4077	LIVELY.....	40	and 5	.43	.57
LAMENT.....	32½ and 5		.35875	LIVERY.....	40	5 and 2½	.44425	.55575
LAMPBLACK.....	32½	5 and 2½	.3748	LIZARD.....	40	5 and 5	.4585	.5415
LANCET.....	32½	5 and 5	.3908	LOADSTONE.....	40	5 and 7½	.47275	.52725
LANDING.....	32½	5 and 7½	.4068	LOBBY.....	40	5 and 10	.487	.513
LANDMARK.....	32½	5 and 10	.4229	LOBSTER.....	40	and 7½	.445	.555
LANE.....	32½ and 7½		.3756	LOCKER.....	40	7½ and 2½	.4589	.5411
LANGUAGE.....	32½	7½ and 2½	.3912	LOCUST.....	40	7½ and 5	.47275	.52725
LANTERN.....	32½	7½ and 5	.4068	LOFTY.....	40	7½ and 7½	.4866	.5134
LAP.....	32½	7½ and 7½	.4226	LOGIC.....	40	7½ and 10	.5005	.4995
LARBOARD.....	32½	7½ and 10	.4381	LONGITUDE.....	40	and 10	.46	.54
LARDER.....	32½ and 10		.3925	LORDSHIP.....	40	10 and 2½	.4735	.5265
LARKSPUR.....	32½	10 and 2½	.4077	LOTTERY.....	40	10 and 5	.487	.513
LASH.....	32½	10 and 5	.4229	LOVELY.....	40	10 and 7½	.5005	.4995
LATCH.....	32½	10 and 7½	.4381	LOWLAND.....	40	10 and 10	.524	.476
LATERAL.....	32½	10 and 10	.45325	LOYAL.....	42½		.4394	.575
LATIN.....	35		.35	LUBBER.....	42½ and 2½		.4294	.5706
LATITUDE.....	35	and 2½	.36625	LUMBAGO.....	42½	2½ and 2½	.4534	.5466
LATTICE.....	35	2½ and 2½	.3821	LUNACY.....	42½	2½ and 5	.4674	.5326
LAUDANUM.....	35	2½ and 5	.3979	LURID.....	42½	2½ and 7½	.4814	.5186
LAUNCH.....	35	2½ and 7½	.4138	LUTHERAN.....	42½	2½ and 10	.4954	.5046
LAUNDRY.....	35	2½ and 10	.4296	LUXURY.....	42½ and 5		.45375	.54625
LAUREL.....	35	and 5	.3825	MACKEREL.....	42½	5 and 2½	.4674	.5326
LAVATORY.....	35	5 and 2½	.3979	MADCAP.....	42½	5 and 5	.4811	.5189
LAWFUL.....	35	5 and 5	.4134	MADHOUSE.....	42½	5 and 7½	.4947	.5053
LAWLESS.....	35	5 and 7½	.4288	MAGAZINE.....	42½	5 and 10	.5084	.5916
LAXATIVE.....	35	5 and 10	.44425	MAGENTA.....	42½ and 7½		.4681	.5319
LAYMAN.....	35	and 7½	.39875	MAGIC.....	42½	7½ and 2½	.4814	.5186
LEADER.....	35	7½ and 2½	.4138	MAGNETIC.....	42½	7½ and 5	.4947	.5053
LEAGUE.....	35	7½ and 5	.4288	MAGNOLIA.....	42½	7½ and 7½	.508	.492
LEAKAGE.....	35	7½ and 7½	.4438	MANDRAKE.....	42½	7½ and 10	.5213	.4787
LEAP.....	35	7½ and 10	.4589	MANKIND.....	42½ and 10		.4825	.5175



Prices and Quotations—Continued.

WILL QUOTE		D'scount per cent.		Equivalent.	Net.	WILL QUOTE		Dis'count per cent.		Equivalent.	Net.
F. C. B.						F. C. B.					
MAPLE.....	42½	10	and 2½	.4954	.5046	OBEDIENT.....	50	10	and 5	.5725	.4275
MARINE.....	42½	10	and 5	.5084	.4916	OBELISK.....	50	10	and 7½	.58375	.41625
MARKET.....	42½	10	and 7½	.5213	.4787	OBITUARY.....	50	10	and 10	.505	.495
MASTIFF.....	42½	10	and 10	.53425	.46575	OBSTACLE.....	52½			.525	.475
MATRIXON.....	45			.45	.55	OCTAGON.....	52½ and 2½			.5369	.4631
MEADOW.....	45	and 2½		.46375	.53625	ODIUS.....	52½	2½	and 2½	.5485	.4515
MECHANIC.....	45	2½	and 2½	.4772	.5228	OFFENSIVE.....	52½	2½	and 5	.56	.44
MELODY.....	45	2½	and 5	.4906	.5094	OFFSPRING.....	52½	2½	and 7½	.5716	.4284
MEMBRANE.....	45	2½	and 7½	.504	.496	ONTMENT.....	52½	2½	and 10	.5832	.4168
MEMORIAL.....	45	2½	and 10	.5174	.4826	OPPOSSUM.....	52½	and 5		.54875	.45125
METHODIST.....	45	and 5		.4775	.5225	OPTIC.....	52½	5	and 2½	.56	.44
MIDWIFE.....	45	5	and 2½	.4906	.5094	ORCHARD.....	52½	5	and 5	.5713	.4287
MIGRATE.....	45	5	and 5	.5036	.4964	ORCHESTRA.....	52½	5	and 7½	.5826	.4174
MILESTONE.....	45	5	and 7½	.5167	.4833	ORGANIC.....	52½	5	and 10	.5939	.4061
MILITARY.....	45	5	and 10	.52975	.47025	ORIENTAL.....	52½	and 7½		.5609	.4391
MILK.....	45	and 7½		.49125	.50875	ORPHAN.....	52½	7½	and 2½	.5716	.4284
MINERAL.....	45	7½	and 2½	.504	.496	OSTRICH.....	52½	7½	and 5	.5826	.4174
MINSTREL.....	45	7½	and 5	.5167	.4833	OUTCAST.....	52½	7½	and 7½	.5936	.4064
MISCHIEF.....	45	7½	and 7½	.5294	.4706	OVATION.....	52½	7½	and 10	.6046	.3954
MIRACLE.....	45	7½	and 10	.5421	.4579	OVERFLOW.....	52½	and 10		.5725	.4275
MISPLACE.....	45	and 10		.505	.495	PACIFIC.....	52½	10	and 2½	.5832	.4168
MISTRESS.....	45	10	and 2½	.5174	.4826	PACKAGE.....	52½	10	and 5	.5939	.4061
MOCK.....	45	10	and 5	.52975	.47025	PADLOCK.....	52½	10	and 7½	.6046	.3954
MONITOR.....	45	10	and 7½	.5421	.4579	PAINTER.....	52½	10	and 10	.61525	.38475
MONKEY.....	45	10	and 10	.5545	.4455	PALISADE.....	55			.55	.45
MONUMENT.....	47½			.475	.525	PALMETTO.....	55	and 2½		.56125	.43875
MOONSHINE.....	47½	and 2½		.4881	.5119	PALSY.....	55	2½	and 2½	.5722	.4278
MORBID.....	47½	2½	and 2½	.5009	.4991	PANSY.....	55	2½	and 5	.5832	.4168
MORTGAGE.....	47½	2½	and 5	.5137	.4863	PANIC.....	55	2½	and 7½	.5942	.4058
MOUNTAIN.....	47½	2½	and 7½	.5265	.4735	PANTHER.....	55	2½	and 10	.6051	.3949
MOUSE.....	47½	2½	and 10	.5393	.4607	PANTRY.....	55	and 5		.5725	.4275
MUDDY.....	47½	and 5		.50125	.49875	PARADISE.....	55	5	and 2½	.5832	.4168
MULE.....	47½	5	and 2½	.5137	.4863	PARADOX.....	55	5	and 5	.5939	.4061
MULTITUDE.....	47½	5	and 5	.5262	.4738	PARCEL.....	55	5	and 7½	.6046	.3954
MUSEUM.....	47½	5	and 7½	.5386	.4614	PARCHMENT.....	55	5	and 10	.61525	.38475
MUSKET.....	47½	5	and 10	.5511	.4489	PARODY.....	55	and 7½		.58375	.41625
MUSLIN.....	47½	and 7½		.5144	.4856	PARROT.....	55	7½	and 2½	.5942	.4058
MUSTARD.....	47½	7½	and 2½	.5265	.4735	PARSLEY.....	55	7½	and 5	.6046	.3954
MUTINY.....	47½	7½	and 5	.5387	.4613	PARTISAN.....	55	7½	and 7½	.615	.385
MUTTON.....	47½	7½	and 7½	.5508	.4492	PASSPORT.....	55	7½	and 10	.6254	.3746
MYRTLE.....	47½	7½	and 10	.5629	.4371	PASTOR.....	55	and 10		.595	.405
MYSTIC.....	47½	and 10		.5275	.4725	PATERNAL.....	55	10	and 2½	.6051	.3949
NAPKIN.....	47½	10	and 2½	.5393	.4607	PATHEIC.....	55	10	and 5	.61525	.38475
NATION.....	47½	10	and 5	.5511	.4489	PATRIARCH.....	55	10	and 7½	.6254	.3746
NATIVITY.....	47½	10	and 7½	.5629	.4371	PATRIMONY.....	55	10	and 10	.6355	.3645
NATURE.....	47½	10	and 10	.57475	.42525	PATROL.....	57½			.575	.425
NAVIGATE.....	50			.50	.50	PAUPER.....	57½	and 2½		.5856	.4144
NEEDLE.....	50	and 2½		.5125	.4875	PAVEMENT.....	57½	2½	and 2½	.596	.404
NECK.....	50	2½	and 2½	.5247	.4753	PEACEFUL.....	57½	3½	and 5	.6063	.3937
NEPHEW.....	50	2½	and 5	.5369	.4631	PEACOCK.....	57½	2½	and 7½	.6167	.3833
NEST.....	50	2½	and 7½	.5491	.4509	PEAK.....	57½	2½	and 10	.6271	.3729
NIMBLE.....	50	2½	and 10	.56125	.43875	PEASANT.....	57½	and 5		.59625	.40375
NIPPLE.....	50	and 5		.525	.475	PEBBLE.....	57½	5	and 2½	.6063	.3937
NOBLE.....	50	5	and 2½	.5369	.4631	PECTORAL.....	57½	5	and 5	.6164	.3836
NORMAL.....	50	5	and 5	.54875	.45125	PEDAGOGUE.....	57½	5	and 7½	.6265	.3735
NOSEGAY.....	50	5	and 7½	.5606	.4394	PEDESTRIAN.....	57½	5	and 10	.6366	.3634
NOSTRIL.....	50	5	and 10	.5725	.4275	PEDIGREE.....	57½	and 7½		.6069	.3931
NOTARY.....	50	and 7½		.5375	.4625	PEGGY.....	57½	7½	and 2½	.6167	.3833
NOURISH.....	50	7½	and 2½	.5491	.4509	PELICAN.....	57½	7½	and 5	.6265	.3735
NUMERAL.....	50	7½	and 5	.5606	.4394	PENALTY.....	57½	7½	and 7½	.6364	.3636
NUPTIAL.....	50	7½	and 7½	.5722	.4278	PENDULUM.....	57½	7½	and 10	.6462	.3538
NURSERY.....	50	7½	and 10	.58375	.41625	PENETRAPE.....	57½	and 10		.6175	.3825
NUTMEG.....	50	and 10		.55	.45	PENITENT.....	57½	10	and 2½	.6271	.3729
OAKUM.....	50	10	and 2½	.56125	.43875	PENSION.....	57½	10	and 5	.6366	.3634





Prices and Quotations—Continued.

WILL QUOTE				WILL QUOTE					
F. O. B.	Discount per cent.	Equivalent.	Net.	F. O. B.	Discount per cent.	Equivalent.	Net.		
PENTAGON.....	57½	10 and 7½	.6462	.3358	POLISH.....	65	10 and 10	.7165	.2835
PENURIOUS.....	57½	10 and 10	.65575	.34425	POLLUTE.....	67½		.675	.325
PEPPER.....	.60		.60	.40	POLYAMV.....	67½ and 2½		.68½	.3169
PERCOLATE.....	.60	and 2½	.61	.39	POLYGON.....	67½	2½ and 2½	.691	.309
PERDITION.....	.60	2½ and 2½	.61975	.38025	POMATUM.....	67½	2½ and 5	.699	.301
PERENNIAL.....	.60	2½ and 5	.6295	.3705	POMMEL.....	67½	2½ and 7½	.7069	.2931
PERFORATE.....	.60	2½ and 7½	.63925	.36075	PONDER.....	67½	2½ and 10	.7148	.2852
PERFUME.....	.60	2½ and 10	.649	.351	PONTOON.....	67½ and 5		.69125	.30875
PERJURY.....	.60	and 5	.62	.38	POPLIN.....	67½	5 and 2½	.699	.301
PERPETUAL.....	.60	5 and 2½	.6295	.3705	POPULAR.....	67½	5 and 5	.7067	.2933
PERSECUTE.....	.60	5 and 5	.639	.361	PORCUPINE.....	67½	5 and 7½	.7144	.2856
PERSIAN.....	.60	5 and 7½	.6485	.3515	PORPOISE.....	67½	5 and 10	.7221	.2779
PERSONATE.....	.60	5 and 10	.658	.342	PORTRICO.....	67½ and 7½		.6994	.3006
PERSPIRE.....	.60	and 7½	.63	.37	POSITIVE.....	67½	7½ and 2½	.7069	.2931
PERVADE.....	.60	7½ and 2½	.63925	.36075	POSTAGE.....	67½	7½ and 5	.7144	.2856
PERUSAL.....	.60	7½ and 5	.6485	.3515	POTASII.....	67½	7½ and 7½	.7219	.2781
PESTILENCE.....	.60	7½ and 7½	.65775	.34225	POTATO.....	67½	7½ and 10	.7294	.2706
PETITION.....	.60	7½ and 10	.667	.333	POTHOOK.....	67½ and 10		.7075	.2925
PETRIEVE.....	.60	and 10	.64	.36	POULTRY.....	67½	10 and 2½	.7148	.2852
PETTICOAT.....	.60	10 and 2½	.649	.351	POVERTY.....	67½	10 and 5	.7221	.2779
PETULANT.....	.60	10 and 5	.658	.342	POWDER.....	67½	10 and 7½	.7294	.2706
PEWTER.....	.60	10 and 7½	.667	.333	POWERFUL.....	67½	10 and 10	.73675	.26325
PHANTOM.....	.60	10 and 10	.676	.324	PRACTICAL.....	.70		.70	.30
PHARMACY.....	.62½		.625	.375	PRATTLE.....	70 and 2½		.7075	.2925
PHYSICAL.....	.62½ and 2½		.6344	.3656	PREACHER.....	70	2½ and 2½	.7148	.2852
PIANO.....	.62½	2½ and 2½	.6435	.3565	PRECINCT.....	70	2½ and 5	.7221	.2779
PLASTER.....	.62½	2½ and 5	.6527	.3473	PRECIOUS.....	70	2½ and 7½	.7294	.2706
PICKET.....	.62½	2½ and 7½	.6618	.3382	PRECIPICE.....	70	2½ and 10	.73675	.26325
PIETY.....	.62½	2½ and 10	.6709	.3291	PRECLUDE.....	70 and 5		.715	.285
PIGEON.....	.62½ and 5		.64375	.35625	PREDESTINE.....	70	5 and 2½	.7221	.2779
PIGMY.....	.62½	5 and 2½	.6527	.3473	PREDICTION.....	70	5 and 5	.72925	.27075
PIILER.....	.62½	5 and 5	.6616	.3384	PREDISPOSE.....	70	5 and 7½	.7364	.2636
PILGRIM.....	.62½	5 and 7½	.6705	.3295	PREFACE.....	70	5 and 10	.7435	.2565
PILLOW.....	.62½	5 and 10	.6794	.3206	PREGNANT.....	70 and 7½		.7225	.2775
PILOT.....	.62½ and 7½		.6531	.3469	PREJUDICE.....	70	7½ and 2½	.7294	.2706
PIMPLE.....	.62½	7½ and 2½	.6618	.3382	PRELATE.....	70	7½ and 5	.7364	.2636
PIPKIN.....	.62½	7½ and 5	.6705	.3295	PREMIUM.....	70	7½ and 7½	.7433	.2567
PIRACY.....	.62½	7½ and 7½	.6791	.3209	PREPARE.....	70	7½ and 10	.75025	.24975
PISTOL.....	.62½	7½ and 10	.6878	.3122	PRESBYTER.....	70 and 10		.73	.27
PITCHER.....	.62½ and 10		.6025	.3575	PRESCRIBE.....	70	10 and 2½	.73675	.26325
PITEOUS.....	.62½	10 and 2½	.6709	.3291	PRESERVE.....	70	10 and 5	.7435	.2565
PIVOT.....	.62½	10 and 5	.6794	.3206	PRESIDENT.....	70	10 and 7½	.75025	.24975
PLAGUE.....	.62½	10 and 7½	.6878	.3122	PRETEND.....	70	10 and 10	.757	.243
PLAINTIVE.....	.62½	10 and 10	.69625	.30375	PRETEXT.....	72½		.725	.275
PLANET.....	.65		.65	.35	PRETTY.....	72½ and 2½		.7319	.2681
PLANTATION.....	.65	and 2½	.65875	.34125	PREVAIL.....	72½	2½ and 2½	.7386	.2614
PLANTER.....	.65	2½ and 2½	.6673	.3327	PREVALENT.....	72½	2½ and 5	.7452	.2548
PLATOON.....	.65	2½ and 5	.6758	.3242	PREVENT.....	72½	2½ and 7½	.752	.248
PLAYFUL.....	.65	2½ and 7½	.6843	.3157	PRIEST.....	72½	2½ and 10	.7587	.2413
PLEASANT.....	.65	2½ and 10	.6929	.3071	PRIMEAGE.....	72½ and 5		.73875	.26125
PLEBEIAN.....	.65	and 5	.6075	.3325	PRIMITIVE.....	72½	5 and 2½	.7453	.2547
PLEBIFUL.....	.65	5 and 2½	.6758	.3242	PRIMROSE.....	72½	5 and 5	.7518	.2482
PLIABLE.....	.65	5 and 5	.6841	.3159	PRINCESS.....	72½	5 and 7½	.7583	.2417
PLOUGHMAN.....	.65	5 and 7½	.6924	.3076	PRINCIPLE.....	72½	5 and 10	.7649	.2351
PLUCK.....	.65	5 and 10	.70075	.29925	PRINTER.....	72½ and 7½		.7456	.2544
PLUMP.....	.65	and 7½	.67625	.32375	PRISMATIC.....	72½	7½ and 2½	.752	.248
PLUNDER.....	.65	7½ and 2½	.6843	.3157	PRISONER.....	72½	7½ and 5	.7583	.2417
POACHER.....	.65	7½ and 5	.6924	.3076	PRIVACY.....	72½	7½ and 7½	.7647	.2353
POCKET.....	.65	7½ and 7½	.7005	.295	PRIVILEGE.....	72½	7½ and 10	.7711	.2289
POINTER.....	.65	7½ and 10	.7086	.2914	PROBATION.....	72½ and 10		.7575	.2425
POISON.....	.65	and 10	.65	.35	PROBLEM.....	72½	10 and 2½	.7587	.2413
POKER.....	.65	10 and 2½	.6929	.3071	PROCESSION.....	72½	10 and 5	.7649	.2351
POLECAT.....	.65	10 and 5	.70075	.29925	PROCLAIM.....	72½	10 and 7½	.7711	.2289
POLICY.....	.65	10 and 7½	.7086	.2914	PRODIGAL.....	72½	10 and 10	.77725	.22275



Prices and Quotations—Continued.

WILL QUOTE F. O. B.		Discount per cent.	Equivalent.	Net	WILL QUOTE F. O. B.		Discount per cent.	Equivalent.	Net.
PRODUCE	75		75	25	PUDDING	77½		775	225
PROFANE	75	and 2½	75625	24375	PUGILIST	77½ and 2½		7866	2194
PROFESSOR	75	2½ and 2½	76234	23766	PULLET	77½	2½ and 2½	7861	2139
PROFILE	75	2½ and 5	7684	2316	PULPY	77½	2½ and 5	7916	2084
PROHIBIT	75	2½ and 7½	7745	2255	PULSATION	77½	2½ and 7½	7971	2029
PROLONG	75	2½ and 10	7806	2194	PULVERIZE	77½	2½ and 10	8026	1974
PROMOTION	75	and 5	7625	2375	PUNCTUAL	77½ and 5		78625	21375
PRONOUN	75	5 and 2½	7684	2316	PUPIL	77½	5 and 2½	7916	2084
PROPHET	75	5 and 5	7744	2256	PUPPY	77½	5 and 5	7969	2031
PROPOSAL	75	5 and 7½	7803	2107	PURGATIVE	77½	5 and 7½	8023	1977
PROSECUTE	75	5 and 10	78625	21375	PURIFY	77½	5 and 10	8076	1924
PROSPECT	75	and 7½	76875	23125	PURPLE	77½ and 7½		7919	2081
PROSTRATE	75	7½ and 2½	7745	2255	PURPORT	77½	7½ and 2½	7971	2029
PROTESTANT	75	7½ and 5	7803	2107	PURSER	77½	7½ and 5	8023	1977
PROUD	75	7½ and 7½	7861	2139	PUSH	77½	7½ and 7½	8075	1925
PROVERB	75	7½ and 10	7919	2081	PUSTULE	77½	7½ and 10	8127	1873
PROVINCE	75	and 10	775	225	PUTRID	77½ and 10		7975	2025
PROVOKE	75	10 and 2½	7806	2194	PUTTY	77½	10 and 2½	8026	1974
PRUDENT	75	10 and 5	78625	21375	PUZZLE	77½	10 and 5	8076	1924
PUBERTY	75	10 and 7½	7919	2081	PYLORUS	77½	10 and 7½	8127	1873
PUBLICAN	75	10 and 10	7975	2025	PYRAMID	77½	10 and 10	81775	18225

Letters and Telegrams.

DATE	HAVE YOU RECEIVED LETTER OF.....	YOUR LETTER OF RECEIVED.	HAVE YOU RECEIVED TELEGRAM OF.....	YOUR TELEGRAM RECEIVED.
1st	FABBIT	SACK	TALLOW	VACCINATION
2d	RADICAL	SADDLE	TANGLE	VAGRANT
3d	RADISH	SAFETY	TARGET	VAILEY
4th	RAINBOW	SAILOR	TELESCOPE	VANDAL
5th	RAKE	SALAD	TEMPEST	VAPOR
6th	RAMBLER	SALLY	TERRACE	VARNISH
7th	RAPTURE	SALOON	TESTAMENT	VENISON
8th	RASCAL	SALVAGE	THIRSTY	VENUS
9th	RATIFY	SAMPLE	TIGER	VERANDA
10th	RAVAGE	SANDAL	TOBACCO	VERBENA
11th	RAVEN	SANITY	TOILET	VERMIN
12th	RAZOR	SAPLING	TOLEKATE	VERSION
13th	REALITY	SARDINE	TOPAZ	VERTEBRA
14th	REAPER	SATIN	TORCH	VESTMENT
15th	REASON	SATISFY	TORPEDO	VESTIBULE
16th	REBEL	SAUCER	TRAFFIC	VESTRY
17th	RECEPTION	SAYAGE	TRANQUIL	VETERAN
18th	RECLINE	SAWDUST	TRANSPIRE	VEXATION
19th	RECORD	SCABBY	TREASURER	VIBRATE
20th	RECRUIT	SCULPTOR	TRIANGLE	VICAR
21st	RECTOR	SEGMENT	TROMBONE	VICTORY
22d	REDRESS	SELFISH	TROPICAL	VINDICATE
23d	REFINE	SENATOR	TRUMP	VIGILANT
24th	REFLECT	SENTRY	TUMBLER	VILLAGE
25th	RIGID	SERENADE	TURKEY	VINEGAR
26th	RIFLE	SERPENT	TURNIP	VIOLATE
27th	RIFFLE	SHABBY	TUTOR	VIRGIN
28th	ROACH	SHADOW	TWINE	VIRTUE
29th	ROBBER	SHAVING	TWINKLE	VISIT
30th	ROCKET	SIGNAL	TWIST	VOLCANO
31st	ROBIN	SLIPPER	TYRANT	VULCAN

WALNUT. . . . . Have written.  
 WASHINGTON. . . . . We can read your telegram, but do not understand it.  
 WATCHMAN. . . . . Answer by telegraph at once.  
 WEDLOCK. . . . . Telegraph to me (or us) at . . . . .  
 WELCOME. . . . . Will answer to-morrow morning.  
 WELFARE. . . . . You have not answered our letter of . . . . .

WHALEBONE. . . . . You have not answered our telegram of . . . . .  
 WHISKY. . . . . Last letter from you was dated.  
 WICKED. . . . . Will write the parties and advise you later.  
 WINDPIPE. . . . . Do not write them until you hear from us.  
 WISDOM. . . . . Will telegraph you.  
 WITNESS. . . . . Your letter was not received until . . . . .

**B**UNDY



STANDARD  
RADIATOR.

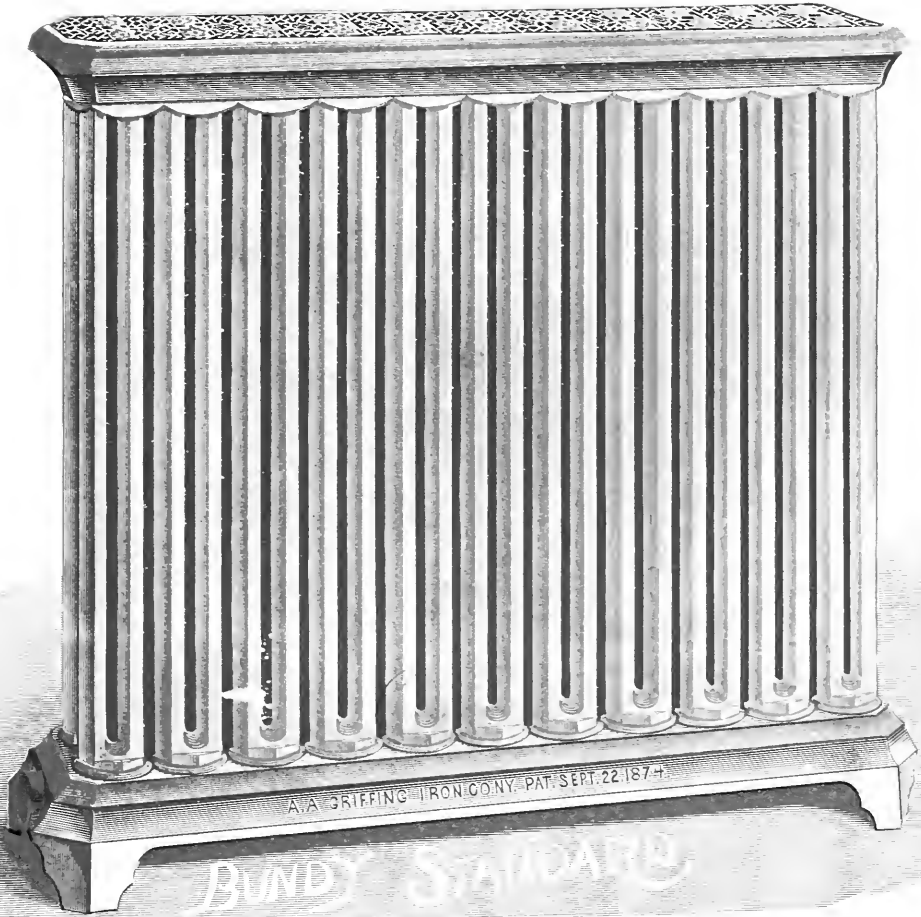

MANUFACTURED BY

**A. A. GRIFFING IRON CO.**

General Office and Works:

430 COMMUNIPAW AVE.,

JERSEY CITY, N. J.

NEW YORK CITY, N. Y.,  
106 LIBERTY STREET.

CHICAGO, ILL.,  
130 DEARBORN STREET.

PHILADELPHIA, PA.,  
18-24 SOUTH 7TH STREET.

Please designate in your specifications or contract for heating as A. A. Griffing Iron Co.'s Bundy Standard Radiator.



## Steam and Hot Water vs. Furnace Heat.



IT IS a conceded fact that buildings cannot be properly heated by hot air furnaces unless they are entirely surrounded by other buildings, or protected from cold winds in some way or other.

Even when a building is properly heated by a furnace, the quality of air is not that which is most desirable to sustain human life; first, because it is devitalized with metal heated from 1200 to 1500 degrees Fahr., which robs it of all its exhilarating and tonic properties; secondly, because it is almost always charged with dust; and thirdly, it has been rendered impure by carbonic oxide, which is generated in a furnace whenever there is an insufficient amount of oxygen introduced into it to produce perfect combustion; said carbonic oxide passing through all heated cast iron almost as readily as atmospheric air passes through any textile fabric.

Summarizing these various objections to furnace heated air, we find it under its best conditions devitalizing. Metal heated above even 250 degrees begins to devitalize atmosphere brought in contact with it; what then must be its effect upon air when heated to a temperature of from 1200 to 1500 degrees. We find it frequently charged with dust and fine ashes, and very often poisoned by carbonic oxide, to say nothing of the aptitude of all furnace heated houses to be extremely cold at the point of greatest exposure, on account of the extreme buoyancy of heated air which is overcome by the pressure of cold air of greater density.

Heating by Hot Water or low pressure Steam, has none of the disadvantages mentioned in regard to the furnace heated houses. The metal of Radiators and boilers is never heated by the use of steam to a detrimental degree—namely 250 degrees, unless from 40 to 45 pounds pressure per square inch is resorted to, which is both unusual and unnecessary in the heating apparatus of the present day.

In Hot Water heating, by the open tank system, the pressure is exceedingly small; not more than one pound to every 28.96 inches of vertical water column, and the temperature of the Radiators throughout the house is seldom greater than 175 degrees Fahr.—a temperature 75 degrees below the point where devitalization commences; which point it is impossible to reach in Hot Water Heating.

It has been sometimes argued that houses heated by Direct Radiation are not properly ventilated; this is the case sometimes, but arises from a neglect of the occupants of the building rather than from a radical defect in the system. It is well, (and we always recommend it) to use a certain amount of Indirect Radiation with every system of Steam or Hot Water Heating, as Indirect Radiators are so placed in connection with flues, ducts and registers, connected directly with the outer air as to draw into a house a sufficient quantity of fresh out-door air for ventilation; and if simple outlets in the shape of grates or flues are provided for removing foul air, the ventilation will be constant and sufficient to supply the needs and wants for breathing purposes without being wasteful of fuel; and as Direct Radiators are always placed at the points of greatest exposure, which absolutely insures a thorough diffusion of heat, they do not, as is the case with a furnace, leave the coldest points unprotected.

The objection Fire Insurance Companies have to flues for conveying hot air from the furnace through the wooden partitions to registers, is wholly overcome by the use of Indirect Steam Heat, as the flues are never run from the boilers, but from the Indirect Radiators, which are never near the boiler, and are oftentimes 100 feet away from it, insuring safety from fire and lessening the rate of insurance.

## Heating by Steam Direct and Indirect Radiation.



THE amount of Steam Direct or Indirect Radiation required to heat a given space depends on the following conditions, viz: Whether building is protected or isolated; structure, whether brick, stone or wood; if wood, whether sheathed and papered; if brick or stone, whether walls are solid or hollow; points of compass, direction taken by prevailing winds; relative location of rooms to one another; whether room has bay window or not, or has maximum or minimum of glass surface, etc., etc.

Without this information it is impracticable to correctly estimate the amount of Radiating Surface required, and even with it, an Engineer on the premises is better able to judge of the requirements of the case. We are perfectly willing and glad to give advice on this subject or answer any questions that may be asked us, but we do not hold ourselves responsible for the heating of any building, and wish what we say to be taken more in the light of suggestions given for the benefit of our friends and customers.

We are frequently asked if we know the name of some good book treating on the subject of Steam Heating. We answer these inquiries by recommending a work entitled "Steam Heating for Buildings, or Hints to Steam Fitters," written by a very able Engineer. It contains much valuable matter, and is a book of 250 pages. To those who cannot conveniently secure a copy we will mail one, post pre-paid, upon receipt of the publisher's price of \$2.50. Also will send John H. Mills' work entitled "Heat for Warming and Ventilation of Buildings," comprising 2 Vols., handsomely bound and aggregating over 600 pages of valuable matter for \$5.00 per Vol.

While it is impracticable to adopt any fixed rule for computing the amount of Radiating Surface necessary to heat a given space, still the following may serve as somewhat of a guide, but please to bear in mind that the figures given are based on New York City climate.

To ascertain the amount of Steam Direct Radiation necessary to heat a certain room, divide its cubical contents, found by multiplying its length, breadth and height together, by 50, 60, 70, or some other figure as the exigencies of the case may make necessary, or for Steam Indirect Radiation by 35, 40, or 50.

**FOR AN ISOLATED RESIDENCE.** To compute the amount of Steam Direct Radiation necessary to heat a North or West Room, divide the cubical contents by 60; South or East Room by 70; Bay Window Room, Hall, Bath or Living Room by 60; and Sleeping Room by 70.

For Steam Indirect Radiation for the 1st floor, divide the cubical contents by 35; 2d floor, by 40; and 3d floor by 50.

**FOR A RESIDENCE IN A ROW.** For Steam Direct Radiation for a North or West Room, Bay-window Room, Hall, Bath or a Living Room, divide the cubical contents by 70; Sleeping Room by 80.

For Steam Indirect Radiation, 1st floor by 40, 2d and 3d floors by 50.

**FOR A BUSINESS BLOCK.** For Steam Direct Radiation for a North or West Room divide by 75; South or East Room by 85, and an inside Room or Hall by 100.

For Steam Indirect Radiation, 1st floor, divide by 40; 2nd floor and above by 50.

**FOR A CHURCH OR OTHER PUBLIC BUILDING.** For Steam Direct Radiation, divide by 100; and for Steam Indirect Radiation by 50. A good arrangement for heating such buildings is an equal amount of both Direct and Indirect Radiation or two-thirds Direct and one-third Indirect.



## Some of the Advantages of Hot Water Heating.

### FIRST.—Absolute Safety.

There can be no danger of explosion in a Hot Water Heating apparatus for it is continually open to the atmosphere through the expansion tank and the only possible pressure on it is the weight of the water in the vertical pipes.

### SECOND.—Simplicity and Ease of Management.

All that is necessary is to keep a fire in the heater. No more skill is necessary to manage it, than an ordinary kitchen range. The domestic in the house, or a child can do all that is necessary to be done.

### THIRD.—Economy in Fuel.

The slow fire which is all that this system requires is extremely economical in fuel, and as water is a most rapid absorbent of heat, very little heat from the fire is allowed to escape unused up the chimney.

### FOURTH.—Noiselessness.

The Hot Water in this system is an unbroken column, kept continually in circulation, from the fact that water of a higher temperature, being lighter, rises, and the colder water, being heavier, falls and takes its place, and all is done without the slightest noise of any kind.

### FIFTH.—Perfectly Controlled.

The Hot Water circulation can be checked by partially closing the valve, which is always set with each Radiator; or by entirely closing the valve when no heat is required. In either case the circulation in the balance of the apparatus is not affected in the slightest degree. A uniform heat can be secured at all times and no heat wasted.

### SIXTH.—Healthfulness.

No argument is necessary to prove that a uniform temperature is highly conducive to good health and long life, and as a Hot Water Apparatus can be controlled and regulated to a nicety, so as to give a uniform heat at all times, its healthfulness is all-apparent. Ask any Doctor his opinion and he will tell you the same thing, and will, probably add that the air in a house heated by Hot Water has greater humidity and that the occupants are less subject to colds, coughs, catarrh and other diseases of the throat and lungs.

### SEVENTH.—Durability.

A good Hot Water Apparatus, such as we offer you, will last as long as any building in which it may be placed, providing it is given ordinary care. It is continually filled with water, which water having been frequently heated, has had all the air driven out of it, and so the apparatus cannot rust, except it be very slightly. We have never known of a single instance where our apparatus has given out except where the most inexcusable and gross carelessness has been exercised. We recommend that the same water which has been in the system during the winter remain there during the summer.

### EIGHTH.—The Bundy Combination Steam and Hot Water Radiator.

This Radiator can be used for Hot Water Heating in mild weather and Steam Heating in extreme cold weather. The change from Hot Water to Steam or from Steam to Hot Water can be quickly made and any one capable of taking care of either apparatus can do it. Where a building is to be rented this system is a great advantage, for tenants may express a preference for one or the other system and all may be suited in this way, and without additional expense.

## Heating by Hot Water Direct and Indirect Radiation.

The amount of Hot Water Radiation necessary to heat a given space depends upon the same conditions enumerated on the preceding page. It may serve as somewhat of a guide to know that the amount of Hot Water Direct Radiation necessary to heat an isolated residence in New York City, is found by dividing the cubical contents of a North or West Room, Bay Window Room, Hall, Bath or Living Room, by 35 and Sleeping Rooms on the 2d floor by 40, and 3d floor by 50.

Indirect Hot Water Radiation should be used discreetly and in most cases for ventilating purposes only. It can often be adopted to good advantage in the Hall, but an Engineer who thoroughly understands his business should be consulted in the matter.

TRADE BUNDY MARK.

## Bundy One Row Steam Direct Radiator.

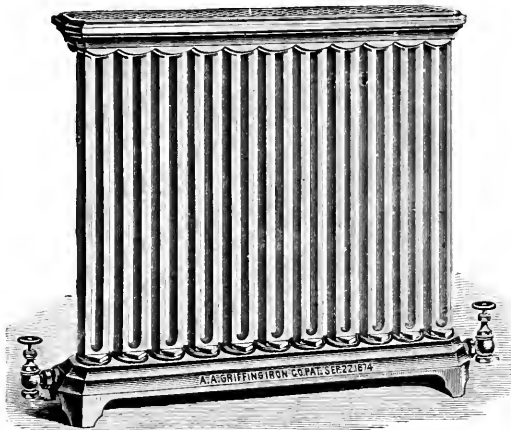

FIG. 1.

FIG. 1 represents the Bundy One Row Steam Direct Radiator, which is without exception the most powerful heating Radiator on the market. It is continually surrounded on all sides by freely circulating air, and being narrow, occupying only 5½ inches of floor space in width, it takes up scarcely more space than is required for an ordinary 1 inch pipe coil. In every impartial test of Radiators the Bundy One Row has always come out ahead; sometimes excelling by 40 per cent., and never less than 10 per cent. For different ways of tapping this Radiator see Fig. 29.

### FORTY-TWO INCHES HIGH, ONE ROW OF LOOPS.

FOR STANDARD, ENLARGED, OR EXTENDED SURFACE LOOPS.								
LIST OF RADIATORS BUILT ON THE FOLLOWING SIZE BASES.			STANDARD.		ENLARGED.		EXTENDED SURFACE.	
Width of base, 5¼ inches.			Each Loop Represents 3¼ Feet of Heating Surface.		Each Loop Represents 4¼ Feet of Heating Surface.		Each Loop Represents 4¾ Feet of Heating Surface.	
Shape of Radiator.	Number of Loops.	Length of Radiators.	LIST PRICE.		LIST PRICE.		LIST PRICE.	
			Per Foot, 70c.	Per Loop, \$2.45	Per Foot, 67½c.	Per Loop, \$2.87	Per Foot, 65c.	Per Loop, \$2.76
			Feet of Heating Surface.	With Iron Top or Binder for Marble Top	Feet of Heating Surface.	With Iron Top or Binder for Marble Top	Feet of Heating Surface.	With Iron Top or Binder for Marble Top
1 × 3	3	12	10½	87 35	12¾	88 61	12¾	88 29
1 × 4	4	15¼	14	9 80	17	11 48	17	11 05
1 × 5	5	18½	17½	12 25	21¼	14 35	21¼	13 82
1 × 6	6	21¼	21	14 70	25½	17 21	25½	16 58
1 × 7	7	25¼	24½	17 15	29¼	20 08	29¼	19 34
1 × 8	8	28¾	28	19 60	34	22 95	34	22 10
1 × 9	9	31½	31½	22 05	38¼	25 52	38¼	24 87
1 × 10	10	34½	35	24 50	42½	28 69	42½	27 63
1 × 11	11	38	35½	26 95	46¾	31 50	46¾	30 39
1 × 12	12	41¼	42	29 40	51	34 43	51	33 15
1 × 13	13	44¾	45½	31 85	55¼	37 30	55¼	35 92
1 × 14	14	47¾	49	34 30	59½	40 16	59½	38 68
1 × 15	15	51	52½	36 75	63¾	43 03	63¾	41 44
1 × 16	16	54	56	39 20	68	45 90	68	44 20
1 × 18	18	60¾	63	44 10	76½	51 64	76½	49 73
1 × 20	20	66¾	70	49 00	85	57 38	85	55 25
1 × 22	22	73¼	77	53 90	93½	63 12	93½	60 78
1 × 24	24	79¾	84	58 80	102	68 85	102	66 30
1 × 26	26	86¼	91	63 70	110½	74 50	110½	71 83

For List of Special High Radiators see bottom of page 27. NOTE.—The above prices are for all Radiators 42" high, or under to 36" high.

All Regular Steam Goods Tapped 1" × ¾" "Right Hand."





THIRTY-SIX INCHES HIGH, ONE ROW OF LOOPS.

FOR STANDARD, ENLARGED, OR EXTENDED SURFACE LOOPS.

LIST OF RADIATORS BUILT ON THE FOLLOWING SIZE BASES.			STANDARD.		ENLARGED.		EXTENDED SURFACE.	
Width of Base 5 1/4 inches.			Each Loop Represents 3 Feet of Heating Surface.		Each Loop Represents 3 1/2 Feet of Heating Surface.		Each Loop Represents 3 3/4 Feet of Heating Surface.	
Shape of Radiator.	Number of Loops.	Length of Radiators.	LIST PRICE.		LIST PRICE.		LIST PRICE.	
			Per Foot, 75c.	Per Loop, \$2.25	Per Foot, 73 1/2c.	Per Loop, \$2.54	Per Foot, 70c.	Per Loop, \$2.45
			Feet of Heating Surface.	With Iron Top or Binder for Marble Top.	Feet of Heating Surface.	With Iron Top or Binder for Marble Top.	Feet of Heating Surface.	With Iron Top or Binder for Marble Top.
1 x 3	3	12	9	\$6.75	10 1/2	\$7.62	10 1/2	\$7.35
1 x 4	4	15 1/4	12	9.00	14	10.15	14	9.10
1 x 5	5	18 1/2	15	11.25	17 1/2	12.60	17 1/2	12.25
1 x 6	6	21 3/4	18	13.50	21	15.23	21	14.70
1 x 7	7	25 1/8	21	15.75	24 1/2	17.77	24 1/2	17.15
1 x 8	8	28 1/8	24	18.00	28	20.30	28	19.60
1 x 9	9	31 1/2	27	20.25	31 1/2	22.84	31 1/2	22.05
1 x 10	10	34 1/2	30	22.50	35	25.38	35	24.50
1 x 11	11	38	33	24.75	38 1/2	27.62	38 1/2	26.95
1 x 12	12	41 1/4	36	27.00	42	30.45	42	29.40
1 x 13	13	44 3/8	39	29.25	45 1/2	32.99	45 1/2	31.85
1 x 14	14	47 3/8	42	31.50	49	35.53	49	34.30
1 x 15	15	51	45	33.75	52 1/2	37.67	52 1/2	36.75
1 x 16	16	54	48	36.00	56	40.60	56	39.20
1 x 18	18	60 3/8	54	40.50	63	45.65	63	44.10
1 x 20	20	66 7/8	60	45.00	70	50.75	70	49.00
1 x 22	22	73 1/4	66	49.50	77	55.83	77	53.90
1 x 24	24	79 3/4	72	54.00	84	60.90	84	58.80
1 x 26	26	86 1/8	78	58.50	91	66.08	91	63.70

For List of Special Height Radiators see bottom of page 27. NOTE.—The above prices are for all Radiators 36" high, or under to 30" high.

THIRTY INCHES HIGH, ONE ROW OF LOOPS.

LIST OF RADIATORS BUILT ON THE FOLLOWING SIZE BASES.			Each Loop Represents 2 1/2 Feet of Heating Surface.		Each Loop Represents 3 Feet of Heating Surface.		Each Loop Represents 3 Feet of Heating Surface.	
Width of Base, 5 1/4 inches.			LIST PRICE.		LIST PRICE.		LIST PRICE.	
1 x	Number of Loops.	Length of Radiators.	Per Foot, 55c.	Per Loop, \$2.13	Per Foot, 52 1/2c.	Per Loop, \$2.48	Per Foot, 50c.	Per Loop, \$2.40
			3	3	12	7 1/2	\$6.30	9
4	4	15 1/4	10	8.40	12	9.90	12	9.60
5	5	18 1/2	12 1/2	10.63	15	12.35	15	12.00
6	6	21 3/4	15	12.75	17	14.85	17	14.40
7	7	25 1/8	17 1/2	14.88	21	17.33	21	16.80
8	8	28 1/8	20	17.00	24	19.80	24	19.20
9	9	31 1/2	22 1/2	19.13	27	22.28	27	21.60
10	10	34 1/2	25	21.25	30	24.75	30	24.00
11	11	38	27 1/2	23.38	33	27.23	33	26.40
12	12	41 1/4	30	25.50	36	29.70	36	28.80
13	13	44 3/8	32 1/2	27.63	39	32.18	39	31.20
14	14	47 3/8	35	29.75	42	34.65	42	33.60
15	15	51	37 1/2	31.88	45	37.13	45	36.00
16	16	54	40	34.00	48	39.60	48	38.40
18	18	60 3/8	45	38.25	54	44.55	54	43.20
20	20	66 7/8	50	42.50	60	49.50	60	48.00
22	22	73 1/4	55	46.75	66	54.45	66	52.80
24	24	79 3/4	60	51.00	72	59.40	72	57.60
26	26	86 1/8	65	55.25	78	64.35	78	62.40

For List of Special Height Radiators see bottom of page 27. NOTE.—The above prices are for all Radiators 30" high, or under to 24" high.

TWENTY-FOUR INCHES HIGH, ONE ROW OF LOOPS.

LIST OF RADIATORS BUILT ON THE FOLLOWING SIZE BASES.			Each Loop Represents 2 Feet of Heating Surface.		Each Loop Represents 2 1/2 Feet of Heating Surface.		Each Loop Represents 2 3/4 Feet of Heating Surface.	
Width of Base, 5 1/4 inches.			LIST PRICE.		LIST PRICE.		LIST PRICE.	
1 x	Number of Loops.	Length of Radiators.	Per Foot, \$1.00.	Per Loop, \$2.00.	Per Foot, \$1 1/2c.	Per Loop, \$3.28.	Per Foot, \$1.50c.	Per Loop, \$3.22.
			3	3	12	6	\$6.00	7
4	4	15 1/4	8	8.00	9 1/2	9.10	9 1/2	8.87
5	5	18 1/2	10	10.00	11 3/4	11.38	11 3/4	11.08
6	6	21 3/4	12	12.00	14	13.65	14	13.30
7	7	25 1/8	14	14.00	16 1/2	15.93	16 1/2	15.52
8	8	28 1/8	16	16.00	18 3/4	18.20	18 3/4	17.73
9	9	31 1/2	18	18.00	21	20.48	21	19.95
10	10	34 1/2	20	20.00	23 1/2	22.75	23 1/2	22.17
11	11	38	22	22.00	25 3/4	25.03	25 3/4	24.38
12	12	41 1/4	24	24.00	28	27.30	28	26.60
13	13	44 3/8	26	26.00	30 1/2	29.58	30 1/2	28.82
14	14	47 3/8	28	28.00	32 1/2	31.85	32 1/2	31.03
15	15	51	30	30.00	34 1/2	34.13	34 1/2	33.25
16	16	54	32	32.00	36 1/2	36.40	36 1/2	35.47
18	18	60 3/8	36	36.00	40 1/2	40.95	40 1/2	39.60
20	20	66 7/8	40	40.00	44 1/2	45.50	44 1/2	44.33
22	22	73 1/4	44	44.00	48 1/2	50.05	48 1/2	48.77
24	24	79 3/4	48	48.00	52 1/2	54.60	52 1/2	53.20
26	26	86 1/8	52	52.00	56 1/2	59.15	56 1/2	57.63

For List of Special Height Radiators see bottom of page 27. NOTE.—The above prices are for all Radiators 24" high, and under.

All Regular Steam Goods Tapped 1" x 3/4" Right Hand.

All Regular Steam Goods Tapped 1" x 3/4" Right Hand.

OCT 7 1949

U S PATENT OFFICE

67132

TRADE BUNDY MARK

## Bundy Two Row Steam Direct Radiator.

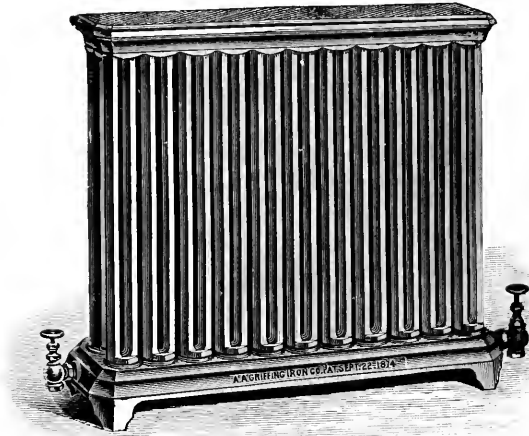

FIG. 2.

FIG. 2 represents the Bundy Two Row Steam Direct Radiator which has an open base in the form of a loop (see Fig. 34), through which sufficient air passes to the inside surface of the Radiator. A Radiator with small air openings, or none at all, cannot compare favorably with the Bundy which has the largest openings of any Radiator made. When used with feed and return on the same end (see Fig. 30), this radiator is equivalent to a One Row Radiator of double the length, owing to the septum in the base, and with our Partition Base one-half of the Radiator can be in use while the other half remains idle, or the entire Radiator may be used at one time. This is a good Radiator for the Direct-Indirect Box Base System (see Figs. 24, 25 and 26). For different ways of tapping see Fig. 30.

### FORTY-TWO INCHES HIGH, TWO ROWS OF LOOPS.

FOR STANDARD, ENLARGED, OR EXTENDED SURFACE LOOPS.										
LIST OF RADIATORS BUILT ON THE FOLLOWING SIZE BASES.			STANDARD.		ENLARGED.		EXTENDED SURFACE.			
Width of Base, 9 $\frac{1}{4}$ inches.			Each Loop Represents 3 $\frac{1}{2}$ Feet of Heating Surface.		Each Loop Represents 4 $\frac{1}{4}$ Feet of Heating Surface.		Each Loop Represents 4 $\frac{1}{4}$ Feet of Heating Surface.			
			LIST PRICE.		LIST PRICE.		LIST PRICE.			
			Per Foot, 70c.	Per Loop, \$2.45.	Per Foot, 67 $\frac{1}{2}$ c.	Per Loop, \$2.87.	Per Foot, 65c.	Per Loop, \$2.76.		
Shape of Radiator.	Number of Loops.	Length of Radiators.	Feet of Heating Surface.	With Iron Top or Binder for Marble Top.	Feet of Heating Surface.	With Iron Top or Binder for Marble Top.	Feet of Heating Surface.	With Iron Top or Binder for Marble Top.	Feet of Heating Surface.	With Iron Top or Binder for Marble Top.
2 X 3	6	12"	21	\$14 70	25 $\frac{1}{2}$	\$17 21	25 $\frac{1}{2}$	\$16 58		
2 X 4	8	15 $\frac{1}{4}$ "	28	19 60	34	22 95	34	22 10		
2 X 5	10	18 $\frac{1}{2}$ "	35	24 50	42 $\frac{1}{2}$	28 69	42 $\frac{1}{2}$	27 03		
2 X 6	12	21 $\frac{3}{4}$ "	42	29 40	51	34 43	51	33 15		
2 X 7	14	24 $\frac{3}{8}$ "	49	34 30	59 $\frac{1}{2}$	40 16	59 $\frac{1}{2}$	38 68		
2 X 8	16	28 $\frac{1}{8}$ "	56	39 20	68	45 90	68	44 20		
2 X 9	18	31 $\frac{1}{4}$ "	63	44 10	76 $\frac{1}{2}$	51 64	76 $\frac{1}{2}$	49 73		
2 X 10	20	34 $\frac{3}{8}$ "	70	49 00	85	57 38	85	55 25		
2 X 11	22	38"	77	53 90	93 $\frac{1}{2}$	63 12	93 $\frac{1}{2}$	60 78		
2 X 12	24	41 $\frac{1}{4}$ "	84	58 80	102	68 85	102	66 30		
2 X 13	26	44 $\frac{3}{8}$ "	91	63 70	110 $\frac{1}{2}$	74 59	110 $\frac{1}{2}$	71 83		
2 X 14	28	47 $\frac{3}{8}$ "	98	68 60	119	80 33	119	77 35		
2 X 15	30	50 $\frac{3}{8}$ "	105	73 50	127 $\frac{1}{2}$	86 07	127 $\frac{1}{2}$	82 88		
2 X 16	32	54 $\frac{1}{8}$ "	112	78 40	136	91 80	136	88 40		
2 X 18	36	60 $\frac{3}{8}$ "	126	88 20	153	103 28	153	99 45		
2 X 20	40	66 $\frac{3}{8}$ "	140	98 00	170	114 75	170	110 50		
2 X 22	44	73 $\frac{1}{4}$ "	154	107 80	187	126 23	187	121 55		
2 X 24	48	79 $\frac{3}{4}$ "	168	117 60	204	137 70	204	132 60		
2 X 26	52	86 $\frac{1}{4}$ "	182	127 40	221	149 18	221	143 65		

For List of Special Height Radiators see bottom of page 27. NOTE.—The above prices are for all Radiators 42" high, or under to 36" high.

All Regular Steam Goods Tapped 1' X  $\frac{3}{4}$ " " Right Hand."



TRADE BUNDEY MARK.

THIRTY-SIX INCHES HIGH, TWO ROWS OF LOOPS.

FOR STANDARD, ENLARGED, OR EXTENDED SURFACE LOOPS.

LIST OF RADIATORS BUILT ON THE FOLLOWING SIZE BASES.			STANDARD.		ENLARGED.		EXTENDED SURFACE.	
Width of Base, 9 3/4 inches.			Each Loop Represents 3 Feet of Heating Surface.		Each Loop Represents 3 1/2 Feet of Heating Surface.		Each Loop Represents 3 1/2 Feet of Heating Surface.	
			LIST PRICE.		LIST PRICE.		LIST PRICE.	
			Per Foot, 75c.	Per Loop, \$2.25.	Per Foot, 72 1/2c.	Per Loop, \$2.54.	Per Foot, 70c.	Per Loop, \$2.45.
Shape of Radiator.	Number of Loops.	Length of Radiators.	Feet of Heating Surface.	With Iron Top or Binder for Marble Top.	Feet of Heating Surface.	With Iron Top or Binder for Marble Top.	Feet of Heating Surface.	With Iron Top or Binder for Marble Top.
2 X 3	6	12'	18	\$13 50	21	\$15 23	21	\$14 70
2 X 4	8	15 1/4'	24	18 00	28	20 30	28	19 60
2 X 5	10	18 1/2'	30	22 50	35	25 38	35	24 50
2 X 6	12	21 3/4'	36	27 00	42	30 45	42	29 40
2 X 7	14	24 8'	42	31 50	49	35 53	49	34 30
2 X 8	16	27 3/8'	48	36 00	56	40 60	56	39 20
2 X 9	18	31 1/8'	54	40 50	63	45 68	63	44 10
2 X 10	20	34 5/8'	60	45 00	70	50 75	70	49 00
2 X 11	22	38 3/8'	66	49 50	77	55 83	77	53 90
2 X 12	24	41 1/4'	72	54 00	84	60 90	84	58 80
2 X 13	26	44 3/8'	78	58 50	91	65 98	91	63 70
2 X 14	28	47 5/8'	84	63 00	98	71 05	98	68 60
2 X 15	30	50 8'	90	67 50	105	76 13	105	73 50
2 X 16	32	54 1/8'	96	72 00	112	81 20	112	78 40
2 X 18	36	60 3/8'	108	81 00	126	91 35	126	88 20
2 X 20	40	66 8'	120	90 00	140	101 50	140	98 00
2 X 22	44	73 1/4'	132	99 00	154	111 65	154	107 80
2 X 24	48	79 3/4'	144	108 00	168	121 80	168	117 60
2 X 26	52	86 1/4'	156	117 00	182	131 95	182	127 40

For List of Special Height Radiators see bottom of page 27. NOTE.—The above prices are for all Radiators 36" high, or under to 30" high.

THIRTY INCHES HIGH, TWO ROWS OF LOOPS.

LIST OF RADIATORS BUILT ON THE FOLLOWING SIZE BASES.			Each Loop Represents 2 1/2 Feet of Heating Surface.		Each Loop Represents 3 Feet of Heating Surface.		Each Loop Represents 3 Feet of Heating Surface.	
Width of Base, 9 3/4 inches.			LIST PRICE.		LIST PRICE.		LIST PRICE.	
			Per Foot, 80c.	Per Loop, \$2.13.	Per Foot, 82 1/2c.	Per Loop, \$2.48.	Per Foot, 80c.	Per Loop, \$2.40.
2 X 3	6	12'	15	\$12 75	18	\$14 55	18	\$14 40
2 X 4	8	15 1/4'	20	17 00	24	19 80	24	19 20
2 X 5	10	18 1/2'	25	21 25	30	24 75	30	24 00
2 X 6	12	21 3/4'	30	25 50	36	29 70	36	28 80
2 X 7	14	24 8'	35	29 75	42	34 65	42	33 60
2 X 8	16	27 3/8'	40	34 00	48	39 60	48	38 40
2 X 9	18	31 1/8'	45	38 25	54	44 55	54	43 20
2 X 10	20	34 5/8'	50	42 50	60	49 50	60	48 00
2 X 11	22	38 3/8'	55	46 75	66	54 45	66	52 80
2 X 12	24	41 1/4'	60	51 00	72	59 40	72	57 60
2 X 13	26	44 3/8'	65	55 25	78	64 35	78	62 40
2 X 14	28	47 5/8'	70	59 50	84	69 30	84	67 20
2 X 15	30	50 8'	75	63 75	90	74 25	90	72 00
2 X 16	32	54 1/8'	80	68 00	96	79 20	96	76 80
2 X 18	36	60 3/8'	90	76 50	108	89 10	108	86 40
2 X 20	40	66 8'	100	85 00	120	99 00	120	96 00
2 X 22	44	73 1/4'	110	93 50	132	108 90	132	105 60
2 X 24	48	79 3/4'	120	102 00	144	118 80	144	115 20
2 X 26	52	86 1/4'	130	110 50	156	128 70	156	124 80

For List of Special Height Radiators see bottom of page 27. NOTE.—The above prices are for all Radiators 30" high, or under to 24" high.

TWENTY-FOUR INCHES HIGH, TWO ROWS OF LOOPS.

LIST OF RADIATORS BUILT ON THE FOLLOWING SIZE BASES.			Each Loop Represents 2 Feet of Heating Surface.		Each Loop Represents 2 1/2 Feet of Heating Surface.		Each Loop Represents 2 1/2 Feet of Heating Surface.	
Width of Base, 9 3/4 inches.			LIST PRICE.		LIST PRICE.		LIST PRICE.	
			Per Foot, \$1.00.	Per Loop, \$2.00.	Per Foot, 97 1/2c.	Per Loop, \$2.28.	Per Foot, 95c.	Per Loop, \$2.22.
2 X 3	6	12'	12	\$12 00	14	\$13 65	14	\$13 30
2 X 4	8	15 1/4'	16	16 00	18 3/4	18 20	18 3/4	17 75
2 X 5	10	18 1/2'	20	20 00	23 1/2	22 75	23 1/2	22 17
2 X 6	12	21 3/4'	24	24 00	28	27 30	28	26 60
2 X 7	14	24 8'	28	28 00	32 1/2	31 85	32 1/2	31 03
2 X 8	16	27 3/8'	32	32 00	37 1/2	36 40	37 1/2	35 46
2 X 9	18	31 1/8'	36	36 00	42	40 95	42	39 90
2 X 10	20	34 5/8'	40	40 00	46 3/4	45 50	46 3/4	44 33
2 X 11	22	38 3/8'	44	44 00	51 1/2	50 05	51 1/2	48 77
2 X 12	24	41 1/4'	48	48 00	56	54 60	56	53 20
2 X 13	26	44 3/8'	52	52 00	60 3/4	59 15	60 3/4	57 63
2 X 14	28	47 5/8'	56	56 00	65 1/2	63 70	65 1/2	62 07
2 X 15	30	50 8'	60	60 00	70	68 25	70	66 50
2 X 16	32	54 1/8'	64	64 00	74 3/4	72 81	74 3/4	70 93
2 X 18	36	60 3/8'	72	72 00	84	81 90	84	79 80
2 X 20	40	66 8'	80	80 00	93 1/2	91 00	93 1/2	88 66
2 X 22	44	73 1/4'	88	88 00	102 3/4	100 10	102 3/4	97 54
2 X 24	48	79 3/4'	96	96 00	112	109 20	112	106 70
2 X 26	52	86 1/4'	104	104 00	121 1/2	118 30	121 1/2	115 27

For List of Special Height Radiators see bottom of page 27. NOTE.—The above prices are for all Radiators 24" high, and under.

Regd. All Regular Steam Goods Tapped 1" X 3/4" Right Hand. No. 344

Regd. All Regular Steam Goods Tapped 1" X 3/4" Right Hand. No. 344

TRADE BUNDY MARK.

## Bundy Three Row Steam Direct Radiator.

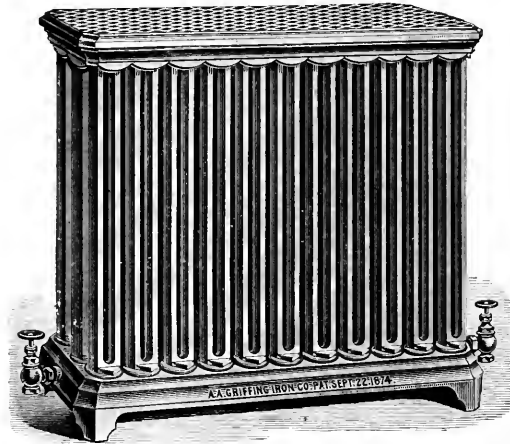

FIG. 3.

Fig. 3 represents the Bundy Three Row Steam Direct Radiator, which has no equivalent in width in any other vertical tube Radiator on the market. It has a base with liberal sized openings through which the air can pass to all the inside surface. This Radiator can be tapped for feed and return on the same end (see Fig. 31), and can be used with perfect success in connection with the One Pipe System, and like all Bundy Radiators, can be furnished with higher legs than usual without extra charge when desired. For different ways of tapping see Fig. 31.

### FORTY-TWO INCHES HIGH, THREE ROWS OF LOOPS.

LIST OF RADIATORS BUILT ON THE FOLLOWING SIZE BASES. Width of Base, 13½ inches.			FOR STANDARD, ENLARGED, OR EXTENDED SURFACE LOOPS.							
			STANDARD.		ENLARGED.		EXTENDED SURFACE.			
			Per Foot, 70c.	Per Loop, \$2.45.	Per Foot, 67½c.	Per Loop, \$2.67.	Per Foot, 65c.	Per Loop, \$2.76.		
Shape of Radiator.	Number of Loops.	Length of Radiators.	Feet of Heating Surface.	With Iron Top or Binder for Marble Top.	Feet of Heating Surface.	With Iron Top or Binder for Marble Top.	Feet of Heating Surface.	With Iron Top or Binder for Marble Top.		
3 × 3	9	12¼	31½	\$22 05	38¼	\$25 52	38¼	\$24 86		
3 × 4	12	15½	42	29 40	51	34 43	51	33 15		
3 × 5	15	18½	52½	36 75	63¾	43 03	63¾	41 44		
3 × 6	18	22	63	44 10	76½	51 64	76½	49 73		
3 × 7	21	25½	73½	51 45	89¼	60 25	89¼	58 02		
3 × 8	24	28½	84	58 80	102	68 85	102	66 30		
3 × 9	27	31½	94½	66 15	114¾	77 46	114¾	74 59		
3 × 10	30	34¾	105	73 50	127½	86 07	127½	82 88		
3 × 11	33	39	115½	80 85	140¼	94 38	140¼	91 17		
3 × 12	36	42	126	88 20	153	103 28	153	99 45		
3 × 13	39	45½	136½	95 55	165¾	111 88	165¾	107 73		
3 × 15	45	51¾	157½	110 25	191¼	129 10	191¼	124 32		

For List of Special Height Radiators see bottom of page 27. NOTE.—The above prices are for all Radiators 42" high, or under to 36" high.

All Regular Steam Goods Tapped 1" × ¾" Right Hand.

TRADE BUNDY MARK

**THIRTY-SIX INCHES HIGH, THREE ROWS OF LOOPS.**

FOR STANDARD, ENLARGED, OR EXTENDED SURFACE LOOPS.								
LIST OF RADIATORS BUILT ON THE FOLLOWING SIZE BASES.			STANDARD.		ENLARGED.		EXTENDED SURFACE.	
Width of Base, 13 1/4 inches.			Each Loop Represents 3 Feet of Heating Surface.		Each Loop Represents 3 1/2 Feet of Heating Surface.		Each Loop Represents 3 3/4 Feet of Heating Surface.	
Shape of Radiator.	Number of Loops.	Length of Radiators.	LIST PRICE.		LIST PRICE.		LIST PRICE.	
			Per Foot, 75c.	Per Loop, \$2.25.	Per Foot, 72 1/2c.	Per Loop, \$2.54.	Per Foot, 70c.	Per Loop, \$2.45.
			Feet of Heating Surface.	With Iron Top or Binder for Marble Top.	Feet of Heating Surface.	With Iron Top or Binder for Marble Top.	Feet of Heating Surface.	With Iron Top or Binder for Marble Top.
3 X 3	9	12 1/4"	27	\$20 25	31 1/2	\$22 84	31 1/2	\$22 05
3 X 4	12	15 1/2"	36	27 00	42	30 45	42	29 40
3 X 5	15	18 1/2"	45	33 75	52 1/2	38 07	52 1/2	30 75
3 X 6	18	22	54	40 50	63	45 68	63	44 10
3 X 7	21	25 3/8"	63	47 25	73 1/2	53 29	73 1/2	51 45
3 X 8	24	28 3/8"	72	54 00	84	60 90	84	58 80
3 X 9	27	31 1/2"	81	60 75	94 1/2	68 52	94 1/2	66 15
3 X 10	30	34 1/4"	90	67 50	105	76 13	105	73 50
3 X 11	33	37 1/2"	99	74 25	115 1/2	83 74	115 1/2	80 85
3 X 12	36	42	108	81 00	126	91 35	126	88 20
3 X 13	39	45 1/2"	117	87 75	136 1/2	98 97	136 1/2	95 55
3 X 15	45	51 3/4"	135	101 25	157 1/2	114 20	157 1/2	110 25

For List of Special Height Radiators see bottom of page 27. NOTE.—The above prices are for all Radiators 36" high, or under to 30" high.

**THIRTY INCHES HIGH, THREE ROWS OF LOOPS.**

LIST OF RADIATORS BUILT ON THE FOLLOWING SIZE BASES.				Each Loop Represents 2 1/2 Feet of Heating Surface.		Each Loop Represents 3 Feet of Heating Surface.		Each Loop Represents 3 Feet of Heating Surface.	
Width of Base, 13 1/4 inches.				LIST PRICE.		LIST PRICE.		LIST PRICE.	
				Per Foot, 85c.	Per Loop, \$2.13.	Per Foot, 82 1/2c.	Per Loop, \$2.48.	Per Foot, 80c.	Per Loop, \$2.40.
				Feet of Heating Surface.	With Iron Top or Binder for Marble Top.	Feet of Heating Surface.	With Iron Top or Binder for Marble Top.	Feet of Heating Surface.	With Iron Top or Binder for Marble Top.
3 X 3	9	12 1/4"	22 1/2	\$19 12	27	\$22 28	27	\$21 60	
3 X 4	12	15 1/2"	30	25 30	36	29 70	36	28 80	
3 X 5	15	18 1/2"	37 1/2	31 87	45	37 13	45	36 00	
3 X 6	18	22	45	38 25	54	44 55	54	43 20	
3 X 7	21	25 3/8"	52 1/2	44 62	63	51 99	63	50 40	
3 X 8	24	28 3/8"	60	51 00	72	59 40	72	57 60	
3 X 9	27	31 1/2"	67 1/2	57 37	81	66 83	81	64 80	
3 X 10	30	34 1/4"	75	63 75	90	74 25	90	72 00	
3 X 11	33	37 1/2"	82 1/2	70 12	99	81 68	99	79 20	
3 X 12	36	42	90	76 50	108	89 10	108	86 40	
3 X 13	39	45 1/2"	97 1/2	82 87	117	96 53	117	93 60	
3 X 15	45	51 3/4"	112 1/2	95 62	135	111 38	135	108 00	

For List of Special Height Radiators see bottom of page 27. NOTE.—The above prices are for all Radiators 30" high, or under to 24" high.

**TWENTY-FOUR INCHES HIGH, THREE ROWS OF LOOPS.**

LIST OF RADIATORS BUILT ON THE FOLLOWING SIZE BASES.				Each Loop Represents 2 Feet of Heating Surface.		Each Loop Represents 2 1/2 Feet of Heating Surface.		Each Loop Represents 2 3/4 Feet of Heating Surface.	
Width of Base, 13 1/4 inches.				LIST PRICE.		LIST PRICE.		LIST PRICE.	
				Per Foot, \$1.00.	Per Loop, \$2.00.	Per Foot, 97 1/2c.	Per Loop, \$2.28.	Per Foot, 95c.	Per Loop, \$2.22.
				Feet of Heating Surface.	With Iron Top or Binder for Marble Top.	Feet of Heating Surface.	With Iron Top or Binder for Marble Top.	Feet of Heating Surface.	With Iron Top or Binder for Marble Top.
3 X 3	9	12 1/4"	18	\$18 00	21	\$20 45	21	\$19 95	
3 X 4	12	15 1/2"	24	24 00	28	27 30	28	26 60	
3 X 5	15	18 1/2"	30	30 00	35	34 13	35	33 25	
3 X 6	18	22	36	36 00	42	40 95	42	39 90	
3 X 7	21	25 3/8"	42	42 00	49	47 78	49	46 55	
3 X 8	24	28 3/8"	48	48 00	57	54 60	56	53 20	
3 X 9	27	31 1/2"	54	54 00	63	61 43	63	59 85	
3 X 10	30	34 1/4"	60	60 00	70	68 25	70	66 50	
3 X 11	33	37 1/2"	66	66 00	77	75 08	77	73 15	
3 X 12	36	42	72	72 00	84	81 90	84	79 80	
3 X 13	39	45 1/2"	78	78 00	91	88 73	91	86 45	
3 X 15	45	51 3/4"	90	90 00	105	102 38	105	99 75	

For List of Special Height Radiators see bottom of page 27. NOTE.—The above prices are for all Radiators 24" high, and under.

All Regular Steam Goods Tapped 1" X 3/4" Right Hand.

All Regular Steam Goods Tapped 1" X 3/4" Right Hand.

TRADE BUNDY MARK.

## Four Row Bundy Steam Direct Radiator.

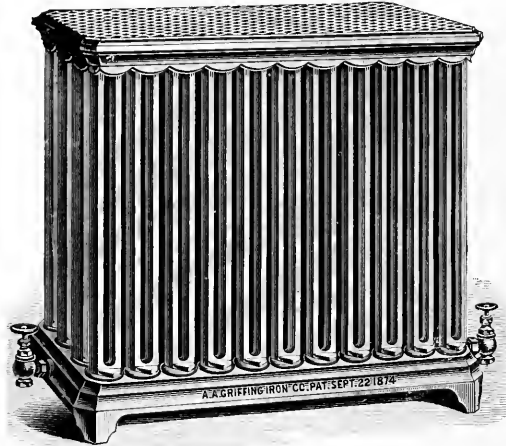

FIG. 4.

FIG. 4 represents the Bundy Four Row Steam Direct Radiator, which has no equivalent in width in any other vertical tube Radiator on the market. The base of this Radiator has a large number of air openings, of liberal size, so that the entire surface of the Radiator is constantly surrounded with freely circulating air, thus giving it an advantage over all other Radiators of equal width of from 25 to 40 per cent greater efficiency. It can be used on the One Pipe System, and can be tapped on same or opposite end as shown in Fig. 32.

### FORTY-TWO INCHES HIGH, FOUR ROWS OF LOOPS.

FOR STANDARD, ENLARGED, OR EXTENDED SURFACE LOOPS.									
LIST OF RADIATORS BUILT ON THE FOLLOWING SIZE BASES. Width of Base, 17½ inches.			STANDARD. Each Loop Represents 3½ Feet of Heating Surface. LIST PRICE. Per Foot, 70c. Per Loop, \$2.45.		ENLARGED. Each Loop Represents 4½ Feet of Heating Surface. LIST PRICE Per Foot, 67½c. Per Loop, \$2.87.		EXTENDED SURFACE. Each Loop Represents 4½ Feet of Heating Surface. LIST PRICE Per Foot, 65c. Per Loop, \$2.76.		
Shape of Radiator.	Number of Loops.	Length of Radiators.	Feet of Heating Surface.	With Iron Top or Binder for Marble Top.	Feet of Heating Surface.	With Iron Top or Binder for Marble Top.	Feet of Heating Surface.	With Iron Top or Binder for Marble Top.	
4 × 4	16	16½"	56	\$39 20	68	\$45 00	68	\$44 20	
4 × 5	20	19½"	70	49 00	85	57 38	85	55 25	
4 × 6	24	22½"	84	58 80	102	68 85	102	66 30	
4 × 8	32	29½"	112	78 40	136	91 80	136	88 40	
4 × 10	40	35½"	140	98 00	170	114 75	170	110 50	
4 × 14	56	48½"	196	137 20	238	160 65	238	154 70	
4 × 18	72	60½"	252	176 40	306	206 55	306	198 90	
4 × 20	80	67½"	280	166 00	340	229 50	340	221 00	
4 × 22	88	73½"	308	215 60	374	252 45	374	243 10	
4 × 24	96	79½"	336	235 20	408	275 40	408	265 20	

For List of Special Height Radiators see bottom of page 27. NOTE.—The above prices are for all Radiators 42" high, or under to 36" high.

All Regular Steam Goods Tapped 1" × ¾" "Right Hand."



TRADE MARK. BUNDY

THIRTY-SIX INCHES HIGH, FOUR ROWS OF LOOPS.

FOR STANDARD, ENLARGED, OR EXTENDED SURFACE LOOPS.									
LIST OF RADIATORS BUILT ON THE FOLLOWING SIZE BASES.			STANDARD.		ENLARGED.		EXTENDED SURFACE.		
Width of Base, 17½ inches.			Each Loop Represents 3 Feet of Heating Surface.		Each Loop Represents 3 Feet of Heating Surface.		Each Loop Represents 3½ Feet of Heating Surface.		
			LIST PRICE.		LIST PRICE.		LIST PRICE.		
Shape of Radiator.	Number of Loops.	Length of Radiators.	Per Foot, 75c.	Per Loop, \$2.25.	Per Foot, 72½c.	Per Loop, \$2.54.	Per Foot, 70c.	Per Loop, \$2.45.	
			Feet of Heating Surface.	With Iron Top or Blinder for Marble Top.	Feet of Heating Surface.	With Iron Top or Blinder for Marble Top.	Feet of Heating Surface.	With Iron Top or Blinder for Marble Top.	
4 X 4	10	10½	48	\$36 00	56	\$40 60	56	\$39 20	
4 X 5	20	19¾	60	45 00	70	50 75	70	49 00	
4 X 6	24	22¾	72	54 00	84	60 00	84	58 80	
4 X 8	32	29¼	96	72 00	112	81 20	112	78 40	
4 X 10	40	35¾	120	90 00	140	101 50	140	98 00	
4 X 14	56	48¾	168	126 00	196	142 10	196	137 20	
4 X 18	72	60½	216	162 00	252	182 70	252	176 40	
4 X 20	80	67¼	240	180 00	280	203 00	280	196 00	
4 X 22	88	73½	264	198 00	308	223 30	308	215 60	
4 X 24	96	79¾	288	216 00	336	243 60	336	235 20	

For List of Special Height Radiators see Bottom of page. NOTE.—The above prices are for all Radiators 36" high, and under to 30" high.

THIRTY INCHES HIGH, FOUR ROWS OF LOOPS.

LIST OF RADIATORS BUILT ON THE FOLLOWING SIZE BASES.			Each Loop Represents 2½ Feet of Heating Surface.		Each Loop Represents 3 Feet of Heating Surface.		Each Loop Represents 3 Feet of Heating Surface.	
Width of Base, 17½ inches.			LIST PRICE.		LIST PRICE.		LIST PRICE.	
			Per Foot, 85c.	Per Loop, \$2.13.	Per Foot, 82½c.	Per Loop, \$2.48.	Per Foot, 80c.	Per Loop, \$2.40.
4 X 4	16	16½	40	\$34 00	48	\$39 60	48	\$38 40
4 X 5	20	19¾	50	42 50	60	49 50	60	48 00
4 X 6	24	22¾	60	51 00	72	59 40	72	57 60
4 X 8	32	29¼	80	68 00	96	79 20	96	76 80
4 X 10	40	35¾	100	85 00	120	99 00	120	96 00
4 X 14	56	48¾	140	119 00	168	138 60	168	134 40
4 X 18	72	60½	180	153 00	216	178 20	216	172 80
4 X 20	80	67¼	200	170 00	240	198 00	240	192 00
4 X 22	88	73½	220	187 00	264	217 80	264	211 20
4 X 24	96	79¾	240	204 00	288	237 60	288	230 40

For List of Special Height Radiators see bottom of page. NOTE.—The above prices are for all Radiators 30" high and under to 24" high.

TWENTY-FOUR INCHES HIGH, FOUR ROWS OF LOOPS.

LIST OF RADIATORS BUILT ON THE FOLLOWING SIZE BASES.			Each Loop Represents 2 Feet of Heating Surface.		Each Loop Represents 2½ Feet of Heating Surface.		Each Loop Represents 2½ Feet of Heating Surface.	
Width of Base, 17½ inches.			LIST PRICE.		LIST PRICE.		LIST PRICE.	
			Per Foot, \$1.00.	Per Loop, \$2.00.	Per Foot, 97½c.	Per Loop, \$2.38.	Per Foot, 95c.	Per Loop, \$2.22.
4 X 4	16	16½	32	\$32 00	37½	\$36 40	37½	\$35 47
4 X 5	20	19¾	40	40 00	46½	45 50	46½	44 35
4 X 6	24	22¾	48	48 00	56	54 60	56	53 20
4 X 8	32	29¼	64	64 00	74½	72 80	74½	70 93
4 X 10	40	35¾	80	80 00	93½	91 00	93½	88 67
4 X 14	56	48¾	112	112 00	130½	127 40	130½	124 13
4 X 18	72	60½	144	144 00	168	163 80	168	159 60
4 X 20	80	67¼	160	160 00	186½	182 00	186½	177 35
4 X 22	88	73½	176	176 00	205½	200 20	205½	195 06
4 X 24	96	79¾	192	192 00	224	218 40	224	212 80

For List of Special Height Radiators see bottom of page. NOTE.—The above prices are for all Radiators 24" high and under.

List of Regular and Special Height Steam Rectangular, Circular, Column and Corner Radiators.

10"	14"	18"	22"	26"	30"	34"	38"	45"
11"	15"	19"	23"	27"	31"	35"	39"	
12"	16"	20"	24"	28"	32"	36"	40"	
13"	17"	21"	25"	29"	33"	37"	42"	

REGD. All Regular Steam Goods Tapped 1" X 3/4" Right Hand. 1" X 3/4" Right Hand.

REGD. All Regular Steam Goods Tapped 1" X 3/4" Right Hand. 1" X 3/4" Right Hand.

TRADE BUNDY MARK.

# Bundy One Row Hot Water Direct Radiator.

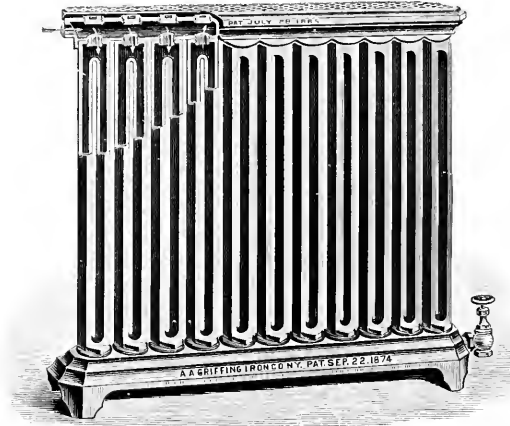

FIG. 35.

FIG. 35 represents the Bundy One Row Hot Water Direct Radiator, which is, without exception, the most powerful Hot Water Heating Radiator on the market. It is made from the Bundy One Row Steam Radiator, which in appearance it resembles, and is very narrow, occupying in width scarcely more space than the ordinary one inch pipe coil. This Radiator holds the minimum amount of water per square foot of surface, and hence the circulation is more rapid and the drain on the heater very much less than when any other style is used; in fact, the saving in fuel where the Bundy Radiator is used makes it the cheapest Radiator on the market. The ease with which the water, after surrendering its heat, falls perpendicularly and passes from this Radiator should commend its use to all desiring the best apparatus.

The cut shows a Radiator tapped for supply connection in the upper circulating chamber, where it can be furnished without extra charge when the overhead system of piping is used or the Radiator is wanted to set on the same or a lower level than the Hot Water Heater proper, but when goods are wanted tapped this way it should be noted on the order, otherwise the regular tapping in the base will be sent (see Fig. 36).

## FORTY-FIVE INCHES HIGH, ONE ROW OF LOOPS.

FOR STANDARD, ENLARGED, OR EXTENDED SURFACE LOOPS.

LIST OF RADIATORS BUILT ON THE FOLLOWING SIZE BASES.			STANDARD.			ENLARGED.		EXTENDED SURFACE.	
			Each Loop Represents 4 Feet of Heating Surface.			Each Loop Represents 4 3/4 Feet of Heating Surface.		Each Loop Represents 4 3/4 Feet of Heating Surface.	
Width of Base, 5 1/2 Inches.			LIST PRICE.			LIST PRICE.		LIST PRICE.	
Shape of Radiator.	Number of Loops.	Length of Radiator.	Per Foot, 85c.	Per Loop, \$3.40.	Per Foot, 82 1/2c.	Per Loop, \$3.92.	Per Foot, 80c.	Per Loop, \$3.80.	
			Feet of Heating Surface.	With Iron Top or Arranged for Marble Top.	Feet of Heating Surface.	With Iron Top or Arranged for Marble Top.	Feet of Heating Surface.	With Iron Top or Arranged for Marble Top.	
1 x 3	3	12"	12	\$10 20	14 1/4	\$11 76	14 1/4	\$11 40	
1 x 4	4	15 1/4	16	13 60	19	15 68	19	15 20	
1 x 5	5	18 1/2	20	17 00	23 3/4	19 60	23 3/4	19 00	
1 x 6	6	21 3/4	24	20 40	28 1/2	23 52	28 1/2	22 80	
1 x 7	7	25 1/8	28	23 80	33 1/4	27 43	33 1/4	26 60	
1 x 8	8	28 1/8	32	27 20	38	31 35	38	30 40	
1 x 9	9	31 1/2	36	30 60	42 3/4	35 28	42 3/4	34 20	
1 x 10	10	34 1/2	40	34 00	47 1/2	39 19	47 1/2	38 00	
1 x 11	11	38	44	37 40	52 1/4	43 12	52 1/4	41 80	
1 x 12	12	41 1/4	48	40 80	57	47 03	57	46 60	
1 x 13	13	44 3/8	52	44 20	61 3/4	50 95	61 3/4	49 40	
1 x 14	14	47 3/8	56	47 60	66 1/2	54 87	66 1/2	53 20	
1 x 15	15	51	60	51 00	71 1/4	58 79	71 1/4	57 00	
1 x 16	16	54	64	54 40	76	62 70	76	60 80	
1 x 18	18	60 5/8	72	61 20	85 1/2	70 54	85 1/2	68 40	
1 x 20	20	66 3/8	80	68 00	95	78 38	95	76 00	

For List of Special Height Radiators see bottom of page 33. NOTE.—The above prices are for all Radiators 45" high, and under to 39" high.

All Regular Hot Water Goods Tapped 1 1/4" x 1 1/4" "Right Hand."





TRADE BUNDY MARK.

THIRTY-NINE INCHES HIGH, ONE ROW OF LOOPS.

LIST OF RADIATORS BUILT ON THE FOLLOWING SIZE BASES.			FOR STANDARD, ENLARGED, OR EXTENDED SURFACE LOOPS.					
Width of Base, 5½ inches.			STANDARD.		ENLARGED.		EXTENDED SURFACE.	
Shape of Radiator	Number of Loops.	Length of Radiators.	Each Loop Represents 3½ Feet of Heating Surface.		Each Loop Represents 4 Feet of Heating Surface.		Each Loop Represents 4 Feet of Heating Surface.	
			LIST PRICE, Per Foot, 90c.	Per Loop, \$3.15.	LIST PRICE, Per Foot, \$7½c.	Per Loop, \$3.50.	LIST PRICE, Per Foot, 85c.	Per Loop, \$3.40.
			Feet of Heating Surface.	With Iron Top or Binder for Marble Top.	Feet of Heating Surface.	With Iron Top or Binder for Marble Top.	Feet of Heating Surface.	With Iron Top or Binder for Marble Top.
1 X 3	3	12 <sup>7</sup> / <sub>8</sub>	10½	\$ 9 45	12	\$10 20	12	\$10 20
1 X 4	4	15 <sup>1</sup> / <sub>4</sub>	14	12 60	16	14 00	16	13 60
1 X 5	5	18 <sup>1</sup> / <sub>2</sub>	17½	15 75	20	17 50	20	17 00
1 X 6	6	21 <sup>3</sup> / <sub>4</sub>	21	18 90	24	21 00	24	20 80
1 X 7	7	25 <sup>1</sup> / <sub>8</sub>	24½	22 05	28	24 50	28	23 40
1 X 8	8	28 <sup>1</sup> / <sub>8</sub>	28	25 20	32	28 00	32	27 20
1 X 9	9	31 <sup>1</sup> / <sub>2</sub>	31½	28 35	36	31 50	36	30 60
1 X 10	10	34 <sup>1</sup> / <sub>2</sub>	35	31 50	40	35 00	40	34 00
1 X 11	11	38 <sup>1</sup> / <sub>2</sub>	38½	34 65	44	38 50	44	37 40
1 X 12	12	41 <sup>1</sup> / <sub>4</sub>	42	37 80	48	42 00	48	40 80
1 X 13	13	44 <sup>3</sup> / <sub>8</sub>	45½	40 95	52	45 50	52	44 20
1 X 14	14	47 <sup>7</sup> / <sub>8</sub>	49	44 10	56	49 00	56	47 60
1 X 15	15	51 <sup>1</sup> / <sub>2</sub>	52½	47 25	60	52 50	60	51 00
1 X 16	16	54 <sup>5</sup> / <sub>8</sub>	56	50 40	64	56 00	64	54 40
1 X 18	18	60 <sup>5</sup> / <sub>8</sub>	63	56 70	72	63 00	72	60 20
1 X 20	20	66 <sup>7</sup> / <sub>8</sub>	70	63 00	80	70 00	80	68 00

For List of Special Height Radiators see bottom of page 33. NOTE.—The above prices are for all Radiators 39" high, and under to 33" high.

THIRTY-THREE INCHES HIGH, ONE ROW OF LOOPS.

LIST OF RADIATORS BUILT ON THE FOLLOWING SIZE BASES.			Each Loop Represents 3 Feet of Heating Surface.		Each Loop Represents 3½ Feet of Heating Surface.		Each Loop Represents 4 Feet of Heating Surface.	
Width of Base, 5½ inches.			LIST PRICE, Per Foot, \$1.00.	Per Loop, \$3.00.	LIST PRICE, Per Foot, 97½c.	Per Loop, \$3.41.	LIST PRICE, Per Foot, 95c.	Per Loop, \$3.33.
Shape of Radiator	Number of Loops.	Length of Radiators.	Feet of Heating Surface.	With Iron Top or Binder for Marble Top.	Feet of Heating Surface.	With Iron Top or Binder for Marble Top.	Feet of Heating Surface.	With Iron Top or Binder for Marble Top.
			1 X 3	3	12 <sup>7</sup> / <sub>8</sub>	9	\$ 9 00	10½
1 X 4	4	15 <sup>1</sup> / <sub>4</sub>	12	12 00	14	13 65	14	13 30
1 X 5	5	18 <sup>1</sup> / <sub>2</sub>	15	15 00	17½	17 06	17½	16 63
1 X 6	6	21 <sup>3</sup> / <sub>4</sub>	18	18 00	21	20 48	21	19 95
1 X 7	7	25 <sup>1</sup> / <sub>8</sub>	21	21 00	24½	23 80	24½	23 28
1 X 8	8	28 <sup>1</sup> / <sub>8</sub>	24	24 00	28	27 30	28	26 60
1 X 9	9	31 <sup>1</sup> / <sub>2</sub>	27	27 00	31½	30 71	31½	29 93
1 X 10	10	34 <sup>1</sup> / <sub>2</sub>	30	30 00	35	34 13	35	33 25
1 X 11	11	38 <sup>1</sup> / <sub>2</sub>	33	33 00	38½	37 54	38½	36 57
1 X 12	12	41 <sup>1</sup> / <sub>4</sub>	36	36 00	42	40 95	42	39 00
1 X 13	13	44 <sup>3</sup> / <sub>8</sub>	39	39 00	45½	44 36	45½	43 23
1 X 14	14	47 <sup>7</sup> / <sub>8</sub>	42	42 00	49	47 78	49	46 55
1 X 15	15	51 <sup>1</sup> / <sub>2</sub>	45	45 00	52½	51 19	52½	49 88
1 X 16	16	54 <sup>5</sup> / <sub>8</sub>	48	48 00	56	54 60	56	53 20
1 X 18	18	60 <sup>5</sup> / <sub>8</sub>	54	54 00	63	61 43	63	59 55
1 X 20	20	66 <sup>7</sup> / <sub>8</sub>	63	60 00	70	68 25	70	66 50

For List of Special Height Radiators see bottom of page 33. NOTE.—The above prices are for all Radiators 33" high, and under to 27" high.

TWENTY-SEVEN INCHES HIGH, ONE ROW OF LOOPS.

LIST OF RADIATORS BUILT ON THE FOLLOWING SIZE BASES.			Each Loop Represents 2½ Feet of Heating Surface.		Each Loop Represents 2¾ Feet of Heating Surface.		Each Loop Represents 2½ Feet of Heating Surface.	
Width of Base, 5½ inches.			LIST PRICE, Per Foot, \$1.15.	Per Loop, \$2 88	LIST PRICE, Per Foot, \$1.12½.	Per Loop, \$3.19.	LIST PRICE, Per Foot, \$1.10.	Per Loop, \$3.12.
Shape of Radiator	Number of Loops.	Length of Radiators.	Feet of Heating Surface.	With Iron Top or Binder for Marble Top.	Feet of Heating Surface.	With Iron Top or Binder for Marble Top.	Feet of Heating Surface.	With Iron Top or Binder for Marble Top.
			1 X 3	3	12 <sup>7</sup> / <sub>8</sub>	7½	\$ 8 63	8½
1 X 4	4	15 <sup>1</sup> / <sub>4</sub>	10	11 50	11½	12 75	11½	12 47
1 X 5	5	18 <sup>1</sup> / <sub>2</sub>	12½	14 38	14½	15 94	14½	15 58
1 X 6	6	21 <sup>3</sup> / <sub>4</sub>	15	17 25	17	19 13	17	18 70
1 X 7	7	25 <sup>1</sup> / <sub>8</sub>	17½	20 13	19½	22 32	19½	21 82
1 X 8	8	28 <sup>1</sup> / <sub>8</sub>	20	23 00	22½	25 51	22½	24 97
1 X 9	9	31 <sup>1</sup> / <sub>2</sub>	22½	25 88	25½	28 69	25½	28 05
1 X 10	10	34 <sup>1</sup> / <sub>2</sub>	25	28 75	28½	31 88	28½	31 17
1 X 11	11	38 <sup>1</sup> / <sub>2</sub>	27½	31 63	31½	35 07	31½	34 20
1 X 12	12	41 <sup>1</sup> / <sub>4</sub>	30	34 50	34	38 25	34	37 40
1 X 13	13	44 <sup>3</sup> / <sub>8</sub>	32½	37 38	36½	41 44	36½	40 54
1 X 14	14	47 <sup>7</sup> / <sub>8</sub>	35	40 25	39½	44 63	39½	43 63
1 X 15	15	51 <sup>1</sup> / <sub>2</sub>	37½	43 13	42½	47 82	42½	45 65
1 X 16	16	54 <sup>5</sup> / <sub>8</sub>	40	46 00	45½	51 00	45½	49 87
1 X 18	18	60 <sup>5</sup> / <sub>8</sub>	45	51 75	51	57 38	51	55 10
1 X 20	20	66 <sup>7</sup> / <sub>8</sub>	50	57 50	56½	63 75	56½	62 34

For List of Special Height Radiators see bottom of page 33. NOTE.—The above prices are for all Radiators 27" high, and under.

All Regular Hot Water Goods Tapped 1¼" X 1¼" "Right Hand." "Left Hand."

All Regular Hot Water Goods Tapped 1¼" X 1¼" "Right Hand." "Left Hand."

TRADE BUNDY MARK.

# Bundy Two Row Hot Water Direct Radiator.

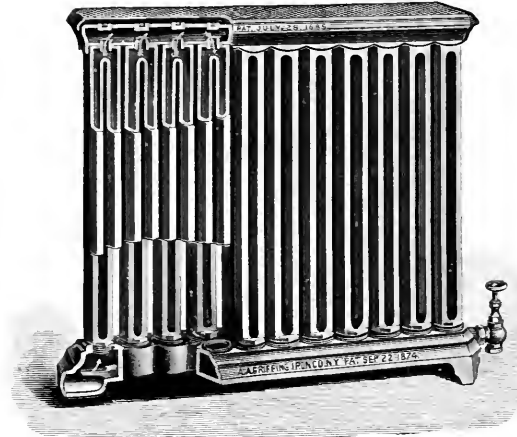

FIG. 36.

FIG. 36 represents the Bundy Two Row Hot Water Direct Radiator which has a base and upper circulating chamber, both made in the form of a loop (see Fig. 34) with large openings, through which freely circulating air can pass to the inside surface of the Radiator. This feature makes this Radiator from 25 to 40 per cent. more efficient than any other Radiator, having only small air openings in the base, or none at all, as is oftentimes the case. It can be furnished tapped for floor and return pipes at the same end, without extra charge, when it is equivalent to a One Row Radiator of double its length, owing to the septum cast in the base and in the upper circulating chamber, and with our partition base and upper circulating chamber, one-half of the Radiator can be in use while the other half remains idle, or the entire Radiator may be used at one time. This represents a great saving of fuel and prevents overheating of apartments. Also this Radiator is a great success in connection with the Direct-Indirect Box Base System (see Figs. 24, 25 and 26), and can be tapped in the upper circulating chamber as shown in Fig. 35 if required, for which no extra charge will be made.

## FORTY-FIVE INCHES HIGH, TWO ROWS OF LOOPS.

LIST OF RADIATORS BUILT ON THE FOLLOWING SIZE BASES. Width of Base, 9 3/4 inches.			FOR STANDARD, ENLARGED, OR EXTENDED SURFACE LOOPS.					
			STANDARD.		ENLARGED.		EXTENDED SURFACE.	
Shape of Radiator.	Number of Loops.	Length of Radiators.	Each Loop Represents 4 Feet of Heating Surface.		Each Loop Represents 4 3/4 Feet of Heating Surface.		Each Loop Represents 4 3/4 Feet of Heating Surface.	
			Per Foot, 50c.	Per Loop, \$3.40.	Per Foot, 82 1/2c.	Per Loop, \$3.92.	Per Foot, 50c.	Per Loop, \$3.80.
			Feet of Heating Surface.	With Iron Top or Arranged for Marble Top.	Feet of Heating Surface.	With Iron Top or Arranged for Marble Top.	Feet of Heating Surface.	With Iron Top or Arranged for Marble Top.
2 x 3	6	12	24	\$20 40	25 1/2	\$23 52	25 1/2	\$22 80
2 x 4	8	15 1/4	32	27 20	38	31 36	38	30 40
2 x 5	10	18 1/2	40	34 00	47 1/2	39 20	47 1/2	38 00
2 x 6	12	21 3/4	48	40 80	57	47 04	57	45 60
2 x 7	14	24 7/8	56	47 60	66 1/2	54 86	66 1/2	53 20
2 x 8	16	28 1/8	64	54 40	76	62 70	76	60 80
2 x 9	18	31 1/4	72	61 20	85 1/2	70 56	85 1/2	68 40
2 x 10	20	34 3/8	80	68 00	95	78 38	95	76 00
2 x 11	22	38	88	74 80	104 1/2	86 24	104 1/2	83 60
2 x 12	24	41 1/4	96	81 60	114	94 06	114	91 20
2 x 13	26	44 3/8	104	88 40	123 1/2	101 90	123 1/2	98 80
2 x 14	28	47 7/8	112	95 20	133	109 74	133	106 40
2 x 15	30	50 7/8	120	102 00	142 1/2	117 58	142 1/2	114 00
2 x 16	32	54 1/8	128	108 80	152	125 40	152	121 60
2 x 18	36	60 3/8	144	122 40	171	141 68	171	136 80
2 x 20	40	66 7/8	160	136 00	190	156 76	190	152 00

For List of Special Height Radiators see bottom of page 33. NOTE.—The above prices are for all Radiators 45" high, and under to 39" high.

All Regular Hot Water Goods Tapped 1 1/4" x 1 1/4" "Right Hand."



TRADE BUNNY MARK.

THIRTY-NINE INCHES HIGH, TWO ROWS OF LOOPS.

FOR STANDARD ENLARGED OR EXTENDED SURFACE LOOPS.								
LIST OF RADIATORS BUILT ON THE FOLLOWING SIZE BASES. Width of Base, 9 3/4 inches.			STANDARD. Each Loop Represents 3 3/4 Feet of Heating Surface. LIST PRICE. Per Foot, 90c. Per Loop, \$3.15.		ENLARGED. Each Loop Represents 4 Feet of Heating Surface. LIST PRICE. Per Foot, 87 1/2c. Per Loop, \$3.50.		EXTENDED SURFACE. Each Loop Represents 4 Feet of Heating Surface. LIST PRICE. Per Foot, 85c. Per Loop, \$3.40.	
Shape of Radiator.	Number of Loops.	Length of Radiators.	Feet of Heating Surface.	With Iron Top or Arranged for Marble Top.	Feet of Heating Surface.	With Iron Top or Arranged for Marble Top.	Feet of Heating Surface.	With Iron Top or Arranged for Marble Top.
2 X 3	6	12 1/2	21	\$18 90	24	\$21 00	24	\$20 40
2 X 4	8	15 1/4	28	25 20	32	28 00	32	27 20
2 X 5	10	18 1/2	35	31 50	40	35 00	40	34 00
2 X 6	12	21 3/4	42	37 80	48	42 00	48	40 80
2 X 7	14	24 3/8	49	44 10	56	49 00	56	47 60
2 X 8	16	28 1/8	56	50 40	64	56 00	64	54 40
2 X 9	18	31 1/4	63	56 70	72	63 00	72	61 20
2 X 10	20	34 3/8	70	63 00	80	70 00	80	68 00
2 X 11	22	38	77	69 30	88	77 00	88	74 60
2 X 12	24	41 1/4	84	75 60	96	84 00	96	81 40
2 X 13	26	44 3/8	91	81 90	104	91 00	104	88 40
2 X 14	28	47 3/8	98	88 20	112	98 00	112	95 20
2 X 15	30	50 3/8	105	94 50	120	105 00	120	102 00
2 X 16	32	54 1/8	112	100 80	128	112 00	128	108 80
2 X 18	36	60 3/8	126	113 40	144	126 00	144	122 40
2 X 20	40	66 3/8	140	126 00	160	140 00	160	136 00

For List of Special Height Radiators see bottom of page 33. NOTE.—The above prices are for all Radiators 39" high, and under to 23" high.

THIRTY-THREE INCHES HIGH, TWO ROWS OF LOOPS.

LIST OF RADIATORS BUILT ON THE FOLLOWING SIZE BASES. Width of Base, 9 3/4 inches.			Each Loop Represents 3 Feet of Heating Surface. LIST PRICE. Per Foot, \$1.00. Per Loop, \$3.00.		Each Loop Represents 3 1/2 Feet of Heating Surface. LIST PRICE. Per Foot, 97 1/2c. Per Loop, \$3.41.		Each Loop Represents 3 3/4 Feet of Heating Surface. LIST PRICE. Per Foot, 95c. Per Loop, \$3.33.	
2 X 3	6	12 1/2	18	\$18 00	21	\$20 48	24	\$19 95
2 X 4	8	15 1/4	24	24 00	28	27 30	28	26 60
2 X 5	10	18 1/2	30	30 00	35	34 12	35	33 26
2 X 6	12	21 3/4	36	36 00	42	40 96	42	39 90
2 X 7	14	24 3/8	42	42 00	49	47 78	49	46 56
2 X 8	16	28 1/8	48	48 00	56	54 60	56	53 20
2 X 9	18	31 1/4	54	54 00	63	61 42	63	59 86
2 X 10	20	34 3/8	60	60 00	70	68 26	70	66 50
2 X 11	22	38	66	66 00	77	75 08	77	73 14
2 X 12	24	41 1/4	72	72 00	84	81 90	84	79 80
2 X 13	26	44 3/8	78	78 00	91	88 72	91	86 46
2 X 14	28	47 3/8	84	84 00	98	95 56	98	93 10
2 X 15	30	50 3/8	90	90 00	105	102 38	105	99 76
2 X 16	32	54 1/8	96	96 00	112	109 20	112	106 40
2 X 18	36	60 3/8	108	108 00	126	132 86	126	119 70
2 X 20	40	66 3/8	120	120 00	140	136 50	140	133 00

For List of Special Height Radiators see bottom of page 33. NOTE.—The above prices are for all Radiators 33" high, and under to 27" high.

TWENTY-SEVEN INCHES HIGH, TWO ROWS OF LOOPS.

LIST OF RADIATORS BUILT ON THE FOLLOWING SIZE BASES. Width of Base, 9 3/4 inches.			Each Loop Represents 2 1/2 Feet of Heating Surface. LIST PRICE. Per Foot, \$1.15. Per Loop, \$2 88.		Each Loop Represents 2 3/4 Feet of Heating Surface. LIST PRICE. Per Foot, \$1.12 1/2. Per Loop, \$3.19.		Each Loop Represents 2 1/2 Feet of Heating Surface. LIST PRICE. Per Foot, \$1.10. Per Loop, \$3.22.	
2 X 3	6	12 1/2	15	\$17 26	17	\$19 14	17	\$18 70
2 X 4	8	15 1/4	20	23 00	22 2/3	25 50	22 2/3	24 94
2 X 5	10	18 1/2	25	28 76	28 1/3	31 88	28 1/3	31 16
2 X 6	12	21 3/4	30	34 50	34	38 26	34	37 40
2 X 7	14	24 3/8	35	40 26	39 2/3	44 64	39 2/3	43 64
2 X 8	16	28 1/8	40	46 00	45 1/3	51 02	45 1/3	49 94
2 X 9	18	31 1/4	45	51 76	51	57 38	51	56 10
2 X 10	20	34 3/8	50	57 50	56 2/3	63 76	56 2/3	62 34
2 X 11	22	38	55	63 26	62 1/3	70 14	62 1/3	68 58
2 X 12	24	41 1/4	60	69 00	68	76 50	68	74 80
2 X 13	26	44 3/8	65	74 76	73 2/3	82 88	73 2/3	81 08
2 X 14	28	47 3/8	70	80 50	79 1/3	89 26	79 1/3	87 26
2 X 15	30	50 3/8	75	86 26	85	95 64	85	91 30
2 X 16	32	54 1/8	80	92 00	90 2/3	102 00	90 2/3	99 74
2 X 18	36	60 3/8	90	103 50	102	114 76	102	112 20
2 X 20	40	66 3/8	100	115 00	113 1/3	127 50	113 1/3	124 67

For List of Special Height Radiators see bottom of page 33. NOTE.—The above prices are for all Radiators 27" high, and under.

All Regular Hot Water Goods Tapped 1 1/4" X 1 1/4" "Right Hand."

All Regular Hot Water Goods Tapped 1 1/4" X 1 1/4" "Right Hand."

TRADE BUNDY MARK.

## Bundy Three Row Hot Water Direct Radiator.

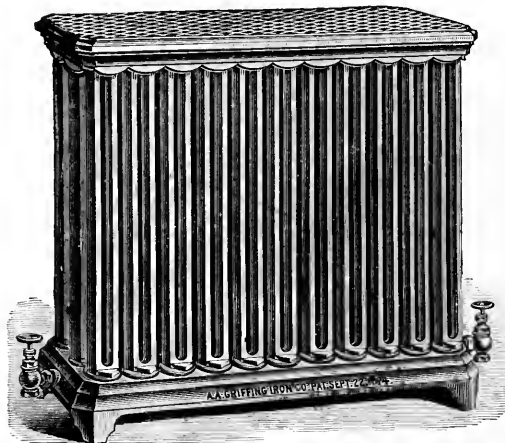

FIG. 36½.

Fig. 36½ represents the Bundy Three Row Hot Water Direct Radiator which, for compactness and efficiency, has no equivalent in width in any other Radiator on the market. Like all Bundy Radiators the base and the upper circulating chambers are liberally supplied with openings for the air to pass through to the inner surface. This Three Row Hot Water Radiator is a special make, costing more than the One or Two Row, and so the list prices below will be found somewhat higher.

It can be tapped for flow and return pipes on the same or opposite ends, or can have flow pipe connect into the upper circulating chamber (see Fig. 35) for use with the overhead system of piping, or when the Radiator is to set on the same or lower level than the Hot Water Heater proper.

### FORTY-FIVE INCHES HIGH, THREE ROWS OF LOOPS.

FOR STANDARD, ENLARGED, OR EXTENDED SURFACE LOOPS.									
LIST OF RADIATORS BUILT ON THE FOLLOWING SIZE BASES.			STANDARD.		ENLARGED.		EXTENDED SURFACE.		
Width of Base 15½ inches.			Each Loop Represents 4 Feet of Heating Surface.		Each Loop Represents 4¾ Feet of Heating Surface.		Each Loop Represents 4¾ Feet of Heating Surface.		
Shape of Radiator.	Number of Loops.	Length of Radiators.	List Price.		List Price.		List Price.		
			Per Foot, 95c.	Per Loop, \$3.80.	Per Foot, 92½c.	Per Loop, \$4.39.	Per Foot, 90c.	Per Loop, \$4.28.	
Feet of Heating Surface.	With Iron Top or Arranged for Marble Top.	Feet of Heating Surface.	With Iron Top or Arranged for Marble Top.	Feet of Heating Surface.	With Iron Top or Arranged for Marble Top.	Feet of Heating Surface.	With Iron Top or Arranged for Marble Top.		
3 × 3	9	12¼	36	\$34 20	42¼	\$39 54	42¾	\$38 48	
3 × 4	12	15½	48	45 60	57	52 73	57	51 30	
3 × 5	15	18½	60	57 00	71¼	65 01	71¼	64 13	
3 × 6	18	22	72	68 40	85½	79 00	85½	76 95	
3 × 7	21	25½	84	79 80	99¾	92 27	99¾	89 78	
3 × 8	24	28½	96	91 20	114	105 45	114	102 60	
3 × 9	27	31½	108	102 60	128½	118 63	128½	115 43	
3 × 10	30	34¼	120	114 00	142½	131 81	142½	128 25	
3 × 11	33	39	132	125 40	156¾	144 99	156¾	141 08	
3 × 12	36	42	144	136 80	171	158 15	171	153 90	
3 × 13	39	45½	156	148 20	185½	171 36	185½	166 73	
3 × 15	45	51¼	180	171 00	213¾	197 72	213¾	192 38	

For List of Special Height Radiators See bottom of page 33. NOTE.—The above prices are for all Radiators 45" high, and under to 39" high.

All Regular Hot Water Goods Tapped 1¼" × 1¼" "Right Hand."



TRADE BUNDY MARK.

THIRTY-NINE INCHES HIGH. THREE ROWS OF LOOPS.

FOR STANDARD, ENLARGED, OR EXTENDED SURFACE LOOPS.									
LIST OF RADIATORS BUILT ON THE FOLLOWING SIZE BASES.			STANDARD.		ENLARGED.		EXTENDED SURFACE.		
Width of Base, 13 1/4 inches.			Each Loop Represents 3 1/4 Feet of Heating Surface.		Each Loop Represents 4 Feet of Heating Surface.		Each Loop Represents 4 Feet of Heating Surface.		
			LIST PRICE.		LIST PRICE.		LIST PRICE.		
			Per Foot, \$1.00.	Per Loop, \$3.50.	Per Foot, \$7 1/2c.	Per Loop, \$3.00.	Per Foot, 95c.	Per Loop, \$3.80.	
Shape of Radiator	Number of Loops.	Length of Radiators	Feet of Heating Surface	With Iron Top or Arranged for Marble Top.	Feet of Heating Surface.	With Iron Top or Arranged for Marble Top.	Feet of Heating Surface.	With Iron Top or Arranged for Marble Top.	With Iron Top or Arranged for Marble Top.
3 X 3	9	12 1/4	31 1/2	\$31.50	36	\$35.10	36	\$34.20	
3 X 4	12	15 1/2	42	42.00	48	48.00	48	45.60	
3 X 5	15	18 1/2	52 1/2	52.50	60	60.00	60	57.00	
3 X 6	18	22	63	63.00	72	72.00	72	68.40	
3 X 7	21	25 3/8	73 1/2	73.50	84	81.00	84	79.80	
3 X 8	24	28 3/8	84	84.00	96	93.60	96	91.20	
3 X 9	27	31 1/2	94 1/2	94.50	108	105.30	108	102.60	
3 X 10	30	34 1/4	105	105.00	120	117.00	120	114.00	
3 X 11	33	37	115 1/2	115.50	132	125.70	132	125.40	
3 X 12	36	42	126	126.00	144	140.40	144	136.80	
3 X 13	39	45 1/8	136 1/2	136.50	156	152.10	156	148.20	
3 X 15	45	51 3/4	157 1/2	157.50	180	175.50	180	171.00	

For List of Special Height Radiators see bottom of page. NOTE.—The above prices are for all Radiators 39" high, and under to 33" high.

THIRTY-THREE INCHES HIGH. THREE ROWS OF LOOPS.

LIST OF RADIATORS BUILT ON THE FOLLOWING SIZE BASES.									
Width of Base, 13 1/4 inches.			Each Loop Represents 3 Feet of Heating Surface.		Each Loop Represents 3 1/4 Feet of Heating Surface.		Each Loop Represents 3 1/4 Feet of Heating Surface.		
			LIST PRICE.		LIST PRICE.		LIST PRICE.		
			Per Foot, \$1.10.	Per Loop, \$3.30.	Per Foot, \$1.07 1/2c.	Per Loop, \$3.76.	Per Foot, \$1.05.	Per Loop, \$3.68.	
Shape of Radiator	Number of Loops.	Length of Radiators	Feet of Heating Surface	With Iron Top or Arranged for Marble Top.	Feet of Heating Surface.	With Iron Top or Arranged for Marble Top.	Feet of Heating Surface.	With Iron Top or Arranged for Marble Top.	With Iron Top or Arranged for Marble Top.
3 X 3	9	12 1/4	27	\$29.70	31 1/2	\$33.20	31 1/2	\$33.05	
3 X 4	12	15 1/2	36	39.60	42	45.15	42	44.10	
3 X 5	15	18 1/2	45	49.50	52 1/2	56.44	52 1/2	55.13	
3 X 6	18	22	54	59.40	63	67.73	63	66.15	
3 X 7	21	25 3/8	63	69.30	73 1/2	79.01	73 1/2	77.15	
3 X 8	24	28 3/8	72	79.20	84	90.30	84	88.20	
3 X 9	27	31 1/2	81	89.10	94 1/2	101.50	94 1/2	99.23	
3 X 10	30	34 1/4	90	99.00	105	112.88	105	110.25	
3 X 11	33	37	99	108.90	115 1/2	124.16	115 1/2	121.25	
3 X 12	36	42	108	118.80	126	135.45	126	132.30	
3 X 13	39	45 1/8	117	128.70	136 1/2	146.74	136 1/2	143.35	
3 X 15	45	51 3/4	135	148.50	157 1/2	169.31	157 1/2	165.35	

For List of Special Height Radiators see bottom of page. NOTE.—The above prices are for all Radiators 33" high, and under to 27" high.

TWENTY-SEVEN INCHES HIGH. THREE ROWS OF LOOPS.

LIST OF RADIATORS BUILT ON THE FOLLOWING SIZE BASES.									
Width of Base, 13 1/4 inches.			Each Loop Represents 2 1/2 Feet of Heating Surface.		Each Loop Represents 2 3/4 Feet of Heating Surface.		Each Loop Represents 2 3/4 Feet of Heating Surface.		
			LIST PRICE.		LIST PRICE.		LIST PRICE.		
			Per Foot, \$1.25.	Per Loop, \$3.13.	Per Foot, \$1.29 1/2c.	Per Loop, \$3.47.	Per Foot, \$1.20.	Per Loop, \$3.40.	
Shape of Radiator	Number of Loops.	Length of Radiators	Feet of Heating Surface	With Iron Top or Arranged for Marble Top.	Feet of Heating Surface.	With Iron Top or Arranged for Marble Top.	Feet of Heating Surface.	With Iron Top or Arranged for Marble Top.	With Iron Top or Arranged for Marble Top.
3 X 3	9	12 1/4	22 1/2	\$28.13	25 1/2	\$31.24	25 1/2	\$30.60	
3 X 4	12	15 1/2	30	37.50	34	41.65	34	40.20	
3 X 5	15	18 1/2	37 1/2	46.88	42 1/2	52.06	42 1/2	51.00	
3 X 6	18	22	45	56.25	51	62.48	51	61.20	
3 X 7	21	25 3/8	52 1/2	65.63	59 1/2	72.89	59 1/2	71.40	
3 X 8	24	28 3/8	60	75.00	68	83.30	68	81.60	
3 X 9	27	31 1/2	67 1/2	84.38	76 1/2	93.71	76 1/2	91.80	
3 X 10	30	34 1/4	75	93.75	85	104.13	85	102.00	
3 X 11	33	37	82 1/2	103.13	93 1/2	114.54	93 1/2	112.20	
3 X 12	36	42	90	112.50	102	124.95	102	122.40	
3 X 13	39	45 1/8	97 1/2	121.88	110 1/2	135.36	110 1/2	132.60	
3 X 15	45	51 3/4	112 1/2	140.63	127 1/2	156.19	127 1/2	153.00	

For List of Special Height Radiators see bottom of page. NOTE.—The above prices are for all Radiators 27" high, and under.

List of Regular and Special Height Hot Water Rectangular, Circular and Corner Radiators.

10"	14"	18"	22"	26"	30"	34"	38"	45"
11"	15"	19"	23"	27"	31"	35"	39"	
12"	16"	20"	24"	28"	32"	36"	40"	
13"	17"	21"	25"	29"	33"	37"	42"	

All Regular Hot Water Goods Tapped 1 1/4" X 1 1/4" "Right Hand."

# Bundy Circular Steam Direct Radiator.



FIG. 5.

FIG. 5 represents the Bundy Circular Steam Direct Radiator. The heating surface of this Radiator is evenly distributed nearest the outer edge of the base, while large openings through the base keep a continual supply of air passing up through the Radiator at all times. It is the most powerful heating Circular Radiator on the market.

## FORTY-TWO INCHES HIGH.

FOR STANDARD, ENLARGED, OR EXTENDED SURFACE LOOPS.

LIST OF RADIATORS BUILT ON THE FOLLOWING SIZE BASES.		STANDARD.		ENLARGED.		EXTENDED SURFACE.	
		Each Loop Represents 3½ Feet of Heating Surface.		Each Loop Represents 4¼ Feet of Heating Surface.		Each Loop Represents 5¼ Feet of Heating Surface.	
		LIST PRICE.		LIST PRICE.		LIST PRICE.	
Number of Loops.	Outside Diameter of Base.	Per Foot, 75c.	Per Loop, \$2.63.	Per Foot, 72½c.	Per Loop, \$3.08.	Per Foot, 70c.	Per Loop \$2.38.
		Foot of Heating Surface.	With Iron Top or Binder for Marble Top.	Foot of Heating Surface.	With Iron Top or Binder for Marble Top.	Foot of Heating Surface.	With Iron Top or Binder for Marble Top.
10	17¼"	35	\$26 25	42½	\$30 82	42½	\$29 75
15	18½"	52½	39 38	63¾	46 22	63¾	44 63
20	21½"	70	52 50	85	61 63	85	59 50
26	22½"	91	68 25	110½	80 12	110½	77 35
34	26½"	119	89 25	144½	104 77	144½	101 15
50	31¼"	175	131 25	212½	154 07	212½	148 75
72	36"	...	.....	306	221 85	306	214 20
74	36"	250	194 25	...	.....	...	.....

For List of Special Height Radiators see bottom of page 27. NOTE.—The above prices are for all Radiators 42" high, and under to 50" high.

## THIRTY-SIX INCHES HIGH.

LIST OF RADIATORS BUILT ON THE FOLLOWING SIZE BASES.		Each Loop Represents 3 Feet of Heating Surface.		Each Loop Represents 3½ Feet of Heating Surface.		Each Loop Represents 3¾ Feet of Heating Surface.	
		LIST PRICE.		LIST PRICE.		LIST PRICE.	
		Per Foot, 80c.	Per Loop, \$2.40.	Per Foot, 77½c.	Per Loop, \$2.71.	Per Foot, 75c.	Per Loop, \$2.63.
		Foot of Heating Surface.	With Iron Top or Binder for Marble Top.	Foot of Heating Surface.	With Iron Top or Binder for Marble Top.	Foot of Heating Surface.	With Iron Top or Binder for Marble Top.
10	17¼"	30	\$24 00	35	\$27 13	35	\$26 25
15	18½"	45	36 00	52½	40 69	52½	39 38
20	21½"	60	48 00	70	54 25	70	52 50
26	22½"	78	62 40	91	70 53	91	68 25
34	26½"	102	81 60	119	92 23	119	89 25
50	31¼"	150	120 00	175	135 63	175	131 25
72	36"	...	.....	252	195 30	252	189 00
74	36"	222	177 60	...	.....	...	.....

For List of Special Height Radiators see bottom of page 27. NOTE.—The above prices are for all Radiators 36" high, and under.

All Regular Steam Goods Tapped 1" x ¾" "Right Hand."

TRADE BUNDY MARK.

## Bundy Direct Hot Water Circular Radiator.

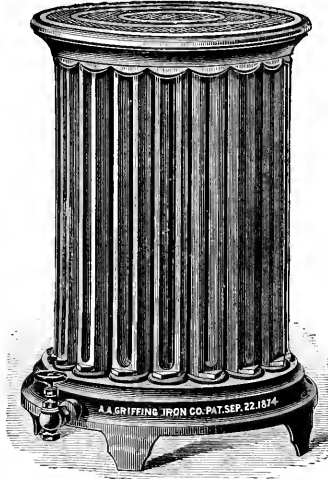

FIG. 37.

FIG. 37 represents the Bundy Circular Hot Water Direct Radiator, being the only Circular Hot Water Radiator made. They are at present in use in many hundreds of buildings, in all of which they are giving perfect satisfaction.

### FORTY-FIVE INCHES HIGH.

FOR STANDARD, ENLARGED, OR EXTENDED SURFACE LOOPS.								
LIST OF RADIATORS BUILT ON THE FOLLOWING SIZE BASES.		STANDARD.		ENLARGED.		EXTENDED SURFACE.		
		Each Loop Represents 4 Feet of Heating Surface.		Each Loop Represents 4¾ Feet of Heating Surface.		Each Loop Represents 4¾ Feet of Heating Surface.		
		LIST PRICE.	Per Foot, 95c.	Per Loop, \$3.80.	LIST PRICE.	Per Foot, 92½c.	Per Loop, \$4.39.	LIST PRICE.
Number of Loops.	Outside Diameter of Base.	Feet of Heating Surface.	With Iron Top or Arranged for Marble Top.	Feet of Heating Surface.	With Iron Top or Arranged for Marble Top.	Feet of Heating Surface.	With Iron Top or Arranged for Marble Top.	
10	17¼"	40	\$38 00	47½"	\$43 04	47½"	\$42 75	
15	18½"	60	57 00	71¼"	65 01	71¼"	64 13	
20	21½"	80	76 00	95	87 88	95	85 50	
26	22½"	104	98 80	123½"	114 24	123½"	111 15	
34	26½"	136	139 20	161½"	149 39	161½"	145 35	
50	31½"	200	190 00	237½"	219 09	237½"	213 75	
72	36"	...	.....	342	316 35	342	307 80	
74	36"	296	281 20	...	.....	...	.....	

For List of Special Height Radiators see bottom of page 33. NOTE.—The above prices are for all Radiators 45" high, and under to 39" high.

### THIRTY-NINE INCHES HIGH.

LIST OF RADIATORS BUILT ON THE FOLLOWING SIZE BASES.		Each Loop Represents 3½ Feet of Heating Surface.		Each Loop Represents 4 Feet of Heating Surface.		Each Loop Represents 4 Feet of Heating Surface.				
		LIST PRICE.	Per Foot, \$1.00.	Per Loop, \$3.50.	LIST PRICE.	Per Foot, 97½c.	Per Loop, \$3.90.	LIST PRICE.	Per Foot, 95c.	Per Loop, \$3.80.
		Number of Loops.	Outside Diameter of Base.	Feet of Heating Surface.	With Iron Top or Arranged for Marble Top.	Feet of Heating Surface.	With Iron Top or Arranged for Marble Top.	Feet of Heating Surface.	With Iron Top or Arranged for Marble Top.	
10	17¼"	35	\$35 00	40	\$39 00	40	\$38 00			
15	18½"	52½	52 50	60	58 50	60	57 00			
20	21½"	70	70 00	80	78 00	80	76 00			
26	22½"	91	91 00	104	101 40	104	98 80			
34	26½"	119	119 00	136	132 60	136	129 20			
50	31½"	175	175 00	200	195 00	200	190 00			
72	36"	...	.....	288	280 80	288	273 60			
74	36"	250	250 00	...	.....	...	.....			

For List of Special Height Radiators see bottom of page 33. NOTE.—The above prices are for all Radiators 39" high and under.

All Regular Hot Water Goods Tapped 1¼" × 1¼" "Right Hand."

TRADE BUNDY MARK.

## Bundy Column Steam Direct Radiator.

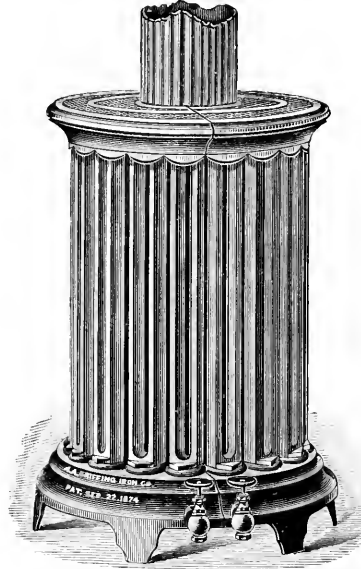

FIG. 7.

FIG. 7 represents the Bundy Column Steam Direct Radiator, made in halves to encircle columns. This popular Radiator has all the advantages of the Bundy Circular Radiator (see Fig. 5), air openings in base, etc., and is made to encircle columns 17 inches in diameter and smaller.

### FORTY-TWO INCHES HIGH, IN HALVES TO ENCIRCLE COLUMNS.

LIST OF RADIATORS BUILT ON THE FOLLOWING SIZE BASES.				FOR STANDARD, ENLARGED, OR EXTENDED SURFACE LOOPS.									
				STANDARD.		ENLARGED.		EXTENDED SURFACE.					
Number of Loops.	Number of Loops on Outside Row.	Outside Diameter of Base.	Inside Diameter of Base.	Each Loop Represents 3½ Feet of Heating Surface.		Each Loop Represents 4½ Feet of Heating Surface.		Each Loop Represent 4¾ Feet of Heating Surface.		List Price.			
				Per Foot, 80c.	Per Loop, \$2.80.	Per Foot, 77½c.	Per Loop, \$3.20.	Per Foot, 75c.	Per Loop, \$3.10.	Per Foot, 80c.	Per Loop, \$2.80.		
				Feet of Heating Surface.	With Iron Top or Binder for Marble Top.	Feet of Heating Surface.	With Iron Top or Binder for Marble Top.	Feet of Heating Surface.	With Iron Top or Binder for Marble Top.	Feet of Heating Surface.	With Iron Top or Binder for Marble Top.		
26	18	26"	9 1/2"	91	\$72 80	110 1/2	\$85 64	110 1/2	\$82 88				
34	22	30"	12 1/4"	119	95 20	144 1/2	111 90	144 1/2	108 38				
50	28	36"	17"	175	140 00	212 1/2	164 60	212 1/2	159 38				

For List of Special Height Radiators see bottom of page 27. NOTE.—The above prices are for all Radiators 42" high, or under to 36" high.

### THIRTY-SIX INCHES HIGH, IN HALVES TO ENCIRCLE COLUMNS.

LIST OF RADIATORS BUILT ON THE FOLLOWING SIZE BASES.				Each Loop Represents 3 feet of Heating Surface.		Each Loop Represents 3½ Feet of Heating Surface.		Each Loop Represents 3¾ Feet of Heating Surface.	
				Per Foot, 85c.	Per Loop, \$2.55.	Per Foot, 83½c.	Per Loop, \$2.80.	Per Foot, 80c.	Per Loop, \$2.80.
Number of Loops.	Number of Loops on Outside Row.	Outside Diameter of Base.	Inside Diameter of Base.	Feet of Heating Surface.	With Iron Top or Binder for Marble Top.	Feet of Heating Surface.	With Iron Top or Binder for Marble Top.	Feet of Heating Surface.	With Iron Top or Binder for Marble Top.
26	18	26"	9 1/2"	75	\$66 30	91	\$75 08	91	\$72 80
34	22	30"	12 1/4"	102	86 70	119	98 18	119	95 20
50	28	36"	17"	150	127 50	175	144 38	175	140 00

For List of Special Height Radiators see bottom of page 27. NOTE.—The above prices are for all Radiators 36" high, and under.

All Regular Steam Goods Tapped 1" x 3/4" "Right Hand."



# Bundy Column Hot Water Direct Radiator.

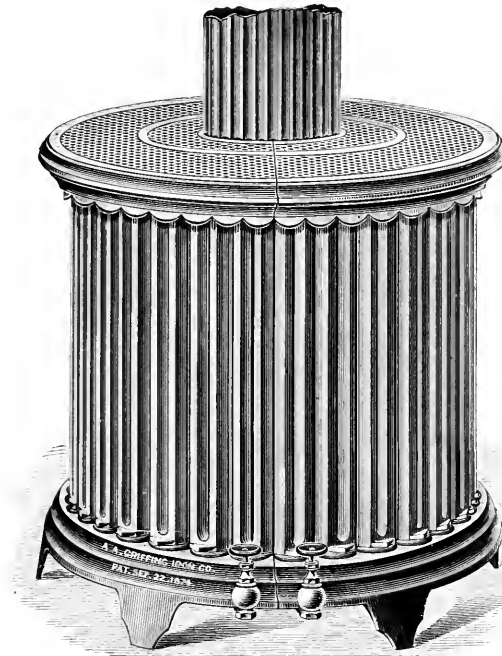

FIG. 7 1/2.

FIG. 7 1/2 represents the Bundy Column Hot Water Direct Radiator, made in halves to encircle columns. It is the only Hot Water Radiator made to go around columns, and the large number already in use and the increasing demand show the great popularity of this Radiator. The space around a column is oftentimes the only available place in which a radiator can be set, and the introduction of this Radiator has filled a long felt want, and received the hearty approval of all Heating Engineers and Architects. Interior loops may be omitted to the extent of 22 in order to reduce the heating surface.

## FORTY-FIVE INCHES HIGH, IN HALVES TO ENCIRCLE COLUMNS.

FOR STANDARD, ENLARGED, OR EXTENDED SURFACE LOOPS.									
DESCRIPTION OF RADIATORS BUILT ON THE FOLLOWING SIZE BASES.				STANDARD.		ENLARGED.		EXTENDED SURFACE.	
Number of Loops.	Number of Loops on Outside Row.	Outside Diameter of Base.	Inside Diameter of Base.	Each Loop Represents 4 Feet of Heating Surface.		Each Loop Represents 4 1/4 Feet of Heating Surface.		Each Loop Represents 4 3/4 Feet of Heating Surface.	
				LIST PRICE.		LIST PRICE.		LIST PRICE.	
				Per Foot, \$1.30.	Per Loop, \$4.80.	Per Foot, \$1.17 1/2.	Per Loop, \$4.58.	Per Foot, \$1.15.	Per Loop, \$5.46.
50	25	36	17	200	\$240 00	237 1/2	\$279 00	237 1/2	\$273 13
In case this Radiator is wanted with less Heating Surface, interior Loops, to the extent of 22 may be omitted without changing the above dimensions				Deduct 3 1/4 Feet of Heating Surface and \$2.00 from List Price for each Loop omitted.		Deduct 4 1/4 feet of Heating Surface and \$2.50 from List Price for each Loop omitted.		Deduct 4 3/4 feet of Heating Surface and \$2.40 from List Price for each Loop omitted.	

For List of Special Height Radiators see bottom of page 33. NOTE.—The above prices are for all Radiators 45" high, and under to 39" high.

## THIRTY-NINE INCHES HIGH, IN HALVES TO ENCIRCLE COLUMNS.

DESCRIPTION OF RADIATORS BUILT ON THE FOLLOWING SIZE BASE.				Each Loop Represents 3 1/4 Feet of Heating Surface.		Each Loop Represents 4 Feet of Heating Surface.		Each Loop Represents 4 Feet of Heating Surface.	
Number of Loops.	Number of Loops on Outside Row.	Outside Diameter of Base.	Inside Diameter of Base.	LIST PRICE.		LIST PRICE.		LIST PRICE.	
				Per Foot, \$1.25.	Per Loop, \$4.38.	Per Foot, \$1.22 1/2.	Per Loop, \$4.90.	Per Foot, \$1.30.	Per Loop, \$4.80.
50	25	36	17	175	\$218 75	200	\$245 00	200	\$240 00
In case this Radiator is wanted with less Heating Surface, interior Loops, to the extent of 22 may be omitted without changing the above dimensions.				Deduct 3 feet of Heating Surface and \$1.70 from List Price for each Loop omitted.		Deduct 3 1/4 feet of Heating Surface and \$3.05 from List Price for each Loop omitted.		Deduct 3 1/4 feet of Heating Surface and \$2.00 from List Price for each Loop omitted.	

For List of Special Height Radiators see bottom of page 33. NOTE.—The above prices are for all Radiators 39" high, and under.



TRADE BUNDY MARK.

## Bundy Column and Circular Steam Direct Radiator.

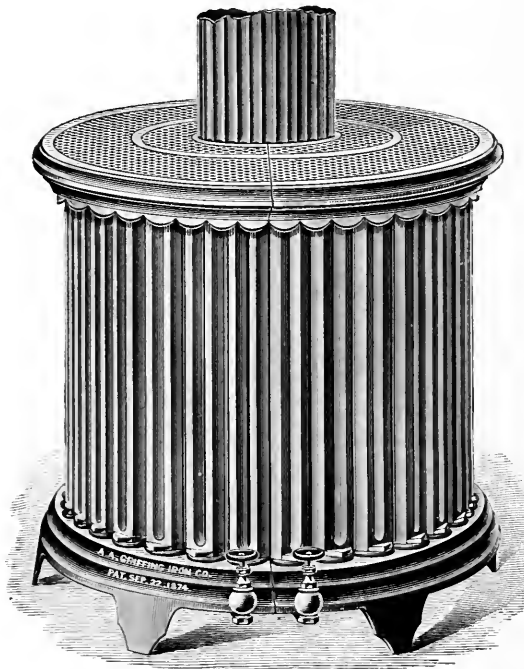

FIG. 8½.

FIG. 8½ represents the Bundy Column and Circular Steam Direct Radiator of extra large size. As it has a large amount of heating surface, it is specially adapted for heating Railroad Depots, Hotel Rotundas, Waiting Rooms, Warehouses, Halls and Public Buildings where a maximum of heating surface in the minimum space is required. For dimensions, amount of heating surface, list prices, and further information see next page.



TRADE BUNDY MARK.

# Bundy Column and Circular Steam Direct Radiator.

FIG. 8½ represents the Bundy Column and Circular Steam Direct Radiator of extra large size. When used as a Circular Radiator it has the appearance of Fig. 5 only much larger. This is, without exception, the largest portable Radiator manufactured in the world. The amount of heating surface it contains is very nearly equal to that found in a mile of inch pipe, and it is so arranged that a very large percentage of its surface is in the outer tier of loops, which, together with 41 liberal sized air spaces through the base, surrounds every part of the Radiator with freely circulating air, hence its great efficiency. As there are a large number of loops in this Radiator the base is a special make, having greater depth of capacity and higher legs, being 7" from floor to center of tapping, and the top also is thicker and stronger, so that the same loops that build with the regular base and top Radiators 36" high, with this base and top build 42" high, or instead of 42" they build 48", measuring in all cases from floor to top of screen or marble, whichever is used. When a maximum of heating surface is desired in the minimum space, this Radiator will be found to be just the thing. As in most cases this Radiator is wanted with Marble top, the price given only includes binder for Marble Top, but when wanted with Fret Work Iron Top, add \$60.00 to List Prices, or with a three inch thick Tennessee or Knoxville Marble top, bevel O. G., or rounded edge, add \$100.00 to List Prices. The same discount named on Bundy Radiators applies thereto.

A few late examples of buildings in which this Radiator has been placed are, "The Rookery" Building, Chicago, Ill.; the Depots of the C. R. R. of N. J. and L. V. R. R., Jersey City, N. J.; and South Brooklyn R. R. and Terminal Co., Cor. 39th St. and 2d Ave., South Brooklyn, N. Y., and the following letter from Mr. Wm. C. D. Gillespie, Engineer of "The Rookery" Building, shows how entirely satisfactory they are.

OFFICE OF "THE ROOKERY" BUILDING.

CHICAGO, Ill., April 26th, 1889.

A. A. GRIFFING IRON CO.,  
Gentlemen:

As Engineer of "The Rookery" Building, in which are placed over 800 of your Bundy Radiators, I wish to express my entire satisfaction as to the working of the same. I consider them thoroughly reliable in every respect.

Respectfully yours,

Wm. C. D. GILLESPIE,

Engineer "The Rookery" Building.

## FORTY-EIGHT INCHES HIGH, IN HALVES.

FOR STANDARD, ENLARGED, OR EXTENDED SURFACE LOOPS.									
DESCRIPTION OF RADIATORS BUILT ON THE FOLLOWING SIZE BASE.				STANDARD.		ENLARGED.		EXTENDED SURFACE.	
				Each Loop Represents 3½ Feet of Heating Surface. List Price.		Each Loop Represents 4¼ Feet of Heating Surface. List Price.		Each Loop Represents 4¼ Feet of Heating Surface. List Price.	
Number of Loops.	Number of Loops on Outside Row.	Outside Diameter of Base.	Inside Diameter Of Base.	Per Foot, 85c.	Per Loop, \$2.98.	Per Foot, 82½c.	Per Loop, 3.51.	Per Foot, 80c.	Per Loop, \$3.40.
142	46	57½"	18"	497	\$422 45	603½	\$497 89	603½	\$482 80
In case this Radiator is wanted with less Heating Surface, Interior Loops to the extent of 96 may be omitted without changing the above dimensions of the Radiator.				Deduct 3 feet of Heating Surface and \$2.00 from List Price for each Loop omitted. If wanted with Fret Work Iron Top, add \$60.00 to List Price, or for 3" Tennessee or Knoxville Marble Top \$100.00.		Deduct 3½ feet of Heating Surface and \$2.50 from List Price for each Loop omitted. If wanted with Fret Work Iron Top, add \$60.00 to List Price, or for 3" Tennessee or Knoxville Marble Top \$100.00.		Deduct 4½ feet of Heating Surface and \$2.40 from List Price for each Loop omitted. If wanted with Fret Work Iron Top, add \$60.00 to List Price, or for 3" Tennessee or Knoxville Marble Top \$100.00.	

NOTE.—The above prices are for all Radiators 48" high, or under to 42" high.

## FORTY-TWO INCHES HIGH, IN HALVES.

DESCRIPTION OF RADIATORS BUILT ON THE FOLLOWING SIZE BASE.				STANDARD.		ENLARGED.		EXTENDED SURFACE.	
				Each Loop Represents 3 Feet of Heating Surface. List Price.		Each Loop Represents 3½ Feet of Heating Surface. List Price.		Each Loop Represents 3½ Feet of Heating Surface. List Price.	
Number of Loops.	Number of Loops on Outside Row.	Outside Diameter of Base.	Inside Diameter Of Base.	Per Foot, 90c.	Per Loop, \$2.70.	Per Foot, 87½c.	Per Loop, \$3.06	Per Foot, 85c.	Per Loop, \$2.98.
142	46	57½"	18"	426	\$383 40	497	\$434 88	497	\$422 45
In case this Radiator is wanted with less Heating Surface, Interior loops to the extent of 96 may be omitted without changing the above dimensions of the Radiator.				Deduct 3½ feet of Heating Surface and \$1.70 from List Price for each Loop omitted.		Deduct 3 feet of Heating Surface and \$2.05 from List Price for each Loop omitted.		Deduct 3 feet of Heating Surface and \$2.00 from List Price for each Loop omitted.	

NOTE.—The above prices are for all Radiators 42" high, and under.

These Radiators are all Tapped 1¼" × 1" "Right Hand." and the Center of Tapping is 7" from the Floor.

TRADE BUNDY MARK.

## Bundy Corner Steam Direct Radiator.

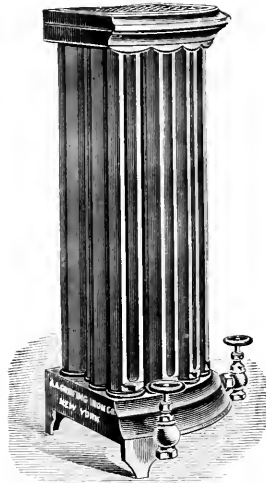

FIG. 9.

FIG. 9 represents the Bundy Corner Steam Direct Radiator designed for the corners of rooms, where it gives a very neat effect, is out of the way and occupies floor space seldom needed for any other purpose. When surmounted with one of our handsome marble tops (see pages 118, 119, 120), and a piece of statuary or bronze image, it presents an appearance of great richness. Two radiators placed in opposite corners of a room, and arranged in this manner are often used and never fail to please.

### FORTY-TWO INCHES HIGH.

FOR STANDARD, ENLARGED, OR EXTENDED SURFACE LOOPS.								
LIST OF RADIATORS BUILT ON THE FOLLOWING SIZE BASES.			STANDARD. Each Loop Represents 3½ Feet of Heating Surface.		ENLARGED. Each Loop Represents 4¼ Feet of Heating Surface.		EXTENDED SURFACE. Each Loop Represents 4¼ Feet of Heating Surface.	
Number of Loops.	Radius of Circle.	Number of Loops in Front Row.	LIST PRICE.		LIST PRICE.		LIST PRICE.	
			Per Foot, 75c.	Per Loop, \$2.63.	Per Foot, 73½c.	Per Loop, \$3.08.	Per Foot, 70c.	Per Loop, \$2.98.
			Feet of Heating Surface.	With Iron Top or Binder for Marble Top.	Feet of Heating Surface.	With Iron Top or Binder for Marble Top.	Feet of Heating Surface.	With Iron Top or Binder for Marble Top.
10	15"	5	35	\$26 25	42½	\$30 52	42½	\$29 75
15	17¼"	6	52½	39 38	63¾	46 22	63¾	44 63
20	19½"	7	70	52 50	85	61 63	85	59 50

For List of Special Height Radiators see bottom of page 27. NOTE.—The above prices are for all Radiators 42" high, or under to 36" high.

### THIRTY-SIX INCHES HIGH.

LIST OF RADIATORS BUILT ON THE FOLLOWING SIZE BASES.			Each Loop Represents 3 Feet of Heating Surface.		Each Loop Represents 3¾ Feet of Heating Surface.		Each Loop Represents 3¾ Feet of Heating Surface.	
Number of Loops.	Radius of Circle.	Number of Loops in Front Row.	LIST PRICE.		LIST PRICE.		LIST PRICE.	
			Per Foot, 80c.	Per Loop, \$2.40.	Per Foot, 77½c.	Per Loop, \$2.71.	Per Foot 75c.	Per Loop, \$2.63
			Feet of Heating Surface.	With Iron Top or Binder for Marble Top.	Feet of Heating Surface.	With Iron Top or Binder for Marble Top.	Feet of Heating Surface.	With Iron Top or Binder for Marble Top.
10	15"	5	30	\$24 00	35	\$27 13	35	\$26 25
15	17¼"	6	45	36 00	52½	40 60	52½	39 38
20	19½"	7	60	48 00	70	54 25	70	52 50

For List of Special Height Radiators see bottom of page 27. NOTE.—The above prices are for all Radiators 36" high, and under.

All Regular Steam Goods Tapped 1" × ¾" "Right Hand."

## Bundy Corner Hot Water Direct Radiator.

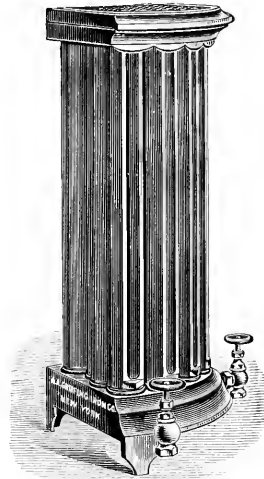

FIG. 38.

FIG. 38 Represents the Bundy Corner Hot water Direct Radiator, designed for the corners of rooms, where it is out of the way, and occupies floor space seldom needed for any other purpose. When surmounted with one of our handsome Marble Tops (see pages 118, 119, 120), and a piece of statuary or a bronze image, it produces a very rich effect, and two Radiators, placed in opposite corners of a room and arranged in this manner, especially if Radiators are 45" high, look like pillars placed there for the express purpose of holding the image, statuary or vase that may be placed on them.

### FORTY-FIVE INCHES HIGH.

FOR STANDARD, ENLARGED, OR EXTENDED SURFACE LOOPS.									
LIST OF RADIATORS BUILT ON THE FOLLOWING SIZE BASES.			STANDARD.		ENLARGED.		EXTENDED SURFACE.		
Number of Loops.	Radius of Circle.	Number of Loops in Front Row.	Each Loop Represents 4 Feet of Heating Surface.		Each Loop Represents 4½ Feet of Heating Surface.		Each Loop Represents 4¾ Feet of Heating Surface.		
			LIST PRICE, Per Foot, 95c. Per Loop, \$3.80.		LIST PRICE, Per Foot, 92½c. Per Loop, \$4.39.		LIST PRICE, Per Foot, 90c. Per Loop, \$4.28.		
			Feet of Heating Surface.	With Iron Top or Blunder for Marble Top.	Feet of Heating Surface.	With Iron Top or Blunder for Marble Top.	Feet of Heating Surface.	With Iron Top or Blunder for Marble Top.	With Iron Top or Blunder for Marble Top.
10	15"	5	40	\$38 00	47½	\$43 94	47½	\$42 75	
15	17¼"	6	60	57 00	71¼	65 01	71¼	64 13	
20	19½"	7	80	76 00	95	87 88	95	85 50	

For List of Special Height Radiators see bottom of page 33. NOTE.—The above prices are for all Radiators 45' high, or under to 39' high.

### THIRTY-NINE INCHES HIGH.

LIST OF RADIATORS BUILT ON THE FOLLOWING SIZE BASES.				Each Loop Represents 3½ Feet of Heating Surface.		Each Loop Represents 4 Feet of Heating Surface.		Each Loop Represents 4 Feet of Heating Surface.	
			LIST PRICE, Per Foot, \$1.00. Per Loop, \$3.50.		LIST PRICE, Per Foot, 97½c. Per Loop, \$3.90.		LIST PRICE, Per Foot, 95c. Per Loop, \$3.80.		
10	15"	5	35	\$35 00	40	\$39 00	40	\$38 00	
15	17¼"	6	52½	52 50	60	58 50	60	57 00	
20	19½"	7	70	70 00	80	78 00	80	76 00	

For List of Special Height Radiators see bottom of page 33. NOTE.—The above prices are for all Radiators 39' high, and under.

All Regular Hot Water Goods Tapped 1¼" × 1¼" "Right Hand."

TRADE BUNDY MARK.

Bundy Corner Steam Direct Radiator.

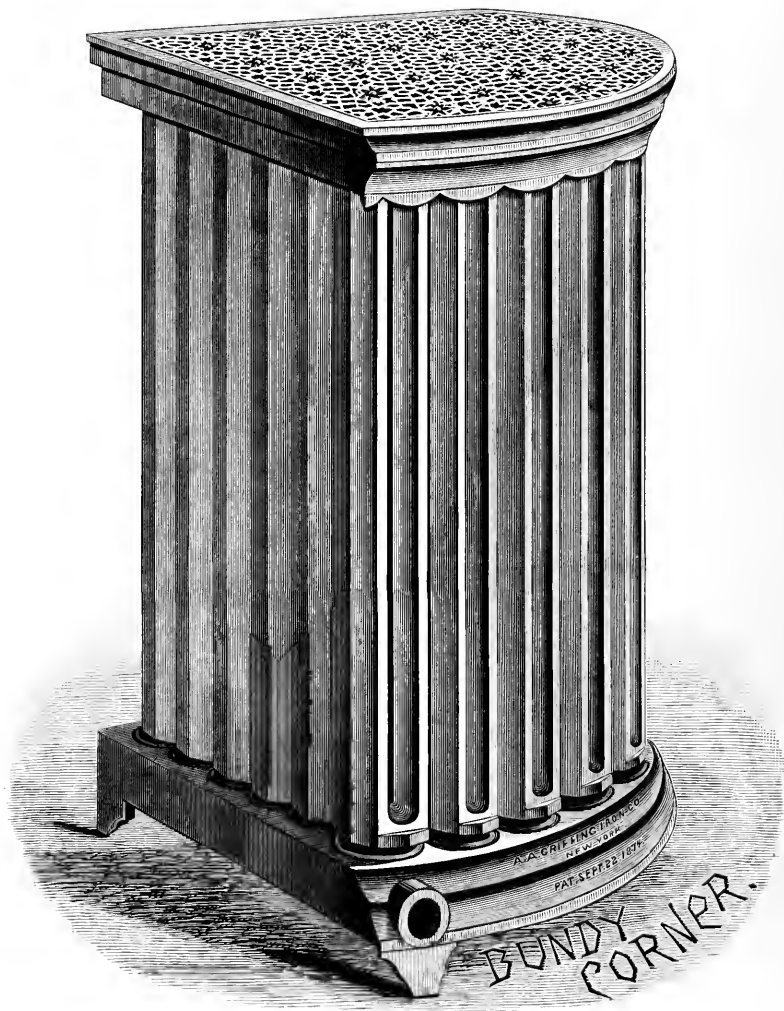

FIG. 9½.

Fig. 9½ represents the Bundy Corner Steam Direct Radiator of extra large size. For full description and list prices see next page.



TRADE BUNDY MARK.

## Bundy Corner Steam Direct Radiator.

Fig. 9½ represents the Bundy Corner Steam Direct Radiator of extra large size. The advantage of using a Radiator of this type is so great and the demand for them so large that we have made patterns for these extra large sizes and are now in a position to furnish Bundy Radiators for setting in corners of a greater variety than ever before. It very often happens that the only available space in a room is in a corner and certainly its appearance in that location is all that any one can desire.

Parties desiring a large circular Radiator can combine four of these Corners Radiators into one, and as they can be handled in parts they are very conveniently set to place.

### FORTY-TWO INCHES HIGH.

FOR STANDARD, ENLARGED, OR EXTENDED SURFACE LOOPS.								
LIST OF RADIATORS BUILT ON THE FOLLOWING SIZE BASES.			STANDARD.		ENLARGED.		EXTENDED SURFACE.	
			Each Loop Represents 3½ Feet of Heating Surface.		Each Loop Represents 4½ Feet of Heating Surface.		Each Loop Represents 4½ Feet of Heating Surface.	
Number of Loops.	Radius of Circle.	Number of Loops in Front Row.	LIST PRICE.		LIST PRICE.		LIST PRICE.	
			Per Foot, S/c.	Per Loop, \$2.68.	Per Foot, S2½c.	Per Loop, \$3.51.	Per Foot, S/c.	Per Loop, \$3.40.
			Feet of Heating Surface.	With Iron Top or Binder for Marble Top.	Feet of Heating Surface.	With Iron Top or Binder for Marble Top.	Feet of Heating Surface.	With Iron Top or Binder for Marble Top.
25	22½	12	87½	\$74.32	106¼	\$87.66	100¼	\$85.00
28	22½	12	103	87.55	119	95.13	119	95.20

\*NOTE The above prices are for all Radiators 42" high, and under to 36" high.

### THIRTY-SIX INCHES HIGH.

LIST OF RADIATORS BUILT ON THE FOLLOWING SIZE BASES.			Each Loop Represents 3 Feet of Heating Surface.		Each Loop Represents 3¾ Feet of Heating Surface.		Each Loop Represents 3½ Feet of Heating Surface.	
			LIST PRICE.		LIST PRICE.		LIST PRICE.	
Number of Loops.	Radius of Circle.	Number of Loops in Front Row.	Per Foot, S/c.	Per Loop, \$2.70.	Per Foot, S7½c.	Per Loop, \$3.03.	Per Foot, S/c.	Per Loop, \$2.98.
			25	22½	12	75	\$67.50	106¼
28	22½	12	84	75.60	119	104.13	119	101.15

The above prices are for all Radiators 36" high and under.

☞ All Regular Steam Goods Tapped 1" x ¾" " Right Hand." ☜

TRADE BUNDY MARK.

# Bundy Hot Closet Dining Room Steam Direct Radiator.

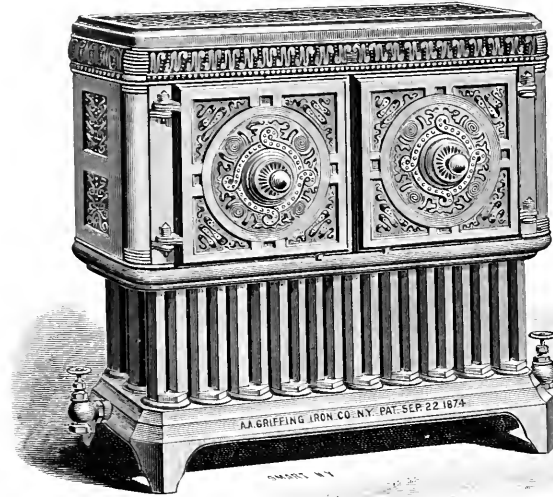

STYLE A. FIG. 10.

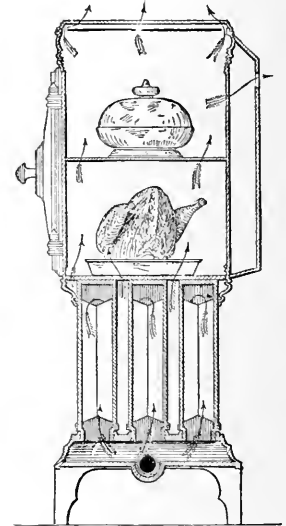

CROSS SECTION. FIG. 10½.

FIG. 10 represents the Bundy Hot Closet Dining Room Steam Direct Radiator, which in this age of modern improvements in appointments of dwelling houses, becomes a necessity as well as a convenience and a comfort where steam heat is used. The design is new and original. These closets are so constructed as to be directly over all of the heating surface in the Radiator, thus utilizing the heat as it passes up through and around the closet in the best manner, as shown by Fig. 10½.

The dimensions of these closets are as follows:—Length, 35 inches; width, 14 inches; height, 18 inches; height of Radiators over all, 36 and 42 inches. These closets have one shelf which can be readily removed or adjusted. The doors are of such size as to admit any dish or cover that the closet can accommodate. The heating surface in these Radiators can be varied from 33 to 70 feet each. Centre of tapping 4½ inches from floor.

## FORTY-TWO INCHES HIGH.

## THIRTY-SIX INCHES HIGH.

### WITH THE FOLLOWING STYLES OF LOOPS.

STANDARD.		ENLARGED.		EXTENDED SURFACE.	
Feet of Heating Surface.	Price.	Feet of Heating Surface.	Price.	Feet of Heating Surface.	Price.
44	\$14 00	51½	\$190 00	51½	\$25 50
46	16 00	53½	102 00	53½	101 00
48	17 00	56	104 50	56	103 00
50	18 00	58½	107 00	58½	105 25
52	19 00	60½	109 00	60½	107 50
54	19 00	63	111 00	63	109 75
56	19 00	65½	113 50	65½	112 00
58	19 00	67½	116 00	67½	114 75
60	110 00	70	118 25	70	116 50

### WITH THE FOLLOWING STYLES OF LOOPS.

STANDARD.		ENLARGED.		EXTENDED SURFACE.	
Feet of Heating Surface.	Price.	Feet of Heating Surface.	Price.	Feet of Heating Surface.	Price.
33	\$11 00	38½	\$97 25	38½	\$96 00
34½	13 00	40½	99 50	40½	98 00
36	15 00	42	101 50	42	100 00
37½	16 75	43½	103 50	43½	102 25
39	18 50	45½	105 75	45½	104 25
40½	19 50	47½	108 00	47½	106 50
42	19 00	49	110 25	49	108 50
43½	104 00	50½	112 50	50½	110 50
45	106 00	52½	114 50	52½	112 50



# BUNDY

## DINING ROOM HOT CLOSET

### RADIATOR

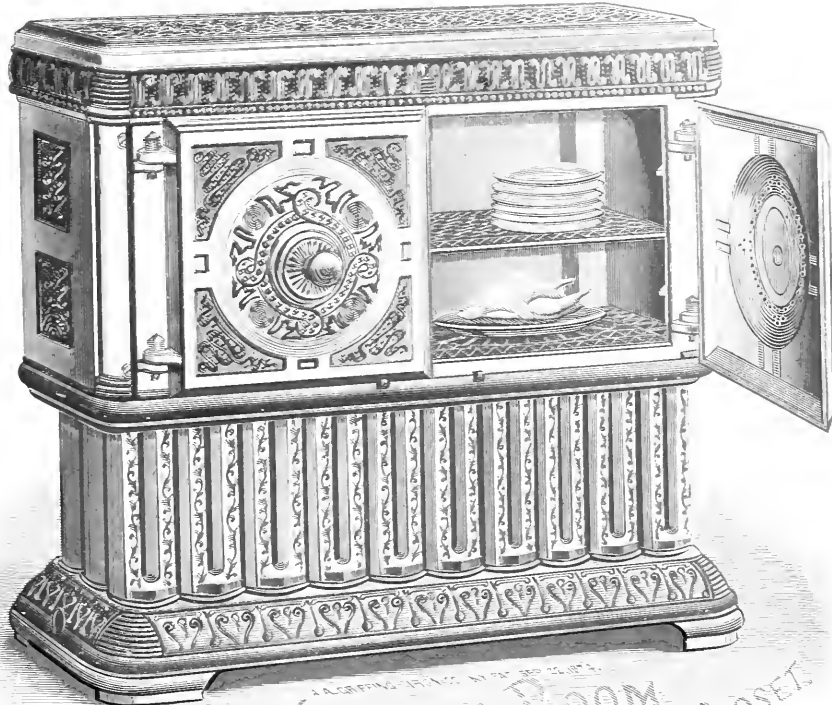

BUNDY DINING ROOM HOT CLOSET

MANUFACTURED BY

## A. A. GRIFFING IRON CO.

General Office and Works:

430 COMMUNIPAW AVE.,

JERSEY CITY, N. J.

NEW YORK CITY, N. Y.,  
106 LIBERTY STREET.

CHICAGO, ILL.,  
130 DEARBORN STREET.

PHILADELPHIA, PA.,  
18-24 SOUTH 7TH STREET.

Please designate in your specifications and contract for heating as A. A. Griffing Iron Co.'s Bundy Dining Room Hot Closet Radiator, Fig. 105g.



TRADE BUNDY MARK

# Bundy Hot Closet Dining-Room Hot Water Direct Radiator

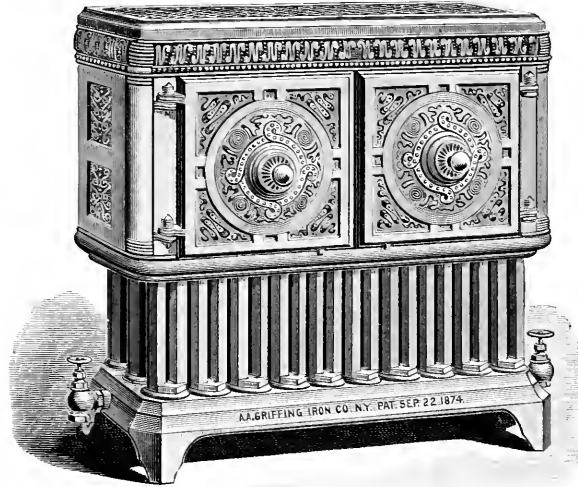

STYLE D. FIG. 49.

FIG. 49 represents the Bundy Hot Closet Dining Room Hot Water Direct Radiator. In heating by hot water lower temperatures are maintained and the entire warmth of the radiator is needed in the hot closet to secure the advantages sought for. These closets set directly over the entire radiator, thus securing the desired temperature, and in no other Dining Room Radiator can food be maintained at so high a degree of heat.

The dimensions of these closets are as follows:—Length, 35 inches; width, 14 inches; height, 18 inches; heights of Radiators over all, 47 and 41 inches. These closets are the same as are used with our steam Radiators and have one shelf which can be readily removed or adjusted. The heating surface can be varied from 52 to 84 feet each, and the centre of tapping is  $4\frac{1}{2}$  inches from floor. The feed pipe can, however, enter the upper circulating chamber of the Radiator, so they can be successfully placed on the same level as the heater or even below.

**FORTY-SEVEN INCHES HIGH.**

**FORTY-ONE INCHES HIGH.**

WITH THE FOLLOWING STYLES OF LOOPS.					
STANDARD.		ENLARGED.		EXTENDED.	
Feet of Heating Surface.	Price.	Feet of Heating Surface.	Price.	Feet of Heating Surface.	Price.
63	\$133 25	$73\frac{1}{3}$	\$142 00	$73\frac{1}{3}$	\$139 75
$64\frac{1}{2}$	137 00	$74\frac{2}{3}$	143 75	$74\frac{2}{3}$	141 50
66	138 50	76	145 75	76	143 50
$67\frac{1}{2}$	140 25	$77\frac{1}{3}$	147 75	$77\frac{1}{3}$	145 50
69	142 00	$78\frac{2}{3}$	149 75	$78\frac{2}{3}$	147 50
$70\frac{1}{2}$	143 50	80	151 75	80	149 50
72	145 00	$81\frac{1}{3}$	153 50	$81\frac{1}{3}$	151 25
$73\frac{1}{2}$	146 75	$82\frac{2}{3}$	155 50	$82\frac{2}{3}$	153 25
75	148 50	84	157 50	84	155 25

WITH THE FOLLOWING STYLES OF LOOPS.					
STANDARD.		ENLARGED.		EXTENDED.	
Feet of Heating Surface.	Price.	Feet of Heating Surface.	Price.	Feet of Heating Surface.	Price.
52	\$132 25	$59\frac{1}{3}$	\$139 25	$59\frac{1}{3}$	\$137 25
53	134 00	$60\frac{2}{3}$	141 00	$60\frac{2}{3}$	139 00
54	135 50	62	143 00	62	141 00
55	137 25	$63\frac{1}{3}$	145 00	$63\frac{1}{3}$	143 00
56	139 00	$64\frac{2}{3}$	147 00	$64\frac{2}{3}$	145 00
57	140 50	66	149 00	66	147 00
58	142 00	$67\frac{1}{3}$	150 75	$67\frac{1}{3}$	148 75
59	143 75	$68\frac{2}{3}$	152 75	$68\frac{2}{3}$	150 75
60	145 50	70	154 75	70	152 75

All Regular Hot Water Goods Tapped  $1\frac{1}{4}$ " x  $1\frac{1}{4}$ " "Right Hand."

TRADE BUNDY MARK

# Bundy Hot Closet Dining Room Steam Direct Radiator.



STYLE B. FIG. 10 $\frac{1}{2}$ .

FIG. 10 $\frac{1}{2}$  represents the Bundy Hot Closet Dining Room Steam Direct Radiator, with newly designed ornamental Base, corresponding in design with the closet. The Bundy loops with new design can be used in this Radiator with good effect, and will be furnished when so ordered without extra charge.

The dimensions of these closets are as follows: Length, 35 inches; width, 14 inches; height, 18 inches; heights of Radiators over all, 36 or 42 inches. These closets have one shelf which can be readily removed or adjusted. The doors are of such size as to admit any dish or cover that the closet can accommodate. The heating surface in these Radiators can be varied from 33 to 70 feet each. Centre of outlet, 4 $\frac{1}{2}$  inches from floor.

## FORTY-TWO INCHES HIGH.

WITH THE FOLLOWING STYLES OF LOOPS.			
STANDARD.		ENLARGED.	
Feet of Heating Surface	Price.	Feet of Heating Surface	Price.
44	\$101 50	51 $\frac{1}{2}$	\$107 50
46	103 50	53 $\frac{3}{4}$	109 50
48	105 50	56	112 00
50	108 50	58 $\frac{1}{2}$	114 50
52	109 50	60 $\frac{1}{2}$	116 50
54	111 50	63	118 50
56	113 50	65 $\frac{1}{2}$	121 00
58	115 50	67 $\frac{3}{4}$	123 50
60	117 50	70	125 75

## THIRTY-SIX INCHES HIGH.

WITH THE FOLLOWING STYLES OF LOOPS.			
STANDARD.		ENLARGED.	
Feet of Heating Surface	Price.	Feet of Heating Surface	Price.
33	\$ 98 50	38 $\frac{1}{2}$	\$104 75
34 $\frac{1}{2}$	100 50	40 $\frac{1}{4}$	107 00
36	102 50	42	109 00
37 $\frac{1}{2}$	104 25	43 $\frac{3}{4}$	111 00
39	106 00	45 $\frac{1}{2}$	113 25
40 $\frac{1}{2}$	108 00	47 $\frac{1}{4}$	115 50
42	109 50	49	117 75
43 $\frac{1}{2}$	111 50	50 $\frac{3}{4}$	120 00
45	113 50	52 $\frac{1}{2}$	122 00

NOTE.—The above prices include new design base and loops

120 All Regular Steam Goods Tapped 1" x  $\frac{3}{4}$ " "Right Hand." 651

TRADE BUNDY MARK.

# Bundy Hot Closet Dining-Room Hot Water Direct Radiator



STYLE E. FIG. 50.

Fig. 50 represents the Bundy Hot Closet Dining Room Hot Water Direct Radiator. The ornamental base is in perfect keeping with the design of the closet, and the general appearance of this Radiator, taken as a whole, is beyond comparison.

The dimensions of these closets are as follows:—Length, 35 inches; width, 14 inches; height, 18 inches; heights of Radiators over all, 47 and 41 inches. These closets are the same as are used with our steam Radiators and are therefore interchangeable. They have one shelf which can readily be removed or adjusted. The heating surface can be varied from 52 to 84 feet each, and the centre of tapping is  $4\frac{1}{2}$  inches from the floor. The feed pipe can, however, enter the upper circulating chamber of the Radiator so they can be successfully placed on the same level as the heater or even below. This is the only Hot Closet Radiator manufactured which can be used in this way.

### FORTY-SEVEN INCHES HIGH.

### FORTY-ONE INCHES HIGH.

WITH THE FOLLOWING STYLES OF LOOPS.			
STANDARD.		ENLARGED.	
Feet of Heating Surface.	Price.	Feet of Heating Surface.	Price.
63	\$142 75	73 $\frac{1}{2}$	\$149 50
64 $\frac{1}{2}$	144 50	74 $\frac{1}{2}$	151 25
66	146 00	76	153 25
67 $\frac{1}{2}$	147 75	77 $\frac{1}{2}$	155 25
69	149 50	78 $\frac{1}{2}$	157 25
70 $\frac{1}{2}$	151 00	80	159 25
72	152 50	81 $\frac{1}{2}$	161 00
73 $\frac{1}{2}$	154 25	82 $\frac{1}{2}$	163 00
75	156 00	84	164 00

WITH THE FOLLOWING STYLES OF LOOPS.			
STANDARD.		ENLARGED.	
Feet of Heating Surface.	Price.	Feet of Heating Surface.	Price.
52	\$139 75	59 $\frac{1}{2}$	\$146 75
53	141 50	60 $\frac{1}{2}$	148 50
54	143 00	62	150 50
55	144 75	63 $\frac{1}{2}$	152 50
56	146 50	64 $\frac{1}{2}$	154 50
57	148 00	66	156 50
58	149 50	67 $\frac{1}{2}$	158 25
59	151 25	68 $\frac{1}{2}$	160 25
60	153 00	70	162 25

NOTE.—The above prices include new design base and loops.

All Regular Hot Water Goods Tapped  $1\frac{1}{4}$ "  $\times$   $1\frac{1}{4}$ " "Right Hand."

TRADE BUNDY MARK.

# Bundy Hot Closet Dining Room Steam Direct Radiator.



STYLE C. FIG. 10 $\frac{3}{4}$ .

FIG. 10 $\frac{3}{4}$  represents the Bundy Hot Closet Dining Room Steam Direct Radiator, elaborately decorated with antique brass screen and ornaments. This beautiful Radiator is designed to rank first in the appointment of a richly furnished dining room, and is certainly the most elegant thing of the kind ever offered to the public.

The dimensions of these closets are as follows: Length, 35 inches; width, 14 inches; height, 18 inches; heights of Radiators over all, 36 to 42 inches. These closets have one shelf that can be readily removed or adjusted. The doors are of such size as to admit any dish or cover that the closet can accommodate. The heating surface in these Radiators can be varied from 33 to 70 feet each. Centre of outlet 4 $\frac{1}{2}$  inches from floor.

### FORTY-TWO INCHES HIGH.

WITH THE FOLLOWING STYLES OF LOOPS.					
STANDARD.		ENLARGED.		EXTENDED SURFACE.	
Feet of Heating Surface.	Price.	Feet of Heating Surface.	Price.	Feet of Heating Surface.	Price.
44	\$131 00	51 $\frac{1}{3}$	\$137 00	51 $\frac{1}{3}$	\$135 50
46	133 00	53 $\frac{2}{3}$	139 00	53 $\frac{2}{3}$	138 00
48	135 00	56	141 50	56	140 00
50	138 00	58 $\frac{1}{3}$	144 00	58 $\frac{1}{3}$	142 25
52	139 00	60 $\frac{2}{3}$	146 00	60 $\frac{2}{3}$	144 50
54	141 00	63	148 00	63	146 75
56	143 00	65 $\frac{1}{3}$	150 50	65 $\frac{1}{3}$	149 00
58	145 00	67 $\frac{2}{3}$	153 00	67 $\frac{2}{3}$	151 75
60	147 00	70	155 25	70	153 50

### THIRTY-SIX INCHES HIGH.

WITH THE FOLLOWING STYLES OF LOOPS.					
STANDARD.		ENLARGED.		EXTENDED SURFACE.	
Feet of Heating Surface.	Price.	Feet of Heating Surface.	Price.	Feet of Heating Surface.	Price.
33	\$128 00	38 $\frac{1}{2}$	\$134 25	38 $\frac{1}{2}$	\$133 00
34 $\frac{1}{2}$	130 00	40 $\frac{1}{4}$	136 50	40 $\frac{1}{4}$	135 00
36	132 00	42	138 50	42	137 00
37 $\frac{1}{2}$	133 75	43 $\frac{3}{4}$	140 50	43 $\frac{3}{4}$	139 25
39	135 50	45 $\frac{1}{2}$	142 75	45 $\frac{1}{2}$	141 25
40 $\frac{1}{2}$	137 50	47 $\frac{3}{4}$	145 00	47 $\frac{3}{4}$	143 50
42	139 00	49	147 25	49	145 50
43 $\frac{1}{2}$	141 00	50 $\frac{1}{4}$	149 50	50 $\frac{1}{4}$	147 50
45	143 00	52 $\frac{1}{2}$	151 50	52 $\frac{1}{2}$	149 50

NOTE.—The above prices include new design base and antique brass screens.

All Regular Steam Goods Tapped 1" x 3/4" Right Hand.

TRADE BUNDY MARK.

# Bundy Hot Closet Dining Room Hot Water Direct Radiator



STYLE F. FIG. 51.

FIG. 51 represents Bundy Hot Closet Dining Room Hot Water Direct Radiator, elaborately decorated with antique brass screen and ornaments. This beautiful Radiator is appropriately placed in the most richly furnished dining room, and is certainly the most elegant thing of the kind ever offered to the public.

The dimensions of these closets are as follows:—Length, 35 inches; width, 14 inches; height, 18 inches; heights of Radiators over all, 47 and 41 inches. The hot closet is the same as is used with our steam Radiator and is, therefore, interchangeable. Each closet has one shelf which is easily removed or adjusted. The doors are of such size and lack of closet concave so as to accommodate the widest dish or platter. The feed pipe can enter the upper circulating chamber of the Radiator if desired, so they can be successfully placed on the same level as the heater or even below.

The heating surface can be varied from 52 to 84 feet each, and the centre of outlet is  $4\frac{1}{2}$  inches from floor.

## FORTY-SEVEN INCHES HIGH.

## FORTY-ONE INCHES HIGH.

WITH THE FOLLOWING STYLES OF LOOPS.					
STANDARD.		ENLARGED.		EXTENDED SURFACE.	
Feet of Heating Surface.	Price.	Feet of Heating Surface.	Price.	* Feet of Heating Surface.	Price.
63	\$172 25	73 $\frac{1}{3}$	\$179 00	73 $\frac{1}{3}$	\$176 75
64 $\frac{1}{2}$	174 00	74 $\frac{2}{3}$	180 75	74 $\frac{2}{3}$	178 50
66	175 50	76	182 75	76	180 50
67 $\frac{1}{2}$	177 25	77 $\frac{1}{3}$	184 75	77 $\frac{1}{3}$	182 50
69	179 00	78 $\frac{2}{3}$	186 75	78 $\frac{2}{3}$	184 50
70 $\frac{1}{2}$	180 50	80	188 75	80	186 50
72	182 00	81 $\frac{1}{3}$	190 50	81 $\frac{1}{3}$	188 25
73 $\frac{1}{2}$	183 75	82 $\frac{2}{3}$	192 50	82 $\frac{2}{3}$	190 25
75	186 50	84	194 50	84	192 25

WITH THE FOLLOWING STYLES OF LOOPS.					
STANDARD.		ENLARGED.		EXTENDED SURFACE.	
Feet of Heating Surface.	Price.	Feet of Heating Surface.	Price.	Feet of Heating Surface.	Price.
52	\$169 25	59 $\frac{1}{3}$	\$176 25	59 $\frac{1}{3}$	\$174 25
53	171 00	60 $\frac{2}{3}$	178 00	60 $\frac{2}{3}$	176 00
54	172 50	62	180 00	62	178 00
55	174 25	63 $\frac{1}{3}$	182 00	63 $\frac{1}{3}$	180 00
56	176 00	64 $\frac{2}{3}$	184 00	64 $\frac{2}{3}$	182 00
57	177 50	66	186 00	66	184 00
58	179 00	67 $\frac{1}{3}$	187 75	67 $\frac{1}{3}$	185 75
59	180 75	68 $\frac{2}{3}$	189 75	68 $\frac{2}{3}$	187 75
60	182 50	70	191 75	70	189 75

NOTE.—The above prices include new design Base and antique brass screen.

All Regular Hot Water Goods Tapped  $1\frac{1}{4}$ " ×  $1\frac{1}{4}$ " "Right Hand."

TRADE BUNDY MARK.

Bundy Steam and Hot Water Direct = Indirect Radiator.

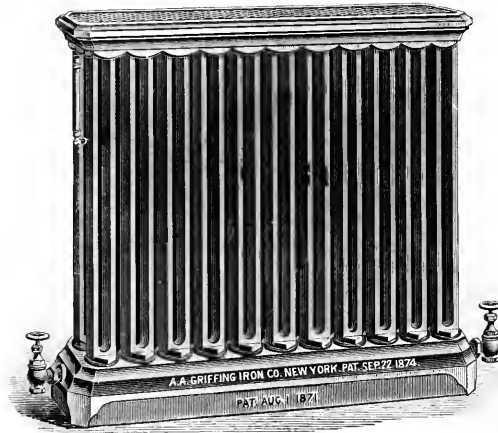

FIG. 24.

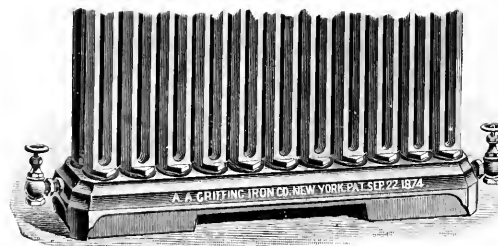

FIG. 25.

FIGS. 24 and 25 represent the Bundy Steam and Hot Water Direct-Indirect Radiator, extensively used in large buildings where direct heat, as well as good ventilation is required. The base is made in the form of a box fitting closely to the floor all around as per Fig. 24, when the fresh air is admitted under the Radiator through a hole in the floor, or an opening may be left in the back of the Base, as per Figs. 25 and 26. This latter plan is most adopted and goods are furnished this way, with an opening in the back 4" high and 8" long, when other instructions are not given. Among the many buildings heated with this Radiator are: The Standard Oil Company's Building, the United Bank Building, Public Schools, Nos. 17, 31, and 32 of N. Y. City, State Normal School, Albany, N. Y., and District School, Mt. Vernon, O.

*NOTE:—The price of these Radiators is 25 cents per Loop in advance of List Prices of Rectangular Steam and Hot Water Direct Radiators.*



TRADE BUNDY MARK.

## Bundy Steam and Hot Water Direct = Indirect Radiator CROSS SECTION.

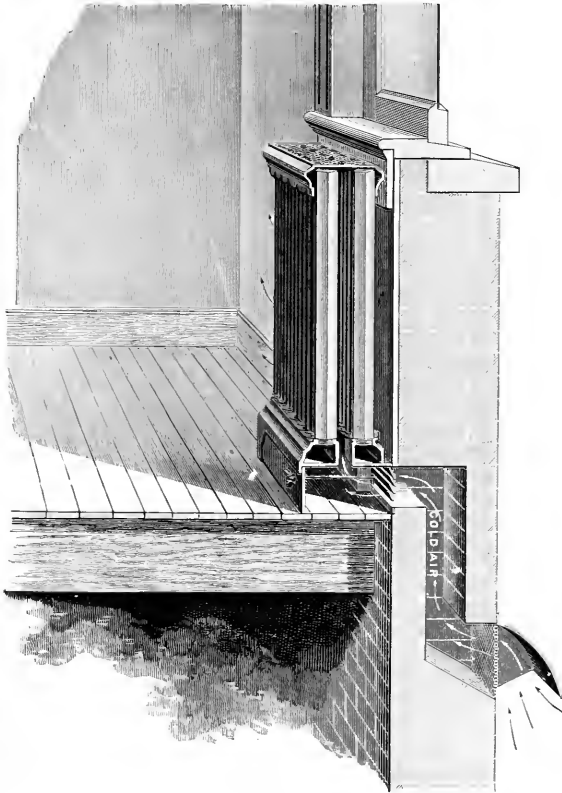

FIG. 26.

This system is economical and efficient and overcomes the difficulty of ventilating rooms where the air has become vitiated and deoxygenized by a large assembly of people, gas lights, and from other causes, by supplying fresh air that is warmed as it passes through Radiators, thus avoiding draughts of cold air that would come from ventilating by open windows.

The Board of Education of New York City, have recently used this method of ventilating class rooms in the public schools with marked success, thus avoiding the necessity of ventilating by open windows, which ruins the health of children sitting near a draught of cold air. Where no Indirect Radiators are used this plan of ventilation is indispensable.

*NOTE.*—This form of construction in Radiators is covered by Letters Patent, No. 117,675. Any infringement on the rights secured by this Patent will be subject to prompt legal proceedings.

TRADE BUNDY MARK.

# Bundy Window Steam Direct Radiator.

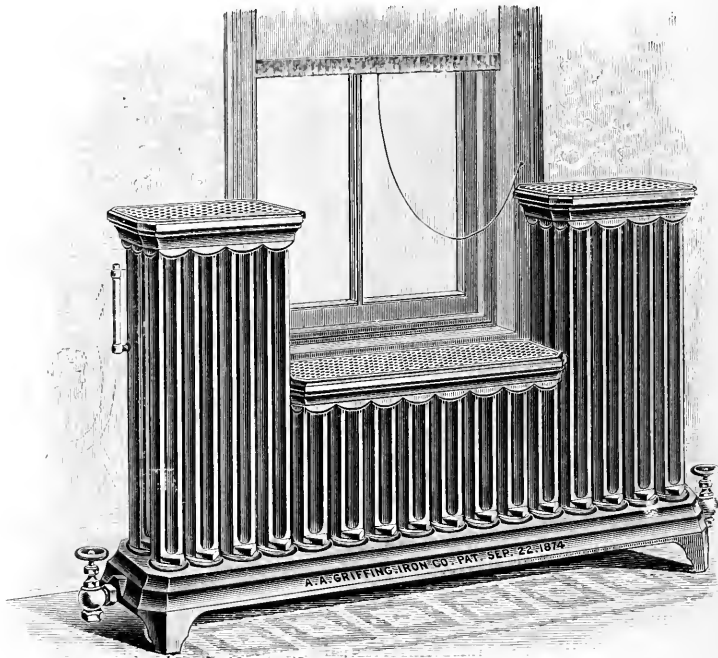

FIG. 11.

FIG. 11 represents the Bundy Window Steam Direct Radiator, which is very convenient where a large Radiator is required in front of a low window.

PRICES SAME AS FOR RECTANGULAR STEAM RADIATORS 42" OR 36" HIGH.

NO ALLOWANCE FOR SHORT LOOPS.

TRADE BUNDY MARK.

# Bundy Stairway Steam Direct Radiator.

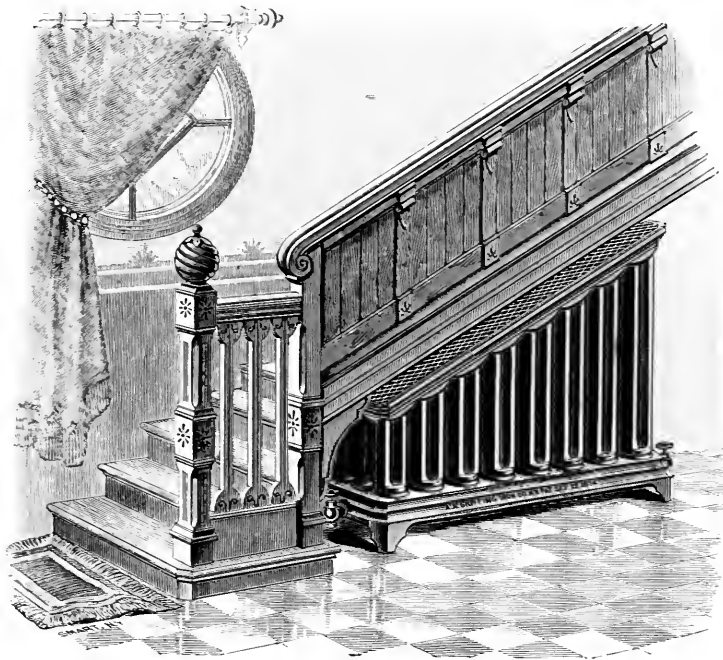

FIG. 11½.

FIG. 11½ represents the Bundy Stairway Steam Direct Radiator, which is a very convenient and attractive form of Radiator to use in the halls of our modern buildings.

PRICES SAME AS FOR RECTANGULAR STEAM RADIATORS 42' OR 36' HIGH.

NO ALLOWANCE FOR SHORT LOOPS.

TRADE BUNDY MARK.

These elegant Radiator covers are made to fit any size Radiator found on our list. They are furnished in Antique Brass (*blackened gold*), Polished Brass (*gold*), Oxidized Silver (*blackened silver*), and Bright Nickel.

For prices on Antique and Polished Brass Screens, see list on page 55; for prices on Oxidized Silver and Bright Nickel, add 30 per cent. to same list. Same discount named on Bundy Radiators applies thereto.



FIG. 39.

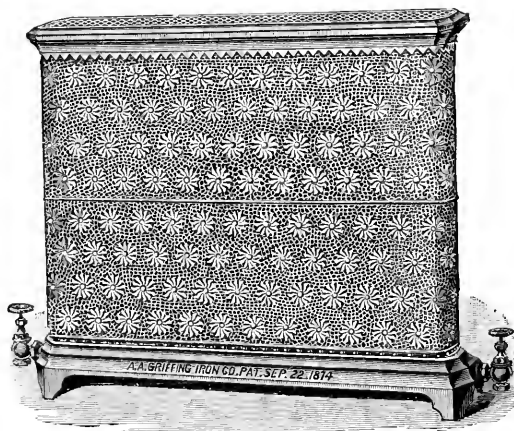

FIG. 40.



FIG. 41.



FIG. 42.



FIG. 43.



FIG. 44.

TRADE BUNDY MARK.

## Vertical Tube Antique Brass Direct Radiator Screens.

Figs. 39½, 40½, 41½, 42½, 43½, 44½, 44½ and 44½ are the latest designs being specially adapted to Renaissance, Moorish and Queen Anne rooms. They can be placed on Radiators before or after setting or at any time.

Furnished in Antique Brass (*Blackened Gold*), Polished Brass (*Gold*), or Oxidized Silver and Bright Nickel.

For prices on Antique and Polished Brass Screens, see list.

For prices on Oxidized Silver and Bright Nickel, add 30 per cent. to list.



Fig. 39½.

These Screens have liberal fret work openings through which the air passes with perfect freedom. They do not increase the space occupied by the Radiator and when mounted with a *Rose Nubedian, Aurania Griotte, Sienna, St. Anne, Italian Dove* or *Ophiate Marble Top* they make a most elegant piece of furniture, and the great variety in which they are made enables one to select those in perfect harmony with the furnishing of any room.

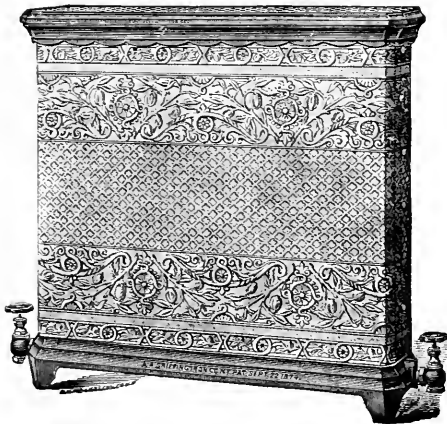

Fig. 40½.

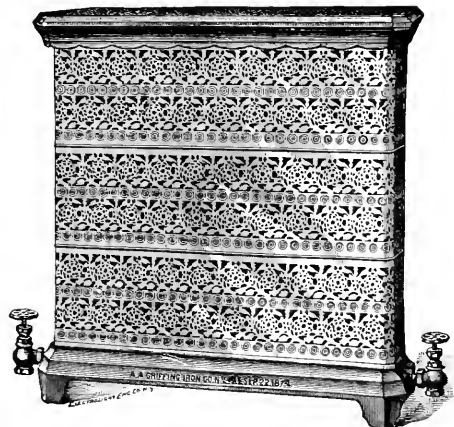

Fig. 41½

TRADE BUNDY MARK.

Bundy Steam & Hot Water Direct Radiator Brass Screens



FIG. 42.



FIG. 43.

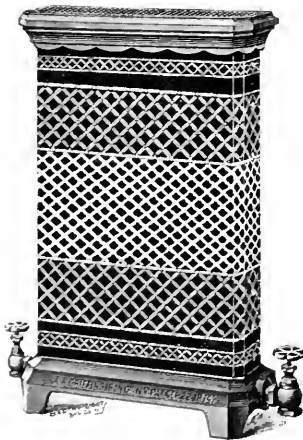

FIG. 44.



FIG. 44.



FIG. 44.



TRADE **BUNDY** MARK.

Bundy Steam and Hot Water Direct Radiator Brass Screen Price List.

42 Inches High—Steam. 45 Inches High—Hot Water.		36 Inches High—Steam. 39 Inches High—Hot Water.		30 Inches High—Steam. 33 Inches High—Hot Water.	
Standard, Enlarged and Extended Surface Radiators.	List Price for Brass Screens.	Standard, Enlarged and Extended Surface Radiators.	List Price for Brass Screens.	Standard, Enlarged and Extended Surface Radiators.	List Price for Brass Screens.
1 X 3	\$24 25	1 X 3	\$20 25	1 X 3	\$16 75
1 X 4	28 75	1 X 4	24 00	1 X 4	20 00
1 X 5	36 00	1 X 5	30 00	1 X 5	25 00
1 X 6	43 25	1 X 6	36 00	1 X 6	30 00
1 X 7	48 50	1 X 7	40 50	1 X 7	33 75
1 X 8	55 75	1 X 8	46 50	1 X 8	38 75
1 X 9	60 25	1 X 9	50 25	1 X 9	41 75
1 X 10	67 50	1 X 10	56 25	1 X 10	46 75
1 X 11	74 75	1 X 11	62 25	1 X 11	51 75
1 X 12	82 75	1 X 12	69 00	1 X 12	57 50
1 X 13	86 50	1 X 13	72 00	1 X 13	60 00
1 X 14	93 50	1 X 14	78 00	1 X 14	65 00
1 X 15	100 75	1 X 15	84 00	1 X 15	70 00
1 X 16	108 00	1 X 16	90 00	1 X 16	75 00
1 X 18	120 50	1 X 18	100 50	1 X 18	83 75
1 X 20	135 00	1 X 20	112 50	1 X 20	93 75
1 X 22	140 75	1 X 22	122 25	1 X 22	101 75
1 X 24	158 50	1 X 24	132 00	1 X 24	110 00
1 X 26	172 75	1 X 26	144 00	1 X 26	120 00
2 X 3	31 50	2 X 3	26 25	2 X 3	21 75
2 X 4	38 75	2 X 4	32 25	2 X 4	26 75
2 X 5	46 00	2 X 5	38 25	2 X 5	31 75
2 X 6	50 50	2 X 6	42 00	2 X 6	35 00
2 X 7	57 50	2 X 7	48 00	2 X 7	40 00
2 X 8	64 75	2 X 8	54 00	2 X 8	45 00
2 X 9	70 25	2 X 9	58 50	2 X 9	48 75
2 X 10	77 50	2 X 10	64 50	2 X 10	53 75
2 X 11	84 50	2 X 11	70 50	2 X 11	58 75
2 X 12	91 75	2 X 12	76 50	2 X 12	63 75
2 X 13	96 25	2 X 13	80 25	2 X 13	66 75
2 X 14	103 50	2 X 14	86 25	2 X 14	71 75
2 X 15	108 00	2 X 15	90 00	2 X 15	75 00
2 X 16	115 25	2 X 16	96 00	2 X 16	80 00
2 X 18	127 75	2 X 18	106 50	2 X 18	89 75
2 X 20	142 25	2 X 20	118 50	2 X 20	98 75
2 X 22	154 00	2 X 22	128 25	2 X 22	106 75
2 X 24	165 50	2 X 24	138 00	2 X 24	115 00
2 X 26	180 00	2 X 26	150 00	2 X 26	125 00
3 X 3	38 75	3 X 3	32 25	3 X 3	26 75
3 X 4	46 00	3 X 4	38 25	3 X 4	31 75
3 X 5	50 50	3 X 5	42 00	3 X 5	35 00
3 X 6	57 50	3 X 6	48 00	3 X 6	40 00
3 X 7	63 00	3 X 7	52 50	3 X 7	43 75
3 X 8	70 25	3 X 8	58 50	3 X 8	48 75
3 X 9	77 50	3 X 9	64 50	3 X 9	53 75
3 X 10	82 00	3 X 10	68 25	3 X 10	57 75
3 X 11	89 00	3 X 11	74 25	3 X 11	61 75
3 X 12	96 25	3 X 12	80 25	3 X 12	66 75
3 X 13	103 50	3 X 13	86 25	3 X 13	71 75
3 X 15	115 25	3 X 15	96 00	3 X 15	80 00
4 X 4	53 00	4 X 4	44 25	4 X 4	36 75
4 X 5	60 25	4 X 5	50 25	4 X 5	41 75
4 X 6	64 75	4 X 6	54 00	4 X 6	45 00
4 X 8	76 25	4 X 8	63 50	4 X 8	53 00
4 X 10	91 75	4 X 10	76 50	4 X 10	63 75
4 X 14	115 25	4 X 14	96 00	4 X 14	80 00
4 X 18	142 25	4 X 18	118 50	4 X 18	98 75
4 X 20	156 50	4 X 20	130 50	4 X 20	108 75
4 X 22	170 75	4 X 22	140 25	4 X 22	116 50
4 X 24	180 00	4 X 24	150 00	4 X 24	125 00
10 Circular	43 25	10 Circular.	36 00	10 Circular.	30 00
15 "	48 50	15 "	40 50	15 "	33 75
20 "	55 75	20 "	46 50	20 "	38 75
26 "	60 25	26 "	50 25	26 "	41 75
34 "	72 00	34 "	60 00	34 "	50 00
50 "	86 50	50 "	72 00	50 "	60 00
74 "	100 75	72 "	84 00	72 "	68 00
26 Column	77 50	26 Column.	56 25	26 Column.	46 75
34 "	82 00	34 "	68 25	34 "	56 75
50 "	100 75	50 "	84 00	50 "	68 00
10 Corner	37 25	10 Corner.	36 00	10 Corner.	30 00
15 "	53 00	15 "	44 25	15 "	36 75
20 "	63 00	20 "	52 50	20 "	43 75

The above prices are for all Steam Radiators 42" high and under to 36" high, and Hot Water Radiators 45" high and under to 33" high.

The above prices are for all Steam Radiators 36" high and under to 33" high, and Hot Water Radiators 39" high and under to 33" high.

The above prices are for all Steam Radiators 30" high and under, and Hot Water Radiators 33" high and under.

TRADE BUNDY MARK.

# One Row Bundy Renaissance Steam Direct Radiator.

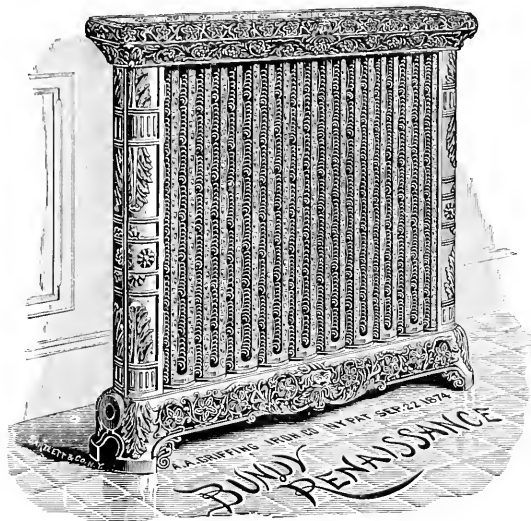

STYLE G, FIG. 64.

FIG. 64, Style G, represents the One Row Bundy Renaissance Steam Direct Radiator with Corner Pillars. This Radiator without Corner Pillars is shown by Fig. 67.

## THIRTY-SEVEN INCHES HIGH, ONE ROW OF LOOPS.

LIST OF RADIATORS BUILT ON THE FOLLOWING SIZE BASES. Width of Base, 7½ inches.			STANDARD.		ENLARGED.	
Shape of Radiator	Number of Loops.	Length of Radiators.	Each Loop represents 3 Feet of Heating Surface. LIST PRICE.		Each Loop represents 3½ Feet of Heating Surface. LIST PRICE.	
			Feet of Heating Surface.	With Iron Top or arranged for Marble Top.	Feet of Heating Surface.	With Iron Top or arranged for Marble Top.
1 × 5	5	21½	15	\$34 50	17½	\$36 00
1 × 7	7	28½	21	40 75	24½	43 00
1 × 9	9	34½	27	47 25	31½	49 75
1 × 11	11	41	33	53 50	38½	56 75
1 × 13	13	47½	39	60 00	45½	63 50
1 × 15	15	54	45	66 25	52½	70 50

## THIRTY-ONE INCHES HIGH, ONE ROW OF LOOPS.

LIST OF RADIATORS BUILT ON THE FOLLOWING SIZE BASES. Width of Base, 7¾ inches.			Each Loop Represents 2½ Feet of Heating Surface. LIST PRICE.		Each Loop Represents 3 Feet of Heating Surface. LIST PRICE.	
1 ×	Number of Loops.	Length of Radiators.	LIST PRICE.		LIST PRICE.	
			Feet of Heating Surface.	With Iron Top or arranged for Marble Top.	Feet of Heating Surface.	With Iron Top or arranged for Marble Top.
5	5	21½	12½	\$34 00	15	\$35 75
7	7	25½	17½	40 00	21	42 50
9	9	34½	22½	46 00	27	49 25
11	11	41	27½	52 25	33	56 00
13	13	47½	32½	58 25	39	62 75
15	15	54	37½	64 25	45	69 50

## TWENTY-FOUR AND ONE-HALF INCHES HIGH, ONE ROW OF LOOPS.

LIST OF RADIATORS BUILT ON THE FOLLOWING SIZE BASES. Width of Base, 7½ inches.			Each Loop Represents 2 Feet of Heating Surface. LIST PRICE.		Each Loop Represents 2½ Feet of Heating Surface. LIST PRICE.	
1 ×	Number of Loops.	Length of Radiators.	LIST PRICE.		LIST PRICE.	
			Feet of Heating Surface.	With Iron Top or arranged for Marble Top.	Feet of Heating Surface.	With Iron Top or arranged for Marble Top.
5	5	21½	10	\$33 25	11½	\$34 75
7	7	25½	14	39 00	16½	41 00
9	9	34½	18	45 00	21	47 50
11	11	41	22	50 75	25½	53 75
13	13	47½	26	56 50	30½	60 25
15	15	54	30	62 25	35	66 50

All Regular Goods Tapped 1" × ¾" "Right Hand."

All Regular Goods Tapped 1" × ¾" "Right Hand."



## Two Row Bundy Renaissance Steam Direct Radiator.

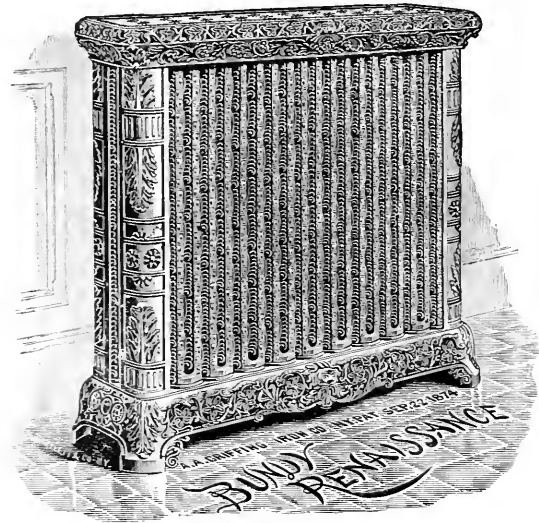

STYLE H, FIG. 65.

FIG. 65, Style H, represents the Two Row Bundy Renaissance Steam Direct Radiator with Corner Pillars. This Radiator without Corner Pillars is shown by Fig. 68. THIRTY-SEVEN INCHES HIGH, TWO ROWS OF LOOPS.

LIST OF RADIATORS BUILT ON THE FOLLOWING SIZE BASES.			STANDARD.		ENLARGED.	
Width of Base, 11 $\frac{3}{4}$ inches.			Each Loop Represents 3 Feet of Heating Surface. List Price.		Each Loop Represents 3 $\frac{1}{2}$ Feet of Heating Surface. List Price.	
Shape of Radiator.	Number of Loops.	Length of Radiator.	Feet of Heating Surface.	With Iron Top or arranged for Marble Top.	Feet of Heating Surface.	With Iron Top or arranged for Marble Top.
2 x 5	10	21 $\frac{1}{2}$	30	\$54 25	35	\$57 00
2 x 7	14	27 $\frac{1}{8}$	42	66 75	49	70 75
2 x 9	18	34 $\frac{1}{4}$	54	79 50	63	84 50
2 x 11	22	41	66	92 00	77	98 00
2 x 13	26	47 $\frac{3}{8}$	78	104 50	91	111 75
2 x 15	30	53 $\frac{3}{8}$	90	117 00	105	125 50

### THIRTY-ONE INCHES HIGH, TWO ROWS OF LOOPS.

LIST OF RADIATORS BUILT ON THE FOLLOWING SIZE BASES.			Each Loop Represents 2 $\frac{1}{2}$ Feet of Heating Surface.		Each Loop Represents 3 Feet of Heating Surface.	
Width of Base, 11 $\frac{3}{4}$ inches.			List Price.		List Price.	
2 x 5	10	21 $\frac{1}{2}$	25	\$53 00	30	\$56 50
2 x 7	14	27 $\frac{1}{8}$	35	65 00	42	70 00
2 x 9	18	34 $\frac{1}{4}$	45	77 00	54	83 50
2 x 11	22	41	55	89 25	66	96 75
2 x 13	26	47 $\frac{3}{8}$	65	101 25	78	110 25
2 x 15	30	53 $\frac{3}{8}$	75	113 25	90	123 75

### TWENTY-FOUR AND ONE-HALF INCHES HIGH, TWO ROWS OF LOOPS.

LIST OF RADIATORS BUILT ON THE FOLLOWING SIZE BASES.			Each Loop Represents 2 Feet of Heating Surface.		Each Loop Represents 2 $\frac{1}{2}$ Feet of Heating Surface.	
Width of Base, 11 $\frac{3}{4}$ inches.			List Price.		List Price.	
2 x 5	10	21 $\frac{1}{2}$	20	\$51 75	23 $\frac{1}{2}$	\$54 50
2 x 7	14	27 $\frac{1}{8}$	28	63 25	32 $\frac{1}{2}$	67 25
2 x 9	18	34 $\frac{1}{4}$	36	74 75	42	79 75
2 x 11	22	41	44	86 50	51 $\frac{1}{2}$	92 50
2 x 13	26	47 $\frac{3}{8}$	52	98 00	60 $\frac{1}{2}$	105 00
2 x 15	30	53 $\frac{3}{8}$	60	109 50	70	117 75

All Regular Goods Tapped 1" x  $\frac{3}{4}$ " "Right Hand."

All Regular Goods Tapped 1" x  $\frac{3}{4}$ " "Right Hand."

All Regular Goods Tapped 1" x  $\frac{3}{4}$ " "Right Hand."

TRADE BUNDY MARK

# Three Row Bundy Renaissance Steam Direct Radiator.

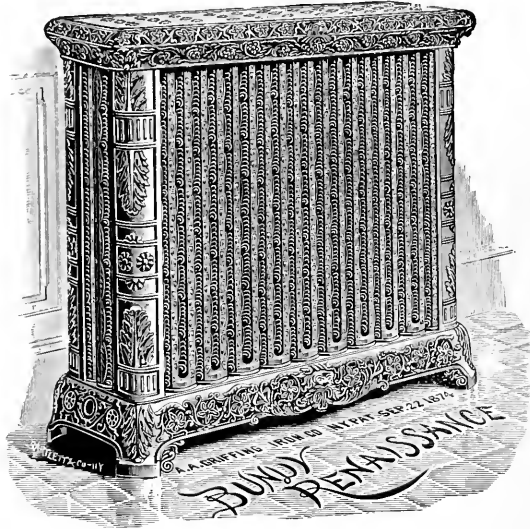

STYLE I, FIG. 66.

Fig. 66, Style I, represents the Three Row Bundy Renaissance Steam Direct Radiator with Corner Pillars. This Radiator with out Corner Pillars is shown by Fig. 69.

## THIRTY-SEVEN AND ONE-HALF INCHES HIGH, THREE ROWS OF LOOPS.

LIST OF RADIATORS BUILT ON THE FOLLOWING SIZE BASES. Width of Base, 15 1/4 inches.			STANDARD. Each Loop Represents 3 Feet of Heating Surface. LIST PRICE.		ENLARGED. Each Loop Represents 3 1/4 Feet of Heating Surface. LIST PRICE.	
Shape of Radiator.	Number of Loops	Length of Radiator.	Feet of Heating Surface.	With Iron Top or arranged for Marble Top.	Feet of Heating Surface.	With Iron Top or arranged for Marble Top.
3 x 5	15	21 1/2"	45	\$73 25	52 1/2"	\$77 50
3 x 7	21	25 3/8"	63	92 50	73 1/2"	98 50
3 x 9	27	34 1/2"	81	111 50	94 1/2"	119 25
3 x 11	33	42"	99	130 75	115 1/2"	140 25
3 x 13	39	48 1/8"	117	149 75	136 1/2"	161 00
3 x 15	45	54 3/4"	135	169 00	157 1/2"	182 00

## THIRTY-ONE AND ONE-HALF INCHES HIGH, THREE ROWS OF LOOPS.

LIST OF RADIATORS BUILT ON THE FOLLOWING SIZE BASES. Width of Base, 15 1/4 inches.			Each Loop Represents 2 1/2 Feet of Heating Surface. LIST PRICE.		Each Loop Represents 3 Feet of Heating Surface. LIST PRICE.	
Shape of Radiator.	Number of Loops	Length of Radiator.	Feet of Heating Surface.	With Iron Top or arranged for Marble Top.	Feet of Heating Surface.	With Iron Top or arranged for Marble Top.
3 x 5	15	21 1/2"	37 1/2"	\$71 50	45	\$76 75
3 x 7	21	25 3/8"	52 1/2"	89 75	63	97 25
3 x 9	27	34 1/2"	67 1/2"	108 25	81	117 75
3 x 11	33	42"	82 1/2"	126 50	99	138 00
3 x 13	39	48 1/8"	97 1/2"	145 00	117	158 50
3 x 15	45	54 3/4"	112 1/2"	163 25	135	179 00

## TWENTY-FIVE INCHES HIGH, THREE ROWS OF LOOPS.

LIST OF RADIATORS BUILT ON THE FOLLOWING SIZE BASES. Width of Base, 15 1/4 inches.			Each Loop Represents 2 Feet of Heating Surface. LIST PRICE.		Each Loop Represents 2 1/2 Feet of Heating Surface. LIST PRICE.	
Shape of Radiator.	Number of Loops	Length of Radiator.	Feet of Heating Surface.	With Iron Top or arranged for Marble Top.	Feet of Heating Surface.	With Iron Top or arranged for Marble Top.
3 x 5	15	21 1/2"	30	\$69 50	35	\$73 75
3 x 7	21	25 3/8"	42	87 25	49	93 00
3 x 9	27	34 1/2"	54	104 75	63	112 25
3 x 11	33	42"	66	122 50	77	131 50
3 x 13	39	48 1/8"	78	140 00	91	150 75
3 x 15	45	54 3/4"	90	157 75	105	170 00

All Regular Goods Tapped 1" x 1/4" Right Hand.

All Regular Goods Tapped 1" x 1/4" Right Hand.

All Regular Goods Tapped 1" x 1/4" Right Hand.

TRADE BUNDY MARK.

# One Row Bundy Renaissance Hot Water Direct Radiator.

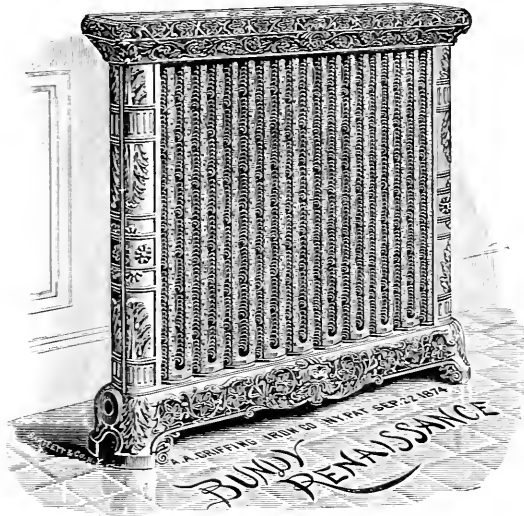

STYLE M, FIG. 70.

Fig. 70, Style M, represents the One Row Bundy Renaissance Steam Direct Radiator with Corner Pillars. This Radiator without Corner Pillars is shown by Fig. 73.

## FORTY AND ONE-HALF INCHES HIGH, ONE ROW OF LOOPS.

FOR STANDARD OR ENLARGED LOOPS.				STANDARD.		ENLARGED.	
LIST OF RADIATORS BUILT ON THE FOLLOWING SIZE BASES.				Each Loop represents 3½ Feet of Heating Surface.		Each Loop Represents 4 Feet of Heating Surface.	
Width of Base, 7½ inches.				LIST PRICE.			
Shape of Radiators.	Number of Loops.	Length of Radiators.	Feet of Heating Surface.	With Iron Top or arranged for Marble Top	Feet of Heating Surface.	With Iron Top or arranged for Marble Top	LIST PRICE.
1 × 5	5	21½	17½	\$39 75	20	\$41 50	
1 × 7	7	25½	21½	45 25	25	50 75	
1 × 9	9	31½	31½	56 50	36	59 75	
1 × 11	11	41	35½	65 00	44	69 00	
1 × 13	13	47½	45½	73 25	52	78 00	
1 × 15	15	54	52½	81 75	60	87 25	

## THIRTY-FOUR INCHES HIGH, ONE ROW OF LOOPS.

LIST OF RADIATORS BUILT ON THE FOLLOWING SIZE BASES.				Each Loop Represents 3 Feet of Heating Surface.		Each Loop Represents 3½ Feet of Heating Surface.	
Width of Base, 7½ inches.				LIST PRICE.			
Shape of Radiators.	Number of Loops.	Length of Radiators.	Feet of Heating Surface.	With Iron Top or arranged for Marble Top	Feet of Heating Surface.	With Iron Top or arranged for Marble Top	LIST PRICE.
1 × 5	5	21½	15	\$33 25	17½	\$40 25	
1 × 7	7	25½	21	46 00	24½	49 00	
1 × 9	9	31½	27	54 00	31½	57 50	
1 × 11	11	41	33	61 75	38½	66 25	
1 × 13	13	47½	39	69 75	45½	74 75	
1 × 15	15	54	45	77 50	52½	83 50	

## TWENTY-SEVEN AND ONE-HALF INCHES HIGH, ONE ROW OF LOOPS.

LIST OF RADIATORS BUILT ON THE FOLLOWING SIZE BASES.				Each Loop Represents 2½ Feet of Heating Surface.		Each Loop Represents 3 Feet of Heating Surface.	
Width of Base, 7½ inches.				LIST PRICE.			
Shape of Radiators.	Number of Loops.	Length of Radiators.	Feet of Heating Surface.	With Iron Top or arranged for Marble Top	Feet of Heating Surface.	With Iron Top or arranged for Marble Top	LIST PRICE.
1 × 5	5	21½	12½	\$37 75	14½	\$39 25	
1 × 7	7	25½	17½	45 25	19½	47 50	
1 × 9	9	31½	22½	52 75	25	55 75	
1 × 11	11	41	27½	60 50	31½	63 75	
1 × 13	13	47½	32½	65 00	36½	72 00	
1 × 15	15	54	37½	75 50	42½	80 25	

\*All Regular Goods Tapped 1¼" × 1¼" "Right Hand."

\*All Regular Goods Tapped 1¼" × 1¼" "Right Hand."

\*All Regular Goods Tapped 1¼" × 1¼" "Right Hand."

# Two Row Bundy Renaissance Hot Water Direct Radiator.

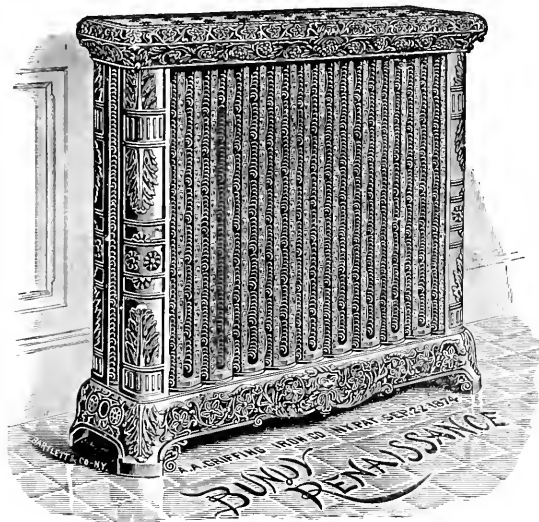

STYLE N, FIG. 71.

Fig. 71, Style N, represents the Two Row Bundy Renaissance Hot Water Direct Radiator with Corner Pillars. This Radiator without Corner Pillars is shown by Fig. 73.

## FORTY AND ONE-HALF INCHES HIGH, TWO ROWS OF LOOPS.

FOR STANDARD OR ENLARGED LOOPS.						
LIST OF RADIATORS BUILT ON THE FOLLOWING SIZE BASES. Width of Base, 13 $\frac{1}{4}$ inches.			STANDARD. Each Loop Represents 3 $\frac{1}{2}$ Feet of Heating Surface. List Price.		ENLARGED. Each Loop Represents 4 Feet of Heating Surface. List Price.	
Shape of Radiator.	Number of Loops.	Length of Radiator.	Feet of Heating Surface.	With Iron Top or arranged for Marble Top.	Feet of Heating Surface.	With Iron Top or arranged for Marble Top.
2 $\times$ 5	10	21 $\frac{1}{2}$	35	\$64 75	40	\$68 25
2 $\times$ 7	14	27 $\frac{7}{8}$	49	81 50	56	86 50
2 $\times$ 9	18	34 $\frac{1}{4}$	63	98 25	72	104 50
2 $\times$ 11	22	41 $\frac{1}{2}$	77	115 00	88	122 75
2 $\times$ 13	26	47 $\frac{3}{8}$	91	131 75	104	140 75
2 $\times$ 15	30	53 $\frac{3}{8}$	105	148 50	120	150 00

## THIRTY-FOUR INCHES HIGH, TWO ROWS OF LOOPS.

LIST OF RADIATORS BUILT ON THE FOLLOWING SIZE BASES. Width of Base, 13 $\frac{1}{4}$ inches.			Each Loop Represents 3 Feet of Heating Surface. List Price.		Each Loop Represents 3 $\frac{1}{2}$ feet of Heating Surface. List Price.	
2 $\times$ 5	11	21 $\frac{1}{2}$	30	\$61 75	35	\$65 75
2 $\times$ 7	14	27 $\frac{7}{8}$	42	77 25	49	83 00
2 $\times$ 9	18	34 $\frac{1}{4}$	54	92 75	63	100 25
2 $\times$ 11	22	41 $\frac{1}{2}$	66	108 50	77	117 25
2 $\times$ 13	26	47 $\frac{3}{8}$	78	124 00	91	134 50
2 $\times$ 15	30	53 $\frac{3}{8}$	90	139 50	105	151 75

## TWENTY-SEVEN AND ONE-HALF INCHES HIGH, TWO ROWS OF LOOPS.

LIST OF RADIATORS BUILT ON THE FOLLOWING SIZE BASES. Width of Base, 13 $\frac{1}{4}$ inches.			Each Loop Represents 2 $\frac{1}{2}$ Feet of Heating Surface. List Price.		Each Loop Represents 2 $\frac{3}{4}$ Feet of Heating Surface. List Price.	
2 $\times$ 5	10	21 $\frac{1}{2}$	25	\$60 50	28 $\frac{1}{4}$	\$63 50
2 $\times$ 7	14	27 $\frac{7}{8}$	35	75 50	39 $\frac{2}{3}$	79 75
2 $\times$ 9	18	34 $\frac{1}{4}$	45	90 50	51	96 00
2 $\times$ 11	22	41 $\frac{1}{2}$	55	105 75	62 $\frac{1}{2}$	112 50
2 $\times$ 13	26	47 $\frac{3}{8}$	65	120 75	73 $\frac{2}{3}$	128 75
2 $\times$ 15	30	53 $\frac{3}{8}$	75	135 75	85	150 00

All Regular Goods Tapped 1 $\frac{1}{2}$ "  $\times$  1 $\frac{1}{4}$ " " Right Hand." " 60

All Regular Goods Tapped 1 $\frac{1}{2}$ "  $\times$  1 $\frac{1}{4}$ " " Right Hand." " 60

All Regular Goods Tapped 1 $\frac{1}{2}$ "  $\times$  1 $\frac{1}{4}$ " " Right Hand." " 60

TRADE MARK. BUNDY MANUFACTURED.

# One Row Bundy Renaissance Steam Direct Radiator.

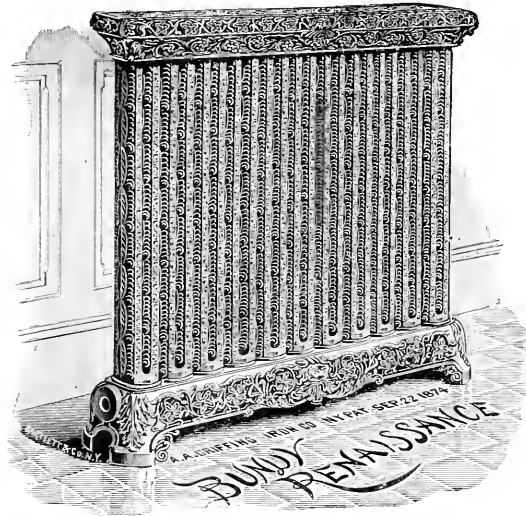

STYLE J, FIG. 67.

Fig. 67, Style J, represents the One Row Bundy Renaissance Steam Direct Radiator without Corner Pillars. This Radiator with Corner Pillars is shown by Fig. 64.

## THIRTY-SEVEN INCHES HIGH, ONE ROW OF LOOPS.

LIST OF RADIATORS BUILT ON THE FOLLOWING SIZE BASES. Width of Base, 7½ inches.			STANDARD. Each Loop Represents 3 Feet of Heating Surface. LIST PRICE.		ENLARGED. Each Loop Represents 3½ Feet of Heating Surface. LIST PRICE.	
Shape of Radiator.	Number of Loops.	Length of Radiator.	Feet of Heating Surface.	With Iron Top or arranged for Marble Top.	Feet of Heating Surface.	With Iron Top or arranged for Marble Top.
I X 5	5	21½	15	\$27 00	17½	\$28 50
I X 7	7	28½	21	33 25	24½	35 50
I X 9	9	34½	27	39 75	31½	42 25
I X 11	11	41	33	46 00	38½	49 25
I X 13	13	47¾	39	52 50	45½	56 00
I X 15	15	54	45	58 75	52½	63 00

## THIRTY-ONE INCHES HIGH, ONE ROW OF LOOPS.

LIST OF RADIATORS BUILT ON THE FOLLOWING SIZE BASES. Width of Base, 7½ inches.			Each Loop Represents 2½ Feet of Heating Surface. LIST PRICE.		Each Loop Represents 3 Feet of Heating Surface. LIST PRICE.	
I X	Number of Loops.	Length of Radiator.	Feet of Heating Surface.	With Iron Top or arranged for Marble Top.	Feet of Heating Surface.	With Iron Top or arranged for Marble Top.
5	5	21½	12½	\$26 50	15	\$28 25
7	7	28½	17½	32 00	21	35 00
9	9	34½	22½	38 50	27	41 75
11	11	41	27½	44 75	33	48 50
13	13	47¾	32½	50 75	39	55 25
15	15	54	37½	56 75	45	62 00

## TWENTY-FOUR AND ONE-HALF INCHES HIGH, ONE ROW OF LOOPS.

LIST OF RADIATORS BUILT ON THE FOLLOWING SIZE BASES. Width of Base, 7¼ inches.			Each Loop Represents 2 Feet of Heating Surface. LIST PRICE.		Each Loop Represents 2½ Feet of Heating Surface. LIST PRICE.	
I X	Number of Loops.	Length of Radiator.	Feet of Heating Surface.	With Iron Top or arranged for Marble Top.	Feet of Heating Surface.	With Iron Top or arranged for Marble Top.
5	5	21½	10	\$25 75	12½	\$27 25
7	7	28½	14	31 50	16½	33 50
9	9	34½	18	37 50	21	40 00
11	11	41	22	43 25	25½	46 25
13	13	47¾	26	49 00	30½	52 75
15	15	54	30	54 75	35	59 00

All Regular Goods Tapped 1" X ¾" "Right Hand." 63

All Regular Goods Tapped 1" X ¾" "Right Hand." 63

All Regular Goods Tapped 1" X ¾" "Right Hand." 63

TRADE BUNDY MARK

# Two Row Bundy Renaissance Steam Direct Radiator.

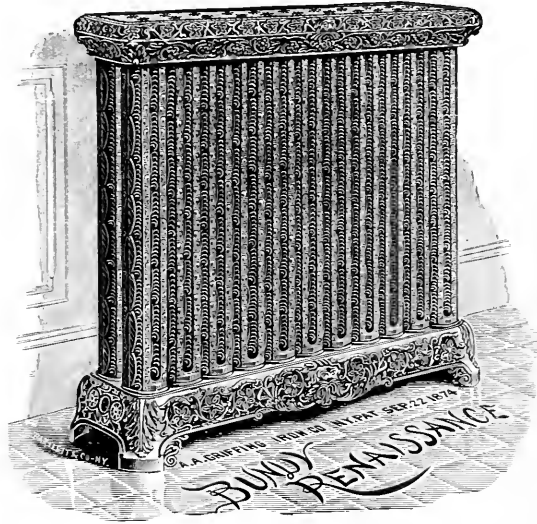

STYLE K, FIG. 68.

FIG. 68, Style K, represents the Two Row Bundy Renaissance Steam Direct Radiator without Corner Pillars. This Radiator with Corner Pillars is shown by Fig. 65.

**THIRTY-SEVEN INCHES HIGH. TWO ROWS OF LOOPS.**

LIST OF RADIATORS BUILT ON THE FOLLOWING SIZE BASES. Width of Base, 13 $\frac{3}{4}$ inches.			STANDARD. Each Loop Represents 3 Feet of Heating Surface. LIST PRICE.		ENLARGED. Each Loop Represents 3 $\frac{1}{2}$ Feet of Heating Surface. LIST PRICE.	
Shape of Radiator.	Number of Loops.	Length of Radiator.	Feet of Heating Surface.	With Iron Top or arranged for Marble Top.	Feet of Heating Surface.	With Iron Top or arranged for Marble Top.
2 x 5	10	21 $\frac{1}{2}$	30	\$46 75	35	\$49 50
2 x 7	14	27 $\frac{3}{8}$	42	59 25	49	63 25
2 x 9	15	34 $\frac{1}{4}$	54	72 00	63	77 00
2 x 11	22	41 $\frac{1}{2}$	66	84 50	77	90 50
2 x 13	26	47 $\frac{3}{8}$	78	97 00	91	104 25
2 x 15	30	53 $\frac{3}{8}$	90	109 50	105	115 00

**THIRTY-ONE INCHES HIGH. TWO ROWS OF LOOPS.**

LIST OF RADIATORS BUILT ON THE FOLLOWING SIZE BASES. Width of Base, 11 $\frac{3}{4}$ inches.			STANDARD. Each Loop Represents 2 $\frac{1}{2}$ Feet of Heating Surface. LIST PRICE.		ENLARGED. Each Loop Represents 3 Feet of Heating Surface. LIST PRICE.	
Shape of Radiator.	Number of Loops.	Length of Radiator.	Feet of Heating Surface.	With Iron Top or arranged for Marble Top.	Feet of Heating Surface.	With Iron Top or arranged for Marble Top.
2 x 5	10	21 $\frac{1}{2}$	25	\$45 50	30	\$49 00
2 x 7	14	27 $\frac{3}{8}$	35	57 50	42	62 50
2 x 9	15	34 $\frac{1}{4}$	45	69 50	54	76 00
2 x 11	22	41 $\frac{1}{2}$	55	81 75	66	89 25
2 x 13	26	47 $\frac{3}{8}$	65	93 75	78	102 75
2 x 15	30	53 $\frac{3}{8}$	75	105 75	90	116 25

**TWENTY-FOUR AND ONE-HALF INCHES HIGH. TWO ROWS OF LOOPS.**

LIST OF RADIATORS BUILT ON THE FOLLOWING SIZE BASES. Width of Base, 11 $\frac{3}{4}$ inches.			STANDARD. Each Loop Represents 2 Feet of Heating Surface. LIST PRICE.		ENLARGED. Each Loop Represents 2 $\frac{1}{2}$ Feet of Heating Surface. LIST PRICE.	
Shape of Radiator.	Number of Loops.	Length of Radiator.	Feet of Heating Surface.	With Iron Top or arranged for Marble Top.	Feet of Heating Surface.	With Iron Top or arranged for Marble Top.
2 x 5	10	21 $\frac{1}{2}$	20	\$44 25	23 $\frac{1}{2}$	\$47 00
2 x 7	14	27 $\frac{3}{8}$	28	55 75	32 $\frac{1}{2}$	59 75
2 x 9	15	34 $\frac{1}{4}$	36	67 25	42	72 25
2 x 11	22	41 $\frac{1}{2}$	44	79 00	51 $\frac{1}{2}$	85 00
2 x 13	26	47 $\frac{3}{8}$	52	90 50	60 $\frac{1}{2}$	97 50
2 x 15	30	53 $\frac{3}{8}$	60	102 00	70	110 25

☞ All Regular Goods Tapped 1" x 3/4" Right Hand. ☞

☞ All Regular Goods Tapped 1" x 3/4" Right Hand. ☞

**B**

# UNDY RENAISSANCE RADIATOR

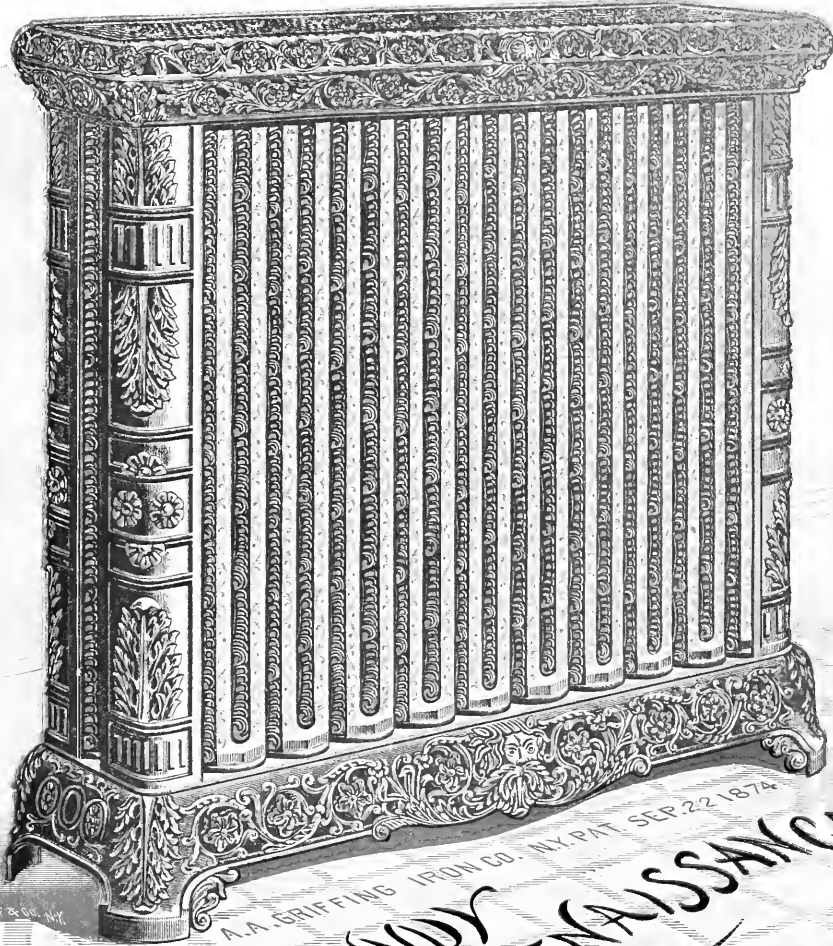

A. A. GRIFFING IRON CO. N.Y. PAT. SEP 22 1874  
**UNDY RENAISSANCE**

MANUFACTURED BY

## A. A. GRIFFING IRON CO.

General Office and Works:

430 COMMUNIPAW AVE.,

JERSEY CITY, N. J.

NEW YORK CITY, N.Y.,  
106 LIBERTY STREET.

CHICAGO, ILL.,  
130 DEARBORN STREET.

PHILADELPHIA, PA.,  
18-24 SOUTH 7TH STREET.

Please designate in your specifications or contract for heating as A. A. Griffing Iron Co.'s Bandy Renaissance Radiator with Corner Pillars.





TRADE BUNNY MARK.

# Three Row Bundy Renaissance Steam Direct Radiator.

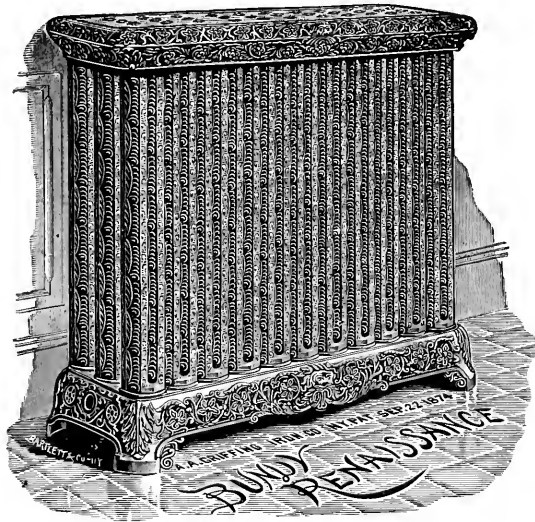

STYLE L, FIG. 69.

Fig. 69, Style L, represents the Three Row Bundy Renaissance Steam Direct Radiator without Corner Pillars. This Radiator with Corner Pillars is shown by Fig. 66.  
**THIRTY-SEVEN AND ONE-HALF INCHES HIGH, THREE ROWS OF LOOPS.**

STANDARD OR ENLARGED LOOPS.						
LIST OF RADIATORS BUILT ON THE FOLLOWING SIZE BASES. Width of Base, 15 $\frac{1}{4}$ inches.			STANDARD. Each Loop Represents 3 Feet of Heating Surface. LIST PRICE.		ENLARGED. Each Loop Represents 3 $\frac{1}{2}$ Feet of Heating Surface. LIST PRICE.	
Shape of Radiator.	Number of Loops.	Length of Radiator.	Feet of Heating Surface.	With Iron Top or arranged for Marble Top.	Feet of Heating Surface.	With Iron Top or arranged for Marble Top.
3 X 5	15	21 $\frac{1}{2}$ "	45	\$65 75	52 $\frac{1}{2}$	\$70 00
3 X 7	21	28 $\frac{3}{8}$ "	63	85 00	73 $\frac{1}{2}$	91 00
3 X 9	27	34 $\frac{1}{2}$ "	81	104 00	94 $\frac{1}{2}$	111 75
3 X 11	33	42"	99	123 25	115 $\frac{1}{2}$	132 75
3 X 13	39	48 $\frac{1}{2}$ "	117	142 25	136 $\frac{1}{2}$	153 50
3 X 15	45	54 $\frac{3}{4}$ "	135	161 50	157 $\frac{1}{2}$	174 50

**THIRTY-ONE AND ONE-HALF INCHES HIGH, THREE ROWS OF LOOPS.**

LIST OF RADIATORS BUILT ON THE FOLLOWING SIZE BASES. Width of Base, 15 $\frac{1}{4}$ inches.			STANDARD. Each Loop Represents 2 $\frac{1}{2}$ Feet of Heating Surface. LIST PRICE.		ENLARGED. Each Loop Represents 3 Feet of Heating Surface. LIST PRICE.	
Shape of Radiator.	Number of Loops.	Length of Radiator.	Feet of Heating Surface.	With Iron Top or arranged for Marble Top.	Feet of Heating Surface.	With Iron Top or arranged for Marble Top.
3 X 5	15	21 $\frac{1}{2}$ "	37 $\frac{1}{2}$	\$64 00	45	\$69 25
3 X 7	21	28 $\frac{3}{8}$ "	52 $\frac{1}{2}$	82 25	63	89 75
3 X 9	27	34 $\frac{1}{2}$ "	67 $\frac{1}{2}$	100 75	81	110 25
3 X 11	33	42"	82 $\frac{1}{2}$	110 00	99	130 50
3 X 13	39	48 $\frac{1}{2}$ "	97 $\frac{1}{2}$	137 50	117	151 00
3 X 15	45	54 $\frac{3}{4}$ "	112 $\frac{1}{2}$	155 75	135	171 50

**TWENTY-FIVE INCHES HIGH, THREE ROWS OF LOOPS.**

LIST OF RADIATORS BUILT ON THE FOLLOWING SIZE BASES. Width of Base, 15 $\frac{1}{4}$ inches.			STANDARD. Each Loop Represents 2 Feet of Heating Surface. LIST PRICE.		ENLARGED. Each Loop Represents 2 $\frac{1}{2}$ Feet of Heating Surface. LIST PRICE.	
Shape of Radiator.	Number of Loops.	Length of Radiator.	Feet of Heating Surface.	With Iron Top or arranged for Marble Top.	Feet of Heating Surface.	With Iron Top or arranged for Marble Top.
3 X 5	15	21 $\frac{1}{2}$ "	30	\$62 00	35	\$66 25
3 X 7	21	28 $\frac{3}{8}$ "	42	79 75	49	85 50
3 X 9	27	34 $\frac{1}{2}$ "	54	97 25	63	104 75
3 X 11	33	42"	66	115 00	77	124 00
3 X 13	39	48 $\frac{1}{2}$ "	78	132 50	91	143 25
3 X 15	45	54 $\frac{3}{4}$ "	90	150 25	105	162 50

All Regular Goods Tapped 1" X  $\frac{3}{4}$ " "Right Hand."

All Regular Goods Tapped 1" X  $\frac{3}{4}$ " "Right Hand."

All Regular Goods Tapped 1" X  $\frac{3}{4}$ " "Right Hand."

TRADE MARK. BUNDY

# One Row Bundy Renaissance Hot Water Direct Radiator

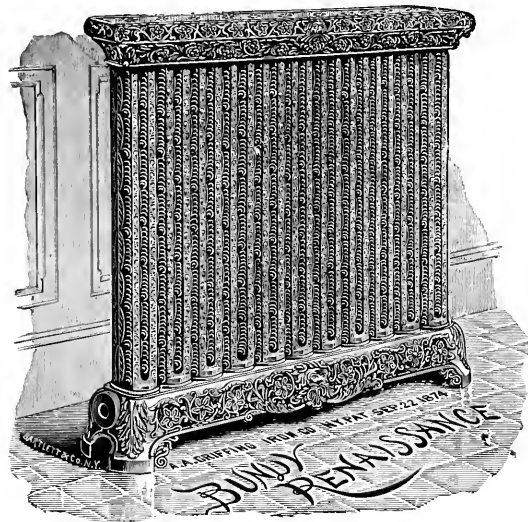

STYLE O. FIG. 72.

FIG. 72, Style O, represents the One Row Bundy Renaissance Hot Water Direct Radiator without Corner Pillars. This Radiator with Corner Pillars is shown by Fig. 7.

## FORTY AND ONE-HALF INCHES HIGH, ONE ROW OF LOOPS.

LIST OF RADIATORS BUILT ON THE FOLLOWING SIZE BASES. Width of Base, 7½ inches.			STANDARD.		ENLARGED.	
Shape of Radiators.	Number of Loops.	Length of Radiators.	Each Loop Represents 3½ Feet of Heating Surface. List Price.	With Iron Top or arranged for Marble Top.	Each Loop Represents 4 Feet of Heating Surface. List Price.	With Iron Top or arranged for Marble Top.
1 × 5	5	21½	17½	\$32 25	20	\$34 00
1 × 7	7	28½	24½	40 75	28	43 25
1 × 9	9	34½	31½	49 00	36	52 25
1 × 11	11	41	38½	57 50	44	61 50
1 × 13	13	47½	45½	65 75	52	70 50
1 × 15	15	54	52½	74 25	60	79 75

## THIRTY-FOUR INCHES HIGH, ONE ROW OF LOOPS.

LIST OF RADIATORS BUILT ON THE FOLLOWING SIZE BASES. Width of Base, 7½ inches.			STANDARD.		ENLARGED.	
Shape of Radiators.	Number of Loops.	Length of Radiators.	Each Loop Represents 3 Feet of Heating Surface. List Price.	With Iron Top or arranged for Marble Top.	Each Loop Represents 3½ Feet of Heating Surface. List Price.	With Iron Top or arranged for Marble Top.
1 × 5	5	21½	15	\$30 75	17½	\$32 75
1 × 7	7	28½	21	38 50	24½	41 50
1 × 9	9	34½	27	46 50	31½	50 00
1 × 11	11	41	33	54 25	38½	58 75
1 × 13	13	47½	39	62 25	45½	67 25
1 × 15	15	54	45	70 00	52½	76 00

## TWENTY-SEVEN AND ONE-HALF INCHES HIGH, ONE ROW OF LOOPS.

LIST OF RADIATORS BUILT ON THE FOLLOWING SIZE BASES. Width of Base, 7½ inches.			STANDARD.		ENLARGED.	
Shape of Radiators.	Number of Loops.	Length of Radiators.	Each Loop Represents 2½ Feet of Heating Surface. List Price.	With Iron Top or arranged for Marble Top.	Each Loop Represents 2½ Feet of Heating Surface. List Price.	With Iron Top or arranged for Marble Top.
1 × 5	5	21½	12½	\$30 25	14 1-6	\$31 75
1 × 7	7	28½	17½	37 75	19 5-6	40 00
1 × 9	9	34½	22½	45 25	25½	48 25
1 × 11	11	41	27½	53 00	31 1-6	56 25
1 × 13	13	47½	32½	60 50	36 5-6	64 50
1 × 15	15	54	37½	68 00	42½	72 75

All Regular Goods Tapped 1¼" × 1¼" "Right Hand."

All Regular Goods Tapped 1¼" × 1¼" "Right Hand."

All Regular Goods Tapped 1¼" × 1¼" "Right Hand."

# Two Row Bundy Renaissance Hot Water Direct Radiator.

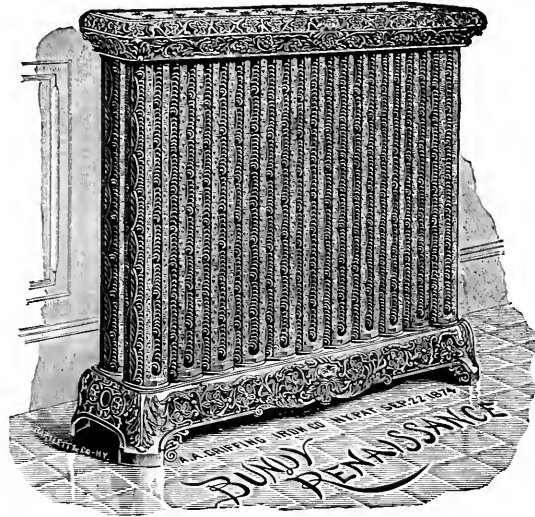

STYLE P, FIG. 73.

Fig. 73, Style P, represents Two Row Bundy Renaissance Hot Water Direct Radiator without Corner Pillars. This Radiator with Corner Pillars is shown by Fig. 71.

## FORTY AND ONE-HALF INCHES HIGH, TWO ROWS OF LOOPS.

LIST OF RADIATORS BUILT ON THE FOLLOWING SIZE BASES.			STANDARD.		ENLARGED.	
Width of Base, 11 $\frac{1}{4}$ inches.			Each Loop Represents 3 $\frac{1}{2}$ Feet of Heating Surface.		Each Loop Represents 4 Feet of Heating Surface.	
Shape of Radiator.	Number of Loops.	Length of Radiator.	Feet of Heating Surface.	With Iron Top or arranged for Marble Top.	Feet of Heating Surface.	With Iron Top or arranged for Marble Top.
2 X 5	10	21 $\frac{1}{2}$	35	\$57 25	40	\$60 75
2 X 7	14	27 $\frac{7}{8}$	49	74 00	56	79 00
2 X 9	18	34 $\frac{1}{4}$	63	90 75	72	97 00
2 X 11	22	41	77	107 50	88	115 25
2 X 13	26	47 $\frac{3}{8}$	91	124 25	104	133 25
2 X 15	30	53 $\frac{7}{8}$	105	141 00	120	151 50

## THIRTY-FOUR INCHES HIGH, TWO ROWS OF LOOPS.

LIST OF RADIATORS BUILT ON THE FOLLOWING SIZE BASES.			STANDARD.		ENLARGED.	
Width of Base, 11 $\frac{1}{4}$ inches.			Each Loop Represents 3 Feet of Heating Surface.		Each Loop Represents 3 $\frac{1}{2}$ Feet of Heating Surface.	
Shape of Radiator.	Number of Loops.	Length of Radiator.	Feet of Heating Surface.	With Iron Top or arranged for Marble Top.	Feet of Heating Surface.	With Iron Top or arranged for Marble Top.
2 X 5	10	21 $\frac{1}{2}$	30	\$54 25	35	\$58 25
2 X 7	14	27 $\frac{7}{8}$	42	69 75	49	75 50
2 X 9	18	34 $\frac{1}{4}$	54	85 25	63	92 75
2 X 11	22	41	66	101 00	77	109 75
2 X 13	26	47 $\frac{3}{8}$	78	116 50	91	127 00
2 X 15	30	53 $\frac{7}{8}$	90	132 00	105	144 25

## TWENTY-SEVEN AND ONE-HALF INCHES HIGH, TWO ROWS OF LOOPS.

LIST OF RADIATORS BUILT ON THE FOLLOWING SIZE BASES.			STANDARD.		ENLARGED.	
Width of Base, 11 $\frac{1}{4}$ inches.			Each Loop Represents 2 $\frac{1}{2}$ Feet of Heating Surface.		Each Loop Represents 3 $\frac{1}{2}$ Feet of Heating Surface.	
Shape of Radiator.	Number of Loops.	Length of Radiator.	Feet of Heating Surface.	With Iron Top or arranged for Marble Top.	Feet of Heating Surface.	With Iron Top or arranged for Marble Top.
2 X 5	10	21 $\frac{1}{2}$	25	\$52 00	28 $\frac{1}{2}$	\$56 00
2 X 7	14	27 $\frac{7}{8}$	35	68 00	39 $\frac{3}{8}$	72 25
2 X 9	18	34 $\frac{1}{4}$	45	83 00	51	88 50
2 X 11	22	41	55	98 25	62 $\frac{1}{2}$	105 00
2 X 13	26	47 $\frac{3}{8}$	65	113 25	73 $\frac{3}{8}$	121 25
2 X 15	30	53 $\frac{7}{8}$	75	128 25	85	137 50

All Regular Goods Tapped 1 $\frac{1}{4}$ " X 1 $\frac{1}{4}$ " "Right Hand."

All Regular Goods Tapped 1 $\frac{1}{4}$ " X 1 $\frac{1}{4}$ " "Right Hand."

All Regular Goods Tapped 1 $\frac{1}{4}$ " X 1 $\frac{1}{4}$ " "Right Hand."

TRADE BUNDY MARK.

Bundy Standard Steam and Hot Water Radiator Loop.

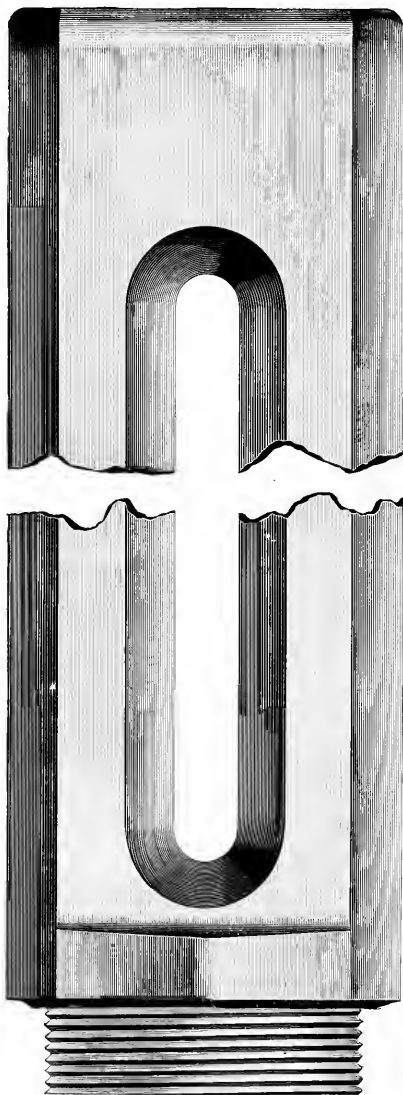

FIG. 17.

FIG. 17 represents the top and bottom, full size, of the Bundy Standard Steam and Hot Water Radiator Loop. For cross section view see Fig. 18.

TRADE BUNDY MARK.

## Bundy Standard Steam & Hot Water Direct Radiator

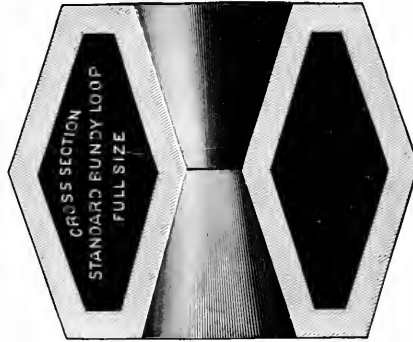

FIG. 18.

FIG. 18 represents a full size cross-section of the Bundy Standard Steam and Hot Water Radiator Loop. Every 12 inches of lineal length represents one square foot of heating surface, full measurement. All Bundy Steam Radiators have one-half square foot of heating surface per loop in the base, and all Bundy Hot Water Radiators have the same amount of heating surface in both base and upper circulating chamber, making one square foot per loop.

## Bundy Enlarged Steam & Hot Water Radiator Loop.

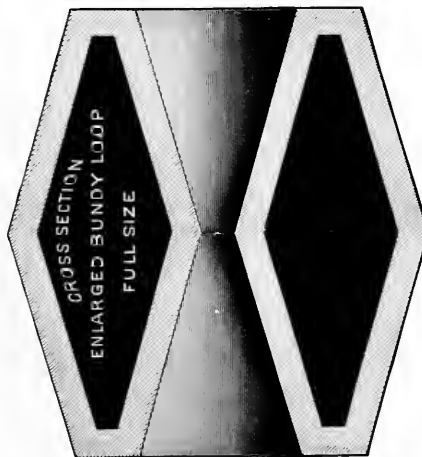

FIG. 19½.

FIG. 19½ represents a full size cross-section of the Bundy Enlarged Steam and Hot Water Radiator Loop. This Loop has 20 per cent. more surface than the Standard Loop. (See cut and description above.)

TRADE BUNDY MARK.

Bundy Ext'd Surface Steam and Hot Water Radiator Loop.

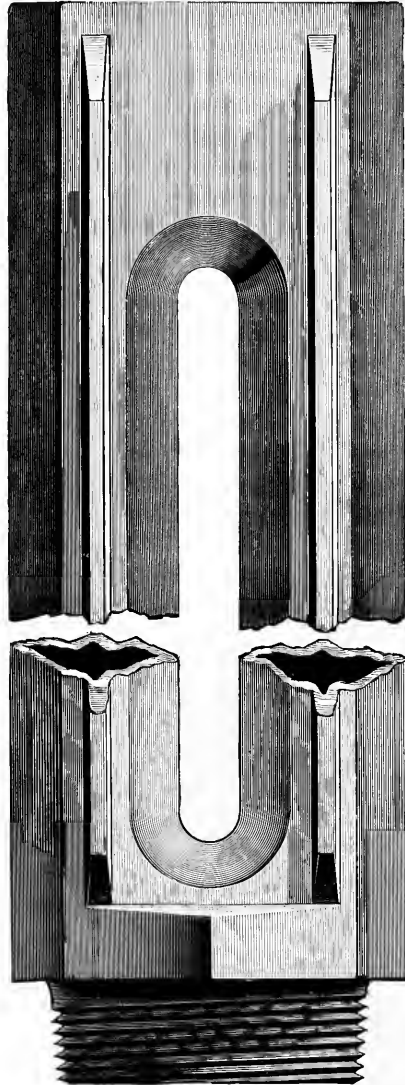

FIG. 19.

FIG. 19 represents the top and bottom, full size of a loop of the Bundy Extended Surface Steam and Hot Water Radiator Loop. (For cross-section view see Fig. 19 $\frac{1}{2}$ .)

TRADE BUNDY MARK.

# Bundy Extended Surface Steam & Hot Water Radiator Loop.



FIG. 19 $\frac{3}{4}$ .

FIG. 19 $\frac{3}{4}$  represents a cross-section, full size, of the Bundy Extended Surface Steam and Hot Water Radiator Loop. This Loop has the same amount of surface as the enlarged Loop (see Fig. 19 $\frac{1}{2}$ ), or 20 per cent more than is contained in the Standard Loop.

# Bundy Ext'd Surface Steam & Hot Water Direct Radiator

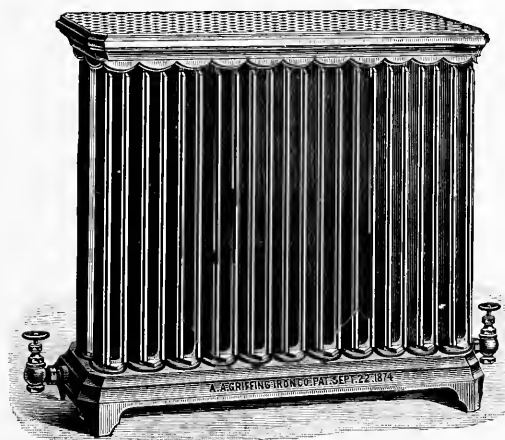

FIG. 16.

FIG. 16 represents the Bundy Extended Surface Loop Steam and Hot Water Radiator, which is furnished in all heights and sizes the same as the Standard or Enlarged Loop.

# Bundy Steam & Hot Water Direct Radiator Measurements.

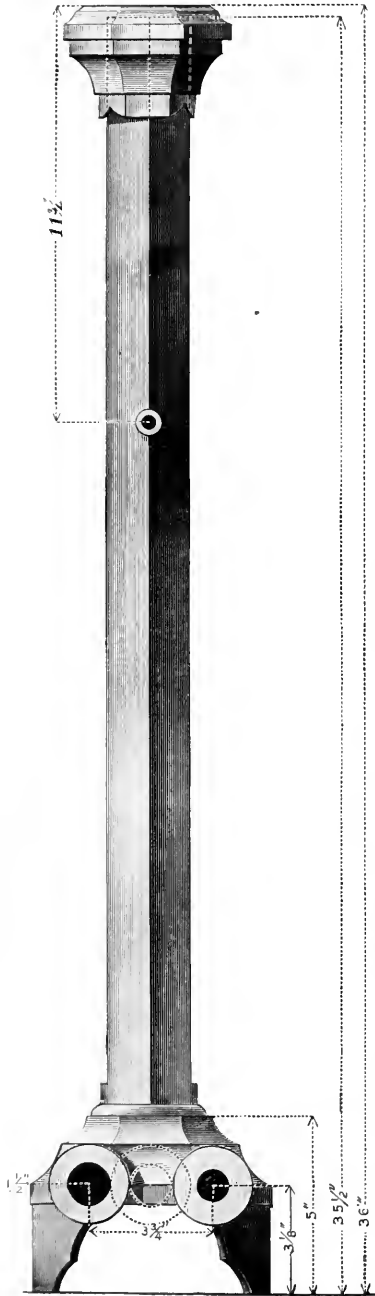

FIG. 29.

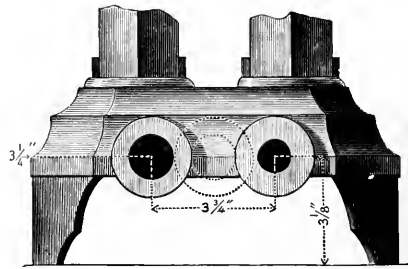

FIG. 30.

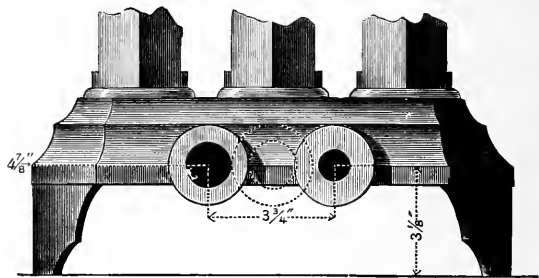

FIG. 31.

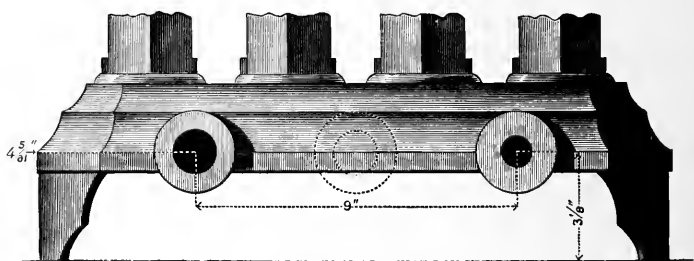

FIG. 32.

Figs. 29, 30, 31 and 32 represent end views of the Bundy One, Two, Three and Four Row Steam and Hot Water Direct Radiators. The uniform tapping of the Bundy Radiator is a great advantage as it allows the fitter to run his pipes before receiving the Radiators, thus saving much time, as well as enabling him to complete his contracts promptly, and make quick returns for his goods, and secure the advantages to be obtained in this way. In addition to the above, all Bundy Hot Water Radiators may be tapped for feed pipe in the upper circulating chamber, and are made in One, Two and Three Rows of Loops.



TRADE BUNDY MARK.

# Bundy Steam and Hot Water Direct Radiator Top.

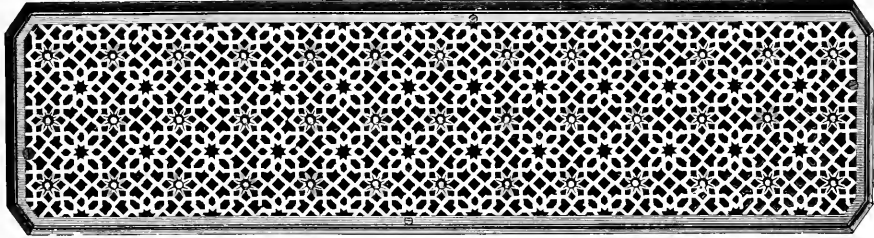

FIG. 33.

FIG. 33 represents the Bundy Steam and Hot Water Direct Radiator Top, called the "Daisy" pattern. It is strong and durable, and the number of daisies represent the number of loops in the Radiator. This fret work top can be quickly removed from the Bundy Radiator and a marble top used instead, an advantage that is highly appreciated by users of these goods.

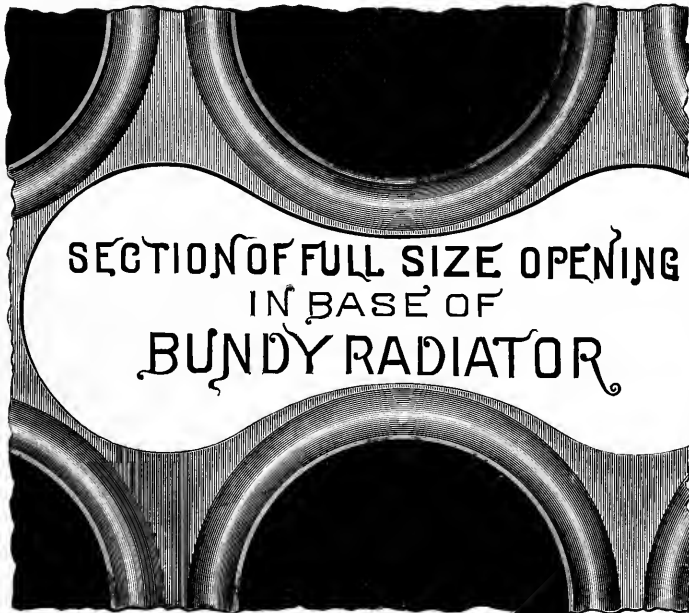

FIG. 34.

FIG. 34 needs no explanation. A comparison of the opening in the base of the Bundy Radiator with that of any other will show an overwhelming advantage in the Bundy.

TRADE BUNDY MARK

# Bundy Thompson Steam and Hot Water Direct Radiator.

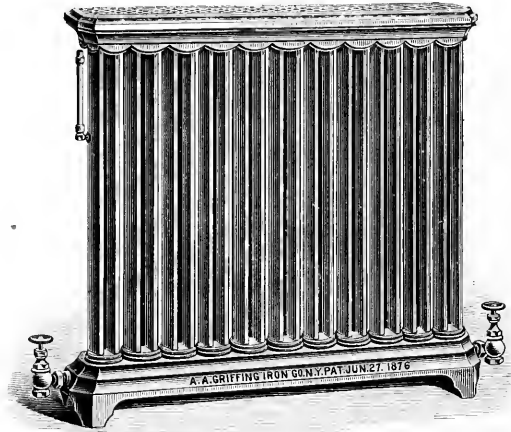

FIG. 20.

FIG. 20 represents the Bundy Thompson Steam and Hot Water Direct Radiator, which is patented June 27, 1876. Like the Bundy Radiator Loop, each one is screwed separately into the base, and represents the same amount of surface as the regular Bundy Standard Loop. Is made in only the standard heights.

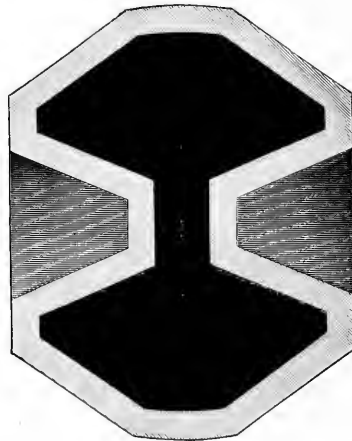

FIG 22.

FIG. 22 represents a cross section of the Bundy Thompson Steam and Hot Water Direct Radiator Loop. It differs from the Bundy Standard Loop in having the two lobes or barrels connected for their entire length, instead of at the ends only.

PRICES QUOTED ON APPLICATION.

TRADE BUNDY MARK.

Bundy Thompson Steam and Hot Water Radiator Loop.

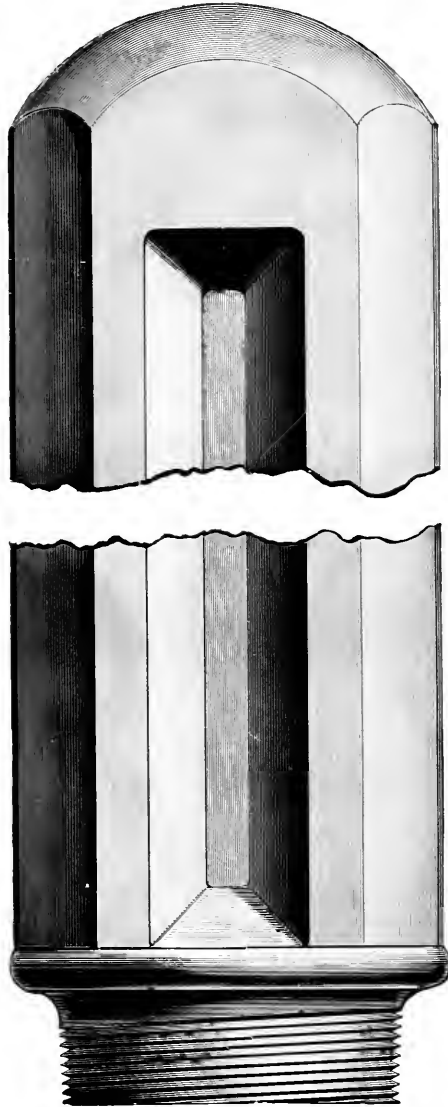

FIG. 21.

FIG. 21 represents the Top and Bottom, full size, of the Bundy Thompson Steam and Hot Water Radiator Loop.



TRADE BUNDY MARK.

## A BRIEF DESCRIPTION OF THE Bundy Elite, Bundy Pyro and Bundy Pyro Wall Radiators.

### THE BUNDY ELITE RADIATOR

(see Figs. 52 and 53), is a three-pipe construction; in other words each section has three barrels or tubes (patented July 3d, 1877), whereby the circulation is continually in a forward direction, up the central and down the two outside tubes. There is never any conflict as to which pipe will take the ascending and which the descending current as is the case in most sectional Radiators, as the central pipe being more direct, takes the steam first every time. Such a Radiator cannot possibly air-bind or water-pocket. Each section has an individual circulation, and will circulate even after the valves are closed.

### THE PARABOLIC CONCAVE SURFACE

(Patented Sept. 10th. 1889), in the Elite Radiator allows more air to come in contact with the surface than with any other Sectional Radiator on the market. The result of this in increasing the efficiency of the Elite Radiator is not necessary to dwell upon with any practical man.

All sections are duplicate and leg arches interchangeable and detachable (patented April 30th, 1889), and so it is an easy matter to add or subtract sections should it become desirable to increase or diminish the heating surface of any Radiator.

### IN DESIGN

the Elite is pure Arabesque, of Moorish Architecture, and nothing can be more beautiful for a Radiator. Do not make the mistake of buying a Radiator having a design, pretty enough perhaps when new, but one you will become heartily sick of before you have had it a month. The Elite Radiator design you will never tire of.

### THE HEIGHTS

in which the Elite Radiator can be had are regular 24", 30", and 36", but by using legs 1" and 2" higher and lower this radiator can be furnished in the following heights: 22", 23", 24", 25", 26", 28", 29", 30", 31", 32", 34", 35", 36", 37" and 38". For cuts and list prices see pages 78 and 79

### THE PYRO AND PYRO WALL RADIATORS

are described in very much the same language as is the Elite above, the only difference being in the design and in the fact that the sections are larger, the Radiator taking less space in length but greater in depth. For cuts and list prices see pages 80, 81, 82 and 83.

**B**

# UNDY · ELITE · RADIATOR.



MANUFACTURED BY

## A. A. GRIFFING IRON CO.

General Office and Works:

430 COMMUNIPAW AVE.,

JERSEY CITY, N. J.

NEW YORK CITY, N. Y.,  
106 LIBERTY STREET.

CHICAGO, ILL.,  
130 DEARBORN STREET.

PHILADELPHIA, PA.,  
18-24 SOUTH 7TH STREET.

Please designate in your specifications or contract for heating as A. A. Griffing Iron Co.'s Bundy Elite Radiator.





TRADE BUNDY MARK.

## A BRIEF DESCRIPTION OF THE BUNDY TRIUMPH AND BUNDY DEFIANCE RADIATORS.

### THE BUNDY TRIUMPH RADIATOR

is in general form like the Elite as it is a three-pipe construction, but it is a plain Radiator and has a fret-work top.

### THE SPECIAL PARABOLIC CURVE

(concave) is used in both Radiators and it very naturally enhances their efficiency. Ninety square feet, and often times less of Triumph and Elite Radiation will do as much work as one hundred feet of other sectional radiation, and when one considers that this means a saving of fuel and attention in proportion to the saving in surface it is very strong argument why the Elite and Triumph Radiators should be used.

### THE DETACHABLE AND INTERCHANGEABLE ECCENTRIC TAPPED BUSHING

used in the Elite, Triumph and Defiance Radiators, as well as Climax and Perfect Indirect, allows all the waters of condensation to pass quickly from the Radiator on gravity action. This keeps the surface dry and in the very best condition for greatest efficiency, and should it be desirable to change the size of the piping connecting the Radiator, the bushing can easily be removed and another one used in its place.

### THE BUNDY DEFIANCE RADIATOR

(see pages 86 and 87), is designed particularly for use where it is desirable to get in a low Radiator a maximum of surface in a minimum space occupied by the Radiator. It presents a neat appearance when set under a window surmounted by a handsome marble top or when placed in a recess in the wall. Sometimes it is placed behind screens with liberal sized openings through which the air passes into the rooms, and the screens are then decorated in keeping with the room. We know of a library where the screen is painted to represent the backs of books and the effect is very fine.

FOR CUTS AND LIST PRICES SEE PAGES 86 AND 87.

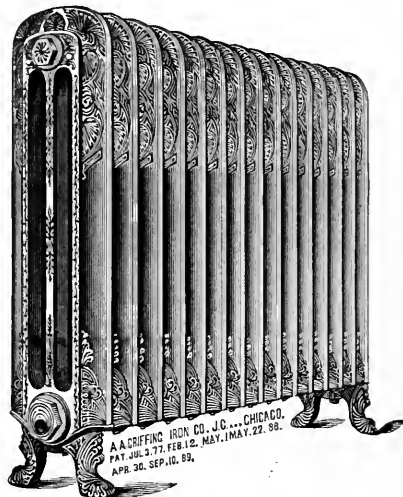

FIG. 52.

FIG. 52, represents the Bundy Elite Steam Radiator. For description see preceding page.

**THIRTY-SIX INCHES HIGH.**

Width of Legs, 8½ inches ; Sections, 8 inches. Each Section represents 5¼ feet of Heating Surface. LIST PRICE. Per foot, 72½ cents. Per Section, \$3.99.									
Number of Sections.	Length of Radiator.	Feet of Heating Surface.	With Detachable Legs.	Number of Sections.	Length of Radiator.	Feet of Heating Surface.	With Detachable Legs.		
3	11'	16½	\$11 56	17	53'	93½	\$67 79		
4	14'	22	15 95	18	56'	99	71 78		
5	17'	27½	19 94	19	59'	104½	75 76		
6	20'	33	23 93	20	62'	110	79 75		
7	23'	38½	27 91	21	65'	115½	83 74		
8	26'	44	31 90	22	68'	121	87 73		
9	29'	49½	35 89	23	71'	126½	91 71		
10	32'	55	39 88	24	74'	132	95 70		
11	35'	60½	43 86	25	77'	137½	99 69		
12	38'	66	47 85	26	80'	143	103 68		
13	41'	71½	51 84	27	83'	148½	107 66		
14	44'	77	55 83	28	86'	154	111 65		
15	47'	82½	59 81	29	89'	159½	115 64		
16	50'	88	63 80	30	92'	165	119 62		

**THIRTY INCHES HIGH.**

Width of Legs, 8½ inches ; Sections, 8 inches. Each Section represents 4½ feet of Heating Surface. LIST PRICE. Per foot, 82½ cents. Per Section, \$3.85.									
Number of Sections.	Length of Radiator.	Feet of Heating Surface.	With Detachable Legs.	Number of Sections.	Length of Radiator.	Feet of Heating Surface.	With Detachable Legs.		
3	11'	14	\$11 55	17	53'	79½	\$65 45		
4	14'	18½	15 40	18	56'	84	69 30		
5	17'	23½	19 25	19	59'	88½	73 15		
6	20'	28	23 10	20	62'	93½	77 00		
7	23'	32½	26 55	21	65'	98	80 85		
8	26'	37½	30 40	22	68'	102½	84 70		
9	29'	42	34 25	23	71'	107½	88 55		
10	32'	46½	38 10	24	74'	112	92 40		
11	35'	51½	42 25	25	77'	116½	96 25		
12	38'	56	46 10	26	80'	121½	100 10		
13	41'	60½	50 05	27	83'	126	103 95		
14	44'	65½	53 50	28	86'	130½	107 80		
15	47'	70	57 35	29	89'	135½	111 65		
16	50'	74½	61 20	30	92'	140	115 50		

**TWENTY-FOUR INCHES HIGH.**

Width of Legs, 8½ inches ; Sections, 8 inches. Each Section represents 3¼ feet of Heating Surface. LIST PRICE. Per foot, 97½ cents. Per Section, \$3.67.									
Number of Sections.	Length of Radiator.	Feet of Heating Surface.	With Detachable Legs.	Number of Sections.	Length of Radiator.	Feet of Heating Surface.	With Detachable Legs.		
3	11'	11¼	\$10 97	17	53'	63½	\$62 16		
4	14'	15	14 63	18	56'	67½	65 81		
5	17'	18½	18 28	19	59'	71½	69 47		
6	20'	22½	21 94	20	62'	75	73 13		
7	23'	26½	25 59	21	65'	78½	76 78		
8	26'	30	29 25	22	68'	82½	80 44		
9	29'	33½	32 91	23	71'	86½	84 09		
10	32'	37½	36 56	24	74'	90	87 75		
11	35'	41½	40 22	25	77'	93½	91 41		
12	38'	45	43 88	26	80'	97½	95 06		
13	41'	48½	47 53	27	83'	101½	98 72		
14	44'	52½	51 19	28	86'	105	102 38		
15	47'	56½	54 84	29	89'	108½	106 03		
16	50'	60	58 50	30	92'	112½	109 69		

All Regular Goods Tapped 1' x ¾" Right Hand.

All Regular Goods Tapped 1' x ¾" Right Hand.

All Regular Goods Tapped 1' x ¾" Right Hand.



# Bundy Elite Hot Water Radiator.

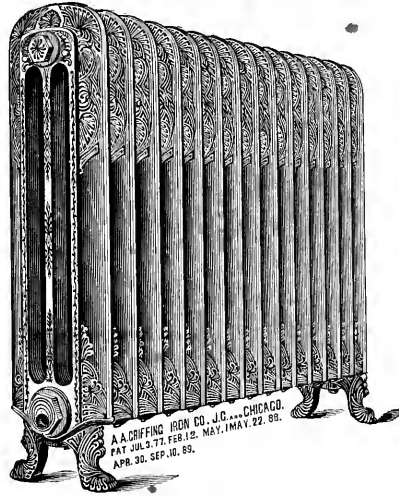

FIG. 53.

Fig. 53 represents the Bundy Elite Hot Water Radiator, which has an Upper as well as a Lower Connecting Water Way. For description see second preceding page.

## THIRTY-SIX INCHES HIGH.

Width of Legs, 8½ inches; Sections, 8 inches. Each Section represents 3½ feet of Heating Surface. LIST PRICE. Per foot, 85 cents. Per Section, \$4.68.							
Number of Sections.	Length of Radiator.	Feet of Heating Surface.	With Detachable Legs.	Number of Sections.	Length of Radiator.	Feet of Heating Surface.	With Detachable Legs.
3	11"	16½	\$14 60	17	73"	93½	\$9 48
4	14"	22	18 70	18	56"	99	84 15
5	17"	27½	23 38	19	59"	104½	88 83
6	20"	33	28 05	20	62"	110	93 50
7	23"	38½	32 73	21	65"	115½	98 18
8	26"	44	37 40	22	68"	121	102 85
9	29"	49½	42 08	23	71"	126½	107 53
10	32"	55	46 75	24	74"	132	112 20
11	35"	60½	51 43	25	77"	137½	116 88
12	38"	66	56 10	26	80"	143	121 55
13	41"	71½	60 78	27	83"	148½	126 23
14	44"	77	65 45	28	86"	154	130 90
15	47"	82½	70 13	29	89"	159½	135 58
16	50"	88	74 80	30	92"	165	140 25

## THIRTY INCHES HIGH.

Width of Legs, 8½ inches; Sections, 8 inches. Each Section represents 4½ feet of Heating Surface. LIST PRICE. Per foot, 97½ cents. Per Section, \$4.55.							
Number of Sections.	Length of Radiator.	Feet of Heating Surface.	With Detachable Legs.	Number of Sections.	Length of Radiator.	Feet of Heating Surface.	With Detachable Legs.
3	11"	14	\$13 65	17	53"	79½	\$77 35
4	14"	18¾	18 20	18	56"	85	81 90
5	17"	23¼	22 75	19	59"	90½	86 45
6	20"	28	27 30	20	62"	96	91 00
7	23"	32½	31 85	21	65"	101½	95 55
8	26"	37	36 40	22	68"	107	100 10
9	29"	42	40 95	23	71"	112½	104 65
10	32"	46½	45 50	24	74"	118	109 20
11	35"	51½	50 05	25	77"	123½	113 75
12	38"	56	54 60	26	80"	129	118 30
13	41"	60½	59 15	27	83"	134½	122 85
14	44"	65½	63 70	28	86"	140	127 40
15	47"	70	68 25	29	89"	145½	131 95
16	50"	74½	72 80	30	92"	151	136 50

## TWENTY-FOUR INCHES HIGH.

Width of Legs, 8½ inches; Sections, 8 inches. Each Section represents 3¾ feet of Heating Surface. LIST PRICE. Per foot, \$1.12½. Per Section, \$4.22.							
Number of Sections.	Length of Radiator.	Feet of Heating Surface.	With Detachable Legs.	Number of Sections.	Length of Radiator.	Feet of Heating Surface.	With Detachable Legs.
3	11"	11¼	\$12 66	17	53"	69¾	\$71 72
4	14"	15	16 88	18	56"	75 ¾	75 94
5	17"	18¾	21 09	19	59"	81 ¾	80 16
6	20"	22¼	25 31	20	62"	87 ¾	84 38
7	23"	26¼	29 53	21	65"	93 ¾	88 60
8	26"	30	33 75	22	68"	99 ¾	92 81
9	29"	33¾	37 97	23	71"	105 ¾	97 03
10	32"	37½	42 19	24	74"	111 ¾	101 25
11	35"	41¼	46 41	25	77"	117 ¾	105 47
12	38"	45	50 63	26	80"	123 ¾	109 69
13	41"	48¾	54 84	27	83"	129 ¾	113 91
14	44"	52½	59 06	28	86"	135 ¾	118 13
15	47"	56¼	63 28	29	89"	141 ¾	122 35
16	50"	60	67 50	30	92"	147 ¾	126 57

All Regular Goods Tapped 1¼" × 1¼" "Right Hand."

TRADE BUNDY MARK.

## Bundy Pyro Steam Direct Radiator.

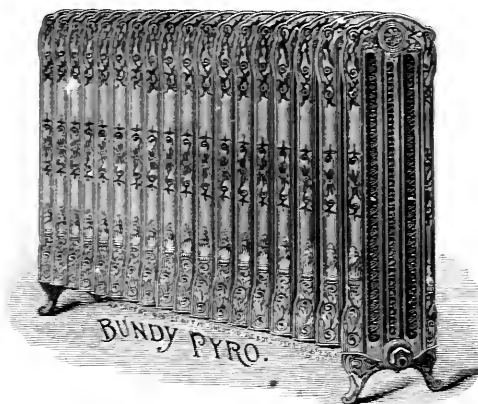

FIG. 74.

The accompanying cut represents the Bundy Pyro Steam Direct Radiator. It has an extremely beautiful design, harmonious and pleasing, pronounced by many to be the handsomest ever shown in connection with Sectional Radiators. All sections are duplicates, the end sections being the same as the intermediates; leg arches are detachable and interchangeable, (Pat. April 30, 1889,) and may be placed under any section; a large portion of the surface is parabolic, incurving, (Pat. Sept. 10, 1889,) being specially adapted to withstand high pressure and insure free circulation of air against the entire surface of the Radiator, and is supplied with the Bundy Eccentric Tapped Bushing, (Pat. Feb. 12, 1889,) thus insuring a quick exit for all waters of condensation and noiseless, uniform circulation throughout, as well as preventing a water pocket, water hammer and freezing of the Radiator when not in use in cold weather. This Radiator can be used with excellent success on the One Pipe system. The distance from center of tapping to floor varies, the average being 5 inches.

### THIRTY-EIGHT INCHES HIGH.

Width of Legs, 10 inches; Sections, 10 inches. Each Section represents 2 feet of Heating surface.				Width of Legs, 10 inches; Sections, 10 inches. Each Section represents 2 feet of Heating surface.			
LIST PRICE.				LIST PRICE.			
Per foot, 70 cents.				Per foot, 70 cents.			
Per Section, \$5.50.				Per Section, \$5.50.			
Number of Sections	Length of Radiator in Inches	Feet of Heating Surface	With Detachable Legs	Number of Sections	Length of Radiator in Inches	Feet of Heating Surface	With Detachable Legs
1	10 $\frac{1}{4}$	2	\$ 60	13	130 $\frac{1}{4}$	104	\$72 80
2	20 $\frac{1}{2}$	4	11 20	14	140 $\frac{1}{2}$	112	78 40
3	30 $\frac{3}{4}$	6	16 50	15	150 $\frac{3}{4}$	120	84 00
4	41	8	22 40	16	161	128	89 60
5	51 $\frac{1}{4}$	10	28 00	17	171 $\frac{1}{4}$	136	95 20
6	61 $\frac{1}{2}$	13	33 60	18	181 $\frac{1}{2}$	144	100 80
7	71 $\frac{3}{4}$	16	39 20	19	191 $\frac{3}{4}$	152	106 40
8	82	19	44 80	20	202	160	112 00
9	92 $\frac{1}{4}$	22	50 40	21	212 $\frac{1}{4}$	168	117 60
10	102 $\frac{1}{2}$	25	56 00	22	222 $\frac{1}{2}$	176	123 20
11	112 $\frac{3}{4}$	28	61 60	23	232 $\frac{3}{4}$	184	128 80
12	123	31	67 20	24	243	192	134 40

All Regular Steam Goods Tapped 1' x  $\frac{1}{4}$ " "Right Hand."

**B**UNDY

PYRO  
RADIATOR

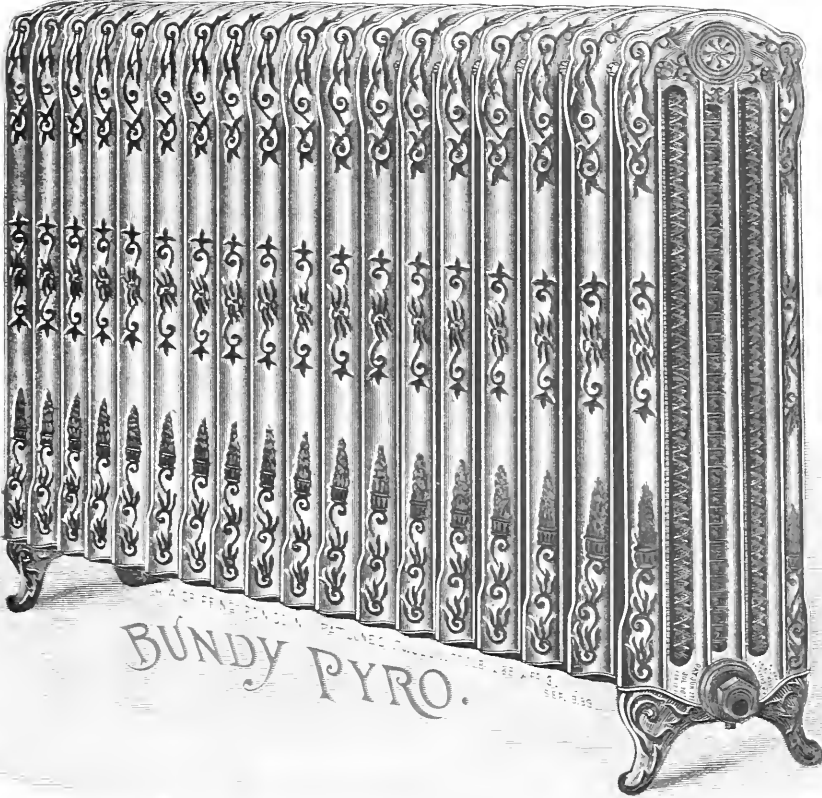

MANUFACTURED BY

**A. A. GRIFFING IRON CO.**

General Office and Works:

430 COMMUNIPAW AVE.,

JERSEY CITY, N. J.

NEW YORK CITY, N. Y.,  
106 LIBERTY STREET.

CHICAGO, ILL.,  
130 DEARBORN STREET.

PHILADELPHIA, PA.,  
18-24 SOUTH 7TH STREET.

Please designate in your specifications and contract for heating as A. A. Griffing Iron Co.'s Bundy Pyro Radiator.

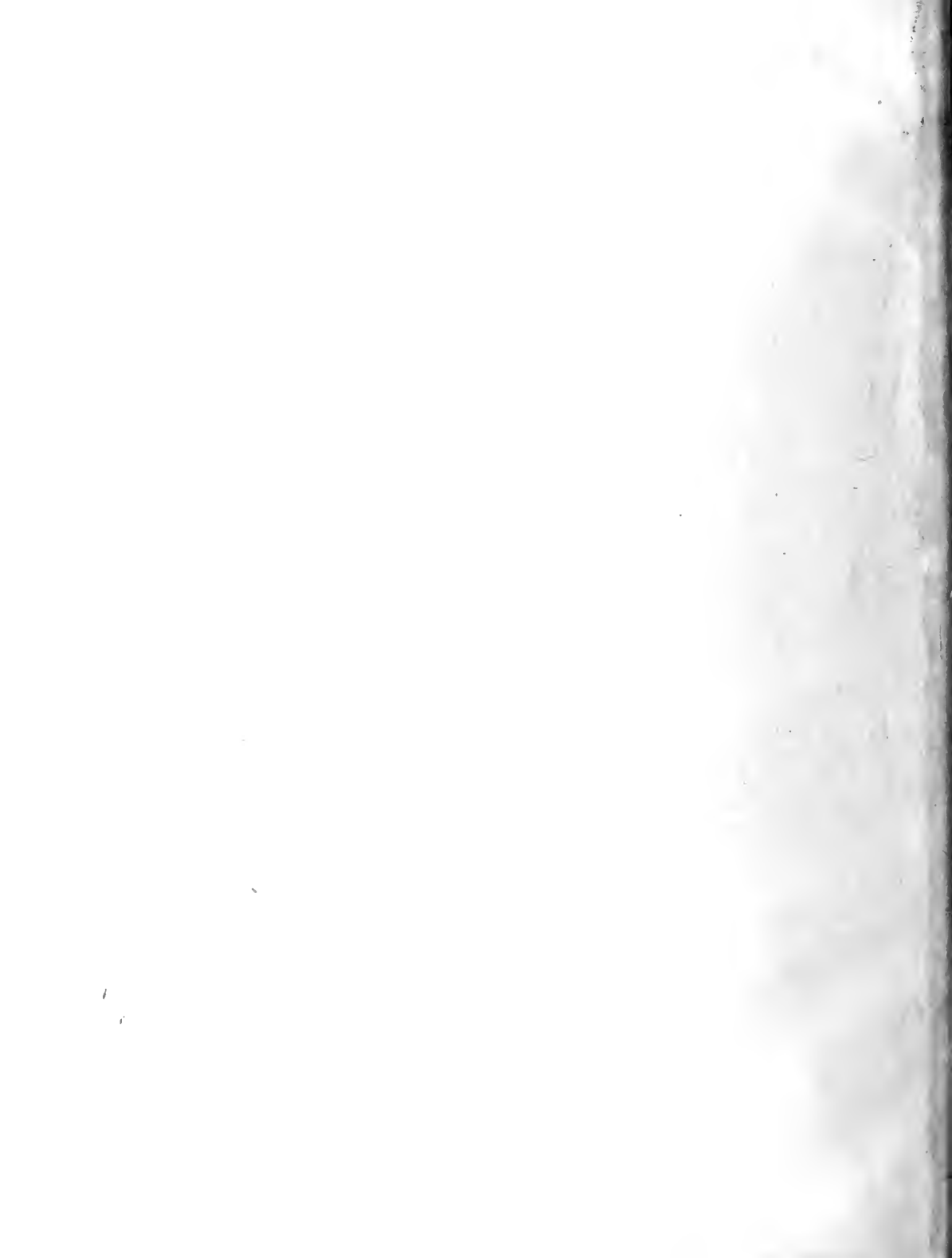

TRADE PYRO MARK.

# Bundy Pyro Hot Water Direct Radiator.

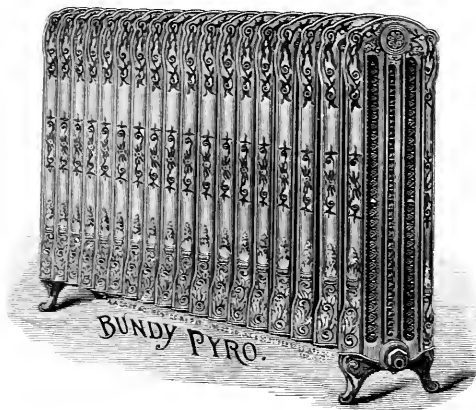

FIG. 75.

FIG. 75 represents the Bundy Pyro Hot Water Direct Radiator. It has an extremely beautiful design, harmonious and pleasing pronounced by many to be the handsomest ever shown in connection with Sectional Radiators. All sections are duplicates, the end sections being the same as the intermediates; leg arches are detachable and interchangeable, (Pat. April 30, 1889,) and may be placed under any section; a large portion of the surface is parabolic, incurving, (Pat. Sept. 10, 1889,) being specially adapted to withstand high pressure and insure free circulation of air against the entire surface of the Radiator, and the amount of water contained in this Radiator is the minimum, thus rendering effective a large amount of Radiating Surface with light drain on the fire and small consumption of fuel. The distances from center of tapping to floor varies, being, if tapped  $3\frac{3}{4}$ ',  $4\frac{7}{8}$ '; 1', 5';  $11\frac{1}{4}$ ',  $5\frac{1}{8}$ ';  $11\frac{1}{2}$ ',  $5\frac{1}{4}$ '.

## THIRTY-EIGHT INCHES HIGH.

Width of Legs, 10 inches; Sections, 10 inches. Each Section representing 3 feet of Heating Surface.				Width of Legs, 10 inches; Sections, 10 inches. Each Section representing 3 feet of Heating Surface.			
LIST PRICE.		LIST PRICE.		LIST PRICE.		LIST PRICE.	
Per foot, 50 cents.		Per Section, \$6.40.		Per foot, 50 cents.		Per Section, \$6.40.	
Number of Sections.	Length of Radiator in Inches.	Feet of Heating Surface.	With Detachable Legs.	Number of Sections.	Length of Radiator in Inches.	Feet of Heating Surface.	With Detachable Legs.
						104	\$53 20
						112	59 00
						120	96 00
						128	102 40
						136	108 80
						144	115 20
						152	121 60
						160	128 00
						168	134 40
						176	140 80
						184	147 20
						192	153 60

### ERRATUM.

The length of Pyro Hot Water Radiators should be the same as Pyro Steam Radiators. For correct lengths see page 80.

and.

EXPLANATION

The length of the line work shall  
be shown in the notes on the plan  
and the total length of the line work shall be shown on page 60.

TRADE PYRO MARK.

# Bundy Pyro Hot Water Direct Radiator.

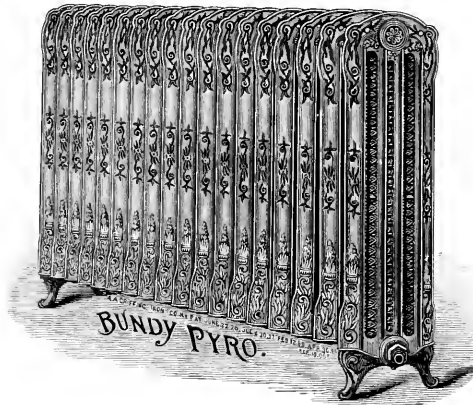

FIG. 75.

FIG. 75 represents the Bundy Pyro Hot Water Direct Radiator. It has an extremely beautiful design, harmonious and pleasing pronounced by many to be the handsomest ever shown in connection with Sectional Radiators. All sections are duplicates, the end sections being the same as the intermediates; leg arches are detachable and interchangeable, (Pat. April 30, 1889,) and may be placed under any section; a large portion of the surface is parabolic, incurving, (Pat. Sept. 10, 1889,) being specially adapted to withstand high pressure and insure free circulation of air against the entire surface of the Radiator, and the amount of water contained in this Radiator is the minimum, thus rendering effective a large amount of Radiating Surface with light drain on the fire and small consumption of fuel. The distances from center of tapping to floor varies, being, if tapped  $3\frac{1}{4}$ ",  $4\frac{7}{8}$ "; 1', 5";  $1\frac{1}{4}$ ",  $5\frac{1}{8}$ ";  $1\frac{1}{2}$ ",  $5\frac{1}{4}$ ".

## THIRTY-EIGHT INCHES HIGH.

Width of Legs, 10 inches; Sections, 10 inches. Each Section representing 8 feet of Heating Surface.				Width of Legs, 10 inches; Sections, 10 inches. Each Section representing 8 feet of Heating Surface.			
LIST PRICE.				LIST PRICE.			
Per foot, 80 cents. Per Section, \$6.40.				Per foot, 80 cents. Per Section, \$6.40.			
Number of Sections.	Length of Radiator in Inches.	Feet of Heating Surface.	With Detachable Legs.	Number of Sections.	Length of Radiator in Inches.	Feet of Heating Surface.	With Detachable Legs.
1	5 $\frac{1}{2}$	8	\$6 40	13	47 $\frac{1}{2}$	104	\$83 20
2	9	16	12 80	14	51	112	89 60
3	12 $\frac{1}{2}$	24	19 20	15	54 $\frac{1}{2}$	120	96 00
4	16	32	25 60	16	58	128	102 40
5	19 $\frac{1}{2}$	40	32 00	17	61 $\frac{1}{2}$	136	108 80
6	23	48	38 40	18	65	144	115 20
7	26 $\frac{1}{2}$	56	44 80	19	68 $\frac{1}{2}$	152	121 60
8	30	64	51 20	20	72	160	128 00
9	33 $\frac{1}{2}$	72	57 60	21	75 $\frac{1}{2}$	168	134 40
10	37	80	64 00	22	79	176	140 80
11	40 $\frac{1}{2}$	88	70 40	23	82 $\frac{1}{2}$	184	147 20
12	44	96	76 80	24	86	192	153 60

All Regular Hot Water Goods Tapped  $1\frac{1}{4}$ "  $\times$   $1\frac{1}{4}$ " "Right Hand."

TRADE PYRO MARK.

# Bundy Pyro Wall Steam Direct Radiator.

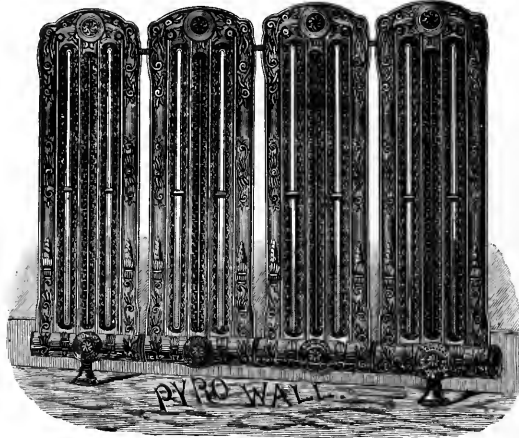

FIG. 76.

FIG. 76 represents the Bundy Pyro Wall Steam Direct Radiator which undoubtedly is the narrowest Radiator in the world, being but 3" wide, from back to front. It occupies scarcely more space than a wall coil of inch pipe, and is by far more efficient, being perpendicular instead of horizontal surface, and so freeing itself of water of condensation much more quickly, is more durable for it is a well known fact that wrought iron rusts out more quickly than cast, especially in coils; and is certainly cheaper when the time consumed in building up coils is taken into consideration, and there are many more joints in coils and hence great liability to leaks.

The Pyro Wall has a handsome design and is just the thing for heating narrow halls and passage ways, and thousands of them have already been used for heating bath rooms where a single section is often times all that is required, and from that up to three or four sections.

There are two sizes of legs furnished with this Radiator, one 5" in diameter and the other 5" in diameter with 1" cut off the rear portion so as to bring the Radiator closer to the wall, either of which is furnished without extra cost, but when parties wish the latter leg, so as to get the Radiator as close to the wall as possible, occupying less space even than a pipe coil, they should specify, in ordering, this size, otherwise the 5" circular leg will be sent.

Center of tapping is 1 1/2" from extreme edge of section and 5" from floor, allowing liberal space under the Radiator for cleaning out.

## THIRTY-EIGHT INCHES HIGH.

Widths of Legs, 5 and 3 inches as above described; Sections, 3 inches. Each Section represents 8 feet of Heating Surface.

LIST PRICE.

Per foot, 72 1/2 cents. Per Section, \$5.80.

Number of Sections.	*Length of Radiator in Inches.	Feet of Heating Surface.	With Detachable Legs.
1	11 1/4	8	\$5 80
2	21 1/2	16	11 60
3	31 3/4	24	17 40
4	42	32	23 20
5	52 1/4	40	29 00
6	62 1/2	48	34 80
7	72 3/4	56	40 60
8	83	64	46 40
9	93 1/4	72	52 20
10	103 1/2	80	58 00

All Regular Steam Goods Tapped 1" x 3/4" "Right Hand."

\*When tapped 1 1/2", deduct 1" from total length of Radiator.



# BUNDY PYRO WALL RADIATOR

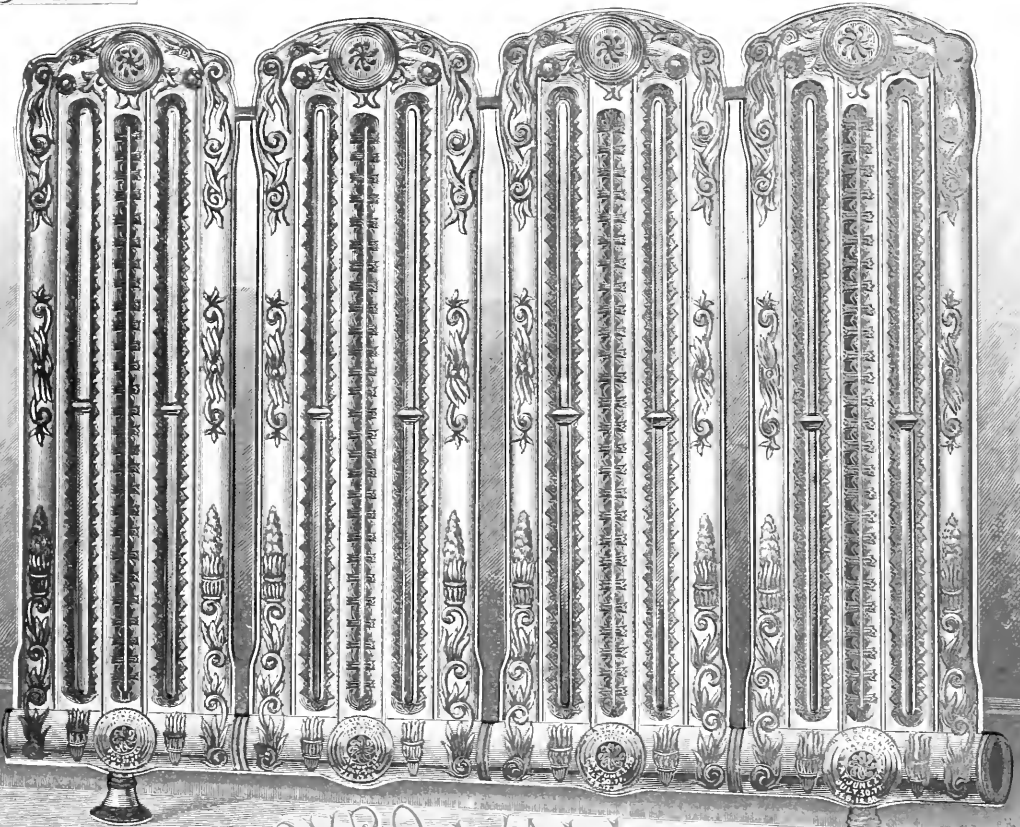

PYRO WALL.

MANUFACTURED BY

## A. A. GRIFFING IRON CO.

General Office and Works:

430 COMMUNIPAW AVE.,

JERSEY CITY, N. J.

NEW YORK CITY, N. Y.,  
106 LIBERTY STREET

CHICAGO, ILL.,  
130 DEARBORN STREET.

PHILADELPHIA, PA.,  
18-24 SOUTH 7TH STREET.

Please designate in your specifications and contract for heating as A. A. Griffing Iron Co.'s Bundy Pyro Wall Radiator.

TRADE TRIUMPH MARK.

## Bundy Triumph Steam Direct Radiator.

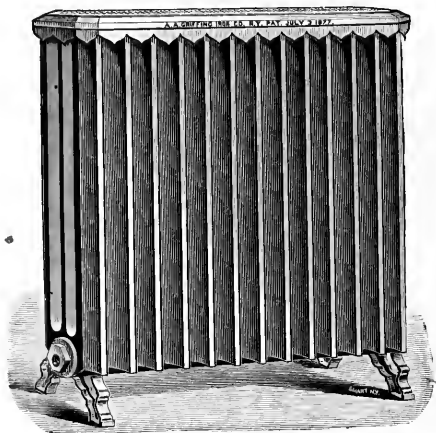

FIG. 47.

Fig. 47 represents the Bundy Triumph Steam Direct Radiator, which is made with a top, and is similar in form to the Bundy Elite Radiator, having three pipes with a circulation up the central and down the two outside pipes. It cannot water pocket or air bind, and the sections being parabolic, (concave or incurving), a more active circulation of air is induced and greater efficiency secured.

The sections are connected by 2" nipples, cut from extra heavy oil well tubing, which gives nearly 50 per cent. larger openings than is found in most other radiators, as they are usually connected by 1½" nipples and these are cut from ordinary steam pipe, which is about one-half as strong as extra heavy oil well tubing.

Center of tapping 4¼" from extreme edge of legs and 4¾" from floor.

### THIRTY-SIX INCHES HIGH.

LIST PRICE. Per foot, 67½ cents. Per Section, \$2.71.				LIST PRICE. Per foot, 67½ cents. Per Section, \$3.71.			
Number of Sections.	Length of Radiator, Inches.	Feet of Heating Surface.	With Legs and Iron Tops.	Number of Sections.	Length of Radiator, Inches.	Feet of Heating Surface.	With Legs and Iron Tops.
3	11	16½	\$11 14	17	53	93½	\$63 11
4	14	22	14 85	18	56	96	66 83
5	17	27½	18 56	19	59	104½	70 54
6	20	33	22 28	20	62	110	74 25
7	23	38½	25 99	21	65	115½	77 96
8	26	44	29 70	22	68	121	81 68
9	29	49½	33 41	23	71	126½	85 39
10	32	55	37 13	24	74	132	89 10
11	35	60½	40 84	25	77	137½	92 81
12	38	66	44 55	26	80	143	96 53
13	41	71½	48 26	27	83	148½	100 24
14	44	77	51 98	28	86	154	103 95
15	47	82½	55 69	29	89	159½	107 66
16	50	88	59 40	30	92	165	111 38

All Regular Steam Goods Tapped 1" x ¾", "Right Hand."

TRADE TRIUMPH MARK.

# Bundy Triumph Hot Water Direct Radiator.

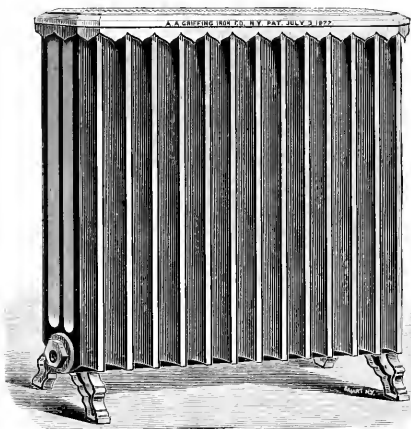

FIG. 48.

FIG. 48 represents the Bundy Triumph Hot Water Direct Radiator of which all sections are duplicates and legs are removable and interchangeable. There is an upper connecting water way, as well as the connection at the bottom, and it is impossible for an air pocket to occur in this Radiator. It has the parabolic (concave or incurving) feature found also in the Bundy Elite Radiator, whereby greater efficiency is secured, in fact this advantage alone gives this type of Radiator from 10 to 15 per cent greater radiating power.

The circulation is positive and uniform, up the central and down the two outside tubes, which being always in a forward direction, there is less friction to overcome in this than any other type of Radiator, all of which advantages are alike possessed by the Bundy Elite, Bundy Pyro, and Bundy Pyro Wall Radiator.

Center of tapping is  $4\frac{1}{4}$ " from extreme edge of legs and  $4\frac{3}{4}$ " from floor.

## THIRTY-SIX INCHES HIGH.

Width of Legs, $8\frac{1}{2}$ inches; Sections, 8 inches. Each Section represents $5\frac{1}{2}$ feet of Heating Surface.				Width of Legs, $8\frac{1}{2}$ inches; Sections, 8 inches. Each Section represents $5\frac{1}{2}$ feet of Heating Surface.			
LIST PRICE.				LIST PRICE.			
Per foot, 80 cents. Per Section, \$4.40.				Per foot, 80 cents. Per Section, \$4.40.			
Number of Sections.	Length of Radiator, Inches.	Feet of Heating Surface.	With Legs and Iron Tops.	Number of Sections.	Length of Radiator, Inches.	Feet of Heating Surface.	With Legs and Iron Tops.
3	11	16½	\$13 20	17	53	99½	\$74 80
4	14	22	17 60	18	56	99	79 20
5	17	27½	22 00	19	59	104½	83 60
6	20	33	26 40	20	62	110	88 00
7	23	38½	30 80	21	65	115½	92 40
8	26	44	35 20	22	68	121	96 80
9	29	49½	39 60	23	71	126½	101 20
10	32	55	44 00	24	74	132	105 60
11	35	60½	48 40	25	77	137½	110 00
12	38	66	52 80	26	80	143	114 40
13	41	71½	57 20	27	83	148½	118 80
14	44	77	61 60	28	86	154	123 20
15	47	82½	66 00	29	89	159½	127 60
16	50	88	70 40	30	92	165	132 00

All Regular Hot Water Goods Tapped  $1\frac{1}{4}$ " x  $1\frac{1}{4}$ " "Right Hand."

TRADE DEFIANCER MARK.

# Bundy Defiance Steam Direct Radiator.

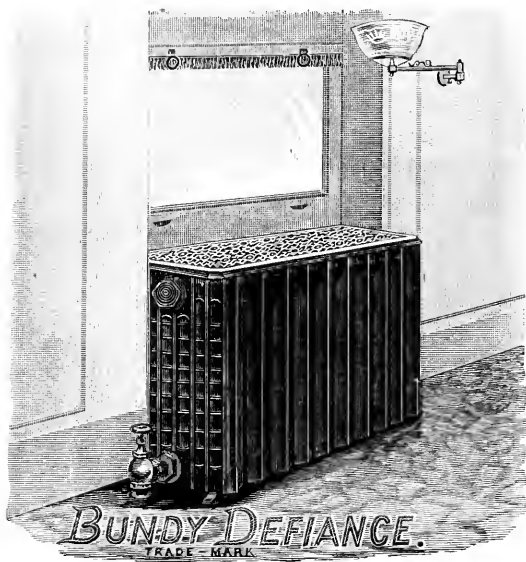

FIG. 83.

Fig. 83 represents the Bundy Defiance Steam Direct Radiator, which is specially designed to go under windows, in recesses, or in any place where it is desirable to get as much surface in a limited space as possible and still use a low Radiator. The sections are 13" and 18" high respectively, and Radiators can be made of varying heights from 14" to 23½" by the use of detachable legs which are furnished with them without extra charge. Can be tapped any size at top or bottom. Cast iron tops can be furnished with most of the sizes but they are extra. Marble tops are usually used.

19", 19½", 20", 20½", 21", 21½", 22", 22½", 23" and 23½" high.					14", 14½", 15", 15½", 16", 16½", 17", 17½", 18" and 18½" high.				
Width of Sections, 11 inches.					Width of Sections, 11 inches.				
Each Section represents 7 feet of Heating Surface.					Each Section represents 7 feet of Heating Surface.				
LIST PRICE.					LIST PRICE.				
Per Foot, 90 cents. Per Section, \$6.30.					Per Foot, 90 cents. Per Section, \$6.30.				
No. of Sections.	Size of Sections, D'th. H'gt. Inches.	Length of Radiator, Inches.	Feet of Heating Surface.	With Detachable Legs.	No. of Sections.	Size of Sections, D'th. H'gt. Inches.	Length of Radiator, Inches.	Feet of Heating Surface.	With Detachable Legs.
2	11" X 15"	5	14	\$12.60	14	11" X 15"	56	98	\$88.20
3	11" X 18"	12	21	18.90	15	11" X 18"	60	105	94.50
4	11" X 18"	16	28	25.20	16	11" X 18"	64	112	100.50
5	11" X 18"	20	35	31.50	17	11" X 18"	68	119	107.10
6	11" X 18"	24	42	37.50	18	11" X 18"	72	126	113.40
7	11" X 18"	28	49	44.10	19	11" X 18"	76	133	119.70
8	11" X 18"	32	56	50.40	20	11" X 18"	80	140	126.00
9	11" X 18"	36	63	56.70	21	11" X 18"	84	147	132.30
10	11" X 18"	40	70	63.00	22	11" X 18"	88	154	138.60
11	11" X 18"	44	77	69.30	23	11" X 18"	92	161	144.90
12	11" X 18"	48	84	75.60	24	11" X 18"	96	168	151.20
13	11" X 18"	52	91	81.90	25	11" X 18"	100	175	157.50

\* The Defiance Radiator Sections are 13" high, and are furnished, without extra charge, with detachable and interchangeable legs varying in height by half inches from 1" to 5½" high, and so build Radiators of the following heights:—19", 19½", 20", 20½", 21", 21½", 22", 22½", 23" and 23½".  
When no height is mentioned, Radiators 22" high will be furnished.

14", 14½", 15", 15½", 16", 16½", 17", 17½", 18" and 18½" high.					14", 14½", 15", 15½", 16", 16½", 17", 17½", 18" and 18½" high.				
Width of Sections, 8 inches.					Width of Sections, 8 inches.				
Each Section represents 4 feet of Heating Surface.					Each Section represents 4 feet of Heating Surface.				
LIST PRICE.					LIST PRICE.				
Per Foot, \$1.05. Per Section, \$4.20.					Per Foot, \$1.05. Per Section, \$4.20.				
No. of Sections.	Size of Sections, D'th. H'gt. Inches.	Length of Radiator, Inches.	Feet of Heating Surface.	With Detachable Legs.	No. of Sections.	Size of Sections, D'th. H'gt. Inches.	Length of Radiator, Inches.	Feet of Heating Surface.	With Detachable Legs.
2	8" X 13"	8	8	\$8.40	14	8" X 13"	56	56	\$58.80
3	8" X 13"	12	12	12.60	15	8" X 13"	60	60	63.00
4	8" X 13"	16	16	16.80	16	8" X 13"	64	64	67.20
5	8" X 13"	20	20	21.00	17	8" X 13"	68	68	71.40
6	8" X 13"	24	24	25.20	18	8" X 13"	72	72	75.60
7	8" X 13"	28	28	29.40	19	8" X 13"	76	76	79.80
8	8" X 13"	32	32	33.60	20	8" X 13"	80	80	84.00
9	8" X 13"	36	36	37.80	21	8" X 13"	84	84	88.20
10	8" X 13"	40	40	42.00	22	8" X 13"	88	88	92.40
11	8" X 13"	44	44	46.20	23	8" X 13"	92	92	96.60
12	8" X 13"	48	48	50.40	24	8" X 13"	96	96	100.80
13	8" X 13"	52	52	54.60	25	8" X 13"	100	100	105.00

\* The Defiance Radiator Sections are 13" high, and are furnished, without extra charge, with detachable and interchangeable legs varying in height by half inches from 1" to 5½" high, and so build Radiators of the following heights:—14", 14½", 15", 15½", 16", 16½", 17", 17½", 18" and 18½".  
When no height is mentioned, Radiators 17" high will be furnished.

TRADE DEFIANCE MARK.

# Bundy Defiance Hot Water Direct Radiator.

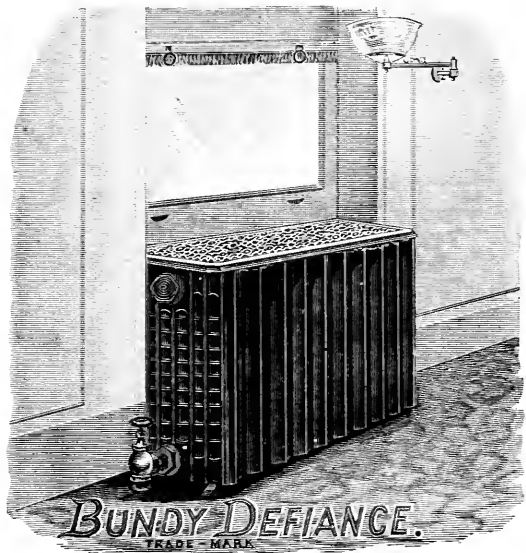

FIG. 84.

Fig. 84 represents the Bundy Defiance Hot Water Direct Radiator, which is specially designed to go under windows, in recesses, or in any place where it is desirable to get as much surface in a limited space as possible and still use a low Radiator. The sections are 13' and 18' high respectively. and Radiators can be made of varying heights from 14' to 23½' by the use of detachable legs which are furnished with them without extra charge. Can be tapped any size at top or bottom. Cast iron tops can be furnished with most of the sizes but they are extra. Marble tops are usually used.

19', 19½', 20', 20½', 21', 21½', 22', 22½', 23' and 23½' high.					14', 14½', 15', 15½', 16', 16½', 17', 17½', 18 and 18½' high.				
Width of Sections, 11 inches. Each Section represents 7 feet of Heating Surface.					Width of Sections, 11 inches. Each Section represents 7 feet of Heating Surface.				
LIST PRICE. Per Foot, 97¼ cents. Per Section, \$6.83.					LIST PRICE. Per Foot, 97¼ cents. Per Section, \$6.83.				
No. of Sections.	Size of Sections. D'th. H'gt.	Length of Radiator. Inches.	Feet of Heating Surface.	With Detachable Legs.	No. of Sections.	Size of Sections. D'th. H'gt.	Length of Radiator. Inches.	Feet of Heating Surface.	With Detachable Legs.
2	11' X 15'	8	14	\$13.65	14	11' X 15'	36	98	\$95.55
3	11' X 15'	12	21	20.45	15	11' X 15'	60	105	102.35
4	11' X 15'	16	28	27.30	16	11' X 15'	64	112	109.20
5	11' X 15'	20	35	34.15	17	11' X 15'	68	119	116.05
6	11' X 15'	24	42	40.95	18	11' X 15'	72	126	122.85
7	11' X 15'	28	49	47.75	19	11' X 15'	76	133	129.65
8	11' X 15'	32	56	54.60	20	11' X 15'	80	140	136.50
9	11' X 15'	36	63	61.43	21	11' X 15'	84	147	143.35
10	11' X 15'	40	70	68.25	22	11' X 15'	88	154	150.15
11	11' X 15'	44	77	75.08	23	11' X 15'	92	161	156.95
12	11' X 15'	48	84	81.90	24	11' X 15'	96	168	163.80
13	11' X 15'	52	91	88.73	25	11' X 15'	100	175	170.67

\* The Defiance Radiator Sections are 18' high, and are furnished, without extra charge, with detachable and interchangeable legs varying in height by half inches from 1' to 5½' high, and so build Radiators of the following heights:—19', 19½', 20', 20½', 21', 21½', 22', 22½', 23' and 23½'.

When no height is mentioned, Radiators 23' high will be furnished.

14', 14½', 15', 15½', 16', 16½', 17', 17½', 18 and 18½' high.					14', 14½', 15', 15½', 16', 16½', 17', 17½', 18 and 18½' high.				
Width of Sections, 8 inches. Each Section represents 4 feet of Heating Surface.					Width of Sections, 8 inches. Each Section represents 4 feet of Heating Surface.				
LIST PRICE. Per Foot, \$1.15. Per Section, \$4.60.					LIST PRICE. Per Foot, \$1.15. Per Section, \$4.60.				
No. of Sections.	Size of Sections. D'th. H'gt.	Length of Radiator. Inches.	Feet of Heating Surface.	With Detachable Legs.	No. of Sections.	Size of Sections. D'th. H'gt.	Length of Radiator. Inches.	Feet of Heating Surface.	With Detachable Legs.
2	8' X 13'	5	5	\$9.20	14	8' X 13'	56	56	\$64.40
3	8' X 13'	12	12	13.80	15	8' X 13'	60	60	69.00
4	8' X 13'	16	16	18.40	16	8' X 13'	64	64	73.60
5	8' X 13'	20	20	23.00	17	8' X 13'	68	68	78.20
6	8' X 13'	24	24	27.60	18	8' X 13'	72	72	82.80
7	8' X 13'	28	28	32.20	19	8' X 13'	76	76	87.40
8	8' X 13'	32	32	36.80	20	8' X 13'	80	80	92.00
9	8' X 13'	36	36	41.40	21	8' X 13'	84	84	96.60
10	8' X 13'	40	40	46.00	22	8' X 13'	88	88	101.20
11	8' X 13'	44	44	50.60	23	8' X 13'	92	92	105.80
12	8' X 13'	48	48	55.20	24	8' X 13'	96	96	110.40
13	8' X 13'	52	52	59.80	25	8' X 13'	100	100	115.00

\* The Defiance Radiator Sections are 18' high, and are furnished, without extra charge, with detachable and interchangeable legs varying in height by half inches from 1' to 5½' high, and so build Radiators of the following heights:—14', 14½', 15', 15½', 16', 16½', 17', 17½', 18' and 18½'.

When no height is mentioned, Radiators 17' high will be furnished.

All Regular Hot Water Goods Tapped 1¼" X 1¼", "Right Hand."

TRADE DEFINACE MARK.

# Bundy Defiance Bay Window Steam and Hot Water Radiator.

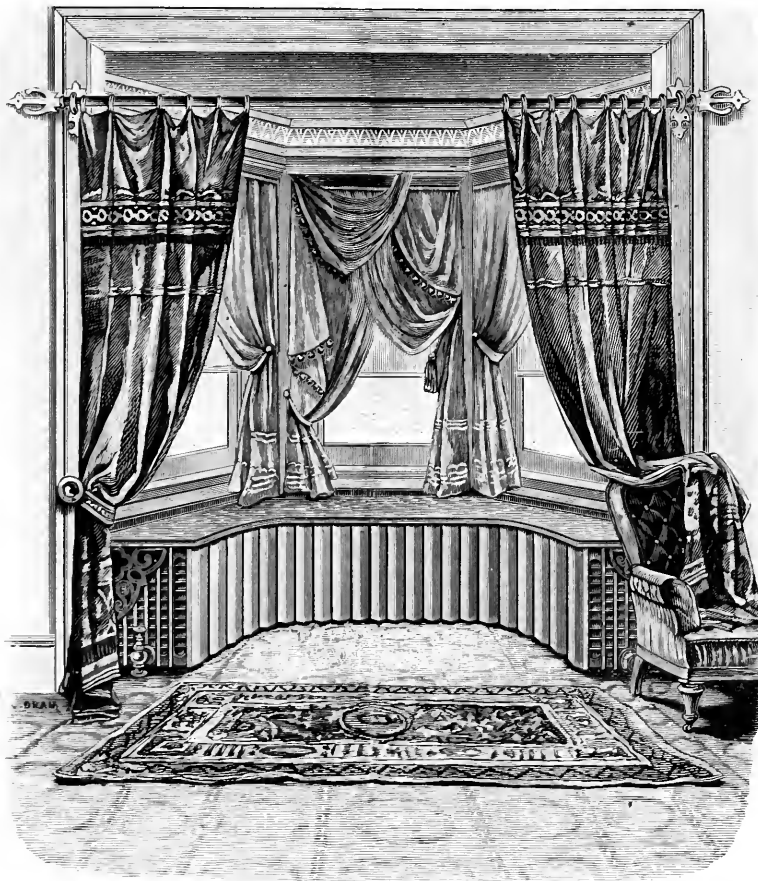

STEAM, FIG. 85.

HOT WATER, FIG. 86.

The Bundy Defiance Bay Window Radiator, as its name clearly implies, is specially designed for use in bay windows, although it can be used in any place where an irregular-shaped Radiator is wanted. It will fit an angular, circular or any shaped space and will fit the outside of a curve as well as the inside. A drawing or paper templet, showing exactly the shape of space to be fitted, is a great aid in the production of this special make of Radiator.

A marble top setting on the Radiator produces a very fine effect, and the large number of these Radiators now in use attest very strongly their many advantages. In the first place, the bay window is the worst exposure a room can have, and the placing of the Radiator at this point of greatest chill secures a more uniform and positive heat at all times, and certainly saves considerable fuel owing to its location. Then again, by placing the Radiator here, it avoids the use of space in other parts of the room that is of more value for other purposes.

For dimensions and list prices, see next page.

TRADE DEFIANCER MARK.

# Bundy Defiance Bay Window Steam and Hot Water Radiator.

The Bundy Defiance Bay Window Radiator, it is impossible to describe accurately as regards dimensions owing to the different forms in which it may be furnished. Owing to the fact that the sections in an event must be set with a wedge shaped space between them.

The Bundy Defiance Bay Window Radiator when setting in a circle has a wedge-shaped space between all sections, the size of which, of course varies with each circle, and so it is impossible to give a table of specific dimensions suited to all cases. Also in an angular bay window there is such a shaped space at each angle or change of direction, but as a guide in the use of this Radiator please bear in mind that the sections are 4" thick, measuring from outside to outside of base, which includes a uniform space of 1/4" between the front of all sections, whether at angles circles or straight.

The sections, irrespective of legs, which are detachable and of varying height, varying from 1' to 5 1/2' inclusive of both, by 1/2' in height, are 13 and 18" high. Radiators can be tapped any size, right or left hand, and at top or bottom connection for hot water.

Fret work cast iron tops can be furnished when wanted, but they cost extra, as do also marble tops, but the latter are usually used.

## FOR STEAM HEATING, FIG. 85.

19", 19 1/2", 20", 20 1/2", 21", 21 1/2", 22", 22 1/2", 23" and 23 1/2" high.						14", 14 1/2", 15", 15 1/2", 16", 16 1/2", 17", 17 1/2", 18" and 18 1/2" high.																		
Width of Sections, 11 inches.			Width of Sections, 11 inches.			Width of Sections, 8 inches.			Width of Sections, 8 inches.															
Each Section represents 7 feet of Heating Surface.						Each Section represents 7 feet of Heating Surface.						Each Section represents 4 feet of Heating Surface.						Each Section represents 4 feet of Heating Surface.						
LIST PRICE.						LIST PRICE.						LIST PRICE.						LIST PRICE.						
Per Foot, \$1.12.			Per Section, \$7.80.			Per Foot, \$1.12.			Per Section, \$7.80.			Per Foot, \$1.43.			Per Section, \$5.70.			Per Foot, \$1.43.			Per Section, \$5.70.			
No. of Sections.	Size of Sections.	Length of Radiator.	Feet of Heating Surface.	With Detachable Legs.	No. of Sections.	Size of Sections.	Length of Radiator.	Feet of Heating Surface.	With Detachable Legs.	No. of Sections.	Size of Sections.	Length of Radiator.	Feet of Heating Surface.	With Detachable Legs.	No. of Sections.	Size of Sections.	Length of Radiator.	Feet of Heating Surface.	With Detachable Legs.	No. of Sections.	Size of Sections.	Length of Radiator.	Feet of Heating Surface.	With Detachable Legs.
2	11" X 18"	8	14	\$15 60	14	11" X 18"	56	95	\$109 20	2	8" X 13"	8	8	\$11 40	14	8" X 13"	56	56	\$79 50					
3	11" X 18"	12	21	23 40	15	11" X 18"	60	105	117 00	3	8" X 13"	12	12	17 10	15	8" X 13"	60	60	85 50					
4	11" X 18"	16	28	31 20	16	11" X 18"	64	112	124 80	4	8" X 13"	16	16	22 80	16	8" X 13"	64	64	91 20					
5	11" X 18"	20	35	39 00	17	11" X 18"	68	119	132 60	5	8" X 13"	20	20	28 50	17	8" X 13"	68	68	96 90					
6	11" X 18"	24	42	46 80	18	11" X 18"	72	126	140 40	6	8" X 13"	24	24	34 20	18	8" X 13"	72	72	102 60					
7	11" X 18"	28	49	54 60	19	11" X 18"	76	133	148 20	7	8" X 13"	28	28	39 90	19	8" X 13"	76	76	108 30					
8	11" X 18"	32	56	62 40	20	11" X 18"	80	140	156 00	8	8" X 13"	32	32	45 60	20	8" X 13"	80	80	114 00					
9	11" X 18"	36	63	70 20	21	11" X 18"	84	147	163 80	9	8" X 13"	36	36	51 30	21	8" X 13"	84	84	119 70					
10	11" X 18"	40	70	78 00	22	11" X 18"	88	154	171 60	10	8" X 13"	40	40	57 00	22	8" X 13"	88	88	125 40					
11	11" X 18"	44	77	85 80	23	11" X 18"	92	161	179 40	11	8" X 13"	44	44	62 70	23	8" X 13"	92	92	131 10					
12	11" X 18"	48	84	93 60	24	11" X 18"	96	168	187 20	12	8" X 13"	48	48	68 40	24	8" X 13"	96	96	136 80					
13	11" X 18"	52	91	101 40	25	11" X 18"	100	175	195 00	13	8" X 13"	52	52	74 10	25	8" X 13"	100	100	142 50					

All Regular Steam Goods Tapped 1" X 3/4", "Right Hand."

## FOR HOT WATER HEATING, FIG. 86.

19", 19 1/2", 20", 20 1/2", 21", 21 1/2", 22", 22 1/2", 23" and 23 1/2" high.						14", 14 1/2", 15", 15 1/2", 16", 16 1/2", 17", 17 1/2", 18" and 18 1/2" high.																		
Width of Sections, 11 inches.			Width of Sections, 11 inches.			Width of Sections, 8 inches.			Width of Sections, 8 inches.															
Each Section represents 7 feet of Heating Surface.						Each Section represents 7 feet of Heating Surface.						Each Section represents 4 feet of Heating Surface.						Each Section represents 4 feet of Heating Surface.						
LIST PRICE.						LIST PRICE.						LIST PRICE.						LIST PRICE.						
Per Foot, \$1.19.			Per Section, \$8.33.			Per Foot, \$1.19.			Per Section, \$8.33.			Per Foot, \$1.53.			Per Section, \$6.10.			Per Foot, \$1.53.			Per Section, \$6.10.			
No. of Sections.	Size of Sections.	Length of Radiator.	Feet of Heating Surface.	With Detachable Legs.	No. of Sections.	Size of Sections.	Length of Radiator.	Feet of Heating Surface.	With Detachable Legs.	No. of Sections.	Size of Sections.	Length of Radiator.	Feet of Heating Surface.	With Detachable Legs.	No. of Sections.	Size of Sections.	Length of Radiator.	Feet of Heating Surface.	With Detachable Legs.	No. of Sections.	Size of Sections.	Length of Radiator.	Feet of Heating Surface.	With Detachable Legs.
2	11" X 18"	8	14	\$16 66	14	11" X 18"	56	95	\$116 62	2	8" X 13"	8	8	\$12 20	14	8" X 13"	56	56	\$85 40					
3	11" X 18"	12	21	24 90	15	11" X 18"	60	105	124 95	3	8" X 13"	12	12	18 30	15	8" X 13"	60	60	91 50					
4	11" X 18"	16	28	33 32	16	11" X 18"	64	112	133 28	4	8" X 13"	16	16	24 40	16	8" X 13"	64	64	97 60					
5	11" X 18"	20	35	41 05	17	11" X 18"	68	119	141 61	5	8" X 13"	20	20	30 50	17	8" X 13"	68	68	103 70					
6	11" X 18"	24	42	49 03	18	11" X 18"	72	126	149 94	6	8" X 13"	24	24	36 60	18	8" X 13"	72	72	109 80					
7	11" X 18"	28	49	58 31	19	11" X 18"	76	133	158 27	7	8" X 13"	28	28	42 70	19	8" X 13"	76	76	115 90					
8	11" X 18"	32	56	66 64	20	11" X 18"	80	140	166 60	8	8" X 13"	32	32	48 80	20	8" X 13"	80	80	122 00					
9	11" X 18"	36	63	74 97	21	11" X 18"	84	147	174 93	9	8" X 13"	36	36	54 90	21	8" X 13"	84	84	128 10					
10	11" X 18"	40	70	83 30	22	11" X 18"	88	154	183 26	10	8" X 13"	40	40	61 00	22	8" X 13"	88	88	134 20					
11	11" X 18"	44	77	91 63	23	11" X 18"	92	161	191 59	11	8" X 13"	44	44	67 10	23	8" X 13"	92	92	140 30					
12	11" X 18"	48	84	99 96	24	11" X 18"	96	168	199 92	12	8" X 13"	48	48	73 20	24	8" X 13"	96	96	146 40					
13	11" X 18"	52	91	108 29	25	11" X 18"	100	175	208 25	13	8" X 13"	52	52	79 30	25	8" X 13"	100	100	152 50					

\*The Defiance Radiator Sections are 18" high, and are furnished, without extra charge, with detachable and interchangeable legs varying in height by half inches from 1' to 5 1/2' high, and so build Radiators of the following heights:—19", 19 1/2", 20", 20 1/2", 21", 21 1/2", 22", 22 1/2", 23" and 23 1/2".

When no height is mentioned, Radiators 32" high will be furnished.

\*The Defiance Radiator Sections are 13" high, and are furnished, without extra charge, with detachable and interchangeable legs varying in height by half inches from 1' to 5 1/2' high, and so build Radiators of the following heights:—14", 14 1/2", 15", 15 1/2", 16", 16 1/2", 17", 17 1/2", 18" and 18 1/2".

When no height is mentioned, Radiators 17" high will be furnished.

All Regular Hot Water Goods Tapped 1 1/4" X 1 1/4", "Right Hand."

TRADE BUNDY MARK.

# Flower City Steam and Hot Water Direct Radiators.

Figs. 95 and 96 represent the Flower City Direct Radiator for Steam and Hot Water Heating. This Radiator has a handsome design and presents a neat appearance, especially when decorated. When desired it can be furnished with a cast iron ornamental top, which may be either plain or nickel plated, or a marble top; but these are extra, for which a moderate charge is made.

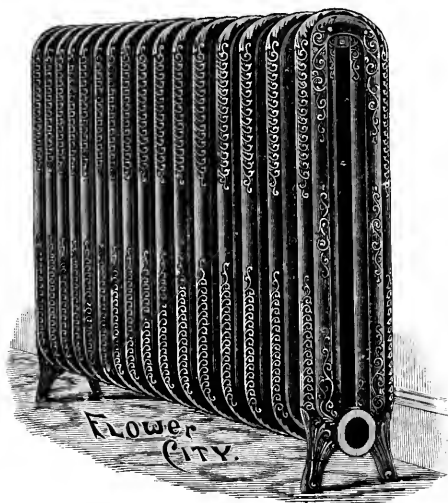

When a special tapping is wanted please state definitely on order what it is, otherwise regular tapping will be sent. The distance from floor to centre of tapping varies according to size of tapping used; being as follows:  $\frac{3}{4}$ " tapping,  $3\frac{3}{4}$ "; 1" tapping,  $3\frac{5}{8}$ ";  $1\frac{1}{4}$ " tapping, 4";  $1\frac{1}{2}$ " tapping,  $4\frac{1}{8}$ "; and 2" tapping,  $4\frac{1}{4}$ ".

STEAM FIG. 95. HOT WATER FIG. 96.

## SIZES AND CAPACITIES OF FLOWER CITY STEAM AND HOT WATER DIRECT RADIATORS.

Width across Section, $7\frac{1}{4}$ inches. Width across Legs, $8\frac{3}{4}$ inches.		SQUARE FEET OF HEATING SURFACE.			
Number of Sections.	Length of Radiator in inches.	42 inches High. $4\frac{1}{2}$ sq. feet of H. S. per Section.	36 inches High. 4 sq. feet of H. S. per Section.	27 inches High. $3\frac{3}{4}$ sq. feet of H. S. per Section.	20 inches High. $2\frac{3}{4}$ sq. feet of H. S. per Section.
3	$7\frac{3}{8}$	$13\frac{1}{2}$	12 sq. feet.	$9\frac{3}{4}$	$7\frac{1}{2}$
4	$9\frac{3}{4}$	18	16 "	13	10
5	$12\frac{1}{4}$	$22\frac{1}{2}$	20 "	$16\frac{1}{4}$	$12\frac{1}{2}$
6	$14\frac{1}{4}$	27	24 "	$19\frac{1}{2}$	15
7	$17\frac{1}{4}$	$31\frac{1}{2}$	28 "	$22\frac{3}{4}$	$17\frac{1}{2}$
8	$19\frac{3}{8}$	36	32 "	26	20
9	$22\frac{1}{8}$	$40\frac{1}{2}$	36 "	$29\frac{1}{4}$	$22\frac{1}{2}$
10	$24\frac{3}{8}$	45	40 "	$32\frac{1}{2}$	25
11	27	$49\frac{1}{2}$	44 "	$35\frac{1}{4}$	$27\frac{1}{2}$
12	$29\frac{1}{2}$	54	48 "	39	30
13	32	$58\frac{1}{2}$	52 "	$42\frac{1}{4}$	$32\frac{1}{2}$
14	$34\frac{1}{2}$	63	56 "	$45\frac{1}{2}$	35
15	$36\frac{3}{8}$	$67\frac{1}{2}$	60 "	$48\frac{3}{4}$	$37\frac{1}{2}$
16	$39\frac{3}{8}$	72	64 "	52	40
17	$41\frac{3}{8}$	$76\frac{1}{2}$	68 "	$55\frac{1}{4}$	$42\frac{1}{2}$
18	$44\frac{1}{4}$	81	72 "	$58\frac{3}{8}$	45
19	$46\frac{3}{4}$	$85\frac{1}{2}$	76 "	$61\frac{3}{4}$	$47\frac{1}{2}$
20	$49\frac{1}{4}$	90	80 "	65	50
21	$51\frac{3}{4}$	$94\frac{1}{2}$	84 "	$68\frac{1}{4}$	$52\frac{1}{2}$
22	$54\frac{1}{8}$	99	88 "	$71\frac{1}{2}$	55
23	$56\frac{3}{8}$	$103\frac{1}{2}$	92 "	$74\frac{3}{4}$	$57\frac{1}{2}$
24	59	108	96 "	78	60
25	$61\frac{1}{2}$	$112\frac{1}{2}$	100 "	$81\frac{1}{4}$	$62\frac{1}{2}$
26	64	117	104 "	$84\frac{3}{8}$	65
27	$66\frac{1}{2}$	$121\frac{1}{2}$	108 "	$87\frac{3}{4}$	$67\frac{1}{2}$
28	$68\frac{3}{8}$	126	112 "	91	70
29	$71\frac{3}{8}$	$130\frac{1}{2}$	116 "	$94\frac{1}{4}$	$72\frac{1}{2}$
30	$73\frac{3}{8}$	135	120 "	$97\frac{3}{4}$	75

☞ All Regular Steam Goods Tapped  $1' \times \frac{3}{4}$ ", Hot Water  $1\frac{1}{4}' \times 1\frac{1}{4}$ " "Right Hand." ☜





# LOWER CITY RADIATOR.

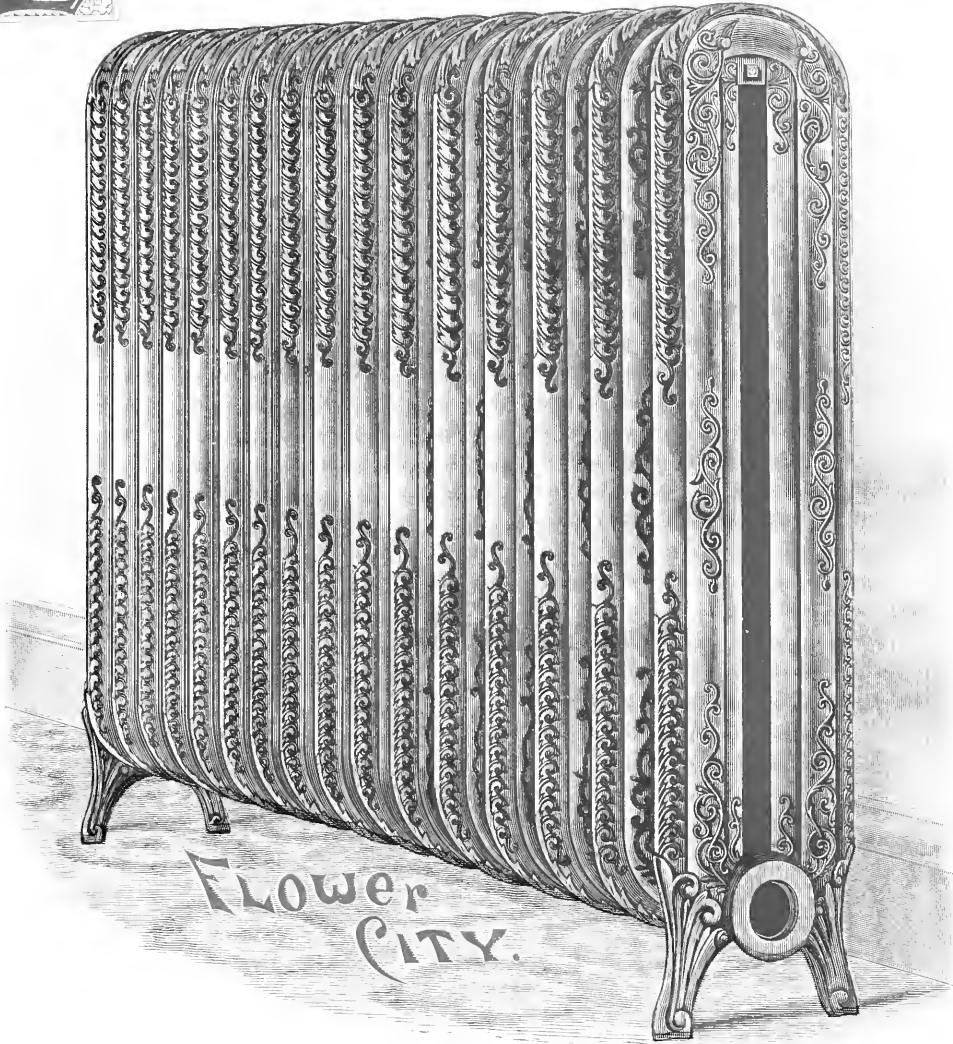

Flower  
CITY.

• MANUFACTURED BY •

## A. A. GRIFFING IRON CO.

General Office and Works:

430 COMMUNIPAW AVE.,

JERSEY CITY, N. J.

NEW YORK CITY, N. Y.,  
106 LIBERTY STREET.

CHICAGO, ILL.,  
130 DEARBORN STREET.

PHILADELPHIA, PA.,  
18-24 SOUTH 7TH STREET.

Please designate in your specifications and contract for heating as A. A. Griffing Iron Co.'s Flower City Radiator.



TRADE EUREKA MARK.

# Eureka Rochester Steam Direct Radiator.

Figs. 97 and 98 represent the Rochester Direct Radiator for Steam and Hot Water Heating. It is furnished with ornamental cast iron fret work top, nickel plated top and marble top. The latter two, however, are subject to a slight additional charge. For a plain Radiator the Rochester is well liked and presents a neat appearance in any building.

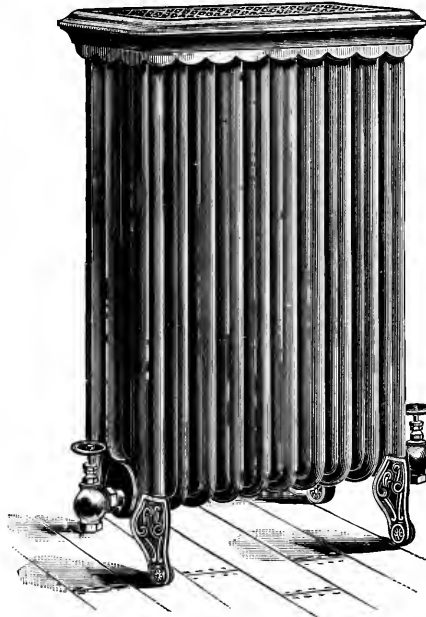

All regular steam goods are furnished tapped  $1 \times \frac{3}{8}$ ", hot water  $1 \frac{1}{4} \times 1 \frac{1}{4}$ " "Right Hand," but other sizes can be furnished when desired without extra charge. When a special tapping is wanted please state definitely in order what it is, otherwise regular tapping will be sent. The distance from floor to center of tapping varies according to the size of tapping used, being as follows:  $\frac{3}{4}$  inch,  $3 \frac{3}{4}$ " ; 1 inch,  $3 \frac{1}{8}$ " ;  $1 \frac{1}{4}$  inch, 4" ;  $1 \frac{1}{2}$  inch,  $4 \frac{1}{8}$ " ; 2 inch,  $4 \frac{1}{4}$ ".

STEAM, FIG. 97. HOT WATER, FIG. 98.

## SIZES AND CAPACITIES OF THE EUREKA ROCHESTER STEAM DIRECT RADIATORS.

Width across Section, $7 \frac{1}{2}$ inches. Width across Legs, $8 \frac{3}{4}$ inches.		SQUARE FEET OF HEATING SURFACE.				
Number of Sections.	Length of Radiator in inches.	42 inches High. $4 \frac{1}{2}$ sq. feet of H. S. per Section.	36 inches High. 4 sq. feet of H. S. per Section.	30 inches High. $3 \frac{1}{2}$ sq. feet of H. S. per Section.	24 inches High. 3 sq. feet of H. S. per Section.	20 inches High. $2 \frac{1}{2}$ sq. feet of H. S. per Section.
3	$7 \frac{3}{8}$	$13 \frac{1}{2}$	12	$10 \frac{1}{2}$	9	$7 \frac{1}{2}$
4	$9 \frac{3}{4}$	18	16	14	12	10
5	$12 \frac{1}{4}$	$22 \frac{1}{2}$	20	$17 \frac{1}{2}$	15	$12 \frac{1}{2}$
6	$14 \frac{3}{4}$	27	24	21	18	15
7	$17 \frac{1}{4}$	$31 \frac{1}{2}$	28	$24 \frac{1}{2}$	21	$17 \frac{1}{2}$
8	$19 \frac{3}{8}$	36	32	28	24	20
9	$22 \frac{1}{8}$	$40 \frac{1}{2}$	36	$31 \frac{1}{2}$	27	$22 \frac{1}{2}$
10	$24 \frac{3}{8}$	45	40	35	30	25
11	27	$49 \frac{1}{2}$	44	$38 \frac{1}{2}$	33	$27 \frac{1}{2}$
12	$29 \frac{1}{4}$	54	48	42	36	30
13	32	$58 \frac{1}{2}$	52	$45 \frac{1}{2}$	39	$32 \frac{1}{2}$
14	$34 \frac{1}{2}$	63	56	49	42	35
15	$36 \frac{3}{8}$	$67 \frac{1}{2}$	60	$52 \frac{1}{2}$	45	$37 \frac{1}{2}$
16	$39 \frac{3}{8}$	72	64	56	48	40
17	$41 \frac{3}{8}$	$76 \frac{1}{2}$	68	$59 \frac{1}{2}$	51	$42 \frac{1}{2}$
18	$44 \frac{1}{4}$	81	72	63	54	45
				$66 \frac{1}{2}$	57	$47 \frac{1}{2}$
					60	50
					63	$52 \frac{1}{2}$
					66	55
					69	$57 \frac{1}{2}$
					72	60
					75	$62 \frac{1}{2}$
					78	65
					81	$67 \frac{1}{2}$
					84	70
					87	$72 \frac{1}{2}$
					90	75

### ERRATUM.

The Rochester Radiator is not made 42" or 20" high, or for Hot Water; Is furnished without top if desired.

10/10/10

TRADE EUREKA MARK.

# Eureka Rochester Steam Direct Radiator.

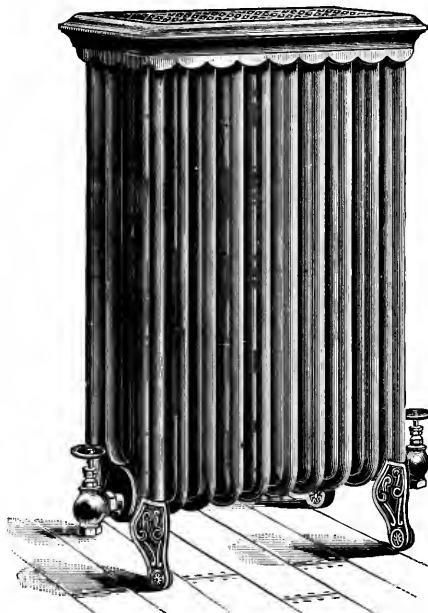

Figs. 97 and 98 represent the Rochester Direct Radiator for Steam and Hot Water Heating. It is furnished with ornamental cast iron fret work top, nickel plated top and marble top. The latter two, however, are subject to a slight additional charge. For a plain Radiator the Rochester is well liked and presents a neat appearance in any building.

All regular steam goods are furnished tapped  $1\frac{1}{4} \times 1\frac{1}{4}$  "Right Hand," but other sizes can be furnished when desired without extra charge. When a special tapping is wanted please state definitely in order what it is, otherwise regular tapping will be sent. The distance from floor to center of tapping varies according to the size of tapping used, being as follows:  $\frac{3}{4}$  inch,  $3\frac{3}{4}$ "; 1 inch,  $3\frac{1}{2}$ ";  $1\frac{1}{4}$  inch, 4"; 1  $\frac{1}{2}$  inch,  $4\frac{1}{8}$ "; 2 inch,  $4\frac{1}{4}$ ".

STEAM, FIG. 97. HOT WATER, FIG. 98.

## SIZES AND CAPACITIES OF THE EUREKA ROCHESTER STEAM DIRECT RADIATORS.

Width across Section, $7\frac{1}{4}$ inches. Width across Legs, $8\frac{3}{4}$ inches.		SQ. FEET OF HEATING SURFACE.				
Number of Sections.	Length of Radiator in inches.	42 inches High. $4\frac{1}{2}$ sq. feet of H. S. per Section.	36 inches High. 4 sq. feet of H. S. per Section.	30 inches High. $3\frac{1}{2}$ sq. feet of H. S. per Section.	24 inches High. 3 sq. feet of H. S. per Section.	20 inches High. $2\frac{1}{2}$ sq. feet of H. S. per Section.
3	$7\frac{3}{8}$	$13\frac{1}{2}$	12	$10\frac{1}{2}$	9	$7\frac{1}{2}$
4	$9\frac{1}{4}$	18	16	14	12	10
5	$12\frac{1}{4}$	$22\frac{1}{2}$	20	$17\frac{1}{2}$	15	$12\frac{1}{2}$
6	$14\frac{3}{4}$	27	24	21	18	15
7	$17\frac{1}{4}$	$31\frac{1}{2}$	28	$24\frac{1}{2}$	21	$17\frac{1}{2}$
8	$19\frac{3}{8}$	36	32	28	24	20
9	$22\frac{1}{8}$	$40\frac{1}{2}$	36	$31\frac{1}{2}$	27	$22\frac{1}{2}$
10	$24\frac{3}{8}$	45	40	35	30	25
11	27	$49\frac{1}{2}$	44	$38\frac{1}{2}$	33	$27\frac{1}{2}$
12	$29\frac{1}{4}$	54	48	42	36	30
13	32	$58\frac{1}{2}$	52	$45\frac{1}{2}$	39	$32\frac{1}{2}$
14	$34\frac{1}{2}$	63	56	49	42	35
15	$36\frac{3}{8}$	$67\frac{1}{2}$	60	$52\frac{1}{2}$	45	$37\frac{1}{2}$
16	$39\frac{3}{8}$	72	64	56	48	40
17	$41\frac{1}{8}$	$76\frac{1}{2}$	68	$59\frac{1}{2}$	51	$42\frac{1}{2}$
18	$44\frac{1}{4}$	81	72	63	54	45
19	$46\frac{3}{4}$	$85\frac{1}{2}$	76	$66\frac{1}{2}$	57	$47\frac{1}{2}$
20	$49\frac{1}{4}$	90	80	70	60	50
21	$51\frac{3}{8}$	$94\frac{1}{2}$	84	$73\frac{1}{2}$	63	$52\frac{1}{2}$
22	$54\frac{3}{8}$	99	88	77	66	55
23	$56\frac{3}{8}$	$103\frac{1}{2}$	92	$80\frac{1}{2}$	69	$57\frac{1}{2}$
24	59	108	96	84	72	60
25	$61\frac{1}{2}$	$112\frac{1}{2}$	100	$87\frac{1}{2}$	75	$62\frac{1}{2}$
26	64	117	104	91	78	65
27	$66\frac{1}{2}$	$121\frac{1}{2}$	108	$94\frac{1}{2}$	81	$67\frac{1}{2}$
28	$68\frac{3}{8}$	126	112	98	84	70
29	$71\frac{3}{8}$	$130\frac{1}{2}$	116	$101\frac{1}{2}$	87	$72\frac{1}{2}$
30	$73\frac{3}{8}$	135	120	105	90	75

All Regular Steam Goods Tapped  $1\frac{1}{4} \times \frac{3}{4}$ "; Hot Water  $1\frac{1}{4} \times 1\frac{1}{4}$  "Right Hand."

TRADE BUNDY MARK.

## Bundy Duplex Stairway Steam Direct Radiator.

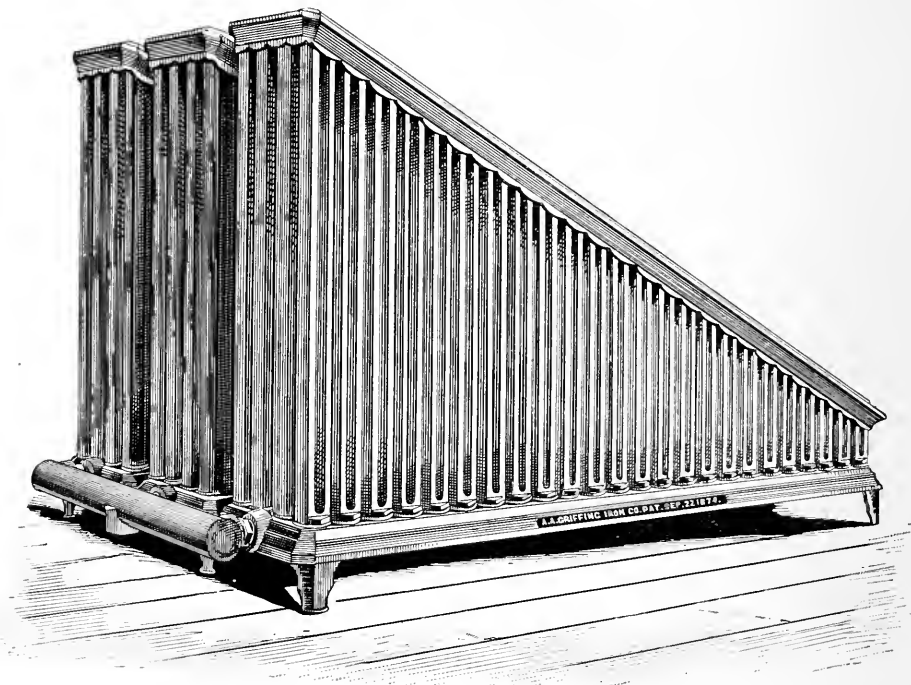

FIG. 113.

Fig. 113 represents the Bundy Duplex Stairway Steam Direct Radiator. It is being largely introduced in hotel halls, lobbies and business blocks where it is possible to place a Radiator under the stairs, thus using floor space that is of little value for any other purpose. In this location the Radiator is out of the way and presents a very attractive appearance.

Usually the Radiator is built on the high leg base, allowing a large space underneath for the air to pass through and up between the loops, so in point of efficiency this Radiator holds a high place. The Rookery Building, Chicago, is a late example where this Radiator is in use.

Prices furnished on application.

TRADE BUNDY MARK.

# Price List of Parts of Bundy Standard Radiator.

RADIATOR.	BASE.	FRET WORK TOP ONLY.	BINDER FOR TOP ONLY.	TOP AND BINDER COMPLETE.	WATER ARCH.
1X 3	\$ 2.10	\$ .45	\$ .45	\$ .90	\$ 1.80
1X 4	2.80	.60	.60	1.20	2.40
1X 5	3.50	.75	.75	1.50	3.00
1X 6	4.20	.90	.90	1.80	3.60
1X 7	4.90	1.05	1.05	2.10	4.20
1X 8	5.60	1.20	1.20	2.40	4.80
1X 9	6.30	1.35	1.35	2.70	5.40
1X 10	7.00	1.50	1.50	3.00	6.00
1X 11	7.70	1.65	1.65	3.30	6.60
1X 12	8.40	1.80	1.80	3.60	7.20
1X 13	9.10	1.95	1.95	3.90	7.80
1X 14	9.80	2.10	2.10	4.20	8.40
1X 15	10.50	2.25	2.25	4.50	9.00
1X 16	11.20	2.40	2.40	4.80	9.60
1X 18	12.60	2.70	2.70	5.40	10.80
1X 20	14.00	3.00	3.00	6.00	12.00
1X 22	15.40	3.30	3.30	6.60	
1X 24	16.80	3.60	3.60	7.20	
1X 26	18.20	3.90	3.90	7.80	
2X 3	4.20	.90	.90	1.80	3.60
2X 4	5.60	1.20	1.20	2.40	4.80
2X 5	7.00	1.50	1.50	3.00	6.00
2X 6	8.40	1.80	1.80	3.60	7.20
5X 7	9.80	2.10	2.10	4.20	8.40
2X 8	11.20	2.40	2.40	4.80	9.60
2X 9	12.60	2.70	2.70	5.40	10.80
2X 10	14.00	3.00	3.00	6.00	12.00
2X 11	15.40	3.30	3.30	6.60	13.20
2X 12	16.80	3.60	3.60	7.20	14.40
2X 13	18.20	3.90	3.90	7.80	15.60
2X 14	19.60	4.20	4.20	8.20	16.80
2X 15	21.00	4.50	4.50	9.00	18.00
2X 16	22.40	4.80	4.80	9.60	19.20
2X 18	25.20	5.10	5.10	10.20	21.60
2X 20	28.00	5.40	5.40	10.80	24.00
2X 22	30.80	5.70	5.70	11.40	
2X 24	33.60	6.00	6.00	12.00	
2X 26	36.40	6.30	6.30	12.60	
3X 3	6.30	1.35	1.35	1.70	5.40
3X 4	8.40	1.80	1.80	3.60	7.20
3X 5	10.50	2.25	2.25	4.50	9.00
3X 6	12.60	2.70	2.70	5.40	10.80
3X 7	14.70	3.15	3.15	6.30	12.60
3X 8	16.80	3.60	3.60	7.20	14.40
3X 9	18.90	4.05	4.05	8.10	16.20
3X 10	21.00	4.50	4.50	9.00	18.00
3X 11	23.10	4.95	4.95	9.90	19.80
3X 12	25.20	5.40	5.40	10.80	21.60
3X 13	27.30	5.85	5.85	11.70	23.40
3X 15	31.50	6.75	6.75	13.50	27.00
4X 4	11.20	2.40	2.40	4.80	
4X 5	14.00	3.00	3.00	6.00	
4X 6	16.80	3.60	3.60	7.20	
4X 8	22.40	4.80	4.80	9.60	
4X 10	28.00	6.00	6.00	12.00	
4X 14	39.20	8.40	8.40	16.80	
4X 18	50.40	10.80	10.80	21.60	
4X 20	56.00	12.00	12.00	24.00	
4X 22	61.60	13.20	13.20	26.40	
4X 24	67.20	14.40	14.40	28.80	
10 Circular.	7.50	1.75	1.75	3.50	
15 "	11.25	2.63	2.63	5.26	
20 "	15.00	3.50	3.50	7.00	
26 "	19.50	4.55	4.55	9.10	
34 "	25.50	5.95	5.95	11.90	
50 "	35.50	8.75	8.75	17.50	
74 "	55.50	12.95	12.95	25.90	
20 Column.	20.80	5.20	5.20	10.40	
34 "	27.20	6.80	6.80	13.60	
50 "	40.00	10.00	10.00	20.00	
10 Corner.	7.50	1.75	1.75	3.50	
15 "	11.25	2.63	2.63	5.26	
20 "	15.00	3.50	3.50	7.00	
25 "	18.75	4.38	4.38	8.76	
28 "	21.00	4.90	4.90	9.80	

**LOOPS ONLY, STEAM.**  
For Rectangular, Circular, Corner and Column Radiators.

* HEIGHT OF RADIATOR.	STANDARD.	ENLARGED.	EXTENDED.
42"	\$2.30	\$2.75	\$2.05
36"	2.10	2.40	2.30
30"	2.00	2.35	2.25
24"	1.85	2.15	2.10

**LOOPS ONLY, HOT WATER.**

45"	\$3.25	\$3.75	\$3.65
39"	3.00	3.35	3.25
33"	2.85	3.25	3.20
27"	2.70	3.05	3.00

\* This refers to height of Radiator the loops built up with the regular height of legs, for example, a loop 24½" long would build 30" high, with base and top, and therefore is listed as 30" high.

The price applies to all intervening heights of loops, i. e., a steam loop that builds 40" high is listed the same as the 42" height.

Discount on Bundy Standard Radiator applies to this list.

TRADE BUNDY MARK.

## Bundy Improved Duplex Radiator Base.

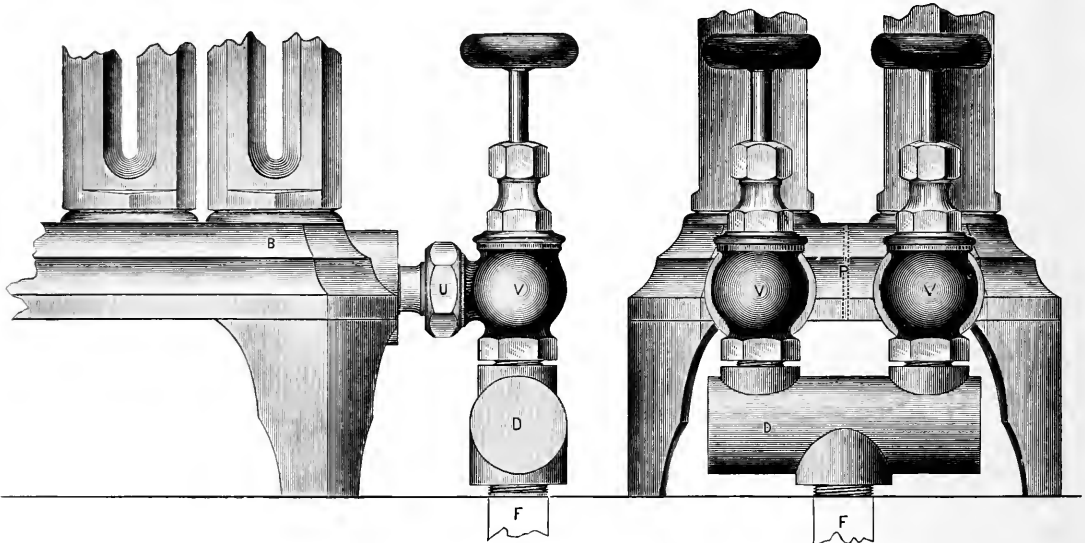

FIG. 99.

FIG. 100.

Figs. 99 and 100 represent two views of the Bundy Improved Duplex Radiator Base with which the Bundy Two-row Radiator is made equivalent to three distinct sizes. The partition, P, divides the base into separate compartments, regulated and controlled by the valve V. The header D, is used for convenience and economy in connecting up, saving pipe and fitting, and cutting of the floor. To secure the necessary room for the header the high leg Bundy Base has to be used, in which the center of tapping, for any size of hole, is 4½" from floor; this allows ample space for cleaning out under the Radiator, and for free circulation of air.

In point of economy the Bundy Duplex Base saves in fuel alone, many times its slight additional cost in a very few weeks, and its value in preventing over heating of apartments, and the perfect control of temperature it gives, cannot be over-estimated. The sudden change of temperature when an entire Radiator is opened or closed, makes it necessary during the moderate weather of the fall, winter and spring, representing fully 75 per cent. of the heating season, to turn on and off the Radiator at short intervals, engendering much loss of time, wear of valves and general inconvenience, all of which the Bundy Duplex Base effectually prevents.

For heating of hotels, business blocks, churches, schools, theatres, residences, and in fact every style of building known to modern architecture, the Bundy Duplex Base will be found of value. It represents an investment, the profits of which are greater than can possibly be secured in any other way. The Bundy Radiator is the only one that can be fitted up in this way, but it can be furnished for both steam and hot water heating.

It can be used with either one or two pipe system. With two pipe, two headers and four valves are required to each Radiator; with one pipe, one header and two valves.

**IN VERY MODERATE WEATHER** open the valve or valves that control the rear row of loops the heat from which is moderated considerably by passing through the front row of loops, which are not in use.

**IN FAIRLY COLD WEATHER** open the valve or valves that control the front row of loops, the rear row remaining idle, when the heat by passing direct and unimpeded into the room gives a considerably higher temperature than in the case above described.

**IN EXTREMELY COLD WEATHER** open all the valves, when the radiator will throw out heat to its full capacity and give the desired temperature in the apartment in the coldest of weather.

The Base cost, exclusive of header, is \$4.00 list per Radiator, which should be added to prices found on pages 22, 23, 30 and 31.

Header costs \$1.00 list each.

Discount on Bundy Radiators applies to both base and header.



TRADE BUNDY MARK.

## Bundy Gold's Pin Steam Indirect Radiator.

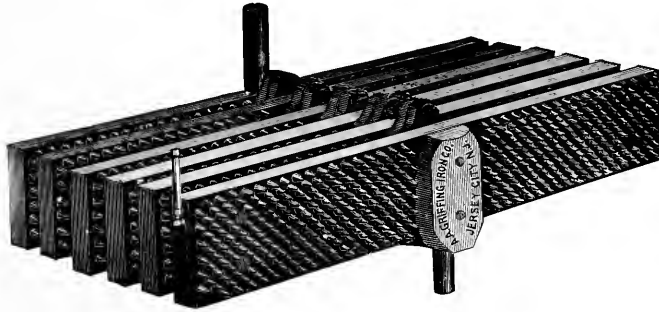

FIG. 15.

Fig. 15 represents the Bundy Gold's Pin Steam Indirect Radiator, which unlike other Radiators of this type, is tested to 100 lbs. pressure instead of 40 lbs. This Radiator is so well known to the trade that it requires no further description, but Architects and users of this Radiator would serve their own interests by specifying the Bundy Gold's Pin and using none other.

Each section is 40½ inches long, 6½ inches deep at ends, 10½ inches deep over all at center, ¾ inches thick over all at center, contains 925 pins and represents 10 square feet of surface.

Prices furnished on application.

## Bundy "Famous" Pipe Hanger.

### A FEW OF ITS ADVANTAGES :

1st. There is no bolts or nuts to be lost, or the nuisance of screwing or unscrewing nuts if desired to be removed.

2d. It is an expansion hanger having 2½ inches play for expansion, without the use of a roller on the bottom.

3d. It can be removed or replaced in an instant.

4th. The lag screws can be furnished any length, thus avoiding the use of couplings and pipe to lengthen them. The lag screws can be cut off and threaded, as the hangers are tapped for standard pipe threads.

FINALLY. It is made of Cast Iron, is cheaper, neater looking, and has more valuable points than any other article of its kind made, and should be used by every first-class plumber and pipe-fitter.

### PRICE LIST.

SIZE.	PIPE FOR HANGER.	1 in.	1½ in.	1½ in.	2 in.
Price	With Lag Screw 4 in. long,	18	20	22	25
"	" " " 6 "	19	21	23	26
"	" " " 9 "	20	22	24	27
"	" " " 12 "	21	23	25	28

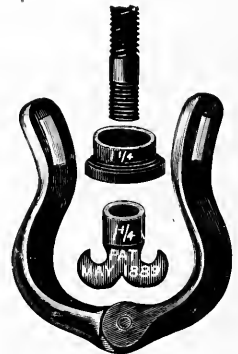

Discount to the Trade.

## Bundy Horizontal Indirect Radiator.

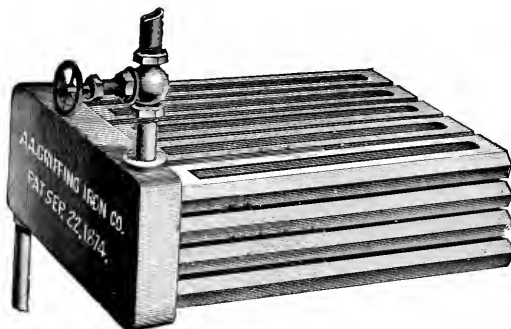

FIG. 12.

Fig. 12 represents a 4x5 Bundy Horizontal Indirect Radiator. These Radiators are adapted to either high or low pressure steam, and are made with the Standard, Enlarged, and Extended surface loop, and occupy less space with the same amount of surface than any other; often a very important point in the economy of space and material used in enclosing the Radiator.

The Old Ladies' Home, 104th Street, and 10th Avenue, New York, Brooklyn Savings Bank, Packer Institute, Brooklyn, are some of the buildings heated with these Radiators.

### FOR STANDARD OR ENLARGED LOOPS.

LIST OF HORIZONTAL INDIRECT RADIATOR.					STANDARD.		ENLARGED.	
NOTE.—We make the following sizes, but if more or less surface is wanted in each Stack, they can be made any size required. The length can be varied by substituting longer or shorter loops.					Each Loop Represents 3 Feet of Heating Surface.		Each Loop Represents 3½ Feet of Heating Surface.	
Shape of Radiators.	Number of Loops.	Depth of Radiators.	Width of Radiators.	Length of Radiators.	LIST PRICE.		LIST PRICE.	
					Per Foot, 67½c.	Per Loop, \$2.03.	Per Foot, 65c.	Per Loop, \$2.28.
					Feet of Heating Surface.	Price.	Feet of Heating Surface.	Price.
3 X 3	9	10 3/8"	10 3/8"	33"	27	\$18 23	31 1/2"	\$20 48
3 X 4	12	10 3/8"	13 3/8"	33"	36	24 30	42	27 30
4 X 3	12	14 1/4"	10 3/8"	33"	36	24 30	42	27 30
4 X 4	16	14 1/4"	13 3/8"	33"	48	32 40	56	36 40
4 X 5	20	14 1/4"	17 1/8"	33"	60	40 50	70	45 50
4 X 6	24	14 1/4"	20 3/8"	33"	72	48 60	84	54 60
4 X 7	28	14 1/4"	23 1/8"	33"	84	56 70	98	63 70
4 X 8	32	14 1/4"	26 3/8"	33"	96	64 80	112	72 80
4 X 9	36	14 1/4"	30"	33"	108	72 90	126	81 90
4 X 10	40	14 1/4"	33 1/8"	33"	120	81 00	140	91 00
5 X 3	15	17 3/8"	10 3/8"	33"	45	30 38	52 1/2"	34 13
5 X 4	20	17 3/8"	13 3/8"	33"	60	40 50	70	45 50
5 X 5	25	17 3/8"	17 1/8"	33"	75	50 63	87 1/2"	56 88
5 X 6	30	17 3/8"	20 3/8"	33"	90	60 75	105	68 25
5 X 7	35	17 3/8"	23 1/8"	33"	105	70 88	122 1/2"	79 63
5 X 8	40	17 3/8"	26 3/8"	33"	120	81 00	140	91 00
5 X 9	45	17 3/8"	30"	33"	135	91 13	157 1/2"	102 38
5 X 10	50	17 3/8"	33 1/8"	33"	150	101 25	175	113 75
6 X 3	18	21 1/4"	10 3/8"	33"	54	36 45	63	40 95
6 X 4	24	21 1/4"	13 3/8"	33"	72	48 60	84	54 60
6 X 5	30	21 1/4"	17 1/8"	33"	90	60 75	105	68 25
6 X 6	36	21 1/4"	20 3/8"	33"	108	72 90	126	81 90
6 X 7	42	21 1/4"	23 1/8"	33"	126	85 05	147	95 55
6 X 8	48	21 1/4"	26 3/8"	33"	144	97 20	168	109 20
6 X 9	54	21 1/4"	30"	33"	162	109 35	189	122 85
6 X 10	60	21 1/4"	33 1/8"	33"	180	121 50	210	136 50

All Regular Goods Tapped 1" x 3/4" "Right Hand,"

TRADE BUNDY MARK.

# Bundy Horizontal Indirect Radiator Stack.

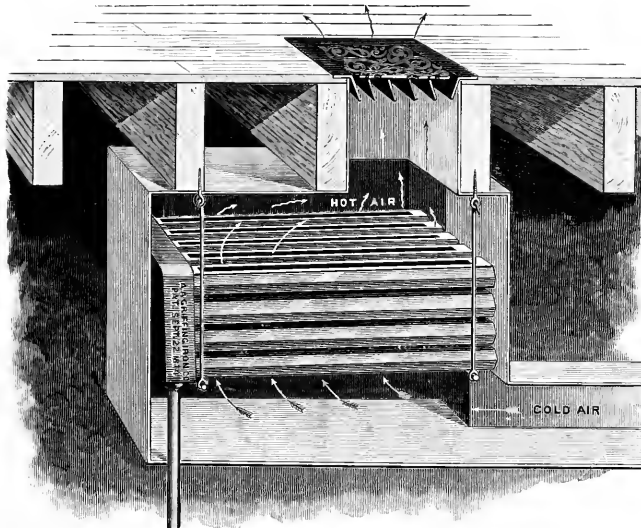

FIG. 12 $\frac{3}{4}$ .

FIG. 12 $\frac{3}{4}$  represents the Bundy Horizontal Radiator set up for indirect radiation. For description, see page 96.

TRADE BUNDY MARK.

# Bundy Horizontal Indirect Extended Surface Radiator.

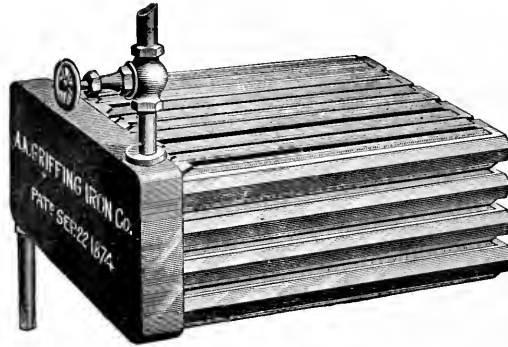

FIG. 12½.

FIG. 12½ represents a 4x5 Bundy Horizontal Indirect Radiator, with extended surface loops, giving 3¾ feet of heating surface to the loop, increasing the depth, and amount of heating surface the air has to pass over with the same number of loops.

## FOR EXTENDED SURFACE LOOPS.

LIST OF HORIZONTAL INDIRECT RADIATORS.						
NOTE.—We make the following sizes, but if more or less surface is required on each stack, they can be made any size required. The length can be varied by substituting longer or shorter loops.						
Each Loop Represents 3½ Feet of Heating Surface. LIST PRICE.—Per Foot, 60c. Per Loop, \$2.25.						
Shape of Radiators.	Number of Loops.	Depth of Radiators.	Width of Radiators.	Length of Radiators.	Feet of Heating Surface.	Price.
3 X 3	9	10⅝	10⅝	33"	33¾	\$20 25
3 X 4	12	10⅝	13⅞	33"	45	27 00
4 X 3	12	14¼	10⅝	33"	45	27 00
4 X 4	16	14¼	13⅞	33"	60	36 00
4 X 5	20	14¼	17⅞	33"	75	45 00
4 X 6	24	14¼	20⅞	33"	90	54 00
4 X 7	28	14¼	23½	33"	105	63 00
4 X 8	32	14¼	26¼	33"	120	72 00
4 X 9	36	14¼	30"	33"	135	81 00
4 X 10	40	14¼	33⅞	33"	150	90 00
5 X 3	15	17¾	10⅝	33"	56¼	33 75
5 X 4	20	17¾	13⅞	33"	75	45 00
5 X 5	25	17¾	17⅞	33"	93¾	56 25
5 X 6	30	17¾	20⅞	33"	112½	67 50
5 X 7	35	17¾	23½	33"	131¼	78 75
5 X 8	40	17¾	26¼	33"	150	90 00
5 X 9	45	17¾	30"	33"	168¾	101 25
5 X 10	50	17¾	33⅞	33"	187½	112 50
6 X 3	18	21¼	10⅝	33"	67½	40 50
6 X 4	24	21¼	13⅞	33"	90	54 00
6 X 5	30	21¼	17⅞	33"	112½	67 50
6 X 6	36	21¼	20⅞	33"	135	81 00
6 X 7	42	21¼	23½	33"	157½	94 50
6 X 8	48	21¼	26¼	33"	180	108 00
6 X 9	54	21¼	30"	33"	202½	121 50
6 X 10	60	21¼	33⅞	33"	225	135 00

All Regular Goods Tapped 1" X ¼" "Right Hand."

TRADE BUNDY MARK.

# Bundy Angle Indirect Extended Surface Radiator.

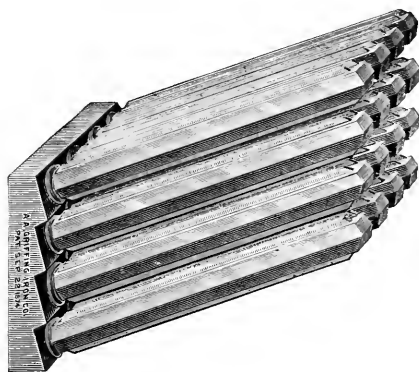

FIG. 13½.

FIG. 13½ represents a 4x4 Bundy Angle Indirect Radiator with Extended Surface Loops.

## FOR EXTENDED SURFACE LOOPS.

### LIST OF ANGLE INDIRECT RADIATORS.

NOTE.—We make the following sizes, but if more or less surface is required in each stack they can be made any size. The length can be varied by using longer or shorter loops.

Each Loop Represents 33½ Feet of Heating Surface. LIST PRICE.—Per Foot, 62c. Per Loop, \$2.33.

Shape of Radiator	Number of Loops.	Depth of Radiator.	Width of Radiator.	Length of Radiator.	Feet of Heating Surface	Price.
3 X 3	9	11½"	10½"	33"	33¾	\$20 93
3 X 4	12	11½"	13½"	33"	45	27 90
4 X 4	16	15½"	13½"	33"	60	37 20
4 X 5	20	15½"	17½"	33"	75	46 50
4 X 6	24	15½"	20½"	33"	90	55 80
4 X 7	28	15½"	23½"	33"	105	65 10
4 X 8	32	15½"	26½"	33"	120	74 40
4 X 9	36	15½"	30"	33"	135	83 70
4 X 10	40	15½"	33½"	33"	150	93 00
5 X 3	15	19½"	10½"	33"	50¼	34 88
5 X 4	20	19½"	13½"	33"	75	46 50
5 X 5	25	19½"	17½"	33"	93¾	58 13
5 X 6	30	19½"	20½"	33"	112½	69 75
5 X 7	35	19½"	23½"	33"	131¼	81 38
5 X 8	40	19½"	26½"	33"	150	93 00
5 X 9	45	19½"	30"	33"	168¾	104 63
5 X 10	50	19½"	33½"	33"	187½	116 25
6 X 3	18	23"	10½"	33"	67½	41 85
6 X 4	24	23"	13½"	33"	90	55 80
6 X 5	30	23"	17½"	33"	112½	69 75
6 X 6	36	23"	20½"	33"	135	83 70

All Regular Goods Tapped 1" X ¼" "Right Hand."

TRADE BUNDY MARK

# Bundy Angle Indirect Radiator.

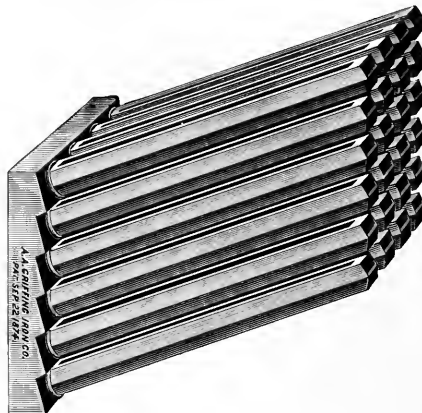

FIG. 13.

FIG. 13 represents a 6x4 Bundy Angle Indirect Radiator, with loops set at an angle of 22 degrees, securing a perfect circulation of steam, and return of condensation. The loops are placed indirectly over each other, evenly dividing up the air passing through the Radiator, and utilizing the heating surface of the loops. These Radiators are adapted to either high or low pressure steam, and are made with either the Standard, Enlarged, or Extended Surface Loops.

These Radiators are in use in the Lehigh University, Pa.; the High School, Lawrenceville, N. J.; at the Hudson River State Asylum, Poughkeepsie, N. Y., and give entire satisfaction.

## FOR STANDARD OR ENLARGED LOOPS.

LIST OF ANGLE INDIRECT RADIATORS.					STANDARD.		ENLARGED.	
NOTE.—We make the following sizes, but if more or less surface is required in each stack they can be made any size. The length can be varied by using longer or shorter loops.					Each Loop Represents 3 Feet of Heating Surface. LIST PRICE, Per Foot, 70c. Per Loop, \$2.10.		Each Loop Represents 3½ Feet of Heating Surface. LIST PRICE, Per Foot, 67½c. Per Loop, \$2.36.	
Shape of Radiators.	Number of Loops.	Depth of Radiator.	Width of Radiator.	Length of Radiator.	Feet of Heating Surface.	Price.	Feet of Heating Surface.	Price.
3 X 3	9	11 3/8"	10 5/8"	33"	27	\$18 90	31 1/2	\$21 26
3 X 4	12	11 3/8"	13 7/8"	33"	36	25 20	42	28 35
4 X 4	16	15 3/8"	13 7/8"	33"	48	33 60	56	37 80
4 X 5	20	15 3/8"	17 1/8"	33"	60	42 00	70	47 25
4 X 6	24	15 3/8"	20 3/8"	33"	72	50 40	84	56 70
4 X 7	28	15 3/8"	23 1/2"	33"	84	58 80	98	66 15
4 X 8	32	15 3/8"	26 3/4"	33"	96	67 20	112	75 60
4 X 9	36	15 3/8"	30"	33"	108	75 60	126	85 05
4 X 10	40	15 3/8"	33 1/8"	33"	120	84 00	140	94 50
5 X 3	15	19 1/4"	10 3/8"	33"	45	31 50	52 1/2	35 44
5 X 4	20	19 1/4"	13 7/8"	33"	60	42 00	70	47 25
5 X 5	25	19 1/4"	17 1/8"	33"	75	52 50	87 1/2	59 06
5 X 6	30	19 1/4"	20 3/8"	33"	90	63 00	105	70 88
5 X 7	35	19 1/4"	23 1/2"	33"	105	73 50	122 1/2	82 69
5 X 8	40	19 1/4"	26 3/4"	33"	120	84 00	140	94 50
5 X 9	45	19 1/4"	30"	33"	135	94 50	157 1/2	106 31
5 X 10	50	19 1/4"	33 1/8"	33"	150	105 00	175	118 12
6 X 3	18	23"	10 3/8"	33"	54	37 80	63	42 53
6 X 4	24	23"	13 7/8"	33"	72	50 40	84	56 70
6 X 5	30	23"	17 1/8"	33"	90	63 00	105	70 88
6 X 6	36	23"	20 3/8"	33"	108	75 60	126	85 05

All Regular Goods Tapped 1" X 3/4" "Right Hand."

TRADE BUNDY MARK.

## Bundy Angle Indirect Radiator Stack.

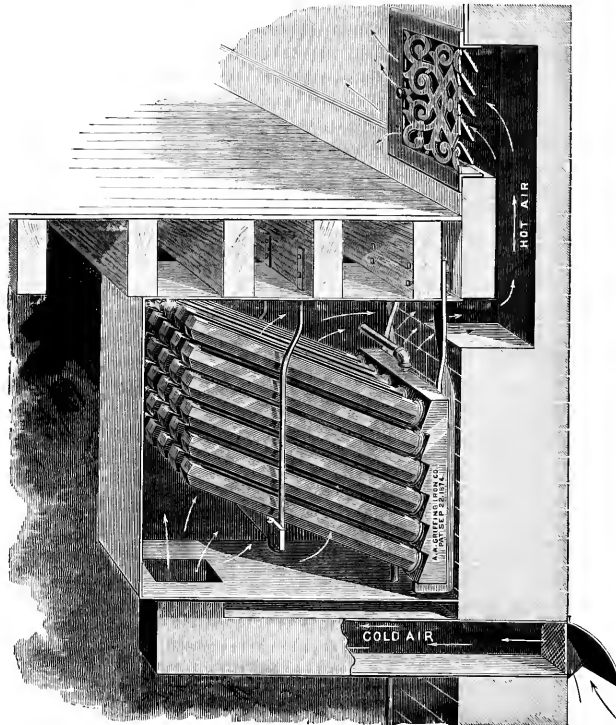

FIG. 14½.

FIG. 14½ represents the Bundy Angle Indirect Radiator with loops set at an angle. This form of Radiator has all of the advantages of a vertical tube Radiator in circulation as the air is easily expelled and the condensation has a free passage to outlet. The air to be warmed in passing through a stack of this kind is more thoroughly broken up and warmed than by any other on account of the double pipes. These Radiators are durable and efficient for high or low pressure steam. They were first used in the Hudson River State Asylum at Poughkeepsie, N. Y., in competition with other kinds of Indirect Radiators, where they gave such perfect satisfaction that they were approved and used in the recent additions to the heating apparatus in 1884-5.

With permission we publish the following testimonial :

HUDSON RIVER STATE ASYLUM, POUGHKEEPSIE, N. Y., February 26, 1883.

This is to certify that the Institution has used the Bundy Indirect Angle Radiators in the centre building for the last four or five years, and they give satisfaction in every way as an indirect heater, and would recommend them to those requiring steam heat for buildings.

WILLIAM C. ATKINSON, Chief Engineer.

TRADE BUNDY MARK.

# Bundy Climax Hot Water or Steam Indirect Radiator.

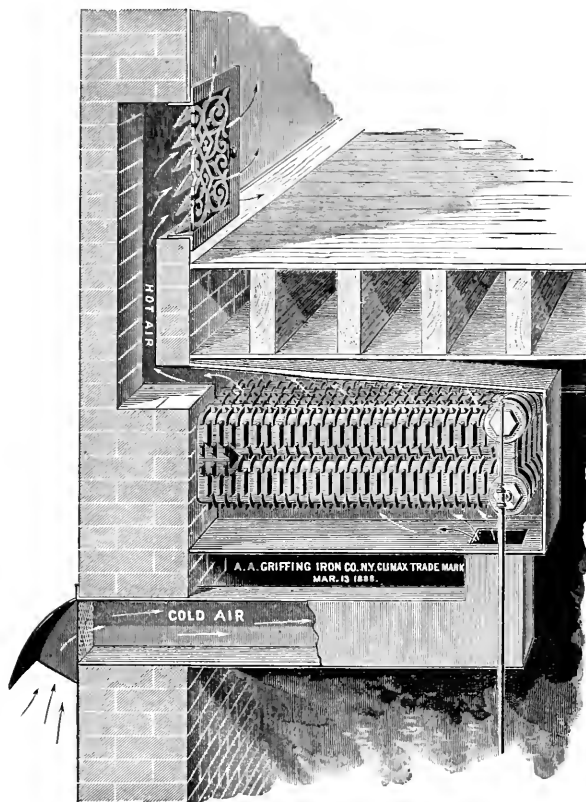

FIG. 27.

Fig. 27 represents the **Bundy Climax** Indirect Radiator for either Hot Water or Steam, High or Low Pressure, although it is specially designed for Hot Water, in which capacity it is not excelled by any other Indirect Radiator on the market. For cut of section see Fig. 28.

## CIRCULATION MOST POSITIVE AND UNIFORM.

Having larger openings throughout, and 2" connections between sections, above and below, which are from 60 to 80 per cent. larger than those found in most other Indirect Radiators, and having no diaphragms whatever, the circulation in the Climax is exceedingly positive and uniform.

## NO PACKED JOINTS, BOLTS, NUTS, RODS, WASHERS, Etc.

All joints are screw-thread connections, iron to iron, no packings, bolts, nuts, rods, washers, etc., being used anywhere; hence leaks of any kind very rarely if ever occur. As all sections are duplicates, they can be easily and quickly made into stacks, and there can be no possibility of a mistake being made in the selection of sections, for with our special tapping, patented in the United States and Canada, June 14, 1887, March 13, 1888, and Feb. 12, 1889, any section may be used as an intermediate, feed or return, and it makes no difference which end of the stack is connected for feed and which for return. The importance of these advantages are at once apparent to the practical man, and as all these features

are fully covered by American and Canadian Patents, which have cost a great deal of money, notice is hereby given that all users of devices infringing on these patents will be promptly prosecuted.

Although heating by Indirect radiation is not quite as cheap as by Direct, it can often be used to advantage where floor space cannot very well be had; and all Architects, Steam and Hot Water Engineers recognize the fact that the use of a certain proportion of Indirect radiation in every house heated by steam or hot water, either in the parlor, hall or dining room, is a valuable accession, for it admits fresh air that is positively heated.

The Bundy Climax Radiator is tested to 100 lbs. hydraulic pressure to the square inch, just prior to being shipped, and where the sections are made into stacks before shipping, and they are often ordered this way, they are tested twice, once in the section and again in the stack, when all joints are found to be absolutely perfect before being sent out. The Radiator is compact, occupying the minimum space, and has from 40 to 60 per cent. more plain surface, as compared with extended surface, than any other Indirect Radiator made. The fins are set "staggered," which together with the high efficiency of the Radiator prevents any air from passing into the rooms to be heated without first being perfectly warmed. The Radiator divides and sub-divides and stratifies the air so perfectly as to be usually adopted wherever a force fan is used to supply the fresh air. A specially designed bearing bar is cast on the under side of each section, running longitudinally, which facilitates very greatly the moving of the stack on the cross bars, as well as in transporting it from place to place.



TRADE CLIMAX MARK.

## Bundy Climax Hot Water or Steam Indirect Radiator.

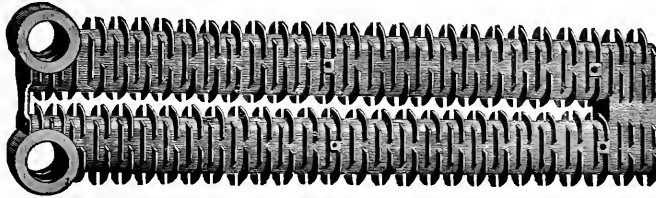

FIG. 28.

Fig. 28 represents a section of the **Bundy Climax** Hot Water or Steam Indirect Radiator. For cut of stack, showing setting, see Fig. 27.

### DIMENSIONS, HEATING SURFACE AND LIST PRICE.

Length of Section.	Height of Section.	Width of Section.	Heating Surface per Section.	List Price per foot.
36 inches.	11 inches.	3½ inches.	13 square feet.	50 cents.

### DATA FOR BUNDY CLIMAX HOT WATER OR STEAM INDIRECT RADIATOR.

Sections in Stack.	* Length of Stack.	Height of Stack.	† Width of Stack.	Feet of Heating Surface.	Area Cold Air Supply.	Area Hot Air Flue.	Size for Brick Work Hot Air Flues.	Size of Register.	Ratio of 1 to 30.	Ratio of 1 to 35.	Ratio of 1 to 40.
Number.	* Inches.	Inches.	† Inches.	Sq. Feet.	Sq. Inches.	Sq. Inches.	Inches.	Inches.	Cu. ft. heated.	Cu. ft. heated.	Cu. ft. heated.
1	3½	11	36	13	36	48	7 × 7	8 × 12	390	455	520
2	7	11	36	26	54	72	8 × 8	9 × 12	780	910	1040
3	10½	11	36	39	72	96	8 × 12	10 × 14	1170	1365	1560
4	14	11	36	52	90	120	8 × 12	12 × 15	1560	1820	2080
5	17½	11	36	65	108	144	12 × 12	12 × 19	1950	2275	2600
6	21	11	36	78	126	168	12 × 12	14 × 22	2340	2730	3120
7	24½	11	36	91	144	192	12 × 16	14 × 24	2730	3185	3640
8	28	11	36	104	162	216	12 × 16	16 × 20	3120	3640	4160
9	31½	11	36	117	180	240	12 × 20	16 × 24	3510	4095	4680
10	35	11	36	130	198	264	12 × 20	20 × 20	3900	4550	5200
11	38½	11	36	143	216	288	12 × 24	20 × 24	4290	5005	5720
12	42	11	36	156	234	312	12 × 24	20 × 24	4680	5460	6240

\* Length of stack refers to the total length found by multiplying the width of one section (3½") by the number of sections in the stack. This does not include the eccentric tapped bushings, which add 2' to the total length of the stack as given above. These figures may vary a trifle owing to the fact that some Fitters will draw the sections closer together than others in building them up, but the above is a fair average.

† Width of stack refers to the length of the sections.

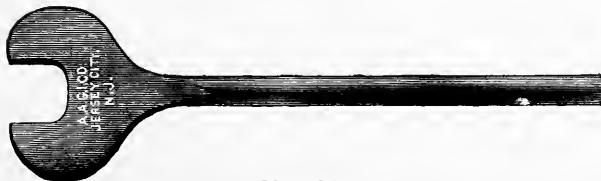

FIG. 28½.

Fig. 28½ represents the Wrench used in building the **Bundy Climax** and **Bundy Perfect** Sections into stacks. Every Fitter should have one of these handy tools in his kit, as well as a Bundy Loop Wrench, (see Fig 57).

Price, \$2.50 each.

TRADE CLIMAX MARK.

# Bundy Climax Steam or Hot Water Indirect Radiator.

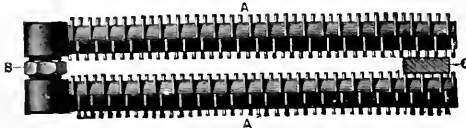

Fig. 27 1/2.



Fig. 27 1/4.

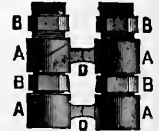

Fig. 27 1/2.

## INSTRUCTIONS FOR MAKING INTO STACKS.

In the accompanying cuts, A are Bundy Climax cast iron sections, B are connecting cast iron nipples, C are two hard wood wedges about 1x8 inches in size at their butt ends, and D are thin connecting strips of iron strengthening the sections to insure perfect casting and safe transportation.

Break the strip or iron (D) with a light blow of a hammer, then lay the section on its side and with the fingers start in the two nipples (B) about half a turn, then place the two wedges (C) one upon the other, as shown, and lay the second section so that the two holes tapped in it shall be directly over the nipples. Now adjust wedges (C) so that both ends shall be equidistant from each other. This being accomplished commence to enter nipples into the second section, and as they make together spread the wedges at the opposite end so that all parts of the second section shall advance toward the first at the same speed.

In screwing up the nipples, care should be used that each are turned alternately, and not more than one-half a turn at a time, thus avoiding any possible binding of the joints.

With two sections connected proceed as before with the third and so on until the stack contains the requisite number of sections.

As all sections are exact duplicates, should the stack in use prove too small, it is an easy matter to add to it another section. If, on the other hand, it is too large, a section can readily be removed.

When one stack is desired to heat two or more apartments and is placed at the base of two or more flues for that purpose, one or more pairs of longer nipples are furnished accommodating the division and subdivision of the stack by the insertion of tin partitions as necessary. This simple arrangement carries to a mathematical nicety the proper proportion of heat to each register and is an advantage fully appreciated by the trade, and of vital importance to the consumer. In this way one stack sufficeth for the heating of two, three and sometimes four or more apartments.

End view Bundy Climax Indirect Radiator Coil

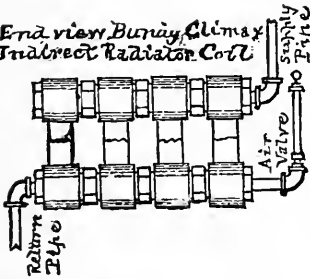

Fig. D.

## PROPER LOCATION OF AIR VALVE.

The location of the air valve depends upon the way the pipes lead to and from the radiator. The accompanying cuts will show the usual methods of piping and the proper location of the air valve in each case.

Too much importance cannot be attached to the use of a good, sensitive and durable air valve, and the one shown is of our own manufacture and highly endorsed. A further description of this air valve is found on a later page in this book under the heading of Automatic Air Valves. They are furnished for both Direct and Indirect Radiators.

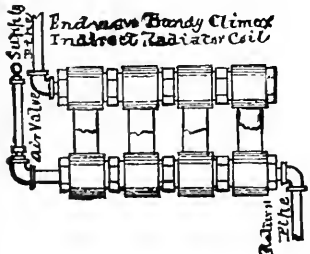

Fig. D.

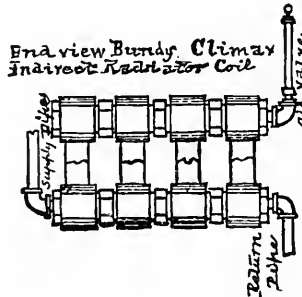

Fig. F.

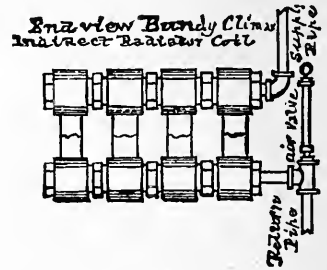

Fig. G.

TRADE PERFECT MARK.

## Bundy Perfect Steam Indirect Radiator.



FIG. 284.

FIG. 284 represents the **Bundy Perfect** Indirect Radiator for heating by High and Low Pressure Steam. For cut of section see Fig 284. It has larger openings than any other Indirect Radiator, and the sections are connected by 2" nipples. These, with many other advantages which this Radiator possesses, make the circulation in the Bundy Perfect absolutely positive and uniform, unexcelled by any other Radiator on the market. All who have used it or seen it tested are surprised at its perfect operation. The size of connections used in most other Indirect Radiators is 1½", which is wholly inadequate, and it is not an uncommon thing to find a Radiator with even a smaller connection than this. Now when one considers that a 2" nipple has 77.79 per cent. greater capacity than one 1½" in size, it will clearly be seen what advantages are secured by the use of the Bundy Perfect. When heating by low pressure or exhaust steam, or in starting circulation in very cold weather when condensation is very rapid, the liberal size of the connections in the Perfect (2") together with the fact that they are in a line and a trifle lower than the balance of the Radiator is a very important feature, for it allows a quick and natural exit for the waters of condensation. No smaller connections than 2" can accomplish this result, and a failure to do so causes the vexatious hammering and cracking noises prevalent where an inferior Radiator is used or the piping is not properly done.

### ALL SECTIONS ARE EXACT DUPLICATES.

In other words, there are no *head* or *tail* sections among them, or right and left intermediates, but all are exactly alike, and so there is no time lost in selecting them or the slightest possible chance of a mistake occurring in assembling the sections into stacks, for such a thing could not possibly happen. The word "inlet" is cast on the inlet side of each section, so that when the stack is complete one can tell at a glance which is the feed end and which the return, but it is a peculiar fact and worthy of mention, that practical use and tests have shown that should a stack of Bundy Perfect be fed from the return end that no difficulties would arise therefrom, nor the efficiency of the Radiator be impaired, the only difference being that in part of the Radiator the waters of condensation would flow in an opposite direction from that of the steam, but in a Radiator having such liberal sized openings as the Bundy Perfect, this does not matter. From the above it will be clearly seen that the Bundy Perfect is the simplest and most convenient Indirect Radiator made, and that it is impossible for a mistake to be made in connecting it up or setting it to place. Perfect drainage is secured without elevating one portion of the stack more than another, for it is so constructed as to secure this when set level. The waters of condensation flow in the same direction as the steam, its operation throughout being on gravity action. Particular attention is called to the specially designed bearing bar running longitudinally the full length of each section on its under side, which facilitates very much the handling of a stack after it has been made up. The practical Steam Fitter will appreciate this feature, for it enables him to move the stack with perfect ease on the cross bars, as well as to transport it from place to place.

### NO PACKED JOINTS, BOLTS, RODS, NUTS, WASHERS, Etc.,

are used in the Bundy Perfect Radiator, all joints being screw thread connections, iron to iron. There is but one connection between sections, therefore they can be very easily and quickly assembled into stacks of any required size, particularly so by following the instructions given with the goods, which explain how this can be done without counting in the threads as is generally the case where right and left hand nipples are used. A stack is also very quickly reduced to sections.

### GREATEST DURABILITY AND FREEDOM FROM LEAKS.

The fewness of joints in the Bundy Perfect, together with the fact that all are screw thread connections and are made by the latest and best of machinery, combine to make this the most durable and best radiator on the market for Indirect heating by Steam. Should it be desired to increase or diminish the size of any stack, sections can be quickly and easily added or subtracted, a feature highly desirable in any Radiator. This and all other special features found in the Bundy Perfect are fully covered by letters patent in the United States and Canada, dated June 14, 1887, and February 12, 1889. We caution parties not to use goods that infringe on our Patents, for our rights have cost us a great deal of money and we will hold infringers strictly accountable for damages.

TRADE PERFECT MARK.

## Bundy Perfect Steam Indirect Radiator.

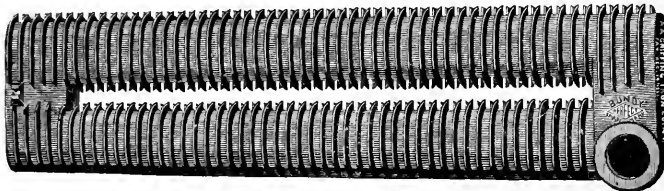

FIG. 28½.

Fig. 28½ represents a section of the **Bundy Perfect Steam Indirect Radiator**. For cut of stack see Fig. 28¼.

### ALL SECTIONS TESTED TO 100 LBS. HYDRAULIC PRESSURE.

All sections are tested to 100 lbs. hydraulic pressure to the square inch before being sent out, and when ordered built up into stacks, which is very frequently done, then they are tested twice, once in the section and again in the stack when the joints are also tested to see that they are perfectly tight. A leak of any kind rarely if ever occurs in this Radiator.

### DIMENSIONS, HEATING SURFACE AND LIST PRICE.

Length of Section.	Height of section.	Width of Section.	Heating Surface per Section.	List Price per Foot.
36 inches.	9½ inches.	3½ inches.	15 square feet.	45 cents.

### DATA FOR BUNDY PERFECT STEAM INDIRECT RADIATOR.

Sections in Stack.	Length of Stack.	Height of Stack.	Width of Stack.	Feet of Heating Surface.	Area Cold Air Supply.	Area Hot Air Flue.	Size for Brick Work Hot Air Flues.	Size of Register.	Ratio of 1 to 33.	Ratio of 1 to 35.	Ratio of 1 to 40.
Number.	Inches.	Inches.	Inches.	Sq. Feet.	Sq. Inches.	Sq. Inches.	Inches.	Inches.	Cu. ft. heated.	Cu. ft. heated.	Cu. ft. heated.
1	3½	9½	36	15	40	53	8 × 8	9 × 12	450	525	600
2	7	9½	36	30	60	80	8 × 12	10 × 14	900	1050	1200
3	10½	9½	36	45	80	107	8 × 12	12 × 15	1350	1575	1800
4	14	9½	36	60	100	134	12 × 12	12 × 19	1800	2100	2400
5	17½	9½	36	75	120	161	12 × 12	14 × 22	2250	2625	3000
6	21	9½	36	90	140	188	12 × 16	14 × 24	2700	3150	3600
7	24½	9½	36	105	160	215	12 × 16	16 × 20	3150	3675	4200
8	28	9½	36	120	180	242	12 × 20	16 × 24	3600	4200	4800
9	31½	9½	36	135	200	269	12 × 20	20 × 20	4050	4725	5400
10	35	9½	36	150	220	296	12 × 24	20 × 24	4500	5250	6000
11	38½	9½	36	165	240	323	12 × 24	20 × 24	4950	5775	6600
12	42	9½	36	180	260	350	14 × 24	24 × 24	5400	6300	7200

\* Length of stack refers to the total length found by multiplying the width of one section, (3½") by the number of sections in the stack. This does not include the eccentric tapped bushings which add 2" to the total length of the stack as given above. These figures may vary a trifle owing to the fact that some Fitters will draw the sections closer together than others in building them up, but the above is a fair average.

† Width of stack refers to length of sections.



FIG. 28¾.

Fig. 28¾ represents the wrench used in building the **Bundy Perfect** and **Bundy Climax** sections into stacks. Every Fitter should have one of these handy tools in his kit, as well as a Bundy Loop Wrench. (See Fig. 57.)

Price, \$2.50 each.

# The Eureka Straight Connection Steam Indirect Radiator.

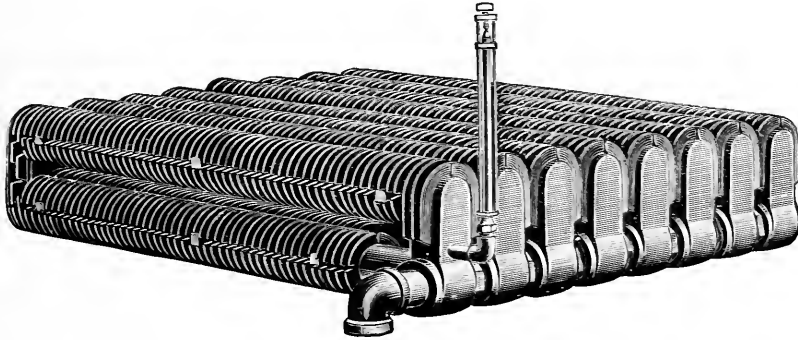

FIG. 93.

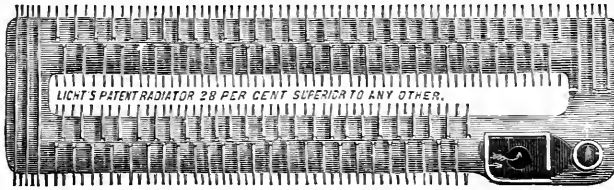

FIG. 94.

FIG. 85 represents a stack of the Eureka Indirect Radiator when set to place, and Fig. 86 a single section with one end cut away to show the direction taken by the steam in circulation. All sections are duplicates.

### AMOUNT OF HEATING SURFACE.

14 square feet per section.

### DIMENSIONS OF STACKS.

Total length of section.....36 inches.

Total depth of section.....  $7\frac{3}{4}$  "

Each section occupies, when made up in a stack,  $3\frac{5}{8}$  inches in width.

**NOTICE**—Always connect the Steam Feed Pipe to the right of stack as shown on cut. Tapped any size, right or left hand.

## Eureka Window Indirect Steam Radiator.

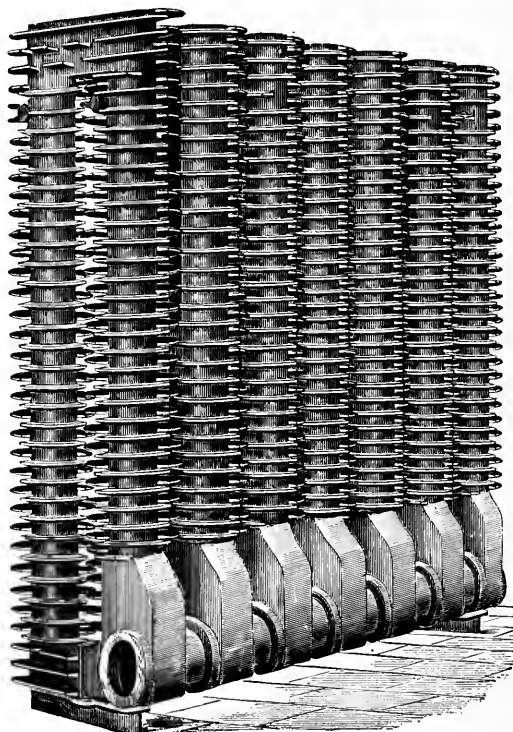

FIG. 87.

Fig. 87 represents the Eureka Window Indirect Steam Radiator which is furnished in four different heights, viz. : 20", 24", 30" and 36". It is set to place on specially designed feet, two inches high in the clear, which are easily and quickly fastened to the end sections.

This Radiator is specially adapted to that class of buildings where fresh air supply is required, and where it is not consistent to carry the flues to upper stories, as with Indirect proper. The Bundy Box Base Direct-Indirect Radiator, shown by figs. 24, 25 and 26, is used for the same purpose.

In front of the Eureka Window Radiator an open work screen of brass or iron can be set through which the heated air passes into the room. It is called a Window Radiator, owing to its special adaptation for use under windows, for which purpose the various heights made makes its very convenient. An opening in the wall or floor back of the Radiator allows for the inflow of fresh air.

### CAPACITIES AND DIMENSIONS.

20 inches high.	8 inches deep.	6 ft. per section.
24 " " "	8 " " "	8 " " "
30 " " "	8 " " "	11 " " "
36 " " "	8 " " "	14 " " "

Can be tapped any size, right or left hand.

TRADE BUNDY MARK.

Bundy Full Opening Radiator Valve.

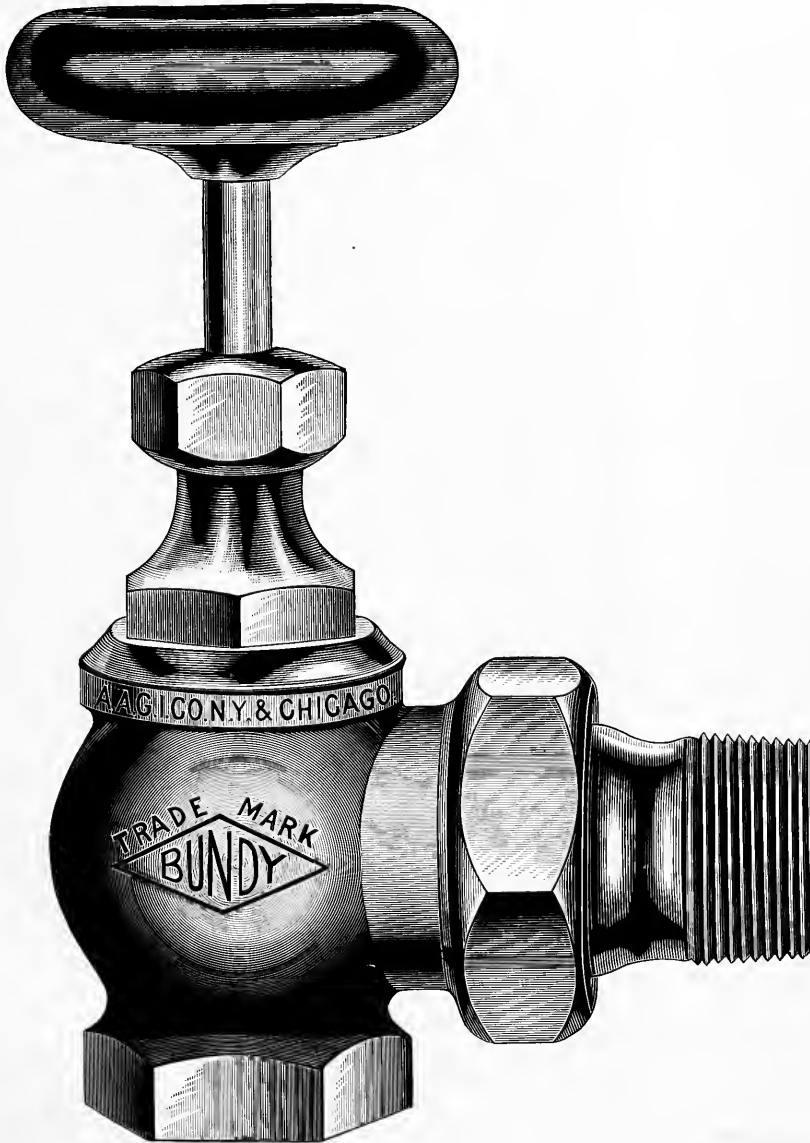

Best Steam Metal.

Improved Raised Disc.

Will not leak or get out of order. Guaranteed Jenkin's Disc. Greater weight of metal.

TRADE BUNNY MARK.

## Bundy Improved Full Opening Radiator Valve.

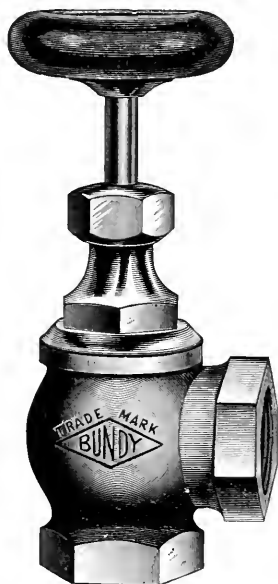

FIG. 89.

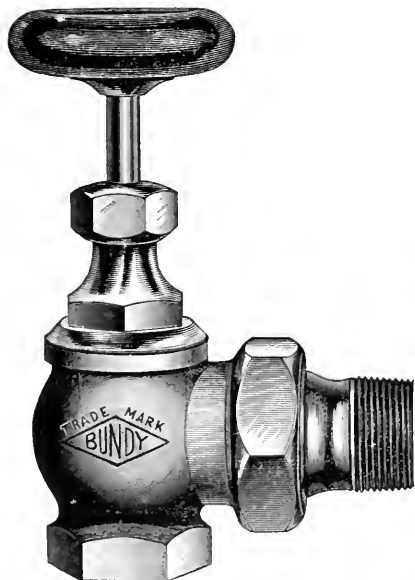

FIG. 90.

Figs. 89 and 90 represent the Bundy Full Opening Improved Radiator Valve. It does not pay to use an inferior valve, for a good one costs but a trifle more and the little difference you may have to pay does not amount to anything compared with the expense and annoyance incident to the use of a poor valve; one that leaks; does not close tightly and gets out of order all the time.

The Bundy Valve is not what is commonly known as a "fighting valve," one made light and cheap to undersell with, but is made as good as is possible to produce them. The metal used is the very best U. S. Government Standard Gun Metal which is the following formula:

Lake Superior Copper.....	88 parts.
Malacca Tin.....	10 parts.
Lead.....	1 part.
Zinc.....	1 part.
	100 parts.

This composition is guaranteed to not steam out. Many other makers of valves use house scrap consisting of plumber's cocks, old gas fixtures, railroad scrap, lamp tops and a general assortment of accumulated matter found in most dwelling houses. In such scrap more or less iron is always found and the unfortunate thing about it is, that when the valve is made up and nickel plated, the presence of iron and other inferior matter cannot be detected only by the short life of the valve and the continual trouble it gives by getting out of order. The only safe way is to buy a valve that is known to be good and the Bundy answers that description perfectly.

The Bundy Valve has a full opening allowing for the unimpeded passage of water and steam, and will outweigh most any other valve on the market from 8 to 16 oz., which, in valves, represents very nearly 15 per cent. of their value. The valve seat is raised and rounded so no dirt or sediment can lodge thereon injure it. The stuffing box is extra large allowing for more packing to be used, and as this is where many valves give out, the Bundy Valve should be used for this if for no other reason. The wood wheel handle is larger and a little higher than what is used in the majority of valves so in opening and closing the valve the danger of burning the palm is largely overcome.

### ARCHITECTS.

You will serve your interests best by specifying the Bundy Full Opening Improved Radiator Valves, and insisting on having them used. The word BUNNY in a diamond is cast plainly in the globe of every valve, (see cuts).



### LIST PRICES.

Size	1/2	3/4	1"	1 1/2	2	
Rough Body, Plain.....	1 35	1 60	2 25	3 25	4 50	7 00
.. .. Plated Trimmings.....	1 55	1 85	2 50	3 50	4 80	7 50
.. .. Plated all over.....	1 65	1 95	2 65	3 70	5 00	7 75
Finished .. Plain.....	1 85	2 15	2 85	4 00	5 50	8 50
.. .. Plated all over.....	2 15	2 50	3 25	4 45	6 00	9 25
Rough .. Plain.....	2 05	2 45	3 25	4 50	6 50	10 00
.. .. Plated Trimmings.....	2 20	2 60	3 35	4 90	6 65	10 25
.. .. Plated all over.....	2 40	2 85	3 65	5 05	7 10	10 85
Finished .. Plain.....	2 55	3 00	3 85	5 25	7 50	11 50
.. .. Plated all over.....	2 90	3 40	4 30	5 80	8 10	12 35
Rough .. Finished Trimmings.....	2 00	2 50	3 20	4 50	6 25	10 50
Finished all over.....	50	3 00	3 75	5 25	7 25	11 75
Rough Body, Plated Trimmings.....	2 25	2 70	3 50	4 75	6 50	10 75
.. .. all over.....	2 50	2 85	3 65	4 90	6 75	11 00
Finished and Plated all over.....	85	3 10	4 00	5 40	7 75	12 25
Rough Body, Finished Trimmings.....	2 75	3 50	4 30	5 85	7 75	12 60
Finished all over.....	3 20	4 00	4 80	6 40	7 75	13 85
Rough Body, Plated Trimmings.....	3 00	3 75	4 65	6 25	8 00	12 85
.. .. all over.....	3 20	3 80	4 75	6 40	8 10	13 10
Finished and Plated all over.....	3 25	4 25	5 25	7 00	9 25	14 35



TRADE BUNNY MARK

# AUTOMATIC Air Valves.

THIS Air Valve has but recently been offered to the Trade with the improvements that past experience in practical use for years has suggested.

It is very sensitive; is adapted to all kinds of work and is very superior for large Radiators where other air valves fail.

When once adjusted is not liable to get out of order owing to the peculiar construction of seat of valve and cannot be carelessly put out of adjustment. It commends itself therefore to Architects and Steam Fitters, and should be included in all steam-heating specifications.

SECTIONAL VIEW OF BAKER AUTOMATIC AIR VALVE



No. 1.  
CROSS SECTION.



No. 2.



No. 3.

FOR INDIRECT RADIATORS.

## PRICE LIST.

	No. 1.	No. 2.	No. 3
Bronzed, -	\$1.00	\$1.00	\$0.75
Plated, - -	1.25	1.25	1.00

MANUFACTURED BY

# A. A. GRIFFING IRON CO.

BAKER AUTOMATIC AIR VALVE



No. 1.  
FULL SIZE

TRADE BUNDY MARK.

## Bundy Safety Positive Pet Cocks.

Cannot be operated without the key. No child can tamper with it. No more soiled carpets. No more spoiled ceilings. No more damaged furniture.

Thousands of dollars are saved annually in the use of these Safety Pet Cocks, for the ordinary kind are so easily opened by a child or thoughtless person that great damage to property is liable to occur.

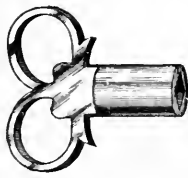

**KEY.**  
Fig. 55.

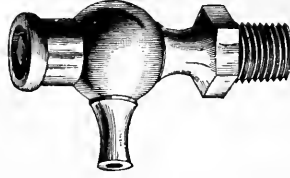

**PET COCK.**  
Fig. 56.

For hot water heating the Bundy Safety Positive Pet Cocks are almost indispensable. They are opened only at long intervals, and it is nice to know that when closed and the key put away they cannot be tampered with. Two nickel-plated keys are furnished with each dozen.

List price \$6.00 per dozen. Extra keys 15 cents each.

## PATTERSON'S IMPROVED PET COCK.

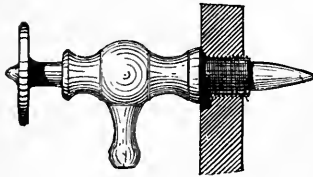

Fig. 91.

Can be used for both steam and hot water heating, but is specially designed for steam.

The water formed by the condensation of the steam in a radiator will adhere to the sides of the loops or sections, leaving the center entirely free from it, and it is on this principal that this air valve is made. The conical-shaped point projecting into the clear space exhausts the air from the radiator in a highly satisfactory manner. Then again, the conical-shaped point has a small opening,

which enlarges as it recedes from the point until it becomes full size of the valve opening, thereby reducing the velocity of the escaping air, which is another safeguard against the escape of water.

Fig. 91 represents the air valve screwed into a radiator.

Fig. 92 represents a cross section, giving size and shape of opening.

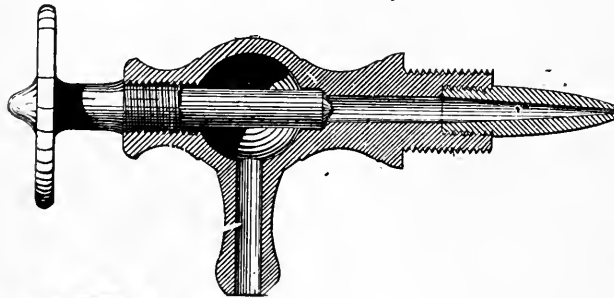

Fig. 92.

### LIST PRICES:

Nickel-Plated, Metal Handle, - - - - -	\$6.00 per dozen.
Nickel-Plated, Wood Handle, - - - - -	7.20 per dozen.

## BUNDY LOOP WRENCH.



Fig. 57.

Fig. 57 represents the Bundy Loop Wrench, used in connecting the Bundy Loops and Base. It is made of the best steel; will fit any style or height of Loop, and the hole in the top of the Wrench is made to take  $\frac{3}{4}$  inch bar iron. Users of the Bundy Radiator will find this a very handy tool to have, and every steam fitter should include one in his kit. List price \$3.00.



**BUNDY**

3/4 FULL  
OPENING

Radiator

Valve

MANUFACTURED BY

**A. A. GRIFFING IRON CO.**

General Office and Works:

430 COMMUNIPAW AVE.,

JERSEY CITY, N. J.

NEW YORK CITY, N.Y.,  
106 LIBERTY STREET.

CHICAGO, ILL.,  
130 DEARBORN STREET.

PHILADELPHIA, PA.,  
18-24 SOUTH 7TH STREET.

Please designate in your specifications and contract for heating as A. A. Griffing Iron Co.'s Bundy Full Opening Radiator Valve.



TRADE BUNDY MARK.

# Elite, Triumph and Climax Supplies.

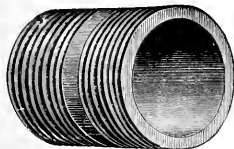

## ELITE AND TRIUMPH NIPPLE.

Fig. 45 represents the Nipple used in the Elite and Triumph Radiators. It is made of extra strong 2" wrought iron pipe, with carefully cut Right-Hand threads at both ends, and is as near perfect as the latest and most improved machinery can make them.

List Price, 35 Cents.

FIG. 45.

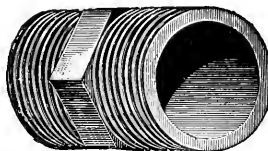

## CLIMAX NIPPLE.

Fig. 45 1/2 represents the Climax Nipple. It is made of cast iron, extra heavy, with carefully cut threads, Right-Hand on one end and Left-Hand on the other.

List Price, 35 Cents.

FIG. 45 1/2.

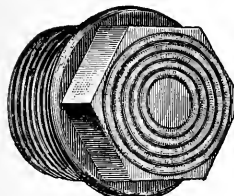

## ELITE, TRIUMPH AND CLIMAX PLUG.

Fig. 46 represents the Plug used in the Elite, Triumph and Climax Radiators. It is made of cast iron, extra heavy, with carefully cut threads, and is ornamental. All Elite and Triumph Plugs have Right-Hand threads, but half the Climax Plugs have R. H., and half L. H., threads. Unless otherwise ordered R. H. Plugs will always be sent. All plugs have 2" standard pipe threads.

List Price, 30 Cents.

FIG. 46.

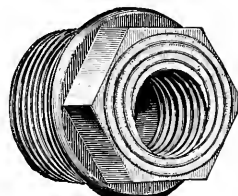

## ELITE, TRIUMPH AND CLIMAX BUSHING.

Fig. 58 represents the Bushing used in the Elite, Triumph and Climax Radiators. It is made of cast iron, extra heavy, with carefully cut threads, and is ornamental. All Elite and Triumph Bushings have Right-Hand threads entering the Radiator, but half the Climax Bushings have R. H., and half L. H., threads. Unless otherwise ordered R. H. Bushings will always be sent. All bushings have 2" standard pipe threads and reduce, with either R. H. or L. H. threads, to such size as may be specified, but when nothing is stated, one-half will be sent 2"x1", and half 2"x3/4", all R. H. threads. The smaller hole is tapped eccentric, insuring perfect drainage of the Radiator.

List Price, 35 Cents.

FIG. 58.

hole is tapped eccentric, insuring perfect drainage of the Radiator.

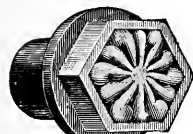

## ELITE TOP NUT.

Fig. 59 represents the Top Nut used in the Elite Hot Water Radiator. It is made of cast iron, extra heavy, and ornamental, and has carefully cut threads to fit the connecting rod, (Fig. 63,) which passes through the Radiator.

List Price, 25 Cents.

FIG. 59.

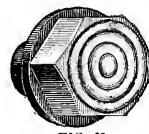

## TRIUMPH TOP NUT.

Fig. 60 represents the Top Nut used in the Triumph Hot Water Radiator. It is made of cast iron, extra heavy, and ornamental, and has carefully cut threads to fit the connecting rod, (Fig. 63,) which passes through the Radiator.

List Price, 25 Cents.

FIG. 60.

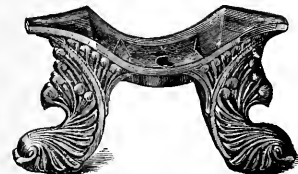

## ELITE AND TRIUMPH LEG.

Fig. 61 represents the Elite and Triumph Leg. It is made of cast iron, extra heavy, and ornamental, and can be attached to any Elite or Triumph section by use of a Hexagon Head Tap Bolt (Fig. 62)

List Price, 60 Cents.

FIG. 61.

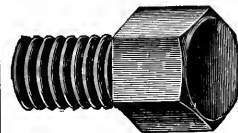

## HEX. HEAD TAP BOLT FOR ELITE AND TRIUMPH LEG.

Fig. 62 represents the Hexagon Head Tap Bolt used in fastening the Elite and Triumph Legs to the Radiator. They are made of the most refined iron, 1/2 inch diameter, and have carefully cut threads to fit the Radiator.

List Price, 10 Cents.

FIG. 62.



FIG. 63.



## ROD FOR HOT WATER ELITE AND TRIUMPH RADIATORS.

Fig. 63 represents the Rod used in the Hot Water Elite and Triumph Radiators. It is made of the best refined iron, 1/2 inch diameter, and has carefully cut threads to fit the Top Nuts, (Figs. 59 and 60).

List Price, per Section, 5 Cents.

In furnishing Elite and Triumph Radiators in sections, knocked down, ten sections will be considered a Radiator, and if for steam, NINE NIPPLES, TWO LEGS, TWO MACHINE SCREWS, ONE 1" R. H., AND ONE 3/4" R. H., ECCENTRIC BUSHINGS will be sent; if for hot water, NINE NIPPLES, TWO LEGS, TWO MACHINE SCREWS, TWO TOP NUTS, ONE ROD, AND TWO 1 1/4" R. H., ECCENTRIC BUSHINGS will be sent. Additional supplies will be charged for extra.

In furnishing the Climax Radiators in sections, knocked down, six sections will be considered a Radiator, and if for steam, TEN NIPPLES, TWO PLUGS, ONE 1" R. H., AND ONE 3/4" R. H., ECCENTRIC BUSHINGS will be sent; if for hot water, TEN NIPPLES, TWO PLUGS, AND TWO 1 1/4" R. H. ECCENTRIC BUSHINGS will be sent. Additional supplies will be charged for extra.

NOTICE.—All the features in these supplies are fully covered by United States and Canadian patents, and we caution parties not to infringe on our rights.

TRADE BUNDY MARK.

# Bundy Bronze Powder and Bronzing Liquid.

## BUNDY BRONZE POWDER.

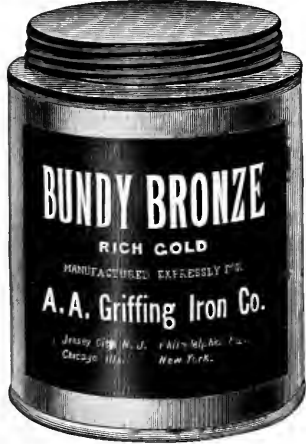

FIG. 79.

After repeated tests and experiments with all kinds and qualities of Bronze we take pleasure in offering the public our Bundy Bronze Powder, which we guarantee to be the best adapted of any for hot surfaces. All cheap Bronzes, and many of the more expensive brands, tarnish quickly, turning to a dull brass color as soon as heat is applied, but the Bundy Bronzes are manufactured expressly for use on hot Radiators and so retain their lustre perfectly. When a cheap Bronze is used the process of ornamentation requires frequent repetition, engendering loss of time and bronze; in fact the Bundy Bronze, originally applied, cost less and the Radiators always present an elegant appearance. Also, many Bronzes impair considerably a Radiator's efficiency, which is wholly avoided by using the Bundy Bronze. In ordering Radiators we can estimate the quantity of Bronze that will be required to ornament them, and, when requested, will do so, and forward all together, thus saving our customers extra transportation expense and the annoyance of writing a special order.

**\* SHADES OF BUNDY BRONZE. \***

\*PALE GOLD. GOLD COLOR. \*SILVER. \*COPPER. RICH GOLD. LEMON. GREEN. CRIMSON. GREEN GOLD. ORANGE. FLESH. FIRE.

\*GENERALLY USED.

**LIST PRICE.**

BUNDY EXTRA QUALITY BRONZE,	\$2.50 per lb.
BUNDY STAR BRONZE (Gold),	1.50 "
BUNDY STAR BRONZE (other than Gold),	2.00 "

All put up in one pound tin cans with full opening top and screw cover, so none is wasted by being blown away or spilled, as is apt to be the case when done up in paper.

**LIBERAL DISCOUNT TO THE TRADE.**

# BUNDY BRONZING LIQUID.

FIG. 54 REPRESENTS THE

## BUNDY BRONZING LIQUID,



FIG. 54.

WHICH UNLIKE ALL OTHERS, EMITS LITTLE OR NO ODOR WHEN APPLIED TO A HOT SURFACE, BEING STRICTLY PURE. IT IS AS IMPORTANT TO HAVE A GOOD BRONZING LIQUID AS GOOD BRONZE, AND THERE IS NONE SO PERFECT AS THE BUNDY BRAND.

PUT UP IN

Gallon, Half-Gallon and Quarter-Gallon Cans.

**PRICE, 3.00 PER GALLON.**

**DIRECTIONS FOR APPLYING BUNDY BRONZE.**

Place the Radiator, if possible, where it is to remain, when bronzed and see that it is free from dust, dirt, oil, rust or any unevenness, which may be removed with a cloth, piece of sand paper, or better still, emery paper or file. If convenient, a good method of removing oil from the Radiator is to admit steam when it will soon evaporate.

When the Radiator is thus prepared, give it a priming or sizing coat of very thin paint made of the best standard grade of white lead and turpentine or naphtha or any other volatile liquid. Mix this to about the consistency of water, and, unless silver bronze is used, stain it with a little yellow ochre. The point is to get as little and not as much paint on the Radiator as possible.

When the priming coat is thoroughly dry, mix the Bundy Bronze with the Bundy Bronzing Liquid in the proportion of about one pint of liquid to one pound of bronze, and apply evenly with a fine camel's hair brush, taking care to brush always in the same direction, either up or down, but never both. If convenient have the Radiator just warm while being bronzed and do not apply so much bronze that it will run. Do not mix more bronze than you will use at one time.

Ordinarily one pound of Bundy Bronze with a pint of Bundy Bronzing Liquid will cover 100 to 200 square feet of surface, but this depends upon the skill with which it is applied.

**TO APPLY BRONZE WHEN DRY.**

Give the Radiator, when barely warm, a medium thick coat of Bundy Maroon Laquer, and before it gets perfectly dry, apply the Bundy Bronze Powder with a Chamois skin or camel's hair brush. Rub the bronze on evenly making as light a coat as possible.

This method of applying bronze does not seem to give as general satisfaction as that where the Bronzing Liquid is used, as the latter can be successfully applied by a novice.



TRADE BUNDY MARK.

## Bundy Enamels Specially Prepared.

We confidently claim for our Specially Prepared Bundy Enamels, qualities of durability and handsome appearance found by experience not possessed by any others. Knowing so well the requirements of such goods we have incessantly striven to secure the standard of excellence which we have now attained, and parties desiring fine finishes for their radiators and pipes, for it is equally well adapted for application on wrought as cast iron surfaces, will do well to specify and use the Bundy Enamels, furnished in the following great varieties :

Bundy Sage,	Bundy Chocolate,	Bundy Gloss Maroon,
Bundy Flesh,	Bundy White,	Bundy Maroon,
Bundy Fawn,	Bundy Blue,	Bundy Slate,
Bundy Terra Cotta,	Bundy Bronze Green,	Bundy Black.

Unlike other paints and enamels, which retard the heating efficiency of the surface to which they are applied, the Bundy Enamels have no effect on the surfaces unless it be to increase their radiating power. This is an important matter, for a finish that reduces the heating power 10 to 25 per cent. would be dear at any cost.

The Bundy Enamels can be used with excellent effect in connection with bronze powder, that is, decorate the body of the radiator with the enamel, touching up the design in bronze. The Bundy Blue Enamel and Bundy Pale Gold Bronze make a beautiful combination, also Terra Cotta and Silver and Chocolate and Rich Gold, and many others.

The enamel comes mixed ready for application, and the quantity required, although depending largely on the skill of the party applying same, is about 1 gallon to 150 square feet of surface, which is a safe basis on which to figure.

In the above list of Bundy Enamels are two maroons—the regular Bundy Maroon Enamel and the Bundy Gloss Maroon Enamel, both of which have that rich color possessed only by maroon paints and enamels, but the latter has a gloss or lustre, being the only enamel possessing that quality, all the other enamels having what is known as a dull, “rubbed down” finish, adopted by most painters for the finest buildings.

The Bundy Enamels are put up in one-gallon, two-gallon or five-gallon cans, and as they do not deteriorate by standing, it is well for all steam and hot water fitters to keep a small supply of same continually on hand.

**List Price on all Colors, \$3.00 Per Gallon. Liberal Discount to the Trade.**

TRADE BUNDY MARK.

## Bundy Patent Adjustable Foot Rest.

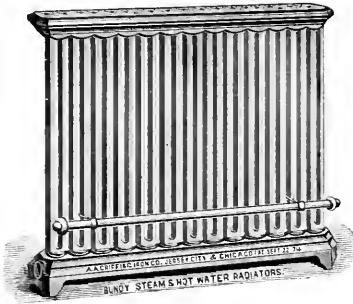

FIG. 88.

FIG. 88 represents **THE BUNDY FOOT REST** which will fit the Bundy Standard, Enlarged or Extended Loops, and can be raised or lowered at will, and can be firmly held at any desired elevation. It is furnished usually in heavy nickel plate, but bronze, copper or silver plate can be had if desired. It can be applied to the Bundy radiator for either Steam or Hot Water, having either one, two, three or four rows of loops, ranging from 3 to 26 loops in length.

### PRICE LIST.

Length of Radiator in Loops.	PRICE COMPLETE, in Nickel, Bronze, Brass or Copper Plate.	Length of Radiator in Loops.	PRICE COMPLETE, in Nickel, Bronze, Brass or Copper Plate.	Length of Radiator in Loops.	PRICE COMPLETE, in Nickel, Bronze, Brass or Copper Plate.
3 and 4	\$2.25	11 and 12	\$3.25	20	\$4.50
5 and 6	2.50	13 and 14	3.50	22	4.75
7 and 8	2.75	15 and 16	4.00	24	5.00
9 and 10	3.00	18	4.25	26	5.25



FIG. 89.

FIG. 89 represents the cast iron extension piece, two of which when placed on the Bundy Elite Radiator affords a rest for the marble top. Can be put on and removed at will. Unless the Radiator is very long two of these extension pieces are sufficient, but in the case of very long radiators it is well to use three, one in the centre.

List price 75 cents per pair.

By using the above extension pieces marble tops can be placed on any Elite Radiator at any time, and we give below list prices on some varieties, although as full a variety as is given on pages 118, 119 and 120 can be furnished. These prices are subject to same conditions as to thickness, style of edge, etc., set forth on the above mentioned pages.

Radiator.	Vermont (A).	Italian (B).	Knoxville (C).	Tennessee (D). Glees Falls (E).	Mexican Onyx (F).
2 Section.	\$1 00	\$1 20	\$1 60	\$2 00	\$6 00
3 "	1 25	1 50	2 00	2 50	7 50
4 "	1 50	1 80	2 40	3 00	9 00
5 "	1 75	2 10	2 80	3 50	10 50
6 "	2 00	2 40	3 20	4 00	11 00
7 "	2 25	2 70	3 60	4 50	12 50
8 "	2 50	3 00	4 00	5 00	14 00
9 "	2 75	3 30	4 40	5 50	15 50
10 "	3 00	3 60	4 80	6 00	17 00
11 "	3 25	3 90	5 20	6 50	18 50
12 "	3 50	4 20	5 60	7 00	20 00
13 "	3 75	4 50	6 00	7 50	21 50
14 "	4 00	4 80	6 40	8 00	23 00
15 "	4 25	5 10	6 80	8 50	24 50
16 "	4 50	5 40	7 20	9 00	26 00
17 "	4 75	5 70	7 60	9 50	27 50
18 "	5 00	6 00	8 00	10 00	29 00
19 "	5 25	6 30	8 40	10 50	
20 "	5 50	6 60	8 80	11 00	Price on Application.
21 "	5 75	6 90	9 20	11 50	" "
22 "	6 00	7 20	9 60	12 00	" "
23 "	6 25	7 50	10 00	12 50	" "
24 "	6 50	7 80	10 40	13 00	" "
25 "	6 75	8 10	10 80	13 50	" "
26 "	7 00	8 40	11 20	14 00	" "
27 "	7 25	8 70	11 60	14 50	" "
28 "	7 50	9 00	12 00	15 00	" "
29 "	7 75	9 30	12 40	15 50	" "
30 "	8 00	9 60	12 80	16 00	" "



TRADE BUNDY MARK.

## Bundy Improved Floor and Ceiling Plates.

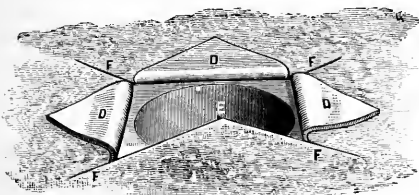

CARPET CUT FOR FLOOR PLATE.

Fig. 1.

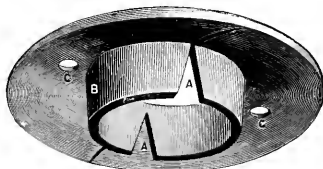

FLOOR PLATE.

Fig. 2.

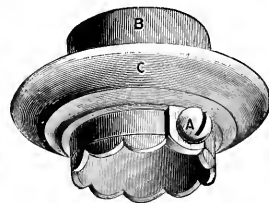

CEILING PLATE

Fig. 3.

The **Bundy Improved Floor and Ceiling Plates** possess advantages strongly commending their use and we solicit your orders.

FIG. 1 shows the carpet cut on the lines (F) exposing to view the hole (E) in which the sleeve (B) of the Floor Plate rests. The carpet points (D) are turned back and lie concealed in the concave part of the Floor Plate. This obviates all damage to the carpets, as the displaced parts perfectly resume their natural position when desired.

The Floor Plate, FIG. 2, is of cast iron and is usually set in one piece, however, when necessary, it can be easily broken by a blow from a hammer, owing to the two slots (A) in its sleeve. When so broken the fracture is irregular and fits so closely as not to be detected, the plate being held firmly in position by plain or nickel plated screws corresponding with its finish. These screws should pass through the holes (C) and lines (F) where the carpet is cut doing it no injury.

The Ceiling Plate, FIG. 3, is also of cast iron and has a set screw (A) which holds it in position. The sleeves (B) in both Ceiling and Floor Plates are of regulation length and thickness and are approved by all Insurance Underwriters.

### PRICE LIST.

SIZE IN INCHES.	$\frac{3}{4}$	1	$1\frac{1}{4}$	$1\frac{1}{2}$	2	$2\frac{1}{2}$	3	4
Floor Plates, Plain, . . . . .	\$ .11	\$ .14	\$ .16	\$ .18	\$ .21	\$ .25	\$ .30	\$ .37
" " Nickel Plated, . . . . .	.29	.32	.34	.36	.39	.43	.48	.55
Ceiling Plates, Plain, . . . . .	.20	.25	.29	.32	.38	.43	.50	.58
" " Nickel Plated, . . . . .	.40	.45	.49	.52	.58	.63	.70	.78



TRADE BUNDY MARK.

# Description of Marble Tops for Bundy Radiators.

In giving a description of these Marble Tops we wish to say a word regarding the difficulties encountered in attempting to convey a correct idea of their appearance. We have given a general idea as to their color, to assist our customers and friends in their selection of appropriate Tops for different rooms, but Marble will frequently, when cut and polished, become darker or lighter than the one from which our description is taken.

We have the finest line of Marble that has ever been produced by any manufacturer, and having made special arrangements for importation, we can furnish at a large saving rare specimens of Marble Tops not obtainable from any other source. We have made our prices low, believing that larger sales will compensate us for so doing.

Please bear in mind that all Marble is not adaptable for Radiators as they will not stand the heat, and this is strong argument why the Tops should come from us, besides thus avoiding any possibility of misfit, which in Marble Tops is especially annoying.

**Vermont (A) Milk White.** Skirting the western slope of the Green Mountains, in the vicinity of Rutland, Vermont, is found a rare specimen of *milk white* marble interspersed with fine, barely distinguishable, grayish veins and spots. This marble so closely resembles the Italian that only an expert can detect the difference. Both stand the heat well, but the Italian is the harder marble and takes a higher polish and is not so susceptible to discoloration, hence it is better for Radiator Tops, but the Vermont is excellent for bed chambers and rooms of that character.

**Italian (B) Blue White.** This beautiful *blue white* marble is found in Italy in the well-known Carrara Quarries of sculptural fame. It is unquestionably a better marble than that used by any other house furnishing Marble Tops for Radiators. One block of Carrara Marble may be sent to the sculptor to receive his cunning handwork in the form of some statuette and the next block go to be wrought into Tops for Bundy Radiators. The chaste whiteness of our Italian Marble is its cardinal feature, and its well-known adamantine hardness takes a high polish and makes it less preagnable to stains of any description.

**Knoxville (C) Pink.** At the base of the Cumberland Mountains in Knox County, Tennessee, occupying a large bend in the Tennessee River, is the Great Bend Quarry, which gives as a rare specimen of *pink* colored Marble, thoroughly mixed with fine spots of white crossed with chance veins of the same color or gray, or even both. This is the Knoxville Marble, which is used in all classes of rooms, but more particularly in bed chambers on account of its low prices.

**Tennessee (D) Brownish Red.** In the northern range of the Cumberland Mountains of Tennessee, is found a Marble of such harmoniously blended colors as to once attract public attention and gain favor. This is the Tennessee Marble. We secure our supply from the well-known Hawkins' Quarry, noted because its Marble has fast colors, unbleachable in the sunlight. This is a very important point to the user. Its predominant color is a rich, mottled pink, with spots and veins of crystallized white, which, blending with the red, takes on a sort of brownish hue. Perhaps more of the Tennessee Marble is used than any other as it is both cheap and serviceable and takes a very high polish.

**Glens Falls (E) Jet Black.** One of the grandest Marbles to be found anywhere is the Glens Falls found in the foot hills of the famed Adirondack Mountains. Its color is a *jet black*, resembling very closely the imported Belgium Black, especially when given a French polish. It is an excellent Marble, both for Radiator Tops and Bases, especially the latter, where its dark color gives an appearance of special elegance.

**Mexican Onyx (F) Pearl White.** This beautiful Marble is purely of a volcanic formation, originating in a violent eruption of the Volcano Popocatepetl, after which the golden quartz, which had been reduced to a white heat, solidified, becoming a semi-transparent mass of rare beauty. Of all the different Onyx that from the Tzucal Quarry, situated 35 miles from the City of Mexico, is conceded by connoisseurs to be the best, and it certainly is the most richly endowed with natural beauty. Arrangements having been made for the importation of this special marble, we offer our customers the rarest Mexican Onyx Tops at a comparatively low price. As Onyx is so well known and so highly prized by the public, and as many eminent connoisseurs have passed their favorable verdict on our Onyx, we feel confident in pleasing our customers. The striking ice-like appearance of our Onyx shows the different lines of sculpting colors, which under varying circumstances give forth the prismatic colors of the rainbow. No Marble is better adapted than Onyx to surmount a Bundy Radiator in a Parlor, Drawing or Reception room of Renaissance, Oriental, Arabesque or Moorish style of furnishing.

**Opalite (G) Green and White.** This Marble is often called Verd-Antique, as its green color gives it an appearance of antiquity. It takes its name from the Latin word opalites, meaning a serpent and is found in the renowned quarries of Mortain. It is a serpentine Marble, with its predominant color *dark green* thoroughly mixed with white, making it resemble granite in figure. Its mottled design is occasionally varied by a greenish black spot, entire or by a green of darker hue, and the blending of all the colors gives an air of mystery and variety of design.

**Italian Dove (H) Light Blue.** Sometimes called *Blue Turquin* owing to its delicate tint of sky blue. It is found in small quantities skirting the Carrara Quarries from which our White Italian Marble is taken. It has occasional dark blue veins running through the *blue*, which by contrast heightens very much its general appearance. It takes a very high finish and is an excellent Marble for a bedroom.

**Royal Red (I) Brownish Red.** This beautiful Marble is also called Rouge Royal owing to its peculiar fascination with the English Royal Family. When first discovered the crown had absolute control of the quarries and for many years the Marble could not be had by any but the Nobility. Our supply is taken from the Visé Quarries near Brussels, Belgium, which is reputed as having the finest specimens. The Marble has the colors *red, brown, drab* and *white*, but the prevailing color which strikes the eye is the *Royal Red*, the color of the English Flag.

**Aurania (Grotto) (J) Dark Drab.** The Alps of Switzerland and Eyrenee of France both contain rare specimens of Aurania Grotto, but by far the choicest specimens are from the Auranian Quarries in Switzerland. The word Grotto means mottled, and so the Marble has a great variety of colors, but that which predominates is *crystal white*, with a few spots of *crystal blue*, *red*, and *spots* of crystallized white, all of which colors are so harmonious as to render the Marble difficult to describe. It should be seen to be appreciated. There is no color strong enough to become offensive, but blending with the *drab* are the colors *red, purple, white*, and *gray*, making a Marble of exquisite beauty.

**Eschalon (K) Light Yellow.** Fringing the Rhone River in France is found the Eschalon Marble. Its color is lighter *yellow* than the Sienna, running more into the gray, which assumes such form as to resemble large shells. This Marble is very largely used in the Public Buildings of Paris, and is also extremely popular among the Spanish Nobility.

**St. Anne (L) Dark Drab and White.** The St. Anne Marble is from the Sambre Quarries, near Liege, Belgium. While all Belgium Marbles are hard, this is the hardest of any, and so is largely used for tiling and flooring purposes in the palaces of foreign countries. Its prevailing colors are *dark drab* and *white*. The drab color, which varies in intensity, is thoroughly intersected by the lines of white. It takes a very high polish and is a magnificent Marble for any apartment, especially a hall or dining room.

**Napoleon (M) Dark Fawn.** The Napoleon Marble is taken from the Rnpel Quarry, near Aatwerp, Belgium. Its color is a *dark fawn*, interspersed with crystallized white veins and intersecting light lines of blood red and golden yellow. It is a handsomely colored Marble and having a neutral tint is appropriate with any style of furnishing.

**Joainville (N) Gray.** The Joainville Marble which is very rarely seen in this country, being found only in very small quantities in the Joainville Quarry of Belgium, is of a light *gray* color with intersecting lines of red and white. This Marble should be seen to be appreciated. It is hard and susceptible of a very high finish.

**Lorraine (O) Light Fawn.** The Lorraine Marble is found in the foothills of the Pyrenees Mountains in Southern France. It has a delicate *light fawn* color, slightly flecked with spots of beautiful pearl and black. As a neutral tint it can be used with good effect, but its low color makes it especially desirable for bed-chambers and kidred apartments.

**Belgium Black (P) Black.** This Marble is found in the Garonne Quarries, in the southern part of Belgium. It has a rich, velvety *black* color, which gives it the appearance of elegance and is a good Marble for either Radiator tops or bases, especially the latter. Its rich color is no doubt largely due to the high polish which it takes.

**Griotte (Q) Blood-red.** This Marble is found at the base of Mt. Veauvius, near the city of Naples, Italy. As its name implies the Griotte Marble has a mottled appearance. The principal colors are *red* and *black*, while occasionally crystallized white eyes, or veins, may be found running through it. It is one of the handsomest Marbles of the world, the Quarry from which our supply is taken is conceded to be the best in the world.

**Numedian (R) Rose.** This is probably one of the oldest Marbles known, as history shows that as far back as B. C. 77 the ancient Romans raised a 30 foot column of Numedian to the memory of Cæsar in the Forum. The Marble is secured at great hazard, as to reach the quarries some of Africa's most dangerous jungles must be penetrated, which are infested with wild animals of every description. It is certainly a historic Marble and every Top has a story to tell touching on the adventures encountered in its perilous journey. The Marble has a rich and delicate *rose* color, made more beautiful, if possible, with resplendent veins of yellow and chance spots and veins of black lined with a *rose* tint of lighter hue.

**Alps Green (S) Dark Green.** The frowning peak of Mt. Blanc in the Alps of Switzerland, which is our supply of Alps Green is taken. This Marble is sometimes called *Vert Alps* and *Vert Antique* owing to its color and the mountain from which it is cut. It has a *dark green* color uniformly veined with white, and although a very popular Marble in Europe it has not until now been imported into this country to be used as Tops for Bundy Radiators. It is an exceptionally fine Marble for a green room.

**Sienna (T) Gold.** All the golden sunshine of sunny Italy seems to have entered this beautiful Sienna Marble. Discovered accidentally by the Good Sisters of Sienna, it was used by them in building the celebrated Sienna Cathedral, which, when completed standing in the sunlight resembled a golden palace. The quarries are still controlled by these Good Sisters of Charity and the handsome revenue obtained from the sale of the Marble is wholly used in their charitable work. The predominant color is gold with delicate veins of pearl and purple running through it, and even the yellow gold color has different shades to assist the general harmony. This is one of the handsomest Marbles known, and looks well wherever used, especially in a light, sunny room.

**St. Beaume (U) Gold and Dove.** This Marble is taken from the renowned Tortosa Quarry in the Pyrenees of France. It takes its name from the *Patron Saint Beaume*, which was given to it by the people who used it largely in building the Ancient Monasteries and Cathedrals of France, which to-day are standing, living monuments of the enduring properties of this magnificent Marble. It is richly endowed with *gold* and *dove* colors well mixed, with occasional spots of pink and crystallized white, and light, scarcely noticeable, veins of purple. A Bundy Radiator setting upon a Belgium Black base and surmounted with one of these Tops is well suited for any of the handsome rooms in our modern houses.

**Famossa (V) Dark Purple.** Throughout the Rhenish Provinces in Germany is found the Famossa Marble, but the finest specimens those having the richest color, are taken from the Essen Quarry from whence comes our supply. This Marble is used largely in the Palaces of the venerable Kaiser William, hence its popularity throughout all Germany. It is more largely used in the houses of the German Nobility than any other Marble. It is curiously formed, so much so that it is difficult to describe, but its predominant color is *dark purple* which reminds one of the purple robes worn by the nobility in their regal splendor.

**Lavanto (W) Sage Green.** Italy is so famous for its blue white Marble that the impression has gone out that it furnishes none other, but situated near the time-honored city of Florence is the Lavanto Quarry producing a most beautiful Marble bearing the same name. The prevailing color is *sage green* largely figured with bright cherry spots and intersecting white veins. It is an excellent Marble, and although very small quantities of it have been imported to this country, it is used very extensively by the Italians and throughout all Europe.

TRADE BUNDY MARK.

# Marble Tops for Bundy Steam or Hot Water Radiators.

These Tops are made of the very best marble; are  $\frac{7}{8}$  inch thick; have bevel or O. G. edge, and project over the Radiator binder  $\frac{3}{4}$  inch all around. To make sure that you get Tops that fit the Radiator perfectly and to guard against the use of inferior marble, order of us according to this list. The Tops can be sent with the Radiators, thus saving freight, as we keep a general assortment of sizes continually on hand.

RADIATOR.	(A.) VERMONT.	(B.) ITALIAN.	(C.) KNOXVILLE.	(D.) TENNESSEE.	(E.) GLENS FALLS.	(F.) MEXICAN ONYX.
1 x 3	\$ .90	\$1.05	\$1.55	\$1.75	\$1.75	\$4.00
1 x 4	1.05	1.25	1.75	2.05	2.05	4.60
1 x 5	1.20	1.40	2.05	2.30	2.30	5.20
1 x 6	1.35	1.60	2.30	2.65	2.65	6.00
1 x 7	1.50	1.80	2.50	2.90	2.90	6.20
1 x 8	1.80	2.10	3.10	3.50	3.50	7.50
1 x 9	1.95	2.30	3.25	3.85	3.85	8.20
1 x 10	2.10	2.50	3.50	4.20	4.20	8.80
1 x 11	2.35	2.75	3.80	4.55	4.55	9.40
1 x 12	2.55	3.00	4.15	5.00	5.00	10.00
1 x 13	2.70	3.15	4.50	5.60	5.60	12.00
1 x 14	2.85	3.35	4.80	6.15	6.15	13.00
1 x 15	2.95	3.45	5.00	6.30	6.30	13.50
1 x 16	3.10	3.60	5.45	6.60	6.60	14.00
1 x 18	3.40	3.95	5.95	7.20	7.20	15.40
1 x 20	4.00	4.65	6.50	8.00	8.00	Special price.
1 x 22	4.40	5.10	7.00	8.80	8.80	"
1 x 24	4.90	5.70	7.90	9.80	9.80	"
1 x 26	5.00	6.00	8.05	10.25	10.25	"
2 x 3	1.25	1.60	2.40	3.00	3.00	6.00
2 x 4	1.50	1.75	2.65	3.25	3.25	6.50
2 x 5	1.95	2.30	3.15	3.85	3.85	8.00
2 x 6	2.15	2.55	3.60	4.40	4.40	9.00
2 x 7	2.40	2.80	3.95	4.85	4.85	10.00
2 x 8	2.80	3.25	4.50	5.45	5.45	12.00
2 x 9	3.00	3.45	4.85	5.95	5.95	12.75
2 x 10	3.30	3.85	5.25	6.50	6.50	13.50
2 x 11	3.35	4.15	5.70	6.95	6.95	14.50
2 x 12	3.85	4.50	6.15	7.55	7.55	16.00
2 x 13	4.05	4.75	6.60	8.05	8.05	17.00
2 x 14	4.35	5.10	7.00	8.60	8.60	18.75
2 x 15	4.65	5.45	7.55	9.10	9.10	22.00
2 x 16	4.90	5.70	7.90	9.65	9.65	25.00
2 x 18	5.55	6.50	8.95	10.95	10.95	Special price.
2 x 20	6.00	7.00	9.75	11.90	11.90	"
2 x 22	6.60	7.70	10.50	12.95	12.95	"
2 x 24	7.55	8.25	11.40	14.00	14.00	"
2 x 26	7.80	9.10	13.15	16.20	16.20	"
3 x 3	1.80	2.10	3.00	3.60	3.60	8.00
3 x 4	2.10	2.45	3.45	4.15	4.15	9.00
3 x 5	2.40	2.80	3.85	4.75	4.75	11.00
3 x 6	2.85	3.35	4.75	5.70	5.70	14.00
3 x 7	3.15	3.70	5.10	6.30	6.30	16.00
3 x 8	3.45	4.05	5.60	7.00	7.00	18.00
3 x 9	3.90	4.65	6.30	7.70	7.70	20.00
3 x 10	4.20	4.90	6.85	8.35	8.35	22.00
3 x 11	4.60	5.35	7.35	9.10	9.10	24.00
3 x 12	5.10	5.95	8.35	10.10	10.10	26.00
3 x 13	5.55	6.50	9.10	11.15	11.15	28.00
3 x 15	6.00	7.00	9.75	11.85	11.85	Special price.
4 x 4	2.65	3.10	4.40	5.50	5.50	12.00
4 x 5	3.10	3.60	5.00	6.05	6.05	14.00
4 x 6	3.60	4.15	5.60	7.00	7.00	16.00
4 x 8	4.45	5.20	7.10	8.75	8.75	30.00
4 x 10	4.90	5.75	7.90	9.75	9.75	34.00
4 x 11	7.05	8.25	11.55	14.00	14.00	41.00
4 x 18	8.10	9.45	13.15	15.95	15.95	51.00
4 x 20	9.00	10.50	14.35	17.95	17.95	Special price.
4 x 22	10.80	12.60	17.50	22.75	22.75	"
4 x 24	12.00	14.00	19.25	24.50	24.50	"
10 Circular	2.65	3.10	4.20	5.25	5.25	12.00
15 "	3.25	3.80	5.10	6.30	6.30	14.00
20 "	3.75	4.40	6.05	7.45	7.45	17.00
26 "	4.60	5.35	7.55	9.10	9.10	22.00
34 "	6.25	7.30	10.15	12.10	12.10	38.00
50 "	8.25	9.65	13.40	16.45	16.45	40.00
74 "	10.20	11.90	16.65	21.00	21.00	60.00
20 Column.	5.35	6.25	8.60	10.50	10.50	24.00
34 "	7.50	8.75	12.25	14.90	14.90	36.00
50 "	10.15	11.85	16.65	20.15	20.15	50.00
10 Corner.	1.80	2.10	3.00	3.60	3.60	8.00
15 "	2.25	2.65	3.50	4.40	4.40	10.00
20 "	3.00	3.50	4.90	6.00	6.00	14.00

**Black Glen Falls Tops** with a very high polish known as French Polish, add **25** per cent. to above prices.

**Cutting Hole** in Tops for Column Radiators **\$1.00** net will be charged extra in each case.

**Marble Tops, 1 inch thick**, add to above prices **15** per cent.;  $1\frac{1}{2}$  inches thick, **35** per cent.

**Marble Bases, 7/8 inch thick** (excepting Onyx), add for 1 row, **35** per cent.; 2 row, **25** per cent.; 3 row, **20** per cent.; 4 Row, Circular, Corner and Column, **15** per cent.



TRADE MARK.

# Marble Tops for Bundy Steam or Hot Water Radiators.

These Marble Tops are specially designed for *Renaissance, Moorish, Arabesque, Oriental* and *Queen Anne* rooms, and the variety is so great that Tops can be had which harmonize perfectly with the furnishing of any apartment. A full description of each marble is given on another page, and for convenience in ordering, they may be designated by letter: For example "J" would mean "*Aurania Griotte*," etc. All Tops are  $\frac{3}{8}$  inch thick, unless ordered otherwise (see bottom of page): have rounded or chamfered edge; project over the Radiator binder  $\frac{3}{4}$  inch all around; fit the Radiator perfectly, and the Marble is of the very best quality, all of which should be convincing arguments why the tops should come from us, thus avoiding all danger of misfits, besides procuring, at a moderate cost, specimens of Marble which are extremely rare.

RADIATOR.	OPHITE (C).	ITALIAN DOVE (H).	ROYAL RED (J).	ST. ANNE (L).	BELGIUM BLACK (P).	SIENNA (T).
			AURANIA GRIOTTE (J).	NAPOLEON (M).	GRIOTTE (Q).	ST. BEAUME (U).
			ECHALEON (K).	JOINVILLE (N).	ROSE NUMEDIAN (R).	FAMOSA (V).
				LORAINE (O).	ALPS GREEN (S).	LAVANTO (W).
1 x 3	\$2.30	\$2.45	\$3.75	\$3.75	\$4.25	\$4.25
1 x 4	2.55	2.80	4.25	4.25	4.75	4.75
1 x 5	2.90	3.20	4.75	4.75	5.50	5.50
1 x 6	3.25	3.60	5.50	5.50	6.25	6.25
1 x 7	3.40	3.75	5.75	5.75	6.50	6.50
1 x 8	4.15	4.60	7.25	7.25	8.50	8.50
1 x 9	4.70	5.20	7.75	7.75	9.25	9.25
1 x 10	5.00	5.50	8.50	8.50	10.00	10.00
1 x 11	5.50	6.05	9.00	9.00	11.00	11.00
1 x 12	6.00	6.60	10.00	10.00	11.75	11.75
1 x 13	6.80	7.50	10.75	10.75	13.50	13.50
1 x 14	7.40	8.15	11.50	11.50	14.75	14.75
1 x 15	7.70	8.50	11.75	11.75	15.25	15.25
1 x 16	8.00	8.80	13.00	13.00	15.75	15.75
1 x 18	8.70	9.60	14.25	14.25	17.25	17.25
1 x 20	9.50	10.45	15.75	15.75	19.00	19.00
1 x 22	10.40	11.45	17.00	17.00	20.75	20.75
1 x 24	11.85	13.05	19.00	19.00	23.75	23.75
1 x 26	12.00	13.20	19.50	19.50	24.00	24.00
2 x 3	3.50	4.85	5.75	5.75	7.00	7.00
2 x 4	4.00	4.40	6.25	6.25	7.75	7.75
2 x 5	4.70	5.20	7.50	7.50	9.25	9.25
2 x 6	5.10	5.60	8.50	8.50	10.50	10.50
2 x 7	5.80	6.40	9.50	9.50	11.50	11.50
2 x 8	6.50	7.15	10.75	10.75	13.00	13.00
2 x 9	7.10	7.80	11.50	11.50	14.25	14.25
2 x 10	7.90	8.70	12.75	12.75	15.75	15.75
2 x 11	8.40	9.25	13.75	13.75	16.75	16.75
2 x 12	9.00	9.90	14.75	14.75	18.25	18.25
2 x 13	9.80	10.80	15.75	15.75	19.50	19.50
2 x 14	10.40	11.45	17.00	17.00	20.75	20.75
2 x 15	11.00	12.10	18.25	18.25	22.00	22.00
2 x 16	11.70	12.90	19.00	19.00	23.25	23.25
2 x 18	13.25	14.60	21.50	21.50	26.50	26.50
2 x 20	14.40	15.85	23.50	23.50	28.75	28.75
2 x 22	15.70	17.30	25.50	25.50	31.25	31.25
2 x 24	17.00	18.70	27.50	27.50	34.00	34.00
2 x 26	19.70	21.70	31.75	31.75	39.25	39.25
3 x 3	4.25	4.70	7.25	7.25	8.50	8.50
3 x 4	5.00	5.50	8.25	8.25	10.00	10.00
3 x 5	5.75	6.35	9.25	9.25	11.50	11.50
3 x 6	6.80	7.50	11.50	11.50	13.75	13.75
3 x 7	7.70	8.50	12.25	12.25	15.25	15.25
3 x 8	8.50	9.35	13.50	13.50	17.00	17.00
3 x 9	9.45	10.30	16.25	16.25	18.50	18.50
3 x 10	10.00	11.00	16.50	16.50	20.00	20.00
3 x 11	11.00	12.10	17.75	17.75	22.00	22.00
3 x 12	12.25	13.50	20.00	20.00	24.50	24.50
3 x 13	13.50	14.85	22.00	22.00	27.00	27.00
3 x 15	14.25	15.70	23.50	23.50	28.50	28.50
4 x 4	6.50	7.15	10.50	10.50	13.00	13.00
4 x 5	7.25	8.00	12.00	12.00	14.50	14.50
4 x 6	8.50	9.35	13.50	13.50	17.00	17.00
4 x 8	10.65	11.75	17.00	17.00	21.25	21.25
4 x 10	11.65	12.85	19.00	19.00	23.25	23.25
4 x 14	17.00	18.70	28.00	28.00	34.00	34.00
4 x 18	19.25	21.20	31.75	31.75	38.50	38.50
4 x 20	21.25	23.40	34.75	34.75	42.50	42.50
4 x 22	27.65	30.45	42.50	42.50	55.25	55.25
4 x 24	29.75	32.75	46.75	46.75	59.50	59.50
10 Circular	6.70	7.40	10.00	10.00	12.75	12.75
15 "	7.70	8.50	12.25	12.25	15.25	15.25
20 "	9.10	9.90	14.50	14.50	18.00	18.00
26 "	11.00	12.10	18.25	18.25	22.00	22.00
34 "	14.70	16.20	24.50	24.50	29.25	29.25
50 "	20.00	22.00	32.50	32.50	40.00	40.00
74 "	25.50	28.05	40.25	40.25	51.00	51.00
96 Column.	32.75	34.65	50.75	50.75	65.50	65.50
34 "	18.00	19.80	24.75	24.75	36.00	36.00
50 "	21.40	23.85	40.25	40.25	48.75	48.75
10 Corner.	1.25	4.70	7.00	7.00	8.70	8.70
15 "	5.25	8.80	8.50	8.50	10.50	10.50
20 "	7.25	8.00	11.75	11.75	14.50	14.50

Cutting Hole in Tops for Column Radiators \$1.00 net will be charged extra in each case.

Marble Tops, 1 inch thick, add to above prices 15 per cent.; 1 1/4 inches thick, 35 per cent.

Marble Bases, 7-8 inch thick (excepting Onyx), add for 1 row, 35 per cent.; 2 row, 25 per cent.; 3 row, 20 per cent.

4 Row, Circular, Corner and Column, 15 per cent.



TRADE BUNDY MARK.

ENGINEERING OFFICE OF CHARLES E. EMERY,

No. 22 Cortlandt Street, New York, Dec. 19, 1888.

A. A. GRIFFING IRON Co., Jersey City, N. J.

*Gentlemen* :—Agreeable to your request I have made a series of tests under similar conditions of different sized Bundy Radiators manufactured by you, and of a number of Radiators manufactured by other parties, in which vertical iron pipes one inch in diameter are screwed in a base to which the steam and return connections are made. As a general result of the tests it may be stated that *I find that the Bundy Radiators circulate more quickly* than any form of Radiator constructed of one inch pipes arranged vertically, even though the same be connected at the top with return bends, and that *this difference is very marked* when comparison is made with that form of Radiator in which the one inch tubes are closed at the top and circulation secured merely by interior diaphragms. The superiority arises evidently from the larger passages provided in the Bundy Loop and the adaptation of the base to the same so as to secure prompt and efficient action. On turning steam on a Bundy Radiator, which has become cold and filled with air, *the loops successively fill from the end where steam is supplied*, to the other, whereas with the Radiator constructed of one inch pipes there appears to be no regularity in heating up, and much more time is required. This is particularly the case with those constructed with pipes closed at their upper ends, and it is not uncommon for several of these to remain cold until heated by the surrounding pipes, and one or two near the steam inlet may thus be cold for a considerable time after the tubes at the other end of the Radiator have become thoroughly heated. *All these points have an important bearing on Radiators for use in dwellings or elsewhere where the pressure is very low*, in fact sometimes below the atmosphere, so that air entering through the slightest leaks, or derived from the water in the boiler, stops the circulation in a portion of the heating surface, and an irregular effect is produced. It has still a more important bearing on the use of direct Radiators when the supply of steam to the same is electrically controlled. With such apparatus it is necessary that the steam circulate promptly when it is turned on, as the mean temperature can only be maintained by shutting off and turning on the steam at short intervals.

*The second question that arises is as to the efficiency of a given amount of surface in Radiators of different kinds after circulation is fully established.* It is customary to make these tests by comparing the amounts of water condensed under similar conditions, and this plan was adopted in this case, unusual care being taken to make the results strictly comparative as is shown hereafter.

When steam, circulating freely, imparts heat through one side of the plate, the amount of condensation which will take place and the quantity of heat imparted will depend upon the degree and time of exposure of the other side of plate to heat absorbing substances, such as fixed bodies receiving heat by radiation or currents of air receiving heat principally by direct contact, and to but a limited extent by radiation.

TRADE BUNDY MARK.

With indirect radiation, the condensation, other things being equal, is chiefly influenced by the quantity of air circulated over the surface. With ordinary Radiators the circulation is only that produced by difference in temperature. The heating surface of a direct Radiator can be divided in two kinds, viz: 1—*The direct surface*, or that on the outside of the Radiator considered as a whole, which therefore radiates directly into the surrounding space, and is also in contact with currents of air of large volume, and— 2—*The “masked” surface*, or that on the sides of the several tubes which are turned toward each other so that the heat is radiated back and forth from one tube to another, and only that transmitted which can be absorbed by direct contact with, and a slight radiation to currents of air of limited area passing upward between the tubes. It will be seen therefore that the “direct” surfaces are very much more efficient than the “masked” surfaces, and that that Radiator with a given amount of heating surface will be most efficient which has the least “masked” surface compared to its outer bounding or “direct” surface. *For this reason, any Radiator, made up of a single row of pipes or loops of any shape is more efficient for a given surface than one with more than one row, and the loss of efficiency increases with the number of rows as more and more of the surface is “masked” and become relatively less efficient.*

*I find that your competitors have taken advantage of this state of facts and published results in which a favorable form of Radiators of their manufacture was compared with a less favorable form of your manufacture, thereby showing your type of Radiator to be inferior, and it is interesting to state that I have found, upon reversing the conditions and selecting a favorable form of Radiator of your manufacture and comparing the same with a less favorable form of their manufacture, that I obtained results showing your opponents’ Radiators very much inferior to yours.* This state of facts will astonish those who have hitherto supposed that differences in result can only be due to the type of Radiator, as the fact that they can be secured by a mere selection of Radiators of the same type containing the same heating surface is not generally known.

Again, in the experiments of one of your opponents, the steam and water connections of the Bundy Radiator were in the same end of the base. It is practically known that a very great difference may be secured in the performance of different Radiators by the way they are graded. In a strictly comparative test the water of condensation should trickle along the bottom of the base from the receiving end to the return end without chance of accumulation. With both connections in the same end of the base, or a base improperly graded, the water may be backed up and discharged intermittently, thereby not only interfering with the regular measurement but preventing the full efficiency of the surface by having a portion of the base covered with water for the whole or a portion of the time, even though the action may not be sufficient to cause interference in the circulation in the tubes.

*In the tests made by your opponents, a long, thin Radiator of their own manufacture, was placed along side and relatively near a short, thick Bundy Radiator.* It is evident, therefore, that one Radiator partially “masked” the other in the same way that one tube “masks” another, as above explained, on which basis their long Radiator reduced the efficiency of the whole of one side of your short one, while yours on the other hand could



TRADE BUNDY MARK.

only reduce the efficiency of a part of the length of theirs. By simply reversing the conditions and comparing a Radiator of your manufacture with a return bend Radiator made by your opponents, commercially rated and of almost identically the same actual surface, the experiments showed conclusively a superiority of the Bundy Radiator of 19.17 per cent, when the surfaces were left in the condition they were furnished by the manufacturer, even when the masking of one by the other was prevented by separating the competing Radiators a considerable distance and placing a screen between them. This superiority was reduced 5.7 per cent. when the surfaces were thoroughly covered with thick paint, but with this allowance the Bundy Radiator was still very greatly superior.

*It will be observed, also, that the Bundy form of Radiator would suffer less in the natural process of selection than any form of Radiator made up of vertical one inch tubes.* Radiators, particularly in small rooms, are necessarily selected to approximately fit a particular place, and therefore those of substantially the same length and height would be used independent of type, and since each of your tubes contains three square feet of surface, and each inch pipe only one square foot, it is evident that in such process of selection, even by parties who did not know the advantage of so doing, your one-row Radiator would be selected, where two or three rows of inch pipe would be required, and your two-row where from four to six rows of inch pipe would be needed to keep within the same length, so that on the average a superior form of your Radiator would be used more often than when the Radiator was made up of small tubes.

There were upwards of two hundred tests made for your information on the general subject by the writer, with the assistance of Mr. H. W. York. The results will be found of great value in suggesting still further improvements in your already excellent designs and proportions, but involved such a mass of detail that it would be difficult to properly edit and publish them in such form as to be useful to the trade. It will, however, be seen that independent of the efficiency of the radiating surface above explained, the Bundy Radiator is superior to the others tested in freedom of circulation, and in the relative amount of direct or effective heating surface, compared with that which is masked or ineffective.

In connection with the experiments, I have carefully measured the radiating surface of two five-loop Bundy Radiators, with the following results :

Total radiating surface with "Standard" loops,	-	-	15.11 square feet.
Total radiating surface with "Enlarged" loops,	-	-	17.99 square feet.

[SIGNED] CHARLES E. EMERY.

### SUMMARY OF CHARLES E. EMERY'S REPORT.

NOTE:—For the benefit of those who feel that they cannot spare the time to read the above report, although we believe it will pay any one to do so, we sum up the entire matter briefly in the following :

CHAS. E. EMERY, M. E., after making 200 competitive tests, using the Bundy with every other type of Radiator manufactured, *finds an average superiority for the Bundy of 19.17 per cent.*

Also, that the tests made by our competitors who have used a favorite form of their Radiator and a less favorable form of Bundy, have no significance whatever, unless it be a flattering admission of the Bundy's superiority signified by their underhanded attempt to mislead the public.

Also, that after measuring carefully the surface of the Bundy Radiators, he reports that they are actually in excess of what we claim for them, in one case .11 square feet, and another .49 square feet.



TRADE BUNDY MARK.

OFFICE, NEW PENSION BUILDING,  
1316 N. St., N. W.  
GEN. M. C. MEIGS, U. S. A.

A. A. GRIFFING IRON CO.,  
Jersey City, N. J.

Washington, D. C., April 2nd, 1886.

Gentlemen:—I have duly received a copy of the Illustrated Catalogue of the Bundy Steam Radiator made by your company.

*I know of no better steam heater.* I first made its acquaintance on a large scale in the erection of the National Museum in this city, where it is used to heat a building of 328 feet square, containing about 3,000,000 cubic feet of space. I was so well satisfied with its work in that building that I specified it in contracting for the heating of the New Pension Building, also in Washington.

I have heated this building containing *6,179,200 cubic feet of air space*, exclusive of cellars, in a building of 3 stories covering a ground plan of 400x200 feet and 150 feet to the ridge of its central roof, since the first of March, 1885. The ratios are for the north rooms 1 sq. foot of Radiator surface to 111 cubic feet of air space. In the south rooms, 1 to 135; in the east and west rooms, 1 to 123, and for the great hall which these rooms surround and enclose to the height of 80 feet, and which itself *contains over 4,000,000 cubic feet of space* only, 1 sq. foot of radiating surface to 777 cubic feet of air space. The building is daily occupied by about 1,600 persons engaged in sedentary employment, and though the thermometer out of doors during the past winter has been frequently much below zero, *no one has complained of being insufficiently warmed, either in room or hall.* A better test of the value and efficiency of a Radiator can scarcely be looked for.

Yours respectfully,

M. C. MEIGS,

Quartermaster General (retired).  
Brevet Major General, U. S. A., and  
Architect New Pension Building.

**CEN. M. C. MEIGS' EXPERIENCE WITH THE BUNDY RADIATOR.**

NOTE:—*The above letter shows results with the Bundy Radiator which have never been even approached by any other.* In a word it means that the immense New Pension Building at Washington, which has a maximum of glass surface, is satisfactorily warmed by the Bundy Radiator on the following adjustments:

In the North Rooms,	1	square feet Heating Surface to	111	cubic feet Air Space.
“ “ South Rooms,	1	“ “ “ “	“ 135	“ “ “ “
“ “ East and West Rooms,	1	“ “ “ “	“ 123	“ “ “ “
“ “ Great Hall,	1	“ “ “ “	“ 777	“ “ “ “

BEING AN AVERAGE ADJUSTMENT FOR THE ENTIRE BUILDING OF

**1 SQUARE FOOT BUNDY HEATING SURFACE TO 275 CUBIC FEET AIR SPACE,**

which is undisputable proof that the Bundy Radiator is the most powerful heater on the market, and that less of its surface can be used and precisely the same results obtained, or with the same amount of surface the apparatus will always work easier, be more economical, consume less fuel and require less attention.





LIBRARY

—> INTRODUCTORY <—

OCT 7 1949

OF

U S PATENT OFFICE

REFERENCES AND ADVERTISEMENTS.



THE following pages we have devoted to references, testimonial letters and advertisements:

The references comprise a list of about twenty-five thousand names of parties who are using the Bundy Radiator. We could not get the names of them all, but have enough to show the world wide adoption of the goods, and if you will take the time to write a few of the parties, they will say whether they have given satisfaction or not.

The testimonial letters have been selected from among thousands of others which we have on our files. Every incoming mail brings more of them. With over thirty million feet of surface now in use, all of which is giving the best of satisfaction, it is not surprising that they keep coming in. Use the goods yourself and you will want to add yours to them.

A word regarding our advertisements may not be out of place. They have been selected with great care, and the concerns they represent are making goods that can be depended on, and we ask our friends and patrons to favor these parties with their orders when it is a possible thing.

Thanking you heartily for past favors and soliciting a continuance of your esteemed patronage, we remain,

Very respectfully yours,

A. A. GRIFFING IRON CO.

Jersey City, N. J.

67132

# THE BOYNTON HOT WATER HOUSE WARMING HEATER

For Private Residences, Schools, Churches, Public Institutions, Greenhouses, Etc.

PATENTED AUGUST 6TH, 1889.

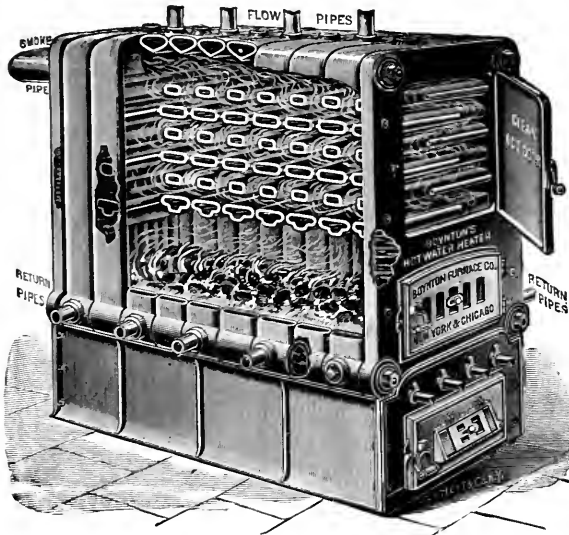

(Sectional view of Size No. 9.)

FOR HARD OR SOFT COAL, WOOD OR NATURAL GAS.

TWELVE SIZES  
NO BRICK WORK REQUIRED.

No. of Heater	Height of Heater.	Size of Grate.	Square Feet of Fire Surface in Heater.	Square feet of Direct Radiation Heater will carry	Cubic Feet of Space Heater will Heat Direct Radiation.	Diameter of Smoke Stack.
No. 0	52 inches.	17½x25	29	250	7,500	8 inches.
" 1	52 "	17½x20	38	400	12,000	8 "
" 2	52 "	17½x25	47	600	18,000	8 "
" 3	52 "	17½x30	56	800	24,000	8 "
" 4	63 "	21x20	65	950	28,500	9 "
" 5	63 "	21x25	80	1,500	45,000	9 "
" 6	63 "	21x30	95	1,750	52,500	9 "
" 7	63 "	21x35	110	2,200	66,000	9 "
" 8	63 "	21x40	125	2,500	75,000	10 "
" 9	63 "	21x45	140	2,750	82,500	10 "
" 10	63 "	21x50	155	3,000	90,000	10 "
" 11	63 "	21x55	170	3,200	100,000	10 "

Flow and return outlets are tapped for two-inch pipe and three-inch orator.

Deduct 25 per cent. from radiation, to allow for flow and return pipes.

For indirect radiation add fifty per cent. to Radiation and Boiler Power.

A covering of asbestos mortar on the sides and top of heater will insure greater economy in fuel.

For anthracite coal use Lehigh small egg size.

Send for Illustrated Pamphlet and Prices.

ESTABLISHED 1849.

MANUFACTURED ONLY BY

INCORPORATED 1884.

# THE BOYNTON FURNACE CO.,

207 and 209 WATER STREET,



47 and 49 DEARBORN STREET,

NEW YORK.

CHICAGO.

These Heaters have been pronounced by scientific experts to be the most effective, economical and of the best mechanical construction of any on the market.

These Heaters are operating in a most successful manner in many Residences, Schools, Apartment Houses and Greenhouses.

On account of the dissolution of the old firm in 1882, which was established in 1849, Boynton's Celebrated Furnaces, Hot Water Heaters, Ranges and Baltimore Heaters, with latest improvements are now manufactured exclusively by

THE BOYNTON FURNACE COMPANY.

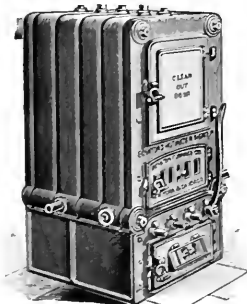

Size No. 4.

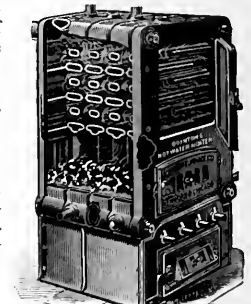

Size No. 4.

## REFERENCES.

### ALABAMA.

#### ANNISTON.

All Angel's Church.  
Anniston City Land Co.  
Anniston Inn Co.  
Boys' High School.  
McConnell & Co.  
Noble, E., residence.  
Noble Institute.  
Parker Memorial Church.  
St. Michael's Church.  
Union Depot.  
Woodstock Iron Co.

#### BIRMINGHAM.

Milner & Kettig, store.  
Morris Bank.  
Morris Building.  
Morris, Josiah & Co., office building.  
Pioneer Mining & Manufacturing Co.  
Tenn. Coal, Iron R. R. Co.

#### DECATUR.

The Tavern.

#### FLORENCE.

Haraldson & Murray.

#### FORT PAYNE.

Flynn, F. M.

#### HUNTSVILLE.

Huntsville Hotel, The.  
Schrimshaw, Jas. R.

#### MOBILE.

United States Custom House.  
United States Post Office.

#### MONTGOMERY.

Forbes, Liddell & Co.  
Friedman Vinegar Works.

#### SHEFFIELD.

First National Bank.

#### TALLADEGA.

Alabama Institute for the Blind.  
Johnson, J. H., Principal.  
Stewart, E. O.

### ARKANSAS.

#### FORT SMITH.

Bomford, Plumbing Co.  
Cooke, C. M., residence.  
Hall, Chas., residence.  
Johnson, W. J., residence.  
Park, J. S., Cashier 1st National Bank.  
Rogers, D. F., residence.  
Wheeler, Stephen, residence.

#### HOT SPRINGS.

Hot Springs Plumbing & Machine Co.

#### LITTLE ROCK.

Arkansas Pump & Pipe Co.  
Peay, N. & Co.  
Penzel, Chas. F., residence.  
Roots, Col. L. H., residence.  
Thompson, C. H.  
Wells & Dungan.

#### VAN BURAN.

Bomford Plumbing Co.

### CALIFORNIA.

#### BERKLEY.

Sutton, A. M.

#### EAST OAKLAND.

Mills College.

#### EDENVALE.

Hayes, E. A.  
Hayes, J. O.

#### GRASS VALLEY.

Kedder, J. E.

#### HUMBOLT CO.

Court House, Eureka.

#### LOS ANGELES.

Scott, J. W.

#### LOS GATOS.

Noviciate College.

#### MISSION.

McIvers, C.

#### NAPA.

Goodman, H. P., Masonic Temple.  
Holden, S. E.  
Menassa, E.  
Norton, J.  
Odd Fellows' Hall.  
Wylie, Rev. H.

#### OAKLAND.

Adult Blind Asylum  
Bailey, A. H.  
Brown, A.  
Burdick, Dr.  
Gray, G. H.  
Handy, E.  
Hawley, G. T.  
Kelley, Geo. B.  
McElrath, J. E.  
Tabiola Hospital.  
Varney, Thos.

#### SAN DIEGO.

Consolidated National Bank.  
New San Diego Court House.

#### SAN FRANCISCO.

.Etna Fire Insurance Co., office building.  
Bank of California.  
Brooklyn Cooperage Co.  
Chambers, R. C.  
Cloutier, Frank.  
Day, Thos. & Co.  
Eisen Vinegar Co.  
Hanson & Co.  
Harvey, C. D.  
Higgins, B.  
Hoag, W.  
Home Savings Bank.  
Howard, W. H.  
Langley & Michaels.  
Lick House.  
Lick Paper Co.  
Lincoln, J.

Montague, W. W. & Co.

Pacific Pine Lumber Co.  
Rosenfeldt, J.  
Sloane, W. & J. Co.  
St. Luke Hospital.  
Whittier, Fuller & Co.

#### SAN GABRIEL.

Hotel San Gabriel.

#### SAN JOSE.

Sanitarium, Sisters of Mercy.

#### SAN LORENZO.

Lewellyn, E. fruit grower.

#### SAN RAFAEL.

Hotel San Rafael.

#### SANTA MONICA.

Scott, J. W.

#### STOCKTON.

Stockton Insane Asylum.

#### WOODLAND.

Stephens, I. D.

### CANADA.

#### HAMILTON.

Asylum for the Insane.  
City Halls.  
Clark, Adam.  
Fairley & Stewart.  
Gibson, J., M. P. P., residence.  
Gurney, E. & C. Co.  
Hendrie, W., residence.  
Mallock, F. S., residence.  
McPherson, James, residence.  
Middleton, J. T., residence.  
Mills, W., residence.  
Morgan, Chas., offices.  
Orphans' Home.  
Post Office.  
Squibb, Frank.  
Stevenson & Poulter.  
Van Ailen, E., residence.  
Walsh, W.  
Y. M. C. A. Building.

#### MONTREAL.

Ambrose, J. D. L.  
Angelicano Rectory.  
Bank of Montreal.  
Burland, G. B.  
Caines, F.  
Caislock, Geo.  
Cairns, W.  
Cheese, W. E.  
Clarke, W. J.  
Costigan, W. T.  
Date, John.  
Davis, G.  
Desbarats, G. E.  
Drummond, Hon. G. A.  
Evans, W. E.  
Fish, E. J.  
Fresch, T.  
Grand Trunk R. R. Station.  
Gross, W.



E. A. WILLIAMS & SON,

105, 107, 109 and 111 PLYMOUTH STREET,

JERSEY CITY, N. J.

BRASS FOUNDERS,

—AND—

METAL DEALERS.

SPECIALTIES.

WILLIAMS \* LION \* BRAND \* PHOSPHOR \* BRONZE,

In Ingot and Castings.

Adopted and endorsed by Pennsylvania R. R. and Fullman Co.'s and other leading companies and manufacturers.

**WILLIAMS ALUMINUM BRONZE.**

**Tensile Strength between 70,000 and 80,000 lbs. per square inch.**

*Its high qualities render its use particularly advisable for Ship Propellers, Pistons, Cylinders, Cog Wheels, Hydraulic and other Machinery, where great strength, resistance to wear and oxidation are requisite.*

**FERRO ALUMINUM FOR IRON FOUNDERS' USE**

*Results.*—Makes Iron melt faster, run fluid, less shrinkage, will soften hard iron. Where it is utilized the Founder has castings free from hard spots and blow holes, can use more scrap and lower grade iron with less percentage of bad castings, and increases tensile strength 20 to 25 per cent.

**INGOT METALS FOR BRASS FOUNDERS.**

*We carry large stock of Ingot Phosphor Bronze, Manganese Bronze, Aluminum Bronze, Gun Metal, Brass, Composition, Carbon Bronze, also Castings of above metals, Special Castings for Electrical Work in Tin, Copper, Lead, Aluminum, Zinc.*



## REFERENCES.

Gurney, E. & C. Co.  
 Hardisty, J.  
 Hiam, T.  
 Hickey, J.  
 Hughes, W.  
 Imperial Fire Insurance Co.  
 Kenwood, R.  
 Lockerty, A.  
 Masson Estate.  
 Millen, H.  
 Nelson, T. E.  
 New York Life Co's Building.  
 Paterson, J. A.  
 Penarte Printing Co.  
 Richelieu Hotel.  
 Robertson, W.  
 Seath, R.  
 Strachin, J.  
 Strachin, W.  
 Standard Life Insurance Building.  
 St. James Methodist Church.  
 St. John's School  
 Temple Buildings.  
 Thorn, W.  
 Underlock, W. C.  
 Walbriet, W. M.  
 Weassup, Lieut. Col.  
 Wilkins, Dr.

### SOUTH BEND.

Oliver Opera House.

### TORONTO.

Aikens, Hon. J. C., residence.  
 Bailey, J. R., residence.  
 Bank of Montreal.  
 Barnhardt, Mrs., residence.  
 Batton, W. S., residence.  
 Bertram, J. and A., store.  
 Best, T., block of offices.  
 Boeckh, Chas., residence.  
 Bolte, A., residence.  
 Boone, William.  
 Boustead, Ald. J. B., residence.  
 Broadway Methodist Tabernacle.  
 Burns, Dr., residence.  
 Burroughs, W. J.  
 Campbell, Donald, residence.  
 Canadian Rubber Co., offices.  
 Carrick, W. H.  
 Carlaw, Major, residence.  
 Carroll, Mrs., residence.  
 Clafne, Schlect & Field.  
 Clark, J., residence.  
 Clatworthy, G., residence.  
 Cuthie, C.  
 Copp, J. C., residence.  
 Collins, Mrs., hotel.  
 Cornell, W. E., block of offices.  
 Cox, A., residence.  
 Crane, S., residence.  
 Dickson, J., residence.  
 Dimmick, C. R. S.

Dominion Bank Building.  
 Faulkner, G., residence.  
 Firstbrooke & Co., offices.  
 Fiskin, John, block of offices.  
 Foy, J. J., residence.  
 Gooch, R. N., block of offices.  
 Graham, Miss, residence.  
 Greey, Mrs. W. G., residence.  
 Gurney, E. & C. Co.  
 Hardy, G., block of offices.  
 Hatton, J. S., residence.  
 Hang, N. E., residence.  
 Hay, R., residence.  
 Holgate, Frank, residence.  
 Holland, Chas., residence.  
 Hospital of St. John, the Divine.  
 Howland, Sir W. P., C. B. K. C. M. G., residence.  
 Hurst, J. C., residence.  
 Jackes, B., residence.  
 Kerr, John, residence.  
 Leys, John, M. P. P., residence.  
 Lord, R. F., residence.  
 Lunness, J., residence.  
 Manning's Arcade.  
 Mark, A. J., residence.  
 McFarlane, McKinley & Co., offices.  
 McGuire, W. J. & Co.  
 McKay, Donald, residence.  
 McLean, A., residence.  
 Merritt, W. M., residence.  
 Miller, G. M., block of offices.  
 Millichamp, R., residence.  
 Morphy, Mrs., residence.  
 Morse, W., residence.  
 Murphy, Mrs., residence.  
 Myles, R., residence.  
 Normal School.  
 O'Neil, J., block of offices.  
 Ontario Lead and Barb Wire Co., offices.  
 Piper, Hiram, residence.  
 Potts, Rev. Dr., residence.  
 Powers, J., hotel.  
 Proudfoot, Hon. W., residence.  
 Richardson, S., hotel.  
 Rogers, Elias, residence.  
 Rolph, J. T., residence.  
 Royal Oil Co., offices.  
 Scott, J., residence.  
 Sellars, Chas.  
 Smith, Austin, residence.  
 Smith, J. B., residence.  
 Snider, E., residence.  
 St. Paul's R. C. Church.  
 St. Mary's R. C. Church.  
 Strathy, H. H., block of offices.  
 Taylor, H. A., residence.  
 Thompson, J. L., residence.  
 Thompns n, W. S., residence.  
 Tomlin, B., residence.  
 Toronto General Trust Co.

Walker House Annex.  
 Warren, W. A., residence.  
 Webb, Mr., residence.  
 West, R., residence.  
 Williams, R. S., offices.  
 Williams, S., residence.  
 Wilson, Sir Adam, residence.  
 Wilson, J., residence.  
 Wilson, W., residence.  
 Wilson, W. D., residence.

## NEW BRUNSWICK.

### BATHURST.

Dominion Government Building.

## MANITOBA.

### WINNIPEG.

Gurney, E. and C. & Co.

### FREDRICKTON.

Blair, Attorney-General, A. G.  
 Edgecombe, F. B.  
 Queen Hotel.

### LEWISVILLE.

Lockhart, M.

### MONCTON.

Connors, T. C.  
 Elliott, Wm.

### NEWCASTLE.

Hickson, Wm.

### ST. JOHNS.

Barker, Dr. F. C., residence.  
 Blake, G. E.  
 Dunn, E. G.  
 Ferguson, R. E., residence.  
 Gear & Co.  
 Lawrence, Bela.  
 Robertson, J. E.  
 Royal Hotel.  
 Victoria Hotel.  
 Wisdom & Fish.

### ST. STEPHENS.

Dominion Government Building.  
 Eaton, G. B.  
 McKenna, P.

## NOVA SCOTIA.

### AMHERST.

Bank of Nova Scotia.

### AUTICOUISH.

Kirk, D. G.

### HALIFAX.

Church of England Institute.  
 Halifax Hotel.  
 Queen Hotel.  
 Victoria General Hospital.

### LUNENBERG.

Davison, F.

### NEW GLASGOW.

St. James Church.  
 Sutherland, H.  
 Thompson, A. C.  
 United Presbyterian Church.

# • FERGUSON • BOILER •

FOR STEAM OR HOT WATER HEATING.

Made in Six Sizes; Heating from 13,000 Cubic Feet to 100,000 Cubic Feet.

This Boiler has a Positive and Rapid Circulation of the Water Throughout all its Parts.

STATE CAPITOL, ALBANY, Feb. 5, 1888.

TO THE FERGUSON BOILER COMPANY.

Gentlemen:

I have examined your boiler in its construction and operation, and am of the opinion that you have a first-class boiler for *steam or hot water heating*, and one that will be very highly appreciated when given trial. In its construction it is strong and durable, easy to clean and repair, automatic in its operation, occupying very little space in its position, *and a very extraordinary steaming capacity*, which I can only account for in the circulating pipes running from top to bottom of boiler on outside of shell, thereby producing a constant and rapid circulation and mixture of water of different temperatures in boiler, and a constant change of water in contact with heating surface; *a condition* well known to steam users as necessary for quick and economical production of steam; also in the additional heating surface in circulating tubes, and position of same in the escaping gases to chimney, which would be lost in other types of boilers.

Yours truly,

WILLIAM J. NORWOOD,

Chief Engineer.

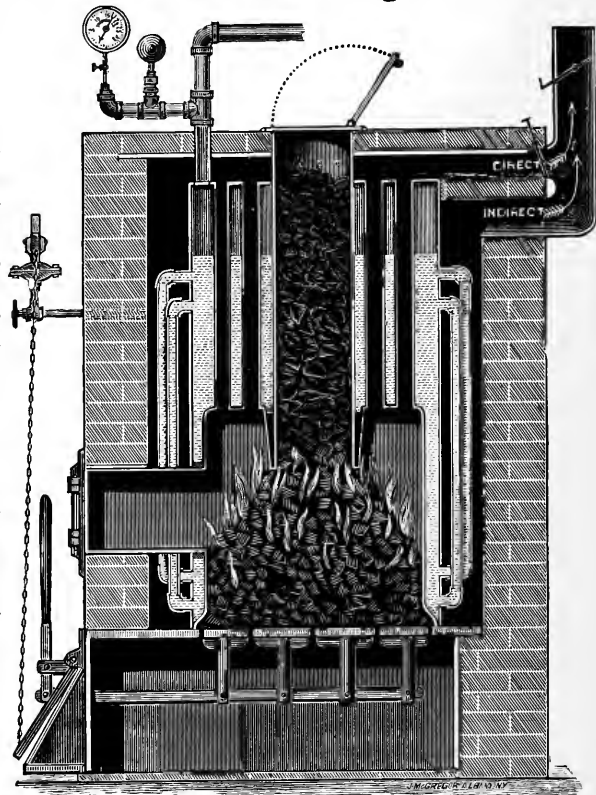

WE would call the attention of the public to our new boiler. (patented February 1, 1887,) and to its principal point, the *outside circulating pipes* which are located on the outside of the shell, and inside the return flue. By means of these pipes the water in the boiler is kept constantly in rapid and positive circulation over the heated portions, thereby the more rapidly absorbing the heat; generating the steam more rapidly and steadily with a great saving in fuel and attention.

They are built of the best *steel*, in the best manner, having coal-magazine entirely surrounded by water, which keeps the coal at a low temperature. Milling and anti-clinker grates, automatic dampers for regulating pressure of steam and controlling draughts; also all appliances necessary to the best working of the boilers.

By filling the coal-magazine, shaking the grate, taking up the ashes once a day, there is little else to do.

We claim that our boiler requires less attention than the ordinary parlor stove, and will use less fuel to heat the same amount of space, saving all the annoyances of dust, ashes and gas.

SEND FOR CATALOGUE.

## FERGUSON BOILER COMPANY,

No. 1 Church Street, cor. Broadway,

ALBANY, N. Y.

## REFERENCES.

**SIDNEY.**  
 Hill, T. C.

**TRURO.**  
 Chambers Woodworking Co.  
 Cummings & Son.  
 Hanson, Wm.

**YARMOUTH.**  
 Boston & Marine Ins. Building.  
 Dominion Government Buildings.

### ONTARIO.

**BELLEVILLE.**  
 Chown, W. W.  
 Corby H., M. P., residence.

**BROCKVILLE.**  
 Alexander Jas., residence.  
 Buell, Chas., residence.  
 Court House.  
 Fitzimmon, Wm.  
 McCram, John, residence.  
 McLean, Geo., residence.

**CARGILL.**  
 Cargill, H., M. P.

**CHATHAM.**  
 St. Joseph R. C. Church.  
 Watt, Jas. & Son.

**CORNWALL.**  
 Cornwall Court House.

**DESERONTO.**  
 The Rathburn Co.

**ELIZABETHTOWN.**  
 The County Court House.

**ESSEX CENTRE.**  
 Dewar, Dr.

**GOODERICH.**  
 Jas. Saunders & Son.

**GUELPH.**  
 Church of Our Lady Immaculate.

**IROQUIS.**  
 Ball, W. D.  
 Beech, M. F.

**KINCARDINE.**  
 Baird, R., residence.

**KINGSTON.**  
 Jamieson, J.  
 McKelvey & Birch.  
 St. Mary's R. C. Cathedral.

**LONDON.**  
 Asylum for Insane.  
 Smith Bros.

**MIMICO.**  
 Asylum Cottages.

**ORILLIA.**  
 Slavin, Dr., residence.

**OTTOWA.**  
 Experimental Farm.  
 McKinley & Northwood.  
 Perihomine, Rev. Father.  
 Topley, H. D.

**PEMBROKE.**  
 Chapman, C.

**PERTH.**  
 Hicks Hotel.  
 Kellock, J. F.  
 Meighen, W.

**PRESCOTT.**  
 Ross, R. W.

**SMITHS FALLS.**  
 Frost, F.

**WINONA.**  
 Carpenter, T. H. P., residence.

**WOODSTOCK.**  
 Patterson Bros., offices.

**PRINCE EDWARD'S ISLAND.**

**CHARLOTTETOWN.**  
 Bank of Nova Scotia, (branch).  
 Government Buildings.  
 Hotel Davies.  
 Pato, Jas.  
 Sullivan, Judge, (Chief Justice of P. E. I.)

**SUMMERSIDE.**  
 Brennan, W. C.  
 Clarke, T.

### QUEBEC.

**CORNWALL.**  
 Rossmore House.

**HUNTINGTON.**  
 Marshall, R. C.

**QUEBEC.**  
 Florence Hotel.

**ST. HYACINTH.**  
 Raymond & Frette.

**ST. JOHNS.**  
 Danderand, H. C.

### CHILI.

**SAN DIEGO.**  
 San Diego College.

### COLORADO.

**ASPEN.**  
 Brown's Block.

**CANON CITY.**  
 Penitentiary Building.

**COLORADO.**  
 Colorado Springs School.  
 Cutler's Hotel.  
 Exchange National Bank.  
 Garfield School.  
 Hall, H. H., residence.  
 Lincoln School.  
 Merrill, W. H. D.  
 Pease & Barber.  
 Robinson, F. E., residence.  
 Spalding Hotel.  
 St. Francis Hospital.

**DENVER.**  
 Albany Hotel.  
 Arcade Saloon.  
 Badgely & Watkins.  
 Barclay Block.  
 Beggs & Tracy.  
 Borch, Charles.  
 Butterfield Block.  
 Chain & Hardy.  
 Cheever Block.  
 Clayton Block.  
 County Jail.  
 Cresswell, Joseph.  
 Cutshaw, L.  
 Daniels & Fisher, store.  
 Davis, Cresswell & Co.  
 Denver High School.  
 Denver National Bank.  
 Eddy, Edward, residence.  
 Essex Building.  
 First National Bank.  
 Fishel Bros. & Wive.  
 Good Block.  
 Granite Building.  
 Hallack & Howard Block.  
 Hughes, A. S., residence.  
 Kountz, C. B.  
 McCarthy & Inness.  
 Masonic Temple.  
 Moffett, D. H.  
 National Tube Works.  
 Paradise, F. H.  
 Parsonage Central Presbyterian Church.  
 Reilly, C. J.  
 Richelieu Hotel.  
 Rogers, J.  
 Sisters' Hospital.  
 Smith, C. H.  
 Smith's Restaurant.  
 Spangler, M., residence.  
 The Markham.  
 Union Pacific Hospital.

**GLENWOOD SPRINGS.**  
 Glenwood Springs Hotel.

**HOLYOKE.**  
 Porter, H. J.

**MANITOU.**  
 Iron Springs Hotel.

**OURAY.**  
 Beaumont Hotel.

**PALMER LAKE.**  
 A. T. & S. F. Ry. Co. Depot.

**SALIDA.**  
 Denver & Rio Grande R. R. offices.

**SALINA.**  
 D. R. S., offices.

**CONNECTICUT.**

**ANSONIA.**  
 Ansonia Brass & Copper Co.  
 Ansonia Hall.

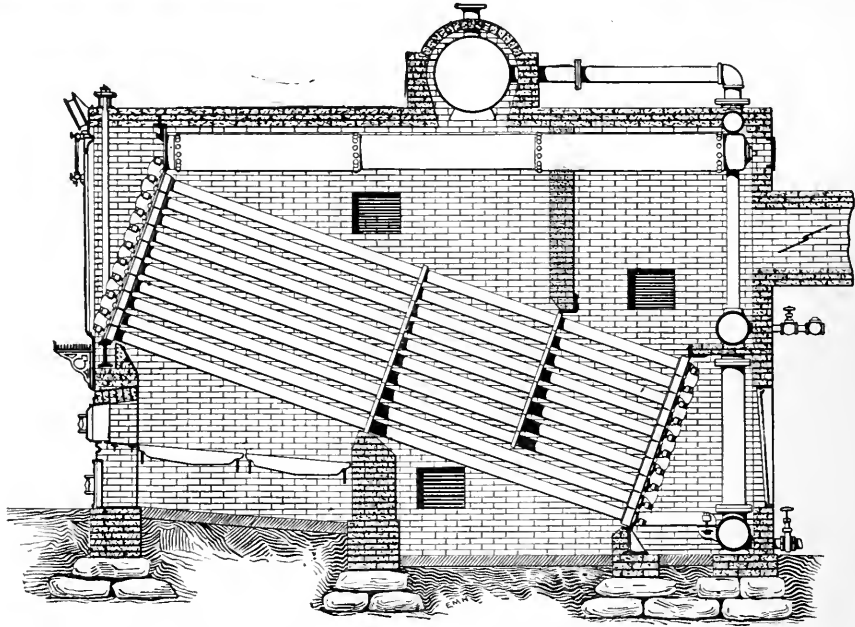

# ROOT'S NEW WATER-TUBE STEAM BOILER.

Absolute SAFETY with highest possible economy.  
Unrivalled for Steam Heating Plants.

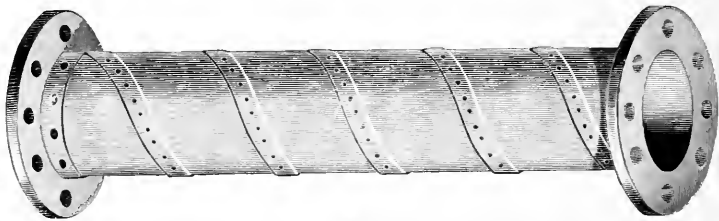

**SPIRAL RIVETED PIPE FOR EXHAUST STEAM HEATING,  
PUMP SUCTIONS AND DISCHARGES, Etc., Etc.**

\*-CATALOGUES ON APPLICATION-\*

**ABENDROTH & ROOT MFG. CO.,  
28 CLIFF STREET, NEW YORK.**



## REFERENCES.

Anson C., residence.  
 Bartholmew, Dana, residence.  
 Billam, H. S., residence.  
 Clemins, F. & M. Co.  
 Farrell Foundry & Machine Co.  
 Finn House.  
 Gilpin, Joseph, residence.  
 Hobday, J., residence.  
 Hitchcock, Dr. M. C.  
 Jackson, John, residence.  
 Jackson, Martin, residence.  
 Moore, Chas., residence.  
 Sceneller, Geo. W. O., residence.  
 Slade, William, residence.  
 Somers, David, residence.  
 Terry, T. P. & Son.  
 Tooles, H. B., residence.  
 The Electrical Supply Co.  
 Wooster, C. B.

### BIRMINGHAM.

Alling, A. H., residence.  
 Arnold, Geo. A., residence.  
 Atwater, Chas. E., residence.  
 Atwater, W. C., residence.  
 Baldwin, N. D., residence.  
 Bassett House, hotel.  
 Bassett, T. S.  
 Bassett, R. M.  
 Birmingham Iron Foundry.  
 Birmingham Public School.  
 Brinsmade, D. S.  
 City Hall.  
 Clark, D. N.  
 Coss, A. J.  
 DeForest, T. B., residence.  
 DeForrest, H. S., residence.  
 Derby Gas Co., office.  
 Derby Savings Bank.  
 Derby Silver Co., office.  
 Downes, William E., residence.  
 Downes, C. N., residence.  
 Downes, S. A., residence.  
 Fennelly, Martin, residence.  
 Flaherty, M., residence.  
 Flanket, M. F., residence.  
 Hallock, F., residence.  
 Kennedy, Rev. P. M., residence.  
 Kelley, D. H., store.  
 Krauss, L. & Co.  
 Lewis, E. Jr.  
 Loomer, L. L., residence.  
 McEmemey, Mrs. P.  
 Maltby, E. C. & Son.  
 Miller, Wm. E., store.  
 Miller, W. J., residence.  
 Peck, E. W. & Co.  
 Perry, F. G., residence.  
 Plumb, D. W., residence.  
 Radcliffe, Thos., residence.  
 Roberts, H. J., residence.

Shelton, E. N., residence.  
 Shelton & Co., shop.  
 Skelton Public School.  
 Smith, A. R., residence.  
 Smith, E. S., residence.  
 Sterling, C. A., residence.  
 Sterling Organ Co.  
 St. Mary's Church and Parsonage.  
 Tomlinson, Joseph, residence.  
 Torrance, David, residence.  
 Turney, G. H., residence.  
 Waite, Frank, residence.  
 Williams, W. H., residence.  
 Wilkinson, Williams.  
 Wooster, Wm. B.  
 Wise, James N., residence.

### BRIDGEPORT

Armstrong, F. Mfg Co.  
 Atwater, Henry.  
 Association Charters.  
 Barnum's Building.  
 Barnum's Gymnasium.  
 Barnum, P. T.  
 Beebe, Dr. W. B., residence.  
 Bill, Dr. Curtis H.  
 Bridgeport Steam Boat Co.  
 Bridgeport Steam Heating Co.  
 Christ Church (Episcopal).  
 Copeland Bros.  
 First National Bank.  
 Fitch's Soldiers Home.  
 Golden Hill Seminary.  
 Goodsell, Zalmon.  
 Hillside Seminary.  
 High School Building.  
 Hopkins, Alfred, residence.  
 Howland & Drouve.  
 Longstaff, & Hurd, Archts, office.  
 Lyon & Gunnan.  
 Marsh, Clark.  
 Nash, Mrs. Isabella.  
 Nawves Opera House.  
 New Fire Department Building.  
 Park City Clothing Store.  
 People's Savings Bank.  
 Perry, W. H., Treasurer W. & W. S. Mach. Co.  
 Plant Hardware Co.  
 Post Office Building.  
 Prospect Street School.  
 Read, The D. M. Co.  
 Revilnor, S., President Wilmot & Hobbs  
 Mfg Co., residence,  
 Rogers & Morford.  
 Rothwell, Chas. R., Agent for P. T. Barnum.  
 Silliman, Fred'k.  
 Springfield Emery Wheel Co.  
 St. John's Church.  
 Stackpole & Lahan.  
 Strang, Dr. C. W.  
 Stevenson, G. F. & Co.  
 United States Express Co.

Van Keuren, Louis.  
 Vanstone & Westlake.  
 Waldo, Geo. C.  
 Wheeler Building.  
 Wheeler, N.  
 Wheeler & Wilson.  
 Wilson, Dr. L. M.  
 Wren, P. W.

### BRISTOL.

Bristol Brass & Clock Co.  
 Coleman, P. J.  
 Hubbard, E. G.  
 Judson, Mrs. Julia.  
 Morse, H. T.  
 Skelly, J. W. & Son.

### DANBURY.

Baldwin, E. M., residence.  
 Beckerle, Wm., residence.  
 Crofut, Henry, residence.  
 Daisie, J. L.  
 Hopkins, Le Grand, residence.  
 Hopkins, L. L., residence.  
 Hull & Rogers.  
 Ives, J. M., The Co.  
 Jones, Timothy.  
 Lasola, F. F., residence.  
 Morris, E. S. & Co.  
 New City Hall.  
 New Street Public School.  
 Purdy, Horace & Son, office.  
 Ryder, Dr. Wm. H., residence.  
 Thomlinson, W.  
 Town Club House.  
 Treadwell, L. P. Block.  
 Tweedy, Edmund, residence.  
 Wildman, A. N., residence.  
 United Bank Building.

### DANIELSONVILLE.

Danielsonville Cotton Co.  
 Jacobs, W. O. & Co.  
 Loren, Bates, residence.  
 Quinebang Co.  
 Tillinghast, Westcott, residence

### DAYVILLE.

Hopkins, T. E.

### EAST HAVEN.

Chamberlain, A. L., residence.  
 Malory, Lester P., residence.  
 Malory, James, residence.  
 Smith, Henry, residence.

### ESSEX.

Coleman, Geo. A.

### FAIR HAVEN.

Bishop, F. F., residence.  
 Chamberlain, C. A., residence.  
 Quinpear Brewing Co.  
 Smith, Henry, residence.  
 Sister Mullory, residence.

### FALLS VILLAGE.

Brinton, J. P.

# THE ECONOMY VENTILATING HEATERS.

## HOT WATER OR STEAM

✧ COMBINED WITH ✧

## ✧ INDIRECT · AIR · HEAT ✧

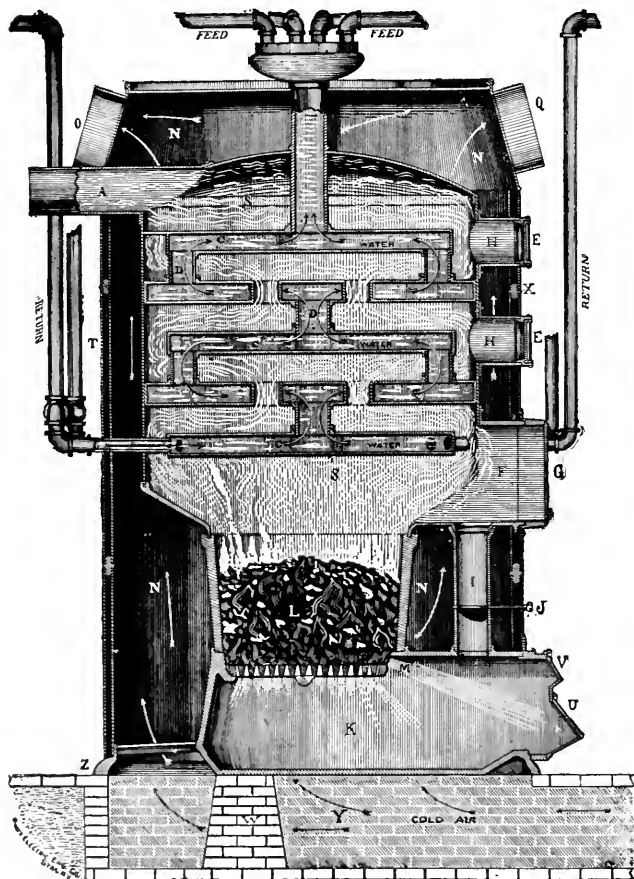

THE ECONOMY HOT WATER COMBINATION.



UNEXCELLED FOR  
Residences,  
Churches,  
Schools, etc.

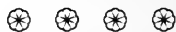

PROVIDE A MEANS FOR  
PERFECT VENTILATION.



SEND FOR CATALOGUE  
AND PAMPHLET,  
"Other People's Opinions."



ADDRESS:

### J. F. PEASE CO.

Main Office, Foundry and Works:

**SYRACUSE, N. Y.**

NEW YORK, BOSTON,  
CHICAGO, TORONTO,  
HARRISBURG.



## REFERENCES.

Brown, A. L. & Son.  
Moore, Rev. D.

### FIVE MILE RIVER.

Smith, Dr. E. E.

### GILDERSLEEVE.

Day, John B., residence.  
White, Charles, residence.

### GREENWICH.

Allen & Marshall.  
Barrett, J. D.  
Greenwich Loan, Trust & Deposit Co.  
Jones, Dr. L. P.  
Mead, N. B.  
Mead, S. M.  
Odds & Whipple.  
St. Mary's Church.  
Sterling Foundry Co.  
Union Gas & Oil Stove Co.

### HARTFORD.

Beach, H. B. & Son.  
Bosworth, N. A.  
Cheney Building.  
Cunningham, W. G.  
Hartford Orphan Asylum.  
Knox, Frank J.  
Lawler, E.  
Mahl & Pinney.  
Miller Building.  
Petken Bros. & Co.  
Porter, Dr. Wm.  
Pratt, H. S. & Co.  
Schayler Electric Light Co.  
St. Patrick's Church.  
Trinity College.  
Walker, Albert H.

### HIGGANUM.

Crittenden, C., residence.  
Higganum Manufacturing Corporation.

### LAKEVILLE.

Phelps, Chas.

### LOCKHAVEN.

Martin, Samuel Z.

### MANCHESTER.

Luther, Spencer.  
Wadsworth, David, residence.

### MANSFIELD DEPOT.

Reynolds, Edwin, residence.  
Reynolds, G. H., residence.

### MERIDEN.

Cashen, Wm. B.  
Davis, C. H. S.  
Gates, C. E.  
Home National Bank.  
Kay & Taylor.  
Lyman, W. W., residence.  
Lyon & Billard Co., The, office.  
Manning & Bowman.  
Meriden High School.  
Meriden Malleable Iron Co. office.  
Merriam, A., residence.

Miller, E. & Co.  
Morehouse, H. L., office and lumber mill.  
Reiley, R. J.  
Wheeler, F. J.  
Wilcox Silver Plate Co.

### MIDDLETOWN.

Barley & Stohart.

### MYSTIC BRIDGE.

Langworthy, Mrs. Sam'l., residence.  
Mattison, R. R.  
Newbury, Chas.  
Newbury, T. H.

### MYSTIC RIVER.

Smith, F. B.

### NAUGATUCK.

Fagan, Rev. James.  
Page, J. M. & Co.  
Town Hall.  
Tuttle, B. B., residence.

### NEW BRITAIN.

Bassett, S.  
Beard, L. H. & Co.  
Beaton, A. J.  
Cadwell, W.  
Case, C. I.  
Comings, B. N., M. D.  
Goodrich, F. M.  
Kenlock, W. G.  
Schmidt, F. W.  
Stanley, Theodore A.  
Tyler, G.

### NEW HARTFORD.

Droune, John.  
Gates, Henry W.  
Greenwoods Co., The  
Greenwoods School.  
North End School.  
Smith, Henry T.  
Smith, R. R.  
Smith & Spencer.  
Spencer, George A.  
St. Marys School and Convent.  
Weaver, Mrs. W. W.

### NEW HAVEN.

Anderson, J. C.  
Atwater, E. B., residence.  
Beecher, Lyman A., residence.  
Beecher, William S., residence.  
Beaumont, Thomas G., residence.  
Bigelow Co., The.  
Bishop, A. F.  
Brown, R. H. & Co.  
Burwell, M. W., residence.  
Candee, L. & Co.  
Church of the Redeemer.  
Convent of the Sisters of Mercy.  
Durham, P. C.  
Fenn, Wallace B., store.  
Foskett & Bishop.  
French, Jas. R.  
Hez, Henry, store.

Hyperion Opera House, The.  
Kimberly, C. G.  
Leonard, J. N. & Co.  
Linsley, Robert A., residence.  
Meegs & Co., store.  
Mersick, C. S. & Co.  
New Haven Steam Heating Co.  
Parsons, W. M.  
Rowland, F. C. & A. E., store.  
Sargent & Co.  
Second Regiment Armory.  
Skelton, B. G., store.  
Smith, E. J.  
Sperry & Barnes, store.  
Steamer "Emily Mansfield."  
Steamer "F. C. & E. A. Rowland."  
Steamer "J. P. Thomas."  
Strong, Hart & Barnes, store.  
St. John's R. C. Church.  
St. Patrick's Church.  
St. Patrick's Pastoral Residence.  
Warner Hall.  
Wheeler, E. S. Co.

### NEW LONDON.

Armory.  
Hilliard, B. H.  
Lewis, Leander.  
Mersick, C. B. & Co.  
Newman & Cronin.  
Palmer, E. A.  
Palmer, E. L.  
Rodgers, George P.  
Russell, P. W.  
Whiton, D. E., residence.  
Whiton, D. E. Machine Co. office.

### NORWALK.

Fairfield Co. National Bank.  
Gregory, Silas W.  
Hyatt, Hon. James W.  
Kinimey, J. D., residence.  
Lockwood, E. K. & Co.  
Lockwood, Miss Julia A.  
Lockwood, Maurice DeF.  
Thomas, W. H.  
Warner, Hon. Levi.  
Wheeler, Arthur C.

### NORWICH.

Camps, F. T.  
Court House.  
Hislop, Porteus & Mitchels.  
Richmond Stove Co.

### PLAINVILLE.

Beard, J. W.  
Newton, William, residence.  
Plainville Manufacturing Co., office.  
Woodford, Mrs. Sarah, residence.  
Wright, Dr. T. G., residence.

### PLANTSVILLE.

Smith, H. D. & Co.

### POMFRET.

Warner, Alexander.

**THE  
 BUTTON HOUSE HEATING BOILER.**

Patented August 8, 1888.

OTHER PATENTS PENDING AND ALLOWED.

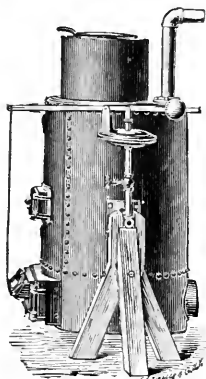

Side View.

THESE CUTS SHOW

the construction of the

**BUTTON BOILER.**

An outer water jacket or water leg, a fire pot formed of Bundy Loops and a magazine similarly formed. All combine to make the water absorb all the heat from the fire.

The low temperature of the smoke pipe proves this.

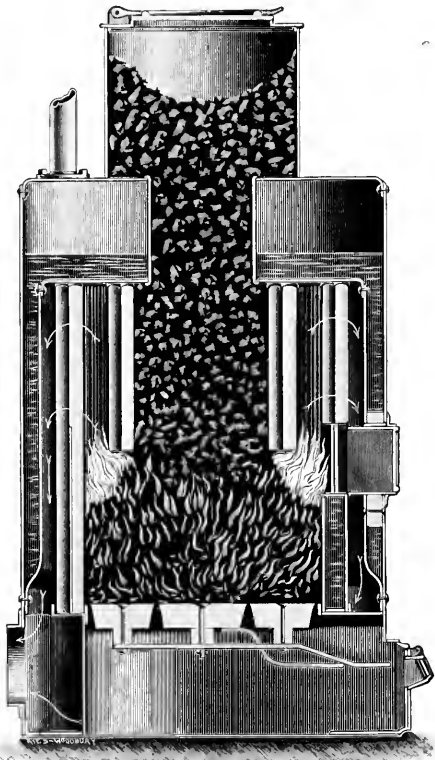

Sectional View—from Front to Rear.

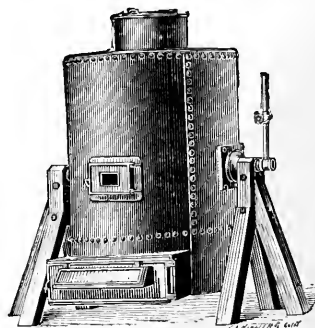

Front View without Trimmings.

AN EXPERIENCE

—IN—

**HEATING.**

About five years ago a well-known manufacturer selected a house-heating boiler of approved design and placed it in his house. Result, as follows: First winter—entire satisfaction. Second winter—tolerable satisfaction. Third winter—no satisfaction. Fourth winter—dissatisfaction. Fifth Winter—a change decided upon. Now he sets a boiler which is always accessible, always easily cleaned. His trouble arose from two causes—the impossibility of thoroughly cleaning his old boiler, and the difficulty in repairing it when necessary. In nine boilers out of ten there are many places which you cannot clean.

He now chooses a **BUTTON BOILER.** Each year's accumulation of soot, dirt, etc., can be perfectly removed from this in one-half day. If you have one of the 50,000 inaccessible boilers in use, change it. Get a **BUTTON**, which is efficient, durable, economical; has 40 square feet of fire surface, to 1 square foot of grate. You can clean it as thoroughly as you can a lamp chimney. It is vertical when in use, horizontal when being cleaned.

Send for circulars.

Address **BUTTON BOILER CO.,**  
 Waterford, N. Y.

**FOR STEAM OR HOT WATER.**

NO BOILER WILL GIVE SATISFACTION UNLESS CLEAN. NO BOILER MADE CAN BE AS THOROUGHLY CLEANED AS THIS. OR AS EASILY. OR AS QUICKLY.

**BUTTON BOILER CO.,**

WATERFORD, N. Y.

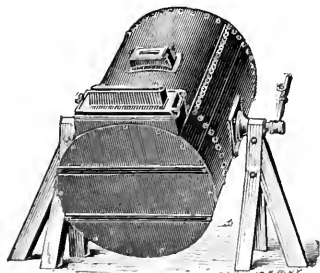

Boiler being tipped up preparatory to cleaning.

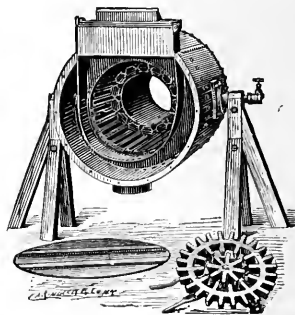

Boiler tipped up, bottom off and grate out, in position for cleaning.

SEE PAGE 154.

## REFERENCES.

### POQUONOCK.

Wilbraham, A.

### PORTLAND.

Day, John B.  
 Ellsworth, E. E.  
 Mack, O. W., residence.  
 Stewart, Capt. T., residence.  
 White, C. H.

### PUTNAM.

Houghton, A.  
 Kent, B. M.  
 Leavens, A.  
 Le Clair, P. M.  
 Putnam Foundry and Machine Corporation.  
 Stoddard, Seth.  
 Whittemore, William.

### RIDGEFIELD.

Gaylor, E. F.

### RIVERSIDE.

Pierce, C. L.

### ROCKVILLE.

Dowling, Thomas, block.  
 Furlong, Rev. J. J., residence.  
 Kuhuley, E. A.  
 Parker, A. B., residence.  
 Parker & Barbee.

### SANDY HOOK.

Curtis, S.

### SEYMOUR.

Buckley, Jas. E.  
 French, A.  
 French, Carlos.  
 Humphrey House, Jos. Riegel, proprietor.  
 Rugg, F. A.  
 Swan, Wm. B.  
 Sykes, O. D.

### SHELTON.

Derby Rubber Co., office.  
 Nettleton, Chas. P.

### SOUTH COVENTRY.

Tracy, E. A.

### SOUTHINGTON.

Neal, S. D., residence.  
 Peck, Stow & Wilcox Co., The.

### SOUTH MANCHESTER.

McCaw, James.

### SOUTH NORWALK.

Congregational Church.  
 Donaldson, T. S.  
 Meeker, W. H. & Co.  
 Millard, R. G., residence.  
 Miller, George E.  
 Morrison, T. H.  
 Raymond & Comstock.  
 South Norwalk School.

### SOUTHPORT.

Hubbell, Rev. Geo. A., residence.

### SOUTH WINDHAM.

Winchester, A. S., residence.

### STAMFORD.

Begent & Lynch.  
 Blickensderfer, G. C., residence.  
 Brown, John M.  
 Collender, H. W., residence and factory.  
 Clark & Hoyt.  
 Cook, Samuel.  
 Christy, Chas. R.  
 Day, Dr. Edward, residence.  
 Evans, Charles, residence.  
 Greenwood, Wm., brick building.  
 Havemeyer, H. O.  
 Hawley, S. J.  
 Hoyt, Harvey.  
 Hoyt, Jos. B.  
 Hurlbut, Dr. A. M.  
 Hurlbutt, Dr. L. R., residence.  
 King, H. M., residence.  
 Lum, B. D. & Son.  
 Lum, Geo. B., residence.  
 McHaig, H. H., residence.  
 Reed, Stephen E., residence.  
 Smith, S. T., residence.  
 St. John's Church.  
 Stamford National Bank.  
 Stark & Wilson.  
 Vail, J. E., Jr.  
 Watson, A. H.  
 Wilson, James, residence.

### STONINGTON.

Stwood, Eugene.  
 Weenes, D. L.

### THOMPSONVILLE.

Cope, A.  
 Leete, Arthur R.  
 Mulligan, William.

### TORRINGTON.

Morton, C. E.

### UNIONVILLE.

Broadbent, J. & Son.

### WALLINGFORD.

McCormack, J. H.

### WATERBURY.

Anderson, R. T.  
 City Hall.  
 Daly, M. J.  
 Smith & Griggs Mfg. Co., office.  
 St. Margaret's School.  
 St. Patrick's Church.  
 State Armory.  
 Thomaston, R. T. Andrews, residence and store.  
 Waterbury Watch Co., office.

### WESTVILLE.

Beecher, E. B.

### WEST WILLINGTON.

Hoyle, James, residence.

### WEST WINSTEAD.

Chase, D. B.

### WHITE RIVER JUNCTION.

Mott, H. L.

### WILLIAMANTIC.

Stearns, F. I.  
 Vanderman, Wm.  
 Willson, F. M.

### WINSOR.

Wilbraham, A.

### WINSTED.

Adams, H. O.  
 Alvord, J. H.  
 Clarke & Hart, store.  
 Herman, S. A.  
 Strong, David, residence.  
 Utton, G. W.

## DAKOTA.

### ABERDEEN.

Aberdeen, New Club House.  
 Brooks, F. W.  
 Curtis & Hungerford.  
 Fennant, Wm.  
 Jumper, S. H.

### AMENIA.

Chaffee, E. W.  
 Chaffee, H. F., residence.

### ARVILLA.

Brown, Rev. J. A.

### CENTERVILLE.

Rowley, F. M.

### DEADWOOD.

Harding, L. G.  
 Syndicate Block.

### FARGO.

Fargo Engine & Boiler Works.

### GRAND FORKS.

Whithed, A. L.

### LISBON.

McWilliams R. A., residence.

### SIoux FALLS.

Dow, W. L.  
 Metropolitan Block.

### WATERTOWN.

Heegaard & Co.

### WESTPORT.

Eno, W. P.

### YANKTON.

Burns, Robt. W., residence.  
 Madole, S. C., residence.  
 Pierce, J. T. M.  
 Potter, J. B.  
 Scongel, Geo. R.  
 Union Block.  
 Yankton Heating & Plumbing Co.

## DELAWARE.

### DOVER.

Forbes, J. A.  
 Hotel Richardson.  
 Jones, E. L. & Co.  
 Lewis, Dr. Ed.  
 Liberman, Mrs. M.  
 Richardson, A. B.

# “PERFECT” HOT WATER HEATER.

(Trade Mark.)

TWELVE SIZES.  
ADAPTED TO HARD OR SOFT COAL.

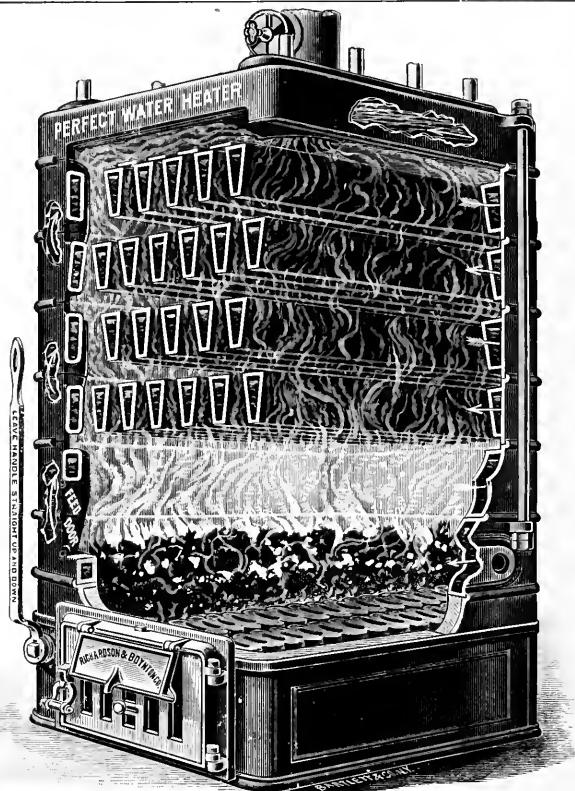

ABSOLUTELY SAFE AND FREE FROM NOISE.  
Easy to Manage as an Ordinary Heating Stove.

The Celebrated “Perfect” Hot Water Heaters are the most powerful, economical and the only positive circulating Heaters ever made. They present  $2\frac{1}{2}$  times more surface exposed to the direct action of the fire than any other heater of equal diameter; 85 per cent being fire surface and only 15 per cent flue surface. Flue surface is of little value in Hot Water Heaters. All the water passes twice around the fire and five times over it, absorbing heat all the way up. There is four inches of brick above the grate which allows the coal to become thoroughly ignited before coming in contact with the water sections, the result is a bright, clean fire over the whole surface. Fitted with “PERFECT” triangular grates. Absolutely water-tight and gas-tight. Universally successful. Heating where others fail.

—\*—

A WONDERFUL BOILER

# “PERFECT” HOT WATER HEATER.

(Trade Mark.)

RICHARDSON & BOYNTON CO.,

MANUFACTURERS,

84 LAKE STREET, CHICAGO.

232 AND 234 WATER STREET, NEW YORK.

## REFERENCES.

Richardson, Henry, residence.  
Willis, Thos.

**ELKTON.**

Howard House.

**MIDDLETOWN.**

Biggs, Sewell.  
Miffin, Wm. P., residence.

**NEWARK.**

D laware Experimental Station.  
Newark Vat Works.  
Newark Water Works.  
Wright, H. B. & Co., store.  
Wright, S. J., residence.

**NEW CASTLE.**

New Castle Co. Jail.

**NEW WILMINGTON.**

Ladies' Dormitory.

**SEAFORD.**

Ross, W. M.

**SMYRNA.**

Hudson, Alfred.  
Hudson, J. P.  
Miffin, J. B.

Taylor, Gilbert, residence.

**WILMINGTON.**

Headenkopf, William, residence.  
Bison, Jno. C.  
Bringhurst, Edward, jr., residence.  
Bush, W. D.  
Canby, Wm.  
Central National Bank.  
Clark, Samuel B.  
Cleland, Geo. D., store.  
Delaware Hospital.  
Driscoll, T. J.  
Eaton, I. N.  
Fritz, Charles E., residence.  
Gause, H. V., residence.  
Gause, H. W., residence.  
Gawthrop, Bro. & Co.  
German Hall, Association Building.  
Gillispie & Co.  
Goodley, Geo. W.  
Grand Union Hotel.  
Harlan & Hollingsworth Co.  
Hartman & Fehrenbach Co.  
Lea, Wm. & Sons Co., office.  
Lobdell, G. G.  
Lore, Hon. Charles B., residen  
Miller & Co.  
Miller & Jenkins.  
New Castle Co. Court House.  
New Castle Insane Asylum.  
Penna. R. R. Depot.  
Public School, No. 16.  
Pusey & Jones Co., The.  
Pyle, Frederic, residence.  
Pyle, Willard S., residence.  
Remington Machine Co.  
Robelen, H. F., store.  
Rogers Printing Office.  
Rumford, Mrs. H. P.

Semple, James H., residence.  
Simmons, S. G. & Bros., office.  
Speakman, Allen, store.  
Speakman Supply & Pipe Co.  
Stewart, Charles.  
Stoeckle, Harry J., residence.  
Stoeckle, Joseph, residence.  
Stirling, John Q., residence.  
Stone, G. W.  
Traynor, James F.  
Vulcanized Fibre Co.  
Willey, S. I., residence.  
Wilmington Mills Manufacturing Co.  
Wilmington Skating Rink.  
Wilmington Trust and Safe Deposit Co.

## DISTRICT OF COLUMBIA.

**GEORGETOWN.**

Dents, Edward L., Iron Works.

**WASHINGTON.**

Adams, Henry, residence.  
Adams Building.  
Agricultural Building.  
Albajns Grand Opera House.  
Alderney Dairy Building.  
Annex to National Medical Museum.  
Arlington Fire Insurance Building.  
Art Gallery.  
Atlantic Building.  
Ball, C. G. & Son.  
Ballentine, William, residence.  
Baltimore & Potomac R. R. Co.  
Bayley, W. B.  
Bell, Prof. A. Graham, residence.  
Belt Line R. R., offices.  
Belvidere Hotel.  
Bergner & Engel, office.  
Bishop, Miss N., residence.  
Blaine, Hon. James G., residence  
Bover, John M.  
Bowden & Buechler.  
Boston Variety Store.  
Boyd, Col. Robert, residence.  
Bradbury, F. B.  
Britton, A. T.  
Brown, Col. W. L.  
Browne, A. B.  
Bryant, O. M., residence.  
Bureau of Education.  
Burns, George N., residence.  
Bugher, A. H., residence.  
Capsland, M., residence.  
Capverly, Edward & Co.  
Carlisle, Calderon, residence  
Carry, Albert, residence.  
Caverly, E., residence.  
Central National Bank.  
Chappelle, N. L. & Co.  
Church of the Covenant.

Chatham, Miss A.  
Children's Hospital.  
C. & P. Telephone Building.  
Clark, General, residence.  
Clements, John T., residence.  
Columbia Institute.  
Columbia Title Insurance Building.  
Columbia Hospital,  
Columbia Preparatory Department.  
Columbia University.  
Convent of Visitation.  
Cochran Art Gallery Estate.  
Corcoran Building.  
Corcoran Fire Insurance Co.'s Building.  
Cranch School Building.  
Curtis School Building.  
Davis' Sons, Jas. Y.  
Deaf and Dumb Asylum.  
De Atley, Jno. H., hotel.  
Demonet & Sons, Mrs. I. M.  
Dent, Edward L. & Co.  
Department of Justice Building.  
De Valin, Chas. E., residence.  
Dennison Public School.  
District Building, Commissioner's Office  
Dominican Convent.  
Dougherty, W. W.  
Ebbitt House.  
Edels Hall.  
Edmonston, Chas. R., residence.  
Emmert House.  
Entwisle, Thos. B.  
Equitable Insurance Building.  
Evans, Dr. Warwick, residence.  
Evans, John O. Building.  
Evans, John O.  
Ewald, H. C., store and residence.  
Fairman, Chas. E., residence.  
Ferguson, Cal., residence.  
Feuman, Jno. S., residence.  
Fitzgerald, N. W. & Co.  
Forrest House, hotel and residence.  
Foster, Gen. Jno. W., residence.  
Franklin School Building.  
Gale, Thos. M., residence.  
Garfield Memorial Hospital.  
Geddis.  
Gheen, Benedict, residence.  
Gheen, Fred'k., residence.  
Gibson Bros.  
Gibson, Thos. A.  
Glover Building.  
Goodfellow, Edward, residence.  
Government Hospital for Insane.  
Grant Public School.  
Grimes, M., residence.  
Groff, D. B.  
Guntton Building.  
Hagner, Dr. Chas. E., residence.  
Harris House.  
Harris & Shafer.  
Hay, Hon. John, residence.

# FURMAN BOILERS

## FOR HOT WATER OR STEAM HEATING,

Have a high reputation for Staunchness, Durability and Safety, and are GREAT COAL SAVERS. They embody every improvement that study and capital can suggest and secure, and are models of inventive and mechanical skill.

Every Architect and Steam Fitter not familiar with our Boilers should send for a copy of our 150 page illustrated manual on Modern Heating and Ventilation, with tables and correct plans for Hot Water Work.

# LEAD THE WORLD

ADDRESS

HERENDEEN MANUFACTURING CO., GENEVA, N. Y.

Mention Bundy Catalogue.

We make over 50 different styles and sizes of Boilers for Heating Purposes.



## REFERENCES.

Hayward & Hutchinson (three stores).  
 Henrick, Christian, residence.  
 Henrick, Christian, restaurant.  
 Herr, Austin, residence.  
 Herzog, Fred., store and residence.  
 Higgins, W.  
 Hill, James M.  
 Hines, Hon. L. G., residence.  
 Hoderman, Mrs., residence.  
 Hoeke, W. H.  
 Hooe Building.  
 Hoffman, Prof., residence.  
 Hotel Arno.  
 Hotel Normandi.  
 Hotel Johnson.  
 Hove Block.  
 Howard University Industrial School.  
 Inter-Ocean Building.  
 Jefferson School Building.  
 Jeffries, Gen. N. L.  
 Jenks, W. S. & Co.  
 Johnson's Eating Saloon.  
 Johnson's Law Building.  
 King, Wm. B., residence.  
 Lamar, Justice L. Q. C., residence.  
 Lang, Mrs. J. M., residence.  
 Lansburg & Bro.  
 Lansburgh, Julius.  
 Leitch, Wm. C., residence.  
 Leitch, R., & Sons, office.  
 Lincoln Hall.  
 Lincoln School Building.  
 Lindekohl, H., residence.  
 Louise Home.  
 Loyd, John, office.  
 Lutheran Church, Penna. Ave. and 2d St.  
 Lutz, F. A., residence.  
 Mason, E. E., residence.  
 Mason, George, residence.  
 Mason, Gen. John S., residence.  
 McAvoy, Geo. F.  
 McDonald, Jno. A.  
 McKenney, Jas. H., residence.  
 McMillan, James.  
 Meigs, Gen. M. C.  
 Metropolitan R. R. Co.'s Offices.  
 Metropolitan Club House.  
 Metzertott W. G. & Co., store.  
 Mexican Legation Building.  
 Miles, H. C., residence.  
 Mills, Henry R., residence.  
 Milton Flats.  
 Mullett, A. B.  
 Munson, H. T.  
 Morton, Hon. L. P.  
 Morrison, H. F.  
 Moore & Leding, store.  
 National Institute.  
 National Museum.  
 National Observatory.  
 National Union Fire Insurance Building.

New Addition to Corcoran Art Gallery.  
 New Pension Building.  
 Noble Secretary, residence.  
 O'Brein's Hotel.  
 Orme, J. W., residence.  
 Oyster, Geo. M., residence.  
 Pacific Building.  
 Panorama Building  
 Peabody School Building.  
 Pearson, Geo. W., residence.  
 Perry, Seaton.  
 Poole, J. S., office building.  
 Portland House.  
 Prall, W. E.  
 Providence Hospital.  
 Quartermaster's Office.  
 Quinter, Jos. R.  
 Real Estate Title Insurance Building.  
 Reed, G. R., residence.  
 Richmond & Danville R. R. Co., offices.  
 Riggs, E. Francis, residence.  
 Roche's Marble and Slate Mantel Factory  
 Rochester, Gen., Paymaster Gen., residence.  
 Saks, A. & Co., store.  
 Sargeant, M.  
 Sawyer, Senator, residence.  
 Seaton School Building.  
 Second National Bank.  
 Schafer E. G. & Co., office.  
 Schmitt, V. F.  
 Schneider, L. H., residence.  
 Solen Bros.' Hotel.  
 Sisters of Notre Dame, N. Capital and K streets.  
 Small & Sons, J. H.  
 Smith, Mrs. Katherine, residence.  
 Smith, Thos. W., residence.  
 Smithsonian Institute.  
 Snow, C. A.  
 Shoreham Apartment House.  
 Spaulding, Wm. L.  
 Spaulding, Harvey, residence.  
 St. Ann's Infant Orphan Asylum.  
 St. Cecilia's Academy.  
 St. Dominic's Church.  
 St. Elizabeth's Insane Asylum.  
 Stevens, F., residence.  
 Stewart, C. E., residence.  
 St. James Hotel.  
 St. Joseph's Asylum.  
 St. Mary's Chapel.  
 St. Patrick's Church, G. and 10th Sts.  
 St. Rose's Industrial School.  
 Stock, Mr.  
 Strong Building.  
 Stuthiger, E. J., residence.  
 Somerville, T. & Sons.  
 Sullivan, T., residence.  
 Sumner School Building.  
 Supply Division of U. S. Post Office Dept.  
 Swain, Gen. D. G., Judge Advocate General,  
 residence.

Talmge, H. H., residence.  
 The Boston Dry Goods House.  
 The Gale's School Building.  
 The Evening "Star" Newspaper Co.'s Build-  
 ings.  
 The Richmond Flats.  
 Thompson, W. S., office building.  
 Thompson, W. S., residence.  
 Thorn, C. G., residence.  
 Tyler & Rutherford.  
 United States Capitol Building.  
 United States Census Office, Harvey Spauld-  
 ing, owner.  
 United States Coast Survey.  
 United States Commission of Fish and Fish-  
 eries.  
 United States Department of Justice.  
 United States Interior Department.  
 United States Soldiers' Home.  
 United States State Department Building.  
 United States Treasury Building  
 United States War Department Building.  
 Vermilya, Jas. H., residence.  
 Vertis, Mrs.  
 Waggaman, Mr. J. F.  
 Wallack Public School.  
 Walter Block.  
 Walter, Dr. John, flats.  
 Warner Building.  
 Washington Beneficial Endowment Associ-  
 ation.  
 Washington High School.  
 Washington Light Infantry.  
 Washington National Republic Office.  
 Washington Post Office.  
 Washington Safe Deposit Co.'s Building.  
 Welker's Hotel.  
 Webster School.  
 Wheeler, Capt. Geo. M., residence.  
 Whiting, H. E., store.  
 Whitlock, Mr.  
 Whitney, Dr., residence.  
 Whitney, Hon. W. C., residence.  
 Williams, Mr.  
 Willard, C. C.  
 Windsor, Col. David A., residence.  
 Woodward & LaThrop.  
 Yulu, Hon. D. L., residence.

## ENGLAND.

### LONDON.

C. O. Sheppard, Panorama.  
 Garrick Theatre.  
 Niagara Panorama.  
 Rosser & Russell, Charing Cross.

### MANCHESTER.

Wilson, William & Co.

### WESTMINSTER, S. W.

Clyde, Navigation Co.

— OVER 15,000 NOW IN USE. —

# THE DUNNING PATENT WROUGHT IRON BOILER,

WITH SELF-FEEDING MAGAZINE.

IT IS THE  
OLDEST AND BEST

Steam or Hot Water Heating Boiler Made,  
AND INSURES A WARM HOUSE  
**NIGHT AND DAY.**

Perfectly free from Carbonic Acid Gas, Smoke or Inhalable Ash  
Dust. An automatic, noiseless and easily managed Heating  
Apparatus, requiring attention but once in  
Twenty-four hours.

MADE IN ELEVEN SIZES,  
SUITABLE TO HEAT FROM THE  
**SMALLEST COTTAGE**

TO THE  
**LARGEST BUSINESS BLOCK,**  
AND IN 4 PATTERNS AS FOLLOWS, VIZ:

- As a **MAGAZINE BOILER**, which requires attention but once in 24 hours.
- As a **SURFACE BURNER**, to burn hard or soft coal, wood, coke, oil or gas.
- As a **HOT-WATER BOILER**, for greenhouses and hot-water heating.
- As a **PORTABLE BOILER**, to be set without brick-work.

The above Boilers are made in **TWO SECTIONS**, when desired, so that they can be taken in through small door or window, where whole one cannot enter.

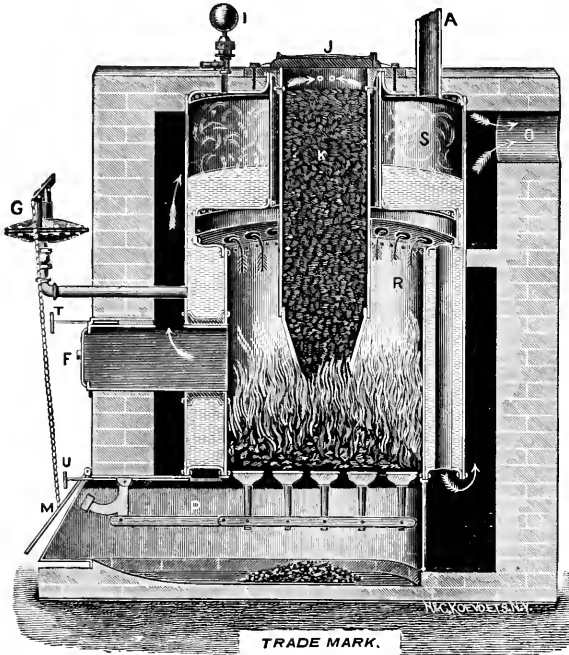

THIS CUT REPRESENTS A NEW  
**ROCKING AND DUMPING GRATE,**

Which are now being furnished with all sizes of the

**DUNNING BOILER,**

And is pronounced by all who have used it to be the most

**PERFECT GRATE YET INVENTED,**

As it shakes the fire over the entire surface, grinds up all clinkers that may form and prevents the accumulation of ashes around the fire pot.

The grate is simple in construction, and should any part give out it can be very easily replaced by any one.

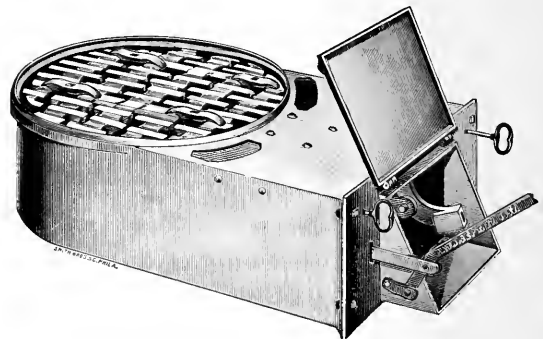

MANUFACTURED BY THE

**NEW YORK CENTRAL IRON WORKS CO.,**

NEW YORK SALESROOM,  
36 PARK PLACE.

46 EXCHANGE STREET, GENEVA, N. Y., U. S. A.

SEND FOR CATALOGUE "A."

## REFERENCES.

### WESTMORELAND.

Broughton Hall, the Seat of Lords.  
Broughton & Vaux.

## FLORIDA.

### FERNANDINA.

Schuyler, Robert S., C. E.

### GOTHA.

Hempel, H. A.

### JACKSONVILLE.

Hubbard, S. B., & Co.  
McClure, A. E.  
Steamer "Eliza Hancox."

### MAGNOLIA.

Magnolia Hotel.

### PALATKA.

Putnam House.

### ST. AUGUSTINE.

Cruft, Isaac F.  
Cruft, J.  
Hotel Casa Monica.  
Hotel Cordova.  
St. Marco Hotel.

### TAMPA.

Wells, J. H.

### TAMPA BAY.

Tampa Bay Hotel.

### WINTER PARK.

Seminole Hotel.

## GEORGIA.

### ATLANTA.

Armstrong, Dr. W. S., residence and office.  
Atlanta Police Headquarters.  
Atlanta Trust & Banking Co.  
Dodd, P. & G. F., office.  
Hebrew Orphan Asylum. The  
Hitzel, Miss Lizzie, residence.  
Johnson Building.  
Hunnicut & Bellingrath.  
Moore, W. A.; residence.  
Neal Loan & Banking Co.  
Packard Hall, The (Female Seminary).  
Peters Block, The.

### AUGUSTA.

Dartmouth Spinning Co.  
Davidson, W. G.  
McAuliffe, P.  
Robbe, C. A.  
St. Paul's Church.

### BRUNSWICK.

Oglethorpe Hotel, The.

### MACON.

Bennett & Boardman.  
Burke, J. W., & Co., building.  
Burke, T. C.  
Carling & Brown.  
Evening News Building.  
Lanier House.  
Macon Telegraph Co.  
Subers, S. M., & Son.

### MILLEDGEVILLE.

Boardman, A. E.

### SAVANNAH.

Altmyer, A. R.  
Baldwin, Geo. J., Prest. Baldwin Fertilizer Co.  
Bringer, DeWitt.  
Carson, John A. G., residence.  
De Sato Hotel.  
Douglass, Jas.  
Guckinheimer, S. & Son, store.  
Haas, I. G., residence.  
Kayton, L., residence.  
McCarthy, L. A.  
Nichols, Wm. N.  
Nicholson, John, Jr.  
Robbe, C. A.  
U. S. Revenue, S. S. Bonteville.

### THOMAS.

Pioneer Mining & Mfg. Co.

### THOMASVILLE.

Piney Wood Hotel.

## IDAHO TERRITORY

### BOISE CITY.

Capitol Building.

## ILLINOIS.

### ALTON.

Schwappe, H. M.

### AURORA.

Aurora Cotton Mills.  
First National Bank.  
Linden & Lake.  
Mason Bros., store.  
Mills & Sencenbaugh.  
Reeves, C. K., residence.  
Reeves, C. H., & Co., store.  
Reeves, C. H., residence.  
Reeves, Meyer, store.  
Ruggles, Geo. F., residence.  
Sencenbaugh, S. S., & Co.  
Smitte, B. F., residence.

### BATAVIA.

Kane County Alms Hou.e.  
U. S. Wind Engine & Pump Co.

### BELVIDERE.

Barnes, Jno., residence.  
Plane, Ed. B., residence.  
Scott, Chas., estate.

### BLOOMINGTON.

London, Robt.  
McGregor, R. R.  
McIntosh, Geo.  
Miller, Geo. H.  
Morrison, F.

### BLUE ISLAND.

Klein, Henry.  
Rehm, Jacob F., residence.

### CHENOA.

Foles, W. M.  
Ketcham, W. E.

### CHICAGO.

Adams, J. Q., store.  
Adkins & Hoffman.  
Allen Building.  
Areal Mining Co., office building.  
Baker & Smith Co.  
Baker, James, residence.  
Baltimore and Ohio Hotel.  
Baltimore and Ohio Passenger Depot.  
Behring, Louis.  
Behr, Dr. Arno.  
Biroth, Henry, manufactory.  
Board of Trade Building.  
Bolton, James, residence.  
Burham & Root.  
Burnett, Wm. H.  
Burke, D. F., residence.  
Bush, P. J., residence.  
"Burtra,"  
Butler, A. L.  
Case, C. H., residence.  
Central Safety Deposit Co.  
Chicago Maleable Iron Co., office  
Clow, J. B., & Son.  
Cobb, Oscar.  
Cook Co. Hospital.  
Cook Co. Insane Asylum.  
Cook Co. Normal School.  
College of Physicians and Surgeons.  
Corkery, D., office.  
Craig, Wm. M., residence.  
Cutler, C. H.  
Davidson, Jno. A., residence.  
Dearborn Railroad Station.  
Denier, T. C., residence.  
Doane, J. W., & Co., store.  
Eiszner, John, office.  
Fisher, L. G., residence.  
Fisher, Reynolds.  
Fleming, J. C., Home Ins. Building  
Fuller & Fuller Building.  
Garrott, Dr. E.  
Gatzert, J. L., residence.  
Gould, E. B., residence.  
Hayes, Frank.  
Hickey, Thos., building.  
Hlodovec, J., flat.  
Hoffman, H. G., store.  
Hooker Co., H. M.  
Home Insurance Building.  
Hottinger, Gustave.  
Hurd, S. N., residence.  
Hurlbut, Walcott.  
Huston, A. C.  
Huston, A. C., flats.  
Jacobs, Theo., & Co.  
Jansen, H. H.  
Kinsley's Restaurant, H. M.  
La Salle Dr. Institute.  
Leslie, J. H., & Co., store.

# THE RICHARDSON & MORGAN CO.

92 BEEKMAN ST., NEW YORK.

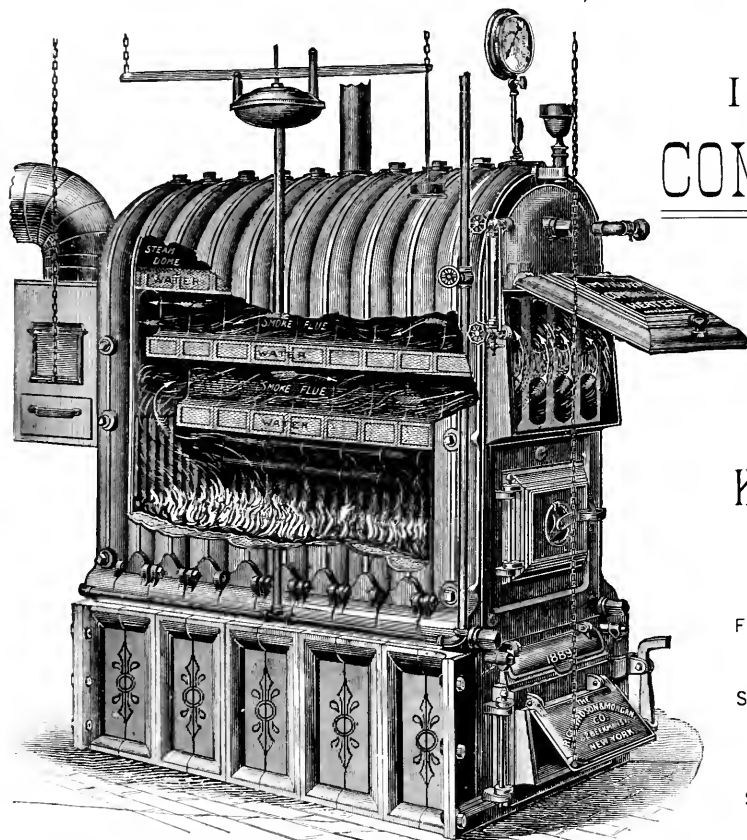

IMPROVED  
COMBINATION  
BOILER

Brick Set or Portable

... FOR ...

Hot Water or Steam  
Heating Plants.

FLUES CAPACIOUS,  
FIRE-BOX AMPLE,  
SUPERIOR FEATURES,  
LARGE HEATING SURFACE  
AND  
SPLENDID SELLING POINTS.

PORTABLE FORM. (10 Sections, with Cast Base.)

## TO THE TRADE:

The power of these boilers is increased or diminished by addition or subtraction of Middle Sections and grates.

The dealer, by carrying one sample only, is enabled to demonstrate the different modes of heating, and to show different capacities, without being compelled to carry in stock different patterns and different sizes of boilers.

Send for our Catalogue, giving reliable results from a series of carefully conducted scientific tests, made to demonstrate the actual heat generating power and fuel economy of these boilers.

## THE RICHARDSON & MORGAN CO.,

— ALSO MANUFACTURERS OF —

Richardson's Celebrated Furnaces, Ranges, Fire-place Heaters, &c.,  
92 BEEKMAN ST., NEW YORK.

## REFERENCES.

Liese, F.  
 Little Sisters of the Poor.  
 Mackin, Thos., residence.  
 Marmerre School.  
 Mason & Miller office building.  
 McCormick, C. H., Estate, residence.  
 McDonnell, E. & H., residence.  
 McIntosh, Alexander, residence.  
 Meyer, Martin, residence.  
 Miller, T. E., residence.  
 Morley, S. F., residence.  
 Morton Flats.  
 Morton, A. H. & E. C.  
 Nixon Building, office building.  
 Oswald, F. A., residence.  
 O'Donnell, R., residence.  
 Otis, F. R., residence.  
 Palmer House.  
 Peacock, E. P., office.  
 Phœnix Insurance Co. Building.  
 Pitney, Fred, residence.  
 Pollard, L. D., residence.  
 Pope, Samuel I., & Co.  
 Prentice, L. H.  
 Propeller "Vernon."  
 Pullman Palace Car Co. Building.  
 Rice, E. S.  
 Rice, Whitacre & Co.  
 Reno, C. A.  
 Riedle, Frank, residence.  
 Rowan, P. J., M. D., residence.  
 Royal Insurance Co. Building.  
 Ruehl, Rev. J. C.  
 Ruehl, Wm., residence.  
 Ryerson Building.  
 Saunders, Mrs. R., residence.  
 Sargent, E. H., residence.  
 Scheel, Chas., residence.  
 Shuman, A. F., residence.  
 Smith, Peter, residence.  
 Smyth, Jno. M., residence.  
 Steele, has. R., flats.  
 Stark, Frank, residence.  
 Sterrett, J. C.  
 Stuart, Robert, residence.  
 Superior Street Hospital.  
 Swartz, David G., residence.  
 Taylor Building.  
 The Rookery.  
 The Masury Apartments.  
 Thiele, E., store.  
 Tobin, Mrs. C. O., residence.  
 Tonk, M., residence.  
 Tyler, W. O., Paper Co.  
 Village Hall (Hyde Park).  
 Weller, E. C.  
 Wheeler Apartments.  
 Wilks, Stephen.  
 Williams, C. R.  
 Williams, Geo. T., residence.  
 Woodruff, C. E., residence.

Woodman, D. J.  
 Yoe, L. G. & Co., store.  
**DECATUR.**  
 Miller & Son, H.  
**EAST ROCKFORD.**  
 Trowe, J. M.  
**EDGEWATER.**  
 Pretzman, Wm.  
**ELGIN**  
 Church, A. B., residence.  
**ENGLEWOOD.**  
 Brownell, Ralph, residence.  
 Claus Bros., residence.  
 Dennison, J. C., residence.  
 Pe'ton, Alonzo, residence.  
 Porter, F. W., residence.  
 Tonsley, W. H.  
**EVANSTON.**  
 Bradley, Seth.  
 Bradshaw, Mrs. S. W.  
 Bragdon, Dr. M. C.  
 Hill, Rob't., residence.  
 Howell, J. W.  
**FREEPORT.**  
 Bartlett Hardware Co., store.  
 Clifton House.  
 Devore, L. M. Hon., residence.  
 Schroder, H., residence.  
 Sunderland, D., residence.  
**GALESBURG.**  
 Brown, Geo. W. & Co., residence.  
 Chapman, Geo. H., residence.  
 Dewey, C. W.  
 Frost, Mfg. Co.  
 Gay, M., residence.  
 Hibbard, E. A., residence.  
 Hopper, Dr. H. C.  
 Mitchell, J. K.  
 Nelson, P., store.  
 Nutshell, J. K. residence.  
 Phelps, E. F., residence.  
 Seacord, Wilkins, residence.  
 Squires, J. G.  
 Webster, C. A., residence.  
 Winsor, C. A.  
**HARVARD.**  
 Ayers Railway Eating House.  
 Blake, N. E., residence.  
 Blake, J. C., Heating Co.  
 Dr. Kerr's Church.  
 Emerson & Talcott, factory.  
 Sheriff's Dwelling.  
 Stewart Block.  
 Third National Bank.  
 Winebago County Jail.  
 Y. M. C. A. Building  
**HENRY.**  
 Powell, F. A.  
**HIGHLAND PARK.**  
 Boulton, George D., residence.  
 Corey, F. W.

**HINSDALE.**  
 Childs, R. A.  
 Froseher, Adolph.  
 Grant, Miss E., residence.  
 Hench, Dr. John B.  
 Ridgeway, J. V., residence.  
 Robbins, Geo. B., residence.  
**JOHN BURG.**  
 Catholic Church.  
**JOLIET.**  
 Barnes, Julian.  
 Barrett & Co.  
 Barrett & Sons.  
 Beach, L. F.  
 Burden, Alex.  
 Dyen, W. D.  
 Dyer, N. P.  
 Hardy, Otis.  
 Holmes & Cady.  
 Mehring, Rev. A., residence.  
 Munroe, Geo. H.  
 Munroe, Geo.  
 St. Mary's Church.  
 Utter, F. G.  
 Woodruff, F. W.  
**KANKAKEE.**  
 Whitman, J. S.  
**KENWOOD.**  
 Bogue, H. B.  
 Thrall, W. A.  
**KEWANNA.**  
 Wilson, M.  
**LA GRANGE.**  
 Turnock, E. Hill.  
**LAKE FOREST.**  
 Larned, W. C., residence.  
**LAKE VIEW.**  
 Henning, F. F.  
**LAWRENCEVILLE.**  
 Watts, F. C.  
**LINCOLN.**  
 Blinn & Hoblet.  
 Brainard, B. H.  
 Cherney, Vincent, saloon and restaurant.  
 Cogsby, J.  
 Holler, J. S.  
 Lincoln National Bank.  
 Lincoln Water Works Co.  
 O'Blinn & Hoblit.  
 Traner, W. H.  
**MINOOK.**  
 Siemous, S. H. & Son.  
**MOLINE.**  
 Keator, Benj.  
 Union Mfg. Co.  
**MORRISON.**  
 Shaford, D. S.  
 Smith, Leander.  
**MORRISONVILLE.**  
 Culp, S. W., residence.  
 Wycoff & Randolph.

ABIJAH WESTON, President.

F. E. BRONSON, Sec'y and Treas.

G. A. BRONSON, Vice-President.

# THE BRONSON

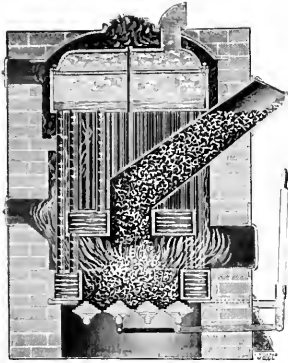

WATER TUBE BOILER

-FOR-

Steam or Hot Water Heating.

ECONOMICAL - AUTOMATIC - GUARANTEED

IMPROVED GRATES.

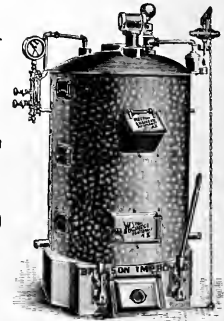

All Styles of Boilers Furnished with Back Outlet for Smoke.

MADE SURFACE BURNERS FOR SOFT COAL.

Results always Satisfactory.

**The Bronson Steam and Hot Water Heater** is an improved form of water-tube boiler every part of which is fire surface of the highest efficiency. It is made principally of the best steel tubing, manufactured expressly for the purpose. Referring to the cuts it will be seen that these tubes are connected with each other by three sections—the bottom or fire-pot ring—the middle ring, the central aperture of which forms the lower end of the coal magazine, and the upper section, or steam dome. These are all connected together with steel tubes, the joints being of a peculiar nature, precluding the possibility of leakage and binding all parts of the boiler into practically one piece of metal.

There is a much larger proportion of heating surface to the grate surface in this boiler than any other—in itself a long step toward economy, as the prominent defect in most heaters is having large grates and small heating surface.

The heating surface in most boilers is also very inefficient, due to poor design, bad circulation, and the difficulty of keeping the heating surface clean. In the BRONSON all the heating surface is of the highest efficiency, is vertical and readily accessible, thus providing for keeping a clean boiler with the least possible trouble.

The hot gases of combustion leaving the fire pass outwardly between a double row of tubes, then passing upward are deflected to the centre of the boiler, crossing all of the tubes, again deflected to the outside, then cross the tubes the third time, and finally pass around and over the steam dome before finding their way out.

This peculiar arrangement of vertical water tubes and horizontal deflections provides at once for the most perfect circulation possible, and for the absorption of heat in the gases—a point seldom before realized, but which must be obtained before a boiler can make the slightest pretense toward economy.

**WESTON ENGINE CO., SOLE MANUFACTURERS,**

ALSO PORTABLE AND STATIONARY, HIGH SPEED AND SLOW MOTION ENGINES, BOILERS, Etc.

PAINTED POST, N. Y.

H. J. BARRON, 74 Cortlandt St., New York City, Agent for the City of New York and vicinity.

Send for Catalogue "G," also Prices.

## REFERENCES.

### MT. VERNON.

Patton, C. H.  
M. E. Church.

### NORMAL.

Hanley & Keiaghan.

### OTTAWA.

Clegg & Dougherty.  
Clegg, Jno. W., residence.  
La Bastie Glass Works.  
Leland, L., residence.  
Trask, Mrs. R. H

### PULLMAN.

Pullman Palace Car Co.

### QUINCEY.

Best, E., Plumbing & Steam Heating Co.

### RAYMOND.

Culp, B. F.

### RAVENSWOOD.

Wallace, Jas.

### RIDGELAND.

Ames, C. L.  
Gates, R. D., residence.

### RIVER FOREST.

Waller, E. C.

### RIVERSIDE.

Harrington, S. H., residence.

### ROCKFORD.

Air Brush Factory.  
Barnes, John.  
Christian Union Church.  
Emerson, Talcott & Co.  
Frowe, J. M.  
Hale, H. B., M. D.  
Manard Bros.  
Stewart's Block.  
Y. M. C. A.

### ROCK ISLAND.

Davis & Co.  
Davis, J. B.  
Weyerhaeuser, F., residence.

### SPRINGFIELD.

Edmonds, C. H.  
Springfield Woolen Mills.

### ST. ANN.

Chineguy, Rev. Chas.

### STERLING.

Wright, E. M.

### SYCAMORE.

Forward, A. M., & Co.

### WASHINGTON.

O'Neil, Jno. & Son.

### WATAGA.

Robson, Wm., residence.

### WAUKEGAN.

Fisher, A. C., residence.  
Peabody, H. B., residence.  
Price, R. C., residence.

### WEST HINSDALE.

Bogue, Geo. M.

### WOODSTOCK.

Hoy, M. D.

## INDIANA.

### ANDERSON.

Davis, Frank.

### BATESVILLE.

Sisters of St. Francis.

### BURTON.

Arnold, Isaac B., residence.

### COAL CITY.

Hyatt, J. F.

### CRAWFORDSVILLE.

Alfrey, H., residence.

### EVANSVILLE.

Bate, S. A.  
Bayard, Sam. I.  
Crawford Bros.  
Evansville National Bank Building.  
First National Bank.  
Foley, J. T. & Co.  
German National Bank.  
Insane Asylum.  
Mesker, J. B. & Son.  
Moaker, J. B.  
Mooney, J. B.  
Old National Bank.  
Reid Bros.  
Tenn. Range Mfg. Co.

### FORT WAYNE.

Hattersley, A., residence.  
Madden, Jas.  
Trentman, A. B., block.

### GOSHEN.

Devor, Jas. R.

### HUNTINGTON.

French, Geo. B.

### INDIANAPOLIS.

City Hospital.  
Farrell, J. S., & Co.  
Farrell, J. S., residence.  
Grand Hotel.  
Healy & O'Brien.  
Highland, L. J., & Co.  
Indiana Female Reformatory.  
Indianapolis Orphan Asylum.  
Institute for the Deaf and Dumb.  
Institute for the Blind.  
Kirkoff & Meyer.  
Knight & Jillson.  
Piel, Wm. F., residence.  
Post Office.  
Spencer House.  
Stephens, Samuel.  
St. Vincents Hospital.

### KNIGHTSTOWN.

Soldiers and Sailors Home.  
Watts, Harry.

### KOKOMO.

Ascher & Co.

### LAFAYETTE.

Sears, M. E., residence.  
Tippecanoe Co. Court House.

### LA PORTE.

Haverly, Jas., brick block hotel.

### LOGANSPORT.

Insane Asylum.

### MADISON.

Madison Machine Co.  
Nik aus, E. G.  
Stribling, U. B.

### MICHIGAN CITY.

Culbert U., residence.  
Dolan Bros.  
Kreuger, Hon. Martin, Mayor, residence.  
Van Dusen, G. S., residence.

### MUNCIE.

Highlands & Kirby.  
New Southern Hotel.

### PERU.

Bunnells, Charles, residence.

### RENSSELAER.

McCoy, A.  
Monette, Miss.

### RICHMOND.

Eastern Hospital for Insane.  
Jav. I. E., Earlham College.

### ROCKVILLE.

Stark, D. W.

### SHELBYVILLE.

Major, W. S., residence.

### TERRE HAUTE.

Briggs, Jos., residence.  
Dunweg, Lewis, residence.  
Phoenix Foundry and Machine Co.  
Terre Haute House.  
United States Government Building.  
Watson's, D. W., Son.

### UNION CITY.

The Knapp Supply Co.

### VALPARAISO.

Porter County Court House.

### VINCENNES.

Bird & Monroe.  
County Court House.  
Foulks, H. A.  
Monroe, Chas. F.

### WARSAW.

Eggiston, W. H.  
Kutz, J. D.  
Warsaw Water Works.

### WHEELER STATION.

Wheeler, H. M.

### WINCHESTER.

Moorman, F. F., residence.

# STEAM, HOT WATER AND COMBINATION

## BOILERS

FOR  
HEATING  
AND  
POWER.



MANUFACTURED BY

The Dimmick & Smith Mfg. Co.

Safety Boiler Works,

WILKES-BARRE, PA.

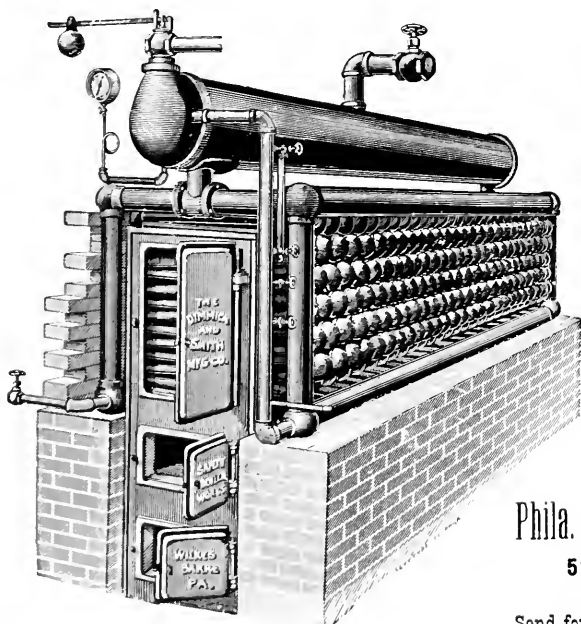
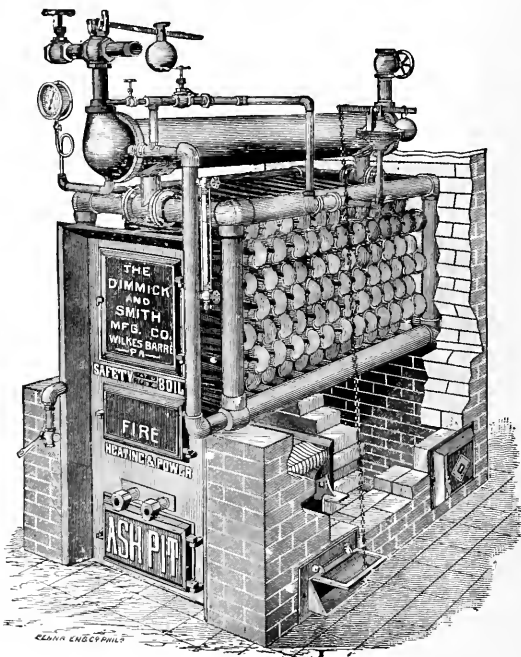

### WE CLAIM FOR THIS BOILER

ABSOLUTE SAFETY. Positive Circulation. Ends of Tubes free to expand. All Tubes graded so that it cleans itself. That there are no packed joints in the fire surface, and no cast iron. Easy to Clean, Erect and Repair. Will last as long as any Wrought Iron Boiler made. That it has kept up steam for 77 hours with once firing. That it will evaporate 11 pounds of Water to one of Coal.

Made in Eighteen Different Sizes,  
FROM 6 H. P. TO 125 H. P.

PHILADELPHIA AGENCY :

THE  
Phila. Exhaust Ventilator Co.  
520 COMMERCE ST.

Send for Catalogue and Price List.

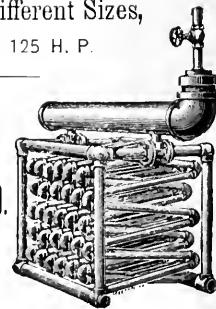





## REFERENCES.

### IOWA.

#### BURLINGTON.

Barhydt, F. N., residence.  
Ranson, Dr. J. J.  
Stewart & Hayden.

#### CALMAR.

Potter, E. V., residence.

#### CEDAR RAPIDS.

Bevier, S. C., residence.  
Clark, C. H., residence.  
Coe College.  
George, A. B., residence.  
Ives, C. J.  
Josselyn & Taylor.  
O'Hara Block.

#### CHEROKEE.

Jackson, F. W.

#### CLINTON.

Bollman, Ben., & Co.  
Kendall, Geo., & Co.

#### COUNCIL BLUFFS.

Bixby, J. C.  
Chapman, J. W., residence.  
Evans, H. J., residence.  
Gilbert, Jno.  
Hancock, W. J., residence.  
Jones, H. R., residence  
New York Plumbing Co., shops and offices.  
Robinson, G. A., residence.  
Shugart, E. L., residence.  
Smith, M. E., residence.

#### CRESTON.

Creston Gas Light Co.  
Holman, O. Q.  
Scigler, D. S., bank and residence.

#### DAVENPORT.

Bishop, William Stephen Perry, residence.  
Carl, Mr.  
Hill, Jno.

#### DES MOINES.

Collis, Jno.  
Foster & Liebber.  
High School Building.  
Yowner Bros.' Block.

#### DUBUQUE.

Brink, J. L.  
Farley, J. K.  
Ferguson, Geo.  
Green, Doctor.  
Morrison Bros. & Kelly.  
Molo, Wm.  
Nesler & Jungk.  
Ris, J. F., & Bro.  
Stewart, Hon. R. W., mayor.  
Thormann, G. F., store.

#### EMMITTSBURGH.

O lmsby Bros. Co., bank and office building.

#### FORT MADISON.

Morrison Mfg. Co.  
Santa Fee Hospital.

#### GRINNELL.

Kittoe, J. F.  
West and Central Colleges.

#### IDA GROVE.

Baxter, J. R.  
Reed, J. W.

#### IOWA CITY.

Church, Christian.  
Fracker, E. G.

#### KEOKUK.

Habinger, J. C.

#### LEMARS.

Western House.

#### MARSHALLTOWN.

Abbott, A. D., residence.  
Andrews, Wm., residence.  
Billings, C. A., residence.  
Birchard, A. T., residence.  
Glick, Geo., residence.  
Lander, C. J.  
Marshall Co. Court House.  
Meeker, J. Frank, residence.  
School House.  
Shorthell, A. E., residence.

#### MUSCATINE.

Barry, N., & Son.  
Birkshire, J. W., residence.  
Gamethsons, G. A., & Co., Bank.  
Hersey, Ben. J., residence.  
Hine, N., residence.  
Johnson, Dr. D. P., residence.  
Magoon, Geo. D., residence.  
Martin, J. O., residence.  
Musser, P. M., residence.  
Peck, J. M., residence.  
Rueling, J. A., residence.

#### OTTUMWA.

Armstrong, W. B.  
Eaton, Daniel.  
Harrow, Albert.  
Leighton, A. C.  
Mast, J. N.  
Mast, Isaac.  
Merrill, J. H., & Co.  
Ottumwa Gas Light Co.  
Ottumwa Iron Works.

#### PENSACOLA.

U. S. Government Building.

#### SHELDON.

Logan, W. P.

#### SHEREVEPORT.

U. S. Government Building.

#### SIoux CITY.

Haley, A. M., & Sons.  
Hogan, H. T.  
Fay, L. C.  
Sioux City Foundry and Machinery Co.  
**TRAEER.**  
Morse, Hon. R. H.

#### WATERLOO.

Coolidge, J. G., & Co., store.  
Cutler & Parker.  
First National Bank.

### JAPAN.

#### AOYMA, TOKYO CO.

Goucher College, J. O. Spencer, principal.

### KANSAS.

#### ARGENTINE.

McGain & Holland.

#### ARMSTRONG.

Holland, W. T.

#### ATCHISON.

Kite & Bowen.  
Perkins & Adams.  
Union Depot.

#### CLAY CENTRE.

Montgomery, J. A.

#### FORT SCOTT.

McCleverty, J. D.  
Union Block.

#### GIRAD.

Hertmer, Henry E.

#### HIAWATHA.

Aten, A. J.  
Schilling, A. J., residence.

#### KANSAS CITY.

Armesdale, K. W.  
Ferguson, J. W.  
Holland, W. T.  
Prichard, J.

#### LAWRENCE.

Cox, J. J.  
Monroe, Alex., residence.

#### LEAVENWORTH.

Angell, Mrs. A. J.  
Doherty & Everett.  
Foley, James.  
Hoffman & Bransfield.  
Townsend, C.

#### LARNED.

First National Bank.

#### NORTH TOPEKA.

James, John A.  
Nading, Mrs. N.

#### OLATHE.

Grange Hall.

#### OTTAWA.

Santa Fee Hospital.

#### SENECA.

Brown, Willis.  
Conway, I. W.

#### TOPEKA.

Callihan, Dr. A. M., residence.  
Crane, D. O., residence.  
Kistler, V. B., residence.



Return-Flue Self-Feeding Steam Boiler  
ONE OF EIGHT KINDS.

UPON REQUEST, I will be happy to send an Illustrated Catalogue containing numerous half-tone pictures of buildings warmed by

**MAHONY BOILERS.**

It is a pretty book, but will repay perusal upon more solid considerations than are implied in that statement.

SEND FOR IT.

**M. MAHONY,**  
Manufacturer,  
TROY N. Y.

**BUY THE BEST!**

ALWAYS CHEAPEST IN THE END.

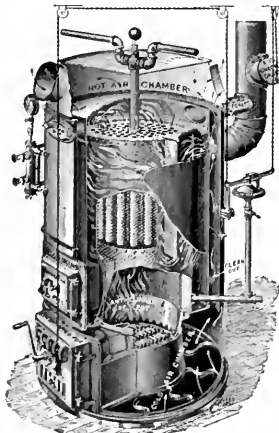

**THE SUPERIOR**  
Hot Air Furnaces  
AND  
Combination Steam AND Warm Air Heaters.

6 STYLES - 15 SIZES.  
STEEL PLATE - CAST IRON - WROUGHT IRON.  
PORTABLE AND BRICK SET.

Embody All Modern Improvements, are Practical, Economical, Durable, and the Most Powerful Heaters on the market.

Experienced and Practical Agents Wanted in every section of the country.

CORRESPONDENCE SOLICITED.

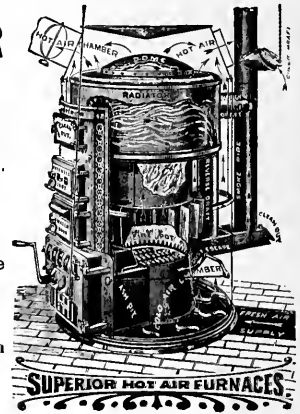

**SUPERIOR FURNACE CO.,** Manufacturers, Little Falls, N. Y.

## REFERENCES.

Mood, Robt.  
 Mooney, A. H. & Co.  
 Mulvane, Joab, residence.  
 Parker & Bodwell, Store and Office Building.  
 Payne, B. M., residence.  
 Prescott & Allen.  
 Sebastian, Jno., residence.  
 Sneathingner, M.  
 Stevenson & Peckham, store.

### WEST STOCKBRIDGE.

Van Buskirk, Chas.

### WICHITA.

A., T. & S. F. Ry. Co.  
 Fletcher Block.  
 Jackman & Billingsley.

### WINFIELD.

Robinson, M. L.

## KENTUCKY.

### CAPLETTSBURG.

Davidson, Mrs. Capt.

### EARLINGTON.

Church of the Immaculate Conception.  
 Coeman, Rev. A. M.

### FRANKFORT.

Court House.  
 Post Office.

### LEXINGTON.

Court House.  
 Falconer, Judge G. D.  
 Kendall, H.  
 Lancaster, M. P., store.  
 Lexington Plumbing Co.  
 McElhone & Malloney.  
 Milward, L. P.  
 National Exchange Bank.  
 The Fayette County Court House.

### LOUISVILLE.

Ahern & Ott Mfg. Co.  
 Bacon J., & Sons.  
 Belknap, W. B., & Co., store.  
 Brennan & Co.  
 Creighton & Son.  
 Gathright, J. B., residence.  
 Kaufman & Strauss store.  
 Kentucky Machine Co.  
 Lewis, Jno.  
 McDonald, Kenneth.  
 McFarland, Mrs. Helen.  
 Morrison, Geo.  
 Newman, H. W.  
 Ramsay, A. M.  
 Ryan, Jno.  
 Vogel, P. A., & Sons.

### MAYSVILLE.

Cox, W. H., residence.  
 Curley, Thos. J.  
 Frank, W. S., residence.  
 Russell, Robt.  
 Wilson, Jno. T., residence.

### PADUCAH.

Berry, E. W.  
 Wilson, C. H.

## LOUISIANA.

### NEW ORLEANS.

Aitken, Jas. H. & Co.  
 Agar, William,  
 Brooklyn Cooperage Co., factory.  
 Burke N., residence.  
 Christ Church (Episcopal).  
 Da Ponta, Durant, residence.  
 Fazende, P. I., residence.  
 French Opera House.  
 Harris Memorial Chapel.  
 Hemsheim, Isidore, residence.  
 Hemsheim, Simon.  
 Ivens', Edmund, Sons.  
 Lawrence, W. E.  
 Lethford, W. H.  
 Louisiana Retreat, Insane Asylum.  
 Manion & Co.  
 McDonald, John S.  
 Morris Building.  
 Morris, John A., residence.  
 Newman, Isidore, residence.  
 N. O. Railway and Mill Supply Co.  
 Patton, Dr. G. F., residence  
 Schmidt, W. B.  
 Turkish Bath House.  
 U. S. Custom House.  
 U. S. Post Office.  
 Wallis, John S., residence.  
 Walmsley, R. M., residence.

## MAINE.

### AUBURN.

Haskell, L. W. & Co.  
 Hersey, S. S.

### AUGUSTA.

Blaisdell, H. S., store.  
 Court House.  
 Harlow Block.  
 Maine Insane Asylum.  
 Murphy, J. J.  
 Ward, A. D.

### BANGOR.

Bangor House.  
 Getchell & Co.  
 Gilbert, Howell.  
 Leighton, Davenport & Co.

### BATH.

Courier Printing Co.  
 Davenport Home.  
 Davenport, Hon. Ira.  
 High School Building.  
 Hyde, Chas. E.  
 Messerschmitt, Jno., hotel.  
 Moulton, Geo. E., Jr.  
 Perine, H. W.

Soldiers' and Sailors' Home.  
 Steuben Co. Vineyard Association.  
 Underhill, A. L., Block, Post Office.

### BELFAST.

Hall, Capt. A. J.

### BRUNSWICK.

Boudoin Paper Manufacturing Co.  
 Brunswick Town Hall.  
 Purinton, F. H.

### BUCKPORT.

Emery & Co.  
 Emery, James.

### COLUMBIA.

Fuller, Arthur A.

### EASTPORT.

Leavitt, S. D.  
 Spates Bros.  
 Wadsworth, S. L. & Son.

### FARMINGTON.

Wheeler, Geo. W.

### GARDENER.

Walker, Capt. James.

### GUILFORD.

Turner, J. L.

### HOULTON.

Watson, Jno.

### LEWISTON.

Bearce, Geo. B.  
 City Poor Farm House.  
 Gay, Woodman & Co.  
 Greenwood, Chas.  
 Lowell & Lowell.  
 May, S. E.  
 Scraton, J. Y.  
 Smith, J. B. & Co.  
 Stewart, Prof. G. A., residence  
 St. Joseph Church.

### PORTLAND.

Barrett, F. R.  
 Barrett, J. F., residence.  
 Best, J. L.  
 Blackstone, F. N.  
 Blake, W. L. & Co.  
 Burrows, John W., residence.  
 Burrows, E. T., residence.  
 Carlton, E. E.  
 Chadbourn, B. F.  
 Cummings, Dr. Geo.  
 Davis, Geo. R.  
 Davies, E. N., house.  
 Eaton, Charlotte E.  
 Eaton, W. S.  
 Evans, O. C.  
 Fenn, Rev. N. H., D.D.  
 Gibson, M. S., residence.  
 Gould, W. E.  
 Hawkins, L. P.  
 Hunt, Geo. S.  
 Kilborn, W. T.  
 Leathe, J. T.  
 Libby, F. B.

# Modern House Heating

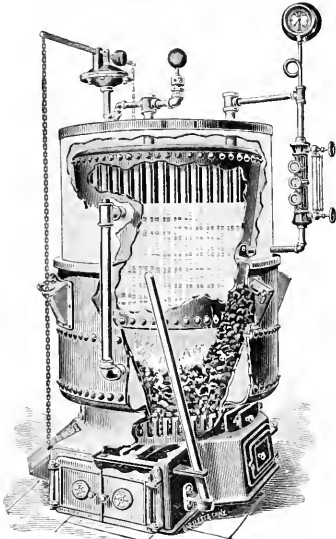

PERFECT COMBUSTION.

Is the title of a book of useful information for anyone considering the subject of

## Steam or Hot Water Heating

MAILED FREE.

WRITE FOR IT AND INVESTIGATE FOR YOURSELF.

GORTON & LIDGERWOOD COMPANY,

NEW YORK, 96 Liberty Street.

CHICAGO, 34 and 36 West Monroe Street.

BOSTON, 201 and 203 Congress Street.

# THE "ALL RIGHT"

A BRICK SET STEAM BOILER, MADE IN FOUR SIZES.

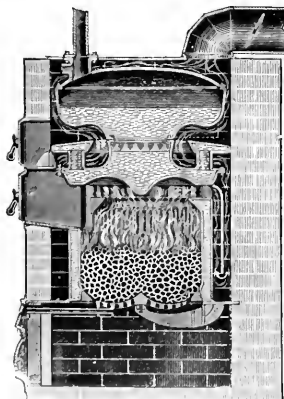

THIS BOILER HAS BEEN IN USE FOR THE LAST FIVE YEARS AND HAS GIVEN UNIVERSAL SATISFACTION—SEVERAL HUNDRED ARE NOW IN USE.

## THE VOLUNTEER

A PORTABLE STEAM BOILER.

Something entirely new—the twenty-five Boilers on trial last season gave the best results. Three sizes now ready—others in preparation.

EAST PROVIDENCE, R. I., January 24th, 1890.

PROVIDENCE STEAM HEATING COMPANY.

GENTS—I had the "Volunteer" No. 2 put into my house last fall and can truly say that I am more than satisfied with its heating qualities. I heat six rooms, two halls and bath room, and average in coldest weather about 1,500 lbs. of coal per month, which I consider very economical. Those who have seen it pronounce it the best little heater they ever saw. Respectfully yours, R. G. MESSINGER.



MANUFACTURED BY

WM. H. PAGE BOILER CO., NORWICH, CONN.

Send for our New Illustrated Catalogue of Heating Apparatus.

## REFERENCES.

Libby & Calhoun.  
 Little, A.  
 Loring, Mrs. Henry.  
 Merrill, E. S.  
 Milliken, Weston F.  
 Morse, J. C.  
 Morse, W. N.  
 Noyes, Edward A., residence.  
 Paine, Arthur C.  
 Payson Block.  
 Pennell, W. H.  
 Pickard, S. T.  
 Plummer, C. M.  
 Pratt, J. A.  
 Smith & Abbott.  
 Spring, E. G., residence.  
 Stanton Block,  
 Steamer "Tremont"  
 Steel, Miss Addie A.  
 United States Hotel.  
 Vose, Dr., office.  
 Weeks, Dr., office.  
 Williams, Henry, residence.  
 Winslow, J. S., residence.

### ROCKLAND.

Berry, Fred. H.  
 Crie, H. H., & Co.  
 Crie, R. Anson.  
 Wright, James.

### SACCARAPPA.

Universalist Church.

### SACO.

Burnham, E. P.  
 Lowell & Lord.

### SPRINGVALE.

Butler & Davenport.

### TOGUS.

Anderson, Major J. D., residence.  
 Elwell, Dr. W. E.  
 Lewis, J. E.  
 National Home for D. V. S.  
 Smith, Capt. A. L.  
 Walker, Capt. Jas.

### WINTHROP.

Baily, H. J.

### WOODFORD.

Ayer, W. P.  
 Baxter, W. H.  
 Smith, George.

## MARYLAND.

### BALTIMORE.

Adams, R. & Co.  
 Adelsberger, D. G.  
 Adler, L.  
 Ads, J. B.  
 Albert, A.  
 Basshor, T. C., & Co.  
 Bates, J.  
 Bauernschmidt, George.  
 Beck, J.

Berry Bros.  
 Biedler, F. R.  
 Boland, Thomas B.  
 Cary, C. J. & Co.  
 Casswell, C. E.  
 Central Iron Foundry.  
 City Hospital.  
 Clark, L. P. & Sons.  
 Clarke, W. J.  
 Clendenin Bros.  
 Codd, Wm. C.  
 Codd, E. J., Co.  
 Crook, Horner & Co.  
 Dare, Wm.  
 Davidson, A. J.  
 Davidson, C. Y.  
 Davis, H.  
 Eck, A.  
 Edmonds, James.  
 Edwards, W. F.  
 Erricson, Wm.  
 Farren, J. S., & Co.  
 Filbert, Isaac.  
 Fiily, John.  
 Fisher, Chas.  
 Friday & Roberts, warehouse.  
 Ganther, F. D.  
 Garrett, Robert.  
 Garrett, T. Harrison.  
 Hambleton, Jno. A., & Co., bank.  
 Healy & Bro.  
 Higgins, Edward.  
 Hoen, A.  
 Hoen Building.  
 Hooper, F. X., & Co.  
 Hopkins, Johns, University.  
 Homer, C. E.  
 Hubbard, Alva, & Co.  
 Hurst, Jno. E., residence.  
 Ironworld & Keysen.  
 Itzel, Adam.  
 Jackson, H.  
 Johnson, Sutton & Co.  
 Kelly, Daniel A.  
 Kelly, Wm.  
 Lee, James.  
 Legg, E. K.  
 Mahone, Pat.  
 Mathai, Ingram Hanover.  
 McLane, Samuel.  
 McShane, Henry, & Co.  
 Noble, H. & Co.  
 Norris, Sydney.  
 O'Hare, J. F.  
 Olase, Louis C.  
 Oliver, John & Son.  
 Phillips, John E.  
 Ports, Wm. J.  
 Posner Bros.  
 Register, Joshua, & Sons.  
 Reilly, W. F.

Renter & Mallory.  
 Robertson, James, & Co.  
 Robins, A. K. & Co.  
 Rothrock, W. H.  
 Schrier & Protze.  
 Sexton, S. P.  
 Sheppard, J. A. & Co.  
 Shryackolo, Thos. J.  
 Snow, S. J.  
 Spittel & Keil.  
 St. Mary's Industrial School, Balto. Co.  
 Variety Iron Works.  
 Volk, Wm. A.  
 Wallace, & Bro.  
 Walther, G. W.  
 Whitehouse, Jas.  
 Winebrenner, H. C., residence.  
 Winternitz, Samuel G. & Bro.  
 Wood, W. E., & Co.

### BAY VIEW.

Hotel Bay View.

### CALORA.

Warry Mfg. Co., The.

### CECILTON.

Atkins, E. C.

### CHARLTON HEIGHTS.

Waugh, Jas. C.

### COLLEGE STATION.

Maryland Agricultural College.

### CUMBERLAND.

Alleghany County Court House.  
 Gephart, P. C., residence.  
 Hamilton, L. M.  
 Johnston Bros.  
 Ladew, A. D., store.  
 Laing, James.  
 Orrick, C. J., residence.  
 Second National Bank.  
 Shepherd, O. C.  
 Walsh, Hon. W. E., residence.  
 Weitzer, S. P.  
 Welsh, E. H., offices.

### EASTON.

Flowers, Willis.

### EMMETTSBURGH.

Annon, Homer & Co., banking building.  
 Rowe, N., & Son.  
 St. Joseph's Academy.

### EMMORTON.

Bill, A. S.

### FREDERICK.

Court House.  
 Ebert, Edward C.  
 Farhneys, Dr. P. D.  
 Rontzahn, Jos. L.  
 Williams, J. H.

### FROSTBURGH.

McCulloh, Thos. G., residence.  
 Paul, Thos. H., & Son.  
 Randolph, B. J.  
 Townsend, Dr. M. M.

THE **BUTTON** HOUSE HEATING **BOILER.**  
 BUNDY LOOP

**EVEN SIZES.** The Size Number indicates the number of Square Feet of Fire Surface in each Boiler  
 No. 60, 85, 105, 125, 150, 175, 200.

**FOR STEAM OR HOT WATER.**

**ADVANTAGES:**

- Circulation Vertical.
- The hottest gases not drawn off to chimney.
- No jacket "hissing hot," as some are.
- A water jacket, or leg, catches what heat some lose in brick work and what others lose through an outer jacket.
- If it is necessary to leave a house through the winter, the boiler can be disconnected, tipped up and emptied in an hour.

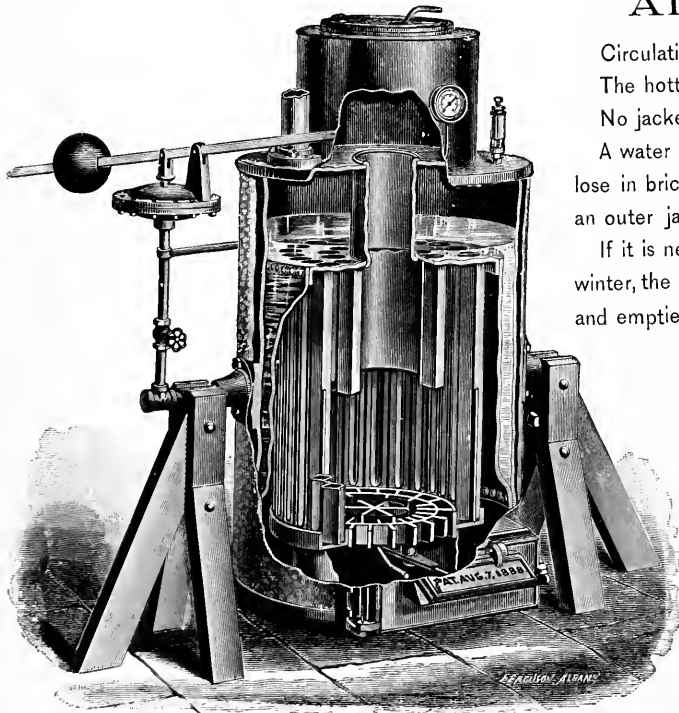

VIEW SHOWING INTERIOR OF BOILER.

IT IS  
**NOT AS CHEAP**  
**AS SOME BOILERS,**

So if you are to decide what to buy by the price ONLY, don't write to us BUT, if you want to get full value for your money, and perfect satisfaction in your heating plant, send for our circular.

**BUTTON · BOILER · CO.**  
**WATERFORD, N. Y.**

Our **CAST IRON BOILER** is **CHEAPER.**

**SEE PAGE 136.**



## REFERENCES.

### GAITHERSBURG.

Rutherford, Gen'l. Allen.

### HAGERSTOWN.

Baldwin House Block.  
Bellman, Oscar.  
Cumberland Valley R. R. Depot.  
Cushua, F. B.  
Fairfax, Admiral D. M., residence.  
Walker, Thomas, store.

### HARVE DE GRACE.

Harve de Grace Milling C.  
Pusey, C. C. & Co.

### MT. PLEASANT.

Crawford, L. H., residence.

### MT. WASHINGTON.

St. Agnes Academy.

### ISING SUN.

Duyckinck, A. L.

### ROCKVILLE.

Higgins, John J.

### SALISBURY.

Jackson, Governor E. E., residence.  
Jackson, Wm. H., residence.  
Powells, R. E., residence.

### SANDY SPRINGS.

Moore, Robert R.  
Moore, R. Rowland.  
Moore, Wm. W.

### STAFFORD.

Stokes, Horace.

### TANEYTOWN.

Davidson, J. & Son.

### UTICA MILLS.

Snook Bros.

### WESTMINSTER.

Albion Hotel, The.  
Schaffer, M. & Co.

## MASSACHUSETTS.

### ADAMS.

David, W. F.  
Todd, F. S.

### AMHERST.

Hunt, W. W.  
Lee & Phillips.

### ASHLAND.

Aldrich, Chas. T.  
Balcom, Josiah A.  
Parker, J. H.  
Perry & Enslin.

### ATHOL.

Ainsworth, Geo. W.  
Ashton, W. W.  
Converse, Ward.  
Cowles, Rufus S.  
Cummings, Mrs. E. E.  
Jordan & Train.  
Miller, Alfred, hotel.

### AYER.

Alley, J. B.

### BEDFORD SPRINGS.

Hayden, Dr. W. R., residence.

### BEVERLY.

Ingersoll, D. S.  
Walker, Herbert, residence.

### BILLERICA.

Herrick, P. R., residence.  
Lane, Dr., residence.

### BOSTON.

Alley, John R.  
Ames Building.  
Allston School.  
Boston Gas Light Co.  
Bosworth & French.  
Bradler-Davis Estate, Office Building.  
Braman, Dow & Co.  
Brastov Stove Co.  
Brigham, C. & Co.  
Brown, Rufus G.  
Buerkel & Co.  
Burrell, A. M., residence.  
Carruthers, H. & Co., residence.  
Chase, R. C.  
Chickering, Elmer, 21 West St.  
Clark, Geo. E., residence.  
Coffin, Isaac & Co.  
Cottings, C. E., office building.  
Cottrell, M. F.  
Davis, S. G., residence.  
Dercalzo, L. & Co.  
Dodge, Haley & Co., store.  
Dorchester Fire Insurance Co.  
Dyar, P. J., store.  
Engine House No. 22.  
Foster, F. W. & Co.  
Graffam, Peter, apartment house.  
Grainger, Dr. W. H., residence.  
Hillings, R. & Co., office.  
Holt, S. L.  
Ingalls & Kendrickson.  
James, Mrs. Mary, residence.  
Josselyn, Capt. A. H. residence.  
Kettellr Bros., residence.  
Le Bosquet Bros.  
Mansen, H.  
Master Builders Association.  
Maynard & Irwin.  
Merrells, S. W., apartment house  
National Hot Water Heating Co.  
National Tube Works Co.  
Norcross Reg. Co.  
Palmer, Mrs. Samuel, residence.  
Paul, G. K. & Co.  
Perry, J. P. & Co.  
Police Patrol.  
Pope, Eugene A.  
Richardson & Clement.  
Ross, Nuttes & Seabury.  
Rossmore Hotel.  
Runkel & Co.  
Russell & Burke.  
Sanborn, A. A.  
Sheldon, Frank M.  
Slessinger, B., flats.

### Souther, J. K.

State Street Exchange.  
Steen Mfg. Co.  
Stowell, D.  
Suits' College.  
The Imperial, apartment house.  
Thomas, H. A., apartment house.  
Timmins & Manning.  
U. S. Heating and Plumbing Co.  
Walker, B. P.  
Walker & Pratt Mfg. Co.  
Walker, Horace E. & Co.  
Weathered, Geo. M.  
Wheeler, J. G.  
Whitmore, Dr., flat.  
White, T. R., apartment house.  
Whittier Machine Co.  
Williams Estate.  
Woodward & Vinal.  
Worrell, S. W.  
Wright & Moody.

### BOYLESTON.

Frink, Rev. L. W.

### BROCKTON.

Battles, Geo.  
Dunham, Chas.  
Jones, S. G.  
Kennedy, T. J.  
Kimble, Rufus C., residence.  
Kingmann, H. M., office.  
Piper & Armour.  
Reynolds, J. E.

### BROOKLINE.

Gardner, H. L.  
Windram, W. J.

### CAMBRIDGE.

County House.  
Harvard University.  
Hews, A. H. & Co.  
Hotel Beacon.  
Legg, C. E., C. E.  
"Record" Building.  
Sherman, Wm. H.

### CAMBRIDGEPORT.

Chandler, I. A.  
Green & Co.  
Green, A. T.

### CHAPINVILLE.

Chapin, E. W.

### CHARLESTOWN.

Baldwin, F. J., & Co., store and opera house.  
Charlestown Gas Co.  
Hallowell Granite Co.  
Pearce & Jackson.  
Smith, William B.

### CHELMSFORD.

Emerson, J. P.

### CHELSEA.

Cheney, E. R.  
Foster, F. W.  
Frost, Hon. Rufus S., residence.  
Robertson, Jno.

# THE EUREKA STEAM HEATING CO., ROCHESTER, N. Y.,

MANUFACTURERS OF

## THE PLAXTON HOT WATER HEATER.

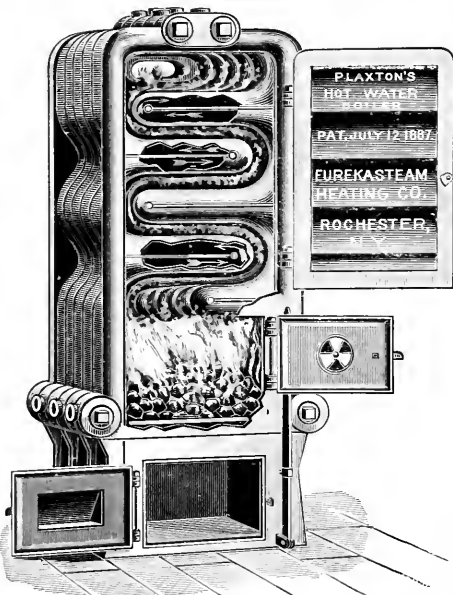

THE PLAXTON consists of pairs of sections, and a back and front, all water spaces, securely bolted together at top and bottom.

THE BOLTS pass through the water spaces, and any difference between the expansion of the bolts and the sections is taken up by the rubber or asbestos gaskets forming the water joint.

THE PECULIAR shape of the sections permits expansion and contraction without danger of fracture.

EACH SECTION forms its portion of Fire Pot, Smoke Flue and Grate Surface.

THE JOINTS are made perfectly true and are packed with a gasket made expressly for this purpose. These joints never leak.

They are made in three different heights, namely, 48, 56 and 68 inches, and 12 sizes. For work needing larger sizes than are shown in Catalogue, we furnish Twin Heaters.

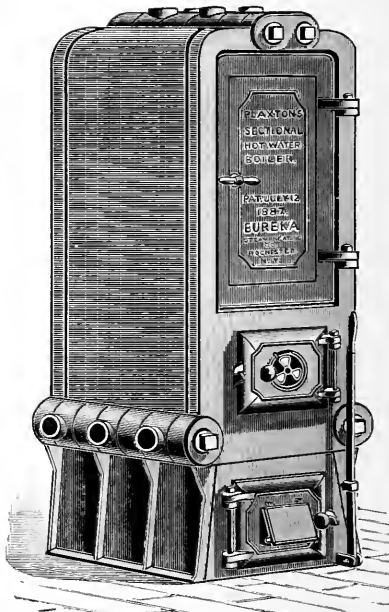

THE CONSTRUCTION of the Heater gives an immense heating surface. HEAT AND WATER travel thirteen feet from grate to outlet, and both move in the same direction, thus avoiding all cross currents and making positive circulation, which cannot be impeded by forcing.

EASILY CLEANED, as upon opening the fire door, all fire surfaces can be seen and reached.

THE AMOUNT OF WATER CARRIED in each Heater is accurately adjusted to the radiating surface to be supplied.

It has relatively greater surface in fire box and crown sheet than has any other Heater. The proportion of grate surface and fire surface to our standard rating is the same for all sizes.

ALL EXPOSED PARTS of Heater except doors are water spaces.

THE ROCKING GRATE is equally well adapted for burning hard or soft coal, or wood. WRITE FOR CATALOGUE A. A.

— SOLE MANUFACTURERS OF THE CELEBRATED —

Eureka Vertical and Horizontal House Heating Steam Boilers,  
Power Boilers of all Descriptions, Eureka Curb Box for Shutting off Gas, Water, &c.  
Rocking Grates and Magazine Feeds for Horizontal Boilers.

**JOBBERS IN ALL GOODS INCIDENT TO THE HOT WATER AND STEAM HEATING TRADE.**

Write for Steam Catalogue G. C. Address

**EUREKA STEAM HEATING CO.,**

**ROCHESTER, N. Y.**



## REFERENCES.

**CHICOPEE FALLS.**  
 Gibbs, Dr. L. J.

**CLEMATIS BROOK.**  
 Mass. School for Feeble Minded.  
**CLINTON.**

Gibbs, A. K.  
 Gibbs, W. H.  
 Patterson, Rev. F.

**CONCORD.**  
 Keyes, J. M.

**DALTON.**  
 Boston and Albany R. R. Station.

**DEDHAM.**  
 Ames' School.

**DORCHESTER.**  
 Brown, G. H.  
 Taft, C. A.

**EAST BOSTON.**  
 Blim, G. W.  
 Huckins, F.

**E. BRIDGEWATER.**  
 Nutter, I. N.

**EVERETT.**  
 Cochrane Chemical Co.  
 Russell, Danie.

**FALL RIVER.**  
 Allen, Chas., residence.

Boone, John H.  
 Borden Block.  
 Borden City School House.  
 Central Congregational Church.  
 Cook & Grew.  
 David, Wm. C., Jr., residence.  
 Davis, W. W., residence.  
 Dwellley, Dr. Jerome.  
 Fall River Steam & Gas Pipe Co.  
 Flint, John D., residence.  
 Holmes, Charles J., residence.  
 Kelley, Edward.  
 Miller & Johnston, residence.

Quequechan Engine House.  
 Sacred Heart Roman Catholic Church.  
 Slade School House.  
 Westgate, Jerome C., residence.

**FALMOUTH.**  
 Nickerson, E. S.

**FISHERVILLE.**  
 Fisher, Albert, residence.

**FITCHBURG.**  
 Ashton, W. E.  
 Cole, R. N.  
 Cowles, R. S.  
 Cummings, J. O.  
 Downs, Henry F.  
 Farnsworth, A. A.  
 Hubbell, C. A.  
 Kennan, Willard M.  
 Litchfield, Andrew.  
 Mack & Jennison.  
 Putnam, H. O.  
 Putnam Machine Co.

Putnam, S. W.  
 Rice, H. L.

**FLORENCE.**  
 Crossman & Polmatier.  
 Gerhards, Mrs. Wm.  
 Schumway & Riley.

**FRAMINGHAM.**  
 Bigelow, Prescott.  
 B. & A. R. R. Station.  
 Cloyes, Jas.  
 Manson, B. T.  
 Mason, Frank.

**GARDNER.**  
 Jaquith & Richardson.  
 Royal Steam Htg. Co.

**GLOUCESTER.**  
 City Hall.  
 Davis & Co.  
 Haskell, Loring B., residence.  
 Smith L. E.  
 Taft, Edgar S.  
 Tarr, Geo. J., & Co., factory and office.  
 Womson, John F., residence.

**GRAFTON.**  
 Fisher, George, residence.  
 Nelson, J. S. & Son, store.  
 Town Hall.

**GRANITEVILLE.**  
 Sargent, A. C.

**GREAT BARRINGTON.**  
 Brewer, J. A.  
 Collins, A. C., residence.  
 French, Dr. W. T., residence.  
 Gorham, E. L.  
 Hollister, E. E., residence.  
 Van Lennep, E. J., residence.  
 Weir & Leonard.

**GREENFIELD.**  
 Lyons, Geo.  
 Potter, W. N.  
 Whipple, R. P.

**HALBROOK.**  
 Underhay, John.

**HARVARD.**  
 Hildreth Bros.

**HATFIELD.**  
 Curtis, Arthur.

**HAVERILL.**  
 Cram, A. W.

**HOLYOKE.**  
 Blevly, Dr. Chas., residence.  
 Carpenter, J. H.  
 Carrington, H. C.  
 Holyoke Steam & Gas Pipe Co.

**HOUSATONIC.**  
 Barnes, E. T.

**HYANNIS.**  
 Cash & Bradford.

**HYDE PARK.**  
 Morse, W. H.

**INDIAN ORCHARD.**  
 Miller, George W.

**LANCASTER.**  
 Harwood, N., residence.  
 Morse, Geo. F., residence.

**LAWRENCE.**  
 Allyn, Thos.  
 Childs, E. F.  
 Clarke, F. E.  
 Humpherys, C. J. R.  
 Rutter, W. F.  
 Rutter, W. F. & Co.  
 Sennoy, J. M.  
 Stearns, A. W.  
 Wright, W. H. P.

**LEE.**  
 Baird, P. C.  
 Bauldwing, W. W.  
 Clark, A. B., residence.  
 Congregational Church.  
 Cormick, John.  
 De Veramess, John.  
 Flynn, F. A.  
 Griswold, John L., residence.  
 Grou, F. S.  
 Haden, Thos.  
 Hayes, M. H.  
 Hayes, M. H. & Co.  
 Hurlburt Paper Co.  
 Lee National Bank.  
 Malley, Edward.  
 Pease, F. M., residence.  
 Sabin, C. H.  
 Smith Paper Co.  
 Stone, W. A.  
 Tainton, B. H.

**LEICESTER.**  
 Bigelow, W. H.  
 Conant, Houghton & Co.  
 Sayent, J. B.  
 Snow, J. W.  
 Snow, T. S.  
 Watson, H. L.  
 Watson, J.

**LENOX.**  
 Bull, W. B.  
 Canfield, R. B., store.  
 Schermerhorn, F. A., residence.  
 Sloane, W. D., residence.  
 Tilotson, S. W., residence.  
 Westinghouse, Geo., Jr., residence.

**LITTLETON.**  
 Conant, Houghton & Co.

**LONGWOOD.**  
 Tower, A. J.

**LOWELL.**  
 Ayer, J. C. & Co.  
 Baker, E. G. & Co.  
 Bennett, J. C., store.  
 Boutwell, R. M., residence.  
 Carolins, Thos., residence.  
 Central Block.

## HOT WATER HEATING APPARATUS

For Dwellings, Greenhouses and Conservatories.

ALSO

## Hot Water Boilers

For Baths, Baptisteries, Gas-Holders, Etc.

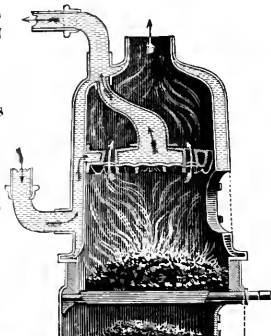

Section through Centre of Boiler.

Boilers specially adapted for Natural Gas.

Greenhouse Pipe, Fittings, Expansion Tanks, Stop Valves, Etc.

Illustrated Catalogue FREE on application.

**John A. Scollay**

74 & 76

MYRTLE AVE.

BROOKLYN, N. Y.

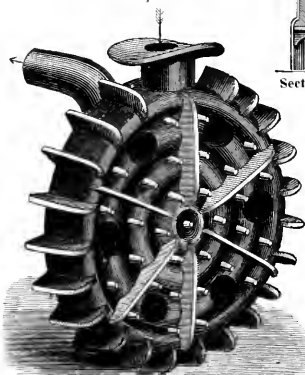

Enlarged View of Inner Tubular Chamber.

## SIMPLEST AND BEST.

Automatic, Economical, AND Durable.

No Engineer or Skilled Labor is required.

Burns either Hard or Soft Coal.

AGENTS in the trade wanted everywhere.

MANUFACTURED UNDER FISKE'S PATENTS.

Illustrated Catalogue, References and estimates furnished free.

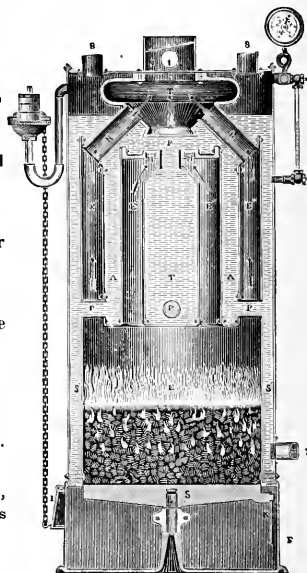

**DUPLEX STEAM HEATER CO.**  
23 Bethune Street, New York.

## VENTILATING FANS

OF EVERY DESCRIPTION.

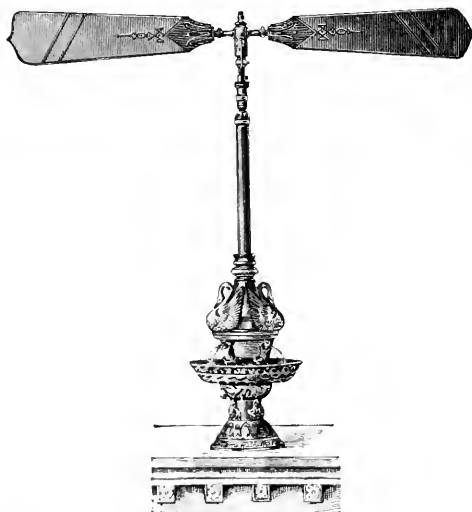

Manufacturer of more and Finer Designs than can be procured anywhere. Write for Catalogue and be convinced.

P. O. Box 345.

**D. H. KULP, Lancaster, Pa.**

## CLINTON WIRE CLOTH CO.

INCORPORATED 1856.

MANUFACTURERS OF

Steel and Iron Locomotive Spark Cloth. Iron, Steel Brass and Copper Wire Cloth for Mining Screens.

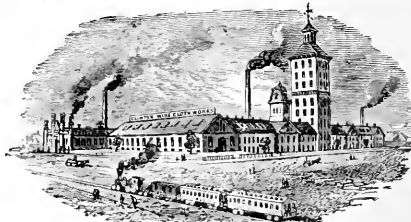

ALSO A FULL LINE OF

Clinton Painted Window Screen Cloth.  
Landscape Cloth. Figured Wire Cloth.  
Iron, Brass, Copper, Tinned and Galvanized Wire Cloth.  
Galvanized Field Fencing.  
"Silver Finish" Cloth for Fruit Evaporator Trays.  
Clinton "Silver Finish" Poultry Netting.  
Clinton "Silver Finish" Window Screen Cloth.  
Perforated Metals for Mining Machinery a Specialty.  
Perforated Steel, Iron, Brass, Copper, Zinc, Tin, &c., for all purposes.  
Screens in heavy Iron or Steel for Stone, Coal and Ore Receivers.  
Malt Kilo Floors, Grain Cleaning Machines, Hominy Mills, Rice Mills  
Oat Meal Mills, Cotton Mills, Coffee Mills, Paper Mills, &c.  
Clinton Metal-Furred, Stiffened Wire Lath. Clinton Double Twist Warp Wire Lath. Corrugated Wire Lath.  
Absolutely Fire-Proof. Send for Samples.

OFFICES: } No. 76 Beekman Street, New York.  
              } No. 8 Congress Street, Boston, Mass.  
              } No. 137 Lake Street, Chicago, Ill.

WORKS AT CLINTON, MASS.



## REFERENCES.

Charlotte, Mrs., residence.  
 City of Lowell Public Buildings.  
 Coburn, C. F., residence.  
 Donahue, Jas., residence.  
 Downing, W. G., residence.  
 Floyd, Warren L.  
 Francis, J. B., residence.  
 Garity, F. R., residence.  
 Glidden, C. J., residence.  
 Goodale, F. C., residence.  
 Goodale, W. W., residence.  
 Hatch, C. F., residence.  
 Hamilton Mfg. Co.  
 Haynes, Frank H.  
 Highland Congregational Church.  
 Jones, S. H.  
 Kingsley, Geo.  
 Lovejoy, E. W., residence.  
 Lowell Master Builders' Exchange.  
 Luscomb, Mrs., residence.  
 Maxfield, R. A., residence.  
 Middlesex Machine Co.  
 Minter, Jas., residence.  
 Mullen, D. W.  
 Munn, F. D., residence.  
 Nesmith, Thomas, office.  
 Noyse, E. J., residence.  
 Odd Fellows' Block.  
 Pearson, Albert, residence.  
 Pevey, J. M., residence.  
 Putnam, A., residence.  
 Putnam, F. E., residence.  
 Putnam, F. P., residence.  
 Railroad National Bank Building.  
 Raynes, Geo., residence.  
 Rice, C. N.  
 Richard Dobbin's Boiler Works.  
 Richardson, C. W. W., hotel.  
 Rogers, J. G., residence.  
 Ryan, J. A., residence.  
 Sayer, J. C.  
 Scribner, Chas., residence.  
 Scribner, Geo. A., residence.  
 Second Universalist Church.  
 Shaw, B. F., residence.  
 Shed, F. B., residence.  
 Shepard, C. S., residence.  
 Smith, E. A., residence.  
 Smith, Geo. S., residence.  
 Spaulding, F. P., residence.  
 Stall, Chas. F.  
 Staples, R. H., residence.  
 St. Chas. Hotel.  
 Stevens, J. T.  
 Thomas, M. A., residence.  
 Viles, Dr. J. A., residence.  
 White, W. H., residence.  
 Whittier Cotton Mills., office.  
 Whittier, N., residence.  
 Wilson, J. M., residence.  
 Worthen St. Methodist Church.  
 Wright, N. M., residence.

**LUDLOW.**

S. H. Halford.

**LYNN.**

Cushing, F. J.  
 Noble Stove Co.  
 Robson, J. J. C.

**MALDEN.**

Barrett, Henry O., residence.  
 Barrett, O. S., residence.  
 Bickford, Dr. Wm., residence.  
 Cook, A. & Co.  
 Cook, Adams.  
 Dowling, Thomas, residence.  
 Ellis, Albert M., residence.  
 Fisher, George.  
 Johnson, Benjamin.  
 Maple Wood School.  
 Pierce, Andrew, residence.  
 Seary, Chas. W.  
 Spiller, Joseph, residence.  
 Staples, Edward, residence.  
 Stevens, Chas. P., residence.  
 Stinson, Wm. B., residence.

**MAYNARD.**

Holt, A. D.

**MELROSE.**

Boyle, Wm.  
 Ellis, Irving W., residence.  
 Kinsley, Wm. B., residence.

**M.I.FORD.**

Swasey, Fred.

**MILTON.**

Hall, J. H.

**NANTUCKET.**

Allen, Geo. C., residence.  
 Workman, W. H., sanitarium.

**NATICK.**

Biglow, F.

**NEPONSET.**

Dorchester Fire Insurance Co.

**NEWBURGH PORT.**

Reardon Bros.  
 Sargent, C. R.

**NEWTON.**

Lawson, Walter U., residence.

**NEWTONVILLE.**

Judkins, Mrs. M. F.  
 Soden, A. H., residence.

**NORTH ABINGDON.**

Murdock, W. S.

**NORTH ADAMS.**

Arnold Paint Works.  
 Boland, P. J.  
 Bracewell, John.  
 Gaylord, W. H.  
 Hamblin, E. B. & Co.  
 Haynes, C. B.  
 Hunter, A. W.  
 Hunter, James & Son.  
 Jones, A. H.  
 North Adams Nat. Bank.  
 North Adams Savings Bank.

North Adams Plumbing Co.  
 Pratt, Edward.  
 Scott, H. N.  
 Turner, Fred.

**NORTH HAMPTON.**

Chase, H. R., residence.  
 Foot, E. N.

**NORTH ATTLEBOROUGH.**

Plash, W. Nelson.  
 Skinner, E. H.

**NORTHBOROUGH.**

Chapin, E. W. & Co.

**NORTH CHELMSFORD.**

Bradley Jno., residence.  
 Emerson, J. P., residence.  
 Gay Ziba., residence.  
 Moore, Geo. C., residence.  
 Wright, Mrs. S., residence.

**NORTHFIELD.**

Caldwell, Fred, residence.  
 Hotel Northfield.  
 Long, G. A., residence.  
 Lunsdy, C. A.  
 Sankey, Ira D., residence.  
 Word, Dr. R. C.

**NORTH GRAFTON.**

Nelson, J. S. & Son.  
 Norwood, Fay G. A.

**PALMER.**

Brown, C. A. & Co.  
 Hitchcock, W. H.

**PITTSFIELD.**

Atwater, Chas., residence.  
 Bailey, G. W., residence.  
 Bishop, Hon. Henry W., residence.  
 Bishop Memorial Bldg.  
 Cutting, Col. Walter, residence.  
 Guller, H. C., residence.  
 Harvey, Henry, residence.  
 Hopkins, G. N., residence.  
 Morse, A. S., residence.  
 Patten, Miss, residence.  
 Parsons & Seart.  
 Powell, Wm. W.  
 Redfield, Mrs. Chas. B.  
 Robbins, Gamwell & Co.  
 Sampson, E. Pope, residence.

**PLYMOUTH.**

Drew, C. P.  
 Harlow & Baily.  
 Mixer, J. W.  
 Newcomb, Marcellus.

**PUTNAM.**

Dorson, Mrs.  
 Houghton, A.  
 Kent, B. M.  
 Leavens, A.  
 Le Clair, P. M.  
 Stoddard, Seth.  
 Whittmore, Wm.

**QUINCY.**

Wolkins, L. C.

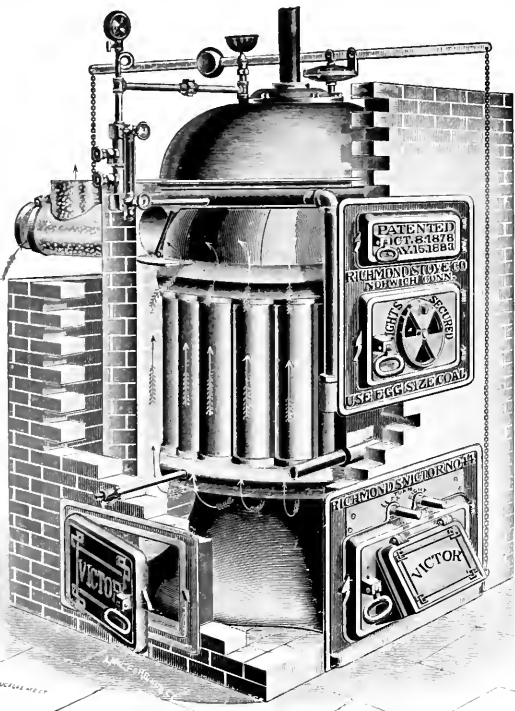

**RICHMOND'S  
Victor Hot Water Heater.  
BRICK SET.**

Has been thoroughly tested and receives the commendation of the best engineers.

**WHAT THEY SAY.**

"Absolutely the best Hot Water Heater extant."

"I have given much thought, and had large experience in Hot Water Heating, having set many of the popular heaters. The Victor beats them all. Its system of flues and water ways are such as to insure the greatest possible utilization of the fuel. Economy and efficiency in use are its claims, and it merits them."

- |                                 |  |
|---------------------------------|--|
| Leighton, Davenport & Co.,      | Bangor, Me.                              |
| Isaac Coffin & Co.,             | No. 52 Sudbury St., Boston.              |
| W. F. Higgins,                  | 379 Lexington Ave., New York.            |
| A. A. Pond,                     | Minneapolis, Minn.                       |
| Danforth & Clark,               | Buffalo, N. Y.                           |
| H. R. Barker Manufacturing Co., | Lowell, Mass.                            |
| Geo. R. Estabrook,              | Springfield, Mass.                       |
| Barker Bros.,                   | Newport, R. I.                           |
| Dewstoc & Schneider,            | Cleveland, O.                            |
| Webster & Meathie,              | Detroit, Mich.                           |
| L. H. Prentiss Co.,             | Nos. 203 and 205 Van Buren St., Chicago. |
| Allan Black,                    | St. Paul, Minn.                          |

**RICHMOND'S  
VICTOR STEAM HEATER.**

BRICK SET AND PORTABLE.

SEVEN YEARS RECORD OF SUCCESS.

**WHAT ENGINEERS AND DEALERS SAY.**

"\* \* \* We have up to this time set over fifty Victors, and have had better success with them than with any Steam Heater we ever handled." \* \* \* \*

"\* \* \* We offer the Victor to our best friends and customers, and look for no complaints or after clap when once properly set." \* \* \* \*

"\* \* \* Our experience in setting and observations of Richmond's Victor confirms the wisdom of our election in recommending it to our clients." \* \* \* \*

**THE RICHMOND STOVE COMPANY,  
NORWICH CONN.**

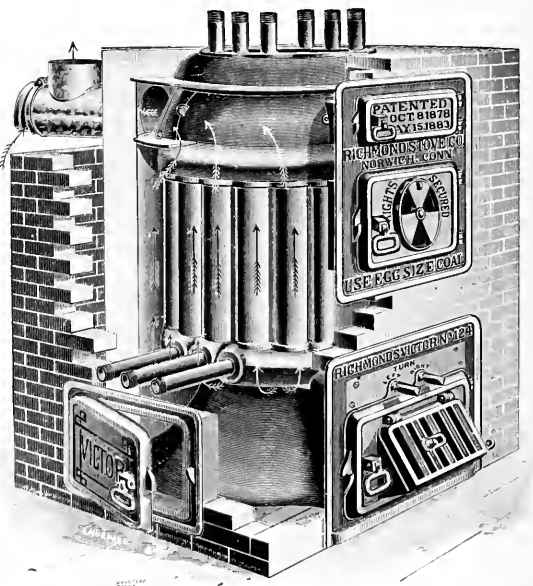



## REFERENCES.

**READING.**  
Aust'n, Henry K.

**ROCKLAND.**  
B. & M. R. R.  
Eastman Steam Heating Co.  
Hunt, David F.  
Tantoun, H. F.  
Somerville Highlands Station.

**SALEM.**  
Wendell, F. A.  
Goodell, Z.  
Millea, L. E.

**SOUTH ABINGTON.**  
Whidden, H. F.

**SOUTH BELLINIA.**  
Herrick, Geo.

**SOUTH BOSTON.**  
Church of Rosary.

**SOUTHBRIDGE.**  
Clemence, J. E.  
Dresser, G. K.  
Morse, E. T.

**SOUTH FRAMINGHAM.**  
Sawyer, H. L.

**SOUTH LEE.**  
Hurlbert Paper Co.

**SPENCER.**  
Bevens, Rev. T. D., school.  
Pike, F. D., residence.

**SPRINGFIELD.**  
Atwater, Dr. D. F., residence.  
Blodgett, Edwin A., residence.  
Clark, F. W.  
Currier, R. B., residence.  
Estabrook, Geo. R.  
First Baptist Church.  
Frink, Geo. E.  
Houghton, S. W.  
Knight, A. M. & Son.  
Oliver & Howland.  
O'Reilly, Rt. Rev. Bishop, P. T., residence.  
Phillips Mfg. Co.  
Republican Block.  
Rising, B. D., residence.  
Seeger, Edward W.  
Shumway, Mrs. Julia M., residence.  
Smith, L. C., residence.  
The Holly Whitmore Steam Heating Co.  
Whitmore & Chase.

**STATE FARM.**  
Blackstone, M. M.  
State Farm.

**STOCKRIDGE.**  
Kirkwood, J.  
Yale, L. M.

**STONINGTON.**  
Belcher, Geo. E.

**TAUNTON.**  
Cooper, L. W.  
Tew, Frank P.

**TEWKSBURY.**  
State Alms House.

**TOPSFIELD.**  
Woodbury, J. M.

**TYNGSBORO.**  
Sutton, Dr. Chas., residence.

**UXBRIDGE.**  
Capron, Henry.  
Hayward, E.  
Mowry, Mrs. L. M.  
Taft, E. C.

**WARE.**  
Stevens, Chas. A.

**WARREN.**  
Putnam, W. A.

**WAVERLY.**  
Mass. School for Feeble Minded.

**WEBSTER.**  
Bigelow, E. N.  
Platt, John.  
Smith, G. D.

**WELLERSLY.**  
Boston and Albany R. R. Station.

**WELLERSLY HILLS.**  
Boston and Albany R. R. Station.

**WELLESLEY.**  
Manly, R. M.  
Porter, F. H.  
Vinal, S. L.

**WESTBORO.**  
Frost, C. B. & Co.

**WEST BOYLSTON.**  
Frink, L. W.  
Holbrook, E. W.

**WEST BROOKFIELD.**  
Blair, E. H., Post Office.

**WESTFIELD.**  
Boston and Albany R. R. Passenger Station.

**WESTFORD.**  
Cameron, A. T., residence.  
Hildreth, C. L., residence.

**WEST SOMERVILLE.**  
Hotel Woodbury.

**WEST STOCKRIDGE.**  
Van Buskirk, Chas.

**WEST WRENTHAM.**  
Davidson, Thomas, residence.

**WEYMOUTH.**  
Clapp, A. W.  
Gale, John B.

**WHITINSVILLE.**  
Trowbridge, C. E.  
Whitin, J. E.

**WILLIAMSTOWN.**  
Carter, Prest. Franklin.  
Cole, John M.  
Fernald, Prof.  
Gales, J. B. residence.  
Hopkins, Mrs. Mark.  
Sherman, B. II.  
Williams College.  
Williamstown Manufacturing Co.

**WINCHENDON.**  
The Murdock School.

**WINTHROP.**  
Belcher, E. S.  
Frost, M.

**WORCESTER.**  
Allen, Wm. & Sons, residence.  
Asylum for Chronic Insane.  
Braman, Dow & Co.  
Buckingham, George B., two houses.  
Caldwell, H. M., residence.  
Church of Sacred Heart.  
City Hospital.  
Convent, Sisters Notre Dame.  
Convent School, Vernon St.  
Daniels, F. H.  
Eaton, E. B.  
Earley, W. H.  
Gorham, C. L., Piano Manufactory.  
Goulding, F. P.  
Hall's Block.  
Harrington, G. H.  
Hogg, W. J.  
Kenerson, V. D.  
Moen, P. L.  
Pierce's Hotel.  
Reed, E. H.  
Roy, B. S.  
Royal Steam Heater Co.  
Safe Deposit & Trust Co.  
Seeley, H. S., residence.  
St. Anne's Church.  
St. Peter's Church and Pastorage.  
Summer, Geo.  
Taber, Jesse P.  
Waite, R. P.  
Washburn & Garfield Mfg. Co.  
Wesson, J. E.  
Whittall, M. J., office.  
Winslow, S., six houses.  
Worcester Carpet Co., office.  
Worcester Lunatic Hospital.  
Young, H. A.

**WYOMING.**  
Russell Daniel.

**ZYLONITE.**  
Amend, Robt. A., Architect.  
Field, Lyman.  
Howland, Chas., residence.  
Ward, J. D., residence.

**MICHIGAN.**

**ALPENA.**  
Rice, Chas. O.

**ANN HARBOR.**  
Clark, A. M.  
Hutzel & Co.  
Jewett, Samuel P., residence.

**BATTLE CREEK.**  
Holser, L. J., residence.  
Raymond, Allan, residence.  
Werstein, L., block.

# WILLIAMS' BELL FOUNDRY.

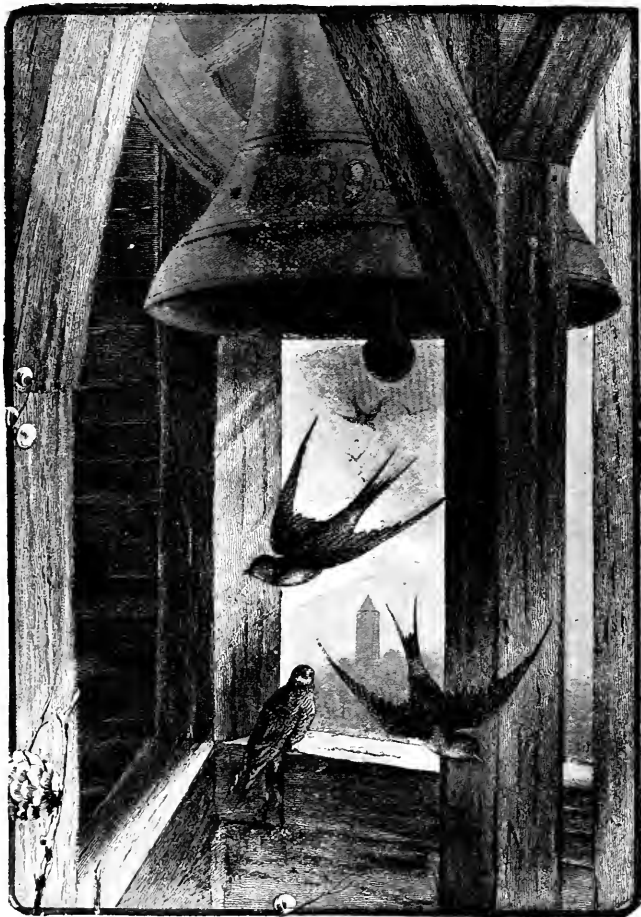

ARCHITECTS ALWAYS SPECIFY

**BELLS**

They have no Superior for Quality or Tone.

**Manufactured by E. A. WILLIAMS & SON,**

105, 107, 109 AND 111 PLYMOUTH ST., JERSEY CITY, N. J.

Send for Catalogue and Prices.

## REFERENCES.

### BAY CITY.

Blackman, Chas. A.  
 Clements, H. C.  
 Clements, Jas. & Son.  
 Cooke, H. J.  
 Davidson, Jas.  
 Eddy, S.  
 Farragut St. Public School.  
 Finn & Fisher.  
 Gustin, R. A., residence.  
 Holcombe Bros.  
 Math, Hon. J. W. M.  
 Merrill, H. P.  
 Nichols, W. H.  
 Pratt, L. A.  
 Pratt & Keope.  
 Republic Hotel.  
 Sixth Ward Public School.  
 Vaughn, W. A.  
 Walther, A.  
 Ward, Wm.  
 Watson Bros. & Lassell

### CADDILLA.

Cummer, W. W.

### CAPILLAC.

Cummer, J. & Son.  
 Cummer, W. W., residence.

### CHARLOTTE.

Foote & Church.

### COLD WATER.

Eligh & Grundy.

### DETROIT.

Berry, Thos.  
 Bruce's, W. W., residence.  
 Carter, David.  
 Craig, W. M.  
 Detroit Heating and Lighting Co.  
 Detroit Metal and Heating Co.  
 Fisher, Reynold.  
 Guilloz, Jno. F.  
 Guiney, Benj.  
 Macdonald Bros. & Co.  
 Monat, Jno. D.  
 Olien, R. C., M. D.  
 Palmer, B. W.  
 Scattens, Daniel, residence.  
 Stroa, Julius.  
 Walker, Jas. & Sons.  
 Webster & Meather.  
 Woodruff, C. E.

### DOUGLAS.

Bishop & Freeman.

### EAST SAGINAW.

Cook, Geo. G., residence.  
 Hoyt Public Library.  
 Keeler, Sanford, residence.  
 Kerr, Moore.  
 Pratt, L. A., Bay City, Mich., residence.  
 St. Mary's Hospital.  
 Strasburg Building.

### FLINT.

Decker, J. C., residence and store.  
 Dullan, J. C.  
 Hubbard & Wager.  
 Phillips, P. D.  
 Stone, O., residence.  
 Wood & Atwood.

### GRAND HAVEN.

O'Connell, Jas.

### GRAND RAPIDS.

Belknap, John J., residence.  
 Byrnes, Mrs. Catharine, residence.  
 Challenge Corn Planter Co., office.  
 Gray, George W.  
 Hansman, Hon. Julius.  
 Herpolsheimer, W. G., residence.  
 Johnson, G. S.  
 Kirby, F. W., residence.  
 Leonard, Charles.  
 Macauley Bros.  
 Miller, Jno. W., residence.  
 O'Connell, Jas., residence.  
 Payden, Charles, residence.  
 School Buildings.  
 Shriver, Weatherly & Co.  
 Sproul & McGurrin.  
 Steamer, "J. C. Ford."  
 Steamer, "Samuel Marshal."  
 Union School Bldg.  
 Weatherly & Pulte.  
 Wyman, D. P., residence.

### GREENVILLE.

Sprague Bros.

### HILLSDALE.

Ammerman, D. C.  
 Lawrence, C. E. & Co.  
 Sumer, Mrs. E.

### HOWELL.

Jewett Block.  
 Jewett, Chas. G.  
 Livingston Co. Jail and Sheriff's office.  
 Livingston Co. Poor House.

### IONIA.

Breckon, Robert J.

### IRONWOOD.

McCann, Chas.

### JACKSON.

State Penitentiary.

### KALAMAZOO.

Dorgan, Thos.  
 Goldberg, Julius, residence.  
 Kalamazoo County Poor House.  
 Lawrence & Chapin Co.  
 Lawrence, W. S., residence.  
 Mich. Asylum for the Insane.  
 Palmer, Dr. Geo. C.  
 Roberts, M. W., residence.  
 Wersteen, L., office, Battle Creek.

### LANSING.

Allen, Claire.  
 Cooley, E. F.  
 Lansing Iron and Engine Works.  
 Wardwell, J. H.

### LAPEER.

Chapman & White.  
 First National Bank.  
 Lapeer County House.

### LEXINGTON.

Teuwebury, J. E.

### LUDINGTON.

Wing, C. G., residence.

### MANKATO.

Christensen, H. P.  
 Hubbard, R. D.  
 Lilly, E.  
 Mankato Linseed Oil Co.  
 Marsh, Geo. H.  
 Palmer, Geo. M.  
 Piper, G. F.  
 Watters, F. L.  
 Willard, J. A.

### MARQUETTE.

Hotel Marquette.  
 Manhard, M. R.  
 St. Paul's Church.  
 Sullivan, Mrs., residence.  
 Sweat, J. B.

### MENOMINEE.

BeDell, A. B.  
 Sawyer, A. L., residence.

### MT. CLEMENS.

Ullrich, R. C.

### MUSKOGON.

Barney, N. A., stores.  
 Central School Building.  
 City Hall.  
 Frobel School Building.  
 Hackley, C. H., residence.  
 Hamilton, C. J.  
 High School Building.  
 Hills, C. T., residence.  
 Howden, J. J.  
 Hume, Thos., residence.  
 Killup, W. M. M., residence.  
 Lee, Capt. S.  
 Long, H. O.  
 Mason, L. G., residence.  
 Misner, C. E., residence.  
 Muskegon Club Building.  
 Nelson School Building.  
 New School Building.  
 Nims, F. A.  
 Occidental Hotel.  
 Outhwait Block.  
 Ranson Street School.  
 Rogers Block.  
 School No. 3.

### NEGAUNEE.

Breitung House.

### ORCHARD LAKE.

Rogers, J. S.

### OSCODA.

Loud, E. F.

### PONTIAC.

Hinman, W. G.  
 Webb, A., residence.

# THE "GIANT" METAL SASH CHAIN

Thoroughly Reliable and an Economical Substitute for CORD for Hanging Weights to Windows.

MANUFACTURED ONLY BY

## THE SMITH & EGGE MANUFACTURING CO.



BRIDGEPORT, CONN.



It is in use at the Patent Office, Washington, and many other prominent buildings all over the country.

It gives satisfaction wherever it is used. Its Tensile Strength and Wearing Quality is simply Wonderful.

The "Giant" Metal is made expressly for us only, and no other metal offered in the market is equal to it for this purpose.

The company also manufacture excellent chains at lower prices than the "Giant" Metal, in "Red Metal" (copper and tin mixture) and Steel.

Steel Axle, square grooved Pullies in Iron and Real Bronze. Single and double grooved with balancing fixtures for the latter to carry two strands of chain side by side for heavy weights—all being nice goods.

Also "Jewett" Double and Single Acting Butts.

S. S. S. S.

SIMPLE, SENSIBLE STRONG AND SECURE.

In use in the Produce Exchange and Stewart Buildings, New York, and many other elegant structures throughout the country.

Send for Descriptive Circular.

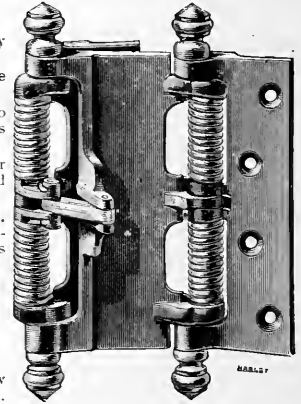

# Steam Damper Regulators.

This Cut shows the Section of our

## Steam Damper Regulators

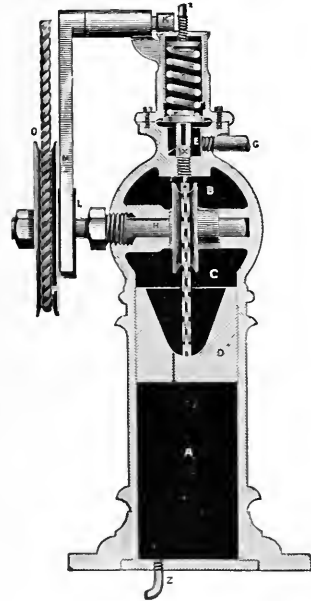

There are only Two Sizes, weighing 15 and 30 pounds,

YET IT WILL DO THE WORK OF LARGER and MORE COSTLY MACHINES.

EACH MACHINE IS NICKEL PLATED. PRICES \$60 AND \$100

An Iron Bracket and 25 feet of Chain with each one.

We also manufacture Reducing Valves, Pressure Regulators, Pump Governors, Balanced and Lever Valves, and other Steam Regulating Devices. Send for Price Lists to

MASON REGULATOR CO.,

BOSTON, MASS.



## REFERENCES.

### PORT HURON.

Haslet, Jas. H.  
 Martin, W. J. K., residence.  
 Richardson & Gibson.  
 Thompson, Geo., residence.

### ROMEO.

Kennedy, Albert.

### SAGINAW.

Barnard Block.  
 Eureka Heating & Vent. Co., office.  
 Hollister, F. W., residence.  
 Louis Quinnan, office building.  
 Louis Quinnan, post office.  
 Sibley & Bearinger building.  
 West Side Club.

### SAULT STE. MARIE.

Anderson, C. L.  
 Anderson, E. A., residence.  
 Bank of Commerce Bldg. and Custom House.  
 Hickler, John & Son.  
 Kamp, Geo., residence.  
 Plummer, H., residence.  
 Plummer, W. H.  
 Ripley, Jas., residence.

### ST. LOUIS.

Elwell, Col. J. A.

### TRAVERSE CITY.

Hannah, Lay & Co  
 Traverse City Jail.

### YPSILANTI.

Drury & Taylor.

## MINNESOTA.

### BRAINERD.

Kinslow, A. G.

### CHASKA.

School Building.

### DULUTH.

Costella, J. J.  
 Duluth Nat'l Bank.  
 Dwyer, P. V. & Co.  
 Hartley, G. G.  
 Patten & McMillan.  
 Sweeny, R. O.

### EAU CLAIRE.

Bailey, Hon. W. F., residence.

### GLENCOE.

Gilbert, G. K.  
 Knight & Dean, Bank.

### HASTINGS.

Heath, Geo. M.

### LAKE CITY.

Dwelle, G. M.  
 Gillett, H. & Son.  
 Gillett, H.  
 Masonic Hall.  
 Young, C. F. & Bro.

### LA SEUR.

Smith, E. R., residence.

### MINNEAPOLIS.

Callom Block.  
 Crosby, John, residence.  
 Gale, S. C., residence.  
 Lee, H. E., residence.  
 Levi, G. L.  
 Little, F. E.  
 Livermore, C. H.  
 Long & Kees.  
 Mable Tainter Memorial Bldg.  
 Martin, F. S.  
 McKnight, S. T., residence.  
 Northrop, Wm., residence.  
 Phelps, E. J., residence.  
 Pilsbury, Geo., residence.  
 Porter Steam Heating Co.  
 Rugg, Fuller & Co.  
 Tunstead & Moore, store.  
 Webb, H. C., residence.

### OWATONNA.

Minnesota Academy.

### ROCHESTER.

Gooding, A., residence.

### STILLWATER.

Becker, Joseph, saloon and residence.  
 Clark, M. M., residence.  
 Folsom, Col. E. L., residence.  
 Grand Opera House.  
 Heitman, Chas., restaurant.  
 Hersey, E. L., residence.  
 Hersey, Col. R. F., residence.  
 Searle, J. N.  
 Stillwater Hardware Co.

### ST. PAUL.

Bank of Minnesota.  
 Eller, H. C.  
 Fairbanks, Morse & Co.  
 First National Bank.  
 Fox, J. L. & Co.  
 German American Insurance Building.  
 Holland & Thompson Mfg. Co.  
 Merchants' Hotel.  
 Osborne, E. F.  
 Porter Steam Heating Co.  
 Rugg, H. P. & Co.  
 State Capitol.  
 Stickney, A. B., residence.  
 Strong, F. P.

### ST. PETER.

Insane Hospital.

### WABASHA.

Southworth, A. B.

### WINONA.

Launberton, Hon. Harry.  
 Ludewig, Hon. Jno., Mayor.

## MISSISSIPPI.

### CLARKSDALE.

Griffing, W. D. & Co.

### JACKSON.

Bustamente, G. D.

### MERIDAN.

Rice, Dr. C. A., Supt. E. Miss. Insane Asylum.

### PASS CHRISTIAN

Mexican Gulf Hotel.  
 Pass Christian Institute.

## MISSOURI.

### CAMERON.

Bohartz, W. H.  
 Pash, R. A.

### CLINTON.

Holiday, Geo. S.

### COLUMBIA.

State University.

### FULTON.

Institution for Deaf and Dumb.  
 State Lunatic Asylum

### HANNIBAL.

Chadwick, Chas. & Co.  
 Dubach, D.  
 Price, J. B.

### HERMAN.

Herzoy, Wm.  
 Stark, George, residence.

### KANSAS CITY.

Bewsher, Jas.  
 Blossom, Mrs. Elizabeth, residence.  
 Brady, J. H.  
 Centropolis Hotel.  
 Creighton & Co., D. F.  
 Durham House Drainage Co.  
 Elliott, H. M. & Co.  
 Goss Heating and Plumbing Co  
 Hanley & Keraghan.  
 Hasbrook, C. E., residence.  
 Hornbrook, E. D., & Co.  
 Johnson, D. D.  
 Kansas City Hot Water Heating and Plumbing Co.  
 Missouri, Kansas, and Texas Loan and Trust Co.  
 Union Depot.  
 Wright, M. B.  
 Yates, Jas.

### KIRKSVILLE.

State Normal School.

### NEVADA.

Bell, M. Fred., State Architect.

### NORTH SPRINGFIELD.

Perkins Water Works Mfg. Co.

### SPRINGFIELD.

Springfield Fdy. & Machine Co.

### ST. LOUIS.

American Central Building.  
 Bank of Commerce.  
 Beal, P. R.  
 Beers, Geo. S., apartment house.  
 Bell, J. W.  
 Brandt, J. G.

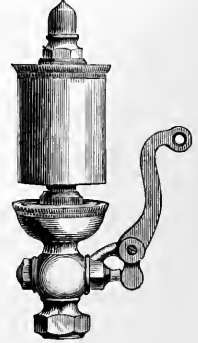
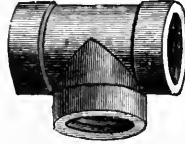
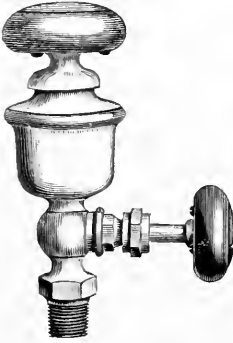

**McNAB & HARLIN MFG. Co.,**

Manufacturers of

**BRASS COCKS AND VALVES**

FOR STEAM, WATER AND GAS.

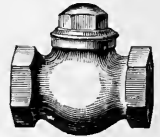

**WROUGHT IRON PIPE and FITTINGS,**

Plumbers' Materials.

**SEAMLESS BRASS AND COPPER TUBES.**



**No. 56 JOHN ST., NEW YORK.**

**FACTORY PATERSON, N. J.**

Catalogue and Price List will be sent to the trade with their first order, or by express, if desired, before ordering.

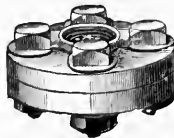
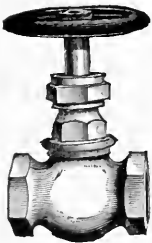

## REFERENCES.

Concordia Seminary.  
Crane, Geo. F.  
Faust's, A. E.  
First Congregational Church.  
Hudson, J. L.  
Kupferle Bros. Mnf'g Co.  
Lincoln Flats.  
Lindell Hotel.  
Nelson, N. O. Mnf'g Co.  
Odd Fellows' Building.  
Phipps & Wallace.  
Provident Savings Bank.  
Public Schools.  
Richardson, J. C.  
Ripley & Bronson.  
Rosenheim, A. F.  
St. Louis Club House.  
St. Louis Heating and Ventilating Co.  
St. Louis Natl. Bank.  
Sprague, J. R. & Son.  
Tutt, D. G.

### ST. JOSEPH.

Bartlett, W. H.  
Eckel & Main, Architects.  
Herbert, M. E.  
Michael, W. A.  
Y. M. C. A. Building.

## MONTANA.

### BILLINGS.

Soule, George.

### BOZEMAN.

Boyle & Rich.  
Nevitt, W. M.  
Story, Nelson.  
Willson, General, residence.

### BUTTE CITY.

De Wolfe, S.  
Grix, R.  
Heesch & Ellerbeck.  
High School.  
Leyson & Tuerk.  
Montana Sanitary Plumbing and Steam Heating Co.

### HELENA.

Adams, Henry, residence.  
Bailey, W. G., block.  
Cannon, C. W., residence.  
Chossman, W. A., three residences.  
Clarke, Albert G., residence.  
Duff, Mrs. Fabitha, residence.  
Episcopal Church.  
Floyd-Jones, R. H., residence.  
Gilpatrick, S. C., residence.  
Hanser, Geo. S. T., residence.  
Helena Steam Heating and Supply Co.  
Holter, A. M., Hardware Co.  
Jacobs, Mrs. Amelia, residence.  
Jones & Galen, Atlas block.  
Jones, S. J., two residences.  
Merchants' Nat Bank.

Montana Nat. Bank, block.  
Parchen, H. M., residence and two blocks.  
Phelps, L. G., block.  
Power & Keefe, block.  
Power, Sullivan & Phelps, Diamond block.  
Power, Senator, T. C., two blocks.  
Reeder, Geo. K.  
Russell, Joseph, residence.  
Sanders, Senator, W. F., residence.  
Sturrock, Frank, residence.  
St. Vincent's Academy.  
Toole, E. W., block.  
Toole, J. R. (Governor of Montana) residence.  
U. S. Assay Office, Government Building.  
Word, S., residence.

### MILES CITY.

Barnard, F.

### MISSOULA.

Higgins Bank.  
St. Patricks Hospital.

## NEBRASKA.

### BEATRICE.

Barclay, F.  
Cook, D. A.  
Ellis, Jno.  
King, Will.  
McConwell I. N.  
Smith, I. E.  
Walback, M. S.

### BLAIR.

Heroes, A. P.

### CRETE.

Foss, F.  
High School.  
Johnson, I. R.

### FAIRBURG.

Champlain, L. C.  
Gribben, G. W.  
Kinyon, V.

### GENOA.

Clark, T. R., M. D.

### GRAND ISLAND.

Phillips, F. C.

### GRANT.

Porter, H. J.

### HASTINGS.

Anson & Pratt.  
Brown, Robt.  
Burggrof, J. G. & Son  
Damron, N.  
Dumerson, F. N.  
Hartwell, Jas. B.  
Nebraska Loan and Trust Co.  
Prall, Geo. H.  
Roher, W. S.

### KEARNEY.

Allen, H. J., residence.  
Baker, N. A., residence.  
Currie, J. C., residence.

Ellis, Geo., residence.  
Finch, C. B., residence.  
Frank, Sr., G. W., residence.  
Frank, Jr., G. W., residence.  
Gamble, Ross., residence.  
Gilchrest, F. H., residence.  
Guston, A. J., residence.  
Henderson, C. H., residence.  
Nevious, S. M., residence.  
Pratt, Warren, residence.  
Scott, Wm. T., residence.  
Snowden, A. J., residence.

### LINCOLN.

Academy of Music.  
Cooper, W. J., & Cole Bros.  
Ewing Clothing Co., block.  
Kosmeyer, F. A. & Co.  
O'Neill, J. H.  
Phillips, Capt. O. R.  
Phillips, R. O.  
Pomerene & Percival.

### NORFOLK.

Barnes, J. B., residence.  
Wiley Hardware Co.

### NORTH PLATTE.

First National Bank.

### OMAHA.

Churchill Pump Co.  
Lewis, E. V.  
McCaffrey, Hugh, business block.  
Omaha Club.  
Perkins, I. P.  
Wind, W. S., Engine and Pump Co.

### YORK.

Sedgwick & Powers.  
Sherman, N. A.  
Shidler, Dr.  
The Meades State Bank.

## NEW HAMPSHIRE.

### BOSCAWEN.

Merrimack County Poor Farm Buildings.

### CLAREMONT.

Beckwith, H. R.  
Dow, R. K.  
Rand & Rice.

Bancroft, Dr. J. D.  
Carter, Dr. W. G., residence.  
City Hospital.  
Eagle Hotel.  
Emery, Geo.  
Hazelton, D.  
Kimball, D. J.  
Larkin, P.  
Minnis & Paige.  
New Hampshire Insane Asylum.  
New Hampshire Savings Bank.  
Stevens, L. D.  
Todd, Geo. E., residence.  
Unitarian Church.

# BRADLEY & HUBBARD

## MFG. CO.

**G A S**  
 —AND—  
**ELECTRIC LIGHT**  
**FIXTURES.**

LARGE LINE OF  
**New and Artistic Designs.**  
 WORKMANSHIP AND FINISH UN-  
 EXCELLED.



## “THE B. & H.” LAMPS

WITHOUT ANY EXCEPTION THE BEST.

HUNDREDS OF PATTERNS IN  
**TABLE, BANQUET, PIANO AND HANGING.**



**FENDERS, ANDIRONS, FIRE SETS, ETC.**

—Brass, Cast and Hand Forged Wrought Iron.

A Full Line of Samples shown at our Salesrooms.

NEW YORK,  
 26 Park Place, 21 Barclay Street.

BOSTON,  
 184 Franklin Street.

CHICAGO,  
 88 Wabash Avenue.

FACTORIES AND OFFICES, MERIDEN, CONNECTICUT.

## REFERENCES.

Vermont Insane Asylum.  
Woodward Building, store and offices.

### DOVER.

Bellamy Club.  
Cacheco Mfg. Co.  
Dover Foundry and Machine Works.  
Jennoy, J. M.  
Littlefield, Frary & Co.  
Munns, Jas.  
Viltum, Col. B. Frank.

### FISHERVILLE.

Catholic Parsonage.

### FRANKLIN FALLS.

Clark & Haynes.  
Griffing, G. W., residence.  
Haynes & Kidder.  
Kemple, G. R. & Co., store.

### GORHAM.

Demond Bros.  
Fuller, A. W.

### HANOVER.

Cobb, S. W.  
Hardy, Prof. H. L.

### HINSDALE.

Robertsons, F. W.

### KEENE.

Davis, Wright & Co.  
Mullard, H. W.

### KINSDALE.

Roberts, F. W.

### LACONIA.

Busiel, Frank E.  
Folsom A.  
Lawrence, E. T. & Co.  
Laconia Car Co.  
Moulton, Hon. Jno. C.  
Newton, N. D.  
Putnam, Perley.  
Russell, N. D.

### LAKE VILLAGE.

Cole Mfg. Co.

### LANCASTER.

Cobleigh & Moore.

### LEBANON.

Heildrth, C. M. & Son.

### MANCHESTER.

City of Manchester, (Engine House).  
Dearborn, Henry  
Elliott Hospital.  
Fauchier, H. I.  
Lane, Thos. A.  
Manchester House.  
Manchester Heating and Lighting Works.  
Pike & Heald.  
The J. B. Varick Co.

### MARLBORO.

Merriam Bros.

### NASHUA.

Bickford, J. D., residence.  
Cross, Jno. A., residence.  
Cross, Levi S., residence.

Davis, Henry H.

Farley, Mrs. E. A., residence.  
Forsaith, Charles, residence.  
Gay, A. E.  
Gregg, W. A., residence.  
Howard, J. W., residence.  
Jackman, C. B. & Son.  
Jackman, Frank E., residence.  
Jackman, S. S. & Co.  
Phanenf, H. C.  
Roby, L. A., residence.  
Wood, E. O., residence.

### PENACOCK.

Bell, W. H.

### PORTSMOUTH.

Sweetser, Jno. F.

### TROY.

Starkey, Geo.  
Starkey, Lanson.

### WESTVILLE.

Beccher, E. B.  
Beccher, L. A.

### WHITEFIELD.

Noyes, J. E. & Co.

### WINCHESTER.

Capron, C. E.  
Merrill, B. C.  
Winchester Steam Heating Co.  
**WOODSVILLE.**  
Grafton Co. Farm.

## NEW JERSEY.

### ALLAMUCHY.

Ayers, W. S.

### ALLENDALE.

Rhodes, Chas. R.

### ALLOWAYS.

Moners, Mr.  
Stretch, Mr.  
Thomas, Howard.  
Van Lier, H. S.

### ANTHONY.

Apgar, N. L.

### ARLINGTON.

Allen, R., residence.  
Allen & Heath, store  
Ackerman, Chas.  
Arlington Public School.  
Bckett Foundry and Mach. Co., offices.  
Cobb, G. B.  
Edmonds, J. Wesley, residence.  
Green, H. C., residence.  
Hathaway, J. O., residence.  
Heath, W. L., residence.  
Holmes, T. D., residence  
Jarvis, R. R.  
Logan, W., residence.  
Rogers, W., residence.  
Roome, H. R., residence.  
School.  
Stowe, I. A., residence.  
Sudderly, H.  
Wood, S.

### ASBURY PARK.

Asbury Park Public School.  
Board of Trade Rooms.  
Brown, Mrs. Wm., residence.  
Brown, Wm. A.  
Byram Bldg.  
Coleman House.  
Crowell, B. & Co.  
Electric Light Works.  
Grand Ave. Hotel.  
Mills, W. S.  
Mitchell, Dr. H., residence.  
Moss, Isaac, residence.  
New Grand Opera House.  
Parisen, R. F.  
Powley, Frank.  
Ripley, J. S.  
Stauffer, Wm. H., photograph gallery.  
Stout, A. T.  
West End Hotel.  
White, Uriah, residence.  
Wynans, John, grocery.

### ATLANTIC CITY.

Atlantic City Water Works.  
Brighton Hotel.  
Buck & McClellan.  
Eldridge, L. H.  
Freeman, L. E.  
Haddon Hotel.  
Hemsley, F. W. & Son.  
Hotel Burkley.  
Jackson, G. W.  
Lee, E. S.  
Newman, Jos.  
San-Marcos Hotel.  
Seaside Hotel.  
Solomon, Isaac.  
Vermont House.  
Warrington, Dr.

### AVON-BY-THE-SEA.

Avon Inn.

### BASKIN RIDGE.

Moore, C. A.

### BAYONNE.

Bayonne Barrel Factory, office.  
Bonny, Geo. W., residence.  
Bulen, G. F.  
Coward, Mr.  
Eddows, R. T.  
Ellsworth, Joseph, residence.  
Farr, Wm. C., residence.  
German Lutheran Church.  
Hansen, Joseph G., residence  
Isabell, Mr.  
Killeen, Rev. T. M.  
Russell, I. W.  
Small, Mr.  
St. Mary's Church.  
Stillman, Mr.  
Watters, Sam'l, residence.  
Wiggam, J.  
Wiggins, L.  
Worden & Brady.



# JERSEY \* CITY \* SMELTING \* WORKS,

105-107-109-111 Plymouth Street,

JERSEY CITY, N. J.

◀◀◀ MANUFACTURERS OF ▶▶▶

Tinners', Canners', Plumbers', Wire, Silver and Spelter

## ✻—SOLDER—✻



## B A B B I T T \* M E T A L

— FOR —

ALL CLASSES OF MACHINERY.



## P U R E A L U M I N U M

— IN —

Ingot, Wire, Castings and Sheet.

## P I G A N D B A R T I N . . . . P I G A N D B A R L E A D .

ANTIMONY.

SPELTER.

COPPER.

SASH

WEIGHTS.

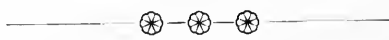

Old Lead, Copper, Tin & Lead Dross taken in Exchange, Cash or Trade.

## REFERENCES.

**BEACH HAVEN.**  
Hotel Engleside.

**BELLEVILLE.**  
Smith, Chas.  
St. Peter's R. C. Church.

**BELVIDERE.**  
Drake, Richard T., residence.  
Givens, Geo. R., hotel.  
Kelsey, A. B., residence.  
Kelsey, Blair, residence.  
Kinnmore, A.  
Lambach, A., hotel.  
Marrow, Wm. H., law office.  
McEwan, W. W., residence.  
McGee, Dr. Wm. H., residence.  
McMurtrie, Abra.m., residence.  
McMurtrie, Geo. K., residence.  
Sampsell, Alex., residence.  
Trester, Jacob, residence.  
Wildrick, Jason K.

**BERGEN POINT.**  
Bellman, C. A.  
Dobson, Thos.  
McGinnis, A.

**BERNARDSTVILLE.**  
Gassabrant, E. F

**BLACK MILLS.**  
Snyder, C. H.

**BLAIRSTOWN.**  
Blair, Dr. J. J.  
Blair, Hon. John I.  
Blair Presbyterian Academy.  
Howell, W. H.  
Miller, Conrad.  
Presbyterian Parsonage.  
Presbyterian Music Hall.  
Stauffer, G. E.  
Vail, J. D.  
Vail, W. H., M D

**BROOMFIELD.**  
Bancroft, J. M.  
Camp, F. T., architect  
Eilers, E.  
Hall, F. S.  
Madison, R.  
Morris, A. T.  
Ward, T. H.

**BLOOMSBURY.**  
Dalrymple, Robt.  
Dalrymple, Wm.  
Little, W. S., M. D., residence.  
Willever, J. J.  
Willever, J. V.

**BOUND BROOK.**  
Close, W. H.  
Gaddis House.  
McNabb, Robt.  
Reynolds, Mr.

**BORDENTOWN.**  
Adams, T. N., residence.  
Bordentown Female College.  
Bordentown Military School,  
Enright, Jas. & Co.

The J. V. Carter Co.  
Woodward, J. B., residence.

**BRANCHPORT.**  
Dobbins & Loeb.  
Monroe Hotel.

**BRIDGETON.**  
Anderson, M.  
West Side Mach. Co.

**BRIGHTON.**  
Allen, William, residence.  
Bright, B. T., residence.  
Buck, Robert, residence.  
Coyle, Rev. L. E., residence.  
Cumberland County Alms House.  
Cumberland National Bank.  
Cumberland Nail and Iron Co.  
Garrison, Prof. W. O., residence.  
Hohenstal's Hotel.  
McGear, Charles P.  
McGear, H. H.  
Minch, F. B.  
Nixon, W. G.  
West Presbyterian Church.  
Woodruff, W. H.

**BUDDS LAKE.**  
Mitchell, Geo.

**BURLINGTON.**  
Burlington M. E. Church.  
Wood, R. F.

**BUTLER.**  
White, Walter C.  
**CALDWELL.**  
Lane, I.

**CALIFON.**  
Adamson, J. H.  
Hoffman, J.  
Philhowers, P.

**CAMDEN.**  
Camden and Atlantic R. R., office.  
New Jersey Trust Co. Bld.  
West Jersey R. R., office.

**CAPE MAY.**  
Allen, Geo. W., cottage.

**CEDARVILLE.**  
Bateman, Dr. E. R.

**CHATHAM.**  
Lum, M. B.

**CHESTER.**  
Collis, Wm. E.  
Davis, J. K.  
Drake, H. P.  
Jenkins, F. N.  
Lansom, Mary.  
Presbyterian Parsonage.  
Yawger, Jas. C.

**CLAYTON.**  
Moon, Bros.  
Silver, A. J.

**CLIFTON.**  
DeMott, Geo. V.  
Merselis, John H.

**CLINTON.**  
Bonnell, Mrs. E. A.

**CLOSTER.**  
Hildeck, Alfred.  
Morrill, F. T.

**CONSTABLE HOOK.**  
Tide Water Oil Co.

**CONVENT STATION.**  
St. Elizabeth's Academy.

**CRANDELL.**  
Chapin, H. A.

**CRANBURY.**  
Applegate, Chas.

**DAYTON.**  
Reynolds, J. R.

**DECKERTOWN.**  
Adams, F. P., residence.  
Coons, J. J., residence.  
DeCamp, Wm.  
Lawrence, J. L. & Sons.  
Little, J.  
Loomis, L. J.  
Margerum, Theo. F.  
Mills & Adams.  
Wilson, C. A.

**DEMOREST.**  
Herring, A.

**DOVER PLAINS.**  
Hanna, J. A.

**DOVER.**

Arndt, Jno.  
Baker, W. H., building.  
Bennett, R. A., M. D.  
Buck, P. C.  
Conlen, Richard.  
Dover Boiler Works.  
Drummer, Jno.  
Eckhart, Jno. J.  
First M. E. Parsonage.  
Goodale, W. E.  
Hairhouse, I.  
Hurd, J. W.  
Martin, John H.  
Moller, Daniel.  
Pierson & Co.  
Public Schools.  
Richards, Geo. & Co., two buildings.  
Searing, J. W.  
Shepherd, Rev. J. A.  
Simpson, J. H.  
St. Mary's Church Parsonage.  
Tippett, Frank.  
Tillyer, Dr. B. J., office.  
Tillyer, L. D.  
The Union Bank.  
Westervelt, G. H.  
Wiedrick, David, residence.  
Wood, Mrs. W. A.

**DRAKESVILLE.**  
Frothingham, H. B.  
King, Theo. F.  
Riggs, Mrs. Nancy.

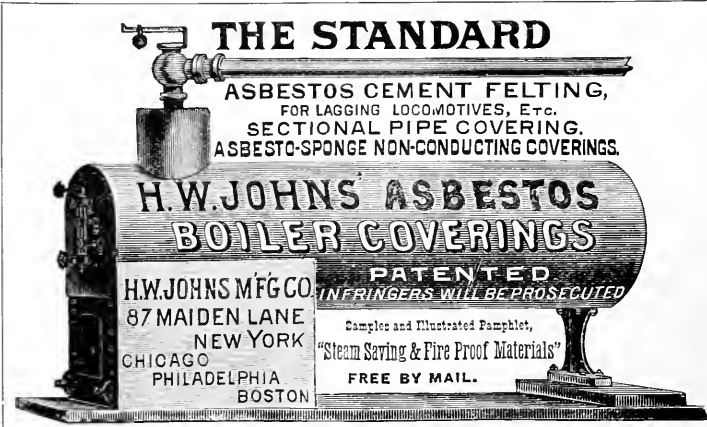

**THE STANDARD**

ASBESTOS CEMENT FELTING,  
FOR LAGGING LOCOMOTIVES, ETC.  
SECTIONAL PIPE COVERING.  
ASBESTO-SPONGE NON-CONDUCTING COVERINGS.

**H. W. JOHNS' ASBESTOS  
BOILER COVERINGS**

**H. W. JOHNS MFG CO.**  
87 MAIDEN LANE  
NEW YORK  
CHICAGO  
PHILADELPHIA  
BOSTON

**PATENTED**  
INFRINGERS WILL BE PROSECUTED

Complete and Illustrated Pamphlet,  
"Steam Saving & Fire Proof Materials"  
**FREE BY MAIL.**

**H. W. JOHNS MANUFACTURING CO.,**  
SOLE MANUFACTURERS OF THE  
**Asbestos Cement Felting, Asbestos Air Chamber Covering.**

Non-Conducting Covering for Steam Pipes and Boilers. Asbestos Locomotive Lagging, a Non-Conducting Covering for Locomotive Boilers. Asbestos Lining Felt, a Protective Lining under Hair Felt. Asbestos Corded Sheathing, a Non-Conducting Covering for Hot Air and Smoke Pipes. Asbestos Sheathing. Asbestos Piston-Rod Packing. Asbestos Mill Board. Asbestos and Rubber Tape. Asbestos Cloth. Asbestos Plastic Stove Lining. Asbestos Building Felt. Asbestos Wick Packing. Asbestos Gaskets. Asbestos and Rubber Cloth. Asbestos Cord and Twine. Asbestos Retort Cement.



**SECTIONAL COVERING.**  
**A NON-CONDUCTING COVERING FOR STEAM AND WATER PIPES.**

**EASILY APPLIED, REMOVED AND REPLACED.**

It is practically Fire-Proof and will prevent more Radiation than double its bulk in Hair Felt.

**ASBESTOS ROOFING...FIRE PROOF.**



This material is supplied in any desired form or in any degree of flexibility, and is invaluable for electrical uses, and for packing joints on Steam, Gas, Hot Air, Oil and Ammonia. Estimates for special requirements will be furnished on application.

**H. W. JOHNS MANUFACTURING CO.,**  
**87 MAIDEN LANE, NEW YORK.**

240 & 242 Randolph Street,  
CHICAGO.

44 Oliver Street,  
BOSTON.

170 & 172 North 4th Street,  
PHILADELPHIA.



## REFERENCES.

### EDENTOWN.

Boyle Chas.  
Littlefield, Chas.  
Stevens, W. R.  
Waere, Peter.

### EDGEWATER PARK.

Hinners, E. H. & Co., factory.  
Hinners, E. H., residence.

### EGG HARBOR.

Gardner, J. J.  
Senn, Edward.

### ELIZABETHPORT.

Brandt, Peter, residence.  
Clauss Bros., residence.  
Clauss, Gen., residence.  
Coleman, Jas. G., residence.  
Gilhowly, Judge, P. H., residence.  
Moore Bros.  
Moore & Bartlett.  
Moore, S. L. & Sons Co.  
Moore, Samuel L., Jr.  
Singer Manufacturing Co.  
Stearns, W. W.  
St. Patrick Church.

### ELIZABETH.

Battin, Jos.  
Braidt, Peter, residence.  
Faulks, Jas. H.  
First National Bank.  
Hoover, W. H., Jr., architect.  
Jacques, C. E., architect.  
Public School No. 1.  
Public School No. 4.  
Stearns, W. W., Supt. C. R. R. of N. J.  
St. Patrick's Church.  
Snow, J. P.  
Thornton, S. P.  
Woodruff, E. C.

### ENGLEWOOD.

Bliss, Delos, residence.  
DeRonde, Abraham.  
Freudenthal, I., residence.  
Hendricks, J. R.  
Ireland, J. R.

### EAST ORANGE.

Adams, A.  
Baldwin, Elias M., residence.  
Doup, Thos. V.  
East Orange Opera House.  
Frederick, Jas. R., residence.  
Greenfield, Jas. H., residence.  
Hall, Chas., residence.  
Hoffman, Chas, residence.  
James, W. H. H., residence.  
King Jno. S., residence.  
Knapp, F. W.  
Lang, F.  
Mandeville, Dr. H. A., residence.  
Manger, Nicolas, residence.  
Picksley, J. D., residence.  
Roche, A.

Worth, Mrs. Maria, residence.  
Williams, Charles S., residence.

### ELMER.

Cheesman, Dr.

### FIELDSBORO.

Mayers, Joseph.

### FINDERNE.

Thompson, A. D.

### FLEMINGTON.

Bartells, W.  
Connet, Jno L.  
Conklen, E. P.  
Fleming Social Club.  
Herr H. Burdett.  
Hopewell Hall.  
Hopewell, J. B.  
Humphrey, Lambert, hotel.  
Hunter-Jon Co Nat. Bank.  
Kline, A. K.  
Knight Templers Room.  
Kuhl, R. H.  
Large, G. H.  
Post-office.  
Public School.  
Shields, Capt. John, residence.  
Stockton Jno. H.

### FORT LEE.

Abbott, Jas.

### FREEHOLD.

Brakeley, Jos.

### FRENCHTOWN.

Apgar, W. C., Hotel.  
Haring, A. B.  
Lone, C. P.  
Uhler Michael.  
Union National Bank.

### GERMAN VALLEY.

Bartles, E. M., residence.  
Presbyterian Church.  
Stephens, F. D. residence.  
Stephens, F. D., store.  
Weise, E., residence.  
Welsh, J. C.

### GLASBORO.

Warrick, J. Price.

### GLEN RIDGE.

Campbell, Ira.

### GLOUCESTER.

Thompson, Wm.

### GREENVILLE.

Bamber Hall.  
Chase, F. N.  
Dominican Convent.  
J. C. Fire Dept. New Truck House.  
Olhauser, Fred.  
Wetmore, Mrs. E. W.

### GREENWICH.

Stathams, D. J.

### HACKENSACK.

Ballage, Robt.  
Banta, A. B., residence.

Banta, C. T., residence and store.

Bergen County Buildings, Jail and Recording Offices.

Cadmus, C. J., residence.  
Conklin, P. L., residence.  
Demarest, S. R., Jr., residence.  
Doremus, J. C., residence.  
Eckerson, E. E., residence.  
Ferdon, Wm. H., residence.  
Grode, J. O., residence and store.  
Hackensack Hall and Armory.  
Harris, C. A., residence.  
Hayler & Son.  
Jacobson, Mrs. S. H., residence.  
Kirby, Richard, residence.  
Lozier, William S., residence.  
Mendelsohn, H., residence and store.  
School Districts No. 31 and 32.  
Shackelton, O. O., residence.  
Smith & Shafer, Messrs., building.  
Van Saun, C. J., residence.  
Williams, Mrs. Jane, residence.

### HACKETTSTOWN.

Buell, A. B.  
Campfield, Margaret, residence.  
Drake, W. N.  
Flock, J. D., residence.  
Grosjean, Mrs. C. T., residence.  
Hackettstown National Bank.  
Howell, T. B., residence.  
Mitchell, Geo. I.  
Trimmer, Dr. Asa.

### HADDENFIELD.

Bell Bros.

### HAMMONTOWN.

Packard, E. S.

### HARRISON.

Church of the Holy Cross and Pastoral, residence.  
Sacred Heart Convent.

### HELMETTA.

Helme, Geo. W. & Co., offices and stores.

### HIBERNIA.

Richards, Beach & Co.  
Richards, Geo. & Co.

### HIGH BRIDGE.

Bryant, G. L.  
Faton, J. H.

### HIGHTSTOWN.

Annex to Peddie Institute.  
De Macknett, M.  
Franklin, Dr. G. F.  
Fisk, D. V. & Son.  
Longstreet Memorial Library.  
Shangle, John R.  
Shangle, S & Son.

### HIGHWOOD.

James, Col. S. A.

### HOBOKEN.

Academy of the Sacred Heart.  
American Lead Pencil Factory, 5th and Clifton Streets.



# MAIL CHUTE IN AN — OFFICE BUILDING, — HOTEL, OR APARTMENT

## HOUSE —

Is now "as much a necessity as an elevator."

OVER 300 IN USE.

Architects should write for detail drawings and other important information.

A vertical fall being essential, the mail chute should be planned for, and if the preparatory work is included in the building contract, quite a saving can be made.

The Mail Chute by arrangement with the postal authorities, is furnished with a "U. S. Mail Box," in connection with the FREE U. S. collection service.



# THE CUTLER MANF'G COMPANY,

ROCHESTER, N. Y.

Sole makers under original and numerous patents. Authorized by P. O. Dept.

## REFERENCES.

Baley, J. G.  
 Beck, A. J.  
 Besson, J. C., residence.  
 Canfield, H., P. R. R.  
 Chamberlain, Mr.  
 Cherey, Dr. C. D.  
 City Hall.  
 Church of the Holy Innocence.  
 Church of Our Lady of Grace.  
 Cop, us, Geo.  
 Coopers, Geo.  
 Consolidated Iron Works.  
 Coyle, M., hall.  
 Delancy, Dr. F.  
 D. L. & W. R. R. Co.  
 Duenkel, L. E.  
 Fehr, Dr. J.  
 First National Bank, Newark and Hudson Sts.  
 German Club.  
 Heitemeyer, C.  
 Hexamers, Phillip, riding academy.  
 Hirtler's Sons, C., pork packing.  
 Hoboken Bank for Savings.  
 Hoboken Land and Improvement Co.  
 Hoboken High School.  
 Holtin, H. C.  
 Jacobs, H. R., theatre.  
 Jenvey, Rev. W. R.  
 Mathey, J.  
 Meyers Hotel.  
 Mill & Ferguson.  
 Newman, K. & Co.  
 Otz, E., silk mills.  
 Public School, No. 4.  
 Public School, No. 6.  
 Public School, No. 8.  
 Reed, Bros., building, 89 Washington St.  
 Round House, D. L. & W. R. R.  
 Second National Bank.  
 Sinclair, G. M., No. 34 4th St.  
 Smith Bros., butcher shop.  
 Smith, James, residence.  
 St. Michael's Monastery.  
 St. Paul's Rectory.  
 Timken, H. L., Hotel.  
 Vanderbeck, H. A., 145 Willow Ave.

### JAMESTOWN.

Kent, A. F.

### JERSEY CITY.

Apgar, E. N., Glenwood Ave.  
 Appleby, Charles.  
 Arion Singing Society.  
 Battin, Rev. S. H.  
 Bedle, Hon. J. D., 473 Jersey Ave.  
 Berkley Club.  
 Bidwell, Mrs. A. G.  
 Bidwell, H. C.  
 Bidwell, Dr. H. G.  
 Brinkerhoff, W. M.  
 Brinkman & Houck.  
 Brown, Capt.

Brown, Joel W.  
 Brown, T. C., & Van Anglen, building.  
 Cairns, Mr.  
 Carteret Club House.  
 Castens, H.  
 Central Railroad, Ferry offices.  
 Clark Bros.  
 Cleveland, A. B., Seed Co.  
 Coffin, Wm. W.  
 Colgate & Co.  
 Coughlin, Geo., residence.  
 C. R. R. of N. J., depot.  
 Culver Building.  
 Cushing, N. B.  
 Daniels, Mrs. Chas. H.  
 Daument, A.  
 Dewar, Capt. J. R., residence.  
 Dickinson, W. H. & Co.  
 Dodge & Co's office.  
 Domestic Spring Bed Co., building.  
 Dominican Convent.  
 Ernest, V. H.  
 Emery M. E. Church.  
 Evans, W. T.  
 Evening Journal Building.  
 Farner, W. W.  
 Fenner, J. H.  
 Fields, J. B.  
 First National Bank.  
 Fountain, Geo. C., drug store.  
 Fountain, Geo. C., residence.  
 Fuller Building.  
 Furst Bros., store.  
 German Evangelical Church.  
 Gibson, W. F.  
 Gifford, G.  
 Gifford, Livingston.  
 Gregory Building.  
 Grossman, R. C.  
 Grumbach, Mrs. Eugene.  
 Grumbach, F.  
 Gurney, W. H.  
 Hamlin, H.  
 Harris, William.  
 Hartzheim, J.  
 Headden, Geo.  
 Henderson, A., residence.  
 Henderson, Chas., residence.  
 High Service Reservoir Bldg  
 Hilton, J. A.  
 Hitchcock, W. H.  
 Holden, D. L., residence.  
 Home for Aged Germans.  
 Houck Bros., factory, Johnston Ave. and Pine Street.  
 Hudson County National Bank.  
 Hudson County Penitentiary.  
 Hussa, O., residence.  
 Ingwersen Building.  
 Jersey City Academy of Music.  
 Jersey City Athletic Club.  
 Jersey City Board of Trade.

Jersey City Electric Light Co.  
 Jersey City Insurance Co.  
 Jersey City Post Office.  
 Kniffen, J. H., 93 Washington street.  
 Kydd, Celes.  
 Lampion, Mortimer, M. D., residence.  
 Lung, Oscar.  
 Lehigh Valley Coal Docks.  
 Leslie, Hugh.  
 Lorillard, P. & Co.'s, office.  
 Lyon, F. W., residence.  
 Mahoney Flats, 8th street, between Jersey Ave and Erie street.  
 Marvin, N. R., residence.  
 McBurney, J. C., residence.  
 McKay, Hugh, residence.  
 McLaughlin, Thos.  
 McNaughton, Wm.  
 McWilliams & Brown.  
 Mecabe, O. S.  
 Mehl, J. & Co.  
 Meyer, C. T. & V. E.  
 Meyer, Miss Lena.  
 Morrow, Day & Co.  
 Mortimer, Rev. F. E.  
 Murphy Flats.  
 Murphy, Michael B.  
 Murray, John P. Co.  
 National Storage Co., offices.  
 New Jersey Car Spring and Rubber Co.  
 New Jersey Paint Works.  
 New York Standard Watch Co.  
 Neise, H. E.  
 North Baptist Church.  
 N. Y. L. E. & W. R. R. Co.'s depot.  
 N. Y. L. E. & W. R. R. Co.'s Ferry House.  
 N. Y. L. E. & W. R. R. Co.'s office.  
 Opdyke, L. A., M. D.  
 Palma Club.  
 Palmers building.  
 Pattberg Hilarius.  
 Patten, Geo. M. residence.  
 Pennsylvania R. ferry house, depot and offices.  
 Perkins, Geo. F., residence.  
 Police Headquarters.  
 Provident Institution for Savings.  
 Public School No. 4.  
 Public School No. 8.  
 Public School No. 20.  
 Public School No. 21.  
 Roberts, P.  
 Robertson, Wm.  
 Roche Building.  
 Sayre, T., residence.  
 Second National Bank.  
 Simpson, R.  
 Smith, Theo., & Bro.  
 Spaulding, Jennings & Co.  
 Standard Wood Turning Co.  
 St. Aloysius Academy.  
 Standard Iron Co.

**J. W. FISKE**

— MANUFACTURER OF —

**ORNAMENTAL IRON, BRASS AND ZINC WORK,**

21 and 23 BARCLAY ST., cor. CHURCH, 26 and 28 PARK PLACE,

NEW YORK.

FOUNTAINS.

DRINKING FOUNTAINS,  
 VASES, STATUARY,  
 DEER, DOGS, LIONS, &C.

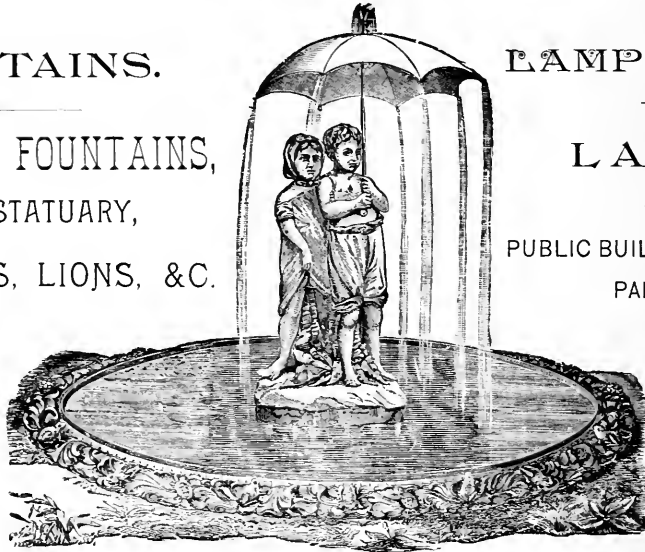

LAMP POSTS

—AND—

LAMPS

—FOR—

PUBLIC BUILDINGS, STREETS,  
 PARKS, &c.

**COPPER WEATHER VANES,**

Over 300 Different Designs. Horses, Cows, Eagles, Arrows, Scrolls, Bannerettes, &c.

Iron Settees and Chairs

—FOR—

CEMETERIES, PARKS, PUBLIC AND PRIVATE GROUNDS, &c., &c.

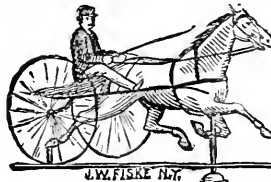

Iron and Wire Railing,

WINDOW GUARDS &C.

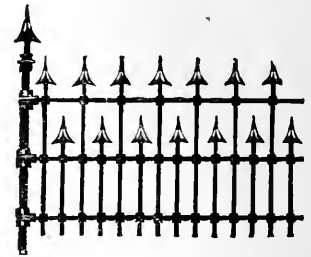
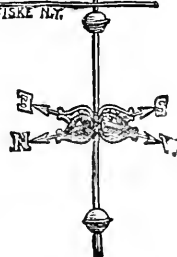

## REFERENCES.

Steel & Condict.  
 Stevens Frank.  
 St. Bridget's R. C. Church.  
 St. Bridget's Pastoral residence.  
 St. Bridget's School.  
 St. Catharen's Home.  
 St. John's German Church.  
 St. Mark's P. E. Church.  
 St. Mark's P. E. Church, Annex Building.  
 St. Mary's P. E. Church.  
 St. Micheals Orphan Asylum  
 St. Patrick's Cathedral.  
 St. Paul's P. E. Church.  
 Tartar Chemical Co.  
 Taylor's Hotel.  
 Taylor, J. & Co.  
 Taylor, W. H. & Son.  
 Teetsel, Mrs. Alice.  
 Thompson, J. R., & Co., office.  
 Tompkins, S. D., residence.  
 Torsion U. S. Balance and Scale Co.  
 United Gas Improvement Co.  
 United States Express Co., stables.  
 Van Winkle, Mrs. Peter, residence.  
 Vreeland, A. J., residence.  
 Vreeland, Mrs., residence.  
 Wallis Iron Works.  
 Washburn, R. C.  
 Weldon Building.  
 Wells, Fargo Express Co.'s Bldg, pier 4.  
 Williams, R. A., residence.  
 Williams, Thos. H., residence.  
 Wilkinson, Geo., M. D.  
 Wilson, Nicholas, residence.  
 Witsch, N.  
 Wood Bros.  
 Wood's Hall.

**JOHNS TOWN.**

Lorillard, P.

**JUNCTION.**

Adams, O. W.

**KEARNEY.**

Kearney, J. Watts.

**KENVIL.**

Ayres, W. S.  
 Burg, C. D.  
 Lawrence, John, residence.  
 Wortman, Wm., hotel.

**LAKE HOPATONG.**

Hotel Breslin.  
 Bryant, G. L.  
 Schafer, D. & Son.

**LAKEWOOD.**

Laurel House.  
 Palmer, J. R.  
 Stevens, Frank, residence.

**LAMBERTVILLE.**

Johnson, Amos.  
 Lear, J. J.  
 Petter, C. M.  
 Robertson, W. S., residence.  
 Vanhorn, R. H.

**LAWRENCEVILLE.**

Hamell House.  
 Lawrenceville School.

**LAYTON.**

Hursh, G. E.  
 Miller, J. N., M. D., residence.

**LEBANON.**

Hoffman, Miss Ann.  
 Hoffman, N. W.

**LITTLE SILVER.**

Hazard, E. C.

**LONG BRANCH.**

Bazley & Burns, store and offices.  
 Castle Hall.  
 Catholic Church.  
 Cooper, Thos. W.  
 Daly, Philip, two Cottages.  
 Garfield Ave. Primary School.  
 Hoey, John, cottage.  
 Hollywood Cottages.  
 Long Branch High School.  
 Monroe, Norman L., residence.  
 Ocean Lodge.  
 Pennsylvania Club House.  
 Pombertson, Dr. H. H., residence.  
 Robillard, O. L., residence.  
 Steinbach, J. Bros.  
 Stillwaggon, Frank, residence.  
 The Hollywood Hotel.  
 Warwick, Wm.

**MADISON.**

Cooke, E. L.  
 Drew Theological Seminary.  
 Genung, M. Y.  
 St. Vincent R. C. Church.

**MATTEWAN.**

Skating Rink.

**MCCAINSVILLE.**

Ayers, W. S.  
 Heller, P. J.  
 Reeves, C. A.

**MENDHAM.**

Bedell, W. J.  
 Garabrant, E. F.  
 Rood, E. J.

**MERCHANTVILLE.**

Bush, Geo. P.

**MIDDLEBUSH.**

Totten, B. S., residence.

**MIDDLETOWN.**

Hendrickson, Miss May.

**MIDDLE VALLEY.**

Farrow, Levi, M. D.  
 Neighbour, Lemuel.  
 Trimer, Lot.

**MILFORD.**

Shafer & Eckel.  
 Wilson, Thomas.

**MILLVILLE.**

Conover, C. B., store.  
 Creamer & Spocks.  
 Foster, J. H., store.

Glass Factory, office.  
 Mulford, Mrs. A. L., residence.  
 Steelman, A. J.

**MINNESINK.**

Shafer, E. & Son.

**MONTCLAIR.**

Anderson, C. W., residence.  
 Deluce, Miss B., residence.  
 Denby, I.  
 Doremus, Philip, stores.  
 Dreste, C. F.  
 Green, J.  
 Heller, P. J., residence.  
 Holt, Mrs. S., residence.  
 Inness, Geo.  
 Love, Dr. J. J. H., residence.  
 McNaughton, J.  
 Merritt, D. F., residence.  
 Mook, Chas. Q.  
 Noyes, Mrs. J. R. D., residence.  
 Reeves, C. J.  
 Sigler, G., residence.  
 Stephens, J., residence.  
 Struder, A. C., residence.  
 Trnsdell, Thos., residence.  
 Tuers, David, residence.  
 Van Riper, P. E., residence.  
 Voorhees, E. M., residence.  
 Watkins, Dr. S. C. G.  
 Williams, E. & J. C.

**MORRISTOWN.**

Birch, F. F., residence.  
 Bishop, Mrs. C. C., residence.  
 Church of the Redeemer Parish House.  
 Cobanks, Estate of Mrs. Mary E.  
 County Offices.  
 Court House and Jail.  
 Dana, Miss E. E., Morris Female Inst.  
 Dobbins, Col. E. L., residence.  
 Douglas, Dr. James, residence.  
 Fairchild, Frank H., residence.  
 Farrelly, P., block.  
 Haley, Capt. B. F.  
 Hibler, Wm. H., meat market.  
 Kountze, L.  
 Lidgerwood, W. V. V., residence.  
 Mansion House.  
 Marsh, C. M., residence.  
 Marsh, Frank, residence.  
 McDermott, Walter, residence.  
 Smith, Mrs. Oscar B., residence.  
 St. Peter's Church.  
 Sullivan, Jas. P., residence.  
 Sunden, Wm. I., residence.  
 United States Hotel.  
 Voorhees, Geo. E. Jr., residence.

**MT. HOLLY.**

Davis, Jno. B.  
 Deacon, Mrs. Anna M.  
 Engle, Robt. B.  
 Gaskill, Geo. E.  
 Mabley & Carew.

THREE OF THE DESIGNS FOR STAINED GLASS WINDOWS,

ST. PAUL'S CATHEDRAL, BUFFALO, N. Y.

R. W. GIBSON, Architect.

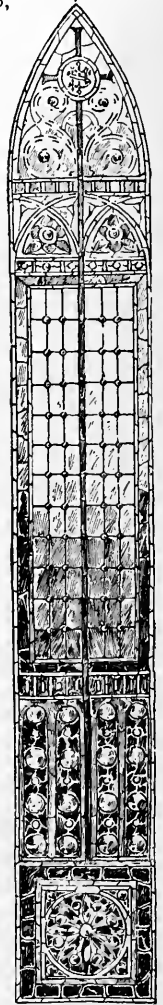
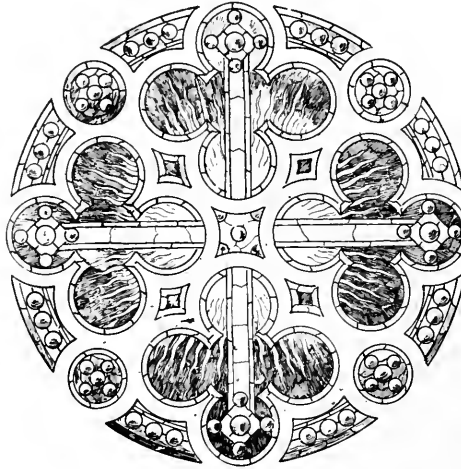

ECCLESIASTICAL · ART · WORKERS

*As Specialists in Ecclesiastical and Memorial Art Work, the Messrs. Lamb can answer definitely from both an artistic and churchly standpoint, all questions regarding the Stained Glass, Color Decoration and Furnishing of the Church Interior.*

\* \* \*

*Established over thirty years (during which time they have designed and executed some of the most important work ever produced in this country,) they can arrange comprehensive schemes, embodying the architect's suggestions, so that unity of effect will be secured in color, line and proportion.*

\* \* \*

*Illustrated hand-books (forwarded when requested), give many ideas in regard to the correct Decoration and Furnishing of the Church, and many suggestions to those about to place Memorials.*

\* \* \*

Stained and Mosaic Glass, Color Decoration and Mural Painting, Carved Wood Work, Bronze, Brass and Wrought Iron Work, Memorial Tablets, Marble Work, Mosaics, Sterling Silver, Ecclesiastical Embroideries, Banners, etc., etc.

\* \* \*

MEMORIAL · WORK · A · SPECIALTY.

ESTABLISHED 1857.

J. & R. LAMB,

59· CARMINE STREET,

NEW YORK.

CARMINE STREET IS A CONTINUATION OF SIXTH AVE., SOUTH,  
 AND THE SIXTH AVE. CARS PASS THE DOOR OF NUMBER 59.

## REFERENCES.

Merritt, C. E.  
 Thomas, Eli R.  
 Worrell, Geo. D.  
  
**MT. PLEASANT.**  
 Pullman Palace Car Co.  
**NETHERWOOD.**  
 Bowen, H. F., residence.  
 Greenwood, G. H.  
 Netherwood Hotel.  
  
**NEWARK.**  
 Albersson, Chas., store.  
 Albright, A.  
 Aldine Apartment House.  
 Allen, Thos. B., 691 Broad St.  
 American Insurance Co., Broad St.  
 Armbuster, Gregorv.  
 Atha, Benjamin, High St.  
 Ball, Jas. T.  
 Ballantine, P. & Son.  
 Ballatine, R. F.  
 Ballatine & Co.  
 Ballentine & Sons.  
 Ballentine, J. H.  
 Bannister & Polland.  
 Barnett & Co.  
 Bawman, C. V.  
 Beuler, Frank.  
 Blaikmoer, G. C.  
 Bon I, C. E.  
 Bonnell, J. M., Son & Co.  
 Borneman, A.  
 Bradley, W. H., Broad St.  
 Brown, Gilbert C.  
 Brown, H. S., residence.  
 Brown, Walter.  
 Brown & Stewart.  
 Brumley, Dr. J. D., residence  
 Burnett St. Public School.  
 Ca'lan, P.  
 Callender Insulating Co.  
 Campbell Tobacco Works.  
 Campbell, C. G., office bldg.  
 Camden Street Public School.  
 Carey, R. J.  
 Carley, T. S.  
 Casey, Jno.  
 Celluloid Mfg. Co.  
 Centennial Building, Market St.  
 City Alms House.  
 City Hall.  
 Chief Engineer's office.  
 Clark, Sanford.  
 Clark, Wm.  
 Clinton Building.  
 Cody, Rev. P.  
 Collin, A. B.  
 Cooper, Chas. & Co., factory.  
 Crane, J., residence.  
 Crockford Steam Generator Co.  
 Curtis, E. A.  
 Demarest, W.  
 Demon, Wm.

Denny Bros. Co.  
 Denny, J. W.  
 Dickerson, F. L.  
 Dixon, W.  
 Dow, Alex. & Co.  
 Dowden, Chas.  
 Dunn, E. & Bro., 104 Market St.  
 Dunn, Walter.  
 Duryce, E. H., residence.  
 Eastwood, John.  
 Egbert, W. V. & Co.  
 Ely & Ely, store.  
 Essex County Bank.  
 Essex County Court House.  
 Essex Club 44 Park Place.  
 Essex County Insane Asylum.  
 Eye and Ear Infirmary.  
 Fehleisen, Albert.  
 Felsberg, Theo.  
 Fire Alarm Telegraph office.  
 Fire Engine House, No. 3.  
 Fire Engine House, No. 4.  
 Fire Engine House, No. 5.  
 Fire Engine House, No. 6.  
 Fire Engine House, No. 9.  
 Fire Engine House, No. 10.  
 Fire Engine House, No. 11.  
 Fireman's Insurance Co.  
 First Baptist Peddie Memorial Ch.  
 First Precinct Station House.  
 First Presbyterian Church.  
 Franklin School.  
 Fritts, C.  
 Geises, Theo.  
 German English School, 10th Ward.  
 German Hospital.  
 Gerth, Theo.  
 Gifford, Jno. A.  
 Gisch, Chris.  
 Goetz, August.  
 Graham, Chas. A.  
 Gray, R. Jr.  
 Grubb, Geo.  
 Hainske, Wm. G.  
 Halme & Co.  
 Hamerslog, N. V.  
 Hansen, Jnr.  
 Hannah, F. A.  
 Hanson, Vanwinkle & Co.  
 Haoldgen, Chas., residence.  
 Hawsling, Henry A.  
 Hawly, Dr. S. S.  
 Heath Building.  
 Heath, S. R. W.  
 Helbig, F. W.  
 Heller, Fred., Clinton Ave.  
 Hensler, Adolph, Sr., Hensler's Hall.  
 Hensler, Adolph, Jr.  
 Hensler, Joseph, Sr.  
 Hensler, Joseph, Jr.  
 Hensler, Jno.  
 Herman, John.

Heroes & Phillips Iron Works.  
 High School.  
 Hill, Wm.  
 Hook & Ladder House, No. 1.  
 Hook & Ladder House, No. 2.  
 Hook & Ladder House, No. 3.  
 Home for the Aged.  
 Hose Depot.  
 House of the Good Shepherd.  
 Howard's Savings Institution.  
 Howarth Bros.  
 Howell, Jas. E.  
 Howell, Samuel.  
 Jeffland, Jno.  
 Jenkenson, Geo. B., High St.  
 Kreuger, G.  
 Lehman, Chas. A.  
 Lenz, August.  
 Libkencher, Julius.  
 Lidenbach, Milton.  
 Link, Wm.  
 London, Liverpool & Globe Ins. Co. Building.  
 Lowentraut, Peter.  
 Macknet & Doremus.  
 Macknet, Morris D.  
 Market Street Public School.  
 McKeon, R.  
 Meekes, S. J.  
 Merchant's Insurance Co., Broad St.  
 Mercy, Meyer.  
 Meserau, W. T. & J., Railroad Ave.  
 Milne, Alex.  
 Miner's Theater.  
 Mockridge & Son.  
 Mount Pleasant Cemetery, office.  
 Murphay, W. H.  
 Murphy, Franklin, Broad St.  
 Murphy Varnish Co.  
 Nessle, J. P.  
 Newark Aqueduct Board Office.  
 Newark Beef Co.  
 Newark City Hospital.  
 Newark Evening News Building.  
 Newark Fire Department.  
 Newark Gas Light Co.  
 Newark Savings Institution.  
 Newark Steel Works.  
 Newark Nickle Plating Co., office and factory  
 Niagara Fire Ins. Co.  
 North End Club.  
 Oliver St. Public School.  
 Oriental Apartment House.  
 Parker & Keasby, Broad St.  
 Parker, Joel, Club Rooms.  
 Passaic Chemical Co.  
 Peddie, T. B. & Co.  
 Pennington, Dr. H. H.  
 Pettet, F. A.  
 Plaut, L. S. & Co.  
 Plum, S. H., residence.  
 Police Headquarters.  
 Preston, T. J. & Co.

S. C.  
SMALL  
& CO.

71 & 73  
PORTLAND  
STREET,  
Boston, Mass.

FACTORY:  
WINCHESTER,  
MASS.



MANUFACTURERS  
+ OF +  
LODGE + + + +  
CHURCH + + + +  
AND PULPIT + + +  
FURNITURE.

INVALID  
CHAIRS.

SHOE STORE  
SETTEES.

Barber's Furniture

+ AND +  
ORDERED WORK.



## REFERENCES.

Price, Theo.  
 Progress Club.  
 Prudential Ins. Co.  
 Rankin, William.  
 Rehman, Louis & Co.  
 Republican Club.  
 Reilly, John.  
 Robb, Jno. T., residence.  
 Roberts, Christopher.  
 Roseville Ave. Public School.  
 Rowe, Jno. E., residence.  
 Rutherford Apartment House.  
 Sargeant Mfg. Co.  
 Sargeant, S. S., residence.  
 Schann Bros.  
 Schick, Jno., residence.  
 Second Presbyterian Church.  
 Shove, Wm.  
 Smith & Abbott.  
 Soffland, Jno., store.  
 South Eighth Street Public School.  
 South Market Street Public School.  
 South Street Public School.  
 State National Bank.  
 State Street Public School.  
 Stabacus, John B., residence.  
 Stademyer, J.  
 State Bank.  
 Stengel Christian.  
 Steam Yacht Bell L.  
 Steam Yacht Cora.  
 Steam Yacht Jean.  
 Steam Yacht Sentinel.  
 St. Barnabas Hospital.  
 St. Joseph's Church.  
 St. Joseph's Rectory.  
 St. Joseph's School.  
 St. James' Church.  
 Stoutenburgh & Co.  
 St. Vincent's Industrial School.  
 Sunday Call, store and offices.  
 Sutcliffe & Noon.  
 Swift, E. C.  
 Theodosius, Rev. T.  
 Toering, Emil.  
 Toomey, Rev. J. J.  
 Trinity Church.  
 Tuttle, Wm., residence.  
 Unger, Hermann.  
 United States Steam Gen. Co.  
 Vanderpool, Beach, Washington Place.  
 Voight, Beda.  
 Ward, Hon. Marcus L., Washington St.  
 Wharton, John, Market St.  
 Wilkenson, Gaddes & Co.  
 Williams, W. B.  
 Wilson, Edward.  
 Wincklehofer, Chas.  
 Wiss, J. & Sons.  
 Young, R. S.  
**NEW BRIGHTON.**  
 Whitman House.

### NEW BRUSSWICK.

Janeway & Co.  
 Johnson & Johnson  
 Lee, J. W.  
 McKeag, Hugh.  
 Middlesex County Jail.  
 Rule, Aaron.  
 Rule, Geo.  
 Shawler, G. L.

### NEW GERMANTOWN.

Crater, Mrs. Amos.

### NEW HAMPTON JUNCTION.

Adams, H.

### NEW MARKET.

Dunham, H. V.

### NEW MILFORD.

Van Wagner, J.

### NEW ROCHELLE.

Sherwood, P. S.

### NEWTON.

Adams, Mrs. Sarah P.  
 Adams, Mrs. Levi.  
 Armstrong, C. N. M., M. D.  
 Earl, W. H.  
 Fellows, A. F.  
 Hamilton Square Baptist Church.  
 Hughson & Van Blarcom.  
 Kays, Thos.  
 Lane, J. W.  
 McMurtry, Mrs.  
 Merriam, H. W.  
 Merriam Shoe Co., H. W.  
 Newton Collegiate Institute.  
 Tuttle, R. & Son.  
 Van Blarcom, A. J. & Son.  
 Woodward Wm. W.

### NORTH BLOOMFIELD.

Martin, A. D., residence.  
 Universalist Church.

### NORTH PLAINFIELD.

Public School.

### OCEAN BEACH.

Haberstick, J.

### OCEAN GROVE.

Atlantic House.  
 Barr, Dr. D. M., sanitarium.  
 Robinson, J. H. & Bro.  
 Rodgers, Mrs. E. S., residence.  
 Sheldon House.

### ORADELL.

Chapin, H. A.  
 Storms, C. H.

### ORANGE.

Bell, Hon. David A., residence.  
 Chandler, Dr. W. G.  
 Edison's Laboratory.  
 Eichhorn Augustus.  
 Freeman Shoe Mfg. Co.  
 Geiger, F. C.  
 Gill, John, residence.

Hartford, Hon. Geo. M.  
 Hindle, Thos., flats.  
 Hindle & Williams.  
 Kingman, T. S., residence.  
 Knowles, W. S.  
 Martin, Chas. J.  
 Masonic Temple.  
 McChensey & Fisher.  
 Minot, J. A., residence.  
 Noyes, J. H.  
 Orange Athletic Club.  
 Orange Baptist Church.  
 Orange National Bank.  
 Park Hotel.  
 Peutsch Lighting Co.  
 Reinhart's Hotel.  
 Roche, E.  
 Rockwell, J. S.  
 Seymour, J. M., residence.  
 Speer, Wm. G. residence.  
 Smith, T. J., residence.  
 St. John's Rectory.  
 St. Mary's Orphan Asylum.  
 Wheeler, Mrs. S. A.  
 Wheeler, T. A., residence.  
 Williams, W. H.  
 Windsor Hotel.  
 Worth, Fred, residence.  
 Young Men's Catholic Association Hall.

### ORANGE VALLEY.

Babbitt, Miss M. E.  
 Chapel of All Saints Church.  
 Church of Our Lady of the Valley.  
 Mathews, N.  
 Yatman, Jno. L.  
 Young Men's Christian Association.

### PASSAIC.

Banker, W. B.  
 Hughes, G. M.  
 Passaic Print Works.  
 Popple, B. F.  
 Popple, F. W.  
 Reid & Barry.  
 Slingerland, D. H.  
 Spencer, B. W.  
 Werthurn, Moses E.

### PASSAIC BRIDGE.

Morton, Rev. G. Nash, seminary.  
 Turner, A.

### PATERSON.

Bandford Joseph, residence.  
 Bandford Joseph, Jr., residence.  
 Beggs, E.  
 Boeger, Carl, residence & Volkstreund Bldg.  
 Bostram, Wm., residence.  
 Brandes Julius, residence.  
 Browne, Jos. J., residence.  
 Bush, E. J.  
 Carshore, W. J., residence.  
 County Clerk's office.  
 Cowan, Wm., residence.

**JAMES H. MASON,**

**Manufacturing Electrician.**

FACTORY:

**118 & 120 PARK AVE., and rear of 116, 118 & 120 Park Ave.**

**✦ BROOKLYN, N. Y. ✦**



SPECIALTIES.



**MASON'S**

FAMOUS

**BATTERIES.**

FOR

Light and Power, &c.



**BATTERY ZINC.**

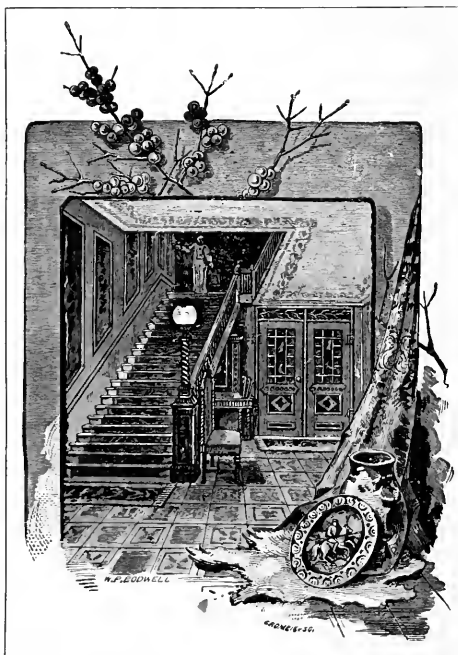

SPECIALTIES.



**Electric Fans**

AND

**SEWING**

**MACHINE**

**OUTFITS.**



**Electric Decoration**



**Domestic Electric Lighting and Power, Without Machinery.**

**ELECTRIC NIGHT LIGHTS,** for the Sick-room and Bed-room.

Special Attention given to the Medical Profession.

**BURGLAR ALARMS, ELECTRIC GAS LIGHTING,**

—AND—

**EVERYTHING ELECTRICAL.**

SEND FOR CATALOGUE "E."

## REFERENCES.

- Engine Co. No. 1.  
 Engine Co. No. 3.  
 Engine Co. No. 5.  
 Engine Co. No. 6.  
 Fayerweather, F. O., residence.  
 First German Pres. Church.  
 Fordzee, Wm., residence.  
 Frost & Sons, Albion Mills.  
 Hood, Thos., residence.  
 Johnson, Dr. W. B., residence.  
 Katz, Bernard, residence.  
 Kinne Building.  
 Kirker, Chas., residence.  
 McCully, F. K., residence.  
 McNab, J. T.  
 McNulty, Rev. William, residence.  
 Muller, Ernest, Germania Hall.  
 Muzzy Bros.  
 Nelson & Fainon.  
 Norwood, John, residence.  
 Norwood, W., residence.  
 Passaic County Court House.  
 Passaic County Jail.  
 Pelyron & Meyer, silk mills.  
 Post M.  
 Public School No. 11.  
 Public School No. 12.  
 Roegiers, B. J.  
 Ryle, Wm. T., residence.  
 Schoonmaker, H., residence.  
 Speer, Jno., residence.  
 Spratter & Mennel.  
 St. Aloysius' Hall, 51 Church St.  
 St. John Baptist School.  
 Ulrich, Frank, residence.  
 Van Dyke, F. C. & Co.  
 Van Houten, Ed. M.  
 Van Nostrand, G.  
 Van Winkle, J. A.  
 Voorhees, G. D., residence.  
 Walker Jacob, residence.  
 Weber, Theo.  
 Williams, Henry A.  
 Williams, William.
- PEMBERTON.**
- Willits & Diver.
- PERTH AMBOY.**
- Ashland Emory Co  
 Buel, A. Mfg. Co.  
 Garretson, John G.  
 Lehigh Vallev R. R. Coal Office.
- PHILLIPSBURG.**
- Aupaugh, Jno.  
 Beam, John H.  
 Dumont, F.  
 Hines, Col. B. F.  
 Phillipsburg Nat'l Bank.
- PLAINFIELD.**
- Adams, Daniel.  
 Babcock, Geo. H.  
 Berry, Jno.  
 Brown, E. F., residence.
- Brown, Geo.  
 Burlingham, Mrs. H. J., residence.  
 Cadmus, A. L.  
 Chase, Dr. F. B.  
 Cooley Institute.  
 Cooley, Rev. J. H.  
 Crescent Ave. Church.  
 Darby, A. B.  
 Day, E. B.  
 Dehand, A.  
 Debaun, Mrs., residence.  
 Egerding, Henry.  
 First Baptist Church.  
 First National Bank.  
 Fritts, J. T., residence.  
 Griffing, A. M.  
 Hall, A. E.  
 Honran, J. P.  
 Krousse, C. W.  
 Latimer, Mrs. A. H.  
 Lewis, A. H., D.D.  
 Locke, Hoffman.  
 Macchutt, B., residence.  
 Male Art Gallery.  
 Maltbee, C.  
 Martine, J. E., residence.  
 Marsh, C. A.  
 Maxwell, John.  
 McCutchen, Chas. W., residence.  
 McCutchen, S. W., residence.  
 McDonald, Mrs. R., residence.  
 McVoy, J., residence.  
 Messchutt, Geo.  
 Miller Bros., block.  
 Miller's Hotel.  
 McIntyre, J. F., residence.  
 Moorstown, Wm.  
 Muhlenberg Hospital.  
 Netherwood Hotel.  
 Park Avenue Baptist Church.  
 Park House.  
 Parse, C.  
 Plainfield Gas Light Co.  
 Pope, E. R.  
 Post Office.  
 Potter, C. Jr., residence.  
 Public School.  
 Radford, R. H., residence.  
 Rafferty, John.  
 Railroad Depot.  
 Randolph, G. W. F., residence.  
 Rockwell, W. S.  
 Schenck, Jno.  
 Shotwell, Mr.  
 Steele, M.  
 Stillman Hall.  
 Taggart, Chas.  
 Talmadge, A. L.  
 Thompson, Wm., residence.  
 Tittsworth, Dr., residence.  
 Vanderbeek, A.  
 Van DeVenter, J.
- Van Dyke, J. C.  
 Van Vliet, Clinton.  
 Van Vliet, Geo.  
 Wakefield, Samuel W.  
 Wareing, E. J., residence.  
 Wareing, Orville.  
 Watson, George.  
 White, Wm., residence.  
 Worth, Thomas.
- PLEASANT GROVE.**
- McClenaghan, Rev. S. J.  
 Presbyterian Parsonage.
- PLEASANTVILLE.**
- Graphic Process Co.
- PORT ORAM.**
- Oram, Hance & Co.
- PORT RICHMOND.**
- Belknap, D. C.
- PRINCETON.**
- Conover, F. S.  
 Marquand Chapel.  
 Princeton College.  
 Seminary Library.
- RAHWAY.**
- Avery, Chas.  
 Bartlett, Mrs.  
 Bonney, A. Staats, architect.  
 Bonney, Mrs. A. S.  
 Florence, Jno. D., residence.  
 Kenyon, J. C.  
 Marsh, D. C.  
 McMahon, Wm. H.  
 Mushon, W. L. & Co.  
 Sanders, Samuel, residence.  
 Shotwell, A. V.  
 Van Fleet, Wm.  
 Welsh, J. H.
- RARITAN.**
- McIntyre, J. H.  
 Pebbles, Wm. L. & Co.
- RED BANK.**
- Allen, Rev. Geo., residence.  
 Burgess, Robt.  
 Cumberson & White.  
 Davis, Thos., residence.  
 Grace M. E. Church.  
 Hendrickson, Applegate & Connors, stores.  
 Kroener, P., store.  
 Laird, R.  
 Payne, B. S., residence.  
 Post Office.  
 Rumsey, George.  
 Sandt, Geo. B.  
 Throckmorton, Capt. D., residence.  
 Vanby, Geo. B.
- RIDGEFIELD.**
- Wilson, C. B.
- RIDGEWOOD.**
- Murphy, W. J., Gen. Supt. N. Y., L. E. & W.



# The National Barrow and Truck Co.,

82 and 84 FULTON ST., NEW YORK.

Manufacturers of

## Steel Wheel Barrows and Hand Trucks.

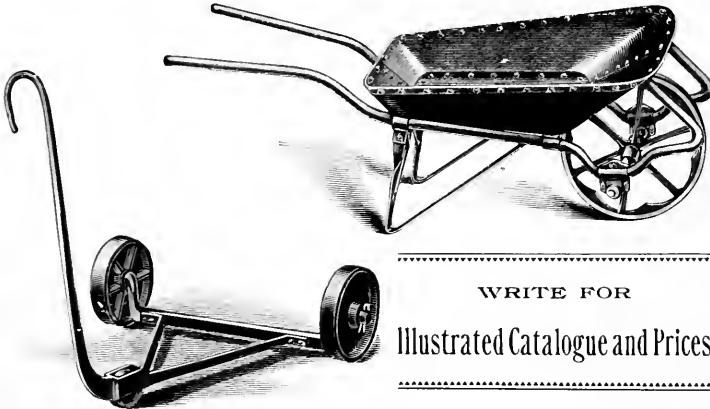

WRITE FOR  
Illustrated Catalogue and Prices

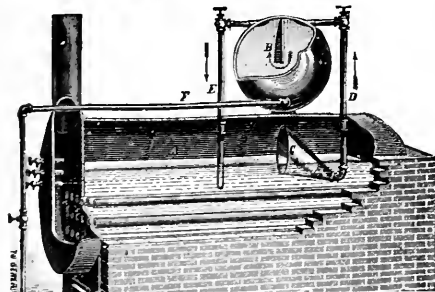

## The Hotchkiss MECHANICAL Boiler Cleaner.

AN AUTOMATIC DEVICE FOR KEEPING BOILERS CLEAN.

Removes OIL, LIME, MAGNESIA, or any other Sediment. Prevents FOAMING, SCALING, BURNING, REPAIRS.

"HOW TO KEEP BOILERS CLEAN."

Is the title of a 96 page illustrated book, containing varied and valuable information for steam users and engineers; how to construct, run and keep a boiler clean, with a list of users and testimonials from the leading steam users of the United States and foreign countries, which will be mailed FREE to any address by

**JAS. M. HOTCHKISS, 120 Liberty St., New York.**

\*—PRICE, \$75.00.—\*

Beware of Infringements.

### MODE OF OPERATION.

By a continuous, rapid circulation of the boiler water (from the surface) through the funnel C by pipe D, the sediment is carried to the Reservoir B, where the current is expanded and given the downward course so that all the mud or sediment is precipitated in the reservoir, the purified water returning constantly to the boiler by pipe E. The mud or sediment being discharged at will by pipe F.

This mechanical device is simple, effective and inexpensive. Avoids the use of compounds and the necessity of cleaning days. Will outlast the boiler and requires no repairs.

TRADE **TRIPSA** MARK.

—OR—  
**TRI-SODIUM PHOSPHATE**

In connection with this Cleaner, furnishes the only known means of preventing scale in boilers using water highly charged with Sulphate of Lime.

HAVEMEYERS & ELDER, Sugar Refiners.

BROOKLYN, E. D., Dec. 15, 1886.

DEAR SIR:—We have been troubled for some years by a muddy deposit in boilers that was comparatively easy to wash from body of boiler, but was gradually baked fast by a hard scale on the outside of the tubes, so that it was necessary to scrape them as well as we could once a year. After scraping the boilers your Cleaners were put on and have given excellent satisfaction, and the sixty boilers having Cleaners on, after a run of from six to eight months, are as clean as new boilers.

Yours truly,  
H. F. ELDER, JR.,  
HAVEMEYERS & ELDER.

Havemeyers & Elder, Aug., 1889, have 110 Cleaners in use

J. F. H.

CROTON FLOUR MILLS, 26 Cherry Street.

New York, February 16, 1887.

DEAR SIR:—We attached five of your special size Boiler Cleaners on five of our tubular boilers, after retubing them. The sixth boiler, at your suggestion, we did not scale or remove the tubes but applied your Cleaner to it as it then was. At this date, after some fifteen months' continuous day and night work, we find all of our six boilers in equally good condition, and free from any accumulation of mud or scale.

Respectfully,  
GEORGE V. HECKER & CO.

WEST ROCK PAPER MILL.

NEW HAVEN, Conn., Jan. 19, 1887.

DEAR SIR:—We have used tubular boilers in our paper mill since 1840 for several years we had a muddy deposit on the tubes and shells, and became so hard we could not scrape it off—used various patented compounds for several years, which did not answer any good purpose, took out the tubes, replaced them; still the deposit continued. We put in new boilers in 1877, and applied your mud drains, since which time our boilers have been clean and free from all deposits; are using less coal, and would not part with them for any consideration; consider them a very valuable improvement.

Yours very truly,  
JOSEPH FAIKER & SON.

## REFERENCES.

**RIEGELSVILLE.**  
Riegel, Jno. L.

**ROCKAWAY.**  
Bruen & Bunnell.  
Bunnell, W. E.  
Forrester, Chas.  
Houglan, Mahlon, Jr.  
Rockaway Mfg. Co.  
Strait, M. B.

**ROSELLE.**  
Banta, C. V.  
Ingram, P. & Son.  
Shangle, P.

**ROSEVILLE.**  
Crauford, Alonzo, residence.

**RUSTIC.**  
Williams, Michael, residence.

**RUTHERFORD.**  
Axford, L. M.  
Benson, Chas. D.  
Burgess, R.  
Buttis, E. E.  
Copeland, H. H.  
Done, R.  
Garner, A. M.  
Garnier, A. F.  
Jackson, A. O.  
Jackson, Jas.  
Jackson, H. R., residence.  
Kipp, Stanley C.  
Luce, E. J.  
Morton, Rev. G. Nash, residence.  
Rutherford Engine Co. No. 2.  
Rutherford Freed Club.  
Slingerland, W. H.  
Slitler, Geo.  
Stahley, C. A.  
Vail, H. C.  
Van Riper, Mrs. C.  
Ver Nooy, C. R.  
Watson, A. L.  
Willis, Thomas.  
Whitmore, A. A.

**SALEM.**  
Ayars, James.  
Ayars, Maurice B.  
Bassett, Joseph, residence.  
Bennett, M. M., residence.  
Bitters & Sons.  
Broadway M. E. Church.  
Casper, Chas. W., store.  
City National Bank.  
Craven Bros., glass mfg.  
Davis, J. Q., residence.  
Davis, J. Q., saloon.  
Finlaw, Wm. P. residence.  
Garwood, John G., residence.  
Garwood, J. F. & Co.  
Geoymer, Robt., residence.  
Geoymer, Robt., Jr., residence.  
Hays, J. H.

Hilliard, James, residence.  
Intermediate Dep't Public School's.  
"John Tyler" Library.  
Jones, Owen L., residence.  
Miller, Jos., store.  
Miller, Watt W., residence.  
Morris, Wm., office.  
Perkins, Rev. C. M., residence.  
Ramsay, Geo. A., residence.  
Salem Co. Club House.  
Salem National Bank.  
South Jerseyman Printing Office.  
Smith, Elmer H., residence, store and office.  
"Sunbeam" Newspaper Office.  
Treas, Harry J., store.  
Treas, Harry J., residence.  
Treas, Wm. R., residence.  
Van Meter, Miss A. K., residence.  
Wheeler & Son, store.  
Zerns, Jno., residence.

**SCHOOLEY'S MT.**  
Bell, Frank.

**SCOBENVILLE.**  
Laird, R.

**SCOTCH PLAINS.**  
Hollingsworth, Loftus, residence.  
Mooney, Chas. E.  
Seeley, E. A., residence.  
Seeley, E. M.

**SEA ISLE CITY.**  
Kelly, M. J.

**SHORT HILLS.**  
Conover, C. L., residence.  
Croscup, Geo. E.  
French, J. W., residence.  
Guiater, A.  
Hartshorn Stewart, several residences.  
Public Hall.  
Rose Geo. H., residence.  
Winter, A. G., residence.

**SMITHVILLE.**  
Willets & Driver.

**SNTERVILLE.**  
Sayre & Fisher Co.

**SOMERVILLE.**  
Amerman, Jno. S., residence.  
Association Building.  
Catholic Church.  
Konklin, Mrs. Jno. T., residence.  
Craig, David K.  
Craton, Dr. A.  
First Church parsonage.  
Fanion, Geo., residence.  
Gumbel, A. Loyd, residence.  
Honeyman, A. L. D.  
Johnson, Mrs. W. S.  
Kenyon, Job C.  
Koehler, Wm., store and dwelling.  
Lawton, Dr. W. J.  
Maxwell, John.

McIntyre, J. F.  
Nevins, Dennis, residence.  
Roberts, Daniel, residence.  
Second Reformed Church.  
Somerville Engine Co.  
Stevens, E., store and dwelling.  
Swinton, Dr. W. J.  
Tenyet, A. S.  
Thornhill, Robert, residence.  
Totten, Geo. D., residence.  
Van Arsdale, C., Somerset Hotel.

**SOUTH AMBOY.**  
R. R. Station House N. Y. & L. B. R. R.

**SOUTH ORANGE.**  
Hart, N. N.  
Shandler, W. G., M. D.  
Ward, R.

**SPARTA.**  
Address, T. H., M. D.  
Gobb, D. W.  
Potter, John A., residence.

**STANHOPE.**  
Allen, Thos. J.  
Drake, A. J., residence.  
Knight, T. I.  
Lunzer, G. H., store.  
Miller, I. P.  
Musconetcong Iron Works.  
Neldon, Chas. R., M. D.  
Valentine, E. O.

**STEWARTSVILLE.**  
Boyer, J. C.  
**SUCCASUNNA.**  
Baker, J. residence.  
Bullock, T. O.  
Burg, C., residence.  
Stoddard, Rev. E. W., church and chapel.  
Vartman Wm., hotel.  
Young, W. H.

**SWEDESBORO.**  
Anderson, M.  
Black, H. J.  
Hanhole & Son.  
Rueon, Mr.  
Turner, Dr.

**TEANECK.**  
Lyons, Wm. A.

**TENAFLY.**  
McNeil, Thos. R.  
Meigs, E. K.

**TRANQUILITY.**  
Stuyvesant, Rutherford.

**TRENTON.**  
Allison, J. T.  
Baker, Wm. H., store.  
Barlow, Richard, hotel.  
Bates, J. B.  
Bird, Jno. T., residence.  
Blair, J. R., residence.  
Boroughs, Ed M., residence.  
Clark Bros., flats.  
Creveling, Wesley E., store.



# The Journal of Commerce and Building Record,

A Monthly, Industrial, Commercial and Maritime Review.

Official Organ of the Texas State Association of Architects.

Cor. Mechanics and 21st St., GALVESTON, TEXAS.

Guaranteed Circulation over 5,000 Copies.

SUBSCRIPTION, \$1 PER ANNUM, INVARIABLY IN ADVANCE.

Sample copies and advertising rates mailed on application.

Manufacturers who wish to reach the southwestern trade will do well to advertise in this newspaper. Address,

Journal of Commerce Co., Publishers and Proprietors.

## ROGERS PATENT GRATE

TOP AND SIDE VIEW.

END VIEW.

COMMENDS ITSELF  
ON SIGHT.



Perfect Combustion,  
Long Life  
and Low Prices.

Argand Grate Bar Co., No. 110 Liberty Street, New York.

## DECORATIVE

## GLASS

AND

## SAND BLAST

## WORK.

## THE MATTHEWS DECORATIVE GLASS CO.

328 and 330 East 26th St., New York.

## DECORATIVE GLASS

From Late Designs Executed by

## SAND BLAST OR EMBOSSING PROCESSES

In a Superior Manner.

Chipped Plate Glass in Design, Lettered, and to a Line.

Ornamental Glass in Stock Sheets, White and Colored Chipped Glass, Glass Signs, and other Specialties for Architects and Jobbing Trade.

Send for Illustrated Catalogue or Estimates.

GEO. T. SMITH.

C. M. ROBINSON.

## SMITH & ROBINSON, ARCHITECTS

Masonic Temple, Altoona, Pa.



Public & Private Buildings

OF ALL KINDS.

If you are about to build a home write us for a copy of

"Art in House Building"

20 Engravings.

Full Descriptions, Accurate

Estimates.

PRICE, 75 CENTS.

OPERA HOUSES — CHURCHES — SCHOOLS.

R. J. CHARD,

96 PINE STREET,

NEW YORK.

LUBRICENE and OILS.

## REFERENCES.

Crozier, Peter, residence.  
 Dawes, Chas. K.  
 Dignan, Jas. W.  
 Dippolt, Dr., stores and offices.  
 Dolton, William, residence.  
 Donnelly, R. A., stores.  
 First National Bank.  
 Forst, D. P., residence.  
 Foster, Thos., residence.  
 German Lutheran Church.  
 Golding, M., residence.  
 Golding, W., residence.  
 Green, Caleb S., store.  
 Hewett, Chas. E., residence.  
 Howell, Chas., residence.  
 Hutchinson, E. C.  
 Jummell, F. R., store and residence.  
 Katzenbach, F. S. & Co.  
 Kelley, James, hotel.  
 Mackcazie, D., residence.  
 Manning, A. V. & Sons, store.  
 Masonic Block.  
 Mercer Co. Court House.  
 Moore, Mrs. Chas., residence.  
 Moses, Jas., residence.  
 N. J. State Normal and Model Schools.  
 Penna, R. R. Co. Office.  
 Schermerhorn & Crozier.  
 Spellenger, E. B.  
 Smith, Frank, residence.  
 State Building.  
 St. John's School & Houses.  
 St. Mary's Catholic Church.  
 Stokes, Edward, residence.  
 Sutphin, Jno. W., residence.  
 Swan & Whitehead.  
 Taylor's Opera House.  
 Throop, Jno. E.  
 Trenton Public Schools.  
 Trenton Terra Cotta Co.  
 Umpleby, W. H., residence.  
 Updesgrove & Letts, hotel and store.  
 Wagner, Franz, building.  
 Wilkinson, O. D., store and offices.  
 Williams, Dr. F. H.  
 Wilkes, Peter.  
 Wilson, S. K.  
 Windsor Hotel.  
 Winkler, Gotwold, residence.  
 Winkler, Emil, residence.  
**UNIONVILLE.**  
 Haynes, C. C., residence.  
**UNION HILL.**  
 Father Griffies' Church.  
 Peters, W., residence.  
 Simon, R. & H., silk mill.  
**UPPER MONTCLAIR.**  
 Anderson, C. W., residence.  
 Anderson, F. P., residence.  
 Gould, O. B., residence.  
 Huestis, C. H.  
 Merritt, M. J.

**VERONA.**

Caniff, J., residence.

**VINELAND.**

Clark, A. G.  
 Hawkins, T. H., Mrs.  
 Mason, C. W. & Son.

**WARETOWN.**

Birdsall, J. H.  
 Holmes, Jno.

**WASHINGTON.**

Hann, P. H.  
 Johnston's, Jos., Sons.  
 Fritts, J. W.  
 Teal, S. S.

**WATERLOO.**

Smith, Seymour.

**WEEHAWKEN.**

Passenger Station West Shore R. R.

**WESTFIELD.**

Alpers, Martin, residence.  
 Decker, Fred., residence.  
 Ferris, M. H.  
 Hanner, W. L., residence.  
 Ingram, Jno., residence.  
 Ingram, Jno. Jr., residence.  
 Smith, C. A., residence.  
 Tice, Geo. W., residence.

**WEST ORANGE.**

District School No. 39.  
 Judge, S.  
 Oliphant Henry D., residence.  
 Randell, Willett S., residence.  
 Williams, B. L.

**WESTWOOD.**

Blakeney, Jacob.  
 DeBaum, C. S.

**WHITEHOUSE.**

Apgar, Dr. T. A., residence.

**WOODBURY.**

Green, Dr. G. G., residence.

**WOODHAVEN.**

Grasseau, F.  
 Salance & Grasseau Mfg. Co.

**WOODPORT.**

Bright, Thos.

**WOODSIDE.**

Heller, E. G., residence.  
 Heller, John, residence.

**WOODSTOWN.**

Alms House.  
 Clawson Martha, residence.  
 Coles, R.  
 Coles, Wm. M.  
 Dickinson, J. V., residence.  
 Hanes, Jno., residence.  
 Pancoast & Lippencott.  
 Strith, Jos. G.  
 Turner, J. H.  
 Weatherly, W.

**YAPHANK.**

Suffolk Co. Alms House.

## NEW YORK.

**ALBANY.**

Albany Brewing Co.  
 Albany Chemical Co.  
 Albany Orphan Asylum.  
 Albany Steam Trap Co.  
 Argus Co.  
 Babcock, Joshua, residence.  
 Ball, Dayton, residence.  
 Bates & Johnson.  
 Beebe, C.  
 Beth Emnet Synagogue,  
 Bethel Jacob Synagogue.  
 Bigelow, John M., M.D.  
 Bissell, C. M.  
 Boyd, James P., M.D., residence.  
 Brainerd & Shepard.  
 Brennan, J., store.  
 Brown, J. F., M.D., residence.  
 Cawley, J. W.  
 City Hall.  
 Converse, H. P., residence.  
 Day, J. H., store.  
 Delaware and Hudson Canal and R. R. Co.,  
     offices and pass'r depot.  
 Dempsey, J., residence.  
 Dewitt, R. V., residence.  
 Dodge, Daniel, residence.  
 Dnolan, R. J., residence.  
 Embossing Co. The, building.  
 Emmett, J. K., residence.  
 Executive Mansion.  
 Fairbanks & Co.  
 Ferguson Boiler Co., office.  
 Fuller, A. W., residence.  
 Fuller, Wm. & Son.  
 Gray, S. R., building.  
 Haine, J., residence.  
 Harrigan, John, store.  
 Hartt, Eugene R., residence.  
 Hasey, Oscar L., residence.  
 Haswell House, hotel.  
 Hawley, Nathan, residence.  
 Hermans, residence.  
 Hoag, S. E., Memands.  
 Keeler, John, restaurant.  
 Keeler, W. H., hotel.  
 Kenmore Hotel.  
 Ladd, M. B., residence.  
 LaRose Mfg. Co.  
 Leonard, Jacob, six houses.  
 Livingstone Boiler and Tank Works.  
 Lynch, J. H., residence.  
 McCredir, Thos. Jr.  
 McElveny, D. & Son, store.  
 Merrill, C. S., M.D.  
 Murray, T. C., Memands.  
 Myers, J. G., residence.  
 National Commercial Bank.  
 National Exchange Bank.  
 National Express Co.

# BOYNTON'S ADJUSTABLE ALLIGATOR WRENCH.

Challenges all Wrenches for work in corners, close coils, radiators and concealed caps, working at an angle of 45 degrees. Quick and handy in adjustment. An indispensable Wrench for water-backs, stud bolts, short nipples, etc., etc.



No. 7, Light, for Plier work, size pipe, $\frac{1}{8}$ to $\frac{3}{8}$ , . . . . .	\$1.50	No. 13, Heavy, for general work, size pipe, $\frac{1}{4}$ to 1, . . . . .	\$2.50
No. 9, Heavy, for general work, size $\frac{1}{2}$ to $\frac{3}{4}$ , . . . . .	1.75	No. 15, Heavy, for general work, size pipe, $\frac{3}{8}$ to $1\frac{1}{4}$ , . . . . .	3.00



## NEW PROCESS Porous, Vitrified, Emery and Corundum Wheels.

FOR ALL GRINDING PURPOSES.

WILL RUN WET OR DRY EQUALLY AS WELL. SUPERIOR  
TO ALL OTHERS FOR RAPID CUTTING AND DURABILITY.

## Grinding and Polishing Machinery

LATEST AND MOST IMPROVED PATTERN.

EMERY, CORUNDUM, QUARTZ, POLISHING SUPPLIES, DIAMOND TOOLS, RUB STONES,  
AND OIL STONES. SPECIAL ATTENTION GIVEN TO NEW AND EXPERIMENTAL WORK.

## VITRIFIED WHEEL COMPANY,

FACTORY AND MAIN OFFICE,

Westfield, Mass.



## REFERENCES.

New York Central and Hudson River R. R.  
Co.'s Freight Offices

Olcott, Dudley.  
Palmer, A. P., residence.  
Patterson, H. & Co.  
Prun, R. C., residence.  
Public School No. 11.  
Reed, Mrs. Mary, residence.  
Richards, Geo. A.  
Ridgeway & Russ.  
Robinson, A. A. & Bro.  
Robinson, Geo.  
Sacred Heart Church Residence.  
St. Agnes School.  
St. John's Church.  
St. Vincent's Orphan Asylum.  
Saul, Julius, store.  
Shafer, John F., Memands.  
Singer Sewing Machine Co., offices.  
Slingerland, J. H., residence.  
Stanwix Hall Hotel.  
State Capitol.  
State Normal School.  
Sweeney, P. J.  
Sweny, A. H., residence.  
The Antwerp.  
Tracy, Gen. Chas., residence.  
Vander Veer, A., M.D.  
Van Heuson, Chas. & Co.  
Viele, M. E.  
Wallen's, Fred. J. Sons.  
Washburn, H. L., residence.  
Weller, Anton.  
Western Union Telegraph Co.  
Wheeler, Seth.  
Whitney, S. W., residence.  
Whittle, Daniel, residence.  
Wooster, B. W., residence.  
Young Men's Christian Association.

### ALBION.

Curtis Mfg. Co.  
Ford, Thos. W.  
Hallock, Stephen.  
Hart, E. K.  
Tilden, M. W.

### ALFRED CENTRE.

Burdick, W. C.

### ALLEGHANY.

Healy, A. & Son.

### ALTAMONT.

Secor & Manchester.

### AMENIA.

Amenia Steam Heating Co.  
Chaffee, J. S.  
First National Bank.  
Hungerford, L. W.  
Lewis, M. K.  
Parson, C. A.  
Reed, H. V. D.  
Thompson, J. R.

### AMSTERDAM.

Amsterdam Academy.  
Austin, Charles D., residence.  
Becker, J. D., residence.  
Becker, N. C., store and residence.  
Becker, N. J., residence.  
Benn, Wm. J., residence.  
Bloods, Gardiner, residence.  
Blood, J. D. & Co., office.  
Boick, Seymour, residence.  
Breedow, Albert, residence.  
Carmichael, Jno., residence.  
Cassidy, D. D., residence.  
Central Hotel.  
DeFerrest, A. A.  
Donlon, Thos., residence.  
Dwyer, Cornelius.  
Dwyer, J. F.  
Dwyer, J. W.  
Electric Light and Power Co.  
Farmers' National Bank.  
First National Bank.  
Greene, Mrs. H. E.  
Herrick, Henry E., residence.  
Hotel Warner.  
Howgate, Jno., residence.  
Inman, Horace.  
Inman Mfg. Co.  
Kellogg, John, residence.  
Kellogg & Miller.  
Kline, Perry, residence.  
Kline & Hubbs, mill.  
Kline, W. J., residence.  
Lewis, Chas., residence.  
McCowatt, W. R., & Co.  
McDonald, John, residence.  
McDonnell, Edm., residence.  
Miller, Jas. A.  
Morris, A. V., residence.  
Morse, Oscar H., residence.  
Munson & Birch.  
Munson, Geo. H.  
New Insurance Building.  
New M. E. Church.  
O'Brien & Dwyer.  
Peckham, Jas.  
Presbyterian Church.  
Presbyterian Parsonage.  
Robb, W. H., M.D., residence.  
Rulison, E. T., M.D., block.  
Rulison, E. T., M.D., residence.  
Shuler, D. W., office.  
Shuler, J. C., residence.  
Snell, Jas. R., residence.  
Sanford Comestead Building.  
Sanford, Hon. Stephen.  
St. Joseph's Convent.  
St. Mary's Parochial Church.  
St. Mary's Parochial Residence.  
St. Mary's Parochial School.  
Stewart, Hon. Jno. K., residence.  
Terwilliger, Jno., block.

Tilton, Dr. C. H., residence.  
Van Brocklin & Co., office.  
Warner, Jno. John.  
Warner, DeForest & Co.  
Wheelock, Jno., residence.  
Yunds, Kyne & Kennedy.

### ANGELICA.

Alleghany Co. Buildings.  
Gillier, Joseph.

### ASTORIA.

Askey, Chas.

### ATTICA.

Stevens, F. C., residence.  
Tolles, E. D.

### AUBURN.

Adams, Thos., residence.  
Allen, Gorton W., residence.  
Allen, Mrs. W., residence.  
Alvord, D. R., residence.  
American Express Co.  
Auburn City Hospital.  
Auburn Steam Heating Co.  
Auburn Academic High School.  
Auburn Bargain House, stores.  
Auburn Button Co.  
Auburn City Club.  
Auburn Electric Light Co.  
Auburn Savings Bank Building.  
Auburn Water Works Co.  
Avery Hotel.  
Barker, Geo., residence.  
Barker, Griswold & Co., store.  
Barker, J. L., residence.  
Barnes, Asa, residence.  
Barrett, S. H., residence.  
Birdsall Co.  
Briggs, Dr. Lansing, residence.  
Boyd, A. A., residence.  
Brown, A. H., M.D., residence.  
Buildings Nos. 7, 9 and 11 Westlake Ave.  
Burdick, Ott, residence and three houses.  
Burtis Opera House.  
Cayuga County Court House.  
Cayuga County Clerk's Office.  
Central Presbyterian Church.  
Chapel, A. W.  
Chedell & Co.  
City Hall.  
Conklin, C. W., residence.  
Davis, Chas., residence.  
Dennison, L. D., residence.  
Dimon, David, M.D., residence.  
Dunning, D. M., residence.  
Empire Wringer Co.  
Empire State Telephone Office.  
Fay, E. R., residence.  
First M. E. Church.  
Fowler & Olmstead, office.  
Fulton St. School.  
Galvin, J. M.  
Gerin, John, M.D., residence.

JAMES G. WILSON,



English Venetian Blinds.



Rolling Partitions.



Rolling Venetian Blinds.



Rolling Steel Shutters.

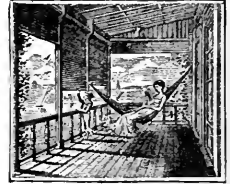

Rolling Venetians.



Outside Venetians.

Patentee and Manufacturer of

Blinds and Shutters.

Special Attention to Export Orders.

Send for large Illustr'd Catalogue.

Cable Address: "Lydian, New York."

74

West 23d St.

NEW YORK.

Standard Emery Wheel Co.,

ALBANY, N. Y.

MANUFACTURERS OF

SOLID EMERY  
AND  
CORUNDUM

WHEELS,  
PATENT PAPER  
POLISHING  
WHEELS.



PATENT  
GRINDING  
AND  
POLISHING  
MACHINERY,  
YIELDING  
JOURNAL  
BEARINGS.

FULL LINE OF NICKEL PLATES AND POLISHERS' SUPPLIES.

A. L. JONES'

LATEST IMPROVED PATENT

Self-Regulating Steam Trap.

It has no Equal. Over 100,000 in use.

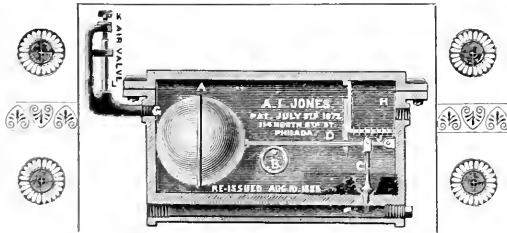

Re-issued and Improved Aug. 10th, 1886.

Highest and only Premium and Medal awarded this Trap at The Great Centennial Exhibition, for the BEST STEAM TRAP in the WORLD. For Descriptive Price List and Reference, send for Catalogue to

A. L. Jones' Steam Heating and Engineers' Supply Store,  
114 N. Sixth Street, PHILADELPHIA, PA.

DEANE'S

Patent Adjustable T Squares.

Correct in Principle and Construction, with a Perfect Screw Adjustment, their MERITS secure for them Universal Favor.

MADE IN THREE STYLES:

"LIMITED" [Adjustment] "UNLIMITED" [Adjustment]  
and "CLIMAX" [Protractors.]

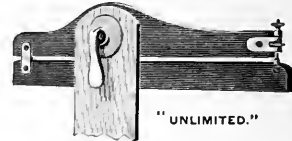

"UNLIMITED."

For full Descriptive Circular and Price List, apply to any responsible dealer in Drawing Materials, or write to

E. L. DEANE,  
Sole Manufacturer, HOLYOKE, MASS.

FOR SALE BY THE TRADE.

## REFERENCES.

Gilbert, Adams & Co.  
 Gilbert, Edward, residence.  
 Greene & Clark.  
 Hagerm, H. W.  
 Ham, Jas., residence.  
 Harrington, J.  
 Harvey, T. C., residence.  
 Hiser, Miss, residence.  
 Hollihan, John.  
 Hollister, W. H., residence.  
 Hollister, A. N., residence.  
 Hughitt, C. W., glove factory.  
 Hughitt & McCarthy, offices.  
 Jenkins, Dr. Jas. M., residence.  
 Kirby, Wm. M., residence.  
 Knapp, James G., residence.  
 Knapp, John N., residence.  
 Knobles' Restaurant.  
 Knobles, Mrs. Wm., restaurant.  
 Lee, F. H., M. D., residence.  
 Lewis, Leroy, M. D., residence.  
 Long, J. D., residence.  
 Longstreet, Geo. W., residence.  
 Lyon, Jas., law office.  
 Masonic Hall.  
 McCarthy, C. A., residence.  
 MacDougall, C. D., residence.  
 Mosher, E. B., residence.  
 New National Hotel.  
 North Str. School.  
 Nye, Mrs. L. W., residence.  
 Olmstead, M. M., residence.  
 Osborn House.  
 Osborne, D. M., residence.  
 Osborne, D. M. & Co., offices.  
 Osborne, John, residence.  
 Owasco Inn.  
 Perry, Miles, residence.  
 Powell, F. H., residence.  
 Pulsifer, F. H., residence.  
 Reed, S. W., residence.  
 Robinson, W. P., residence.  
 Ross, Mrs., residence.  
 Ross, Napoleon, residence.  
 Roseboom, A. W.  
 Sagar, C. H., Co.  
 Sagar Drug Co., store.  
 Senter, E. P., residence.  
 Seward, Hon. W. H., block.  
 Seward, Hon. W. H., residence.  
 Sheldon & Co.  
 Sheldon, E. L., residence.  
 Slocum, A. E., residence.  
 Smith, D. A. & Co.  
 Smith, Byron C., residence.  
 Smith, C. A., residence.  
 Smith, D. A. & Co., offices.  
 Smith, Wilbur, residence.  
 Stanley, E. C., residence.  
 State Armory.  
 Stevens, A. W., residence.  
 Storke, H. L., residence.

Stringer, Geo., residence.  
 Slocum, A. E., residence.  
 Standart, Chas.  
 St. Peter's Church.  
 The Birdsall Co. Offices.  
 Tubbs, R. H.  
 Wait, H. R., store.  
 Wait, W. F., residence.  
 Walley, M. L., residence.  
 Walley, M. L., store.  
 Webster, Benjamin, residence.  
 Wheeler, The. Flat.  
 Weeks, Cossum & Co.  
 Western Union Telegraph Office.  
 Woodcock & Co.  
 Woodruff, E. Delavan, residence.  
 Young Men's Christian Ass'n, building.

### AUBORA.

Frisbee, E. S.  
 Gridley, C. H. & Co.  
 Haines, S. A.  
 Wells College.

### AUSABLE CHASM.

Parker, Fred.

### AVON.

Allen & Carson, sanitarium.  
 Livingston House.  
 Nisbet, Wm., sanitarium.

### BABYLON.

Babylon Railroad Depot.  
 Remsen, Phoenix, residence.

### BALLSTON.

Adams, Geo. E. & Co.

### BALLSTON SPA.

Hayner Bros.  
 Mitchell, Frank.  
 Redmond, W. J.  
 Verbeck, James W., residence.  
 West, Hon. George, office.

### BATAVIA.

Brush Electric Light Co.  
 Catholic Convent.  
 N. Y. State Institute for the Blind.  
 Sawyer, C. F., residence.  
 Sherwin, S. A., residence.  
 Worthington, G. B., Son & Co., residence.

### BATH.

Courier Printing Co.  
 Davenport, Hon. Ira.  
 Gould & Hardenbrook.  
 High School Building.  
 LeValley & Gould.  
 Olmstead, H. M.  
 Soldiers' and Sailors' Home.

### BAY RIDGE.

Kearney, Geo. W.

### BAVILLIE.

Road, Miss B.

### BELFAST.

Chamberlain, Jos., M. D., office.  
 Chamberlain, Jos., M. D., residence.

### BINGHAMPTON.

Hancock & Stowell.  
 Barlow, Geo., residence.  
 Barlow, Rogers & Simpson, factory.  
 Bartlett & Co., office building.  
 Bennett, Fred., factory.  
 Bennett Mfg. Co., office.  
 Bennett Mfg. Co., factory.  
 Binghamton Asylum for Chronic Insane.  
 Binghamton Hydraulic Power Co.  
 Binghamton Post Office.  
 Binghamton Savings Bank.  
 Bramble, M. S.  
 Brown, G. W., laundry.  
 Chenango Valley Savings Bank.  
 Childs, N. T.  
 Church of Christ.  
 City National Bank.  
 Congdon House.  
 Congregational Church.  
 Crandle, Stone & Co., office.  
 Crary, H. H., residence.  
 County Clerk's Office.  
 Court House.  
 First National Bank.  
 Gaylord & Eitapenc.  
 Hanchett, I., residence.  
 Hull, Grummond & Co., factory.  
 Jenks, F. S., flats.  
 Jones, Gen. E. F., residence.  
 Johnson, Mrs. M.  
 Kent, Geo. A., residence.  
 Kilmer, S. A., M. D.  
 Lester & Co., two buildings.  
 Lewis House.  
 MacNamara Block.  
 Meagley, R. H.  
 National Broom Co. Bank.  
 New York State Asylum.  
 Otis Bros., store.  
 Perry Block.  
 Phelps Bank.  
 Phelps, W. G., residence.  
 Quick, W. M.  
 Reynolds, Rogers & Co., factory.  
 Ricks, G. M.  
 Rogers, R. J., residence.  
 Ross Buildings.  
 Rossville Cigar Factory.  
 Sanford, E. N., residence.  
 Safe Deposit Co.  
 Shapley & Wells, offices.  
 Shapley, Mrs. M. W., residence.  
 Sisson, C. F., residence.  
 Sisson, Wm., residence.  
 Sisson Bros. & Welden.  
 Smith, C. A., store.  
 Smith, C. A., residence.  
 Smith, W. S. & Sons, two blocks.  
 Spaulding & Vandebogart.  
 Stone, Goff & Co., office.  
 Stone, J. M., factory.



ARCHITECTS SHOULD ALWAYS SPECIFY THE  
**PATENT LEAD SASH WEIGHTS,**

MANUFACTURED BY  
**JERSEY CITY SMELTING WORKS, JERSEY CITY, N. J.**

✱ ————— **FACTS** ————— ✱

1. They will run without any friction or noise.
2. Being made by Hydraulic Pressure, are solid all the way through, and are heavier and smoother than any other sash weight.
3. They hang plumb and true, and each one is centre-balanced.
4. Prices lower than ordinary weights.
5. They are twice as heavy as iron, consequently economize space.
6. It is impossible for eyes to come out, as is often the case with other weights.
7. We will furnish any desired shape or size on short notice.

✱ ————— **SEND FOR PRICES.** ————— ✱

**HOW TO SECURE  
A GOOD TIN ROOF.**

USE THE  
**Genuine Taylor "OLD STYLE" Brand Tin.**

The Original Brand The Standard Tin that has been  
so often imitated.

It has stood a practical test of over 40 years, and then been  
found just as good as when first put on.



N. & G. TAYLOR CO. originated the idea  
of stamping the brand and the thickness on  
sheets of tin. They were also the first to offer  
a bona fide guarantee to Architects, Property  
Owners and Tin Roofers.

**They Publicly Challenge Contra-  
diction on these two points.**

They further assert that through their exer-  
tions, a complete change has been wrought  
among the trade. Bidders placed on an equal,  
more honest work, done and better tin used.

N. & G. TAYLOR CO. offer the following  
**ABSOLUTE PROTECTION** to the use of their  
Special Brand of Roofing Tin.

1st. By guaranteeing every sheet to be perfect, square and true to  
standard gauge, all wasters rigidly excluded.

2d. Guaranteeing the sheets to be heavier coated than any of its imitations.

3d. Every sheet stamped with the name of N. & G. TAYLOR CO. It being  
the only tin made that bears the name of the Guarantor upon the sheets.

4th. Protection by stamping the Registered Trade Mark of Target and  
Arrow, also the thickness and the name "OLD STYLE" on each sheet.

5th. If the tin should not be found as represented, it will be removed from  
the roof and replaced, the expense being borne by the Guarantor, N. & G.  
TAYLOR CO.

Our book "How to secure A Good Tin Roof," sent free to any  
address, also Samples of Tin, etc.

**N. & G. TAYLOR CO.,**

Established 1810. 81st Year.

**CHICAGO. PHILADELPHIA. LIVERPOOL.**

**GEO. P. HALL & SON,**  
**General Photographers**

157 Fulton St., and 30 Broadway. New York.

TELEPHONE CALL 3844 CORTLANDT

**Joined Views, any size, Residences, Shipping, In-  
stantaneous Photos, Monuments, Machinery,  
Elevated R. R. Views, Interiors, Bridges.**

We Send Experienced Operators anywhere in the United States.

PHOTOGRAPHS for Book, Magazine, Newspaper and Catalogue  
Illustration. Process Prints of all kinds. Advertising Special-  
ties. Full line of New York City Views. Architectural Photographs.  
Valuable Papers Copied and Prints Supplied Mounted on Muslin for  
Filing and Binding.

Samples Mailed on application.

Illustrations in this Catalogue are from our Photographs.



## REFERENCES.

- Stone, J. M., flats.  
 Stowe, Edward.  
 Strong, Cyrus, residence.  
 Vanwormer, Gumberg & Co., factory.  
 Vosburg, Edward, residence.  
 Weed, C. A. & Co., store.  
 Weiden Building.  
 Wescott, Fred., residence.  
 Wescott, C., five blocks.  
 Wescott, Wm., residence.  
 Woodruff, Chas., residence.  
 Wright & O'Connor, factory.
- BLOOMINGDALE.**  
 Smith, A. A.
- BRATTEBORE.**  
 Cusby, E.  
 Marshall, O. C.
- BROADALBIN.**  
 Husted, Miss Kate.
- BREWSTERS.**  
 Dixon, E. W.  
 Everett, B. D.  
 M. E. Church.  
 Wells, F.
- BRONXVILLE.**  
 Chambers, F. R.
- BROOKLYN.**  
 Acme Building.  
 Alden Apartment House.  
 Allen, T. J.  
 Aller, D., hotel.  
 Apartment House, Hall st. & Willoughby ave.  
 Arbuckle Building, 373 Fulton.  
 Astor, Col. Wm., Remsen st.  
 Avon Hall.  
 Bedell, A. S.  
 Beecher Memorial Church.  
 Berkley Place School.  
 Birdsall, D. A. T., residence, Bedford ave  
 Birkett, James W. Mfg. Co.  
 Board of Education.  
 Boemmerman Bldg, Nostrand and Gate aves.  
 Booream Street School.  
 Bornsivade, H. N.  
 Breitenstein, L.  
 Brooklyn Bridge Trustees.  
 Brooklyn City Hospital.  
 Brooklyn Savings Bank.  
 Brooklyn School, Rockaway ave. and McDougal.  
 Brooklyn High School, Nostrand ave. and Halsey st.  
 Brooklyn Theatre.  
 Brown's Millinery Store.  
 Building 365 Putnam ave.  
 Bullock, L. R., 96 Lexington ave.  
 Burwell Building, Montague st.  
 Byrne, Dr., Clinton and Harrison.  
 Carpenter, James O., residence.  
 Carroll, Rev. Martin.  
 Cevedra Apartment House.  
 Chapel First Dutch Reformed Church.
- Children's Aid Society.  
 Childs & Co., 545 Tenth ave.  
 Church of our Lady of Good Counsel, Madison ave. nr Alf ave.  
 Citizens Building.  
 Civil Eng. Dwelling, U. S. Navy Yard.  
 Clarendon Hotel.  
 Clark, Thomas, 90 Fort Greene Place.  
 Clark, Robt.  
 Columbia Flats.  
 Convent of the Visitation.  
 Cockshaw, Herbert.  
 Corcoran, Edward.  
 Corey, Charles, M.D. 23 S. Oxford st.  
 DeBaun, A. E.  
 Degraw Street School.  
 Deiter's Saloon.  
 DeKalb Avenue Railroad Depot.  
 Dittman, J. G.  
 Douglass, W. H., 90 Lafayette.  
 Dwiniel House, 197 Fulton st.  
 East New York Saving Bank.  
 Eitel, J. E., 292 Myrtle ave.  
 Eggert, Wm.  
 Evans, F. H.  
 Fish, Latham A.  
 Flats, corner Lafayette ave. and Ryerson st.  
 Flinn, John.  
 Flynn, Hugh.  
 Ford Flats.  
 Ford, Gordon L., residence 97 Clark St.  
 Forrest Flats, Hancock st. and Marcy st.  
 Forty-seventh Regiment Armory.  
 Fougera, E., apartment house, Atlantic av. and Clinton st.  
 France, T. J.  
 Franklin Building.  
 Franklin Hotel.  
 Fraser, Jno., cor. McDonough st. and Throop.  
 Friedlander, A. & Co.  
 Garfield Building.  
 Germania Club.  
 German Evan. Ch., Schermerhorn st.  
 Good Samaritan.  
 Grimes, James.  
 Hall, Bedford ave. and Oxford st.  
 Hall, Gates & Reid Av's.  
 Hall, S. W.  
 Halz, P. L., cor. Suydam & Herkimer.  
 Harris Furnishing Co., 140 Pearl st.  
 Hamilton Club.  
 Hanly, M. J.  
 Hecla Architectural Bronze and Iron Co.  
 Heyward Street School.  
 Hill, W. H., Clinton ave.  
 Hester, William, residence.  
 Hickey, Rev. J. D., Sixth ave. and Pres. st. High School, Nostrand ave.  
 Historical Society Building.  
 Hoagland, J. C., Clinton ave.  
 Hoogland Laboratory, Pacific and Henry sts.
- Hoople, Wm.  
 Holmes, W. H., 46 Halsey.  
 Home for Consumptives.  
 Home for Aged, Church Charity.  
 Home for Aged, Little Sisters of the Poor  
 Home for Destitute Children.  
 House of the Good Shepherd, Atlantic ave.  
 Howard Colored Orphan Asylum.  
 Husted, William, residence.  
 Huston, Mrs. G.  
 Hyde & Gould Mfg. Co.  
 Jacobs, Geo. P. & Co.  
 Jennings, A. G., Clinton ave.  
 Johnston Bros., store.  
 Jones, H. R., residence.  
 Jones, W. E., office.  
 Keeney, E. W., 580 Henry.  
 Kuntz, F.  
 Lawrence, C. F.  
 Lawrence, I. A., 361 Decatur ave.  
 Levedia Flats.  
 Lipsius, Catharine.  
 Litchfield Mansion, Ninth ave. and Fifth st.  
 Long Island College Hospital.  
 Long Island Hospital.  
 Long Island Savings Bank.  
 Lynch's Hotel.  
 MacKensie, A.  
 Marcy Ave. Baptist Church.  
 Matlock, J. N., residence.  
 Maun, Schmidt, J.  
 McCartee, Peter.  
 McCormack, J. M.  
 McCormick, J., Fifth ave. and Ninth st.  
 McEvoy Bros., artist studio.  
 McShane, Henry & Co.  
 M. E. Hospital, 7th st. and 7th ave.  
 Meehan, John, 1300 Bushwick ave.  
 Merchants & Traders Bank.  
 Morse, G. L., residence.  
 Mullins, John, Furniture Warehouse.  
 Mumford, John.  
 Murphay, Michael.  
 Mynderse, W.  
 New Adelpia Academy Building.  
 New Episcopal Residence, Claremont and Green aves.  
 Nickenig, C.  
 Nutting, A. J., store.  
 N. Y. and So. Brooklyn R. R. Terminal Co., building, 29th st. and 2d ave.  
 O'Brien's Building, P. F.  
 O'Reilly, Rev. Thos.  
 Ovington Building.  
 Oxford Club, Lafayette ave. and Oxford st.  
 Packard, Edwin.  
 Palace Skating Rink, Claremont ave.  
 Patner, Dr. A. J. 90 Hancock.  
 Pastoral Residence Church of the Sacred Heart.  
 Peck, Mr.

THE "WILLER"

Inside Sliding Blinds

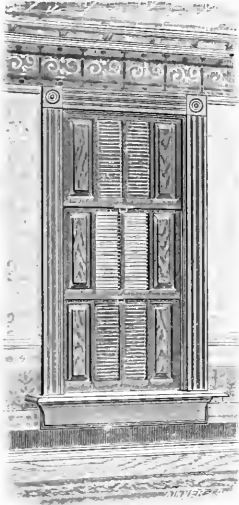

Are acknowledged the Standard Sliding Blinds of the country by all who have used them.

For further particulars send for Catalogues as follows:

Catalogue No. 10. Pocket Edition, mailed free upon request.

Catalogue No. 9. Special Architects' and Builders' Edition, mailed free only to Architects. To others upon receipt of 50 cents in postage stamps.

THE Willer Manufacturing Co. Sole Manufacturers, FOURTH and CEDAR STREETS, Milwaukee, Wis.

BELMONT IRON WORKS,

(LIMITED.)

(Successors to MANLY & COOPER MFG. CO.)

2426 Washington Ave., PHILADELPHIA.

Iron Lawn and Farm Fences,

BRIDGE and HOUSE RAILINGS,

Iron Stairs, Grilles and Shutters,

CEMETERY RAILINGS,

Gates, Crestings and Finials.

BUILDERS' IRON WORK.

ART METAL WORK.

IRON TREE GUARDS, CHAIRS, SETTEES, STABLE FIXTURES.

JOHN TRAGESER STEAM COPPER WORKS

ESTABLISHED 1850.

447 to 457 W. 26th Street, NEW YORK CITY.

MANUFACTURERS OF

Galvanized Iron and Copper Range Boilers,

Copper Bath Tubs.

Oval and Square Sinks,

AND ALL KINDS OF COPPER WORK FOR PLUMBERS, BREWERS, SUGAR HOUSES, DISTILLERIES, CHEMICAL AND DYE HOUSES.

Plans and Estimates Furnished on Application.

THE P. & B. Products, thoroughly Water, Acid and Alkali proof. Electrical Compounds. P. & B. Building Papers, practically indestructible. The Universal Building Paper, the best for the money ever put in the market. Giant Insulating and Building Paper. Water-proof, Lining and Wrapping Papers. Roof and Preservative Paints resist the strongest Acids and Alkalies. Perfect protection to all kinds of wood, iron and brick work.

These products all free from odor.

THE STANDARD PAINT CO.,

SOLE MANUFACTURERS,

59 Maiden Lane,

New York.

## REFERENCES

Peed, C. N.  
 Phelps, E. D., flats, Hicks and Pineapple sts.  
 Phillips, Doup & Co., Adams st.  
 Phoenix Building.  
 Pierce, H. O.  
 Porter, D. C.  
 Prang, Leo.  
 Pratt, Judge C. E., 1453 Pacific st.  
 Prospect Park and C. I. R. R. Depot.  
 Public School No. 40.  
 Puels, J. P., McDonald st. nr Marsey.  
 Rebesehl, D. O.  
 Reid Ave. M. E. Church.  
 Reeves, G. H.  
 "Royal" Apartment House, Montague st.  
 Rutzler, E., residence 35 Berkeley Place.  
 Rutzler, Wm. E., Montgomery st. bet 8th and 9th aves.  
 Ryan, Jos.  
 Scallag, John.  
 Schelensner, C. F.  
 Schelenburg, B., store.  
 Schmidt, L.  
 School No. 9, Vanderbilt and Butler st.  
 School No. 16, Wilson st. nr Bedford ave.  
 School No. 7, Patchen ave. and McDonough st.  
 School No. 10.  
 School, Evergreen ave. and Ralph st.  
 School, Koscush st. and Bushwick.  
 School, Wyona st. nr Fulton.  
 School No. 15, cor Third ave. and State st.  
 Scollay, J.  
 Schilling, Louis, Flatbush and St. Mark's.  
 Seward Flays, 175 and 177 E 93d st.  
 Sherman, N. B.  
 Sheldon Apartment House, Seventh ave. and Pres. st.  
 Sheltering Arms Nursery.  
 Silbe's Oyster House.  
 Simpson M. E. Church.  
 Smith, Gray & Co., Broadway and 4th st.  
 Smith, Gray & Co., Flatbush Av. & Fulton st.  
 Sneider, Dr., 32 Lafayette Av.  
 St. Catherine's Hospital, Bushwick ave.  
 St. George's Hotel.  
 St. George's Church, Gates and Marcy aves.  
 St. John's Home.  
 St. Paul's Industrial School.  
 St. Matthew's Church.  
 St. Stephen's Church.  
 St. Teresa's Church.  
 St. Teresa's School.  
 Stockton Street School.  
 Stover Building, cor Bedford and So. 5th,  
 Sullivan, J. O.  
 Taft, Rev. T.  
 Third Gatling Battery Armory.  
 Thirty-second Reg. Armory Building.  
 Thomas Gen. Seminary for Deanes House.  
 Trumbridge Apartment House, Pineapple st.  
 Van Buren School.

Van Loan, Thos.  
 Vosburgh Mfg. Co.  
 Walbridge, A. C., building, Garfield pl nr 9th ave.  
 Walbridge Music Hall.  
 Wallace, Mr.  
 Waverly Avenue School.  
 Wechler & Abraham, store, Fulton st.  
 Weidman Cooperage Co., North 6th st.  
 Welch, J.  
 Werner, Chas., apartment house.  
 Weils, Henry, apartment. Montague and Hicks sts.  
 Wemple, J. C.  
 West End Flats.  
 Whalen Bros.  
 White, J. J.  
 Williams, J. J., residence.  
 Williams, S. T.  
 Wischerth, John G.  
 Woleott, Chas. O., Smith and Oxford sts.

**BUFFALO.**

American Press Association.  
 Argus, John.  
 Barnd & Geiger.  
 Beebe, M. E.  
 Becker Building.  
 Bensler House.  
 Bishop & Arnold.  
 Case, W. A. & Son.  
 Coatsworth & Eddy.  
 Cook, E. L.  
 Commercial Advertiser Office.  
 Court House.  
 Danforth & Clark.  
 Dixon, W. G.  
 Fitch Institute.  
 Flerls, Conrad, store.  
 German Young Men's Association.  
 Gibbons, Charles L.  
 Grand Trunk R. R. Offices.  
 Hardwicke & Ware.  
 Harrington, James.  
 Hedstrom, E. L.  
 Irlbacker & Davis.  
 Iron Review Office.  
 Kenyon, Dr. L. M.  
 Kneppes, J. H. & Son.  
 Lewis, Geo. H.  
 Lewis Building.  
 Mathews Building.  
 McNamra, M.  
 Merchant's Exchange.  
 Moore, James D., building.  
 "Morning Express" Building.  
 N. Y. C. & H. R. R. Depot.  
 N. Y., W. S. & B. R. R. Car Shops.  
 Post Office.  
 Smith, John D., & Son.  
 Sweet, J. B., residence.  
 Summerhays, C. K.

Taber, B. F., residence.  
 Throop's Grain Cleaner Co.  
 Tiftt House.  
 Van Bokelyn. Mrs. N.  
 Warren Building.  
 Young Men's Christian Association Building.

**CAIRO.**

Pelen, J., residence.

**CAMDEN.**

Conant's, F. H., Sons, store.  
 Costello, P. H., residence.  
 Crimmins, D. J., hotel.  
 DuBois, H. G., residence.  
 Frisbie & Stansfield, mill.  
 Osborne, S. M., residence.  
 Rendalle, C. T. & Co., mill.  
 Robson, A. G.

**CAMBRIDGE.**

Eldridge, A

**CAMPBELL HALL.**

Slaughter, George.

**CANAJOHARIE.**

Arkell, James, residence.  
 Hotel Wagner.  
 White, Mrs., residence.

**CANANDAIGUA.**

Atwater Building.  
 Brigham Hall Insane Asylum.  
 Canandaigua Gas Light Co.  
 Canandaigua Steam Navigation Co., Steamers "Ogarita" and "Onnalurda."  
 Canandaigua Water Works Co., pump house.  
 Coe, W. W.  
 Cooley, J. S. & Co.  
 Fox, Mrs. Frank, residence.  
 Grand Opera House.  
 Howe, H. D.  
 Knight, N. S.  
 Lamport Bros.  
 Mason, Jesse, residence.  
 McPherson, J. H.  
 Munger, D. M.  
 Ontario Co. County House.  
 Ontario Co. Orphan Asylum.  
 Perkins, Theo., & Co.  
 St. John's Episcopal Church.

**CANASTOTA.**

Bruce, J. W., residence.  
 Delano, Milton, residence.  
 Knight, N. S.  
 Staford, Norman, residence.  
 Stebins, E., residence.

**CANDOR.**

Booth, E. A.  
 Heath, H. D.

**CANTON.**

Haven House.  
 Haven, J. M.  
 Sackrider, R. H., residence.

**CASTLETON.**

McKnight, Jno.  
 Van Denburgh, Wm. H.  
 Van Hoesen, J. W.

PICTURESQUE

# California Homes No. 3.

PUBLISHED BY

SAMUEL NEWSOM, ARCHITECT,

ROOM 318, PHELAN BUILDING,

SAN FRANCISCO, CAL.

A work on Modern Homes containing 50 lithographic plates of Buildings, costing from \$700 to \$50,000, including interiors, sketches of mantels, side boards, hat racks, etc.

—PRICE, \$3.50.—

## SUCCESS AT LAST!

### A RADIATOR FOOT REST

Which is at once practical and ornamental.

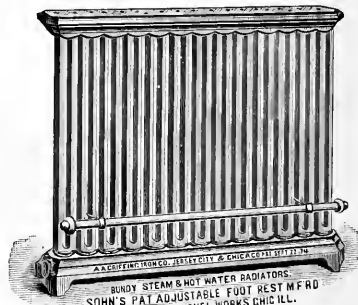

—THE—

### “Sohn” Patent Adjustable Foot Rest

completely overcomes all objections heretofore raised against Radiator Foot Rests. It is quickly attached and can instantly be raised or lowered. It is substantially made. It is an ornament. No home using radiators for heating is complete without it. It is made for all styles and sizes radiators. For circular and price list, address

CHICAGO NICKEL WOKKS,

Cor. ONTARIO and FRANKLIN STS., CHICAGO, ILL.

—THE—

## Pullman Sash Balance

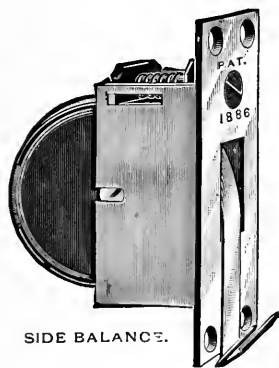

SIDE BALANCE.

Can be applied much more easily than the clumsy pulleys and weights, and without altering or defacing frame or sash. By its use boxes, pockets, &c., in frame are rendered entirely unnecessary, a great saving, particularly on old houses and brick buildings

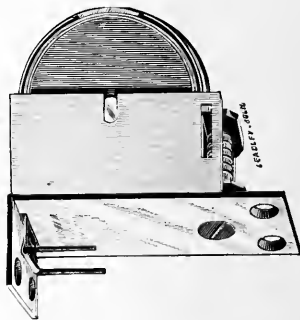

TOP BALANCE.

It balances a sash more perfectly than weights. It is adjustable. It has no cords to get frayed and broken. Its bearings are of cast iron on steel, making it very much less noisy than if all of cast iron. Our Top Balance (see cut) is just the thing for Mullion Windows. These goods are constructed of the very best materials and are put together to last.

Ask your dealer for the “Pullman” or address,

PULLMAN SASH BALANCE CO.,  
ROCHESTER, N. Y.



## REFERENCES.

### CATSKILL.

Adams & Spenser.  
Aldrich, H. B., residence.  
Bates, Geo.  
Brandon, I. W., residence.  
Bulkley, H. C., residence.  
Catskill Woodworking Co.  
Conklin, B. F.  
Conklin, H. & W. S., residence.  
Cryer, A. A.  
Day & Holt.  
Egnor, Charles.  
Ferrier, Thos. E.  
Hallock, Jennings & Chase.  
Hallock, Joseph, residence.  
Holdridge, G. W., residence.  
Johnson & Co.  
Jones, H. T., & Son.  
Lampman, Edward.  
Lampman, W. E., residence.  
Mann, J. T.  
M. E. Church.  
Myers, A.  
Paleing, John.  
Prayn, Isaac, residence.  
Reformed Church, parsonage.  
Warner, G. H.

### CATSKILL MOUNTAINS.

Grand Hotel.  
Hotel Kaaterskill.

### CHATHAM.

Blinn, P. B. Jr.  
Chatham House.  
Chesterman, Jas.  
Haynor, A. H., M.D., residence.  
Howes, Prof. E. W., sanitarium.  
M. E. Church.  
Moorehouse, J. J., residence.  
Payn, Hon. L. F.  
Rosboro, Chas., hotel.  
Shuphels, R. E., residence.  
Union Free School Building.

### CHESTER.

Chamberlain, R. W., residence.  
Roe, A. B., residence.  
Smith, C. P., M.D., residence.  
Thompson, John T., residence.

### CHESTERTOWN.

Faxon, Chas. H.  
Vetter, F.

### CLAIRMONT.

Dow, R. H.

### CLAYTON.

Bastian, Eugene.

### CLIFTON SPRINGS.

Bestwick & List.

### CLINTON.

Kelsey, Professor.

### CLOVE BRANCH.

Storm, G., residence.

### CLYDE.

Buf. J. P., M.D.  
Denison, A. J., residence.  
Eby, J., residence.  
Graham, A., residence.  
Gridley, E., residence.  
Holmes, A. O., residence.  
Murphy & McElgiott, residence.  
Muth, J. R., residence.  
Newbury, S., residence.  
Shepard, S., residence.  
Smith, J. E., residence.  
Streeter, Jas., residence.  
Streeter, S. D., residence.  
Tobin, Wm., residence.  
Wells, C., residence.

### COCHETON.

Irvine, Mrs. Chas., residence.

### COEYMANS.

Pulver, Peter.  
Tobin, Geo.

### COHOES.

Akin John, residence.  
Akin William H., residence.  
Beatie, William, residence.  
Bottom & Lancaster.  
Brady, Rev. P. I., parsonage.  
Brooks, J. A., residence.  
Brown, Frank, residence.  
Campbell, Hon. George, residence.  
Clute, John, residence.  
Curtis & Co.  
Germania Hotel.  
Hornby, Ralph, residence.  
Horrorks, John, residence.  
Leroy, William B., residence.  
Moor, William, residence.  
Ravenscroft, Jonas, residence.  
Rey, Rev. Eugene, parsonage.  
Scott, Jno., residence.  
St. Agnes' Church.  
St. Joseph's Church.  
Sutherland, Daniel, residence.  
Van Benthuser, Miron, residence.  
Vermilyea, Leroy, residence.  
Wilcox, Rodny, residence.

### CONEXY ISLAND.

Hotel Brighton.  
Manhattan Beach Hotel.  
Oriental Hotel.

### COOPERSTOWN.

First National Bank.  
Grant, G. W., residence.  
Grant, G. W. & Co., store.  
Gymnasium.  
Hinman, H., residence.  
Hooker, H. M. & Co.  
Hotel Fenimore.  
Millis, M. M.  
Orphan House.

Otsego County Court House.  
Second National Bank.  
Turner, T. C., residence.

### COPAKE IRON WORKS.

Martin, Asa, residence.

### CORNING.

Brown, F., residence.  
Clisdell, Edward, residence.  
Corning Glass Works.  
Corning Water Works.  
Dickins House.  
Drake Block.  
Drake, F. N., residence.  
Fall Brook Coal Co. Depot.  
First Fational Bank.  
Fuller Bros., Hotel.  
Griffin, Peter.  
Hawkes, T. G.  
Heermans, Mrs. John, residence.  
Heermans & Lawrence, office.  
Heyniger, Mr., residence.  
Houghton, Hon. C. F., residence.  
Hood C. S. & Co.  
Howell C. G.  
Huber, John H., store.  
Ingersoll, A. J., Water Cure.  
Lang, J. H., residence.  
Lewis, John L., residence.  
Maltby, C. R., residence.  
Maltby, C. R. & Bro., store.  
Pease, F.  
Robinson, L. B.  
Robinson, O. P.  
Walker & Clark.  
Walker, William, residence.  
Wellington, Q. W., & Co., Bank.  
Young Men's Christian Association.

### CORTLAND.

Bandes, D.  
Benton, H. F., residence.  
Boynton, Fitz.  
Brown C. F.  
Buck & Rose.  
Bull, J. S., residence.  
Bull, J. S. and Company.  
Clark, William H.  
Copeland, William S.  
Cortland Co., Aims House.  
Cortland Co. Court House.  
Cortlandt House.  
Cortlandt Standard office.  
Cortland Wagon Co.  
Corcain, D. G., residence.  
Crandall L. S., residence.  
E. C. & N. R. R. Co.  
Fitzgerald, S. J.  
Hollister, H. T.  
Hubbard & Buck.  
Kelsey, W. W.  
Lewis, L. R.  
Liddane & Kavanaugh, residence.

## LEAD SASH WEIGHTS.

Architects should always specify the Patent  
Lead Sash Weights, Manufactured only by

**JERSEY CITY SMELTING WORKS,**  
JERSEY CITY, N. J.

**WHY? WHY? WHY?**

They save 10 per cent. in Cord and Head Room in Pocket. Run without Friction. They hang plumb and true. Send for price.

-- ALSO --

IRON DUMB WAITER, IRON ELEVATOR WEIGHTS.

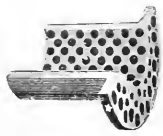

Metalined or Oilless Bearings,

—FOR—

SHEAVES, ELEVATOR PULLEYS,

LOOSE PULLEYS, &C. &C.

An absolutely Dry Bearing requiring no oil or other lubricant to be applied either at the start or afterwards.  
Send for Testimonial Circular No. 4.

**NORTH AMERICAN METALINE CO.,**

**SOLE MANUFACTURERS,**

West Avenue, cor. West 3d St., (Formerly 33 Bleeker St., N. Y. City.)

One Block from Ferry.

**LONG ISLAND CITY, N. Y.**

## OWEN & SALTER,

(Successors to BROWN, OWEN & TAYLOR.)

Manufacturers of and Dealers in

**Plumbers', Steam and  
Gas Fitters' Materials.**

—ALSO—

***Cemetery Enclosure Supplies.***

OFFICE AND WAREHOUSE:

S. W. Cor. 12th & Buttonwood Sts.,

**PHILADELPHIA.**

**Plumbers' Sanitary Goods**

**A SPECIALTY.**

## THE YALE & TOWNE M'F'G CO.,

Manufacturers, Engineers and Machinists.

**LOCKS,**

**BUILDERS'**

**HARDWARE.**



WORKS AT  
STAMFORD, CONN.

**CRANES,**

**HOISTS,**

**TRAM-RAIL.**

CATALOGUES ON APPLICATION.

STAMFORD, CONN.

NEW YORK, 84 and 86 CHAMBERS STREET.

CHICAGO, 152 and 154 WABASH AVENUE.

PHILADELPHIA, 15 NORTH 6th STREET.

BOSTON, 224 FRANKLIN STREET.



## REFERENCES.

Mahan, A.  
 Messenger House.  
 Newton, W. H.  
 Presbyterian Church.  
 Robertson, Rev. J. R.  
 Selooe, C. E., residence.  
 Sherwood S. W., residence.  
 Smith, F. D., residence.  
 Smith, W. F.  
 Standard Block.  
 Stevenson, Theo.  
 Tisdale, W. D.  
 Wallace, D. F.  
 Whiteson, J.  
 Wickwire Bros.  
 Wickwire, C. S.

### CROWN POINT.

Barker, Major E. J., residence.  
 Huestis, F. E.  
 Huestis, F. E., & Bro.

### DALTON.

Thornton, C. B.

### DANSVILLE.

Austin, Jackson & Co.  
 Jackyns, Dr., sanitarium.  
 Our Home.  
 The Sanitarium.  
 Whitman Paper Co.

### DELHI.

White, E. D.  
 White & Co.

### DEMAREST.

Herring, A. Z., residence.  
 Sayres, R., residence.  
 Westervelt, W. H.

### DEWITTVILLE.

Insane Asylum.

### DEXTER.

Dexter Sulphite Pulp and Pipe Co.

### DOBBS FERRY.

Ackerman, J. R.  
 Cushing, Prof., school.  
 Elting, J. D. & Co., store.  
 Hamil, R.  
 McComb, J. J., residence.  
 The Misses Neasters, 3 School Buildings.

### DOLGEVILLE.

Dolge, Alfred, felt department.  
 Dolge, Alfred, lumber department.  
 Dolge, Alfred, private offices.

### DRYDEN.

Southworth, A., residence.  
 Williams, E., residence.

### DUNDEE.

Harpending, A. C.  
 Harpending House.  
 Kline, John.  
 Lord, Hon., Geo. P., residence.  
 Raple, Miles W.

### DUNKIRK.

Brooks, H. G., residence.  
 Brooks' Locomotive Works.  
 Martin Anti-Fire Car Heater Co.  
 Owen, R. B., residence.  
 Perry E. C., residence.  
 Perry E. C. & Co., office.  
 Smith, R. H., residence.

### EAST AURORA.

Bowen, L. E., & Co.

### EAST BLOOMFIELD STATION.

Chapin, Charles, residence.  
 McWilliams, D., & Son.  
 Munson, T., & Co., brick block.  
 Murrell, William, residence.  
 Page, Charles, residence.

### EAST BUFFALO.

N. Y. Sleeping Car Co.

### EAST CHATHAM.

Chesterman, Jas.

### EAST NEW YORK.

House of the Good Shepherd.  
 Wortburg Home.

### EAST TARRYTOWN.

Westchester Co., Alms' House.

### EDGEWATER.

Village Hall.

### ELIZABETHTOWN.

Putnam, H. A.  
 Smith, Wm. F.

### ELLENVILLE.

Beers & Stevens.  
 Brodhead, Miss Sarah A., residence.  
 Donaldson, Jas., residence.  
 Du Bois, Eli.  
 Eaton, Burr.  
 Ellenville Tanning Co.  
 First National Bank.  
 Grimley, A. B., residence.  
 Hornbeck, John C., residence.  
 Hornbeck, S. E. D., residence.  
 Hunt & Donaldson, store house.  
 Kuhlman, Jno.  
 McCarthy, Jas. W.  
 Mount Vernon Brewing Co.  
 Turell, John A., residence.  
 Tice, D., store.  
 Tice, W., residence.  
 Webb, R. O., residence.

### ELMIRA.

Arnot's Arcade Block.  
 Beach, Wm., block.  
 Bell, Harry, residence.  
 Brand, John, & Co., store.  
 Brand, John, residence.  
 Briggs, J., & Co., Brewery.  
 Brown, J. L., residence.  
 Campbell, Jos. A., & Co.  
 Couch, Arthur, office.  
 Crane, T. W., residence.  
 D. L. & W. R. R. Depot.

Durland & Pratt, store.

E. C. & N. Ry.  
 Eastabrook, T. T.  
 Eastabrook, T. W., residence.  
 Fish, W. W., residence.  
 Fish W. W., store.  
 Fraiser House.  
 Fraiser, F. A., residence.  
 Gerrity Bros., wholesale druggists.  
 Gridley, C. H., & Co.  
 Hand, H. P., residence.  
 Ingraham Bros., store.  
 Knowl & LeValley.  
 Lorimer & Tompkins.  
 Mauder Adam, residence.  
 Miller, Valentine.  
 N. Y. Glue Co., factory.  
 Pierce & Dockstader, office.  
 Plumb & Sheldon, store.  
 Rathbun House.  
 Richardson, J.  
 Robertson & Bull, office.  
 Robertson, H. C., office.  
 Robinson, G. L., residence.  
 Sadler, Guy F.  
 School No. 4.  
 Second National Bank.  
 Slaymaker & Holmes, store.  
 Taylor & Bacon, office.  
 Thomas, N. S., residence.  
 Torry, Thos. F.  
 Townsend, P. M. C., residence.  
 Varnum, J. E., office.  
 Walker, J. & R. H.  
 Wyckoff, Mrs. George, residence.

### ERIE.

Sims, Henry.

### ERIN.

Rodburn, J. H., residence.

### ETNA.

Ellis, E. E.

### FAIRPORT.

Baptist Church.  
 Cott, A. H.  
 Mordoff, A. F.

### FARMERS' VILLAGE.

Beardsley, E.  
 Case, C. F.  
 Cobb, R. B., residence.  
 Convert E. N., residence.  
 Ditmars, Wm., residence.  
 Huff George C., residence.  
 Johnson, G. W.  
 Otis, Dr. C., residence.  
 Wheeler, O. G.

### FAR ROCKAWAY.

Horton, S. J.  
 McKenna, W. H.

### FISHKILL.

Byram, W. H.  
 District School Building.  
 Dutchess Shoe Co., office.

**The Curtis Regulator Co.**  
 MANUFACTURERS OF  
**Engineering Specialties**  
 STEAM WATER PUMPS DAMPER REGULATORS  
 TRAPS VALVES ETC.

*Office  
 and  
 Manufactory  
 63 Beverly St. Boston.*

**ONLY** **W.M. Q. WALES** **Selaw Ternes,**  
**OLD PROCESS** **METAL MERCHANT** **ANCHOR**  
**Hand Dipped Ternes.** **26 Oliver Street** **Soldering Fluid.**  
 BOSTON  
 TELEPHONE 476.

TIN PLATE, SHEET IRON, ZINC, PIG TIN, ANTIMONY, MANUFACTURED COPPER,  
 SOLDER, SPELTER, LEAD, WIRE, Etc.

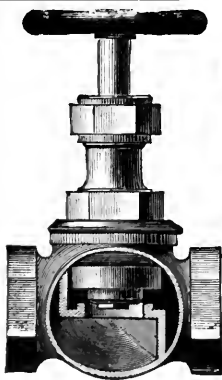

**THE JOHN H. MCGOWAN CO.**  
 PUMPS FOR ALL PURPOSES  
 CINCINNATI, OHIO.  
 FACTORY OFFICE 46 CENTRAL AVE. ON APPLICATION  
 PRICE LIST

**MANUFACTURERS OF**  
**Steam Pumps for all Services,**  
 Globe, Angle and Straightway Valves,  
 Brass and Iron Fittings for Steam, Water and Gas.  
 Iron Pipes and Supplies.  
**The JOHN H. MCGOWAN CO.,**  
 Branch, RICHMOND, VA. **CINCINNATI, O.**

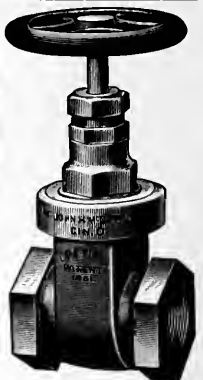

## REFERENCES.

Dutchess Hat Works.  
 Flannery's Hotel.  
 Jones, W., residence.  
 Mechanic's Savings Bank.  
 Morth, Dr. E. J., residence.  
 Mowatt, Miss Mary.  
 Mt. Beacon Academy.  
 Place John, residence.  
 Redman, John.  
 Roller Skating Rink.  
 Shay, Bros.  
 Shay, Frank.  
 Toohey, W. A., residence.  
 Tompkins, E. L., residence.  
 Vanderburgh, Geo.  
 Verplank W., residence.

**FLORAL PARK.**

Childs, John Lewis.

**FLORIDA.**

Jayne, Wm.

**FLUSHING.**

Elliott, Thos.  
 Flushing Water Works.  
 Rauttier, G. A.

**FORDHAM.**

Mitchell, Mary P.

**FORT EDWARDS.**

Hyanny, Ira.  
 Young, Ira H.

**FORT HENRY.**

Witherby, W. C.

**FORT PLAIN.**

Clark, Mr., residence.  
 Clark, W. Jr.  
 Clinton Liberal Institute.  
 Delemater, James, residence.  
 Dunn, Smith & Co.  
 Elwood, B. H. & E. E.  
 Fort Plain Water Works.  
 Hotel Grant.  
 Law, J. M.  
 Pickard, Adam, residence.  
 Pietny, M., residence.  
 Shearer, R. H., residence.  
 Wood, Smith & Co.  
 Woods, E. W., residence.

**FREDONIA.**

Case & Zahn.  
 Couch, Dr. A. S.  
 Putman, H. J.  
 Scott, F. W.  
 Waterhouse, Dr. J. A., residence.

**FREEPORT.**

Wallace, Geo.

**FULTONVILLE.**

Starin Silk Fabric Co.

**GARDEN CITY.**

St. Paul's School.

**GENEVA.**

Alcock, Charles.  
 Baldwin, A. A.  
 Brush Swan Electric Station.  
 Catchpole, A., & Co.  
 Catholic Convent.  
 Chase, R. G., & Co.  
 Chase, W. D.  
 Chew, A. L., residence.  
 Church Home.  
 Clark, Dr. H. K.  
 Covert, Dr. N. B.  
 Dorchester & Rose  
 Dunning, W. B.  
 Franklin House.  
 First National Bank.  
 Greene, Dr. F. A.  
 Geneva National Bank.  
 Hammond, S. H.  
 Hardison, F. K.  
 Henry, D. H.  
 Herendeen Manufacturing Co.  
 Herendeen, L.  
 Hobart College.  
 Hurd, Mrs. E. H.  
 Johnson, G. W.  
 King, Wm. J., Jr.  
 Maxwell, T. O.  
 Maxwell, Mrs. H. E.  
 McDougal, G. C.  
 McMannus, Rev. J., T. V. G., residence.  
 Methodist Church.  
 Mellen, J. P.  
 Moore, W. G.  
 Nash, Prof.  
 Nester, S. K.  
 New York Central Iron Works.  
 New York State Experimental Station.  
 Patter, Dr. E. U., residence.  
 Patterson, J. D.  
 Patty, D. H.  
 Pickett, J. H.  
 Potter, W. G., residence.  
 Post Office.  
 Pronty, P.  
 Rice, Mrs. Harry.  
 Sanford, M. S.  
 Scoon, C. K.  
 Sears, J. S.  
 Sheffield, Mrs. C.  
 Smith, Dr. A. B.  
 Smith, J. W., & Co., store.  
 Smith, Mrs. J. W.  
 Smith, William.  
 Squires, E. N.  
 Southworth, Saml., residence.  
 Vansickel, Mrs. E.  
 Weyburn, Dr. H. D.  
 Wilson, William.  
 Wright, Hon. W. W.  
 Youngs, W. L., store.

**GENOA.**

Tift, A. E.

**GLEN.**

Edwards & Edwards.

**GLEN COVE.**

Duryea, L. T.  
 Duryea, W.

**GLENS FALLS, N. Y.**

Adams, Geo. E. & Co.  
 Calhoun Bros.  
 Glen Falls Insurance Company, Office bldg.  
 Goodman, S. L., residence.  
 Goodman, S. B., residence.  
 Leavens, H. R., store.  
 Moore, William, residence.  
 Ordway Jones, residence.  
 Pruynt, Samuel, residence.  
 Rogers, W. G., residence.  
 Sherman, Mrs. H. A., residence.  
 Spies, Wm. E., residence.

**GLOVERSVILLE.**

Adler & Co., factory.  
 Allen, C. F., factory.  
 Alvoord Honee.  
 Anthony, A. J.  
 Anthony, N. J.  
 Burr Bros.  
 Collins, E. C.  
 Cummings & Burr, office.  
 Curtin, Frank.  
 Darling & Bard.  
 Demerest, W. N.  
 Dempster & Place, factory.  
 Dodge, Samuel.  
 Felmer Bros, factory and residence.  
 Fideo, J., residence.  
 Fonda Johnstown & Gloversville, R.R. depot.  
 Gloversville Gas Light Co.  
 Gloversville Hair Co., factory.  
 Hill, Charles, residence.  
 Hoag, J.  
 Honeywell, Jesse, residence.  
 Hosmer, Jas. S.  
 Huggett & Bridger.  
 Kasson, A. J., residence.  
 Kasson, H. Z., residence.  
 Klein, A., factory and residence.  
 Klein, G.  
 Leftes, Dr., residence.  
 Levos, G., residence.  
 Littaner Block.  
 Littaner Bros., factory.  
 Mandaville, G. W., factory.  
 McGuire, Bernard, residence.  
 McNabb, John, residence.  
 Memorial Hall Opera House.  
 Methodist Episcopal Church.  
 Miller, J. A., residence.  
 Mills Bros.  
 Mills, E. J., residence.  
 Pawley, F.  
 Peck, E. W., residence

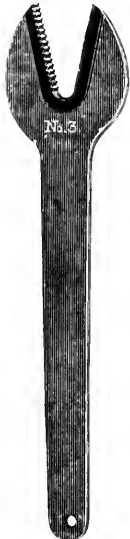

Patented August 31, 1875.

ALWAYS ADJUSTED,  
**Positive, Ready & Never Slip.**

	No. 1.	No. 2.	No. 3.	No. 4.
Holds Pipe,	$\frac{1}{2}$ to $\frac{3}{4}$	$\frac{3}{4}$ to $1\frac{1}{4}$	$\frac{1}{2}$ to $\frac{3}{4}$	$1\frac{1}{4}$ to 2 in.
Holds Round Iron,	$\frac{3}{4}$ to $1\frac{1}{4}$	$\frac{1}{2}$ to 1	$\frac{3}{4}$ to $1\frac{1}{4}$	$1\frac{1}{4}$ to $2\frac{1}{2}$ in.
Length,	6 $\frac{1}{2}$	10	16	22
Price, per doz.,	\$4.00	\$12.00	\$24.00	\$36.00

	No. 5.	Twin.	Pocket.	
Holds Pipe,	2 to 3	$\frac{1}{2}$ to $\frac{3}{4}$		inches.
Holds Round Iron,	$2\frac{3}{4}$ to 3 $\frac{3}{4}$	$\frac{3}{4}$ to 1		"
Length,	27	10	4	"
Price,	\$54.00	\$18.00	\$3.00	per doz.

These Wrenches are forged solid in one piece, from best refined iron, with tempered steel jaws. They have ratchet teeth, cut diagonally across one jaw, thus enabling them to bite with three teeth at once. A single Wrench will hold many sizes of nuts or bolts without adjusting.

They are invaluable to engineers, gas fitters, blacksmiths, and jobbers of all kinds, and for general household or farmers' use.

Manufactured only by  
**American Saw Company,**  
**Trenton, N. J.**

# BUFFALO STEAM PUMP CO.

BUFFALO, N. Y.

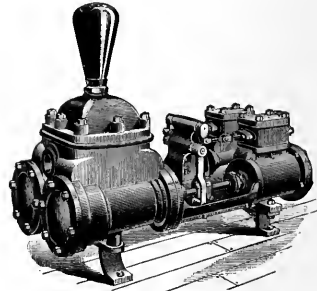

Manufacturers of

## STEAM PUMPS

FOR ALL DUTIES.

"I advise all parents to have their boys and girls taught shorthand writing and type-writing. A stenographer who can type-write his notes would be safer from poverty than a great Greek scholar."—CHARLES READE, on "The Coming Man."

# REMINGTON

## STANDARD

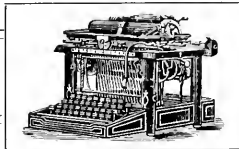

## TYPewriter

### WYCKOFF, SEAMANS & BENEDICT, NEW YORK.

For Fifteen Years the Standard, and to-day the most perfect development of the writing machine, embodying the Latest and Highest Achievements of inventive and mechanical skill. We add to the REMINGTON every improvement that study and capital can secure.

## REFERENCES.

Place, I. V.  
 Quackenbush, J., residence.  
 Reea, Robert.  
 Sporbours, W. L., residence.  
 Smith, D. W., residence.  
 Still, E., residence.  
 Stockamore, John, residence.  
 Zimmer, A. J., residence.

### GOSHEN.

Bull, James.  
 Campbell Hall.  
 Cateret Hose Co., truck house.  
 Coleman, James, C. M. D.  
 Coleman, R. C.  
 Court House.  
 County Asylum.  
 County Jail.  
 Cuddeback, Lewis, residence.  
 Dikeman Hose Co., truck house.  
 Elliot Hook and Ladder Co.  
 Elliott, Chas. G.  
 Gregory, J. S.  
 Greene, Geo. W., office.  
 Gosben Corporation building.  
 Gosben Foundry and Gas Mfg. Co.  
 Hatfield, T. T.  
 Height & Newell.  
 Height, Mrs. D. H.  
 Height, H. E., office.  
 Hoek, R. B.  
 Holbert, Adam, residence.  
 Hork, R. B.  
 Howell, Sidney O., residence.  
 Howell, M. A., residence.  
 Howell, Jas. A., residence.  
 Johnson, Jacob M.  
 Kergham, Rev. J. J., residence.  
 Mapes, W. E., office.  
 Moore, J. A.  
 Neafe, A.  
 Post Office.  
 Ray, William V.  
 Reayse, Edwin L., residence.  
 Reemer, Mrs. G. M., residence.  
 Seely, F. B.  
 Slaughter, Geo., residence.  
 Smith, Theodore, residence.  
 St. John's Church and residence.  
 Surrogate's Office.  
 Tuthill, T. D., residence.  
 Valentine, Jno., residence.  
 Van Steenburg, J. H., residence.  
 Wallace, Mrs. Hannah, residence.  
 Wykes, W. H., residence.

### GOUVERNEUR.

Abbott, V. P., residence.  
 Gouverneur Mach. Co.  
 Herald-Times Building.  
 McCarty, John, residence.  
 Reynolds, H. G.

Van Buren House.  
 Van Duzee, S. B.  
 Van Duzee, C. A.

### GRANVILLE.

Baker, O. K., residence and store.  
 Baldwin, O., residence.  
 Betts, F. W., residence.  
 Butlock, R., residence.  
 Burtis, W. J., residence.  
 Central Hotel.  
 Collings, J. H., residence.  
 Conry, G. W., residence.  
 Dillingham, H., residence.  
 Finch, G. N., hotel.  
 Henry, Geo. W., residence.  
 Hught, H. W., residence.  
 Maloney, Rev. Father, residence.  
 Martin, John T., residence.  
 McFadden, C. E., residence.  
 Mosher, Dr., residence.  
 Potter, S. G., residence.  
 Potter, Jno. D., residence.  
 Rogers, D., residence.  
 Simonds, Geo. O., residence.  
 Stafles, Jno., residence.  
 Temple, Geo., residence.  
 Tenny, W. A., residence.  
 Woodward, D. D., residence.  
 Wyman, E. W., residence.

### GRASSY POINT.

Collins, L. D., residence.  
 Denan, Thos.  
 Wadsworth, Jas. W.  
 Wiles, A. M. & W. H.

### GREAT NECK.

Arnold, W. H.

### GREENBUSH.

Electric Manufacturing Co.  
 Hilt, O. F.  
 Sisters of Mercy, (Convent).  
 Wilson, R. I.

### GREENPOINT.

Gleason, E. P.  
 Mechanics' and Traders' Bank.  
 St. Anthony's Church.  
 St. Anthony's Parochial Residence.

### GREENPORT.

Hedges, S. P.

### GREENWICH.

Greenwich School Building.  
 Thompson, J. H., residence.

### GRIFFINS CORNERS.

Todd, A. H.

### GROTON.

Avery, O., residence.  
 Crandall Type Writer office.  
 Croton Carriage Co., office.  
 Conger, C. W. & Co., store.  
 Conger, Benn, residence.

Groton Bridge & Mfg. Co.  
 Jones & Gobel.  
 Marsh, D. M., residence.  
 McLachlan, D.  
 Perrigo, Charles, residence.  
 Smiley Everett.  
 Union School Building.  
 Watrous Jason.  
 Williams, Wm.

### HAGGAMANS MILLS.

Pawling, H. H.

### HALLS CORNERS.

Perkins, Clarence.

### HAMBURGH.

Bunting, J. L., residence.

### HAMDEN.

Brice, Samuel.

### HAMILTON.

Tooke, W. E., office.

### HANCOCK.

Blake, Peter.

### HARFORD.

Blumers, Jno., cheese factory.

### HAVERSTRAW.

Chapman, Edward.  
 Dinan, Thomas.  
 N. Y., W. S. & B. R. R. Station.  
 West, J. E.  
 Wills, A. M.

### HERKIMER.

Churchill, A., residence.  
 Folts, J. P., residence.  
 Herkimer Paper Co.  
 Howell, Wm. B., residence.  
 Mark, Morris, residence.  
 Mark, Elias, residence.  
 Palmer, C. W. & Co.  
 Palmer, Joseph, residence.  
 Salmo, James, residence.

### HEMPSTEAD.

Adams, Geo. W.  
 Carman, T. A.  
 Hall, M. W.  
 Norton, C. F.

### HIGH BRIDGE.

Ferguson, Dr. Jas.

### HIGH FALLS.

Van Dermark, Hon. W.

### HIGHLAND.

Van Woret, T.

### HILBURN.

Curtis, Lyman F., residence.  
 Easton, W. G.  
 Ramapo Iron Works.

### HOGANSBURG.

Bouker, H. E.

### HOLLIS.

Duntou, F. W.

## Wood Engraving.

### Designing.

### Catalogue Printing.

Specimens of our work are found in almost all of the prominent Catalogues and Newspapers issued.

### THE REASON IS OBVIOUS.

We employ the most skilled Engravers and Artists. Our facilities are unequalled, and our guarantee to give Complete Satisfaction, accompanies the acceptance of each order.

Address all communications to "Art Department."

**BARTLETT & CO.,**

194 Broadway, New York.

Correspondence invited.

## GEM

# SPRING HINGES



FOR DOORS.		Length of Flanges	JAPANED.	
Feet.	Inch.		Single Acting Per Pair.	Double Acting Per Pair.
6x2	x 3/4 to 1 1/4	3 1/2 in.	No. 63, \$0 70	No. 83, \$1 40
7x2	x 1 to 1 3/4	4 in.	" 64, 90	" 84, 1 70
7x3	x 1 to 1 1/2	5 in.	" 65, 1 10	" 85, 2 25
7x3 1/2	x 1 to 1 3/4	6 in.	" 66, 1 40	" 86, 2 80
8x2 1/2	x 1 1/4 to 1 3/4	7 in.	" 67, 1 75	" 87, 3 50
8x3	x 1 1/2 to 2 1/4	8 in.	" 68, 2 50	" 88, 5 00
9x2	x 1 3/4 to 2 1/2	10 in.	" 69, 3 50	" 89, 7 00
10x3	x 2 to 3	12 in.	" 70, 4 50	" 90, 9 00

## GEM

# Wire Coat and Hat Hooks

Easily Put Up or Removed. No Screws or Tools Required.

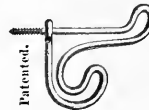

Size.	JAPANED.		COPPERED.	
	No.	Per Gross.	No.	Per Gross.
2 inch	50	\$1 90	150	\$1 75
2 1/2 inch	60	2 15	180	2 00
3 inch	70	3 55	170	2 40
3 1/2 inch	80	3 20	180	3 00

MANUFACTURED BY

**VAN WAGONER & WILLIAMS CO.**

82 Beekman Street, NEW YORK.

Send for Catalogue.

# A. WYCKOFF & SON,

## ELMIRA, N. Y.

# Patent Steam-Pipe Casing for Underground Steam-Pipes.

CUT No. 1.

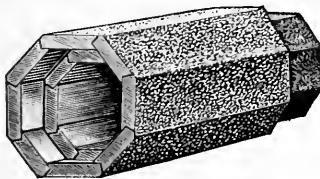

Cut No. 1 represents a section of our new Steam Pipe Casing complete.

CUT No. 2.

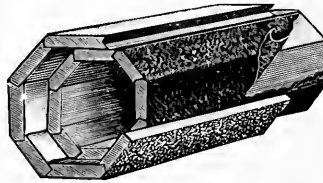

Cut No. 2 shows two staves removed to show the lining between the inside and outside staves.

CUT No. 3.

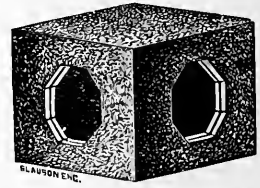

Cut No. 3 showing the manner of casing Tees and Elbows. The top is put on with screws and can be easily and quickly removed when necessary.

The Wyckoff Patent Steam-Pipe Casing is made of eight thoroughly seasoned white pine staves, free from sap, one-inch thick, joined together and wound with galvanized steel wire, then wrapped with two thicknesses of heavy corrugated paper, then another casing of one-inch staves is put on the outside and wound with galvanized steel wire, making a two-inch casing with a non-conducting lining between. The casing is then coated on the outside with asphaltum.

Wood and paper are excellent non-conductors of heat, and when used as above described, make a perfect casing for underground Steam-Pipe.

We have tested this casing in the same line, and in connection with the solid wood casing, both round and square, the solid casing would heat through while this casing would remain perfectly cool on the outside.

The heat from the steam pipes would check the solid wood casing, causing serious loss of heat. The Wyckoff Patent Steam-Pipe Casing being made of thoroughly seasoned pine lumber and wound with galvanized wire will not check.

It can be tapped for branches or cut at any point. It is more easily handled than the solid casing, as it weighs only one-third as much.

We would be pleased to quote prices for Casing delivered at any point.

### WE MAKE THE FOLLOWING SIZES :

#### INTERNAL DIMENSIONS.

2 inch,	2 1/2 inch,	3 inch,	4 inch,
5 inch,	6 inch,	7 inch,	8 inch,
9 inch,	10 inch,	11 inch,	12 inch,
13 inch,	14 inch,	15 inch,	16 inch,
17 inch,	18 inch,	19 inch,	20 inch.

When asking quotations or ordering Casing, please state whether any Tees, Elbows, or Expansion-Joints will be used in the line.

SEND FOR CIRCULAR AND PRICES.



## REFERENCES.

**HOMER.**  
Brockway, W. N.

**HONEOYE FALLS.**

Burton, A., residence.  
 Burton, L. A., residence.  
 Dann, John R., residence.  
 Dutton, G. R., store.  
 Lapp, John.  
 Ritzenhaler, E., hotel.  
 Schermerhorn & Co., store.  
 Sheldon, Hon. Judson F., residence.  
 Wilcox, G., residence.

**HONESDALE.**

Irving Cliff Hotel.

**HOOSICK FALLS.**

Brien Bros.  
 Commercial Hotel.  
 Eldredge, Charles Q., residence.  
 Haren, P. J.  
 Healy, D., hotel.  
 Holmes, W., Holmes' Block.  
 Hoosick Falls Armory.  
 Union House.  
 Wallace, Jones & Ely.  
 Wallace, V. J., residence.  
 Wood, W. A., offices.

**HOPEWELL JUNCTION.**

Porret, A. A.

**HORNELLSVILLE.**

Berwick, O., residence.  
 McDougal, Avery, block.  
 O'Connor, Wm., residence.  
 O'Connor, Geo. W., residence.  
 Rouch, A., block.

**HUDSON.**

Court House.  
 Evans, C. H. & Sons, offices.  
 Faulk, W. C., store and residence.  
 House of Refuge for Women.  
 Miller, Chas.  
 Parker, Byron.  
 Presbyterian Church.  
 Van Vleck, Dr. Chas.

**HYDE PARK.**

Howatt, D. E.  
 Rogers, A.  
 White, Wm. A.

**IRVINGTON.**

Burnham, W. A.  
 Church of the Immaculate Conception.  
 Dearman, Geo. E.  
 Eagen, Father.  
 Elder, Andrew.  
 Lord & Burnam Co.  
 Lord, Henry F.  
 Lord's Horticultural Mfg. Co.  
 Lord, F. A.  
 Manning, A. J.  
 McCullough, Capt. John.  
 Parish, H.

Phelps, A. E.  
 Public School.  
 Sarven, J. D.  
 Seigher, Mrs. Anton.

**ISLIP.**

Head, Mrs. R.  
 Neal, J.  
 Nicoll, Wm., residence.

**ITHACA.**

Adams, Prof., Pres. Cornell University.  
 Andrus & Church.  
 Avery, Oliver.  
 Baker, Geo.  
 Beckwith, C. K.  
 Blood, Col. Chas. F.  
 Bool, Henry.  
 Bostwick, H. V., residence.  
 Burdick, D. W.  
 Campbell, T. B.  
 Church, Prof. I. P., residence.  
 Clark, Uri.  
 Clinton, M. L.  
 Cornell, Frank.  
 Cornell University Buildings.  
 Davenport, H. A.  
 Doherty, T. F., residence.  
 Ellston, J. A.  
 Esty, W. W.  
 Evans, E. D.

Fiske, Mrs. Jennie McGraw, residence.  
 Ferry, Mrs. Jacob.  
 Fuertes, Prof. E. A., residence.  
 Glenzer, J. J.  
 Hewitt, Prof. W. T., residence.  
 Hill, Harmon.  
 Hymes, J. H.  
 Ithaca Hotel.  
 Jackson & Bush.  
 Jamieson & McKinney.  
 Kavanagh, W. K. & Co.  
 Law, Prof. James, residence.  
 Lewis, Mrs. John, residence.  
 MacKoon, Prof., residence.  
 Memorial Cottage, Cornell University Campus.  
 Morgan, Dr. E. J., Jr., residence.  
 Morris, Prof. J. L., residence.  
 Newman, J. T., residence.  
 Newman, Isaac H., residence.  
 Parks, Henry S., residence.  
 Phelps, E. G.  
 Platts, A. H., residence.  
 Psi U Fraternity Club House.  
 Public School, East Hill.  
 Randolph, F. P.  
 Sage, Hon. H. W.  
 Sage, W. H.  
 Sherman, George.  
 Stowell, C. D., residence.  
 Terry, F. C.  
 Thurston, Prof. R. H.  
 Titus, Hon. C. M., residence.

Thompson, T. S.  
 Tompkins County Jail.  
 Van Natta, J. E.  
 Wait, Prof. L. A.  
 White, Prof. H. S., residence.  
 Whitlock, C. A.  
 Williams Bros.  
 Williams, DeForrest, residence.  
 Williams, Prof. E. L., Treas. Cornell Univ.  
 Williams, Prof. Henry, residence.  
 Winton, S. H., residence.  
 Wood, Mrs. Caroline B., residence.

**JAMAICA.**

DeGrauw, Aaron A.

**JAMESTOWN.**

Berry, C. A.  
 Chair, W. S., & Co., block.  
 Conway & Chatfield.  
 Fenton, G. W. T.  
 Fenton, W. S., residence.  
 Frisby, O. C., residence.  
 Gokey, N. W. & Son.  
 Hall, Erie L.  
 Kent, A. Flyn, residence.  
 Kent, A. M., residence.  
 Lynes & Randall,  
 Tew, H. W., residence.  
 Warner, Leonard B., block.

**JEKICHO.**

Seaman, Elias H.

**JOHNSONVILLE.**

Gibbs, L. H.

**JOHNSTOWN.**

Abel, C. C.  
 Argensinger, P. T. & Co., factory.  
 Bailey, S. C. & Son.  
 Calahan & Selmsler.  
 Callamer, G. R.  
 Cambria Iron Co.  
 Decker, Son & Co., factory.  
 Fairchilds & Co.  
 Ireland Bros., factory.  
 Johnstown R. R. Depot.  
 Johnson Company.  
 Kennedy, M. & Son.  
 Lynes, Wesley.  
 Mason, Campbell & Co., factory.  
 McMillan, J. A.  
 Sir William Johnson Hotel.  
 Waters, J. H. & Bro.  
 Vosburg, Barney, residence.

**JORDAN.**

Phillips, C. J.

**KATONAH.**

Putney, D.

**KEESEVILLE.**

Callanan, W. J.  
 Commercial Hotel.  
 Forance, H.  
 Kingsland, G. U., residence.  
 McGeairs, M.

## Users of Steam Take Notice!

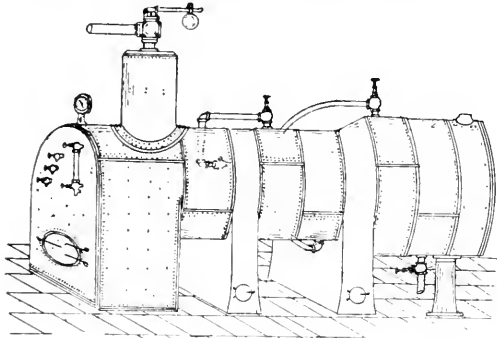

### ← ARE YOU AWARE →

That a large percentage of heat in the ordinary Boiler passes unused up the chimney. This lost heat the

### DAVIDSON BOILER

utilizes according to approved scientific principles. This Boiler is a Steam Generator and Feed Water Heater combined, and the heat that in other boilers would be wasted is used in the Feed Water Heater.

MANUFACTURED BY

**CHARLES J. DAVIDSON,**

409 Lafayette Street, SIOUX CITY, IA.  
PATENT FOR SALE.

Asbestos Sheathing and Building Felts,  
Asbestos Steam Packing,  
**STEAM PIPE COVERING, &c.**

Imperial Brand Prepared Roofings,  
Best Quality. Easily Applied.

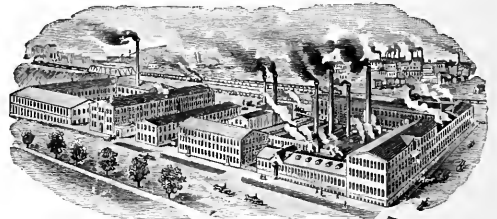

Erie Paper Mills. Capacity 80 tons per day.

EVERY VARIETY OF

**BUILDING, ROOFING and CARPET PAPERS**

**H. F. WATSON, Manufacturer,**  
ERIE, PA.

136 Washington St., CHICAGO, ILL.

SENECA FALLS PUMP &

PUMPS FOR ALL PURPOSES

FIRE APPARATUS WORKS

RUMSEY & CO. (LIMITED) PROPRIETORS, SENECA FALLS, N.Y. U.S.A.

The "Kaiser" Yard Hydrant and Street Washer.

# PUMPS

Centrifugal, Rotary and Piston Power Pumps,  
and House Pumps.

OVER 800 VARIETIES OF BRASS and IRON LIFT and FORCE PUMPS

SEND FOR ILLUSTRATED CATALOGUE.

**RUMSEY & COMPANY, Limited,**

New York City Office: 16 Dey Street.

Factories: Seneca Falls, N. Y.



## REFERENCES.

Romeyn, E. K., residence.  
Taylor, C. S., residence.

### KINDERHOOK.

Bair, Mrs. Peter.  
Hoag, F.  
Hoag, F. S.

### KINGSTON.

Alderman, Brown, residence.  
Boddy, Rev. Wm., Catholic Church.  
Chambers, Dr.  
Clarke, J. F. R., residence.  
Clinton House, Wm. D. Hill, prop.  
Conover, Edward, residence.  
Cornell Steamboat Co's Building.  
County Clerks Building.  
Court House.  
Cusack & Morgan.  
Cusack, Thos. J.  
Darrow, Prof. H. W.  
Drakes, S. L., residence.  
Eagle Hotel.  
Eichler, A., hotel.  
Fair St. Reformed Church Parsonage.  
First Reformed Church.  
Forsyth Building, law offices and hotel.  
Gallagher, Fred., residence.  
Gaskill, E., residence.  
Hasbrouck, C.  
Heiser, J. A.  
Johnston, Mrs. D.  
Kingston Armory.  
Kingston National Bank.  
Lecture Room First Ref'd Church.  
Loughran, B.  
Low, J. M.  
Mauroz, J. A.  
Merritt, C. O.  
Merritt, Geo. B. & Co., store.  
Millard, Jas. & Son.  
Murphy, F. M.  
Noone, Luke.  
N. Y., W. S. & B. R. R. Depot.  
Oppenheimer, Max, residence.  
Osterhoudt, Howard, residence.  
Ostrander, Jas. E.  
Preston, Geo., residence.  
Rice, Max, bakery and residence.  
Romer, Mrs. W. F., residence.  
Rosa, Dr. Hyman.  
Shafer, Col. C. B., residence.  
Stillwell, C. S.  
St. John's Episcopal Church and Parsonage.  
St. Mary's Church and Rectory.  
Surrogate's Building.  
Tremper, Hon. Thomas H.  
Ulster County Savings Institution.  
Van Duzen, Mrs. Columbus.  
Van Gaasbeek, R. M., residence.  
Van Gaasbeek, P.  
Van Luren, J.  
Van Slyke, Rev. J. G., Parsonage.  
Watson, Rev. L. S.

### LACKAWACK.

Moss, C. W.

### LAKE MAHOPAC.

Clark, Emerson.

### LAKE PLACID.

Mirror Lake Hotel.

### LANSINGBURGH.

Betts, E. K., residence.  
Bolton, Joseph, residence.  
Bolton, C., residence.  
Bolton, William, residence.  
Gray & Temple.  
Hoyt, Mr., residence.  
Parks, Charles, residence.  
Phoenix Hotel.  
Pine, J. K. P.  
Thompson, D. F., residence.  
Witbeck, C. W., residence.

### LARCHMONT.

Jardine, D.

### LAWTON.

Clark, Miss Elizabeth.

### LEFEVER FALLS.

Coutant, S. W., residence.  
Hardenburgh, Mr., residence.

### LE ROY.

Wells, D. C. & Co.

### LITTLE FALLS.

Adams, Victor, office.  
Astoronga Knitting Mill.  
Barnet, J. S. & Bro.  
Benedict, Charles, residence.  
Brown, Henry.  
Chapple, W. R., residence.  
Clark, J. D. & Co., office.  
Collins, Dennis, residence.  
First Presbyterian Church.  
Gilbert, J. J., residence.  
Girvan House.  
Grand Central Hotel.  
Little Falls Knitting Mill office.  
McCauley, John.  
McDermott & Ashenhurst.  
McKinnair, R., office.  
Metropolitan Hotel.  
Mullen, Joseph, residence.  
Oppel, G. A., residence.  
Senior, James S. & Co.  
Sheard, Hon. Titus, residence.  
T. Sheard Co., knitting mill office.  
White, George, residence.  
Whitman, Walter W., residence.  
Zoller, Jacob, residence.

### LIMA.

Beadle Bros.  
Beadle, Mrs., residence.  
Gen. Wes. Seminary.  
Lima Baptist Church.  
Sherwood, G.

### LIVINGSTON MANOR.

DuBois, A. P.

### LIVINGSTON STATION.

Hudson River Iron & Ore Co.

### LIVONIA.

Davis, J. W., residence.

### LOCKPORT.

American District Steam Co.  
Blackley, M. H., residence.  
Carnell & Holton.  
Court House.  
Doty, E. A., store.  
Grace Church Parish House.  
Hall, B. D., residence.  
McCue, John.  
McCue & Fairfield.  
Moyer, E. M., residence.  
N. Y. C. R. R. depot.  
Pierson, W.  
Pound, Waterman S., residence.  
Sawyer, F. J., residence.  
Tarbox, M. H., residence.  
Trevor Mfg. Co.

### LOWVILLE.

Easton, F. S., residence.

### LYON.

Alloway Hotel.  
Baltzen Bros.  
Franklin, Mrs. N. D., residence.  
Franklin, W. D.  
Hotel Price.  
Johnson, Geo. W.  
Rudd, J. H.

### MADRID.

Hall, W. H.  
Hepburn, A. T., residence.  
Meeker, John A., residence.  
Powell, C., residence.  
Robinson, John H., residence.  
Walsh, Dr. E. C., residence.

### MALONE.

Goff, W. J. & Co.  
Huntington & Wyman.  
Kelley, John.

### MAMARONECK.

Constable, F. A.  
McGregor, A. M., residence.  
McLoughlin, J. H.  
Parish Building and Rectory, St. Thomas Memorial Church.

### MANUET.

Hutton, Louis H.

### MARLBOROUGH.

Bailey, Dr. A., residence.  
Coldwell, Wilcox & Co.  
Gillespie, Rev. D. D., residence.  
Greaves, Jos. & Son.  
Greaves, Herbert, residence.  
Harcourt, Eli, residence.  
Lockwood, E. T., residence.

M. J. DRUMMOND,

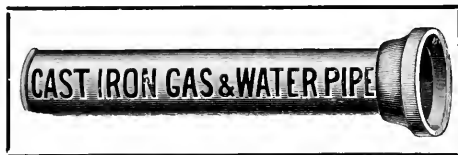

SOLE SALES AGENT FOR

BUILDERS' IRON FOUNDRY

**"GLOBE" SPECIAL CASTINGS**

OFFICE:

CORBIN BUILDING. 192 BROADWAY,

NEW YORK.

ESTABLISHED 1851.

CHARLES CRASKE.

*Electrotyper and Stereotyper,*

21 & 23 ROSE STREET,

NEW YORK.

COPPER PLATING.

Fac-similes of Engravings and Type. Special Attention Given to Fine Work. Engravers' Metal Plates Furnished. Blocking on Wood and Solid Bodies. Originals Carefully Handled. Embossing and Bookbinding Plates.

THE BERRYMAN  
Patent Feed Water Heater  
AND PURIFIER.

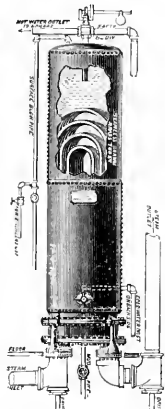

If you are using a steam boiler and have exhaust steam there is no safer or better paying investment than a Berryman Feed Water Heater and Purifier. It heats the feed water to the highest possible temperature with the exhaust without back pressure. It increases the steaming capacity of boilers; keeps boilers clean and free from scale; saves fuel, labor and boiler repairs. This is what we point hardest at: Our prices are no higher than other heaters of equal size and carrying capacity in gallons. To investigate will cost you nothing and may put money in your purse.

BENJ. F. KELLEY & SON,  
91 Liberty Street, NEW YORK.

— THE —

**Kanneberg Roofing Co., Canton, O.**

(The Originators of Strictly Genuine Steel Roofing.)

MANUFACTURERS OF



The KANNEBERG PATENT

Latest Improved Folding Lock Seam Roofing,  
Made of Strictly Genuine Steel.

Also, CORRUGATED IRON,  
ALL SIZES AND GAUGES, AND  
CRIMPED EDGE IRON ROOFING, BEADED IRON SIDING AND  
CEILING, WATER-PROOF BUILDING PAPERS, READY-  
MIXED PAINTS, TEN FEET SEAMLESS EAVE  
TROUGH AND CONDUCTOR PIPE, ETC.

Write for Catalogues, Price List and Samples.

**Jersey City Smelting Works,**

105, 107, 109 and 111 Plymouth Street,

JERSEY CITY, N. J.

MANUFACTURERS OF

**Electrical Specialties,**

FUSE WIRE, WIRE SOLDER, GONGS.

## REFERENCES.

Milliard, S. N., residence.  
 Stillwell, Wm.  
 Whitney, O. B., residence.  
**MASSENA SPRINGS.**

Balch, F.  
 Berkley House.  
 Cline, J. E., residence.  
 Hatfield Bros., hotel.  
 Smith, Paul.  
 Warren, H., residence.  
**MATTEAWAN.**

Brett, A., residence.  
 Caldwell, S. A.  
 Caldwell, S. I.,  
 Green, Francis, residence.  
 Greene, F. B., residence.  
 Jackson, W., carriage store.  
 Myers, Mrs. Mary.  
 N. D. & C. R. R. Co., supt's office.  
 Presbyterian Church.  
 Parett, A. S.  
 Rushmore, Thos. L.  
 Shaw, Dr. E. J.  
 St. Joachims Church and School.  
 Teill, Dr., residence.  
 Union Free School.

**MAYSVILLE.**  
 Clark, E. H., store.  
**MECHANICVILLE.**  
 Mechanicville Valve Works.  
 Terrey, S. T.  
 Tilly, Finn & Co.

**MELROSE.**  
 Schmidt, H., residence.  
 Wagner Palace Car Sheds.

**MERRIFIELD.**  
 Mosher, S.

**MIDDLETOWN.**  
 Academy Ave School.  
 Anglo-Swiss Condensed Milk Co.  
 Baldwin, Chas.  
 Boak, A. V., residence.  
 Board of Education.  
 Brink, Chas. H.  
 Carson, Luckey & Towner.  
 Childrens' Home.  
 Cochran, Rev. John.  
 Corwin, Jno. E.  
 Crawford, C. E., store.  
 Cummings, Ira.  
 DeGraw, J. C., residence.  
 Dill, H. B., residence.  
 First Presbyterian Parsonage.  
 Gordon, B. F., residence.  
 Gunther, Jacob, hotel.  
 Hanford, C. D., residence.  
 Hayes, U. T., residence.  
 Hinchman, Joseph, residence.  
 Insane Asylum.  
 Iseman, John E. & Son.  
 Ketcham, C. C. V., residence.

King, T. J., store.  
 Madden, E. M., residence.  
 Madison House.  
 Middletown Savings Bank.  
 Middletown Asylum.  
 Middletown Post Office.  
 Mills, T. A., residence.  
 Mills, Dr, Theo. D., residence.  
 Millsbaugh, Wm. & Son.  
 Orange County Foundry Company.  
 Purvis, S. S., residence.  
 Russell House.  
 Royce, W. B., residence.  
 Sliter, R. G., residence.  
 Stien, L., store and residence.  
 Swalm, Geo. A.  
 Talcott, Dr. S. H.  
 The Maxwell-Hinchman Company.  
 Vail, Hon. N. W.  
 Van Duzer, E. W., residence.  
 Wheeler, Madden & Clemson, Mfg. Co.  
 Worcester, Chas. W.

**MIDDLEVILLE.**  
 Cole, N. S., store.  
 Nelson & Lansing, office.  
 Richie, Henry, store.  
 Thomas, Frank, residence.  
**MILTON.**

Ball, John G.  
 Clark, J. V.  
**MONROE.**  
 Brewster, H. S.  
 Brooks, W. G., residence.  
 Conklin, Geo. R., residence.  
 Fitzgerald, Chas.  
 Gregory, John S., residence and store.  
 Mapes Charles, residence.  
 Mapes, Henry, residence.  
 Reed, N., residence and store.  
 Smith, G. T., residence.  
 Smith, I. D., residence and store.  
 Tannery, J. B., residence.

**MONTGOMERY.**  
 Condit, Dr.  
 Elliott, Dr. R.  
 Palace Hotel.  
 Senior, W. H.

**MONTICELLO.**  
 Mansion House.  
**MORRISANIA.**  
 Nolan, Rev. M. A.  
**MT. CARMEL.**  
 Robertson, Geo.  
**MT. LOREITA.**  
 Drumgoole, Rev. J. C.

**MT. ST. VINCENT.**  
 Mt. St. Vincent Academy.  
**MT. VERNON.**  
 Anderson, W. S.  
 Archer, William.  
 Bartells, Wm.

Burr, Davis & Son.  
 Chivvis, A.  
 Close, Dr. L. S.  
 Conklin, W. H.  
 Davidson & Archer,  
 Davison, John.  
 Davis, Burr.  
 Davis, F. T.  
 Denman, William.  
 Downing, Henry W.  
 Drake, R. V.  
 Durham, C. W.  
 Fisher & Bogart.  
 Fiske Heating and Plumbing Co.  
 Fiske, Samuel.  
 Frill & Hand.  
 Furber, Jesse & Co.  
 Furgeson, G. D. & Co.  
 Gill, Dr. Geo.  
 Hart, W.  
 Hatch, Moses.  
 Henneberger, H.  
 Higgins Bros.  
 Hummel, J. H.  
 Jenkins, James H.  
 Johnston, S. T.  
 Magee, Peter.  
 Mager, Joseph Jr.  
 McCartin, A. J.  
 Murphy, Winfield & Lucas.  
 Murphy, John H.  
 N. Y. Infant Asylum.  
 Patterson, Geo.  
 School No. 5.  
 Smith, H. C.  
 Starr, Dr. F. J.  
 Swart, S. A., residence.  
 Tier, Chas. A.  
 Underhill, H. M.  
 Weiman, Jacob.

**NAPANOCH.**  
 DuBois, Gilbert.  
 Pillsbury, M. M., residence.  
**NEWARK.**  
 Cronise, J. S.  
 Garlock, Frank.  
 N. Y. State Custodial Asylum.  
 Sleight, P. R.  
 Vary, C. P. H.

**NEW BERLIN.**  
 Bradley, J. S.  
**NEW BRIGHTON.**  
 New Brighton Building Co.  
 Prentice, A.  
 Public School No. 3.  
 Whitman, Clarence.

**NEWBURGH.**  
 Academy of Music.  
 Andrews, J. P., residence.  
 Hell, David, residence.  
 Bemullard, A. E. E.  
 Bigler, J., residence.

**DAVID GARRISON**  
 AND  
**EDW. B. STAGGERS,**  
 TRADING AS



**HALL AND GARRISON**

**WORMEN MACHINERY FACILITIES**

**HAVE THE BEST**  
**INTERIOR & EXTERIOR**  
**WOOD DECORATIONS**

**SPECIAL FURNITURE AND FINE MILL WORK FOR**  
**PRIVATE DWELLINGS & PUBLIC BUILDINGS**

FROM AMONG THE MANY FINE BUILDINGS THROUGHOUT THE COUNTRY PUBLISHED BY THEM THE FOLLOWING ARE NAMED

BALTIMORE & OHIO NEW BUILDING, BALT. M. D.  
 CENTRAL PARK BUILDINGS, NEW YORK.  
 THE CHELSEA BUILDINGS, NEW YORK.  
 GEO. W. CHILDS MANSION, BRYN MAWR, PA.  
 JAS. R. SCOTT'S MANSION, PHILA. PA.  
 ST. GEORGE PHARMACY, PHILA. PA.  
 NEW CITY HALL, WASHINGTON D. C.  
 NATIONAL MUSEUM, WASHINGTON D. C.

ESTIMATES FOR COMPETITION REQUESTED

FACTORIES 945 MAIN OFFICE, PHILADELPHIA PA.  
 NEW YORK BRANCH, 280 BROADWAY

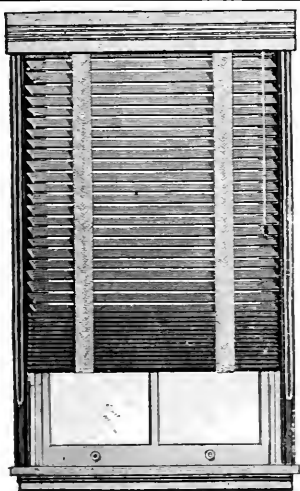

C. B. KEOGH. H. C. SMITH.

**G. B. KEOGH & CO.**  
 MANUFACTURERS OF



**DOORS**  
**SASHES**  
**BLINDS & C.**  
**MANTELS**  
**NEWELS**  
**BALUSTERS**

**ENAMELED**  
**EMBOSSED**  
**& CUT GLASS**  
**WOOD**  
**MOULDINGS**  
**& C. & C.**

**6 & 8 HOWARD ST. NEW YORK.**

SEND FOR ESTIMATES AND PRICE LIST.

We also make the best VENETIAN BLINDS in the market, either in Hard Woods or Painted in any Color desired. Particular attention given to Hard Wood Doors and Cabinet Trim.

**C. B. KEOGH & CO.,**

6 and 8 HOWARD STREET,

NEAR CENTRE ST.

NEW YORK.



## REFERENCES.

Brown, W. C., residence.  
 Caldwell, W. J., residence.  
 Cameron, W. F., residence.  
 Chadwick, Joseph, residence.  
 Childrens' Home.  
 Coldwell, Wilcox & Co.  
 Columbia Skating Rink.  
 Collis, M. L., residence.  
 Cornell, Geo. T.  
 Covert, C. J., residence.  
 Cranshaw, S., residence.  
 "Daily Journal," office.  
 "Daily News," office.  
 DeGroat, Peter.  
 Dumphey, J. G., News Building.  
 Flannery, John.  
 Fowler, Mess. E., residence.  
 Greaves, Joseph, residence.  
 Harrison, James, residence.  
 Harrison, J. J. E., store.  
 Harrison, William, residence.  
 Havemeyer, A. H.  
 Higginson, H. C., office.  
 Johnston, B. K., hotel.  
 Kelley, Wm. H.  
 Linch, Francis.  
 Lyon, Wm. H., residence.  
 Marshall, W. J., residence.  
 Marvell, T. S., & Co.  
 McCabe, Mrs., residence.  
 McDonald, Patrick, residence.  
 Merritt, Theodore, store and residence.  
 Miller, Miss Mary, residence.  
 Monell, G. L., residence.  
 Moscow, Chas. E., residence.  
 Newburgh Savings Bank.  
 Nugent, Patrick, residence.  
 Olympic Skating Rink.  
 Perkins, F. W., residence.  
 Perkins, G. C., residence.  
 Perkins, Friend, residence.  
 Pierce, Mrs. E., residence.  
 Police Headquarters.  
 Post Office.  
 Quade, John, flats.  
 Riley, Patrick.  
 Ross, G. H., residence.  
 Schaeffer, F. J. N., residence.  
 Schaeffer's Flats.  
 Scuff, T. W.  
 Sloat, J. L., residence.  
 Smith, A. C. & Co.  
 Sneed, Joseph, residence.  
 St. Patrick's Church.  
 St. Patrick's Institute.  
 Stewart & Sager.  
 Stewart, Lachlan, residence.  
 Sunsbury News Co., store.  
 Sweet, Joseph A., residence.  
 Vail, Walter.  
 Walsh, E. A.

West Shore R. R. Depot.  
 Wiggins, Dr.  
 Wilcox, G. R. M., residence.  
 Wilkinson, John G., store.

### NEW ROCHELLE.

Aspinwall, Geo. H.  
 Banks, G. W.  
 Barrett, H. T.  
 District School No. 1.  
 Embury, A. L.  
 Fueler, H. F.  
 Hallweg, J.  
 Howe, G. W.  
 Jenkins, F.  
 Lafevre, Capt. J.  
 O'Kelly, P. J.  
 Stevens, B.  
 Vulte, N. T.

### NEW LOTS.

Fulton Ave. School.  
 Henry Ave. School.

### NEWTON.

Thompson & Son.

### NEW YORK MILLS.

Walcott, D. W., residence.

### NIAGARA FALLS.

Bank of Niagara.  
 Gaskell, C. B.  
 Gazette Block.  
 Hotel Kaltenbach.  
 N. Y. C. R. R. Depot.  
 Orpheus Park Theatre.  
 Spencer House.  
 The Atlantique.  
 The Porter Building.

### NORTH BLOOMFIELD.

Davis, W. P.  
 Fairchild, C. H.  
 Martin, A. D.  
 North Bloomfield Foundry and Machine Tool Works, office.  
 Universalist Church.  
 Wiggins, C. P.

### NORTH LANSING.

Wilcox, William.

### NORTHPORT.

Cahill, Jesse.

### NORTH TARRYTOWN.

Cowe, J.

### NORTHVILLE.

Brown, G. N., residence and store.  
 Hubbell, Ray, residence and store.  
 Icheul House.  
 Palmer, Allen A.  
 Winnies Hotel.

### NORWICH.

Harkness, Robt., residence.  
 Merritt, Chas. H., residence.

### NORWOOD.

Abbott, Rev. H. C., residence.  
 Ducolin, S., residence.  
 Nightingale, C. C., residence.

### NYACK.

Ackerman, David, residence.  
 Ackerman, V., store.  
 Bannister, W. H.  
 Barginannath, H.  
 Blauvelt, W. E.  
 Bliven, A., residence.  
 Brinkerhoff, A.  
 Brush, B. M.  
 Datchman, Julius.  
 Davison, John, residence.  
 Ernst & Bro.  
 Feltor, John M., residence.  
 Kessler, Henry, residence.  
 Laichdell Villa.  
 Leadly, James, residence.  
 Maynard, Dr.  
 Mecker, Chas. H., residence.  
 Morrell, G. T., residence.  
 Morrow, G. W., residence.  
 Murray, Andrew.  
 Nyack School.  
 Oatman, Dr. E. L.  
 Ondesdauk, W. F., residence.  
 Partridge, J. E., residence.  
 Porter, P. J., residence.  
 Radford, Mrs. M., residence.  
 Rockland College.  
 Tallman, Francis J. M.  
 Voorthis, Wm., residence.

### OKDALE.

Butting, W. Bayard.

### OGDENSBURGH.

City Hall.  
 City Hospital.  
 Deane, H. C., residence.  
 Fitzgerald, Capt. Richard, residence.  
 Judson, J., residence.  
 Kellogg, Geo., residence.  
 Lavier, Chas.  
 Lavier, Thos. H.  
 New Opera House.  
 Newell, Hon. E. A., Mayor, residence.  
 Proctor, W. F., residence.  
 St. Mary's Cathedral.  
 St. Mary's Rectory.  
 Wadhans, Rev. Bishop, residence.  
 Wilson, J. N., residence.

### OLEBAN.

Simpson, W. H.

### ONEIDA.

Franklin Iron Works.  
 Hotel Brunswick.  
 Oneida Community.  
 Reynolds, H.  
 Reynolds, H. W. & Co.  
 Tuttle, J. F.  
 Warner, J. M.

### ONEONTA.

Brown, W. L.  
 Eppo, O.



NATHANIEL CHENEY.

CHAS. HEWLETT.

# CHENEY & HEWLETT, ARCHITECTURAL IRON WORKS.

Fronts, Roofs, Bridges, Domes,  
Beams, Girders,  
Columns, Lintels, Sills,  
Window Guards, Lamp Posts,  
Area Elevators,  
Stirrups, Folding Shutters,

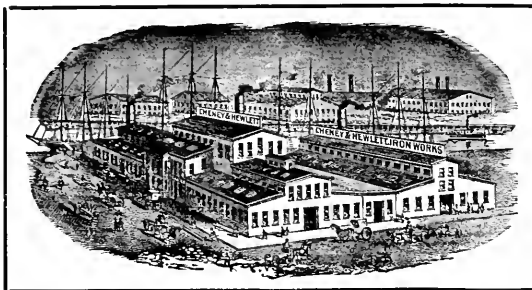

Stairs, Cornices, Capitols,  
Arches, Railings, Stoops, Doors,  
Vaults, Anchors,  
Awning Posts, Area Lights,  
Sky Lights,  
Balconies, Rolling Shutters.

WORKS, NEWTOWN CREEK, PAIDGE AVENUE,  
SETAUKET AND BRANT STREETS,  
GREENPOINT, L. I.

OFFICE, 207 BROADWAY, NEW YORK.

ESTIMATES GIVEN FOR WORK IN ANY PART OF THE COUNTRY

CORRESPONDENCE SOLICITED.

## EKSTROM'S VENTILATOR

is unquestionably the best and cheapest means of removing excessive heat, smoke, cooking odors, etc., equally adapted to old or new houses, there is in the market. . . . .

For particulars apply to

CHENEY & HEWLETT

NO. 207 BROADWAY,

NEW YORK.

No Separate Ventilating Flue Required.

212

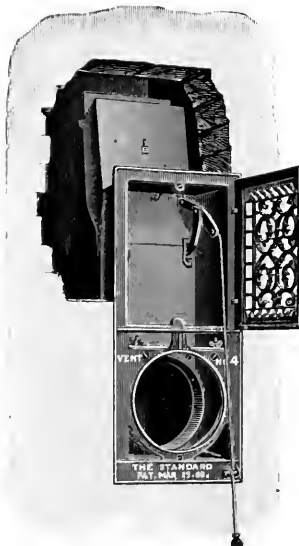

WITH STOVE PIPE RING.

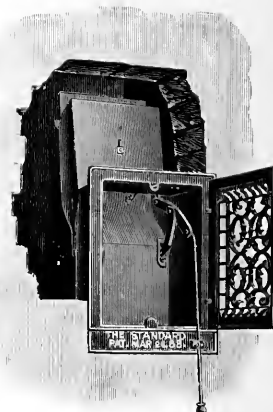

FOR VENTILATION ONLY.



## REFERENCES.

Jennings & Bixby.  
 Mattesons, S. S., residence.  
 Moody & Gould Co.  
     **ORIENT.**  
 Hallett, G. M. & Son.  
     **OSWEGO.**  
 Arcada Building.  
 Austin, E. W., store.  
 Becksteads, Chas., residence.  
 Brown, O. H., residence.  
 City Hall.  
 City Savings Bank.  
 Coude, L., residence.  
 Crandall, Mrs. Chas., residence.  
 Crawford & Donovan.  
 Cussack, Woods & Hennessy.  
 Custom House.  
 D. L. & W. R. R. Depot.  
 Dowale, Hon. John, residence.  
 First National Bank.  
 Gray, Neil, residence.  
 Hayes, Dennis, residence  
 Home Comfort Hotel.  
 Hughes, Rev. M. J., residence  
 Johnson, Samuel, residence.  
 Johnsons, Ed., residence.  
 Judsons, D., residence.  
 Kaspinski Dye Works.  
 Keep Bros.  
 Kellogg, E. P.  
 Kinsford, Thomson, residence.  
 Linnanion, John, residence.  
 Macfarland, D. residence.  
 Macfarland, J. D.  
 Narrish Bakery.  
 Neal, M. P., residence.  
 O'Keefe, T. E., store.  
 Oswego City Poor House.  
 Oswego City Hospital.  
 Oswego Orphan Asylum.  
 Oswego Starch Factory.  
 Oswego Shade Cloth Factory office.  
 R. W. & Q. R. R. Co., Depot.  
 Richardson, Hon. Max, residence.  
 Second National Bank.  
 Shead, C. G. & Co.  
 State Armory.  
 Sullivan, John C., residence.  
     **OTISVILLE.**  
 Dodge, A.  
 Reed, Henry, residence.  
 Smith, G., residence.  
     **OWASCO LAKE.**  
 Thompson, Geo., residence.  
     **OWEGO.**  
 Atwaga House.  
 Brant, H. R.  
 County Jail.  
 Davis, B. J.  
 Direlle, J. C., residence.  
 D. S. & W. R. R. Depot.

Goodrich, Mrs. G. B., residence.  
 Hubbard & King.  
 King & Co.  
 Maloney, P.  
 Owego Iron Works.  
 Phelps, Dr. E. B.  
 Renwick, W. C., residence.  
 Sheriff's Office.  
 Stairs, Chatfield & Co.  
 Starebrough, J. B.  
 Thompson, C. A., residence.  
     **OXFORD.**  
 Bull, Chas. R.  
 Bull, Chas. I.  
     **PALANTINE BRIDGE.**  
 Taylor, J. D., residence.  
 Wagner, Hon. Webster, residence.  
     **PALMYRA.**  
 Power's Hotel.  
     **PAINTED POST.**  
 Bronson, F. E.  
 Bronson, G. A., block.  
 Bronson, W. C., bank.  
 Campbell, Mrs. E., residence.  
 Weston Engine Co.  
     **PARISH.**  
 Parish Mfg Co.  
     **PEEKSKILL.**  
 Andreson, Homer.  
 Armstrong, A. L.  
 Armstrong, H. L.  
 Convent of Our Lady of Angels.  
 Franciscan Convent.  
 Hammond, C. E.  
 Hartin & Mabie.  
 Mason, Dr. Cras  
 R. C. Orphan Asylum.  
 St. Paul M. E. Church.  
 Wessells, W. F.  
     **PENN YAN.**  
 Baldwin, M. L.  
 Catholic School.  
 Dwelle, E. C.  
 First National Bank.  
 Fox, W. H.  
 Hamlin, L. O.  
 Hollowell, W. D.  
 Hollowell & Wise.  
 Hughes, C. J.  
 Knapp House.  
 Knapp, O. C.  
 Lapham, G. H.  
 Lown, J. H.  
 Ogden, Hon. D. A., residence.  
 Quick, Wixon & Co.  
 Sheppard, Morris F.  
 Wheeler, F. F.  
 Wise, W. N.  
 Yates County Surrogate's Office.  
     **PERKASIC.**  
 Hendrick, J. A.

**PERRY.**  
 Broughton, John M.  
 Olin, M. H.  
 Walkes, D. S.  
     **PHELPS.**  
 Beardsley, E.  
 Cobb, R. R., residence.  
     **PHILMONT.**  
 Philmont Paper Co.  
     **PIFFARD.**  
 Royal Salt Co.  
     **PINE BUSH.**  
 Wallace, J. H.  
     **PINE ISLAND.**  
     **PINE PLAINS.**  
 Eno, W. S.  
 Keller, G. M.  
 Knickerbocker, H. B.  
 Mattice, Rev. A.  
 Pizie, Benj. J.  
 Seymour, Smith Institute.  
     **PLATTSBURGH.**  
 Arcada Restaurant.  
 Barbes, C. E.  
 Bluff Point Hotel.  
 Bowen, Hon. S. P.  
 Browne's Restaurant.  
 Casanaugh, Joseph.  
 Clinton County Poor House.  
 Costello, Thos.  
 County Clerk's Office.  
 D. H. R. R. Depot.  
 Edwards, C. E. W.  
 Fauquet House.  
 First National Bank.  
 Hartwell, W. W.  
 Hayes, L. W.  
 Kellogg, Hon. S. A.  
 Louis & Demert.  
 Meyer's Restaurant.  
 Mooers, W. B. & Co.  
 Myers, H. P. & Co.  
 McHattill, A.  
 New Court House.  
 Normal School.  
 St. Johns Roman Catholic Church.  
 Thomas, A.  
 Trinity Church.  
 Vilas, S. T., House.  
 Weaver, A. M.  
 Weaver, John.  
 Weaver, T. M.  
 Webb, Geo. N.  
 Weed, Hon. S. M.  
 Wickerall House.  
 Wieaslow, E. S.  
     **PLEASANT VALLEY.**  
 Lasher, Frank P.  
     **PLEASANTVILLE.**  
 Hall, C. W.

# LIGHTEST.

## THE DODGE PATENT "INDEPENDENCE"

LOOK FOR THIS  
TRADE MARK  
  
ON Hub of Pulley.

WOOD SPLIT PULLEYS  
— ARE —  
FAR AHEAD OF ALL OTHERS  
In EXCELLENCY of

EVERY PULLEY HAS  
THIS  
  
TRADE MARK.

Construction, Finish and Performance.

SIMPLEST.

The ORIGINAL and only Pulley made  
under the FOUNDATION PATENTS  
on Wood Split Pulleys.

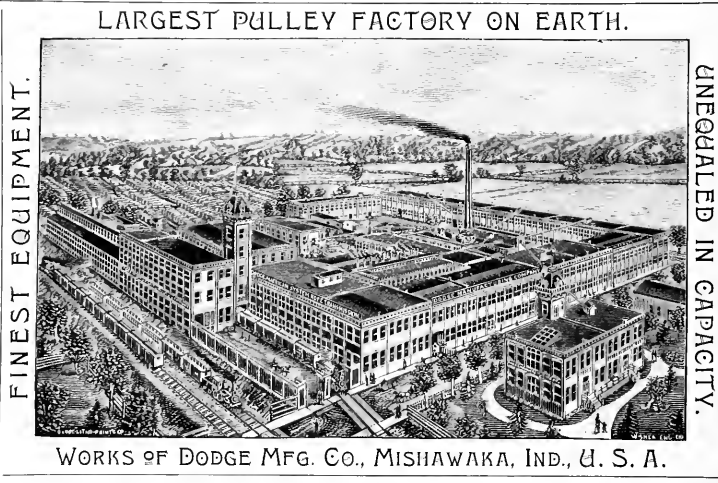

LARGEST PULLEY FACTORY ON EARTH.

WORKS OF DODGE MFG. CO., MISHAWAKA, IND., U. S. A.

FINEST EQUIPMENT.

UNEQUALLED IN CAPACITY.

Avoid the many INFERIOR and WORTH-  
LESS INFRINGEMENTS which can  
only cause you endless trouble.

STRONGEST.

THIS PULLEY has always received the HIGHEST AWARDS wherever it has been exhibited. NO OTHER WOOD PULLEY has received an Award for Merit anywhere.

By every mail we have letters from parties who have tried the so-called NEW PULLEYS, found them Worthless and returned to the GENUINE INDEPENDENCE PULLEY.

MANUFACTURED ONLY BY  
**DODGE MANUFACTURING CO.**  
MISHAWAKA, IND.

— ALSO —  
Sole Manufacturers of the DODGE PATENT  
American System of Power Trans-  
mission by Manilla Rope.  
NO LICENSEES.

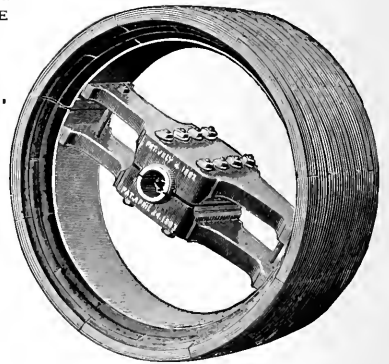
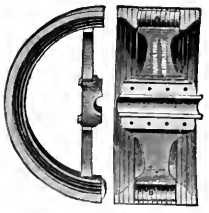

**BEST.**



## REFERENCES.

### POPLAR RIDGE.

Haines, Seaman W., residence.  
 Hazard, J. W., residence.  
 Hazard, Wm. R., residence.  
 Meader, Wm. C., residence.  
 Mosher, Sidney, residence.

### PORT BYRON.

Howard Hotel.

### PORT CHESTER.

Clark, Mr.  
 Curtis, E. & Co.  
 Kelley, W. E.  
 Lambet, C. S.  
 Lambert, Robert.  
 Madden, M. H.  
 McCarthy, John.  
 Osborn, F. M.  
 Pond, West & Simmons.  
 Sloan, M.  
 Wesley, E. B.

### PORT HENRY.

Breadner, J. T.  
 Hathaway, W. C.  
 McRay, Joseph.  
 Sherman, G. R.  
 Witherbee, F. F.  
 Witherbee, Mrs T. L.

### PORT JERVIS.

Banks, W. C.  
 Bolton, Jas.  
 Boyed, C. C.  
 Conrad, W.  
 Cuddeback, Dr. W. L.  
 Cuff, Andrew.  
 Decker, James.  
 Delaware House.  
 Farnum Building.  
 Farnum, E. P.  
 Farnum, P. E.  
 Fowler, E. G.  
 Frautey, J. D.  
 Gray, T. J., residence.  
 Heller, M. V.  
 Ketcham, L. B.  
 Lyons, J. W.  
 Maloen, Gordon & Co.  
 Malvin, Gordon & Co.  
 Monahan's Hotel.  
 Margot, A. C.  
 McGuire, Thos.  
 Mills, J. J.  
 Mountain House School.  
 Riverside School.  
 Sharp, Thos., residence.  
 Slade, Aaron.  
 Sparrowbush School.  
 Stanton, Geo.  
 Stewart, D. T.  
 St. John, Chas. J.  
 Swinton, Shimer & Co.  
 Throp, Jerry B.

### PORT RICHMOND.

Sloan, W. A.  
 Toggin, F. J.  
 Wood, Ambrose, residence.

### POTSDAM.

Academy of Music.  
 Albion Hotel.  
 Bailey, D. A. B. & Co.  
 Sisson, G. W., residence.  
 State Normal School.  
 Town Hall.

### POUGHKEEPSIE.

Adriance, Platt & Co.  
 Alms House.  
 Atwater, Dr.  
 Baptist Church of Christ.  
 Brinkerhoff, T. Van Wyck.  
 Caire, Adam.  
 Dates, Chas.  
 Dinsmore, W. B.  
 Doherty, P. C.  
 Dutchess County Mutual Ins. Building.  
 Eastman's College.  
 Hammond, C. E.  
 Heath, J. Parker.  
 Hudson River State Asylum.  
 Hudson River State Hospital.  
 Lane Bros.  
 Lasher, W. P.  
 Morgan House.  
 Nelson House.  
 Old Ladies' Home  
 Peckham, Mrs.  
 Post Office.  
 Poughkeepsie Savings Bank.  
 Reynolds, Capt. M.  
 Ritter, W. H.  
 Schwartz, M.  
 Shaw, Dr. John.  
 Smith, W. W.  
 Spross, Elias.  
 Taggart, R. W.  
 Thompson, James.  
 Trowbridge & Adriance.  
 Tripp, S. V.  
 Tasher, W. P.  
 Tuthill, Dr. R. K.  
 Van Wagner, Peter.  
 Vassar Home for Aged Men.  
 Wells & Zimmerman.

### QUOGNE.

Howell, B. H., residence.

### RAMAPO.

Easton, W. C.  
 Ramapo Iron Works.  
 Snow, Fred. M.

### RHINEBECK.

Miiler, Geo. N., M.D., residence.  
 M. E. Church.  
 Sherwood, Phil., residence.  
 Suckley, R. B., residence.  
 Suckley, Thos., residence.

### RICHFORD.

Finch, C. W.

### RICHMOND HILL.

Forbes, Dr. W. H., residence.

### RIDGEFIELD.

Wilson, C. B.

### RIVER-HEAD.

Griffing, T. H.  
 Newsin, J. H.  
 Vail, David F.  
 Vail, Geo.

### ROCHESTER.

Abendroth & Root Mfg. Co.  
 Adler Bros.  
 Allen, W., residence.  
 Alling & Cory, store.  
 Archer, Geo, W., building.  
 Barr & Creelman.  
 Bartholomay Block.  
 Bartholomy Park Hotel.  
 Birdsall, C., residence.  
 Bishop Building.  
 Bracket House.  
 Brewster, Gordon & Co.  
 Briggs, J. E., residence.  
 Bucke, C. J., residence.  
 Buell, G. C. & Co.  
 Buff, Roch., & Pitts. R. R. Depot.  
 Cauffman, Jos.  
 City Hall.  
 City Hospital.  
 Chase, E. B., residence.  
 Clark, B. H., residence.  
 Conklin, Henry R.  
 Corinthian Academy of Music.  
 Corning Building.  
 Cook, E. H. & Co.,  
 Crossman, Bros.  
 Cumpeaugh, E. O. & Sons, store.  
 Cunningham, Chas. E., residence.  
 Cunningham, J., Son & Co.  
 Cunningham, J.  
 Danforth, Judge.  
 Davis, W. P.  
 Deaf Mute Asylum.  
 Dickson, Allen.  
 Duffy, Bussey & Wile.  
 Dumond, F. & Son.  
 Dwyer, Rufus K.  
 Eastman Dry Plate Co.  
 Eastwood Estate.  
 First Baptist Church.  
 Fitzsimmons, Chas.  
 Fitzsimmons, Burke, Hone & Co.  
 Ford, Thomas W.  
 Gaechem, John E.  
 Garson, Myers & Co.  
 Gillis, J. W.  
 Gorsline, Wm. H.  
 Graves, L. S. & Son.  
 Hapnean, C. B.

ALL KINDS OF ARCHITECTURAL PLANS FURNISHED AT PRICES THAT WILL GUARANTEE SATISFACTION.

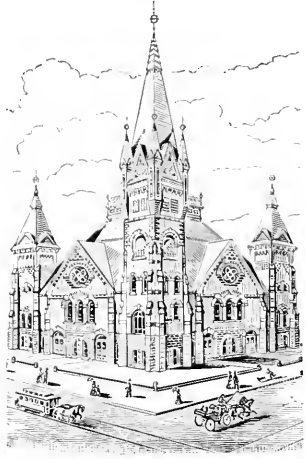

CORRESPONDENCE SOLICITED AND PROMPTLY ANSWERED.

ONEIDA BAPTIST CHURCH.

**M. H. HUBBARD,**  
 ARCHITECT  
 117 Genesee Street, **UTICA, N. Y.**  
 CHURCHES A SPECIALTY.

ESTABLISHED 1861.

**S. SLACK & CO.,**  
 MANUFACTURERS OF  
**Stained & Leaded Windows**  
 OF  
 Antique, Cracked, Venetian,  
 Muffled, Opaline, Cathedral and  
 Window Glass.  
 99 CENTRAL AVENUE,  
**ORANGE, N. J.**



**Do You Intend to Build ?**

A NEW ATLAS,  
 ENTITLED  
**Sensible Low-Cost Houses,**

**HOW TO BUILD THEM, NOW READY.**

The illustrations of fifty-six New, Beautiful and Cheap Country Houses, costing from \$800 to \$7500, from which your selection can be made, would cost you over \$3000, or any one drawing from \$30 to \$40. It also contains plans and complete descriptions. Shows how you can build a \$2000 house for \$1750, and how to make them handsome, convenient, healthy, light, cool, and airy in summer; warm and cheaply heated in winter. Tells intending builders of homes what to do, and warns them what not to do. Describes homes adapted to all climates. If you intend to build now or twenty years from now, you want this book. Price \$1.00, by mail.



**Nat'l Architects' Union,**  
 1927 CHESTNUT ST.  
**PHILADELPHIA, PA.**



MANUFACTURERS AND IMPORTERS OF

**DETECTIVE AND VIEW CAMERAS,**  
 —AND ALL—  
**PHOTOGRAPHIC REQUISITES.**

Sole Agents for the Celebrated

**DALLMEYER LENSES.**

A Full Line of all the BEST BRANDS OF DRY PLATES.

**ANTHONY'S CLIMAX FILMS**

Reduce weight and space to a minimum. 14 dozen films weigh less than one dozen dry plates. Send postage for sample 4-5 or 5-8 films, and carrier for same.

Amateur Outfits from \$7.50 upwards. Books of Instruction for Amateur and Professional. All the Necessary Apparatus for making Flash Light Pictures.

**SEND FOR ILLUSTRATED CATALOGUE.**

## REFERENCES.

Harrison, Jas. M.  
 Hastings, Chas. S.  
 Hayden & Havens Co.  
 Hennegan, George.  
 Hennon, Dr. J. B., residence.  
 Hobbie, Mrs. A. C., residence.  
 Hollister Bros.  
 Howe & Bassett.  
 Johns, Geo. W., store.  
 Jones, Dr. Jonas.  
 Kelly, W. Foster, arch.  
 King, W. W., residence.  
 Lamberton's Commercial Building.  
 Levi, Nathan.  
 Lines Bros.  
 Loss, L. M.  
 Madden & Sullivan.  
 Manderville, Dr. F. A., residence.  
 Manderv, L., office.  
 McFarlin, M. F. & Son.  
 McGuire, Horace.  
 McQuade, Rt. Rev. B. J.  
 Mensing & Stecher.  
 Mechanics' Savings Bank.  
 Merriman, C. C.  
 Michaels, Stern & Co.  
 Monroe County Court House.  
 Moore, John C.  
 Morey, John E., Jr.  
 Nation Hotel.  
 Nazareth Convent.  
 New Osborne House.  
 Nott Hotel.  
 Noyes, Col.  
 N. Y. C. & H. R. R. Round House.  
 Osborne House Block.  
 O'Kane, John, residence.  
 Osborne, E. W., residence.  
 Phelan, J., factory.  
 Pitkins, Peter, building.  
 Powers, D. W., Commercial Building.  
 Powers, D. W., residence.  
 P. & R. R. car shops.  
 P & R. R. R., round house.  
 Rebaz, Wm. N.  
 Reynolds' Arcade.  
 Rice Bros.  
 Ridley, B. F., arch.  
 Roby, S. B., & Co.  
 Roberts, Owen N., residence.  
 Rochester Free Academy,  
 Rochester Brewing Co., office.  
 Rochester Axle Works.  
 Rochester Savings Bank.  
 Rochester Paper Co.  
 Sanford, D. J. E.  
 Sagar, Joseph.  
 Shaffer, Edward.  
 Selden, L. E. block.  
 Shalklin, Mrs. J. R.  
 Shipman Engine Co.  
 Shipman, A. H.

Sibley, Hiram & Co.  
 Sibley, Lindsey & Curr.  
 Sloan, Samuel, residence.  
 Sloan, Samuel, store.  
 Smith, John A.  
 Smith, J. Morean.  
 Smith, John.  
 St. Joseph's Asylum.  
 St. Joseph's Orphan Asylum.  
 St. Mary's Hospital.  
 Talvez, John & Co.  
 Tichnor Building.  
 Trotter, Chas. W.  
 Union Bank of Rochester.  
 Valtz, C. H.  
 Vredenburgh, E. H., residence.  
 Vogts, A., building.  
 Walker, F. R.  
 Walbridge, S. D.  
 Warner, Dr. H. H., building.  
 Warner, Dr. H. H., residence.  
 Warner Observatory.  
 Warren, E. H. building.  
 Washington Skating Rink.  
 Western House of Refuge.  
 Wheelock, Dr. J. F.  
 Woodbury, E. F., building.  
 Wright, Alfred N., factory.  
 Wright, Alfred N. residence.  
 Williamson & Higbie, building.  
 Whitcombe House.  
 Wilder Block.  
 Y. M. C. A. Building.

**ROCKVILLE CENTRE.**  
 Athenæum Hall.  
 Engels, F. W.  
 Hawkins, W. H.

**ROME.**  
 Armstrong, Wheeler.  
 Bissell, J. C.  
 Caswell, H. A.  
 Central N. Y. Institute for Deaf and Dumb.  
 Central National Bank.  
 Commercial Hotel.  
 County House.  
 Ely, John D., & Co.  
 Glassman, Howes, block.  
 Jackson, Chas. H.  
 Maxwell & Mowry.  
 M. E. Church.  
 Orton, A. W.  
 Prince, D. B. Store.  
 Rome Opera House.  
 Russ, Geo. P.  
 Salspaugh & Armstrong.  
 Sink Opera House.  
 Spencer & White, store.  
 Washington Street Opera House.  
 Wiggins, J. B., store.

**RONDOUT.**  
 Addis, David D., residence.  
 Boise, Peter, residence.

Broadhead, A. W., residence.  
 Button, F.  
 Canfield, P. A., residence.  
 Canfield, P. A., Jr., residence.  
 Connelly, Carey S., residence.  
 Connelly, Hon. H. C., residence.  
 Cornell, Hon. Thos.  
 Cornell Steamboat Co., office.  
 Crosby, A. A.  
 Crosby, M. C., residence.  
 De DaVergne, I. V.  
 Dubois, Remsen B., residence.  
 Edmonds, C. L.  
 Ernest, Frank, residence.  
 Gibson, Samuel D., residence.  
 Griffith, F. H., residence.  
 Gurnee, P. J.,  
 Halloran, John F.  
 Hasbrouck, Conrad.  
 Hasbrouck, Guilford, residence.  
 Hickey, T. J.  
 Hoffman, Jacob, Brewing Company, office.  
 Houston Electric Company.  
 Huhne, Dr. Aug., residence.  
 Hudson River Furniture Stores.  
 Johnstons, W. G., residence.  
 Kennedy, David D., residence.  
 Lindsley, Hon. James G.  
 Main, Robert, residence.  
 Mayes, J. H.  
 Mantusterk, A.  
 McEntee & Dillon.  
 McMullen, Andrew, residence.  
 North, I. M.  
 Pratt, Geo. W., residence.  
 Rodce, James, residence.  
 Schoonmaker, P. E.  
 Sleight, Mrs. I. M.  
 Standard Oil Co., office.  
 Shrobes, John H., residence.  
 Standard Oil Company, office.  
 Staples, A. S., residence.  
 Thompson, Houston Electric Co.  
 Tompkins, Edward.  
 Tomkins, R. F., residence.  
 Townsend, R. G., residence.  
 Turck, Wm. I.  
 Van Buren, A. P., residence.  
 Van Deusen, James L.  
 Van Keuren, Jas. G.  
 Weiber, H. E.

**ROSENDALE.**  
 Schoonmaker, Dr. J., residence.  
 Schoonmaker, S., M. D., residence.  
 Veeder, Mr., store and residence.

**ROSETON.**  
 Java, J. J.

**SACKETT'S HARBOR.**  
 Day, Lewis W.  
 Knowlton, C. E.

**SAG HARBOR.**  
 Fahy Watch Case Co.



... THE ...

# AMERICAN ARCHITECT

—AND—

## BUILDING NEWS.

PUBLISHED EVERY SATURDAY

Is the Best Advertising Medium that could be used by our fellow advertisers in this Catalogue as well as by every maker of and Dealer in Building Materials.

The subjoined letter draws attention to a fact which sometimes works to our disadvantage with advertisers, namely, that architects are not consumers, they are the advisors of, not the purchasing agents for, their clients.

THOS H WILLIAMS Pres

JAS L OGDEN, Vice Pres

JOHN MATLOCK, M. E. Genl. Superintendent

SAMLD. TOMPAINS Treas

J L OGDEN JR Secy

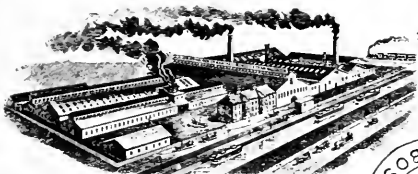

Principal Office & Works  
449 EDMUNDPARK AVE JERSEY CITY, N J  
Western Branch Office  
42 & 44 W MONROE ST CHICAGO, ILLS



### A. A. GRIFFING IRON COMPANY

STEAM & HOT WATER HEATING APPARATUS

SOLE MANUFACTURERS OF THE

Bundy Patent Direct & Indirect  
RADIATORS.

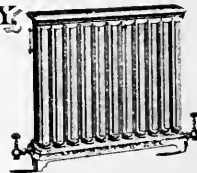

Jersey City, N.J. Jan. 21-89.

Messrs. Ticknor & Co.,  
211 Tremont Street,  
Boston, Mass.

Gentlemen: -

We were formerly represented in your paper, The American Architect & Building News, but declined to continue our advertisement as we thought we did not hear from it often enough to make it pay, overlooking perhaps the fact that Architects are not themselves consumers and have comparatively little reason for putting themselves in direct communication with manufacturers; at any rate, we have concluded to again take space with you and enclose herewith matter for a 4" -ad- to run one year which please insert and oblige.

K

Very truly yours,

A. A. Griffing Iron Co.

For terms and further particulars, address,

TICKNOR & CO., PUBLISHERS,  
112 TREMONT STREET, BOSTON.

## REFERENCES.

**SANDY HILL.**  
 Court House.

**SARANAC LAKE.**  
 Hague, Pelham,  
 Saranac Lake Hotel Co.

**SARATOGA SPRINGS.**  
 Academic School Building.  
 Adirondack R. R., office.  
 Aerisworth, Geo. W., residence.  
 Ainsworth, W. W., residence.  
 Allen, Rev. Perry S., residence.  
 American Hotel.  
 Arcade Building.  
 Avery, Geo. H., residence.  
 Babcock, Dr. M. N., residence.  
 Baker & Shevlin.  
 Bockes, Wm. Hay, residence.  
 Bracket, E. F., residence.  
 Bronson, W. C., residence.  
 Brown, J. R., residence.  
 Brown, W. E.  
 Brumer, B., store.  
 Cameron, Mrs. J. E., residence.  
 Clement & Cox.  
 Colcord, J. M., residence.  
 Comstock, G. W., residence.  
 Congress Hall.  
 Cooper, Mrs., residence.  
 Corckey, John F., residence.  
 Crawford, F., residence.  
 Crippon, G. M., residence.  
 Cushing, Albert, residence.  
 Darrow, F. E., residence.  
 Darrow, W. F., residence.  
 Davison, Mrs. John B., residence.  
 Day, Oscar A., residence.  
 Douglass, Thos., residence.  
 Driewer, J.  
 Episcopal Church.  
 Farnham, Geo. A.  
 Ferguson, Robert G.  
 First National Bank.  
 Fitzpatrick, Wm. J., residence.  
 Fuller, J. A., residence.  
 Fuller, Mrs. Joseph, residence.  
 Fuller, S. W., residence.  
 Gibbs, James R., residence.  
 Gibbs, W. H.  
 Gillis, George H., residence.  
 Gilson, J. P., residence.  
 Goldsmith, B. J.  
 Grammar School No. 4.  
 Grant, Dr. C. S., residence.  
 Guiltman, Michael, residence.  
 Hamilton, Hon. T. F., residence.  
 Hansom, H. B., residence.  
 Harrison, H. B.  
 Hart, H. H.  
 Hathorn, Hon. H. H., residence.  
 Herslip, Jos.  
 High School.  
 Hilton, Hon. Henry residence.

Hotel Todd.  
 Holmes, Morris II., residence.  
 Ingleam, William, residence.  
 Jennings, Mrs. M. J., residence.  
 Jones, E. N., (Supt. of Schools.)  
 Kearney, Hon. Edward, residence.  
 Kenmore Hotel.  
 Kirkpatrick, D. E., residence.  
 Knapp, A. P.  
 Lee, Jas., residence.  
 Lester Bros.  
 Lester, Hon. C. S., residence.  
 Lockwood, Mrs. A. A., residence.  
 Lockwood Wm. H., residence.  
 Mallory, T. F., residence.  
 Mariarte, Dr. D. C., office.  
 McEwen, Dr. R. C., residence.  
 McNaies, A. R., residence.  
 McPherson & Meehan.  
 McRea, W. S., residence.  
 Monroe, Dr., residence.  
 Mott, Mrs. Laura, residence.  
 Noonan, D. H., hotel.  
 Nunnick, Jas., residence.  
 Olmsted, Geo., residence.  
 Patrick, Mrs. C. E., residence.  
 Patrick, Mrs. J., residence.  
 Pearsall, Dr. A. J., residence.  
 Phelps, M. B., residence.  
 Phillips, Charles.  
 Pond Alurbert, office.  
 Powers & Smith.  
 Quickpatrick, John, residence.  
 Rainsie, J. M.  
 Rich, A. E., office.  
 Richard, S. A., residence.  
 Robertson, Andrew, residence.  
 Roods, Miss E. A., residence.  
 Salway Process Co.  
 Scovill, J. P., residence.  
 Schacklefind, G. R. P.  
 Seavey & Gardiner.  
 Smith, J. H.  
 Stiles, E.  
 Stiles, Jesse, residence.  
 Strong, Dr., residence.  
 Sweeney, J. F., hotel.  
 Temple Grove Seminary.  
 Terwiliger, S. F., residence.  
 Thomas, C. B., residence.  
 Thomas, W. H., residence.  
 Toeon, B. J., residence.  
 Totten, T. J., residence.  
 Town Hall.  
 Travers, Mrs. W. R., residence.  
 Trim & Douglass.  
 Trim & Tarrant.  
 Valentine & Morris, store.  
 Valentine, Thos. B., residence.  
 Vilaney, Hon. Edward, residence.  
 Wakefield, J. I., residence.  
 Warden Hotel.

Warden, W. N.  
 Waterbury, E. R., residence.  
 Waterbury, W. R., residence.  
 Weeles, Robert, residence.  
 Western Union Telegraph Co.  
 White, F. A., residence.  
 Wind or Hotel.  
 Wing, D. E., residence.  
 Yeungling, D. G. Jr., residence.

**SAUGERTIES.**  
 Boer, N. C., residence and factory.  
 Bogardus, Howard, residence.  
 Davis Block.  
 Davis, J. W.  
 District School No. 10.  
 Eitting, G. W., residence.  
 Kembler, J. H., residence.  
 Lamb, Daniel.  
 Lasher, Alfred, residence.  
 Lasher, John E., residence.  
 Low, J. M.  
 Loerzel, Fran.  
 Malden Methodist Parsonage.  
 Meyer, Andrew D., residence.  
 Montross, S., residence.  
 Porter, Wellington, residence.  
 Ryan, Edward, residence.  
 Scaring, S. J.  
 Sheffield, J. B. & Son.  
 Spellman, Thos., residence.  
 Vanneton, Uriah.  
 Washburn, Richard, residence.  
 Ziegler Bros.

**SCHAGHTICOKE.**  
 Quackenbush, A., residence.  
 Rexford, A. W.

**SCHENECTADY.**  
 Allen & Williams.  
 Atwell, F. J., residence.  
 Barney, H. S.  
 Carmichael, B. F.  
 Case, Levi & Co.  
 Chapel of First Presbyterian Church.  
 Clute, H. J.  
 Clute, J. W., residence.  
 Dillenbeck, A., residence and store.  
 Ellis, C. G.  
 Ellis, Edward.  
 Fuller, R., residence.  
 Hanford, G. T., residence.  
 Hardin, J. T.  
 Henke, August, residence.  
 Heilbronner, H., residence.  
 Locomotive Works.  
 McClyman, Wm.  
 Potter, Hon. Platt, residence.  
 Powers, A. M., residence.  
 Schenectady Knitting Mills.  
 Schmeihorn, E. N., residence.  
 Stevenson Bros.  
 Susholz, S., residence.  
 Swits, Dr. H., residence.



# EAGLE PRINTING HOUSE.

## A. V. HAIGHT, FINE PRINTER,

12 Liberty St., Poughkeepsie, N. Y.

Largest and Best Equipped Printing Office on the Hudson River.

Illustrated Catalogues, Books, Pamphlets, and Fine Color Work executed  
in the highest style of the art at reasonable prices.

### WHAT IS SAID OF OUR WORK.

. . . . AT HOME . . . .

*From the American Newspaper Reporter, New York.*

Mr. Haight's reputation as an artist is world-wide, and no eulogy of ours could do him the honor his work truly merits.

*From the American Model Printer, New York.*

Mr. Haight ranks at the top round of the ladder of American printerdom.

*From the Inland Printer, Chicago.*

In unique and artistic design, absolute perfection of execution, and harmonious blending of colors, no establishment in this country surpasses, and few equal its productions.

*From the Typographic Advertiser, Philadelphia.*

The handiwork of a true typographical artist, whom we take to be Mr. A. V. Haight. No printing office in the land turns out better work.

*From the Printers' Cabinet, Chicago.*

We can only reiterate what we have before said in these columns in regard to Mr. Haight, and it can be summed up by saying that he is one of the comparatively few natural artists among the craft in our country, and any job coming from his own hands may be set down as nearly perfect in style and execution as can be reached.

. . . . ABROAD . . . .

*From the Paper and Printing Trades Journal, London, England.*

Mr. Haight keeps up his reputation as the most versatile of American artistic typographers, and like a true artist is constantly endeavoring to improve on all previous efforts; his thorough knowledge of the chromatic scale is shewn equally in neat combinations of quiet tints and in bold, handsome effects with two or three strongly contrasting colours; while his mastery of every detail of execution is simply wonderful; his strong individuality marks every specimen from his hand so distinctly as scarcely to need the evidence of the imprint to decide its paternity.

We scarcely know which to admire most—the cultivated taste shewn in the artistic and well balanced design, the bright and happy arrangement of the wonderfully clear tints, the exact finish of details, the "dead" register, or the beautiful presswork; as a specimen of ornamental chromo-typography is simply marvelous.—*Id.*

We have often said of Mr. Haight's work "this is his best yet: he won't be able to beat *that*!"—but as often as not the next line specimen shews us that we were wrong.—*Id.*

Mr. Haight's skill as an original designer of artistic colour work is too well known to need comment; frequently we have said "this is the best—he won't beat it!" but the next specimen shews that his inventive faculty knows no rest.—*Id.*

*From the London Press News.*

We have heard Mr. Haight described as the "Boss" Printer of the United States. His work is certainly of the finest possible kind, and he himself must be an artist of no ordinary pretensions.

Mr. A. V. Haight, of Poughkeepsie, New York, has sent us a business circular announcing the enlargement of premises. The job itself is in striking contrast to the many handsome samples of intricate composition and brilliant press work that we have hitherto received from this versatile and artistic typographer. This specimen is a rare sample of chaste and delicate printing, and as such bears favourable comparison with anything we have received.—*Id.*

*From the British and Colonial Printer and Stationer, London, England.*

We have recently described and commended some exquisite specimens of this printer's typography. It is not excelled by anything produced in the States, which is certainly saying a good deal.

*From the Printer's Register, London, England.*

Mr. Haight takes advantage of all that is beautiful in the new productions of the type founders, and eschews the monstrosities of some of his American conferrers of note.

*From Hailing's Circular, Cheltenham, England.*

To us his work is simply marvelous.

This Catalogue was Printed and Bound at our Establishment.



## REFERENCES.

Veddes, Alex., residence.  
 Veeder, G. S., residence.  
 Vroom, J. V. & Sons.  
 Westinghouse, George, Jr.  
 Westinghouse, Jay.  
 Westinghouse, John.

**SCHUYLERVILLE.**

Fanson, R.  
 Gow, Dr.

**SENECA LAKE.**

Gould, S. S., residence.  
 Hoag, Milton, residence.  
 Williard Asylum.

**SENECA FALLS.**

Allen, Dr. D. S.  
 Baird, T. B., residence.  
 Beckes, N. H., residence.  
 Binney, W. W., residence.  
 Burt, Mrs. E. E., residence.  
 David, B. B., residence.  
 Exchange National Bank.  
 Gleason & Bailey Mfg. Co.  
 Gould, Mrs. Hannah.  
 Gould, James H., residence.  
 Gould, S. S., residence.  
 Goulds Mfg. Co., office.  
 Guion, Col. G. M., residence.  
 Hale, J. E.  
 Harrold, G. W.  
 Henion, Mrs. Henry, residence.  
 Hoag Opera House.  
 Hoag, Milton, residence.  
 Lathrop, W. B., residence.  
 Maurer, John, residence.  
 McDonald, J. H., residence.  
 Monroe, S. L., residence.  
 Partridge, Mrs. Leroy C., residence.  
 Presbyterian Parsonage.  
 Rumsey & Co., office.  
 Seymour, Mrs. W. T.  
 Silsby, H. S., residence.  
 Silsby Mfg. Co., office.  
 Stearns, G. R., residence.  
 Teller, James, residence.  
 Wessell, Bronson A., residence.  
 Wessell, C. E., residence.

**SENECA MILLS.**

Russell, C. H.

**SENNETT.**

County Almshouse.

**SHEEPSHEAD BAY.**

McKane, John Y.

**SHERBURN.**

Beebe, Albert.  
 Elsbre, Gladine & Co., store.

**SIDNEY CENTRE.**

Beach, F. S.  
 Beaks, J. E.  
 Brien, F. S.

**SING SING.**

Baker, Mrs. H. J.  
 Berlow & Co.  
 Birney, Mrs. J. Y.  
 Bryant, Wallace G., residence.  
 Foshay, V. Burton,  
 Foshay, Wilbur.  
 Holbrook, Dr.  
 Jenks, Benj.  
 Jenks, Julius.  
 Lemmy, Robert.  
 Lompbenis, S. E.  
 Lowry, Robert,  
 M. E. Church.  
 Miller, H. D., residence.  
 Roller Skating Rink.  
 Secor Flats.  
 Secor, Mrs. I. R.  
 Sherwood, Dr. E. B.  
 Sing Sing Prison.  
 Townsend, Farny.  
 Williamson, Mrs. Geo.  
 Young, A. L.

**SKANEATELES.**

Benson, T. O.  
 Hall, E. E.  
 McManvia, J. A.  
 Shallish, Jerry.  
 Webb, Mrs. H., residence.  
 Willetts, Joseph C., residence.

**SLOATSBURG.**

Allen, Edward.

**SMITHTOWN BRANCH.**

Fanny, Geo. F.  
 Smith, C. D.

**SODOS.**

Rice, A. J.

**SOLSVILLE.**

Lewis, E.

**SOUTHOLD.**

VanDusen, M. P.

**SOUTH YONKERS.**

Gunther, C. P.

**SPARKVILLE.**

Dominician Sisters.

**SPENCER.**

Seely, A. & Bro.

**SPRING VALLEY.**

Van Orden, P. L.

**SPUYTEN DUYVIL.**

Sisters of Charity,

**STATEN ISLAND.**

Baltimore Flats, Tompkinsville.  
 Bechtel, Geo., brewery.  
 Bechtel, Geo., residence.  
 Building of the Mission of the Immaculate  
 Virgin, Pleasant Plains.  
 Drungoole, Rev. J. C., Mt. Loreita.  
 New Brighton Building Co.  
 Public School, No. 3, New Brighton.  
 Whitman, Clarence, New Brighton.

**STAATSBURGH.**

White, W. A.

**STEINWAY.**

Cassebeer, H. A., residence.  
**STILLWATER.**

Newland, R & H.  
 Quackenbush, John.

**STONY POINT.**

Wiles, A. M., residence.

**STUYVESANT.**

Blair, James, residence.

**SUFFERN.**

Musser, A.

**SUSPENSION BRIDGE.**

New York Central R. R. Depot.  
 Phillips & Co.

**SYRACUSE.**

Arcade Building.  
 Barnum, H. C., residence.  
 Bates, R. P.  
 Beecher, Mr.  
 Belden, Mrs. Mead, residence.  
 Bishop, R. M., residence.  
 Century Club.  
 Cline, J. B., residence.  
 County Clerk's Building.  
 Court House.  
 Cox, W. W., residence.  
 Crouse, John, residence.  
 Crouse, D. E., residence.  
 Curtis & Smith, office.  
 Denison, L. S., residence.  
 Dueston, Thos. W., residence.  
 Dunn, P. J.  
 Eagle Hotel.  
 Eager, J. W., residence.  
 Friend, George S.  
 Garvey & Tobin.  
 Gere, W. H. H., residence.  
 Globe Hotel.  
 Greenway Building.  
 Greenway, John Jr., residence.  
 Hanchett, Chas. G.  
 Hasbrouck, E. P., residence.  
 Heir & Aldridge, manufactory.  
 House of Providence.  
 Howard Furnace Co.  
 Joy, Edward.  
 Kearney, Wm., residence.  
 Kelsey, W. W.  
 Klein, J., store.  
 Leahy, M. J.  
 Magee, Dr. C. M., residence.  
 McClellan, E. B., store.  
 McClure, J. H.  
 McClure, R. C.  
 Moser, Lucius, residence.  
 Morrison, James.  
 Pease, J. F., Furnace Company.  
 Phoenix Foundry.  
 Pierce, Butler & Pierce Mfg Co.

# THE BUILDING NEWS

PUBLISHED AT

97 OLIVER STREET, BOSTON, MASS., BY THE BUILDING NEWS COMPANY

A WEEKLY JOURNAL DEVOTED TO BUILDING INTERESTS.

PUBLISHED EVERY SATURDAY.

Containing the freshest and most authentic news that it is possible to obtain in regard to buildings contemplated and in process of erection, by means of special correspondents in all the principal cities and towns in New England, and through correspondence with all New England architects; real estate gossip; trade notes for the benefit of patrons; in short, all news in relation to building or in any way allied therewith.

**SUBSCRIPTION, \$5.00 IN ADVANCE.**

Advertising rates upon application.

As a means of introducing any specialty to the notice of New England architects and builders, THE BUILDING NEWS is positively without a rival, as it is the only paper in New England which covers this ground. Address all communications to

**THE BUILDING NEWS CO.**

## A NEW BOOK ON HEATING AND VENTILATION.

WITH EXHAUSTIVE TREATISE ON COMBUSTION **"HEAT."** ITS SCIENCE, PRODUCTION AND APPLICATION TO THE WARMING AND VENTILATION OF BUILDINGS.

By JOHN H. MILLS, 10 Westland Avenue, Boston, Mass.

INDEX OF CHAPTERS AND SUBJECTS.

### VOLUME I.

#### PART FIRST.—Combustion Practically and Scientifically Considered.

CHAP.	Subject	PAGE.
CHAP. I.	Heat: Its Nature and Source	11
CHAP. II.	Mineral Coal and its Production	19
CHAP. III.	Combustion a Chemical Process	29
CHAP. IV.	Elements employed in Combustion	37
CHAP. V.	Separation of the Fuel previous to Combustion	49
CHAP. VI.	Volatile Constituents of Coal	55
CHAP. VII.	Character of the Coke, Volume of Air Required	61
CHAP. VIII.	Construction of Furnaces for the Proper Combustion of Fuel	93

*Illustrated by 9 Colored Diagrams and 4 full-page Tables.*

#### SECOND.—Solid, Liquid, and Gaseous Fuels, and their Furnaces.

CHAP. IX.	Pulverized Coal and other Fine Fuels, Mechanical Stokers, etc.	107
CHAP. X.	Petroleum: Its Production and Transportation	121
CHAP. XI.	Petroleum Oil as Fuel vs. Coal	143
CHAP. XII.	Natural Gas: Transportation and Use	167
CHAP. XIII.	Manufactured and Carburetted Gas	195

*Illustrated by 4 Diagrams and 4 full-page Tables.*

#### THIRD.—Boilers of Wrought and Cast Metal.

CHAP. XIV.	Unsafe Boilers and Steam Generators	213
CHAP. XV.	Safety Sectional and Power Boilers	241
CHAP. XVI.	The Mills and other Heaters—Low Pressure Boilers	269-302

*Illustrated by 11 Plates, several Tables, and Reports of Engineers.*

### VOLUME II.

#### FOURTH.—Radiators, Direct and Indirect, for Steam and Water Heating.

CHAP.	Subject	PAGE.
CHAP. XVII.	The Laws and Phenomena of Heat Applied to Radiators	303
CHAP. XVIII.	Various Materials and Forms as Radiators	315
CHAP. XIX.	Cast Iron Radiator Construction	337
CHAP. XX.	"Indirect" Radiators—Steam and Hot Water Heat Compared	353

*Illustrated by 21 Plates, 4 Colored Diagrams, and 8 Tables.*

#### FIFTH.—The Warming of Buildings by Steam and by Water Apparatus.

CHAP. XXI.	Hot Air and Steam Furnaces	373
CHAP. XXII.	Steam and Water as Heating Mediums	391
CHAP. XXIII.	Water Heating Apparatus, Ancient and Modern	409
CHAP. XXIV.	Examples of late Water Construction and Operation	433
CHAP. XXV.	General Proportions of Water Apparatus	461

*Illustrated by 8 Diagrams, 11 Tables, 8 Plates and Figures.*

#### SIXTH.—The Ventilation of Buildings—The Amount of Air Required.

CHAP. XXVI.	Air Hygienically and Scientifically Considered	487
CHAP. XXVII.	Condition of Public Schoolhouses	507
CHAP. XXVIII.	Methods of securing Ventilation, Pipes and Chimneys considered	525
CHAP. XXIX.	Mechanical or Power Ventilation—Modern Examples	547
CHAP. XXX.	Examples of Mechanical Ventilation	571-591

*Illustrated by 8 Plates and Figures, 4 Colored Diagrams, and 16 Tables.*

NOTE.—On account of the large size and weight of the books, and the fact that the tables and diagrams relating to the same subject are necessarily separated, some in one volume and some in the other, it is the author's intention to gather all the Tables, Diagrams and other key pages, and bind them in a small indexed volume, which may be rolled and carried in the pocket, thus placing the practical results of experiments and tables in a connect and compact form. **PRICE (when ready) \$3.**

From Volume I.: 15 Tables, 4 Diagrams, 6 Plates, and 20 explanatory and miscellaneous pages—45 Pages.

From Volume II.: 35 Tables, 20 Diagrams, 5 Plates, and 25 explanatory pages, being 85 Pages, or a total of 130 Pages.

For Sale by A. A. GRIFFING IRON CO., Jersey City, N. J., and JOHN H. MILLS, No. 10 Westland Ave., Boston.

Price for Volumes 1 and 2, \$10.00.



## REFERENCES.

Post Office.  
 Roscoe Bros.  
 Salisbury, F. A.  
 Samuals & Orr.  
 Saving Bank Building.  
 Schermerhorn, Jr., J. M., residence.  
 Solway Process Co.  
 Stoup, J. R., residence.  
 Sweet, W. A., residence.  
 Syracuse Screw Co.  
 Syracuse Tube Co.  
 Vanderbilt House.  
 Van Ranke Library.  
 Waggoner, F. W.  
 Yale, J. W., residence.

**TAPPAN.**  
 Brinkerhoff, A.  
 German Masonic Home.  
 Herring, Joh T., residence.

**TARRYTOWN.**  
 Bird, J. & Son.  
 Bishop, C. A. & Co.  
 Eagan, Father.  
 Eastman, T. E.  
 Field, Hon. Cyrus W., residence.  
 Fisher, M. A., store.  
 Griffen, Henry T., residence.  
 Husted, Dr.  
 Jones, Eugene.  
 Lewis, F. E., residence.  
 Lovat, E. T., residence.  
 Pierson, Frank R.  
 Pierson, Lincoln.  
 Reformed Church.  
 Rockefeller, W.  
 Rockwell, George.  
 Roe, L. V.  
 Sackett, S. J.  
 Sarven, J. D.  
 Silver, David, residence.  
 Sleepy Hollow Cemetery Office.  
 Solomon's Lodge Building.  
 Tarrytown Station.  
 Vanderbilt, Chas.  
 Webb, W. H.

**THROGG'S NECK.**  
 Huntington, C. P.  
 Joseph's Institute.

**TICONDEROGA.**  
 Bascon, D. C.

**TIVOLI.**  
 Otis, W. C.

**TOMKIN'S COVE.**  
 Tomkins, C.  
 Tomkin's Cove Lime Co.  
 Thompson, C.

**TOMKINSVILLE.**  
 Baltimore Flats.  
 Bechtel, Geo., brewery.  
 Bechtel, Geo., residence.  
 Light House Tender, "Mistletoe."  
 Light House Tender, "John Rodgers."

Light House Tender, "Grace Darling."  
 U. S. General Light House Department.

**TONAWANDA.**  
 Sime, Walkenshaw & Co.  
 State Bank Building.

**TREMONT.**  
 Farrigan, H.  
 Ferguson, Jas. F.  
 Hellman, R.  
 Jefferson, J. J.  
 Lewis, Peter.  
 Patterson, E.  
 Ryan, I. P.  
 Shelden, Samuel.  
 St. Joseph's Academy

**TRIBE HILL.**  
 Shanahan, Hon. James.

**TROY.**  
 Barnes, W. H.  
 Beade, W. H., residence.  
 Berdett Building.  
 Bottom & Daly.  
 Bowman & Calhoun.  
 Brown, Chas. A.  
 Browne, Chas. A., residence.  
 Burden Iron Co.  
 Burden, J. Townsend.  
 Burden, J. H.  
 Carey, S. T., residence.  
 Church, A. M. & Co.  
 City Hall.  
 Cluet, G. B.  
 Consalus, John.  
 Cramer, Legrande G., residence.  
 Curtsey's Hotel.  
 Delehanty & Murphy.  
 Dun, R. G. & Co., office.  
 Electric Mfg. Co.  
 Elmor, Mrs. A. E., residence.  
 Ferguson, Wm.  
 First National Bank.  
 Flynn, John, residence.  
 Francis, Hon. J. M.  
 Frear, Wm. H., residence.  
 Frie, Anthony, residence.  
 Fuller & Warren Co.  
 Gate, E. Courtland, residence.  
 Gates, J. P., residence.  
 Gray & Temple.  
 Gurley, W. & L. E.  
 Hall, B. H.  
 Hall's Building.  
 Harris & Couples.  
 Henderson, J. C., & Co.  
 Holland & Thompson Mfg Co.  
 Horton, Capt. G. W.  
 Holmes, Henry, residence.  
 Howe, John K., residence.  
 Kennedy, M.  
 Keenan, James, residence.  
 Lee, Chamberlin.  
 Lee, Ed.

Loyd, James H., residence.  
 Ludlow, H. T., residence.  
 Maguire, J. P.  
 Mahoney, M.  
 Marks, E.  
 Marvin, Rev. Uriah, residence.  
 McCusker, A., residence.  
 McDonald, J. A. & Co., office.  
 Morris, Samuel.  
 Mulligan, M., residence.  
 Mulligan & Schermerhorn.  
 Mutual National Bank.  
 Nickols, J. H.  
 Oakwood Cemetery Offices.  
 Orr, Alexander, residence.  
 Orrs & Co., factory.  
 Packer, George A.  
 Paris, Daniel E.  
 Peckham, W. M., residence.  
 Pine, James, K. P.  
 Proudfit, Mrs. E., residence.  
 Quinn, W. F.  
 Rand, G. S., residence.  
 Rand's Opera House.  
 Ranken Steamer House.  
 Reid, J. A.  
 Reide, E. W.,  
 Saunders, J. S.  
 Saxe, Mrs. Ellen, S.  
 Saxton, S. B.  
 State Armory.  
 Stone, Geo. A., residence.  
 St. Vincent's Female Orphan Asylum.  
 Taylor, W. D.  
 Thompson, Geo. S., residence.  
 Thompson, Robert A., residence.  
 Troy City Bank.  
 Troy Club.  
 Troy Fire Department Buildings.  
 Troy House.  
 Troy Jail.  
 Troy Times Building.  
 Union National Bank.  
 United National Bank.  
 Vail, S. M., residence.  
 Warren & Co., J. M.  
 Whitman, W. W., residence.  
 Wills, Chas.  
 Worthington, Jno., residence.

**TRUMANSBURG.**  
 Bowmah, J. H., hotel.  
 Quigley, Mrs. D. C.  
 Robinson, Fred, residence.

**TUCKAHOE.**  
 Gilford, Silas D., residence.

**TUXEDO PARK.**  
 Lorillard, P. Jr.  
 Tuxedo Park Club House.

**UNADILLA.**  
 North, S. S., residence.  
 North, S. S., bank building.



# THE SANITARY NEWS

A WEEKLY JOURNAL

..... DEVOTED TO .....

PLUMBING, STEAM FITTING, SEWERAGE, GAS FITTING,  
ARCHITECTURE, BUILDING, VENTILATION,  
WATER SUPPLY, HEATING, ENGINEERING,  
SANITARY INTELLIGENCE, PREVENTIVE MEDICINE.

A. H. HARRYMAN, Editor.

## THE SANITARY NEWS

Has a LARGER CIRCULATION among the Trades to whose Interests it is devoted than any other Journal of its class in the World.

Subscription \$2.00 a Year in Advance.

Advertising Rates Furnished on Application.

PUBLISHED EVERY SATURDAY

.....BY.....

THOMAS HUDSON,

88 & 90 LASALLE STREET,

CHICAGO, ILL.

SEND FOR A SPECIMEN COPY.

## REFERENCES

**UNION.**  
 Cafferty, E. M.  
**UNIONVILLE.**  
 Hayne, I. C.

**USHERS.**  
 Sternburg, F. I.  
**UTICA.**

Arcade Building.  
 Baggis Hotel.  
 Barnard, Miss, residence.  
 Buller, J. M., residence.  
 Butler, J. M., residence.  
 Chronic Insane Asylum.  
 City Library.  
 Clark, B. A., residence.  
 Clark, Dr. Wallace, residence.  
 Cook, Henry H., residence.  
 Crouse & Brandegee, manufactory.  
 Curtis, Philo S.  
 Devereaux Block.  
 Duffy, Estate Chas G.  
 Fitch & Stewart.  
 Foster, Thomas, residence.  
 Glenn, Hugh, & Co., store.  
 Goldwaite, Mrs., residence.  
 Hackett, C. W., residence.  
 Hubbard, M. H.  
 Lawrance, L. H., residence.  
 Martin, Edward, residence.  
 Middleton, Robert, residence.  
 Millar, Charles & Son.  
 N. Y. State Armory.  
 New York State Lunatic Asylum.  
 Patterson & Davies, store.  
 Reynolds Building.  
 Saturday Globe Building.  
 St. John's Church Parsonage.  
 Shaughnessy Brothers, store.  
 St. James Hotel.  
 Tucker, Colder & Co.  
 Utica Steam Guage Co.  
 Wendt, Fred.  
 Wicks, Hughes & Griffith.  
 Y. M. C. A. Building.

**VALTIC.**  
 Merwin, J. W. D., office and residence.

**VERPLANCK.**  
 King & Lynch.

**VICTOR.**  
 Frazer, John B., residence.  
 French, Alex, residence.

**WALDEN.**  
 Davidson, G. A.  
 New York Knife Co.  
 Radeker, Bros.  
 Stoddard, G. W., residence.

**WALTON.**  
 Ogden, C. E.

**WARRENSBURGH.**  
 Church of the Holy Cross.  
 Church of the Holy Cross, rectory.  
 Hunt, John G., residence.

**WARSAW.**  
 Higgins & Webster.  
 Jackson, J. Arthur.  
 Peck, C. C.

**WAWARSING.**  
 Hainbeck, John C., residence.  
 Terwilliger, H. C.

**WARWICK.**  
 Burt, Grinnell, residence.  
 Demarest Hotel.  
 Demarest, T. H.  
 Finch & Colwell.  
 Hood, J. H., M.D., residence.  
 Ogden & Pelton.  
 Sanford, Pierson E., residence.  
 Sanford, W. L., residence.  
 Servin, Mrs. S. A. F.  
 Smith, Miss A. N., residence.  
 Taylor, P. E., residence.  
 Wedling, Mrs. W. R., residence.

**WASHINGTONVILLE.**  
 Brewster, H. C.  
 Emmerson, E. R.  
 Emmerson, J. M., & Sons.  
 Hooper, Chas. G.  
 Nichols, Chas.  
 Tuthill, M. S.

**WASSAIC.**  
 Lewis, Miles K.  
 Parsons, Chas.  
 Swift, Jas. H.  
 Thompson, J. R.  
 Williams, Wm.

**WATERFORD.**  
 Baker, M. A.  
 Barnfather, F. B. & Co.  
 Breslin, W. W., residence.  
 Button Boiler Co.  
 Button Fire Engine Company.  
 Button, Theo. E., residence.  
 Conaughty, W. S., residence.  
 Curtis, Wm. H., residence.  
 Davis, G. E., residence.  
 Davis, T. D., residence.  
 Devitt, A. C., residence.  
 Dooiley, Daniel, residence.  
 Enlis, J. R., hotel.  
 Fuller, O. residence.  
 Gilbert, J., residence.  
 Gugerty, Patrick.  
 Harshaw, Seth T., residence.  
 Hawley, A. T., residence and office.  
 Holroyd, Geo., residence.  
 Holroyd, Wm., residence.  
 Holroyd & Co., office.  
 Kelso, John S., residence.  
 Lawrance, Hon. John, residence.  
 Lee, Russell, residence.  
 Martin, Chas., residence.  
 Old Ladies' Home.  
 Palmateer, R. D.  
 Perrin, Francis, residence.

Platt, J. C., residence.  
 Porter, Scott, residence.  
 Rowley, Chas., residence.  
 Saxe, Wm. A., residence.  
 Stewart, Chas. A., residence.  
 Stone, J., residence.  
 Turner, Geo., residence.  
 VanDenburg, Mrs. H. C.  
 Van Ness, Wm., residence.  
 Zeh, D. Edgar, residence and office.

**WATERLOO.**  
 Allen & Nugent.  
 Bacon, Benj.  
 Bacon, Fred, residence.  
 Bacon, W. F.  
 Bellows, Dr., residence.  
 Brophy, K. J., residence and store.  
 Brooks, Joseph.  
 Bule, Wm.  
 Clark, A.  
 Clark, Frank M. E.  
 Clark, W. B.  
 Day, Dr. J. W.  
 Dimus, Mrs. E. M. E.  
 First National Bank.  
 Gridley, C. C., residence.  
 Historical Building.  
 Hopkios, John, residence.  
 Magee House.  
 Magee, W.  
 Maloney Bros.  
 Manning, F. I.  
 Mercer, General M. D.  
 Patterson, Hon. A. M., factory.  
 Pierson, H. B.  
 Raymond, F. F., residence.  
 Reed, Geo., residence.  
 Richardson, Chas., residence.  
 Semser & Son.  
 Smith, R. G., residence.  
 Snook, Jesse, residence.  
 Spencer Iron Co.  
 Spencer, J. C.  
 St. Paul's Church.  
 St. Paul's Parish Building.  
 St. Paul's School.  
 St. Paul's Sunday School Building.  
 Story, Leonard.  
 Terwilliger, A. H.  
 Towseby, House.  
 Walsh, P. G., residence.  
 Waterloo Library.  
 Waterloo Wagon Co.  
 Watkins, Mrs. J. C., residence.  
 Wells, Hon. S. R.  
 Yules, Wm.

**WATERTOWN.**  
 Baffrey, A., residence.  
 Baffrey & Mowe.  
 Board of Education.  
 Braggs, J. J., & Son.  
 Bush, Bull & Roth.



10 Cents a Copy.

Issued Monthly.

\$1.00 a Year.

**THE LEADING**

and representative journal of the Carpentry Building and Decorating Trades, in this country and Canada. Contains the latest news and is full of practical information. Leading experts on our staff for every branch. Technical articles on interesting subjects in every number accompanied by accurate scale, models and designs.

**AS AN ADVERTISING MEDIUM**

It requires no argument to prove that a publication which is universally recognized as the representative journal of the Carpentry and Building trades, an eagerly looked for and welcome monthly visitor, whose pages are scanned alike by both employer and workman, and whose influence and circulation are daily increasing, must be an invaluable channel of communication between the producer and purchaser. The fact that its advertising patrons are the leading manufacturers of Builders' Materials, Saws, Carpenters' Tools, Decorative Supplies, etc., a fact of which the publisher is justly proud, furnishes the best evidence of its value, influence and circulation. All that is standard, novel, or deserving in connection with the Carpentry and Building business can be brought, through the use of its columns, to the attention of the trade at rates and with results which no wide-awake, enterprising firm, desirous of extending its business, can afford to overlook.

ADVERTISING RATES ON APPLICATION.

**FOR SALE**

—BY—

**NEWS DEALERS**

THROUGHOUT THE COUNTRY.

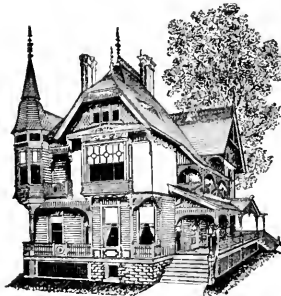

Cottage Designs a Specialty.

**F. V. STRAUSS,**

PUBLISHER,

120-126 WALKER STREET,

NEW YORK.

**ESPECIALLY INTERESTING.**

"THE CARPENTER AND JOINER is especially interesting, combining as it does the double advantages of a trade newspaper and an illustrated magazine."—*New York World.*

"Should be in the hands of every carpenter, builder and interior decorator."—A. BENNETT, Brooklyn, N. Y.

"I assure you I have derived more benefit from your paper than twenty times the cost of subscription."—GEO. W. BRIGGS, Kansas City, Mo.

"The results to us from advertising in your journal have been more than satisfactory."—AINSWORTH MFG. CO., New York.

"THE CARPENTER AND JOINER is one of the most complete trade publications issued in this country."—*Harlem Reporter.*

"We are well pleased with the results of our advertising in the CARPENTER AND JOINER. You will please continue our advertisement another year."—HARVEY W. PEACE CO., Limited, Saw Manufacturers, Brooklyn.

"This sterling periodical, the leading exponent of the carpentry and building trades in this country, presents an unusually rich table of contents this month. Every man who is interested in carpentry, building or decoration, and who wishes to do his work in an artistic and honest manner, should take THE CARPENTER AND JOINER for the authoritative information it gives."—*Journal of Commerce.*



## REFERENCES.

Church of the Sacred Heart.  
Commercial Building.  
County Clerk's Office.

Court House.  
Crown House.  
Eames, E. D.  
Gates & Spratt.  
Haney, M. J., residence.  
Kirby House.  
Knowlton Bros.  
Knowlton, Geo. W.  
Ingles, L., residence.  
McCartin, Judge John C., residence.  
Miller, Col. J. R., residence.  
Moffat, Hodgkins & Clarke.  
Moffett, J. F., residence.  
Mullen, Joseph, residence.  
Orphans' Home.  
Poor House.  
Powers, I. P., residence.  
Remington Mansion.  
Remington Paper Co., office.  
Reep, Henry, residence.  
Sanger, Judge, residence.  
State Armory.  
Stinten, F. W.  
Story, F. T., residence.  
Sun Fire Insurance Co.  
Taggart, Bros.  
Union Carriage & Gear Co.  
Woodruff House.

### WATERVILLE.

Livermore, Daniel, residence.  
Episcopal Parsonage.

### WATKINS.

Cowing, A. A., store.  
Davis, F., Jr., residence.  
Dunn & Co.  
Durland, Smith & Co., store.  
Demunn, Henry L.  
Firman, C. H.  
First National Bank.  
Fall Brook House.  
Goundrey, The, Wagon Co.  
Horhoff, A. T., residence.  
Jefferson House.  
Lakeview Sanitarium Building.  
Magee, Gen. T. J., residence.  
Miller, Geo. W.  
Smith, J. J., store.  
White, Geo. R., residence.  
Woodward, C. M., office.

### WAVERLY.

Clark, J. T.  
Lyman, Moses, residence.  
Merriman Bros.  
Thacher, Mrs. W. S., residence.  
Tioga Hotel, The.  
Vail, A. V. C., residence.  
Watrous, Mrs. Addison.

### WELLAVILLE.

Scott, Rufus, residence.

### WEST ALBANY.

Freight Shed and Transfer Building.

### WESTBURY.

Post, S. & J.  
Titus, Wm. P.

### WEST CHESTER.

Catholic Protectors.  
Davidson, Chas. M.  
Lorillard, L. J.

### WESTFIELD.

Bremer, Hon. F. B.  
Cowden, Mrs. H. J.  
Guild, Jas. O.  
Hathaway, M. J., residence.  
Hungerford, M. E., residence.  
Mathews, G. P., residence.  
National Bank.  
Presbyterian Church.  
Ramsay, Mrs. O. C.  
Sheevehelt Green Houses.  
Skinner, E. A., residence.  
Skinner, J. A., residence.  
Taylor, D. H.  
Union School.  
York, G. P., residence.

### WEST POINT.

Administration Building.  
Brooks, W. H.  
Cadet Barracks.  
Cadet Gymnasium.  
Cadet Hospital.  
Cadet Mess-hall.  
Rockwell, Lieut. C. H.  
Shopt, Q. M.  
U. S. Military Academy.

### WEST TROY.

Atkins, J. R., residence.  
Bartell, James, residence.  
Bells, E. T.  
Fair View Home.  
Jones, John & Sons.  
Marks, George.  
McGalton, A.  
Ray & Co.  
Robinson, John S., residence.  
Shafer, John H., residence.  
St. Bridgets Church.  
St. Bridgets Parsonage.  
St. Colemans Orphan Asylum.  
West Troy and Troy Ferry Boats and Offices.  
Winnie, John L., residence.

### WHEATLEY.

Post, Henry R.

### WHITEHALL.

Allen, Mrs. W. B.  
Burdette, A. M.  
Burdette, James.  
Baptist Church.  
Bush, J. L.  
Davis, O. F.,  
Dodge, Daniel.  
Donaldson, S. H.

George, W. A.  
Griswold, S. K.  
Knights, H.  
Lillie, Judge T. A.  
Manville, M. M.  
Martin, H.  
Pittenger, E.  
Potter, Judge James.  
Prefontaine & Lortir.  
Reed, John.  
Rush, Capt.  
Skeels, E. W.  
Witherbee, R. M.

### WHITE PLAINS.

Banks, Wm. L., residence.  
Barry, I. J., residence.  
Budway, Mrs. C., residence.  
Carhart, Mrs. Thos. F.  
Collins, Mrs. E.  
Digney, I., residence.  
Dykeman, John.  
Gibson, James, residence.  
Jackman, Robert.  
Magnien, Geo. H.  
Sherwood, Chas.  
St. Johns Hall.  
Westchester County Court House.

### WHITESBORO.

Ablett, Robert, factory.  
Wight, Dr., residence.

### WHITESTONE.

Merritt, I. J.

### WILLINK.

Tuttle & Phillips.

### WINSOR.

Dusenbury, E., residence.  
Russell, R. M.  
Wheeler, J. N., residence.

### YONKERS.

Archer, Chas. D., residence.  
Balke, F. B.  
Callen, Dr. P. A.  
Chelsea Flats.  
City Club.  
Doty, W. H.  
Ellenderhill's Sons.  
Fagan, H. J.  
Getty House.  
Gunther, C. B.,  
Halbrook, H.  
Howard, Robert H., residence.  
Lawrence, J. V.  
McIntyre, J. D.  
Moore, James J., residence.  
Nierney, Dennis.  
Opera House.  
Peene, Geo., residence.  
Quick, E. A.  
Rides, A. L., residence.  
Stewart, James.  
Stewart, T. & G.  
St. Joseph's Hospital.



## INFORMATION ABOUT THE SOUTH.

The marvelous mineral and timber wealth of the Southern States, their unrivaled capabilities as a manufacturing area, and the astonishing progress they are making in developing their natural resources and in utilizing their facilities for manufacture, are attracting the attention of the whole world. The extent of these resources and advantages is so fully and carefully set forth, and the progress of this development so faithfully chronicled from week to week in the *Manufacturers' Record*—the great industrial paper of the South, and the most widely quoted industrial paper in the world—that it is now accepted everywhere as unquestioned authority on Southern affairs, and its statistics and statements are drawn upon by almost every writer or speaker on any Southern topic.

It is the accepted authority upon Southern progress—the medium through which the great advantages and resources of the South are made known to the business men of the North and West—and its circulation not only covers the entire South from Maryland to Texas, but also the North and West. It is widely read by bankers, capitalists, and others in the North, seeking profitable investments in the South, by manufacturers of all classes who desire to increase their Southern trade, and by all others, North and South, who are interested in the general progress of this section.

Its weekly issues constitute an authentic history of the material development of the Southern States and furnish every week a vast variety of information on Southern affairs that can be gained from no other source. It discusses in its editorial columns and in its correspondence every topic of Southern interest. It publishes every week particulars of every manufacturing, mining and railroad enterprise organized or projected in the entire South, from Maryland to Texas. Subscribe for it. Price \$4.00 a year.

### • • • SOUTHERN TRADE • • •

The *Manufacturers' Record* has widespread influence. It is read and quoted and commended in every part of the United States. It numbers among its subscribers the most prominent houses and the officers of the largest corporations in the Southern States; the proprietors of mills and factories in every line of manufacture, leading contractors, hardware dealers, the presidents and managers of railroads, mining companies, pig iron furnaces, cotton and woolen mills, banks, owners of saw mills, furniture factories, spoke and handle factories, flour mills, cottonseed oil mills, stove foundries, etc., etc. It is a pushing, live, enterprising, vigorous paper. Its matter is fresh, interesting and original. It differs from all other industrial papers in that it has a specialty—a mission—viz: The advancement of the South. As an advertising medium it is unequalled. Try it.

**SEND FOR SAMPLE COPY AND ADVERTISING RATES.**

ADDRESS R. H. EDMONDS, PRESIDENT.

**MANUFACTURERS' RECORD CO.,**  
**BALTIMORE, MD., PUBLISHERS.**



## REFERENCES.

St. Mary's Church and Parsonage.  
 St. Mary's School Buildings.  
 Thomas, Edwin L.  
 Turner, T. M.  
 Tyler, C. C.  
 Warburton Hall.  
 Washburne Brass and Iron Works, The W. F.  
**YORK.**  
 Wilson, Wm. R.

## NEW YORK CITY.

### APARTMENT HOUSES.

"Aldhams," 76th St., between Madison & 4th Aves.  
 "Alpine," West 33d St.  
 Apartment Houses on 72d. St., & 4th Ave.  
 Apartment Houses on West 9th St. nr. 6th Av.  
 Apartment Houses on East 119th St., Jacob Doll, owner.  
 Apartment House, 80 Madison Ave.  
 Apartment House, 16th St. and Irving Place.  
 Apartment House, 126th St. and 6th Av.  
 Apartment House, 92d St. and 9th Ave.  
 Apartment House, 78th St. & 9th Ave.  
 "Barcelona," 59th St., & 7th Ave.  
 Beck, F.  
 "Bella," 26th St., & 4th Ave.  
 "Benedict," 80 E. Washington Sq.  
 "Bliss," 73d St. & 4th Ave.  
 "Bookman," 72d St., Lexington & 3d Aves.  
 "Boston," 59th St., between 5th & 6th Aves.  
 Brackholst, 85 St. & 9th Ave.  
 "Carlyle," 324 West 60th St.  
 "Chelsea," 23d St., between 7th & 8th Aves.  
 "Chesterfield," 16 East 53d St.  
 "Cleveland," 124 East 24th St.  
 Clausen's, H., Apartment House.  
 Clausen, Henry, 58th St. & 6th Ave.  
 "Correll," 81st St., between Lexington & 4th Aves.  
 Crimmins, J. D. & T. E., 1037 3d Ave.  
 "Cumberland," 173 5th Ave.  
 Disken, Martin, 47th St., & Lexington Ave.  
 "Drew," 41 Union Square.  
 Dwyer, D. J., 312 West 60th St.  
 "Elise," 1431 2d Ave.  
 "Essex," 61st St. & 9th Ave.  
 Ferris, O. C., Apartment House.  
 "Fisher's," West 33d St.  
 Flanagan, 66th St., & Boulevard.  
 Flat, on West 50th St.  
 "Florence," 105 E. 18th St.,  
 "Frederick," 53d St. & 4th Ave.  
 Gorman, John J., flat.  
 Gibbons, A.  
 Graves, Mrs. M. H., flats.  
 "Grenoble," 57th St. & 7th Ave.  
 "Grosvenor" Apartment House, 3d Ave. & 10th St.  
 Hall, William & Sons, 87th St. & Park Ave.

"Hanover," 2 East 15th St.  
 Harris, N. D., flats.  
 "Hathorne," 128 W. 50th St.  
 "Hearn," 31 W. 10th St.  
 "Hoefler," 55th St. and Broadway.  
 "Hoffman Arms," 59th St. & Madison Av.  
 Hubert Home Club, 80 Madison Ave.  
 "Imperial," 76th St., between Madison & 4th Aves.  
 "Jansen," 11 & 13 Waverly Place.  
 "Kenmore," 57th St. & 9th Ave.  
 Kennington Flats.  
 "Kensington," 57th St. & 4th Ave.  
 "Knickerbocker," 28th St. and 5th Ave.  
 "Lawrence," 54th St. and 7th Ave.  
 "Lexington," 49th St. and 3d Ave.  
 "Maginn," 57th St. and 10th Ave.  
 Mahone & Coyne, 27 West 11th St.  
 "Manhattan," 2d Ave., bet. 36th and 87th Sts  
 "Manhattan Square," 9th Ave. and 78th St.  
 "Marcella Flats," 125th St. & 5th Ave.  
 McGinnis Flats.  
 Meyer, S. T., 34th St., Park & Lexington Aves.  
 Meyers, J. H. D., 91st St., & Park Ave.  
 "Monroe," 59th St. and 6th Ave.  
 Morris & Cahill, Flats, 81st St.  
 "Morton," 206 E. 33d St.  
 "Oriente," 155 E. 72d St.  
 "Orleans," 975 8th Ave.  
 "Osborne," 7th Ave. and 57th St.  
 "Oxford," 137 W 36th St.  
 "Palermo, 125 E. 57th St.  
 "Pallisades," 56th St. bet. 8th & 9th Aves.  
 "Park View," 59th St. bet. 7th and 8th Aves.  
 Pikes, S. N., Apartment House.  
 Plyer's C. W., Apartment House, 424 W. 60th Street.  
 "Princeton," 57th St. bet. 8th and 9th Aves.  
 Purcell, Edward, 318 W. 60th St.  
 Randall, S. S., 1323 Franklin Ave.  
 Rankin & Co., 74th St. and 1st Ave.  
 "Rembrandt," 152 W. 57th St.  
 Rhineland Estate, 80th St. and 2d Ave.  
 Robert's Apartments.  
 Rollwagon, L. P., 56 Irving Place.  
 "Rutland," Broadway and 57th St.  
 "Saratoga," 225 W. 52d St.  
 "Scott," 129 E. 17th St.  
 "Seward," 175 E. 93d St.  
 "Sherwood, 531 5th Avenue.  
 "Sommer," 57th St. and 7th Ave.  
 "Sony," 57th St. and 6th Ave.  
 "St. Albans," 349 W. 58th St.  
 Steimetz, J. H., 9th Ave., bet. 103d & 104th Streets.  
 "Steinhart" 61st St. and Boulevard.  
 Sterling Flats.  
 "St. George," 223 & 225 E. 17th St.  
 "Strathmore," Broadway and 52d St.  
 "Sturtevant," 3d Ave.

"Stuyvesant," 142 E. 18th St.  
 "Sunny Side," Park Ave. and 73d St.  
 Taconia Apartment House, Lexington Ave.  
 "Union," 109 W. 56th Street.  
 "Vanderbilt," 399 Lexington Ave.  
 Voorhees, J. D., Grand Circle and 59th St.  
 Watkins, J. O., 107th St., & 4th Av.  
 "Washington," 122d St., and 7th Ave.  
 "Westmoreland," 100 E. 17th St.  
 "Windsor," 1700 Broadway.

### MANUFACTORIES.

Columbia Brewery, 450 W. 26th St.  
 Consolidated Card Co., 222-228 W. 14th St.  
 Dunn, Jacob, carriages, 87th St. & 3d Ave.  
 Hazleton Piano Manufactory, 34 & 36 University Place.  
 Herring's Safe Co., 13th and Hudson Sts.  
 L. & H. Brewing Co., 135 W. 18th St.  
 Miller's Tobacco Works, Columbia and Staunton Sts.  
 Sherwood's Pickle Works.  
 Sohmer & Co., 14th St. and 3d Ave.  
 Wallace, James, Brewery, Cherry St.

### PUBLIC BUILDINGS.

American Art Gallery.  
 Armory Board, 4th, 94th & 95th Sts.  
 Baptist Publication Society Building.  
 Bellevue Hospital, Gate House.  
 Berkley Lyceum, 44th St.  
 Bloomingdale Asylum.  
 Broadway Theatre, 41st St. & Broadway.  
 Casino, Broadway and 39th St.  
 Central Park Home Club.  
 Central Turnverin, 67th St. & 3d Ave.  
 Century Club.  
 Collegiate Institute.  
 Colored Orphan Asylum.  
 Daly's Theatre.  
 Demilt Dispensary, 23d St. & 2d Ave.  
 Department Public Charities and Corrections.  
 Department of Docks, Pier "A." N. R.  
 Deutches Verein, 59th St., West of 6th Ave.  
 Eighth Regiment Armory.  
 Engine Co. No. 56.  
 Fourteenth St. Theatre.  
 Foundling Asylum, 69th St. & 3d Ave.  
 Freundschaft Society, Park Ave. & 72d St.  
 Germania Club.  
 German Hospital.  
 German Mission Building, Ave. C. & 3th St.  
 German Odd Fellows' Hall.  
 Grand Central Depot, 42d St.  
 Hahnemann Hospital, 4th Ave., between 67th & 68th St.  
 Harlem Turn Verein, 124th St., near 3d Ave.  
 Home for the Aged Hebrews.  
 Home for Aged and Infirm Hebrews, 105th St. near 8th Ave.  
 Home for Aged Females, 104th St., & 10 Ave.  
 House of Good Shepherd, 89th St. & Ave. A.  
 House of Refuge, Randalls Island.

For Builders, Carpenters, Architects and Draftsmen.

ONE DOLLAR A YEAR—96 Plates each Year, 8x12 inches.

## The Builder Woodworker

Is now in its Twenty-fifth Volume, and is the oldest Business and Architectural Journal in America.

Handsomely illustrated throughout the text, and each number contains eight full-page Plates of new designs for Buildings, Interiors and Details. Edited by Fred. T. Hodgson, author of "The Steel Square and its Uses," "The Builder's Guide," "Practical Carpentry," etc., etc. Published monthly by

**HODGSON & BARWOOD,**

**294 BROADWAY,**

**NEW YORK.**

Send stamp for sample copy and book circular.  
N. B.—All kinds of Mechanical and Architectural Books for sale.

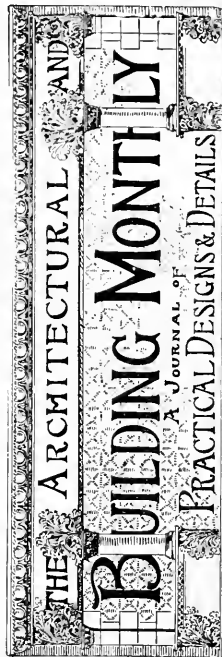

A NEW PUBLICATION

Of special interest to Architects, Contractors, Carpenters and Builders, Sash and Blind Manufacturers, Mason Builders, Plasterers, and all others connected with the Architectural and Building Industry.  
Each number will contain from eight to twelve six plates of Original Drawings to scale. During the year there will be shown a large variety of Designs and Details suited to Cities, Towns and Villages, including Public and Private Buildings, medium and low cost Cottages, Suburban or Country Houses, Stables and Out-Buildings, street and park architecture, and the latest and most valuable designs for Furniture.  
Manufacturers and dealers in Builders' Supplies will find it to their interest to advertise in this Journal, so on account of its thoroughly practical character and value, the numbers will be saved for use and reference for many months. Advertising rates furnished on application.

SUBSCRIPTION, \$5.00 PER YEAR.

CIRCULATION 5,000 to 10,000 MONTHLY.

**A. J. BICKNELL, Publisher,**  
115 Broadway, NEW YORK.

If you wish to reach

**Farmers of Georgia,**  
AND SURROUNDING STATES,

Put your advertisement in

**The Plowboy  Country Farmer**

A Monthly Magazine edited by

**Farmers who Dig in the Earth,**

AND NOT OFFICE FARMERS.

Published by

**The Plowboy Company,**  
**ATLANTA, GA.**

50 CENTS A YEAR.

ADVERTISING RATES REASONABLE.

ONE NUMBER OF

## Domestic Engineering

CONTAINS

INFORMATION WORTH MORE THAN THE  
PRICE OF A YEAR'S SUBSCRIPTION TO  
EVERY ONE WHO IS INTERESTED  
IN PLUMBING, HEATING, LIGHT-  
ING AND VENTILATING.

NOW IS THE TIME TO SUBSCRIBE.

ONLY \$1.00 A YEAR.

Address,

**Domestic Engineering,**

**557 and 559 The Rookery, CHICAGO.**

## REFERENCES.

- |   |  |  |
|---|--|--|
| <p>Hospital of L. G. Thomas, 52d St. &amp; Lexington Ave.<br/>         Hubert Home Club, 50th St., between 7th &amp; 8th Aves.<br/>         Inebriates Home.<br/>         Insane Asylum, Ward's Island.<br/>         Jackson Square Library, 251 W. 13th St.<br/>         Lancashire Insurance Co., 25 Pine St.<br/>         Laura Franklin Hospital, 111th St., near 5th Avenue.<br/>         Leidenkranz Hall, 58th St. between, 4th and Lexington Aves.<br/>         Little Sisters of the Poor.<br/>         Lyceum Theatre, 4th Ave. &amp; 24th St.<br/>         Madison Square Theatre.<br/>         Manhattan Club.<br/>         Manhattan Elevated Railroad cars.<br/>         Marquand Pavilion, 26th St. &amp; 1st Ave.<br/>         McKee Rankin's Theatre, 31st St. &amp; 3d Ave.<br/>         Methodist Book Concern.<br/>         Methodist Home, 10th Ave., between 92d &amp; 93d Streets.<br/>         Metropolitan Museum of Art, 83d St. &amp; 5th Ave.<br/>         Metropolitan Opera House.<br/>         Mt. Sinai Hospital, 65th St. &amp; Lexington Ave.<br/>         New York Athletic Club, 6th Ave. &amp; 55th St.<br/>         New York Cancer Hospital.<br/>         New York Christian Home, Madison Ave.<br/>         New York City Hall.<br/>         New York Cotton Exchange.<br/>         New York Foundling Asylum, 3d Ave.<br/>         New York Mercantile Exchange.<br/>         New York Tombs.<br/>         New York Fire Dept. Headquarters 67th St.<br/>         New York Fire Dept. Engine House Liberty Street.<br/>         New York Fire Dept. Engine House, Elm St.<br/>         New York Sanitarium, 247 West 49th St.<br/>         Odd Fellows Hall, Grand &amp; Centre Sts.<br/>         Orange Music Hall.<br/>         Panorama Building, 55th St. &amp; 7th Ave.<br/>         Presbyterian Hospital, Madison Ave. &amp; 73th St.<br/>         Produce Exchange.<br/>         Progress Club, 5th Ave. &amp; 63d St.<br/>         Roosevelt Hospital, 59th St. between 9th &amp; 10th Aves.<br/>         Scottish Rite Hall.<br/>         Shaeffer's Terrace Garden.<br/>         Sisters of Bon Secours, Lexington Ave. and 51st St.<br/>         Sloan Hospital, 59th St., &amp; 10th Ave.<br/>         Society for the Prevention of Cruelty to Children, 100 East 23d St.<br/>         Standard Theatre, 6th Ave.<br/>         St. Catherine's Hospital, 51st St. &amp; Madison Avenue.<br/>         St. Francis Hospital, 613 &amp; 615 East 5th St.<br/>         St. Leo's Church, 11 East 28th St.<br/>         St. Mark's Mission, Ave. A &amp; 10th St.</p> | <p>St. Mary's Hospital.<br/>         St. Vincent de Paul School, 43d St., between 5th &amp; 9th Aves.<br/>         Stock Exchange Building, Wall St.<br/>         Theis's Music Hall &amp; Garden, East 14th St.<br/>         Turn Hall, 66 East 4th St.<br/>         Twenty-third Regiment Armory.<br/>         Twenty-fourth Regiment Armory.<br/>         Twenty-sixth Precinct Police Station.<br/>         United States Assay Office.<br/>         Young Women's Christian Association, 15th St. &amp; 5th Avenue.</p> <p style="text-align: center;">STORES AND OFFICE BUILDINGS.</p> <p>Ackins Sons &amp; Co.<br/>         Akron Iron Co.<br/>         Altman B. &amp; Co., 301 6th Ave.<br/>         American Exchange National Bank.<br/>         American Mechanics &amp; Engineers.<br/>         American News Co.<br/>         American Safe Deposit Co's Building, 42d St. &amp; 5th Ave.<br/>         Ams, Max, Greenwich St.<br/>         Anderson Estate, 12 &amp; 14 John St.<br/>         Andrade James, 95 Bleeker St.<br/>         Ansonia Brass &amp; Copper Co.<br/>         Apgar &amp; Co.<br/>         Appleby Estate.<br/>         Appleton D. &amp; Co., Grand &amp; Green Sts.<br/>         Arnold, Constable &amp; Co., 17th St.<br/>         " " 19th St.<br/>         " " 23d St.<br/>         " " Union Square.<br/>         " " Canal &amp; Mercer Sts.</p> <p>Astor Estate, Broadway &amp; Prince St.<br/>         " " 6, 8, 10 &amp; 12 Wall St.<br/>         " " Grand St.<br/>         " " cor Houston &amp; Green Sts.<br/>         " " 94, 96, &amp; 98 Broadway.</p> <p>Backus, Peter &amp; Son.<br/>         Baker, Smith &amp; Co.<br/>         Bank of the State of New York, 33 William St.<br/>         Banks, John.<br/>         Barber Shop, 61st St. &amp; 9th Ave.<br/>         Barnes, Demas, 21 Park Row.<br/>         Barney's Studio.<br/>         Baron &amp; Co.<br/>         Barr Co., Edward, L'Id.<br/>         Barrett, Nephews &amp; Co., 5 &amp; 7 John St.<br/>         Baumen Bros., 22 &amp; 24 East 14th St.<br/>         Becar, A., 187 Broadway.<br/>         Bechstein, F., &amp; Sons.<br/>         Beggs, James &amp; Co., 9 Dey St.<br/>         Benedict Building, Broadway &amp; Cortland St.<br/>         Biddle, Clement M. &amp; Co.<br/>         Bird, W. E., &amp; Co.<br/>         Black, J. R.<br/>         Blackstone Building, Spring &amp; Green Sts.<br/>         Blake &amp; Williams.<br/>         Bloomingdale Bros., 3d Ave. and 59th St.<br/>         Blum, P. B., Jr.<br/>         Bogart, Albert G. &amp; Bro., 115 Bank St.</p> | <p>Bonner &amp; Van Court.<br/>         Bramhall, Dean &amp; Co.<br/>         Breen &amp; Nason.<br/>         Breives, G. T.<br/>         Broadway Bank, 237 Broadway.<br/>         Broadway &amp; 7th Ave. Railroad Office 50th St.<br/>         Brokers' Exchange.<br/>         Brooks Bros., Broadway &amp; 22d St.<br/>         Brown Bros.<br/>         Bryant Building, Nassau &amp; Liberty Sts.<br/>         Building 102 &amp; 104 Prince St.<br/>         " 512, 514 &amp; 516 Broadway.<br/>         " 39 Broadway.<br/>         " 69 &amp; 71 Broadway.<br/>         " 78 &amp; 80 " "<br/>         " 746 " "<br/>         " 265 " "<br/>         " 369 " "<br/>         " 50 Exchange Place.<br/>         " 16 &amp; 18 Wall St.<br/>         " 91 Wall St.<br/>         " N. E. cor. Broadway &amp; 17th St.<br/>         " 47 &amp; 49 Greene St.<br/>         " 124 East 123 St.<br/>         " 77th St. &amp; Madison Ave.<br/>         " 10 East 14th St.<br/>         " 691 Broadway.<br/>         " 38 Wall St.<br/>         " 27 East 4th Street.<br/>         " 322 Broadway.<br/>         " 108 &amp; 110 Green St.</p> <p>Burrall &amp; Marcellus.<br/>         Burt, O. C. &amp; Co.<br/>         Busch Building.<br/>         Butterick Pub. Co.<br/>         Callahan, Cornelius.<br/>         Callanan &amp; Kemp.<br/>         Cammeyer, A. J.<br/>         Camp, F. T., architect.<br/>         Canfield Isidore.<br/>         Carpenter, H. M., building, 41 Liberty St.<br/>         Carrens, A., 86 Maiden Lane.<br/>         Carroll, D. J.<br/>         Carter Building, 8th St., &amp; Broadway.<br/>         Carraher &amp; Co.<br/>         Chattellons, John, Sons, 85 Cliff St.<br/>         Chappell, Chase, Maxwell &amp; Co., store.<br/>         Cheeseborough, P. A., State &amp; Pearl Sts.<br/>         Children's Aid Society.<br/>         Childs &amp; Co.<br/>         Christy, Mrs. E. A.<br/>         Claffin, H. B. &amp; Co., store.<br/>         Clarke, John D.<br/>         Cohn Bro.<br/>         Cohen, A. E. &amp; Bro.<br/>         Cohnfield Building.<br/>         Cohnfield R.<br/>         Cohnfield, Theo., 163 Greene St.<br/>         Colgate &amp; Co., John St.<br/>         Colwell Lead Co.<br/>         Combination Stove &amp; Water Heater Co.</p> |
|---|--|--|



— A D V E R T I S E —

IN THE

ILLUSTRATED HOTEL WORLD

AN

RECEIVE FREE

BENEFIT OF

FULL PAGE ILLUSTRATIONS OF YOUR GOODS.

ALSO,

DESCRIPTIVE ARTICLE AND NOTICE GIVEN FROM TIME TO TIME.

SEND FOR COPY OF PAPER, MENTIONING THIS CATALOGUE, TO

No. 150 Nassau Street, New York, N. Y.

Fine Printing. Photo Engraving.

Architectural Books. Photogravure Reproductions.

**A CHICAGO MONTHLY**  
 Regular Edition, \$3.00 per year.  
 Photogravure Edition (94 plates), \$5.00 per year.  
**ARCHITECTURE, DECORATION AND FURNISHING.**

---

**INLAND ARCHITECT** ADVERTISE  
 IN IT.  
 SUBSCRIBE  
 FOR IT.

++ AND NEWS RECORD ++

---

*Sumptuous in Illustrations.*  
 LARGEST ADVERTISING PATRGNAGE IN AMERICA.  
 Samples of The Standard Contract free.  
 19 TRIBUNE BUILDING, CHICAGO.

LICENSEES FOR THE EXCLUSIVE PUBLICATION OF

The Standard Contract,

FRAMED AND ADOPTED BY

THE AMERICAN INSTITUTE OF ARCHITECTS,  
 THE WESTERN ASSOCIATION OF ARCHITECTS,  
 THE NATIONAL ASSOCIATION OF BUILDERS.

J. W. TAYLOR'S  
 American Photograph Series.

5000 SUBJECTS from all  
 Parts of the United States.

RESIDENCES, (City and Country),

BUSINESS FRONTS,

INTERIORS,

PUBLIC BUILDINGS,

75 PHOTOS OF ARCHITECTURAL DETAILS,  
 CHICAGO AUDITORIUM, MOORISH STUDIES,  
 EXTERIOR, INTERIOR, &c., &c.  
 AND DETAILS.

200 Photos sent out to select from to Purchasers  
 of not less than Two Dozen.

PRICE, \$4.50 Per Doz. Unmounted. (8x10 size.)

CORRESPONDENCE SOLICITED.

STATE YOUR WANTS.

J. W. TAYLOR,

151 Monroe Street,

CHICAGO, ILL.



## REFERENCES.

- Commercial Union Ass'n Co.  
 Conners, I. S.,  
 Conover, J. S. & Co.  
 Continental Insurance Co., 102 Broadway.  
 Continental National Bank,  
 Consolidated Gas Co.  
 Cooke & Co.  
 Cornell, Hiscock & Underhill.  
 Cozzens, Edward C., 24 East 7th St.  
 Culklin, H. C. & J. H.  
 Cristy, Walcott & Co.  
 Crum, F. H.  
 Cunningham, S. D.  
 Cutting, R. L.  
 Dahnke Bros., store, 86th St. & 3d Ave.  
 Hudson & Townsend Co.  
 Daniel & Son.  
 Davidson Building, 33 Bridge St.  
 Dawson & Archer.  
 Deane Steam Pump Co., 92 Liberty St.  
 Deeve & Co.  
 DeForrest, W. H. & Co., Broadway & Broome St.  
 Demarest, W. J., 30 & 32 East 14th St.  
 Demas & Barnes.  
 Dennison Mfg. Co.  
 Derycknigh, A. C.  
 DeWitt Wire Works Co., 90 John St.  
 Dimock, O. K., 77 Maiden Lane.  
 Dicker, T. W. & Sons.  
 Domestic Sewing M. Co., B'way & 14th St.  
 Donnegan & Swift.  
 Donnell, E. J., 19 & 21 Bridge St.  
 Dougherty, H. B. & W. H., 147 Bank St.  
 Doying, Wm. L., 124th St.  
 Duncan, John P.  
 Dunham, Buckley & Co., store, Broadway.  
 Duplex Steam Heater Co.  
 Eagle Insurance Building, Wall & Pearl Sts.  
 Eaton, Cole & Burnham Co.  
 Economical Printing Co.  
 Edison Manufacturing Co., 65 5th Ave.  
 Ehret, Geo.  
 Ehrich Bros.  
 Eppen, Smith & Wiemann.  
 Elviech Bros.  
 Elviech, W. L.  
 Endus, Martin.  
 Ennis, Thos.  
 Evans, The Construction Co.  
 Exchange Building.  
 Fairbanks & Co., 311 Broadway.  
 Farmers' Loan & Trust Co., 20 William St.  
 Faulkner, F. G., Co., 41 Dey St.  
 Field's Building, Whitehall St.  
 Fifth Avenue Presby. Church Parsonage.  
 Fingerhut, Richard.  
 Flanson, M., 416 West 71st St.  
 Fleischman & Co., Perry & Washington Sts.  
 Fleming & Kimball.  
 Forrest Building.  
 Fourth National Bank.
- Fox, Richard K., building, Dover & Pearl Sts.  
 Fuller's Building.  
 Fullner, J. P.  
 Frank, J. & Co.  
 Fritsche Bros., 34 Barclay St.  
 German Savings Bank, 14th St. & 4th Ave.  
 German Life Insurance Co., Nassau & Cedar Sts.  
 Germania Life Insurance Building, 149 B'way.  
 Gidley & Co., 75 Maiden Lane.  
 Gilbert & Barker Mfg. Co.  
 Gillender, H. L., 2 Nassau St.  
 Gillis & Geoghegan.  
 Gleason, E. P.  
 Goelet, R. & O., Hudson & Leonard Sts.  
 Gordon Building.  
 Gorton & Lidgerwood.  
 Gorton Boiler Co.  
 Goldenberg, S., store, 126 Greene St.  
 Graham, C., & Sons.  
 Graham & Murphy.  
 Graves, L. S.  
 Grimes, M. F.  
 Groff & Co., 208 Water St.  
 Guardian Assurance Co.  
 Guernsey Building, Broadway.  
 Haight Building.  
 Haley, J. S. Co.  
 Hall Steam Pump Co.  
 Hallett, G. G.  
 Hamburg-American Packet Co., 61 B'dway.  
 Hanover Insurance Co.  
 Harris, A. W.  
 Hart, Harmon H.  
 Havemyer & Elden Building Co.  
 Hazard Building.  
 Headquarters N. Y. Fire Department, 67th St. between Lexington & 3d Aves.  
 Hearn Building, 23 & 27 West 13th St.  
 Hedden, V. J., & Sons.  
 Hegeman & Co., 203 Broadway.  
 Higgins Bros.  
 Hine & Robertson.  
 Hoffman, C. Jr.  
 Hoe, Mrs. R.  
 Hollman, H.  
 Hollender & Co., Beaver St.  
 Holmes & Co.  
 Howard Building, 176 Broadway.  
 Hussey Reheater & Steam Plant Improvement Co.  
 Huyler, 18th St. & Irving Place.  
 Imperial Building.  
 Iron Clad Mfg. Co.  
 Iselin, C. O. D.  
 Iselin, Neeser & Co., Canal & Greene Sts.  
 Jamer, Jacob.  
 James, E. F.  
 Jackson Architectural Iron Works.  
 Johnson, Geo. F., office building, 17 & 19 Broadway.  
 Johnson, John F., 69 Wall St.
- Johnson, Mr., of the Edison Electric Light Company.  
 Johnson & Morris.  
 Johnson & Johnson, Wm. & Platt.  
 Kaufman, L. E., 1st Ave., & 33d St.  
 Kaldenberg, M. J.  
 Keil, W. J.  
 Keily, T.  
 Kellogg, E. H., 13 Cedar St.  
 Kelly & Jones Co.  
 "Kemble" Office Building, Whitehall & Stone Sts.  
 Kernochan Building.  
 Ketcher, Geo. P., & Co.  
 Kingsland, A. C., 5th Ave. & 20th St.  
 Kirshedt, F. A., 78 Grand St.  
 Knapp, F. W.,  
 Kurzman, M. & Co.  
 Lawrence Building.  
 Lawrence, W. B., Estate, White St. & Broadway.  
 Lazelle, Dally & Co.  
 Le Boutillier Brothers, store, 50 West 23d St.  
 Ledevens, Bondoy.  
 Ledons & Rickett, 10 Cedar St.  
 Lees, Samuel & Co.  
 Lemon, Thos. K.  
 Lewis Bros.  
 Lewis Bros. & Co.  
 Lewis Building, 623 Broadway.  
 Lincoln Safe Deposit Co., 42d St., opp. Vanderbilt Ave.  
 Livingstone Building.  
 Loeser, Fred., Prince & Greene Sts.  
 Logan & Stephens.  
 Lorillard Estate, Jay & Greenwich Sts.  
 " " 84 & 86 Chambers St.  
 " " 61 to 73 Wooster St.  
 " " 416 & 448 Broadway.  
 " " 451 & 453 " "  
 " " 368 " "  
 " " 495 " "  
 " " 740 " "  
 " " 827 " "  
 Loudon & Johnson, 180 Chambers St.  
 Macy, R. H. & Co., 14th St. & 6th Ave.  
 Maddock, T. H., 234 Broadway.  
 Maddock Building, 35 Bleecker St.  
 Manhattan Company Building, 42 Wall St.  
 Manhattan Railroad Stations.  
 Manhattan Railroad Office.  
 Manhattan Real Estate Co.  
 Manhattan Life Insurance Co. Building.  
 Mahoney, M.  
 Manning, Maxwell & Moore.  
 Marcellus, C. N. & Co., 69 Varick St.  
 Marine Bank, Wall & Pearl Sts.  
 Martin, G. W.  
 May Building.  
 Mazette, T. F., 6th Ave. & 49th St.  
 McCreery, James, stores, 22, 24 & 26 East 14th Street.

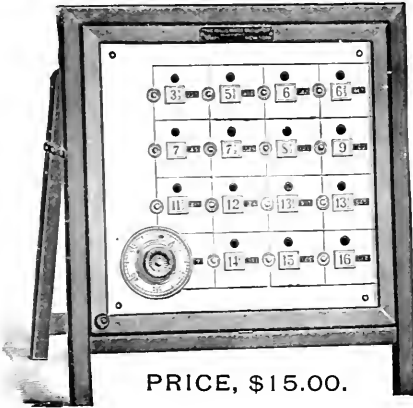

PRICE, \$15.00.

Saves Time and Money.

## The Willis Wages Calculator

Gives Instantly the Amount to be paid for any time at any rate of wages.

APPLICABLE TO ALL PAY ROLLS.

PIECE WORK CALCULATORS also furnished to suit any kind of manufacturing.

Further information furnished on application to

**J. C. SAXTON, Gen'l Agent,**

SALESMEN WANTED.

52 Broadway, New York.

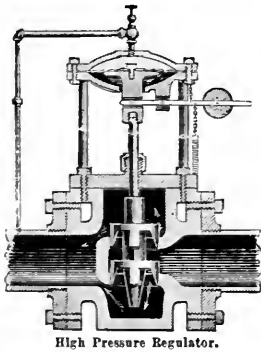

High Pressure Regulator.

# ACTON'S PATENT High & Low Pressure Regulators AND HYDRAULIC VALVES. THOUSANDS IN USE.

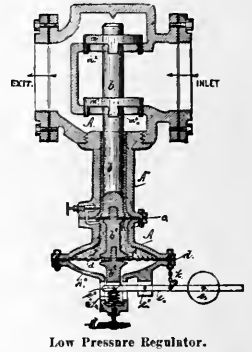

Low Pressure Regulator.

Absolute Control and Sensitive Regulation Guaranteed.

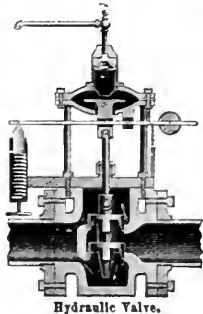

Hydraulic Valve.

MANUFACTURER OF ACTON'S IMPROVED **Universal Eccentric Bogardus Mill.**

Also, PUMP GOVERNORS and DAMPER REGULATORS.

Send for Circulars and Prices.

**JOHN ACTON, 191 & 193 Worth St., near Chatham Square, NEW YORK.**

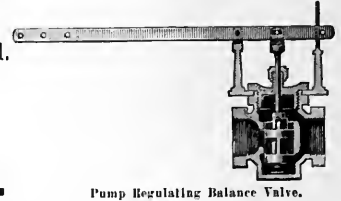

Pump Regulating Balance Valve.

## REFERENCES.

- McIntyre, G. & Son.  
 McIntyre & Phillips.  
 McMann, T. R. & Bro.  
 McNab, Harlin, Mfg. Co.  
 Merahins, Robert.  
 Merchant's Building, 4 & 6 Stone St.  
 Meriden Britannia Co., 46 East 14th St.  
 Merrill, E. R.  
 Merrill, H. B.  
 Meyers, Sniffen & Co., The  
 Middleton, W. S.  
 Miller, Chas. & Son, 19 Park Place.  
 Mills & Gibbs, 452 & 462 Broadway.  
 Minot, Hooper & Co.'s Store, 53 Leonard St.  
 Mitchell, Vance & Co.  
 Molwitz, Earnst.  
 Moore, F. G.  
 Mortimer Building, Wall St.  
 Mott, J. L., The, Iron Works.  
 Mount Morris Bank, 125th St. & 4th Ave.  
 Mutual Life Insurance Co., 144 Broadway.  
 Murray Building, 135 Broadway.  
 National Shoe & Leather Bank.  
 Neal's John, Sons.  
 N. Y. C. & H. R. R., 11th Avenue & 33d St.  
 N. Y. C. & H. R. R., Elevated Building.  
 New York Life Insurance & Trust Co.  
 New York Rubber Clothing Co., 457 B'dway.  
 New York Steam Co., The  
 New York Steam Fitting Co., The  
 Niagara Fire Insurance Co.  
 Nursery & Childs' Hospital.  
 Nolan, Rev. M. A.  
 Nolan, W. M.  
 North River Bank,  
 Office Building, 187 Broadway.  
 " " 149 "  
 " " 39 "  
 " " 67 Wall St.  
 " " 14, 16, 18 Wall St.  
 O'Neil, H. & Co., 6th Ave. & 20th St.  
 Orient Building, 41 Wall St.  
 Orth, G. A., 25 Frankfort St.  
 Outcalt, J. P. V.  
 Palliser, Geo., Arch., office.  
 Pancoast & Rogers.  
 Parish, Daniel, Estate, 860 Broadway & 67 Wall Street.  
 Parker, Stearns & Co., 79 Centre St.  
 Parshall, J. L.  
 Peck Bros. & Co., 78 Beekman St.  
 Peoples' Bank, Canal St.  
 Phelps, Dodge & Co., 19 & 21 Cliff St.  
 Phillip Tobacco Co.  
 Pitt, Wm. R., Composite Iron Works.  
 Plenty, Jos.  
 Pollack, Alexander.  
 Potter Building, Astor Place & Broadway.  
 " " Park Row.  
 Powers, Rev. J. N.  
 Printers' Tool & Supply Co.  
 Prior, F. S.  
 Protective Ventilator Co.  
 " Pulitzer " Building.  
 Pursell & Dwyer, 60th St., bet. 8th & 9th Aves.  
 Quincy, John & Co.  
 Ransom, S.  
 Ransom, W. H.  
 Raymond Farnace Co.  
 Raymond, Russell, 42d St. & 5th Ave.  
 Reay, M. A., 77 John St.  
 Renwick, E. S., 19 Park Place.  
 Reynolds, G. H.  
 Rhinehart, E.  
 Rhineland Estate.  
 Richardson & Boynton Co., 232 Water St.  
 Rineham, John.  
 Robbins, Rowland A.  
 Roberts, E. E., 107 Liberty St.  
 Rogers, H. A., 19 John St.  
 Rogers, J. F., & Co.  
 Rosendorf & Sons, store.  
 Rothchilds, Jacob, 622 & 624 Broadway.  
 Rouse Building.  
 Rouse, Chas., Broadway.  
 Royal Chemical Co.  
 Rusher & Fagan.  
 Rusher, Jas., & Co.  
 Rutzler, E.  
 Rutzler & Blake.  
 Sackett Estate.  
 Safety Car Heating & Lighting Co.  
 Schermerhorn Building, 96 Broadway.  
 Schermerhorn, W. L., 116 East 14th St.  
 Schlesinger, Leo, Crosby & Jersey.  
 Schlesinger, M., Canal & Baxter Sts.  
 Schultz, Carl H.  
 Schwartzwalden, H., building.  
 Seasongood, I. & L., 83 & 85 Greene St.  
 Seymour Manufacturing Co., 45 John St.  
 Sneider, John & Co.  
 Shoe & Leather Bank.  
 Sidenburgh & Co., Broadway, Crosby & Houston Sts.  
 Simmons, John.  
 Simpson & Co.  
 Simpson, Crawford & Simpson, 19th St., & 6th Ave.  
 Slatterly, Rev. Edward.  
 Sloane, W. & J., Broadway & 19th St.  
 Smith, F. B.  
 Smith, J. B., & Son.  
 Solomon, M. & E., 85 Maiden Lane.  
 Spencer, Lorillard.  
 Spingler Estate, 20 East 15th St.  
 Staats, R. P. & J. H.  
 Standard Oil Co.'s Building,  
 Stearns & Spingham.  
 Stern Bros., 34 West 23d St.  
 Sterns & Spencer, Building.  
 Sternburger, M. & L., 34 Thompson St.  
 Stevans, B. H., Estate.  
 Stevenson Building, 44 & 46 Broadway.  
 Stevenson, Mrs. E. K.  
 Stewart, T., 4 & 6 John St.  
 Stone, Fred. J., 28-36 Liberty St.  
 Store & Apartment, N. E. Cor. Broadway & 19th Street.  
 Store, Fulton & Gold Streets.  
 " 77 West Houston Street.  
 " N. E. cor. Canal & Greene Sts.  
 " 560-566 Broadway.  
 " Broadway & White Sts.  
 Stout, Spencer & Co.  
 Street, Geo. O., & Sons, 15 John St.  
 Stuyvesant, Rutherford, 1st Av. & 10th St.  
 Suckley, Robert B.  
 Sutton Building, 30 West 23d St.  
 Taylor, E. N., 45 Greene St.  
 Taylor, C. F. & H. D.  
 Taylor & Bryan.  
 Tarrant & Co., 278 Greenwich St.  
 Temple Court.  
 The Meyer, Sniffin Co., Cliff St.  
 Thompson, The, Co.  
 Times Building.  
 Tivy, Lawrence.  
 Toerge, Nicholas.  
 Tower, A., 691 Broadway.  
 Tower Building.  
 Trask & Carmichael.  
 Travers Bros., 52d St. & 10th Ave.  
 Tribune Building.  
 Trumbley Building, Broadway & Beaver St.  
 Unger, John.  
 Union Dime Savings Bank.  
 Union Trust Co.  
 U. S. Trust Co.  
 United Bank Building, Broadway & Wall St.  
 United Brass Co.  
 Urquhart, Jno. S., 46 Courtlandt St.  
 Vanderbilt Building, Beekman & Nassau Sts.  
 Van Buren Building, 7, 9, 11, West 13th St.  
 Van Tine, A. A. & Co.  
 Waefalaer, Louis, Co., 81 Beekman St.  
 Wallace, G. W.  
 Wallbridge, A. C. Spring & Crosby Sts.  
 Warren Mfg. Co., 45 John St.  
 Washington Bldg., 1 Broadway.  
 Watton Mfg., Co.  
 Weathered, Thos. W.  
 Wells Building, Broadway.  
 Wendel's Saloon, 7th Ave. & 49th St.  
 Western Union Telegraph Building.  
 Weston & Fiske, 61 Water St.  
 Wetman Building.  
 Wheeler & Wilson Machine Co., 44 East 14th St.  
 White Building.  
 White, Fred. B.  
 Whittier Machine Co.  
 Wicke, Wm., & Co., 31st St. & 1st Ave.  
 Wilkes Building.



# GOULD & EBERHARDT NEWARK, N. J.

— BUILDERS OF —

We lead: let those who can, follow. | **EBERHARDT'S PATENT DRILL PRESS.** | The only one built on "KORRECT" principles.

- Boynton Furnace Co. uses them.
- Fuller, Warren & Co. use them.
- H. K. Worthington uses them.
- Corliss Engine Co. uses them.
- Struthes, Wells & Co. use them.
- A. A. Griffing Iron Co. use them.
- McGill University uses them.
- Brown University uses them.
- Pratt Institute uses them.
- Water-vet Gov. Arsenal uses them.
- John Good uses them.
- Iron Co. use them.
- Cook Locomotive Works use them.
- Knowles Loom Works use them.
- R. Hoe & Co. use them.
- F. E. Reed uses them.
- Otis Bros. use them.
- King Iron Bridge Works use them, and hundreds of others.
- L. Shuttle & Co. use them.
- Brush Electric Co. uses them.
- Pond Mach. Tool Works use them.
- Thompson-Houston Electric Co. uses them.
- J. S. Mundy uses them.

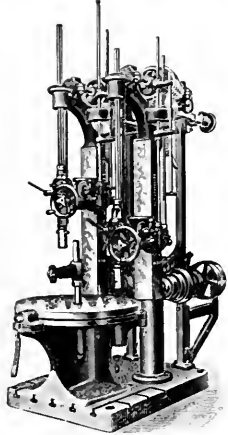

EBERHARDT'S PATENT DUPLEX DRILL PRESS. NEW CONSTRUCTION. NO COPY OF ANY ONE ELSE.

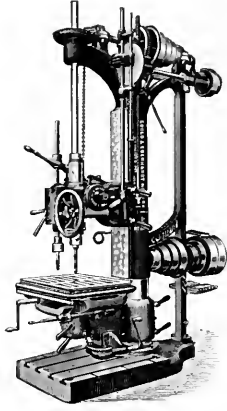

WITH EBERHARDT'S PATENT TAPPING ATTACHMENT AND COMPOUND TABLE.

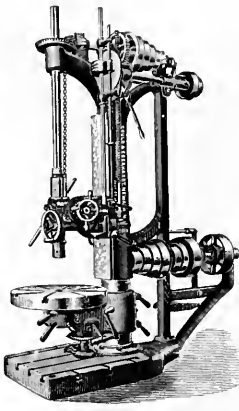

ARRANGED WITH PATENT FRICTION CLUTCHES AND BACK BRACE FOR TAPPING LARGE HOLES.

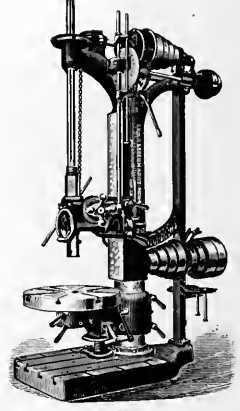

EBERHARDT'S STANDARD DRILL PRESS. 22", 25", 32", 37", 42", 48", 52", ETC.

## CURTIS & CO., COHOES, N. Y.

MANUFACTURERS OF

### WROUGHT IRON PIPE

OF EVERY DESCRIPTION FOR

### Steam, Gas and Water.

ALSO,

MALLEABLE AND CAST IRON FITTINGS,  
BRASS AND IRON VALVES AND COCKS,  
AND A FULL LINE OF

Steam and Gas Fitters' and Plumbers' Supplies.

PIPE is especially adapted for Coils, or any other purpose where bending is necessary.

Pipe made to order of any Outside or Inside Diameter required.



BEFORE placing any orders for **Bronze Powder** and **Bronzing Liquid**, see page 114 of this catalogue. **Japans and Enamels**, see page 115. **Radiator Full Opening Valves**, see pages 109 and 110. **Air Valves, Automatic and Positive**, see pages 111 and 112. **Floor and Ceiling Plates**, see page 117. **Marble Tops**, see pages 118, 119 and 120. **Brass Screens**, see pages 54, 55, 56 and 57, in fact everything accessory to a first-class Steam or Hot Water Heating Apparatus is illustrated in this catalogue, and will be sold by us at prices as low as the lowest, quality of goods taken into account.

### A. A. GRIFFING IRON CO.,

JERSEY CITY, N. J.

NEW YORK. CHICAGO. PHILADELPHIA.

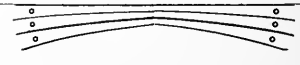



## REFERENCES.

Wilson, Alfonso.  
 Wilson Boiler Co.  
 Wills Rustless Iron Co.  
 Winkles, Egbert.  
 Winslow, Lanier & Co., Nassau St.  
 Wisweell, H. D.  
 Wood, Hon. Fernando, 117 & 119 Nassau St.  
 Wood, Wm., & Co.  
 Wolfee, P. H. & Co.  
 "World" Building, Park Row.  
 Wolcott, Christy & Co., 524 West 23d St.  
 Worthington Steam Pump Co., 82 Liberty St.  
 Wright, H. B.  
 Wright, Jas. T.  
 Wyson & Kernochan, 61-65 West 23d St.

HOTELS AND RESTAURANTS.

Albermarle, Broadway & 24th St.  
 Ashland House, 24th St. & 4th Ave.  
 Baron & Co., 32 Broadway.  
 Barrett House, Broadway & 43d St.  
 Belvidere, 4th Ave. & 18th St.  
 Betts, J. H.  
 Bode Bros., 28th St. & 4th Ave.  
 Buckingham Hotel.  
 Cable's Hotel, 141 Fulton St.  
 Centennial, 51st St. & 8th Ave.  
 Continental, 902 Broadway.  
 Cusack, J. A., 45 Broadway.  
 Delmonico Estate.  
 Eastern Hotel.  
 Fifth Avenue Hotel, 5th Ave. & 23d St.  
 Fisher's, 38th St. & Broadway.  
 Gaelet, R. O., Broadway & 32d St.  
 Gedney House, Cor. Broadway & 40th St.  
 Gee, Geo. W., 75 8th Ave.  
 Gilsey House, 1202 Broadway.  
 Goelet Hotel.  
 Hamilton, 5th Ave. & 42d St.  
 Hatfield House, 46 & 48 Ridge St.  
 Hotel Bristol, 1 West 42d St.  
 Hotel Brunswick, 225 5th Ave.  
 Hotel Martin, 9th St. & University Place.  
 Hotel Normandie, 38th St. & Broadway.  
 Hotel Royal, 40th St. & 6th Ave.  
 Hotel Shelburne, 36th St. & 5th Ave.  
 Irving House, 48 East 12th St.  
 Kerker, F. A., Bowery & Grand St.  
 Langham Hotel, 52d St. & 5th Ave.  
 Mailborougharms Hotel.  
 McKeever Bros., Christopher & West Sts.  
 Metropolitan Hotel.  
 Morton & Chesley, 42d St.  
 Mulligan, P., 1259 Broadway.  
 Murray Hill Hotel, Park Ave.  
 Nash & Brush, 16 & 18 Park Place.  
 O'Neil, John, Oyster House, 22d St. & Ave C.  
 Park Avenue Hotel.  
 Parker's Hotel, 32d St. & 6th Ave.  
 Plaza Hotel.  
 Purdy's, 52d St & 5th Avenue.  
 Rossmore Hotel, Broadway & 42d St.

Schmenger, 194 3d Ave.  
 Shady, John, 125th St., & 8th Ave.  
 St. Cloud Hotel, 42d St. & Broadway.  
 St. Dennis Hall.  
 St. Dennis Hotel Co., Broadway & 11th St.  
 St. Marc's Hotel.  
 Sturtevant House.  
 University Place Hotel.  
 Victoria Hotel, 5th Ave.  
 Warren House.  
 Waverly Hotel.  
 Webb's Hotel.  
 Westminster Hotel.  
 White's Restaurant, 349 Canal St.  
 Windsor Hotel, 5th Ave. & 47th St.

CHURCHES.

Baptist Church, 56th St., between 8th & 9th Aves.  
 Bloomingdale Reformed Church.  
 Broome Street Church.  
 Chapel of the House of Refuge.  
 Church of All Saints, 50 East 130th St.  
 Church of the Epiphany, 22d St. & 2d Ave.  
 Church of the Holy Communion, 6th Avenue & 20th Street.  
 Church of the Holy Redeemer, 3d Avenue.  
 Church of Our Lady of Perpetual Help, 323 East 61st St.  
 Church of Our Lady of Sorrow, Pitt & Stanton Streets.  
 Church of St. Cecelia, 106th St., near Lexington Ave.  
 Church of St. John the Evangelist, 351 East 55th Street.  
 Church of St. Thomas the Apostle, 118 St., near St. Nicholas Ave.  
 Church of St. Veronica, Washington & Christopher Streets.  
 Church of the Transfiguration, Christ Church.  
 Gospel Tabernacle, 8th Ave. & 44th St.  
 Mt. Morris Baptist Church.  
 Park Presbyterian Church, 8th St. & 10th Ave.  
 Presbyterian Church, Madison Ave. & 24th Street,  
 Rivington Street Church.  
 Rittger's Riverside Church, 73d Street, near Boulevard.  
 St. Agnes', 43d St., near Lexington Ave.  
 St. Andrews', City Hall Place & Duane St.  
 St. Ann's Church.  
 St. Augustine's Chapel, 105 East Houston St.  
 St. James', Oliver St.  
 St. James' Church, Madison Ave. & 73d St.  
 St. John's 21st St., between 5th & 6th Aves.  
 St. John's Evangelist Church, 55th St. & 1st Avenue.  
 St. Leo's Church, 11 East 28th St.  
 St. Mary's, Grand & Ridge Sts.  
 St. Patrick's, Mulberry St.  
 St. Patrick's Cathedral, 50th St. & 5th Ave.

St. Stephen's P. E. Church, 120th St. & Lexington Ave.  
 St. Teresa's, 141 Henry St.  
 St. Vincent De Ferrer, 66th & Lexington Ave.

RESIDENCES.

Aldham, F., 76th Street, near Madison Ave.  
 Andreas, Mrs. J. J., 126 East 57th St.  
 Beck, Mr., 5th Ave. & 30th St.  
 Belden, W. H.  
 Bookman, J., East 72d St.  
 Comfort, Jno. E., 169th St. & Franklin Ave.  
 Cooper, Peter, Lexington Ave., near 22d St.  
 Cowell, Fred., 81st St., bet. Lex. & 4th Ave.  
 Dawdney, A., 65th St., near 5th Ave.  
 Frazel, Edwin.  
 Ferguson, Dr. Jas., Waverly Place.  
 Gallatue, Frederick, 5th Ave. & 53d St.  
 Gilsey, Henry.  
 Herb, E. H., 515 W. 57th St.  
 Hewett, Hon. A. S., 9 Lexir gton Ave.  
 Hoe, R. J.  
 Hughes, Rev. J. J.  
 Jones, Mrs. M. Mason, 2 W. 58th St.  
 King, Mrs. E., 431 5th Avenue.  
 Leibman, Jas., 40 East 74th St.  
 McCreery, Robt., 5th Ave. & 74th St.,  
 McCormack, W. J., 55th St. & 1st Ave.  
 Macy Villa Bloomingdale Asylum 117th St. & W. Boulevard.  
 Marquand, H. G., 68th St. & Madison Ave.  
 Merrill, E. R., 361 West 19th St.  
 Mintum, Mrs. Louisa, 22 N. Washington Sq.  
 Methodist Home, 10th Ave., bet. 92d & 93d Streets.  
 Pastoral Residence, St. Agnes' Church.  
 Pastoral Residence, Church Sacred Heart, 51st St. & 10th Avenue.  
 Pope, W. B., 89th St.  
 Powers, Rev. J., 105 East 30th St.  
 Randall, S. S., 1323 Franklin Ave.  
 Roach, David, 76th St., & Lexington Ave.  
 Robertson, T. J., 13 East 56th St.  
 Robertson, T. R., 15 East 50th St.  
 Roosevelt, H. I., 18th St.  
 St. Monica's Rectory, 334 East 79th St.  
 Steinhart, Selig, West 61st St.  
 Thomas, F. F., East 41st St.  
 Vanderbilt, Wm. K., 5th Avenue.  
 Wright, J. E., 127th St. & 7th Ave.  
 Wright, J. Hood, 172d St., & Ft. Washington.  
 Zensier, A., 58th St., & 10th Ave.

SCHOOLS.

Columbia College, President's house.  
 Columbia Grammar School.  
 Childrens' Aid Society School Building.  
 Comstock's, Miss, School, 32, 34 W. 40th St.  
 Convent of the Holy Cross, West 42d St.  
 Dominican Convent, 65th St. & Lexington Avenue.  
 Dominican Convent, 63d St. & 1st Ave.  
 Five Points House of Industry, 155 Worth St.



Engines, Boilers and all Connections Furnished and erected in Complete Running Order.

Shafting put up and General Millwright Work.

With competent Mechanics in our employ, First-Class Work can be Guaranteed at Reasonable Terms.

Estimates Furnished and Prompt Attention given to all orders.

New York Steam Fitting Co., 211 Centre Street, New York City.

# ↔ — HALL'S — ↔ MINERAL MACHINE OIL.

Warranted Not to Gum.

Is an Odorless Oil. Adapted for Light or Heavy Work. Contains no Grit. Leaves Bearings Smooth and Clean. Free from Acid. Has no Equal.

SOLD IN ANY QUANTITY.

Samples Free on Application.

All Orders Promptly Filled.

**G. E. HALL, 211 Centre Street, New York City.**



## REFERENCES.

French, D. C., studio.  
 Grammar School No. 2, 116 Henry St.  
 " " " 11.  
 " " " 18, 121 East 51st St.  
 " " " 31, 198 Monroe St.  
 " " " 32, 351 West 35th St.  
 " " " 51, 523 West 44th St.  
 " " " 65, West Farms.  
 " " " 68, 128th St., n. 6th Ave.  
 " " " 72, Lex. Ave., bet. 105th  
 and 106th Sts.  
 " " " 79.

Grammar Department No. 46.  
 Hebrew Orphan Asylum.  
 Homœopathic Medical College, Ave. A., bet.  
 63d & 64th St.'s.  
 Loomis Laboratory.  
 Primary School No. 9, 42 1st Ave.  
 " " " 11, 31 Vesey St.  
 " " " 31, 200 Monroe St.  
 " " " 32, 36th St. & 9th Ave.  
 " " " 36, 70 Monroe St.

And over 30 other Public Schools.  
 R. C. Orphan Asylum.  
 School of Epiphany, 22d St. & 2d Avenue.  
 School for Ethical Culture, 109 West 54th St.  
 Sisters of St. John's Convent, 205 E. 17th St.  
 Sister Sophia's Private School, 313 & 315 E.  
 10th St.  
 St. Alphonsus' School, So. 5th Ave., Grand  
 Street.  
 St. Anne's School.  
 St. Catherine's Convent, 81st St. & Madison  
 Avenue.  
 St. Francis Xavier College, W. 16th St., bet.  
 5th & 6th Aves.  
 St. Gabriel's School, East 36th St.  
 St. James' School, James St.  
 St. James' School, New Bowery & James St.  
 St. John's College, Fordham.  
 St. Joseph's Industrial Home, 81st St. &  
 Madison Ave.  
 St. Lawrence Academy, 42 East 34th St.  
 St. Patrick's School, Mulberry St., 50th St. &  
 Lexington Ave.  
 St. Vincent de Paul School & House, West  
 24th St.  
 St. Vincent Ferrer School, 65th St. & Lexing-  
 ton Avenue.  
 St. Vincent's Home for Boys, Gt. Jones St. &  
 Lexington Ave.  
 St. Vincent's Hospital, 12th St., bet. 6th &  
 7th Aves.  
 The Vanderbilt Clinic, 59th St. & 10th Ave.  
 Training School for Male Nurses, Bellevue  
 College.  
 Wallace, Geo. W., 80 West 126 St. (Daring  
 Academy.)

## NEW MEXICO.

SANTA FE.  
 Capitol Building,  
 Sisters Hospital.

## NEWFOUNDLAND.

ST. JOHNS.  
 Academia Club House.  
 Angel, James & Co.  
 Castle Linbury,  
 Church of England Cathedral.  
 Gear & Co.  
 Gemmel, Hugh.  
 Mackey, A. M.  
 McCowen, John B., office.  
 Methodist College.  
 Methodist Home.  
 Sailors' House.  
 St. Mary's Episcopal Church.

## NORTH CAROLINA.

ASHEVILLE.  
 Carrier, E. G.  
 Coxe, Col. Frank.  
 Garrett, A. & R. U., hotel.  
 Peck, G. W.  
 Porter, A. T.  
 Reynolds & Spears.

CHARLOTTE.  
 Atkinson, W. R., residence.  
 Bufard House.  
 Charlotte Female Institute.  
 Charlotte Oil Co.  
 Kittelle, Geo. W.  
 Oliver Fred., residence.

DURHAM.  
 Carr, J. S.  
 Duke, B. N.  
 Manufacturers House Furnishing Agency.  
 Watts, G. N.

GOLDSBORO.  
 Dewey Bros.  
 "Messenger" Newspaper Office.  
 Steamboat "Alpha."  
 " " "Louise."

GREENSBORO.  
 Stephens & Garrett.

HENDERSON.  
 Burgwyn, W. H. S.  
 HENDERSONVILLE.  
 Anderson, Jas.

HOT SPRINGS.  
 Mountain Park Hotel.  
 Southern Improvement Co.  
 LAURENBERG.  
 Bizzell, A. F.

MORGANTOWN.  
 N. C. Insane Asylum.  
 Scroggs, F. M.

NEWBERN.  
 Hotel Albert.  
 Crabtree, John H. & Co.

RALEIGH.  
 Brewster, J. C.  
 Briggs, Thos. H.

Stevenson, T. J.  
 St. Mary's School.  
 ROAN MOUNTAIN.  
 Cloudland Hotel.  
 SALEM.  
 Fries, F. H., residence.  
 Vance, J. A., office.  
 SUMTER.  
 Winn, D. Jas.  
 Sumter Cotton Mills.  
 WILMINGTON.  
 Grant, R. H.  
 U. S. Marine Hospital.  
 Burr & Bayley.  
 U. S. Revenue Steamer "Colfax."

WINSTON.  
 Bailey, P. N., residence.  
 Brown, Rogers & Co.  
 City Block.  
 Gilmore, J. E., residence.  
 Gray, Jas. A.  
 Hanes, P. H., & Co.  
 Miller Bros.  
 Presbyterian Church.  
 Tise, J. C., block.  
 Vaughn, T. L., residence.  
 Williamson, M. N.

## OREGON.

ASHLAND.  
 Myer, H. C.  
 CORVALLIS.  
 Benton County Court House.  
 Public School Building.  
 EAST PORTLAND.  
 Breymen, A. H., residence.  
 Ocobock, A. W., residence.  
 Wade, R. M., residence.

MIT TABOR.  
 Clark, Mrs. Fred. J.  
 Smith, J. H.  
 Warner, J. G.

PENDELTON.  
 East Oregonian Building.  
 East Oregonian Publishing Co.  
 Umatilla County Court House.

PORTLAND.  
 Bickel, F., residence.  
 Bullivant, J., residence.  
 Comstock, Mrs. M., residence.  
 DeHart, E. J., residence.  
 Durham, Geo. H., residence.  
 Everding, Henry, residence.  
 Fisher, J.  
 Gardner, W., & Co.  
 Goldsmith & Lowenberg.  
 Good Samaritan Hospital.  
 Hegele, Chas., residence.  
 Holman, Edward, residence.  
 Ladd, Chas. E., residence.  
 Lewis, C. H., residence.



# Kieley's Steam-Heating Specialties.



Send for Catalogue containing Cuts and Price Lists of BEST

RETURN STEAM TRAPS, POSITIVE-ACTING PUMP GOVERNORS,  
PRESSURE REGULATING VALVES,

Noiseless Back Pressure Valves, Oil and Water Separators.

COMBINATION EXHAUST FITTING AND OIL SEPARATOR,

Drain Trap of Largest Capacity and Sensitive Damper Regulator,

♦ ♦ ♦ ♦ TO ♦ ♦ ♦ ♦

## TIMOTHY KIELEY,

7 to 11 West 13th Street, NEW YORK.

The above mentioned Machines are made of the Best Material and Guaranteed.

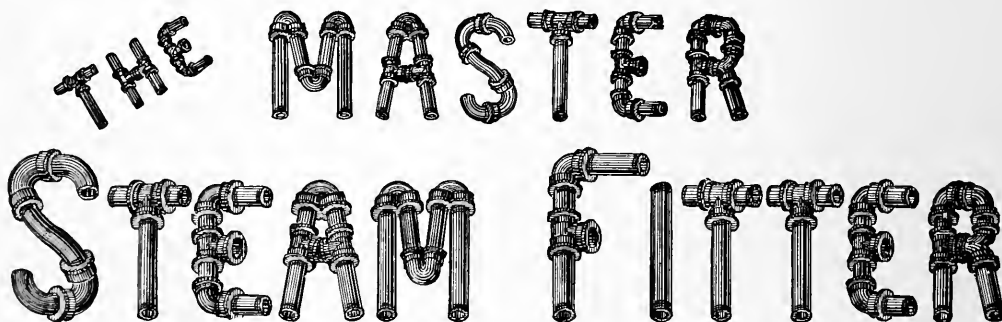

DEVOTED TO

Steam and Water Heating and Ventilation.

The only Journal in the World devoted to these branches of  
Engineering.

→ — SUBSCRIPTION, ONE DOLLAR PER ANNUM IN ADVANCE. — ←

The Engineers' Co.,

9 Lakeside Building, Chicago, Ill.

## REFERENCES.

Mitchell, W. H., residence.  
Multnomah County Court House.  
St. Mary's Academy.  
The John Barrett Co.  
Wallace, L. W., residence.  
Wilson, John, residence.

### OHIO.

#### AKRON.

Bowers, W. H.  
Brabes, O.  
Dodge & Plummer, office.  
Ginther, C. M. & Bro.  
Helpe, Henry, residence.  
Knight, Prof. R. S., residence.  
McNeil, J. C. & Co.  
Morgan, D. F.  
O'Neal & Dyus, block.  
Rankin, G. T., residence.  
Robb, John.

#### ASHTABULA.

Ashtabula Carriage Bow Co., factory.  
Ashtabula Gas Co., office.  
Crosby, J. B., & Sons.  
Hall, H. H., block.  
Hall, P. E., store.

#### ATHENS.

Patgison, D. P.  
Whitman, B. F.

#### ATTICA.

Sutton, Lester, bank.

#### AVERY.

Stoakes, J. W.

#### AVONDALE.

Dana, S. F.  
Granible, D. B., residence.  
Hillis, S. E., residence.  
Voorhies, A. B., residence.

#### BOWLING GREEN.

The American Foundry & Machine Co.

#### BROOKLYN VILLAGE.

Fish, D. B.

#### BOEYRIES.

County Infirmary.

#### CANTON.

Canton Mfg. Co.  
Conatton Railroad Depot.  
General City offices.  
Gibbs, Lewis, residence.  
Harting, L.  
McGregor, John.  
Oby & Co.

#### CARROLLTON.

Ensign, F. E.  
Stockon, V. E.

#### CAYAHOGA FALLS.

Babcock, E. L., residence.  
Falls Rivet & Machine Co., office.  
Kittleberger, C., residence.  
Stamburgh, H. J., residence.

#### CINCINNATI.

Aylard, N. K.  
Batterman Bros.  
Bissett, Robert.  
Burkhardt, A. E. & Co.  
Burkhold & Co.  
Chamber of Commerce Building.  
Clark & Hawley.  
Cleveland Varnish Co., office.  
Cincinnati Lead, Pipe & Sheet Lead Works.  
Crane, H. D.  
First National Bank.  
Frisbie, John L.  
Hinckle, Howard, residence.  
Howe, A. F., residence.  
Jewish Home for Aged and Infirm.  
Kirchner, Frank, residence.  
Keichling, J.  
Kirkup, Wm., & Sons.  
Laidlaw & Dunn Co.  
Mably & Carew, store.  
Maesbrink Building.  
Merchants National Bank.  
Merrie, Verhage & Co.  
Nickles, Dr. Samuel.  
Ohio Hospital.  
Perrin Estate Building.  
Reed, E. S., residence.  
Reed, L. A., residence.  
Rugg, G. W., residence.  
Sargent, J. W., block.  
Schlmmmer, Oliver.  
Smith Building.  
Standard Marble Works.  
Stearns & FASTER, office.  
The Strobridge Lithographing Co.  
Third National Bank.  
Thomas, M.

#### CHICAGO JUNCTION.

Balto. & Ohio R. R. Depot.

#### CLEVELAND.

Auschultz, C. R.  
Bethlehem Day Nursery.  
Botsford Car Heating Co.  
City Hospital.  
Clausen Building.  
Cleveland Steam Fitting Company.  
Hay, Col. John.  
Hawrea, M. A., residence.  
Howe, A. F.  
Jones, E. H. & Co.  
Levy, Isaac, residence.  
Levy, J., residence.  
Macbeth & Co.  
Mark's Ante Car Coupler Co.  
McIntosh, Good & Huntington.  
Morgan Steam Heating Co.  
New Medical College Building.  
Ohio Gas Heater and Dryer Co.  
Rouse & Halls Co.  
Stillman Building.

The W. Bingham Company.  
Worswick Mfg. Co.

#### CLIFTON.

Convent of the Sacred Heart.  
McDonald Alex., residence.  
Vass, J. H.

#### COLLEGE HILL.

Guno, John A., residence.

#### COLUMBIA.

Brown, John W.  
Burns, Straaton & Co.  
Columbia Rubber Co.  
Columbia Supply Co.  
Dennison, Mrs. Anna.  
Etown, Mrs. D. D. S.  
Fay, F. W.  
Haydon, P., Saddlery Hardware Co.  
Kelly, D. N.  
Kelly & Co.  
Knauss, Thomas E., residence.  
Knoderer, J. L. F.  
Neskie, Thos. & Co.  
Neil, S.  
Sacred Heart Church.  
Schwartz, A., Plumbing Co.

#### COLUMBUS.

Balston, A. L.  
Columbus Insane Asylum.  
Columbus Brass & Steam Pipe Works.  
Deaf & Dumb Asylum.  
Hayden, Chas., residence.  
Hayden, Wm. B., residence.  
Hutchinson, S. G.  
Idiotic Asylum.

#### DAYTON.

Antrim, J. S., residence.  
Barney, E., store.  
Beckel House.  
Brooks & Kemper.  
Brooks & Son.  
Calahan, W. P., residence.  
Fauves & Congdon.  
Fourth National Bank.  
Friends, Howard, residence.  
Gibbons, M. F.  
Kramer, Wm., greenhouse and residence.  
Malthy, C., residence.  
McCormac, F. J. & Co.  
Mead, Col. D. E., residence.  
Meceches, F., residence.  
Montgomery County Court House.  
O'Meir's, M. Sons.  
Phillips House.  
Post Office building.  
Reynolds & Reynolds.  
Spinning, D. C., residence.  
Stimson, E. A. & Co.  
Stoddard Mfg. Co.  
Stomps, G. & Co.  
Teutonia Insurance Co.  
Trinity Church.  
Ware & Moodie.

HAVE YOU EVER  
Seen **SQUARE** Turned

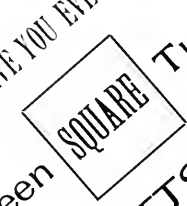

Correspondence  
Solicited

**BALUSTERS?**

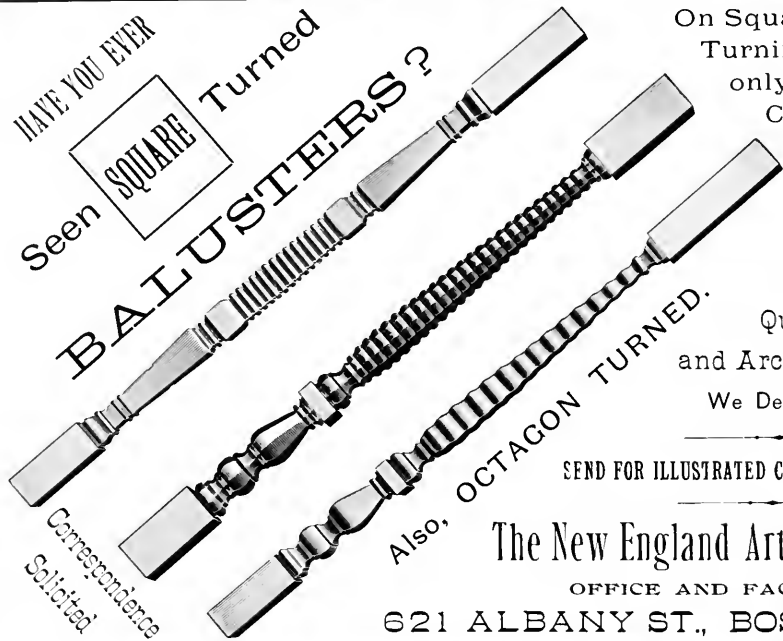

Also, **OCTAGON TURNED.**

On Square and Octagon  
Turning, we are the  
only Concern in the  
Country produc-  
ing this Artistic  
Work.

On Round Turning

FOR

Quality of Work  
and Architectural Design.  
We Defy **COMPETITION.**

SEND FOR ILLUSTRATED CATALOGUE AND PRICE LIST.

**The New England Artistic Carving Co.**

OFFICE AND FACTORY:

**621 ALBANY ST., BOSTON, MASS.**

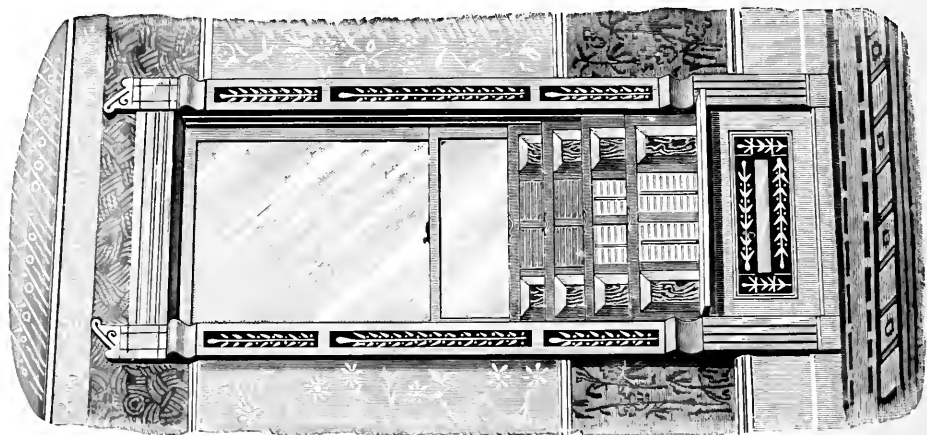

**ELEVEN REASONS WHY THE HARTMAN PATENT SLIDING BLINDS Are Preferred to All Others.**

1. There is no other blind with a burglar-proof lock attached to each set, free of charge.
2. There is no other that is furnished with a fine and complete set of patented hardware.
3. There is no other with pockets and cover.
4. There is no other with patented supporting strips.
5. There is no other with guideway set back on sub-jamb from the front or outer surface of the jambs so that the sashes can be renewed without removing the guideways.
6. There is no other with tenanted overlapping stationary slats forming a perfect imitation of rolling slats.
7. There is no other with combination of panels and stationary slats.
8. There is no other with combination of stationary slats and rolling slats.
9. There is no other with "Novelty" sections. (Patented.)
10. There is no other so durable and so well made for the money.
11. There is no other blind so popular, and that gives such universal satisfaction.

The item of "Burglar-proof Lock" alone may be worth to the purchaser in these times of house robbing, many times the cost of the Blinds, and perhaps save life also. **STATE PATENT RIGHTS FOR SALE. AGENTS WANTED EVERYWHERE.** Send for Illustrated Catalogue and Prices to

**HARTMAN & DURSTINE, 30 Beaver Street, WOOSTER, O.**



## REFERENCES.

**EAST LIVERPOOL.**  
Bursher, John M.

**ELYRIA.**  
Armstrong, Thos. J.  
Reefy, F. S.

**FINDLAY.**  
School Building.  
**FORRESTVILLE.**  
King, Phillip.

**FOSTORIA.**  
Foster's, Sec., Block.

**FREMONT.**  
Johnson, J. C.

**GALION.**  
Riblet, S. E. & Bro.  
Sponhauser & Gill.

**GIRARD.**  
Scheible, L. E.

**GRANVILLE.**  
Kerr, Mrs. W. P., residence.

**HAMILTON.**  
Deumer, Chas., residence.  
Deumer, Chas. & Co.  
Gilchrist, V.  
Henn, John P.  
Schneider, Joseph, residence.  
The Fisher Ice Tool Co.  
Zschan, A. E.

**IRONTON.**  
Children's Home.

**JACKSON.**  
U. S. Wire Nail Co.

**LIMA.**  
Allen County Court House.  
Allen County Jail.

Allen County Infirmary,  
Porter, W. L., residence.  
Baxter, A. C.  
Baxter & Co.,

**LOUISVILLE.**  
Bauman Bros.

**MASSILLON.**  
Knapp & Dillon.  
Sailer, Peter.

**MIAMISBURGH.**  
Brookwater, D.

**MIDDLETOWN.**  
Thomas, J. K.

**MT. VERNON.**  
Cooper, C. & G., & Co.  
Fairchild, F. L., residence.  
Gilmore, W. H.  
Union School Building.

**NEWARK.**

Bailey, J. S., residence.  
Baker, M. Q., residence.  
Black, D. M., residence.  
Black, Dr. J. R., residence.  
Burner, J. V.  
Burner, H. R., M. B.  
Davis, W. H., residence.  
Franklin, B., residence.

Johnson, J.  
Jones, William.  
Kibler, Chas. H., residence.  
McNamar, J. H., residence.  
Miller, A., residence.  
Miller, William, residence.  
Moore, Moses B.,  
Newark Water Works, office.  
Peoples' National Bank.  
Sook, O. P., M.[D.], office.  
Speer, A. T., M. D.  
Strong, Henry C., residence.  
Thomas, James E., residence.  
Tucker, John.  
Tucker & Sayre.  
Van Atta, Geo.  
Winegarner, D. C., residence.

**NEW LISBON.**  
Armstrong, P.  
Nichols, Wm. A.

**NILES.**  
Anderson, J. A.  
Winfield, W. C.

**NORWALK.**  
Dunnison, Thomas.  
Owen, Henry, Jr.  
Parker, John.

**OBERLIN.**  
Decker, J. H.  
Hurlburt, H. L.  
Jump, R. E.  
Oberlin Gas Light Co.  
Spear, Rev. C. B.

**PAINESVILLE.**  
Joughlin, John.  
Wetherbee, E. G.

**PORTSMOUTH.**  
Portsmouth Foundry & Machine Works.  
Portsmouth National Bank.

**RAVENNA.**  
Portage County Court House.

**SANDUSKY.**  
Krantz, F.  
Engles & Krudwig.  
Sandusky Infirmary.

**SOUTH POINT.**  
Davidson, Mrs. Capt. David, residence.

**SPRINGFIELD.**

Arcade Hotel.  
City Hospital.  
City Market.  
Desormoux, F. & Son.  
Willis R. P. & Son.

**STUEBENVILLE.**  
City Hall.  
Opera House.  
The Steubenville Gas & Electric Co.

**THORNVILLE.**  
Yost, J.  
Baxter & Brown.  
Methodist Episcopal Church.

School Building.  
Shawhan House.

**TOLEDO.**  
Darst, H. M.  
Foster, S. Z., residence.  
Milburn, C. F., residence.  
Shaw, Kendall & Co.  
Thomas, G. W.

**UNION STATION.**  
Moore, Moses B.

**URBANA.**  
Weaver, Geo. A.

**WALNUT HILLS.**  
Koester, C. F., residence.  
Wessell, Honces, residence.

**WARREN.**  
Kirk, Christy, & Co.  
Lyman, Dr. A. E., residence.  
Pendleton, W. C.  
Scholl, Semple & Co.  
Stiles, Wm. R.

**WAUSCON.**  
Brigham H., residence.  
Brigham & Lyons.  
Bryant & Harris.

Eages, Henry, residence.  
Fisher & Harris.  
Harris, W. S., residence.  
Howe Bros, office.  
Hubbell, W. F., residence.  
Terrell, Dr., office and residence.  
Williams, Walter, residence.

**WEST CLEVELAND.**  
Auschnetz, C. R.

**WOOSTER.**  
Aglesworth, Mrs. Warren, residence.

Boyd, S. H., residence.  
Foss, W. D., residence.  
McClure & Craighead.  
Miller, D. D., & Co.  
Miller, F. W.  
Overholt, J. S. R., residence.  
Tieche, J. C., residence.  
Winster, F. S.  
Winster, J. F.

**WYOMING.**

Blair, J. M.  
Fox, John. W.  
**YOUNGSTOWN.**  
Helen Memoria! Chapel.

**ZANESVILLE.**  
American Encaustic Tiling Company.  
Bailey, Willis, residence.  
Clarendon Hotel.

Gibbons, Geo. residence.  
Griffith, Thos. residence.  
Hoge, John. residence.  
Leroy & Stemm, store.  
Lindsay, H. C.  
Newkirk, Wm. S.  
New Passenger Depot B. & O. Rail Road.  
Pinkerton, J. W., store.  
Roeckel, A.

# JEWETT'S Automatic Damper Regulator FOR HOT WATER HEATER.

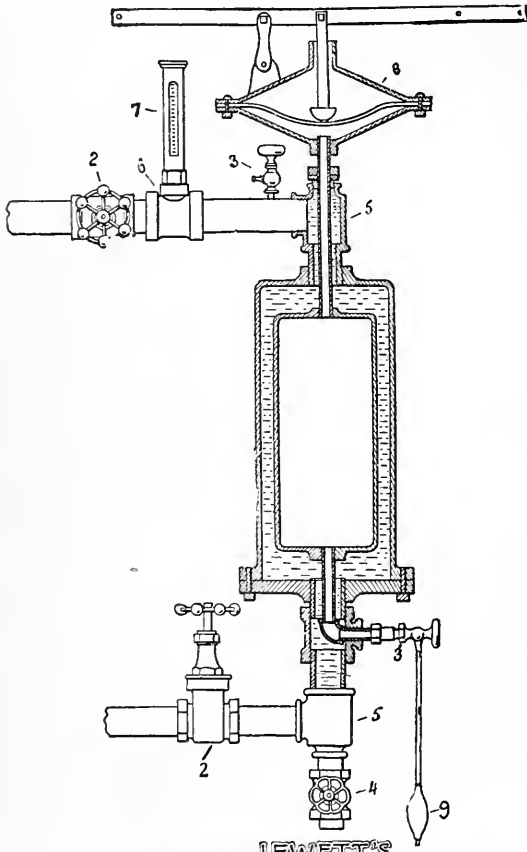

JEWETT'S  
AUTOMATIC DAMPER REGULATOR  
FOR HOT WATER HEATER



This device has proven itself perfect and positive in its operation.

It is easily controlled; quickly changed for a higher or lower temperature.

It will maintain a uniform temperature for any length of time.

It is simple in construction; never gets out of order; can be attached to any hot water boiler.

Many manufacturers have accepted it and ship one with every boiler.

In all cases it has proven itself a profitable investment.

It has been thoroughly tested and is no experiment.

Full particulars furnished on application.



MANUFACTURED BY

## CHARLES G. JEWETT, HOWELL, MICHIGAN.



## REFERENCES.

Stansburg, Geo.  
Stevens, Wheeler, residence.  
Townsend, W. C., residence.

### PENNSYLVANIA.

**ABINGTON.**  
Diller, W. R.

**ALLENTOWN.**  
Addis, James H.  
Albright, Son & Co.  
Allen House.  
Allentown Steam Heat & Power Co.  
Allentown Spinning Co., office.  
Birchall & Parton.  
Earl, E. M.  
Earle & Graffin.

Evens, Seagreaves & Co.  
Grossman, W. & Co., factory.  
Johnston & Swartz, factory.  
Lehigh Iron Company.  
Leiberman, Joseph, office.  
Lentz, John E., office.  
Lindenmaith, A. L.

Mosser, W. F.  
Sacred Heart, church, school and residence.  
Seagreaves, Geo. W., store.  
Seagreaves, Miles F., residence.  
Second National Bank.  
Shafer & Willenbacker.  
Taylor, W. H. & Co.  
Trexler & Hartzell.  
Uylie, D.  
Wolf, A. N. & Co.

**ALTOONA.**  
Akers, A. E.  
Blanchard, W. E., residence.  
Bloomenthal, Joel.  
Cannon, M. H.  
Cauley, H. M.  
Delane, P. J.  
Dern, H. C., residence.  
Elder, R. T.  
Fay, John, M.D.  
Harris, W. H.  
Mateer, J. Ross.  
McCauley, J. H., residence.  
McLanahan & Stone.  
Mechanics' Library.  
Mervine, N. P.

Mountain City Theatre.  
O'Reilly, Rev. N. J.  
P. R. R. Depot.  
St. John's School.  
St. Luke's Episcopal Church.  
Stone, Geo. R.  
Stranton, G. W.  
Wolf, A. R., & Co.  
Wylie, Charles.  
Wylie, David.

**AMBLER.**  
Buchanan, Joseph, store.  
Keasby & Mattison, chemical works.  
The Magnesia Sectional Covering Co.

**ASHLAND.**  
Beech, Peter E.,  
Biddle, I. C.  
Citizens' National Bank Building.  
First Ward School House.  
Marr, W. A.  
McConnell & Bro.  
Miners' Hospital.  
Phillips, D. D., residence.  
Salada, John.  
St. Joseph's Catholic Parsonage.  
State Hospital.

**ATHENS.**  
Stimpson House.

**ATLANTIC CITY.**  
Chalfonte House.  
Develin, C. A. & Co.  
English, Matthew, hotel.  
Roberts, E. & Son.

**AUDENBECK.**  
Hollenbeck, J. J.

**AUDENREID.**  
Bullock, E. L., residence.  
Dodson, C. M. & Co.  
Hollenbeck, J. S.  
Lehigh & Wilkes-Barre Coal Co.  
Presbyterian Church.  
Stout, F. S., residence.

**BANGOR.**  
Buzzards, Dr. J., residence.  
Ditchett, Thos., residence.  
First National Bank.  
Flory, S. & Co.  
High School.  
Honck, J. Frank.  
Hyatt Schove Slate Factory.  
Jackson, Richard, residence.  
Long, J. E., residence.  
Oberholzer, A. A.  
Opera House.  
Opera House Drug Store.  
Paffs, A. M., residence.  
Snyder & Hawley.  
Snyder & Houck.  
St. John's Reformed Church.  
St. John's Reformed Church Parsonage.  
Wolf, John, residence.

**BARNESTON.**  
Isabella Furnace and Offices.

**BARTO.**  
Shultz, Mrs. Mary A. M., residence.

**BATTLE CREEK.**  
Bock & Adams.

**BEAVER BROOK.**  
Bullock, E. L.

**BEAVERSTOWN.**  
Specht, A. B.

**BEDFORD.**  
Daniels, Dr. A. C., residence.  
Emory, L. Jr. & Co.

Hawkins, Geo. C.  
Lutz, John.

**BELLEFONTE.**  
Arcade Building.  
Barnard, Prof. L. H.  
Beaver, ex-Gov. Jas. H., residence.  
B. E. V. R. R. Station.  
Brokenhoff House.  
Bush, Mrs. G. D., residence.  
Bush House.  
Center Banking Co.  
Crides, P. B. & Son.  
Crides, F. W., residence.  
First National Bank.  
Free Masons.  
Furst, Hon. A. O., residence.  
Gannon, D. & Sons.  
Garman Hotel.  
Hale, Dr., residence.  
Hastings, Gen. D. H.  
Humes, E. C., residence.  
Jenkins & Lingel.  
Logan Machine Works.  
Mann, J. F. & Co., office.  
Olds, F. L.  
Orvis, Hon. J. H., residence.  
P. R. R. Station.  
Reynolds, W. & Co., stores.  
Rhoads, Hon. Daniel, residence.  
Schad, R. J.  
State College.

Valentine, Robert, residence.  
**BELLWOOD.**  
Ghen, T. A.

**BENNETT STATION.**  
Thomas, Dr. A. D.

**BENEVEW FARM.**  
Derr, Thompson.

**BENEZET.**  
Gilbert, S. H.

**BERKS COUNTY.**  
DeLong, E.

**BERLIN.**  
Floto, A. C.  
Kressinger, C. A. M.  
Lutheran Church.  
Reitz, D. G. & Son.

**BERWICK.**  
Evans, C. C.  
Fairchilds, Jno. M., hotel.  
The Jackson & Woodin Mfg. Co.

**BERWYN.**  
Cleaver, I. A.  
Leamy, N. P.  
Neyo, P. J.  
Oteham, J.

**BETHLEHEM.**  
Bethlehem Iron Company.  
" Silk Mill.  
Brinker, A., residence.  
Church of the Holy Infancy.

HEATED BY  
 NO. 9  
 BOLTON HEATER  
 LIGHTED BY  
 100 LIGHT  
 COMBINATION  
 GAS  
 MACHINE.



RESIDENCE OF DR. GEO. L. MILLER, "SEYMOUR PARK," OMAHA, NEB.

OMAHA, NEB.,  
 Jan 17, 1890.

GENTLEMEN:

My heating and lighting continue to be the joy of my new house, and I cannot tell you how I appreciate the unquestionable economy and perfection of both.

Most truly yours,  
 GEO. L. MILLER.

## BOLTON HOT WATER HEATER.

JEREMIAH DWYER, President Michigan Store Co., writes:  
 DETROIT, MICH., April 22, 1890.

GENTLEMEN:—It was only after considerable thought by my associates and self that we concluded hot water was the best artificial heat. Your BOLTON Hot Water Heater I consider A 1, and your system of circulation and workmanship is well done and every way satisfactory to myself and family, and I take great pleasure in making this statement. Yours respectfully.

Send for Illustrated Book,  
**"WARMTH FOR WINTER HOMES."**

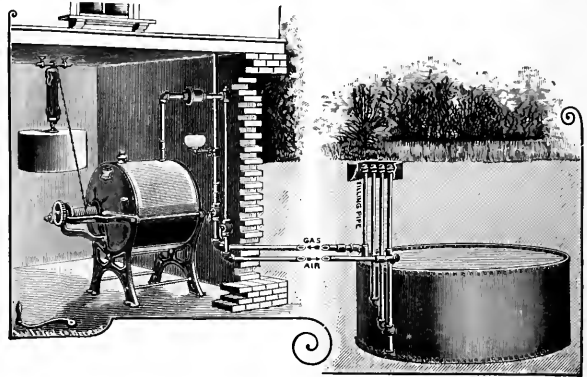
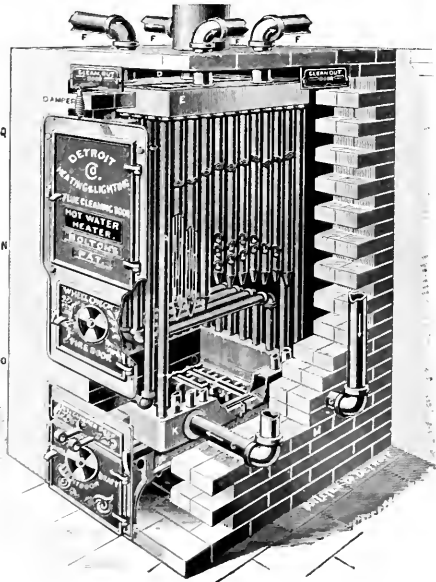

## COMBINATION GAS MACHINE.

P. JOHNSON, Merchant, Anna, Illinois, writes:  
 February 8, 1890.

"Have used your Gas Machine ten years. It gives better light than the incandescent electric light, at one-quarter cost."

Send for Illustrated Book,  
**"LIGHT FOR EVENING HOURS."**

## Detroit Heating and Lighting Co.

470 WIGHT ST., DETROIT, MICH.

CHICAGO, 88 LAKE ST.

BOSTON, 42 PEARL ST.

ST. LOUIS, 508 N. FOURTH ST.

NEW ORLEANS, 182 GRAVIER ST.

## REFERENCES.

Cox, Mrs. Mary E., residence.  
 Dodson, T. N., residence.  
 Fetter, M. C., hotel.  
 General Office L. V. R. R. Co.  
 Jetter, Tinsley.  
 Johnston, Joseph, residence.  
 Laufer, Edwin.  
 Lehigh University.  
 L. V. R. R. Cos' Office.  
     "    "    Laboratory.  
     "    "    Car House.  
 McKee & Milson.  
 Milson, Thos. H., residence.  
 Myers, Richard, residence.  
 Naylor, Mary A., residence.  
 Newman, J., residence.  
 Pacific House.  
 Post Office.  
 Rauch, John, store.  
 Rice, Thos. J.  
 Rice, J. J.  
 Sayre, Robt. H., General Manager, L.V.R.R.  
 Society House.  
 Sloyer, David, residence.  
 Stahr, Geo. F., residence.  
 St. Luke's Episcopal Hospital.  
 Wilbur C. O.  
 Wollé, S. O.  
 Worsly, C., residence.

**BGN. MAUL**

Bevan Bros.

**BIRDSBORO.**

Brooke, E. & G. Iron Co., office.  
 March, F. J., residence.

**BLACKLICK.**

Blacklick Mnfg. Co., store.  
 Weldren, E. H., residence.

**BLACK WALNUT.**

Stroud, Jacob.

**BLAIRSVILLE.**

Blairsville Female Seminary.  
 Harvey, Jno., store.  
 Kirtland, A. P.  
 Pennsylvania Railroad Depot.

**BLOOMSBURG.**

Barton, Caleb, residence.  
 Billmeyer, F. P., residence.  
 Bloomsburg Steam & Electric Light Co.  
 Brower, E. B.  
 Campbell, Chas.  
 Clark, H. J., residence.  
 Columbia County Court House.  
 Court House.  
 Creasy, C. A., residence.  
 Creasy, D. A., residence and store.  
 Deutlar, Frank.  
 Eshleman & Wolf.  
 Eut, Mrs. M. E., store and office.  
 Eyer, Wesley.  
 Fetterman, J.  
 First National Bank.  
 Hartman & Edgar.

Herring, Grant S., residence.  
 Ikler, E. R., residence.  
 Kane, Col.  
 Knapp, C. F.  
 Lockard, John E., store and offices.  
 Moyer Bros.  
 Moyer, L. N., residence.  
 Moyer, W. L., residence.  
 Neal, R. C., residence.  
 Neal, Wm., residence.  
 Paul, E., office.  
 Peacock, C. C., residence.  
 Reber, Dr. W. M., residence.  
 Reeber, Dr. J.  
 Robbins, C. B., residence.  
 Robbins, Geo. S., residence.  
 Runyan, Layton.  
 Sairts, B. F.  
 Schoch, A. Z., residence.  
 Sharpless, Lloyd, store.  
 Stoa, Miss Sarah, residence.  
 St. Paul's Episcopal Parsonage.  
 The Rest Cure.  
 Waller, David J., Jr., residence.  
 Waller, David J., Sr., residence.  
 Willetts, Dr. J.  
 Wintersteen, L. S., residence.  
 Wirt, S. E.  
 Wonterskein, L.

**BOSTON.**

Shultz, Miss Mary A.

**BOWERS STATION.**

DeLong, E., residence.  
 Schweger, D. H., residence.

**BOYERSTOWN.**

Aaron, C. F., store.  
 Brauss, P. A. & Co., store.  
 Brumbach, V. C., store and residence.  
 Farmers' National Bank.  
 Freed, S. C., residence.  
 Geiger, J. D. F., store.  
 Graver, Dr. J. D., residence.  
 Latsbaw, B. Irwin, residence.  
 Latshaw, S. B., hall.  
 Latshaw, S. B., residence.  
 Moarys, M. A., residence.  
 Nix, J. J., residence.  
 Scheegel, Daniel.

**BRADFORD.**

Bradford Electric Light and Power Co.  
 Emery, L. J. & Co.  
 Masonic Temple.  
 Miloin, T. J., residence.  
 Producers' Oil Exchange.

**BRADDOCK.**

Dowler, E. R.

**BRIDESBURG.**

Laboratory, E. & G. Brooks Iron Co.  
 Lyford, Major L. C., residence.

**BRIDGEPORT.**

Newton, I.

**BRISTOL.**

Grundy, Wm. H. & Co.  
 St. Mary's Church.  
 Wilson & Fennimore, offices.

**BROCKWAYSVILLE.**

Cartwright, B. E., store.

**BUTLER**

Bunter & Hoff.

**CANTON.**

Inness, C. A., residence.  
 Inness, J. K., residence.

**CARBONDALE.**

Crane, I.  
 Parry, Thos. W.

**CARLISLE.**

Carlisle Mfg. Co.  
 Henninger, Dr. George, residence.

**CARMICHAELS.**

Gibbons, Dr. A. J.

**CARROLLTOWN.**

St. Benedict Church.

**CARWENSVILLE.**

Patton, A. E., residence.

**CATASAUQUA.**

Catasauqua Mfg. Company's Office.  
 Holly Wee Coffee House.  
 Hunt, Joseph, residence.  
 Milson, Daniel, residence.  
 Pioneer Mining and Manufacturing Co.  
 Thomas, Edwin.  
 Thomas, Samuel, residence.  
 Williams, J., residence.  
 Wilson, Samuel.

**CATAWISSA.**

Schwick, Charles.

**CENTRALIA.**

Catholic Church.  
 Church of St. Ignatius.  
 Pastoral residence of St. Ignatius Church.  
 Russell, Rev. J., residence.  
 Troutman, Geo.

**CHAMBERSBURG.**

County Jail.  
 Cumberland Valley R. R.  
 Eyster, W. H.,  
 Franklin County Court House.  
 Gehr, Hon. H., residence.  
 Gilbert, Daniel.  
 Gilbert, H. S. & Co.  
 Hastings, G.,  
 Haycock, Dr. A. B.  
 Hill & Crawford.  
 Ives, Major Chauncey.  
 Kennedy, T. B.  
 McGrath, A. C.  
 McKinley, W. H., hotel.  
 Miller, J. B.  
 Monath, Sam'l.  
 Nixon, Jacob S.,  
 Rinick, Jacob.

1. 2. 3. 4. 5. 6. 7. 8. 9. 10. 11. 12. 13. 14. 15. 16. 17. 18. 19. 20. 21. 22. 23. 24. 25. 26. 27. 28. 29. 30. 31. 32. 33. 34. 35. 36. 37. 38. 39. 40. 41. 42. 43. 44. 45. 46. 47. 48. 49. 50. 51. 52. 53. 54. 55. 56. 57. 58. 59. 60. 61. 62. 63. 64. 65. 66. 67. 68. 69. 70. 71. 72. 73. 74. 75. 76. 77. 78. 79. 80. 81. 82. 83. 84. 85. 86. 87. 88. 89. 90. 91. 92. 93. 94. 95. 96. 97. 98. 99. 100.

[TRANSLATION.]

To  
 The A.A. Griffing Iron Co  
 Jersey City, N.J. U.S.A.  
 Dear Sirs;



The Tokyo Ei Wa  
 Gakko (Tokyo Anglo-Japanese College) had  
 recently placed the Bundy radiator  
 in one of its buildings (Goucher Hall)  
 and it is with pleasure that we  
 speak of its great merit as a heater.

We believe it to be just the thing  
 for heating large buildings in North  
 ern Japan. The simplicity of its structure  
 we should recommend it to be used  
 in this country.

Yours Very Truly,  
 J. C. Spencer  
 President

## REFERENCES.

Rosedale Opera House.  
 Shank, W. H., hotel.  
 Taylor Mfg. Company.  
 Washington House.  
 Wilson Female College.  
 Wolf, A. & Co., mill.

### CHESTER.

Arasapha Mfg. Co., office.  
 Baker, J. F.  
 Bickley, W. H., store.  
 Blakeley Co.  
 Burke, W. Scott.  
 Chester Foundry and Machine Co., office.  
 Chester Electric Light and Power Co.  
 Chester Pipe Tube Co.  
 Chester Bank and Saving Fund.  
 Clayton, T. J.

Crowther, S., residence.  
 Delaware County National Bank.  
 Eureka Steel Works.  
 Gartsede, J. P. & Son.  
 Gartside & Turner.  
 Hatton, M. S., residence.  
 Hetzel, G. E. & Co.  
 Hotel Cambridge.  
 Lincoln Mfg. Co.  
 Mather, William.  
 McMann W. S., residence.  
 Palmer, Rees, residence.  
 Rawlins, J. H., residence.  
 Shaw, Esvey & Co.  
 Shaw, Hugh.  
 Smith, Mrs. Geo.  
 Stewart, James F.  
 Turner, S. C., office and shop.  
 Wetheril, Robert, & Co., office and drawing room.

### CHICKIES.

Penna. Railroad Depot.

### CHRISTIAN.

Pownall, J. D. C.

### CLARION.

Arnold's M., building.

### CLARK'S SUMMIT.

Seranton Poor District.

### CLEARFIELD.

County Jail.  
 Johnson, Fred & Bro.

### CLENOLDEN.

Urian, Wm.

### COATESVILLE.

Harlans, Hon. A. W., residence.  
 Horton, A. F.  
 Sotter, George & Co.  
 Speakman, J.  
 Stevens House.

### COLLEGEVILLE.

Landers, Jos. C.  
 Williard, P.  
 Yost, Geo. W.

### COLUMBIA.

Craig, Dr. A., residence.  
 Emons, Chas.  
 Heise, H. H., residence.  
 Markels, C. F.  
 Neckel & Paine.  
 Patton, Wm. F.  
 P. R. R. Depot.  
 R. & C. Railroad Depot.  
 Rothschild, Jacob, store.  
 Tremont House.  
 Warren Jno., store.  
 Wilson Hiram.  
 Yergey, H. F., store.

### CONNEAUTVILLE.

Warmald, Robert, residence.  
 Warmald, Mrs. J., residence.

### CONNELLVILLE.

Balsley, J. R., residence.  
 Lytle & Soisson.  
 Munson Bros.  
 Munson, George A.  
 Munson, John C.  
 Youghioghny Bank.

### CONFLUENCE.

Kurtz, Henry.

### CONSHOHOCKEN.

Bate, R. H., residence.  
 Bates, William, & Son.  
 Cleaves, J.  
 First National Bank.

### COOPERSBURG.

Cooper, T. S.

### COPLAY.

American Improved Cement Co.

### CORNWALL.

Coleman, Miss S. H.  
 Cornwall Iron Co.  
 Cornwall Ore Bank.  
 Cornwall Railroad Co.  
 Del. River Iron Ship Build'g & Engine Room.  
 Freeman, W. C.

### CORY.

Barlow, Brigham & Follert.  
 Blair, Dr. H. W.  
 Harmon, Gibbs & Co.  
 St. Thomas' Church.

### CRESSON.

St. Frances' College.

### DAMASCUS.

Irvine, Mrs. Alexander.  
 Variety Wood Working Co.

### DANVILLE.

Angle, F. C.  
 Boyd, D. M.  
 Gerwiger, John K., hotel.  
 Kearns, Henry.  
 Monton House.  
 Opera House.  
 Riche, James.  
 Scofield, J. E. & Co.  
 State Hospital for Insane.

Thos. Beowes Free Library.

Wetzel, C. S.  
 Wetzel, E. W.  
 Wilmer & Cole.

### DAWNINGTOWN.

Dawning, Chas. A., residence.  
 High School Building.  
 Methodist Church.  
 Morgan, Wm., store and residence.  
 Sides, H. B., store.

### DE LANCEY.

Clunde, Adrian.

### DICKSON CITY.

Moosic Coal Co.

### DOUGLASSVILLE.

Gorrell, Mrs. Robert, residence.

### DOWNINGTON.

Gordon, Jas. R.

### DOYLESTOWN.

Kane & Rufe.

### DU BOIS.

Boyles, B. W.  
 Commercial Hotel.  
 Dale, J. E.  
 DuBois, J. E.  
 Fowler, C. R.  
 Hebner, Hallester & Co.  
 Horner, J.  
 Krearr, H. S.  
 Loeb, H.  
 Mac Nun, H. S.  
 National Hotel.  
 Nettleton, E. B.  
 Pettigrew, Dr. S. H.  
 Vosburg, E. F.  
 Vosburg, G. R.

### DUNCANNON.

Richter, W. H.

### DUSHORE.

Convent.  
 Denslow, W. H. & Co.  
 Jackson, Mrs. B. W.  
 Jackson, Geo. C.  
 St. Basil's Church.  
 Thomson, R. J.

### EAST FALLS.

Bew, James H.

### EAST GREENVILLE.

Krauss Bros.  
 Perkimes National Bank.  
 Robb, Dr. H.

### EAST MAUCH CHUNK.

Pollock, J.  
 Sharp, Miss.

### EAST STROUDSBURG.

East Stroudsburg National Bank.  
 Saunders & Wetzel.  
 Stauffers, Geo. E.

### EASTON.

Andrews & Nolf.  
 Brown, John, estate.  
 Brown, John, residence.



GILLIS & GEOGHEGAN,  
STEAM HEATING APPARATUS,  
116, 118, 120 and 122 Wooster Street,  
NEW YORK.

May 6<sup>th</sup> 1886.

A. A. Griffing Iron Co.  
Gentlemen:

We have used several hundred thousand Bundy tubes from the time of their first introduction on the market, and have always found that they gave entire satisfaction to our customers.

Besides the numerous Churches, Apartments, Private Houses etc. which we have supplied with Bundy Radiators, we have furnished them for many of the large Office Buildings in this city, of which the new Potter Building, Park Row, Beekman and Nassau Sts is the latest example.

Very truly Yours

Gillis & Geoghegan.

## REFERENCES

Court House, Hotel.  
 C. R. R. Co., new depot.  
 Daub, Wm. H., factory.  
 Downs, J. S., residence.  
 Drakes, Jno., Sons & Co.  
 Evans, P. C.  
 Gebhardt, C.  
 Geiser, Geo. W.  
 Glendon Iron Co.  
 Griffiths, Wm., residence.  
 Ivey, Mrs. E., residence.  
 Keller, Wm. H., store.  
 Kelly, W. L.  
 Kinsey, W. P., residence.  
 Lawall, Walter, residence.  
 Leitz, Charles.  
 Masonic Temple.  
 Messinger, S. S., Son.  
 Moore, J. M.  
 Morrison, C., residence.  
 Northampton County Court House.  
 Northampton County Prison.  
 Norton, H. M.  
 Osterstock, Joseph S.  
 Pardee Hall.  
 Pascoe, W. F.  
 Peacock, R., & Son.  
 Pomfert Building.  
 Porter's Block.  
 Raub Jacob.  
 Rinck, Henry.  
 Steckel, Henry, residence.  
 Stout, John V., residence.  
 Taub, W. H.  
 Temple of Music.  
 Thompson, William, residence.  
 Trumboro, Samuel.  
 Uhler, Dr., store and house.  
 William Hackett Estate.  
 Wilson Bros.

**EDINBOROUGH.**

State Normal School.

**EDDINGTON.**

St. John's Industrial School.

**ELIZABETHTOWN.**

Boggs & Dissinger.  
 Beech & Hersey.  
 Bush, A. & Sons.  
 Coble, E. E. store and residence.  
 Eaby, Simon A., residence.  
 Elizabethtown Exchange Bank.  
 Elizabethtown National Bank.  
 Farmers' Bank.  
 Heisey, A. G., residence.

**EMPORIUM.**

Sage, C. H. Jr.

**ENGLISH ECENTER.**

Davidge & Co.  
 Horton, C. S., residence.

**ERIE.**

Ashley & Vincent's Building.  
 Ball, Hon. G. J.

Brein, R. O., residence.  
 Butler, M.  
 Butler, W. J.  
 Carey & Campbell.  
 Casey, James, residence.  
 Downing, Hon. J. F., residence.  
 Downing, Hon. J. F., Ins. Building.  
 Dumgaris, Dr., residence,  
 Dunning, M. A.  
 Dunnigan, Dr. M. C., residence.  
 Erie County Court House.  
 Galbraith, Hon. W. A., residence.  
 Hall, L. H., residence.  
 High School.  
 Jarecki, Charles, residence.  
 Kochler, F. & Co.  
 MacIntosh, J. C., residence.  
 Masonic Building.  
 Mercer County Court House.  
 Mercer County Alms House.  
 Miller Bros.  
 O'Brien, R., residence.  
 Orphan Asylum.  
 Porsch Bros.  
 Reed, Hon. Chas. M., residence.  
 Reed Estate.  
 Reed House.  
 Scoet, W. L., residence.  
 Sims, Henry.  
 Strong, Chas. H., residence.  
 Taylor, M. H., residence.  
 Tracy, D. D., residence.  
 Talcott, Geo., residence.  
 Williams, R. T., & Co.

**ESCHBACH.**

Brunner, Dr. Frank, residence.  
 Harris, W. D.  
 Heins, W. D.  
 Schlegel, Daniel.

**EVENSBURGH.**

Alms House.

**FERNDALE.**

Catasauqua Manufacturing Co., offices.

**FLEMINGTON.**

Humphrey, L., residence.

**FLETWOOD.**

Schaeffer & Merkel & Co.

**FLORIN.**

Kriess, Dr. P. L.

**FOXBURGH.**

Foxburgh Hotel.

**FRAINERS.**

Frainer, D. & Sons.  
 Frainer, D.  
 Frainer, E. E.  
 Frainer, W. E.

**FRANKFORD.**

Conly, James.  
 Hart, Chas.  
 McFarland, Edwin.

**FRANKLIN.**

Bunce, J. H.  
 City Hall.

Clarke & Bunce.  
 Clarkson, R. S.  
 Eclipse Lubricating Oil Co.  
 Millers, Hon. Chas., residence.  
**FREEMANSBURGH.**  
 Knecht, John.

**GALESBURY.**

Frst Mfg Co.

**GARNVILLE CENTRE.**

Inness, J. A., residence.

**GARVEN.**

Spinner, M.

**GERMANTOWN.**

Ayers, Wm. M.  
 Cope, E., residence.  
 Eberlie, Chas. L., residence.  
 Gregg, Col. Wm.  
 Green, Stephen.  
 Haines, W. H.  
 Hendrickson, S. A.  
 Hinkle, David, residence.  
 King, J., residence.  
 Kinney & Garrett.  
 Longstreet, Samuel, residence.  
 Mauple, Nathan, residence and store.  
 McCann & Savage, office.  
 Miller, Geo., residence.  
 Paul, H. S.  
 Pilling, W. S.  
 Savage, Howard J., office.  
 Sharpless, W. S., residence.  
 Shore, Jas., & Co.  
 Woodcock, Thos., & Son.

**GETTYSBURG.**

Armor, R. D., & Son.  
 Diehl, Dr. Howard L.  
 Timmins, F. M.  
 Ulrich, L. L.

**GIRARDSVILLE.**

Beacey, Thomas, residence.  
 Eberle, Christian, store and post office.  
 Morrell, James, residence and store.  
 Parker, Wm. G.

**GLEN LYON.**

Susquehanna Coal Co., supply store.

**GLEN RIDDLE.**

Chapel Residence of Sisters of St. Frances.

**GONSHOKEN.**

Catholic Church.

**GREEN CASTLE.**

McLanahan, A. G.  
 Rahauer, J. P., & Bro.

**GREENSBURGH.**

Sloan, S. J.  
 Westmoreland County Alms House.

**GREENVILLE.**

Beatty, Wm., residence.  
 Blair, J. F., residence.  
 Chase, G. B., residence.  
 Fell's Hotel.  
 Maxwell, Wm., residence.  
 Packard, D. P.  
 Stone, Thos.

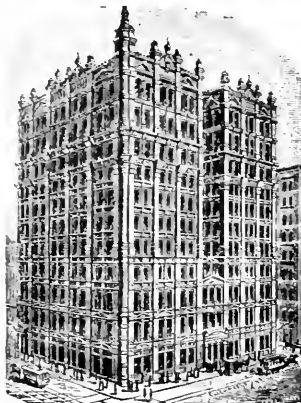

POTTER BUILDING, 38 PARK ROW.

O. B. POTTER,  
Potter Building, 38 Park Row.

New York, Jan. 5, 1887

A. A. Griffing Iron Co.,  
Jersey City, N. J.

Gentlemen:-

You are entitled to an expression of my opinion in reference to the merits of your radiators. I have been using radiators for many years in various buildings owned by me. More recently, I have used those manufactured by your Company; and have used them exclusively in the "Potter Building," 38 Park row.

Thus far, they have proved themselves equal to your recommendation of them, and I am confident they will continue to do so.

They were set with the greatest care by Messrs. Gillis & Geoghegan; and the efficient and equal distribution of heat throughout the building I have never seen equalled. They are entirely noiseless, easily managed, and accomplish everything to be desired in a steam radiator.

Very respectfully yours,





## REFERENCES.

**GROVER.**  
Inness, Daniel, residence.

**GULF MILLS.**  
Henderson & Supplee.  
MacFarland, Elbridge.  
McFarland, J. A.

**HAGERSTOWN.**  
C. V. R. R. Co., depot.

**HAMDON.**  
Lahr, F. A.

**HANOVER.**  
Bingley, J. J.  
Hostetter, E. H. & Bro., store.  
Keagy, Jas. G.  
Young, J. S. & Co.  
Young, J. S., office.  
Young, N. E., residence.  
Young, W.

**HARRISBURGH.**  
Alms House.  
Bergner, Chas. H.  
Bigler, Samuel, residence.  
Bochman, F. A.  
Bradley, P. P.  
Coover, Mrs. B. H.  
Hammersley & Co., offices.  
Harrisburgh Boiler and Mfg. Co.  
Harrisburgh National Bank.  
Harrisburgh Stove and Steam Heating Co.  
Harrisburgh Steam Heating and Power Co.  
Harrisburgh Telegram Building.  
Hazleton Depot.  
Hildrup, W. F.  
Holberts, H., residence.  
Kelker Bros.  
Lochiel Hotel.  
Marklays, Dr., drug store.  
Mayor's Office.  
Mitchell, E. B.  
Pennsylvania State Lunatic Asylum.  
Quickel, H. F.  
Roelech, Wm.  
Shoemakers, Jno. R., residence.  
Snyder, Edward, residence.  
State Capitol Building.  
St. Patrick's Cathedral.

**HATBORO.**  
Cope, Alfred.  
Hallowell, Wm.  
Monkley, Dr. A. W.

**HAWLEY.**  
Atkinson, Joseph, residence.  
Dexter, Lambert & Co., office.  
Hawley Glass Co., office.  
Milliam, Hon. James, residence.  
Murray, E. V.  
Suydam, W. F., residence.  
Torry, E. F.

**HAZELTON.**  
Allison & Warren.  
Allison, L. S.  
Bright, J. C., & Co.

Brill, Chas.  
Central Hotel.  
Deisroth, William.  
Dershuck, Peter.  
Dryfoos, H., market.  
Episcopal Church.  
First National Bank.  
Gibbons, Geo.  
Gorman, G. D., store.  
Hazleton Machine and Supply Co.'s Store.  
Hazleton Savings Bank.  
Kisner, Wm.  
Landerburn, Smith & Deisroth, store.  
Laudbachs, W., residence.  
L. V. R. R. Depot.  
Mandaville, H. E., & Co.  
Markle Bros. & Co., bank.  
McNair, T. S., residence.  
Miner's Hospital.  
Moyer, John H.  
Opera House.  
Pardee, A., & Co.  
Platt, A. P., store.  
Schaffer, Geo.  
Silverbrook Coal Co.  
Smith, Sampson, residence.  
Town Hall.  
Valley Hotel.  
Williams, Jno. M.

**HOKENDAUQUA.**  
Fetridge, D. W. M.  
The Thomas Iron Co.

**BOLIDAYSBURGH.**  
Colvin, S. A., residence.  
McLanahan & Stone.  
Wolf, J. S.

**HOMEWOOD.**  
Swartze, J. E., residence.

**HONESDALE.**  
Allen House.  
Baker, H. F.  
Clarke, T. B. & Co.  
Darflinger, L. J.  
Delaware & Hudson R. R. Depot.  
Honesdale High School, 2 Bldg.  
Honesdale Iron Works.  
Irving Cliff Hotel.  
Knapp, Charles E.  
Menner, David.  
National Bank.  
Powell, S. W.  
Rose, L. O.  
Torrey, E. F., residence.  
Wayne Co. Saving Bank.

**HUNTINGTON.**  
Africa, B. F.  
Akers, T. H., residence.  
Akers, Mrs. M. R. and daughter, store.  
Gage, G. F., residence.  
Holy Trinity Catholic Church.  
Huntingdon Gas Co., office.

Isenberg & Stewart, store/rooms.  
Read, C. C., residence.

**HUNTINGDON VALLEY.**  
Jones, Hallowell & Bethayers.

**HYNDMAN.**  
Hoblitzell, Geo.

**INDIANA.**  
American House.  
Blair, Jno. P., residence.  
Catholic Church.  
Catholic Parsonage.  
Cosmopolitan Club House.  
County Jail.  
Court House.  
Cunningham, A. V.  
Dougherty, Jas. R., residence.  
Ellis, David, residence.  
Ellis, Griffith, residence.  
Guthrie, J. M., residence.  
Hamilton, George T.  
Hildebrand, T. E., store.  
Laughry, W. R. & Co., store.  
McCartney, S. M., & Son.  
McCartney, S. M., residence.  
Penn. State Normal School.  
Penn. Flouring Mills.  
Steele, J. T.  
Sutton, Jno. W., residence.  
Sutton Bros. & Bell.  
Taylor, Alex.  
Thompson, H. S., residence.  
Wood, Mrs. Harvey, residence.  
Wood, Mrs. Harvey, conservatory.

**IRWIN.**  
Schull, J. R.  
**JENKENTOWN.**  
Baker, A. H.  
Bates, L. M.  
Gaskill, U. B.

**JENNYN.**  
Moosic Powder Co.  
**JERSEYMAN.**  
Stocher, J. F.  
**JERSEY SHORE.**  
Beech Creek R. R.  
Hepburn, M. P.

**JOHNSTOWN.**  
& Co.  
Cambria Iron Co., Club House.  
General Offices and Laboratories.  
Johnson & Co.  
Johnstown Supply Co.  
Odd Fellows' Hall.  
Waters, J. H., & Bro.

**KENNETT SQUARE.**  
Larkin, C.  
Public Schools.

**KIDLEY PARK.**  
Kidley Park Hotel.

**KINGSTON.**  
D., L. & W. R. R. Station.  
Kingston Coal Company.

Richard M. Johnson.

George H. Morris.

# JOHNSON & MORRIS,

SUCCESSORS TO  
BATES & JOHNSON,  
IN NEW YORK AND WASHINGTON.

## STEAM HEATING APPARATUS

No. 114, Leonard Street.

New York, 27 Jan'y 1887

TELEPHONE, MURRAY 407.

A. A. Griffing Iron Co  
Jersey City, N.J.

Gentlemen

We have used the Bundy Radiator in its various forms almost exclusively, in our business for the last twelve years. In that time we have placed at least half a million square feet of heating surface. We are satisfied that there is no better radiator made than this, and we recommend it to all who have use for heating surface either for Steam or Hot water.

Yours Respectfully  
Johnson & Morris



## REFERENCES.

Monks & Shephard.  
Payne, W. C., & Co.  
Rost, A. J.

### KITTANNING.

Reickert Bros.  
Reickert, J. E., residence and store.

### KLINE'S GROVE.

Deer, John.

### KNOXVILLE.

Wass, David.

### LAFAYETTE.

Hamilton, W. C.

### LANCASTER.

Arnold, J. T.  
Bachler, L. H.  
Bachler, Mrs. Sophia, residence.  
Best, John, & Sons.  
Best, John, residence.  
Blickenderfer, N.  
Brubaker, Roland, residence.  
Buckins, B. R.  
Daily Intelligence Office.  
Diller, I. & Son.  
Eberly, A. J., residence.  
Flinn & Brenneneau.  
Fulton Opera House.  
Graham, Dana, residence.  
Heitshn, Wm.  
Hotel Franke.  
Intelligencer Printing & Publishing Co.  
Johnson, O. S., & Co., store.  
Keller, Jno. residence.  
Kendig, John S.  
Keystone Lock Works.  
Krauskop, F. L., residence.  
Lancaster Steam Laundry Co.  
Lancaster Mannorchor.  
Lancaster Hotel.  
Lancaster Cork Works.  
Leopard Hotel.  
Lipp, H. S., residence.  
Mannerchor Hall.  
Martin, J. B., store.  
Mayer, Israel P., residence.  
Metzger, J. L., residence.  
Northern National Bank.  
People's National Bank.  
Prangle, James, residence.  
Reed, McGrann & Co., bank building.  
Rhoads, H. Z., store.  
Ricker, F. A., residence.  
Rohrer, Jeremiah, residence and store.  
Rohrer, Dr. George.  
Rudy, Martin, residence.  
Smith, W. J.  
Stamm, Frederick, residence.  
Steinmetz, J. L., residence.  
Steinman, G. M., store.  
Stettler, S. N. & Co., store.  
St. Mary's Academy.  
Welchhaus, A. C.  
Yecker, B., residence.

### LANDISVILLE.

Kauffman, J. H.  
Long, C.

### LANSDALE.

Effrig, Samuel, & Co.  
Godshall, J. C.  
Jacobs, J. N.  
Jones, Isaac.  
Lansdale M. E. Church.  
Lansdale Trust Co.  
Stetson, C.

### LANSDOWNE.

Pennock, Charles E.

### LANSFORD.

Drumbeller, William.

### LARABEE.

Carpenter, J. H.

### LEBANON.

American House.  
Boyes, Bassler, residence.  
Boyes, Isaac, store and residence.  
Bressler & Sprang.  
Coleman, Mrs. G. D., residence.  
Coleman, R. H., office.  
Cornwall & Lebanon R. R. Co., offices.  
First National Bank.  
Gossler, James, store.  
Greenawalt, P. S., residence.  
Gross, H. A., residence.  
Hoffman, G. W., residence and store.  
Karch, Jacob, residence.  
Krause, George, & Co.  
Lautz, C. R., building.  
Lebanon County Court House.  
Lebanon Furnace Co., office.  
Lebanon House.  
Lebanon Iron Co., office.  
Lebanon Steam Co.  
Mahaney, G. W.  
Martin & Bowman, residence.  
Mathew & Zerman.  
McLaughlin, H., & Son.  
Mease, Mr., residence.  
Meigs, H. V. L., residence.  
Penn. Bolt & Nut Works.  
Rauch, J. B., store.  
Schools, George W., store.  
Seventh Street Lutheran Church.  
Trust & Safe Deposit Bank Block.  
Uhler, Clarence, residence.  
United Express Office.  
Valley National Bank.  
Walmer, T. S., residence.  
Weimer, L. E., residence.  
Weimer, Jno. A., residence.  
Weiss, Samuel, M.D., residence.  
Wolf, Isaac.  
Young, James.  
Zeheder, W. D., residence.

### LEHIGHTON.

Lehigh Valley Spring Works.

### LEWISBURG.

Baker House.  
Benshoff, L. A., & Co.  
Bucknell Female Institute.  
Brown & Dankles, store.  
Central Manufacturing Co.  
Dill, Hon. A. H., store.  
Dill, Hon. A. H., residence.  
Dreisbach, C., office.  
Lewisburg Plumbing Co.  
Reber, David, residence.

### LINCOLN STATION.

Burling, W. N.

### LINCOLN UNIVERSITY.

Cope, Josiah,

### LITIZ.

Brubacker, N. K.  
Buckhart, A. M.  
Erly, Jno. B., residence.  
Linden Hall Seminary.  
Regennes, W. H.

### LITTLE BUTTON.

Preston, F., residence.

### LOCK HAVEN.

Bickford, James A., residence.  
Bickford, S. M., residence.  
Bridgins, J. W., residence.  
Brown, William H., block.  
Court House.  
Dunn, Mrs. Annie, residence.  
Furst, Clie G., office.  
Mackey, Mrs. L. A., residence.  
Mason, George W., residence.  
Martin, Samuel Z., residence.  
Martin & Conderman.  
Presbyterian Church.  
Simon Block.  
Third Ward School building.

### LORETTO.

Comerford, W. S.

### LUZERNE.

Haddock, John.

### MAHOFFEY.

Kick, Thomas,

### MAHONNY CITY.

Morgan, William.

### MALVERN.

Entrikan, J. C.

### MANAS VILLAGE.

Cornwall Oil Bank Co.

### MANAYUNK.

Benard & Son.  
Boon, Thomas.  
Hughes, George.  
Hyde, Joseph.  
Kinney, J. N.  
Priest, James S.  
Roth, Gregor.

### MANCHESTER.

Norton Brothers.

### MANETTA.

Frey, Samuel S.



Steam Heat saved his only child's life. Read this letter.

GEO. C. FOUNTAIN,

→ PHARMACIST ←

219 Pacific Avenue, Jersey City.

Jersey City Oct 10/88  
A A Griffing Iron Co

Gentlemen

My Store and Residence are both heated by your Bundy Radiators which I consider a great Success

Regarding Steam as a medium for heating buildings I must say that I attribute very much of the good health of myself and family to the system certain it is that the life of my Daughter was saved by the good effects brought about by opening the small pet cock on one of your Radiators and allowing the Steam to escape into the room at an <sup>Even</sup> temperature of 80° to 82° for Eighteen days My Daughter was suffering from a severe attack of Malignant Diphtheria and Diphtheretic Croup and by this means my Physicians increased the Humidity of the Air in the room and checked the disease

Respectfully Yours  
George C. Fountain

219 Pacific Ave

Steam Heat saved his only child's life. Read this letter.

## REFERENCES.

**MANHEIM.**  
American Steam Heating & Mfg. Co.  
Beck, T. S.  
Cresmings, James.  
Echert, Henry E.  
Gingrich, H. H., residence.  
Hershey, B. H.  
Home for Widows and Single Women.  
Horst, Abram, residence.  
Klein, Abraham.  
Manheim "Sentinel."  
Sunny House.  
Summy, S. G.  
Tyson, A. Harvey.

**MAUCH CHUNK.**  
C. R. R. depot.  
C. R. R. offices.  
Dimmick Memorial Library.  
First Ward Public School.  
Packer, Mrs. H. E.  
Saunders & Wetzell.  
Spangles & Esser.

**MAYTOWN.**  
Nissley, Elias, residence.  
**McEWINGSVILLE.**  
Lembuck, O.

**McKEESPORT.**  
National Tube Works.  
Peterson, Andrew.

**MEADSVILLE.**  
Phoenix Iron Wks Co.

**MECHANICSBURG.**  
Stevenson, D. Jr.

**MEDIA.**  
Lodge, L. K.

**MERCER.**  
Junkin, J.  
Mowry & Finch.

**MEYERSDALE.**

Appel, A.  
B. & O. R. R. Station.  
Cook, W. B.  
Graves, Jno. A.  
Hersh, A.  
Horlitzell, W. T.  
Johns, A. F.  
Olinger, J. M.  
Parker, J. A.  
Philson, Sam'l.  
Truxall, C. W.  
Woom, Paul.

**MIDDLEBURGH.**  
Wittemeyer, W. W., residence and store.

**MIDDLETOWN.**  
Croll, A. B.  
Matheson, A. S.

**MIFFLINBURG.**  
Glover, Hon. H. P.

**MILLERSTOWN.**  
Fitzell, J. Ed.

Rippman, C. A., residence.

**MILFORD.**  
Baker, H. T.  
Baker, Mrs. E. J.

Brown, A. D., & Son.  
Fanchere, L.  
**MILTON.**

Ball, Jno. G.  
Bickell & Bailey.  
Broadway House.  
Clark, J. O.  
Clinger, D.  
Colvin, E. F.  
Fairchilds, S., residence.  
Follmer, Wm., residence.  
Heaton, E. H.  
Hoag, B. K., hotel.  
Hull, E. J., residence.  
Milton Gas Fitting and Plumbing Co.  
Overpeck, H. M.  
Reformed Church.  
Schreyer, W. A., residence.  
Shimer, E. S.  
Shimer, S. J.  
Taggart, James, residence.  
Wilson, R. F.

**MINERSVILLE.**  
Schwenk, Wm., residence.

**MIRION STATION.**  
Lucas, J. C.

**MONONGAHELA CITY.**  
Alexander, J. B., residence.

**MONT ALTO.**  
Mont Alto Iron Co.

**MONTROSE.**  
Doolittle, J. W., residence.  
Searle Hon. D. W., residence.  
Searle, Hon. D. W., offices.  
Sherman, E. C.  
Tarbell House.  
Tennant, J. M.

**MORRIS RUN.**  
Frost, A. C.  
Morris Run Coal Mining Co., store.

**MOSCOW.**  
Phoenix Medicine Co.

**MOOSIC.**  
Housick, S. H.

**MOUNT CARMEL.**  
Bergstresse, E., residence.  
Bickle, Tobias, residence.  
Bolish, D. A., residence.  
Bolish, D. R.  
Camp, David.  
Fisher, D. H.  
Harvey, Barney, residence.  
Herb, E. C., hotel.  
Keifer, A. & A., store.  
Keifer, Wm., residence.  
Klonowski, Rev. J., residence.  
Koskie, L. J., residence.  
Kulisk, John, hotel.  
Matulus, Jacob, store.  
Monlellius, Dr. R. W., residence.  
Mt. Carmel Hotel.  
O'Neill, Rev. A. M.  
Renn & Co.

Robbins, H., residence.  
Robertson, George, residence.  
Siegfried, William, residence.  
Snively & Co.  
St. Joseph Polish Church.  
Tier, C. W., residence.  
Umlauf & Lawton.  
Ward, M. P.

**MOUNT HOLLY SPRINGS.**  
Mount Holly Springs Paper Co.

**MOUNT JOY.**  
Engle, A. H., residence.  
Engle, D. H.  
Greider, B. M., residence.  
Greider, Martin L., residence.  
Hoffman, S. S.  
Linderworth, H. H.  
Mount Joy Steam Heater Co.  
Peiffer, Martin B.

**MOUNT PLEASANT.**  
Haven, C. C.

**MYERSTOWN.**  
See, R. J., residence.

**NANTICOKE.**  
Alexander, E. N.  
Enke & Bennett, stores.  
James, John H., hotel.  
Jones, Bergin & Co.  
Kingsbury, O. N., M. D.  
Lafe, A.  
Meyer, R. H.  
Morgan, George.  
Savage, Simon.  
Thomas, C. B.  
Welliver, S. J., & Co.

**NEWBERY.**  
Buster, Royal.

**NEWCASTLE.**  
Dunlap, H. R.  
Gill, James H.  
Kirk, C. J.  
McKarnes & Stevenson.  
Newell & Garvin.

**NEW MILFORD.**

Kistler, R.  
**NEW WILMINGTON.**

Ladies' Dormitory.  
**NEWVILLE.**

McCachson, Robert.  
**NICETOWN.**

Franklin Baptist Church.  
**NORRISTOWN.**

Berndt, Julius, residence.  
Bolton, Frank H., residence.  
Borneman, W. S.  
Borough Hall.  
Brown, J. Morton, & Co.  
Chain Street School.  
Conden, S. L.  
Council Chamber.  
Court House.  
"Daily Times" office and building.  
De Hall Street School.



EDWARD C WALLER  
Home Insurance Building  
N E CORNER ADAMS AND LA SALLE STR  
REAL ESTATE AND LOANS.

CHICAGO May 11th., 1889

(Dictated)

T. C. Perry, Esq.,  
99 Madison St.,

Dear Sir:- When deciding upon the radiators for the Home Insurance and "The Rookery" Buildings, the subject, of course, was gone into very thoroughly and exhaustively on the part of the building committees of the respective buildings. It was finally decided to use the Bundy Standard Radiators made by The A. A. Griffing Iron Co., of Jersey City. I think we have about thirteen hundred (1300) in use, and I am thoroughly satisfied that they are certainly as good as any on the market, if not the very best. They have given us excellent service and we are entirely satisfied with them.

Should I have to decide, to-day, on another radiator job, I should undoubtedly give the Bundy radiator the preference.

Very truly yours,

*Edward C. Waller*

This letter was written after using over 2,000 Bundy Radiators. What better proof can there be of their value.

## REFERENCES.

Dettra, J. M.  
 Fornanse, Joseph, residence.  
 Hutchinson, Streeper, residence.  
 Jenkins, Philip, residence.  
 Oak Street School.  
 Rennyson, William, residence.  
 Rittenhouse, W. H.  
 Schall, John, residence.  
 Slingluff, Jno.  
 Streeper, D. H.  
 State Hospital for Iosane.  
 St. Patrick's Church and School.  
 Warrall & Taylor, mill.

### NORTH BEND.

Hogan, J. O., & Co.

### NORTH EAST.

Short, Hon. Alfred.

### NORTH GRAFTON.

Nelson, J. S., & Son, boot manufactory.

### NORTHUMBERLAND.

Linton, C. C.  
 Taggart, Harry, residence.

### OBERLINS.

Oberlin Gas & Electric Co.

### OIL CITY.

National Transit Co.

### OSCEOLA.

Catholic Church.  
 Hammond, J., residence  
 Hammond, R., residence.  
 Pie, Justice J.  
 Tubbs, Henry, residence.

### OXFORD.

Burling, W.  
 Gryder, Anea M.  
 Gilligan, E. L., residence.  
 Kirk, Roger A., residence.  
 McCommon & Smith.  
 Passmore Sisters, residence.  
 Perkins, F. L., residence.  
 Pugh, Wm., residence.

### PACKERTON.

Car Shops, L. V. R. R.

### PEN ARGYLE.

Allen House.  
 Barton, S.  
 Jones & Dory, residence and store  
 Keat, Samuel, residence.  
 Koch, C. J., residence and store.  
 Kutz, Mr.  
 Moyer, Peter, residence.  
 Pen Argyle Iron Works.

### PERKASIE.

Auglemeyer, Samuel.  
 Bishop Bros.  
 Meyers, M. H.  
 Perkasio Bank Co.

### PHILADELPHIA.

Abram Cox Stove Co.  
 Allen, W. H., & G. H.  
 Aldine Hotel.  
 Allison's, Jas., Sons.

Am. Baptist Publication Society Building.  
 American Dredging Co.  
 Ante-Cobden Club House.  
 Arnot Wm., Chestnut Hill.  
 Ajax Lead Coating Co.  
 Ayres, Wm., & Son.  
 Bannan, J. R.  
 Barnes, S. H., & Son.  
 Barnes, S. W.  
 Barnet, G. A., & Sons.  
 Bartholomew Brewing Co.  
 Bauman, J. R.  
 Belfield, H., & Co.  
 Beneficial Savings Fund Society Building.  
 Betz, John, & Sons.  
 Blessing, C. A.  
 Blumenthal Bros.  
 Boorse, D. O.  
 Bourne, John.  
 Braines, Chase & Co.  
 Bricklayer's Hall.  
 Broad St. Station Penna. R. R.  
 Broad S. Market.  
 Brodie & Comfort.  
 Brogan & Smith.  
 Brooks, J., & Son.  
 Brown Bros., & Co.  
 Brown Bros. Building, 4th and Chestnut.  
 Brown, Owen & Taylor.  
 Brown, E. E., & Co.  
 Bryn Mawr College.  
 Buildings of the Little Sisters of the Poor.  
 Butterworth, C. E.  
 Byran, Jas. G.  
 Cadwallader, Frank.  
 Calhoun School.  
 Cale, Chum & Co.  
 Cathedral, T. A. B. Hall.  
 Cassett, A. J.  
 Chandler, T. P. Jr., 325 Chestnut, St.  
 Chelton Ave. Station.  
 Children's Homœopathic Hospital.  
 Church, School and Pastoral Res. St. Chas.  
 Borreomes.  
 Church, School and Pastoral Res. St. Theresa.  
 Church and Pastoral Residence of St. John  
 the Evangelist.  
 Clark Bros.  
 Cleveland & Hardwick.  
 Cooper, Wm. S., & Co.  
 Collins, A. M., Son & Co.  
 Columbia Saving Fund Co.  
 Company "B" Armory.  
 Comly, J.  
 Commercial Union Ins. Co.  
 Conderman, G. W.  
 Comer, L., Brown and Broad.  
 Conard, Theo. P.  
 Consolidated National Bank.  
 Davis, Jacob B. M.  
 Davis & Evans.  
 Davis, J. M., Jr.

Department of Construction and Repairs, U  
 S. N.  
 Devlin, Thos., & Co.  
 Devon Inn.  
 Dooner's Hotel.  
 Dounton, W. D., residence.  
 Drummond, Rob't.  
 Drawing Room, 40th and Chestnut Sts.  
 Drexel Building.  
 Dyatt, M. J.  
 Eagle Gas Fixture Works.  
 Egyptian Musee.  
 Eletch Bros.  
 Ellison, J. B., & Sons.  
 Elverson, James.  
 English, Thos., 1317 Fairmount Ave.  
 Erdman, Francis B.  
 Estate Wm. Forrest.  
 Evans, Geo. C.  
 Fairmount Worsted Mills.  
 Faith, S., & Co.  
 Faros & Hartman.  
 Fetlow, Henry.  
 Finklorans, Theo., office.  
 Finley, Acker & Co.  
 Fitchburg Steam Engine Co.  
 Flan, Rev. Michael, residence.  
 Ford & Kendig.  
 Franck, Wm. L.  
 French, Richards & Co.  
 Friends' School, 16th and Cherry Sts.  
 Froelich Bros.  
 Garney, Rev. P. J., residence.  
 Gaway, A. J., residence.  
 German American Title Ins. Co.  
 German Hospital.  
 Germantown Grammar School.  
 Getze & Reeves.  
 Getze Bros.  
 Girard Estate.  
 Girard College.  
 Girls' Catholic Home.  
 Gormely, John.  
 Gormely, P.  
 Gossler, J. H., residence.  
 Grand Opera House.  
 Grand Central Theatre.  
 Grace Baptist Church.  
 Graff, Low & Co.  
 Gray, Chas. W.  
 Gregg & Bowe.  
 Green's Restaurant.  
 Haehnen Building.  
 Haines, Jones & Cadbury.  
 Hamilton, John, carpet mills.  
 Hanley, John.  
 Harding, John.  
 Harkness Bros.  
 Harrison, Jos. Jr., estate.  
 Harrison Bros., & Co.  
 Hazlehurst & Hueklebrecht.  
 Henry, W. T., & Co.



HAZELHURST & HUCKEL,  
ARCHITECTS,  
410 WALNUT STREET

PHILADELPHIA,

April 26<sup>th</sup> 87

A. A. Griffing Iron Co.

Sir,

We have used  
used the "Bundy Patent Direct & Indirect  
Radiators" in most of our larger build-  
ings, Court House, Church & City Building  
and have found them thoroughly sat-  
isfactory in every respect.

Yours truly,  
Hazelhurst & Huckel

The Bundy Radiator successfully heats Philadelphia's largest buildings, the Court House, Mutual Life, Wannamaker's Store, Hotel Lafayette, Girard Estate Buildings and hundreds of others.



## REFERENCES.

- Hexamer, John C.  
 Hills, A. S., & Co.  
 Holman, A. J., & Co.  
 Home for Crippled Children.  
 Home for Indigent Women.  
 Hooper, Dorsen, residence.  
 Hopkind & Small.  
 Horn, W. H., & Bro.  
 Hotel Lafayette.  
 Houghton, B. F., & Co.  
 House of the Good Shepherd.  
 Hunter & Dickson.  
 Incomparable Laundry.  
 Jackson, J. Elvin.  
 James Logan School.  
 Janney, O. S., & Co.  
 Janney, Jos. A.  
 Johnson's Ink Works.  
 Judge, Wm., & Bro.  
 Jummel, Frank R.  
 Kelly & Armstrong.  
 Ketterline's Printing House.  
 Keystone Watch Case Co.  
 Keystone School.  
 Kinsler, L. C.  
 Kitchen & Bounds.  
 Kline & Bro.  
 Knickerbocker Ice Co. Building.  
 Krauss, Godfrey & Co.  
 Land, Title and Trust Co.  
 Laudrett & Sons.  
 Lehigh V. R. R. Co.'s offices.  
 Lippincott, Chas. K., & Co.  
 Lewis, H. K., & Co.  
 Lippen, Hiram.  
 Long, E. M., residence.  
 Lowry, A. A.  
 Lutheran Church.  
 Macfarland, Dr. M., residence.  
 Maneely, John.  
 Manell, John.  
 Mantel, A. C.  
 Marks Bros.  
 Mary J. Drexel Home.  
 Martin, Wm. L.  
 Maturity Hospital.  
 McCann, John.  
 McFarland, Ed.  
 McGowan, D.  
 McGuire, James.  
 McInnes, John.  
 McManemin, John C.  
 McNeely & Co.  
 McNulty & Connor.  
 Mentzinger, W. M., & Son.  
 Merchants' Exchange.  
 Middleton, H. & W. H.  
 Miller, Jacob, & Sons.  
 Morris, E. P.  
 Morse, Williams & Co.  
 Moss, H. T.  
 Muchle, W. R. Jr.
- Mullin, D. D.  
 Mulliken, H. E.  
 Mullholland, Rev. J. E., residence.  
 National Theatre.  
 National Security Bank.  
 Naylor, Jacob, Girard Ave. and Front St.  
 Naylor, John.  
 Neafie & Levy.  
 Neptune Laundry.  
 Newman, J., building.  
 New Columbia Hall.  
 Nicetown Baptist Church.  
 Noel, Mrs. M. L.  
 Norfolk and Western R. R.  
 Northwestern Bank.  
 Northern Electric Light and Power Co.  
 O'Connor, Rev. C. P., residence.  
 Office Building, 6 South Merrick St.  
 Otis Bros., & Co.  
 Owen & Salter.  
 Park Ave. School.  
 Park Theatre.  
 Pancoast & Maule.  
 Patent Metal Works.  
 Paul & Summers.  
 Penn. Asylum for Insane.  
 Penn. Mutual Building.  
 Penn. National Building.  
 Penn. R. R. Co.  
 Penn. Salt Wks.  
 Penn. University.  
 Penn. Sugar Refinery Co.  
 Petty, J. K., & Co.  
 Phila. Steam Heating Co.  
 Phila. Music Academy.  
 Philadelphia Ex. Vent Co.  
 Pillings, W. S.  
 Potter, Thos., & Sons, stores.  
 Poth, Fred. A., residence.  
 Priest, Jas. S.  
 Presbyterian Orphanage.  
 Provident Life and Trust Co. Building.  
 Reading Iron Co.  
 Reading Iron Works Warehouse.  
 Real Estate Trust Co.  
 Residence of St. Machachy.  
 Residence of the Nativity of the B. C. M.  
 Residence of the Visitation of the B. V. M.  
 Reeves & West.  
 Roberts & Clark.  
 Royal, Chas. H.  
 Russell & Armstrong.  
 Saller, Lewin & Co.  
 Schmitt, Henry.  
 Scholl, Jos.  
 Schull, B. F.  
 Sciple, E. M.  
 Scott, John & Co.  
 Seyfert, L. F.  
 Sheid, H. H., & Co., office.  
 Sheid & Vandegrift, office.  
 Sichel & Meyer, store.
- Smedley House.  
 Smith, W. S.  
 Spellenburgh & Co.  
 Stambach & Love.  
 Starkey & Palen, Doctors.  
 Steamer "Brandywine."  
 Steamer "Charlotte."  
 Steamer "City of Chester."  
 Steamer "Mary E. McCabe."  
 Steamer "Morse."  
 Steamer "Wilmington."  
 St. Boniface Parsonage.  
 St. Clemens Hospital.  
 Stores 7, 19, 721, 723 Vine St.  
 Storem, Geo. W.  
 St. Frances School, 24th and Green Sts.  
 Stewart, Ralph, & Co.  
 St. Frances Residence.  
 St. Francis Xavier.  
 St. James' Church.  
 St. James' Parochial School.  
 St. Joseph's Hospital.  
 St. Joachim's School.  
 St. John's Orphan Asylum.  
 St. Patrick's School.  
 St. Peter's Hall.  
 St. Vincent's Hospital.  
 St. Vincents' Home, 18th and Wood.  
 Sunderland, John.  
 Temple Theatre.  
 Tenth National Bank.  
 Tetlow, Henry.  
 The Arnholt & Schaffer Brewing Co.  
 The Henry Miller Estate.  
 The J. & P. Baltz Brewing Co., office.  
 The Keystone Steam and Hot Water Htg. Co.  
 The Church of the Gesee.  
 Third National Bank.  
 Thompson Bros.  
 Thompson, Wm. & R. P.  
 Thompson, James D.  
 Trismuth Bros. & Co.  
 Twenty-fifth District Station House.  
 United States Mint.  
 United Security Co.  
 Union Insurance Co.  
 Van Beil, H., & Co.  
 Vendig, Chas. H.  
 Verner, Wm.  
 Victoria Hall.  
 Volmer Building.  
 Walnut St. Theatre.  
 Walnut St. Freight Depot P. R. R.  
 Walton, Geo. E.  
 Walsh, John.  
 Wannamaker, S. M., & Co.  
 Wannamaker & Co.'s Store.  
 Warder & Montgomery Hospital.  
 Warder, Henry.  
 Watt, Rob't.  
 Watson & McDanill.  
 Watson, Frank R.



TELEPHONE NO. 25

ESTABLISHED 1853.

CABLE ADDRESS "DUNNING, GENEVA"

*Wm. B. Dunning's*  
*New York Central Iron Works.*

*Steam Engines, Boilers*  
*of all kinds*  
*and Machinery Generally*

*Dunning's Patent*  
*Steam Heating Boiler a Specialty*  
*Over 14,000 in use*

*Geneva, N. Y. May 27, 1889.*

A. A. Griffing Iron Co.,

Jersey City, N. J.

Gentlemen:--

Replying to yours of the 22nd inst. would say that, the Bundy Radiator has been specified in connection with The Dunning Steam and Hot Water Boilers for the past twelve years in heating contracts all over the United States and from Italy to Japan, and I have the pleasure of knowing that they have worked well in every instance. I believe there is no radiator that is superior to the Bundy and none that is more handy for repairs, especially should any accident happen to them whereby they are broken. It is but a short job to unscrew the tube and replace it with another, which you cannot do very easily with any other in the market. They are a good circulator and have given the best of satisfaction wherever used.

Wishing you success with them, I remain,

Very truly yours,

*Wm. B. Dunning*

## REFERENCES.

Weir & Nixon.  
 Weitzel, P. E. & Co.  
 Whetstone & Co.  
 White, William.  
 Widener, D. O.  
 Wilbur, H. O., & Sons.  
 Williamson & Cassidy.  
 Wilmington Steamboat Co.  
 Wilson, Cass & Co.  
 Wingate, Webb & Melvin.  
 Wissahickon Inn.  
 Wolf, Frank & Co.  
 Wolstencroft & Sons.  
 Wood, H.  
 Wood, Jas. P., & Co.  
 Wright, Peter, & Sons.  
 Wyeth, Jno., & Bros.  
 Y. M. C. A. Building.  
 Yewdall, John.

### PHILLIPSBURG.

Carlisle, Henry.  
 Holly, C. B.  
 Passmore House.  
 Shepard, Dr.

### PHENIXVILLE.

Buckwalter, Enos T.  
 Caswell & Moore.  
 Hughes, Robert G.  
 Hunter, Theodore.  
 Lippert, M. L.  
 Shaffer, Mrs. Thomas.  
 Shaffer, V. N.  
 Towers, Michael.  
 Wilkinson, J. M.  
 Wynn, Samuel.

### PINE CREEK.

Gale, W. & R.

### PINE GROVE.

Werntz, John F.

### PINE IRON WORKS.

Bailey, Joseph L.

### PITTSBURGH.

Alleghany Hotel.  
 Anderson Hotel.  
 Armstrong, Brother & Co.  
 Atwood & McCaffrey.  
 Bailey, Farrell & Co.  
 Baird's Restaurant.  
 Best, Fox & Co.  
 Bourne, John.  
 Clentick, M., estate.  
 Duquense Bank.  
 Fairbanks & Co.  
 French, Dr. Gale.  
 Garretson & Ricketson.  
 Grootzinger Building.  
 Home for Incrables.  
 Horne's, Jos., dry-goods house.  
 Hotel Duquense.  
 Jenkins, T. C.  
 Jones & Laughlin.

Kauffman Bros.  
 Kelly & Jones Co.  
 Kohne, F. C., & Co.  
 Lewis Building.  
 Lutz, D., & Sons.  
 Maginn Bros.  
 McClintock building.  
 McGraw, P.  
 McGinness, Smith & Co.  
 McKnight & Vectory.  
 Office of Crescent Steel Works.  
 Office of Westinghouse Air Brake Co.  
 Oil Exchange building.  
 Oil Well Supply Co.  
 Painter & Sons.  
 Philadelphia Co. building.  
 Penna. Incline Plane Co.  
 Pittsburgh Club.  
 Pittsburgh High School.  
 Pittsburgh Petroleum Exchange.  
 Price, W. G. & Co.  
 Power Hall building.  
 Reincke, Wilson & Co.  
 Royal Insurance Co.'s building.  
 Schmidt & Friday, building.  
 Schwartz, J. E., residence.  
 Second Ward School.  
 Seventh Avenue Hotel.  
 Sixth Ward School.  
 Standard Car Heating Co.  
 Stewart, Robert, residence.  
 Twenty-third Ward School.  
 United Pipe Line offices.  
 Westinghouse Building.  
 Westinghouse, H. H., residence.  
 West End M. E. Church.  
 Y. M. C. A. Building.

### PITTSSTON.

Butler Colliery Co.  
 Exeter Machine Co.  
 Fiinn, N., office.  
 Hileman, Joseph, office.  
 Long, Dr. E. B.  
 Maloney, T.  
 Ronimell, G. B.  
 Sax, W. R.  
 Scrimgeour, Jno.  
 Wyoming Valley Paper Mill.

### PITTSSTON JUNCTION.

Old Forge Coal Co.

### PLAINESVILLE.

Evans Bros.  
 Langdon, A., & Co.  
 Hartland, O. H.

### PLYMOUTH.

Lindsay & Co.

### POTTSTOWN.

Antrim, W. L., store.  
 Ashenfelter, Dr. W. J., residence.  
 Bailey & Baldwin.  
 Bauer, Geo., residence.

Beecher, L. & W. C., store.  
 Boyer, Benj., residence.  
 Colles, Mahlon, residence.  
 Dengler, Jacob, residence.  
 Eck, Dr. W. H., office.  
 Ehrgood, Elmer, residence.  
 Ellis, W. S., residence.  
 Evans, A., store.  
 Feather, Hiram, store.  
 Fegely, J., residence.  
 Fegely, J., & Son, store.  
 Fire Engine House.  
 Fisher, John M., store and residence.  
 Fryer, J. Rush, residence.  
 Gabel, H.  
 Geist, Matthias, residence.  
 Gilbert, John, residence.  
 Graffen, H. N., store.  
 Harrison, Geo., residence.  
 Healy, J. Allen, residence.  
 Hill School.  
 Hoffman, Nathan, residence.  
 Kugler, Mrs. Wm. G., residence.  
 Landis, J. D. F. residence.  
 Ledger Building.  
 Leopold, H., store.  
 Lessig, M. S., residence.  
 Low, Matthew, residence.  
 Manger, John H., residence.  
 McCarthy, Felix, residence.  
 Merchants' Hotel.  
 Missimer, W. C., residence.  
 National Bank.  
 National Iron Bank.  
 Philadelphia Steam Fire Engine Co.  
 P. R. R. Station.  
 Potts, Geo. H., residence.  
 Pottstown Iron Co., office.  
 Reinert, D. F., residence.  
 Retter, J. H., residence.  
 Rudy, Wm., residence.  
 Sampson, Alex., residence.  
 Saylor, H. D., residence.  
 Schwab, Geo., store.  
 Security Co.'s building.  
 Shetler, L. F., residence.  
 Shoemaker, C. B., residence.  
 Shuler House.  
 Sotter Bros.  
 Sotter, Ferdinand.  
 Sotter, Henry.  
 Sotter, Jacob.  
 Sotter, Philip.  
 Swinehart, Wm. Y., residence.  
 Trinity Reformed Church.  
 Washington High School building.  
 Weand, John, store.  
 Weitzenkorn, A., residence.  
 Wells, Herman, residence.  
 Yeager, Mason, residence.  
**POTTSVILLE.**  
 Academy of Music.

## REFERENCES.

Jackson Street School building.  
Lear, S. Edgar.  
Lineweaver, Dr. W. J.  
Merchants' Hotel.  
"Miners' Journal" building.  
Mountain City Bank building.  
Pottsville Steam Heat & Power Co.  
P. & R. R. Co. depot.  
Riest, C. H.  
Roads, Geo. W.  
Styles & Parker.

**PRESCOTT.**

Phillips, Samuel.

**QUAKERTOWN.**

Durner, Dr. C. F.  
Ehrgood, E.  
Kolle, Wm.  
Roberts, Scyopes & Co.  
Sheetz, O. R.  
Thomas, Dr. Jos.

**READING.**

Agricultural & Horticultural Society.  
Barbey, John.  
Beaver, Dr. D. B. D.  
Bear, Geo. F., residence.  
Bechtel, John R., store.  
Becker, I. C.  
Bessinger, Philip.  
Boyer, D. B., residence.  
Boyer, Jerome L.  
Bright & Leach, store.  
Brownback, Frank, residence.  
Central House.  
Centre Street Public School.  
City Hall.  
Coleman, Wm. N., residence.  
Dauth, J. P.  
Davis, F. B.  
Davis Printing Co.  
Davis, W. B., greenhouse.  
Douglass & Connard.  
Eckert, H. S., Pres. Farmers' National Bank.  
Ennentrous, Geo. M.  
Farmers' National Bank.  
First Presbyterian Church.  
First Reformed Church.  
Fries, Jacob, residence.  
Fulmer, S. H., residence.  
Goodman, Jas., residence.  
Green Street Public School.  
Greth Machine Works.  
Greth, D. P.  
Hamptden Engine House.  
Hangen, H. W., residence.  
Heckman, W. A.  
High, Mrs. Mary, residence.  
Hoff, H. A.  
Home for Widows and Single Women.  
Hotel Penn.  
Jacobs, T. S.

Jameson, Jas., residence.  
Jameson & Co., store.  
Jones, Richard H., residence.  
Keller, F. M., residence.  
Keiser, David.  
Keystone Steam Heating Co.  
Kline & Eppenheimer.  
Kline, Wm., residence.  
Knight, John.  
Koeller, Jas. O., residence.  
Kretz, A.  
Kurtz, Henry, residence.  
Lauer, Frank, residence.  
Leinbach, J. G., residence.  
Leiss, L. H., residence.  
McAlvaïne, M. C.  
Moser, C. H., residence.  
Muhlenberg, Dr. W. F.  
Muhlenberg & West.  
Muhlenberg & Glymer.  
Nagle, Dr. H. N., store.  
Nerthanimer, John, store.  
Nyce, C. S.  
Pennsylvania R. R., new depot.  
Philadelphia & Reading R. R., dining rooms.  
Public School.  
Quier, Leon, residence.  
Rader, Geo., residence.  
Rambo, F.  
Raser, Dr. John B.  
Reading Iron Works.  
Reading Steam Heat & Power Co.  
Remmle, W. T., & Co.  
Righter, J. K., residence.  
Ritter, W. S.  
Rollond, Augustus, residence.  
Rosenthal, W., Editor "Reading Post."  
Rote, A. E.  
Rowe, H. T.  
Schaeffer, Chas. H., residence.  
Scull, Edward.  
Sheible, J. N.  
Shelter, Henry.  
Steinbach, Rev. A. S., residence.  
Stevens, G. A., office.  
Stichber, Mrs. J. L., residence.  
Stroechecker, Jacob, residence.  
Summons, E. S.  
Sweetzer, Wilson, residence.  
Thalheimer, A. T., residence.  
Tyson, A. Harvey.  
Union National Bank.  
Weida, Solomon, residence.  
Wenrich, Samuel G., residence.  
Willson, T. A., residence.  
Wilttrout, Chas., residence and store.  
Wood Memorial Chapel.

**REFTON.**

Herr, Daniel.

**RENOVO.**

Dedier, Samuel F., residence.  
Holman, Wm. L., residence.

Lees, David, residence.  
Murphy, Jas., residence.  
O'Hagan, Jas., residence.  
O'Hagan, P. & Son, store.  
P. R. R., offices and buildings.  
P. R. R., passenger station.  
P. R. R. "Renovo" Hotel.  
Pennsylvania R. R., Superintendent's & Master Mechanic's residences.  
Public School building.  
Renovo Public School buildings.  
Roberts, Thos. A., residence.  
Russ, Frank, restaurant.  
Simpson, R. D., residence.  
Stevenson, A. N., store.  
Stevenson, A. N., residence.  
Ward, John, hotel.  
Youts, Wm., residence.

**RICHLANDTOWN.**

Shelly, J. H.

**RIDGEWAY.**

Elk County Court House.

**RIDLEY PARK.**

Burke, Edward.  
Burke, Mrs. R.  
Leedom, Chas.  
Paitredge, Thos.  
Ridley Park Hotel.  
School Building.  
Ward, Abram.  
Ward, Jos.

**RIEGELSVILLE.**

Riegel, J. L.

**RINGTOWN.**

Rumel, A. H.

**ROARING SPRING.**

Carver, A. L.

**ROCK GLEN.**

Morton, Joel, residence.  
Norton, Neal, residence and hotel.

**ROTHVILLE.**

Ballanger, Jas.

**ROYERSFORD.**

Graves, Dr. J. S., residence and store.  
Latschaw Building.  
Latschaw, B. Irvin, residence.  
Latschaw, L. B., residence and hall.  
National Bank of Royersford.  
Nix, J. J., residence.  
Nix & Latschaw.  
Treed, Aaron C., restaurant.  
Treed, Samuel C., residence.

**SAEGERTOWN.**

Eureka Spring Mineral Co.

**SALIEGO.**

Greider, J. M.  
Puffer, Jno.

**SALTSBURG.**

Kiskiminetas Springs School.  
SANDY HILL.

Court House.

**SANDY LAKE.**

Austin Potter.

## REFERENCES.

**SAYRE.**

General Offices Pa. & N. Y. R. R.  
L. V. R. R. depot.  
Packer, Robt. A., residence.  
Wilbur House.

**SCHUYLKILL HAVEN.**

Meyer, Jos. N.  
Wilttrouts, Chas., residence and store.

**SCRANTON.**

Archer, John M.  
Assembly Rooms.  
Bauman, Anthony, store and residence.  
Belin, H., residence.  
Bougel, J.  
Bristol House.  
Burke, O. T.  
Burrs, Dr. A. E., block.  
Catholic College.  
Church, Sister House and School, St. Mary  
Provider.  
Clarke, Geo. A., building.  
Connell, W. P., & Son.  
Connell, Wm., residence.  
Cosey Bros., store.  
Cosey Bros., residence.  
Daniel & Elinger.  
Davis, E. J., store.  
Dickson, J. P., residence.  
Dickson, Mrs. Thos. residence.  
D. L. & W. R. R. depot.  
Evans & Jacobs, store.  
Farmer Dairy Co.  
Farris, Ed., hotel.  
Faurot House  
Finch, I. A. & Co.  
First National Bank Building.  
Fish, J. B.  
Francois, Alex L., residence.  
Galland, B., residence.  
German Presbyterian Church.  
Goldsmith Bros.  
Gould, R. S., residence.  
Gunster & Forsyth.  
Gunste, J. H., residence.  
Hand, Hon. A., residence.  
Hands, Justice, building.  
Hazleton Machinery and Supply Co., ware-  
house.  
House of Good Shepherd.  
Howley Bros.  
Hulbert, A. A., residence.  
Hulbert, W. A., store and residence.  
Hulbert F. H., residence.  
Hunt & Connell, Limited.  
Insane Asylum.  
Jermyn's, John, Coal Ex. Block.  
Jewish Synagogue.  
Jones, C. D.  
Lackawanna County Court House.  
Lackawanna Hospital.  
Lawler, Jas. J., store.  
Leonard Bros.

Leonard, B. E.  
Lewis, E. R.  
Manly, P. D., stores, residence and hall.  
Mattis, C. C.  
Matti, C. F., G. M. L. I. & C. Co., residence.  
McArcher, John.  
McEachen, Samuel.  
Mear's Hotel.  
Memorial Hall Association.  
Moses Taylor Hospital.  
O'Brien, Richard, residence.  
Piatt, J. C., residence.  
Post Office.  
Reese, S. M.  
Rosen, Jno.  
Sanderson, J. Gardner, residence.  
Sanderson, Geo.  
Schlage, Chas.  
Schneider Bros.  
Scranton, Arthur.  
Scranton, Hon. J. A.  
Scranton Steel Co.  
Scranton Supply and Hardware Co.  
Sloane, J. D.  
St. Charles Hotel.  
St. Cecilia's Academy.  
St. "Dennis" Hotel.  
St. Peter's Cathedral.  
Stock, F. K., residence.  
Sturgis, E. B.  
The Lackawanna Iron and Coal Co., stores.  
The Lackawanna Iron and Coal Co., offices.  
The Lackawanna Iron and Coal Co., labora-  
tory.  
The Pancoast Coal Co., store and office.  
Van Stouch, Wm., residence.  
Watson & Jermyn.  
Wehlan, Dr. Ludwig, residence and office.  
Welsh Baptist Church.  
Welsh Tabernacle Church.  
Willard, E. A.  
Williams, L. J., residence.  
Wirnke, Mrs. Mary.  
Y. M. C. A., building.

**SEWICKLEY.**

Dryman & Son.

**SHAMOKIN.**

Aucker, R. S.  
Aucker, Slayman & Co., office.  
Catholic Church.  
City Hotel.  
Doolittle, Wm.  
Eisenhart, Daniel.  
Epler & Odgen.  
Exchange Hotel.  
First National Bank.  
First M. E. Church.  
Fisher, Geo. S.  
Floyd, H.  
Garfield School Building.  
G. A. R. Opera House.  
Graeber, Jacob.

Heilner, B. N.  
Helfenstein, Jno. P.  
Keiser, Jacob R.  
Kessler, Jos. W.  
Kulp, Darlington R.  
Kutzner, Wm. R., store room.  
Leader, C. C., residence.  
Lorenz, Fred., residence.  
Lutheran Church.  
Marshall, Geo.  
Martz, Geo. O.  
Martz, Miss C.  
Marr, A. G., residence, business block and  
office.  
May, Isaac, Sr.  
McConnell, W. C., residence.  
McWilliams & McConnell, office.  
Mullen, Jno.  
Robertson, A.  
Robertson, Geo., residence.  
Rothschild, Harry, residence.  
Seiler, E. G.  
Shamokin Water Co.  
Shuster, D. E.  
Smink, D. C.  
Smink, Wm. H. R.  
Smuck, Daniel C., residence.  
Spettler, John H.  
St. Edward's Church.  
St. Edward's Parsonage.  
Williams, C. Q.  
Windsor Hotel.  
Zimmerman Henry, residence.

**SHARPSVILLE.**

Sharpville School.

**SHARON.**

Convent of the Holy Child Jesus.  
First Presbyterian Church.  
Walker & Carley, office.

**SHEFFIELD.**

Horton, Walter, residence.

**SHENANDOAH.**

Schimpf Bros.

**SHICKSHINNY.**

Campbell, W. A.  
Hess, Amos J., residence.  
Hollopeten, D. F., block.

**SHIMERSVILLE.**

Kern, D. N.

**SHIPENSBURG.**

Currender, A. W.  
Harris, S. J.

**SHIPPOCKVILLE.**

Wolfe, D. S., residence.

**SILVER BROOK.**

Silver Brook Coal Co.

**SMITHPORT.**

McKean Co., buildings.

**SMOOTH GROVE.**

Glatfeller, W. L.

**SMYRNA.**

Priest, J. S.

## REFERENCES.

### SOMERSET.

Beisecker, Frederick, offices.  
 Beisecker, Mrs. James, residence.  
 First National Bank.  
 Fox, Samuel, residence and office.  
 Love, Geo., residence.  
 Ogle, J. G., residence.  
 Schell, P. A., & Co.  
 Somerset Dairy Co., offices.

### SOUTH BETHLEHEM.

Administration Building.  
 Bethlehem Iron Co.'s stores.  
 Brinker & Sloyer, office building.  
 Children's Pavilion.  
 Deitrick, H. A. R.  
 Fetters, M. C., hotel.  
 Halacher, J. B.  
 Jeter, F., office building.  
 Johnston, T. H.  
 Ladies' Pavilion.  
 Lamberton, Dr. R. A.  
 Laufer, Edwin, residence & office.  
 Lehigh University.  
 L. V. R. R., offices.  
 L. V. R. R., freight depot.  
 McEnroe, Rev. Father Philip.  
 Naylor, Mary A., residence.  
 Newman, J., office.  
 Pacific House.  
 Packer Hall.  
 Pitchel, H. S.  
 Sayer, R. H.  
 Sayer, W. H.  
 Stahr, George F.  
 St. Luke's Hospital.  
 Wilbur, R. H.  
 Wilson, T., residence.

### SOUTH CHESTER.

South Chester Public School.

### SOUTH EASTON.

Franklin Steam Fire Engine Co.  
 Fryberger, H.  
 Gould, O. B.  
 Hubb, Jacob, L. V. R. R. shops.  
 L. V. R. R. E. offices.  
 L. V. R. R. depot.  
 Musick, M. D., residence.  
 Slough, Dr. Sr., residence.  
 Steiner, T. A., residence.  
 Turner, Amos.  
 Wilhelm, Chas., residence.

### SOUTH WILKES-BARRE.

James, J.

### STARTINGTON.

Williams, David.

### STEELTON.

Alleman Bros., residence, office.  
 High School building.  
 Penn Steel Co.

### ST. MARY'S.

Church of the Sacred Heart.  
 Commercial Hotel.

Coryell & Russ.

Episcopal Church.  
 Geis, Wm.  
 German Catholic Church.  
 Hall, James.  
 Hall, J. K. P.  
 Haul, Kaul & Co.  
 Hanhouse, Joseph.  
 Kaul, A., residence.  
 Kaul, John.  
 Kline, Chas.  
 Luhr, Chas.  
 Mosier, A. D.  
 Russ, Eben J.  
 St. Joseph's Convent.  
 Wendfelder, Joseph, Jr.  
 Winner, Hon. Sebastian.

### STRASBURG.

Groff, A. J.

### STROUDSBURG.

Cooke, J. W., residence.  
 Hodd & Bassard.  
 Kistler, M. L., residence.  
 Landers, F.  
 Stauffer, Geo. E.  
 Stroudsburg Social League.

### SUGAR GROVE.

Green, Clark.

### SUMNEYTOWN.

Barndt, Harvey, residence and store.

### SUNBURY.

Brice, A. W., residence.  
 Burrows, G. S., residence.  
 Cake, J. N., residence.  
 Central Hotel.  
 City Hotel.  
 Clement, I. F., residence.  
 Conrad, J. R.  
 Derr, John F., residence.  
 Dwait Building.  
 Fry Landis, residence and store.  
 Greenough, E. W., residence.  
 Malick, S. P.  
 Neff House.  
 N. C. R. W. C. station.  
 Phil. & Reading R. R. depot.  
 P. R. R. depot.  
 Reed, J. B.  
 Savidge, C. R., residence.  
 Silvins, C. L., residence.  
 Steineard, John.  
 Stimer, T.  
 Tweed, H., residence.  
 Wolverton, S. P., residence.

### SUSQUEHANNA.

Sperl, H.

### SWISVALE.

Union Switch & Signal Co.

### TAMAQUA.

Fry, E. E.

### TELFORD.

Telford Machine Co.

### THOMPSONTOWN.

Haldeman, A. G., residence.  
 Tennis, E. A., residence.

### THORNBURY.

Brinton, Jos. H.

### THURLOW.

McMains, W. F.  
 McManns, W. S.  
 Stainton & Thomas.  
 Standard Steel Casting Co.

### TIDIOUTE.

Tidioute Chair Co.

### TIOGA.

Odd Fellows' Orphanage.  
 P. & R. R. depot.

### TITUSVILLE.

Bates, H. S.

### TOWANDA.

Ayers, Monroe, residence.  
 Becker Bros.  
 Catholic Church.  
 Christ's Church.  
 Citizens' National Bank.  
 Dayton, Geo. A., mill.  
 Decker, A., residence.  
 Decker, Geo., residence.  
 Denslow & Jackson.  
 Denslow, W. H.  
 Dettrich, Mr.  
 Dodge, W. H.  
 Dye, A. D., & Co.  
 Ellsbree, N. C., block.  
 Episcopal Church.  
 Estabrook, A. J., residence.  
 Fox, John E., residence.  
 Griffith, J. J., residence.  
 Hale, B., residence.  
 Hale, E. W., residence.  
 Humphrey Bros. & Tracy, factory.  
 Humprey Mfg. Co.  
 Kelly, Rev. Father, residence.  
 Little, Stanly, residence.  
 Manville, J. A.  
 Mercur Block.  
 Opera House block.  
 Overton, E., residence.  
 Penn Mutual Ins. Co.  
 Porter, C. B., store.  
 Porter, H. C. & Son., store.  
 Presbyterian Church.  
 Scott, H. L., residence.  
 Second Ward School House.  
 Smith, G. S., residence.  
 Susquehanna Collegiate Institute.  
 Towanda Foundry Co.  
 Ward House.

### TRAINER.

Trainer, D. & Son.  
 Trainer, D.  
 Trainer, E. E.  
 Trainer, W. E.

## REFERENCES.

### TRAPPE.

Lutheran Church parsonage.  
 Miller, J. G. T.

### TROUTVILLE.

Ginter, H. E.

### TROY.

Bowen, D., residence.

### TUNKHANNOCK.

Billings, Hon. Paul, residence.  
 Court House.  
 Jenkins, Judge, residence.  
 Packer House.  
 Sittsen, Judge, residence.  
 Slawson, A. J., store and residence.  
 Whipple, O., residence.

### UHLERTOWN.

Uhler, Michael.

### ULSTER.

Mather, Jos.

### UNIONTOWN.

Baylis, Hon. C. E., residence.  
 Brown, S. S.  
 Fayette County Alms House.  
 Opera House.

### UPLAND.

Theological Seminary.  
 Upland School House.

### VILLA NOVA.

Church of St. Thomas.

### WARREN.

Citizens' National Bank.  
 Jefferson, I. P.  
 Kirberger & Mock.  
 Leonhart, G. H.  
 Lesser & Co.  
 Mintzer, A.  
 Spinner, M.  
 Struthas Hotel.  
 Warren Opera House.  
 Warren Ref'g Co.

### WATERVILLE.

Duirge & Co.

### WATSONTOWN.

Buck Robert, residence.  
 Rombach, G. W., residence.  
 Shannon & High.  
 Star, Durham & Co., office.  
 Watsontown Planing Mill.  
 Watsontown National Bank.  
 Wright, Thos. P.

### WAYNESBORO.

Aller, J. F.  
 Frick, A. O.  
 Frick, George.  
 Landes, F. F.  
 Miller, J. J.  
 Moore, Geo. W.  
 Phillips, J.  
 Shoemaker, J. P.

### WEATHERLY.

Hoffecker, Phillips, M. M. L. V. R. R.

### WELLSBORO.

Cole's House.  
 County Clerk's Office.  
 Elliott, M. F., office and residence.  
 Feild, T. B., residence.  
 Harrison, J., residence.  
 Kaess, W. C.  
 Parkhurst House.  
 Robinson, J. M., residence.  
 Tioga Co. Club House.  
 Watrous Frank B., residence.  
 Wellsboro Graded School.  
 Wilcox House.

### WEST BROWNSVILLE.

Gibbons, A. J.

### WEST CHESTER.

Daily Local News, office.  
 Gray, Jerome B., residence.  
 Hoopes Bros. & Thomas.  
 Hoopes, Josiah, residence.  
 Jackson, C. C.  
 James Bros.  
 Morgan, J. G.  
 Normal School of West Chester.  
 Palmer, Rees.  
 P. R. R. Depot.  
 Roberts, Capt. G. W., offices.  
 Savery, Edward.  
 Sharpless, W. P., residence.  
 State Normal School.  
 Thomas, Geo. B., residence.

### WEST CONSHOCTEN.

McFarland, E.  
 McFarland, J. A.

### WEST POINT.

Brooks, W. H.  
 West Point Engine & Machine Works.  
 West Point Mfg. Co.

### WHITE HAVEN.

Baker, John J., residence.  
 Blakslee, Mrs. Lucius, residence.  
 Cammeron, Geo. W., & Co.  
 Driggs, J. A., residence.  
 Dwyer, Wm., residence.  
 Feist, W. A., Printing House.  
 Hammond, Geo. H., & Co.  
 Keek, C. L.  
 Lavelle, Martin, residence.  
 LeVan, D. W., residence.  
 Peters, A. F., residence.  
 Peters M. G., residence.  
 Post Office.  
 Wallace Samuel, residence.

### WILKESBARRE.

Ahlborn, Fred, residence.  
 Alexander, M., residence.  
 Andes, Peter F.  
 Brown, S. L., & Co.  
 Carpenter, B. G. & Co.  
 Central School Building.  
 Dennire, H. P.  
 Dickson Mfg. Co., works.

Dimmick, A. M., residence.  
 Dimmick & Smith.  
 Forve, Peter, & Bro.  
 Gorman & Co.  
 Hancock School Building.  
 Hollenback, J. W., office.  
 Howell, Dr. J. T., residence.  
 Hunt, Chas. B., & Bro.  
 Leim, J. W., & Co.  
 Lewis, Josiah, residence.  
 L. V. R. R. Depot.  
 Lowenstein, Samuel, residence.  
 Luebrecht, M. L., residence.  
 Martin, A. I.  
 Neuer, W. N., office.  
 N. Y. C. & H. R. R. R. Depot.  
 Osborn, E. S., residence.  
 Patten, J. W., & Co.  
 Phelps, F. A., & Co.  
 P. & N. Y. C. R. R. R. Depot.  
 Raeder, Jno. L., hotel.  
 Shelley, Geo.  
 Sheppard, Wm.  
 Smith, Marcus, supt.  
 Stegmaier, C. S., & Son, brewery.  
 Vulcan Iron Works.  
 Welles, Edw.  
 Wilkes-Barre Gas Co.  
 Wyoming Valley Hotel.

### WILKINSBURG.

Allen, W. H., residence.  
 Brandt E. K., residence.

### WILLIAMSPORT.

Beece, A., residence.  
 Beech Creek R. R. Station.  
 Bloodgood, J. F.  
 Bower, Henry, restaurant.  
 Camp, C. F.  
 Coleman, F.  
 Coleman, Fletcher, residence.  
 Corning, L. L., National Bank.  
 Court House.  
 Cummings, Judge, residence.  
 Edison Electric Illuminating Co., offices.  
 First National Bank.  
 Forseman, R. M.  
 Hays, J. W.  
 Henry House.  
 Hermance, A. D.  
 Kash, A. J., hotel.  
 Keeler, E., & Co.  
 Kline & Co.  
 Locoming National Bank.  
 Maffhey, D. T., residence.  
 Mowbray, R., residence.  
 Neyhart, A. B., & Co.  
 Parker, J. O., residence.  
 P. R. R. Depot.  
 Ryan, J. R. S., residence.  
 Ryan, S. R. F., residence.  
 Sanderson, G. H., residence.  
 Slate, A., residence.

## REFERENCES.

Slate, G.  
Spafford, O. J., residence.  
Stenber, S. C.  
Tally, G. W.  
Turner, Jacob R.  
Vermance, A. D., residence.  
Wagner, A. L.  
West Branch National Bank.  
Williamsport National Bank.  
Williamsport Hardware & Stove Co.  
Williamsport Steam Co.  
Wyland, Mrs., G. G.  
Young, J. M.

**WILMINGTON.**

Westminster College.

**WIND GAP.**

Leibert, Geo.

**WITMER STA.**

Musselman, C.

**WYOMING.**

Hutchings, J. A.

**YORK.**

Bell, Geo. W.  
Boll, Henry.  
Broomel, Schmidt & Co.  
Chambers, Thos., & Co.  
Children's Home.  
City Bank.  
City Hotel.  
County Alms House.  
Court House.  
Dale & Hart.  
Dempwolf, C. H.  
Ebert, H. A.  
Elliott's, W. D., estate.  
Farmers' Ins. Co.  
Farquhar, A. B.  
First M. E. Church.  
Frey, Motler & Co.  
Frey, Enoch.  
Getz & Horn.  
Hirsch, D. F.  
Hoffman, Amos.  
Killer, David.  
Kraber, E. I., & Sons.  
Kunkle, Wm.  
Lehmayer & Bros., store.  
Marshall, L. W.  
Manc, Edward.  
McClelland & Gatwalt.  
Miller, E. J.  
Myers, Mrs. S., store.  
National Hotel.  
Patton, Jno., & Co.  
Recker, Fred.  
Schultz, D. P.  
Small, D. E., estate.  
Small, O. A. & S.  
Smith, Wm., & Co.  
Stall, O. B. & A.  
St. Mary's R. C. Church.  
Stacey, J. W.

Stuck, O.  
Stueckler, D. E., residence.  
Thomas, J. F.  
Throne, Jno. M.  
Torry, David.  
Trinity Reformed Church.  
Weiser, Carl, & Son.  
Weist, P. C.  
Your County Bank.

## RHODE ISLAND.

**ANTHONY.**

Capwell, J. H.  
James, D.  
Sisson, N. E.  
Whipple, J. R.

**BRISTOL.**

Church, Samuel W.

**EAST PRO. CENTRE.**

Judkins, F., residence.

**JOHNSTONE.**

Eaton, Edward, residence.

**NEWPORT.**

Burdick, Clark, residence.  
Golet, Odgen, residence.  
Granby, C. E.  
Havemeyer, T. E., residence.  
Langley & Sharpe.  
Lynch & Sullivan.  
Mawton, Mr., residence.  
Morgan, E. D.  
Newport Gas Light Co.  
Powell, John H., residence.  
Sherman, Watt, residence.  
Van Allen, Mr., residence.

**PAWTUCKET.**

Bryant, E. B.  
Pawtucket Steam & Gas Pipe Co.  
Roy, Elmer M.

**PROVIDENCE.**

Aldrich, E. K.  
Aldrich House.  
Almy, E. C., & Co.  
Bristol Hotel.  
Brown, A. W.  
Chamsilver, S. B.  
Chase, Geo., F.  
City Hall.  
Coggeshall, F.  
Cole, C. J., residence.  
Conroy, James C.  
Darling, M. V. P.  
Earle & Prew.  
Eaton, Edward, residence.  
Evans, John.  
Farnham, E., residence.  
Fitzgerald, M.  
Heath, Wm. G., & Co.  
Hotel Perrin.  
Kingsbury, E. B.  
Luther, H. P.

Masonic Hall.  
National Exchange Bank.  
Perry, Wm. N.  
Providence Steam & Gas Pipe Co.  
Reed, J. B.  
Rumford Chemical Works.  
Sherman, Wm. D., residence.  
Slater, A. B.  
Smith, J. M.  
Stone, Lorenzo, residence.  
Tierney, P. & J.  
Wilkinson Building.  
Winsor, Ira, & Co.

**SAYLESVILLE.**

Clarke, G. M.

**WAKEFIELD.**

Sheldon, G. W., & Co.  
Wakefield National Bank building.

**WELLESLEY.**

B. & A. R. R. depot.  
Porter, F. H.

**WELLESLEY HILLS.**

B. & A. R. R. depot.

**WESTERLEY.**

Crandle, Dr. H. W.  
Deysdale, Robert.  
Kenyon, Herbert.  
Newton Flats.  
Prestwick & Fuller.

**WOONSOCKET.**

Ballow, Chas. E., residence.  
Foss Memorial Building.  
Greene, James W., residence.  
Mowry, Wm. C., residence.  
"Patriot" building.  
Talcott, C. W.  
The Dr. Seth Arnold Medical Corporation.  
Warfield, A. B., & Co.

## SCOTLAND.

**GLASGOW.**

Combe, James, & Son.

## SOUTH CAROLINA.

**CHARLESTON.**

Cameron & Barclay.  
Charleston Cotton Mills.  
Charleston Fire Dept. Co.  
Charleston Hotel.  
City Hall.  
City Hospital.  
Cohon & Triest.  
Court House.  
Courtney Public School.  
Mallonce, J. C.  
Pitcher, C. S.  
Rodgers, Frank J., residence.  
Scotch Presbyterian Church.  
Shepard, Dr. Chas. U., residence.  
Steamer "Pocosin."  
Taylor, Frank F., residence.



## REFERENCES.

The "News & Courier."  
 Valk, C. R., residence.  
 Valk & Murdoch.  
 Wagener, Geo. A., residence.  
 Walker, Evans & Cogswell.  
**COLUMBIA.**  
 The Oliver Oil Co.  
**ROCK HILL.**  
 Rock Hill Construction Co.

### TEXAS.

**AUSTIN.**  
 Gerhard Hardware Co.  
 Tips, Walter.  
 State Blind Asylum.  
 State Deaf & Dumb Asylum.  
 State Lunatic Asylum.  
**BREMIAN.**  
 Giddons, Col. D. E., residence.  
**CORPUS CHRISTI.**  
 Carroll, Chas.  
**CORSICANA.**  
 Drane & Son, offices.  
 Navarro County Prison.  
 Orphan Asylum buildings.  
**CROCKETT.**  
 Smith, Rev. John B.  
**DALLAS.**  
 Dallas County Record building.  
 Martens, William.  
 Tompkins, M. & L., & Co.  
**EL PASO.**  
 Wells-Fargo Express.  
**FORT WORTH.**  
 Higly, L.  
 Hoffman, W. H., Imp. Co.  
 Lake, W. F.  
 Powell, E. H.  
**GALVESTON.**  
 Avenue K Public School.  
 Avenue L Public School.  
 Beach Hotel.  
 May & Wainwright.  
 Redfield, E. F., & Co.  
 Second District School.  
 Stuart, J. C.  
 Tremont House.  
 West End School.  
**GATESVILLE.**  
 Brook, F. S.  
 Texas State Reformatory.  
**HOUSTON.**  
 Board of Trade building.  
 Capital Hotel.  
 Cleveland, W. D., & Co.  
 Heiner, Eugene G.  
 House, T. W., building.  
 Houston Cotton Exchange.  
 Hutchins House.  
 H. & T. C. R. R. depot.  
 Medfred, E.  
 Morris, J. R., Sons.

Otter, W. W.  
 The Redfield Co.  
 Turco-Russian Baths.  
**PARIS.**  
 Paris Water Works.  
 Thomas, J. D.  
**THORP'S SPRING.**  
 Add Ran University.

### TENNESSEE.

**BOLIVAR.**  
 Western Hospital for Insane.  
**CHATTANOOGA.**  
 Geise, Conrad, & Co.  
 Gibson & Love Mfg. Co.  
 James, C. E., & Co.  
 Marshall, W. S., residence.  
 McGowen & Cooke, printers.  
 Read House.  
 Richardson building.  
 Richardson, Jno. P., & Bros.  
 Richmond, Theo., residence.  
 Southern Lumber Co.  
 Stanton House.  
 Whigham, R., Plumbing Co.  
**CLARKSVILLE.**  
 Aheran, Jas. P.  
 Tucket, T. D.  
 Wilson, Dr. C. G.  
**JACKSON.**  
 Court House.  
 Post Office.  
**KNOXVILLE.**  
 Comfort, James.  
 Deaderick, C.  
 E. T., V. & G. R. R. depot.  
 Kurth, Chas.  
 Palace Hotel.  
 Rourke, M. F.  
 Schubert's Hotel.  
 The D. B. Bayles Stove Co.  
 Van Deventer, J.  
**MEMPHIS.**  
 Browne, J. W.  
 Coleman & Co.  
 Jones, Drs. H. & K., offices.  
 Lattig & Bailey.  
 Memphis City Bank.  
 Schatlenberg, Keith & Co.  
 Toof, S. C., residence.  
 Wellford, J. L., residence.  
**NASHVILLE.**  
 Duncan & Gaines.  
 Duncan, Wm.  
 Grewar, David.  
 Mooney & Blaine.  
 Nashville Machine Co.  
 Nelson, Chas.  
 Perry Machine Co.  
 Perry, W. H.  
 Tenn. Range Mfg. Co.  
 Thompson, H. C.  
 West End Church.

**RIDGEDALE.**  
 Divine, S. W.  
**SOUTH PITTSBURGH.**  
 Perrv Stove Mfg. Co.  
 South Pittsburgh City Co.  
 Tenn. Coal, Iron & R. R. Co., offices.

### UTAH.

**MURRAY.**  
 Haynes, Henry.  
**OGDEN.**  
 Doyle & Hulverson.  
 Driver, George.  
 Fife, W. N.  
 First National Bank.  
 Funge, W. W.  
**PROVO CITY.**  
 Pike, Dr. W. R.  
 Territorial Insane Asylum.  
**SALT LAKE CITY.**  
 Benedict, Dr. Jos., residence.  
 Burton, John H., Archt.  
 Conklin, J. C.  
 Connelly, Mrs. T. D.  
 Daly, John J.  
 David, James & Co.  
 Deseret National Bank.  
 Ellerbeck, T. W., Supt. Salt Lake City Gas Co.  
 Farrell, J. W., & Co.  
 First National Bank.  
 Fox & Symons.  
 Graves, Dr. W. H.  
 Heesch & Ellerbeck.  
 Herald Office Building.  
 Hills, L. S., Cashier Deseret National Bank.  
 Karrick, L. C.  
 McComick, W. S.  
 McCune, A. W.  
 Midgley & Sons.  
 Moran, P. I.  
 Park, Boyd.  
 Paul, Capt. Sam'l.  
 Pitt, W. H., residence.  
 Roberts, Bolivor.  
 Salisbury, O. J.  
 Salt Lake Daily Tribune.  
 Salt Lake Herald.  
 Sebree, Howard.  
 Utah & Montana Machinery Co.  
 Wasatch Office Building.  
 Webber, T. G., residence.  
 Z. C. M. I. Block.

### VERMONT.

**BARRE.**  
 McKanna & Griffin.  
**BELLOWS FALLS.**  
 Alber & Bodine.  
 Brown, A. H. & T. H.  
 Fairbank & Labaree.  
**BENNINGTON.**  
 Adams, Enos, residence.  
 Cooper, Chas., residence.

## REFERENCES

Newton's, W. D., building.  
 Post Office buildings.  
 Tiffany, E. J., residence.  
 Tiffany, F. M., residence.  
 Valentine's, A. B., building.

### BRANDON.

Electric Light station.

### BRATTLEBORO.

Anderson, John S.  
 Brooks, E. F. residence.  
 Brooks House.  
 Broom, Jno. T., residence.  
 Carpenter, E. P., factory.  
 Crosby & Adams.  
 Crosby, E.  
 Crowell, Geo. E., residence.  
 Dowley, Geo. T.  
 First Baptist Church.  
 Fleming, P., & Co.  
 Galvin, John.  
 Goodhue, F. W., residence.  
 Hawley, N. J., residence.  
 Herrick, S. M., residence.  
 Johnson, A. O.  
 Leonard & Noess, residences.  
 Leonard, Wm., residence.  
 Marshall, O. A.  
 May, A. V., residence.  
 People's National Bank.  
 Pratt, Andrew, residence.  
 Punce & Gregg.  
 Robertson, Wm.  
 Roess, Jno. D., residence.  
 Sawyer, N. A., residence.  
 Sherman, S. H.  
 Town Farm buildings.  
 Vermont National Bank.  
 Walker, Rev. Dr., residence.  
 White, E., residence.  
 White, Norris, residence.  
 White, U. H.  
 Whitney, E. D., residence.  
 Whitney, F. A., residence.  
 Whitney, J. D., residence.

### BURLINGTON.

Blodgett, G. S., & Co.  
 Cloarec, Rev. J. M., residence.  
 Griffin, Jno., & Son.  
 Kingsland, A. B.  
 Lanan, J. E.  
 Mellor, John, residence.  
 Nash & Roche.  
 Peck, E. W., residence.  
 Reed, C. C., residence.  
 Smith, Wm., residence.  
 Stiles, R. S., residence.  
 Wheelock & Kingsland.  
 Willard, Dr. A. J.

### DUMMERSTON.

Pratt, R. W.

### FACTORY POINT.

Wait, C. J.

### HARTFORD.

French, Watson & Co.

### LYNDON CENTRE.

Lyndon Institute.

### MANCHESTER CENTRE.

Connor, A. B., residence.  
 Wait, C. W., store.  
 Wyman, Dr. E. L., residence.

### MANCHESTER DEPOT.

Conner, A. C.

### MONTPELIER.

Adams, W. E., store and residence.  
 Houghton, J. C., residence.  
 Lyons, P. L.  
 Page, John A., residence.  
 Peck, John W.  
 The Pavilion Hotel.  
 Washington County Court House.

### NEWPORT.

Carwell, H.  
 Crane, W. D.  
 Grandy, C. E.  
 Lane & Davis.  
 Root, H. S.  
 True & Blanchard.

### NORTH BENNINGTON.

Simmons, H. C.

### POULTNEY.

Moseley-Stoddard Mfg. Co.

### PROCTOR.

Johnson, Dr. J. G., residence.

### RUTLAND.

Bailey, Wayne, residence.  
 Bardwell House.  
 Chaffee, Geo. T., residence.  
 Channell, C. E.  
 Dunn & Cramton.  
 Gaffeny, Rev. Thos., residence.  
 Gould, J. A., residence.  
 Landon, W. C., store.  
 Meldon, Mrs. Mary, residence.  
 Stearns, M., residence.  
 St. Mary's Catholic School.  
 Sullivan, Mrs. Catherine, residence.  
 Velequette, E. A.  
 Wyman, Dr. E. L.

### ST. ALBANS.

Greene & Clark.  
 Noble, G. C., residence.

### ST. JOHNSBURY.

Bray, W. J.  
 Doran, H. W., & Co.  
 First National Bank.  
 Merchants' National Bank.  
 St. Johnsbury House.  
 Thompson & Goss.

### WEST RANDOLPH.

Lamson, J. H.  
 McIntyre, Dr.

### WHITE RIVER JUNCTION.

Nott, H. L.  
 Windsor State Prison.

## VIRGINIA.

### ABINGDON.

Palmer, G. W.

### ALEXANDRIA.

Cogans', Wm. Sons.  
 Fowler, Jno. S., residence.  
 Janney, Maj., E. H., residence.  
 Lannon, John.  
 Opera House.  
 Smoot, C. C., & Sons, factory.

### BERKLEY.

Baker, Capt., O. S., residence.  
 Brown, Dr., residence.

### BLACKSBURG.

Lomax, Gen., L. L., residence.  
 Virginia, A. & M. College.

### CLOVERDALE.

Cocke, C. H.

### CROZET.

Miller, Manual, Labor School.

### DANVILLE.

Fitzgerald, Geo. T., & Co.  
 Newton House.

### FARMVILLE.

Farmville Mfg. Co.  
 Presbyterian Church.

### FREDERICKSBURG.

Fleming, D. E.  
 Hurkamp, A. G.  
 Presbyterian Church.

### GRAFTON.

Sincil, A.

### HAMPTON.

Goodrich, E. O.  
 National Home for Disabled Soldiers.  
 Normal and Agricultural Institute.

### HARRISONBURG.

Thomas & Bowman.

### LYNCHBURG.

Cleland, Jas., & Son.  
 Coe, W. W.  
 Faulkner & Hanory, store.  
 Guggenheimer Building.  
 Johnsons, F. D., & Sons, store.  
 Kinmer, Wm., residence.  
 Law Building.  
 National Bank.  
 National Hotel.  
 New Arlington Hotel.  
 Smith, G. W., residence.  
 Watts & Ryland, store.

### MARION.

Hull, D. B.  
 So. Western Lunatic Asylum.

### MOUNT JACKSON.

Pennahackin, F. S., residence.

### NORFOLK.

Barnes, J. B.  
 Barracks, Marine.  
 Centenary M. E. Church.  
 City Gas Light Co.  
 Cumberland St. M. E. Church.  
 Davis, W. B., residence.

## REFERENCES.

Dey, G. W., residence.  
 Griffith, E. J., & Co.  
 Groner, V. D.  
 Gutman, I., residence.  
 Guy, E. E., residence.  
 Isidor, Leslie.  
 Johnson, H. W., residence.  
 Lauler, J. J.  
 LeKies., J. B., residence.  
 McCullough, A. A., residence.  
 Morris, Chas. S., residence.  
 Naval Constructors' Building.  
 Retreat for the Sick.  
 Santos, R. W.  
 Selden, Miss Julia.  
 St. James Hotel.  
 St. Vincent's Hospital.  
 Thain, A. P.  
 Thorne, A. P.  
 Trice, W. H. H., residence.  
 Walke, Henry.  
 Woodward, C. A.  
 Y. M. C. A. Building.

**PETERSBURGH.**

Brady, J. B.  
 Central Lunatic Asylum.

**PORTSMOUTH.**

Griffith, E. J. & Co.

**PULASKI CITY.**

Bertha Zinc Co.  
 Jones, Thos.

**RICHMOND.**

Ballard Hotel.  
 Bargamin, G. & A.  
 Bowers, John.  
 Brecker, Henry.  
 Christian, E. D., residence.  
 Cohen Co., store.  
 Exchange Hotel.  
 First Regiment Armory.  
 Gaines & Glover.  
 Harris, A. T., residence.  
 Lindsay, J. L.  
 Morris Street School.  
 P. Whitlock Tobacco Mfg.  
 Register J., & Son.  
 Rose, Jno. E. & Co.  
 Shanks, John.  
 Shanks & Barrett.  
 Saunders, E. A., residence.  
 Smith & Courtney.  
 Tanner & Delaney Engine Co.  
 Tanner, W. E., residence.  
 Thomas, Mrs. Jas., residence.  
 Young Men's Christian Assn.  
 West & Branch.

**ROANOKE.**

Grieder, B. S.  
 Rust, Walter.

**SALEM.**

Carper, R. J.

**STAUNTON.**

Bargamin, C.  
 Blackley, Jas. H., residence.  
 Hudson, W. A., residence.  
 Summerson, W. F., residence.  
 Weller, W. H., residence.

**SUFFOLK.**

Sherman, G. A.

**VIRGINIA BEACH.**

Crittenden, S. E.  
 Norfolk & Va. Beach R. R. Imp. Co.

**WEST POINT.**

Adams, P. H.

**WHITE POST.**

Conrad, W. G.

**WILLIAMSBURGH.**

Eastern Lunatic Asylum.

**WINCHESTER.**

Barton, R. P.

## WASHINGTON.

**EAGLE CLIFF.**

Hume, Wm.

**OLYMPIA.**

First National Bank.  
 Olympia Hotel.  
 Sisters' Hospital.

**SEATTLE.**

Academy of the Holy Name.  
 Central School.  
 Colonial Block.  
 Machintosh, A., residence.  
 Miles, Z. C., & Co.  
 Moran Bros. & Darie.  
 Occidental Hotel.  
 Providence Hospital.  
 Russell House.  
 Russell's, Mrs., "Select Hotel."  
 Seattle Plumbing & Supply Co.  
 The Boston Block.  
 Toklas & Slingerman, building.

**SPOKANE FALLS.**

Boyd, J. H., & Co.  
 Holley, Mason, Marks & Co.  
 Sacred Heart Hospital.

**TACOMA.**

Barlow & Catlin.  
 Borthwick, Dr., residence.  
 Cady, H. A., residence.  
 Clements, H. C., residence.  
 Collier & Hartenberg Building.  
 Collyer & Hartenberg.  
 Drum, Henry, residence.  
 Emerson School.  
 Fraser, W., residence.  
 Gross Bros., building.  
 Honey, A. A.  
 Hotel Fife.  
 Hotel Rochester.  
 Olds, T. T.  
 Olympium Hotel.

Presbyterian Church.  
 Rice, E. Jr., residence.  
 Sprague, Gen. J. W.  
 Sullivan, M. C.  
 Tacoma Opera House.  
 The N. P. R. R. General Office building.  
 The Tacoma National Bank.  
 Thompson, W. J., residence.

**VANCOUVER.**

House of Providence.

**WALLA WALLA.**

The Territorial Penitentiary.

## WEST VIRGINIA.

**ALDERSON.**

Alderson Hotel.  
 Howell, Clark.

**BENRY.**

Berry, J. L.

**BETHANY.**

Eyster, J. A.  
 Pendleton, W. K., residence.

**BLOCKSBURG.**

Carper, R. H.

**CHARLESTON.**

Charleston Water Works.  
 Howell, Shanklin & Dowman.

**COAL VALLEY.**

Montgomery, J. C.

**GORMANIA.**

McCrum, L. L.

**HUNTINGDON.**

Florentine Hotel.  
 Smith, J. O.

**MARTINSBURG.**

Cline, Conrad, residence.  
 Emmert & Fierv, store.  
 Farrin, John, & Co.  
 Faulkner, Judge Chas. J., residence.  
 Faulkner, Mrs. Mary, residence.  
 Fitsy, John, residence.  
 Flick, Hon. W. H. H., residence.  
 Grammar Public School building.  
 Hannis Distillery Co., office.  
 Jones, W. L.

**MORGANTOWN.**

Methodist E. Church.

**PARKERSBURG.**

Hotel Blennerhassett.  
 Ohio River R. R. depot & offices.  
 Turner, Chas. H.

**RANCEVERTE.**

Ranceverte Foundry Co.

**WHEELING.**

Baggs, A. J., residence.  
 Harr, Wm., & Son.  
 Hibberd, Geo., & Son.  
 Hubbard, Hon. W. P., residence.  
 Trimble & Lutz.

**WYTHEVILLE.**

Wadley, H. G.

## REFERENCES.

### WISCONSIN.

**APPLETON.**

Harriman, Judge J. E., residence.  
 Jeuss, Adolph, residence.  
 Patterson, W. S., & Co.  
 Rieves, Dr. J. L., residence.  
 Waverly House.  
 Whorten, John H., residence.  
 Whorten, Wm. G., residence.

**ASHLAND.**

McMinder, E. J.  
 The Northwest Heating Co.

**BAYFIELD.**

Bayfield County Court House.

**BLACK RIVER FALLS.**

Pope's, Colonel, residence.

**CHIPPEWA FALLS.**

Chippewa Lumber & Broom Co.  
 Stanley House.

**EAU CLAIRE.**

Bailey, W. F.

**FON DU LAC.**

Davis, Mrs., residence.  
 Fon du Lac Hospital.

**GREEN BAY.**

Britton, D. W., residence.  
 Comte, A. J.

**LA CROSSE.**

Austen, Hon. M., "Mayor."  
 Fall, James, residence.  
 Freeman, A. A., Co., office.  
 Roosevelt, W. A., & Co.  
 Roosevelt, W. A., residence.

**MANITANIC.**

Moffett, Hodgkins & Clark.

**MARSTON.**

Heath, J. T.

**MILWAUKEE.**

Adler, D.  
 Belvidere Building.  
 Chapman, F. A., & Co.  
 Chicago, Milwaukee & St. Paul R. R. station.  
 Coogan, M., & Co.  
 Finney, J. N.  
 Fourth District School.  
 Grassler & Gezelschap.  
 Hoffman & Billings Mfg. Co.  
 Johnson, J. B., residence.  
 Light Horse Squadron Armory.  
 Mack Block.  
 Mendels, H. M., residence.  
 O'Connor, W. P., residence.  
 Pawling & Hamishfaeger.  
 Rundle, Spence & Co.  
 Stark Bros. & Co.  
 State Normal School.  
 St. Hyacinth Catholic Church.

St. Paul depot building.  
 The Bayley Steam Heating Co.  
 Twelfth District School.  
 Windsor Hotel.  
 Y. M. C. Ass'n building.

**OCONOMOWOC.**

Lorleberg, H.

**OSHKOSH.**

Amos, Frank.  
 Bowen, Capt.  
 Brown, R. C., residence.  
 Campbell, Rob., residence.  
 Cook, O., residence.  
 Cranford, W. H., residence.  
 Dempsey, L.  
 Doughty, Benj., residence.  
 Foster, Carlton.  
 Gould, James P., residence.  
 Hutchinson, K. M., residence.  
 Loper, Mrs. J. R.  
 McKoy, H. W., residence.  
 McMillen, R., residence.  
 Morgan, John.  
 Quaw, Clayton.  
 Rundle, C. L.  
 Wakeman, Wm. J., residence.  
 Washburne, Hon. G. W.  
 Watterman, S.  
 Webb & Rundle.

**RACINE.**

Bull, Wakely.  
 Davis, O. C.  
 Elliot, Mrs. Jas.

**SHEBOYGAN.**

Barrows, A. S.  
 Dillingham, J.  
 Frank Yeele Hardware Co.  
 Lawrence, F.  
 Rineking, Dr.  
 Treat, Mrs. E. H.  
 Zimmerman Julius.

**ST. CROIX.**

Baker, J. S.

**STEVENS POINT.**

Cook, R. A.

**WAUKESHA.**

Waukesha County Jail.

**WEST SUPERIOR.**

First National Bank.  
 Knapp, I. Jay.  
 National Implement Co.  
 Towes Hotel.

**ZANESVILLE.**

King, Wm. T.  
 Lowell, L. E.  
 Smith, D. P.  
 Valentine, A. M.

### WYOMING.

**CHEYENNE.**

Carey's, Judge J. M., & Bro., buildings.  
 Carey's, Judge J. M., residence.  
 Catholic Church.  
 Catholic Convent.  
 Cheyenne National Bank Block.  
 Collens, J. W.  
 Davids, E. C., residence.  
 Dolan, T. F., & Co.  
 Holt, Geo. L., store.  
 Kent, T. A., residence.  
 Masten, Charles, residence.  
 Means, F.  
 Morgan, George F., residence.  
 Post, M. E., residence.  
 Ritchell, A. F.  
 Sun Building.  
 Swan, A. H., residence.  
 Swan, W. R., & Co.  
 Tompkins, J. N.  
 Truckley & Van Dyke, store.  
 Zehner, Jackson & Bucher, store.

**LARAMIE CITY.**

Albany Co. National Bank.  
 Arnold, S. B., residence.  
 Cordiner & Bruekner.  
 Cordiner, Wm., residence.  
 Crumrine, E., residence.  
 Dawson, M., residence.  
 Gramm, Otto, residence.  
 Marsh & Cooper's market.  
 Peabody, U. S., residence.  
 Reilly, C. J.  
 Roman Catholic Church.  
 Simons, J. H.  
 Symmons, J. K., residence.  
 Thomas, Mr., residence.  
 Willeston, W., residence.  
 Wyoming National Bank.  
 Wyoming University.

**OGDEN.**

Zitman, L.

### BRITISH COLUMBIA

**NEW WESTMINSTER.**

St. Mary's Hospital.

**VICTORIA.**

Arcade Building.  
 Fisher, E. H., residence.  
 Spencer, D.  
 St. Ann's Convent.  
 St. Joseph's Hospital.  
 Y. M. C. A. Building.





