



37

The PHOENIX
MANUFACTURING CO.

SAWMILL MACHINERY



EAU CLAIRE, WIS.

— U.S.A. —

1911-1912

ILLUSTRATED CATALOGUE

... OF ...

SAW MILL MACHINERY

MANUFACTURED BY

THE PHOENIX
MFG. CO.

25
9427

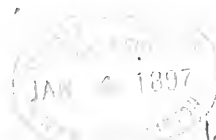

61455-

EAU CLAIRE, WIS., U. S. A.

COPYRIGHT 1896.

ENGINEERS MILWAUKEE

TS853
P4

To Our Patrons: —————

We have aimed to present in this catalogue a brief description of Standard Saw Mill Machinery, and feel satisfied that those interested in the manufacture of lumber will find much that is of interest herein.

We furnish plans and estimates, and take contracts for the erection of mills complete from the ground up.

We have built and equipped some of the fastest and best mills in this country and parties contemplating building new mills or remodeling old ones will find it to their advantage to place themselves in communication with us.

In conclusion we beg to say that as our endeavors in the past have always been to keep abreast of the times, and give our patrons the benefit of the most advanced practice in Saw Mill Construction, so shall we strive in the future to make our product superior to any in the market, and to maintain the foremost position in our particular line.

PHOENIX MANUFACTURING COMPANY.

111

1886-1887

INDEX.

A	PAGE.
Anvil, Saw	243
Approximate Numbers	292
Arbors and Boxes.....	134- 229
Arches, Wall	128
Areas and Circumference of Circles	299- 303
Attachments for Link Belt.....	148
Automatic Fuel Feeder.....	270, 271
Automatic Lumber Trimmer	74, 75, 76
Automatic Offset	46, 47
Automatic Saw Sharpener, Band..	232, 233
Automatic Saw Sharpener Circular	235, 236
Automatic Steam Engine.....	247, 250
B	
Babbitt Metal	230
Ball and Socket Hanger.....	132, 133
Band Saws	149
Table of Strain for.....	291
Band Saw Brazing Clamp.....	242
Carriage	30, 37
Filing Clamp and Jointer	239
Lap Grinder	234
Guides	21- 24
Mills	14- 27
Offsets	46- 49
Sharpener	232, 233
Stretching Machine	238
Swage	240
Tools (Hammers, Anvil, etc.)	243
Bar Iron, Weight of.....	293, 294
Bar Steel, Weight of.....	295
Base Plates	127
Belt Lacing	150
Leather	150
Horse Power of	287
Rubber	150
Bevel Core Wheels and Pinions..	217, 218

B	PAGE.
Bevel Gears, Iron	219- 227
Iron Frictions	180- 183
Paper Frictions	180- 183
Board Measure	304
Boiler Fronts	255
Fuel Feeders, Automatic	270, 271
Grates	256
Bolt Cut-off Machine.....	112- 114
or Wood Machine, Hand	
Feed	114
Bolter, Knee	115
Lath Mill	119- 122
Spoke	278, 279
Bolting Machine, Dimension..	281, 282
Boss Dogs	53- 55
Boxes, Adjustable Step	131
Arbor	134
Bracket	130- 132
Eccentric	129
Flat Bottom	127
Hanger Adjustable Ball and	
Socket	133
Post Adjustable Ball and	
Socket	132
Post, Rigid	130
Slide	129
Step	130- 131
Take-up	138
Vertical	131
Wall	132
Bracket Box (See Post Box.....	130
for Steam Feed	52
Wall Box	132
Brazing Clamp	242
Buggy, Lumber	275, 276
Bull Chain	110
Bull Chain Idlers	111
Bull Chain Sheaves for foot of log	
slip	110
Bumpers, Carriage	50, 51

C	PAGE.	D	PAGE.
Cant Flipper, Steam.....	104, 105	Decimal parts of an inch.....	298
Caps, Pile Driver	264	Detachable Chair	143
Carriage and Set Works.....	30- 45	Dial Wheel	43
Bumpers	50, 51	Dimension Bolter	281, 282
Offset	46- 49	Dog, Double Acting Forden	56
Track, Steel	60	Straight Tooth	57
Truck Boxes	59	Phoenix Boss	53- 55
Truck Wheels and Axles....	59	Rack and Pinion	58
Carts, Two Wheel Lumber....	275, 276	Drive Rig for Live Rolls....	124, 125
Cast Washers	230	Drop Hanger	133
Castings, Weight of, from Patterns	292	Drop Lumber Wagon	274
Center Deck	101		
Circular Saws	149	E	
Saw Mandrels	229	Eccentric Boxes	129
Mills	28, 29	Edgers, Gang	61- 73
Sharpeners	235, 236	Saws	149
Circumference and Areas of Circles	299- 303	Edging Grinders	84, 85
Chain, Link Belt	143	Emery Saw Gummer	237
V Top	142	Engines	247- 254
Log Haul-up	110	Engine Feed	90- 94
Sawdust	139- 140	Governors	261, 262
Slabs	139, 140	Engineering Notes and Tables.	283- 304
Special Transfer	142		
Wheels	144- 147	F	
Clamp, Brazing	242	Face Couplings	135
Filing	239	Face Flanges for Pulleys.....	134
Clutch Couplings, Friction	199	Feed, Friction Rope.....	95, 96
Jaw	134	Steam Direct	88, 89
Pulleys	184- 198	Twin Engine	90- 94
Cogs, Maple	228	Feed Water Heaters	257- 260
Cogging core wheels	228	Filing Clamp and Jointer.....	239
Collars, Brown Patent	137	Filing Room Equipment.....	231
Common Set	136	Filling Gears, price of.....	228
Compression Couplings	135	Flanged Face Couplings	135
Conveyor Slab	266- 269	Flanges, Pulley and Sleeve....	111, 134
Core Wheels, Bevel	217, 218	Sleeve	111
Mitre	214	Flat Bottom Boxes	127
Spur	213	Flippers, Cant	104, 105
Couplings, Clutch	134- 199	Foot Sheave for Log Slip.....	110
Compression	135	Forge, Portable	241
Flange Face	135	Friction Clutch Cut-off Coupling.	199
Crab, Single Geared.....	265	Friction Clutch Pulley	184- 198
Cut-off Machine, Shingle Bolt	112, 113	Iron (Spur or Bevel)....	180- 183
Saw, Steam Jump	99, 100	Frictions, Paper	180- 183
Swing	83	Friction Rope Feed Works....	95, 96
Cushions, Carriage	50- 51	Fronts, Boiler	255
Cutting Pipe Threads (Price of)..	230	Fuel Feeders (for Boiler Furnace)	
Cylinder, Steam	106		270, 271

G	PAGE.
Gang Edgers	61- 73
Lath Bolter	119, 122
Lath Mill	119- 122
Lath Mill and Bolter....	119- 122
Gang Lumber Trimmer	74- 78
Slab Slashers	79- 82
Geared Windlass	265
Gears, Bevel Core	217, 218
Horse Power of	289
Iron Bevel	219- 227
Iron Mitre	215, 216
Iron Spur	200- 211
Mitre Core	214
Spur Core	213
Governor, Engine	261, 262
Grate Bars	256
Grinder, Slab and Edging....	84, 85
Grip Set Works	40- 45
Gummers Saw	232- 237
Guides, Band Saw	21- 24
H	
Hand Carts, Lumber	275, 276
Hanger, Adjustable Ball and Socket	133
Hanger, Ball and Socket, Post....	132
Hammers, Pile	263
Hammers, Saw	243
Haul-up Chain, Idlers.....	111
Chain, Log	110
Head Blocks	30- 39
Heater, Feed Water	257- 260
Heavy Duty Saw Mill Engine.....	251- 254
Hill Steam Nigger	97, 98
Hinges for Ladder Saw	83
I	
Idlers for Bull Chain	111
Index Wheel for Set Works.....	43
Iron Center Wood Split Pulleys..	170- 174
Frame Log Jackers	107- 109
Frame Tighteners	125
Frictions	183
Pulleys	151- 167
Rivets	297
Rollers	124- 126
Weight of	293- 295

J	PAGE.
Jackers, Log	107- 109
Jointer, Filing	239
Jump Saw, Steam	99, 100
K	
Keyseats, Width of	136
Kline Cant Flipper	104, 105
Log Loader	103
Knee Bolter	115
Knot Saw Machine	116
L	
Lacing, Belt	150
Ladder, Saw	83
Saw Hinges	83
Lap Grinders	234
Lath Binder and Trimmer.....	123
Bolter	119- 122
Mills	119- 122
Mills and Bolter	119- 122
Leather Belting	150
Belting, Horse Power of....	287
Link Belt Attachments	148
Belt Chain	143
Belt Sprockets	144- 147
Live Roll Drive Rig.....	124, 125
Live Rolls	124- 126
Loading Platform	272, 273
Log Car Wheels and Axles.....	277
Chain Idlers	111
Haul-up Chain	110
Jackers	107- 109
Loader, Steam	103
Roller, Steam	101, 102
Turner	97, 98
Lumber Buggies	275, 276
Drop Wagon	274
Measure	304
Trimmers	74- 78
Truck Wheels	277
M	
Mandrels, Saw	229
Maple Cogs	228
Metal, Babbitt	230
Mill Dogs	53- 58
Miscellaneous	244
Mitre Core Wheels and Pinions...	214
Mitre Gears, Iron	215, 216

N	PAGE.	R	PAGE.
Nigger, Hill Steam	97, 98	Rope Power Transmitted	288
Nippers, Pile Hammer	263	Rotaries	28, 29
O		Rubber Belting	150
Offset, Automatic	46, 47	Belting, Horse Power of....	287
Head Block	48, 49	S	
P		Sapper, Shingle	115
Packers, Shingle	117, 118	Sapper and Bolter	115
Paper Frictions	180- 183	Saws, Circular	149
Patent Cap (for pile driving).....	264	Band	149
Pile Driver Caps	264	Edger	149
Driver Hammer	263	Saw Anvil	243
Driver Nippers	263	Arbors	134- 229
Pillow Blocks	127	Filing Clamp and Jointer....	239
Blocks, Arches	128	Gummer	232- 237
Blocks, Base Plates	127	Guides, Band	21- 24
Pinions, for Bevel Core Wheels....	217, 218	Hammers	243
for Mitre Core Wheels.....	214	Ladder	83
Stone	212	Mandrels	229
Pipe Rollers	126	Mill, Band	14- 21
Pipe Threads, Price of Cutting....	230	Mill, Carriage	30- 37
Plates, Base	127	Mill, Circular	28, 29
Portable Forge	241	Price of	149
Post Boxes, Adjustable	132	Speed of	288
Boxes, Rigid	130	Set, Combined Adjustable..	241
Hangers	132	Sharpeners	232- 237
Pulleys, Clamp Hub	169	Stretcher	238
Clutch	184- 198	Swage, Band	240
Flanges	111, 134	Sawdust Chain	139, 140
Iron	151- 167	Feeders	270, 271
Iron Split ..	167	Grates	256
Rule to Calculate Speed of..	290	Sprockets	141
Tightener	125	Scarfing Machine	234
Tight and Loose	168	Self-Feed Spoke Bolter	278, 279
Wood Split	170- 179	Separator, Steam	86, 87
Pump, Steam	245, 146	Set Collars	136, 137
R		Saw	241
Rack and Pinion Mill Dog.....	58	Works	36- 45
Re-Saw, Gilbert Band	25- 27	Shaft Bearings, Distance of ..	286
Rivets, Weight of	297	Shafting	136- 284
Rolls, Drive Rig	124, 125	Horse Power of	285, 286
Iron Live and Idle.....	125, 126	Shears, Pile Hammer	263
Rollers, Steam Log	101, 102	Sheave, Foot, for Log Slip.....	110
Rope, Feed Friction	95- 96	Sheet Iron, Weight of	296
Feed Steam	90- 94	Shingle Bolter and Sapper.....	115
		Bolt Cut-off Machine...112,	113
		Clipper	116
		Packing Frames	117, 118

S	PAGE.	S	PAGE.
Slab Conveyor	266- 269	Strain on Band Saws. Table of....	291
Grinder	84, 85	Stretcher, Saw	238
Slasher. Gang	79- 82	Swage, Saw	240
Slasher, Wood	82	Swing Saw	83
Sleeve Flanges	111	Saw Irons	83
Slide Box	129	T	
Slip Collars	136, 137	Tables and Engineering Notes 283-	304
Sorting Works and Loading Plat- form	272, 273	Take-up Boxes	138
Special V Transfer Chain.....	142	Taper Movement, Standard .38,	39
Speed of Saws	288	Tighteners, Iron Frame	125
Splitter Stave	280	Timber Measure	304
Spoke Bolting Machine	278, 279	Track for Saw Carriage	60
Splitter. Stave	280	Steel Carriage	60
Sprockets for Link Belt Chain...144-	147	Transfer Chain	142
for Steel Sawdust Chain ...	141	Trimmer, Automatic	74- 76
Spur Core Wheels	213	Lath	123
Gears	200- 211	Two Saw	77, 78
Paper Frictions	180- 183	Truck Boxes, Carriage	59
Pinions for Core Wheels... 212		Trucks, Carriage	59
Standard for Head Block.....38, 39		Lumber	277
Keyseats	136	Turned Shafting	136
Stave Splitter	280	Turners, Log	97, 98
Splitter Spoke	280	Twin Engine Feed	90- 94
Steam Cant Flipper	104, 105	Two Saw Trimmer	77, 78
Cut-off Saw	99, 100	Saw Wood Machine	82
Cylinders	106	V	
Engines	247- 254	Vertical Boxes	131
Engine Governors 261, 262		W	
Feeds	88, 89	Wagon, Lumber Drop	274
Feed, Bracket	52	Wall Arches	128
Feeds, Rope	90	Bracket Box	132
Jump Cylinders	106	Washers, Cast	230
Jump Saw	99, 100	Weight of Bar Iron	293
Log Loader	103	of Bar Steel	295
Log Roller	101, 102	of Castings	292
Nigger	97, 98	of Iron Rivets	297
Pump	245, 246	Wheels and Axles for Log Car....	277
Separator	86, 87	Windlass, Geared	265
Step Boxes, Adjustable	131	Wood Machine (or bolt cut-off)..	114
Rigid	130	Slasher	82
Steel Sawdust Chain	139, 140	Split Pulleys	170- 179
Stone Pinions	212		
Straight Edge	243		

ENGINEERING NOTES.

Areas and Circumference of Circles	299- 303	Saws—Rule for Calculating Speed	288
Belting—Formula for Horse Power, with table.....	287	of	288
Rule for Approximating the Length of	290	Table for Straining Band Saws.....	291
Board Measure	304	Shafting—Formula for Horse Power, with table	284- 286
Decimal parts of an inch.....	298	Table of Approximate Numbers for various purposes.....	292
Gears—Formula for determining Horse Power of	289	Weight of Casting from Patterns..	292
Iron—Weight of Round, Square and Sheet	293- 296	Weight of a Superficial Foot of Cast Iron	292
Pulleys—Formula for Speed and Size of	290	Weight of Sheet Iron and Steel...	296
Rope Drive—Table for H. P....	288	Weight of Iron Rivets	297
		Weight of Round and Square Iron	293, 294
		Weight of Flat Bar Steel.....	295

ABBREVIATIONS.

P. B. Pillow Blocks.....	127	V. B. Vertical Box.....	131
B. P. Base Plates	127	S. B. Step Box.....	130, 131
W. A. Wall Arch.....	128	B. B. Bracket Box	130
Y. H. Double Braced Hangers....	133	(Or Post Box)	
P. H. Post Hangers	132	W. B. Wall Bracket	132

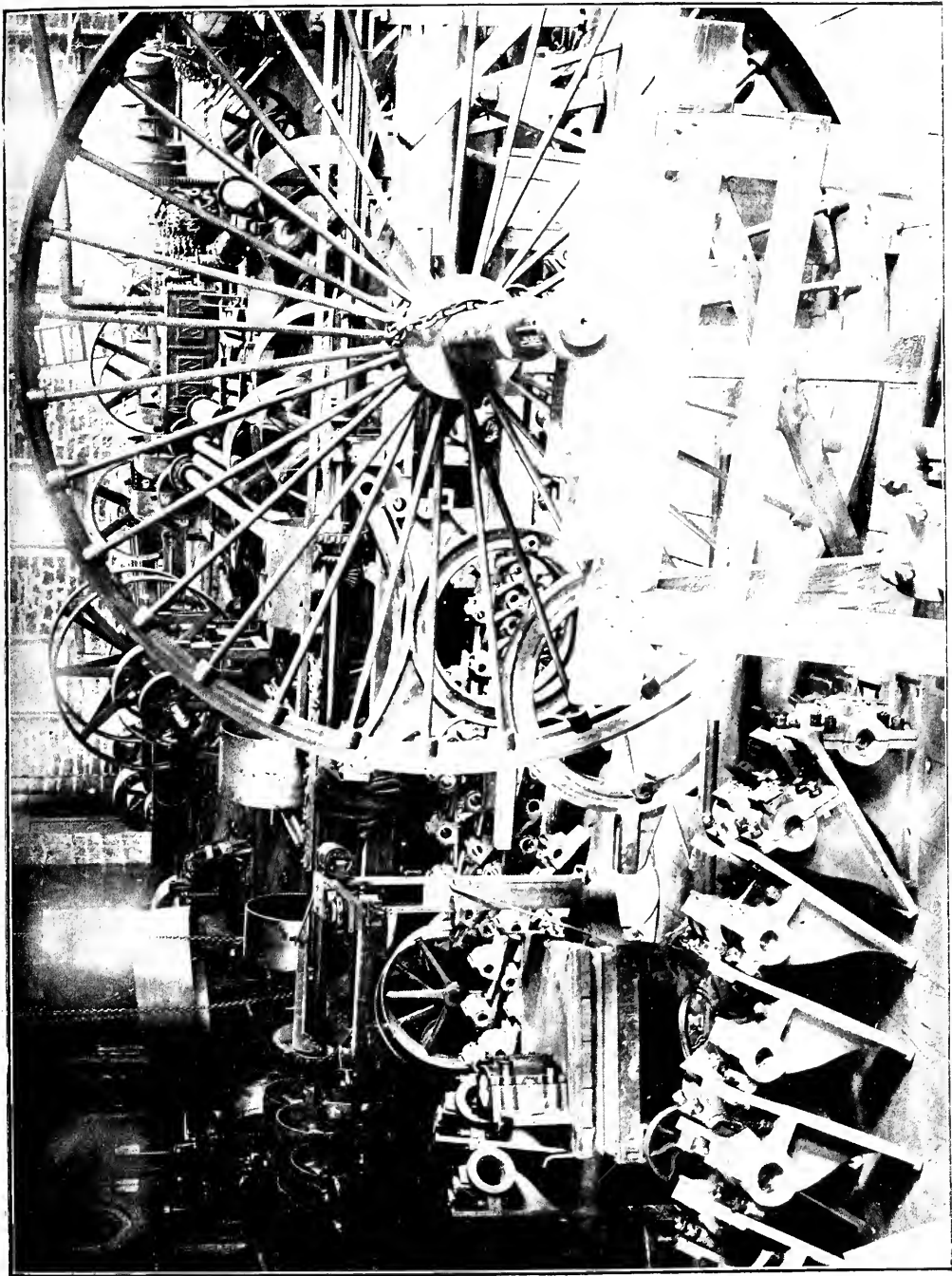

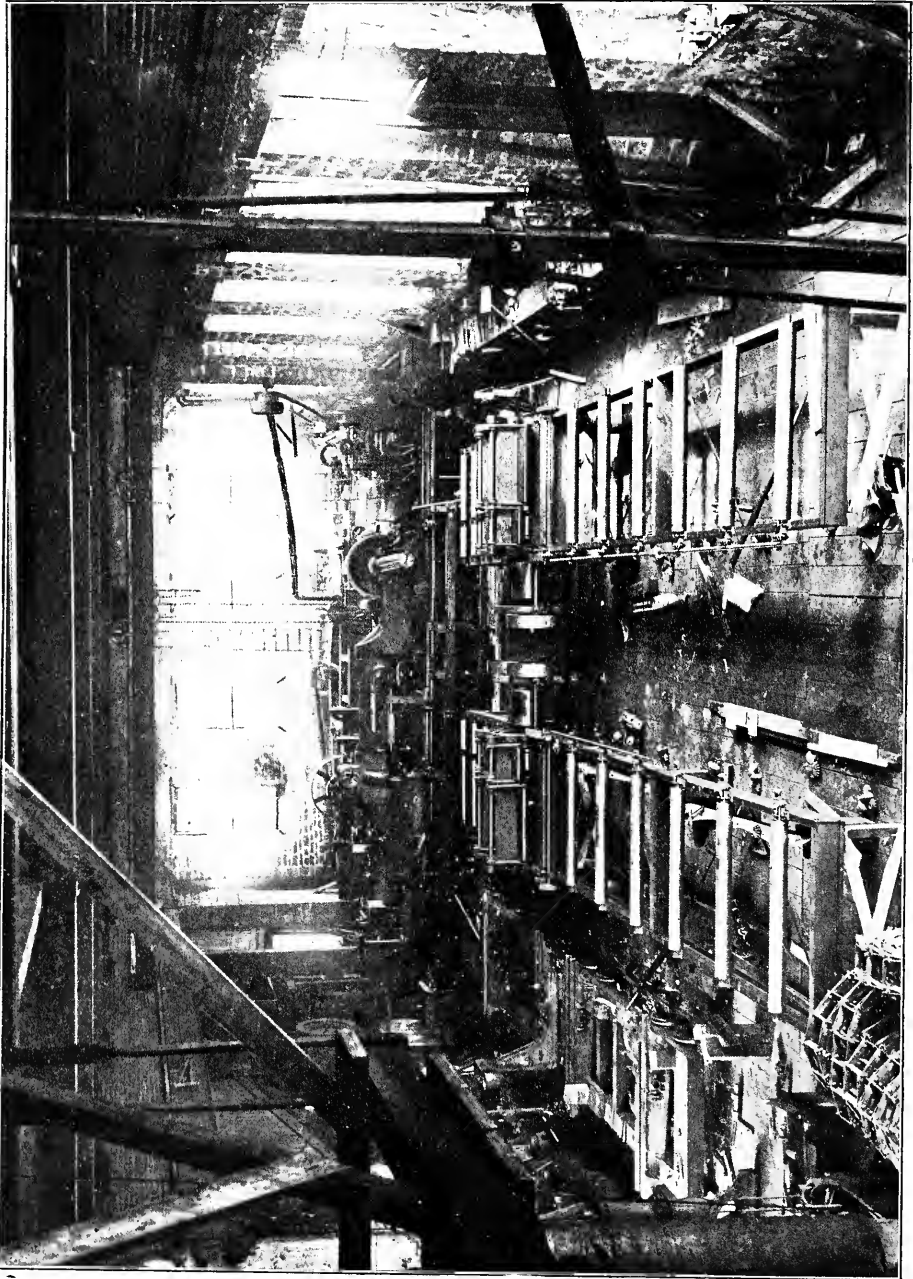

View in Erecting Shop.

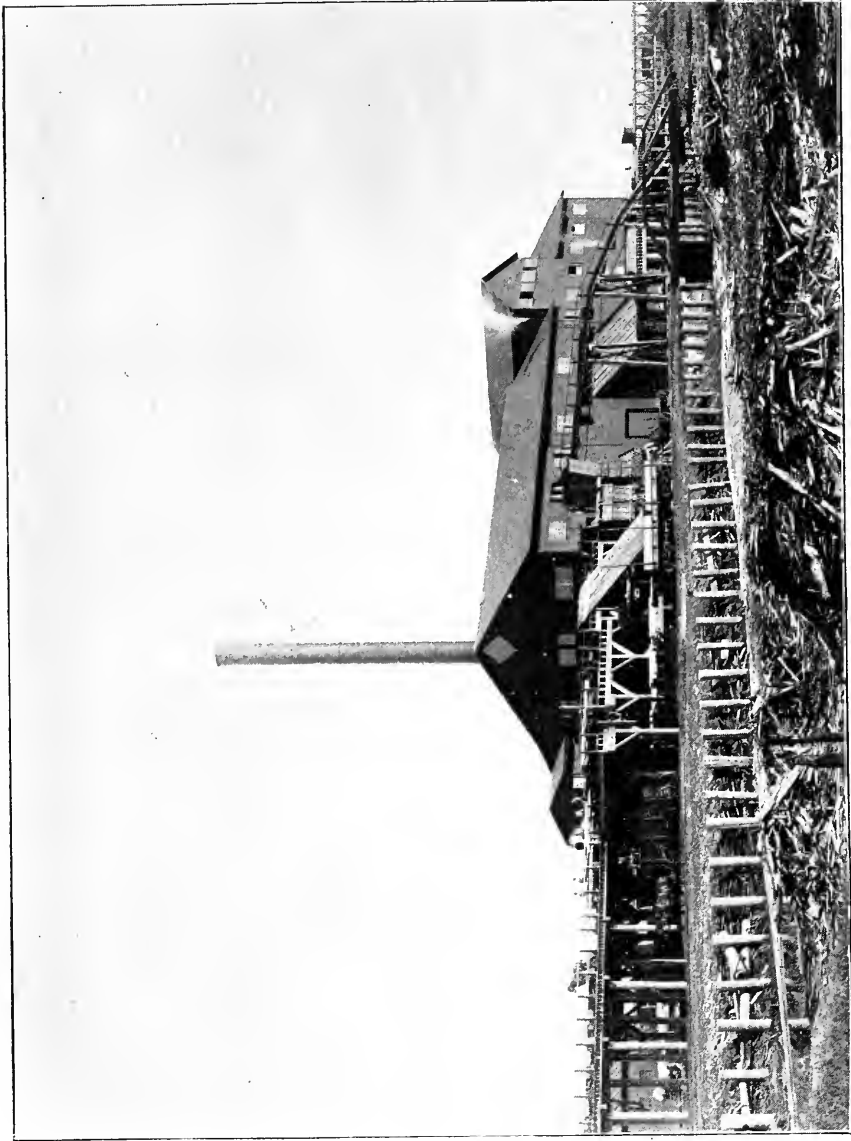

■ Mill of the Murphy Lumber Company, Green Bay, Wis.

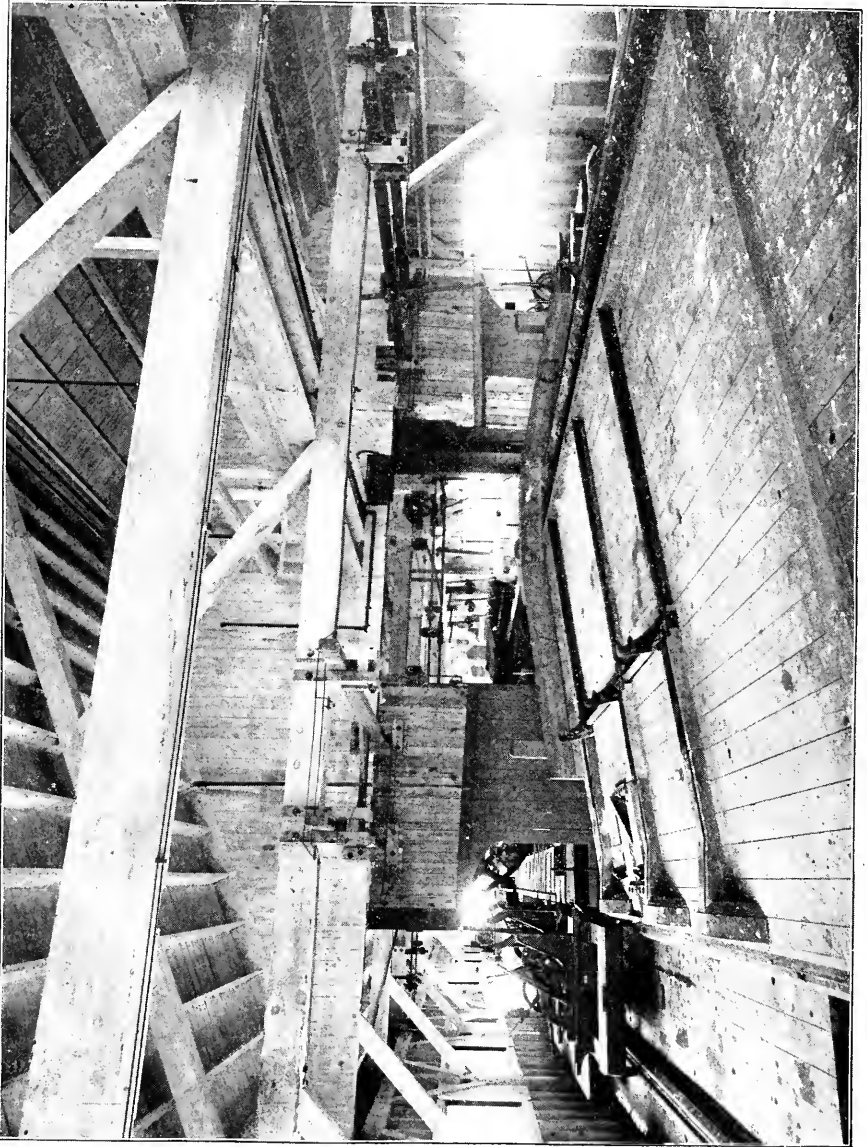

Interior View Showing Log Deck of the Saw Mill of the Murphy Lumber Co., Green Bay, Wis.



Interior View of the Saw Mill of the Murphy Lumber Company, Green Bay, Wis.
Taken from Rear End.

**THE NEW No. 3 PHOENIX BAND MILL.
WITH NINE FOOT WHEELS.**

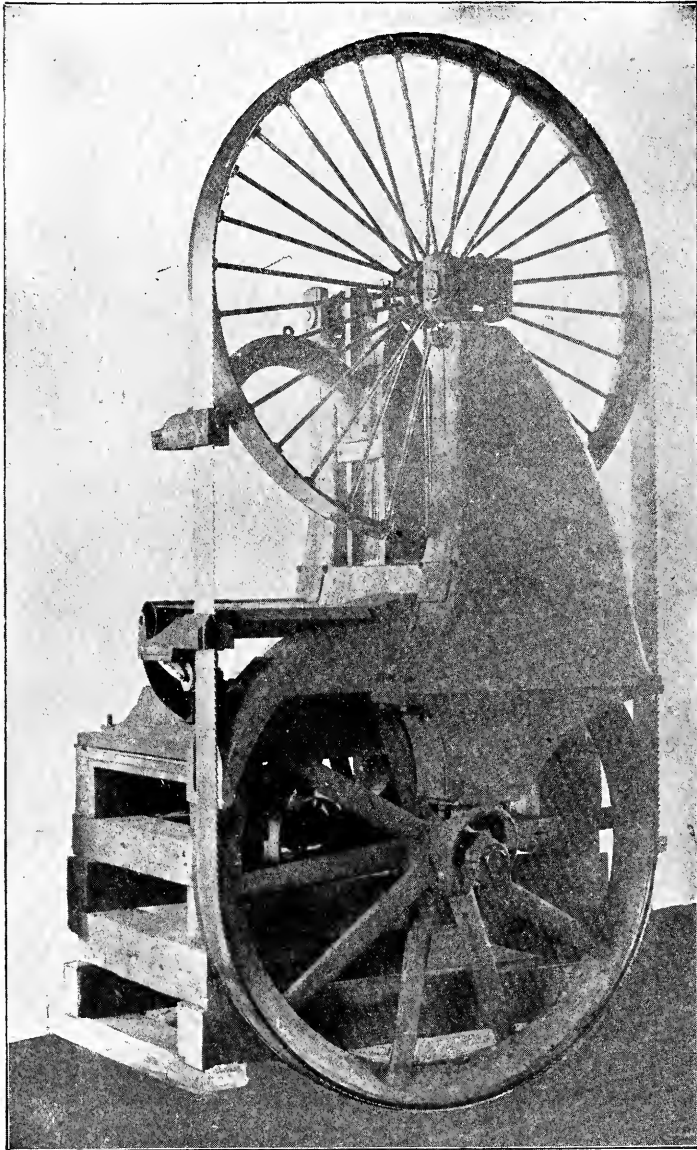

Front View.

**THE NEW No. 3 PHOENIX BAND MILL
WITH NINE FOOT WHEELS.**

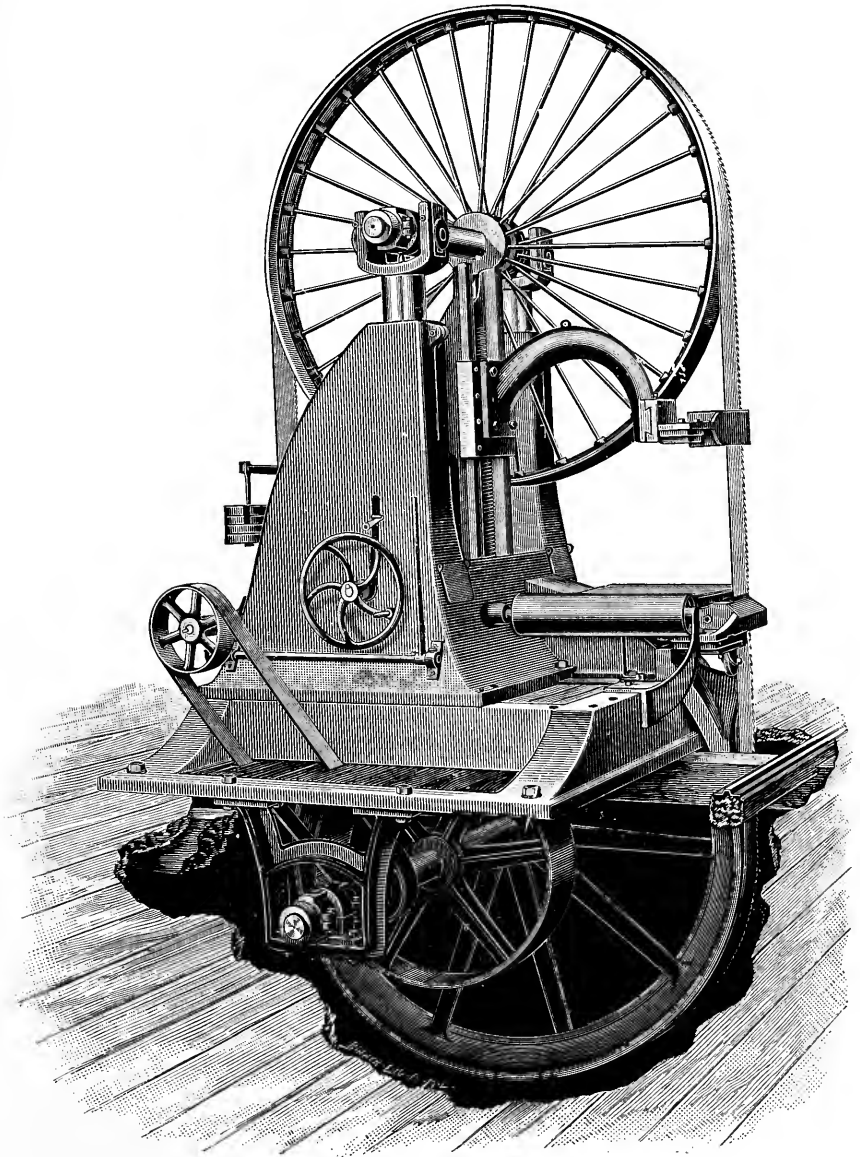

Rear View.

For description see following pages.

**THE NEW No. 3 PHOENIX BAND MILL
WITH NINE FOOT WHEELS.**

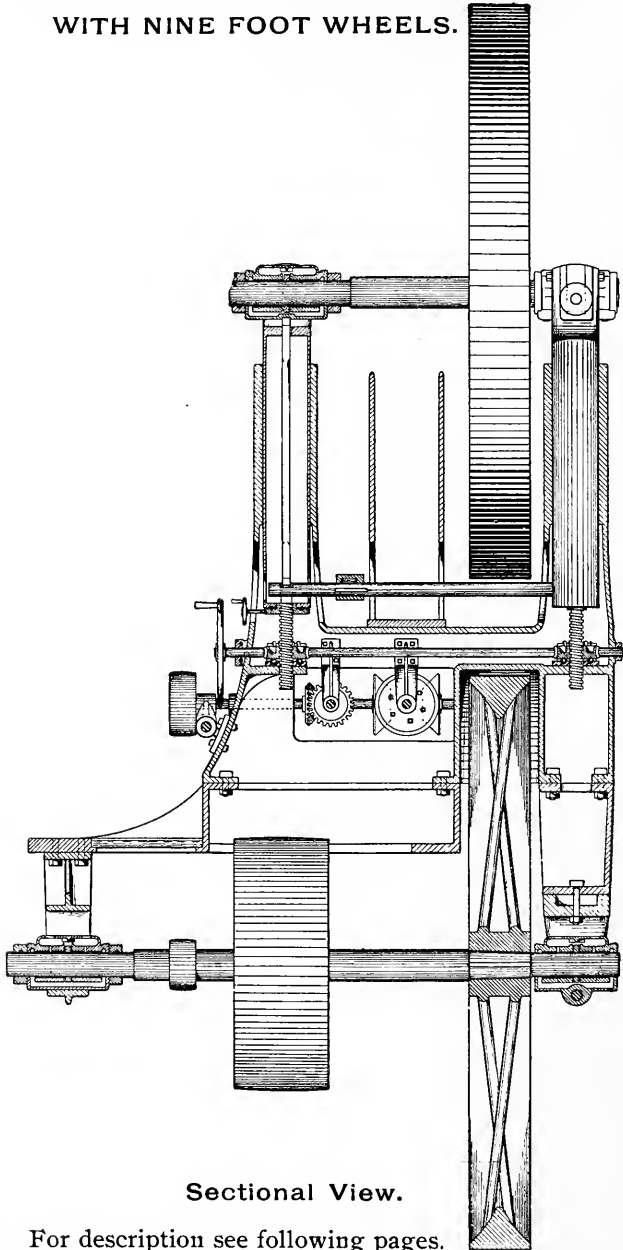

Sectional View.

For description see following pages.

THE NEW No. 3 PHOENIX BAND MILL. WITH NINE FOOT WHEELS.

The illustrations convey a clear idea of the general construction of this new mill and any particular part not thoroughly shown, we can, if desired, send blue prints of, fully explaining same.

It is conceded by all that the mill has a strong and substantial appearance, besides being neat and symmetrical in design. The hurst or bed plate rests on floor timbers similar to a circular mill. The total weight of the machine being fully thirty thousand pounds.

The mill is of such a heavy design that there is not the least danger of vibration; besides as an additional safeguard the base is made large, being six and one-half by eight feet where it rests on the floor.

The shield or wheel guard is cast on the frame of the mill so that this part is as rigid and firm as it is possible to make it.

The upper and lower wheels are made for saws twelve inches wide unless otherwise ordered, and saws fifty to fifty-four feet in length can be used.

The lower wheel is made of cast iron with arms in same set staggering which makes it very strong and well braces the rim, the weight of this wheel never being less than six thousand pounds. The inside of rim rises from the edge at an angle of about forty-five degrees, which prevents the saw dust lodging thereon. This wheel is turned and balanced on its own arbor.

The upper wheel combines strength with lightness and has thirty-two one and one-eighth inch Norway iron spokes, and is constructed as follows, these spokes being laid in place in the mold, the metal which composes the rim of the wheel is poured and the following day the metal for the hub is poured into the mold, sufficient time having elapsed between the two operations to avoid any shrinking or casting strain. Both ends of the spokes are deeply grooved and as the melted iron fills these grooves the union between the two is of the most complete and enduring character. This wheel is also turned and balanced on the shaft upon which it is to run.

THE NEW No. 3 PHOENIX BAND MILL.

Continued.

The upper and lower shafts are made of six inch steel and have fifteen inch bearings. The boxes for these shafts being self-oiling, so that it is not necessary to refill or look after them oftener than two or three times during a month, are absolutely reliable, clean and economical.

The straining device is simple, effective, strong, and not liable to get out of order, being controlled by the weight and lever shown on perspective view of machine. The shaft, operated by hand or power for raising and lowering the yokes when changing saws, runs on ball bearings, so that it can be worked with the utmost ease.

The upper guide arm is raised and lowered by power and is of such shape as to allow the sawyer a clear and unobstructed view of his work. For filling between the jaws, we use hard maple blocks saturated in oil, which give the best of satisfaction and are easily renewed. The lower guide is provided with a steel wheel back of the saw as a safeguard, should anything happen to force the saw back out of position.

A practical mechanism is provided for tipping the top wheel forward or back, also for cross lining, raising or lowering the top wheel. To receive various lengths of saws does not change the position or action of the tension device, as all parts thereof are connected with the mechanism that supports the top wheel and each part retains the same relative position to the wheel at any elevation.

A live roller is placed immediately back of saw and is driven from the lower shaft of mill. The belt pulley on lower shaft to drive mill is fifty inches in diameter for an eighteen inch belt, unless otherwise ordered.

The mill is so made that the sawyer can stand in front or back of the saw as preferred.

Although the mill is shown resting upon the floor timbers, we furnish, when desired, heavy cast iron legs for foundation.

This is the only mill built having self-oiling ring bearings on both upper and lower arbors, and ball bearings under the elevating screws. These are features that easily place the PHOENIX MILL in the lead of all competitors.

BAND SAW MILL No. 2.
WITH EIGHT FOOT WHEELS.

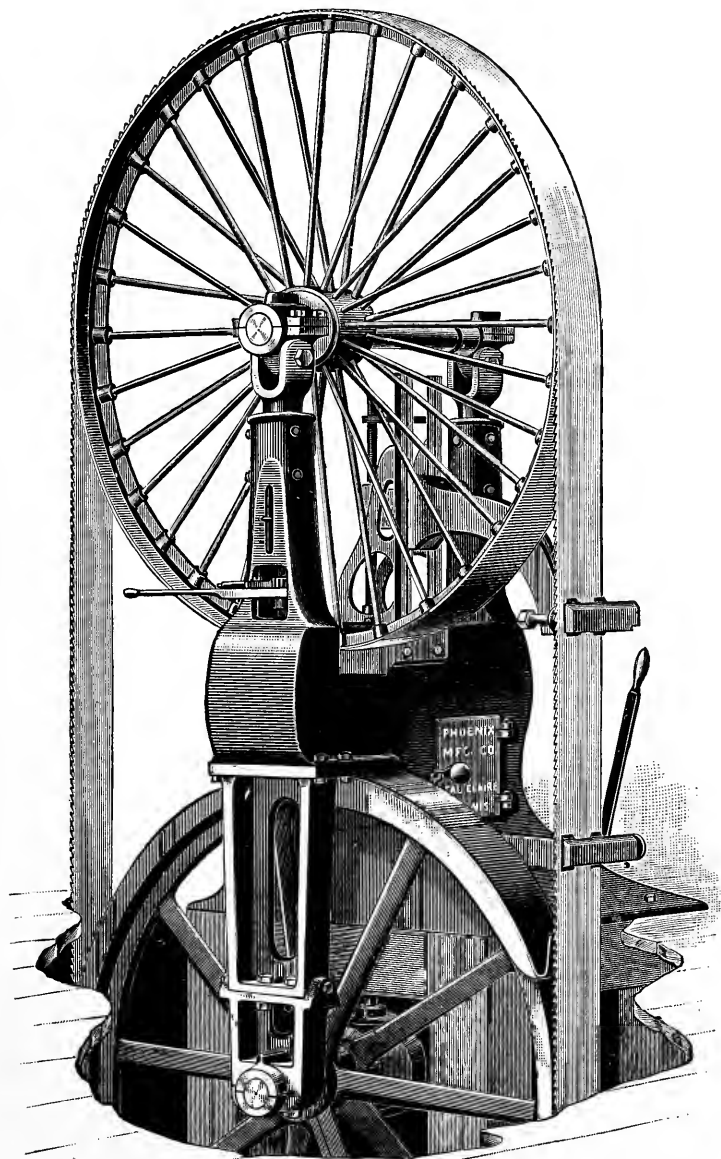

BINNER ENG. CO. MIL.

BAND SAW MILL No. 2.

WITH EIGHT FOOT WHEELS.

It is needless for us to mention the advantages of the band saw over the circular. Its economy and capacity are too well known to require any explanation, so we will confine ourselves to describing the points in this machine which we claim make it one of the best in the market.

The two upper columns and the entire bed are cast in one piece. There are no bolts used to fasten them on, so that it must be very rigid and substantial. Another thing that helps to make this the steadiest mill is the fact of its having two upper columns, and having the upper shaft five feet long by five inches in diameter, running in long boxes, the outside bearing being twelve inches and the back one same length.

The handle projecting from the outside of the front column is for raising the upper shaft, and putting tension in the saw. It operates a ratchet (inside of column) which is attached to a screw, thus raising or lowering the shaft as desired.

We keep the tension in the saw by a series of powerful and extremely sensitive levers, which are entirely concealed inside the base and are regulated by weights under the mill. Extra weights are furnished, which can be attached at any time, the same as scale weights, so that any strain desired can be put on the saw.

A door, 18x18 inches, is put in the base so that a man can enter it to get at the levers. The base of the machine where it rests on the iron legs, is five feet square.

The wheels are 8 feet in diameter and $11\frac{1}{2}$ inches wide, so that saws of any desired width, up to 12 inches, may be used. The upper wheel weighs about 1,600 pounds, and the bottom one 6,000 pounds. The bed alone weighs 8,000 pounds and the entire mill about 20,000 pounds. We have not spared iron to make this as strong, or stronger, than any other mill built. The guides work easily in every direction, so that the saw can be held in any position and are so made as to get the greatest possible strength and steadiness. The top guide is raised and lowered by power and controlled by a handle near the sawyer. The lower guide has a hardened steel wheel inside of it to keep the saw from running too far back. It is also made with the distance from the saw to the guide at bottom of the guide, larger than at the top, so as to insure the saw dust falling out. It is impossible for the dust to accumulate. Sawyers will appreciate this.

We can cut a board 4 feet wide, and can lay down a board $3\frac{1}{2}$ feet wide, between the saw and column. We use a saw only $44\frac{1}{2}$ feet long. We furnish iron legs or not, as desired. When we do not furnish the iron legs, we furnish a heavy iron bracket to carry the back end of the lower shaft.

LIST PRICE OF THE "PHOENIX" BAND MILLS.

- No. 4 has wheels 9 ft. by 12 in. face, carries saws 54 ft. long and makes a cut 72 in. deep; has 60 in. falling down space between saw and column.....Price, \$1600 00
- No. 3 carries saws 50 ft.; has the same size wheels as No. 4, a falling down space between saw and column of 46 in. and will make a cut 50 in. deep.....Price, 1500 00
- No. 2 has wheels 8 ft. diam., 10 or 12 in. face and carries saws 44½ ft.; will make a cut 48 in. deep and has 42 in. between column and saw for lumber to fall down...Price, 1100 00

The above gives the longest saws; either will take saws 24 in. shorter. No saws or belts are included in the above price.

Shipping Weight No. 4.....	35,000 lbs.
Shipping Weight No. 3.....	30,000 lbs.
Shipping Weight No. 2.....	20,000 lbs.

Discount.....

LOWER BAND SAW GUIDE.

FOR LEFT HAND No. 3 MILL.

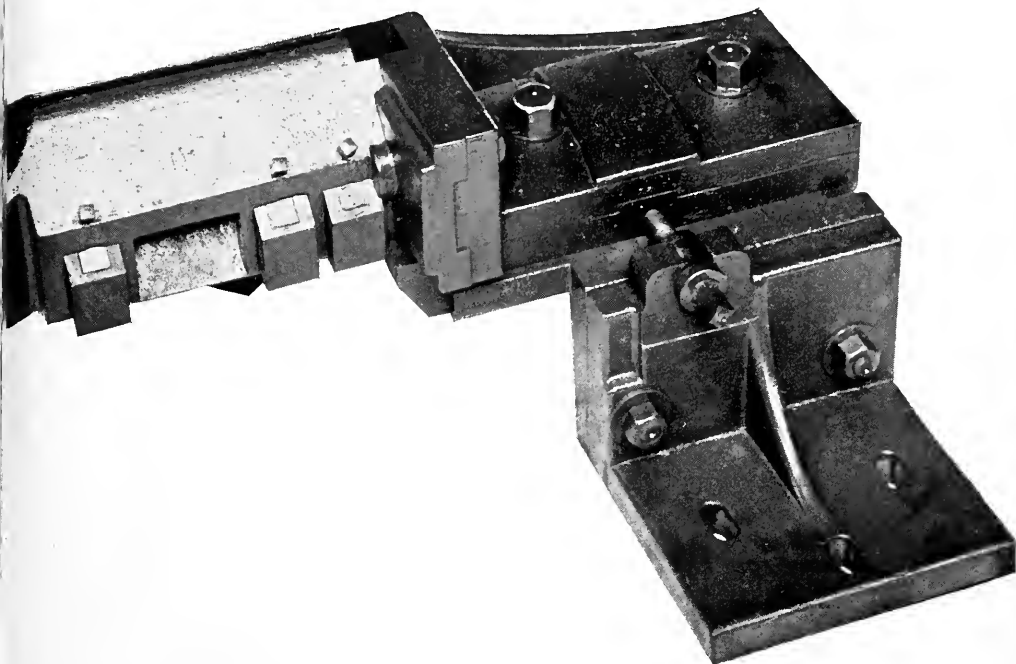

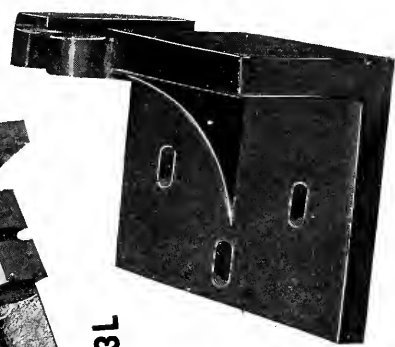
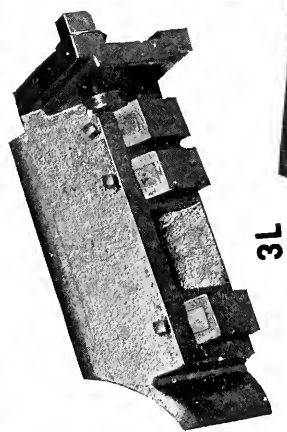
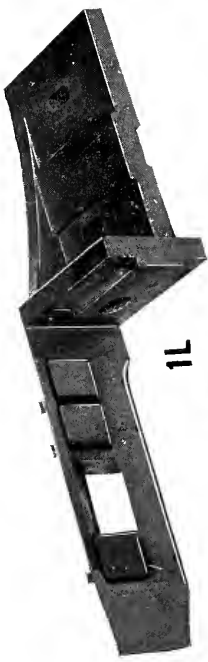
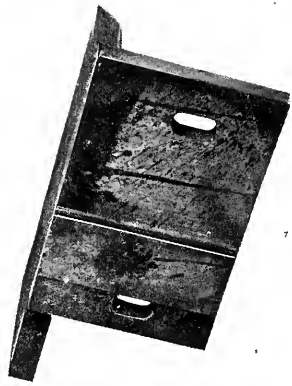
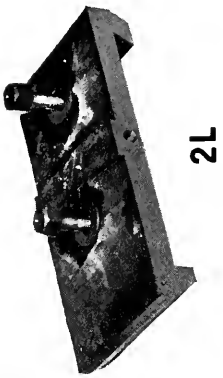

DETAILS OF LOWER BAND SAW GUIDE.
FOR LEFT HAND No. 3 MILL.

UPPER BAND SAW GUIDE WITH MOLD.

FOR RIGHT HAND No. 3 MILL.



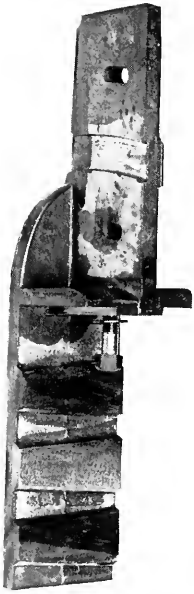

1U

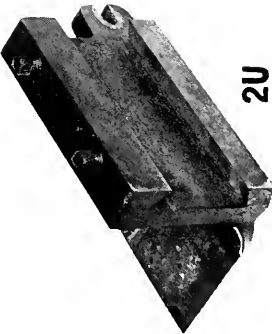

2U



4U



3U



5U

DETAILS OF UPPER BAND SAW GUIDE.
FOR RIGHT HAND No. 3 MILL.

THE GILBERT BAND RE-SAW.

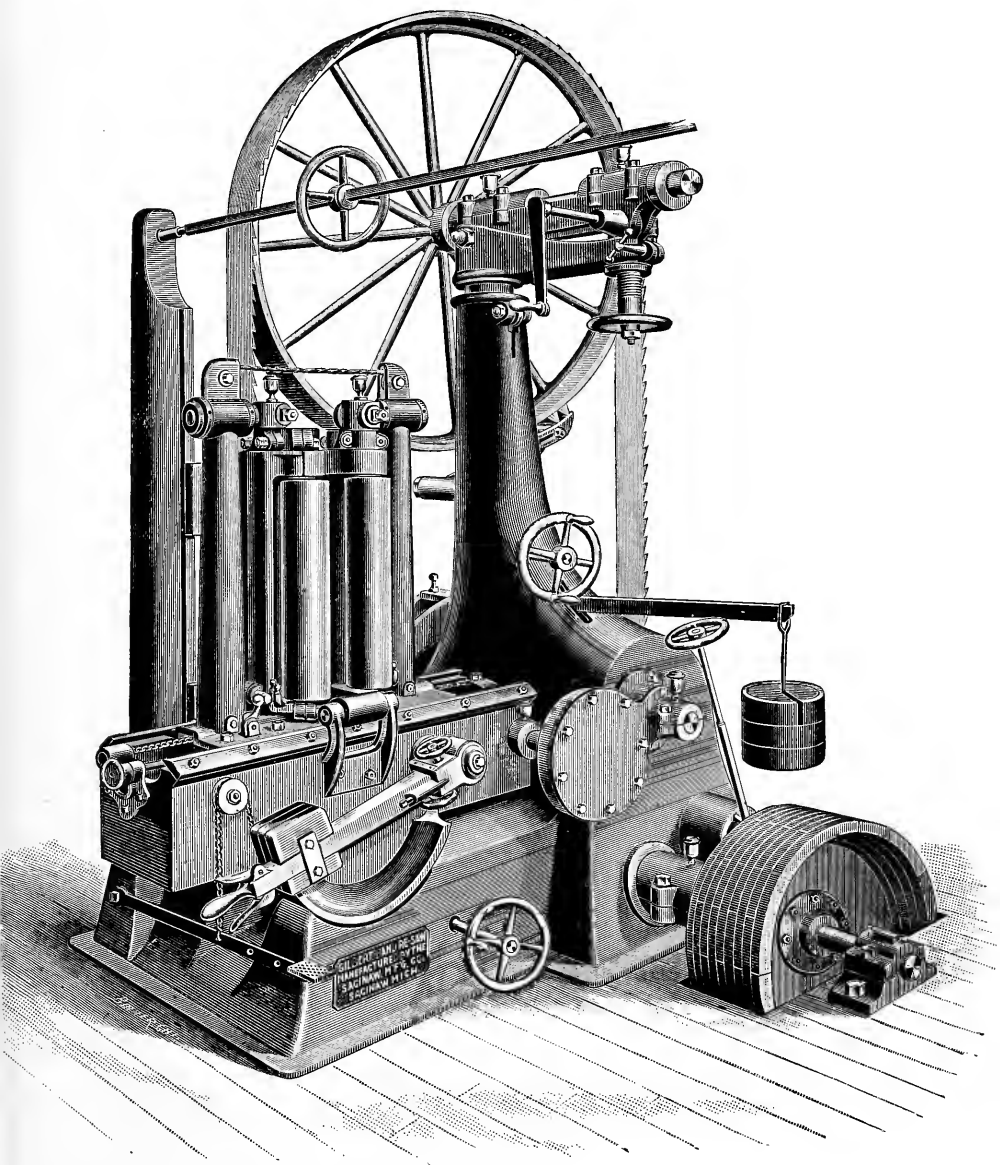

Front View.

THE GILBERT BAND RE-SAW.

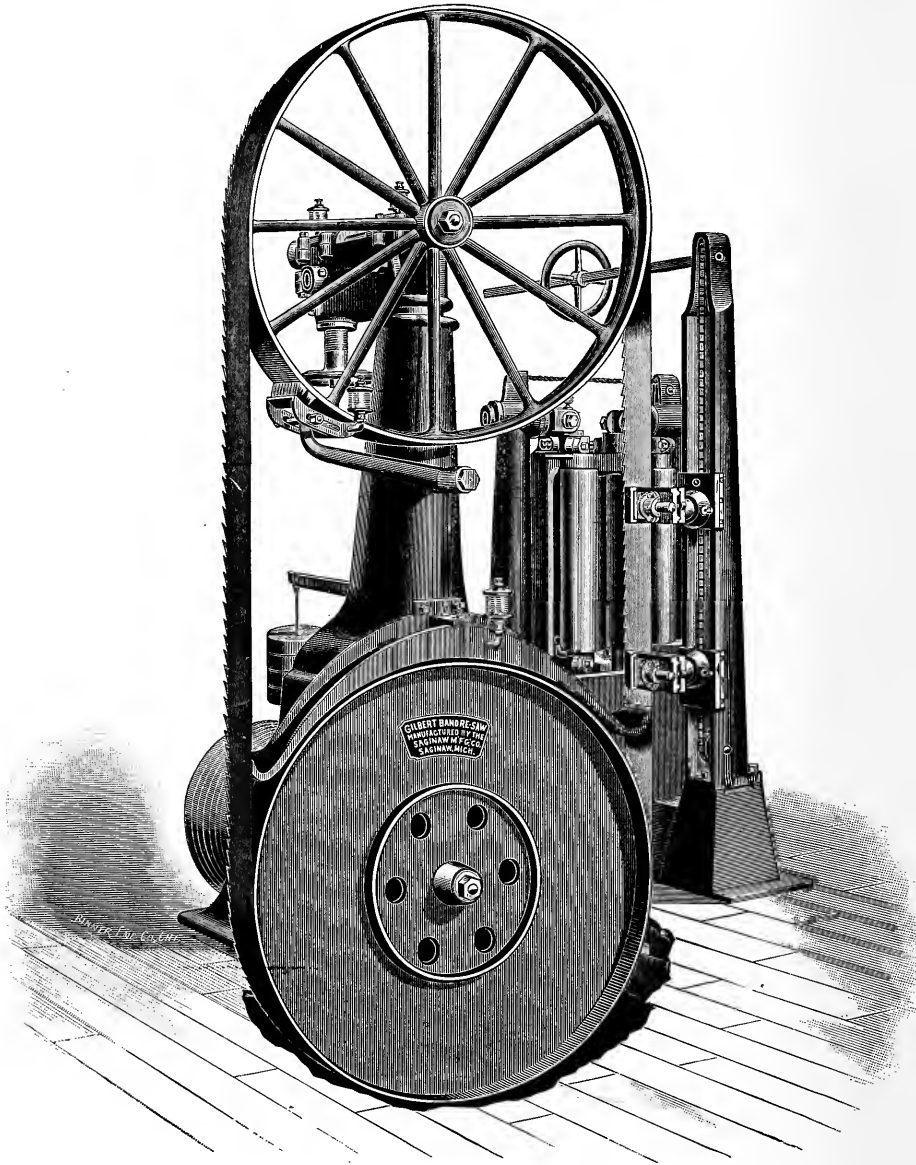

Back View.

GILBERT BAND RE-SAW.

This machine is eminently suited for heavy saw mill work, and is equally well adapted for light work. It has the power and capacity to re-saw lumber as fast as any man can handle it.

As to the quality and variety of its work, we call special attention to the following points:

1. THICK STOCK.—It will center-saw stock 12 inches thick.
2. THIN STOCK.—It will cut very thin veneers, such as picture backing, etc.
3. WIDE STOCK.—Up to 32 inches.
4. SHORT STOCK.—Down to 6 inches, perfectly; 5 to 3 inches, well.
5. BEVEL SIDING.—The Roll-carrying Frame may be tilted for this kind of work.
6. SLAB.—One set of rolls may be made stationary, so that a piece can be cut from one side of a board.
7. CROOKED STOCK.—The most crooked, kiln-dried hardwood, lumber that is warped or twisted, or any other stock needing extreme tension of the rolls, may be sawn almost perfectly.
8. VARIABLE STOCK.—Icy stock or poorly manufactured stock, the thickness of which varies greatly, may be cut in a very satisfactory manner, no matter whether the variations are between the edges or the ends of the board.

DIMENSIONS, ETC.

WEIGHT.—6,000 pounds.

WHEELS.—54 inches diameter, 6 inch face.

EXTREME HEIGHT.—9 feet 6 inches.

SAWS.—27 feet 8 inches long.

FLOOR SPACE.—5 feet 6 inches x 6 feet 6 inches.

DRIVING PULLEY.—Diameter, 24 inches; face, 12 inches; designed to be driven 550 revolutions.

Special circulars on application.

Price..... \$1,100.00

Discount.....per cent.

CIRCULAR SAW MILLS.

The Husk, shown on page 29, is heavy, strong and especially adapted for mills cutting from twenty-five to fifty thousand feet of lumber per day. The floor space occupied is $5\frac{1}{2}$ feet by 8 feet, and the size of timbers used is 6x12. The lower mandrel is of $3\frac{1}{2}$ inch steel and the upper mandrel is 3 inch steel.

The size of pulley on top saw mandrel is 12 inches in diameter and 10 inch face, while the pulley on lower mandrel, which drives the upper mandrel, is 24 inches diameter and 10 inch face. The main drive pulley on lower mandrel is 24 inches diameter and 16 inch face.

The frame of tightener is of iron and the tightener pulley is 16 inches diameter with a 10 inch face. The boxes for lower mandrel are 9 inches long with water chamber in each, while the boxes for upper mandrel are 6 inches long.

The splitter wheel behind saw is 18 inches diameter and the roller attached to same is 4 inches in diameter. The roller in front of saw is also 4 inches in diameter. The upper mandrel is raised and lowered in slides by means of the screws and gearing, shown in cut, the hand wheel operating same being almost hid from view by the tightener pulley.

The top saw frame is of heavy cast iron, made in the most approved manner. The arms of saw guide are made of wrought iron and readily adjustable to the saw.

On the lower mandrel any size of saw can be used from 48 to 60 inches in diameter with a top saw in proportion.

The sizes of various parts of the machine can be varied somewhat if desired.

Price without saws or belts.....	\$400 00
Price without top saw frame, saws or belts.....	200 00
Price of heavy mill with iron husk, iron top saw frame, no saws...	600 00
Price of same without top saw frame.....	400 00

Discount..... per cent.

DOUBLE CIRCULAR MILL.

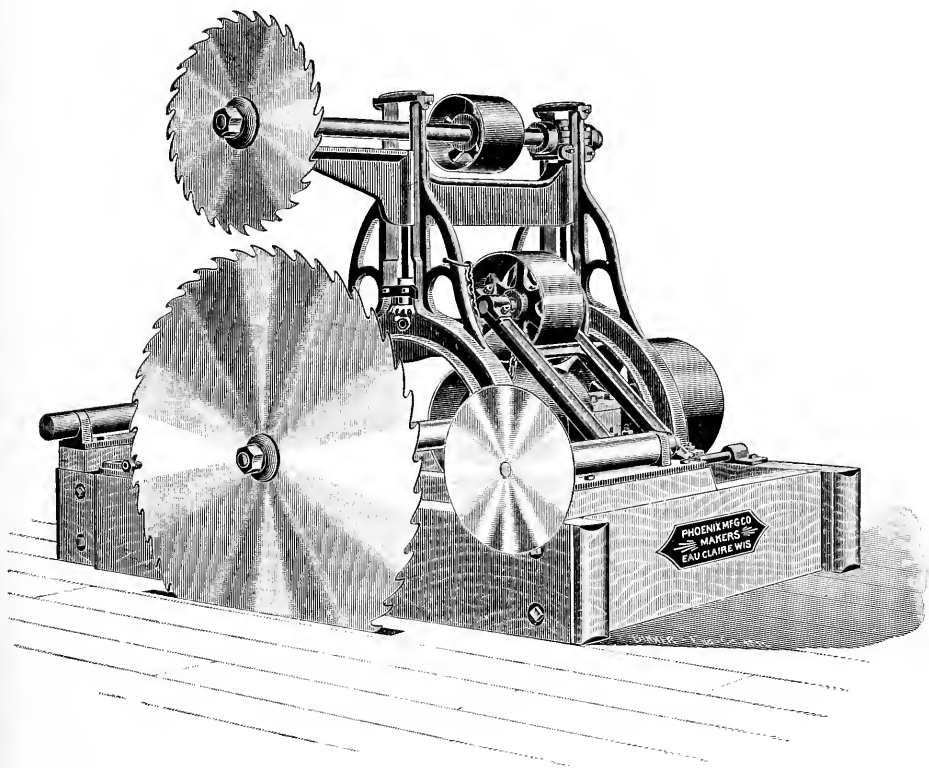

For description see opposite page.

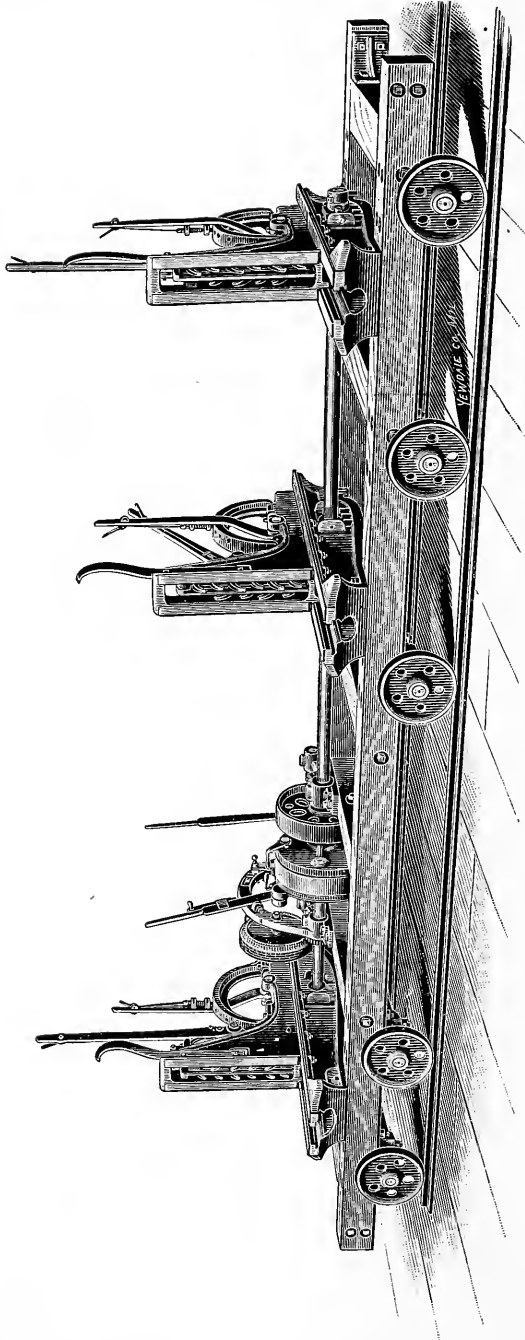

PHOENIX THREE BLOCK CARRIAGE.

Knees Receding by Friction Device, Taper Movement, Reinforced Nose, and Phoenix Boss Dogs.
We also furnish Spring Receding Device if desired.

See page 37 for larger illustrations.

HEAVY SAW MILL CARRIAGE.

On the preceding page is illustrated what we have reason to believe is the best saw mill carriage yet put upon the market. All of the parts are strong, well made and composed of nothing but first-class material. Each of the standards has a taper movement attachment so that it can be moved independent of the others; double acting dogs of the most approved pattern are incorporated in the face of each standard; guard hooks are put upon each standard so as to prevent the log turner from throwing small logs over the top of the standards and on to the set works. The rack under each standard and the pinions on the set shaft are of steel with machine cut teeth which insures accuracy in the movement of each standard. The face of each standard and top of each head block are plated with heavy steel to prevent wear of those parts. The head blocks are very heavy and have reinforced noses to prevent being broken by the log turner.

The setting mechanism is of the well-known Phoenix grip design and is the smoothest and most accurate device for the purpose yet constructed; it is double acting in its movement and noiseless in its operation, setting lumber accurately to the smallest fraction of an inch desired. To the set shaft is geared a revolving brass dial wheel of the latest design for showing the thickness of the log or cant on the carriage yet uncut. The drawing back or reversing of the standards is accomplished by coil springs on set shaft or a friction wheel geared to the truck axle, working upon the under side of the brake wheel and controlled by the upright lever next to the set lever. The reverse motion of the standards is stopped by a steel band or brake wrapped around the wheel on the right of the set wheel fastened to a foot lever and controlled by the man who operates the set works. The set shaft is of steel, 2 11-16 inches in diameter. The carriage frame is thoroughly bolted together with bolts, having cup-shaped washers let into the wood so that no bolt-heads project beyond the surface of the timber; heavy cast iron braces, as shown, are fastened to each corner of the carriage and the girt timber for bolting the steam feed bracket to is put upon the inside of the tail block so that the carriage frame cannot spring up or buckle, as is often the case when the

HEAVY SAW MILL CARRIAGE—Continued.

bracket is fastened to the extreme end of the saw carriage. The truck wheels are of cast steel, 14 inches in diameter, fastened to $2\frac{1}{2}$ inch axles extending entirely across the carriage and running in long self-oiling boxes; the wheels next the saw having a flat face, while those on the opposite side of the carriage have a V-shaped face. The track upon which the carriage runs is of rolled steel, planed accurately to size and drilled for bolts to fasten to timbers.

When an offset is wanted, so that the carriage may be used with a band saw mill, we furnish one that is automatic or to be operated by hand, as desired.

For more minute description of mill dogs, set works and offsets, see their respective departments in this catalogue.

HEAD BLOCKS AND SET WORKS.

Double Acting Fractional Set Works with two head blocks standards opening back from saw 42 in.; and dogs in same; no carriage	\$500 00
The same with 44 inch standards.	510 00
The same with 46 inch standards.	520 00
The same with 48 inch standards.	530 00
Each extra 42 inch standard and block with dogs in same.	145 00
Each extra 44 inch standard and block with dogs in same.	150 00
Each extra 46 inch standard and block with dogs in same.	155 00
Each extra 48 inch standard and block with dogs in same.	160 00
Set works only	195 00
Deduct for each standard sent without mill dogs.	50 00
Wood work for carriage per foot.	4 00

Prices for Steel Knees and Blocks on application.

Discount. per cent.

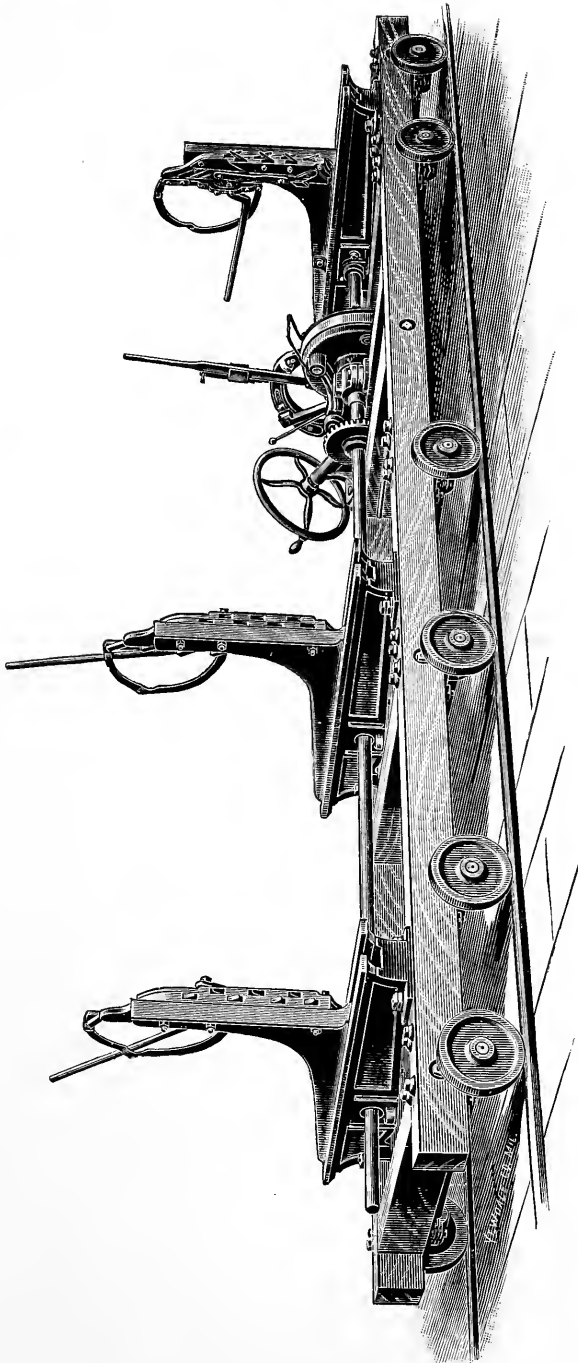

THE PHOENIX PATENT SAW MILL CARRIAGE.
FOR LIGHT MILLS.

LIGHT SAW MILL CARRIAGE.

The Saw Carriage illustrated on opposite page is especially designed for mills cutting from fifteen to twenty-five thousand feet of lumber per day and is a much better outfit than those usually furnished for mills of that size.

Each standard is equipped with a double acting mill dog (see page 56). The distance which the standards open back from the saw is 36 inches. The Set Works are of the Phoenix patent, Grip Pattern, which are double acting in their operation and noiseless in their movement, making the lumber any thickness desired to the smallest fraction of an inch. The standards are drawn back by means of the large hand wheel and gearing shown in cut. The set shaft is 1 15-16 inches in diameter. The carriage frame is made of 6x6 timber. The truck wheels are 10 inches in diameter, fastened to long axles extending across the carriage running in babbitted boxes. The truck wheels next to the saw have flat faces, while those on the opposite side of carriage have V-shaped faces. The flat track is of rolled iron drilled for screws, and the V track is of planed cast iron.

The price of this saw carriage, as illustrated, which is 18 feet in length, with 60 feet of flat and 60 feet of V top track, is \$400.00.

Discount per cent.

HEAVY SAW MILL CARRIAGE.

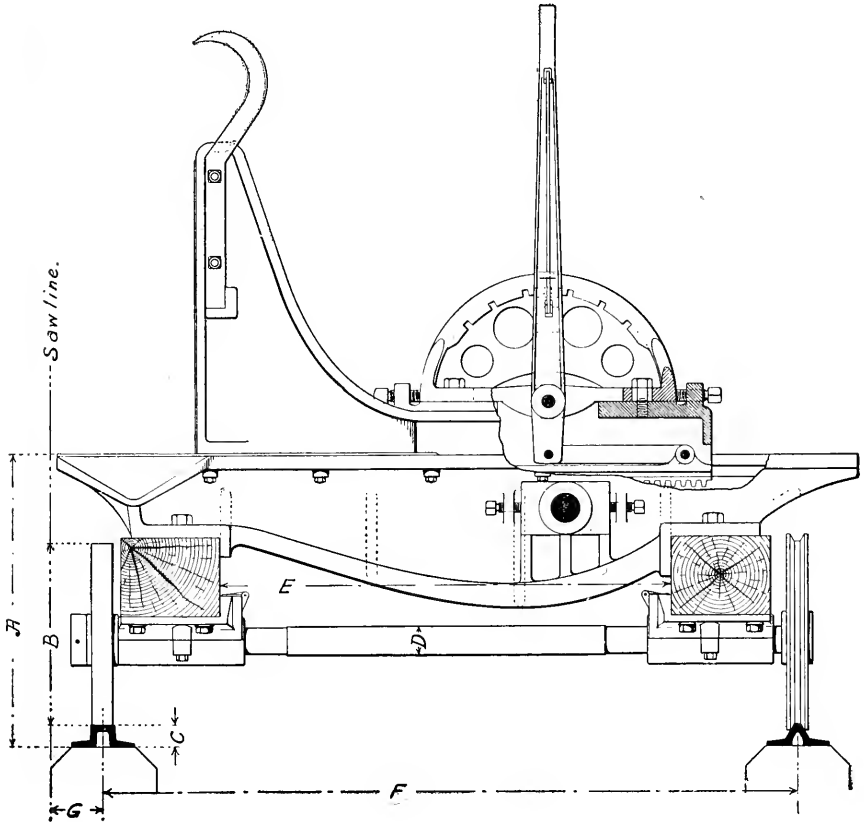

The above cut represents an end elevation of our heavy saw mill carriage. We make the blocks in various sizes, so that the standards can open back from saw from 44 to 60 inches, as desired.

On previous pages we give a general description of the saw mill carriage and on following pages we describe our set works, mill dog, track and truck wheels, with boxes which we use in connection with these carriages.

We also make the knees and blocks of cast steel when specially ordered.

PACIFIC COAST CARRIAGE AND SET WORKS.

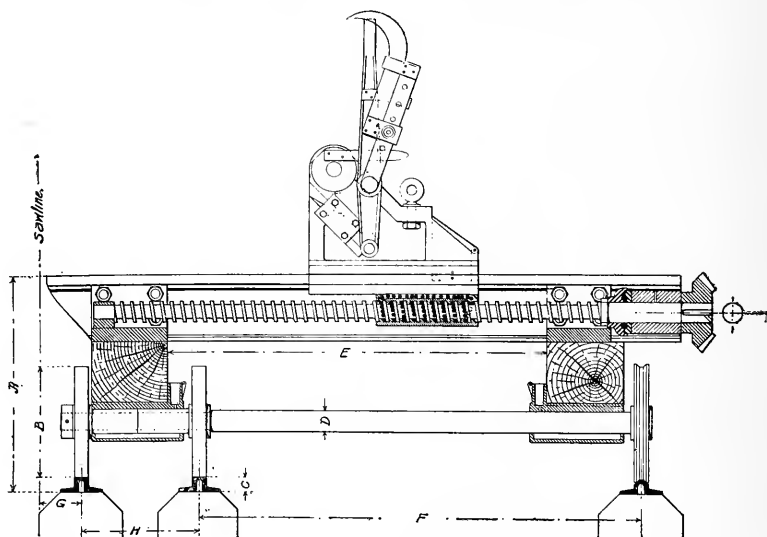

The above outline shows a cross section of our especially designed set works and carriage for the Pacific Coast.

The blocks are constructed of 9 inch steel I beams, faced with steel bars from $1\frac{1}{2}$ to 2 inches thick and are made to open for any size of timber.

The standards, set shaft, gears and set works are all made of steel. The large steel screw for actuating the standards or knees has ball bearing thrust collars, and the nut which is fastened to the knee is entirely frictionless, being a ball bearing. All gears are cut from solid steel and insure easy and exact work.

Each knee is provided with improved dogs for securing and holding the largest logs in position while being sawed, the hook forming the upper part of dog can be extended or drawn in to suit the size of log.

The dog lever being pivoted to the side of knee and its lower end connected to the straight tooth working in the side of knee, when the lever is pulled downward the tooth is forced into the log and at the same time the hook catches the top of the log, the whole gripping the log tight to the knee.

The carriage is carefully made and each truck axle is of 3 inch steel, having three steel wheels, one on each side of the front carriage rail and the third on the outside of carriage farthest from saw, forming a substantial support for the carriage and equipment.

When used in connection with band mills we furnish special heavy offsets for same.

When writing for prices, give all information possible as to the requirements, and we will furnish drawings and full particulars.

THE PHOENIX PATENT SAW MILL CARRIAGE AND SET WORKS.

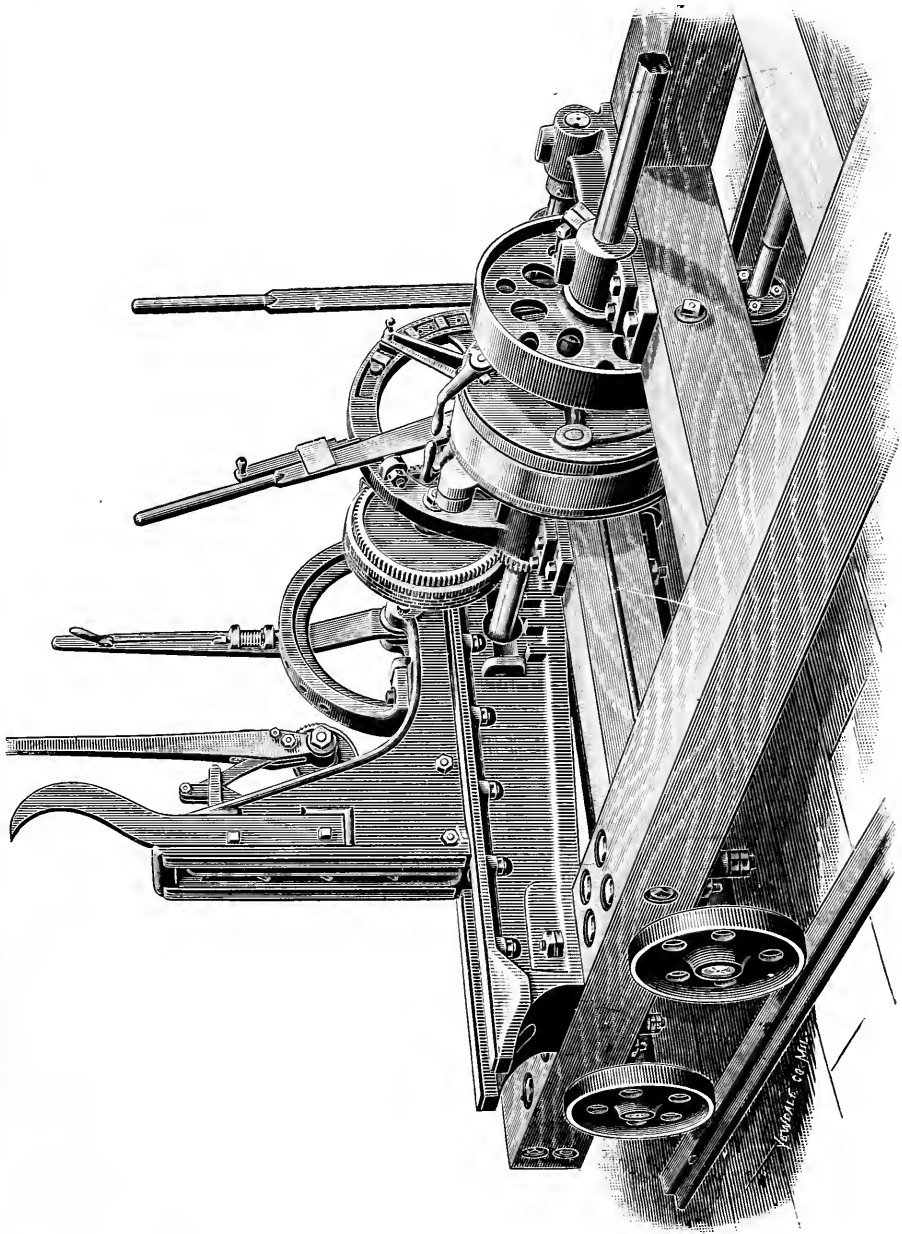

Also see page 30.

KEWITT & CO. MIL.

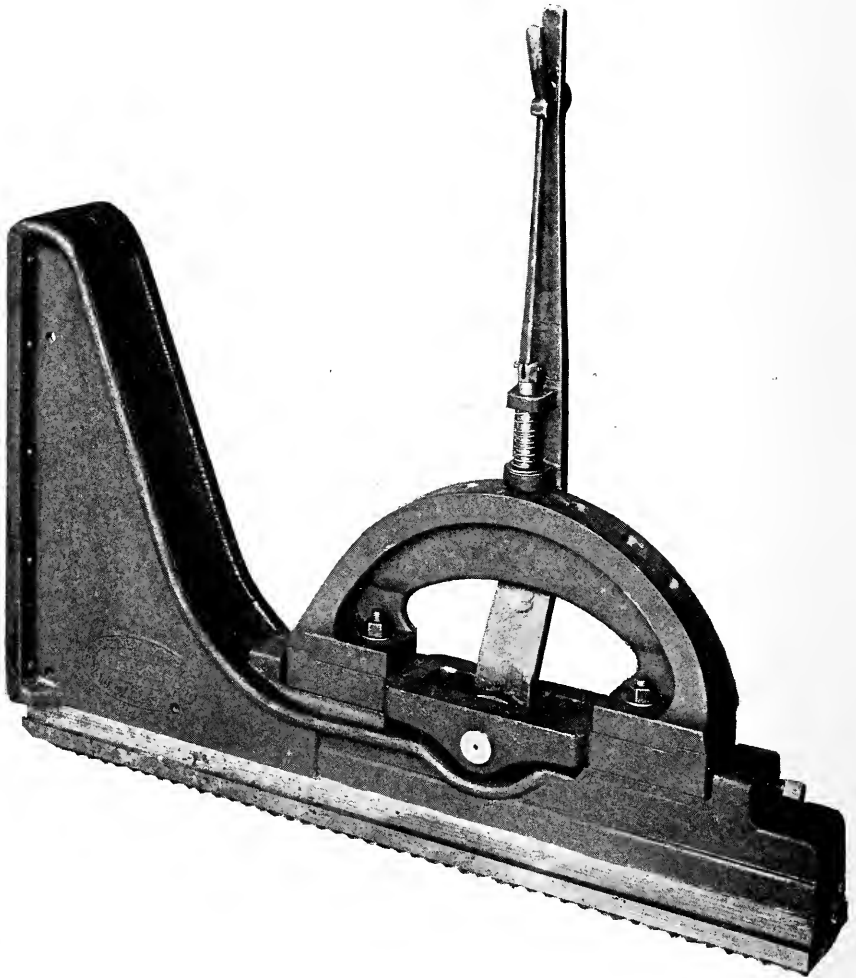

STANDARD OR KNEE FOR HEAD BLOCKS.

Showing Patent Taper Movement.

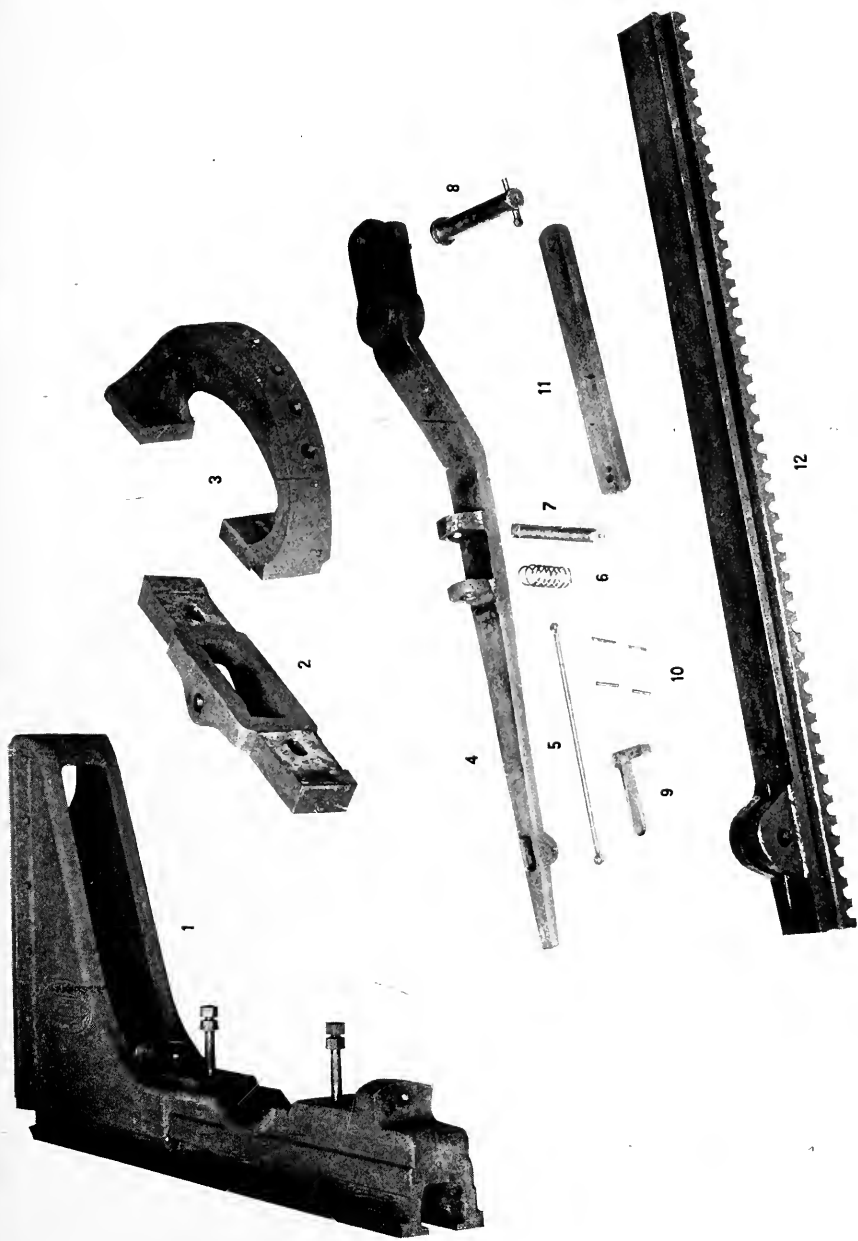

Details of Standard or Knee with Taper Movement for Head Blocks.

THE PHOENIX PATENT GRIP SET WORKS.

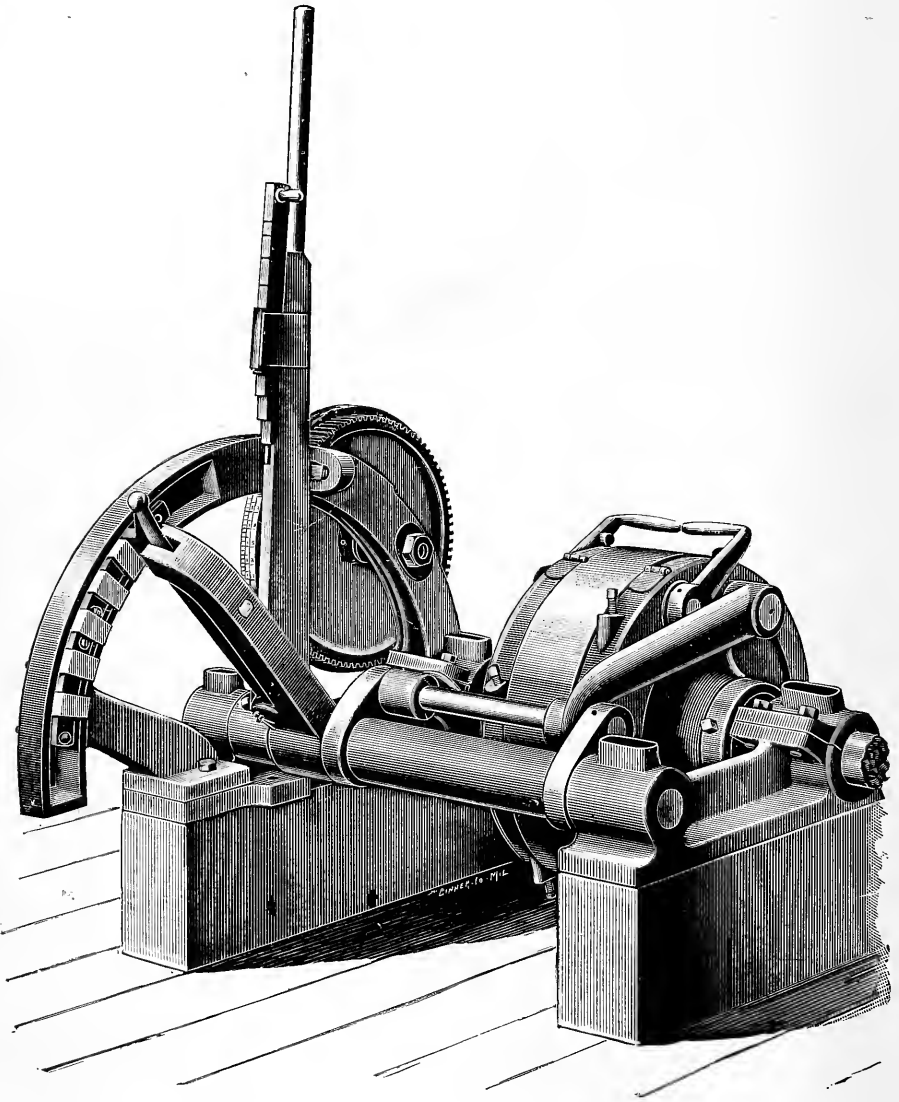

THE PHOENIX PATENT GRIP SET WORKS.

On the preceding pages we show different cuts of these Set Works and Blocks, the latest thing out, and a wonderful advance in setting mechanism for saw mill carriages.

When timber was plenty the old rotary was used for sawing up, and anything was good enough for setting out the log. The past few years, however, have witnessed wonderful improvements in saw mill machinery. The rotary is in "innocuous desuetude," as it were, and now the ratchet set works must give way to something more modern, and in line with the Band Mill.

Since the advent of the Band Mill, the manufacturers have been striving for something more accurate in the way of set works, a set works that would set accurately to any fraction of an inch, and stand long and hard usage without any lost motion or detrimental wear.

It is very evident that this cannot be accomplished with the Ratchet Set Works, for (without considerable complication) the ratchet will only set to the particular fraction for which it is constructed, usually 1-16 of an inch, some, however, to 1-32. The latter, however, requiring such a fine tooth ratchet wheel that the teeth will not stand and are continually being broken.

The Phoenix GRIP Set Works will set accurately to ANY thickness desired, at any and all times, and we can safely say THAT THEY ARE THE ONLY SET WORKS THAT WILL.

By referring to the cuts it will be seen that these set works are extremely simple, consisting of but few pieces and almost entirely of steel.

The set wheel, which is keyed to the set shaft, has an annular groove on either side into which loosely fit the steel grip. Now it is evident that this grip is nothing more or less than a lever or pry, and by forcing down the end of the "Grip" the set wheel must either turn or the "Grip" break. There can be no lost motion or slippage, for the harder the end of the "Grip" is forced down, the tighter it grips in the annular groove in the set wheel.

PATENT GRIP SET WORKS—Continued.

Experience has demonstrated that there is very little wear on the grip or groove, but no matter how much wear there might be, the grip seats itself and is always in contact with the sides of the groove, consequently there is absolutely no lost motion at this point.

Another thing has been demonstrated with these set works, unlike the old ratchet wheel, where the set lever had to move just so far in order to let the pawls drop into the right notch, any wear in these pawls, teeth or pin joints, would differ the thickness of the lumber, but with the Phoenix "Grip," no matter how little or how much, the set lever is moved the grips being always in contact, as before stated, the set wheel will rotate just that much.

Another feature of the Phoenix Grip Set Works is that the quadrant has adjustable steel stops or notches for the set lever to strike against, which together with the spring latch and adjustable home stop makes it one of the most complete rigs ever devised.

It can readily be seen that the thickness of lumber is easily changed to start with, for the throw or distance the set lever moves for any given thickness is quickly changed by moving the stop on quadrant up or down as the case may be, then again the lumber can be made scant or plump to the extent of $\frac{1}{8}$ inch by $\frac{3}{32}$ ds by the slide on edge of set lever.

The stops on the quadrant after once being adjusted are supposed to be clamped and made permanent.

The adjustable quadrant enables us to attach these set works to any saw carriage, for no matter what the size of pinion is on the set shaft, we can adjust the throw of the set lever to advance the knees the required distance.

These Set Works are fully covered by letters patent and we will prosecute any and all infringers where found.

In ordering set works for old carriages, give the diameter of set shaft and width of keyseat, and when we are to furnish and mark new dial, give thickness of lumber to be sawed, thickness of saw kerf, number of teeth and pitch of same in set pinion and say whether for right or left hand mill.

A printed card of instructions is attached to each set works when shipped.

THE INDEX WHEEL AND BOARD RULE.

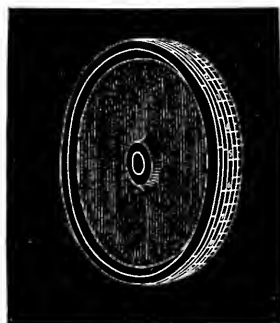

The index wheel and board rule is geared to the set shaft with cut wrought gears, consequently as the knees move toward the saw the index wheel rotates toward the setter, plainly showing on its figured face the exact distance the knees are from the saw, and also the number of boards or plank that can be gotten out of log, allowing for the saw kerf.

No figuring is required to leave the last board or plank the desired thickness, or in canting for a gang, for if you start at the right mark the stock will come out even every time.

The face of the wheel is brass and by putting a piece of felt so that the face will always press against it when turning it will be kept bright and the figures which are large and plain can readily be seen.

ADJUSTMENT OF PHOENIX SET WORKS.

The engraving shows position when ready to set up the log or cant. In this position the set screws A and C as shown should have about 1-32 clearance between point and grip E, and the set screws B and D should have about an inch clearance between point and grip E, as shown.

When receding the set screws B and D will come in contact with grip E just enough to allow the standards to recede freely. Set screws A and C are merely to keep the grip from jumping up when rolling on a log and if screwed down too close to the grip, will cause the grip to wedge in the groove and in that position cannot be moved or will work hard. They should never be in contact with grip E when setting up. Set screws B and D are for tripping or raising the grips so that standards will recede, and if set up too close will not let the standards recede or will cause them to recede very hard. Also if this screw (D) does not raise the grip quite enough it will cause the standards to recede hard. This should be adjusted accurately.

The internal working parts should be oiled with a thin oil. Black oil reduced largely with kerosene will answer the purpose and kerosene used alone now and then is most excellent to keep th grips from gumming up which sometimes causes them to slip if heavy black oil is used.

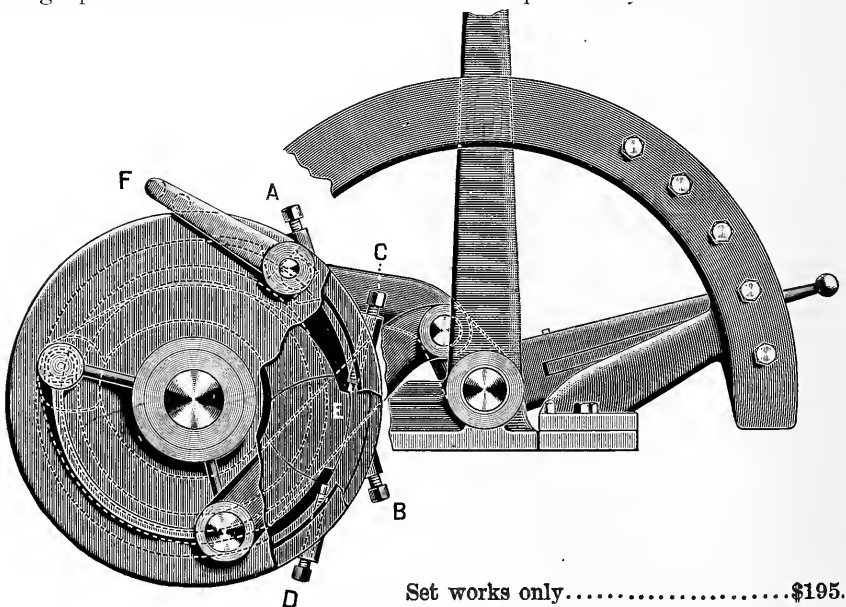

Set works only.....	\$195.00
Set works with dial wheel complete..	220.00
Dial wheel with pinion for do.....	31.00

Discount.....per cent.

DETAILS OF SET WORKS.

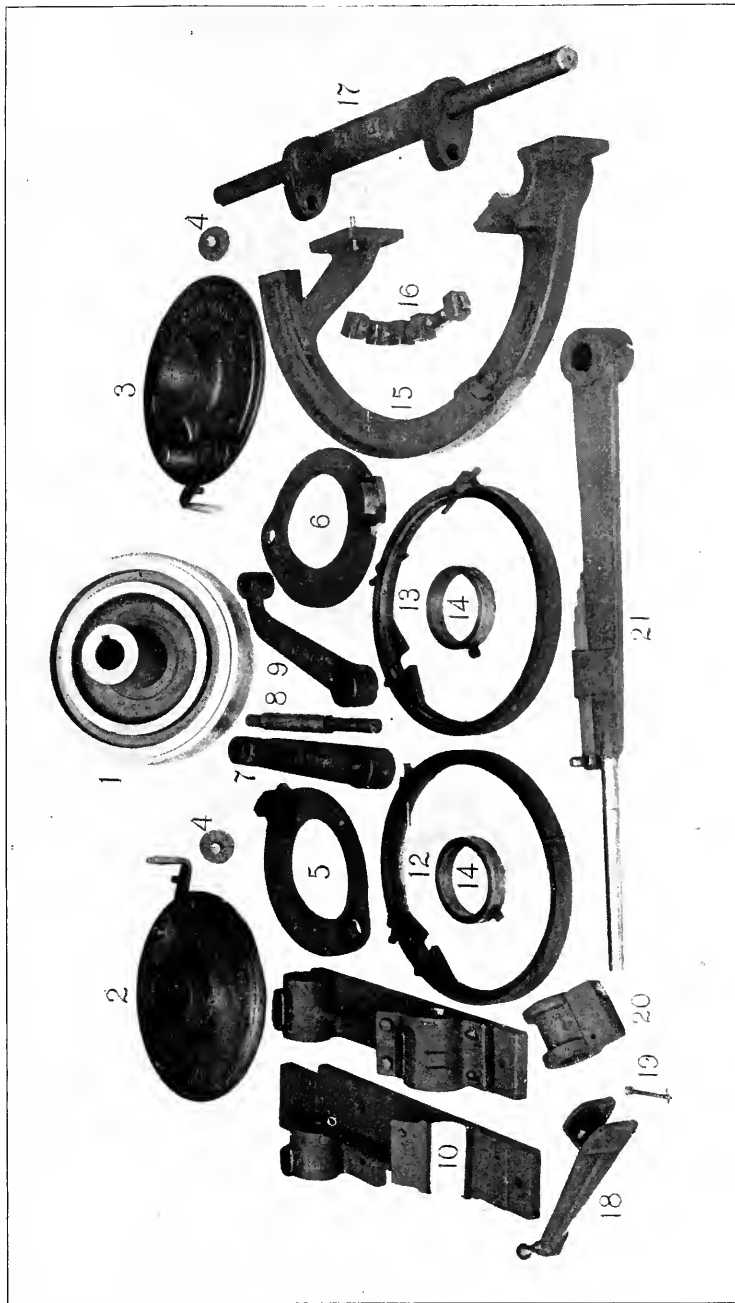

No. 1 Cast iron set wheel.
 No. 2 Left hand side plate.
 No. 3 Right hand side plate.
 No. 4 Cap for side plate pin.
 No. 5 Left hand steel grip.
 No. 6 Right hand steel grip.
 No. 7 Right hand steel connection.

No. 8 Steel rocker arm pin.
 No. 9 Left hand steel connection.
 No. 10 Cast iron double box.
 No. 11 Cast iron double box with cap.
 No. 12 Right hand trip ring.
 No. 13 Left hand trip ring.
 No. 14 Plate collar.

No. 15 Arch or quadrant.
 No. 16 Adjustable steel clip and clamp.
 No. 17 Cast iron rocker arm and shaft.
 No. 18 Steel lever stop arm.
 No. 19 Steel pin for lever stop arm.
 No. 20 Cast iron hub for lever stop arm.
 No. 21 Steel set lever.

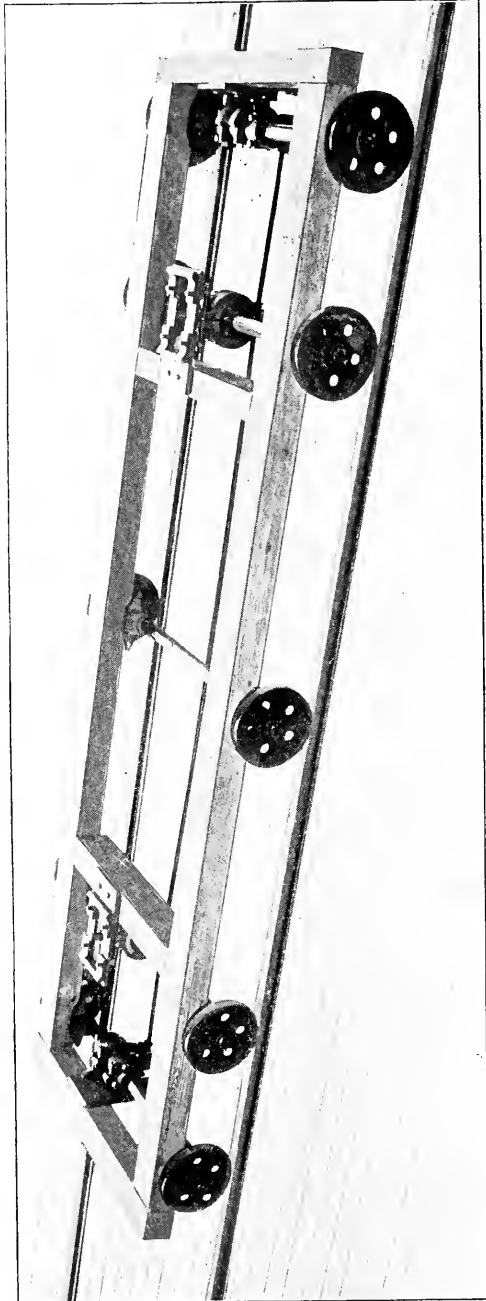

PHOENIX AUTOMATIC OFFSET.

PHOENIX AUTOMATIC OFFSET.

This offset is very simple, holds the carriage remarkably steady, and is entirely free from that characteristic "Snakey Wabbly" motion of all other offsets.

A feature of this device and one that will commend itself to all mill men is the facility with which it can be attached to the carriage. Every part of this offset is split, or in halves, thus enabling a person to put it on the carriage without removing the trucks or disturbing the carriage in any way; also in case of breakage it can be repaired without tearing the carriage all to pieces.

A device is provided so that when it becomes necessary to back out of the cut the offset becomes inoperative.

The full throw of the offset is accomplished by the carriage moving not more than six inches on the track.

Price of offset for 3 block carriage..... \$150 00

Price of offset for 4 block carriage..... 225 00

Discount..... per cent.

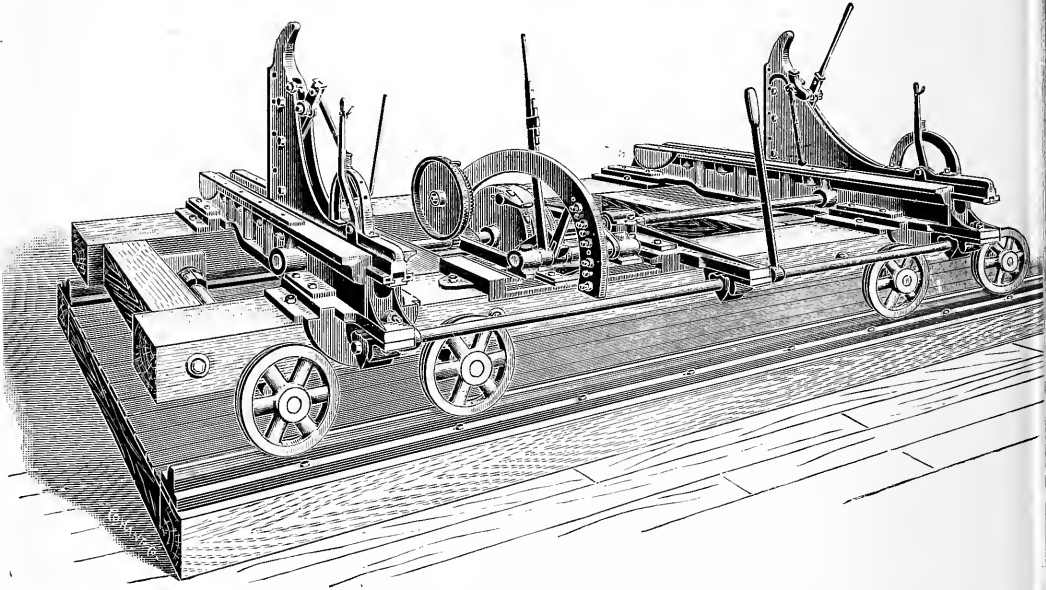
SHAW'S PATENT HEAD BLOCK OFFSET.

The above illustration represents a radical departure from the usual method of offsetting the log for Band Mills.

Heretofore the entire carriage and all parts connected therewith have been offset, the result of which is to bring surfaces together that are in continual motion whenever the carriage moves and with such pressure that there is a continual wear, requiring daily adjustment to ensure any degree of accuracy and at best when considered in perfect working order, there is more or less lost motion, the result of which is that the scale of the setworks is adjusted to give additional thickness to the lumber to provide for thick and thin lumber and tapering boards that the lumber may finish to the standard thickness.

The result is a loss which goes to shavings and is of no value.

The carriage axles are provided with split nuts, said nuts being made in halves and clamped on the axles inside the bearing where a thread is cut on the axle to correspond with the split nut, and all the lateral movement of the carriage is taken up so that the carriage makes as straight lines as the track.

SHAWS' PATENT HEAD BLOCK OFFSET.**Continued**

The head blocks and set works are offset by a positive movement that cannot vary, as the forward movement brings the blocks to a rigid stop by two iron surfaces coming together at a point where there cannot possibly be an accumulation of saw dust, bark, or chips, to prevent a contact of the metal surfaces and as neither of them are in motion, there can be no wear.

As the carriage has no lateral movement the steam feed bracket is bolted rigidly to the carriage and if located central with the steam feed cylinder, the friction is reduced and the wear and danger of breakage much less.

The scrapers for the track may be fitted accurately to the same, thereby ensuring a smooth running carriage and prolonging the life of the track and trucks.

By reason of the accuracy of this offset the thickness of the lumber may be reduced one thirty-second of an inch and then finish thicker than with the old style offset, with the additional thickness.

As the carriage is held rigidly in place from lateral movement and makes absolutely straight lines, the saw will take more feed and do accurate work with an increase of five thousand feet per day.

The offset may be fitted to any head block in use and can be operated automatically or by hand as may be desired.

Price complete for 3 block carriage..... \$500 00

Price complete for 2 block carriage..... 437 50

If new blocks are wanted, add \$35.00 for each block.

Discount..... per cent.

**KILGORE'S
SAW MILL CARRIAGE
CUSHION.**

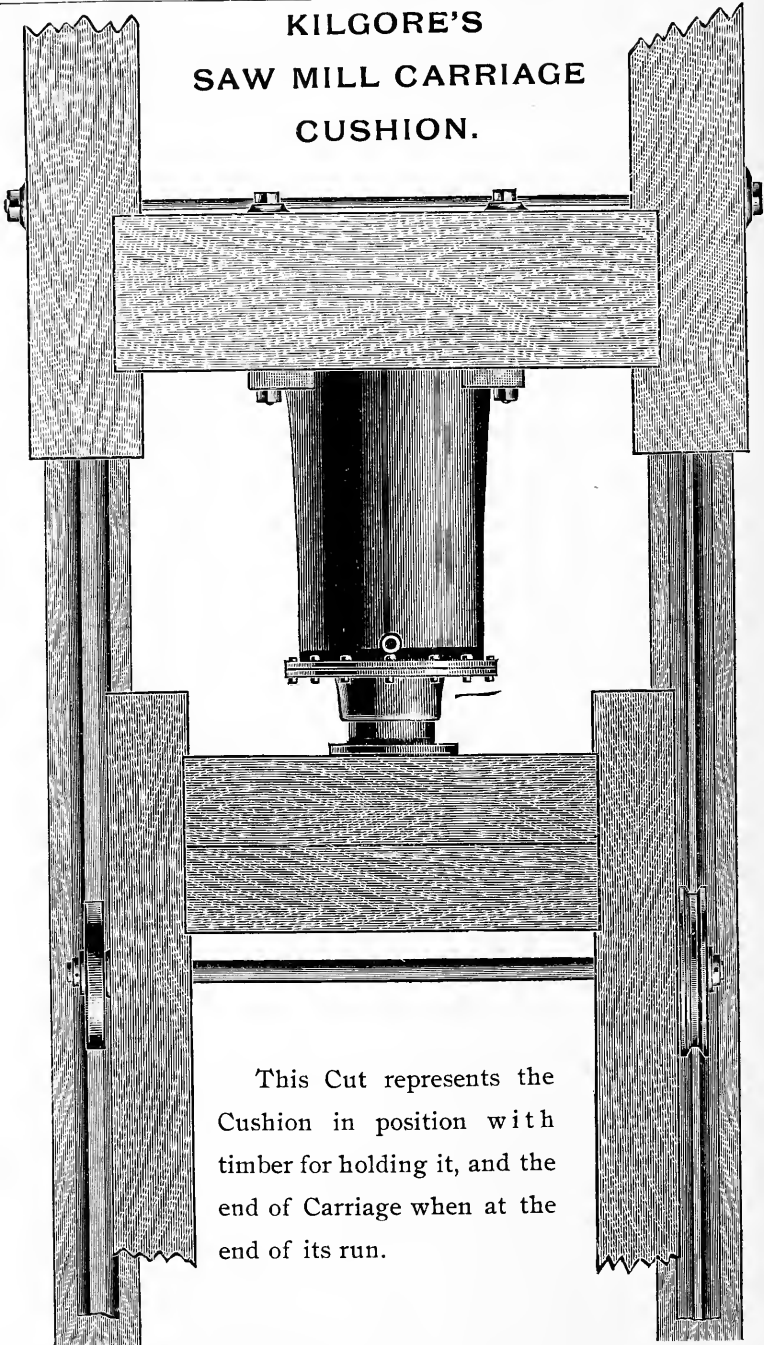

This Cut represents the Cushion in position with timber for holding it, and the end of Carriage when at the end of its run.

KILGORE'S SAW MILL CARRIAGE CUSHION.

Kilgore's Saw Mill Carriage Cushion will increase the cut of your Band or Circular.

Save accidents and repairs by using a cushion for your carriage that will stop it easy in all cases. It is a well known fact that if the sawyer hits the bumpers hard, even if he does not hurt the men or injure the carriage or head blocks, he is sure to handle his carriage very carefully for some time afterward, thus lessening the cut for a few hours at least, and if through any sticking or breakage of valve levers, or feed, the sawyer loses control of the carriage, there is apt to be a serious accident to men and mill.

This Kilgore Saw Mill Carriage Cushion is built to stop these carriages without jar. It consists of a cast iron cylinder bored out and fitted with a piston having a projection on one side to receive the blow from the carriage, which compresses air in the back end of cylinder and causes vacuum in front end, giving powerful resistance when the piston is driven in. It is simple and durable; will not break or wear out under a constant bumping.

Will increase the cut by allowing the sawyer to run his carriage at full speed without danger. One Cushion at each end of the track to act against a plate on the carriage end girt is a guaranty against injury to men or machinery. It has sufficient air vent to avoid giving a rebound to the carriage. This device is in all respects superior to any other, and is the only reliable cushion. It is always ready to receive the carriage; no breakage in the feed affects its working. Allows the carriage to run full length of track. It can be attached in a short time to any mill, and when in place needs no more care or expense.

O 12x 9 for very light 2 block carriages, price, each.....	\$ 60 00
A 12x12 for light 2 block carriages, price, each.....	70 00
B 12x16 for light 2 block carriages, price, each.....	80 00
C 15x18 for medium 2 block carriages, price, each.....	90 00
D 15x24 for heavy 3 block carriages, price, each.....	120 00
E 20x30 for heavy 4 block carriages, price, each.....	160 00

Weight of cushions from 450 lbs. to 2,000 lbs. each.

Discount..... per cent.

STEAM FEED BRACKET.

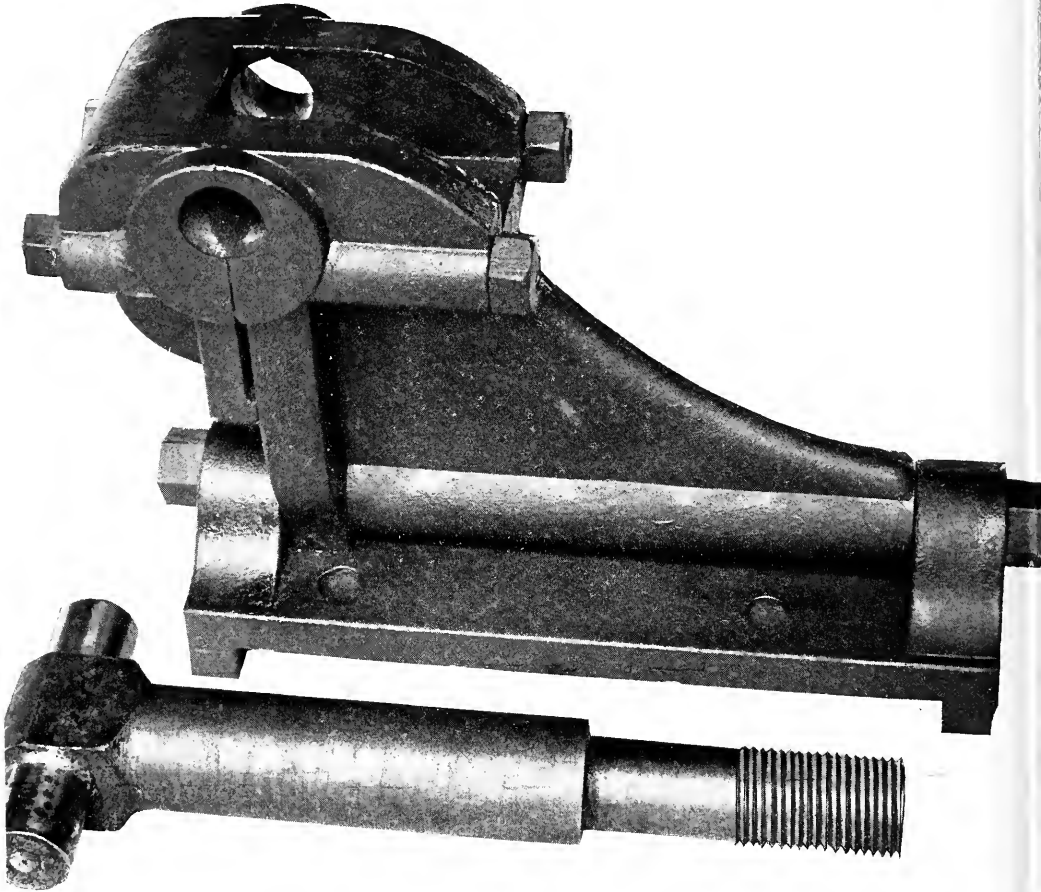

The above cut represents a Universal Self-Adjusting Steam Feed Bracket for attaching steam feed rod to carriage.

The advantage of this bracket over the common bracket lies in the universal pivoted joint which makes the connection between it and the rod. This prevents the end of the rod from crystalizing and breaking. The lower part of the rod is exposed so as to allow it to travel over the support.

Price with stub end to fit old rod..... \$60 00

Discount..... per cent.

THE PHOENIX DOUBLE TOOTH BOSS DOG.

MADE ENTIRELY OF STEEL.

Can be Bolted to the Knee or Standard of any Mill.

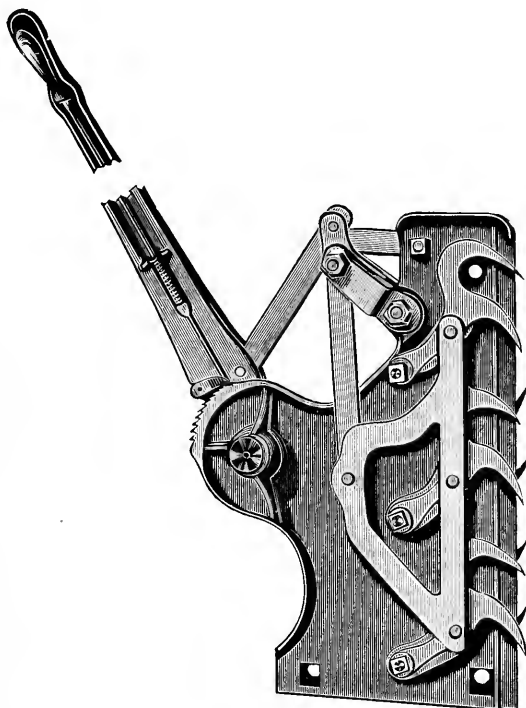

The above cut represents a right-hand dog, which is made to bolt to the right-hand side of the knee, viewed from the platform of the carriage.

This dog combines all the best features of the "Reliance" single tooth and "Boss" double tooth dogs, and has double grip hook teeth, working

in both directions, up and down, and all operated by one lever. Made entirely of steel, and so constructed as to be used independent, to bolt to knees or standards of any mill, or inserted and used in our patent hollow knee. The lever has downward movement to dog log or cant and is held firmly in position by a ratchet and stop, operated by hand piece on the end of lever, making it impossible for the teeth to work out and release the cant or log and allow it to crowd or break the saw. By the peculiar construction of the teeth, the pivotal point is further removed from the face of the knee, thereby giving a nearer vertical direction to the points of the teeth, and therefore avoids crowding a sawed or flat surface away from the knee or standards. There is but one lever to operate both lines or teeth, thus avoiding any complication of cams or levers to advance or recede the dog, to hold round logs, flat cant, or last board, the teeth advance $2\frac{1}{2}$ inches, to hold round log, or $\frac{5}{8}$ of an inch to hold the last board. To dog flat or sawed surface, the line of short teeth advance $\frac{5}{8}$ of an inch, with but slight movement of the lever to hold the last board securely to the knee.

To dog a round log, continue the downward movement of the lever and the long teeth advance $2\frac{1}{2}$ inches, or any part, and the short teeth recede into the knees, or back of face line, the ratchet holding the dog in position, so that it is impossible for the log to work loose or slide out at the bottom, as it is secured from both directions, up and down.

Price..... \$50 00.

Discount..... per cent.

DETAILS OF DOUBLE TOOTH DOG.

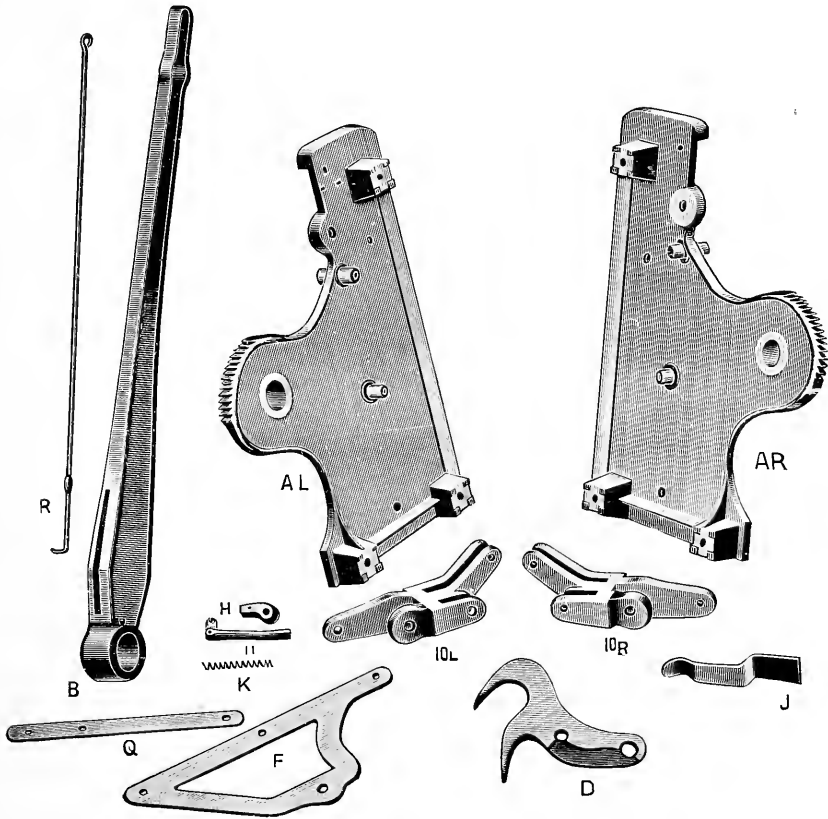

- A L, Plate for left hand dog.
 A R, Plate for right hand dog.
 B, Dog lever.
 H, Dog lever pawl.
 K, Dog lever pawl spring.
 R, Dog lever pawl connection.
 11, Dog lever handle.
 10 L, Double ended lever for left hand dog.
 10 R, Double ended lever for right hand dog.
 J, Steel spring for double ended lever.
 F, Dog teeth connection.
 D, Double dog tooth.
 Q, Wrought connection for dog teeth.

FORDEN DOUBLE ACTING MILL DOG.

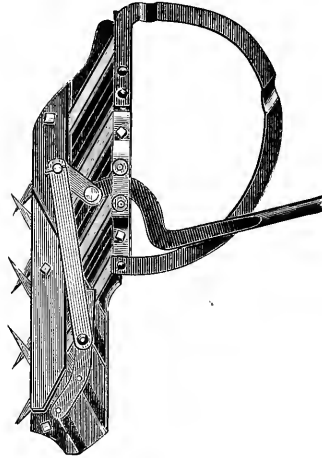

This we believe to be a first class and at the same time the cheapest double acting mill dog on the market. Its construction is simple and every part is made durable and strong.

It can be bolted to any head block standard as holes may be drilled through various places in the frame at most any point desired.

The teeth are made of the best tool steel and by bolting the dog to the standard in such a manner that when the lever is in the second slot the teeth of the dog extend beyond the face of the standard five-eighths of an inch, the last piece of lumber can be cut one inch thick.

From the front of the mill dog frame in a horizontal direction to the point of the teeth is two inches, while the teeth move on the angle in which they work about four inches. This dog holds the largest or smallest log firm and solid against the face of the standard and is the most satisfactory and quickest operated device for the purpose yet invented.

This cut shows a left hand dog.

Sent on approval to responsible parties.

Price each. \$30 00.

Discount. per cent.

THE STRAIGHT TOOTH DOUBLE-ACTING MILL DOG.

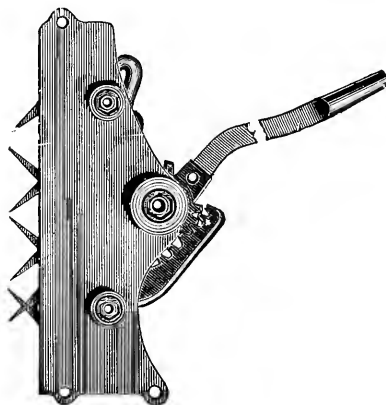

We show herewith a cut of our double-acting saw mill dog, put in an iron case ready for bolting on the side of any common knee or standard. This dog has few, if any, equals in the market, as all the working parts are of steel and each piece is made strong and durable.

The teeth are chisel pointed and being easily forced into the timber do not bite or tear out the side of the lumber and thus destroy many valuable boards and plank. Logs are held firmly against the standard, and those of ordinary size can be sawn up entire, without turning.

We make knees or standards with the dogs incorporated in their face which will fit any head block of the usual pattern.

The cut shows a left hand dog. State, when ordering, whether you desire right or left hand.

Price, each, of dogs in iron case..... \$40 00

Discount.....per cent.

RACK AND PINION MILL DOG.

SIMPLE,

DURABLE,

CHEAP.

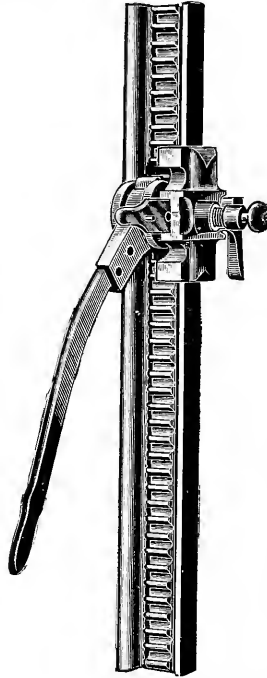

EFFECTIVE,

AND EASY

TO OPERATE.

The above Mill Dog is invaluable in sawing hard wood lumber or frozen timber, as it does not have a tendency to crowd the logs away from the face of the standard, and does not tear or mar the lumber while being sawed.

This Mill Dog is powerful in its operation and cannot slip as the tooth is forced into the log by the lever pinion working in the rack bar. By raising the lever to an upright position, the teeth in the pinion are disengaged from the rack bar, and the dog head can be raised or lowered to any position desired. The tooth bar can be set to hold the last board of a cant, or, a large round log, and is held in place by the spring pin in the side of the head.

The tooth bar is of steel and head of malleable iron, so that the apparatus is strong and durable.

When ordering state the number of right or left hand ones wanted. The one shown above is right hand.

Price each..... \$20 00

Discount.....per cent.

SELF-OILING PATENT TRUCK BOX AND AXLE.

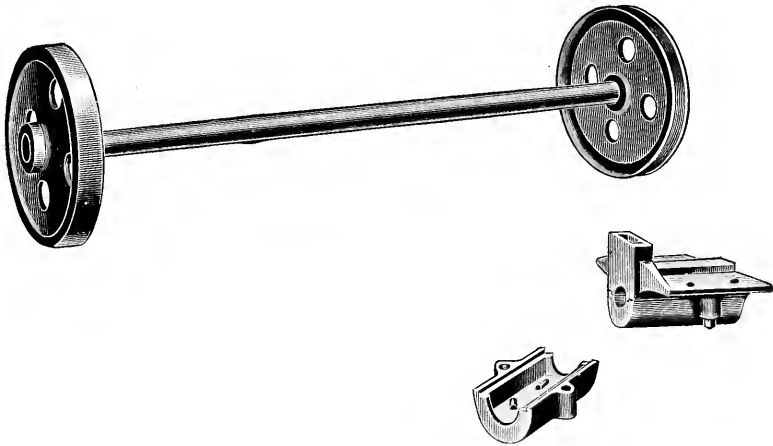

The above cut clearly represents the Self-Oiling Truck Boxes that are used with the Phoenix carriages. There is a large oil chamber below the axle, filled with oil and supplied with corks, which float on the oil and are at all times in contact with the axle, and consequently roll around as the axle revolves, keeping the bearing supplied with oil without any waste, as the surplus falls back into the oil chamber to be used again.

Price for 2½ inch steel axle with two 14 inch steel wheels and two
Boxes \$30 00

Price for 2¼ inch steel axle with two 12 inch steel wheels and two
self-oiling Boxes \$25 00

Discount.....per cent.

ROLLED STEEL CARRIAGE TRACK.

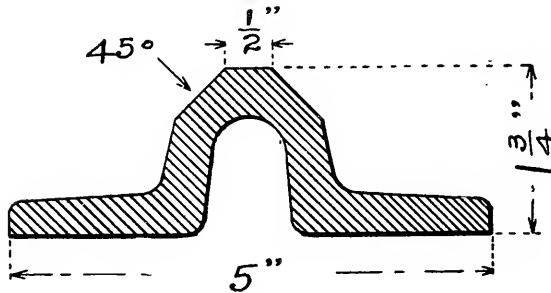
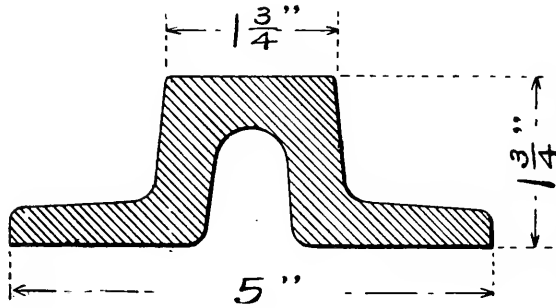

This track is made of rolled steel, heavy, well proportioned, strong and durable.

We are prepared to furnish this track in any length desired up to 12 feet, planed and drilled ready to bolt to timber.

Price per foot for flat..... \$0 90

Price per foot for V..... 1 00

Discount..... per cent.

NEW SPECIAL PHOENIX GANG EDGER.



For description see following page.

NEW SPECIAL PHOENIX GANG EDGER.

Our special gang edger, (shown on other side) is the heaviest and most substantial edger manufactured. The steel arbor, 4 to 6 inches in diameter according to size of machine, is provided with three self oiling ring boxes, the most perfect and satisfactory bearing made. Clean, absolutely reliable, and economical. This bearing is a great advantage over the old style on account of the saving in oil and grease, besides the bearing always runs cool.

All three boxes are on slip bridgetrees. This is a great advantage in removing arbor or putting on belt, and the two bearings on the driving end one on each side of the arbor pulley, hold the arbor in place while the other bearing is removed for changing saws.

Four large feed rolls are used on this edger, thus insuring not only a reliable feed, but straight lumber, for the material to be edged has a bearing on the four rollers at once and is held down by the heavy automatic press rolls, as shown, thus preventing the board from shifting.

All four of the feed rolls are driven by a single belt from the counter shaft which drives the edger, and when so desired we make a changeable feed. The rolls are geared together with brass gears, which is admitted to be far ahead of the short belts which are continually slipping from the accumulation of grease and oil.

The saws are all movable and are shifted by means of levers which extend from saws to the front end of table where they can be handily operated.

Ample provision is made for taking up any lost motion in these levers and in adjusting for different widths.

Any size of saw up to twenty-eight inches in diameter can be used. The twenty-eight inch saws will rip material eight inches in thickness.

SPECIAL PHOENIX GANG EDGER—Continued.

On each stationary guide on the front table we place a small spiked roller for keeping the lumber tight against the same.

The automatic press rolls do not have to be handled in any way by the edger man as they are self-operating, both in front and behind the saws.

On these edgers when desired we place a movable battery of six saws set two inches apart for making 2x4's or 2x6's. When this battery is not in use it can, by means of the hand wheel as shown, be moved out to one side, and thus give the edger man the benefit of the full width of the edger and stationary straight guides.

Mill men tell us that this is a great advantage and that this machine, on small logs, will increase the cut very materially, for by sizing the little logs this edger will rip them up into 2x4's, 2x6's or 6 inch strips much quicker than a gang.

We also build this edger with water boxes, and also stationary battery; that is to say, the pocket shown on the right of machine is left off and the battery of saws made stationary in the proper position on arbor. See cut on page 64.

Price includes front table, but no saws or back table.

Number of Saws.	Width of Working Space.	Speed for 24 inch Saws.	Size of Arbor Pulley.	Price with Battery Attachment.
8	96	1600	18 x 19	\$1300 00
7	84	1600	18 x 19	1100 00
6	72	1600	18 x 19	900 00
5	60	1600	15 x 15	860 00
5	54	1600	15 x 15	780 00
4	42	1600	12 x 12	680 00

Discount per cent.

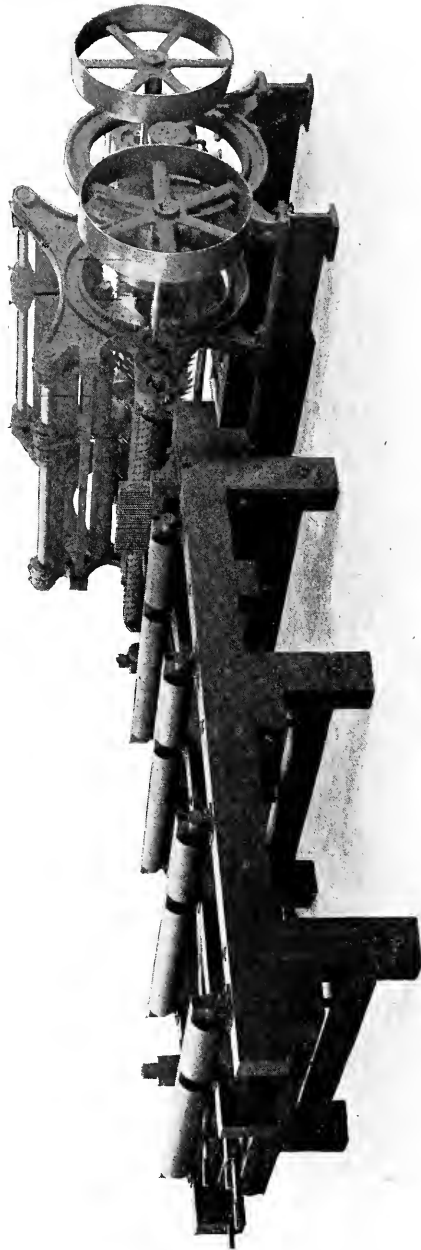
HEAVY STANDARD GANG EDGER.

For general description see page 63.



MEDIUM WEIGHT FIVE SAW GANG EDGER.

MEDIUM WEIGHT FIVE SAW GANG EDGER.

We show herewith a view of our Medium Weight Five Saw Gang Edger. The frame of the sawing part of machine is entirely of iron, while the front table rests on iron legs and has a heavy timber frame well bolted and made substantial.

This machine has five saws, 20 inches in diameter, but we can vary the number of saws as desired.

The saw arbor is of steel, $3\frac{1}{2}$ inches in diameter, with two feather keys let into it the entire distance, between bearings, for driving the saws which have key ways in their collars. The driving pulley is 12 inches in diameter with a 13 inch face. Speed about 1500 revolutions per minute.

The distance between the saws is regulated by the three hand wheels at end of machine, which have notches on their rims into which snap spring catches, holding the saws firmly in place at any desired point, but so arranged as to shift easily when desired. Each notch on the rim of the hand wheels represents a space of two inches between the saws. The hand wheels are attached to long shafts, having upon their ends spur pinions, which work in sliding rack bars attached to the guides that hold the rims of the saws.

The short front rollers have coarse cut spiral grooves turned in their face similar to the threads of a screw—those on one side of the machine being right hand and on the other left hand, so that the lumber resting upon the surface of these rollers, while passing through the machine, is crowded constantly against the guides and is split or edged in a perfectly straight manner. The roller shaft is driven by a belt from the front feed roller.

The feed rollers are three in number, of wrought iron $3\frac{1}{2}$ inches in diameter, fluted, two are back of the saws and one in front. The two back of the saws are geared together by a pair of spur gears; the feed roller in front and one of those back of the saws have upon their outer ends pulleys 26 inches in diameter, with a 4 inch face, which are driven by a belt around the end of the saw arbor, and thus feeds the lumber

FIVE SAW GANG EDGER—Continued.

through the machine in a very strong and rapid manner, yet without marring it in the least.

The notched brake in front of saws is so arranged that the brake rests on the lumber as it passes through the machine, but does not allow a piece or splinter to fly back towards the sawyer. This is a valuable device as lumber often flies from the saws and kills or injures numbers of men yearly.

The saws can be changed in a few moments' time by taking out the movable bridgetree at the farther end of the saw arbor, which allows the saws to be slipped off the end of the saw mandrel.

All of the idle rollers and press rollers are made in two sections across the machine, the body of the rollers being made of gas pipe, turned and finished, and heads of cast iron. The idle rollers turn upon strong iron shafts extending entirely across the machine, while the ends of the shafts rest and turn in iron boxes. The idle and press rollers being in two sections admits of one inch lumber being run through on one side of machine and two inch, or thicker, upon the other side, without one interfering with the other, this cannot be done when the rollers are of one piece the entire width of machine. The press rollers are raised, when it is desired to pass very thick lumber through the machine, by means of ropes attached to the ends of wooden levers, the levers not being here shown.

PRICE WITH FRONT TABLE, BUT NO SAWS OR BACK TABLE.

Number of Saws.	Width of Working Space. Inches.	Price.
7	76	\$750 00
6	66	650 00
5	54	550 00
4	42	450 00

Discount per cent.

THREE SAW EDGER.



We make this style of machine with three or four saws as desired. For description see opposite page.

THREE SAW EDGER.

The edger shown on opposite page is compact, strong and very effective in its operation, manufacturing lumber just as accurately as the machines made for larger mills, and has a capacity of from fifteen to thirty thousand feet of lumber per day.

The Feed Rollers, Saw Arbor and Press Rollers are all hung in a Solid Iron Frame, thus avoiding any of those parts getting out of line with each other.

The Saw Arbor is of $2\frac{1}{2}$ inch steel, thoroughly finished, and has three bearings, one on each side of the arbor pulley. (The machine, as shown in cut, is driven from the left side, with small pulley upon right end of arbor to drive feed roller pulleys, but this can be changed to either side as desired.)

The Arbor Pulley is 10 inches in diameter, with a 10 inch face, and should be driven from 1,500 to 2,200 revolutions per minute; the latter speed being necessary when the full capacity of machine is desired.

The saws are three in number, two being movable and one stationary and are 16 inches in diameter, with a $\frac{1}{4}$ inch hole in each to fit upon the saw collars, which are finely finished and close together, with a right or left hand thread, according to the direction the saws run.

The Feed Rollers are of wrought iron $2\frac{1}{2}$ inches in diameter, two in number, one being in front and one back of the saws, grooved lengthwise, and carry the lumber through the machine very rapidly, yet without marring it in the least. The rollers are driven by a belt wrapping around small pulley upon end of saw arbor and over the large feed pulleys shown in cut.

The small pulley in front of feed rollers, shown in above design, drives a shaft which has upon it two short rollers each being upon opposite sides of machine, one has a very coarse cut left-hand thread upon the surface while the other has the same kind of a right-hand thread, and as they revolve, the lumber, passing through the machine resting upon their spiral grooved surfaces, is continually crowded against the guides and thus sawn in a perfectly even and straight manner. This device is fully patented and is conceded by all users of Gang Edgers to be a valuable invention.

THREE SAW EDGER.—Continued.

The hinged guide pieces upon each side of machine are respectively two and three inches wide and can be turned up or down as desired, which, with the arrangement of the saws, is such that lumber can be cut any width from two to twenty-eight inches.

The saws are regulated by the Hand Wheels shown at the front of machine, which are attached to long shafts having upon their ends spur pinions which mesh into rack-bars attached to arms, which in turn work in slotted grooves in the saw collars.

The Pinions and Rack-Bars are very accurate, an entire revolution of either pinion moving a saw exactly 12 inches. The Arms and Rack-Bars moving the saws are underneath the saw arbor, which facilitates taking the arbor out of the frame and prevents the rack-bars from being clogged with sawdust, as does the other method of having them in front of the saws.

The Hand Wheels have upon the rims notches, each representing two inches in width between the saws, into which snap spring catches, holding the saws firmly at any desired point, but so arranged as to shift with ease when required.

The Press Rollers are of heavy cast iron and regulated by the hand rope.

The sawing part of the machine and front rollers are all in one frame, about fourteen feet in length and four feet in width, while the back rollers, four in number, are set in a separate frame twelve feet long, thus facilitating the handling and placing of the machine.

All idle rollers are of Hardwood, with iron shafts, and resting at each end in iron boxes. Each roller is banded with Iron Bands, driven into grooves turned in the end. The entire machine rests upon Iron Legs.

In ordering be sure to state whether you want the drive pulley upon the right or left side, when standing in front of the machine.

Price of Edgers with Front and Back table and three saws. . . . \$300 00

Discount.per cent.

TWO SAW EDGER.

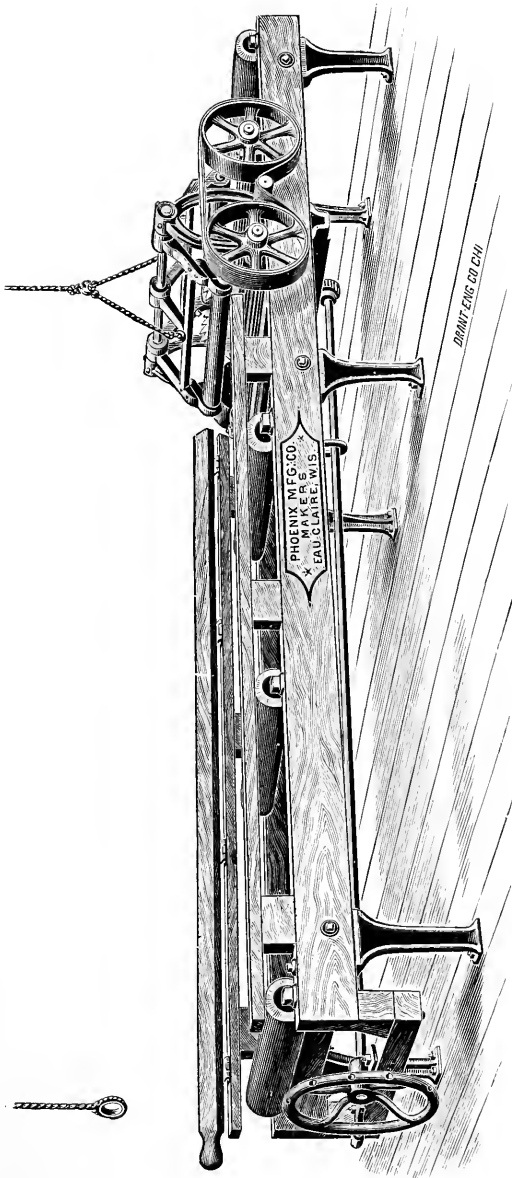

For description, see following page.

TWO SAW EDGER.

We show herewith a view of our Two Saw Gang Edger, designed for mills which do not cut over 25,000 feet of lumber per day. This machine will do as good work as the larger ones, the only difference being in its capacity and size.

The Feed Rollers, Saw Arbor and Press Rollers are all attached to a Solid Iron Frame, thus avoiding any of those parts getting out of line with each other.

The Saw Arbor is of $2\frac{1}{2}$ inch steel and has three bearings, one on each side of the arbor pulley. [The machine as shown in cut is driven from the left hand side with small pulley upon the right end of arbor to drive the feed roller pulleys, but this can be changed to either side as desired.]

The Arbor Pulley is 8 inches in diameter, with a 9 inch face, and should be driven from 1500 to 2300 revolutions per minute—the latter speed being necessary when the full capacity of machine is desired.

The Saws are two in number, one being movable and one stationary, and are 16 inches in diameter, with a 4 inch hole in each to fit upon the collars, the collars closing upon the saw, with a right or left hand thread according to the direction the saw runs.

The Feed Rollers are two in number, and made of $2\frac{1}{2}$ inch round wrought iron, which is fluted so as to carry the lumber through the machine in a rapid and perfectly straight manner and yet without marring it in the least. One roller is in front and one back of the saws, both rollers being driven by the belt wrapping around the end of saw arbor, and over the large pulleys as shown in cut. The hinged guide piece upon side of machine is three inches wide and can be turned up or down as desired, which with the arrangement of the saws is such that any width of lumber can be cut from three to twenty-two inches wide.

TWO SAW EDGER—Continued.

The movable saw is regulated by the hand wheel at front end of machine. This hand wheel being attached to a long shaft having upon its end a spur pinion, which works into a rack bar, which has fastened to it an upright arm that engages in a groove in the collar of the saw.

The Pinion and Rack Bar have machine cut teeth and are very accurate, an entire revolution of the pinion moving the saw exactly 12 inches.

The Arm and Rack Bar moving the saw are underneath the saw arbor which facilitates taking the arbor out of the frame and prevents the rack bar from getting clogged with saw dust, as does the other method of having them in front of the saws.

The Hand Wheel has upon its rim notches, each representing two inches in width between the saws, into which snap a spring catch holding the saw firmly at any desired point, but so arranged as to shift with ease when required.

The Press Rollers are two in number and made of heavy cast iron nicely finished, these rollers are regulated by the hand rope over machine.

This machine occupies a floor space of 16 feet in length by 40 inches in width. All idle rollers are of hard wood with iron shafts passing entirely through them and resting at each end in iron boxes. Each roller is banded with iron bands driven into grooves turned in the end. The entire machine rests on iron legs.

When ordering be sure to state whether you want the drive pulley upon right or left side when standing in front of machine.

Price of machine as shown and described with two saws..... \$200 00

Discount..... per cent.

GANG LUMBER TRIMMER.

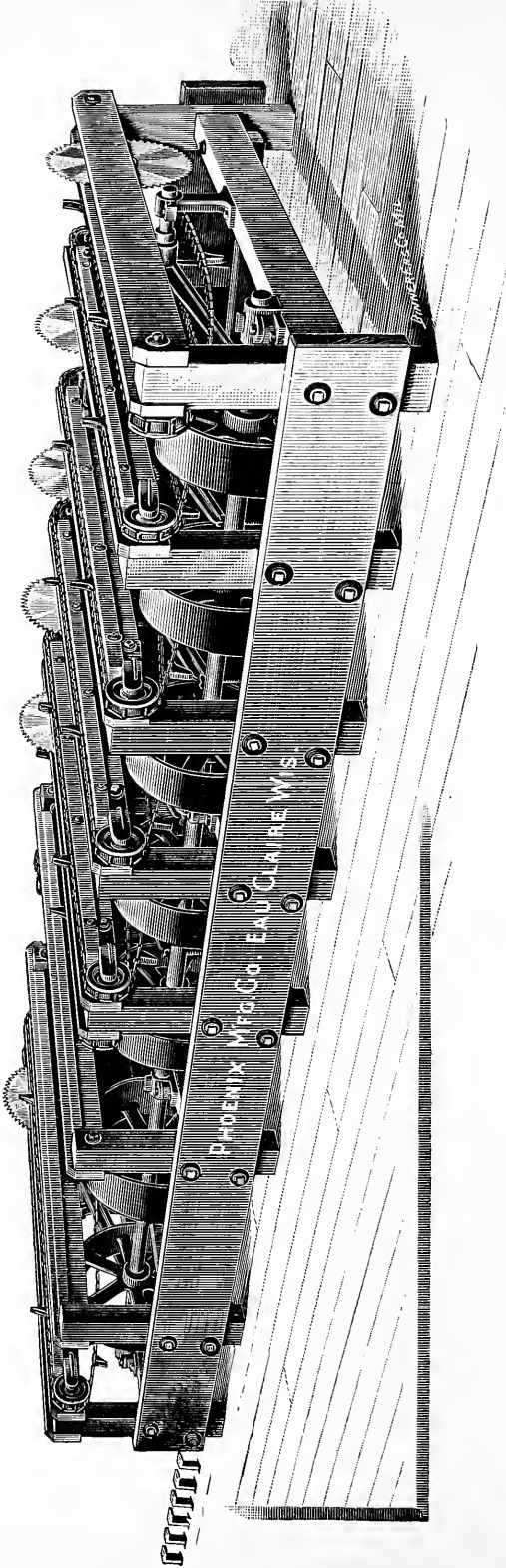

For description see page 76.

END ELEVATION OF TRIMMER.

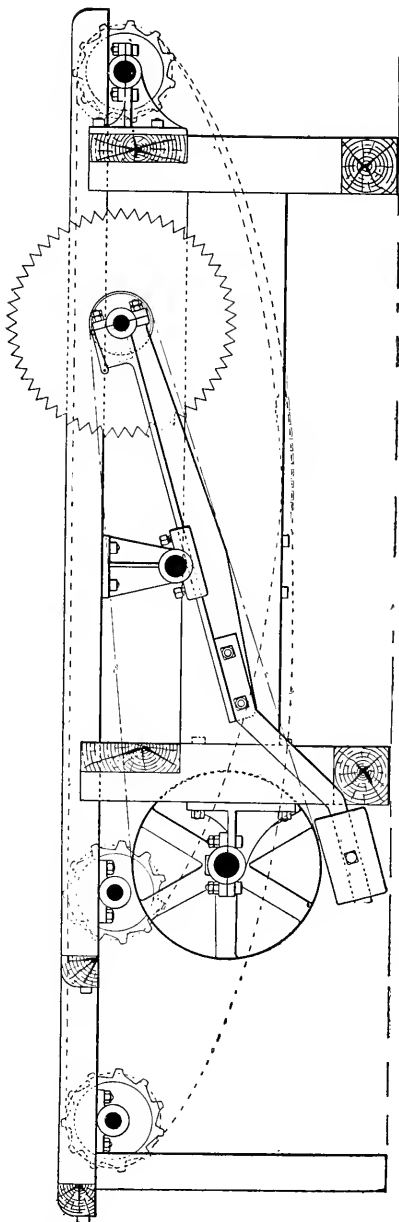

For description see page 76.

THE PHOENIX PATENT LUMBER TRIMMER.

The cut on page 74 gives a general view and that on page 75 an end view of our Improved Automatic Lumber Trimmer. All of the saws and feed work are driven from the long shaft in front of machine, necessitating only one connection with the driving power, which makes it a self-contained machine.

The main drive pulley is 20 inches in diameter for an 8 or 10 inch belt, and should make 460 revolutions per minute.

The saws are 20 inches in diameter and are arranged in iron tilt frames as shown, so that the frame can be moved forward, taking up the slack or stretch of belt. This feature enables the use of endless belts and places the Phoenix Trimmer clearly in the lead of all competitors, being the first and only trimmer made *upon which endless belts can be used.*

The machine here shown trips the saws by a series of foot levers at the end of the table, but we can vary the arrangement so as to have a lever in front of each saw, or have the saws operated by a man on a platform overhead.



Left-Hand.

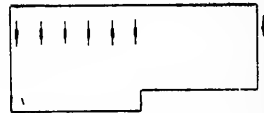

Right-Hand.

PRICES WITHOUT BELTS OR SAWS.

To trim 10, 12, 14, 16 feet	\$500 00
To trim 10, 12, 14, 16, 18 feet	550 00
To trim 10, 12, 14, 16, 18, 20 feet	600 00
To trim 10, 12, 14, 16, 18, 20, 22 feet	650 00
To trim 10, 12, 14, 16, 18, 20, 22, 24 feet	700 00

Add \$50.00 for each additional saw and frame.

Discount per cent.

TWO SAW LUMBER TRIMMER.

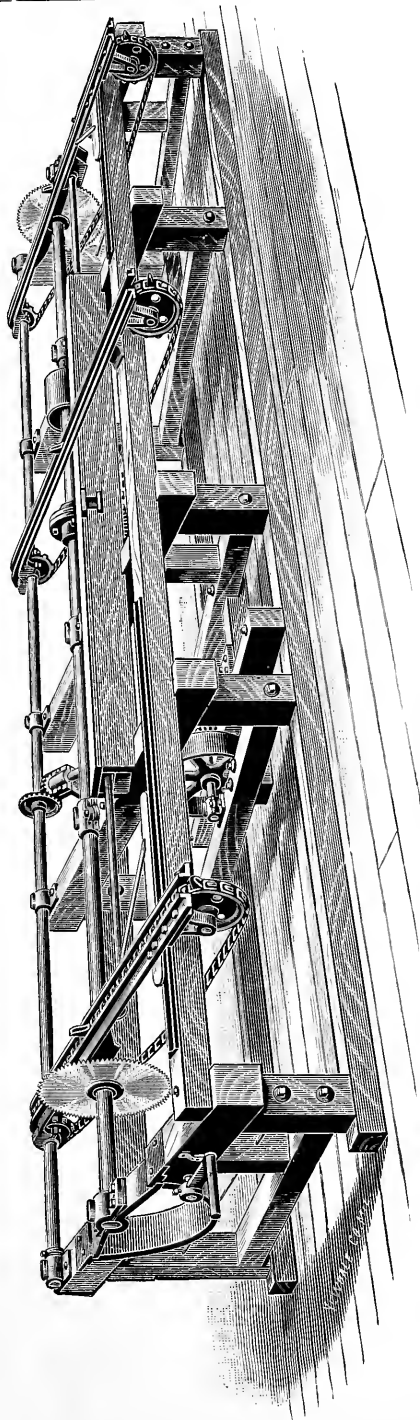

For description see following page.

TWO SAW LUMBER TRIMMER.

This machine with the improvements lately placed upon it has secured the approbation of all mill men who have tried it.

The crank to move the saws can be placed at either end of the machine. One turn of the crank changes the distance between the saws 2 feet. Attached to the crank is a spring that fits into notches holding the saws at correct distances.

This machine is furnished with a movable bridgetree so that the saws can readily and quickly be changed.

Three sizes of this trimmer are made. No.1 trims from 8 to 16 feet, No. 2 trims from 10 to 18 feet, and No. 3 trims from 10 to 20 feet. The machine will also trim one end of pieces shorter than the full distance between the saws, if so desired.

These machines will trim from seventy-five to one hundred thousand feet per day according to their size.

The driving pulley is 8 inches in diameter, with a 10 inch face, and the saw arbor is of $2\frac{1}{2}$ inch steel, running the entire length of the machine.

The entire trimmer is built strong and heavy, much more so in fact than any other two saw trimmer on the market, and is so arranged that it can be taken apart for shipping, each piece being marked so that any mechanic can put it together. Or, it can be shipped all set up ready for belts, as the party ordering may desire. The boxing is extra.

Each machine is furnished with two 20 inch saws which should run about 1500 revolutions* per minute.

We also manufacture lumber trimmers of various other ranges in length and will be pleased to give full particulars and name prices at any time.

PRICE OF MACHINE COMPLETE WITH SAWS.

No. 1.....	\$225 00
No. 2.....	250 00
No. 3.....	275 00

Discount..... per cent.

END ELEVATION OF
OVERHEAD SLAB SLASHER.

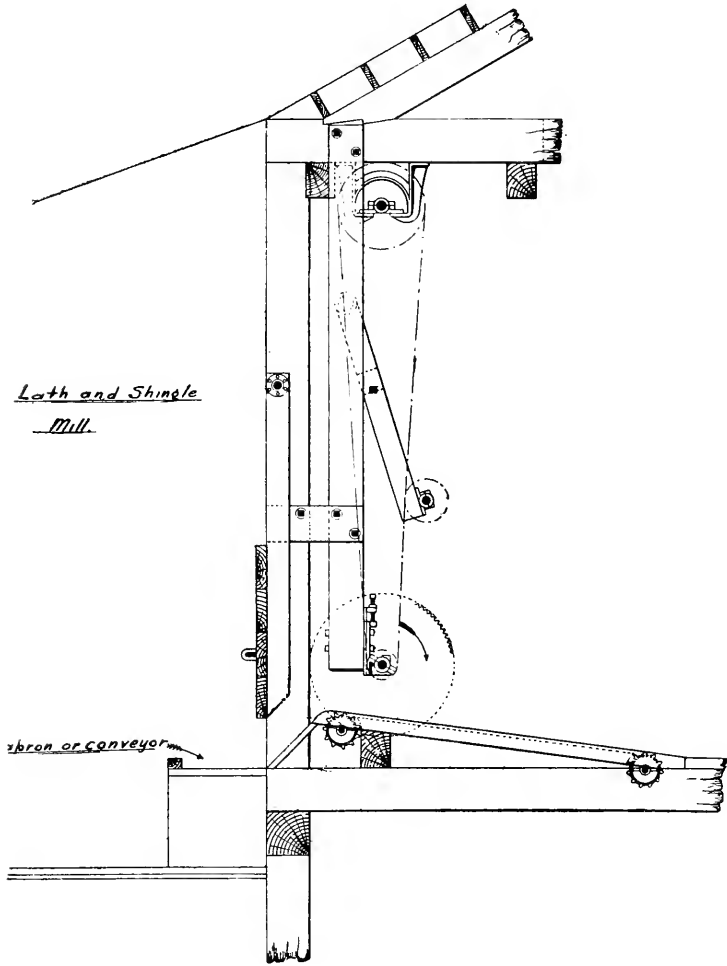

Lath and Shingle
Mill.

skron or conveyor

FRONT VIEW OF
OVERHEAD SLAB SLASHER.

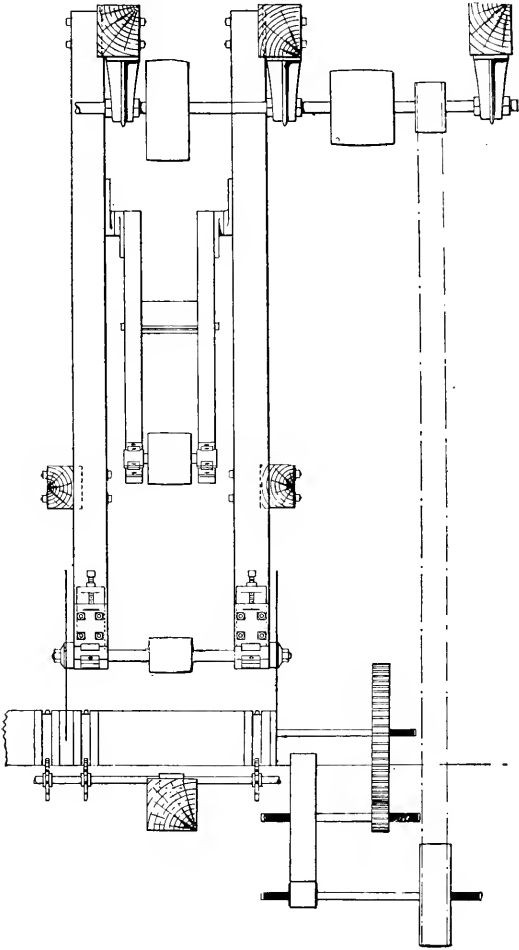

OVERHEAD SLAB SLASHER.

On pages 79 and 80 we show an outline of our overhead slab slasher as usually constructed. We furnish the iron work only, with a complete set of working drawings. The cut shows the slasher chains driven from the drive shaft overhead, but we have constructed them to be driven from below with a number 114 drive chain, which makes a very simple drive.

The arbors are 2 15-16 inches in diameter provided with 10 inch collars, and a 10x11 solid web center pulley finished all over and put in running balance.

The arbor boxes are a special design, being adjustable up and down to compensate for the wear of saw, and are provided with large grease pockets.

Any size saws can be used on these slashers, but 36 inch is the size usually used.

Iron work for four saw slasher, no saws.....	\$305 00
Iron work for five saw slasher, no saws.....	340 00
Iron work for six saw slasher, no saws.....	375 00

Discount.....per cent.

TWO SAW 4 FOOT SLASHER.

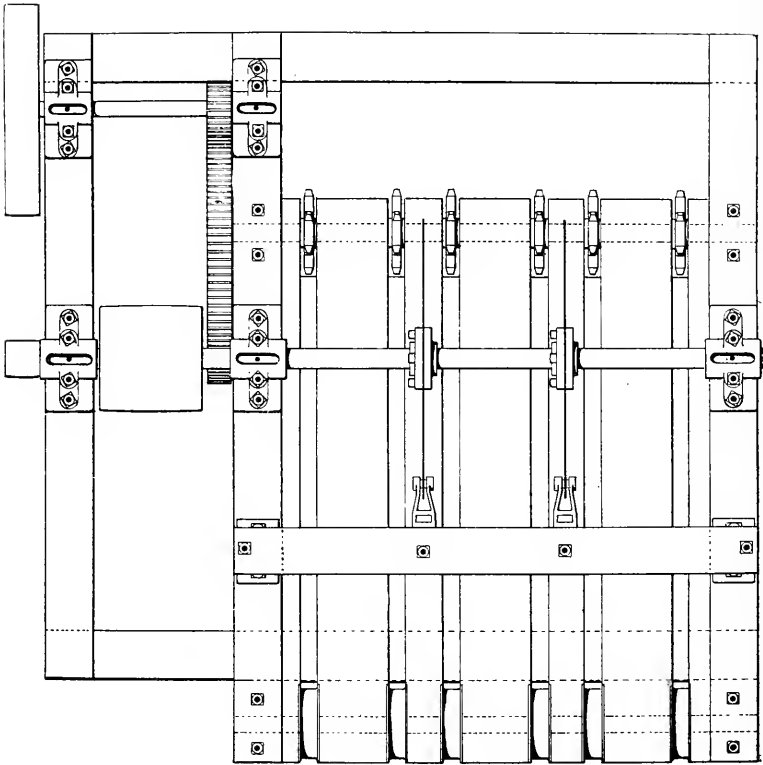

The above cut illustrates a new two saw slab slasher for cutting 4 ft. slabs into 16 inch wood. The saws, which are on an overhead arbor, are 32 inches in diameter, the arbor is 2 7/16 inches, arbor pulley 12x14, and should make 1300 revolutions.

Price without saws or belts..... \$250 00

Discount..... per cent.

LADDER SAW.

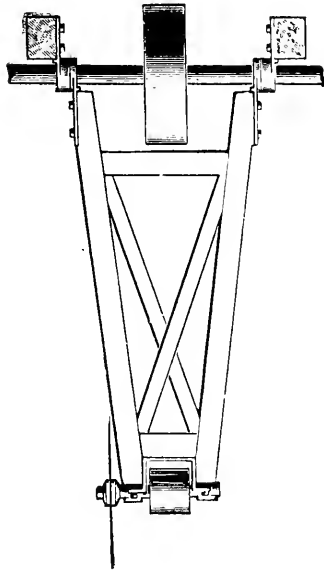

Arbor 1 7-16 inch, with Yoke and Pulley 7x7 inches..... 20 00

Arbor 1 15-16 inch, with Yoke and 8x8 1-2 inch Pulley..... 34 00

When ordering state whether it is to swing from above or below.

The wooden frame is not included in the price list.

Discount.....per cent.

LADDER SAW HINGES.

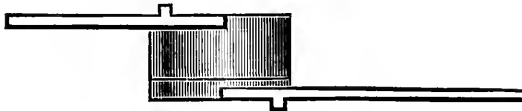

When ordering state diameter of Eye wanted.

Price per pair \$7 00

Discount.....per cent.

EDGING GRINDER.

The sawdust in mills using band saws, is too fine to burn well.

This grinder will make chips of all the slabs, edgings, bark and short pieces of boards; or, as much as may be needed to make enough fuel, which can be burned alone or mixed with the band sawdust.

In many localities the saw mill boilers are used at night to make steam for other purposes, as in making salt and in running electric lights. In such cases, the slabs and edgings can be ground during the day and deposited in a large hopper or any convenient place, and at night can be fed to the furnaces by conveyors or otherwise.

In this way all expense of handling the fuel by men and teams is avoided, and a saving effected both in labor and the outlay for horses and carts and the cost of their maintenance.

If the mills are where slabs and edgings can be sold at satisfactory prices, and it is an object to save fuel, the smallest edgings from the lath mill, or pieces from the trimmer, will ordinarily make sufficient fuel, when added to the sawdust, to run the mill.

In many sections of the country slabs and edgings are used for filling low ground, and it requires much labor to pile them in a suitable manner, but where they are passed through the grinder the chips are easily carried in carts and dumped into place, and make the best kind of filling with the least amount of labor.

In ordering Nos. 1, 2 and 3, state whether it is to be right or left hand. We furnish a suitable wrench with each machine, also put one set of knives in the wheel and furnish an extra set in a box and deliver on the cars without charge for boxing or cartage.

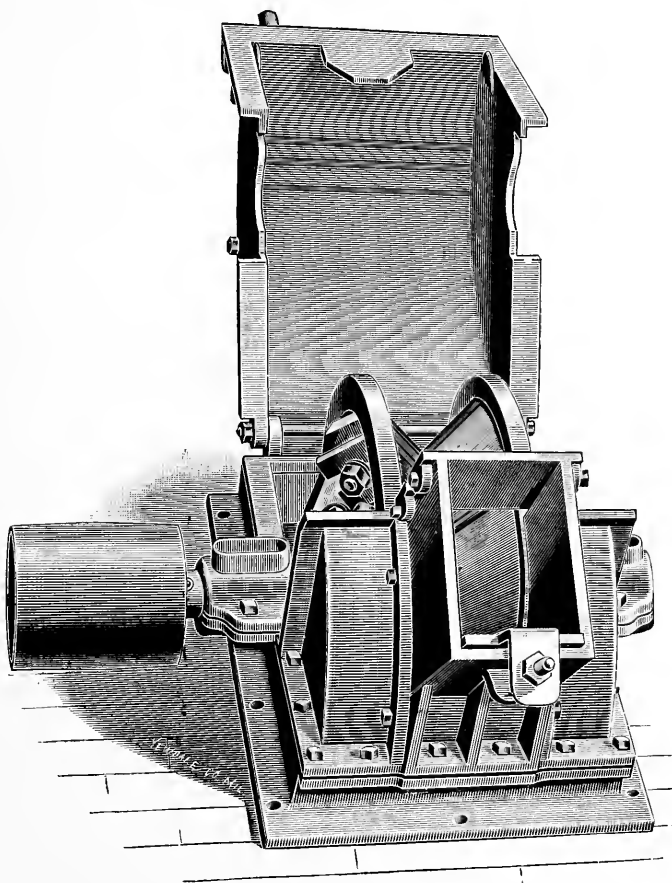
EDGING GRINDER.**PRICE LIST OF EDGING GRINDER.**

No. 1, 6x 8 in. Spout, 10x 8 in. Drive Pulley	\$150 00
No. 2, 12x10 in. Spout, 12x11 in. Drive Pulley	300 00
No. 3, 18x10 in. Spout, 14x11 in. Drive Pulley	350 00
No. 4, 12x12 in. Spout, Pulley on each side of Grinder 15x 9 in.	375 00
No. 5, 12x20 in. Spout, Pulley on each side of Grinder 15x 9 in.	387 00
No. 6, 16x20 in. Spout, Pulley on each side of Grinder 25x11 in.	500 00

Discount.....per cent.

AUSTIN STEAM SEPARATOR.

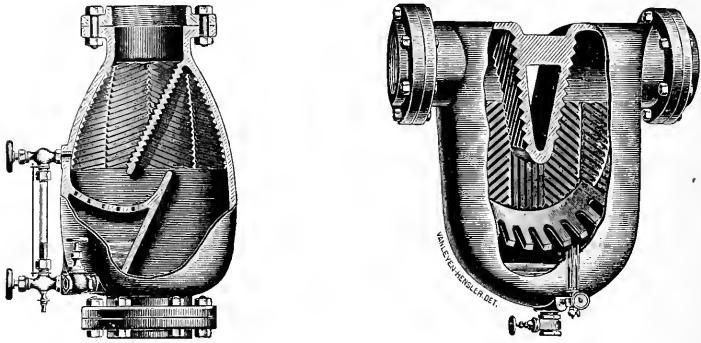

On page 87 we illustrate and show dimensions of an Improved Separator designed primarily for steam engine use, but it has been found by experience to be an excellent device to be used in connection with the steam feed.

By placing one of these separators in the feed pipe, close up to the steam feed valve it will separate and carry off all of the water contained in the steam, thereby overcoming possibility of accidents from water getting in the valve which causes same to "kick" and sometimes stick.

Every sawyer knows that in starting up, after the feed has been idle a short time, it is necessary to go through the "pumping" process to work the water out of the valve, etc., then again the valve will get stuck, when away goes the carriage and a smash up is the result.

Also, by separating the water from the steam better lubrication is obtained; for all practical users of steam know that when saturated with water there is great danger of the valve and piston cutting, which causes leakage, the hot water neutralizes the action of the oil in the valve and cylinder causing same to become dry and forming a dry, sticky substance around the valve and in the cylinder which permits cutting, practically having the same effect as if no oil was used.

No steam feed should be used without one of these separators, it will pay for itself every day, by not only preventing the possibility of an accident, but it will increase the cut by making a quicker acting feed

Discount per cent.

AUSTIN SEPARATOR FOR EXHAUST AND LIVE STEAM.

Sizes and Prices Include Connecting Flanges, Water Gauge, Nipple and Straight-Way Valve.

Size, inches	1½	2	2½	3	3½	4
Prices	\$30 00	40 00	45 00	50 00	60 00	70 00
Size, inches	4½	5	6	7	8	10
Prices	\$75 00	80 00	110 00	125 00	160 00	220 00

Discount.....per cent.

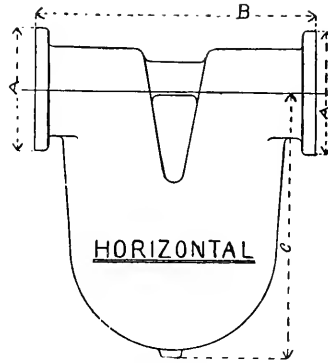
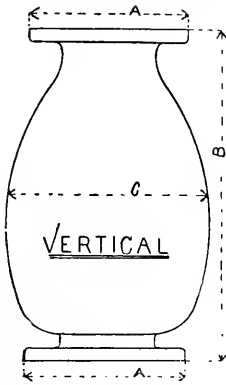

DIMENSIONS IN INCHES.

Vertical.

	In.	In.	In.	In.	In.	In.	In.	In.	In.	In.	In.	In.
	1½	2	2½	3	3½	4	4½	5	6	7	8	10
A	6½	6½	6½	7½	9	9	10	10	11	12½	13½	16
B	12½	12½	12½	15	18	18	22	22	25	28	31	34
C	8	8	8	9	11	11	13	13	15	17	19	23

Horizontal.

	In.	In.	In.	In.	In.	In.	In.	In.	In.	In.	In.	In.
	1½	2	2½	3	3½	4	4½	5	6	7	8	10
A	Screwed Ends.		6½	7½	8	9	9½	10	11	12½	13½	16
B	9	9	13	15	16	18	19	20	24	27	30	31
C	9	9	12	13	14	15	17	19	22	25	29	36

IMPORTANT—In ordering, state if Horizontal or Vertical is wanted, and if for Live or Exhaust Steam.

PHOENIX DIRECT ACTING STEAM FEED.

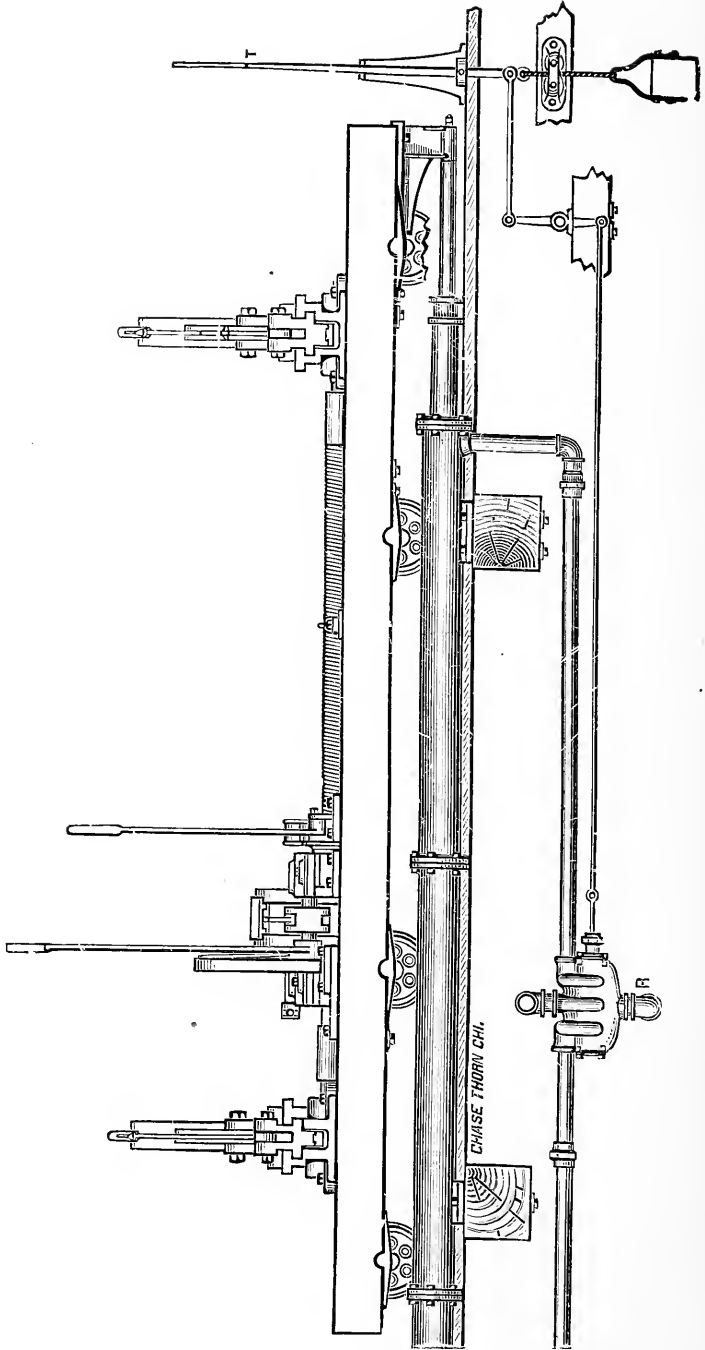

Price on Page 89.

THE PHOENIX DIRECT ACTING STEAM FEED.

Has radically changed and revolutionized the business of sawing lumber at all great lumbering points in the United States. So that a mill constructed at the present time would not be considered modern if it did not contain the Phoenix Steam Feed.

We claim that no feeding device yet produced can or does compare with this for simplicity, durability, efficiency and economy.

LIST PRICE.

Length of Cylinders, Feet.	Price of 7 inch.	Price of 8 inch.	Price of 9 inch.	Price of 10 inch.	Price of 11 inch.	Price of 12 inch.	Length of Cylinder. Feet.
18	\$500 00	\$550 00	\$600 00	\$650 00	\$700 00	\$750 00	18
20	510 00	561 00	612 00	663 00	714 00	765 00	20
22	520 00	572 00	624 00	676 00	728 00	780 00	22
24	530 00	583 00	636 00	689 00	742 00	795 00	24
26	540 00	594 00	648 00	702 00	756 00	810 00	26
28	550 00	605 00	660 00	715 00	770 00	825 00	28
30	560 00	616 00	672 00	728 00	784 00	840 00	30
32	570 00	627 00	684 00	741 00	798 00	855 00	32
34	580 00	638 00	696 00	754 00	812 00	870 00	34
36	590 00	649 00	708 00	767 00	826 00	885 00	36
38	600 00	660 00	720 00	780 00	840 00	900 00	38
40	610 00	671 00	732 00	793 00	854 00	915 00	40
42	620 00	682 00	744 00	806 00	868 00	930 00	42
44	630 00	693 00	756 00	819 00	882 00	945 00	44
46	640 00	704 00	768 00	832 00	896 00	960 00	46
48	650 00	715 00	780 00	845 00	910 00	975 00	48
50	655 00	720 00	786 00	851 00	917 00	982 00	50
52	660 00	726 00	792 00	858 00	924 00	990 00	52

Discount. per cent.

BECK'S PATENT DUPLEX FEED ENGINE.

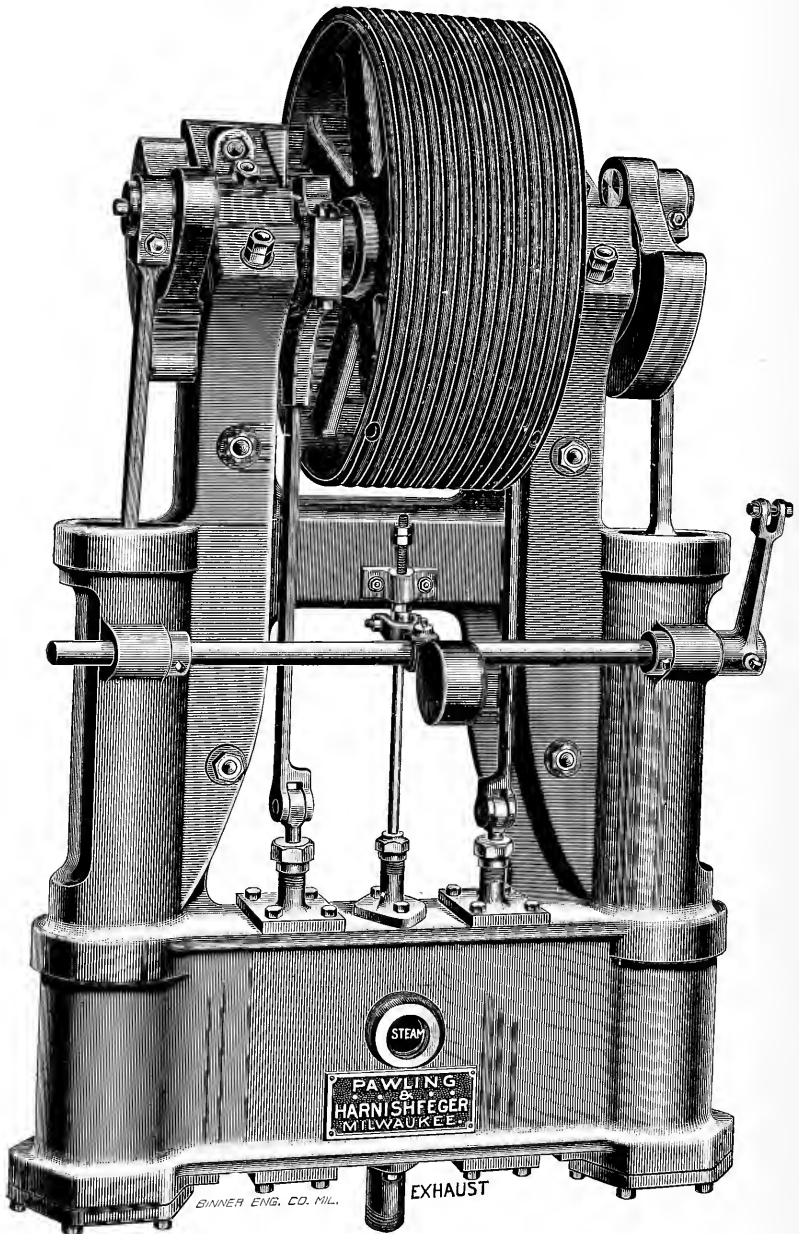

GINNER ENG. CO. MIL.

BECK'S PATENT DUPLEX FEED ENGINE. FOR EXTREMELY LONG LOGS.

This Machine is nothing more nor less than a pair of straight forward, self-contained, double acting steam engines, with self-packing pistons, steel piston rods, improved self-oiling cross heads and steel connecting rods with adjustable boxes, such as every man about the mill is familiar with. The main valves are absolutely balanced and are so made that the steam is entirely within the valve. The guiding heads at each end are self-packing and present a wearing surface of over 80 square inches. These heads, filled with small oil grooves for lubrication, carry the valve proper between them and absolutely within the center of the valve chamber. By this novel construction the valve is kept from wearing either itself or its seat, and is, therefore, always tight. All water around the valve is drained automatically into the exhaust chamber and passes out through the exhaust pipe.

Outside of the cylinder heads there is not a single bolted or packed joint or gasket which comes under live steam pressure; hence, no matter how hard the engine is worked, there is not a single joint to work loose and leak. The steam passages are extremely short and direct, are quickly filled and emptied, and there is the least possible amount of clearance to be filled with steam at each reversal of the engines.

There is absolutely no so-called steam chest, as one might be led to suppose from the cut, and the steam occupies not a particle of space outside of the regular ports or passages, and that provided inside the reversing and main valves; hence the use of a large steam chest filled with steam undergoing condensation is avoided, as well as the danger of running such water through the engine. The reversing valve stem is under exhaust pressure only and can be packed very lightly; on this account the valve works very lightly and without effort on the part of the sawyer.

TABLE OF SIZES AND PRICES.

Size of Feed.	Dia. of Drum Inches.	Carriage Run in Feet Using Double Rope: (Duplex Cable)					Pull with 80 lbs. Steam one Engine on the Center.	Length: Center of Drum to Cylinder Head.	Price.
		$\frac{1}{2}$	$\frac{9}{16}$	$\frac{5}{8}$	$\frac{11}{16}$	$\frac{3}{4}$			
		Feet.	Feet.	Feet.	Feet.	Feet.			
8 x 10	20	71	2000	5 ft. 0 in.	\$400 00
8 x 10	22	70	72	1800	timbers	400 00
8 x 10	24	85	78	72	1600	12 in. x 14 in.	400 00
8 x 10	26	92	84	78	1400	16½ apart.	400 00
9 x 11	22	78	72	2500	5 ft. 6 in.	475 00
9 x 11	24	85	78	72	2300	timbers	475 00
9 x 11	26	92	84	78	2100	12 in. x 14 in.	475 00
9 x 11	28	100	90	84	1900	16½ apart.	475 00
10 x 12	24	69	63	56	50	44	3200	6 ft. 0 in.	550 00
10 x 12	26	75	68	61	54	47	2950	timbers	550 00
10 x 12	28	80	73	65	58	51	2700	14 in. x 16 in.	550 00
10 x 12	30	85	78	70	63	55	2450	16½ apart.	550 00
11 x 14	28	80	73	65	58	51	3800	6 ft. 8 in.	625 00
11 x 14	30	85	78	70	63	55	3550	timbers	625 00
11 x 14	32	92	84	75	67	58	3300	14 in. x 16 in.	625 00
11 x 14	34	98	89	80	71	62	3050	16½ apart.	625 00
12 x 16	32	92	84	75	67	58	4500	7 ft. 4 in.	725 00
12 x 16	34	98	89	80	71	62	4250	timbers	725 00
12 x 16	36	103	94	85	75	66	4000	16 in. x 16 in.	725 00
12 x 16	38	109	99	90	80	70	3750	16½ apart.	725 00
13 x 18	36	103	94	85	75	66	5300	8 ft. 0 in.	925 00
13 x 18	38	109	99	90	80	70	5150	timbers	925 00
13 x 18	40	114	104	95	84	74	5000	16 in. x 16 in.	925 00
13 x 18	42	120	109	100	89	78	4850	16½ apart.	925 00

Note:—For good average work the combined weight of log and carriage should not exceed 10 times the pull of feed engine as given in table.

The sizes of rope most generally used are as follows:

For 8 x 10 and 9 x 11 Feeds 1-2 inch or 9-16 inch diameter.

For 10 x 12 and 11 x 14 Feeds 9-16 inch or 5-8 inch diameter.

For 12 x 16 and 13 x 18 Feeds 5-8 inch or 3-4 inch diameter.

Nothing is gained by using rope larger than $\frac{5}{8}$ inch diameter, even for the largest Feed Engine. When the smaller sizes specified are used, Transmission instead of Hoisting rope can be adopted with advantage.

See description on page 91.

Discount. per cent.

BECK'S PATENT DUPLEX FEED ENGINE.

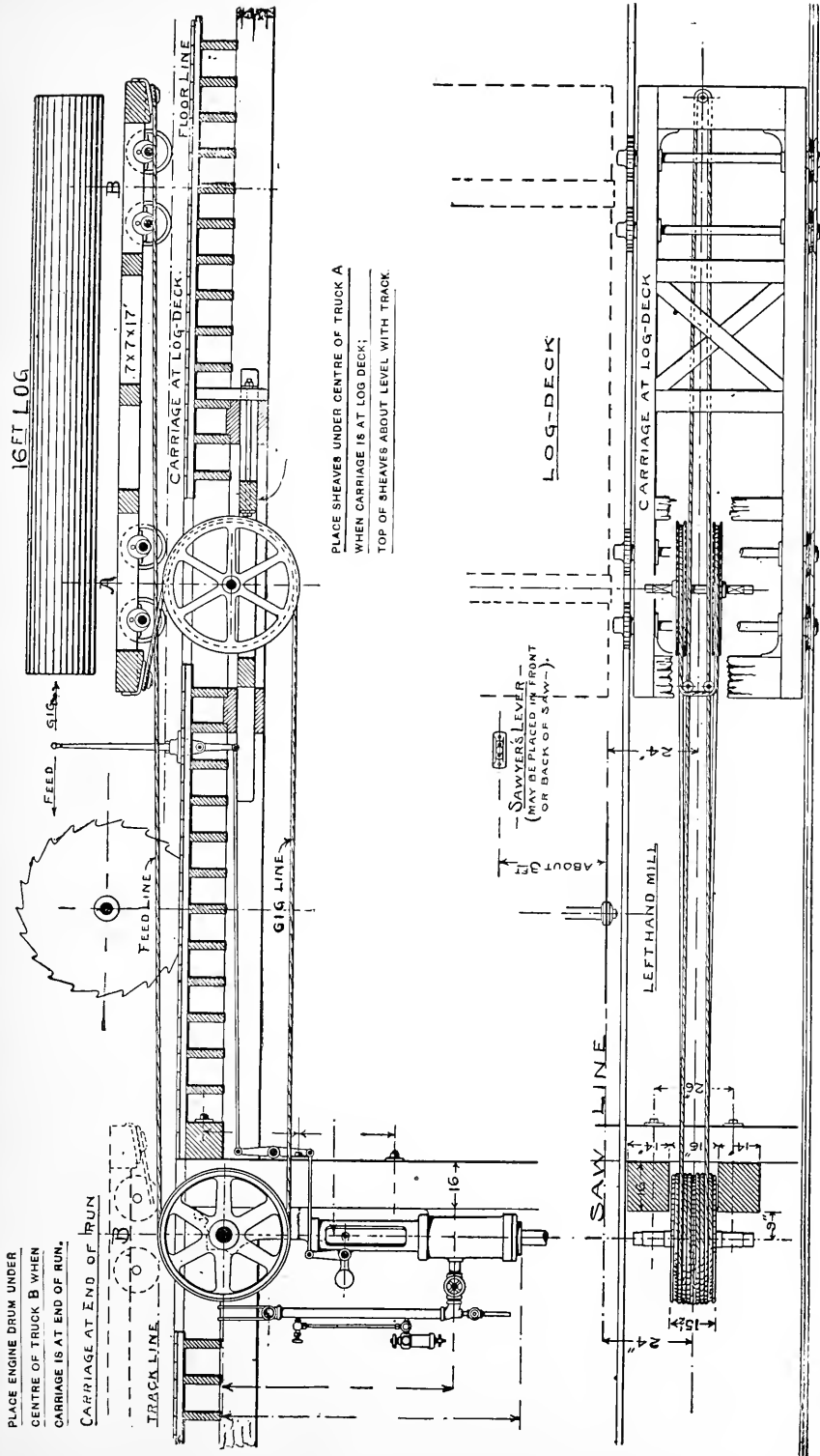

PLACE ENGINE DRUM UNDER
CENTRE OF TRUCK B WHEN
CARRIAGE IS AT END OF RUN.
CARRIAGE AT END OF RUN
TRACKLINE.

PLACE SHEAVES UNDER CENTRE OF TRUCK A
WHEN CARRIAGE IS AT LOG DECK;
TOP OF SHEAVES ABOUT LEVEL WITH TRACK.

BECK'S PATENT DUPLEX CABLE FEED.
PATENT NO. 457415.
USED EXCLUSIVELY WITH BECK'S PATENT DUPLEX FEED ENGINE.

COPYRIGHT 1891
BY M. A. BECK.

TABLE GIVING LENGTH OF WIRE ROPE.

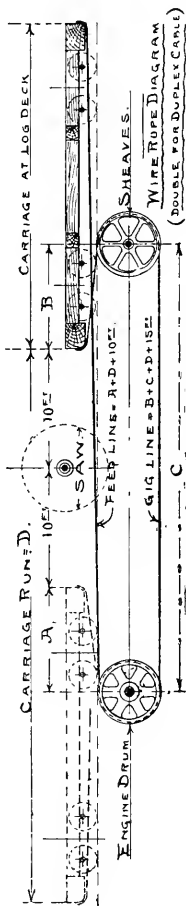

Length of Feed and Gig Ropes When Distance C=30 ft., 40 ft., 50 ft., 60 ft. and 70 ft.

Centre of Drum to Sheaves.	Length of Carriage, feet..	20	25	30	35	40	45	50	55	60	65	70	75	80	85	90	95	100
	Run of Carriage, feet.....	40	45	50	55	60	65	70	75	80	85	90	95	100	105	110	115	120
C=30 ft.	Feed Line, feet.....	55	60	65	70	75	80	85	90	95	100	105	110	115	120	125	130	135
	Gig Line, feet.....	90	95	100	105	110	115	120	125	130	135	140	145	150	155	160	165	170
C=40 ft.	Feed Line, feet.....	60	65	70	75	80	85	90	95	100	105	110	115	120	125	130	135	140
	Gig Line, feet.....	105	110	115	120	125	130	135	140	145	150	155	160	165	170	175	180	185
C=50 ft.	Feed Line, feet.....	65	70	75	80	85	90	95	100	105	110	115	120	125	130	135	140	145
	Gig Line, feet.....	120	125	130	135	140	145	150	155	160	165	170	175	180	185	190	195	200
C=60 ft.	Feed Line, feet.....	70	75	80	85	90	95	100	105	110	115	120	125	130	135	140	145	150
	Gig Line, feet.....	135	140	145	150	155	160	165	170	175	180	185	190	195	200	205	210	215
C=70 ft.	Feed Line, feet.....	75	80	85	90	95	100	105	110	115	120	125	130	135	140	145	150	155
	Gig Line, feet.....	150	155	160	165	170	175	180	185	190	195	200	205	210	215	220	225	230

NOTE—In any other case the lengths will be thus: Feed Line=A+D+10 ft. Gig Line=B+C+D+15 ft.

Double these figures for Duplex Cable.

FRICITION ROPE FEED WORKS.

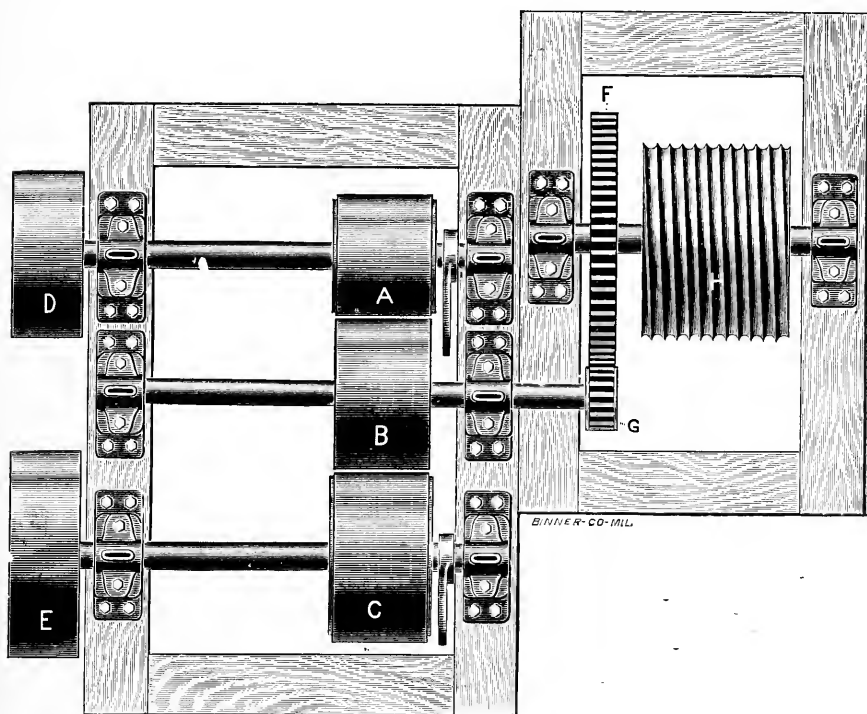

See description on following page.

FRICTION ROPE FEED WORKS.

We show on preceding page what we believe to be the best form of friction rope feed works yet devised. By the use of the gearing the size and speed of the paper frictions is reduced and a reduction in the size of the iron friction B is also made, thus saving a vast amount of wear and expense. All users of the old style of friction feed works will appreciate any new arrangement which saves the burning of the paper frictions and the breaking of the iron one as such accidents have always been a source of constant annoyance and delay. For heavy work we make the dimensions of the various pieces as follows: Paper feed friction A 18 inches in diameter and 15 inch face. Paper gig friction C 24 inches in diameter and 15 inch face. Iron friction B 24 inches in diameter and 15 inch face. Drive pulley D 24 inches diameter and 10 inch face. Gig pulley E 32 inches diameter and 10 inch face. The shafts for above are $3\frac{1}{2}$ inches in diameter. The pinion G is 8 inches in diameter and $\frac{1}{4}$ inch face. Gear wheel F is 36 inches in diameter and $\frac{1}{4}$ inch face and $1\frac{3}{4}$ inch pitch. Rope drum H is 28 inches in diameter and runs on a $\frac{1}{4}$ inch shaft. The bearings are all 8 inches long. The paper frictions A and C are thrown in and out of contact with the iron friction B by the two eccentric boxes with levers, as shown in cut. The size of the various pulleys, gears and drum can be changed according to the capacity of the mill and kind of lumber to be sawed.

Price with iron drum and 15 inch face frictions..... \$300 00

Price with wooden drum and 12 inch face frictions..... 250 00

Discount.....per cent.

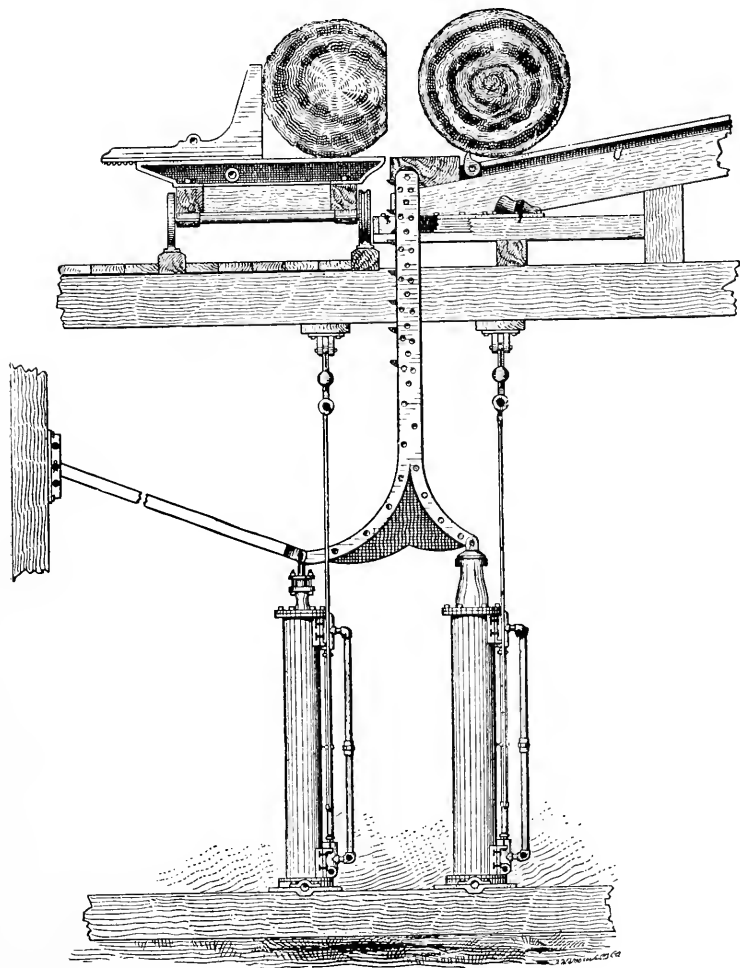
HILL'S STEAM NIGGER.

This well-known labor saving device needs no extended description. They are manufactured in various dimensions for all sizes of timber. When writing for price state class of timber, diameter and length of logs to be handled.

List on page 98.

PRICE OF STEAM NIGGERS.

(With tooth bar center built up of steel plates.)

		Oscillating	Stationary.
No. 1 Mammoth.	Cylinders, 14 in. x 6 ft. and 10 in. x 6 ft.		
	Bar, 1 1/4 in. x 7 in. sides.		
	With 3 in. forged steel teeth.	\$785 00	\$810 00
	With 4 in. forged steel teeth.	805 00	830 00
	With bar 1 1/4 in. x 8 in. sides.		
	With 3 in. forged steel teeth.	795 00	820 00
	With 4 in. forged steel teeth.	815 00	840 00
No. 1 Standard.	With 6 in. forged steel teeth.	835 00	860 00
	Cylinders, 10 in. x 6 ft. and 8 in. x 6 ft.		
	Bar 1 in. x 6 in. sides.		
	With 2 in. forged steel teeth.	630 00	655 00
	With 3 in. forged steel teeth.	640 00	665 00
	With 4 in. forged steel teeth.	650 00	675 00
	With bar 1 1/4 in. x 6 in. sides.		
No. 2 Standard.	With 2 in. forged steel teeth.	655 00	680 00
	With 3 in. forged steel teeth.	680 00	705 00
	With 4 in. forged steel teeth.	690 00	715 00
	With bar 1 in. x 7 in. sides.		
	With 2 in. forged steel teeth.	660 00	685 00
	With 3 in. forged steel teeth.	685 00	710 00
	With 4 in. forged steel teeth.	695 00	720 00
	Cylinders 10 in. x 5 ft. and 8 in. x 5 ft.		
	Bar 1 in. x 6 in. sides.		
	With 2 in. forged steel teeth.	605 00	630 00
No. 3 Standard.	With 3 in. forged steel teeth.	615 00	640 00
	With 4 in. forged steel teeth.	625 00	650 00
	With bar 1 1/4 in. x 6 in. sides.		
	With 2 in. forged steel teeth.	625 00	650 00
	With 3 in. forged steel teeth.	635 00	660 00
	With 4 in. forged steel teeth.	645 00	670 00
	With bar 1 in. x 7 in. sides.		
	With 2 in. forged steel teeth.	630 00	655 00
	With 3 in. forged steel teeth.	640 00	665 00
	With 4 in. forged steel teeth.	650 00	675 00
No. 3 Standard.	Cylinders 10 in. x 4 1/2 ft. and 8 in. x 4 1/2 ft.		
	Bar 1 x 4 1/2 in. sides.		
	With 2 in. forged steel teeth.	560 00	585 00
	With 3 in. forged steel teeth.	570 00	595 00

We manufacture the well-known Friction Nigger and Log Turners and will be pleased to send drawings and prices on application.

Discount per cent.

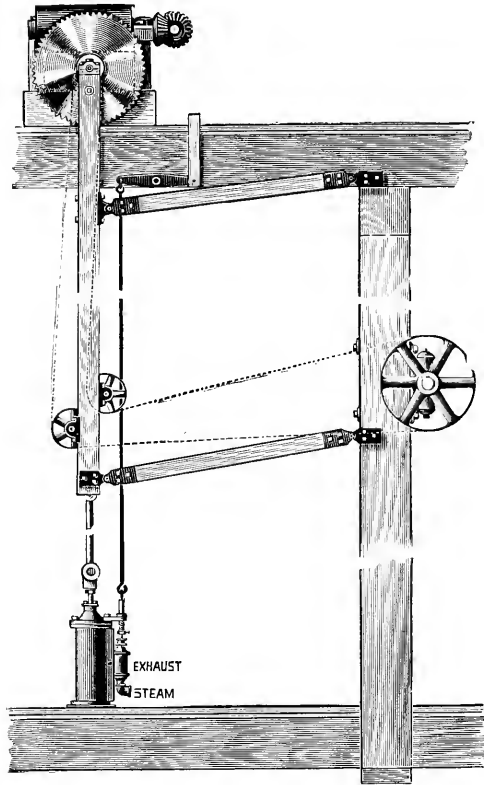
STEAM CUT-OFF SAW.

This machine is intended principally for cutting slabs, timber, shingle-bolts, etc., and can be used in all cases in place of the friction, swinging, or similar style of cut-off saw. The cut illustrates but one of many positions for erecting the machine, as it can be placed in such a way as to meet special requirements.

STEAM CUT-OFF SAW—Continued.

The machine consists of a steam cylinder with a valve so arranged that there is constantly a steam cushion on the piston, which prevents sudden jerking and jarring of the machinery, and enables the saw to work with absolute safety under high steam pressure. A check valve in the steam exhaust perfectly controls the speed at which the saw raises or lowers.

The No. 1 machine has a cylinder 6 in. bore, with a stroke ranging from 12 to 17 inches. The steel saw arbor is 2 in. diameter, with an arbor pulley 8 in. diameter, 9½ in. face, and a saw 26 in. to 36 in. diameter can be used.

Price of machine, complete, excepting saw..... \$100 00

The No. 2 machine has a cylinder 8 in. bore, with stroke ranging from 14 to 18 inches. Steel saw arbor is 2 3-16 in. diameter, with an arbor pulley 10 in. diameter, 12 in. face, and a saw from 40 in. to 48 in. can be used.

Price of machine, complete, excepting saw..... \$150 00

The No. 3 machine has a cylinder 8 in. bore, with a stroke ranging from 18 to 24 inches. The steel saw arbor is 2 7-16 in. diameter, with an arbor pulley 12 in. diameter, 14 in. face, and a saw as large as 60 in. may be used.

Price of machine, without saw..... \$175 00

In ordering, please state whether arbor is to have Right or Left Hand Thread, and the stroke desired.

Always rotate the saw away from the operator.

Discount..... per cent.

THE PHOENIX STEAM LOG ROLLER.

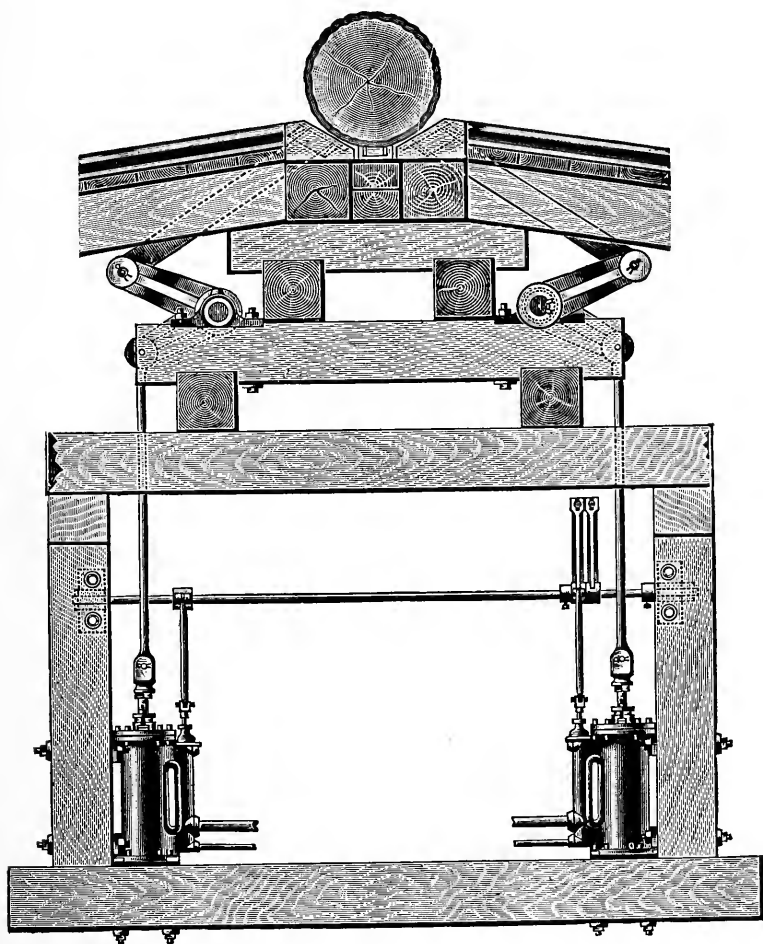

See description and price list on following page.

THE PHOENIX STEAM LOG ROLLER.

The cut on preceding page shows our steam log roller for rolling the logs out of the log haul up slip of the mill.

The machine is made either double or single. The cut shows a double machine and will throw logs to either side of the deck; while the single machine will throw the logs to one side only.

The length of shaft and number of arms depend on the length of logs to be handled.

The cylinders are operated by foot levers which are connected to the rock shaft and extend up through the deck where the operator can handle them.

The punch bars are made of steel and are guided through the trough by cast iron thimbles.

The haul up chain need not be stopped while throwing over the logs.

PRICE—SINGLE.

2 Arm with 10x30 inch cylinder	\$200 00
3 Arm with 10x30 inch cylinder	225 00

Prices for larger cylinders quoted on application.

Discount.....per cent.

KLINE'S PATENT LOG LOADER.

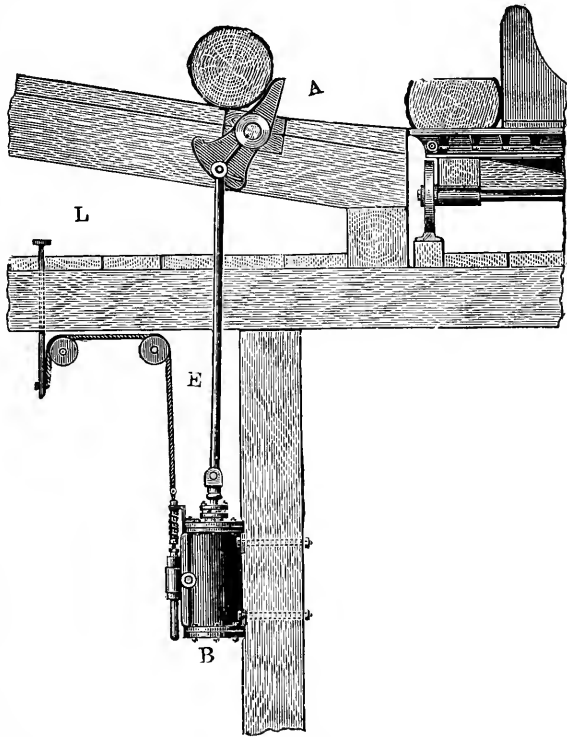

An invention of great merit, which has been thoroughly tried and proven to be the best machine in the market for holding the logs on the skids when not wanted, with no possible chance of their rolling down and endangering the carriage to accident, and for instantly placing them on the carriage when wanted.

It not unfrequently happens that the carriage is disabled by bent piston-rod, cracked cylinder of steam-feed, or broken rack and pinion of friction feed, by logs rolling from the skids. Such accidents are rendered impossible with the use of the Kline Steam Log Loader.

The loading of a log on the carriage is done instantly, the log placed where wanted on the carriage, to be fastened by the dogs or turned by the steam nigger. The machine consists of two or more curved arms, (A), keyed rigid to a shaft three inches in diameter placed in the skids, parallel to the carriage track with concave side of arms up, into which the logs roll as into a cradle. These arms are caused to rotate by means of a steam cylinder (B) connected to one of the arms by connecting rod E, and operated by the foot pedal L.

Price on page 105.

THE KLINE STEAM CANT FLIPPER.

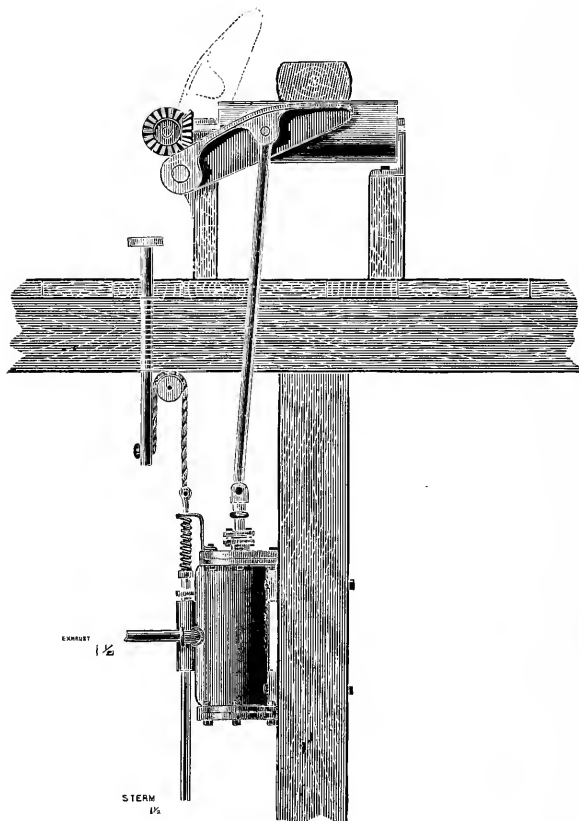

The cut on this page is an illustration of the flipper as set in a line of live rolls, and is designed for throwing the cants from live rolls to skids leading to gang or other machines. It will be noticed that the shaft connecting the two arms is located just below the shaft and gearing that drives the live rolls.

Price on page 105.

**PRICE OF STEAM CANT FLIPPERS
AND LOG LOADERS.**

2 arms, 2 boxes, 9 ft. shaft, 8 in. cyl. valve and connections . . .	\$200 00
3 arms, 3 boxes, 16 ft. shaft, 8 in. cyl. valve and connections . . .	225 00
4 arms, 4 boxes, 24 ft. shaft, 8 in. cyl. valve and connections . . .	262 00
2 arms, 2 boxes, 9 ft. shaft, 10 in. cyl. valve and connections . . .	215 00
3 arms, 3 boxes, 16 ft. shaft, 10 in. cyl. valve and connections . . .	240 00
4 arms, 4 boxes, 24 ft. shaft, 10 in. cyl. valve and connections . . .	277 00
Oiler and pipe for above	10 00

Price for larger cylinders quoted on application.

Discount per cent.

STEAM CYLINDERS.

We give below, prices for different sizes of steam jump cylinders which are used for skid lifters, cant flippers, etc.

The cylinders have balanced valves and steam cushion on each end, the valve is receded by the coil spring as shown, so that the connections can be made to operate with either hand or foot.

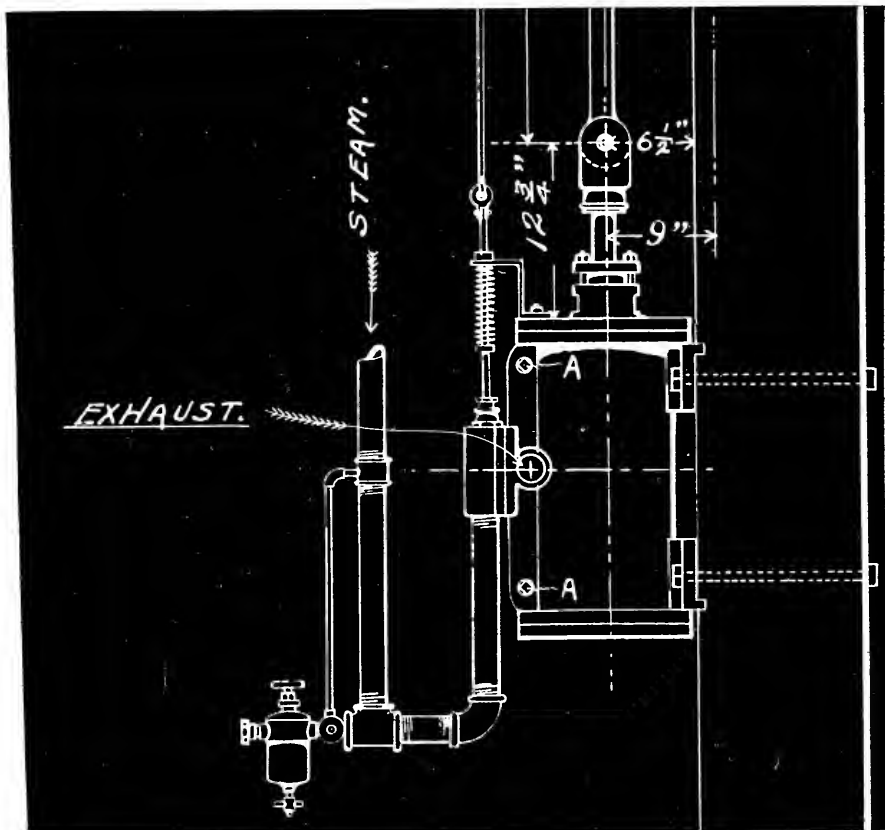

PRICE LIST OF CYLINDERS.

7 x 14 inches.....	\$ 80 00
8 x 16 inches.....	90 00
10½ x 15 inches.....	100 00
10½ x 20 inches.....	110 00
10½ x 24 inches.....	120 00
10½ x 30 inches.....	130 00
10½ x 36 inches.....	140 00
10 x 42 inches.....	150 00
14 x 36 inches.....	220 00

Discount.....per cent.

IRON FRAME LOG JACKER.

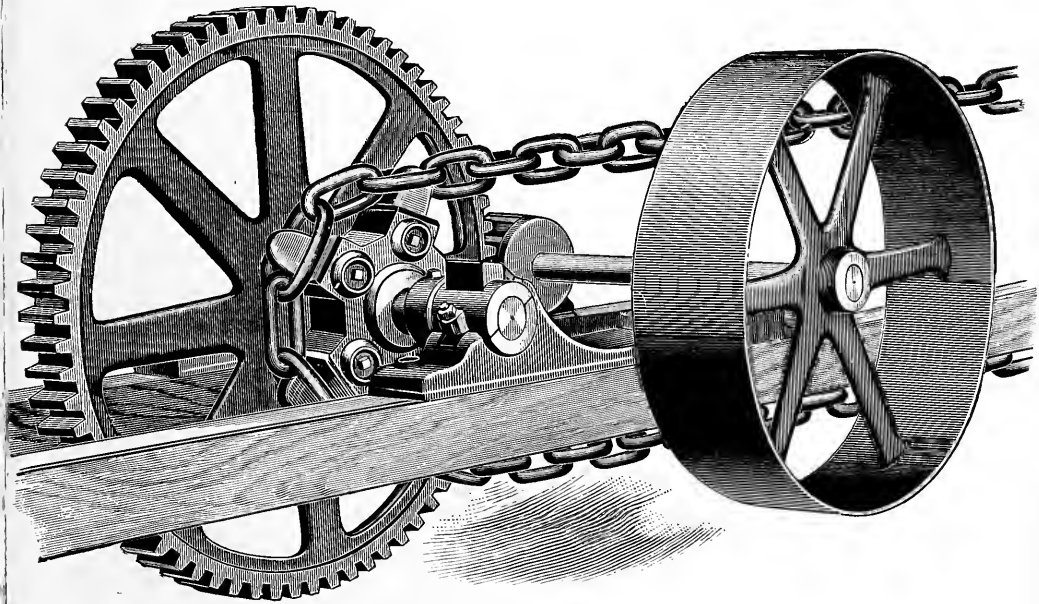

The bull wheel has 75 teeth $1\frac{3}{4}$ pitch and $4\frac{1}{2}$ inch face. The pinion has 14 teeth, $1\frac{3}{4}$ in. pitch, 5 inch face, with double flanges.

The pulley is 48 inches in diameter by 13 inch face. The bull wheel shaft is 3 15-16 in. diameter and the pinion shaft 2 15-16 in. diameter. Inserted tooth sprocket with steel teeth made to fit any chain.

Weight

Price \$200 00

Discount.....per cent.

IRON FRAME LOG JACKER.

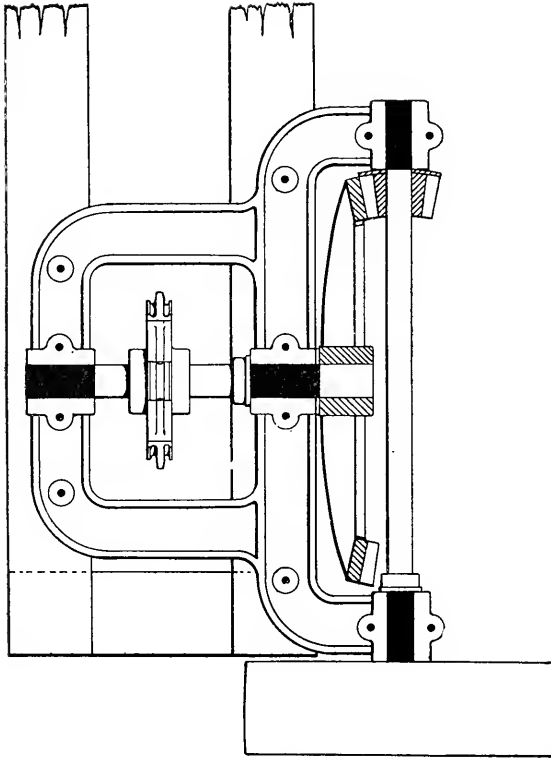

The above cut shows our single geared Log Jacker for Band Saw Mills where the main drive shaft runs lengthwise of the mill. We also make the same style double geared.

The sprocket has inserted teeth of forged steel, which can be replaced by new ones when badly worn.

The drive pulley will be made any size, as ordered, to give the proper speed and power.

Price, Single Geared	\$200 00
Price, Double Geared	300 00
Discount.....	per cent.

IRON FRAME LOG JACKER.

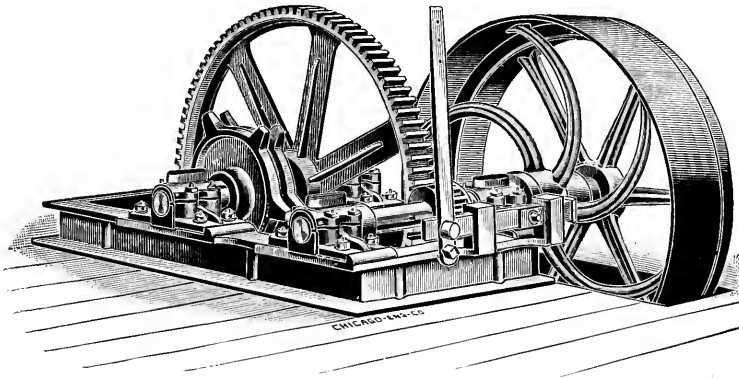

The above Log Jacker is very strong, exceedingly heavy and, as will be observed, is self-contained, that is, the arrangement for starting and stopping it being on the same frame with the other parts of machine; one common belt pulley on the driving shaft of mill being all that is necessary to operate it.

The large gear-wheel has 98 teeth, $1\frac{1}{2}$ inch pitch, 4 inch face and is about 48 inches in diameter on the outside; the pinion having 16 teeth, $4\frac{1}{2}$ inch face and is about $7\frac{3}{4}$ inches in diameter on the outside and has a flange on each end.

The belt-pulley is 48 inches in diameter for a 10 inch belt and runs loose upon the shaft, the inside of pulley-rim being turned smooth so that the paper faced friction which is keyed fast on the outer end of shaft, is started and stopped by the running loose pulley which is shifted on and off the male friction by the upright lever shown in cut.

The sprocket-wheel is usually about 20 inches in diameter. Size of frame 2 feet 9 inches by 5 feet 4 inches. The diameter of sprocket-wheel shaft is 4 inches and pulley-shaft 3 inches. This apparatus can be set on or under the main floor of mill as desired.

Price \$250 00

Discount.....per cent.

LOG HAUL UP CHAIN.

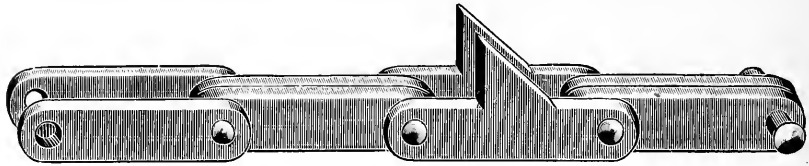

Style A.

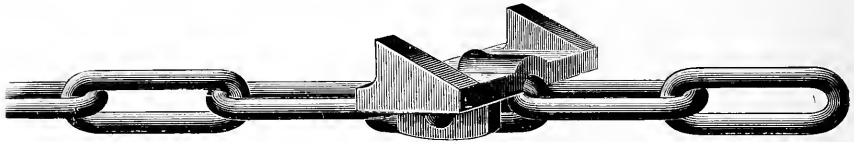

Style B.

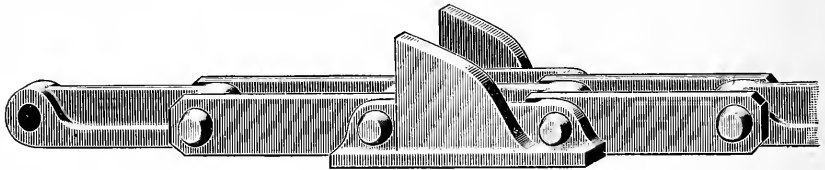

Style C.

PRICE.

Style A—Outside link $\frac{3}{4}$ in. x $1\frac{3}{4}$ in. and center links $\frac{3}{4}$ in. x $1\frac{3}{4}$ in.,
 doubled steel dogs every 8 ft., $\frac{3}{4}$ in. steel rivets, per foot. . . \$2 30

Style B—Steel dogs every 8 feet.

1 inch iron	1 50
$1\frac{1}{4}$ inch iron	2 40
$1\frac{1}{2}$ inch iron	3 30

Style C—Side link $\frac{5}{8}$ x 2, centers 2 inches wide solid, $\frac{3}{8}$ steel rivets,
 steel dogs every 8 feet, per foot. 2 60

FOOT SHEAVE FOR FOOT OF LOG SLIP.

20 inch, 2 7-16 x 8 inch Journals, including boxes.	\$25 00
24 inch, 2 15-16 x 10 inch Journals, including boxes.	30 00
Discount.	per cent.

IDLER FOR LOG HAUL UP CHAIN.

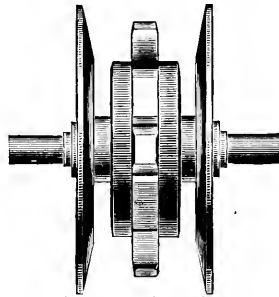

Price for 16 in. sprocket with 20 in. flanges, 12 in. between shoulders, $2\frac{1}{4}$ in. x 4 in. bearing, shaft and solid boxes..... \$30 00
 . Discount..... per cent.

SLEEVE FLANGES FOR WOOD PULLEYS.

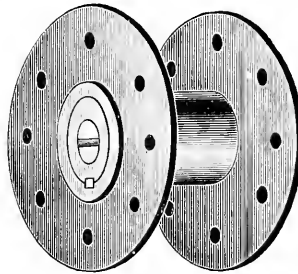

Diameter of Flanges.	Size of Shaft.	Thickness of Center.	Price.
8	1 15-16	3 1-2	\$ 4 00
10	1 15-16	3 1-2	5 00
12	1 15-16	3 1-2	6 00
14	3 15-16	4	7 00
14	3 7-16	4	7 00
16	1 15-16	3 1-2	7 00
16	3 15-16	4	8 00
16	3 15-16	6	14 00
16	3 15-16	11	16 50
18	3 7-16	4	13 00
20	2 15-16	4 1-2	14 30
24	3 7-16	6	23 00
24	3 15-16	8	27 50
25	8	10	65 00
30	3 15-16	6	42 00
30	5	8	47 50
30	6	10	47 70
30	6	11	52 20
40	8	10	135 00

For common pulley flanges see page 134.

Discount.....per cent.

SHINGLE BOLT CUT-OFF MACHINE.

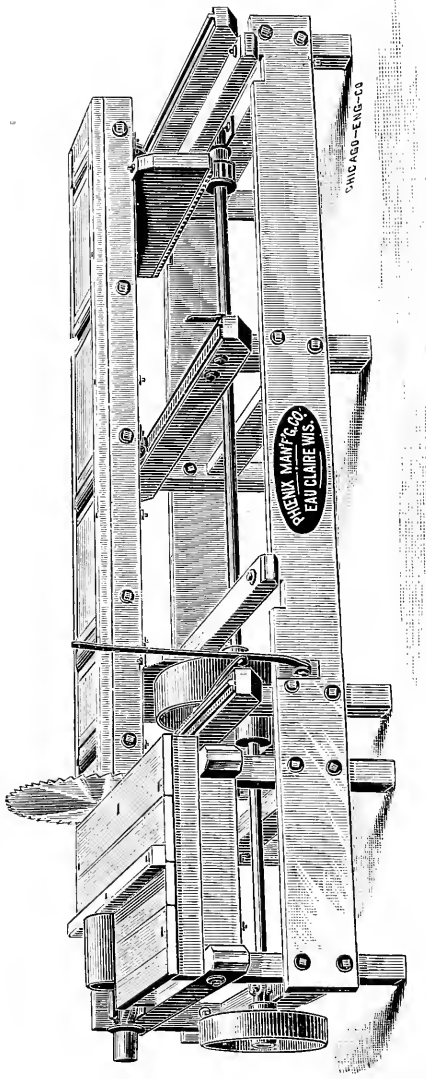

SHINGLE BOLT CUT-OFF MACHINE.

This machine is constructed for cutting off shingle bolts from cants, and has all its parts made in a strong and substantial manner, so that by fair usage it will last for many years. It occupies a floor space of 5 by 13 feet.

The arbor is of steel and has upon it a 10x10 pulley, which should run about 1000 revolutions per minute.

The small pulley upon end of saw arbor is for driving the counter shaft in the lower part of machine. This counter shaft has upon one end a small paper friction pulley which works upon the outside of hub, to feed, and inside of rim, to gig, of the large pulley on pinion shaft and is operated by upright hand lever in front of table.

The table is 10 feet long, made of hard wood, and has finished iron rollers. The wheel under table running on planed cast-iron track. The table being moved forward and back by the rack and pinion under each end.

In ordering state whether you desire a right or left hand machine. The one shown in cut is left hand.

Price with 34 inch saw..... \$250 00

Discount.....per cent.

BOLT CUT-OFF OR WOOD MACHINE.

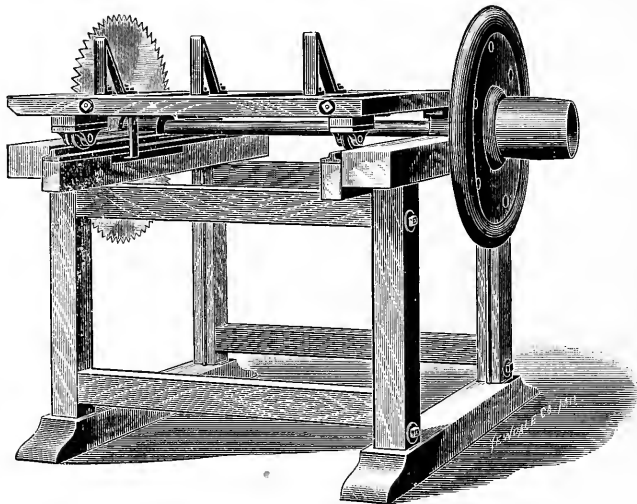

This is a first class machine for cutting up bolts or cord wood.

The frame is constructed of hardwood and put together with joint bolts.

The carriage travels squarely to and from the saw on a cast iron track.

The arbor is of steel $2\frac{1}{2}$ inches in diameter. Arbor pulley 8 inches in diameter by 8 inch face. Diameter of saw is 40 inches and should run 1200 revolutions per minute.

Weight1000 lbs.

Price with balance wheel but no saw..... \$100 00

Discount.....per cent.

SHINGLE BOLTER AND SAPPER.

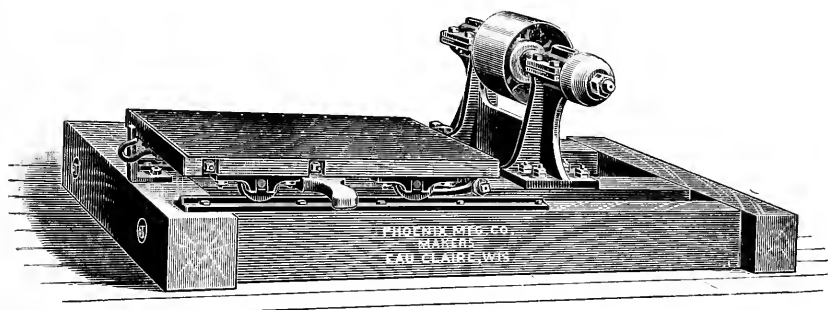

By the use of this machine a considerable saving is made over the old way of using the axe, besides the first cut is always a shingle.

Arbor $2\frac{1}{2}$ inch steel.

Arbor pulley, 16 in. diameter, 11 in. face. Saw, 50 in. diameter and should make 1000 revolutions.

Weight1200 lbs.

Price with 50 inch saw..... \$200 00

Discount.....per cent.

KNOT SAWING MACHINE.

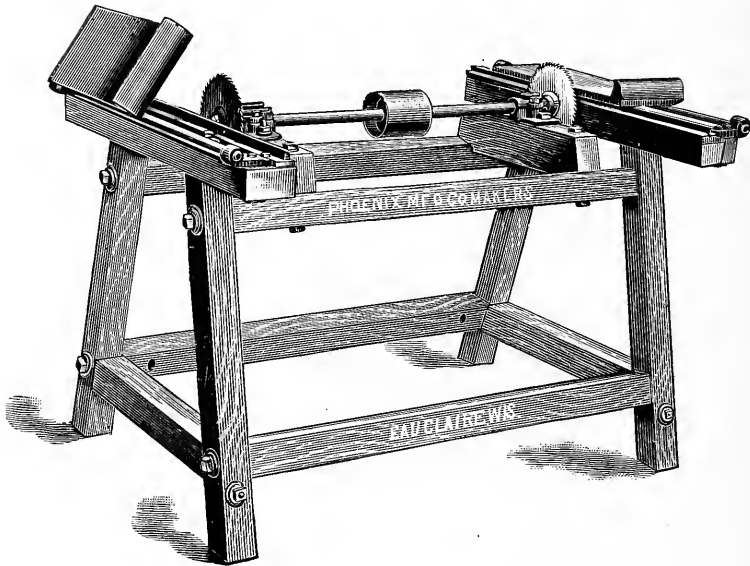

The above machine for trimming shingles is for use by two persons.

Distance between the saws is 3 feet. Arbor is of steel $1\frac{1}{4}$ inches in diameter and has upon it a pulley $\frac{1}{2}$ inches in diameter and $\frac{1}{4}$ inch face. Diameter of saws is 8 inches.

The shingle carriers are of wood, plated upon the under side with metal so as not to wear in sliding on the track. The ways upon which the shingle carriers slide are one piece of flat track and one round rod. The carriers being hinged on the rod so that they cannot get off the track, yet can be swung up, as shown in cut, to brush off the sawdust or clean the table in an instant as desired. The frame work is of oak, well bolted together and made strong.

This machine is very easy of operation as the parts are light yet of sufficient strength to do all necessary work for which it is designed.

Floor space occupied is 3 by $4\frac{1}{4}$ feet.

Price, double, with saws..... \$50 00

Price, single, with saws..... 30 00

Discount.....per cent.

PATENT DOUBLE-ACTING SHINGLE PRESS.

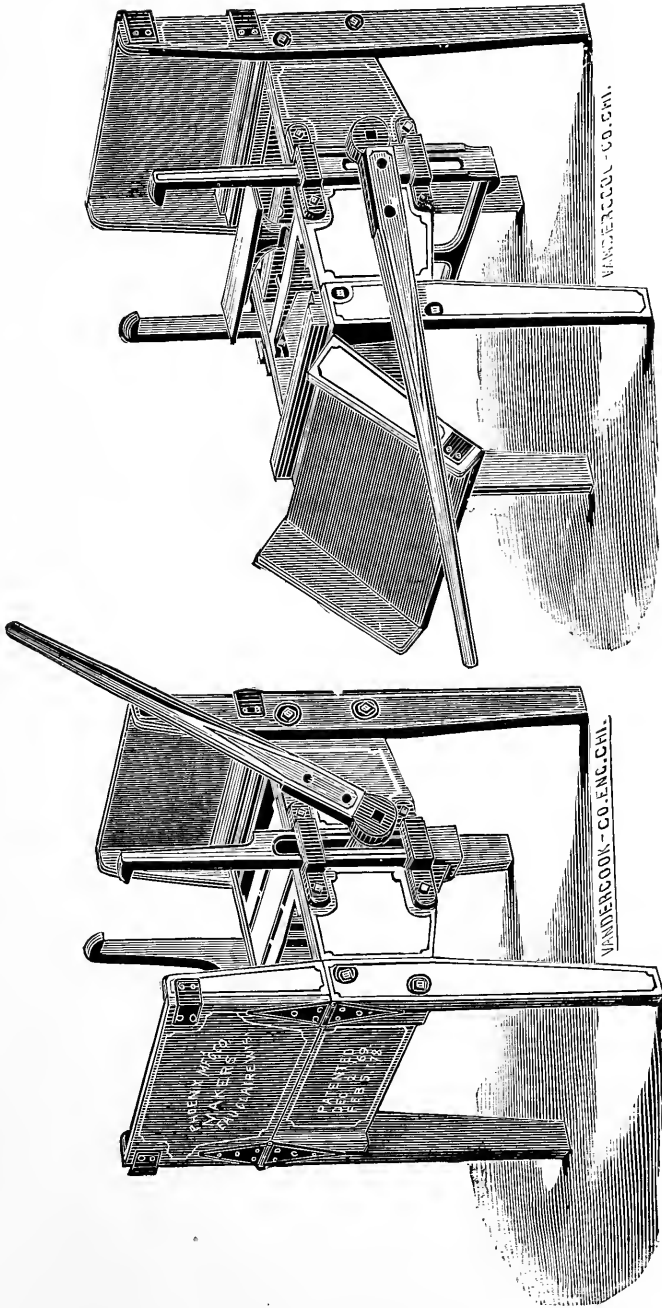

For description, see following page.

PATENT DOUBLE-ACTING SHINGLE PRESS.



We show two views of our late improved Shingle Press which are so clear as to need but little explanation.

As will be seen it is double acting, pressing the shingles from both top and bottom of bunch, thus giving the bunches a much better appearance than if pressed from one side only.

The shaft, to which the press lever or handle is attached, extends across the machine so that the lever can be used upon either side, making a right or left hand press as desired.

There is a small spur pinion on center of lever shaft having a rack-bar upon either side of it, one piece of rack being attached to the center platform, pushing it up, while the other piece of rack is attached to the side-clamps, pulling them down at the same movement of the lever, giving a throw to both parts fully $7\frac{1}{2}$ inches.

The frame is of hard wood, firmly bound and bolted at every corner, and all parts of machine are made durable and strong.

These presses have stood the test of several years' practical use, are fully covered by two distinct patents, and well liked by all manufacturers of shingles who have put them in operation.

Price \$18 00

Discount.....per cent.

**IMPROVED COMBINED GANG BOLTER AND
LATH MILL.**

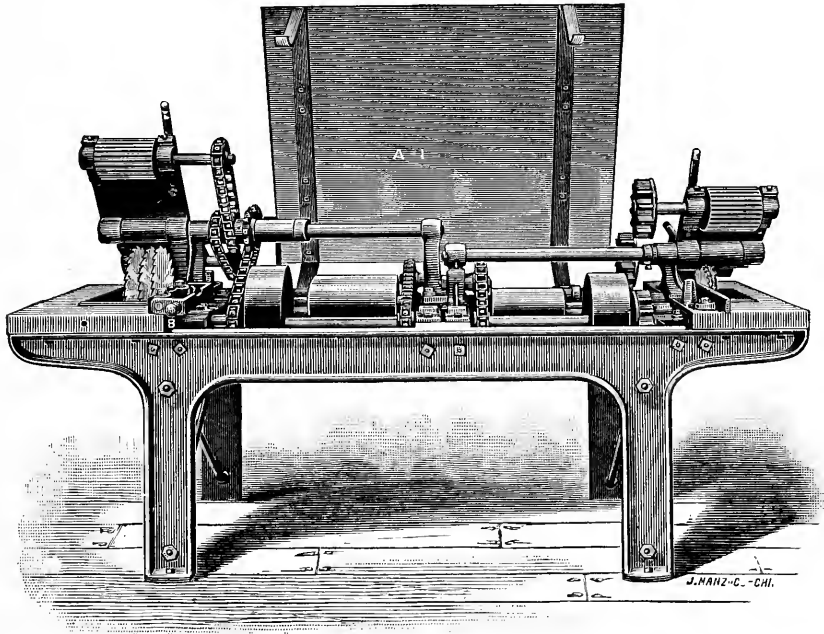

Open for Changing Saws.

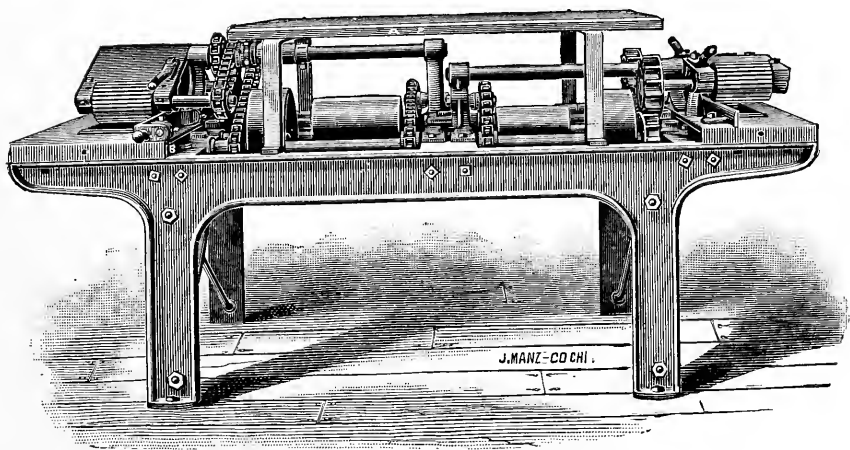

Closed—Ready for Sawing.

IMPROVED COMBINED GANG BOLTER AND LATH MILL.

The cuts on preceding page illustrate Garland's improved Bolter and Lath Mill combined, in substantial iron frame, and in addition to cutting lath and lath bolts, by slight change of collars, it can be adapted to cutting pickets and any stock from $\frac{1}{2}$ to 4 inches square, or other forms. The bolter and lath mill are provided with upper and lower fluted feed rolls in front and rear of saws, insuring a strong and positive feed of stock to saws. A wide deck or table A-1 is arranged conveniently to receive the bolts from the bolter, from which they are taken and passed through the lath mill. The capacity of the machine is from 40,000 to 60,000 perfect lath per day, if properly handled.

The bolter mandrel pulley is 10 inches diameter, 11 inch face; motion, 1,800 revolutions per minute. The bolter feed pulley is 14 inches diameter, 4 inch face; motion, 105 revolutions per minute. The lath mill pulley is 7 inches diameter, 9 inch face; motion, 2,600 to 3,000 revolutions per minute. The feed pulley is 11 inches diameter, 4 inch face; motion, 130 revolutions per minute.

Price of Bolter and Lath Mill combined, with three 12 inch and three 18 inch saws.....	\$385 00
Price of Lath Mill with three 12 inch saws, iron frame through- out	205 00
Price of Bolter with three 18 inch saws, iron frame throughout..	215 00

**COMBINED LATH MILL AND BOLTER.
WITH POWER FEED.**

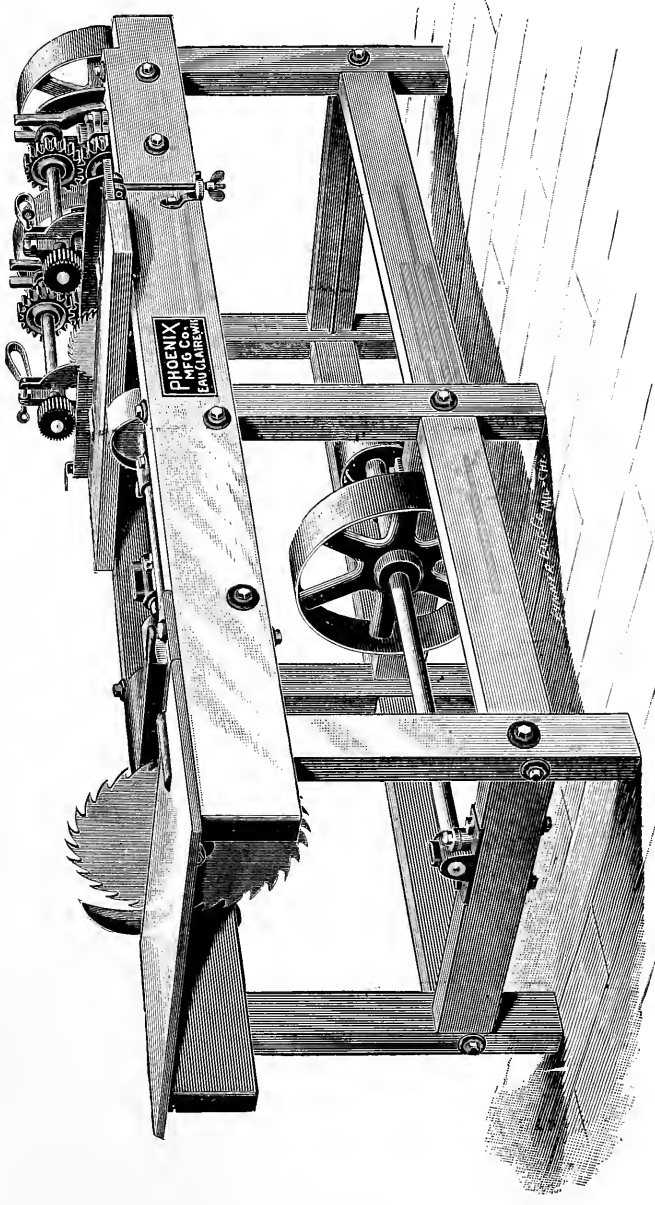

Can furnish this machine with two or three Lath Saws, as desired.

For description see following page.

COMBINED LATH MILL AND BOLTER.

Our Combined Lath Mill and Bolter embodies very nearly the same machinery that we put on the Lath Mills and Bolters which are in separate frames, hence, where a first-class machine is wanted, and the space in which to put it is limited, the combined mill is recommended. We make these machines right or left hand, and can vary the arrangement as desired.

The Lath Machine has two saws, 12 inches in diameter, upon a steel arbor. The arbor-pulley is 7 inches in diameter, with an 8 inch face, and should be run about 3000 revolutions per minute.

The feed works are strong and positive in their action, carrying the bolts through the machine very rapidly and are driven by a belt wrapping around a small pulley on the end of the saw arbor and over the feed roller pulleys.

The top feed-rollers are held down upon the bolts by a spring over the bearings which slide in ways.

The plate, which the lath slide on, is of heavy cast iron and hinged on one end, to facilitate raising it when desired to change the saw.

The Bolting machine has an arbor of steel, having upon it a drive pulley 8 inches in diameter with a 9 inch face.

The saw is 20 inches in diameter and should run about 1800 revolutions per minute.

The table upon which the lumber rests is of heavy cast iron, planed smooth and true, and hinged upon the back, so that it can be raised readily while changing the saw.

Lumber is fed to the bolting saw by the friction feed-roller in front—the shaft being driven from the counter-shaft below.

This machine is very desirable for cutting pickets as well as lath bolts—the hinged gauge, at the side of saw, being specially arranged for that purpose and can be changed in an instant.

The whole floor space occupied by machine is 3x9 feet.

Price with saws \$200 00

Discount.....per cent.

COMBINATION LATH BINDER AND TRIMMER.

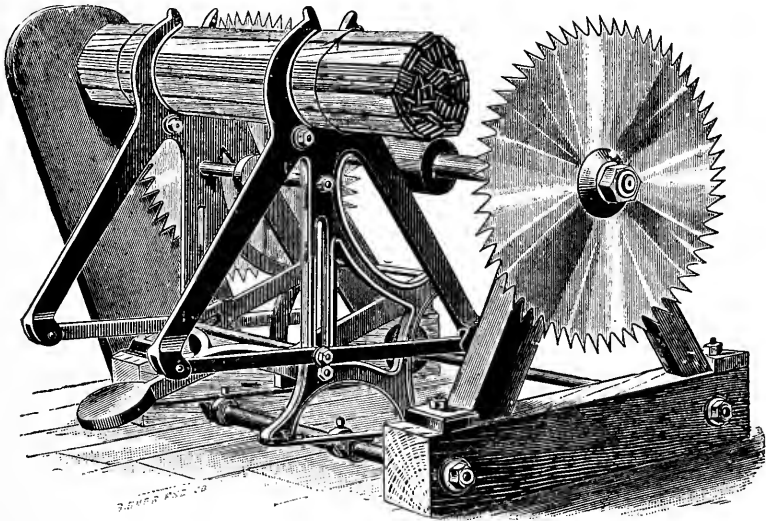

The above cut represents a Combination Lath Binder and Trimmer. By this arrangement the operator can trim the bundles with very little extra work, simply by tilting the packing frame over from him, causing the bundles to pass between the saws, thereby trimming both ends at one movement. The lath being held in the jaws of the Binder permits the saws to make a smooth cut which gives a nice appearance to the ends of the bundles. The bundle does not have to be removed from the Binder until after it is trimmed, thereby saving time and doing the work in a workmanlike manner. The machines are made with steel arms for fifty lath and furnished complete with twenty-six inch saws. Arbor pulley $4\frac{1}{2}$ inches x 8 inches.

Shipping weight	600 lbs.
Price, complete	\$111 00
Price, Binder only	40 00

Discount.....per cent.

LIVE ROLL DRIVE RIG.

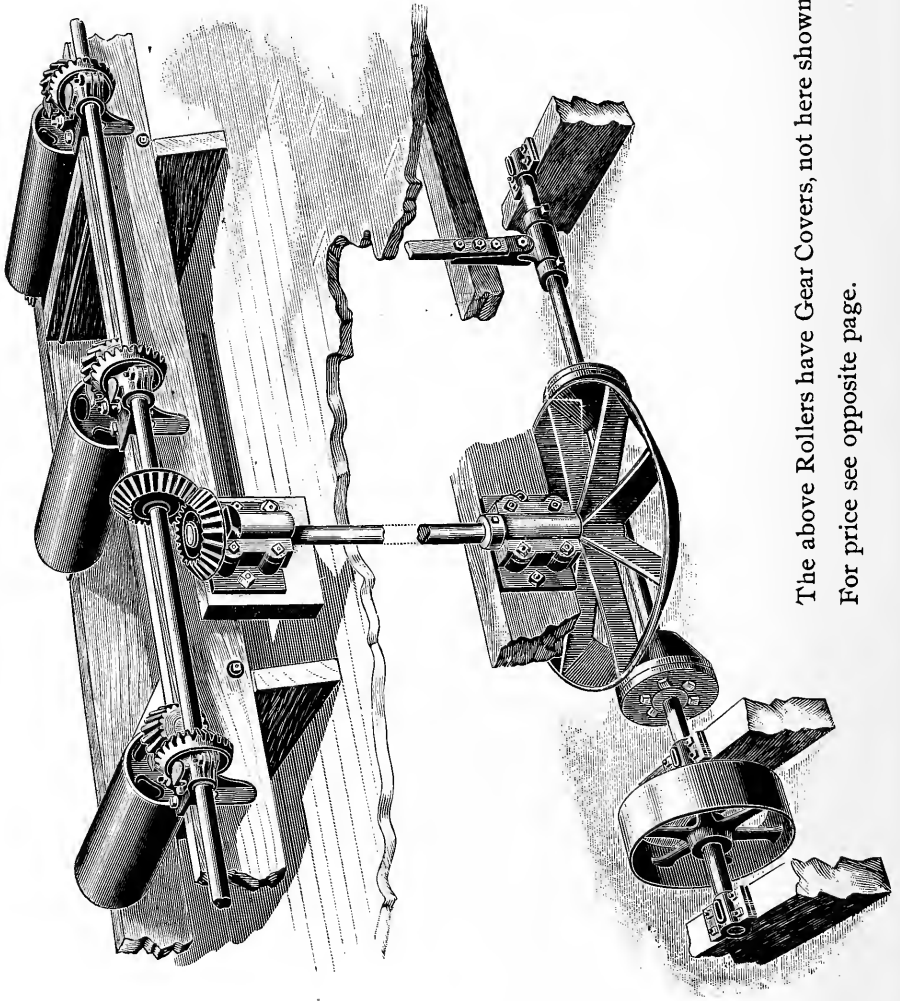

The above Rollers have Gear Covers, not here shown.
For price see opposite page.

LIVE AND IDLE ROLLS.

Price is for set of ten rolls with driving apparatus complete to drive one way. Where rolls are wanted to reverse add \$25.00 to price.

		Extra Rolls*
8 x 20 Gas Pipe	\$150 00	\$10 50
8 x 24 Gas Pipe	165 00	12 00
8 x 28 Gas Pipe	180 00	13 50
8 x 32 Gas Pipe	195 00	15 00
10 x 20 Gas Pipe	175 00	13 00
10 x 24 Gas Pipe	195 00	15 00
10 x 28 Gas Pipe	215 00	17 00
10 x 32 Gas Pipe	235 00	19 00
12 x 20 Gas Pipe	205 00	16 00
12 x 24 Gas Pipe	230 00	18 50
12 x 28 Gas Pipe	255 00	21 00
12 x 32 Gas Pipe	280 00	23 50

For a set of ten live hard wood rollers take two thirds the price of same size of iron rollers.

Extra live hard wood rollers half the price of iron.

Discount.....per cent.

IRON FRAME TIGHTENERS.

30 x 30 in. face.....	\$85 00	24 x 30 in. face.....	\$70 00
30 x 28 in. face.....	80 00	24 x 28 in. face.....	65 00
30 x 26 in. face.....	75 00	24 x 26 in. face.....	60 00
30 x 24 in. face.....	70 00	24 x 24 in. face.....	55 00
30 x 22 in. face.....	65 00	24 x 22 in. face.....	50 00
30 x 20 in. face.....	60 00	24 x 20 in. face.....	45 00
30 x 18 in. face.....	55 00	24 x 18 in. face.....	40 00
30 x 16 in. face.....	50 00	24 x 16 in. face.....	35 00

For smaller sizes take price of belt pulley, add \$13.00 for iron frame, shaft and boxes, and deduct discount same as on larger tighteners.

Discount.....per cent.

CAST IRON ROLLS.
DIMENSIONS AND PRICES.

Diameter.	Length.	Size of Journal.	Price.
12 inch.	26 inch.	2 $\frac{3}{16}$ inch.	\$17 25
12 "	24 "	2 $\frac{3}{16}$ "	16 25
10 "	26 "	1 $\frac{5}{16}$ "	15 30
10 "	24 "	1 $\frac{5}{16}$ "	14 40
10 "	20 "	1 $\frac{5}{16}$ "	12 50
8 "	24 "	1 $\frac{11}{16}$ "	10 00
8 "	20 "	1 $\frac{11}{16}$ "	8 75
6 "	24 "	1 $\frac{7}{16}$ "	6 50
6 "	20 "	1 $\frac{7}{16}$ "	5 50

Discount.....per cent.

PIPE ROLLS.
DIMENSIONS AND PRICES.

Outside Diameter.	Length.	Size of Journal.	Price.
14 $\frac{5}{8}$ inch.	26 inch.	2 $\frac{3}{16}$ inch.	\$25 40
14 $\frac{5}{8}$ "	24 "	2 $\frac{3}{16}$ "	24 00
12 $\frac{3}{4}$ "	26 "	2 $\frac{3}{16}$ "	22 40
12 $\frac{3}{4}$ "	24 "	2 $\frac{3}{16}$ "	21 00
10 $\frac{3}{4}$ "	26 "	1 $\frac{5}{16}$ "	19 90
10 $\frac{3}{4}$ "	24 "	1 $\frac{5}{16}$ "	18 70
10 $\frac{3}{4}$ "	20 "	1 $\frac{5}{16}$ "	16 25
8 $\frac{5}{8}$ "	26 "	1 $\frac{11}{16}$ "	16 00
8 $\frac{5}{8}$ "	24 "	1 $\frac{11}{16}$ "	15 00
8 $\frac{5}{8}$ "	20 "	1 $\frac{11}{16}$ "	13 15
7 $\frac{5}{8}$ "	24 "	1 $\frac{7}{16}$ "	12 40
7 $\frac{5}{8}$ "	20 "	1 $\frac{7}{16}$ "	10 50
6 $\frac{5}{8}$ "	24 "	1 $\frac{7}{16}$ "	9 75
6 $\frac{5}{8}$ "	20 "	1 $\frac{7}{16}$ "	8 00

Discount.....per cent.

FLAT BOTTOM BOXES.

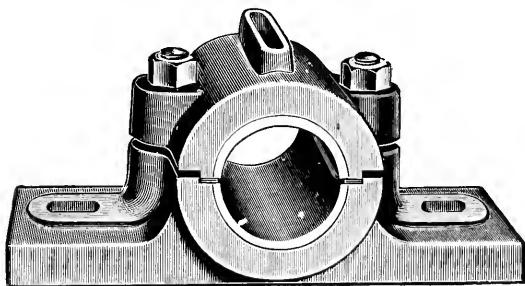

BABBITED BEARINGS.

Size.	Backing.	Price.	Size.	Backing.	Price.
1 $\frac{7}{16}$	2 $\frac{1}{4}$	\$2 00	3 $\frac{1}{16}$	4	\$11 50
1 $\frac{11}{16}$	2 $\frac{1}{4}$	2 50	4 $\frac{7}{16}$	4 $\frac{1}{4}$	15 00
1 $\frac{15}{16}$	2 $\frac{1}{4}$	3 10	4 $\frac{15}{16}$	4 $\frac{1}{2}$	19 00
2 $\frac{3}{16}$	2 $\frac{1}{2}$	3 80	5 $\frac{7}{16}$	5 $\frac{1}{4}$	23 50
2 $\frac{7}{16}$	2 $\frac{3}{4}$	4 60	5 $\frac{15}{16}$	5 $\frac{1}{2}$	28 50
2 $\frac{11}{16}$	3	5 50	6 $\frac{7}{16}$	6	34 00
2 $\frac{15}{16}$	3 $\frac{1}{4}$	6 50	6 $\frac{15}{16}$	6	40 00
3 $\frac{3}{16}$	3 $\frac{1}{2}$	7 60	7 $\frac{1}{2}$	7	55 00
3 $\frac{7}{16}$	3 $\frac{1}{2}$	8 80	8	7	65 00
3 $\frac{11}{16}$	3 $\frac{7}{8}$	10 10			

Discount..... per cent.

BASE PLATES.

Including Bolts to Secure Pillow Block to Base Plate.



Diameter of Shaft.	Price.	Diameter of Shaft.	Price.
1 $\frac{1}{16}$	\$ 4 40	5	\$15 80
2 $\frac{3}{16}$	4 70	5 $\frac{1}{2}$	18 00
2 $\frac{7}{16}$	5 25	6	20 20
2 $\frac{11}{16}$	6 00	6 $\frac{1}{2}$	22 40
2 $\frac{15}{16}$	7 00	7	24 50
3 $\frac{3}{16}$	8 10	7 $\frac{1}{2}$	26 70
3 $\frac{7}{16}$	9 20	8	28 90
3 $\frac{11}{16}$	10 30	8 $\frac{1}{2}$	31 10
3 $\frac{15}{16}$	11 40	9	33 30
4 $\frac{1}{2}$	13 60	9 $\frac{1}{2}$	35 50

Discount..... per cent.

WALL ARCHES.

For Pillow Blocks of any Style.

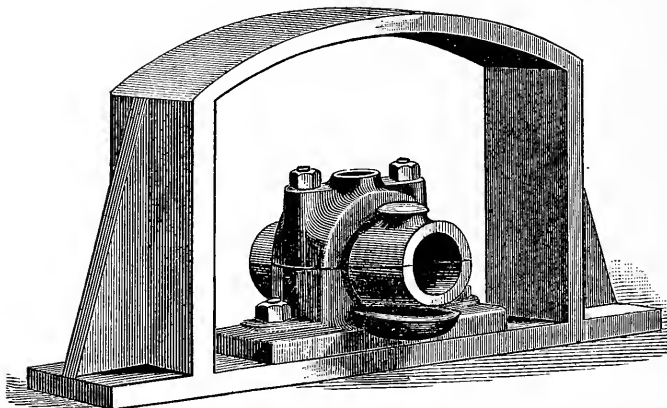

PRICE LIST.

Without Pillow Blocks, but including Bolts for securing Pillow Block to Wall Arch.

Diameter of Shaft.	Price.	Diameter of Shaft.	Price.
$1\frac{7}{16}$	\$ 6 60	$3\frac{11}{16}$	20 00
$1\frac{11}{16}$	6 60	$3\frac{15}{16}$	20 00
$1\frac{5}{8}$	6 60	$4\frac{7}{8}$	34 00
$2\frac{3}{16}$	8 00	$4\frac{5}{8}$	34 00
$2\frac{7}{16}$	8 00	$5\frac{7}{8}$	50 00
$2\frac{11}{16}$	12 00	$5\frac{15}{16}$	50 00
$2\frac{15}{16}$	12 00	$6\frac{7}{8}$	70 00
$3\frac{3}{16}$	16 00	$6\frac{5}{8}$	70 00
$3\frac{7}{16}$	16 00		

Discount per cent.

ECCENTRIC BOX.

Used for Engaging and Disengaging Friction Gearing.

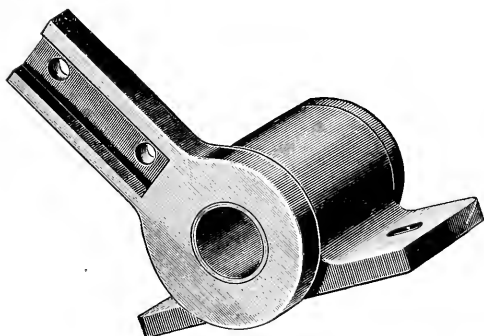

Diameter of Shaft. Inches.	Price, each.
$1 \frac{3}{16}$	\$ 7 00
$1 \frac{7}{16}$	8 25
$1 \frac{11}{16}$	9 50
$1 \frac{15}{16}$	11 00
$2 \frac{3}{16}$	12 90
$2 \frac{7}{16}$	14 50
$2 \frac{11}{16}$	16 60
$2 \frac{15}{16}$	18 75

Discount.....per cent.

SLIDE BOXES.

For Engaging and Disengaging Spur Friction Gearing.

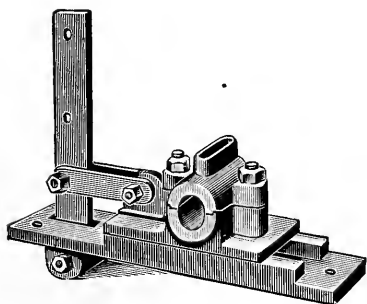

Size of Box.	Price, Each.
$1 \frac{3}{16}$	\$ 7 25
$1 \frac{7}{16}$	8 50
$1 \frac{11}{16}$	9 75
$1 \frac{15}{16}$	11 25
$2 \frac{3}{16}$	12 15
$2 \frac{7}{16}$	14 75
$2 \frac{11}{16}$	16 80
$2 \frac{15}{16}$	18 90
$3 \frac{3}{16}$	21 00
$3 \frac{7}{16}$	23 50

Discount.....per cent.

RIGID POST OR BRACKET BOXES.

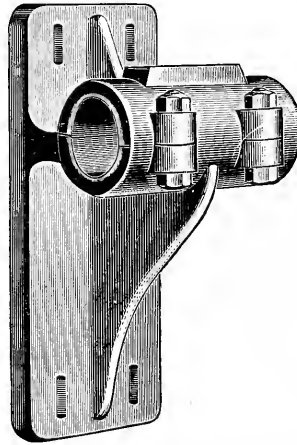

Diameter, Inches.	Backing.	Price.	Diameter, Inches.	Backing.	Price.
1 ⁷ / ₁₆		\$3 70	3 ⁷ / ₁₆	8 ¹ / ₄ in.	\$12 00
1 ¹¹ / ₁₆		4 00	3 ¹¹ / ₁₆	8 ¹ / ₄ "	12 70
1 ⁵ / ₈	6 in.	4 70	3 ¹⁵ / ₁₆	8 ¹ / ₄ "	16 70
2 ³ / ₁₆	6 "	5 35	4 ⁷ / ₁₆	8 ¹ / ₄ "	20 00
2 ⁷ / ₁₆	6 "	6 00	4 ¹¹ / ₁₆	8 ¹ / ₄ "	22 50
2 ¹¹ / ₁₆	8 ¹ / ₄ "	7 35	4 ¹⁵ / ₁₆	8 ¹ / ₄ "	24 70
2 ¹⁵ / ₁₆	8 ¹ / ₄ "	8 00	5 ⁷ / ₁₆	8 ¹ / ₄ "	28 00
3 ³ / ₁₆	8 ¹ / ₄ "	9 35	5 ¹⁵ / ₁₆	8 ¹ / ₄ "	32 00

Discount.....per cent.

STATIONARY STEP FOR UPRIGHT SHAFT.

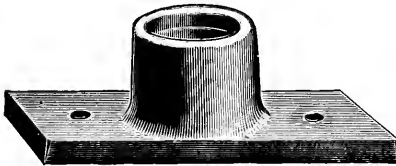

Diameter of Shaft, Inches.	Price Babbitted.
1 ⁷ / ₁₆	\$4 00
1 ¹¹ / ₁₆	4 50
1 ⁵ / ₈	4 75
2 ³ / ₁₆	5 00
2 ⁷ / ₁₆	5 60
2 ¹¹ / ₁₆	6 30
2 ¹⁵ / ₁₆	7 70
3 ³ / ₁₆	8 50
3 ⁷ / ₁₆	9 80
3 ¹¹ / ₁₆	12 30
3 ¹⁵ / ₁₆	15 75

Discount.....per cent.

**ADJUSTABLE STEP BEARINGS.
WITH OIL POT.**

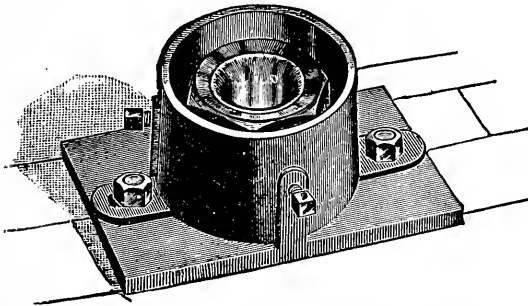

Adjustable in every direction, with tempered steel button-shaped step and brass bushing accurately fitted. A first-class article in every way.

PRICE LIST.

Size.	Price.	Size.	Price.	Size.	Price
1 ³ / ₁₆	\$6 00	2 ³ / ₁₆	\$11 00	3 ³ / ₁₆	\$22 80
1 ⁷ / ₁₆	6 75	2 ⁷ / ₁₆	13 00	3 ⁷ / ₁₆	26 20
1 ¹¹ / ₁₆	7 80	2 ¹¹ / ₁₆	16 00	3 ¹¹ / ₁₆	29 90
1 ⁵ / ₈	9 20	2 ⁵ / ₈	20 00	3 ⁵ / ₈	36 00

Discount.....per cent.

VERTICAL SHAFT BOX.

Rigid Post Hanger for Upright Shaft. Babbitted. Not self-oiling.

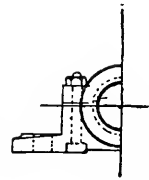
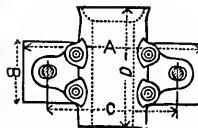
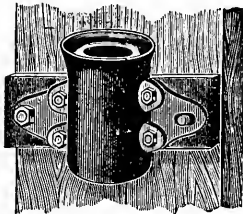

Diameter of Box.	Distance from Bottom to Center.	Price.	Diameter of Box.	Distance from Bottom to Center.	Price.
1 ¹ / ₁₆	1 ¹ / ₁₆	\$1 40	3 ⁷ / ₁₆	3	\$ 8 80
1 ³ / ₁₆	1 ¹ / ₄	1 60	3 ¹¹ / ₁₆	3 ¹ / ₄	10 10
1 ⁷ / ₁₆	1 ¹ / ₂	2 00	3 ¹⁵ / ₁₆	3 ¹ / ₂	11 50
1 ¹¹ / ₁₆	1 ³ / ₈	2 50	4 ⁷ / ₁₆	4	15 00
1 ⁵ / ₈	1 ³ / ₄	3 10	4 ¹¹ / ₁₆	4 ¹ / ₈	19 00
2 ³ / ₁₆	2	3 80	5 ⁷ / ₁₆	4 ¹ / ₄	23 50
2 ⁷ / ₁₆	2 ¹ / ₄	4 60	5 ¹¹ / ₁₆	5 ¹ / ₈	28 50
2 ¹¹ / ₁₆	2 ¹ / ₂	5 50	6 ⁷ / ₁₆	5 ³ / ₄	34 00
2 ⁵ / ₈	2 ³ / ₄	6 50	6 ¹¹ / ₁₆	6 ¹ / ₄	40 00
3 ³ / ₁₆	2 ⁷ / ₈	7 60			

Discount.....per cent.

WALL BRACKETS.
INCLUDING BOLTS FOR PILLOW BLOCKS.

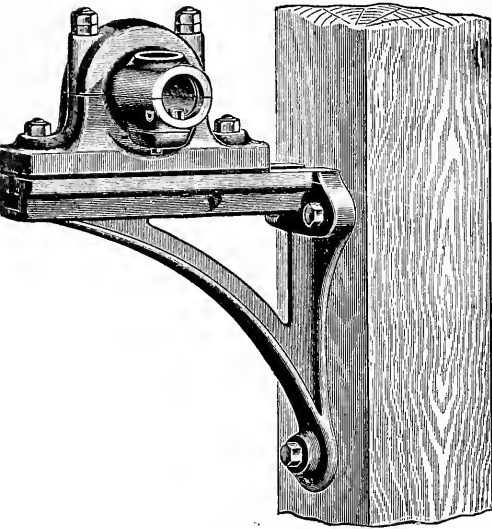

Size. Shaft.	Full Projection to Center of Shaft.		
	16 in.	20 in.	25 in.
1 ¹ / ₁₆	\$ 4 50	\$ 6 70	\$ 9 00
1 ⁵ / ₁₆	4 90	7 30	9 80
2 ³ / ₁₆	5 40	8 10	10 80
2 ⁷ / ₁₆	6 10	9 20	12 20
2 ¹¹ / ₁₆	6 90	10 40	13 80
2 ⁵ / ₈	7 90	11 80	15 80
3 ³ / ₁₆	9 00	13 50	18 00
3 ⁷ / ₁₆	10 30	15 50	20 60
3 ¹¹ / ₁₆	11 70	17 60	23 40
3 ⁵ / ₈	13 30	20 00	26 60
4 ⁷ / ₁₆	15 00	22 50	30 00
4 ⁵ / ₈	16 90	25 40	33 80
5 ⁷ / ₁₆	18 90	28 35	37 80
5 ¹⁵ / ₁₆	20 20	30 50	40 50

Discount.....per cent.

OPEN BALL AND SOCKET POST HANGERS.

Diam. of Shaft.	Price, Cham Oiling.	Price, Plain.	Length of Boxes.	Distance from Foot to Center.
1 ¹ / ₁₆		\$ 5 20	5 ¹ / ₄	} 6 in.
1 ⁵ / ₁₆	\$ 8 25	6 00	6	
2 ³ / ₁₆	10 30	7 30	6 ³ / ₄	
2 ⁷ / ₁₆	12 70	8 90	7 ¹ / ₂	
2 ¹¹ / ₁₆	15 40	10 90	8 ¹ / ₄	} 8 in.
2 ⁵ / ₈	18 75	13 30	9	
3 ³ / ₁₆	22 50	16 20	9 ³ / ₄	
3 ⁷ / ₁₆	26 60	19 40	10 ¹ / ₂	
3 ¹¹ / ₁₆	31 00	23 00	11 ¹ / ₄	} 13 ¹ / ₄ in.
3 ⁵ / ₈	36 15	27 00	12	
4 ⁷ / ₁₆	47 75	36 30	13 ¹ / ₂	
4 ⁵ / ₈	60 75	47 10	15	
5 ⁷ / ₁₆	78 00	64 00	16 ¹ / ₂	} 13 ¹ / ₄ in.
5 ¹⁵ / ₁₆	95 75	80 00	18	
6 ⁷ / ₁₆	120 00	100 00	18	
6 ¹⁵ / ₁₆	140 00	120 00	18	

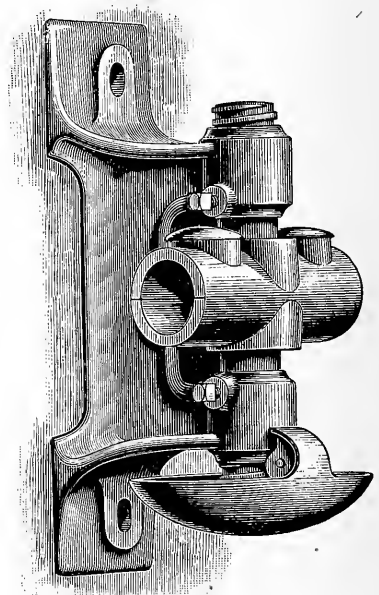

Discount.....per cent.

OPEN BALL AND SOCKET DROP HANGER.

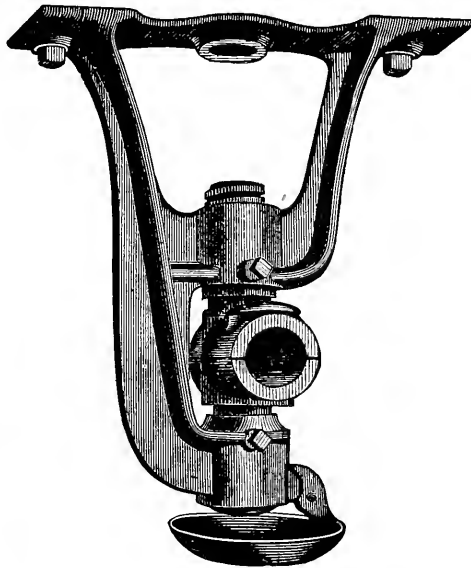

PRICE LIST.

Size of Box.	Drop in Inches.					
	10	13	16	20	25	30
1 $\frac{3}{16}$	\$ 4 40	\$ 4 60				
1 $\frac{7}{16}$	4 60	4 90	\$ 5 30			
1 $\frac{11}{16}$	6 00	5 50	6 00	\$ 7 00		
1 $\frac{15}{16}$	5 10	6 50	7 10	8 30	\$ 9 50	
2 $\frac{3}{16}$	7 30	7 90	8 60	10 00	11 40	\$12 80
2 $\frac{7}{16}$	9 00	9 70	10 50	12 10	13 70	15 30
2 $\frac{11}{16}$	11 10	11 90	12 80	14 60	16 40	18 20
2 $\frac{15}{16}$	13 60	14 50	15 50	17 50	19 50	21 50
3 $\frac{3}{16}$		17 50	18 60	20 80	23 00	25 20
3 $\frac{7}{16}$		20 90	22 10	24 50	26 90	29 30
3 $\frac{11}{16}$		24 70	26 00	28 60	31 20	33 80
3 $\frac{15}{16}$			30 30	33 10	35 90	38 70
4 $\frac{7}{16}$			40 10	43 30	46 50	49 70
4 $\frac{15}{16}$				55 10	58 70	62 30

The Drop of a Hanger is the distance from top of hanger to center of box.

Discount.....per cent.

CLUTCH COUPLINGS.

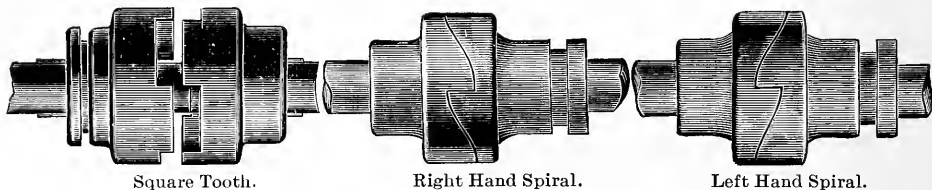

Square Tooth.

Right Hand Spiral.

Left Hand Spiral.

Size.	Price, Fitted to Shaft.	Size.	Price, Fitted to Shaft.
1 7-16	\$ 6 80	3 7-16	20 20
1 11-16	8 10	3 11-16	22 30
1 15-16	9 60	3 15-16	24 50
2 3-16	11 10	4 7-16	29 30
2 7-16	12 80	4 15-16	34 50
2 11-16	14 50	5 7-16	40 00
2 15-16	16 30	5 15-16	46 00
3 3-16	18 20		

Discount..... per cent.

PULLEY FLANGES.

Bored, Set-Screwed or Key-Seated.



Diameter.	Price, each.	Diameter.	Price, each.
4	\$2 00	14	\$3 50
6	2 25	16	4 00
8	2 50	18	4 50
10	2 75	20	5 00
12	3 00	24	6 50

For sleeve flanges see page 111.

Discount.....per cent.

PRICE LIST OF LARGE ARBOR HEADS, BOXES AND ARBORS.

2 7-16 inch Arbor Boxes.....	each,	\$ 9 20
2 15-16 inch Arbor Boxes.....	each,	13 00
3 3-8 inch Arbor Boxes.....	each,	17 50
Arbor Heads, 3 3-8 inch.....	each,	22 00
Arbors, 3 3-8 inch steel, exclusive of the Head.....	per foot,	3 00
Arbor Heads, 2 15-16 inch.....	each,	16 00
Arbors, 2 15-16 inch steel, exclusive of the Head.....	per foot,	2 20
Arbor Heads, 2 7-16 inch.....	each,	12 00
Arbors, 2 7-16 inch steel, exclusive of the Head.....	per foot,	1 50

Discount.....per cent.

FLANGE FACE COUPLINGS.

PRICE LIST.

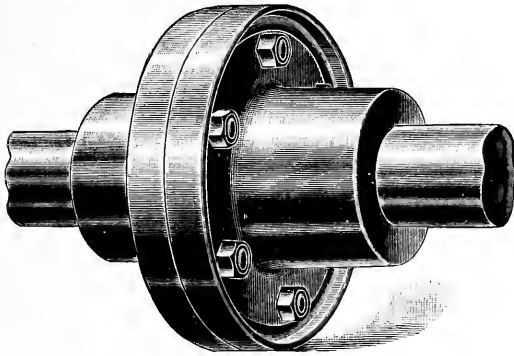

Discount.....per cent.

Size.	Price.
1 ⁷ / ₁₆	\$ 8 00
1 ¹¹ / ₁₆	8 50
1 ¹⁵ / ₁₆	9 00
2 ³ / ₁₆	10 50
2 ⁷ / ₁₆	12 50
2 ¹¹ / ₁₆	15 25
2 ¹⁵ / ₁₆	18 25
3 ³ / ₁₆	21 75
3 ⁷ / ₁₆	25 25
3 ¹¹ / ₁₆	29 25
3 ¹⁵ / ₁₆	33 25
4 ⁷ / ₁₆	43 25
4 ¹¹ / ₁₆	54 75
5 ⁷ / ₁₆	67 00
5 ¹¹ / ₁₆	81 00
6 ⁷ / ₁₆	95 50
6 ¹¹ / ₁₆	110 00
7 ⁷ / ₁₆	126 00
7 ¹¹ / ₁₆	142 00
8 ⁷ / ₁₆	160 00
8 ¹¹ / ₁₆	179 00
9 ⁷ / ₁₆	200 00

RIBBED COMPRESSION COUPLINGS.

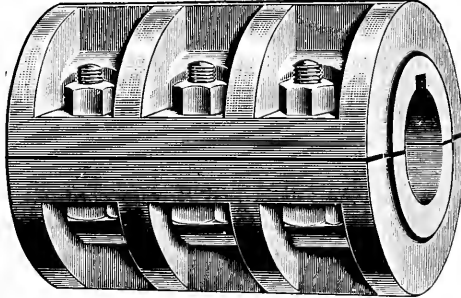

PRICE LIST.

Size of Shaft.	Price.	Size of Shaft	Price.
1 ³ / ₁₆	\$ 5 50	3 ⁷ / ₁₆	\$ 24 00
1 ⁵ / ₁₆	5 70	3 ¹¹ / ₁₆	28 00
1 ⁷ / ₁₆	6 00	3 ¹⁵ / ₁₆	32 00
1 ¹¹ / ₁₆	7 00	4 ⁷ / ₁₆	42 00
1 ¹⁵ / ₁₆	8 00	4 ¹¹ / ₁₆	53 40
2 ³ / ₁₆	9 00	5 ⁷ / ₁₆	65 00
2 ⁷ / ₁₆	10 75	5 ¹¹ / ₁₆	73 00
2 ¹¹ / ₁₆	13 00	6 ⁷ / ₁₆	90 00
2 ¹⁵ / ₁₆	16 50	6 ¹¹ / ₁₆	112 00
3 ³ / ₁₆	20 00		

Discount.....per cent.

PRICE LIST OF TURNED SHAFTING.

Size.	Price Per Foot.	Width of Key Seat.	Size.	Price, Per Foot.	Width of Key Seat.
$1\frac{5}{16}$	\$0 70	$\frac{1}{4}$	$3\frac{5}{16}$	\$ 4 00	1
$1\frac{3}{16}$	75	$\frac{3}{8}$	$4\frac{1}{16}$	5 30	$1\frac{1}{8}$
$1\frac{7}{16}$	80	$\frac{1}{2}$	$4\frac{1}{2}$	6 90	$1\frac{1}{4}$
$1\frac{1}{2}$	87	$\frac{5}{8}$	$5\frac{7}{16}$	8 75	$1\frac{3}{8}$
$1\frac{1}{8}$	1 05	$\frac{3}{4}$	$5\frac{1}{2}$	10 85	$1\frac{1}{2}$
$2\frac{3}{16}$	1 25	$\frac{7}{8}$	$6\frac{7}{16}$	13 20	$1\frac{5}{8}$
$2\frac{7}{16}$	1 50	1	$6\frac{1}{2}$	15 90	$1\frac{3}{4}$
$2\frac{1}{8}$	1 80	$1\frac{1}{8}$	$7\frac{1}{16}$	18 90	$1\frac{7}{8}$
$2\frac{5}{16}$	2 15	$1\frac{1}{4}$	$7\frac{1}{2}$	22 25	2
$3\frac{3}{16}$	2 60	$1\frac{3}{8}$	$8\frac{7}{16}$	25 90	$2\frac{1}{8}$
$3\frac{7}{16}$	2 95	$1\frac{1}{2}$	$8\frac{1}{2}$	30 00	$2\frac{1}{4}$
$3\frac{1}{2}$	2 45	$1\frac{5}{8}$	$9\frac{7}{16}$	34 60	$2\frac{1}{2}$

Thickness of keyseat at large end same as width. Taper $\frac{1}{8}$ inch per foot. All feather and parallel keys to be square.

SAFETY COLLARS, WITH SET SCREWS.

Diameter Bore.	Price Each.	Diameter Bore.	Price, Each.	Diameter Bore.	Price, Each.
$1\frac{5}{8}$	\$0 70	$2\frac{5}{8}$	\$2 40	$5\frac{7}{16}$	\$ 7 20
$1\frac{3}{16}$	80	$3\frac{3}{16}$	2 70	$5\frac{1}{2}$	8 60
$1\frac{7}{16}$	1 00	$3\frac{7}{16}$	3 00	$6\frac{7}{16}$	10 10
$1\frac{1}{2}$	1 20	$3\frac{1}{2}$	3 30	$6\frac{1}{2}$	11 70
$1\frac{5}{16}$	1 40	$3\frac{5}{16}$	3 60	$7\frac{7}{16}$	13 80
$2\frac{3}{16}$	1 60	$4\frac{7}{16}$	4 70	$7\frac{1}{2}$	15 90
$2\frac{7}{16}$	1 80	$4\frac{1}{2}$	5 90	$8\frac{7}{16}$	18 15
$2\frac{1}{2}$	2 10			$8\frac{1}{2}$	20 70

For split collars add 50 per cent. to above list.

Discount.....per cent.

BROWN'S PATENT SET OR SLIP COLLARS.

Fig. 1.

Fig. 2.

Fig. 3.

**These Set Collars Prevent Accidents, Avoid Law Suits
and thus Save Money.**

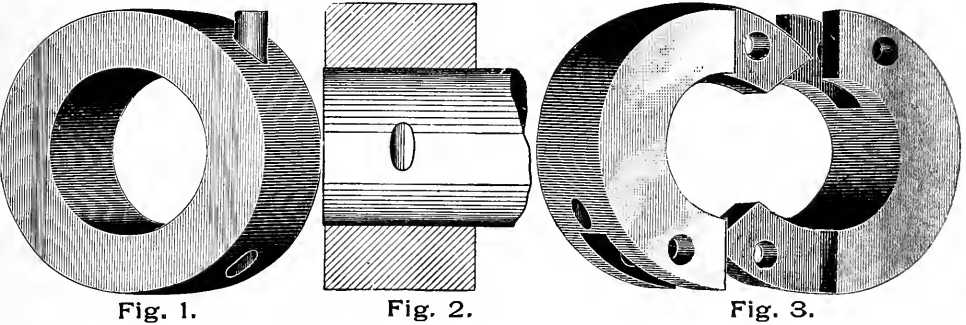
Figure 1 shows a collar with the fastening pin partly driven home.

Figure 2 shows a sectional view of collar and shaft with mark on the shaft which the pin makes.

Figure 3 shows a set collar in halves which is fastened together by two pins driven through the laps, the collar being held in place on shaft same as Figure 1. The pin holding the collar in place cuts a piece out of the shaft about one-sixteenth of an inch deep of the shape shown in Figure 2, yet a pulley or gear can readily be slipped over this mark made by the set collar as the shaft is not upset at that point. When the pin is driven in place it is cut off even with the face of the collar and nothing whatever projects to catch the clothing of anyone working near it, as the collar is perfectly smooth on all sides.

A collar can be used any number of times as the pin can be driven out, the collar moved, and then the pin driven back again, the pins being all of steel and fit the holes in side of collars accurately.

The fastening of these collars is perfect, being strong, easily adjusted and not liable to get out of order.

As all are well aware, many serious and even frightful accidents have been occasioned by set screws projecting from edge of collars, all of which could have been avoided had these collars been in use, and there is no further excuse for any manufacturer allowing his employes to get injured or for having a law suit on his hands by reason of projecting set screws in slip collars now that this device is on the market.

For Price list see page 136.

Discount.....per cent.

TAKE-UP BOXES.

PRICE LIST AND DIMENSIONS.

No. or Length of Movement.	Diameter of Shaft.	Price, Each, A or B.
12	1 7/16	\$ 3 25
12	1 9/16	3 50
12	1 11/16	4 00
12	1 15/16	4 75
12	2 3/16	6 00
12	2 5/16	6 25
12	2 7/16	6 75
20	2 7/16	9 00
20	2 9/16	9 50
20	2 11/16	10 00
20	2 13/16	11 00
24	2 13/16	11 00
24	2 15/16	13 50
24	3 7/16	14 00
24	3 15/16	15 00
36	2 15/16	19 00
36	3 7/16	19 50

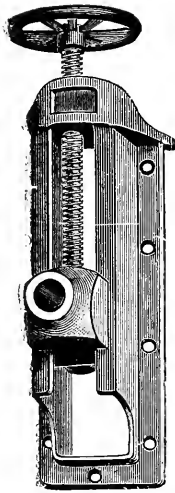

Style A.

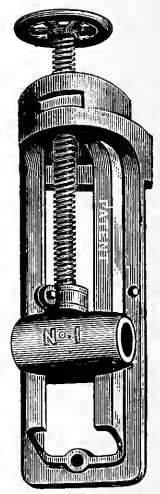

Style B.

Always state if Style "A" or "B" is wanted.

Style B is used extensively for taking up the stretch of sawdust chain, etc.

Note:—In ordering, give diameter of Shaft for which Take-up is desired.

Discount.....per cent.

STEEL SAWDUST CHAIN.

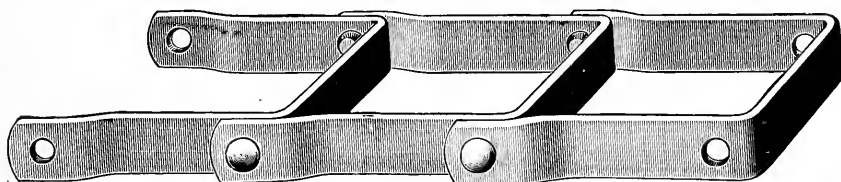

A

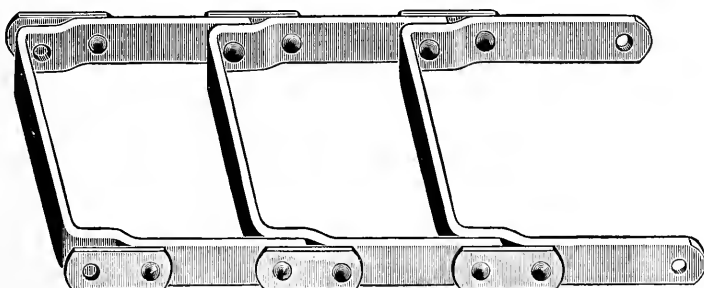

B

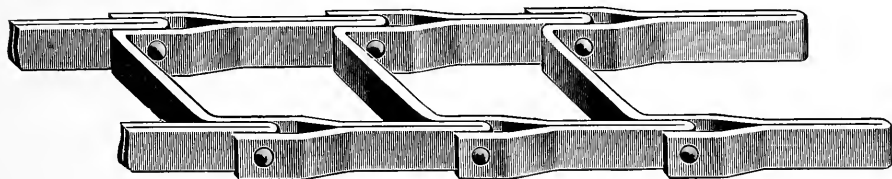

C

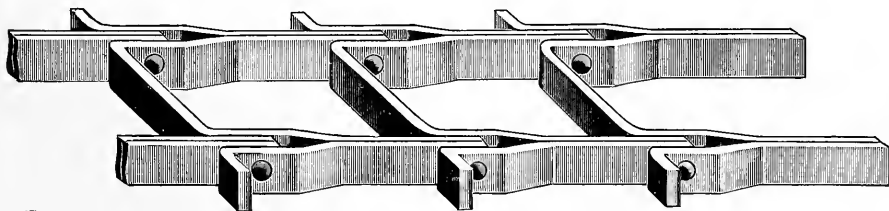

D

For price list see next page.

STEEL SAWDUST CHAIN.

The four cuts on preceding page represent the various kinds of sawdust chain which we manufacture. A represents the plain, B and C the reinforced and D the reinforced with the end of reinforced links turned out one inch on each side.

DIMENSIONS AND PRICES.

No. of Chain.	Pitch, Inches.	Outside Width, Inches.	Size of Steel for Style A, Inches.	Size of Steel for Styles B, C and D, Inches.	Size of Rivets, Inches.	Price, Plain, as shown by Cut A.	Price, Reinforced, as shown by Cuts B and C.	Price, Reinforced, with End Turned Out, as shown in Cut D.
1	6	8	$\frac{1}{2}$ x $1\frac{1}{2}$	$\frac{1}{4}$ x $1\frac{1}{2}$	$\frac{1}{2}$	\$0 90	\$1 25	\$1 40
2	6	10	$\frac{1}{2}$ x $1\frac{3}{4}$	$\frac{1}{4}$ x $1\frac{3}{4}$	$\frac{1}{2}$	1 15	1 40	1 55
3	6	12	$\frac{1}{2}$ x $1\frac{5}{8}$	$\frac{1}{4}$ x $1\frac{5}{8}$	$\frac{1}{2}$	1 20	1 55	1 70
4	6	14	$\frac{1}{2}$ x $1\frac{7}{8}$	$\frac{1}{4}$ x $1\frac{7}{8}$	$\frac{1}{2}$	1 40	1 75	1 90
5	8	8	$\frac{1}{2}$ x $1\frac{1}{2}$	$\frac{1}{4}$ x $1\frac{1}{2}$	$\frac{1}{2}$	80	1 15	1 30
6	8	10	$\frac{1}{2}$ x $1\frac{3}{4}$	$\frac{5}{16}$ x $1\frac{3}{4}$	$\frac{1}{2}$	1 00	1 35	1 50
7	8	12	$\frac{1}{2}$ x $1\frac{5}{8}$	$\frac{5}{16}$ x $1\frac{5}{8}$	$\frac{1}{2}$	1 20	1 55	1 70
8	8	14	$\frac{1}{2}$ x $1\frac{7}{8}$	$\frac{5}{16}$ x $1\frac{7}{8}$	$\frac{1}{2}$	1 40	1 75	1 90
9	10	16	$\frac{1}{2}$ x $1\frac{7}{8}$	$\frac{5}{16}$ x $1\frac{3}{4}$	$\frac{1}{2}$	1 50	1 85	2 00
10	10	18	$\frac{1}{2}$ x 2	$\frac{5}{16}$ x 2	$\frac{1}{2}$	1 70	2 05	2 20
11	10	20	$\frac{1}{2}$ x 2	$\frac{5}{16}$ x 2	$\frac{1}{2}$	1 90	2 25	2 40

Discount per cent.

The widths above given are of chain without the ends of reinforced links turned out.

See price of sprockets on next page.

SPROCKETS FOR SAWDUST CHAIN.

DIMENSIONS AND PRICES.

No. of Chain.	Diameter, Inch.	Face, Inch.	Pitch, Inch.	No. of Teeth.	Price, Plain.	Price, with Flanges.	Price, Double.	Price, Double with Flanges.
1	17	3 $\frac{1}{2}$	6	8	\$ 6 90	\$13 80	\$13 80	\$20 90
1	22	3 $\frac{1}{2}$	6	9	9 80	19 60	19 60	29 40
2	17	5 $\frac{1}{2}$	6	8	8 40	16 80	16 80	25 20
2	22	5 $\frac{1}{2}$	6	9	14 20	28 40	28 40	42 60
3	17	7 $\frac{1}{2}$	6	8	9 80	19 60	19 60	29 40
3	22	7 $\frac{1}{2}$	6	9	13 60	27 20	27 20	40 80
4	17	9 $\frac{1}{2}$	6	8	11 20	22 40	22 40	33 60
4	22	9 $\frac{1}{2}$	6	9	16 50	33 00	33 00	49 50
5	17	3 $\frac{1}{2}$	8	6	6 10	12 20	12 20	18 30
5	19 $\frac{1}{2}$	3 $\frac{1}{2}$	8	7	7 50	15 00	15 00	22 50
5	25	3 $\frac{1}{2}$	8	9	10 50	21 00	21 00	31 50
6	17	5 $\frac{1}{2}$	8	6	7 60	15 20	15 20	22 80
6	19 $\frac{1}{2}$	5 $\frac{1}{2}$	8	7	11 30	22 60	22 60	33 90
6	25	5 $\frac{1}{2}$	8	9	15 50	31 00	31 00	46 50
7	17	7 $\frac{1}{2}$	8	6	9 00	18 00	18 00	27 00
7	19 $\frac{1}{2}$	7 $\frac{1}{2}$	8	7	11 60	23 20	23 20	34 80
7	25	7 $\frac{1}{2}$	8	9	17 20	34 40	34 40	51 60
8	17	9 $\frac{1}{2}$	8	6	10 40	20 80	20 80	31 20
8	19 $\frac{1}{2}$	9 $\frac{1}{2}$	8	7	13 20	26 40	26 40	39 60
8	25	9 $\frac{1}{2}$	8	9	18 80	37 60	37 60	56 40
9	18 $\frac{1}{4}$	11 $\frac{1}{2}$	10	5	14 75	29 50	29 50	49 25
9	21	11 $\frac{1}{2}$	10	6	17 25	34 50	34 50	51 75
9	24 $\frac{1}{4}$	11 $\frac{1}{2}$	10	7	20 50	41 00	41 00	61 50
10	18 $\frac{1}{4}$	13 $\frac{1}{2}$	10	5	17 00	34 00	34 00	51 00
10	21	13 $\frac{1}{2}$	10	6	20 00	40 00	40 00	60 00
10	24 $\frac{1}{4}$	13 $\frac{1}{2}$	10	7	23 00	46 00	46 00	69 00
11	18 $\frac{1}{4}$	15 $\frac{1}{2}$	10	5	19 00	38 00	38 00	57 00
11	21	15 $\frac{1}{2}$	10	6	22 00	44 00	44 00	66 00
11	24 $\frac{1}{4}$	15 $\frac{1}{2}$	10	7	25 00	50 00	50 00	75 00

When ordering state whether teeth are wanted in the Tail Sheaves or not. We use the Sprockets above listed for tail of chain, either with or without teeth as the purchaser may desire. They will be sent with teeth unless otherwise ordered. The price will be the same whether teeth are used or not.

Discount.....per cent.

SPECIAL TRANSFER CHAIN.

(Patented.)

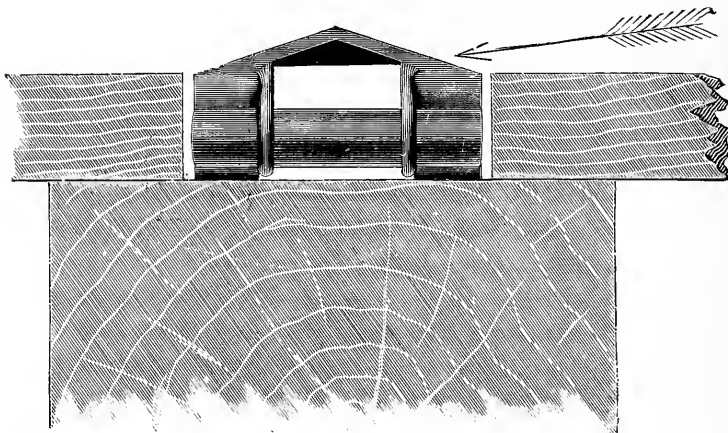

No. 500.

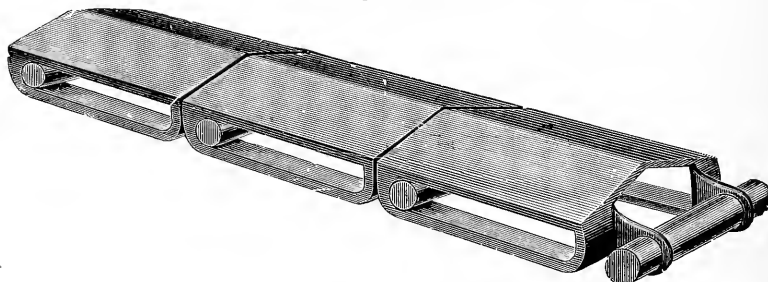

This cut represents a Special Transfer Chain, which has proven of great advantage to mill men in transferring from edger to trimmer. As the illustrations show, this chain presents an unbroken, beveled surface for the lumber to ride upon, and there is no opportunity for clogging or catching. If the runway is built as shown in the section, lumber may be delivered transversely without striking obstructions.

Working strain, 2,000 lbs.

Price per foot, 65 cents.

WHEELS.

8 inches diameter, 12 teeth.....	\$3 25
12 inches diameter, 16 teeth.....	4 50
16 inches diameter, 24 teeth.....	6 00

Discount.....per cent.

EWART DETACHABLE LINK-BELTING.

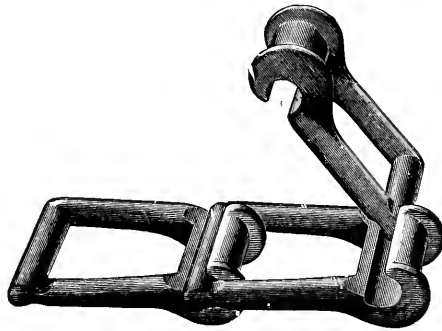

No.	PRICE PER FOOT.			Approximate Links in 10 Feet.	Maximum Power in Pounds.	Approximate in Leather Belting.
	All Plain Links.	All Special Links.	With Special Links Interspersed.			
25	\$0 08	\$0 19	\$0 11	133	75	1 in. single.
32	08	17	11	104	150	1 1/2 " "
33	07	17	10	86	200	2 " "
34	08	17	11	86	225	2 1/2 " "
35	08	17	11	74	250	2 1/2 " "
42	09	18	12	88	300	3 " "
45	09	18	12	74	350	3 1/2 " "
51	11	20	14	104	375	3 1/2 " "
52	12	20	14	80	500	4 " "
55	12	18	13	74	450	4 " "
57	12	24	16	52	600	6 " "
62	16	27	20	73	650	6 1/2 " "
66	16	20	14	60	700	6 1/2 " "
67	16	27	20	52	700	7 " "
75	18	30	22	46	750	7 1/2 " "
77	18	30	22	52	800	8 " "
78	21	38	27	46	1000	10 " "
83	25	45	35	30	1200	12 " "
85	27	45	35	30	1300	9 in. double.
88	25	45	32	46	1200	8 " "
95	32	60	45	30	1600	10 " "
103	40	60	50	39	1800	12 " "
105	35	50	43	20	1500	10 " "
108	40	70	55	25 1/2	2000	13 " "
114	50	65	55	36 1/2	2000	13 " "
122	60	95	80	20	2200	15 " "
124	60	1 00	80	30	2200	17 " "
146	60	90	75	20	2800	19 " "
160	80	1 20	1 00	12	4000	

Discount.....per cent.

PRICE LIST OF SPROCKET WHEELS.

Bored and Key-Seated or Set-Screwed.

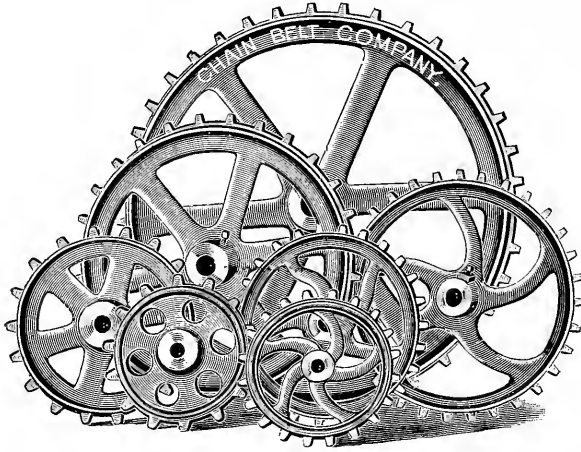

No. 25.			No. 32.			Nos. 33 and 34.		
Pitch Diameter, Inches.	No. of Teeth.	Price.	Pitch Diameter Inches.	No. of Teeth.	Price.	Pitch Diameter, Inches	No. of Teeth.	Price.
2	7	\$0 80	2	5	\$0 80	7	16	\$1 80
2½	8	85	2½	6	85	8½	19	2 00
2¾	9	90	2¾	7	90	9¾	22	2 25
3¼	11	1 00	3	8	95	12	27	2 60
3½	12	1 05	3½	9	1 05	14¼	32	3 05
3¾	13	1 10	3¾	10	1 10	15¼	34	3 20
4	14	1 10	4¼	11	1 15	16	36	3 40
4¼	15	1 15	4¾	13	1 25	18¼	41	3 90
4¾	16	1 20	6	16	1 45	24	54	5 30
5	17	1 25	8¼	22	1 80	Nos. 35, 45, 55.		
6	21	1 45	8½	23	1 95	2½	5	\$0 90
6¼	22	1 50	9	24	2 05	3	6	1 00
7½	26	1 70	12	33	2 60	3¾	7	1 10
8	28	1 80	14	38	2 90	4¼	8	1 25
10	35	2 10	16	44	3 30	4¾	9	1 35
10¼	36	2 15	16½	45	3 40	5¼	10	1 45
12	42	2 40	Nos. 33 and 34.			5¾	11	1 55
13¾	48	2 70	3	7	\$0 95	6	12	1 65
15	52	2 90	4	9	1 15	7	13	1 75
16	56	3 10	4½	10	1 25	7¼	14	1 85
17¼	60	3 30	5½	12	1 45	8½	16	2 05
18¼	64	3 50	6½	15	1 70	8¾	17	2 15
24	84	5 00						

Discount per cent.

PRICE LIST OF SPROCKET WHEELS—Continued.

Bored and Key Seated or Set Screwed.

Nos. 35, 45, 55.			No. 51.			Nos. 57, 67, 77.		
Pitch Diameter, Inches.	No. of Teeth.	Price.	Pitch Diameter, Inches.	No. of Teeth.	Price.	Pitch Diameter, Inches.	No. of Teeth.	Price.
9½	18	\$2 25	8	22	\$2 00	8¾	12	\$2 30
10	19	2 35	10	27	2 35	9½	13	2 50
10½	20	2 45	12	33	2 75	11	15	2 85
11½	22	2 70	14	39	3 20	12½	17	3 25
12	23	2 80	16	45	3 70	14	19	3 65
12½	24	2 90	18¼	50	4 10	14¾	20	3 85
13	25	3 00	No. 52.			15½	21	4 05
14¼	27	3 30				16½	22	4 25
16	31	3 70	3½	7	\$1 10	17	23	4 50
18¼	35	4 20	4	8	1 20	18¼	25	5 00
20¼	39	4 65	4¼	9	1 30	19¾	27	5 50
21¾	42	5 00	5	10	1 40	20	28	5 75
23½	45	5 40	5½	12	1 55	22	30	6 25
28	54	7 00	6	13	1 65	24¼	33	7 00
30	58	7 50	6½	14	1 75	26	36	7 75
36	69	10 50	7	15	1 85	28	38	8 25
42	82	14 00	7½	16	1 95	30	41	9 00
No. 42.			8	17	2 05	32½	44	9 75
			9	19	2 30	36	49	12 00
3	7	\$1 10	10	21	2 50	38½	52	13 50
3¾	9	1 20	12½	26	3 00	41½	56	15 50
4¾	11	1 35	13	27	3 15	44½	60	17 00
5¾	13	1 45	14½	30	3 50	47½	64	21 00
6¼	14	1 60	16½	34	4 00	No. 62.		
8	18	1 95	18	38	4 50			
8¼	19	2 00	20	42	5 00	4¼	8	\$1 40
9½	22	2 25	22	46	5 45	5	9	1 50
10½	24	2 40	23¾	49	5 80	5¾	11	1 70
11¾	27	2 70	24½	51	6 15	7¼	14	2 00
14	32	3 20	26¼	55	7 00	8	15	2 10
15½	36	3 50	30½	64	8 00	8¼	16	2 20
18	41	4 00	Nos. 57, 67, 77.			9¼	18	2 45
20	46	4 50						
24	55	5 75	4½	5	\$1 35	10½	20	2 75
No. 51.			4¾	6	1 45	11½	22	3 05
			5½	7	1 55	12	23	3 20
1¾	5	\$0 90	6	8	1 70	14¾	28	3 95
2½	7	1 00	6½	9	1 85	16	30	4 25
4	11	1 25	7½	10	2 00	18	34	4 85
5	14	1 40	8	11	2 15	20	38	5 45
6¼	17	1 60				23	43	6 20

Discount..... per cent.

PRICE LIST OF SPROCKET WHEELS—Continued.

Bored and Key Seated or Set Screwed.

No. 62.			Nos. 75, 78, 88.			No. 103.		
Pitch Diameter Inches.	No. of Teeth.	Price.	Pitch Diameter Inches.	No. of Teeth.	Price.	Pitch Diameter Inches.	No. of Teeth.	Price.
24	45	\$6 50	42	49	\$16 50	12 $\frac{1}{2}$	13	\$4 20
26	49	7 50	48	58	22 50	13 $\frac{1}{2}$	14	4 55
30 $\frac{1}{2}$	58	9 00	64	77	33 50	14 $\frac{1}{2}$	15	4 90
No. 66.			No. 83.			15 $\frac{1}{2}$	16	5 25
7 $\frac{1}{2}$	12	\$2 00	All Double Teeth.			16 $\frac{1}{2}$	17	5 60
8 $\frac{1}{2}$	13	2 25	12	18	\$ 3 50	18	19	6 30
10 $\frac{1}{4}$	16	2 60	16	26	4 50	19 $\frac{1}{2}$	20	6 65
12 $\frac{1}{2}$	19	3 10	20	32	6 00	21 $\frac{1}{2}$	22	7 35
16 $\frac{1}{4}$	25	4 25	24	38	6 50	22 $\frac{1}{2}$	23	7 70
Nos. 75, 78, 88.			28 $\frac{1}{2}$	44	8 50	23 $\frac{1}{2}$	24	8 00
5	6	\$1 65	30	48	10 00	25 $\frac{1}{2}$	26	9 00
6	7	1 80	34	54	12 00	30	31	11 50
6 $\frac{1}{2}$	8	2 00	41	64	18 00	32	33	12 50
7 $\frac{1}{2}$	9	2 20	Nos. 85 and 95.			37	38	15 25
8 $\frac{1}{4}$	10	2 40	7 $\frac{3}{4}$	6	\$2 60	41	42	17 50
9	11	2 60	10	8	3 25	45	46	21 00
10	12	2 80	12 $\frac{1}{2}$	10	4 00	48	49	23 50
10 $\frac{3}{4}$	13	3 00	13 $\frac{1}{2}$	11	4 30	79	81	70 00
11 $\frac{1}{2}$	14	3 20	16	13	5 35	Nos. 105 and 107.		
12 $\frac{1}{2}$	15	3 40	17 $\frac{1}{2}$	14	5 70	11 $\frac{3}{4}$	6	\$4 50
14 $\frac{1}{4}$	17	3 90	20	16	6 90	15 $\frac{3}{4}$	8	4 90
16	19	4 40	22 $\frac{1}{2}$	18	8 10	19 $\frac{1}{2}$	10	6 25
16 $\frac{1}{2}$	20	4 65	24	19	8 70	23	12	7 75
18 $\frac{1}{2}$	22	5 15	30	24	11 75	25 $\frac{1}{4}$	13	9 75
20	24	5 65	33	26	13 50	27 $\frac{1}{2}$	14	10 75
21	25	5 90	34	27	14 50	31	16	13 00
22 $\frac{1}{2}$	27	6 40	35 $\frac{1}{2}$	28	15 50	36 $\frac{3}{4}$	19	16 00
24	29	6 90	60	47	36 00	48 $\frac{1}{2}$	25	25 50
24 $\frac{3}{4}$	30	7 15	No. 103.			No. 108.		
28 $\frac{1}{2}$	34	8 55	7	7	\$2 60	12	8	\$4 50
29 $\frac{1}{2}$	35	8 90	7 $\frac{3}{4}$	8	2 80	13 $\frac{1}{2}$	9	5 00
30 $\frac{1}{2}$	37	10 00	8 $\frac{3}{4}$	9	3 00	16 $\frac{1}{2}$	11	6 00
32 $\frac{1}{2}$	39	10 90	9 $\frac{3}{4}$	10	3 25	18	12	6 50
33 $\frac{1}{2}$	40	11 40	11 $\frac{3}{4}$	12	3 85	20	14	7 50
37	44	12 80						
38	46	14 00						

Discount.....per cent.

PRICE LIST OF SPROCKET WHEELS—Continued.

Bored and Key Seated or Set Screwed.

No. 108.			No. 114.			No. 124.		
Pitch Diameter Inches.	No. of Teeth.	Price.	Pitch Diameter Inches.	No. of Teeth.	Price.	Pitch Diameter Inches.	No. of Teeth.	Price.
24	16	\$ 9 00	33	32	\$17 00	15 $\frac{1}{4}$	12	\$ 6 25
30	20	12 50	36	35	20 00	16 $\frac{1}{2}$	13	7 00
36	24	15 50	48 $\frac{1}{2}$	47	30 00	18 $\frac{3}{4}$	15	9 00
48	32	25 00	No. 122.			21 $\frac{1}{2}$	17	11 00
No. 114.						17 $\frac{1}{2}$	9	\$ 9 00
8	8	\$3 60	19	10	10 00	26	20	14 00
10	10	4 40	23	12	12 50	31	24	16 50
13 $\frac{1}{4}$	13	5 60	29 $\frac{1}{2}$	15	17 00	36	28	20 00
14 $\frac{1}{4}$	14	6 00	42 $\frac{1}{2}$	22	25 00	44	34	26 00
16 $\frac{1}{2}$	16	6 80	No. 124.			48	38	35 00
19 $\frac{1}{2}$	19	9 00				11 $\frac{1}{2}$	9	\$ 4 75
24	23	11 50	12 $\frac{1}{2}$	10	5 10	No. 160.		
24 $\frac{1}{2}$	24	12 00	14 $\frac{1}{2}$	11	5 60	30	9	\$35 00
31	30	15 00				40	12	45 00
						48	15	55 00

Additional Price to be added to the List Price for Split Sprocket Wheels and Clutch Wheels.

Diameter.	No. of Chain Belt.	Price.
6 to 12	25 to 52	\$1 70
6 to 12	57 to 77	1 85
6 to 12	78 to 95	2 00
6 to 12	103 to 160	2 20
12 $\frac{1}{4}$ to 24	25 to 52	2 35
12 $\frac{1}{4}$ to 24	57 to 77	2 50
12 $\frac{1}{4}$ to 24	78 to 95	2 65
12 $\frac{1}{4}$ to 24	103 to 160	2 80
24 $\frac{1}{4}$ to 36	32 to 52	2 90
24 $\frac{1}{4}$ to 36	57 to 77	3 20
24 $\frac{1}{4}$ to 36	78 to 95	3 60
24 $\frac{1}{4}$ to 36	103 to 160	4 00
36 $\frac{1}{4}$ to 60	57 to 77	4 60
36 $\frac{1}{4}$ to 60	78 to 95	6 00
36 $\frac{1}{4}$ to 60	103 to 160	7 80
Above 60	78 to 160	12 00

Discount.....per cent.

ATTACHMENTS FOR LINK BELTING.

We show herewith the attachments most in use.

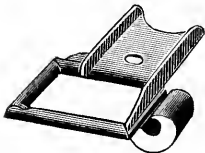

A 3

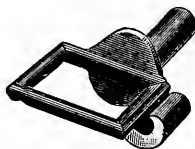

D 5



E 2

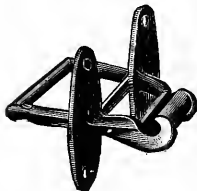

FF



F 2

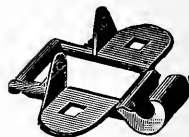

F 4

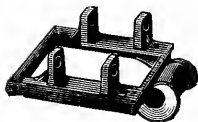

F 5

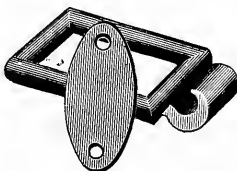

G 1

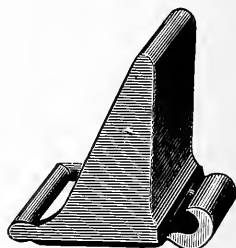

H 2

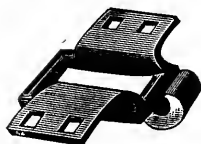

K 2



K 3



M 3

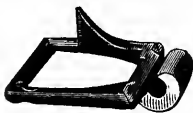

R 1

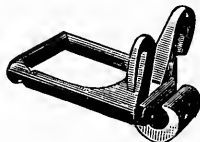

S 1

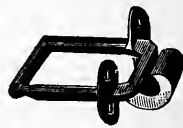

S 2

Various others can be furnished if desired.

SOLID TOOTH CIRCULAR SAWS.

Diam. inches.	Thick-ness Gauge.	Size of Hole, Inches.	Price Each.	Extra for each Additional Gauge Heavier.	Diam. Inches	Thick-ness Gauge.	Size of Hole, Inches.	Price Each.	Extra for each Additional Gauge Heavier.
4	19	$\frac{3}{4}$	\$ 1 00	\$ 0 03	38	9	$1\frac{5}{8}$	\$30 00	\$ 1 75
5	19	$\frac{3}{4}$	1 20	04	40	9	2	35 00	2 00
6	18	$\frac{3}{4}$	1 40	05	42	8	2	42 00	2 50
7	18	$\frac{3}{4}$	1 70	06	44	8	2	50 00	3 00
8	18	$\frac{3}{4}$	2 00	08	46	8	2	60 00	3 50
9	17	$\frac{3}{4}$	2 50	10	48	8	2	70 00	4 00
10	16	1	3 00	12	50	7	2	80 00	4 50
12	15	1	3 75	17	52	7	2	90 00	5 00
14	15	$1\frac{1}{8}$	4 50	21	54	7	2	100 00	6 00
16	14	$1\frac{1}{8}$	5 50	25	56	7	2	115 00	7 00
18	13	$1\frac{1}{8}$	7 00	30	58	7	2	130 00	8 00
20	13	$1\frac{1}{4}$	8 50	35	60	6	2	145 00	9 00
22	12	$1\frac{1}{4}$	10 00	45	62	6	2	160 00	10 00
24	11	$1\frac{1}{4}$	12 00	55	64	6	2	180 00	12 00
26	11	$1\frac{1}{4}$	14 00	65	66	6	2	200 00	15 00
28	10	$1\frac{3}{8}$	16 00	80	68	5	2	225 00	18 00
30	10	$1\frac{3}{8}$	18 00	90	70	5	2	255 00	21 00
32	10	$1\frac{1}{2}$	20 00	1 00	72	5	2	290 00	24 00
34	9	$1\frac{1}{2}$	22 50	1 20	74	5	2	330 00	27 00
36	9	$1\frac{1}{2}$	25 50	1 40	76	5	2	375 00	30 00

No extra charge for saws one gauge thicker than list.

Discount.....per cent.

BAND SAWS.

Width.	Usual Gauge.	Per Running Foot.	Width.	Usual Gauge.	Per Running Foot.
8 inches	14 to 16	\$2 50	12 inches.	14 to 16	\$5 00
9 "	14 to 16	3 50	13 "	13 to 15	6 00
10 "	14 to 16	3 50	14 "	13 to 15	7 00
11 "	14 to 16	4 20			

Discount.....per cent.

EDGER SAWS.

	16	18	20	22	24 in.
10 gauge.....	\$6 25	\$7 60	\$9 20	\$10 45	\$12 00
9 "	6 50	7 90	9 55	10 90	12 55
8 "	6 75	8 20	9 90	11 35	13 10

Discount..... per cent.

REVISED PRICE LIST OF RUBBER BELTING.

APRIL 22, 1895.

Intermediate Widths at Proportionate Prices. Heavy Double Belts Twice the Price of Single.

Price Per Running Foot.

1 inch..... \$0 12	6½ inch..... \$1 00	21 inch..... \$3 60
1¼ " 16	7 " 1 08	22 " 3 80
1½ " 20	8 " 1 24	24 " 4 20
1¾ " 24	9 " 1 40	25 " 4 40
2 " 28	10 " 1 56	26 " 4 60
2¼ " 32	11 " 1 72	28 " 5 00
2½ " 36	12 " 1 88	30 " 5 50
2¾ " 40	13 " 2 04	32 " 6 00
3 " 44	14 " 2 20	34 " 6 50
3½ " 52	15 " 2 40	36 " 7 00
4 " 60	16 " 2 60	40 " 7 80
4½ " 68	17 " 2 80	50 " 9 80
5 " 76	18 " 3 00	60 " 11 80
5½ " 84	19 " 3 20	72 " 14 40
6 " 92	20 " 3 40	

Discount.....per cent.

RUBBER BELTING.

Width, Inches.	2-Ply.	3-Ply.	4-Ply.	5-Ply.	6-Ply.	Width, Inches.	2-Ply.	3-Ply.	4-Ply.	5-Ply.	6-Ply.
1	\$0 07	\$0 11	\$0 15			15	1 16	1 38	1 66	2 08	2 49
1¼	09	13	17			16	1 25	1 50	1 78	2 23	2 67
1½	11	15	19			18	1 41	1 70	2 02	2 53	3 03
2	15	17	21			20	1 58	1 90	2 26	2 83	3 39
2½	18	22	26			22	1 76	2 12	2 52	3 15	3 78
3	22	26	31			24	1 96	2 36	2 80	3 50	4 20
3½	26	30	37			26	2 15	2 60	3 08	3 85	4 62
4	30	34	42			28	2 35	2 84	3 36	4 20	5 04
4½	33	39	47			30	2 55	3 10	3 64	4 55	5 46
5	36	43	52			32	2 75	3 35	3 92	4 90	5 88
6	43	52	62	\$0 78	\$0 93	34	2 95	3 60	4 20	5 25	6 30
7	51	60	73	92	1 10	36	3 15	3 85	4 48	5 60	6 72
8	59	70	84	1 05	1 26	38	3 35	4 10	4 76	5 95	7 14
9	67	80	95	1 19	1 43	40	3 65	4 35	5 04	6 30	7 56
10	75	90	1 07	1 34	1 61	42	3 75	4 60	5 32	6 65	7 98
11	83	1 00	1 18	1 48	1 77	44	3 95	4 85	5 60	7 00	8 40
12	91	1 08	1 30	1 63	1 95	46	4 15	5 10	5 88	7 35	8 82
13	1 00	1 18	1 42	1 78	2 13	48	4 35	5 35	6 16	7 70	9 24
14	1 08	1 28	1 54	1 93	2 31						

Discount.....per cent.

RAW HIDE LACE.

This lace leather is made from selected hides, and so prepared that it does not become hard or brittle by age.

Lace Leather in full Sides.....25 cents per square foot.

Discount.....per cent.

MACHINE CUT LACING.

¼ in. wide.....per 100 ft., \$1 00	½ in. wide.....per 100 ft., \$2 00
⅜ in. wide.....per 100 ft., 1 25	¾ in. wide.....per 100 ft., 2 75
½ in. wide.....per 100 ft., 1 50	1 in. wide.....per 100 ft., 3 25

Discount.....per cent.

IRON PULLEYS.

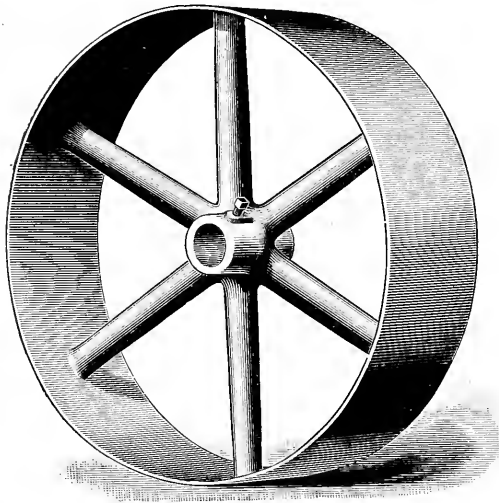

Bored, Turned and Balanced, with Set Screws or Key Seats.

Diameter in Inches.	Face in Inches.	Single Belt.	Double Belt.	Double Arm Double Belt.	Diameter in Inches.	Face in Inches.	Single Belt.	Double Belt.	Double Arm Double Belt.
6	3	\$1 95	\$2 55		8	3	\$2 25	\$2 95	
	4	2 10	2 80			4	2 45	3 20	
	5	2 30	3 10			5	2 70	3 55	
	6	2 55	3 45			6	2 95	3 95	
	7	2 80	3 80			7	3 20	4 35	
	8	3 05	4 15			8	3 45	4 75	
	9	3 30	4 50			9	3 80	5 20	
	10	3 60	4 85			10	4 15	5 70	
	11	3 90	5 25			11	4 50	6 15	
	12	4 20	5 65			12	4 80	6 60	
						14	5 60	7 75	
	7	3	2 10	2 75			9	3	2 40
4		2 25	3 00		4	2 60		3 45	
5		2 50	3 35		5	2 85		3 80	
6		2 75	3 70		6	3 15		4 25	
7		3 00	4 05		7	3 45		4 65	
8		3 25	4 45		8	3 75		5 10	
9		3 55	4 85		9	4 10		5 60	
10		3 85	5 25		10	4 45		6 10	
11		4 20	5 70		11	4 80		6 60	
12		4 50	6 10						

IRON PULLEYS—Continued.

Bored, Turned and Balanced, with Set Screws or Key Seats.

Diameter in Inches.	Face in Inches.	Single Belt,	Double Belt.	Double Arm Double Belt.	Diameter in Inches.	Face in Inches.	Single Belt.	Double Belt.	Double Arm Double Belt.
9	12	\$5 15	\$7 10		12	12	\$6 20	\$ 8 75	
	14	5 90	8 30			14	7 25	10 10	
						16	8 40	11 50	
10	3	2 55	3 35		13	18	9 60	13 00	
	4	2 75	3 70			3	3 05	3 95	
	5	3 05	4 10			4	3 35	4 45	
	6	3 40	4 55			5	3 70	5 00	
	7	3 70	5 00			6	4 10	5 60	
	8	4 05	5 50			7	4 45	6 20	
	9	4 40	6 00			8	4 90	6 80	
	10	4 75	6 55			9	5 25	7 45	
	11	5 10	7 10			10	5 70	8 10	
	12	5 50	7 65			11	6 15	8 75	
11	14	6 35	8 90		12	6 60	9 40		
	16	7 50	10 05		14	7 75	10 85		
	3	2 70	3 55		16	8 95	12 40		
	4	2 95	3 95		18	10 25	14 00		
	5	3 25	4 40		20	11 60	15 70		
	6	3 60	4 90		14	3	3 25	4 20	
	7	3 95	5 40			4	3 55	4 70	
	8	4 35	5 95			5	3 90	5 30	
	9	4 65	6 45			6	4 35	5 95	
	10	5 05	7 05			7	4 70	6 55	
11	5 40	7 65		8		5 20	7 20		
12	5 85	8 20		9		5 60	7 90		
14	6 80	9 50		10		6 10	8 60		
16	7 85	10 75		11		6 55	9 30		
12	3	2 85	3 75			12	7 05	10 00	
	4	3 15	4 20		14	8 25	11 60		
	5	3 50	4 70		16	9 50	13 25		
	6	3 85	5 25		18	10 90	15 00		
	7	4 20	5 80		20	12 40	16 80		
	8	4 55	6 35		15	3	3 40	4 40	
	9	4 95	6 95			4	3 75	5 00	
	10	5 35	7 55			5	4 15	5 65	
	11	5 75	8 15						

See additional prices for Split, Tight and Loose, Clamp and Flanged Pulleys, pages 168 and 169.

IRON PULLEYS—Continued.

Bored, Turned and Balanced, with Set Screws or Key Seats.

Diameter in Inches.	Face in Inches.	Single Belt.	Double Belt.	Double Arm Double Belt.	Diameter in Inches.	Face in Inches.	Single Belt.	Double Belt.	Double Arm Double Belt.
15	6	\$ 4 60	\$ 6 30		18	3	\$ 4 00	\$ 5 25	
	7	5 05	6 95			4	4 45	5 95	
	8	5 50	7 65			5	4 95	6 75	
	9	5 95	8 40			6	5 50	7 60	
	10	6 45	9 15			7	6 05	8 45	
	11	6 95	9 90			8	6 60	9 30	
	12	7 50	10 70			9	7 15	10 20	
	14	8 75	12 35			10	7 75	11 10	
	16	10 10	14 15			11	8 40	12 05	
	18	11 60	16 00			12	9 10	13 05	
	20	13 20	17 90			14	10 80	15 10	
16	3	3 60	4 70		16	12 60	17 20		
	4	3 95	5 30		18	14 50	19 40		
	5	4 40	6 00		20	16 50	21 70		
	6	4 90	6 70		19	3	4 25	5 55	
	7	5 35	7 45			4	4 70	6 30	
	8	5 85	8 20			5	5 25	7 15	
	9	6 30	9 00			6	5 85	8 10	
	10	6 85	9 90			7	6 45	9 00	
	11	7 40	10 60			8	7 05	9 95	
	12	8 00	11 45			9	7 65	10 95	
	14	9 40	13 25			10	8 30	11 95	
16	10 90	15 15		11		9 00	12 95		
18	12 55	17 15		12		9 75	14 00		
20	14 30	19 15		14		11 60	16 25		
17	3	3 80	5 00		16	13 55	18 50		
	4	4 20	5 65		18	15 55	20 90		
	5	4 70	6 40		20	17 70	23 35	\$26 85	
	6	5 20	7 15		22	20 70	25 80	29 65	
	7	5 70	7 90		24	23 40	28 50	32 77	
	8	6 20	8 75		26	26 00	31 30	36 00	
	9	6 75	9 60		28	28 65	34 20	39 35	
	10	7 30	10 45		30	31 30	37 30	42 90	
	11	7 90	11 30		20	3	4 45	5 85	
	12	8 50	12 25			4	4 95	6 65	
	14	10 05	14 15			5	5 55	7 55	
16	11 70	16 15		6		6 20	8 60		
18	13 50	18 25		7		6 85	9 60		
20	15 40	20 40		8		7 50	10 60		

IRON PULLEYS—Continued.

Bored, Turned and Balanced, with Set Screws or Key Seats.

Diameter in Inches.	Face in Inches.	Single Belt.	Double Belt.	Double Arm Double Belt.	Diameter in Inches.	Face in Inches.	Single Belt.	Double Belt.	Double Arm Double Belt.
20	9	\$ 8 15	\$11 70		22	10	\$ 9 95	\$14 50	
	10	8 85	12 80			11	10 80	15 75	
	11	9 60	13 90			12	11 70	17 00	
	12	10 40	15 00			14	14 05	19 70	
	14	12 40	17 40			16		22 40	
	16	14 50	19 80			18		25 40	
	18	16 60	22 40			20		28 30	\$32 55
	20	18 90	25 00	\$28 75		22		31 50	36 25
	22	21 95	27 70	31 85		24		34 80	40 00
	24	24 50	30 60	35 20		26		38 10	43 85
	26	27 25	33 55	38 60		28		41 60	47 85
	28	29 90	36 65	42 15		30		45 20	52 00
	30	32 60	40 95	47 10					
21	3	4 70	6 15		23	3	5 15	6 70	
	4	5 25	7 00			4	5 80	7 75	
	5	5 85	8 00			5	6 50	8 90	
	6	6 55	9 10			6	7 25	10 10	
	7	7 25	10 20			7	8 05	11 40	
	8	7 95	11 30			8	8 85	12 70	
	9	8 65	12 45			9	9 65	14 00	
	10	9 40	13 65			10	10 50	15 35	
	11	10 20	15 85			11	11 45	16 65	
	12	11 05	16 00			12	12 40	18 00	
	14	13 20	18 55			14	14 85	20 85	
	16	15 45	21 10			16		23 75	
	18	17 60	23 90			18		26 90	
	20	20 10	26 65	30 65		20		29 95	34 45
	22	23 10	29 60	34 05		22		33 45	38 45
24	25 70	32 70	37 60	24		36 90	42 45		
26	28 50	35 80	41 15	26		40 40	46 45		
28	31 30	39 10	44 95	28		44 10	50 75		
30	33 95	42 65	49 05	30		48 00	55 20		
22	3	4 90	6 45		24	3	5 40	7 00	
	4	5 55	7 40			4	6 10	8 15	
	5	6 15	8 45			5	6 85	9 35	
	6	6 90	9 60			6	7 65	10 65	
	7	7 65	10 80			7	8 45	12 00	
	8	8 40	12 00			8	9 30	13 40	
	9	9 15	13 20			9	10 20	14 80	
						10	11 10	16 20	

IRON PULLEYS—Continued.

Bored, Turned and Balanced, with Set Screws or Key Seats.

Diameter in Inches.	Face in Inches.	Single Belt.	Double Belt.	Double Arm Double Belt.	Diameter in Inches.	Face in Inches.	Single Belt.	Double Belt.	Double Arm Double Belt.
24	11	\$12 10	\$17 65		26	12	\$15 00	\$21 10	
	12	13 15	19 00			14	17 65	24 55	
	14	15 70	22 00			16	20 40	28 10	
	16		25 10			18	23 30	31 80	
	18		28 40			20	26 30	35 55	\$40 85
	20		31 70	\$36 45		22	29 40	39 75	45 70
	22		35 40	40 70		24	32 40	43 45	50 00
	24		39 00	44 95		26	35 40	47 40	54 50
	26		42 70	49 10		28	38 40	51 55	59 25
	28		46 60	53 60		30	41 45	55 80	63 85
	30		50 70	58 35					
25	3	5 70	7 40		27	3	6 35	8 25	
	4	6 50	8 65			4	7 30	9 60	
	5	7 25	9 90			5	8 15	11 00	
	6	8 10	11 25			6	9 05	12 50	
	7	8 95	12 70			7	10 00	14 10	
	8	9 90	14 15			8	11 10	15 65	
	9	10 85	15 60			9	12 20	17 25	
	10	11 85	17 10			10	13 35	18 90	
	11	12 90	18 60			11	14 60	20 60	
	12	14 05	20 05			12	15 90	22 20	
	14	16 65	23 25			14	18 60	25 80	
	16		26 60			16	21 45	29 60	
	18		30 10			18	24 50	33 55	
	20		33 60	38 65		20	27 55	37 50	43 10
22		37 45	43 05	22	30 70	41 70	47 95		
24		41 20	47 40	24	33 85	45 70	52 55		
26		45 05	51 80	26	36 95	50 75	58 35		
28		49 10	56 95	28	40 05	54 00	62 10		
30		53 25	61 10	30	43 10	58 40	67 20		
26	3	6 00	7 80		28	3	6 75	8 70	
	4	6 90	9 15			4	7 70	10 10	
	5	7 65	10 45			5	8 50	11 55	
	6	8 60	11 90			6	9 50	13 15	
	7	9 45	13 40			7	10 60	14 80	
	8	10 55	14 90			8	11 70	16 40	
	9	11 50	16 40			9	12 90	18 05	
	10	12 60	18 00			10	13 10	19 80	
	11	13 75	19 60			11	15 45	21 60	
						12	16 85	23 30	

IRON PULLEYS—Continued.

Bored, Turned and Balanced, with Set Screws or Key Seats.

Diameter in Inches.	Face in Inches.	Single Belt.	Double Belt.	Double Arm Double Belt.	Diameter in Inches.	Face in Inches.	Single Belt.	Double Belt.	Double Arm Double Belt.	
28	14	\$19 55	\$27 10		30	16	\$24 70	\$34 20		
	16	22 50	31 10			18	28 00	38 70		
	18	25 65	35 25			20	31 40	43 25	\$49 75	
	20	28 80	39 45	\$45 35		22	34 80	47 80	54 95	
	22	32 00	43 75	50 30		24	38 20	52 40	60 25	
	24	35 25	47 90	55 10		26	41 60	56 95	65 45	
	26	38 50	52 15	60 00		28	45 00	61 50	70 70	
	28	41 70	56 50	65 00		30	48 45	66 10	76 00	
	30	44 85	60 90	70 05						
	29	3	7 25	9 15			31	3	8 05	10 00
4		8 10	10 60		4	8 95		11 65		
5		9 00	12 15		5	9 95		13 40		
6		10 00	13 85		6	11 10		15 30		
7		11 15	15 50		7	12 35		17 10		
8		12 35	17 15		8	13 70		19 00		
9		13 60	18 85		9	15 10		21 50		
10		14 90	20 70		10	16 55		22 70		
11		16 30	22 60		11	18 05		24 70		
12		17 70	24 40		12	19 55		26 75		
14		20 55	28 40		14	22 60		31 15		
16		23 60	32 60		16	25 85		35 80		
18		26 80	37 00		18	29 25		40 50		
20		30 10	41 40	47 60	20	32 75		45 35	52 15	
22		33 40	45 80	52 65	22	36 10		49 90	57 40	
24		36 70	50 15	57 70	24	39 75		54 60	62 80	
26		40 05	54 00	62 80	26	43 25		59 30	68 20	
28		43 35	59 00	67 85	28	46 80		64 05	73 65	
30	46 55	63 45	73 00	30	50 35	68 00	78 20			
30	3	7 60	9 60		32	3	8 45	10 45		
	4	8 55	11 10			4	9 40	12 20		
	5	9 45	12 70			5	10 45	14 10		
	6	10 55	14 55			6	11 65	16 05		
	7	11 75	16 20			7	12 95	17 90		
	8	13 00	18 09			8	14 40	19 85		
	9	14 30	19 80			9	15 90	22 20		
	10	15 75	21 60			10	17 40	23 85		
	11	17 15	23 50			11	19 00	25 90		
	12	18 60	25 50			12	20 55	28 00		
	14	21 55	29 70			14	23 70	32 65		
						16	27 05	37 45		

IRON PULLEYS—Continued.

Bored, Turned and Balanced, with Set Screws or Key Seats.

Diameter in Inches.	Face in Inches.	Single Belt.	Double Belt.	Double Arm Double Belt.	Diameter in Inches.	Face in Inches.	Single Belt.	Double Belt.	Double Arm Double Belt.	
32	18	\$30 55	\$42 30		34	20	\$36 95	\$51 65	\$59 40	
	20	34 15	47 45	\$54 50		22	41 05	56 20	64 60	
	22	38 40	52 00	59 80		24	44 50	61 30	70 50	
	24	41 35	56 85	65 35		26	48 35	66 50	76 45	
	26	44 95	61 70	70 90		28	52 20	71 80	82 55	
	28	48 60	66 65	76 65		30	56 05	76 70	88 20	
	30	52 25	70 90	81 55						
33	3	8 90	11 00		35	3	9 90	12 30		
	4	9 90	12 80			4	10 90	14 10		
	5	11 00	14 80			5	12 10	16 20		
	6	12 25	16 80			6	13 50	18 40		
	7	13 60	18 80			7	15 00	20 60		
	8	15 05	20 80			8	16 60	22 75		
	9	16 70	22 85			9	18 25	24 90		
	10	18 25	24 95			10	19 95	27 20		
	11	19 90	27 10			11	21 75	29 50		
	12	21 50	29 25			12	23 50	31 80		
	14	24 80	34 10			14	27 00	37 05		
	16	28 25	39 05			16	30 65	42 35		
	18	31 80	44 10			18	34 40	47 70		
	20	35 50	49 55	56 95		20	38 30	53 75	61 80	
	22	39 70	54 10	62 30		22	42 35	58 30	66 95	
	24	42 90	59 05	67 90		24	46 10	63 65	73 20	
26	46 65	64 10	73 70	26	50 40	68 90	79 25			
28	50 40	69 20	79 60	28	54 00	74 40	85 55			
30	54 15	73 80	84 85	30	57 95	79 60	91 55			
34	3	9 40	11 60		36	3	10 40	12 75		
	4	10 40	13 50			4	11 40	14 75		
	5	11 50	15 50			5	12 65	16 95		
	6	12 90	17 60			6	14 10	19 20		
	7	14 35	19 70			7	15 70	21 45		
	8	15 85	21 75			8	17 35	23 70		
	9	17 55	23 85			9	19 10	26 00		
	10	19 10	26 10			10	20 85	28 30		
	11	20 85	28 30			11	22 70	30 70		
	12	22 50	30 50			12	24 50	33 10		
	14	25 90	35 60			14	28 10	38 55		
	16	29 45	40 70			16		44 00		
	18	33 10	45 90			18		49 50		
						20		55 90	64 30	

IRON PULLEYS—Continued.

Bored, Turned and Balanced, with Set Screws or Key Seats.

Diameter in Inches.	Face in Inches.	Single Belt.	Double Belt.	Double Arm Double Belt.	Diameter in Inches.	Face in Inches.	Single Belt.	Double Belt.	Double Arm Double Belt.
36	22		\$60 40	\$69 45	38	18	\$38 50	\$58 50	
	24		65 80	75 70		20	42 80	59 80	\$68 75
	26		71 30	82 00		22	47 10	65 05	74 80
	28		76 90	88 45		24	51 45	70 85	81 45
	30		82 55	94 95		26	55 80	76 75	88 25
37	4	\$11 95	15 50		28	60 20	82 75	95 15	
	5	13 25	17 95		30	64 55	88 75	102 05	
	6	14 85	20 10		32	68 95	94 80	109 00	
	7	16 80	22 45		34		100 85	115 95	
	8	18 20	24 80		36		106 95	123 00	
	9	20 00	27 15		38		113 10	130 05	
	10	21 80	29 55		40		119 20	137 10	
	11	23 70	32 00		40	4	13 70	17 75	
	12	25 55	34 50			5	15 30	19 60	
	14	29 30	40 10			6	17 10	22 90	
	16		47 45			7	18 90	25 45	
	18		51 50			8	20 80	28 10	
	20		57 85	66 50		9	22 75	30 70	
	22		62 70	72 10		10	24 75	33 30	
	24		68 30	78 55		11	26 80	36 05	
	26		74 00	85 10		12	28 80	38 75	
	28		79 80	91 75		14	32 90	44 80	
30		85 65	98 50	16	37 10	52 65			
32		91 50	105 20	18	41 35	57 50			
34		97 40	112 00	20	45 90	63 70	73 25		
36		103 30	118 80	22	50 55	69 70	80 15		
38		109 30	125 80	24	55 25	75 90	87 30		
40		115 25	132 50	26	59 90	82 20	94 55		
38	4	12 55	16 25		28	64 60	88 60	101 90	
	5	13 95	17 15		30	69 25	94 95	109 10	
	6	15 60	21 05		32	73 95	101 40	116 60	
	7	17 95	23 45		34		107 80	124 00	
	8	19 05	25 90		36		114 20	131 35	
	9	20 90	28 35		38		120 70	138 80	
	10	22 80	30 80		40		127 15	146 20	
	11	24 75	33 35		42	4	14 90	19 30	
	12	26 65	35 95			5	16 70	22 05	
	14	30 50	41 65			6	18 60	24 80	
	16	34 45	49 15			7	20 55	27 55	

IRON PULLEYS—Continued.

Bored, Turned and Balanced, with Set Screws or Key Seats.

Diameter in Inches.	Face in Inches.	Single Belt.	Double Belt.	Double Belt. Double Arm	Diameter in Inches.	Face in Inches.	Single Belt.	Double Belt.	Double Belt. Double Arm
42	8	\$22 55	\$30 30		44	38		\$137 20	\$157 80
	9	24 60	33 05			40		144 50	166 15
	10	26 70	35 85		46	4	\$17 65	22 75	
	11	28 85	38 75			5	19 70	25 80	
	12	31 00	41 60			6	21 85	28 90	
	14	35 30	47 95			7	24 05	32 00	
	16	39 70	54 40			8	26 35	35 15	
	18	44 20	61 00			9	28 60	38 35	
	20	49 00	67 60	\$77 75		10	30 95	41 55	
	22	54 00	74 30	85 45		11	33 40	44 90	
	24	59 00	81 00	93 15		12	35 80	48 20	
	26	64 00	87 70	100 85		14	40 60	55 30	
	28	69 00	92 45	108 60	16	45 70	62 60		
	30	74 00	101 20	116 40	18	50 90	70 00		
	32	79 00	108 00	124 20	20	56 30	77 40	89 00	
	34		114 75	131 95	22	62 00	84 80	97 50	
	36		121 50	139 70	24	67 60	92 30	106 15	
38		128 25	147 50	26	73 30	99 90	114 90		
40		135 09	155 28	28	79 00	107 55	123 70		
44	4	16 25	21 00		30	84 60	115 20	132 50	
	5	18 20	23 90		32	90 30	123 00	141 45	
	6	20 25	26 85		34		130 70	150 30	
	7	22 30	29 75		36		138 40	159 15	
	8	24 45	32 70		38		146 20	168 10	
	9	26 60	35 65		40		154 00	177 00	
	10	28 80	38 65		47	4	18 30	23 60	
	11	31 10	41 80			5	20 45	26 75	
	12	33 40	44 90			6	22 70	29 95	
	14	37 90	51 60			7	24 95	33 15	
	16	42 70	58 50			8	27 30	36 40	
	18	47 55	65 50			9	29 60	39 70	
	20	52 60	72 50	83 45		10	32 05	43 00	
	22	58 00	79 50	91 40		11	34 55	46 45	
	24	63 30	86 65	99 65		12	37 00	49 85	
	26	68 60	93 80	107 85		14	41 95	57 15	
	28	74 00	100 95	115 10	16	47 20	64 65		
	30	79 30	108 20	124 45	18	52 55	72 25		
	32	84 70	115 50	132 80	20	58 15	79 85	91 80	
34		122 70	141 10	22	64 00	87 45	100 55		
36		129 90	149 40						

IRON PULLEYS—Continued.

Bored, Turned and Balanced, with Set Screws or Key Seats.

Diameter in Inches.	Face in Inches.	Single Belt.	Double Belt.	Double Arm Double Belt.	Diameter in Inches.	Face in Inches.	Single Belt.	Double Belt.	Double Arm Double Belt.
	26		102 95	118 40		14	46 20	62 70	
	28		110 85	127 50		16	52 00	70 85	
	30		118 75	136 55		18	57 95	79 15	
	32		126 75	145 75		20	64 00	87 40	\$100 50
	34		134 70	154 90		22	70 40	95 70	110 50
	36		142 65	164 05		24	76 85	104 10	119 70
	38		150 70	173 30		26	83 20	112 60	129 50
	40		158 75	182 55		28	89 60	121 25	139 45
						30	96 00	129 90	149 40
48	4	19 00	24 50			32	102 50	138 60	158 80
	5	21 20	27 70			34		147 40	169 50
	6	23 50	31 00			36		156 10	179 50
	7	25 85	34 30			38		164 90	189 65
	8	28 25	37 65			40		173 80	199 85
	9	30 65	41 05						
	10	33 15	44 45		52	5	24 50	31 85	
	11	35 70	48 00			6	27 10	35 65	
	12	38 20	51 50			7	29 65	39 30	
	14	43 30	59 00			8	32 30	43 00	
	16	48 70	66 70			9	35 00	46 75	
	18	54 20	74 50			10	37 75	50 50	
	20	60 00	82 30	94 65		11	40 50	54 35	
	22	66 00	90 10	103 60		12	43 40	58 15	
	24	72 00	98 00	112 70		14	49 20	66 45	
	26	78 00	106 00	121 90		16	55 30	75 05	
	28	84 00	114 15	131 25		18	61 75	83 80	
	30	90 00	122 30	140 65		20	68 10	92 80	106 40
	32	96 00	130 50	150 05		22	74 80	101 30	116 50
	34		138 70	159 50		24	81 70	110 30	126 85
	36		146 90	168 95		26	88 40	119 30	137 20
	38		155 10	178 35		28	95 20	128 40	147 65
	40		163 30	187 80		30	102 05	137 65	158 20
						32	109 00	146 80	168 80
50	5	22 80	29 75			34		156 10	179 50
	6	25 30	33 30			36		165 30	190 10
	7	27 75	36 80			38		174 70	200 90
	8	30 25	40 30			40		184 10	211 70
	9	32 80	43 85						
	10	35 45	47 45		54	5	26 20	33 95	
	11	38 10	51 15			6	28 90	37 90	

IRON PULLEYS—Continued.

Bored, Turned and Balanced, with Set Screws or Key Seats.

Diameter in Inches.	Face in Inches.	Single Belt.	Double Belt.	Double Arm Double Belt.	Diameter in Inches.	Face in Inches.	Single Belt.	Double Belt.	Double Arm Double Belt.	
54	7	\$ 31 65	\$ 41 80		56	40		\$204 60	\$235 30	
	8	34 40	45 70							
	9	37 20	49 65			58	6	\$ 32 80	43 25	
	10	40 05	53 60				7	35 50	47 20	
	11	43 00	57 55				8	38 35	51 30	
	12	46 00	61 50				9	41 35	55 45	
	14	52 20	70 25				10	44 55	59 65	
	16	58 70	79 25				11	47 95	64 00	
	18	65 50	88 50				12	51 50	68 50	
	20	72 20	97 70	\$112 35			14	58 60	78 45	
	22	79 30	107 00	123 05			16	65 90	87 85	
	24	86 50	116 50	133 95			18	73 50	98 50	
	26	93 60	126 00	144 90			20	81 00	108 85	125 20
	28	100 85	135 60	155 95			22	89 05	119 25	137 15
	30	108 15	145 30	167 10			24	97 15	129 80	149 25
	32	115 50	155 00	178 25			26	105 20	140 40	161 45
	34		167 00	189 40			28	113 25	150 90	173 55
	36		174 50	200 65			30	121 50	161 70	185 95
	38		184 30	212 95			32	129 50	172 40	198 25
	40		194 20	223 35			34		182 90	210 35
56	6	30 85	40 65		36			193 50	222 50	
	7	33 55	44 50		38			204 30	234 95	
	8	36 30	48 50		40		215 00	247 25		
	9	39 25	52 55		60	6	34 80	46 00		
	10	42 25	56 60			7	37 50	50 00		
	11	45 45	60 75			8	40 35	54 10		
	12	48 75	65 00			9	43 45	58 35		
	14	55 40	74 35			10	46 85	62 75		
	16	62 30	83 55			11	50 45	67 30		
	18	69 50	93 50			12	54 20	72 00		
	20	76 60	103 25	119 75		14	61 80	82 55		
	22	84 15	113 10	130 05		16	69 60	92 15		
	24	91 80	123 15	141 60		18	77 50	103 50		
	26	99 40	133 20	153 20		20	85 50	114 45	131 60	
	28	107 05	143 20	164 70		22	93 95	125 45	144 25	
	30	114 80	153 50	176 50		24	102 50	136 50	157 00	
	32	122 50	163 70	188 25		26	111 00	147 65	169 80	
	34		173 80	199 85		28	119 50	158 80	182 60	
	36		184 00	211 60		30	128 20	169 90	195 40	
	38		194 30	223 45		32	137 00	181 00	208 15	

IRON PULLEYS—Continued.

Bored, Turned and Balanced, with Set Screws or Key Seats.

Diameter in Inches.	Face in Inches.	Single Belt.	Double Belt.	Double Arm Double Belt.	Diameter in Inches.	Face in Inches.	Single Belt.	Double Belt.	Double Arm Double Belt.
60	34		\$192 10	\$220 90	64	28	\$131 90	\$174 90	\$201 15
	36		203 20	233 60		30	141 85	187 10	215 20
	38		214 30	246 55		32	150 60	199 00	228 55
	40		225 40	259 20		34		211 50	243 25
62	6	\$ 36 70	48 30		66	36		223 80	257 35
	7	39 79	52 65			38		235 95	271 30
	8	42 85	57 10			40		248 25	285 30
	9	45 85	61 65			6	40 50	53 00	
	10	49 75	66 30		7	44 20	58 05		
	11	53 55	71 10		8	47 95	63 15		
	12	57 40	76 00		9	51 80	68 30		
	14	65 40	86 95		10	55 75	73 50		
	16	73 50	97 25		11	59 80	78 75		
	18	81 60	108 70		12	64 00	84 00		
	20	90 30	120 35	138 40	14	72 70	95 75		
	22	99 05	131 85	150 60	16	81 50	107 55		
	24	108 00	143 20	164 70	18	90 50	119 50		
	26	116 80	155 15	178 40	20	99 95	132 15	152 05	
	28	125 70	166 85	191 85	22	109 45	144 80	166 50	
	30	134 70	178 50	205 30	24	119 00	157 50	181 10	
32	143 80	190 00	218 50	26	128 60	170 20	195 70		
34		201 80	232 00	28	138 20	182 95	210 40		
36		213 50	245 50	30	147 85	195 70	225 05		
38		225 10	258 55	32	157 50	208 50	239 80		
40		236 80	272 30	34		221 30	254 50		
64	6	38 60	50 60		36		234 10	269 20	
	7	41 90	55 35		38		246 90	283 95	
	8	45 35	60 10		40		259 70	298 65	
	9	48 30	64 95		68	6	42 80	55 70	
	10	52 75	69 90			7	46 70	60 95	
	11	56 65	74 90			8	50 60	66 25	
	12	60 70	80 00			9	54 60	71 60	
	14	69 10	91 35			10	58 70	77 10	
	16	77 50	102 35			11	62 90	82 55	
	18	85 80	113 85			12	67 30	88 20	
	20	95 10	126 25	145 20		14	76 30	100 25	
	22	104 25	138 30	159 05		16	85 50	112 55	
	24	113 50	150 90	173 55		18	95 00	125 10	
	26	122 70	162 65	187 05		20	105 15	138 35	159 10

IRON PULLEYS—Continued.

Bored, Turned and Balanced, with Set Screws or Key Seats.

Diameter in Inches.	Face in Inches.	Single Belt.	Double Belt.	Double Arm Double Belt.	Diameter in Inches.	Face in Inches.	Single Belt.	Double Belt	Double Arm Double Belt.
68	22	\$115 10	\$151 50	\$174 25	72	16	\$ 93 70	\$122 75	
	24	124 90	165 00	189 75		18	104 00	136 50	
	26	134 90	178 05	204 75		20	115 70	150 60	\$173 20
	28	145 00	191 35	220 05		22	126 50	165 00	189 75
	30	155 15	204 60	235 30		24	136 50	179 50	207 40
	32	165 40	218 00	250 70		26	147 55	193 85	222 90
	34		231 30	266 00		28	158 65	208 20	239 45
	36		244 60	281 30		30	169 80	222 60	256 00
	38		258 00	296 70		32	181 00	237 00	272 55
	40		271 30	312 00		34		251 40	289 10
70	6	45 10	58 40		74	36		265 80	305 65
	7	49 20	63 85			38		280 20	322 25
	8	53 30	69 25			40		294 60	338 80
	9	57 40	75 00			8	58 90	75 75	
	10	61 70	80 70			9	63 40	81 90	
	11	66 05	86 40			10	68 00	88 50	
	12	70 60	92 40			11	72 75	94 80	
	14	80 05	104 85			12	77 60	101 00	
	16	89 60	117 65			14	87 65	114 45	
	18	99 50	130 80			16	98 00	128 25	
20	110 40	144 55	166 25	18	108 60	142 50			
22	120 80	158 25	182 00	20	120 50	157 10	180 65		
24	130 70	172 50	198 40	22	131 85	172 00	197 80		
26	141 20	185 95	213 85	24	143 00	187 00	215 05		
28	151 80	199 75	229 70	26	154 15	201 85	232 10		
30	162 45	213 60	245 65	28	165 75	216 75	249 25		
32	173 20	227 50	261 60	30	177 30	231 70	266 45		
34		241 30	277 50	32	189 00	246 60	283 60		
36		255 15	293 40	34		261 60	300 85		
38		269 10	309 45	36		276 50	317 95		
40		282 90	325 35	38		291 40	335 10		
72	6	47 50	61 00		76	40		306 40	352 30
	7	51 75	66 75			8	61 80	79 05	
	8	56 00	72 55			9	66 50	85 50	
	9	60 30	78 40			10	71 30	92 70	
	10	64 70	84 30			11	76 25	99 30	
	11	69 25	90 30			12	81 30	105 50	
	12	74 00	96 50			14	91 60	119 45	
	14	83 75	109 45			16	102 30	133 75	

IRON PULLEYS—Continued.

Bored, Turned and Balanced, with Set Screws or Key Seats.

Diameter in Inches.	Face in Inches.	Single Belt.	Double Belt.	Double Arm Double Belt.	Diameter in Inches.	Face in Inches.	Single Belt.	Double Belt.	Double Arm Double Belt.
76	18	\$113 30	\$148 45		80	20	\$136 00	\$177 10	\$203 65
	20	125 40	163 70	\$188 25		22	148 75	193 40	222 40
	22	137 25	179 00	205 85		24	161 50	210 00	241 50
	24	149 50	194 50	223 70		26	174 25	226 25	260 20
	26	160 75	209 85	241 30		28	187 15	242 85	279 30
	28	172 85	225 35	259 15		30	200 05	259 35	298 25
	30	184 85	240 80	276 90		32	213 00	276 00	317 40
	32	197 00	256 30	294 75		34		292 50	336 35
	34		271 80	312 55		36		309 10	355 45
	36		287 20	330 30		38		325 70	374 55
	38		302 60	348 00		40		342 20	383 55
	40		318 20	366 00					
	78	8	64 75	82 35			82	8	70 65
9		69 70	89 10		9	75 90		96 70	
10		74 70	95 90		10	81 30		103 85	
11		79 80	102 85		11	86 80		111 15	
12		85 00	110 00		12	92 30		118 65	
14		95 65	124 50		14	104 05		134 50	
16		106 65	139 25		16	116 20		150 65	
18		118 00	154 50		18	128 60		167 10	
20		130 30	170 30	195 85	20	141 70		183 90	211 48
22		142 65	186 10	214 00	22	154 85		200 70	230 80
24		155 00	202 00	232 30	24	168 00		218 00	250 70
26		167 45	217 95	250 65	26	181 15		234 65	269 85
28		179 95	233 95	269 05	28	194 45		251 75	289 50
30		192 45	249 95	287 45	30	207 65		268 80	309 10
32		205 00	266 00	305 90	32	221 00		286 00	328 90
34			282 00	324 30	34			303 10	348 55
36		298 00	342 70	36		320 20	368 20		
38		314 00	361 10	38		337 40	388 00		
40		330 00	379 50	40		354 50	407 65		
80	8	67 65	85 95		84	8	73 65	93 25	
	9	72 80	92 90			9	79 10	100 50	
	10	78 00	99 85			10	84 65	107 85	
	11	83 30	106 95			11	90 30	115 35	
	12	88 60	114 30			12	96 00	123 00	
	14	99 85	129 50			14	108 35	139 60	
	16	111 40	144 95			16	121 00	156 40	
	18	123 30	160 80			18	134 00	173 50	
						20	147 45	190 75	219 35

IRON PULLEYS—Continued.

Bored, Turned and Balanced, with Set Screws or Key Seats.

Diameter in Inches.	Face in Inches.	Single Belt.	Double Belt.	Double Arm Double Belt.	Diameter in Inches.	Face in Inches.	Single Belt.	Double Belt.	Double Arm Double Belt.		
8½	22	\$160 95	\$208 10	\$239 30	96	24		\$276 00	\$317 40		
	24	174 50	225 50	259 30		26	297 00	341 55			
	26	188 05	243 05	279 50		28	318 00	365 70			
	28	201 65	260 65	299 75		30	339 50	390 45			
	30	215 30	278 30	320 05		32	361 00	415 15			
	32	229 00	296 00	340 40		34	382 30	439 65			
	34		313 70	360 75		36	403 60	464 15			
	36		331 40	381 10		38	424 90	488 65			
	38		349 10	401 45		40	446 25	513 15			
	40		366 80	421 80							
	90	8		104 75			102	8		130 75	
		9		112 80				9	140 70		
10			121 00		10	150 75					
11			129 40		11	160 85					
12			138 00		12	171 00					
14			155 60		14	192 00					
16			173 40		16	213 40					
18			191 50		18	233 50					
20			210 70	242 30	20	256 25		294 70			
22			230 05	264 55	22	279 05		320 90			
24			249 50	286 95	24	302 00		347 30			
26			268 95	309 30	26	324 95		373 70			
28			288 45	331 70	28	347 95		400 15			
30			307 95	354 15	30	370 95		426 60			
32			327 50	376 65	32	394 00		453 10			
34			347 00	389 05	34	417 10		479 65			
36		366 50	421 50	36	440 20	506 25					
38		386 00	443 90	38	463 30	532 80					
40		405 50	466 30	40	486 40	559 35					
96	8		117 10		108	8		144 35			
	9		125 85			9	154 75				
	10		134 75			10	165 35				
	11		143 85			11	176 10				
	12		153 00			12	187 00				
	14		172 10			14	209 50				
	16		191 75			16	232 50				
	18		212 50			18	256 00				
	20		233 00	267 95		20	280 20	322 25			
	22		254 50	292 70		22	304 55	350 25			
						24	329 00	378 35			

IRON PULLEYS—Continued.

Bored, Turned and Balanced, with Set Screws or Key Seats.

Diameter in Inches.	Face in Inches.	Single Belt	Double Belt.	Double Arm Double Belt.	Diameter in Inches.	Face in Inches.	Single Belt.	Double Belt.	Double Arm Double Belt.
108	26		\$353 35	\$406 35	120	28		\$439 20	\$505 10
	28		377 80	434 45		30		467 60	537 75
	30		402 35	462 70		32		496 00	575 40
	32		427 00	491 05		34		524 40	603 10
	34		451 60	519 35		36		552 80	635 70
	36		476 20	547 65		38		581 20	668 40
	38		500 80	575 90		40		609 60	701 00
	40		525 40	604 20					
114	8		159 45		126	10		212 10	
	9		170 75			11		224 90	
	10		182 10			12		238 00	
	11		193 50			14		264 30	
	12		205 00			16		291 10	
	14		228 40			18		319 00	
	16		252 45			20		349 00	401 30
	18		277 00			22		380 30	437 80
	20		303 00	348 50	24		409 25	470 60	
	22		329 50	379 40	26		433 40	486 90	
	24		356 00	409 40	28		469 75	541 20	
	26		382 30	439 60	30		495 00	569 25	
	28		408 70	470 00	32		530 50	610 10	
	30		435 30	500 60	34		561 00	645 10	
	32		462 00	531 30	36		591 40	680 10	
	34		488 60	562 00	38		621 80	715 10	
36		515 20	592 50	40		652 30	750 10		
120	8		172 85		132	10		227 60	
	9		184 60			11		241 10	
	10		196 55			12		255 00	
	11		208 65			14		282 50	
	12		221 00			16		310 50	
	14		246 10			18		340 00	
	16		271 75			20		372 00	427 80
	18		298 00			22		404 00	464 60
	20		325 90	374 80	24		436 00	501 40	
	22		353 80	406 90	26		468 00	538 20	
24		382 50	439 90	28		500 30	575 30		
26		410 80	473 40	30		532 50	612 50		
				32		565 00	649 75		
				34		597 50	687 10		
				36		630 00	724 50		

IRON PULLEYS—Continued.

Bored, Turned and Balanced, with Set Screws or Key Seats.

Diameter in Inches.	Face in Inches.	Single Belt.	Double Belt.	Double Arm Double Belt.	Diameter in Inches.	Face in Inches.	Single Belt.	Double Belt.	Double Arm Double Belt.
132	38		\$662 50	\$761 90	138	40		\$736 50	\$847 00
	40		695 00	799 25					
138	10		243 60		144	10		259 50	
	11		257 60			11		274 10	
	12		272 00			12		289 00	
	14		300 25			14		318 00	
	16		329 75			16		349 00	
	18		361 00			18		382 00	
	20		395 00	454 25		20		418 00	480 70
	22		429 00	493 40		22		454 00	522 10
	24		463 00	533 50		24		490 00	563 50
	26		497 00	571 60		26		526 00	604 90
	28		531 20	610 90		28		562 00	646 30
	30		565 20	650 00		30		598 00	687 70
	32		599 50	689 40		32		634 00	729 10
	34		633 75	728 80		34		670 00	770 50
	36		668 00	768 20		36		706 00	811 90
	38		702 25	807 60		38		742 00	853 30
						40		778 00	894 70

Discount per cent.

FINISHED SPLIT PULLEYS.

Additional Price to be Added to List Prices of Common Pulleys.

Diameter in Inches.	Face in Inches.	Price.	Diameter in Inches.	Face in Inches.	Price.
6 to 10	2 to 3	\$ 1 30	19 to 23	3 to 4	\$ 2 65
	4 to 6	1 75		5 to 6	3 40
	7 to 10	2 15		7 to 10	4 05
	11 to 14	3 10		11 to 14	5 60
	15 to 20	4 00		15 to 20	7 30
11 to 18	2 to 3	1 50	24 to 30	21 to 30	11 00
	4 to 6	2 20		3 to 4	3 60
	7 to 10	2 85		5 to 6	4 40
	11 to 14	4 00		7 to 10	5 40
	15 to 20	5 25		11 to 14	7 25

Discount per cent.

FINISHED SPLIT PULLEYS—Continued.
Additional Price to be Added to List Prices of Common Pulleys.

Diameter in Inches.	Face in Inches.	Price.	Diameter in Inches.	Face in Inches.	Price.	
24 to 30	15 to 20	\$10 00	48 to 60	5 to 6	\$10 00	
	21 to 30	14 00		7 to 10	13 00	
32 to 36	3 to 4	4 50	60 to 84	11 to 14	18 00	
	5 to 6	5 60		15 to 20	25 00	
	7 to 10	6 75		21 to 30	34 50	
	11 to 14	9 80		31 to 40	48 00	
	15 to 20	13 00		85 to 120	7 to 10	20 00
	21 to 30	19 00			11 to 14	26 00
38 to 44	3 to 4	6 50	15 to 20		35 00	
	5 to 6	7 50	21 to 30	48 00		
	7 to 10	9 90	31 to 40	64 00		
	11 to 14	13 50	11 to 14	38 00		
	15 to 20	18 00	15 to 20	53 50		
	21 to 30	27 00	21 to 30	70 00		
	31 to 40	37 00	31 to 40	90 00		

Discount.....per cent.

Tight and Loose Pulleys and Finished Flange Pulleys
Additional Price to be Added to List Price of
Common Pulleys.

Diameter in Inches.	Price, Tight and Loose Pulleys, Per Pair.	Price, Double Flanged Pulleys, Each.	Diameter in Inches.	Price, Tight and Loose Pulleys, Per Pair.	Price, Double Flanged Pulleys, Each.
6 to 8	\$ 1 60	\$ 4 65	49 to 52	\$ 9 30	\$ 33 00
9 to 10	1 95	5 20	53 to 56	10 00	36 30
11 to 12	2 30	5 75	57 to 60	10 70	40 70
13 to 14	2 65	6 30	61 to 66	11 70	46 20
15 to 16	3 00	7 15	67 to 72	12 70	51 70
17 to 18	3 30	8 00	73 to 78	13 70	57 20
19 to 20	3 70	8 80	79 to 84	14 70	62 70
21 to 22	4 05	9 90	85 to 90	15 70	68 20
23 to 24	4 40	11 00	91 to 96	16 70	73 70
25 to 26	4 75	12 10	97 to 102	17 70	79 70
27 to 28	5 10	13 75	103 to 108	18 70	85 80
29 to 30	5 45	15 40	109 to 114	19 70	91 30
31 to 32	5 80	17 05	115 to 120	20 70	96 80
33 to 34	6 15	18 70	121 to 126	21 70	102 30
35 to 36	6 50	20 35	127 to 132	22 70	107 80
37 to 40	7 20	23 10	133 to 138	23 70	113 80
41 to 44	7 90	26 40	139 to 144	24 70	119 80
45 to 48	8 60	29 70			

Discount.....per cent.

For Pulleys with one flange add only one-half of price given above.
 For Pulleys with three flanges add one-half more than price given above.

CLAMP HUB PULLEYS.

Additional Price to be Added to List Price of Common Pulleys.

Diameter in Inches.	Face in Inches.	Price.	Diameter in Inches.	Face in Inches.	Price.	
8 to 10	2 to 3	\$ 0 80	38 to 46	3 to 4	\$ 3 90	
	4 to 6	1 05		5 to 6	4 50	
	7 to 10	1 30		7 to 10	5 95	
	11 to 14	1 85		11 to 14	8 10	
	15 to 20	2 40		15 to 20	10 80	
10 to 18	2 to 3	90		21 to 30	16 20	
	4 to 6	1 30		31 to 40	22 20	
	7 to 10	1 70		48 to 60	5 to 6	6 00
	11 to 14	2 40			7 to 10	7 80
	15 to 20	3 15			11 to 14	10 80
19 to 23	3 to 4	1 60	15 to 20		15 00	
	5 to 6	2 05	21 to 30		20 70	
	7 to 10	2 45	31 to 40	28 80		
	11 to 14	3 35	62 to 84	7 to 10	12 00	
	15 to 20	4 40		11 to 14	15 60	
21 to 30	6 60	15 to 20		21 00		
24 to 30	3 to 4	2 15		21 to 30	28 80	
	5 to 6	2 65		31 to 40	38 40	
	7 to 10	3 25	86 to 120	11 to 14	22 80	
	11 to 14	4 35		15 to 20	32 10	
	15 to 20	6 00		21 to 30	42 00	
21 to 30	8 40	31 to 40		54 00		
31 to 36	3 to 4	2 70		122 to 144	11 to 14	31 20
	5 to 6	3 35	15 to 20		43 20	
	7 to 10	4 05	21 to 30		57 60	
	11 to 14	5 90	31 to 40		76 40	
	15 to 20	7 80				
	21 to 30	11 40				

Discount.....per cent.

GILBERT WOOD SPLIT PULLEYS.

Special, Iron Center.

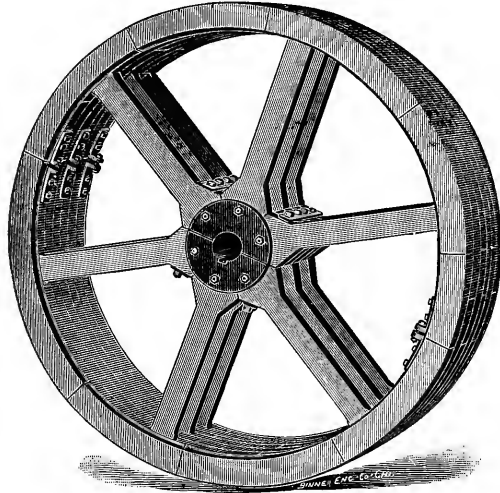

Style A. Special Pulley.

This is especially adapted for main driving pulley, and for other extremely severe work.

It is made entirely of selected, thoroughly seasoned maple, and finished with two coats of shellac varnish.

The rim is both nailed and glued.

The spokes are securely dovetailed into and glued and nailed in the rim; and each one is set in a line running direct from the center of the shaft to the rim—thus affording its utmost support.

It is fitted with a split, iron center which is turned on the outside, bored to exact size of shaft, and key-seated.

It cannot get out of round.

Every pulley is perfectly balanced.

Remember that a maple rim will transmit from 40 to 50 per cent. more power than an iron rim, with like tension of belt; and that this pulley can be run with perfect safety, at from two to three times the speed which would cause the best iron pulley to fly to pieces.

GILBERT WOOD SPLIT PULLEYS.

Special, Iron Center.

Diam. In.	Face, In.	Price.	Diam. In.	Face, In.	Price.	Diam. In.	Face, In.	Price.
36	6	\$ 24 30	44	6	\$ 32 50	52	6	\$ 42 30
	8	29 20		8	39 40		8	51 20
	10	34 20		10	46 40		10	60 20
	12	39 30		12	53 50		12	69 30
	14	44 50		14	60 70		14	78 50
	16	49 80		16	68 00		16	87 80
	18	55 20		18	75 40		18	97 20
	20	60 70		20	82 90		20	106 70
	22	66 30		22	90 50		22	116 30
24	72 00	24	98 20	24	126 00			
38	6	26 20	46	6	34 80	54	6	45 00
	8	31 60		8	42 20		8	54 40
	10	37 10		10	49 70		10	63 90
	12	42 70		12	57 30		12	73 50
	14	48 40		14	65 00		14	83 20
	16	54 20		16	72 80		16	93 00
	18	60 10		18	80 70		18	102 90
	20	66 10		20	88 70		20	112 90
	22	72 20		22	96 80		22	123 00
24	78 40	24	105 00	24	133 20			
40	6	28 20	48	6	37 20	56	6	47 80
	8	34 10		8	45 10		8	57 70
	10	40 10		10	53 10		10	67 70
	12	46 20		12	61 20		12	77 80
	14	52 40		14	69 40		14	88 00
	16	58 70		16	77 70		16	98 30
	18	65 10		18	86 10		18	108 70
	20	71 60		20	94 60		20	119 20
	22	78 20		22	103 20		22	129 80
24	84 90	24	111 90	24	140 50			
42	6	30 30	50	6	39 70	58	6	50 70
	8	36 70		8	48 10		8	61 10
	10	43 20		10	56 60		10	71 60
	12	49 80		12	65 20		12	82 20
	14	56 50		14	73 90		14	92 90
	16	63 30		16	82 70		16	103 70
	18	70 20		18	91 60		18	114 60
	20	77 20		20	100 60		20	125 60
	22	84 30		22	109 70		22	136 70
24	91 50	24	118 90	24	147 90			

GILBERT WOOD SPLIT PULLEYS—Continued.

With Iron Centers.

Diam. In.	Face, In.	Price.	Diam. In.	Face, In.	Price.	Diam. In.	Face, In.	Price.		
60	6	\$ 53 70	66	24	\$178 50	74	22	\$195 00		
	8	64 60						24	210 70	
	10	75 60	68	6	66 70	76	8	96 20		
	12	86 70			8		79 60		10	111 20
	14	97 90			10		92 60		12	126 30
	16	109 20			12		105 70		14	141 50
	18	120 60			14		118 90		16	156 80
	20	132 10			16		132 20		18	172 20
	22	143 70			18		145 60		20	187 70
	24	155 40			20		159 10		22	203 30
62	6	56 80	70	22	172 70	78	22	203 30		
	8	68 20			24		186 40		24	219 00
	10	79 70			6		70 20		8	100 60
	12	91 30			8		83 60		10	116 10
	14	103 00			10		97 10		12	131 70
	16	114 80			12		110 70		14	147 40
	18	126 70			14		124 40		16	163 20
	20	138 70			16		138 20		18	179 10
	22	150 80		18	152 10		20	195 10		
	24	163 00		20	166 10		22	211 20		
64	6	60 00	72	22	180 20	80	24	227 40		
	8	71 90			24		194 40		8	105 10
	10	83 90			6		73 80		10	121 10
	12	96 00			8		87 70		12	137 20
	14	108 20			10		101 70		14	153 40
	16	120 50			12		115 80		16	169 70
	18	132 90			14		130 00		18	186 10
	20	145 40			16		144 30		20	202 60
	22	158 00		18	158 70		22	219 20		
	24	170 70		20	173 20		24	235 90		
66	6	63 30	74	22	187 80	82	8	109 70		
	8	75 70			24		202 50		10	126 20
	10	88 20			8		91 90		12	142 80
	12	100 80			10		106 40		14	159 50
	14	113 50			12		121 00		16	176 30
	16	126 30			14		135 70		18	193 20
	18	139 20			16		150 50		20	210 20
	20	152 20			18		165 40		22	227 30
	22	165 30		20	180 40		24	244 50		

GILBERT WOOD SPLIT PULLEYS—Continued.

With Iron Centers.

Diam. In.	Face, In.	Price.	Diam. In.	Face, In.	Price.	Diam. In.	Face, In.	Price.	
84	8	\$114 40	92	12	\$172 30	100	14	\$218 90	
	10	131 40		14	191 50		16	240 20	
	12	148 50		16	210 80		18	261 60	
	14	165 70		18	230 20		20	283 10	
	16	183 00		20	249 70		22	304 70	
	18	200 40		22	269 30		24	326 40	
	20	217 90		24	289 00				
	22	235 50					102	8	161 20
	24	253 20						10	182 70
86	8	119 20	94	8	139 40		12	204 30	
	10	136 70		10	158 90		14	226 00	
	12	154 30		12	178 50		16	247 80	
	14	172 00		14	198 20		18	269 70	
	16	189 80		16	218 00		20	291 70	
	18	207 70		18	237 90		22	313 80	
	20	225 70		20	257 90		24	336 00	
	22	243 80		22	278 00				
	24	262 00		24	298 20	104	8	166 90	
88	8	124 10	96	8	144 70		10	188 90	
	10	142 10		10	164 70		12	211 00	
	12	160 20		12	184 80		14	233 20	
	14	178 40		14	205 00		16	255 50	
	16	196 70		16	225 30		18	277 90	
	18	215 10		18	245 70		20	300 40	
	20	233 60		20	266 20		22	323 00	
	22	252 20		22	286 80		24	345 70	
	24	270 90		24	307 50	106	8	172 70	
90	8	129 10	98	8	150 10		10	195 20	
	10	147 60		10	170 60		12	217 80	
	12	166 20		12	191 20		14	240 50	
	14	184 90		14	211 90		16	263 30	
	16	203 70		16	232 70		18	286 20	
	18	222 60		18	253 60		20	309 20	
	20	241 60		20	274 60		22	332 30	
	22	260 70		22	295 70		24	355 50	
	24	279 90		24	316 90	108	8	178 60	
92	8	134 20	100	8	155 60		10	201 60	
	10	153 20		10	176 60		12	224 70	
				12	197 70		14	247 90	
						16	271 20		

GILBERT WOOD SPLIT PULLEYS.—Continued.

With Iron Centers.

Diam In.	Face, In.	Price.	Diam. In.	Face, In.	Price.	Diam. In.	Face, In.	Price.
108	18	\$294 60	110	8	\$184 60	110	18	\$303 10
	20	318 10		10	208 10		20	327 10
	22	341 70		12	231 70		22	351 20
	24	365 40		14	255 40		24	375 40
				16	279 20			

N. B.—Gilbert Pulleys are made of sufficient width of face for width of belt listed.

Can furnish any diameter up to 20 feet or any intermediate sizes desired.

Discount.....per cent.

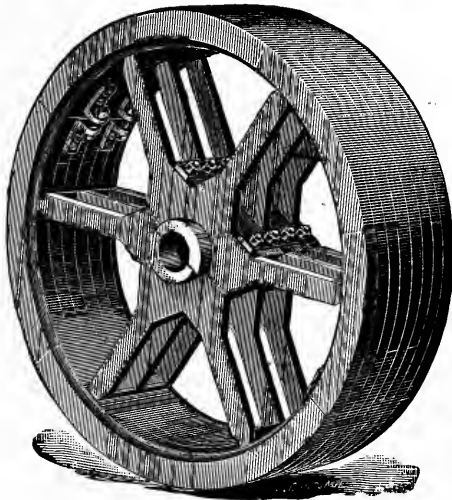

Style B.

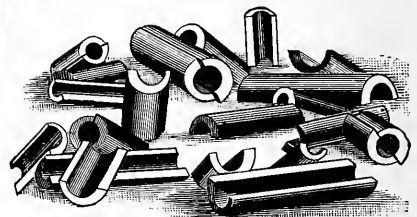

Bushings for Style B Pulleys.

Made entirely of thoroughly seasoned maple and finished with two coats of shellac varnish.

The rim is both nailed and glued.

Each spoke is securely dovetailed into and glued in the rim, and is set in a line running direct from the center of the shaft to the rim—thus affording its utmost support.

GILBERT WOOD SPLIT PULLEYS—Continued.**Style B.**

Every pulley is perfectly balanced.

These pulleys cannot get out of round.

They are furnished with the only Bushing that gives a perfect bearing on the entire circumference of the shaft.

By using different Bushings, the same Pulley may be made to fit different sizes of shafting.

Made in sizes from 12 inches in diameter up.

Pulleys from 12 to 14 inches in diameter are bored for a bushing $3\frac{1}{2}$ inches outside diameter, and will go on a shaft $2\frac{1}{2}$ inches or less in diameter.

Pulleys from 15 to 20 inches in diameter are bored for a bushing $3\frac{5}{8}$ inches outside diameter, and will go on a shaft 3 inches or less in diameter.

Pulleys from 21 to 47 inches in diameter are bored for a bushing $4\frac{1}{2}$ inches outside diameter, and will go on a shaft $3\frac{1}{2}$ inches or less in diameter.

Pulleys 48 inches and larger in diameter are bored for a bushing $4\frac{5}{8}$ inches outside diameter, and will go on a shaft 4 inches or less in diameter.

Pulleys may be bored to fit larger shafting, when so ordered.

We furnish a bushing with every pulley.

N. B.—Gilbert Pulleys are made of sufficient width of face for width of belt listed.

Diam. In.	Face. In.	Price.	Diam. In.	Face, In.	Price.	Diam. In.	Face, In.	Price.
12	3	\$2 75	16	4	\$ 3 65	20	4	\$ 4 40
	4	2 95		6	4 60		6	6 00
	6	3 50		8	5 40		8	7 10
	8	3 80		10	6 20		10	8 00
	10	4 30		12	7 00		12	9 50
	12	5 10		14	7 70		14	11 00
	14	5 90					16	12 50
14	3	2 95	18	3	3 65	22	4	4 90
	4	3 20		4	4 00		6	6 80
	6	4 05		6	5 10		8	8 00
	8	4 65		8	6 10		10	8 00
	10	5 30		10	7 10		12	9 35
	12	5 90		12	8 00		14	11 10
	14	6 50		14	9 00		16	13 00
16	3	3 25		16	10 65		14	13 00
				18	13 00		16	14 10

GILBERT WOOD SPLIT PULLEYS—Continued.

Style B.

Diam. In.	Face, In.	Price.	Diam. In.	Face, In.	Price.	Diam. In.	Face, In.	Price.
22	18	\$17 00	30	12	\$16 40	36	24	\$49 50
				14	20 90			
24	4	5 35		16	25 40	38	4	13 00
	6	7 25		18	29 90		6	14 00
	8	8 75		20	34 15		8	17 50
	10	10 40		22	38 15		10	20 50
	12	12 70		24	42 15		12	24 50
	14	15 00					14	28 50
	16	17 50	32	4	8 75		16	33 50
	18	20 00		6	10 25		18	38 50
	20	24 00		8	12 85		20	44 50
	22	29 00		10	15 00		22	49 00
	24	33 00		12	17 75		24	53 50
				14	22 75			
26	4	6 30		16	27 50	40	4	13 50
	6	7 85		18	32 00		6	16 00
	8	9 55		20	36 00		8	19 00
	10	11 40		22	40 00		10	22 25
	12	14 20		24	44 00		12	26 75
	14	17 50					14	30 75
	16	20 80	34	4	9 50		16	36 25
	18	24 10		6	11 50		18	41 25
	20	31 40		8	14 25		20	47 75
	22	35 40		10	17 00		22	52 25
	24	40 00		12	19 75		24	58 00
				14	24 25			
				16	30 00	42	4	15 00
				18	34 00		6	17 00
				20	38 00		8	21 00
				22	42 00		10	25 00
				24	46 00		12	29 00
							14	33 50
			36	4	10 50		16	38 50
				6	13 00		18	43 50
				8	16 00		20	50 50
				10	19 00		22	55 50
				12	22 00		24	62 00
				14	26 50			
				16	31 50	44	4	16 50
				18	36 50		6	19 50
				20	41 50		8	23 50
				22	45 50		10	27 50
30	4	8 00						
	6	9 40						
	8	11 40						
	10	13 20						

GILBERT WOOD SPLIT PULLEYS—Continued. Style B.

Diam. In.	Face, In.	Price.	Diam. In.	Face, In.	Price.	Dia m In.	Face, In.	Price.	
44	12	\$31 50	48	16	\$45 00	52	24	\$85 00	
	14	35 50		18	50 00		54	6	33 00
	16	40 50		20	61 00	8		37 00	
	18	45 50		22	71 00	10		41 00	
	20	53 50	24	80 00	12	45 00			
	22	58 50	50	6	27 00	14		49 00	
	24	67 00		8	31 00	16	55 00		
46	4	18 75		10	35 00	56	18	64 00	
	6	22 00	12	39 00	20		73 00		
	8	26 00	14	44 00	22		82 00		
	10	30 00	16	50 00	24		91 00		
	12	33 25	18	56 00	6		6	36 00	
	14	38 00	20	64 00			8	40 00	
	16	43 00	22	74 00			10	44 00	
	18	48 00	24	84 00			12	48 00	
	20	56 00	52	6			30 00	14	53 00
	22	64 00		8			34 00	16	59 00
	24	72 00		10			38 00	18	69 00
48	4	20 00		12	42 00	20	84 00		
	6	24 00	14	46 00	22	93 00			
	8	28 00	16	52 00	24	101 00			
	10	32 00	18	60 00					
	12	36 00	20	68 00					
	14	40 00	22	76 00					

N. B.—Gilbert Pulleys are made of sufficient width of face for width of belt listed.

Can furnish any diameter up to 12 feet or any intermediate sizes not herein listed.

Discount. per cent.

GILBERT WOOD SPLIT PULLEYS.

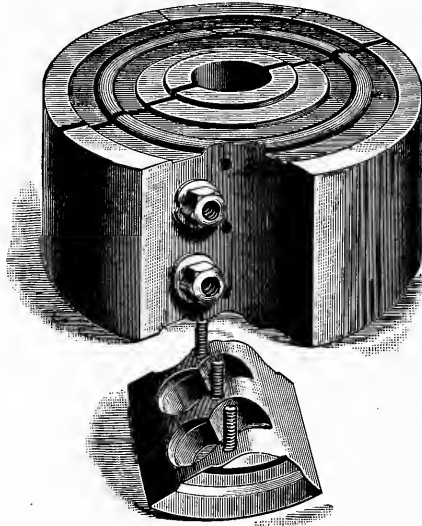

Style C.

Made entirely of thoroughly seasoned maple and finished with two coats of shellac varnish.

It is bolted together—the nuts on the clamping bolts being covered with sectional blocks which cannot get out of place.

When putting the pulley on a shaft, all its parts are accessible from the face.

By using different bushings the same pulley may be made to fit different sizes of shafting.

Made in sizes from three to fourteen inches in diameter.

Pulleys 3 or 4 inches in diameter are bored $1 \frac{11}{16}$ inches, and will go on a shaft $1 \frac{11}{16}$ inches or less in diameter.

Pulleys 5 inches or larger in diameter are bored 3 inches, and will go on a shaft 3 inches or less in diameter.

Pulleys may be bored to fit larger shafting, when so ordered.

We furnish a Bushing with every Pulley when size of shaft requires one.

GILBERT WOOD SPLIT PULLEYS—Continued.
Style C.

Diam. In.	Face, In.	Price.	Diam. In.	Face, In.	Price.	Diam. In.	Face, In.	Price.	Diam. In.	Face, In.	Price.	
3	2	\$1 75	7	2	\$2 15	9	13	\$4 30	12	7	\$3 65	
	3	1 85		3	2 25		14	4 50		8	3 80	
	4	1 95		4	2 35		10	2		2 45	9	4 05
	5	2 05		5	2 60			3		2 55	10	4 30
	6	2 20		6	2 80			4		2 70	11	4 70
	7	2 35		7	2 95			5		2 95	12	5 10
	8	2 50		8	3 10			6		3 15	13	5 50
	4	2		1 85	9			3 25		7	3 35	14
3		1 95	10	3 40	8	3 50		3	2 85			
4		2 05	11	3 60	9	3 70		4	3 05			
5		2 15	12	3 80	10	3 85	5	3 35				
6		2 35	8	2	2 25	11	4 05	6	3 70			
7		2 50		3	2 35	12	4 25	7	3 95			
8		2 65		4	2 45	13	4 45	8	4 20			
5		2		1 95	5	2 75	14	4 65	9	4 50		
	3	2 05		6	2 95	11	2	2 55	10	4 75		
	4	2 15		7	3 10		3	2 65	11	5 15		
	5	2 30		8	3 25		4	2 80	12	5 55		
	6	2 50		9	3 40		5	3 05	13	5 95		
	7	2 65	10	3 55	6		3 25	14	6 25			
	8	2 80	11	3 75	7		3 45	14	2	2 85		
	6	2	2 05	12	3 95		8		3 65	3	2 95	
3		2 15	9	2	2 35		9		3 85	4	3 20	
4		2 25		3	2 45	10	4 05		5	3 60		
5		2 45		4	2 60	11	4 25		6	4 05		
6		2 65		5	2 85	12	4 45		7	4 35		
7		2 80		6	3 05	13	4 65		8	4 65		
8		2 95		7	3 25	14	4 85		9	5 00		
9		3 10		8	3 40	12	2	2 65	10	5 30		
10	3 25	9		3 55	3		2 75	11	5 60			
11	3 45	10	3 70	4	2 95		12	5 90				
12	3 65	11	3 90	5	3 15		13	6 20				
		12	4 10	6	3 50		14	6 50				

BEVEL AND SPUR PAPER FRICTIONS.

PRICE LIST.

Diam. In.	Face, In.	Price.	Diam. In.	Face, In.	Price.	Diam. In.	Face, In.	Price.
6	4 $\frac{1}{2}$	\$6 50	10	7 $\frac{1}{2}$	\$13 50	13	7 $\frac{1}{2}$	\$18 00
	5 $\frac{1}{2}$	7 15		8 $\frac{1}{2}$	15 30		8 $\frac{1}{2}$	20 40
	6 $\frac{1}{2}$	8 45		9 $\frac{1}{2}$	17 10		9 $\frac{1}{2}$	22 80
	7 $\frac{1}{2}$	9 75		10 $\frac{1}{2}$	18 90		10 $\frac{1}{2}$	25 20
	8 $\frac{1}{2}$	11 05		11 $\frac{1}{2}$	20 70		11 $\frac{1}{2}$	27 60
	9 $\frac{1}{2}$	12 35		12 $\frac{1}{2}$	22 50		12 $\frac{1}{2}$	30 00
	10 $\frac{1}{2}$	13 65		13 $\frac{1}{2}$	24 30		13 $\frac{1}{2}$	32 40
				14 $\frac{1}{2}$	26 10		14 $\frac{1}{2}$	34 80
				16 $\frac{1}{2}$	29 70		16 $\frac{1}{2}$	39 60
				18 $\frac{1}{2}$			18 $\frac{1}{2}$	44 40
7	4 $\frac{1}{2}$	7 00	11	4 $\frac{1}{2}$	10 00	14	4 $\frac{1}{2}$	13 00
	5 $\frac{1}{2}$	7 70		5 $\frac{1}{2}$	11 00		5 $\frac{1}{2}$	14 30
	6 $\frac{1}{2}$	9 10		6 $\frac{1}{2}$	13 00		6 $\frac{1}{2}$	16 90
	7 $\frac{1}{2}$	10 50		7 $\frac{1}{2}$	15 00		7 $\frac{1}{2}$	19 50
	8 $\frac{1}{2}$	11 90		8 $\frac{1}{2}$	17 00		8 $\frac{1}{2}$	22 10
	9 $\frac{1}{2}$	13 30		9 $\frac{1}{2}$	19 00		9 $\frac{1}{2}$	24 70
	10 $\frac{1}{2}$	14 70		10 $\frac{1}{2}$	21 00		10 $\frac{1}{2}$	27 30
	11 $\frac{1}{2}$	16 10		11 $\frac{1}{2}$	23 00		11 $\frac{1}{2}$	29 90
8	4 $\frac{1}{2}$	7 50	12	12 $\frac{1}{2}$	25 00	15	12 $\frac{1}{2}$	32 50
	5 $\frac{1}{2}$	8 25		13 $\frac{1}{2}$	27 00		13 $\frac{1}{2}$	35 10
	6 $\frac{1}{2}$	9 75		14 $\frac{1}{2}$	29 00		14 $\frac{1}{2}$	37 70
	7 $\frac{1}{2}$	11 25		16 $\frac{1}{2}$	33 00		16 $\frac{1}{2}$	42 90
	8 $\frac{1}{2}$	12 75		18 $\frac{1}{2}$	37 00		18 $\frac{1}{2}$	48 10
	9 $\frac{1}{2}$	14 25		4 $\frac{1}{2}$	11 00		20 $\frac{1}{2}$	53 30
	10 $\frac{1}{2}$	15 75		5 $\frac{1}{2}$	12 10			
	11 $\frac{1}{2}$	17 25		6 $\frac{1}{2}$	14 30			
	12 $\frac{1}{2}$	18 75		7 $\frac{1}{2}$	16 50			
				8 $\frac{1}{2}$	18 70			
9	4 $\frac{1}{2}$	8 00	13	9 $\frac{1}{2}$	20 90	15	4 $\frac{1}{2}$	14 00
	5 $\frac{1}{2}$	8 80		10 $\frac{1}{2}$	23 10		5 $\frac{1}{2}$	15 40
	6 $\frac{1}{2}$	10 40		11 $\frac{1}{2}$	25 30		6 $\frac{1}{2}$	18 20
	7 $\frac{1}{2}$	12 00		12 $\frac{1}{2}$	27 50		7 $\frac{1}{2}$	21 00
	8 $\frac{1}{2}$	13 60		13 $\frac{1}{2}$	29 70		8 $\frac{1}{2}$	23 80
	9 $\frac{1}{2}$	15 20		14 $\frac{1}{2}$	32 00		9 $\frac{1}{2}$	26 60
	10 $\frac{1}{2}$	16 80		16 $\frac{1}{2}$	36 40		10 $\frac{1}{2}$	29 40
	11 $\frac{1}{2}$	18 40		18 $\frac{1}{2}$	40 80		11 $\frac{1}{2}$	32 20
	12 $\frac{1}{2}$	20 00		20 $\frac{1}{2}$	45 20		12 $\frac{1}{2}$	35 00
	13 $\frac{1}{2}$	21 60					13 $\frac{1}{2}$	37 80
	14 $\frac{1}{2}$	23 20					14 $\frac{1}{2}$	40 60
							16 $\frac{1}{2}$	45 80
10	4 $\frac{1}{2}$	9 00	13	4 $\frac{1}{2}$	12 00	15	18 $\frac{1}{2}$	51 00
	5 $\frac{1}{2}$	9 90		5 $\frac{1}{2}$	13 20		20 $\frac{1}{2}$	56 20
	6 $\frac{1}{2}$	11 70		6 $\frac{1}{2}$	15 60			

BEVEL AND SPUR PAPER FRICTIONS—Cont.
PRICE LIST.

Diam. In.	Face, In.	Price.	Diam. In.	Face, In.	Price.	Diam. In.	Face, In.	Price.	
16	4½	\$15 00	18	16½	\$56 10	22	6½	\$26 00	
	5½	16 50		18½	62 90		7½	30 00	
	6½	19 50		20½	69 70		8½	34 00	
	7½	22 50		22½	76 50		9½	38 00	
	8½	25 50	20	4½	18 00		10½	42 00	
	9½	28 50			19 80		11½	46 00	
	10½	31 50			23 40		12½	50 00	
	11½	34 50			27 00		13½	54 00	
	12½	37 50			30 60		14½	58 00	
	13½	40 50			34 20		16½	66 00	
	14½	43 50			37 80		18½	74 00	
	16½	49 50			41 40		20½	82 00	
18½	55 50	45 00	22½	90 00					
20½	61 50	48 60	24½	98 00					
17	4½	16 00	14½	52 20	24	4½	21 00		
	5½	17 60	16½	59 40		5½	23 10		
	6½	20 80	18½	66 60		6½	27 30		
	7½	24 00	20½	73 80		7½	31 50		
	8½	27 20	22½	81 00		8½	35 70		
	9½	30 40	24½	88 20		9½	39 90		
	10½	33 60	21	4½		19 00	10½	44 10	
	11½	36 80		5½		21 00	11½	48 30	
	12½	40 00		6½		24 70	12½	52 50	
	13½	43 20		7½		28 50	13½	56 70	
	14½	46 40		8½		32 30	14½	60 90	
	16½	52 80		9½		36 10	16½	69 30	
18½	59 20	10½		40 00	18½	77 70			
20½	65 60	11½		43 70	20½	86 10			
22½	72 00	12½	47 50	22½	94 50				
18	4½	17 00	13½	51 30	26	4½	22 00		
	5½	18 70	14½	55 10		5½	24 20		
	6½	22 10	16½	62 70		6½	28 60		
	7½	25 50	18½	70 30		7½	33 00		
	8½	28 90	20½	78 00		8½	37 40		
	9½	32 30	22½	85 50		9½	41 80		
	10½	35 70	24½	93 10		26	4½	22 00	
	11½	39 10	26½	100 00			5½	24 20	
	12½	42 50	22	4½			20 00	6½	28 60
	13½	45 90		5½			22 00	7½	33 00
	14½	49 30						8½	37 40
								9½	41 80

BEVEL AND SPUR PAPER FRICTIONS—Cont. PRICE LIST.

Diam. In.	Face, In.	Price.	Diam. In.	Face, In.	Price.	Diam. In.	Face, In.	Price.
26	10 $\frac{1}{2}$	\$ 46 20	30	20 $\frac{1}{2}$	\$ 98 40	36	11 $\frac{1}{2}$	\$ 62 10
	11 $\frac{1}{2}$	50 60		22 $\frac{1}{2}$	108 00		12 $\frac{1}{2}$	67 50
	12 $\frac{1}{2}$	55 00		24 $\frac{1}{2}$	117 60		13 $\frac{1}{2}$	72 90
	13 $\frac{1}{2}$	59 40		26 $\frac{1}{2}$	127 20		14 $\frac{1}{2}$	78 30
	14 $\frac{1}{2}$	63 80		28 $\frac{1}{2}$	136 80		16 $\frac{1}{2}$	89 10
	16 $\frac{1}{2}$	72 60		32	7 $\frac{1}{2}$		37 50	18 $\frac{1}{2}$
	18 $\frac{1}{2}$	81 40	8 $\frac{1}{2}$		42 50		20 $\frac{1}{2}$	110 80
	20 $\frac{1}{2}$	90 20	9 $\frac{1}{2}$		47 50		22 $\frac{1}{2}$	121 60
	22 $\frac{1}{2}$	99 00	10 $\frac{1}{2}$		52 50		24 $\frac{1}{2}$	132 40
	24 $\frac{1}{2}$	107 80	11 $\frac{1}{2}$		57 50		26 $\frac{1}{2}$	143 20
	26 $\frac{1}{2}$	116 60	12 $\frac{1}{2}$		62 50		28 $\frac{1}{2}$	154 00
	28 $\frac{1}{2}$	125 40	13 $\frac{1}{2}$	67 50	38		8 $\frac{1}{2}$	47 60
28	5 $\frac{1}{2}$	25 30	14 $\frac{1}{2}$	72 50		9 $\frac{1}{2}$	53 20	
	6 $\frac{1}{2}$	29 90	16 $\frac{1}{2}$	82 50		10 $\frac{1}{2}$	58 80	
	7 $\frac{1}{2}$	34 50	18 $\frac{1}{2}$	92 50		11 $\frac{1}{2}$	64 40	
	8 $\frac{1}{2}$	39 10	20 $\frac{1}{2}$	102 50		12 $\frac{1}{2}$	70 00	
	9 $\frac{1}{2}$	43 70	22 $\frac{1}{2}$	112 50		13 $\frac{1}{2}$	75 60	
	10 $\frac{1}{2}$	48 30	24 $\frac{1}{2}$	122 50		14 $\frac{1}{2}$	81 20	
	11 $\frac{1}{2}$	52 90	26 $\frac{1}{2}$	132 50		16 $\frac{1}{2}$	92 40	
	12 $\frac{1}{2}$	57 50	28 $\frac{1}{2}$	142 50		18 $\frac{1}{2}$	103 60	
	13 $\frac{1}{2}$	62 10	34	7 $\frac{1}{2}$		39 00	20 $\frac{1}{2}$	114 80
	14 $\frac{1}{2}$	66 70		8 $\frac{1}{2}$		44 20	22 $\frac{1}{2}$	126 00
	16 $\frac{1}{2}$	75 90		9 $\frac{1}{2}$		49 40	24 $\frac{1}{2}$	137 20
	18 $\frac{1}{2}$	85 10		10 $\frac{1}{2}$	54 60	26 $\frac{1}{2}$	148 40	
20 $\frac{1}{2}$	94 30	11 $\frac{1}{2}$		59 80	28 $\frac{1}{2}$	159 60		
22 $\frac{1}{2}$	103 50	12 $\frac{1}{2}$		65 00	40	8 $\frac{1}{2}$	51 00	
24 $\frac{1}{2}$	112 70	13 $\frac{1}{2}$	70 20	9 $\frac{1}{2}$		57 00		
26 $\frac{1}{2}$	121 90	14 $\frac{1}{2}$	75 40	10 $\frac{1}{2}$		63 00		
28 $\frac{1}{2}$	131 10	16 $\frac{1}{2}$	85 80	11 $\frac{1}{2}$		69 00		
30	6 $\frac{1}{2}$	31 20	18 $\frac{1}{2}$	96 20		12 $\frac{1}{2}$	75 00	
	7 $\frac{1}{2}$	36 00	20 $\frac{1}{2}$	106 60		13 $\frac{1}{2}$	81 00	
	8 $\frac{1}{2}$	40 80	22 $\frac{1}{2}$	117 00		14 $\frac{1}{2}$	87 00	
	9 $\frac{1}{2}$	45 60	24 $\frac{1}{2}$	127 40		16 $\frac{1}{2}$	99 00	
	10 $\frac{1}{2}$	50 40	26 $\frac{1}{2}$	137 80		18 $\frac{1}{2}$	111 00	
	11 $\frac{1}{2}$	55 20	28 $\frac{1}{2}$	148 20		20 $\frac{1}{2}$	123 00	
	12 $\frac{1}{2}$	60 00	36	7 $\frac{1}{2}$		40 50	22 $\frac{1}{2}$	135 00
	13 $\frac{1}{2}$	64 80		8 $\frac{1}{2}$		45 90	24 $\frac{1}{2}$	147 00
	14 $\frac{1}{2}$	69 00		9 $\frac{1}{2}$	51 30	26 $\frac{1}{2}$	159 00	
	16 $\frac{1}{2}$	79 20		10 $\frac{1}{2}$	56 70	28 $\frac{1}{2}$	171 00	
	18 $\frac{1}{2}$	88 80		42	10 $\frac{1}{2}$	56 70	8 $\frac{1}{2}$	59 50

BEVEL AND SPUR PAPER FRICTIONS—Cont.

PRICE LIST.

Diam. In.	Face, In.	Price	Diam. In.	Face, In.	Price.	Diam. In.	Face, In.	Price.	
42	8½	\$ 59 50	44	13½	\$108 00	46	22½	\$202 50	
	9½	66 50		14½	116 00		24½	220 50	
	10½	73 50		16½	132 00		26½	238 50	
	11½	80 50		18½	148 00		28½	256 50	
	12½	87 50		20½	164 00		48	9½	95 00
	13½	94 50		22½	180 00			10½	105 00
	14½	101 50		24½	196 00			11½	115 00
	16½	115 50		26½	212 00			12½	125 00
	18½	129 50		28½	228 00	13½		135 00	
	20½	143 50		46	9½	85 50		14½	145 00
	22½	157 50			10½	94 50	16½	165 00	
	24½	171 50			11½	103 50	18½	185 00	
	26½	185 50			12½	112 50	20½	200 00	
	28½	200 00			13½	121 50	22½	220 00	
44	9½	76 00	14½		130 50	24½	240 00		
	10½	84 00	16½	148 50	26½	260 00			
	11½	92 00	18½	166 50	28½	280 00			
	12½	100 00	20½	184 50					

For price of iron spur or bevel frictions add 50 per cent. to list price of double belt Iron Pulleys and take per cent. discount.

Discount. per cent.

THE SHAW FRICTION CLUTCH PULLEY.

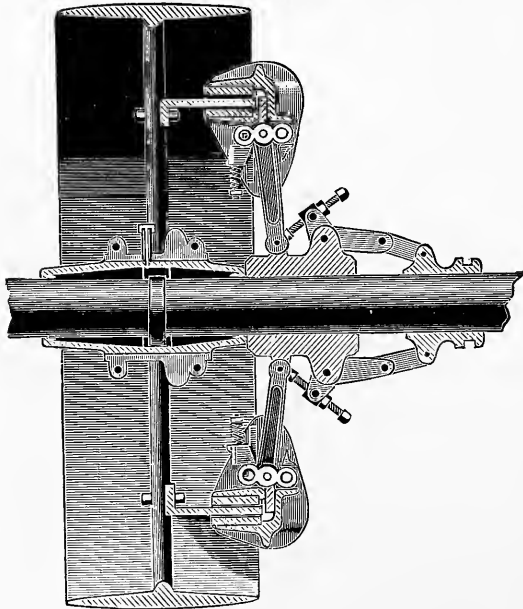
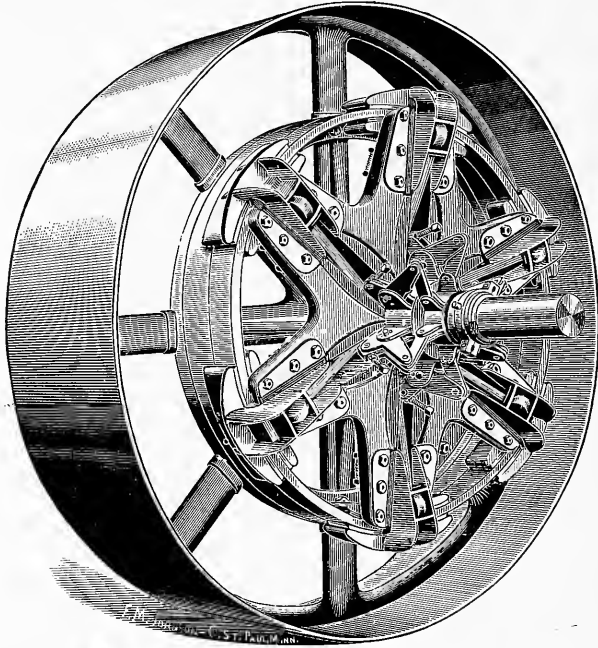

SHAW'S FRICTION CLUTCH PULLEYS.

Size of Pulley.	Price.	Largest Bore of Pulley with Clutch.	Space Required on Shaft.		H. Power 100 Rev.	Shipping Weight.
			Pulley.	Clutch.		
18x 4	\$34 90	4	7 $\frac{1}{2}$	11 $\frac{1}{2}$	5 40	195
18x 5	36 25	4	8 $\frac{1}{2}$	11 $\frac{1}{2}$	6 75	205
18x 6	37 75	4	9 $\frac{1}{2}$	11 $\frac{1}{2}$	8 10	215
18x 7	39 20	4	10 $\frac{1}{2}$	11 $\frac{1}{2}$	9 45	225
18x 8	40 80	4	11 $\frac{1}{2}$	11 $\frac{1}{2}$	10 80	235
19x 4	36 30	4	7 $\frac{1}{2}$	11 $\frac{1}{2}$	5 84	205
19x 5	37 75	4	8 $\frac{1}{2}$	11 $\frac{1}{2}$	7 30	215
19x 6	39 30	4	9 $\frac{1}{2}$	11 $\frac{1}{2}$	8 76	220
19x 7	40 80	4	10 $\frac{1}{2}$	11 $\frac{1}{2}$	10 22	230
19x 8	42 45	4	11 $\frac{1}{2}$	11 $\frac{1}{2}$	11 68	240
19x 9	44 15	4	12 $\frac{1}{2}$	11 $\frac{1}{2}$	13 14	250
20x 4	37 75	4 $\frac{1}{2}$	8	12 $\frac{1}{2}$	6 00	265
20x 5	39 30	4 $\frac{1}{2}$	9	12 $\frac{1}{2}$	7 50	275
20x 6	40 80	4 $\frac{1}{2}$	10 $\frac{1}{2}$	12 $\frac{1}{2}$	9 00	285
20x 7	42 45	4 $\frac{1}{2}$	11	12 $\frac{1}{2}$	10 50	295
20x 8	44 15	4 $\frac{1}{2}$	12	12 $\frac{1}{2}$	12 00	305
20x 9	45 95	4 $\frac{1}{2}$	13	12 $\frac{1}{2}$	13 50	315
20x10	47 75	4 $\frac{1}{2}$	14	12 $\frac{1}{2}$	15 00	325
20x11	49 60	4 $\frac{1}{2}$	15	12 $\frac{1}{2}$	16 60	335
20x12	51 55	4 $\frac{1}{2}$	16	12 $\frac{1}{2}$	18 30	345
21x 4	39 30	4	7 $\frac{1}{2}$	11 $\frac{1}{2}$	6 48	230
21x 5	40 80	4	8 $\frac{1}{2}$	11 $\frac{1}{2}$	8 10	240
21x 6	42 45	4	9 $\frac{1}{2}$	11 $\frac{1}{2}$	9 70	250
21x 7	44 15	4	10 $\frac{1}{2}$	11 $\frac{1}{2}$	11 34	260
21x 8	45 95	4	11 $\frac{1}{2}$	11 $\frac{1}{2}$	12 96	270
21x 9	47 75	4	12 $\frac{1}{2}$	11 $\frac{1}{2}$	14 58	280
21x10	49 60	4	13 $\frac{1}{2}$	11 $\frac{1}{2}$	16 20	290
21x11	51 65	4	13 $\frac{1}{2}$	11 $\frac{1}{2}$	17 82	300
21x12	53 70	4	15 $\frac{1}{2}$	11 $\frac{1}{2}$	19 44	310
22x 4	41 05	5	8 $\frac{1}{2}$	13	6 96	255
22x 5	42 75	5	9 $\frac{1}{2}$	13	8 70	265
22x 6	44 50	5	10 $\frac{1}{2}$	13	10 41	275
22x 7	46 35	5	11 $\frac{1}{2}$	13	12 18	285
22x 8	47 20	5	12 $\frac{1}{2}$	13	13 92	365
22x 9	50 35	5	13 $\frac{1}{2}$	13	15 66	375
22x10	52 40	5	14 $\frac{1}{2}$	13	17 40	385
22x11	54 60	5	15 $\frac{1}{2}$	13	19 14	395
22x12	56 90	5	16 $\frac{1}{2}$	13	20 88	405

SHAW'S FRICTION CLUTCH PULLEYS—Cont.

Size of Pulley.	Price.	Largest Bore of Pulley with Clutch.	Space Required on Shaft.		H. Power 100 Rev.	Shipping Weight.
			Pulley.	Clutch.		
23x 4	\$42 75	4	8	11½	7 32	230
23x 5	41 50	4	8	11½	9 15	240
23x 6	46 35	4	8	11½	10 98	250
23x 7	47 20	4	8	11½	12 81	260
23x 8	50 35	4	9	11½	14 64	270
23x 9	52 40	4	9	11½	16 47	280
23x10	54 60	4	10	11½	18 30	290
23x11	56 90	5½	15¾	15	20 13	430
23x12	59 25	5½	16¾	15	21 96	440
24x 4	41 50	4	8	11½	7 68	240
24x 5	46 35	4	8	11½	9 60	250
24x 6	47 20	4	8	11½	11 52	260
24x 7	50 35	4	8	11½	13 44	270
24x 8	52 40	4	8	11½	15 36	280
24x 9	54 60	4	9	11½	17 28	290
24x10	56 90	4	10	11½	19 20	300
24x11	59 25	5½	15¾	15	21 12	440
24x12	61 65	5½	16¾	15	23 04	450
24x13	64 25	5½	17¾	15	24 70	460
24x14	66 95	5½	17¾	15	26 60	470
25x 4	46 35	4	8	11½	7 92	250
25x 5	48 30	4	8	11½	9 90	260
25x 6	50 35	4	8	11½	11 88	270
25x 7	52 40	4	8	11½	13 86	280
25x 8	54 60	4	9	11½	15 84	290
25x 9	56 90	4	9	11½	17 82	300
25x10	59 25	4½	10	12½	19 80	340
25x11	61 65	4½	11	12½	21 78	350
25x12	64 25	4½	12	12½	23 76	360
25x13	66 95	4½	13	12½	25 74	370
25x14	69 70	4½	14	12½	27 72	380
26x 4	48 30	4	8	11½	8 24	260
26x 5	50 70	4	8	11½	10 30	275
26x 6	53 25	4	8	11½	12 36	290
26x 7	55 90	4	8	11½	14 42	305
26x 8	58 70	4	9	11½	16 48	320
26x 9	61 60	4	9	11½	18 54	335
26x10	64 70	4½	10	12½	20 60	380
26x11	67 95	4½	11	12½	22 66	395

SHAW'S FRICTION CLUTCH PULLEYS—Cont.

Size of Pulley.	Price.	Largest Bore of Pulley with Clutch.	Space Required on Shaft.		H. Power 100 Rev.	Shipping Weight.
			Pulley.	Clutch.		
26x12	\$71 30	4½	12	12½	21 72	415
26x13	74 85	4½	12½	12½	26 78	340
26x14	78 60	5	17½	13	28 84	500
26x15	82 55	5	18¼	13	30 90	515
26x16	86 70	5	19½	13	32 96	530
27x 5	51 95	4	8	11½	10 70	285
27x 6	54 55	4	9	11½	12 85	300
27x 7	57 30	4	9	11½	14 98	315
27x 8	60 10	4	9	11½	17 12	330
27x 9	63 10	4	10	11½	19 26	345
27x10	66 30	4½	10	12½	21 40	390
27x11	69 55	4½	11	12½	23 55	404
27x12	73 00	4½	12	12½	25 66	420
27x13	76 70	5	13	13	27 82	490
27x14	80 50	5	14	13	29 96	505
27x15	84 55	5	15	13	32 10	520
27x16	88 75	5	16	13	34 24	535
28x 5	53 65	4	8	11½	11 10	295
28x 6	56 35	4	9	11½	13 32	310
28x 7	59 15	4	9	11½	15 54	325
28x 8	62 05	4	9	11½	17 76	340
28x 9	65 15	4	10	11½	19 95	355
28x10	68 40	4½	10	12½	22 20	405
28x11	71 85	4½	10	12½	24 42	415
28x12	75 40	4½	12	12½	26 64	425
28x13	79 15	5	13	13	28 86	495
28x14	83 10	5	14	13	31 08	505
28x15	87 25	5	15	13	33 30	515
28x16	91 65	5½	18	15	35 52	595
28x17	96 25	5½	19	15	37 74	605
28x18	101 05	5½	20	15	39 96	615
29x 5	55 30	4	9	11½	11 50	305
29x 6	58 10	4	9	11½	13 80	320
29x 7	61 00	4	9	11½	16 10	335
29x 8	64 05	4	9	11½	18 40	350
29x 9	67 20	4	10	11½	20 70	365
29x10	70 55	4½	10	12½	23 00	415
29x11	74 10	4½	11	12½	25 30	430
29x12	77 80	4½	12	12½	27 60	445

SHAW'S FRICTION CLUTCH PULLEYS—Cont.

Size of Pulley.	Price.	Largest Bore of Pulley with Clutch.	Space Required on Shaft.		H Power 100 Rev.	Shipping Weight.
			Pulley.	Clutch.		
29x13	\$ 81 65	5	13	13	29 90	515
29x14	85 75	5	14	13	32 20	530
29x15	90 05	5	15	13	34 50	545
29x16	94 55	5½	16	15	36 80	625
29x17	99 25	5½	17	15	39 10	640
29x18	104 15	5½	18	15	41 40	655
30x 5	57 10	4	9	11½	11 90	315
30x 6	59 95	4	9	11½	14 24	330
30x 7	62 90	4½	9	12½	16 66	380
30x 8	66 05	4½	10	12½	19 04	395
30x 9	69 40	4½	10	12½	21 42	410
30x10	72 85	5	11	13	23 80	480
30x11	76 50	5	12	13	26 18	495
30x12	81 30	5	12	13	28 56	510
30x13	84 30	5½	13	15	30 94	590
30x14	88 45	5½	14	15	33 32	605
30x15	92 90	5½	15	15	35 70	620
30x16	97 50	5½	16	15	38 08	635
30x17	102 40	5½	17	15	40 46	650
30x18	107 55	5½	18	15	42 84	665
31x 5	58 90	4	9	11½	12 25	325
31x 6	61 85	4	9	11½	14 70	340
31x 7	64 95	4½	9	12½	17 15	390
31x 8	68 20	4½	10	12½	19 60	405
31x 9	71 55	4½	10	12½	22 05	420
31x10	75 15	5	11	13	24 50	490
31x11	78 90	5	12	13	26 95	505
31x12	82 85	5	13	13	29 40	520
31x13	87 05	5½	13	15	31 85	600
31x14	91 40	5½	14	15	34 30	615
31x15	95 90	5½	15	15	36 75	630
31x16	100 70	5½	16	15	39 20	645
31x17	105 75	5½	18	15	41 65	660
31x18	111 05	5½	18	15	44 10	675
32x 5	60 75	4	9	11½	12 65	335
32x 6	63 75	4	9	11½	15 18	350
32x 7	67 00	4½	10	12½	17 71	400
32x 8	70 30	4½	10	12½	20 24	415
32x 9	73 80	4½	10	12½	22 77	430

SHAW'S FRICTION CLUTCH PULLEYS—Cont.

Size of Pulley.	Price.	Largest Bore of Pulley with Clutch.	Space Required on Shaft.		H. Power 100 Rev.	Shipping Weight.
			Pulley.	Clutch.		
32x10	\$ 77 50	5	11	13	25 30	500
32x11	81 35	5	12	13	27 83	515
32x12	85 45	5	13	13	30 36	530
32x13	89 70	5½	13	15	32 89	610
32x14	94 15	5½	14	15	35 42	625
32x15	98 85	5½	15	15	37 95	640
32x16	103 80	6	16	16	40 48	735
32x17	109 00	6	18	16	43 01	750
32x18	114 45	6	18	16	45 54	765
33x 5	62 70	4	9	11½	13 05	345
33x 6	65 80	4	9	11½	15 66	360
33x 7	69 10	4½	10	12½	18 27	410
33x 8	72 55	4½	10	12½	20 88	425
33x 9	76 15	4½	11	12½	23 49	440
33x10	80 00	5	12	13	26 10	510
33x11	84 10	5	12	13	28 71	525
33x12	88 30	5	13	13	31 42	540
33x13	92 70	5½	14	15	33 93	620
33x14	97 35	5½	14	15	36 54	635
33x15	101 15	5½	15	15	39 15	650
33x16	106 25	6	16	16	41 76	745
33x17	111 15	6	18	16	44 37	760
33x18	117 10	6	18	16	46 98	775
34x 5	64 60	4	10	11½	13 45	350
34x 6	67 85	4½	10	12½	16 14	415
34x 7	71 25	4½	10	12½	18 85	420
34x 8	74 75	4½	10	12½	21 52	435
34x 9	78 50	5	11	13	24 21	505
34x10	82 45	5	12	13	26 90	520
34x11	86 15	5	12	13	29 59	535
34x12	90 90	5½	13	15	32 28	615
34x13	95 45	5½	14	15	34 97	630
34x14	100 20	5½	15	15	37 66	645
34x15	105 20	5½	16	15	40 35	660
34x16	110 45	6	16	16	43 04	775
34x17	116 00	6	18	16	45 73	770
34x18	121 80	6	18	16	48 42	780
35x 5	66 65	4	10	11½	13 85	365
35x 6	70 00	4½	10	12½	16 62	415
35x 7	73 50	4½	10	12½	19 39	430

SHAW'S FRICTION CLUTCH PULLEYS—Cont.

Size of Pulley.	Price.	Largest Bore of Pulley with Clutch.	Space Required on Shaft.		H. Power 100 Rev.	Shipping Weight.
			Pulley.	Clutch.		
35x 8	\$ 77 10	4 $\frac{1}{2}$	10	12 $\frac{1}{2}$	22 16	445
35x 9	80 95	5	11	13	24 93	515
35x10	85 00	5	12	13	27 70	530
35x11	89 25	5	12	13	30 47	545
35x12	93 70	5 $\frac{1}{2}$	13	15	33 34	625
35x13	98 40	5 $\frac{1}{2}$	14	15	36 01	640
35x14	103 25	5 $\frac{1}{2}$	15	15	38 78	655
35x15	108 40	5 $\frac{1}{2}$	16	15	41 55	670
35x16	113 85	6	17	17	44 32	765
35x17	119 55	6	18	16	47 09	780
35x18	125 50	6	18	16	49 86	795
36x 5	68 80	4 $\frac{1}{2}$	10	12 $\frac{1}{2}$	14 25	425
36x 6	72 20	4 $\frac{1}{2}$	10	12 $\frac{1}{2}$	17 10	440
36x 7	75 80	4 $\frac{1}{2}$	10	12 $\frac{1}{2}$	19 95	460
36x 8	79 60	5	10	13	22 80	530
36x 9	83 60	5	11	13	25 65	545
36x10	87 75	5	12	13	28 50	560
36x11	92 15	5	12	13	31 35	575
36x12	96 75	5 $\frac{1}{2}$	13	15	34 20	635
36x13	101 60	5 $\frac{1}{2}$	14	15	37 05	650
36x14	106 65	5 $\frac{1}{2}$	15	15	39 90	665
36x15	112 00	5 $\frac{1}{2}$	16	15	42 75	680
36x16	117 55	6	17	16	45 60	775
36x17	123 45	6	18	16	48 45	790
36x18	129 60	6	18	16	51 30	805
36x19	136 10	6	20	16	54 15	820
36x20	142 90	7	20	16 $\frac{1}{2}$	57 00	925
38x 5	74 35	4 $\frac{1}{2}$	10	12 $\frac{1}{2}$	15 05	455
38x 6	78 05	4 $\frac{1}{2}$	10	12 $\frac{1}{2}$	18 06	470
38x 7	81 95	5	10	13	21 07	540
38x 8	86 05	5	11	13	24 08	565
38x 9	90 35	5	11	13	27 09	580
38x10	94 85	5	12	13	30 10	595
38x11	99 60	5	12	13	33 11	610
38x12	104 60	5 $\frac{1}{2}$	13	15	36 12	700
38x13	109 80	5 $\frac{1}{2}$	14	15	39 13	715
38x14	115 30	5 $\frac{1}{2}$	15	15	42 14	730
38x15	121 05	6	16	16	45 15	835
38x16	127 10	6	17	16	48 16	850
38x17	133 45	6	17	16	51 17	855

SHAW'S FRICTION CLUTCH PULLEYS—Cont

Size of Pulley.	Price.	Largest Bore of Pulley with Clutch.	Space Required on Shaft.		H. Power 100 Rev.	Shipping Weight.
			Pulley.	Clutch.		
38x18	\$140 10	7	18	16 $\frac{1}{2}$	54 18	960
38x19	147 10	7	20	16 $\frac{1}{2}$	57 19	980
38x20	154 45	7	20	16 $\frac{1}{2}$	60 20	1000
39x 5	77 35	4 $\frac{1}{2}$	11	12 $\frac{1}{2}$	15 45	470
39x 6	81 20	4 $\frac{1}{2}$	11	12 $\frac{1}{2}$	18 54	485
39x 7	85 25	5	11	13	21 63	555
39x 8	89 55	5	11	13	24 72	570
39x 9	94 00	5	11	13	27 81	585
39x10	98 70	5	12	13	30 90	600
39x11	103 65	5	13	13	33 99	615
39x12	108 80	5 $\frac{1}{2}$	13	15	37 08	715
39x13	114 25	5 $\frac{1}{2}$	14	15	40 17	730
39x14	119 95	5 $\frac{1}{2}$	15	15	43 26	745
39x15	125 95	6	16	16	46 35	850
39x16	132 25	6	17	16	49 44	865
39x17	138 85	6	18	16	52 53	880
39x18	145 80	7	18	16 $\frac{1}{2}$	55 62	985
39x19	153 05	7	20	16 $\frac{1}{2}$	58 71	1000
39x20	160 70	7	20	16 $\frac{1}{2}$	61 80	1015
40x 5	80 40	4 $\frac{1}{2}$	11	12 $\frac{1}{2}$	15 85	485
40x 6	84 40	5	11	13	19 02	555
40x 7	88 65	5	11	13	22 19	570
40x 8	93 05	5	11	13	25 36	585
40x 9	99 70	5	12	13	28 53	600
40x10	102 60	5 $\frac{1}{2}$	12	15	31 70	680
40x11	107 75	5 $\frac{1}{2}$	13	15	34 87	700
40x12	113 10	5 $\frac{1}{2}$	13	15	38 04	720
40x13	118 75	5 $\frac{1}{2}$	14	15	41 21	740
40x14	124 70	6	15	16	44 38	850
40x15	130 90	6	16	16	47 55	865
40x16	137 45	6	17	16	50 72	880
40x17	144 35	6	18	16	53 89	895
40x18	151 55	7	18	16 $\frac{1}{2}$	57 06	995
40x19	159 15	7	20	16 $\frac{1}{2}$	60 33	1010
40x20	167 10	7	20	16 $\frac{1}{2}$	63 40	1025
40x21	174 45	7	22	16 $\frac{1}{2}$	66 57	1055
40x22	184 20	7	22	16 $\frac{1}{2}$	69 74	1090
40x23	193 40	7	24	16 $\frac{1}{2}$	72 91	1130
40x24	203 05	7	24	16 $\frac{1}{2}$	76 08	1175

SHAW'S FRICTION CLUTCH PULLEYS—Cont.

Size of Pulley.	Price.	Largest Bore of Pulley with Clutch.	Space Required on Shaft.		H. Power 100 Rev.	Shipping Weight.
			Pulley.	Clutch.		
41x 5	\$ 83 65	4½	11	12½	16 25	500
41x 6	87 85	5	12	13	19 50	570
41x 7	92 20	5	12	13	22 75	585
41x 8	96 85	5	12	13	26 00	600
41x 9	101 65	5	13	13	29 25	615
41x10	106 75	5½	13	15	32 50	695
41x11	112 10	5½	14	15	35 75	710
41x12	117 70	5½	14	15	39 00	725
41x13	123 55	5½	14	15	42 25	745
41x14	129 70	6	15	16	45 50	855
41x15	136 20	6	16	16	48 75	870
41x16	143 00	6	17	16	52 00	885
41x17	150 15	6	17	16	55 25	900
41x18	157 65	7	18	16½	58 50	1005
41x19	165 55	7	20	16½	61 75	1020
41x20	173 80	7	20	16½	65 00	1035
41x21	182 50	7	22	16½	68 25	1065
41x22	191 70	7	22	16½	71 50	1100
41x23	201 30	7	24	16½	74 75	1140
41x24	211 35	7	24	16½	78 00	1185
42x 5	86 95	5	11	13	16 65	585
42x 6	91 30	5	12	13	19 98	600
42x 7	95 85	5	12	13	23 31	615
42x 8	100 55	5½	12	15	26 64	695
42x 9	105 55	5½	13	15	29 97	710
42x10	110 85	5½	13	15	33 30	725
42x11	116 40	5½	13	15	36 63	740
42x12	122 20	6	14	16	39 96	835
42x13	128 30	6	14	16	43 29	850
42x14	134 70	6	15	16	46 62	865
42x15	141 45	6	16	16	49 95	880
42x16	148 50	7	17	16½	53 28	985
42x17	155 95	7	17	16½	56 61	1000
42x18	163 75	7	18	16½	59 94	1025
42x19	171 90	7	20	16½	63 27	1055
42x20	180 50	7	20	16½	66 60	1085
42x21	189 50	7	22	16½	69 90	1115
42x22	199 00	8	22	17½	73 26	1270
42x23	208 95	8	24	17½	76 59	1300
42x24	219 35	8	24	17½	79 92	1330

SHAW'S FRICTION CLUTCH PULLEYS—Cont.

Size of Pulley.	Price.	Largest Bore of Pulley with Clutch.	Space Required on Shaft.		H. Power 100 Rev.	Shipping Weight.
			Pulley.	Clutch.		
43x 5	\$ 90 45	5	11	13	17 05	600
43x 6	94 95	5	12	13	20 46	615
43x 7	99 70	5	12	13	23 87	630
43x 8	104 70	5½	12	15	27 28	710
43x 9	109 90	5½	13	15	30 69	725
43x10	115 40	5½	13	15	34 10	740
43x11	121 20	5½	14	15	37 51	755
43x12	127 25	6	14	16	40 92	850
43x13	133 60	6	14	16	44 33	865
43x14	140 25	6	15	16	47 74	880
43x15	147 26	6	16	16	51 15	895
43x16	154 65	7	17	16½	54 56	1000
43x17	162 35	7	17	16½	57 97	1015
43x18	170 45	7	18	16½	61 38	1040
43x19	178 95	7	20	16½	64 79	1070
43x20	187 90	7	20	16½	68 20	1100
43x21	197 30	7	22	16½	71 61	1130
43x22	207 15	8	22	17½	75 02	1285
43x23	217 50	8	24	17½	78 43	1315
43x24	228 36	8	24	17½	81 84	1345
44x 5	94 05	5	11	13	17 45	615
44x 6	98 75	5	12	13	20 94	630
44x 7	103 70	5½	12	15	24 43	710
44x 8	108 85	5½	12	15	27 92	725
44x 9	114 30	5½	13	15	31 41	740
44x10	120 00	6	13	16	34 90	835
44x11	126 00	6	14	16	38 39	850
44x12	132 30	6	14	16	41 88	865
44x13	138 90	6	15	16	45 37	880
44x14	145 85	7	15	16½	48 86	985
44x15	153 15	7	16	16½	52 35	1015
44x16	160 80	7	17	16½	55 84	1015
44x17	168 85	7	17	16½	59 33	1075
44x18	177 30	7	18	16½	62 82	1105
44x19	186 15	7	20	16½	66 31	1135
44x20	195 45	7	20	17½	69 80	1290
44x21	205 20	7	22	17½	73 29	1320
44x22	215 45	7	22	17½	76 78	1350
44x23	226 25	7	24	17½	80 27	1380
44x24	237 55	7	24	17½	83 76	1410
45x 5	97 80	5	12	13	17 85	630

SHAW'S FRICTION CLUTCH PULLEYS—Cont.

Size of Pulley.	Price.	Largest Bore of Pulley with Clutch.	Space Required on Shaft.		H. Power 100 Rev.	Shipping Weight.
			Pulley.	Clutch.		
45x 6	\$102 70	5	12	13	21 42	645
45x 7	107 80	5½	12	15	24 99	725
45x 8	113 20	5½	13	15	28 63	740
45x 9	118 85	5½	13	15	32 13	755
45x10	124 80	6	14	16	35 70	850
45x11	131 05	6	14	16	39 27	865
45x12	136 60	6	14	16	42 84	880
45x13	144 50	6	15	16	46 41	895
45x14	151 70	7	15	16½	49 98	1000
45x15	159 30	7	16	16½	53 55	1030
45x16	167 25	7	17	16½	57 12	1060
45x17	175 60	7	18	16½	60 69	1090
45x18	184 40	7	19	16½	64 26	1120
45x19	193 60	7	20	16½	67 83	1150
45x20	203 30	8	20	17½	71 40	1305
45x21	213 45	8	22	17½	74 97	1335
45x22	224 10	8	22	17½	78 54	1365
45x23	235 30	8	24	17½	82 11	1395
45x24	247 05	8	24	17½	85 68	1425
46x 5	101 70	5	12	13	18 25	645
46x 6	106 80	5½	12	15	21 90	745
46x 7	112 10	5½	12	15	25 55	760
46x 8	117 70	5½	13	15	29 20	775
46x 9	123 60	6	13	16	32 85	900
46x10	129 70	6	14	16	36 50	920
46x11	136 25	6	14	16	40 15	940
46x12	143 05	6	14	16	43 80	960
46x13	150 20	7	15	16½	47 45	1135
46x14	157 70	7	15	16½	51 10	1155
46x15	165 55	7	16	16½	54 75	1175
46x16	173 85	7	17	16½	58 40	1195
46x17	182 55	7	18	16½	62 05	1215
46x18	191 65	8	19	17½	65 70	1415
46x19	201 25	8	20	17½	69 55	1445
46x20	211 30	8	20	17½	73 00	1475
46x21	221 25	8	22	17½	76 65	1505
46x22	232 95	8	22	17½	80 30	1535
46x23	244 60	8	24	17½	83 95	1705
46x24	256 80	8	24	17½	87 60	1735
46x25	269 65	8	26	17½	91 25	1765
46x26	383 10	8	26	17½	94 40	1795

SHAW'S FRICTION CLUTCH PULLEYS—Cont.

Size of Pulley.	Price.	Largest Bore of Pulley with Clutch.	Space Required on Shaft.		H. Power 100 Rev.	Shipping Weight.
			Pulley.	Clutch.		
47x 5	\$105 80	5	12	13	18 65	660
47x 6	111 10	5½	12	15	22 38	785
47x 7	116 65	5½	12	15	26 11	800
47x 8	122 45	5½	13	15	29 84	815
47x 9	128 60	6	13	16	33 57	965
47x10	135 00	6	14	16	37 80	980
47x11	141 75	6	14	16	41 03	995
47x12	148 85	6	14	16	44 76	1010
47x13	156 35	7	15	16½	48 49	1185
47x14	164 15	7	15	16½	52 22	1205
47x15	172 35	7	16	16½	55 95	1225
47x16	180 95	7	17	16½	59 68	1245
47x17	190 00	7	18	16½	63 41	1265
47x18	199 50	8	19	17½	67 14	1465
47x19	209 45	8	20	17½	70 87	1495
47x20	217 90	8	20	17½	74 60	1525
47x21	228 80	8	22	17½	78 33	1555
47x22	240 25	8	22	17½	82 06	1585
47x23	252 25	8	24	17½	85 79	1615
47x24	264 85	8	24	17½	89 52	1785
47x25	278 10	8	26	17½	93 25	1815
47x26	292 00	8	26	17½	96 98	1845
48x 5	110 00	5½	12	15	19 00	785
48x 6	115 50	5½	12	15	22 80	800
48x 7	121 25	6	12	16	26 60	950
48x 8	127 35	6	13	16	30 40	965
48x 9	133 70	6	13	16	34 20	980
48x10	140 35	6	14	16	38 00	995
48x11	147 40	7	14	16½	41 80	1170
48x12	154 75	7	14	16½	45 00	1190
48x13	162 45	7	15	16½	49 40	1210
48x14	170 60	7	15	16½	53 20	1230
48x15	179 15	7	16	16½	57 00	1250
48x16	188 10	7	17	16½	60 80	1270
48x17	197 50	8	18	17½	64 60	1470
48x18	207 35	8	19	17½	68 40	1500
48x19	217 70	8	20	17½	72 20	1530
48x20	228 60	8	22	17½	76 00	1560
48x21	240 00	8	22	17½	79 80	1590
48x22	252 00	8	22	17½	83 60	1620
48x23	264 60	8	24	17½	87 40	1790

SHAW'S FRICTION CLUTCH PULLEYS—Cont.

Size of Pulley.	Price.	Largest Bore of Pulley with Clutch.	Space Required on Shaft.		H. Power 100 Rev.	Shipping Weight.
			Pulley.	Clutch.		
48x24	\$277 85	8	24	17½	91 20	1840
48x25	281 70	8	26	17½	95 00	1890
48x26	306 30	8	26	17½	98 80	1940
49x 5	114 40	5½	12	15	19 40	800
49x 6	120 10	5½	12	15	23 28	815
49x 7	126 10	6	13	16	27 16	965
49x 8	132 40	6	13	16	31 04	980
49x 9	139 05	6	13	16	34 92	995
49x10	146 00	6	14	16	38 80	1010
49x11	153 30	7	14	16½	42 69	1185
49x12	160 95	7	14	16½	46 56	1205
49x13	169 00	7	15	16½	50 44	1225
49x14	177 40	7	15	16½	54 32	1245
49x15	186 40	7	16	16½	58 20	1265
49x16	195 70	7	17	16½	62 08	1285
49x17	205 50	8	18	17½	65 96	1485
49x18	215 75	8	19	17½	69 84	1515
49x19	226 55	8	20	17½	73 72	1545
49x20	237 85	8	20	17½	77 60	1575
49x21	249 75	8	22	17½	81 48	1605
49x22	262 20	8	24	17½	85 36	1635
49x23	275 30	8	24	17½	89 24	1805
49x24	289 05	8	24	17½	93 12	1855
49x25	303 50	8	26	17½	97 00	1905
49x26	318 70	8	26	17½	100 88	1955
50x 6	123 75	5½	13	15	23 76	830
50x 7	129 95	6	13	16	27 72	980
50x 8	136 40	6	14	16	31 68	995
50x 9	143 30	6	14	16	35 61	1010
50x10	150 45	7	14	16½	39 60	1185
50x11	157 95	7	14	16½	43 56	1205
50x12	165 85	7	15	16½	47 52	1225
50x13	174 15	7	15	16½	51 48	1245
50x14	182 85	7	15	16½	55 44	1265
50x15	192 00	7	16	16½	59 40	1285
50x16	201 60	8	18	17½	63 36	1485
50x17	211 65	8	18	17½	67 32	1515
50x18	222 25	8	19	17½	71 28	1545
50x19	233 35	8	19	17½	75 24	1575
50x20	245 00	8	20	17½	79 20	1605

SHAW'S FRICTION CLUTCH PULLEYS—Cont.

Size of Pulley.	Price.	Largest Bore of Pulley with Clutch.	Space Required on Shaft.		H. Power 100 Rev.	Shipping Weight.
			Pulley.	Clutch		
50x21	\$257 25	8	22	17 $\frac{1}{2}$	83 16	1635
50x22	270 10	8	22	17 $\frac{1}{2}$	87 12	1805
50x23	283 60	8	24	17 $\frac{1}{2}$	91 08	1855
50x24	297 80	8	24	17 $\frac{1}{2}$	95 04	1905
50x25	312 65	8	26	17 $\frac{1}{2}$	99 00	1955
50x26	328 30	8	26	17 $\frac{1}{2}$	102 96	2005
50x27	344 70	8 $\frac{1}{2}$	28	18 $\frac{1}{2}$	106 92	2230
50x28	361 95	8 $\frac{1}{2}$	28	18 $\frac{1}{2}$	110 88	2270

Prices for larger sizes on Application.

Discount.....per cent.

PARTS OF SHAW'S FRICTION CLUTCH PULLEY

- | | |
|--|------------------------------------|
| A.—Spider. | K.—Link. |
| B.—Outside member. | L.—Pin for center of outside lever |
| C.—Inside member. | M.—Lower pin for lever D. |
| D.—Inside lever. | N.—Inside plate. |
| E.—Tension screw. | O.—Outside plate. |
| F.—Trunnion nut. | P.—Shipper ring. |
| G. R.—Right hand outside lever. | Q.—Pin for upper end of lever D. |
| G. L.—Left hand outside lever. | R.—Tension socket. |
| H.—Shipper hub. | S.—Spring yoke. |
| I.—Pin for shipper hub. | T.—Jam nut. |
| J.—Pin for outer end of outside lever. | U.—Spring. |

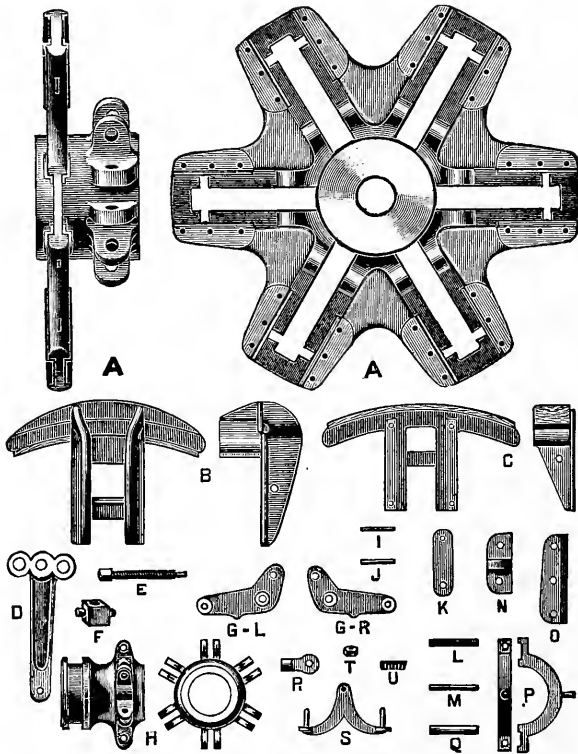

SHAW FRICTION CLUTCH CUT-OFF COUPLINGS.

With Four and Six Arm Clutches.

Price.	H. Power 100 Rev.	Space Required.			Shipping Weight.
		Clutch Rim.	Clutch.	Shifter.	
\$ 60 00	8	5	4	7 $\frac{1}{2}$	196
75 00	11	6 $\frac{3}{8}$	5	7 $\frac{1}{2}$	251
90 00	15	6 $\frac{3}{4}$	5 $\frac{1}{2}$	7 $\frac{1}{2}$	314
105 00	18	7	6	9	409
120 00	29	7 $\frac{1}{8}$	7	9	554
135 00	43	8 $\frac{1}{8}$	7 $\frac{1}{2}$	9	684
160 00	57	9 $\frac{5}{8}$	7 $\frac{1}{2}$	10	890
210 00	75	9 $\frac{5}{8}$	7 $\frac{1}{2}$	10	1057
220 00	90	10 $\frac{3}{8}$	8	10 $\frac{1}{2}$	1180
260 00	107	10 $\frac{3}{8}$	8	10 $\frac{1}{2}$	1428
300 00	150	11 $\frac{1}{2}$	9	11	1701
360 00	224	11 $\frac{1}{2}$	9	11	2050
400 00	275	12 $\frac{3}{4}$	10 $\frac{1}{2}$	13	2321
460 00	320	12 $\frac{3}{4}$	10 $\frac{1}{2}$	13	2857
700 00	403	12 $\frac{3}{4}$	17 $\frac{1}{4}$	15	5018
1200 00	756	14 $\frac{1}{4}$	29		9300
2000 00	1200	16	31		14800

Discount.....per cent.

SPUR GEARING:

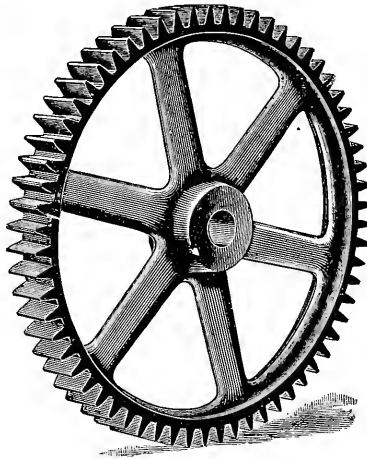

No.	Description.	Teeth.	Pitch.	Face.	Diameter in Inches.	Weight.
599	Wheel	22	$\frac{1}{4}$	$\frac{5}{8}$	1.76	
255	Wheel	24	$\frac{1}{4}$	$\frac{1}{4}$	1.92	
677	Wheel	20	$\frac{3}{8}$	$\frac{3}{8}$	1.80	
889	Wheel	14	$\frac{5}{16}$	$\frac{3}{4}$	1.40	
260	Wheel	15	$\frac{5}{16}$	$\frac{1}{8}$	1.50	
888	Wheel	22	$\frac{1}{8}$	$\frac{3}{4}$	2.20	
152	Wheel	13	$\frac{3}{8}$	$\frac{3}{4}$	1.56	
545	Wheel	15	$\frac{3}{8}$	$1\frac{1}{4}$	1.80	
877	Wheel	21	$\frac{3}{8}$	$1\frac{3}{8}$	2.40	
581	Wheel	26	$\frac{3}{8}$	$1\frac{1}{4}$	3.12	
547	Wheel	29	$\frac{3}{8}$	1	3.48	
264	Wheel	94	$\frac{3}{8}$	$\frac{1}{2}$	11.28	
267	Wheel	22	$\frac{7}{16}$	$1\frac{1}{16}$	3.08	
846	Wheel	22	$\frac{7}{16}$	$1\frac{1}{2}$	3.08	
847	Wheel	27	$\frac{7}{16}$	$\frac{5}{8}$	3.75	
866	Wheel	40	$\frac{7}{16}$	1	5.60	
542	Wheel	50	$\frac{7}{16}$	1	7.00	
263	Wheel	90	$\frac{7}{16}$	$\frac{5}{8}$	12.60	
261	Wheel	96	$\frac{7}{16}$	$\frac{3}{4}$	13.44	
393	Wheel	100	$\frac{7}{16}$	$\frac{7}{8}$	14.00	
837	Wheel	19	$\frac{1}{2}$	$\frac{7}{8}$	2.85	
454	Wheel	21	$\frac{1}{2}$	$1\frac{1}{2}$	3.15	

SPUR GEARING—Continued.

No.	Description.	Teeth.	Pitch.	Face.	Diameter in Inches.	Weight.
840	Wheel	12	$\frac{1}{2}$	$2\frac{1}{4}$	1.92	
453	Wheel	13	$\frac{1}{2}$	$1\frac{1}{8}$	2.08	
620	Wheel	14	$\frac{1}{2}$	$1\frac{3}{8}$	2.24	
787	Wheel	16	$\frac{1}{2}$	$1\frac{5}{8}$	2.56	
656	Wheel	17	$\frac{1}{2}$	1	2.72	
538	Wheel	17	$\frac{1}{2}$	$1\frac{1}{16}$	2.72	
566	Wheel	17	$\frac{1}{2}$	$1\frac{1}{8}$	2.72	
212	Wheel	18	$\frac{1}{2}$	$1\frac{1}{8}$	2.88	
631	Wheel	22	$\frac{1}{2}$	$1\frac{1}{8}$	3.52	
836	Wheel	24	$\frac{1}{2}$	$1\frac{5}{8}$	3.84	
718	Wheel	24	$\frac{1}{2}$	2	3.84	
838	Wheel	26	$\frac{1}{2}$	$1\frac{7}{8}$	4.16	
451	Wheel	26	$\frac{1}{2}$	$1\frac{1}{8}$	4.16	
881	Wheel	29	$\frac{1}{2}$	$1\frac{1}{2}$	4.64	
450	Wheel	31	$\frac{1}{2}$	$1\frac{1}{8}$	4.96	
572	Wheel	34	$\frac{1}{2}$	1	5.44	
829	Wheel	36	$\frac{1}{2}$	$2\frac{1}{4}$	5.76	
844	Wheel	38	$\frac{1}{2}$	1	6.08	
848	Wheel	47	$\frac{1}{2}$	$1\frac{1}{2}$	7.52	
449	Wheel	52	$\frac{1}{2}$	1	8.32	
786	Wheel	89	$\frac{1}{2}$	$1\frac{1}{2}$	14.24	
668	Wheel	90	$\frac{1}{2}$	$1\frac{1}{8}$	14.40	
590	Wheel	94	$\frac{1}{2}$	$1\frac{3}{4}$	15.04	
536	Wheel	103	$\frac{1}{2}$	$1\frac{1}{2}$	16.48	
723	Wheel	104	$\frac{1}{2}$	$1\frac{3}{4}$	16.64	
489	Wheel	112	$\frac{1}{2}$	$1\frac{7}{8}$	17.92	
394	Wheel	134	$\frac{1}{2}$	$1\frac{1}{2}$	21.44	
644	Wheel	36	$\frac{3}{4}$	$1\frac{3}{4}$	5.94	
865	Wheel	19	$\frac{1}{2}$	$1\frac{1}{2}$	3.23	
797	Wheel	42	$\frac{1}{2}$	$1\frac{1}{2}$	7.14	
446	Wheel	11	$\frac{9}{16}$	$1\frac{1}{8}$	1.98	
858	Wheel	12	$\frac{9}{16}$	1	2.16	
652	Wheel	12	$\frac{9}{16}$	$1\frac{1}{4}$	2.16	
649	Wheel	15	$\frac{9}{16}$	$1\frac{5}{8}$	2.70	
717	Wheel	18	$\frac{9}{16}$	$2\frac{1}{4}$	3.24	
513	Wheel	21	$\frac{9}{16}$	$1\frac{5}{8}$	3.78	
76	Wheel	28	$\frac{9}{16}$	$1\frac{3}{8}$	5.04	
609	Wheel	42	$\frac{9}{16}$	1	7.56	
707	Wheel	42	$\frac{9}{16}$	$1\frac{1}{8}$	7.56	
765	Wheel	47	$\frac{9}{16}$	$1\frac{1}{2}$	8.46	
274	Wheel	60	$\frac{9}{16}$	$1\frac{1}{8}$	10.80	
447	Wheel	9	$\frac{5}{8}$	$1\frac{3}{8}$	1.80	

SPUR GEARING—Continued.

No.	Description.	Teeth.	Pitch.	Face.	Diameter in Inches.	Weight.
811	Wheel	10		$1\frac{3}{4}$	2.00	
856	Wheel	11		$1\frac{1}{2}$	2.20	
714	Wheel	12		$1\frac{1}{4}$	2.40	
388	Wheel	12		$1\frac{1}{2}$	2.40	
564	Wheel	12		2	2.40	
895	Wheel	13		2	2.60	
873	Wheel	13		4	2.60	
712	Wheel	14		1	2.80	
904	Wheel	15		1	3.00	
355	Wheel	15		$2\frac{1}{8}$	3.00	
493	Wheel	16		$1\frac{5}{8}$	3.20	
636	Wheel	16		$1\frac{1}{16}$	3.20	
445	Wheel	17		$2\frac{1}{8}$	3.40	
903	Wheel	18		1	3.60	
511	Wheel	18		$2\frac{3}{8}$	3.60	
245	Wheel	19		$1\frac{3}{4}$	3.80	
719	Wheel	20		1	4.00	
589	Wheel	20		$1\frac{1}{2}$	4.00	
598	Wheel	22		$1\frac{1}{2}$	4.40	
386	Wheel	24		$1\frac{1}{2}$	4.80	
387	Wheel	25		$1\frac{1}{2}$	5.00	
330	Wheel	27		$1\frac{1}{2}$	5.40	
875	Wheel	28		$1\frac{1}{2}$	5.60	
713	Wheel	30		1	6.00	
909	Wheel	31		$1\frac{1}{2}$	6.20	
385	Wheel.	38		$1\frac{3}{4}$	7.60	
724	Wheel	40		1	8.00	
444	Wheel	40		$1\frac{3}{8}$	8.00	
544	Wheel	52		$1\frac{3}{4}$	10.40	
384	Wheel	53		$1\frac{3}{4}$	10.60	
588	Wheel	61		$1\frac{1}{2}$	12.20	
727	Wheel	70		$1\frac{1}{4}$	14.00	
796	Wheel	89		2	17.80	
320	Wheel	100		1	20.00	
75	Wheel	101		$1\frac{1}{2}$	20.20	
492	Wheel	105		3	21.00	
653	Wheel	8		$1\frac{1}{8}$	1.68	
802	Wheel	14		1	2.94	
671	Wheel	13		$1\frac{5}{8}$	2.86	
573	Wheel	16		2	3.52	
309	Wheel	21		$1\frac{1}{2}$	4.62	
147	Wheel	26		$1\frac{1}{2}$	5.72	

SPUR GEARING—Continued.

No.	Description.	Teeth.	Pitch.	Face.	Diameter in Inches.	Weight.
798	Wheel	120	$1\frac{1}{16}$	1	26.40	
258	Wheel	8	$\frac{3}{4}$	$\frac{3}{4}$	1.92	
153	Wheel	10	$\frac{3}{4}$	1	2.40	
546	Wheel	10	$\frac{3}{4}$	3	2.40	
597	Wheel	11	$\frac{3}{4}$	$1\frac{3}{4}$	2.64	
878	Wheel	11	$\frac{3}{4}$	3	3.12	
524	Wheel	12	$\frac{3}{4}$	$1\frac{1}{2}$	2.88	
354	Wheel	13	$\frac{3}{4}$	$1\frac{5}{8}$	3.12	
578	Wheel	13	$\frac{3}{4}$	$2\frac{1}{8}$	3.12	
580	Wheel	15	$\frac{3}{4}$	$1\frac{1}{16}$	3.60	
781	Wheel	15	$\frac{3}{4}$	$1\frac{3}{8}$	3.60	
331	Wheel	15	$\frac{3}{4}$	$1\frac{3}{4}$	3.60	
443	Wheel	15	$\frac{3}{4}$	$2\frac{1}{4}$	3.60	
169	Wheel	16	$\frac{3}{4}$	$1\frac{1}{2}$	3.84	
879	Wheel	16	$\frac{3}{4}$	2	3.84	
683	Wheel	16	$\frac{3}{4}$	$2\frac{1}{4}$	3.84	
864	Wheel	16	$\frac{3}{4}$	$2\frac{3}{4}$	3.84	
319	Wheel	17	$\frac{3}{4}$	1	4.08	
612	Wheel	17	$\frac{3}{4}$	$2\frac{1}{4}$	4.08	
591	Wheel	18	$\frac{3}{4}$	$2\frac{1}{4}$	4.32	
610	Wheel	19	$\frac{3}{4}$	$1\frac{1}{4}$	4.56	
708	Wheel	19	$\frac{3}{4}$	$3\frac{1}{4}$	4.56	
368	Wheel	20	$\frac{3}{4}$	$1\frac{3}{4}$	4.80	
902	Wheel	20	$\frac{3}{4}$	2	4.80	
660	Wheel	20	$\frac{3}{4}$	$2\frac{7}{8}$	4.80	
664	Wheel	22	$\frac{3}{4}$	$1\frac{1}{2}$	5.28	
259	Wheel	24	$\frac{3}{4}$	$\frac{3}{4}$	5.76	
507	Wheel	24	$\frac{3}{4}$	1	5.76	
369	Wheel	24	$\frac{3}{4}$	$1\frac{3}{4}$	5.76	
146	Wheel	25	$\frac{3}{4}$	$1\frac{3}{4}$	6.00	
604	Wheel	28	$\frac{3}{4}$	$1\frac{1}{2}$	6.72	
508	Wheel	34	$\frac{3}{4}$	1	8.16	
663	Wheel	36	$\frac{3}{4}$	$1\frac{1}{2}$	8.64	
812	Wheel	39	$\frac{3}{4}$	$1\frac{3}{4}$	9.36	
352	Wheel	40	$\frac{3}{4}$	$1\frac{1}{2}$	9.60	
648	Wheel	40	$\frac{3}{4}$	$2\frac{3}{4}$	9.60	
293	Wheel	42	$\frac{3}{4}$	$1\frac{1}{2}$	10.08	
780	Wheel	48	$\frac{3}{4}$	$1\frac{5}{8}$	11.52	
682	Wheel	54	$\frac{3}{4}$	$2\frac{1}{4}$	12.96	
300	Wheel	60	$\frac{3}{4}$	$1\frac{1}{2}$	14.40	
535	Wheel	68	$\frac{3}{4}$	2	16.32	
823	Wheel	72	$\frac{3}{4}$	2	17.28	

SPUR GEARING—Continued.

No.	Description.	Teeth.	Pitch.	Face.	Diameter in Inches.	Weight.
600	Wheel	76	$\frac{3}{4}$	$1\frac{5}{8}$	18.24	
339	Wheel	100	$\frac{3}{4}$	$1\frac{3}{8}$	24.00	
396	Wheel	160	$\frac{3}{4}$	$2\frac{1}{8}$	38.40	
900	Wheel	20	$\frac{2}{3}$	$2\frac{3}{8}$	5.00	
365	Wheel	9	$\frac{1}{2}$	$2\frac{1}{4}$	2.34	
595	Wheel	10	$\frac{1}{4}$	$1\frac{3}{4}$	2.60	
662	Wheel	10	$\frac{1}{6}$	$1\frac{3}{4}$	2.60	
237	Wheel	11	$\frac{1}{6}$	$1\frac{1}{4}$	2.86	
440	Wheel	11	$\frac{1}{6}$	2	2.86	
256	Wheel	12	$\frac{1}{6}$	$2\frac{1}{4}$	3.12	
908	Wheel	14	$\frac{1}{6}$	$1\frac{1}{5}$	3.64	
438	Wheel	14	$\frac{1}{6}$	2	3.64	
439	Wheel	15	$\frac{1}{6}$	$2\frac{1}{8}$	3.90	
807	Wheel	15	$\frac{1}{6}$	2	3.90	
790	Wheel	15	$\frac{1}{6}$	$2\frac{1}{8}$	3.90	
616	Wheel	16	$\frac{1}{6}$	2	4.16	
168	Wheel	17	$\frac{1}{6}$	$1\frac{1}{5}$	4.42	
819	Wheel	18	$\frac{1}{6}$	2	4.68	
584	Wheel	19	$\frac{1}{6}$	2	4.94	
818	Wheel	23	$\frac{1}{6}$	$2\frac{1}{8}$	5.98	
609	Wheel	39	$\frac{1}{6}$	1	9.75	
771	Wheel	46	$\frac{1}{6}$	$2\frac{1}{2}$	11.96	
764	Wheel	47	$\frac{1}{6}$	$1\frac{1}{2}$	12.22	
661	Wheel	55	$\frac{1}{6}$	$1\frac{3}{4}$	14.30	
698	Wheel	58	$\frac{1}{6}$	$3\frac{1}{6}$	15.08	
294	Wheel	60	$\frac{1}{6}$	$1\frac{1}{8}$	15.60	
236	Wheel	60	$\frac{1}{6}$	$1\frac{1}{4}$	15.60	
364	Wheel	72	$\frac{1}{6}$	2	18.72	
788	Wheel	75	$\frac{1}{6}$	$1\frac{3}{4}$	19.50	
623	Wheel	78	$\frac{1}{6}$	1	20.28	
897	Wheel	17	$\frac{3}{8}$	2	4.59	
370	Wheel	9	$\frac{1}{8}$	$2\frac{3}{8}$	2.52	
241	Wheel	9	$\frac{1}{8}$	$2\frac{1}{2}$	2.52	
774	Wheel	10	$\frac{1}{8}$	$2\frac{3}{8}$	2.80	
659	Wheel	11	$\frac{1}{8}$	$1\frac{3}{4}$	3.08	
441	Wheel	11	$\frac{1}{8}$	$2\frac{1}{2}$	3.08	
179	Wheel	11	$\frac{1}{8}$	$2\frac{1}{8}$	3.08	
525	Wheel	12	$\frac{1}{8}$	2	3.36	
437	Wheel	12	$\frac{1}{8}$	$2\frac{5}{8}$	3.36	
342	Wheel	13	$\frac{1}{8}$	$1\frac{3}{8}$	3.64	
136	Wheel	13	$\frac{1}{8}$	$1\frac{1}{5}$	3.64	
882	Wheel	13	$\frac{1}{8}$	$2\frac{1}{4}$	3.64	

SPUR GEARING—Continued.

No.	Description.	Teeth.	Pitch.	Face.	Diameter in Inches.	Weight.
164	Wheel	13	2	3 $\frac{1}{4}$	3.64	
157	Wheel	13	2	4	3.64	
389	Wheel	14	2	1 $\frac{3}{8}$	3.92	
442	Wheel	14	2	1 $\frac{5}{8}$	3.92	
154	Wheel	14	2	1 $\frac{1}{2}$	3.92	
172	Wheel	14	2	2	3.92	
391	Wheel	14	2	2	3.92	
576	Wheel	14	2	2 $\frac{1}{4}$	3.92	
367	Wheel	14	2	3 $\frac{1}{4}$	3.92	
145	Wheel	15	2	2	4.20	
911	Wheel	15	2	2	4.20	
42	Wheel	15	2	2 $\frac{1}{4}$	4.20	
279	Wheel	15	2	3	4.20	
143	Wheel	16	2	1 $\frac{1}{2}$	4.48	
537	Wheel	16	2	2 $\frac{1}{8}$	4.48	
160	Wheel	16	2	2 $\frac{1}{4}$	4.48	
171	Wheel	17	2	2	4.76	
130	Wheel	17	2	2 $\frac{3}{4}$	4.76	
135	Wheel	17	2	2 $\frac{3}{4}$	4.76	
392	Wheel	17	2	2 $\frac{3}{4}$	4.76	
134	Wheel	18	2	1 $\frac{3}{4}$	5.04	
640	Wheel	19	2	1 $\frac{1}{4}$	5.32	
292	Wheel	20	2	2	5.60	
435	Wheel	22	2	2 $\frac{1}{4}$	6.16	
815	Wheel	22	2	2 $\frac{1}{2}$	6.16	
658	Wheel	32	2	1 $\frac{3}{4}$	8.96	
276	Wheel	33	2	1 $\frac{1}{2}$	9.24	
721	Wheel	42	2	1 $\frac{7}{8}$	11.76	
275	Wheel	44	2	2 $\frac{1}{4}$	12.32	
715	Wheel	50	2	1 $\frac{3}{4}$	14.00	
434	Wheel	82	2	1 $\frac{5}{8}$	22.96	
34	Wheel	86	2	2	24.08	
35	Wheel	103	2	2	28.84	
36	Wheel	119	2	2	33.32	
33	Wheel	137	2	2	38.36	
890	Wheel	9	1	2	2.70	
627	Wheel	12	1	1 $\frac{1}{2}$	3.60	
789	Wheel	14	1	3 $\frac{3}{4}$	4.20	
433	Wheel	15	1	2 $\frac{1}{2}$	4.50	
498	Wheel	16	1	2 $\frac{1}{4}$	4.80	
253	Wheel	39	1	1 $\frac{3}{8}$	11.70	

SPUR GEARING—Continued.

No.	Description.	Teeth.	Pitch.	Face.	Diameter in Inches.	Weight.
676	Wheel	77	$\frac{2}{3}\frac{1}{2}$	2	23.87	
603	Wheel	9	1	$1\frac{3}{4}$	2.88	
455	Wheel	10	1	2	3.20	
594	Wheel	10	1	$2\frac{1}{4}$	3.20	
615	Wheel	10	1	$2\frac{1}{4}$	3.20	
287	Wheel	10	1	3	3.20	
702	Wheel	10	1	$3\frac{1}{2}$	3.20	
853	Wheel	10	1	$3\frac{1}{2}$	3.20	
822	Wheel	11	1	$1\frac{7}{8}$	3.52	
617	Wheel	11	1	$2\frac{1}{4}$	3.52	
223	Wheel	11	1	$3\frac{1}{2}$	3.52	
432	Wheel	12	1	2	3.84	
129	Wheel	12	1	$2\frac{1}{2}$	3.84	
131	Wheel	12	1	2	3.84	
539	Wheel	12	1	$2\frac{1}{2}$	3.84	
540	Wheel	12	1	$3\frac{1}{2}$	3.84	
657	Wheel	13	1	$1\frac{3}{4}$	4.16	
225	Wheel	13	1	$2\frac{1}{4}$	4.16	
390	Wheel	13	1	$2\frac{1}{4}$	4.16	
716	Wheel	13	1	$2\frac{1}{4}$	4.16	
149	Wheel	13	1	$2\frac{3}{4}$	4.16	
618	Wheel	13	1	3	4.16	
127	Wheel	13	1	$4\frac{1}{2}$	4.16	
505	Wheel	14	1	$1\frac{7}{8}$	4.48	
133	Wheel	14	1	$3\frac{1}{2}$	4.48	
849	Wheel	14	1	$3\frac{1}{2}$	4.48	
667	Wheel	15	1	$1\frac{1}{2}$	4.80	
128	Wheel	15	1	2	4.80	
614	Wheel	15	1	$2\frac{1}{4}$	4.80	
495	Wheel	15	1	$3\frac{1}{2}$	4.80	
161	Wheel	16	1	2	5.12	
39	Wheel	16	1	$2\frac{1}{2}$	5.12	
41	Wheel	16	1	$2\frac{3}{4}$	5.12	
429	Wheel	17	1	$2\frac{1}{4}$	5.44	
806	Wheel	18	1	$1\frac{1}{2}$	5.76	
527	Wheel	18	1	2	5.76	
697	Wheel	18	1	$3\frac{1}{4}$	5.76	
430	Wheel	19	1	$1\frac{1}{2}$	6.08	
139	Wheel	19	1	$1\frac{3}{4}$	6.08	
77	Wheel	19	1	$2\frac{1}{2}$	6.08	
526	Wheel	20	1	2	6.40	
71	Wheel	24	1	2	7.68	

SPUR GEARING—Continued.

No.	Description.	Teeth.	Pitch.	Face.	Diameter in Inches	Weight.
126	Wheel	25	1	$1\frac{3}{4}$	8.00	
621	Wheel	25	1	$2\frac{3}{4}$	8.00	
431	Wheel	27	1	2	8.64	
632	Wheel	33	1	$2\frac{1}{2}$	10.56	
633	Wheel	35	1	$2\frac{1}{2}$	11.20	
631	Wheel	40	1	$2\frac{1}{2}$	12.80	
88	Wheel	44	1	2	14.08	
457	Wheel	50	1	2	16.00	
72	Wheel	63	1	2	20.16	
491	Wheel	64	1	$2\frac{1}{4}$	20.48	
528	Wheel	69	1	$3\frac{5}{8}$	22.08	
395	Wheel	75	1	$2\frac{1}{4}$	24.00	
86	Wheel	97	1	2	31.04	
854	Wheel	16	$1\frac{1}{3\frac{1}{2}}$	$2\frac{1}{2}$	5.28	
596	Wheel	12	$1\frac{1}{16}$	$2\frac{1}{4}$	4.08	
629	Wheel	12	$1\frac{1}{16}$	$2\frac{1}{4}$	4.08	
766	Wheel	13	$1\frac{1}{16}$	$2\frac{1}{4}$	4.42	
321	Wheel	13	$1\frac{1}{16}$	$2\frac{1}{8}$	4.42	
593	Wheel	18	$1\frac{1}{16}$	$1\frac{5}{8}$	6.12	
728	Wheel	35	$1\frac{1}{16}$	$2\frac{1}{2}$	11.90	
624	Wheel	44	$1\frac{1}{16}$	$2\frac{1}{4}$	14.96	
725	Wheel	48	$1\frac{1}{16}$	2	16.32	
871	Wheel	60	$1\frac{1}{16}$	$2\frac{1}{4}$	20.40	
428	Wheel	9	$1\frac{1}{8}$	$2\frac{3}{4}$	3.24	
138	Wheel	9	$1\frac{1}{4}$	4	3.24	
155	Wheel	10	$1\frac{1}{8}$	$2\frac{1}{2}$	3.60	
427	Wheel	11	$1\frac{1}{8}$	$3\frac{3}{8}$	3.97	
306	Wheel	12	$1\frac{1}{8}$	$2\frac{1}{4}$	4.32	
579	Wheel	12	$1\frac{1}{8}$	$4\frac{1}{4}$	4.30	
338	Wheel	13	$1\frac{1}{8}$	2	4.68	
543	Wheel	13	$1\frac{1}{8}$	$2\frac{1}{8}$	4.68	
137	Wheel	13	$1\frac{1}{8}$	3	4.68	
167	Wheel	14	$1\frac{1}{8}$	$2\frac{1}{4}$	5.04	
363	Wheel	14	$1\frac{1}{8}$	$2\frac{5}{8}$	5.04	
503	Wheel	14	$1\frac{1}{8}$	3	5.04	
426	Wheel	14	$1\frac{1}{8}$	$3\frac{1}{4}$	5.04	
124	Wheel	15	$1\frac{1}{8}$	$2\frac{1}{4}$	5.40	
692	Wheel	17	$1\frac{1}{8}$	$2\frac{3}{4}$	6.12	
880	Wheel	24	$1\frac{1}{8}$	$3\frac{1}{8}$	8.64	
665	Wheel	27	$1\frac{1}{8}$	$2\frac{1}{4}$	9.72	
70	Wheel	28	$1\frac{1}{4}$	$2\frac{1}{2}$	10.08	
646	Wheel	28	$1\frac{1}{8}$	$4\frac{1}{8}$	10.08	

SPUR GEARING—Continued.

No.	Description.	Teeth.	Pitch.	Face.	Diameter in Inches.	Weight.
645	Wheel	39	$1\frac{1}{8}$	$4\frac{1}{8}$	14.04	
341	Wheel	43	$1\frac{1}{8}$	2	15.48	
726	Wheel	44	$1\frac{1}{8}$	$2\frac{1}{8}$	15.84	
869	Wheel	67	$1\frac{1}{8}$	$2\frac{1}{2}$	24.12	
490	Wheel	74	$1\frac{1}{8}$	$2\frac{1}{4}$	26.64	
729	Wheel	78	$1\frac{1}{8}$	$2\frac{1}{2}$	28.08	
305	Wheel	82	$1\frac{1}{8}$	$2\frac{1}{2}$	29.52	
299	Wheel	100	$1\frac{1}{8}$	$2\frac{1}{2}$	36.00	
575	Wheel	10	$1\frac{3}{16}$	2	3.80	
530	Wheel	12	$1\frac{3}{16}$	$2\frac{3}{4}$	4.56	
626	Wheel	12	$1\frac{3}{16}$	$3\frac{1}{2}$	4.56	
173	Wheel	13	$1\frac{3}{16}$	$2\frac{5}{8}$	4.94	
701	Wheel	14	$1\frac{3}{16}$	3	5.32	
203	Wheel	15	$1\frac{3}{16}$	3	5.70	
816	Wheel	16	$1\frac{3}{16}$	$1\frac{5}{8}$	6.08	
720	Wheel	20	$1\frac{3}{16}$	$1\frac{5}{8}$	7.60	
892	Wheel	20	$1\frac{3}{16}$	$2\frac{3}{8}$	7.60	
73	Wheel	80	$1\frac{3}{16}$	$2\frac{3}{8}$	30.40	
424	Wheel	10	$1\frac{1}{4}$	$2\frac{1}{2}$	4.00	
178	Wheel	10	$1\frac{1}{4}$	3	4.00	
425	Wheel	10	$1\frac{1}{4}$	3	4.00	
423	Wheel	11	$1\frac{1}{4}$	$2\frac{1}{2}$	4.40	
703	Wheel	11	$1\frac{1}{4}$	$2\frac{1}{2}$	4.40	
156	Wheel	11	$1\frac{1}{4}$	$2\frac{1}{4}$	4.40	
357	Wheel	11	$1\frac{1}{4}$	$3\frac{1}{2}$	4.40	
421	Wheel	11	$1\frac{1}{4}$	4	4.40	
422	Wheel	12	$1\frac{1}{4}$	$2\frac{1}{2}$	4.80	
520	Wheel	12	$1\frac{1}{4}$	$2\frac{3}{4}$	4.80	
118	Wheel	13	$1\frac{1}{4}$	3	5.20	
611	Wheel	13	$1\frac{1}{4}$	3	5.20	
827	Wheel	13	$1\frac{1}{4}$	3	5.20	
150	Wheel	13	$1\frac{1}{4}$	$3\frac{1}{2}$	5.20	
158	Wheel	13	$1\frac{1}{4}$	4	5.20	
704	Wheel	13	$1\frac{1}{4}$	4	5.20	
353	Wheel	13	$1\frac{1}{4}$	$4\frac{5}{8}$	5.20	
132	Wheel	14	$1\frac{1}{4}$	$2\frac{1}{2}$	5.60	
509	Wheel	14	$1\frac{1}{4}$	$4\frac{1}{2}$	5.60	
37	Wheel	15	$1\frac{1}{4}$	$1\frac{1}{2}$	6.00	
420	Wheel	15	$1\frac{1}{4}$	$2\frac{1}{2}$	6.00	
419	Wheel	15	$1\frac{1}{4}$	3	6.00	
675	Wheel	15	$1\frac{1}{4}$	3	6.00	
418	Wheel	15	$1\frac{1}{4}$	$3\frac{3}{8}$	6.00	

SPUR GEARING—Continued.

No.	Description.	Teeth.	Pitch.	Face.	Diameter in Inches.	Weight.
773	Wheel	15	$1\frac{1}{4}$	4	6.00	
637	Wheel	15	$1\frac{1}{4}$	6	6.00	
417	Wheel	16	$1\frac{1}{4}$	3	6.40	
90	Wheel	16	$1\frac{1}{4}$	$3\frac{1}{2}$	6.40	
699	Wheel	16	$1\frac{1}{4}$	$3\frac{3}{8}$	6.40	
700	Wheel	17	$1\frac{1}{4}$	4	6.80	
625	Wheel	18	$1\frac{1}{4}$	$1\frac{1}{2}$	7.20	
641	Wheel	18	$1\frac{1}{4}$	3	7.20	
165	Wheel	20	$1\frac{1}{4}$	$2\frac{1}{2}$	8.00	
95	Wheel	20	$1\frac{1}{4}$	3	8.00	
605	Wheel	20	$1\frac{1}{4}$	3	8.00	
415	Wheel	23	$1\frac{1}{4}$	3	9.20	
456	Wheel	24	$1\frac{1}{4}$	$2\frac{1}{2}$	9.60	
252	Wheel	28	$1\frac{1}{4}$	3	11.20	
414	Wheel	35	$1\frac{1}{4}$	$2\frac{1}{2}$	14.00	
772	Wheel	40	$1\frac{1}{4}$	4	16.00	
769	Wheel	48	$1\frac{1}{4}$	3	19.20	
120	Wheel	53	$1\frac{1}{4}$	3	21.20	
116	Wheel	57	$1\frac{1}{4}$	3	22.80	
413	Wheel	72	$1\frac{1}{4}$	$2\frac{1}{2}$	28.80	
814	Wheel	86	$1\frac{1}{4}$	$2\frac{3}{4}$	34.40	
332	Wheel	11	$1\frac{1}{5}$	$4\frac{1}{2}$	4.62	
376	Wheel	12	$1\frac{1}{5}$	$3\frac{3}{8}$	5.04	
675	Wheel	15	$1\frac{1}{5}$	3	6.30	
409	Wheel	36	$1\frac{1}{5}$	$2\frac{3}{4}$	15.12	
410	Wheel	9	$1\frac{3}{8}$	$3\frac{1}{2}$	3.96	
613	Wheel	10	$1\frac{3}{8}$	$2\frac{1}{2}$	4.40	
820	Wheel	11	$1\frac{3}{8}$	3	4.84	
862	Wheel	12	$1\frac{3}{8}$	$2\frac{1}{2}$	5.28	
678	Wheel	12	$1\frac{3}{8}$	$2\frac{1}{8}$	5.28	
828	Wheel	13	$1\frac{3}{8}$	4	5.72	
688	Wheel	14	$1\frac{3}{8}$	$1\frac{3}{4}$	6.16	
541	Wheel	26	$1\frac{3}{8}$	$2\frac{1}{2}$	11.44	
606	Wheel	30	$1\frac{3}{8}$	4	13.20	
808	Wheel	16	$1\frac{1}{3}$	$4\frac{5}{8}$	7.20	
722	Wheel	9	$1\frac{1}{6}$	$3\frac{3}{4}$	4.14	
883	Wheel	18	$1\frac{1}{6}$	$4\frac{1}{2}$	8.28	
619	Wheel	11	$1\frac{1}{2}$	$1\frac{1}{4}$	5.28	
117	Wheel	11	$1\frac{1}{2}$	$3\frac{1}{2}$	5.28	
344	Wheel	11	$1\frac{1}{2}$	$3\frac{5}{8}$	5.23	
404	Wheel	11	$1\frac{1}{2}$	$4\frac{1}{2}$	5.28	
405	Wheel	12	$1\frac{1}{2}$	$4\frac{1}{4}$	5.76	
608	Wheel	12	$1\frac{1}{2}$	$4\frac{1}{2}$	5.76	

SPUR GEARING—Continued.

No.	Description.	Teeth.	Pitch.	Face.	Diameter in Inches.	Weight.
779	Wheel	13	$1\frac{1}{2}$	$3\frac{1}{2}$	6.24	
842	Wheel	13	$1\frac{1}{2}$	$3\frac{1}{2}$	6.24	
362	Wheel	13	$1\frac{1}{2}$	4	6.24	
601	Wheel	14	$1\frac{1}{2}$	$3\frac{1}{4}$	6.72	
705	Wheel	14	$1\frac{1}{2}$	4	6.72	
228	Wheel	15	$1\frac{1}{2}$	$3\frac{1}{2}$	7.20	
403	Wheel	15	$1\frac{1}{2}$	$3\frac{3}{4}$	7.20	
706	Wheel	15	$1\frac{1}{2}$	4	7.20	
162	Wheel	16	$1\frac{1}{2}$	3	7.68	
400	Wheel	16	$1\frac{1}{2}$	4	7.68	
94	Wheel	17	$1\frac{1}{2}$	3	8.16	
125	Wheel	17	$1\frac{1}{2}$	3	8.16	
401	Wheel	17	$1\frac{1}{2}$	$3\frac{1}{8}$	8.16	
402	Wheel	17	$1\frac{1}{2}$	4	8.16	
778	Wheel	20	$1\frac{1}{2}$	4	9.60	
607	Wheel	21	$1\frac{1}{2}$	$2\frac{1}{2}$	10.08	
691	Wheel	21	$1\frac{1}{2}$	4	10.08	
602	Wheel	22	$1\frac{1}{2}$	4	10.56	
166	Wheel	24	$1\frac{1}{2}$	3	11.52	
227	Wheel	27	$1\frac{1}{2}$	3	12.96	
690	Wheel	29	$1\frac{1}{2}$	4	13.92	
684	Wheel	31	$1\frac{1}{2}$	4	14.88	
99	Wheel	37	$1\frac{1}{2}$	$2\frac{1}{2}$	17.76	
850	Wheel	39	$1\frac{1}{2}$	4	18.72	
119	Wheel	43	$1\frac{1}{2}$	$3\frac{1}{2}$	20.64	
97	Wheel	51	$1\frac{1}{2}$	3	24.48	
366	Wheel	51	$1\frac{1}{2}$	3	24.48	
334	Wheel	60	$1\frac{1}{2}$	3	28.80	
777	Wheel	61	$1\frac{1}{2}$	3	29.28	
343	Wheel	63	$1\frac{1}{2}$	$3\frac{1}{2}$	30.24	
399	Wheel	98	$1\frac{1}{2}$	4	47.04	
285	Wheel	104	$1\frac{1}{2}$	4	49.92	
711	Wheel	12	$1\frac{9}{16}$	$2\frac{1}{2}$	6.00	
406	Wheel	16	$1\frac{9}{16}$	$2\frac{1}{4}$	8.00	
686	Wheel	10	$1\frac{5}{8}$	$3\frac{3}{8}$	5.20	
817	Wheel	13	$1\frac{5}{8}$	$3\frac{1}{4}$	6.76	
371	Wheel	14	$1\frac{5}{8}$	$4\frac{1}{2}$	7.28	
852	Wheel	18	$1\frac{5}{8}$	$2\frac{1}{2}$	9.36	
585	Wheel	18	$1\frac{5}{8}$	$3\frac{1}{2}$	9.36	
407	Wheel	20	$1\frac{5}{8}$	$4\frac{1}{2}$	10.40	
586	Wheel	23	$1\frac{5}{8}$	$2\frac{3}{4}$	11.96	
217	Wheel	31	$1\frac{5}{8}$	$3\frac{1}{2}$	16.12	

SPUR GEARING—Continued.

No.	Description	Teeth.	Pitch.	Face.	Diameter in Inches.	Weight.
408	Wheel	45	$1\frac{5}{8}$	$7\frac{1}{8}$	23.40	
373	Wheel	70	$1\frac{5}{8}$	4	36.40	
905	Wheel	13	$1\frac{1}{16}$	$4\frac{1}{4}$	7.02	
643	Wheel	12	$1\frac{3}{4}$	$2\frac{1}{4}$	6.72	
512	Wheel	12	$1\frac{3}{4}$	$4\frac{1}{2}$	6.72	
843	Wheel	14	$1\frac{3}{4}$	$4\frac{1}{4}$	8.12	
804	Wheel	15	$1\frac{3}{4}$	$4\frac{3}{4}$	8.40	
219	Wheel	15	$1\frac{3}{4}$	5	8.40	
220	Wheel	18	$1\frac{3}{4}$	6	10.08	
642	Wheel	33	$1\frac{3}{4}$	$2\frac{1}{4}$	18.48	
899	Wheel	75	$1\frac{3}{4}$	$4\frac{1}{2}$	42.00	
824	Seg't	75	$1\frac{3}{4}$	$5\frac{1}{2}$	42.00	
803	Wheel	96	$1\frac{3}{4}$	$4\frac{1}{2}$	53.76	
122	Wheel	17	$1\frac{1}{8}$	$2\frac{5}{8}$	10.20	
696	Wheel	45	$1\frac{1}{8}$	$8\frac{1}{8}$	27.00	
891	Wheel	9	2	4	5.76	
710	Wheel	10	2	$2\frac{5}{8}$	6.40	
830	Wheel	12	2	$5\frac{1}{2}$	7.68	
170	Wheel	13	2	3	8.32	
98	Wheel	14	2	3	8.96	
510	Wheel	14	2	$3\frac{1}{8}$	8.96	
867	Wheel	14	2	$5\frac{3}{4}$	8.96	
901	Wheel	15	2	5	9.60	
831	Seg't	78	2	5	49.92	
673	Wheel	13	$2\frac{3}{16}$	3	9.10	
504	Wheel	13	$2\frac{1}{4}$	$7\frac{1}{2}$	9.36	
650	Wheel	10	$2\frac{1}{2}$	$5\frac{5}{8}$	8.00	
412	Wheel	27	$2\frac{1}{2}$	12	21.60	
821	Wheel	9	$2\frac{5}{8}$	$5\frac{1}{8}$	7.56	

STONE PINIONS,

Or Pinions to Work with Spur Core Wheels of
Corresponding Pitch.

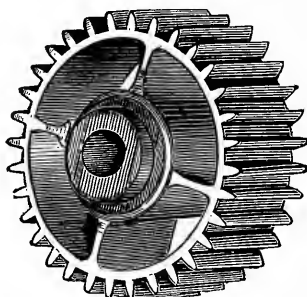

No.	Description.	Teeth.	Pitch.	Face.	Can make these Pinions any Face Required.	Diameter.
288	Pinion	44	$1\frac{3}{4}$	$4\frac{1}{2}$	From 4 to 10 inches.	24.64
82	Pinion	35	$1\frac{7}{8}$	8	From 4 to 10 inches.	21.00
84	Pinion	16	2	$5\frac{1}{2}$	From 4 to 10 inches.	10.24
85	Pinion	16	2	8	From 4 to 10 inches.	10.24
801	Pinion	22	2	9	From 4 to 10 inches.	14.08
800	Pinion	28	2	9	From 4 to 10 inches.	17.92
603	Pinion	10	2	8	From 4 to 10 inches.	25.60
604	Pinion	42	2	8	From 4 to 10 inches.	26.88
695	Pinion	48	2	$7\frac{1}{3}$	From 4 to 10 inches.	30.72
411	Pinion	23	$2\frac{1}{4}$	$9\frac{1}{2}$	From 4 to 10 inches.	16.56

SPUR CORE WHEELS.

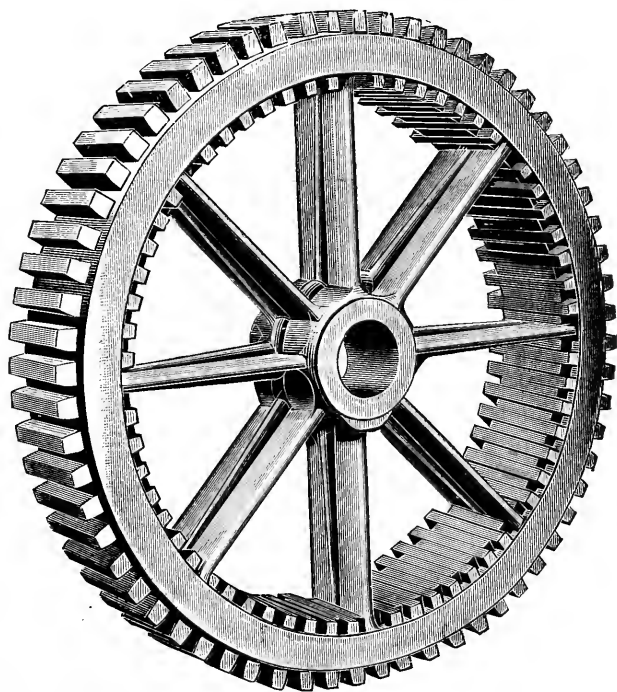

No.	Description.	Teeth.	Pitch.	Face.	Diameter in Inches.	Weight.
1	Wheel	78	$1\frac{1}{2}$	$7\frac{1}{2}$	46.80	
3	Wheel	62	2	7 or 8	39.68	
2	Wheel	72	2	7	46.08	
759	Wheel	80	$2\frac{1}{4}$	10	57.60	
762	Wheel	63	3	10	60.48	

MITRE CORE WHEELS AND PINIONS.

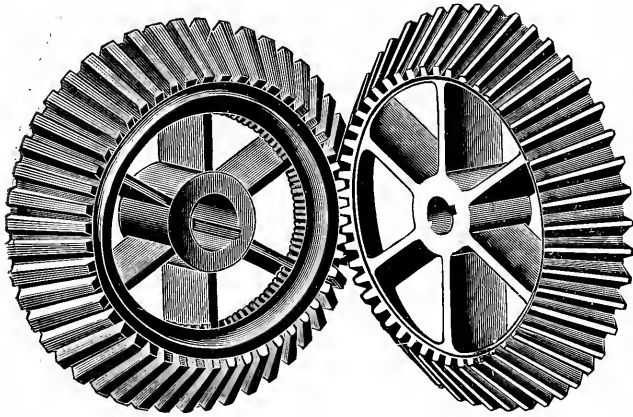

No.	Description	Teeth.	Pitch.	Face.	Backing.	Diameter in Inches.	Weight.
494	Wheel	33	$1\frac{7}{8}$	$4\frac{1}{2}$	$2\frac{3}{4}$	19.80	
495	Pinion	33	$1\frac{7}{8}$	$4\frac{1}{2}$	$2\frac{1}{8}$	19.80	
499	Wheel	47	2	8	$4\frac{1}{2}$	30.08	
832	Pinion	47	2	8		30.08	
5	Wheel Pinion	48	$2\frac{1}{4}$	$6\frac{1}{2}$	$4\frac{1}{2}$	34.56	

MITRE GEARING.

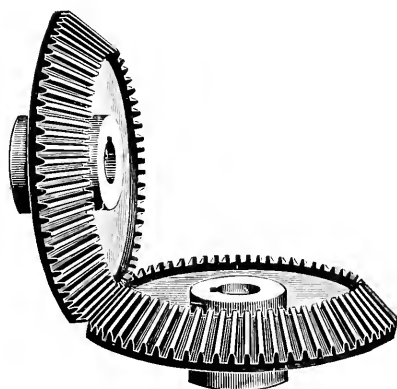

No.	Description.	Teeth.	Pitch.	Face.	Backing.	Diameter in Inches.	Weight.
910	Wheel	25	$\frac{5}{16}$	$\frac{1}{2}$	$\frac{1}{2}$	2.50	
103	Wheel	24	$\frac{3}{8}$	$\frac{1}{2}$	$\frac{5}{8}$	2.88	
785	Wheel	47	$\frac{1}{3}$	$1\frac{1}{4}$	$\frac{3}{4}$	6.11	
835	Wheel	25	$\frac{7}{16}$	$\frac{7}{8}$		3.50	
784	Wheel	27	$\frac{1}{2}$	$1\frac{3}{8}$	$1\frac{1}{8}$	4.32	
308	Wheel	22	$\frac{5}{8}$	$1\frac{3}{8}$	$\frac{3}{4}$	4.40	
202	Wheel	23	$\frac{5}{8}$	$1\frac{1}{8}$	$\frac{1}{2}$	4.60	
857	Wheel	28	$\frac{3}{4}$	$1\frac{7}{8}$	$1\frac{3}{4}$	6.72	
855	Wheel	23	$\frac{7}{8}$	$1\frac{7}{8}$	1	6.44	
209	Wheel	38	$\frac{7}{8}$	$2\frac{1}{4}$	$1\frac{1}{8}$	10.64	
799	Wheel	43	$\frac{7}{8}$	$1\frac{7}{8}$	$1\frac{1}{2}$	12.04	
45	Wheel	54	$\frac{7}{8}$	$2\frac{1}{4}$	$1\frac{3}{4}$	15.12	
562	Wheel	20	$1\frac{5}{16}$	$1\frac{3}{8}$	$1\frac{1}{4}$	6.00	
674	Wheel	26	$1\frac{5}{16}$	$1\frac{3}{4}$		7.80	
886	Wheel	15	1	$1\frac{5}{8}$	$1\frac{5}{8}$	4.80	
372	Wheel	18	1	$1\frac{1}{4}$	$\frac{7}{8}$	5.76	

MITRE GEARING—Continued.

No.	Description.	Teeth.	Pitch	Face.	Backing.	Diameter in Inches.	Weight.
681	Wheel	19	1	$2\frac{1}{4}$	1	6.08	
791	Wheel	20	1	$2\frac{1}{8}$		6.40	
558	Wheel	23	1	$2\frac{1}{2}$	1	7.36	
49	Wheel	25	1	2	$\frac{1}{2}$	8.00	
502	Wheel	25	1	2	$\frac{7}{8}$	8.00	
851	Wheel	25	1	$2\frac{1}{4}$	1	8.00	
50	Wheel	25	1	$2\frac{3}{4}$	3	8.00	
861	Wheel	30	1	2	$1\frac{1}{4}$	9.60	
463	Wheel	38	1	$2\frac{1}{4}$	1	12.16	
208	Wheel	38	1	$2\frac{1}{4}$	$1\frac{1}{4}$	12.16	
52	Wheel	38	1	$2\frac{1}{2}$	$1\frac{1}{2}$	12.16	
242	Wheel	43	1	$2\frac{1}{4}$	$1\frac{3}{8}$	13.76	
329	Wheel	14	$1\frac{1}{16}$	$1\frac{3}{8}$	$\frac{7}{8}$	4.76	
563	Wheel	18	$1\frac{1}{16}$	$1\frac{3}{8}$	$1\frac{1}{8}$	6.12	
647	Wheel	22	$1\frac{1}{8}$	$2\frac{1}{4}$		7.92	
628	Wheel	22	$1\frac{1}{8}$	$2\frac{1}{2}$		7.92	
48	Wheel	24	$1\frac{1}{8}$	$2\frac{3}{8}$	$\frac{3}{4}$	8.64	
211	Wheel	28	$1\frac{1}{8}$	$2\frac{1}{2}$	$\frac{7}{8}$	10.08	
240	Wheel	35	$1\frac{1}{8}$	2	$1\frac{1}{4}$	12.60	
210	Wheel	45	$1\frac{1}{8}$	$2\frac{1}{2}$	$1\frac{1}{8}$	16.20	
638	Wheel	18	$1\frac{1}{4}$	2	1	7.20	
805	Wheel	25	$1\frac{1}{4}$	3	$1\frac{1}{2}$	10.00	
44	Wheel	30	$1\frac{1}{4}$	3	$\frac{3}{4}$	12.00	
760	Wheel	30	$1\frac{1}{4}$	3		12.00	
53	Wheel	30	$1\frac{1}{4}$	$3\frac{1}{4}$	$\frac{7}{8}$	12.00	
47	Wheel	40	$1\frac{1}{4}$	$2\frac{1}{2}$	$2\frac{3}{4}$	16.00	
462	Wheel	45	$1\frac{1}{4}$	$4\frac{3}{4}$	$2\frac{1}{4}$	18.00	
235	Wheel	50	$1\frac{1}{4}$	$3\frac{1}{4}$	$1\frac{3}{4}$	20.00	
46	Wheel	38	$1\frac{7}{16}$	3	2	17.48	
887	Wheel	21	$1\frac{1}{2}$	3	1	10.08	
356	Wheel	26	$1\frac{1}{2}$	4	2	12.48	
465	Wheel	31	$1\frac{1}{2}$	$3\frac{1}{4}$	2	14.88	
43	Wheel	31	$1\frac{1}{2}$	4	$1\frac{1}{2}$	14.88	
809	Wheel	14	$1\frac{3}{8}$	$2\frac{1}{2}$		7.28	
669	Wheel	15	$1\frac{3}{8}\frac{1}{2}$	$2\frac{1}{4}$		7.95	
898	Wheel	16	$1\frac{3}{4}$	$2\frac{3}{4}$	$1\frac{1}{4}$	8.96	
322	Wheel	26	$1\frac{3}{4}$	5		14.56	
310	Wheel	30	$1\frac{7}{8}$	$4\frac{1}{2}$	$1\frac{1}{2}$	18.00	
670	Wheel	20	$1\frac{1}{16}$	$3\frac{1}{2}$		12.40	

BEVEL CORE WHEELS AND PINIONS.

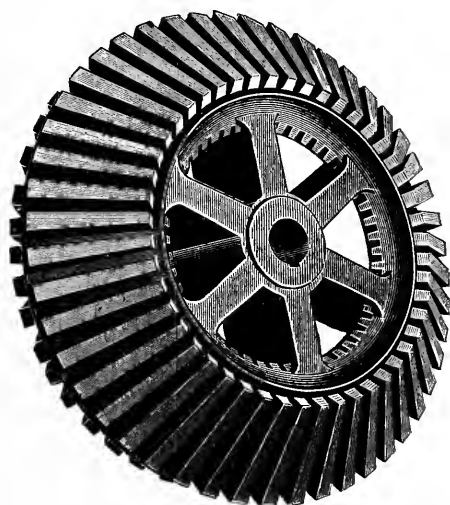

Nos.	Description.	Teeth.	Pitch.	Face.	Backing.	Diameter in Inches.
518	Wheel	55	$1\frac{3}{8}$	$3\frac{1}{2}$	4	24.20
519	Pinion	39	$1\frac{3}{8}$	$3\frac{1}{2}$	1	17.16
516	Wheel	60	$1\frac{3}{4}$	5	$3\frac{3}{4}$	33.60
517	Pinion	48	$1\frac{3}{4}$	5	$2\frac{1}{8}$	26.88
243	Wheel	40	2	$5\frac{1}{2}$	$3\frac{1}{2}$	25.60
244	Pinion	25	2	$5\frac{1}{2}$	$1\frac{1}{4}$	16.00
456	Wheel	50	2	8	$4\frac{1}{2}$	32.00
457	Pinion	45	2	8	$3\frac{1}{2}$	28.80
12	Wheel	70	$2\frac{1}{8}$	8	6	47.60
13	Pinion	35	$2\frac{1}{8}$	8	$1\frac{5}{8}$	23.60
694	Wheel	86				61.92
	Pinion	30	$2\frac{1}{4}$	7		21.60

BEVEL CORE WHEELS AND PINIONS—Cont.

Nos.	Description.	Teeth.	Pitch.	Face.	Backing.	Diameter in Inches.
530	Wheel	50	$2\frac{1}{4}$	8	$6\frac{1}{2}$	36.00
529	Pinion	25	$2\frac{1}{4}$	8		18.00
756	Wheel Pinion	40	$2\frac{3}{8}$	9	4	30.40
6	Wheel	70	$2\frac{1}{2}$	11	8	56.00
7	Pinion	48	$2\frac{1}{2}$	11	$2\frac{1}{2}$	38.40
757	Wheel	50	$2\frac{3}{4}$	10		44.00
758	Pinion	45	$2\frac{3}{4}$	10		39.60
884	Wheel	34	$3\frac{1}{2}$	10		38.08
885	Pinion	23	$3\frac{1}{2}$	10		25.76
761	Wheel Pinion	64	$3\frac{1}{2}$	12		71.68

BEVEL GEARING.

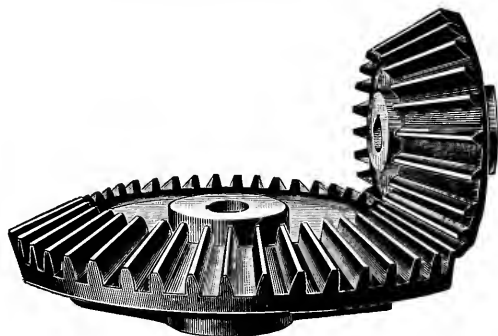

No.	Description.	Teeth.	Pitch.	Face.	Backing.	Diameter in Inches.
775	Wheel	38	$\frac{5}{16}$	$\frac{3}{4}$	$\frac{13}{16}$	3.80
776	Pinion	22	$\frac{5}{16}$	$\frac{3}{4}$	$1\frac{1}{8}$	2.20
770	Wheel	22	$\frac{5}{16}$	$\frac{3}{4}$	$1\frac{3}{4}$	2.20
569	Wheel	63	$\frac{3}{8}$	1	3	7.56
570	Pinion	30	$\frac{3}{8}$	1	1	3.60
654	Wheel	64	$\frac{3}{8}$	1		7.68
655	Pinion	16	$\frac{3}{8}$	1		1.92
567	Wheel	23	$\frac{1}{2}$	$\frac{7}{8}$	$\frac{3}{8}$	3.68
568	Pinion	14	$\frac{1}{2}$	$\frac{7}{8}$	1	2.37
859	Wheel	25	$\frac{1}{2}$	$\frac{5}{8}$		4.00
860	Pinion	15	$\frac{1}{2}$	$\frac{5}{8}$		2.40
380	Wheel	31	$\frac{1}{2}$	$\frac{3}{4}$	$\frac{5}{8}$	4.96
381	Pinion	19	$\frac{1}{2}$	$\frac{3}{4}$	$\frac{5}{8}$	3.04
767	Wheel	32	$\frac{1}{2}$	$\frac{7}{8}$	$2\frac{1}{4}$	5.12
768	Pinion	15	$\frac{1}{2}$	$\frac{7}{8}$		2.40
651	Wheel	45	$\frac{9}{16}$	$1\frac{1}{8}$		8.10
	Pinion					
870	Wheel	22	$\frac{9}{16}$	1		3.96
630	Wheel	30	$\frac{5}{8}$	$1\frac{1}{8}$	$\frac{7}{16}$	6.00
639	Pinion	15	$\frac{5}{8}$	$1\frac{1}{8}$		3.00
	Wheel					
868	Pinion	15	$\frac{5}{8}$	$1\frac{5}{8}$		3.00

BEVEL GEARING—Continued.

No.	Description.	Teeth.	Pitch.	Face.	Backing.	Diameter in Inches.
180	Wheel	34	$\frac{11}{16}$	$1\frac{5}{8}$	$1\frac{1}{8}$	7.48
181	Pinion	19	$\frac{11}{16}$	$1\frac{5}{8}$	$\frac{1}{4}$	4.18
841	Wheel Pinion	32	$\frac{3}{4}$	$1\frac{3}{4}$	1	8.08
582	Wheel	38	$\frac{3}{4}$	$1\frac{1}{2}$	$\frac{3}{8}$	9.12
583	Pinion	19	$\frac{3}{4}$	$1\frac{1}{2}$	1	4.56
265	Wheel	40	$\frac{3}{4}$	2	$1\frac{3}{4}$	9.60
266	Pinion	12	$\frac{3}{4}$	2	$\frac{1}{4}$	2.88
316	Wheel	45	$\frac{3}{4}$	$1\frac{3}{16}$	$2\frac{1}{8}$	10.80
317	Pinion	15	$\frac{3}{4}$	$1\frac{3}{16}$	$\frac{5}{8}$	3.60
114	Wheel	56	$\frac{3}{4}$	$2\frac{1}{2}$	2	13.44
115	Pinion	20	$\frac{3}{4}$	$2\frac{1}{2}$	$\frac{1}{2}$	4.80
337	Wheel	60	$\frac{3}{4}$	$1\frac{3}{4}$	$1\frac{3}{4}$	14.40
338	Pinion	19	$\frac{3}{4}$	$1\frac{3}{4}$	$1\frac{1}{4}$	4.56
397	Wheel	112	$\frac{3}{4}$	$1\frac{1}{2}$	$2\frac{3}{4}$	26.88
398	Pinion	12	$\frac{3}{4}$	$1\frac{1}{2}$	$1\frac{1}{8}$	2.88
191	Wheel Pinion	15	$\frac{3}{4}$	2	$\frac{1}{8}$	3.60
187	Wheel Pinion	19	$\frac{3}{4}$	2	$\frac{1}{2}$	4.56
561	Wheel Pinion	20	$\frac{3}{4}$	$2\frac{1}{2}$		4.80
845	Wheel	32	$\frac{13}{16}$	2	$1\frac{3}{4}$	8.32
792	Pinion	16	$\frac{13}{16}$	2	$1\frac{3}{4}$	4.16
741	Wheel Angle Pinion	46	$\frac{13}{16}$	$2\frac{1}{4}$		11.96
874	Wheel Pinion	40	$\frac{7}{8}$	2		11.20
679	Wheel	45	$\frac{7}{8}$	2	$1\frac{1}{8}$	12.60
680	Pinion	18	$\frac{7}{8}$	2	$\frac{7}{16}$	5.04
500	Wheel	72	$\frac{7}{8}$	$2\frac{1}{2}$	$2\frac{5}{8}$	20.16
501	Pinion	12	$\frac{7}{8}$	$2\frac{1}{2}$	$\frac{1}{8}$	3.36

BEVEL GEARING—Continued.

No.	Description.	Teeth.	Pitch.	Face.	Backing.	Diameter in Inches.
549	Wheel Pinion	10	$\frac{7}{8}$	$2\frac{1}{2}$		2.80
693	Wheel Pinion	12	$\frac{7}{8}$	2		3.36
751	Wheel Pinion	14	$\frac{7}{8}$	$1\frac{5}{8}$	$\frac{1}{2}$	3.92
749	Wheel Pinion	18	$\frac{7}{8}$	$1\frac{7}{8}$	$\frac{7}{16}$	5.04
825	Wheel Pinion	21	$\frac{7}{8}$	$2\frac{1}{4}$		5.88
359	Angle Gate	14	$\frac{15}{16}$	3		4.20
56	Wheel	30	$\frac{15}{16}$	2	$1\frac{1}{8}$	9.00
57	Pinion	24	$\frac{15}{16}$	2	$\frac{5}{8}$	7.20
58	Wheel	39	$\frac{15}{16}$	$2\frac{1}{4}$	$1\frac{1}{2}$	11.70
59	Pinion	19	$\frac{15}{16}$	$2\frac{1}{4}$	$\frac{5}{16}$	5.70
906	Wheel	14	1	$1\frac{3}{4}$	$\frac{1}{2}$	4.48
907	Pinion	13	1	$1\frac{3}{4}$	$1\frac{1}{2}$	4.16
470	Wheel	15	1	$1\frac{1}{2}$	2	4.80
471	Pinion	12	1	$1\frac{1}{2}$	$1\frac{1}{8}$	3.84
833	Wheel	20	1	2		6.40
834	Pinion	16	1	2		5.12
78	Wheel	30	1	$2\frac{1}{4}$	1	9.60
79	Pinion	16	1	$2\frac{1}{4}$	$\frac{1}{2}$	5.12
311	Wheel	35	1	$2\frac{1}{2}$	$1\frac{3}{4}$	11.20
312	Pinion	12	1	$2\frac{1}{2}$	$\frac{3}{16}$	3.84
522	Wheel	45	1	$2\frac{1}{2}$		14.40
523	Pinion	13	1	$2\frac{1}{2}$	$\frac{1}{8}$	4.16
514	Wheel	50	1	2	2	16.00
515	Pinion	33	1	2	$1\frac{1}{8}$	10.56
60	Wheel	50	1	$2\frac{1}{8}$	3	16.00
61	Pinion	13	1	$2\frac{1}{8}$	$\frac{1}{4}$	4.16

BEVEL GEARING—Continued.

No.	Description.	Teeth.	Pitch.	Face.	Backing.	Diameter in Inches.
204	Wheel	50	1	$2\frac{1}{2}$	$2\frac{1}{4}$	16.00
205	Pinion	20	1	$2\frac{1}{2}$	$\frac{5}{8}$	6.40
231	Wheel	51	1	$2\frac{1}{4}$	$1\frac{1}{2}$	16.32
232	Pinion	35	1	$2\frac{1}{4}$	$\frac{3}{4}$	11.20
290	Wheel	60	1	$2\frac{1}{4}$	$2\frac{1}{2}$	19.20
291	Pinion	30	1	$2\frac{1}{4}$	$\frac{3}{4}$	9.60
110	Wheel	60	1	$2\frac{1}{2}$	$2\frac{3}{8}$	19.20
111	Pinion	15	1	$2\frac{1}{2}$	$\frac{3}{8}$	4.80
66	Wheel	68	1	$2\frac{1}{2}$	$2\frac{1}{4}$	21.76
67	Pinion	56	1	$2\frac{1}{2}$	$1\frac{7}{8}$	17.92
54	Wheel	70	1	$2\frac{1}{2}$	$2\frac{3}{8}$	22.40
55	Pinion	30	1	$2\frac{1}{2}$	$\frac{3}{8}$	9.60
68	Wheel	94	1	$2\frac{1}{2}$	$4\frac{3}{4}$	30.08
	Pinion					
21	Wheel	96	1	$2\frac{1}{2}$	4	30.72
22	Pinion	14	1	$2\frac{1}{2}$	$\frac{1}{4}$	4.48
	Wheel					
550	Pinion	10	1	$2\frac{1}{2}$		3.20
	Wheel					
313	Pinion	11	1	$2\frac{1}{4}$	$\frac{1}{4}$	3.52
	Wheel					
735	Pinion	13	1	3		4.16
	Wheel					
580	Pinion	14	1	$2\frac{1}{4}$	$\frac{1}{4}$	4.48
	Wheel					
635	Pinion	18	1	3	$\frac{1}{2}$	5.76
	Wheel					
239	Pinion	11	$1\frac{1}{16}$	2		3.74
	Wheel					
373	Pinion	28	$1\frac{1}{8}$	2	$1\frac{1}{4}$	10.08
	Wheel					
753	Pinion	28	$1\frac{1}{8}$	$2\frac{1}{2}$		10.08

BEVEL GEARING—Continued.

No.	Description.	Teeth.	Pitch.	Face.	Backing.	Diameter in Inches.
277	Angl. $6\frac{1}{2}$ in.	35	$1\frac{1}{8}$	$2\frac{1}{4}$	$1\frac{1}{4}$	12.60
278	to 1 ft.	10	$1\frac{1}{8}$	$2\frac{1}{4}$		3.60
229	Wheel	40	$1\frac{1}{8}$	$2\frac{1}{2}$	$1\frac{3}{8}$	14.40
230	Pinion	35	$1\frac{1}{8}$	$2\frac{1}{2}$	$1\frac{1}{8}$	12.60
24	Wheel	44	$1\frac{1}{8}$	3	2	15.84
25	Pinion	22	$1\frac{1}{8}$	3	$\frac{3}{4}$	7.92
379	Wheel	44	$1\frac{1}{8}$	$2\frac{3}{4}$	$2\frac{3}{4}$	15.84
	Pinion					
295	Wheel	45	$1\frac{1}{8}$	$2\frac{1}{2}$	$2\frac{1}{4}$	16.20
296	Pinion	31	$1\frac{1}{8}$	$2\frac{1}{2}$	$1\frac{1}{4}$	11.16
297	Wheel	52	$1\frac{1}{8}$	$2\frac{1}{2}$	$1\frac{3}{8}$	18.72
298	Pinion	30	$1\frac{1}{8}$	$2\frac{1}{2}$	$1\frac{1}{8}$	10.80
375	Wheel	56	$1\frac{1}{8}$	$2\frac{1}{2}$	$2\frac{5}{8}$	20.16
376	Pinion	28	$1\frac{1}{8}$	$2\frac{1}{2}$	$2\frac{5}{8}$	10.08
377	Wheel	69	$1\frac{1}{8}$	$2\frac{1}{4}$	$2\frac{7}{8}$	24.84
378	Pinion	23	$1\frac{1}{8}$	$2\frac{1}{4}$	$2\frac{5}{8}$	8.28
336	Wheel	10	$1\frac{1}{8}$	$2\frac{1}{4}$	$\frac{1}{4}$	3.60
	Pinion					
795	Wheel	14	$1\frac{1}{8}$	3	2	5.04
	Pinion					
183	Wheel	14	$1\frac{1}{8}$	2	$\frac{3}{8}$	5.04
	Pinion					
374	Wheel	14	$1\frac{1}{8}$	2	$\frac{3}{8}$	5.04
	Pinion					
469	Wheel	14	$1\frac{1}{8}$	$2\frac{1}{8}$	$\frac{5}{8}$	5.04
	Pinion					
565	Wheel	14	$1\frac{1}{8}$	3	$\frac{1}{4}$	5.04
	Pinion					
587	Wheel	14	$1\frac{1}{8}$	$3\frac{1}{2}$		5.04
	Pinion					
896	Wheel	13	$1\frac{3}{16}$	3	$\frac{1}{2}$	4.94
	Pinion					

BEVEL GEARING—Continued.

No.	Description.	Teeth.	Pitch.	Face.	Backing.	Diameter in Inches.
863	Wheel Pinion	53	$1\frac{3}{16}$	$3\frac{1}{4}$		20.14
360	Wheel	25	$1\frac{7}{32}$	$2\frac{1}{4}$	$1\frac{5}{8}$	9.75
361	Pinion	17	$1\frac{7}{32}$	$2\frac{1}{4}$	$\frac{3}{8}$	6.63
280	Wheel Pinion	10	$1\frac{1}{4}$	3	$\frac{1}{2}$	4.00
733	Wheel Pinion	13	$1\frac{1}{4}$	$2\frac{3}{4}$	$\frac{1}{4}$	5.20
810	Wheel Pinion	15	$1\frac{1}{4}$	$3\frac{3}{4}$	1	6.00
747	Wheel Pinion	16	$1\frac{1}{4}$	$3\frac{1}{4}$	$\frac{5}{16}$	6.40
467	Wheel Pinion	32	$1\frac{1}{4}$	$3\frac{1}{2}$	$1\frac{1}{4}$	12.80
28	Wheel	30	$1\frac{1}{4}$	$2\frac{1}{4}$	$1\frac{3}{4}$	12.00
29	Pinion	24	$1\frac{1}{4}$	$2\frac{1}{4}$	1	9.60
893	Wheel	36	$1\frac{1}{4}$	3	$1\frac{1}{2}$	14.40
894	Pinion	18	$1\frac{1}{4}$	3	1	7.20
233	Wheel	47	$1\frac{1}{4}$	3	$2\frac{3}{8}$	18.80
234	Pinion	20	$1\frac{1}{4}$	3	$\frac{1}{2}$	8.00
382	Wheel Pinion	60	$1\frac{1}{4}$	$2\frac{1}{2}$	$2\frac{1}{2}$	24.00
482	Wheel	60	$1\frac{1}{4}$	$2\frac{1}{2}$	$2\frac{3}{4}$	24.00
483	Pinion	23	$1\frac{1}{4}$	$2\frac{1}{2}$	$1\frac{3}{4}$	9.20
64	Wheel	60	$1\frac{1}{4}$	3	3	24.00
65	Pinion	30	$1\frac{1}{4}$	3	$1\frac{1}{8}$	12.00
206	Wheel	60	$1\frac{1}{4}$	$2\frac{1}{2}$	$3\frac{1}{2}$	24.00
207	Pinion	15	$1\frac{1}{4}$	$2\frac{1}{2}$	$\frac{1}{4}$	6.00
62	Wheel	62	$1\frac{1}{4}$	$2\frac{1}{2}$	$3\frac{1}{4}$	24.80
63	Pinion	32	$1\frac{1}{4}$	$2\frac{1}{2}$	$1\frac{1}{8}$	12.80
586	Wheel	63	$1\frac{1}{4}$	$3\frac{1}{2}$	$1\frac{1}{16}$	25.20
585	Pinion	39	$1\frac{1}{4}$	$3\frac{1}{2}$	$1\frac{1}{16}$	15.60

BEVEL GEARING—Continued.

No.	Description.	Teeth.	Pitch.	Face.	Backing.	Diameter in Inches.
281	Wheel	76	$1\frac{1}{4}$	$3\frac{3}{4}$	$2\frac{1}{2}$	30.40
282	Pinion	50	$1\frac{1}{4}$	$3\frac{3}{4}$	$1\frac{1}{4}$	20.00
108	Wheel	88	$1\frac{1}{4}$	4	$3\frac{3}{4}$	35.20
109	Pinion	45	$1\frac{1}{4}$	4	1	18.20
506	Wheel					
	Pinion	13	$1\frac{5}{16}$	3		5.46
826	Wheel					
	Pinion	22	$1\frac{5}{16}$	3		8.36
246	Wheel	44	$1\frac{3}{8}$	$3\frac{1}{2}$	$1\frac{7}{8}$	19.36
247	Pinion	39	$1\frac{3}{8}$	$3\frac{1}{2}$	$1\frac{1}{2}$	17.16
283	Wheel	50	$1\frac{3}{8}$	$3\frac{1}{2}$	2	24.00
284	Pinion	39	$1\frac{3}{8}$	$3\frac{1}{2}$	$1\frac{1}{4}$	17.16
104	Wheel	60	$1\frac{3}{8}$	4	4	26.40
105	Pinion	15	$1\frac{3}{8}$	4	$\frac{3}{8}$	6.60
30	12 Seg't	228	$1\frac{3}{8}$	$2\frac{1}{2}$		100.32
31	Pinion	18	$1\frac{3}{8}$	$2\frac{1}{2}$	$\frac{3}{8}$	7.92
213	12 Seg't	228	$1\frac{3}{8}$	$3\frac{1}{4}$		100.32
214	Pinion	26	$1\frac{3}{8}$	$3\frac{1}{4}$	$\frac{1}{4}$	11.44
199	Wheel					
	Pinion	12	$1\frac{3}{8}$	$3\frac{5}{8}$		5.28
689	Wheel					
	Pinion	14	$1\frac{3}{8}$	$3\frac{1}{2}$		6.16
26	Wheel	52	$1\frac{1}{2}$	4	$3\frac{5}{8}$	24.96
27	Pinion	25	$1\frac{1}{2}$	4	$1\frac{1}{8}$	12.00
460	Wheel	75	$1\frac{1}{2}$	$3\frac{1}{2}$	4	36.00
461	Pinion	25	$1\frac{1}{2}$	$3\frac{1}{2}$	$\frac{3}{4}$	12.00
521	Wheel					
	Pinion	11	$1\frac{1}{2}$	$3\frac{3}{8}$		5.28
325	Wheel					
	Pinion	12	$1\frac{1}{2}$	$3\frac{1}{4}$	$\frac{1}{4}$	5.76
479 *	Wheel					
	Pinion	13	$1\frac{1}{2}$	$2\frac{1}{8}$	$\frac{1}{4}$	6.24

BEVEL GEARING—Continued.

No.	Description.	Teeth.	Pitch.	Face.	Backing.	Diameter in Inches.
327	Wheel Pinion	13	$1\frac{1}{2}$	$3\frac{1}{4}$	$\frac{1}{4}$	6.24
737	Wheel Pinion	13	$1\frac{1}{2}$	$3\frac{5}{8}$	$\frac{5}{8}$	6.24
584	Wheel Pinion	15	$1\frac{1}{2}$	$3\frac{1}{2}$	$\frac{3}{8}$	7.20
839	Wheel Pinion	15	$1\frac{1}{2}$	$3\frac{1}{2}$	$\frac{1}{2}$	7.20
872	Wheel Pinion	17	$1\frac{1}{2}$	4		8.16
588	Wheel Pinion	25	$1\frac{1}{2}$	4	$\frac{1}{2}$	12.00
685	Wheel Pinion	25	$1\frac{1}{2}$	4		12.00
743	Wheel Pinion	35	$1\frac{1}{2}$	4	$\frac{3}{4}$	16.80
475	Wheel Pinion	12	$1\frac{5}{8}$	$2\frac{3}{8}$	$\frac{3}{4}$	6.24
477	Wheel Pinion	13	$1\frac{5}{8}$	$2\frac{1}{2}$	$\frac{3}{4}$	6.76
783	Wheel Pinion	15	$1\frac{5}{8}$	$3\frac{1}{2}$	$\frac{5}{8}$	7.80
782	Wheel Pinion	16	$1\frac{5}{8}$	$3\frac{1}{2}$	$\frac{5}{8}$	8.32
813	Wheel Pinion	24	$1\frac{5}{8}$	4	$\frac{1}{2}$	12.48
687	Wheel Pinion	11	$1\frac{3}{4}$	$3\frac{5}{8}$		6.16
763	Wheel Pinion	12	$1\frac{3}{4}$	$3\frac{1}{2}$	$\frac{5}{8}$	6.72
739	Wheel Pinion	13	$1\frac{3}{4}$	$2\frac{7}{8}$		7.28

BEVEL GEARING—Continued.

No.	Description.	Teeth.	Pitch.	Face.	Backing.	Diameter in Inches.
784	Wheel Pinion	14	$1\frac{1}{16}$	$3\frac{1}{2}$	$\frac{5}{8}$	8.12
106	Wheel	28	$1\frac{7}{8}$	4	$2\frac{3}{8}$	16.80
107	Pinion	14	$1\frac{7}{8}$	4	1	8.40
102	4 Seg't	72	$1\frac{7}{8}$	6		43.20
103	Pinion	26	$1\frac{3}{8}$	6	3	15.60
473	Wheel Pinion	10	$1\frac{7}{8}$	$2\frac{3}{8}$	$\frac{3}{4}$	6.00
350	Wheel Pinion	10	$1\frac{7}{8}$	$2\frac{1}{2}$	$\frac{1}{8}$	6.00
201	Wheel Pinion	11	$1\frac{7}{8}$	$4\frac{1}{2}$	$\frac{1}{4}$	6.60
18	Wheel	48	2	$4\frac{1}{2}$	5	30.72
19	Pinion	16	2	$4\frac{1}{2}$	$\frac{1}{2}$	10.24
458	Wheel	59	2	5	$5\frac{5}{8}$	37.76
459	Pinion	28	2	5	$2\frac{3}{8}$	17.92
745	Wheel Pinion	13	2	4 $\frac{1}{4}$	$\frac{1}{4}$	8.32
793	Wheel	60	$2\frac{1}{8}$	$5\frac{1}{2}$	$6\frac{3}{8}$	40.80
794	Pinion	15	$2\frac{1}{8}$	$5\frac{1}{2}$	$\frac{1}{2}$	10.20
10	8 Seg't	112	$2\frac{1}{8}$	$8\frac{1}{2}$		76.16
11	Pinion	41	$2\frac{1}{8}$	$8\frac{1}{2}$	$1\frac{1}{4}$	27.88
752	Ag'l Wh. Pinion	28	$2\frac{1}{4}$	$4\frac{1}{8}$	$2\frac{3}{4}$	20.16
333	Wheel Pinion	12	$2\frac{1}{2}$	$3\frac{5}{8}$	$\frac{5}{8}$	9.60

HARD MAPLE COGS.

When ordering cogs for mortise wheels please give us the measurements as indicated on the outline diagrams here shown.

Bevel Tooth.

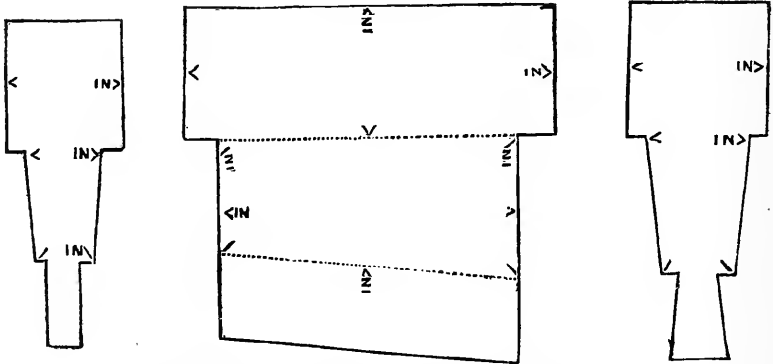

Allowance having been made for fitting.

Spur Tooth.

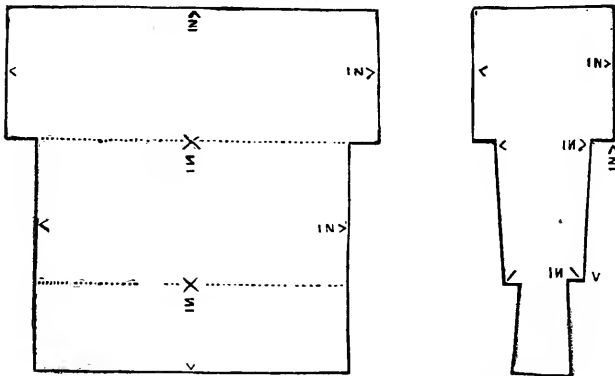

Allowance having been made for fitting.

Price List of Hard Maple Cogs.

Face in Inches	4	5	6	7	8	9	10	11	12
Price Each	\$0 09	11	13	15	18	22	28	33	40
Discount	per cent.								

Filling Mortise Gears with Hard Maple Cogs, either Bevel or Spur

Width of Face	3 in.	4 in.	5 in.	6 in.	7 in.
Price per Cog	30 cts.	40 cts.	50 cts.	60 cts.	70 cts.
Width of Face	8 in.	9 in.	10 in.	11 in.	12 in.
Price per Cog	\$0 80	90	1 00	1 10	1 20
Discount	per cent.				

CIRCULAR SAW MANDRELS.

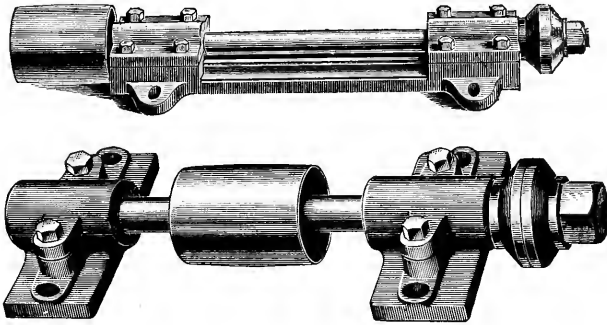

When ordering state whether you want pulley between or outside of boxes.

PRICE LIST.

(Price does not include Saws.)

No.	Extreme Length, Inches.	Diam. of Arbor, Inches.	Diameter of Pulley, Inches.	Face of Pulley, Inches.	Diameter of Collars, Inches.	Size of hole in Saw Inches.	Size of Saw, Inches.	Price, Each.
1	14	$1\frac{1}{16}$	3	3	3	1	6 to 12	\$ 7 50
2	16	$1\frac{1}{16}$	3	$3\frac{1}{2}$	3	1	14 to 18	8 50
3	18	$1\frac{3}{16}$	3	4	$3\frac{1}{2}$	$1\frac{1}{8}$	20 to 24	9 00
4	20	$1\frac{3}{16}$	$3\frac{1}{2}$	$4\frac{1}{2}$	$3\frac{1}{2}$	$1\frac{1}{8}$	26 to 28	10 50
5	22	$1\frac{5}{16}$	4	5	4	$1\frac{1}{4}$	30 to 32	11 50
6	24	$1\frac{5}{16}$	$4\frac{1}{2}$	$5\frac{1}{2}$	4	$1\frac{1}{4}$	34 to 36	13 00
7	26	$1\frac{7}{16}$	5	6	$4\frac{1}{2}$	$1\frac{3}{8}$	36	14 50
8	28	$1\frac{7}{16}$	$5\frac{1}{2}$	$6\frac{1}{2}$	$4\frac{1}{2}$	$1\frac{3}{8}$	36	16 00
9	32	$1\frac{9}{16}$	6	7	$4\frac{1}{2}$	$1\frac{1}{2}$	36	22 00
10	36	$1\frac{11}{16}$	7	8	5	$1\frac{1}{2}$	38	26 00

Our Mandrels are made with left-hand thread, unless otherwise ordered.

Discount per cent.

CAST IRON WASHERS.

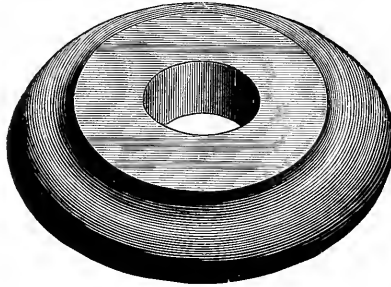

Price List.

Size of Bolt.....	$\frac{3}{8}$ in.	$\frac{1}{2}$ in.	$\frac{5}{8}$ in.	$\frac{3}{4}$ in.	$\frac{7}{8}$ in.	1 in.	$1\frac{1}{8}$ in.
Price per 100 pieces..	\$0 80	1 30	1 90	3 20	4 60	6 20	8 10

Size of Bolt.....	$1\frac{1}{4}$ in.	$1\frac{3}{8}$ in.	$1\frac{1}{2}$ in.	$1\frac{5}{8}$ in.	$1\frac{3}{4}$ in.	$1\frac{7}{8}$ in.	2 in.
Price per 100 pieces..	\$10 60	14 00	17 80	22 30	28 00	34 00	42 00

Discount.....per cent.

BABBIT METAL.



Genuine	Per lb.,	\$0 30
Extra	Per lb.,	25
No. 4	Per lb.,	10

Discount.....per cent.

Prices for Cutting Standard Threads on Iron Pipe.

Size in Inches ...	$\frac{1}{8}$	$\frac{1}{4}$	$\frac{3}{8}$	$\frac{1}{2}$	$\frac{3}{4}$	1	$1\frac{1}{4}$	$1\frac{1}{2}$	2	$2\frac{1}{2}$	3
Price, each	\$0 05	05	05	05	05	06	07	08	10	15	20

Size in In...	$3\frac{1}{2}$	4	$4\frac{1}{2}$	5	6	7	8	9	10	12	14
Price, each ..	\$0 25	35	45	55	70	85	1 00	1 25	1 50	2 50	3 50

Discount.....per cent.

FILING ROOM EQUIPMENT.

**RICH'S MODERN AUTOMATIC BAND SAW
SHARPENER AND GUMMER, No. 1.**

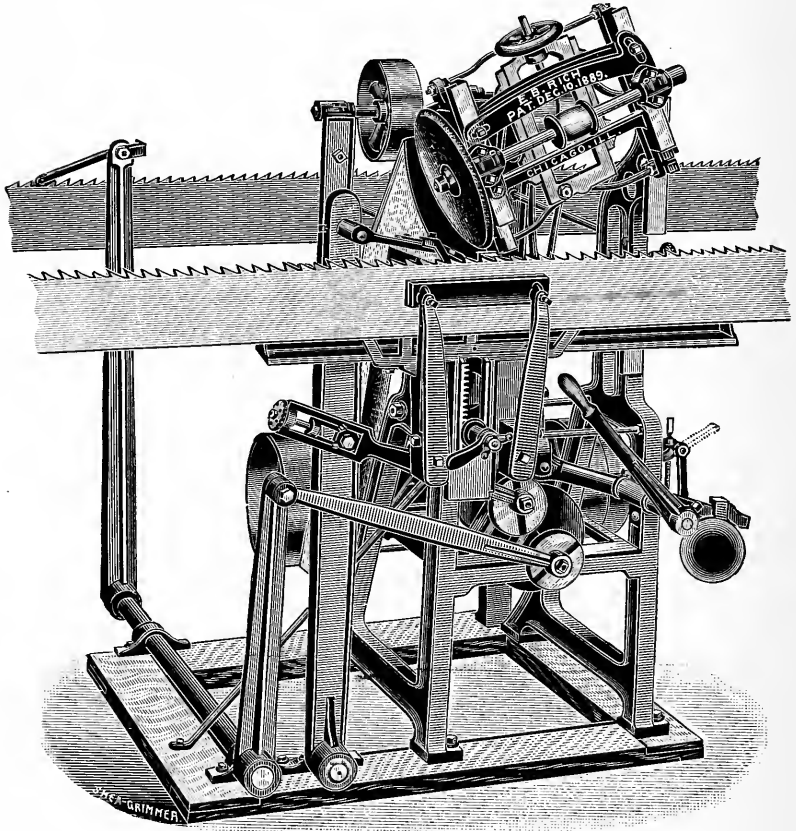

When ordering for Band Saws, give hand of mill and state if for one or two mills, also if saw is to straddle machine or go in front.

Reduced Price for Band Saws, 1 Mill.....	\$225 00
Extra Attachment to make machine suitable for 2 Mills, Price,	
Net	6 00

Discount.....per cent.

COVEL'S IMPROVED AUTOMATIC BAND SAW SHARPENER.

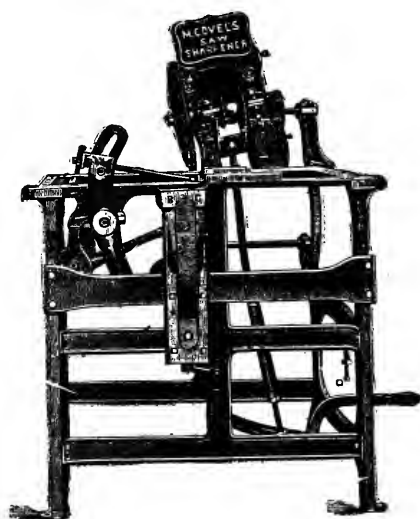

No. 3.

This machine is now made either right or left hand, or combined right and left, and is furnished with Post Brackets and back feed.

Price of Sharpener with any feed as above. \$200 00

Discount. per cent.

**AUTOMATIC EMERY WHEEL BAND SAW
SCARFING MACHINE.**

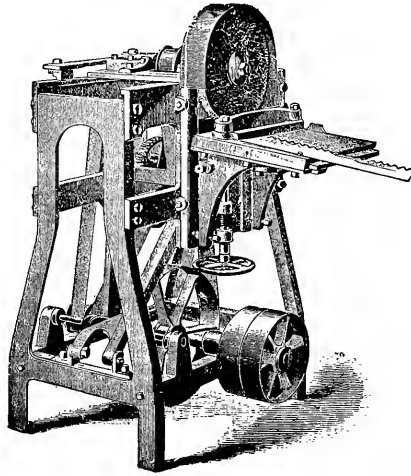

This machine is the strongest, most compact, and most accurate in its work of any scarfer or lap grinder made. It dresses with the utmost accuracy, leaving the two ends in such shape that when put together an almost invisible joint is formed, and no filing is required.

The movement of the emery wheel is automatic both lengthwise and sidewise, thus keeping both the face and roundness of the wheel perfectly true at all times, without dressing. One emery wheel with each machine.

Price \$125 00

Discount.....per cent.

**IMPROVED AUTOMATIC SHARPENER FOR
CIRCULAR RIP SAWS.**

From 8 to 72 inches.

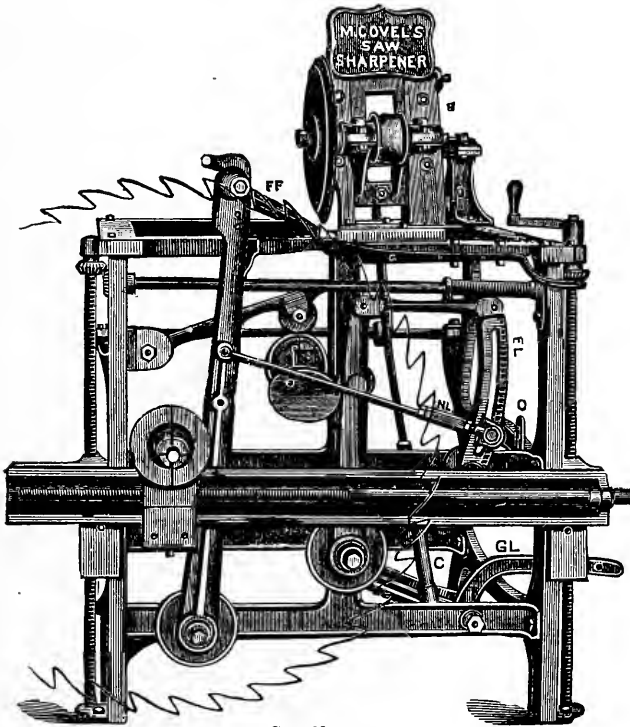

CUT No. 1.

This is the most complete circular saw sharpener ever made and the only one that will sharpen all kinds of inserted tooth saws complete without removing the points. Such saws will do 10 per cent. better and more work and require less hammering when sharpened on this machine.

The above is a correct view of the different parts as they are now made, showing the operating parts and the letters to be found on each piece.

Full instructions will accompany each machine as to operation and adjustment.

Price \$175 00

Discount per cent.

AUTOMATIC "E" SHARPENER FOR RIP AND CUT-OFF CIRCULAR SAWS.

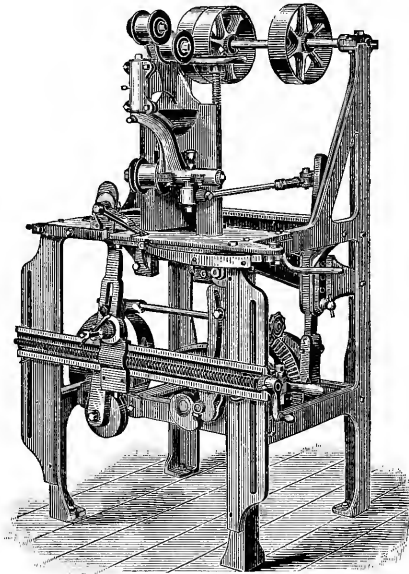

This machine has been constructed to meet the demand for a sharpener to dress saws from 4 to 48 inches in diameter. If desired will sharpen a 60 inch saw by turning the cross bar over.

A portion of the frame is broken away in the cut to show the working parts.

The emery wheel is stationary and the saw is raised to it when dressing the tooth; when dressing Rip Saws the workings of the machine are essentially the same as the large machine; when dressing Cut-off Saws the emery wheel reverses on every tooth.

This machine is especially adapted for Bolting and Trimmer Saws and for factories where saws under 4 feet are used.

Price	\$150 00
Emery Wheel and Belt extra.....	5 00
Discount.....	per cent.

EMERY SAW GUMMER.



We illustrate herewith what we believe to be the cheapest first-class Emery Saw Gummer in the market.

It combines in the simplest possible manner, all the essential features of the higher priced machines.

An adjustable stop is provided for regulating the depth of cut.

The counter-shaft on gummer has tight and loose pulleys, 4 inches in diameter, with $2\frac{1}{4}$ inch face, which should be driven about 950 revolutions per minute.

The pulley on counter-shaft which drives emery-wheel arbor is $5\frac{1}{2}$ inches in diameter, and the pulley on emery-wheel arbor is $3\frac{1}{4}$ inches in diameter, for a $2\frac{1}{2}$ inch belt. The emery-wheel is 12×3 .

We babbitt the four main bearings and put caps on the boxes, so that all wear of journals can be taken up.

This machine will accommodate any diameter of circular saw in use.

The slotted arm on which the saw hangs is so fitted to the collars on the upright column that it can be swung around for gumming a square or bevel toothed saw as required.

Price \$10 00

Discount.....per cent.

IMPROVED SAW STRETCHER, No. 1.

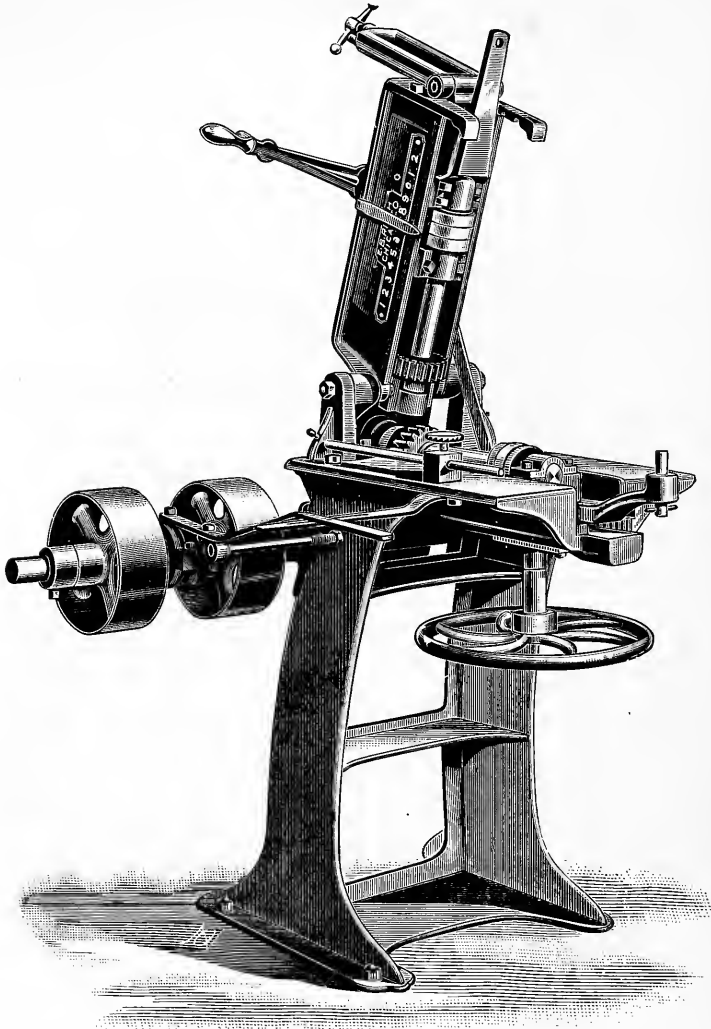

The above cut represents our new Saw Roller or Stretcher. In this machine we have added an entirely new feature, viz.: the movable rolls. The rolls move out across the saw, by the large hand wheel shown at the bottom of rolls, thus avoiding the moving of saw in and out edge-wise.

By its use the Filer can stretch the saw in considerable less time than on the old style machine.

This machine has its own support or stand and requires no building into bench as in other Rollers.

Machine has clutch pulleys 9x4, speed 450.

Counter Shaft for Stretcher complete, with all necessary pulleys, hangers, etc., \$15.00.

Reduced price on machine \$200 00
Discount.....per cent.

No. 2 FILING CLAMP AND JOINTER.

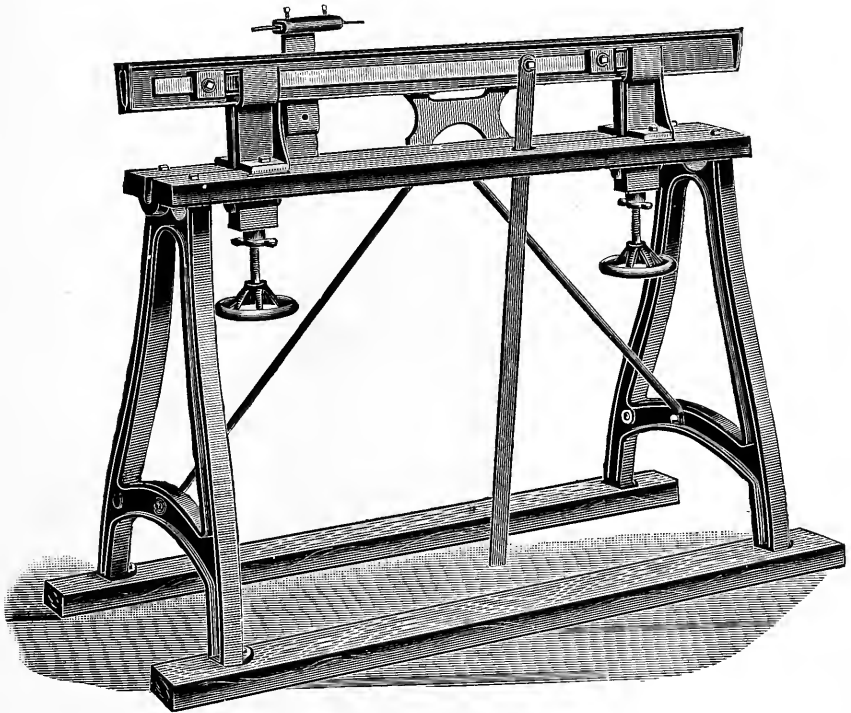

Reduced Price.

6 Feet	\$50 00
8 Feet	55 00
10 Feet	60 00
Wheels and stand furnished with filing clamps, net.....	10 00

Discount..... per cent.

WHITE'S HAND SAW SWAGE.

**Illustration and description
of this machine will be sent
upon application.**

This swage is the only swage made with an Adjustable Anvil and consequently it will fit any shape tooth, and properly swage the under-side of teeth on Band, Gang or Circular Saws.

It is the only swage made with a peek hole through the block showing the point of tooth and die when swaging. Descriptive circulars on application.

Price \$40 00

Discount.....per cent.

COMBINED ADJUSTABLE SAW SET.

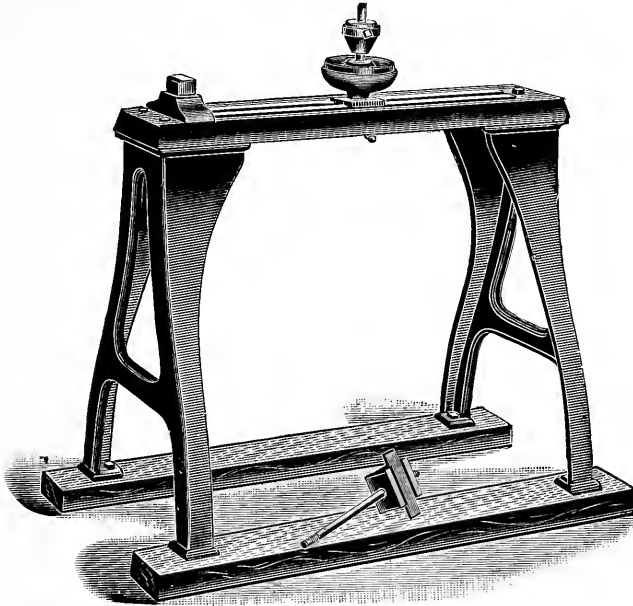

Price \$35 00
 Discount..... per cent.

PORTABLE FORGE.

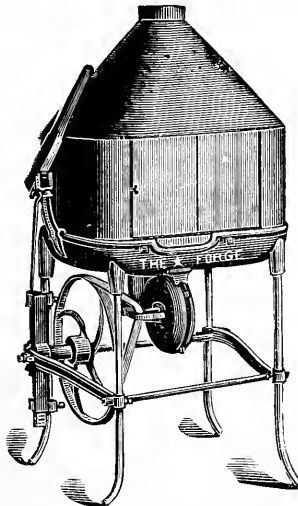

For Heating Brazing Irons and other Repairs about Mill, a handy Tool.
 Price \$12 00
 Discount..... per cent.

IMPROVED BRAZING CLAMP.

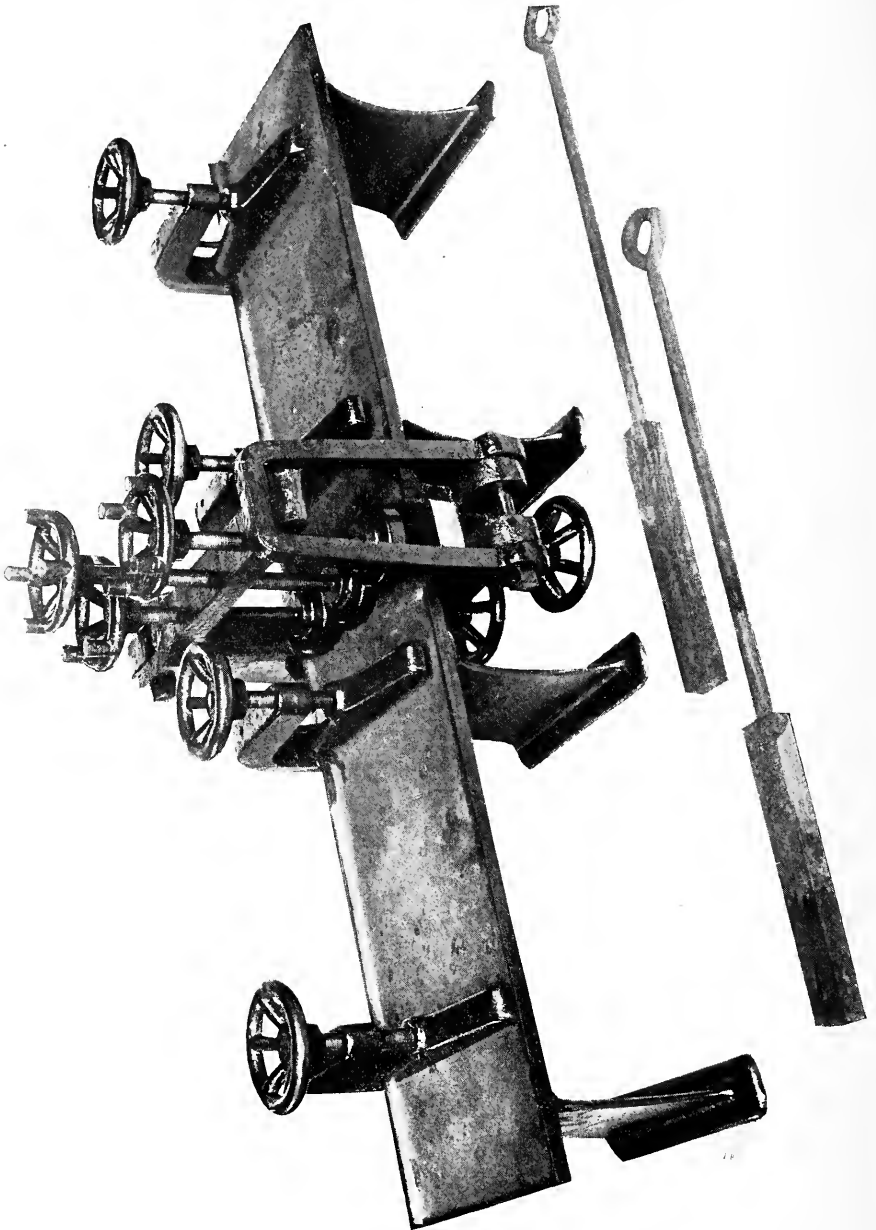

The bed is recessed to take the lower heating iron, which can be adjusted to equal pressure by the hand wheels placed in bed as shown. With this clamp equal pressure can be had top and bottom, always insuring a good braze.

Weight	Price	\$45 00
	Discount.....per cent.	

The following saw tools are a necessary auxiliary to the filing room and we are prepared to furnish them, when so desired, at factory prices.

STRAIGHT EDGE.



$\frac{1}{4}$ in. x 4 in. x 6 ft., Price..... \$10 00
Discount.....per cent.

SAW ANVIL.

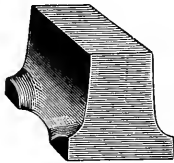

50 to 250 lbs., Price, per lb..... \$0 12
Discount.....per cent.

CROSS PEIN SAW HAMMER.

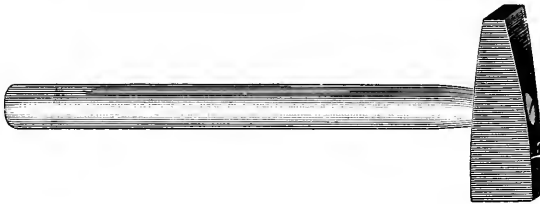

ROUND FACE SAW HAMMER.

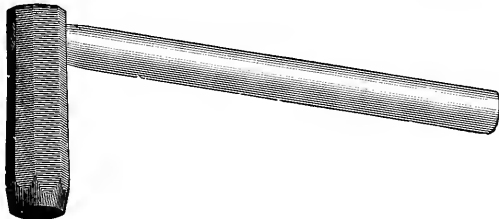

Price, per lb..... \$0 50
Discount.....per cent.

...MISCELLANEOUS...

DUPLEX STEAM PUMPS.

For boiler feeding, fire, hydraulic elevators and general purposes.

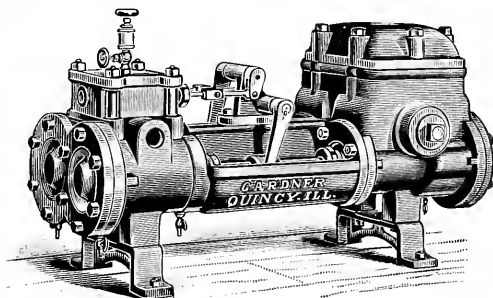

BOILER FEEDER.

Design of 6x4x6 and smaller sizes.

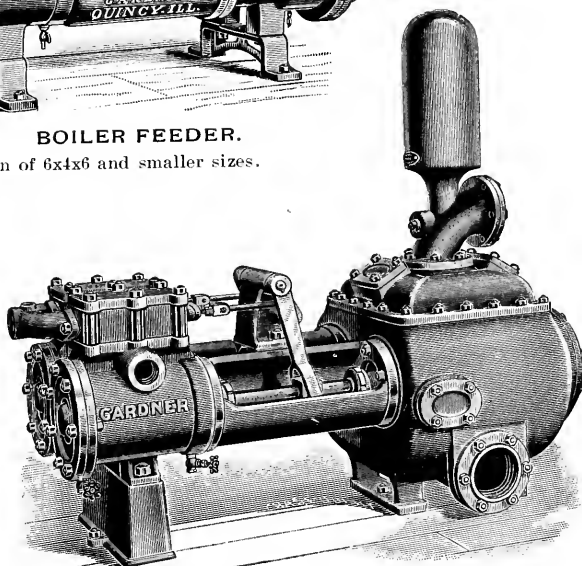

BOILER FEEDER.

Design of 7x4½x10 and larger sizes.

THE GARDNER DUPLEX STEAM PUMP.

The smaller cut illustrates the regular Boiler Feed Pump, made in sizes from 3x2x3 to 6x4x6; the larger cut from 7x4½x10 to 12x7x12, as shown in the table of dimensions below, with pistons or plungers, and fitted with rubber or metal valves for hot or cold water, as may be desired. All Pumps are made on the interchangeable plan of duplication, so that worn or broken parts may be replaced with absolute certainty of a fit.

All Pumps, both piston and plunger, are furnished with solid composition removable sleeves or linings, without extra charge. Tobin bronze rods are used in all composition fitted Pumps, and the composition used is pure copper and tin. Piston pumps will in all cases be shipped unless the plunger pattern is especially ordered. For clear water it is advisable to use the plunger pattern pump, and for muddy or gritty water the piston pattern pump. When ordering, always give size by diameter of Steam Cylinder and Water Plungers, and length of stroke. All Pumps are furnished with Sight Feed Lubricators. Air Chambers are not furnished up to and including 6x4x6.

**THE GARDNER DUPLEX STEAM PUMP.
TABLE OF SIZES AND CAPACITIES.**

No.	Diameter of Steam Cylinder.	Diameter of Water Cylinder.	Length of Stroke.	Displacements in Gallons per Stroke of one Plunger.	Proper Strokes per minute of one Plunger, varying with kind of work and Pressure.	Gallons per Minute by both Plungers at stated number of Strokes.	Price.		Sizes of Pipes for Short Lengths, to be increased as Length increases.				Approximate Weight.	Horse Power of Boiler, Based on 30 lbs. Water per hour.
									Steam Pipe.	Exhaust Pipe.	Suction Pipe.	Disch. Pipe.		
0	2	1	3	.02	100 to 250	4 to 11	\$ 50 00	1	1	1	1	95	40	
00	3	2	3	.04	100 to 250	8 to 20	55 00	1	1	1	1	140	60	
1	3	2	3 $\frac{1}{2}$.05	100 to 250	10 to 25	60 00	1	1	1	1	200	70	
1 $\frac{1}{2}$	4	2 $\frac{1}{2}$	4	.08	100 to 250	16 to 32	80 00	1	1	1	1	300	100	
2	5	3	4	.12	100 to 200	24 to 50	90 00	1	1	2	1	400	150	
3	5 $\frac{1}{2}$	3 $\frac{1}{2}$	6	.24	100 to 150	50 to 75	120 00	1	1	2 $\frac{1}{2}$	1	650	300	
4	6	4	6	.33	100 to 150	70 to 100	140 00	1	1	3	2	800	400	
5	7	4 $\frac{1}{2}$	10	.69	75 to 125	100 to 170	300 00	1	2	4	3	1550	700	
6	8	5	10	.85	75 to 125	130 to 220	390 00	1 $\frac{1}{2}$	2	5	4	2500	800	
7	10	6	10	1.22	50 to 100	125 to 245	430 00	2	2 $\frac{1}{2}$	5	4	2600	1200	
8	12	7	12	2.00	50 to 100	200 to 400	550 00	2 $\frac{1}{2}$	3	6	5	4100	1400	
9	12	8	12	2.61	50 to 100	260 to 520	625 00	2 $\frac{1}{2}$	3	7	6	4800		
10	12	10	12	4.07	50 to 100	407 to 814	720 00	2 $\frac{1}{2}$	3	8	7	5800		
11	14	8	12	2.61	50 to 100	260 to 520	650 00	2 $\frac{1}{2}$	3	7	6	4950		
12	14	10	12	4.07	50 to 100	407 to 814	775 00	2 $\frac{1}{2}$	3	8	7	5800		
13	14	12	12	5.87	50 to 100	587 to 1174	920 00	2 $\frac{1}{2}$	3	10	8	6800		
13 $\frac{1}{2}$	16	9	12	3.30	50 to 100	330 to 660	800 00	2 $\frac{1}{2}$	3	8	6	6500		
14	16	10	12	4.07	50 to 100	407 to 814	835 00	2 $\frac{1}{2}$	3	8	7	6500		
15	16	12	12	5.87	50 to 100	587 to 1174	975 00	2 $\frac{1}{2}$	3	10	8	7100		
16	16	14	12	7.99	50 to 100	799 to 1598	1080 00	2 $\frac{1}{2}$	3	12	10	8300		
17	18	10	12	4.07	50 to 100	405 to 814	980 00	3	4	8	7	7500		
18	18	12	12	5.87	50 to 100	587 to 1174	1035 00	3	4	10	8	8100		
19	18	14	12	7.99	50 to 100	799 to 1598	1150 00	3	4	12	10	9400		
20	20	12	12	5.87	50 to 100	587 to 1174	1200 00	4	5	10	8	8400		
21	20	14	12	7.99	50 to 100	790 to 1598	1350 00	4	5	12	10	10000		

Composition Pistons and Plungers will be furnished at slight additional cost. Composition Piston and Plunger Rods should be used when Pump is required to handle liquids injurious to steel and iron. Hot Water should always flow to Pump by gravitation.

Discount..... per cent.

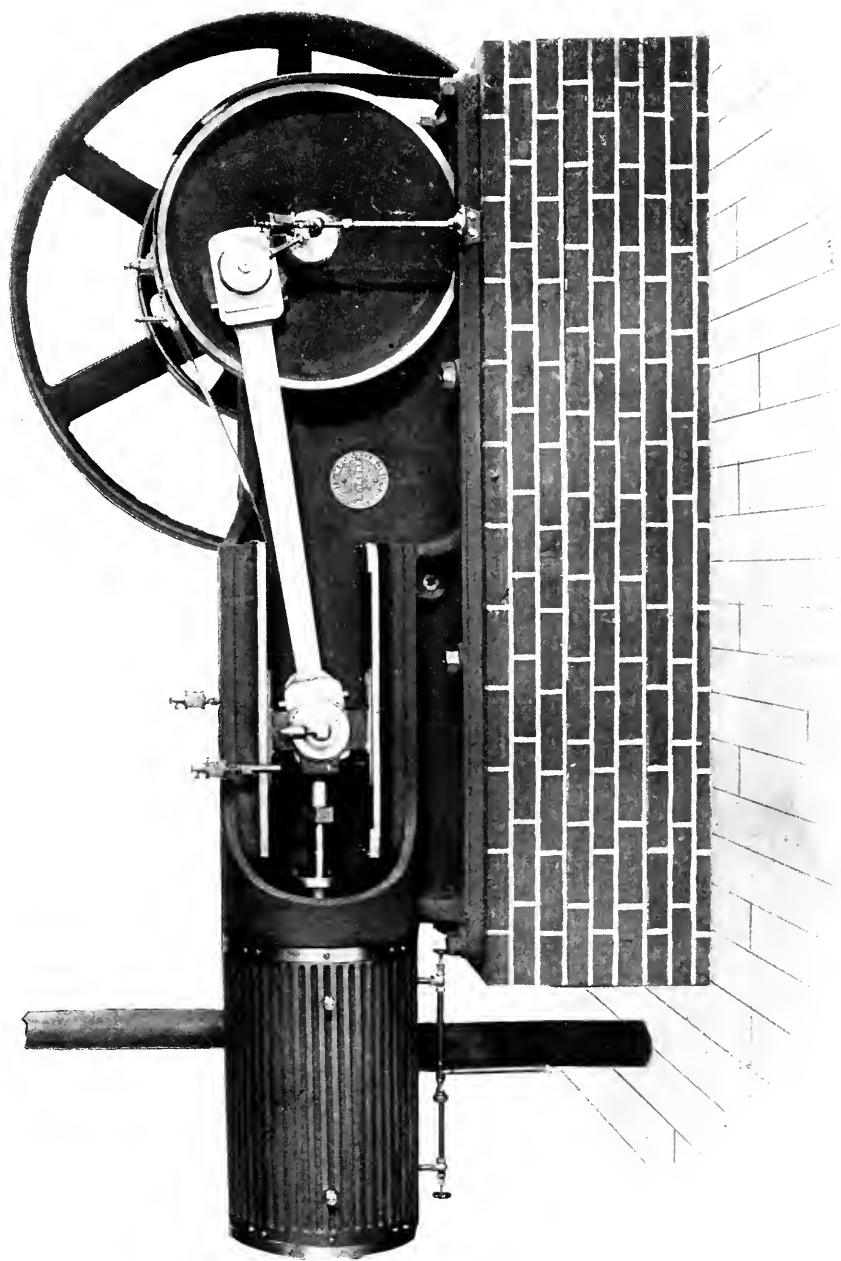

PHOENIX AUTOMATIC ENGINE. FRONT VIEW.

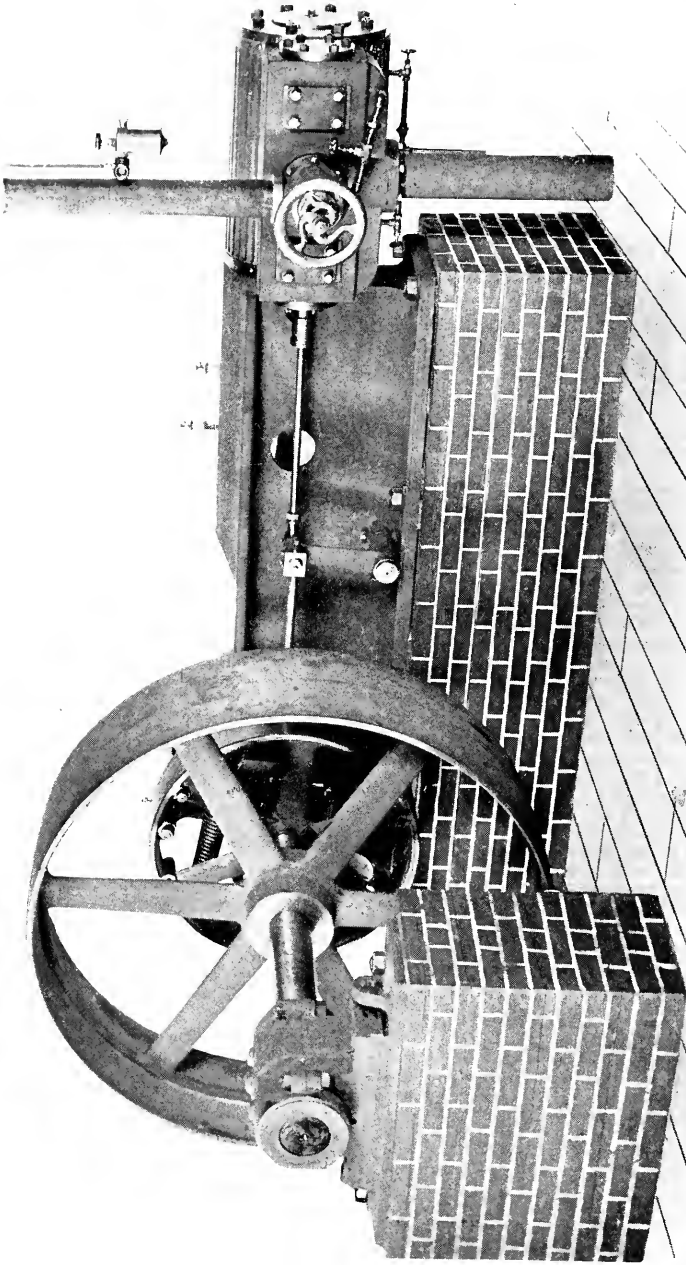

PHOENIX AUTOMATIC ENGINE. BACK VIEW.

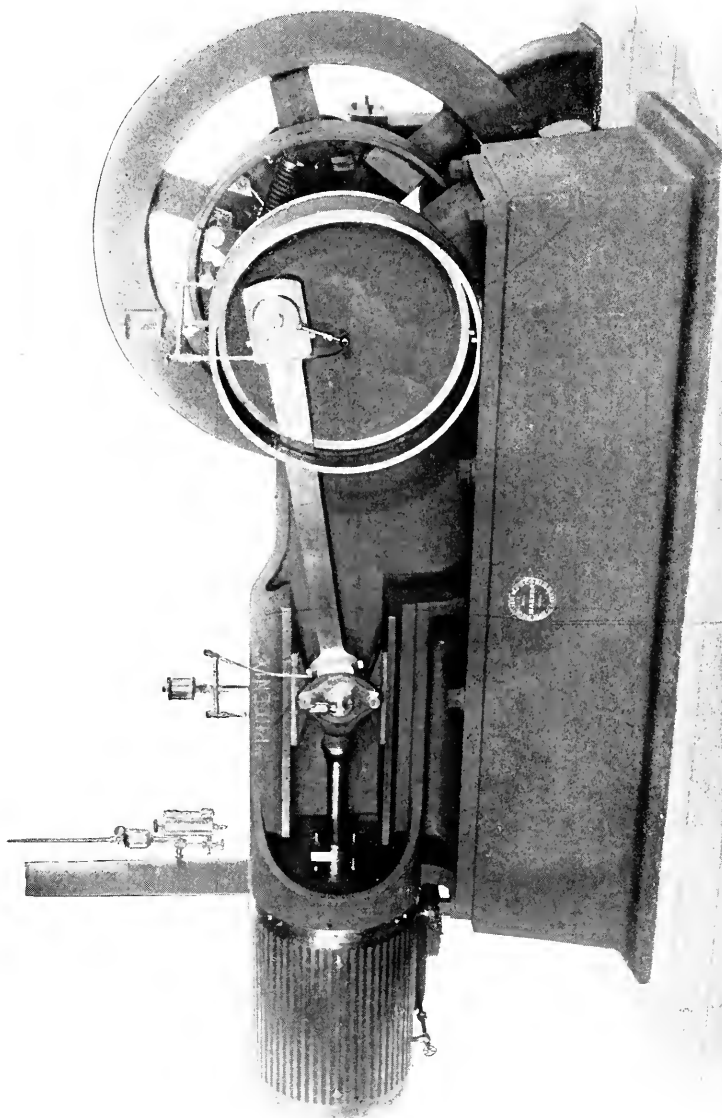

PHOENIX AUTOMATIC ENGINE WITH SUB-BASE.

SINGLE CYLINDER PHOENIX AUTOMATIC CUT-OFF ENGINES.

Prices, Sizes and Dimensions.

Cylinders.		Speed.	Horse Power.		Band Fly Wheel.		Diameter of Steam Pipe.	Diameter of Exhaust Pipe.	Complete Weight in Pounds.	Price, Standard Finish.
Bore, inches.	Stroke, inches.		Revolutions Per Minute.	Standard Rating, Best Economy $\frac{1}{4}$ Cut-off 85 to 90 Lbs. B. P.	Maxim $\frac{3}{4}$ Cut-off 85 to 90 Lbs. B. P.	Diameter in Inches.				
8	14	260	40	72	56	14	2 $\frac{1}{2}$	3 $\frac{1}{2}$	6000	\$ 750 00
9	14	260	50	90	62	14	3	4	7000	850 00
10	14	260	60	114	62	16	3 $\frac{1}{2}$	4 $\frac{1}{2}$	7500	950 00
11	16	240	75	144	66	16	4	5	8500	1125 00
12	16	240	90	172	66	19	4	5	9000	1250 00
13	16	240	105	202	68	19	4 $\frac{1}{2}$	6	10000	1375 00
14	16	240	125	235	68	22	4 $\frac{1}{2}$	6	12000	1500 00
15	18	225	150	285	78	23	5	7	15000	1800 00
16	18	225	170	322	78	26	6	8	16000	2000 00

We manufacture these Engines with Sub-Base, and Compound Condensing, either Cross or Tandem.

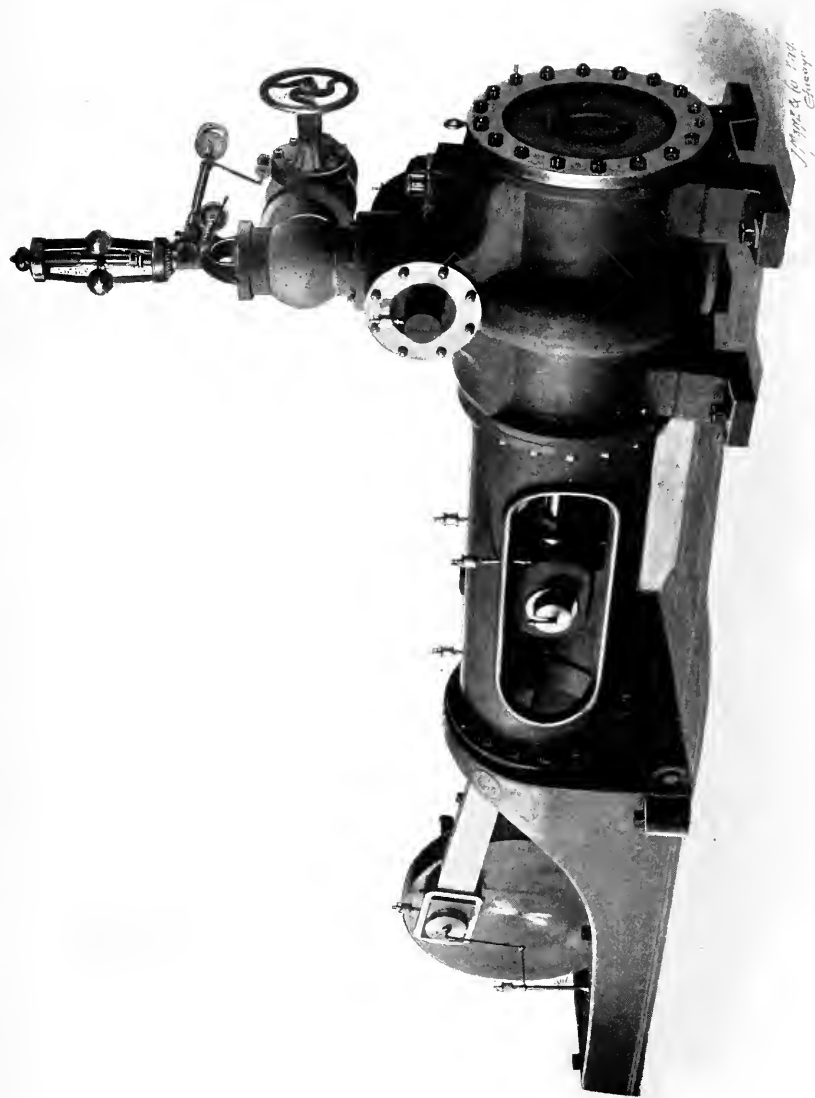

PHOENIX IMPROVED HEAVY DUTY SAW MILL ENGINE.

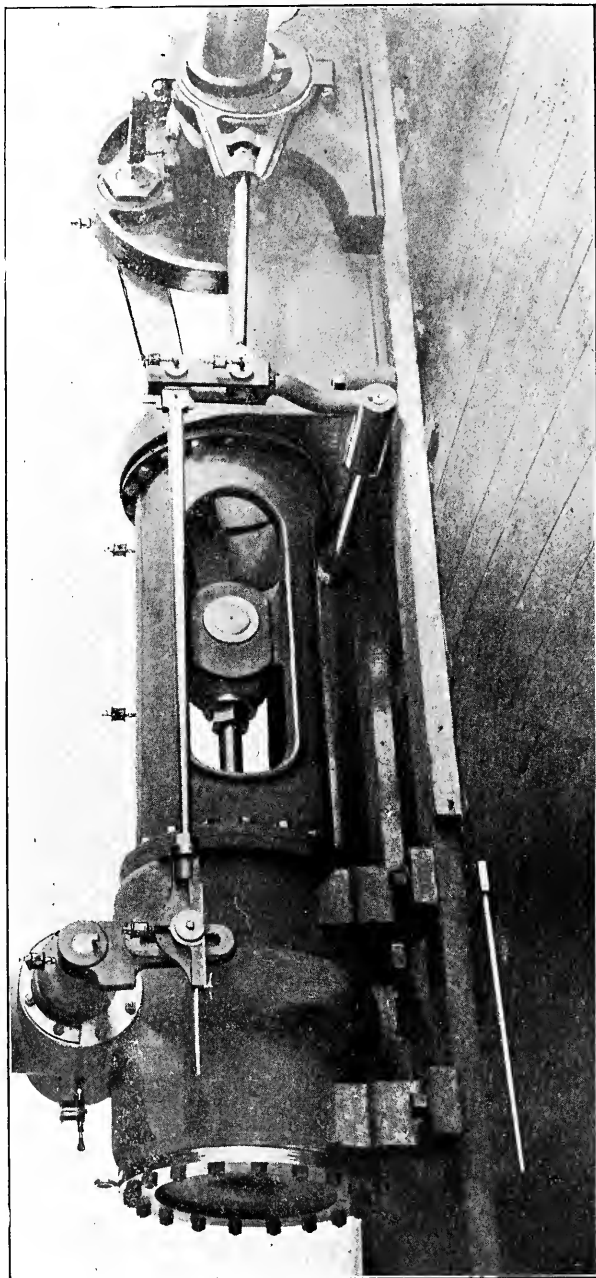

PHOENIX HEAVY DUTY SAW MILL ENGINE.

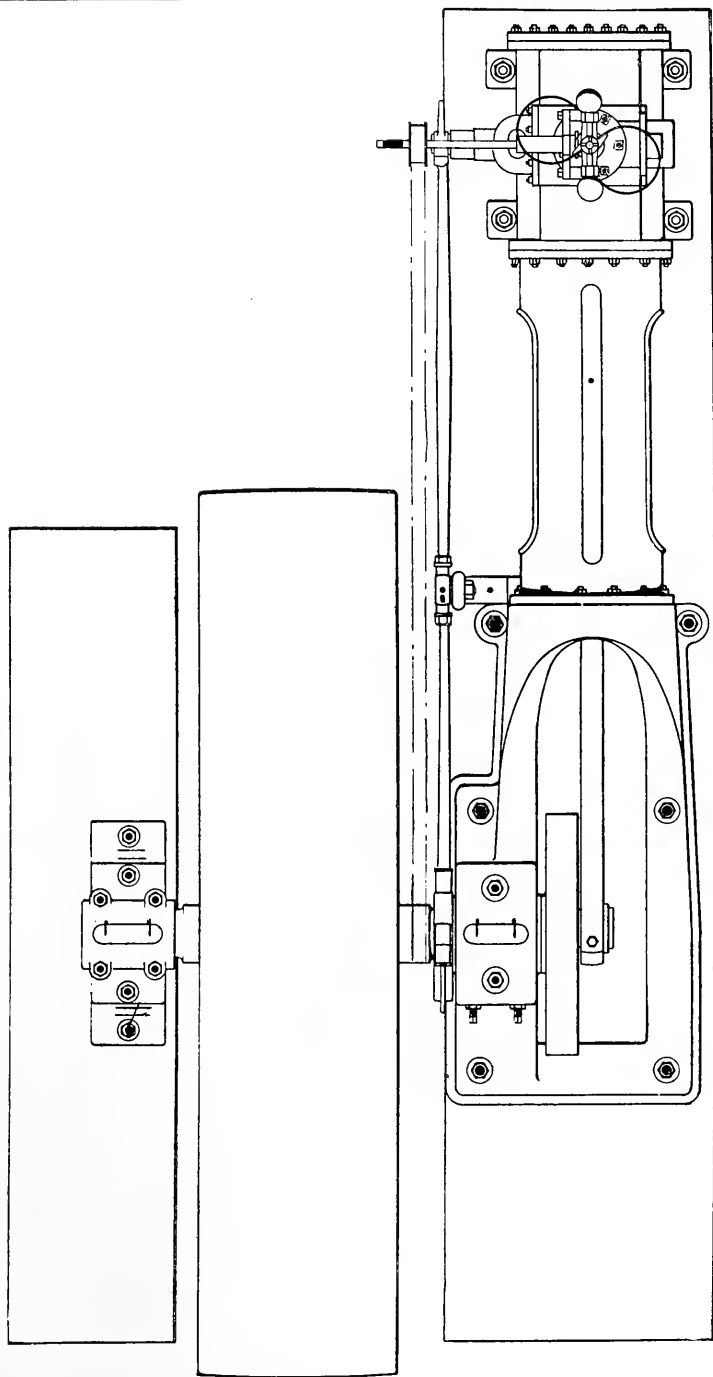

Plan of the Phoenix Heavy Duty Saw Mill Engine.

THE PHOENIX HEAVY DUTY SAW MILL ENGINE.

On the preceding pages we illustrate our "Heavy Duty" engine, a specially designed engine for the saw mill trade, also our automatic cut-off engine, and as considerable space would be required for anything like a comprehensive description of these engines we have thought best to reserve that for a special catalogue devoted to engines and boilers, which we will mail upon application.

We manufacture "Heavy Duty" engines in sizes as follows:

Size.			Indicated Horse Power.			Wheel		Diameter of Steam Pipe, Inches.	Diameter of Exhaust Pipe, Inches.	Price.
Diam. of Cylinder, Inches.	Stroke of Cylinder,	Revolutions.	80 lbs. Pressure, % Cut-Off.	90 lbs. Pressure, % Cut-Off.	100 lbs. Pressure, % Cut-Off.	Diameter, Feet.	Face, Inches.			
16	24	150	245	277	310	9	24	5	6	\$1500 00
16	30	120	245	277	310	10	24	5	6	1875 00
18	24	150	310	351	392	10	26	6	7	1750 00
18	30	120	310	351	392	12	26	6	7	2000 00
20	30	120	384	435	487	12	30	7	9	2250 00
22	30	120	463	525	587	14	30	7	9	2500 00
24	34	110	571	648	725	14	36	8	10	3000 00
26	34	100	614	697	779	16	36	8	10	3250 00
28	34	100	706	801	896	16	40	8	10	3750 00
30	48	80	917	1041	1164	20	52	9	11	4170 00
32	48	80	1045	1185	1326	20	60	10	12	4750 00
34	48	80	1179	1337	1496	20	68	11	14	5360 00
36	48	80	1319	1497	1674	20	76	12	15	6000 00

BOILER FRONTS.

DUTCH OVEN BOILER FRONT.

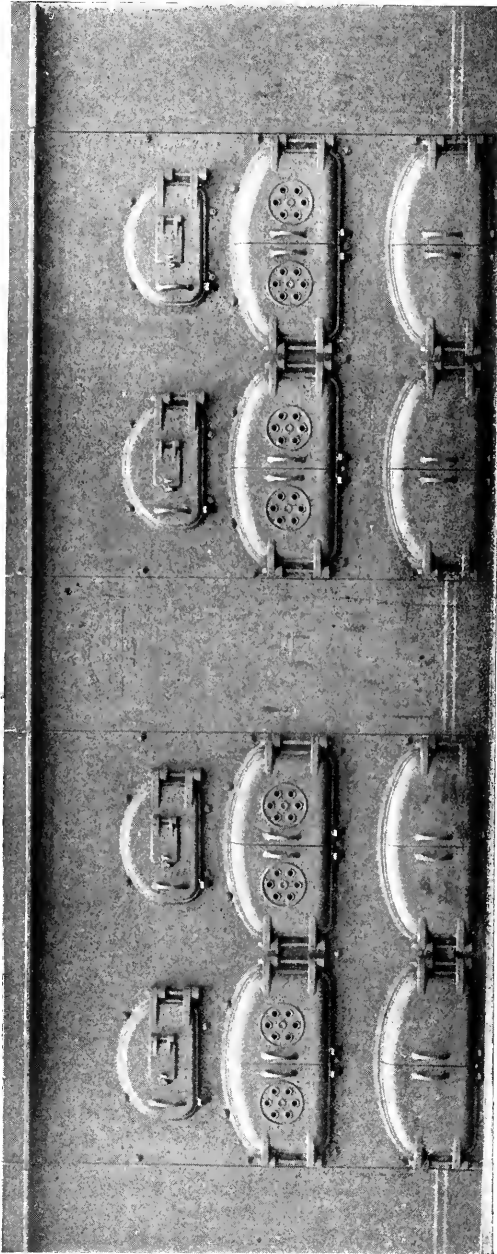

All Sizes, in Full, Half Arch and "Dutch Oven."

GRATE BARS.

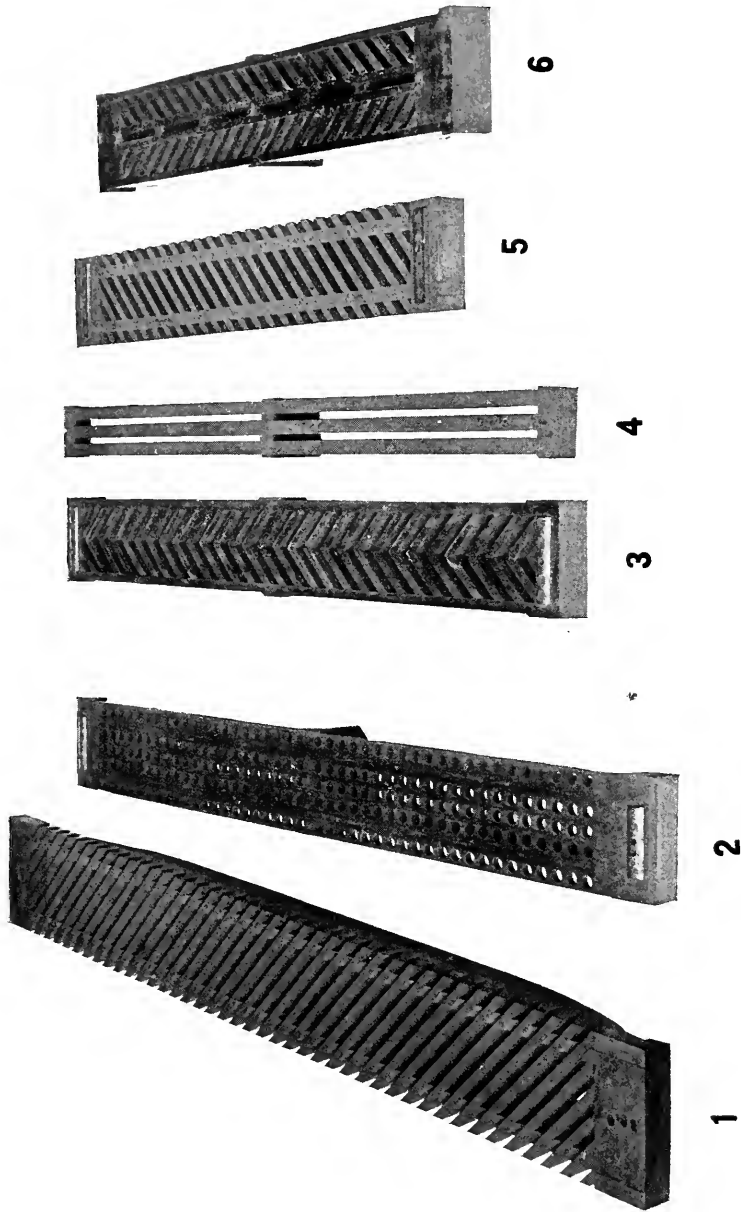

All Styles and Sizes.

Price per poundCents.

PHOENIX FEED WATER HEATER.

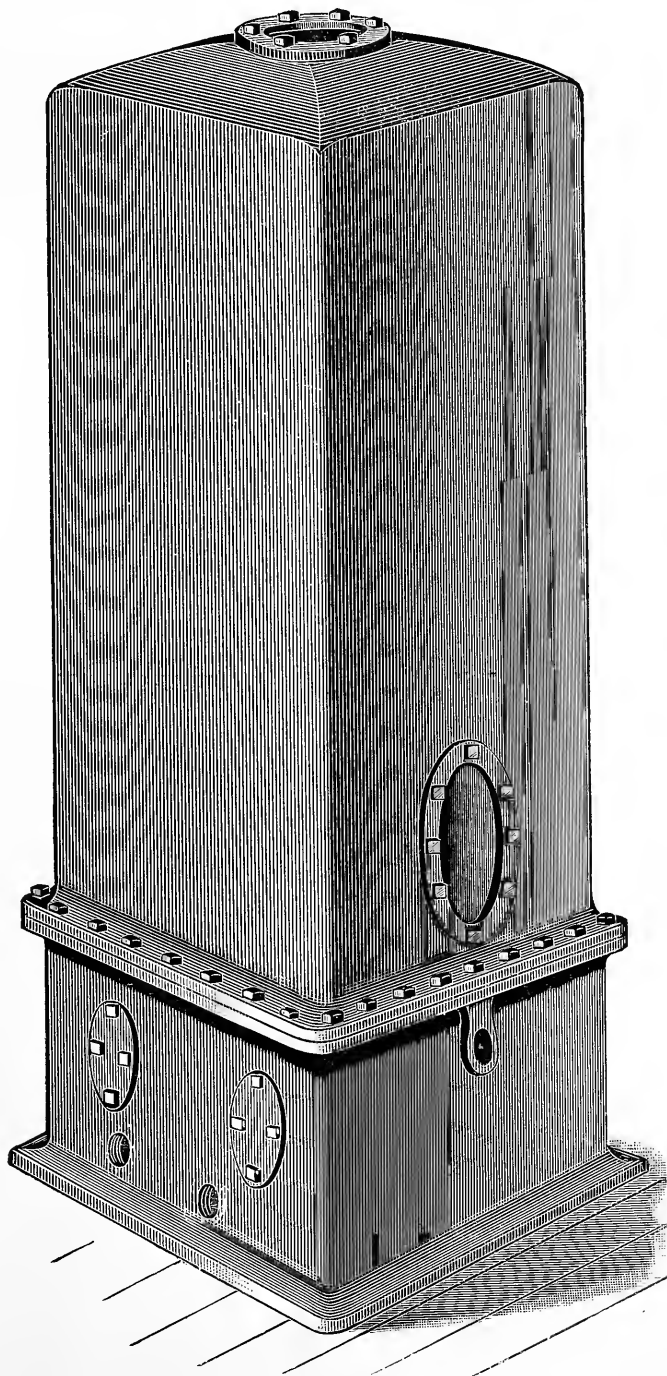

PHOENIX FEED WATER HEATER.

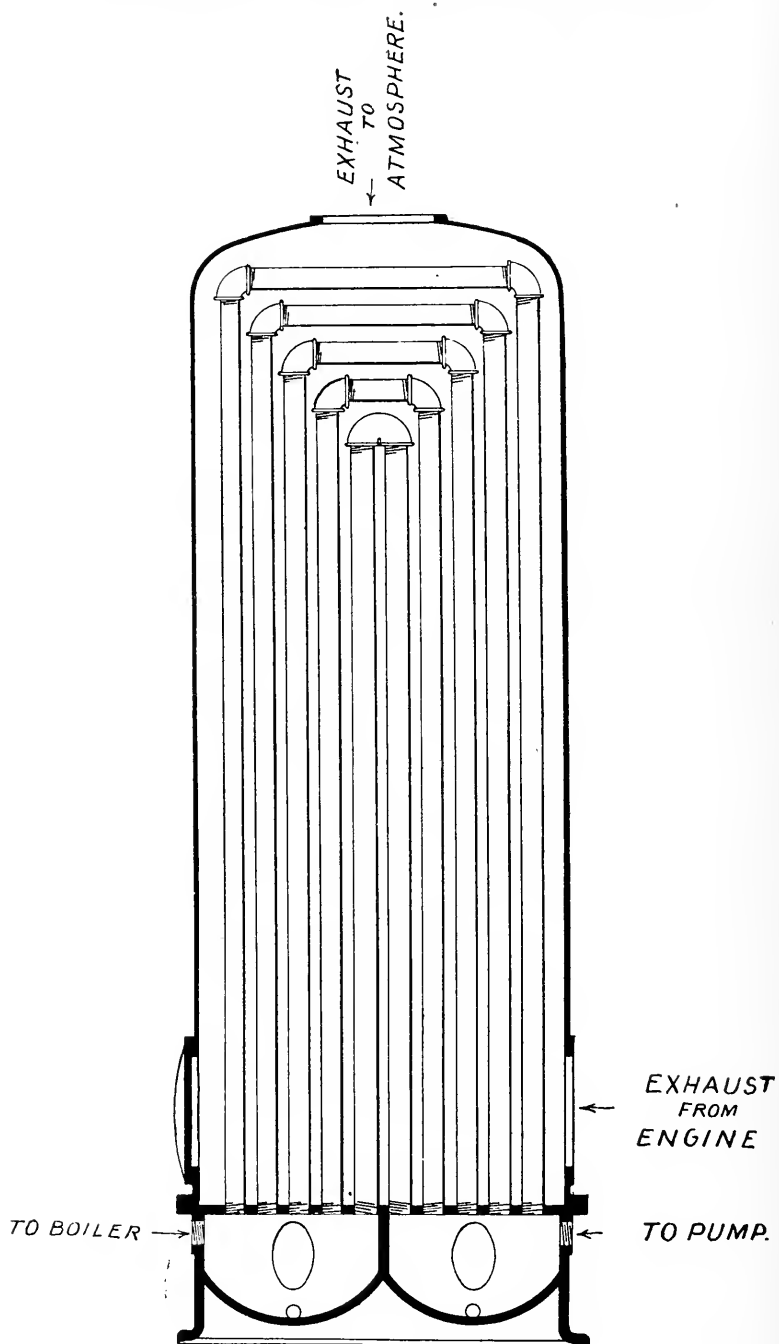

Sectional View.

PHOENIX FEED WATER HEATER.

On page 257 we show a perspective and on page 258 a sectional view of our Heater. They are strong, well made and extremely simple in construction, possessing all the advantages of a closed heater.

The exhaust openings are amply large to prevent any back pressure.

The heater being square enables us to get a larger percentage of useful heating surface per space occupied than is the case with any other heater.

The body or shell of this heater is of cast iron, with the lower end fastened to a heavy cast iron base. The tubes are of seamless drawn brass or wrought iron pipe as shown, and are expanded into a single head at the lower end of the shell. This allows for all expansion and contraction which can possibly take place, and makes each tube absolutely independent of every other tube.

OPERATION.

The feed water enters at the side, close to the bottom, and circulates through the U shaped tubes, taking up, as it does so, the heat from the exhaust steam which has entered at the exhaust inlet near the bottom. The exhaust passes out through the top of the heater and is thrown away, or used if required. The feed water is then taken from the opposite side and delivered to the boiler at a temperature of from 200 to 210 degrees Fahrenheit.

PHOENIX FEED WATER HEATER.

We furnish heaters of any size, fitted with either brass, copper or iron tubes, and will quote prices on application.

Size in Inches.	Height in Feet.	Diameter of Exhaust. Inches.	Horse Power.	Price, Iron Tubes.
20x20	6	6	46	\$100 00
20x20	7	6	58	120 00
20x20	8	6	70	140 00
20x20	9	6	82	160 00
26x26	9	7	129	200 00
26x26	10	7	147	220 00
26x26	11	7	165	247 00
26x26	12	8	183	274 00
33x33	10	8	156	234 00
33x33	11	8	288	360 00
33x33	12	12	320	400 00
40x40	10	12	395	493 00
40x40	11	12	445	556 00
40x40	12	12	495	618 00
40x40	13	12	540	675 00
40x40	14	12	590	737 00

Discount.....per cent.

WATERS' IMPROVED STEAM ENGINE GOVERNORS.

Price List and Table of Dimensions.

IN ORDERING.—For convenience in ordering, Governors are described in two classes, "A" and "B," Class "A" having Automatic Stop Motion, and Class "B" without Stop Motion. Workmanship and quality are the same. Class "A," see Fig. 8; Class "A," for small sizes, see Fig. 27.

The Plain High Speed Governor in accordance with table will be sent in all cases, unless otherwise ordered. Sizes up to and including $1\frac{1}{4}$ inch will be sent screwed, unless ordered flanged. In ordering Governors, state which class is wanted, whether "A" or "B," Plain or Finished, and with or without Improved Angle or Globe Stop Valve. Give the number of revolutions the engine is to run, and the diameter of the pulley on the crank-shaft, which drives the Governor, and a pulley the proper size for the Governor will be sent; otherwise, a standard pulley will be furnished. In ordering springs, always specify size of Governor, and state speed at which Governor is marked on top collar to run. This is important. In ordering Valves or Linings, specify whether old one has two ports or four ports. Also state size of Governor, and give number (if there is one) stamped on upper flange of Valve Chamber. The Correct speed is plainly stamped on the brass top collar of each Governor. Arrange the pulley diameters to give the Governor the correct speed at the desired speed of engine.

PRICE LIST OF CLASS "A" AND "B" GOVERNORS.

Size of Governor, Diameter of Opening, $\frac{1}{2}$	$\frac{3}{4}$	1	$1\frac{1}{4}$	$1\frac{1}{2}$	2	
Price, Class B, Plain ..	\$16 00	18 00	20 00	22 00	25 00	30 00
Price, Class B, Fin'd ..	18 00	20 00	22 00	25 00	29 00	34 00
Price, Class A, Plain	23 00	25 50	29 50	36 00
Price, Class A, Fin'd	25 00	28 50	33 50	40 00
Size of Governor, Diameter of Opening, $2\frac{1}{4}$	$2\frac{1}{2}$	3	$3\frac{1}{2}$	4	$4\frac{1}{2}$	
Price, Class B, Plain ..	\$35 00	40 00	50 00	60 00	71 00	83 00
Price, Class B, Fin'd ..	40 00	45 00	58 00	69 00	81 00	94 00
Price, Class A, Plain ..	42 00	48 00	59 00	71 00	83 00	96 00
Price, Class A, Fin'd ..	47 00	53 00	67 00	80 00	93 00	107 00
Size of Governor, Diameter of Opening, 5	6	7	8	9	10	
Price, Class B, Plain ..	\$ 94 00	122 00	150 00	185 00	215 00	240 00
Price, Class B, Fin'd ..	106 00	136 00	166 00	202 00	235 00	260 00
Price, Class A, Plain ..	109 00	140 00	170 00	210 00	241 00	270 00
Price, Class A, Fin'd ..	121 00	154 00	186 00	227 00	261 00	290 00

Discount.....per cent.

WATERS' IMPROVED STEAM ENGINE GOVERNORS.

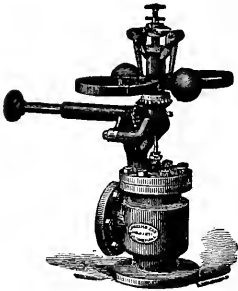

FIG. 1.

Shows the Style, including and above 1½ inches, without Safety Stop Attachment.

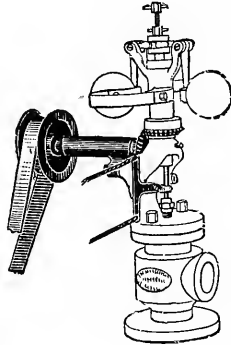

FIG. 24.

Sawyer Lever, on sizes from 1¼ to 2¼ inches only, without Safety Check.

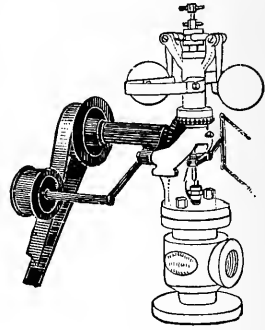

FIG. 27.

"Safety Check" or "Stop Motion" and Sawyer's Lever Check combined.

For Safety Check on Fig. 27	1¼ in.	1½ in.	2 in.	2½ in.	3 in.	3½ in.
Extra	\$3 50	4 50	6 00	7 00	9 00	11 00

CLASS "A" AUTOMATIC SAFETY STOP.

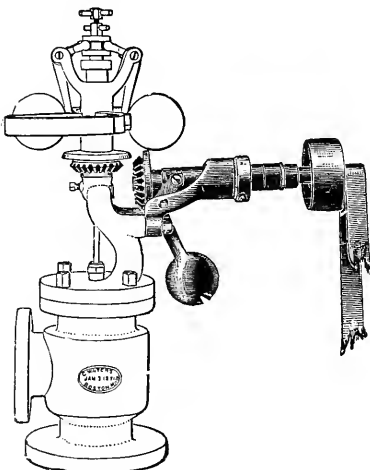
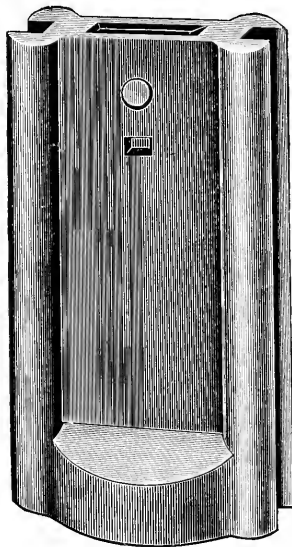

FIG. 8.

Position of governor when belt breaks or runs off the pulley, the weighted lever drops, throwing the shaft back out of gear, allowing the top to drop and close the valve. To start again, simply raise the top part and lift the weighted lever into position, and hold it while putting on the belt. This device works equally well with either horizontal, vertical, or angular belt, and only when the belt breaks or runs off; consequently, never use flanged pulleys, which would prevent the belt going off.

PILE HAMMERS.



The above engraving represents our Improved Drop Hammers, which we make of any size desired. They are much longer for a given weight than the older forms, thus avoiding the sideway throw when the hammer strikes near one edge. As a result the wear upon the leaders is greatly diminished and the effect of the blow increased. The bottoms of the hammers are made concave while the sides are cored and planed perfectly straight. We make the dies in three different styles:

First—Of hammered steel, triangular in form, fitted in the hammer and stationary.

Second—A hammered steel triangular die, rotating on a pin which is keyed in the hammer.

The above forms are used with nippers.

Third—A turned steel pin to which the hoisting line is attached direct. This rope is used where driving is done by friction.

Price, including die, $4\frac{1}{2}$ c per lb.

Discount per cent.

PILE HAMMER NIPPERS.

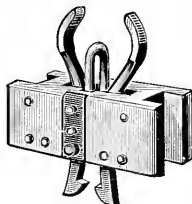

This engraving shows the style of hammer nippers which we manufacture in various sizes according to the weight of hammer with which they are to be used. The frame work in which the nippers hang is made of oak thoroughly bolted and fastened together, while the nippers are nicely finished, having steel pins and points, the latter hardened.

Small size \$15 00 Large size \$20 00

Discount per cent.

CAP FOR PILE DRIVING.

In connection with drop hammers, we call attention to our improved Pile Caps, as shown in the engravings. In the operation of pile driving it frequently happens that the piles are either split or broomed on their tops by the concussion of the hammer. To overcome this difficulty, recourse is had to pile bands. The expense of taking off these bands, to say nothing of broken ones and the consequent delays, were such that it became necessary to adopt a protecting cap that would prevent the head of the pile from splitting or brooming, at the same time delivering the full force of the blow given by the hammer. We make them of the forms shown in the engravings, to suit the dimensions of leaders.

Fig. 1 shows the cap in place just when the operation of driving is completed, while Figs. 2 and 3 show the cap detached.

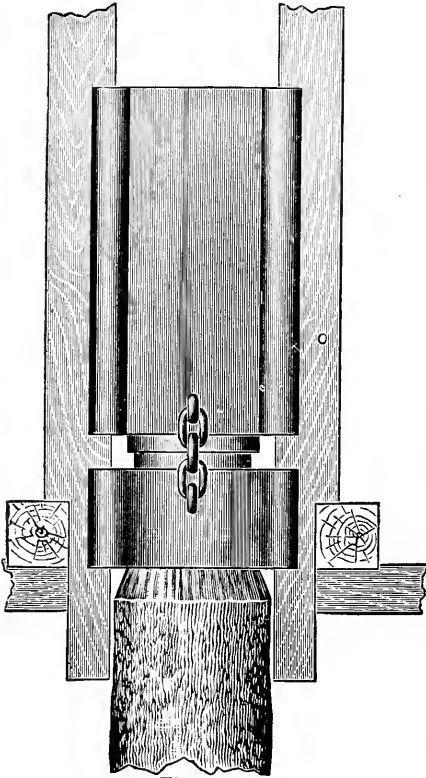

Fig. 1.

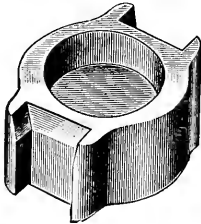

Fig. 2.

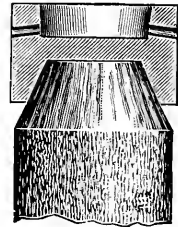
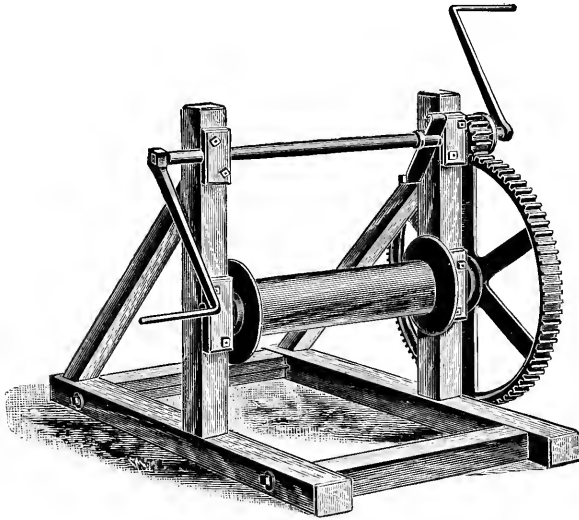

Fig. 3.

Briefly described, it consists of a cast iron cap with tapered recesses above and below, the chamfered head of the pile fitting the lower one and the wooden block fitting the upper one. Suitable jaws, similar to those on the hammer, engage the leaders, and form a movable toggle-iron, steadying the pile as it is being driven. As the hammer descends, it strikes the timber or cushion-block set in the upper cavity, and the pile is forced down by the blows. When the pile is driven, the short chains on either side of the hammer are connected to the caps by means of pins, and both hammer and cap are hoisted up and secured for another operation. Price 4½ cents per lb.

Discount per cent.

SINGLE GEARED WINDLASS.



We show herewith a very convenient form of windlass for use around saw mills or other places where machinery, etc., is handled. The frame work is of hardwood thoroughly bolted together and well painted to protect it from the weather. The spool is of oak 33 inches long and 8 inches in diameter, and has upon its ends iron flanges 12 inches in diameter. The large gear wheel upon the end of the spool shaft is 32 inches in diameter with a 2 inch face. The crank shaft has upon it a pinion $5\frac{1}{2}$ inches in diameter. The cranks are 14 inches long. The arrangement of the crank shaft is such that the pinion can be put out of mesh with the large gear wheel in a moment and the rope on drum allowed to unwind rapidly.

Price , \$35 00

Discount.....per cent.

SLAB CONVEYOR, USING OUR LONG LINK CRANE CABLE CHAIN.

The line engraving on page 269 shows our Slab Conveyor with wrought iron extension of forty feet over the fire pit, which prevents all danger of fire. As will be seen no rigging on the opposite side of the pit for tightening the chain is required. The driving and tightening mechanism is wholly within the mill and is shown in the lower left hand corner of the engraving and in detail on page 268. In constructing this conveyor, presuming that the ground is level, the incline starts at the mill deck and has a foot raise in ten or twelve feet, or at every bent. The wrought iron trough is made of channel bar iron, with heavy boiler plate bottom, and is held in its place by wire rope guys secured to the last bent which is made sufficiently high and is stayed on the opposite side. Stays and guys are provided with long threaded eye bolts so as to give them equal tension. At the end of the boiler plate trough is a cast iron drum, grooved to receive the chain, and of ample face to permit the cleats to pass squarely over. This drum has a heavy shaft and the journals run in cast iron bracket boxes. The conveyor may pass through the mill in any direction, slabs and refuse being dumped upon it at various points in its passage, and conveyed by the cleated cable in the trough, which is 26 inches wide and made of hard wood plank, to the iron trough which extends over the fire pit, 20, 30 or 40 feet as may be desired. In order to obtain the best insurance rates this conveyor should dump into a pit about 300 feet from the mill. The return plank starts at the high bent and is directly under the trough. Grooved hardwood cleats are attached to the chain at intervals of four to eight feet, keeping the trough free from debris at all times while in motion. It is important that the chain, exposed to the heat of the fire pit and the sun in summer, should be kept wet to prevent expansion and cutting, either by having it pass through a shallow trough or having water drip upon it at some convenient point. It is intended that this machinery be placed under the sawing floor, but the general arrangement of this plan may be modified to conform to different mill constructions or locations.

SLAB CONVEYOR—Continued.

We manufacture these conveyors in four sizes, with iron troughs, 20, 30 or 40 feet long as ordered.

The light size has iron trough with 6 inch channel beams, suitable for a $\frac{5}{8}$ inch chain 450 feet or less in length.

The medium size has iron trough with 8 inch channel beams suitable for a $\frac{3}{4}$ to 1 inch chain 1000 feet or less in length.

The heavy size has iron trough with 10 inch channel beams suitable for a $\frac{7}{8}$ to $1\frac{1}{8}$ inch chain 1000 feet or less in length.

The extra heavy size has iron trough with 12 inch channel beams suitable for a $1\frac{1}{4}$ inch chain 1000 feet or less in length.

We shall be pleased to correspond with parties contemplating the erection of slab conveyors, and will build them to suit any location or requirement.

Prices quoted on application.

DETAIL OF SLAB CONVEYOR.

Showing Manner of Driving.

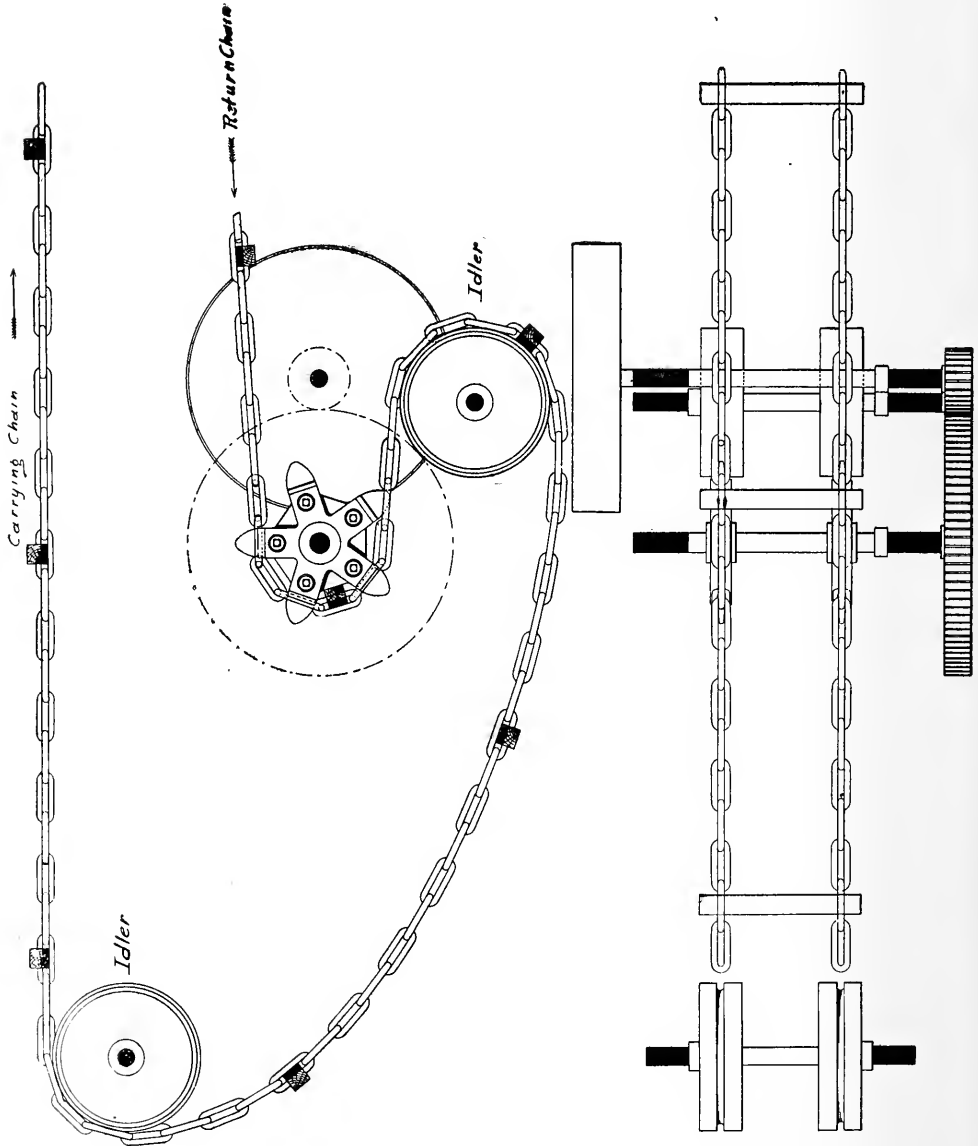

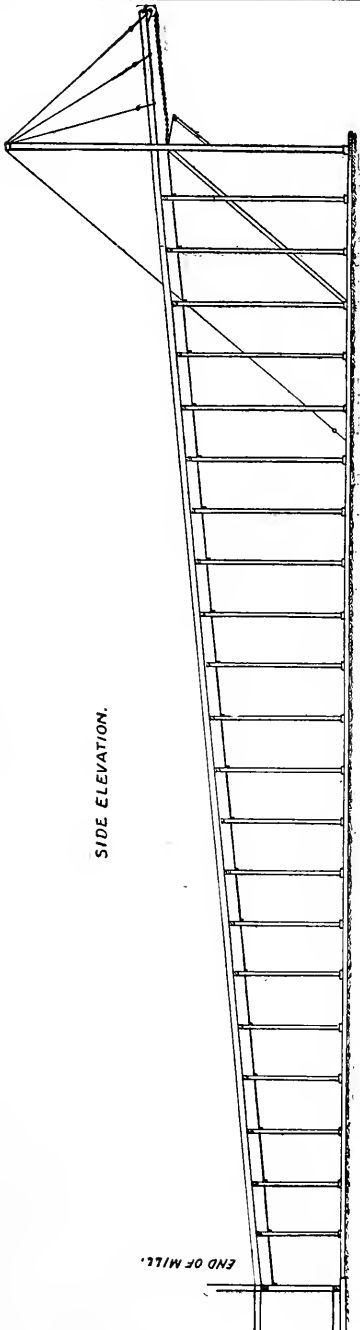

SIDE ELEVATION.

END OF MILL.

NIGH BENT

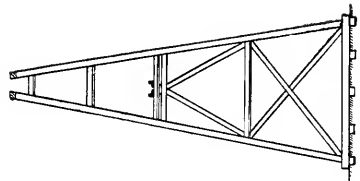

FIRST BENT

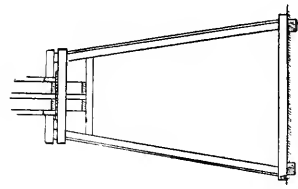

DRIVING MACHINERY
IN MILL.

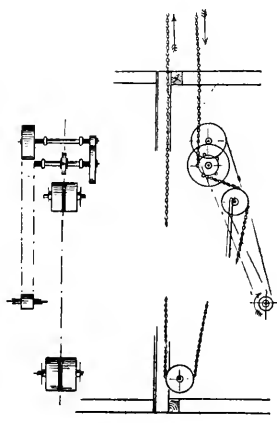

SLAB CONVEYOR.

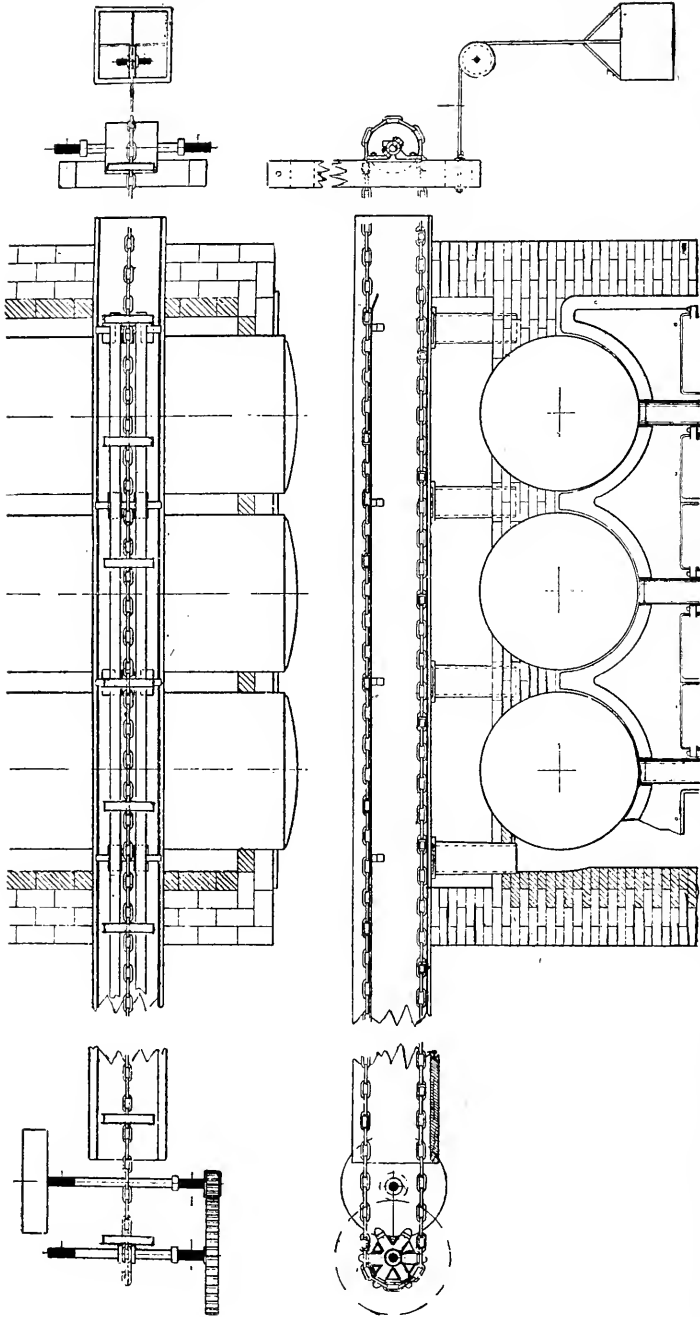

AUTOMATIC SAW DUST OR FUEL FEEDERS FOR BOILER FURNACES.

AUTOMATIC SAW DUST OR FUEL FEEDERS FOR BOILER FURNACES.

On the opposite page we present a line engraving of our Automatic Fuel Feeder for conveying and automatically discharging into the boiler furnaces, through spouts placed between the boilers, saw dust and other fine combustible material. By the use of this arrangement the admission of large quantities of cold air to the furnaces is obviated, quite an advantage over the ordinary method of firing.

The trough is made of heavy sheet iron, bottom and sides riveted to angle iron in the lower outside corners. Cross braces at the top carry away irons over which the chain returns. The supply of fuel may be regulated by the firemen by means of slide doors placed over the spouts; balance dampers which shut automatically when not feeding, are furnished when ordered, and are an additional precaution against fire. All the parts are made entirely of iron, and the arrangement of delivery spouts is such that the liability of fire communicating with the fuel before being fully discharged, is reduced to a minimum.

In sending for estimates, give the number of boilers, their exact diameter, the space between boilers, and state whether the feed is right or left hand. For a right hand feed the lower chain runs to the right when standing in front of the boilers. If the measurements are correct, we can build and send you a feeder, and guarantee a fit. It can be set up and bricked in by two men in a day and be ready for use.

The engraving shows long link cable chain, but of course, we make the feeders of any style chain. The chain shown on page 139 is the style generally used.

Prices quoted on application.

SORTING WORKS AND LOADING PLATFORM.

The outline on opposite page shows a plan and elevation of the Phoenix method of sorting and loading lumber directly from the trimmer. For yard piling the drop wagon shown on page 274 is backed up to the loading frame containing the load to be hauled to the yard, and rolled onto the wagon by means of the crank as shown, the crank is usually carried on the wagon as it is used also to unload at the yard.

This is undoubtedly the simplest and best method in existence for handling lumber from the mill to yard. The lumber is taken directly from the trimmer chains and piled onto the loading frames according to the grader's mark, each set of rolls holding a wagon load. The number of grades, lengths and width, etc., is only limited to the number of loading frames and length of sorting chains. The sorting chains from trimmer in this case are led down onto the ground and then carried out as far as desired on loading platform.

We also make the loading frames automatic by doing away with the crank and placing a line of shafting just in front of this roll, the shafting being always in motion it is only necessary to either push the load forward until it catches onto the live shaft, or by backing the wagon against a trip drop the load onto same, when the shaft will roll the load onto the wagon.

This arrangement is also nicely adapted for tramway use in loading onto a car in place of wagon.

We will send blue prints with full information and estimates when requested.



ELEVATION.

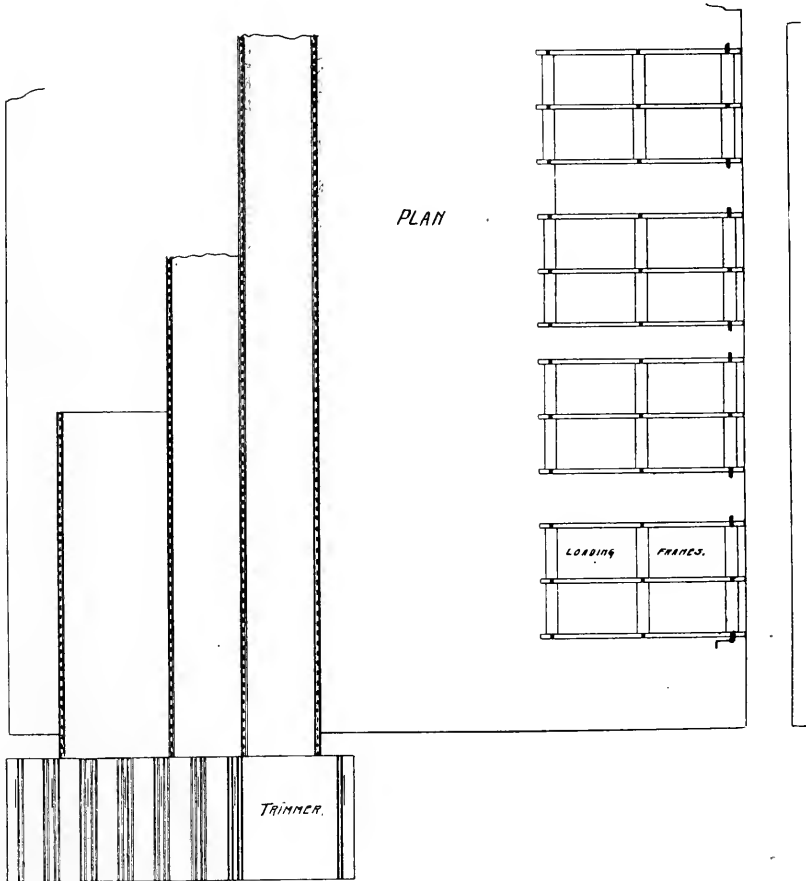

PLAN

TRIMMER.

LOADING FRAMES.

PHOENIX PATENT LUMBER DROP WAGON.

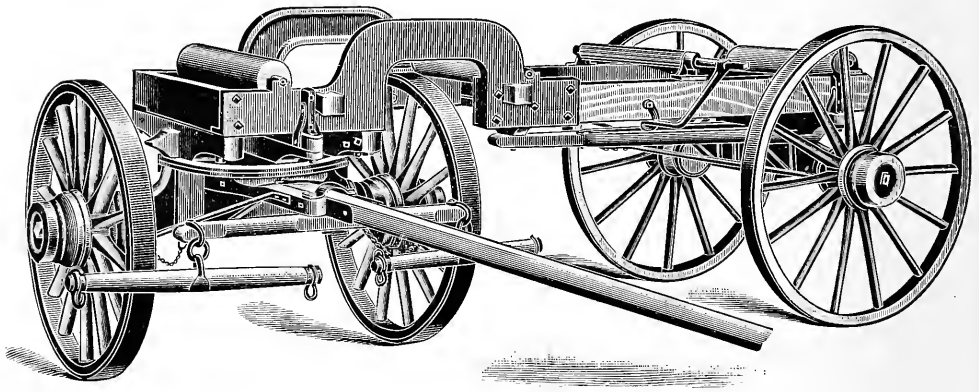

Bed complete as shown by the above cut, ready to attach to wagon, for 18 ft. lumber and under.....	\$ 60 00
Bed complete with trussed sides, ready to attach to wagon, for lumber from 18 ft. to 24 ft.....	85 00
Running Gear Complete as shown	100 00

Discount.....per cent.

LUMBER BUGGY.

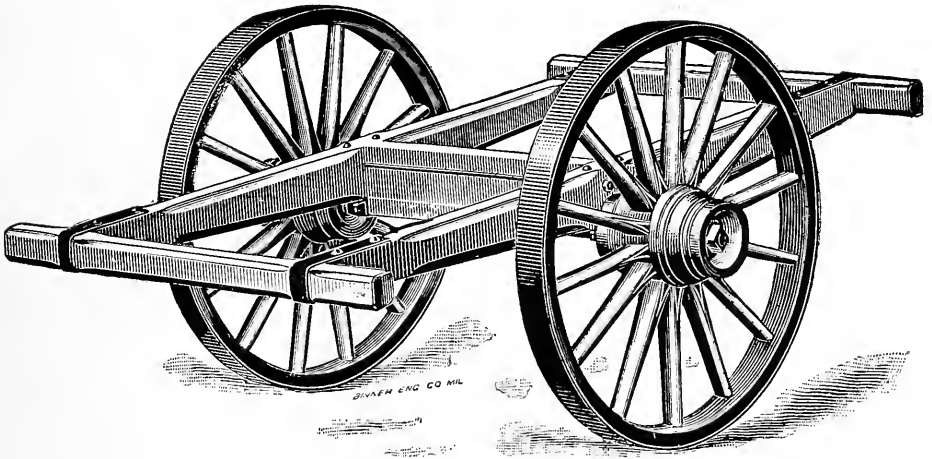

This cut shows our Heavy Lumber Buggy which is one of the best and most substantial carts made. The wheels are 34 inches high with 3 inch wide tire, the hub is 8 inches in diameter by 9 inches long and contains from 12 to 14 $2\frac{1}{4}$ spokes. The axle is made from $1\frac{3}{4}$ inch steel with turned bearings and the boxes are bored out to fit, making a very easy running cart.

The cart is made from A 1 dry stock and is the largest, strongest, most durable and most perfect Lumber Buggy ever offered to mill men—and quality of work considered—the cheapest cart in the market.

Capacity 1200 to 1500 feet of green lumber.

Shipping weight 240 lbs.

Price \$20 00

Discount.....per cent.

LUMBER BUGGY.

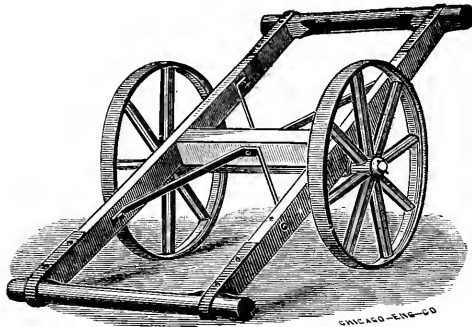

This cut represents our Lumber Buggy with Iron Wheels which we make in a good and substantial manner, all complete, with frame of white oak well ironed and bound, and painted to prevent damage by weather.

Can furnish three sizes as follows:—

Wheels, 24 inches in diameter; axles, $1\frac{1}{2}$ inch square iron; distance, between wheels, 30 inches. Price, \$15 00.

Wheels, 28 inches in diameter; axles, $1\frac{1}{2}$ inch square iron; distance, between wheels, 30 inches. Price, \$17 00.

Wheels, 31 inches in diameter; axles, $1\frac{3}{4}$ inch square iron; distance, between wheels, 31 inches. Price, \$19 00.

All of above wheels are banded with wrought iron $\frac{1}{4}$ inch thick by $2\frac{1}{4}$ inches wide. The larger wheels can be made with bands $2\frac{1}{2}$ inches wide, if desired.

Discount per cent.

LUMBER TRUCK WHEELS AND AXLES.

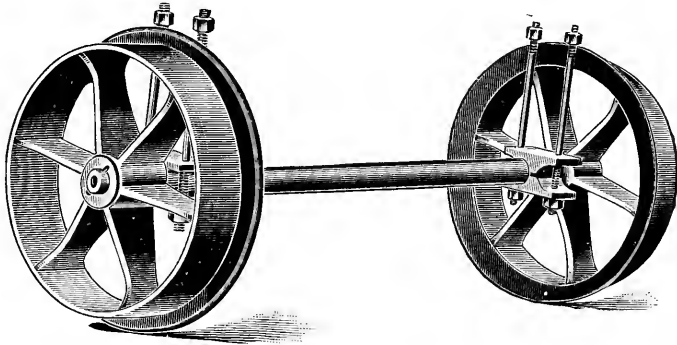

DIMENSIONS AND PRICES.

Diameter of Wheel.	Diameter of Axle.	Gauge.	Price.
10 inch.	$1\frac{1}{2}$ inch.	36 inch.	\$25 00
12 "	$1\frac{1}{2}$ "	36 "	29 00
14 "	$1\frac{3}{4}$ "	36 "	32 00
16 "	$1\frac{3}{4}$ "	36 "	37 00
18 "	2 "	36 "	42 00
20 "	2 "	36 "	48 00
24 "	2 "	36 "	55 00

Each price is for 4 Wheels, 4 Boxes, 2 Axles, and 8 Bolts for 10 in. timber.

Discount per cent.

SELF-FEED SPOKE BOLTING MACHINE.

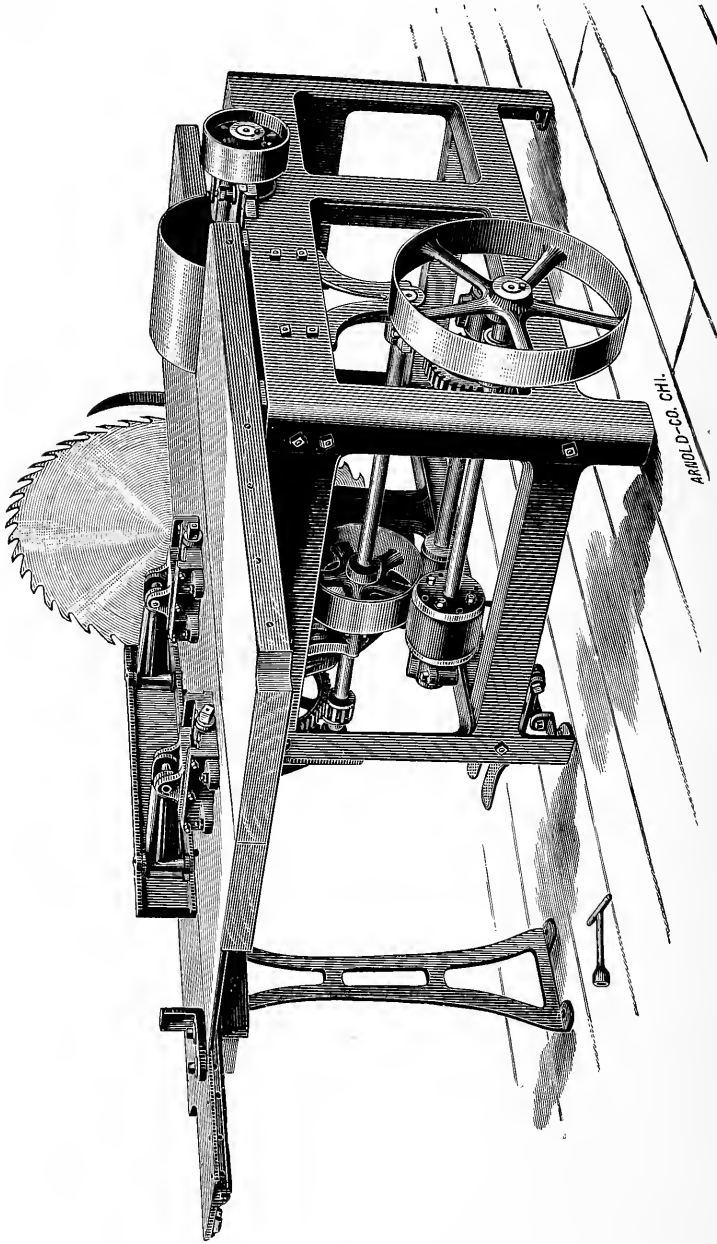

For description see opposite page.

SELF-FEED SPOKE BOLTING MACHINE.

We show on opposite page a view of our Self-Feed Bolting Machine made especially for use in splitting timber for spokes, and similar purposes. The design was obtained from one of the best known manufacturers of spokes in the Northwest and is considered by all who have seen it to be complete in every respect.

The frame is of heavy cast-iron and the table on which the bolt lies, as well as that part upon the right next the saw is of the same material, while the balance of the top is of white oak plank. The saw is 42 inches in diameter and the arbor is of $2\frac{1}{4}$ inch steel, with a drive pulley upon it 14 inches in diameter for a 12 inch belt. The sliding table, upon which the bolt or timber to be cut rests, is 6 2-3 feet long, and the whole floor space covered by the machine is about 4 feet in width by $8\frac{1}{2}$ feet in length.

The table is fed to and from the saw by means of the two foot treadles, which work the gig and feed frictions, driving the pinion shaft which in turn operates the idle gear-wheel that meshes in the rack under the table.

Shipping weight of machine 2500 lbs.

Price without saw \$300 00

Discount.....per cent.

SPOKE STAVE SPLITTER.

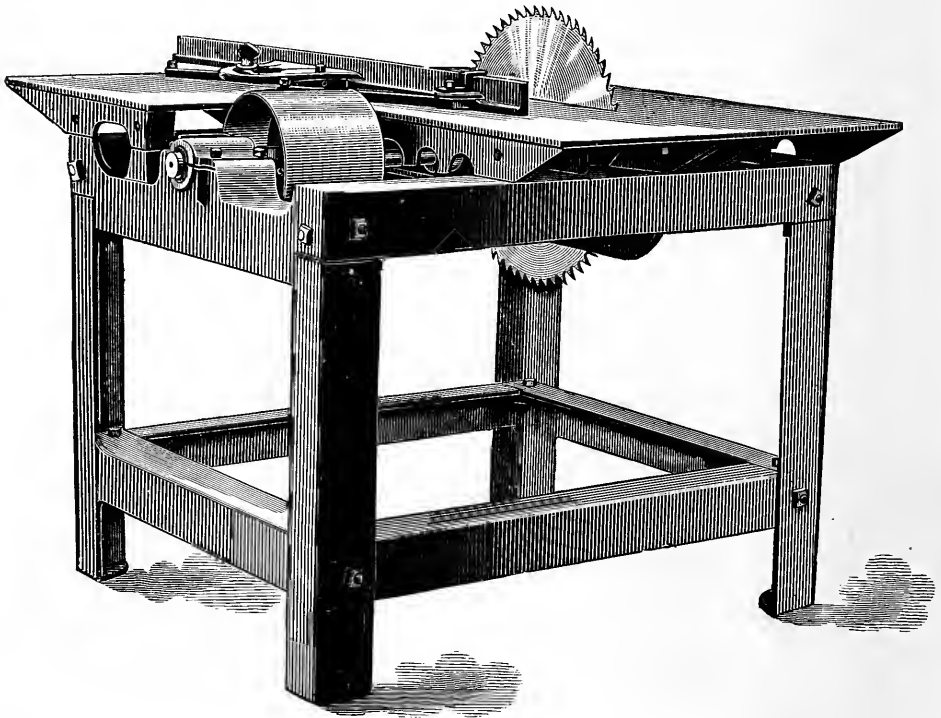

This is intended as a companion machine to the Self-Feed Spoke Bolter and is for use in splitting the hardwood bolts into pieces of the proper width for spokes.

The frame work and table is of cast-iron and covers a floor space of 3 by 4 feet.

The arbor is of steel $1\frac{3}{4}$ inches in diameter and has upon it a drive pulley 8 by 8. Size of saw is 18 inches. The guide is hinged and fastened at any point desired by the thumb screw shown in cut.

This is a strong, substantial machine and can be used for various purposes where the splitting of lumber is desired.

Shipping weight 750 lbs.

Price without saw \$90 00

Discount.....per cent.

DIMENSION BOLTING MACHINE.

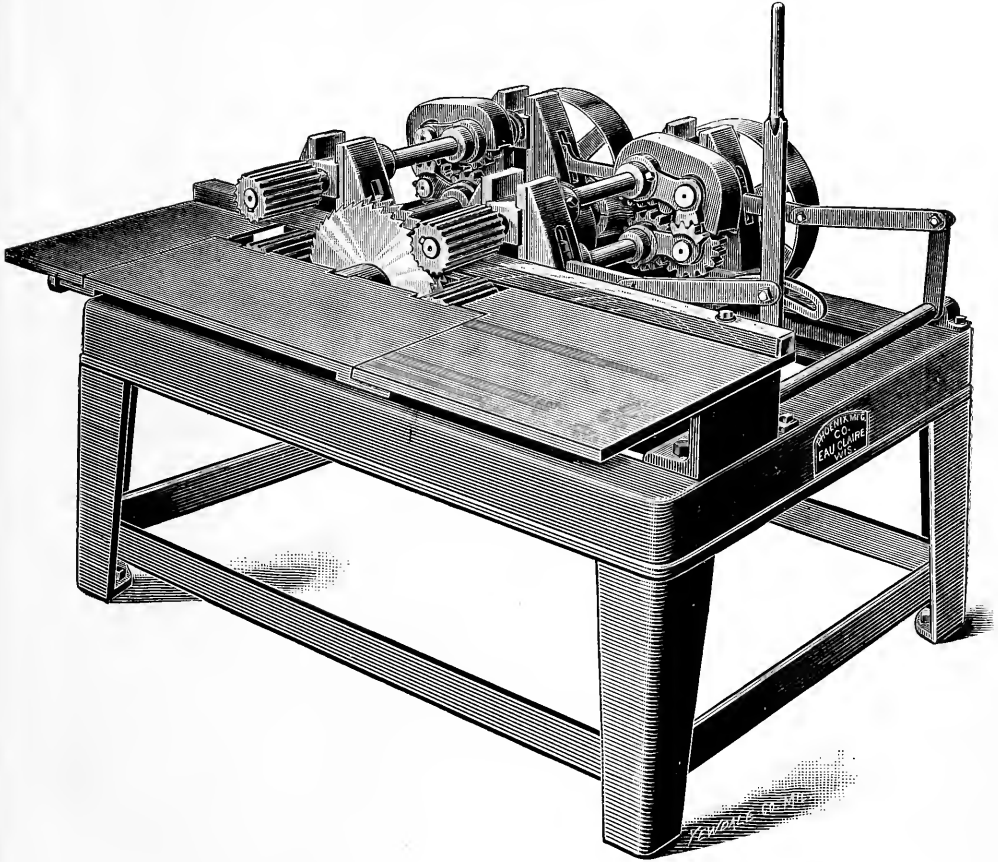

For description see following page.

DIMENSION BOLTING MACHINE.

On the preceding page we show an illustration of a heavy iron frame dimension machine for cutting up hardwood boards and plank into strips of various sizes for chair and furniture factories, or for any other purpose where it is desired to use strips or pieces of particular dimensions.

The machine usually has two saws which are set at any distance apart by means of loose collars which go between them. The upper and lower feed rollers are geared together similar to the arrangement on a flooring machine so that they move in the same time.

The raising of the upper feed rollers is accomplished by means of the upright hand lever at the front of the machine.

The feed rollers are fluted and are four inches in diameter by six inches in length and are driven by a belt wrapping around the end of the saw arbor and over the feed roller pulleys.

The saws are usually fourteen to sixteen inches in diameter running upon a $2\frac{1}{4}$ inch steel arbor which has upon it a driving pulley eight inches in diameter for ten inch belt.

The frame work and table of the machine are all of cast iron. The arrangement and diameter of the saws can be varied to quite an extent to suit the desires of the purchaser.

The price as usually constructed, including two 14 inch saws is \$225.00.

Discount. per cent.

ENGINEERING NOTES,

EMBRACING

*Reliable Data and Formulæ on Shafting, Belting,
Pulleys, Gears, Strength of Material,
Weights, Etc.*

SHAFTING.

Recognized authorities differ in their opinions about the proper sizes of shafts to be used for the transmission of power, and it is difficult to present rules which are universal in their application. We publish herewith a table, which we have found in our experience a safe one to use in general practice, for the distribution of power through belts, etc., where the shafts are properly supported. When the shafts are used for transmission only, without any of the bending strains of pulleys, gears, etc., we frequently use the next smaller size to that given; but for head shafts, carrying heavy pulleys and subjected to heavy belt strains, it is well to use larger sizes than those given in the table. We are aware that this table calls for a heavier shaft for the same duty, than some of those published by other authorities, but the difference is only in the factor of safety used, the material under consideration in all such cases being the same.

It is well to say in this connection, that no matter what general rules are adopted, there are frequently special cases in which the mill-wright must depart from his rules, and use his judgment in determining both the size of shaft required, and the number and location of bearings.

HORSE POWER OF TURNED IRON SHAFTING.

For given Diameter and Speed.

LINE SHAFTING. $H = \frac{D^3 \times R}{80}$

Diameter of Shaft in inches.	Revolutions Per Minute.									
	100	125	150	175	200	225	250	300	350	400
1 $\frac{1}{4}$	2.4	3.1	3.7	4.3	4.9	5.5	6.1	7.3	8.5	9.7
1 $\frac{3}{8}$	4.3	5.3	6.4	7.4	8.5	9.5	10.5	12.7	14.8	16.9
1 $\frac{1}{2}$	6.7	8.4	10.1	11.7	13.4	15.1	16.7	20.1	23.4	26.8
2	10.0	12.5	15.0	17.5	20.0	22.5	25.0	30.0	35.0	40.0
2 $\frac{1}{4}$	14.3	17.8	21.4	24.9	28.5	32.1	35.6	42.7	49.8	57.0
2 $\frac{3}{8}$	19.5	24.4	29.3	34.1	39.0	44.1	48.7	58.5	68.2	78.0
2 $\frac{1}{2}$	26.0	32.5	39.0	43.5	52.0	58.5	65.0	78.0	87.0	104.0
3	33.8	42.2	50.6	59.1	67.5	75.9	84.4	101.3	118.2	135.0
3 $\frac{1}{4}$	43.0	53.6	64.4	75.1	85.8	96.6	107.3	128.7	150.3	171.6
3 $\frac{3}{8}$	53.6	67.0	79.4	93.8	107.2	120.1	134.0	158.8	187.6	214.4
3 $\frac{1}{2}$	65.9	82.4	97.9	115.4	121.8	148.3	164.8	195.7	230.7	243.6
4	80.0	100.0	120.0	140.0	160.0	180.0	200.0	240.0	280.0	320.0
4 $\frac{1}{2}$	113.9	142.4	170.8	199.3	227.8	256.2	284.7	341.7	398.6	455.6
5	156.3	195.3	234.4	273.4	312.5	351.5	390.6	468.7	546.8	625.0
5 $\frac{1}{2}$	207.9	260.0	311.9	363.9	415.9	459.9	520.0	623.9	727.9	830.0
6	270.0	337.5	405.0	472.5	540.0	607.5	675.0	810.0	945.0	1080.0
6 $\frac{1}{2}$	343.3	429.0	514.9	600.7	686.5	772.4	858.0	1029.0	1201.0	1372.0
7	428.8	535.9	643.1	750.3	847.5	964.7	1071.9	1286.0	1500.0	1695.0
8	640.0	800.0	960.0	1126.0	1280.0	1440.0	1600.0	1920.0	2240.0	2560.0

For head shafts, supported by bearings close to main pulley, or gear, so as to wholly guard against the transverse strain, the following formula affords an ample margin for strength:

D = Diameter of Shaft in inches. R = Revolutions per minute.
 H = Horse-Power. $H = \frac{D^3 \times R}{100}$

USEFUL RULES

FOR HORSE POWER, ETC., OF SHAFTING.

CO-EFFICIENTS.

Wrought Iron Main Shaft: Hammered and Turned.....	=120.
Steel Main Shaft: Hammered and Turned.....	= 90.
Wrought Iron Line Shaft: Hammered and Turned.....	= 90.
Steel Line Shaft: Hammered and Turned.....	= 67.5
Wrought Iron Line Shaft: Rolled and Turned.....	=100.
Steel Line Shaft: Rolled and Turned.....	= 75.

FORMULÆ.

Rule 1.—To find maximum horse power of a shaft within good working limits:—

$$\frac{\text{Diameter}^3 \times \text{revolutions per min.}}{\text{Co-efficient.}}$$

Rule 2.—To find the diameter of a shaft, capable within good working limits, of transmitting a given horse power:—

$$\frac{\text{Horse Power} \times \text{Co-efficient}}{\text{Revolutions per minute.}}$$

The cube root of the quotient is the diameter in inches.

Rule 3.—To find the speed required for transmitting a given horse power within good working limits:—

$$\frac{\text{Horse power} \times \text{Co-efficient}}{\text{Diameter}^3.}$$

SHAFT BEARINGS.

The distance apart of shaft bearings may be obtained by the following rule; which is applicable for shafts up to 4 inches diameter. Extra bearing should be provided wherever power is taken off by main belts or gears—

$$L = 4.8 \sqrt[3]{d^2}.$$

L = Length in feet between supports.

d = Diameter of shaft in inches.

$$\text{For a 4 in. shaft } L = 4.8 \sqrt[3]{16} = 12 \text{ feet.}$$

HORSE POWER OF LEATHER BELTING.

Transmitted at a Velocity of 100 feet per minute.

Width of Belt. Inches.	Horse Power.		Width of Belt. Inches.	Horse Power.		Width of Belt. Inches.	Horse Power.	
	Single Belt.	Double Belt.		Single Belt.	Double Belt.		Single Belt.	Double Belt.
1	.15	.30	10	1.51	3.02	32	4.84	9.68
1 $\frac{1}{4}$.18	.36	11	1.66	3.32	34	5.15	10.30
1 $\frac{1}{2}$.22	.44	12	1.81	3.62	36	5.45	10.90
1 $\frac{3}{4}$.26	.52	13	1.96	3.92	38	5.75	11.50
2	.30	.60	14	2.12	4.24	40	6.06	12.12
2 $\frac{1}{4}$.34	.68	15	2.27	4.54	42	6.36	12.72
2 $\frac{1}{2}$.37	.74	16	2.42	4.84	44	6.66	13.32
2 $\frac{3}{4}$.41	.82	17	2.57	5.14	46	6.96	13.92
3	.45	.90	18	2.72	5.44	48	7.27	14.54
3 $\frac{1}{4}$.49	.98	19	2.87	5.74	50	7.57	15.14
3 $\frac{1}{2}$.53	1.06	20	3.03	6.06	52	7.86	15.72
3 $\frac{3}{4}$.56	1.12	21	3.18	6.36	54	8.18	16.36
4	.60	1.20	22	3.33	6.66	56	8.48	16.96
4 $\frac{1}{2}$.67	1.34	23	3.48	6.96	58	8.78	17.56
5	.75	1.50	24	3.63	7.26	60	9.09	18.18
5 $\frac{1}{2}$.83	1.66	25	3.78	7.56	62	9.39	18.78
6	.90	1.80	26	3.93	7.86	64	9.69	19.38
6 $\frac{1}{2}$.98	1.96	27	4.09	8.18	66	10.00	20.00
7	1.06	2.12	28	4.24	8.48	68	10.30	20.60
8	1.21	2.42	29	4.39	8.78	70	10.66	21.32
9	1.36	2.72	30	4.54	9.08	72	10.90	21.80

The above table has been computed by the following formula:

$$\frac{D \times 3.1416 \times R \times W \times C}{33,000} = \text{H. P.}$$

In which

D=Diameter of pulley in feet.

R=Revolutions per minute.

W=Width of belt in inches.

C= $\left. \begin{array}{l} 50 \text{ for single belt} \\ 100 \text{ for double belt} \end{array} \right\}$ Tension of belt per inch of width.

H. P.=Horse power.

To use the table divide the velocity of belt in feet per minute by 100 and multiply the horse power shown in table by this quotient.

Example:—What horse power can be transmitted by a 10 inch single leather belt running 4000 ft. per minute?

Find in table for a 10 inch single belt 1.51, then $4000 \div 100 = 40$ and $1.51 \times 40 = 60.40$ horse power.

Four ply rubber and four ply cotton will transmit about the same power as a single leather and six ply about 70 per cent more.

HORSE POWER TRANSMITTED BY MANILA ROPE.

Diameter of Ropes.	HORSE POWER OF "STEVEDORE" TRANSMISSION ROPE AT VARIOUS SPEEDS.											Smallest Diam. of Pulleys in Inches.
	SPEED OF ROPE IN FEET PER MINUTE.											
	1500	2000	2500	3000	3500	4000	4500	5000	6000	7000	8000	
$\frac{1}{8}$	1.45	1.9	2.3	2.7	3.	3.2	3.4	3.4	3.1	2.2	0	20
$\frac{1}{4}$	2.3	3.2	3.6	4.2	4.6	5.0	5.3	5.3	4.9	3.4	0	25
$\frac{3}{8}$	3.3	4.3	5.2	5.8	6.7	7.2	7.7	7.7	7.1	4.9	0	30
$\frac{1}{2}$	4.5	5.9	7.0	8.2	9.1	9.8	10.8	10.8	9.3	6.9	0	36
1	5.8	7.7	9.2	10.7	11.9	12.8	13.6	13.6	12.5	8.8	0	42
$1\frac{1}{4}$	9.2	12.1	14.3	16.8	18.6	20.0	21.2	21.2	19.5	13.8	0	54
$1\frac{1}{2}$	13.1	17.4	20.7	23.1	26.8	28.8	30.6	30.6	28.2	19.8	0	60
$1\frac{3}{4}$	18.	23.7	28.2	32.8	36.4	39.2	41.5	41.5	37.4	27.6	0	72
2	23.1	30.8	36.8	42.8	47.6	51.2	54.4	54.4	50.	35.2	0	84

For a temporary installation when the rope is not to be long in use, it might be advisable to increase the work to double that given in the table.

SPEED OF SAWS.

To ascertain the proper number of revolutions per minute of any size saw divide 36,000 by the diameter of the saw in inches, thus:—
 $36,000 \div 60 = 600$, the number of revolutions a 60 inch saw should make.

HORSE POWER OF GEARS.

Cast Iron.

F=Breadth, or face, of tooth in inches.

T=Thickness of tooth at pitch line in inches.

V=Velocity at pitch line in feet per minute.

L=Length of tooth from root to point in inches.

C=Co-efficient.

H P=Horse power transmitted with a safety of eight; ultimate tensile strength 30,000 lbs. per square inch.

FORMULA.

$$(1) \text{ Horse power of spur gear } \frac{F \times T^2 \times V}{L \times 53}$$

$$(2) \text{ Horse power of bevel gear } \frac{F \times T^2 \times V}{L \times 77}$$

$$(3) \text{ Horse power of mitre gear } \frac{F \times T^2 \times V}{L \times 82}$$

For bevel or mitres the thickness and length of teeth have been computed at center of face. With a view, however, of facilitating calculation the proportion of factors T and L in formulas (2) and (3) have been taken at large end of the tooth, thus giving same dimensions as for spur gears; hence the spur gear formula has been utilized with the exception of the co-efficient, which has been determined by averaging the proportions of the teeth of bevel and mitre gears having the largest and smallest number of teeth in our list of sizes.

The resultant horse power is consequently less than in spur gears of like pitch.

For Mortise wheels and pinions use thickness of pinion tooth. If different margin of safety is desired multiply above result by 8 and divide by factor of safety desired.

2200 feet per minute at pitch line for iron gearing, and 3000 feet for wood and iron are excessive velocities and should be avoided if possible.

RULES FOR CALCULATING THE SPEED AND SIZE OF PULLEYS.

In calculating the speed and size of pulleys it should be remembered that the diameter of the driving pulley multiplied by its number of revolutions is equal to the diameter of the driven pulley multiplied by its number of revolutions. Therefore the following rules may be easily remembered.

(1) Diameter of the driving pulley multiplied by number of revolutions per minute and divided by diameter of driven pulley equals the revolutions per minute of the driven pulley.

(2) Diameter of the driving pulley multiplied by number of revolutions per minute and divided by revolutions per minute of driven pulley equals diameter of driven pulley.

(3) Diameter of driven pulley multiplied by revolutions per minute and divided by diameter of driving pulley equals revolutions per minute of driving pulley.

(4) Diameter of driven pulley multiplied by revolutions per minute and divided by revolutions per minute of driving pulley equals diameter of driving pulley.

By substituting the number of teeth wherever diameter occurs, the above rules may be used for gears.

Rule for Approximating Length of Belting before Pulleys are placed in Position.

Add together the diameter of the two pulleys in inches and multiply the sum by 3.1416, divide the product thus obtained by 24 and add twice the distance from the center of one pulley (or shaft) to center of the other pulley (or shaft).

Example: Given the distance between centers of pulleys 20 ft., diameter of pulleys 30 in. and 40 in. What is the approximate length of belt?

$$\begin{array}{r}
 30+40 \times 3.1416 \div 24 = 9.16 \text{ ft.} \\
 20 \times 2 \quad - \quad - \quad \frac{40.00}{\hline} \\
 \text{Answer} \quad \quad \quad 49.16
 \end{array}$$

TABLE OF STRAIN FOR BAND SAWS.

(For 9,000 and 10,000 ft. Velocity)

Compiled from an Average of Over 100 Mills.

Width of Saw, Inches.	Gauge of Saw, Inches.	Proper Strain on Saw in lbs. Net at 9000 Feet.	Proper Strain on Saw in lbs. Net at 10000 Feet.
8	14	4920	5466
8	15	4512	5014
8	16	4104	4560
9	14	5535	6150
9	15	5076	5640
9	16	4617	5130
10	14	6154	6838
10	15	5641	6268
10	16	5130	5700
11	13	7333	8148
11	14	6769	7521
11	15	6205	6894
12	13	8000	8800
12	14	7384	8200
12	15	6769	7520
13	13	8666	9630
13	14	8000	8800
14	15	7333	8148
14	13	9333	10370
14	14	8615	9566
14	15	7897	8775

WEIGHT OF CASTINGS FROM PATTERNS.

A Pattern Weighing One Pound Made of	Will Weigh when Cast in					
	Cast Iron.	Zinc.	Copper.	Yellow Brass.	Gun Metal.	Steel.
	Lbs.	Lbs.	Lbs.	Lbs.	Lbs.	Lbs.
White Pine	16.7	16.1	19.8	19.	19.5	18.2

**WEIGHT OF A SUPERFICIAL FOOT OF
CAST IRON.**

Thickness.	Weight.	Thickness.	Weight.	Thickness.	Weight.	Thickness.	Weight.
Inch.	Lbs.	Inch.	Lbs.	Inch	Lbs.	Inch.	Lbs.
$\frac{1}{4}$	9.37	$\frac{3}{4}$	28.12	$1\frac{1}{4}$	46.87	$1\frac{3}{4}$	65.62
$\frac{1}{2}$	14.06	$\frac{7}{8}$	32.81	$1\frac{3}{8}$	51.56	$1\frac{7}{8}$	70.31
$\frac{3}{4}$	18.75	1	37.50	$1\frac{1}{2}$	56.25	2	75.
$\frac{1}{2}$ inch	23.43	$1\frac{1}{8}$	42.18	$1\frac{5}{8}$	60.93		

**TABLE OF APPROXIMATE NUMBERS FOR
VARIOUS PURPOSES.**

WEIGHT OF METALS.

- Cube Inches x .252 = Lbs. of Zinc.
- Cube Inches x .26 = Lbs. of Cast Iron.
- Cube Inches x .262 = Lbs. of Tin.
- Cube Inches x .28 = Lbs. of Wrought Iron.
- Cube Inches x .283 = Lbs. of Steel.
- Cube Inches x .3 = Lbs. of Brass.
- Cube Inches x .32 = Lbs. of Copper.
- Cube Inches x .41 = Lbs. of Lead.
- Cube Inches x .281 = Lbs. of Babbitt.

- Diameter of a circle x 3.1416 = circumference.
- Diameter of a circle x .8862 = side of an equal square.
- Diameter of a circle x .7071 = side of inscribed square.
- Square of diameter x .7854 = area of a circle.
- Circumference of a circle x .31831 = diameter.
- Side of a square x 1.128 = diameter of equal circle.
- Cube of the diameter of a sphere x .5236 = solidity.

WEIGHTS OF SQUARE AND ROUND BARS OF WROUGHT IRON.

One Cubic Foot Weighing 480 Lbs.

Thickness or Diameter in Inches.	Weight of Square Bar One Foot Long.	Weight of Round Bar One Foot Long.	Thickness or Diameter in Inches.	Weight of Square Bar One Foot Long.	Weight of Round Bar One Foot Long.
0			2	13.33	10.47
$0\frac{1}{16}$.013	.010	$2\frac{1}{16}$	14.18	11.14
$0\frac{3}{8}$.052	.041	$2\frac{3}{8}$	15.05	11.82
$0\frac{3}{16}$.117	.092	$2\frac{3}{16}$	15.95	12.53
$0\frac{1}{4}$.208	.164	$2\frac{1}{4}$	16.88	13.25
$0\frac{5}{16}$.326	.256	$2\frac{5}{16}$	17.83	14.00
$0\frac{3}{8}$.469	.368	$2\frac{3}{8}$	18.80	14.77
$0\frac{7}{16}$.638	.501	$2\frac{7}{16}$	19.80	15.55
$0\frac{1}{2}$.833	.654	$2\frac{1}{2}$	20.83	16.36
$0\frac{9}{16}$	1.055	.828	$2\frac{9}{16}$	21.89	17.19
$0\frac{5}{8}$	1.302	1.023	$2\frac{5}{8}$	22.97	18.04
$0\frac{11}{16}$	1.576	1.237	$2\frac{11}{16}$	24.08	18.91
$0\frac{3}{4}$	1.875	1.473	$2\frac{3}{4}$	25.21	19.80
$0\frac{13}{16}$	2.201	1.728	$2\frac{13}{16}$	26.37	20.71
$0\frac{7}{8}$	2.552	2.004	$2\frac{7}{8}$	27.55	21.64
$0\frac{15}{16}$	2.930	2.301	$2\frac{15}{16}$	28.76	22.59
1	3.333	2.618	3	30.00	23.56
$1\frac{1}{16}$	3.763	2.955	$3\frac{1}{16}$	31.26	24.55
$1\frac{1}{8}$	4.219	3.313	$3\frac{1}{8}$	32.55	25.57
$1\frac{3}{16}$	4.701	3.692	$3\frac{3}{16}$	33.87	26.60
$1\frac{1}{4}$	5.208	4.091	$3\frac{1}{4}$	35.21	27.65
$1\frac{5}{16}$	5.742	4.510	$3\frac{5}{16}$	36.58	28.73
$1\frac{3}{8}$	6.302	4.950	$3\frac{3}{8}$	37.97	29.82
$1\frac{7}{16}$	6.888	5.410	$3\frac{7}{16}$	39.39	30.94
$1\frac{1}{2}$	7.500	5.890	$3\frac{1}{2}$	40.83	32.07
$1\frac{9}{16}$	8.138	6.392	$3\frac{9}{16}$	42.30	33.23
$1\frac{5}{8}$	8.802	6.913	$3\frac{5}{8}$	43.80	34.40
$1\frac{11}{16}$	9.492	7.455	$3\frac{11}{16}$	45.33	35.60
$1\frac{3}{4}$	10.21	8.018	$3\frac{3}{4}$	46.88	36.82
$1\frac{13}{16}$	10.95	8.601	$3\frac{13}{16}$	48.45	38.05
$1\frac{7}{8}$	11.72	9.204	$3\frac{7}{8}$	50.05	39.31
$1\frac{15}{16}$	12.51	9.828	$3\frac{15}{16}$	51.68	40.59

WEIGHTS OF SQUARE AND ROUND BARS OF WROUGHT IRON—Continued.

Thickness or Diameter in Inches.	Weight of Square Bar One Foot Long.	Weight of Round Bar One Foot Long.	Thickness or Diameter in Inches.	Weight of Square Bar One Foot Long.	Weight of Round Bar One Foot Long.
4	53.33	41.89	6 $\frac{5}{16}$	132.8	104.3
4 $\frac{1}{16}$	55.01	43.21	6 $\frac{3}{8}$	135.5	106.4
4 $\frac{1}{8}$	56.72	44.55	6 $\frac{1}{4}$	138.1	108.5
4 $\frac{3}{16}$	58.45	45.91	6 $\frac{1}{2}$	140.8	110.6
4 $\frac{1}{2}$	60.21	47.29	6 $\frac{9}{16}$	143.6	112.7
4 $\frac{5}{16}$	61.99	48.69	6 $\frac{5}{8}$	146.3	114.9
4 $\frac{3}{8}$	63.80	50.11	6 $\frac{1}{2}$	149.1	117.1
4 $\frac{7}{16}$	65.64	51.55	6 $\frac{3}{4}$	151.9	119.3
4 $\frac{1}{2}$	67.50	53.01	6 $\frac{3}{8}$	154.7	121.5
4 $\frac{9}{16}$	69.39	54.50	6 $\frac{7}{8}$	157.6	123.7
4 $\frac{5}{8}$	71.30	56.00	6 $\frac{1}{2}$	160.4	126.0
4 $\frac{11}{16}$	73.24	57.52	7	163.3	128.3
4 $\frac{3}{4}$	75.21	59.07	7 $\frac{1}{16}$	166.3	130.6
4 $\frac{11}{16}$	77.20	60.63	7 $\frac{1}{8}$	169.2	132.9
4 $\frac{7}{8}$	79.22	62.22	7 $\frac{3}{16}$	172.2	135.2
4 $\frac{5}{8}$	81.26	63.82	7 $\frac{1}{4}$	175.2	137.6
5	83.33	65.45	7 $\frac{5}{16}$	178.2	140.0
5 $\frac{1}{16}$	85.43	67.10	7 $\frac{3}{8}$	181.3	142.4
5 $\frac{1}{8}$	87.55	68.76	7 $\frac{1}{4}$	184.4	144.8
5 $\frac{3}{16}$	89.70	70.45	7 $\frac{1}{2}$	187.5	147.3
5 $\frac{1}{4}$	91.88	72.16	7 $\frac{9}{16}$	190.6	149.7
5 $\frac{5}{16}$	94.08	73.89	7 $\frac{5}{8}$	193.8	152.2
5 $\frac{3}{8}$	96.30	75.64	7 $\frac{1}{2}$	197.0	154.7
5 $\frac{7}{16}$	98.55	77.40	7 $\frac{3}{4}$	200.2	157.2
5 $\frac{1}{2}$	103.0	79.19	7 $\frac{3}{8}$	203.5	159.8
5 $\frac{9}{16}$	103.1	81.00	7 $\frac{7}{8}$	206.7	162.4
5 $\frac{5}{8}$	105.5	82.83	7 $\frac{1}{2}$	210.0	164.9
5 $\frac{11}{16}$	107.8	84.69	8	213.3	167.6
5 $\frac{3}{4}$	110.2	86.56	8 $\frac{1}{4}$	226.9	178.2
5 $\frac{13}{16}$	112.6	88.45	8 $\frac{1}{2}$	240.8	189.2
5 $\frac{7}{8}$	115.1	90.36	8 $\frac{3}{4}$	255.2	200.4
5 $\frac{15}{16}$	117.5	92.29	9	270.0	212.1
6	120.0	94.25	9 $\frac{1}{4}$	285.2	224.
6 $\frac{1}{16}$	122.5	96.22	9 $\frac{1}{2}$	300.8	236.3
6 $\frac{1}{8}$	125.1	98.22	9 $\frac{3}{4}$	316.9	248.9
6 $\frac{3}{16}$	127.6	100.2	10	333.3	261.8
6 $\frac{1}{4}$	130.2	102.3			

Add 2 per cent. for steel.

WEIGHT OF BAR STEEL PER LINEAL FOOT.

Width in Inches.	THICKNESS IN INCHES.															
	1/16	1/8	3/16	1/4	5/16	3/8	7/16	1/2	5/8	3/4	7/8	1	1 1/8	1 1/4	1 3/8	1 1/2
1	.21	.43	.638	.850	1.06	1.28	1.49	1.70	1.92	2.12	2.35	2.55	2.87	3.19	3.57	3.88
1 1/8	.24	.48	.720	.955	1.20	1.43	1.68	1.92	2.19	2.39	2.65	2.87	3.19	3.57	3.88	4.25
1 1/4	.27	.53	.797	1.06	1.33	1.59	1.86	2.12	2.42	2.65	2.92	3.19	3.57	3.88	4.25	4.68
1 3/8	.30	.59	.875	1.17	1.46	1.76	2.05	2.34	2.67	2.92	3.21	3.46	3.77	4.09	4.47	5.10
1 1/2	.32	.64	.957	1.28	1.59	1.92	2.23	2.55	2.92	3.19	3.53	3.83	4.15	4.51	4.84	5.53
1 3/4	.35	.69	1.04	1.38	1.73	2.08	2.42	2.77	3.16	3.46	3.83	4.15	4.47	4.84	5.20	5.95
2	.38	.75	1.11	1.49	1.86	2.23	2.60	2.98	3.40	3.72	4.15	4.47	4.84	5.20	5.53	6.80
2 1/8	.43	.85	1.28	1.70	2.12	2.55	2.98	3.40	3.83	4.25	4.68	5.10	5.53	5.95	6.38	7.65
2 1/4	.48	.96	1.44	1.91	2.39	2.87	3.35	3.83	4.31	4.78	5.25	5.75	6.22	6.69	7.16	8.50
2 3/8	.53	1.06	1.59	2.12	2.65	3.19	3.72	4.25	4.78	5.31	5.84	6.38	6.91	7.44	7.97	9.35
2 1/2	.59	1.17	1.75	2.34	2.92	3.51	4.09	4.67	5.25	5.84	6.43	7.02	7.61	8.20	8.79	10.20
2 3/4	.64	1.28	1.91	2.55	3.19	3.83	4.46	5.10	5.75	6.38	7.02	7.65	8.29	8.93	9.57	11.05
3	.69	1.38	2.07	2.76	3.45	4.15	4.83	5.53	6.22	6.91	7.61	8.31	9.01	9.71	10.41	11.90
3 1/8	.75	1.49	2.23	2.98	3.72	4.47	5.20	5.95	6.70	7.44	8.19	8.93	9.67	10.41	11.16	12.75
3 1/4	.80	1.60	2.39	3.19	3.99	4.78	5.58	6.38	7.17	7.97	8.77	9.57	10.37	11.16	11.96	13.60
3 3/8	.85	1.70	2.55	3.40	4.25	5.10	5.95	6.80	7.65	8.50	9.35	10.20	11.05	11.90	12.75	14.40
4	.96	1.92	2.87	3.83	4.78	5.74	6.70	7.65	8.61	9.57	10.53	11.48	12.44	13.39	14.35	16.00
4 1/8	1.07	2.13	3.19	4.25	5.31	6.38	7.44	8.50	9.57	10.63	11.69	12.75	13.81	14.87	15.93	17.00
5	1.17	2.34	3.51	4.67	5.84	7.02	8.18	9.35	10.53	11.69	12.85	14.03	15.20	16.36	17.53	18.70
5 1/8	1.28	2.55	3.83	5.10	6.38	7.65	8.93	10.20	11.48	12.75	14.03	15.30	16.57	17.85	19.12	20.40
6	1.49	2.98	4.46	5.95	7.44	8.93	10.41	11.90	13.39	14.87	16.36	17.85	19.34	20.83	22.32	23.80
7	1.70	3.40	5.10	6.80	8.50	10.20	11.90	13.60	15.30	17.00	18.70	20.40	22.10	23.80	25.50	27.20
8	1.70	3.40	5.10	6.80	8.50	10.20	11.90	13.60	15.30	17.00	18.70	20.40	22.10	23.80	25.50	27.20

WEIGHTS OF SHEETS OF IRON AND STEEL.

(Per Square Foot.)

Thickness of Birmingham Wire Gauge.	Iron.	Steel.	Thickness in Inches.	Iron.	Steel.
No.	Lbs.	Lbs.	No.	Lbs.	Lbs.
18	1.97	2.10	$\frac{1}{16}$	2.52	2.70
16	2.61	2.79	$\frac{1}{8}$	5.05	5.40
14	3.33	3.56	$\frac{3}{16}$	7.58	7.80
12	4.37	4.67	$\frac{1}{4}$	10.10	11.00
10	5.38	5.75	$\frac{5}{16}$	12.63	13.50
9	5.94	6.02	$\frac{3}{8}$	15.16	16.00
8	6.62	7.08	$\frac{7}{16}$	17.68	18.50
7	7.22	7.35	$\frac{1}{2}$	20.21	21.00
6	8.15	8.72	$\frac{9}{16}$	22.73	23.50
5	8.83	9.00	$\frac{5}{8}$	25.26	26.25
4	9.55	10.21	$\frac{3}{4}$	30.31	31.25
3	10.40	10.60	$\frac{7}{8}$	35.37	36.50
2	11.40	11.65	1	40.42	42.00

The low temperature (as compared with Iron) at which Steel Plates have to be finished, causes a slight springing of the rolls, leaving the plate thicker in the centre. This, combined with greater density, causes Steel Plates, if kept up to full thickness on the edges, to weigh more than Iron. Both Iron and Steel over 72 inches wide are liable to run even heavier than the weights given above.

IRON RIVETS.

Weight per 100 Rivets.

Length Under Head.	Diameter.						
	$\frac{3}{16}$	$\frac{1}{4}$	$\frac{5}{16}$	$\frac{3}{8}$	$\frac{1}{2}$	$\frac{5}{8}$	$\frac{3}{4}$
$\frac{1}{2}$.594	1.207	1.876	3.300			
$\frac{5}{8}$.720	1.379	2.062	3.687			
$\frac{3}{4}$.846	1.551	2.248	4.074			
$\frac{7}{8}$.972	1.723	2.434	4.461			
1	1.098	1.895	2.620	4.848	9.66	16.79	26.49
$1\frac{1}{8}$	1.224	2.067	2.806	5.235	10.34	17.86	27.99
$1\frac{1}{4}$	1.350	2.238	2.992	5.616	11.04	18.96	29.61
$1\frac{3}{8}$	1.476	2.410	3.178	6.003	11.73	20.03	31.13
$1\frac{1}{2}$	1.602	2.582	3.364	6.402	12.43	21.04	32.74
$1\frac{5}{8}$	1.728	2.754	3.550	6.789	13.12	22.11	34.25
$1\frac{3}{4}$	1.854	2.926	3.736	7.179	13.81	23.21	35.86
$1\frac{7}{8}$	1.984	3.098	3.922	7.566	14.50	24.28	37.37
2	2.106	3.269	4.108	7.956	15.19	25.48	38.99
$2\frac{1}{8}$	2.232	3.441	4.294	8.343	15.88	26.56	40.40
$2\frac{1}{4}$	2.358	3.613	4.480	8.733	16.57	27.65	42.11
$2\frac{3}{8}$	2.484	3.785	4.666	9.120	17.26	28.73	43.67
$2\frac{1}{2}$	2.610	3.957	4.852	9.511	17.95	29.82	45.24
$2\frac{5}{8}$	2.736	4.129	5.038	9.898	18.64	30.90	46.80
$2\frac{3}{4}$	2.862	4.301	5.224	10.29	19.33	31.99	48.36
$2\frac{7}{8}$	2.988	4.473	5.410	10.67	20.02	33.08	49.92
3	3.114	4.644	5.096	11.06	20.71	34.18	51.49
$3\frac{1}{8}$	3.240	4.816	5.782	11.44	21.40	35.27	53.05
$3\frac{1}{4}$	3.366	4.988	5.968	11.84	22.09	36.35	54.61
$3\frac{3}{8}$	3.492	5.160	6.154	12.23	22.78	37.44	56.17
$3\frac{1}{2}$	3.618	5.332	6.340	12.62	23.48	38.52	57.74
$3\frac{5}{8}$	3.744	5.504	6.526	13.01	24.17	39.60	59.30
$3\frac{3}{4}$	3.870	5.676	6.712	13.39	24.86	40.69	60.86
$3\frac{7}{8}$	3.996	5.848	6.898	13.78	25.55	41.78	62.42
4	4.022	6.019	7.084	14.17	26.24	42.87	63.99
$4\frac{1}{8}$	4.148	6.191	7.270	14.56	26.93	43.94	65.55
$4\frac{1}{4}$	4.274	6.393	7.456	14.95	27.62	45.01	67.11
$4\frac{3}{8}$	4.526	6.565	7.828	15.73	29.20	47.15	70.23
$4\frac{1}{2}$	4.778	7.081	8.200	16.51	30.78	49.29	73.35
5	5.030	7.425	8.572	17.29	32.36	51.43	76.47
$5\frac{1}{4}$	5.282	7.769	8.944	18.07	33.94	53.57	79.59
$5\frac{1}{2}$	5.534	8.113	9.316	18.85	35.52	55.71	82.71
$5\frac{3}{4}$	5.756	8.457	9.688	19.63	37.10	57.85	85.83
6	6.008	8.801	10.060	20.41	38.68	59.99	88.95

DECIMALS OF AN INCH FOR EACH $\frac{1}{64}$ th.

$\frac{1}{32}$ ds.	$\frac{1}{64}$ ths.	Decimal.	Fraction.	$\frac{1}{32}$ ds.	$\frac{1}{64}$ ths.	Decimal.	Fraction.
	1	.015625			33	.515625	
1	2	.03125		17	34	.53125	
	3	.046875			35	.546875	
2	4	.0625	1-16	18	36	.5625	9-16
	5	.078125			37	.578125	
3	6	.09375		19	38	.59375	
	7	.109375			39	.609375	
4	8	.125	1-8	20	40	.625	5-8
	9	.140625			41	.640625	
5	10	.15625		21	42	.65625	
	11	.171875			43	.671875	
6	12	.1875	3-16	22	44	.6875	11-16
	13	.203125			45	.703125	
7	14	.21875		23	46	.71875	
	15	.234375			47	.734375	
8	16	.25	1-4	24	48	.75	3-4
	17	.265625			49	.765625	
9	18	.28125		25	50	.78125	
	19	.296875			51	.796875	
10	20	.3125	5-16	26	52	.8125	13-16
	21	.328125			53	.828125	
11	22	.34375		27	54	.84375	
	23	.359375			55	.859375	
12	24	.375	3-8	28	56	.875	7-8
	25	.390625			57	.890625	
13	26	.40625		29	58	.90625	
	27	.421875			59	.921875	
14	28	.4375	7-16	30	60	.9375	15-16
	29	.453125			61	.953125	
15	30	.46875		31	62	.96875	
	31	.484375			63	.984375	
16	32	.5	1-2	32	64	1.	1

CIRCUMFERENCE AND AREAS OF CIRCLES.

$$A=D^2 \times .7854$$

Diameter.	Circumference.	Area.	Diameter.	Circumference.	Area.
$\frac{1}{32}$.0981	.00076	$2\frac{1}{4}$	7.068	3.976
$\frac{1}{16}$.1963	.00306		7.461	4.430
$\frac{1}{8}$.3926	.01227	$\frac{1}{2}$	7.854	4.908
$\frac{3}{16}$.5890	.02761		8.246	5.411
$\frac{1}{4}$.7854	.04908	$\frac{3}{4}$	8.639	5.939
$\frac{5}{16}$.9817	.07669		9.032	6.491
$\frac{3}{8}$	1.178	.1104	3	9.424	7.068
$\frac{7}{16}$	1.374	.1503	$\frac{1}{4}$	10.21	8.295
$\frac{1}{2}$	1.570	.1963	$\frac{1}{2}$	10.99	9.621
$\frac{9}{16}$	1.767	.2485	$\frac{3}{4}$	11.78	11.044
$\frac{5}{8}$	1.963	.3067	4	12.56	12.566
$\frac{11}{16}$	2.159	.3712	$\frac{1}{4}$	13.35	14.186
$\frac{3}{4}$	2.356	.4417	$\frac{1}{2}$	14.13	15.904
$\frac{13}{16}$	2.552	.5184	$\frac{3}{4}$	14.92	17.720
$\frac{7}{8}$	2.748	.6013	5	15.70	19.635
$\frac{15}{16}$	2.945	.6902	$\frac{1}{4}$	16.49	21.647
1	3.141	.7854	$\frac{1}{2}$	17.27	23.758
	3.534	.9940	$\frac{3}{4}$	18.06	25.967
$\frac{1}{4}$	3.927	1.227	6	18.84	28.274
	4.319	1.484	$\frac{1}{4}$	19.63	30.679
$\frac{1}{2}$	4.712	1.767	$\frac{1}{2}$	20.42	33.183
	5.105	2.073	$\frac{3}{4}$	21.20	35.784
$\frac{3}{4}$	5.497	2.405	7	21.99	38.484
	5.890	2.761	$\frac{1}{4}$	22.77	41.282
2	6.283	3.141	$\frac{1}{2}$	23.56	44.178
	6.675	3.546	$\frac{3}{4}$	24.34	47.173

CIRCUMFERENCE AND AREAS OF CIRCLES— Continued.

Diameter.	Circumference.	Area.	Diameter.	Circumference.	Area.
8	25.13	50.265	15 $\frac{1}{4}$	47.90	182.65
8 $\frac{1}{4}$	25.91	53.456	15 $\frac{1}{2}$	48.69	188.69
8 $\frac{1}{2}$	26.70	56.745	15 $\frac{3}{4}$	49.48	194.82
8 $\frac{3}{4}$	27.48	60.132	16	50.26	201.06
9	28.27	63.617	16 $\frac{1}{4}$	51.05	207.39
9 $\frac{1}{4}$	29.05	67.200	16 $\frac{1}{2}$	51.83	213.82
9 $\frac{1}{2}$	29.84	70.882	16 $\frac{3}{4}$	52.62	220.35
9 $\frac{3}{4}$	30.63	74.662	17	53.40	226.98
10	31.41	78.539	17 $\frac{1}{4}$	54.19	233.70
10 $\frac{1}{4}$	32.20	82.516	17 $\frac{1}{2}$	54.97	240.52
10 $\frac{1}{2}$	32.98	86.590	17 $\frac{3}{4}$	55.76	247.45
10 $\frac{3}{4}$	33.77	90.762	18	56.54	254.46
11	34.55	95.033	18 $\frac{1}{4}$	57.33	261.58
11 $\frac{1}{4}$	35.34	99.402	18 $\frac{1}{2}$	58.11	268.80
11 $\frac{1}{2}$	36.12	103.86	18 $\frac{3}{4}$	58.90	276.11
11 $\frac{3}{4}$	36.91	108.43	19	59.69	283.52
12	37.69	113.09	19 $\frac{1}{4}$	60.47	291.03
12 $\frac{1}{4}$	38.48	117.85	19 $\frac{1}{2}$	61.26	298.64
12 $\frac{1}{2}$	39.27	122.71	19 $\frac{3}{4}$	62.04	306.35
12 $\frac{3}{4}$	40.05	127.67	20	62.83	314.16
13	40.84	132.73	20 $\frac{1}{2}$	64.40	330.06
13 $\frac{1}{4}$	41.62	137.88	21	65.97	346.36
13 $\frac{1}{2}$	42.41	143.13	21 $\frac{1}{2}$	67.54	363.05
13 $\frac{3}{4}$	43.19	148.48	22	69.11	380.13
14	43.98	153.93	22 $\frac{1}{2}$	70.68	397.60
14 $\frac{1}{4}$	44.76	159.48	23	72.25	415.47
14 $\frac{1}{2}$	45.55	165.13	23 $\frac{1}{2}$	73.82	433.73
14 $\frac{3}{4}$	46.33	170.87	24	75.39	452.39
15	47.12	176.78	24 $\frac{1}{2}$	76.96	471.43

CIRCUMFERENCE AND AREAS OF CIRCLES— Continued.

Diameter.	Circumference.	Area.	Diameter.	Circumference.	Area.
25	78.54	490.87	38½	120.9	1164.1
25½	80.10	510.70	39	122.5	1194.5
26	81.68	530.93	39½	124.0	1225.4
26½	83.25	551.54	40	125.6	1256.6
27	84.82	572.55	40½	127.2	1288.2
27½	86.39	593.95	41	128.8	1320.2
28	87.96	615.75	41½	130.3	1352.5
28½	89.53	637.94	42	131.9	1385.4
29	91.10	660.52	42½	133.5	1418.6
29½	92.67	683.49	43	135.0	1452.2
30	94.24	706.86	43½	136.6	1486.1
30½	95.81	730.61	44	138.2	1520.5
31	97.38	754.76	44½	139.8	1555.2
31½	98.96	779.31	45	141.3	1590.4
32	100.5	804.24	45½	142.9	1625.9
32½	102.1	829.57	46	144.5	1661.9
33	103.6	855.30	46½	146.0	1698.2
33½	105.2	881.41	47	147.6	1734.9
34	106.8	907.92	47½	149.2	1772.0
34½	108.3	934.82	48	150.7	1809.5
35	109.9	962.11	48½	152.3	1847.4
35½	111.5	989.80	49	153.9	1885.7
36	113.0	1017.8	49½	155.5	1924.4
36½	114.6	1046.3	50	157.0	1963.5
37	116.2	1075.2	50½	158.6	2002.9
37½	117.8	1104.4	51	160.2	2042.8
38	119.3	1134.1	51½	161.7	2083.0

CIRCUMFERENCE AND AREAS OF CIRCLES— Continued.

Diameter.	Circumference.	Area.	Diameter.	Circumference.	Area.
52	163.3	2123.7	66	207.3	3421.2
52½	164.9	2164.7	66½	208.9	3473.2
53	166.5	2206.1	67	210.4	3525.6
53½	168.0	2248.0	67½	212.0	3578.4
54	169.6	2290.2	68	213.6	3631.6
54½	171.2	2332.8	68½	215.1	3685.2
55	172.7	2375.8	69	216.7	3739.2
55½	174.3	2419.2	69½	218.3	3793.6
56	175.9	2463.0	70	219.9	3848.4
56½	177.5	2507.1	70½	221.4	3903.6
57	179.0	2551.7	71	223.0	3959.2
57½	180.6	2596.7	71½	224.6	4015.1
58	182.2	2642.0	72	226.1	4071.5
58½	183.7	2687.8	72½	227.7	4128.2
59	185.3	2733.9	73	229.3	4185.3
59½	186.9	2780.5	73½	230.9	4242.5
60	188.4	2827.4	74	232.4	4300.8
60½	190.0	2874.7	74½	234.0	4359.1
61	191.6	2922.4	75	235.6	4417.8
61½	193.2	2970.5	75½	237.1	4476.9
62	194.7	3019.0	76	238.7	4536.4
62½	196.3	3067.9	76½	240.3	4596.3
63	197.9	3117.2	77	241.9	4656.6
63½	199.4	3166.9	77½	243.4	4717.3
64	201.0	3216.9	78	245.0	4778.3
64½	202.6	3267.4	78½	246.6	4839.8
65	204.2	3318.3	79	248.1	4901.6
65½	205.7	3369.5	79½	249.7	4963.9

CIRCUMFERENCE AND AREAS OF CIRCLES—

Continued.

Diameter.	Circumference.	Area.	Diameter.	Circumference.	Area.
80	251.3	5026.5	90½	284.3	6432.6
80½	252.8	5089.5	91	285.8	6503.8
81	254.4	5153.0	91½	287.4	6575.5
81½	256.0	5216.8	92	289.0	6647.6
82	257.6	5281.0	92½	290.5	6720.0
82½	259.1	5345.6	93	292.1	6792.9
83	260.7	5410.6	93½	293.7	6866.1
83½	262.3	5476.0	94	295.3	6936.7
84	263.8	5541.7	94½	296.8	7013.8
84½	265.4	5607.9	95	298.4	7088.2
85	267.0	5674.5	95½	300.0	7163.0
85½	268.6	5741.4	96	301.5	7238.2
86	270.1	5808.8	96½	303.1	7313.8
86½	271.7	5876.5	97	304.7	7389.8
87	273.3	5944.6	97½	306.3	7466.2
87½	274.8	6013.2	98	307.8	7542.9
88	276.4	6082.1	98½	309.4	7620.1
88½	278.0	6151.4	99	311.0	7697.7
89	279.6	6221.1	99½	312.5	7775.6
89½	281.1	6291.2	100	314.1	7853.9
90	282.7	6361.7			

**CONTENTS IN FEET BOARD MEASURE OF
BOARDS, JOISTS, SCANTLING AND TIMBER.**

Length in Feet.

Size.	12	14	16	18	20	22	24	26	28	30
1x 4	4	5	5	6	7	7	8	9	9	10
1x 6	6	7	8	9	10	11	12	13	14	15
1x 8	8	9	11	12	13	15	16	17	19	20
1x10	10	12	13	15	17	18	20	22	23	25
1x12	12	14	16	18	20	22	24	26	28	30
2x 4	8	9	11	12	13	15	16	17	19	20
2x 6	12	14	16	18	20	22	24	26	28	30
2x 8	16	19	21	24	27	29	32	35	37	40
2x10	20	23	27	30	33	37	40	43	47	50
2x12	24	28	32	36	40	44	48	52	56	60
2x14	28	33	37	42	47	51	56	61	65	70
3x 8	24	28	32	36	40	44	48	52	56	60
3x10	30	35	40	45	50	55	60	65	70	75
3x12	36	42	48	54	60	66	72	78	84	90
3x14	42	49	56	63	70	77	84	91	98	105
4x 4	16	19	21	24	27	29	32	35	37	40
4x 6	24	28	32	36	40	44	48	52	56	60
4x 8	32	37	43	48	53	59	64	69	75	80
4x10	40	47	53	60	67	73	80	87	93	100
4x12	48	56	64	72	80	88	96	104	112	120
4x14	56	65	75	84	93	103	112	121	131	140
6x 6	36	42	48	54	60	66	72	78	84	90
6x 8	48	56	64	72	80	88	96	104	112	120
6x10	60	70	80	90	100	110	120	130	140	150
6x12	72	84	96	108	120	132	144	156	168	180
6x14	84	98	112	126	140	154	168	182	196	210
8x 8	64	75	85	96	107	117	128	139	149	160
8x10	80	93	107	120	133	147	160	173	187	200
8x12	96	112	128	144	160	176	192	208	224	240
8x14	112	131	149	168	187	205	224	243	261	280
10x10	100	117	133	150	167	183	200	217	233	250
10x12	120	140	160	180	200	220	240	260	280	300
10x14	140	163	187	210	233	257	280	303	327	350
12x12	144	168	192	216	240	264	288	312	336	360
12x14	168	196	224	252	280	308	336	364	392	420
14x14	196	229	261	294	327	359	392	425	457	490



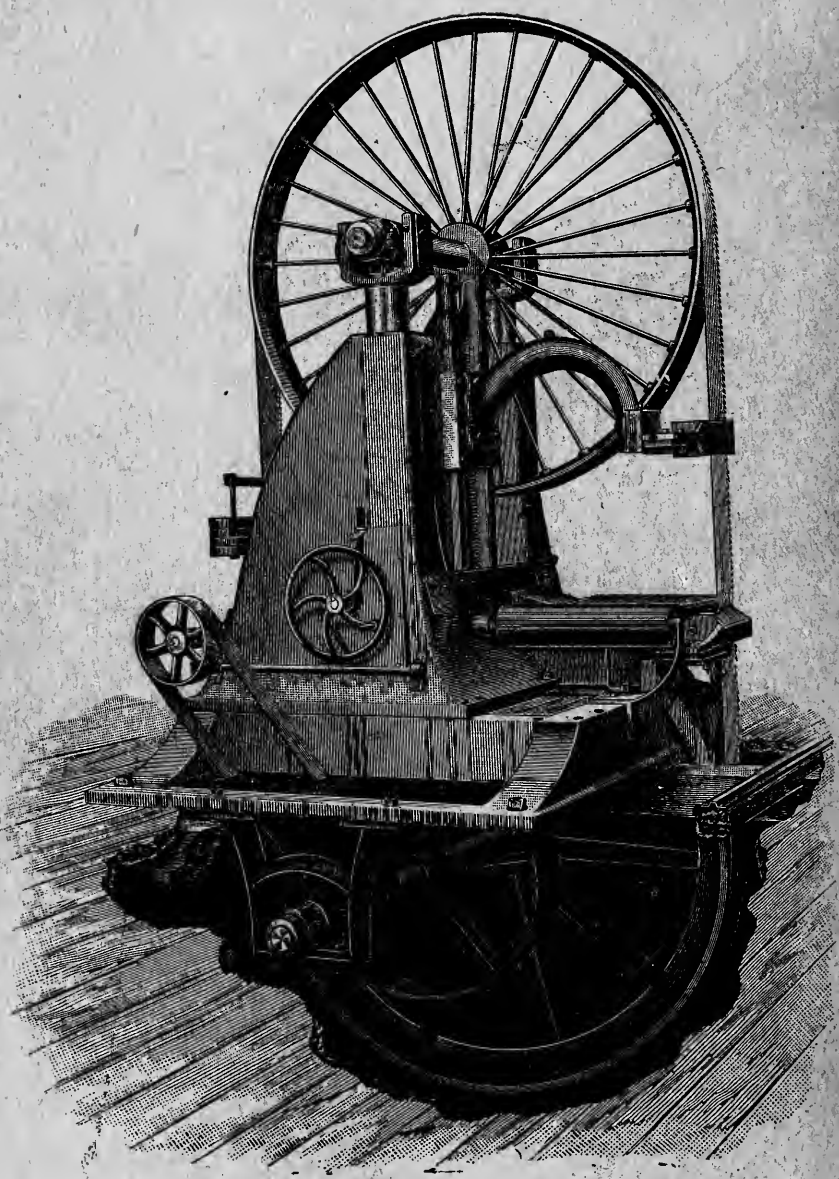

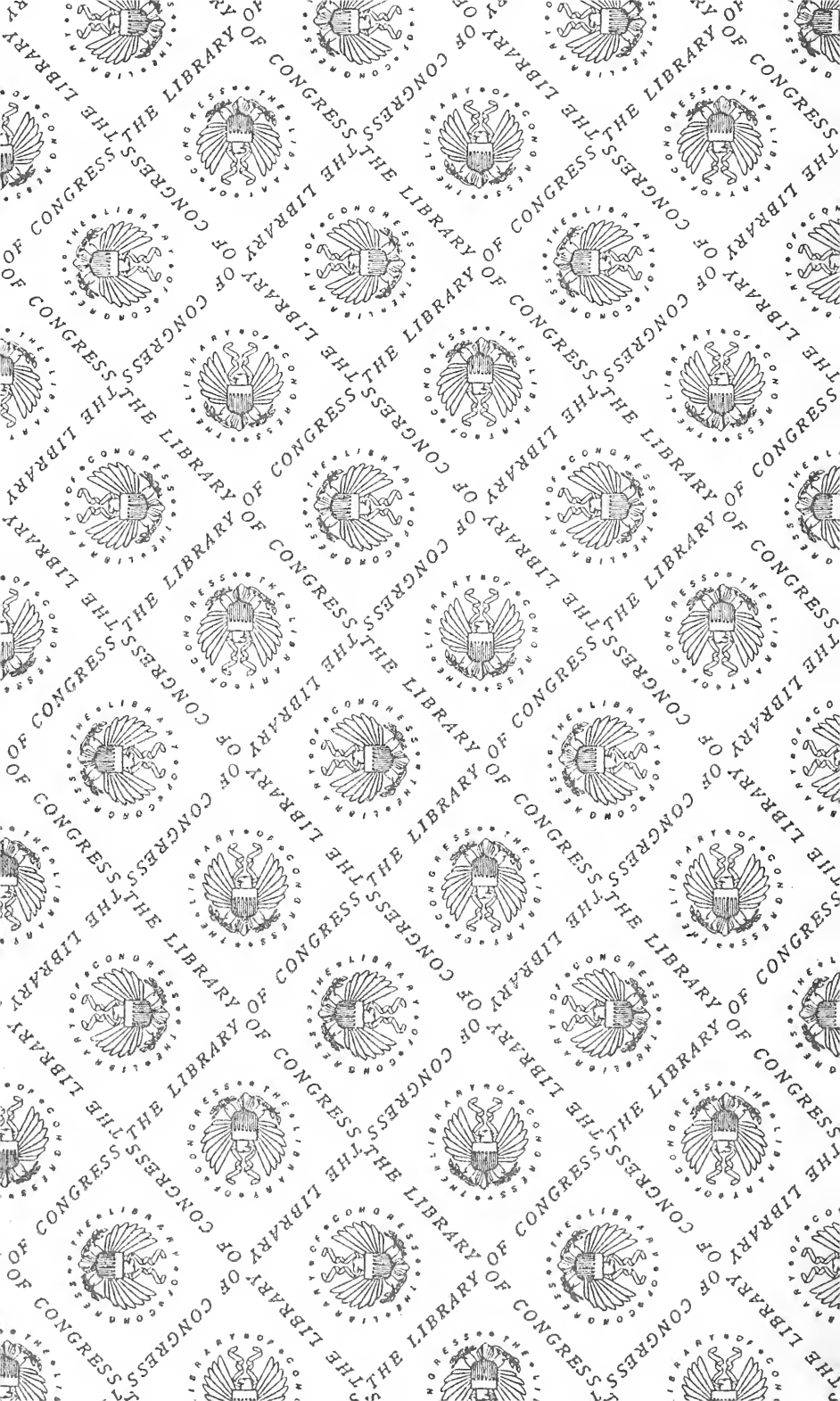



DOBBS BROS.
LIBRARY BINDING

ST. AUGUSTINE
FLA.
32084

LIBRARY OF CONGRESS



0 017 100 382 9

