

JOHN REYNDERS & CO'S  
Catalogue of  
Surgical Instruments

Essex Institute Library



DEPOSITED BY

THE ESSEX SOUTH DISTRICT  
MEDICAL SOCIETY



*Received October 6, 1906*







Digitized by the Internet Archive  
in 2011 with funding from  
Open Knowledge Commons and Harvard Medical School

# JOHN REYNDERS & CO'S

ILLUSTRATED CATALOGUE

AND

PRICE LIST

—OF—

# SURGICAL INSTRUMENTS

SPECTACLES, EYEGLASSES, OPTICAL GOODS,  
ORTHOPAEDICAL APPARATUS, TRUSSES,  
SUPPORTERS, ETC., ETC.

*"Non ergo despicias ullum Instrumentum; quum sint omnia  
apud te praeeparata; inexcusabilis est enim, qui hanc artem  
profitetur, et non habet impromptu, quae ad hanc artem  
requiruntur."*

*Albucasis, Lib. II. Meth. Cap. 67.*

---

SIXTH EDITION.

---

NEW YORK:

JOHN REYNDERS & Co.

---

*Copyright, 1880, by Chas. Reynders.*

# CONTENTS.

## ALPHABETICAL INDEX, TWO PAGES FURTHER ON. CORRECTIONS AND MODIFICATIONS, PAGE 398.

	Page.		Page.
I.	General Necessities for Surgical Operations.....	2 to 7F	
II.	Capital and Minor Operating Instruments.....	8 to 37B	
	Amputating, Aneurism, Trephining and Resection Instruments.....	8	
	Oral Instruments.....	21	
	Harelip and Bullet Instruments.....	22	
	Hernia Instruments.....	23	
	Amputating, General and Minor Operating Sets.....	24	
	General Surgical Appliances.....	31	
	Instruments for Lithotrity.....	31 and 33	
	Instruments for Lithotomy.....	35	
	Instruments for Tracheotomy.....	37	
	Intubation.....	37A	
III.	Pocket Case Instruments.....	39 to 48	
IV.	Trocars and Aspirators.....	49 to 52	
V.	Instruments for Cupping.....	65	
VI.	Appliances for Fracures.....	55 to 64	
VII.	Eye Instruments.....	68 to 91A	
	Ophthalmoscopes.....	69	
	Douches.....	71	
	Eye Shades.....	71	
	Condensing Lenses.....	71	
	Artificial Leeches.....	71	
	Phantoms.....	71	
	Artificial Eyes.....	73	
	Trial Cases.....	73, 91Q, R and S	
	Test Types.....	75 and 91S	
	Specula and Lid Elevators.....	77	
	Entropium Forceps.....	77	
	Lachrymal Instruments.....	79	
	Iris Instruments.....	81	
	Scissors.....	81	
	Strabismus Instruments.....	83	
	Fixation.....	83	
	Knives.....	83	
	Scoops.....	85	
	Hooks, Needles, Cystotomes.....	87	
	Double Instruments.....	89	
	Sundries.....	89	
	Cases (Sets).....	91	
	Anatomical Models.....	91	
	Spectacles and Eyeglasses.....	91D to 91S	
VIII.	Ear Instruments.....	91B, 93 to 104	
	Specula.....	93	
	Reflecting Mirrors.....	93	
	Forceps.....	95	
	Scissors.....	95	
	For Eustachean Tubes and Middle Ear.....	95	
	Politzer's Inflating Apparatus.....	97	
	For Membrana Tympani and Auditory Canal.....	99	
	For Removing Secretions, Foreign Bodies, Polypi, etc.....	99	
	For Operating upon Mastoid Bones.....	101	
	Ear Trumpets.....	103	
	Ear Cases.....	104	
IX.	Oesophageal Instruments.....	105	
X.	Laryngeal Instruments.....	106 to 124	
	Tongue Depressors.....	107	
	Mirrors.....	109	
	Laryngoscopes.....	111	
	For Making Applications.....	112	
	For Excision Tonsils & Uvula.....	120	
	For Removing Foreign Bodies, Polypi, etc.....	123	
XI.	Nasal Instruments.....	125 to 131D	
	For Examination.....	125	
	For Making Applications.....	127	
	For Removing Foreign Bodies, Polypi, etc.....	129	
	Addenda.....	131A to D	
XII.	Dental Instruments.....	132 to 137	
XIII.	Obstetric Instruments.....	138 to 144 and 197A	
XIV.	Gynaecological Instr.....	145 to 197F	
	For Examination.....	145	
	Vaginal Specula.....	149	
	For Illumination.....	155	
	Vaginal Depressors.....	155	
	For Diagnosis.....	157	
	For Urethra and Bladder.....	158	
	For Dilatation.....	159	
	For Replacement of Uterus.....	163	
	For Incision of the Uterus.....	165	
	For Vaginal Irrigation.....	166	
	For Making Applications.....	167	
	For the Removal of Abnormal Growths, Tissues, etc.....	173	
	For Gynaecological Surgery, Pessaries.....	177	
	Addenda.....	189	
	Rectal Instruments.....	197A to F	
XV.	Rectal Instruments.....	197B, 199 to 203	
XVI.	Male Urethral Instr.....	204 to 218	
	For Examination.....	204	
	Comparative Schedule of Gauges.....	205	
	Catheters.....	207	
	For Making Applications.....	209	
	Urethral Forceps.....	209	
	For Strictures.....	210	
	Phimosi Instruments.....	217	
	Scrotal Instruments.....	217	
	Spermatorrhoeal Appliances.....	218	
	Urethral Sets.....	218	
XVII.	Dermic Instruments.....	219, 220	
XVIII.	Post-Mortem and Dissecting Instruments.....	221 to 224	
XIX.	Microscopic Instruments.....	225 to 228	
XX.	Instruments for General Diagnosis.....	229 to 234	
XXI.	Respiratory Instruments and Apparatus.....	235 to 237A	
XXII.	Syringes and Douches.....	238 to 239	
XXIII.	Hypodermic Syringes.....	240 to 243	
XXIV.	Instruments for Vaccination.....	237B	
XXV.	Electric Apparatus.....	244 to 262 and 380 to 390	
XXVI.	Cases for Carrying Medicines.....	263 to 271	
XXVII.	Therapeutic Sundries.....	274 to 279	
XXVIII.	Human Osteology.....	283	
XXIX.	Rubber Goods.....	284 to 286	
XXX.	Miscellanies.....	287 to 289	
XXXI.	Invalids' Comforts.....	290 to 291	
XXXII.	Elastic Stockings, Trusses, Supports, Bandages, etc.....	292 to 302H	
XXXIII.	Orthopaedic Apparatus.....	303 to 377	
XXXIV.	Appendix.....	378	

BOSTON MEDICAL LIBRARY  
 MAY - 1



# DISCOUNTS—TO THE PROFESSION.

On the basis of Cash—with order or within about 15 days after Receipt of Goods—

## 25%

**EXCEPTING:** Everything under a Heading mentioned with either of the signs shown below, and also Single Articles thus designated. The signs indicate less discount as follows:

†† 20%	12½%	† 5%
** 15%	‡ 10%	* 0%

§ Special Price on Application.

The privilege is reserved of making out bills at full catalogue prices and stating separately that \$\_\_\_\_\_ may be deducted from total amount, remittance being made on or before a certain day mentioned in accordance with notice above given.

---

## POSTAL INSURANCE.

The Home Insurance Company, capital \$3,000,000, will insure the delivery of merchandise from the principal cities to any Post Office in the United States in the registered or ordinary mail. The cost of transmitting merchandise in the mail is 1 cent per ounce, or 16 cents per pound. It is well known that the Government assumes no financial responsibility for registered or ordinary mail. Should a parcel be lost or stolen, the loss falls on the shipper or addressee. The cost of insurance of unregistered parcels valued at \$5 or less, is 5 cents; \$5 to \$10, 10 cents. For registered parcels, valued at from \$10 to \$25, it is 5 cents, and for registered parcels, valued at from \$25 to \$100, it is 10 cents.

### ILLUSTRATION.

Postage on a parcel in ordinary mail weighing 4 oz., . . . . .	4 cts.
Insurance (value of parcel at \$5 or less), . . . . .	5 "
Total, . . . . .	<u>9 cts.</u>

If parcel is worth more than \$5 or less than \$10, 5 cents additional.

For registered parcels the cost is as follows, viz:

Postage on parcel weighing 4 oz., . . . . .	4 cts.
Registration fee, . . . . .	10 "
Insurance on parcel valued at more than \$10 and less than \$25, . . . . .	5 "
Total, . . . . .	<u>19 cts.</u>

We would therefore advise you to have your parcels valued at less than \$10 sent by ordinary mail instead of registering them, as has been the practice in the past. By so doing you will save 5 cents on packages valued at \$5 or less, and on parcels valued at from \$5 to \$10 the expense will be the same as the cost for registration, with the additional guarantee that in case the parcel is lost you will be reimbursed therefor.

**JOHN REYNDERS & CO.**

# GENERAL SUGGESTIONS.

**Observance of which will tend to prompt dispatch in the transaction of business.**

1. Correspondents should write their own name, as well as those of P. O., County and State, distinctly; also state that they refer to our Catalogue of the sixth edition.

2. Correspondence to insure prompt attention should be addressed to the firm. Individuals are frequently out for hours, days or weeks and answers to letters directed to them therefore liable to serious delay. Letters are always opened by a responsible party, one who knows best what to do regarding their contents and from whom the others have learned the business.

3. By consulting "Alphabetical Index," following this page, and the "Contents," previous to it, there should be no difficulty encountered to find anything. Please mark "Corrections and Modifications," at page 398—also all other notices and everything else.

4. When ordering an article of which different sizes are made, state whether smallest, largest or which intermediate size is wanted, or give measurements.

5. A mail of about 200 letters per day requires destruction of files as soon as one year old. Reference to former correspondence should be limited to the utmost.

6. State how goods are to be sent—by mail, express or otherwise.

7. Our terms are Cash. Parties not known to us and ordering for the first time should remit with their order or give us satisfactory references and thereby save time necessary for making inquiries.

8. No goods are sent C. O. D. to parties unknown to us without a remittance of **Three Dollars** as security against any risk of goods not being taken on arrival, which in such cases are returned to us at our expense for transit both ways. In case of bulky goods or large orders we request for a further remittance of about one-third of the entire value of the goods ordered.

9. Packing Material is charged at cost price and all goods packed with utmost care by competent hands. After having received a receipt from transportation companies for a case or package in good order, our responsibility ceases. We are not liable for goods lost in transit, when ordered to be sent by mail.

10. Claims for overcharges, etc., must be made within ten days after receipt of bill.

11. Our desire is to give entire satisfaction in every transaction. Should there be any misapprehension or error on our part in putting up an order, it will afford us pleasure to correct the same.

12. To parties desiring to return orthopaedical apparatus, or anything which is, as they always are, made to order, we cannot offer favorable conditions.

13. Remittances are most safely made by Post Office Orders, Drafts or by Express. Money in ordinary or registered letters goes at the sender's risk.

14. When a different catalogue from ours is used in ordering from us, care should be taken to designate by date or otherwise its editions; articles not in our catalogue will be furnished at advertised rates.

**15. We reserve the privilege of changing the prices in this Catalogue, as the fluctuations in the cost of materials and wages may require.**

## REGARDING PACKAGES SENT TO US:

16. We at all times are more or less in receipt of packages whose owners remain temporarily or forever unknown to us. This would not be so were every package marked with name of its sender.

17. In addition, advice should be sent with every package by letter or postal outside of same.

18. Packages must be fully prepaid, on packages at the rate of one cent per ounce or fractional part thereof. Limit of weight, four pounds.

19. All packages must be so wrapped that the contents may be readily examined by Post-masters without destroying the wrapper. **Please do not seal, sew or paste up with or without adhesive plaster any package sent to us by mail.**

**JOHN REYNDERS & CO.**



## ALPHABETICAL INDEX—Continued.

Ecrasseurs.....	175,	197C
Elastic Ligature.....		203
“ Stockings.....		293
“ Bandage.....		292
“ Supporters.....	302E and	F
Electric Apparatus.....	244 to 262,	280 to
“ Apostoli.....	250, 251,	379
“ Belts.....	244,	246
“ Cabinet.....	378,	379
“ Cox’s.....		245
“ Dynamo.....		251
“ Flemming’s.....		249
“ Gaffe.....		244
“ Galvano Faradic.....		250
“ Garratt’s.....		246
“ Illuminators.....	387,	390
“ McIntosh.....	246,	250
“ Motors.....	385	386
“ Soles.....		245
“ Storage.....	380 to	385
“ Vetter’s.....	247,	248
“ Waite & Bartlett.....		250
Electro-Cautery, Ear.....		99
“ “ Nasal.....	129, 131, 380 to	390
“ “ Phimosal.....		217
“ “ Throat.....	124, 380 to	390
“ “ Uterine.....	183, 380 to	390
Electrodes.....	258 to	387
“ Cautery.....	384,	387
Elm City Supporters.....		301
Embalming.....	221,	281B
Endoscopes.....	204, 217A and	B
Esmarch Tourniquet.....		8
Ether Inhalers.....		3
Eugenie.....	285,	300
Eustachean.....		95
Evacuators, Stone.....	31,	33
“ Stomach.....	52,	276
Examining Chairs.....	145,	146
Exploring Needle.....		38
“ Trocar.....		49
Extension Apparatus.....	57,	327
Eye Instruments.....	69 to 91A,	393
“ Glasses.....	91C to	P
Faradic Apparatus.....	244 to	250
Felt for Splints.....		55
Felt Splints.....		61
Fitch’s Supporters.....	302E	
Flat Foot Apparatus.....		371
Flemming’s Batteries.....		249
Flexion Straighteners.....		163
Forceps, Artery.....	13, 14, 187,	391
“ Bone.....		17
“ Bullet.....		22
“ Cilia.....		75
“ Craniotomy.....		143
“ Dental.....		133
“ Dissecting.....		221
“ Dressing.....		40
“ Ear.....	91B,	95
“ Entropium.....		77
“ Fixation.....		83
“ Haemostatic.....	187,	197F
“ Iris.....		81
“ Laryngeal.....	118,	122
“ Lithotomy.....		35
“ Microscopic.....		225
“ Nasal.....	129,	393
“ Needle.....	5,	13
“ Obstetric.....	139,	141
“ Oesophageal.....		105
“ Ovariotomy.....		187
“ Phimosis.....		217
“ Pile.....		201
“ Placental.....		143
“ Polypus.....		173
“ Pocket Case.....		40
“ Post Nasal.....		131C
“ Sequestrum.....		17
“ Splinter.....		38
“ Thumb.....		13
“ Throat.....	118,	122
“ Tracheal.....		37
“ Trachoma.....	91A,	393
“ Uterine Dressing.....		167
“ “ Tenaculum.....	157,	197D
“ “ Vulsellum.....		173
“ “ Wire Twisting.....		183
“ “ Tissue Holding.....		177
“ Uvula.....		121
Fountain Syringe.....		239
Fractures.....	55 to 64,	392
Funia Clamp.....		144

Gags.....	21,	131C
Gaiffe Batteries.....		244
Galvanic.....	247 to	250
Garratt’s Disks.....		246
Gas Arm.....		111B
Gauges for Sounds.....	204,	205
Gauze, Antiseptic.....		7C
General Diagnosis.....	229 to	234
“ Operating Cases.....		24
“ “ Instruments.....	8 to	40
Geysier Vaporizer.....		115
Glassware, Antiseptic.....		7D
“ Chemical.....		289
Gloves, Rubber.....		285
Glycerine Atomizer, 115, 115B. Recipes for Same.....		397
Goggles.....		91L
Gongs, Bone.....		19
Gutta Percha.....		55
Gynaecological Instruments.....	145 to 197F	
“ Cases.....	176,	184

Haemorrhoidal Syringes.....		201
Haemostatic Forceps.....	15, 187,	197F
Hagedorn Needles.....		5
Harelip.....		22
Hawk Bill Scissors.....		197D
Head-Rest, see Jury-Mast.....		
Hernia Instruments.....	23,	299
“ Trusses.....	294 to	302A
Hip Splints.....	326 to	340
Home Bath.....		279
Hones, Arkansas.....		288
Hooks, Obstetric.....		143
Hot Air Bath.....		278
“ Apparatus, Consumption.....		237A
“ Water Coil.....		278
Human Osteology.....		283
Hypodermic Syringes.....	240 to 243,	393
“ Tablets.....		243
Hysterotome.....		165

Ice Caps and Bags.....		285
Illuminators, Lamps.....		155
“ Throat.....		111
“ Electric.....	387,	390
“ Microscopic.....		390
Inhalers, Ether and Chloroform.....		3
“ Iodine, Ear.....		97
“ Throat or Pulmonary.....		116
Insane Restraints.....	302G and	H
Intubation.....		302
Intubation.....		37B
Invalid Bedstead.....		291
“ Chairs.....		290
“ Cushions.....		285
Irrigators, Bladder.....		207
“ Chamberlain’s Tube.....		169
“ Rectal.....		239
“ Vaginal, see Douches.....		

Jury-Mast.....	317 to 321,	332D
Jute.....		7C

Kelly’s Cushions.....	7B,	197D
Kidder’s Battery.....		246
Knee Apparatus.....	343 to	354
Knives, Amputating.....		9
“ Brain.....		251
“ Cartilage.....		221
“ Ear.....		99
“ Eye.....	83,	85
“ Laryngeal.....		124
“ Mastoid.....		101
“ Microscopic.....		225
“ Minor Operating.....	10, 21,	391
“ Plaster of Paris.....		56
“ Pocket Case.....		39
“ Uterine.....	163, 177,	391
Knock Knee Apparatus.....		355A
Knot Tier, Carroll’s.....	17F,	189

Lachrymal Probes.....		79
“ Syringes.....	79,	118
Lamps, Students’.....		288
“ Alcohol.....		289
“ Examination.....		155
“ Electric.....		390
Lancets.....		39
Laryngeal Instruments.....	106 to 131D,	281B
Laryngoscopes.....	111 to 111B,	396,
Lateral Curvature Spine.....	306,	307
“ (See Suspension Apparatus.).....		
Leather Jackets.....		318
leg Holders.....	7F,	34
Lenses.....		91O

ALPHABETICAL INDEX—Continued.

Lever Braces, Stillman's..... 308 to 311D  
 Levis' Splints..... 58 to 60, 392  
 Life Waker..... 277  
 Ligatures..... 7, 7E  
 Litholapaxy..... 31, 33, 217A  
 Lithotomy..... 33  
 Lock Jaw..... 21  
 Locomotor Ataxia..... 324B  
 London Supporters..... 302A  
**M**  
 Magneto-Electric Machine..... 246  
 Magnet for Eye..... 85  
 Manikin, Gynaecological..... 146  
 " " Obstetric..... 139, 396  
 Mark's Chairs..... 145  
 Martin's Bandages..... 293  
 Mastoid Instruments..... 101  
 McIntosh Batteries..... 250  
 " " Pessary..... 197  
 Meatotomes..... 210  
 Medicine Cases..... 263 to 271  
 " " Chests..... 270  
 " " "..... 282  
 Metric System..... 390  
 Microscopic Illuminator..... 228  
 " " Instruments..... 25 to 396  
 " " Slide Boxes..... 396  
 Microscopes..... 226 to 298  
 Minor Operating Instruments..... 391  
 " " Cases..... 29  
 Mirrors, Ear..... 92  
 " " Laryngeal..... 109  
 Miscellanies..... 287 to 289  
 Models, Bock-Steger's..... 394  
 " " Ear..... 91  
 " " Eye..... 91  
 " " Ophthalmoscopic Practice..... 69  
 " " Laryngeal..... 107  
 " " Uterine Demonstrating..... 146  
 Motors, Electric..... 385, 386  
 " " Gas..... 113, 131D  
 Mouth..... 131A  
 Muscle Beater..... 283  
**N**  
 Nasal Instruments..... 125 to 131D, 384  
 " " Burs and Trephines..... 386  
 " " Forceps..... 393  
 Necrosis..... 17, 19  
 Needles, Aneurism..... 10  
 " " Suture..... 5, 87  
 " " Uterine..... 178, 197B  
 " " Hagedorn..... 5  
 " " Hypodermic..... 242  
 " " Exploring..... 38  
 " " In Handle..... 181  
 " " Microscopic..... 225  
 " " Post-Mortem..... 222  
 " " Reverdin's..... 7F  
 Needle Holders..... 5, 13, 81, 91A, 179, 197C, 391  
 Nursery Sheeting..... 286  
**O**  
 Obstetric Instruments..... 138 to 144, 197A  
 " " Manikin..... 139  
 " " "..... 396  
 Oesophageal..... 105  
 O'Dwyer Intubation..... 37B  
 Oil Silk and Muslin..... 7C  
 Operating Chair, Knapp's..... 90  
 " " Tables..... 145, 146  
 Ophthalmoscopes..... 69  
 Optical..... 91C to T  
 Oral Instruments..... 21  
 Orthopaedics..... 303 to 377  
 Osteological..... 283  
 Otoscopes..... 93  
 Ovariotomy..... 185 to 188  
 Oxygen..... 236  
**P**  
 Paquelin's Caутery..... 274  
 Paralysis Apparatus..... 354  
 Pellets, Hypodermic..... 243  
 Pelvimeters..... 141  
 Pelvis..... 283  
 Percussors..... 231  
 Pereosteotomes..... 19  
 Perforators, Obstetric..... 141  
 Periodical Bandage..... 285, 300  
 Pessaries..... 189 to 197, 197E  
 Phantom, Eye..... 71  
 Phelps' Supporter..... 302A  
 Phimosis..... 21F  
 Pile Clamps..... 201  
 Pill Machines..... 287  
 Pins, Suture..... 23  
 Plaster Jacket..... 313  
 " " of Paris..... 56  
 " " Bandages..... 56

Pleximeters..... 231  
 Pneumatic Cabinet..... 237  
 Pocket Cases, Instruments..... 42 to 48  
 " " " Empty..... 41  
 " " " Medicine..... 263 to 267  
 " " " Magnifying Lenses..... 289  
 " " " Measures..... 288  
 Politzer Apparatus..... 91B, 97  
 Port Caustics, Pocket..... 40  
 " " Urethral..... 209  
 " " Uterine..... 169  
 Post-Mortem Cases..... 223  
 " " Instruments..... 221  
 Pott's Disease, Apparatus..... 304 to 324A  
 Pouches, Obstetric, 144. Uterine..... 184  
 " " Dental..... 137  
 Powder Blowers, Ear..... 99  
 " " " Nasal..... 127  
 " " " Throat..... 114, 117, 131B  
 " " " Urethral..... 217A  
 Pratt's Splints..... 62  
 Prescription Blanks..... 282  
 Prisms..... 91R  
 Probangs..... 119  
 Probes, Bullet..... 22  
 " " Ear..... 93  
 " " Lachrymal..... 79, 97A  
 " " General..... 7B, 22  
 " " Pocket Case..... 41  
 " " Uterine..... 157  
 Prolapsus..... 197  
 Pulleys for Fractures..... 55, 57  
 Pulmonary Atomization Recipes..... 396  
 Pump, Allen's..... 280 to 281B  
 Pus Basins..... 7B  
**R**  
 Razors..... 225, 395  
 Recipes, Atomizer..... 395  
 Rectal Instruments..... 198 to 203, 197B  
 Reflectors, Ear..... 93  
 " " Laryngeal..... 109  
 Register and Account Book..... 217B  
 Repositors, Uterine..... 163  
 Resection..... 15  
 Respiratory..... 235 to 237A  
 Restraints, Insane..... 302G and H  
 Retractors, General Operating..... 17  
 " " Tracheal..... 37  
 " " Vaginal..... 177  
 " " Uvula..... 131B  
 Retroversion Pessaries..... 191, 193  
 Rhinoplastos..... 127  
 Ring Pessaries..... 189, 197  
 Roller Bandages..... 7C  
 Rubber..... 293  
 " " Coils..... 278  
 " " Goods..... 284 to 286  
**S**  
 Saccharometers..... 233  
 Saddle Bags..... 271  
 Satchels..... 176, 267, 191B  
 Saws, Nasal..... 131B, 393  
 " " Operating..... 11, 12  
 " " Post-Mortem..... 221  
 " " Pocket Case..... 39  
 Sayre-Barwell Brace..... 306  
 Scales..... 289  
 Scarificators..... 65  
 " " Mastoid..... 91B  
 Scarifiers, Uterine..... 165  
 Schedule of Gauges..... 205  
 Scissors, Ear..... 95  
 " " Eye..... 81, 83  
 " " General Operating..... 6  
 " " Enucleation, Eye..... 81  
 " " Iris..... 81  
 " " Pocket Case..... 41  
 " " Skin Grafting..... 17  
 " " Strabismus..... 83  
 " " Uterine..... 165, 173, 179, 197D  
 " " Dissecting..... 221  
 Scoops, Ear..... 90  
 " " Rectum..... 201  
 " " Uterine..... 171, 173  
 Scrotal..... 217  
 Sea Tangle Tents..... 150  
 Seaton Needles..... 39  
 Sector Joint Braces..... 338 to 342  
 Sequestrum Forceps..... 17  
 Sets, Amputating..... 24  
 " " Bone Excising..... 29  
 " " Ear..... 104  
 " " Eye..... 90, 91  
 " " Dental..... 137  
 " " Dissecting..... 224

ALPHABETICAL INDEX—Continued.

Sets, General Diagnosis ..... 231  
 " " Operating ..... 24 to 30  
 " Lithotomy..... 28  
 " Microscopic..... 228  
 " Minor Operating..... 30  
 " Obstetric..... 144  
 " Ovariectomy..... 189  
 " Pocket Case..... 42 to 47  
 " Post-Mortem..... 223  
 " Tracheotomy..... 37  
 " Uretal..... 218  
 " Uterine..... 176, 177, 184  
 " Vesico Vag. Fistula..... 184  
 Shears, Plaster of Paris..... 56  
 Short Leg Apparatus..... 355C  
 Shoulder Braces..... 302F  
 Silk..... 7  
 Silver Wire..... 7  
 Skeletons..... 283  
 Skirt Supporters..... 302F  
 Slides, Microscopic..... 228, 396  
 Slippery Llm Tents..... 197D  
 Snare, Polypus, for Ear..... 91B, 101  
 " " " Nose..... 131  
 " " " Throat..... 123  
 Sole Leather Jackets..... 318  
 Sounds, Cupped..... 209  
 " Urethral..... 211  
 " Uterine..... 157  
 Spatulas, Tongue, 107. Plaster..... 289  
 Spectacles..... 91C to P  
 Specula, Cervical..... 189  
 " Ear..... 91B, 93  
 " Eye..... 77, 91A, 393  
 " Female Urethral..... 158  
 " Mouth..... 21, 131A  
 " Nose..... 125, 131B  
 " Rectal..... 197B, 199  
 " Urethral, Male..... 204, 217A  
 " Uterine..... 189, 197C  
 " Vaginal..... 149 to 154, 197A and B  
 " Bathing..... 166  
 Spheratorrhoeal Appliances..... 218  
 Sphygmographs..... 234  
 Spiral Spring Corset..... 306  
 " " Rotator..... 365, 366  
 Spirometers..... 234, 235  
 Splints..... 31, 55 to 64, 392  
 Sponge Holders, Post Nares..... 127  
 " " Throat..... 119  
 " " Uterine..... 167, 197E  
 " Tents..... 159  
 Spray, Antiseptic..... 6  
 " Eustachean..... 97  
 " Nasal..... 127  
 " Throat..... 112, 115  
 Spring Lancets..... 65  
 Staphyloorrhaphy Instruments..... 21  
 Steam Atomizers..... 112, 115B  
 Stem Pessaries..... 191  
 Stenophaic Disks..... 75  
 Sterilizer, Steam (Milk)..... 302D  
 Stethoscopes..... 231  
 Stevens' Eye Instruments..... 393  
 Stilbene for Removing Rust..... 10 and 20 cts.  
 Stockings, Elastic..... 293  
 Stomach Pumps..... 276, 281B  
 " Tubes..... 276, 281B  
 Stone Searchers..... 33  
 Storage Batteries..... 380 to 385  
 Strabismus Instruments..... 83  
 Straight Jackets..... 302  
 Stricture (Male Urethral) Instrument..... 210 to 215  
 Students' Lamps..... 288  
 Stump Protector..... 32  
 Styles, Eye..... 79, 91A  
 Supporters, Abdominal..... 301, 302E  
 " Rectal..... 203  
 " Uterine..... 197  
 " London..... 302A  
 " Phelps'..... 302A  
 " Teufel's..... 302B, C and D  
 " Gray & Foster's..... 301  
 " Elm City..... 302E  
 " Elastic..... 302E and F  
 " Fitch's..... 302E  
 Suppositories..... 287  
 Suppository Moulds..... 287  
 Suspension Apparatus..... 312, 318  
 Suspensories..... 302  
 Sutures..... 7, 391  
 Suture Pins..... 22  
 Syringes, Anatomical..... 22  
 " Bladder..... 207  
 " Ear..... 91B, 100

Syringes, Hard Rubber..... 239  
 " Hernia..... 23, 301  
 " Hypodermic..... 240 to 243, 393  
 " Lachrymal..... 79, 91A  
 " Microscopic..... 224  
 " Nasal..... 127  
 " P. P..... 209  
 " Pile..... 201, 203  
 " Rectal..... 239  
 " Urethral..... 209, 217A, 391  
 " Uterine..... 171, 197F  
 " Vaginal..... 166, 197C, 239, 396

Tables, Examining or Operating..... 146  
 Tablets, Hypodermic..... 243  
 Talipes..... 359 to 370  
 Tampons..... 167  
 Tape Measures..... 288  
 Tenacula Uterine..... 157  
 Tents, Uterine..... 159  
 Test Types..... 75, 91T  
 Teufel's Supporters..... 302B, C, D  
 Therapeutic Sundries..... 274 to 279  
 Thermo-cautery..... 274, 275  
 Thermometers..... 229, 230, 391  
 Throat Instruments..... 106, 131D, 396, 397, 384  
 Tobold's Apparatus..... 209  
 Tongue Depressors..... 107  
 Tonsilotomes..... 121, 131D  
 Tooth Forceps..... 132 to 137  
 Torticollis Apparatus..... 303, 305  
 (See Jury-Mast.)  
 Tourniquets, Amputating..... 9  
 " Uterine..... 165  
 Tracheotomy Instruments..... 37  
 Transfusion Apparatus..... 277, 281B  
 Trephining Instruments..... 19  
 Trial Cases..... 73, 75, 91Q, R, S  
 " Frames..... 91S and T  
 Tripod, Sayre's..... 318  
 Trocars..... 41, 49, 52  
 " Ovariotomy..... 185  
 Trumpets, Ear..... 103  
 Trusses..... 23, 294 to 302A  
 Tubes, Conversation..... 103  
 Tubing, Rubber, 286. Drainage..... 7B  
 Tuning Forks..... 93  
 Tupelo Pents..... 159  
 Turkish Bath..... 279  
 Tympanum Perforators..... 99

Umbilical Supporters..... 300, 302A  
 Urethral Instruments..... 204 to 218, 391  
 Urethrometers..... 213  
 Urethrotomes..... 215  
 Urinals..... 286  
 Urine Test Apparatus..... 232 to 234  
 Urinometers..... 232  
 Uterine Instruments..... 145 to 197F  
 " Sets..... 176, 184  
 Uterotomes..... 165  
 Uvula Scissors..... 121  
 Uvulatomes..... 121

Vaccinating Instruments..... 237B  
 Vaccine..... 237B  
 Vaginal Depressors..... 155  
 " Specula..... 149 to 154, 197A and B  
 " Irrigators..... 166, 197C, 239, 396  
 Variococele Instruments..... 217  
 Vaseline Atomizers..... 115, 115B  
 Vectis..... 141  
 Vesico Vag. Fistula Instruments..... 177 to 184  
 Vetter's Batteries..... 247, 248, 378, 379  
 Vial Cases..... 263, 267

Wadsworth's Pessary..... 197  
 Waldenburg's Apparatus..... 237  
 Wallets..... 175, 197B  
 Water Beds..... 286  
 " Bottles and Bags..... 286  
 Weak Ankle Apparatus..... 356 to 358  
 Weigert's Apparatus..... 237A  
 Whalebone Bougies..... 211  
 Wheel Chairs..... 290  
 " Crutch..... 324A, 373  
 Wire, Cuirass..... 333  
 " Silver..... 7  
 " Platinum..... 384, 387  
 Wound Dressing Materials..... 277  
 Writers' Cramp Apparatus..... 7C  
 Wry Neck Apparatus..... 303 to 315  
 (See Jury-Mast.)

# **PLEASE DO NOT MUTILATE THIS BOOK,**

**BUT KEEP IT INTACT FOR PERMANENT  
REFERENCE.**

It is not in anywise essential or indispensable, for the purpose of elucidation, to make and send us clippings from this Catalogue. Pages, headings and articles are designated by numbers or otherwise, and by quoting these our full understanding can be depended upon in every case.

---

## **NOTICE.**

Attention is called to Announcement on page following the List of Contents, after the Title Page. Orders filled according to any reputable U. S. Price List, less discount given therefrom by those issuing it. Our Price List is essentially a General Guide as to the rates at which we stand ready to furnish goods of quality unsurpassed.

I. GENERAL NECESSITIES FOR SURGICAL OPERATIONS.

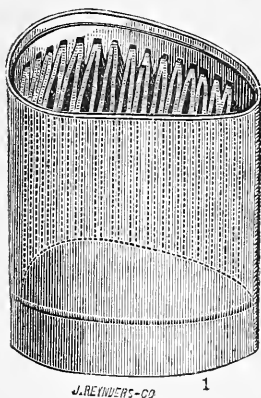

J. REYNDERS - CO

1

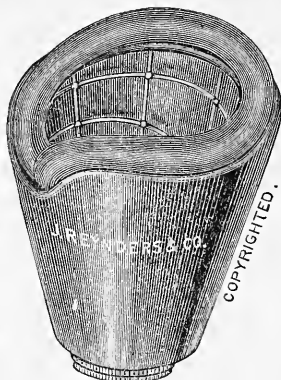

9

COPYRIGHTED.



2

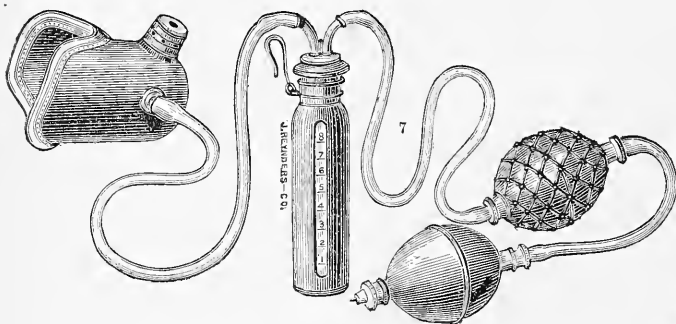

J. REYNDERS - CO

7

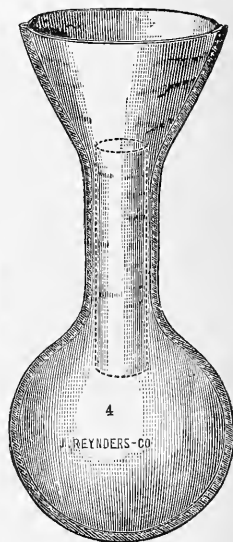

4



8

J. REYNDERS, - CO.

"Clover's" Portable Regulating Ether Inhaler \$25.00.

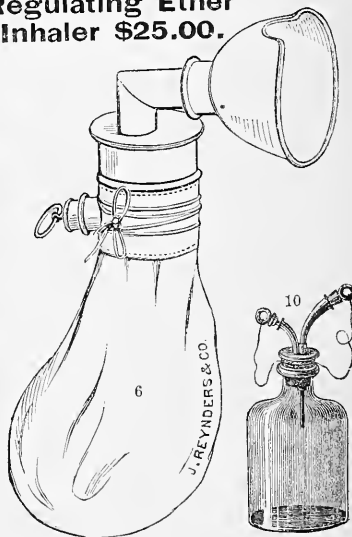

J. REYNDERS & CO.

6

10



**I. GENERAL NECESSITIES FOR SURGICAL OPERATIONS.**

**1.\* Ether Inhaler, Allis'**

It consists of a metallic frame, sufficiently large to cover the lower part of the face; the bars are parallel, about an eighth of an inch broad, leaving one eighth of an inch space between each and its fellow. The spaces are made by a punch which removes a section from a solid sheet of metal. Between the bars from side to side, a strip of bandage, two and one half inches wide, is passed. The instrument is only about four inches long and three inches at its greatest width, and yet it consumes more than three yards of bandage when passed between all the bars. Its advantages are these: The ether being very thoroughly mixed with air, the patient does not suffer from the suffocation usually felt at first inhaling; there is a large evaporating surface. A very much smaller quantity of ether is used, and less escapes into the room than with the usual mode of giving this anæsthetic; the ether can be dropped from a bottle on the distal end of the inhaler, without removing it from the face; the mask is soft and pliable, fitting accurately to the nose and mouth; and, lastly, it is of very simple construction and cannot get out of order.

Over this frame is drawn a piece of stout sheet india rubber, so as to make a covering for the frame, projecting over one end two inches, to form the mask, and at the other one inch. The ether is poured on the bandage, which forms a close, well-made artificial sponge.

The instrument is especially serviceable when a prolonged use of ether is required. A slight *dripping* will suffice to prolong the effect, and economy of ether, though not a great desideratum, is still worthy of consideration.

The same, with improved wire frame, very strong and therefore less easily crushed or bent out of shape. The wire bars presenting round surfaces, permit the replacement of a bandage more readily, when soiled. . . . \$3.00; superior \$4.00

**2.\* Ether or Chloroform Inhaler, Luer's** . . . . . 4.50

This apparatus has two openings *A* and *B*, controlled by cork ball valves (as shown by the dotted lines). When the patient inhales, air enters the inlet *B* and then passes through a sponge saturated with the anæsthetic, held in position by a crib of wire gauze. Expired air passes through *A*. *D* shows the margin of the rubber mask covered by a rubber cushion, inflatable through the tube *C*.

**3.\* Ether Inhaler, Sims'** . . . . . \$1.50

A sponge saturated with the anæsthetic is placed into the mask. The latter is also made with numerous small perforations to admit atmospheric air.

**4.\* Ether Inhaler, Squibb's** . . . . . \$1.50

**5. Ether Inhaler, metal tube with rubber mask** . . . . . 7.00

**6.\* Ether Inhaler, Hutchison's, in tin box** . . . . . 4.50

**MODE OF USING THE INHALER.**—When about to be used, the large tube is filled with a piece of coarse sponge of proper size and shape, which has been previously wet with water and thoroughly squeezed. The bag is then wet and squeezed, so that it does not drip, and secured over the mouth of the tube. The sponge will hold two ounces of ether, which should be poured upon it through the opening on top of the tube containing the sponge. In most operations the first charge of ether is all that is required, and in many, half the quantity mentioned is quite sufficient. The rubber hood is applied accurately over the mouth and nose, but the opening through which the anæsthetic is poured is left uncorked until tolerance or partial anæsthesia of the mucous membrane of the air passages is established, as indicated by deep inspirations. Free dilution of the ether vapor with atmospheric air when its administration is first begun, prevents, in a measure, the coughing and strangling that is liable to occur from the sudden application of the concentrated vapor.

The bag ordinarily lies upon the upper part of the chest, but in operations about the neck and upper part of the body, it may be placed to one side or the other, or upward over the face, by turning the sponge-holder on the rubber hood, the latter retaining its position.

**THE ADVANTAGES OF THE INHALER.**—The advantages which Dr. Hutchison believes this apparatus possesses are: 1st. The mechanical act of respiration is entirely free—"the lower end of the bag rises and falls with the respiration without offering any practical obstruction to the mechanical process" (Squibb), and the breathing can be closely watched.

2d. No part of the instrument is liable to become soiled by expectorated or vomited matters, except the rubber hood, and this is easily cleaned—an advantage of no small importance for these antiseptic days. But it is better to throw the whole apparatus into a basin of water after each inhalation, to free it from the products of respiration. No *inhaler* should be used a second time without being thoroughly cleansed.

3d. The apparatus economizes ether, the first charge (two ounces) being usually sufficient for a long operation; it prevents, in a great measure, the vapor from permeating the apartment, and affecting the comfort of the operator and his assistants, and especially the anæsthetizer, who often suffers from inhaling a large quantity of the vapor himself.

4th. It is simple in its construction, having no valves, and is inexpensive and portable.

**7.\* Chloroform Inhaler, Junker's** . . . . . \$12.50

**8.\* Ether Inhaler, Ormsby's** . . . . . 9.00

**DESCRIPTION OF INHALER, AND DIRECTIONS FOR USE.**—It consists of—No. 1—An india-rubber flexible bag, covered over with a network to prevent undue expansion during expiration. No. 2—A soft metallic mouth-piece, which allows of adaptation to any face, the soft metal being able to be bent into any shape; along the border applied to the face it is lined with india-rubber tubing, in order to fit more closely, and thus prevent the ingress or exit of air. No. 2 represents a simple sliding valve, to admit air if required, or allow its escape if necessary. In the body of the inhaler there is a cone-shaped wire cage, into which fits a similarly shaped hollow sponge, into which one ounce of Anhydrous Anæsthetic Ether, sp. gr. 0.720, is poured, and the inhaler is then ready for administration. If it is necessary to give more Ether in a prolonged operation, at fig. 2 there is a tube passing down to the centre of the sponge, into which the Ether can be poured without raising the mouth-piece from the face. At first it is advisable to allow the small aperture at fig. 2 to remain open for a few moments, when it should be closed, so as to allow the patient to breathe and re-breathe the same Ether-charged air, until complete Anæsthesia is produced.

**9.\* Ether Inhaler, Scudder's** . . . . . \$4.00

**10.\* Chloroform Drop Bottle, Esmarch's** . . . . . 1.25

**11. " " " " English model** . . . . . 2.75

**12. " " " " Mask, Esmarch's** . . . . . 2.00

**13.\* Anæsthetic Set, in moulded horseshoe-shaped russet leather case, consisting of Esmarch's Drop Bottle, Mask, and a Tongue Seizing Forceps** . . . . . 7.00

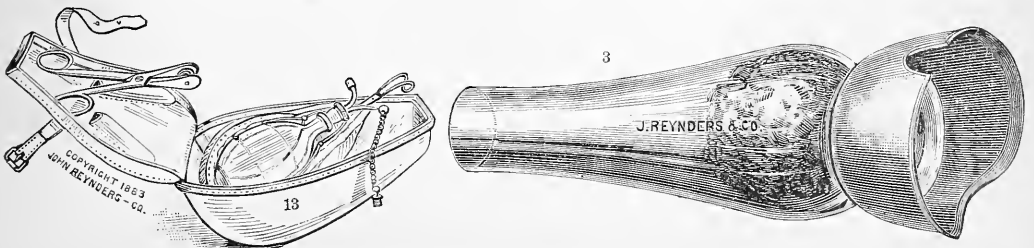

All Instruments illustrated are designated by a \*

I. GENERAL NECESSITIES FOR SURGICAL OPERATIONS.

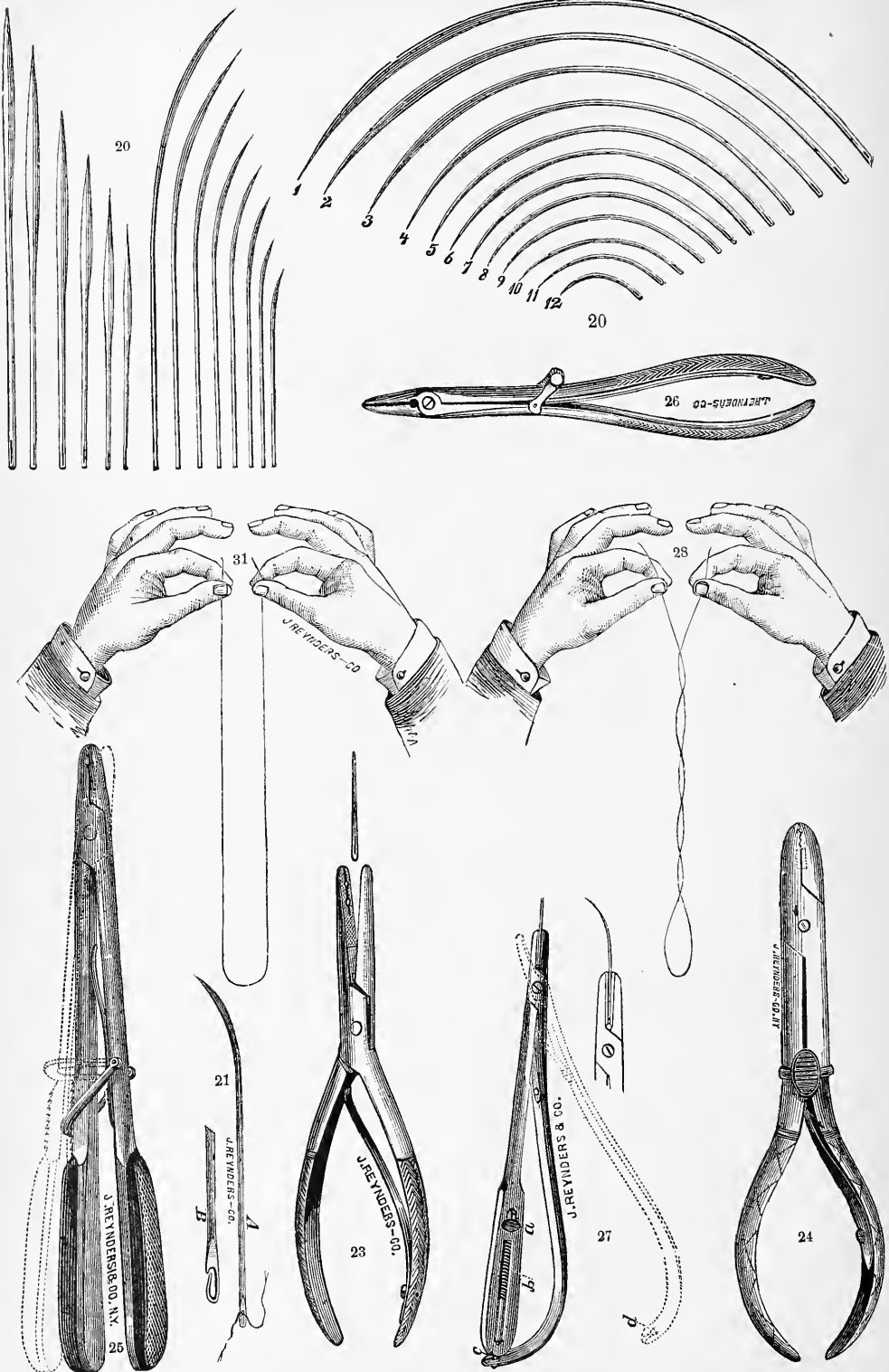

**I. GENERAL NECESSITIES FOR SURGICAL OPERATIONS.**

20.*	Needles; straight, half or full curved..	each 10 cts.; per doz.	\$0.60
21.*	“ open eyed .....	“ 15 “ “	1.00
22.*	“ into which silver wire can be screwed.....	each	0.30
22a.	“ Hagedorn's, any style.....	per doz.	1.75
22b.	“ “ sample card of twenty, full curved.....		3.00
22c.	“ “ with open eye, like fig. 31, page 4.....	per doz.	3.50
23.*	Needle Holder, J. R. & Co.'s, plain.....		2.50
24.*	“ “ Stimson's, combined with wire nipper.....		3.50
25.*	“ “ Russian, regular.....		4.00
25a.*	“ “ automatic catch.....		4.00
25b.*	“ “ T. & Co.'s patent, holding Hagedorn's or any other needle.....	\$6.00,* to take apart	*7.00
26.*	“ “ Reiner's, automatic.....		4.00
27.*	“ “ Nyrop's.....		5.00
27a.*	“ “ Wyeth's.....		5.00
27b.	“ “ with holder like 25b.....		*6.00
27c.	“ “ Fowler's.....		2.50
27d.*	“ “ Hagedorn's No. 1, for all ordinary operations, 6 in.....		7.00
27e.*	“ “ ditto, for ophthalmic, plastic operations and intestinal sutures, 5 in.....		6.00
27f.*	“ “ ditto, Gynecologist's 8 in. jaw, rectangular or oblique.....		7.00
28.	“ “ Collin's, modified and adapted to Hagedorn's Needles, see No. 400, page 179; can be taken apart.....		4.00

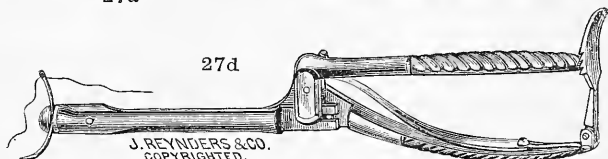
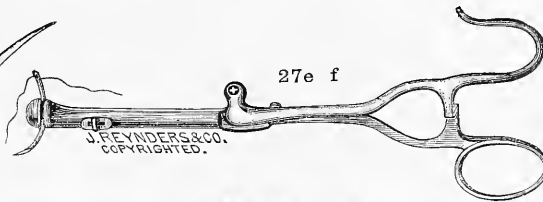
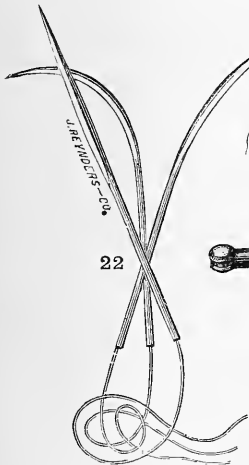
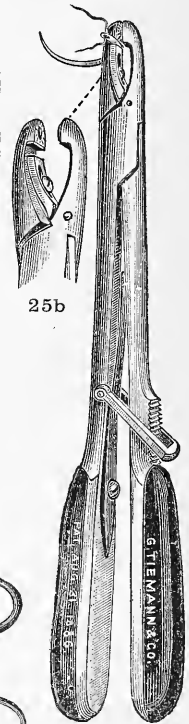
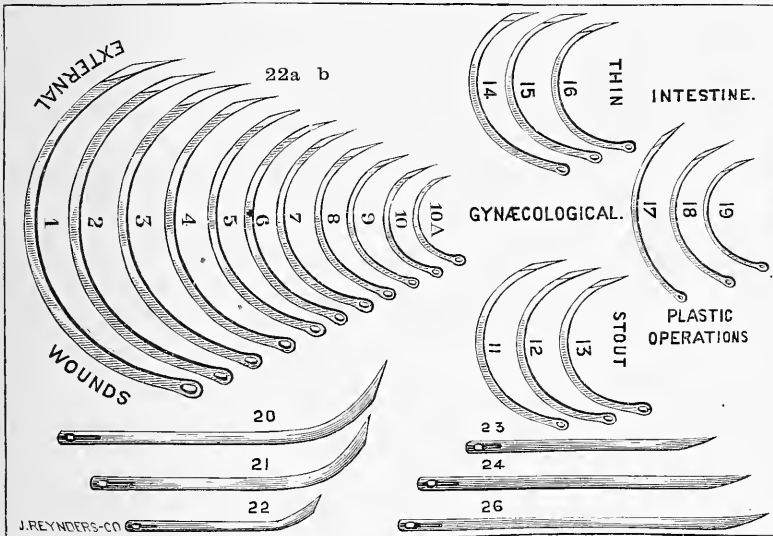

## I. GENERAL NECESSITIES FOR SURGICAL OPERATIONS.

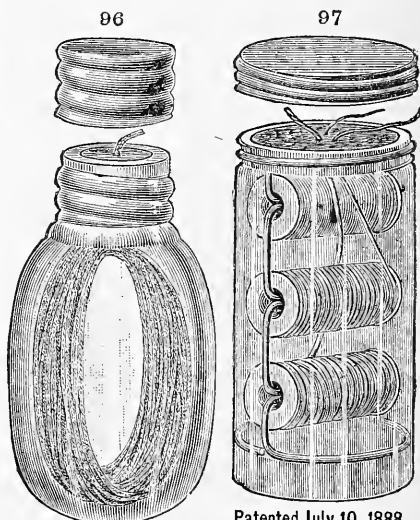
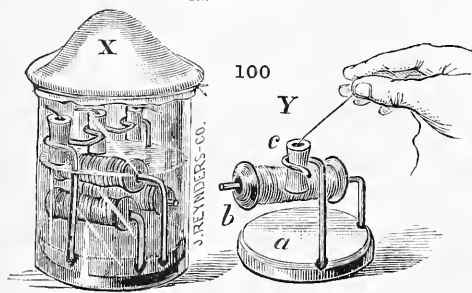
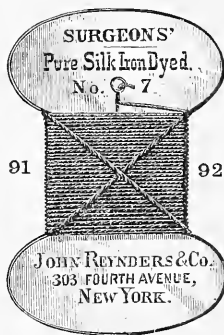
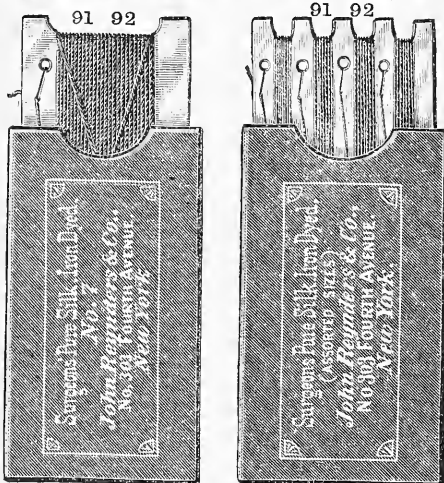
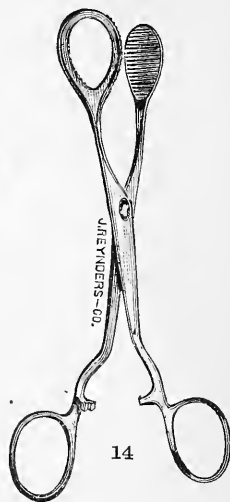
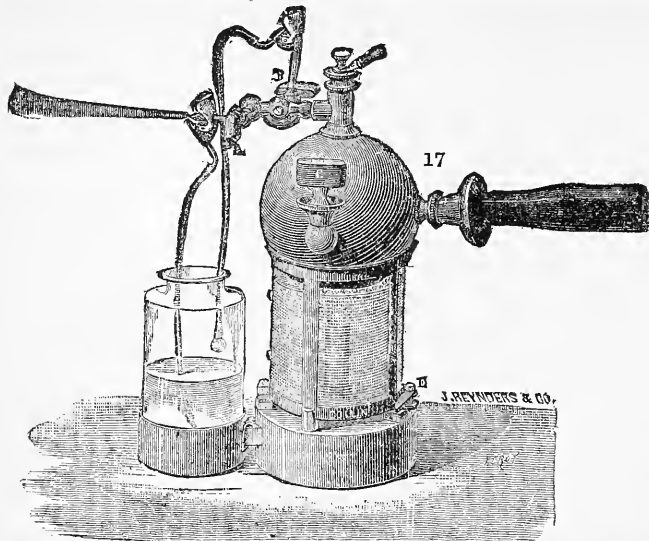

Patented July 10, 1888.

**I. GENERAL NECESSITIES FOR SURGICAL OPERATIONS.**

- 14.\* Tongue Seizing Forceps..... \$5.00
- 15.\* Same, acc. to Esmarch, as shown in fig. 13, page 3..... 2.00
- 16. Antiseptic Atomizer, C. & S. No. 90, boiler 15 oz. capacity..... ††12.00
- 16a. Same, No. 109, Boiler 26 oz. capacity..... ††15.00
- Extra Atomizing Tubes, with clearer for 16 and 16a. 1.25
- 17.\* Same, Championnière's..... large \$60.00; small 30.00
- 19. Same, Leiter's, on stand..... 60.00
- 28.\* Silk, ordinary, three sizes, per skein (see page 4)..... 0.05
- 30. " extra fine "Chinese Pearl," white or black, per skein..... 0.15

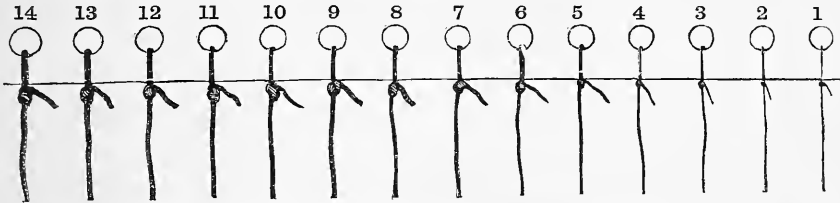

The above illustration shows the approximate size in which the following varieties of silk can be furnished. It may also serve for designating size of Catgut and Silver Wire.

- 31.\* Silk, Braided, genuine English, "will not kink or curl," in hanks, each 12, 18, 25, 30, 36, 40, 45, 50, 55, 60, 65 and 70 cts.
- 32.\* " Braided, genuine English, one size on tablet in slip case..... \$0.35
- 33.\* " Braided, genuine English, four sizes on tablet in slip case..... 0.75
- 34.\* " "Cable Twist," No. 4, 7, 10 and 13..... each 0.25
- 91.\* " pure American, twisted, white or iron dyed black, 14 sizes, each per reel 0.12
- per tablet in slip case, one size..... 0.30
- " " " " " four sizes..... 0.35
- 92.\* " pure American, braided, white or iron dyed black, 14 sizes, each per reel 0.25
- per tablet, one size, in slip case..... 0.50
- " " " " " four " " " " " 0.60
- 93. " Carbolized, dry, per reel..... \$0.18
- 94. " " " per 4 sized tablet in slide..... 1.00
- 95. " " " " " 1 " " " " " 0.50
- 96.\* Superior Ligatures, 10 foot coil in oil, carbolized, chromitized, Juniper or Sublimitized: Silk, twisted, white or black 0.25
- Silk, braided, white or black..... 0.30
- Catgut..... 0.35
- 97.\* Superior Ligatures, three sizes on Glass Spools, in bottle with nickel-plated screw cap, put up in oil carbolized 6% or in Juniper oil. Also chromitized or sublimitized 1 to 2000 in 5% carbolic solution.
- Silk, twisted, white or black..... \$0.75
- Silk, braided, white or black..... 0.85
- Catgut..... 1.00
- hospital size..... 2.25
- 30 feet of catgut on each spool.
- 98. Catgut, dry, six sizes corresponding to 4, 6, 8, 10, 12, 14 of silk.....per coil 0.25
- 99.\* " (Kocher's, Lister's or Chromitized) per coil..... 0.35
- 100.\* " Same, three spools on lead plate. 3.00
- 101. " " one spool " " " 1.50
- 102. " " four spools loose in bottle.. 1.33
- 103. Silk Worm Gut.....10 in. \$1.00; 12 in. 1.33
- 42. Silver Wire.....per oz 4.00
- 43. " " nine sizes in yard coils, Nos. 24 to 27 incl.....each 0.30
- Nos. 28 to 32 incl..... " 0.25
- 43a.\* " " Case, Wyeth's..... 6.66
- 44.\* " " Twister..... 1.50
- 45.\* " " Shouldering Forceps, Robert's, short..... 3.00
- 46.\* " " Shouldering Forceps, Robert's, long..... 4.00

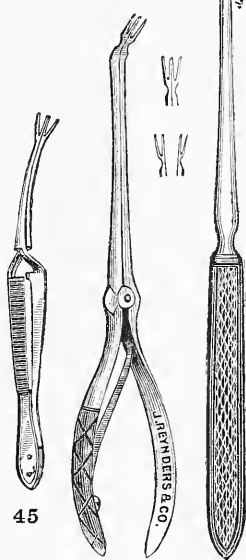

J. PENNINGTON & CO.

46                      44                      43a

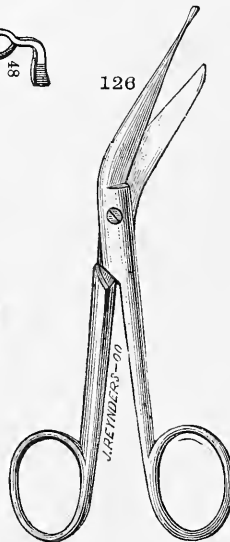
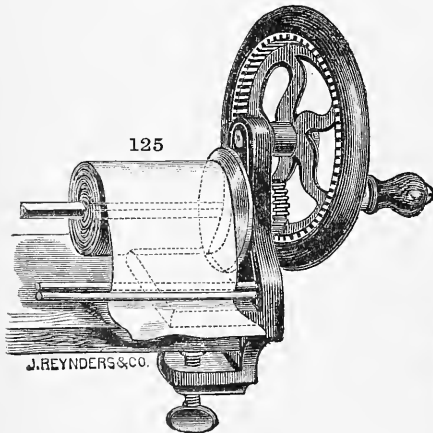
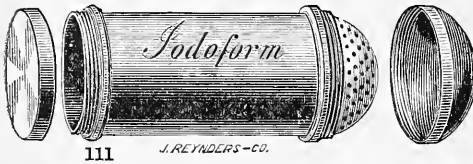
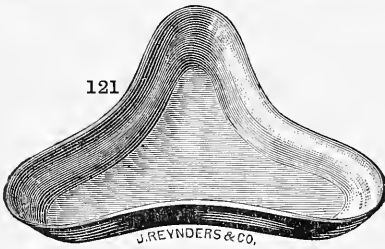
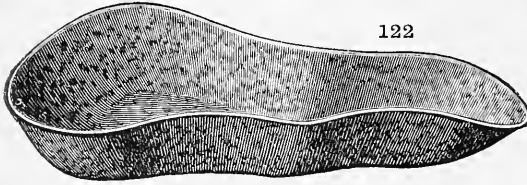
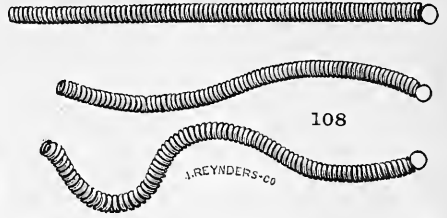
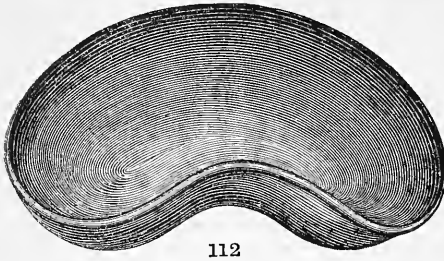

I. GENERAL NECESSITIES FOR SURGICAL OPERATIONS.

- 48.\* Serrefines, straight or curved, assorted sizes..... each \$0.25
- 49. Scissors, straight, sharp or round pointed..... each \$1.00 or 1.25
- 50. " " curved or flat or angular..... each 1.50
- 52. Dressing Forceps..... short \$1.25; long 1.75
- 53.\* Probe 8 in., coin or pure silver..... light 50 cts.; heavy 0.75
- 55.\* " Steele's Elastic, pure silver, covered with French Bougie material, leaving head and eye at each end free..... 2.00
- 56. Suture Pins, plain, assorted sizes..... per hundred 0.40
- 57. " " lance pointed..... per doz. 0.25
- 104. Drainage Tubing, pure gum, in yard lengths, perforated, per yard 22 French and below 45; 23 to 30 French scale..... 0.60
- 105. Same, pure gum, not perforated, 4 sizes..... per yard, 25, 35, 40 and 50 cts.
- 106.\* Same, in carbolic solution, six pieces, assorted sizes, in nickel plated screw cap covered glass tube..... 5 in. 50 cts.; 6 in. \$0.60
- 107.\* Same, Neuber's Bone, 4 sizes, No. 1 smallest..... per bottle 0.60
- 108.\* Same, Spiral Wire, aseptic, openings can be enlarged at will by overstretching, assorted sizes in 6 in. pieces..... each 0.25
- 109.\* Same, Glass, made after patterns furnished by Prof. S. W. Gross. These tubes have large holes, one-half in. apart, arranged alternately on opposite sides. They are carefully finished, especial care being taken to make them smooth. In addition to the drainage holes, each tube has at one end two smaller holes for the insertion of Safety Pin, through which it is prevented slipping into the wound.



FURNISHED IN SEVEN SIZES.

1. Length 63 mm., Diam. 7 mm., 4 Holes, per doz. \$1.25	5. Length 102 mm., Diam. 9 mm., 7 Holes, per doz. \$1.70
2. " 63 " " 8 " 4 " " 1.25	6. " 114 " " 9 " 8 " " 1.90
3. " 76 " " 9 " 5 " " 1.40	7. " 126 " " 10 " 9 " " 2.10
4. " 88 " " 9 " 6 " " 1.55	

- 110. Same, Glass in Nests of 6, similar to test tubes, 5 to 10 cm. long, hole at ends and sides..... \$1.50
- 111.\* Iodoform Dust Box, h. r., two sizes..... each 60 cts. and 0.80
- 112.\* Pus Basin, h. r., full depth, 3 sizes..... @ \$2.50, \$3.00, 3.50
- 113. Same, h. r., less deep..... 16 oz. \$1.75; 24 oz. \$2.00; 34 oz. \$2.25; 50 oz. \$250
- 114. Same, papier-maché, shallow..... 16 oz. 25 cts.; 24 oz. 50 cts.; 34 oz. 50 cts.; 50 oz. 75 cts.
- 115. Same, white metal..... 22 oz. \$1.25; 32 oz. \$1.50
- 116. Same, brass, nickel plated, 22 oz. \$1.75; 32 oz. \$2.00; 50 oz. \$3.00.
- 117. Same, tin, "Agate" finish.

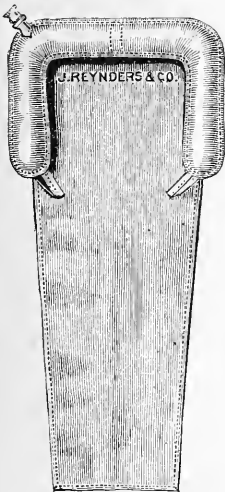

123

- 118. Same, glass, rather shallow, 16 oz. \$0.75; 24 oz. \$1.25; 34 oz. \$1.50
- 119. Same, glass, shallow, better, 11 in. \$1.50; 13 in. \$2.00.
- 120. Same, glass, full depth, 11 in. \$1.50; 13 in. \$2.25; 16 in. \$3.00; 19 in. \$7.00.
- 121.\* Same, triangular, 32 oz., h. r.; \$1.50; papier-maché \$1.00.
- 122.\* Same, multiform, "Agate" finish, various curves for different parts of body, \$2.00.\*
- 123.\* Surgical Cushion, Red Soft Rubber, inflatable, square part less apron 12x10, apron 22 in. \$3.00.\*
- 124.\* Same, circular, apron 24 in. diameter, 24 in. \$5.50;\* 20 in. \$4.00.\*
- 125.\* Bandage Roller, \$6.00.
- 126.\* " Scissors, Bull's, 6 in. \$3.00; 8 1/4 in. \$4.00.

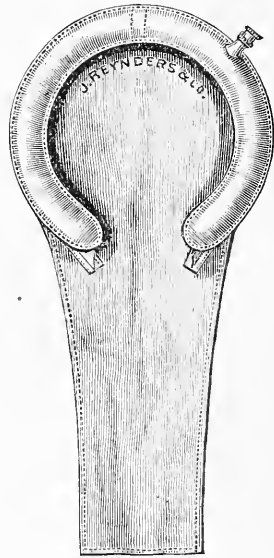

124

I. GENERAL NECESSITIES FOR SURGICAL OPERATIONS.  
WOUND DRESSING MATERIALS.\*

130. Roller Bandages per dozen.\*

	A	B	C	D	E
	Unbleached Muslin.	Muslin.	Flannel.	All Wool Flannel.	Gauze, Antiseptic.
1 in. x 1 yd.	\$0.10	\$0.15	\$	\$	\$0.08
1 in. x 3 yds.	0.18	0.40			
1½ in. x 3 yds.	0.25	0.40	0.85	1.25	0.25
2 in. x 3 yds.	0.36	0.45	1.12	1.50	0.30
2 in. x 8 yds.	0.75	1.25	3.00	4.00	0.70
2½ in. x 3 yds.	0.35	0.55	1.25	1.88	0.35
2½ in. x 8 yds.	1.00	1.50	3.60	5.00	0.80
3 in. x 4 yds.	0.50	0.90	2.20	3.00	0.50
3 in. x 8 yds.	1.25	1.50	4.50	6.00	1.00
3½ in. x 5 yds.	0.90	1.25	3.00	4.00	0.75
3½ in. x 8 yds.	1.50	1.88	4.50	6.75	1.20
4 in. x 6 yds.	1.25	1.60	3.00	6.00	1.00
4 in. x 8 yds.	1.50	2.00	5.40	7.50	1.25

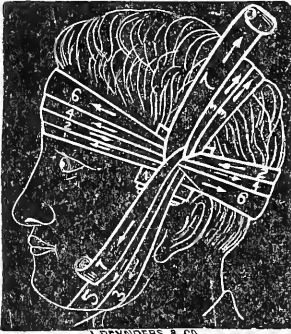

131. Same in Boxes, containing following assortment :

	Inches wide.	Yards long.	
8 Roller Bandages,	1	1	for fingers and toes, and hands and feet.
5 " "	1½	3	
3 " "	2	3	for forearms, arms, head and legs of children.
2 " "	2	8	
3 " "	2½	3	for forearms, arms and head of adult.
2 " "	2½	8	
3 " "	3	4	for lower extremities, clavicle, etc., for adults.
1 " "	3	8	
1 " "	3½	5	
1 " "	3½	8	for the body or trunk.
1 " "	4	6	
1 " "	4	8	

A, Unbleached, \$1.75; B, Muslin, \$2.00; C, Flannels, \$5.00  
D, All Wool Flannel, \$6.50; Gauze, \$1.25.

Remarks: Bandages A per lb. \$1.00. Bandages B are washed, ironed and sterilized in boiling water. Bandages D guaranteed all wool. Bandages E washed and ironed, plain, sublimatized (1 to 2,000 C. S.) or glycerinated at same price. First four sizes 2 doz., other sizes one dozen in a box.

- The same, one yard wide in Tin Cans, per roll of 5 yards 60 cents; per dozen rolls, of 1 yard, \$2.00.
- 132. Bandages A. E. Plain Gauze 5 yards long, per doz. 1 in. \$0.35; 1½ in. \$0.45; 2 in. \$0.55; 2½ in. \$0.65; 3 in. \$0.75; 4 in. \$0.90; 5 in. \$1.20; 6 in. \$1.35
  - 133. Bandages A. E. Antiseptic Gauze—Boracic, Carbolic or Corrosive Sublimate, 5 yards long, per doz.: 1 in. \$0.50; 1½ in. \$0.60; 2 in. \$0.70; 2½ in. \$0.80; 3 in. \$0.90; 4 in. \$1.00; 5 in. \$1.25; 6 in. 1.50
  - 134. Either of 132 or 133—10 yards long, double the price.
  - 135. Jute per lb. plain, \$0.25; bleached, \$0.35; absorbent 0.45
  - 136. " plain carbolated. per lb. 0.35
  - 137. " Corrosive Sublimate, per lb. bleached, \$0.40; absorbent 0.50
  - 138. " Tarred, per lb. \$0.40; 25 lb. case 7.50
  - 139. Oakum, per lb. \$0.18; per 50 lb. bale 7.50
  - 140. Sponges, plain, chromatized, sublimated or carbolated, 2 dozen in a box, per box No. 1, small oval, \$0.30; No. 2, larger conic. 0.45
  - 141. Absorbent Cotton, ordinary, per lb. \$0.45; ½ oz. \$0.25; ¼ lb. \$0.15; oz. each, \$0.10; lb. 0.60
  - 142. Same, best, lbs. \$0.60; ½ lbs. \$0.35; ¼ lbs. 0.20
  - 143. Absorbent Cotton, carbolized, salicylated or borated, per lb. \$1.00; ½ oz. \$0.50; ¼ oz. \$0.25; ounce \$1.00; per dozen.
  - 144. Combined Dressings, consisting of Gauze 10x60, and Borated Cotton. Gauze Borated, Carbolized or C. S., \$0.75; Gauze Iodoform 7½% 1.00
  - 145. Same, extra fine Gauze 10x72 as aforesaid, \$1.00; Gauze Iodoform 7½% 1.50
  - 146. Gauze, plain, purified, hospital, per yd. 0.08
  - 147. " best absorbent, per yd. 0.12
  - 148. " Boracic, absorbent, per yd. \$0.12; 5 yd. tin. 0.60
  - 149. " Carbolic, " per 5 yd. tin. 0.60
  - 150. " Corr. Subl., in rolls, per yd. 0.10
  - 151. " " Same, absorbent 0.15
  - 152. " " warranted permanent, per 5 yd. tin 0.75
  - 153. " Iodoform 7½ or 10%, 1 yd. in tin 0.30
  - 154. " " 7½ or 10%, 5 yds. in tin. 1.25
  - 155. " " 33%, per tin, 1 yd. 0.50
  - 156. " " 50%, " " 1 yd. 0.65
  - 157. " " 50%, " " 5 yds. 3.00
  - 158. Gutta-percha Tissue, light, per box, 1 yd. \$0.35; 3 yds. \$1.00; 5 yds. 1.50
  - 159. " " heavy, per box, 1 yd. \$0.40; 5 yds. 1.75
  - 160. Oil Silk, regular weight, 28 in., 1 yd. \$0.70; 5 yds. 3.25
  - 161. " Superior, 30 in., 1 yd. \$1.00; 5 yds. 4.50
  - 162. " Muslin, 1 yd. \$0.50; 5 yds. 2.25
  - 163. McIntosh, 44 in., 1 yd. \$1.50; 5 yds. 6.50
  - 164. Waxed Manilla Paper, per 100 yds. 2.00



**I. GENERAL NECESSITIES FOR SURGICAL OPERATIONS.**

**A — AND ANTISEPTIC GLASSWARES, ETC.**

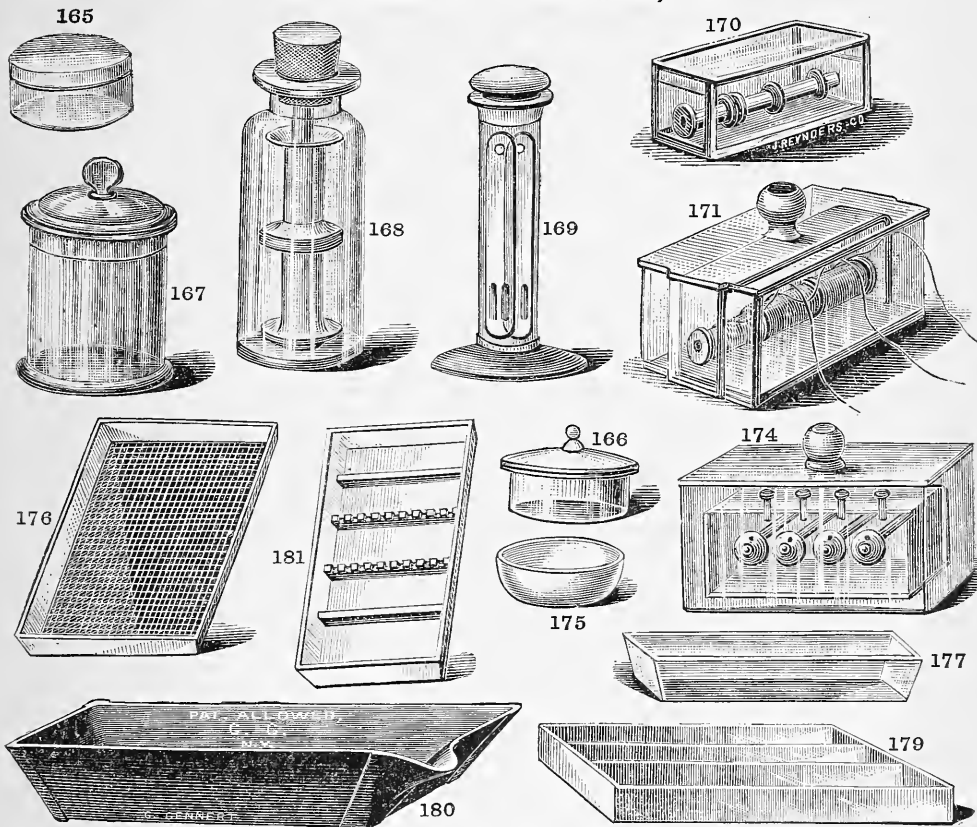

- 165.\* Circular Glass Boxes, 1½ in. high, with overlapping cover, for keeping small articles, such as pins, needles, shot, etc. (297 b. k. 143); diameter 1½ in., \$0.35; 2½ in., \$0.45; 3 in., \$0.50; 4 in., \$0.80; 5 in., \$1.20
- 166.\* Same, with knob on cover (297c.); 1x1½, \$0.40; 1x2½, \$0.60; 1½x3½, 0.75
- 167.\* Same, larger (k. 83).....4x4, \$0.90; 6x6, \$2.00; 7x7, \$2.50; 8x8, 3.00
- 168.\* Bottle, rubber stoppered ..... with two glass spools, \$1.00; with one spool, 0.70
- 169.\* Glass Cylinders (k. 95), wooden base, ground stopper, 10 in. high, 2 in. diameter, containing two long reels, \$3.75; same, smaller, with one reel..... 2.00
- 170.\* Box, for keeping silk or catgut (k. 85) with inside cover and three spools..... 2.75  
Same, with overlapping cover (k. 86)..... 3.50
- 171.\* Same, with knob on cover, three spools, one glass reel, latest improved; the spools can be readily removed (k. 89)..... 11.00
172. Same, with six spools (k. 90)..... 12.50  
“ “ two “ (k. 87)..... 5.00  
173. “ “ four “ (k. 88)..... 8.00
- 174.\* One Box, setting inside of another, four spools, all very handily arranged (k. 91) 6.00
- 175.\* Glass Bowls: white, diam..... 6½, \$1.50; 11, \$3.75; 12, \$4.50; 16, 7.50  
blue, “..... 6½, 1.75; 11, 4.00; 12, 4.88; 16, 10.00  
red, “..... 6½, 2.00; 11, 5.00; 12, 5.62; 16, 11.50
- 176.\* Flat Dishes of glass, for Instruments (487 l. k. 104), 4x5, \$0.60; 5x6½, \$0.80; 6x8½, \$1.00; 8x10, \$1.75; 10x12½, \$3.50; 12x14, \$5.25; 12x16½, 6.00
- 177.\* Same, 2½ in. high (487 l. l.), 5x13½, \$3.75; 3x13½, \$3.38; 2½x7½, 2.00
178. Same, for Catheters and Bougies (k. 105), 3x13..... 3.00
- 179.\* Dish of Porcelain, three compartments (k. 109), 7x16½..... 10.00
- 180.\* Hard Rubber Trays\* (deep), 4½x5½, \$0.50; 5½x7½, \$0.60; 5½x8½, \$0.70; 7x9, \$0.88; 8½x10½, \$1.15; 10½x12½, \$1.75; 12x16, \$2.40; 15x19, \$4.25; 18x22, \$5.00; 19x23, \$5.75; 21x26..... 7.50
- 181.\* Porcelain Dish for Eye Instruments, 6½x13½, \$6.00; 4½x10½..... 5.00



ADDENDA TO SURGICAL SUNDRIES.

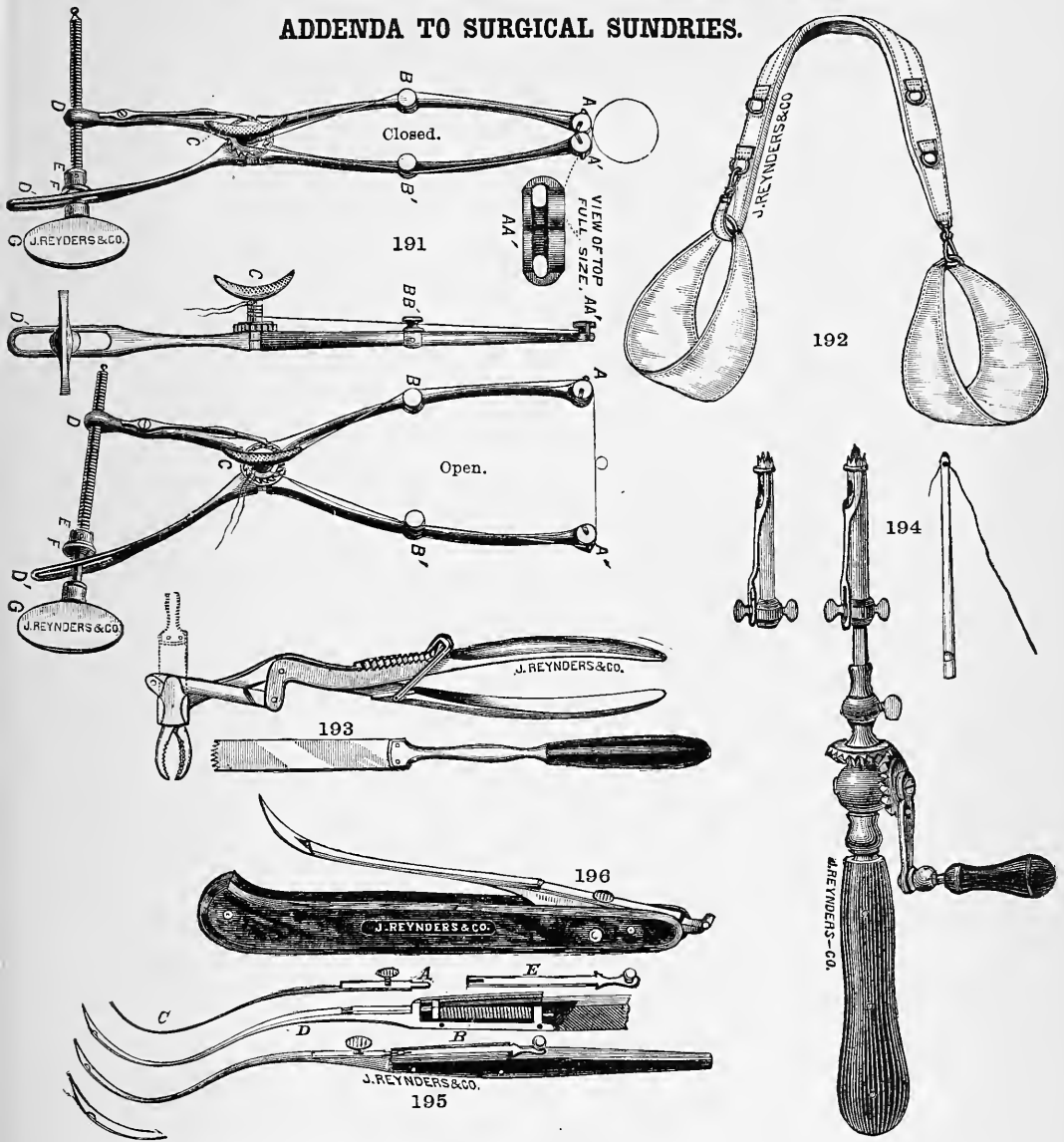

191.* Forne's Loop and Knot Constrictor (circular on application).....	
192.* Halter, for keeping legs in lithotomy position for perenial work.....	\$5.00
193.* Gowan's Osteotome, improved.....	21.00
Same, with narrower saw and shield.....	26.00
194.* Bevel Gear Drill .....	\$9.00; without crown 4.00
195.* Reverdin's Needle, as modified by E. L. Keyes, M.D.....	6.66
196.* Same, for pocket cases.....	6.00

197. Copper Boiler with Guage, pressure valve, vacuum valve, thermometer, tray inside; for disinfecting instruments by steam. See Medical Record, Nov. 3, 1888, Vol. II., page 535. (Full particulars on application.) The same also by dry hot air.

II. CAPITAL AND MINOR OPERATING INSTRUMENTS.

Comprising: Amputating, Aneurism, Trephining, Resection, Bullet Extracting; Harelip, Oral, Lithotomy, Hernia, Tracheotomy Instruments, and Sets of same put up in Cases.

II. AMPUTATING, ANEURISM, TREPHINING, AND RESECTION INSTR'S.

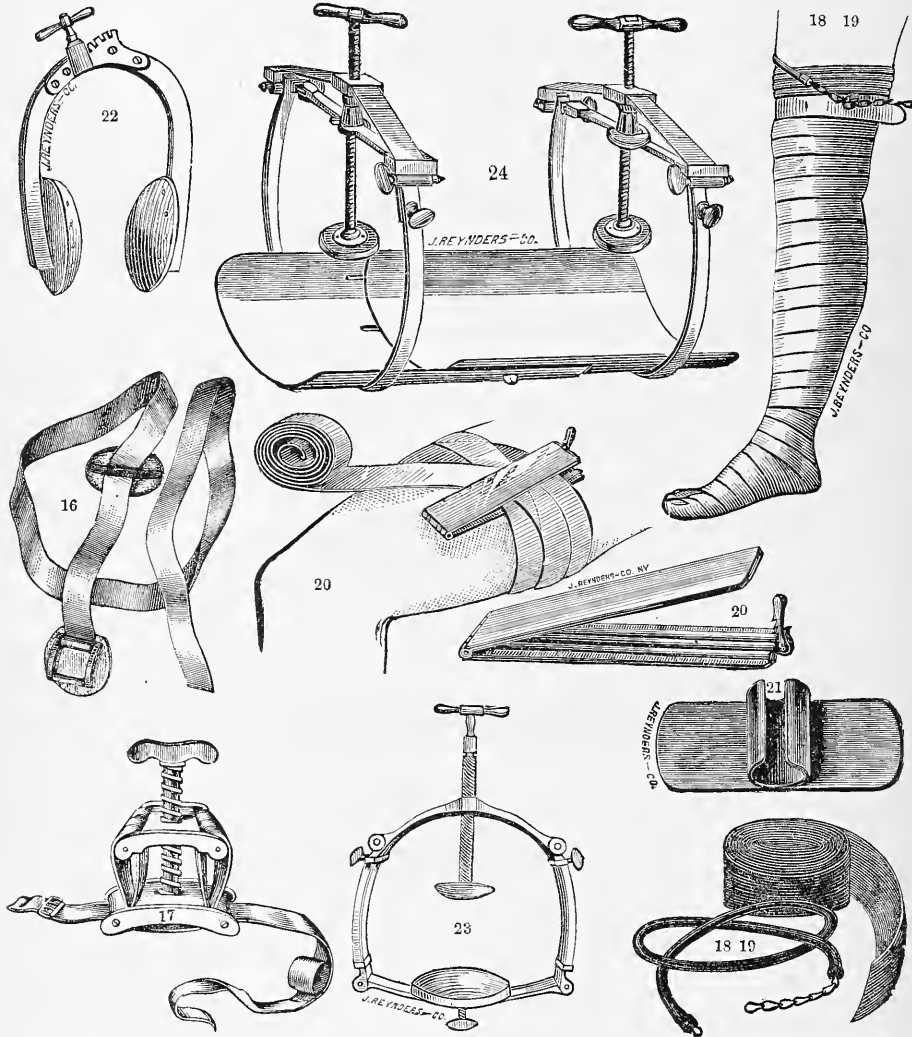

16.*	Tourniquet, Field.....	\$1.00
17.*	“ Petit’s, screw.....	2.00
18.*	“ Esmarch’s: 3 yards of 2 inches wide heavy white rubber bandage, and flat rubber strap, with safety chain.....	4.00
19.*	“ “ the same with 6 yards of 2 inches wide bandage.....	6.00
20.*	“ “ Bandage Clamp for same.....	2.50
21.*	“ “ Strapholder.....	1.50
22.*	“ Signoroni’s.....	13.50
23.*	“ Skey’s.....	24.00
24.*	Arterial Compressor, Briddon’s.....	\$30.00 to 60.00
	Tourniquet, Esmarch’s, inferior to above, consisting of:	
24a.	3 yds. strong Elastic Webbing 2½ in., 1 yd. pure Rubber Tubing with Chain and Hook.....	4.00
24b.	3 yds. heavy pure Rubber Bandage 2½ in., 1 yd. pure Rubber Strap “.....	3.00

All Instruments Illustrated are designated by a.\*

II. AMPUTATING, ANEURISM, TREPHINING, AND RESECTION INSTR'S.



COPYRIGHT 1883  
BY JOHN REYNOLDS & CO.

25.	Amputating Knife, aseptic metal handles.....	long*	\$4.00;	med.	\$3.50;	short	2.50
26.*	"	"	"	"	"	"	"
27.*	"	fine	"	"	"	"	"
27.*	Catling, aseptic metal handles.....	"	* 4.50;	"	* 3.50;	"	2.50
28.*	"	fine.	"	"	"	"	"
28.*	"	"	4.00;	"	* 3.00;	"	2.25
29.*	Knife, French, plain.....	"	"	"	2.75;	"	* 2.25
30.*	Catling, " " short.....	"	"	"	"	"	2.00
31.*	Knife, Wood's circular.....	"	"	"	"	"	4.00
32.*	Scalpel.....	"	"	"	"	"	"
33.*	Fingerknife.....	either rivetted, ebony	\$1.00;	ivory.....	"	"	1.50
34.*	Tenaculum.....	" ferruled, "	1.50;	"	"	"	2.00
35.*	Aneurism Needle.....	aseptic handle.....	"	"	"	"	2.00
36.*	Knives, Parker's Set, consisting of a long and a med. blade, attachable to one screw handle, and a catling with fixed handle, ebony	"	"	"	"	"	8.00
	Ivory.....	"	"	"	"	"	10.00
37.*	Knives, Conant's Set, consisting of Knife, Saw with movable back and Chisel, ebony	\$6.00;	ivory.....	"	"	"	7.50
38.*	Knives, Conant's Set, consisting of Knife, Catling and Saw, with movable back; ebony	\$7.00;	ivory.....	"	"	"	8.50

All Instruments illustrated are designated by a \*

II. AMPUTATING, ANEURISM, TREPHINING, AND RESECTION INSTR.'S.

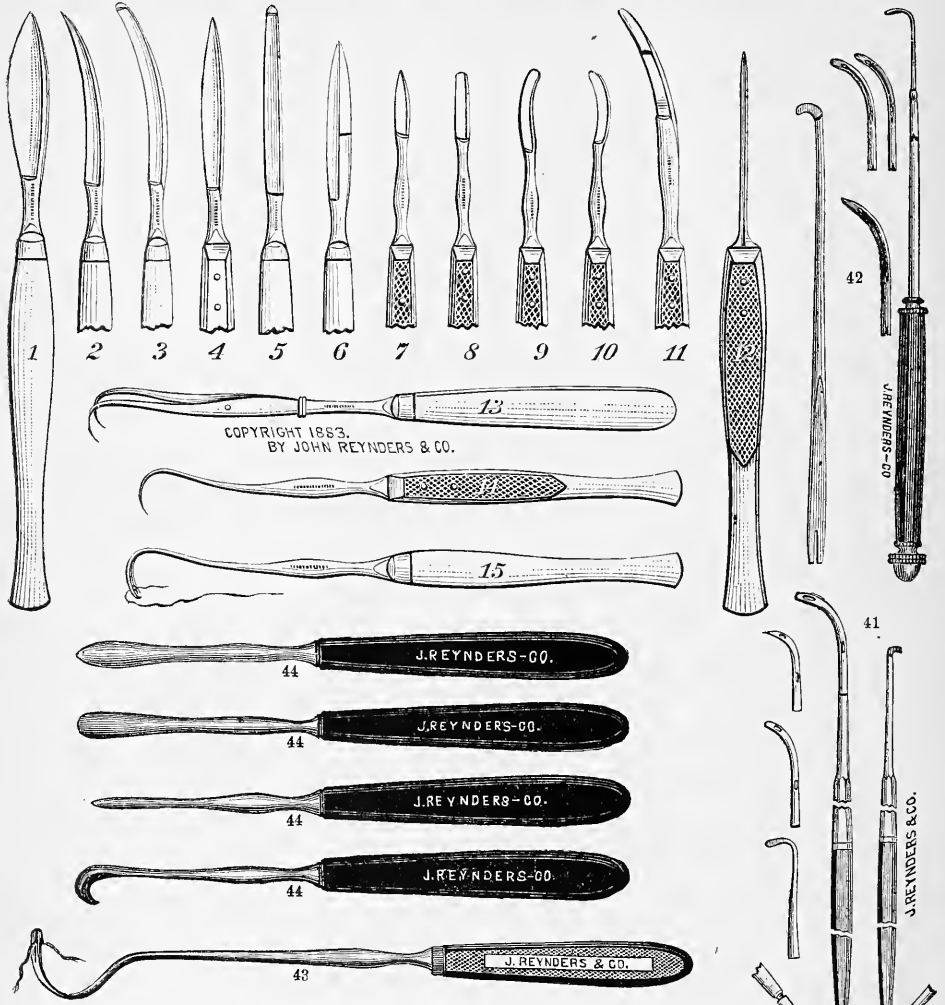

1.*	Minor Operating Scalpels—4 sizes.	.....		
2.*	“ “ Bistoury; curved sharp pointed.	.....	} In rivetted ebony handles, like 7, 8, 9, 10, 11, 12, each \$1.00	
3.*	“ “ “ “ probe pointed.	.....		
4.*	“ “ “ “ straight sharp pointed.	.....		
5.*	“ “ “ “ “ probe pointed.	.....		
6.*	“ “ “ “ “ double edged.	.....		
7.*	“ “ “ “ Tenotome; “ sharp pointed.	.....		
8.*	“ “ “ “ Sayre's straight	.....		
9.*	“ “ “ “ “ convex	.....		
10.*	“ “ “ “ “ concave	.....		
11.*	“ “ “ “ Hernia Knife	.....		
12.*	“ “ “ “ Exploring Needle	.....		} In feruled ivory handles, like 1, 2, 3, 5, 6..... each 1.50
14.*	“ “ “ “ Tenaculum	.....		
15.*	“ “ “ “ Aneurism Needle	.....	} In metal aseptic handles, each 1.35	
39.*	“ “ “ “ Hollow for wire Needle	.....		
13.	Double Tenaculum, ebony rivetted.	.....		2.50
13.*	“ “ “ “ ivory “ feruled.	.....	2.75	
40.	Tenotomes, Sayre's, in case 8 and 9 \$4.50; 8, 9 and 10.	.....	6.00	
41.*	Aneurism Needle, Mott's	.....	3.00	
42.*	“ “ “ “ Students'	.....	3.00	
43.*	“ “ “ “ Spiral	.....	1.75	
44.*	Dry Dissectors, Hamilton's, set of four.	.....	each 1.50	

All Instruments illustrated are designated by a \*

II. AMPUTATING, ANEURISM, TREPHINING, AND RESECTION INSTR'S.

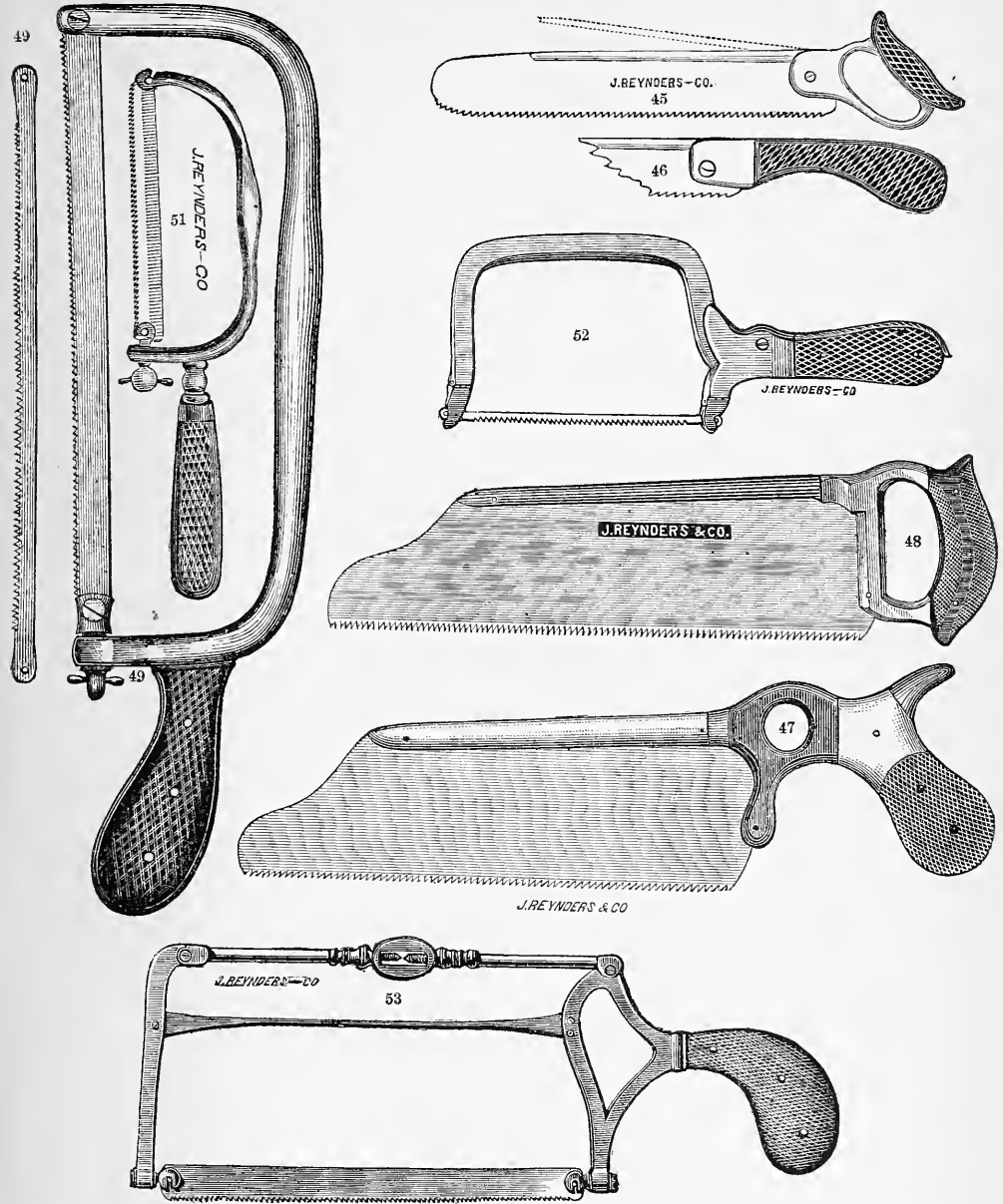

45.*	Amputating Saw, movable back, open handle.....	\$4.00
46.*	“ “ “ solid “ .....	4.00
47.*	“ “ “ pistol handle .....	\$5.00; aseptic 6.50
48.*	“ “ “ Parker's .....	4.50; “ 6.00
49.*	“ “ “ Bow, with two blades.....	7.00
50.*	“ “ “ “ same with handle unscrewing.....	8.50
51.*	“ “ “ “ small.....	6.00
52.*	“ “ “ Szymanowski's, with three blades.....	15.00
53.*	“ “ “ Butcher's .....	12.00

All Instruments illustrated are designated by a \*

II. AMPUTATING, ANEURISM, TREPHINING, AND RESECTION INSTR.'S.

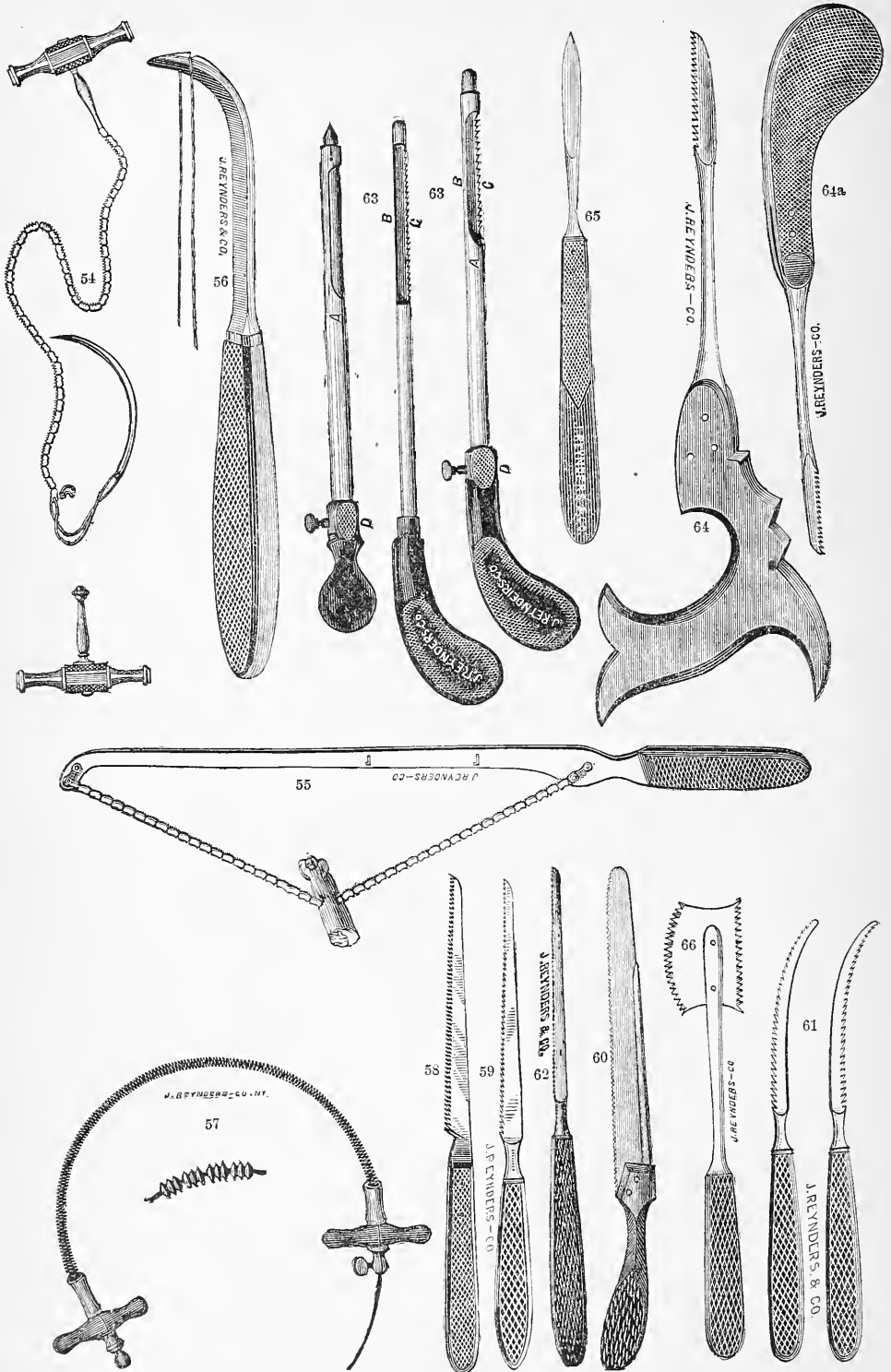



**II. AMPUTATING, ANEURISM, TREPHINING, AND RESECTION INSTR'S.**

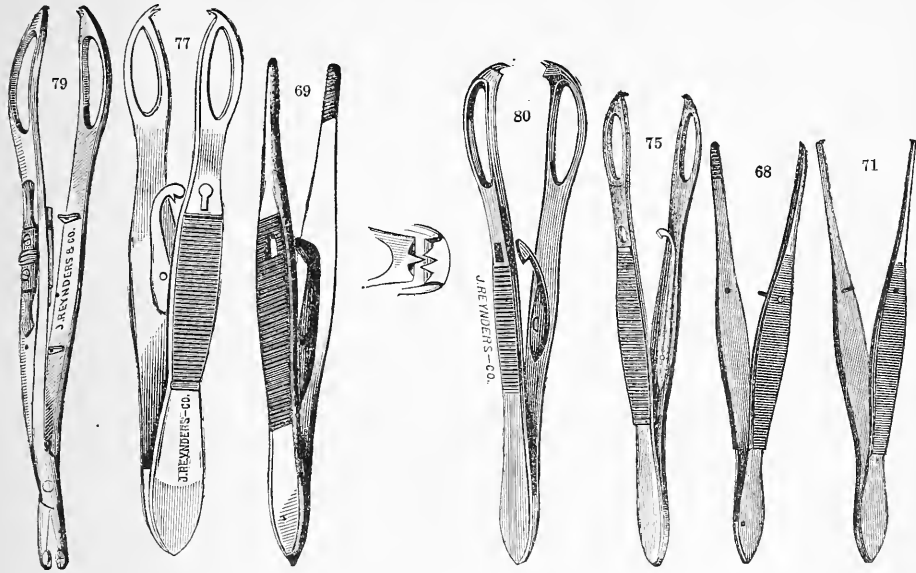

54.*	Chain Saw, best with rotating handles.....	\$10.00
55.*	Carrier.....	5.50
56.*	Introducer and Periosteum Scraper, Gurdon Buck's \$4.50; plain.....	3.00
57.*	New, made of coiled wire, sharp edged. Parts broken can be readily replaced while operating.....	6.00
58.*	Metacarpal Saw, plain.....	1.25
59.*	“ “ feruled, fine.....	1.75
60.*	“ “ movable back.....	\$2.50, 3.00
61.**	“ “ convex and concave edge.....	each 2.00
62.*	Interosseous Saw, Lente's.....	1.50
63.*	Subcutaneous Saw and Knives, Shady's.....	*7.00
64.*	Adam's Saw.....	4.00
64a.*	“ “ small.....	3.50
65.*	“ “ Knife.....	1.50
66.*	Skull Saw, Heyes' plain.....	1.75
66a.	“ “ with Elevator.....	3.00
67.*	Brush for cleaning saws and trephines.....	0.50
68.*	Artery Forceps, plain.....	0.75
69.*	“ “ “ with spring catch.....	1.50
70.	“ “ “ Coxeter's.....	1.00
71.*	“ “ “ with mouseteeth.....	1.00
72.	“ “ “ “ springcatch.....	1.75
73.	“ “ self-closing, solid jaws.....	2.50
74.	“ “ “ fenestrated jaws.....	2.50
75.*	“ “ fenestrated, with spring catch.....	2.00
76.	“ “ “ “ slide “.....	2.50
77.*	“ “ “ Coxeter's.....	3.00
78.	“ “ “ with needle holder, spring catch.....	3.00
79.*	“ “ “ “ “ slide catch.....	3.50
80.*	“ “ “ Bulldog, Hamilton's, spring catch.....	2.50
81.	“ “ “ “ “ slide catch.....	2.75
82.	“ “ “ “ “ with needle holder spring catch.....	3.50
83.	“ “ “ “ “ “ slide.....	4.00

All Instruments illustrated are designated by a \*  
 Everything on this page aseptic, when required.

II. AMPUTATING, ANEURISM, TREPHINING, AND RESECTION INSTR'S.

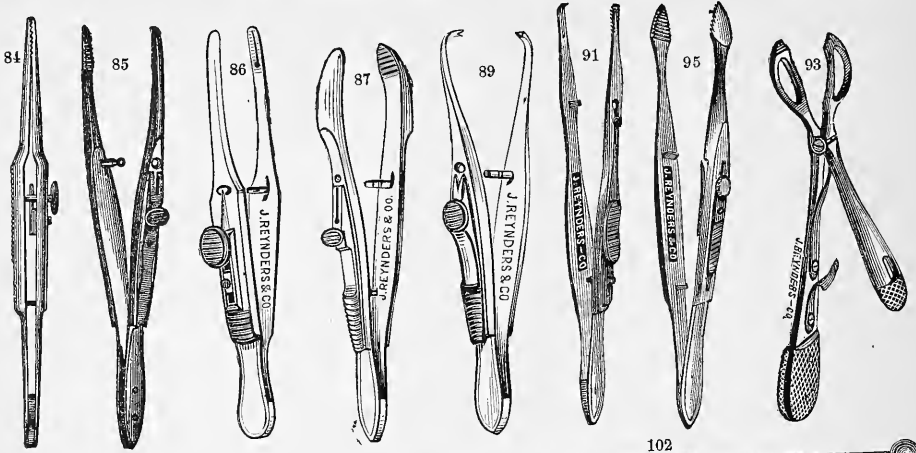

102

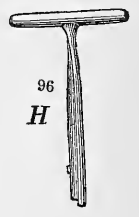
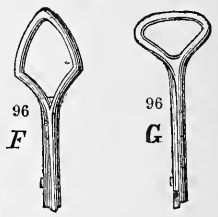
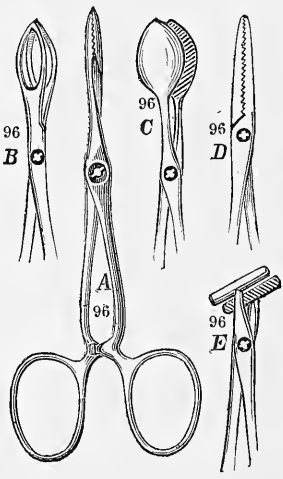
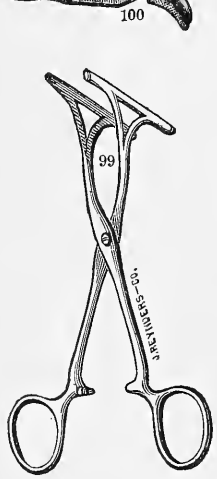
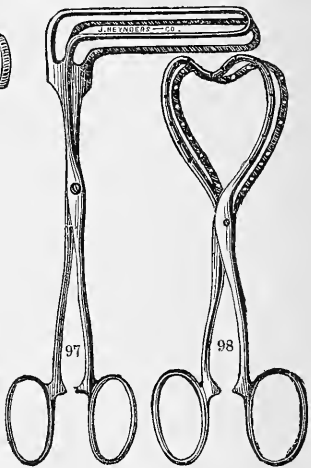
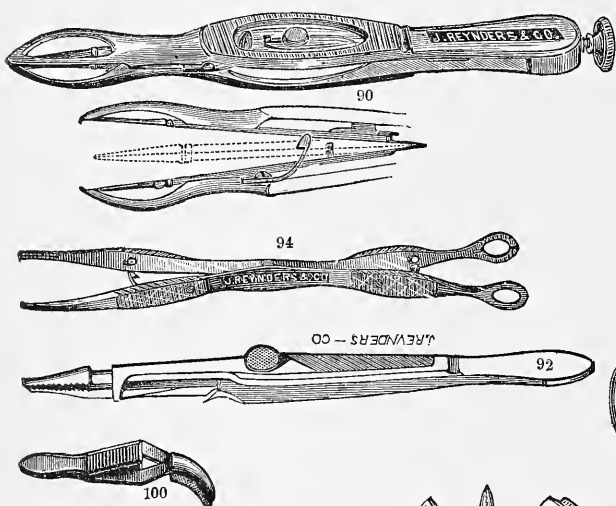

**II. AMPUTATING, ANEURISM, TREPHINING, AND RESECTION INSTR'S.**

84.*	Artery Forceps,	Fricke's, steel.....	\$2.50
85.*	"	" " G. S. ....	2.00
86.*	"	" " Langenbeck's G. S. ....	2.00
87.*	"	" " Esmarch's.....	2.00
88.*	"	" " Liston's, spring catch, steel .....	2.25
89.*	"	" " " " slide catch G. S. ....	2.50
90.*	"	" " Wheeler's .....	7.00
91.*	"	" " Hunter's .....	2.50
92.*	"	" " Wright's .....	2.50
93.*	"	" " Phelps' .....	4.50
94.*	"	" " Cleborn's (also tissue and needle forceps).....	3.50
95.*	"	" " Andrews .....	2.00
96a.*	Haemostatic	Wood's or Pean's .....	2.00
96b.*	"	Fenestrated, scissor-handled.....	2.75
96c.*	"	Broad, solid bladed " .....	2.75
96d.*	"	Wyeth's (gua) .....	2.00
96e.*	"	Forceps or Clamps, Pean's.....	2.75
96f.*	"	" " " " .....	2.75
96g.*	"	" " " " .....	2.75
96h.*	"	" " " " .....	2.75
97.*	"	" " Houze's.....	5.00
98.*	"	" " " " .....	5.00
99.*	"	" " " " .....	5.00
100.*	Artery Clamps, straight or curved.....	each, plain	\$0.50; fine
101.*	"	Constrictor, Speir's.....	2.50
102.*	Acupressure Pins, Simpson's.....	each	0.25

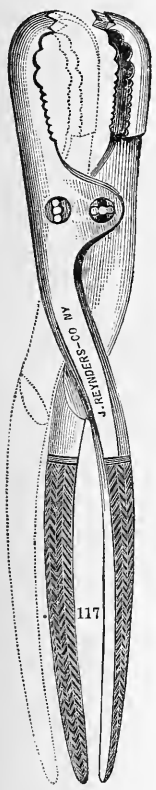

Wyeth's Artery Forceps, aseptic \$2.00

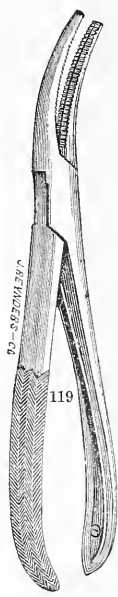
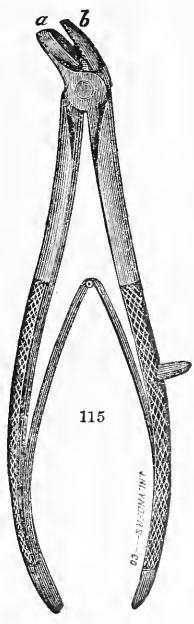
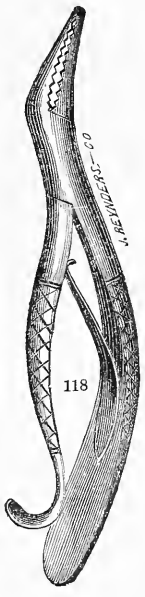

All Instruments illustrated are designated by a \*  
 Everything on this page aseptic.

II. AMPUTATING, ANEURISM, TREPHINING, AND RESECTION INSTR'S.

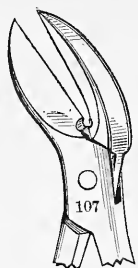
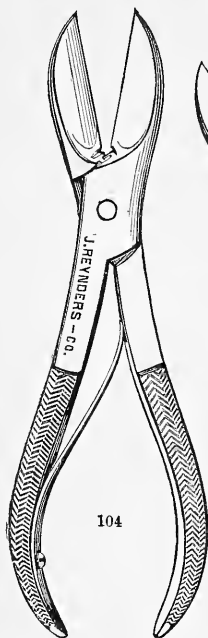

COPYRIGHT 1883 BY JOHN REYNDERS.-CO.

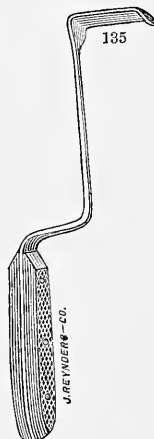
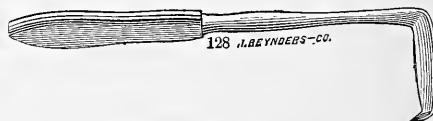
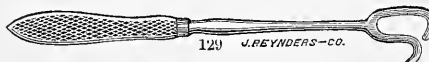
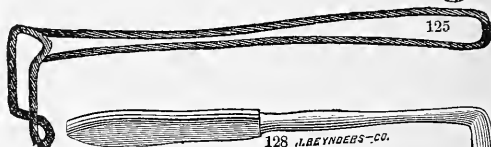
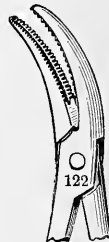

**II. AMPUTATING, ANEURISM, TREPHINING, AND RESECTION INSTR'S.**

103.	Bone Cutting Forceps, straight, small	\$2.50
104.*	" " " " med. \$3.00; with spring	3.50
105.	" " " " large, with spring	\$4.00 to 7.00
106.*	" " " " laterally angular, med.	3.50
107.*	" " " " angular on flat, med.	3.50
108.	" " " " " " large	\$4.50 to 7.00
109.*	" " " " Satterlee's, straight	2.50
110.*	" " " " " " curved	4.50
111.*	" " " " Isaacs', bayonet	\$4.00 to 7.00
112.*	" " " " Hamilton's	10.00
113.*	" Gnawing " straight or curved	3.50
114.	" " " " Little's, small	2.50
115.*	" " " " Hoffmann's	6.00
116.*	" Holding " Fergusson's lion jaw	3.00
117.*	" " " " Faraboeuf's	7.00
118.*	Sequestrum " Fergusson's	2.75
119.*	" " " " Gross', straight or curved	2.75
120.*	" " " " Duckbill	3.00
121.*	" " " " Van Buren's, plain \$2.50; fine	3.00
122.*	" " " " Markoe's	3.00
123.*	Retractor, Parker's, per pair	1.50
124.*	" Mott's	1.50
125.*	" Buck's	1.50
126.*	" Billroth's blunt	each 3.00
127.*	" Langenbeck's blunt	2.00
128.*	" " sharp	2.00
129.*	" Bush's	2.50
130.*	" Lange's, sharp	3.00
131.*	" " pronged	3.00
132.*	" Rectangular	2.50
133.*	" Middeldorp's	3.00
134.*	" Curved, blunt	2.50
135.*	" Durham's	3.00

For illustrations see page 15.

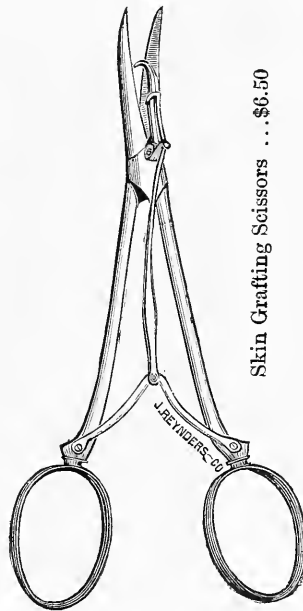
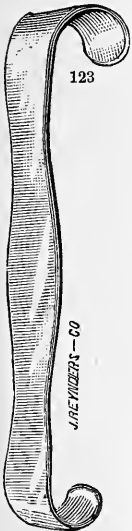

All Instruments illustrated are designated by a \*

II. AMPUTATING, ANEURISM, TREPHINING, AND RESECTION INSTR'S.

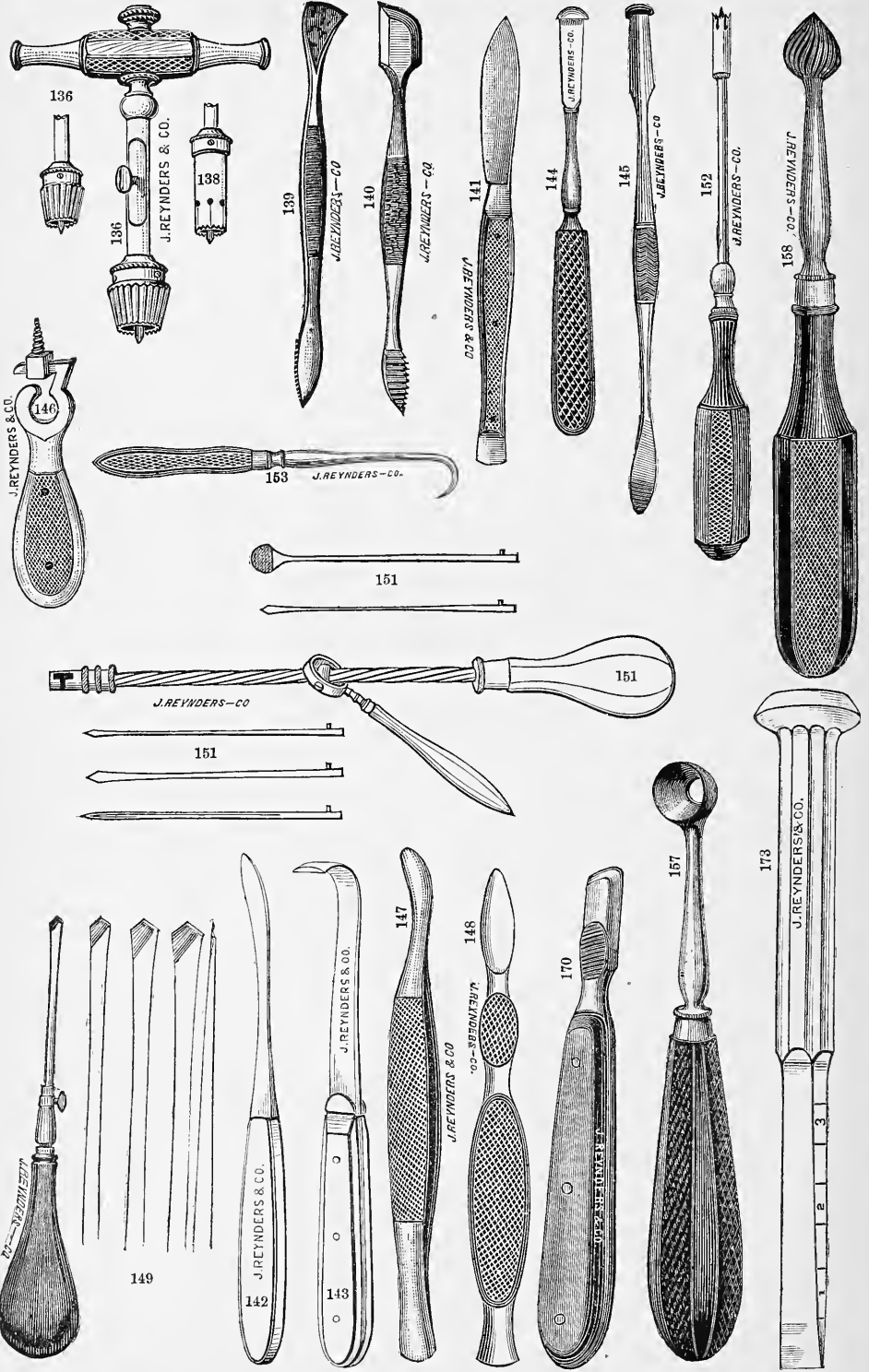

II. AMPUTATING, ANEURISM, TREPHINING, AND RESECTION INSTR'S.

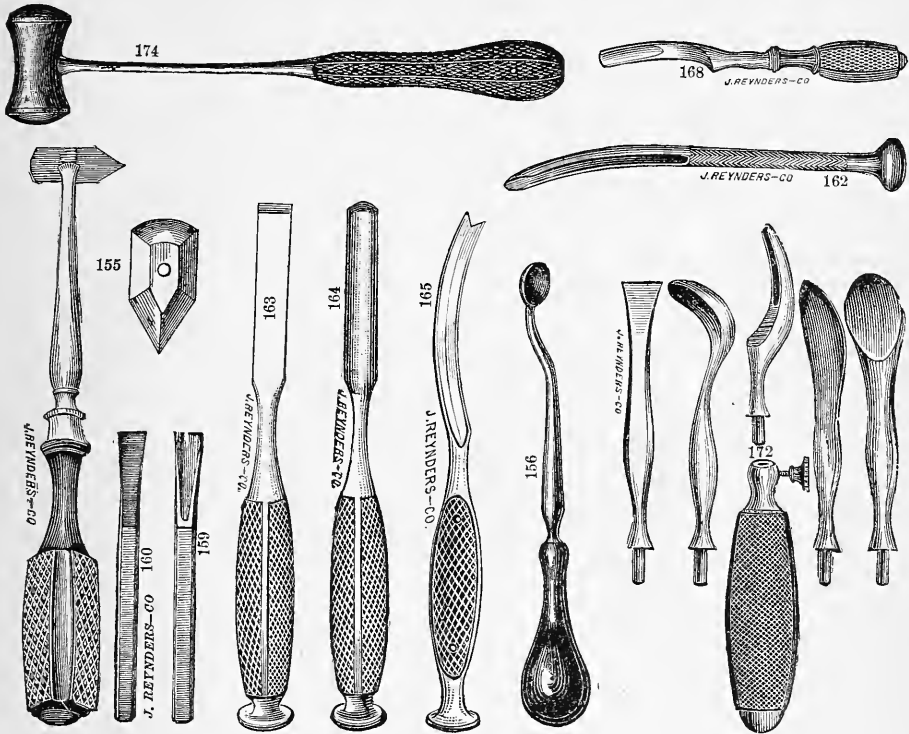

136.** Trephine, Conic, 2 sizes @.....	\$4.00	158.* Bone Burr, Marshall's.....	\$2.50
137. " " set of two.....	7.50	159.* Chisel, plain.....	1.25
138.* " " Cylindric.....	4.00	160.* Gouge, ".....	1.50
139.* Trephining Elevator.....	1.50	161.* Chisel, steel head (like 162).....	1.50
140. " " and Raspatory.....	1.75	162.* Gouge, " ".....	2.00
141.* " " Raspatory and Scalpel.....	1.50	163.* Chisel, long, ebony sides.....	2.50
142.* Elevator, Lange's.....	1.50	164.* Gouge, " ".....	2.50
143.* Raspatory, ".....	1.50	165.* Chisel " " " V-shaped.....	2.50
144.* Lenticular.....	1.75	166. Chisel, in hard rubber handle (like	
145.* " " and Elevator.....	1.75	167).....	3.00
146.* Tirefonde.....	\$1.50 and 2.00	167.* Gouge, in hard rubber handle (cut	
147.* Periosteotome, Sayre's.....	2.00	see page 21).....	3.00
148.* " " Sands'.....	2.50	168.* Gouge, Szymanowki's, plain.....	2.50
149.* Bone Drill, Branard's set of three	2.75	169.* " " " with finger-	
150. " " " " " five.....	3.50	rest (cut see page 21)	3.50
151.* " " " Hamilton's.....	7.00	170.* Periosteotome, Legouest's.....	2.50
152.* Antrum Drill, Pope's.....	3.50	171.* Gouge, Legouest's, (cut see page	
153.* Bone Hook.....	1.50	21).....	2.50
154.* " " Knife, Esmarch's (see cut		172.* Set of Osteotomes, Darby's.....	7.00
pape 21).....	1.75	173.* " " " Chisels, MacEwen's, three in	
155.* Lenticular Knife.....	3.00	case.....	10.00
156.* Bone Curette, Simon's.....	3.00	174.* Mallet, Lead, non-rebounding.....	2.50
157.* " " " Charrières.....	2.50	175. " " Box wood or Rawhide.....	0.75

All Instruments illustrated are designated by a \*

II. ORAL INSTRUMENTS.

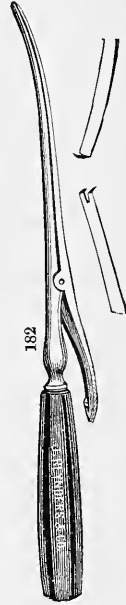
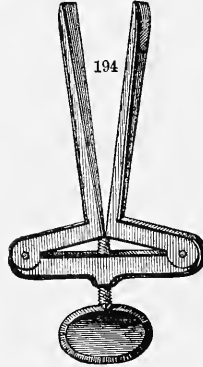
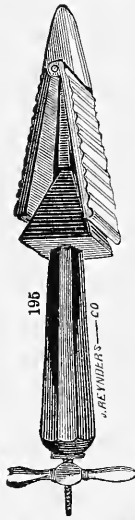
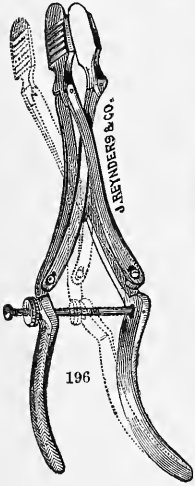
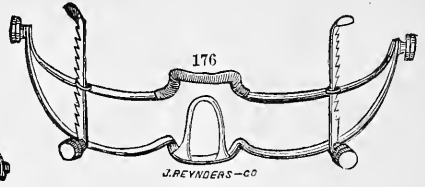
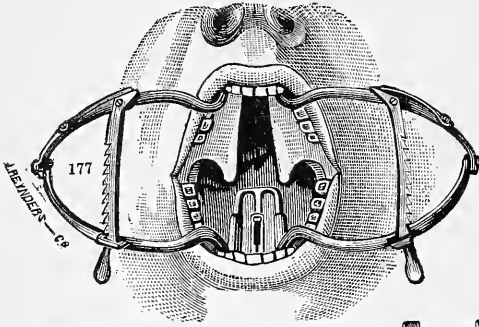



**II. ORAL INSTRUMENTS.**

176.*	Mouth Speculum, Mussey's.....	\$7.00
177.*	“ “ Whitehead's.....	12.00
178.*	“ Gag, Weinlechner's.....	2.50
179.*	Cheek Retractor, box wood.....	2.00
180.	Tongue “ “.....	1.50
181.*	Seizing Forceps, Whitehead's.....	4.50
182.*	“ “ Agnew's, rat-toothed.....	3.50
183.	Knife for Staphylorraphy, plain, right or left.....	2.50
184.*	“ “ “ double edged.....	2.50
185.*	“ “ “ “ Pease's.....	2.50
186.*	“ “ “ Agnew's chisel-shaped.....	1.50
187.*	“ “ “ “ “.....	1.50
188.*	“ “ Paring Edges, Whitehead's right or left.....	1.50
189.*	“ “ Dividing Muco-perceal membranes.....	1.50
190.*	“ “ Gums, Whitehead's.....	1.50
191.*	Spiral Needle, Whitehead's.....	1.75
192.*	Suture Adjuster.....	1.50
Other Instruments for Cleft Palate find mentioned under “Instruments for Ruptured Perinaeum and Vesico Vaginal Fistula.”		
193.*	Locked Jaw Dilator, horn or hard rubber.....	1.00
194.*	“ “ “ Heister—Mott's.....	6.00
195.*	“ “ “ Goodwillies'.....	8.00
196.*	“ “ “ John Reynders & Co's.....	20.00

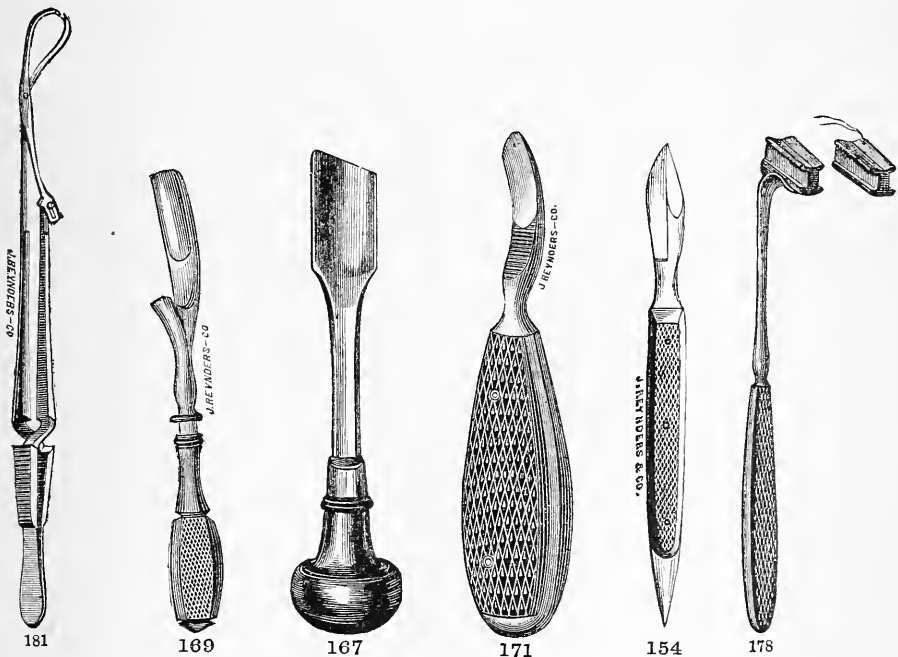

All Instruments illustrated are designated by a \*

II. INSTRUMENTS FOR HARELIP AND EXTRACTION OF BULLETS.

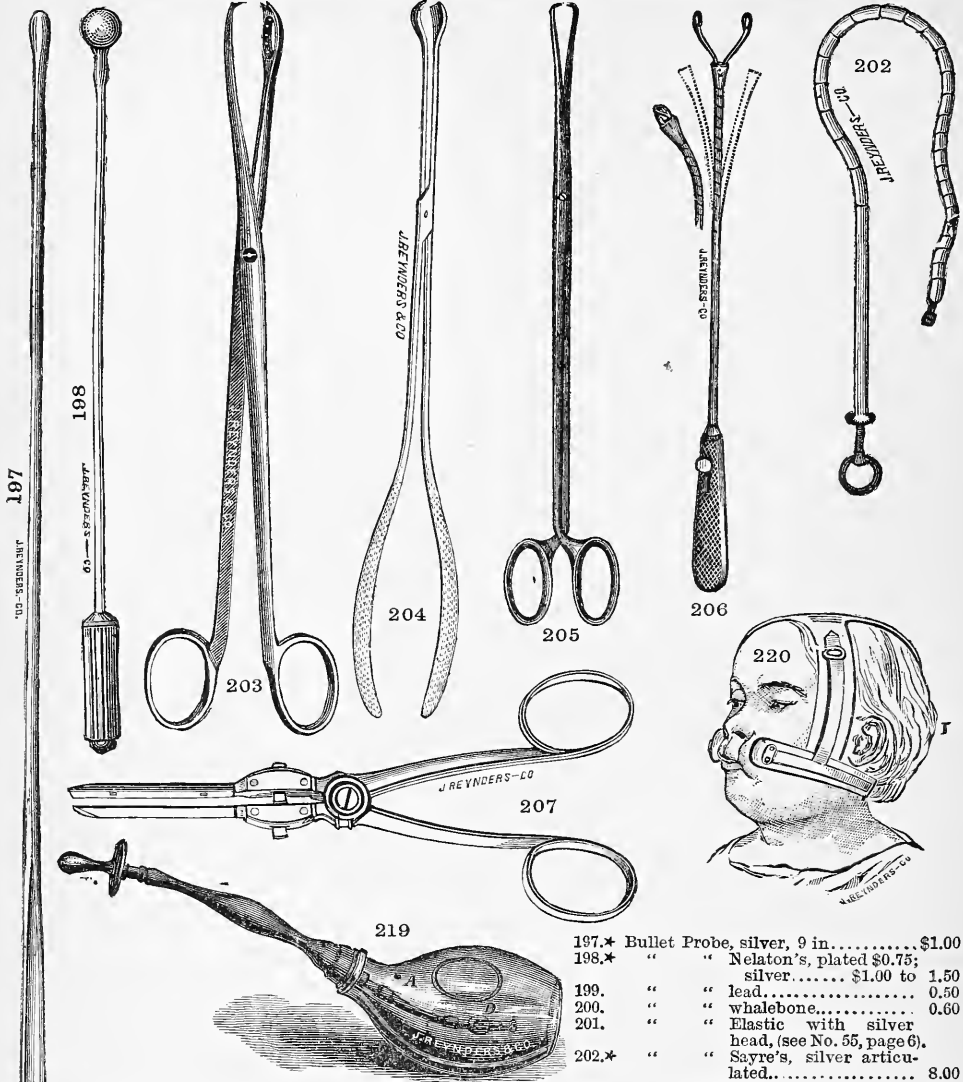

- 197.\* Bullet Probe, silver, 9 in. .... \$1.00
- 198.\* " " Nelaton's, plated \$0.75; silver ..... \$1.00 to 1.50
- 199. " " lead..... 0.50
- 200. " " whalebone..... 0.60
- 201. " " Elastic with silver head, (see No. 55, page 6).....
- 202.\* " " Sayre's, silver articulated..... 8.00
- 203.\* " Extracting Forceps, Gross'.. 2.50
- 204.\* Bullet Extracting Forceps, U. S. A..... 2.00
- 205.\* " " " American..... plain \$2.25; with catch 4.50
- 206.\* " " " Canulated, John Reynders & Co..... 3.00
- 207.\* Harelip Forceps, parallel opening..... 9.00
- 208.\* " " " Hutchison's (see cut page 23)..... 3.00
- 209.\* " " " Smith's (see cut page 23)..... 6.00
- 210.\* " " " Clamp, Prince's (see cut page 23)..... 3.00
- 211. " " " Scissors (see Numbers 56 to 61, page 39).....
- 212. " " " Hamilton's, angular..... 2.25
- 213.\* " " " Pins, different sizes (see cut page 23)..... per 100 0.40
- 214.\* " " " lancepointed (see cut page 23)..... per doz. 0.25
- 215.\* " " " Buck's Gilt (see cut page 23)..... each 0.25
- 216.\* " " " silver, with removable point (see cut page 23)..... 0.50
- 217.\* Pin Conductor, Post's (see cut page 23)..... " 0.75
- 218. " " " (see No. 38a page 39).....
- 219.\* Feeding Bottle (for feeding without sucking)..... 4.00
- 220.\* Harelip Truss, Hainsby's..... 6.00

(Extract from Dr. J. E. Erichsen's Book on the Science and Art of Surgery. Vol. 2, Page 491.)

If the fissure be wide, and the child restless, so that there is danger of the parts being dragged upon during its screaming or crying, it is a very good thing to apply the spring cheek compressor invented by Hainsby. Indeed, whenever obtainable, this excellent contrivance should be employed. Its use adds greatly to the success of the operation.

MEASUREMENTS REQUIRED.—Circumference of face and neck taken in an oblique direction.—Circumference of head under the chin and over the head.

All Instruments illustrated are designated by a \*

## II. HERNIA INSTRUMENTS.

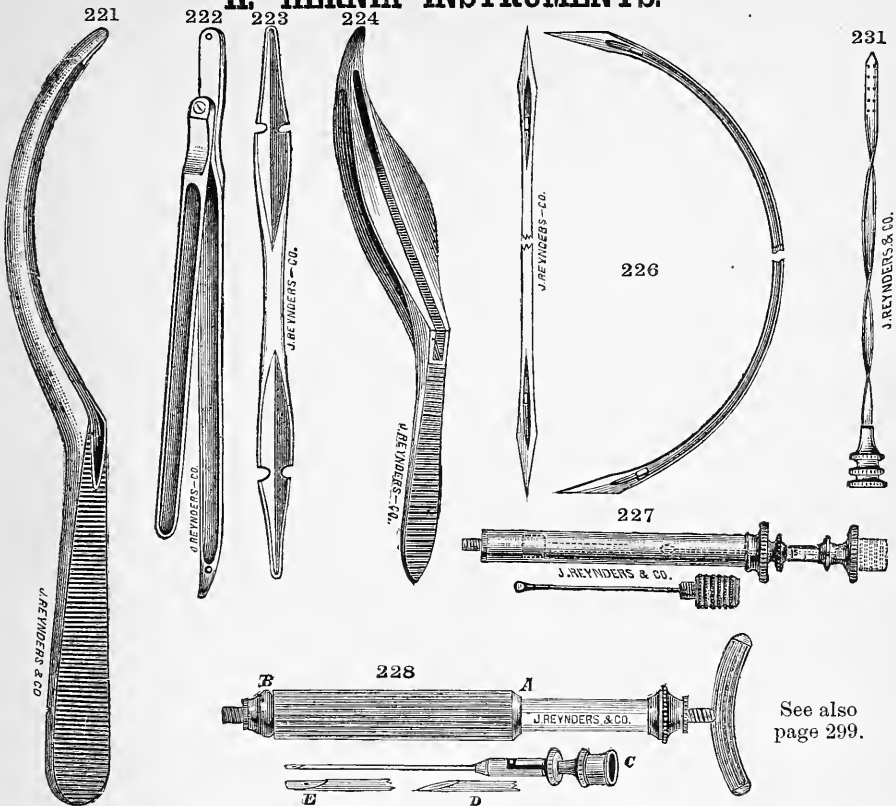

221.*	Director, Grooved.....	\$2.50
222.*	“ Double.....	1.50
223.*	“ Levis'.....	1.50
224.*	“ Peter's.....	2.50
225.	Knife Cooper's (see No. 11, page 10).....	
226.*	Needles, Greenville Dowell's.....	1.00
227.*	Syringe for Radical Cure, Heaton's.....	5.00
228.*	“ “ “ De Garmo's.....	8.00
229.	“ “ “ “ Warren's with Common Piston †.....	12.00
230a.	“ “ “ “ “ Spring and lever pattern †.....	18.00
231.*	Spiral Tube, Warren's, for any syringe.....	3.00
232.	Truss for treatment after operation for Radical Cure, elastic, single \$4.00; double.....	5.00
233.	“ “ “ “ “ “ “ Warren's single*.....	3.50
234.	“ “ “ “ “ “ “ “ double*.....	7.00

See also page 299.

The latter two are recommended by Dr. J. H. WARREN of Boston, Mass.

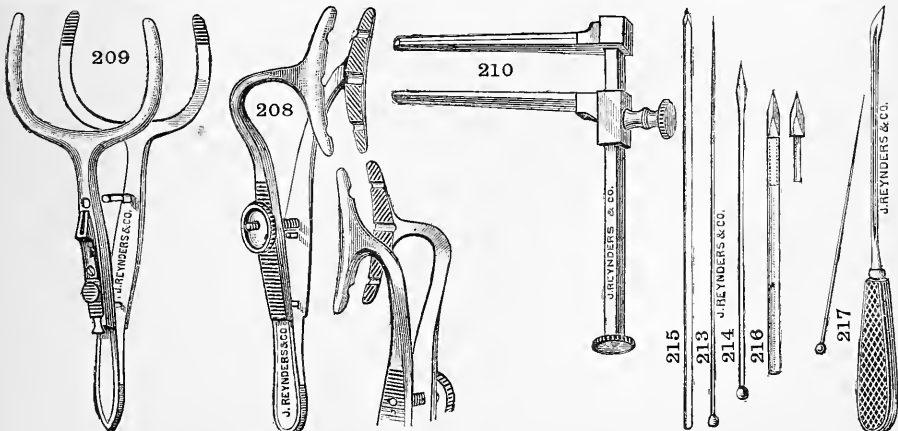

All Instruments illustrated are designated by a \*

II. AMPUTATING, GENERAL AND MINOR OPERATING CASES.

All Sets mentioned on this and the following pages are also put up aseptically

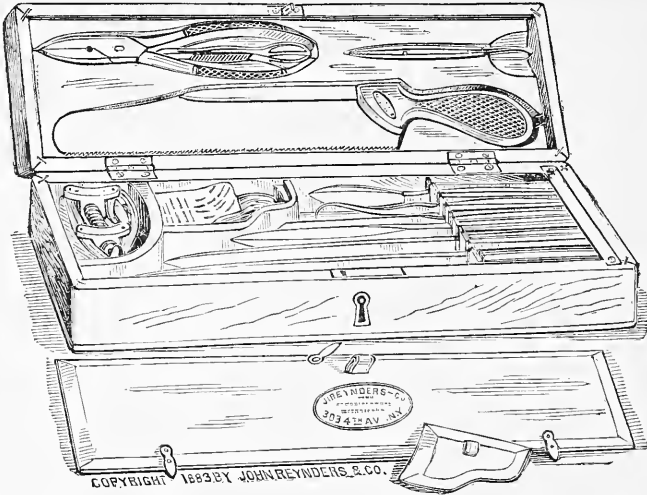

at 10 per cent. advance in prices quoted.

**Amputating Case No. 1,\*** contains: Liston's long Knife; Liston's medium Knife; Catling; Scalpel; Tenaculum; Artery Forceps; Metacarpal Saw; large Movable Back Saw; Tourniquet; Bone Forceps and one dozen Needles; Wax, Pins and Silk; in a black walnut case, oil dyed, velvet lined.....Price \$25.00  
 The same with addition of Fenestrated Artery Forceps..... " 27.00

**Amputating Case No. 2,** contains: Liston's long Knife; Liston's medium Knife; Catling; Scalpel; Tenaculum; Capital Saw, (fig. 47); Metacarpal Saw; Fenestrated Artery Forceps; Tourniquet; Bone Forceps; 12 Needles; Wax, Pins and Silk; in a black walnut case, oil dyed, velvet lined..... Price \$30.00  
 The same with Bow Saw, two-bladed instead of Capital Saw, solid bladed, Aneurism Needle and Needle Holder with Artery Forceps, in addition..... \$33.00

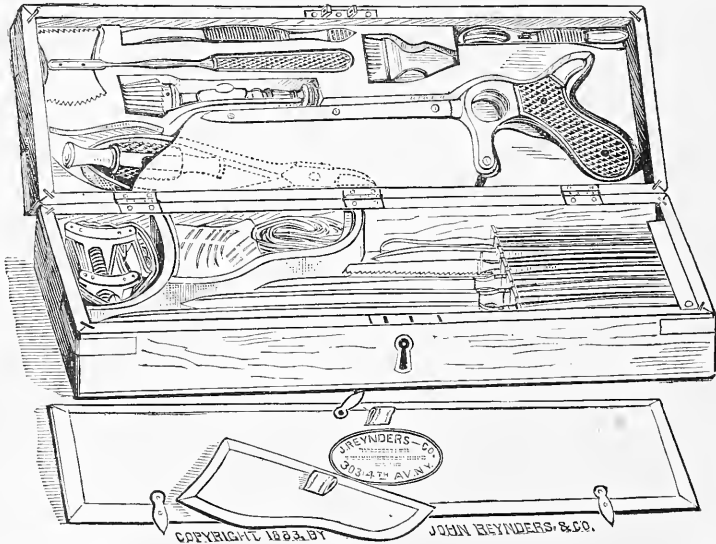

**Amputating and Trephining Case,\*** contains: Liston's Knife for hip and thigh; Liston's Knife for leg and arm; Catling; Ampt. Scalpel; Ampt. Tenaculum; large Saw; Finger Saw; Fenestrated Artery Forceps; Tourniquet; Liston's Bone Forceps; Galt's Conical Trephine and handle; Heys' Skull Saw; Elevator and Raspatory; Brush for cleaning saws; Needles, Silk, etc.; in a fine brass bound mahogany case....Price \$37.00  
 The same with modifications as mentioned under Amputation Case No. 2..... 40.00  
 The same with further additions of Finger Knife and small Trephine..... 45.00

**II. AMPUTATING, GENERAL AND MINOR OPERATING CASES.**

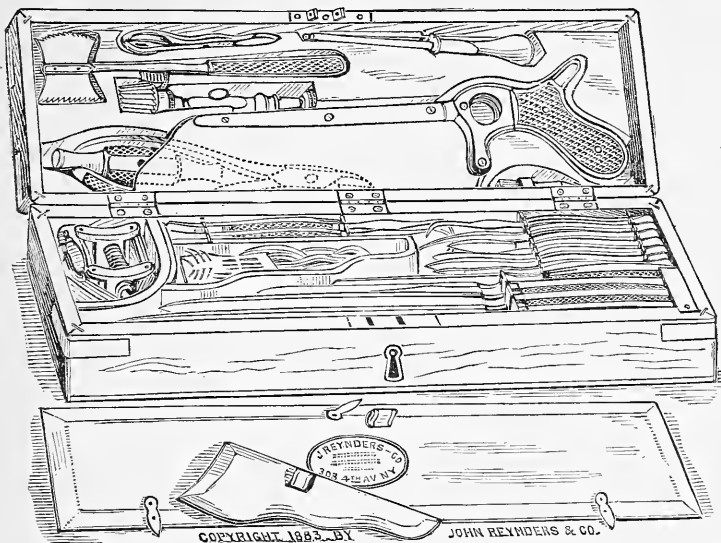

Standard Operating Case No. 1,\* contains: Liston's Knife for thigh and hip; Liston's Knife for leg and arm; Catling; Ampt. Scalpel; Tenaculum; Fenestrated Artery Forceps; large Saw; Finger Saw; Liston's Bone Forceps; Screw Tourniquet; Galt's Conical Trephine and handle; Heys' Skull Saw; Elevator and Raspatory; 2 minor operating Scalpels; sharppt. curved Bistoury; Probe pointed curved Bistoury; Finger Knife; Tenotome; Aneurism Needle; Trocar and Canula; Brush; Needles and Silk; in a fine mahogany brass bound case, lined with oil dyed velvet.....Price \$50.00

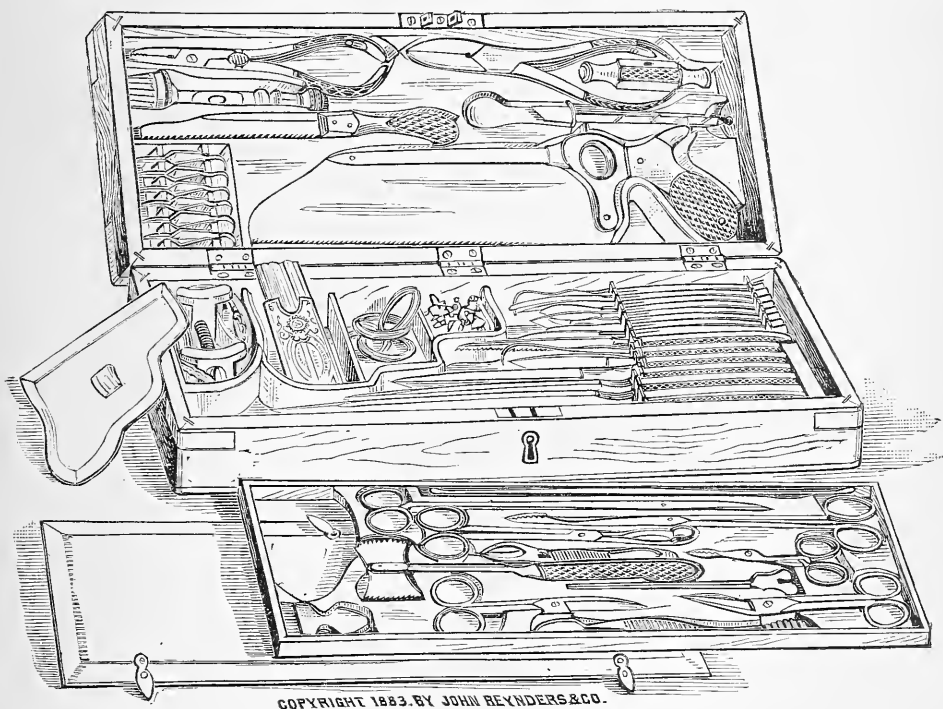

STANDARD OPERATING CASE No. 2.—(For contents see page 27.)

II. AMPUTATING, GENERAL AND MINOR OPERATING CASES.

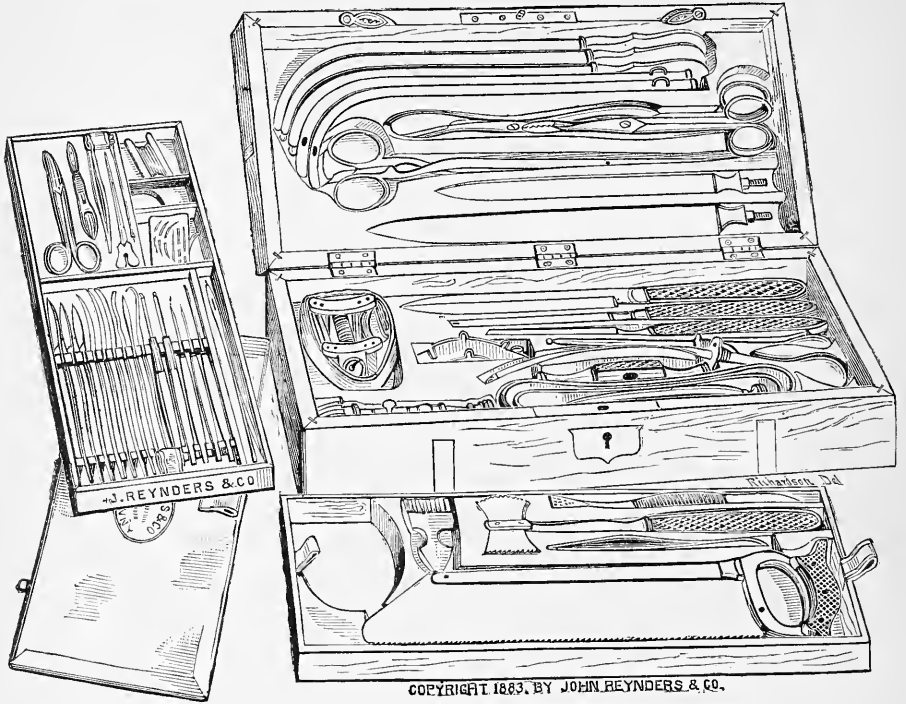

COPYRIGHT 1883, BY JOHN REYNDERS & CO.

PARKER'S GENERAL OPERATING CASE.—(For contents see next page.)

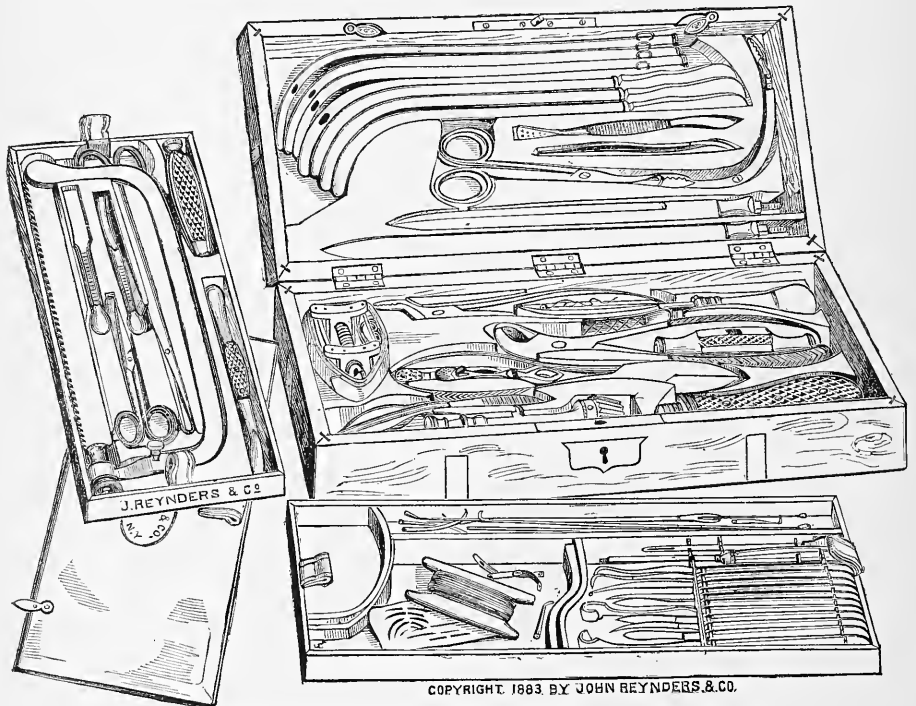

COPYRIGHT 1883 BY JOHN REYNDERS & CO.

LITTLE'S GENERAL OPERATING CASE.—(For contents see next page.)

## II. AMPUTATING, GENERAL AND MINOR OPERATING CASES.

**Standard Operating Case No. 2,\*** the same as No. 1, with the addition of: 2 Pean's Artery Forceps; Interosseous Saw; Needle-holder and Wire-cutter, Stimson's; Scissors, curved or flat; Scissors, laterally angular; Director; Polypus Dressing Forceps; Vulsellum Forceps; Nelaton's Probe, pure silver; Bullet Forceps; 6 self-closing Artery Clamps; 6 silver Serrefines; 3 coils Silver Wire; board braided Silk, four sizes; movable Back Finger Saw, instead of plain ditto; 2 Sayre's Tenotomes, instead of one sharp-pointed ditto; in black walnut or mahogany case..... Price \$84.00

**General Operating Case No. 10, J. R. & Co's,** contains, in addition to Standard Operating Case No. 2: Minor operating double-edged Finger-knife; Trephining Scalpel and Raspatory; Bone Gouging Forceps; Ferguson's Sequestrum Forceps; Lion Jaw Forceps; Pereosteotome; Chisel; Gouge; Boxwood Mallet; Parker's Retractors; Buck's Retractors; small Claw Forceps; Delicate Silver Probe; Needle in handle; curved Trocar; Sinus Syringe; Tongue Spatula; Tonsil Bistoury; Mathieu's latest Throat Forceps; 2 H. R. Trachea Canulas; Trach. Dilator; Thompson's Stone Searcher; steel Sound; silver Catheter; in a fine brass-bound rosewood case..... Price 150.00

**General Operating Case No. 2, W. Parker's,\*** contains: Set of Parker's Knives; Parker's Saw; Finger Saw; plain Artery Forceps; Fenestrated spring catch Artery Forceps; Tenaculum; American Bullet Forceps; Liston's Bone Forceps; pair Parker's Retractors; Screw Tourniquet; 3 Scalpels, ass.; Sharppt. curved Bistoury; Probept. curved Bistoury; Finger Knife; Tenotome; Cooper's Hernia Knife; Polypus Forceps; set Mott's Aneurism Needles; Exploring Trocar; Steel Director; pair of Silver Probes; Galt's Trephine and handle; Heys' Saw; Trephining Elevator and Raspatory; Wire Eye Speculum; Cataract Knife; Parker's Fistula Lachrymalis Knife; Eye Scissors, curved on flat; curved Eye Needle; Strabismus Forceps; steel Sound; 2 male Catheters; 2 Lithotomy Staffs; Lithotomy Bistoury; Lithotomy Forceps; straight Trocar; curved Trocar; Needles, Silk, etc. In a fine rosewood, brass bound, silk oil dyed velvet lined case and patent leather cover for same..... Price \$100.00

**General Operating Case No. 9, Jas. L. Little's,\*** contains: 2 Amputating Blades with one handle; large Bow Amp. Saw; Phelps' Torsion Forceps; plain Artery Forceps; Bone Cutting Forceps; Screw Tourniquet; Nelaton's Probe; American Bullet Forceps; Student's Aneurism Needle; Director with Tongue-tie, silver; broad Hernia Director; Trocar; Polypus Forceps; fine straight Scissors; strong Scissors, curved on flat; Cusco's Throat Forceps, plain Trephining Elevator; curved Bone Gnawing Forceps or Ronceur; Van Buren's Sequestrum Forceps; plain Chisel; plain Gouge; Pereosteotome; Galt's Trephine; 3 ass. Scalpels; straight sharppt. Bistoury; curved sharppt. Bistoury; curved probept. Bistoury; Hernia Knife; 2 Retractors; Tenaculum; plain Aneurism Needle; 1 fine Silver Probe; pair Silver Probes; 3 plated Catheters; Prostatic Catheter; 3 steel Sounds; in a fine brass bound rosewood case, oil dyed silk velvet lined. Price \$100.00

The same with mousetoothed plain Artery Forceps; Fenestrated Artery Forceps, spring-catch; Sands' Needle Holder..... Price 110.00

**General Operating Case No. 3, Hamilton's,** contains: Catling Hip; Catling Thigh; Liston's Knife for arm and leg; large Saw; slide-catch Artery and Torsion Forceps; Hamilton's Artery Forceps; Tenaculum; Liston's Bone Forceps; pair Mott's Retractors; American Bullet Forceps; German silver or whalebone Bullet Probe; Screw Tourniquet; Field Tourniquet; 3 Acupressure Needles; 6 Serrefines; narrow French Saw; probept. curved Bistoury; broad French Bistoury; narrow French Bistoury; straight Dressing Scissors; Dressing Polypus Forceps; long Director and Ear Scoop; set Mott's Aneurism Needles; plain Artery Forceps; extra long plain Artery Forceps; Conic Trephine; Necrosis Trephine; Handle for both; Trephining Elevator and Raspatory; Heys' Saw; Tirefond; Steel Sound; 2 male Catheters; Harelip Scissors; h. r. Dental Syringe; Saw Brush; Needles, Silk, etc. In a fine rosewood brass-bound case, oil dyed silk velvet lined and patent leather cover..... Price 100.00

**General Operating Case No. 4, Jas. R. Wood's,** contains: long Ampt. Knife; circular Knife, Catling; large Saw; Tenaculum; spring catch Artery Forceps; Liston's Bone Forceps; Screw Tourniquet; American Bullet Forceps; Galt's Trephine and handle; Trephining Scalpel and Raspatory; Trephining Elevator; Heys' Saw; Brush; Finger Saw; straight Dressing Scissors; curved probept. Bistoury; curved sharppt. Bistoury; 2 Scalpels; Aneurism Needle; steel Director; pair silver Probes; curved Eye Scissors; Beer's Cataract Knife; Strabismus Hook; curved Strabismus Forceps; straight Eye Needle; curved Eye Needle; 2 steel Sounds; silver-plated Catheter; Double Web Catheter; 2 Elastic Bongies; Needles, Silk, etc. In a rosewood, brass-bound, silk, oil-dyed velvet lined case..... Price \$65.00

Either of the Amputating or Operating Cases mentioned on pages 24 to 30, inclusive, are put up with Esmarch instead of Spiral Tourniquet, at \$2.00 or \$4.00 increase in price. Page 8.

## II. AMPUTATING, GENERAL AND MINOR OPERATING CASES.

**General Operating Case No. 6, Mott's,** contains: large Knife; medium Knife; small Catling; large Saw; Tenaculum; Double Hook; plain Artery Forceps; plain spring-catch Forceps; Liston's Bone Forceps; pair Mott's Retractors; Screw Tourniquet; American Bullet Forceps; Galt's Trephine and handle; Trephining Elevator and Raspator; Heys' Saw; Saw Brush; Finger Saw; sharppt. and probept. curved Bistoury; set Mott's Aneurism Needles; Tenotome; 3 Scalpels; Finger Knife; Hernia Knife; straight Scissors; laterally bent Scissors; steel Director; Polypus Forceps; 2 silver Probes; Trocar and Canula; Needles, Silk, etc. In a rosewood, brass-bound, oil dyed silk velvet lined case. .... \$72.75

**General Operating Case No. 7, Parker's Compact,** contains: Parker's set of Ampt. Knives; Tenaculum; large Saw; Liston's Bone Forceps; spring-catch Artery Forceps; Tourniquet; Whalebone Bullet Probe; American Bullet Forceps; Galt's Trephine and handle; Treph. Brush; Treph. Elevator and Raspator; Heys' Saw; 2 Scalpels; Finger Knife; Finger Saw; curved Bistoury, probept.; Aneurism Needle; Dressing Forceps; straight Scissors; steel Director; 2 silver Probes; Needles, Silk, etc. In a rosewood brass-bound, oil dyed silk velvet lined case. .... Price \$62.00

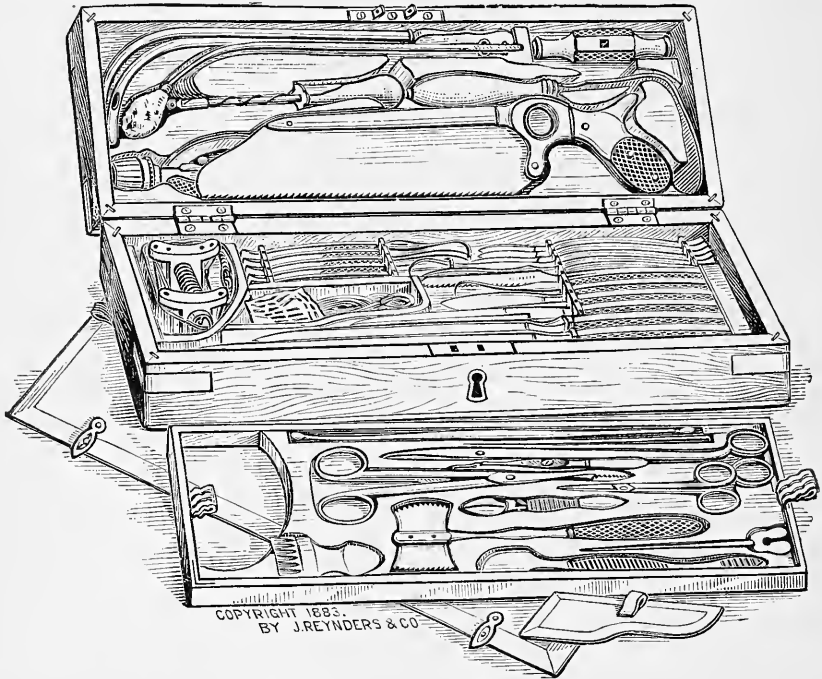

**General Operating Case No. 8, "California,"** \* contains: long and medium Ampt. Knife; small Catling; Ampt. Scalpel; Ampt. Tenaculum; spring and slide catch plain Artery Forceps; large Saw; Liston's Bone Forceps; Tourniquet; American Bullet Forceps; Galt's Trephine and handle; Elevator and Raspator; Heys' Saw; 3 ass. Scalpels; Finger Saw; probept. and sharppt. curved Bistoury; Finger Knife; Tenotome; Aneurism Needle; Polypus Forceps; steel Director; straight Scissors; plated Tongue Depressor; Probang; Green's Tonsil Bistoury; double Hook; straight Trocar; metal Bougie; silver-plated Catheter; Needles, Silk, etc. In a mahogany, brass-bound, oil dyed silk velvet lined case. .... Price \$63.00

**Trephining Case,** contains: Galt's Trephine; Cylindric Trephine; Handle for both; Elevator; Scalpel and Raspator; Heys' Saw; Brush. In a mahogany case. Price \$16.00

**Lithotomy Case, Jas. L. Little's,** contains: 4 Little's Median Lithotomy Staffs; Little's Director; Little's Knife; 3 Little's Lithotomy Forceps; Dressing Forceps (for small stones); Stone Crusher; Thompson's Stone Searcher; small Searcher; Canula "Chemise"; Lithotomy Scoop; in a fine rosewood case. .... Price \$60.00

*With the addition of the following instruments, the case will be complete for the lateral or bi-lateral operation: 3 Staffs for Lateral Operation; Wood's Bisector. .... Price complete \$72.50*

*A Lithotomy Syringe can be added if desired.*



## II. AMPUTATING, GENERAL AND MINOR OPERATING CASES.

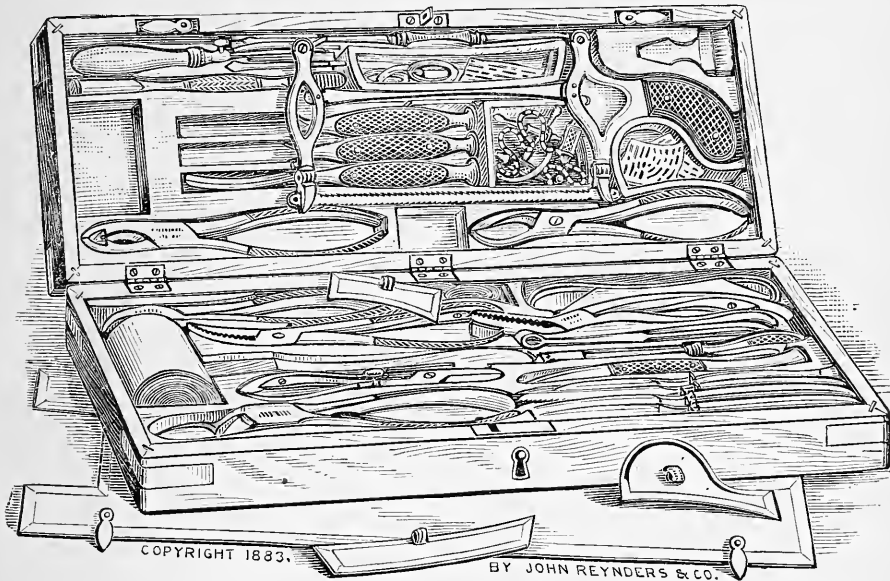

RESECTION AND EXSECTION CASE.

**Bone Exsecting Case,\*** contains: Two all steel Resection Knives; Interosseous Saw; Butcher's Resection Saw; Chain Saw; Isaac's Bayonet Bone Forceps; Bone Forceps, angular on flat; Markoe's Sequestrum Forceps; Fergusson's Sequestrum Forceps; Bone Holding Forceps, lion jaw; Bone Gnawing Forceps; Sayre's Periosteotome; Elevator and Lenticular; Braniard's Set of Bone Drills; Gouge; Chisel; Chisel V; Bone Scraper; Pope's Autrum Drill; Rawhide non-rebounding Mallet; Brush for Saws; Silver wire Needles and Silk in a brass-bound Blackwalnut case .....Price \$100.00

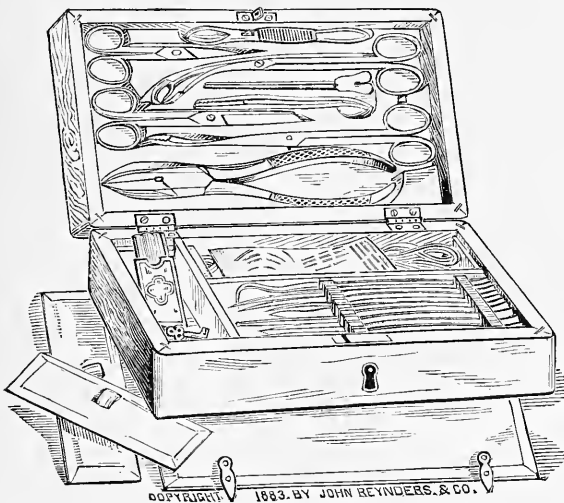

**Minor Operating Case No. 1,\*** Plain, contains: 3 ass. Scalpels; Finger Knife; probept. and sharppt. curved Bistoury; Cooper's Hernia Knife; Tenotome; Tenaculum; Aneurism Needle; Bone Forceps; Dissecting Forceps; Vulsellum; Polypus Forceps; fenestrated Artery Forceps; straight Scissors; curved Scissors; Director; Needles, Silk, etc. In a mahogany, velvet lined case; instruments rivetted. ....Price \$27.00

## II. AMPUTATING, GENERAL AND MINOR OPERATING CASES.

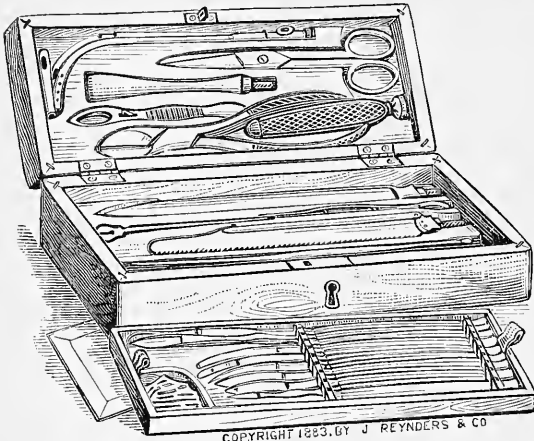

**Compact Minor Operating Case No. 2,\*** Conant's contains: Conant's Set (fig. 37, page 9); Double Tenaculum; fenestrated spring catch Artery Forceps; plain Artery Forceps; Bone Forceps; Sims' Uterine Scalpel; Sims' Tenaculum; steel Director; 2 Scalpels; curved sharppt. Bistoury; curved probept. Bistoury; Tenotome; Hernia Knife; straight Scissors; compound Catheter, male and female with child's part; 2 silver Probes; Needles, Silk, etc. In a rosewood, brass bound, oil dyed silk velvet lined case. . . . . Price \$40.00

The same with set, fig. 38, page 9. . . . . " 41.00



**Minor Operating Case No. 3,\*** Gross', contains: 3 ass. Scalpels; Scalpel and Raspatory; Finger Knife; probept. and sharppt. Bistoury; Cooper's Hernia Knife; Lithotomy Bistoury; Tenotome, each sharppt. and probept.; Tenaculum; Aneurism Needle; Finger Saw; Hernia Director; steel Director; pair Retractors; Bone Forceps; Sequestrum Forceps; straight Scissors; Scissors, curved on flat; Polypus Forceps; Vulsellum; Dissecting Forceps; Fenestrated Artery Forceps. In a mahogany or blackwalnut brass bound, oil dyed silk velvet lined case.

Instruments with ferrulled handles. . . . . \$45.00  
Do. rivetted handles. . . . . 38.00

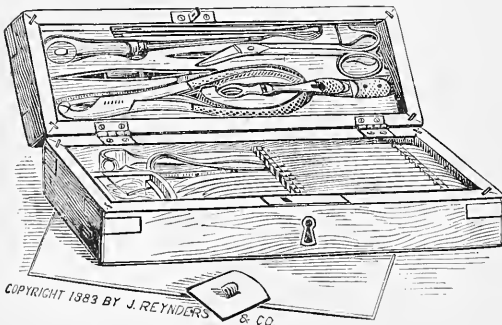

**Minor Operating Case No. 4,\*** Jas. L. Little's, contains: 3 ass. Scalpels; curved Bistoury, sharppt.; curved Bistoury, probept.; straight Bistoury, sharppt.; Tenaculum; Hernia Knife; Thumb Forceps, plain; Phelps' Artery and Torsion Forceps; Artery Needle; 2 Retractors; Trocar and Canula; Scissors, angular; Director, silver; 2 Probes, silver; Rongeur, curved, small size; Needles, Silk, etc.; in a fine rosewood, oil dyed, silk velvet lined case. . . . . Price \$37.00

II. SURGICAL APPLIANCES.

Otis' Evacuator.

"Directions for Operating.—The evacuating catheter having been well oiled and carefully introduced into the bladder, the contained urine is evacuated, and six to eight ounces of tepid water are introduced into the bladder. The evacuating catheter is then attached to the evacuator. Gentle pressure of the bulb, sufficient to displace one-third to one-half of its contained air, drives a current of water into the bladder and produces

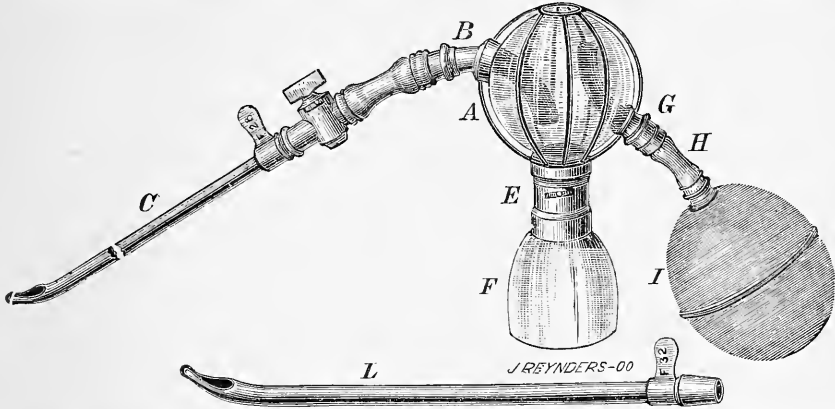

the necessary vacuum. The returning current from the bladder brings a portion of its contained water, and with it the calculous debris. This is quietly, quickly and certainly deposited into the receiver, from which there is no possibility of return into the bladder. Repeating the pressure on the bulb at intervals of two or three seconds, as long as fragments are seen to fall into the receiver, the catheter, the point of which has been in contact with the most dependent portion of the bladder, is then withdrawn a little and gently moved about in order that floating or reluctant fragments may find access to it, and the rhythmic pressure of the bulb is continued, until no more debris is seen to fall into the receiver. If, then, there are evidences that calculous material still remains in the bladder after removal of the evacuating catheter, the crushing is renewed, after which the same operation for removal of debris is repeated, and so on, until the stone is completely removed."—F. N. Otis, M. D., &c. *Medical Record*, November 3d, 1883.

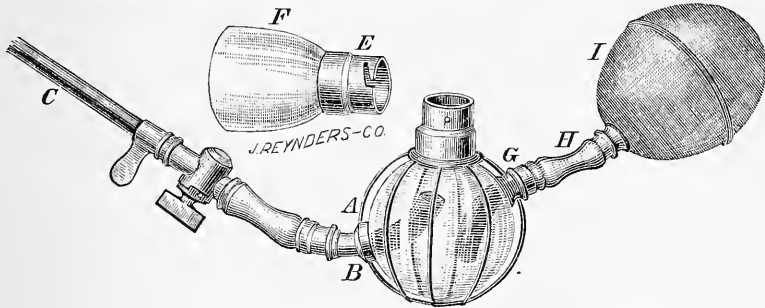

N. B.—"The readiest and best way of filling the instrument is to plunge the evacuating end into a vessel of water, of a temperature of 98 degrees, and, by one or two firm compressions of the rubber bulb, the filling is complete and the evacuator is ready for use. If, during the operation, it is found desirable to introduce additional water into the bladder, this is done with great ease, by attaching the discharge pipe of a Davidson's Syringe to the stop-cock (at K), while the supply end is immersed in a vessel (preferably a large glass graduate), filled with water of a proper temperature. The easy attachment and detachment of the Davidson's Syringe, allows any desired amount of fluid to be introduced into the bladder without delay or inconvenience."—F. N. O., Feb. 4th, 1885. Price..... \$30.00

D. J. F. Packard's Knee Splint for Treatment after Exsection.

The same is shaped like a leg and made of inch board (thinner stuff is used for small limbs). At the buttock end this board is beveled off so that no edge shall irritate the skin, and a hollow is near the lower end to receive the heel; the whole is slightly hollowed from side to side, so as to make a very shallow trough.

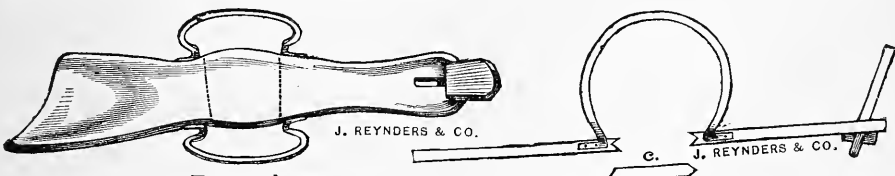

a. From above.

b. From the side (the slide removed).

## II. SURGICAL APPLIANCES.

A slit is mortised lengthwise in the middle line, close to the lower end of the splint, to receive the tendon of the foot piece. This latter is slightly inclined and long enough to extend up above the toes, so as to keep the weight of the bedclothes off the foot. It is fastened securely at any desired point by means of a wooden pin or wedge.

A piece corresponding to the knee, a little wider on the outer side of splint, and working in grooves, is made removable.

Two strong metal brackets of suitable size are screwed on to the thigh piece above, and the leg piece below, so as to connect them firmly. These brackets are from six to nine inches high, and flare sharply outward at their point of attachment, as seen in Fig. a; this prevents all pressure against the limb in case the latter should swell. Side pieces of soft leather are tacked on the upper surface near the edge of each portion of the splint, they are made to close by laces.

The limb being laid on this splint previously padded is perfectly secure. Sometimes it is well to add a small stripe of pasteboard on the upper surface of the thigh, and another for the leg.

To change the dressings it is only necessary to undo the leathers, and to draw out the middle shelf holding the dressings at the inner side, (*c* on fig. *b*) least they should have become adherent. The knee is thus left exposed, and, when the dressings have been changed, the shelf is slipped in again and fastened as before. Before using the splint it is well to have the knee-piece, and the adjoining portions of the thigh and leg-pieces thoroughly oiled, so that they may be less apt to absorb any discharges which may flow down over them.

## MEASUREMENTS REQUIRED.

1) Trace an outline of the limb upon a sheet of coarse strong paper placed beneath it. Should the knee be very much flexed, the outline of the thigh may be made first, and then that of the leg, marking the limb and paper so that the two proportions may exactly correspond. This tracing should extend on the outer side up to the greater trochanter, on the inner up to the perineum and about four inches beyond the heel. Send this tracing to us and

2) Mention if for right or left leg.

3) Circumference at letters L, N, O, F, Q and S. (See figure of leg, page 293.)

Price, \$8.25\*

### Support for the Leg after Resection of the Femur, or un-united Fracture.

This apparatus consists of two strong steel bars passing laterally along the leg with joints at ankle, knee and hip. A well padded band encloses the body at the hip and the two lateral bars are connected by very strong leather bands around the thigh and calf. For additional support a strong perineal strap may be added. The joint at the knee can be modified in different ways as mentioned at the end of the description of apparatus 50.

## MEASUREMENTS REQUIRED:

- 1) Patient's Sex.
- 2) " general appearance.
- 3) Position of leg.
- 4) Right or left?
- 5) Circumference of body between crest of ilium and trochanter major.
- 6) Circumference of thigh at perineum.
- 7) " " midway between perineum and knee-joint.
- 8) Circumference of thigh 3 inches above knee-joint.
- 9) " " leg 3 " below " "
- 10) " " calf.
- 11) " " ankle.
- 12) Distance from sole to ankle-joint.
- 13) " " " knee- "
- 14) " " " knee to hip- "
- 15) Send a strong shoe to lace down to the toes.

Price \$35.00 to \$75.00

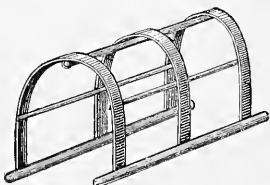
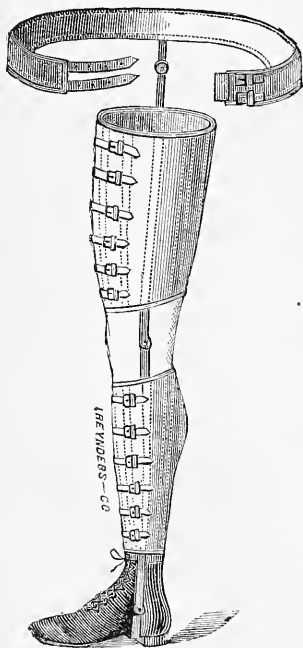

Arched Frame for Protection of Stumps.

II. INSTRUMENTS FOR LITHOTRITY.

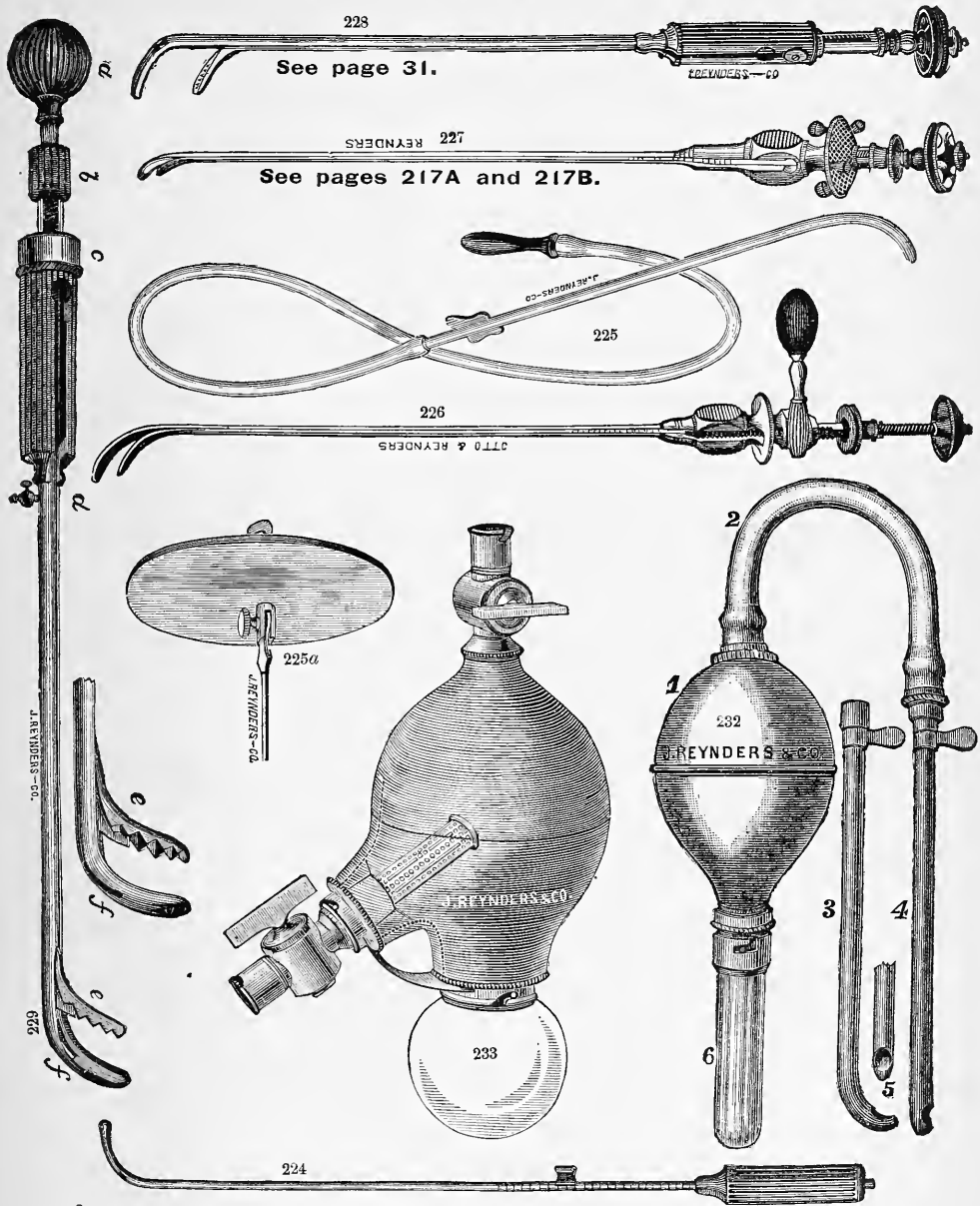

223.	Stone Searcher, solid.....	\$2.00
224. *	“ “ Thompson’s, adult’s or child’s.....	4.00
225. *	“ “ Andrew’s.....	2.50
225a. *	Resounding Plate, adaptable to any stone searcher.....	1.50
226. *	Lithotrite, Fergusson’s.....	25.00
227. *	“ Civiale’s.....	25.00
228. *	“ Thompson’s.....	35.00
229. *	“ Bigelow’s.....	40.00
230.	“ Keyes’.....	
231.	See also Index for Allen’s Pump.	
232. *	Evacuator, Bigelow’s original.....	10.00
233. *	“ “ latest.....	30.00

All Instruments illustrated are designated by a \*

II. INSTRUMENTS FOR LITHOTOMY.

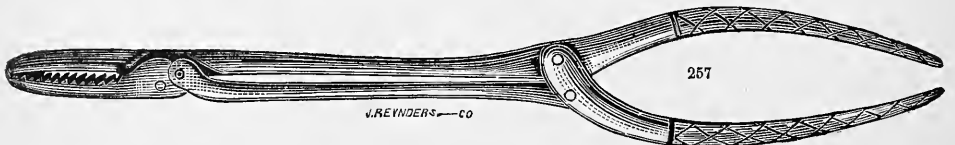
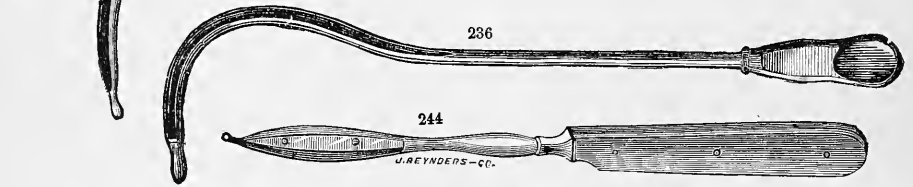
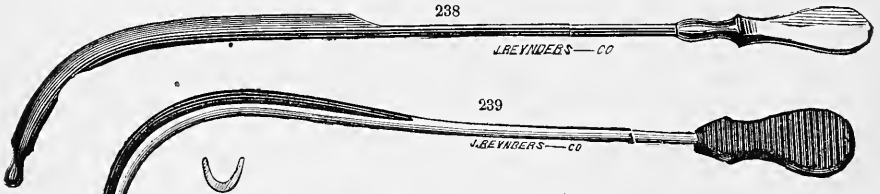
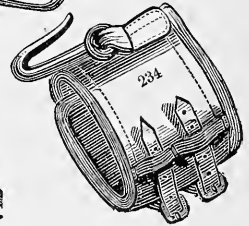
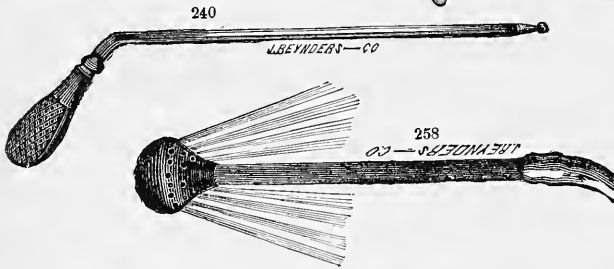
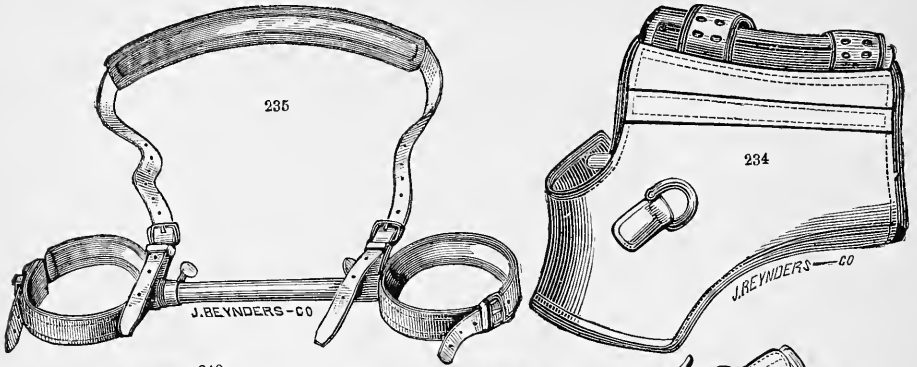

II. INSTRUMENTS FOR LITHOTOMY.

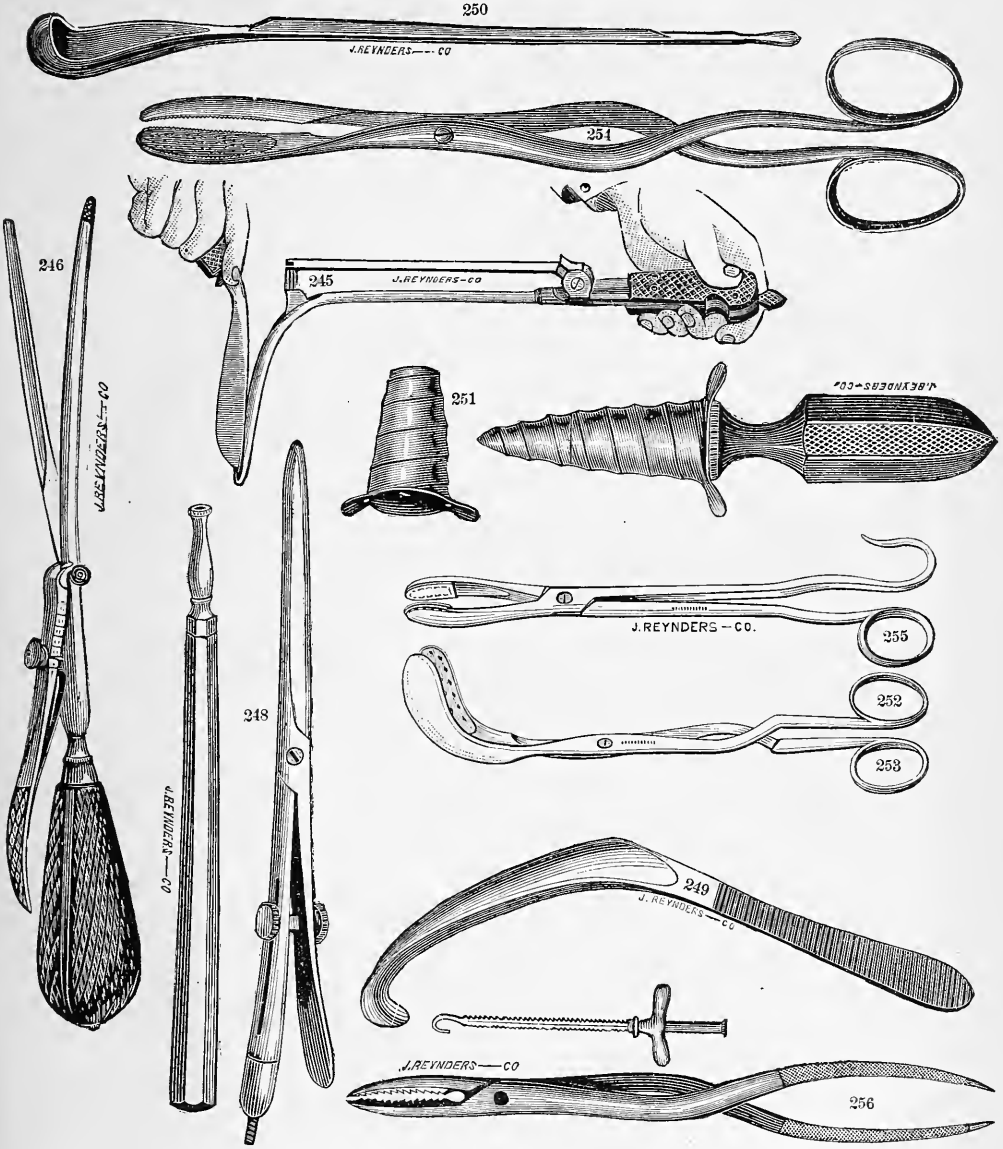

234.*	Anklets and Wristlets, Pritchard's	\$6.00 to \$8.00
235.*	Apparatus for holding apart the lower extremities.....	16.00
236.*	Lithotomy Staff, median.....	2.00
237.	“ lateral.....	2.00
238.*	“ Markoe's.....	2.00
239.*	“ Little's.....	2.00
240.*	“ Director, Little's.....	1.50
241.*	“ Knife, broad.....	2.00
242.*	“ narrow.....	2.00
243.*	“ Little's.....	2.00
244.*	Bisector, Wood's.....	4.50
245.*	Lithotome, N. R. Smith's.....	12.00
246.*	“ caché, Cosmé Frère.....	8.00
247.	“ Dupuytren's.....	16.00
248.*	Artery Forceps, Gross', for deep seated arteries.....	\$3.50

249.*	Gorget, hooked.....	\$3.00
250.*	Scoop Director.....	2.50
251.*	Luer's Instrument for Dilating the Incision.....	3.50
252.*	Lithotomy Forceps, small bladed, upward curve, 7¼ inches.....	3.00
253.*	Lithotomy Forceps, larger bladed, 7½ inches, upward curved.....	3.00
254.*	Lithotomy Forceps, long, slender, slightly curved, 9¼ inches.....	3.00
255.*	Lithotomy Forceps, jaw chamois 8 inches.....	3.00
256.*	Lithoclast.....	6.00
257.*	“ Gouley's.....	6.00
258.*	H. R. Tube for Washing out Debris.....	2.00
259.	Canula à Chemise.....	2.50

All Instruments illustrated are designated by a \*





**II. INSTRUMENTS FOR TRACHEOTOMY.**

260.* Scalpel, sharp-pointed .....	\$1.50
261.* " " probepointed .....	1.50
262. Long slender Knife, sharp-pointed .....	1.50
263. " " " probepointed .....	1.50
264.* Tracheotome, Langenbeck's .....	4.00
265.* " " Pitha's .....	4.50
265a.* " " Hank's, with tube .....	9.00
266.* Sharp-hooked Forceps, Esmarch's .....	\$1.50; with catch 2.50
267.* Retractors, round blunt .....	per pair 3.00
268.* " " flat, " .....	" 3.00
269.* " " Luer's .....	each 0.75
270.* " " Rose's .....	" 1.50
271.* " " Bose's .....	" 1.25
272.* " " Wells' .....	2.00
273.* Sharp Hook, right, Bose's .....	1.25
274.* " " left, " .....	1.25
275.* " " straight .....	1.25
276.* Blunt " .....	1.25
277.* Trachea Dilator, Elsberg's .....	5.00
278.* " " v. Roth's .....	2.00
279.* " " Luer's .....	2.00
280.* " " Lefferts' .....	2.50
281.* " " Hutchison's .....	2.50
281a.* " " Trousseau's .....	2.50
282.* Canula, double, h. r., five sizes .....	@ 2.50
283. " " single, G. s. plated .....	3.00
284.* " " double, G. s. " latest style .....	4.50
285.* " " silver, latest style .....	\$6.50; aluminum @ 4.00
286.* " " " Durham's, with Obdurator, five sizes, @ \$14.00; 16.00; 18.00; 21.00; 23.00	
288.* Forceps, Meunier's, for removing false membranes .....	\$3.50 and 5.00
289.* " " Gross' .....	3.50
290.* Tracheal Mirror, Czermak's .....	1.50

**Tracheotomy Case No. 1**, contains: 3 fine ivory handled Scalpels; ebony handled Scalpel, heavy; 2 button end Bistouries, heavy; Tenaculum heavy; 2 Retractors; 2 Retractors, extra light; Meunier's Trachea Forceps; Lefferts' Trachea Dilating Forceps; Trachea Tube Forceps, sharp hooked Forceps, Esmarch's; 2 Tube Brushes; 3 h. r. Trachea Tubes; von Roth's Trachea Forceps. In fine morocco case. Price \$44.00  
The same with silver Trachea Tubes. " 58.00

**Tracheotomy Case No. 2**, Dr. G. M. Lefferts. Complete for all external operations on the throat. (Laryngotomy, Thyrotomy, etc., etc.), contains: 2 Scalpels of ass. sizes; straight probe-pointed Bistoury; Finger Knife or straight sharp pointed Bistoury; Tenaculum; Curette; 2 Retractors; 3 hard rubber Trachea Canulae of diff. sizes; Artery Forceps, fenestrated with spring-catch; Artery Forceps, plain; Torsion Forceps; Meunier's Forceps; v. Roth's Trachea Dilator; Trousseau's Trachea Dilator; Sands' Needle Holder; Director with Tongue Tie; Scissors, straight; Scissors, curved on the flat; Scissors, angular curved; Needles; Silk; Wax; and Tapes. Price \$59.00

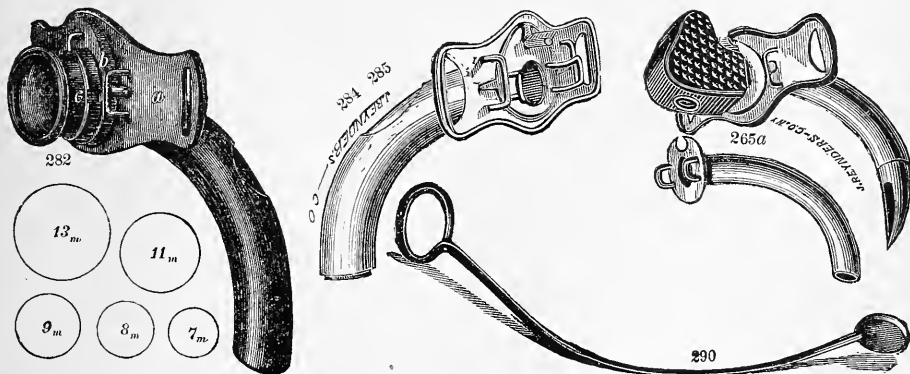

All Instruments illustrated are designated by a \*

## A NEW INSTRUMENT FOR TRACHEOTOMY.

By EDGAR HOLDEN, M.D.,

NEWARK, N. J.

This instrument was designed to add to our resources for relief in occlusion of the larynx, and possibly to take the place of tracheotomy and intubation in some cases, particularly where interference must be immediate. The drawings submitted are of the full size of the instrument.

It consists, 1st, of a curved pair of smooth blades about one inch in length, and one-sixth to one-eighth in width, fringed at the base with flaring lower ends and lever-like projections; 2d, of a handle with curved, trocar-like point, on which the blades fit for introduction.

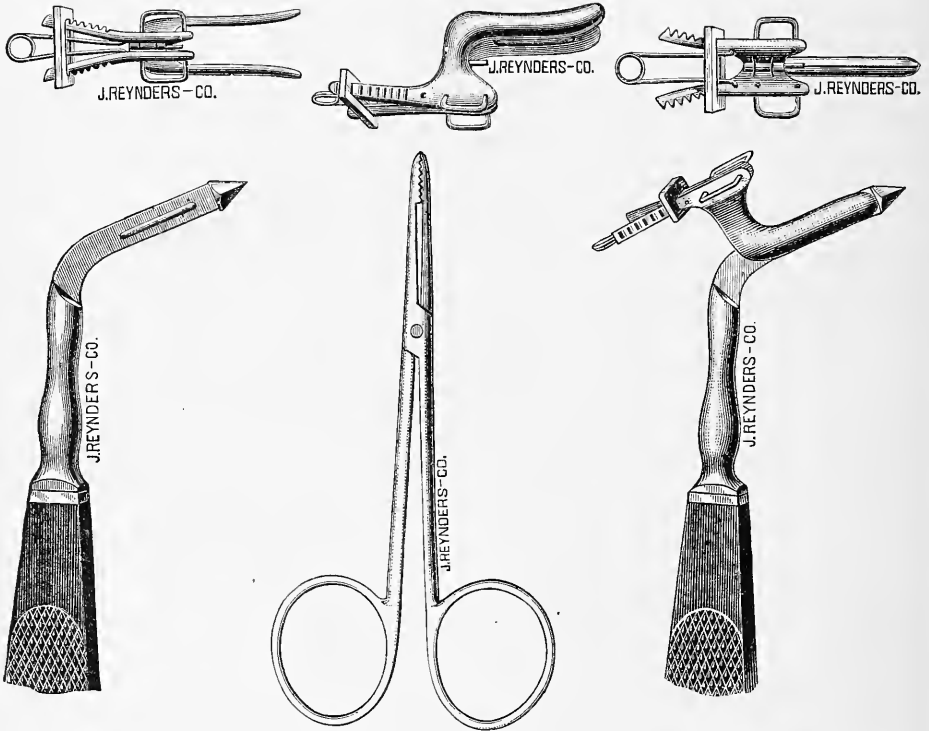

The perforation is made through the crico-thyroid space, the hinged blades (or divulsor) are detached, the trocar withdrawn and the closed blades slipped upward between the vocal cords, separated and held apart by a perforated bar, which drops or can be pressed downward for the purpose. The operation can be almost instantaneous, almost bloodless, and the instrument withdrawn and replaced at will.

The opening into the air-passages is but two lines in width, and is closed by the divulsor. The parts remaining outside permit a view of the edges of the wound.

The drawings will perhaps explain the device without further description.

It is, perhaps, not applicable to infants, in whom the crico-thyroid space has not developed so as to be readily felt by the finger.

Price, in neat morocco case..... \$18.00

INTUBATION OF THE LARYNX.

According to the method of

DR. JOSEPH O'DWYER.

The set of instruments for this operation consists of Introducer and six Laryngeal Tubes (Fig. 1), Denhardt's Gag (Fig. 2), Extractor (Fig. 3), Scale (Fig. 4).

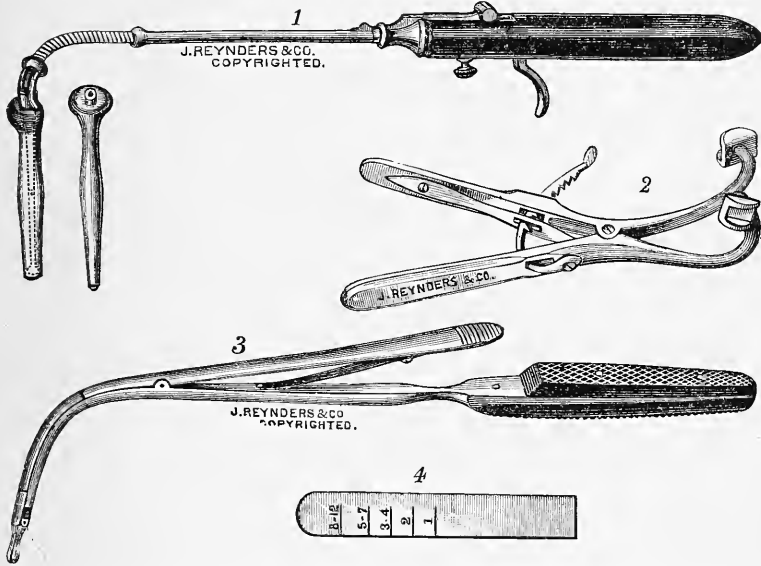

The numbers on the scale (Fig. 4) indicate the years for which the corresponding tubes are suitable. For instance, the smallest tube when applied to the scale will reach to the first line, marked 1, and is intended to be used up to the age of twelve or fifteen months; the size marked 2 is suitable for the next year, 3 and 4 for these years, and so on. When the proper tube is selected for the case to be operated on, a fine thread is passed through the small hole near its anterior angle, and left long enough to hang out of the mouth, its object being to remove the tube should it be found to have passed into the œsophagus instead of the larynx.

The Obturator is then screwed tightly to the Introducer, to prevent the possibility of its rotating while being inserted and passing into the tube; the groove in the upper extremity of the Obturator being made to correspond to the small hole in the tube intended for the string.

The following is the *method of introducing the tube*, which is done without the use of an anæsthetic. The child is held upright in the arms of a nurse, and the Speculum (Fig. 2) inserted in the left angle of the mouth, well back between the teeth, and opened widely; an assistant holds the head, thrown somewhat backward, while the operator inserts the index finger of the left hand to elevate the epiglottis and direct the tube into the larynx.

The handle of the Introducer (Fig. 1) is held close to the patient's chest in the beginning of the operation, and rapidly elevated as the tube approaches the glottis. The tube is then pushed downwards, without using much force. It is then detached. The joint in the shank of Obturator is for the purpose of facilitating this part of the operation. As soon as the Introducer is removed, and it is ascertained that the tube is in the larynx, the thread is withdrawn, but at the same time the finger is kept in contact with the tube to prevent its being also withdrawn.

It is important that the attempt at introduction be made quickly, as respiration is practically suspended from the time that the finger enters the larynx until the Introducer is removed. It is therefore, under the circumstances, much safer to make several abortive attempts than one prolonged effort, even if successful.

For the purpose of removal the patient is held in a similar position, except that the head is not inclined backwards, or very slightly so, and the Extractor passed into the tube guided by the index finger of the left hand, which also fixes the epiglottis, and is brought in contact with the head of the tube. Firm pressure with the thumb is then made on the lever above the handle while the tube is being withdrawn. If secondary dyspœa supervenes at any time, the tube should be removed and a larger one substituted. If the case progresses favorably the tube should be removed on about the fifth day.

To avoid accidents it is very essential to have some preliminary practice on the cadaver, particularly in extracting, which is the more difficult operation, owing to the aperture of the tube being so much smaller than that of the larynx.

Price per set, in fine morocco case .....\$30.00

Dr. Waxham's modification of above, consisting of O'Dwyer's Introducer, Extractor, Gauge, and Waxham's Gag, Trachea Forceps, Respirator, Tubes (5), with Epiglottis and Intubators, in case ..... 36.00

III. POCKET CASE INSTRUMENTS.

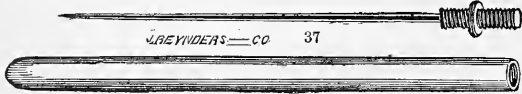
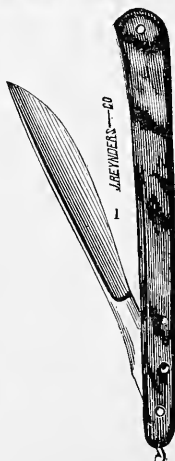
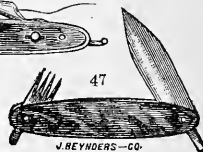
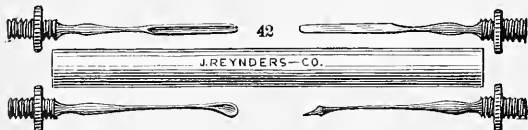
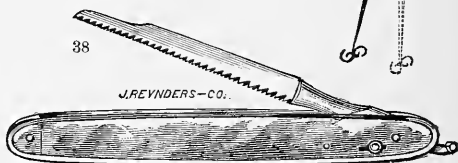
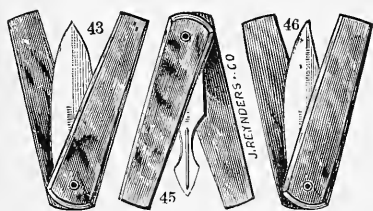
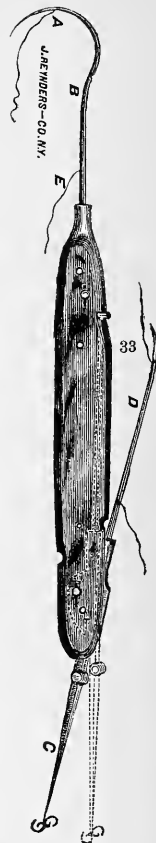
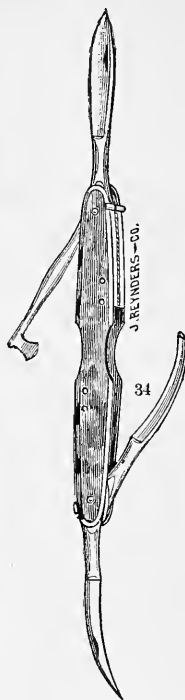

**III. POCKET CASE INSTRUMENTS.**

Scalpels ; Bistouries and Tenotomes, straight and curved, sharp and probe pointed ; Finger Knives ; Gum Lancets ; Tenacula ; Aneurism Needles ; Exploring Needles ; Post's Needle ; Buck's Needle ; Exploring Needle ; Hernia Knife ; Syme's Knife, Hollow Needle for wire, etc. ; any of these—

In h. r. handle, without catch, 75 cts. ; h. r. baked on, resembling figures on page 10, but small enough for pocket cases.....each \$1.25  
 " shell " " " ..... 1.00  
 " " " with slide-catch ..... 1.50  
 Spring Backs, single ..... 2.00

16.* Scalpel and Tenotome .....	}	In shell handles, without catches .....each 1.50		
17.* " " Finger Knife.....				
18. " " Bistoury, curved, sharp-pointed.....				
19. " " " " probe-pointed.....				
20. " " Exploring Needle.....				
21.* Bistouries, curved, sharp and probe-pointed .....				
22. " " " and Tenotome.....				
23. " " " Tenaculum.....				
24. Tenaculum and Tenotome .....			}	In shell handles, with slide-catch ..... 2.50
25. " " Aneurism Needle.....				
26.* " " Gum Lancet.....	}	In shell handles, with spring backs..... 3.00		
27. Finger Knife and Hernia Knife.....				
28. Post's and Buck's Needles .....				
29.* Tenotomes, sharp and blunt.....	}	In G. S. separating aseptic handles ..... 3.00		
30.* " Sayre's.....				
31. Two Scalpels, different sizes.....				

Any other combination of two blades supplied at the same prices.

32.* Sets of ten blades, with two adjustable handles.....	12.00
33.* Combination Instrument, Cleborne's, consisting of Tenaculum, two Hollow Wire Needles and Wire Twister.....	7.00
34.* Fourbladed Pocket Case Instrument, any combination of blades, with spring catch	each 6.00
35. Syme's Knife and Gum Lancet, in form of pocket knife .....	2.00
36.* Seaton Needle, in shell handle.....	1.50
37.* Exploring Needle.....	0.75
38.* Finger Saw, in shell handle, with slide catch.....	2.00
38a.* Hollow Needle for wire, new improved.....	2.00
39. Wire Twister (see No. 44, page 6) .....	1.75
40.* Gross' Foreign Body Instrument for ear.....	1.00
41.* " " " " " " .....	1.00
42.* " " " " " eye, any two instruments to one handle.....	2.50
43.* Lancet, Thumb, h. r. sides \$0.50; shell sides .....	0.60
44. " " Evans' genuine .....	1.00
45.* " spearpointed, vaccinating, shell sides.....	0.75
46.* " Abscess, shell sides .....	1.00
47.* " Vaccinating, with comb, shell sides .....	1.00
48.* Splinter Forceps.....	1.00

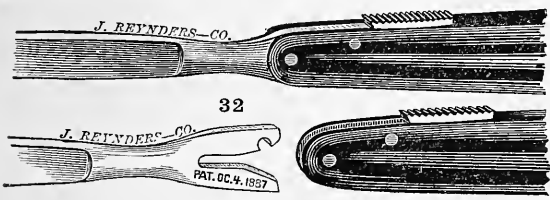

The annexed figures show the mode of adjustment of our No. 32 Set of 10 Blades and 2 Handles; the same are further illustrated on page 48.

Handles.....each \$1.00  
 Blades..... " 1.00

All Instruments illustrated are designated by a \*



III. POCKET CASE INSTRUMENTS.

53.*	Forceps, Polypus Dressing.....	\$1.25
54.*	“ “ “ with catch .....	2.00
55.*	“ Combination: Needle holding, Polypus Dressing, Torsion, Artery, Phymosis, Harelip and Vulsellum with adjustable blades.....	5.50
56.*	Scissors, straight, one point blunt, one sharp, 3¼ and 4½ inches.....	each 1.00
57.*	“ “ “ both points blunt, “ “ “ “ .....	1.00
58.*	“ “ “ “ sharp “ “ “ “ .....	1.00
59.	“ “ “ either of above 5 inches.....	1.25
60.*	“ “ curved on flat.....	1.50
61.*	“ “ laterally angular.....	1.50
62.	Catheters, Combination, male and female, in 3 parts.....	plated \$1.50; silver 2.50
63.	“ “ “ “ “ “ 4 “ .....	“ 1.75; “ 3.00
64.*	“ Parker's Combination .....	“ 2.00; “ 4.00
65.	“ Same, with protecting cap over caustic holder.....	“ 3.00; “ 5.00
66.	“ male and female, with French joint .....	“ 3.50; “ 5.50
67.	“ female.....	“ 0.50; “ 1.00
68.*	“ “ new model telescopic .....	2.50
69.	Caustic Holder, h. r.....	@ \$0.50, \$0.60, 0.75
70.*	“ “ “ silver burner.....	2.00; “ 1.25
71.*	“ “ “ with platinum burner .....	3.00
72.*	“ “ metal .....	plated \$1.00; silver 1.50
73.*	“ “ silver, heavy .....	2.50
74.*	“ “ aluminum and platinum .....	5.00
75.*	“ “ new self-holding, all silver .....	6.00
76.*	“ “ Byford's.....	silver \$2.00; platinum 3.00
77.*	“ “ with exploring trocar.....	5.50
78.*	“ “ “ “ needle.....	4.00
79.	“ “ h. r., with trocar.....	3.00

The following named Instruments marked with a \* are illustrated on the next page.

80.*	Trocar, Exploring, silver.....	1.50
81.	Small aspirating bulb for same .....	1.00
82.*	Director, with Tongue Tie.....	steel \$0.60; pure silver 1.25
83.*	“ “ Scoop.....	“ 0.75; “ 1.50
84.*	“ “ Aneurism Needle, steel.....	0.75
85.*	“ “ Hunter's, steel .....	0.75
86.*	Spatula, with Elevator .....	1.00
87.*	“ “ Scoop .....	0.75
88.*	“ “ Tongue Tie.....	0.75
89.*	Porte Mèche .....	0.40
90.*	Probes, A and B.....	per pair, plated \$0.50; coin silver \$0.75; pure silver 1.00
91.*	“ C, two parts, screwing together, silver.....	1.25
91a.	Probe and Director, “ .....	1.25
92.*	“ F, very delicate, silver.....	0.50
93.*	“ Set of C, D, E, .....	2.50
94.*	“ “ same without the eyed Probe (Hamilton's set).....	2.00
95.	Probes, whalebone.....	each 0.25
96.*	Tweezer and Ear-spoon combined.....	0.75
97.	Fulcrum and Tenaculum, Helmuth's.....	1.25
98.	Uterine Sound, in two parts, Helmuth's .....	2.00
99.	Pocket Cases, empty, two-fold.....	plain \$2.00; fine 2.75
100.	“ “ “ three- “ .....	“ 2.75; “ 3.25
101.	“ “ “ four- “ .....	“ 3.50; “ 4.50
102.	“ “ “ Russia.....	\$3.00 to 4.00
103.	“ “ “ Morocco.....	3.00 to 4.00
104.	“ “ “ Alligator.....	3.00 to 5.00
105.	“ “ “ Sealskin.....	3.00 to 5.00

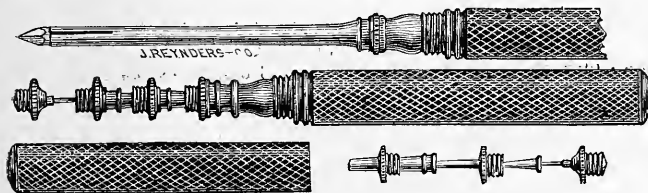

7. New Set of four Trocars, in cylindric chased metal case. This trocar is a great improvement on No. 7, page 49. Being entirely of metal, it is more compact and more durable....\$7.00

All Instruments illustrated are designated by a \*

III. POCKET CASE INSTRUMENTS.

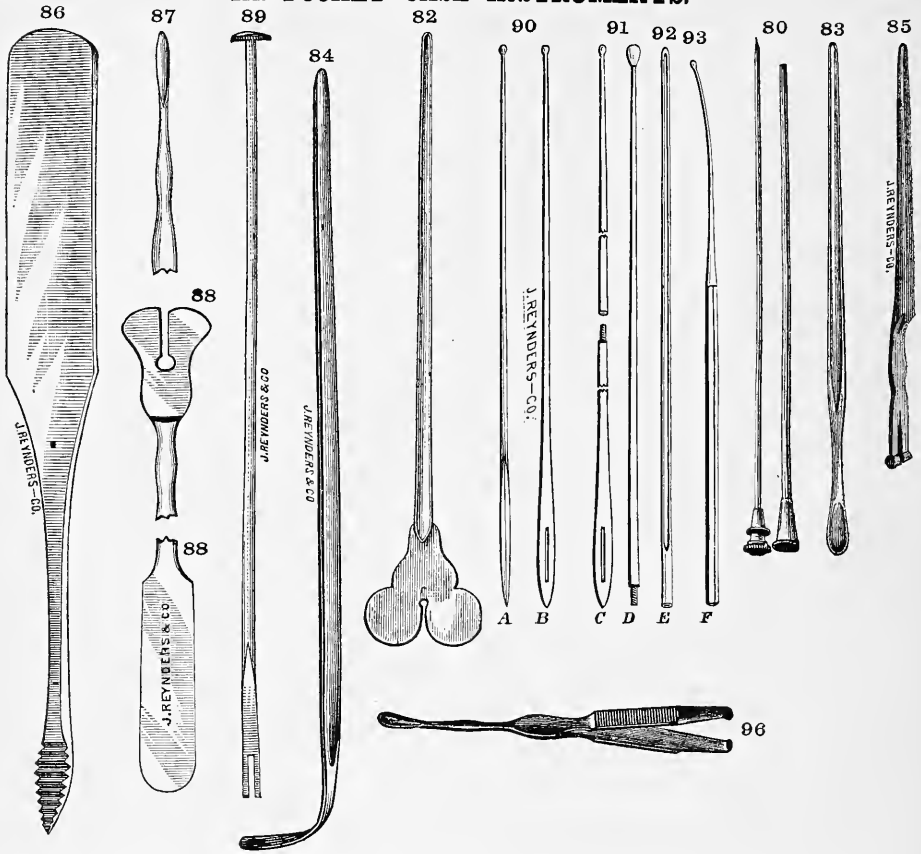

POCKET CASES.

- No. 1,** Twofold, contains: Scalpel; probept. curved Bistoury; Tenaculum; straight Scissors; Artery Forceps; Spatula; male and female comb. Catheter; Director; pair silver Probes; Needles and Ligature Silk. Instruments, single and without catches, hard rubber handles, in a morocco case..... Price \$11.00
- No. 2,** Twofold, contains: Scalpel; sharppt. and probept. curved Bistoury; Tenaculum; plain Artery Forceps; straight Scissors; ebony Porte Caustic silver holder; comb. male and female Catheter; steel Director and Tongue-Tie; pair plated Probes; Needles and Ligature Silk. In a plain morocco velvet lined case. Instruments with hard rubber handles..... Price \$12.50
- The same in a fine morocco case, instruments with shell handles, Probes silver, " 13.50
- No. 3,** Threefold, contains: Scalpel; probept. and sharppt. Bistoury; Tenaculum; Thumb Lancet; Polypus Dressing Forceps; plain Artery Forceps; straight Scissors; Scissors, curved, flat or angular bent; Spatula and Elevator; screw male and female Catheter; pair Probes; steel Director and Tongue-Tie; Needles and Ligature Silk. Instruments single, in hard rubber handles; morocco, velvet lined case. .... Price \$15.00
- The same in a fine morocco case, instruments in shell handles..... " 16.50
- No. 4,** Fourfold, contains: Scalpel; probept. and sharppt. curved Bistoury; Finger Knife; Gum Lancet; Tenaculum; Thumb Lancet; straight Scissors; Scissors either curved on flat or angular; Polypus Dressing Forceps; plain Artery Forceps; plain Needle Holder; h. r. Caustic Holder; screw male and female Catheter; Spatula and Elevator; steel Director and Tongue-Tie; pair Probes; Needles and Ligature Silk. In a morocco case, velvet lined, instruments single in hard rubber handles..... Price \$18.00
- The same in a fine morocco case, instruments in tortoise shell handles. .... " 20.00



III. POCKET CASES.

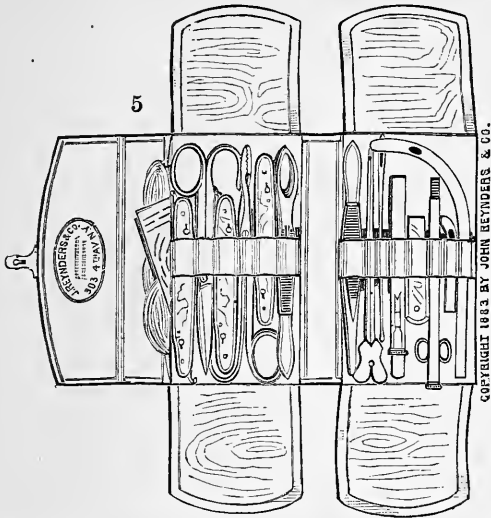

No. 5,\* H. B. Sands', contains: Scalpel and probept. curved Bistoury; Tenotome and sharppt. Bistoury; Tenaculum and Aneurism Needle; Liston's Artery Forceps; Caustic Holder; Thumb Lancet; Plain Artery Forceps; Dressing Forceps; Straight Scissors; Director and Tongue-Tie; male and female Catheter; Eyed Probe; Needles and Silk. Twofold case, size 5x2 $\frac{1}{2}$ x $\frac{1}{2}$  inches.....Price \$20.00

No. 6, Sayre's, contains: Sayre's straight and convex edge Tenotomes; Tenaculum and sharppt. Bistoury; Scalpel and probept. Bistoury; Finger Knife (single); plain Artery Forceps; straight Scissors; Director and Tongue-Tie; pair silver Probes; male and female silver Catheter (3 parts); silver Porte Caustic; Needles and Ligature Silk twofold case, size 5x2x1 inches.....Price \$23.50

No. 7,\* Hamilton's, contains: Scalpel and Exploring Needle; sharppt. and probept. Bistoury; Tenaculum and Aneurism Needle; sharp and blunt Tenotome; Metacarpal Saw (single); Thumb Lancet; Hamilton's Bull Dog Artery Forceps; plain Artery Forceps; plated Male and Female Screw Catheter with silver Porte Caustic; straight Scissors; set Hamilton's Probes (see III 94); 2 Whalebone Probes; Needles and Ligature Silk. *Russia Leather, threefold case, size 4 $\frac{1}{2}$ x2 $\frac{1}{2}$ x1 $\frac{1}{2}$  inches.*

Price \$25.00

The same in Genuine Morocco case and containing instead of Hamilton's Probes (see III 94) a pair of silver Probes and Steel Director with Tongue-Tie.

Price \$24.00

With silver Catheter and Porte Caustic \$2.00 additional in each case.

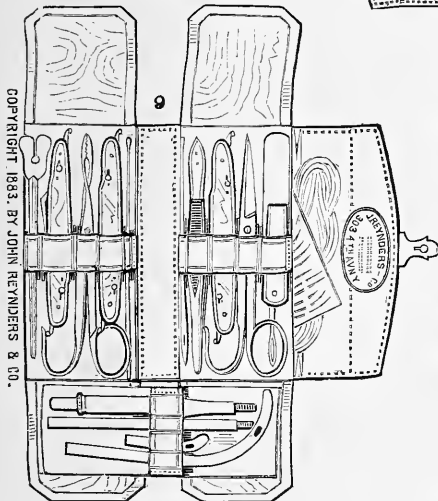
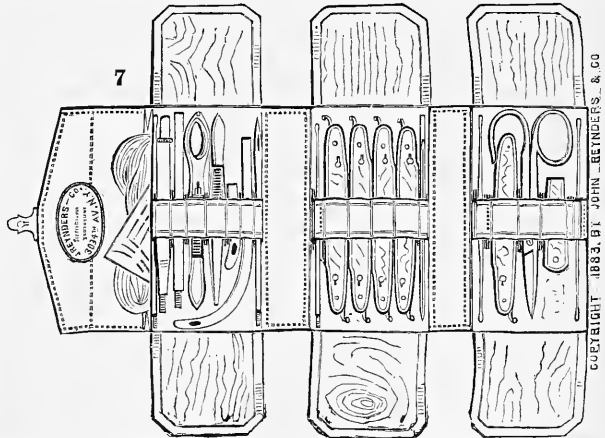

No. 8, Parker's, contains: sharppt. and probept. curved Bistoury; Scalpel and Tenotome; Gum Lancet and Tenaculum; Spatula with Scoop; Thumb Lancet or Exploring Needle; plain Artery Forceps; straight Scissors; plated Male and Female Catheter with porte-caustic; Director with Tongue-Tie; pair silver Probes; Needles and Ligature Silk. Case, two-fold, size 5x2x1 inches. Price \$15.00

The same with Catheters and Porte-caustic of silver.....Price \$17.00

The above with double instruments without catches.....\$12.00 and \$14.00 respectively.

No. 9,\* Parker's (fine) contains: Polypus Dressing Forceps in addition to the above instruments, extra-fine finished, size 5x2x1 inches.

Price \$20.00

The same with silver Catheter..... " 22.00

III. POCKET CASES.

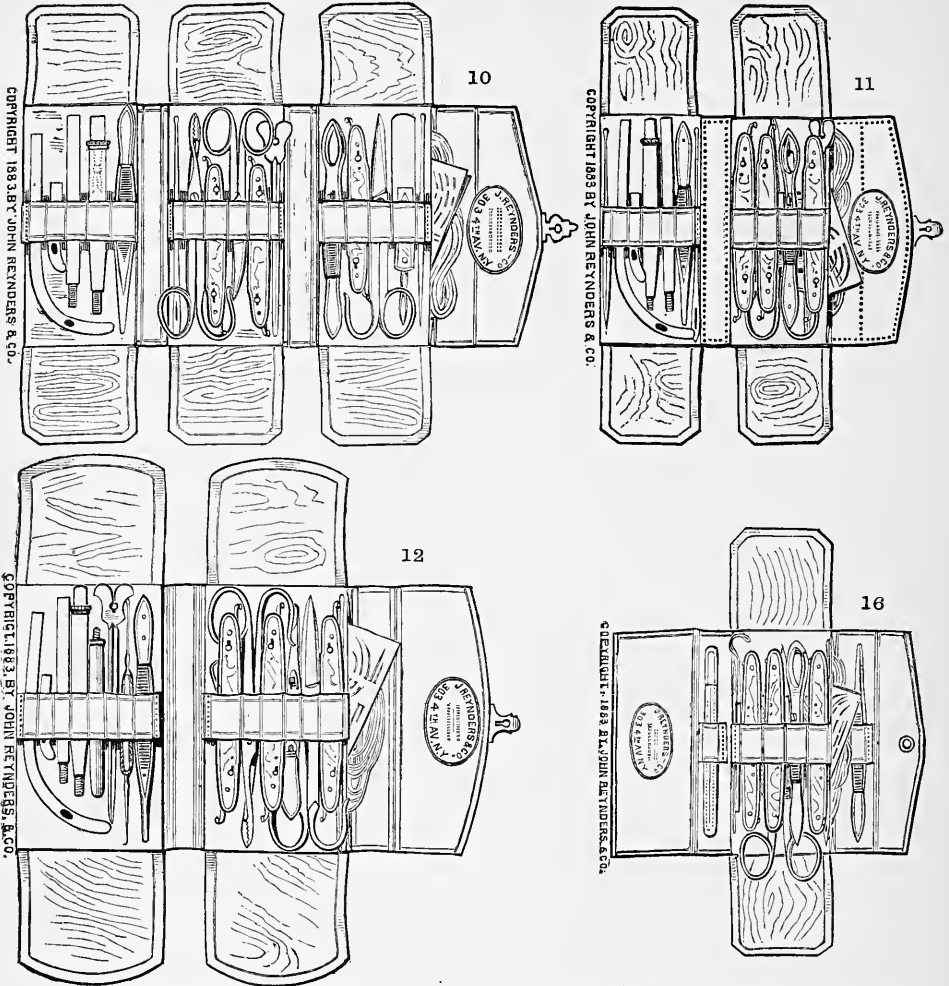

No. 10,\* Parker's, threefold, contains the instruments of No. 8, with addition of Polypus Dressing Forceps, Scissors, curved on the flat, instead of straight Scissors and fenestrated Artery Forceps. Size  $5 \times 2\frac{1}{4} \times 1\frac{1}{2}$ ..... Price \$22.00 and \$24.00 respectively.

No. 11,\* Van Buren's, contains: Sharppt. and probept. Bistoury; Scalpel and Tenotome; Gum Lancet and Tenaculum; Fenestrated Artery Forceps; straight Scissors; Plain Artery Forceps; Screw Director with Probe, or, pair silver Probes and Director with Tongue-Tie; plated Male and Female Catheter with Porte-caustic; Needles and ligature silk. Twofold case. Size  $5 \times 2\frac{1}{4} \times 3$ .....\$18.00  
 Same with silver comp. Catheters and silver Porte-caustic ..... 20.00  
 Same with Tortoise shell handled instruments without catches. \$15.00 and \$17.00 respectively.

Either style of case No. 11 without the fenestrated Artery Forceps \$2.00 less.

No. 12,\* Gross', contains: Scalpel and Finger Knife; sharppt. and probept. curved Bistoury; Tenotome and Tenaculum; Artery and Needle Forceps combined; Straight Scissors; Polypus and Dressing Forceps; Dissecting Forceps; Exploring Needle (single); plated Male and Female Catheter with Porte-caustic; Gross' instrument for removing foreign bodies from the ear; Director and Tongue-Tie; pair Probes; Needles and ligature silk. Case twofold. Size  $5 \times 2\frac{1}{4} \times 3$ .....Price \$20.00  
 Same with Thermometer and Hypodermic Syringe..... " 25.00

No. 16,\* Crosby's, contains: Tenotome and Exploring Needle; sharppt. curved Bistoury and Tenaculum. Scalpel and probept. curved Bistoury; Straight Scissors; Bull Dog Artery Forceps; Plain Artery Forceps; Director and Aneurism Needle; pair silver Probes; Self-registering Body Thermometer in German silver case; Needles and ligature silk. Russia leather case, spring-catch instruments. Size  $4 \times 2\frac{1}{4} \times 3$ .....\$18.00

III. POCKET CASES.

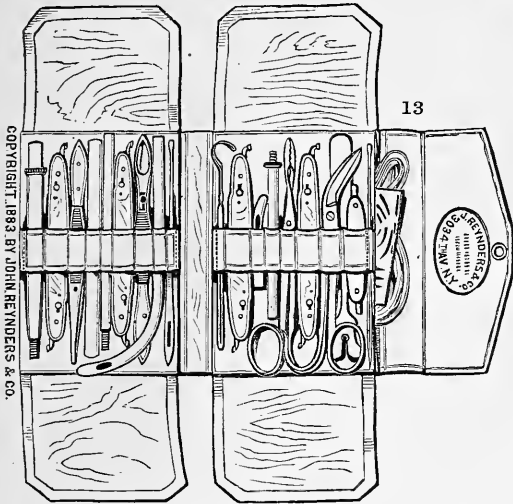

COPYRIGHT, 1893 BY JOHN REYNOLDS & CO.

No. 13,\* Jas. A. Little's, contains: Scalpel and sharp pointed curved Bistoury; Tenaculum and probe pointed curved Bistoury; Gum Lancet and Tenotome; Hernia Bistoury and Finger Knife; Angular Scissors; Polypus Dressing Forceps; Plain Artery Forceps; Vaccinating Comb and Lancet combined; Exploring Needle; Spatula with Tongue Tie; Director with Aneurism Needle; Parker's Catheter and Caustic Case; two Silver Probes; six Needles and Ligature Silk. In a two-fold, Russia leather case, silk velvet lined. Instrument slide, catch. Turtle Shell Handles. . . . . Price \$22.00  
 With Thermometer. . . . . " 25.00  
 With Thermometer and Bull Dog Artery Forceps . . . . . " 27.00  
 Case twofold. Size  $4\frac{1}{2} \times 3 \times 1$  inches.

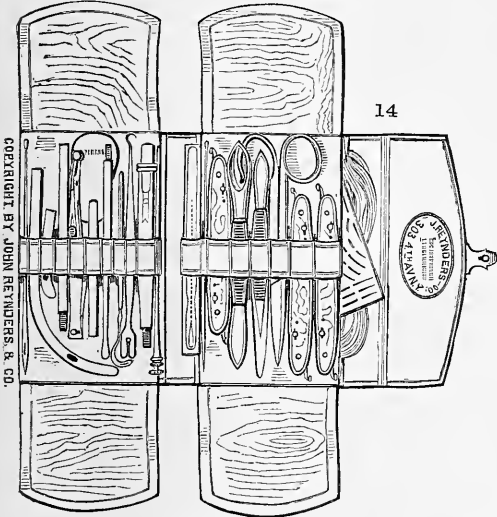

COPYRIGHT BY JOHN REYNOLDS & CO.

No. 14,\* W. T. Helmuth's, contains: Scalpel and Tenotome Knife; probept. and sharppt. curved Bistoury; Tenaculum and Aneurism Needle; Scissors; Forceps; Prout's Needle Holder; Artery Forceps; Fulcrum (wire twister and sharp hook); Screw Uterine Sound; Exploring Trocar; 2 Probes; Director; Fever Thermometer; comp. Catheter and caustic holder; Needles, Silk, etc. Size  $5 \times 2\frac{1}{4} \times \frac{1}{4}$  inches. . . . . Price \$30.00

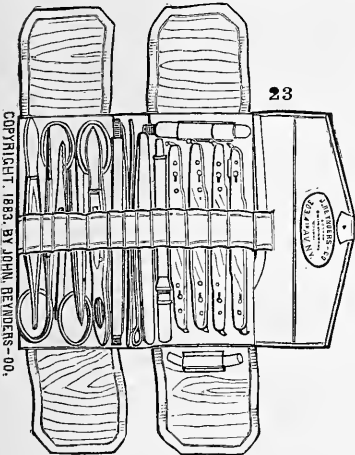

COPYRIGHT, 1893 BY JOHN REYNOLDS & CO.

No. 15, Wood's, contains: Scalpel and Gum Lancet; Scalpel and Tenotome; sharppt. and probept. curved Bistoury; Aneurism and Exploring Needles; straight Scissors; Polypus Dressing Forceps; Hamilton's Artery Forceps; plain Artery Forceps; Hamilton's Probe (see III 94); Thumb Lancet; 2 silver Probes; compound Male and Female silver Catheter and Porte-caustic; coil Silver Wire; Needles and ligature silk. Threefold case. Size  $4\frac{1}{2} \times 2\frac{1}{4} \times 1\frac{1}{2}$  inches. Price \$25.00

No. 23,\* W. W. Kean's, contains: Scalpel and Finger Knife; Bistouries curved, sharp and probepointed; Tenotome and Tenaculum; Gum Lancet and Hollow Needle; Straight Scissors; Polypus Dressing Forceps with catch; Plain Artery Forceps; Fenestrated Artery Forceps; Hypodermic Syringe; Thermometer; Instrument for foreign bodies in ear; Compound Catheter: straight branch contains Exploring Needle; Combination Director and Probes, Needles, Silk; etc. Size  $4\frac{1}{2} \times 2\frac{1}{4} \times 1\frac{1}{2}$  inches. Price \$28.00

## III. POCKET CASES.

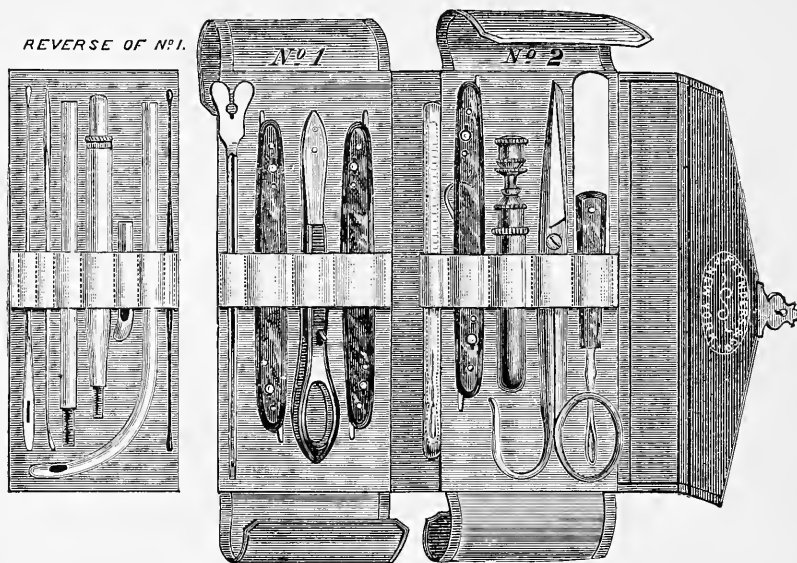

J. REYNDERS &amp; CO.'S POCKET CASE.

No. 17,\* J. Reynders & Co.'s, contains: Same as Parker's No. 8, with the addition of: Hypodermic Syringe, needle screwing in the piston; Self-registering Thermometer in a neat German silver case; Hamilton's Artery Forceps. Size  $4\frac{1}{2} \times 2 \times 1\frac{3}{8}$  inches.  
Price \$25.00 and \$27.00, respectively.

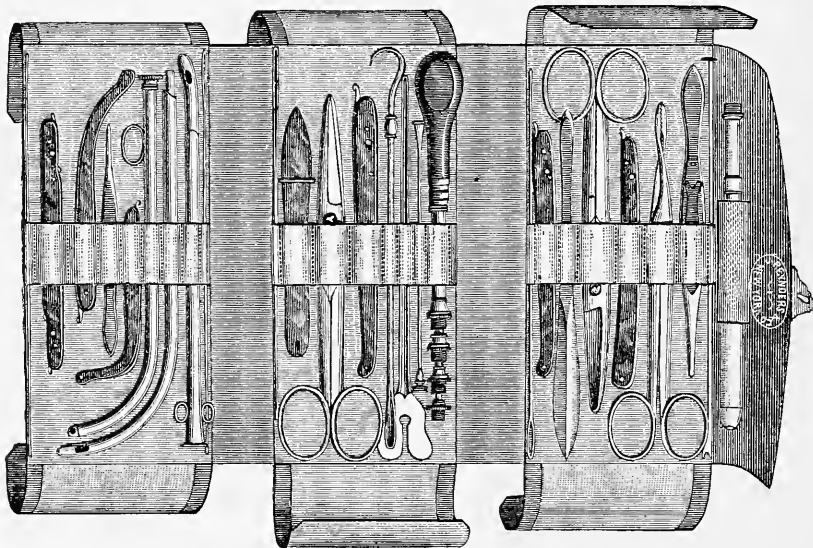

FRENCH POCKET CASE No. 18.

No. 18,\* French, threefold, contains: Silver Porte Caustic; Porte Mèche; Fricke's Artery Forceps; Dressing Forceps; straight Scissors; Spatula with Scoop; 4 silver Probes; Director; Exploring Trocar; Set of four Trocars in one handle; Double Hook with Scoop; Plated Male and Female Catheter, French joints; Plated, Belocque's Canula; Plain Artery Forceps; Tenotome and Finger Knife; Sharp pointed Bistoury; Probe-pointed Bistoury; Scalpel; Tenaculum; Gum Lancet; Seaton Needle..... Price \$45.00

III. POCKET CASES.

No. 19, Dr. J. P. Munn's, contains: Probe pointed Bistoury and Tenaculum; Hernia Bistoury and Finger Knife; Sharp pointed Bistoury and Scalpel; Exploring Needle and small Scalpel; Gum Lancet and Tenotome; Straight Eye Needle and Aneurism Needle; Straight Scissors; Spiral twist self-registering Thermometer in plated metal case; Plain Artery Forceps; Hamilton's Bulldog Artery Forceps; Sands' Needle Holder; Vaccine Comb and Lancet; Dressing Forceps; Wilde's Ear Forceps; Buck's Ear Knife; Buck's Tympanum Perforator; 2 Buck's assorted sized Ear Scoops; Silver Director with Tongue Tie; Hypodermic Syringe of glass with metal fittings; Spatula and Scoop; Pair silver Probes; Needles and Ligature Silk. Case two-fold. Size  $4\frac{1}{2} \times 3\frac{1}{2} \times 1$  inches. . . . Price \$50.00

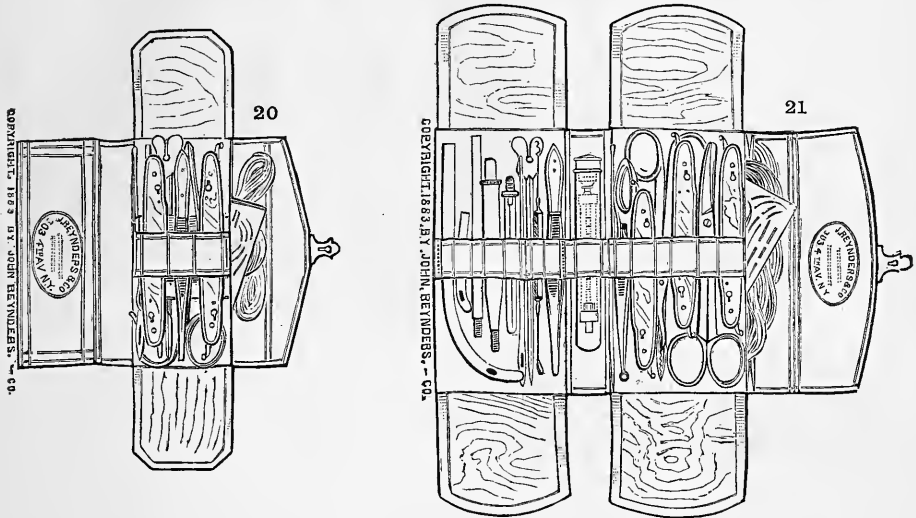

No. 20, \* Smith's, contains: Scalpel and Tenotome; Curved Bistouries, sharp and probe-pointed; Plain Artery Forceps; Scissors; Director and Tongue Tie; Probe; Needles and Silk. Case two-fold. Size  $3\frac{1}{2} \times 1\frac{1}{2} \times \frac{1}{2}$  inches.  
 Price with catch instruments. . . . . \$11.00  
 " " plain " . . . . . 9.00

No. 21, \* Standard, contains: Scalpel and Finger Knife; Curved Bistouries, sharp and probe-point; Tenotome and Tenaculum; Scissors, curved on flat; Polypus Dressing Forceps; Fenestrated Artery Forceps and Needle Holder, combined; Hypodermic Syringe; Plain Artery Forceps; Foreign body ear Instrument; Director and Tongue Tie; Exploring Needle; Male and Female Catheter plated with silver Porte Caustic; two Probes; Needles and Silk. Two-fold case. Size  $5 \times 2\frac{3}{4} \times \frac{3}{4}$ . . . . . \$25.00

No. 22, \* Esmarch's, contains: Scalpel; Finger Knife; Straight probe pointed Bistoury; Scissors; Artery Forceps, G. S. slide; Scoop; Director; Eye Needle; Probes and Lancet. All closing into two handles, held together by the Artery Forceps. It is put up in a neat morocco pocket case. Size  $3\frac{1}{2} \times \frac{1}{2}$  inches square. . . . . Price \$12.00

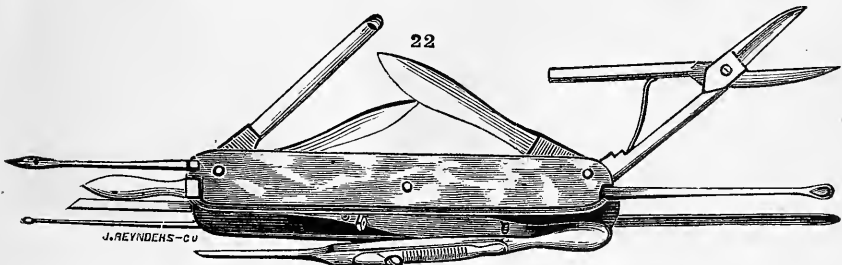

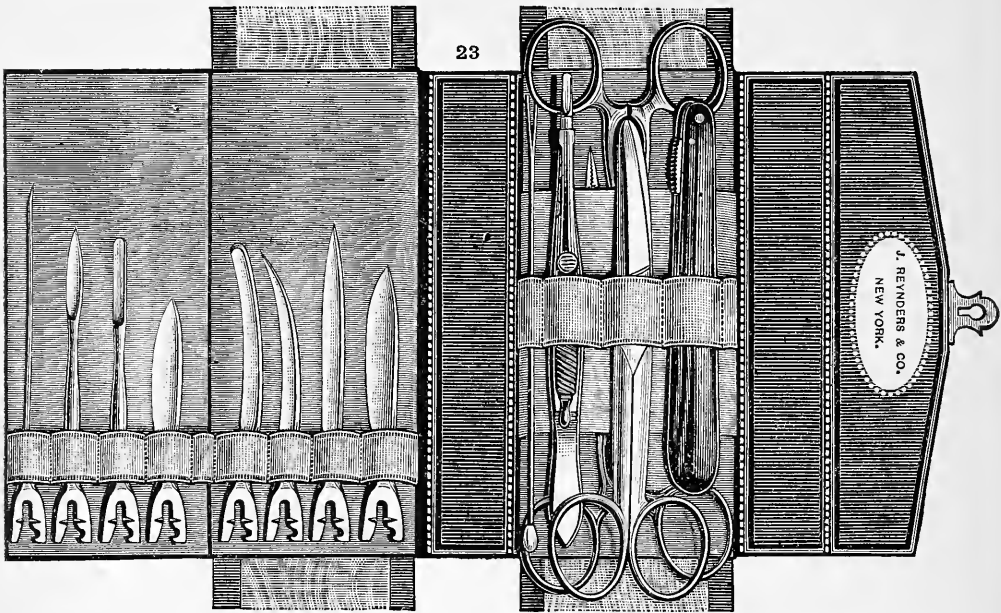

Pocket Case No. 23, "Tiffany Aseptic," contains: 2 Scalpels, Straight Bistoury, Sharp-Pointed Curved Bistoury, Blunt-Pointed Curved Bistoury, Round-Pointed Tenotome, Grooved Needle, all fitting into 3 Adjustable Hard Rubber Handles, 6 Needles, Silver Wire and Silk, Slide Catch, Needle Forceps, 2 Woods' Hæmostatic Forceps, Grooved Director, Aneurism Needle, Pair Scissors, curved or flat, 2 Silver Probes, Porte Meche, French Joint Compound Catheter. In a Handsome 3-fold Genuine Morocco Case. . . Price \$22.00

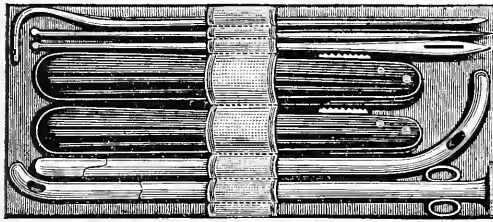

Pocket Case No. 24, "Reynders' Aseptic Vest Pocket," contains: Pair Scissors, Pair Artery and Needle Forceps, Pair Probes, Ear Scoop, Grooved Director, Needles and Silk, Adjustable Hard Rubber Handle Antiseptic, Antiseptic Scalpel, Antiseptic Gum Lancet, Antiseptic Probe-Pointed Bistoury, Antiseptic Sharp-Pointed Bistoury. All in Genuine Morocco 2-flap Case, lined with Silk Velvet. . . . . Price \$16.00

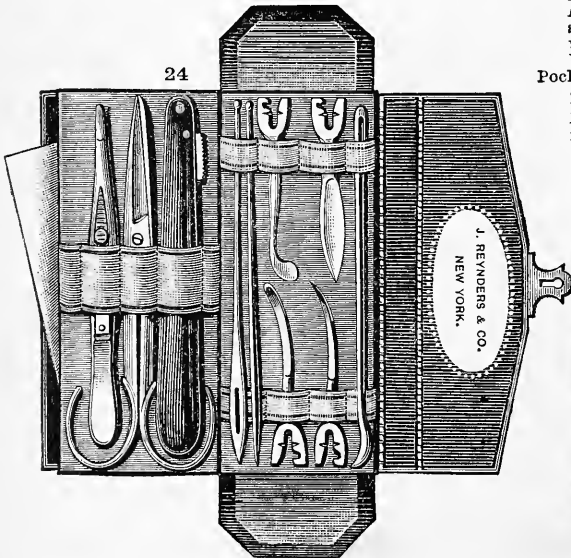

Pocket Case No. 25, "Stephen Smith's Aseptic," contains: Reynders' Patent (B) Catch, Hard Rubber Handles, for following blades: Scalpel, Probe Bistoury, Sharp Bistoury, Tenotome, Tenaculum, Gum Lancet, Scissors, Director and Aneurism Needle, Pair Silver Probes, Artery Forceps, Needles and Silk, Vial for Iodoform, Vial for Bi-chloride of Mercury. In Morocco Case (3 1/2 inches long, 2 inches wide). . . . . Price \$18.00

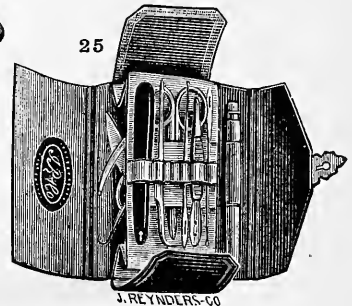

IV. TROCARS AND ASPIRATORS.

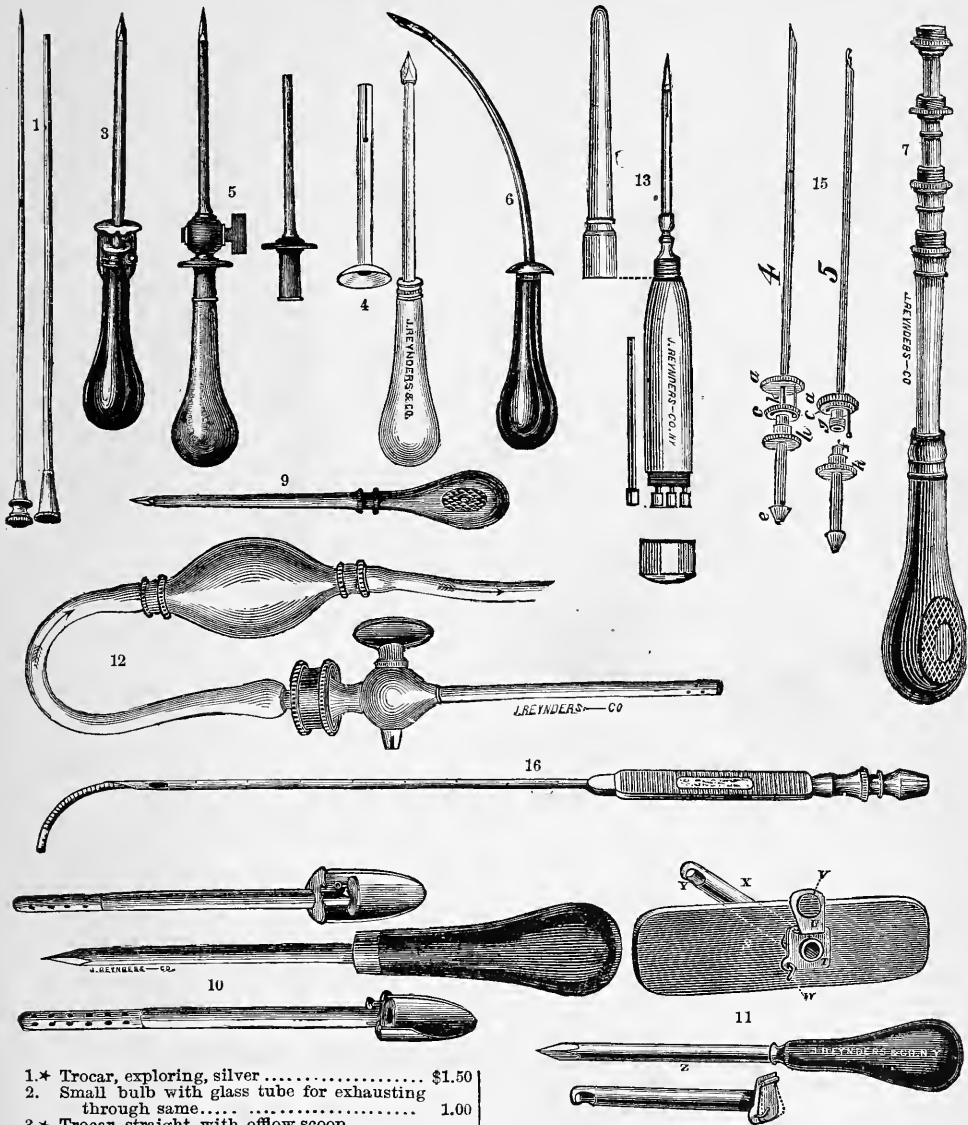

- 1.\* Trocar, exploring, silver ..... \$1.50
- 2. Small bulb with glass tube for exhausting through same..... 1.00
- 3.\* Trocar, straight, with offlow scoop, G. s. \$1.50; silver 2.00
- 4.\* " " snap canula, silver..... 2.50
- 5.\* Trocar, straight, with stop cock..... 3.50
- 6.\* " curved, G. s. \$2.50; silver..... 3.00

- 7.\* Trocar, in sets, silver..... of 3 \$5.00; of 4 \$6.00
- 8. " " of 4, in fine chased case .... 7.00
- 9.\* " with reversible stylet ..... 3.00
- 10.\* " Wood's, in case..... 5.00
- 11.\* " Phelps's, for Empyema..... 4.50

The latter No. 11 consists of a trocar (z) with a canula (a), on whose plate surrounding the outlet there is a hinged cover having as much play for movement as a little rectangular piece of wire inserted into the plate will allow; all of which is shown in a. By c it is shown how the canula is inserted into a piece of sheet soft rubber, x y is the canula, z v the cover (without the hole, shown in the figure by mistake) hinged on the plate T of the canula; w is the rectangular piece of wire, allowing the plate u w but little play for movement. The canula is inserted between the ribs to allow passage to the fluid in the pleural cavity. As the patient makes the enehaling and exhaling movements the little hinged plate moves alternately against the rectangular wire and the plate on the canula and whenever the former takes place some of the fluid passes out, which may be collected into a little rubber bag tied to the canula.

- 12.\* Paracentesis Thoracis Trocar, Flint's..... \$4.50
- 13.\* Trocar, Southey's, for Anasarca, four canulas and tubing in ivory case ..... 5.00
- 14.\* " " two sizes of trocars fitting in set screw handle, four canulas to each trocar, with attachable plate to prevent canulas from slipping in; in morocco case ..... 12.00
- 15.\* Dome Trocars, Fitch's..... 2.50
- 16.\* Pericardial Trocar, Roberts'..... 6.00

All Instruments illustrated are designated by a \*

See also bottom of page 41.

IV. TROCARS AND ASPIRATORS

(See page 52 for Special Needles and Trocars.)

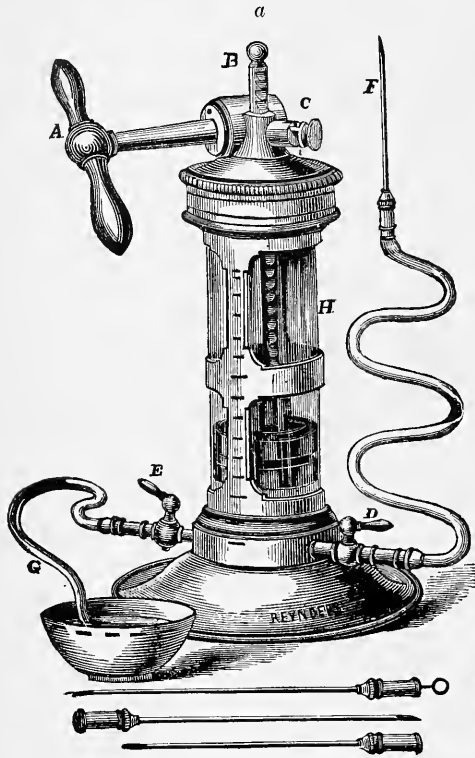

Dieulafoy's Aspirator.

Nickel-plated, with three needles and trocar in black walnut case.

- 17. Large size, slanting position..... \$60.00††
- 18. " " upright " ..... 50.00††
- 19. Small " " " ..... 40.00††

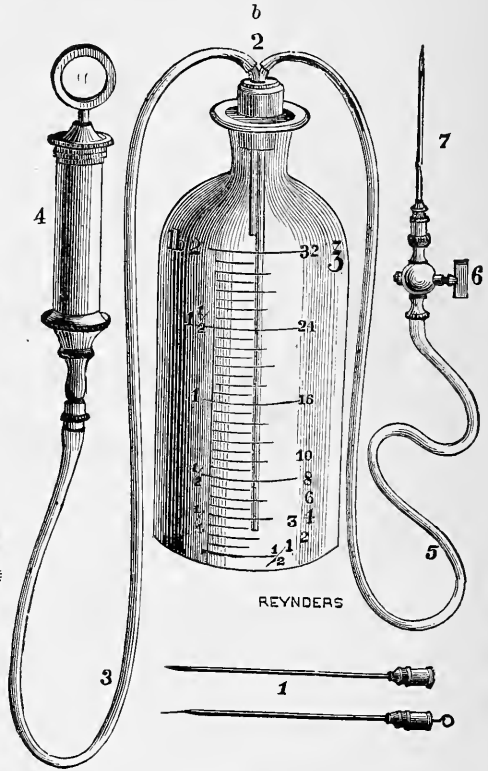

Potain's Aspirator.

- 20. Nickel-plated, with two needles and trocar in case, with aspirating pump only, with bottle ..... \$13.00
- without bottle ..... 11.50
- 21. The same, with compound pump for aspirating and injecting, with bottle..... 18.00
- without bottle ..... 16.50

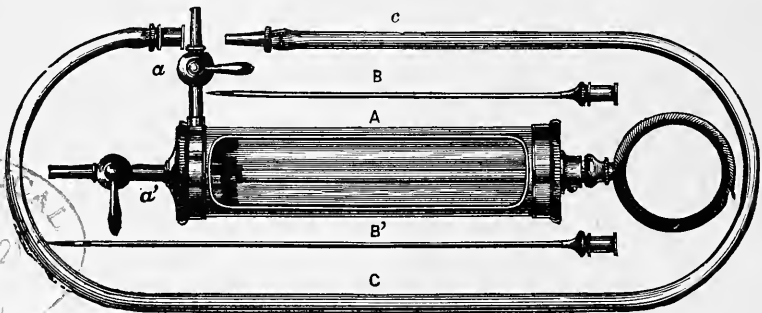

Dieulafoy's Small Aspirator.

Is now made with one three-way stopcock at the end, instead of two separate stopcocks, as shown in this figure.

- 22. Nickel-plated, with three Needles and Trocar in case.....small \$10.00; medium \$12.00; large \$15.00

For Allen's Pump See Index.

BOSTON MEDICAL LIBRARY  
MAY - 1 192



**IV. TROCARS AND ASPIRATORS.**

**24a. JOHN SMITH'S ASPIRATOR AND INJECTOR. \$15.00.**

We believe this Aspirator possesses advantages over any other in the market, and its low price places it within the reach of nearly every practitioner. It is supplied with three needles of different sizes, is nickel plated and is put up in a neat velvet-lined leather covered case. It has two automatic metal valves, one the reverse of the other, which enables the operator to quickly change it from an exhaust to a force pump, thus converting it into an injector. The valves are brass, easily cleaned and not injured by coming in contact with liquids, and as the fluid passes only through the needle, long pipe, and stop-cock, the instrument is easily cleaned

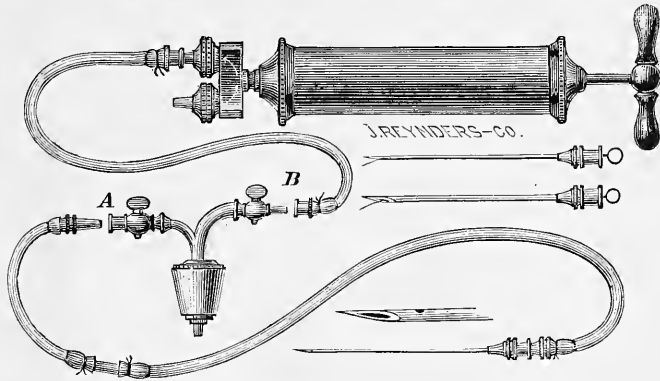

Stomach pump attachment for this Aspirator..... \$7.00

24b. Aspirator Exploring Syringe and Hypodermic combined, in handsome Leather Case, containing Syringe, holding 70 minims; Aspirator Attachment, Trocar, Canula, and two Hypodermic Needles, forming a very portable and complete instrument..... 5.00

**25. Fitch's Handy Aspirator.**

A represents the dome aspirator needle with the cutting point projected ready for puncture. G a magnified diagram of the same after insertion, with the dome advanced so as to protect the interior of the cavity during aspiration; E bulb in upright position to insure the best action of the valves; CC valves; D entrance tube; E exit tube; FF bits of glass tubing, through which to observe the passage of the fluid. Price, \$5.00.

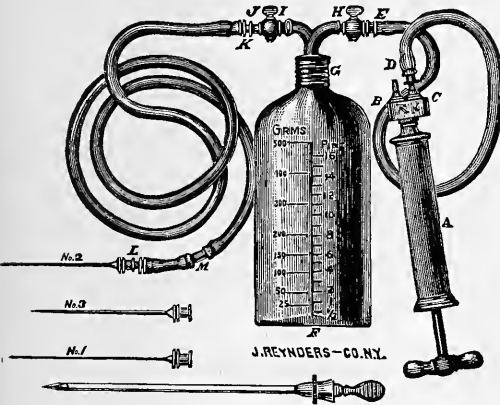
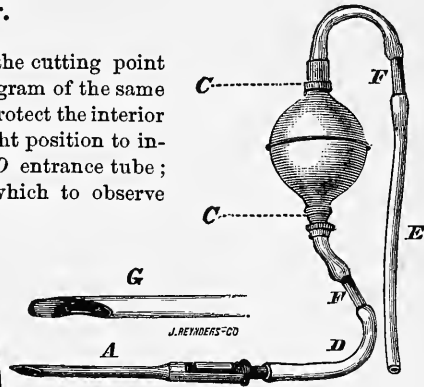

**26. J. R. & Co.'s New Screw Cap Aspirator.**

Full descriptive circular sent on application.

Prices: All metal parts nickel-plated, with three steel seamless needles of sizes 3, 6 and 8, French scale, respectively, and one plain trocar, with tubing, etc.,

in a neat black walnut case with lock and key .....\$18 00

The same, without the plain trocar, as mentioned above..... 16 00

IV. TROCARS AND ASPIRATORS.

27. Phelps' Aspirator.

This new aspirator has been devised with a view to facilitate as much as possible the operation for which it is made. It is provided with a pump with two ends, one for aspiration and the other for injection, so constructed that either can be done without any preliminary preparation other than attaching it at the proper end to accomplish what is desired of the two.

As the figure shows, three tubes emanate from the top of the bottle; one of which passes only through the cover of the bottle, and the other two to its bottom. The former is to be connected with the pump and serves as a channel for air, to be forced in or out of the bottle. Of the two tubes reaching to the bottom of the bottle, one is for conducting liquids into, the other for conducting them from the bottle. Each tube is provided with a stopcock.

This Aspirator is now made with a screw cap and graduated bottle like Number 26.

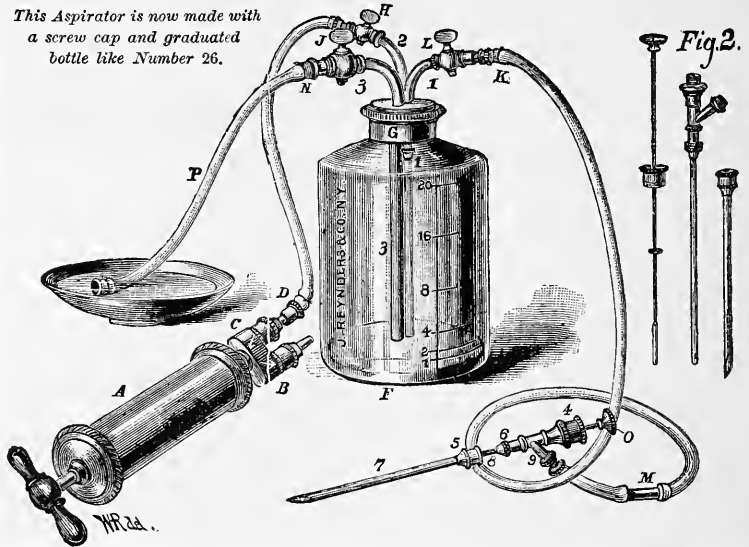

This arrangement yields an instrument which answers its purpose more readily than any other. Supposing the bottle to be empty or more like filled with air and that an aspiration is to be made, the stopcocks *L* and *N* should be closed, the pump attached to the tubing *D* at the end designated with the backward pointed arrow, showing that through it the air passes into the pump. The pump upon being then worked will produce a vacuum in the bottle. When this is achieved the stopcock *H* should be closed and *L* opened after the needle has been introduced. As soon as the bottle is filled, it can be emptied by attaching the pump at its end *B*, closing the stopcock *L* and opening *N*. Upon working the pump the contents of the bottle will pass out through *P*. By reversing this proceeding an injection can be made. The bottle is filled through *P* and emptied through *K*.....Price with Phelps' Needle \$28.00

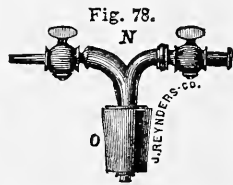
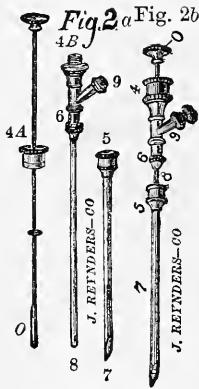
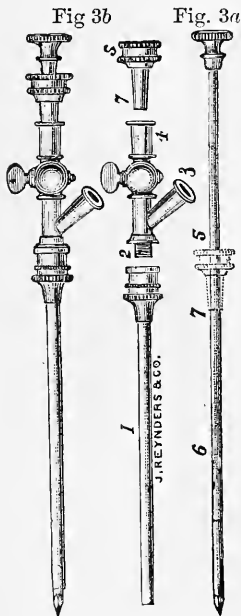

Stomach Evacuation Attachment to Aspirators.

Fig. 78 shows the stopper forming a part of Potain's Aspirator when put up without a bottle (page 119). The same without the little stopcocks shows the stopper to our stomach evacuation attachment. Stopcocks are avoided so as to leave the inside diameter of the metal tubes as large as possible, thereby allowing particles of undigested food to pass through more readily. To each branch of the metal tube a soft rubber tube is attached, each of which have outside clamps for compressing the same and taking the place of stopcocks. To the end of one soft rubber tube a pump is attached; to the other a stomach tube.

Price, \$7.00 ; with pump, \$10.00.

Fig. 3b and 3a. Billroth's Improved Trocar for performing aspiration without permitting the entrance of air into the cavity; 3 sizes, 4, 6 and 8, French scale, each .....\$5 00

Fig. 2b. Phelps' Needle for performing aspiration without permitting the entrance of air into the cavity.....\$6 00

Full description of both of these contrivances sent on application.

**APPLIANCES FOR FRACTURES.**

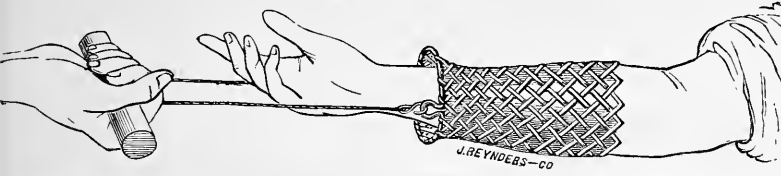

The above figure illustrates a very practical contrivance for securing a firm hold to extremities, when extension is to be made. It consists of braidings of slitted rattan, with a steel ring on one end with eyes for connecting with the extending power. It is readily slipped over the extremity and when tension is made it lengthens and narrows, thus giving a firm and reliable hold to the extremity. They are made for the finger, arm, leg and thigh, and can be used as illustrated by the figure or in the place of adhesive plaster on the leg and thigh in connection with an extension apparatus.

- For fingers.....\$0.25
- “ leg or arm..... 3.25
- “ thigh..... 5.00

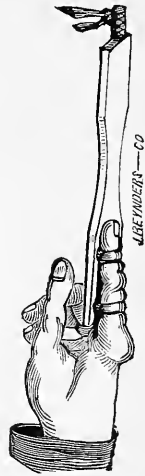

2. Levis' Instrument for reducing phalangeal dislocations..... \$1.50

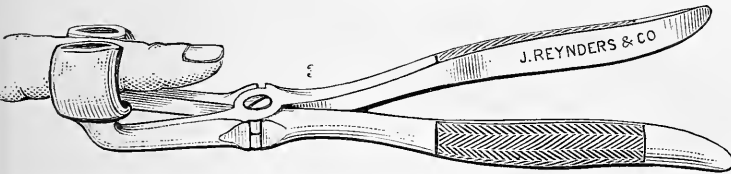

- 3.\* Forceps with rubber lined jaws for reducing phalangeal dislocations..... 5.00
- 4. Adhesive Plaster, heavy domestic..... per yard 0.60
- 5. “ “ “ English on Swansdown..... “ 0.75
- 6. “ “ “ “ Moleskin..... “ 1.00
- 8. Roller Bandages see page 7.

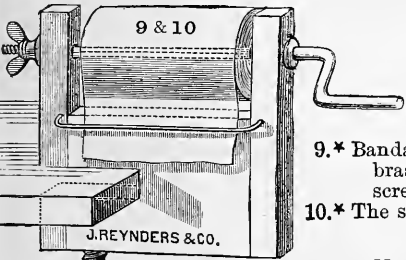

9.\* Bandage Roller, Blackwalnut, brass wire, spindle with set screw..... \$3.00  
 10.\* The same, without set screw.. 1.75

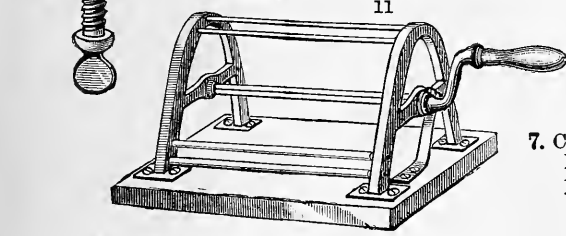

- 11.\* Bandage Roller, brass frame..... \$8.00
- 12. Splint Material, Binder's Board..... per sheet \$0.10, 0.20, 0.30
- 13. “ “ Felt, in sheets..... per square foot, 1.00
- 14. “ “ Gutta Percha, in sheets  $\frac{1}{8}$ ,  $\frac{1}{4}$ ,  $\frac{3}{8}$  inch thick..... per lb. \$3.00

It comes 24 inches wide.  $\frac{3}{8}$  inch thickness weighs 4½ lbs. per yard.

**15. Splint Material, Koehler's, (carbolated).**

**DIRECTIONS FOR USE.**—Cut with shears or knife to the size and shape required, then pass it over flame or a coal fire till quite soft and pliable, (care being taken that it is not burned). Mould to the desired shape with the hand, or better, bandage it to the limb, previously covered with cotton batting. It will become quite hard and retain a perfect mould of the limb in from 5 to 10 minutes. The Splint can be remoulded at any time by softening it with dry heat. It can also be used by softening with steam or immersing in boiling water till quite limp and pliable, (care being taken not to allow it to remain in the water too long). The use of dry heat, however, is preferable.

Sold in sheets only, measuring 38 by 20 inches.....Price \$2.00

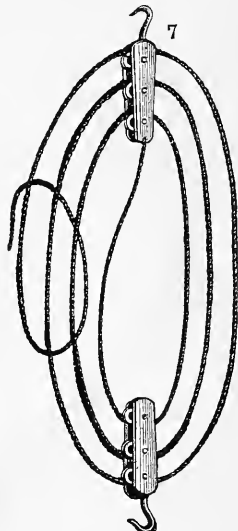

7. Compound Pulleys and Cord, per pair..\$6.00

APPLIANCES FOR FRACTURES.

- 16. Plaster of Paris Bandages, \* 3 inches wide, 5 feet long, per box of six, air tight, wrapped up in oil paper—ready for instant use..... \$1.00
- 17. Plaster of Paris, extra fine.....per can, net, 10 lbs. \$0.50; 25 lbs. \$1.20; 50 lbs. 2.00
- 18. Crossbarred Muslin, for making Plaster of Paris Bandages..... per yard\* 0.20

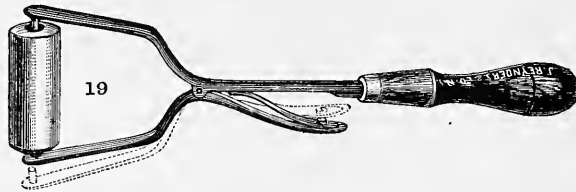

- 19. Rolling Flat Iron as used by Dr. L. A. Sayre to hasten the drying and setting of Plaster of Paris Bandages, after application .....Price \$4.00

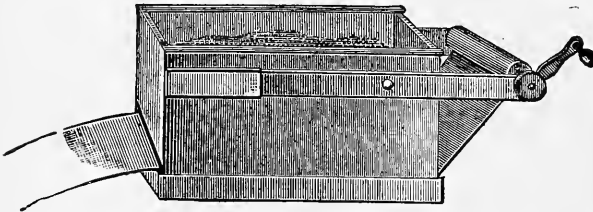

- 20. Plain machine for preparing and rolling Plaster of Paris Bandages.....Price \$3.00

- 21. Plaster of Paris Bandages, each bandage wrapped in wax paper and packed in a neat tin box.

3 in. x 4 yds.....	per doz.	\$1.80
3 " " x 6 " .....	"	2.50
3 " " x 8 " .....	"	3.20
2 " " x 5 " .....	"	1.60
2 1/2 " " x 5 " .....	"	2.00
Phelps' Bandage Shears..		6.00
" " Saw .....		6.00



- 22. Esmarch's Knife and Wedge for removing Plaster of Paris Bandages.\$1.75

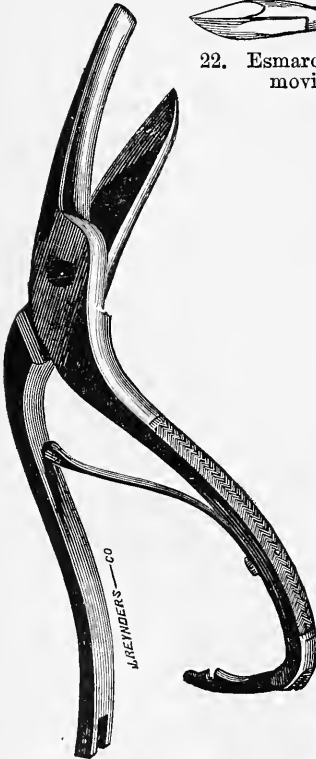

- 23. Plaster of Paris Bandage Shears, Henry's....\$7.00



- 24. Plaster of Paris Bandage Shears, Sayre's.....\$7.00

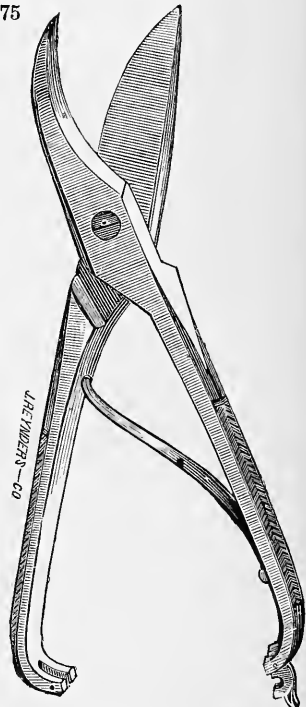

- 25. Plaster of Paris Bandage Shears, Seutin's....\$5.00

**26. Dr. Gurdon Buck's Extension Apparatus.**

Consists of: 1st. Two bands of heavy Adhesive Plaster to which are attached the necessary Buckle and Elastic Webbing. 2d. A Perineal Band for Counter Extension, made of heavy rubber tubing with straps, buckles and rings. 3rd. Four guttered coaptation Splints, leather covered, three Elastic Straps with buckles for fastening the same. 4th. One Pulley, one Bag for shot and some strong fishing line.

Put up in a neat case..... Price, \$ 7.50  
 The same, three sets of different sizes in one case..... " 13.50

Directions for applying accompany each apparatus.

**Iron Fulcra for Extension of the Lower Extremities.**

The application of the principle of weight-extension to the treatment of fractures, and in diseases and deformities of joints, is of such importance as to require more effectual and convenient apparatus than is ordinarily used.

It is desirable that the mechanical appliances for this object should be convenient and inexpensive, portable, not cumbersome, and readily and securely applicable to various forms of bedsteads or couches. It is also important that the amount of tension by weight can be estimated and varied to the requirements of the case.

All these requisites are secured in an accurate and mechanical manner by the apparatus devised by Dr. R. J. Levis (fig. 28) which has been used for a number of years in the Pennsylvania Hospital, and also by that of the late Dr. Gurdon Buck, (fig. 27), the former being preferable with wooden and the latter with iron bedsteads.

The wood-cuts render a full description of the apparatus unnecessary. In both adjustable clamps hold the upright rod which supports the pulley in position. Rod and pulley can be adjusted at any elevation required.

The amount of weight extension is simply effected by a series of one-pound weights suspended upon a rod, (fig. 29, a and b), bent into the form of a hook at the top, for catching in a loop in the extending cord.

The upper portion of this rod (an inch-and-a-half or two inches) is flattened or narrowed, the remainder of the rod maintaining a uniform diameter. In the centre of the weights a hole is drilled, into which the rounded or lower portion of the rod fits very tightly, and from which centre hole a slot is cut (b) that, while it permits the passage of the rod in the upper constricted and flattened portion, is too narrow to allow of the weights slipping off the rod, no matter in what direction or with what force a blow may be struck or the apparatus displaced.

The bag shown in connection with fig. 27, designed to hold sand or shot, answers the same purpose as the sets of weights.

Fig. 30 shows Sayre's "Extension Sundries," consisting of two stout tapes (A) adjusted through button holes to the cross piece C. The ends of A are attached to the plaster secured to the limb and C very nearly approaches the sole of the foot. To C is attached a strong cord, to run over the pulley B. To the end of the cord is to be attached a bag as shown in fig. 27.

In figure 27 Sayre's Extension Sundries are shown applied.  
 The following are the prices of these apparatus:

Buck's Extension Fulcrum only, (fig. 27) .....	\$3.00
The same with Sayre's Extension Sundries .....	4.00
Sayre's Extension Sundries, fig. 30 .....	1.00
Levis' Extension Fulcrum only, fig. 28 .....	3.50
The same with Series of Weights.....	5.00
Series of Weights separate.....	2.00

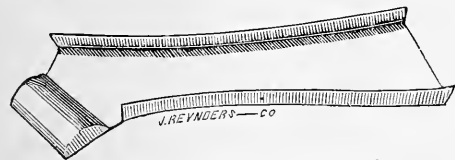
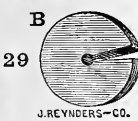
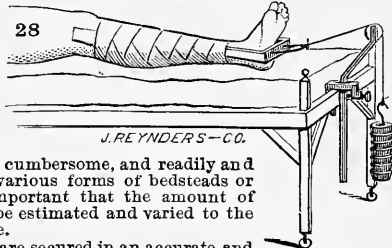
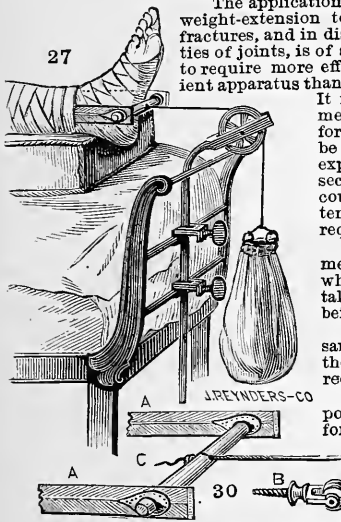

31. Bond's Splint for fracture of the radius ..... \$1.00

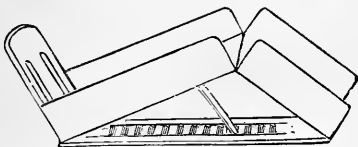

32. Double inclined plain Fracture Box ..... \$7.00; \$8.00 and \$9.00



33. Splints of Basswood. (This wood being of loose texture, light, readily cut, is peculiarly adapted for splints.)  
 Price per package of one dozen, plain \$1.00; lined with canton flannel ..... \$1.50

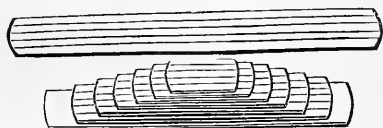

34. Sets of guttered wooden Splints, leather covered on back..... \$1.00

## LEVIS' METALLIC SPLINTS, \*

**FLEXIBLE, PERFORATED, NICKEL-PLATED,**  
Conformable to every size and condition of limbs,  
very light, indestructible and inexpensive.

*Designed by R. J. LEVIS, M. D., Surgeon to the Pennsylvania Hospital, and to the Jefferson College Hospital.*

The Copper used in the manufacture of these Splints being less than *one-eightieth* of an inch in thickness, makes them *very light* and readily conformable by bending so as to suit the peculiarities of any limb, and yet the Splints when applied are as firm as the heaviest wooden appliances. They fit so accurately that but little padding is required; a piece of woven lint, or of cotton or woolen flannel, is all that is necessary for their lining. A slight roughness is left on the outside of the Splints, by perforations, to prevent the bandage from slipping.

They are nickel-plated to prevent oxidation.

They are *invaluable* when the parts are lacerated, as the *perforations allow ventilation*, and *secretions are not confined and liable to be absorbed*, as in every other kind of splints, but readily pass off through the numerous orifices. *They do not become offensive*, like those made of porous materials.

These Splints are cooler, lighter in weight, thinner in material, more correct in shape and more perfect in fit than any other Splints offered to the profession. They are all made in two sizes—one for adults, and one for children—and all, except the radius, fit the same on either the right or left limb. The following comprise a complete set, and are ample to apply to any fractures that may occur:

1. Radius Splints, right and left, four in each set, for fracture of lower end of the Radius, price, for each piece. . . . \$1.00

In the treatment of fracture of the lower end of the radius it is essential that proper allowance be made for the curvature of the anterior or palmar surface of this part of the bone. This is insured in this splint, which follows correctly the radial curvature; and the fixing of the thenar and hypothenar eminences of the hand in their moulded beds, maintains the Splint immovably in its correct position with reference to the radial curve.

To neglect of complete primary reduction of the displacement of the lower fragment, and to inefficient restoration and retention of the normal radial curve, are due the frequent unfortunate sequences of this fracture.

No dorsal Splint is needed, but a small pad will, in most cases, be required over the dorsal surface of the lower fragment. For retention of the Splint, an ordinary bandage, two inches and a half to three inches wide, is all that is necessary.

This Splint has the merits of being applicable to all cases of fracture of the lower end of the radius, and also to many other injuries involving the forearm and wrist.

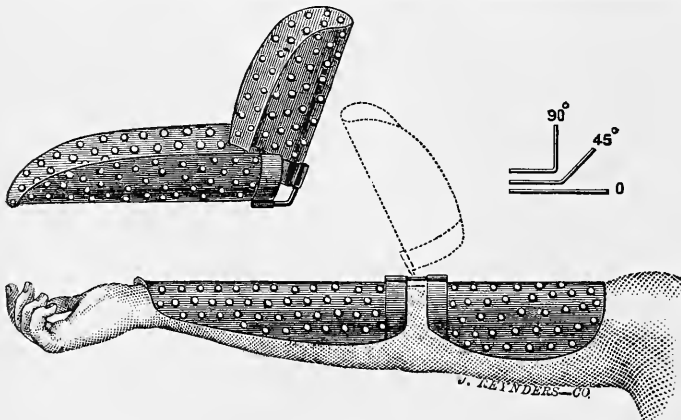
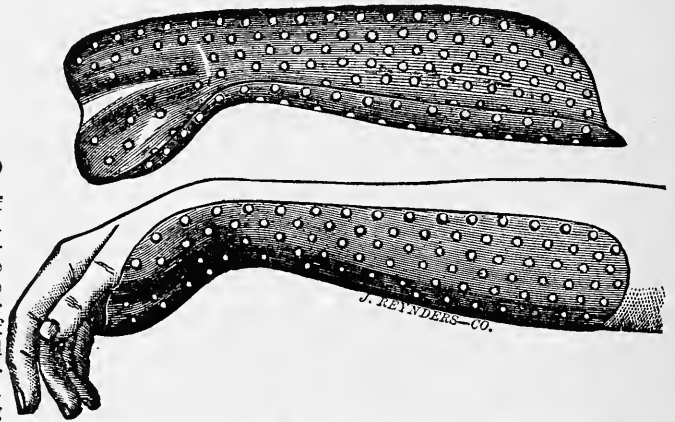

2. Adjustable Angular Splint. Two in each set. For all Fractures of the Elbow Joint, and of the Arm and Forearm, excepting those of the lower end of the Radius. Price, each. . . . \$1.50

This Splint can be applied either anteriorly or posteriorly, and is conformable and adjustable to any angle.

The pieces are detachable, and can be used separately.

This Splint is also applicable to diseases and to resections of the elbow joint.

3. Humerus Splint.  
Two in each set.  
Price, each.....\$0.50  
For fractures of the  
Humerus.

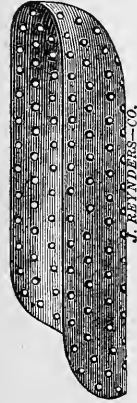
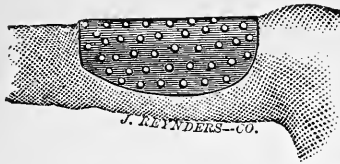

5. Clavicle Splint. Two  
in each set.

Price, each.....\$0.75

This splint forms a cap  
for the shoulder, and can  
be applied to fractures of  
the clavicle and humerus.

4. Phalanges  
Splints.  
Three in each set.  
Price, each piece \$0.15  
For fracture of Fin-  
gers or Toes.

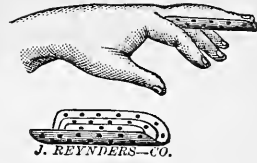

6. Maxilla Splint. Two  
in each set.

Price, each.....\$0.75

This splint forms a com-  
plete cap or covering for  
the entire chin and lower  
maxillary bones, and keeps  
the fractured parts rigidly  
in the correct position.



8. Patella Splint. Two in each set. Price, each.....\$1.00  
This splint can be applied to all fractures from middle of femur to middle of tibia and  
fibula, and is particularly well adapted for fractures of the patella and other fractures  
occurring near the knee joint, either above or below it.

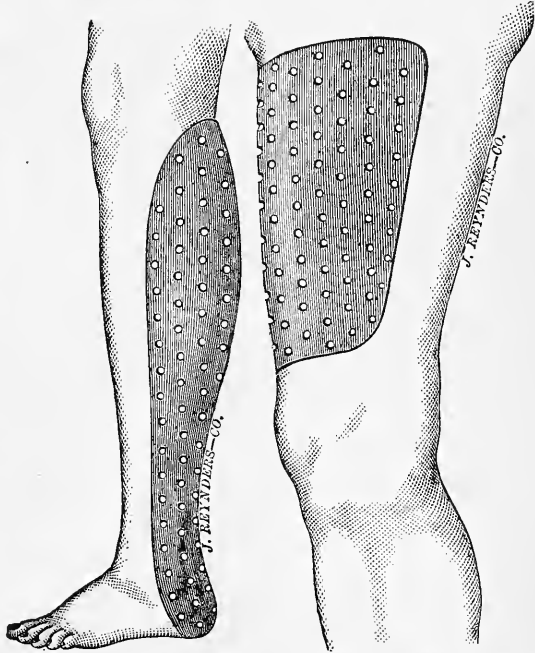
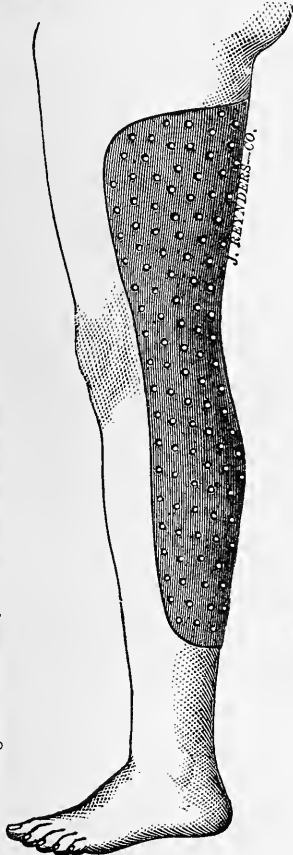

9. Tibia and Fibula Splint. Two in each set.

Price, each.....\$1.00

For all fractures and other  
injuries of the leg below the  
knee, and especially adapted for  
those at or about the ankle  
joint.

7. Femur Splint. Two in  
each set.

Price, each.....\$0.50

For fractures of femur, ribs  
and hip joint.

The complete set consists of the twenty-one pieces just described, in a neat, compact  
case. Price, per set.....\*\$15.00

**Levis' Metallic Splints. Set for Infants.\***

Consisting of eleven pieces for Infants of three years of age and under. They are made of the same shapes as the foregoing, No. 1 being in Right and Lefts, while the other shapes fit either limb. Prices: No. 1, 75 cts. each; No. 2, \$1.00 each; No. 3, 25 cts. each; No. 4, 10 cts. each; No. 5, 50 cts. each; No. 6, 50 cts. each; No. 7, 25 cts. each; No. 8, 75 cts. each; No. 9, 75 cts. each. All put up in a Walnut Case, \$5.00.\* It is never included in the Regular Adult and Children Set, unless so specified. Price of all combined, \$18.00.\*

**Additional Splints.\***

11. Dr. H. A. Wilson's Metacarpal Splint, four in each set.....Price 75 cts. for each piece.

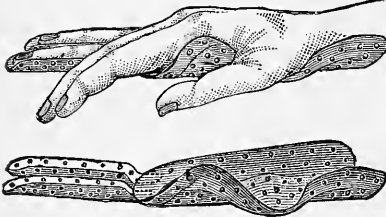

The usefulness of this Splint is fully illustrated in accompanying cut. It is made in Rights and Lefts for Adults and Children, of thin, flexible, perforated and nickel-plated copper, which can be readily moulded to the parts as desired. It is indestructible by use, and can be thoroughly and easily cleansed by simply immersing in hot water—a very important consideration in this age of antiseptic surgery. It has been found very useful in the treatment of all kinds of injuries to the hand where support and immobility are desired. In the treatment of fractures of the metacarpal bones it meets every requirement, and at the same time permits of the judicious use of the fingers, thereby avoiding the troublesome anchylosis that is so apt to follow injuries to the hand.

It is made adaptable for the adjustment of Levis' Metallic Splint, No. 4 (Phalanges), so that one or more of which may be used at a time, as the exigencies of the case requires. The injured fingers are given full support in their adjusted position, leaving the sound ones free for limited use, so as to avoid anchylosis.

**New Combined Fore-Arm and Hand Splint.\***

Made in two forms as shown in the cuts below. These Splints are designated to fill a long-felt want for a Splint that could be universally used for all fractures and injuries of the fore-arm, hand and fingers. Thus, the bandage can be applied (if necessary) above and below the injury, leaving it open or exposed for treatment. In addition to their "Antiseptic" qualities, our Splints retain the members in their correct and normal position; these are very important and essential features, not possessed by any other Splints in the market.

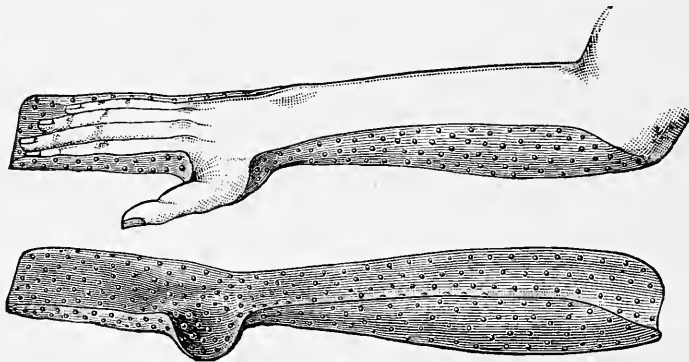

12. Combined Fore-Arm Splint, Rights and Lefts, Adults and Children, four in each Set. For all Fractures and Injuries of Fore-Arm, Hand and Fingers... ..Price \$1.00 each.

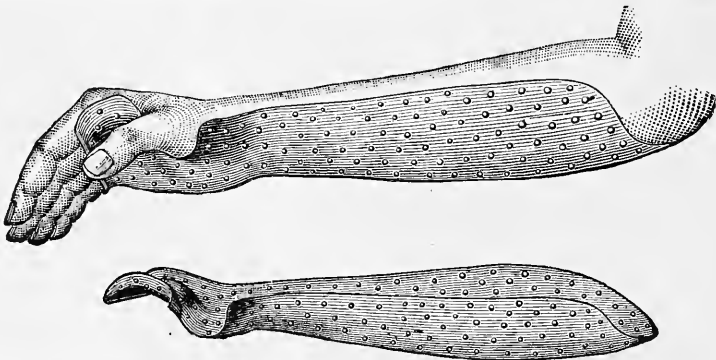

13. Combined Fore-Arm Splint, Improved Bond's Splint, Rights and Lefts, Adults and Children, four in each Set. For all Fractures and Injuries of Fore-Arm and Hand.....Price \$1.00 each.



**Johnstone's Improved Ahl's Adaptable Porous Felt Splints.\***

Splints included in a Regular Set:

1.) Inferior Maxillary.....	Adult	\$0.60;	Child's	\$0.30
2.) Clavicle.....	"	0.90	"	0.60
3.) Shoulder Cap.....	"	0.90	"	0.60
4.) Humeral.....	"	0.50	"	0.30
5.) Elbow, Right and Left.....	each	0.90	"	0.60
6.) Radial, " " ".....	"	0.90	"	0.60
7.) Ulnar, " " ".....	"	0.90	"	0.60
8.) Femoral.....	"	0.90	"	0.60
9.) Knee, Anterior, Right and Left.....	"	1.20	"	0.90
10.) " Posterior, " " ".....	"	1.20	"	0.90
11.) Tibial, Right and Left.....	"	1.20	"	0.90
12.) Fibula, " " ".....	"	1.20	"	0.90
13.) Straight Pieces for Fingers and Toes.....	each			0.30
14.) Club Foot, Right or Left.....	"			0.90
Complete Sets, 50 pieces; 25 Adult's and 25 Child's.....	Price per Set	*30.00		
Laced Splints for Knee.....				*10.00
" Corsets for Spinal Curvature.....				*30.00

**Richardson's Splint for Fractures of the Leg.**

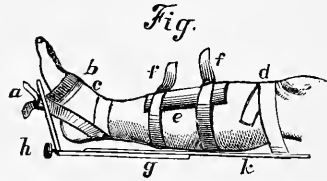
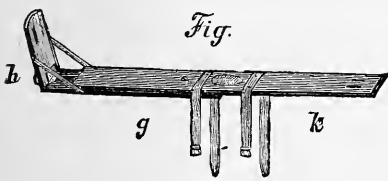

This Splint is remarkably simple in construction and easy of adjustment. Extension is obtained and regulated by a single screw at the bottom of the foot-piece. The counter-extension is perfect. The limb is sustained in a natural and comfortable position, the heel being suspended, avoiding all pain and danger of sloughing, and the injured part is at all times accessible for examination and treatment without removing the Splint.

Shortening of the limb, even in difficult cases, is entirely avoided.

Full directions for use accompany each Splint.

There are three sizes for adults and two for children.

Adults Sizes.....Price, \$6.00\*each.  
Childrens' Sizes..... " 5.00\* "

In ordering for special cases, state the position of fracture, and its distance from the heel.

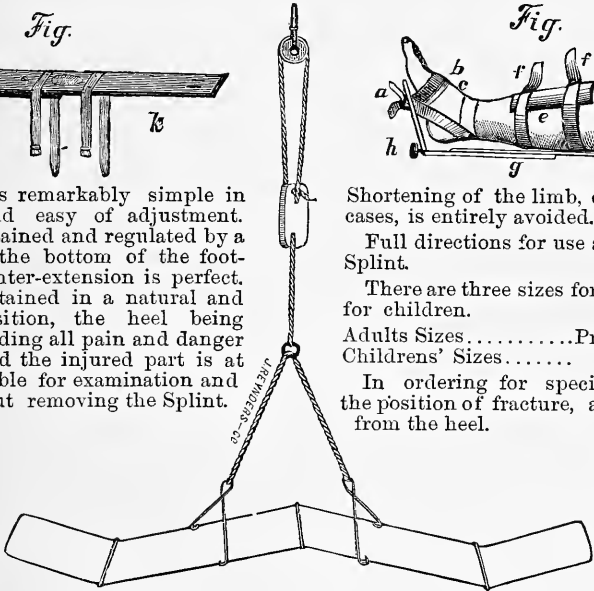

- 40. Dr. Nathan R. Smith's Suspending Apparatus for fractures of the leg or thigh... \$3.00
- 40a. Modification of above as used in New York Hospital.

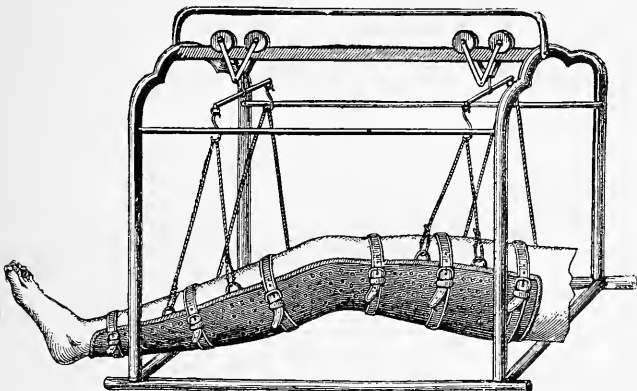

- 41. Fracture Cradle.....\$20.00

Wire Splints.



For the entire leg.....	\$6 50
“ “ Forearm .....	3 00
“ “ leg below knee.....	4 00
“ “ foot and ankle.....	3 00

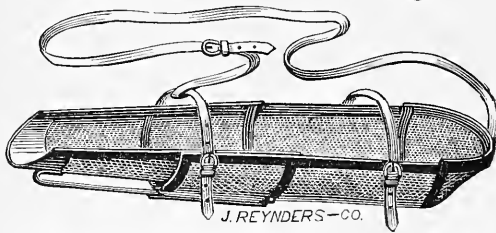

49. Improved Wire Arm Sling.....\$4.50  
 The same is with sliding extension for the hand to facilitate passive motion of the wrist, without removing the support.

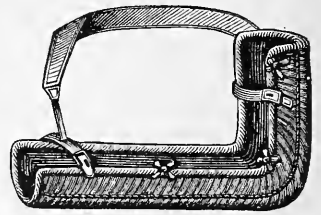

50. Patent Leather Arm Sling, \$4.50

36. Pratt's, late Day's, Carved Wood Splints. ††

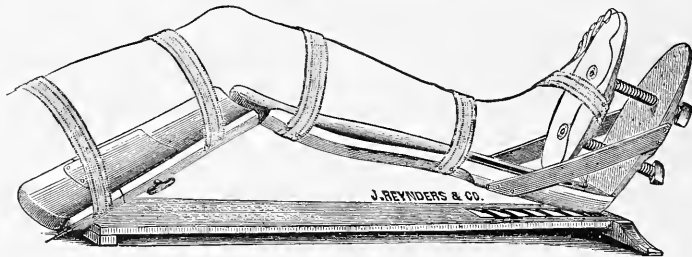

Size	Double Incline Plane.	Price.
Small.....		\$4 00
Medium.....		5 00
Large.....		6 00



	Extension Bar.	
	Size:	Price.
	Small .....	\$5 00
	Large .....	6 00



Right Ankle Splint.

No. 0.....	\$ 75	No. 2.....	\$1 25
No. 1.....	1 00	No. 3.....	1 50

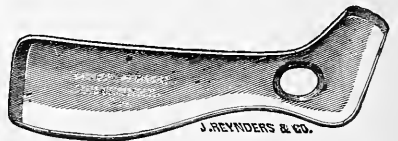

Left Ankle Splint.

Sizes and prices of Left Ankle Splints are the same as those of Right Ankle.

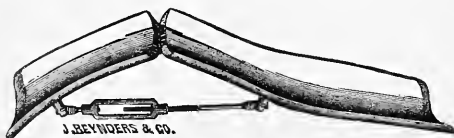

Jointed Patella Splint—with Screw.

No. 1.....	\$2 00	No. 3.....	\$2 50
No. 2.....	2 25	No. 4.....	2 75



Patella Splint.

No. 1.....	\$ 80	No. 3.....	\$1 00
No. 2.....	90	No. 4.....	1 25



**Joint Arm Splint—with Screw.**

No. 1.....	\$2 00
No. 2.....	2 25
No. 3.....	2 50

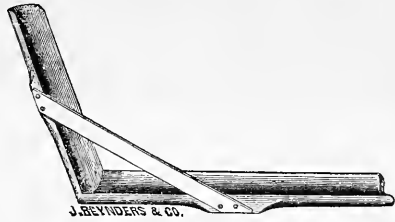

**Condyle and Humerus Splint.**

No. 1.....	\$ 75
No. 2.....	1 00
No. 3.....	1 25



**ForeArm Splint.**

No. 1.....	\$ .40	No. 4.....	\$ .70
No. 2.....	.50	No. 5.....	.80
No. 3.....	.60	No. 6.....	.90



**Interosseous Splint.**

No. 1.....	.30	No. 4.....	\$ .60
No. 2.....	.40	No. 5.....	.70
No. 3.....	.50		



**Right and Left Radius Splints.**



No. 1.....	\$ .50	No. 3.....	\$ .70
No. 2.....	.60	No. 4.....	.80



**Dressing Splints.**

Per set of five ..... \$ .50

**Squire's Fore-Arm Splint.**



No. 1.....	\$1 00
No. 2.....	1 10
No. 3.....	1 20
No. 4.....	1 30
No. 5.....	1 40
No. 6.....	1 50

**Jointed Condyle and Humerus Splint.**

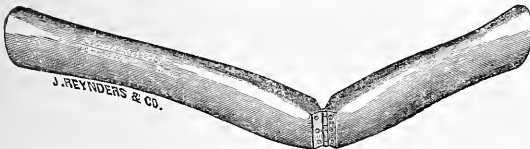

No. 1.....	\$1 00
No. 2.....	1 25
No. 4.....	1 50

The Squire's Jointed Fore-arm Splint, the Jointed Condyle and Humerus Splint and the Jointed Patella Splint are not in the regular set of Splints.

The following comprises the Complete Set of Splints:

1 Extension Bar—small.....	\$5 00	5 Interosseous—set.....	\$2 00
1 " " —large.....	6 00	3 Jointed Arms—set.....	6 00
1 Double Incline Plane—small.....	4 00	8 Ankles (new)—set.....	9 00
1 " " " —medium.....	5 00	4 Patella—set.....	3 75
1 " " " —large.....	6 00	3 Condyle and Humerus—set.....	2 50
8 Radius or Crooked Hands—set.....	5 00	5 Dressing Splints.....	50
6 Fore-arm or Straight Hands—set.....	3 75		

 The above set in box, \$50 00.

42. Richardson's Splint for Fractures of the Clavicle, Scapula and Humerus. \*

This splint is made of four sizes, at the following prices:

- First size for Adults.....\$6.00
- Second size for " ..... 5.50
- First size for Children..... 5.00
- Second size for " ..... 4.50



It is composed of three parts, and has three points of attachment, viz: to the side, axilla and arm.

The arm and body pieces are semi-cylindrical in shape, made of hard rubber, and fastened together by means of rivets, with sufficient space left between them to allow the passage of straps of adhesive plaster. The crescentic pad is received as a crutch in the axilla.

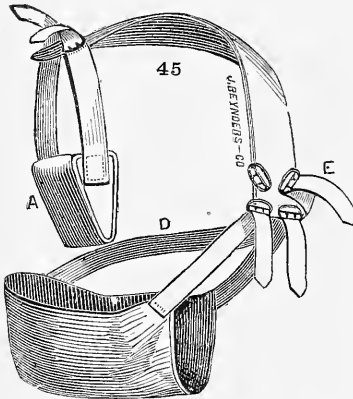

45. Levis' Splint for Fractures of the Clavicle.

It consists of a short, firm pad in the axilla, by which the shoulder is held from the side and over which, as a fulcrum, the elbow is drawn to the side. To the front and back of the axillary pad are fastened straps, which pass directly upwards, and are buckled to a wide main supporting band which passes from the shoulder across the upper part of the back, and over the shoulder of the sound side, and terminates on the front of the chest. To the front end of the wide supporting band is suspended a sling, by which the elbow is supported. On the back of the sling, at a short distance above the point of the elbow, a strap is attached, which passes obliquely across the back, and, coming in front, is buckled to the main supporting band. The extra buckle, which will be noticed at the front end of the wide band, comes in use when the apparatus is reversed for the opposite shoulder.

Price \$5.00

46. Hartshorn's for Fractured Patella.

46

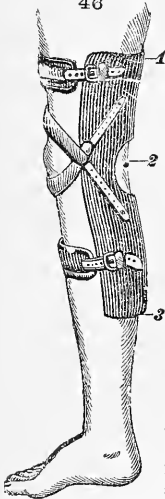

This apparatus consists of a piece of sheet steel well adapted to the lower part of the thigh and calf, secured to the leg by straps above and below. The parts of the fractured patella are held together by straps passing crosswise over its upper and lower margins.

MEASUREMENTS REQUIRED:

- 1) Length from ankle to knee-joint.
- 2) " " knee-joint to perineum
- 3) Circumference of calf.
- 4 " of thigh midway between knee-joint and perineum.

Price, \$7.00

47. Levi's Apparatus for Fractured Patella.

This apparatus consists of two pads, one well adapted to the popliteus, the other over the upper margin of the patella. They are connected by straps passing laterally downwards to a foot piece acting as a fulcrum. In this manner the upper fragment of the patella is drawn downward. The lower one is secured with adhesive plaster.

MEASUREMENTS REQUIRED:

- 1) Circumference of knee.
- 2) " of calf.
- 3) Length from sole to knee-joint.

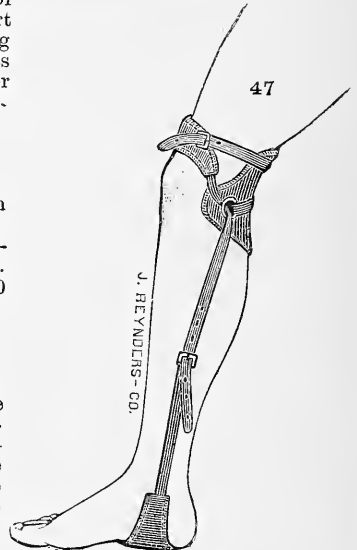

Price \$6.00

## V. INSTRUMENTS FOR CUPPING.

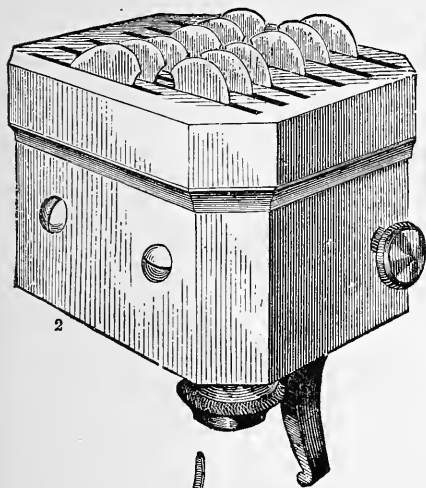

17

J. REYNOLDS—CO.

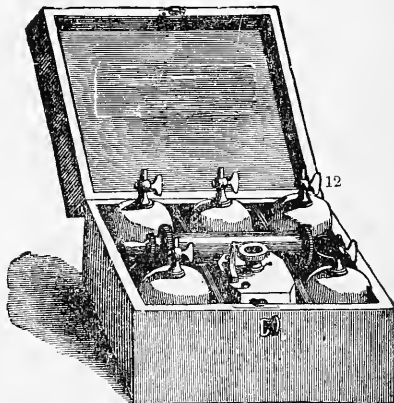
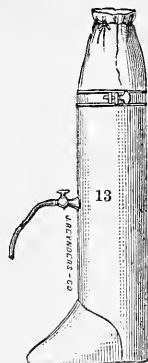
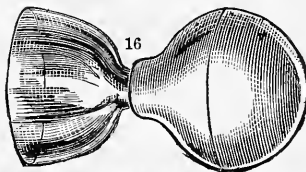
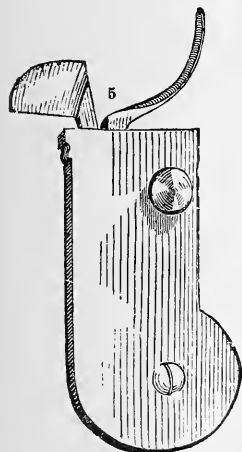

1.	Scarificator, reverse blades.....	10 bladed	\$4.50
2.*	“ “ “ “.....	12 “	5.50
3.	“ “ “ “.....	16 “	6.50
4.	“ “ for Temple.....		4.00
5.*	Spring Lancet's, in case.....	G. s. with button	2.50
5a.	Spring Lancet with Lever.....		2.00
6.	Cupping Glasses, ordinary.....	per doz.	1.50
7.	“ “ with screw hole.....	each	0.60
8.	Stopcocks for same.....		0.50
9.	Brass Pumps.....		2.50
10.	Cupping Case, containing : Pump, 3 Glasses and 3 stopcocks.....		8.00
11.	“ “ “ “ “ 5 “ “ 5 “ “.....		10.00
12.*	Either of the two above with scarificator, add price of the latter.....		
13.*	Leg Receiver, to be used with pump †.....		6.00
14.	Arm “ “ “ “ “ †.....		3.00
15.	Cupping Cups, all rubber.....	each	0.75
16.*	“ “ glass and rubber bulb, best quality.....		0.75
17.*	“ “ Goodyear set.....		

See also next page

All Instruments illustrated are designated by a \*

See Also Allen's Pump.

VI. EYE INSTRUMENTS.

OPHTHALMOSCOPES, DOUCHES, ETC.

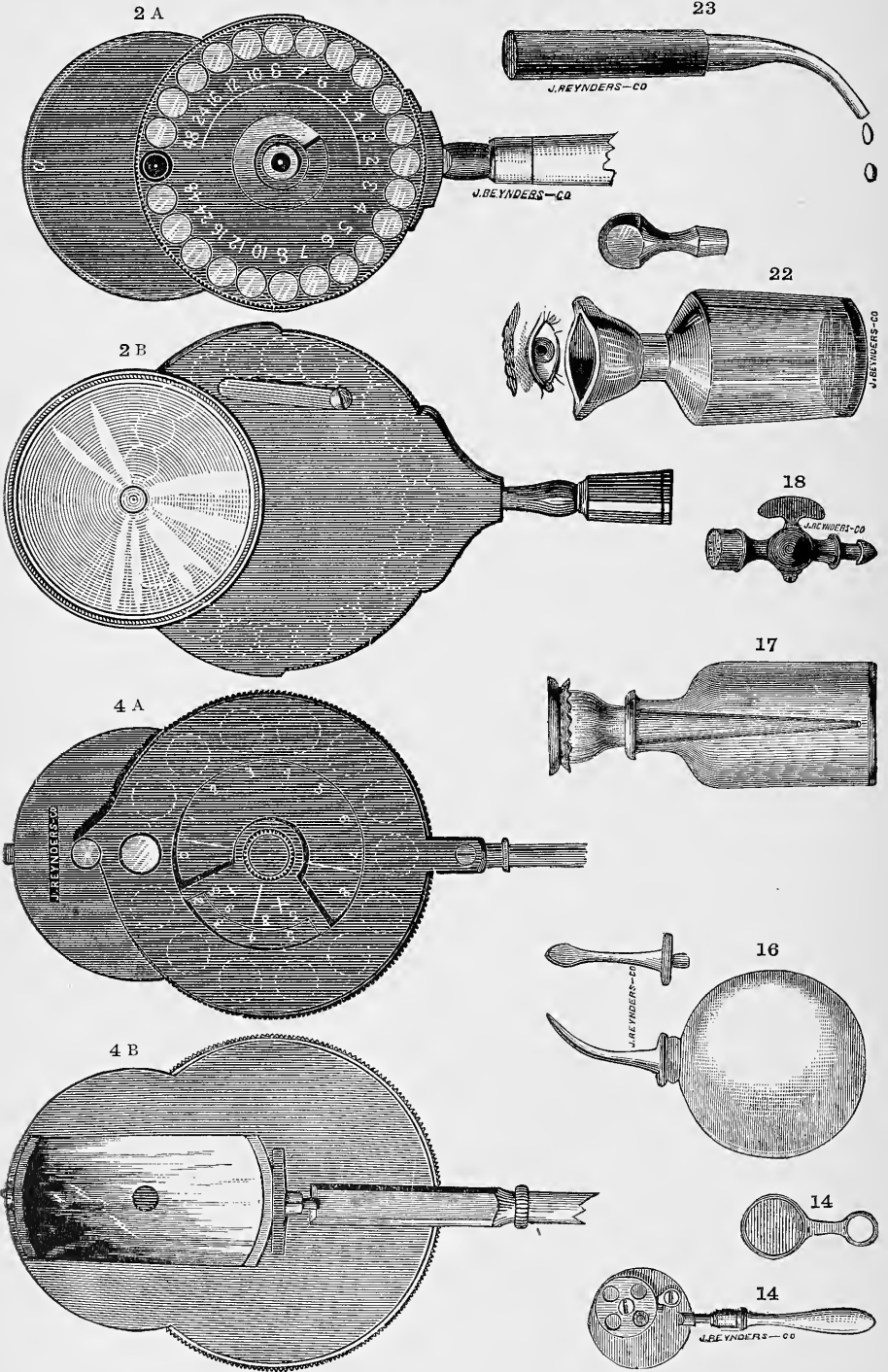

**VI. EYE INSTRUMENTS.**

**OPHTHALMOSCOPES.**

- 1.\* Knapp's Ophthalmoscope, with circular mirror of  $1\frac{1}{2}$  inches diameter, revolving disc at back of mirror, containing : 14 convex and 15 concave lenses, revolving beneath a metal cover for protecting the lenses from dust and injury. 2 Convex condensing lenses of  $1\frac{1}{2}$  inches diameter. (See page 70.) In morocco case . . . \$17.00\*
- 2 A and B.\*\* Knapp's Ophthalmoscope, same as the above, containing : 11 convex and 12 concave lenses. 2 Convex condensing lenses of  $1\frac{1}{2}$  inches diameter. In morocco case . . . . . 14.00\*
- 4 A and B.\*\* Loring's Ophthalmoscope, with rectangular mirror swung on two pivots, so as to tilt to either side to angles of 20 and 25°; revolving disc at back of mirror containing : 7 convex and 8 concave lenses ; immediately over this disc a quadrant rotating around the same centre as the disc, containing : 2 convex and 2 concave lenses. Convex condensing lense of  $1\frac{1}{2}$  inches diameter. In morocco case . . . . . 20.00\*
- 4C. Same with twenty lenses and quadrant; circular or rectangular—tilting mirror. . 23.00\*
- 4D. Same as 4 C, but with three rows of figures. . . . . 25.00\*
- 5. Loring's Ophthalmoscope, with circular mirror of  $1\frac{1}{4}$  inches diameter, revolving disc at back of mirror containing : 12 convex and 12 concave lenses, revolving beneath a metal ring for protecting the lenses from dust and injury. 1 Convex condensing lens of  $1\frac{1}{2}$  inches diameter. In morocco case. . . . . 21.00\*
- 6. Loring's Ophthalmoscope, same as the above, but with rectangular mirror as on No. 4. In morocco case. . . . . 22.00\*
- 7.\* Loring's Ophthalmoscope, with circular mirror of  $1\frac{1}{4}$  inches diameter, revolving disc at back of mirror containing : 7 convex and 8 concave lenses. 1 Convex condensing lense of  $1\frac{1}{2}$  inches diameter. (See page 70.) In morocco case. . . . . 13.00\*
- 8. Loring's Ophthalmoscope, same as the above, containing : 6 convex and 6 concave lenses. 1 Convex condensing lense of  $1\frac{1}{2}$  inches diameter. In morocco case . . 11.25\*
- 9.\* Loring's Ophthalmoscope, same as the above (No. 7) containing : 3 convex and 4 concave lenses. Condensing lens of  $1\frac{1}{2}$  inches diameter. (See page 70.) In morocco case . . . . . 5.00\*
- 9A. Same as No. 9, but with nine lenses. . . . . 6.75\*

The numbers of each lens according to the metric and inch systems of measurement are engraved on the discs of all the ophthalmoscopes enumerated above.

- 11. Liebreich's Ophthalmoscope. . . . . 3.50\*
- 12. " " French model. . . . . 5.50\*
- 13. Allen's modification of Liebreich's Ophthalmoscope . . . . . 2.00\*
- 14.\* Nacet's Ophthalmoscope in portmonnaie case. . . . . 4.90\*
- 15.\* Perrin's model of the Eye for the practice and study of the ophthalmoscope, packed in a wooden case, with twelve colored shells representing normal and diseased conditions of the fundus of the eye-ball. (See page 70.) . . . . . 25.00

**DOUCHES.**

- 16.\* Liebold's Subpalpebral syringe . . . . . 1.50
- 17.\* Drop Bottle with rubber covered pipette. . . . . .75
- 18.\* Eye Douche Sprinkler of H. R., combined with stopcock. . . . . 1.25

All Instruments illustrated are designated by a \*

VI. EYE INSTRUMENTS.

OPHTHALMOSCOPES, CONDENSING LENSES, ARTIFICIAL LEECHES, ETC.

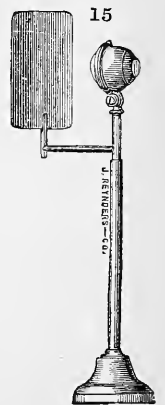
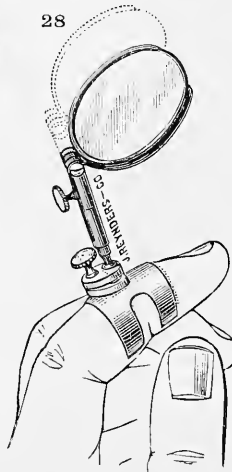
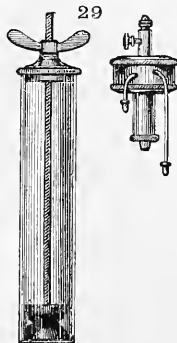
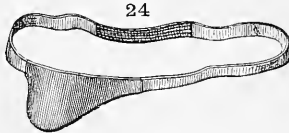
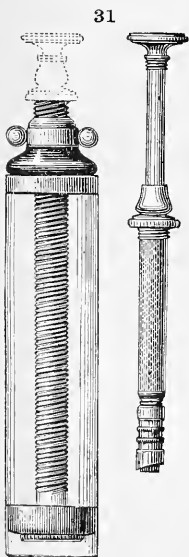
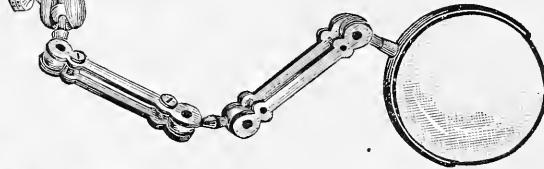
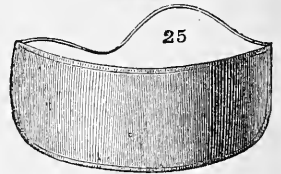
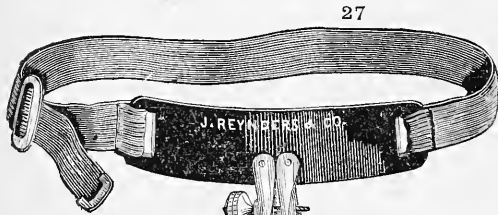
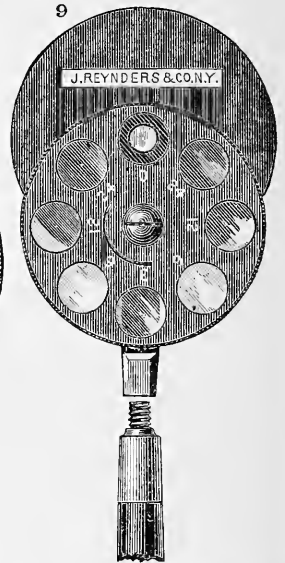
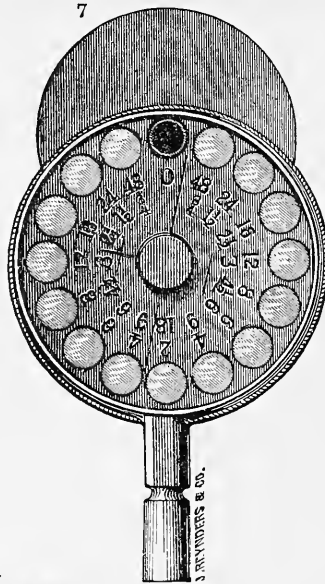



## VI. EYE INSTRUMENTS.

### DOUCHES.—Continued.

19.	Eye Douche Sprinkler of nickel plated metal, combined with stopcock.....	\$2.00
20.	“ “ Noyes', consisting of Sprinkler No. 19, tubing and sinker. In tin box	3.00
21.	Eye Douche Sprinkler of H. R., plain. ....	.50
22.*	Eye Bath Bottle \$1.00. Eye Bath Glass Cup. (See page 68.) .....	.50
23.*	Drop Tube with rubber cap. ( “ “ “ ).....	.20

### EYE SHADES.

24.*	Eye Shade for one eye. Silk.....	.40
25.*	“ “ “ both eyes. “ .....	.75
26.	“ “ “ “ “ “ patent.....	1.50

### CONDENSING LENSES.

27.*	Loring's Condensing Lens Holder with headband.....	8.00
28.*	Noyes' Condensing Lens Holder.....	6.00

### ARTIFICIAL LEECHES.

29.*	Case of Artificial Leeches, containing: 1 scarifier making a circular cut, one glass cylinder with cork piston and screw piston rod. In a morocco case.....	8.00
30.	Case of Artificial Leeches, same as the above with two cylinders of assorted sizes.	10.00
31.*	Artificial Leech and Scarifier, in ornamental metal case, Collin's model.....	13.50

### PHANTOMES.

32.*	Eye Phantome with Hard Rubber Mask. (See page 72.).....	18.00
33.	“ “ “ Japanned mask, one eye on fixed stand.....	7.50
34.	“ “ “ “ “ two eyes on “ .....	10.00
35.	“ “ “ “ “ one eye on jointed stand.....	11.00
36.*	“ “ “ “ “ two eyes on “ (See page 72.).....	13.00

All Instruments illustrated are designated by a \*

VI. EYE INSTRUMENTS.

TRIAL CASES, PHANTOMES, ETC.

42

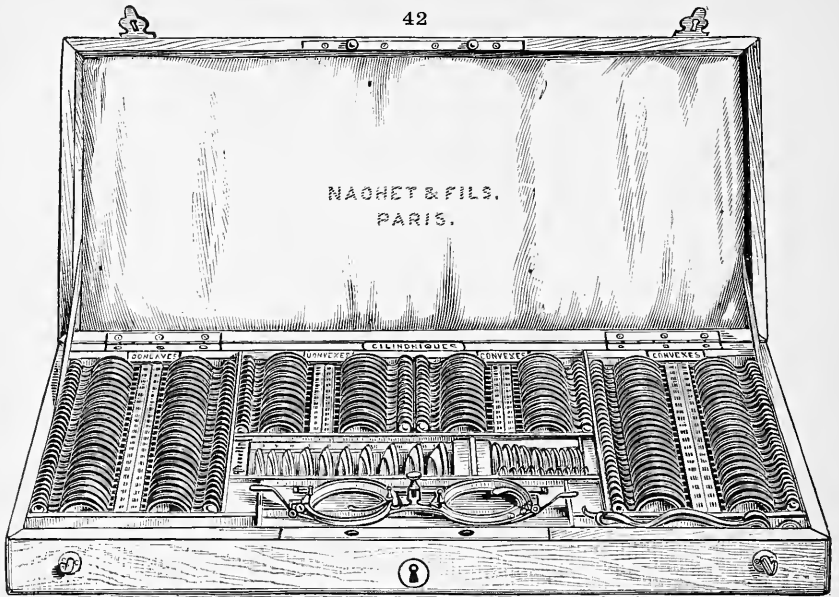

COPYRIGHT 1883 BY J. REYNDERS-CO. N.Y.

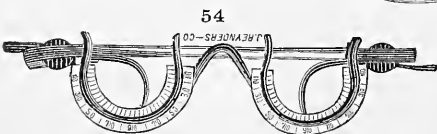
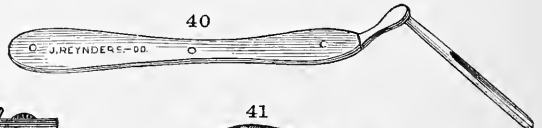
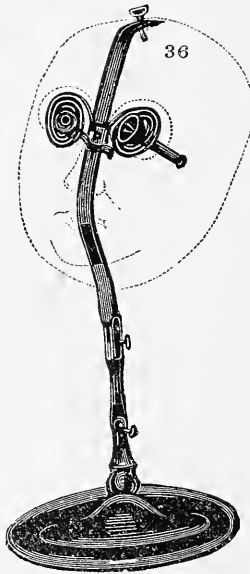
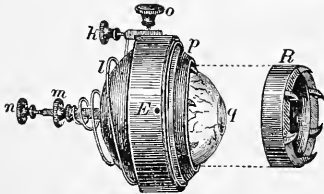

## VI. EYE INSTRUMENTS.

37.* Bowman's Cornea Trephine, 2 sizes .....	Each	\$5.00
38.* v. Graefe's Strabismometer. Ivory graduated.....		2.25
39. Pupillometer.....		5.00
40.* Noyes' Lachrymal Gouge.....		2.50

## ARTIFICIAL EYES.

41.\* Artificial Eyes. Each \$10.00. Higher in price when made to order.

When ordering, enclose a colored drawing of iris showing as near as possible the shades of color desired. Also state:

- Distance from inner to outer canthus.
- Color and diameter of iris.
- Diameter of pupil.
- If for right or left eye.
- Whether eye-ball has been removed or is shrunken.

## TRIAL CASES.

- 42.\* Trial Case, Nacet's complete series of trial glasses, comprising 30 pairs each of spherical convex and concave lenses from  $1\frac{3}{4}$  to 148 inches focus; 18 pairs each of cylindrical convex and concave lenses from 6 to 148 inches focus; 10 prisms of angles from 2 to 20 degrees; 4 plane glasses of assorted colors; 1 plane white glass; 1 half ground glass; 2 metal discs with slits of assorted widths; 1 each metal discs solid and with central perforation. All mounted in gold and silver plated metal rims with handles. 1 Adjustable spectacle frame with graduated revolving fittings for holding the varicus lenses; 1 adjustable lens holder of horn. In rosewood case..... \$85.00\*
44. Trial Case, Roulot's complete series of trial glasses, comprising 30 pairs each of spherical convex and concave lenses from  $1\frac{1}{2}$  to 144 inches focus; 18 pairs each of cylindrical convex and concave lenses from 6 to 144 inches focus; 10 prisms of angles from  $3\frac{1}{4}$  to 36 degrees; 4 plane glasses of assorted colors; 1 half ground glass; 1 ground glass; 1 each metal discs with slit and central perforation. All mounted in gold and silver plated metal rims with handles; 4 rectangular pieces of glass of assorted colors; 1 double grooved graduated spectacle frame; 1 plain spectacle frame; 1 single lens holder. In imitation rosewood case..... 65.00\*
45. Trial Case, Roulot's, same as the above but with only one cylindrical, convex and concave lens of each number. In imitation rosewood case..... 52.00\*
46. Trial Case, Roulot's, comprising 23 pairs each of spherical convex and concave lenses from 2 to 72 inches focus; 8 each convex and concave cylindrical lenses from 6 to 72 inches focus; 6 prisms of angles from 2 to 10 degrees; 4 plane glasses of assorted colors; 1 ground glass; 1 half ground glass; 1 each metal discs with slit and central perforation. All mounted in gold and silver plated metal rims with handles. 4 Rectangular pieces of glass of assorted colors; 1 double grooved graduated spectacle frame; 1 single lens holder. In mahogany case..... 35.00\*

All Instruments illustrated are designated by a \*

VI. EYE INSTRUMENTS.

SPECULA AND LID ELEVATORS.

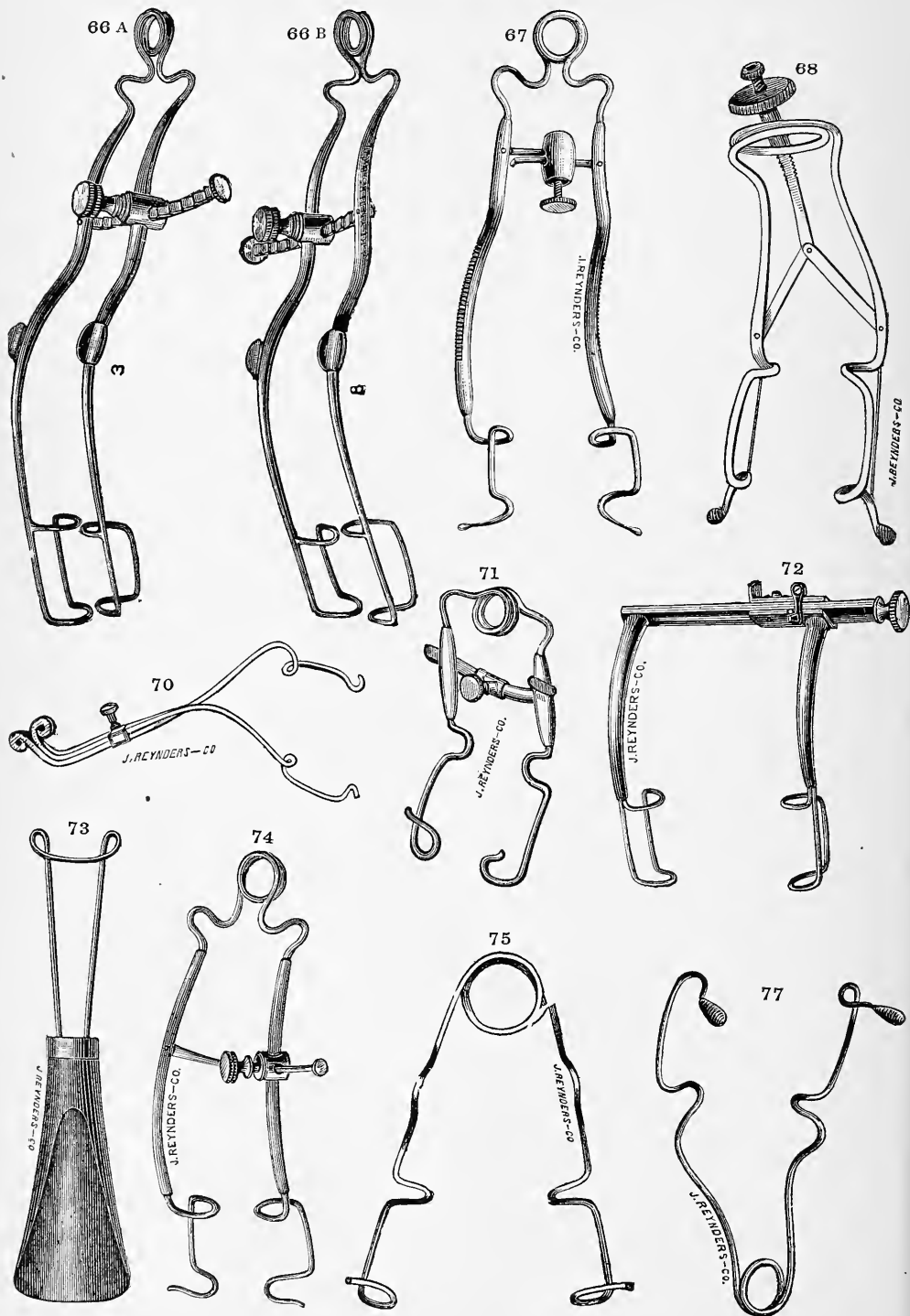

## VI. EYE INSTRUMENTS.

## TRIAL CASES.—Continued.

47. Trial Case, Roulot's, comprising 25 pairs of spherical convex lenses from 2 to 80 inches focus; 23 pairs of spherical concave lenses from 2 to 50 inches focus; 12 prisms of angles from 3 to 18 degrees; 7 plane glasses of assorted colors. All mounted in gold and silver plated metal rims with handles. 4 Rectangular pieces of glass of assorted colors; 1 plain spectacle frame; 1 single lens holder. In mahogany case.....
48. Trial Case, Roulot's, comprising 25 pairs of spherical convex lenses from 2 to 72 inches focus; 23 pairs of spherical concave lenses from 2 to 50 inches focus; 12 prisms of angles from 3 to 18 degrees. All without rims. 7 Square pieces of glass of assorted colors; 1 plain spectacle frame. In mahogany case..... \$29.00\*
49. Trial Glasses, hard rubber frames, from 5 to 48 inches focus, convex or concave..... Each 12.00\*
50. Trial Case of Cylindric Glasses, comprising 17 pairs each of cylindrical convex and concave lenses from 6 to 148 inches focus; 1 graduated double spectacle frame; 1 plane white glass; 1 half ground glass; 1 each metal discs with slit and with central perforation. All lenses mounted in gold and silver plated metal rims. In morocco case..... 25.00\*
51. Trial Case of Cylindric Glasses, same as the above but with only one cylindrical convex and concave lens of each number. In morocco case..... 18.00\*
52. Trial Case of Prismatic Glasses, comprising 10 prisms of angles, 1, 2, 4, 6, 8, 10, 12, 15, 18 and 20 degrees, mounted in gold or silver plated metal rims. In morocco case..... 9.75\*
53. Trial Glass Spectacle Frame, single groove for one pair of lenses..... 2.50
- 54.\* Trial Glass Spectacle Frame, double groove for two pairs of lenses, the outer ones graduated for reading the astigmatic axis of the eyes. (See page 72.)..... 5.00
55. Trial Glass Spectacle Frame, Nacet's adjustable, with graduated revolving fittings for the cylindric lenses..... 5.00\*
56. Stenopaic Disk with handle..... 2.00
57. Stenopaic Disk with handle and adjusting screw..... 6.50
58. v. Graefe's Binocular Optometer..... 22.00
59. Cretes' Optometer..... 26.00
60. Stoke's Lens for astigmatism..... 6.50

## TEST TYPES.

61. Snellen's Test Types, German or English, with book..... 1.50\*
62. Snellen's Test Letters \$0.25\*; mounted on card board..... .50\*
63. Pray's Series of Astigmatic Letters on card board. These letters are composed of black lines and white spaces, the white and black spaces of each letter being all ruled at one angle in each letter, and this angle being varied for every letter. There are twelve of the latter and the angles of the lines are horizontal, 15°, 30°, 45°, 60°, 75°, 90°, 105°, 120°, 135°, 150°, 165°..... .75\*
64. Green's Test Diagrams for Astigmatism. This set consists of a pasteboard dial 12 inches in diameter, divided into 12 parts as a clock dial. To this a series of 14 diagrams of lines and circles can be attached separately at pleasure and made to revolve against the face of the dial..... 5.00\*

All Instruments illustrated are designated by a \*

VI. EYE INSTRUMENTS.

ENTROPIUM FORCEPS, LID ELEVATORS, ETC.

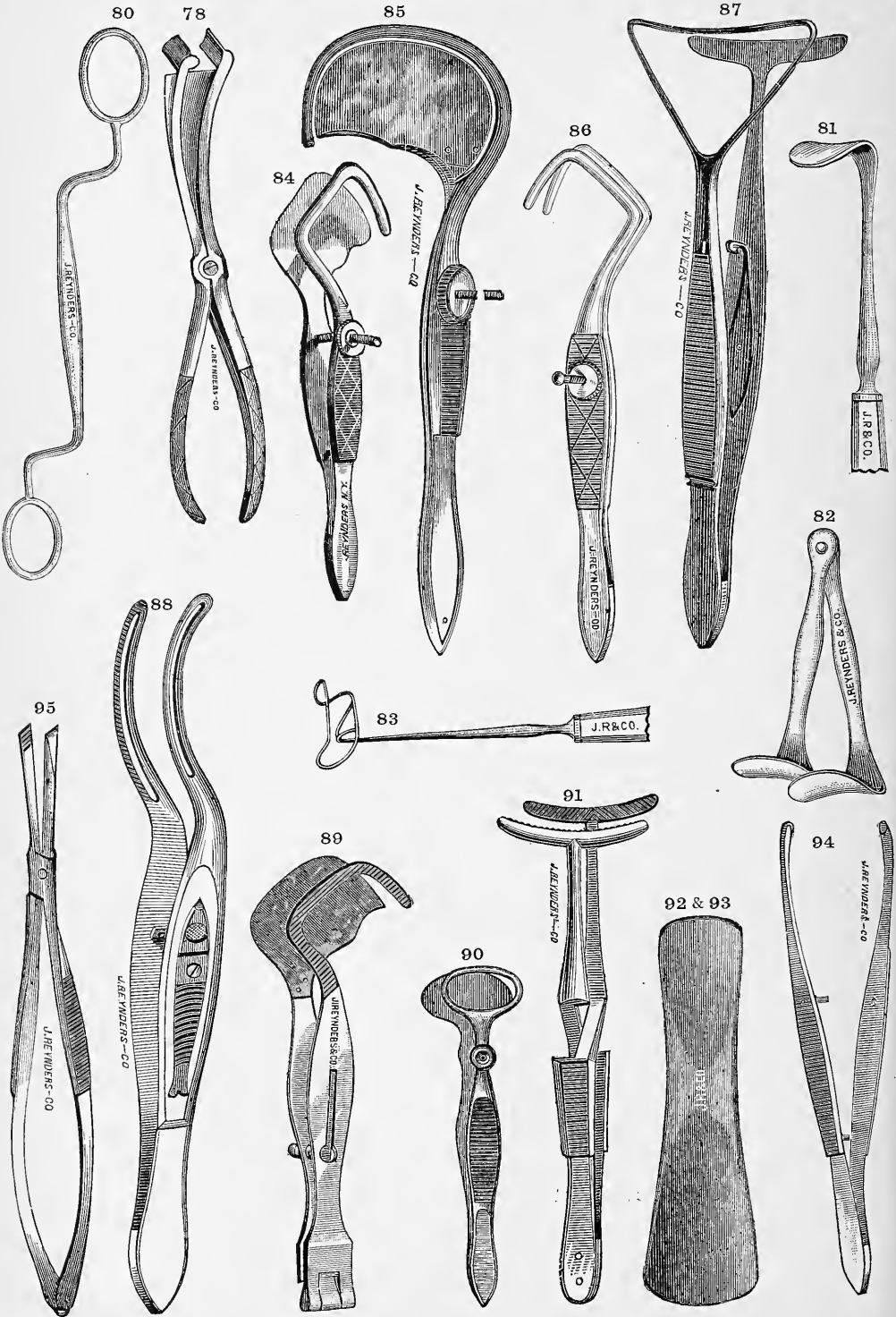

## VI. EYE INSTRUMENTS.

### TEST TYPES.—Continued.

65. Wood's Test Types and Tests for Color Blindness, consisting of: Snellen's tests, 3 plates, 30 sizes of type; Jaeger's tests, 2 plates, 20 sizes of type; 4 plates astigmatism tests Snellen, Green, Wecker, etc.; Holmgren's tests for color blindness; 100 skeins of different colored worsteds; 1 lithographic plate, 17 colors; a set of trial lenses, with plated holder; explanatory text by Dr. G. R. Cutter. In strong box ..... \$7.00\*

### EYE SPECULA AND LID ELEVATORS.

66 A and B.** v. Graefe's, right and left ..... (See page 74.).....	Each	2.50
67.* Williams', with revolving post of set screw..... ( " " " ).....	"	2.50
68.* Noyes' ..... ( " " " ).....	"	4.50
69. Noyes' plain ..... ( " " " ).....	"	1.75
70.* Liebold's..... ( " " " ).....	"	2.50
71.* Liebreich's..... ( " " " ).....	"	2.50
72.* Murdoch's ..... ( " " " ).....	"	4.00
73.* Jaeger's Lid Holder and plate combined..... ( " " " ).....		2.50
74.* Weber's, right and left ..... ( " " " ).....	Each	1.75
75.* Plain Wire..... ( " " " ).....	"	.80
76. Plain Wire with set screw ..... ( " " " ).....	"	1.50
77.* Hart's ..... ( " " " ).....	"	1.50
78.* Manfredi's. ....		5.00
79. McNamara's Eye Speculum.....		5.00
80.* Townsend's Lid Holder .....		1.75
81.* Desmarres' Lid Retractor.....		1.75
82.* Desmarres' Lid Retractor, two sizes jointed.....		1.75
83.* Noyes' Lid Retractor.....		1.75

### ENTROPIUM FORCEPS.

84.* Snellin's, right and left.....	Each	2.50
85.* Knapp's, right and left, upper and lower .....	"	4.00
86.* Noyes'.....	"	2.75
87.* Rattis' Trichiasis Forceps .....	"	3.00
88.* Entropium Forceps with slide catch .....	"	3.50
89.* Prout's Reversible.....	"	4.00
90.* Desmarres' .....	"	3.00
91.* Cross Bar .....	"	2.25
92.* Lid Plate of hard rubber.....	"	.50
93.* Lid Plate of shell.....	"	1.50
94.* Cilia Forceps .....	"	1.00
95.* Henry's Depilating Forceps.....	"	2.50

All Instruments illustrated are designated by a \*

VI. EYE INSTRUMENTS.

LACHRYMAL PROBES, CATHETERS, STYLES AND SYRINGES.

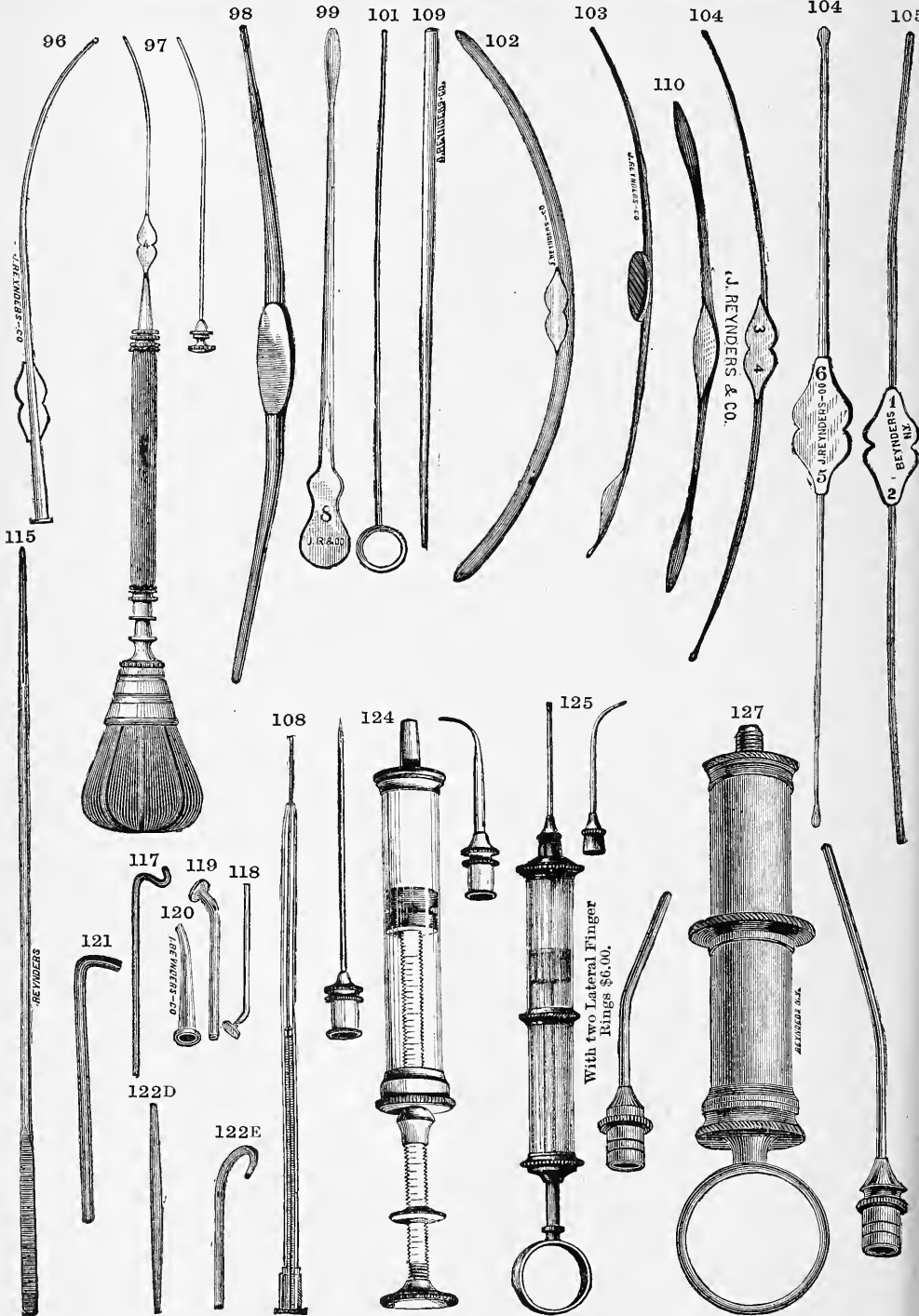



## VI. EYE INSTRUMENTS.

## LACHRYMAL PROBES, CATHETERS, STYLES AND SYRINGES.

96.* Wecker's Lachrymal Canula. Plated \$1.25 ; silver . . . . .	\$1.75
97.* Bulb Syringe with tubing and fittings for either of the above . . . . .	7.25
98.* Weber's Probe. Plain \$1.00. Graduated . . . . .	1.25
99.* Noyes' Probes of pure silver, Nos. 4 to 9 millimètre scale . . . . . per set	8.00
100. Noyes' Probes of hard rubber, Nos. 6 to 11 millimètre scale . . . . . "	2.00
101.* Anel's Probe, silver . . . . .	.50
102.* Theobald's Probes, Nos. 1 to 16 . . . . . per set	3.75*
103.* Liebreich's Probe and Canalicula Knife combined . . . . .	2.00
104.* Williams' Probes, silver . . . . . per set of 8 sizes	3.50
105.* Bowman's " " . . . . . " "	3.00
106. Bowman's " hard rubber . . . . . " "	2.00
107. Levis' Probe. Two ass't sizes on one ivory handle . . . . .	2.00
108.* Livingston's Elastic Probe . . . . .	2.50
109.* Peck's Lachrymal Dilator . . . . .	.50
110.* William's " " . . . . .	1.00
111. Sea Tangle " " . . . . . set of 6	1.50
112. Galezowski's " " . . . . .	2.50
113. Gensoul's " Porte Caustic . . . . .	3.00
114. Gensoul's " Catheter . . . . .	2.00
Speir's " " . . . . .	1.25
Wecker's " " silver . . . . .	1.50
115.* Bowman's Director . . . . .	.75
116. Critchet's Director . . . . .	.75
117.* Style of hard rubber . . . . .	.25
118.* Style of silver \$0.40 to \$0.75. Gold \$1.50 to . . . . .	3.50
119.* Style canulated of silver . . . . .	.50
120.* Style canulated of silver . . . . .	.75
121.* Style of lead . . . . .	.25
122 D and E** Styles Williams . . . . . each	.50
123. Anel's Lachrymal Syringe with German silver cylinder and 3 silver canulas. In case . . . . .	6.00
124.* Anel's Lachrymal Syringe with glass cylinder, 1 Hypodermic needle and 1 silver canula. In case . . . . .	\$5.00
125.* Anel's Lachrymal Syringe with glass cylinder and 2 silver canulas. In case . . . . .	5.00
126. Anel's Lachrymal Syringe with hard rubber cylinder, 3 plated and 1 hard rubber canulas. In case . . . . .	5.00
127*. Agnew's Lachrymal Syringe with glass cylinder and 2 pliable silver canulas. In case . . . . .	5.00

All Instruments illustrated are designated by a \*

VI. EYE INSTRUMENTS.

IRIS FORCEPS, NEEDLE HOLDERS, ETC.

128



129



130



132



133



134



135



136



140



137

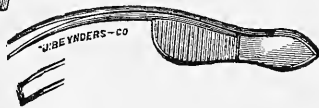

169



141

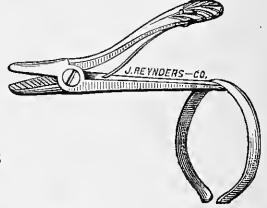

138



142



143



144



145

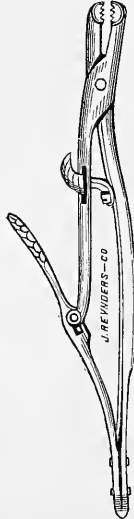

146

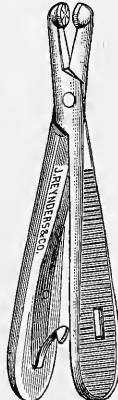

147

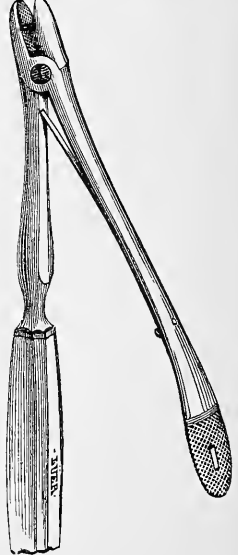

## VI. EYE INSTRUMENTS.

## IRIS FORCEPS, NEEDLE HOLDERS, ETC.

128.*	Iris Forceps, straight with projecting teeth .....	\$1.50
129.*	“ “ straight.....	1.50
130.*	“ “ Agnew's short curve.....	1.75
131.	“ “ “ “ “ and back teeth.....	2.25
132.*	“ “ long curve.....	1.75
133.*	“ “ angular curve.....	1.75
134.*	“ “ Mathieu's.....	5.50
135.*	“ “ Walton's self closing.....	2.50
136.*	“ “ Liebreich's.....	4.75
137.*	“ “ Fisher's, with plain serrations or mouse teeth..... each	1.25
138.*	“ “ Liebold's .....	5.25
139.*	“ “ canulated, Wilde's. (See page 88.).....	12.00
140.*	Forceps Needle, Lannes.....	4.50
141.*	Needle Holder, Galezowsky's.....	3.00
142.*	“ “ J. Reynders & Co.'s.....	4.50
143.*	“ “ Dudley's .....	4.50
144.*	“ “ Prout's .....	3.50
145.*	“ “ Sand's .....	4.50
146.*	“ “ plain.....	2.50
147.*	“ “ Wecker's .....	4.50

## IRIS SCISSORS.

148.*	Iris Scissors, Wecker's, with one each sharp and round points.... (See page 82.)	8.00
149.*	“ “ Wecker's, with round points.....( “ “ “ )	8.00
150.*	“ “ McCluer's.....( “ “ “ )	6.00
151.*	“ “ Liebreich's.....( “ “ “ )	5.50
152.*	“ “ Agnew's straight.....( “ “ “ )	1.50
153.*	“ “ “ curved on flat.....( “ “ “ )	1.75
154.*	“ “ Maunoir's angular, one blade probe pointed.....( “ “ “ )	2.25
155.	“ “ Noyes'.....( “ “ “ )	4.50
156.*	“ “ straight... ..( “ “ “ )	1.50
157.*	“ “ curved on flat.....( “ “ “ )	1.75
158.	“ “ Liebold's .....	7.25
159.*	“ “ canulated and Forceps to one handle, Wilde's. (See page 88.)....	15.00

## ENUCLEATION SCISSORS, ETC.

160.*	Enucleation Scissors, Agnew's. (See page 82.).....	1.75
161.*	“ “ Warlomont's combined with Hemostatic Forceps. (See page 82.).....	6.00
162.*	Enucleation Scoop.....(See page 82.)	2.75
163.*	Enucleation Forceps, with claws.....( “ “ “ )	1.50

All Instruments illustrated are designated by a \*

VI. EYE INSTRUMENTS.

IRIS, STRABISMUS AND ENUCLEATION SCISSORS, ETC.

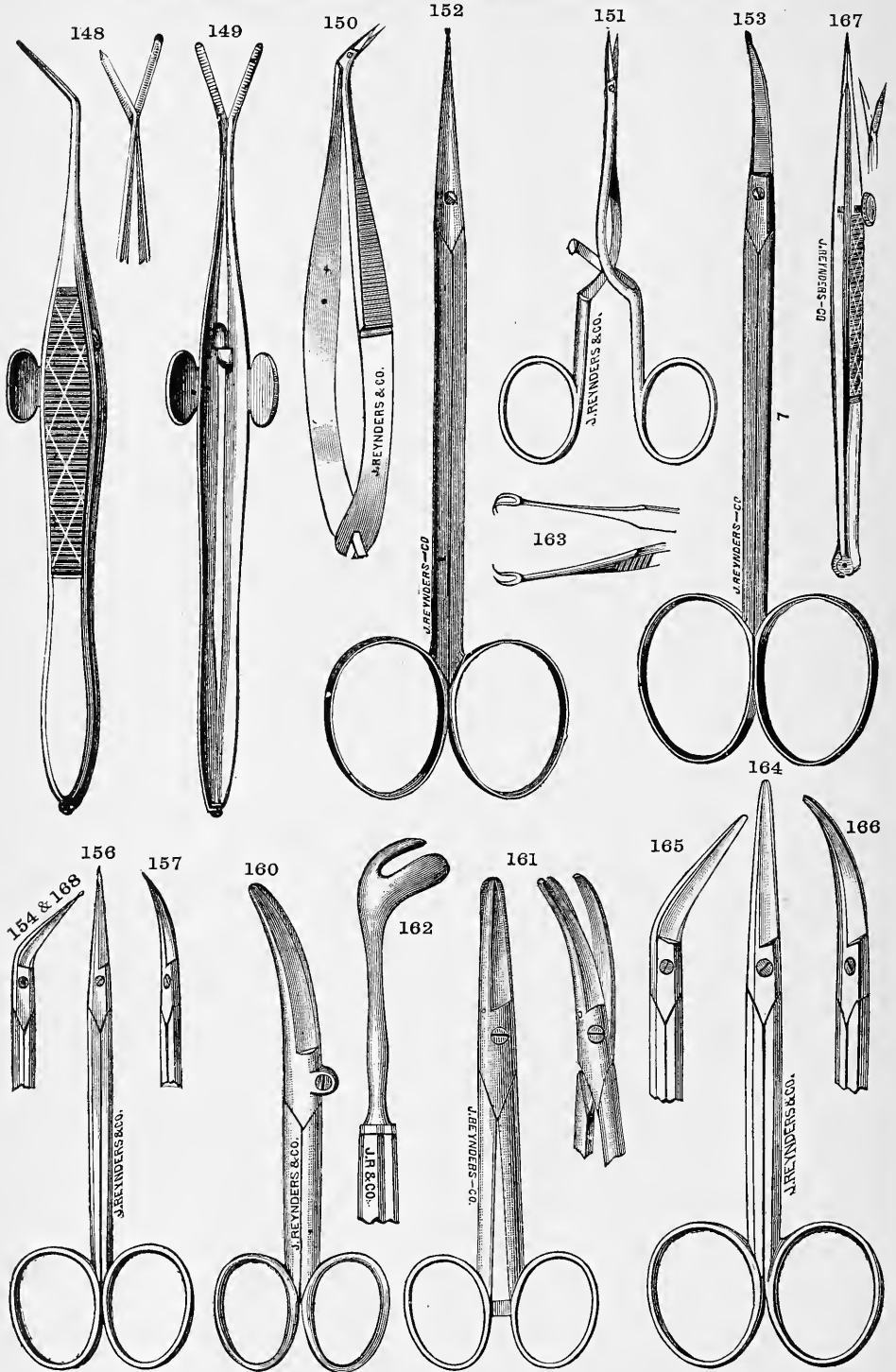

## VI. EYE INSTRUMENTS.

## STRABISMUS SCISSORS, FIXATION AND STRABISMUS FORCEPS, ETC.

164.* Strabismus Scissors, straight .....	\$1.50
165.* " " angular .....	1.50
166.* " " curved on flat.....	1.50
167.* Keratome " Strawbridge's .....	10.00
168.* Canalicula " Maunoir's .....	2.25
169.* Fixation Forceps, Noyes', attachable to his speculum. (See page 80.).....	3.00
170.* " " plain.....( " " 84).....	1.50
171.* " " with spring catch.....( " " " ).....	2.00
172.* " " with slide catch.....( " " " ) .....	3.00
173. " " Monoyer's, double..... ( " " " ).....	5.50
174.* Strabismus Forceps, straight.....( " " " ).....	1.25
175.* " " curved.....( " " " ).....	1.50
176.* Suction Syringe, Bowman's, for soft cataract.....( " " " ).....	7.00
177. Suction Instrument, " " " " .....	4.50
178.* Magnet, Gruening's, for the removal of particles of steel or iron from the Vitreous Chamber. (See page 84.).....	8.00
179. Electro-magnet, Hirschberg's.....	8.00
180.* Spatula, Daviel's, of German silver. (See page 84.).....	1.25
181.* " Althof's, of steel gilt... ..( " " " ).....	1.75
182. " of hard rubber.....( " " " ).....	.75
183.* " of German silver..... ( " " " ).....	1.25
184.* Probe, of silver in ivory handle.....( " " " ).....	1.25
185.* Double Eye Instruments in cases for the pocket, any two instruments to one handle. (See page 84.).....	2.50

## KNIVES.

186.* Canalicula Instrument, Luer's modification of Girard Teulon's. (See page 84.)	8.00
187.* Canalicula Knife, Bowman's probe pointed.....( " " " )	1.50
188.* " " " sharp " .....	1.50
189.* " " Weber's straight probe pointed .....	1.50
190. " " " full curved probe pointed .....	1.50
191. " " " half " sharp " .....	1.50
192. " " Noyes', with straight probe point.....	1.75
193.* " " " curved " " .....	1.75
194.* " " Knapp's, with " " " .....	1.50
195.* " " Stilling's .....	1.50
196.* " " " with bayonet curve shank.....( " " " )	1.75

All Instruments illustrated are designated by a \*

VI. EYE INSTRUMENTS.

FIXATION AND STRABISMUS FORCEPS, CANALICULA KNIVES, ETC.

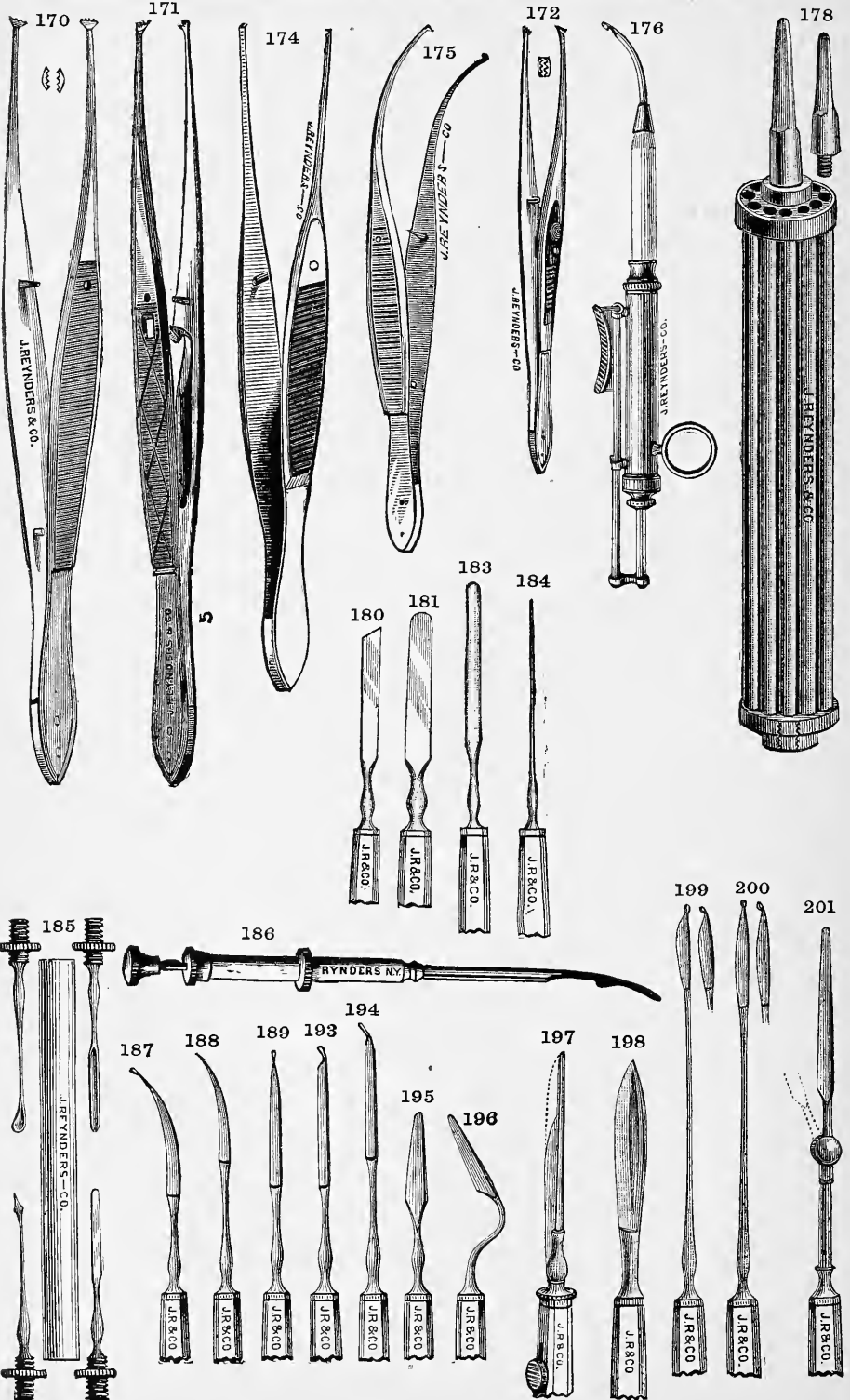

## VI. EYE INSTRUMENTS.

## KNIVES.—Continued.

197.*	Canalicula Knife, Greenslade's, combined with Director	\$4.00
198.*	“ “ Petit's	2.00
199.*	“ “ Noyes', with pliable shank and straight or curved probe point	1.75
200.*	“ “ Agnew's, “ “ “ “ “ “ “ “ “ “	1.75
201.*	“ “ Noyes', jointed	4.00
202.*	Cataract Instrument, Liebreich's, consisting of a v. Graefe's cataract knife, a Cystotome and an ivory scoop, in one handle. (See page 86.)	10.00
203.*	Cataract Knife, Noyes', hollow ground. ( “ “ “ )	2.00
204.*	“ “ Knapp's, hollow ground. ( “ “ “ )	2.00
205.*	“ “ v. Graefe's narrow ( “ “ “ )	1.50
206.*	“ “ “ “ wide ( “ “ “ )	1.50
207.*	“ “ Zehender's 3 sizes. ( “ “ “ )	each 1.50
208.*	“ “ Beer's “ “ ( “ “ “ )	“ 1.50
209.*	“ “ Weber's. ( “ “ “ )	3.00
210.*	“ “ Sichel's (See page 88.)	1.50
211.*	Keratome, Jaeger's, angular. 3 sizes. (See page 86.)	each 1.75
212.*	“ “ straight. “ “ ( “ “ “ )	1.50
213.*	Hooked Knife, Agnew's (See page 88.)	1.75
214.*	Bistoury curved, sharp pointed. ( “ “ “ )	1.50
215.*	“ “ probe “ ( “ “ “ )	1.50
216.*	Lid Scarifier, Desmarres'	( “ “ “ ) 1.50
217.*	Scalpels, 3 sizes ( “ “ “ )	each 1.50
218.*	Secondary Knife, Desmarres' concave edged. ( “ “ “ )	1.50
219.*	“ “ “ straight “ ( “ “ “ )	1.50
220.*	“ “ “ angular right and left. ( “ “ “ )	each 1.50
221.*	Knife Needle, Hayes'	( “ “ “ ) 1.50
222.*	“ “ Knapp's ( “ “ “ )	2.00
223.*	Iris Knife, sickle shaped ( “ “ “ )	1.75
224.	“ “ with stop ( “ “ “ )	1.75
225.*	“ “ double edged. ( “ “ “ )	2.00
226.*	“ “ straight edged. ( “ “ “ )	1.50
227.	Iridotomy Knife, Agnew's	1.75
228.*	Strabismus Hook, Wecker's, with sliding blade for advancing the muscle. (See page 86.)	4.00
229.*	“ “ Hooks, plain, 3 sizes. (See page 86.)	each 1.25
230.*	“ “ Agnew's, 3 sizes, with an eye near the point for ligatures. (See page 86.)	each 1.25
231.*	“ “ barbed.	1.50

## SCOOPS.

232.*	Scoop of hard rubber in ivory handle. (See page 86.)	1.75
233.	“ “ shell “ “ “	1.75

All Instruments illustrated are designated by a \*

VI. EYE INSTRUMENTS.

HOOKS, SCOOPS, KNIVES AND NEEDLES.

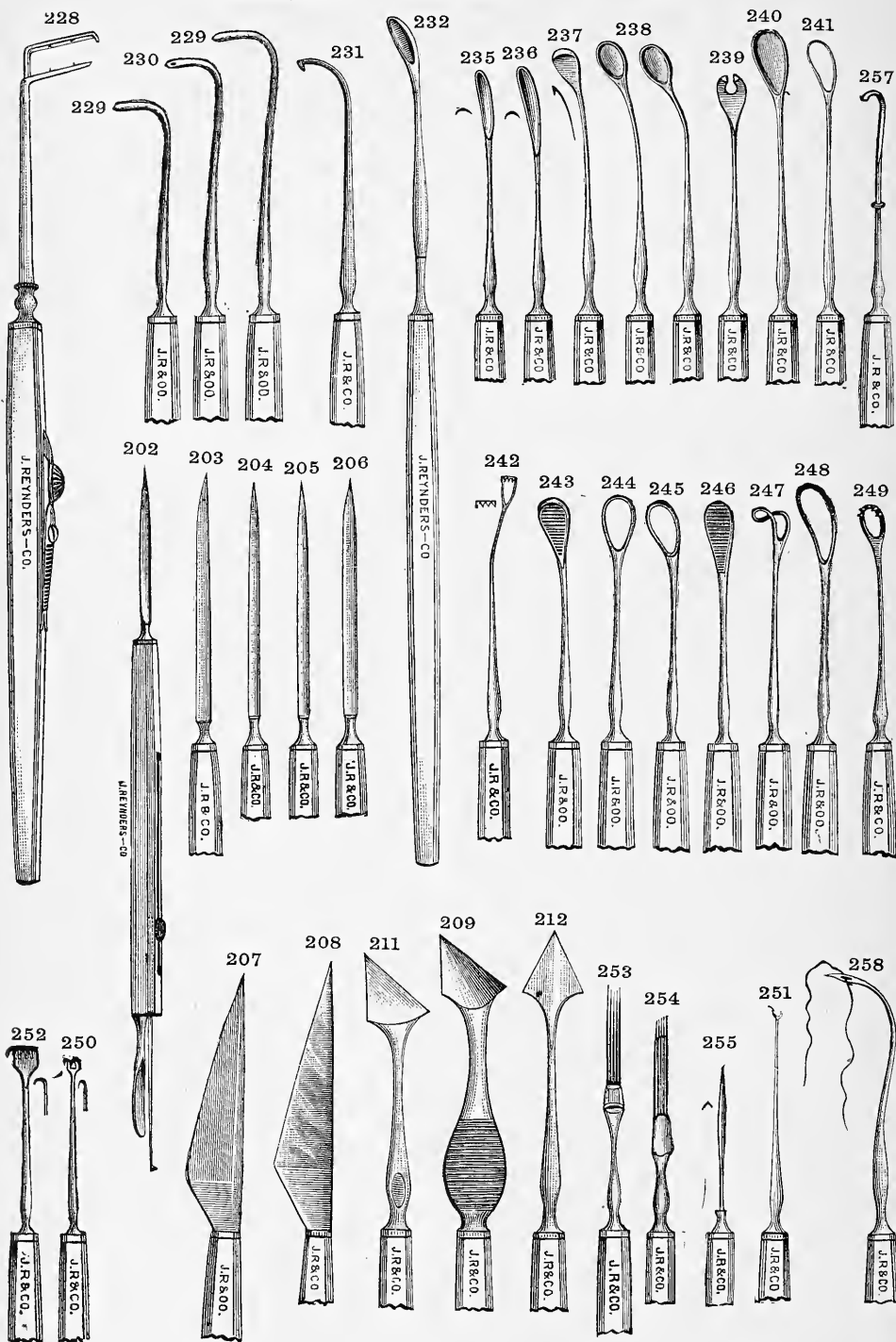



## VI. EYE INSTRUMENTS.

## SCOOPS.—Continued.

234.	Scoop of shell, Weber's, in ivory handle.....	\$1.75
235.*	“ “ steel, sharp edged, Wecker's.....	1.75
236.*	“ “ German silver, Daviel's.....	1.50
237.*	“ “ “ “ concave, Critchett's.....	1.75
238.*	Scoops of silver, Waldau's.....each	2.00
239.*	Scoop of German silver, Noyes'.....	1.75
240.*	“ “ silver, Knapp's.....	2.00
241.*	“ “ steel, fenestrated, Levis'.....	1.75
242.*	“ “ “ toothed, Perrin's.....	2.25
243.*	“ “ German silver, concave, with serrations, Critchett's.....	1.75
244.*	“ “ “ “ fenestrated, straight, Bowman's.....	1.50
245.*	“ “ “ “ curved, Bowman's.....	1.50
246.*	“ “ “ “ serrated, “.....	1.50
247.*	“ v. Graefe's.....	1.75
248.*	“ of German silver, fenestrated, with serrations, Bowman's.....	1.75
249.*	“ “ steel, toothed, Noyes'.....	2.25

## HOOKS, NEEDLES, CYSTOTOMES, ETC.

250.*	Hook for Fixation, double pronged.....	1.50
251.*	“ “ “ spiral, Luer's.....	1.75
252.*	“ many pronged, for obliterating the Lachrymal sack.....	2.00
253.*	Tatooing Needle, Agnew's.....	2.00
254.*	“ “ Baader's.....	2.00
255.*	“ “ grooved.....	1.50
256.	Hook Sharp for lens, v. Graefe's.....	1.75
257.*	Hook Blunt “ “ “ “ (See page 86).....	1.50
258.*	Needle for sutures, Himley's.....	2.00
259.*	Ophthalmostate, Delluce's. (See page 88.).....	2.00
260.*	“ Pamard's. (“ “ “).....	1.50
261.	“ three pronged.....	1.50
262.*	Hook Blunt, English model. (See page 88.).....	1.25
263.*	Needle, round pointed, Walton's. (See page 88.).....	1.25
264.*	Needle Paracentesis, Desmarre's straight and angular. (See page 88.).....each	1.75
265.*	“ “ “ “ “ “ (“ “ “).....	1.75
266.*	Needle, Beer's, straight or curved, wide.....(“ “ “).....	1.25
267.*	“ “ “ “ narrow.....(“ “ “).....	1.25
268.*	“ with stop, Bowman's.....(“ “ “).....	1.50
269.*	“ “ Knapp's.....(“ “ “).....	1.50
270.*	“ Broad.....(“ “ “).....	1.25
271.	“ sickle-shaped, Roosa's.....	1.25

All Instruments illustrated are designated by a \*

VI. EYE INSTRUMENTS.

KNIVES, NEEDLES, HOOKS, CYSTOTOMES, ETC.

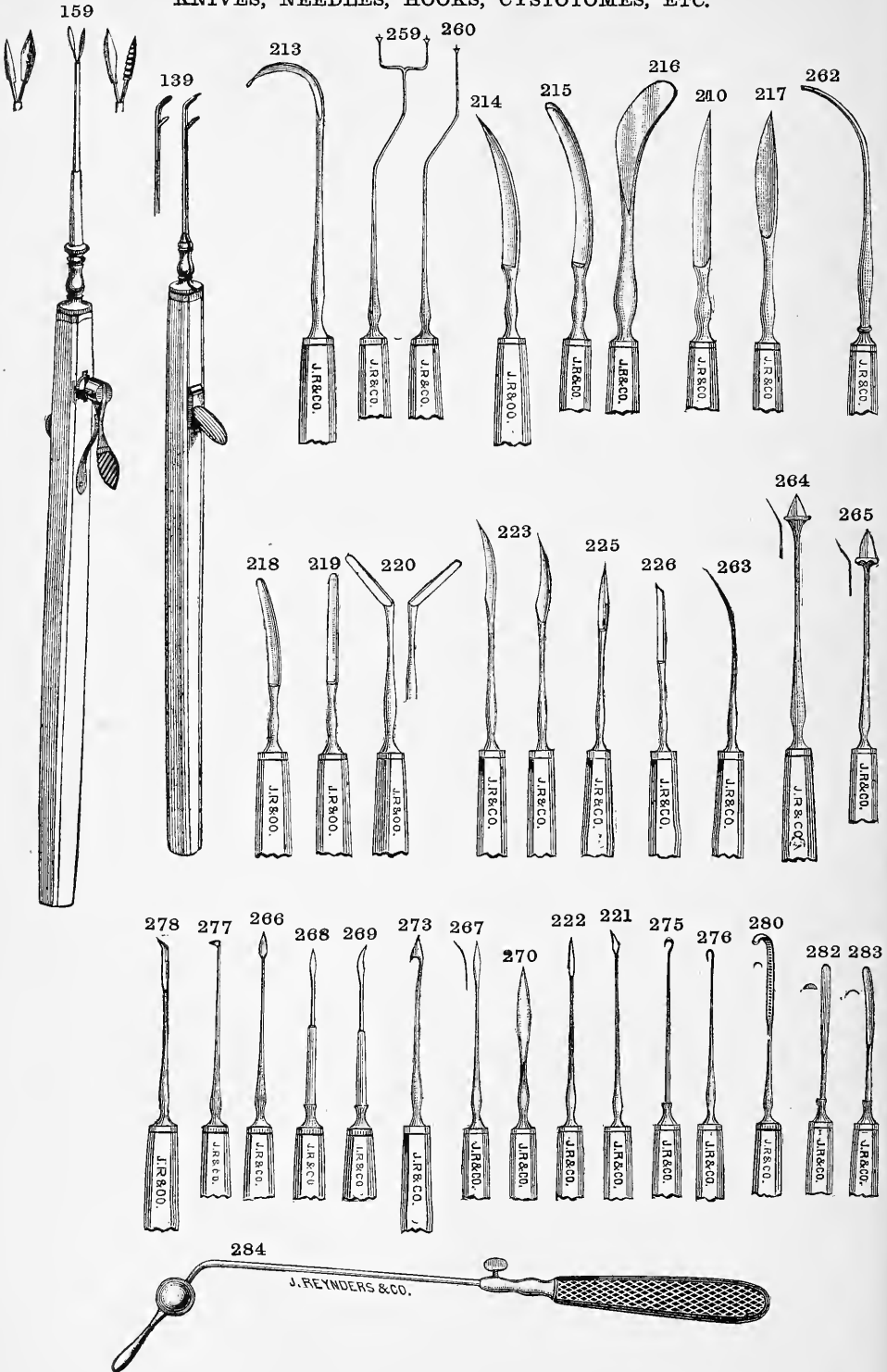

## VI. EYE INSTRUMENTS.

## HOOKS, NEEDLES, CYSTOTOMES, ETC.—Continued.

272.	Needle, hooked, Critchett's.....	\$1.25
273.*	“ hooked, Luzzardi's. (See page 88.).....	1.50
274.	“ grooved for soft cataract, Walton's.....	2.00
275.*	Hook Sharp, Tyrell's.....each	1.25
276.*	“ Blunt “ .....	1.25
277.*	Cystotome, v. Graefe's.....	1.50
278.*	“ Knapp's.....	1.75
279.	“ hook, Agnew's.....	1.50
280.*	Foreign Body Hook, Knapp's.....	2.00
281.	“ “ Scoop of hard rubber, plain.....	.50
282.*	Spud.....	1.25
283.*	Gouge, grooved.....	1.50
284.*	Cautery Iron, Desmarres', for obliterating the sack.....	3.00

## DOUBLE INSTRUMENTS.

285.	Knapp's hooked Spatula and Silver Probe.....	} each \$2.50
286.	Broad Needle and Critchet's Scoop.....	
287.	“ “ “ S. Waldau's Scoop.....	
288.	“ “ “ Daviel's “ .....	
289.	“ “ “ Cystotome.....	
290.	“ “ “ Silver Probe.....	
291.	Cystotome and Daviel's Scoop.....	
292.	“ “ silver “ .....	
293.	“ “ Paracentesis Needle.....	
294.	Desmarres' Paracentesis Needle and Silver Probe.....	

Others made to order.

## SUNDRIES.

295.	Drum for testing the points and edges of eye instruments..	.75
296.	Suture needles, very fine..... per dozen	1.50
297.	“ “ medium .....	1.00
298.	Chinese Pearl Silk, white or black, per skein.....	.15
299.	Holder for Sulphate of Copper .....	.25
300.	Sulphate of Copper Stick, in wooden handle, with cap.....	.75*
301.	Alum Stick “ “ “ “ “ .....	.75*
302.	Lapis Divinus Stick “ “ “ “ “ .....	.75*
303.	Mitigated Caustic (Argent. nitric. c. Kali nitric 1:1, 1:2 and 1:3)..... per stick	.75

All Instruments illustrated are designated by a \*

VI. EYE INSTRUMENTS.

OPERATING CHAIR AND CONTENTS OF EYE CASES.

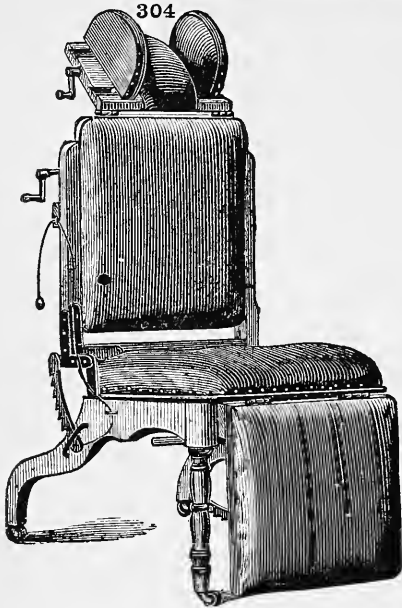

304.\* Knapp's Oculists' Operating Chair. By its aid the patient's head can be placed in any position and held steady by two adjustable jaws.

The back of the chair can be raised to suit the height of the patient's shoulders and also inclined backwards to any degree. For children the seat can be raised evenly or tilted forward and backward at different angles. The foot piece for the support of the lower extremities, can be raised to any angle.

Upholstered in leather, metal parts bronzed ..... \$50.00\*

CONTENTS OF EYE CASES.

Case of Eye Instruments No. 1, contains: 1 plain wire Speculum; 1 straight Iris Forceps; 1 Strabismus Hook; 1 Scissors curved on flat; 1 silver Probe; 1 Spud for foreign bodies; 1 Daviel's Curette; 1 Beer's Knife; 1 curved Needle; 1 Iris Needle; 1 Tyrell's sharp Hook; fine Needles and Silk. In a neat morocco, velvet lined case. .... \$17.00

Case of Eye Instruments No. 2, contains: 1 plain wire Speculum; 1 Iris Forceps; 1 Agnew's Lachrymal Knife; 1 Strabismus Scissors; 1 Strabismus Hook; 1 silver Probe; 1 Beer's Knife; 1 curved Needle; 1 straight Needle; 1 Critchet's Lens Scoop; 1 Keratome; 1 straight Iris Scissors; 1 Tyrell's blunt Hook; 1 Spud; Needles and Silk. In a fine morocco case, velved lined ..... \$23.00

Case of Eye Instruments No. 3, contains: 1 plain wire Speculum; 1 Fixation Forceps; 1 Cilia Forceps; 1 Anel's Probe; 1 Agnew's Lachrymal Knife; 1 Desmarres' Lid Scarifier; 1 small Scalpel; 1 Strabismus Hook; 1 Strabismus Forceps; 1 Beer's Cataract Knife; 1 Graefe's Cataract Knife; 1 small curved Needle; 1 Cystotome; 1 Tyrell's blunt Hook; 1 Daviel's Scoop; 1 straight Keratome; 2 angular Keratomes, large and medium; 1 straight Iris Needle; 1 straight Iris Forceps; 1 straight Iris Scissors; 1 Iris Scissors, curved on flat; 1 Couching Needle; Needles and fine Silk. In a fine morocco case, \$35.00

Case of Eye Instruments, No. 4, Knapp's, contains: 2 Desmarres' Lid holders; 2 Fixation Forceps, spring catch; 1 Artery and Needle Forceps; 1 hard rubber Lid plate; 1 Porte caustic; 2 Bistouries; 2 Lanceshaped Knives; 2 Knapp's Entropium Forceps, right and left; Strab. Scissors; 2 Strab. Hooks; 1 set Bowman's Probes; 1 Weber's Cataract Knife; 1 Blunt Hook; 1 Cystotome; 1 Silver Knapp's Cataract Scoop; 2 Knapp's Cataract Knives; 1 Beer's Cataract Knife; 1 Stop Needle; 2 Sickle-shaped Needle; 2 Iris Forceps; 2 Iris Scissors; 1 Foreign Body Needle; 1 Knapp's Foreign Body Hook; 1 Tattooing Needle, In a grooved fine morocco case, with Anel's Syringe separate ..... \$80.00

Case of Eye Instruments No. 5, Agnew's, contains: 1 pair v. Graefe's Specula; 1 Fixation Forceps, spring catch; 1 Desmarres' double lid Retractor; 1 Agnew's Lachrymal Syringe, with two pliable silver points; 1 set of Bowman's Probes; 1 Bowman's Lachrymal Director, gilt; 1 Weber's Probe, plain; 1 Agnew's Lachrymal Knife with long pliable shank; 1 Prout's Needle Holder; 1 Scissors, straight, small, round points; 1 Scissors, straight, large; 1 Scissors, curved on flat, delicate; 1 Agnew's Strabismus Hook, with eye at tip; 1 plain Strabismus Hook; 1 Strabismus Forceps; 1 Agnew's Tattooing Needle; 1 Beer's Cataract Knife; 1 v. Graefe's Linear Cataract Knife; 1 Liebreich's Linear Cataract Knife, narrow; 1 Cystotome; 1 small Cataract Needle; 1 h. r. Scoop; 2 Stop Needles; 1 Iris Forceps, straight, delicate; 1 Tyrell's sharp Hook; 1 Iridectomy Knife, angular; 1 Desmarres' Paracentesis Needle; 1 large Scissors, curved on flat for enucleation; Needles and Silk. In fine morocco case, velved lined. .... \$65.00

Case of Eye Instruments No. 6, H. D. Noyes', contains: 2 Desmarres' Eye Lid Retractors; 1 Noyes' Speculum; 1 Noyes' Canaliculus Knife; 1 set Bowman's Probes; Lead Wire; for Styles; 1 small Scalpel; 1 Lachrymal Syringe; 2 Strabismus Hooks; 1 Strabismus Scissors; 1 Enucleation Scissors; 1 Iris Scissors, straight; 1 Iris Scissors, curved; 1 Fixation Forceps, spring-catch; 1 plain Forceps; 1 Dix's Spud; 1 Spatula; 1 Iridectomy Knife, straight; 1 Iridectomy Knife, angular; 1 curved Iris Forceps; 1 Tyrell's blunt Hook; 2 straight Discission Needles; 3 Graefe's Cataract Knives, ass.; 1 small sharp Iris Hook; 1 Prout's Entropium Forceps; 1 Cystotome and Curette; 1 Sand's Needle Holder; 1 h. r. Spoon; 1 Lens Scoop; Needles and Silk; in a rosewood, velvet lined case. .... \$75.00

## VI. EYE INSTRUMENTS.

## CONTENTS OF EYE CASES.—Continued.

**Case of Eye Instruments No. 7**, W. F. Mittendorf's, contains: 1 Plain wire Eye Speculum; 2 Noyes' Cataract Knives; 1 Curved Iridectomy Knife; 1 Agnew's Lachrymal Knife; 1 Cystotome and Scoop; 1 Shell Scoop; 1 Bowman's Needle with Stop; 1 Straight Needle and Spud; 2 Strabismus Hooks, assorted; 1 Lid Retractor; 1 Prout's Entropium Forceps; 1 Small Scalpel; 1 Curved Iris Scissors; 1 Curved blunt pointed Strabismus Scissors; 1 Fixation Forceps with spring catch; 1 Cilia Forceps; 1 Curved Iris Forceps; 1 Prout's Needle Holder; 1 set Bowman's Probes; 3 Fine Curved Needles; Silk; 1 Artificial Leech Cylinder with Piston; in a morocco covered, velvet lined case . . . . \$41.00

**Pocket Case of Eye Instruments No. 8**, Edward S. Peck's, contains: 1 Weber's Universal Eye Speculum; 1 Weber's Lachrymal Knife; 1 Wecker's Lachrymal Canula; 2 Bowman's Probes Nos. 1:2 and 3:4; 1 Beer's Cataract Knife; 2 v. Graefe's Hollow Ground Cataract Knives; 1 Curved Iridectomy Knife; 1 German Silver Spoon and Dissection Needle; 1 Hard Rubber Scoop and Knapp's Cystotome; 1 Foreign Body Needle; 1 Plain Fixation Forceps; 1 Conjunctiva Forceps; 1 Cilia Forceps; 1 Curved Iris Forceps; 1 Curved Iris Scissors; 1 Curved Scissors for Strabismus and Enucleation; 2 assorted Strabismus Hooks; 2 Jointed Lid Elevators; 1 Peck's Canaliculus Dilator; 1 Sand's Needle Holder; 1 Test Drum and Cannepin; 6 assorted Needles; 1 Skein black Silk; in a morocco covered, velvet lined case . . . . . \$44.00

## ANATOMICAL MODELS OF THE EYE.

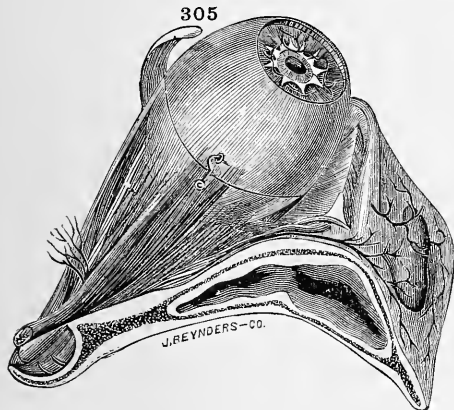

305.\* Dr. Auzoux's Clastic Papier-mâché Model of the Eye, on which is exhibited, not only the muscles, vessels, nerves, membranes, vitreous body and crystalline lens in separable parts, but also the different microscopic strata of the retina, choroid and iris. Colored in imitation of nature. With full descriptive pamphlet . . . . . \$35.00\*

306. The same, divided by a vertical section, and representing its inner half with all the foregoing details and the disposition of the anterior and posterior chambers, in addition a portion of the orbit, the conjunctiva, the structure of the eyelids the meibomian glands, the lachrymal canals and points, the muscles of Horner, etc. With full descriptive pamphlet. \$40.00\*

307. Prof. Bock's Model of the Eye, made of a hard composition of plaster of Paris. Separable and showing the cornea, iris, crystalline lens, and different microscopic strata of retina, choroid and iris. Colored in imitation of nature. Large size, suitable for class demonstration. . . . . \$6.50\*

308. The same of smaller size . . . . . 5.75\*

## ANATOMICAL MODELS OF THE EAR.

309. Dr. Auzoux's Clastic Papier-mâché Model of the Ear. Temporal bone, two feet long, showing the internal, middle, and external ear, in their most minute details; the expansion of the auditory nerve, fenestra ovalis, fenestra rotunda, membranous canals, endolymph, perilymph, double spiral of the cochlea, infundibulum, etc. All parts separable, the mechanism of audition may be clearly demonstrated and understood. Colored in imitation of nature with full descriptive pamphlet . . . . . \$102.00\*

310. The same, half the size of the preceding and showing the same details. With full descriptive pamphlet . . . . . \$51.00\*

311. Prof. Bock's Model of the Ear, made of a hard composition of Plaster of Paris. Separable and showing the drum, the ossicles, labyrinth, and the cochlea, half open. Colored in imitation of nature. Large size suitable for class demonstration . . . . . \$8.00\*

312. The same of smaller size . . . . . 6.00\*

313. Osteological Preparation of Ear, separable, and showing mastoid cells, semicircular canals, cochlea, etc., etc. . . . . \$8.00\*\*

ADDENDA TO EYE.

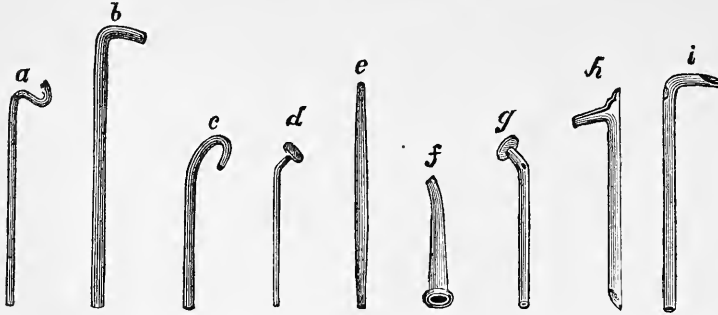

Lachrymal Styles *a b c*, silver..... each \$0.30  
 " " *d e*, " ..... " 0.40  
 " " lead ..... " 0.20  
 " Canula, *f g h i*, silver..... each 50 cts.; plated, each 0.40  
 Any of above of gold \$3.00 per pwt.

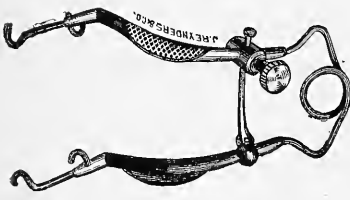
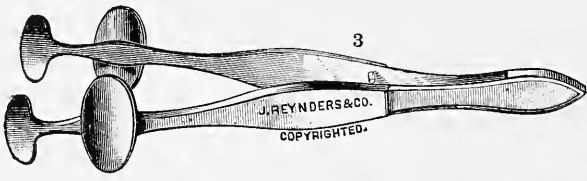

4 and 5. Landolt's Eye Specula. These are made after patterns made by us under supervision of Dr. Landolt of Paris, while he was in this city. The style of fig. 8 is placed over the nasal canthus and is called the inner, that of fig. 9 along the temple is called the outer—of each there are right and left—so that four constitute a set. Fig. 8 is the inner left, fig. 9 the outer right. Price of each.....\$2.00

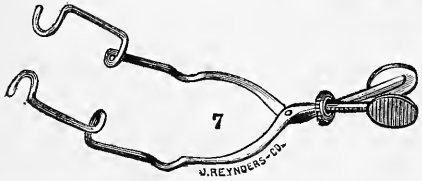
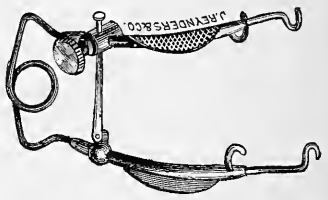

- 1.\* Dudley-Sand's Needle Holder..... \$4.50
- 2.\* Agnew's Bi-Dent, in case ..... 2.50
- 3.\* May's Trachoma Forceps ..... 3.00
- 6.\* Gruening's Platinum Probe for Actual Caution. Platinum running through entire handle..... 2.75
- Probe merely inserted in handle..... 1.75
- 7.\* Mittendorf's Eye Speculum ..... 2.00
- 8.\* Knapp's Lachrymal Syringe, in case ..... 5.00
- 9.\* Tansley's Lachrymal Syringe..... 6.66

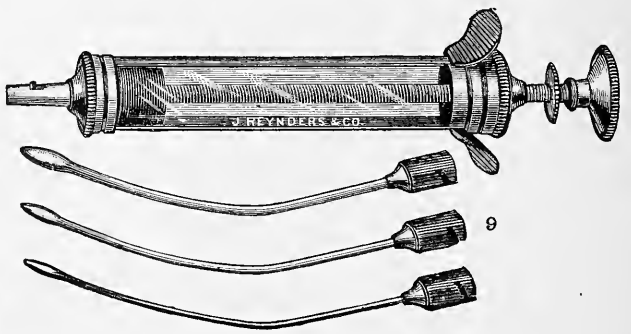

ADDENDA TO EAR.

1.\* Ear Syringe with Syphonic Piston. The piston of this syringe is hollow, and its channel continued by means of the soft rubber tube attached to the rear ring; a spiral spring is coiled around that part of the piston rod remaining outside of the syringe. The dotted lines show the natural position of the piston rod, the full drawing as it is pushed in. When the sinker at the end of the soft rubber tube is placed in a basin with water and the piston rod

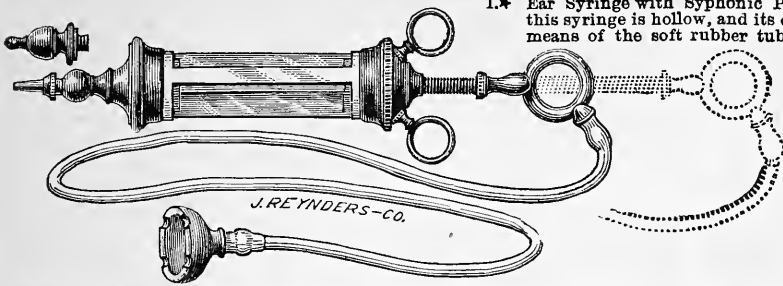

pushed in, water will enter the cylinder of the syringe behind the piston; when by releasing pressure upon the piston, the coiled spring moves it back ward, the water passes through an opening, controlled by a valve in the piston, in front of it. When the piston is pushed in again, the water in the cylinder is ejected while more water enters from the rear end of the piston. By continuing this manipulation an ear can be syringed as long as desired without removing the syringe therefrom during the operation. Price..... \$8.00

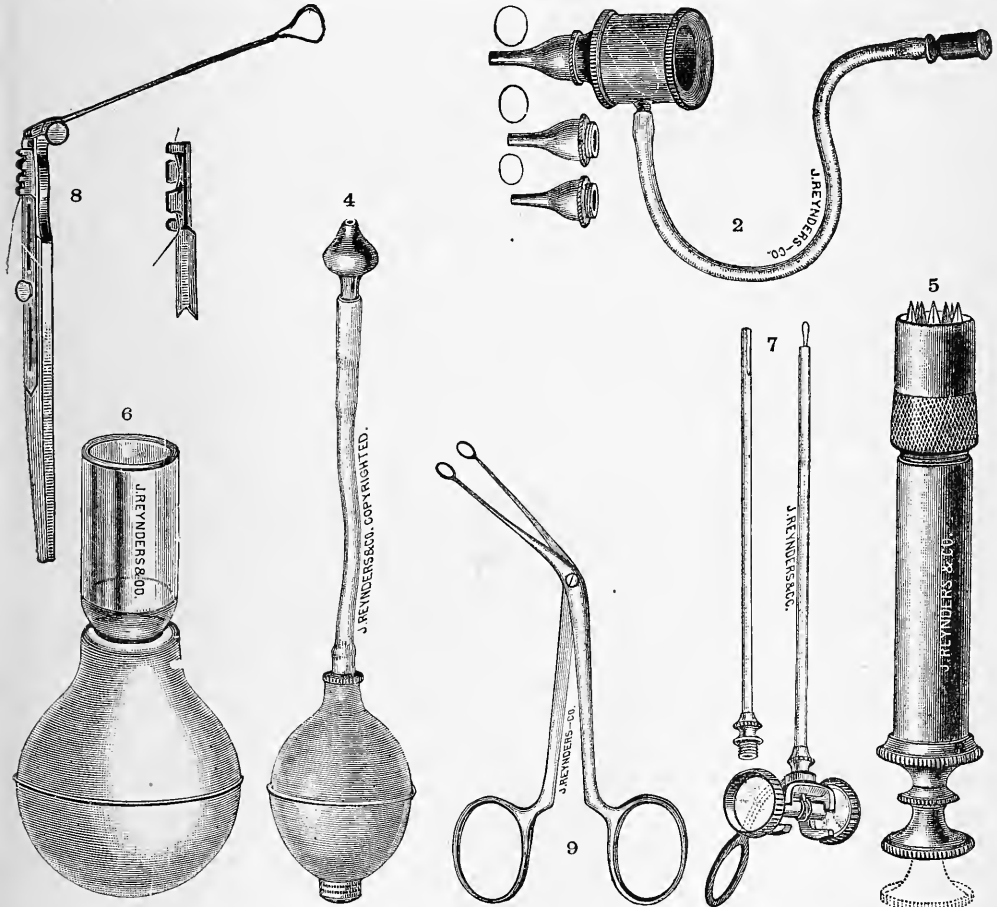

2.* Bacon's modification Siegle's Oscope.....	\$5.00
3. Allen's Ear Forceps.....	4.50
4.* Mitchell's Politzer.....	1.00
5.* Bacon's Scarifier.....	8.00
6.* " Cup.....	0.80
7.* Tansley's Snare.....	4.00
8.* Sexton's ".....	6.00
9.* Bacon's Blunt Curette Ear Forceps.....	5.00

SPECTACLES AND EYEGLASSES.

Having manufactured and supplied the above in the full range of their varieties to our friends for several years, we herewith present a list embracing those mostly in favor; and while not as pretentious and formidable as that of some others, it seems to us that, in offering only the best for use and appearance, we are avoiding mystification, and simplifying to those who have to select the task they therewith must undergo.

LENSES.

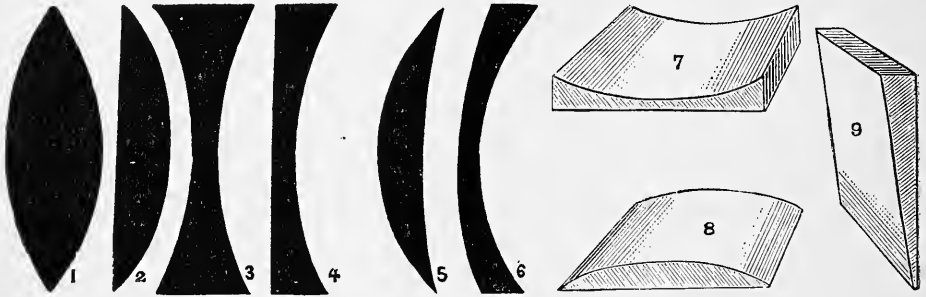

- |                                     |                                    |
|-------------------------------------|------------------------------------|
| 1. Shows double- or bi-convex lens. | 5. Shows periscope convex lens.    |
| 2. " plano-convex lens.             | 6. " " concave lens.               |
| 3. " double- or bi-concave lens.    | 7. " cylindric plano-concave lens. |
| 4. " plano-concave lens.            | 8. " " " convex lens.              |
|                                     | 9. Shows prismatic lens.           |

DIRECTIONS FOR THE FITTING OF FRAMES.

To facilitate giving the same we present herewith a facsimile of the essential part of our Prescription Blanks, pads of which (with or without record stub) will be sent upon application.

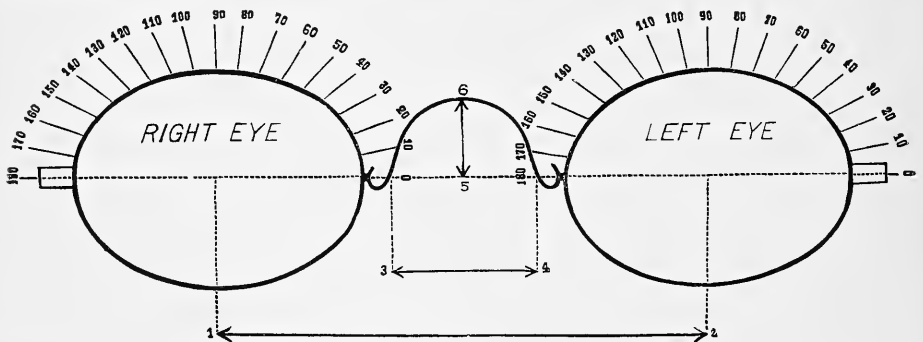

Spherical.....	Spherical.....
Cylind. .... Axis .....	Cylind. .... Axis.....
" .....	" .....
Prism .....° Base .....	Prism .....° Base.....

Distance between center of pupils (1 to 2)..... inch.  
 " " temples ..... "  
 Width of nose (3 to 4) ..... "  
 Height of nose (5 to 6) above pupillary line..... "

See note at foot of page 91-F.



## SPECTACLES AND EYEGLASSES.

Our Prescription Diagram indicates the principal measurements required:

1. Distance between centers of pupils, which, as the term implies, is taken from center to center of pupils, and is indispensable for having the focal centers of the lenses properly adjusted; the diagram shows a frame with a pupillary distance (P. D.) of  $2\frac{9}{16}$  inches.

The pupillary distance for spectacle frames designed for distant use should be measured while the eyes are directed at remote objects of twenty feet or more.

Frames intended for near work, the distance between pupils should be measured while the visual axes are converging at an object about twelve to fourteen inches from the eyes.

2. Distance between temples, which is taken by measuring the width across the face from one temporal bone to the other; in the diagram this is  $4\frac{3}{8}$  inches, measuring from one extreme end of spectacle joint to the other.

3. Height of nose bridge is an important measurement, and should be carefully taken; being designated as arising from or falling below the plane of pupils, as denoted on diagram by dotted horizontal lines. Much of the "fitting" depends upon the manner in which the spectacles rest upon the nose; special "trial frames" to do this with can be found in this catalogue. A simple method, however, may be employed by measuring from the bridge of the nose where the spectacles should rest down to a straight line drawn across the face on a line with the pupils.

In the diagram (on previous page) the height of nose is three-eighths of an inch, being about the average, but, as may be seen by the dotted lines, this measurement is quite likely to vary from nothing to one-half of an inch, or more; shallow or flat noses will generally be suited by a frame like style No. 50 on page 91-I, with the bridge almost identical with the pupillary line. There are, however, faces with prominent eyes and long eyelashes which require the lenses to be removed further from the face than the natural formation of the nose permits; for such we recommend the "Saddle bridge," which is illustrated on page 91-J, No. 68, and consists of a regular "C" bridge with extra long shanks set at right angles to it, which may be carried backward and downward to any desired plane or height; for such, in addition to the foregoing measurements, state in what plane the top of the bridge should be set.

4. In ordering eyeglasses a fourth measurement is necessary: the "width of the nose," which can be estimated by the use of a pair of calipers, or by looking at the nose over the edge of a rule, or by putting on a pair of frames that fit passably well and measuring the distance between nose-clips at top and bottom; difficult cases will, however, be met with where these rules do not suffice; for such we will send any of the frames enumerated in this catalogue to assist in a proper selection.

These diagrams below show our "Standard" sizes of eyes for spectacles and eyeglasses; should any special size be desired it may be designated by number.

Sizes 1 and 2 are those most commonly employed. If no size of eye is mentioned we shall use whatever appears to be in best proportion to the measurements given.

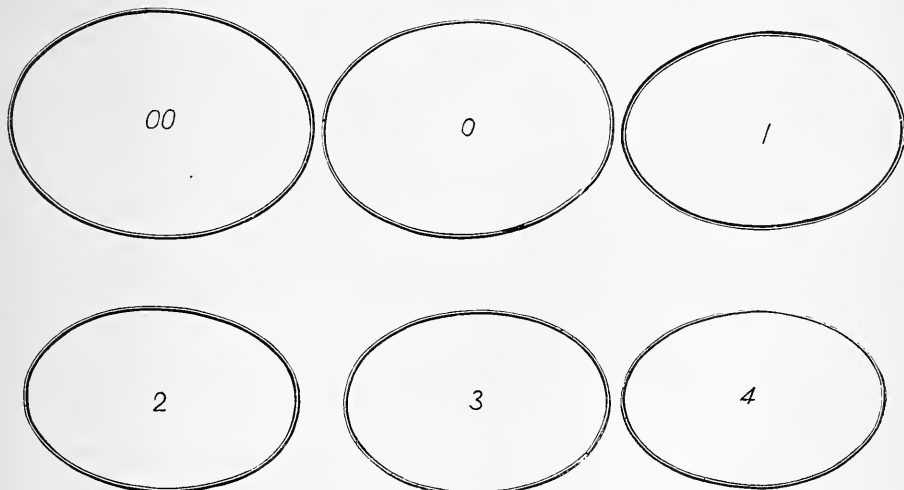

See further, page 91-F.

## SPECTACLES AND EYEGLASSES.

Below is a cut giving the various sizes of spectacle frames in ordinary use, and from this it will be understood that the different parts of a frame must necessarily bear a relative proportion to each other, so that, for instance, a frame with a P. D. of  $2\frac{1}{32}$  inches cannot have eyes the size of the frame with a P. D. of  $2\frac{5}{8}$  inches and still leave sufficient space for the nose,

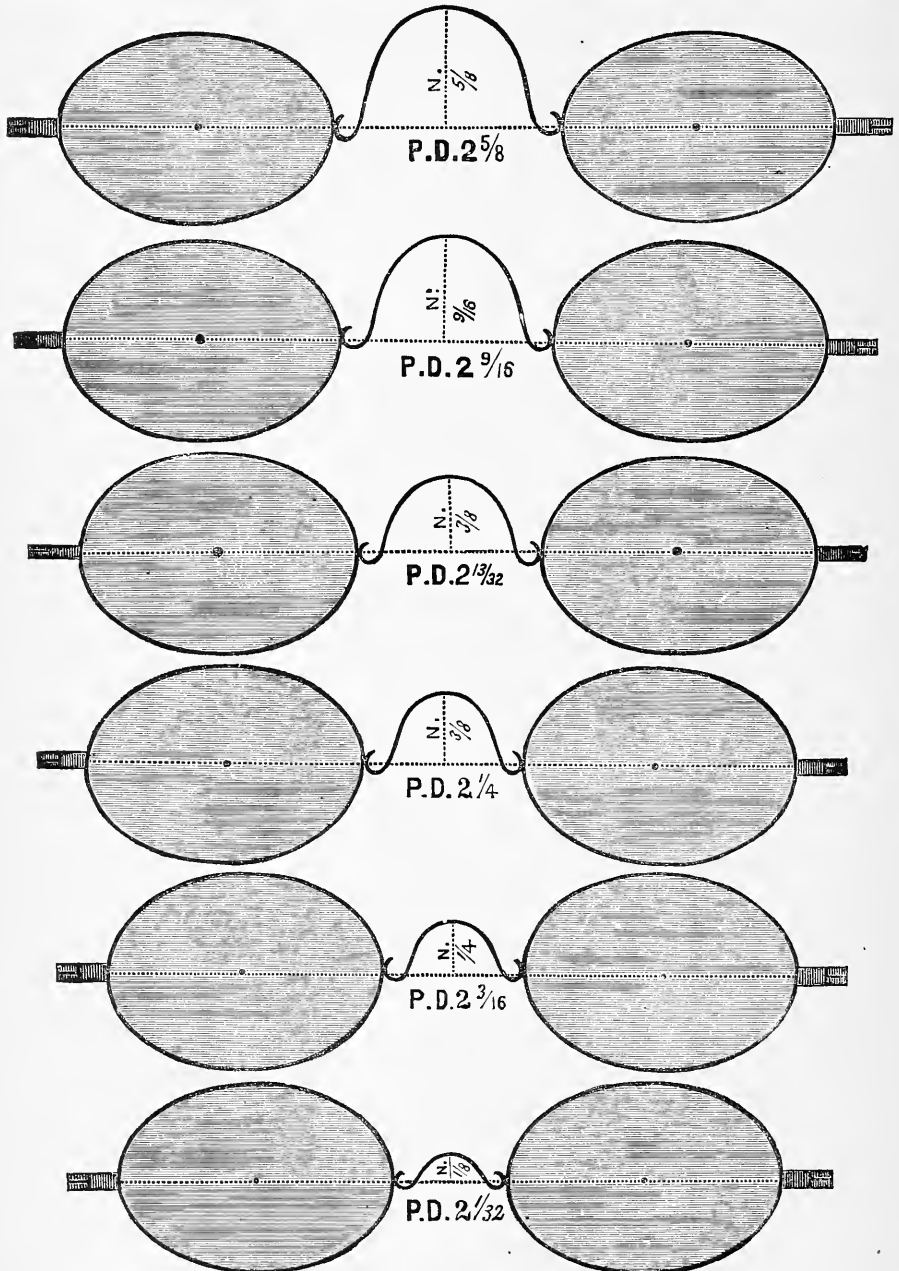

nor can it measure more than  $3\frac{3}{4}$  inches between joints, unless these were made longer than usual, which would be unsightly as well as troublesome to make. Our space does not permit our going more fully into this subject. The few simple rules on the preceding page are sufficient to secure a reasonably good fit to begin with, and if observed will save unnecessary correspondence and delay; experience will do the rest.

**SPECTACLES AND EYEGLASSES.**

In further reference to our Prescription Diagram, page 91-C, we state that, by the same provision is made for the ordering of simple as well as compound lenses; the graduated semi-circles indicate the direction in which the axis of cylindrical lenses is set by us; the angles are marked in accordance with our own, Nacet's and the majority of trial frames in use; should a trial frame be employed on which the graduation runs in an opposite direction from ours, special mention of this fact must be made.

We execute orders in the metric as well as the inch system; care should be taken about placing decimal periods and adding a D (dioptric) when ordering in the metric system.

The style of frames or mountings desired need be indicated only by reference to catalogue number. We furnish steel goods usually in straw color; if the blue finish is preferred, it should be mentioned; nickel plating prevents rusting of steel to a great extent.

It is important that the measurements as given on our blank should be carefully taken: the chief points are covered by directions to be found on this and the previous three pages; in some cases a few sample frames (which upon request will be furnished at cost) will help materially; by trying these frames on it can be seen how nearly right they are, and by allowing for the necessary changes a very good fit may be secured.

The scale between the two semi-circles on our blank is designed for measuring the height of bridges of spectacles; by placing the sample frame with joints resting on the horizontal lines of the semi-circles the height of bridge can be measured on this scale, and should any change be necessary such may be readily noted.

To ascertain the P. D. of spectacle frames our method is to measure from the portion of the right eye-wire where it joins the end piece to that part of the left eye-wire where it joins the bridge; this will be the same as measuring between centers and is more easily obtained.

The use of eyeglass frames for cylindrical or compound lenses is not to be recommended; but if insisted upon, follow directions given on page 91-D, sections 1 and 4, carefully.

**COMPARATIVE TABLE GIVING THE REAL AND APPROXIMATE VALUES OF THE METRIC AND OLD SYSTEMS.**

I. No. of the new (Metric) in system.	II. Equivalents in <i>English</i> in. (old system).	III. Number of the old (In.) system.	IV. Equiv. in dioptries (new system).	I. No. of the new (Metric) in system.	II. Equivalents in <i>English</i> in. (old system).	III. Number of the old (In.) system.	IV. Equiv in dioptries (new system).
0.25	157.48	—	—	5.5	7.15	7	5.6
0.5	78.74	72	0.54	6	6.50	6½	6.02
0.75	52.49	48	0.81	6.50	6.05	6	6.52
1	39.37	40	0.93	7	5.62	5½	7.12
1.25	31.49	30	1.08	8	4.92	5	7.83
1.50	26.24	26	1.30	9	4.37	4½	8.70
1.75	22.49	22	1.63	10	3.93	4	9.72
2	19.68	20	1.96	11	3.58	3½	11.2
2.25	15.50	18	2.17	12	3.28	3¼	12
2.5	15.74	16	2.46	13	3.02	3	13
2.75	14.91	14	2.8	14	2.81	2¾	14.4
3	13.12	13	3	15	2.62	—	—
3.25	12.11	12	3.26	16	2.46	2½	15.7
3.50	11.25	11	3.56	17	2.30	—	—
4	9.84	10	3.9	18	2.18	2¼	17.4
4.5	8.75	9	4.35	20	1.96	2	19.6
5	7.87	8	4.9				

We give the above list for comparison, but all orders will be filled either in the metric or inch system, as designated in the Prescription, as we have a full assortment of both metric and inch lenses; also, tools for grinding both kinds.

The technical procedure for securing the requisite specifications for conveying directions for perfect fitting spectacle and eyeglass frames heretofore requiring considerable dexterity (and even then leaving it rather a precarious matter), is now facilitated and simplified to the utmost by our **New Combined Pupillary, Temple and Nose Measurer**, to an extent not previously achieved by any other device. (See page 91-T.)

**SPECTACLES.—STEEL AND GOLD.**

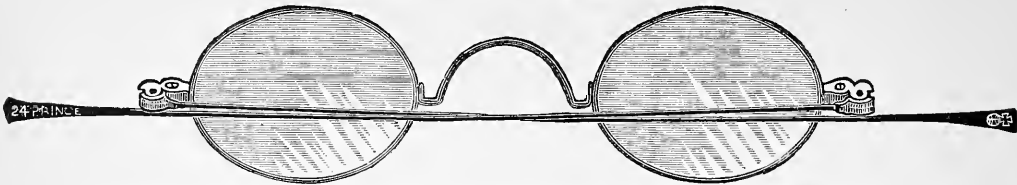

- 1. Spectacles, common steel frames, with double convex or concave lenses, second quality ..... \$0.75
- 2. Same, with first quality double convex lenses..... 1.00

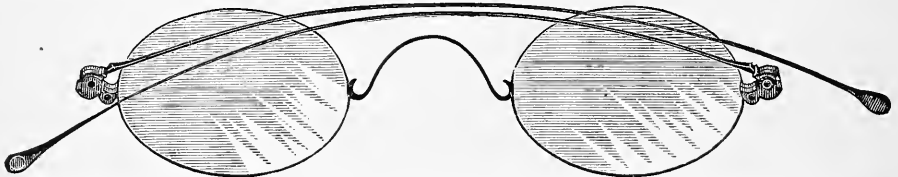

- 3. Spectacles, medium steel frames, with double convex or concave lenses, first quality ..... \$1.50
- 4. Same, with periscopic lenses..... 2.00
- 100. Same, medium, **Gold** frames, with first quality lenses, according to karat of gold..... 10 k. \$7.00; 12 k. \$8.00; 14 k. \$10.00; 18 k. \$12.00
- 101. Same, heavy gold frames..... “ 8.00; “ 10.00; “ 12.00; “ 16.00

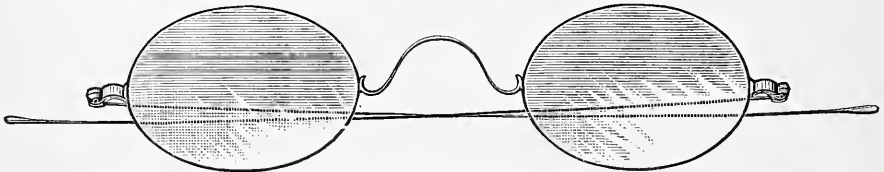

- 5. Spectacles, light steel frames, hard tempered, with periscopic concave or convex lenses, first quality..... \$2.50
- 6. Same, with frames inserted into grooved edge of lenses..... 3.00
- 102. Same, lightest **Gold** frames, with first quality lenses,  
10 k. \$6.00; 12 k. \$7.00; 14 k. \$8.00; 18 k. \$10.00



- 7. Pulpit Spectacles, with double concave or convex lenses, first quality..... \$2.00
- 8. Same, with periscopic lenses ..... 2.50
- Same, with gold frames, with best quality lenses:
- 107. Light..... 10 k. \$7.00; 12 k. \$8.00; 14 k. \$10.00; 18 k. \$12.00
- 108. Medium..... “ 8.00; “ 10.00; “ 12.00; “ 16.00
- 109. Heavy..... “ 10.00; “ 12.00; “ 14.00; “ 18.00

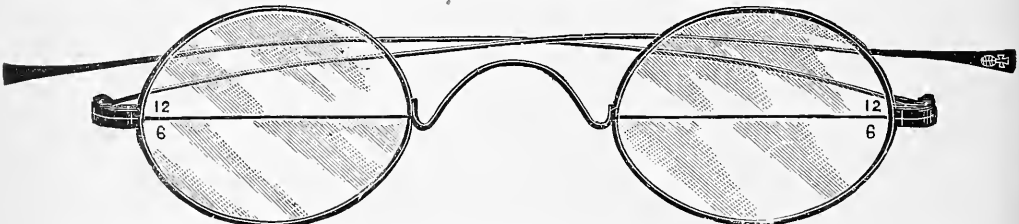

- 18. Bifocal Spectacles, medium steel frames, with *split* lenses..... \$2.50
  - 19. Same, fine steel frames, straight or hook temples... 3.00
- These Spectacles are intended for near and distant vision and made of *two* pairs of glasses, each carefully cut from the center of an entire lens, preserving its focus, and avoiding the prismatic effect occasioned by cutting one pair of lenses through the center.
- Same, with gold frames, with best quality of lenses:
  - 118. .... 10 k. \$9.00; 12 k. \$11.00; 14 k. \$13.00; 18 k. \$16.00

For prices with cylindric and compound lenses, see page 91-0.

**STEEL SPECTACLES.**



24. Steel Lorgnette to hook over distant vision spectacles, making them suitable for near vision ..... \$2.50

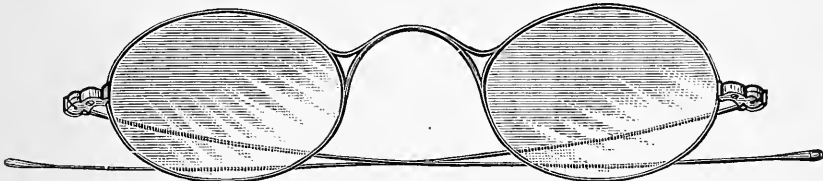

34. Pantoscopic Spectacles, having the plane of the lenses tilted, to allow the eyes to see through them at right angles at near objects, while the top part of the glasses falls below the visual lines for distance, and render the same well adapted for desk work and public speakers. In fine steel frames, first quality convex lenses ..... \$2.00; same, with periscopic lenses \$2.50  
 Same as above... ..with blue lenses \$2.50; London smoke 3.00

**CATARACT SPECTACLES.**

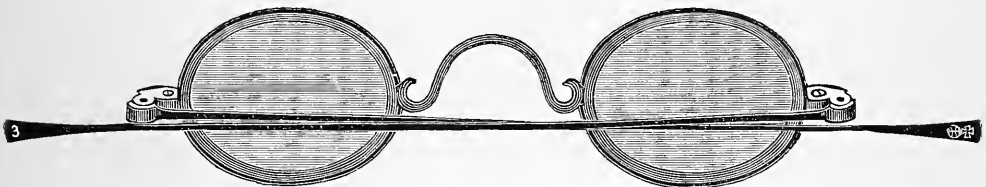

40. Strong steel frames, single or turn-pin temples, with cataract lenses, concave or convex:  
 $4\frac{3}{4}$  to 4 inches focus..... for one eye \$1.75; for both eyes \$2.00  
 $3\frac{3}{4}$  to 3 " " ..... " " 2.00; " " 2.50  
 $2\frac{3}{4}$  to 2 " " ..... " " 2.50; " " 3.00

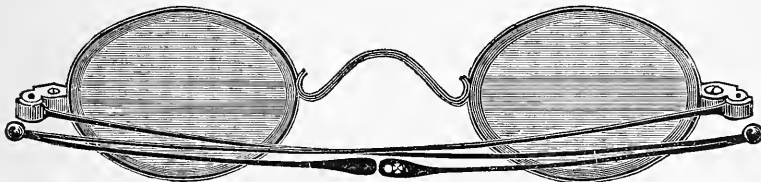

41. Strong steel reversible frames, cataract lenses for near and distant vision..... \$3.00

**CROSSED CYLINDRICAL CATARACT LENSES.**

Recent experiments, in accordance with suggestions made by Dr. Loring, have demonstrated that, by crossing two strong cylinders of equal strength at right angles, a superior lens, quite free from spherical aberration, can be made for the use of cataract patients; we are prepared to furnish these from Nos. 2 to  $4\frac{3}{4}$  inches focus.

In frames like Nos. 15 and 16..... for one eye \$6.00; for both eyes \$10.00

**BRAZILIAN PEBBLES.**

Spectacles and Eyeglasses with finest periscopic concave or convex Pebbles..... \$4.00  
 Same, fine steel frames ..... 5.00

N. B.—Any of the Spectacles and Eyeglasses, in steel, frameless, rubber shell, silver and gold frames, will be mounted with the finest Brazilian Pebble Lenses at an additional cost of \$2.50 per pair.

**SPECTACLES, HOOKED TEMPLES, STEEL AND GOLD.**

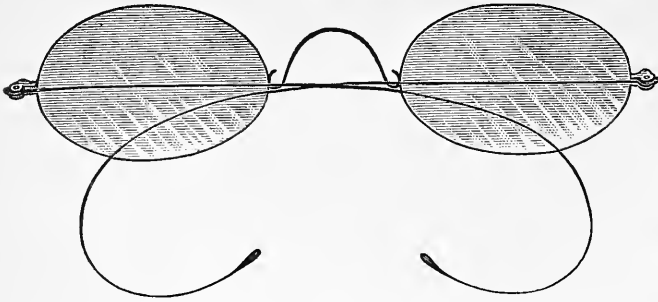

- 50. Steel frames, C nose piece, double concave or convex lenses .....\$1.50
- 51. Extra fine steel frames, C nose piece, with periscopic concave or convex lenses, first quality .....\$2.50
- 52. Same, with frames inserted into grooved edge of lenses .....\$3.00

Same frames, gold, first quality lenses, according to karat:

10 karat .....	light, \$6.00;	medium, \$7.50;	heavy, \$9.50
12 " .....	" 6.50;	" 8.50;	" 10.50
14 " .....	" 7.50;	" 10.00;	" 12.00
16 " .....	" 9.00;	" 14.00;	" 16.00

With frames inserted into grooved edge of glass 50 cents additional.

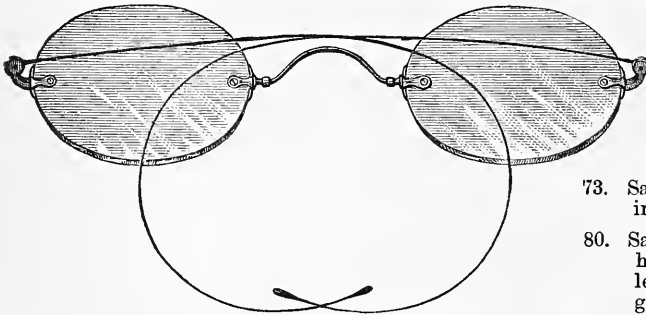

- 71. Frameless hook spectacles, German silver or steel mountings, with periscopic concave or convex lenses, first quality \$2.50
- 72. Same, with fine steel mountings... \$3.00

- 73. Same, with fine steel mountings, nickel-plated .. \$3.50
- 80. Same, gold mountings, with hook temples, first quality lenses, according to karat of gold as follows:

10 karat \$6.00 ; 12 karat \$6.50 ; 14 karat \$7.50 ; 18 karat \$9.50

- 81. Same, with "Saddle" bridge, at same prices. (See 68 to 70 next page.)

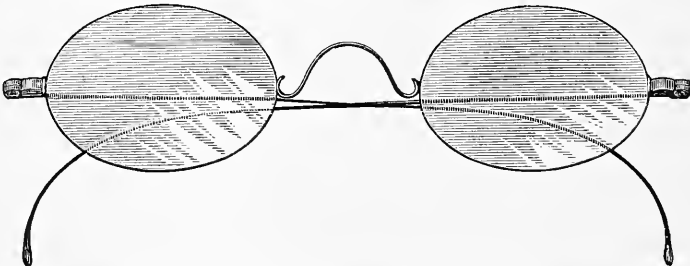

- 64. Short hook spectacles, medium steel frames, with double concave or convex lenses, first quality ..... \$2.00
- 65. Same, fine steel frames, with periscopic lenses ..... 2.50

- 66. Same, with frames inserted into grooved edge of lenses . . . . . \$3.00

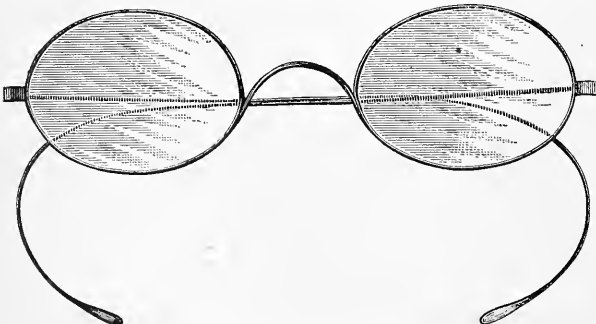

- 67. Children's hook spectacles, with double concave or convex lenses, first quality .....\$2.00

These spectacles are made of medium steel wire, hard tempered, and very durable. For low noses saddle bridge is recommended. (See No. 63 to 70.) Can also be furnished in all Aluminium frame at 60 cts. additional.

For Prices with Cylindric Compound Lenses see page 91-0.

HOOK FRAME SPECTACLES, STEEL AND GOLD.

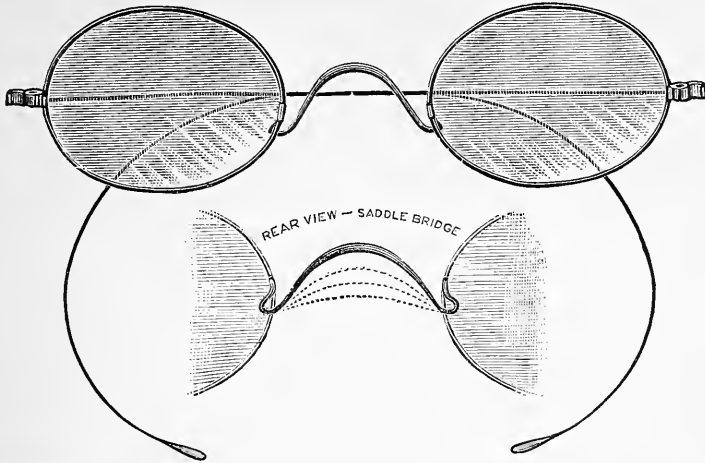

- 68. Saddle bridge, steel frames, with double concave or convex lenses . . . . . \$1.50
  - 69. Extra fine steel frames, saddle bridge, with periscopic concave and convex lenses, first quality . . . . . 2.50
  - 70. Same, with frames inserted into grooved edge of lenses . . . . . 3.00
- This frame can be used advantageously for any nose, but more particularly where the eyelashes are long or eyes prominent.

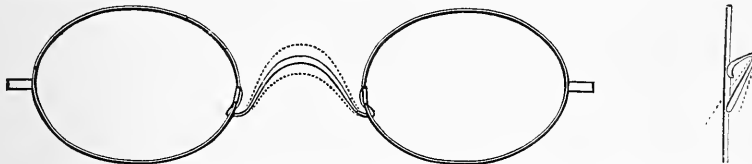

Sectional view of saddle bridge, showing the angle at which it may be set either back or in front of the plane of lenses. For further directions see page 91-D, lower part of section 3.

- 169. Same, gold frames, with first quality periscopic lenses:  
 10 karat . . . . . \$7.00; 14 karat . . . . . \$8.00; 18 karat . . . . . \$10.00
- 170. Same, medium weight, \$1.00 additional.

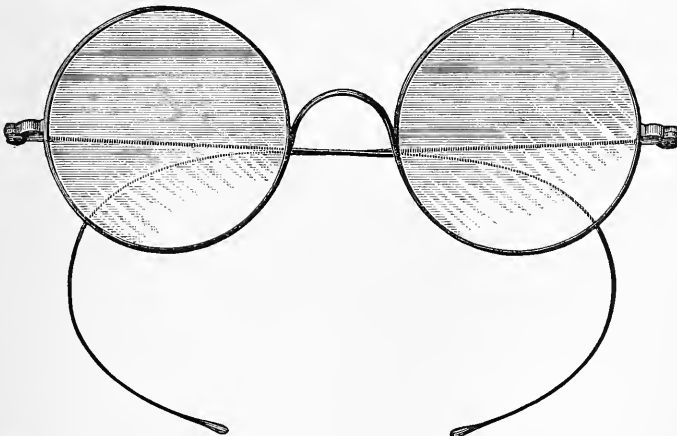

- 74. Operating spectacles, with extra large round lenses . . . . . \$3.00
- These spectacles will be fitted with either plane or focus lenses,  $1\frac{3}{4}$  inches in diameter, and are worn by physicians while operating.

**CHANGES AND COMBINATIONS.**

Should any special change in style or any combination of the parts of different styles of spectacles or eyeglasses be desired, it will be furnished upon order at catalogue prices.

**COLORED SPECTACLES.**

We have six shades each in both blue and London smoke, No. 1 being the lightest and No. 6 the darkest, and furnish plain, spherical and compound lenses in every one thereof. Card of sample colors sent on application.

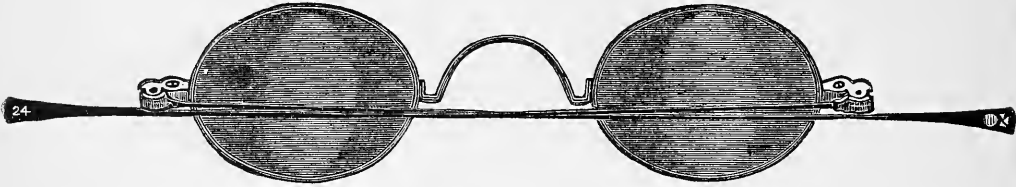

- |     |  |        |
|-----|--|--------|
| 81. | Medium steel frames, plain blue or smoked lenses, second quality.....                    | \$1.00 |
| 82. | Medium " " " " first quality (see No. 3).....  | 1.50   |
| 83. | Fine " " " " first quality (see No. 5).....  | 2.50   |
| 84. | Medium steel frames, <i>large eyes</i> , plain blue or smoked lenses, first quality..... | 1.50   |

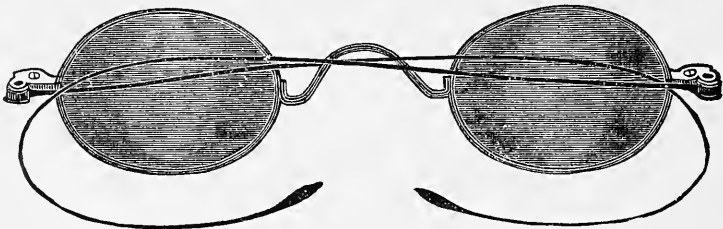
**COLORED COQUILLE OR PROTECTIVE SPECTACLES.**

- |     |   |      |
|-----|---|------|
| 91. | Hooked spectacles, medium steel frames, straight or hook temples, second quality lenses, blue or smoke shades.....  | 1.00 |
| 92. | Same, fine steel frames, straight or hook temples, second quality lenses, blue or smoke shades.....   | 1.50 |
| 93. | Same, fine steel frames, straight, turn-pin, or hook temples, with the best ground non-refractive lenses, blue shades.....  | 2.00 |
| 94. | Same, smoke shades.....   | 2.50 |
| 95. | Spectacles, extra fine steel hook frames, with the best ground Coquille non-refractive lenses, of blue or smoke shades, frame inserted into grooved edge of lenses..... | 3.00 |
| 96. | Fine steel spectacles, straight, turn-pin, or hook temples, Coquille lenses, with focus concave or convex, blue shades.....   | 3.50 |
| 97. | Same, smoke shades.....   | 4.00 |

**COLORED EYEGLASSES.**

(See fig. 389, next page.)

- |      |  |      |
|------|--|------|
| 471. | Hard rubber frames, with blue or smoked lenses, second quality.....  | 0.75 |
| 472. | Heavy steel " " " " " " " ".....   | 0.75 |
| 473. | Medium steel " " " " first " ".....  | 1.50 |
| 474. | Fine steel " " " " " " " ".....  | 2.50 |
| 475. | Frameless eyeglasses, blue or smoked lenses, first quality, German silver mounting and nickel-plated steel spring..... | 2.50 |

**COLORED COQUILLE EYEGLASSES.**

(See fig. 389, next page.)

- |      |   |      |
|------|---|------|
| 480. | Coquille eyeglasses, hard rubber frames, blue or smoked lenses, second quality.....                       | 1.00 |
| 481. | " " medium steel " " " " " ".....   | 1.50 |
| 482. | " " fine steel " " " " best ground, non-refractive lenses, first quality.....                             | 2.50 |
| 483. | Same, in hard rubber frames.....  | 2.00 |
| 484. | Same, in tortoise shell frames.....   | 2.50 |
| 485. | Same, mounted up as frameless eyeglasses, with German silver mounting and nickel-plated steel spring..... | 2.50 |



GOGGLES.

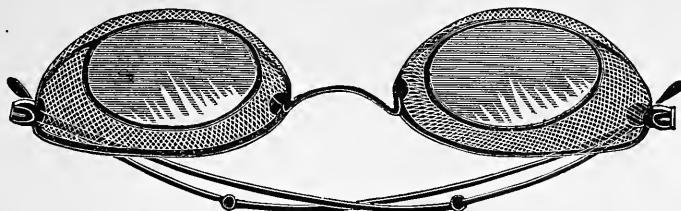

- 303. Goggles, wire gauze, with steel frames, blue or smoke shades, second quality, with single or turn-pin temples ..... \$1.50
- 300. Goggles, wire gauze with elastic, blue or smoke shades, third quality ..... 0.25
- 301. " " " " " " second quality ..... 0.50
- 302. " " " " " " first quality, velvet bound edges ..... 1.00

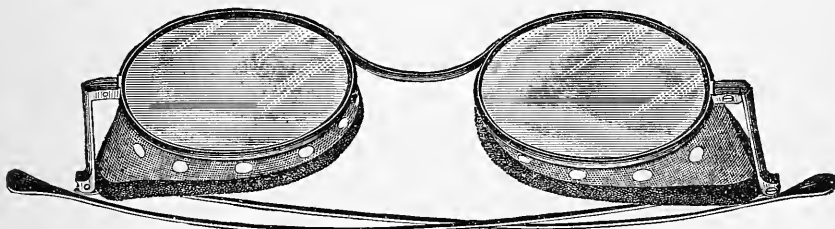

- 304. Superior English driving goggles, blue or smoke shades, first quality ..... \$4.00
- 302, 303 and 304 will be fitted with spherical lenses at 50 cts. add. ; colored at \$1.00 add.

EYEGLASSES.

HARD RUBBER AND TORTOISE SHELL.

- 385. Hard rubber only, bow spring, round eyes, with double concave or convex lenses, second quality ..... \$0.75
- 386. Same, with periscopic lenses, second quality ..... 1.00
- 387. Hard rubber only, bow spring, oval eyes, with double concave or convex lenses, second quality ..... 0.75
- 388. Same, with periscopic lenses, second quality ..... 1.00

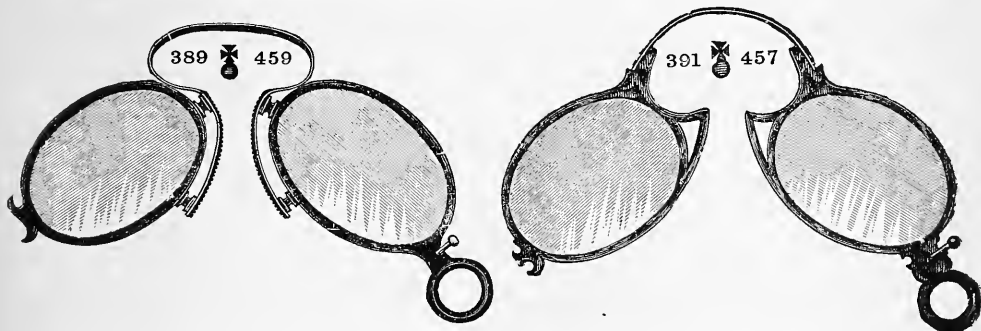

- 389. Hard rubber frame, patent spring, with double concave or convex lenses, first quality ..... \$1.00
- 390. Same, with periscopic lenses, first quality ..... 1.50
- 459. Same, tortoise shell, with periscopic lenses, first quality ..... 2.50
- 391. Hard rubber frame, anatomical pattern, with double concave or convex lenses, first quality ..... 1.50
- 392. Same, with periscopic lenses, first quality ..... 2.00
- 457. " tortoise shell, with periscopic lenses, first quality ..... 2.50
- 458. Same frame, with extra large eyes, periscopic convex or concave lenses, first quality ..... 3.00

**EYEGLASSES.**

**HARD RUBBER AND TORTOISE SHELL FRAMES.**

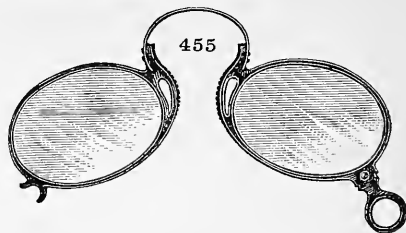
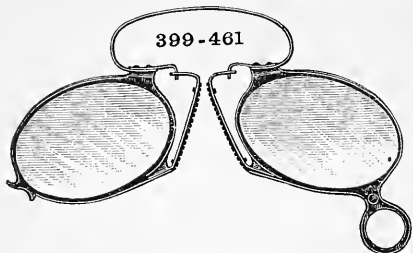

- 399. Hard rubber frame, patent self-adjusting clips, with double concave or convex lenses, first quality ..... \$1.50
- 400. Same, with periscopic lenses, first quality ..... 2.00
- 461. Same, tortoise shell, with periscopic lenses, first quality ..... 2.50
- 462. Same, with zylonite frames, an imitation of tortoise shell, with or without cork nose-shields ..... 2.50
- 455. Tortoise shell, short spring pattern, with periscopic concave or convex lenses, first quality ..... 2.50
- Same, hard rubber ..... 2.00

**STEEL AND GOLD FRAMES.**

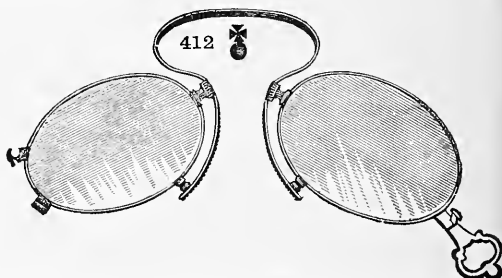
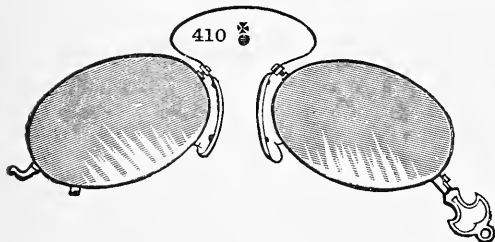

- 410. Steel frame only, patent spring, double concave or convex lenses, second quality \$0.75
- 411. Same, with double concave or convex lenses, first quality ..... 1.00
- 412. Steel only, patent spring, with double concave or convex lenses, first quality.... 1.50
- 413. Same frame, nickel-plated, with periscopic lenses, first quality ..... 2.00

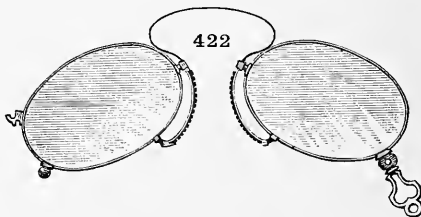
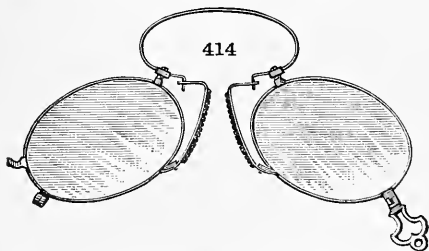

- 414. Steel, light hard-tempered frames, English model, with periscopic concave or convex lenses, first quality ..... \$2.50
- 415. Same, with frames inserted into grooved edge of lenses ..... 3.00
- Gold frames, with periscopic concave or convex lenses, according to weight and karat of gold:
  - Light .. 8 k. \$5.00; 10 k. \$6.00; 14 k. \$7.50; 18 k. \$10.00
  - Medium .. " 6.00; " 7.00; " 9.00; " 12.00
  - Heavy .. " 7.50; " 9.00; " 11.00; " 14.00
- 422. Steel, patent self-adjusting clips, medium frames, with double concave or convex lenses, first quality ..... 2.00
- 423. Same, in light hard-tempered frames and periscopic lenses ..... 2.50
- 424. Same, with frames inserted into grooved edge of lenses ..... 3.00
- Same, gold frames, with cork or shell nose-shields, and periscopic concave or convex lenses, according to weight and karat of gold:
  - Light ..... 8 k. \$5.50; 10 k. \$6.50; 14 k. \$8.00; 18 k. \$10.00
  - Medium ..... " 6.50; " 7.50; " 9.50; " 12.00
  - Heavy ..... " 8.00; " 10.00; " 12.00; " 15.00

**EYEGLASSES.**  
**STEEL AND GOLD FRAMES.**

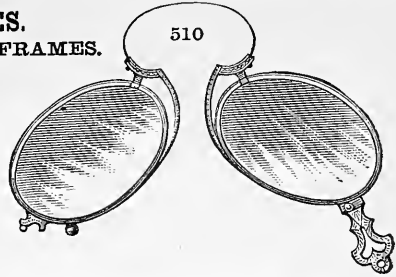
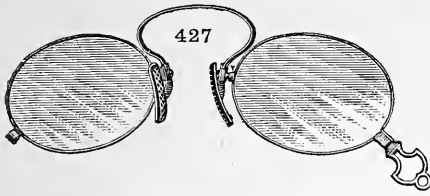

427. Steel, medium frames, patent clip, projecting back of the plane of lenses, with malleable shank, permitting the adjustment of clips to shape of nose, with double concave or convex lenses, first quality ..... \$2.00
428. Same, with light hard-tempered frames and periscopic lenses..... 2.50
429. " with frames inserted into grooved edge of lenses ..... 3.00
- Same, gold, with periscopic concave or convex lenses, according to weight and karat of gold:
- |             |  |       |
|-------------|--|-------|
| Light.....  | 8 k. \$5.50; 10 k. \$6.50; 14 k. \$8.00; 18 k. | 10.00 |
| Medium..... | " 6.50; " 7.50; " 9.50; "                      | 12.00 |
| Heavy.....  | " 8.00; " 10.00; " 12.00; "                    | 15.00 |
510. Gold frames only, new model, with periscopic concave or convex lenses, according to weight and karat of gold :
- |             |   |       |
|-------------|---|-------|
| Light.....  | 10 k. \$7.00; 12 k. \$7.50; 14 k. \$8.00; 18 k. | 10.00 |
| Medium..... | " 8.00; " 9.00; " 10.00; "                      | 12.00 |
| Heavy.....  | " 10.00; " 11.00; " 12.00; "                    | 15.00 |

**FRAMELESS OR SKELETON ; GERMAN SILVER AND GOLD MOUNTINGS.**

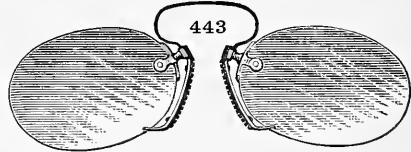
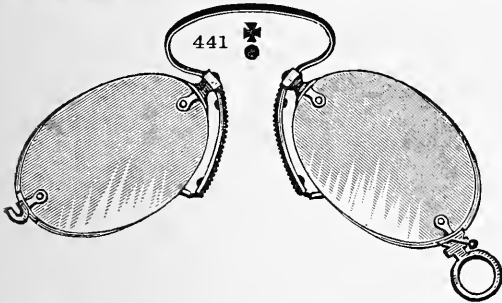

441. German silver mounting, nickel-plated steel spring, with periscopic concave or convex lenses, first quality ..... \$2.50
442. Same, with steel mounting ..... 3.00
- " Gold mounting, with first quality periscopic concave or convex lenses, according to karat of gold..... 10 k. \$6.00; 12 k. \$6.50; 14 k. \$7.50; 18 k. 9.50
443. German silver mounting, periscopic concave or convex lenses, first quality..... 2.00
- Gold, first quality, periscopic concave or convex lenses, according to karat of gold..... 10 k. \$5.00; 12 k. \$5.50; 14 k. \$6.50; 18 k. 8.50

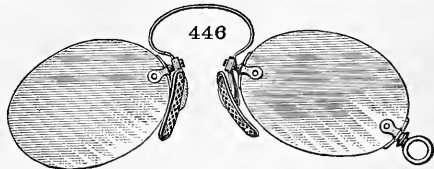
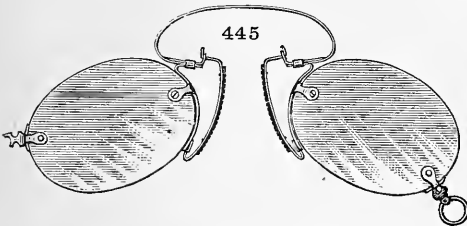

445. Frameless eyeglasses, German silver mounting, nickel-plated steel spring, patent self-adjusting clips, with periscopic concave or convex lenses, first quality... \$2.50
- Frameless eyeglasses, German silver mounting, nickel-plated steel spring, patent clip, same as No. 427 ..... 2.50
- 446 and 445 in Gold mountings, with first quality periscopic concave or convex lenses, according to karat of gold ..... 10 k. \$6.00; 12 k. \$6.50; 14 k. \$7.50; 18 k. 9.50
450. Extra spring and nose-pieces, attachable to steel, gold and frameless eyeglasses, 0.50
451. Slanting spring only..... 0.25

**SPECTACLES AND EYEGLASSES.**

WITH CYLINDRICAL, PRISMATIC AND COMPOUND LENSES.

	One Eye. (The other eye spherical.)	Both Eyes.
Spectacles or Eyeglasses with plano-cylindric lenses.....	\$2.00	\$2.50
“ “ “ “ prismatic lenses, 1-5° .....	2.00	2.50
“ “ “ “ “ “ 6-8° .....	2.50	3.00
“ “ “ “ “ “ 9-12° .....	3.00	3.50
“ “ “ “ sphero-cylindric “ 5-144 in. ....	3.50	4.50
“ “ “ “ “ “ 4-4 $\frac{3}{4}$ “ .....	3.75	5.00
“ “ “ “ “ “ 3-3 $\frac{3}{4}$ “ .....	4.00	5.50
“ “ “ “ “ “ 2-2 $\frac{3}{4}$ “ .....	4.25	6.00
“ “ “ “ prismatic “ 1-5° .....	3.50	4.50
“ “ “ “ “ “ 6-8° .....	4.00	5.50
“ “ “ “ “ “ 9-12° .....	4.50	6.50
“ “ “ “ double-cylindric lenses.....	4.00	6.00
“ “ “ “ sphero-cylindro-prismatic lenses.....	5.00	9.00
“ “ “ “ double “ “ .....	6.00	10.00
“ “ “ “ colored plano-cylindrical or compound lenses, blue, extra.....	0.25	0.50
“ “ “ “ colored plano-cylindrical or compound lenses, smoke, extra.....	0.50	1.00

The above prices include frames furnished with Nos. 203, 250, 267, 268, 389, 391, 399, 412. Finer frames, like Nos. 205, 207, 234, 251, 264, 269, 414, 421, 428, and 455 to 461, are 50 cts. additional.

With frames inserted into grooved edge of lenses or mounted frameless, like Nos. 206, 252, 266, 270, 271, 415, 423, 429, 441, 443, 445 and 446, \$1.00 additional.

All steel frames will be nickel-plated for 50 cents additional.

To gold spectacles and eyeglasses, also shell, silver and gold lorgnettes, add to list prices as follows:

	One Eye. (The other eye spherical.)	Both Eyes.
For plano-cylindrical or prismatic lenses.....	\$0.50	\$1.00 per pair.
“ sphero “ “ “ .....	1.50	2.50 “
“ double “ “ “ .....	2.50	4.00 “
“ sphero-cylindro-prismatic “ “ .....	3.50	6.00 “
“ double “ “ “ .....	4.00	7.00 “

**LENSES WILL BE SET INTO FRAMES  
AT THE FOLLOWING PRICES:**

	Ground into Frames.		Mounted Frameless or with frames set into grooved Edge of Lenses.	
	One Eye.	Both Eyes.	One Eye.	Both Eyes.
Double convex or concave spherical lenses, 5-144 in.....	\$0.40	\$0.75		
Periscope “ “ “ “ 5-144 “ .....	0.50	1.00	\$0.75	\$1.50
Double “ “ “ “ 4-4 $\frac{3}{4}$ “ .....	0.50	1.00	0.75	1.50
Periscope “ “ “ “ 4-4 $\frac{3}{4}$ “ .....	0.75	1.50	1.00	2.00
Double “ “ “ “ 3-3 $\frac{3}{4}$ “ .....	0.75	0.50	1.00	2.00
Periscope “ “ “ “ 3-3 $\frac{3}{4}$ “ .....	1.00	2.00	1.25	2.50
Double “ “ “ “ 2-2 $\frac{3}{4}$ “ .....	1.00	2.00	1.25	2.50
Periscope “ “ “ “ 2-2 $\frac{3}{4}$ “ .....	1.25	2.50	1.50	3.00
Brazilian Pebbles, first quality .....	1.50	3.00	2.00	4.00
Plano-cylindrical lens .....	1.00	2.00	1.25	2.50
“ prismatic “ 1-5° .....	1.00	2.00	1.25	2.50
“ “ “ 6-8° .....	1.50	3.00	1.75	3.50
“ “ “ 9-12° .....	2.00	4.00	2.25	4.50
Sphero-cylindrical “ 5-144 in. ....	2.00	4.00	2.25	4.50
“ “ “ 4-4 $\frac{3}{4}$ “ .....	2.25	4.50	2.50	5.00
“ “ “ 3-3 $\frac{3}{4}$ “ .....	2.50	5.00	2.75	5.50
“ “ “ 2-2 $\frac{3}{4}$ “ .....	2.75	5.50	3.00	6.00
“ prismatic “ 1-5° .....	2.00	4.00	2.25	4.50
“ “ “ 6-8° .....	2.50	5.00	2.75	5.50
“ “ “ 9-12° .....	3.00	6.00	3.25	6.50
Double-cylindrical lens.....	3.25	5.50	3.50	6.00
Sphero-cylindro-prismatic lens .....	4.00	8.00	4.25	8.50
Double-cylindro-prismatic .....	5.00	9.00	5.50	9.50
Colored, spherical lenses, blue or smoke, extra.....	one eye	0.25	both eyes	0.50
“ cylindrical and compound lenses, blue, extra.....	“	0.25	“	0.50
“ “ “ “ “ “ smoke, extra.....	“	0.50	“	1.00

**FRAMES.**

Spectacle and eyeglass frames without lenses will be furnished at the following prices:

Spectacle frames, same as No. 201	\$0.50
“ “ “ “ “ 203, 218, 250, 268, 292	1.00
“ “ “ “ “ 207, 240, 241, 267, 293, 294	1.25
“ “ “ “ “ 205, 224, 234, 251, 264, 265, 269, 295	1.50
Eyeglass frames, “ “ “ 385, 387, 389, 410	0.50
“ “ “ “ “ 391, 399, 412	1.00
“ “ “ “ “ 413, 421, 427	1.25
“ “ “ “ “ 414, 422, 428	1.50
Solid nickle spectacle and eyeglass frames	\$.100 to 1.50

For prices of silver and gold frames: deduct 50 cents from list prices of spectacles and eyeglasses.

**REPAIRING.**

Straight steel temple on spectacles	\$0.25	Two	\$0.50
Hook “ “ “ “	0.40	“	0.75
Temple, silver, “ “	0.75	“	1.50
“ gold, “ “	\$1.50 to 2.50	“	\$3.00 to 4.00
Eye-wire on steel spectacles			0.50 to 0.75
“ “ silver “			0.75 to 1.00
“ “ gold “			2.00 to 4.00
Nosepiece “ “ “			1.50 to 3.00
“ “ silver “			1.00 to 1.50
“ “ steel “			0.50 to 0.75
Soldering steel spectacles			0.30
“ silver “			0.40
“ gold “			0.50
Side on steel eyeglass, without lens			\$0.50 to 0.75
“ rubber “ “			0.40
“ shell “ “			0.75
“ gold “ “			\$2.00 to 4.00
Steel spring, ordinary			0.25
“ fine			0.30
Gold “	\$1.00	if old spring is returned	0.75
Clip on steel or frameless eyeglass			0.25
“ gold “ “			\$0.75 to 1.00
Handle on steel eyeglass			0.50
“ “ frameless eyeglass			0.25
“ “ gold frameless eyeglass			1.50
Catch “ frameless			0.15
“ “ gold frameless “			1.00
Pin “ steel eyeglass			0.10
“ “ gold “			0.50
Soldering steel “			0.30
“ silver “			0.40
“ gold “			0.50

**ALUMINO SPECTACLE AND EYEGLASS FRAMES.**

Every Spectacle and Eyeglass mentioned on the foregoing pages at the price of \$2.50 or higher can be had at an additional cost of 50 cts. with frame of Alumino, a new non-corrosive composition resembling polished steel in color and possessing the flexibility of gold, the strength of steel, lighter in weight than either, and absolutely resisting moisture. Never tarnishing and elegant in appearance, we can confidently recommend it.

**HOOKS AND CHAINS FOR EYEGLASSES.**

Hook, h. r. or tortoise shell	\$0.25
Automatic holder	0.25
Gold Hook	10 k. \$2.00; 14 k. 2.50
“ engraved	“ 3.50; “ 5.00
Long silk Guards	light 5 cts.; medium 10 cts.; heavy 0.15
Short “ “ with pin and catch	0.15
Chain, with pin and catch, sterling silver	1.50
“ “ “ rolled plate gold	1.50
“ “ “ gold	10 k. \$3.00; 14 k. 4.50
“ “ “ fancy, 14 k.	5.00
Extra Snaps for chains, rolled plate	15 cts.; gold 0.50
“ Hooks “	25 “ “ 1.00

## OCULISTS' TEST CASES.\*



## SPHERICAL AND CYLINDRIC LENSES.

(See also pages 73 and 75.)

500. Loring's Student's Trial Case, complete, with test types .....\$14.00

*Contents:*

- 7 pairs convex spherical lenses, .25, .5, 1, 2, 3., 4., 8.
- 7 pairs concave spherical lenses, .25, .5, 1, 2, 3., 4., 8.
- 5 pairs convex cylindrical lenses, .25, .5, 1, 2., 3.
- 5 pairs concave cylindrical lenses, .25, .5, 1, 2., 3.
- 1 triple-groove graduated trial frame (No. 252), and test types.

The lensee are numbered in the metric system, and so arranged that by means of combination all the numbers contained in the larger sets can be successfully obtained with this.

## SPHERICAL, CYLINDRICAL AND PRISMATIC LENSES.

501. Roosa's No. 2..... \$12.50

*Contents:*

- 11 pairs convex spherical lenses, .50, .75, 1, 1.25, 1.50, 1.75, 2., 2.25, 2.50, 2.75, 3.
- 11 pairs concave spherical lenses, .50, .75, 1, 1.25, 1.50, 1.75, 2., 2.25, 2.50, 2.75, 3.
- 3 convex cylindrical, .50, .75, 1.
- 3 concave cylindrical, .50, .75, 1.
- 2 prisms, 8°, 10°.
- 1 red glass.
- 1 opaque glass.
- 1 double-groove graduated trial frame (No. 851).
- 1 book "On the Determination of the Necessity for Wearing Glasses," complete, with test types and description, by D. B. St. John Roosa, M.D.

502. Stevens' Portable Trial Case, lenses mounted in gilt and silvered metal rims, with handles. ....\$40.00  
Same, without rims, 30.00

*Contents:*

- 20 single convex spherical lenses, from .25 to 10. D.
- 20 single concave spherical lenses, from .25 to 10. D.
- 13 single convex cylindrical lenses, from .25 to 4.5 D.
- 13 single concave cylindrical lenses, from .25 to 4.5 D.
- 8 prisms of 1, 2, 3, 4, 5, 6, 8, 10 degrees.
- 1 red glass.
- 1 green glass.
- 1 blue glass.
- 1 opaque glass.
- 1 stenopaic disc, with hole.
- 1 stenopaic disc, with slit.
- 1 adjustable, triple-grooved graduated trial frame (No. 856) and test types.



TEST CASES—Continued.\*

PRISMATIC LENSES.

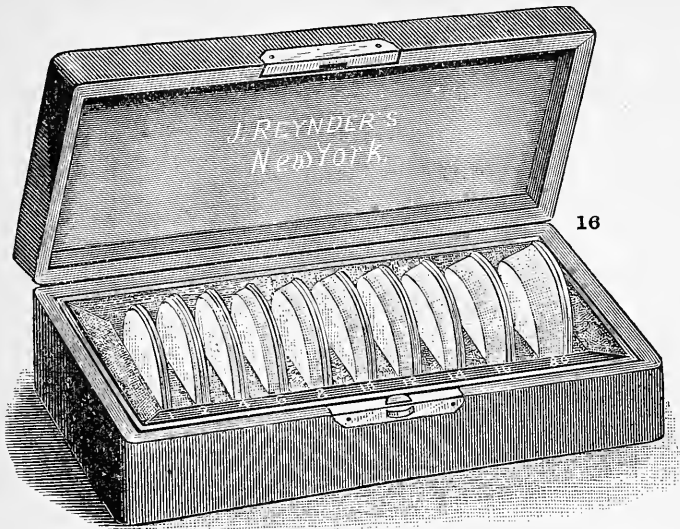

- 15. Case containing 10 round prisms, to fit trial frames: 1, 2, 4, 6, 8, 10, 12, 14, 16, 20 degrees ..... \$7.00
- 16. Same, mounted in gilt rims ..... 9.00
- 17. Case containing 17 round prisms, to fit trial frames: 1, 2, 3, 4, 5, 6, 7, 8, 9, 10, 12, 14, 16, 18, 20, 30, 40 degrees ..... 15.00
- 18. Same, mounted in gilt rims ..... 18.00

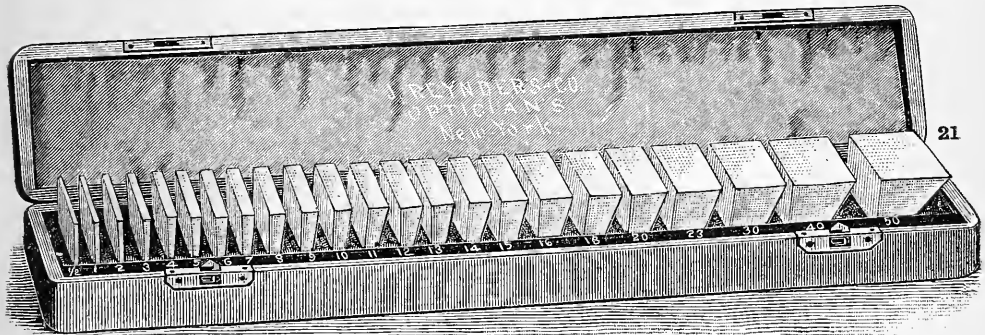

- 19. Case containing 10 square prisms: 1, 2, 4, 6, 8, 10, 12, 14, 16, 20 degrees, 1½ in. square \$7.00
- 20. Case containing 17 square prisms: 1, 2, 3, 4, 5, 6, 7, 8, 9, 10, 12, 14, 16, 18, 20, 30, 40 degrees ..... 15.00
- 21. Case containing 23 square prisms: ½, 1, 2, 3, 4, 5, 6, 7, 8, 9, 10, 11, 12, 13, 14, 15, 16, 18, 20, 25, 30, 40, 50 degrees ..... 22.00
- Extra prisms, for muscle exercise, furnished in cardboard cases, as follows:
  - 1° to 9° ..... each 0.50
  - 10° to 14° ..... " 0.75
  - 15° to 18° ..... " 1.00
  - 20° \$1.25 ..... 25° \$2.00 ..... 30° \$2.50 ..... 40° \$3.00 ..... 50° 4.00
- 27. Cataract Cylinder Case, single lenses without rims. Contents: 11 single cylindrical convex lenses, from 8. to 20. D.; 11 single cylindrical concave lenses, from 8. to 20. D.; solid metal disc; opaque glass; half ground glass; double grooved graduated trial frame (No. 2) ..... 16.00
- 28. Same as 27, lenses mounted in gilt and silvered metal rims ..... 20.00
- 29. Same as 27, cylinders in pairs, without rims ..... 28.00
- 30. Same as 29, lenses mounted in gilt and silvered metal rims ..... 35.00

**TEST CASES—Continued.\***

**CYLINDRICAL LENSES.**



- 22. Case of cylindric glasses, in pairs, without rims . . . \$25.00
- In pairs, lenses mounted in gilt and silvered metal rims 35.00

*Contents :*

- 22 pairs each of cylindrical convex lenses, .25 to 8. D. (5 to 144 inches focus).
- 22 pairs each of cylindrical concave lenses, .25 to 8. D. (5 to 144 inches focus).
- 1 metal disc, with stenopaic slit.
- 1 metal disc, with hole.
- 1 opaque glass.
- 1 half-ground glass.
- 1 double-grooved graduated trial frame (No. 2).

*Price of same :*

- Glasses, single and plain . \$18.00
- “ rimmed . . . . . 24.00

**EXTRA TEST LENSES.**

Test lenses of every focus, spherical, cylindrical, convex or concave, in either dioptric or inch system, will be furnished at following prices :

	WITHOUT RIMS.	WITH RIMS.
Spherical, convex or concave, 5 to 144 inch. (.25 to 8. D.) . . . . .	each, \$0.35	\$0.50
“ “ “ 4 to 4 $\frac{3}{4}$ “ (8.50 to 10. D.) . . . . .	“	0.50
“ “ “ 3 to 3 $\frac{1}{2}$ “ (10.50 to 13. D.) . . . . .	“	0.75
“ “ “ 2 to 2 $\frac{1}{2}$ “ (14. to 20. D.) . . . . .	“	1.00
Cylindric, “ “ 5 to 144 “ (.25 to 8. D.) . . . . .	“	0.50
“ “ “ 4 to 5 “ (8. to 10. D.) . . . . .	“	0.75
“ “ “ 3 to 3 $\frac{1}{2}$ “ (11. to 13. D.) . . . . .	“	1.00
“ “ “ 2 $\frac{1}{4}$ to 2 $\frac{3}{4}$ “ (14. to 18. D.) . . . . .	“	1.25
“ “ “ 2 “ (20. D.) . . . . .	“	1.50
Colored lenses, red, green, blue and smoke . . . . .	“	0.30
Plain ground glass . . . . .	“	0.30
Metal disc, with hole . . . . .	“	0.50
“ “ “ stenopaic slit, plain . . . . .	“	0.75
“ “ “ movable “ . . . . .	“	1.50
“ “ “ solid . . . . .	“	0.25

Our standard size is 1 $\frac{1}{2}$  inch diameter. When ordering lenses with rims, state whether same should be with or without handles, and if cylinders are to be plain or opaque on sides.

**TRIAL FRAMES.**

- 1. Single groove, for one pair of lenses . . . . . \$2.00
- 2. Double groove, with graduated scale for two pair of lenses . . . . . 3.00
- 3. Same, triple groove, for three pair of lenses . . . . . 3.50
- 4. Improved double grooved, with screw motion adjustment and movable nose piece (as in trial case No. 502, page 91-Q) . . . . . \$8.00 ; same, with triple groove, 8.50
- 5. Nacet's frame, with revolving glass holders . . . . . 10.00



TRIAL FRAMES AND TEST CARDS.

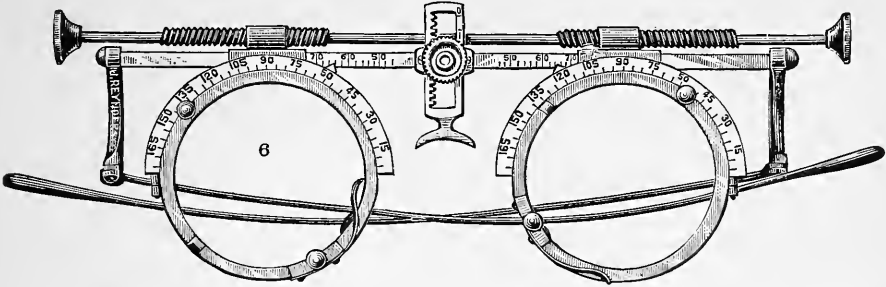

6. Improved Trial Frame..... \$10.00\*

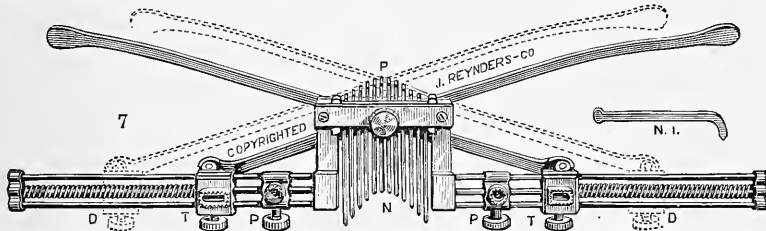

7. The above illustration shows the Trial Frame referred to on page 91-F; it more than fills the indications there given. The temples, sliding upon three parallel wires, become, when placed in position upon a person, self-retaining and self-adjusting by means of the tension caused by the spiral springs and are set tight by turning the set screws T T; the parts P P slide upon the same wire and are for determining the pupillary distance, and the parts above N are for determining the curve, width and height of nose. The stems above N are loosely adjusted in their guards above, so that when the frame is in place each one thereof will rest upon the nose; by the screw above, readily discernable, they may be set tight. The stems are shown separately to the left (N); they are curved and bluntly pointed; P and T are also pronged, as can be observed. When then every part of the frame is set tight, indentures on paper may be made by the same which will convey the various dimensions needed for making well fitting frames for permanent wear. This frame has been invented by Mr. M. A Vanderwaag, and is fully secured to him by patent right, whereof hereby due notice is given. Prices will be given on application.

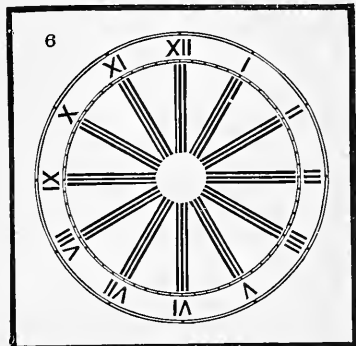
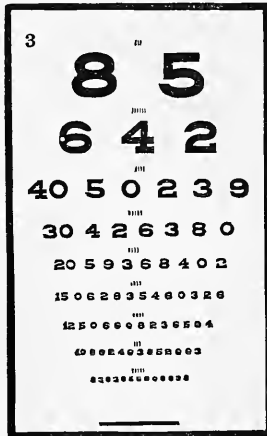
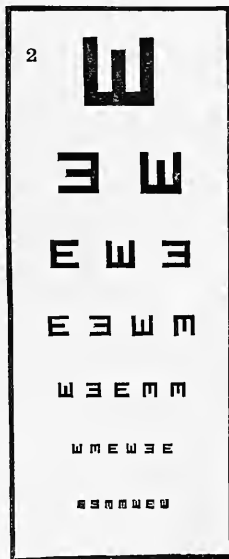
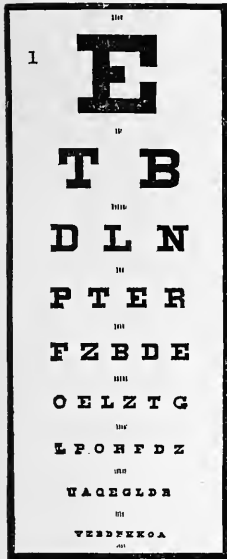

- 1.\* Snellen's Test Types...cardboard 25\* cts.; mounted \$0.50\*
- 2.\* Same, for Illiterates... " 25\* " " 0.50\*
- 3.\* Same, Numbers..... " 25\* " " 0.50\*
- 4. Snellen's Optotypi Advisum Determinandum, in paper cover \$1.50;\* bound 2.00\*
- 5. Wecker's Eschelle Metrique pour mesure l'Acuité Visuelle..... 3.50\*
- 6.\* Green's Astigmatic Dial, on pasteboard..... 0.50\*
- 7. Pray's Astigmatic Letters, on pasteboard..... 0.50\*
- 8. Green's set of Astigmatic Tests, consisting of a clock dial mounted on heavy cardboard and 12 circular discs which can be separately attached to it..... 3.75\*

VIII. EAR INSTRUMENTS.

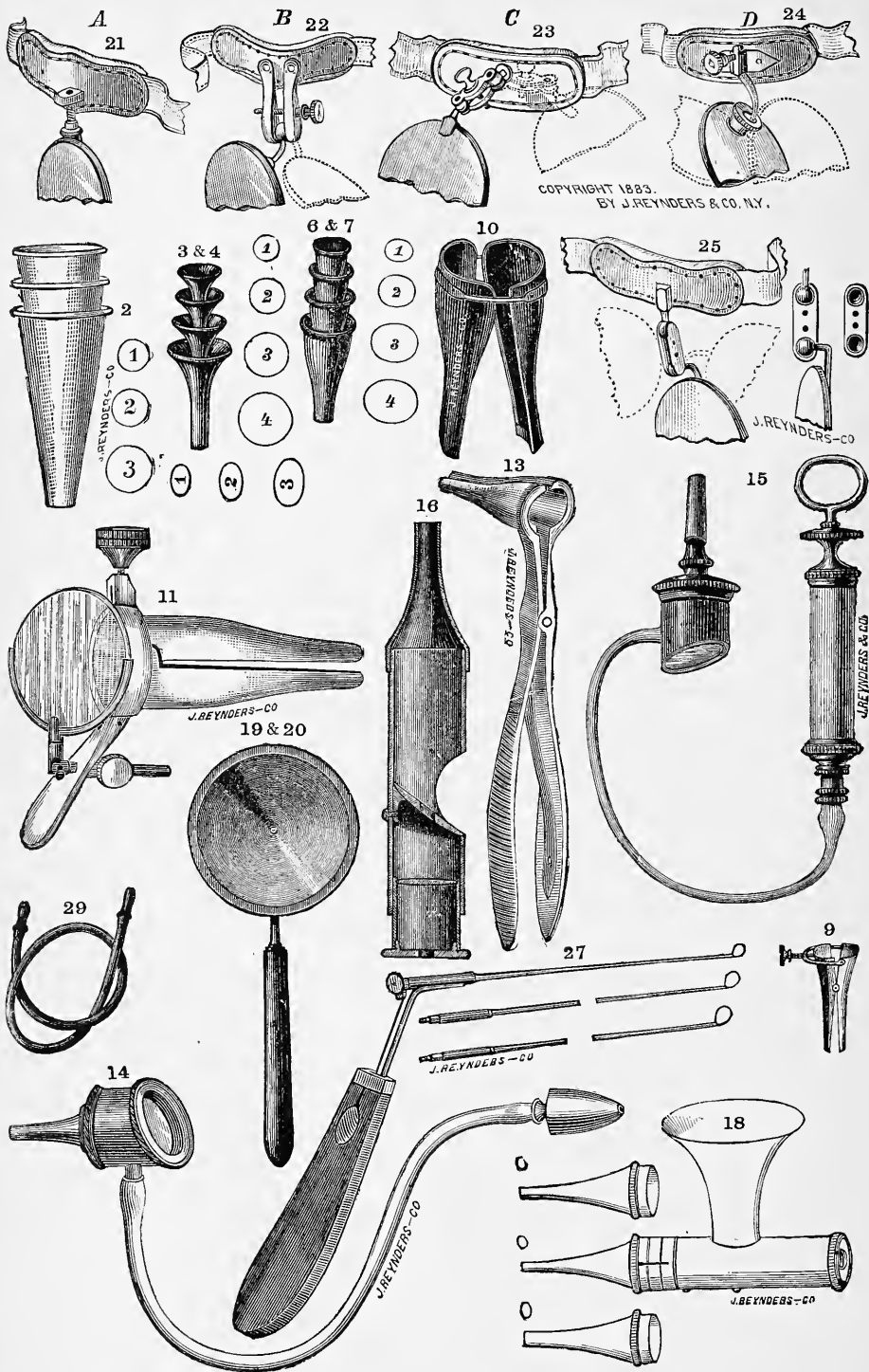

**VIII. EAR INSTRUMENTS.—For Diagnosis.**

**SPECULA.**

See page 91B.

1. Wilde's, h. r., set of 3 .....	\$1.50
2.* " " metallic, set of 3.....	plated \$1.50; silver 3.00
3.* Politzer's, h. r.....	set of 3 1.50; set of 4 1.75
4.* Toynbee's, metallic, ends circular, set of 3,.....	plated 1.50; silver 3.00
5.* " " " " oval, set of 3.....	" 2.00; " 3.00
6.* Gruber's, h. r.....	set of 3 1.50; set of 4 2.00
7.* " " G. s.....	set of 3 1.50; set of 4 2.00
8. Glass Reflecting, or Porcelain .....	each 0.50
9.* Speir's, Selfretaining .....	3.00
10.* Milliken's, " .....	1.50
11.* Simrock's, dilating, with magnifying lense.....	5.00
12.* Bivalve, ordinary .....	1.50
13.* Kramer's bivalve .....	2.00
14.* Siegle's, Pneumatic.....	4.50
15.* " " Ely's modification.....	7.00
16.* Otoscope, Hassenstein's.....	5.00
17. " " Clarke's .....	\$10.00 and 12.00
18.* " " Brunton's.....	Genuine \$8.00; Imitation 6.00

**REFLECTING MIRRORS.—(See also pages 108 and 109.)**

19.* Plain, with handle.....	2.50
20.* Fine, " " .....	3.00
21.* " " Roosa's Headband .....	2 $\frac{3}{4}$ in., \$4.50; 3 $\frac{1}{2}$ in., 5.00
22.* " " Pomeroy's " .....	do. 3.75; do. 4.50
23.* " " Smallwood's " (and cover) .....	do. 6.00; do. 6.50
24.* " " J. R. Co's. " .....	do. 6.00; do. 6.50
25.* " " Wilson's " .....	do. 6.00; do. 6.50
26. " " Buck's " .....	7.00
27.* Inner Ear Mirrors, Blake's, per set.....	8.00
28.* Acumeter, Politzer's, in case.....	3.50
29.* Diagnostic Tube and Explorer, Toynbee's.....	0.75
30.* Rubber Tube with tip 87, and either of 81 to 86 incl .....	1.00
31.* Manometer, Politzer's.....	1.50
32.* Probe, heavy silver.....	1.25
33.* " " fine " Buck's.....	0.50
34.* " " steel.....	0.75
35. Tuning Fork, small, A or C.....	0.50
35a.* " " round .....	2.00
36.* " " square, medium.....	2.00
37. " " " " with Politzer's clamps .....	3.50
38.* " " " " large .....	3.50
39. " " " " with Politzer's clamps .....	4.50
40.* " " " " Politzer-Blake's.....	7.00

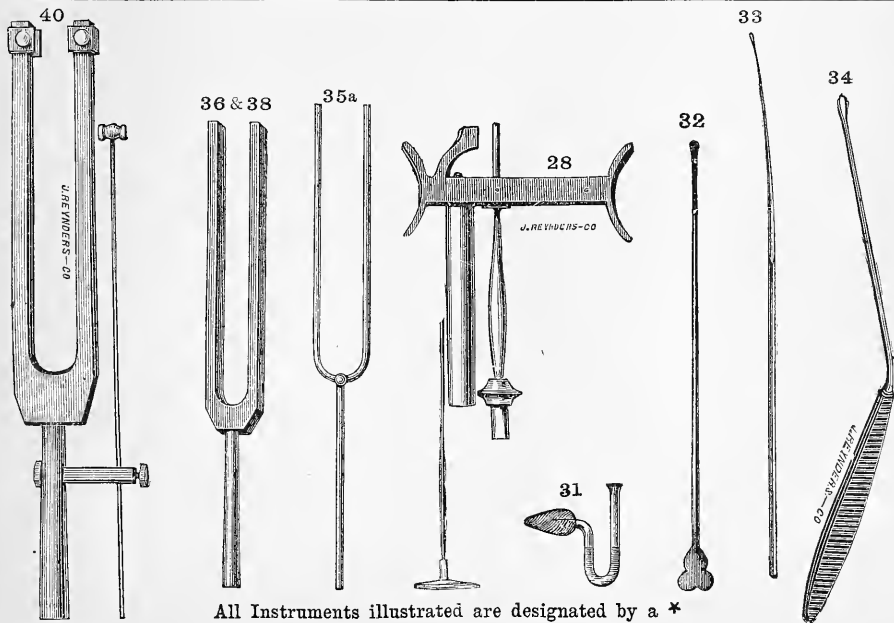

All Instruments illustrated are designated by a \*

VIII. EAR INSTRUMENTS.

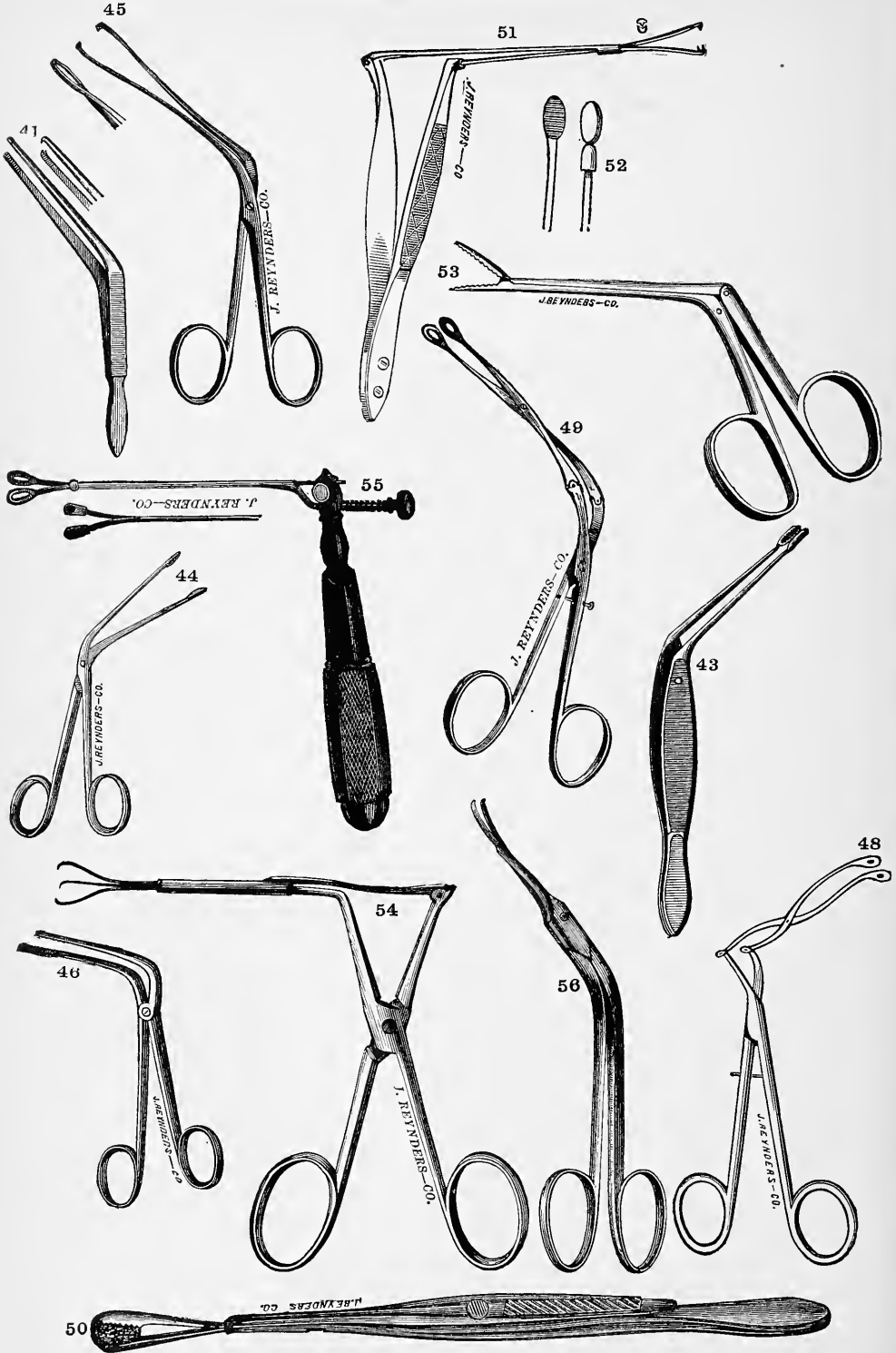

VIII. EAR INSTRUMENTS.

FORCEPS.

41.* Wilde's, mousetoothed or serrated points.....	\$1.50
42. " Sexton's modification.....	1.75
43.* Politzer's.....	2.50
44.* Roosa's.....	1.75
45.* Pomeroy's.....	2.50
46.* Toynbee's.....	2.00
47. " delicately mousetoothed.....	4.50
48.* Hinton's.....	4.00
49.* " double jointed.....	4.50
50.* Mathieu's.....	4.00
51.* Sexton's.....	4.00
52.* Bumstead's.....	4.00
53.* Noyes'.....	4.50
54.* Allen's.....	4.50
55.* Avery's.....	4.50

SCISSORS.

56.* Politzer's.....	2.25
57. Similar in action to forceps No. 53.....	7.00

FOR THE EUSTACHEAN TUBES AND MIDDLE EAR.

58.* Eustachean Catheter, h. r., 4 sizes... ..	each	0.60
59.* " " G. S., plated, 3 sizes.....	"	0.75
60.* " " Coin silver, 3 sizes.....	"	1.25
61.* " " Pure " 3 sizes.....	"	1.50
62. " " " Elastic plain \$0.50; Kramer's, fine.....		1.00
63.* " " Noyes', r. and l.....	each	2.50
64.* " " Gensoul's.....		3.00
65.* Faucial " Pomeroy's.....	\$1.75; with bag	3.25
66. Eustachean Bougies (see Urethral Bougies).		
67.* " Catheter Holder, Bonnafant's.....		2.00
68.* " " Politzer's.....		1.00
69.* " " Tip (like A in fig. 91).....		0.25
70.* Powder Blower.....		2.50

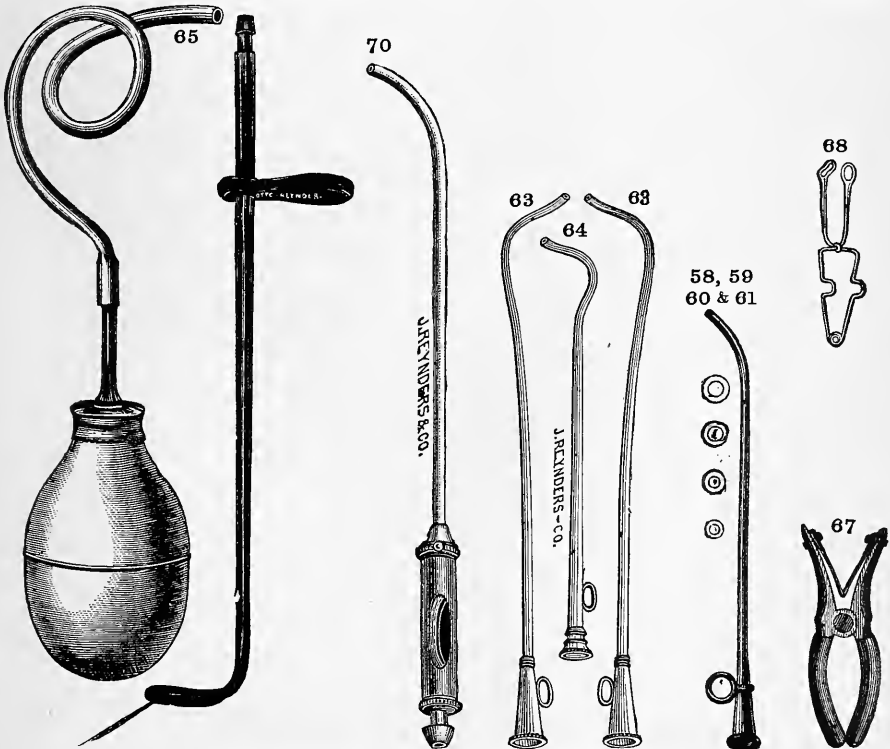

All Instruments illustrated are designated by a \*

VIII. EAR INSTRUMENTS.  
POLITZER'S APPARATUS.



VIII. EAR INSTRUMENTS.

POLITZER'S INFLATING APPARATUS.

(With either of Nozzles Nos. 81 to 86 inclusive, with Nozzles Nos. 88 and 89 the difference in price additional.)

71.* Bag, pure gum English black, .....		
72. " " " " " " .....		
73. " red or green " 8 oz., .....	} with valve, \$2.50 no valve... 2.00	
74. " " " " " 8 oz., .....		
75. " " " " " 10 oz., .....		
76. " " " " " 10 oz., .....		
77. " " " " " 12 oz., plain .....		3.00
78. " " " " " 12 oz., with valve .....		3.50
78. " white like fig. (89), plain .....		1.50
80.* " " " " " with valve .....		2.00
81.* Nozzle, Buck's h. r. ....		0.30
82.* " Knapp's, h. r. ....		0.30
83.* " Glass .....		0.20
84.* " Roosa's, h. r. ....		0.30
85.* " Agnew's, round, h. r. ....		0.30
86.* " " oval, h. r. ....		0.40
87.* H. R. Mouth Piece (Pipe stem shape for blowing) .....		0.25
88.* Nozzle, double, Allen's .....		1.75
89.* " " Pomeroy's .....		2.00
90.* Wilson's Combined Politzer and Syringe .....		8.00
91.* Füllgraß's Inflator for Eustachean Tubes .....		2.25
-----		
92.* Apparatus for throwing hot vapor into middle ear .....		5.00
93.* Iodine Inhaler, Buttle's, h. r., small two tips .....		1.75
94. " " " " large three tips .....		2.25
95.* " " Pomeroy's .....		0.50
96.* Chloroform Inhaler, Roosa's, metal .....		2.25
97. Eustachean Spray, complete .....		6.00

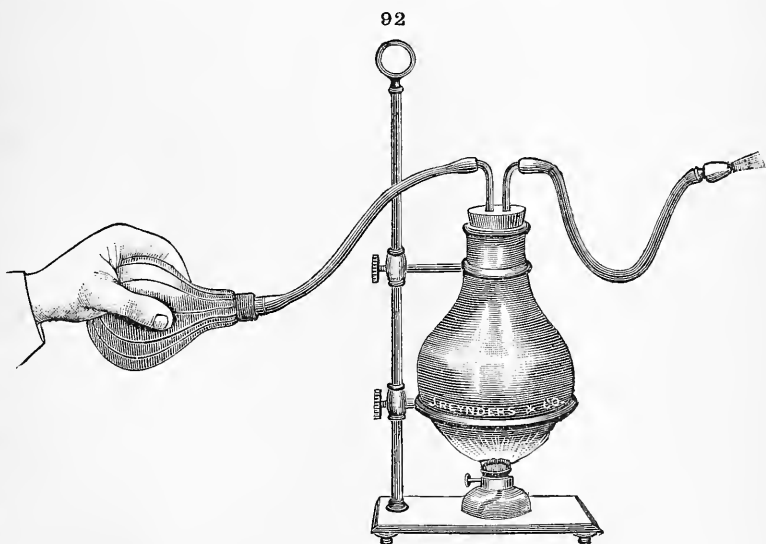

All Instruments illustrated are designated by a \*

VIII. EAR INSTRUMENTS.

FOR THE AUDITORY CANAL AND MEMBRANA TYMPANI.

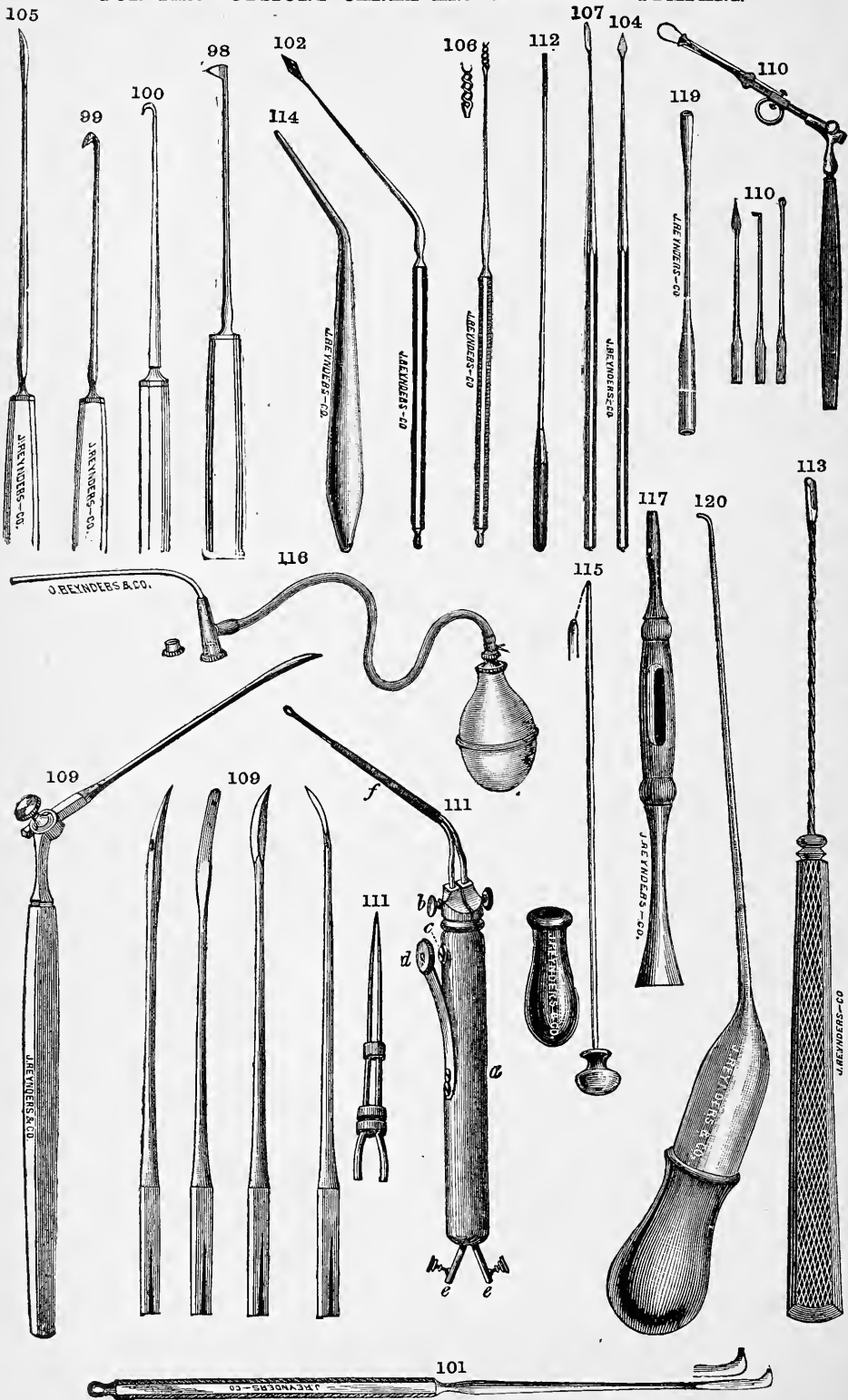



**VIII. EAR INSTRUMENTS.**

**INSTRUMENTS FOR THE MEMBRANA TYMPANI AND AUDITORY CANAL.**

98.*	Knife, Politzer's.....	\$1.50
99.*	" " Fowler's.....	1.75
100.*	" " Sickleshaped.....	1.50
101.*	" " Agnew's.....	1.50
102.*	Tympanum Perforator, all steel.....	1.50
103.	" " " ivory handle.....	1.50
104.*	" " " Buck's.....	1.25
105.*	" " " Roosa's.....	1.75
106.*	" " Spiral Tractor.....	2.00
107.*	Tenatome, Buck's.....	1.00
108.	" " Gruber's.....	3.00
109.*	" " " " set of three \$6.50; set of five.....	8.50
110.*	Set of Ear Instruments with Snare in case.....	14.00
111.*	" " " Electrodes.....	Handle \$7.00; each Electrode 2.75
112.*	Cotton Carrier, Halcomb's, steel.....	each 0.25
113.*	Porte Caustic, Wilde's.....	Silver \$3.00; Platinum 5.00
114.*	" " " Roosa's, Glass.....	0.35
115.*	Andrew's Drop Tube for injecting through perforated tympanum.....	1.50
116.*	" " Powder Blower for blowing powder through perforated tympanum.....	3.00
117.*	Powder Blower, Knapp's.....	1.50
119.*	Porte Acid, Buck's, with platinum Wire.....	0.50
120.*	Pipette, Buck's.....	0.40

**FOR THE REMOVAL OF SECRETIONS, FOREIGN BODIES, POLYPI, ETC.**

121.*	Ear Scoop, Politzer's, h. r.....	0.50
122.*	" " " with Ciliary Forceps.....	1.50
123.*	" " " in h. r. or ivory handle.....	1.50
124.**	" " " for foreign bodies, Gross'.....	each 0.75
125.*	" " " Buck's fenestrated, blunt 3 sizes.....	@ 0.75
126.*	" " " " sharp 3 sizes.....	@ 1.50
127.*	Foreign Body Instrument, Speir's, flat spiral.....	1.25
128.*	" " " " Squire's.....	2.25

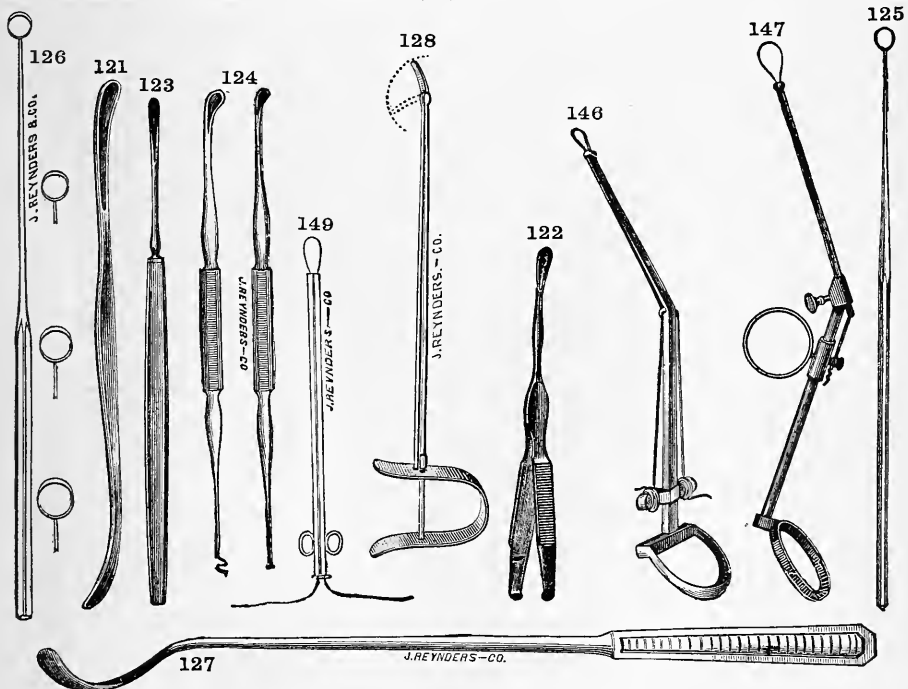

All Instruments illustrated are designated by a \*

VIII. EAR INSTRUMENTS.

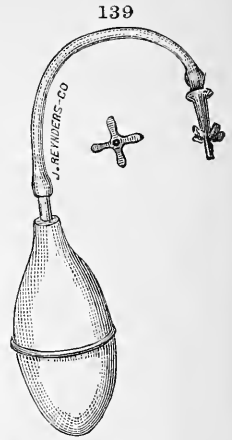
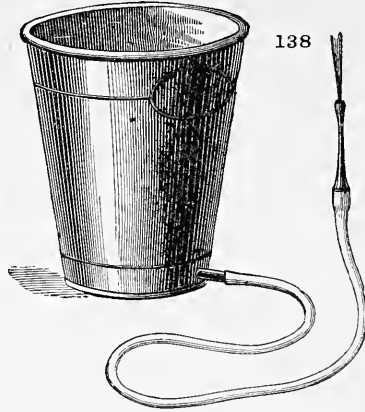
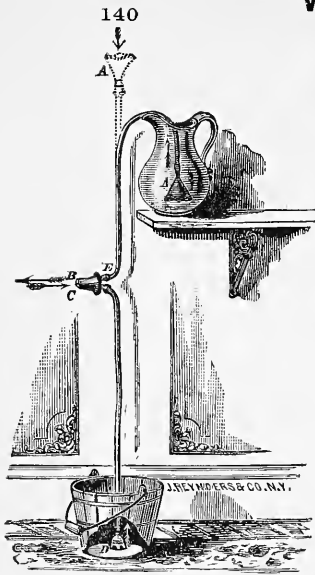

143

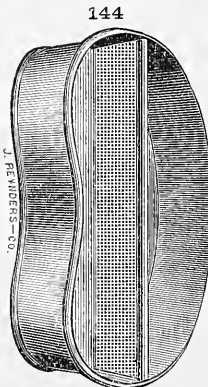
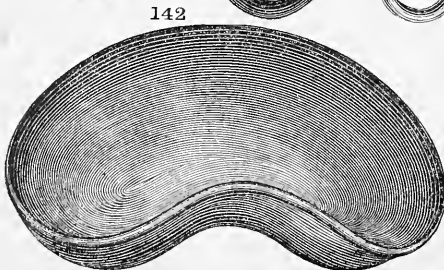
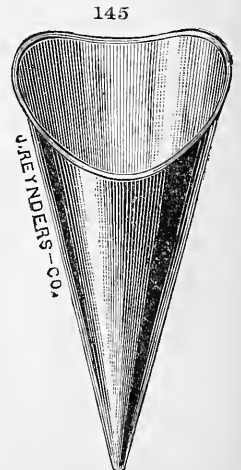
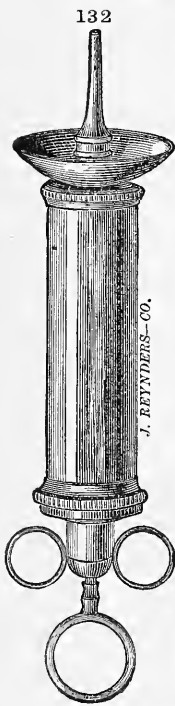
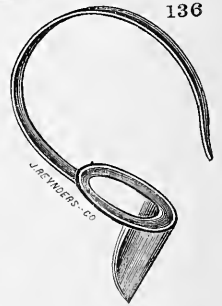
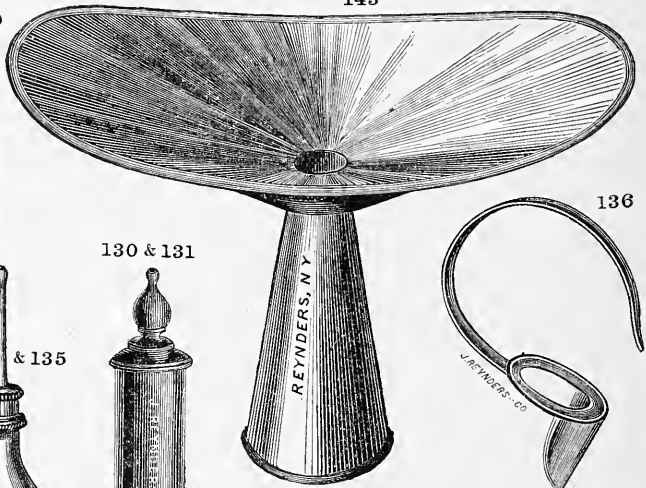

VIII. EAR INSTRUMENTS.

153

154

129.*	Ear Syringe, h. r., 1/2 oz.....	\$1.25
130.*	“ “ “ 2 “.....	2.00
131.*	“ “ “ 4 1/2 “.....	3.00
132.*	“ “ metal, Pomeroy's, 1 1/2 oz.....	4.50
133.	“ “ like Pomeroy's, but with nozzle like 130, and without shield, 4 oz.....	4.50
134.*	“ “ (and eye) ordinary in paper box.....	0.75
135.*	“ “ fine in hinged box.....	1.25
136.*	Ear Spout to adjust over head.....	.80
137.	“ “ “ ear.....	.40
138.*	Ear Douche, Clark's.....	1.50
139.*	“ “ Buck's.....	1.75
140.*	“ “ Fayette's.....	1.75
141.*	“ “ Nozzle, Buck's.....	.75
142.*	Basin for Ear, “ “ “ h. r., 3 sizes @ \$2.50; 3.00; 3.50; brass.....	4.00
143.*	“ “ “ Donder's “ “ “ tin \$0.75; “ “ “ 1.00; “ “ “ 1.50.....	1.50
144.*	“ “ “ Agate “ “ “ 3 sizes @ \$1.50; \$1.75; 2.00.....	2.50
146.*	Polypus Snare, Wilde's (cut see page 99).....	2.50
147.*	“ “ Blake's (“ “ 99).....	3.50
148.	The same with three assorted Canulas and Tympanim Perforator in case.....	8.50
149.*	Double Canula for removing polypj (see cut page 99)..... plated \$1.25; silver.....	2.25



FOR OPERATING UPON THE MASTOID BONES.

150.*	Drill, plain.....	2.75
151.*	“ guarded.....	4.00
152.*	“ Buck's Set.....	5.00
153.*	Knife, Burnett's.....	1.50
154.*	“ Green's.....	1.50
155.*	Chisel.....	1.00
156.*	Set of Chisels and Gouges, Schwartz's..... each \$1.00; per set.....	7.00
157.*	Set of Mastoid Instruments, Politzer's, Chisel \$0.75; 2 Gouges @ \$1.00; Knife \$2.00; Scoop.....	2.50
158.*	Mallet, lead filled.....	2.50
159.	Mastoid Drainage Tube, Gruening's.....	1.50
160.*	“ and Frontal Sinal Drainage Tube, Knapp's..... 8 in set \$5.00; each.....	.75

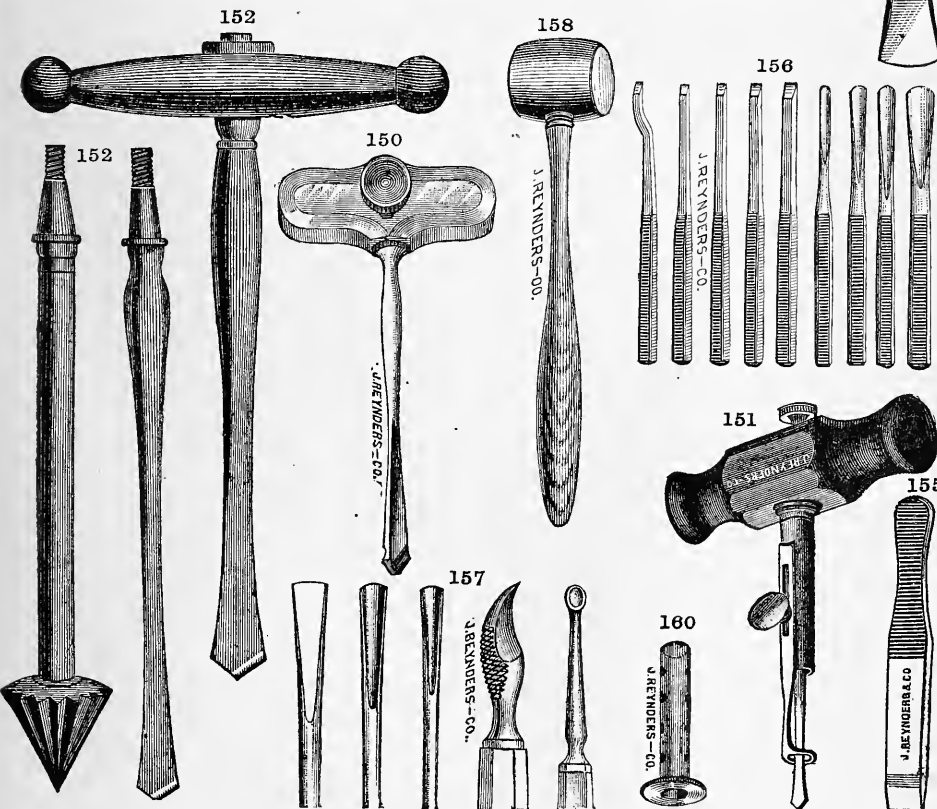

All Instruments illustrated are designated by a \*

VIII. EAR INSTRUMENTS.

EAR TRUMPETS, ETC.

648



654

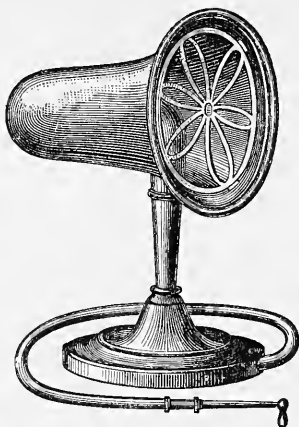

637

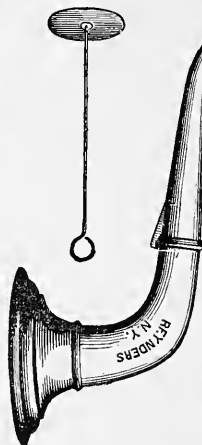

643

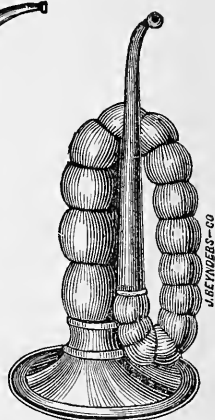

647

641

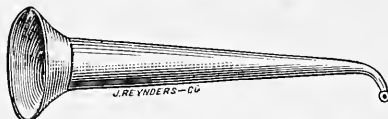

638



638



642

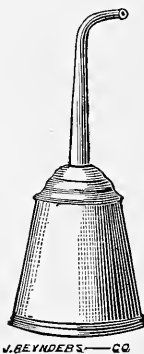

656



649



650

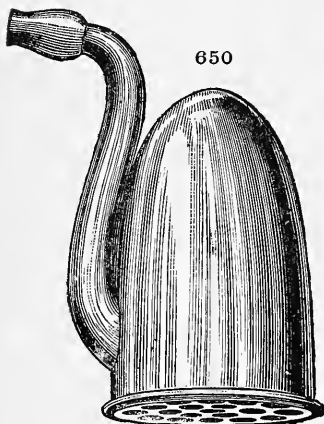

646

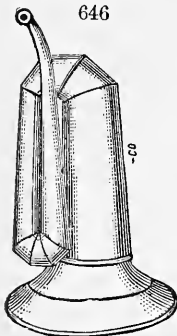

644

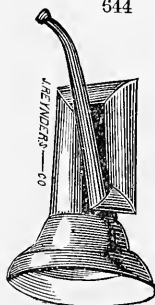

645



653



VIII. EAR INSTRUMENTS.

EAR TRUMPETS, Etc.



637.*	Artificial Tympanum, Toynbee's.....	each 30 cts.; per dozen	\$3.00
638.*	* Silver Cornets, per pair.....		2.50
640.	Ear Trumpet, conical.....	black japanned	\$1.75; G. S. nickel-plated 2.75
641.*	“ “ straight.....	“ “	1.75; “ “ 2.75
642.*	“ “ bell formed.....	“ “	3.00; “ “ 5.00
643.*	“ “ double curved.....	“ “	2.50; “ “ 5.00
644.*	“ “ compact.....	“ “	2.50; “ “ 4.50
645.*	“ “ “ 3 sizes.....	black japanned	\$2.50; G. S. 4.00
646.*	“ “ “ 2 “.....	black japanned	\$2.50; nickel-plated 4.00
647.*	“ “ “ 3 “.....	“ “	4.00; “ “ 5.00
648.*	Sound Concentrator.....		4.50
649.*	Ear Trumpet, G. S., articulated, in case.....		7.00
650.*	“ “ 3 sizes.....	each, brass	\$5.00; nickel-plated 6.00
651.	“ “ h. r. telescopic.....		5.00
652.	“ “ silver, compact (see fig 644).....		12.00
653.*	Auricles, per pair.....	plain	\$3.00; fine 5.00
654.*	Ear of Dionisius.....		8.00
656.*	Conversation Tube, mohair, h. r. fittings.....	plain	\$3.00; conical 9.00
657.	“ “ silk.....		\$4.50; ivory fittings 9.00
660.	“ “ conical silk, h. r. fittings.....		12.00; “ “ 16.00
662.*	Ear Trumpet and Walking Cane, combined.....		15.00

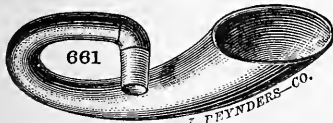

661.\* Sound Accumulator Pocket, Opera Miniature..... \$4.00  
 661a.\* Same, "Opera Grand"..... 10.00

VIII. EAR INSTRUMENTS.

THE AUDIPHONE.

Ordinary size ..... \$8.00  
 Opera " ..... 10.00



Fig. 1. The Audiphone in its natural position; used as a fan.



Fig. 2. The Audiphone in tension; the proper position for hearing.



Fig. 3. The Audiphone properly adjusted to the upper teeth; ready for use. (Side view.)

Buck's Set of Instruments No. 1, consisting of 3 Buck's Blunt Ear (125) Scoops, Tympanum Perforator (104), Tenotomy (107) Knife, Buck's Ear (33) Probe and 2 Holcomb's (112) Cotton Carriers in a neat compact case ..... \$6.50  
 The same with 2 Buck's sharp (126) Scoops in addition ..... \$9.00

Buck's Set of Instruments No. 2 contains: 2 Curettes, blunt; 2 Curettes, sharp; 4 Cotton Holders; 1 Silver Probe; 1 Mastoid Process Knife; 1 Port Acid Glass; 1 Blunt pointed curved Bistoury; 2 Marryngotomes; 1 Furnucle Knife; 1 sharp pointed curved Bistoury; 2 Drills for Mastoid Process; 1 Mirror, 3-inch diameter; 1 Wilde's Ear Forceps; 1 Blake's Snare, silver Canula; 1 Set 4 Wilde's Specula, in a fine Morocco Case, \$35.00

EAR CASES.

- Ear Case No. 1, contains, 1 plain Ear Mirror; 3 h. r. Eustachian Catheters; 1 Wilde's Ear Forceps; 1 Wilde's set (3) of Ear Specula, plated; 2 Cotton Carriers; in a neat morocco, velvet lined case ..... \$15.00  
 With finer Ear Mirror ..... 16.00
- Ear Case No. 2, D. B. St. John Roosa's: 1 fine Ear Mirror with headband and handle; 2 silverplated Eustachean Catheters; 1 gilt Cotton Holder; 1 set (4) Gruber's G. s. Ear Specula; 1 Wilde's Ear Forceps; in a neat morocco case, velvet lined ..... \$18.25
- Ear Case No. 3, contains: 1 plain Ear Mirror; 3 h. r. Eustachian Catheters; 1 H. R. Ear Syringe; 1 set of (3) Wilde's Specula; 1 Wilde's Ear Forceps; 2 Cotton Carriers; 1 Wilde's Polypus Snare; 1 Tympanum Perforator; in a neat morocco case, velvet lined ..... \$21.75
- Ear Case No. 4, contains: 1 Ear Mirror with head-band and handle; 1 set of Politzer's or Wilde's h. r. Ear Specula; 1 set of Grubers G. s. Ear Specula; 1 Politzer's Ear Forceps; 3 G. s. Eustachean Catheters; 3 h. h. r. Eustachean Catheters; 1 set Gruber's Tenotomes; 1 Wilde's Snare; 1 h. r. Ear Syringe; 1 Tympanum Perforator; in a neat morocco case ..... \$35.00
- Ear Case No. 5, Politzer's: 1 Ear Mirror with handle; 1 set (3) Politzer's Specula; 1 Politzer's h. r. Scoop; 1 Curette and Hook; 1 Polypus Knife; 1 Politzer's Ear Forceps; 1 Wilde's Snare; 3 Eustachian Catheters; 1 Toynbee's Diagnostic Tube; 1 h. r. Syringe; in a neat morocco case ..... \$22.00
- Ear Case No. 6, Gruber's: 1 Ear Mirror and handle; 1 set (4) Gruber's G. s. Specula; 2 Polypus Knives; 1 Wilde's Ear Forceps; 1 Eustachean Catheter G. s.; 2 Eustachean Catheters, h. r.; 1 h. r. Ear Syringe; in a neat case ..... \$20.00
- Ear Case No. 7, Politzer's large: 1 Mirror with head-band and handle; 1 set (3) h. r. Specula; 1 h. r. Curette; 1 Gross' Foreign body instrument; 1 Polypus Knife; 1 angular Tympanum Perforator; 1 Wilde's Ear Forceps; 1 Polypus Forceps; 1 Wilde's Polypus Snare; 1 Politzer's Forceps for introducing eyelets, with 6 eyelets; 5 Eustach. Catheters, h. r.; 1 G. s. Eustach. Catheter; 1 Toynbee's Diagnostic Tube; 1 Tuning Fork; 1 h. r. Ear Syringe; in a fine morocco case ..... \$35.00
- Ear Case No. 8, D. B. St. John Roosa's complete, contains: 1 large metal Ear Syringe; 1 small Fountain Ear Douche; 1 nickel plated Pus Basin; 1 Wilde's Ear Forceps; 1 set of four Gruber's G. s. Ear Specula; 1 English Politzer Bag with Roosa's Nozzle; 1 Roosa's metal Inhaler; 2 Cotton Carriers; 1 set Slegle's Pneumatic Ear Specula with Ely's Suction Pump; 1 Blake's Snare; 1 Ear Mirror, with Roosa's headband and handle; 3 H. R. Eustachian Catheters; 1 Glass Rod; 1 Rhinoscopic Mirror; 1 Tuning Fork; 1 small Scalpel; 1 small Bistoury; 1 Tenaculum; 1 Roosa's latest Tympanum Perforator; 1 set Buck's Drills; 1 long silver Probe; 1 folding Tongue Depressor; 1 Sponge Holder; 1 Gross' Hook and Curette; 1 Hinton's Scissors; 1 small Dressing Forceps; 1 Body Thermometer; 1 H. R. Post Nares Syringe; 1 Robert & Collin's Nose Speculum; 1 Otoscope; 1 Nasal Polypus Forceps; put up in a compact and durable Case of satchel form ..... \$115.00
- Ear Case No. 9, Medical Record: 1 fine Ear Mirror with head-band and handle; 1 set of three h. r. Ear Specula, Gruber's; 2 ass. sized Throat Mirrors and handle; 1 Tongue Spatula; 1 Wilde's Ear Forceps; 2 Holcomb's Cotton Carriers; in morocco velvet lined case ..... \$17.00

# IX. OESOPHAGEAL INSTRUMENTS.

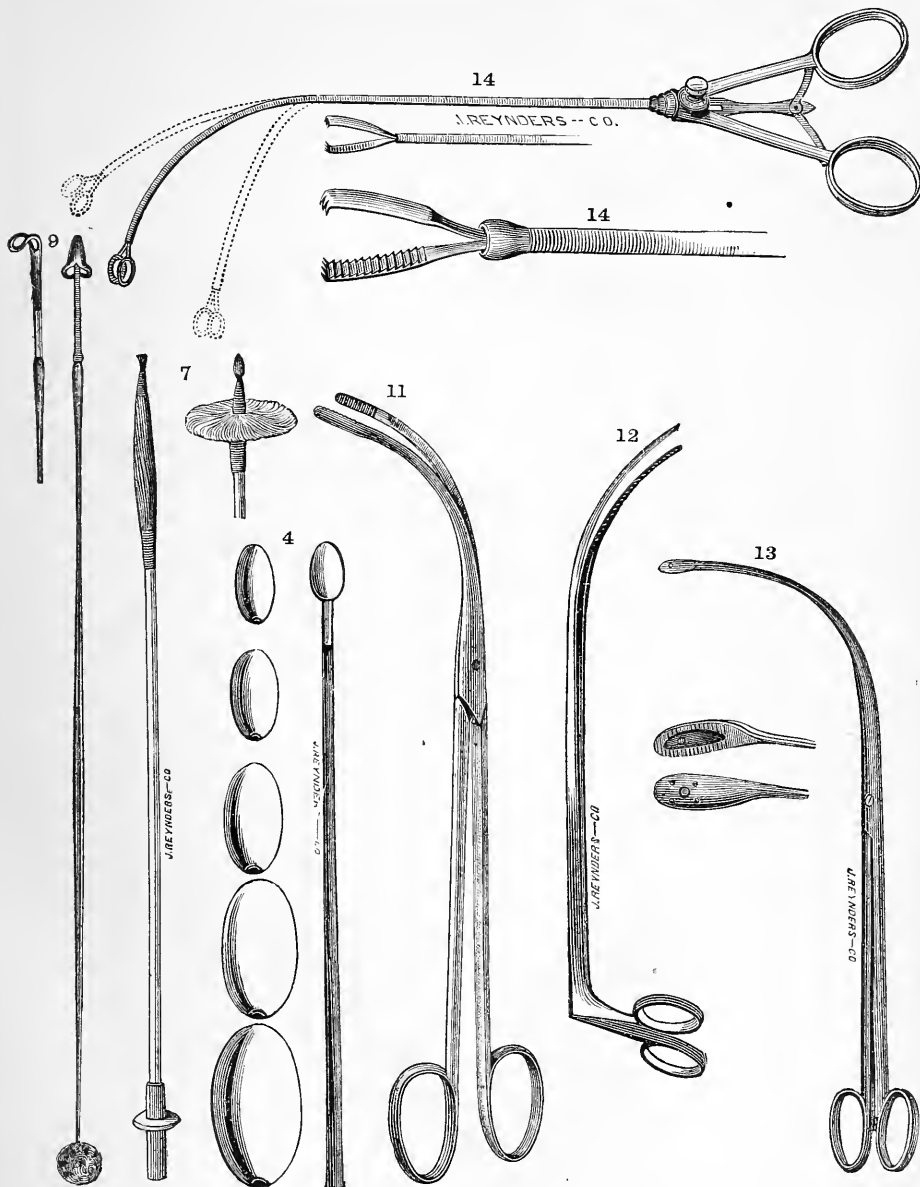

- |      |   |               |                      |      |
|------|---|---------------|----------------------|------|
| 1.   | Bougie, English Red Elastic, cylindrical.....                                   | each \$1.25;  | olivepointed each    | 1.50 |
| 2.   | “ French, Black, Olivepointed, leadweighted.....                                |               | each                 | 2.00 |
| 3.   | “ Bulbous, h. r., with whalebone stem.....                                      |               |                      | 1.50 |
| 4.*  | “ Set of six bulbs to one stem.....   |               |                      | 5.00 |
| 5.   | “ “ ten “ “ “ “.....  |               |                      | 7.00 |
| 6.   | Flexible Rectal stem for either of two latter.....                              |               |                      | 1.50 |
| 7.*  | Bristle Probang.....  | sponge tipped | \$1.75; ivory tipped | 2.00 |
| 8.   | “ “ ivory tipped with ring and finger-rest.....                                 |               |                      | 2.50 |
| 9.*  | Articulated Probang, Graef’s, hinged bucket at one, and sponge at other end.... |               |                      | 2.00 |
| 10.  | The same in three sections, to screw together.....                              |               |                      |      |
| 11.* | Oesophageal Forceps, plain.....   |               |                      | 3.25 |
| 12.* | “ “ Burge’s.....  |               |                      | 4.50 |
| 13.* | “ “ Fauvel’s.....   |               |                      | 4.00 |
| 14.* | “ “ flexible, can be bent in any curve and opens in front only..                |               |                      |      |

All Instruments illustrated are designated by a \*

X. LARYNGEAL INSTRUMENTS.

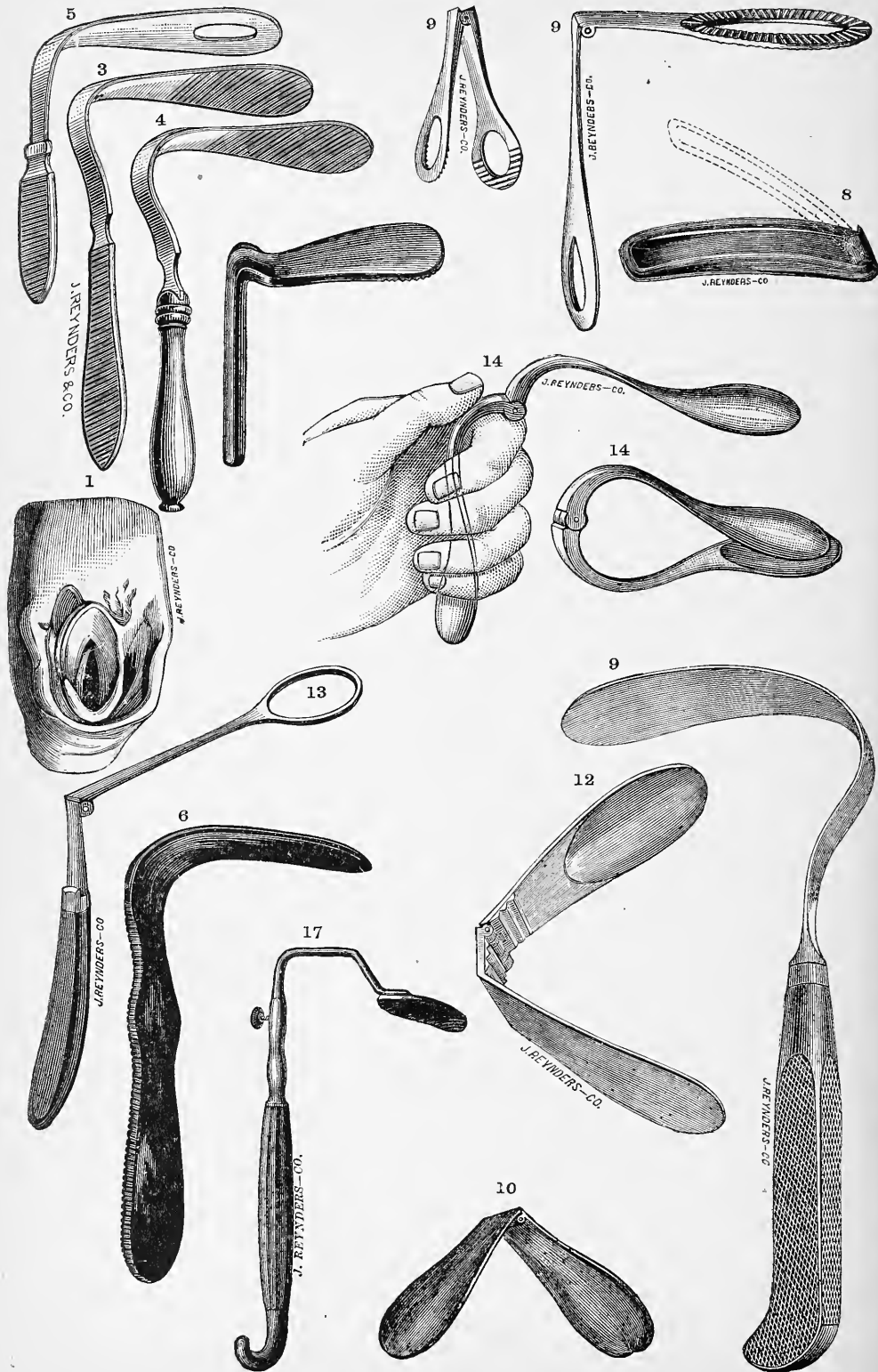



**X. LARYNGEAL INSTRUMENTS.**

1. Anzoux' Models of Larynx.....	\$14.00**
2. " " " Cartilages of Larynx.....	13.00**

**TONGUE DEPRESSORS.**

3.* Plain Steel, nickelplated.....	1.00
4.* " " with horn or h. r. handle.....	1.50
5.* " " Bosworth's, n. p.....	1.00
6.* " H. R.....	1.00
7.* Leiter's, Steel, h. r. covered, handle curved laterally.....	1.75
8.* Hinged, Smith's, n. p.....	1.00
9.* " n. p.....	1.00
10.* " metallic, n. p.....	1.00
11.* " h. r.....	2.25
12.* " Steel, n. p.....	1.50
13.* " Green's, fenestrated or solid blade steel..... n. p. \$2.50, brass, n. p.	1.75
14.* " Goodwillie's, pocket.....	1.75
15.* " Elsberg's, combined with mouth gag (the latter removable).....	5.00
16. Tuerck's, one bladed, inseparable, n. p.....	2.50
17.* " two " separable, ".....	3.50
18. " three " " ".....	4.50
19.* Sass'.....	2.50
20. Cohen's, h. r.....	1.25
20a.* Higgins'..... with gag \$7.00; without gag	2.50

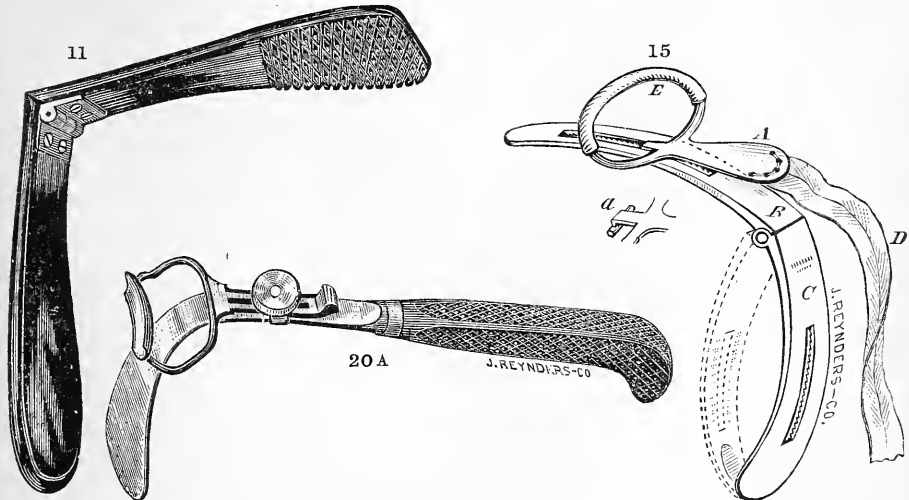

All Instruments illustrated are designated by a \*

X. LARYNGEAL INSTRUMENTS.

33

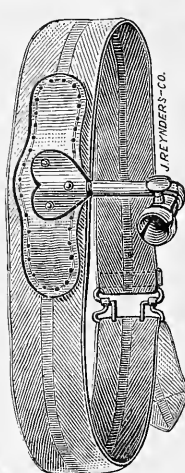
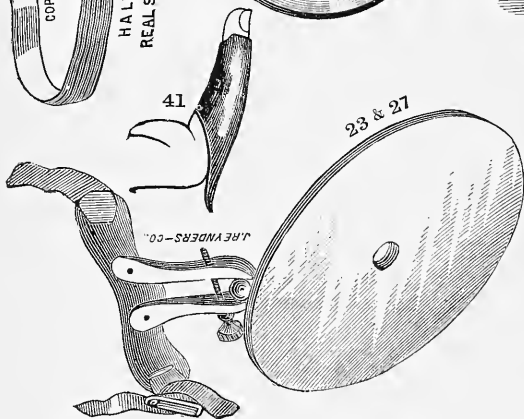
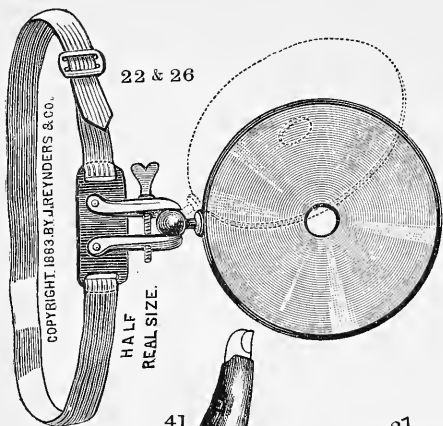

Dr. F. L. Ives' Headband—specially designed for practitioners wearing glasses while making examinations. Price \$3.75. Diameter, Dr. F. L. Ives' Reflector, 4 inches diameter, with oval instead of circular hole \$8.00.

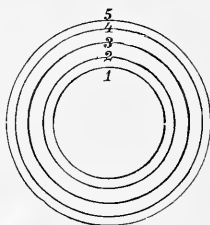
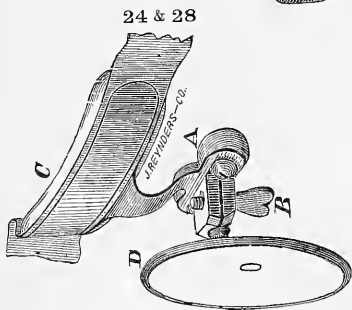
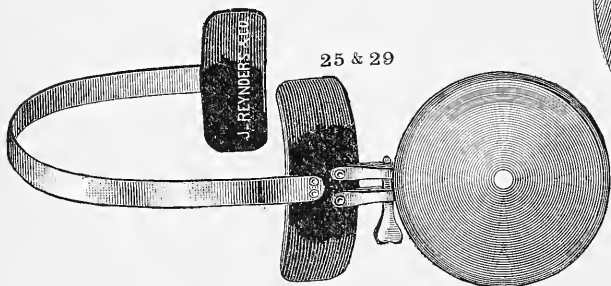

Sizes of Mirrors 30x32.

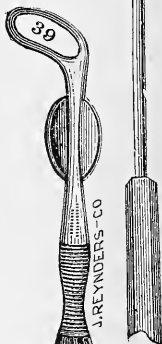
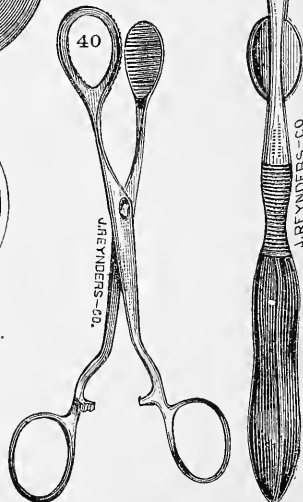

OTTO & REYNDERS

## X. LARYNGEAL INSTRUMENTS.

### MIRRORS.

Mirror, with Bosworth's (26) or Pomeroy's (27) Headband, 2½ in. \$4.00; 3 in. \$4.50;	
	3½ in. \$5.00; 4 in. \$6.00; 4 + in. \$6.50
Mirror, with Nasal Rest (28) Headband, 2½ in. \$5.00; 3 in. \$5.50; 3½ in. \$6.00;	
	4 in. \$6.50; 4 in. + 7.00
Mirror, with Spring over Head (29), prices same as with 28; with Simrock's Holder (see 56c, page 111a) each \$2.00 additional.	
26.* Headband, Bosworth's.....	\$1.50
27.* " Pomeroy's.....	1.50
28.* Nasal Rest .....	2.50
29.* Spring over Head.....	2.50



Electric Illuminator in case, complete, \*6.00



30.* Laryngoscopic Mirrors, without handles, 5 sizes, .....	each 0.80
31.* " " Set Screw Handle for same, .....	h. r., \$0.60, ivory 1.00
32.* " " with fixed handles.....	1.00
33.* " Examining Set, consisting of Reflector 21, 3 ass. Laryngoscopic Mirrors, 30 and 31, and Tongue Depressor 3, in a neat morocco case.....	13.00
34. The same without Tongue Depressor.....	12.00
35. For an Examining Set with first class Reflector, 3 ass. Laryngoscopic Mirrors with a Set Screw handle, add the price of Reflector wanted to.....	8.50
36. Tongue Spatula No. 3 in addition thereto.....	1.00
37. Six Brushes with handle and three wires as in addition thereto.....	2.50
38. Uvula Retractor, open or solid, with set screw handle.....	2.00
39.* Velum Retractor, Voltolini's.....	3.50
40.* Tongue Holding Forceps.....	5.00
41.* Finger Protector.....	1.00

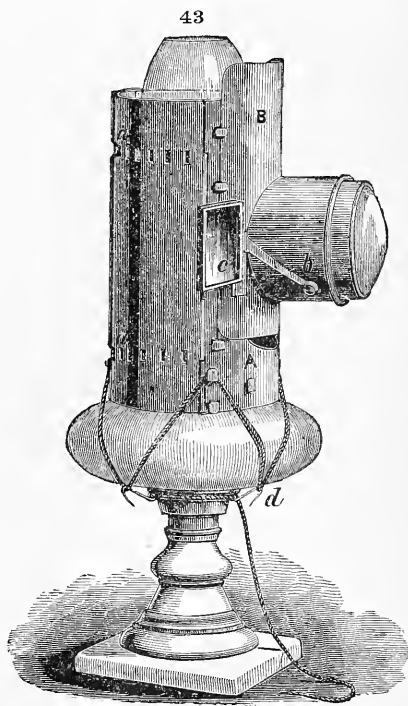
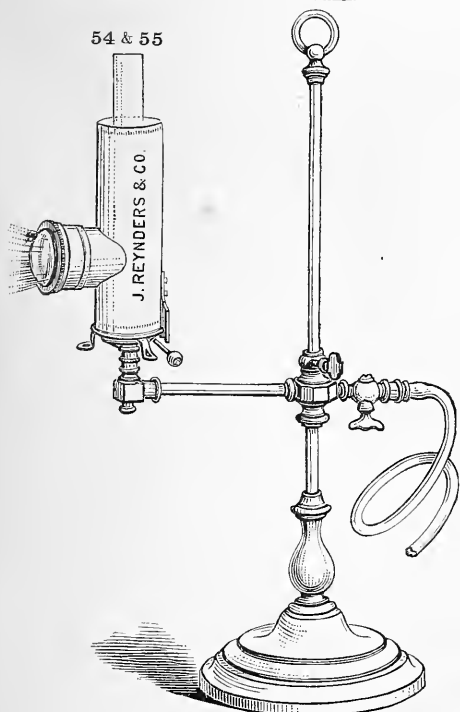

All Instruments illustrated are designated by a \*

X. LARYNGEAL INSTRUMENTS.

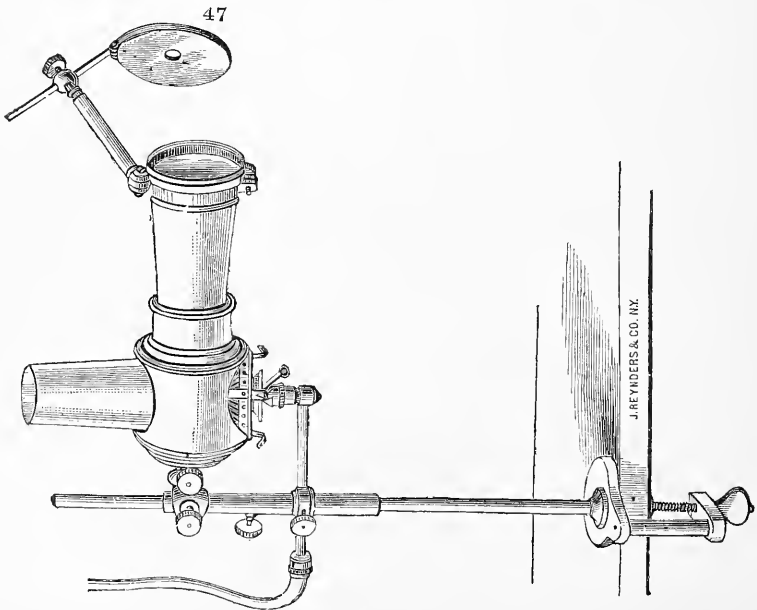
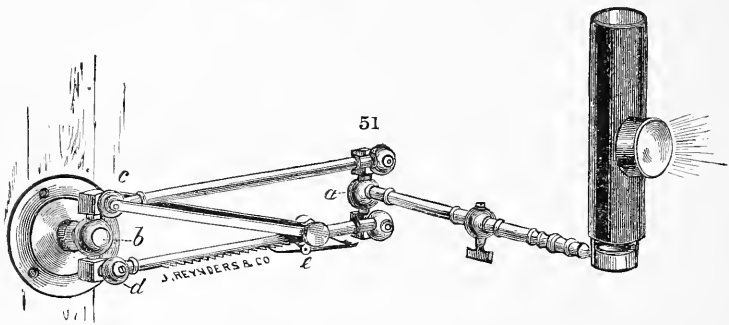
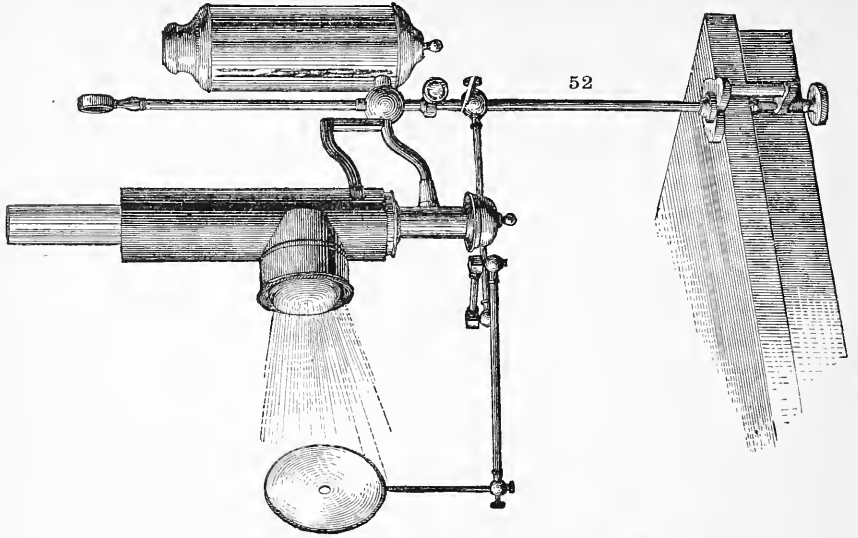

**X. LARYNGEAL INSTRUMENTS.**

**LARYNGOSCOPES.**

- 42.\* Elsberg's ..... \$6.00
  - 43.\* Oliver's (see page 109), adaptable to any ordinary kerosene lamp with one auto-laryngoscopic and three laryngoscopic mirrors in black walnut box ..... 9.00†
  - 44.\* Tobold's ..... large \$20.00; n. p. 22.00
  - 45. " small ..... 15.00
  - 46.\* Student's Lamp for same. .... \$5.00\*; n. p. 6.00\*
  - 47.\* Seeger's, n. p. .... 34.00
  - 48. " Stand with Mackenzie's Light Concentrator ..... 21.00
  - 49.\* Light Concentrator, Mackenzie's, for argand burner ..... 6.00
  - 50. The same for Students Lamp ..... 7.00
  - 51.\* Mackenzie's (with universal motion), improved style, without ratchet. .... 18.00
  - 52.\* Mackenzie-Beebe's, complete with 3 inch. Mirror ..... 20.00
  - 53. " without mirror and jointed arm 15.00
  - 54.\* Mackenzie's (see page 109), with stand and Argand Burner, n. p. iron \$18.00; brass \$20.00
  - 55.\* The stand as in figure 54 with Seeger's Light Concentrator (as in fig. 47) and the Reflector attached to same. .... \$30.00  
Without the Reflector and arm... 24.00
  - 56. The above with an extra heavy stand \$4.00 in addition.
- Either Laryngoscope with 6 feet Gas Gas Tubing, fittings, goose neck, shade and shade holder, add to price 3.00\*

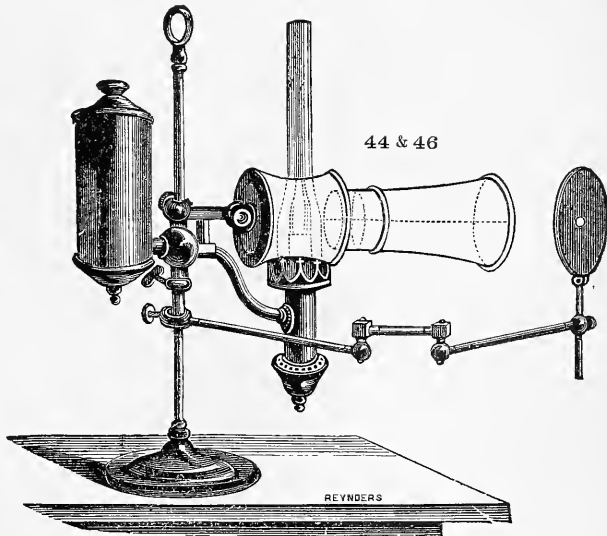
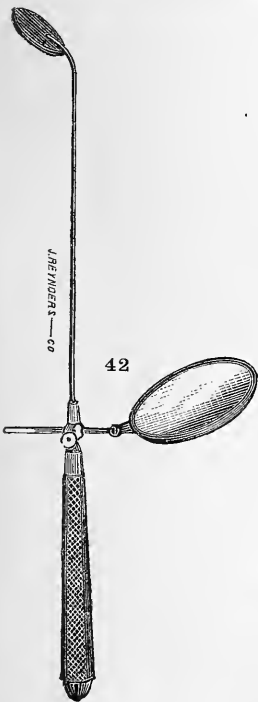
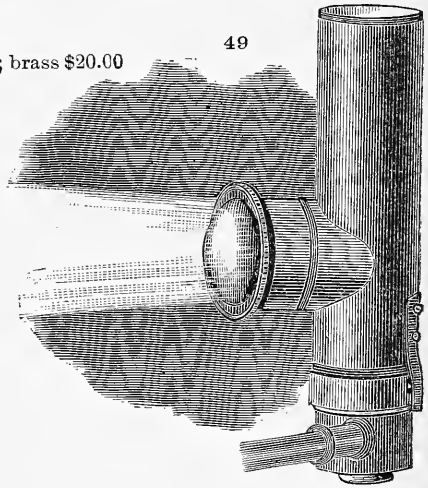

All Instruments illustrated are designated by a \*

X. LARYNGEAL INSTRUMENTS.

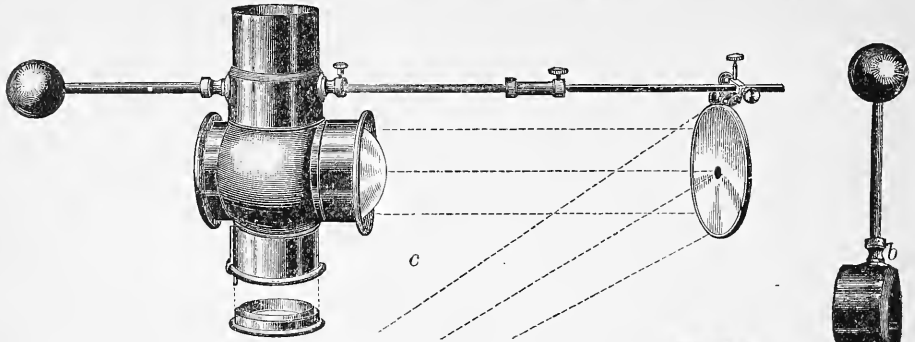

56a.\* J. R. & Co.'s Modification of Mackenzie's Condensor. Recommendable for the following reasons:

*First.* On account of the spherical or round form of the flame chamber, which has a tendency to concentrate the rays, producing thereby a more powerful light than could be otherwise obtained. The light, thus condensed, is thrown forward through the lens onto the mirror by a reflector in the rear.

*Second.* To avoid the annoyance of placing the mirror in the right position each and every time when brought to use, we have added a rod or bracket fastened to a band, which slides over the chimney and rests on the sphere, while the rod penetrates the chimney, holding it steadily and parallel with the focal line. At the extreme end of this rod the mirror is suspended by means of a ball joint, similar to the one used on the improved headbands, to allow the direction of the light wherever needed. The ball joint can be raised or lowered according to the size of the mirror. With this bracket the operator is never hindered in his movements, as the mirror is thereby always held in the focal line, which is most decidedly an improvement over the independent stand or headbands and all the other devices that have been used before for that purpose.

*Third.* A ball-shaped weight, which screws on the back of the band, counterbalances the mirror when adjusted to a gas bracket or lamp. The Laryngoscope with its attachments is constructed with screw-joints and can readily be taken apart for convenient packing.

Fig. a. Plain Laryngoscope..... \$6.66

Fig. b. Arm adjustable to same.

Fig. c. The two combined..... with mirror \$14.66; without mirror 11.00

56b.\* Sardy's Headband..... for 3 in. mirror \$3.20; for 3½ in. mirror 3.33

56c.\* New Adjustable Mirror Holder (over head). The figure shows it ready for use and also put together for the pocket ..... Price without Mirror \$4.50

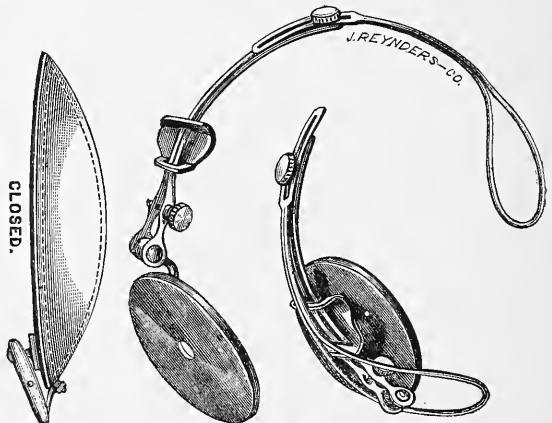
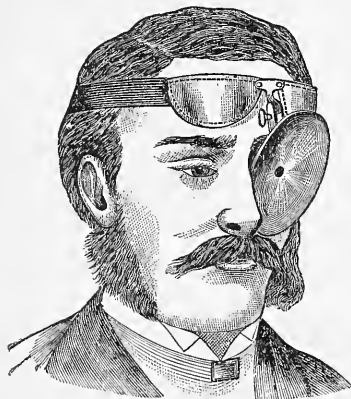
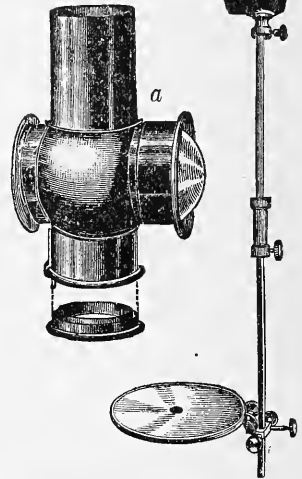

X. LARYNGEAL INSTRUMENTS.

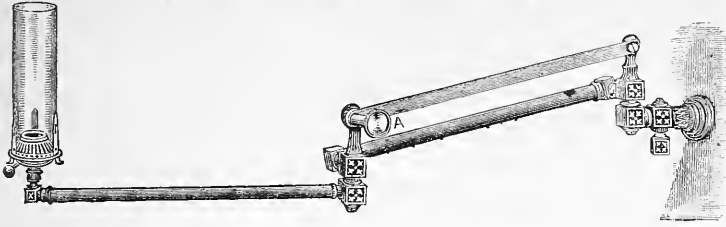

56d.\* Adjustable Gas Bracket, designed for J. R. & Co.'s Laryngoscope, fig. 56a (extreme length 30 inches).

The handle "a" is at the same time the set-nut for the friction disc, by means of which the bracket is held in position; only one hand is required to loosen, move and set the bracket with ease.

Price, pol. brass \$7.50;\* n. p. \$8.00.\*

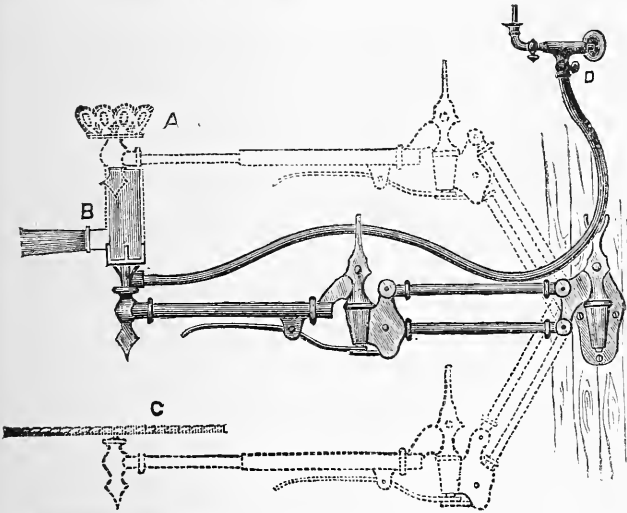

56e.\* A New Adjustable Lamp Bracket, by Seth S. Bishop, M. D.

The accompanying cut illustrates the working of an adjustable lamp bracket, designed for carrying lights, instruments, etc. It overcomes the difficulty of properly illuminating various parts from any desired direction and at any given angle. The lamp is easily adjustable to any point lying within a perpendicular line a foot and a half in length (from A to C) and it will swing through the arc of a circle, having a radius of three feet.

It is supplied with joints, parallel arms and an extensible lamp holder, in such a manner as to place the light (B) either within a few inches of any wall to which it is attached, or at any intermediate point in a horizontal, to a distance of three feet from the wall. It is so constructed that, in order to raise or lower the light, you need only to press the thumb and finger on the extension arm and brake beneath, so as to close them together; then set the lamp at the desired point; release the brake, and it sets automatically, holding the light wherever it is placed. These points will be appreciated by those who have to use light concentrators on the imperfect brackets now in use.

The lamp holder is prepared to receive an Argand burner connected with a flexible gas tube, so that the bracket may be attached to a wall or desk in any part of an office or house, and connected with the gas fixtures like an ordinary drop lamp. Or, where there is no gas, an oil lamp holder (A) is screwed on instead of a gas burner (B), and an oil lamp of large size may be used to obtain brilliant illumination. The bracket is very strong, and will support a weight of five pounds or more. Its utility is extended by substituting a tray (C) for the lamp receiver (A), so as to make it a convenient instrument holder for surgeons and dentists alike. I have employed this bracket in my office a sufficient length of time to demonstrate its superiority over any other that I have been able to find after a most exhaustive search.

The bracket is made of brass or iron, and is an elegant addition to any office, both as to utility and beauty.

The nickel plated light concentrator (B) of my design is made to use over any Argand chimney, and is much less expensive than any other in market.

The bracket is fitted with an oil lamp in the holder (A) and a light concentrator when so ordered.

Price..... \$10.00\*

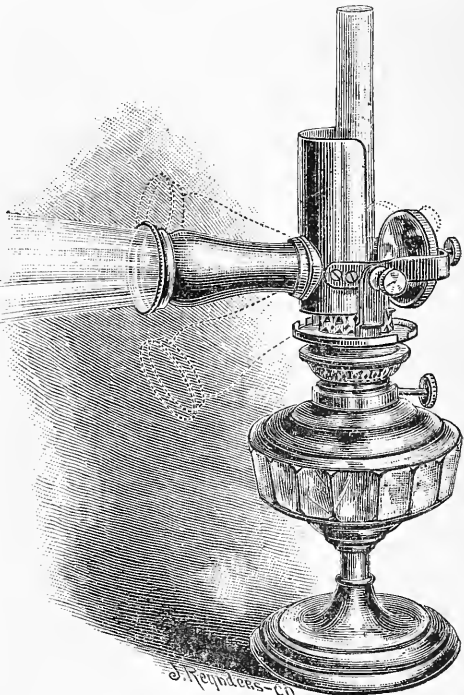

St. Croix Laryngoscope, \$15.00.

**X. LARYNGEAL INSTRUMENTS.**

FOR MAKING APPLICATIONS.

CONDENSED AIR RECEIVERS AND PUMPS.

For Operating Spray Tubes and Powder Blowers of every description by Compressed Air.  
*All Prices on this and the three following pages Net.*

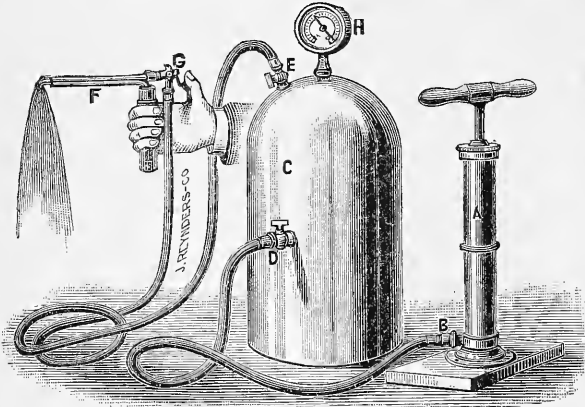

57a. Receiver.

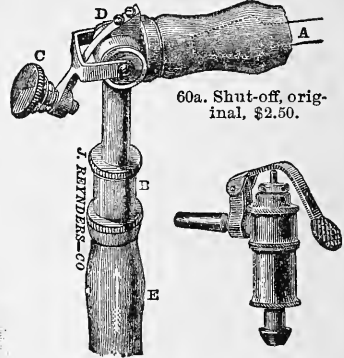

60a. Shut-off, original, \$2.50.

60a. Shut-off, new, brass, n. p., \$1.50.

- 57a.\* Receiver, copper, highly finished and nickel-plated. Size, 9 in. diameter by 16 in. high. Guage first-class, registering from one to fifty pounds pressure; plated Air Pump, capable of producing fifty pounds pressure; Automatic Cut-off; three Sass Spray Tubes with fittings and test tubes; four feet of Silk Covered Tubing and four feet Lined Rubber Tubing ..... \$37.50
- Same without the Pressure Guage..... \$32.50; Receiver only 20.00
- 57b. The same as 57a, with the exception of having two latest improved High Pressure Valves, warranted not to leak, with couplings for attaching the tubing as necessary; this latter part (i. e., Guage and two Valves) being the same as in receiver fig. 58a, \$2.00 additional to the prices given with 57a.
- 57c. The same as 57a with the exception of receiver being 9 in. diameter by 12 in. high in size. Price of the whole outfit as specified \$34.50; without Guage or Receiver \$29.50; Receiver only \$17.00.

- 57d. Receiver resembling 57a in shape, 10 in. diameter by 18 in. high, but made of superior tinned steel, japanned in rich chocolate color. With first-class Guage, registering from one to one hundred pounds pressure, and High Pressure Valves warranted not to leak. Also, provided with Couplings warranted not to leak. The Guage and Valves are made entirely of bronze, highly finished and plated. Prices throughout \$1.00 less than those of 57a.

- 58a.\* Receiver as shown with fig. 58a, size 7 in. diameter by 28 in. high. Made of copper, nickel-plated. Tested to 300 lbs. to the sq. in. Guage first-class, registering from one to two hundred pounds pressure. Guage and Valves made of bronze and nickel-plated, and the latter warranted never to leak. Receiver stands as high as an ordinary table, the Valves thus being conveniently reached. Price of Receiver only \$27.00; same with Sass' Pump \$62.00; also with outfit as specified with 57a \$72.00.

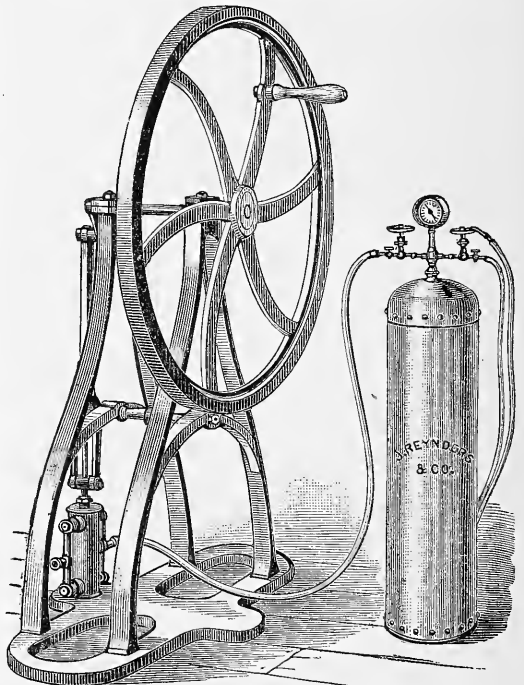

58a. Receiver with Sass' Pump.



**X. LARYNGEAL INSTRUMENTS.**

FOR MAKING APPLICATIONS.

CONDENSED AIR RECEIVERS AND PUMPS.

58b. Receiver of superior tinned steel, japanned in rich chocolate color; size 10 in. diameter by 32 in. high, resembles fig 58a in general appearance. With first class Guage, registering from one to one hundred pounds pressure, and two latest improved High Pressure Valves, warranted not to leak. Also provided with Couplings for attaching the necessary rubber tubing. Price of Receiver only \$24.00.

58c. Same, with three Valves. Price \$25.00.

59a.\* Receiver, copper, nickel-plated, small, 6 in. diameter by 10 in. high, outfit generally the same as with 57a. The improvement of this over others consists in the reduction of size, weight, ornamental appearance and the arrangement of the stopcocks A, B and C. Of these the one designated by the letter C, consists of a rod, conic at one extremity, supplied with a screw thread, and a wheel for readily propelling it outward or for gently screwing the conic end of the rod perfectly air-tight into a corresponding mother cone, thus (when the apparatus is not in use) relieving the stopcocks A and B of pressure, or when worn by continued use preventing the escape of air through them. Price of this Receiver with outfit as mentioned with 57a \$50.00.

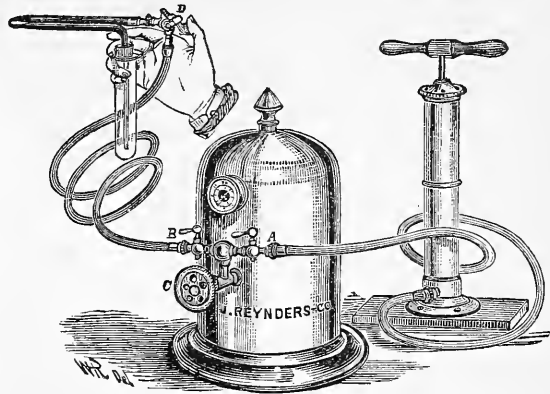

59a. Receiver.

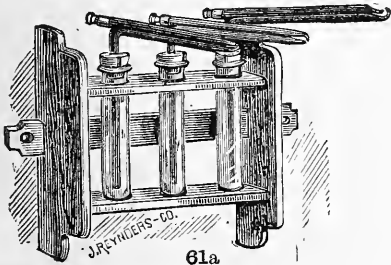

61a

61a.\* Sass' Spray Tubes, forward, up or down, with Receptacle,—Glass each \$1.00; H. R., J. R. & Co.'s \$2.00; Davidson's \$2.00; metal, each \$1.50.

62a. Bayonet Fittings to same, each 30 cts.

63a. Silk Covered Rubber Tubing, per foot, between Receiver and Shut-off 25 cts.; Pump and Receiver 35 cts.

64a. Rack for attachment to wall or to stand, 3 tubes \$1.25; 6 tubes \$2.50.

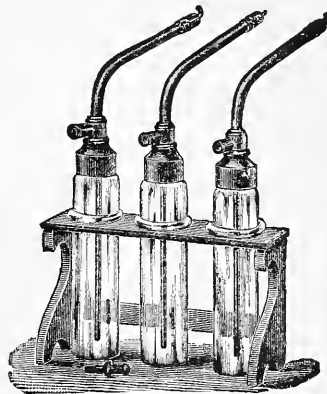

61a

**GAS OR GASOLENE MOTORS COMB. WITH AIR PUMP, FOR CHARGING CONDENSORS.**

APPLICABLE IRRESPECTIVE OF WHETHER THERE IS A GAS SUPPLY FROM FACTORY OR NOT.

See illustration, page 131D.

There is no need of dwelling upon the satisfaction of having a Receiver filled without the exertion of pumping by hand. A jet of gas needs only to be lit and the little engine will start. Big fly-wheel with each engine on which a belt can be slipped, offering thus a motive power for a variety of domestic uses.

65a. One-Half Horse Power—will fill an 82 gal. Receiver to 60 lbs. in 35 minutes... \$230.00

66a. Man Power.....vertical \$200.00; horizontal \$160.00 and 130.00

More explicit circular on Air Receivers sent on application.

X. LARYNGEAL INSTRUMENTS.

ACCESSORIES TO AIR RECEIVERS.

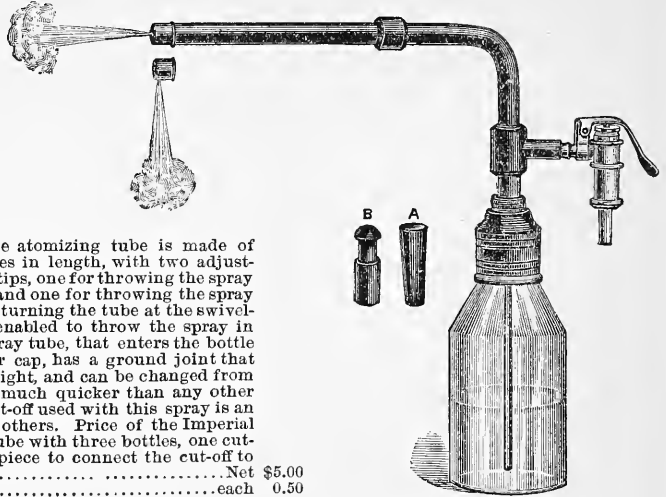

67a. Imperial Atomizer. The atomizing tube is made of hard rubber, five inches in length, with two adjustable platinum pointed tips, one for throwing the spray parallel with the tube, and one for throwing the spray at right angles, and by turning the tube at the swivel-joint the operator is enabled to throw the spray in any direction. The spray tube, that enters the bottle through a hard rubber cap, has a ground joint that makes it perfectly air-tight, and can be changed from one bottle to another much quicker than any other style of spray. The cut-off used with this spray is an improvement over all others. Price of the Imperial Spray, including one tube with three bottles, one cut-off, and female metal piece to connect the cut-off to the tubing.....Net \$5.00  
Extra bottles.....each 0.50

POWDER BLOWERS.

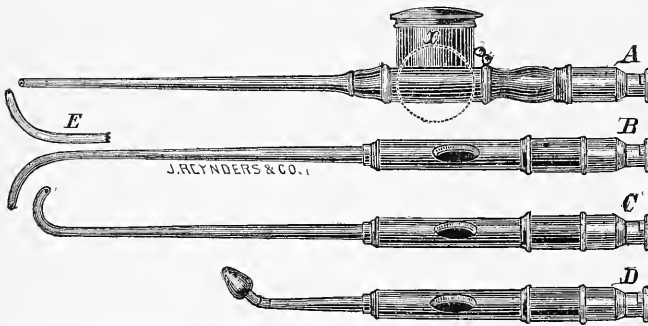

Figures A, B, C, D and E illustrate styles of Powder Blowers, applicable with the Condensed Air Receiver; they are attached to the Automatic Cut-Off in the same manner as the Spray Tubes. Where the same powder is to be permanently used the style A (which can be had of every one of the curves shown) is the best. The little cylindrical box holds the supply of powder and by a quarter of a turn and a little tap to the same enough will fall into the tube of the powder blower for one application. To prevent air from the receiver entering the supply box, the same should

be turned into its original position. The manner of using the other style can be readily seen. In using either of these styles of powder blowers with a receiver, the full supply of air in the same, should not be permitted to act upon the powder, as very slight pressure is sufficient to discharge and distribute it properly—the best way to do this is the following: the cut-off being closed; open and immediately there upon close the stopcock on the receiver to which the tube leading to the cut-off is attached—the tube itself will then contain enough air to act properly upon the powder.

Price of each, with box as on A..... \$2.25  
" " " arranged like B, C, D or E..... 1.75

These Powder Blowers can also be had without the metal fitting for attachment to the cut-off, and with the ordinary bulb as used on hand atomizers—the styles with supply box in this arrangement are particularly recommended for patient's own use.

Price of styles with supply box with bulb..... \$3.00  
" " " arranged like B, C and D with bulb..... 2.25

As to Powder Blowers see also pages 117, 126 and 127.

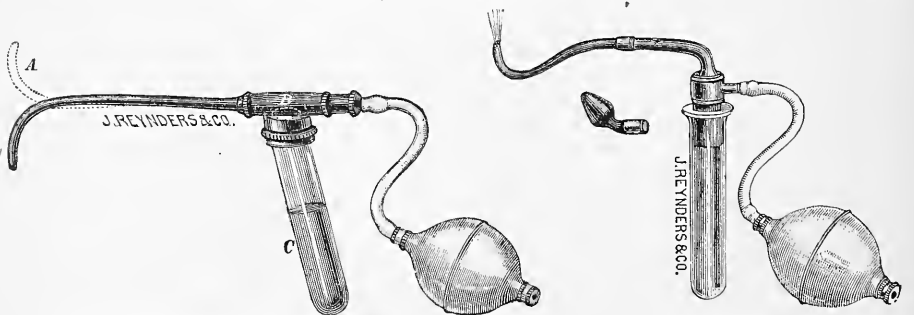

Ive's Powder Blower for Iodoform, \$2.00.

Lefert's Powder Blower, \$1.75.

**X. LARYNGEAL AND PULMONARY.**

This page is devoted to Vaporizing or Nebulizing Apparatus to be used when glycerine, cosmoline or similar preparations (other than water) are to be the vehicle of the chosen medicinal agent. Such a fluid is first atomized and then further broken into a fine cloud by striking against a hard surface. Issuing from the inhaling tube it floats upon the atmosphere for a long time without being absorbed into it. Possessing this quality it is admirably adapted to be received by the air-cells of the lungs into which it surely penetrates, as abundantly proved by careful observers. The beneficial results from its use are often remarkable. It resists chemical action of all remedies.

The well-known Evans' Inhaler is an apparatus of the above made description; and as our below-named No. 4 Geyser Inhaler is a most decided improvement upon the same, we give only the prices of the Evans' Inhaler without illustrations.

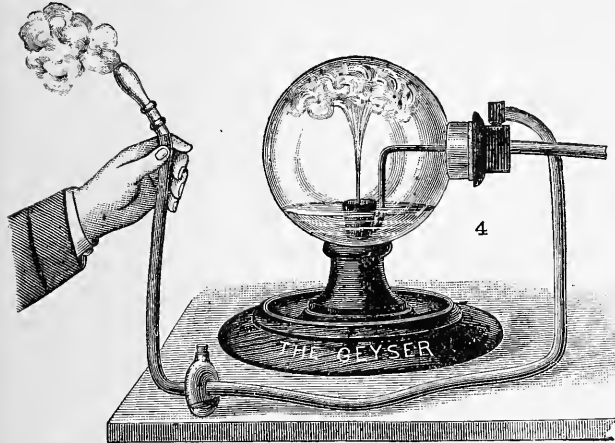

1. Evans' Inhaler No. 1, Apparatus consisting of Jar, Spray Tube, Glass Spray Chamber, Saliva Bulb, Respiratory Tube, Mouth-piece, Nose Clamp, etc., designed for physicians who have the condensed air apparatus, and to be used with same \$8.50\*
2. Evans' Inhaler No. 2, Apparatus for home use consisting of the complete arrangement as shown in cut on page 8, Evans' pamphlet.... \$20.00\*
3. Evans' Inhaler No. 3, Apparatus for home use, very compact, as shown in cuts on pages 27 and 28, Evans' pamphlet..... \$25.00\*
4. Geyser Vaporizer, vastly superior to either 1, 2 or 3, dispenses with suction tubes by a new and simple device, thus obviating the chief source of annoyance, facilitates the more the use of heavy liquids such as cosmoline, etc.

The point of exit for the compressed air being surrounded by the fluid to be vaporized, a denser vapor is produced than by the old method. This will be appreciated by those that use the hand pump, for we produce more vapor with one-third less air than any vaporizer or inhaler in the market. Price of the latest improved ..... \$12.00\*

Evans' Inhaler No. 1 and the Geyser Vaporizer No. 4 require the use of either of our Air Receivers and Pumps, mentioned on pages 112 and 113. The Gas Motor with these is particularly recommended. Cosmoline for either of the Apparatus mentioned on this page..... per pound tin can 50\* cts.

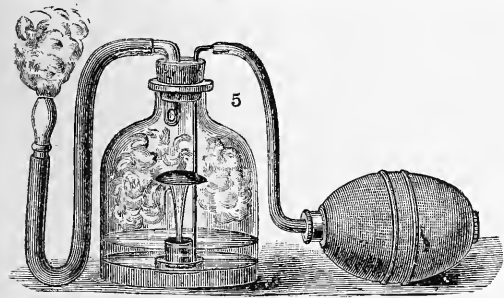

5. The Geyser Hand Vaporizer commends itself for simplicity and convenience being constructed on the same principle as the large Geyser, but deriving its power from a hand-bulb. It produces a large volume of vapor; is not liable to break, owing to the fact that all tubes are of rubber, and will be found of great convenience to physicians desiring to have their patients continue the vaporizing treatment at home. What we have said of the Geyser, as to the use of heavy oils, equally applies to this hand apparatus, and this is a very essential point in favor of both the large and small Geysers. Price..... \$2.50\*
6. Vaporizer (169)..... \$1.13; post-paid \$1.35
7. " (165), with Atomizing Tubes, nickel-eled \$2.50; platinum \$3.25; either with double bulbs, extra 75 cts.

Cosmoline for either Apparatus mentioned on this page, per pound tin 50\* cts.

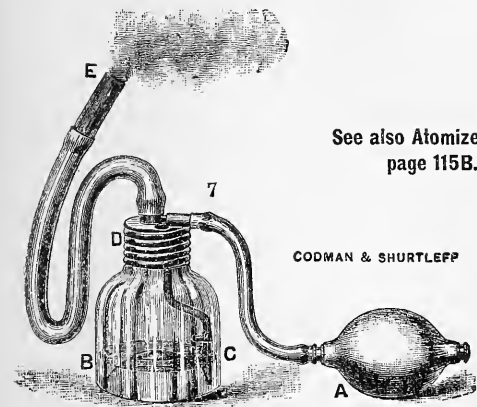

See also Atomizer 84a, page 115B.

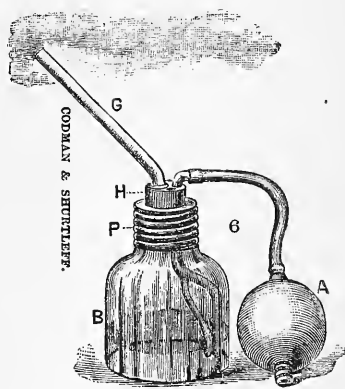

X. LARYNGEAL-ATOMIZERS.

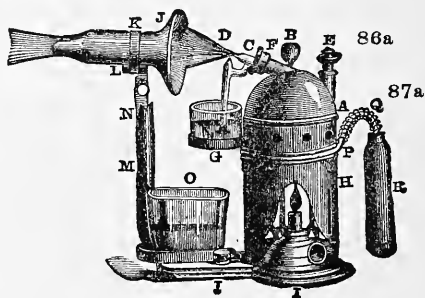
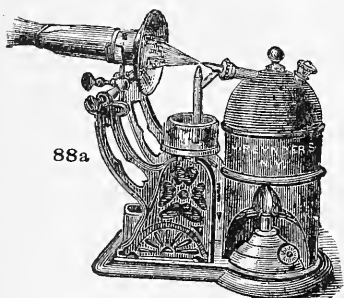
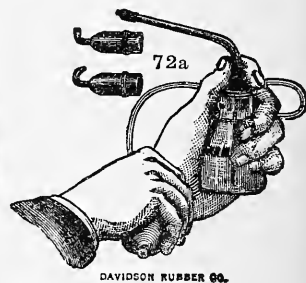
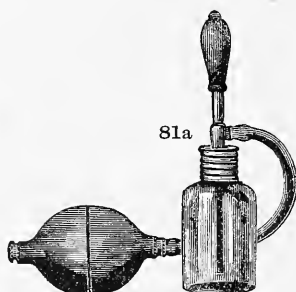
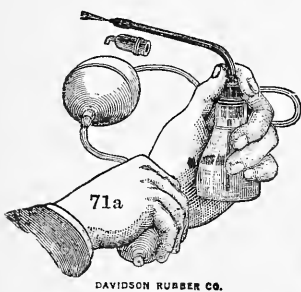
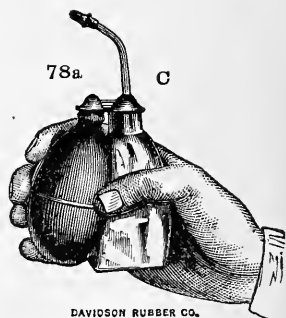
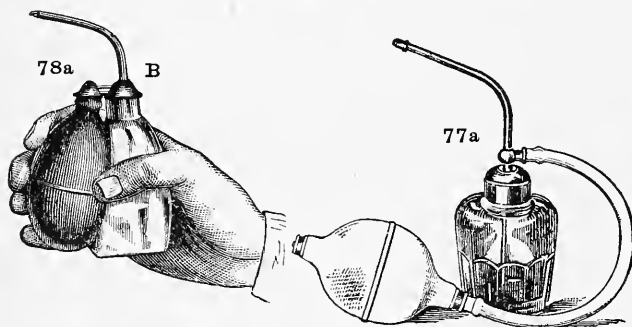
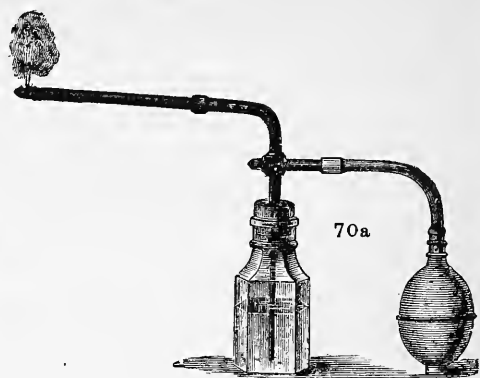
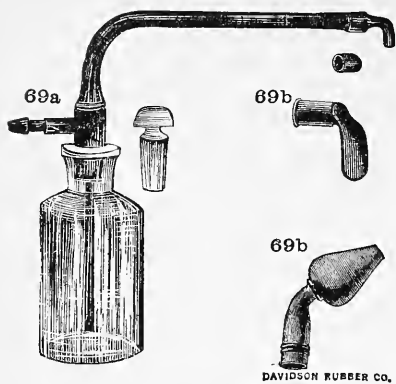

X. LARYNGEAL—ATOMIZERS.

- 69a.\* Hard rubber, blue bottle, double bulbs ..... \$3.00
- 69b.\* Hard rubber, Fullgraft's Flat or Nasal Bulbous Nozzle to same, each 0.50
- 70a.\* Hard rubber, imperial, with two adjustable tips, one for throwing spray in same direction with tube, the other for throwing spray at right angles; by turning the latter at swivel-joint, the spray can be thrown in any direction. This spray is also adapted to spraying cold oil.  
Plain \$2.00; platinum pointed 2.66
- 71a.\* Hard rubber, two Nozzles platinum tipped, double bulb ..... 3.00
- 72a.\* Hard rubber, three Nozzles platinum tipped, single bulb. .... 3.00
- 73a.\* Hard rubber, Leffert's Nasal, see 33, pages 126 and 127. .... 3.00
- 74a. Glass, Newman's, without bulbs, up, down or straight. ....each 2.00
- 75a.\* Glass, Hank's, up, down or straight 1.00
- 76a.\* Glass, Sass', see pages 112 and 113.....each 1.33

- 77a.\* Tyrian . . . hard rubber \$1.75; metal \$1.25
- 78a.\* Metal. . . . . style B \$1.50; style C 1.75
- 79a.\* Metal, A, B, C or D. . . . . each 1.50
- 81a.\* Metal, Millard, Nasal . . . . . 1.50
- 82a.\* Metal, Richardson's, with double bulbs, one tip \$5.00;  
two tips \$5.50; three tips 6.00
- 83a. Metal, Fullgraft's Inter-Tracheal. . 5.00
- 84a.\* Ointment, glass . . . . . 1.33
- 85b.\* " metal, DeVilbis' \$2.66;  
with bulb 3.00
- 86a.\* Steam Atomizer, C. & S. standard  
++\$5.00; nickeled ++6.00
- 87a.\* Steam Atomizer, C. & S. Large Hospital ++\$15.00; nickeled ++20.00
- 88a.\* Steam Atomizer, J. R. & Co.'s ... 4.00
- 89a.\* " " Aeme ++\$1.50;  
C. & S. 248 ++2.50
- 90a.\* Steam Atomizer, C. & S. 247. .... ++3.50
- 91a. Tubes for Steam Atomizers, glass 25 cts.; metal plated 50 cts.; silver \$2.00; platinum with regulator 4.00
- 92a. Nasal Shield for Steam Atomizer, see page 127. .... 0.50

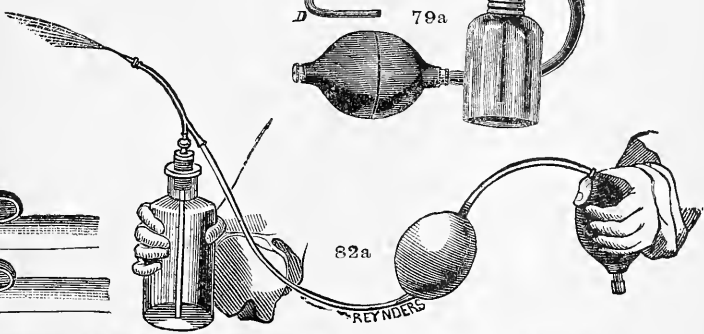
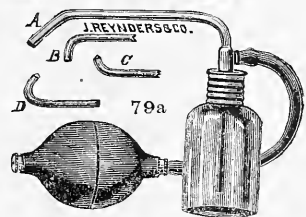
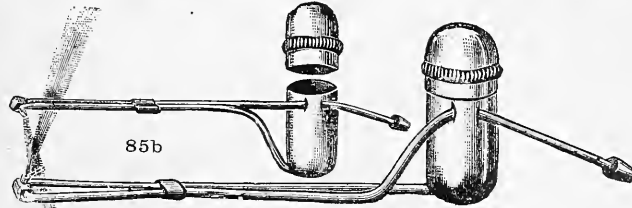
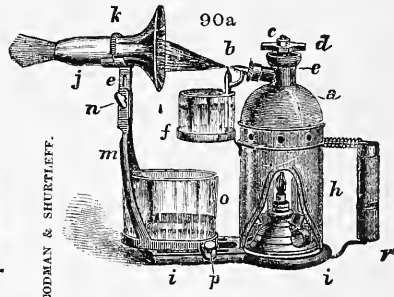
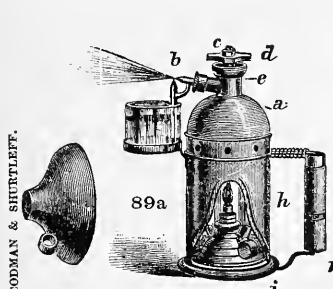

X. LARYNGEAL INSTRUMENTS.  
FOR MAKING APPLICATIONS.

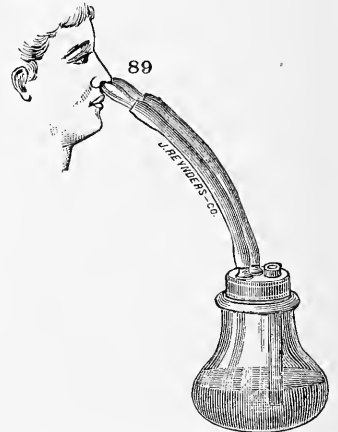
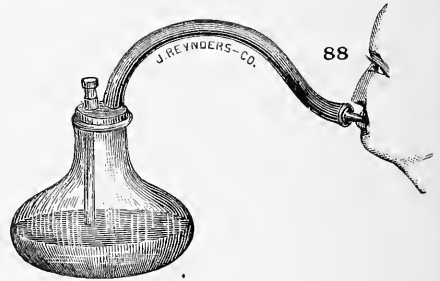
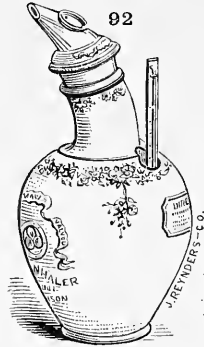
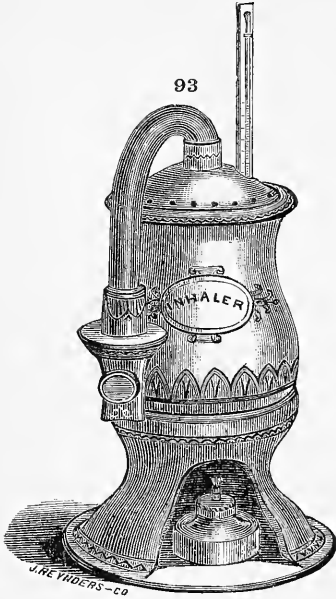

INHALERS.

88.* Hunter's, one nozzle, oral .....	\$1.75
89.* " two " nasal.....	2.00
90. Kirkwood's small .....	\$2.50*; large \$5.00*
91.* Maw's improved ..	2.50
92.* " double valved .....	4.00
93.* Bullock & Reynold's.....	6.00*
94.* Roe's.....	2.00

See also under Instruments for the Respiratory Organs.

All Instruments illustrated are designated by a \*

**X. LARYNGEAL INSTRUMENTS.**

FOR MAKING APPLICATIONS.

BRUSH HOLDERS, BRUSHES AND POWDER BLOWERS.

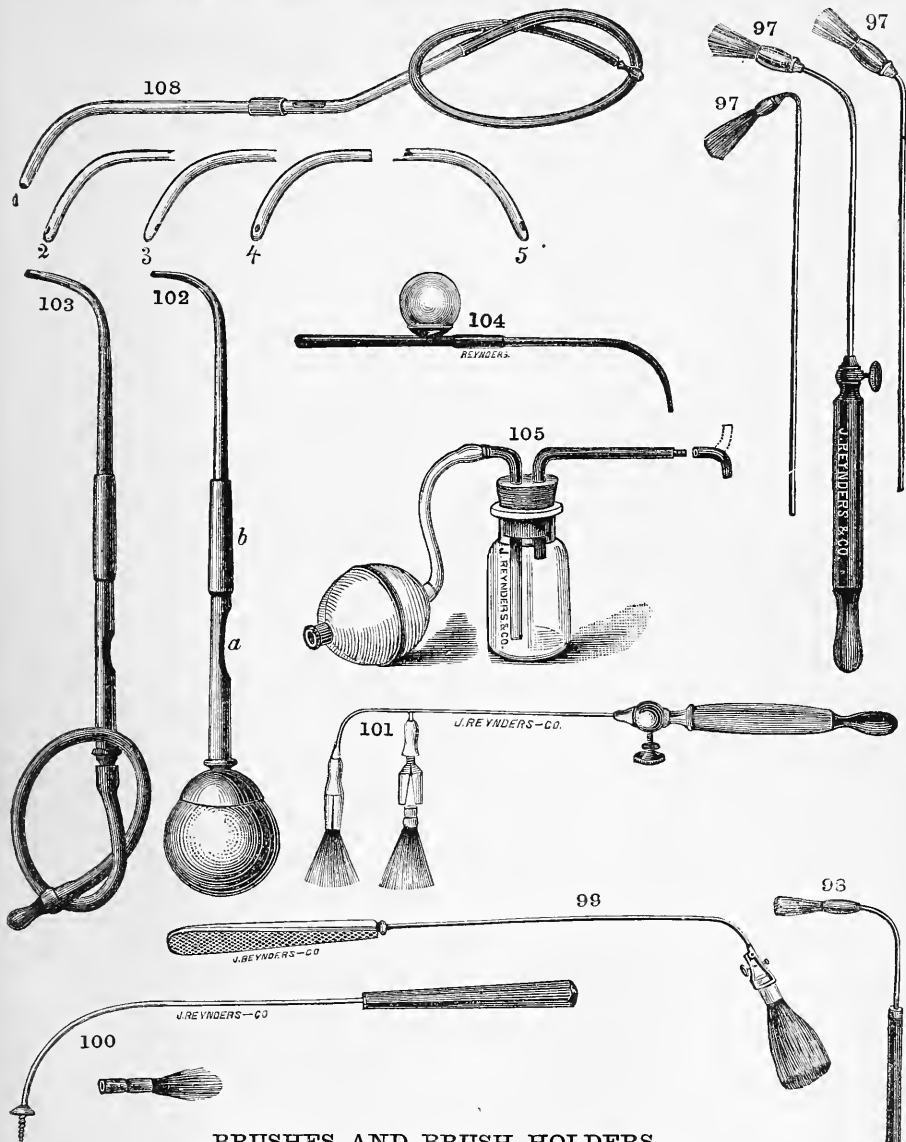

**BRUSHES AND BRUSH HOLDERS.**

95.*	Brush, Camel's hair, plain, on goose quill.....	(See page 119) ... per doz.	\$0.75
95a.*	" " " " " wood handle. (See page 119) .....	" " " "	0.90
95b.*	" " " " " bent. (See page 119) .....	" " " "	1.25
96.*	" " " " " wire " (See page 119) .....	" " " "	1.50
97.*	Vienna Brush Holder.....	3 ass. Wires each, \$0.25; handle h. r. \$0.60; ivory	1.00
	Brushes.....	per doz.	2.50
98.*	Mackenz e's Holder, pliable with one brush.....	per doz.	1.50
	Brushes for same.....	per doz.	2.50
99.*	Seeger's Holder for any Camel's Hair Brush.....		2.50
100.*	Ruppaner's Holder for any Camel's Hair Brush.....		1.25
101.*	J. R. & Co's Holder for any Camel's Hair Brush.....		1.50

**POWDER BLOWERS.**

102.*	H. R., with ball at end .....	\$1.50	104.*	H. R., Leffert's.....	\$1.50
103.*	H. R., to blow.....	1.25	105.*	H. R. Universal.....	2.00
106.*	H. R., Universal, improved No. 39, page 126. with tips as with 105 this page in addition....	\$4.50			
	This Powder Blower No. 40, page 126, forms one of the best sets for their purpose.				
107.*	Glass, Goodwillie's, with one bulb and bottle arranged on plan of No. 105 this page; up, down or straight .....	each			\$2.00
108.*	Glass, six styles, with rubber tube to blow.....	each			\$1.25
	No. 1 opening downward, No. 2 convex forward, No. 3 concave backward, 4 left, 5 right, 6 upwards.—(For further Powder Blowers see page 113.)				

All Instruments illustrated are designated by a \*

X. LARYNGEAL INSTRUMENTS.

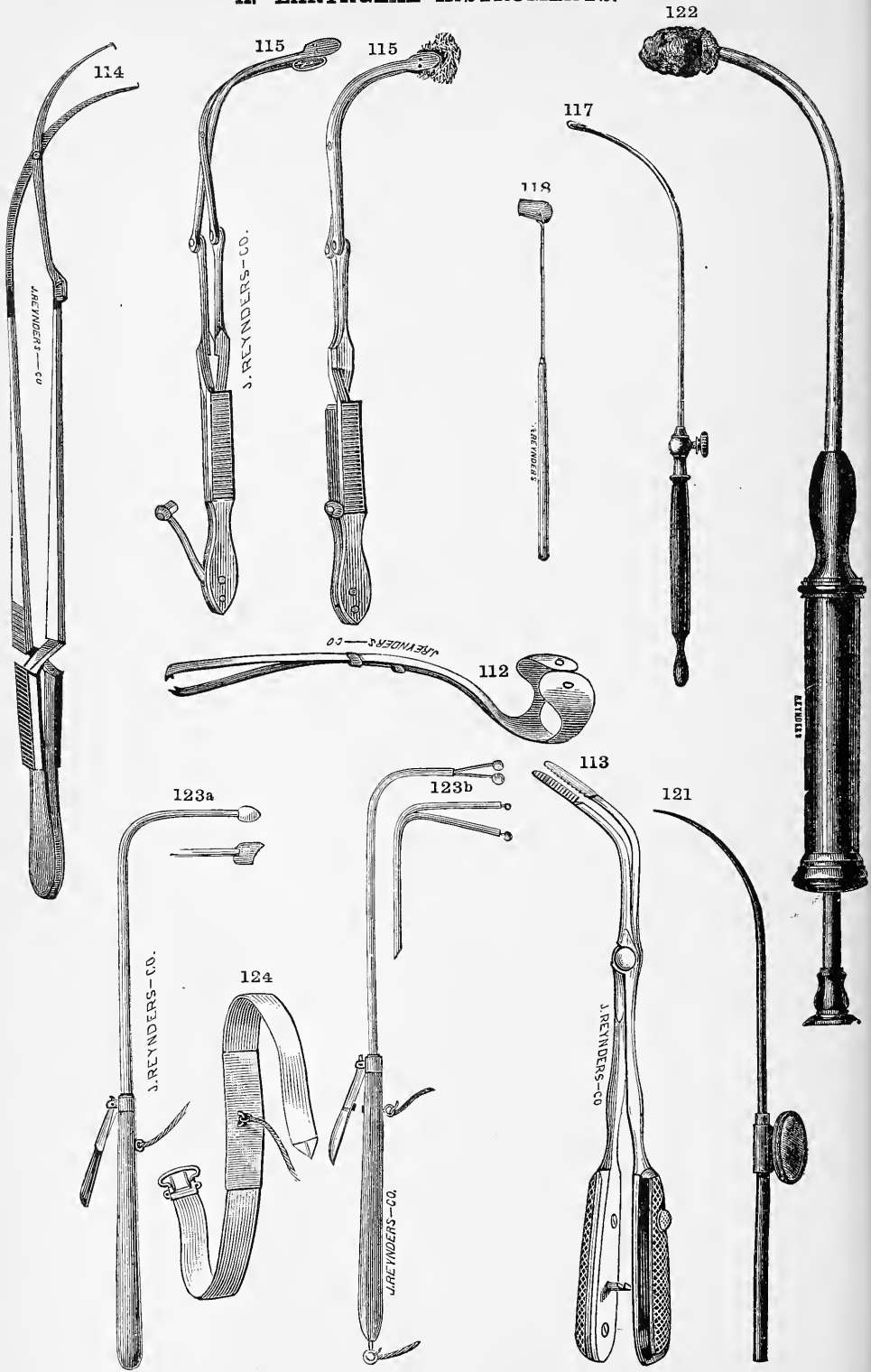



**X. LARYNGEAL INSTRUMENTS.**

**FOR MAKING APPLICATIONS.**

**SPONGE HOLDERS.**

109.*	Probang, plain handle .....	\$0.20
110.*	“ bone tipped handle .....	.25
111.*	“ silver plated wire handle .....	.25
112.*	Finger Probang, Elsberg's .....	1.50
113.*	Sponge Holder, Elsberg's, new .....	6.00
114.*	“ “ Forceps .....	5.00
115.*	“ “ “ with wedge catch .....	6.00
116.	“ “ Metal plain curved .....	1.00

**SUNDRIES FOR APPLICATIONS.**

117.*	Caustic Probe, pure silver with handle .....	1.50
118.*	Crucible for same, platinum, shallow .....	\$2.50
119.	“ “ “ porcelain with holder, (See page 169) .....	3.50
120.*	Soft Copper Probe, with handle .....	1.50
121.*	Drop Tube, Stoerck's, H. R. ....	1.00
122.*	Sponge Syringe, Tuereck's .....	2.25
123.*	Mackenzie's Electrode, style a or b .....	3.50
124.*	“ “ (necklet) .....	each 2.00
125.*	“ “ Fauvel's modification, each style .....	4.50

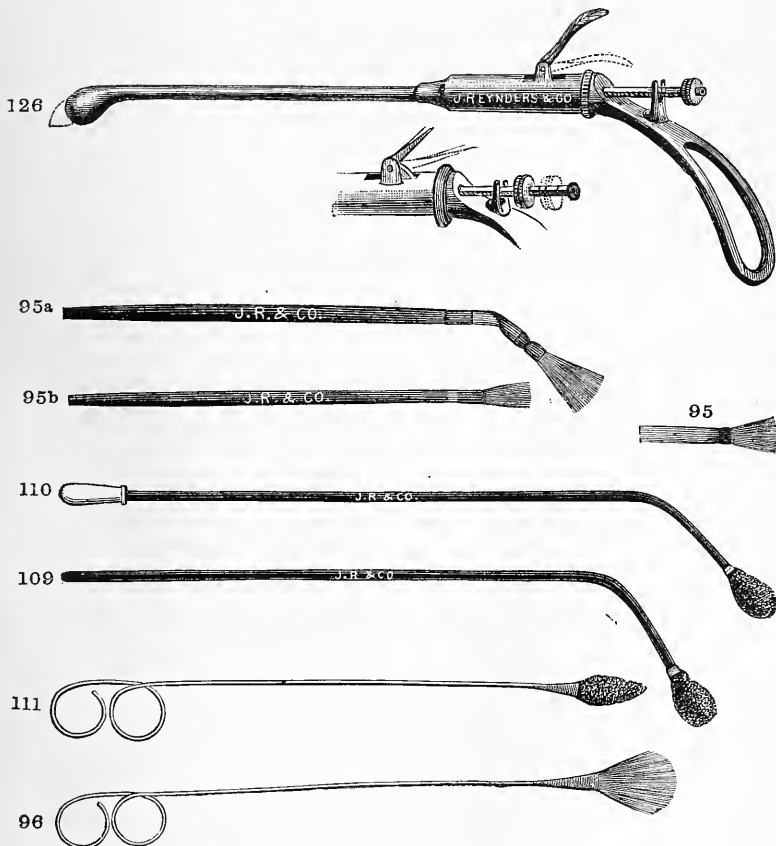

All Instruments illustrated are designated by a \*

X. LARYNGEAL INSTRUMENTS.

FOR EXCISION OF TONSILS AND UVULA.

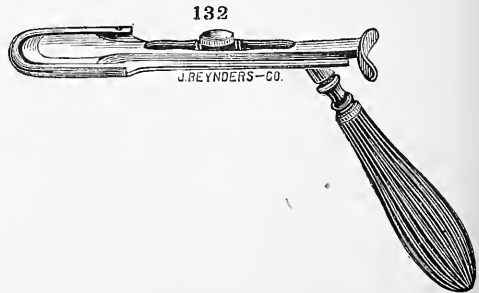
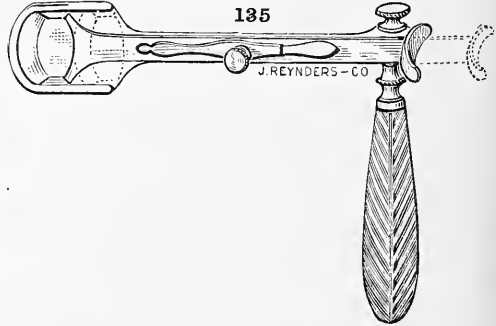
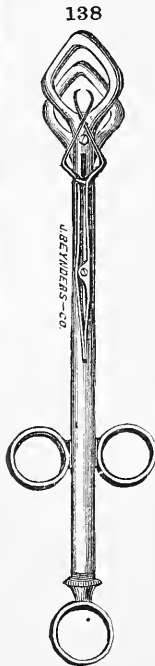
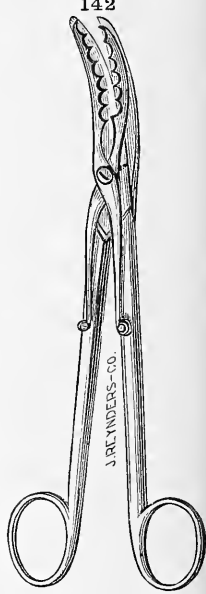
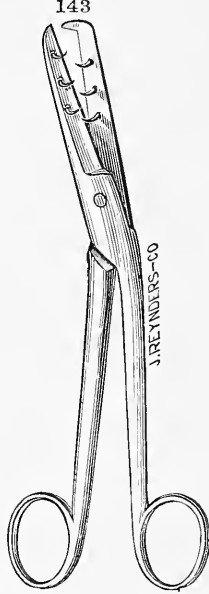
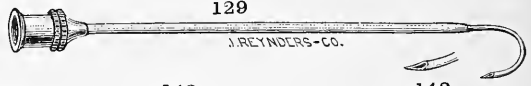
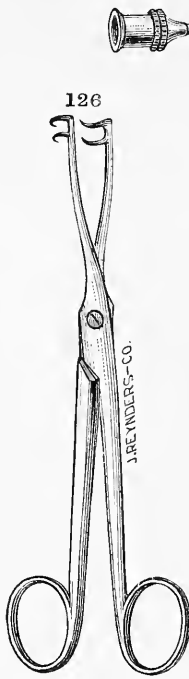
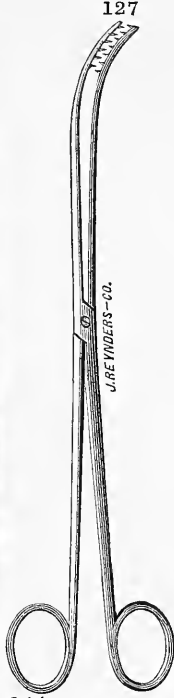

**X. LARYNGEAL INSTRUMENTS.**

FOR EXCISION OF TONSILS AND UVULA.

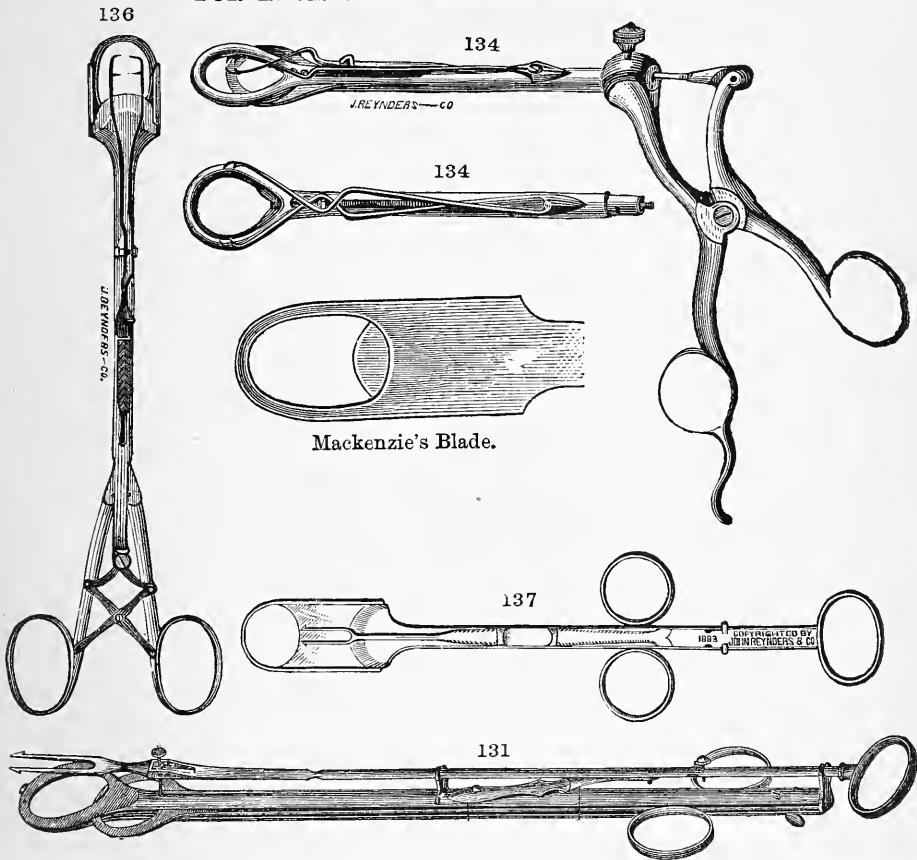

126.*	Tonsil Lancet, concealed, (see page 119).....	\$15.00
126.*	Vulsellum, with side prongs .....	3.00
127.*	Museau's Forceps, for holding Tonsils.....	3.00
128.*	Tonsil Bistoury, straight or curved, ebony rivetted \$1.75; feruled \$2.00; ivory rivetted \$2.00; feruled	2.25
129.*	Needle, Horton's, for Injecting Tonsils .....	1.75
130.*	Tonsilotome, Fahnestock's.....	8.00
131.*	Mathieu's, 3 sizes .....	each 8.00
132.*	Mackenzie's, 3 sizes .....	" 7.50
133.	" " 3 sizes in case with one handle and attachment to latter for left side.....	21.00
134.*	" American in case .....	one blade \$15.00; 2 blades 24.00
135.*	" Elsberg's, reversibl for right or left side .....	10.00
136.*	" J. R. & Co's., now .....	14.00
137.*	" Marconi's-Mack. nzie', blade and Mathieu's movement.....	11.00
138.*	" Mathieu's, modified.....	12.00
139.*	Uvula Forceps like 126.....	
140.*	" " " 127.....	
141.	" Scissors, plain, curved on flat.....	2 50
142.*	" " with claws.....	4.50
143.*	" " " Smith's.....	6.00
144.*	Uvulatome, Sayre's .....	10.00
145.*	" Elsberg's .....	10.00

All Instruments illustrated are designated by a \*

X. LARYNGEAL INSTRUMENTS.

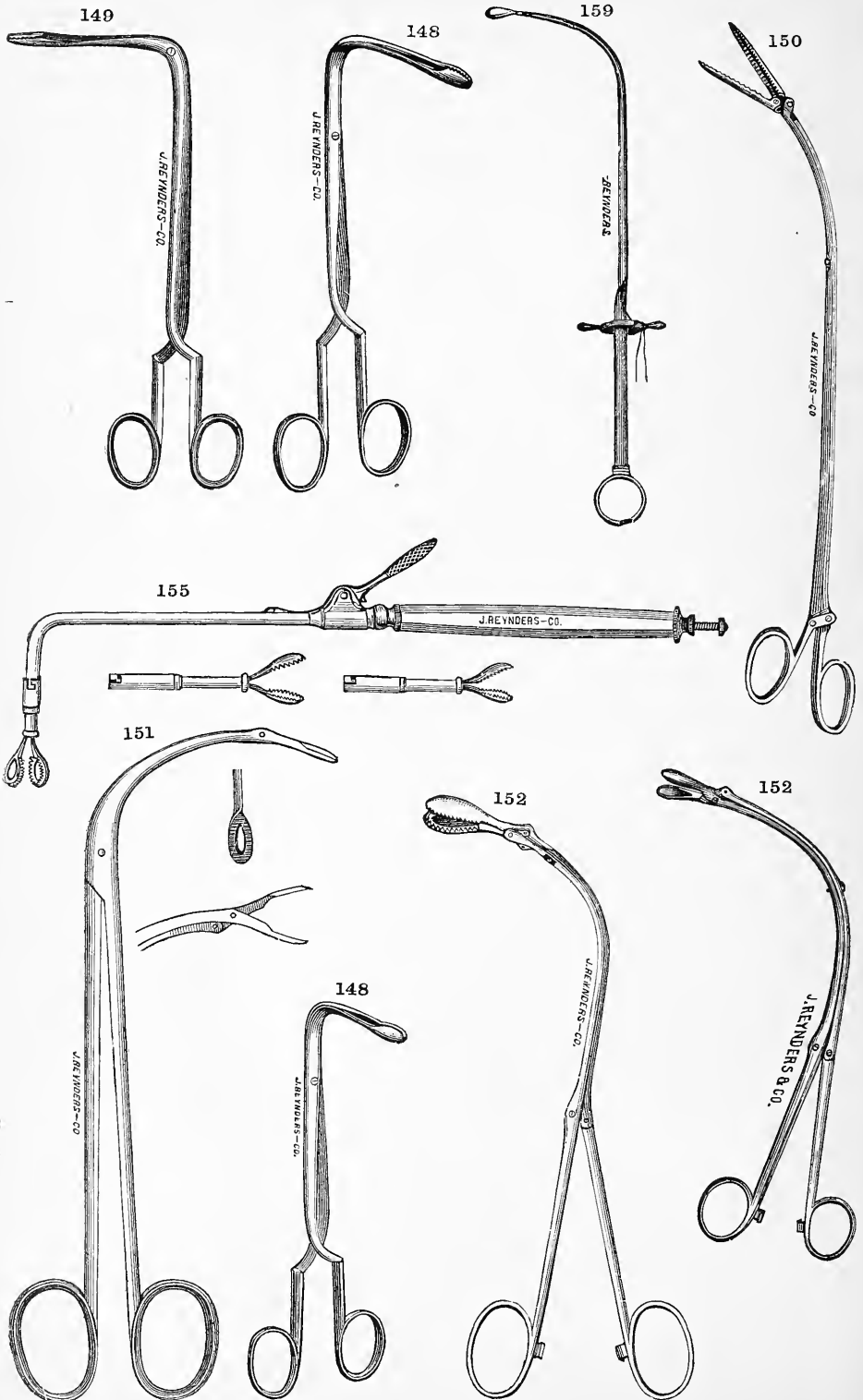

**X. LARYNGEAL INSTRUMENTS.**

FOR THE REMOVAL OF FOREIGN BODIES, POLYPI, ETC.

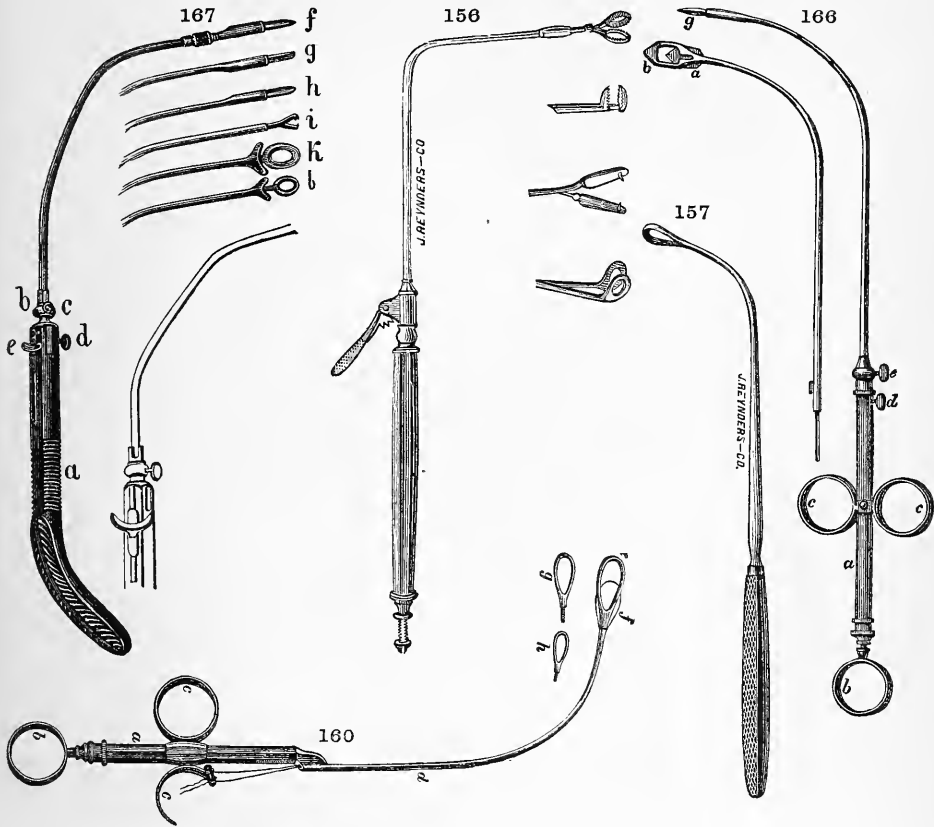

146.	Throat Forceps, light, opening laterally.....	\$3.00
147.	“ “ “ for- and backward .....	3.00
148**	“ “ Mackenzie's, opening laterally, downward part of curve in three lengths, viz: 2, 2 $\frac{3}{4}$ and 3 $\frac{1}{8}$ inches, serrated or cutting edge jaws..... each	3.50
149.*	“ “ Mackenzie's, opening for- and backward, downward part of curve in three lengths, viz: 1 $\frac{7}{8}$ , 2 $\frac{2}{3}$ and 3 $\frac{1}{2}$ inches, serrated* or cutting edge jaws..... each	3.50
150.*	“ “ “Alligator”.....	6.00
151.*	“ “ Cusco's.....	4.00
152.**	“ “ Matthieu's latest; opening laterally, serrated* jaws \$10.00; cutting edge and jaws.....	9.00
153.	“ “ Matthieu's latest, opening for- and backward, serrated jaws \$9.00; cutting edge jaws (construction like that of 152) ..	10.00
155.*	“ “ Mackenzie's, Canulated, with three attachments .....	25.00
156.*	“ “ and Scissors, Mackenzie's.....	25.00
See also under Oesophageal Instruments.		
157.*	Curette, plain blunt, pliable.....	2.00
158.	“ Mackenzie's, with changeable angle and set screw.....	5.00
159.*	Ecrasseur, Gibb's.....	3.00
160.*	Snare, Stoerck's.....	11.00

See also “Snares”, pages 130 and 131.

All Instruments illustrated are designated by a \*

X. LARYNGEAL INSTRUMENTS.

FOR THE REMOVAL OF FOREIGN BODIES, POLYPI, ETC.

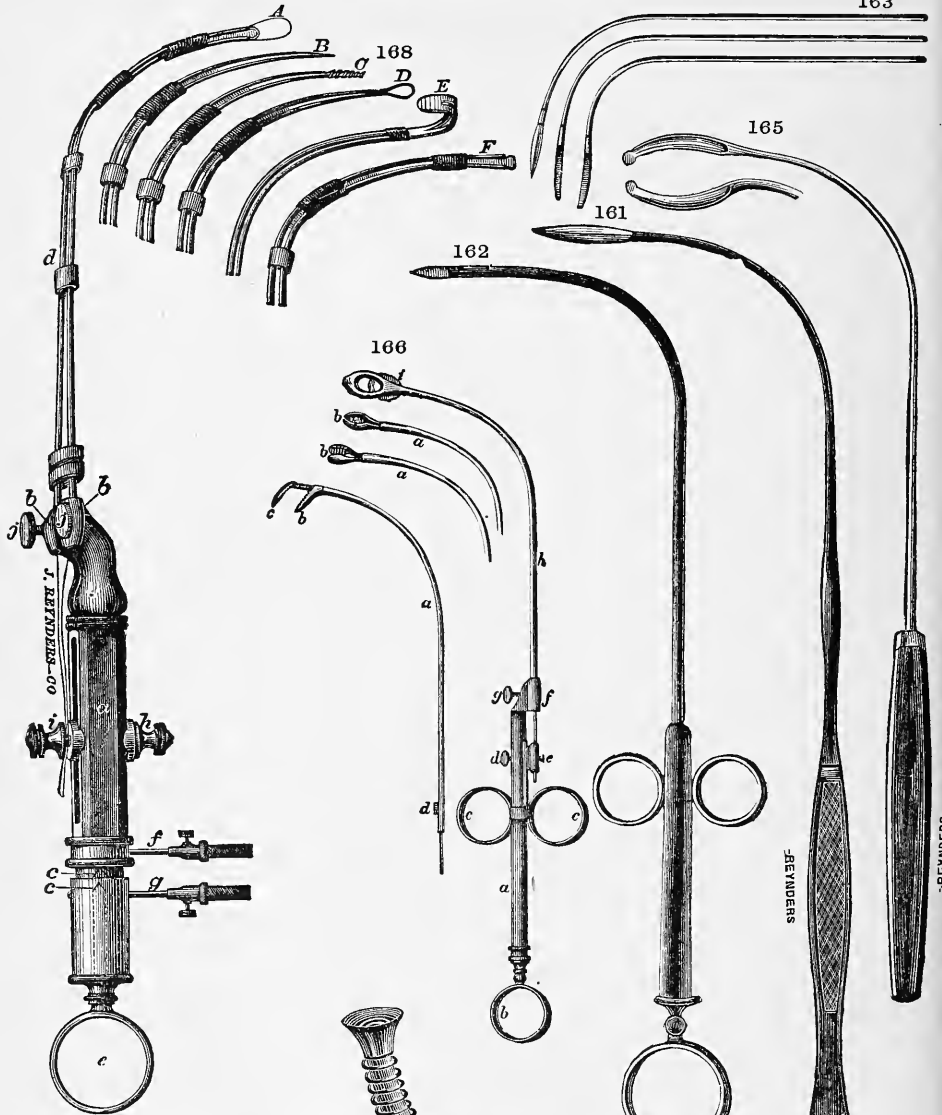

- 161.\* Lancet, Tobold's . . . . \$1.50
- 162.\* " " concealed 4.00
- 163.\* Polypus, Knives, 3 styles . . . . . each 1.50
- 164 Handle for same, h. r. . . . 0.60
- 165.\* Polypus, Knives, Tobold's . . . . . each 1.50
- 166.\* Extirpation Instruments. Schroetter's and Stoerck's. Handle 7.00  
Each Instrument, (see pages 123 and 124) . . . 6.50
- 167.\* Extirpation Instrument, Tuerck's (see page 123), Handle . . . . . \$6.00  
Each Instrument . . . . . 6.50
- 168.\* Electrodes for removing Polypi: A) Snare, \$2.75;—B) Knife, \$3.00;—C) Porcelain Burner, \$3.50;—D) Knife, \$3.00;—E) Knife, Voltolini's pattern, \$3.25;—F) Ligature Carrier, with holders, \$3.00. Universal Handle, attached to A. . . . . 17.00
- 169.\* Cautery Electrode, Lincoln's, fits to handle of 168. . . . . 4.00

All Instruments illustrated are designated by a \*

# XI. NASAL INSTRUMENTS.

## FOR EXAMINATION.

### SPECULA.

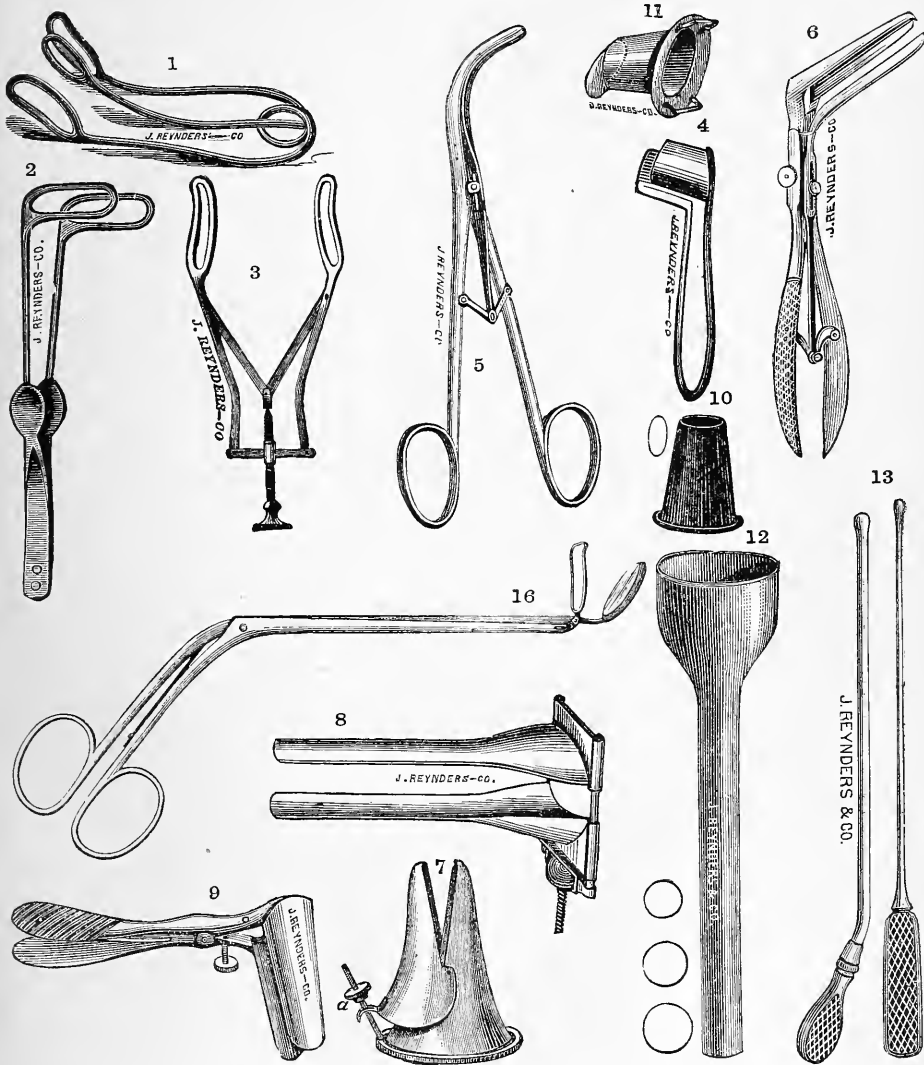

1.* Goodwillie's..	.....	\$1.00
2.* Bosworth's .....	.....	1.00
3.* Fränkel's .....	.....	3.50
4.* Thudichum's, with set screw ..	.....	2.50
5.* Elsberg's .....	.....	5.00
6.* Brandeis' .....	.....	8.00
7.* Robert & Collin's, metal .....	.....	3.50
8.* Zaufal's, metal.....	.....	5.90
9.* Roth's .....	.....	4.50
10.* H. R., Tubular.....	.....	0.75
11.* Simrock's, silver, ass. sizes .....	each	1.50
12.* Zaufal's, H. R., 3 sizes.....	“	1.00
13.* H. R., Probes .....	each	0.75
14. Rhinoscopic Mirrors, see X., No. 30, 31, 32 (page 108, No. 0.) .....	.....	.....
15. “ “ with universal joint and handle.....	.....	3.00
16.* Rhinoscope, Duplay's .....	.....	8.00

All Instruments illustrated are designated by a \*

XI. NASAL INSTRUMENTS.

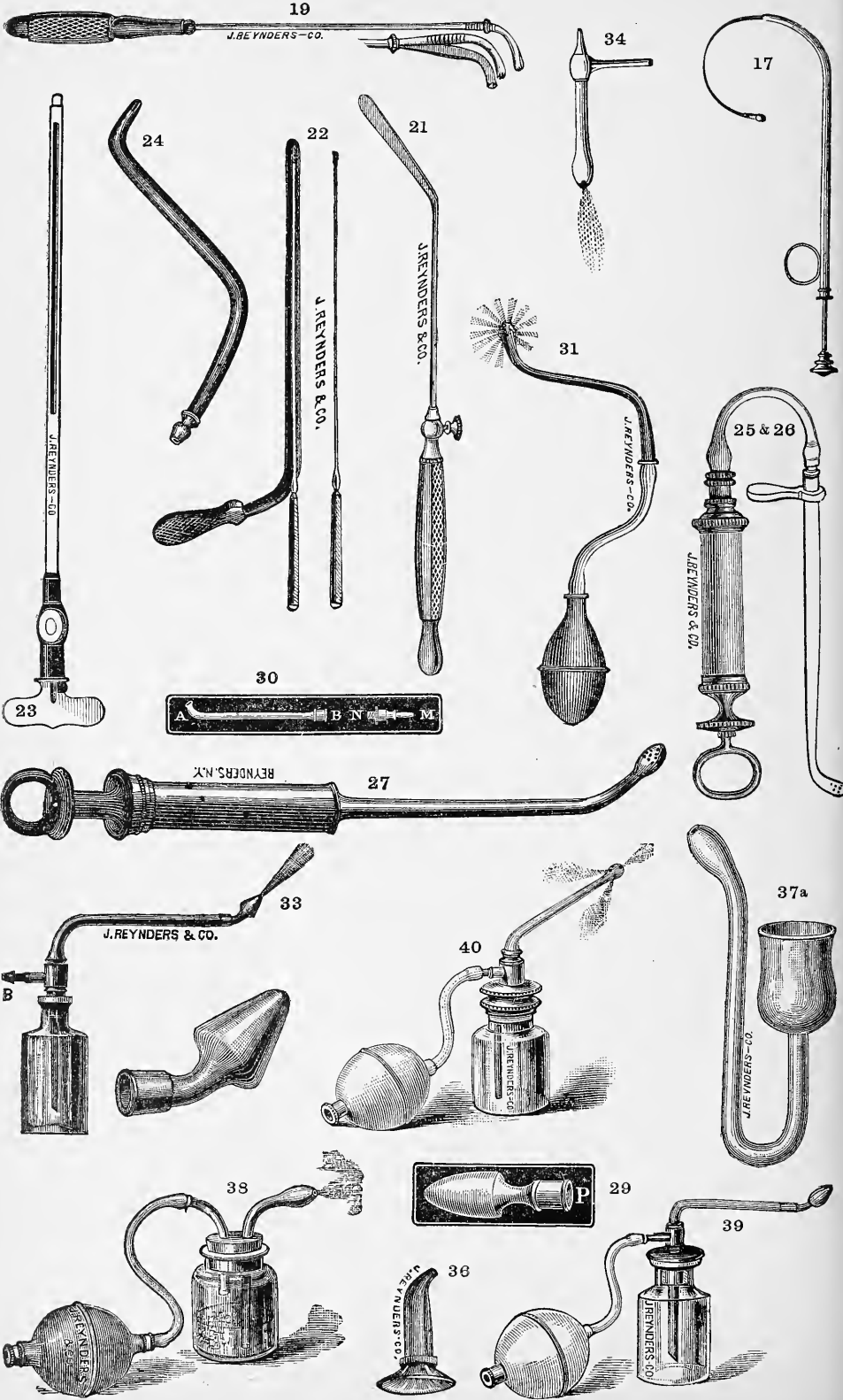



## XI. NASAL INSTRUMENTS.

### FOR MAKING APPLICATIONS.

17.* Canula, Belocqu's, for Epistaxis, .....	plated \$2.00; silver	\$3.00
18.* Holcomb's Cotton Carrier, steel. (See 112, page 99.) .....		0.25
19.* Post Nasal Sponge Holder .....		1.00
20.* Brushes, see page 117.		
21.* Flat Applicator, Bosworth's .....		1.50
22.* Applicator, A. H., Smith's, for Nitric acid .....		2.50
23.* Porte Caustique, Schroetter's .....		5.00
24.* Posterior Nares Tube, plain, with holes or cut .....		0.75
25.* " " " " with handle .....		1.25
26.* " " " " and Syringe .....		2.50
27.* " " Syringe .....		1.00
28.* Anterior " " .....		1.25
29.* Nasal Irrigator, Mattson's .....		2.00
30.* Naso-Pharyngeal Irrigator, Mattson's .....		1.30
31.* Nasal Douche, Warner's .....		1.50
32.* " " Thudichum's .....		1.50
33.* Nasal Spray, Leffert's, complete .....		4.00
34.* " " Newman's, Glass .....		1.25
35.* Other Sprays and Inhalers see pages 112 to 116.		
36.* Nasal Face Shield for Steam Atomizers .....		0.75
37.* Inhaler, Robinson's .....		1.50
37a.* Weir's Snuffler Glass .....	\$0.75; h. r.	1.50
38.* Powder Blower, Anterior, glass, Robinson's .....		1.50
39.* " " " " H. R., Gruening's .....		3.50
40.* " " " to pass through anterior nares to pharyngeal wall .....		3.50
41.* " " " posterior .....		2.50
42.* " " " with universal tubes .....		3.00
43.* " " " see also X, page 117.		

(For other Powder Blowers see 113.)

### FOR PLASTIC OPERATIONS ON THE NOSE.

(Illustrations next page.)

44.* Rhinoplastos, Adams' .....	3.00
45.* " " Bosworth's .....	4.00
46.* Permanent Clamp, Bosworth's .....	3.50
47.* Emporte-Pièce, Blandin's .....	3.50
48.* " " Robert's .....	6.00
49.* Double Gouge .....	3.50
50.* Plugs, h. r. ....	per pair 0.75

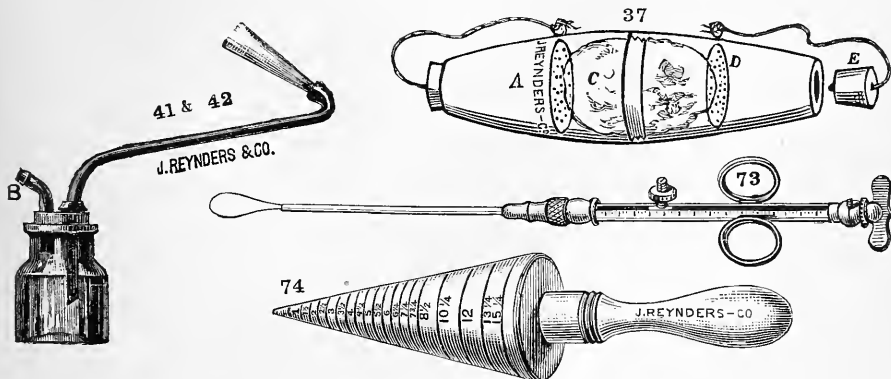

All Instruments illustrated are designated by a \*



**XI. NASAL INSTRUMENTS.**

**FOR THE REMOVAL OF POLYPI, HYPERTROPHIC MEMBRANES, ETC.**

51.*	Nasal Polypus Forceps, angular (see 44, page 94)	\$1.75
52.*	“ “ “ Gross’	2.25
53.	“ “ “ Elsberg’s	2.75
54.*	“ “ “ Simrock’s	2.50
55.*	“ “ “ Vulsellum	2.75
56.*	“ “ “ Posterior, Stoerck’s	3.50
57.*	Forceps for Pharyngeal Polypi, Robinson’s	5.00
58.*	“ “ Hypertrophic Membranes, Robinson’s	4.50
59.*	Double Canula, small	plated \$1.50; silver
60.*	Scissors, Smith’s	2.25
61.*	Galvano. Caution Instruments for Naso-Pharyngeal Catarrh. (Shurly)	5.00

These instruments were designed by E. L. Shurly, M. D., for the treatment of Naso-pharyngeal catarrh by galvano-cautery, and consist of:

- a) Universal hard rubber handle with circuit breaker, to which the pharyngeal electrode is attached.
- b) The two parallel tubes, mounted in ivory, through which the wire for a snare runs.
- c) The short straight electrode or knife for use in the anterior part of the nares.
- d) The post-nasal electrode to be introduced behind the soft palate.
- e) The long electrode or knife for introduction through the nares to posterior ends of turbinated bones and pharynx.
- f) Small Windlass, easily attachable to Universal handle and used for winding the wire snare upon.
- g) The self-retaining nasal specula, with sliding ivory blade (A), which serves to protect opposite side of nasal passage from the glowing electrode. (B, the opening of the speculum, C, the small screw that retains the speculum in situation and open,

The Speculum only..... \*3.50  
 The whole put up in a neat morocco case, velvet lined..... \*25.00

62.\* Nasal Caution Instruments, Roe’s.....

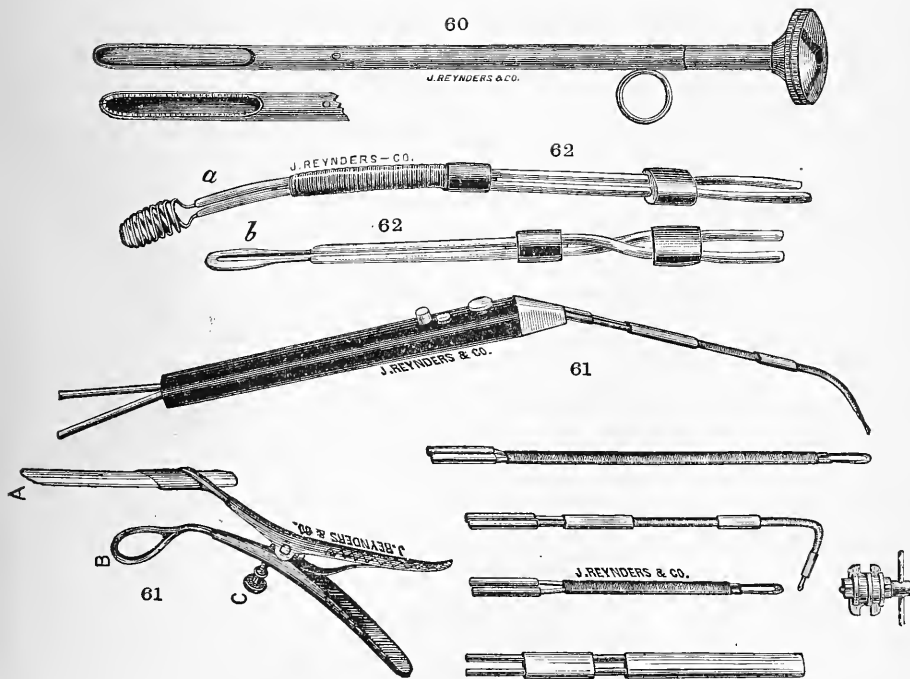

All Instruments illustrated are designated by a \*

XI. NASAL INSTRUMENTS.

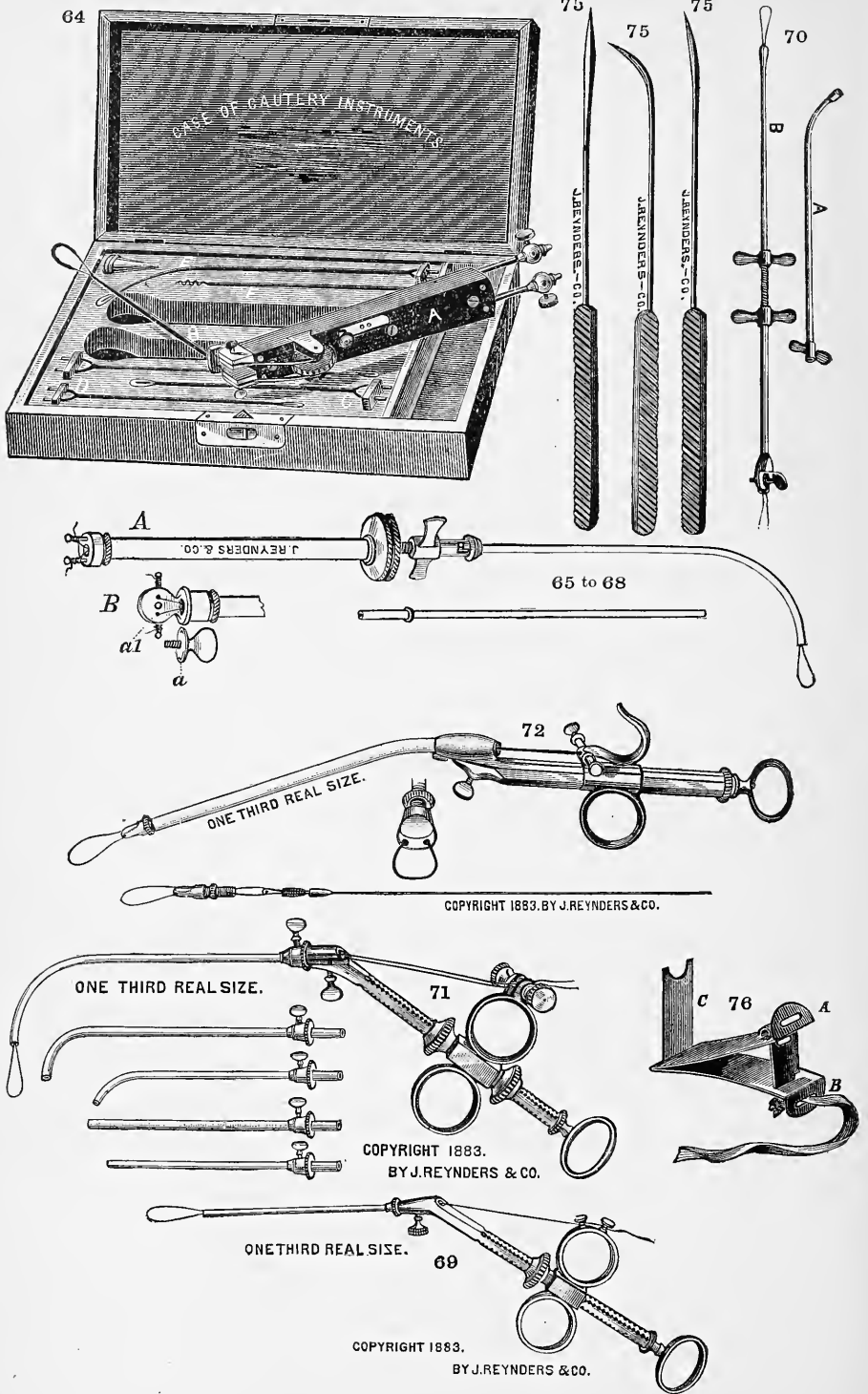

XI. NASAL INSTRUMENTS.

FOR THE REMOVAL OF POLYPI, HYPERTROPHIC MEMBRANES, Etc.

- 64.\* Galvano-Cautery Instruments for Naso-Pharyngeal Operations, Seiler's: *A*, the Universal Hard Rubber Handle with Circuit Closer to which any of the instruments below may be attached; *B*, the Two Parallel Tubes with Platinum Loop Wire and Windlass; *C*, the Short, Straight Electrode or Knife for use in the anterior part of the nares; *D*, the Post-Nasal Electrode for introduction behind the soft palate; *E*, the Long Knife Electrode for introduction through the nares to posterior ends of turbinated bones and pharynx; *F*, The Spiral or Moxa Electrode; *G*, one Set of Three Rubber Nasal Specula. Complete in Morocco Case..... \$25.00
- Single Universal Rubber Handle, with Platinum Loop Wire and Windlass (Ecraseur), representing *A* and *B*..... \$10.00
- Single Universal Rubber Handle, with either Electrode, *C*, *D*, *E* or *F*..... \$5.00
- Single Knives or Electrodes..... each \$2.00
- Single Cautery Cords..... " \$2.00

SNARES.

- |  |  |           |
|--|--|-----------|
| 65.* Jarvis' "A," straight only, good \$4.00; best \$5.00  | 74.* Elsberg's Conical Measure for the wire loop (page 127).....   | \$3.50    |
| 67.* Same, "A," straight and curved.....   | 75.* Jarvis' Set of Transfixing Needles, comprising straight and curved, ranging in size 1 to 3½ inches..... | each 0.35 |
| 68.* Same, "B," arrangement for holding wire more firmly, with curved and straight attachment..... | 76.* Jarvis' Tape Holder.....  | 1.00      |
| 68a.* Same as modified by Sajous.....  | 76a. Steele's Septum Punch.....  | 4.00      |
| 68b. Sajous', with three Canulas.....  | 76b. Sajous' Septum Punch, with 5 different Punches to one forceps.....                                      | 12.00     |
| 69.* Bosworth's or Cohen's.....  | 76c. Septum Knife, Harrison Allen's.....   | 1.75      |
| 70.* Bettman's.....  | 76d. " Gouge, Seiss'.....  | 2.00      |
| 71.* Douglas'.....   | 76e. " " Seiler's.....   | 2.00      |
| 72.* Stoerck's.....  | 76f. " Scissors, Knight's.....   | 3.00      |
| 73.* Elsberg's (see page 127).....   | 76g. " Planer, Vaux.....   | 3.00      |
| 73a. Wright's.....   |  |           |
| 73b. Cohen's Combination.....  |  |           |

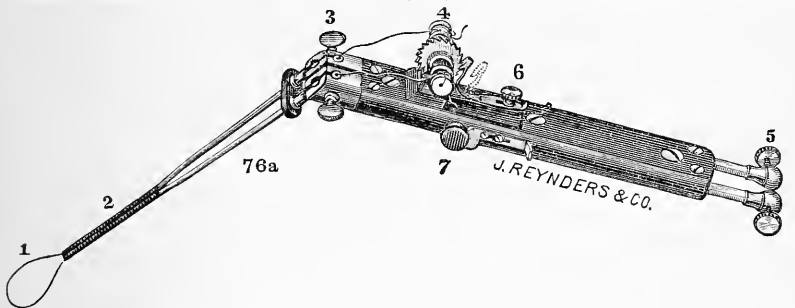

- 76a. Gleitsmann's Snare to be used with Galvano-Cautery..... \$13.33
- Platinum-Iridium Wire for same, per 21 inch piece, \$1.00.

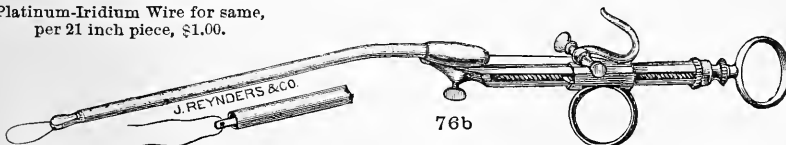

- 76b. G. B. Hope's Snare..... \$11.00

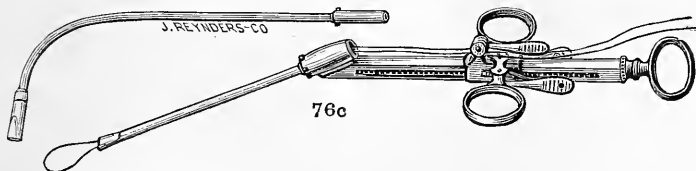

- 76c. Allen's Snare..... \$15.00
- 77a. Allen's Aluminum Cautery Snare, very light..... 13.33

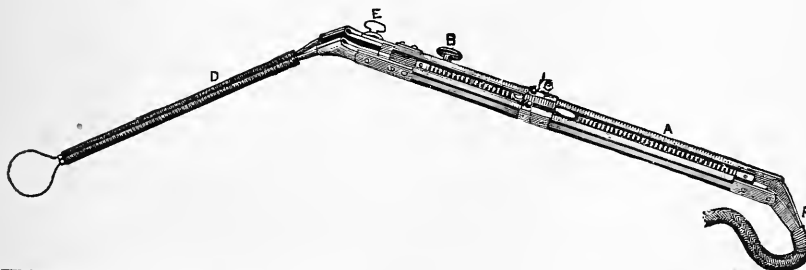

- J. A. White's Combined Cautery and Cold Wire Snare..... \$10.00

All Instruments Illustrated are designated by a \*

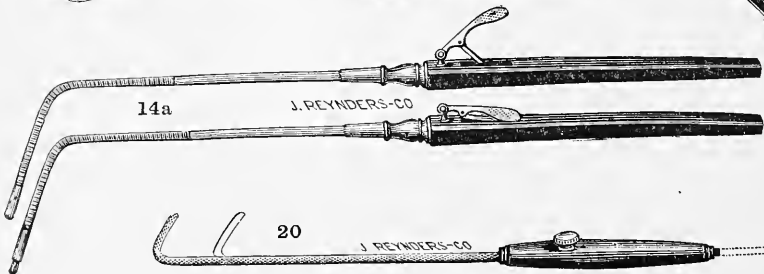
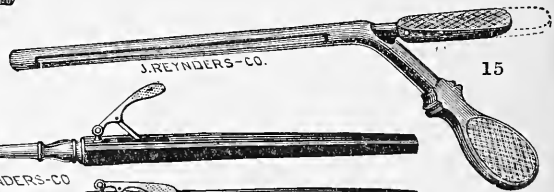
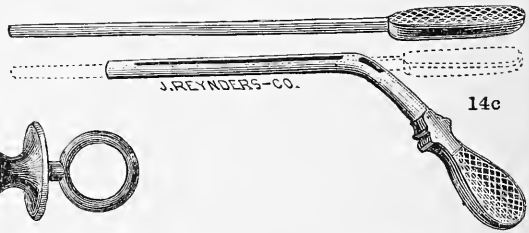
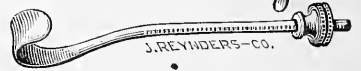
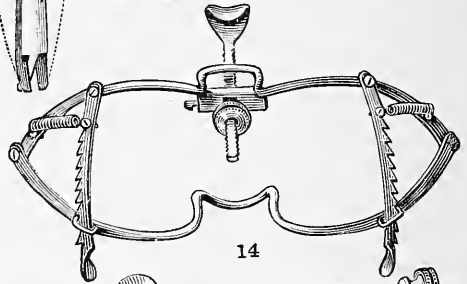
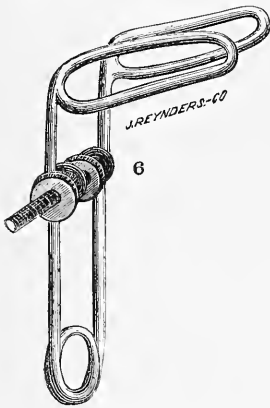
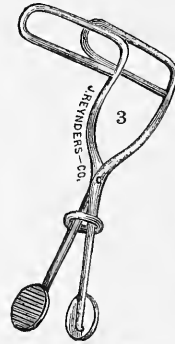
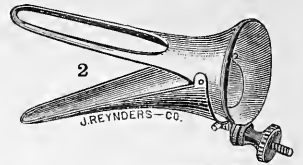
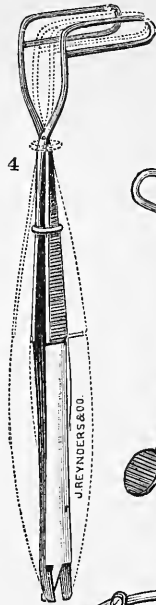
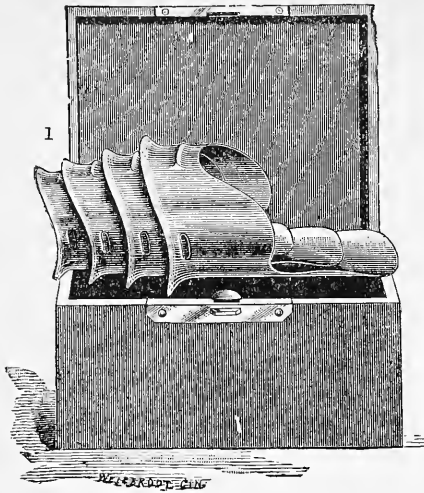

**ADDENDA TO LARYNGEAL AND NASAL INSTRUMENTS.**

Our New Circular on the subject of Air Receivers and Sprays, Electro-Cautery about Nose, Larynx and any other part of the body, Electro-Storage, Electro-Motors, etc., etc., mailed free on application.

1.* Ehrhardt's Mouth and Throat Speculum, depresses the tongue, fixes the jaws, thus bringing to view the interior of the mouth and throat, with the laryngoscope exposing the larynx and nares and useful in electric and other operations about these parts. Sets of four nested in case .....					*\$5.00
2.* Nasal Speculum, Collin's, new... \$3.50	9.	Nasal Speculum, Duplay's.....			3.50
3.* " " Jarvis', short... 1.00	10.*	" " Bacon's .....			3.50
4.* " " " long... 3.50	11.	" " Sajous'-Good-			
5.* " " " Elsberg's, tri-		willie .....			1.75
		valve .....			5.00
6.* " " Bishop's .....	12.	" " Seiler's for Cau-			1.00
7.* " " French's .....		tery use.....			
8.* " " Folsom's, new.. 1.75	13.	" " Seiler's-Bosworth			2.50
		for Cautery use			
14.* Swinburne's Combination of Uvula Retractor with Mouth Gag for distention of the nasal-pharyngeal space .....					12.00
14a.* Applicator, Robertson's, for Chromic Acid, etc .....					4.00
14b. Same, Gleitsmann's .....					1.00
14c.* Acid Applicator, Stucky's, top opening.....					2.75
15.* Same, lateral opening.....					2.75
16.* Same, Post-Nasal .....					3.00
17.* Nasal Saw, Bosworth's.....				each	2.50
18. " " Sajous', for Exostosis.....				per pair	4.00
19. " " Buckley's, up and down, reversible .....					4.00
20.* Uvula Retractor or Palate Hook, Leffert's.....					2.00
21.* " " " " White's... silver wire \$2.75; copper wire, plated					2.25
22. " " " " " children's, with extra point.....					3.50
23.* Syringe, large, Ear and Post-Nasal.....					3.00
24.* Uvula Scissors, Stucky's .....					6.00
25.* Powder Blower, De Vilbis' Universal.....				\$1.50; with bulb	2.00

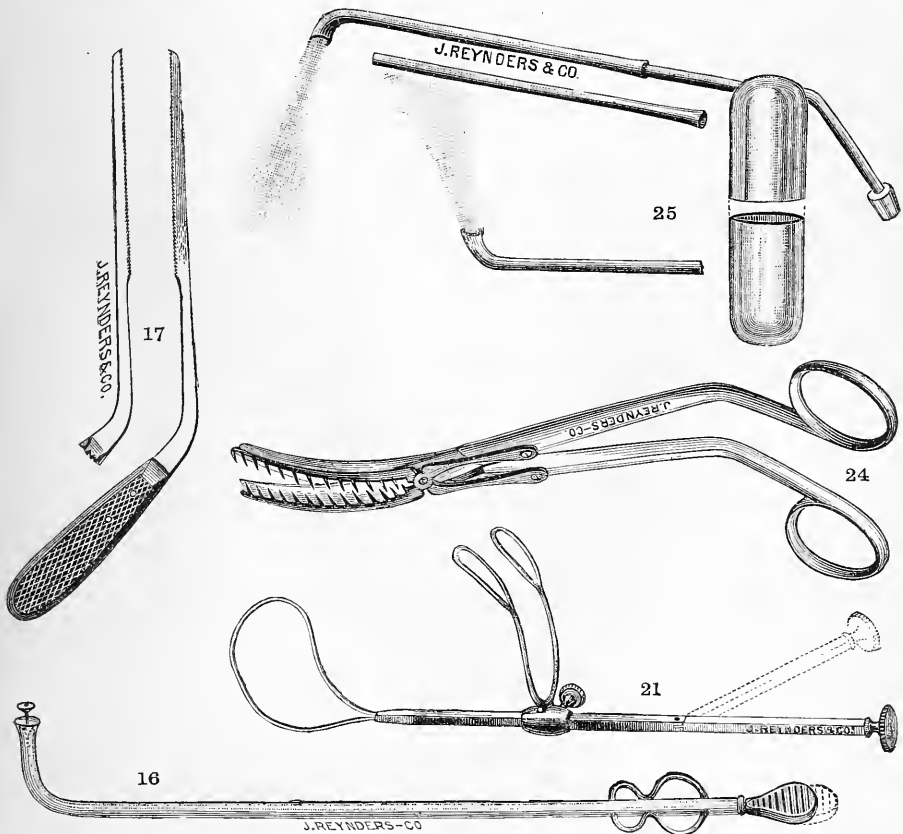

ADDENDA TO THROAT AND NASAL INSTRUMENTS.

27.* Powder Blower, Henry's Universal, glass, with bulbs for throat, nose, eustachian tubes, etc.....	\$4.00
28.* Curette, Leffert's.....	2.50
29.* " May's.....	3.00
30.* Finger Protector, May's.....	2.50
31.* Mouth Gag, May's, all metal.....	2.50
32.* Post-Nasal Polypus Forceps, Swinburne's.....	4.50
33. " " " Hooper's.....	4.50
34. " " " Douglas'.....	5.00
35.* " " " Loewenberg's.....	5.00
36. " " " Knight's.....	4.50
37. " " " Hope's.....	4.50
38.* Tonsilotome, Mandeville's modification of Mackenzie's 2 sizes (illustrated next page), adjustable to right or left side..... each	10.00
39. Powder Blower, Cohen's.....	2.50

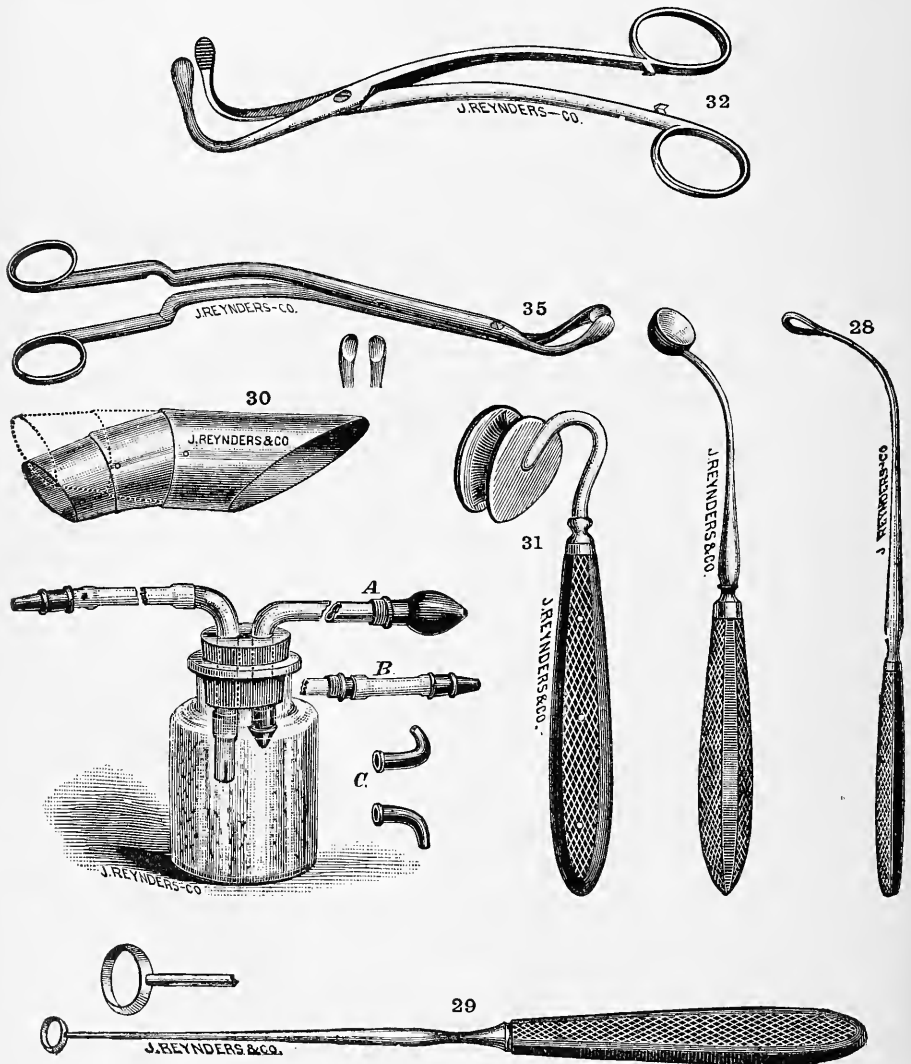



ADDENDA TO THROAT AND NASAL INSTRUMENTS.

- A. Olive-shaped, globular, cylindrical and conic Nasal Burrs, Nasal Trephines and Saws, to be worked by Electro-Motor. See notice in left hand bottom corner
- B. Covered Rotary Eliminators of Nasal Hypertrophies, worked by Electro-Motor. See notice in left hand bottom corner.
- C. Canulas for Platinum Wire in Nasal and Laryngeal Electro-Cautery Operations.
- D. Gasolene or Gas Motor, mentioned and described on page 113.

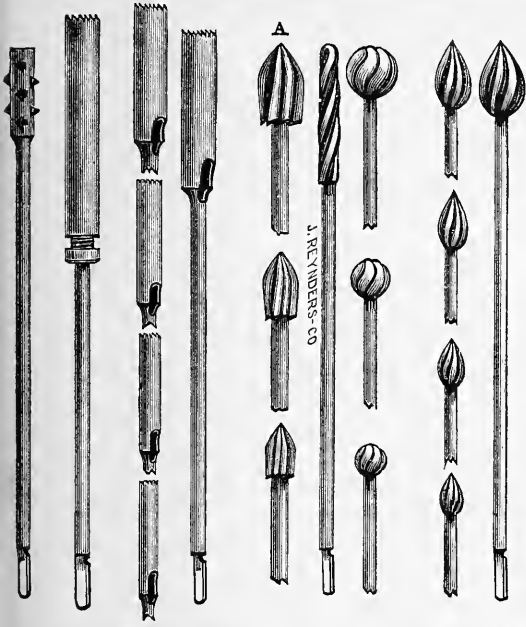

See page 131C.

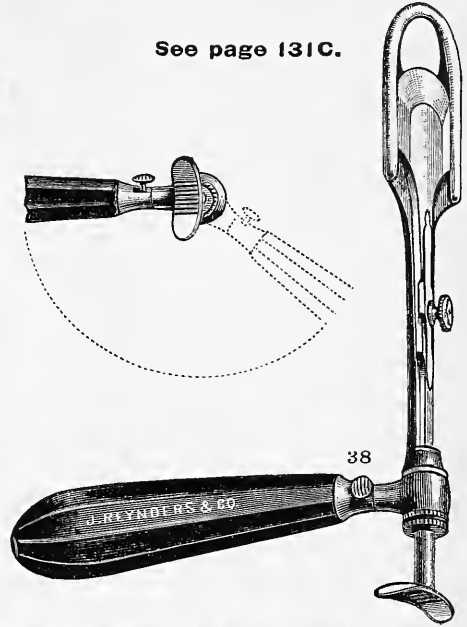

Nat. Size, Copyrighted.

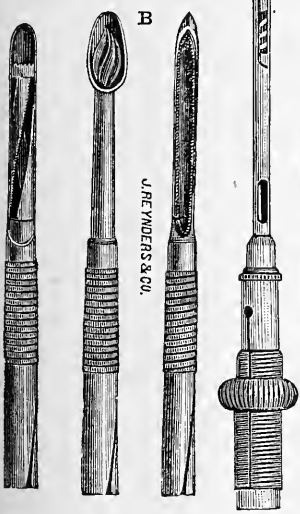

See page 113.

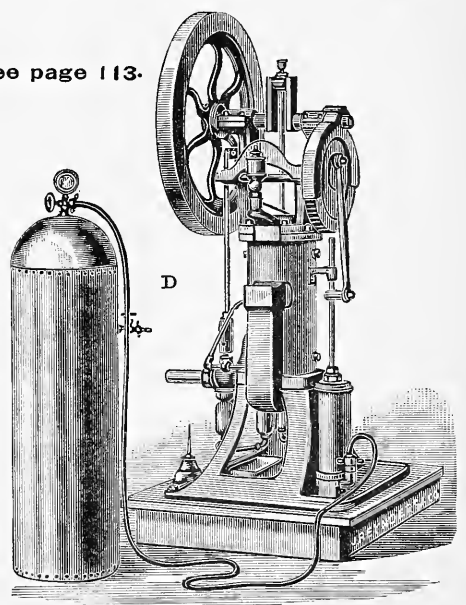
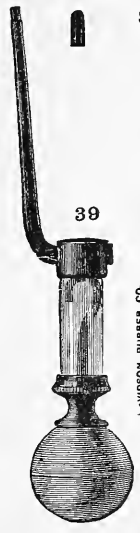

Full Information about A, B, C, D, Air Receivers, Electro-Storage, Cautery-Motors and all requisites thereto to be had exhaustively from our Circular on the subject, sent on application.

XII. DENTAL INSTRUMENTS.

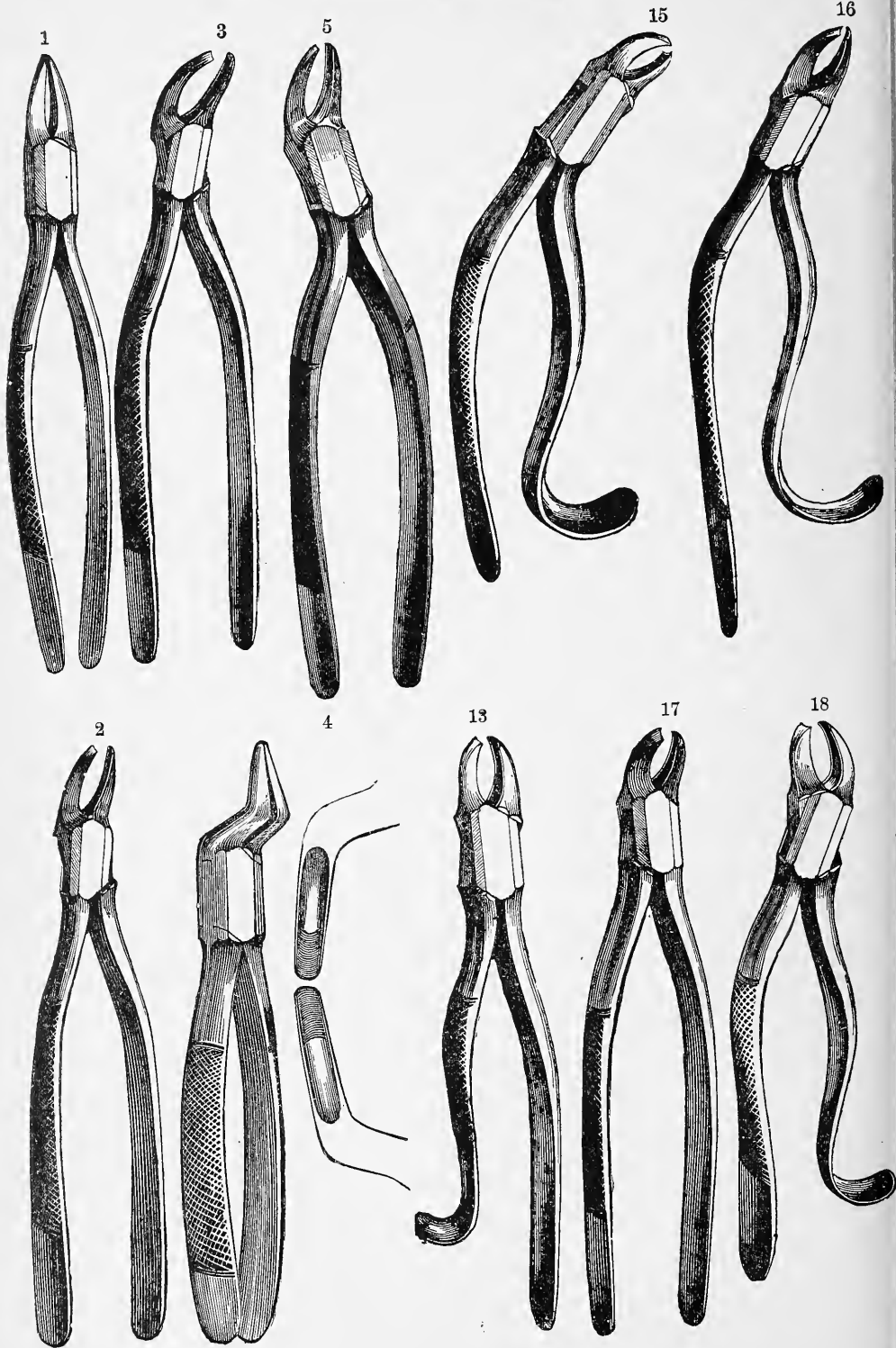

19

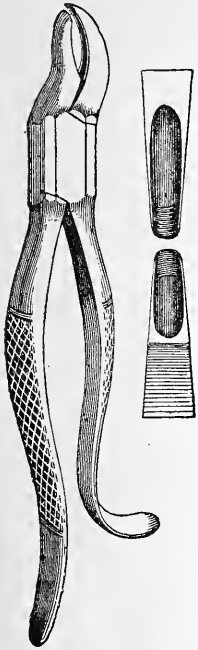

**XII. DENTAL INSTRUMENTS.**

**DENTAL FORCEPS.**

We manufacture dental forceps in two styles, viz:

- With octagon joints, fine finish, warranted . . . . . @\$2.50
- With oval joints, plain finish, not warranted . . . . . @ 1.75
- Children's forceps, octagon, warranted . . . . . 2.00
- Children's forceps, oval, not warranted . . . . . 1.50
- Nickel-plated forceps in addition to above prices . . . . . 25



20



- 1.\* Root, upper front straight, (a) four sizes: long, slender, large, medium and small.
- 2.\* Root, upper or lower, half curved (u) three sizes: large, medium and small.
- 3.\* Root, lower, full curved (g) three sizes: large, medium and small.
- 4.\* Root, bayonet shaped (gn).
- 5.\* Root, universal (l).
- 6. Root, right and left—two pairs (nk).
- 7. Alveola, Parmly's, bayonet (gu).
- 8. " straight beak (gs).
- 9. " curved beak (ge).
- 10. " half curved (gc).
- 11. " lower, for either side (nu).
- 12. " bayonet (ba),
- 13.\* Incisor, upper (ag) with or without hook on handle.
- 14. " " lateral (ei).
- 15.\* " lower, hawk bill (c).
- 16.\* " or Bicuspid, lower for either side (ae).
- 17.\* Bicuspid, upper or lower (e), half curved.
- 18.\* " or Canine, upper (as).
- 19.\* " or Incisor, upper (ek.)
- 20.\* " or Canine, lower (ua).

All Instruments illustrated are designated by a \*

XII. DENTAL INSTRUMENTS.

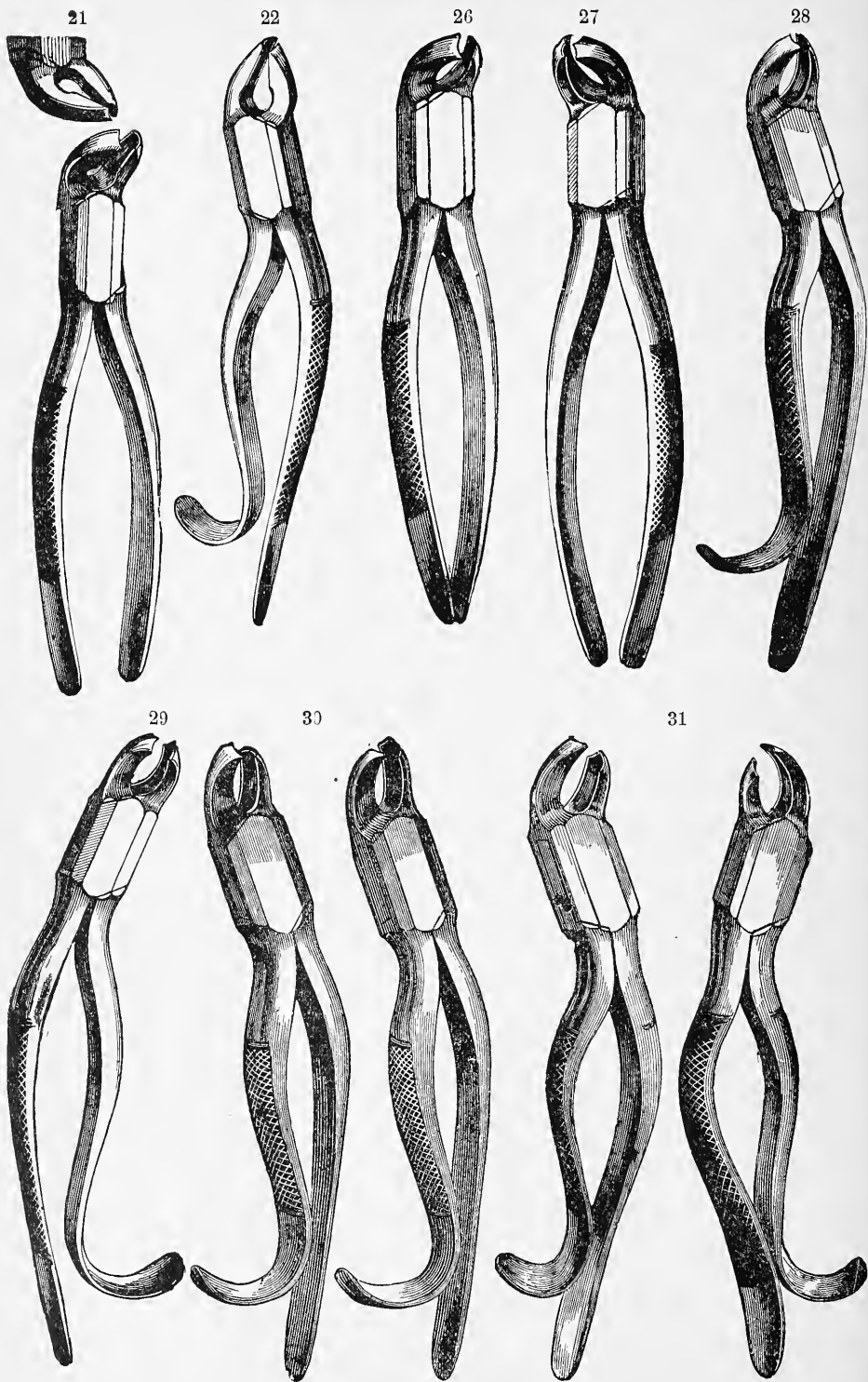

**XII. DENTAL INSTRUMENTS.**  
**DENTAL FORCEPS.**

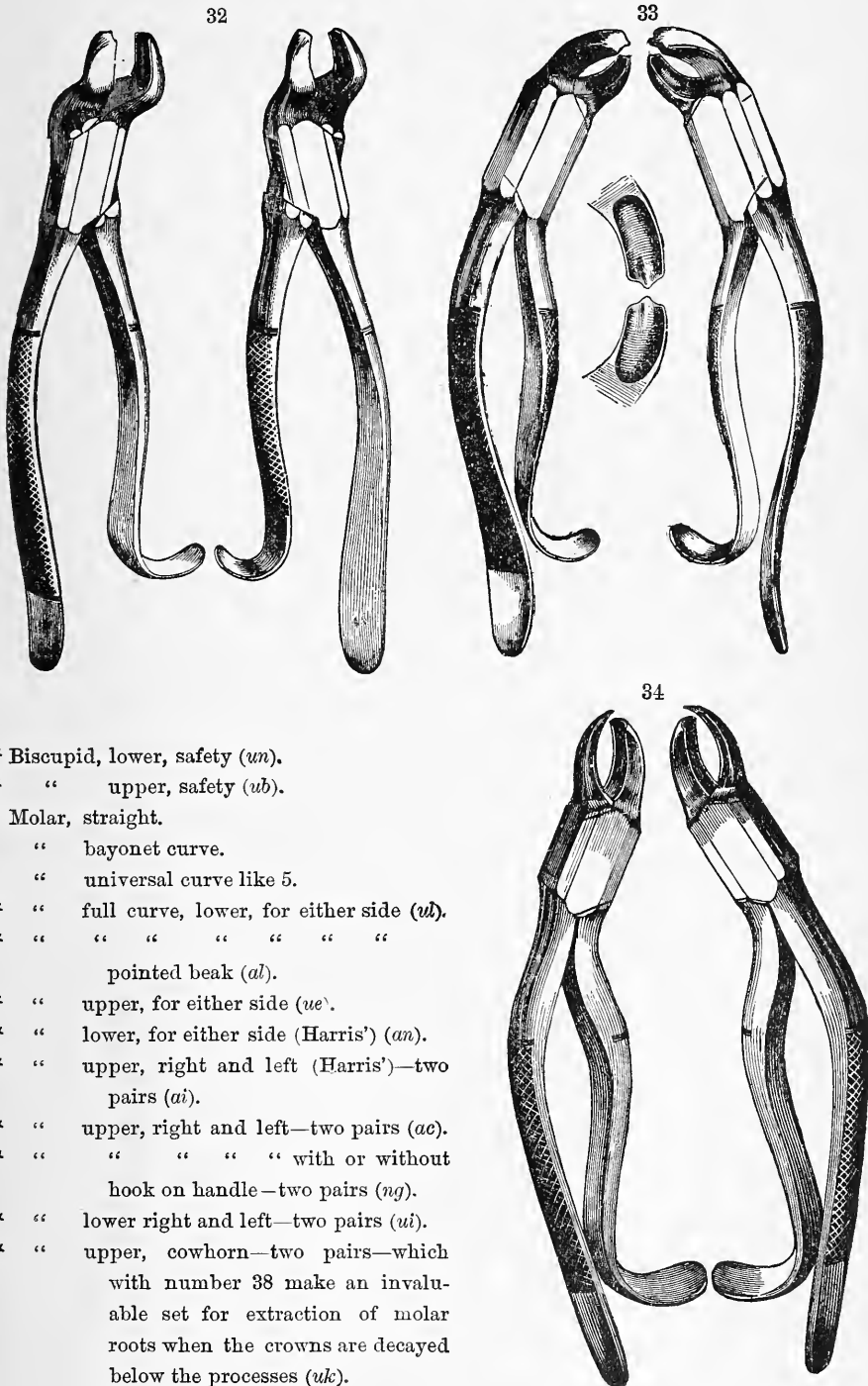

- 21.\* Biscupid, lower, safety (*un*).
- 22.\* “ upper, safety (*ub*).
- 23. Molar, straight.
- 24. “ bayonet curve.
- 25. “ universal curve like 5.
- 26.\* “ full curve, lower, for either side (*ul*).
- 27.\* “ “ “ “ “ “ “ “  
pointed beak (*al*).
- 28.\* “ upper, for either side (*ue*).
- 29.\* “ lower, for either side (Harris’) (*an*).
- 30.\* “ upper, right and left (Harris’)—two pairs (*ai*).
- 31.\* “ upper, right and left—two pairs (*ac*).
- 32.\* “ “ “ “ “ “ “ “  
hook on handle—two pairs (*ng*).
- 33.\* “ lower right and left—two pairs (*ui*).
- 34.\* “ upper, cowhorn—two pairs—which  
with number 38 make an invaluable set for extraction of molar roots when the crowns are decayed below the processes (*uk*).

All Instruments illustrated are designated by a \*

XII. DENTAL INSTRUMENTS.

DENTAL FORCEPS.

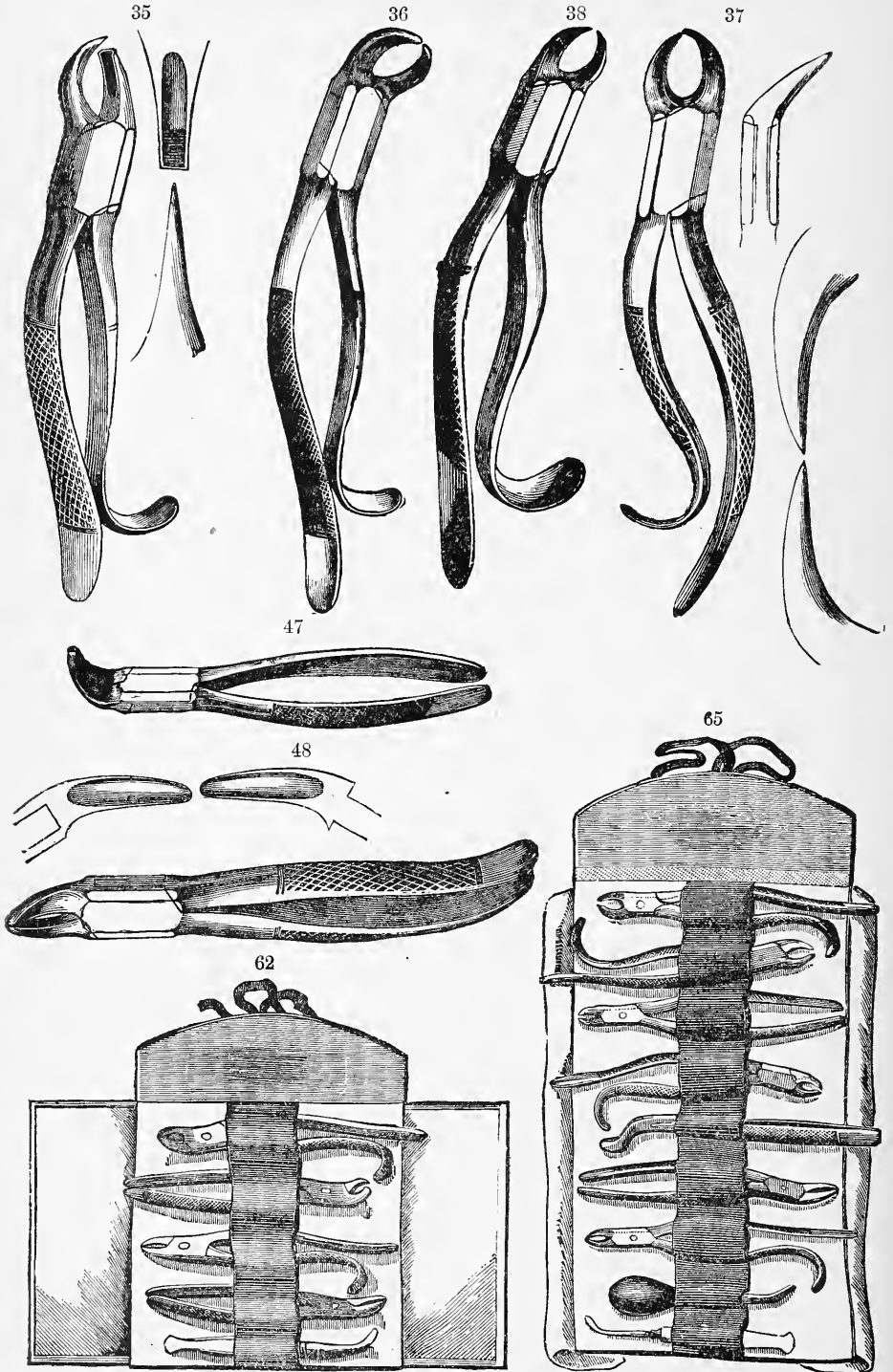

## XII. DENTAL INSTRUMENTS.

### DENTAL FORCEPS.

- 35.\* Molar, upper, cow horn, for either side (*en*).  
 36.\* “ lower, cow horn, right side (*ns*).  
 37.\* “ lower, cow horn, left side (*nb*). This pair of Forceps with number 36 for the right side makes a very efficient set for lower molars.  
 38.\* “ lower, cow horn, for either side (*ab*).  
 39. Dentes Sapientiae, upper for either side (*i*).  
 40. “ “ “ “ “ “ with or without hook on handle (*ak*).  
 41. “ “ lower for either side (*n*).  
 42. “ “ “ “ “ “ (*us*).  
 43. Separating or splitting (*b*).  
 44. Excising, upper straight beak (*au*).  
 45. “ lower, curved beak (*ga*).  
 46. Children’s, straight (*gk*).  
 47.\* “ curved (*uc*).  
 48.\* “ and universal root (*bu*).
49. Stump Elevators, 9 patterns, ebony handles, round \$0.75; octagon \$1.50.  
 50. Tooth Key, Fox’s \$2.50.  
 51. “ “ Fitch’s, round handle \$2.50; octagon handle \$3.00.

### DENTAL POUCHES.

61. Empty: For 5 Forceps \$2.00; 7 Forceps \$2.50; 9 Forceps \$3.00; 10 Forceps \$3.25;  
 12 Forceps \$3.50  
 62.\* Dental Pouche A, contains four Forceps and Gum Lancet, viz: Universal Root Forceps (*l*); upper Molar, either side (*ue*); lower Molar, either side (*an*), and Bicuspis (*un*).  
 Price,..... Forceps oval jointed \$10.00; octagon jointed 13.00  
 64. Dental Pouche B, contains six Forceps: Root upper or lower, half curved (*u*); Root, bayonet shaped (*bn*); Bicuspis, upper or lower (*e*); Molar, upper right and left, two pairs (*ac*); Molar, lower (*an*).  
 Price,..... Forceps oval jointed \$12.50; octagon jointed 17.00  
 65.\* Dental Pouche C, contains seven Forceps, Gum Lancet and Elevator, viz: Root upper or lower, half curved (*u*); Root, bayonet shaped (*bn*); Bicuspis (*un*); Molar, upper right and left, two pairs (*ac*); Molar, lower right and left, two pairs (*ui*).  
 Price,..... Forceps oval jointed \$16.50; octagon jointed 22.00  
 66. Dental Case No. 4, containing: 11 pairs of best octagon joint Forceps, viz. Nos. 1, 5, 13, 16, 18, 20, 29, 31, 38, 42; 2 round ebony handle Elevators, one ebony handle Gum Lancet in morocco covered case, valise form, with lock and key, as adopted by the U. S. Government for Army and Navy Surgeons..... 40.00  
 With the Forceps nickel-plated..... 43.00  
 With oval-jointed Forceps..... 36.00

All Instruments illustrated are designated by a \*

XIII. OBSTETRIC INSTRUMENTS.

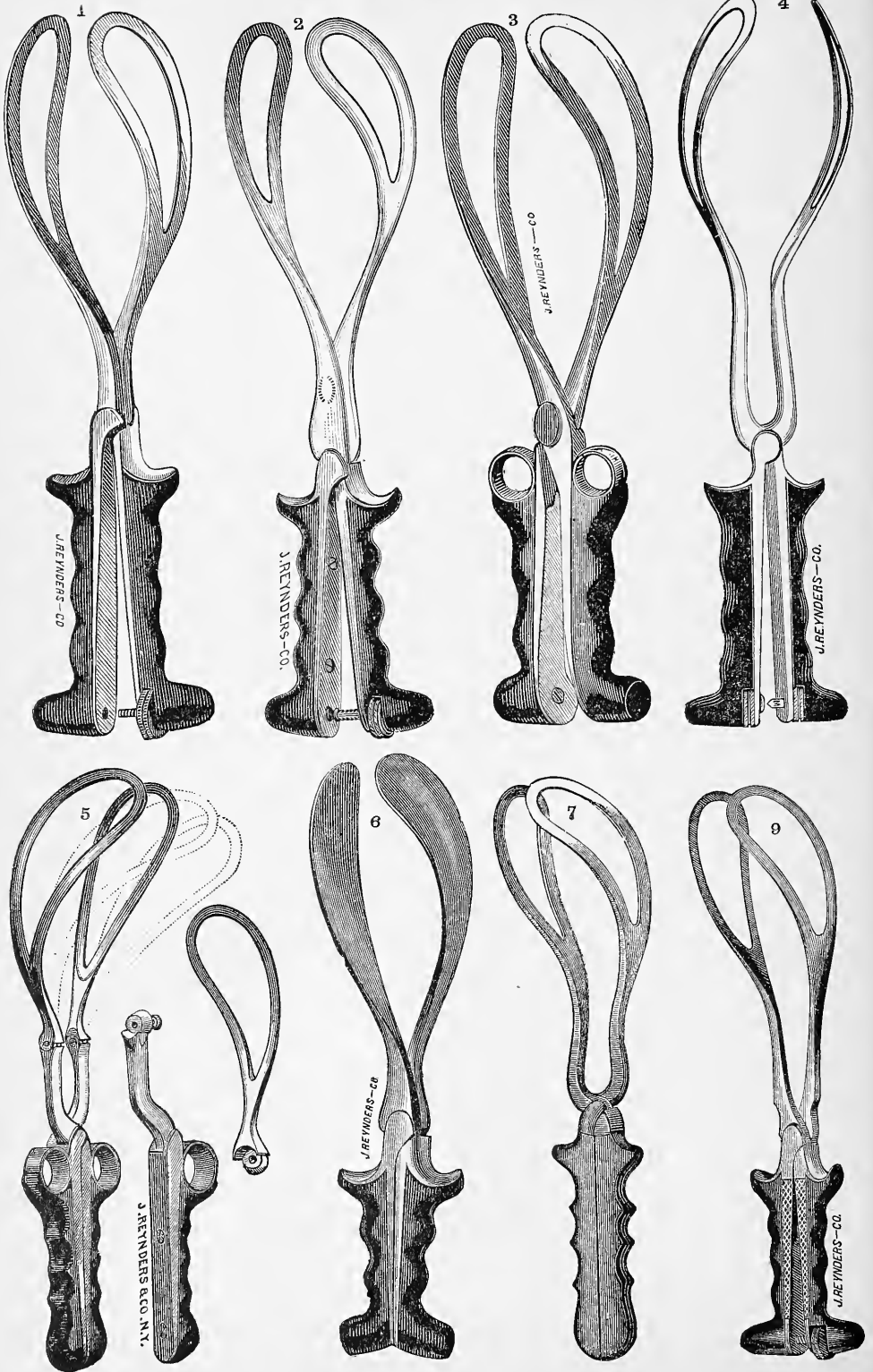



**XIII. OBSTETRIC INSTRUMENTS.**

**FORCEPS.**

Obstetric Manikin, leather on wood and wire frames with foetus and placenta . . \$50.00  
 Obstetric Manikin, Budin's.—Descriptive Circular sent on application.

complete .....		
1. * Elliot's .....	good \$7.00; best	9.50
2. * Bellevue .....		9.50
3. * Bedford's .....		8.00
4. * Burdick's .....		9.00
5. * Vedder's .....		13.00
6. * McLane's, solid or open bladed .....	each	8.00
7. * Simpson's, long .....		8.00
8. * " short, (see page 140) .....		7.00
9. * Gillette's .....		9.50
10. * Hodges' .....	good \$7.00; best	8.00
11. * Parson's .....		8.00
12. * Wallace's .....		8.00
12. * Jenk's, long .....		8.50
14. * " short .....		6.00
15. * Roler's, plain .....		8.00
16. * " with screw .....		9.00
17. * Barclay's .....		13.00
18. * Miller's .....	plain \$8.00; jointed handles	15.00
19. * Rockwell's .....		8.00
20. * Lusk's Modification of Tarnier's .....		24.00

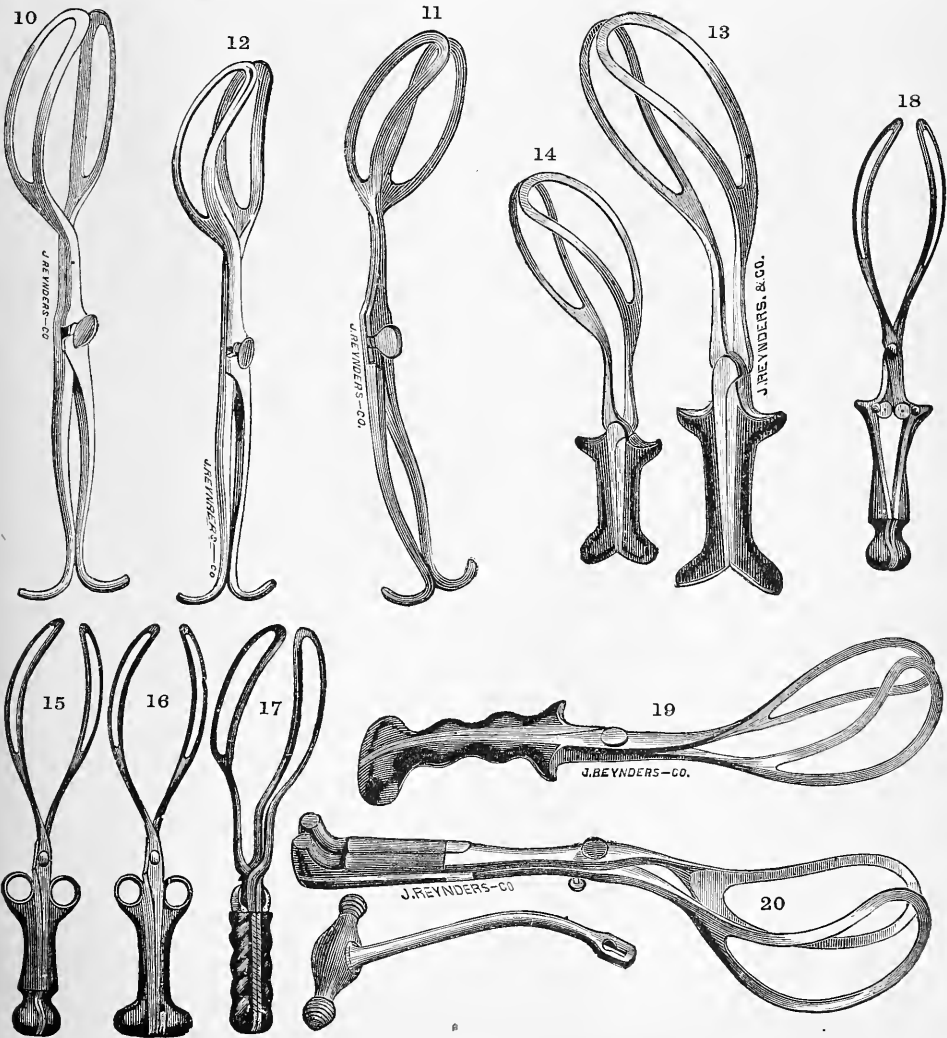

All Instruments illustrated are designated by a \*

XIII. OBSTETRIC INSTRUMENTS.

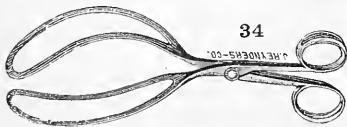
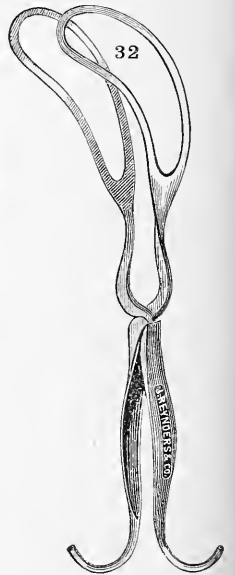
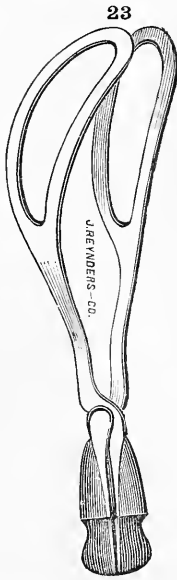
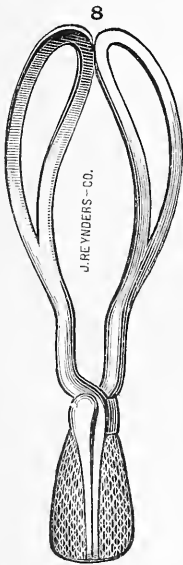
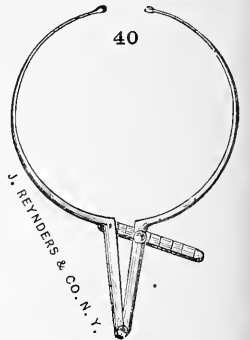
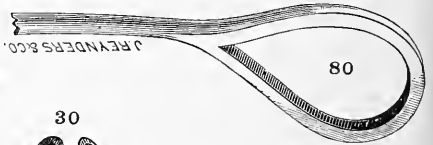
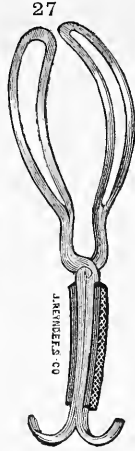
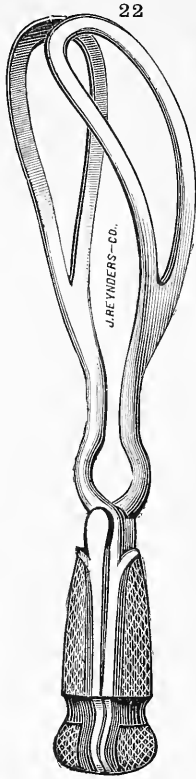
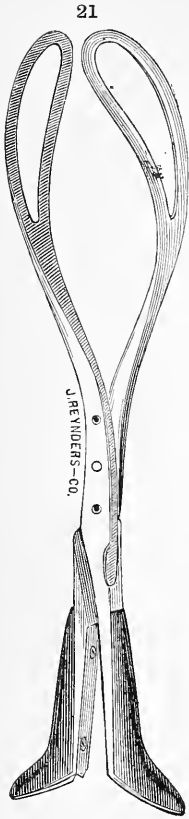

**XIII. OBSTETRIC INSTRUMENTS.**

**FORCEPS.—Continued.**

21.* Taylor's	.....	\$11.00
22.* Barnes'	.....	8.00
23.* Davis', straight or curved	.....	7.50
24.* Thomas'	.....	7.00
25.* Denman's	.....	7.00
26.* Sawyer's, first model	..... good \$6.00; best	7.00
27.* " latest model	..... long \$10.00; short	8.00
28.* Hale's	.....	8.50; " 7.00
29.* Stone's	.....	7.00
30.* Braithwaite's	.....	8.00
31. Budd's	.....	8.00
32.* Comstock's (St. Louis)	.....	7.00
33. White's	..... \$8.00; improved	9.00
34.* Newman's, Scissorhanded	.....	7.00
35. Ranney's	.....	7.00
36. Adam Miller's	.....	12.00
37. Byford's	.....	8.00
38. T. D. Fitch's	.....	9.00
39. Naegeli's	.....	8.00
40.* Pelvimeter, Baudelocqu's	.....	8.00
41.* " Robert & Collin's, see page 142	.....	8.00
42. " King's	.....	4.00
43.* Vectis, plain, ebony handle	.....	3.00
44. " double	.....	3.50
45. " jointed	.....	3.00
46. " Ryerson's, adjustable	.....	5.00
47.* Perforator, Smellie's	.....	2.50
48.* " Naegeli's	.....	4.00
	..... improved	5.50
49.* " Simpson's	.....	3.00
50.* " Bedford's	.....	3.00
51.* " Holmes'	.....	5.00
52.* " Blot's	.....	6.00

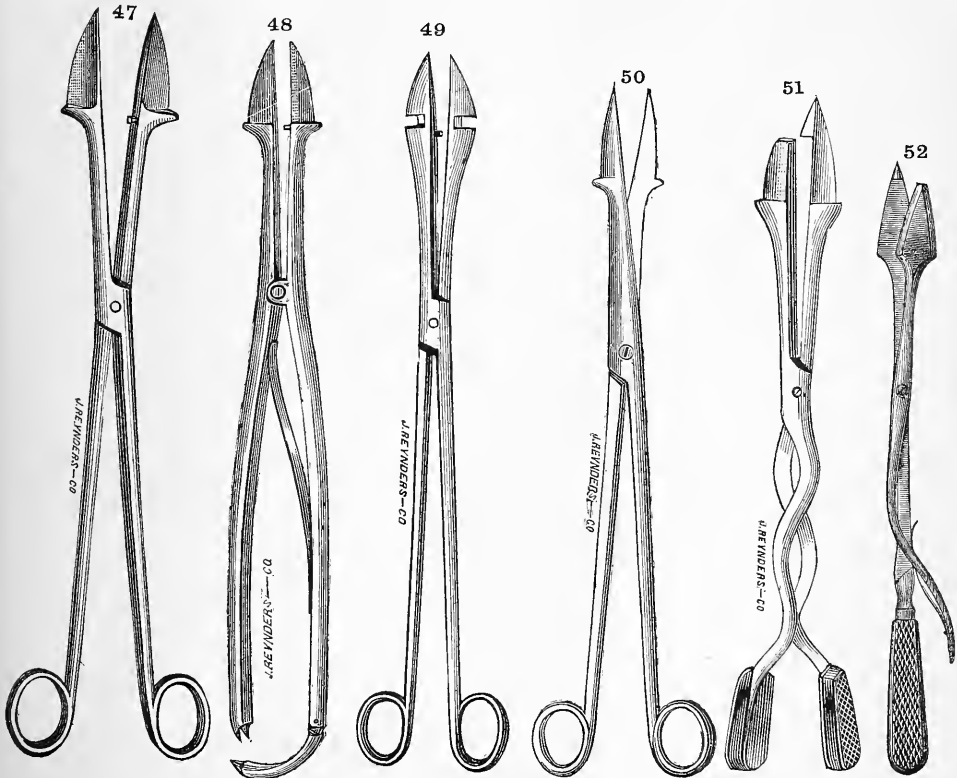
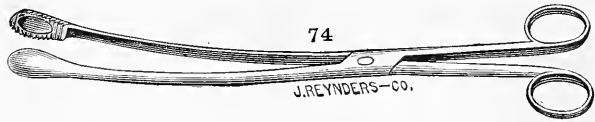

All Instruments illustrated are designated by a \*

XIII. OBSTETRIC INSTRUMENTS.

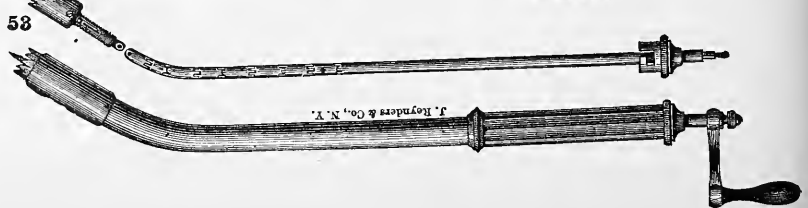
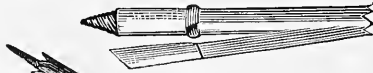
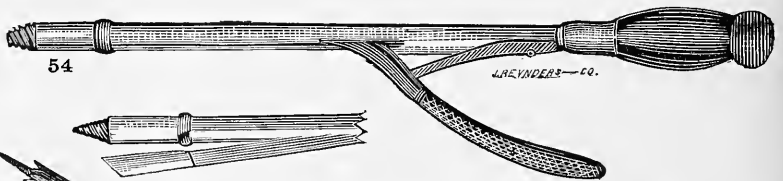
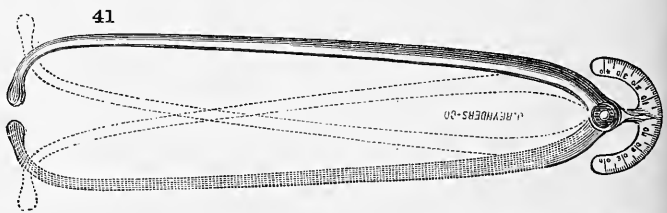
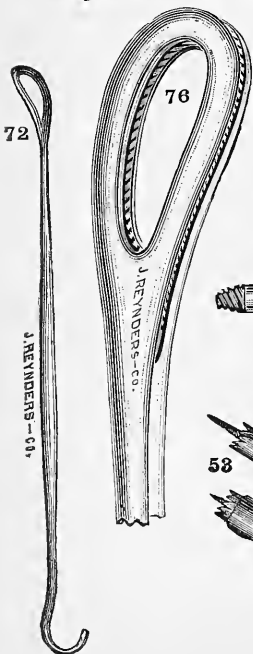
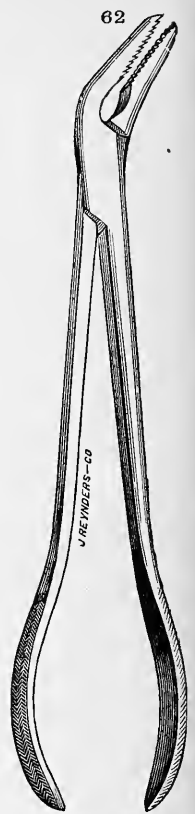
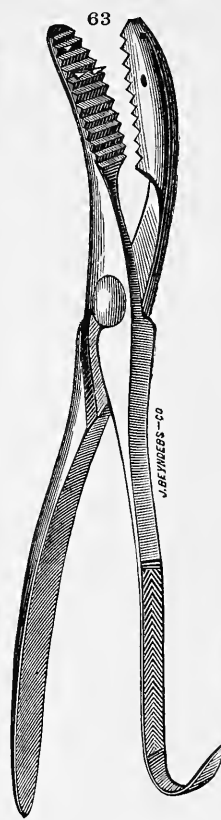
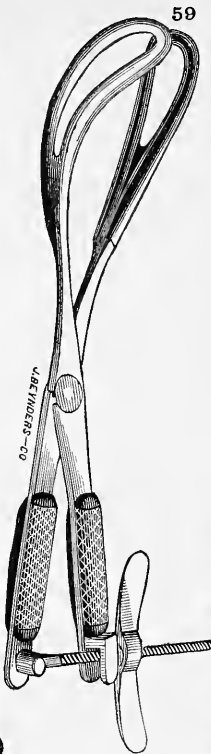
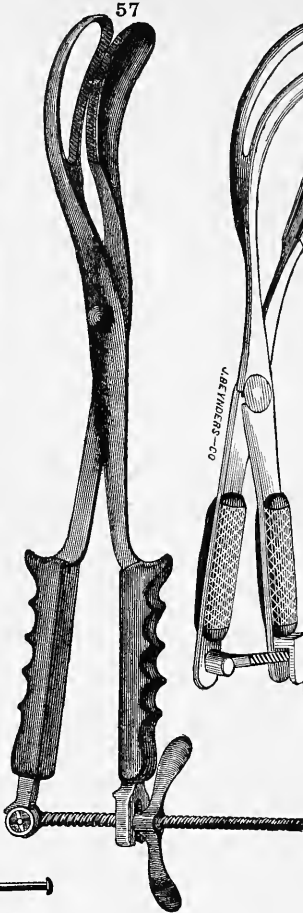
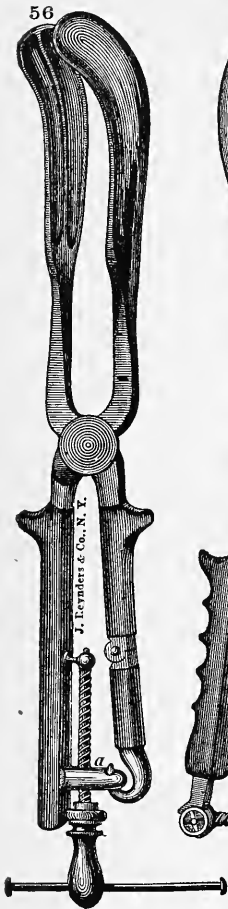

**XIII. OBSTETRIC INSTRUMENTS.**

53.*	Trephine Perforator, Braun's.....	\$15.00	70.*	Hooks, Decapitating.....	\$2.50
54.*	“ “ Thomas'.....	8.00	69.	“ Taylor's blunt.....	2.50
55.	Cephalotribe, Braxton-Hick's.....	20.00	66.*	“ blunt or sharp in handle, Braun's.....	each 4.00
56.*	“ Braun's.....	24.00	71.	“ Placenta.....	.75
57.*	“ Simpson's.....	20.00	72.*	“ Dewey's & Carey's Lever..	1.00
58.	“ Munde's.....	20.00	73.*	Placenta Forceps, Budd's.....	2.50
59.*	“ Lusk's.....	18.00	74.*	“ “ Bond's (see page 141)	2.50
60.	Cranioclast, Simpson's.....	10.00	75.*	“ “ Loomis'.....	6.00
61.	“ Roler's.....	15.00	76.*	“ “ Munde's.....	3.00
62.*	Craniotomy Forceps, Meigs', straight or curved.....	3.50	77.*	“ “ Double Crossing	3.25
63.*	Craniotomy Forceps, Thomas'.....	6.00	78.*	“ “ and Ovum, Corey's	4.00
64.*	“ Scissors, Hodge's.....	5.00	79.	“ Scissors.....	1.50
65.	Hook, blunt or sharp, in ebony handle, each	2.00	80.*	“ Curette, Munde's, 16 in. long, for removal of Pla- center after abortion...	2.50
67.*	“ blunt and sharp, one in- strument	1.50	81.	The same of more longitudinal form.....	2.50
68.*	“ “ “ “ guarded	4.50			

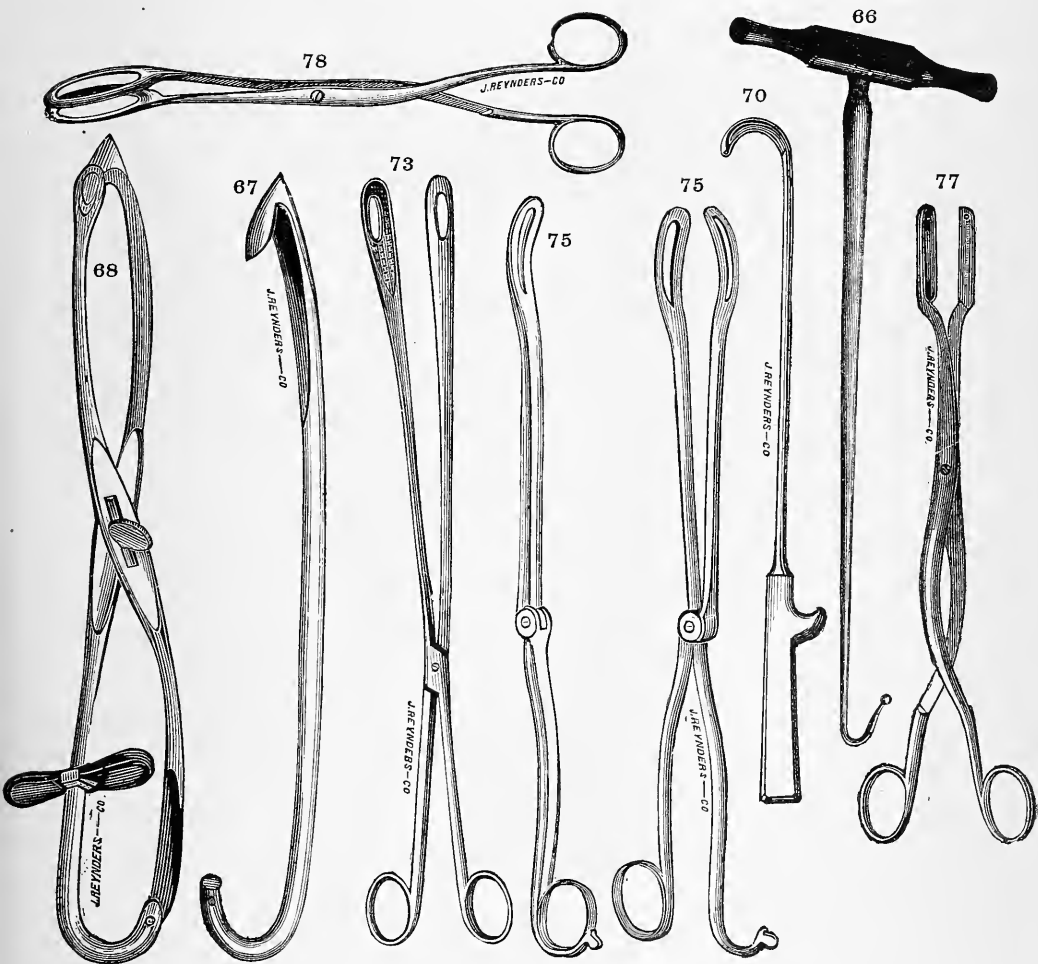

All Instruments illustrated are designated by a \*

XIII. OBSTETRIC INSTRUMENTS.

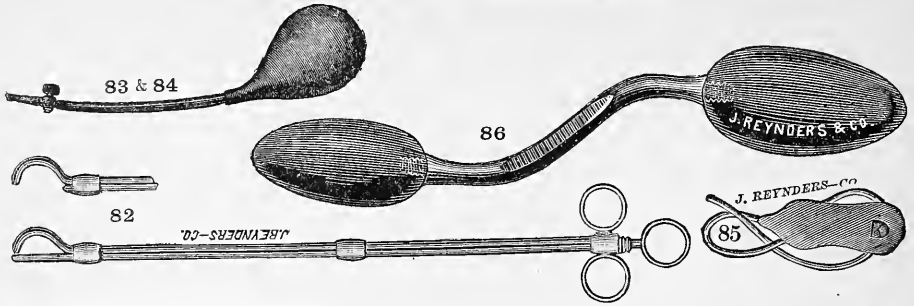

82.*	Cori Carrier, Schöller's, Whalebone.....		\$4.00
83.*	Colpeurynter, Braun's.....	\$2.00; with stopcock	2.75
84.*	“ “ attached to hard rubber tube with stopcock.....		4.50
85.*	Dilator, Barnes', set of three, with fittings and stopcock.....		4.00
86.*	“ Hanks', h. r., per set of 10.....		5.50
87.*	Premature Labor Instrument with claws.....		4.50
88.*	“ “ stilet.....		4.50
89.*	Pouches for Obstetric Instruments.....	large	\$5.00; short 4.00
90.*	Satchels for Obstetric Instruments (see page 175).		

(Extract from the Medical Record.)

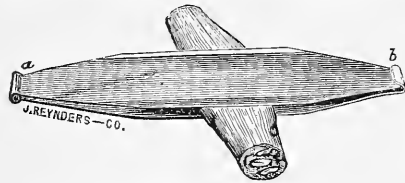

**PULLING'S FUNIS CLAMP.**—The possible occurrence of hemorrhage from the umbilical cord, through loosening of the ligatures, is frequently a source of anxiety to the accoucheur, when he leaves his patient after delivery. Accidents from this cause, if not very frequent, are yet sufficiently formidable to give importance to effective means by which pressure on the cord may be rendered constant under all circumstances. Having this end in view, I have devised an elastic funis clamp, made of a single strip of thin steel doubled on itself, and shaped as shown in the cut, which represent it enclosing a section of the funis. Through the skill of Messrs. J. Reynders & Co, it has been rendered safe, effective, simple and cheap. The opposed surfaces being convex, the pressure is nearly as great when they are approximated as when the separation is considerable. It is clasped and unclasped by sliding the extremities of the arms at *b* past each other. I have used one of these little instruments in about twenty cases, and it is still in good order. I generally remove it on my second visit, when I find the cord beneath it compressed to the thickness of paper and the vessels perfectly obliterated. It is very convenient, besides giving such a sense of security that I should be very unwilling to do without it now. Two or more clamps should be carried, one being used to apply temporarily to the placental end of the funis.

— EZRA R. PULLING, M.D., New York.  
April 2, 1875. Price, \$0.40

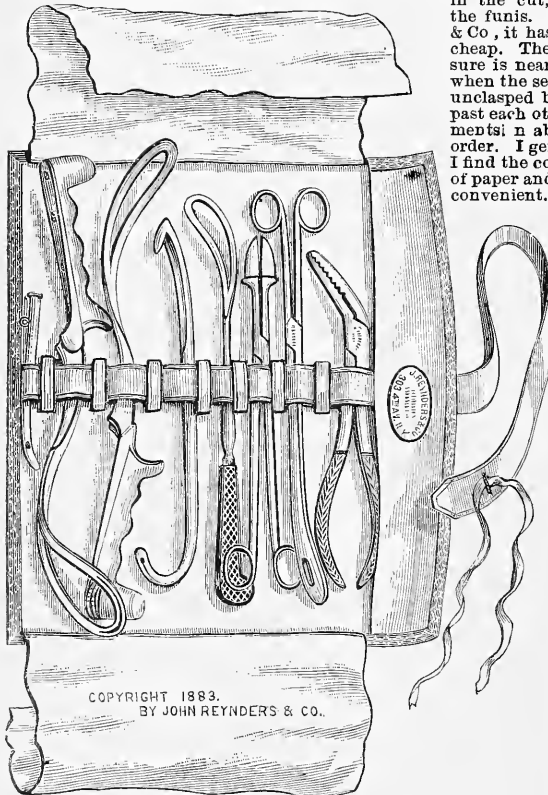

COPYRIGHT 1883.  
BY JOHN REYNDERS & CO.

John Reynders & Co's Obstetric Pouch (No. 2).

- Obstetric Set No. 1, Hodge's, contains: 1 Hodge's Forceps; 1 Blunt Hook and Crotchet; 1 Bedford's Perforator; in a leather pouch..... \$16.00
- Obstetric Set No. 2.\* J. R. & Co's, contains: 1 Elliot's Obstetric Forceps; 1 plain Vectis; 1 Smellie's Perforator; 1 Meig's Craniotomy Forceps; 1 Blunt Hook and Crotchet; 1 Budd's Placenta Forceps; 1 Female Catheter, plated, in a morocco, leather pouch to roll up. \$28.00
- Obstetric Set No. 3, Elliot's, contains: 1 Elliot's Forceps; 1 Craniotomy Forceps; 1 Blot's Perforator; 1 Blunt Hook and Crotchet; 1 Placenta Forceps; 1 pair Scissors.  
Price in a leather pouch..... \$30.00  
“ “ case..... \$36.00
- Obstetric Set No. 4, Brickell's, contains: 1 Brickell's long Forceps; 1 short Forceps; 1 Perforator; 1 Vectis; 1 guarded Blunt Hook; 1 guarded Crotchet, in a leather pouch; all instruments nickel-plated..... \$50.00
- Obstetric Pouch No. 5, Thomas', contains: 1 Elliot's Forceps; 1 Thomas' short Forceps; 1 Cranioclast; 1 Placenta Forceps; 1 Blunt Hook; 1 Crotchet; 1 Thomas' Trephine; 1 pair Scissors; 1 Naegele's Perforator; 1 Thomas' Cephalotribe; all nickelplated; in a valise-form case, latest style..... \$100.00

All Instruments illustrated are designated by a \*

**XIV. GYNAECOLOGICAL INSTRUMENTS.  
FOR EXAMINATION.  
CHAIRS AND TABLES.**

The variety of Examination Chairs and Tables is so great, that we prefer to mention those most in favor by name and price only. We will, upon inquiry, send descriptive circulars and pamphlets of either or all giving the fullest information, more than we can allow space for in this catalogue. Will also then give bottom prices.

**I. IRON FRAME CHAIRS.  
THE MARKS' CHAIR.\***

	PRICES.*		
	No. 2. Standard Height.	No. 4. New Improved.	No. 6. New Improved Jr'd Strrup.
Cane Seats, with Black Walnut or Upholstered Arms, without cushions....	\$30	\$45	\$65
Upholstered with Union Rep, Jutes, Ramies, Domestic Raw Silk, or Cretonnes, filled with extra quality moss .....	35	50	70
Upholstered as above, filled with good Curled Hair ..	40	55	75
Upholstered with No. 1 fine Cord-Wood Reps or Terry, Crepes, Moquettes, or Imitation Leather, filled with extra quality Hair .....	45	60	80
Upholstered in Raw or Spun Silk, Figured Tapestry, Silk, Terry, Corded and Double Lined Cushions, filled with extra quality Hair.....	55	70	90
Upholstered in best quality Silk or Mohair Plush (plain or embossed), or best quality Leather, any color, Corded Seams, complete with Pillow, best quality hair.....	\$65	\$80	\$100
Chairs finished with upholstery made with springs.....	10 extra.		
No. 2a Chair, with adjustment for elevating front of seat.....	10 "		

Our combined Reading and Writing Desk, as shown in illustrations, can be attached to any chair, is a very complete and desirable article; price, complete, in cabinet, cloth-finish, drawer for stationery and ink well, \$5.

**THE CANTON AUTOMATIC SURGICAL CHAIR.\***

No. 1. Ornamental iron base, with gold striping, nickel-plated head rest, stirrups and handle, upholstered in silk plush, mohair plush or leather, with heavy fringe on arm rests.....	\$55.00
No. 2. Trimmed the same as No. 1, upholstered in velvet carpet, plush carpet, corduroy or terry .....	50.00
No. 5. Trimmed the same as No. 1, upholstered in imitation leather .....	45.00
No. 4. upholstered in imitation leather, without nickel .....	40.00
Oculist Head Rest (extra) .....	5.00
Physician's Revolving Instrument and Book Case.....	30.00

**THE GLOBE SURGICAL CHAIR.**

All frames are alike, being made of wrought and malleable iron, and are practically indestructible. They are japanned in black and ornamented with stripes of gold and bright colors, which makes a neat and durable finish, easily cleaned and kept aseptic. With each chair will be included: 1 pair Globe Limb-Supporting Stirrups, 1 Knee Rest for Sims' position, and 1 Spittoon Holder. The head rest, as shown and described in the illustrated catalogue, is attached to and furnished with each and every chair. The chair will be sold upholstered if desired, or will be upholstered as ordered; in each case the stirrups and Sims' knee rest being upholstered to match the chair. The foot rest is covered with Brussels carpet. The chair upholstered, or with different styles of upholstery, will be furnished at the following prices:

No. 1. The Globe Surgical Chair Frame, unupholstered, but including head rest, stirrups, knee rest and spittoon holder, all japanned as described.....	\$55.00
No. 2. Same as No. 1, and upholstered in imitation leather, with pillow, and filled with curled hair....	73.00
No. 3. Same as No. 1, and upholstered in genuine imported Irish corduroy, of different shades, with pillow, and filled with curled hair .....	75.00
No. 4. Same as No. 1, and upholstered in genuine leather, or crimson mohair plush, with pillow to match, and filled with curled hair .....	80.00

No. 2, 3 and 4, if filled with best picked moss, instead of curled hair, will each be \$3.00 less. In all cases the cushions will be provided with movable pillow as described, and draped with appropriate fringes to match covering, as shown in cuts. The foregoing prices are for chairs properly packed for shipment and on board cars, the purchaser paying freight or express charges. In all styles of upholstery the cushions are made detachable from chair for greater convenience in cleaning and transportation. The Irish corduroy is recommended as being both inexpensive and durable.

The improved Globe Limb-Supporting Stirrups can be used to advantage with many of the old styles of chairs, tables and lounges, and can in fact be readily used with any flat top table or desk. These stirrups will be sold separately, and will be accompanied by the proper lugs, whereby they may be attached to the chair or table with which they are to be used. When bought separately they will be upholstered in crimson plush, unless otherwise ordered. They are finished in black japan, as is the chair. The price of the Globe stirrups, when sold without chair, is \$7.00, and they will be securely packed for shipment by express.

**II. WOODEN FRAME CHAIRS.**

**THE ARCHER (IMPROVED) CHAIR.**

PRICES Complete with Extra Seat Extension and Platform Step.	Without Air Cushions and Pivot Springs.	With Air Cushions and Pivot Springs.
Made in walnut, cherry, or ebony finish, complete, and upholstered with imitation leather, any color.....	\$55.00	\$65.00
Best hand buffed leather, any color.....	60.00	70.00
Best embossed leather, any color.....	65.00	75.00
Best mohair plush, any color.....	68.00	78.00
Leather Pillow to match, extra.....		\$5.00
Oculist Head Rest, extra.....		10.00
Chair made of solid mahogany, extra.....		8.00

**THE "CLARK" PHYSICIAN'S OFFICE CHAIR.**

Dimensions: Length, 6 feet; Height, 28 inches; Width inside of arms, 21 inches.	
Extra fine mohair plush or leather.....	\$60.00
Japanned Irons.....	55.00

Made from selected walnut, cherry or imitation mahogany, nicely carved and oil finished.

#### XIV. GYNAECOLOGICAL INSTRUMENTS. THE HARVARD CHAIR.

No. 1. Without Harvard head rest, the back being extended to form support for the head. Iron work painted and neatly ornamented. Upholstered in a fine quality of imitation leather.....	\$48.00
No. 13. Same as No. 1, with stirrups nickel-plated. Upholstered in leather.....	65.00
Numbers 1 and 13 are so made that all the woodwork is covered by the upholstering. They have all the movements of the other chairs, except those of the head rest.	
No. 17. Cherry, walnut or antique oak frames, hard oil finish. Harvard nickel-plated head rest, nickel-plated stirrups, iron work highly finished and ornamented in gold bronze. Upholstered in leather.....	70.00
No. 22. Same as No. 17 Upholstered in embossed leather or crimson mohair plush.....	75.00
No. 33. Cherry, mahogany stain, walnut or antique oak frame, hard oil finish, nickel-plated head rest; small iron parts nickel plated, large parts highly finished and ornamented in gold bronze. Upholstered in embossed leather, patterns specially adapted to the chair.....	85.00
No. 44. Same as No 33. Upholstered in decorated leather.....	100.00
Oculist's Head Rest, extra.....	5.00

#### SARGENT'S COMBINATION GYNAECOLOGICAL LOUNGE AND OPERATING TABLE.\*

Prices: In imitation leather including every attachment except pillow.....	\$85.00
In real leather, otherwise same as above.....	100.00
Pillow.....	imitation leather \$4.00; real leather 5.00

#### CHILD'S ADJUSTABLE CHAIR.

Parlor Chairs.....	\$55.00 to \$80.00
Physician's.....	63.00 to 80.00

#### DACQUET'S EXAMINING TABLE.

Standard, wood top.....	\$60.00
“ upholstered in imitation leather.....	65.00
“ “ in leather.....	70.00
Star, wood top.....	50.00
“ upholstered in imitation leather.....	35.00
Cushions, canvas.....	5.00
“ imitation leather.....	10.00
“ leather.....	20.00

Turner's Table.....	plain \$37.50; complete \$60.00
Franklin Table.....	35.00
University Table.....	32.00
Set of Klein's Stirrups, adjustable to any chair, bed or table.....	*6.00

#### PROF. THOMAS' GYNAECOLOGICAL MANIKIN.

With eighteen representations of the Uterus in different conditions and of tumors.—Descriptive Circulars on application.

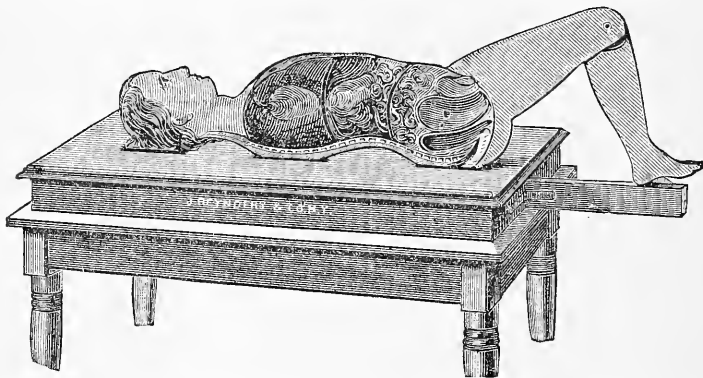

Showing manikin in back position for demonstration of Diagnosis by touch and conjoined manipulation.

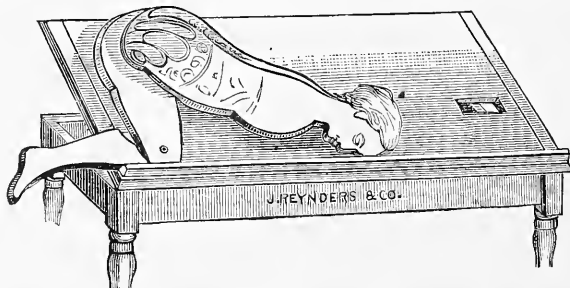

Showing manikin in Sims' position for demonstration of the use of Speculum, Sound etc. Price \*\$55.00



**XIV. GYNAECOLOGICAL INSTRUMENTS.**  
**FOR EXAMINATION.**  
**SPECULA.**

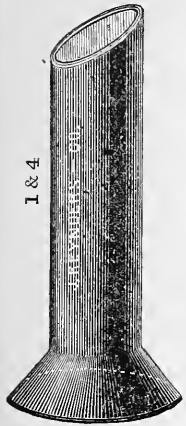

1 & 4

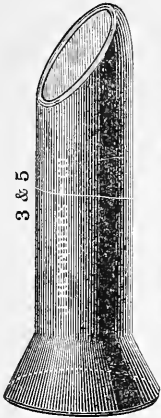

3 & 5

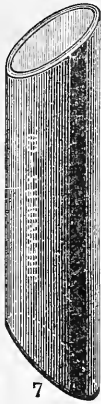

7

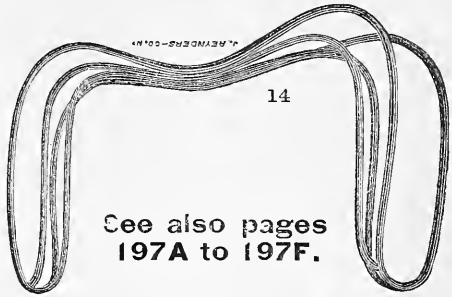

14

See also pages  
 197A to 197F.

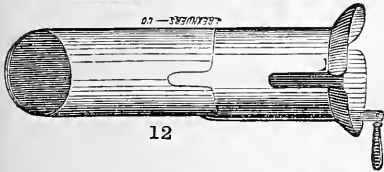

12

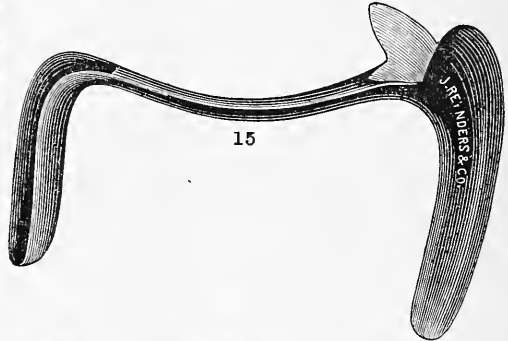

15

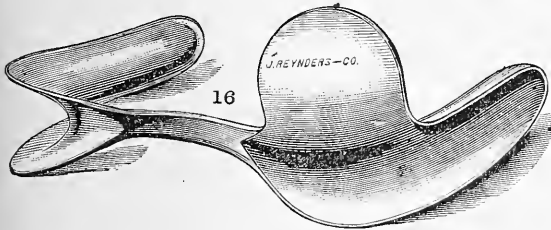

16



13

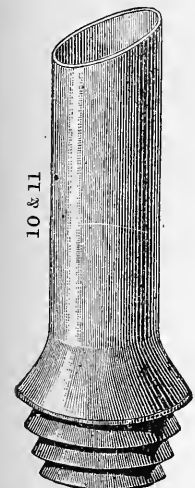

10 & 11

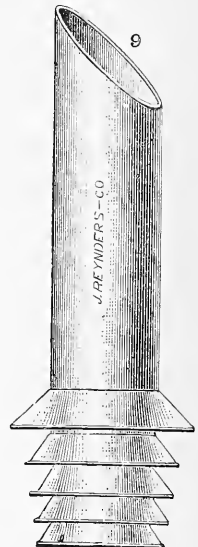

9

- |      |   |                               |
|------|---|-------------------------------|
| 1.*  | Fergusson's, Glass Reflecting, American..   | \$0.50                        |
| 2.   | The same, American, fenestrated.....  | 0.75                          |
| 3.*  | The same, " Dome top.....   | 0.75                          |
| 4.*  | The same, English, 3 sizes..... each  | 1.50                          |
| 5.*  | The same, " Dome top, 3 sizes, "  | 1.75                          |
| 6.   | The same, Clear Glass.....  | 0.50                          |
| 7.*  | The same, Buttles' modification, 3 sizes<br>each.....   | American 0.75<br>English 1.50 |
| 8.   | Fergusson's, Porcelain or white Glass.....  | 0.60                          |
| 9.*  | " Metal, n. p. .... each  | 1.50                          |
|      | set of 5  | 7.00                          |
| 10.* | " H. R., ... each \$1.00, set of 4  | 3.50                          |
| 11.* | " H. R., reflecting, metal lined<br>inside..... each  | 2.00                          |
| 12.* | Thomas', telescopic.....  | 5.00                          |
| 13.* | Sims', four styles: Virgins', regular, Dr.<br>Sims' own pattern and large operating<br>size as used in N. Y. State Women's Hos-<br>pital, each n. p. .... good \$2.00; best | 2.50                          |
| 14.* | Sims', Fryer's Wire.....  | 2.00                          |
| 15.* | " Heburn's (St. Louis).....   | 3.00                          |
| 16.* | " Munde's.....  | 3.50                          |

All Instruments illustrated are designated by a \*

XIV. GYNAECOLOGICAL INSTRUMENTS.  
VAGINAL SPECULA.

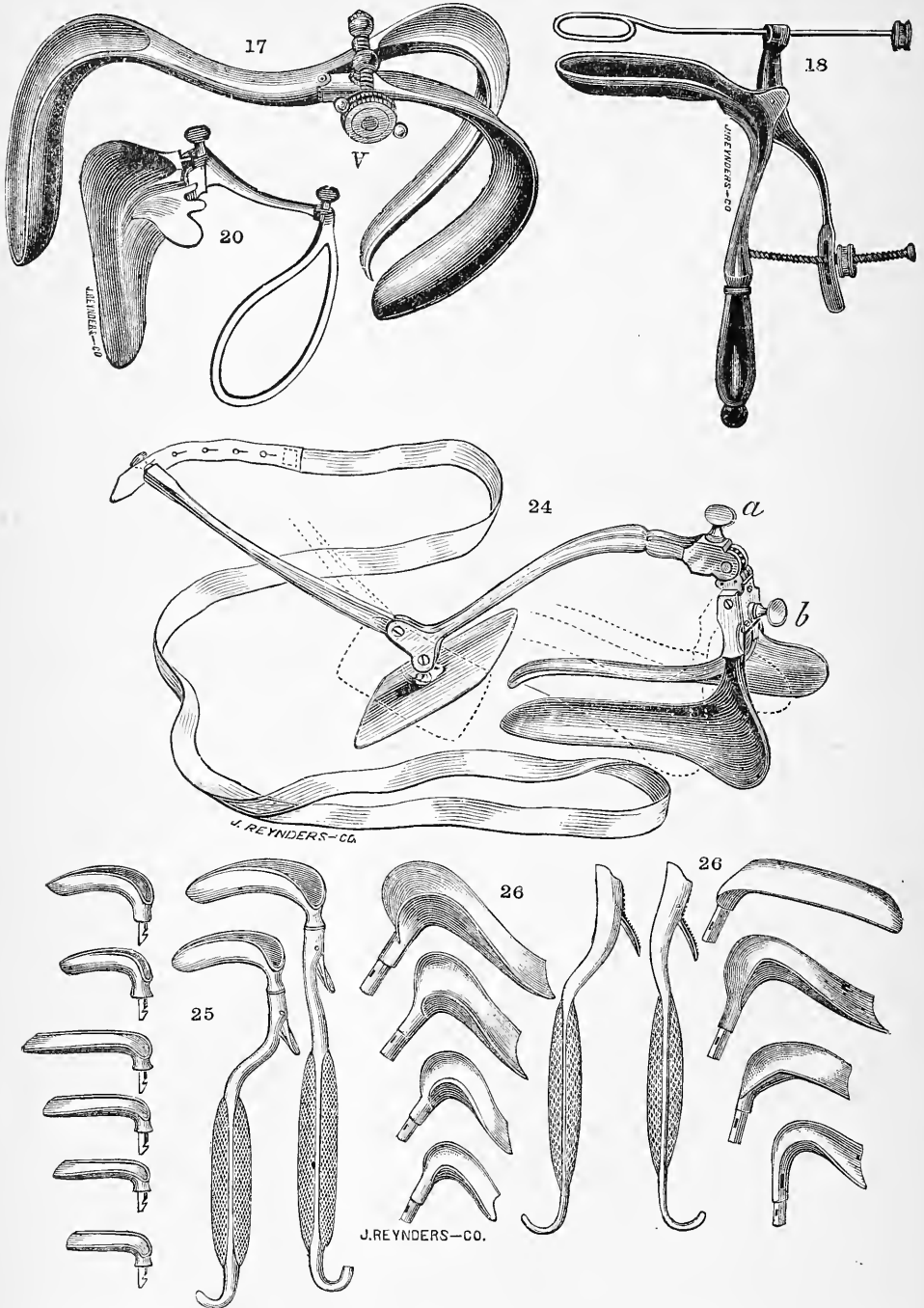

17.*	Sims', Dawson's.....	\$7.00
18.*	" Thomas'.....	10.00
19.	" Goelet's (Sims' with a removable depressor like Thomas' modification of Sims').....	8.00
20.*	Emmett's (Retractor), solid blade.....	10.00
21.	" " dilating blade.....	15.00
22.	Erich's, latest with dilating blade.....	12.00
23.	" with solid blade as modified by Hunter.....	9 00

**XIV. GYNAECOLOGICAL INSTRUMENTS.**

VAGINAL SPECULA.

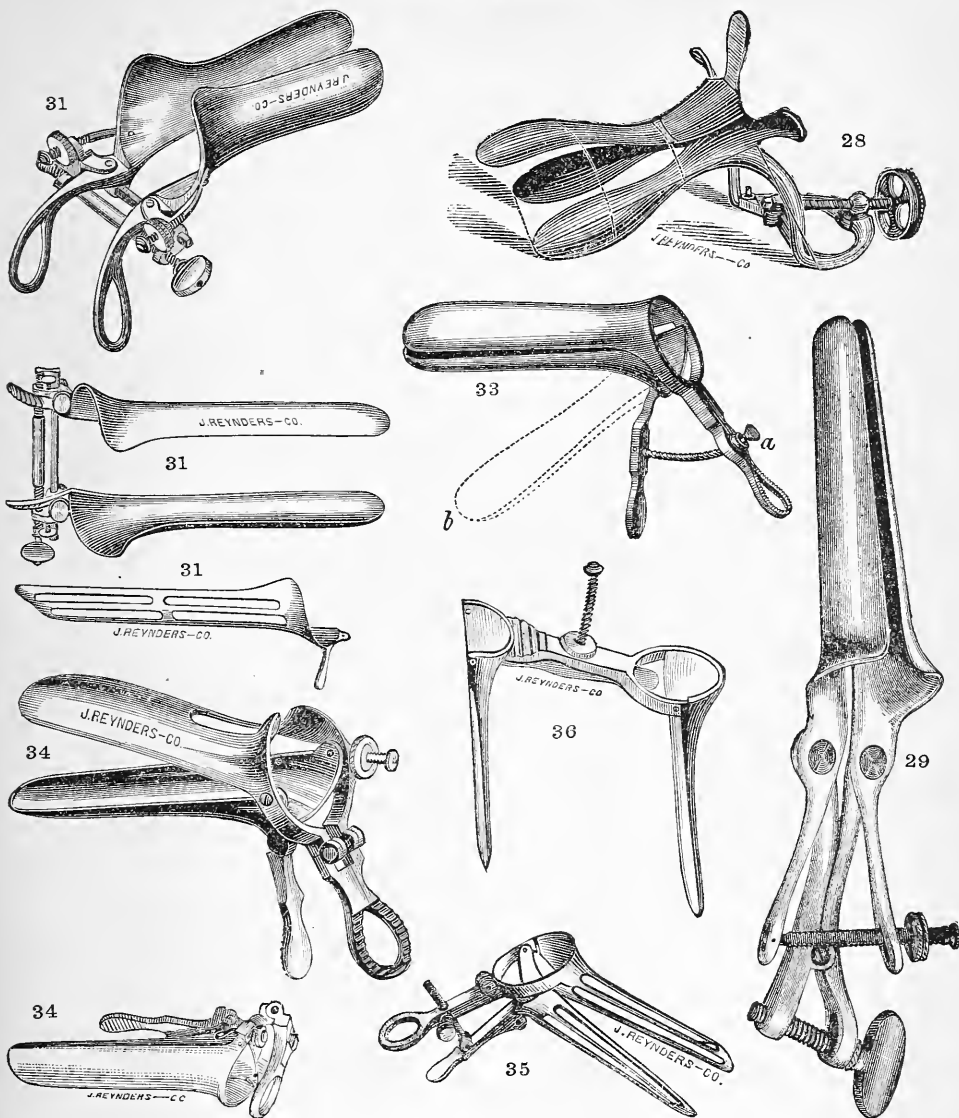

24. \* Erich-Hunter's, modified by Dawson; the retractive movement of the blade is made by an archimedean screw as on Emmet's Speculum (or Retractor). With this device the blade when in position can be very readily moved backwards, which can not be done with the original Erich instrument; its only objectionable feature. The improvement is well worth its additional cost. With solid blade \$12.00 with dilating blade 16.00

25. * Simon's	} see page 150 {	.....	20 00
26. * " "		.....	20 00
27. * " "	Retractors, see Nos. 377 and 378, page 177.	.....	20 00
28. * Bozeman's	.....	.....	12 00
29. * Goodall's	.....	.....	7 00
30. * " "	Jarvis' modification, with shorter and wider blades	.....	8 00
31. * A. Smith's	.....	\$10.00; fenestrated blade extra	2 00
32. * Cusco's, "Duckbill," plain	.....	good	\$3.33; best 4 00
33. * " "	with stiff handles	.....	3 33; " 4 50
34. ** " "	" " " jointed handles, solid blades	.....	" 4 00; " 5 00
35. * " "	" " " fenestrated blades	.....	8 50
36. * " "	Storer's modification, reversible to a Sims'	good	\$3.33; best 4 00

Specula 32 to 36 have the upper blade slotted to prevent pressure on the urethra and to facilitate introduction of the sound.

XIV. GYNAECOLOGICAL INSTRUMENTS.  
VAGINAL SPECULA.

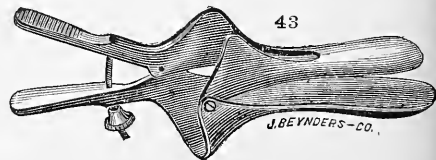
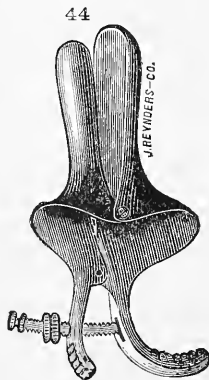
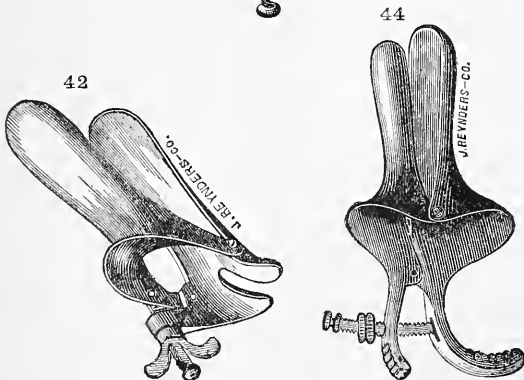
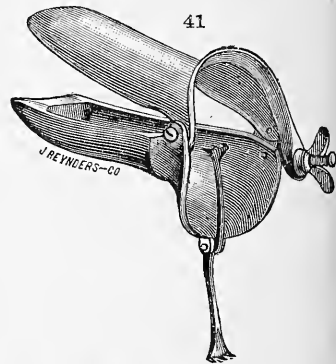
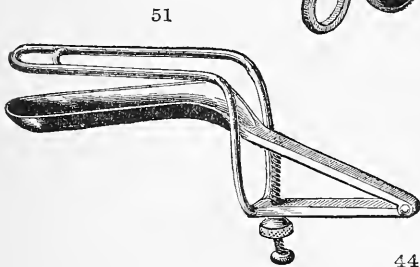
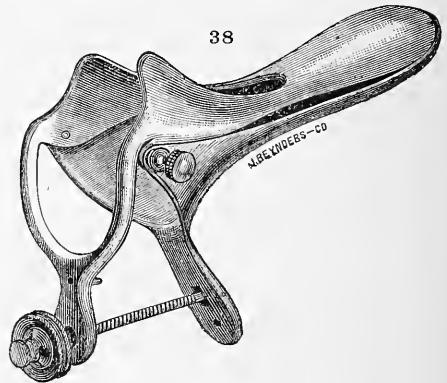
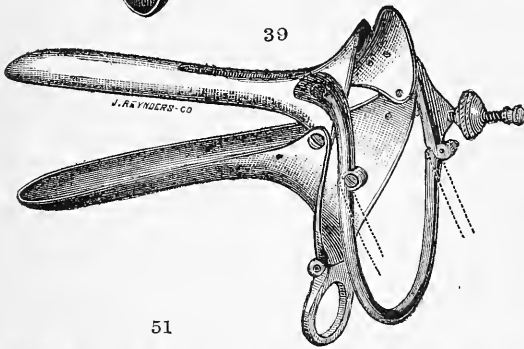
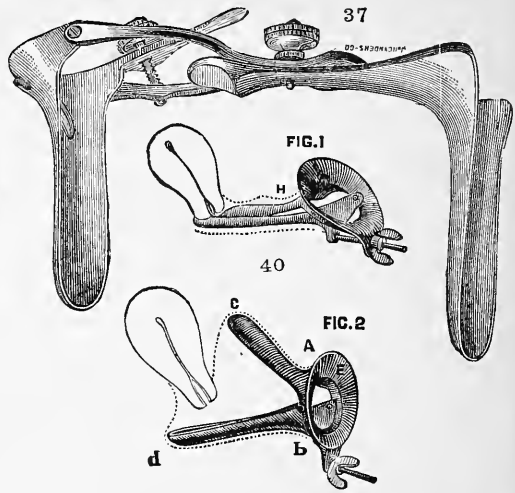
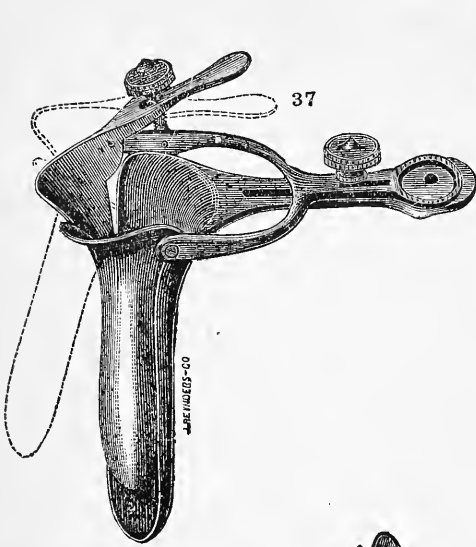

**XIV. GYNAECOLOGICAL INSTRUMENTS.**

**VAGINAL SPECULA.**

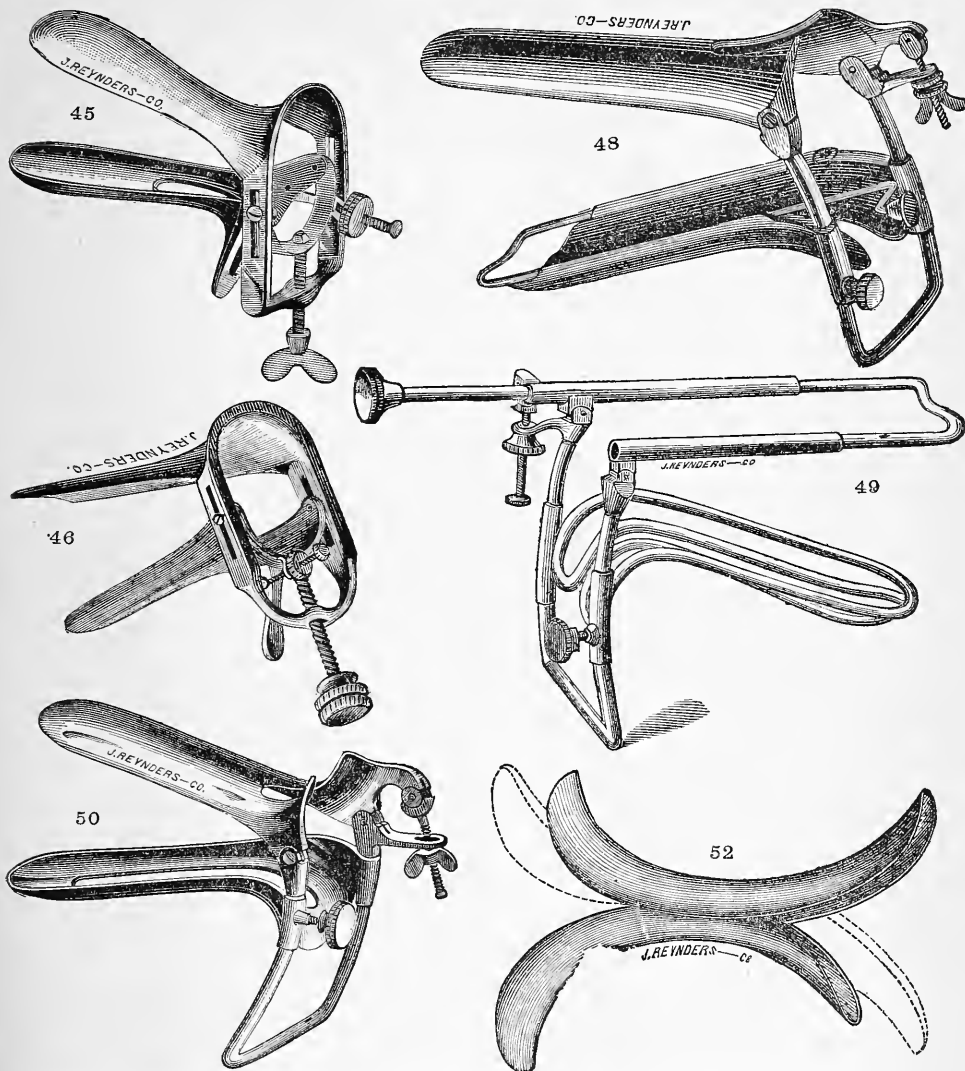

37.** Graves', reversible to Sims' (the figure shows the manner in which the size of its anterior opening can be increased).....	good \$3.33; best	\$5.00
38.* Brewer's, reversible to Sims'.....	" 3.33; "	4.00
39.* Howard's.....	" 4.00; "	6.00
40.* Higbee's, 3 sizes.....	good, each \$3.33; best, each	4.50
41.* Hunter's.....		6.00
42.* Taylor's.....	good \$3.33; best	4.00
43.* Miller's.....	3 sizes, each, " 3.33; "	4.50
44.* J. D. Fitch's.....		4.00
45.* Hale's.....		4.00
46.* Jackson's.....	\$4.00; long	5.00
47.* Jones'.....		4.00
48.* Wackerhagen's.....		10.00
49.* Byrne's.....		11.00
50.* Leonard's.....		6.00
51.* Churchill's.....		6.00
52.* Neugebauer's-Barnes'.....		2.50

All Instruments illustrated are designated by a \*

XIV. GYNAECOLOGICAL INSTRUMENTS.  
VAGINAL SPECULA.

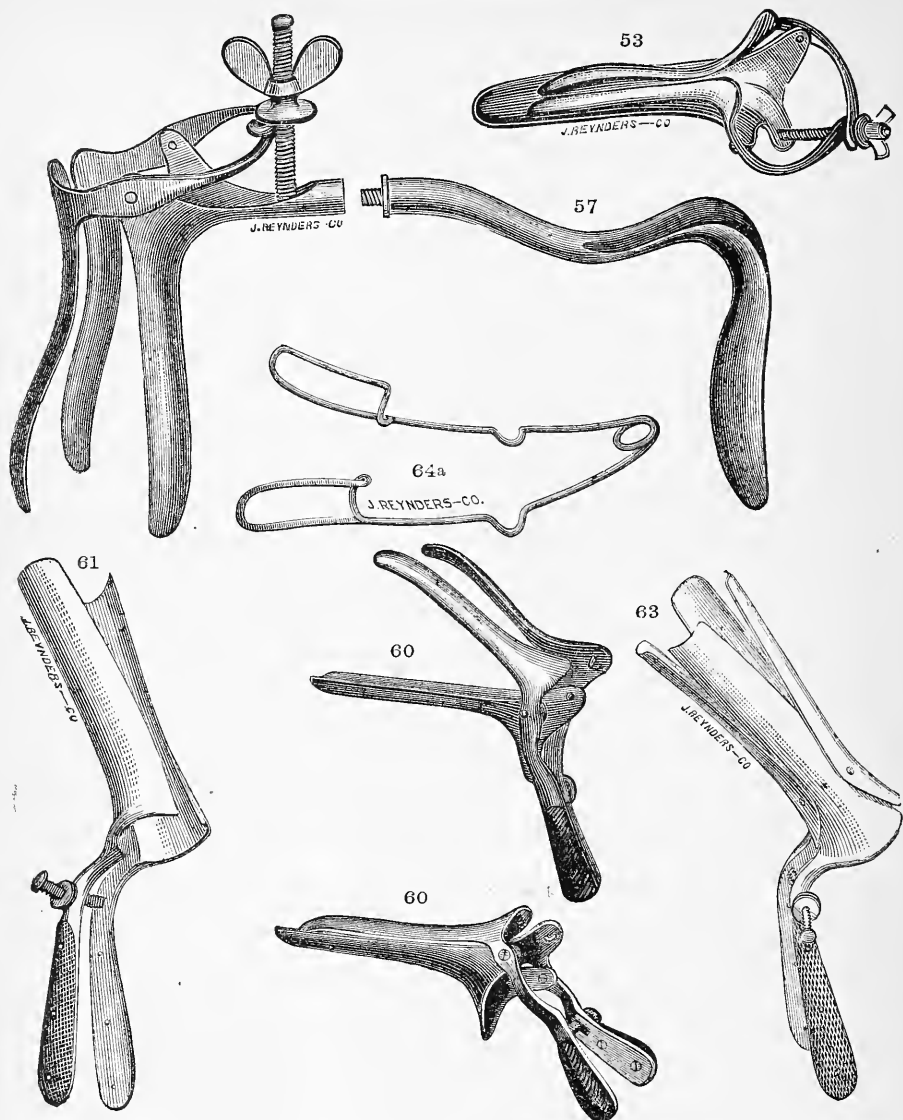

53.* Nott's, three sizes	..... each, good \$3.33; best	\$4.00
55. " with tenaculum each in addition	.....	0.50
56. " with Sim's, Munde's pattern	.....	5.00
57.* " " " Gillette's	.....	5.00
58. " " " Winston's	.....	6.00
On the latter the two upper blades of Nott's are readily detachable, when only the Sims' is to be used. In all other respects it is like Gillette's.		
59. Nott's, with Sims' Jenk's, similar to Gillette's, but an additional third blade between the two upper ones of Nott's	.....	8.00
60.** Nelson's, with tenaculum, 2 sizes	..... each, good \$4.00; best @	4.50
61.* French, two bladed, open ends	.....	4.00
62. " " " closed ends	.....	4.00
63.* " four " open ends	.....	6.00
64. " " " closed ends	.....	6.00
64a.* Wire Labia Speculum	.....	2.00

All Instruments illustrated are designated by a \*

**XIV. GYNAECOLOGICAL INSTRUMENTS.  
FOR ILLUMINATION.**

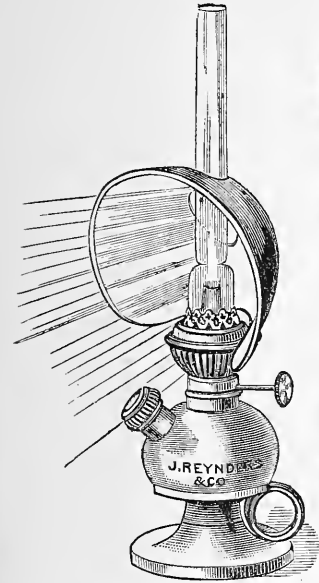

65. New Illuminating Lamp for Throat, Vagina, Rectum, etc., made of metal, nickelplated.

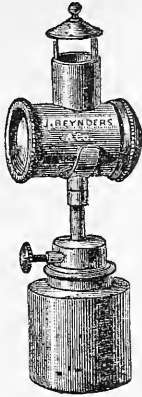

66. Collin's Lamp \$7.00; in case \$9.00

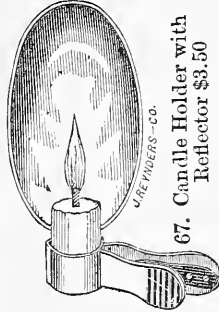

67. Candle Holder with Reflector \$3.50

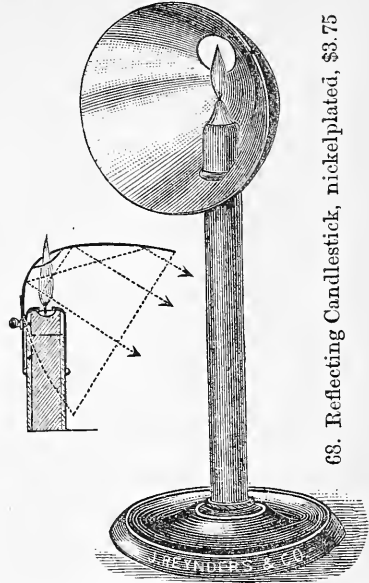

68. Reflecting Candlestick, nickelplated, \$3.75

A parabolic metallic reflector, highly polished, is secured to a spring candlestick in such manner as to collect the greater part of the light and throw it upon the parts to be examined. This light is nearly sixteen times as great as that of a naked candle placed at the same distance. The candlestick can be taken apart, and then occupies little space.

It is cheap in first cost and in use. An adamantine candle—six to the pound—fits it and burns nine hours, at a cost of less than 2½ cts.

**VAGINAL DEPRESSORS.**

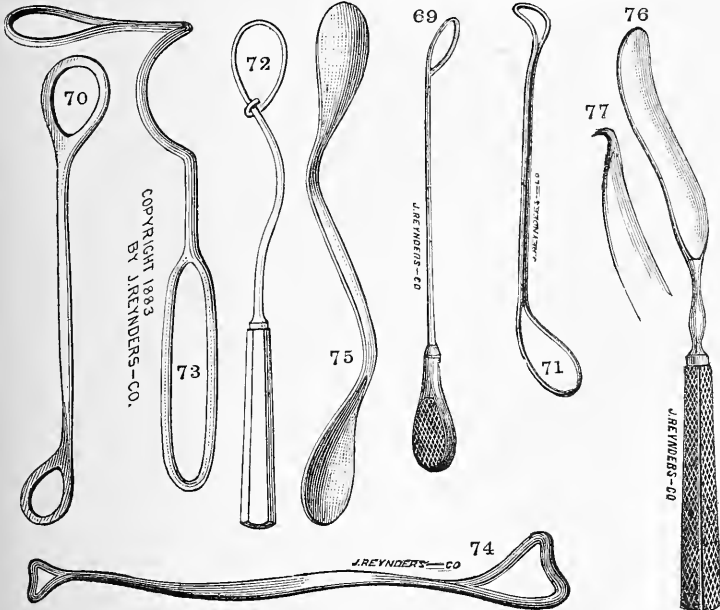

69	Sim's, single	\$1.33
70	" double flat	1.33
71	" round	1.33
72	Emmet's	1.33
73	Garrigue's	2.50
74	Nott's, double	1.33
75	Dawson-Hunter's	2.00
76	Bozeman's, plain	2.50
77	" with hook	2.50

All Instruments illustrated are designated by a \*

XIV. GYNAECOLOGICAL INSTRUMENTS.

FOR DIAGNOSIS.

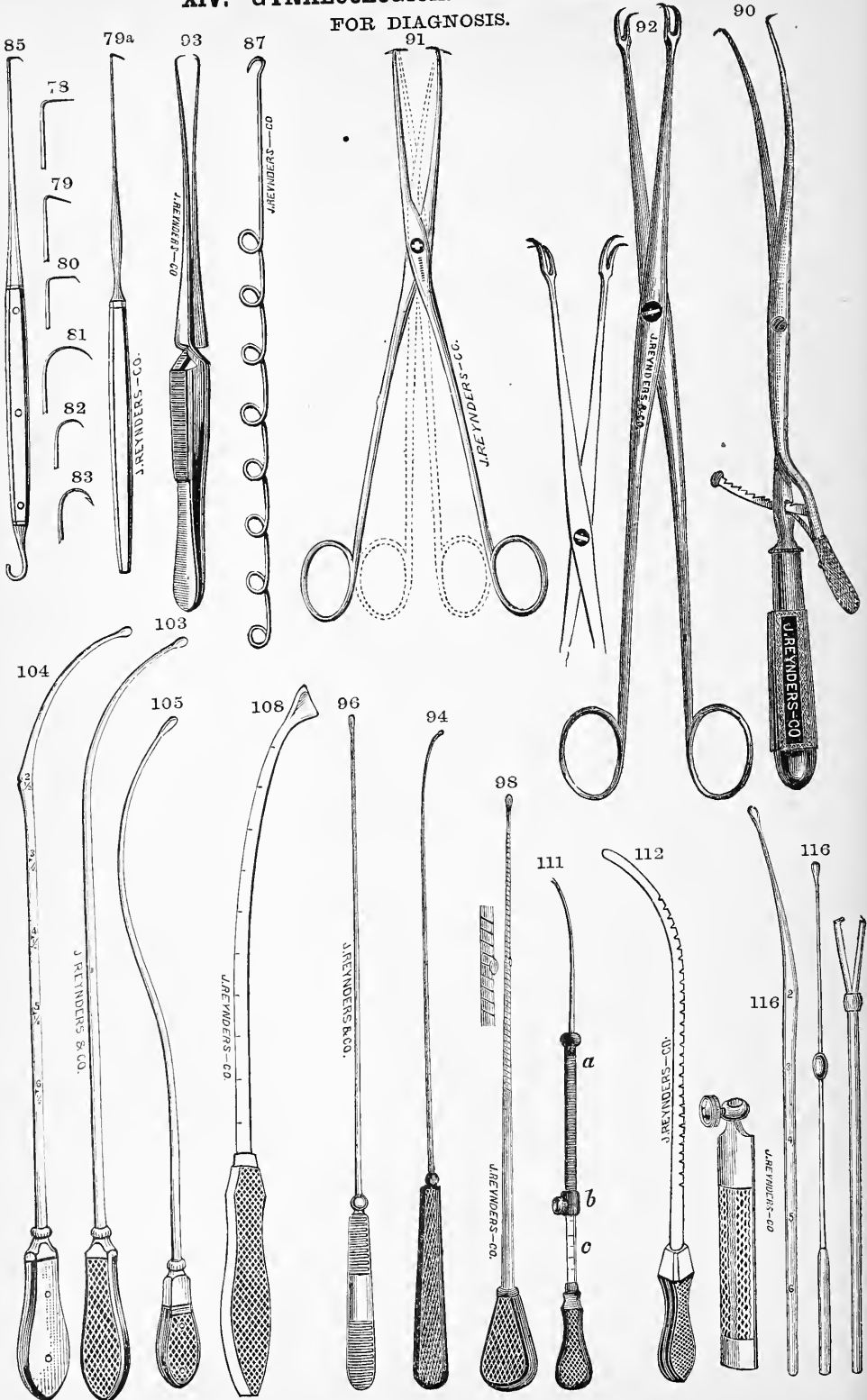



**XIV. GYNAECOLOGICAL INSTRUMENTS.**

**FOR DIAGNOSIS.**

78.*	Tenaculum, Sims',	metal handle	\$1.25;
79.*	" Emmet's,	"	1.25;
80.*	" "	"	1.25;
81.*	" "	"	1.25;
82.*	" "	"	1.25;
83.*	" Perry's,	"	1.50;
85.*	Tenaculum, Emmet's, new, steel shank running through handle and blunt hook at other end		2.50
86.	" The same without blunt hook		2.00
87.*	" Nott's		0.30
88.	" Nelson's		0.75
89.	" Miller's		0.50
90.*	" Double, Emmet's		5.00
91.*	" " Forceps, Hanks' single pronged		3.00
92.*	" " " double		3.00
93.*	" " " Nott's		3.00
94.*	Probe, Pure Silver or Aluminium, h. r. handle, light		1.25
95.	" " " heavy		1.75
96.*	" " in metal handle light, made of different degrees of pliability,	each	1.25
97.	" " metal handle, heavy		1.75
98.*	" Jenk's Spiral		1.75
99.*	" Thomas', all h. r.		0.75
100.*	" Dawson's, flat h. r.		1.00
101.*	" whalebone, h. r. handle, ball end		1.25
102.*	" " " "		1.25
103.*	Sound, Sims',	plain or graduated	1.25
104.*	" Simpson's,	" " "	1.25
105.*	" Wylie's, silver		2.50
106.*	" Simpson's, folding		2.50
107.	" Protheroe-Smith's, folding		2.50
108.*	" Cutter's		2.00
109.*	" Jenk's, measuring		2.50
110.*	" J. R. & Co's		3.00
111.*	" Fitch's		2.00
112.*	" Peaslee's		1.75
113.*	" Bozeman's measuring, set of six, Nos. 12, 14, 16, 18, 20 and 22, French Scale	each	1.25
114.*	" Handle for same		1.75
115.	" Jennison's, exploring (see fig. 172, page 163)		*3.00
116.*	" with Probe and Sponge Holder, to one handle. Buttlet's set		3.50

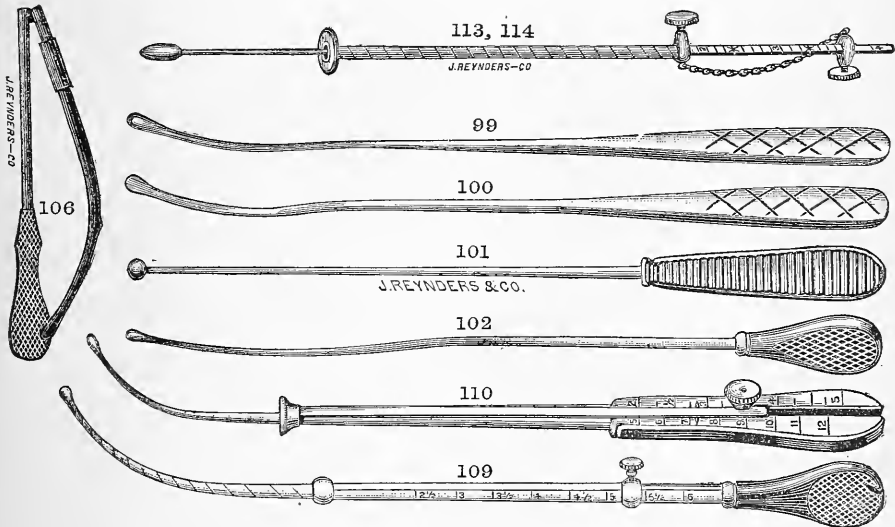

All Instruments illustrated are designated by a \*

XIV. GYNAECOLOGICAL INSTRUMENTS.

FOR URETHRA AND BLADDER.

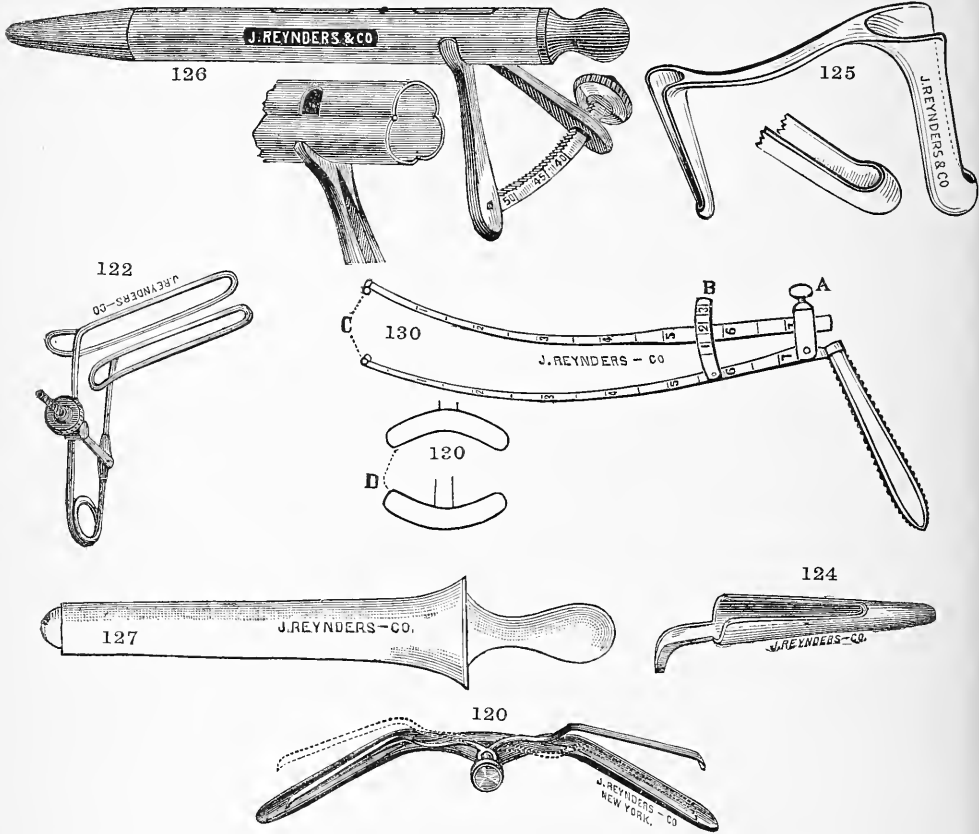

- 117. Female Catheter,..... plated \$0.50; silver \$1.00; h. r. \$0.75; soft metal \$0.50
  - 118. " " new telescopic (see fig. 68, page 40).
  - 118a. " " see also Nos. 453 to 461, page 183.
  - 119. " " Double Current, see Nos. 280, 281, 282, page 171.
  - 120.\* " Urethral Speculum, Skene's on Sims' plan..... 3.00
  - 121. " " " " " with Mirror ..... 2.75
  - (An adaptation from Skene's Rectal Specula—see amongst Rectal Specula).
  - 122.\* Female Urethral Speculum, Skene's on Folsom's plan ..... 1.50
  - 123. " " " J. R. & Co's, two bladed..... 2.00
  - 124.\* " " " Woodward's..... 3.00
  - 125.\* " " " " combined with Rectum Speculum..... 10.00
  - 126.\* Fem. Urethr. Spec., combined with Dilator, Stein's..... 6.50
  - 127.\* " " " " " Simon's set of 7, h. r..... 7.00
  - 128. " " " " " Weiss (same principle as fig. 24, p. 198) 16.00
  - 129. Female Urethral Dilator, see "Powell's" amongst Male Urethral Dilators.
  - 129a. Instrument for Applications to Urethra, see No. 290, page 170.
- 
- 130.\* Vaginometer, Cutter's..... 6.50

All Instruments illustrated are designated by a \*

**XIV. GYNAECOLOGICAL INSTRUMENTS.  
FOR DILATATION.**

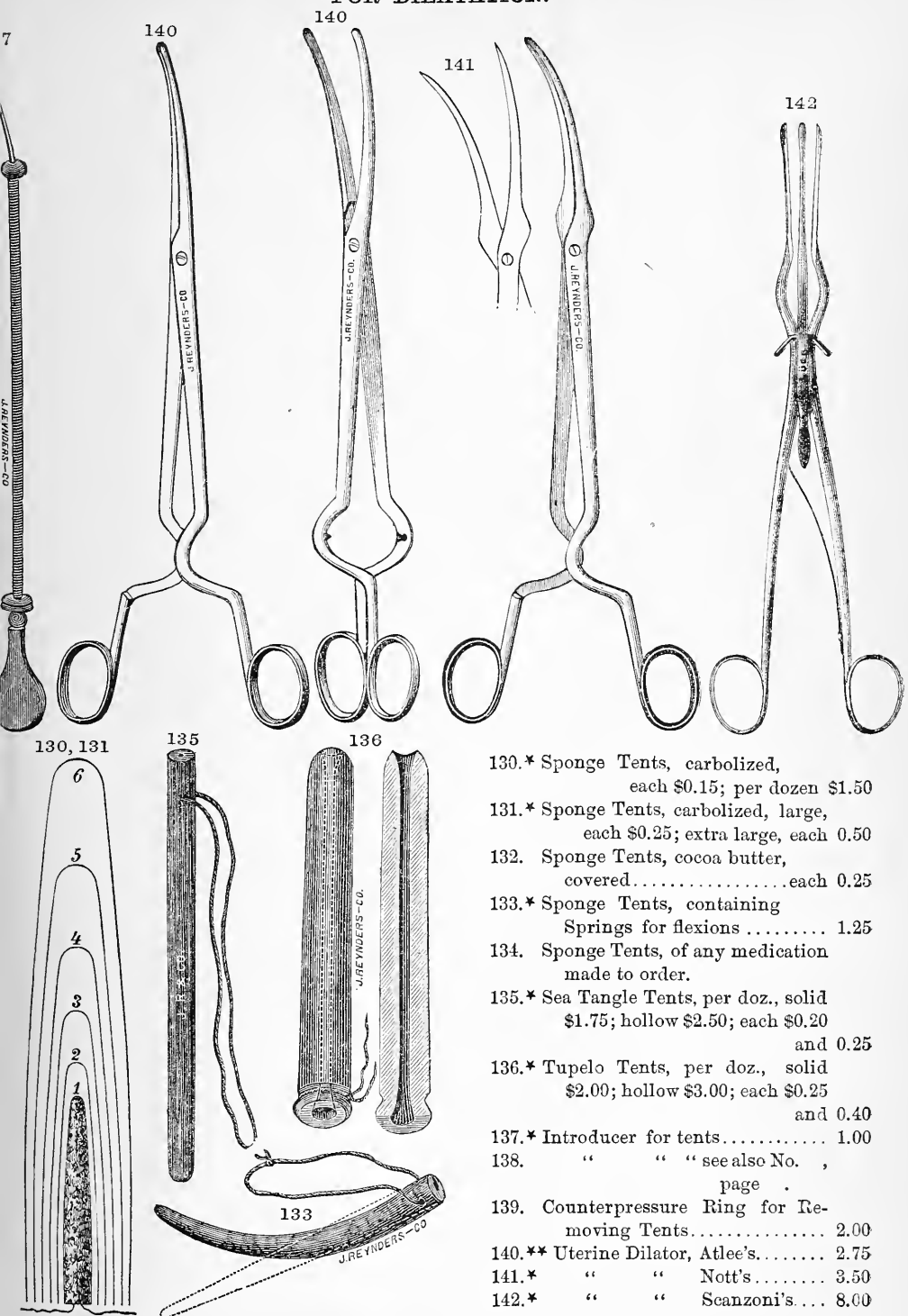

- 130.\* Sponge Tents, carbolized,  
each \$0.15; per dozen \$1.50
- 131.\* Sponge Tents, carbolized, large,  
each \$0.25; extra large, each 0.50
- 132. Sponge Tents, cocoa butter,  
covered.....each 0.25
- 133.\* Sponge Tents, containing  
Spirits for flexions ..... 1.25
- 134. Sponge Tents, of any medication  
made to order.
- 135.\* Sea Tangle Tents, per doz., solid  
\$1.75; hollow \$2.50; each \$0.20  
and 0.25
- 136.\* Tupelo Tents, per doz., solid  
\$2.00; hollow \$3.00; each \$0.25  
and 0.40
- 137.\* Introducer for tents..... 1.00
- 138. " " " see also No. ,  
page .
- 139. Counterpressure Ring for Re-  
moving Tents..... 2.00
- 140.\*\* Uterine Dilator, Atlee's..... 2.75
- 141.\* " " Nott's..... 3.50
- 142.\* " " Scanzoni's... 8.00

All Instruments illustrated are designated by a \*

XIV. GYNAECOLOGICAL INSTRUMENTS.  
FOR DILATATION.

155



147

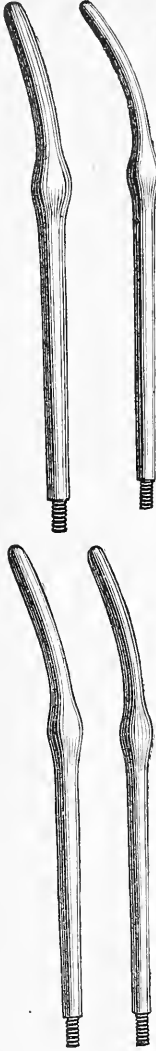

143

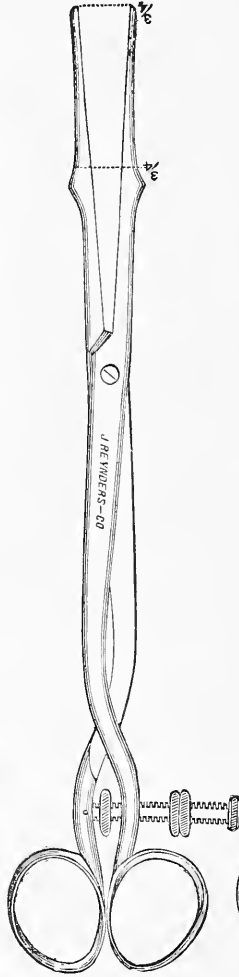

144

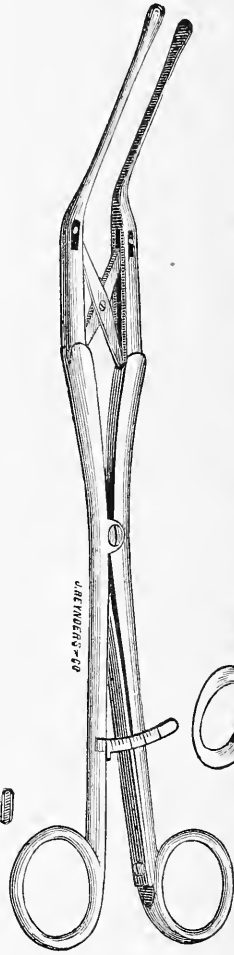

145

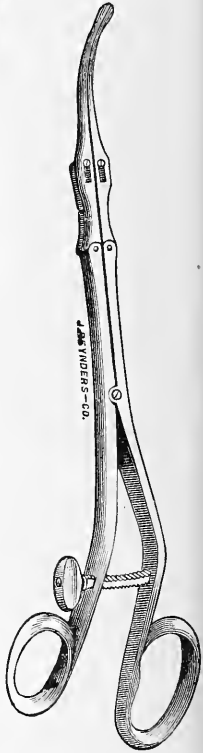

158

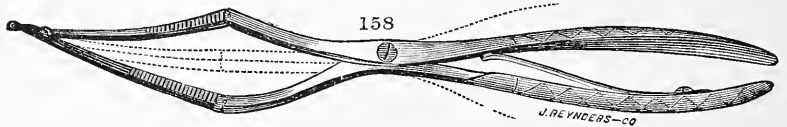

149

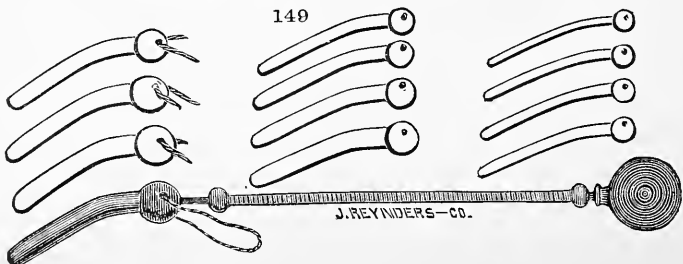

**XIV. GYNAECOLOGICAL INSTRUMENTS.  
FOR DILATATION.**

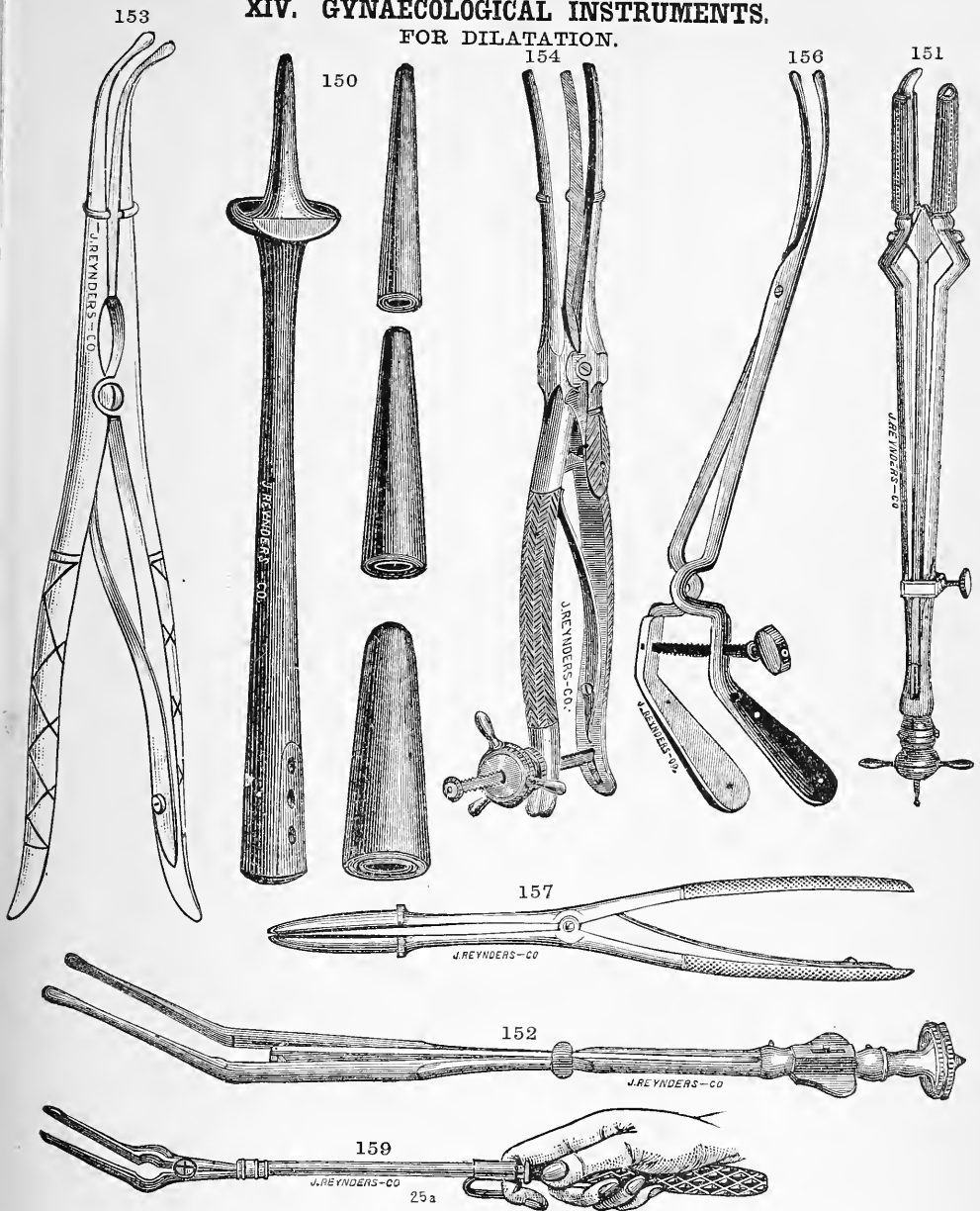

143.*	Uterine Dilator, Palmer's.....	\$5.00
144.*	" " Ellinger's.....	9.00
145.*	" " Baer's modification.....	9.00
146.	" " Peaslee's, steel, set of 3.....	4.50
147.*	" " " " 5.....	6.50
148.*	* " " Hank's, 18 sizes in case... (See next page.).....	7.50
149.*	" " Simpson's, 12 sizes in case.....	9.00
150.*	" " Lawson-Tait's.....	2.50
151.*	" " Hunter's.....	12.00
152.*	" " Miller's.....	10.00
153.*	" " Wylie's.....	5.00
154.*	" " Sims'.....	12.00
155.*	" " J. R. & Co's.....	7.00
156.*	" " Wilson's, 3 sizes.....	5.00
157.*	" " Thomas' (glove stretcher).....	5.00
158.*	" " Vanderveer's.....	5.50
159.*	" " Bishop's.....	8.00
160.	" " Ball's.....	10.00

Polychrome \$4. 0; Standard

25a

XIV. GYNAECOLOGICAL INSTRUMENTS.

FOR DILATATION.

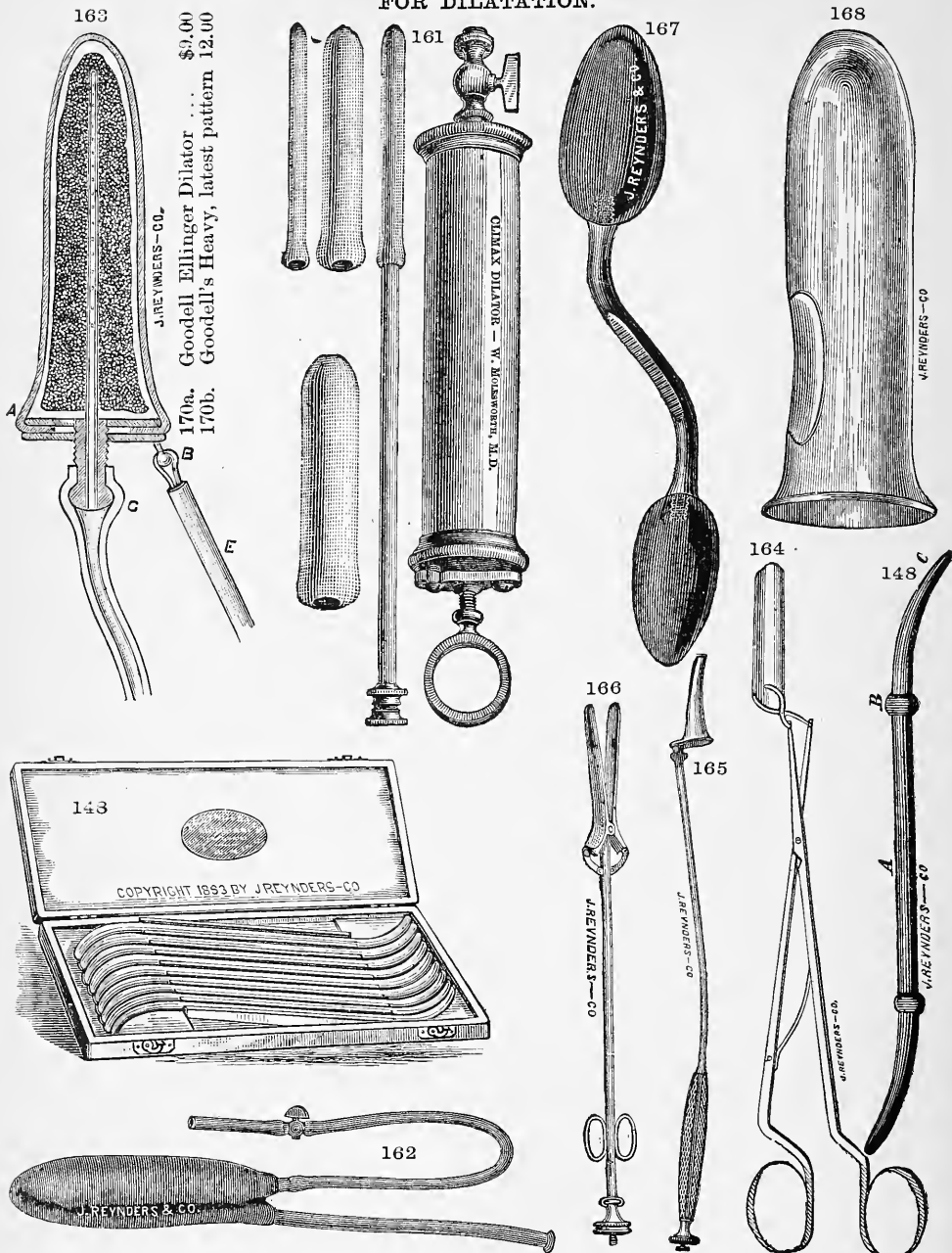

161.★	Uterine Dilator,	Molesworth's (also Vaginal), in case.....	†\$15.00
162.★	"	Emmet's, Water .....	2.00
163.★	"	" " Sponge .....	2.50
164.★	"	and Speculum, Elliot's .....	7.00
165.★	"	" " J. R. & Co's.....	10.00
166.★	"	" " Byford's .....	11.00
167.★	Vaginal	Hank's, h. r., set of 10 .....	5.50
168.★	"	Sims', glass .....	0.50
169.	"	Emmet's, glass, curved .....	0.60
170.	Barnes'	see page 144. (Urethral Dilators see page 158).	

All Instruments illustrated are designated by a ★  
(See also foot of page 189.)

**XIV. GYNAECOLOGICAL INSTRUMENTS.**

**FOR REPLACEMENT OF THE UTERUS.**

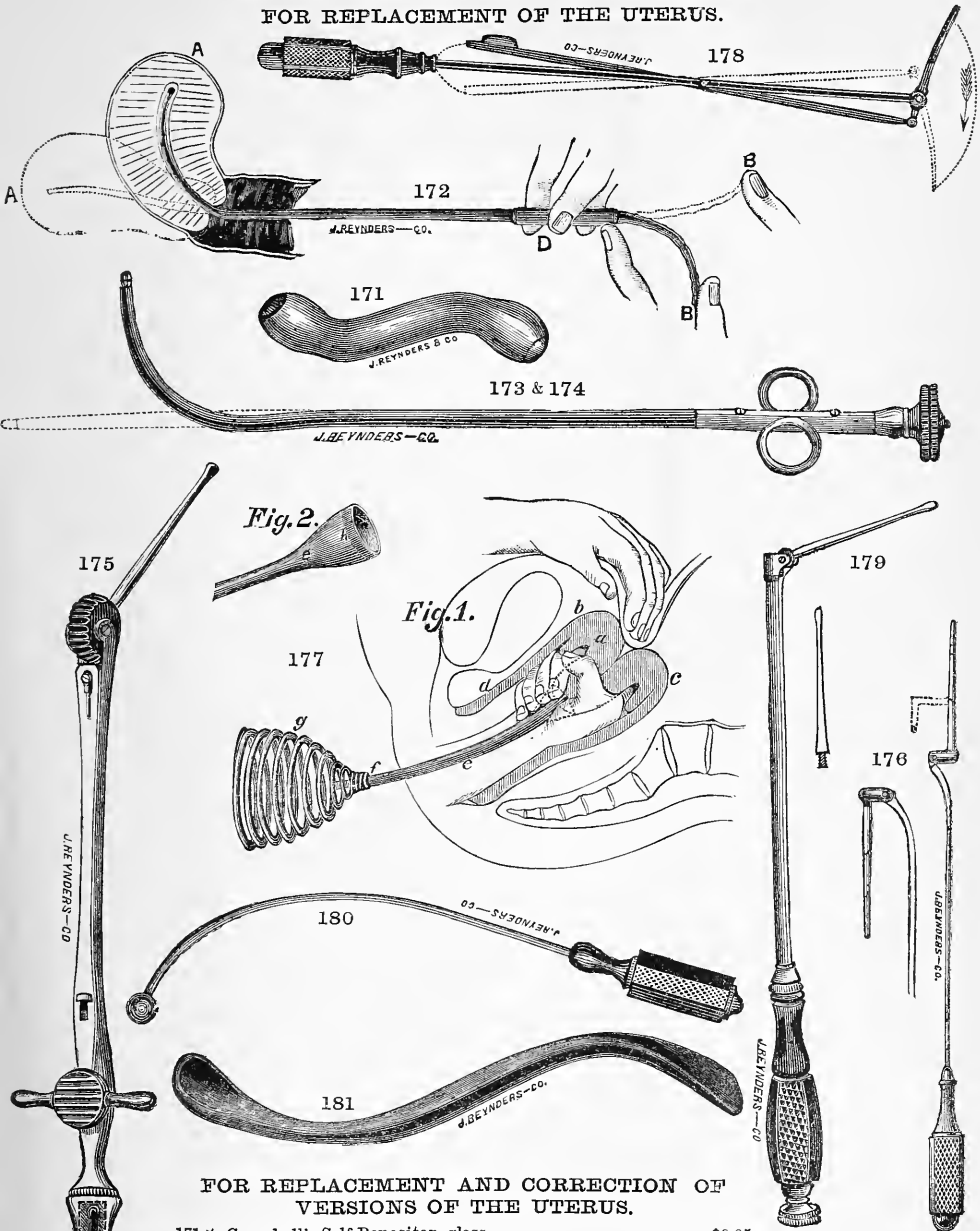

**FOR REPLACEMENT AND CORRECTION OF VERSIONS OF THE UTERUS.**

- 171.\* Campbell's Self-Repositor, glass . . . . . \$0.25
- 172.\* Jennison's Sound . . . . . 3.00\*

It is made in three grades:

- No. 1. Very flexible, for diagnosis only.
- No. 2. For general use; suitable for diagnosis and for replacement in all ordinary cases.
- No. 3. Sufficiently powerful for replacement in difficult cases.

- 173.\* Flexion Straightener, Elliot's, covered with black elastic material. . . . . \$7.00
- 174.\* The same, all metal, spiral n. p. . . . . 8.00
- 175.\* Repositor, Sims', latest. . . . . \$6.00
- 176.\* " Emmet's, latest. . . . . 4.50
- 177.\* " White's. . . . . 5.00
- 178.\* " Skene's. . . . . 8.00
- 179.\* " Gardner's. . . . . 8.00
- 180.\* " Guernsey's. . . . . 1.50
- 181.\* " Whitney's, h. r. . . . . 1.25

Pessaries see pages 189 to 197.

XIV. GYNAECOLOGICAL INSTRUMENTS.  
FOR INCISION OF THE UTERUS.

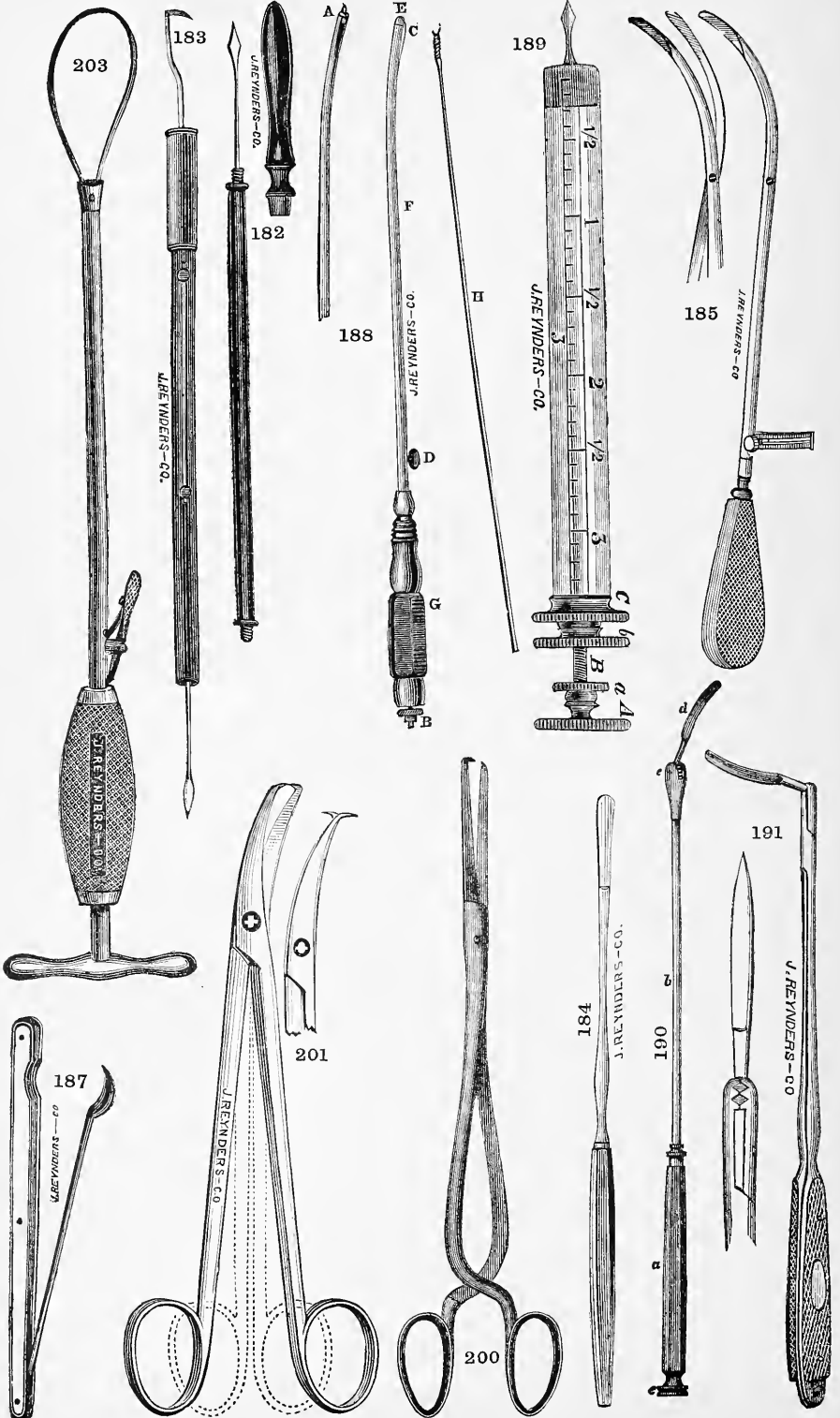



**XIV. GYNAECOLOGICAL INSTRUMENTS.**

FOR INCISION OF THE UTERUS.

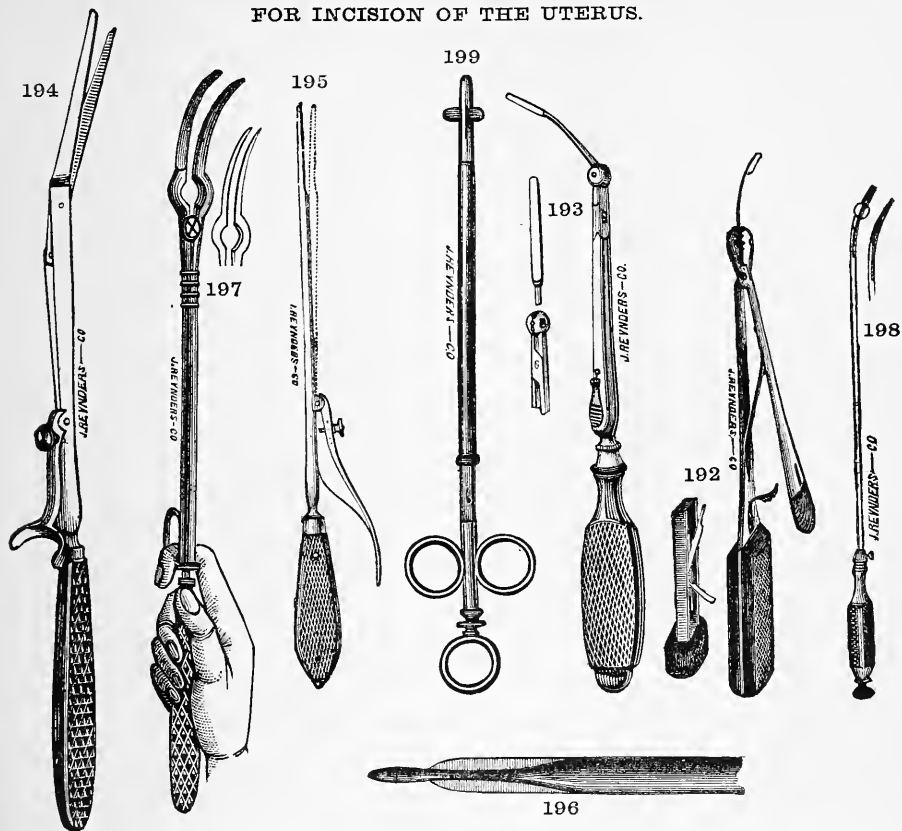

182.* Scarifier Buttlers' .....	\$1.25
183.* " " with hock .....	2.50
184.* " Peaslee's .....	2.00
185.* " Skene's, with Sound .....	5.50
186.* " Chapman's, in stiff handle .....	1.50
187.* " " closing in handle .....	2.50
188.* " Pinkham's .....	\$6.00; in case 8.00
189.* " Reese's, with Exhauster .....	4.50
190.* Knife, Sims' .....	4.00
191.* " Emmet's .....	6.50
192.* " Sims', set .....	10.00
193.* " " modified by .....	8.00
194.* Hysterotome, Atlee's .....	3.50
195.* " Simpson's .....	7.00
196.* " Peaslee's, .....	one blade \$4.50; two blades 6.50
197.* " Bishop's .....	8.00
198.* " White's .....	12.00
199.* " Swedish .....	12.00
200.* Scissors, Kuechenmeister's .....	\$3.00 and 5.00
201.* " Dawson's (see also page 173 and 178) .....	5.00
202. Cupping Pump, Thomas' (see No. 227, page 167).	
203.* Tourniquet, Emmet's .....	6.00*

All Instruments illustrated are designated by a \*

XIV. GYNAECOLOGICAL INSTRUMENTS.  
FOR VAGINAL IRRIGATION.



204.*	Bathing Speculum, h. r., ass. sizes.....	each	\$1.25
205.*	“ “ metal nickel plated.....		3.00
206.*	Vaginal Irrigator, with recurrent tube, h. r.....		3.50
207.*	“ Douche, Scanzoni's, with improved stopcock.....		2.25
208.*	“ “ J. R. & Co's.....	1 gall. \$2.75; 2 gall. \$3.25; 3 gall.	3.75
209.*	“ “ “ with thermometer.....		
210.*	“ “ Merriam's.....		6.00
211.	“ “ Woodward's.....		2.50
212.*	“ “ Cleveland's.....		
213.*	“ “ Lord's.....		4.00*
214.	“ “ Scott's.....		4.00*
215.	“ “ “ Douche alone with three feet of tubing and without syringe.....		2.00*
216.	“ “ Foster's.....		2.50*
217.	“ “ “ Counterpressure, rad.....		3.00*

See also "Douches and Syringes."

218.\* Eugenie, or Rubber Periodical Bandage with sponge ..... 2.50

All Instruments illustrated are designated by a \*

**XIV. GYNAECOLOGICAL INSTRUMENTS.**

FOR MAKING APPLICATIONS.

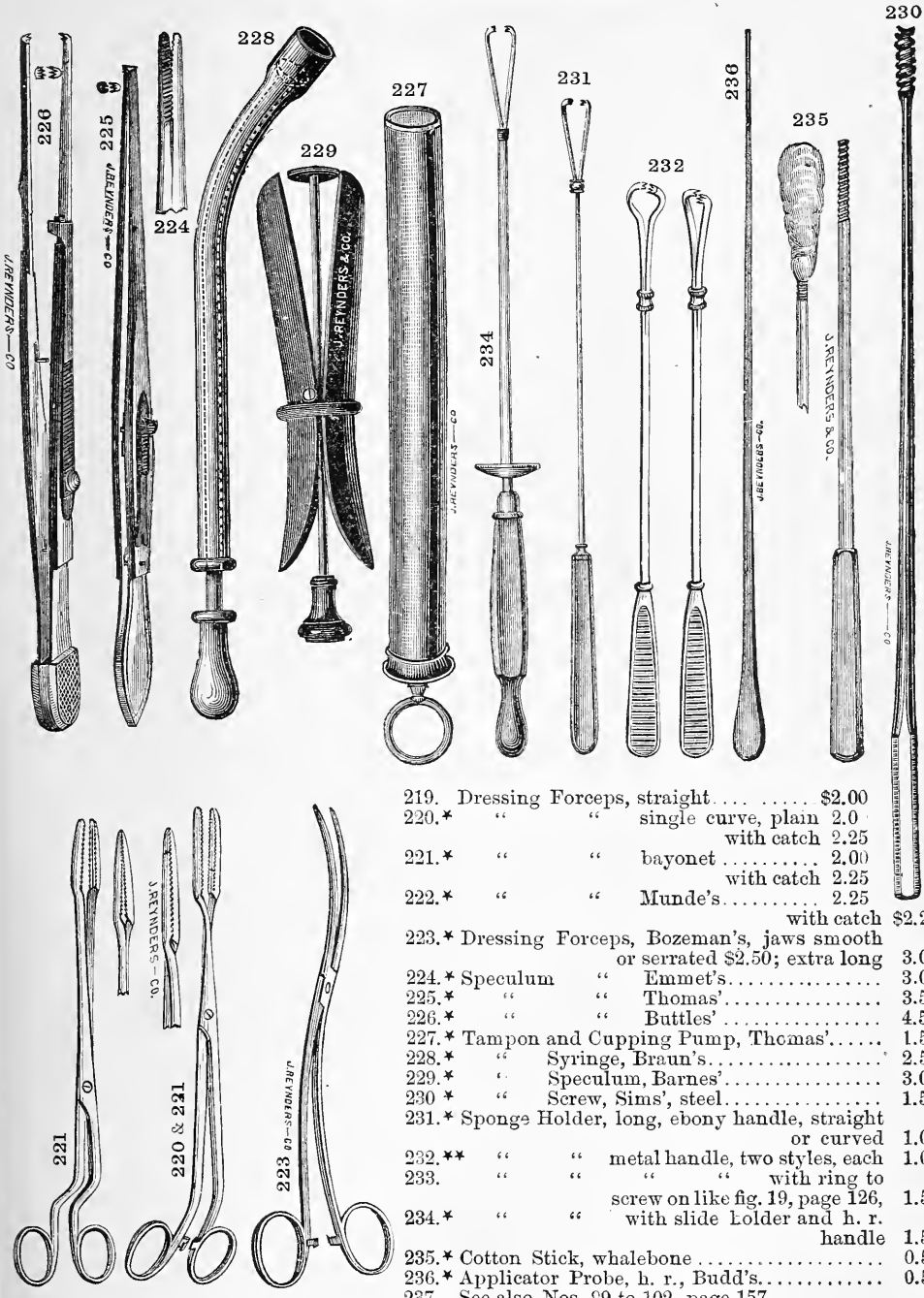

- 219. Dressing Forceps, straight . . . . . \$2.00
- 220.\* " " single curve, plain 2.0  
with catch 2.25
- 221.\* " " bayonet . . . . . 2.00
- 222.\* " " Munde's . . . . . 2.25
- 223.\* Dressing Forceps, Bozeman's, jaws smooth  
or serrated \$2.50; extra long with catch \$2.25 3.00
- 224.\* Speculum " Emmet's . . . . . 3.00
- 225.\* " " Thomas' . . . . . 3.50
- 226.\* " " Buttles' . . . . . 4.50
- 227.\* Tampon and Cupping Pump, Thomas' . . . . . 1.50
- 228.\* " Syringe, Braun's . . . . . 2.50
- 229.\* " Speculum, Barnes' . . . . . 3.00
- 230.\* " Screw, Sims', steel . . . . . 1.50
- 231.\* Sponge Holder, long, ebony handle, straight  
or curved 1.00
- 232.\*\* " " metal handle, two styles, each 1.00
- 233. " " with ring to screw on like fig. 19, page 126, 1.50
- 234.\* " " with slide holder and h. r. handle 1.50
- 235.\* Cotton Stick, whalebone . . . . . 0.50
- 236.\* Applicator Probe, h. r., Budd's . . . . . 0.50
- 237. See also Nos. 99 to 102, page 157.

All Instruments illustrated are designated by a \*

XIV. GYNAECOLOGICAL INSTRUMENTS.  
FOR MAKING APPLICATIONS.

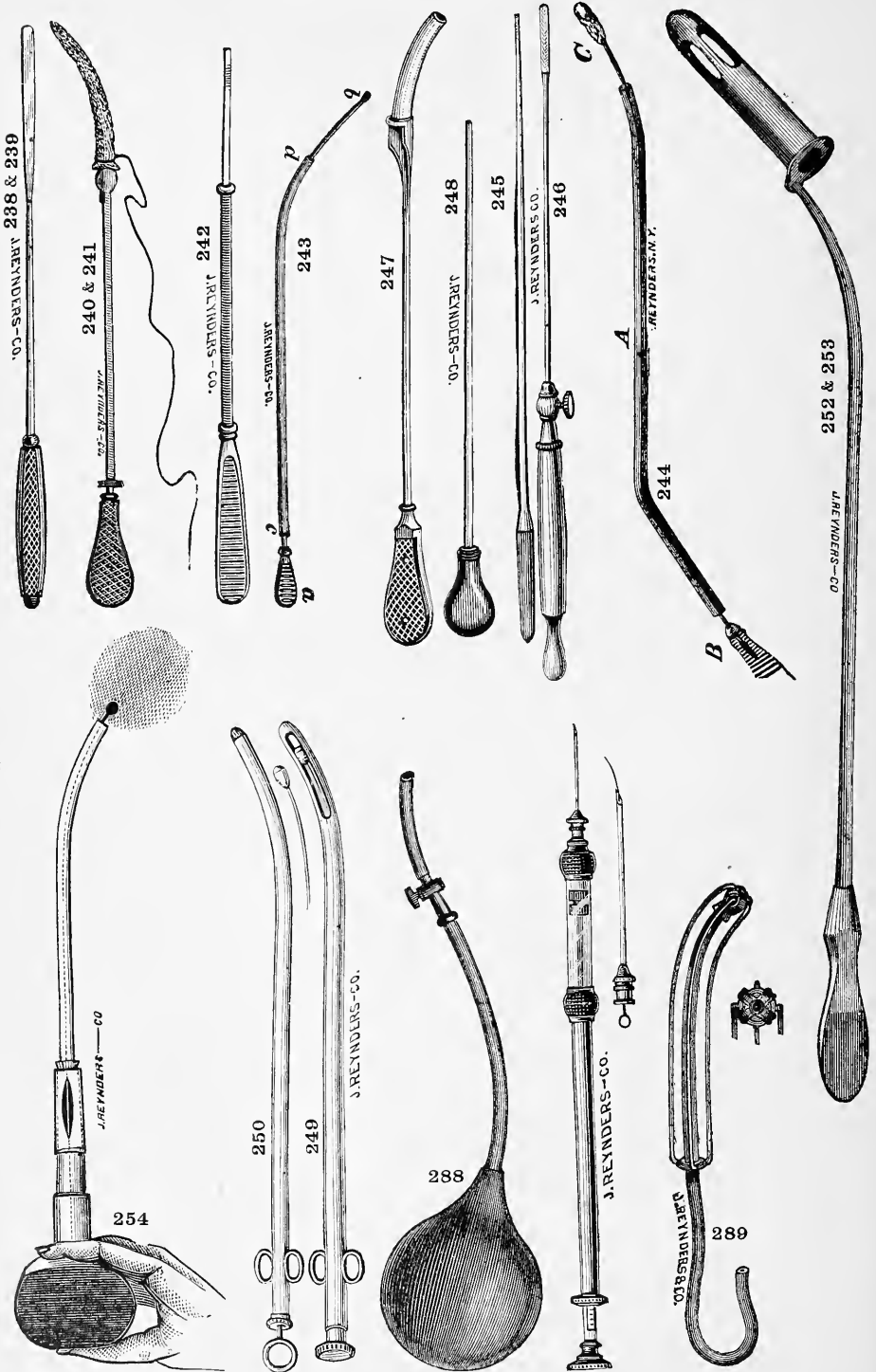

**XIV. GYNAECOLOGICAL INSTRUMENTS.**

FOR MAKING APPLICATIONS.

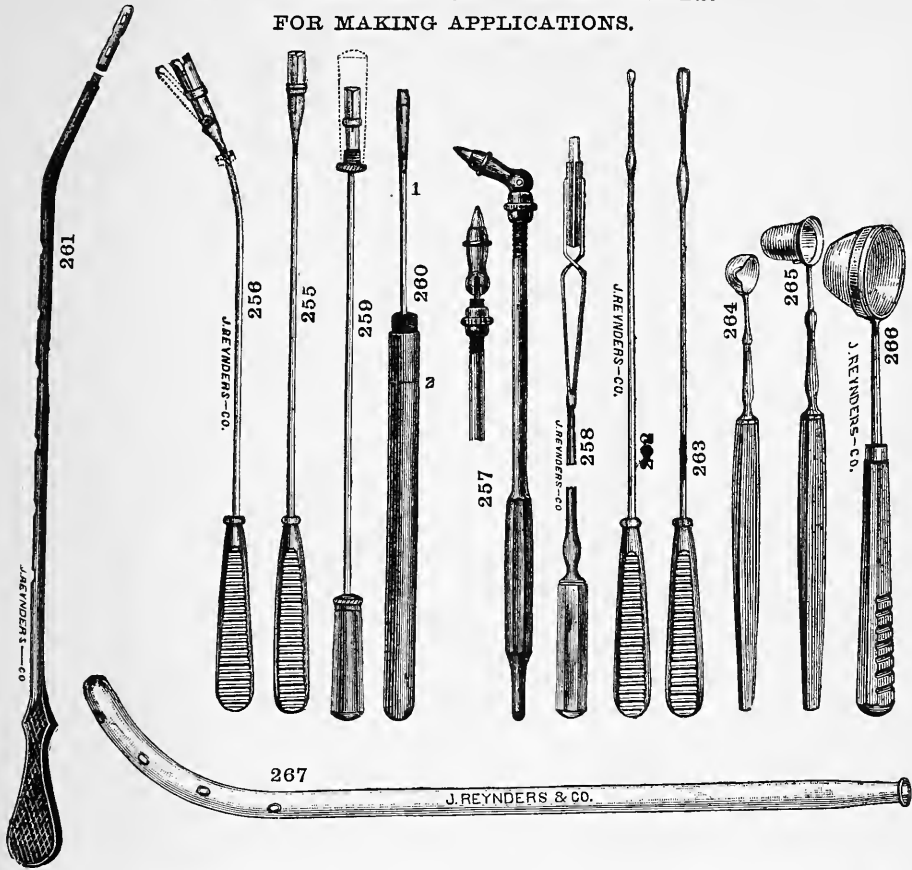

238.*	Applicator, flat, pure silver,	h. r. handle,	light	\$1.25;	heavy	\$1.75
239.	"	" metal "	"	1.25;	"	1.75
240.*	The above, with spiral slide,	plated, light				1.25
241.*	"	" silver, light				1.75
242.*	"	" Dawson's				2.00
243.*	Applicator, whalebone and h. r.,	Turner's				1.75
244.*	"	Woodbury's, glass				0.50
245.*	Long Steel Cotton Holder,	malleable				0.75
246.*	Aluminium Probe in set screw	handle				1.50
247.*	Speculum, Wylie's, for application,	two sizes			@	2.50
248.*	Probe, Wylie's, used with above					2.00
249.*	Tube, Barnes', side holes, for	ointments,	plated	\$2.00;	silver	3.00
250.*	"	front holes, for depositing solid	sticks,	"	2.00;	" 3.00
251.	Sulphate of Zinc, sticks for latter,				per dozen	1.00
252.*	Tubes, Peaslee's, for intra uterine	medication, plated or h. r.			each	1.25
253.*	"	Holder for same				1.50
254.*	Powder Insufflator, Clay's					2.00
255.*	Porte Caustic, long, silver, ebony	handle				1.50
256.*	"	Leiter's				2.00
257.*	"	" universal joint,	all h. r.	\$1.25;	silver holder	2.50
258.*	"	Edward's				3.00
259.*	"	Green's				2.50
260.*	"	Byford's,	silver	\$1.50;	platinum	3.00
261.*	"	Chiari's				6.00
262.*	"	Lente's, Probe, 2 bulbs, light				1.75
263.*	"	" " " heavy				2.50
264.*	"	" Crucible, platinum shallow				2.75
265.*	"	" " " deep				3.50
266.*	"	China, " with Holder				1.50
267.*	Chamberlain's, Intra Uterine Tube	for Irrigation, glass				1.00

All Instruments illustrated are designated by a \*

XIV. GYNAECOLOGICAL INSTRUMENTS.  
FOR MAKING APPLICATIONS.

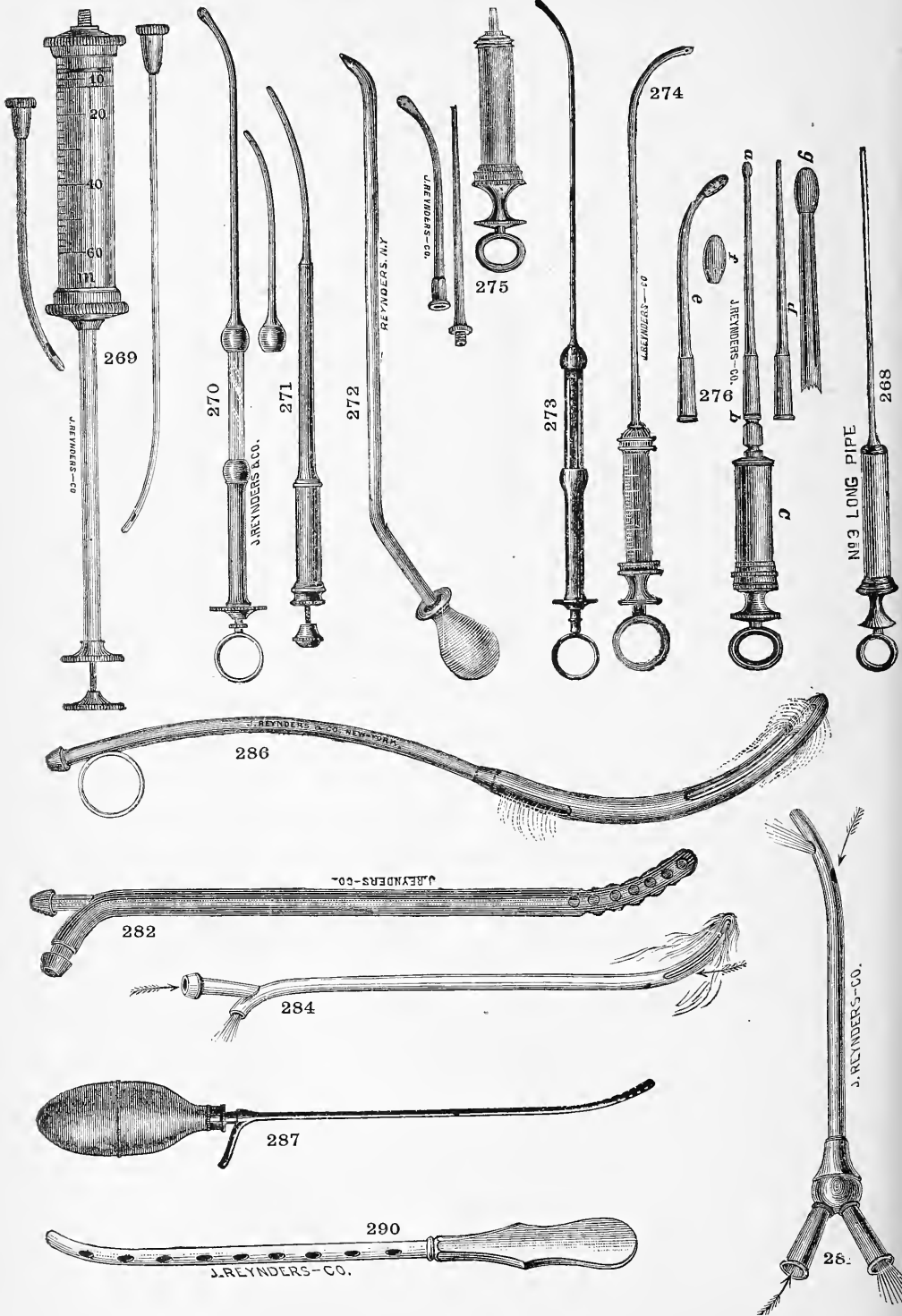

**XIV. GYNAECOLOGICAL INSTRUMENTS.**

**FOR MAKING APPLICATIONS.—CURETTES.**

268.*	Syringe, h. r.,.....	½ oz. \$1.0 ; 1½ oz.	\$2.00
269.*	“ Lente’s .....	\$6.50; in case	8.00
270.*	“ Cushier’s .....		3.50
271.*	“ Buttles’, Drop .....		3.00
272.*	“ Woodbury’s, glass .....		0.50
273.*	“ Braun’s .....		2.50
274.*	“ Taylor-Bumstead’s .....		2.50
275.*	“ Nott’s, h. r. ....		2.50
276.*	“ Pierce’s, h. r. ....		5.00

(*g* shows the tube *a* enlarged, towards its end it has four longitudinal grooves, facilitating the return-flow of injected liquids. *f* is a larger bulb than on *g*, which can be substituted. The tube *d* throws a small jet forward and *e* is for the posterior nares).

277.*	“ Uterine Hypodermic, for injecting and aspirating the body of the uterus with two needles in case (see page 168) .....	6.00
278.	“ see also under Heading “Syringes.”	
279.	“ for Impregnation, Sims’ .....	\$12.00
280.	Double Current Catheter, Fem., plated \$2.75; silver .....	4.00
281.*	“ “ “ “ h. r., plain .....	3.50
282.*	“ “ “ “ “ Skene’s .....	2.00
283.	Uterine Backflow Tube, ordin. plated \$2.75; silver .....	4.00
284.*	“ “ “ “ Nott’s, “ 2.75; “ .....	4.00
285.	“ “ “ “ Byrne’s .....	
286.*	“ “ “ “ and Vaginal Escapement Tube, Bozeman’s, plated \$3 00; silver .....	4.50
287.*	“ Backflow Syringe, Molesworth’s .....	6.00
288.*	Colpurynter Braun’s, see page 144 (illustr. see page 168).	
289.*	Metrocyst, Coleman’s (illustr. see page 169) .....	1.25
290.*	Cupped Sound, for application of salve to Female Urethra, ass. sizes .....	2.00

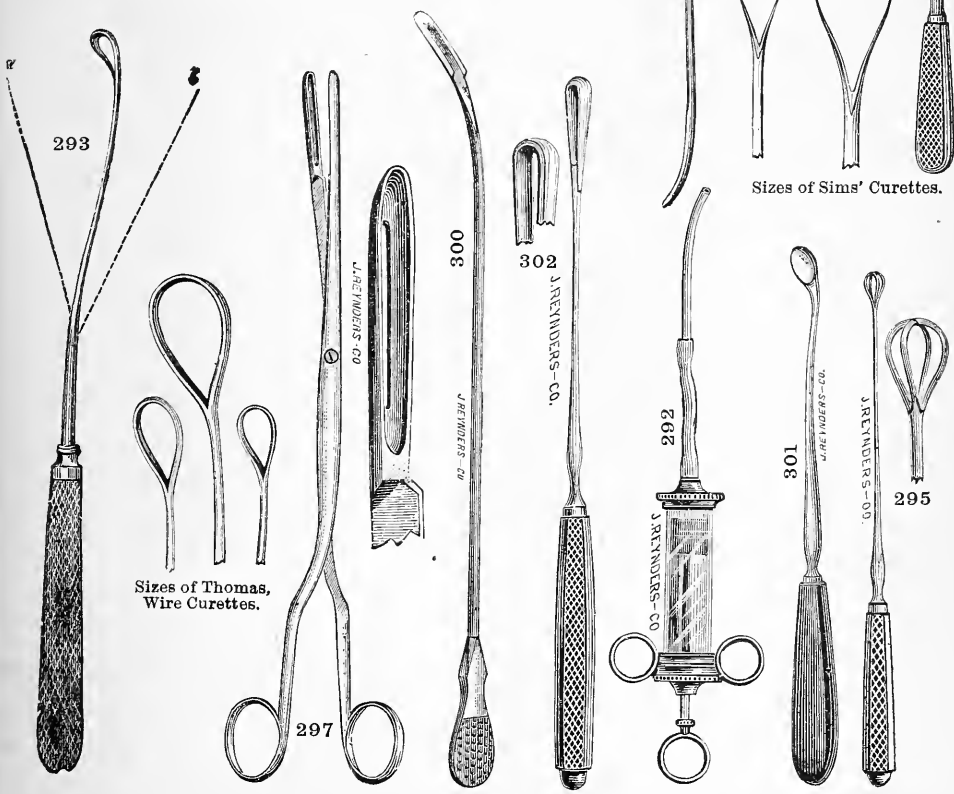

Sizes of Thomas, Wire Currettes.

Sizes of Sims' Currettes.

XIV. GYNAECOLOGICAL INSTRUMENTS.

FOR THE REMOVAL OF ABNORMAL GROWTHS, TISSUES, ETC.

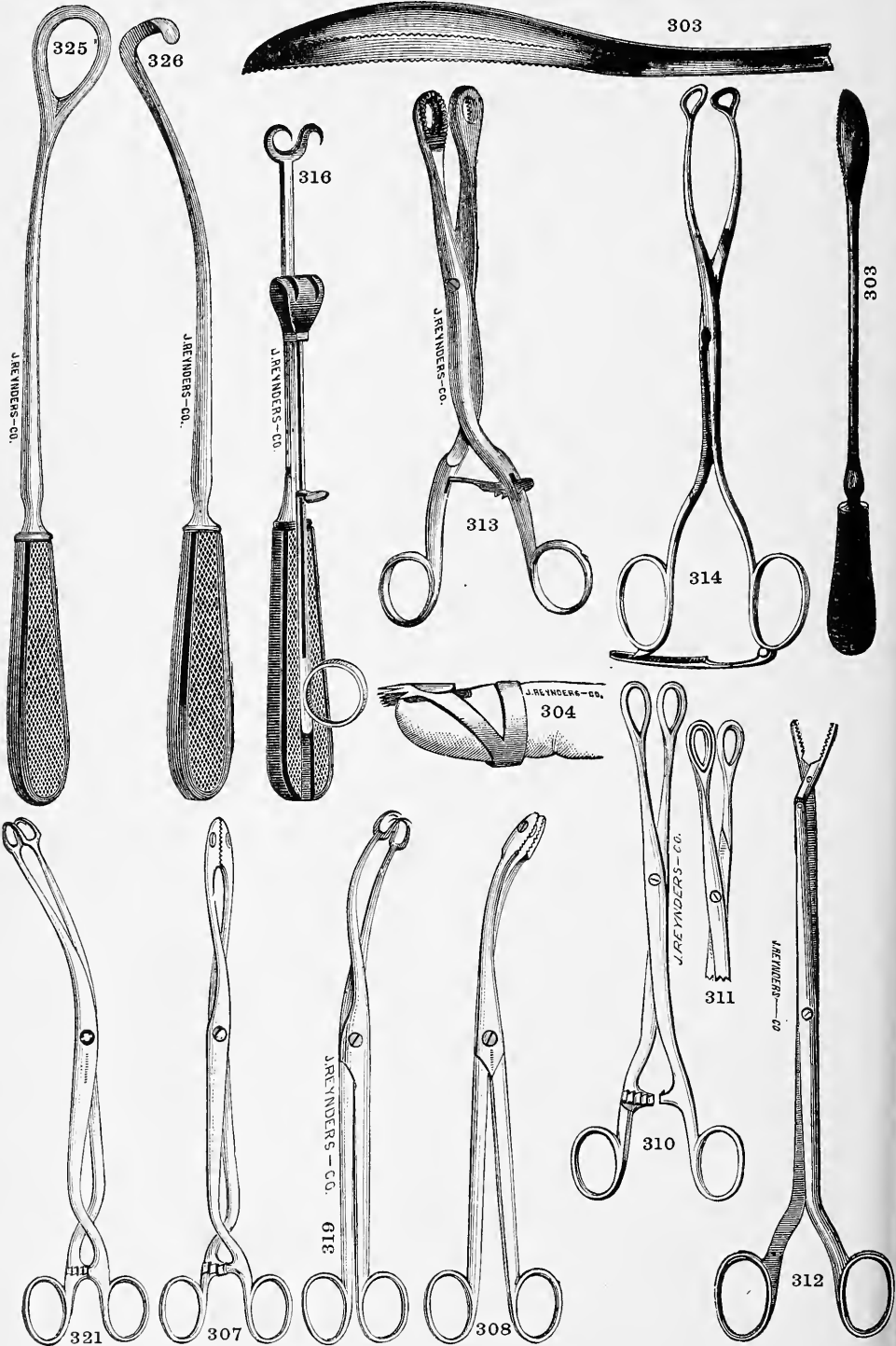



**XIV. GYNAECOLOGICAL INSTRUMENTS.**

**FOR THE REMOVAL OF ABNORMAL GROWTHS, TISSUES, ETC.**

(For Illustrations of Nos. 292 to 302 see page 171.)

291.	H. R. Syringe for the removal of Cervical Mucus.....	\$2.00
292.*	Wylie's Syringe for the same purpose.....	4.50
293.*	Curette, blunt, Thomas', (real sizes indicated in cut).....	three sizes @ 1.33
294.*	" " " Récamières.....	2.00
295.*	" " " Duke's (real size shown).....	2.00
296.	" " " Hale's.....	2.50
297.*	" Forceps, Emmet's.....	3.50
298.*	" sharp, Sims' (sizes shown), four sizes.....	@ 1.75
299.	" " " four sizes to one handle.....	6.00
300.*	" " " Peaslee's.....	3.00
301.*	" " " Simon's, three sizes.....	@ 2.50
302.*	" " " Hank's size and inward turned edge shown; this instrument is something between a sharp and blunt curette).....	2.00
303.*	* Serrated Scoop, Thomas', three sizes.....	each 3.50
304.*	Enucleator, Emmet's.....	1.50
305.	Tumor Clamp, Thomas', (fig. 222 and 223, page 560, Thomas' book).....	price 12.00
306.	Polypus Forceps, straight.....	8½ or 9 in. \$2.00; 10½ in. 2.50
307.*	" " " " with catch.....	9 in. \$3.00; 10½ in. 3.50
308.*	" " " " curved.....	8½ or 9 in. \$2.25; 10½ in. 2.75
309.	" " " " with catch.....	9 in. \$3.00; 10½ in. 3.50
310.*	" " " " with rounded jaws.....	3.50
311.*	" " " " jaws meeting flat with an inner sharp groove.....	3.50
312.*	" " " " Double joint.....	4.00
313.*	" " " " McClintock's.....	6.00
314.*	" " " " Luer's.....	6.00
314a.	" " " " see also Page 187, Nos. 503 and 504; Page 201, Nos. 63 and 64.	
315.*	Vulsellum Hook in handle.....	single \$1.75; double 2.00
316.*	" " " " Sims'.....	5.50
316a.	" " " " see also Page 201, fig. 67.	
317.	" Forceps, straight.....	7 in. \$2.00; 10 in. 2.75
318.	" " " " with catch, 10 in.....	3.50
319.*	" " " " curved or flat, plain.....	3.00
320.	" " " " with catch.....	3.50
321.*	" " " " " edgewise with catch.....	\$3.00 and 3.50
322.	" " " " with side teeth, see fig. 126, page 120.	
323.*	" " " " Byrnc's.....	3.00
324.*	" " " " Museaux', see fig. 127, page 120.....	3.00
324a.	" " " " see also Page 201, fig. 65.	
325.*	Enucleator, Sims'.....	3.50
326.*	Blunt Hook, Sims'.....	3.50
327.*	Double Canula, Gooch's.....	2.50
328.*	Ligature Carrier, Cloquet's.....	6.00
329.*	Knot Tier, Carroll's, see page 189.....	2.50
330.*	Uterine Scissors, Sims'.....	4.00
331.*	" " " " Tooth edged, Clark's.....	6.00
332.	" " " " lighter and less curved.....	4.50
333.	" " " " see also pages 164 and 178.	
334.*	Polypome, Aveling's.....	8.00
335.*	" " " " Simpson's (see fig. 70, page 143).....	2.50

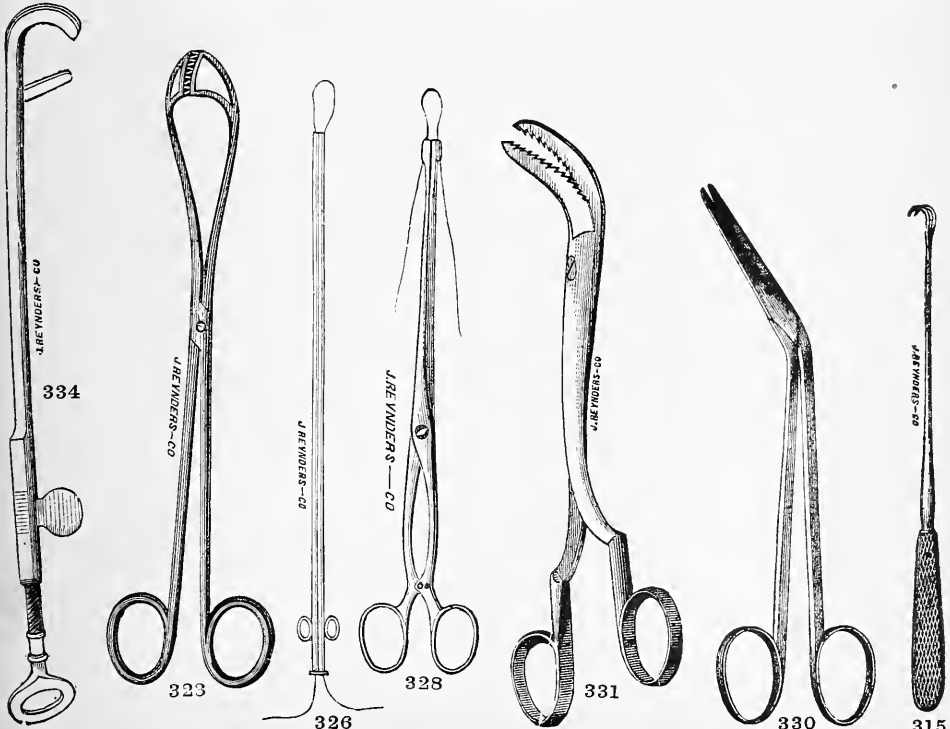

All Instruments illustrated are designated by a \*

XIV. GYNAECOLOGICAL INSTRUMENTS.

FOR THE REMOVAL OF ABNORMAL GROWTHS, TISSUES, ETC.

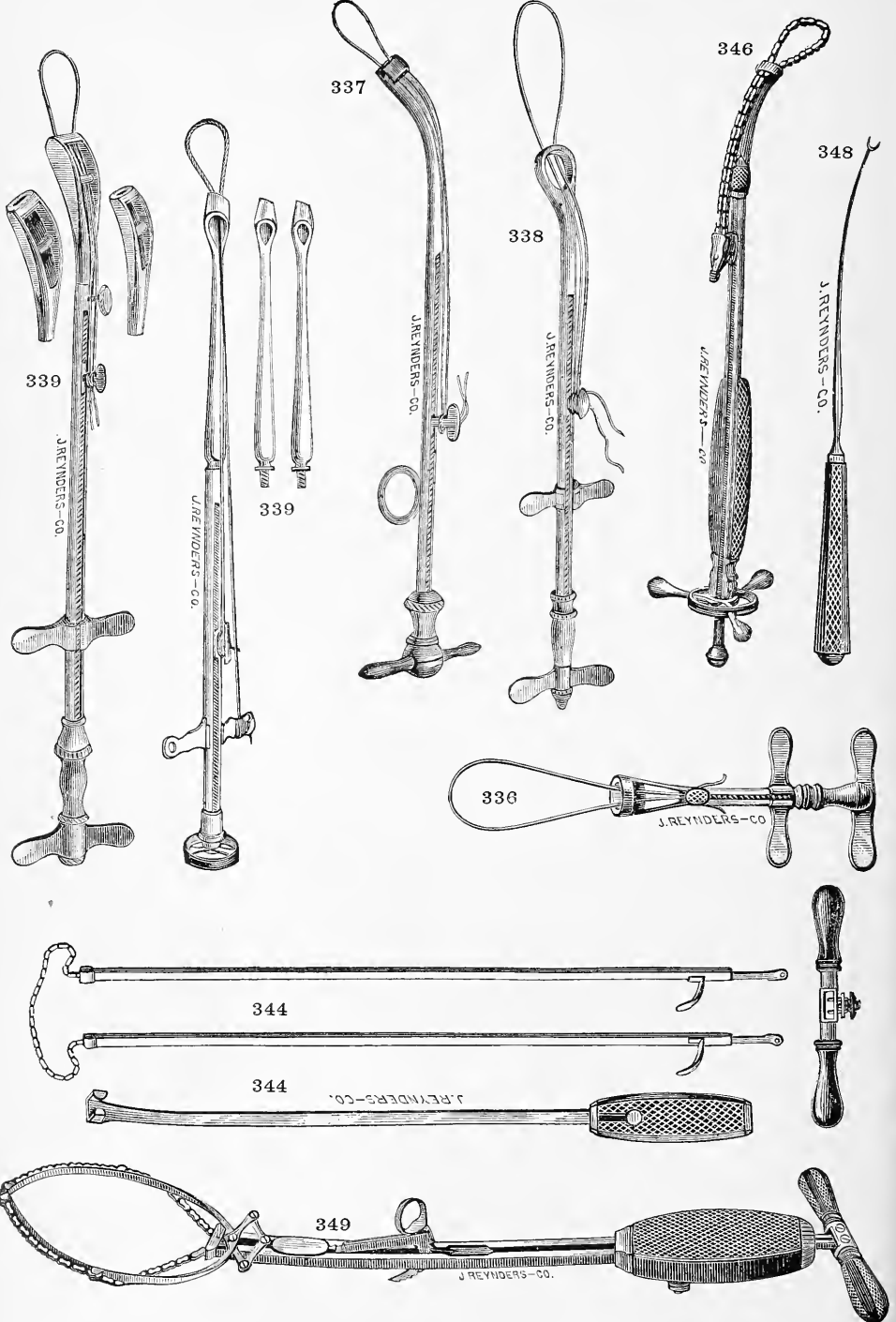

**XIV. GYNAECOLOGICAL INSTRUMENTS.**

FOR THE REMOVAL OF ABNORMAL GROWTHS, TISSUES, ETC.

- 336.\* Ecrasseur, for Wire, Sims'..... \$6.00
  - 337.\* " " Smith's, straight \$5.50; curved 6.00
  - 338\*\* " " Barnes'..... 5.50
  - 339.\* " " Braxton Hick's, two styles,  
each 15.00
  - 340. " " per foot..... 0.15
  - 341. " With Chain, Chassaing's, small curved 16.00
  - 342. " " " " large, straight 25.00
  - 343.\* " " " " " curved 25.00
  - 344.\* " " Emmet's, the inner bars to  
which the chain is attached can be readily  
taken out of the canula and used for placing  
it around the growth. Its exterior appear-  
ance is like No. 343..... 35.00
  - 345.\* Ecrasseur, Chain, Thompson's (balance like  
No. 343)..... 25.00
  - 346.\* Ecrasseur, Chain, Maisonneuve's, curved..... 20.00
  - 347. " " " with straight  
and curved chain, straight and curved attach-  
ments for chain and wire and three different  
styles of twisted wire..... 36.00
  - 348.\* Ecrasseur, Chain, Adjuster or Positor..... 2.00
  - 349.\* " " Sims'..... 35.00
- Galvano Caution Batteries and Instruments, see page 48  
and also amongst Electric Batteries.

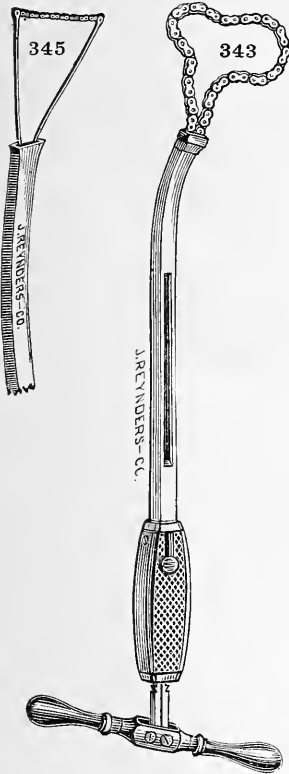

**WALLETS FOR OBSTETRIC AND GYNAECOLOGICAL INSTRUMENTS.**

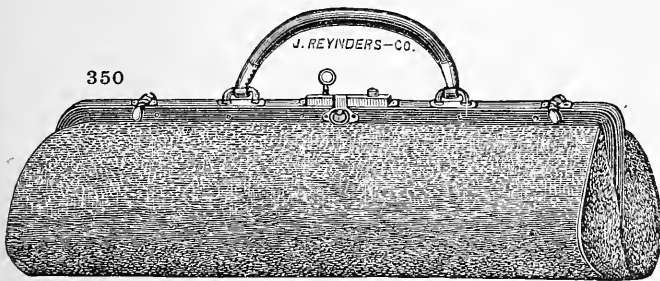

350.\* Flexible sides,  
Black Leather, lined  
inside:

- 14 inch.... \$4.75
- 16 inch.... 5.00
- 18 inch.... 7.50

See also page 197a.  
350 is supplied with  
four or six bottles, as  
shown there.

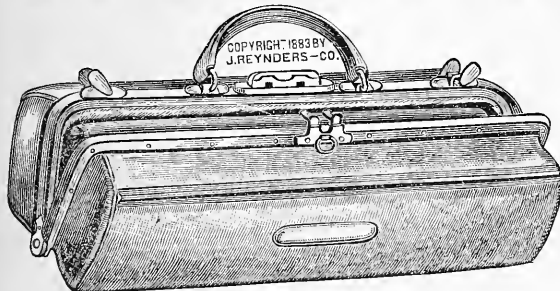

**See also page 197B.**

352.\* Stiffened sides, square cor-  
ners, Black Leather, lined in-  
side:

- 13 inch..... \$7 00
- 14 inch..... 8.00
- 15 inch..... 8.50
- 16 inch..... 9.50
- 18 inch..... 12.00

All Instruments illustrated are designated by a \*

## XIV. GYNAECOLOGICAL INSTRUMENTS.

## GYNAECOLOGICAL SETS.

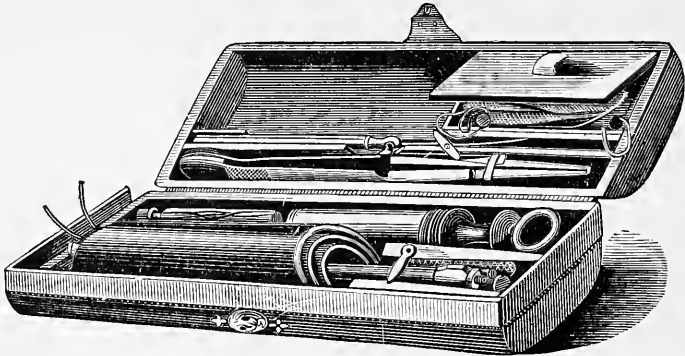

Buttles' Gynaecological Case.

- 353.\* Set No. 1, Buttles', contains: 1 set of 3 Buttles' Glass Specula; 1 h. r. Uterine Syringe; 1 Buttles' Uterine Scarifier and Hook; 2 Budd's h. r. Applicators; 1 set of Buttles' Uterine Sound, Probe and Sponge Carrier, fitting on one handle; in a russet leather case, velvet lined. . . . . Price \$19.00. Same with Buttles' Uterine Forceps. Price \$23.00
354. Set No. 2, J. R. & Co's, contains: 3 English ass. Buttles' Specula; 1 Nott's Speculum, medium; 1 Nott's Depressor; 1 h. r. Uterine Syringe; 2 Budd's h. r. Applicators; 1 Buttles' Uterine Tenaculum and Scarifier; 1 Bozeman's Uterine Forceps; 1 set Buttles' Uterine Sound, Probe and Sponge Holder, fitting in one handle; 1 Uterine Porte Caustic; 1 Aluminum Probe; in a russet leather satchel, silk velvet lined. . . . . Price \$36.00
355. Set No. 3, Budd's, contains: 1 Sims' Speculum; 3 English Fergusson's Reflecting Specula, ass.; 1 h. r. Uterine Syringe; 1 single curved Uterine Forceps; 1 Simpson's Sound; 1 Uterine Probe, silver; 1 Uterine Tenaculum; 1 Uterine Sound, h. r.; 2 Budd's Applicators, h. r.; 1 Sponge Carrier; 1 Uterine Porte Caustic, h. r.; in a patent leather, silk velvet lined satchel. . . . . Price \$40.00

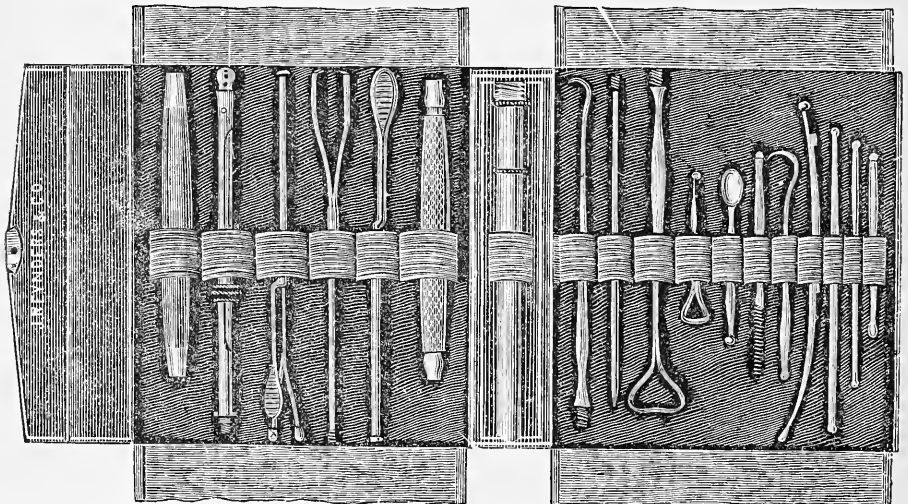

- 356.\* Pocket Case, containing: two handles to both ends of which the following instruments can be screwed: Tenaculum; blunt wire Curette; Needle Holder; Sponge Holder; Stilet and a clamp holding the following instruments: 5 ass. Uterine Knife Blades; Tenaculum; solid sharp Curette; fenestrated sharp Curette; Tampon Screw; Sound and two Probes; Porte Caustic and Needles; Case two-fold, morocco. This with a Speculum is almost a complete Uterine outfit. . . . . Price \$28.00

(See also page 184.)

All Instruments illustrated are designated by a \*

**XIV. GYNAECOLOGICAL INSTRUMENTS.  
FOR GYNAECOLOGICAL SURGERY.**

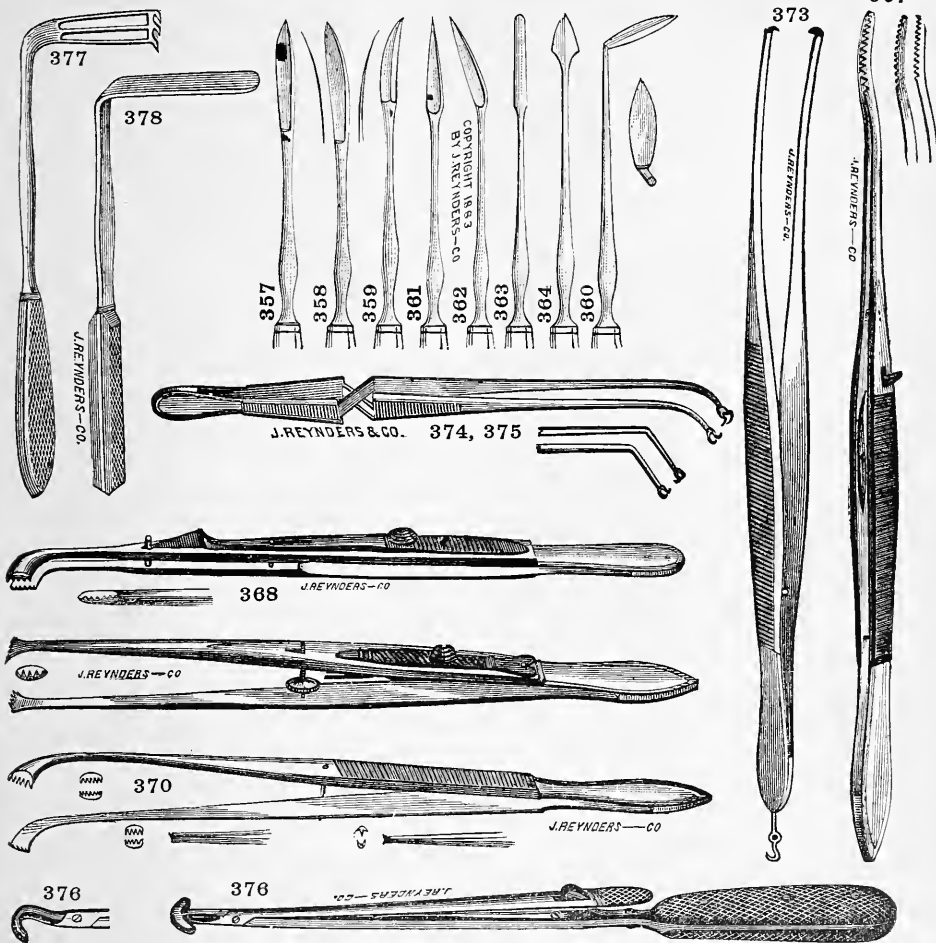

357.*	Uterine Scalpel, straight	\$1.50
358.*	“ “ curved on flat, right or left	each 1.75
359.*	“ “ double edged curved on flat	1.75
360.*	“ “ “ angular	2.25
361.*	“ “ pointed, straight	1.50
362.*	“ “ angular	1.50
363.*	“ Knife, slender	1.50
364.*	“ “ Smith's	1.50
365.	“ “ see also Nos. 190 to 193, page 165.	
366.	Tenacula, see Nos. 78 to 93, pages 156 and 157; Nos. 374 and 375, page 177.	
367.*	Tissue Holding Forceps, each r. and l.	4.50
368.*	“ “ “ Thomas'	4.50
369.	“ “ “ Dawson's, like 368	4.50
370.*	“ “ “ three styles, curved, straight and rat toothed	each 2.50
371.*	“ “ “ with regulating screw	5.50
372.	“ “ “ same, curved right and left	each 5.50
373.*	“ “ “ Hayes'-Agnew's	2.50
374.*	“ “ “ Dawson's	4.00
375.*	“ “ “ Byrne's	3.00
376.**	Artery and Torsion Forceps, Sims', two styles	each 6.00
377.*	Retractor, Simons'	3.50
378.*	“ “ “	2.50

All Instruments illustrated are designated by a \*

N B.—See No. 235, page 94, for an Apparatus for Securing Patients in the Knee and Elbow Position.

KIV. GYNAECOLOGICAL INSTRUMENTS.

FOR GYNAECOLOGICAL SURGERY.

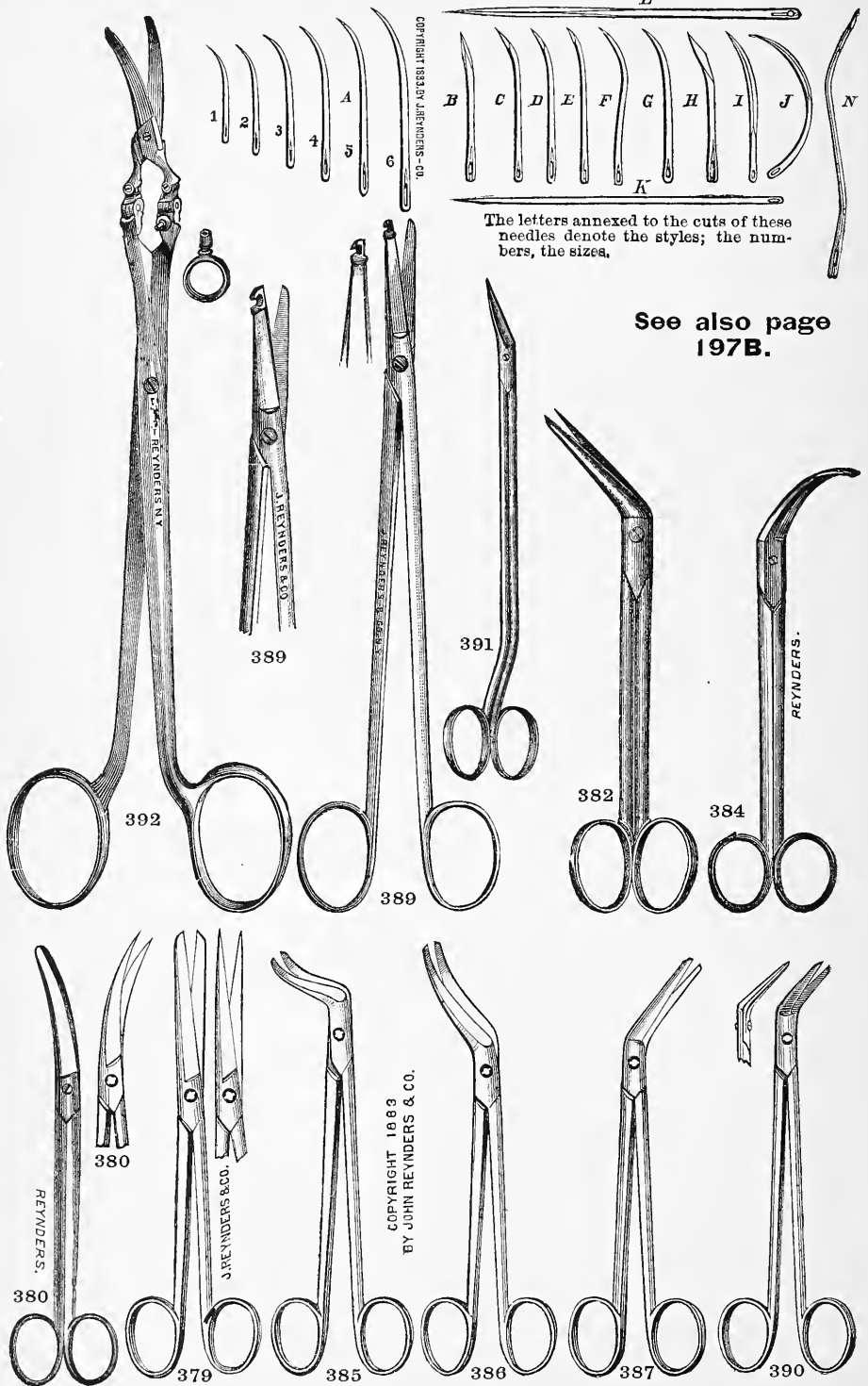

The letters annexed to the cuts of these needles denote the styles; the numbers, the sizes.

See also page 197B.

COPYRIGHT 1883 BY JOHN REYNDERS & CO.

**XIV. GYNAECOLOGICAL INSTRUMENTS.**

**FOR GYNAECOLOGICAL SURGERY.**

379.**	Scissors, straight, blunt or sharp, . . . . . plain	\$1.50; French lock, each	\$2.50
380.**	" " " " " " " " " " " " " " " "	curved on flat, blunt or sharp . . . . .	2.00; " " " " " " " " " " " " " " " "
381.	" " " " " " " " " " " " " " " "	" " " " " " " " " " " " " " " "	3.50
382.*	" " " " " " " " " " " " " " " "	" " " " " " " " " " " " " " " "	3.00
383.	" " " " " " " " " " " " " " " "	angular . . . . .	2.50
384.*	" " " " " " " " " " " " " " " "	Jenk's, for Perineorrhaphy . . . . .	4.50
385.*	" " " " " " " " " " " " " " " "	Emmet's, full curve, original, r. and l. . . . .	each 4.50
386.*	" " " " " " " " " " " " " " " "	" " " " " " " " " " " " " " " "	new, r. and l. . . . . " 5.50
387.*	" " " " " " " " " " " " " " " "	" " " " " " " " " " " " " " " "	slight " r. and l. . . . . " 4.50
388.	" " " " " " " " " " " " " " " "	" " " " " " " " " " " " " " " "	laterally angular . . . . . " 3.00
389.**	" " " " " " " " " " " " " " " "	" " " " " " " " " " " " " " " "	wire cutting . . . . . " 3.00
390.*	" " " " " " " " " " " " " " " "	" " " " " " " " " " " " " " " "	wire loop cutting . . . . . " 4.50
391.*	" " " " " " " " " " " " " " " "	" " " " " " " " " " " " " " " "	angular on the flat, delicate. . . . .
392.*	" " " " " " " " " " " " " " " "	" " " " " " " " " " " " " " " "	" " " " " " " " " " " " " " " "
393.	" " " " " " " " " " " " " " " "	Bozeman's, r and l. . . . .	each 4.50
394.*	Needle A, Emmet's, round pointed, with groove counter sunk for wire, sizes 3, 4, 5 and 6. . . . .		each 0.15
	" B, Emmet's, triangular point, keen, large eye, with groove counter sunk for wire, sizes 4 and 6. . . . .		each 0.15
	" H, Emmet's, same as B, but more curved, sizes 2, 3, 4. . . . .		" 0.15
	" A M, Emmet's, slender, small; eye ordinary, for delicate sutures, sizes 1, 2 and 3. . . . .		each 0.15
	" K, Emmet's, straight, for rupt. perineum, round pointed . . . . .		" 0.05
	" L, " " " " " " " " " " " " " " " "		" " " " " " " " " " " " " " " "
	" C, Sims', point scooped out, plain eye, sizes 3, 4, 5, 6. . . . .		" 0.15
	" D, " " " " " " " " " " " " " " " "		" " " " " " " " " " " " " " " "
	" E, Dawson's, sizes 1, 2, 3 4. . . . .		" 0.15
	" F, Wylie's, sizes 3, 4, 5, 6. . . . .		" 0.15
	" G, sharp, flat pointed, sizes 2 and 3. . . . .		" 0.15
	" I, Bozeman's, curved triangular, flat on convexity, sharp ridge on concavity, sizes 3, 4, 5. . . . .		each 0.15
	" N, Goodall's . . . . .		" 0.15
	" J A, curved, points like A } size of cut. . . . .		" 0.15
	" J C, " " " " " " " " " " " " " " " "		" " " " " " " " " " " " " " " "
395.*	Needle Holder, Sims', latest . . . . .	\$2.50	
396.	" " " " " " " " " " " " " " " "	Needles in handle in the same manner as the knife blades in figure. 192, page 165. . . . .	8.00
397.*	" " " " " " " " " " " " " " " "	Emmet's . . . . .	3.00
398.*	" " " " " " " " " " " " " " " "	Roux' . . . . .	4.50
399.*	Needle Holder, Dawson's. . . . .	\$3.50	
400.**	" " " " " " " " " " " " " " " "	Collin & Co's., new . . . . .	4.50
401.	" " " " " " " " " " " " " " " "	see also pages 4 and 5.	
402.	Silver Wire, see page 6.		
403.	Silk, see page 5.		

Either of these per doz. \$1.00

Hagedorn Needles, see page 5.

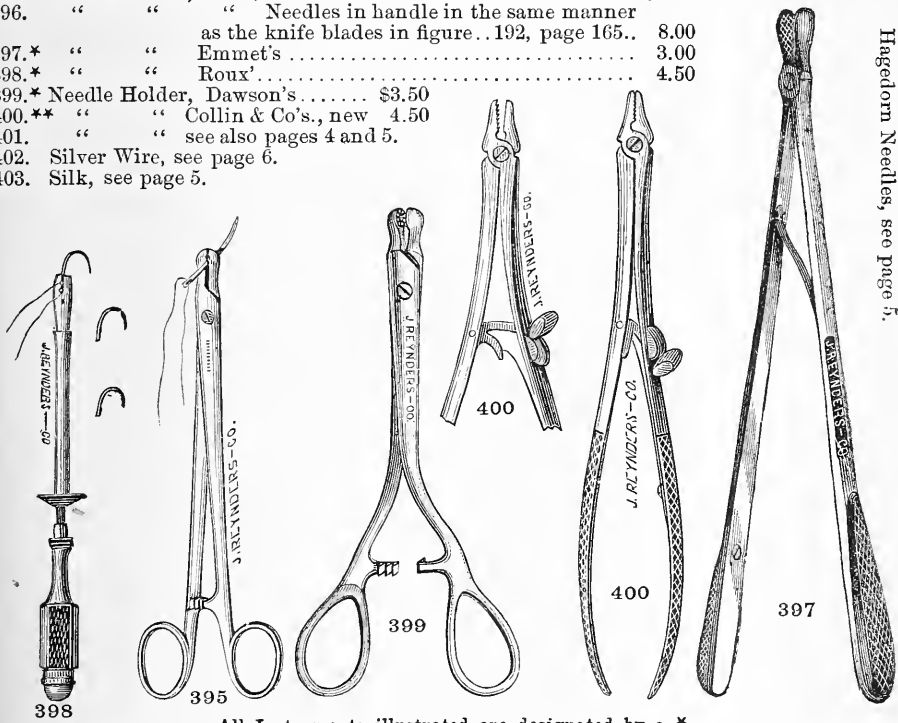

All Instruments illustrated are designated by a \*

XIV. GYNAECOLOGICAL INSTRUMENTS.  
FOR GYNAECOLOGICAL SURGERY.

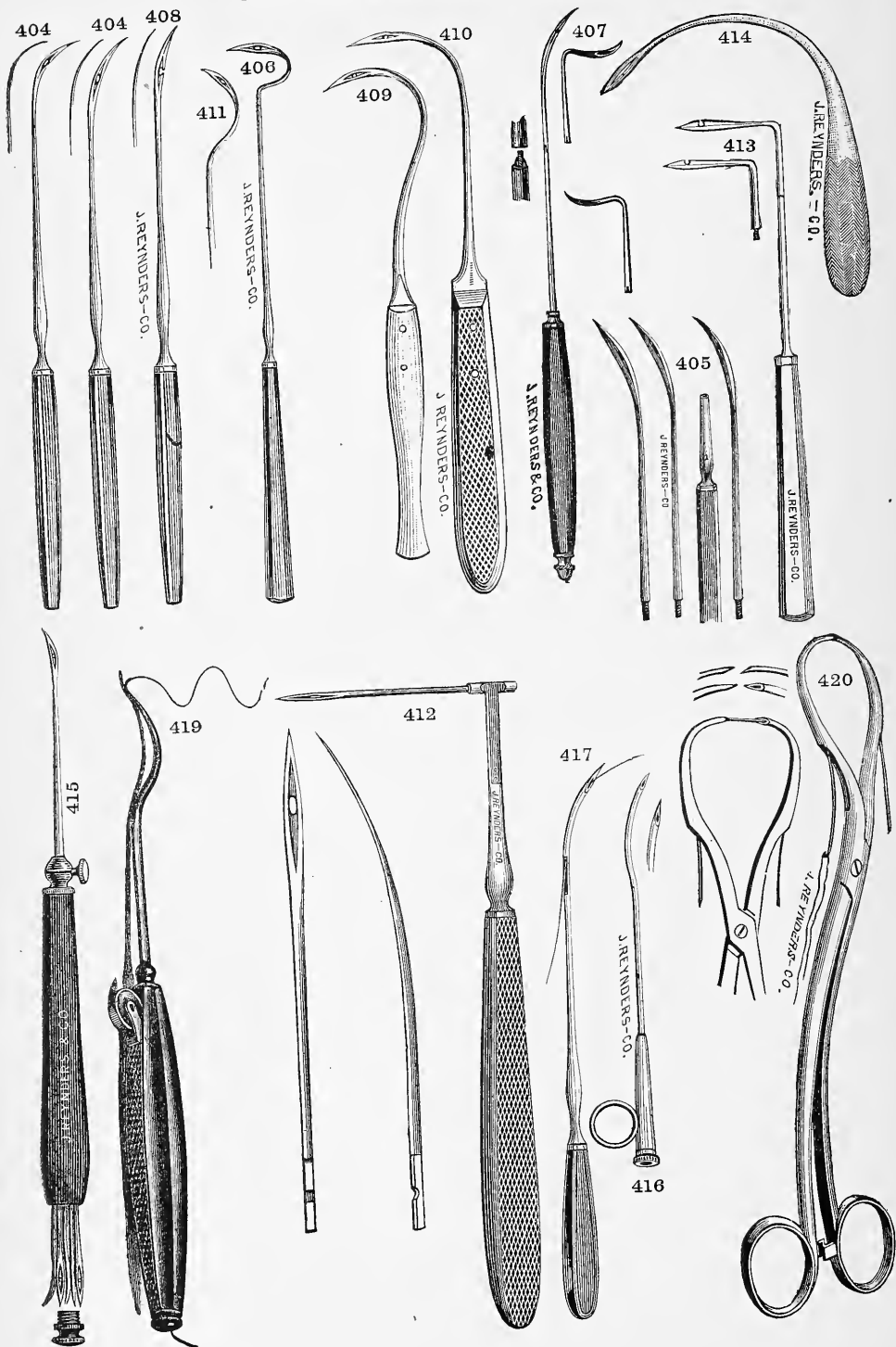



**XIV. GYNAECOLOGICAL INSTRUMENTS.**

**FOR GYNAECOLOGICAL SURGERY.**

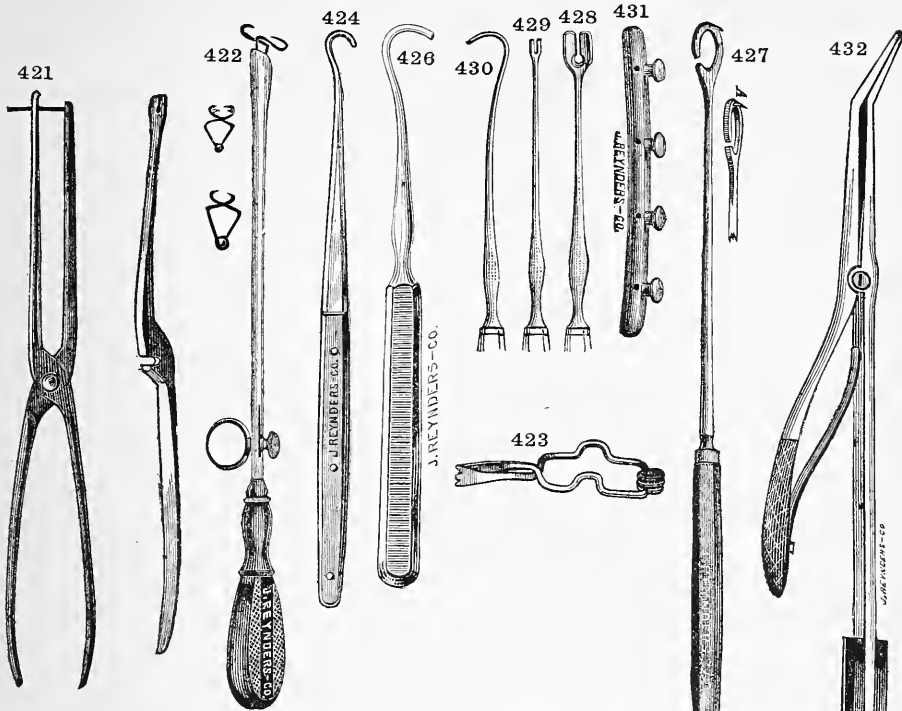

404.**	Needle in handle, light or heavy, straight or curved, two curves as per figures.....	each	\$1.50
405.*	“ “ “ Peaslee’s, set of 3.....	3.00	
406.*	Needle in handle, Peaslee’s, r. and l.....	each	1.75
407.*	“ “ “ new set, r. l. and curved.....		3.50
408.*	“ “ “ Skene’s.....		1.75
409.*	“ “ “ Ashton’s.....		1.50
410.*	“ “ “ Baker Brown’s.....		1.75
411.*	“ “ “ Spiral.....		1.75
412.*	“ “ “ Hayes-Agnew’s, set of two straight and curved, can be inserted straight forward or at right angle.....		4.50
413.*	Needle in handle, Jackson’s, rectangular set of 2.....		3.00
414.*	“ “ “ Ellwood Wilson’s.....		1.50
415.*	“ “ “ Parker’s, set of 4 needles, Exploring Needle, Small Gouge.....		5.00
416.*	“ “ “ Hollow, Atlee’s.....		2.00
417.*	“ “ “ Simpson’s, in stiff handle.....		2.00
418.*	“ “ “ “ closing in handle.....		2.00
419.*	“ “ “ Pease’s, the silver wire is passed through handle and needle and is driven forward by a wheel.....		6.00
420.*	“ Double, Canulated, Currier’s, for wire sutures in staphylorrhaphy and fistula operations.....		7.00
421.*	“ Van de Warker’s, for lacerated Perineum.....		5.00
422.*	Automatic Suture Instrument, Hoff’s, with one dozen serrefines.....		5.50
423.*	Serrefines, Garrigue’s.....	each	0.25
424.*	Counterpressure Hook, Emmet’s.....		2.00
425.*	“ “ “ with minute Tenaculum Hook.....		2.25
426.*	“ “ “ Merriam’s.....		2.00
427.*	“ “ “ Tenaculum, Hank’s.....		2.00
428.*	Sims’ Shield, ebony or ivory handled or all metal.....	each	1.50
429.*	“ Pulley, “ “ “ “ “ “.....	“	1.50
430.*	“ Blunt Hook-Probe, ebony or ivory handled or all metal.....	“	1.50
431.*	Quill Suture, Munson’s.....	per pair	0.75
432.*	Wire Shouldering Instrument, Thomas’.....		4.00
433.*	“ “ “ Roberts’, see page 6, fig. 46.....		

All Instruments illustrated are designated by a \*



**XIV. GYNAECOLOGICAL INSTRUMENTS.**

**FOR GYNAECOLOGICAL SURGERY.**

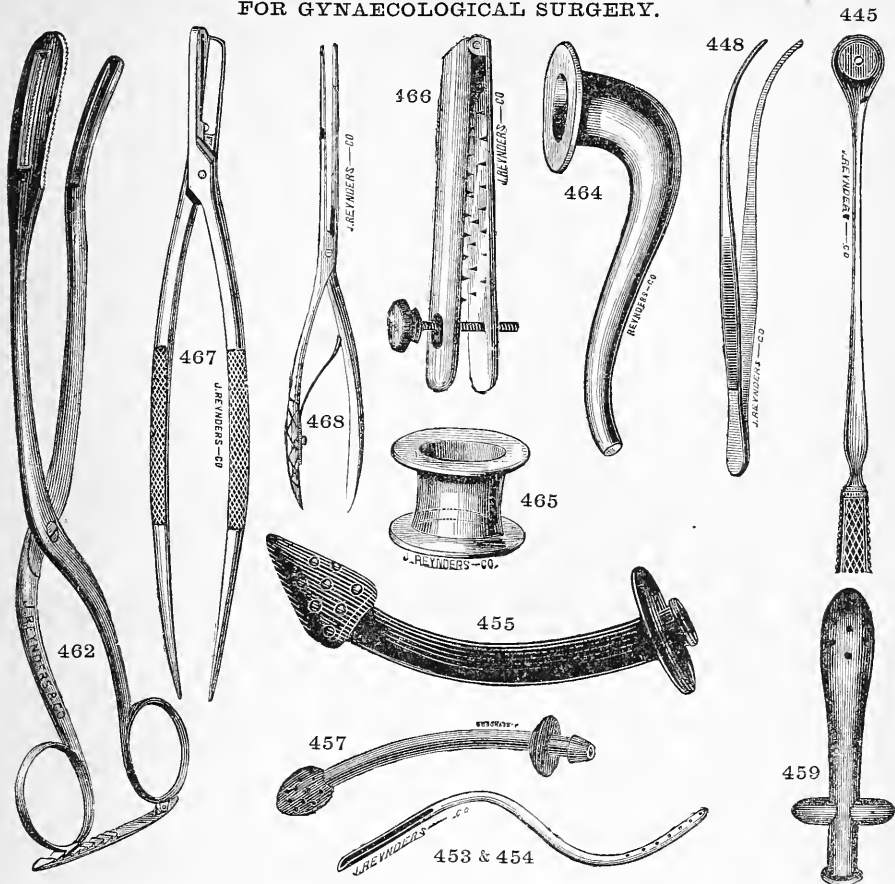

434.*	Wire Twisting Forceps, Emmet's	\$3.00
435.*	" " " Thomas'	3.00
436.*	" " " Sims'	3.00
437.*	" " " Fitch's	4.00
438.*	" " " Dawson's (like Needle Holder No. , page )	5.00
439.*	" " " Instrument, Dawson's	2.00
440.	Perforated Shot	per dozen 0.30
441.*	Shot Perforator	2.50
442.	" " J. R. & Co's., the best, consisting of two instruments.	4.00
443.*	" Compressing Forceps	2.00
444.*	Bozeman's Wire Adjuster	2.50
445.*	" Button Adjuster	2.00
446.*	" Buttons	each 0.25
447.*	" Button Moulder	3.50
448.*	" Forceps for Extracting Needles	3.00
449.*	" Needle Holders, per pair	8.00
450.*	" Perineal Elevator	11.00
451.*	" Button Perforator	1.50
452.	Sponge Holders, see Nos. 231 to 234, page 168.	
453.*	Female Catheter, Sims', sigmoid, soft metal	9.50
454.*	" " " " " h. r. \$0.75; plated \$1.00; silver	1.50
455.*	" " " Goodman's, h. r.	each 1.00
456.*	" " " " set of 3 in case	3.00
457.*	" " " Goodman-Skene's h. r.	each 1.00
458.*	" " " " set of 3 in case	3.00
459.*	" " " Thomas', h. r.	1.50
460.	" " " see also.	
461.	" " " "	
462.*	Byrne's Forceps, for burning an opening into the Vesico-Vaginal wall by means of the Galvano-Cautery	10.50
463.	Emmet's Instrument for doing the same by excision.	
464.*	Fistula Tube, Emmet's, glass	0.30
465.*	Cystitis, Eyelet	0.25
466.*	Clamp, Thomas', for compressing Vaginal wounds	8.00
467.*	Scissors, Thomas', for excising or punching out pieces of tissue	6.00
468.*	Forceps, Thomas', for separating tissues	2.50
469.*	Knot Tightening Instrument	1.75

All Instruments illustrated are designated by a \*

#### XIV. GYNAECOLOGICAL INSTRUMENTS. OPERATING SETS.

470. Case for Vesico-Vaginal Fistula No. 1, Sims', contains: 1 Scissors, curved on flat; 1 Scissors, straight; 1 Scissors, curved, for removing wire sutures; 1 Sims' Tenaclum; 2 Sims' Uterine Scalpels; 1 Sims' Speculum; 1 Sims' Fulcrum; 1 Sims' wire Carrier; 1 Sims' blunt Hook; 1 Sims' Dressing Forceps; 1 Sims' Tissue Forceps; 1 Sims' wire twisting Forceps; 1 Sims' Needle Forceps;  $\frac{1}{2}$  doz. Sims' Sponge Holders; Silk, Silver Wire; Needles; in a morocco pouch. . . . . Price \$50.00
471. Case for Vesico-Vaginal Fistula No. 2, Bozeman's, contains: 1 Bozeman's Speculum; 1 Bozeman's Perineal Elevator, with two blades; 1 pair Bozeman's Needle Holders; 1 Bozeman's Button Perforator; 1 Bozeman's Spatula; 1 Bozeman's Wire and Shot Adjuster; 2 Bozeman's Tenacla; 1 Bozeman's probe, curved Uterine Bistoury; 2 Bozeman's sharppt. straight Bistouries; 1 plain straight spring Forceps; 1 Bozeman's curved Forceps, ends copper lined; 3 Sponge Holders; 1 h. r. Uterine Syringe; 2 silver Uterine Probes; 2 Bozeman's curved Scissors; 1 Bozeman's Uterine Forceps; 2 Bozeman's heavy straight Scissors; 1 curved shot compressing Forceps; 1 Shot Punch; 1 Bozeman's Button Moulder; in a fine rosewood, brass bound case, silk velvet lined. . . . . Price \$130.00

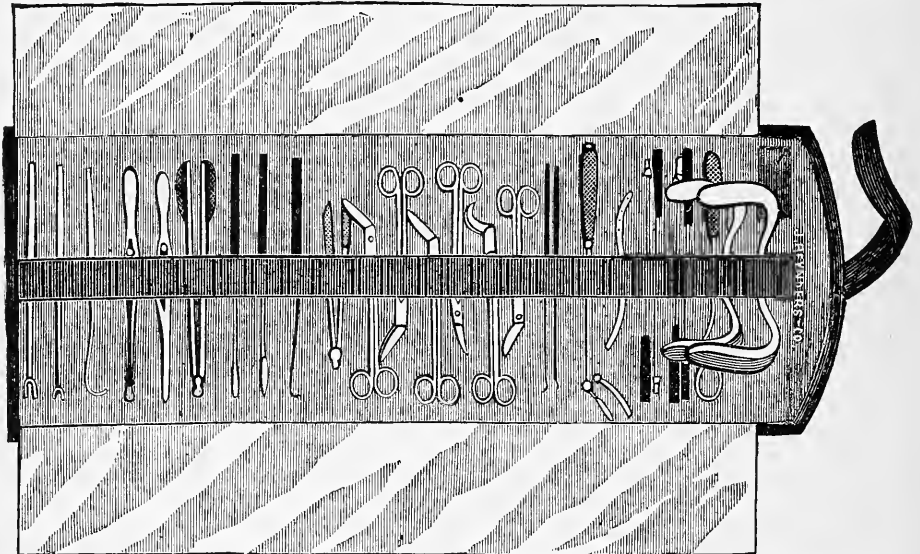

472. Case for Vesico-Vaginal Fistula No. 3, Emmet's, contains: Sims' Hospital Speculum; Sims' Virgin Speculum; Emmet's Depressor; 4 Emmet's Sponge Holders; Sims' Catheter, soft metal; Emmet's Uterotome; 2 Emmet's Tenacla; Perry's Tenaclum; 6 Emmet's Scissors; Emmet's Wire Pressing Forceps; 2 Bistouries; Scalpel; Emmet's Needle Forceps; Emmet's Dressing Forceps; Emmet's Wire Twisting Forceps; Sims' Blunt Hook; Sims' Shield; Sims' Wire Carrier; Coil Silver Wire; 1 dozen Emmet's Needles; in an ordinary pouch, price \$80.00; in a pouch with tray protecting the Scissors from pressure. . . . . Price \$85.00
473. Post Graduate Set of Gynaecological Instruments by B. F. Dawson, M.D., contains: Dawson's modified Erich Speculum with dilating blade; Dawson-Hunter Depressor; Uterine Sound; Dawson's Uterine Probe; Dawson's Uterine Applicator; Sims' Dressing Forceps; Thomas' Curette; Dawson's Perineal Scissors; Dawson's Cervix Scissors; Dawson's Needle Holder; Set of Hank's Dilators; 2 Tenacla, all steel stout and slender; Dawson's Wire Twister; 2 Dawson's Tissue Forceps; 6 Sponge Holders—all in a roll-up poche, except Speculum and Dilators. . . . . Price \$74.00
474. Polyclinic Set of Office Examining Instruments by W. G. Wylie, M.D., contains: Long bladed Sims' Speculum; Sims' Depressor, double; Sims' Dressing Forceps; 2 Tenacla; Simpson's graduated Uterine Sound; Wylie's pure silver Sound; Sims' Repositor; Emmet's Applicator, pure silver; Wylie's Cervical Protector; Small Sims' Curette; Wylie-Sims' Dilator; Wylie's Mucus Syringe, in a poche to roll up. . . . . \$45.00
475. Bellevue Hospital Clinic Gynaecological Operating Set of W. G. Wylie, M.D., contains: Sims' Speculum, short bladed; Sims' Depressor; 2 Sims' Tenacla; 12 Sponge Holders; 2 Scissors curved on flat, blunt and sharp pointed; 2 Knives; Thumb Forceps; 6 Haemostatic Pressure Forceps; Angular Forceps; 3 ass. Sims' Curettes; 12 Sims' Cervix Needles, 1 inch long; 12 straight Suture Needles; Silk; 5 Coils Silver Wire, each sizes 26 and 27; 2 Coils Catgut, sizes 2 and 3; Sims' Shield; Sims' Wire Twister; 2 Whalebone Applicators; Pure Silver Applicator; Wylie's Cervical Protector; Sims' Rectal Speculum; Sims' Uterotome; Wylie-Sims' Dilator; 3 Glass Plugs—most of these instruments in a leather poche. . . . . Price \$100.00



XIV. GYNAECOLOGICAL INSTRUMENTS.  
FOR GYNAECOLOGICAL SURGERY—OVARICTOMY.

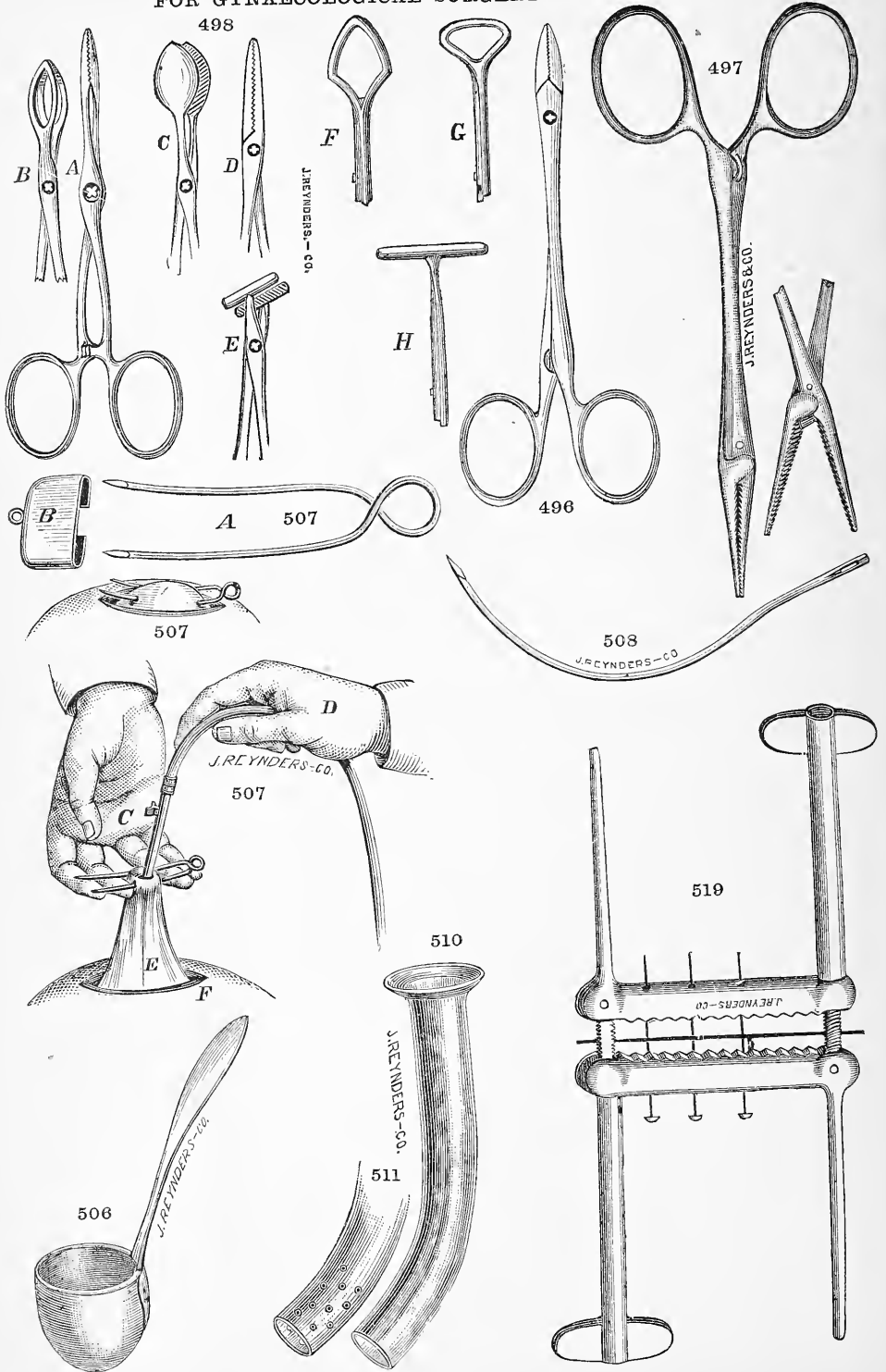

**XIV. GYNAECOLOGICAL INSTRUMENTS.**  
**FOR GYNAECOLOGICAL SURGERY—OVARIOTOMY.**

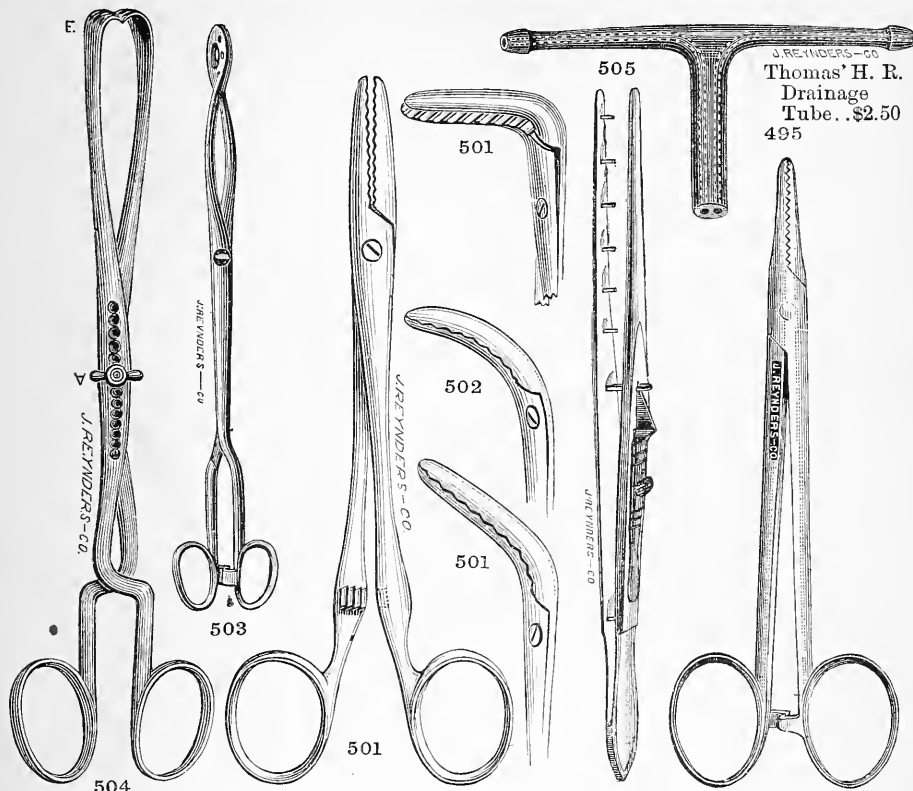

J. REYNOLDS & CO.  
 Thomas' H. R.  
 Drainage  
 Tube..\$2.50  
 495

495.*	Haemostatic Forceps, Spencer Well's, first model.....	\$1.75
496.*	“ “ “ last “ .....	1.75
497.*	“ “ “ Jones' .....	2.00
498a.*	“ “ “ Pean's .....	2.00
498a.	“ “ “ 7 inches long .....	2.75
498a.	“ “ “ 6½ “ “ curved.....	3.00
498b.*	“ “ “ .....	2.75
498c.*	“ “ “ .....	2.75
498d.*	“ “ “ .....	2.00
498e.*	“ “ “ .....	2.75
498f.*	“ “ “ .....	2.75
498g.*	“ “ “ .....	2.75
498h.*	“ “ “ .....	2.75
499.	“ “ “ see also page 14 and 15.	

500.	Artery Forceps, see page 13 and 14.	
501.*	Pedicle Forceps, Spencer Wells'; straight, obtuse and right angular, 9 in. long .....	each 5.00
502.*	“ “ “ 9 inches long, Goodall's .....	5.00
503.*	Tumor “ Nelaton's.....	5.00
504.*	“ “ “ Greenhalg's.....	8.00
	“ “ “ see also Page 173, Nos. 306 to 324; Page 201, Nos. 63 to 67.	
505.*	Clamp “ Spencer Wells' .....	5.50
506.*	Dipper for Blood etc., Thomas' .....	
507.*	Cyst Elevator, Borck's ass. sizes.....	each 1.50
	(Fig. 1—A, the Elevator; B, a cap to protect the points. Fig. 2—the Elevator in first position. Fig. 3—C, the right hand of assistant; D, the right hand of operator; E, the cyst; F, Abdomen.)	
508.*	Needles, Goodall's long.....	each .25
509.	Drainage Tube, Rubber, see page 6.	
510.*	“ “ “ Glass, 3 sizes .....	“ .50
511.*	“ “ “ “ 3 “ perforated walls.....	“ .75

All Instruments illustrated are designated by a \*

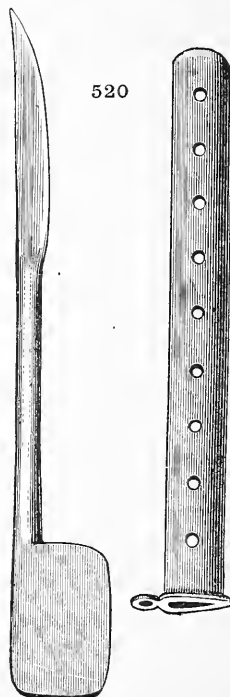

XIV. GYNAECOLOGICAL INSTRUMENTS.  
FOR GYNAECOLOGICAL SURGERY—OVARIOTOMY.

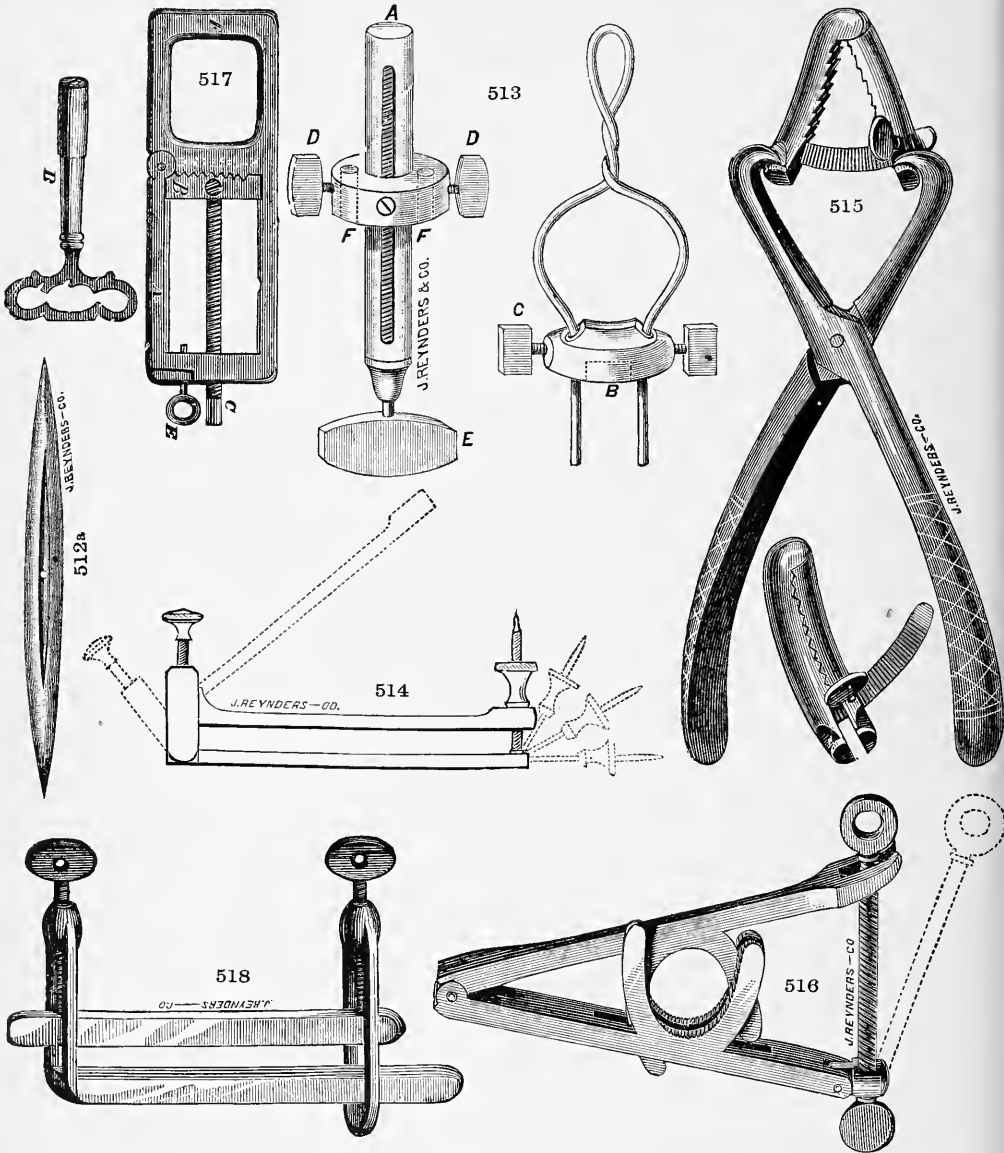

512.	Silk, extra heavy and warranted pure, specially prepared for tying Pedicles,	
		per spool \$0.50
512a.*	Ivory Holders for tightening above around Pedicle.....	per pair 1.00
513.*	Clamp, Lawson Tait's.....	8.00
514.*	“ Spencer Wells'.....	6.00
515.*	“ “ set of three clamps and forceps for closing them.....	18.00
516.*	“ Thomas'.....	4.50
517.*	“ Dawson's.....	8.00
518.*	“ French.....	5.00
519.*	“ Atlee's (see figure on page 186).....	6.00
520.*	Knife and sheath for Pedical (see figure on page 187).....	3.00

All Instruments illustrated are designated by a \*



**XIV. GYNAECOLOGICAL INSTRUMENTS.**

**GYNAECOLOGICAL SURGERY.**

**521. Case of Ovariectomy Instruments—contains:**

Spencer-Wells' Trocar; Large curved Trocar; 2 Brown's Retractors; 2 Needles in Handle; 2 Peaslee's Needles, r. and l.; Clark's tooth-edged Scissors; Scissors; Steel Sound; 2 Artery Forceps; Slide Catch; Female Catheter; Director, Key's; Adams' Pedicle Hook; 6 Artery Forceps, either of Nos. 495 to 498a; 6 Borch's Cyst Elevators; Wire cutting Forceps; 2 Scalpels; Straight Bistoury, each sharp and probe-pointed; Tenaculum; 12 Ovariectomy Pins; Granite enameled Tray, 6 inches long, 1 inch high, 2 inches broad, for carbolized Silk Ligature, Oil Paper, etc.; Thomas' Clamp; Nelaton's Tumor Forceps; 6 Sponge Holders; Wire Twister; Shield and Silver Wire—Case Blackwalnut, brass bound..... Price \$115.00

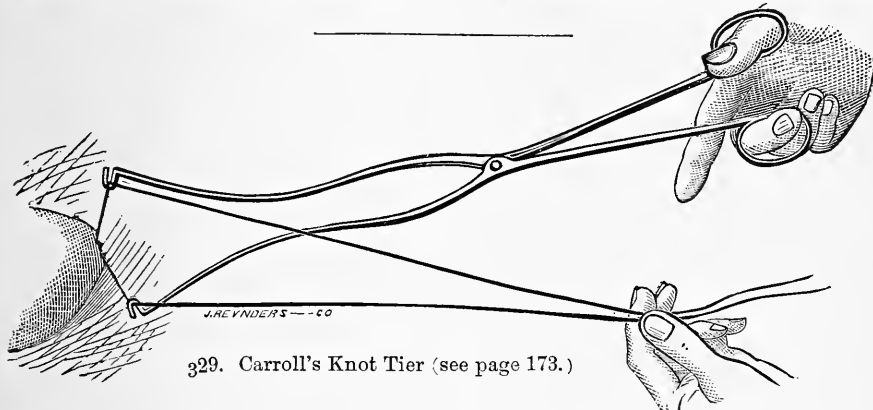

329. Carroll's Knot Tier (see page 173.)

**PESSARIES.**



522. Campbell's Self Repositor \$0.25



523. Sims' Pessary Introducer \$8.00

**RING PESSARIES.**

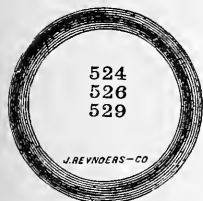

524  
526  
529

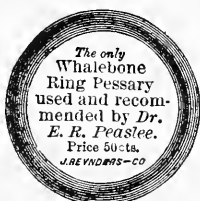

528

- 524.\* Block—tin, flexible.....\$0.30
  - 525.\* Copper—soft rubber, covered......75
  - 526. Jackson's, soft rubber, partly copper inside......75
  - 527.\* Whalebone, spring, soft rubber, covered......50
  - 528.\* " surrounded by spiral spring, soft rubber covered......60
- In No. 527 the size of material is smaller and the weight lighter than in No. 528; its durability is practically the same.
- 529. Hard Rubber......25
  - 530. " " interrupted......50

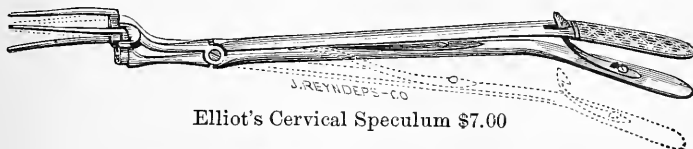

Elliot's Cervical Speculum \$7.00

All Instruments illustrated are designated by a \*

XIV. GYNAECOLOGICAL INSTRUMENTS—PESSARIES.  
INTRA UTERINE STEM AND RETROVERSION PESSARIES.

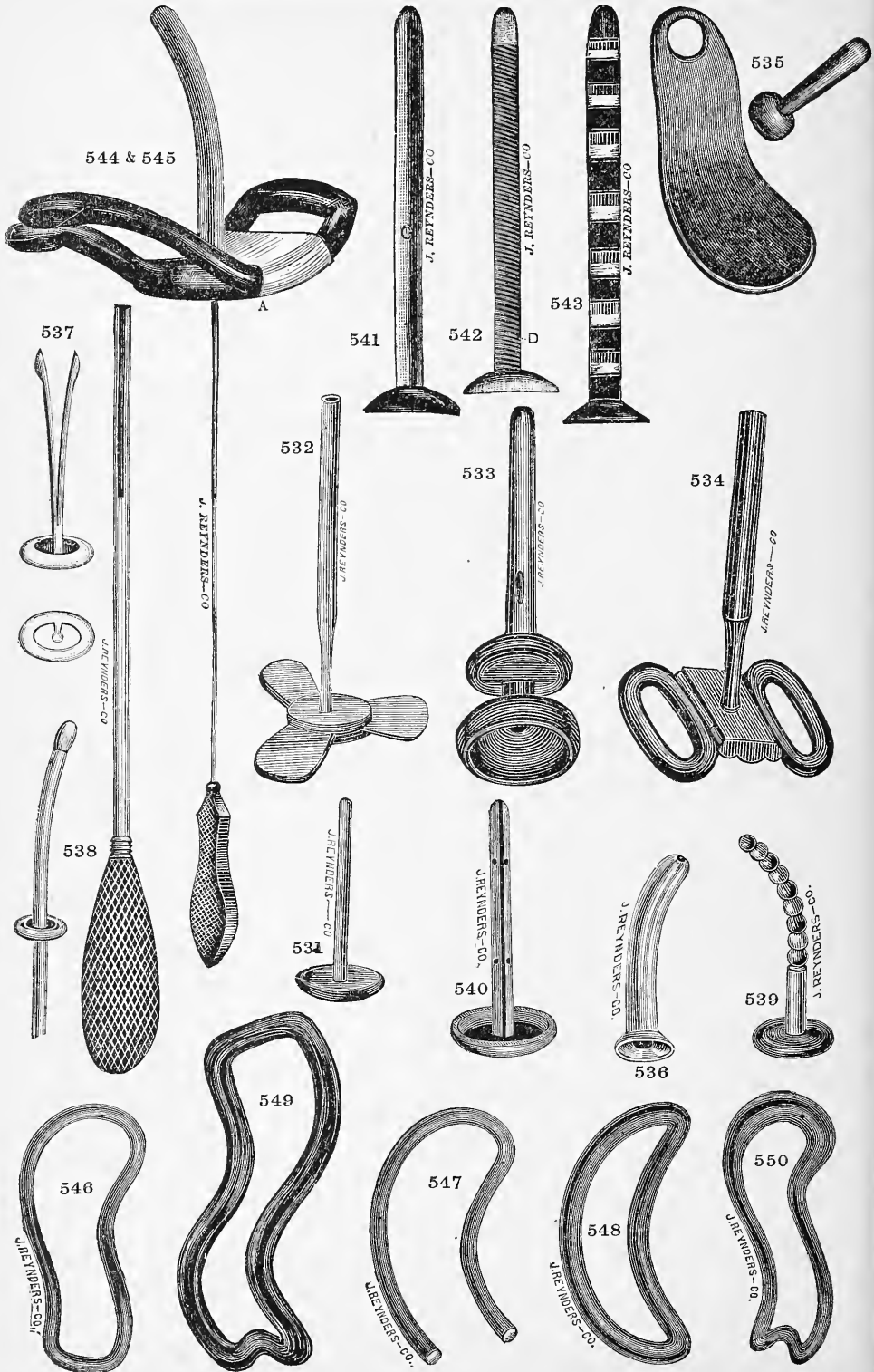

**XIV. GYNAECOLOGICAL INSTRUMENTS—PESSARIES.**

**INTRA UTERINE STEM AND RETROVERSION PESSARIES.**

**STEM.**

531.*	Hard Rubber, plain.....	\$0.50
532.*	“ “ Edward’s.....	3.00
533.*	“ “ Peaslee’s.....	1.25
534.*	“ “ Conant’s.....	2.50
535.*	“ “ with support.....	1.00
536.*	Glass, solid or hollow.....	.50
537.*	Chamber’s, h. r., spreading.....	1.50
538.*	“ “ Introducer.....	1.50
539.*	Galvanic.....	1.25
540.*	“ B. Cole’s, h. r. insulation through entire length.....	2.00
541.*	Donelson’s h. r.....	.75
542.*	“ flexible soft rubber covered.....	1.50
543.*	“ Galvanic.....	2.50
544.*	“ Rubber Band for holding stem on pessary.....	each .30
545.*	“ Stem Introducer.....	1.25

**FOR POSTERIOR DISPLACEMENTS.**

546.*	Bow, h. r.....	0.25
547.*	Horseshoe, h. r.....	.40
548.*	Hewitt’s, h. r.....	.25
549.*	Hodge’s “S. S.” h. r.....	.25
550.*	“ “ “ with thick back.....	.75
551.*	“ “ elastic whalebone, rubber covered.....	.75
552.*	“ “ h. r., Thomas’ modification.....	1.50
553.*	Smith’s, h. r., 1 to 5.....	each .25
554.*	“ “ 0.....	.40
555.*	“ elastic, whalebone, rubber covered.....	.75
556.*	“ Thomas’ modification, h. r.....	.50
557.*	“ “ elastic, whalebone, rubber covered.....	1.50
558.*	“ Gehrung’s modification, h. r.....	.6
559.*	Noeggerath’s, h. r.....	.60
560.*	“ with thick back, h. r.....	1.00

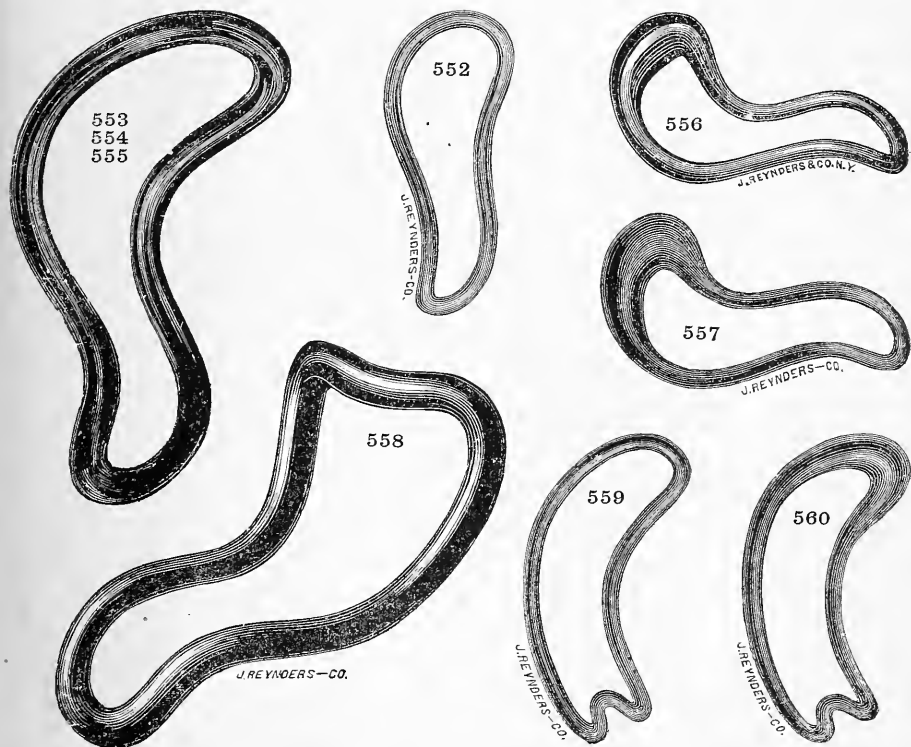

All Instruments illustrated are designated by a \*

XIV. GYNAECOLOGICAL INSTRUMENTS—PESSARIES.  
FOR POSTERIOR DISPLACEMENTS.

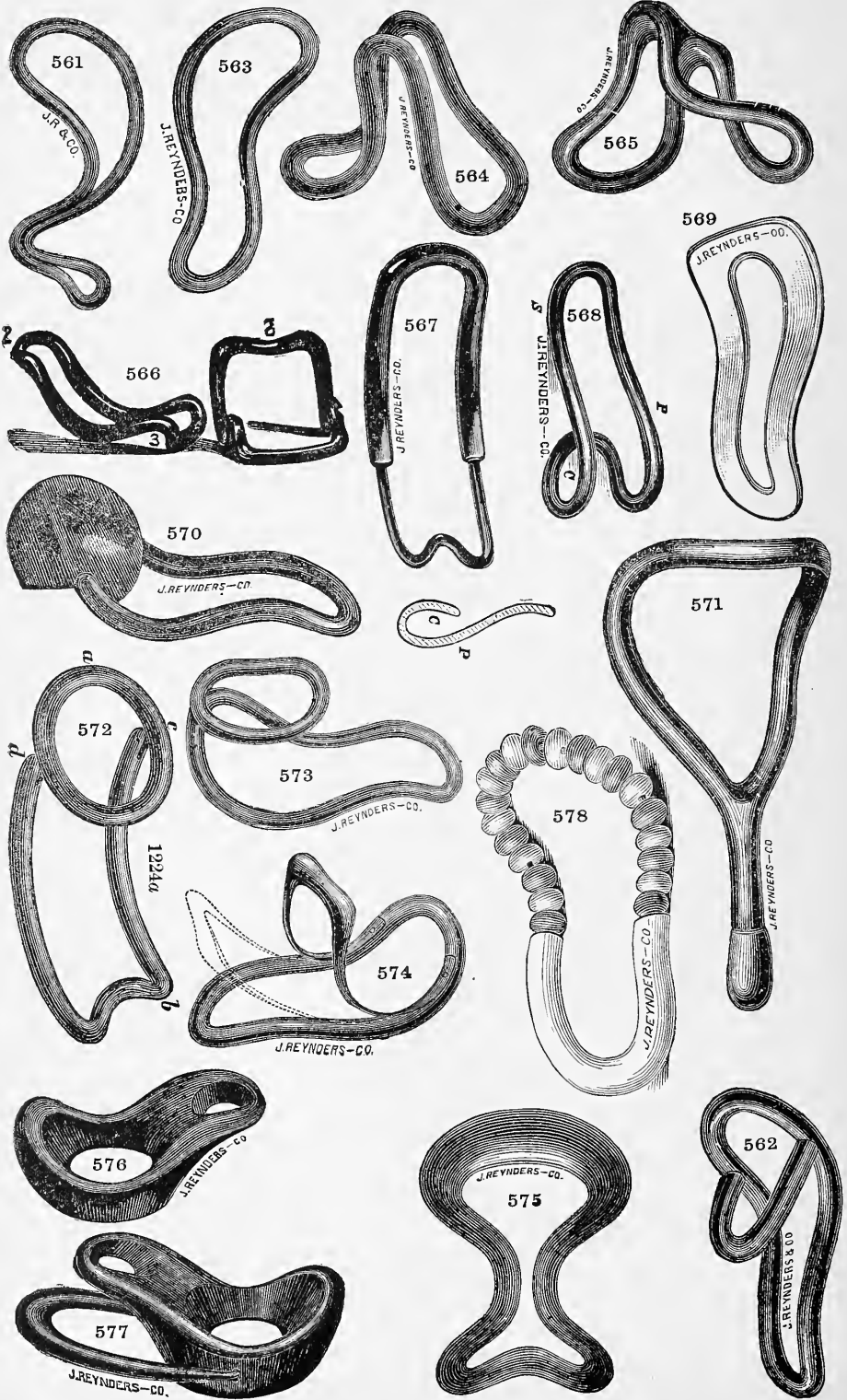

**XIV. GYNAECOLOGICAL INSTRUMENTS—PESSARIES.**

**FOR POSTERIOR DISPLACEMENTS.**

561.* Thomas' h. r. ....	\$1.00	575.* Carroll's elastic .....	\$0.75
562.* " h. r. with cervical rest .....	1.25	576.* Fowler's h. r. ....	1.25*
563.* Emmet's h. r. ....	0.50	577.* " " with bow .....	1.75*
564.* Gralley-Hewitt's .....	1.00	578.* Galvanic Hank's .....	1.50
565.* " " modified by Thomas. ....	1.00	579.* Cutter's h. r. ....	1.50
566.* Higbee's l. r. ....	0.75	580.* " " Thomas modification .....	1.75
567.* Scattergood's h. r., with elastic gold spring .....	2.50	581.* " " with cervical rest ...	3.00
568.* Wylie's h. r. ....	1.00	582.* " " Doneison's modification, pliable .....	2.50
569.* Woodward's h. r. ....	1.25	583.* Hurd's soft rubber .....	1.50
570.* Pallen's h. r. ....	2.50	584.* " " h. r. ....	2.00
571.* Chamberlain's h. r. ....	1.25	585.* McIntosh's (see fig. 631) .....	4.00
572.* Fitch's .....	2.00	586.* Trask's—the same as Page's made of soft rubber inflated .....	2.00
573.* " .....	1.50		
574.* B. Cole's .....	3.00		

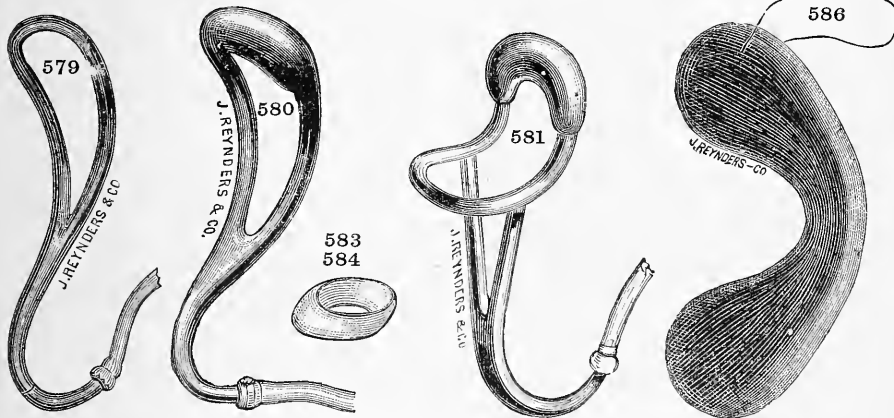

587. DR. R. A. PAGE'S DUMB BELL PESSARY.

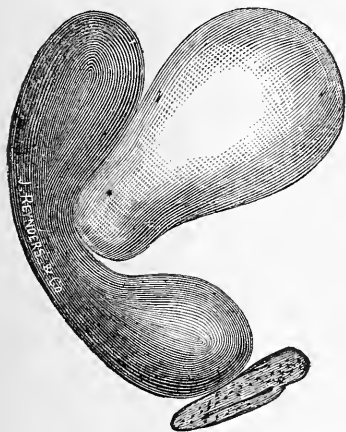

This pessary is for the treatment of retro-version and prolapsus in cases where the vagina is so sensitive that an instrument of hard material cannot be worn. It is made of fine jeweler's cotton and covered with a thin rubber capsule. The extremities are flattened antero-posteriorly and are connected by a curved isthmus which is sufficiently broad to afford a resting place for the cervix.

The pessary is soft and elastic, and yet so compact that it retains its shape while in use.

"When an instrument of the right size is properly applied, it will be perfectly retained, and will give the uterus complete and unirritating support. The uncovered cotton pessary can be used as a temporary support, and is useful in making detergent or other medicinal applications to the cervix."

"No instrument that I had before introduced could be retained more than two or three days, by reason of sense of tenderness in sitting down, which was by that time inevitably felt in the perineum. When, however, this time had elapsed, my patient experienced no discomfort; and declared that, for the first time, had she been aware of any real sense of support from a pessary, or been relieved from the distressing pain in the back incident to standing or walking. Moreover, on making examination some time after removal of the instrument, the uterus was found to have retained its proper position. I have no idea that this form of pessary is destined to supplant all others; but as an expedient in the class of cases of which the first one referred to is an example, I am certain, it will

prove a most valuable acquisition to our resources. Every practitioner has at times cases in which the uterus, remaining enlarged from defective involution, is crowded down to the floor of the pelvis by the weight of the superincumbent intestines, with the bladder pressed upon by the fundus, and the cervix pushed against the rectum, or lying in the directly opposite position; with the uterus more or less oedematous from retarded circulation and a generally relaxed state of the system from protracted ill health, and has had occasion to deplore the inefficiency of all instruments in common use. To such I would most heartily commend a trial of the dumb-bell pessary. It differs essentially in form, so far as my acquaintance with them extends, from all pessaries previously constructed. From the combined employment of the knee-and-breast position and the dumb-bell pessary I cannot but confidently anticipate a greatly increased satisfaction and success in the management of hitherto intractable cases of uterine displacements."—Article of Dr. James D. Trask, in the *Medical Record*, May 9th, 1876.

The pessary is applied by placing one of its extremities in the posterior cul-de-sac and pushing the other upwards until it rests against the posterior surface of the pubis. The uterus will then be supported by the isthmus and uterine extremity of the pessary.

We can furnish these pessaries with or without rubber covers of four sizes, 2½, 3, 4 and 5 inches long.  
 Prices : plain cotton . . . . . each 35 cts., per doz. \$3 50  
 rubber covered . . . . . each 75 cts., " " 8.00

All Instruments illustrated are designated by a \*

XIV. GYNAECOLOGICAL INSTRUMENTS—PESSARIES.  
FOR ANTERIOR DISPLACEMENTS.

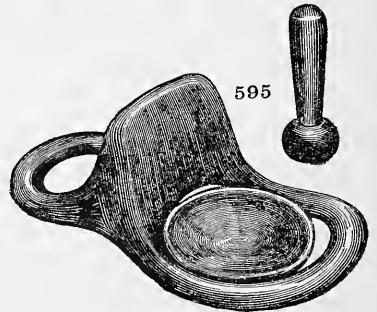
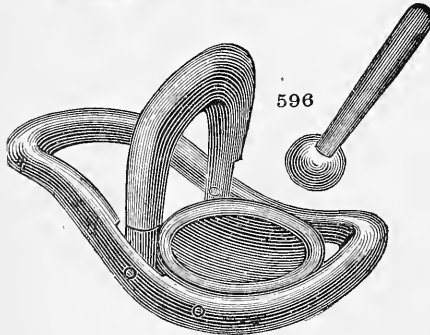
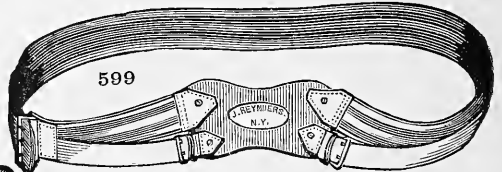
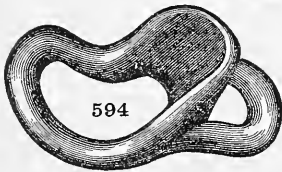
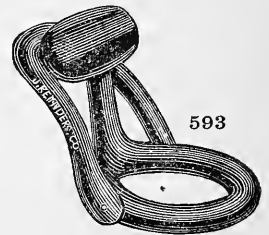
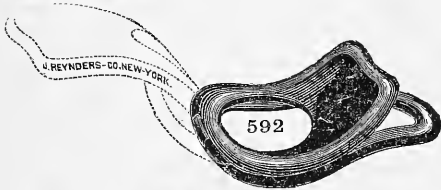
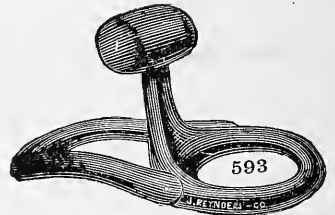
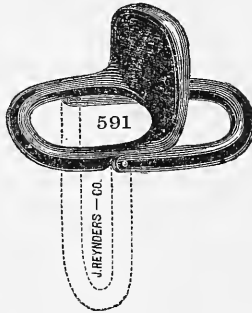
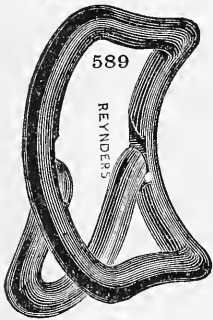
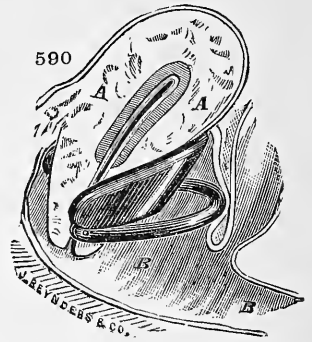
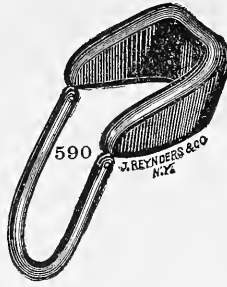
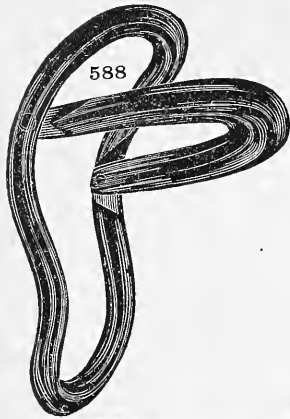

**XIV. GYNAECOLOGICAL INSTRUMENTS—PESSARIES.**

**FOR ANTERIOR DISPLACEMENTS.**

588.*	Thomas h. r., 1st pattern	1201	.....	\$1.00
589.*	" " 2nd "	1202	.....	1.00
590.**	" " 3rd "	1211, fig. A shows how it should be held for introduction, fig. B as it should be in situ.	.....	1.00
591.*	" " 4th "	1224 B	.....	1.25
592.*	" " 5th "	2410	.....	1.75
593.**	" " 6th "	2659	.....	2.00
594.*	" " 7th "	2660	.....	2.50
595.*	" " 8th "	2661	.....	3.50
596.*	" " 9th "	1210	.....	2.50
597.*	" " 10th "	2664, on Cutter's plan with band	.....	2.66
598.*	" elastic 11th "		.....	1.50
599.*	" Wood pad supporter for anteversion		.....	3.00
600.*	Cutter's h. r. with band		.....	1.50
601.*	" h. r. Thomas' modification with band		.....	1.75
602.*	" Donelson's modification, pliable soft rubber covered	..... 2.50		
603.*	" T shape	..... 2.00		
604.*	Beverly Cole's	..... \$2.00		
605.*	Gehring's	..... 0.50		
606.*	Pallen's	..... 2.50		
607.*	Wylie's	..... 1.00		
608.*	Hitchcock's	..... 1.00		
609.*	Hurd's soft rubber	..... 1.50		
610.*	" hard "	..... 2.00		
611.	McIntosh's. (See fig. 631)	..... 7.00		

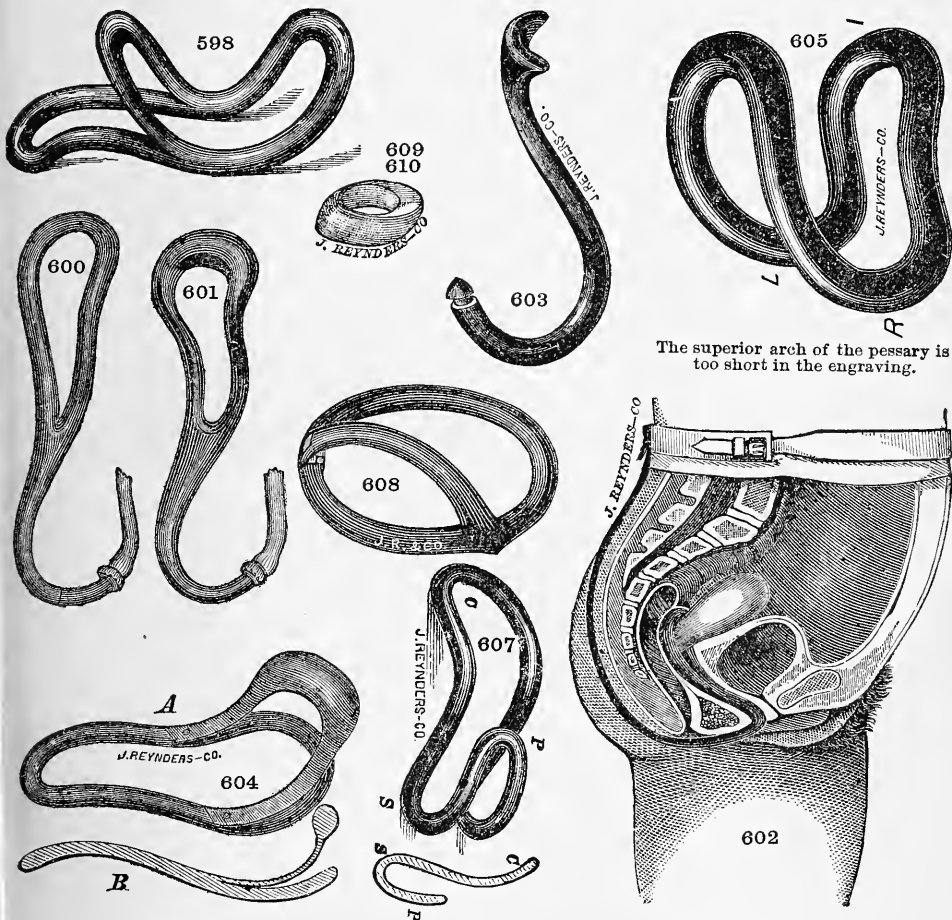
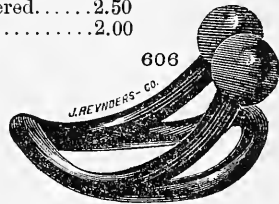

The superior arch of the pessary is too short in the engraving.

All Instruments illustrated are designated by a \*

XIV. GYNAECOLOGICAL INSTRUMENTS—PESSARIES.

FOR PROLAPSUS.



612

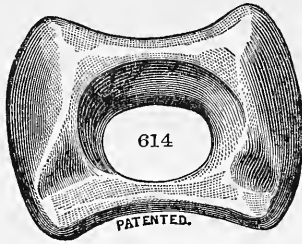

614

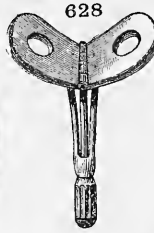

628

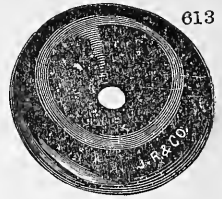

613



615, 616



617

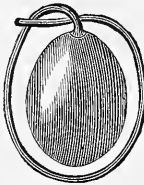

618

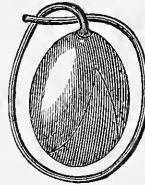

619



620

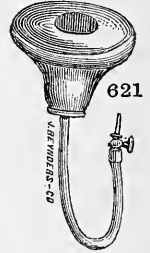

621

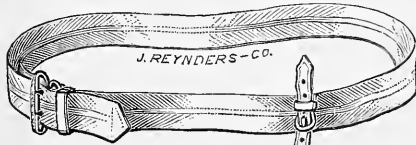

J. REYNDERS & CO.

624

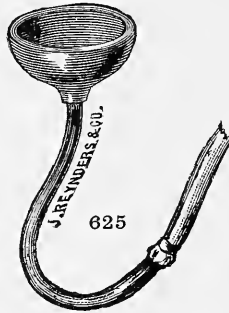

625

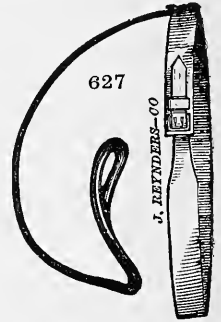

627

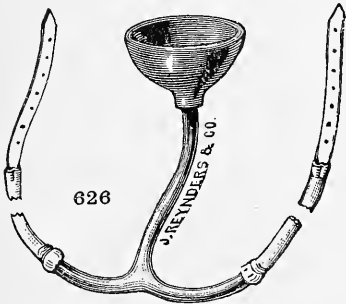

626

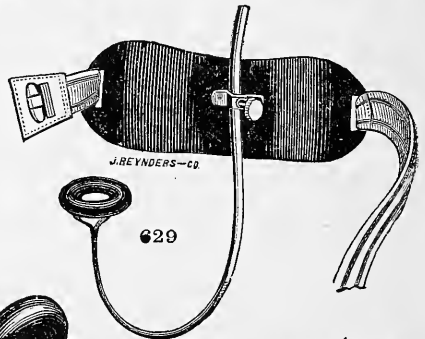

J. REYNDERS & CO.

629

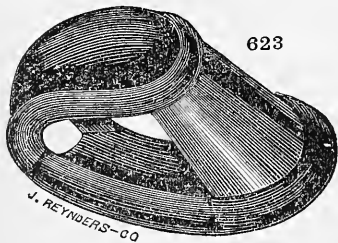

623



632

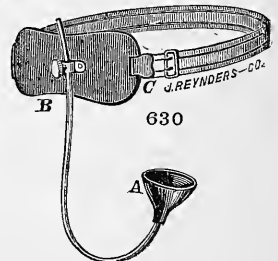

630



**XIV. GYNAECOLOGICAL INSTRUMENTS—PESSARIES.**

**FOR PROLAPSUS.**

612.*	Globe, h. r.	.....	\$1.00; glass	\$0.50
613.*	Concave h. r.	.....		0.25
614.*	Hoffmann's	.....	soft rubber \$1.50;*	hard rubber 3.00
615.*	Soft Rubber Inflated ring, light black (cl.)	.....		0.60
616.*	“ “ heavy, white (clax.)	.....		0.75
617.*	“ “ Inflatable (ca.)	.....		0.75
618.*	“ “ (ce.)	.....		0.75
619.*	“ “ (cn.)	.....		0.75
620.*	“ “ pearshaped.	.....		0.75
621.*	“ “ Gariel.	.....		1.50
622.	Stopcock's, for the five latter.	.....	h. r. \$0.50; brass	0.75
623.*	Bozeman's Vaginal Support	.....		2.50
624.*	Cutter's h. r. with ring and band	.....		2.00
625.*	“ h. r. “ cup and band.	.....		2.00
626.*	“ Thomas' mod. with cup and band.	.....		2.66
627.*	“ Donelson's mod. pliable soft rubber covered with band.	.....		2.50
628.*	Zwang's	.....		2.00
629.*	Scanzoni's	.....	\$5.00	
630.*	James'	.....		6.00
631.*	McIntosh's	.....		4.00
632.*	Cushiers—on McIntosh's plan, without support	.....		5.00
633.*	O'Leary's—“ with spiral spring \$5.00; with screw	.....		5.00
634.*	Wadsworth, soft rubber.	.....		6.00
635.	“ cup arranged on McIntosh's plan.	.....		8.00
636.*	Babcock's Silver	.....		15.00
637.	Herrick's	.....		5.00
638.	Shannon's	.....	* 8.00*	
639.	Wilson's	.....		8.00

**FOR CYSTOCELE.**

640.*	Skenes h. r.	.....	2.00
641.*	McLean's—Urethrocele and Cystocele. A is a pad to which straps are attached to go around the body; <i>bb</i> a forked branch of pliable metal holding the spring <i>c</i> ; the spring <i>c</i> is covered with soft rubber and holds the hard rubber part <i>d</i> . The opening in the parts <i>c</i> and <i>d</i> is to avoid pressure upon the urethra. The spring allows the part <i>d</i> to be held in the direction towards <i>e</i> ; in this position <i>d</i> is introduced into the vagina, so that when released the spring will press towards <i>d</i> and thereby against the urethrocele. The branches <i>bb</i> are to be moulded so as to fit well over the pubic portions of the body.....	Price	6.00

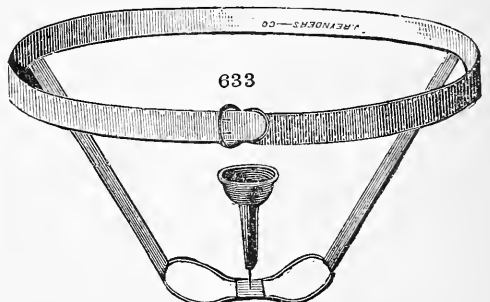
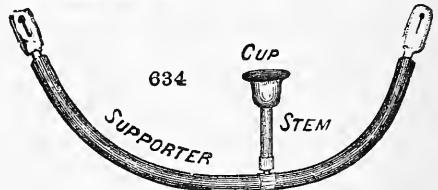
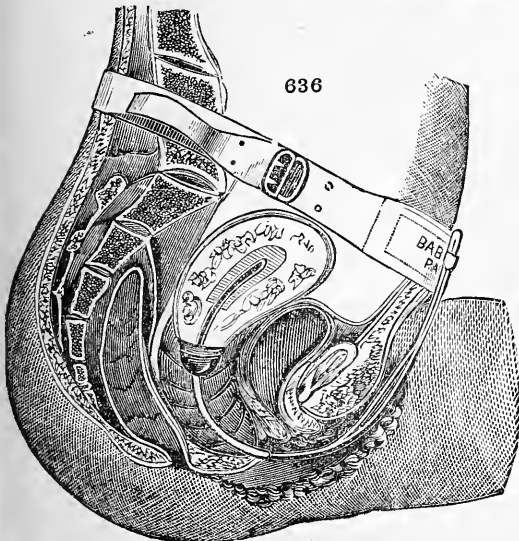
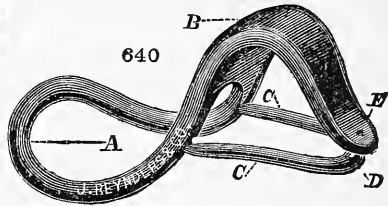
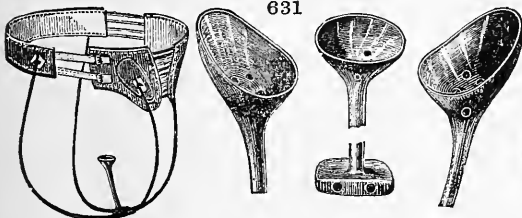
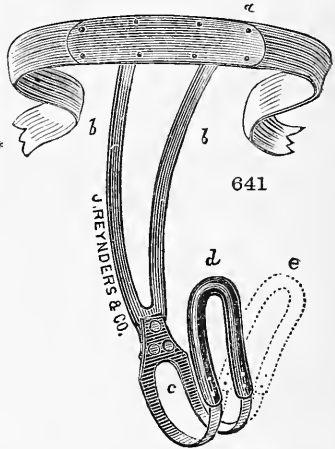

ADDENDA. OBSTETRIC AND GYNAECOLOGICAL.

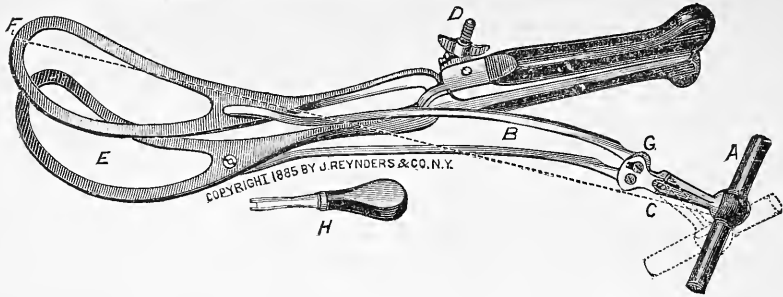

1. Simpson-Tarnier Fraction Forceps (descriptive circular on application) ..... \$14.00

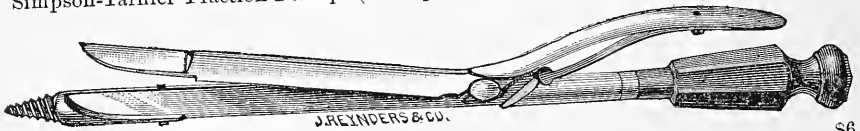

2. Ayres-Thomas Perforator ..... \$6.00

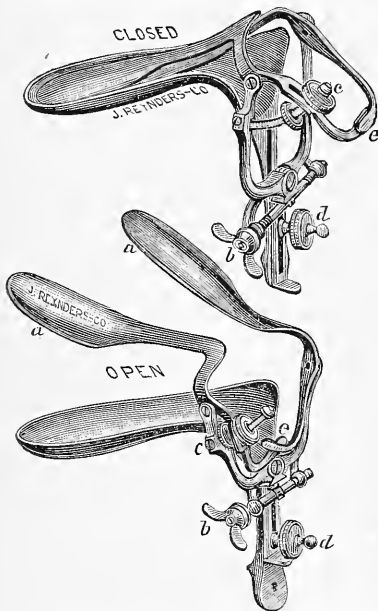

3. Nunn's Vaginal Speculum, tri-valve, enables adjustment of orifice by screw "d" and also the lateral movement of the upper blades "a" ..... \$12.00

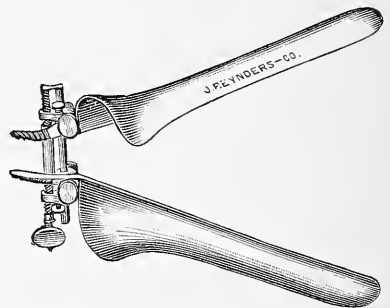

4. Kenilworth Vaginal Speculum... \$5.00

Fig. 1.

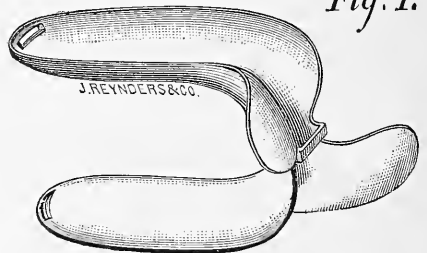

Fig. 3.

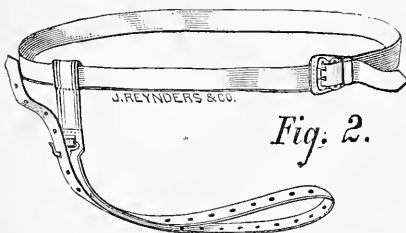
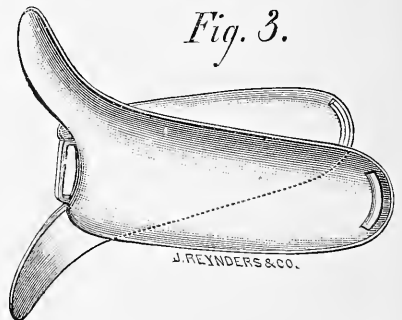
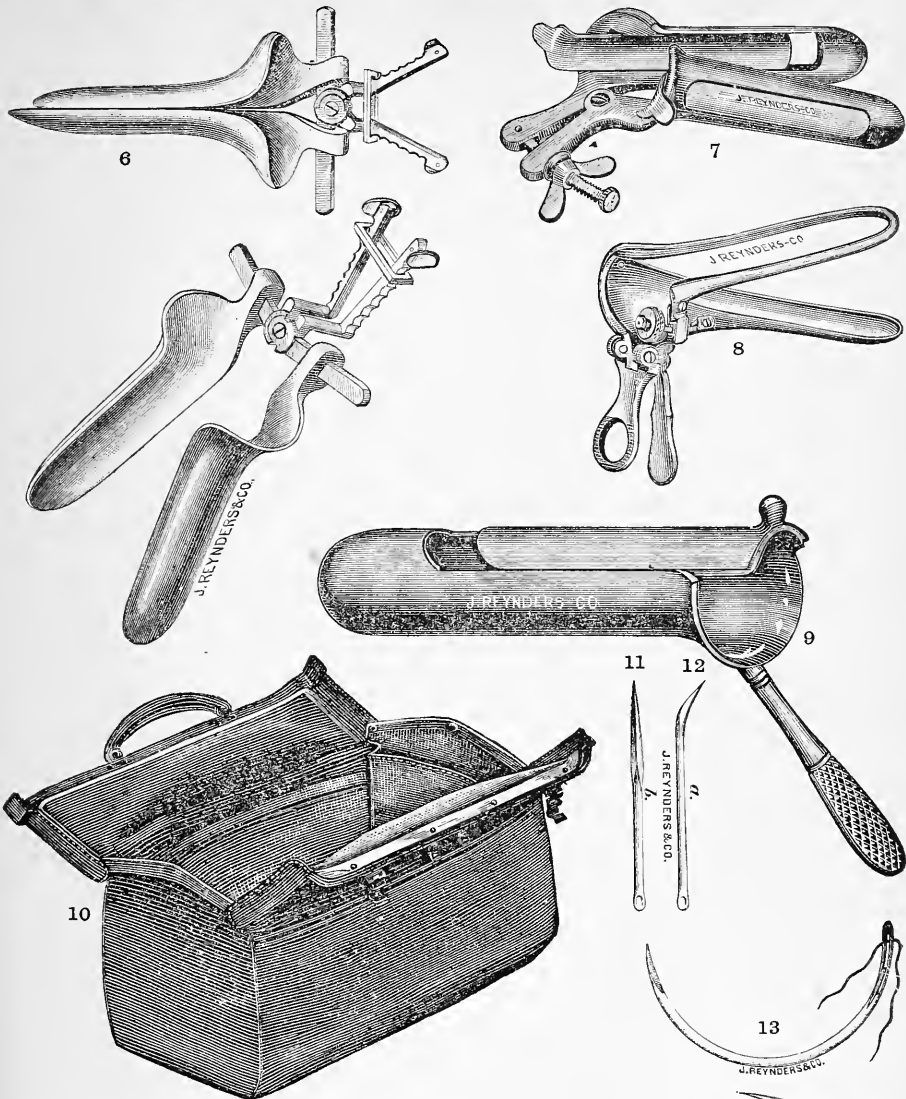

Fig. 2.



5. Figs. 1, 2 and 3, Cleveland's Speculum ..... \$5.00

ADDENDA. RECTAL AND VAGINAL SPECULA, Etc.



- 6.\* Vaginal Speculum, Reid's circular on application) ..... \$5.00
- 7.\* Rectal Speculum, O'Neil's, both blades fenestrated, for examination, injecting or application ..... good \$5.00; best \$6.50
- 8.\* Rectum Speculum, Kelsey's..... 6.00
- 9.\* " " Walker's, single .. 5.00  
 Same with Mirror at end, inside..... 7.00  
 Set of three, one handle..... 15.00
- 10.\* New Satchel, very neat, handy and capacious, contents not disturbed by opening same. Grain leather, 10 in. \$6.00; 11 in. \$6.75; 12 in. \$7.50; 13 in. \$8.00; 14 in. \$8.50; 15 in. \$9.50; 16 in. \$10.50; 18 in. \$11.50. Same in Alligator one-third more in price. See also page 175.
- 11.\* Gynaecological Needle, Skene's,  $\frac{13}{16}$ , 1 and  $\frac{1}{8}$  in..... each 15 cts.; per doz. \$1.50
- 12.\* Gynaecological Needle, Hanks', 1,  $\frac{13}{16}$  in ..... each 15 cts.; per doz. \$1.50
- 13.\* " " Boldt-Martin ..... " 25 " " 2.00
- 14.\* " " Hagedorn's..... " 15 " " 1.50
- As to Needles, see also pages 178 and 179. Hagedorn's, see page 5.

ADDENDA. GYNAECOLOGICAL.

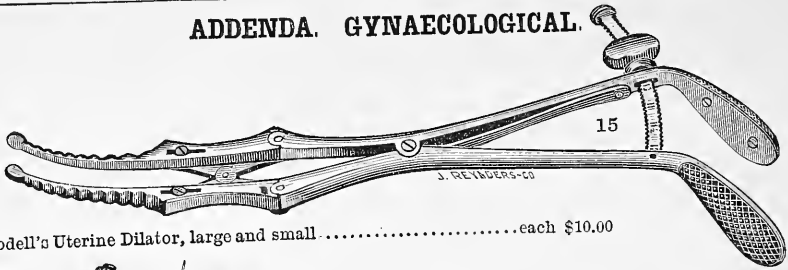

15.★ Goodell's Uterine Dilator, large and small .....each \$10.00



22a.★ Boldt's Tenaculum..... \$4.00

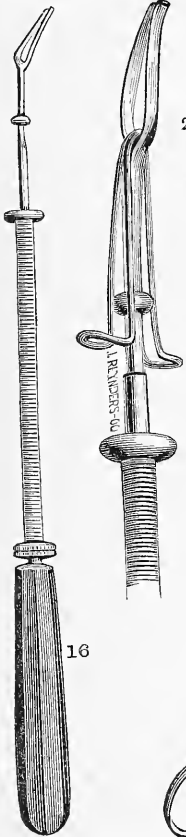

16.★ Outerbridge's Introducer for Wire Dilators (see below).....\$3.50

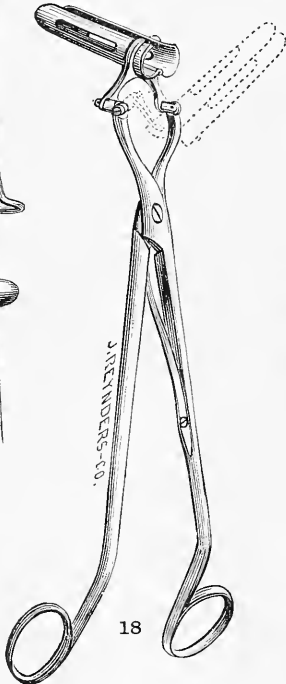

18.★ Elliot's Cervical Speculum ..... 7.00

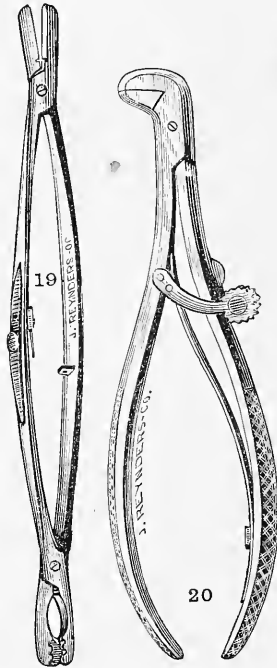

19.★ Skene's Needle Holder ..... 5.50



20.★ Improved Hagedorn Needle Holder, jaw rectangular or oblique angled ..... \$4.00

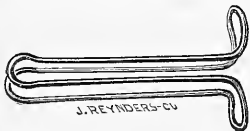

21.★ Harry Sims' Ecrasseur ..... 6.00

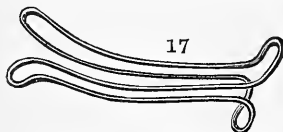

17.★ Outerbridge's Wire Dilators, 6 sizes, 1 to 3 in... each \$0.50

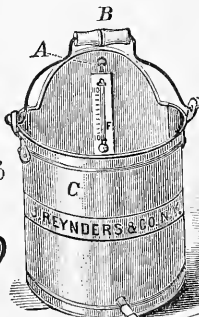

22.★ Dr. Branch Clark's Vaginal Douche (descriptive circular on application) .....\$6.00

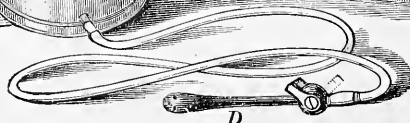
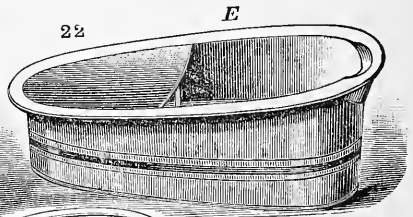

ADDENDA. GYNAECOLOGICAL.

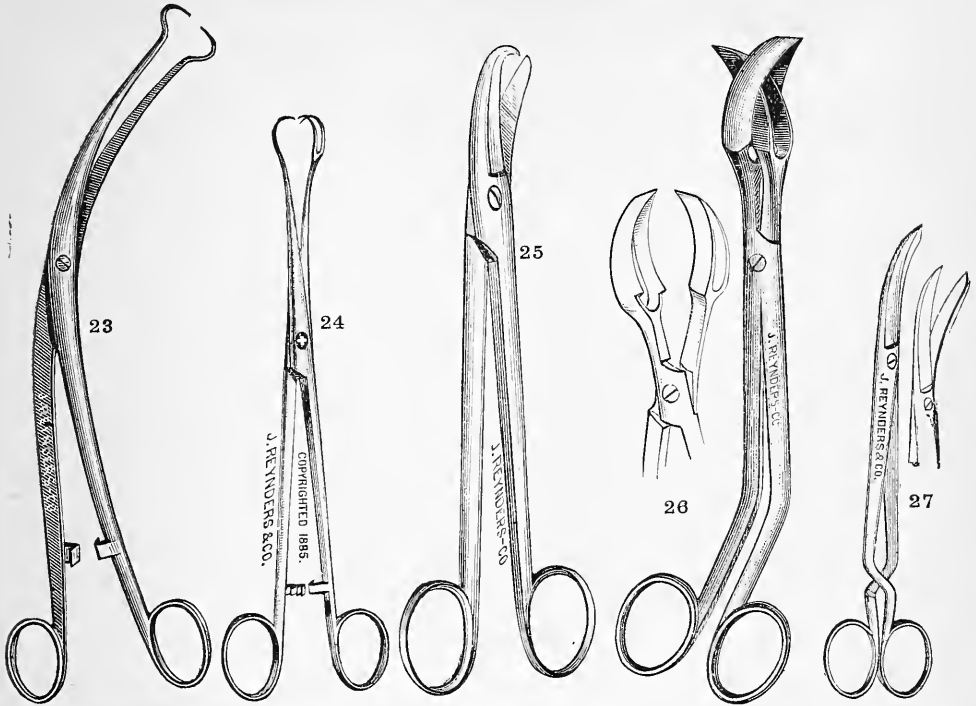

- 23.\* Tenaculum Forceps, Skene's..... \$3.00
- 24.\* " " (Angle Forceps), Wylie's..... 3.00
- 25.\* Boldt's Wire Scissors..... 3.00
- 26.\* " " "Hawkbill," Skene's..... 10.00
- 27.\* Boldt's Trachelorrhaphy Scissors..... 3.50

28.\* **Kelly's Rubber Cushions**, with Inflatable Rims, for general use in all perineum, cervix, rectal and ovariectomy operations. [See *American Journal of Obstetrics*, Vol. xx., October, 1887, as also the *New York Medical Journal*, April 28, 1888.]

No. 1.—For general use in perineal, cervical and rectal operations. Extreme length, 34 in.; width at top for buttocks, 14 inches..... net 3.50

No. 2.—Used in ovariectomy work; has a narrow, inflatable rim. Extreme length, 50 in.; width at broadest of rim, 24 in..... net 5.00

No. 3.—Used for Obstetrical work; similar in style to No. 2, but with a broad, inflatable rim, and long apron..... net 5.75

No. 4.—Similar in style to No. 2; for general surgical work. Extreme length, 44 in.; width, 20 in..... net \$4.50

No. 5.—Bed Pan and Cushion combined. Extreme length, 39 in.; length of pan, 18½ in.; width of pan, 12½ in..... net 5.75

These Pads are now in constant use for all operations as described above. Can be used on office table, operating chair or bed, without soiling either clothes or bedding; at the same time can have constant irrigation, while all fluids pass down the apron into a vessel.

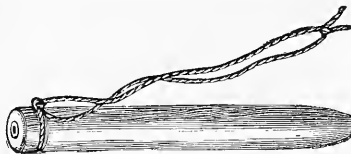
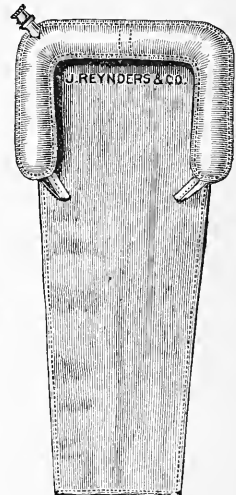
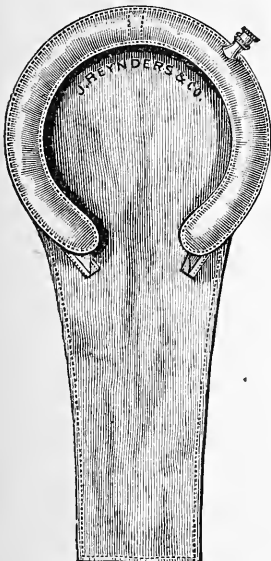

- 29. Slippery Elm Tents, see also page 159 (antiseptic), solid, 3/32, 5/32, 7/32, \* 3/16 in. diam..... per doz. \*\$1.00
- Solid, curved, same sizes as above, per doz. \*2.00
- Hollow Elm Tents, 7 and 8, 32 eds., per doz. \*1.50

ADDENDA. GYNAECOLOGICAL.

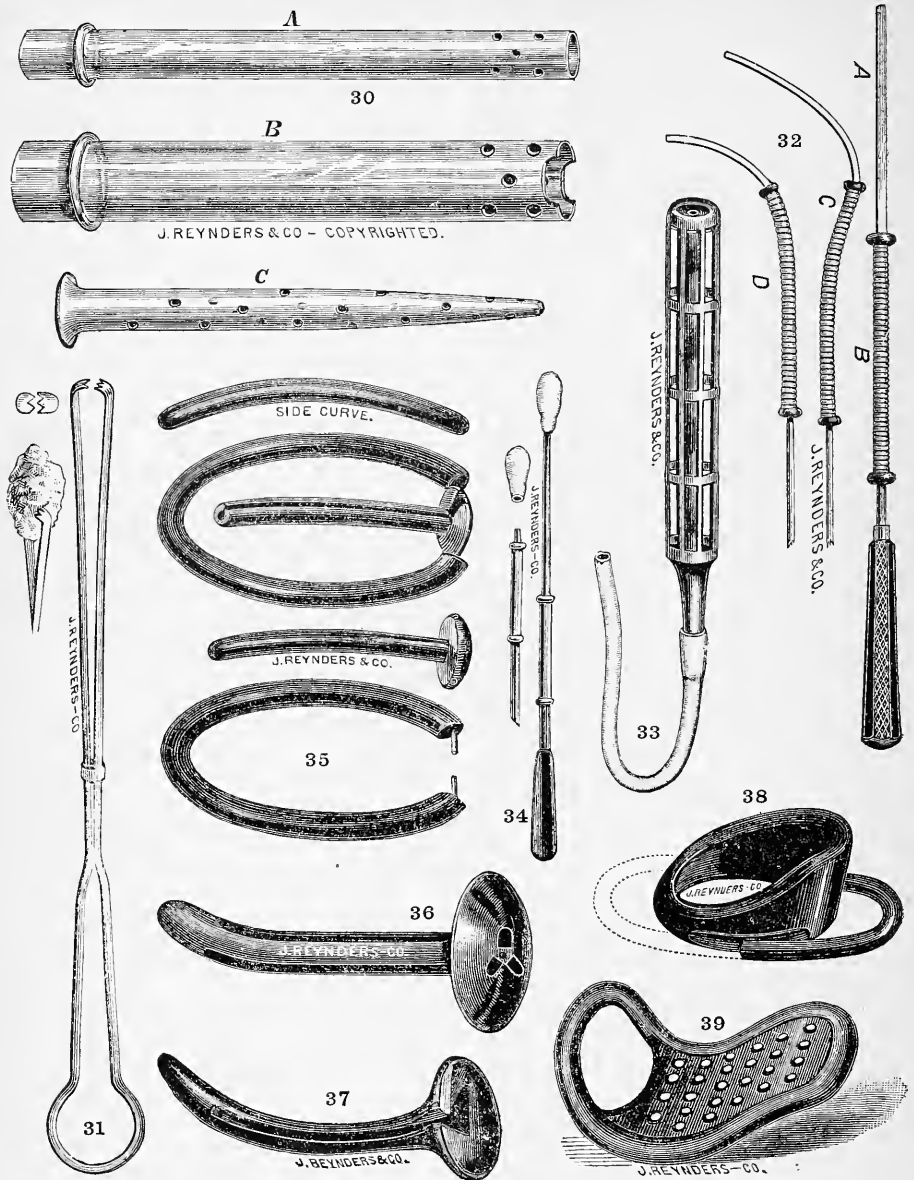

- 30.\* Wylie's Drainage Tubes, glass, vary in length 4 to 6½ in., in diameter 3/16 to 1/2 in. each \*\$0.25
- 31.\* Husson's Sponge Holder..... 1.00
- 32.\* Phillip's Applicator..... 2.00
- 33.\* J. S. Coleman's Improved Metroclyst..... 3.00
- 34.\* Munde's Applicator..... 1.25
- 35.\* Donaldson's Intra-Uterine Stem Pessary..... 1.00
- 36.\* Boldt's Hard Rubber Drainage Tube..... 0.75
- 37.\* Wylie's " " " "..... 0.75
- 38.\* Munde-Thomas' Anteversicn Pessary..... 1.25
- 39.\* Conkey's Pessary..... 1.00

ADDENDA. GYNAECOLOGICAL-LITHOTOMY.

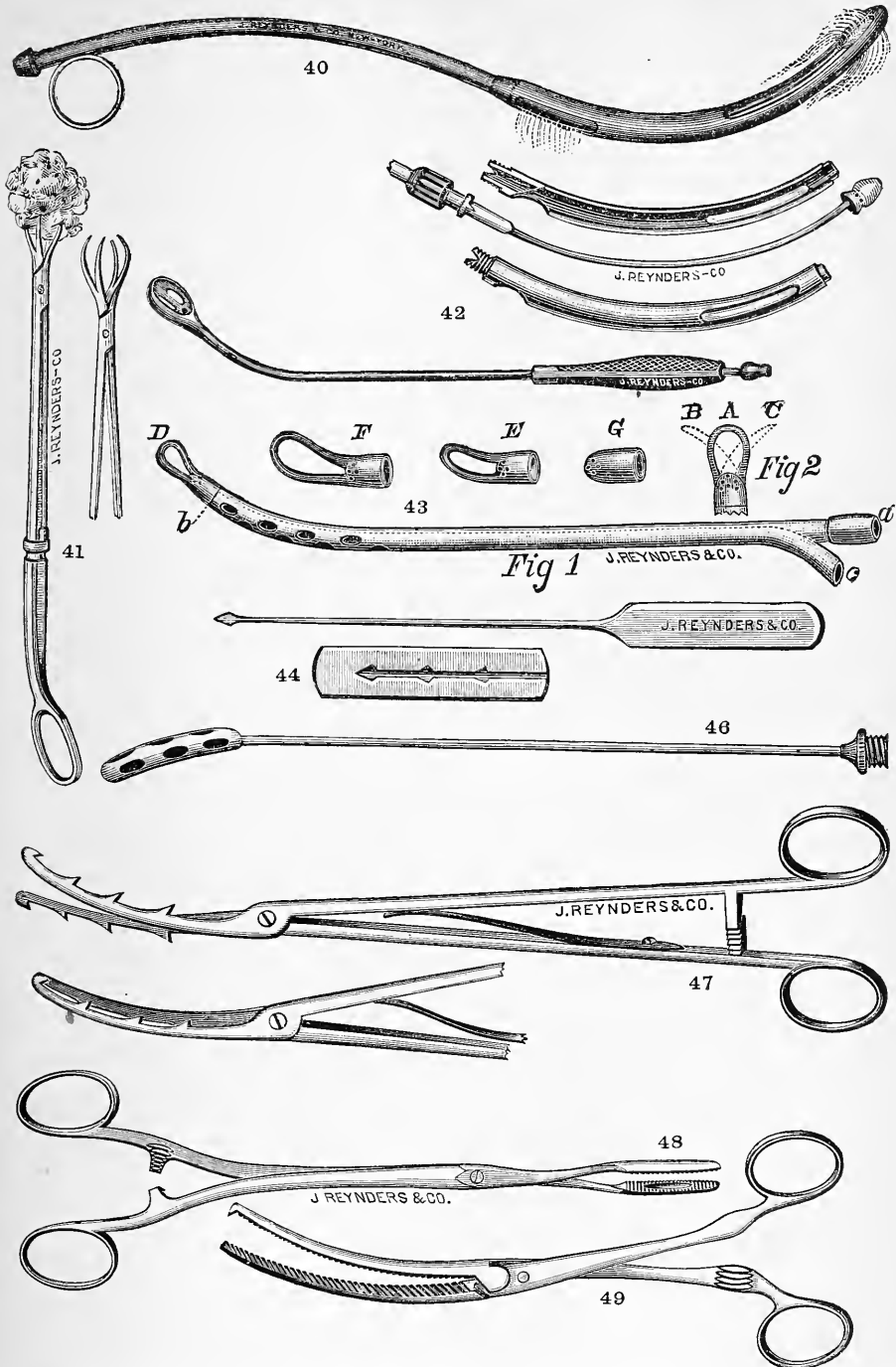

- 40.\* Bozeman's Improved Aseptic Back-flow Tube, all parts can most readily be separated for cleansing, \$4.50; the same plain \$2.50
- 41.\* Combination Curette and Sponge Mop.... 5.00
- 42.\* Combination Curette and Rinser, by Reinsetter..... 4.00
- 43.\* Combination Curette and Double Catheter, Abbott's..... 6.00
- 43a. Skene's Curette, 3 styles..... each 1.75

- 44.\* Wylie's Skewer and Guard..... \$2.00
- 45. Boldt's Tenaculum..... 3.00
- 46.\* Longear's Curette-Tubes (two sizes), pure silver with h. r. Syringe \$7.00; tubes plated 5.00
- 47.\* Bernay's Utero-Tractor..... 6.00
- 48.\* Thomas' Hysterotomy Clamp..... 3 50
- 49.\* Delery's Hysterotomy Clamp, straight or curved..... 4.00

XV. RECTAL INSTRUMENTS.

SPECULA.





**XV. RECTAL INSTRUMENTS.**

(Apparatus for Illumination see page 155.)

**SPECULA.** See also page 197B.

1.*	Glass, reflecting, American.....	\$0.80
2.*	“ “ English.....	1.30
3.*	H. R., set of 4.....	4.00
4.*	Squire's.....	4.50
5.*	Hosmer's.....	4.50
6.*	Allingham's.....	3.00
7.*	Reed's, with glass slide.....	3.50
8.	Nott's, see fig. 53, page 154.....	4.50
9.	Cusco's, see fig. “ 151.....	4.50
10.	Higbee's, see fig. 40, “ 152.....	4.50
11.	Sims, see fig. , page 149.....	2.50
12.*	Van Buren's.....	3.00
13.*	Skene's.....	4.50
14.*	Ricord's open ends.....	3.00
15.	“ closed ends.....	3.00
16.*	Woodward's, combined with female urethral speculum.....	4.00
17.*	Hinged.....	5.00
18.*	Bodenhamer's 2 bladed, brass, n. p.....	6.00
19.*	“ “ steel, n. p.....	6.00
20.	“ “ short anal.....	4.50
21.*	Sims', steel n. p.....	5.50
22.*	Thompson's.....	7.00
23.*	Ashton's, 3 bladed.....	7.50
24.*	Weiss, 3 bladed.....	16.00
25.	“ -Bodenhamer's (blades fenestrated).....	16.00

---

26.*	Gorgeret, ebony.....	1.00
27.*	“ steel.....	2.50
28.*	Bougie, Red English, cylindric.....	1.00
29.*	“ “ olivepoint.....	1.50
30.*	“ “ conic.....	1.50
31.*	“ H. R. long, cylindric..... per set	\$3.00
32.*	“ “ short “.....	3.00
33.	“ “ conic.....	3.00
34.*	Soft Rubber Wale's.....	\$1.50 to 4.00
35.*	Steel n. p., Nelson's, straight or curved.....	2.00
36.	Bulbous, on whalebone stem.....	1.50
37.	“ “ set of six.....	5.00
38.	“ “ “ with oesophageal stem one doz.....	10.00
39.	Tents, Sponge; according to size, each	\$0.50 and 0.75
40.*	“ Sea Tangle.....	0.75
41a.	“ Slippery Elm.....	.50 cts. and 0.75



All Instruments illustrated are designated by a \*

XV. RECTAL INSTRUMENTS.

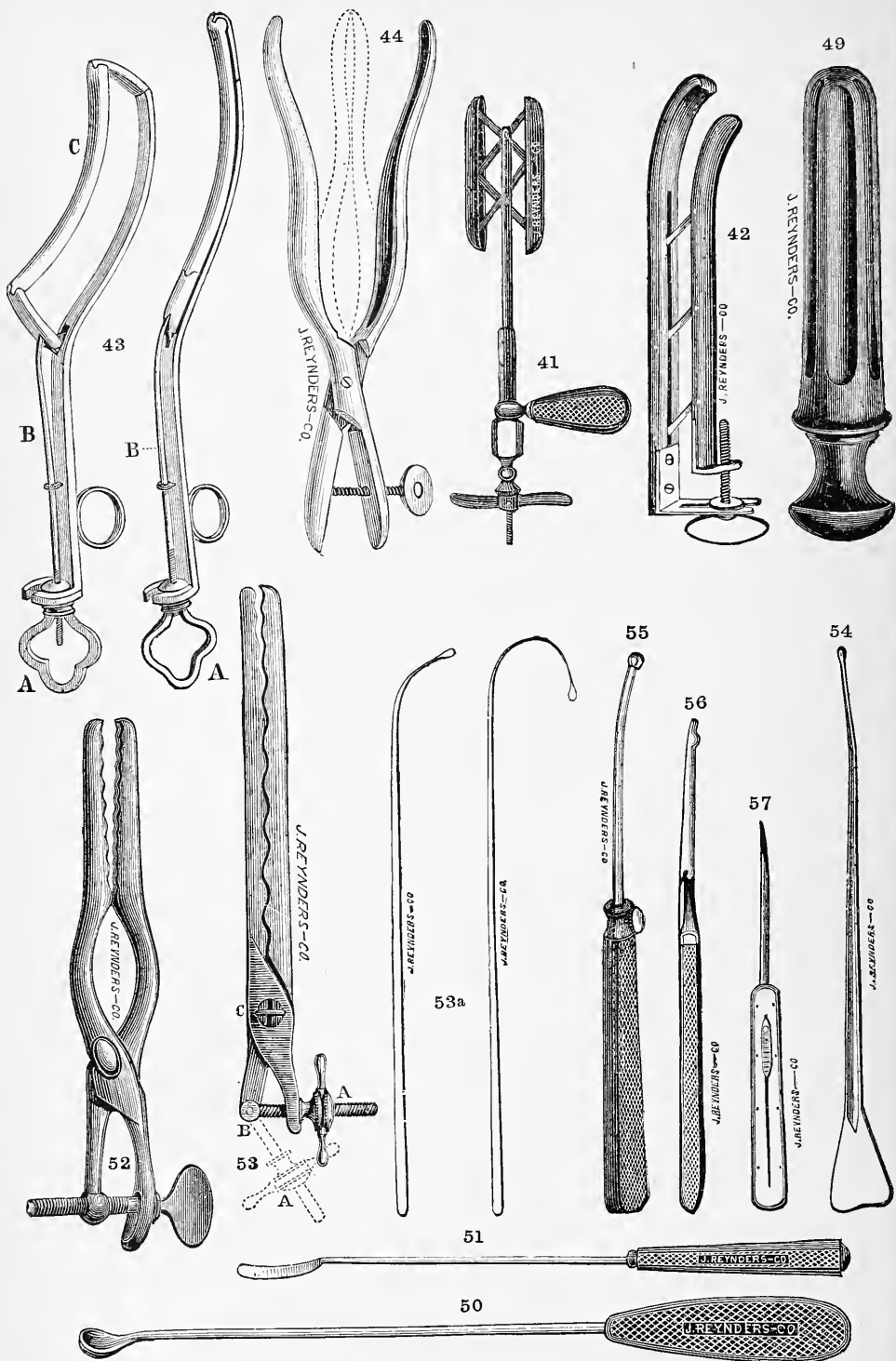

**XV. RECTAL INSTRUMENTS.**

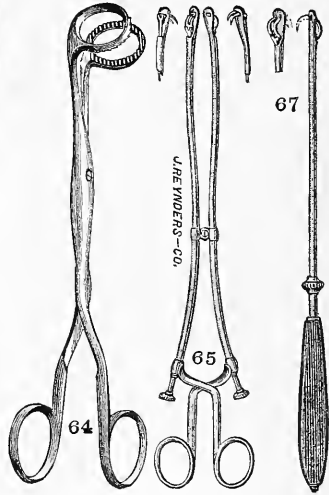
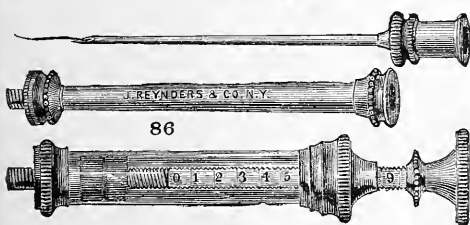
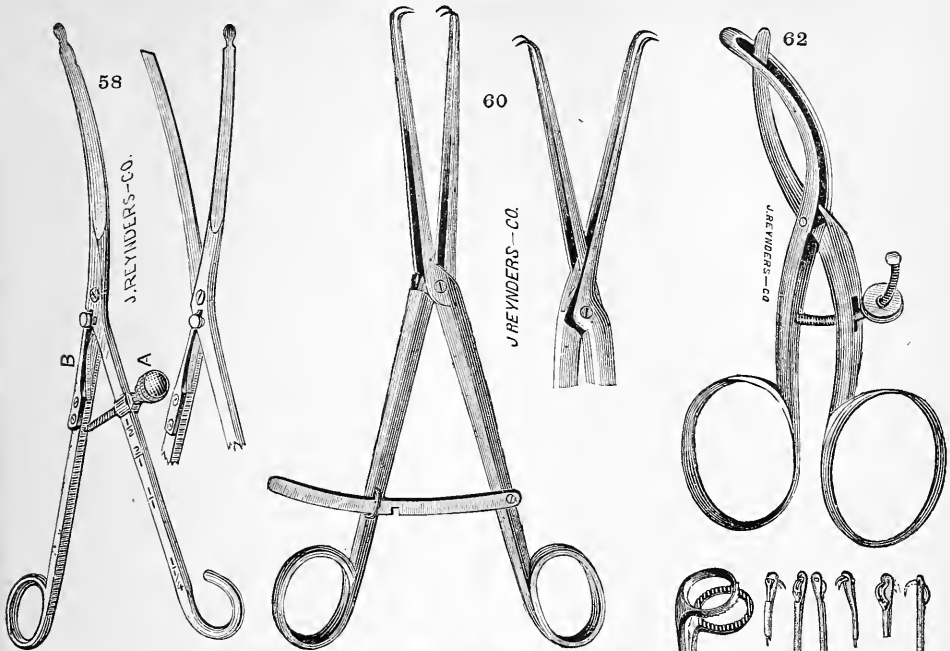

41.*	Dilator, Durham's.....	\$15.00
42.*	" Rigand's.....	10.00
43.*	" Collin's.....	10.00
44.*	" Sims'.....	4.50
45.	Sponge Holders. See page 67.	
46.	Brushes. See pages 117 and 119.	
47.	Powder Blower Rectal.....	2.50
48.	Suppository Tube. See pages 167 & 287	
49.*	Salve Bougies, h. r. grooved, Parker's	1.50
50.*	Scoop for the removal of faeces.....	\$2.00
51.*	Scarifier for the Rectum.....	1.50
52.*	Enterotome, Dupuytren's.....	5.00
53.*	" Pana's.....	6.00
53a.**	Probes, Bodenhamer's.....	each 1.25
54.*	Probe Director, Gowland's.....	1.25
55.*	Director, Gowland's.....	3.00
56.*	Anal Fissure Knife, Bodenhamer's.....	5.00
57.*	" " Blandin's, for submucous and subcutaneous section of the sphinctores ani muscles.....	8.00
58.*	Bistoury-caché for fistulas.....	7.00
59.*	Scissor Director, Allingham's.....	7.00
60.*	Double Spring Tenaculum, Byrnes, for pulling down the rectum...	6.00
61.	Other Instruments for the same purpose. See.....	
62.*	Curvilinear Forceps, Bodenhamer's.....	5.00
63.*	Pile Forceps, Ashton's.....	3.00
64.*	" " ".....	3.00
65.*	" " Collins', double.....	20.00
66.	" " See also Polypus Forceps, page 173, Nos. 306-324, Page 187, Nos. 503, 504.	
67.*	Vulsellum, single, Collins'.....	15.00
68.*	Clamp, Smith's.....	6.00
69.*	" Langenbeck's.....	5.00
70.*	" Curling's.....	5.00

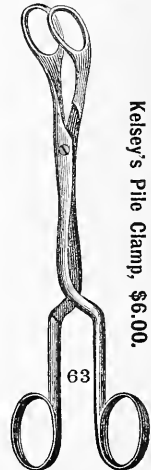

XV. RECTAL INSTRUMENTS.

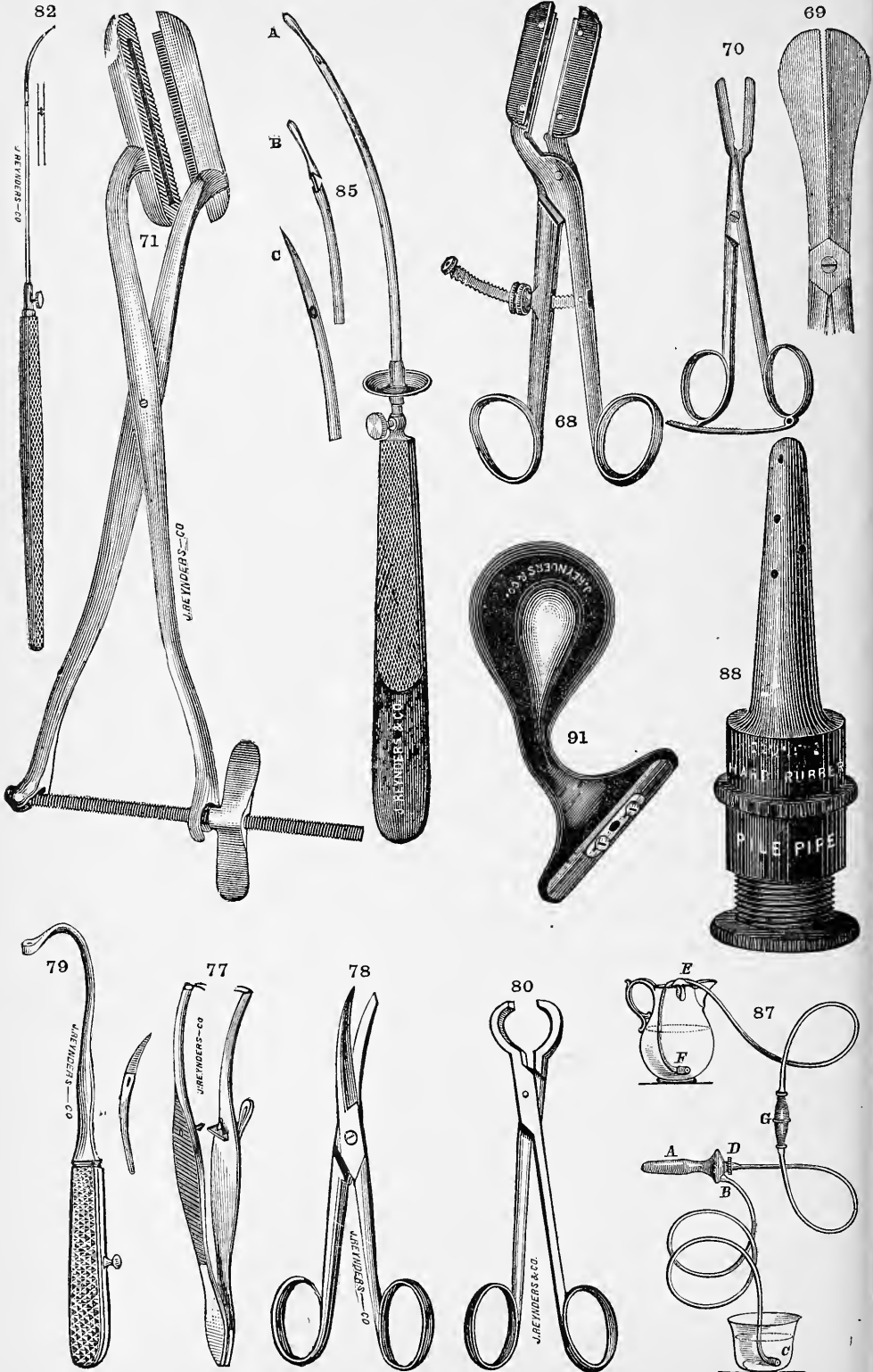

**XV. RECTAL INSTRUMENTS.**

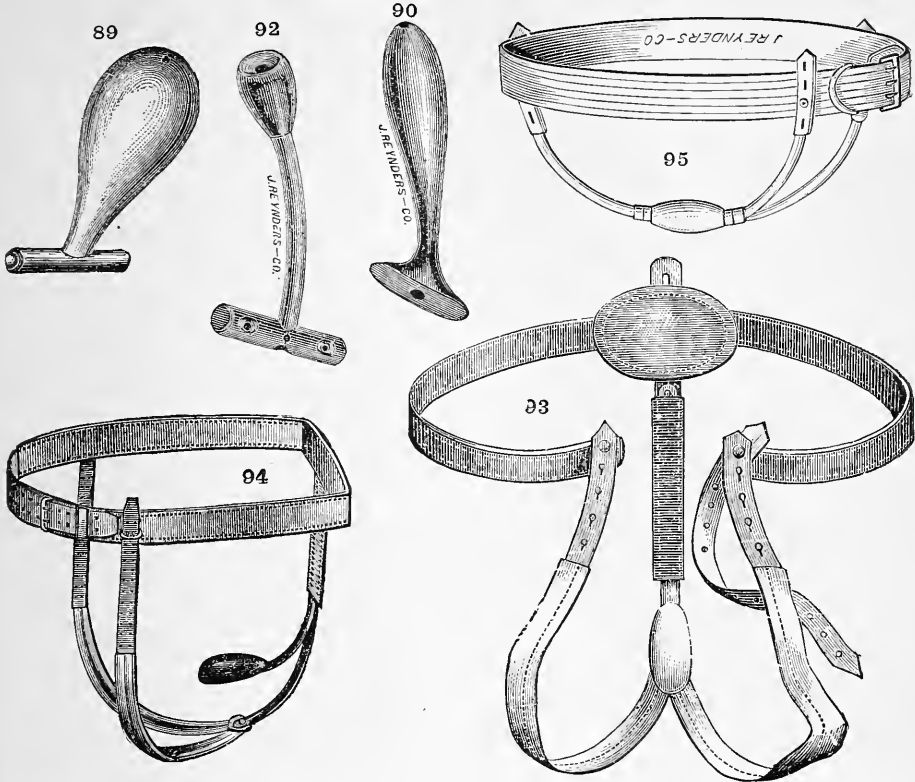

71.* Rectilinear Ecrasseur, Nott's.....	\$10.00
72. Cautery Irons	} See Division XXVII.—Pages 274 and 275.
73. “ Lamps	
74. “ Pacquelin’s	
75. Knot Tier Carroll’s. See page 189.....	2.50
76. Gooch’s Double Canula. See page 173, fig. 327.....	5.00
77.* Bush’s Pile Forceps.....	2.25
78.* “ “ Scissors.....	1.50
79.* “ “ Needle Holder.....	2.00
80.* “ “ “ Extractor.....	3.00
81. Needles in handle. See page 180.	
82.* “ “ “ Hutchinson’s.....	2.50
83. Elastic Ligature, English, assorted sizes, per foot.....	0.15
84. “ “ “ Dittel’s, per yard.....	0.25
85.* “ “ “ Carrier, Allingham’s.....	3.50

With this instrument a double ligature can readily be drawn through a fistula or under a tumor. It is not necessary in fistula operations to see the hook, for if the finger with a loop of india rubber around it be passed up the rectum, the loop can with great facility be directed over the end of the probe and caught in the notch. C shows the sharp pointed instrument adapted to the same canula, so that only one handle and one canula are required to complete the double instrument. There are many other surgical operations in which the use of elastic ligature is particularly indicated.

86.* Adams’ Pile Injecting Syringe. See page 201.....	4.50
87.* Mattson’s Cold Water Cone.....	2.00
88.* Seeley’s Pile Pipe for application of salves.....	3.00
89.* Pile Supporter, plain.....	1.25
90.* “ “ Bolton’s.....	1.25
91.* “ “ Trousseau’s.....	2.75
92.* “ “ Reed’s.....	1.25
93.* “ “ elastic.....	5.00
94.* “ “ Spring h. r. covered.....	5.00
95.* “ “ Huxley’s.....	6.00
96. Syringes. See under the heading of “Syringes and Douches.” Pages 238 and 239.	
96a. Rectum Tube, O’Beirne’s..... 6 and 8 in., each \$0.50; 20 in. \$1.25; 24 in.	1.50

All Instruments illustrated are designated by a \*

XVI. MALE URETHRAL INSTRUMENTS.  
FOR EXAMINATION.

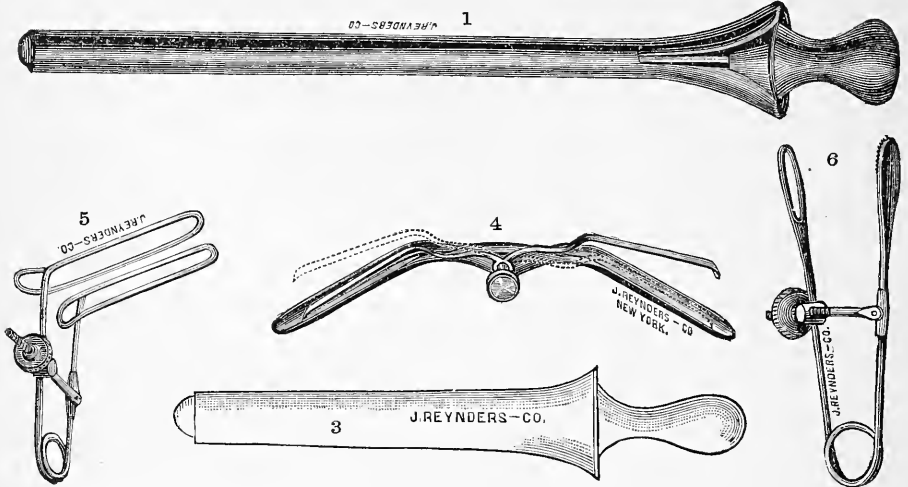

1.* Endoscopic Tube, Otis', h. r. ....	\$1.50
2.* Meatoscope, Weir's. ....	1.25
3.* " Piffard's, 3 sizes, .... each h. r.	\$1.00; ivory 2.00
4.* Speculum, Skene's. ....	3.00
5.* " " Folsom's. ....	1.50
6.* " " Otis'. ....	1.50
7.* " " Glass, white. ....	\$0.50; reflecting .75
8.* Endoscope, Skene's, (see page 199, fig. 13) .....	2.75

GAUGES.

9. Charrière's or French, G. S. ....	3.50
10. Otis' G. S. ....	4.00
11. American, Van Buren & Keyes' .....	steel 4.00
12. English. ....	" 4.00
13.* Handerson's (see next page) .....	6.00

On cardboard free. American V. B. & K. scale with approximation of the French celluloid, light 10 cts.; heavy 15 cts.

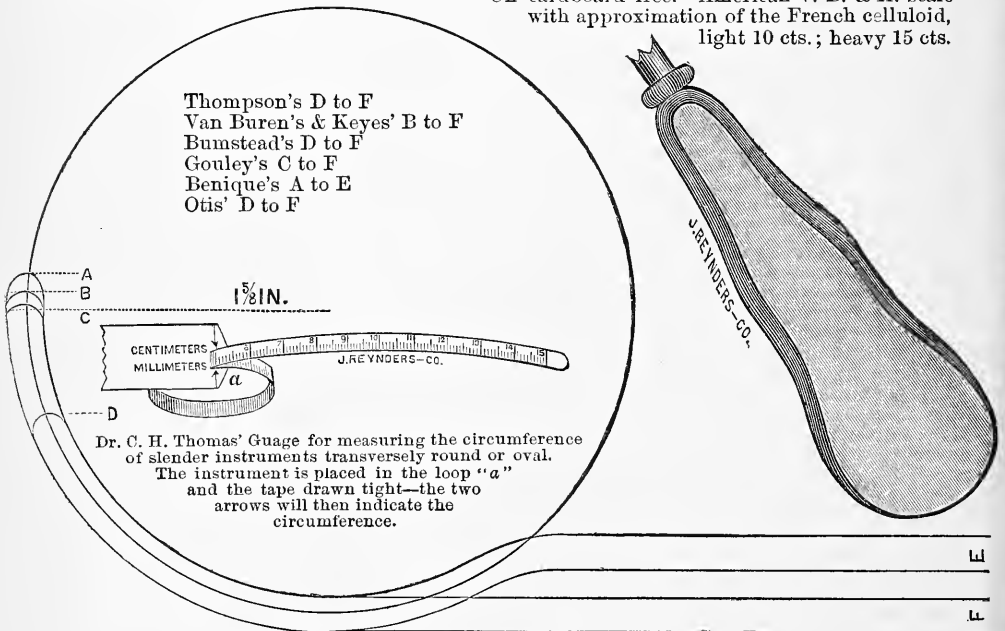

CORRECT CURVES OF UNYIELDING URETHRAL INSTRUMENTS.

**XVI. MALE URETHRAL INSTRUMENTS.**  
**COMPARATIVE SCHEDULE OF GAUGES MOST IN USE.**

Diameters in Milli- metres.	American or Van Buren & Keyes' Numbers.	Gouley's Numbers.	French or Otis' Numbers.	Approximations of English Scale to the French according to						Sir Henry Thomp- son No. 1. ±	Sir Henry Thomp- son No. 2. ≈
				John Reyn- ders & Co.	Tie- mann & Co.	Ford.	Phila- delphia.	Codman & Shurtleff.			
1	1	1	1								
1	2	1/4	2						1		
1	3	1/2	3		1			1			
2	4	1	4	1	2	1	1	2	2	1	
2	5	2	5		3	2		3	3	2	
3	6	3	6	2	4	3	2	4	4		
3	7	4	7	3	5	4	3	5	5	3	
3	8	5	8	4	6		4	6	6	4	
4	9	6	9	5	7	5	5	7	7	5	
4	10	7	10	6	8	6	6	8	8	6	
5	11	8	11	7	9	7	7	9	9	7	
5	12	9	12	8	10	8	8	10	10	8	
6	13	10	13	9	11	9	9	11	11	9	
6	14	11	14	10	12	10	10	12	12	10	
7	15	12	15	11	13	11	11	13	13	11	
7	16	13	16	12	14	12	12	14	14	12	
8	17	14	17	13	15	13	13	15	15	13	
8	18	15	18	14	16	14	14	16	16	14	
9	19	16	19	15	17	15	15	17	17	15	
9	20	17	20	16	18	16	16	18	18	16	
10	21	18	21	17	19	17	17	19	19	16, 18	
10	22	19	22	18	20	18	18	20	20	19	
11	23	20	23	19	21					20	
11	24	21	24	20	22					21	
12	25	22	25	21	23					22	
12	26	23	26	22	24					23	
13			27	23	25						
13			28	24	26						
13			29	25	27						
13			30	26	28						
13			31	27	29						
13			32	28	30						
13			33	29	31						
13			34	30	32						
13			35	31	33						
13			36	32	34						
13			37	33	35						
13			38	34	36						
13			39	35	37						
13			40	36	38						

+ According to comparative list in his Clinical Lectures on Diseases of the Urinary Organs. 4th Edition 1876, pages 55 and 56.

≈ Compared with a "Standard Gauge" as per his letter to us of December 23rd, 1877, of which he says that it may be considered accurate.

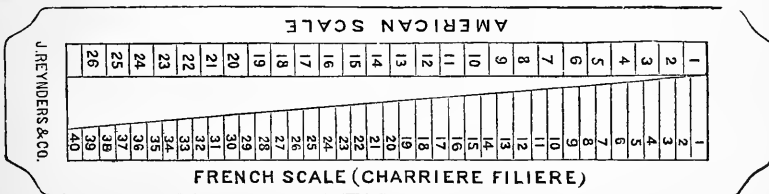

Entered according to Act of Congress in the year 1883, by JOHN REYNOLDERS & Co., in the office of the Librarian of Congress at Washington, D. C.

XVI. MALE URETHRAL INSTRUMENTS.

18 21 22 23 24 25

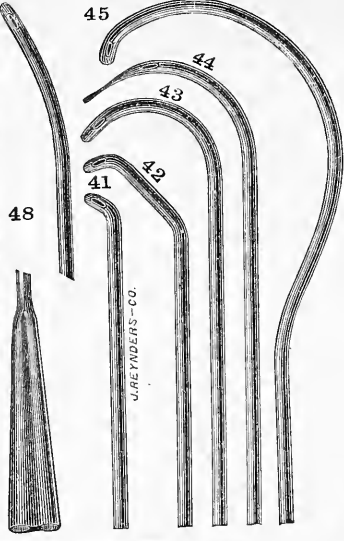
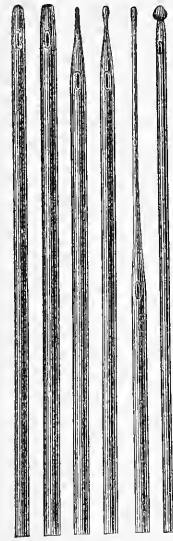

This figure illustrates the new countersunk eye in Jacques' Catheters—superior to any other style for preventing irritation.

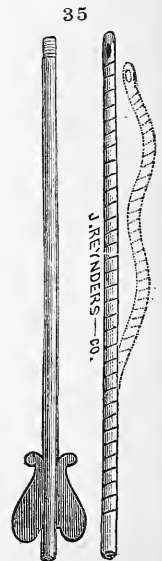
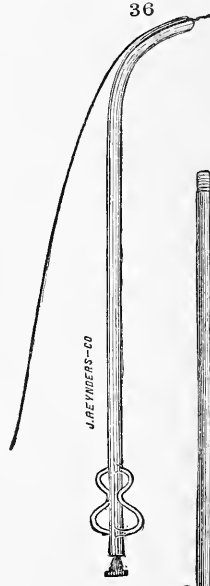
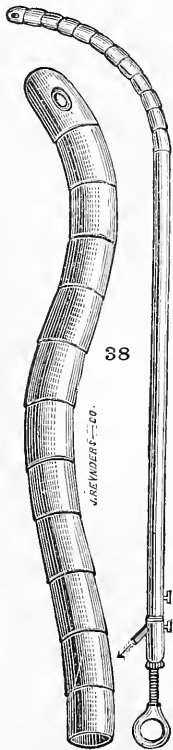
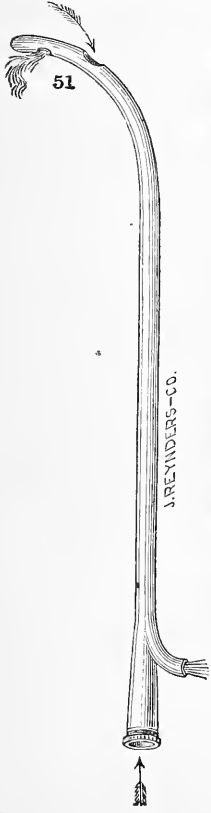
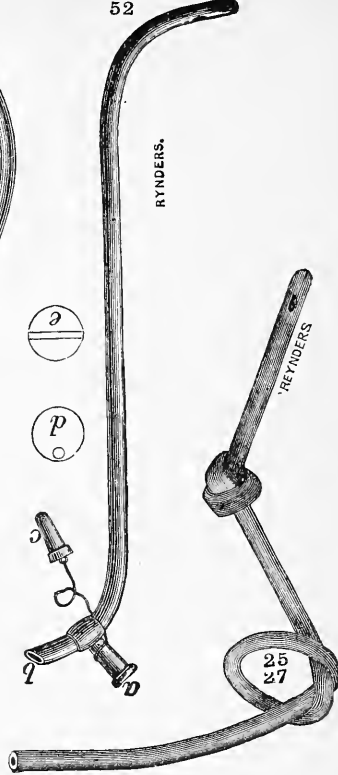



XVI. MALE CATHETERS.

(When ordering designate size and by what scale. See page 217A for box for same.)

ELASTIC WEB.

- 14. English, ordinary, 1 to 12, each 20 cts. per doz. \$1.60
- 15. " brown, black tipped, each 40 cts. above 12, each 0.50
- 15a. Belfast Linen, cylindrical, olive or conical, 1 to 12.....each 60 cts.; 13 to 18 each 0.75
- 15b. Same, with metal eye, 13 to 18..... " 0.75
- 18.\* French, cylindrical..... " 0.35
- 21.\* " open at end..... " 0.60
- 22.\* " conical.....each 80 cts.; Vergue's 1.00
- 23.\* " olive-pointed " 80 "..... 1.00
- 24.\* " with antecedent Bougie..... 1.00
- 25.\* " exploring, bulbous..... 0.75

SOFT RUBBER.

- 27.\* \* Jacques', with depressed eye..... 0.67
- 28. Davidson's, with open end..... 0.75
- 28a. Tiemann's velvet eye; A, 67 cts.; C, 80 cts.; D, \$1.33; E, 80 cts.; F, 80 cts.; G, 80 cts.; H, 80 cts.; I, 1.33
- 30.\* Conductor for same..... 1.00
- 29. Hard Rubber.....each 0.80

METALLIC.

- 31. Britannia.....each 0.67
- 32. German silver plated..... " 0.75
- 33. Coin silver (hard), 1 to 4, each \$1.50; 5 to 8, each \$1.75; 9 and 10, each \$2.00; 11, \$2.25; 12, 2.50

METALLIC—Continued.

- 34. Pure silver (pliable).....\$2.50 to \$4.00
- 35.\* Gross' spiral, plated, plain or Mercier, each 2.00
- 36.\* Gouley's, tunneled..... 2.50
- 37. Guides for above.....1 foot 50 cts.; 2 feet 1.00
- 38.\* Squire's, vertebrated..... 6.00
- 39.\* Probe-pointed, silver, Otis' or Bumstead's (see page 208).....each 2.50

PROSTRATIC.

- 40. Elastic, English, brown..... 0.75
- 40a. " Belfast linen, Mercier, 1 to 12, plain 80 cts.; met. eye 1.75
- 41.\* " French, Mercier's, single curve 75 cts.; Vergue's 1.00
- 42.\* " French, Mercier's, double curve.. 0.75
- 43.\* " " fixed curve..... 0.75
- 44.\* " " "..... 0.75
- 45.\* " " Duboc's..... 1.00
- 46. Metallic, G. S. plated \$1.25; hard silver \$2.00 to \$3.00; pliable silver \$3.00 to 5.00

DOUBLE CURRENT.

- 48.\* Elastic, English, brown \$1.25; French black 1.75
- 49.\* Soft rubber..... 3.00
- 50.\* Hard rubber..... 3.00
- 51.\* Metallic, plated.....plain \$2.00; Nott's 2.66
- 51a. " silver..... " 3.75; " 4.00
- 52.\* " Billroth's.....plated \$3.00; silver 5.00

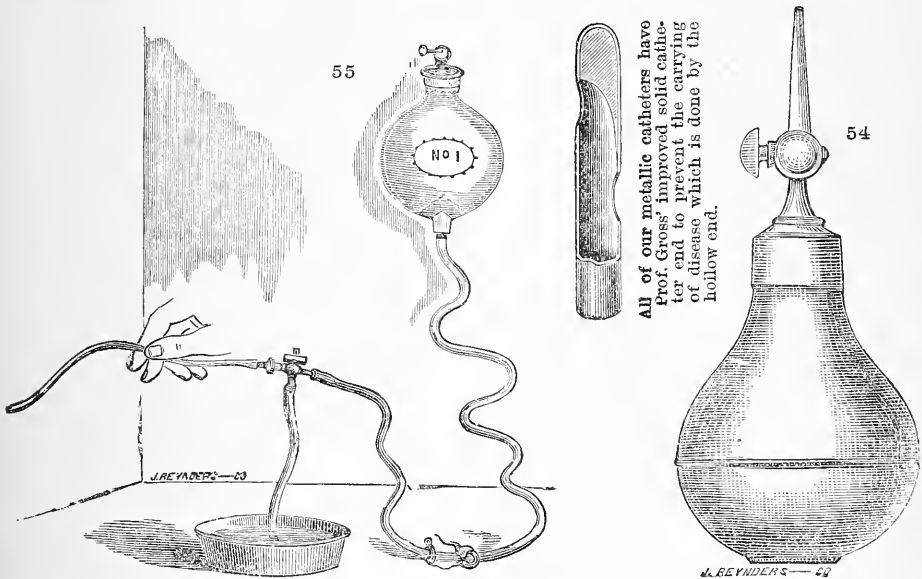

- 55.\* Keyes' Bladder Irrigator..... \$5.00
- Three-way Stopcock only..... 2.50
- 54.\* Van Buren's Bag and Stopcock..... \$3.50

All Instruments Illustrated are designated by a \*

MENTION NUMBER AND SCALE WHEN ORDERING.

XVI. MALE URETHRAL INSTRUMENTS.

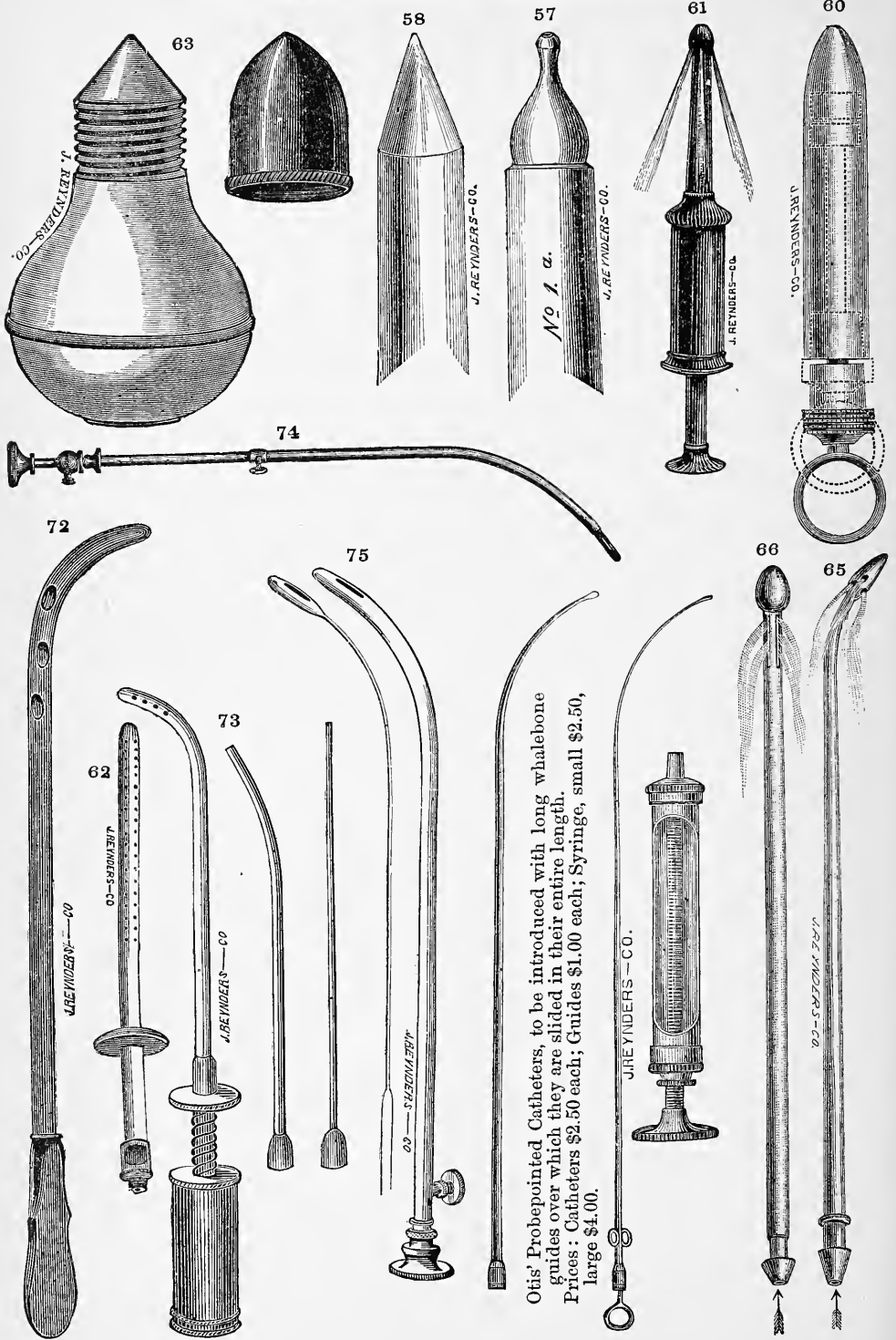

**XVI. MALE URETHRAL INSTRUMENTS.**  
**FOR MAKING APPLICATIONS.**

57.*	P. P. Syringe, Bumstead's, h. r.	.....	\$0.75
58.*	" Sigismund's, h. r.	.....	1.50
59.	" Royal, h. r.	.....	0.75
60.*	" Imperial, h. r.	.....	1.00

In this syringe the piston cap consists of a cone fitting the upper end of the barrel snugly; this cone with piston can be readily removed, and the liquid then poured into the syringe, whereby the inconvenience of filling an obtuse nozzleed syringe from a narrow necked bottle is avoided.

61.*	P. P. Syringe, Wheelock's Reverseflow, h. r.	.....	1.25
62.*	" Tube, Otis' h. r.	.....	1.50
63.*	" Bulb.	.....	.75
64.	" Buttles', with Dilating Contrivance	.....	5.00
65.*	Backflow Tube, Durham's.....	elastic \$0.75; h. r.	1.00
66.*	" " metal, nickelplated.....		1.00
67.*	Deep Urethral Syringe, Bumstead's.....		2.00
68.*	" " " with an additional bulbous tube resp.	.....	3.00
69.*	" " " a catheter with piston, silver	.....	4.00
70.*	" " " Bigelow's	.....	6.00

This is to be attached to a h. r. syringe; the outflow tube to the left contains a stylet running through the entire instrument and having a plug, controlling an opening in front. The instrument is introduced with the stylet withdrawn, so as to be able to determine when the bladder has been reached; the tube is then withdrawn, so that the small openings on the sides at the end of the instrument, reach where the application is to be made—the stylet is then pushed forward and the injection made. H. R. Syringe herefore \$1.50; Glass Syringe metal mounted \$3.00; the whole in case extra \$2.00.

71.	Psychrophor, Winternitz's—like a metal double catheter without holes, for the application of cold to the urethra..	3.50
72.*	Cupped Sound, Van Buren's.....	2.00
73.*	Breech loading Syringe, Hutchison's, for applying ointments, silver	11.00
74.*	Urethral Port Caustic, Lallemand's.....	4.50
75.*	" " " Gross'.....	4.50

**URETHRAL FORCEPS.**

76.*	Thompson's.....	2.00
77.*	Alligator..... straight \$5.33; curved	6 00
78.*	Mathieu's latest.....	9.00

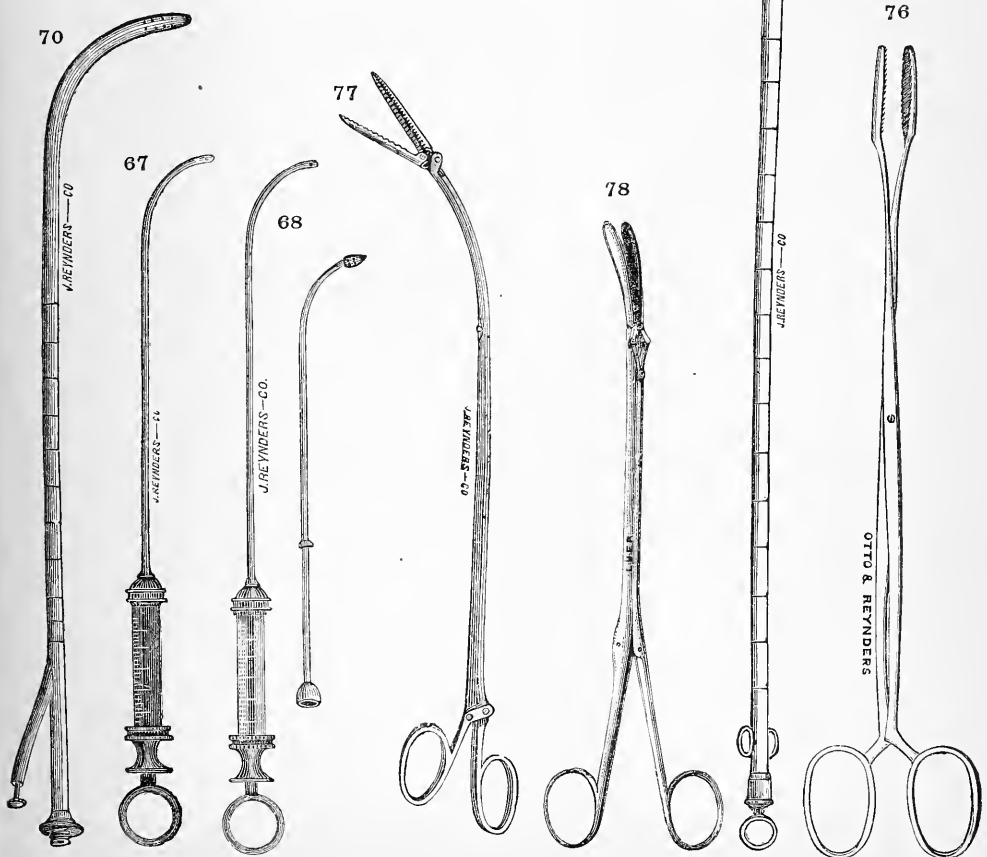

XVI. MALE URETHRAL INSTRUMENTS.

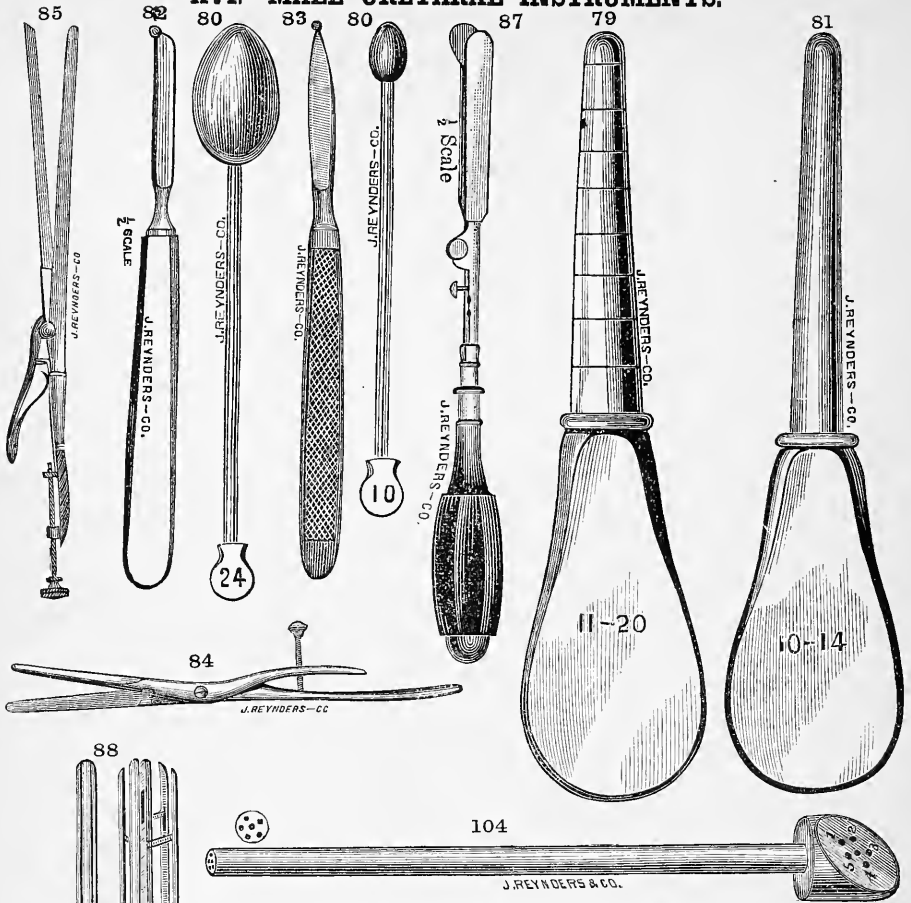

FOR STRICTURES.—IN THE MEATUS.

79.*	Meatometers, Piffard's, according to American Scale, Sizes No. 8 to 18; No. 12 to 22 etc. ....	each	\$1.00
80.*	Fossal Bougie à Boule, Piffard's, acc. to American Scale .....	"	.50
81.*	" Sounds, Piffard's, acc. to American Scale: Sizes 10 to 14; 12 to 16; 14 to 18; 16 to 20; 18 to 22; 20 to 24 .....	each	1.00
82.*	" Stricture Knife, Piffard's.....	.....	2.00
83.*	" " Otis'.....	.....	2.00
84.*	Meatotome, Gouley's.....	.....	3.00
85.*	" " Otis'.....	.....	6.00
86.*	" " Civiale's.....	.....	6.00
87.*	" " Piffard's.....	.....	10.00
88.*	Dilator, Powell's.....	.....	.....

ELASTIC BOUGIES.

(See page 217A for box for same.)

89.*	English, ordinary, 1 to 12.....	each 20 cts.; per doz.	1.75
90.	" " " 13 to 16.....	each 35 cts.; 17 and 18 each	0.50
91.	" " cherry, olive-point, 1 to 12.....	"	0.67
91a.	" " same, 13 to 16 .....	each 87 cts.; 17 and 18 "	1.20
91b.	Belfast Linen, 1 to 12, cylindrical, conical or olive, each 60 cts.; 15 to 18 .....	"	0.75
91c.	Same, Silk .....	"	1.00
92.*	French, cylindrical.....	.....	0.25
93.*	" " conical.....	.....	0.67
94.*	" " olive-point .....	.67 cts.; Vergne's	0.80
95.*	" " " with inside leaden stem.....	.....	0.67
96.*	" " filiform .....	.....	0.67
97.*	" " " central whalebone stem.....	.....	0.67
99.*	" " bellied .....	.....	0.75
101.*	" " exploring, bulbous.....	.....	0.75
102.*	" " " knotted .....	.....	1.00

103.\* Pathfinder for filiform bougies..... 3.50

Whalebone Bougies, see page 217B.

All Instruments Illustrated are designated by a \*

In Ordering state by what Gauge and Size.

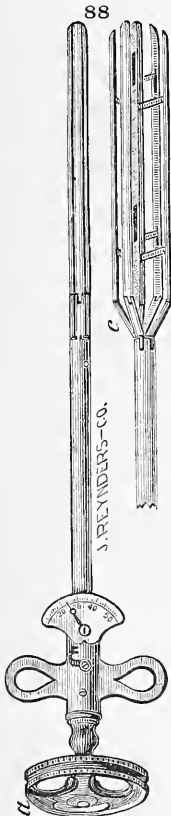

**XVI. MALE URETHRAL INSTRUMENTS.**

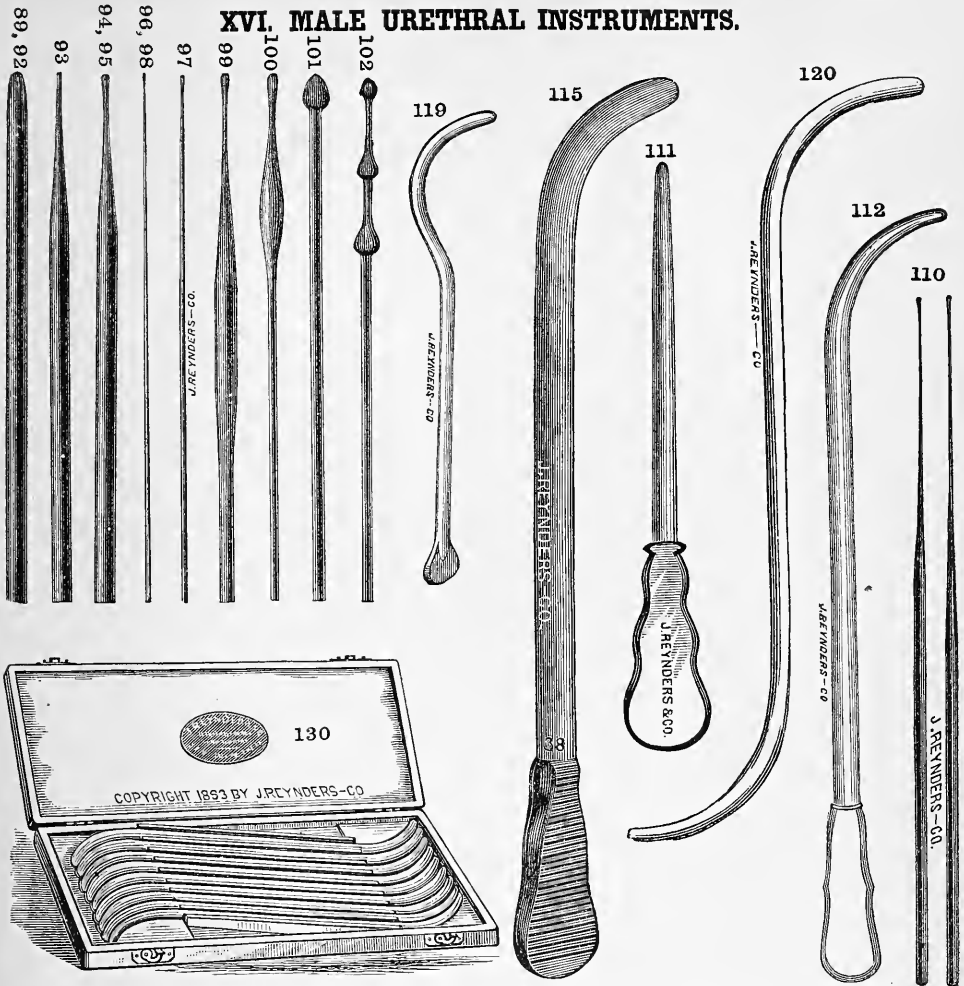

105.	Bougie, Catgut.....	each	0.20 to	\$0.50
106.	“ Wax.....	“	“	0.25
107.	“ Seatangle, 6 sizes in box.....	“	“	0.75
108.*	“ Bulbous, Otis, acc. to French Scale No. 8—40. See page 212.....	“	“	0.50
109.*	Wedge-Shaped Indicator, Whyeth’s acc. to American scale. See page 212.....	“	“	0.75
110.*	Bougie, Bank’s filiform, flat wedge shaped straight or curved.....	“	“	1.25
111.*	Sound, steel, straight, conic or cylindric.....	“	“	1.00
112.*	“ “ Van Buren’s.....	“	“	1.00
	“ “ “ “ above 18.....	“	“	1.25
113.	“ “ “ “ extra fine.....	“	“	2.50
114.	“ “ Van Buren & Keyes’.....	each	“	1.00
	“ “ “ “ above 20.....	“	“	1.25
115.*	“ “ Otis’.....	“	“	1.00
	“ “ “ “ above 30.....	“	“	1.25
116.	“ “ Gouley’s.....	“	“	1.50
117.	“ “ Sayres’.....	“	“	1.50
118.	“ “ Bumstead’s.....	“	“	1.50
119.*	“ “ Benique’s.....	1.50; soft metal	“	1.00
120.*	“ “ Double curve, two sizes, on one.....	each	“	1.50
121.	“ “ Bank’s Nos. 9 to 21 inclusive, American scale.....	“	“	2.00
132.*	“ “ Gouley’s tunneled (Guides for same see page 217B).....	“	“	2.00
131.	“ soft metal.....	“	“	0.60

All Instruments Illustrated are designated by a \*

**IN ORDERING STATE BY WHAT QUAGE AND SIZE.**

XVI. MALE URETHRAL INSTRUMENTS.

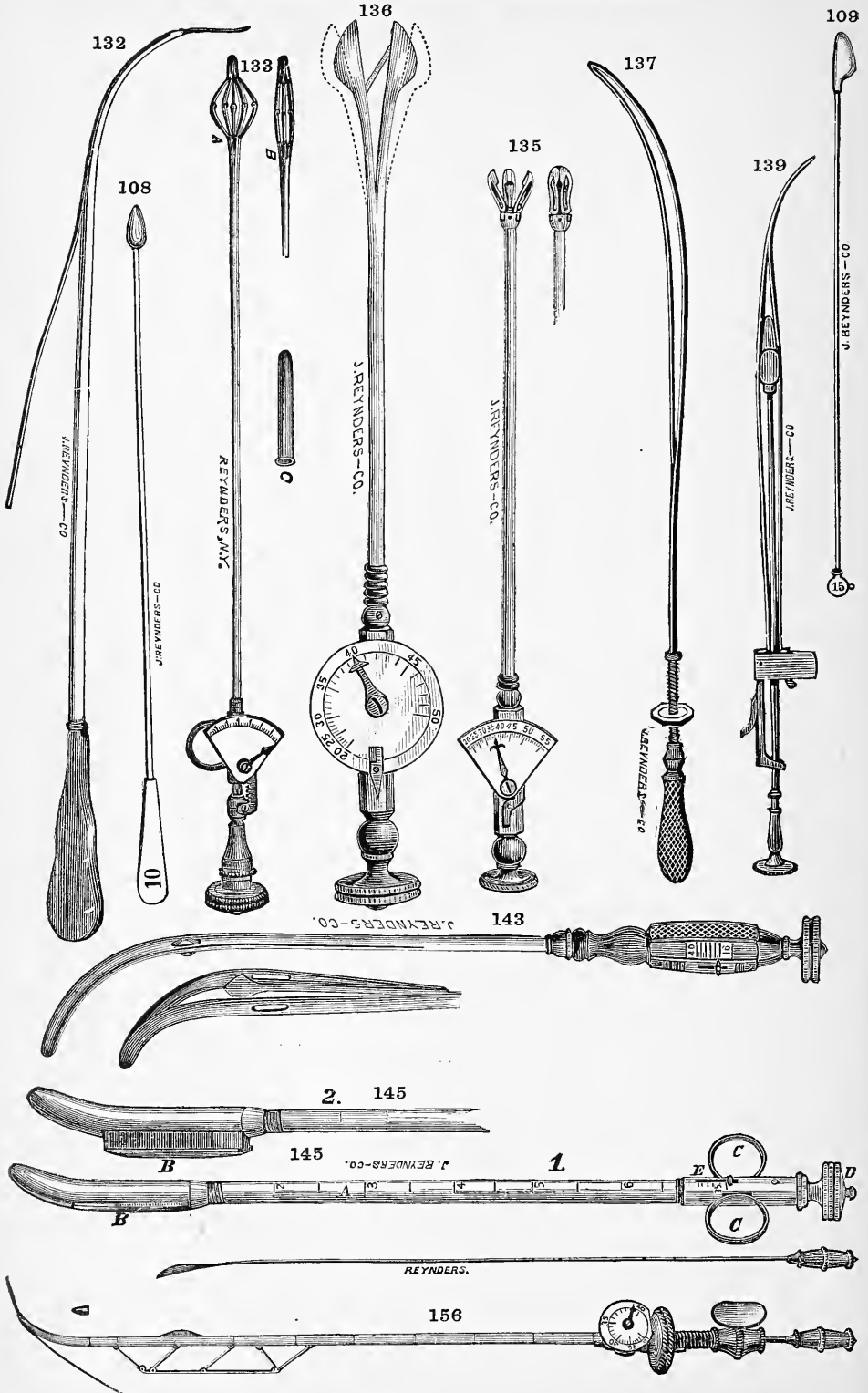

**XVI. CASES OF STEEL SOUNDS, SETS OF METAL BOUGIES, Etc.**

- 122. Case of twelve conical steel Sounds, Van Buren or Van Buren & Keyes'; mahogany, brass bound ..... \$22.00; fine morocco case \$20.00
- 123. Case of twelve Sounds, Nos. 116, 117, 118 or 119..... respectively, \$25.00 and 23.00
- 129. Case (morocco) 6 double curve Sounds (12 sizes)..... 10.00
- 130.\* " " " " " (18 sizes)..... 13.50
- 130a & b.\*\* Weiss' Sounds for treating strictures, anterior to triangular ligament. Either from 9 to 20 American gauge..... each 1.00
- Set of twelve sizes of either in neat morocco case..... 8.00
- Both combined in one case..... 16.00
- (See also No. 4, page 207A.)
- 130c. Set of Otis' Bougie à Boule (108, page 212), in roll up pouche..... 18 \$10.50; 34 20.00

**MALE URETHRAL INSTRUMENTS FOR STRICTURES.**

- 133.\* Urethrometer, Otis'.... spring \$18.00; hinged \$20.00
- 134 " " " rubber caps for same, per doz. 3.00
- 135.\* " " Gross'..... 20.00
- 136.\* " " Weirs' .. 18.00
- 137.\* Dilator, Stearn's..... 5.00
- 138.\* " " Holt's, per set in case..... 18.00
- 139.\* " " Berkeley-Hill's in case..... 30.00
- 140.\* " " Gouley-Thompson 12.00; in case..... 14.00
- 141.\* " " Gouley's (over distendor).... 12.00
- 142.\* " " Voillemier's .. 20.00
- " " in case 22.00
- 143.\* " " Gross'..... 14.00
- 144.\* " " Steurer's..... 8.00
- 145.\* " " Schweig's..... 10.00

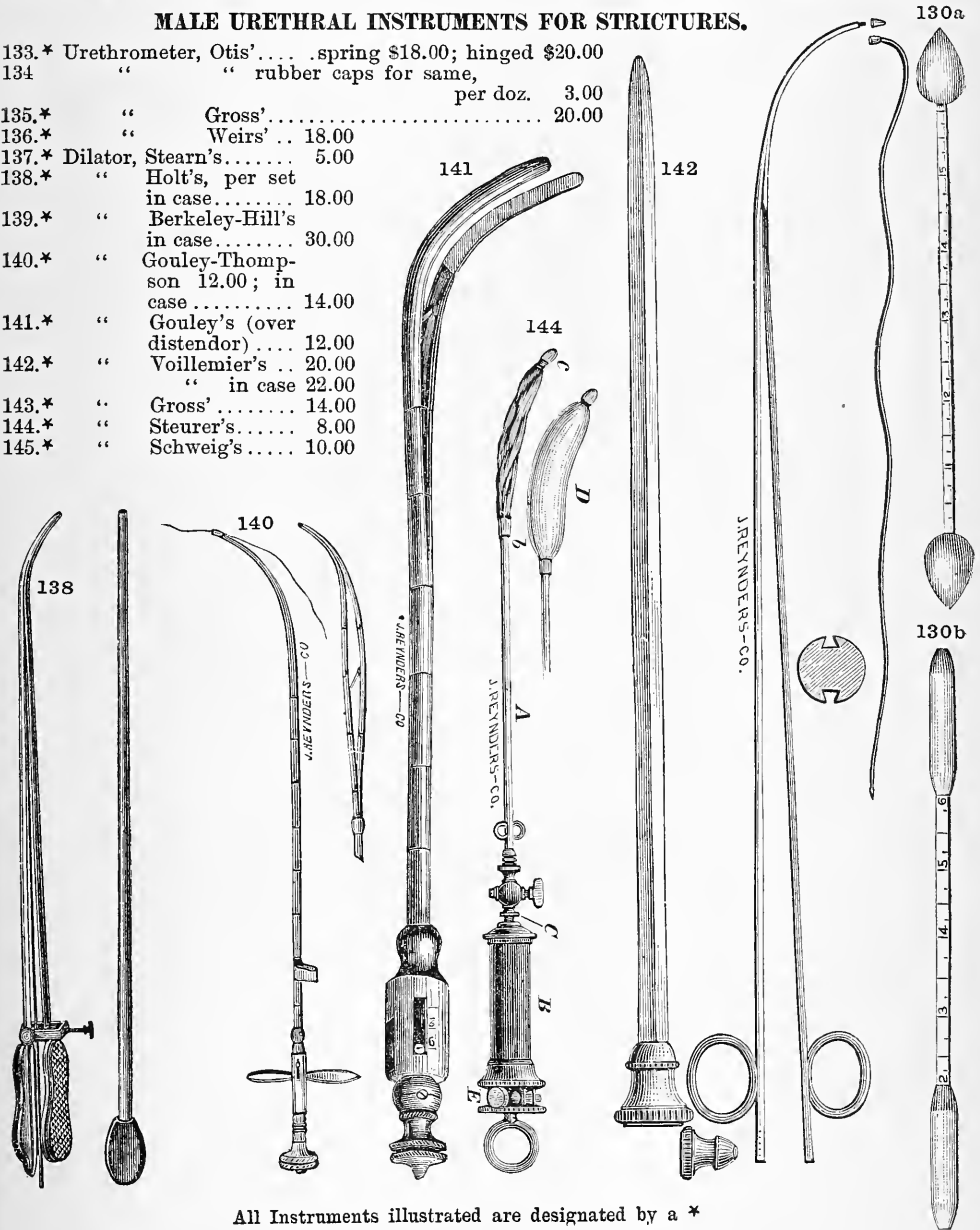

All Instruments illustrated are designated by a \*

XIV. MALE URETHRAL INSTRUMENTS.

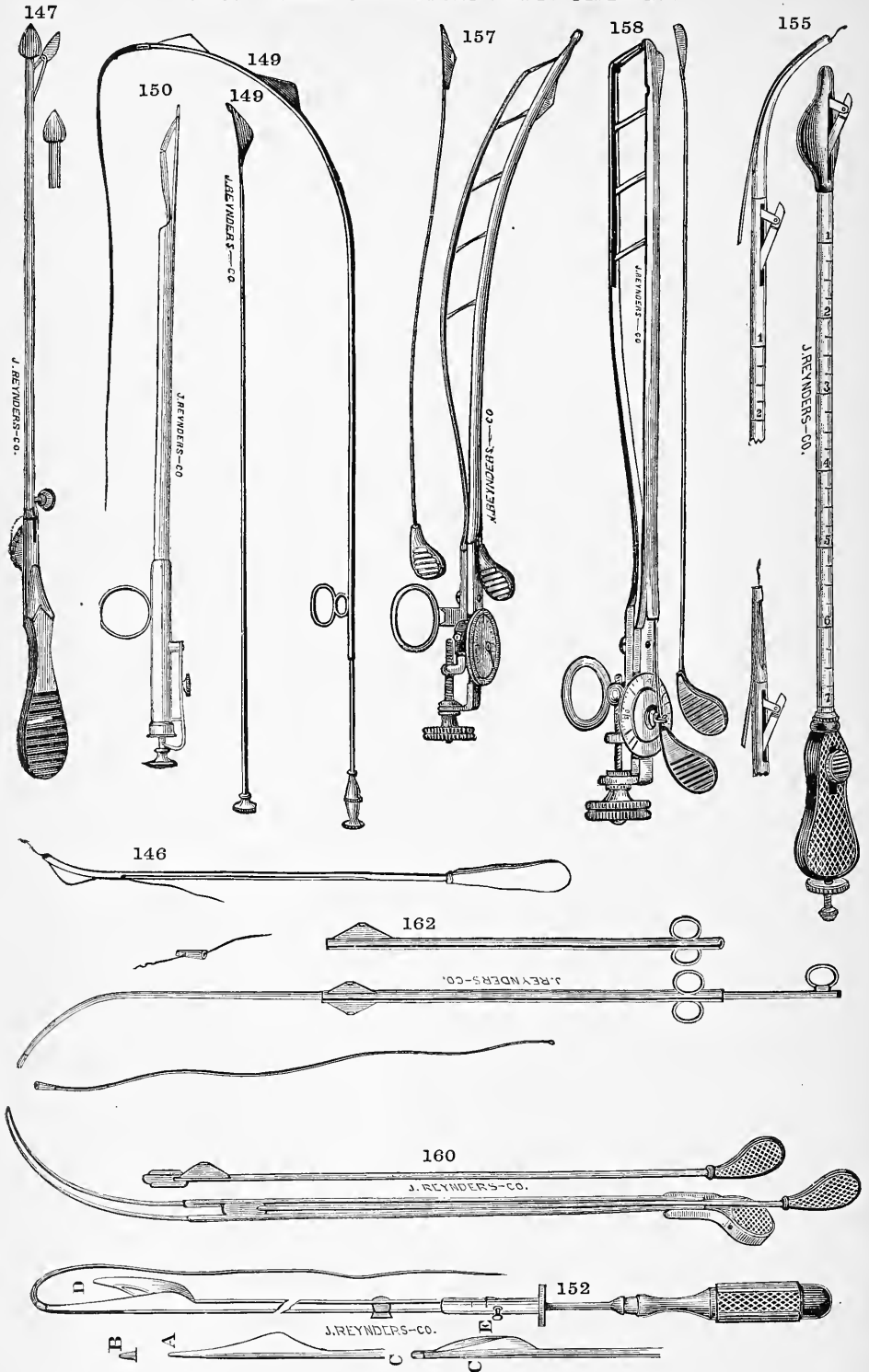



**XVI. MALE URETHRAL INSTRUMENTS.**

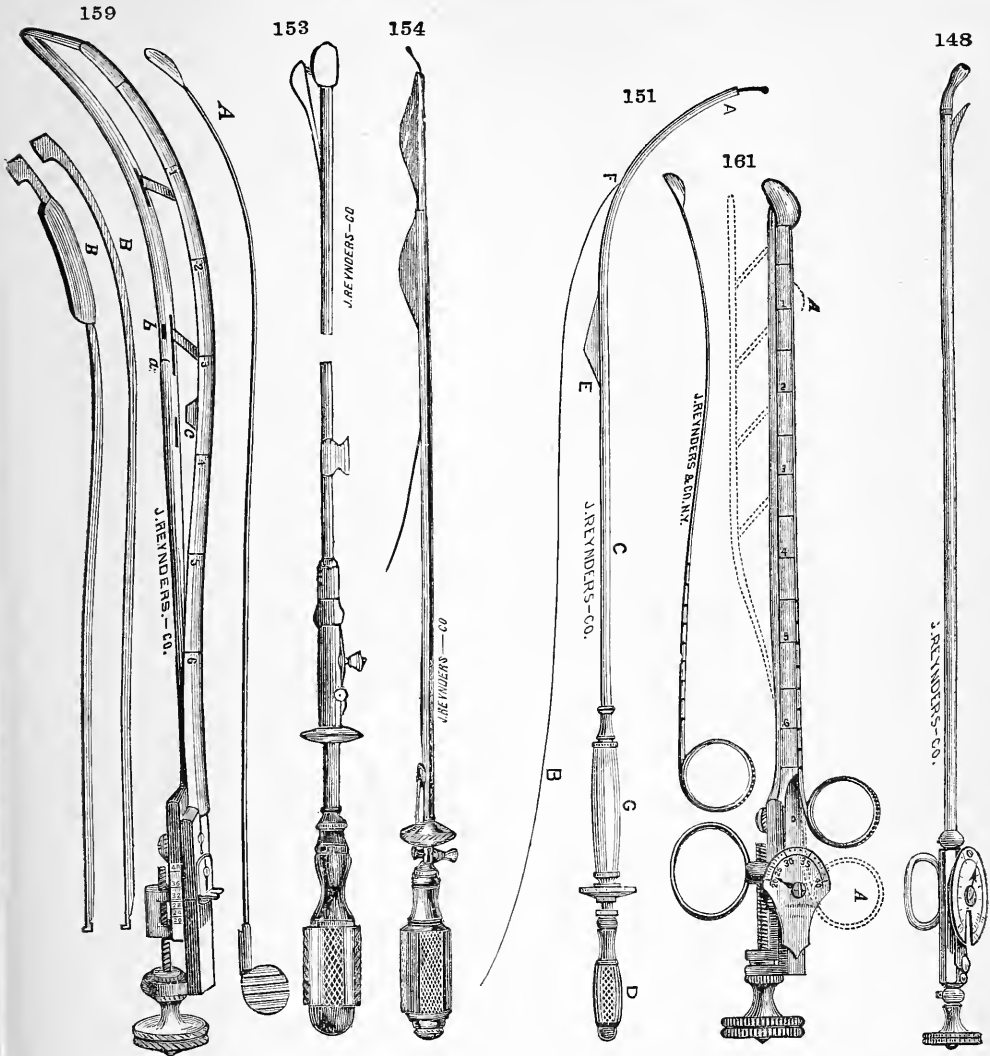

146.*	Urethrotome (Knife), Gouley's.....	\$5.00
147.*	“ Gross.....	6.00
148.*	“ Bate's.....	15.00
149.*	“ Maisonneuve's in case.....	14.00
150.*	“ Trelat's.....	16.00
151.*	“ Teevan's.....	12.00
152.*	“ Charrier's.....	12.00
153.*	“ Civales.....	12.00
154.*	“ Gouley's.....	12.00
155.*	“ Bank's, in case (bulbs 14, 15, 16, 17, 18 and 22 American).....	20.00
156.*	Dilating Urethrotome, Otis No. 2.....	30.00
157.*	“ “ “ No. 3.....	30.00
158.*	“ “ “ No. 4.....	30.00
159.*	“ Hunter's.....	32.00
160.*	“ Stearn's.....	12.00
161.*	“ Mastin's.....	35.00
162.*	Rotating “ Pritchett's.....	25.00

All Instruments illustrated are designated by a \*

XVI. MALE URETHRAL INSTRUMENTS.

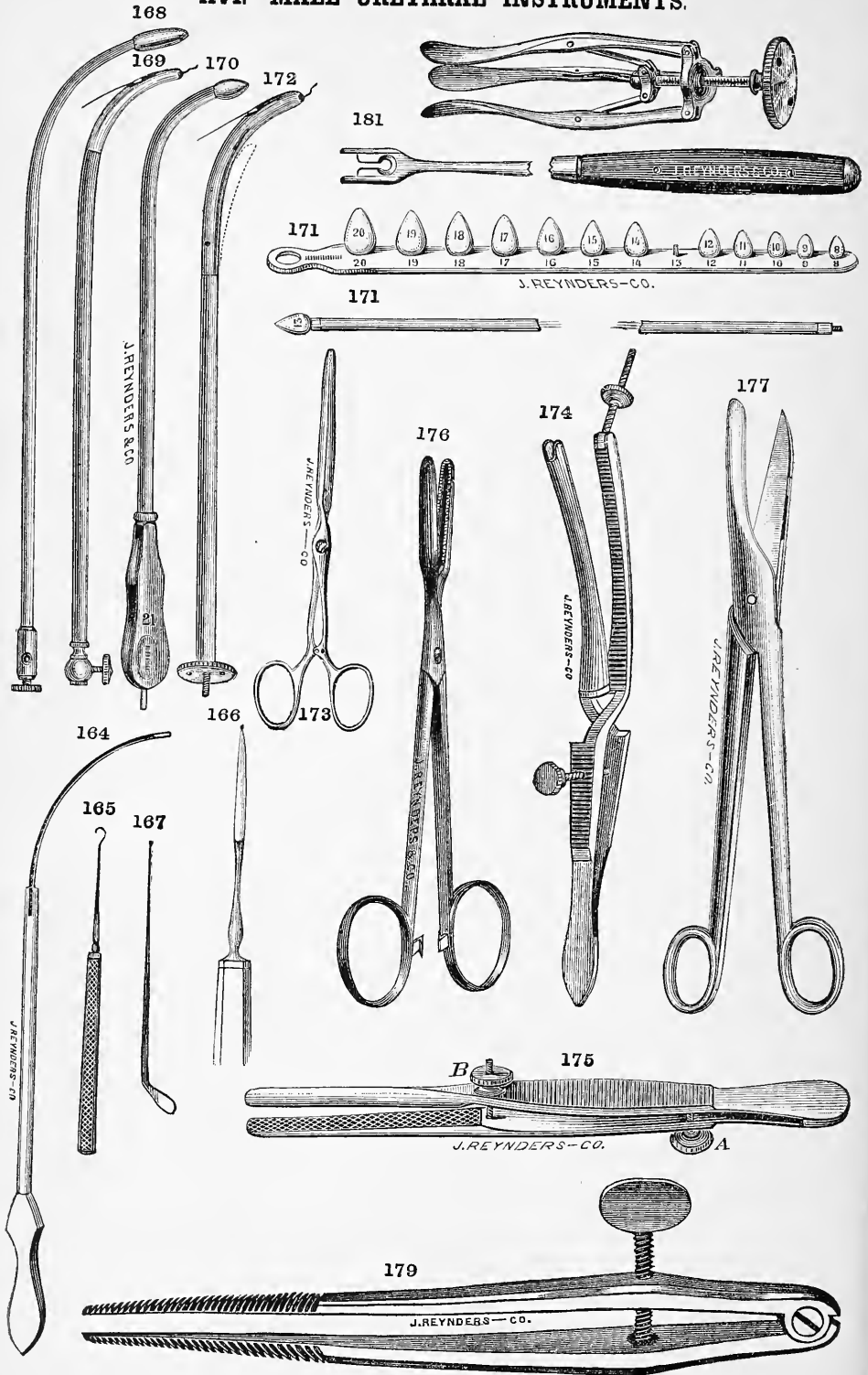

**XVI. MALE URETHRAL INSTRUMENTS.**

164.*	External Urethrotomy Staff, Symes'.....	\$2.00
165.*	" " Hook, Gouley's.....	1.50
166.*	" " Knife, ".....	1.50
167.*	" " Director, Gouley's.....	1.50
168.*	Electrolysis Bougie, long Ovoid bulb.....	2.00
169.*	" " Butler's.....	3.00
170.*	" " Newman's.....	2.50
171.*	" " Set of 8 to 20 and 21 to 30.....	8.00
172.*	" " Stricture Knife, Butler's curved 12.00; straight.....	10.00
	Batteries—see amongst Batteries.	

**PHIMOSIS INSTRUMENTS.**

173.*	Forceps, Ricord's, plain 2.50; with catch.....	3.00
174.*	" " Henry's.....	4.50
175.*	" " Roger's.....	3.00
176.*	" " Byrne's, used with Galvano-Cautery Battery.....	5.00
177.*	Scissors, Taylor's.....	5.00
178.	Forceps, for rupturing prepuceal membrane, Hutchison's, see page 36, No. 281.....	2.25
179.*	Levi's Instrument for the same purpose.....	3.50
180.*	Girdner's " " " ".....	3.50
181.*	George's " " " ".....	9.00
182.	Wire Shouldering Forceps, Roberts'. See Fig. 45, page 6.....	3.75

**SCROTAL INSTRUMENTS.**

183.*	Variocoele Clamp, Wood's.....	2.50
184.	" " Markoe's for silver wire ligature.....	2.00
185.	" " Ring.....	0.75
186.*	Scrotal Compressor, Miliano's (Suspensory), 3 sizes.....	2.00
187.*	" " O. A. White's, h. r.....	3.00
188.*	" " Carroll's (elastic).....	1.50
189.*	Clamp, Sayre's, for Amputation of Redundant Scrotum.....	4.00
190.*	" " Henry's, for same purpose.....	8.00
191.*	Shears " ".....	5.00
192.	Hydrocele Trocars. See page 49.	
193.	Suspensories. See amongst Bandages.	

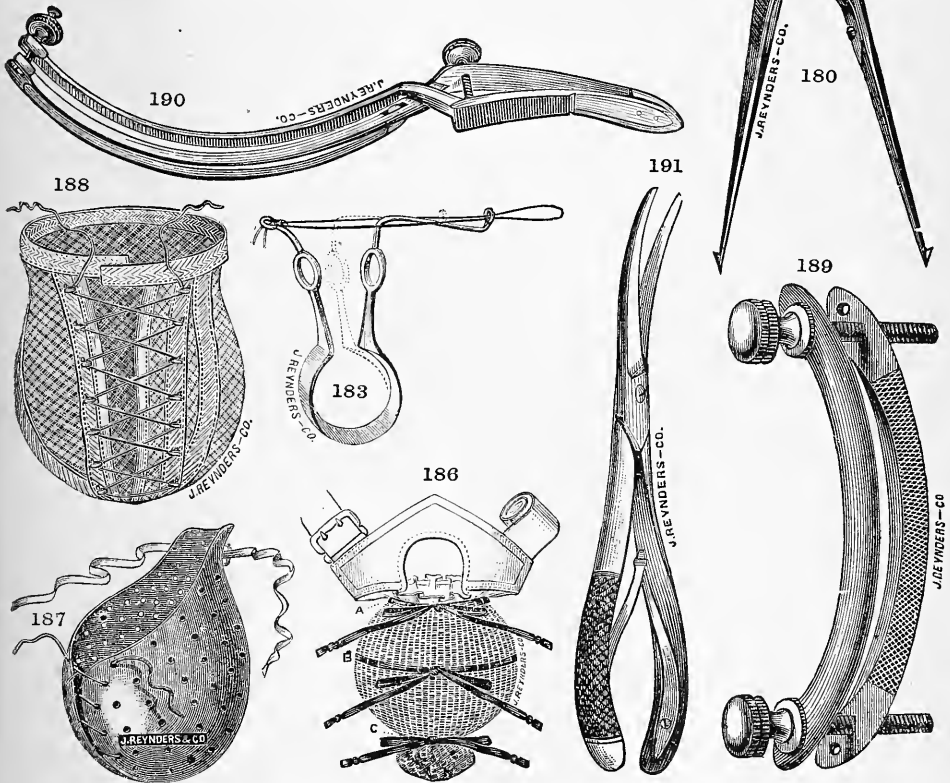

All Instruments illustrated are designated by a \*

ADDENDA TO URETHRAL AND CYSTIC.

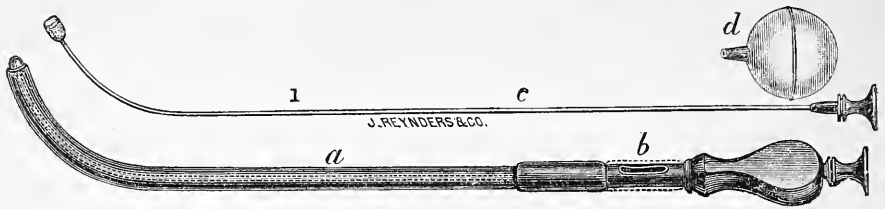

1.\* Waechter's Urethral Powder Blower, with Obturator..... \$2.50

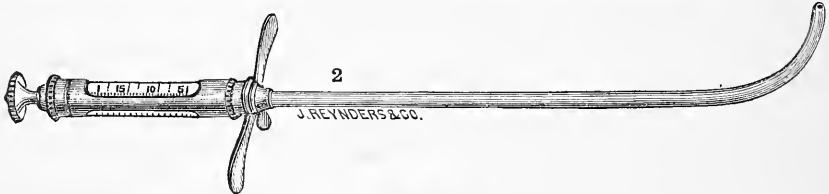

2.\* Keyes' new Urethral Syringe \$6.00  
3.\* Sage's Powder Applicator. Price and descriptive circular on application.)

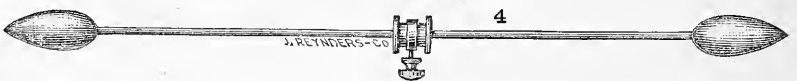
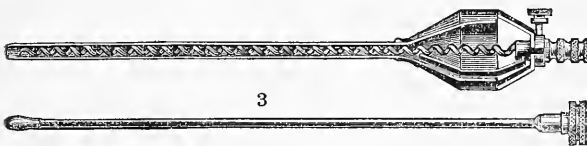

4.\* Fowler's double sized Bulbous Bougie, with sliding set screw indicator .....each \$1.25  
Set of 16 sizes, in case..... 10.00

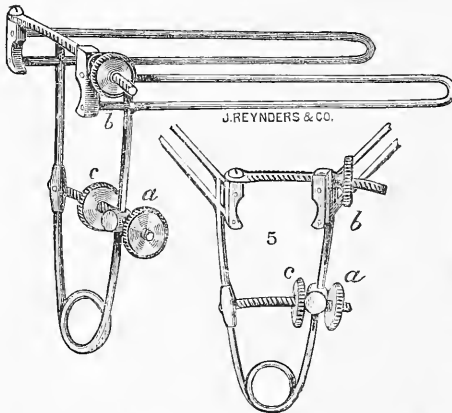

5.\* Tuttle's Meatic Speculum..... \$4.00

6.\* Klotz' Endoscope, with Obturator, any size from 20 French upwards.....each Highly satisfactory, with Head Mirror and Artificial Light. 2.50

7.\* Neat tin ornamental Box for Catheters and Bougies..... 0.50

8.\* Lithotrite by Dr. E. L. Keyes. He says: "I prefer the Reliquet pattern of roughening the male blade. The instrument is narrow, but exceedingly strong. It grasps well and cannot clog. With any reasonable care it is unlikely to catch a fold of the bladder in its bite. The larger instrument will lock upon a stone two and a half inches in diameter." The figure shows the small size, the other size is a trifle over half as large again. Price, each 35.00

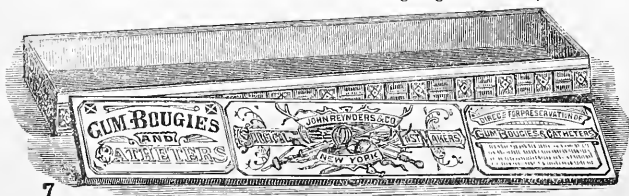
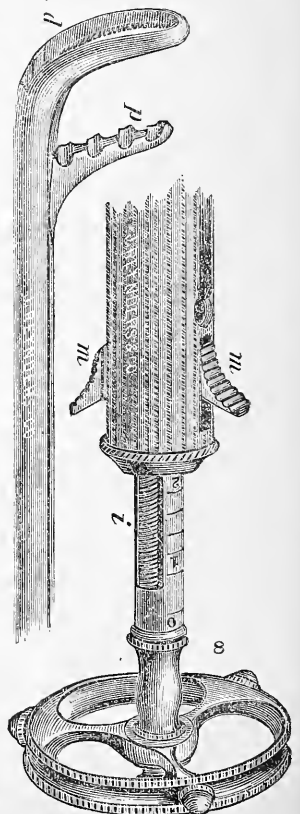

ADDENDA TO URETHRAL AND CYSTIC.

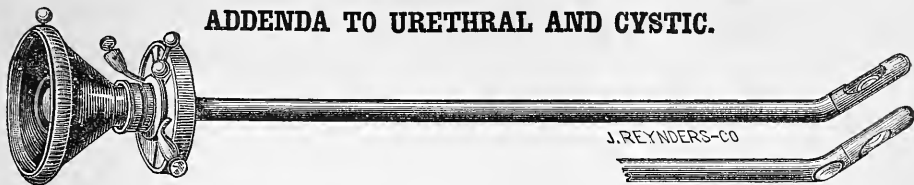

9. Leiter's Cystoscope (electric light). Description on application ..... about \$50.00

10. Whalebone filiform Bougies..... each \$0.50



11. One dozen tin box assorted whalebone Bougies..... \$3.50

PHYSICIAN'S REGISTER AND ACCOUNT BOOK.

Copyrighted 1888.

OFFICE REGISTER.

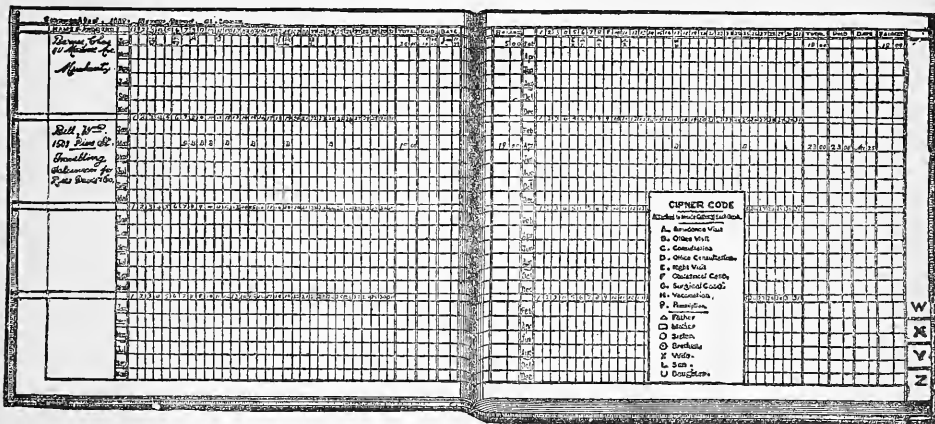

No posting—no transferring—no indexing—no writing of patient's name for entire year enables you to keep the run of your accounts without referring to auxiliary books.

POCKET REGISTER.

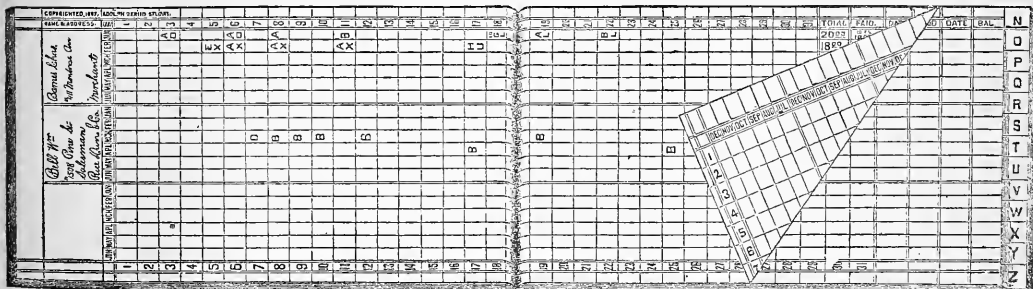

- 500 Account Office Register, size 10x12..... \*\$4.00
- 700 " " " " 12x17..... \*5.00
- 800 " " " " 10x12..... \*6.00
- 1200 " " " " 10x12..... \*8.00
- 300 Account Pocket Register..... \*3.00
- 400 " " " " ..... \*4.00

XVI. MALE URETHRAL INSTRUMENTS.

SPERMATORRHOEAL APPLIANCES.

- 194.\* Ring..... \$1.00
- 195.\* Miniere's Waker, without cells or battery..... 50.00
- 196.\* Contrivance for preventing lying on back..\$5.00

Spermatorrhoeal Suppressors. See Nos. 89 to 92, page 203.

- 197.\* Pereneal Tourniquet, Otis'..... 5.50

For Urinals—see page 286.  
194

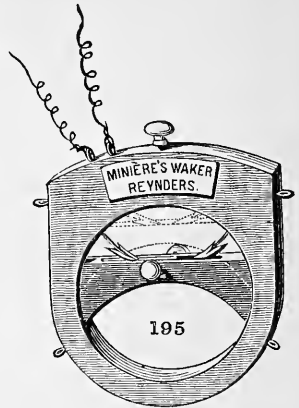
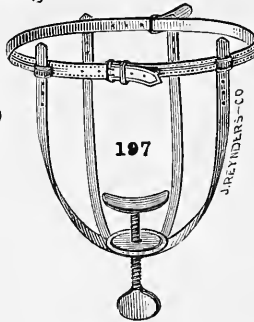
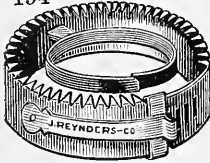

URETHRAL SETS.

Case No. 1, Otis' contains : 1 set of 33 Otis' bulbous Bougies, from No. 8—40, Charrière's Scale; 1 Otis' Urethrometer; 1 Otis' Registering Dilating Urethrotome, 1st pattern; 1 Otis' Registering Dilating Urethrotome, 2nd pattern; 1 extra blade for same; 1 Otis' Meatotome; 1 Otis' beaked Bistoury; 1 Otis' Bougie Gauge; 1 doz. Rubber Caps for Otis' Urethrometer and Urethrotome; 1 Tape Measure; 2 Otis' Silver Urethral Suppositories; in a fine morocco case, silk velvet lined. Price \$145.00.

Case No. 2, Van Buren and Keyes', contains: Gauge; Conical Steel Sounds Nos. 9 to 20 inclusive; Long Whalebone Filiform Guide; 2 Short Whalebone Guides; Thompson's probe-pointed Catheter, modified by Otis; Silver Catheter, short curve No. 12; 2 Silver Prostratic Catheters Nos. 10 and 16; Thompson's Divulsor, tunneled; Civiales' Concealed Bistoury; Civiales' Urethrotome; Gouley's Catheter Staff No. 10; Urethral Forceps; Mathieu's Cupped Sound No. 12; 4 Yellow English Elastic Catheters; Conical Elastic French Bougies Nos. 1 to 12 incl.; 6 ass. Ovary French Catheters; 4 Mercier's Elbowed Catheters; Bulbous Bougies Nos. 3 to 20 incl.; in a fine morocco covered case. Price \$125.00.

198. COLLINS' ANTI-ONANISM APPARATUS.

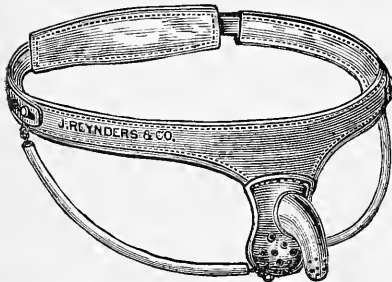

This is the most efficient contrivance known for its purpose. It consists of a well padded steel belt, coin silver part for enveloping the sexual organs and pereneal straps. The belt is made adjustable by means of a button or staple at one, and a series of holes at the other end, so that it can be exactly fitted to the size of the body, which for the successful use of this apparatus is essential.

The belt holds the silver envelope, enclosing the penis and scrotum completely; the envelope has the scrotal part perforated for ventilation, and also perforations at the end of the penis part; it is held securely in place by the pereneal bands made of chain covered with leather or rubber tubing. The

pereneal bands are permanently fastened at one end to a ring at the back of the scrotal part of the envelope, the other releasable ends are fastened on each side of the belt by rings passed over buttons placed there for the purpose. Two steel bands, slotted at one end and perforated with a series of holes at the other, are passed with their slotted ends over the buttons, thus locking the rings of the pereneal bands to the latter. The perforated ends of the steel bands are then upon closing the body belt, pressed over the button or staple fastened to one end of the latter and locked in place and the belt closed by a heavy split ring passed through the staple. Owing to the position of the locking contrivance it is impossible for the patient to disarrange or remove the apparatus.

The patient can evacuate the bowels and micturate whilst the apparatus is in position.

MEASUREMENTS REQUIRED :

- 1) Circumference of the body between the crest of ilium and trochanter major, below fullness of the abdomen.
- 2) Send also a good plaster of Paris cast of the penis and scrotum of the patient.

Prices from \$50.00 to \$100.00.

**XVII. DERMIC INSTRUMENTS.**

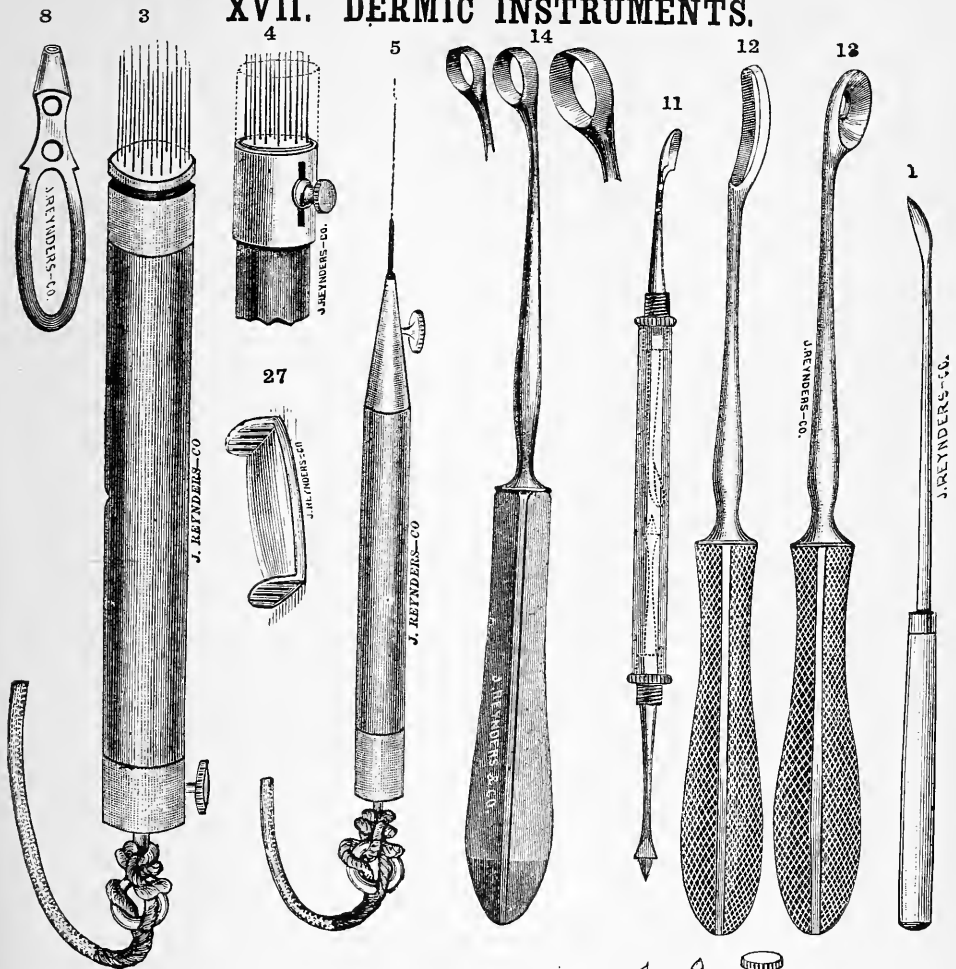

- 1.\* Naevus Needle..... \$0.75
- 2.\* Galvano Caution Instrument, Neumann's, for  
Lupus, see 2d page of Electric apparatus..... 20.00
- 3.\* Set of Needles for the destruction of wine marks  
by Electrolysis, G. H. Fox'..... 5.00
- 4.\* The same, with guard..... 7.00
- 5.\* Needle and Handle for the destruction of hair  
follicles by electrolysis, G. H. Fox'..... 2.00
- 6.\* The same, with magnifying lense, Piffard's..... 11.00
- 7.\* Needles for same, separately..... 0.10
- 8.\* Comedone Extractor, Piffard's..... 0.50
- 9.\* Acne Lance, in shell handle, Piffard's..... 2.00
- 10.\* The same, with Comedone Extractor..... 4.00
- 11.\* Sharp Curette and Acne Lance, Fox's..... 2.75
- 12.\* " " Fox's..... 2.25
- 13.\* " " "..... 2.25
- 14.\* " " Piffard's, 3 sizes..... each 2.25
- 15.\* Epilating Forceps, Piffard's..... 1.50
- 16. " " Henry's, see No. 95, page 77.
- 17. " " Others, see page 77.
- 18. Irido-Platinum Needle, Piffard's..... 1.00
- 19. Miliium Needle, Piffard's..... 1.25
- 20. Scarifying Spud, Piffard's..... 1.25
- 21. Grappling Forceps, Piffard's, with slide catch—  
No. 226, page 36..... 3.00
- 22. Skin Grafting Scissors, see page 17.

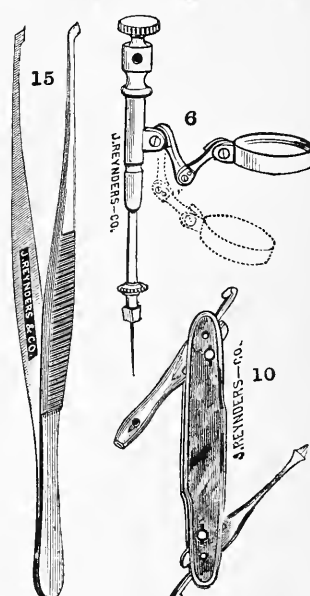

All Instruments illustrated are designated by a \*  
For Rubber Bandages see Page 293.

XVII. DERMIC INSTRUMENTS.

25

- 23. Curette, Hebra's, 2 styles ..... each \$1.75
- 24. " Daviel's..... 1.50
- 25.\* Cutisector, Fox'..... 1.75
- 26. " Piffard's..... 5.00
- 27.\* Glass Pleximeter for observing skin  
under pressure..... 0.50
- 28. Cups for Melting Caustic, see page 169.
- 29. Fine Scissors, see page 82.
- 30. Scalpels, see pages 10 and 225.
- 31. Microscopic Instruments, see page 225.
- 32. Counter Irritants, see Division XXVII.
- 33.\* Calomel Vaporizer, Bumstead's (is  
now made of perforated tin)..... 3.50
- 34. Calomel Vaporizer, Maury's..... 12.00  
See page 279 for Turkish Bath (Plain and Medicated).

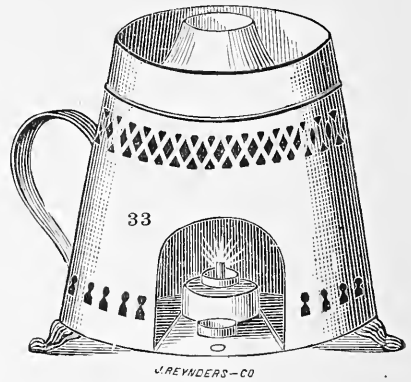

XVIII. POST MORTEM AND DISSECTING INSTRUMENTS.

1

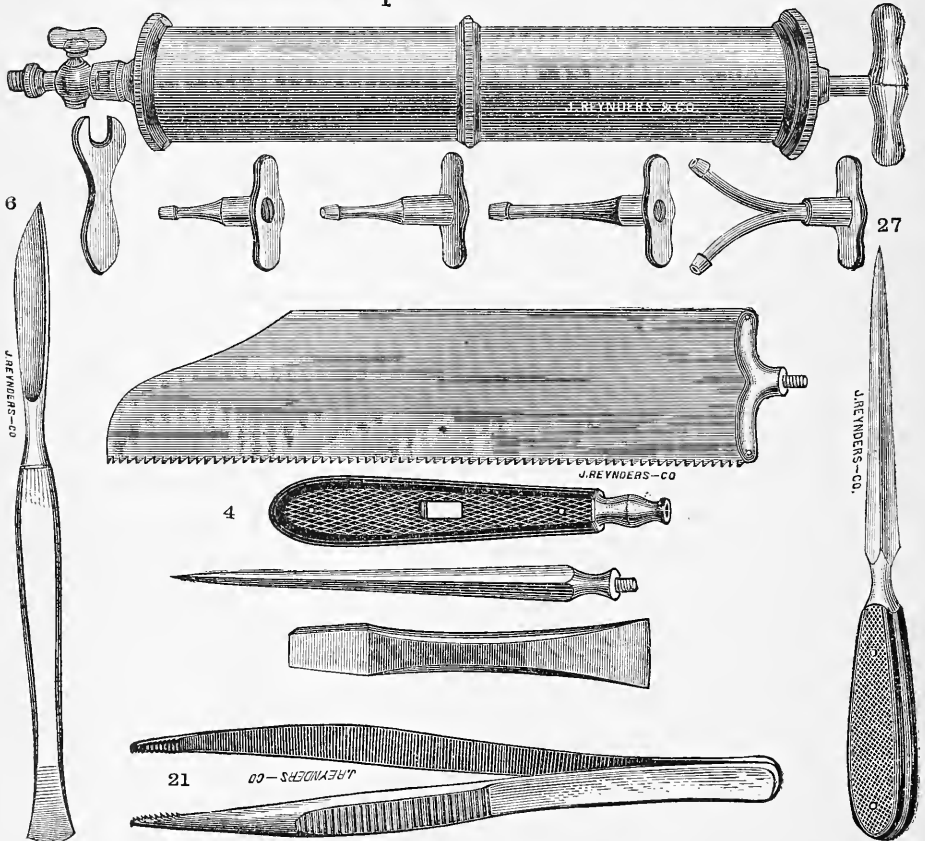

All Instruments illustrated are designated by a \*



**XVIII. POST MORTEM AND DISSECTING INSTRUMENTS.**

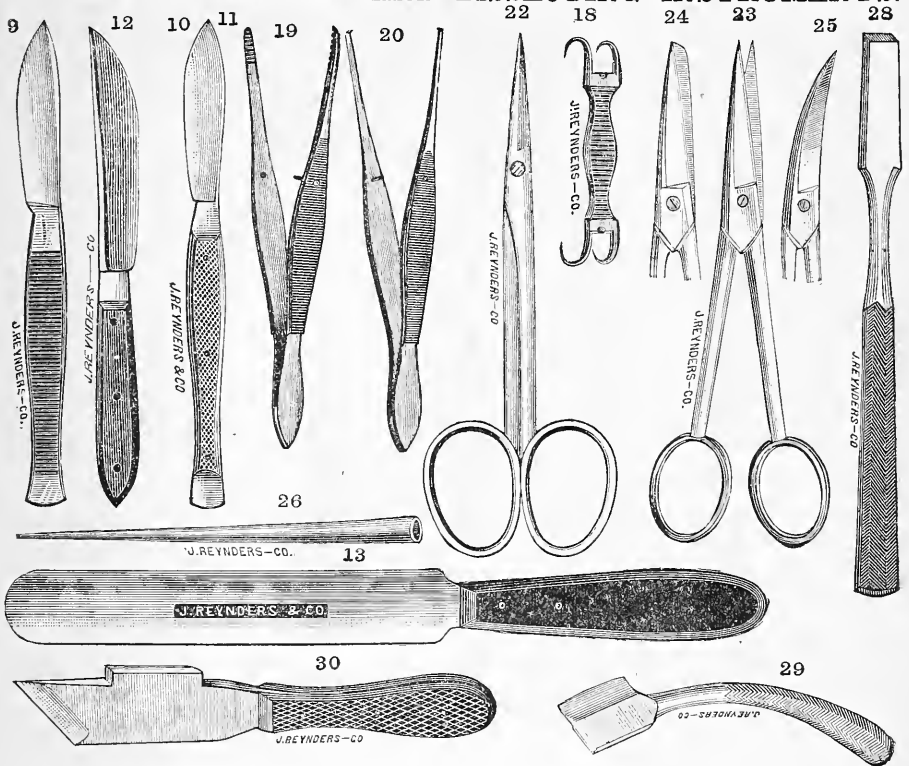

- 1. \* Anatomical Syringe No. 1 with one double injection pipe, 3 ass. single pipes, stopcock and wrench to loosen or tighten the latter, in mahogany case.....\$40.00
- 1a. \* Anatomical Syringe No. 2..... 30.00
- 2. Knife and Saw, Fimmel's fitting in one-handle similar to Nos. 37 and 38 page 9, but no back to saw. 4.50
- 3. " " " the same with movable back..... 6.50
- 4. \* Saw Chisel and Reamer, fitting in one handle..... 5.00
- 5. " like No. 4 and Knife, fitting in one handle..... 6.00
- 6. \* Scalpels, 4 sizes..... handles ebony \$0.60; ivory 0.75
- 7. " " Darling's, ebony..... 0.75
- 8. " " with graduated ivory handle..... 2.00
- 14. Tenaculum, handle..... ebony \$0.60; ivory 0.75
- 15. " " all steel..... 0.60
- 9. \* Cartilage Knife, all steel..... 0.75
- 10. \* " " Gouley's, ebony sides..... 1.50
- 11. \* " " " ivory..... 1.75
- 12. \* " " " extra heavy..... \$2.00; still more so 3.00
- 13. \* Brain Knife..... 1.50
- 16. Hooks and Chain..... 0.50
- 17. " " Darling's..... 0.75
- 18. \* Grappling Hook..... 0.60
- 19. \* Dissecting Forceps..... plain \$0.75; extra long 1.50
- 20. \* " " " mousetoothed..... 1.00
- 21. \* " " " Coxeter's..... 0.75
- 22. \* " " Scissors, Gouley's..... 0.90
- 23. \* " " " plain \$0.50; best quality 1.00
- 24. \* " " " ..... 1.00
- 25. \* " " " curved on flat..... 1.50
- 26. \* Blow Pipe..... 0.25
- 27. \* Reamer..... 1.00
- 28. \* Chisel..... \$0.50 to 1.50
- 29. \* Rachtome, straight or curved..... 2.00
- 30. \* Knife Chisel, Linhardt's..... 2.50

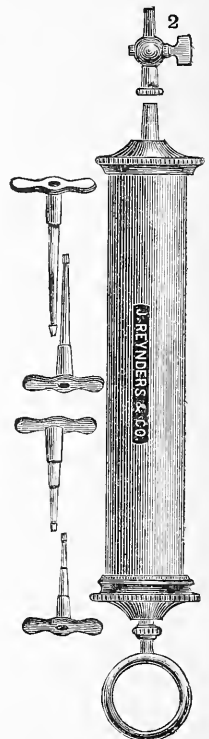

All Instruments illustrated are designated by a \*

XVIII. POST MORTEM AND DISSECTING INSTRUMENTS.

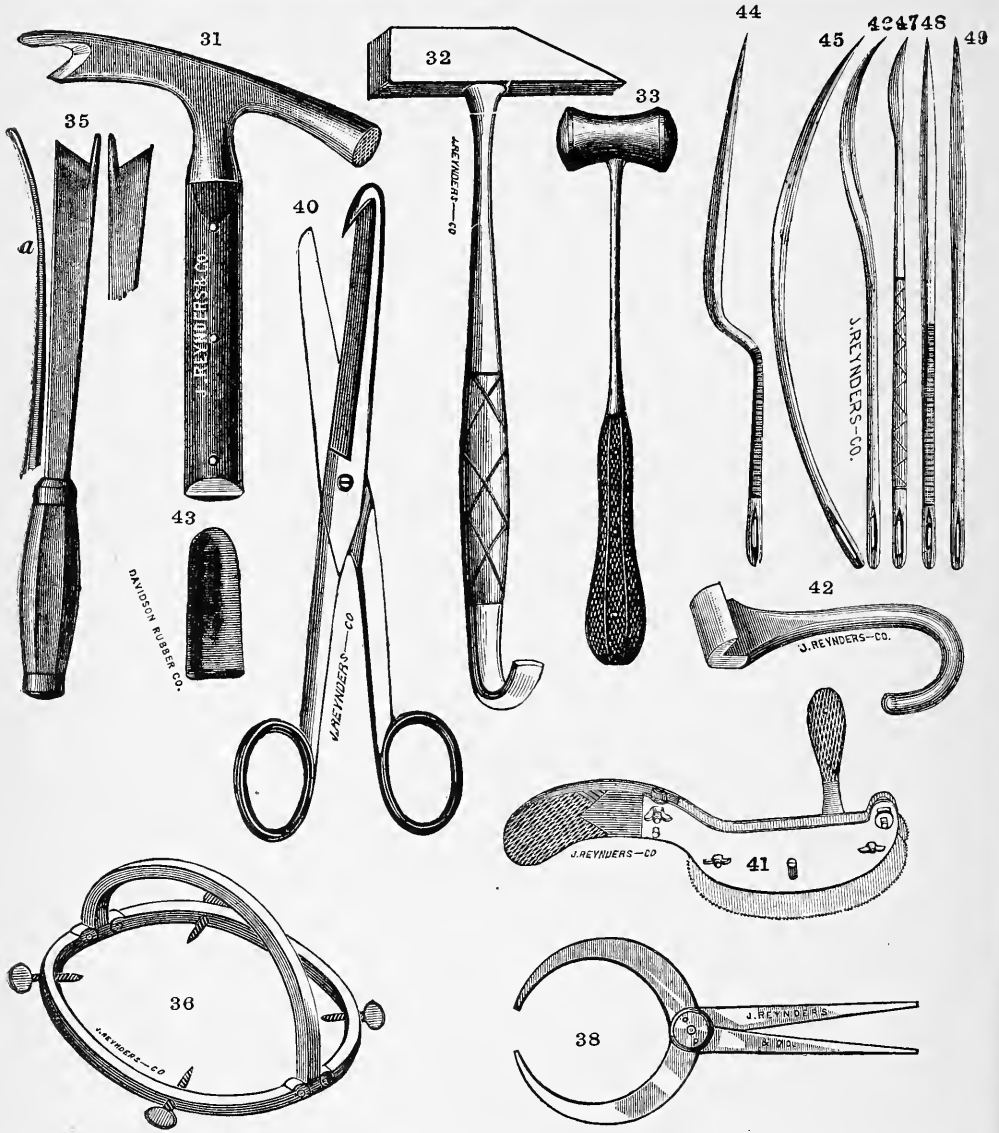

31.*	Rachitome Mallet, Satterthwaite's .....	\$5.00
32.*	Hammer, all steel .....	2.50
33.*	“ leadfilled, non-rebounding .....	2.50
34.*	Skull Breaker .....	2.50
35.*	Chisel, Branetti's, for operating upon the spinal column, r. & l .....	each 3.50
36.*	Skull Clamp, for holding skull while sawing .....	12.00
37.	Tripod Headrest .....	3.00
38.*	Callipers, Satterthwaite's .....	2.50
39.*	Costatome or Rib Shears .....	6.00
40.*	Enterotome .....	2.50
41.*	Double Rachitome Saw .....	15.00
42.*	Calvarian Hook .....	1.50
43.*	Finger covers, soft rubber, assorted sizes .....	each 0.10
44.*	Post Mortem Needle, bayonet .....	0.25
45.*	“ “ “ full curve .....	0.15
46.*	“ “ “ half curve .....	0.15
47.*	“ “ “ slightly curved .....	0.25
48.*	“ “ “ straight triangular .....	0.20
49.*	“ “ “ flat point .....	0.15

All Instruments illustrated are designated by a \*

**XVIII. POST MORTEM AND DISSECTING INSTRUMENTS. CASES.**

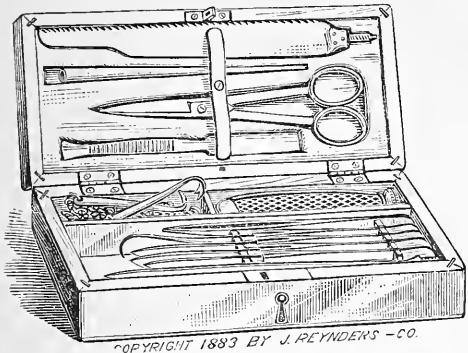

Post Mortem Case No. 4, Finnell's, contains : 1 Finnell's Saw and Knife : 3 ass. Scalpels ; 1 Tenaculum. 1 plain Dissecting Forceps ; 1 Scissors ; 1 Chisel ; 1 Blowpipe ; 1 Set of Hooks and Chain ; Needles and Thread, in a mahogany case.

Price, ebony handled instruments \$11.25 ; ivory handled instruments... \$13.00.

Post Mortem Case No. 5, contains : 1 Finnell's Saw and Knife, fitting in one handle ; 1 Gouley's Cartilage Knife ; 3 ass. Scalpels ; 1 Tenaculum ; 1 Chisel, plain ; 1 Rachitome ; 1 Steel Mallet ; 1 Enterotome ; 1 Scissors ; 1 plain Dissecting Forceps ; 1 Blow-Pipe ; 1 Set of Hooks and Chain ; Needles and Linen Thread ; in a rose-wood case. Price \$22.00.

The same, with set of Knives No. 4 instead of No. 2 and a Rib Shears..... \$30.00.

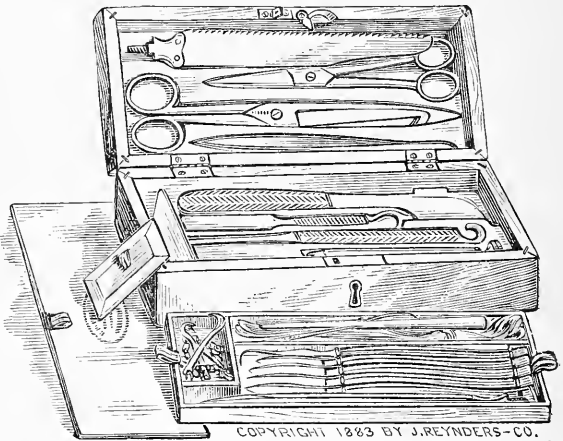

Post Mortem Case No. 5, contains : Saw with movable back ; Chisel ; Scalpel, extra large and heavy, and Knife, extra long, fitting into one handle with spring catch ; Blowpipe ; Scissors, straight ; Scissors, curved on flat ; Dissecting Forceps ; Set of Hooks on chain ; Tenaculum ; Cartilage Knife, with steel handle ; 4 Scalpels, ass. sizes, in a fine mahogany case polished in and outside, no lining inside, Price \$20.00.

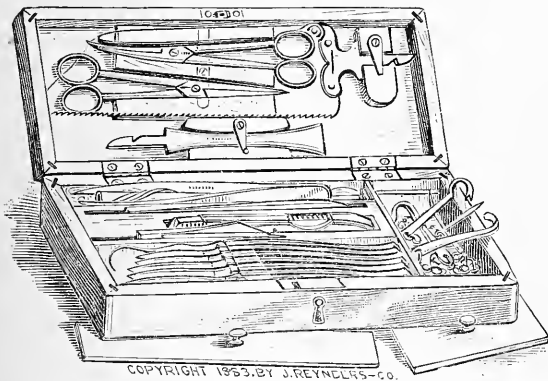

34

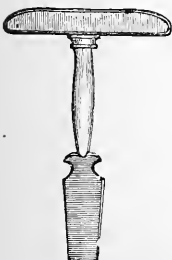

39

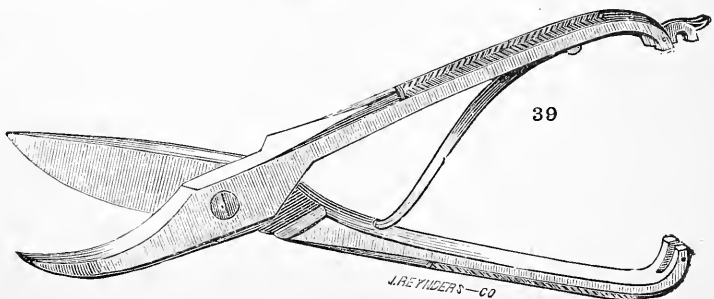

**XVIII. POST MORTEM AND DISSECTING INSTRUMENTS.**

**POST MORTEM AND DISSECTING CASES.**

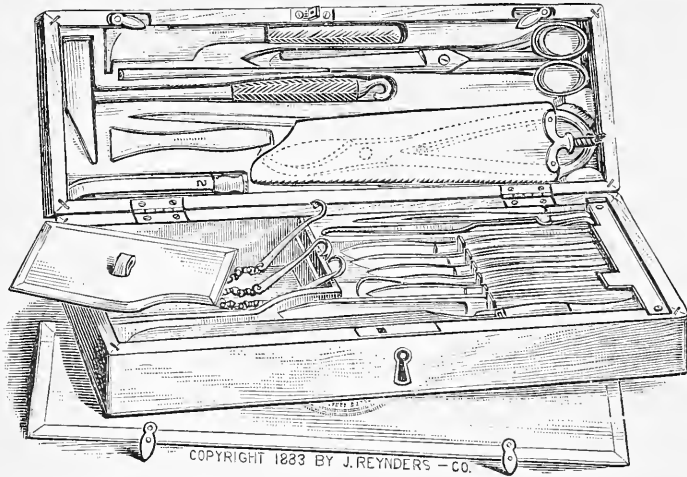

Post Mortem Case No. 6, contains: Saw, Chisel and Stilet fitting on one handle; 1 Cartilage Knife, all steel; 1 Cartilage Knife, extra heavy; 3 ass. Scalpels; 1 Tenaculum; 1 Dissecting Forceps, plain; 1 Dissecting Forceps, extra long; 1 Enterotome; 1 Costatome; 1 Gouley's Scissors; 1 Steel Mallet; 1 Rachtome; 1 Blow Pipe; 1 Set of Hooks and Chain; 1 Brain Knife; Needles and Linen Thread; in a mahogany, velvet lined case . . \$35.00.

Dissecting Case No. 1, Darling's, contains 3 ass. Darling's Scalpels, ebony handles; 1 Darling's Set of Hooks and Chain; 1 Coxeter's Dissecting Forceps; 1 Darling's Scissors, curved; in a mahogany case. Price \$5.50.

Dissecting Case No. 2, contains 2 ass. Scalpels; 1 Tenaculum; 1 Cartilage Knife; 1 Dissecting Forceps; 1 Scissors; 1 Set of Hooks and Chain; in a mahogany case. Price, ebony handled instruments \$4.00; ivory handled instruments \$4.50.

Dissecting Case No. 3, contains 4 ass. Scalpels; 1 Tenaculum; 1 Cartilage Knife; 1 Dissecting Forceps; 1 Scissors; 1 Blowpipe; 1 Set of Hooks and Chain; in a mahogany case. Price, with ebony handled instruments \$5.50; ivory handled instruments \$6.25. Same in rosewood case, Price \$6.75 and \$7.75 respectively.

Dissecting Case No. 4, Charrières, contains 4 Scalpels; 1 Tenaculum; 1 Cartilage Knife; 1 Scissors; 1 Dissecting Forceps; 1 Blowpipe; 1 Set of Hooks and Chain; in a zinc case, black oil cloth covered. Price, instruments ebony handles \$7.50; ivory \$8.50.

Dissecting Case No. 5, contains 4 ass. Scalpels; All steel Cartilage Knife; Tenaculum; Blow Pipe; Dissecting Scissors, curved on flat; Dissecting Forceps; Chain and Hook; Chisel in a neat case with lock and key. Ebony handled instruments \$8.00; ivory handled instruments \$9.00.

**XIX. MICROSCOPIC INSTRUMENTS.**

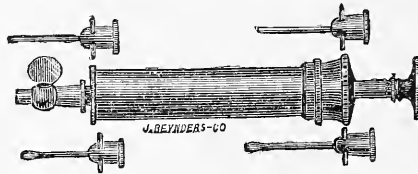

Microscopic Syringe No. 2.....in case, h. r. \$5.50; brass \$6.50

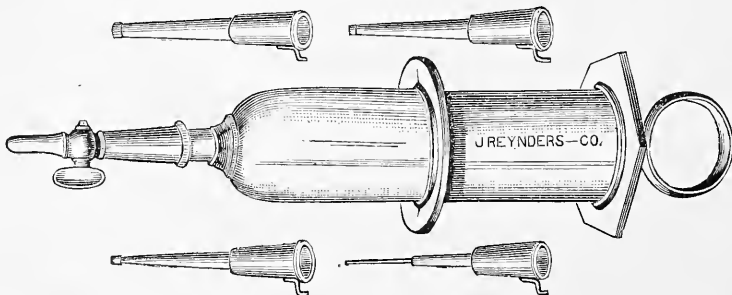

Microscopic Syringe No. 1.....in case \$10.00

**XIX. MICROSCOPIC INSTRUMENTS.**

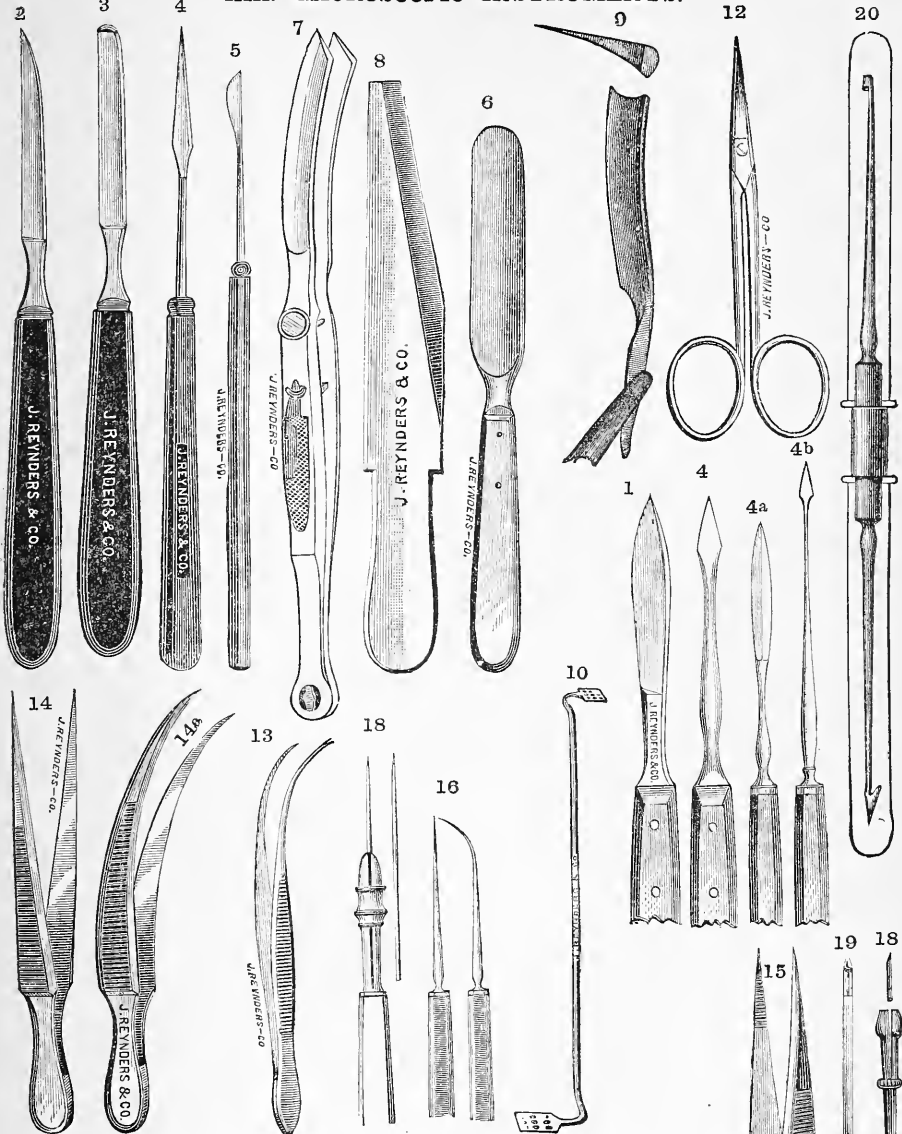

- |  |        |   |        |
|--|--------|---|--------|
| 1.* Scalpels, three sizes..... each  | \$0.75 | 14a.* Forceps, stouter, curved.... each   | \$1.00 |
| 2.* Sharp-pointed Bistoury.....  | 1.25   | 15.* " " broad back.....  | 1.00   |
| 3.* Probe " ".....   | 1.25   | 16.* Needle in handle, fine straight  |        |
| 4.* * Spear " ".....   | 0.75   | and curved..... each  | 0.75   |
| 4a.* Double edged Knife.....   | 1.00   | 17. Needle in handle, plain.....  | 0.20   |
| 4b.* " " slender.....  | 1.25   | 18.* Needle Holder.....   | 1.25   |
| 5.* Knife.....   | 0.75   | 19.* Duchenne's Trocar, for securing  |        |
| 6.* Section Knife.....   | 1.50   | bits of muscle for microscopic  |        |
| 7.* Valentine's Knife.....   | 8.00   | examination. Back of the point  |        |
| 8.* Section Knife, F. L. Vincent's...<br>In using this its back should be<br>pushed along the nail of the left<br>thumb as a steadying point over a<br>section cutter. | 3.00   | (which is solid), one part with<br>knife edge slides over the other.<br>It is introduced with the knife<br>part slid back and when far<br>enough the latter is pushed for-<br>ward, and a bit of muscle cut<br>and removed by the withdrawal<br>of the entire instrument..... | 3.50   |
| 9.* Razor, hollow on one, and flat on<br>the other side.....   | 2.00   | 20.* Harpoon—one end is used for se-<br>curing muscular fibres—the<br>other for cutting out a piece of<br>skin.....   | 3.00   |
| 10.* Section Lifter, Satterthwaite's...  | 1.00   |   |        |
| 11.* " " not perforated....  | 0.50   |   |        |
| 12.* Scissors—see page 82.   |        |   |        |
| 13.* Forceps, very delicate, straight<br>and curved..... each  | 1.25   |   |        |
| 14.* Forceps, stouter, straight....  | 0.75   |   |        |

All Instruments illustrated are designated by a \*

## 263. THE ECONOMIC MICROSCOPE.

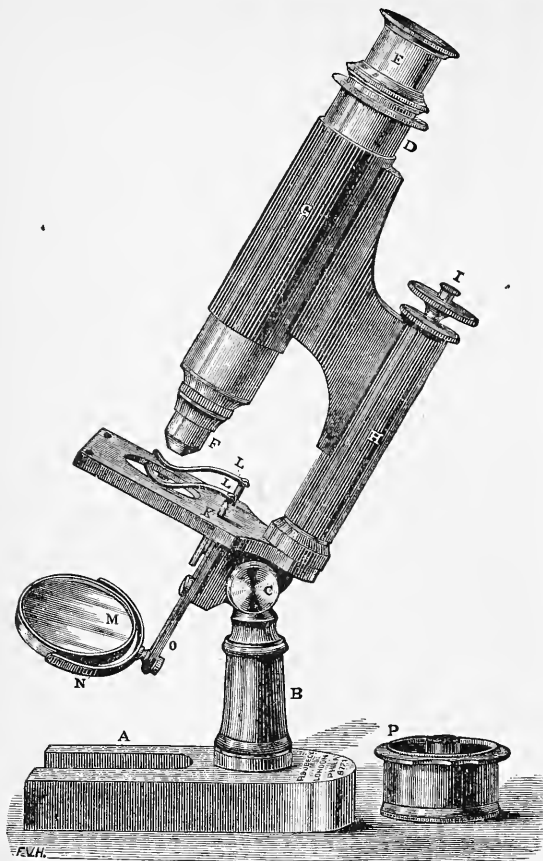

two the magnifying power depends. The *Microscope Stand* is an arrangement for carrying the body, and is combined with a *Stage* for holding or giving traverse to an object, and a *Mirror* or some other provision for illumination.

The *Stand* of the *Economic Microscope* is made in two forms—the one with a *sliding coarse adjustment* for focussing the object, and the other where the *quick movement* is produced by a rack and pinion. On both stands the fine adjustment is given by means of a milled head at the top of the stem. The *Object-glasses* are attached to the stand with the *Universal or Society Screw*.

## DESCRIPTION OF THE STAND (Fig. 263) AND APPARATUS AS SUPPLIED FOR \$40.00.

The foundation of the stand (Fig. 263) is a heavy horse-shoe base, *A*, at the bend of which is a firm pillar, *B*, having at its top a hinge joint, *C*, which allows the body, *D*, to be inclined at any angle, and is sufficiently firm to permit of its being placed horizontal for use with the *Camera Lucida*.

At this price the instrument includes one *Eye-piece* No. 2, and two *Object-glasses*, called the 1-inch and the  $\frac{1}{2}$ -inch, from their magnifying power being nearly the same as single lenses of such focal lengths, a condensing lens for the illumination of opaque objects, a glass plate with ledge, for examination of fluids, and a pair of brass pliers. The whole packed in a neat Mahogany case, with lock and key.

Its *Linear Magnifying-powers* are nearly as under:—

	Draw-tube closed.	Draw-tube pulled out.
1-inch.....	63	110
$\frac{1}{2}$ -inch.....	240	330

The *Body* is supplied with a draw- or lengthening-tube, *V*, which must be pulled out to give the full power to the *object-glass*, *F*.

The *Quick-focussing movement* is produced by sliding the body, *D*, up and down in the tube, *G*, and the *slow motion* is given by the tube, *H*, sliding over the inner stem with a spring inside, and adjusted by the milled head, *I*.

The *Stage*, *K*, upon which the object is placed, has two springs, *L, L*, the pins attached to which may be inserted in any of the four holes on the stage, and by their pressure, (which can be varied by pushing them more or less down) they will hold the object under them or allow it to be moved about with the greatest accuracy.

The *Mirror*, *M*, besides swinging in the rotating semicircle, *N*, is attached to a bar, *O*, with a joint at each end allowing a lateral movement, so as to throw oblique light on the object; and for this purpose the tube beneath the *Stage*, carrying the *Diaphragm* is attached by

The microscope is now such an absolute necessity for the student, to enable him to carry on his investigations, that it is more than ever incumbent on the optician to construct a sound economic instrument, adapted to the special requirements of this large and increasing class.

For ordinary pathological, physiological, and botanical investigations, many of the delicate adjuncts applied to the higher-priced instruments are unnecessary, and tend rather to confuse than to assist the beginner.

A firm stand and well-corrected *Object-glasses* are, however, indispensable; and, with a view to meet this want, we have constructed and now introduce to the special attention of professors and students, the "*Economic Microscope*."

The description following will fully explain both construction and the mode of using this instrument; whilst the scale of prices at the conclusion will, we trust, convince all who peruse them that we are able, by means of the machinery at our command, to offer those who do not desire to spend a large sum on a microscope, an instrument thoroughly adapted to their necessities, at a very moderate outlay.

A *Compound Achromatic Microscope*, consists essentially of two parts,—an *Object-glass* and an *Eye-piece*,—so called because they are respectively near the object and the eye when the instrument is in use. The *object-glass* screws, and the *eye-piece* slides, into opposite ends of a tube termed the *Body*, and upon the union of the

bayonet catches, and can be instantly removed, leaving a clear and very thin stage, allowing the utmost obliquity of illumination. This tube also carries the Polariscope, etc.

The *Diaphragm, P*, slides in the substage-fitting, and consists of a tube containing two caps furnishing two sizes of openings, immediately in contact with the under surface of the slide to be examined, and also completely cutting off all light from the mirror when opaque objects are to be viewed.

With the exception of the substitution of a *Rackwork coarse adjustment* for the sliding movement by hand the addition of a plane Mirror, larger Eye-pieces, and Tripod Base, the *Stand* (Fig. 264) in no way differs from that described as Fig. 263.

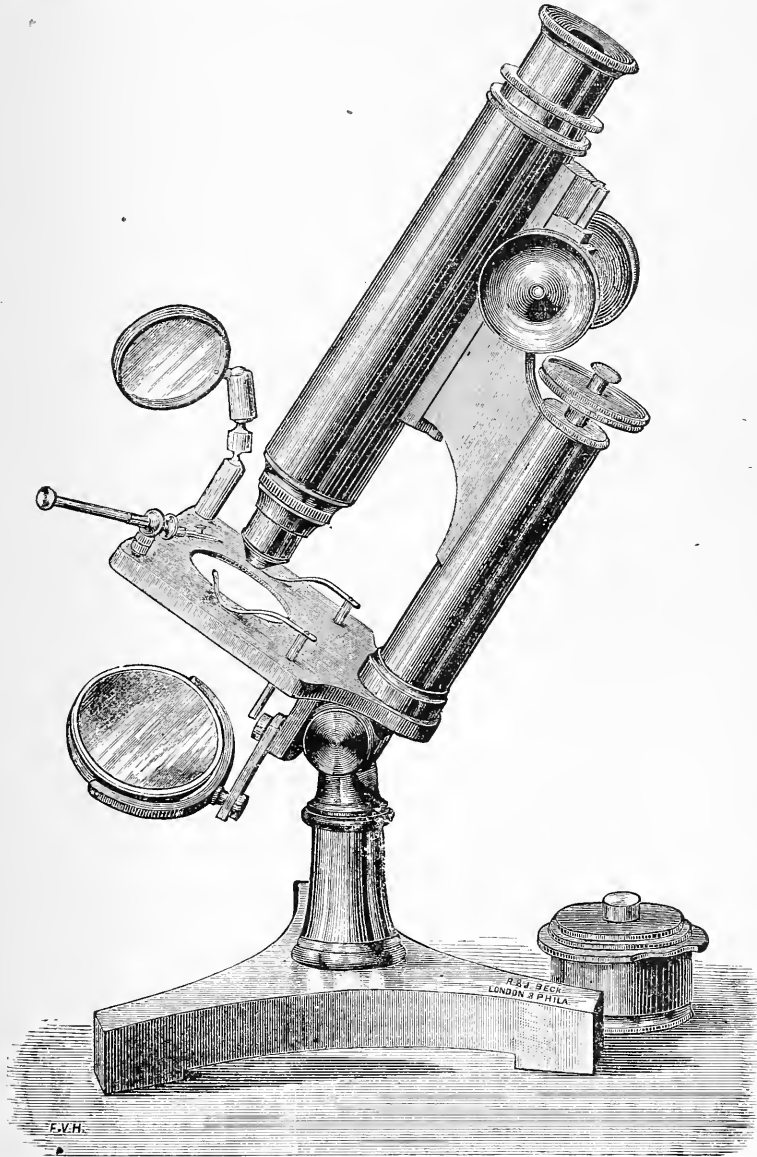

The *Coarse Adjustment* is produced by a rack and pinion conveniently placed, which moves the body-tube, carrying the object-glass and eye-piece up and down with greater precision. For the price of *sixty dollars*, the Instrument is supplied with *two Eye-pieces*, and *two Object-glasses*, as described below:

	Draw-tube closed.			Draw-tube pulled out.		
	No. 1, E. P.	No. 2, E. P.	No. 3, E. P.	No. 1, E. P.	No. 2, E. P.	No. 3, E. P.
1-inch.....	48	63	105	68	93	155
1/4-inch.....	150	200	340	215	290	480

A *Side Condensing-Lens*, for the illumination of opaque objects, fitting into any of the holes on the stage, a pair of *Stage Forceps*, also fitting into the holes on the stage, a pair of *Brass Pliers* and a *glass plate with a ledge*, specially intended for the examination of fluids. The whole packed in an upright polished Mahogany case, with brass handle and lock, and drawer for accessories.

RECAPITULATION OF PRICES OF MICROSCOPES.

263.	The Monocular Economic Microscope, with sliding coarse adjustment, 1-inch and ¼-inch Object-glasses, one Eye-piece, Concave Mirror, condensing lens, glass plate with ledge, brass pliers and Diaphragm, in Mahogany Case.....	\$40.00
264.	The Monocular Economic Microscope, with Rack-and-pinion coarse adjustment, with 1-inch and ¼-inch Object-glasses, two Eye-pieces, Concave and Plane Mirrors, side Condensing Lens, Diaphragm, Stage-Forceps, Pliers, Glass slip, with ledge, in Mahogany Case.....	\$55.00
264.*	The Monocular Economic Microscope, with Movable Glass Stage and the same fittings and case as with No. 264.....	\$65.00
	Eye-pieces for 263. Nos. 1, 2 or 3.....	each \$4.50
	Eye-piece for 264. Nos. 1, 2 or 3.....	" \$5.00
	Side Condensing Lens.....	\$2.50
	Stage-Forceps.....	\$2.50
	Pliers.....	\$0.35

2216. EDUCATIONAL MICROSCOPE.

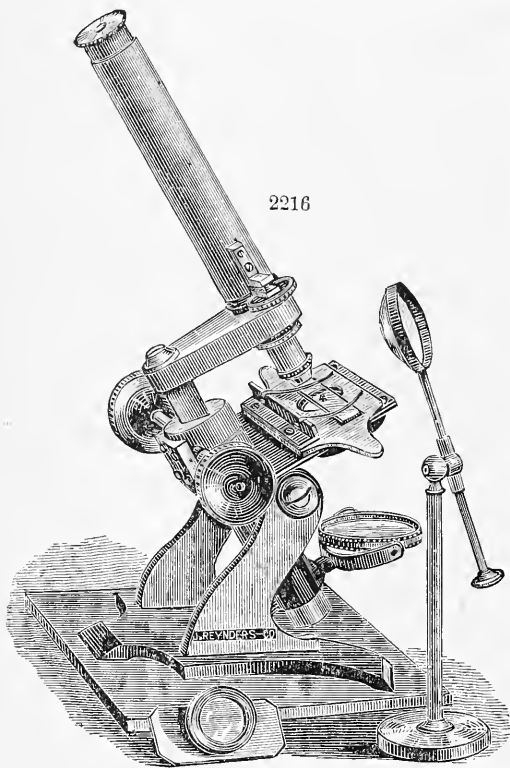

An admirable instrument, giving a flat though small field, great magnifying powers, clear definition, and is quite achromatic, *i. e.* without those fringes of rainbow coloring which are always seen surrounding the objects in inferior microscopes.

It is furnished with one eye piece and a series of three object glasses, namely: the inch, half inch and quarter inch, so made that in order to obtain the highest power, all that is needed is to employ all the three, which screw into each other; two giving a less power, and one the least of all. The convenience of this arrangement will be readily understood.

Objectives of any manufacturer can be screwed into the tube of the instrument, as the latter contains the thread of the society screw.

The body of the instrument turns on two pivots so as to suit the position of the head, coarse and fine screws permit quick or slow moving of the tube to and from the object.

For conveniently moving the object is provided a sliding stage, with a revolving diaphragm secured under the same.

A dissecting forceps, animalcule cage, or life box, and condenser, accompany this instrument. All fitting in a neat mahogany case with handle on its top.

A drawer fitted with racks for holding microscopic objects is also contained in the case.

Price \$35.00

MICROSCOPIC MOUNTING MATERIALS.

Glass Slides, 3 in. and 4 in., ground edges.....	per hundred	\$2.00
Glass Covers, Square No. 3.....	per dozen*	0.18; per oz.* 1.25
" " " " 2.....	" " *	0.20; " " * 2.25
" " " " 1.....	" " *	0.25; " " * 2.75
" " Circular " 3.....	" " *	0.20; " " * 2.25
" " " " 2.....	" " *	0.25; " " * 2.75
" " " " 1.....	" " *	0.30; " " * 3.75
Wood Boxes for Slides.....		0.20
Pasteboard Cabinets for keeping Slides, warranted not to warp; Sets of six and eight (each holding 24) in strong pasteboard boxes, respectively.....		\$4.00 and 5.00
Filtering paper, per package of 10 sheets.....		0.30
Labels, per hundred.....		0.20
Camel's Hair Brush.....		0.15

MICROSCOPIC CASES.

- No. 1, contains: 1 straight Scissors; 1 curved Scissors; 1 Forceps; 1 Scalpel; 1 Delicate Knife, straight; 1 Knife, spearpt.; 1 Valentine's Knife; 1 Needle Holder; Needles and Silk; in a morocco case. Price \$20.00.
- No. 2, contains: 1 Straight Scissors; 1 Forceps; 1 Scalpel; 1 straight delicate Knife; 1 spearpt. Knife; 1 Needle Holder; Needles and Silk; in a morocco case. Price \$10.00.
- No. 3, contains: Needle Holder; 6 Needle Points; Section Knife; Fine Lacerating Needle; Heavy Lacerating Needle; 3 Microscopic Scalpels; Curved Microscopical Forceps; straight Microscopical Forceps; Scissors, straight; Scissors, curved on flat; in a neat rosewood case. Price \$15.00.



**XX. INSTRUMENTS FOR GENERAL DIAGNOSIS.**

*Clinical Thermometers (self-registering), when ordered to be sent by mail, will be forwarded carefully packed at purchaser's risk of breakage or damage in transit.*

**NOTICE.**—Self-Registering Thermometers are now made essentially in two styles, the original with detached register and safety contraction near bulb and the much-to-be-preferred "Indestructible Index." With the latter the entire column of mercury upon removal of the instrument from the body, remains stationary, its top showing the maximal temperature until shaken down in the usual manner; no care whatsoever need be observed as to preservation of the register, an advantage in view of which the "original" style aforesaid should fall irredeemably into everlasting desuetude.

**DIRECTIONS FOR SHAKING DOWN THE COLUMN.**—The worst way of doing it is to form a fist around the bulb and slam the thermometer down upon the knee, desk, table or other hard substance. Instead, grasp the thermometer gently, holding it not tighter than necessary by the thumb and index finger over the bulb, letting the balance of thermometer lie in the palm of the hand, raise the forearm and then throw it down without resistance by its full dead weight. Repeat this operation as often as necessary.

All prices NET, including case of hard rubber or metal.



100. Plain contraction near bulb . . . . . \$0.75



101. Indestructible Register . . . . . 0.90  
 102. Same, extra fine, American . . . . . \$1.25; with certificate as good as Yale's 1.50  
 103. Same, extra fine, English . . . . . 1.50  
 104. Same, flat back (to prevent rolling) . . . . . 1.50  
 105. Same, colored bulb (said to register sooner) . . . . . 1.50



106. Indestructible Register, with jet black back and broad, flat mercury column, specially adapted to darkened rooms. . . . . 1.50



107. Spiral Twist (102-105 are better) . . . . . 1.50



108. Syphon-shaped . . . . . \$1.25; back black like 106 1.50



109. "Instantaneous," with indestructible Register. . . . . 2.00

**IMMISCH'S "AVITREOUS."**



Metal Case with Safety Pin, this style or any other, add to above prices. . . . . 0.25

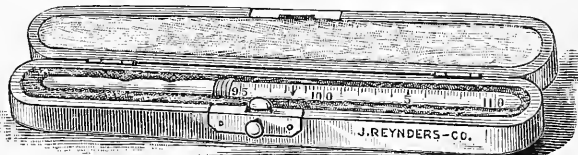

Morocco velvet-lined Case, add to price . . . . . 0.50

Silver . . . . . \$7.50  
 Gold . . . . . 20.00

**XX. INSTRUMENTS FOR GENERAL DIAGNOSIS.**  
**HICK'S THERMOMETERS, LENS FRONT,\* Prices Net.**

110. Ordinary Index..... \$2.50



111. Indestructible Index..... 3.00



112. Indestructible Index, "One Minute" ..... 3.50

113. Same, "Instantaneous," like 109..... 5.00

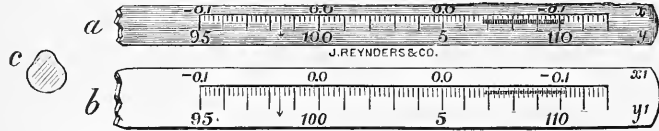

*a* shows Thermometer 114 naturally; *b* its surface as though flattened out; upper line shows verifications, the lower the degrees.

114. With Kew Verifications, etched on stem ..... additional \$0.50  
**Kew or Yale Observatory Verifications.** Irrespective of what any one or any house may claim, thermometers are only reliable with one of same; the assurance as to any divergency being thereby given. Price of either..... 0.50

115. Seguin's Surface Thermometer, without case..... 2.00

116. Seguin's Thermoscope..... 75 cts.; in case 2.00

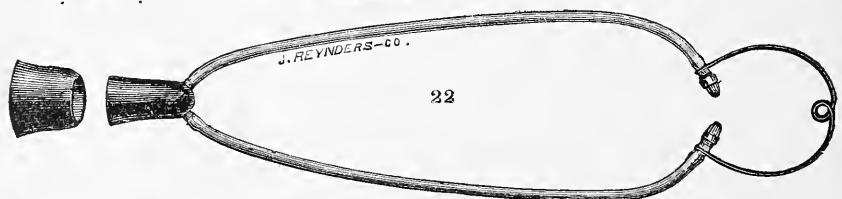
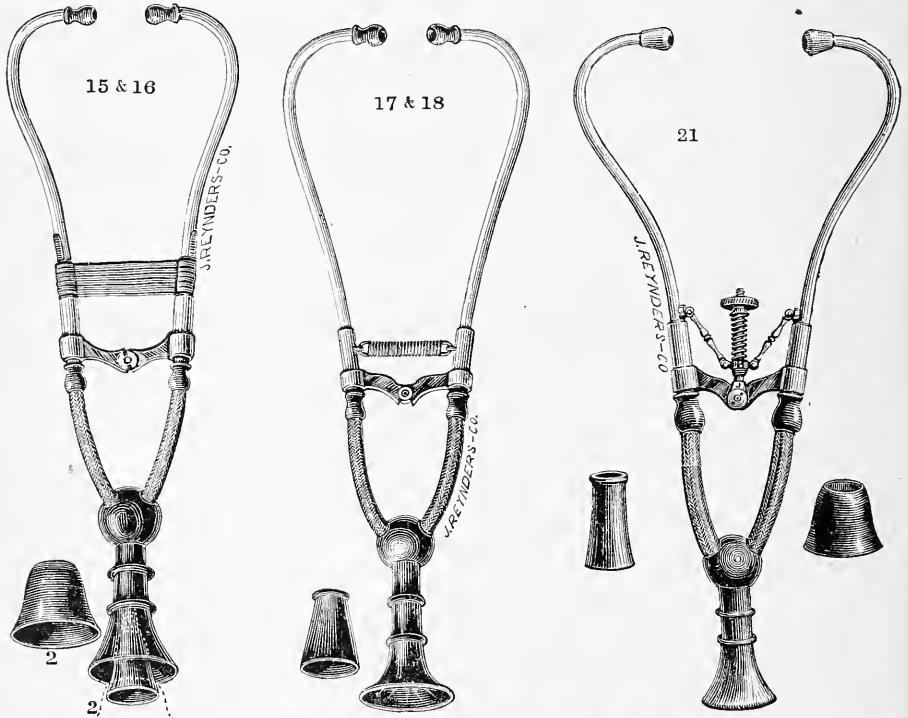

**XX. INSTRUMENTS FOR GENERAL DIAGNOSIS.**

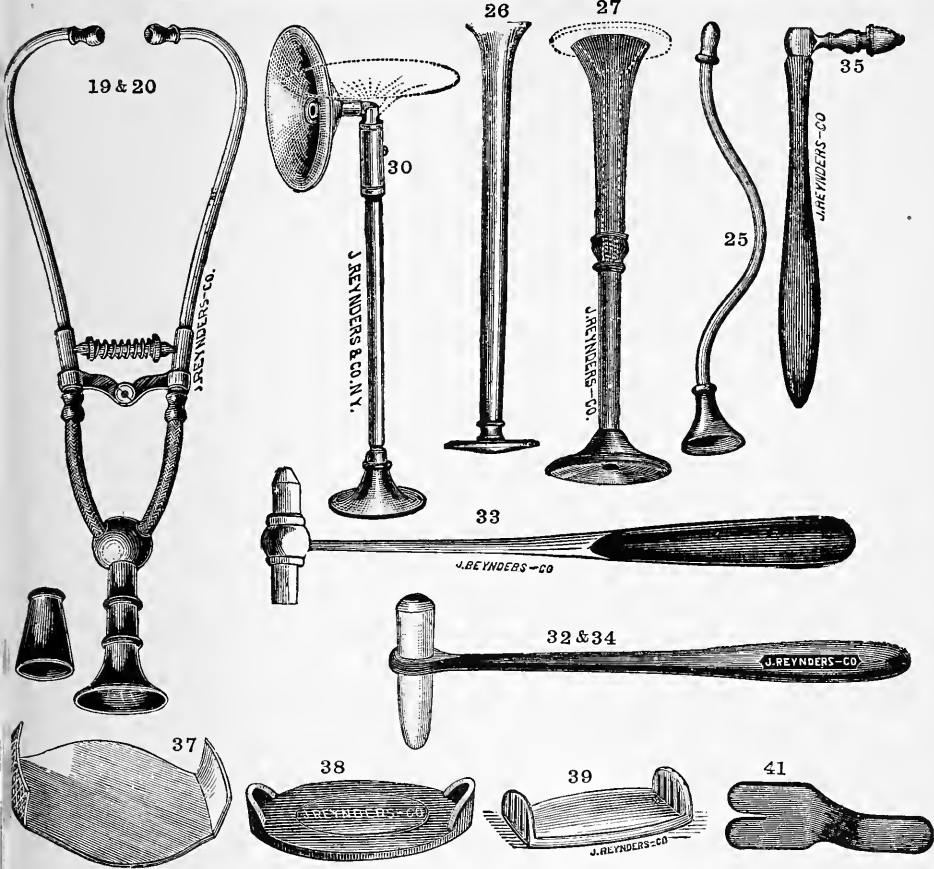

**FOR AUSCULTATION.**

15.*	Stethoscope, Camman's, with elastic, extra fine .....	\$4.00
16.*	" " " " " " good \$3.00; student's .....	2.66
17.*	" " " " plain spiral spring, extra fine .....	4.00
18.*	" " " " " " " " good \$3.00; student's .....	2.66
19.*	" " " " " " " " .....	5.00
20.*	" " " " " " " " 2d quality .....	4.00
21.*	" Knight's .....	6.50
22.*	" J. R. & Co.'s .....	3.00
23.*	" Vacuum .....	3.00
24.*	" Allison's Differential .....	6.00
25.*	" Single, h. r., with elastic tube .....	1.25
26.*	" " " " plain .....	1.25
27.*	" " " " to unscrew .....	\$2.00
28.*	" " " " with hammer & pleximeter .....	3.50
29.*	" Metal, Hawksley's .....	1.50
30.*	" " " improved .....	2.50
31.*	" New Ear Tip .....	per pair 0.50
32.*	Percussor, Flint's, metal, plain .....	1.25
33.*	" " " " fine .....	1.75
34.*	" " h. r. ....	0.75
35.*	" Traube's .....	2.50
36.*	" Metcalf's .....	1.00
37.*	Pleximeter, h. r., plain .....	0.25
38.*	" h. r., Flint's .....	0.40
39.*	" glass .....	0.50
40.*	" ivory .....	1.00
41.*	" h. r., combined with Tongue-tie .....	0.75

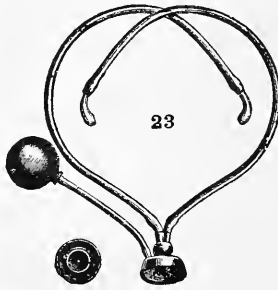

All Instruments Illustrated are designated by a \*

**XX. INSTRUMENTS FOR GENERAL DIAGNOSIS.**  
**FOR EXAMINATION OF URINE.** (See also pages 288 and 289.)

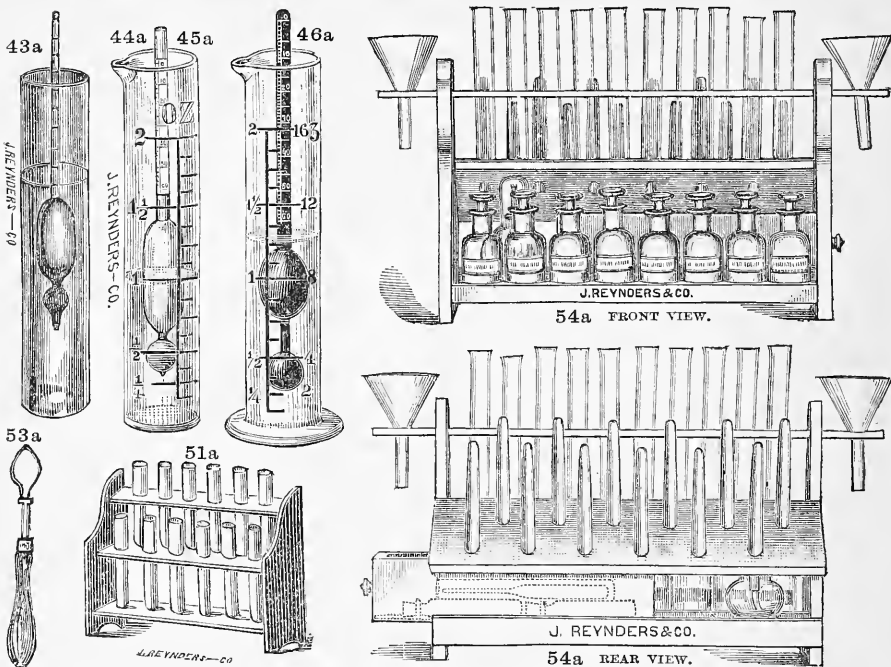

**URINOMETERS.**

43a. *	Plain.....	good 75 cts.; best	\$1.25
44a. *	In graduated receptacle.....		1.50
45a. *	Flat china scale inside of glass.....		2.00
46a. *	Hard rubber in graduated receptacle.....		5.00
47a.	With thermometer (in one) and receptacle as advocated by Prof. Doremus.....		1.75
48a.	Set of two (1000-1020 and 1020-1040) according to Neubauer & Vogel.....		2.00
	49a. Correct, according to Dr. Squibb, with thermometer, receptacle and table for corrections..		3.33
	Same, without thermometer.....		2.00
50x. *	Mohr's Burette (a) 200 grains \$2.00; with glass stopcock \$3.33; (b) stand \$2.00; (c) beaker 2 oz.		0.10
51a. *	Stand, with one doz. Test Tubes.....		1.75
52a.	Test Tubes, each 5 cts.; per doz. 50 cts.; per nest of 4		0.20
53a.	Test Tube Holder for 2 sizes and tweezer combined		0.66

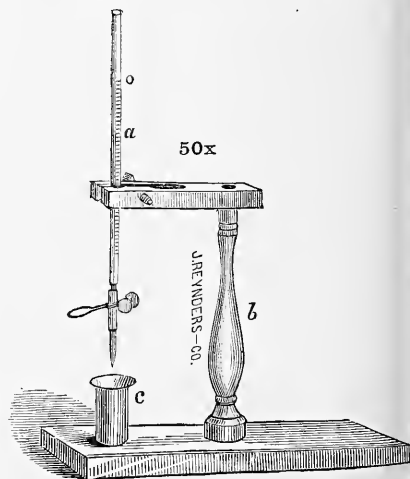
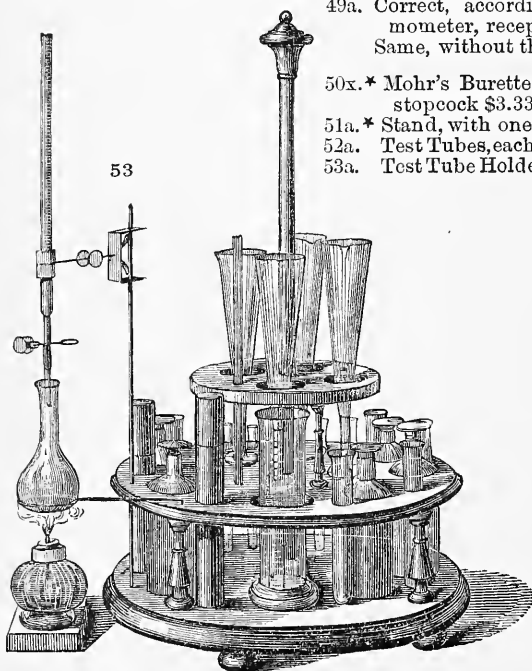

XX. INSTRUMENTS FOR GENERAL DIAGNOSIS.

URINE TEST STANDS.

53. \* Urine Test Stand, Robert's, consisting of one set of Neubauer's Urinometers, 4 Urine Glasses, conical with lip and foot, 6 Test Tubes, 1 Alcohol Lamp, 5 5 oz. Glass Stopped Bottles, with engraved labels, containing the following reagents, c. p.: Acetic Acid, Nitric Acid, Liquor Pottassae, Liquor Amonii and Fehling's Solution, one Burette with spring clamp, one Bunsen's Burette Holder; three Pipettes, three Glass Rods, one Graduate, one flask with flat bottom, one ring support for same; one box with Litmus Paper, assorted. All arranged tastefully and conveniently on a circular stand of two tiers, made of polished wood. . . . \$25.00  
 N. B.—Any change in the engrossed bottles can be made.

54a. \* Lucchesi's Test Stand, consisting of ten Test Tubes, two Glass Funnel, Alcohol Lamp, eight labeled Glass Bottles for reagents, Urinometer, red and blue Litmus Paper, Filtering Paper, two Watch Crystals, Stirring Rod and Drop Tubes 5.33

55a. Same, more elaborate. The case is made of hard wood, finely polished, and is constructed on a new principle which possesses many advantages. The upper part, which forms the test tube rack when in use, can be closed down and fastened; the hollow slats holding the funnels slide into the case; the drawer can be returned to its socket, thus forming a neat, compact box that guards its contents from breakage and protects them from the injurious effects of dust, light and air, so that the contents may be kept clean and always ready for use. It contains 8 Reagent Bottles, 2 Glass Funnel, Alcohol Lamp, 2 Beakers, Porcelain Evaporating Dish, 2 small Glass Evaporating Dishes, 14 Test Tubes, assorted sizes, Test Tube Holder, Urinometer, Graduated Pipette and Litmus Paper. Two of the reagent bottles contain the two solutions now used in making Fehling's Test; one a solution of Sodio Potassic Tartrate, the other a solution of Cupric Sulphate, both so adjusted that, with the directions that accompany the case, a physician may easily make both a qualitative and quantitative analysis for Glucose, thus enabling the practitioner not only to detect sugar in suspected cases, but to make comparative tests, from time to time, in known cases of Diabetes. They are always ready for use and will keep for any length of time. Price of Case, with bottles all filled. . . . . 9.33

FERMENTATION SACCHAROMETER.

FOR THE ESTIMATION OF SUGAR IN URINE.

By MAX EINHORN, M.D.

DIRECTIONS FOR USE.

Take one gramme of commercial compressed yeast (or  $\frac{1}{16}$  of a cake of Fleischmann's yeast), shake thoroughly in the graduated test tube with 10 C.C. of the urine to be examined. Then pour the mixture into the bulb of the Saccharometer. By inclining the apparatus the mixture will easily flow into the cylinder, thereby forcing out the air. Owing to the atmospheric pressure the fluid does not flow back, but remains there.

The apparatus is to be left undisturbed for 20 to 24 hours in a room of ordinary temperature.

If the urine contains sugar, the alcoholic fermentation begins in about 20 to 30 minutes. The evolved carbonic acid gas gathers at the top of the cylinder, forcing the fluid back into the bulb.

On the following day the upper part of the cylinder is filled with carbonic acid gas. The changed level of the fluid in the cylinder shows that the reaction has taken place and indicates by the numbers—to which it corresponds—the approximate quantity of sugar present.

If the urine contains more than one per cent. of sugar, then it must be diluted with water before being tested.

Diabetic urines of straw color and a specific gravity of 1018-1022 may be diluted twice; of 1022-1023, five times; 1023-1038, ten times.

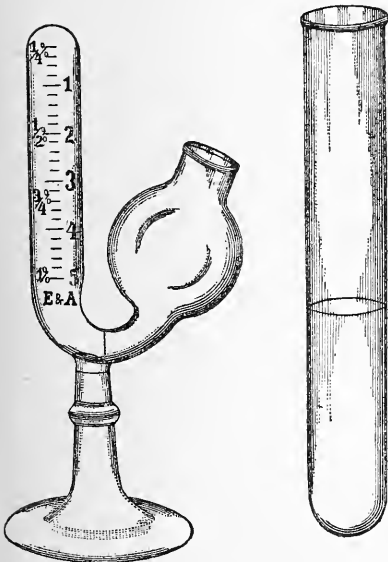

## XX. APPARATUS FOR URINARY ANALYSIS.

## FERMENTATION SACCHAROMETER—Continued.

The original (not diluted) urine contains in proportion to the dilution two, five or ten times more sugar than the diluted urine.

In carrying out the fermentation test, it is always recommendable to take besides the urine to be tested, a normal one, and to make the same fermentation test with it.

The mixture of the normal urine with yeast will have on the following day only a small bubble on the top of the cylinder. That proves at once the efficacy and purity of the yeast.

If there is likewise in the suspected urine a small bubble on the top of the cylinder, then no sugar is present; but if there is a much larger gas volume, then we are *sure* that the urine contains sugar.

Single Tubes, 75 cts. each, net. For convenience of physicians we have put it up in a set consisting of two (2) Saccharometers and one graduated Test Tube, for \$1.50 net.

## APPARATUS FOR THE RAPID ESTIMATION OF UREA.

Designed by CHAS. DOREMUS, M.D., Ph.D.

*Professor Adjunct of Chemistry and Toxicology, Bellevue Hospital Medical College.*

The apparatus shown in the cut is designed for the rapid approximate estimation of urea. It yields, when the test is carefully made, results closely in accord with the theoretical.

That determination of the quantity of urea voided is of importance in diagnosis has long been felt, but the difficulties met with in the manipulation of the tests which were to supply the data were too irksome to physicians.

## REAGENTS NECESSARY.

The Sodium Hydrate Solution (100 grammes to 250 C.C. of water, or 6 ozs. to 1 pint of water) will keep indefinitely when tightly stoppered.

The Bromine may be removed from the bottle in which it is kept by means of the nipple pipette.

1 C.C. suffices for a test. More can be removed if a quantity of hypobromite is to be made up. Some care must be exercised in handling the Bromine, since it gives off irritating fumes—but by the above method of procedure no inconveniences ought to be experienced.

The concentrated hypobromite must be diluted with its own volume of water. This can be done approximately.

The long arm and the bend of the ureometer must be filled with the hypobromite.

Having washed the pipette draw up exactly 1 C.C. of urine, pass the pipette through the bulb of the ureometer as far as it will go in the bend. Compress the nipple *gently* and *steadily*. The urine will rise through the hypobromite and the urea instantly decompose, giving off nitrogen gas.

Withdraw the pipette after the urine has been expelled, taking care not to press the nipple hard enough to drive the air out after the urine, and read the volume of gas after allowing the froth to subside. *The ureometer indicates according to its graduation either in milligrammes of urea in 1 C.C. of urine or grains of urea per fluid ounce of urine.*

It also indicates by the signs + and - on either side of the central division whether the urea is present in a normal quantity or is increased or diminished.

In this connection it is well to remember that no two specimens from the same individual are alike when collected at different times of the day. Unless the urine of 24 hours is collected, mixed and a specimen taken, no accurate data can be had. Next to collecting the 24 hours urine and ascertaining the quantity voided, the morning urine, that passed on rising, is the best upon which to base a diagnosis.

When the total quantity voided in 24 hours is known the calculation of the amount of urea is very simple. Multiply the result found in milligrammes by the number of cubic centimeters voided, or the grain per fluid ounce by the number of ounces voided.

The percentage by volume, or milligrammes of urea per 100 cubic centimeters of urine is ascertained by multiplying the milligrammes of urea found by the test by 100.

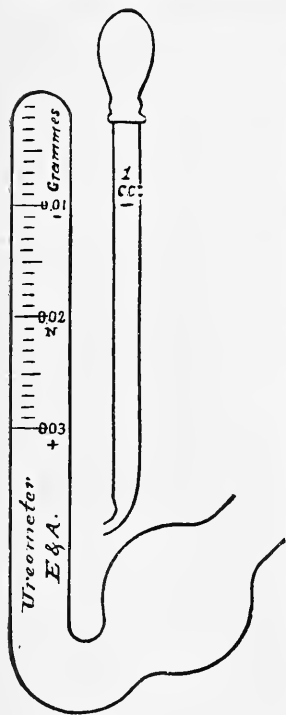

**XX. APPARATUS FOR URINARY ANALYSIS.****APPARATUS FOR THE RAPID ESTIMATION OF UREA—Continued.**

Lowering the ureometer in a vessel of water until the water and hypobromite inside and out of the graduated limb are on a level, will give a more correct reading. The ureometer is graduated for 65° F., and upon an experimental basis.

In the office of the consulting physician, or in hospitals where a quantity of hypobromite can be made every day or so, this apparatus should supply a long felt need.

After use simple washing will leave it ready for subsequent tests.

Price of apparatus, complete, in box, with pipette, \$1.25 net.

Solution Sodid Hydrate, used with the above apparatus, 60 cts. net, per pound, including bottle.

Bromine, 25 cts. net, per ounce, bottle included.

A support with clamp-like figure for the apparatus will be supplied if desired for \$1.00 net. Iron foot for same, 30 cts. net.

This apparatus is also furnished on glass foot like the Einhorn Saccharometer, see page 233. Price, complete, \$1.50 net.

---

**ESBACH'S ALBUMENOMETER.****FOR THE QUANTITATIVE ESTIMATION OF ALBUMEN IN URINE.****DIRECTIONS FOR USE.**

Fill the tube up to the mark U with urine, then fill up to the mark R with the test solution. Place the thumb over the top of the tube and *reverse twelve times and back, without shaking*. Then close the tube tightly with a rubber stopper, and set aside 24 hours. The graduation of the tube represents, in grammes, the quantity of albumen contained in 1 liter of the urine under examination. Be careful to read the height of the precipitate from the middle of the albuminous surface.

**IMPORTANT REMARKS.**

**FIRST.**—The urine to be examined should be acid. It is always necessary to be sure the urine will freely redden blue litmus paper. Very often, in consequence of their ready decomposition, albuminous urines are neutral or ammoniacal. In that case, place the urine in a conical glass, add a drop of acetic acid, and stir with a glass rod. Then place a drop of the fluid on blue litmus paper. If the spot produced is brick red, stop. If violet red, add acid until distinct acid reaction is obtained. It is always better to work with fresh urine.

**SECOND.**—The results are more exact and constant, when the percentage of albumen is low. Therefore when an unknown specimen of urine seems to be loaded with albumen, greater accuracy will be obtained by diluting with one or two volumes of water, so that the result will not exceed 4 grammes, for example. Of course this dilution must be taken into account on making final calculations.

The test-solution consists of:

- 10 grammes Picric Acid, to coagulate the Albumen.
- 20 grammes Citric Acid, to keep the Phosphates in solution.
- Water sufficient to make 1 liter.
- 2 grammes Picric Acid represent one gramme of Albumen.

Test-solution, per pound, with glass-stoppered bottle, 40 cts. net; instrument, in box, price 75 cts. net.

XX. INSTRUMENTS FOR GENERAL DIAGNOSIS.

AESTHESIOMETERS.

- 63.\* Carroll's ..... \$4.00
- 64.\* Birdsall's (arranged for attachment of an electric cord) 3.50
- 65.\* J. R. & Co.'s Pocket Case.... 4.50
- 66.\* Hammond's..... 3.00
- 67.\* Dr. Grace Peckham's..... 6.00

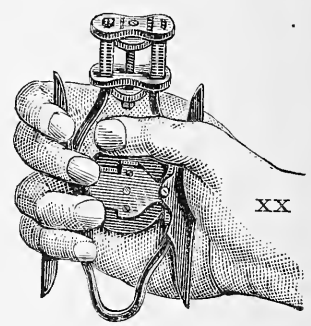
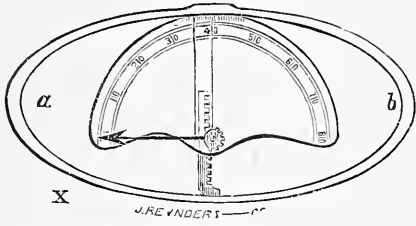
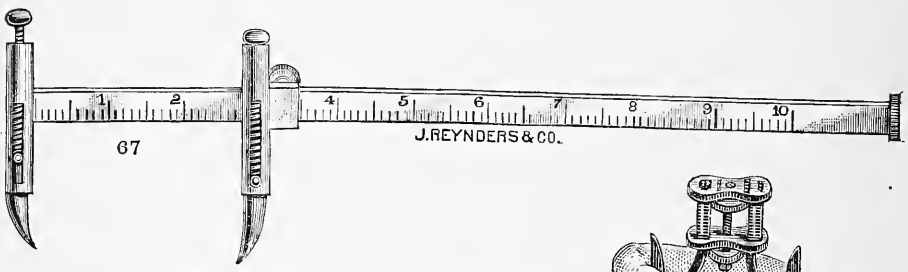
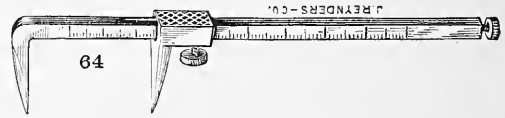
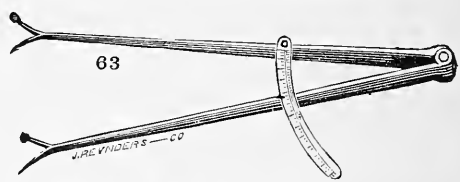
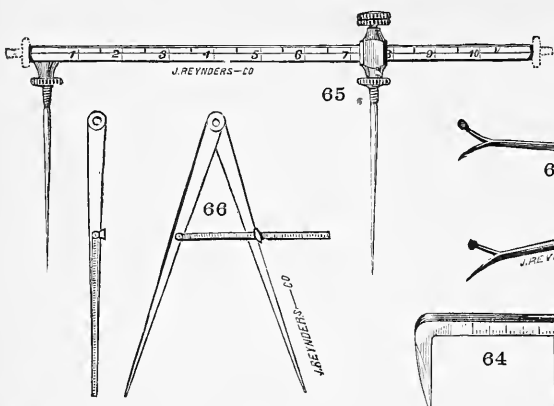

- X.\* Dynamometer ..... \$3.00 and \$16.00
- XX.\* " Burgk's ..... 16.00\*

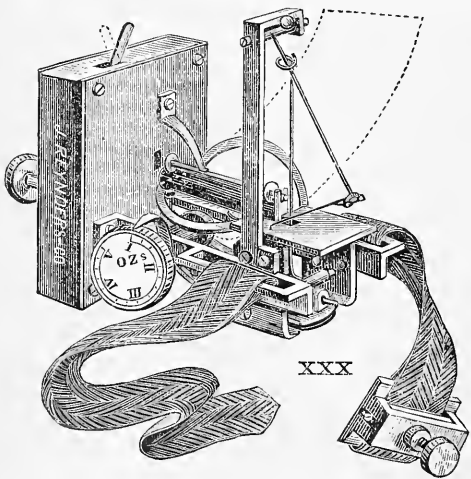

- XXX.\* Dudgeon's Sphyginograph (figure above).... 25.00
- Marey's " ..... 75.00
- Mahomed's..... 75.00



XXI. RESPIRATORY APPARATUS AND APPLIANCES.

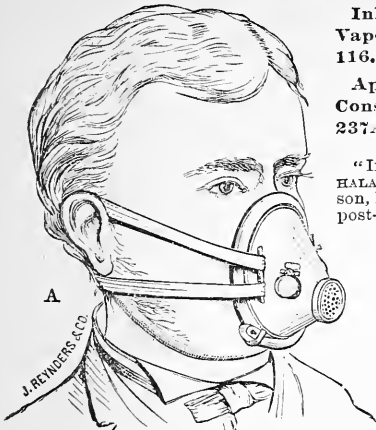

Blake's Respirator, \$3.00.

Inhalers for Medicated Vapors, see pages 115 and 116.

Apparatus for Cure of Consumption, see page 237A.

"INHALERS, INHALANT AND INHALATIONS," by Beverly Robinson, M.D. Sent to any address, post-paid, for 25 cents.

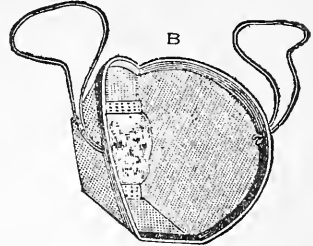

Robinson's Respirator. Net, 50 cts. each; per doz., \$4.50.\*

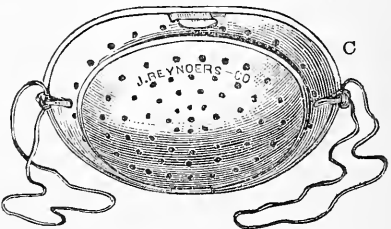

Respirator, metallic, for mouth only, \$2.00.

The Respirators are made to fit accurately the mouth and lower part of the nose. A membrane in the shape of a sieve separates the main body of the inhaler from a detachable cup also perforated for the reception of absorbent cotton, sponge, lint or oakum, upon which is dropped the antiseptic to be used. Openings on either side of the mouthpiece allow of the escape of exhaled air. The respirator is fastened behind the ears by thin, round elastic ribbons or by spectacle wires, as desired. Before beginning an inhalation the sponge should be properly moistened with water or alcohol, and the inhaling fluid poured upon it. In cases reported, the fluid used consisted of equal parts of creasote, alcohol, and spirit of chloroform. Of this mixture, ten to fifteen drops were put upon the sponge. The treatment was begun with an inhalation of fifteen minutes duration three or four times daily, increased until, in some cases, the inhalers were worn almost constantly except at night. There was no irritation produced by the inhalation, all the patients saying that after a few trials it relieved the cough and the irritability of the throat. In some cases in which the sweating at night was very profuse, atropine,  $\frac{1}{99}$  of a grain, with fifteen drops of aromatic sulphuric acid, were given at bed-time. In a number of cases in which the appetite was very poor, a tonic, usually a mixture of iron, quinine and strychnine, was administered before meals. In some cases in which the cough was very severe, a palliative cough-mixture of spirit of chloroform, dilute hydrocyanic acid, and syrup of wild cherry was used. No other medication was employed.

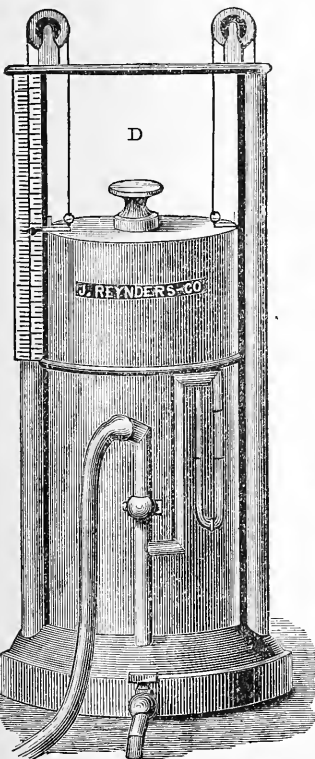

Hutchinson's Spirometer, \$20.00.  
Barnes' Spirometer (see right hand lower corner of previous page), \$10.00.

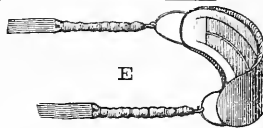

Respirator (anti-dust), mouth only. Plain, \$1.00; better, \$2.00; Jeffries', \$4.00.

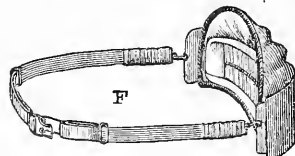

Respirator (anti-dust), mouth and nose. Plain, \$1.50; better, \$2.50; Jeffries', \$6.00.

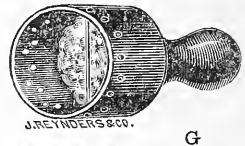

B. Robinson's Nozzles for Medicated Breathing. Each, 50 cts.

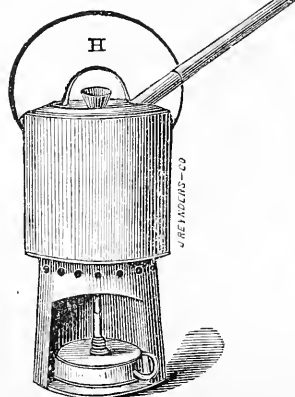

Standard Croup Kettle, \$3.50.

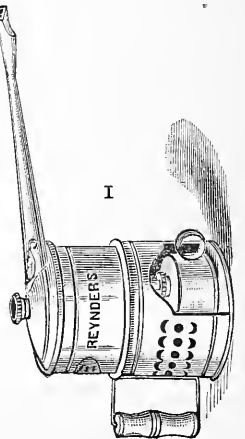

Shaw's Croup Kettle, \$2.00.

**XXI. RESPIRATORY INSTRUMENTS AND APPARATUS.**

- A. Home Oxygen Apparatus .....\$22.50;\* Retort only \$10.50\*  
 One charge in the retort will generate 1 to 100 gallons of oxygen.

The apparatus consists of a Russia sheet-iron retort, 2 inch. diameter by 12 inch. long, mounted on a nicely-finished cast-iron base, 6 inch. by 14 inch.; gas burner, four one-quart wash-bottles, with rubber corks and glass tubes; one double-necked four-gallon gas bag, with nickel-plated stopcocks; nine feet of 5/16 inch rubber tubing, two glass mouth-pieces, and one retort cleaner. One pound of prepared chemicals will be sent with each apparatus. A non-explosive Argand spirit lamp will be furnished in place of gas-burner, where house gas is not available. This apparatus is also adapted for the preparation of Nitrogen Monoxide, but for that purpose a gasometer should take the place of gas bag F. Can furnish a 30-gallon gasometer, well constructed, made nicely of zinc, for \$25.00.\* Printed instructions for preparing the chemicals, etc., will be sent with each apparatus. Prepared Chemicals for Oxygen, in 5-lb. lots, per lb. 35 cts.; Prepared Chemicals for Nitrogen Monoxide, in 10-lb lots, per lb. 30 cts.

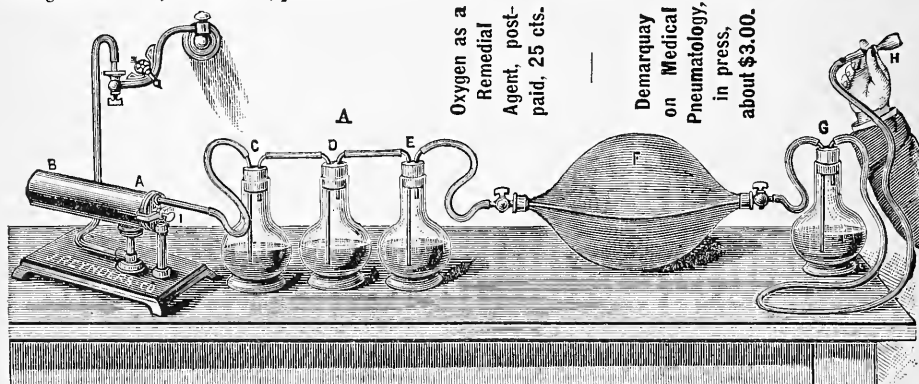

Oxygen as a Remedial Agent, post-paid, 25 cts.

Denarquist on Medical Pneumatology, in press, about \$3.00.

- B. Portable Oxygen Generator. Size No. 1, "The Economic." Capacity, 7 gallons every 15 minutes. Size of case, 11x10x6½ in. Complete with 10-gallon gas holder, 6 retorts and prepared chemicals to make 100 gallons oxygen ..... net \$25.00  
 C. Portable Oxygen Generator. Size No. 2, "The Climax." Size of case, 16x10x7 in. Capacity, 12 gallons every 15 minutes. Complete with 12 retorts, 2 10-gallon gas holders, 2 lamps and prepared chemicals to make 200 gallons oxygen. Full directions and all formulæ with each instrument..... net \$50.00  
 D. Storage Gasometer. 50 gallons capacity. Self-supporting frame, cord weights and pulleys, with conical oxygen retort, capacity 40 to 50 gallons at each operation, set of 6 wash-bottles and fittings, kerosene heater in position for operation. Also automatic depression weight obviating the necessity for a pump in transferring gas. The gasometer is fire-japanned and beautifully ornamented. Complete as shown in the cut, \$50.00

- E. Dispensing Gasometer, complete (8-gal.), \$25.00\*  
 F. Plain Storage Gasometer (storage 75-gal., producing capacity same as E, but not as handy), complete..... \$45.00\*  
 Prepared material for apparatus B to F, either for Oxygen or Nitrogen Monoxide, per lb. 40\* cts.; in 20-lb lots per lb. 35 cts.

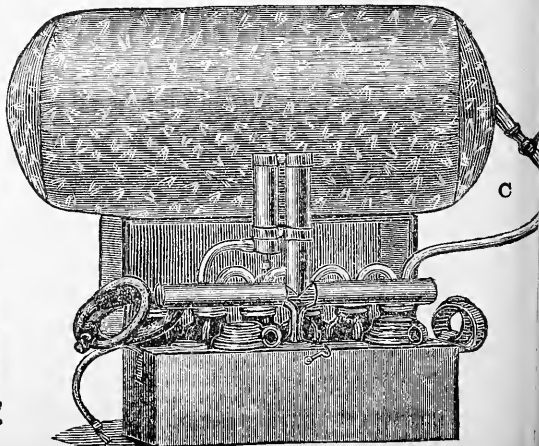
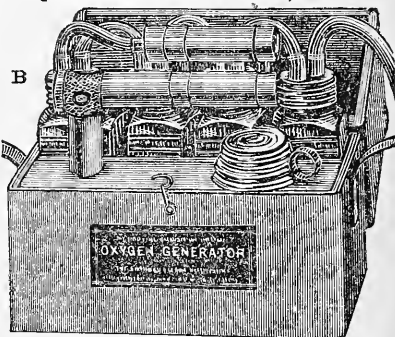
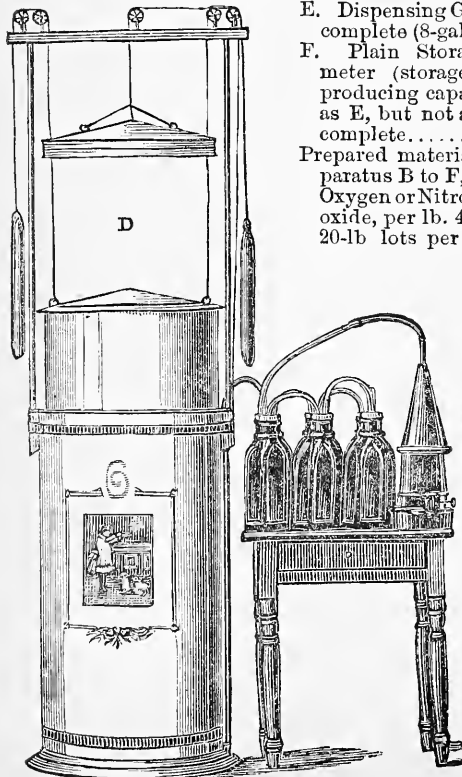

**XXI. RESPIRATORY INSTRUMENTS AND APPARATUS.**

The purpose of these apparatus is to serve as a means for completing and invigorating respiratory actions both ways, and in the case of inspiration to gently and forcibly expand the air passages. In doing the latter the expansibility of the air passages is to be acted upon by an untiring steady power, such as an unchanging medium of compressed or condensed air. This should be distinguished from voluntary forcible inspirations, especially in more advanced stages of disease; when the strength of the patient is not sufficient to expand the air passages to their full capacity, while with any of the apparatus illustrated herewith this can be accomplished.

In Emphysema, when the contractile power of the air passages is impaired, the application of the rarified medium of air to the lungs will withdraw the residual air and gradually restore the lost power.

The most thorough ventilation of the lungs can also be accomplished by treatment with these apparatus.

The use of these apparatus is essentially indicated in the following diseases: Early stages of Phthisis, Emphysema, Chronic and Sub-acute Bronchitis, etc.; also for Expansion of the Lungs after Pleurisy with Effusion.

Apparatus 22 and 23 are constructed upon the usual gasometer principle, while No. 24 works on the principle of the bucket wheel—the latter is in the interior of the apparatus and partially immersed in water; the wheel is turned; when out of water the buckets become filled with air, which after being carried under the water, arises from the buckets and is led into a bell. Thus a medium of condensed air is produced. The bell is also contained inside of the apparatus and by a change of stoppers the air can be removed from the bell and thus a medium of rarefied air produced.

To each of these apparatus an arrangement can be added by which the air to be inspired can be medicated; there are no better means for reaching the lungs with therapeutic agents than these apparatus.

22.* Waldenburg's Apparatus .....	\$80.00
23.* Tobold's .....	50.00
24 * Hess' .....	35.00

**PNEUMATIC CABINET, DESCRIPTION ON APPLICATION, \$500.00.\***

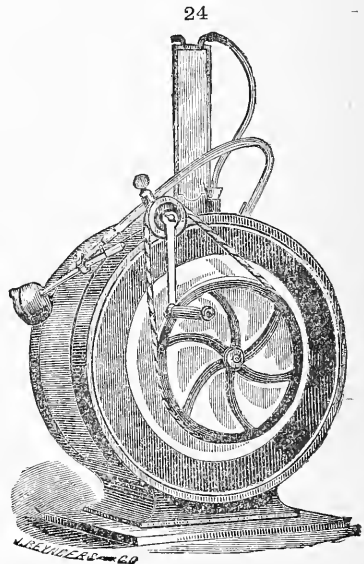
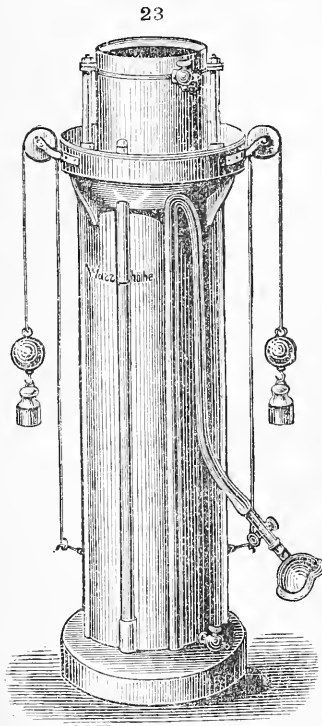
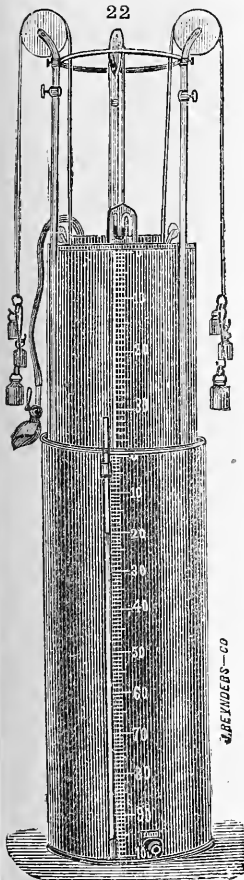

## XXI. RESPIRATORY INSTRUMENTS AND APPLIANCES.

APPARATUS FOR THE GENERATION AND INHALATION OF SUPERHEATED AIR—DRY OR MOIST—FOR THE TREATMENT OF DIPHThERIA, CROUP, BRONCHIAL CATARRH AND CONSUMPTION.

The whole procedure is based upon Professor Robert Koch's discoveries and researches, showing that consumption is caused by bacteria—minute organisms belonging to the vegetable kingdom. They increase very rapidly by subdivision, and gradually destroy or disintegrate the organ in which they are found, either by their mere presence or by some specific poison they produce. The bacteria identified with consumption are named tubercle-bacilli. Since the professor's discovery of this fact,

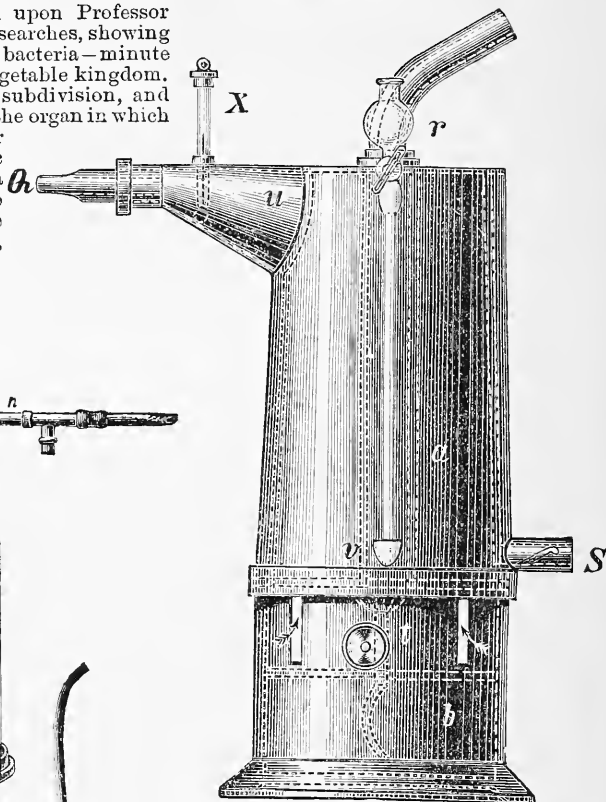
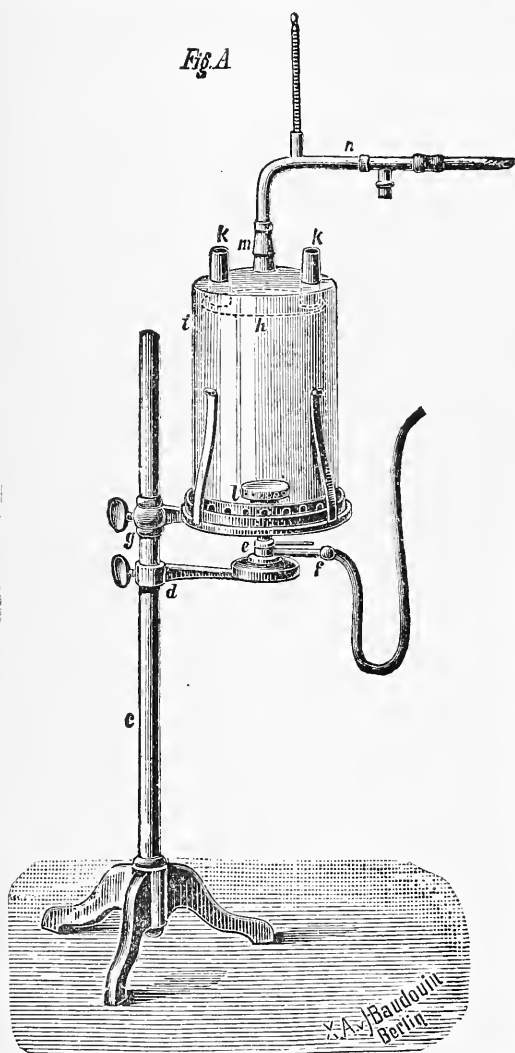

it has been the aim of every disciple of the healing art who seriously undertook to battle with the ravages of this disease to find some means by which these germs could be destroyed, and at the same time allow the tissues of the lungs to remain intact. It was then found that bacteria flourish only within certain well-defined limits of temperature, their normal temperature being the same as that of the human body. Quite trivial raising of the temperature of the body considerably hindered the power of development and increase of the tubercle-bacilli. For instance, at 101.3° Fahr. they hardly grow at all, and at 107.6° their development ceases altogether. When they are exposed to a temperature of 122° Fahr. they die within one month, and one single boiling is sufficient to destroy them entirely.

Now these facts have suggested the idea of attacking the tubercle-bacilli in their weak point; that is to say, by exposing them in the lung to a high degree of heat, so as to weaken them and to hinder their

development and multiplication—so that they may be finally destroyed within the body. The only question was whether the human body is capable of resisting this superheated air without undesirable results, and this has now been satisfactorily settled by trials on hundreds of individuals, covering a period of about a year and a half.

Pamphlet with report on at least twelve patients under the care of a committee of three physicians of unquestionable standing in this city, all treated by the Hot Air Method, conscientiously according to directions, will be sent on application. Also, further information as to latest improvements, price, etc.



XXII. DOUCHES AND SYRINGES.

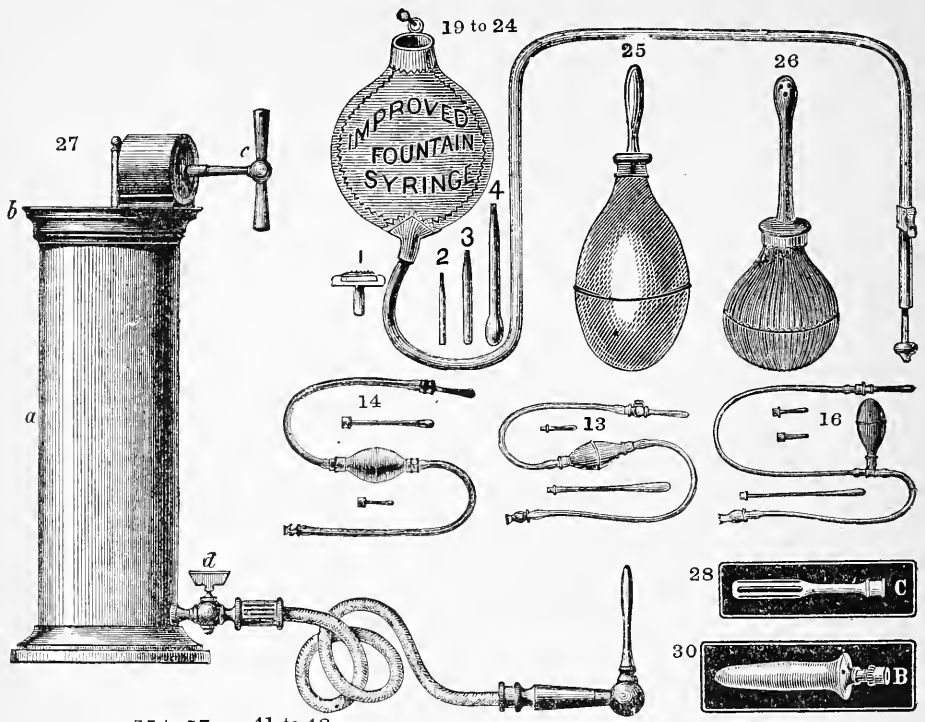

Patented, Feb. 8th, 1881.

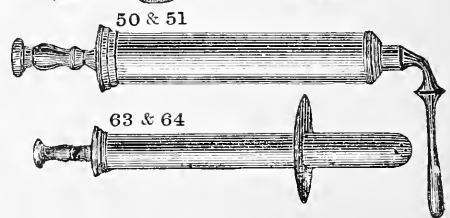
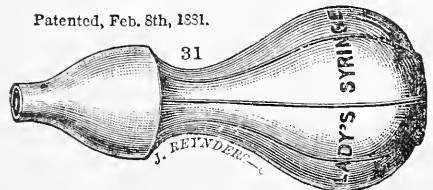

## XXII. DOUCHES AND SYRINGES.

1. Eye Syringes and Douches, see page 69.	17. Soft R. Syringe, Mattson's Vag. Irrigator.. \$1.50
2. Ear " " " " " " 100.	18. " " " " " " Pile Cure..... 3.50
3. Nasal " " " " " " 12.	19.* Fountain Syringe, Empire, best, h. r. tubes
4. Vaginal " " " " " " 166,	small—2.00
4a. P. P. Urethral Syringes, see page 208.	med.—2.25
5. Douche Basins, like fig. 133, p. 100. 1 quart \$1.00	large—2.50
2 quarts 1.25	21.* " " " " " " tubes
6. " " " " " " 208, " 166..... 1.75	large—2.50
7. Connections for Rubber tubing ..... .20	22.* " " " Delano, glass tubes small—1.75
8. Outside Clamp Stopcocks for Rubber	23.* " " " " " " med.—2.00
Tubing..... .25	24.* " " " " " " large—2.25
9. Sinkers for Tubing ..... .25	25.* Bag Syringe .6 oz. \$1.25; 10 oz. 1.75; 16 oz. 2.00
10. Nasal Douche Nozzles... glass \$0.20; metal .25	26.* " " " Vaginal..... 2.50
11. Vaginal " " " " " " .25; h. r. .50	27.* Irrigateur Eguisier..... 6.50
12. Soft Rubber Syringe, ordinary ..... 1.00	28.* Mattson's Vaginal Irrigator Tube, alone... 1.25
13.* " " " " " " Davison's No. 1. .... 2.00	29.* " " " Nasal " " " " 2.50
14.* " " " " " " No. 2. .... 1.67	30.* " " " Pile Cure Cone, alone..... 3.00
15. " " " " " " h. r. nozzles 2.50	31.* Lady's Syringe ..... 3.00
16.* " " " " " " Mattson's Family..... 2.50	

### HARD RUBBER SYRINGES.

32.* Universal ..... in morocco case \$12.00	50.* With Male Pipe Bent, No. 4.....3 oz. \$1.50
33.* " " " " " " all h. r. 3.00	51.* " " " " " " 5.....6 " 1.75
34. With straight Pipe No. 00..... $\frac{1}{2}$ oz. .50	52.* " " Pipe Bent Female, " 4.....3 " 1.50
35. " " " " " " 0..... $\frac{3}{8}$ " .60	53.* " " " " " " 5.....6 " 1.90
36. " " " " " " 1..... $\frac{1}{2}$ " .60	54.* " " Shield Pipe " 4.....3 " 1.90
37. " " " " " " 1A..... $\frac{1}{4}$ " .60	55.* " " Full Set of Pipes, " 4.....3 " 1.75
38. " " " " " " 1B..... $\frac{1}{2}$ " .75	56.* " " " " " " 5.....6 " 2.25
39.* " " " " " " 1C..... $\frac{3}{8}$ " .70	57.* " " " " " " 6.....12 " 2.50
40.* " " " " " " 1D..... $\frac{1}{2}$ " .75	58.* " " Straight Pipes, " 4a.....1 $\frac{1}{2}$ " 1.25
41.* " " " " " " 2..... $\frac{3}{4}$ " .75	59.* " " " " " " long, " 4a.....1 $\frac{1}{2}$ " 1.75
42.* " " " " " " 3.....1 " .90	60.* Vaginal, No. 1..... $\frac{1}{4}$ " .60
43.* " " " " " " 3A.....2 " 1.20	61.* " " " " " " 2..... $\frac{3}{4}$ " .60
44.* " " " " " " 4.....3 " 1.25	62.* " " " " " " 3..... $\frac{1}{2}$ " .90
45.* " " " " " " 5.....6 " 1.75	63.* " " with Shield..... $\frac{1}{2}$ " 1.00
46.* " " " " " " 6.....12 " 2.50	64.* " " " " " " 1..... $\frac{1}{2}$ " 1.25
47.* " " " " " " 10..... $\frac{1}{4}$ " .40	65.* Dental ..... 3-16 " .80
48.* " " " " " " 30.....1 " .75	66.* Pump, with flexible tube and full set of
49. " " " " " " Long No. 3..... $\frac{1}{2}$ " 1.00	Pipes. .... 3.00

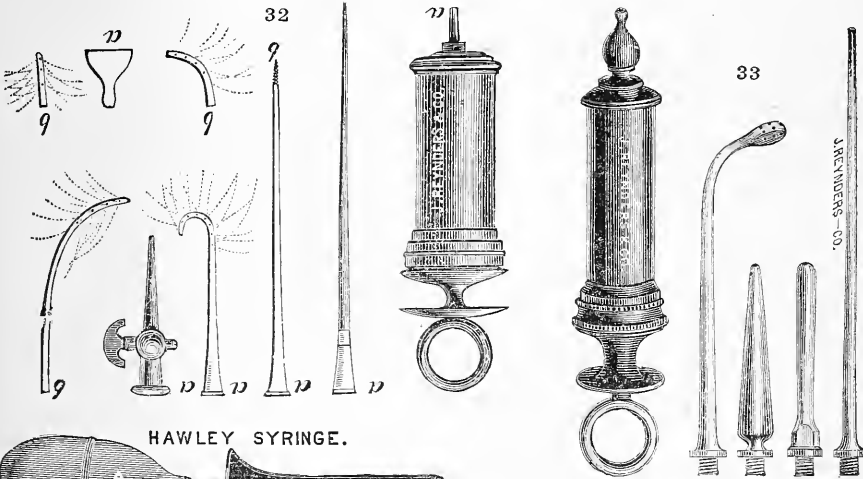

HAWLEY SYRINGE.

REVERSIBLE CURRENT.

\$4.00 SECTIONAL VIEW.

BAKER'S COMMON SENSE™  
PROBE POINTED INTRA-UTERINE SYRINGE

\$1.25

BAKER'S COMMON SENSE™  
PROBE POINTED FAMILY SYRINGE

75 cts.

Mayer's Douche, \$6.00

J. REYNOLDS CO.

XXIII. HYPODERMIC SYRINGES.\*

GENERAL REMARKS.

We confine our list to Syringes with Glass Barrels, most generally of the manufacture of J. J. Hicks of London of thermometer fame (excepting No. 27 and a few others); lengthwise the part bearing the graduations and numbers, in clear and conspicuous black, is of white (milk) glass, and the rest of transparent glass allowing the contents to be seen, all of which is well illustrated by the figure in the upper left hand corner of this page. Every syringe has a screw cap closing the barrel airtight, preventing to a great extent evaporation of the moisture in the packing, thus tending to keep it in good condition.

All needles are of our superior drawn steel seamless tube, and are gilt unless otherwise stated.

Our Vials are other important features. The one shown here (X) is an ordinary 60 minim vial. The cork is of soft rubber with a small round hole in the center. If the bottle is filled with solution to the top, the perforated cork then carefully

inserted so as to allow all air and excess of fluid to escape through the hole, and then stoppered (with the hard rubber pin fitting into the center hole, with a flat milled edge extending over the entire surface of the cork) the bottle is filled airtight—and to the exclusion of any trace of air from the inside. A solution, if made from sulphate of morphia with water, doubly distilled and filtered through cotton, will keep for six months without deterioration.

The perforated cork has another and still greater advantage. Take the vial partly or entirely filled, lay it down (see illustration) and not a drop of liquid will escape. This does away with the great care which otherwise the physician must exercise, in order not to upset his solution bottle.

This Vial we now put with every Syringe unless otherwise indicated.

The figure to the right at the head of this page is our well-known Screw Cap Vial. It is attached to the Syringe and held uppermost while the solution is drawn into the latter, which procedure, besides being very convenient, offers the further advantage of excluding air from the Syringe, as the same rises to the upper end of the Vial. To many practitioners this mode of charging a syringe has become indispensable. The price of a Syringe with Vial Y is 35 cts. additional to prices given.

*When about sending us Hypodermic Syringes for repair every part thereto belonging should be included; this is important in order to enable us making anything new in conformity with the rest. Packages inclosing same should always bear sender's name, so that we will know whom to return the Syringe to.*

ALL OF THE FOLLOWING PRICES ARE NET.



X



Y

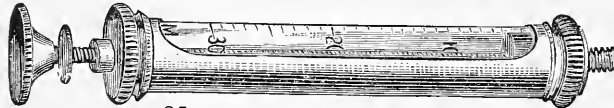

25

J. REYNDERS - CO.

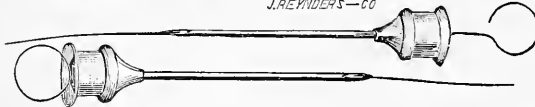

Hypodermic Syringe, No. 25, in leather case, with Vial X, Needles steel, \$1.50; end of barrel removable for introduction of tablets \$1.75; Gilt Needles, heavy plate, 25 cts. additional.

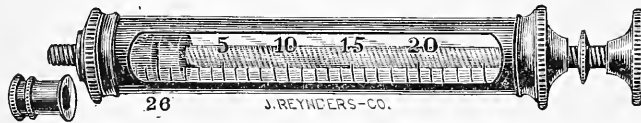

26

J. REYNDERS - CO.

Hypodermic Syringe, No. 26, in leather case with Vial X, Needles steel, like No. 1, Syringe double fenestrated, very handsome, \$2.00; end of barrel removable for introduction of tablets \$2.25; Gilt Needles, heavy plate, 25 cts. additional.



27

J. REYNDERS - CO.

Hypodermic Syringe, No. 27, with Vial X and steel Needles, end of barrel not removable, \$1.25.

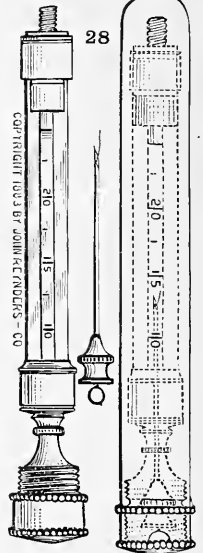

28

J. REYNDERS - CO.

Hypodermic Syringe, No. 28, for pocket or pocket case. Two caps, to be screwed towards each other on the handle of the piston rod, hold the parts of this syringe firmly together when the same is to be carried in the pocket, which is a decided improvement on pocket syringes whose pistons can always be pulled out. The long cap protects the glass barreled syringe, while the short one holds the needle in place in the hollow piston rod. Price \$2.00.

Needles, separately, see page 242. Fraser's Tablets, see page 243.



XXIII. HYPODERMIC SYRINGES.\*

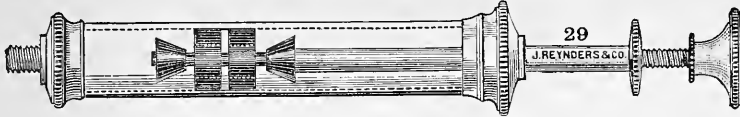

Hypodermic Syringe, No. 29, with expanding Piston, Vial X, extra fine morocco case, Needles gilt, end of barrel unscrewing, bifenestrated..... gilt \$4.00; nickeled \$3.00

NOTE.—By turning the screw the cones at the piston approach each other, dig into and expand the piston. Furnished at same price with finger-rests.

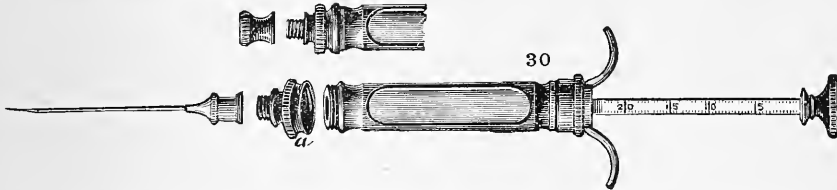

Hypodermic Syringe, No. 30, fenestrated, graduated Cylinder with finger-rest, 30 minims, two gilt Needles and Vial X. Figure shows screw cap and end of barrel unscrewing for introduction of tablets ..... \$2.50

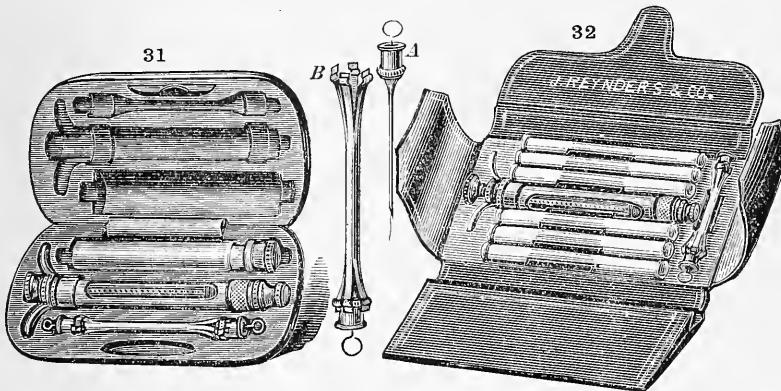

With either of the two above goes our new Hypodermic Needle Holder. "A" shows a needle, "B" how it is inserted. For holding needle in place and protecting it nothing is superior.

Hypodermic Syringe, No. 31, same as No. 25, only in smooth hard rubber case, cavities countersunk in same for holding contents, very cleanly; case self-closing and remaining closed without catch..... \$3.00

Hypodermic Syringe, No. 32, same as No. 25, only in flexible morocco case, particularly adapted to vest pocket; six Vials for tablets ..... 3.50

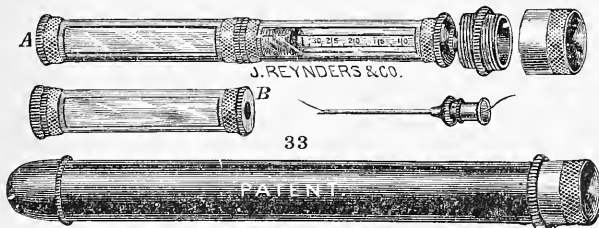

Hypodermic Syringe, No. 33, by Dr. S. F. Grant. Patented for the benefit of the medical profession. The lower figure above shows it in longitudinal case for pocket, holding vial, syringe and needle (platinum and iridium). For filling vial screws onto the syringe as explained at head of previous page. The end of case holds a receptacle for tablets ..... 3.75

DIRECTIONS.—Unscrew the bottom A, and draw up the water; drop in a globule, replace the button and agitate the contents of vial until a solution is effected. Before charging the syringe, reverse the screw at B slightly, and push down the piston. This gives vent to contained air and forms a partial vacuum. Now screw lightly at B, and charge the syringe. Remove the vial and attach needle. When the physician desires, he may carry an injection in the syringe, for use at a moment's notice.

XXIII. HYPODERMIC SYRINGES.\*

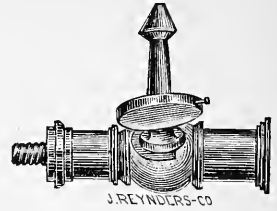
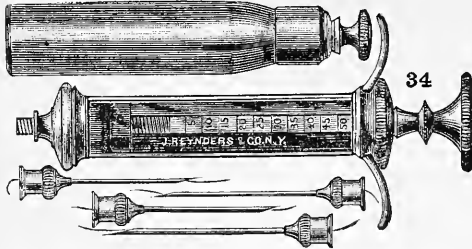

Hypodermic Syringe, No. 34, Deelat's, holding 80 minims, double fenestrated, end of barrel unscrewing for introduction of tablets; with Vial X and three assorted hypodermic Needles, morocco case ..... \$3.00  
 Same, with needles gilt and in addition one needle for explorative aspiration, also gilt. 3.75  
 The latter with vial "Y" as illustrated. .... 4.00  
 Double Stopcock, as illustrated to the right, \$1.25; can be furnished with syringe 34 if desired.  
 See also No. 24b, page 51.

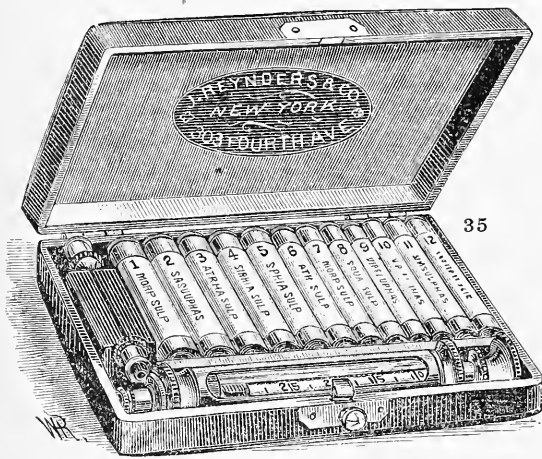

Hypodermic Syringe, No. 35, similar to tablet syringe No. 25, but is now put up with only six vials, containing each six tablets of the following varieties:  
 Morphine Muriate 1/6 gr.  
 Strychnine Sulphate 1/50 gr.  
 Atropine Sulphate 1/50 gr.  
 Morphine Sulphate 1/4 gr.  
 Cocaine Muriate 1/50 gr.  
 Morphine Sulphate 1/50 gr.  
 Price ..... \$2.50

Hypodermic Syringe (pocket), No. 36 ..... \$3.00  
 These figures below show the neatest and most compact metallic Case nickel-plated made. The needles are firmly held by spring holders around their mountings; no velvet and nothing to absorb uncleanness. Prices, with any Syringe mentioned on page 240, add for upper case 85 cts.; for lower case 50 cts.

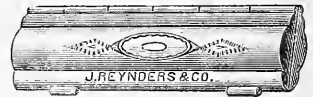
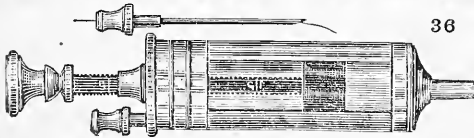

NEEDLES.

Best steel, plain or nickel-plated, 35 cts.; extra fine \$0.45  
 Best steel, gold plated, 45 cts.; extra fine 0.50  
 Best steel, reinforced nickeled, 50 cts.; gilt 0.60  
 Gold, steel pointed. .... 1.00  
 Steel, platinum lined inside. .... 1.00  
 Platinum and iridium alloy (the hardest of incorrosive metals). .... 1.25

SUNDRIES.

Reamer for needles. .... \$0.05  
 Bundle of Wires ..... 0.05  
 Aspirating Needle ..... 0.75  
 Adams' Pile Injecting Needle and Elongating Part ..... 1.50  
 Hernia Tube, Heaton's, \$1.50; DeGarmo's 3.00



Dr. Otis' Cocaine Tube, silver ..... 1.25

XXIII. HYPODERMIC SYRINGES.\*

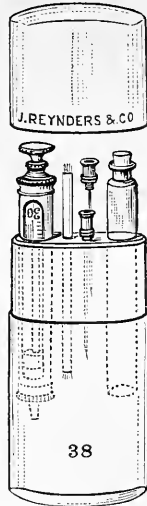
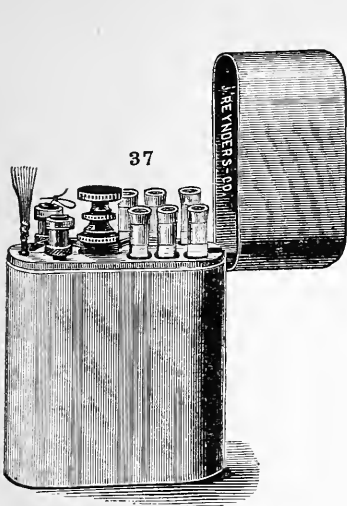

- No. 37. Hypodermic Syringe, in metal case, with six empty tablet Vials, size about  $2\frac{3}{4} \times 1\frac{1}{4}$  ..... \$3.50
- Same, with only one ordinary Vial, very compact..... 2.00
- No. 38. Hypodermic Syringe, in metal case ..... 3.00
- No. 39. Hypodermic Syringe, chased plated case, Vial X, syringe like 25..... 3.00
- Same, with finger-rest..... 3.50

FRASER'S SOLUBLE HYPODERMIC TABLETS, 25% off.

Made according to Dr. Robert M. Fuller's method. (See *Medical Record*, March 25th, 1882.)



The medicines in these tablets are combined with an unobjectionable base. They do not cause abscesses, and may be given internally as well as administered hypodermically.

They are easily soluble in 10 minims of water; are hard enough to retain their form, and will not pulverize or crumble in the bottle.

It is unnecessary to use warm water for the Morphia, Atropia, or Hyoscyamia Tablets; but better to use hot water for the others to insure the complete solution of the alkaloids.

They possess the advantages of accuracy of dose and perfect preservation of the drug.

		Per Hundred.				Per Hundred.	
Aconitia Nitrate (Duquesnel's)	1-50 gr.	0.85	\$1.25	Morphia Sulphate	1-2 gr.	0.75	\$1.25
" "	1-100 gr.	0.85		Atropia	1-120 gr.	0.75	
" "	1-150 gr.	0.75		Morphia Sulphate	1-3 gr.	0.75	1.00
" "	1-200 gr.	0.60		Atropia	1-150 gr.	0.75	
Apomorphia Muriate (Merck's)	1-10 gr.	1.00		Morphia Sulphate	1-4 gr.	0.75	
" "	1-20 gr.	0.75		Atropia	1-150 gr.	0.75	
Arsenite of Potass. (F. & Co.'s)	1-20 gr.	0.40		Morphia Sulphate	1-6 gr.	0.65	
" "	1-30 gr.	0.40		Atropia	1-180 gr.	0.65	
" "	1-50 gr.	0.40		Morphia Sulphate	1-8 gr.	0.60	
Atropia Sulphate (Merck's)	1-50 gr.	0.50		Atropia	1-200 gr.	0.60	
" "	1-100 gr.	0.40		Morphia Phthalate*	1-2 gr.	2.50	
" "	1-150 gr.	0.40		" "	1-3 gr.	1.70	
" "	1-200 gr.	0.40		" "	1-4 gr.	1.30	
Brucia Nitrate (Merck's)	1-50 gr.	0.40		" "	1-8 gr.	1.00	
" "	1-100 gr.	0.40		Morphia Phthalate	1-2 gr.	2.50	
Caffeine Citrate (Merck's)	1-2 gr.	0.75		Atropia Sulphate	1-120 gr.	0.75	
Cocaine Hydrochlorate	1-8 gr.	0.85		Morphia Phthalate	1-3 gr.	2.00	
" "	1-10 gr.	0.75		Atropia Sulphate	1-150 gr.	0.75	
" "	1-20 gr.	0.50		Morphia Phthalate	1-4 gr.	1.50	
Corrosive Sublimate	1-20 gr.	0.75		Atropia Sulphate	1-150 gr.	0.75	
" "	1-30 gr.	0.40		Morphia Phthalate	1-6 gr.	1.30	
" "	1-50 gr.	0.40		Atropia Sulphate	1-1 gr.	1.20	
Digitalia (Duquesnel's)	1-100 gr.	1.25		Morphia Phthalate	1-8 gr.	1.20	
Ergotine	1-10 gr.	6.00		Atropia Sulphate	1-200 gr.	1.20	
Hyoscyamia Sulph. (Merck's wh. crys)	1-25 gr.	3.00		Pilocarpine Muriate (Merck's)	1-10 gr.	1.00	
" "	1-50 gr.	1.50		" "	1-20 gr.	0.75	
" "	1-100 gr.	1.00		Strychnia Sulphate	1-25 gr.	0.40	
" "	1-200 gr.	1.00		" "	1-50 gr.	0.40	
Hyoscin Hydrobrom.	1-100 gr.	1.25		" "	1-100 gr.	0.40	
Morphia Sulphate	1-2 gr.	1.35		" "	1-200 gr.	0.30	
" "	1-3 gr.	0.85					
" "	1-4 gr.	0.65					
" "	1-6 gr.	0.60					
" "	1-8 gr.	0.50					

\*Phthalate of Morphia is more easily and quickly soluble than the Sulphate, and has been specially recommended for hypodermic use, causing less nausea and general morphia disturbance.

XXV. ELECTRIC APPARATUS.

SYSTEM GAIFFE.\*

Bi-Sulphate of Mercury, for above,	
per oz.....	\$0.10
per lb.....	1.25
Extra cells, closed or open.....	1.50
Zinc plates.....	0.25

Battery, complete, as shown to the	
right.....	5.00*
Battery, Gaiffe, genuine.....	6.50*

Another style of American make; case opening the same way, with full set of electrodes; switch for continued running or intermittent shocks; cell double square, open or closed; cylindric. \$8.00\*

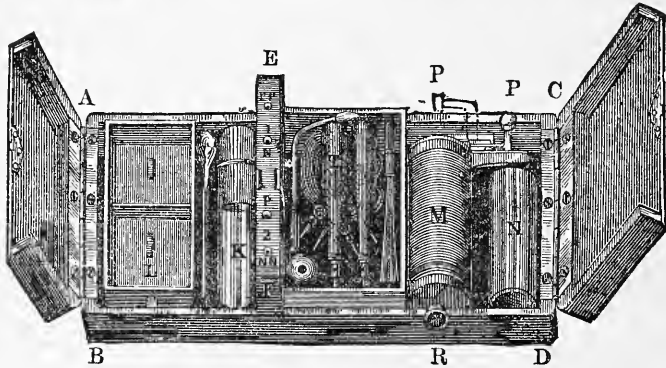
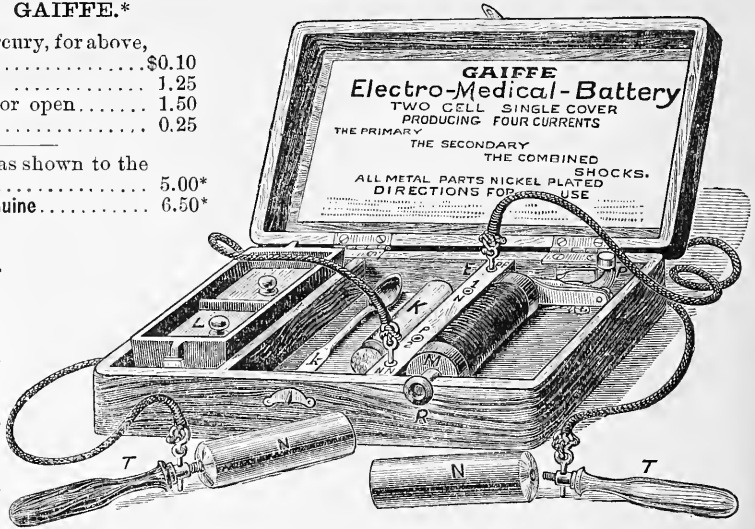

Standard, double opening, American.....	\$9.00*
Same, French (genuine).....	\$9.00* ; extra fine, 12.00*

This is the simplest electric belt. A more simple and perfect belt could not be made. A child that can read may use it. The current can be made mild, or so strong as to meet any medical demand. Its pain-killing and strengthening influence is shown instantly, and it is unnecessary to wear this most powerful belt all day, as two hours, or during the evening, makes a good, long application. Price to patients..... \$3.00

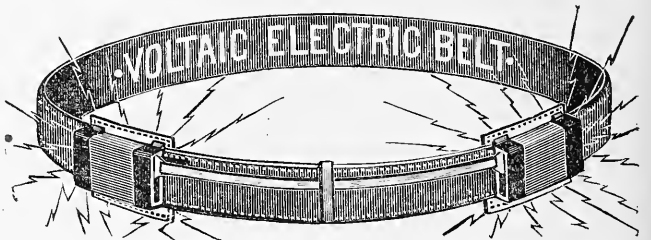

MAMMOTH VOLTAIC ELECTRIC BELT, WITH SUSPENSORY.

Extra full power. Especially designed for the cure of Nervous Debility, Spermatorrhœa, Impotency, Varicocele, Urinary and Bladder troubles, and such organic weaknesses that cannot be cured by drugs. It is the best electro-curative appliance made. It is the best for men to buy. It not only cures the diseases mentioned, but its curative influence reaches every organ of the body and tones up the entire system. Men should buy the belt with suspensory. Price, complete with suspensory, to patients..... \$5.00

Also manufacture a special appliance for ladies that gives equally good satisfaction.

GAIFFE'S LARGE 3-CELL FARADIC APPARATUS.

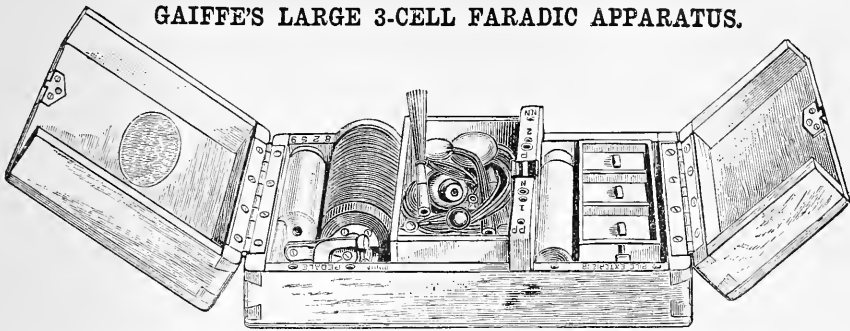

COPYRIGHT 1893 BY J. REYNDERS & CO.

In range of power from the scarcely perceptible to the very strongest, quality of current, elegance of appearance, good workmanship and compactness this battery has no superior. The size is 8½x4½x2 inches. It works on the same principle as the battery shown on page 245 and is provided with two sponge covered flat carbon electrodes, two curved olivepoint, one ball, one brush electrode and a water rheostat. Price... \$28.00

**The Cox Automatic Medical Battery.** Shown by cut to the left. Opening the lid or cover closes the circuit and places the current immediately in operation; closing it stops it. Cell is the dry gelatine, does not need any liquid, warranted to work without renewal for one year. Price ..... Family's \$10.00;\* Physician's (more powerful) \$15.00\*

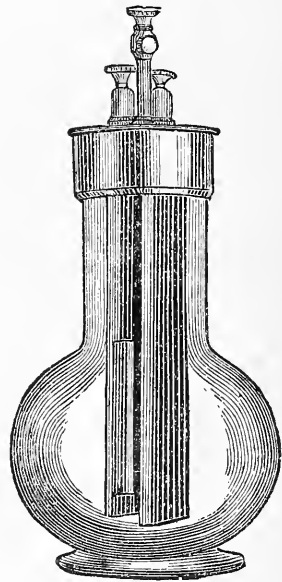
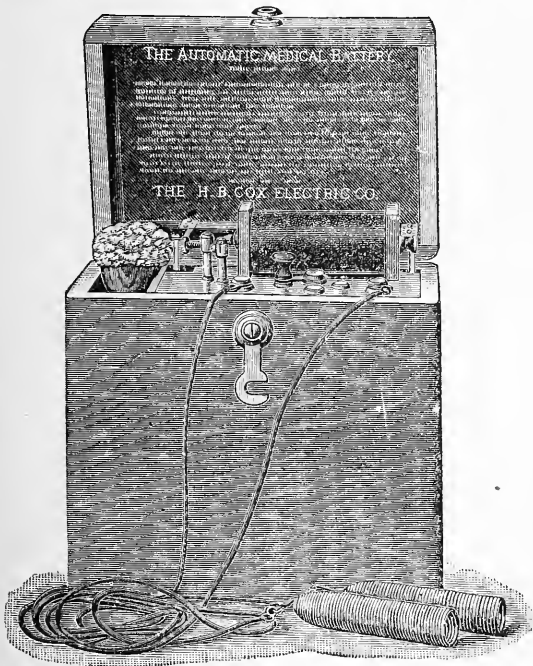

**Grenet Cell** (bichromate of potassa) is shown to the right. Very recommendable for physicians' office use with Gaiffe Batteries. Can be run for one-half or one year at an expense of 25 or 50 cents.

Price ..... No. 1, \$1.75;\* No. 2, \$2.50\*



LADIES' SOLE.



GENTS' SOLE.

Price, either ..... per pair \$1.00.

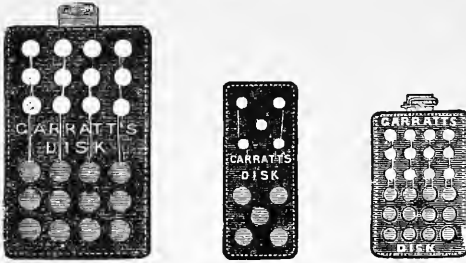

- LARGE DISK, 24 Poles, 5 by 8 in.,.....\$2.50\*\*
- CHILDREN'S DISK, 10 Poles, 2½ by 5 in.,..... 1.00\*\*
- SIMPLE DISK, 2 Poles, 4 by 6 in., ..... .50\*\*
- LONG DISK, 4 by 12 in., and Strap, ..... 3.50\*\*
- EXTRA LONG DISK, 4 by 18 in., and Straps, ..... 5.00\*\*

(The LARGE DISKS are by far mostly called for.)

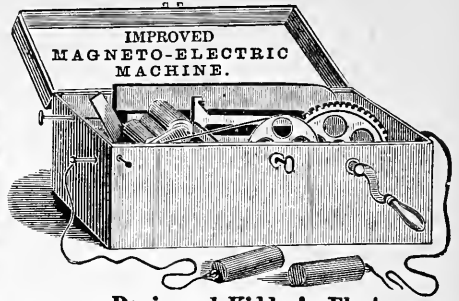

Davis and Kidder's Electro-Magnetic Machine, \$8.00.\*

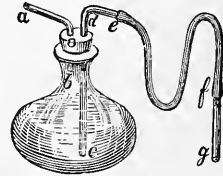

Battery filling bottle is an apparatus for filling galvanic batteries with fluid and for withdrawing the same therefrom without spilling. Can be used for any battery.  
1 pint, \$1.25; 1 quart. . . . 2.00

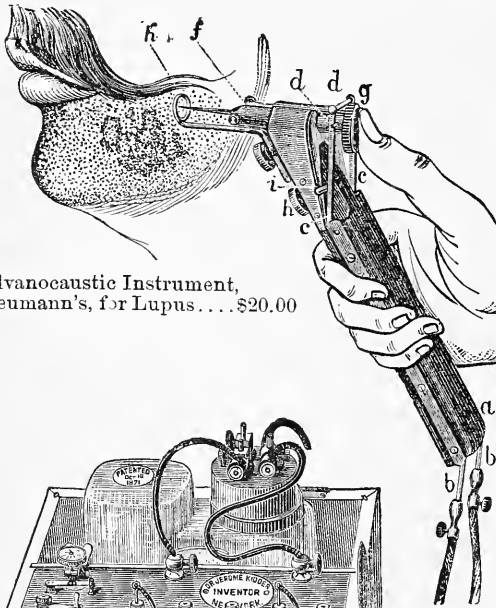

Galvanocaustic Instrument, Neumann's, for Lupus. . . . \$20.00

McIntosh's Electric or Galvanic Belt.

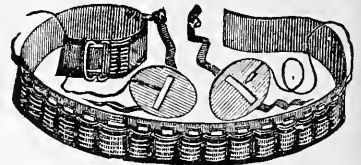

For the treatment and cure of Chronic and Nervous Diseases.

The McINTOSH Electric Belt is constructed on purely scientific principles. It consists of a series of Galvanic cells placed in pockets on a belt. Each cell is composed of hard rubber, in which the negative and positive plates are

packed in porous material to hold a weak acid, to generate an electric current and permit its passage from plate to plate. The cells obviate the necessity of wetting the belt, and the discomfort following to the patient. The belt is so arranged that the current can be used strong or weak, and the patient can apply it, by means of the fine connecting cords, to a particular part of the body, or the whole system can be brought under its influence.

Price \$10.00‡; with suspensory, \$12.50‡

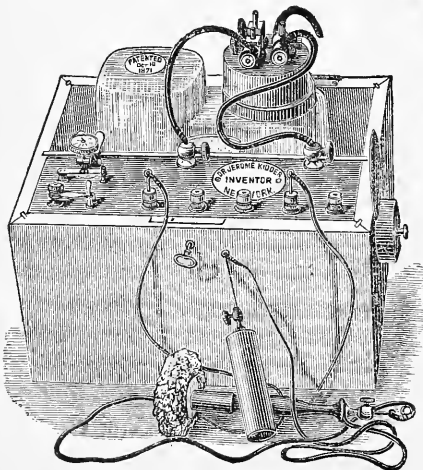

Dr. Jerome Kidder's Electro-Medical Apparatus (No. 5, the lid not shown) has four differently conditioned coils, arranged to be used in various combinations, producing ten different qualities of electricity. Price, with Hydrostat Tip Battery, \$27.00‡. Price, with open battery, \$24.00‡. Patented in the United States, England, and France.

**THE VETTER  
ELECTRO**



**MEDICAL  
APPARATUS.**

**FARADIC BATTERIES. ††**

Amongst apparatus heretofore constructed there is no lack of such generating a current adapted to the highest degree of efficiency for purposes we naturally are justified to expect, and therefore improvements are possible only in the convenience of manipulation afforded in their various parts.

The Potassium Bi-Chromate, Zinc, Carbon element, still mostly in use, has the objectionable features of frequent necessity of renewal of the liquid and also of removal of the zinc after every use. The apparatus now recommended by us, generating a uniform current, is inexpensive, needs but little care, no acids, no refilling, no raising of zines when through using, no consumption of material when not in use. The elements are carbon and zinc, the excitant sal-ammonia, one charge lasting about one year.

**THE LECLANCHE FARADIC ††**

Fig. 1. We make them in two styles, the metallic parts nickel-plated. Size,  $8\frac{1}{2} \times 6\frac{3}{4} \times 5\frac{1}{4}$  inches.

No. 1. Fig. 1. Mounted in an ornamental covered case, for patients' or family use. Price, \$10.00

No. 2. Fig. 1. In finely polished hardwoods, with most suitable electrodes designed for physicians' use. Price, \$13.00

They are simplicity itself, and in ordinary use will run from one to two years without any attention or expenditure to the Battery.

The advantages justly claimed for this over all others are: It is always ready for use. No strong poisonous and dangerous acids required. No zincs to raise or lower; no drip cups; no fluids to be removed, and does not corrode or loose power when not in use.

The Leclanche Cell is universal, it can be obtained in any part of the world, and will fit our Faradic Instrument. It is long of life and very constant in its action from day to day.

The Leclanche Faradic has three currents, mild, medium and strong, each of which can be regulated from mild to strong by means of our improved and most perfect graduator.

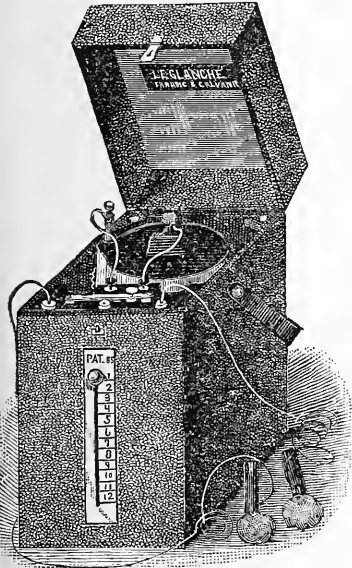

Fig. 1.

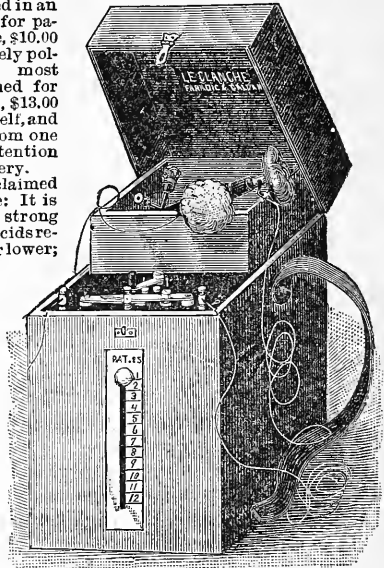

Fig. 2.

**LECLANCHE FARADIC, No. 3. ††**

Size,  $8\frac{3}{4} \times 7\frac{1}{2} \times 6$ .

Fig. 2. This Battery has a double perfectly dry cell sealed up and is as good as the Barrett Chloride of Silver Battery is said to be; actually covers the ground the Barrett's claims for itself.

It is put up in finely polished black walnut case; has a switch by which both cells can be joined when one is not considered sufficient, or only one may be used. Tray contains pair of Universal handles with cords, pair of sponge desks, interrupting handle, curved extension point and small electrode.

The cells will last from one to three years, according to amount of usage they are put to, and when exhausted will be taken in exchange for new ones at \$1.00 per cell.

Price..... \$20.00

**PORTABLE LECLANCHE GALVANIC MEDICAL BATTERIES WITHOUT FLUID. ††**

Having the following advantages over all others, viz.:

1. No acids or expensive materials are used.
2. Interchangeable Cells. Our Automatic Connection enables any one to replace a defective cell without a moment's loss of time. [In all Batteries except ours the cells are not interchangeable. When one cell becomes defective the whole Battery becomes useless until shipped to the manufacturer, repaired and returned, entailing delay, expense and loss in many ways.]
3. Durability. Our cells will last from one to four years varying according to the care used in keeping or handling the apparatus.
4. Economy in cost of replacing cells when exhausted. We will exchange new cells for your

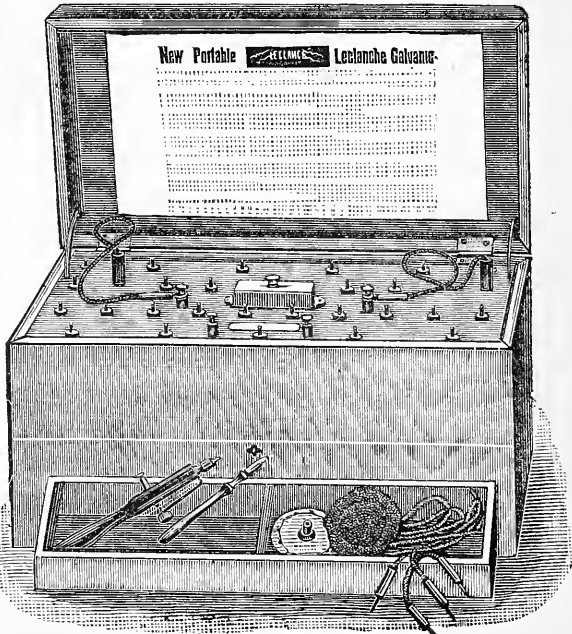

Fig. 3.

See also pages 378 and 379.

old ones when exhausted at a cost of 25 cents each; which is practically equivalent to obtaining a new Portable Battery at one-sixth the original cost, and a Cabinet Battery at a still smaller proportion.

5. Portability, strength, uniformity of current, moderate first cost and inexpensive future cost.
6. Our Leclanche Battery Cell is the result of over five years' experiment, and has had a practical test of four years in hospital and private practice.

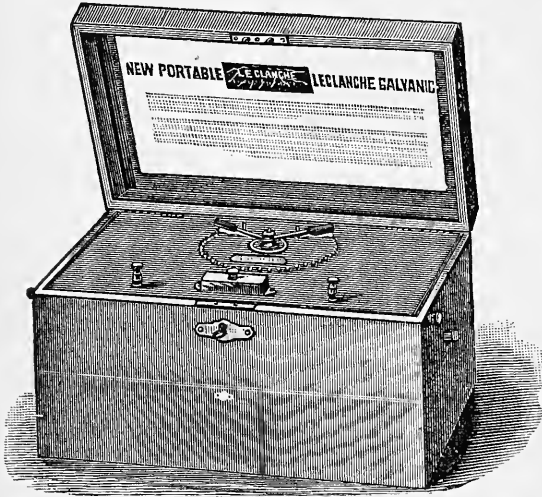

Fig. 4.

Fig. 3 (see page 247) represents our Plug and Socket Selector Battery in finely polished hardwoods, provided with our new pole changer and automatic connection as above described, with tray containing electrodes, pair Universal handles, pair 2 in. sponge discs, pair conducting cords, interrupting handle, extension joint and small sponge disc.

20 rubber cells, dimen. 8x6½x7....	\$35.00
30 " " " 8x9x7.....	45.00
40 " " " 8x11½x6½.	55.00
48 " " " 8x11½x7....	60.00
60 " " " 8x14x7½....	70.00

Fig. 4 represents our Improved Double-Arm Selector Battery. The arms of which can be carried either way, right or left, thereby any of the cells can be put in circuit, can be instantly used. In finely finished hardwoods with polished hard rubber base, pole changer, etc., as per plug and socket.

30 cells, dimensions 8x9x7,	price, \$55.00
40 " " " 8x11½x6½ "	65.00
48 " " " 8x11½x9 "	75.00
60 " " " 8x14x7½ "	85.00

**THE VETTER TESTING SET VOLT AND MILLI-AMPEREMETER.\***

Fig. 5. A new and useful combination instrument; can be carried in the pocket; indispensable to physicians.

First as a galvanometer battery and key for testing conductors, electrodes, etc.

Second for measuring battery currents in volts.

Third as a good mil-am-meter measuring to 50 milliamperes.

Price..... \$15.00\*



Fig. 5.

**CIRCULAR ON STORAGE BATTERIES, ELECTRO-MOTORS AND CAUTERY, SENT ON APPLICATION.**

See also pages 378 and 379.





## XXV. ELECTRIC APPARATUS.

## GALVANO-FARADIC APPARATUS.

No. 1. Faradic.....		\$10.00
No. 2. ".....	\$15.00; hard rubber cell, extra,	1.00
No. 3. ".....	20.00; " " " " "	1.00
No. 4. ".....	double cells, 35.00; " " " " "	2.00
Galvanic, 16 cells.....	glass, \$35.00; hard rubber,	39.00
" 32 ".....	" 60.00; " " " "	68.00
<hr/>		
Galvanic, 12 cell (eye and ear).....		30.00
" 24 " (general practice).....		50.00
" 36 " (very powerful).....		70.00
Rheotome, extra.....	\$10.00; Rheostat, extra,	10.00
Hard rubber cells with above, each extra.....		0.25

## COMBINATION G. &amp; F.

16 cells.....	\$45.00; 24 cells,	60.00
Hard rubber cells, each extra.....		0.25
36 cell, with Rheotome.....		80.00

## CABINET HOSPITAL COMBINATION.

60 cells.....	\$250.00; 40 cells,	200.00
Wall cabinet, 30 cells.....		70.00

Faradic closed cell.....		12.00
Same, with 12 galvanic cells.....		40.00
" " 18 " ".....		50.00
" " 24 " ".....		60.00

Milliamperemeter.....		25.00
-----------------------	--	-------

## WAITE &amp; BARTLETT'S BATTERIES.

No. 1. Family, Faradic.....		10.00
No. 2. Physicians' ".....		20.00
No. 4. Faradic (two coils).....		28.00
24 cell galvanic.....		50.00
36 " ".....		70.00
32 " combination.....		80.00

Complete office cabinet, 40 cells.....		260.00
" wall cabinet.....		200.00
Physicians' handy cabinet.....		100.00

## McINTOSH BATTERIES.††

Family, Faradic.....		10.00
Physicians', Faradic.....		18.00
" " No. 3.....		30.00
12 cell galvanic.....	\$30.00; galvanic and Faradic,	40.00
18 " ".....	40.00; " " " "	52.50
24 " ".....	55.00; " " " "	67.50
Table battery.....		150.00
Office battery.....	\$100.00 and	185.00
Office cabinet.....		225.00

Apostoli's Method of Treating Tumors of the Uterus by Electricity.††—Flemming's batteries of 40 cells and upward and the Chloride of silver batteries of 50 cells and upward are sufficient.

We also recommend 50 diamond carbon cells (similar to the Leclanché)..... \$1.25  
 Carpenter Resistance Box.††—For reducing the too powerful current from electric light circuits (such as are not operated with the alternating system; for instance, the Edison, U. S., Brush-Swan, or Sperry systems), so as to be adapted to the delicate needs of medical treatment. Further information on demand..... \$80.00

Hydro-Aluminum Rheostat.††—To be used with the above (Carpenter resistance box) and indispensable as a more gradual means of increasing or decreasing the current from the street..... \$15.00

Martin's Abdominal Electrode††..... 4.00

Martin's Set of Intra-Uterine and Vaginal Puncture Electrodes††..... 20.00

Milliamperemeter, see page 248.

**XXV. ELECTRIC APPARATUS.**

**THE MEDICAL DYNAMO.**

The machine differs from the ordinary dynamo for electric light purposes in (1) being constructed so as to be capable of generating two distinct currents; (2) each of the currents can be increased in gradual gradation from zero to their full power without altering the speed of the machine; (3) both varieties of current can be utilized at the same time in different work, or, at the will of the operator, either one can be used; (4) the machine possesses an automatic safety device by which the current is not allowed to reach a strength that can do harm to the patient or the machine itself.

The two currents generated by the machine are identical with those generated by a cautery battery of large cells and large surface, and with that generated by a large number of small cells arranged in series, and are designated respectively the cautery current and the electrolytic current. The maximum strength of the cautery current is 60 amperes, with a possible electro-motive force of 5 volts. The maximum strength of the electrolytic current is 1 ampere, with an electro-motive force of 200 volts. This little machine will generate a cautery current that is steady, uniform and enduring, and will accomplish the work of our largest cautery batteries made for office purposes. It will, at the same time it is accomplishing its maximum cautery work, generate a totally different current that will furnish energy sufficient to run at least one of Edison's 16-candle incandescent light, or will do any work that can be accomplished by a battery of 150 Leclanche cells. When run for lighting alone two 16-candle lamps can be used at the same time. This latter current also possesses the following advantages over cell-battery currents: In case of the cells the current must be turned on, one volt at a time, whereas with this machine it can be evenly increased or diminished in less gradation than the hundredth of a volt.

The capabilities of the machine can be brought out by one-half to one actual horse power force.

This Dynamo can be run by an Electric Motor, Gas Engine, Water Motor or steam power. It requires 1 H. P. to run to its maximum capacity. It will ordinarily require  $\frac{1}{2}$  to

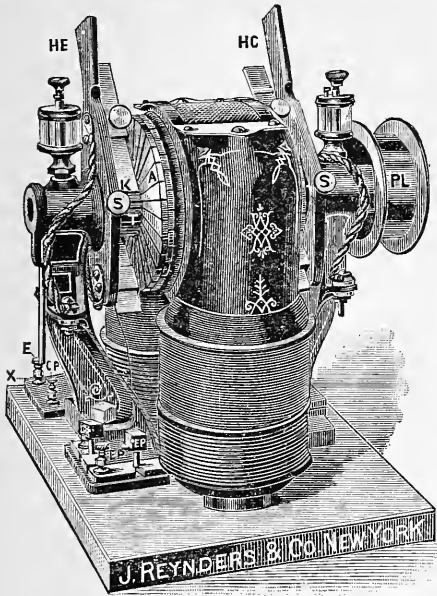

- H E—Handles for rotating brushes on the electrolytic side.
- H C Handles for rotating brushes on the cautery side.
- S S—Thumb screws for setting brushes.
- A—Armature.
- K K—Brushes.
- C P—Positive post of cautery current.
- C—Negative post of cautery current.
- T—Commutator.
- X—Safety fuse.
- E P—Positive post of electrolytic side.
- E—Negative post of electrolytic side.
- C and E P—Plugs for increasing or diminishing the current.
- P L—Driving pulley.

$\frac{2}{3}$  H. P. Speed required, from 1500 to 1800 per minute. Size of pulley, 4 inches in diameter; width of belt,  $1\frac{1}{2}$  inch.

Price of MEDICAL DYNAMO.....	\$200.00
“ ONE H. P. ELECTRIC MOTOR.....	about 125.00
“ ONE H. P. WATER MOTOR.....	“ 60.00
“ ONE H. P. OIL ENGINE (see pages 113 and 131D).	

The Electric Motor can be used on any electric light circuit. In ordering, the name of the system should be given. If a Water Motor is to be used, the pressure in lbs. per square inch should be given. To run a one H. P., the pressure must not be less than 30 lbs.

The New Dynamo is Applicable to the Following Uses: I. To work Cautery Knives or Ecrasseur. II. Running Cautery and Incandescent Lamp at same time. III. For Electrolytic purposes. IV. To run small Glow Lamps. V. To run Faradic Machines. VI. Electro-Plating. The Resistance Box and Hydro-Aluminium Rheostat mentioned on previous page is applicable and useful with the Dynamo.

Summarizing as to the Sources of Electricity: 1. Cell batteries, such as the Leclanche or Diamond Carbon (see previous page), are the only practical means of obtaining an electric current when an incandescent light system is not convenient or when no form of power which will operate Dynamo is practicable. 2. Carpenter's method is practicable only where an electric light system is convenient, and where a current of high voltage only is required. It is not practicable for cautery. 3. The Medical Dynamo is practicable when some means is present by which one-half horse power can be obtained in order to operate it. 4. The Medical Dynamo is the only practicable means of obtaining a current of high electro-motive force suitable for electrolytic work and at the same time a current of large amperage suitable for cautery work.

ELECTRODES.

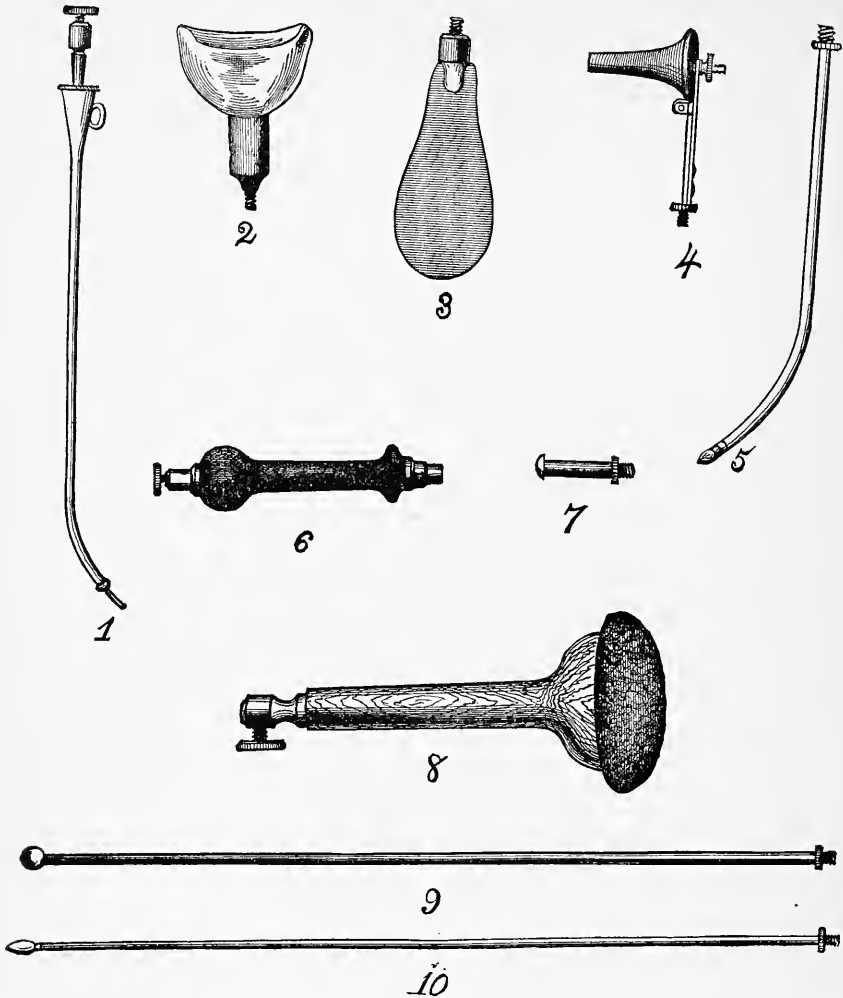

1.	Laryngeal (Dr. Strawbridge's Eustachian Tube) Electrode.....	\$2.00
2.	Eye, Electrode.....	2.00
3.	Tongue, ".....	.75
4.	Ear, ".....	2.00
5.	Nasal, ".....	1.50
6.	Interrupting handle.....	1.50
7.	For Special Nerves.....	.75
8.	Large Sponge, Electrode.....	1.00
9.	Uterine and Rectum, ".....	1.25
10.	Urethral, ".....	1.25
11.	Cup-shaped for Mouth of Womb.....	1.50
12.	Vaginal Electrode.....	1.50
13.	Sympathetic Nerve Electrode.....	1.00
14.	15 and 16. Disks, Olives, Points, etc.....	.75
17.	Carbon Electrode.....	1.00
18.	Wire Brush ".....	.75

**ELECTRODES.**

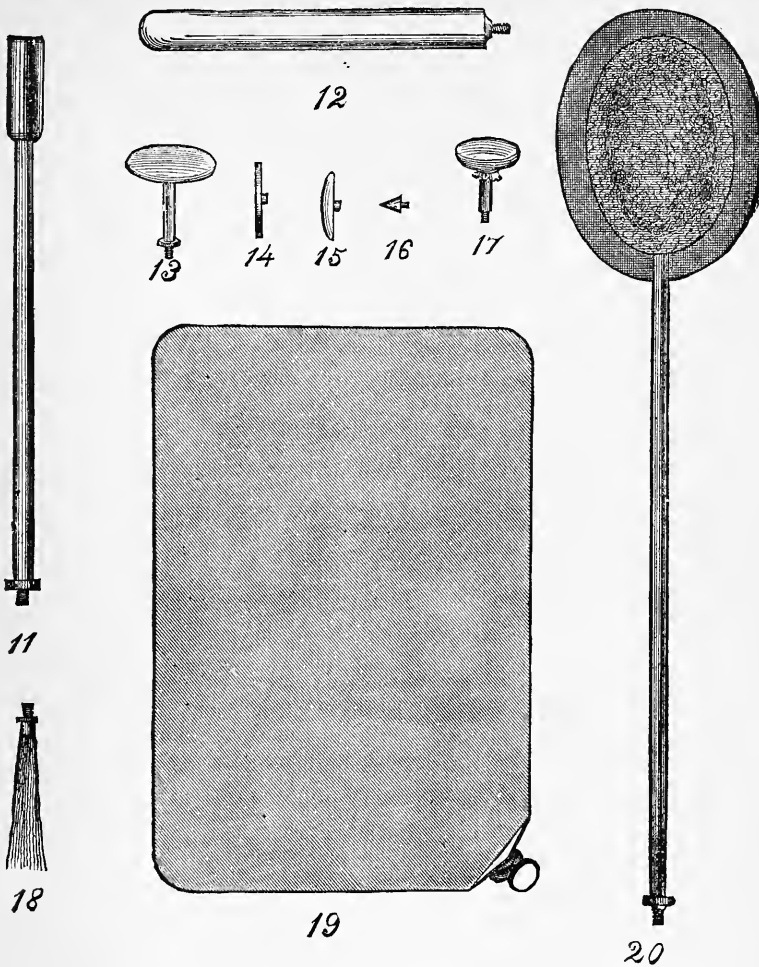

19. Foot-Plate Electrode . . . . .	\$ .75
20. Spinal " . . . . .	1.50

These include only the ordinary forms of Electrodes in general use. Special shapes and sizes will be made to order in 24 or 48 hours upon receipt of drawings or description of the kind desired.

**NOTICE.**

The probability is strong that ere 1890 we will put upon the market a Brand of Faradic and Galvanic Batteries of our own, in construction and workmanship superior to most and equal to the best. They will correspond in scale of prices to "Flemming's" and the "New York City" (see page 249), the former 25% off, the latter net. Unless specifically advised to the contrary with orders received, we will assume ourselves privileged to substitute our own, guaranteeing satisfaction in every case.

**JOHN REYNDERS & CO.**

ELECTRODES.

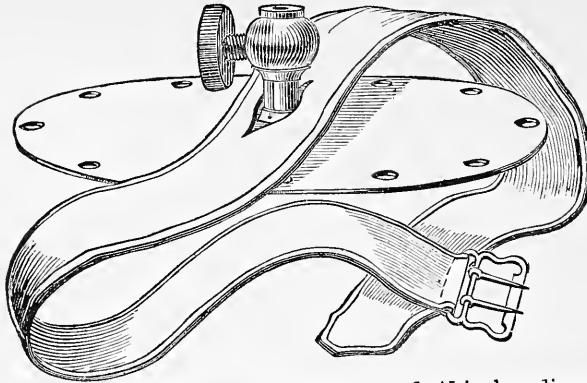

Nickel-Plated Universal Adjustable Electrode Plate, round, 4 $\frac{7}{8}$ inches diameter.....	\$1 25
Nickel-Plated Oblong, 1 $\frac{3}{4}$ x 2 $\frac{3}{4}$ .....	75
“ “ “ 1 $\frac{1}{2}$ x 4 $\frac{1}{2}$ .....	75
“ “ “ 2 $\frac{1}{2}$ x 3 $\frac{1}{2}$ .....	35
Strap for Adjustable Electrode, 19 inches long .....	40
“ 29 inches long.....	45
“ 37 “ “.....	45
“ 47 “ “.....	50

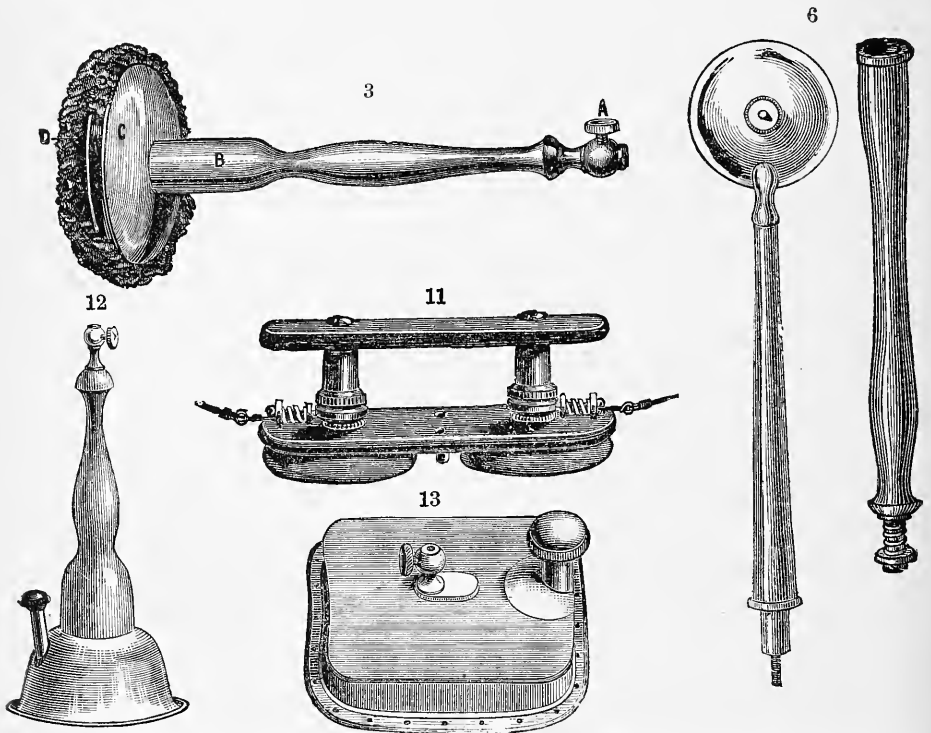

- 3. Large Sponge Electrode, to which sponge can be clamped, enabling renewal of sponge without having to sew it on..... \$1 50
- 6. Long side sponge holder (in two parts for compactness,) \$2.25, the same in one piece, 2 00
- 11. Carbon Sponge Holders for both negative and positive electrodes, enabling application of electricity with one hand..... 3 00
- 12. Reservoir Sponge Holder, for holding warm water, with clasp for holding the sponge; also holes to sew on a sponge. Diameter 4 $\frac{1}{2}$  inches..... 3 00
- 13. Reservoir chest electrode 8 in. square and curved, ..... 3 50
- Something similar to the above for the feet 12 in. long, 9 in. wide and 1 inch deep, 5 00

**ELECTRODES.**

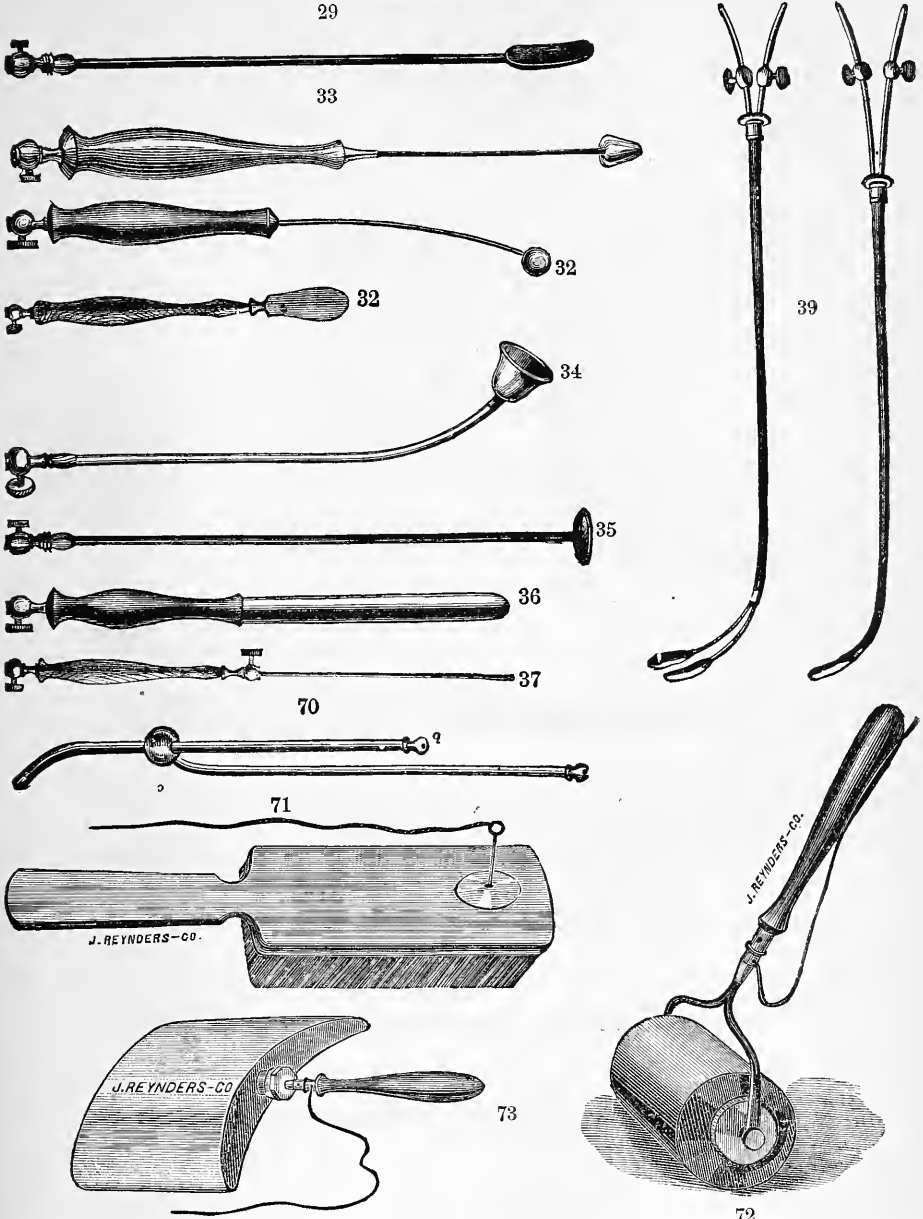

28. Tongue Electrode.....	\$1 50
29. " " oblong concave.....	2 00
32. Uterine electrode.....	1 50
33. " ".....	1 50
34. " " bell shaped, 3 sizes, each.....	2 00
35. " " slightly concave.....	2 00
36. Vaginal Electrode.....	1 75
37. Urethral Electrode, not insulated.....	1 50
39. Duchenne's Double Vesical Electrode for paralysis of the bladder and incontinence of urine. Open and closed to apply one or both poles.....	2 50
70. Butler's Uterine adjustable sliding Electrode.....	3 50
71. Hair Brush Electrode, according to quality.....	\$2 50 and 3 50
72. Rolling Electrode, chamois covered, for massage.....	8 00
73. Concave Plate for holding warm water.....	2 75

ELECTRODES.

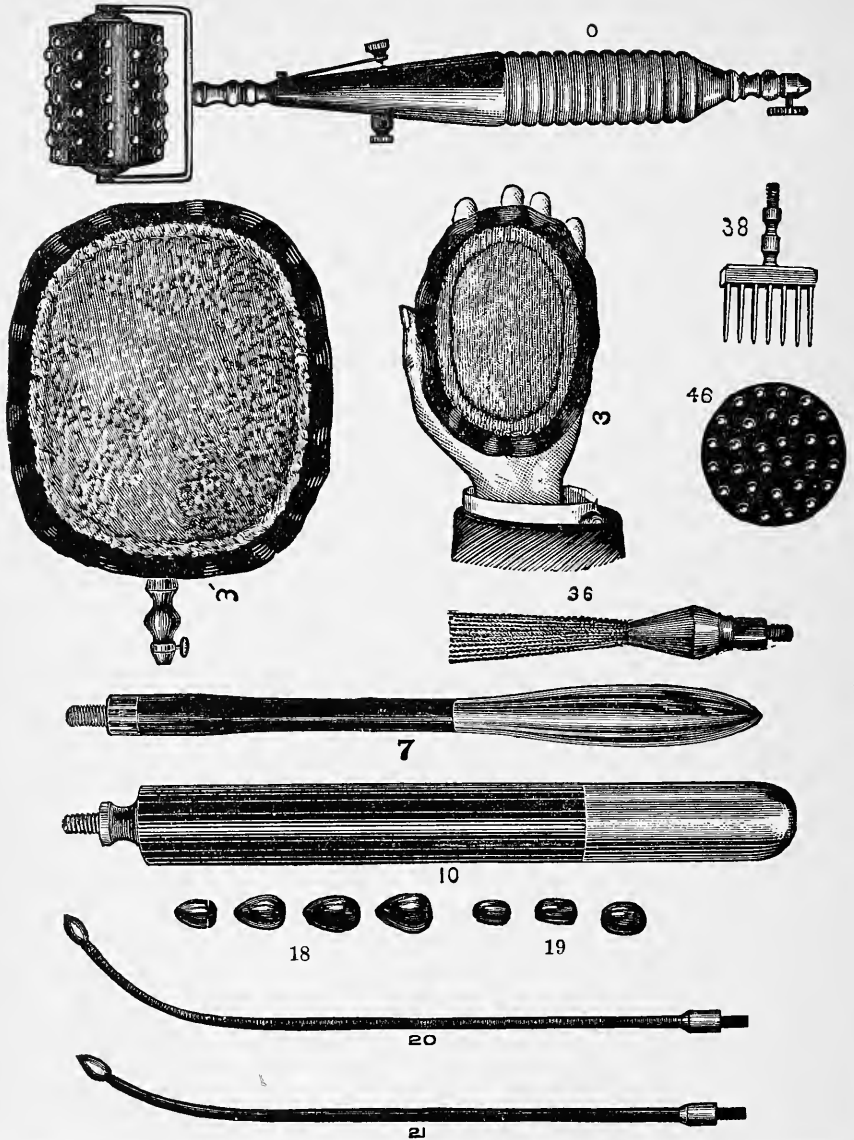

0.	Wheel Electrode of Hard Rubber, set with metallic points for muscular Faradization; universal hard-rubber handle, with current interrupter.....	\$5 00
3.	Sponge-covered Electrode, Insulated with Soft Rubber for general application with the hand .....	1 50
3'.	Sponge-covered Foot Plate, Insulated on one side with Soft Rubber, to prevent wetting carpet .....	3 00
7.	Rectal Electrode, insulated with hard rubber .....	2 00
	The same, not insulated .....	1 25
	The same, extra large.....	1 50
10.	Vaginal Electrode, insulated.....	2 50
	The same, not insulated.....	1 50
18, 19.	Olives, different sizes, which may be attached to No. 20, each,.....	20
20.	Uterine or Urethral Electrode, insulated with hard rubber .....	1 25
21.	Spiral Flexible Uterine or Urethral Electrode, insulated .....	1 25
36.	Metallic Scourge, nickel-plated.....	75
38.	Metallic Points for Faradization.....	1 00
46.	Disc. Electrode, with insulated points .....	1 00
	Handle for any of above electrodes.....	3 00



XXVI. CASES FOR CARRYING MEDICINES.\*

POCKET VIAL CASES.

- 1. (SPP) contains 20—2 drachm vials, morocco, strap, gilt, size 6x3x1 $\frac{1}{2}$  in., like 16...\$1.25\*
- 2. (SPA) " 4—2 $\frac{1}{2}$  " " for the vest pocket, size 3 $\frac{1}{2}$ x2 $\frac{1}{2}$ x $\frac{1}{2}$  in. .... .50\*
- 3. (SFS) " 20—2 " " calfskin, sewed, size 5x3x1 $\frac{1}{2}$  in., like 16. .... 1.25\*
- 4. (SPO) " 20—2 " " morocco, sewed, size 7x3 $\frac{1}{2}$ x1 $\frac{1}{2}$  in., like 16. .... 1.10\*
- 5. (SAN) " 20—4 " " morocco, strap, gilt, size 7 $\frac{1}{2}$ x3 $\frac{1}{2}$ x1 $\frac{1}{2}$  in., like 16.. 2.00\*
- 6. (SAP) " 20—4 " " calfskin, sewed ..... 1.75\*

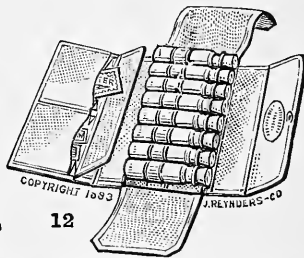
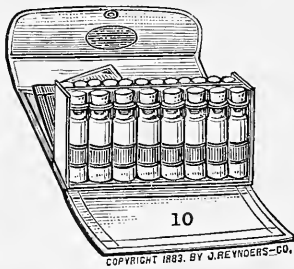
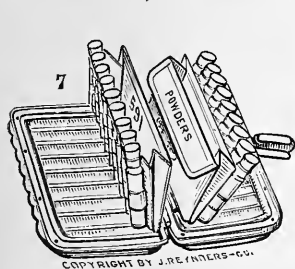

- 7.\* (SRE) contains 16—1 $\frac{1}{2}$  drachm vials, portmonnaie style, size 5 $\frac{1}{2}$ x3 $\frac{1}{2}$ x1 $\frac{1}{2}$  in. ....\$1.50\*
- 8. (SRR) " 18—1 $\frac{1}{2}$  " " portmonnaie style, size 7x4 $\frac{1}{2}$ x1 $\frac{1}{2}$  in., like 7... 1.70\*
- 9. (SAA) " 24—2 " " gilt numbers, size 7 $\frac{1}{2}$ x3 $\frac{1}{2}$ x1 $\frac{1}{2}$  in., like 39, but vials all cork-stoppered. .... 2.00\*
- 10.\* (SAL) " 12—2 $\frac{1}{2}$  " " and 8—6 do. vials, best Turkey morocco, size 8 $\frac{1}{2}$ x3 $\frac{1}{2}$ x2 in. .... 2.75\*
- 11. (SAM) " 20—2 " " wrapper case, size 6 $\frac{1}{2}$ x3 $\frac{1}{2}$ x1 $\frac{1}{2}$  in., like 20. .... 1.50\*
- 12.\* (SAS) " 8—3 " " on one side and 2 pockets for powders on the other side; made of the best Russia leather, size 6 $\frac{1}{2}$ x3 $\frac{1}{2}$ x1 $\frac{1}{2}$  in. .... 2.50\*

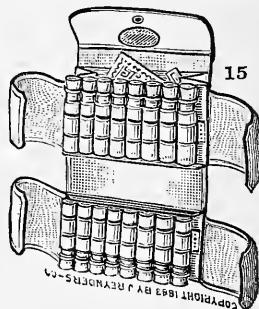
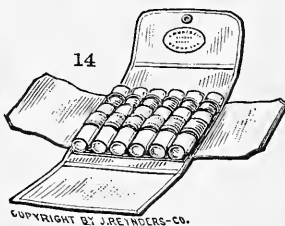
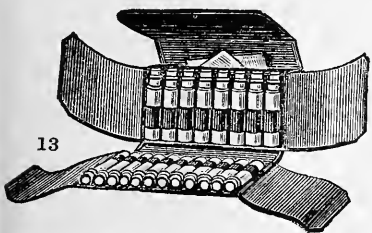

- 13.\* (SAE) contains 12—2 drachm vials, and 8—4 do. vials, wrapper case, size 7 $\frac{1}{2}$ x3 $\frac{1}{2}$ x1 $\frac{1}{2}$  in., like 20.\$1.75\*
- 14.\* (SAO) contains 6—3 drachm vials, wrapper case, soft red morocco, size 4 $\frac{1}{2}$ x3 $\frac{1}{2}$ x1 $\frac{1}{2}$  in. .... 1.00\*
- 15.\* (SAT) contains 16—3 drachm vials, of best Russia leather, size 6 $\frac{1}{2}$ x3 $\frac{1}{2}$ x1 $\frac{1}{2}$  in. .... 2.75\*

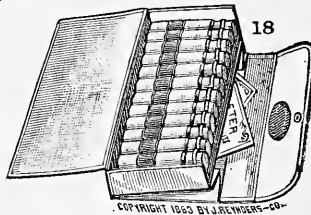
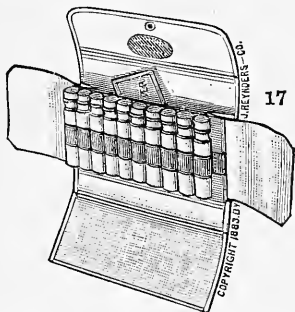
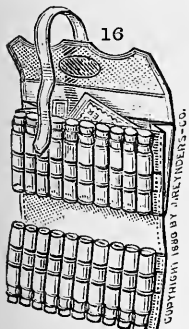

- 16.\* (SLN) contains 20—2 drachm vials, sewed case, soft red morocco, size 7x3 $\frac{1}{2}$ x1 $\frac{1}{2}$  in. ....\$1.40\*
- 17.\* (SLP) contains 10—3 drachm vials, wrapper case, size 8x3 $\frac{1}{2}$ x1 $\frac{1}{2}$  in. .... 1.40\*
- 18.\* (SLA) contains 12—3 drachm vials, wrapper case, stiff ends, size 8 $\frac{1}{2}$ x3 $\frac{1}{2}$ x1 $\frac{1}{2}$  in. .... 1.40\*
- 19. (SLL) contains 10—3 drachm vials and 14—1 $\frac{1}{2}$  do. vials, soft red morocco, size 7 $\frac{1}{2}$ x3 $\frac{1}{2}$ x1 $\frac{1}{2}$  in., like 20. .... 2.00\*
- 20.\* (SLM) contains 18—3 drachm vials, soft red morocco, size 7x3 $\frac{1}{2}$ x1 $\frac{1}{2}$  in. .... 1.85\*

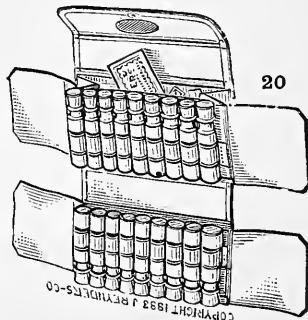

XXVI. CASES FOR CARRYING MEDICINES.\*

POCKET VIAL CASES.

- 21. (SLE) contains 24—3 drachm vials, 16—1½ drachm vials, 3 folds, 2 pockets, soft red morocco, size 7¼x3¼x2¼ in., like 38, but has cork-stopped vials. . . . . \$2.50\*
- 22. (SLR) contains 24—3 drachm vials, 2 pockets and place for powders, size 7¼x3¼x1¾ in., like 20. . . . . 2.00\*

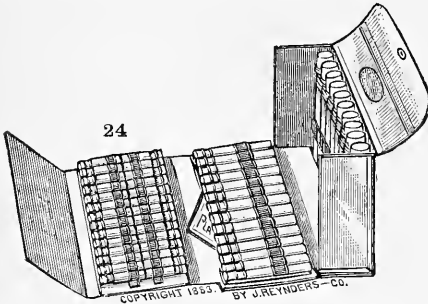

- 23. (SLT) contains 10—4 drachm vials, and 28—2 drachm vials, 3 folds, soft red morocco, size 8½x4½x2½ in., like 24, but all bottles full length. . . . \$3.20\*
- 24.\* (SLO) contains 10—4 drachm vials, 14—2 drachm vials, and 28—1 drachm vials, 3 folds, soft red morocco, size 8½x4½x2½ in. . . . . 3.40\*

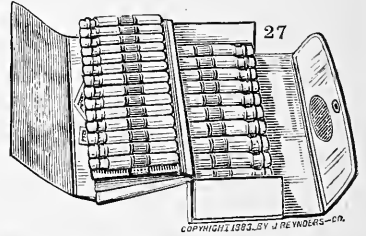

- 25.\* (SLS) contains 10—4 drachm vials and 18—1½ drachm vials, the latter all upright when carried in pocket, size 7¼x3¼x1½ in. . . . . \$2.25\*
- 26. (SMN) contains 8—2 drachm vials, morocco, size 5¾x3x7¼ in., like 14 . . . . . 0.85\*
- 27.\* (SMP) “ 10—4 “ and 14—2 drachm vials, soft red morocco, size 8x3½x1¼ in. . . . . 2.35\*
- 28. (SMA) contains 10—2 drachm vials, stiff ends, size 6½x3½x1½ in., like 18. . . . . 1.10\*
- 29. (SML) “ 6—1 “ for the vest pocket, size 3½x2¼x¼ in. . . . . 0.50\*
- 30. (SMN) “ 8—4 “ glass-stoppered, and 12—2 drachm vials, cork-stoppered, stiff ends, size 7¾x3½x1¾ in., like 39. . . . . 2.50\*

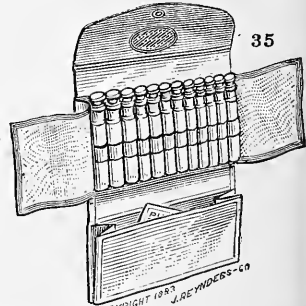
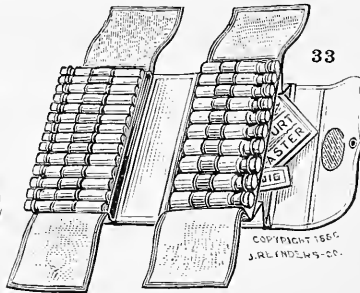
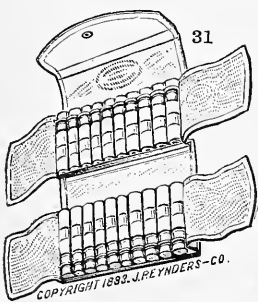

- 31.\* (SME) contains 20— drachm vials, wrapper case, metal ends, soft red morocco, size 5¾x2¾x1¾ in. . . . . \$1.75\*
- 32. (SMR) contains 24 2 drachm vials, wrapper case, metal ends, soft red morocco, size 6¾x3½x1¾ in. . . . . 2.25\*
- 33.\* (SMS) contains 10—3 drachm vials and 14—1½ drachm vials, wrapper case, metal ends, soft red morocco, size 7¾x3¾x1¾ in. . . . . 2.50\*
- 34. (SMT) contains 30—2 drachm vials, long, wrapper case, metal ends, soft red morocco, size 7¾x4x1¾ in., like 44, but all vials full length. . . . . 2.75\*
- 35.\* (SMN) contains 12—2 drachm vials, glass-stoppered, well ground metal ends, soft red morocco, size 7¼x3½x1 in. . . . \$2.25\*

- 36. (SEP) contains 12—2 drachm vials, glass-stoppered, and 10—3 drachm vials, corked metal ends, soft red morocco, size 7¼x3½x1¾ in., like 41, but center piece movable. . . . . 3.00\*
- 37.\* (SMO) contains 15—2 drachm vials, long, 30—1 drachm vials, short, wrapper case, metal ends, soft red morocco, size 7¼x4x1¾ in. . . . . 3.00\*

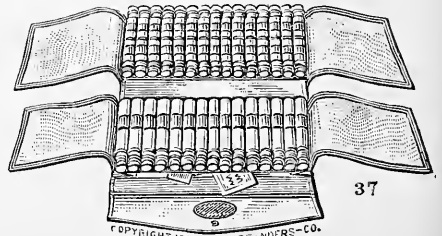

XXVI. CASES FOR CARRYING MEDICINES.\*  
POCKET VIAL CASES.

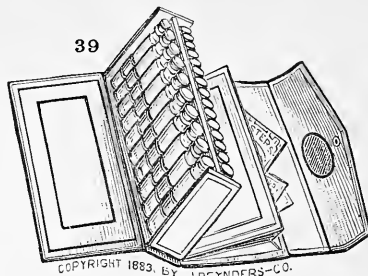
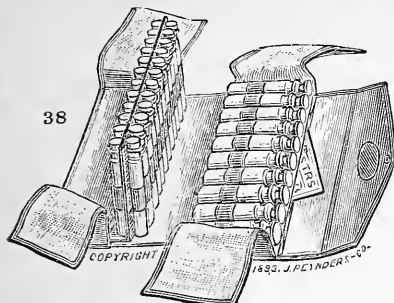

- 38.\* (SEL) contains 10 3 drachm vials, glass-stoppered, 12—2½ do. and 15 2 do., corked, two pockets, metal ends, dark morocco, size 7½x3½x2¼ in. .... \$3.35\*
- 39.\* (SEM) contains 10—3 drachm vials, glass-stoppered, and 15—2 do., corked, stiff ends, dark morocco, size 8x3½x1¼ in. 2.50\*
- 40. (SEE) contains 8 4 drachm vials, glass-stoppered, on one side and pocket on the other, stiff ends, dark morocco, size 7½x3½x1¼, like 35. .... 2.00\*
- 41.\* (SEA) contains 10—3 drachm vials, glass-stoppered, on one side and silicate paper on the other, metal ends, dark morocco, size 7½x3½x1¼ in. .... 2.25\*

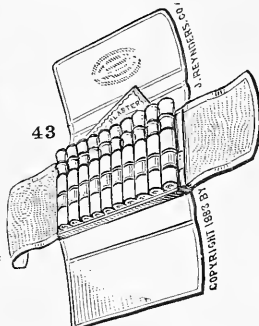
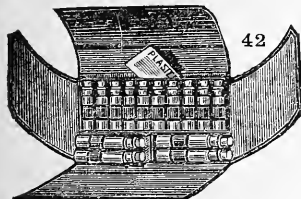
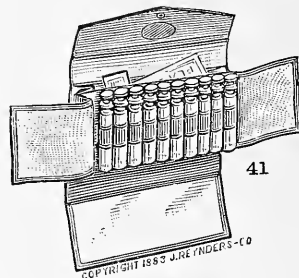

- 42.\* (SRT) contains 4—4 drachm vials, and 10—2 drachm vials, flexible. .... \$2.25\*
- 43.\* (SER) contains 10—2 drachm vials, flexible case, dark long flap, size 6½x3¼x7¼ in. .... 1.75\*
- 44.\* (SES) contains 24—2 drachm vials, flexible case, size 7½x3½x1¼ in. .... \$2.75\*
- 45. (SET) contains 12—2 drachm vials, flexible case, size 7½x3½x2½ in., like 47, but with a lock. .... 2.00\*

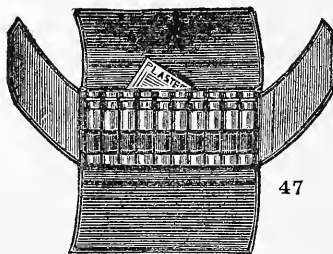
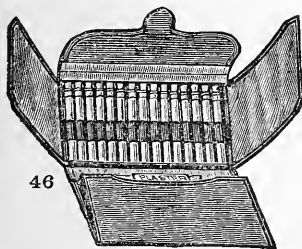
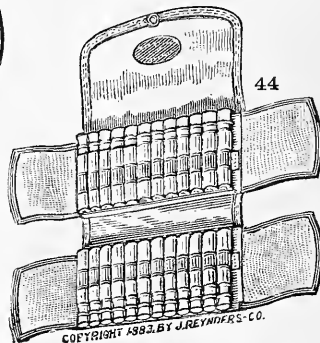

- 46.\* (SEO) contains 15—2 drachm vials, flexible case, size 7½x3½x1¼ in., has a tuck or tongue instead of catch. .... \$2.25\*
- 47.\* (SRP) contains 10—6 drachm vials, flexible case, dark. .... 2.20\*
- 48. (SRL) contains 8—3 drachm vials, flexible case, fine calf, two pockets. .... 2.50\*
- 49. (SRM) contains 16—3 drachm vials, flexible case, fine calf, two pockets. .... 2.75\*
- 50.\* (SRO) contains 8—4 drachm vials and 6—1½ drachm vials, flexible. .... 2.25\*
- 51. (SSN) contains 10—4 drachm vials, flexible case. .... 2.00\*

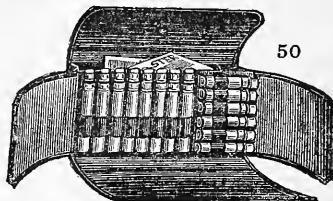

XXVI. CASES FOR CARRYING MEDICINES.\*  
HAND AND BUGGY CASES.

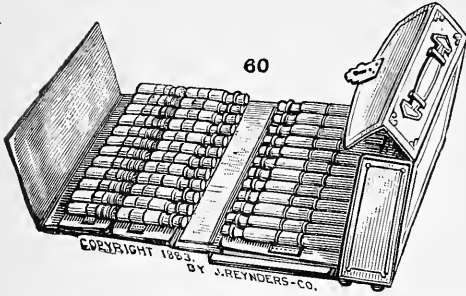

60.\* (ONS) Morocco, with handle, contains 12—4 drachm and 24—2 drachm vials, size of case  $9\frac{1}{2} \times 5\frac{1}{2} \times 2\frac{3}{4}$  in.....\$5.00\*

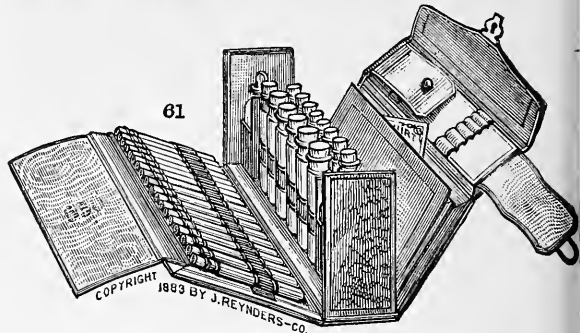

61.\* (OPN) Sealskin, contains 2—2 oz. glass-stoppered, 6—1 oz., 8—4 drachm and 18—2 drachm, corked vials, and elastic loops for surgical instruments, size  $10\frac{1}{2} \times 6\frac{1}{2} \times 3\frac{1}{4}$  in.....\$10.00\*

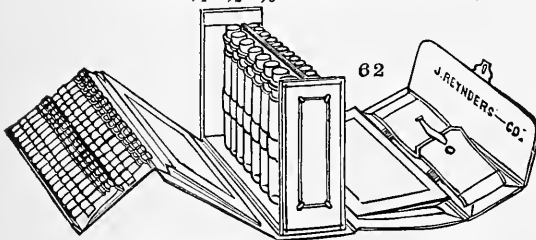

62.\* (ONO  $\frac{1}{2}$ ) Dark morocco, contains 8—1 oz., 12—4 drachm, 15—2 drachm corked vials, and elastic loops for surgical instruments, size  $9 \times 6 \times 3$  in.....\$7.00\*

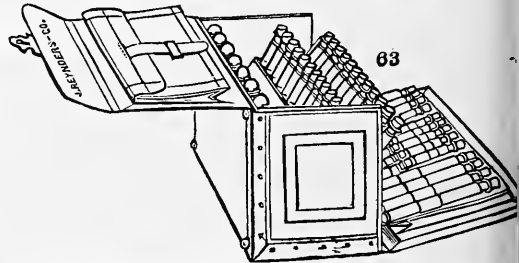

63.\* (ONT) Red morocco, very compact and well protected, contains 8—1  $\frac{1}{2}$  oz. glass-stoppered, 10—1 oz., 12—6 drachm, 8—4 drachm and 10—2 drachm corked vials; the rows of vials are arranged to show the labels; size  $11\frac{1}{2} \times 6 \times 5\frac{1}{4}$  in.....\$10.00\*

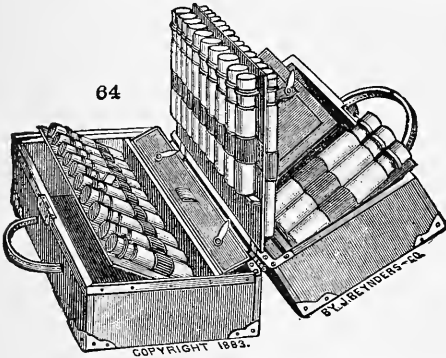

64.\* (OAP) Dark morocco, contains 20—1 oz., 15—4 drachm and 3—2 oz. vials, loops for instruments and space for sundries, size  $11 \times 7\frac{1}{2} \times 6\frac{1}{4}$  in.....\$12.50\*

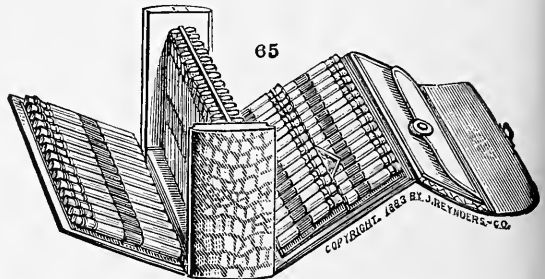

65.\* (LNTS) Imitation alligator skin, contains 24—2 drachm and 90—1 drachm or 72—2 drachm and 30—1 drachm vials, size  $9\frac{1}{4} \times 6\frac{1}{4} \times 3\frac{3}{4}$  in.....\$12.00\*

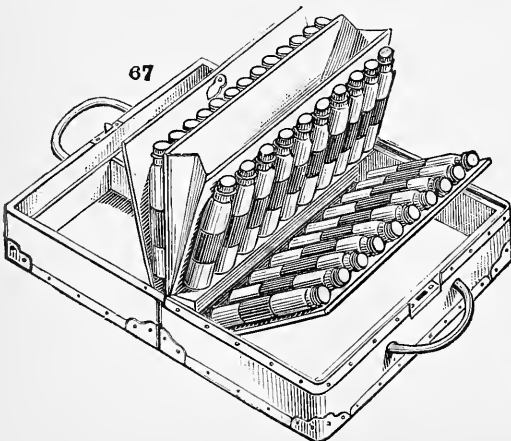

66.\* (OPP) Dark morocco, contains 8—1 oz., 12—4 drachm and 24—2 drachm corked vials and space for sundries, size  $10 \times 5\frac{1}{2} \times 4\frac{3}{4}$  in. \$6.75\*

67.\* (AMES) Dark leather, nicked corners, contains 20—8 drachm, 13—5 drachm, one side empty, space with partition over it on other side, size  $10\frac{1}{2} \times 4\frac{1}{2} \times 6\frac{1}{2}$  in..... 10.00\*

**XXVI. CASES FOR CARRYING MEDICINES.\***  
**HAND AND BUGGY CASES.**

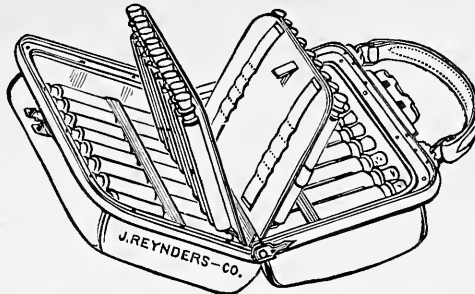

**Satchel Case.**

These illustrations show one of the neatest vial cases offered to the medical profession. Its outward appearance conveys no inference of its contents.

- 300. Contains 16-1 oz. and 18-½ oz. vials, and loops for surgical instruments; size of Satchel, 8x6x4½ in. .... \$ 9.00\*
- 307. Contains 18-1 oz., 11-6 drachm and 11-4 drachm vials, loops for surgical instruments, space for hypodermic syringe and sundries; size of Satchel, 10x7x5½ in ..... 11.25\*

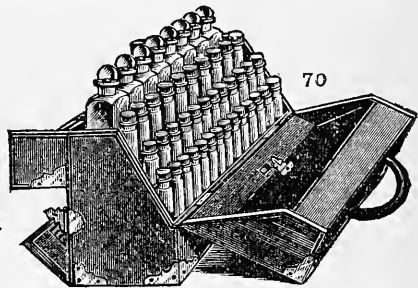
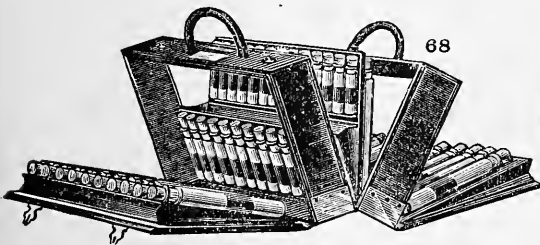

- 68.\* (OPA) dark morocco, two handles, opens in center and both broadsides, contains 20-6 drachm, 12-4 drachm, 26-2 drachm vials; size, 9½x5½x3¾ in ..... \$ 8.25\*
- 69. (OPM) red morocco, contains 8-1½ oz., glass-stoppered, 10-1 oz., 8-4 drachm and 14-2 drachm vials, and space for sundries; size, 12¼x6x5¾ in ..... 9.00\*
- 70.\* (OPT) dark morocco, two handles, opens in center, vials arranged each row higher to display label, contains 8-1½ oz., glass-stoppered, 10-1 oz., 12-6 drachm and 14-4 drachm vials, and space with loops for sundries; size, 11¼x8½x5¼ in. .... 12.50\*

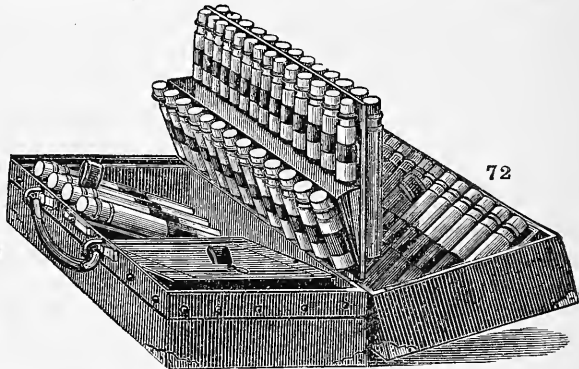
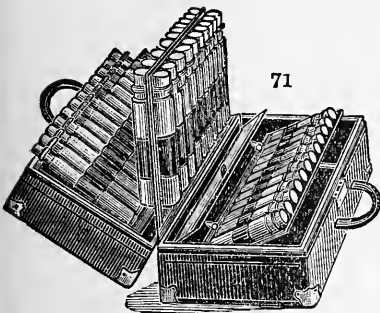

- 71.\* (ATNN) valise shape buggy case, black seal grain or deer brown seal, cowhide, with stitched edges. Mounted with heavy nickel corners, nickel spring lock, with key, and nickel name plate. Contains 12-4 drachm, 12-1 oz. and 20-1½ oz. cork-stoppered vials and box and pocket for sundries, making the most substantial, complete and richest looking case ever placed on the market; size, 11¼x7¾x5 in ..... \$14.00\*
- 71a. (ATNA) the same, in either of above-named leathers, containing 10-1 oz. salt mouths, 10-1 oz. liquid, rubber stoppers, 10-½ oz. liquid, rubber stoppers, 10-½ oz. salt mouths; size, 10¼x7½x4 in ..... 12.00\*
- 72.\* (OPR) dark morocco, one handle, opens in center, contains 4-3 oz., 26-1 oz. and 26-½ oz. vials, and space for sundries; size, 12¼x7½x5¾ in ..... 12.50\*
- 73. (OPO) dark morocco, two handles, opens in center, contains 20-1 oz. and 13-5 drachm vials, and space for sundries; size, 10x6½x4¾ in ..... 12.00\*
- 74. (OAN) dark morocco, plain, one handle, contains 8-1 oz., 10-6 drachm and 12-4 drachm vials; size, 9½x4½x3¾ in ..... 4.00\*
- 75. (OAL) russet sole leather, contains 16-1½ oz., glass-stoppered, 10-1 oz., 8-4 drachm and 14-2 drachm corked vials, metal trimmings; size, 12¼x6x5¾ in ..... 12.00\*

XXVI. CASES FOR CARRYING MEDICINES.\*  
HAND AND BUGGY CASES.

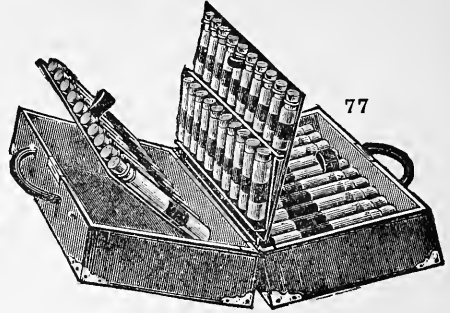
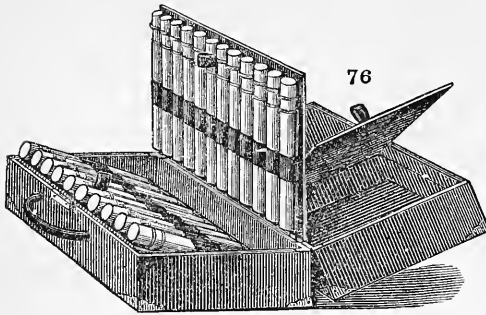

- 76.\* (OAA) dark morocco, contains 10—1 oz., 12— $\frac{1}{2}$  oz. vials, and space for instruments and sundries, size  $10\frac{1}{2} \times 6 \times 4\frac{1}{4}$  in. .... \$9.00\*
- 77.\* (OPE) dark morocco, 2 handles, opens in center, contains 10—1 oz., salt mouth, 10—1 oz. liquid, rubber stop, 10— $\frac{1}{2}$  oz. liquid, rubber stop, 10— $\frac{1}{2}$  oz. salt mouth, size  $10\frac{1}{2} \times 7\frac{3}{4} \times 4$  in. .... 11.00\*

PATENT BUGGY HAND CASES.

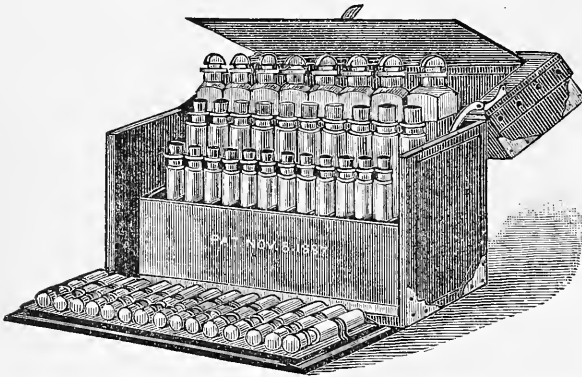

Light, durable and convenient. Covered with russet or black sole leather. The rows of vials arising in step shape when case opens and descending when case closes, making the hand-somest and most compact buggy case ever placed on the market.

78. (N) Buggy Case, russet or black sole leather, contains 6— $\frac{1}{2}$  oz., glass-stoppered, 8—1 oz., 10—6 drachm and 12—4 drachm vials, and space in lid for sundries, size  $9\frac{3}{4} \times 7 \times 5\frac{1}{2}$  in. .... \$11.25\*
- 79.\* (P) Buggy Case, russet or black sole leather, contains 8— $1\frac{1}{2}$  oz., glass-stoppered, 10—1 oz., 12—6 drachm and 15—4 drachm vials, space in lid for sundries, size  $12\frac{1}{4} \times 7 \times 5\frac{1}{4}$  in. .... 13.50\*
80. (A) Buggy Case, russet or black sole leather, contains 10— $1\frac{1}{2}$  oz., glass-stoppered, 13—1 oz., 16—6 drachm and 20—4 drachm vials, space in lid for sundries, size  $15 \times 7 \times 5\frac{3}{8}$  in. .... 15.75\*
81. (L) Buggy Case, russet or black sole leather, contains 12— $1\frac{1}{2}$  oz., glass-stoppered, 15—1 oz., 19—6 drachm and 24—4 drachm vials, space in lid for sundries, size  $17\frac{1}{2} \times 7 \times 5\frac{3}{8}$  in. .... 18.00\*

SEAMLESS EDGE BUGGY CASES.

Furnished either in russet leather, black seal grain cowhide or plain black calf skin at same prices as given.

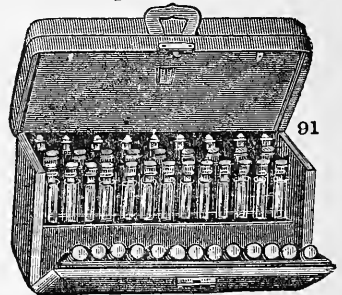
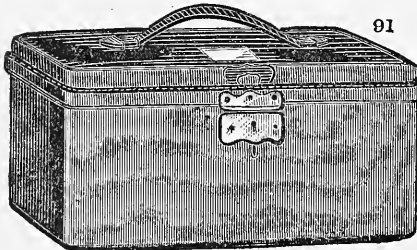

90. (ASSN) space in top for instruments, very compact, contains 12—3 drachm, 8—1 oz., cork-stoppered, and 6— $1\frac{1}{2}$  oz., glass-stoppered, vials, size  $10 \times 6\frac{3}{4} \times 4\frac{1}{4}$  in. \$11.00\*
91. (ASSL) large space in top for instruments, contains 26—3 drachm, 9—1 oz., cork-stoppered, and 8— $1\frac{1}{2}$  oz., glass-stoppered, vials, size  $11 \times 6\frac{3}{4} \times 5\frac{1}{2}$  in. .... 13.00\*

XXVI. CASES FOR CARRYING MEDICINES.\*

SEAMLESS EDGE BUGGY CASES.

- 92. (ASSR) Large space in top for instruments; contains 30—1½ drachm, 13—3 drachm, 9—1 oz., cork-stoppered, and 8—1½ oz., glass-stoppered, vials; size, 11x6¼x5½ in. . . . . \$13.00\*
- 93. (ASSO) Large space in top for instruments; contains 16—3 drachm, 11—1 oz., cork-stoppered, and 16—1½ oz., glass-stoppered, vials; size, 13x6¾x5½ in. 16.00\*

- 94.\* (ASTA) Space in top for instruments, also large space for sundries; contains 14—1½ drachm, 8—3 drachm, 12—4 drachm, cork-stoppered, and 8—1½ oz., glass-stoppered, vials; size, 12½x7¼x5¼ in. . . . . 13.00\*
- 95. (ASTE) Large space for sundries, 5x4½x2½ in.; contains 16—3 drachm, 12—4 drachm, cork-stoppered, and 8—1½ oz., glass-stoppered, vials; size, 12½x6¾x5¼ in. . . . . 12.00\*

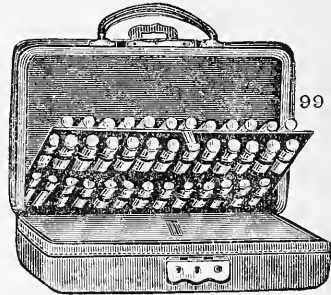
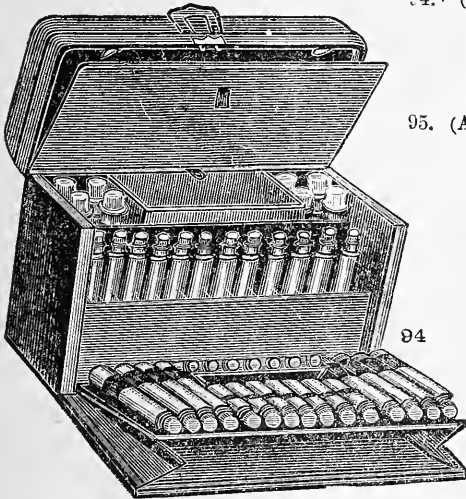

- 96. (ASTT) Valise Shape Buggy Case, russet leather, outside appearance smooth, as shown by figure to the left at bottom of previous page. This is a very compact and handsome case, has all round corners, contains 22—2 drachm, 11—3 drachm and 10—6 drachm cork-stoppered vials; size, 9½x6x3½ in. . . . . \$11.00\*
- 97. (ASOP) Same. Contains 44—2 drachm and 11—3 drachm cork-stoppered vials. 11.00\*
- 98. (ASOM) Same. Contains 66—2 drachm cork-stoppered vials. . . . . 11.00\*
- 99.\* (ASOS) Same. All one side empty for instruments. Contains 24—3 drachm, 12—1 oz. cork-stoppered vials; size, 11½x7x1 in. . . . . 12.00\*

All of the above in three kinds of leather, as stated on previous page. The following in russet and black calfskin only :

SMOOTH, SEAMLESS EDGE HAND CASES.

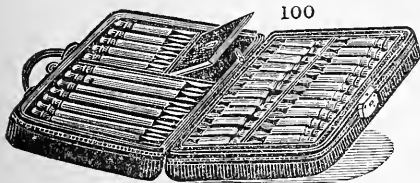

Vials held firmly in place by self-adjusting nickel-plated springs, holding them firmly, but allowing them very readily to be removed or replaced.

- 100.\* (ATNM) Nickel-plated lock with key, contains 7—6 drachm, 5—3 drachm, 24—2½ drachm, cork-stoppered, vials and box for hypodermic syringe; size, 9½x7x2½ in. \$9.00\*
- 101. (ATNR) With lock and key, contains 36—3½ drachm cork-stoppered vials and large space for sundries; size, 9½x7x2½. . . . . 9.00\*
- 102. (ATNS) Nickel-plated spring lock with key, contains 41—3 drachm screw cap vials. . . . . 9.50\*
- 103. (ATNO) Nickel lock, contains 20—¾ oz. screw cap vials; size of case, 11x5x2½ in. 8.00\*
- 104. (ATPP) With clasp, no handle, contains 10—¾ oz. screw cap vials; size of case, 11x5x1¾ in. . . . . 5.50\*
- 105. (ATPL) Lock and key, no handle, contains 24—4 drachm cork-stoppered vials; size, 10½x4½x2 in. . . . . 5.00\*
- 106. (ATPE) Physicians' hand case, russet leather with clasp, contains 24—2½ drachm vials, cork-stoppered; size, 9x3½x2½ in. . . . . 4.50\*

XXVI. CASES FOR CARRYING MEDICINES.\*

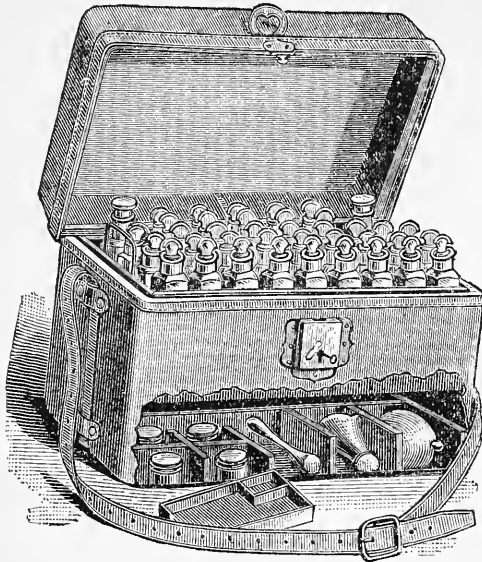

MEDICINE CHESTS.

Our Medicine Chests are made of the best Russet Leather, and are acknowledged to be the neatest, most durable and best Medicine Chests in the market.

SEAMLESS EDGE  
MEDICINE CHESTS,

PATENTED

July 12th, 1881. March 27th, 1883.

They have Nickel-plated Locks and Trimmings.

They contain our improved Glass Mushroom Stopper Bottles.

The following contain Glass Stoppered Bottles in Mahogany Trays, also a Mortar, a Graduated Measure, Four Jars, a Tray for Scales and a space for Instruments under Bottles.

101	contains	4	4-oz.,	18	2-oz.,	20	1-oz.,	8	½-oz.—50	bottles;	price	\$19.50,	15½	in. long,	9¼	in. wide,	9¼	in. high	
102	"	4	"	16	"	13	"	6	"	44	"	"	18.00,	14½	"	8	"	8½	"
103	"	"	"	16	"	"	"	13	"	34	"	"	14.50,	11½	"	8	"	8½	"
104	(see cut)	2	"	16	"	19	"	"	"	37	"	"	16.00,	12¾	"	8¼	"	9¼	"
105	contains	2	"	14	"	13	"	"	"	32	"	"	14.50,	11	"	8¼	"	9¼	"
106	"	2	"	12	"	13	"	"	"	27	"	"	13.50,	9¾	"	8¼	"	9¼	"
107	"	"	"	"	"	28	"	"	"	28	"	"	12.00,	11	"	7¾	"	8¾	"

The following without Mortar, Measures or Jars.

108	contains	4	4-oz.,	10	2-oz.,	6	1-oz.—20	bottles;	price	\$10.50,	9½	in. long,	7½	in. wide,	8¼	in. high
109	"	15	1½-oz.,	"	"	"	"	"	"	8.50,	8¼	"	5¾	"	7¼	"

The following with a Tray in Front of the Bottles.

110	contains	4	4-oz.,	9	2-oz.,	12	1-oz.,	6	½-oz.—51	bottles;	price	\$13.00,	13	in. long,	9	in. wide,	5¾	in. high	
111	"	5	"	7	"	6	"	"	"	18	"	"	10.00,	11	"	7¾	"	5¾	"
112	"	"	"	10	"	4	"	"	"	14	"	"	8.50,	9	"	6½	"	5¾	"

All of the above with Locks. The following with a Strap and Buckle.

113	contains	2	4-oz.,	6	2-oz.,			} Space in front.	price	\$5.25,	7	in. long,	5¼	in. wide,	5	in. high
114	"	5	1½-oz.,	4	1-oz.,	"	"									

FAMILY CASES.

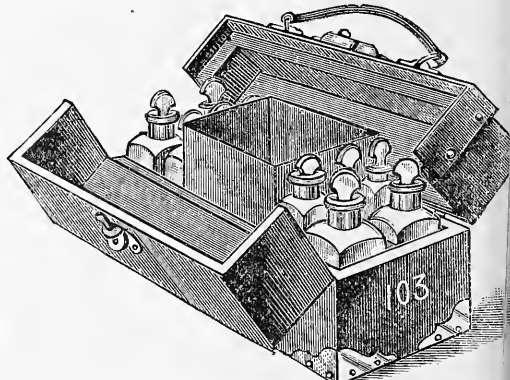
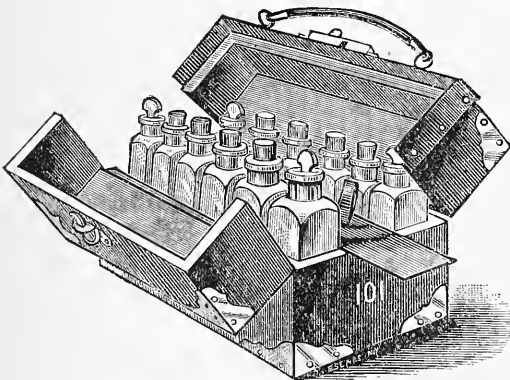

- 101.\* Morocco, black, contains 4—1½ oz. glass-stoppered, 8—1½ cork-stop and space for sundries, one handle, spring lock and key, size 8¾x4¾x5¾ in. . . . . \$6.00\*
- 103.\* Morocco, black, contains 4—4 oz. glass-stoppered, 6—1½ oz., space for sundries, one handle, spring lock and key, size 11¾x5x6 in. . . . . 7.50\*



XXVI. CASES FOR CARRYING MEDICINES.\*

MARSHALL'S CONVERTIBLE SADDLEBAGS  
HAND CASE.

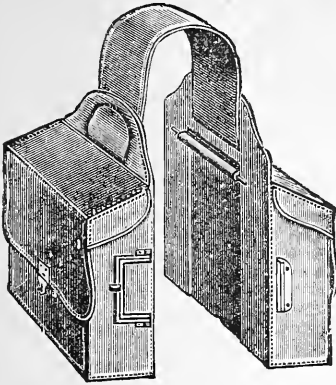

Fig. 1 is Fig. 2 in Saddlebags Form.

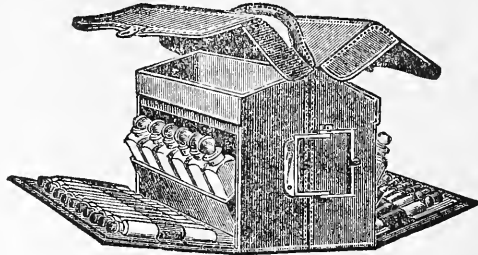

Fig. 2 is Fig. 1 in Hand Case Form.

Has two trays, one on either side,  $7\frac{1}{2} \times 2\frac{1}{2} \times 2\frac{1}{2}$  in., 12—14 oz. glass-stoppered bottles, 16—8 drachm and 8—2 drachm cork-stoppered vials. Total, 36 bottles. Spaces between round and square bottles for papers.

- |                                  |         |
|----------------------------------|---------|
| A. Grade or russet leather ..... | \$16.00 |
| B. Grade or black leather .....  | 15.50   |

A. and B. Grades are exactly alike in every respect except color of leather.

Size of case, 6x8x8.

SOUTHWESTERN CONVERTIBLE SADDLE BAG BUGGY CASE.

Fig 3



Readily convertible, 24 bottles  $1\frac{1}{2}$  and  $\frac{1}{2}$   $\frac{3}{4}$ , glass stoppers. Stoppers cannot get out of place. Great economy of space. Bottles occupy only one-third of same, leaving balance of space for other things. Absolute proof of water, horse hair or dirt. When open full contents are conspicuously exposed.

Price, \$11.00 net.

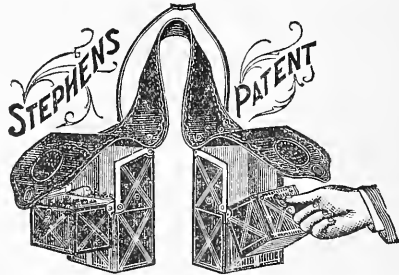

- |        |                            |                 |
|--------|----------------------------|-----------------|
| No. 1. | 24 bottles, leather, black | \$10.00;*       |
|        |                            | russet \$11.00* |
| No. 2. | 30 bottles, leather, black | \$11.00;*       |
|        |                            | russet 12.00*   |
| No. 3. | 36 bottles, leather, black | \$12.00;*       |
|        |                            | russet 13.00*   |

## XXVII. THERAPEUTIC SUNDRIES.

## DR. PAQUELIN'S THERMO-CAUTERY.

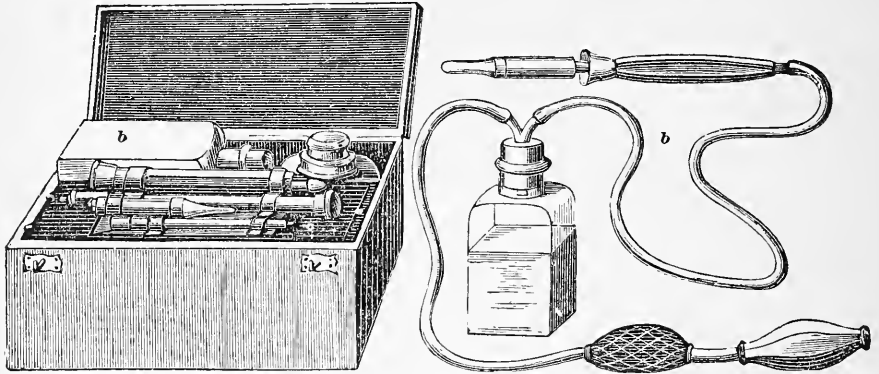

The use of this instrument is derived from the fact that when Platinum, as well as several other metals, slightly heated, is brought into contact with certain hydrocarbon vapors, it gradually becomes incandescent and retains its heat as long as the vapors are supplied.

**DESCRIPTION.**—It consists of three principal parts, which are the combustion chamber, a receptacle for the volatile hydrocarbon and an air-blowing contrivance. The combustion chamber is the cautery itself.

It chiefly consists of an enclosure of platinum of small volume and large surface. This is the cautery proper, which may be made of various forms to suit any requirement of application. Two tubes are attached to this, the inner one leading the vapors into the chamber or enclosure and the outer one conducting off the products of combustion.

The receptacle is a bottle which can, as is most convenient, be attached to a buttonhole, button or pocket of the operator's clothing. It is closed by a rubber cork through which a tube passes having two outlets. Through one of these atmospheric air is forced into the bottle, which passes out through the other outlet mixed with vapors of the hydrocarbon. Naphtha is the best hydrocarbon for use with this apparatus.

The air-blowing contrivance is an ordinary set of Richardson spray bulbs. A handle made of non-heat-conducting material is attached to the platinum chamber and the two tubes. The tube leading to the chamber is extended through the handle.

To the bottle or receptacle the other two parts are united by rubber tubing.

**DIRECTIONS FOR USE.**

The chamber of combustion is held into the white part of the flame of an alcohol lamp for about a minute in the mean time (but not at the same time) the bulbs should be worked.

Once incandescent the chamber of combustion will remain heated as long as the bulbs are worked and hydrocarbon supplied, without any other assistance whatever.

The Thermo-Cautery is to take the place of the ordinary Cautery Irons and has the advantage of being much more readily heated and of maintaining its heat instead of losing it. It may be used to separate any human tissue, liquid or even in cold water without impairing its incandescency.

No danger whatever is involved in the use of this apparatus.

This apparatus is now made in two styles as shown by figures *a* and *b*. In figure *a* the receptacle is made of nickelplated metal and can very conveniently be placed into the vest-pocket. Price \$30.50.\*

Figure *b* shows the original form of this apparatus. Price \$30.00.\*

Two cauteries are included with above prices.

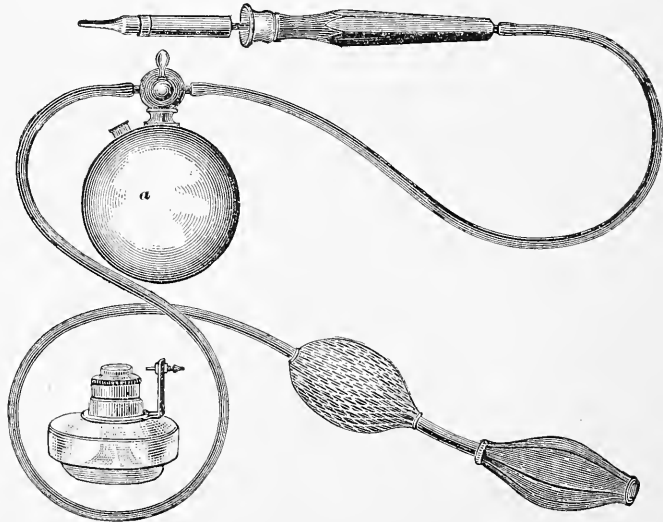

**XXVII. THERAPEUTIC SUNDRIES.**  
**APPLIANCES FOR ACTUAL CAUTERY.**

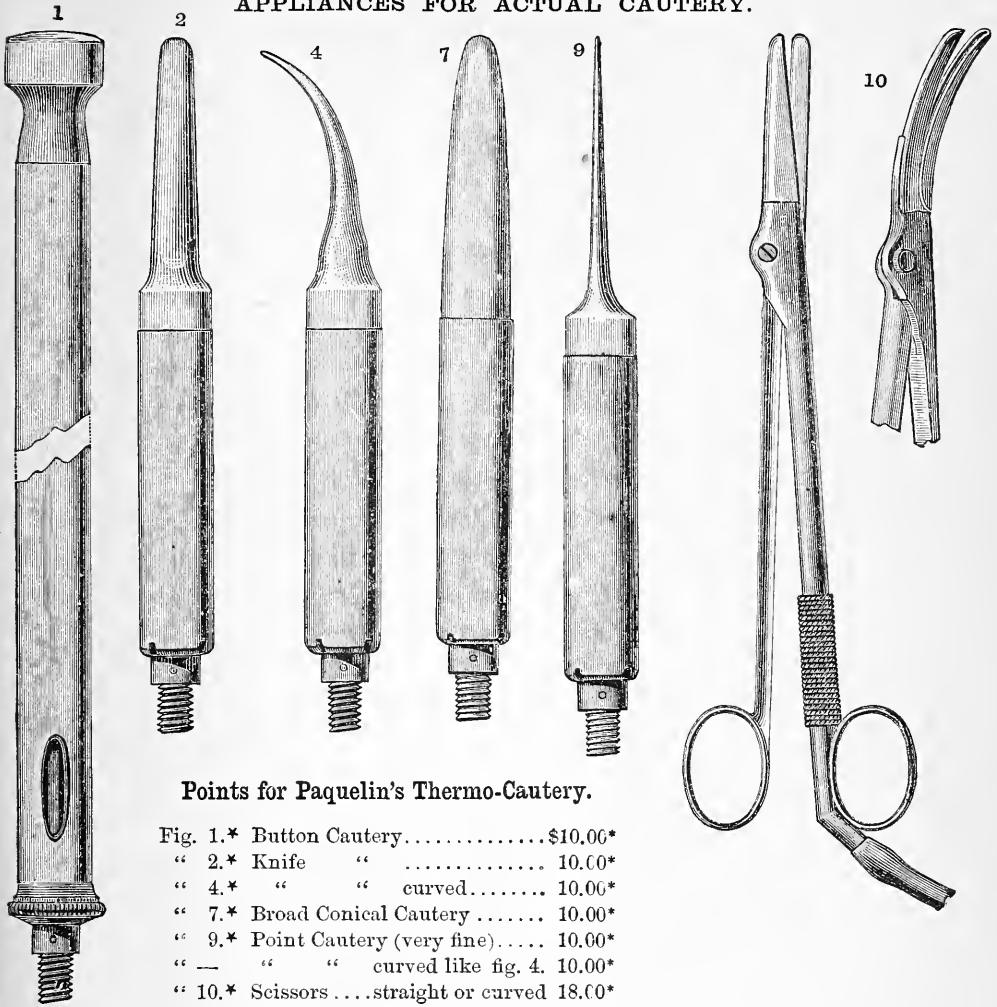

**Points for Paquelin's Thermo-Cautery.**

- Fig. 1.\* Button Cautery.....\$10.06\*
- " 2.\* Knife " ..... 10.00\*
- " 4.\* " " curved..... 10.00\*
- " 7.\* Broad Conical Cautery ..... 10.00\*
- " 9.\* Point Cautery (very fine)..... 10.00\*
- " — " " curved like fig. 4. 10.00\*
- " 10.\* Scissors....straight or curved 18.00\*

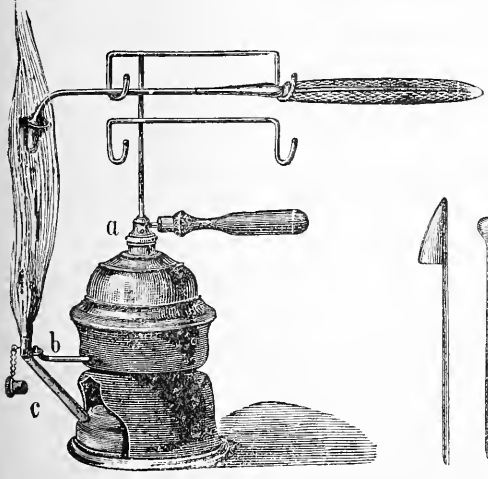

Self-blowing Alcohol  
 Lamp for heating  
 Cautery Irons ...\$7.50

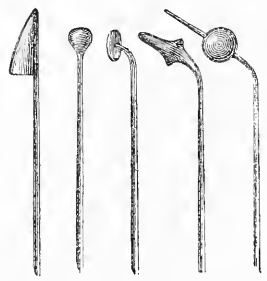

Irons for Actual Cau-  
 tery, various styles,  
 each \$1.50

The same platinum  
 covered.....each \$6.00

XXVII. THERAPEUTIC SUNDRIES.

a STOMACH PUMPS AND TUBES.

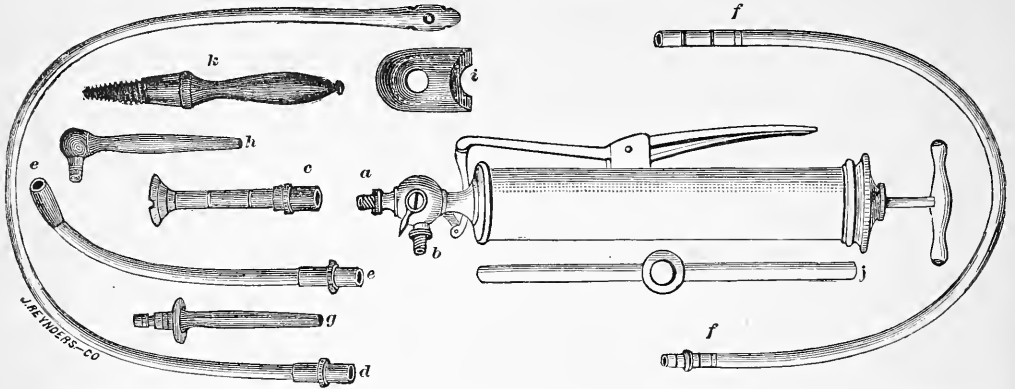

Lever Action Stomach Pump ..... \$15.00

STOMACH TUBES, Etc.

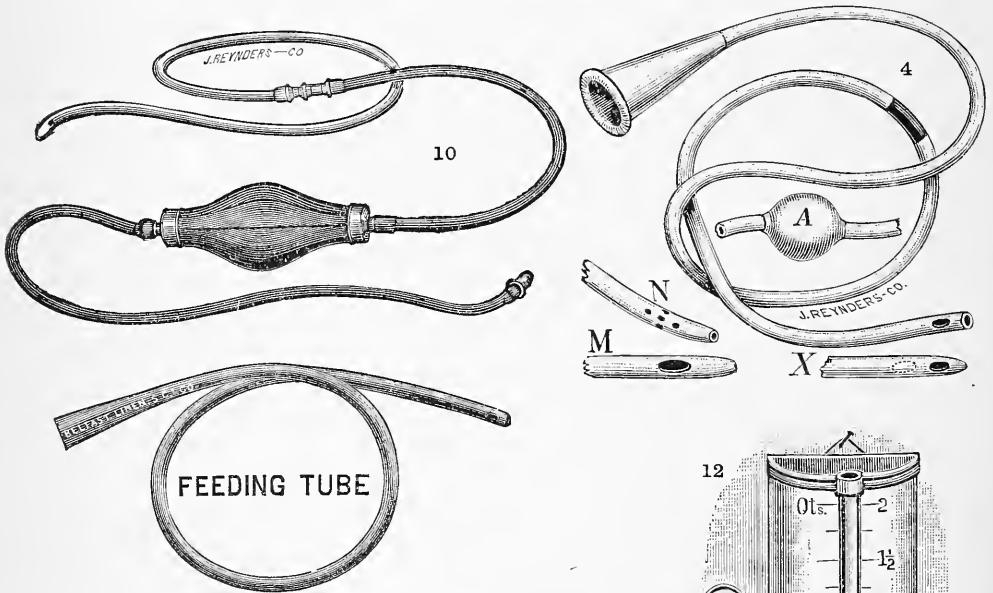

FEEDING TUBE



- 1. Elastic, plain. .... \$1.50
- 2.\* " funnel end..... 1.75
- 3. Same as No. 2, metal eye 2.50
- 4.\* Rubber, open end and side hole..... 1.75
- 5.\* Rubber, closed end (X)... 2.25
- 6. " like 4, but with bulb A ..... 2.50
- 7. Rubber, one end plain, the other open end, one side like M, the other like N..... 2.00

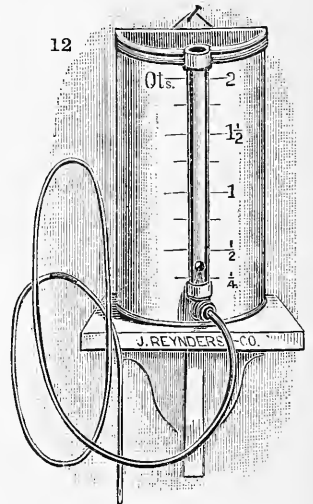

- 8. Rubber, "Velvet Eye" ..... \$1.50; long \$2.00
  - 9.\* " both ends plain, beveled off..... 2.00
  - 10.\* Toswill's Syphon..... 2.50
  - 11.\* Stomach Washing Apparatus, h. r. funnel ..... 3.00
  - 12.\* " " " for infants..... 3.00
- (Can be furnished for adults at same price.)

**XXVII. THERAPEUTIC SUNDRIES.**  
**AVELING'S TRANSFUSION APPARATUS.**

The apparatus consists of two small nickelplated or silver tubes to enter the vessels and of an india-rubber tube, by which they are united, and which has in its centre an elastic receptacle holding about two drachms.

The tube for insertion into the vein of the blood-donor is rounded and the other beveled; the former is inserted downward, the latter upward. The vein may be opened, as suggested by Dr. Aveling by seizing it with a pair of forceps and incising it so as to form a V-shaped flap. The india-rubber portions of the apparatus should be completely filled with warm water, partly for cleanliness and partly to insure the absence of air. The tubes, also containing water, are inserted in the vein, each tube being held by an assistant; then

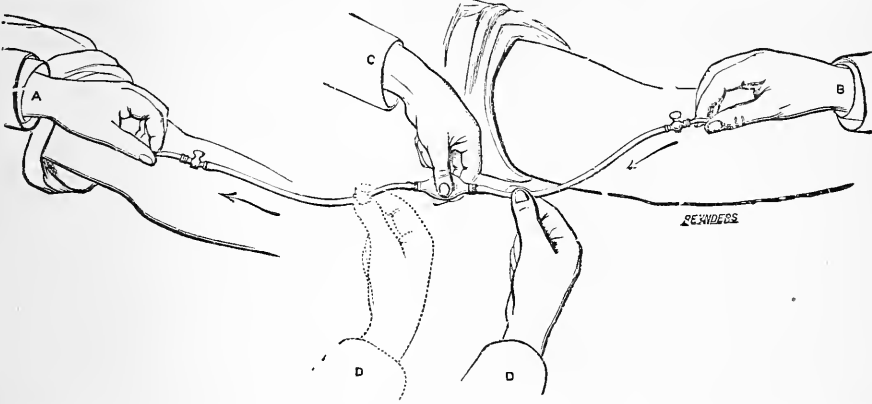

the connection is made, and the operator compresses the bulb holding the rubber tube on the side toward the donor; then let the bulb expand while holding firmly the rubber tube between it and the recipient; immediately the bulb fills with blood, and now repeating the previous manipulation it is transferred to the recipient.

(From the "American Practitioner," October 1874. See also "Transactions of Obst. Soc. of London," vol. 6, May 4, 1864; Lancet, Aug. 3, 1872; Obst. Journal, August 1873 and N. Y. Medical Record, April 1, 1874.)

Price \$4.50; with a Scalpel and one pair of forceps in a neat morocco case. . . . . \$8.00

**VELPEAU'S WRITERS' CRAMP APPARATUS.**

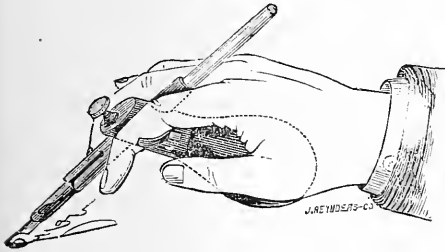

There are many devices for this purpose, of which the above is one of the simplest and most effective. It consists of an oblong ball made of wood or hard rubber, to be grasped by the hand, keeping it in a proper position. To this are attached a couple of half-rings, serving as rests for the index and middle fingers. A penholder passes through the neck of the ball at a convenient place near the extremity, which can be adjusted and made firm by a thumb screw. Thus a person affected with writers' cramp may be effectually treated without being necessitated to leave off writing. Price \$13.50

**Duchenne's Writer's Cramp Apparatus.**

**Zabludowski's Writer's Cramp Apparatus.**

**Nussbaum's Writer's Cramp Apparatus.**

**BANNSCHEIDT'S INSTRUMENT OR LIFE WAKER.**



Original Pattern \$2.50; Oil, per bottle \$1.50; American Pattern with bottle of Oil \$6.50.

Cupping Instruments, see page 53.

Allen's Pump, see pages 280 to 281B.

XXVII. THERAPEUTIC SUNDRIES.

APPARATUS FOR APPLICATION OF COLD OR HEAT TO THE BODY.

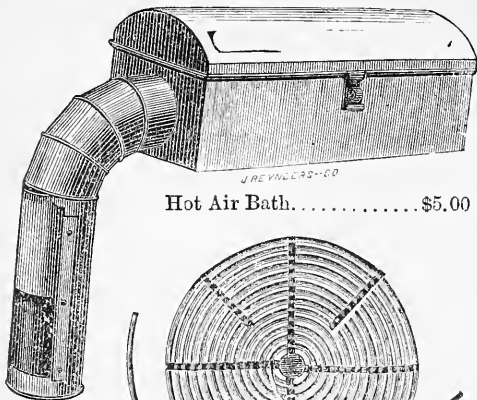

Hot Air Bath..... \$5.00

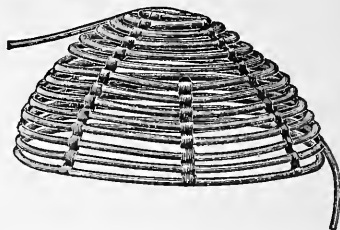

A. Rubber Coil for Head.  
7 in. diam., 4 in. deep, \$3.00  
Same, 5 in. deep ..... 3.50

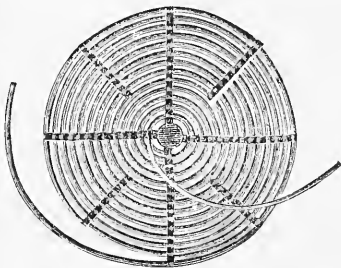

B. Round Rubber Coils.  
Diam: 5 in., \$1.50; 7 in., \$2.00; 9 in., \$2.50  
" 11 " 3.00; 13 " 3.50; 15 " 4.00

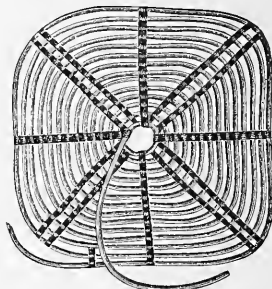

C. Square Rubber Coils.  
6 in., \$2.50; 8 in., \$3.00  
10 in., \$4.00  
12 in., \$5.00; 14 in., \$6.00

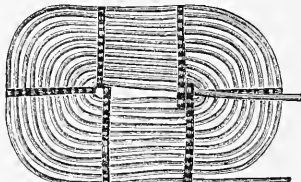

D. Oblong Rubber Coils.  
5x3 in., \$1.50; 7x4 in., \$2.00  
9x5 " 2.50; 10x6 " 3.00  
11x7 " 3.50; 11x8 " 4.00

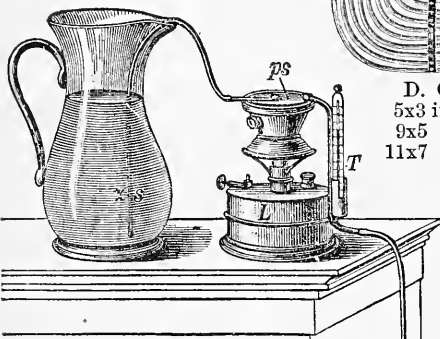

J. REYNDERS & CO.



No. 4.

Throat.

Throat Coils.  
9x3 in., \$1.75; 10x3 in., \$2.00  
11x3 " 2.25; 12x3 " 2.50

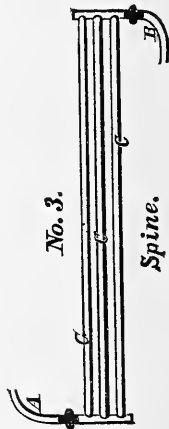

No. 3.

Spine.

No. 3, for the Spine.....\$4.00

The above figure is illustrative of using the Coils. A lamp is shown for the production of a prolonged supply of heat to any degree within the range of the thermometer.  
Price.....\$10.00

GENERAL NEEDS.

THE "HOME" TURKISH BATH.

Can be taken Plain or Medicated. Heretofore the blessings and luxury of a Turkish Bath could only be enjoyed and secured in our larger cities in establishments put up for such purpose. We now, however, have succeeded in placing within the reach of every home an apparatus by means of which these baths may be taken with a minimum of inconvenience and



delay, and maximum of comfort and beneficial effect, all at less expense than ever before, anywhere throughout the land. Even in cities our Home apparatus is preferable, as the head is left exposed, and the bath may be taken at any time, immediately before going to bed, within ten to thirty minutes, and without the drawback of having to go to and fro between home and the bathing establishment. The apparatus consists of a gas or alcohol burner of proper construction, which is placed under a solid

bottom chair upon which the person is to sit while taking the bath (this is shown by the left hand figure), with which part a pan for generating sulphur fumes can be connected. The right hand figure illustrates the actual taking of the bath. We do not supply the covering unless specially ordered, but do furnish with every bath a pattern from which any one can make or have made the same; the material for same being obtainable anywhere and in many different qualities, every one can thus suit him or herself in this particular. Our circular upon this subject, mailed anywhere upon application, gives particulars and directions in every respect, as for instance as to the indications for Sulphur, Chamomile Seed, Gin, Brandy, Alcohol, Vinegar, Wild Thyme, Formica, Turpentine, Juniper Berries, Spirits of Pine Needle, etc., as Medicated Baths. These Baths offer a most valuable adjunct to the treatment of Gout, Rheumatism, Kidney Troubles, Colds, Pains in Back, aside of the only means for thorough cleanliness of the outside body.

Price, arranged for Gas.....	\$12.00*
“ “ “ Alcohol.....	15.00*

THE "HOME" UNIVERSAL WATER BATH.

It is a single vessel, compact in storage; can be set up in a moment, in any room in the house; and for a full or submergent bath, it requires less than one-third the quantity of water necessary in a metallic bath. It is readily transformed from a full to a sitz, sponge, spine, or almost any variety of local bath.

FOR PHYSICIANS

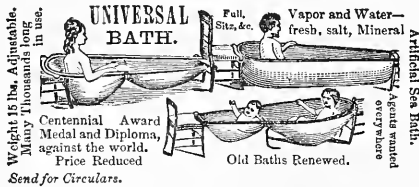

AND FAMILIES.

This apparatus is very durable, and costs no more than the yearly interest on the cost of an ordinary bath room and fixtures. In addition to all these advantages, the material of which it is made is proof against Salts, Sulphur and Iodine. In fact, it is the only bath known which is really adapted to medicated baths, or to artificial sea bath. Persons living at a distance from the salt waters, with this apparatus may enjoy the priceless benefit of expensive sea bathing at their own quiet home, with merely nominal expense. Full explanations and reliable testimonials mailed free on application to the manufacturer. Send for circulars. Address as above. Patented March 1, 1870. Reissued, 1872. Beware of infringements.

Prices to patients, regular size .....	\$16.00*
“ “ “ extra large.....	18.00*

## THE ALLEN SURGICAL PUMP.

More Explicit Pamphlet Sent On Application.

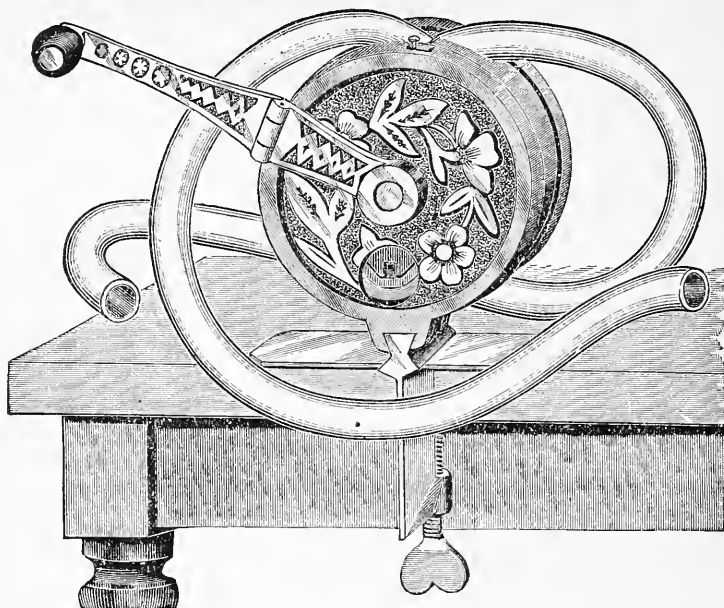

Fig. 1.—Showing the Pump attached to a Table.

By means of suitable attachments it forms an Aspirator, Injector, Stomach Pump, Bladder Syringe, Cupping Pump, Dilator, Universal Syringe, Breast Pump, and Force and Vacuum Pump, all combined in one instrument (see outfit No. 12, Fig. 73).

With our improved attachments we claim for this pump :

- First.*—The most powerful, rapid, safest and only aseptic aspirator in use.
- Second.*—The only injector that can be used without admitting air with the fluid injected.
- Third.*—The most effective stomach pump in the market.
- Fourth.*—A safe bladder Syringe that may be used with an ordinary catheter.
- Fifth.*—A reliable cupping pump of great power.
- Sixth.*—A dilator (uterine, rectal, vaginal, etc.) superior to any other.
- Seventh.*—A tamponning or plugging instrument for arresting hemorrhage.
- Eighth.*—A universal syringe without valves, giving a steady, uniform current.
- Ninth.*—A breast pump that will always work.
- Tenth.*—A vacuum pump capable of raising mercury in a vacuum to a height of twenty-eight inches.
- Eleventh.*—A force pump that will force up (and sustain) a column of mercury to a height of twelve feet (equal to a column of water over one hundred and sixty feet in height).

(A pump and all the above-mentioned attachments can be purchased in one outfit, see Fig. 33.)

- Twelfth.*—The only perfect blood transfuser yet devised.
- Thirteenth.*—An improved instrument for Litholopaxy.
- Fourteenth.*—The cleanliest and most effective embalming syringe made.
- Fifteenth.*—A douche having a continuous current that can be made slow or fast as desired.

It is at the same time both a force and a vacuum pump, depending only on the direction in which the crank is turned, possesses an instantly reversible current, is without valves or stop-cocks, and so arranged that the same tube need not be used for a second operation, as the tube may be easily changed in a few seconds with no further expense than the cost of a new one.



## THE ALLEN SURGICAL PUMP.

While the Allen Surgical Pump may be easily manipulated by being held in the hand, or attached by means of the clamp to a table, it can be worked to the best advantage by being fastened to the top of a chair-back or to one of its side rails. When attached to a chair, the chair may be moved about as occasion may require, placed against a bed or sofa, or in close proximity to the patient, wherever situated. The clamp being provided with two faces, admits of its being attached in almost any position.

A professor of surgery in one of the leading medical colleges in New York, when showing this pump to his class recently, said: "The chief merit of this instrument lies in the fact that it so completely fulfills the requirements of modern aseptic surgery."

This device consists of a metal cylinder, upon the inner surface of which is coiled a single loop of rubber tubing, formed in the center of a piece a yard or more in length (see Fig. 3). A shaft having a suitable crank passes through the cylinder, to which is attached a roller provided with springs so arranged that any degree of pressure desired can be

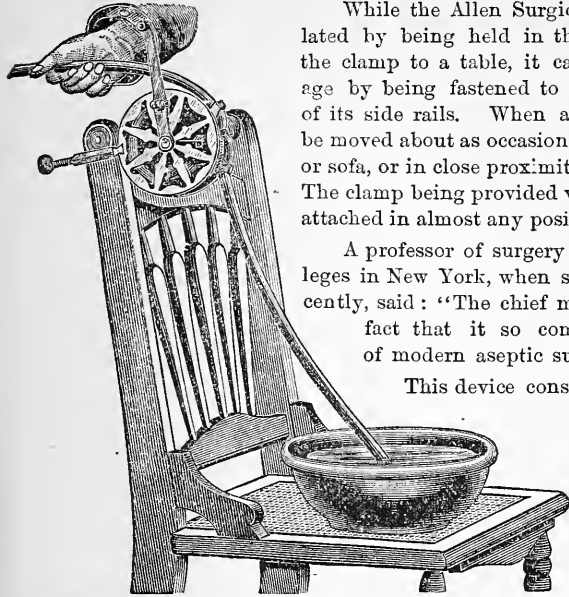

Fig. 2.—Showing the Pump attached to a Chair.

made by it on the tubing (see Fig. 4). By properly adjusting the springs each revolution of the crank will displace as much air or liquid as is contained in that portion of the rubber tubing forming the loop. As the roller in passing around the circle must rest on the tubing, completely closing it at some point, there is no necessity for any valves. If one end of the tubing be attached to a vacuum bottle and the crank turned so as to force the air in the

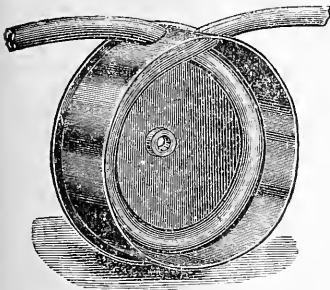

Fig. 3.—Showing the Rubber Tube coiled within the Cylinder.

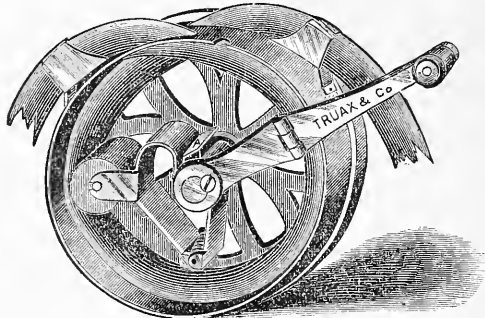

Fig. 4.—Showing the action of the Roller.

tubing in the opposite direction, a powerful vacuum will soon be formed; or if the same end be attached to an air receiver and the crank turned toward it, a high pressure of condensed air will be obtained. This apparatus is adapted for pumping both gases and liquids, and is either a force or vacuum pump, depending only on the direction in which the crank is turned. It has no valves or stop-cocks, and the current may be instantly reversed. It has sufficient power to force a column of water to a height of one hundred and sixty feet, maintaining it at that height, and the next to the smallest size will easily pump one quart of liquid per minute.

There are no delicate or complicated parts to get out of order. The rubber tubing will not wear out, and should it deteriorate after a few years' use, it may be replaced at the cost of a few cents. Our best outfits are supplied with duplicate tubes, so that the surgeon may be provided with one for septic and another for aseptic use.

**THE ALLEN SURGICAL PUMP\***

**SIZES OF PUMPS AND NET PRICES.**

No. 1.	Diameter of cylinder 3 inches,	price of pump only	.....	\$8.00
No. 2.	“ “ 3½ “ “ “	“ “ “	.....	9.00
No. 3.	“ “ 4 “ “ “	“ “ “	.....	10.00
If in case.....like fig. 31, extra \$1.75; like fig. 33, extra				5.00

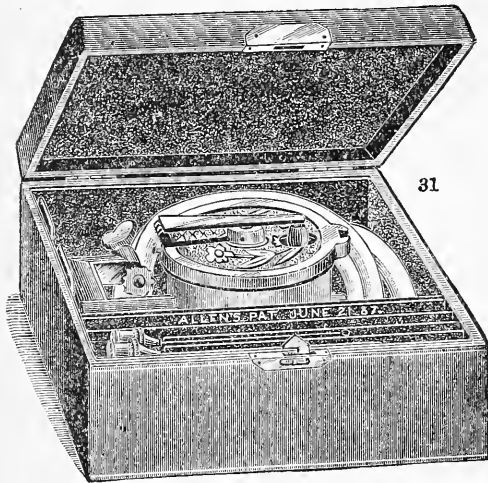

Physician's Outfit No. 10 (see fig. to the left), consisting of :

- 3½-inch Pump and Tube,
- Clamp, to fasten to table, chair, etc.,
- Set Universal Connectors,
- Tube Connector,
- Glass Cupper,
- Connector and Cut-off for same,
- Stomach Tube and Connector,
- 3 Aspirating Needles,
- 2 Tampons,
- Uterine Dilator, small,
- Uterine Dilator, large,
- 2 Silk Covers for same,
- 2 extra Rubber Bags, for tampons, dilators, etc.,
- Olive Tip Catheter and Connection.

All in a neat velvet-lined leather covered case (see fig. to the left) net price, \$15.00

Physician's Outfit No. 12 (shown by the illustration at foot of page), consisting of :

- 3½-inch Pump and Tube,
- Extra Tube for same,
- Clamp, to fasten to table, chair, etc.,
- 2 sets Universal Couplings,
- Tube Connector,
- 5 glass Cuppers,
- 3 Connectors and Cut-offs for same,

- Uterine Cupper, metal,
- Stomach Tube and Connector,
- Dome Trocar,
- 4 Aspirating Needles,
- Two-way Cock, for injecting,
- 2 Tampons,
- Uterine Dilator, small,
- Uterine Dilator, large,

- 4 Silk Covers for same,
- 4 extra Rubber Bags, for tampons, dilators, etc.,
- Olive Tip Catheter and Connector,
- 5 Syringe Pipes, (ear, post-nasal, vaginal, rectal and uterine),
- Breast Pipe.

All in a neat, velvet-lined leather bag, with lock and key, as shown by fig. 33 (see below)..... net \$25.00

The above outfit contains nine sets of instruments, each one of which is more perfect, and possesses greater advantages, than any one instrument of its class to be purchased elsewhere. In other words, a physician may purchase the nine best instruments for these several operations to be found in the market, and will find on comparison that this one outfit is a better one for not only one but all of the various operations for which it is recommended than the entire nine; and these nine cannot be purchased for less than six times the sum asked for this one set.

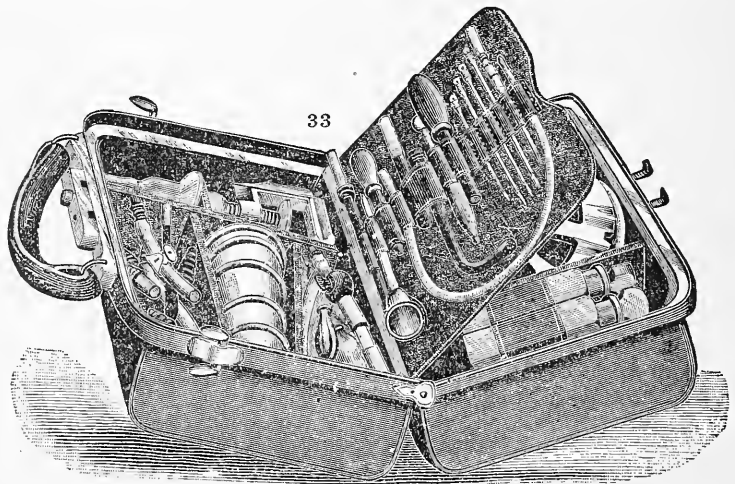

**THE ALLEN SURGICAL PUMP.\***

Gynecological Outfit No. 13, consisting of :

- |  |  |   |
|--|--|---|
| 3½-inch Pump and Tube,<br>2 extra Tubes for same,<br>Clamp, to fasten to table,<br>chair, etc.,<br>3 sets Universal Connectors,<br>2 Tube Connectors,<br>2 glass Cuppers,<br>2 Connectors for same,<br>Metal Uterine Cupper, | 4 Aspirating Needles,<br>Dome Trocar,<br>Two-way Stopcock for in-<br>jecting,<br>3 curved Dome Trocars,<br>3 Emmett's Trocars,<br>2 Tampons,<br>Uterine Dilator, small,<br>Uterine Dilator, large, | 5 Silk Covers for same,<br>6 extra Rubber Bags, for<br>tampons, dilators, etc.,<br>2 Olive Tip Catheters and<br>Connectors,<br>3 Syringe Pipes (uterine,<br>vaginal and rectal),<br>Uterine Douche. |
|--|--|---|

All in a neat, velvet-lined leather bag, similar to fig. 33. .... net \$45.00\*

Hospital Outfit No. 14, consisting of :

- |   |  |  |
|---|--|--|
| 3½-inch Pump and Tube,<br>2 extra Tubes for same,<br>Clamp, to fasten to table,<br>chair, etc.,<br>3 sets Universal Connect-<br>ors,<br>2 Tube Connectors,<br>5 glass Cuppers,<br>3 Connectors and Cut-off for<br>same,<br>Uterine Cupper, metal,<br>Stomach Tube and Con-<br>nector. | 3 Aspirating Trocars and<br>Stopcock,<br>2 Aspirating Needles,<br>Large curved Dome Trocar,<br>Two-way Cock, for injecting,<br>2 Tampons,<br>Uterine Dilator, small,<br>Uterine Dilator, large,<br>5 Silk Covers for same,<br>6 extra Rubber Bags, for<br>dilators, tampons, etc.,<br>2 Olive Tip Catheters and<br>Connectors, | 5 Syringe Pipes, (ear, post-<br>nasal, rectal, vaginal and<br>uterine),<br>Breast Pipe,<br>2½-inch Transfusion Pump<br>and Tube,<br>2 Hard rubber Transfusion<br>Canulas,<br>Canula Pin,<br>Phlebotome,<br>Rectal Obturator and In-<br>jector. |
|---|--|--|

All in a neat, velvet-lined, leather bag, with lock and key, similar to fig. 33. .... \$50.00\*

Hospital Outfit No. 15, consisting of same as above with addition of :

- |   |  |  |
|---|--|--|
| 2 Emmett's Trocars, large<br>and medium,<br>Curved Dome Trocar,<br>small, | 5 Water Bags, for chest, ab-<br>domen, spine, neck and<br>head,<br>Uterine Douche, | 3 Dilators: Esophageal,<br>Tracheal,<br>Nasal. |
|---|--|--|

All in a neat, velvet-lined, leather bag, similar to fig. 33. .... \$85.00\*

Walter A. Reid's British Naval Case, consisting of :

- |   |  |  |
|---|--|--|
| 3½-inch Pump and Tube,<br>2 extra Tubes for same,<br>Clamp, to fasten to table,<br>chair, etc.,<br>3 sets Universal Connectors,<br>2 Tube Connectors,<br>3 glass Cuppers, | 2 Connectors and Cut-offs for<br>same,<br>Stomach Tube (without var-<br>nish) and Connector,<br>2 Aspirating Needles,<br>3 Aspirating Trocars, gold-<br>plated, with Stopcock,<br>Rectal Syringe Pipe, | Brass Two-way Cock for in-<br>jector,<br>2 Tampons,<br>Rectal Dilator,<br>4 extra Rubber Bags, for dila-<br>tors, tampons, etc.,<br>2 Olive Tip Catheters and<br>Connectors. |
|---|--|--|

All in a velvet-lined heavy sole leather case, with handle, lock and key ..... \$30.00\*

- Outfit No. 16. Blood Transfuser, consisting of: 2½-inch Pump with suitable Tube, 2 hard rubber Canulas, Canula Pin and Phlebotome. All in a neat, velvet-lined case \$15.00\*
- Outfit No. 18. Embalming Syringe, consisting of: No. 2 Pump, Jointed Evacuating Trocar, 3 Injection Pipes, set Universal Connectors. All in a neat, velvet-lined case 13.00\*
- Outfit No. 19. Embalming Syringe, consisting of: No. 2 Pump, Jointed Evacuating Trocar, 3 Injection Pipes, Catheter, 2 Scalpels, Dissecting Forcep, Dissecting Scissors, Artery Needle, set Universal Connectors. All in a neat, velvet-lined case 15.00\*
- Outfit No. 21 (Aspirator only), containing: No. 1 Pump, 3 Aspirating Needles with set Universal Connectors. In neat, velvet-lined leather covered case ..... 10.00\*
- Outfit No. 23 (Stomach Pump only), containing: No. 2 Pump, Stomach Tube with set Universal Connectors. In neat, velvet-lined leather covered case ..... 11.00\*
- Outfit No. 25 (Cupping Pump only), containing: No. 1 Pump with 4 Cuppers, each with suitable Cut-off and Connections ..... 10.00\*
- Outfit No. 26. Laryngological, consisting of: 3½-inch Pump, Esophageal Dilator, Trachea Dilator, Nasal Dilator, Aspirating Needles, 6 extra Rubber Bags for dilators, Clamp and Tube Connector. All in a neat, velvet-lined case ..... 14.50\*

Sample Page of Dr. Seguin's Prescription and Clinic Record or Bed-Side Notes.

Date, ..... No. of Visit, .....  
 Name, ..... Sex, ..... Et. ....  
 Temper., ..... Barom., ..... of the room.  
 Time of Observations, .....  
 Temper., ..... Respir., ..... Pulse, .....  
 Urine Frequency, ..... Quantity, .....  
 Do. Specific Gravity and .....  
 .....  
 Skin, .....  
 Tongue, .....  
 Attitude, .....  
 Sleep, .....  
 Food, .....  
 Drink, .....  
 Medication. Following :

R

The Prescription and Clinic Record,  
 Or, Bed-Side Notes.

The use of this note-book fulfils several indications:—To give more precision and certainty to prescriptions by writing them twice—once for keeping, the other for the apothecary.—To substitute more and more positivism for conjecture in diagnosis and prognosis.—To record the signs of disease on the spot, in no time, and keep their series in sight, in order to compare similar cases, and to treat the complex or protracted ones with scientific unity of plan.—To enable a physician to continue with perfect knowledge the treatment of a confere absent or sick.—To habituate the families to keep similar records of health of every child and adult.—To furnish accurate data to the keepers of public-health statistics.—To offer an easy transition from the heterogeneous weights and measures of the Gothic period to the system of this scientific epoch, universal language of weights and measures.

Necessity for using these Records:—The practice of medicine is so much more complicated and scientific than it used to be, that no physician can feel safe to treat patients without taking notes of their cases—bed-side-notes we would say.—These notes refer to the diagnostic, which may change from a visit to another as the disease progresses favorably or otherwise; and to the therapeutics, whose effects may be so marked as to require watching, or so insensible as to require changing. They are particularly adapted to the recording of the signs given and by the new instruments of observation, without neglecting the old means of diagnosis. Their series express the diurnal fluctuations of each function and their relations to each other. Their weekly tabulation indicates the movement of the vital dynamics. These records may be represented by *curves* (graphic method) which show to the eye the ebb and flow of the course of life; or by their true *figures* (mathematical method) which speak more directly to the mind, and provoke induction. We give tables for both; so that experience may decide of their respective merits.

Price per book, 35 Cts.

M.D

- 1 Meter = 1/4000000 of the earths circumference = 39.3707 in.
- 1/10 Meter = decimeter = 3.937 inches.
- 1/100 " = centimeter = .3937 "
- 1/1000 " = millimeter = .03915 "
- 10 " = decometer = 32 feet 9.708 "
- 100 " = hectometer = 19.8842 rods or 106 363 yards.
- 1000 " = kilometer = .62137 of a mile.
- 1.600 Ki'ometer = 1 mile.

The Metric System.

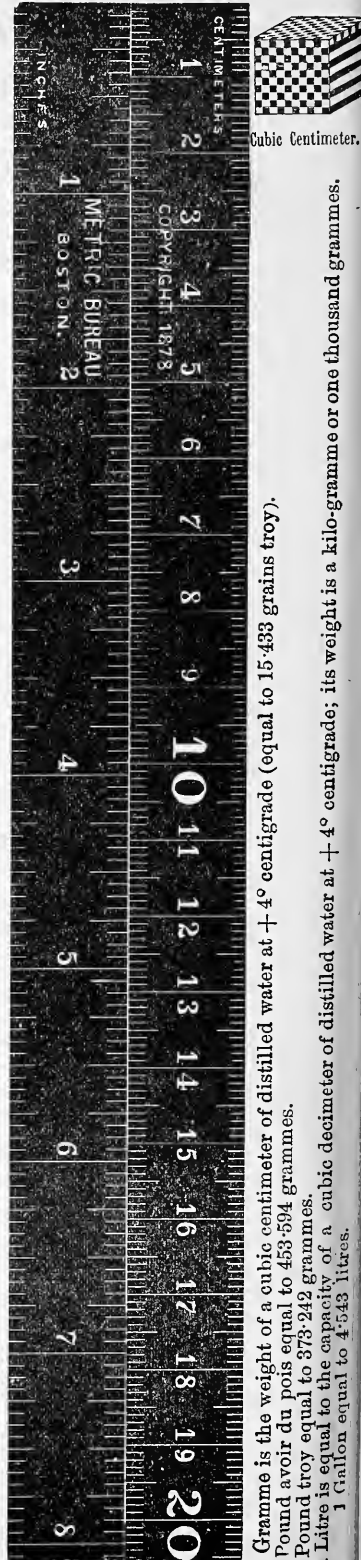

A Gramme is the weight of a cubic centimeter of distilled water at + 4° centigrade (equal to 15.433 grains troy).

1 Pound avoirdupois equal to 453.594 grammes.

1 Pound troy equal to 373.242 grammes.

A Litre is equal to the capacity of a cubic decimeter of distilled water at + 4° centigrade; its weight is a kilo-gramme or one thousand grammes.

1 Gallon equal to 4.543 litres.

**XXVII. THERAPEUTIC SUNDRIES.**

**KLEMM'S MUSCLE BEATER.**



The employment of mechanical means, particularly for the treatment of chronic diseases, has been in vogue since the early history of medical science, and their use for this purpose has continued to the present time assisted by manipulators. The muscle beater invented by Mr. Klemm has been designed and possesses special advantages for gymnastic exercising at home without the aid of manipulators.

If the muscle beater be used for a short time upon any exposed portion of the body, a more rapid blood circulation is the result, as shown by reddening of the skin where the manipulation has taken place.

The cause of this phenomenon is in the first place due to the fact that every increase in sensation of an organic structure is followed, as a result of reflex action, by an increased dilation of the contractile structures. In the second place an increased mechanical reflux of the circulation is produced, corresponding to the degree of intensity of transient contact (in this instance beating), which causes a momentary displacement of the blood current. It is evident that tissue metamorphosis can be considerably quickened in this manner in the regions manipulated.

Muscle beating may animate the circulation in persons of sedentary habits; excite in paralysis; deplete in congestion; and initiate retrograde metamorphosis in superficial deposits, resulting from rheumatism and gout or fatty degeneration of the integument.

Delicate persons should use the thin walled beaters only, whilst muscular and less sensitive persons should employ those having thicker walls.

The muscle beaters are made in the following varieties, and directions for use accompany each one.

**No. 1. LENGTH 16½ INCHES.**

- Thick walls. Described by number 1 A.
- Medium thick walls. Described by number 1 B
- Thin walls. Described by number 1 C.

**No. 2. LENGTH 14½ INCHES.**

- Thick walls. Described by number 2 A.
- Medium thick walls. Described by number 2 B.
- Thin walls. Described by number 2 C.

**No. 3. LENGTH 13¼ INCHES.**

- Thick walls. Described by number 3 A.
- Medium thick walls. Described by number 3 B.
- Thin walls. Described by number 3 C.

Number 2 B and number 3 B are employed most.

Price.....each \$3.50

**XXVIII. HUMAN OSTEOLOGY.**

The different prices of these preparations are based upon their degree of whiteness and development.

1. Half Skeletons, disarticulated, in boxes, consisting of the skull, the spinal column, twelve ribs, pelvis, one arm and one leg. The bones of the spine, hand and foot are held together by cat-gut..... \$25.00\*\*
2. Articulated Skeletons to suspend, male or female..... \$36.00 to 50.00\*\*
3. " " with stand (Box for either of above 1.00)..... 42.00 to 55.00\*\*
4. " " à la Beauchène (imported to order only)..... 150.00 to 200.00
5. Foetal Skeletons, assorted ages, on stand, under glass.....each 12.00\*\*
6. Disarticulated Skulls, in boxes, with apartments for each bone..... 16.00 and 18.00\*\*
7. Entire Skulls, plain..... 8.00\*\*
8. " " one cut, horizontal..... 9.50\*\*
9. Entire Skulls, two cuts, one horizontal, the other vertical.. 12.50\*\*
10. Entire Skulls, seven cuts, showing the ear completely on one side..... 27.50\*\*
11. Skulls, disarticulated, and all bones united with polished metal strips, according to Beauchène's method. By turning a screw the front part moves forward and the back part backwards; the lower jaw can be removed. Each bone can readily be studied separate, including those of the ear. Price, under glass..... 60.00
12. Maxilla, with dental vessels, nerves and roots..... 30.00
13. Internal Ear, semi-circular canals, cochlea, etc., on stand.... 8.00\*\*
14. Foetal Skull..... 2.50 "
15. Female Pelvis with Ligaments. 14.00\*\*
16. Hands and Feet, articulated with cat-gut.....each 3.50\*\*
17. Skull and Thigh Bones, for Masonic Societies..... 11.50\*\*

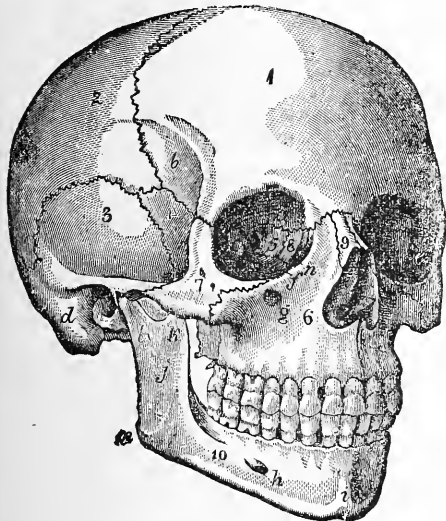

XXIX. RUBBER GOODS.



XXIX. RUBBER GOODS.

Where two prices are given without any other qualification, the lower price is for second quality.

1.*	Air Beds	32x80 \$25.00; 42x80 \$33.00; 52x80	\$42.00
2.*	Bellows for Inflating same		*5.00
3.*	Air Pillows	.9x13, \$2.00 and \$3.00; 10x16, \$2.50 and \$3.50; 12x18, \$3.50 and \$4.00;	
4.*	Rubber Bandages.	(See page 293.)	14x23, \$4.00 and 5.00
5.*	Bath Tubs, oval,	20x25 inches	11.00
6.*	"	round. . . . 24 in., \$14.00 and \$16.00; 30 in., \$17.00 and \$21.00; 34 in.,	\$21.00 and 23.00
7.*	"	upright	\$20.00 and 25.00
8.*	"	red round, with bag	different sizes @ \$10.00 and 14.00
9.*	Breast Pumps D		1.25
10.*	"	" M	2.50
11.*	"	" h. r.	2.00
12.*	Breast Exhaustor		0.50
13.*	Nipple Shield		0.25
14.	"	"	0.25
15.*	Bed Pans, white or black		\$3.50 and 5.00
16.*	"	white	4.50 and 5.50
17.*	Chair Cushion, Hospital		4.50 and 6.00
18.*	Eureka Diaper		4 sizes @ 1.00
21.*	Eugenic Periodical Bandage with sponge		2.50
22.*	Gloves, short	ladies' fine \$1.25; men's \$1.50; heavy driving \$2.00; acid pure gum	3.50
23.*	"	long	ladies' 1.80; " 2.00; " 2.50; " " 4.50
24.*	"	long	5.00
25.*	Mittens	light \$1.25; heavy \$1.0; extra heavy	2.00
26.*	Ice Bags, spinal, white	12 and 14 in., each \$1.25; 16, 18 and 20 in., each	1.50
27.*	"	pure gum	1.50 " " 1.75
28.*	"	for Throat	7, 8, 9, 10, 11 in., each 0.90
29.*	Ice Caps, white	small \$2.25; medium \$2.50; large	3.00
30.*	"	pure gum	2.50
31.*	Invald Cushions, strictly the best; diam. 9 and 10 in., each \$2.25; 11 in. \$2.50; 12 in. \$2.75; 13 in. \$3.00; 14 in. \$3.25; 15 in. \$3.33; 16 in. \$3.50; 17 in. \$4.00; 18 in. 4.50		
	Same, fair quality; 9 in. \$1.75; 10 and 11 in., each \$2.00; 12 and 13 in., each \$2.25; 14 and 15 in., each \$2.50; 16 and 17 in., each \$2.75; 18 in. 3.00		

The best quality of this article is most decidedly preferable over the latter.

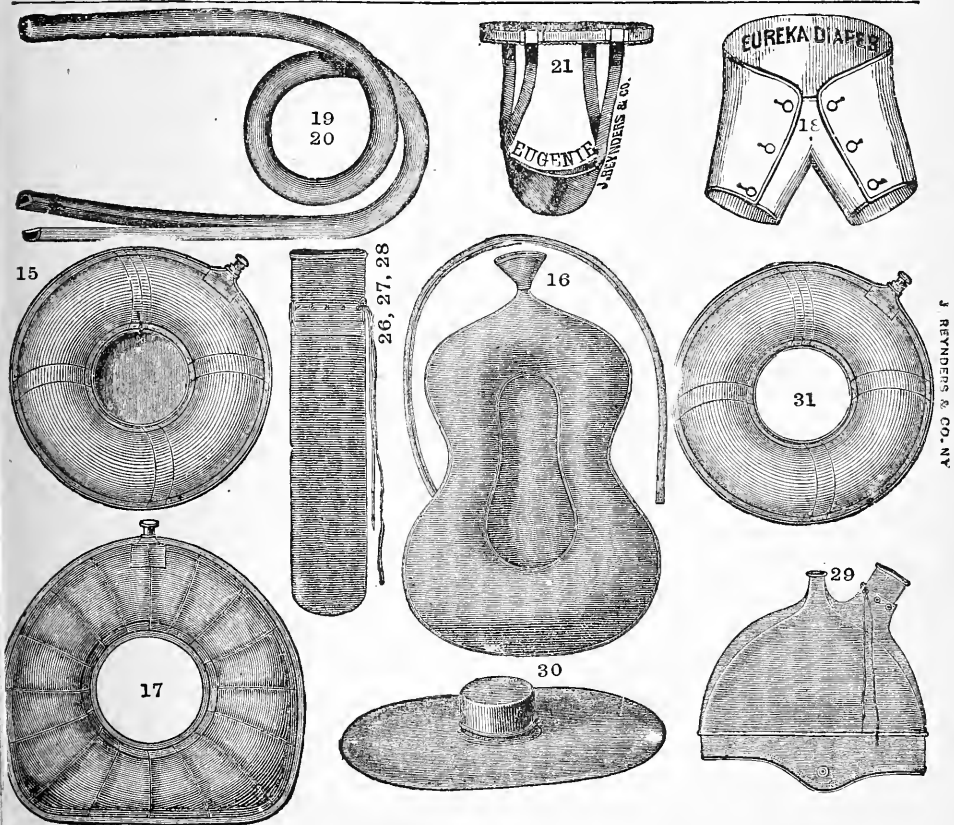

XXIX. RUBBER GOODS.

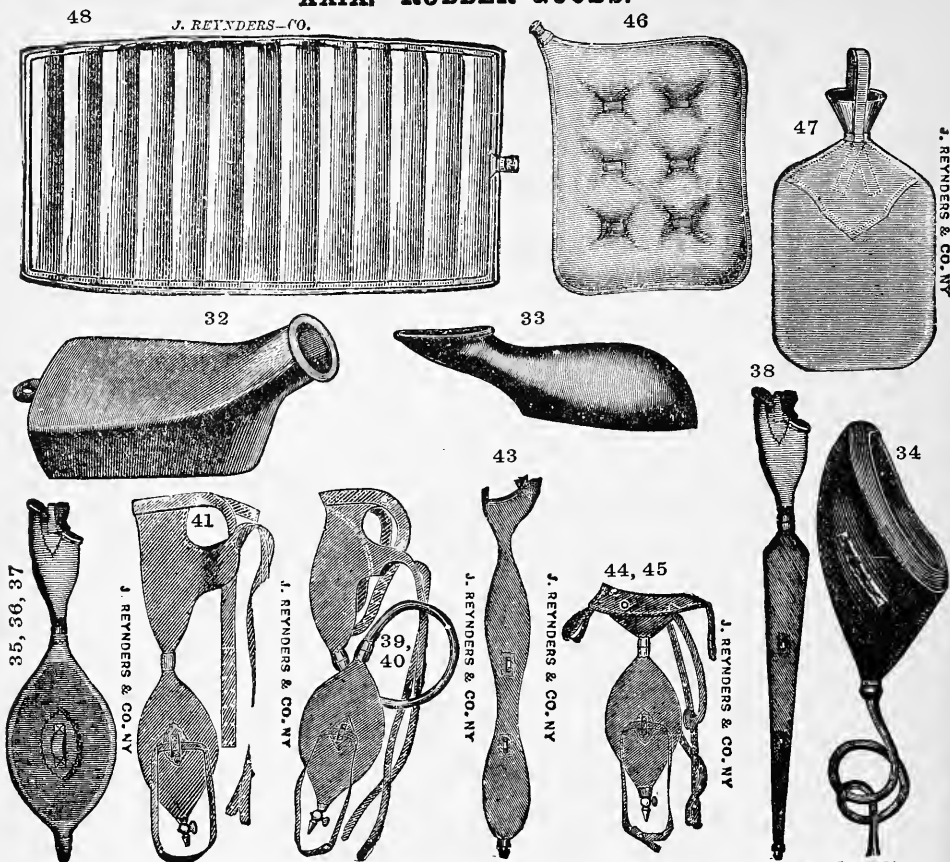

Where two prices are given without any other qualification, the lower price is for second quality.

URINALS.

(We particularly advise against ordering these of second quality). S. F. stands for standard fine; II. for second (inferior) quality; A., adult's; B., boy's; G., girl's; D., day; N., night.

- 32.\* Male, h. r. . . . . \$3.25
- 33.\* Female, h. r. . . . . 3.25
- 33a. Similar to 32 and 33, Glass, with handle, M. or F., plain 50 cts.; graduated 0.75
- 34.\* Female, h. r., with off-flow . . . . 5.00
- 35.\* Soft rubber, D., A., or B., 102-301 1.75
- 38.\* Same, D. and N., male A. 104. . . . 2.00
- 39.\* Same, D. and N., male A., II. \$3.50; S. F. 5.00
- 40.\* Same as 39, B. . . . II. \$3.00; S. F. 4.00
- 41.\* Same, D. and N., male A. 105, II. \$3.00; S. F. 3.50
- 42.\* Same, upper part 41 and long tube like 39 . . . . . S. F. 5.00
- 43.\* Same, female only, 103, A. . . . . 2.00
- 44.\* Same, female only, 107, A., II. \$3.00; S. F. 3.50
- 45.\* Same as 44, G. . . . . 3.50
- 46.\* Water Bags, 13x15 \$3.00 and \$4.50; 14x18 \$4.50 and \$5.00; 17x19 \$5.00 and 6.00

- 47.\* Water Bottles, best, 1 quart. \$2.50; 2 quarts. \$2.75; 3 quarts. 3.00; 4 quarts. \$3.00  
Same, II. quality, 1 and 2 quarts., each \$1.50; 3 and 4 quarts., each 1.75
- 48.\* Water Beds, \* 24x36 \$16.00; 32x80 \$25.00; 42x80 \$33.00; 52x80 42.00
- 49. Hospital or Nursery Sheeting, per yard in following widths:  $\frac{3}{4}$  yd. 75 cts.;  $\frac{1}{4}$  yd. \$1.00;  $\frac{5}{4}$  yd. \$1.25;  $\frac{6}{4}$  yd. 1.50
- 50. Bed Sheets\* . . . . 4x6 \$4.50; 6x6 5.50
- 51. Soft Rubber Tubing,\* white, net, per foot in cents (internal diameter), best,  $\frac{1}{16}$  6 cts.,  $\frac{1}{8}$  6 cts.;  $\frac{3}{16}$  9 cts.;  $\frac{1}{4}$  12 cts.;  $\frac{5}{16}$  15 cts.;  $\frac{3}{8}$  20 cts.;  $\frac{1}{2}$  25 cts.;  $\frac{5}{8}$  30 cts.;  $\frac{3}{4}$  50 cts.; 1 60 cts.
- 52. Soft Rubber Tubing,\* white, net, per foot in cents (internal diameter), fair,  $\frac{1}{16}$  6 cts.;  $\frac{1}{8}$  6 cts.;  $\frac{3}{16}$  6 cts.;  $\frac{1}{4}$  8 cts.;  $\frac{5}{16}$  10 cts.;  $\frac{3}{8}$  15 cts.;  $\frac{1}{2}$  18 cts.;  $\frac{5}{8}$  20 cts.;  $\frac{3}{4}$  35 cts.; 1 30 cts.
- 53. Soft Rubber Tubing,\* black or red, per foot in cents (internal diameter),  $\frac{1}{8}$  6 cts.;  $\frac{3}{16}$  8 cts.;  $\frac{1}{4}$  18 cts.;  $\frac{5}{16}$  25 cts.;  $\frac{3}{8}$  40 cts.

All Instruments Illustrated are designated by a \*



### XXX. MISCELLANIES.

#### PILL MACHINES, SUPPOSITORY MOULDS, ETC.

**1.\* Pill Machines, with Brass Plates and Brass Sides, and Walnut Rolling Board.**

Each machine warranted to turn out perfectly round Pills, and the full number of grooves at every operation. The sides of the Rolling Board are of the requisite height to roll the stick just the size of the groove and pill, thereby insuring a perfect pill.

Our machines, as now constructed, will turn out more pills in any given time, than any other in the market.

**PRICES.**

12 pills, 3 gr., 4 gr., 5 gr., either size.....	each	\$3.50*
18 " 3 " 4 " 5 " " " " ".....	"	4.50*
24 " 1, 3 " 4 " 5 " " " " ".....	"	5.50*

Side Rollers, \*\$1.00 extra.

Machines for 30, 36, 50 or 100 Pills...respectively, \*\$10.50, \*\$15.00, \*\$22.00 and \*\$34.00

Any size made to order.

Machines for Compressed Pills - 2 sizes in set..... \*3.50

Plaster Spreaders and Irons; Suppository Moulds; Camphor Ice Moulds; Cosmetic Moulds; Punches for Lozenges; Sprinkler Tops for Perfumes and Tooth Powders; Collapsible Tubes for Ointments and Perfumes.

**2.\* Cooper's Patent Pill Machine, brass plates, mahogany board and drawer..... 12.00**

This Machine has two sets of reversible Plates, on which four different sizes of Pills can be made and the sides of the rolling board are so constructed as to allow the mass to be rolled just the size required for each respective size of pills, thereby ensuring always the full number of perfectly round pills.

**3.\* Rectum Suppository Moulds, best white metal. 10, 15 or 30 grains, Trays with 6 moulds, tin, \*75c. Trays with 12 moulds, tin..... \*1.25**

**4.\* Vaginal Suppository Moulds, best white metal, Trays with 6 moulds, tin, \*\$1.13. Trays with 12 moulds, tin..... \*1.87**

**5.\* Rectum Suppository Moulds, brass, 2 sizes, to make 6 or 12... resp. \*\$3.00 and 5.00\***

**6.\* Vaginal Suppository Moulds, brass, to make 6..... 4.50\***

Moulds for Gelatine Bougies, Camphor Ice, Cosmetics—all sizes and shapes.—Caustic, Pastilles; Punches for Lozenges, all shapes.

The illustration section contains several detailed drawings of medical and pharmaceutical equipment. At the top is a large rectangular pill machine with a rolling board and a handle, labeled '2'. Below it are two smaller hand-operated machines, one labeled '1' and another labeled '2'. To the right are two sets of rectangular trays with multiple small compartments, labeled '2'. Below these is a long, thin cylindrical tool with a handle, labeled 'L. REYNOLDS - CO.'. In the middle left is a hand-operated machine with a row of rollers, labeled '1'. Below that is another hand-operated machine with a row of rollers and a handle, labeled '5&6'. At the bottom left is a small tray with several oval-shaped items, labeled '1'. In the bottom center is a circular tray with several small circular indentations, labeled '3&4'. To the right of this is a small cylindrical container. At the bottom right is a rectangular glass tile with a ruler-like scale on its surface, labeled '2'.

**SUPPOSITORIES.**

Glass.....	\$0.25
H. R. with Ring and Finger Rest.	
No. 1, 1/4 in. diameter, 2 1/2 in. long.....	0.75
No. 2, 3/8 in. diameter, 3 in. long.....	0.90
H. R. without Finger Rest.	
No. 5, 1/4 in. diameter, 3 1/4 in. long....	0.50
No. 6, 3/8 " " " 4 " ".....	0.60

**PILL TILES.—GRADUATED.**

OUR HEAVY PLATE GLASS PILL TILES, Engraved with Polished Edges, are much preferred for their perfectly level surface, and for not being liable to the action of grease.

	Earthenware.	Plateglass.
5 inch.....	\$0.75	1.00
6 ".....	1.00	1.33
8 ".....	1.50	2.00
10 ".....	2.25	3.00
12 ".....	4.00	5.00
6x8 in.....	0.75	2.00
8x10 in.....	2.25	3.00
10x12 ".....	4.00	5.00

XXX. MISCELLANIES.

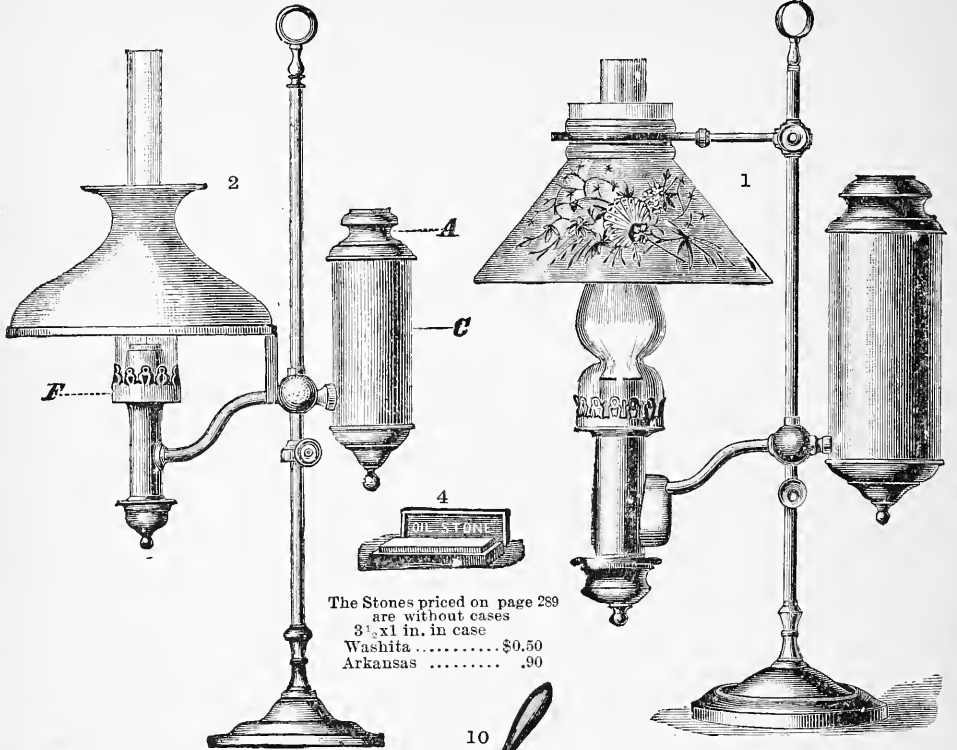

The Stones priced on page 289  
 are without cases  
 3<sup>1</sup>/<sub>2</sub> x 1 in. in case  
 Washita ..... \$0.50  
 Arkansas ..... .90

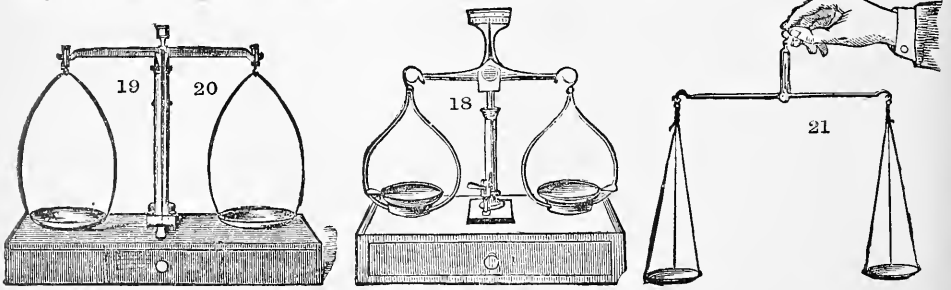
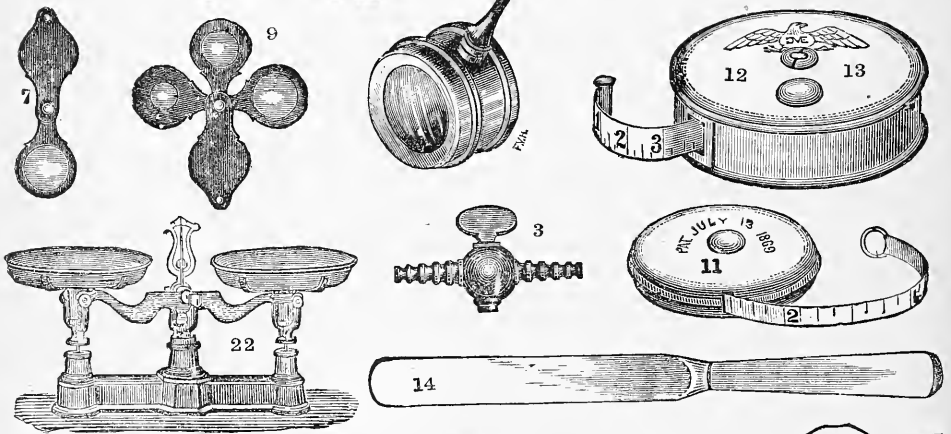

XXX. MISCELLANIES.

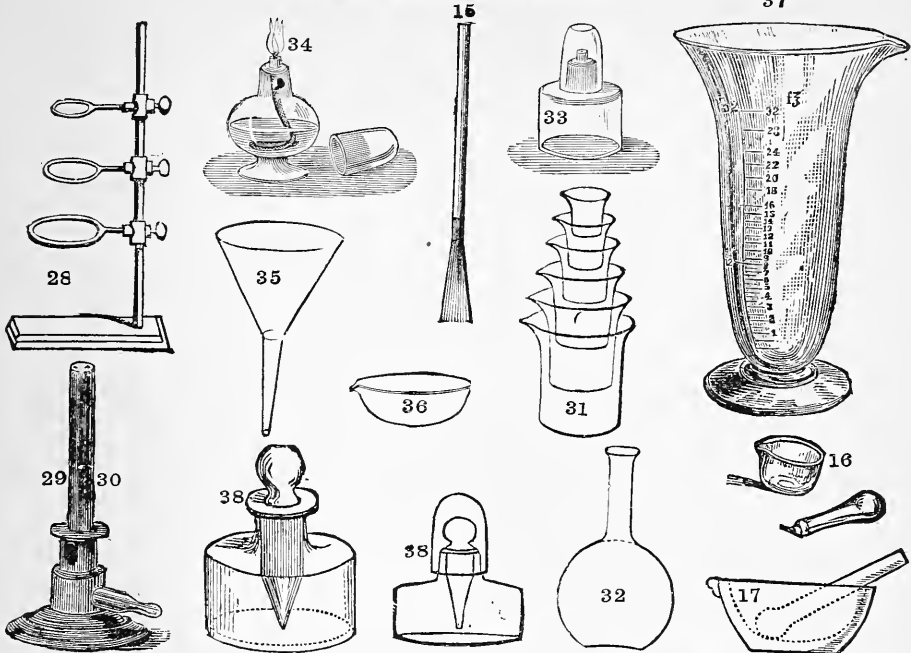

- 1.\* Student's Lamp, Imperial, with plain shade, complete brass \*\$9.00; nicked \*\$10.00  
 In brilliancy of flame this lamp has no superior.
- 2.\* Student's Lamp, regular.....brass \$4.00; \* nicked \*4.50
- 3.\* Stopcock, both ends for rubber tubing..... 0.75
- 4.\* Arkansas Stones, for honing.....\$0.25; \$0.50 and 0.80
5. Bottles, boxwood cased, ½ oz. 0.75; 1 oz. 0.90; 2 oz. 1.10; 3 oz. 1.25; 4 oz. 1.50; 6 oz. 2.00
6. Champagne Taps..... \$1.25
- 7.\* Pocket Magnifying Lense, one glass..... 0.75 and 1.00
8. " " " two glasses..... 1.00 and 1.25
- 9.\* " " " three..... 1.25 and 1.50
- 10.\* " " " Coddington ½ in. 1.25; ¾ in. 1.50; 1 inch 2.00; 1 ¼ in..... 2.50
- 11.\* Tape Measures, plain..... 3 ft. 0.50; 5 ft. 0.60; 6 ft. 0.75
- 12.\* " " fine..... 3 ft. 1.00; 5 ft. 1.10; 6 ft. 1.25
- 13.\* " " with steel tapes..... 3 ft. 1.80; 4 ft. 2.00; 5 ft. 2.25; 6 ft. 2.50
- 14.\* Steel Plaster Spatulas..... 3 in. 0.35; 4 in. 0.35; 5 in. 0.45; 6 in. 0.50; 7 in. 0.60; 8 in. 0.75; 9 in. 1.00
- 15.\* Acid Brushes, glass..... 2 in. 0.30; 3 in. 0.40; 4 in. 0.50; 5 in. 0.60; 6 in. 0.80
- 16.\* Mortars,\* glass..... 2 in. 0.25; 3 ½ in. 0.50; 4 ½ in. 0.75; 6 in. 1.20; 7 ½ in. 2.00; 8 ½ in. 2.50
- 17.\* " porcelain..... 2 in. 0.25; 3 ½ in. 0.50; 4 ½ in. 0.75; 6 in. 1.20; 7 ½ in. 2.00; 8 ½ in. 2.50
- 18.\* Balance,\* Prescription, on blackwalnut box, with drop lever, Beam 5 in..... \*5.00
- 19.\* " " \*Prescription, on French polished box, with drawer, drop lever, bows and removable pans; 7 in. beam for a charge up to 2 oz. and sensible to one-fiftieth grain..... 11.00
- 20.\* " " \*Same as 19, chargeable to 5 oz. and sensible to one-fiftieth grain..... 15.00
- 21.\* Scales, Hand, with brass beam and horn pans suspended by silk cords, Beams 5, 6 and 7 in., resp. 1.75, 2.25 and 2.50
- 22.\* " Roberwall\* ½ kilo. \$3.75; 1 kilo. \$4.00; 2 kilo. \$5.00; 4 kilo. \$6.00; 5 kilo. \$7.00; 10 kilo. \$8.00; 15 kilo. \$10.00; 20 kilo. \$12.00. 25 kilo. 15.00
23. Weights, cup style, brass Troy, 16 oz. to ½ dr..... 6.00
24. " Grain, Aluminium, wire. ½ to 5 grains..... 0.50
25. " " square, ½ to 10 "..... 0.50
26. " Gramme, 50 to 1 centigramme..... 2.50
27. " " 10 to 1 "..... 3.50
- 28.\* Retort Stand,\* Iron..... 2 rings 0.70; 3 rings 0.90
- 29.\* Burner, Finckner, improved..... \*2.00
30. " Bunsen, ordinary..... \*0.75
- 31.\* Beaker\*s, in nests: 0 to 2, 0.50; 0 to 3, 0.60; 1 to 4, 0.95; 1 to 5, 1.35; 1 to 6, 1.85; 1 to 8, 3.00; 1 to 12, 6.00
- 32.\* Flasks, Florence,\* flat Bottom,..... ass. sizes @ 0.25 0.30, 0.35, 0.45, 0.60, 0.75 and 0.90
- 33.\* Alcohol Lamps, Glass, straight..... 0.60
- 34.\* " " Globe..... 0.60
- 35.\* Funnel Glass \$0.25; H. R., not polished, ¼ pt. 0.50; ½ pt. 0.60; 1 pt. 0.75; 1 qut. 1.00; 1 qut. polished 1.25
- 36.\* Evaporating Dishes,\*..... ass. sizes @ 0.25 0.30, 0.35, 0.45, 0.60, 0.75 and 0.90
- 37.\* Graduates,\*..... ½ oz. 0.25, 1 oz. 0.25, 2 oz. 0.30, 4 oz. 0.40; 6 oz. 0.6, 8 oz. 0.60; 16 oz. 0.90
- 38.\* Acid Bottle,\*..... ½ oz. 0.40, 3 oz. 0.45; capped, ½ oz. 0.40
- 39.\* Medicine Tumbler..... 0.50
- 40.\* " "..... 0.75
- 41.\* Minim Measure..... 0.80

All Instruments illustrated are designated by a \*

XXXI. INVALID'S COMFORTS.

WHEEL CHAIRS, ETC.\*

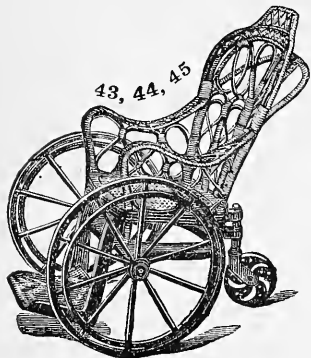

Chair No. 43\*, has caned seat, double frame rattan back, wide flat arms, back handle to push with and standard foot-rest; is very comfortable, and strong enough for a person of 250 lbs. Price, with 24-in. double-rim wheels \$36.00

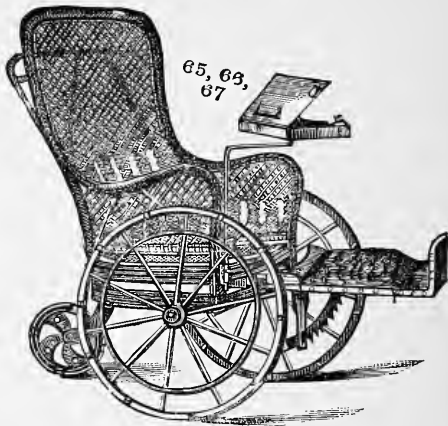

Chair No. 44\*, style as 43, medium size, for young persons, or those not over 4 feet in height. Price, with 20-in. double-rim wheels \$33.00

Chair No. 45\*, style as 43, size for children under nine years of age. Price, with 20-in. double-rim wheels....\$30.00

Chair No. 32, has caned seat, single-frame rattan back and standard foot-rest; strong enough for a person of 175 lbs.; like 43, but without back handle to push with. Price, with 24-in. double-rim wheels .....\$32.00

Chair No. 33, style as 32, medium size, for young persons, or those not over 4 feet in height. Price, with 20-in. double-rim wheels.....\$29.00

Chair No. 34, style as 32, size for children under nine years of age. Price, with 20-in. double-rim wheels .....\$26.00

Chair No. 65\*, has caned seat, a well braced frame, wide arms, back handle to push with, and is strong enough for a person of 250 lbs.

It is the most handsome, salable, durable and comfortable of all rattan chairs. The back and arms are made of fine split machine-prepared rattan, plaited closely in three strands wide, leaving no ridges objectionable to the delicately sensitive or to those having spinal complaint, and making a flexible, springy support for the occupant's full length of back, to which it conforms.

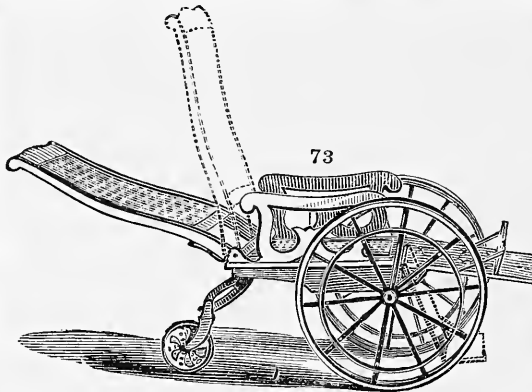

Chair No. 65.—Continued. The ADJUSTABLE DESK shown herewith on cut is Extra, and can be added to any of the chairs at an additional price of \$5.00. Price, with 24-in. double-rim wheels.....\$40.00

Chair No. 66\*, style as No. 65, medium size, for young persons, or those not over four feet in height. Price, with 20-in. double-rim wheels \$37.00

Chair No. 67\*, style as No. 65, size for children under 9 years of age. Price, with 20-in. double-rim wheels .....\$34.00

Chair No. 73\*. is a Black Walnut framed Reclining Chair, having caned seat and back, and Folding Leg-Rest with cord attachment for self-adjustment to numerous positions. The back has a carved and veneered head piece (not shown in cut), and is adjustable, either by occupant or other person, from either side of the chair, the adjusters being connected at the back by a rod, and working together. When the adjusters are in place, the back can be secured by moving either up or down, and may be used to push with, by a second person.

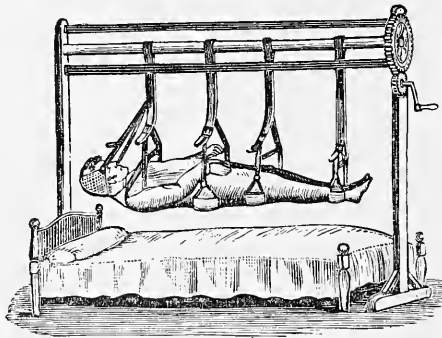

Chair No. 73.—Continued. Back 33 inches high, seat 20 inches deep, 18½ inches wide, and 15 inches to foot-rest; arms, 8½ inches high, strong enough for a person of 250 lbs., and will pass through a 30-inch doorway. Price, with 24-in. double-rim wheels.....\$42.00

Chair No. 75\*, same style and size frame as above, upholstered in green terry, with spring seat, piped back and stuffed arms on sides and tops, making a very fine chair. Price, with 24-in. double-rim wheels .....\$60.00

JENCKE'S ALLEVIATOR.\*

An invention, both simple and complete, for raising from the bed,—in invalids, or any one bed-ridden,—with ease and comfort, and without jar, allowing bed to be made up. For ordinary bedsteads, any weight invalid, and can be operated by one attendant. In use over sixty years. Price .....\$50.00

Further information regarding any of the above given on demand.

**XXXI. INVALID'S COMFORTS.**

**THE CROSBY INVALID BEDSTEAD.**



This Bedstead is designed to give comfort and ease to those patients so exhausted from disease that they are obliged to be lifted from one bed to another to have it made up; also to prevent bed-sores and cure those already existing. In all cases of Fractures, Amputations, Dysentery, Acute Rheumatism, the last stages of Consumption and Typhoid Fever, attended with great prostration and involuntary discharges, it affords easy access to the body—permitting the bed-clothes to be changed, the bed made up, securing perfect cleanliness, without fatigue or annoyance, and allowing defecation to be performed without moving the patient. It is also especially adapted for use in cases of Child-Bed.

One person can perform all the necessary duties to a sick person, make up the bed, wash and ventilate the body, dress bed-sores, and use the bed-pan, without assistance or disturbing the patient.

It is simple in its construction, and not liable to get out of repair. A child twelve years old can manage it. Hundreds of them in use, and in no instance have they failed to give satisfaction.

**PRICES.**

Bedstead . . . . .	\$25.00*
Head Rest . . . . .	5.00*
Adjustable Table . .	5.00*
Excelsior Mattress .	2.50*
Soft Top Excelsior Mattress . . . . .	4.50*

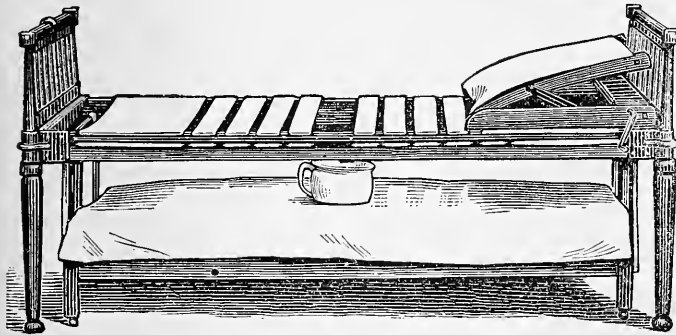

**THE SOLID COMFORT BED REST AND UTILITY FOLDING BED TRAY.**

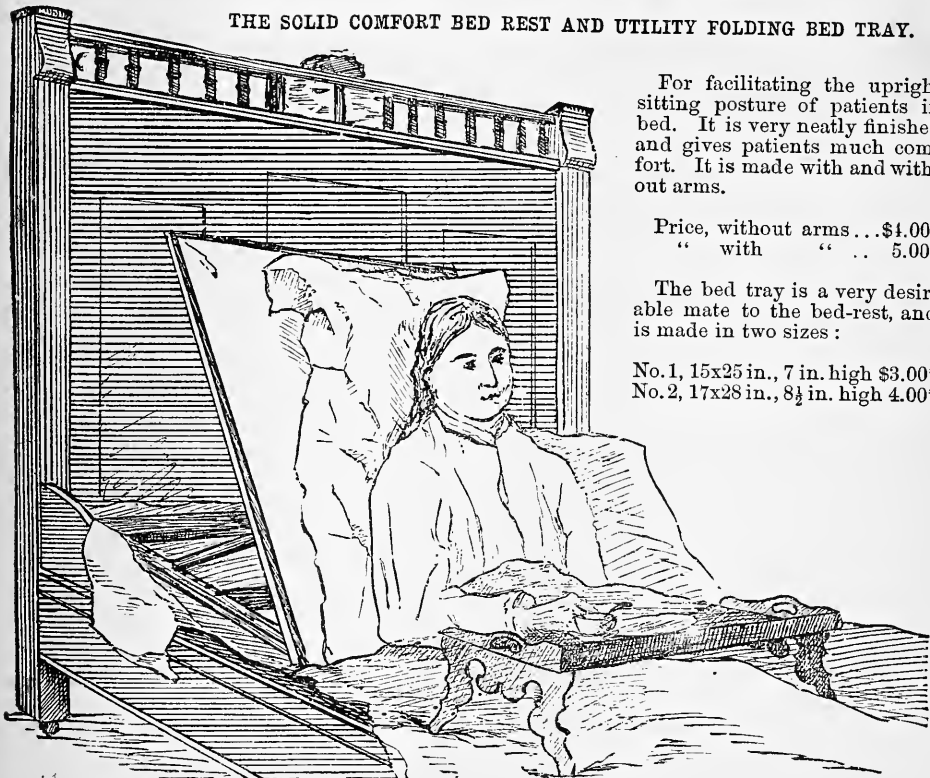

For facilitating the upright sitting posture of patients in bed. It is very neatly finished and gives patients much comfort. It is made with and without arms.

Price, without arms . . .	\$4.00*
“ with “ . . . . .	5.00*

The bed tray is a very desirable mate to the bed-rest, and is made in two sizes :

No. 1, 15x25 in., 7 in. high	\$3.00*
No. 2, 17x28 in., 8½ in. high	4.00*

**XXXII. ELASTIC GAUNTLETS, WRISTLETS AND ELBOW CAPS.**

TO BE WORN AFTER SPRAINS AND DISLOCATIONS.

DIRECTIONS FOR MEASUREMENT.

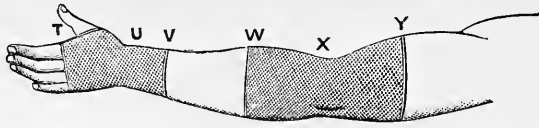

Indicate the circumferences of the limb in inches at the points represented by letters on above figure, and the distance each way from the point which it is desired the appliance should cover.

- For a Gauntlet..... measure at T U & V.
- “ “ Wristlet..... “ “ U & V.
- “ an Elbow Cap..... “ “ W, X & Y.

**PRICES PER PIECE.**

	SILK.		THREAD.
	First Quality.	Second Quality.	First Quality.
Gauntlet, to cover hand .....	\$2.50	\$2.25	\$2.00
Wristlet, four inches long .....	1.75	—	1.25
Elbow Cap.....	2.75	2.50	2.00

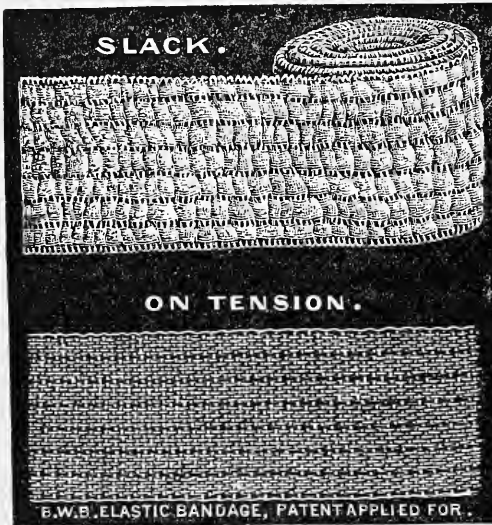

**ELASTIC BANDAGE.\***

Unexcelled in porosity, elasticity, absorbent qualities, ease of application and self-holding qualities. Tucking end under last fold insures permanent stay.

3 yds. long, 2 in. 50 cts.; 2½ in. 60 cts.;  
3 in. 75 cts.

5 yds. long, 2 in. 65 cts.; 2½ in. 75 cts.;  
3 in. \$1.00.

**THE EMPIRE UMBILICAL TRUSS.\***

- Infant's..... \$1.00
- Adult's ..... 4.00

**EMPIRE ABDOMINAL SUPPORT.\***

As shown by figure to the right, in ordering give the measure of the abdomen. The Supporter should be from four to ten inches larger, according to the degree of support required.

- Common size, 8 in. wide ..... \$2.50
- Extra “ 11 “ ..... 3.00



**XXXII. ELASTIC STOCKINGS, TRUSSES, SUPPORTERS, BANDAGES, &C.**

**ELASTIC STOCKINGS.**

**DIRECTIONS FOR MEASUREMENT, ETC.**

The measures should be taken moderately tight at points required as per annexed diagram. Morning measurements are preferable as the limbs become increased in size as the day advances. Especially for the first time and also as a rule stockings should be put on immediately after rising.

The damage caused to stockings by drawing on and removing is greater than by the actual wear.

We allow for Compression, and the actual measurements of the limb should be sent to us.

Diagrams to aid in taking Measurements will be mailed free upon application. The following Measurements are required:

For stockings to reach to O: Circumferences at I, K, A E, L, M, N, O, C to D and E to F.

For Knee Stockings. The same as above and also circumference at F, the desired length above F, and circumference at upper margin.

For Knee Caps. Circumference at F, Length up and downward, Circumference at upper and lower border.

For Calf Pieces. Circumferences at L, M, N and O and the desired length.

For Anklets, Circumferences at K, A E and upper border. State how high above A C wanted.

For Full Leg Stockings, the same as for Stockings to reach to O, and also circumference at F, P, Q, R and S and length G to H.

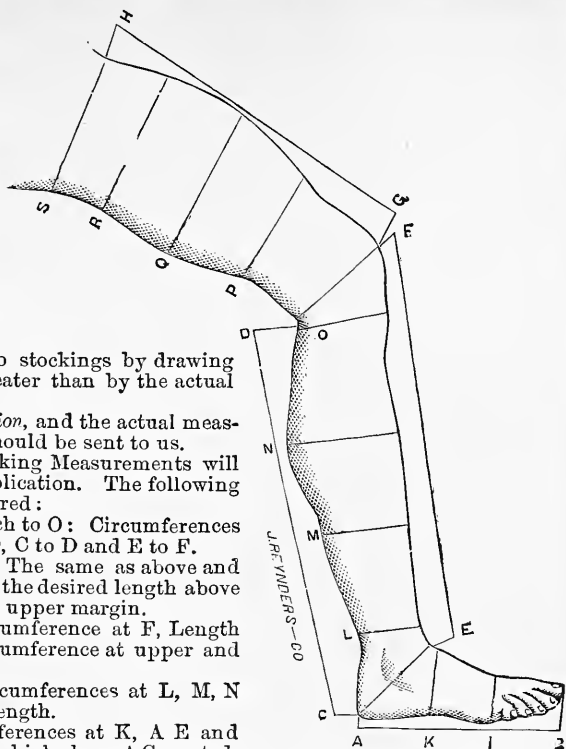

Instead of approximating Elastic Stockings when filling orders for same from a ready-made stock kept on hand to the measures sent, we now make everything in this line to order. We have increased our facilities so that we can do this within several hours upon receipt of order and without additional charge. We are thus enabled to give much better satisfaction than in years past and every care taken in measuring will now result in securing a better fit.

**PRICES PER PIECE.**

	SILK.				UNBLEACHED COTTON THREAD LIGHT OR HEAVY.
	HEAVY.		FINE.		
	FIRST QUALITY.	SECOND QUALITY.	FIRST QUALITY.	SECOND QUALITY.	
For whole Leg to S.....	\$12.00	\$9.00	\$10.00	\$9.00	\$7.00
“ Leg to P.....	7.50	7.00	7.00	6.50	4.50
“ “ to O.....	4.75	4.00	4.50	3.75	2.50
“ Calf only.....	3.25	3.00	3.25	2.75	2.25
Knee-Caps.....	2.75	2.50	2.75	2.50	2.00
Anklets.....	2.75	2.50	2.75	2.50	2.00

Diagrams to aid in taking measurements will be mailed free upon receipt of application.

**RUBBER BANDAGES.**

FOR THE TREATMENT OF VARICOSE VEINS AND DISEASES OF THE SKIN.

Made of the purest gum. All with tapes.

1½ inches by 2 yards..... 25 cents.

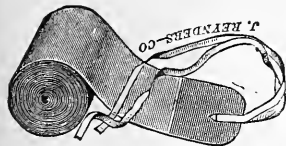

	3 yds.	4½ yds.	6 yds.
2 inches wide	\$0.60	\$0.90	\$1.25
2½ “ “	..0.80	..1.25	..1.50
3 “ “	..1.00	..1.50	..1.75

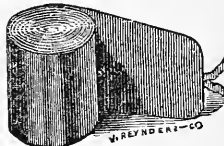

Bandage 1 inch wide for fingers, per yard, 20c.

Rubber Bandages of any of these widths and any length supplied on the basis of above prices.

Lower priced Rubber Bandages are of inferior material and can be also supplied by us at lower rates.

Dr. G. H. Fox's Tubular Rubber Bandage, per foot.....\$0.50

TRUSSES.

When ordering Trusses state:

- 1) Sex of patient.
- 2) Occupation of patient.
- 3) Circumference of body between the crest of ilium and trochanter major. (On an adult two inches below the tips of the hips, avoiding the fullness of the abdomen.)
- 4) Whether the hernia is on the right, left, or on both sides.
- 5) Whether it is *Inguinal, Scrotal or Femoral Hernia.*

During our experience (extending over thirty years) in applying trusses, we have never met a case of hernia which could not be relieved by the German or French models of trusses as manufactured by us. The practical knowledge obtained during this period enables us to manufacture these trusses of shapes that are calculated to suit the greatest average of cases; this together with the correct shapes and bearings of our pads and necks, complete instruments that are readily fitted with the certainty of giving relief. The peculiar curves given to our springs causes our trusses when properly applied to fit the body perfectly; no motion, position or effort will be found to move them from place; in their manufacture the best German steel, a superior quality of leather and horse hair for upholstering the pads are used only.

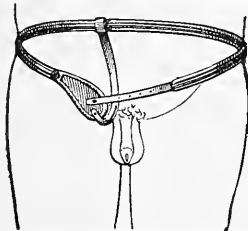

The best workmanship executed by skilled mechanics is guaranteed.

For severe cases and for hardworking patients our German Truss, containing strong spring with large pad and wide leather covering, will be found most suitable; for others our French Truss containing light spring with smaller pad and narrow leather covering.

Perineal straps are furnished with all of them. Regular sizes of Adult's Trusses run from 30 to 38 inches; Youth's from 22 to 28 inches and Child's from 12 to 20 inches.

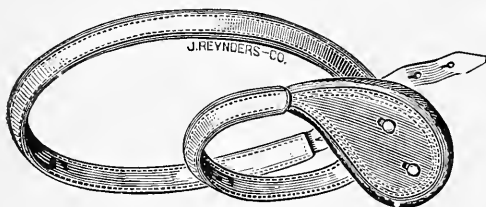

2026.A.

2026.A. German Single Truss.

Adult's, .....	\$4 00
Youth's, .....	3 50
Child's, .....	2 50

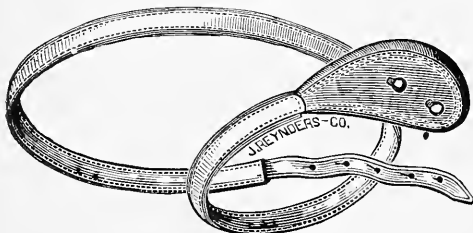

2026.B.

2026.B. French Single Truss.

Adult's, .....	\$4 00
Youth's, .....	3 50
Child's, .....	2 50

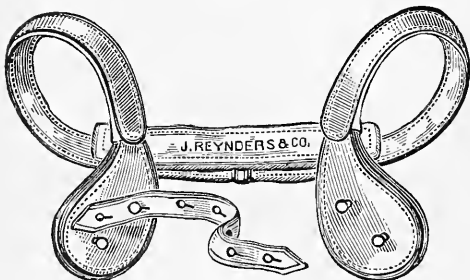

2026.C.

2026.C. German Double Truss.

Adult's .....	\$7 50
Youth's, .....	6 50
Child's, .....	4 00

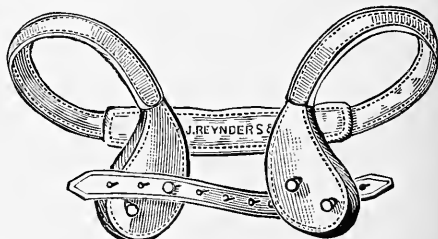

2026.D.

2026.D. French Double Truss.

Adult's, .....	\$7 50
Youth's, .....	6 50
Child's, .....	4 00

25% off if applied by ourselves, 50% off otherwise.



**2027. German Single Truss with elongated pad tapering into a perineal strap for severe cases of Scrotal Hernia.**

Adult's, .....\$5 00  
 Youth's, ..... 4 50  
 Child's, ..... 3 50

Double:

Adult's, .....\$9 00  
 Youth's, ..... 8 00  
 Child's, ..... 5 50

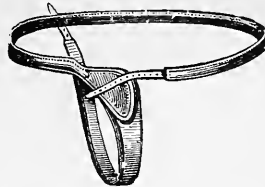

2027.

**2028. French Single Truss, Extra light, with pad for the protection of the spine. The covering is stitched on the outside of the spring.**

Adult's, .....\$5 00  
 Youth's, ..... 4 50

Double:

Adult's, .....\$9 50  
 Youth's, ..... 8 50

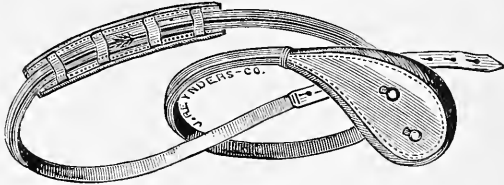

2028.

With Hard rubber pads.

Single:

Adult's, .....\$5 50  
 Youth's, ..... 5 00

Double:

Adult's, .....\$10 00  
 Youth's, ..... 9 00

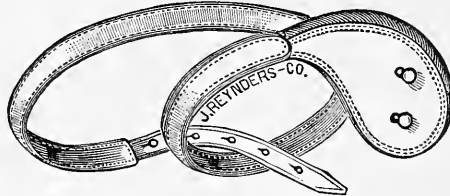

2029.

**2029. French Single Truss for Femoral Hernia.**

Ladies', .....\$4 00  
 Misses', ..... 3 50  
 Child's, ..... 2 50

Double \$7.50, \$6.50 and \$4.00 respectively.

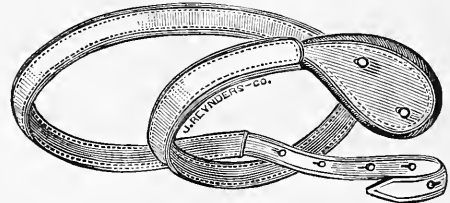

2030.

**2030. French Single Truss for Femoral Hernia.**

Ladies', .....\$4 00  
 Misses', ..... 3 50  
 Child's, ..... 2 50

Double \$7.50, \$6.50, and \$4.00 respectively.

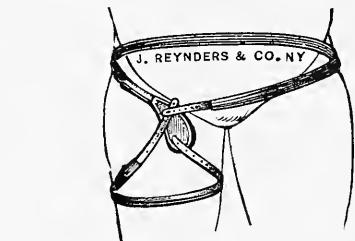

2031.

**2031. French Single Truss, with high strap for Femoral Hernia.**

Ladies', .....\$5 00  
 Misses', ..... 4 50  
 Child's, ..... 3 00

Double \$9.00, \$8.00 and \$5.50 respectively.

**2036. Elastic Truss. Made reversible for the right or left side, and furnished with extra heavy elastic webbing. Plain, embossed and nickel-plated, with polished cedar or fine chamois pad.**

Single \$3.00; double \$5.00.

Gold, embossed and nickel-plated, with polished cedar or fine chamois pad.

Single \$3.50. double \$6.00.

The latter, with extra heavy silk elastic webbing.

Single \$5.00; double \$7.50.

Youth's, furnished at same prices with Water Pads. Plain, embossed and nickel-plated, with polished cedar or fine chamois pad.

Single \$2.50; double \$4.00.

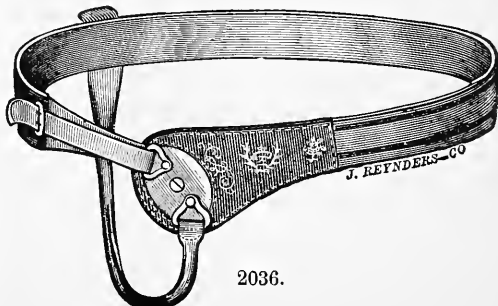

2036.

TRUSSES.

CHAMPION TRUSS,

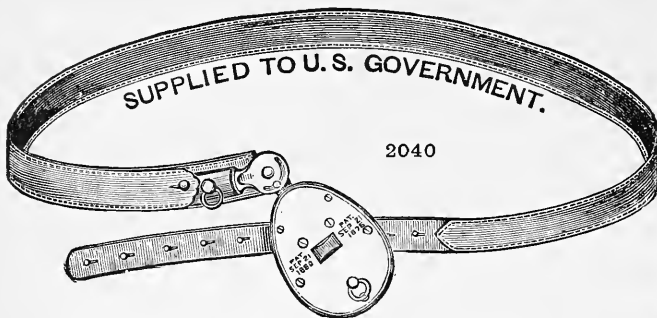

with the pad and swivel ratchet so made as to fit for either side, and adjustable to any angle required. The truss consists of a socket, riveted to the spring in which the swivel-arm turns, with a ring screw to hold the swivel-arm, to which the pad is attached; the pad can also be turned around on the swivel-arm, and is held firm by a ring screw on the top of pad.

- 2040.\* Single, leather covered, adult's \$1.00; youth's \$2.50; child's \$2.00
- Single, h. r. covered, adult's \$4.00; youth's \$3.00; child's 2.50
- Double, leather covered, adult's \$6.00; youth's \$4.00; child's 3.50
- Double, h. r. covered, adult's 9.00
- 2041.\* Radical Cure:
- Single, leather covered, adult's 4.00
- “ h. r. “ “ 5.00
- Double, leather “ “ 7.00
- “ h. r. “ “ 9.00

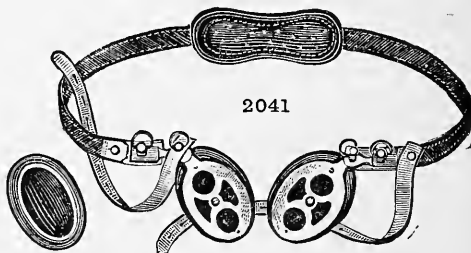

WATER PADS.

These are made with a rubber bag filled with water, securely fastened to a metal plate and covered with a fine quality of silk jersey cloth. They are especially adapted to elastic trusses, and may be used on some of our other trusses.

- Either Leather Trusses.....additional to prices given: single \$1.00; double \$2.00
- Hard rubber, adult's .....single, 1, 1c and 5, each \$6.00; double, 2 and 5 10.00
- “ youth's and infant's.....single \$4.00; double 7.00

HARD RUBBER TRUSSES.

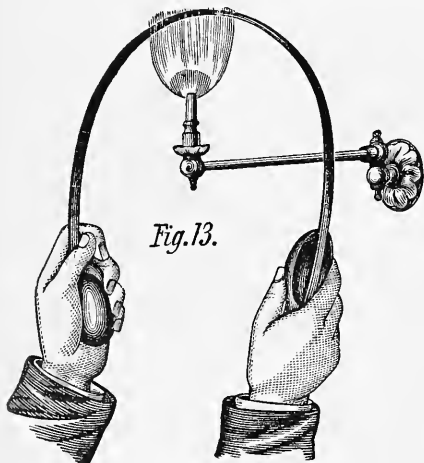

Important advantages in manipulating power and shape.

The following illustrations show the advantages of our special hard rubber and steel spring combination as a material in the manufacturing and manipulating of a truss to obtain any desired fixed power or shape.

DIRECTIONS.

To INCREASE POWER OF SPRING.—Warm, by passing quickly through flame (gas jet, large spirit lamp, or twisted paper), heating both sides from end to end, as shown in fig. 13, until warm to the hand; then bend the spring by passing pads across, holding until cool (see fig. 14), when it will be found, by the stretching of rubber on outside and contracting on inside while warm, the spring has been increased one-half to double its original power, remaining unchanged until again heated.

25% off if applied by ourselves; 50% off otherwise.

**HARD RUBBER TRUSSES.**



Fig. 14.

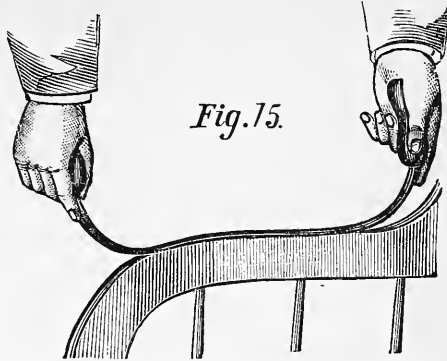

Fig. 15.

To WEAKEN POWER OF SPRING.—Warm as above, then straighten gradually with hand, or bend over arm of chair, holding until cool. (See fig. 15.)

FITTING TO FORM.—Warm as above, shaping with hands or over arm of chair, that the truss may fit the body perfectly, when no motion, position, or effort will be found to move it from place

**SINGLE HARD RUBBER TRUSSES.**

Fine steel springs, neatly covered with highly polished hard rubber, unaffected by time, use or climate; mountings made of the best quality of brass, highly finished and nickel-plated.

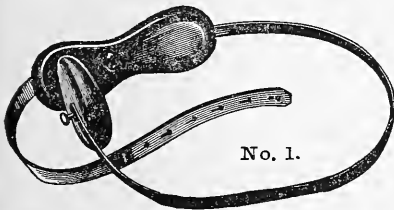

No. 1.

No. 1 represents our Cross Body or English Pattern Single Truss, equally applicable to right or left Inguinal Hernia, by adjusting the pad so that the "top" end points upward and outward.

This truss should be applied from the well or opposite side, with the center of back pad resting directly over the spine, and the flat ends bearing upon the heavy muscles on either side, the front of spring passing across the abdomen to rupture being peculiarly shaped to conform perfectly to that part of the body, a noticeable feature long

recognized in trusses of our manufacture only. This pattern of truss is fitted with either of the pads shown in the illustrations below.

Adult's, with Pads 1, 3, 3-A or 3-F .....	\$5.00
“ “ “ 3-B. & S., 4 or 8 .....	6.00
“ “ Concave Pad .....	6.00
“ “ Sectional Pad 12 .....	7.50
Youth's .....	\$4.00; Infant's 3.00

**PADS GOING WITH HARD RUBBER TRUSSES.**



No. 1. No. 3-A. No. 3. Concave. No. 3-B. & S. No. 3-F. No. 4. No. 8. No. 12 Sect.

No. 1 represents a Grooved or Corrugated Hollow Pad, and is attached to spring with stud-head screw.

No. 3 represents a Plain Convex Hollow Pad (as shown on truss).

No. 3-A represents a Small Convex or Femoral Pad.

No. 3-F represents an Oval Pad, slightly narrower and much thicker over its lower half than No. 3.

No. 3 Concave represents a Concave Pad, applicable in cases of small, irreducible hernia, shown, and its proper use described in print for the first time, in "Agnew's Surgery."

No. 4 represents a Ball and Socket Action Pad, slightly convex, apex center.

No. 8 represents a Convex Pad, ball and socket action, with set screw.

No. 12 Sectional represents a pad having a hard rubber ball surrounded by a soft rubber or kid ring, and is more fully described on next page with No. 12.

N. B. Any of these pads can be supplied, when so ordered, with ball and socket action joint, as shown in No. 3-B. & S.

25% off if applied by ourselves; 50% off otherwise.

**HARD RUBBER TRUSSES.**

No. 12 represents our Cross Body or English Pattern Single Truss, with Combination Pad, and is applied from the well or opposite side (made both right and left). It is used successfully in the mechanical treatment of Direct Omental, Large Scrotal, or Complicated Cases, and when it has been intelligently used, in accordance with our directions, a radical cure has frequently been effected in cases where it was least expected. In the illustration the hernia pad attached to truss is shown in sections A, B and C.

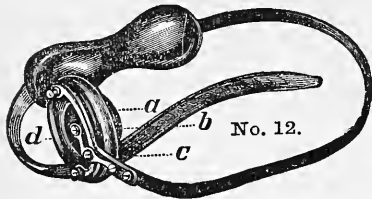

a shows the face or abdominal bearings of the pad, and is connected to the spring by a gold-plated, double-arm brass attachment, with stud-head screws.

b shows the hard rubber oval ball and concave cushion-rest; the ball (which is made in various sizes to meet the requirements of different cases) is attached to a steel spring, and can be regulated to give more or less direct pressure by a thumb screw.

c shows the cushion, which is made either of soft rubber or of a yielding material covered with kid, conforming perfectly to the cushion-rest, and retained in position by the oval ball.

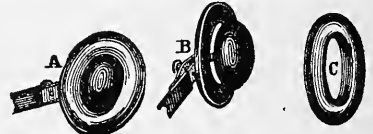

This pad, when connected, is designed to make both general and concentrated pressure, as illustrated in "Agnew's Surgery," Vol. 1., page 457.  
Price..... \$15.00

No. 12-C. Pad, same as above. The spring is so constructed as to encircle and conform perfectly to the shape of the body; the continuous or back end of spring is fastened by a stud-head screw to a small flat pad resting upon the hip. The additional strap support can

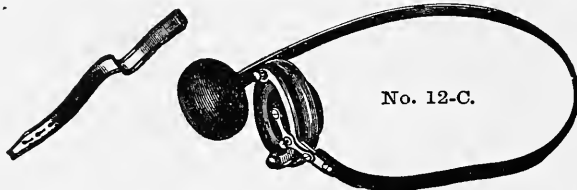

be readily attached to the stud-head screws connecting the two pads, if desired. This truss will retain its position and can be worn with safety in most cases without the use of strap.  
Price..... \$15.00

No. 5 represents our Adjustable French Single Truss, applied from the affected or ruptured side, and is designed for one side only (made both right and left). The hernia pad is especially constructed to conform to the inguinal region and lower abdomen, and can be moved laterally by a set-screw attachment (shown at "A" in illustration). "C" shows our detachable strap fixture, by which a new strap may be applied by the wearer at will. "D" shows our improved clip for holding the adjustable fixture "B" and preventing rusting of the spring at the screw holes.

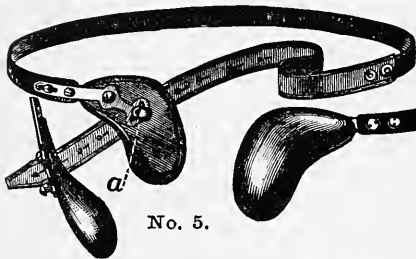

The pad is made in two sizes, "No. 1 A. F." being the larger and "No. 2 A. F." the smaller.  
Price..... \$5.00

No. 11 represents our French Pattern Single Truss, applied from the affected or ruptured side; designed for one side only (made both right and left). It is extremely light and elastic, and popular in the trade for slight cases of inguinal hernia, and has our improved strap attachment same as No. 5 shown above.

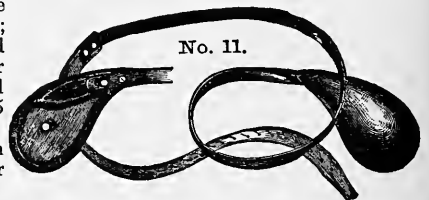

The pad is made after the genuine French pattern, in two sizes, "No. 1 F." being the larger and "No. 2 F." the smaller.

Price..... Adult's \$5.00; Youth's \$4.00; Infant's \$3.00

25% off if applied by ourselves; 50% off otherwise.

**HARD RUBBER TRUSSES.**

No. 29 represents our Chase Pattern Single Truss, with Flexible Neck Pad Attachment, applied from the affected or ruptured side, and designed for one side only (made both right and left). The pad is of that peculiar shape which will be recognized at once as a *fac-simile* of the original Dr. Chase Pad, and unlike the various so-called Chase trusses. The pad is made in two sizes, "No. 1" being the larger and "No. 2" the smaller.

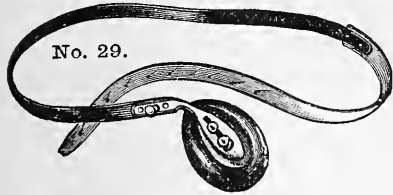

"c" shows our detachable strap fixture, by which a new strap may be applied by the wearer at will.

Price ..... \$5.00

No. 1-C is our Cross Body Continuous Spring Single Truss, and is applied from the well or opposite side, being so constructed as to encircle and conform perfectly to the shape of the body; the continuous or back end of spring is fastened by a stud-head screw to a small flat pad resting upon the hip. The additional strap support can be readily attached to the stud-head screws connecting the two pads, if desired. This truss will retain its position and can be worn with safety in most cases without the use of strap.

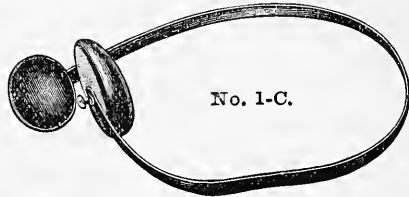

If properly adjusted, it is unobservable even when worn beneath the thinnest garment, and is usually preferred by ladies. All of the various pads shows in No. 1 are equally adapted to this truss. (See page 297.)

Adult's, with Pads 1, 3, 3-A or 3-F .....	\$5.00
" " " 3 B. & S., 4 or 8 .....	6.00
" " Concave Pad .....	6.00
" " Sectional Pad 12 .....	7.50
Youth's .....	\$4.00; Infant's 3.00

**DOUBLE HARD RUBBER TRUSSES.**

No. 2 represents our Plain Double Truss, consisting of two separate springs, mounted upon flat posterior or back pads joined by strap, or connected by a broad ribbon-like curved spring, as shown at "a" below. Plain No. 3 Convex Hernia Pads attached to front ends of springs by stud-head screws with connecting strap. This truss, when properly applied, should fit perfectly to the form; the springs should be of sufficient power to retain the hernia without girthing tightly with connecting strap, and the "rop" ends of hernia pads should point upward and outward.

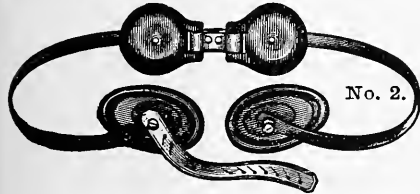

The various pads shown on page 207, No.

1, Adult's Single Trusses, are applicable to this truss.

Adult's, with Pads 1, 3, 3-A, 3-F, spring back .....	\$7.50
" " " 3 B. & S., 4, 8, spring back .....	8.00
" " Concave Pad .....	10.00
" " No. 12 Sectional Pad .....	15.00
Youth's .....	\$6.00; Infant's 5.00

No. 5, double, represents our "Adjustable French" Double Truss. (For description of hernia pads and improvements, see No. 5, page 293.) Fitted either with Hollow Cushion-Shaped Stiff Back Pads, or with the Extension Spring Back Pad Attachment (same as "No. 2, Spring Back," page 299).

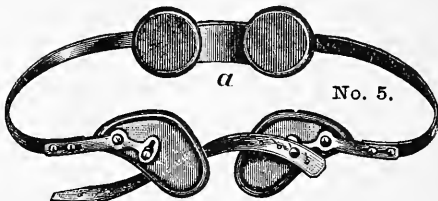

Price ..... \$8.00

25% off if applied by ourselves; 50% off otherwise.

**HARD RUBBER TRUSSES.**

No. 11, Double, represents our French Pattern Double Truss. It is extremely light and elastic, and applicable to slight cases of double inguinal hernia, where the patient is not engaged in laborious work or active exercise—the hernia pads being of the genuine French pattern, in two sizes, “No. 1 F.” being the larger, and “No. 2 F.” the smaller. Fitted either with Hollow Cushion-Shaped Stiff Back Pads, or with the Extension Spring Back Pad Attachment (same as “No. 2, Spring Back,” page 299).

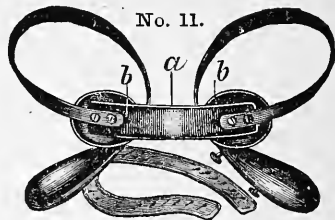

In the illustration “a” shows the broad, ribbon-like curved spring, and “bb” the round, flat back pads.

Prices.....Adult’s \$7.50; Youth’s \$6.00; Infant’s \$5.00

**HARD RUBBER UMBILICAL TRUSS.**

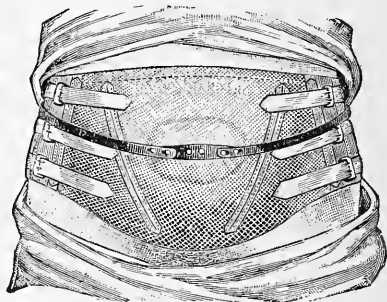
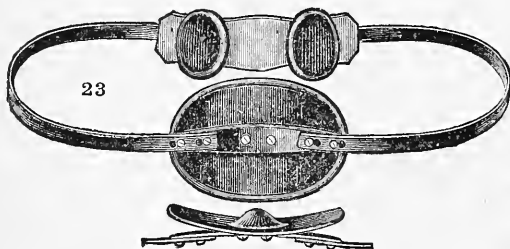

23.\* Hard Rubber Umbilical Truss..... \$8.00  
 24.\* Same as 23, combined with Elastic Supporter 38 in. and below..... 20.00

25% off if applied by ourselves; 50% off otherwise.

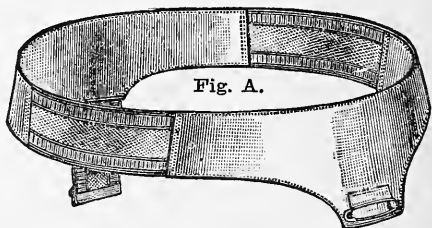
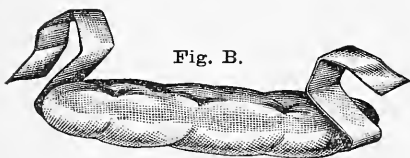

Fig. A.—Elastic Doily Belt, made of fine colored sateen, with silk elastic sides and back, nickeled or japanned safety pins front and back. Sizes in inches to correspond with waist measure. Worn by ladies during the menstrual period for the convenience of attaching the napkin. The peculiar elasticity prevents chafing, and whether walking or sitting it conforms to the various positions of the body without danger of loosening.

Price .....cotton \$1.00; silk \$1.50

Fig. B.—Antiseptic Catamenial Absorbent Pads, made of fine absorbent cotton, neatly inclosed in a gauze covering, firmly stayed with a muslin band, by which they may be attached to our Elastic Doily Belt, or other arrangement. These pads have been found far superior to anything heretofore in use. For traveling, especially on long voyages, they have become a necessity, promoting health, cleanliness and comfort. Their low price makes them cheaper than washing, which, combined with convenience, recommends them for general use.

Packed in boxes holding one dozen for convenience of sending by mail..... \$1.00



DR. W. B. DE GARMO'S IMPROVED TRUSS FOR FEMORAL HERNIA.

(From the Medical Record, August 4th 1877.)

Those of the profession who have had experience in the treatment of femoral hernia appreciate the many difficulties attending such an undertaking, and are aware that it is almost impossible to select from the many trusses one which will retain hernia of this character fully and with any degree of comfort.

In constructing trusses for femoral hernia, the prevailing idea seems to have been to make the pad large enough to keep the hernia out of sight, and this, in fact, is about all they can do, except to make undue pressure upon the vessels and nerves of this region; they are exceedingly uncomfortable to wear, move from their place easily, and fail in most instances to retain the hernia perfectly.

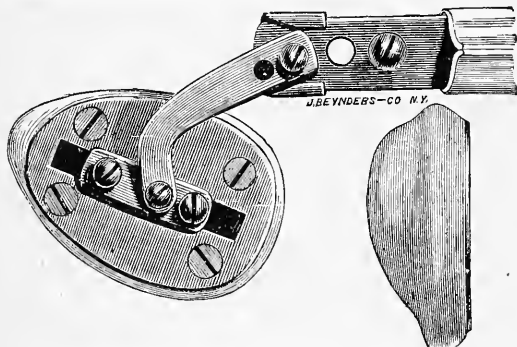

In devising the truss represented in the accompanying cut I have endeavored to rectify the faults mentioned. The form of spring which I have found most convenient and successful is that known as the English pattern, which passes around the hip opposite the affected side. To the end of this is attached a movable curved arm, as shown in the cut; the movements of the latter upwards and downwards are limited by the clasp partially surrounding the main spring. To the larger end of this arm is attached a thin bar of steel, which carries two screws, with nuts beneath the plate on the hernial pad, the nuts move easily in a groove beneath the plate, even under strong pressure.

The pad differs in shape from those in ordinary use. Its size is only one-third larger than represented in the cut; two-thirds of its inner surface is thin and flat, the remaining one-third being quite prominent.

It is designed that the flat surface shall rest over Poupart's ligament, and the prominent portion pass immediately beneath. In this position the pad is securely held, and the hernia is completely retained without discomfort to the patient.

The advantages claimed for this truss over all others are:

- First. Safety. It holds the hernia more secure, and with proportionately less pressure than ordinary trusses.
- Second. Comfort. The combination which attaches the pad to the spring, allows a relative change in position of the latter in sitting or stooping, without displacing the former or crowding it against and compressing the femoral vessels.
- Third. Ease in fitting. Every part can be shaped to suit individual peculiarities in form, after which it is perfectly self-adjusting.

MEASUREMENTS REQUIRED.

- 1) General appearance of patient.
- 2) Circumference of body between crest of ilium and trochanter major.
- 3) Mention whether rupture is right, left, or on both sides.

Price.....\$6.00.

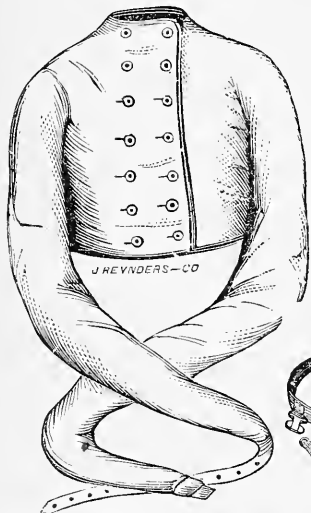

Straight Jacket for Idiots, etc., \$15.00.\*

Buckles for same \$2.50.

SUSPENSORIES.

With Knitted Bags.

- Elastic in Back, linen 75 cts.; silk \$1.00.
- With Perineal Straps, linen 75 cts.; silk \$1.00.
- With Draw String, linen 75 cts.; silk \$1.00.
- Bag buttoned to belt, linen 1.00; silk 1.50
- Bag of loose web, linen..... 1.00
- " " Elastic Material, silk 0.75; cotton 0.50

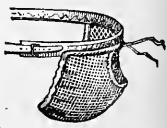

RAWSON'S SUSPENSORIES.

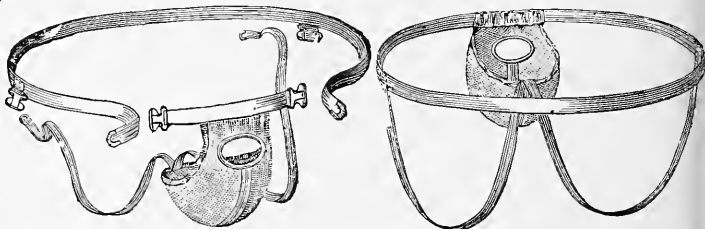

The Different Numbers are made Regularly in 3 Sizes, Large (L.) Medium (M.) Small (S) and Specially in any Desired Size and Shape.

- Styles. Every Bandage, in the Several Styles, is trimmed and finished with Silk.
- No. 1—Frilled Elastic Waistband and Buttlock Straps, made whole (without buckles). Bags of German or American material, soft and durable, trimmed and finished in silk.....\$1.50
- No. 1½—Frilled Elastic Waistband and Buttlock Straps, with 2 adjusting buckles at abdomen. Bags of German or American material, soft and durable, trimmed and finished in silk..... 1.75
- No. 2—Fine Plain Elastic Waistband and Buttlock Straps, made whole (without buckles). Bags of extra fine quality German or American Material, soft and durable, trimmed and finished in silk..... 2.00
- No. 3—Superfine Plain Elastic Waistband and Buttlock Straps, with 2 adjusting buckles at abdomen. Bags of French material, very soft and durable. Extra quality silk trimmings and beautifully finished..... 2.50
- No. 4—Superfine Plain Elastic Waistband and Buttlock Straps, with 2 adjusting buckles at abdomen, and 2 buttlock strap adjusting buckles. Bags of finest French material, very soft and durable. Extra quality silk trimmings, and beautifully finished..... 3.00
- No. 5—Silk Bag—Superfine Elastic Waistband and Buttlock Straps with 2 adjusting buckles at abdomen, and 2 Buttlock Strap adjusting buckles. Bags of fine English silk netting in white or flesh color. Superfine quality silk trimmings, and beautifully finished..... 3.50
- No. 6—All Silk—Superfine Silk Elastic Waistband and Buttlock Straps, with 2 adjusting buckles at abdomen, and 2 Buttlock strap adjusting buckles. Bags of fine English or French silk netting in white or flesh colors. Superior quality of silk trimmings and artistically finished..... 5.00



**Umbilical Trusses and Bandages, Abdominal Supporters,  
Shoulder-Braces, etc., etc.**

MEASUREMENTS REQUIRED:

When ordering an Umbilical Truss or Bandage, state: Circumference of the body at the navel and diameter of the hernia.  
 When ordering an Abdominal supporter, state: Circumference of the body between the crest of ilium and trochanter major, (on an adult about two inches below the tips of the hips) over the fullness of the abdomen.  
 When ordering a Shoulder Brace, state: Diameter of the back, from tip to tip of shoulders. Length from the superior border of the scapula to the spinous process of the fifth lumbar vertebra. Circumference of the body at the waist.  
 When ordering a Rectum Supporter, state: Circumference of the body between the crest of ilium and trochanter major. Length from the spinous process of the second sacral vertebra to the rectum.

2038

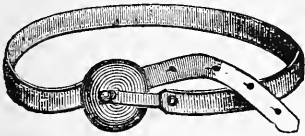

2040

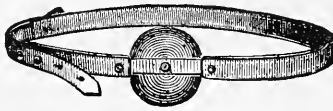

2038.\*Chase's Umbilical, soft or cedar pad, .....Adult's \$4 00, Children's \$2 50  
 2039. French " " " " " " " " " " " " 4 00, " " 2 50  
 2040.\*Bow " " " " " " " " " " " " 4 00, " " 2 50

2041.

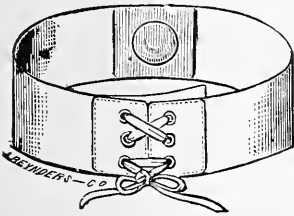

2041.\* Children's Umbilical Belt, to lace, ..... \$2 00 to \$2 75

2042.

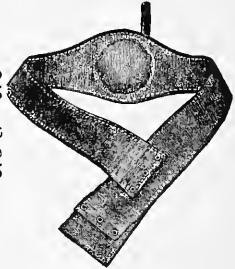

2042.\* Children's Umbilical Belt of rubber, to lace, with inflatable pad,.....\$1 25

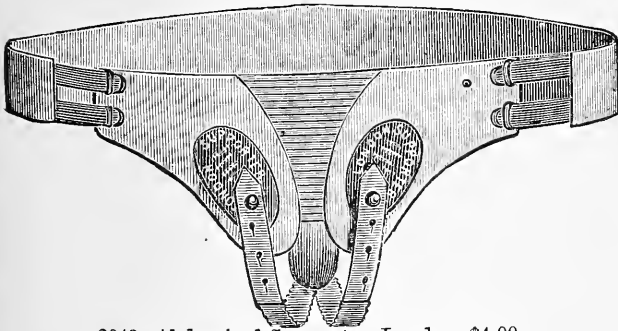

2043. Abdominal Supporter, London, \$4.00.

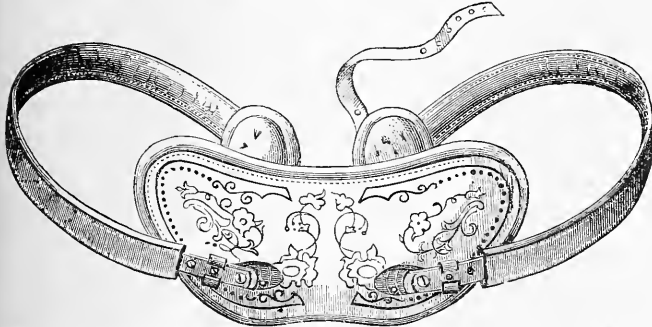

2045.\* Phelps's Abdominal Supporter..... \$5 00  
 2046. The same, with Pessary. .... 10 00

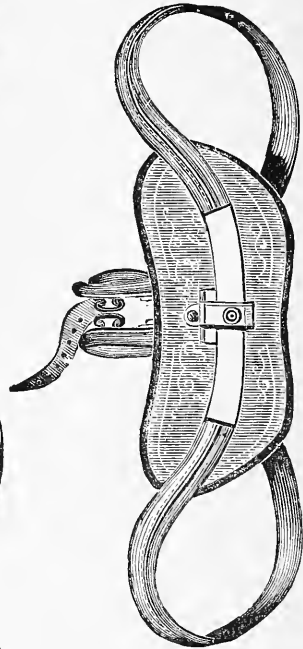

2044. Abdominal Supporter, improved spring, velvet or kid \$6 00

## TEUFEL'S ABDOMINAL SUPPORTERS.

JOHN REYNDERS & CO., Sole Assignees for the U. S., under Patent 261,494, dated July 18, 1882.

## Special Descriptive List on Application.

Having introduced these Supporters three years ago into our domestic market, we now can give the assurance of the continually increasing demand and many spurious imitations of the same proving their excellencies above all others heretofore known.

## DIRECTIONS FOR MEASUREMENT.

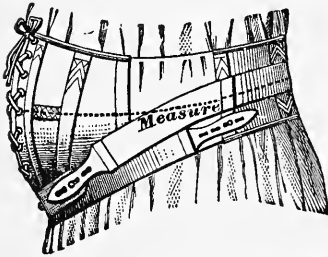

The measurement of circumference should be taken over the chemise and over the fullness of the abdomen, as indicated by the dotted line in figure herewith. Additional measurements are necessary for exceptionally corpulent persons of small stature, as otherwise the depth, which in the ordinary belt is proportioned to the length, would be too great, and would inconvenience the wearer when sitting or bending forward.

Conversely, exceptionally corpulent persons of large stature would find the belt not sufficiently deep, and the support to the abdomen inadequate.

For the two cases last mentioned, the depth of supporter required in front from the os pubis upward should

be furnished. This measurement can be taken best whilst the patient is in a sitting position.

## SYSTEM I.

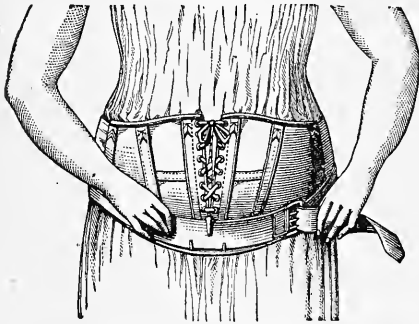

## SYSTEM II.

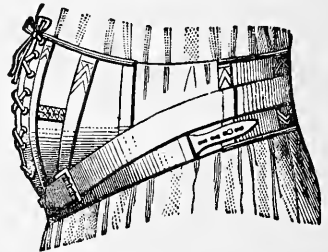

System I.—Renders most effective service in Pregnancy, by greatly diminishing the suffering and burden usually entailed; much reduces the danger of the confinement: and is the best preventive of premature delivery, sinking of the womb, anteversions and anteflexions, affording immediate assistance when such derangements have taken place.

System II.—Pre-eminently useful before and after Confinement, affording the most effectual support to the abdominal viscera, preventing pressure upon the body of the fundus, and serving as a preventive from the numerous diseases and deformities which are liable to occur from improper care at these critical periods. Furthermore, this form of supporter, by reason of its admirable shape and construction, will fit the form perfectly, prevent pendulous abdomen after confinement, improve the form, whilst giving to the lower abdomen an agreeable, even support.

To gentlemen who are troubled with corpulency, or weakness in the abdominal regions, this supporter will prove of inestimable service, it being the greatest aid ever devised for giving comfort and support during locomotion, riding over rough roads, or any active exercise whatever.

The advantages and superiority of these Supporters is briefly shown in the following Enumeration:

1. The perfect anatomical shape of each System;
2. The guarantee of an admirable fit, without any discomfort to the abdomen;
3. Never get out of place when properly applied;
4. Support and raise the weakened organs of the abdomen in the most effective manner;
5. May be tightened or widened in any part;
6. Diminish the troubles of pregnancy.

TEUFEL'S ABDOMINAL SUPPORTERS.

Further advantages:

7. Prevent excessive dilatation during pregnancy ;
8. Lessen the danger of delivery ;
9. Afford the most excellent assistance after confinement, in restoring the abdomen to its normal condition.
10. The best possible preventive of premature confinement ;
11. Give immediate assistance in cases of sinking or displacement of the womb, anteversion, antefluxion, etc., etc. ;
12. Give the most comfortable and effective support in cases of relaxation of the abdominal organs, etc., etc. ;
13. Are the most successfully employed after operations on the abdominal organs ;
14. Are unsurpassably useful in cases of umbilical hernia.

SYSTEM III.

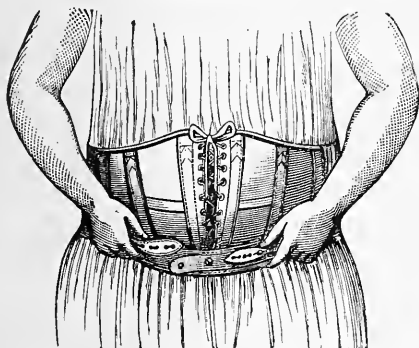

SYSTEM IV.

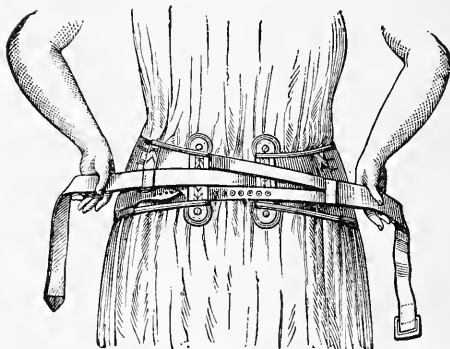

System III.—Should be employed when pregnancy causes exceptional enlargement, or for ladies suffering from corpulency, and is unsurpassable in point of efficiency and comfort. Its action is also most beneficial in cases of pressure of the womb on the bladder, and of the consequences resulting therefrom, as well as in the pains which so frequently make themselves felt in the hips, loins and sides. A peculiarly constructed, very flexible steel spring, with well-cushioned pad attached, maintains an even and gentle pressure immediately above the pubes.

System IV.—This supporter, by its peculiar construction, is particularly well adapted for relieving pains in the back, as also other disorders, often caused by weakness of the spine. Attached to the terminal ends of this supporter are two well-covered flexible steel springs, and to the ends of each of the latter are secured well-cushioned pads, which act as agreeable and powerful stays to the spine.

SYSTEM V.

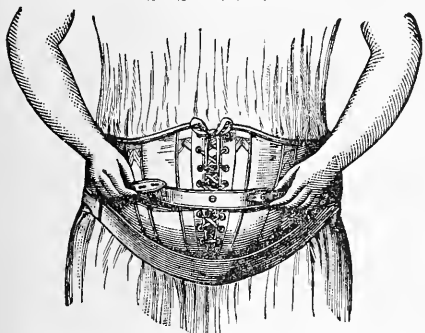

SYSTEM VI.

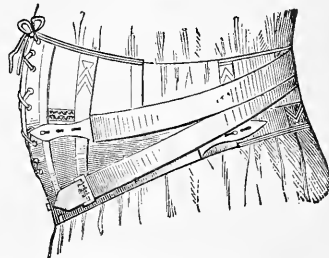

System V. — Is of unequalled service in cases of umbilical hernia, as its excellent construction causes it to maintain its position ; and by its exceedingly comfortable support to the abdomen and the internal abdominal organs, it most effectually fulfills its purpose.

System VI. - Is the only successful remedy in cases of displacement of the Kidneys, which its excellent construction retains in their natural position, without injury or troublesome pressure, and with immediate cessation of pain. In ordering this Supporter, information should be given as to whether the displacement is on the right, or the left, or on both sides.

Prices, from 28 to 40 in. in length, Systems I. & II. . . . . quality A \$7.00; quality E \$10.00  
 " " " " " III. & V. . . . . " " 8.50; " " 11.80  
 " " " " " IV. & VI. . . . . " " 8.00; " " 11.00  
 For lengths 42 in. add 30 cts. to the above price; 44 in. add 60 cts.; 46 in. add \$1.00;  
 48 in. add \$1.50; 50 in. add 2.00

Quality A consists of Satin Jean; quality E consists of Horse Hair Web. The latter is equally light, strong and porous and makes a fine material especially for summer wear.

**TEUFEL'S ABDOMINAL SUPPORTERS.**

**FLANNEL CHOLERA BELTS.**

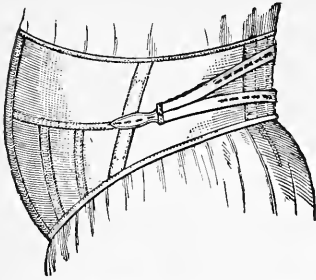

This belt is only worn as a protection against chill and to maintain warmth over the abdomen. Its perfect anatomical shape is a guarantee of its fitting admirably. The advantage of its patented construction is that, with the simplest manipulation in dressing and undressing, it never gets out of place, and in every respect most efficiently fulfills the requirements. This belt is only manufactured in white and red flannel and its low price brings it within the reach of everybody.

Price, from 30 to 40 in. \$1.80; sizes over 40 in. \$2.00

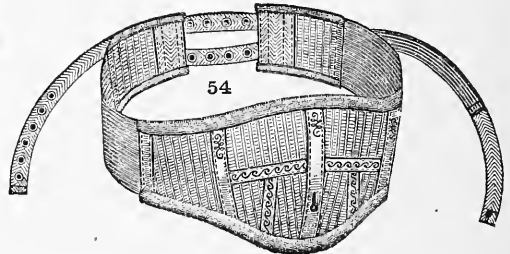
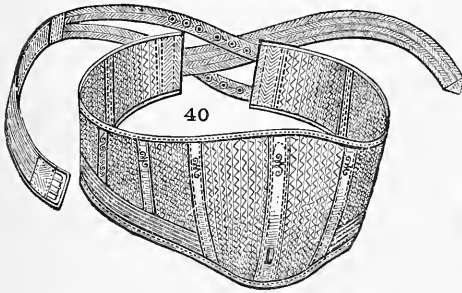

These figures show two Simplified Belts of Teufel's manufacture, both made of horse hair web as described on previous page. 40 is without, 54 with elastic on sides. The lower margin on both sides is lined with elastic, thus giving an extra support to those parts most needing it.

Price..... each \$5.00

**THE ARNOLD STEAM STERILIZER.**

FOR STERILIZING MILK.

This apparatus maintains, by means of steam, a uniform temperature of 212° F., in every part of its sterilizing chamber.

DESCRIPTION.—A, Shallow Copper Steam Generator; B, Reservoir or Pan; C, Steam Funnel; D, Sterilizing Chamber; E, Hood.

Water is poured into the pan or reservoir, whence it passes slowly through three small apertures into the shallow copper vessel beneath, becomes converted into steam and rises through the large funnel in the center, to the sterilizing chamber above. Here it accumulates under moderate pressure at a temperature of 212° F. The excess of steam escapes about the cover, becomes imprisoned under the hood and serves to form a steam jacket between the wall of the sterilizing chamber and the hood. As the steam is forced down from above and meets the air it condenses and drips back into the reservoir.

It will generate steam from cold water in three or four minutes over an ordinary fire—coal, gas or oil. It is manufactured from a superior grade of tin plate with copper bottom.

Family size, holding about nine ordinary nursing bottles..... \$2.50

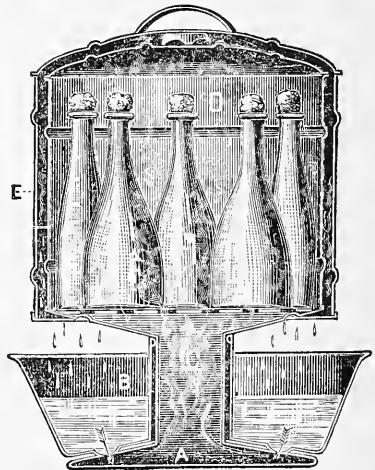

Prices of larger sizes for hospitals, laboratories, and physicians, made known upon application.

2047

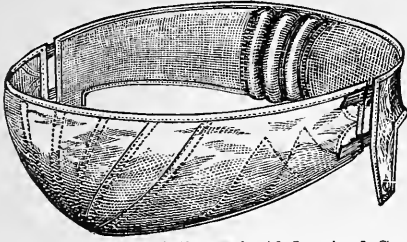

2047A.

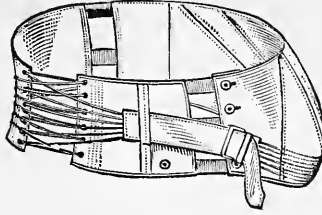

2047. Drs. Gray & Foster's Abdominal Supporter, made in two widths of front, and in sizes from 24 in., 26 in., 28 in., even numbers to 42 in. inclusive.

Regular width, ..... \$2 50  
 Extra width, ..... 3 00

2047A. Dr. Linquist's Swedish Abdominal Supporter, made in sizes from 24 in., 26 in., 28 in., even numbers, to 42 in. inclusive, ..... net \$2 50

On the above two styles of Supporters, provision is made for attaching hose supporters. For slender forms these will aid materially in keeping the abdominal supporters in place.

Hose Supporters, ..... net \$0 50

2047B.

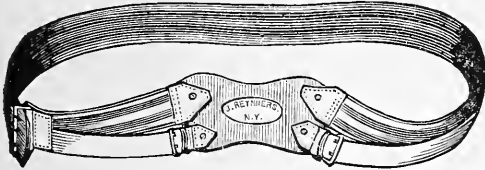

2047C.

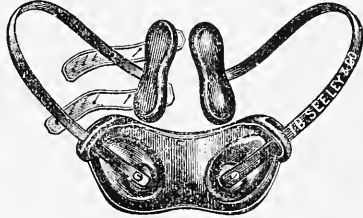

2047B. Dr. Thomas' Wood Pad Abdominal Supporter for Anteversion ..... \$3.00

2047C. This Supporter, hard rubber covered, has been very largely used with signal success in cases of Falling of the Womb, Leucorrhœa, Chronic Diarrhœa, Piles, Irritability of the Bladder, and in Pregnancy. Business men also have found that its use removes that peculiar "goneness" so much complained of ..... 8.00

2047D.

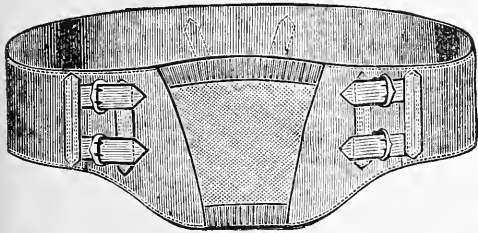

2047E.

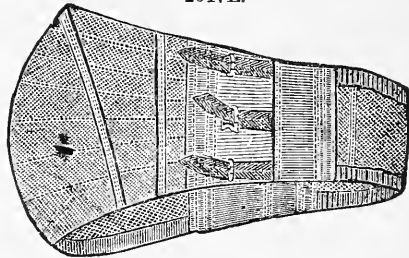

2047D. Plain Supporter, clastic front, 8 in. deep and less, \$5.00; 50 cts. add per additional inch deep.

2047E. Superior Elastic and Jean Supporter, buckles or laces on sides or in back. 11 inches deep in front or less. Unbleached cotton thread \$7.00; silk \$10.00; greater depth, per inch add 50 cts.

2048

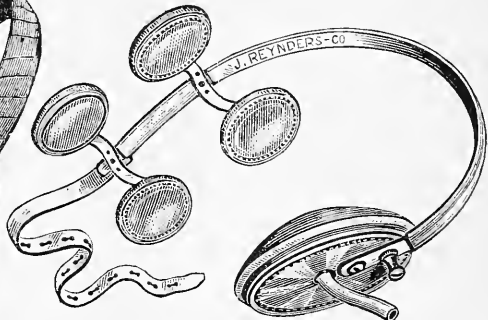

Supporter for Floating Kidney with Air Pad, \$10.00.

2048. Abdominal Supporter, Fitch's, \$5.00

**RESTRAINTS FOR THE HUMANE CARE OF THE VIOLENT INSANE.\***  
**THE LYNCH BED STRAP.**

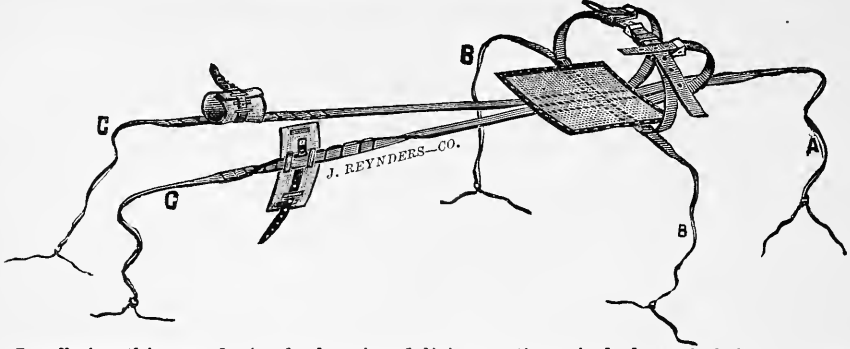

In offering this new device for keeping delirious patients in bed, we feel that we are supplying one of the most important articles in the whole hospital armamentarium. It deserves to, and we believe it will, quickly find its way into every hospital of every description and every place where delirious persons are treated or detained. It is the product of many months' experimentation, stimulated by hundreds of inquiries for such an apparatus and aided by the suggestions and criticisms of a large number of the most expert physicians and surgeons in this country.

1. It is new, simple, practical and durable. 2. It is quickly and easily attached to beds of every size. 3. It is adjustable to persons of every size. 4. It is made of strong hemp web manufactured especially for this purpose. 5. The anklet is of soft, pliable, woven material which will not chafe. 6. While it secures the patient firmly to the bed, sufficient freedom of motion may be permitted to allow him to rest on either side.

A. Attachment to head rail. B. B. Attachments to side rails. C. C. Attachments to foot rail. Turn cords around rails two or three times and tie with small cords at end; draw tightly. To permit patient to turn on one side, relax at B or B.

Price ..... 10.00\*

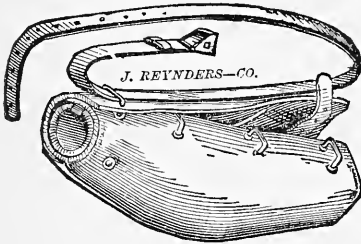

**THE LYNCH MUFF**

Is of a new design, much superior to all the older styles, and made of russet leather. Its form is permanent. Permanent wristlets are attached and so fitted with buckles as to be adjustable to any size of wrist. These wristlets are turned on the edge and lined with best buckskin, as are also the seams in the muff. The most thorough ventilation is secured by perforations on the under surface and back.

Price, with waist strap and patent lock buckle, complete ..... \$8.00\*

**MITTS.**

This cut represents our Leather Mitt. The wristlet and upper part of palm are made of heavy russet leather and lined with best buckskin. The front and back of hand are of calf russet, soft and pliable. Ventilation by perforation in the back. Attachment to waist strap by two brass staples on each wrist, as shown in cut.

Price per pair, with waist strap and patent lock buckle, complete ..... \$8.00\*

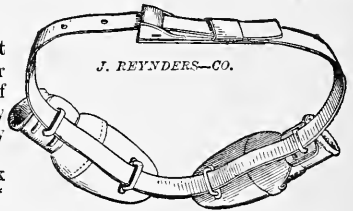

**ANKLETS.**

We make two styles of Anklet, one with small and one with large buckle. Those with small buckles do not become separated when detached from the patient, but are always together when required for use. They are adjustable to any ankle and are especially designed for day use.

WITH SMALL BUCKLES. WITH LARGE BUCKLES.—Those with large buckle may be used separate and are best adapted for night use. Both are made of No. 1 russet leather, lined with best buckskin, and rolls are turned on both edges.

Price of either, complete, with straps and buckles ..... \$6.00\*

**WRISTLETS.**

These are made of the very best heavy russet stock and lined with best buckskin. A roll is turned on the side next the hand. The wristlet is attached to the waist strap by a brass staple and plate and is adjustable for three sizes of wrists.

Price, complete, with waist strap and patent lock buckle ..... \$5.50\*

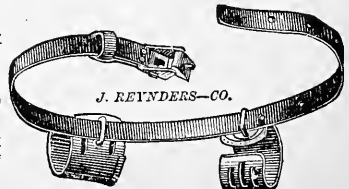

### XXXIII. ORTHOPAEDICAL APPARATUS.

#### 1. Apparatus for Torticollis or Wryneck.

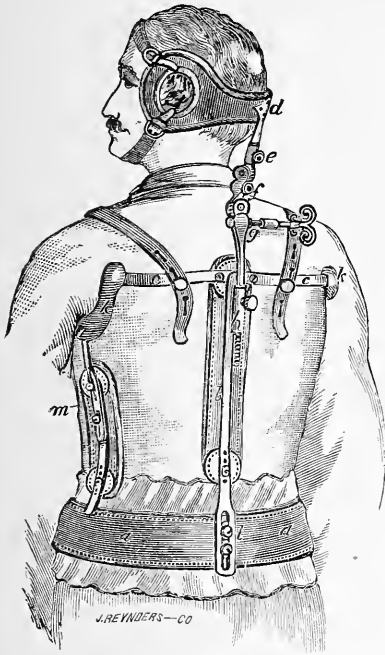

This apparatus consists of a well padded pelvic band, *a*, to which an upright steel bar is attached at *l*, passing upwards along the spine to the upper dorsal region. A cross-bar, *c*, is attached to its upper end, passing from one axilla to the other and fastened to two crutches, *k*, fitting well under the arm. These are connected to the pelvic band by two lateral bars, *m*, which by means of a slot and screw can be raised and lowered somewhat, at will. The part of the apparatus so far described is applied firmly to the trunk by means of straps passing over the shoulder and fastened to the axillary cross-bar at *cc*. A firm hold of the head is secured by a pad, sheet steel inside, reaching almost from eye to eye backwards around the skull, with apertures for the ears and fastened to the head by straps over the forehead and under the chin. To its back part a steel bar is rivetted, *d*, which connects the upper part of the apparatus with that applied to the trunk. The lower end of this steel bar is ratched and adjusted in a slide at the upper end of the steel rod, passing up along the spine and held in a desired position by a thumb screw shown near the letter *h* (on the figure). This connecting bar is intercepted by three different joints, *e*, *f* and *g*, by which flexion can be made in any direction, when worked with the key. At the joint *g*, flexion can be made to the right or left, at *f* forward and backward and at *e* rotation.

The advantage of this apparatus over many others is, that firstly a firm hold is effected to the head and trunk, and that then the head can be brought in a proper position by a true and irresistible mechanism. The apparatus when worn is almost entirely hidden under the clothing, and patients can not very easily withdraw themselves from its action.

#### MEASUREMENTS REQUIRED:

When patients can not call at our office a plaster cast of the involved parts of the deformity is desirable, and

- 1) Sex of patient.
- 2) General appearance of patient.
- 3) Circumference of body between the crest of ilium and trochanter major.
- 4) Circumference of body under axilla.
- 5) Distance from sacro-lumbar articulation of the spine to the vertebra prominens.
- 6) Distance from the same point to the base of the skull.
- 7) Distance from crest of ilium to axilla, each side.
- 8) Circumference of the head at the base of the skull, over the ears and upper line of the forehead. Price \$85.00

#### 2. Markoe's Apparatus for Torticollis.

This apparatus is principally the same as the one before named. A ball and clamp socket-joint allows movements of the head into the proper position. A short stem projects backwards from the back of the headband, terminating in a ball, which is grasped by a clamp at the end of the upright bar passing up along the spine. The pressure of this clamp is regulated by a thumb-screw which is tightened after the head has been brought into proper position.

Measurements required, same as for apparatus 1

Price \$35.00--\$45.00

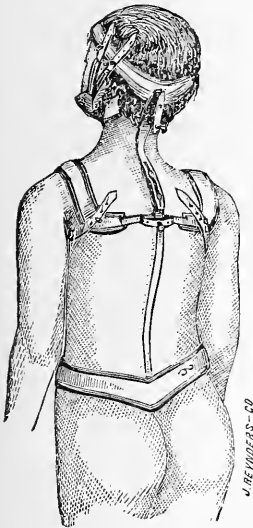

3. Davis' Apparatus for Torticollis.

This apparatus, fig. 3 consists of a steel bar, *D*, surrounding the head at a distance of about two inches, which is held in position at *G*, by a collar brace, *C*, connected by *B*, and a similar bar

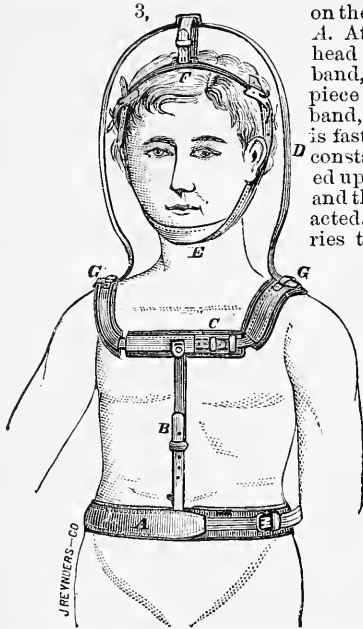

on the back, to the pelvic band, *A*. At the top of the bar, *D*, the head is held by a strong elastic band, connected to a curved piece of steel, *F*, to which a band, *E*, passing under the chin is fastened. By these means a constant elastic tension is effected upon the contracted muscles and the deformity thus counteracted. This apparatus also carries the whole weight of the head, thus causing relief to the spine, which in many cases of Torticollis is also affected.

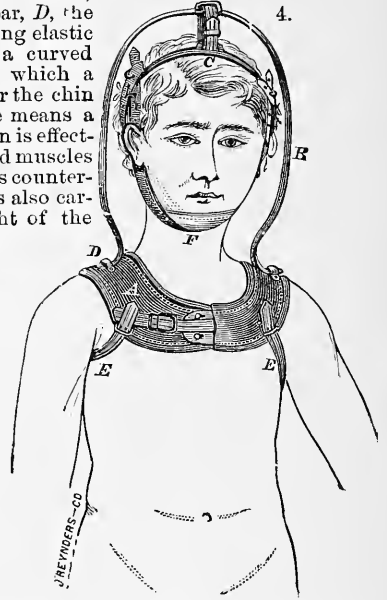

When ordering this apparatus the shape of the steel bar, *D*, should be ascertained, by giving its desired shape to a piece of pliable wire and making a tracing of the latter on a piece of paper. Measures required are:

- 1) Sex of patient.
- 2) General appearance of patient.
- 3) Circumference of the head, passing under the chin and behind the ears to the top of the head.
- 4) Distance between the axillae.

- 5) Distance around the shoulder, avoiding the arm pits.
- 6) Circumference of body between the crest of ilium and trochanter major.
- 7) Distance from the navel to the top cavity of the sternum. Price \$25.00—\$35.00

This apparatus is also made for the sake of cheapness, without the pelvic band as shown by figure 4 Price \$20.00—\$25.00

5. Washburne's Brace for Pott's Disease or Posterior Curvature of the Spine.

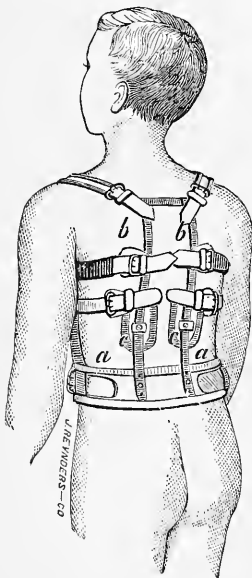

In the accompanying figure *aa* is a steel band which passes half way around the pelvis, just above the trochanters, *bb* are two flat bars of steel, parallel to each other, and curved upon their flattened sides to the form of the spine to which the apparatus is fitted. These bars are curved a little less than the spine, so that when secured in position, their elasticity will constantly operate to rectify the spinal curve. The cross bar at the upper ends of parallel ones is firmly riveted to them, and is to cross the back just above the spines of the scapulae. At the ends of this bar are affixed buckles to receive the shoulder straps; *cc* are two movable pads which slide upon the bars to which they are attached—these are best stuffed with cork filings. These compresses are to be brought one upon each side of the projecting knuckle of spine and secured firmly by means of the screws provided for that purpose. Buckles are attached to various parts of the brace, by means of which it is secured to the front part of the apparatus, which consists, as shown, of a piece of twilled muslin, or other strong material, which covers the chest and abdomen and is provided with straps. Such parts as are in contact with the body are carefully padded.

Success with this apparatus depends entirely upon the faithfulness with which it is kept adjusted to the spine of the patient. It is only necessary that a gentle pressure should be maintained if it is constant. As the spine approaches its normal shape the curve of the brace will require to be altered from time to time. The steel has a soft temper, so that it will take the form into



which it is bent when considerable power is applied, but will be sufficiently elastic for the purposes of this apparatus. With children's braces the necessary bending is readily accomplished by hand. Measurements required, the same as for Apparatus 6. Price \$15.—\$25.

## 6. Dr. Chas. F. Taylor's Apparatus for Pott's Disease or Posterior Curvature of the Spine.

Extracted from TAYLOR: "On Mechanical Treatment of Angular Curvature of the Spine."

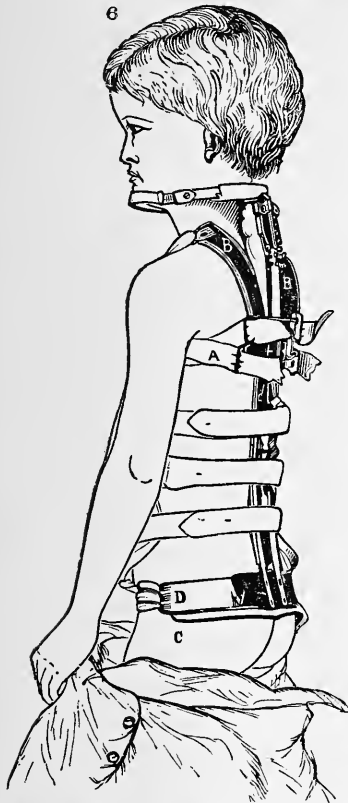

In endeavoring to apply this mechanical principle (direct pressure upon the curvature of the spine) toward overcoming the pressure at the diseased portion of the spinal column, we find a happy conjunction of favoring conditions. Such an instrument is shown by figure 7. There is no painful pressure downward on the abdomen and hips; but a broad band passes around the trunk, low down—so low that in front it almost touches the thighs in sitting. It passes just above the pubis and entirely below the abdomen, so that the abdomen is sustained upward instead of being, as in most instruments, pressed downward. There are two pieces or levers passing up the back; not

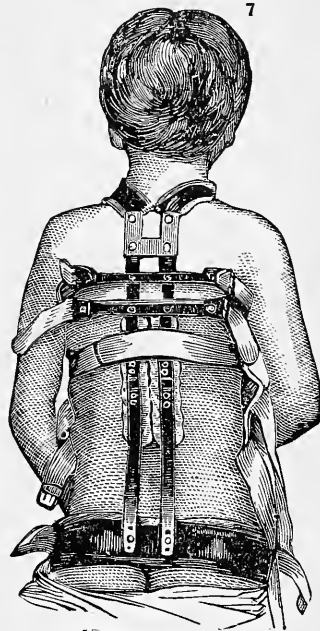

J. REYNOLDS—CO

may pass directly forward and around the shoulder, and thus prevent a great loss of force by diagonal action; and also that they shall touch the person only where their pressure is needed—namely, on the forward part of the shoulders. This arrangement entirely obviates the painful and injurious ligaturing of the arms, which would occur if the straps passed forward from one point. At a part of the instrument, opposite the point of disease—the point where we make our fulcrum—the pads are placed. These pads are very important. They are made of chamois skin or canton flannel, and are filled with cork filings, which has no felting qualities, or, if desirable, can also be made of hard rubber. The shoulder-straps and the band around the hips are likewise provided with similar pads to protect the skin from pressure and abrasion. It will be seen that the instrument, like the spine itself, acts like a double lever with a common fulcrum at the curvature. This action is directly backward at the hips and shoulders and directly forward at the middle of the back, or, wherever the diseased part is located. Thus the posterior portion, the only healthy portion of the diseased vertebrae, is made to support a part of the weight of the body and the intervertebral cartilage and bodies of the vertebrae, where the disease exists, are relieved of pressure.

In addition to all this, the lower part of the body—the abdomen—is still further sustained in the upward direction by the apron in front which is fastened on each corner, as shown by the figures

Should the disease have developed itself in the upper dorsal or cervical region of the spine, it can be treated even more effectually, than when lower down. An apparatus, constructed for such cases, is shown by figure 6. It is like the ordinary apparatus, but with an attachment for sustaining the head. The effect and form of this attachment is that of a lever, acting backwards to raise the head and neck.

### MEASUREMENTS REQUIRED\*

- 1) Sex of patient.
- 2) General appearance of patient.
- 3) Lay a soft piece of lead wire along the back, moulding it exactly to the spine, from the seventh cervical vertebra to the middle of the sacrum. With this pattern trace carefully the shape of the spine on a sheet of paper, marking the points opposite the upper and lower borders of the scapula and the crest of ilium.

4) Circumference of body between crest of ilium and trochanter major. 5) Distance between the upper borders of scapula. 6) Distance between the lower borders of scapula. Price \$20.00 to \$30.00  
For the apparatus with the cervical or Wry-neck attachment give the following measurements in addition to the above: 7) Distance from seventh cervical vertebra to the base of skull. 8) Circumference of head around the chin and head. Price \$30.00 to \$40.00

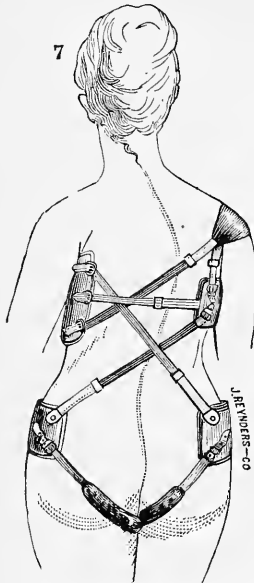

### 7. Sayre's Barwell's Brace for Lateral Cur- vature of the Spine.

From *Dr. Sayre's Orthopaedic Surgery*,  
1st Ed. Page 392.

Another elastic apparatus that can be used with benefit is one devised in accordance with an idea I first obtained from Mr. Barwell of London. It is more a reminder to the patients what they are to do than anything else; but at the same time furnishes considerable aid in the efforts made to straighten themselves by means of muscular contraction.

It consists of a piece of sole leather four or five inches wide and six or eight inches long, with its upper end hollowed out like a crutch, this is placed under the axilla of the depressed shoulder; a band going over the opposite shoulder is buckled to the lower end of this leather crutch in front and behind. This band on either side has a few inches of elastic inserted, so that it has a constant tendency to lift the depressed shoulder which is in fact suspended from the opposite one. Two other bands, one in front and one behind, descend from the top of the crutch to the opposite hip, and are there secured to a piece

of leather which is retained in place by a perineal strap passing around the thigh.

From the centre of the crutch, two elastic bands, one in front and one behind, go around the body to another piece of leather placed over the projecting portions of the ribs upon the opposite side of the body. This leather pad is retained in position by straps descending from the first mentioned strap over the shoulder, and also has elastic bands extending to another piece of leather over the opposite hip, which is secured like the first hip piece by a perineal band going around the thigh.

All these bands are made partially of elastic webbing, and by their constant contraction have a tendency to twist the body straight or rather to untwist it from its distorted position. Price \$13.00 to \$16.00

Figure 8 illustrates

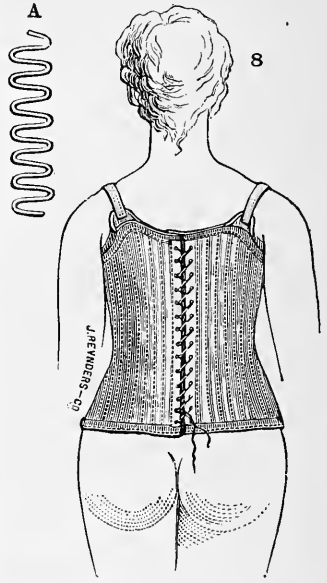

### Sayre's Spiral Spring Corset.

It is made by having spiral springs of a form as shown by the side figure "A," a few inches longer than the corset quilted into pockets, and forcibly pressed into these pockets and retained there, so that the corset is constantly making efforts to extend itself. As the patient is generally smaller at the waist than at the upper or lower extremity of trunk, this corset is very much like a double cone in shape, and the patients trunk having been extended, it is placed upon him or her by first fastening the central point at the waist, and then the slope of the corset above and below. On account of the constant action of the spiral springs, it will keep the patient extended, and prevent deformity.

In the majority of cases of the deformity in their earlier stages, before the bones and ligaments have become changed in form, the treatment with above brace, together with vigorous out-door exercise, to improve the tone of general system, will generally be found all that is required to correct it. Price \$20.00 to \$30.00

#### MEASUREMENTS REQUIRED FOR THE ABOVE TWO BRACES.

1) Sex of Patient. 2) General appearance of Patient. 3) Circumference, body under axilla. 4) Circumference of body between crest of ilium and trochanter major. 5) Distance from crest of ilium to axilla.  
For the spiral Spring Corset—in addition to those for the brace: 6) Circumference at waist.

### 9. Apparatus for Lateral Curvature of the Spine.

This apparatus consists of a padded pelvic band made of steel, hinged on the sides to admit of easy application. Two crutches extend from this band, made to be lengthened or shortened, which receive the weight of the shoulders under the axilla. A horizontal piece of steel connects the crutches, and a perpendicular piece connects the horizontal piece with the pelvic band; a frame is thereby formed which can not tilt. To the perpendicular bar a broad band of stout leather is attached, which is intended to pass over the convexity of the curve, under the crutch next to the body, fastening on the crutch on the concave side. When this band is brought to bear upon the curve through the ribs, the opposite shoulder is lifted and drawn to the other side, by which means the weight of the spine is changed in the opposite direction.

#### MEASUREMENTS REQUIRED.

1) Sex of Patient.  
2) General appearance of Patient.  
3) Circumference of body between the crest of ilium and trochanter major.  
4) Length from crest of ilium to axilla—right side.  
5) do. do. do. left do.  
6) Circumference of body under axilla.  
7) Curve—to the right or left. Price \$20.00 to \$35.00

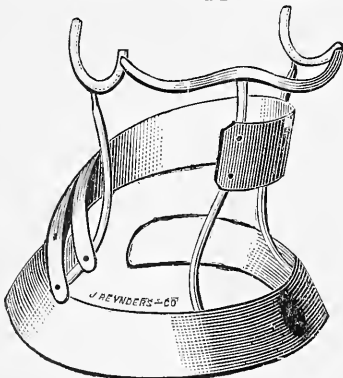

## 10. APPARATUS FOR LATERAL CURVATURE OF THE SPINE.

### WITH ELASTIC EXTENSION CRUTCHES.

This consists of a well padded pelvic band of steel, to the posterior portion of which is attached an upright steel bar, conforming in shape with that of the spine, and holding at its upper extremity upon an adjustable cross piece a couple of circular pads, resting when the

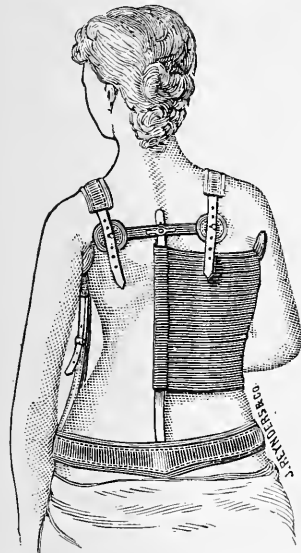

brace is applied upon the scapulae. Immediately below this crosspiece is attached to the upright bar, upon a series of small buttons, an elastic band of proper width, passing over the protuberance obliquely and fastening by straps upon the buttons of another very short upright bar, placed for this purpose on the anterior portion of the belt, several inches beyond its centre. This elastic band exercises a gentle but continuous elastic pressure, at the same time rotating the ribs around their vertebral axis, thus unfolding the helical curve. For relieving the spine of the weight of the upper portion of the body, crutches, well padded on top, are fastened to each side of the pelvic belt. These crutches are composed of two compound bars, and are constructed with special reference to exerting continuous elastic extension upon the body between the axillae and the pelvis.

The mechanism, by which this is accomplished, is constructed as follows: One of the compound bars forming the crutch is provided with expanded margins which are turned over so as to form a channel through which the other slides. The upper end of the channel is converted into a loop which completely incloses the sliding bar and upon this loop a button is secured. The lower end of the sliding bar is also provided with a loop and button. To the button on the upper end of the channelled bar and to the button on the lower end of the sliding bar are attached an elastic webbing strap, the length of which can be graduated by its buckle. The force which brings the buttons nearer together by shortening the elastic webbing strap, must of necessity

lengthen the crutch, which by these means exerts a continuous elastic extension.

Well padded shoulder straps secured to the anterior points of the crescent shaped parts of the crutches and fastening upon buttons placed upon the circular scapular pads, stay the forward tendency of the upper part of the body.

#### MEASUREMENTS REQUIRED.

1. Sex of patient.
2. General appearance of patient.
3. Place a thin and flexible strip of lead along the spine, moulding it exactly to the spine and all its sinuities from the seventh cervical vertebra to the middle of the sacrum. With this pattern trace carefully the shape of the spine on a sheet of paper, marking the points opposite the upper and lower borders of the scapulae and the crest of ilium, also the affected parts of the spine. Send us this tracing.
4. Length from crest of ilium to axilla—right side.
5. Length from crest of ilium to axilla—left side.
6. Distance from the centre of one scapula to the centre of the other.
7. Circumference of body under the axillae.
8. Circumference of body between the crest of ilium and trochanter major.
9. Mention whether the convexity of the curve is to the right or to the left side.

PRICES, according to size, from \$35.00 upwards.

## 11. IMPROVED APPARATUS FOR LATERAL CURVATURE OF THE SPINE.

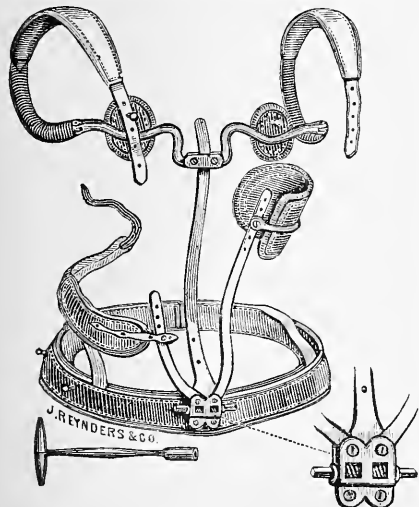

This apparatus consists of a well padded steel pelvic band to the posterior centre of which is attached an upright steel bar, its curves conforming to those of the spine, and holding at its upper extremity upon an adjustable cross piece two oval pads, resting upon the shoulder blades when the brace is applied.

Attached to the ends of the adjustable cross piece, by means of horizontal joints, are padded crescent shaped crutches terminating in padded shoulder straps which fasten on buttons, placed upon the oval shoulder blade pads. These support the upper portion of the trunk and stay its forward tendency.

To the posterior centre of the pelvic band is attached also a metal box, containing two archimedian screws which move with the aid of the key; (so as to exert and maintain any amount of pressure against the protuberances), the two upright bars armed at their upper extremities with well padded metal adjustable pads. As the uprights are constructed of spring tempered steel, all pressures exerted by them in combating the deformities are elastic while constant.

In addition to measurements for the before-named apparatus (10) we require:

10. Diameter of the back from axilla to axilla.

PRICES, according to size, from \$45.00 upwards.

## 12. DR. CHARLES F. STILLMAN'S DORSAL LEVER BRACES FOR POTT'S DISEASE.

(Extracts from Dr. C. F. Stillman's article, entitled "Resumé of Methods in General Use for the Mechanical Treatment of Pott's Disease," in *The Am. Journal of Obstetrics and Diseases of Women and Children*, of October, 1883.)

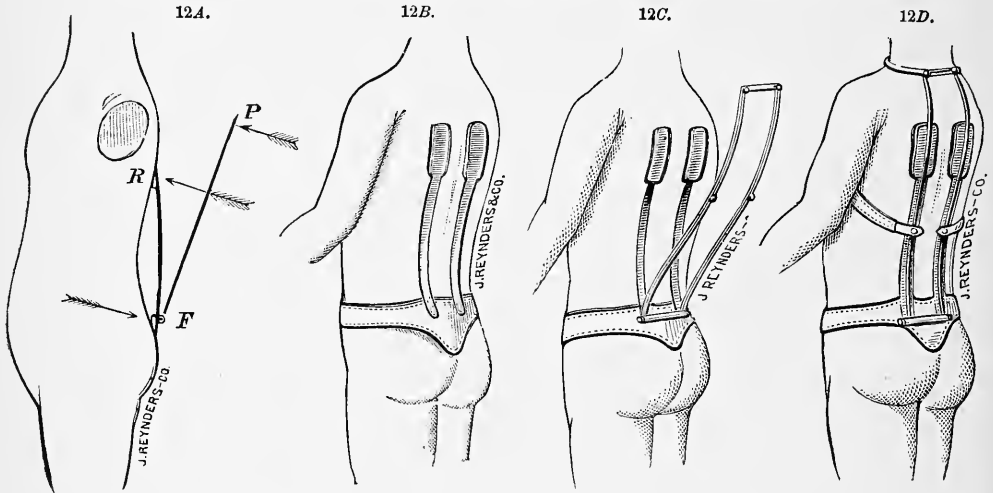

Their object, like the brace of Dr. Taylor, is, first, to produce extension of the bodies of the vertebræ by backward traction, thus aiming at the arrest of disease, and, second, to exert forward pressure at the seat of the disease, and thus tend to lessen or obliterate deformity; but in order to effect these objects, the brace is constructed upon a different plan, a totally distinct order of lever being employed, possessed of special advantages.

To thoroughly understand the principle upon which the new brace is constructed, a patient having a well-defined knuckle is laid upon his back upon a table, the padded edge of which comes to the apex of the deformity, the shoulders and head being allowed to fall downward.

You will observe, as the patient's head and shoulders descend, that a physiological and true extension of the spine is effected, the traction force being all that portion of the patient above the seat of the disease. This, augmented by gravity, produces a backward curve of the spine, most marked at the seat of disease. There is also a tendency to obliterate the knuckle, and this partially disappears, unless it be so firm as to render futile any force so applied.

We have thus produced by this position the two effects we consider to be necessary to successful treatment, and have placed the spine in curves, the reverse of those is held before this posture was assumed. If this position could be maintained indefinitely there would be rapid improvement in the disease, but as this is obviously impossible, we attempt to embody in a brace the forces involved it being for this purpose constructed in two parts — one to represent the table and the other the backward traction force. The "table" portion of the brace (and by this we mean that portion of the brace which is to produce upon the patient an effect identical with the table) consists of a firm pelvic band, from which strong padded strips pass upward on either side of the median line to the seat of disease. (See figure 12B.)

The "backward traction" portion of the brace consists of a back frame see figure 12C secured on the pelvic girth by a ratchet, which allows it to be adjusted to any angle with the body, and thus regulates the degree of traction force employed. This may be varied from a simple upright support to a powerful lever at the will of the surgeon, depending entirely upon the angle at which it is thrown out from the body.

The upper part of this traction frame is secured to the body by padded straps connected to a chest T-plate in front, thus avoiding constriction, and when bound down to the body, as in figure 12D, presents the appearance there shown.

We thus observe that by means of the two parts of this braces, we can obtain the effects desired to be incorporated in a dorsal brace, the mechanical action being shown in figure 12A, R representing the resistance, P the power and F the fulcrum. It will be observed, after the line FP of the "traction" frame is securely fastened by F to the "table" frame FR, and the whole firmly fastened to the body, that the forward tendency of the upper part of the body would be prevented by the pads at R, and this forward tendency would, at the same time, be acting to force in the knuckle by pressure over the transverse processes of the diseased

vertebræ, so that a curative automatic effect would be produced by the brace to keep the body erect, and at the same time improve the deformity.

Also that the spring effect produced by the setting off of the traction frame, and drawing the body back against it and retaining it there by appropriate straps—would cause the brace to be held more tightly against the back, and produce there a higher degree of fixation of the spine than any form of apparatus in use.

In the beginning of the treatment, it is well to have the traction frame set off at such an angle as to cause considerable pressure upon the sides of the knuckle, and produce thorough extension of the diseased portion; but this angle may be lessened week by week as the case improves, until finally the traction frame lies directly upon the pads, and becomes a mere fixation brace or support, without any leverage whatever, as in figure 12D.

This is what we wish to accomplish with this brace—to grasp firmly the lower part of the spine as high as the seat of disease—corresponding to the part lying upon the table—and then by force above bend the spine backward sufficiently to relieve the bodies of the vertebrae from pressure, and also effect as much obliteration of the deformity as is practicable. The object of the brace is to fix the spine in the position of riding by a frame provided with a suitable clamp for regulating the backward traction; and thus, by the use of a *very light* frame, we can produce sufficient lever power to retain the spine in any desired position, and as this *backward* power is distributed along the entire dorsal and lumbar spine, and as the *forward* pressure is exerted along the spine below the seat of disease, decreasing from the knuckle to the sacrum, it will be found that no injurious pressure is exerted at any one point. The brace thus shown is specially adapted for the dorsal region, but when the disease is situated below this, it will be found less efficacious.

### 13. DR. CHAS. F. STILLMAN'S LEVER BRACE FOR POTT'S DISEASE OF THE LUMBAR REGION.

To adopt this principle of backward traction to the lumbar region, the patient is laid on the back upon the table, and all that portion *below* the seat of disease is allowed to hang over, the reversal of the position just detailed for disease of the dorsal region. In this manner we produce the extension of the spine, by means of the backward traction of the lower extremity, and produce the pressure upon the knuckle by the edge of the table. It is to sustain these effects that we use the lever brace, and to adapt it to this portion of the spine, we reverse the

13A.

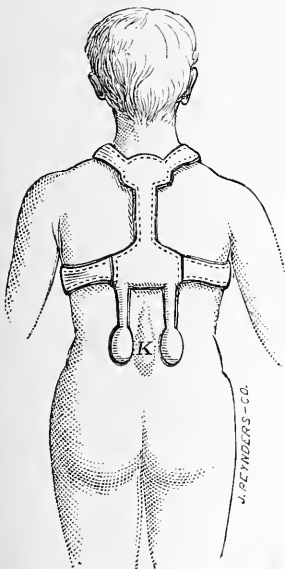

13B.

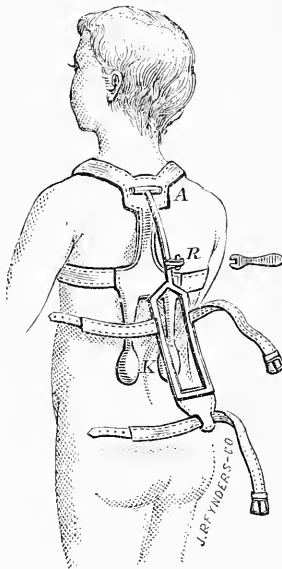

13C.

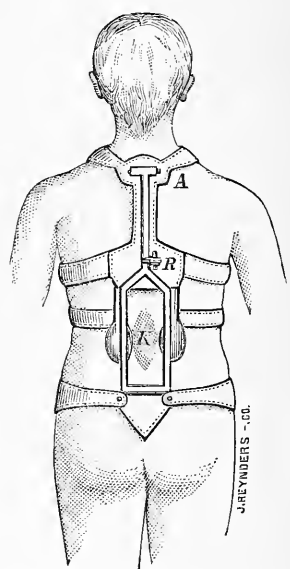

construction already detailed. If the knuckle be at K, figure 13A, the table portion of the brace is constructed as there shown, the pads being placed opposite the knuckle, and the whole being firmly bound down to the body without constriction by a T-plate over the

sternum. To produce the backward traction, a frame (fig. 13*B*) is attached to the table frame by a ratchet at A, so that it may be thrown out at any desired angle from the body, depending upon the degree of backward traction desired; and this frame extends to the coccyx inferiorly, and is provided with appropriate straps for its attachment to the body, a rotary ratchet at R assisting to control any lateral curvature which may be present. When this brace is secured to the body, as in figure 13*C*, it forms a lever which produces extension of the bodies of the vertebræ, and improves the deformity while holding the spine firmly fixed, these being, as we have seen, the desiderata for successful treatment.

#### MEASUREMENTS REQUIRED.

1. Sex of patient.
2. General appearance of patient.
3. Lay a soft piece of lead wire along the back, moulding it exactly to the spine, from the seventh cervical vertebra to the middle of the sacrum. With this pattern trace carefully the shape of the spine on a sheet of paper, marking the points opposite the upper and lower borders of the scapula and the crest of ilium.
4. Circumference of body between crest of ilium and trochanter major.
5. Circumference of body at waist.
6. Circumference of body under axillæ.
7. Distance between the upper borders of the scapulæ.
8. Distance between the lower borders of the scapulæ.

The PRICES for Dorsal Lever Braces, figure 12*D*, vary, according to the sizes of same, from \$20.00 to \$35.00 ..

Those of Lever Braces for the Lumbar Region, figure 13*C*, from \$25.00 to \$40.00.

## 14. DR. CHAS. F. STILLMAN'S APPARATUSES FOR THE TREATMENT OF ROUND SHOULDERS OR ANTERO.—POSTERIOR CURVATURE OF THE SPINE.

(Extracts from Dr. C. F. Stillman's article on this subject, in *The Medical Record*, of August 25th, 1883.)

A second and much more satisfactory method of utilizing the backward traction in the formation of a brace is one constructed on my adjustable lever plan—the *fulcrum*, F, to be over the sacrum the *resistance*, R, to be greatest just below the central region of the dorsal curve, and distributed all along the spine below this region, and the *power*, P, to be the forward tendencies of the upper extremities and head (see figure 12*A*, page 308), so that while the body is maintained erectly no force is exerted upon the spine at any point; but the least tendency to rounding the shoulders brings a power to bear exactly opposed to the power of the deformity, which increases automatically in proportion to the extent of the deformative force.

To construct a brace so as to bring the force to bear under these conditions we place a girth, provided with a sacral projection, about the hips (see figure 12*B*, page 308). From the upper edge of this hip-girth springs a pair of padded strips, one on each side of the median line, so as to avoid the spinous processes, and these strips extend upward to the middle dorsal region (see figure 12*B*, page 308). So far the brace is a substitute for the table, but to give it efficacy we must supply a frame for backward traction as a substitute for the backward force exerted by the weight of the upper extremities when the body is in the traction position. To effect this, a light steel frame moulded to the shape of the back and extending from the sacrum to the cervical vertebræ is attached at its lower extremity to the hip-girth (see figure 12*C*, page 308) and there provided with a ratchet which admits of its being secured at any angle. The upper extremity of this frame is secured to the body by means of chest and shoulder-bands (see figure 12*D*, page 308), which buckle in front to a firm leather chest-plate, the use of which permits us to avoid the constriction and discomfort attending the use of bands passing around the chest without such intervention.

The action of the brace (see figure 12*D*, page 308) is, as you see, that of a lever, exerting its force in such a manner as to distribute its pressure along the spine and not at any one point; the dorsal centre being the point of greatest pressure, and the sacrum the least, the intermediate pressure being so graduated as to decrease from the dorsal centre to the sacrum. We thus see that direct pressure is provided to the greatest degree where it is needed most, *i. e.*, at the dorsal centre, and in the least degree where it is needed the least, over the sacrum; and there is thus no portion of the spine below the dorsal centre without direct support. This support and forward pressure is just in proportion to the backward angle of the brace-frame and the forward tendencies of the deformity. In the beginning of the treatment this brace-frame may be secured at a considerable angle (see figure 12*C*, page 308), but as improvement ensues, this may be lessened, until it lies flat upon the padded strips (see fig. 12*D*, page 308) and becomes in its action a mere spinal support instead of a lever.

This brace makes an extremely effective and comfortable instrument, and can be made to exercise any desired degree of power on the deformity. But there are many cases which do not require so pronounced an instrument as this - cases in which the youth and imma-

turity of the patient have not as yet allowed the parts to become perpetuated in the abnormal curves to such an extent as to demand its use.

Such cases require merely a light, strong, compound spring, or pair of springs, which will act supplementary to the impaired muscles of the back, and if we can adapt this spring power to the form so that it will not be apparent to an observer that the patient is wearing an aid of this kind, so much more successful will we be in our practice. We must remember that this class of deformities is unattended by pain, and it is, therefore, desire for symmetry which brings them to you; so that if an unwieldy spring makes a protrusion along the course of the spine it would be an objection to treatment in the eyes of the patient. But it is possible, by incorporating into an ordinary well-fitting corset, a pair of compound springs, one on either side of the median line, to provide against the objection which attends the use of a single spring. The under springs are somewhat longer than the corset and are provided with pads at their extremities so as to allow sufficient grasp of surface to prevent the edges of the pads from digging into the flesh when the body is laced down to the spring (see

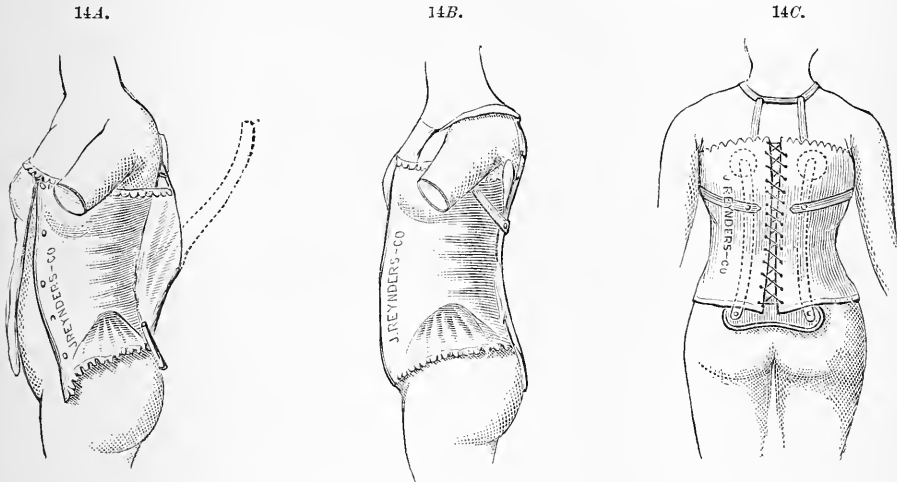

figure 14A). The upper springs extend to the neck and are connected to the chest-plate in front as in the lever brace. The only springs which we have used heretofore in the profession to combat round shoulders have been fashioned in an exaggeration of the normal curves of the spine—a shape which would tend to increase and intensify the abnormal curves which are symptomatic of the deformity.

To make round-shoulder springs effective, however, the curves of the under spring should be the reverse of the curves of the deformity—opposing apex to apex. Thus the curve of the deformity and the curve of the combating spring should be so placed in contact with each other that when the centres are together and the curves drawn tightly toward each other there will be reduction in exaggerated curves of the spine as well as the curves of the spring.

The curve of the back springs are opposed to the curves of the back (see figure 14A) before the stays are brought together, but when the corset is tightened and secured to the figure (see figure 14C), its action is to flatten the dorsal curve in direct proportion to the strength of the springs.

For males, corsets are not so applicable for obvious reasons, and we, therefore, provide the springs with girths in such a manner as to be as effective for the purpose intended. So much for the mechanical treatment.

#### MEASUREMENTS REQUIRED.

The same as for Dr. Stillman's Dorsal Lever Braces (see page 310). When the apparatus is to be worn by a lady, send us in addition to the measurements a substantial, well-fitting corset.

The prices of above described apparatus for gentlemen's use vary, according to size, from \$20.00 to \$35.00.

The same for ladies use, when incorporated into a corset furnished us, from \$8.00 to \$15.00.

### DR. CHAS. F. STILLMAN'S LEVER BRACES FOR POTT'S DISEASE.

(Extracts from a Clinical Lecture on the "Mechanical Treatment of Pott's Disease," by Charles F. Stillman, M.S., M.D. From the *Journal of the American Medical Association*, January 31st, 1885.)

You have thus seen and had demonstrated to you some of the typical forms of apparatus which are largely used by the profession for the treatment of spondylitis, and have seen several of them in successful operation, and we now proceed to the discussion and description of

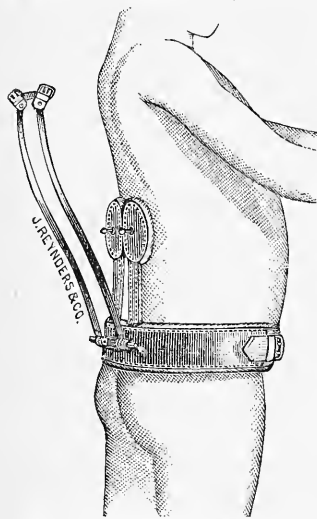

Fig. 14D. Showing Lever Brace for lower dorsal region before the long arm is strapped to the body, the backward angle of the long arm being regulated by a clamp inferiorly.

another and more recent form of spinal brace which embodies some valuable attributes not possessed by any of those enumerated.

It has already been stated to you that if the patient bent forward while wearing any of the braces or appliances described, the spine was more apt to give way at the seat of disease than at any other portion of its extent, owing to the yielding character of the diseased osseous structure, and that this tendency was only combated by the strength of the material employed in the splints. Now, this bending forward is one of the most important factors for increase of deformity and the retardation of cure, and to meet it successfully I have been obliged to use a lever or spring, which would bring a constant forward elastic power to bear directly and

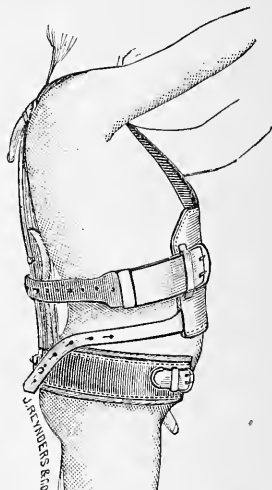

Fig. 14E. The same strapped to the body, the pads there exerting forward pressure at the seat of disease.

automatically upon the kyphos, and after considerable experience I am prepared to advocate a form of spring lever which meets this bending tendency successfully.

If the disease is in the dorsal region, a brace is constructed so as to embody a lever with a short and a long arm; the short arm extending from the site of the disease to the sacrum, and the long arm from the neck to the sacrum, the two being there connected by an adjustable clamp, and together forming a V-shaped lever, which automatically acts to press forward the deformity and yet hold the spine firmly in the erect position.

The force is so graduated that if leaning forward is attempted, the shorter arms press firmly over the transverse processes adjacent to the kyphos, and exert a forward pressure which prevents the spine yielding at the seat of disease. In no other brace known is this accomplished, and it thereby secures a greater degree of fixation than either of the braces or splints described. If the lumbar region be involved, the short arm of the lever passes from the diseased part to the second dorsal vertebra, and the long arm from the sacrum to the same point; and they are there secured together by an adjustable clamp and connected to the front of the chest by straps and a T plate, the latter utilizing the infra-clavicular spaces and sternum as pressure points, thus preventing interference with or constriction of the soft parts. The braces formed upon this lever plan afford fixation in the erect position and exert forward pressure at the seat of disease, and no posture of the patient can influence or derange the action of the instrument, since it is compensatory.

The other systems of treatment described in the course of our lecture have, with a few exceptions, been before the profession for a sufficiently long period to have their merits generally understood, and have been employed with a varying degree of success; but, on the whole, the mechanical treatment of Pott's disease is considered to be in an unsatisfactory condition. There are two requisites which must enter into the consideration of this mechanical problem, if its treatment is to be attended with success, and these are: 1st, arrest of the disease; and, 2d, obliteration of the deformity.

Nature herself points out the direction in which force should be applied to relieve the diseased bodies and produce curative results.

Who among us has not noticed the position assumed by a patient with the disease in the stage of invasion? The body is held rigidly, the head and shoulders being thrown back as far as possible, and in stooping to pick up an object from the floor, this position is still maintained, the patient having every muscle exercised to hold the spine perfectly fixed and bent backward, the position being very much that of an equestrian "head and chest up, the shoulders held back, and the small of the loins well knit in." Were it possible for the patient to retain this position indefinitely, progress of the disease to the stage of deformity would be almost impossible; but it is a natural tendency in unguarded moments and for the purpose of resting the spine, to bend forward, and bending forward from any cause, removes the weight from the articular processes, and proportionately transfers it to the bodies of the vertebrae and their intervening cartilages. The muscles are unable to continue supporting the



spine in its hyper-erect position at all times, and consequently the patient bending forward occasionally, causes increased pressure upon the diseased cancellous bodies, hastening absorption of their structure and the formation of deformity.

Nature's indication for the treatment of Pett's disease is to put a splint on the back of the patient which will maintain this erect position, for since the tendency of the disease is to curve the affected portion of the spine forward, the center of this curve being anteriorly, our corrective force should be applied to produce exactly an opposite curve to the diseased one, the center of such a corrective curve being posterior to the column. In other words, we must follow nature's lead and hold the spine erectly and slightly curved backward, the tendency of the disease being to curve it forward; and to thoroughly understand the principle upon which the new brace for this purpose is constructed, this patient having a well-defined knuckle is again laid on his back upon a table, the padded edges of which come to the apex of the deformity, the shoulders and head being allowed to fall downward.

You will observe, as the patient's head and shoulders descend, that a partial, but physiological and true, extension of the spine is affected, the traction force being all that portion of the patient above the seat of disease. This augmented by gravity, produces a backward curve of the spine, most marked at the seat of disease. There is also a tendency to obliterate the knuckle, and this is only prevented from taking place entirely by such consolidation as has become perfected.

We have thus produced by this position the two effects we consider to be necessary to successful treatment and have placed the spine in curves the reverse of those it held before this posture was assumed.

If this position could be maintained indefinitely there would be rapid improvement in the disease; but as this is obviously impossible we attempt to embody in a brace the forces involved, it being for this purpose constructed in two parts. The "table" portion of the brace (and by this we mean that portion of the brace which is to produce upon the patient an effect identical with the table) consists of a firm pelvic band from which strong padded strips pass up on either side of the median line to the seat of disease (see fig. 14D) and these form the short arm of the lever.

The "backward traction" portion of the brace consists of a back frame secured on the pelvic girth by a ratchet or clamp which allows it to be adjusted at any outward angle, and thus regulates the amount of forward pressure upon the kyphos.

The angle at which this back frame, or long arm of the lever, is thrown out from the body (see fig. 14D) determines whether the brace shall act as a lever or as a simple fixation brace, and the angle between the long and short arms determines the degree of power employed; and when the back frame is set outward at an angle with the short arm and is drawn down to the body and fastened firmly (as shown in figs. 14E and 14F) the short arms terminating in the pads press forward upon the transverse processes of the diseased vertebræ with a constant elastic force.

There are also other features of this brace which deserve mention. It will be observed that if the angle between the short and long arms of the lever is considerable when the long arm is fastened firmly to the body, the bending tendency forward of the upper part of the trunk does not cause the spine to give way at the seat of disease, for in proportion as the patient leans forward the short arms press forward upon the kyphos, and oppose a resistance to the bending at that point, so that by the brace a curative automatic effect is produced to keep the body erect, and at the same time prevent further deformity while tending to improve that which already exists. Also that the *spring* effect, produced by the setting off of the traction frame, and drawing it forward against the body which is thus held erectly when properly strapped, causes the brace to be held more tightly against the back and insures a higher degree of fixation than any form of apparatus in use.

In the beginning of the treatment it is well to have the traction frame set off at such an angle as to cause considerable pressure upon the transverse processes of the kyphos, and produce thorough extension of the diseased portion; but this angle may be lessened week by week as the case improves, until finally the traction frame lies directly upon the pads, and the brace becomes a mere fixation brace without any leverage whatever.

To further illustrate the action of this brace, if a bent lead strip is taken and one extremity held firmly by one hand, with the thumb pressed against the knuckle, it will be found that a force comparatively slight (when contrasted with that used in linear traction to produce not so perfect a result) with the other hand will serve to straighten the rod into its original position, knuckle and all. This is precisely what is accomplished by this brace. We grasp firmly the lower part of the spine as high as the seat of disease, and then, by force applied above, bend the spine backward sufficiently to relieve the bodies of the vertebræ from pressure, and at the same time with the short arm of the lever, corresponding to the action of the thumb upon the lead strip, press forward upon the deformity, and thus, by the use of a very light frame-work, we can exert sufficient leverage to retain the spine in the erect position of the equestrian; and as this *backward* force is distributed along the entire dorsal and lumbar spine, while the *forward* pressure is exerted only along the spine from the seat of disease downward, decreasing from the kyphos to the sacrum, it will be found that no injurious pressure is exerted at any one point, as is the case in the Taylor or Chance braces.

For the middle dorsal region the short arms of the lever are longer than in the lower dorsal, so as to be opposite the seat of disease, and the brace may be attached by straps.

For the upper dorsal region the straps in front are dispensed with, the attachment of the long arm of the lever superiorly being effected by padded strips, curved so as to pass under the axillæ and terminating in infra-clavicular pads, which are still better retained in place by straps over the shoulder. As in the other braces, the short arms pass to the seat of disease,

and this makes a very light and effective brace for this region, which is generally considered to be the most difficult to treat mechanically of any part of the spine.

For the cervical region or disease of the first and second dorsal vertebrae, the brace just exhibited should have added to it a jury-mast or a headpiece (as in fig. 14G), which is provided with facilities for fixing the head firmly in any position, by the insertion in the neck strip

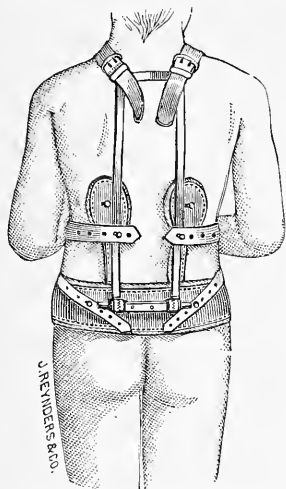

Fig. 14F. The same (posterior view). The position of the kyphos, if shown, would be between the two pads.

connecting the head-piece to the rest of the brace of three clamps, which are so placed as to secure this object. The choice between the jury-mast and fixed headpiece in these cervical cases is usually one which the surgeon is called upon to decide for himself, and is to some extent regulated by the gravity of the case; the latter being more effective in *caries* which is proceeding very rapidly in its course.

When the disease is situated in the lumbar, in some cases in the lower dorsal region, and the short arms of the lever are too short to exert sufficient forward pressure upon the kyphos, the lever is reversed, the point of intersection of the long and short arms being placed in the dorsal region instead of over the sacrum.

In such a brace the base plate is placed in the upper and middle dorsal regions and there secured to the body by appropriate straps. From this the short arm lever strips pass down on either side of the spine to the seat of disease where they terminate in pads, the whole being bound down to the body without constriction by a T plate over the sternum and the long arm of the lever passes to the sacrum, there terminating in the pelvic girth.

When this brace is secured to the body, it forms a V-shaped lever which produces extension of the bodies of the vertebrae and tends to improve the deformity, while it maintains the spine firmly in the erect position, these being, as we have seen, the desiderata for successful treatment. To illustrate this reversal of the lever, so as to obtain sufficient leverage to be of use in the lumbar region, a patient is laid on the back upon the padded table, and all that portion of the body *below* the seat of disease is allowed to hang over, just the reversal of the position already demonstrated. In this manner also we produce the extension of the spine by means of the backward traction of the lower extremity, and also produce the forward pressure upon the kyphos by the edge of the table. It is to sustain these effects when the erect position is assumed that we use the lever brace, and to adapt it to this portion of the spine, we reverse its construction as already detailed.

To resume the consideration of the patient before us: A brace was constructed for him upon this V lever plan, the apex of the V being placed in the middle dorsal region; and there firmly fixed by a chest-plate and straps so arranged as to secure the base plate to the back without impingement of the soft parts. The short arm of the lever passed downward and bifurcated just above the kyphos and passing to either side terminated opposite its inferior boundary.—In this manner the direct forward pressure of the brace upon the diseased portion, was borne by the transverse processes without pressure upon the kyphos itself.

The long arm passed downward in the median line and terminated in the pelvic band, the clamp at the intersection of the two arms serving to regulate the amount of forward pressure at the seat of disease.

The child is now before you with the brace in position, and as we remove the apparatus and inspect the patient's back, you will see but a slight kyphos, which does not materially increase as he bends forward. You will see, as he jumps from the floor at our request, that on alighting there is no anxious or painful expression upon the face, as there would be if the concussion took place between the vertebrae in an active stage of the disease, and pressure can elicit no points of tenderness.

He looks rugged and vigorous, and his stepmother desires to know if he can go without the brace, as he seems to be cured, or, as she expresses it, "just like any other boy," but this we cannot yet advise.

We will, however, diminish the forward pressure at the kyphos by decreasing the V angle between the short and long lever, so that the brace will become only a fixation splint of the first class. For all practical purposes the disease and its consequent deformity are arrested, and it remains now only to be careful, to restrain the spine for a few months to insure the improvement becoming permanent; care being taken at the same time, of course, to continue the constitutional measures.

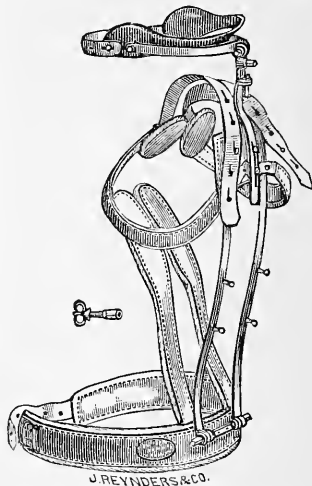

Fig. 14G. Same, with head-piece and clamps in neck strip, for fixation in any direction, instead of jury-mast.

There is one more point in respect to the mechanical treatment of these cases which is of prime importance, and that is, the right management.

Changes of position during sleep are very apt to cause spinal curves to be assumed which produce compression of the diseased vertebrae, and interfere with the processes of repair, and therefore the use of some sort of spinal splint for the night is strongly advised, where the dorsal and lumbar braces already described cannot be tolerated in sleep; and sometimes they cannot, although many become so habituated to them as not to have their sleep interfered with, especially if the sleeper lies upon the breast or side. A very effective splint may be prepared for night wear by applying a plaster-of-paris jacket during partial suspension.

Plaster-of-paris is mentioned first because it is so cheap and procurable, but felt or any other firm, rapidly hardening material will do as well, and this jacket is then to be divided anteriorly and provided with lacings in the ordinary manner. So far it does not differ from any other, but the additions which we are about to make to it, to some extent alter its character. A pair of thin pads should be placed on either side of the kyphos, posteriorly, and should be attached to the jacket at its edge by strips of metal, which are of a length, equal to the distance from the kyphos to edge of the jacket. (P. P. in fig. 14H.) These strips are bent so as to throw the pads inward, and thus become



Fig. 14H. Showing plaster jacket with pads for forward pressure.

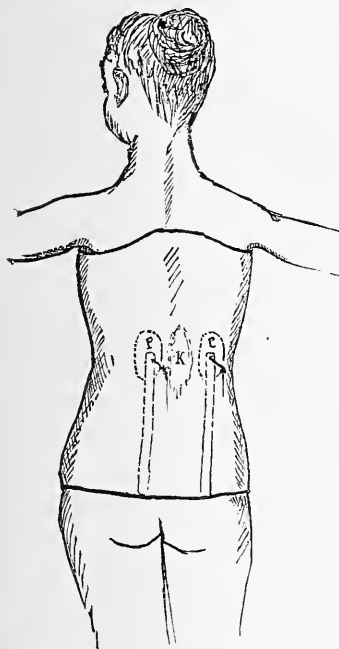

Fig. 14J. The same applied.

also to attach the pads to the back of the jacket opposite the transverse processes of the kyphos, by means of coiled spiral springs; but whatever form of lever or spring is used for its production it is impossible to bring the plaster jacket to its highest degree of effectiveness without the employment of forward pressure at the seat of disease. The jacket maintains the body in the erect position, while the pads tend to prevent increase of the deformity and to diminish whatever already exists, until the process of repair and consolidation is complete.

MEASUREMENTS REQUIRED.

- 1, sex of patient. 2, general appearance of patient. 3, lay a soft piece of lead wire along the back, moulding it exactly to the spine and all its sinuosities from the top of the head to the middle of the sacrum; with this pattern trace carefully the shape of the spine and head on a sheet of paper, marking the points opposite the upper and lower borders of the scapula and the crest of ilium, also the affected parts of the spine; send us this tracing. 4, circumference of body between crest of ilium and trochanter major. 5, circumference of body at waist. 6, circumference of body under axilla. 7, distance between the upper borders of the scapulae. 8, distance between the lower borders of the scapulae. 9, circumference of shoulder, pass the tape measure under the axilla and over the shoulder. 10, circumference of head, around the chin and back of the neck; in taking this measure, care should be exercised that the tape encircles these parts in an even horizontal line.

The prices for Lever Spinal Braces vary, according to the sizes and styles of the same . . . . . from \$35.00 to \$50.00  
 Lever Spinal Brace with Headrest for Cervical Caries . . . . . 45.00 to 50.00

This jacket, so modified, is an excellent spinal splint to be used during the day also, since it embodies the principles of the braces just described, and can be recommended for such cases as do not care to use a brace, and also for young children. In applying it, draw back the pads and secure them against the back of the jacket by the cords and then when the jacket is laced in front, after being placed on the body, the cords are to be loosened, and the pads will then press forward on either side of the kyphos, with a constant elastic force which depends for its intensity upon the strength and angle of the springs by which they are attached to the jacket.

(Fig. 14H shows such a lever jacket with the pads projecting inward and their spring strips attached to the jacket inferiorly, while fig. 14J illustrates the same jacket in position.) It is not, however, necessary for the lever or spring effect that the strip connecting the pads with the jacket should be attached to it inferiorly in all cases, for they may be also attached (although not so advantageously) superiorly, transversely or obliquely; or, indeed, in any position, so long as the pads are on either side of the kyphos and are forced to exert a forward pressure upon the diseased vertebrae. It is perfectly practical

15. DR. L. A. SAYRE'S APPARATUS FOR SUSPENDING PATIENTS WHILE APPLYING HIS PLASTER OF PARIS JACKETS.



It consists of a curved iron rod, having an eye in its centre and hooks at each end.

From the end hooks, loops pass down under each axilla and also to the chin and occiput, to support the head. The length of these loops can be graduated to suit every patient, by separate straps and buckles that connect the loops with the iron rod. Those parts of the loops that pass under the axillæ and chin are well padded.

The whole apparatus is attached by the eye in the centre of the iron rod to one of a set of compound pulleys;



and the opposite pulley being secured to the ceiling or some other safe attachment of sufficient height; the patient is easily elevated by the bands under the axillæ, chin and occiput until the heels cannot touch the floor. . . . . Price, \$11.00

16 represents an improved form of the same apparatus. The improvement consists:

*First.*—In two extra hooks placed on the iron rod between the end hooks and the eye in its centre. These serve for the attachment of the loops of the padded chin-piece, and being in direct lines with the sides of the patient's head, support the latter in a more direct and, therefore, more comfortable position.

*Second.*—Into the loops that pass under the axillæ small steel bars are sprung, that keep the loops apart when patient is suspended; they prevent the loops from chafing the anterior and posterior parts of the shoulders, pressure on the axillary plexus of nerves producing numbness of the fingers, in some cases of adult, or even very heavy children, thus aiding in placing the patient in a comfortable position during suspension. . . . . Price, \$12.00

Extra Chin Neck Bands, different sizes, each. . . . . 2.50

The above two apparatus are furnished with the best compound pulleys, each of the latter containing three rollers; when specially mentioned, we furnish the same apparatus with sets of plainer compound pulleys, containing only two rollers each; the elevation of the patient by the latter is more difficult than with the former, as more power is required.

Apparatus No. 15, with plain compound pulleys . . . . . \$8.00

Apparatus No. 16, with plain compound pulleys . . . . . 9.00

MEASUREMENTS REQUIRED.

1. Age and Sex of Patient.
2. General appearance of Patient.
3. Circumference of head, around the chin and back of the neck.

In taking this measure care should be taken that the tape encircles these parts in an even horizontal line.

DIRECTIONS FOR THE APPLICATION OF DR. L. A. SAYRE'S PLASTER OF PARIS JACKETS FOR THE TREATMENT OF ANGULAR AND LATERAL CURVATURE OF THE SPINE.

(Extracted from *The Transactions of the American Medical Society.*)

In a discourse, on the above subject, before the American Medical Association, Dr. Alfred C. Post, of New York, says:

"I consider, that this principle, introduced by Dr. Sayre, constitutes an epoch in the treatment of this very distressing form of disease."

**Tripod, see page 318.**

After seconding the motion, to refer Dr. Sayre's paper to the committee of publication, Dr. Lee, of Philadelphia, says:

"The idea which underlies this mode of treatment is undoubtedly the true principle for the treatment of Pott's disease. We have done wrong in considering it a purely constitutional affection. We must look upon it as a surgical disease, and treat such cases much as we treat a fractured limb. It is this that Dr. Sayre has done in applying his plaster bandage. He has treated a carious spine as any one of you would treat a broken leg, and in doing so has achieved the results which he has shown you, which we must all admit to be wonderfully successful. If have not yet myself put this plan in practice. I have been so long making use of other appliances, having the same end in view, have become so accustomed to them, and so well satisfied with them, that I have hesitated to make a new experiment; but after hearing the demonstration of to-day, I feel that I shall be wanting in justice to my patients if I do not at least make the effort to use it."

#### APPLICATION.

The proper plan of applying the Plaster of Paris Jacket is to take loosely woven cloth, such as cross barred muslin, mosquito netting, or cheese-bandage cloth, and cut it into strips three or four inches in width, according to the size of the patient upon whom it is to be used, and then fill its meshes completely by drawing the cloth through and at the same time rubbing into them freshly ground plaster of Paris, such as has not been exposed to the air. The strips are then rolled up into tight rollers after the fashion of the ordinary roller bandage, and are ready for use at any time occasion may require. They should be kept in an airtight tin vessel.

When you wish to apply a jacket, the patient is to be suspended by means of an apparatus, prepared for the purpose. (See figures 15 and 16.)

Previous to the suspension, however, a thin flexible leaden strip should be laid upon the spinous processes for the entire length of the spinal column, and bent into all the sinuosities, so that it may take a perfect outline of the deformity. This strip is then laid upon paper and its outline marked with ink, and we have a perfect mathematical outline of the irregularities along the spinal column. After the patient has been suspended, the same leaden strip should again be applied along the spinous processes, as is in the first instance, and another pattern made upon paper by the side of the first.

Now we have a means by which comparison can be made, and we are able to determine exactly what changes have taken place in the curve. The shirt, which should be woven or knit without seams, and tightly fitting the body, is next pulled down and an opening made in front and rear through which a ribbon or piece of bandage is passed for the purpose of holding in place a handkerchief placed in the perineum, and at the same time making the shirt fit the hips exactly; for the tighter the shirt fits the less number of wrinkles there will be in it. The roller bandages, previously prepared, are now set on end in a vessel containing sufficient depth of water to cover them entirely, and, at first, bubbles of gas will escape through the water freely. When the bubbles cease to escape, the bandages are ready for use. Then taking a roller in the hand, and squeezing it gently so as to remove all surplus water, commence just around the smallest part of the body, going to the crest of the ilium and a little below it, and lay it around the body smoothly, but do not draw upon it at all; simply unroll the bandage with one hand while the other follows and brings it into smooth close contact with all the irregularities of the surface, over the ilium and dipping into the groin over the abdomen and dipping into the groin again, and so on, from below upwards in a spiral direction until the entire trunk has been enclosed from the pelvis to the axillæ.

If there are any very prominent spinous processes, which at the same time may have become inflamed in consequence of pressure produced by instruments previously worn, or from lying in bed, it is well to guard such places by means of little pads of cotton or cloth or little glove fingers filled with wool which is elastic, which are to be placed upon either side of them before applying the bandage.

Another suggestion, which I have found to be of practical value, is to take two or three thickness of roller bandage, three or four inches long, and place them over the anterior superior spinous processes of each ilium. These little pads are to be removed just before the plaster has completely set, consequently leave the bony part free from pressure after the soft parts have shrunken under the influence of the continued pressure produced by the plaster dressing. It is also well, just before the plaster has set completely, to place one hand in front of the ilium and the other over the buttocks, and squeeze the cast together so as to increase the space over the bony prominences. In a very short time the plaster becomes set sufficiently so that the patient can be removed from the suspending apparatus and laid upon the face or back upon an air-bed, where they are to remain until the hardening process is complete. A hair mattress answers a very good purpose, but the air-bed is preferable, especially, if there is much projection of the spinous processes or the sternum.

#### VALUABLE SUGGESTIONS FOR THE TREATMENT OF SPINAL DISEASE BY THE PLASTER JACKET.

Extracts from "Correspondence" of *The Medical and Surgical Reporter*, of July 2, 1881, entitled:

##### A TALK WITH PROF. LEWIS A. SAYRE.

"There is another subject, while not directly allied to talipes in any shape, is yet one which I find in my daily practice has not yet become understood by many of the profession. I refer to Pott's disease and its treatment by means of the plaster jacket. While the patho-

logy of the disease is now fairly well comprehended by surgeons, yet they seem to persist in making an error in regard to the best, and, I am tempted to say, the easiest manner of treating the complaint. Changes, almost innumerable, have been made upon the various mechanical appliances that have been devised for the relief of the unhappy sufferers from this complaint. I have daily coming to me patients who inform me that the remedy is as bad, and perhaps, worse, than the disease; and truly I can believe them when I see upon their skins spots of ecchymosis and ulceration denotive of the points upon which iron braces and pads have been made to push and pull, in the vain hope of thus forcing the column into place, and then keeping it there. Others, again, are the victims of the wheel-chair mania, or some of the modifications of an apparatus to support the shoulders by passing the body through an open framework supported upon wheels, and allowing the body to drag from supports catching under the axillæ, the feet touching the ground, the plea being that thus the sufferer is allowed the boon of out-door exercise; but while this may be granted, yet is it a favor for the enjoyment of which he pays dearly, by the fact that he drags around with him a burden that, by its very weight, draws out of him the strength that it is so essential that he retain.

Now, I contend, and I think by the record of my cases I am justified in assuming the ground, that any apparatus further than a bandage, best made of cross-bar muslin, cheese cloth, or crinoline, some plaster-of-Paris and water, is not at all necessary for the treatment of Pott's disease. But, I must attach this proviso: the apparatus must be applied correctly, and further, that the patient must not be made to feel that he is about to be martyred at every renewal of the jacket. I know of people who have come here with the expectation, not unfrequently originated by their medical attendant, that they were to be hung up, in much the same manner as we would hang up a sheep to dress it; that they were to be tortured, etc.; and at times, I am sorry to say, sad experience has been their teacher in this matter; they have had jackets applied by those whose education and judgment should have dictated a proper and rational course to be pursued in their application, but who, unfortunately, transgressed one of the golden rules of the procedure, namely, *that never, under any circumstances or conditions, be they what they may, should the extension of the patient's body be carried beyond the point of absolute and easy comfort*, for there is nothing to be gained and everything to be lost by transgressing this rule. The idea of hauling patients up and leaving them to swing round and round unsupported while the bandage is applied, in order, as argued by the votaries of *absolute* suspension, to get the utmost extension, and consequent straightening of the spinal column, is simply barbarous, and has nothing to recommend it, either in poetry or reason. The patient must learn to have confidence in, and not fear of, him who seeks to relieve him, in this as in all other procedures in our art. The sufferer must himself be the judge of the amount of comfortable extension; he can be elevated to that point, and then allowed to hold himself there by means of the pulley cords, upon which a small, spindle-shaped, wooden, sliding handle should be placed, for the patient to grasp; this being secured from slipping by means of a knot made in the rope beneath it, *he should never be suspended so that his feet do not rest upon the ground sufficiently to afford a fair amount of support*.

Further, in regard to the shirt to be employed: we are wont to give the name skin fitting to any ordinary gauze shirt, or vest, such as is commonly used for summer underwear, whereas, the fact exists, that in ninety-nine cases out of a hundred they are not skin-fitting, but more or less creased, and consequently, I hold, unfitted for the purpose here in view. I make it an invariable rule to have each patient's shirt woven to fit him; he is sent to a manufacturer of these goods, who measures him over all the angles and curves of the trunk, and then weaves a seamless shirt in accordance with these measurements.\* Placing a shirt on a man, that, to fit him skin-tight, has to be creased and doubled, is not the correct thing; a creased stocking is not pleasant to wear, and a creased shirt cutting into flesh, already at a low ebb of vitality, beneath a case jacket, is but another form of Dante's Inferno.

Again, it is not at all essential that the jacket, when finished, shall measure half an inch in thickness, as I have seen them; nor yet should dry plaster be rubbed over the bandages while still wet, to give the dressing a finished appearance; it simply requires to be calcimined so to speak, by rubbing the bandages with the wet hands; thus finished, the patient does not leave in his track a line of plaster chippings. After the plaster has set, any portion of the shirt extending above or below the jacket, as well as the portion knotted over the shoulders, should be cut off; at any point where the jacket impinges unpleasantly a small section should be removed. Ordinarily there should be placed over the mammæ, in girls, pads or woven screens, that can be withdrawn after the dressing is completed; it may be well, also, in both sexes, to fit the jacket after dinner or a full meal, in order that the stomach may not be pressed upon when in a state of repletion, as it would be if it were fitted over an empty stomach. Before commencing the application of the bandage the shirt should be secured in position by means of a nursery pin, passed through the skirts of the shirt, close to the perineum. In case it is desired, the jacket can be slit up in front in about twenty-four or forty-eight hours, and lacers inserted, thus permitting ablation, etc., to be performed; but this remark applies rather to the second than the first jacket, which should be retained *in situ*, uncut, for some length of time (a month or six weeks), in order to afford the best possible support. It probable will transpire that, at the end of a week or ten days, the jacket, if examined, will be found to have seemingly grown too large for the patient, over the scapulæ or the ilium. The remedy for this is to remove a wedge-shaped portion marking the greatest amount of seeming enlargement, to bevel the remaining edges, and by a series of, first entirely circular, and then *loosely reversed* turns, to cover in the gap, finishing off by a few circular turns around the trunk, in the same manner as the first turns. The piece removed

will denote the amount of straightening gained, the measure taken being from the integument to the inner aspect of the section, before removal, when placed somewhat on the stretch. In a case of a lady of this city, seen by the reporter, this amounted to as much as two inches; in a case that had been under treatment for about ten days, and in whom, before the application of the jacket, the space between the inferior angle of the scapula and the crest of the ilium barely admitted the insertion of two fingers' breadth. It is interesting to study, from week to week, the amount gained, and not only gained, but permanently retained. Of course, it is essential that the patient be placed upon a generous diet and tonics, with which latter, however, the patient must not be flooded, and that the out-door exercise, being permitted to walk and move around as freely as he wills, with the reservation that he do not tire his system too much; in other words, that he be governed by the rule of a "happy medium," remembering that in overdoing himself, every ounce of vitality carelessly used up will be by nature required to be compensated for by more prolonged suffering. As to the time that the jacket must be worn, there can be no rule; every man is a law to himself in this case; just so long as the vertebrae feel that they need the support, just so long will the man's feelings dictate to him to retain it; in fact, so much is its function like that of a corset, that its removal becomes, after a time, as much of a loss as the loss of that piece of apparel; there is such a certain sense of security, and of being braced about it, that it becomes rather pleasant than irksome to wear; at least, this is the testimony of a number to whom the reporter has spoken, and who, of course, should be capable judges."

\*The measurements required for a seamless shirt, are:

1. Circumference of body at bust.
2. " " " at waist.
3. " " " at hips, between the crests of ilium and trochanters major.
4. State age of patient.

#### PRICES OF MATERIALS, ETC.

Cross-orrard muslin, for Plaster Bandages, per yard . . . . .	net \$0 25
Prepared Plaster-of-Paris Bandages, 3 in. wide and 5 yds. long, each, net	0 25
Air-beds . . . . .	see descriptions and prices on page 285
Strips or perforated tin . . . . .	each 0 10
Seamless Shirts, to order . . . . .	from net \$2 00 to 3 50
Plaster of Paris, per pound . . . . .	net 0 05
Boxes and cans extra.	

#### 17. TRIBOLITH.

This is a substance, which is used as a substitute for *plaster-of-Paris* in surgical practice. It is a gray, very fine powder, chiefly composed of calcium and silicium, with a minute quantity of iron. Originally it was intended for use in stucco-work, for which it is said to be particularly suitable on account of its lightness and resistance to water. It is not known how it is prepared, but, according to Prof. Langenbeck, of Berlin (*Berl. Klin. Wochenschr.*), it has several advantages over gypsum. It is said to absorb less moisture from the air, hence, does not lose its cohesion on exposure; tribolith bandages are lighter than plaster bandages, and harden quicker, requiring only 3 to 5 minutes, while plaster requires 10 to 15 minutes. The tribolith bandages loses water for some time afterwards by evaporation, and though soon set, still feel damp even after 24 hours. After having hardened, a tribolith dressing absorbs no more water, while plaster must be rendered water-proof by coating it with varnish.

PRICE, per pound . . . . . \$0 10

#### 18. APPLICATION OF THE PLASTER JACKET IN LATERAL CURVATURE.

(Extracts from Dr. L. A. Sayre's Lectures on Orthopedic Surgery and Diseases of the Joints, Second edition.)

The patient is to be fitted with a knitted shirt—the same as in the application of the shirt for spondylitis—with the exception, that it is made twice the length for the purpose of being reversed on the outer-side of the jacket and made into a corset; in cases where the patient is a female, pads of a proper size are then placed over the mammae, according to the development of the patient, and the shirt then tied tightly over the shoulders. The patient then suspending herself, as seen in figure 22, page 318, the shirt is to be pulled down snugly by an assistant, the dinner pad not being used in lateral curvature, a full meal being taken before the application of the jacket. The plaster bandage then being immersed in water sufficient to cover it when standing on its end, is left until all gas has escaped; a second bandage is then placed in the water, and the first one being removed, and the surplus water pressed out of it, is then applied snugly around the waist, each turn of the bandage covering two-thirds of the one previously applied; it is, in this manner, carried down below the crests of the ilia; then, passing back, up toward the thorax and over the mammae, an assistant rubbing each turn of the bandage into the one previously applied, until a sufficient thickness

has been secured to give the necessary support to the patient, which varies according to the size of the patient, the adult not requiring more than the thickness of the bookbinders' paste-board.\*

In a few minutes the plaster is sufficiently set to allow of the removal of the jacket, this being effected by a section made from the centre of the sternum to the centre of the pubes, using a sharp curved knife for this purpose, dividing both shirt and plaster dressing, the jacket being taken off while the patient still retains the suspended position. In cases of persons who are very obese, a small strip is cut out of the centre of the jacket, in order that it may be drawn in at the waist, but in the majority of cases this is not requisite.

On the removal of the jacket the edges are brought closely together, and a roller bandage passed around it in order to retain its shape; it is then placed before the fire until thoroughly hardened—which occupies generally about twenty-four hours. The following day the patient suspends herself as before, but having on at this time a thin under-vest, the jacket is then

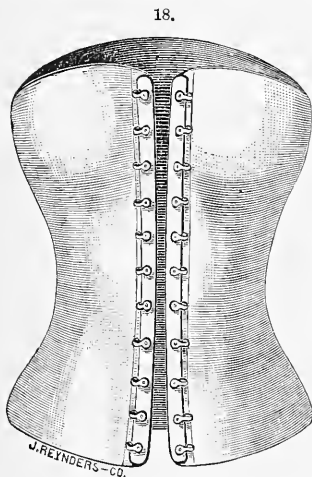

opened and sprung around her, and fitted into the exact position in which it was first applied, it is then secured by passing a roller bandage around the waist, making also a few turns of the bandage above and below the waist. The patient is then removed from the suspending apparatus, and the jacket cut out under the arms, on either side, until she is perfectly comfortable, so that no pressure is made in the axilla, and the shoulders are not elevated by the jacket; the patient is then allowed to sit down and flex the limbs, the lower part of the jacket being trimmed sufficiently to admit of free motion of the limbs. The jacket is then removed and sent to the instrument-maker, where the shirt is reversed and stitched at the top, cutting off all superfluous material; strips of leather, arranged with eyelet-hooks, are then sewed down the front of the jacket for the purpose of lacing it, thus forming a complete corset (see figure 18), this being worn during the day, and always removed at night, the patient taking the gymnastic exercises previous to the application of the jacket in the morning, and after its removal at night. The patient is to be self-suspended in the morning before the application of the jacket, in order that it may be properly adjusted while in the extended position.

#### PRICES.

Covering Plaster-of-Paris Jackets and sewing on in front strips of leather, containing eye-let hooks for lacing .....	\$3 00 to \$3 50
Dr. L. A. Sayre's books on Spinal Disease and Spinal Curvature, illustrated with wood cuts and photographs .....	3 50*

### 19. DR. M. JOSIAH ROBERTS' METAL CLASPS FOR PLASTER-OF-PARIS JACKETS.

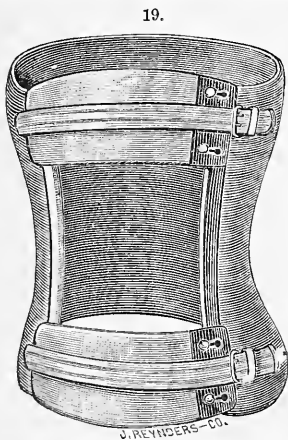

In order to make the jacket removable for the purposes of cleanliness and the manipulation of the trunkal muscles, and yet to retain its full supporting power, I have made use of metallic clasps, secured in position by elastic bands passing over them. They are attached to the jacket after the removal of a wide longitudinal section in front. Being curved so as to correspond to the contour of the chest and abdomen, and closed by means of strong bands of rubber webbing, the anterior part of the chest is not pressed upon, nor are the movements of respiration unduly restricted, as they are when the ordinary non-elastic corset lacings and mountings are used.

The metallic clasps are neatly covered with buckskin, and the webbing used is of the best quality. Price according to the size of the jacket from.....\$5 00\* to \$7 00\*

\* I used formerly to apply light strips of tin in the meshes of the bandage in order to give additional strength, but experience has proved it to be entirely unnecessary if the different layers are properly rubbed together; and, therefore, for the past five years I have discontinued the use of these strips of tin.



## 20. DR. L. A. SAYRE'S "JURY MAST,"

See page 324A.

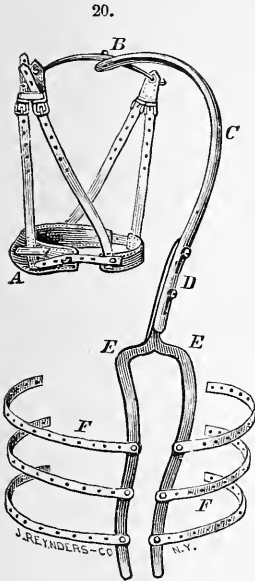

In case of disease of the cervical and upper dorsal vertebræ, Dr. Sayre uses the head suspension or "Jury Mast," consisting of a steel rod, secured to two pieces of malleable steel, which are placed on either side of the spine, and which can be bent so as to accurately fit any curve in the plaster jacket, which has already been applied to the entire trunk of the diseased patient, and retained accurately in position by having attached to them three narrow strips of perforated tin, F. F., which should be long enough to very nearly encircle the entire trunk, leaving only a central line of an inch or so in width in front of the body, for the purpose of cutting or sawing down the plaster jacket whenever it may become necessary to remove it. The central bar, C, is attached by a cross-bar to the upper portion of this malleable framework, and is curved over the top of the head to the vertex; to its extremity is attached a swivel bar, B, three to five inches in length, from which the head is suspended by an adjustable chin piece, A, secured under the chin and occiput. This central bar is made in two pieces passing over each other at the straight portion, D, behind the neck, and capable of being extended to any desired length, and firmly secured in position by screws.

To apply the apparatus the patient is suspended in the usual way, from the axillæ, chin and occiput, and the plaster bandage applied, as usual, over a tight fitting knit or woven shirt. After the bandage has been accurately applied, the patient is removed from the suspending apparatus and carefully laid upon an air-bed until the plaster has hardened or "set." The patient can then stand up, and the apparatus for suspending the head is applied in its proper position, over the back of the plaster jacket, and the lower portion of it bent and moulded until it accurately fits all its various curves. The loose tin strips, being very flexible, can then be smoothly moulded around the jacket which has already been applied to the trunk, and another plaster bandage having been wetted in water is to be carefully and tightly applied over the apparatus and jacket first applied, in sufficient number of layers to make it perfectly secure. The tin being rough and perforated, a sufficient amount of plaster will be incorporated into its holes and meshes to prevent any possibility of displacement. We have now a secure point of support from the pelvis and trunk from which the head can be sustained by properly adjusting the moveable rod and securing it by screws.

The ease and comfort to the patient, together with the perfect freedom of mobility to the head, make it very much more satisfactory than any contrivance that we have yet seen used.

PRICE, ..... \$12 00

## MEASUREMENTS REQUIRED.

1. Lay a thin and flexible strip of lead along the spine, moulding it exactly to the spine and all its sinuosities from the top of head to the middle of sacrum. With this pattern trace carefully the shape of the spine and head on a sheet of paper, marking the points opposite the upper and lower borders of the scapulae and the crest of ilium, also the affected parts of the spine. Send this tracing to us. Upon receipt of application, we will mail free of charge to parties desirous of ordering one of the above named apparatus, a flexible strip of lead to aid in securing the tracing above referred to.
2. Circumference of head, under the chin and over the head.
3. Circumference of head, around the chin and back of the neck. In taking this measure care should be exercised that the tape encircles these parts in an even horizontal line.
4. Circumference of body at crest of ilium.

21. Hardened Sole Leather Jackets.

[Extracts from an article by Dr. G. F. Touwers, of Philadelphia, Pa., in the *Chicago Medical Journal and Examiner*, March, 1880.]

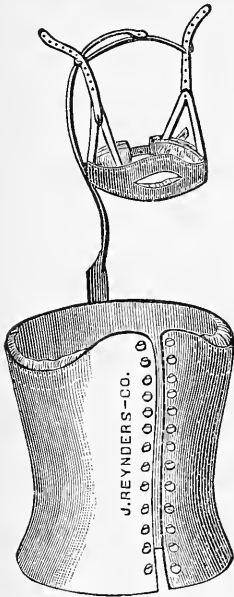

This apparatus, which has been very successfully employed in the Pennsylvania Hospital, in Philadelphia, and the manner of making it, may be described as follows: An accurate mould of the trunk is taken by means of the plaster-jacket, the patient of course being suspended; before becoming entirely set the jacket is cut open in front, in the middle line. The mould thus obtained should be sent to Messrs. J. Reynders & Co., who are enabled to reproduce it exactly of stiffened sole leather, which upon examination is found to be so accurate that even the intercostal and intermuscular spaces are clearly shown in the leather. It is provided with eyelets and lacing cords in front, so that, if desirable, the apparatus may be removed at night, the mattress then acting as the spinal supporter. To this apparatus Dr. Sayre's "jury-mast" may be added; this supports the head in an erect position, and the spine is relieved of superincumbent weight by a rod reaching above the back of the head, and from which supporting bands extend beneath both occiput and lower jaw.

The weight of the leather jacket is almost *nil* comparatively, being about  $\frac{1}{3}$  of that of the plaster-jacket. I have before me a jacket made for a boy fourteen years of age, and worn by him with great comfort for over six weeks, the weight of which is eighteen ounces. In this case fenestrae were cut in the jacket, to allow for the prominences of the anterior superior spinous processes of the ilium. In those cases in which extra support is required, narrow bands of steel may be placed on the back and sides of the jacket; these were used in the case above mentioned. The apparatus will stand a large amount of ill-usage and not be broken or bent out of position. The jacket can readily be removed by simply unlacing the front thus providing for ablution, etc.

Price .....\$25 00

When ordering a jury-mast with one of the above jackets, send us also in addition to the mould of the trunk, the measurements and tracing as directed for a jury-mast on page 317 of this catalogue.

Price of hardened sole-leather jacket with Dr. Sayre's jury-mast .....\$35 00

22



22. Dr. L. A. Sayre's Apparatus for the Gymnastic Exercising of Patients suffering from Pott's Disease and Lateral Curvature of Spine.

A further use of Dr. Sayre's mode of extension is shown in Fig. 22 for the above named purposes, the patient pulling himself up by means of a rope and compound pulleys; the former having egg-shaped blocks, secured by the rope being tied into a knot under each and at regular intervals. These blocks enable the patient to draw himself up with ease. A padded chin-piece only, looped into an iron rod completes the apparatus. No other person should pull the ropes in this exercise, and the patient should always hold both hands elevated, one nearly opposite the forehead, and the other above. This contrivance can be hung up in any part of the house.

Price, \$9.00

Dr. Sayre suggested to us to make tripods as shown in Fig. 22 for the sake of convenience, thereby enabling patients to use this Gymnastic Apparatus wherever they please.

Plain Tripod with Suspension Apparatus, Price, \$18.00  
Disjointed Tripod with Suspension Apparatus, put up in canvass pouch, Price, \$22.00

MEASUREMENTS REQUIRED.

1. Sex of Patient. 2. Weight. 3. Height. 4. Circumference of head around the chin and back of the neck. In taking this measure care should be exercised that the tape encircles these parts in an even horizontal line.

See page 312.

**23. DR. M. JOSIAH ROBERTS' IMPROVED "JURY MAST."**

(Extracts from Dr. M. J. Roberts' article, entitled "Non-Uniformity in the Principles of Treating Pott's Disease," etc., etc., in *The N. Y. Medical Journal and Obitrual Review*, of October, 1882.

23.

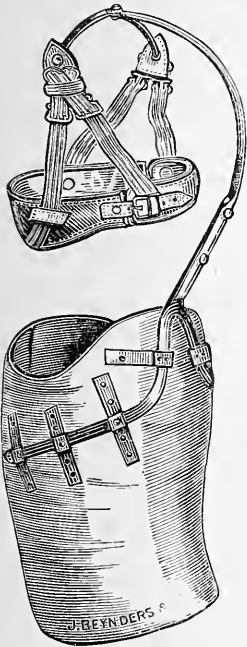

The "Jury Mast," in its modified form, differs mainly from its antecedent in that the arms, which are incorporated between the layers of the jacket, are curved forward under the axillæ. This disposition of the trunkal shafts secures for the instrument, when sustaining the weight of the head and neck, a state of stable equilibrium, the centre of gravity of the whole falling within the base, and being located inferiorly to the lowest point of the shafts. Undue pressure against the spine is impossible, and the head is sustained without mechanical strain. It is unnecessary for me, in this connection, to make more than a passing allusion to the mechanical advantage thus gained.

Another point gained in the modified form of the instrument is that of securing the maximum amount of strength with the minimum weight of metal. This is accomplished by making the cephalic shaft of a light strip of steel bent upon its edge, instead of flatwise, and widest at the point of greatest curvature, a feature not well shown in figure 23.

**MEASUREMENTS REQUIRED.**

1. Age of patient.
2. General appearance of patient.
3. Place a thin and flexible strip of lead along the spine, moulding it exactly to the spine and all its sinuosities from the top of head to a point on a line with the inferior angle of the scapulae. With this pattern trace carefully the shape of the spine and head on a sheet of paper, marking the points opposite the upper borders of the scapulae. Send us this tracing.
4. Circumference of head, around the chin and back of the neck. In taking this measure care should be exercised that the tape measure encircles these parts in an even horizontal line.

PRICE.....\$12 00

**24. DR. M. JOSIAH ROBERTS' IMPROVED ELASTIC TRACTION HEAD REST.**

24.

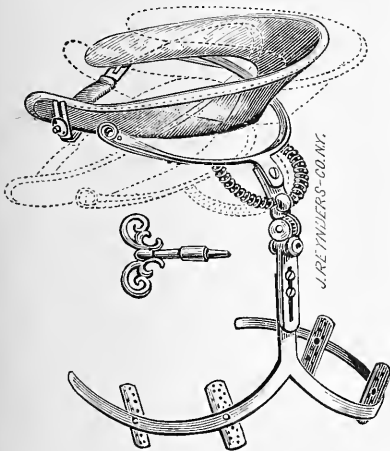

24A.



Though the altered head-rest, with elastic straps attached (fig. 23), probably fulfills the more important mechanical indications for treatment, it is, nevertheless, on some accounts, very objectionable. It, like all supports that pass over the head, is unsightly in appearance, and never fails to fix the eyes of the curious on the already over-sensitive patient whenever he chances to appear in public highways. Mothers, too, usually find fault with it, because of attracting so much attention. For these reasons, among others, I set about devising an instrument which, while not extending over the head, would exert continuous elastic traction upon the diseased vertebræ, and permit of voluntary motion of the cervical vertebræ.

Figure 24a, from a photograph, illustrates the inconspicuousness of the apparatus when the patient is dressed. It permits of all the normal movements

of the head being made at the pleasure of the patient, or controlled and directed by the surgeon.

It consists, first, in an upper or cervico-mental encasement provided with a metallic clasp under the chin, permitting of easy removal and reapplication. This is connected by means of lateral coiled springs with the cervical piece, which in turn is hinged posteriorly by a simple flat joint with a slotted adjustable shaft, extending down the spine and connected with the trunkal segment of the instrument. At the junction of the posterior shaft with the trunkal shafts that pass forward under the arms, is placed an archimedian screw which works in the line of the mesial plane of the body. By means of this, and the longitudinally adjustable posterior shaft, any desired antero-postero position of the head, or degree of linear traction upon the cervical spine, can be readily maintained. By means of the lateral springs, above referred to, a gentle tensile or elastic linear traction upon the cervical spine is constantly exerted while at the same time moderate anterior-posterior movement of the head is permitted. Moderate rotatory movement of the head is also permitted by the flat hinge at the junction of the cervical piece with the posterior shaft. The lower part of the instrument, like that of the before described Jury Mast, is held between the layers of the gypsum bandage, the shafts being curved forward under the arms, so as to bring its base beneath the parts supported.

## MEASUREMENTS REQUIRED.

The same as for Jury Mast No. 23.

PRICE .....\$.....

## 25. DR. M. JOSIAH ROBERTS' BARS WITH ELASTIC TENSION SPRINGS AND BRACKETS FOR SECTIONIZED SPINAL CORSETS.

*These can be used equally as well on divided corsets of Raw Hide, Sole Leather, Felt or any other materials, by simply altering the base of the brackets so they can be rivetted to, instead of incorporated, with the material of the corset.*

(Extracts from his clinical lecture on "The Mechanical Treatment of Caries of the Lumbar Vertebrae." Reported in *The Lancet*, London, January 27th, 1883.)

We must substitute some mechanical device for this manual support, and for obvious reasons it is important that the patient be permitted to walk; that the support used be portable. To accomplish this by means in a single splint or apparatus, and to have the force which is exerted upon the spine in the various directions elastic, as it is when the hands are used for support, would seem to be a somewhat difficult mechanical problem to solve. That this is possible, I wish now to demonstrate.

As I have elsewhere described, the dressing to be worn can be applied directly to the patient, but for reasons which I cannot here discuss, the plan that I shall now employ is to be preferred. It is essential to get an accurate cast of the body upon which we can fashion our mechanical prop, so that it will fit the patient when applied. To obtain a cast we must first make a mould of the body. After the cast is made a tightly fitting knit shirt is drawn over, and we proceed to apply over the shirt rollers of plaster bandage.

25.

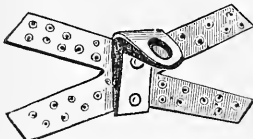

layer of gypsum bandage over the entire cast, four pairs of light steel brackets are placed in position upon it. These have thin perforated sheet-copper arms attached to them, in order that they may be securely held in position by layers of plaster bandage passed over them (figure 25). They are arranged in pairs, one above the other, (*vide* dotted lines, figure 25 B), and temporarily held in place with a rubber band (such as is used to hold bundles of paper together), slipped over the cast. Two pairs of brackets are placed behind, one on either side of the spine, and one on either side of the body, in front of the arms. These brackets are for the purpose of retaining the elastic spinal extension bars, presently to be described, in position. A wet roller, saturated with calcined gypsum, is now carried over the brackets, the projecting part of them only remaining uncovered. This holds them securely in position. When the dressing has become thoroughly dry a circumferential division of it and the shirt into an upper and lower

segment is made at the smallest part of the waist. A longitudinal section, four or five inches in width, is next cut out of each segment in front. This permits of their easy removal from the cast without disturbing their shape. As will be seen further on, the same is true in regard to their application to, and removal from the patient. At this stage we have to call in the aid of an instrument



25.A.

maker. It will be his business to fit and attach metallic clasps to these segments. The clasps extend across the space left by the removal of the wide section of plaster dressing in front, thus completing the circumference of the body. Three of these are required, two for the upper and one for the lower segment (*vide* figure 25A). The ends of these clasps, upon one side, are secured to the plaster dressing by hinges; and upon the other side are kept from sliding upward or downward by steel pins projecting through slots made in them. When the segments are applied to the patient, the clasps are closed and secured in position by



25.B.

means of strong bands of elastic webbing buckled over them, as can be seen in figure 25A. This arrangement permits of the easy removal and reapplication of the segments at the pleasure of the surgeon. The rubber bands admit of the necessary expansion of the thorax with each inspiration, and at the same time the efficiency of the support is not invalidated. I should also call your attention to the fact that the clasps are curved, so as to correspond to the contour of the chest and abdomen.

The segments having been placed in position on our little patient, and held by the bands of elastic webbing as above indicated, we now adjust the elastic extension bars. These are four in number. They consist of steel rods turned up at one end, as shown in figure 25C. Each is provided with a nut and strong spiral spring. They are secured in position by

25.C.



25.D.



passing their upper and lower ends through the perforations in the projecting part of the brackets, that have been previously embedded between the layers of plaster bandage (figure 25B). The weight of the body, which is now sustained by the upper segment resting on the springs, and transmitted by them to the lower or pelvic segment, serves to keep the extension bars in place. With a wrench (see figure 25D) the nuts may be moved up or down, and any desired amount of elastic traction force exerted. The improved position gained by suspension is thus preserved. By moving up the nuts from time to time, the kyphotic curve may be still further reduced without producing the slightest irritation. The perforations in the brackets, through which the extension bars pass, are large enough to admit of a very considerable amount of motion, while, at the same time, continuous elastic extension of the spine is maintained. You will observe that, by means of this mechanical appliance, we have placed the spine under very nearly the same conditions that it was when I extended it with my hands, and my assistant made forward and backward movements of the involved part.

When rotation of the spine exists in conjunction with posterior curvature, as in this case it can be very readily overcome in the following simple manner. To the summit of one or more of the extension rods, a nut, bearing two arms curved upward, so as to make almost a complete ring (figure 25*E*), is screwed. Rubber bands, such as are procurable at stationery stores, are now passed from the summit of one steel rod to the base of another, as seen in the figure. It should be remembered that these do not oppose the action of the steel springs, as would be the case if they were attached directly to the upper and lower segments of the jacket. They are attached to opposite ends of rigid steel bars. Any desired amount of elastic rotating force can thus be exerted, while at the same time continuous elastic traction of the spine is maintained.

Occasionally you will meet with cases in which the whole spinal column will be tilted to one side (fig. 25*F*). This is not infrequently due to unilateral weakness of the muscles of the lower dorsal and lumbar regions. The improved position gained by suspension is not maintained, no matter with how much skill the dressing is applied. And for this reason the power of the spinal lever is not applied below, or external to the weakened muscles. Were it practicable to carry a rigid spinal prop below the hip joints down upon the thighs, the improved position of the spine gained by suspension would be readily maintained. In a case such as is represented

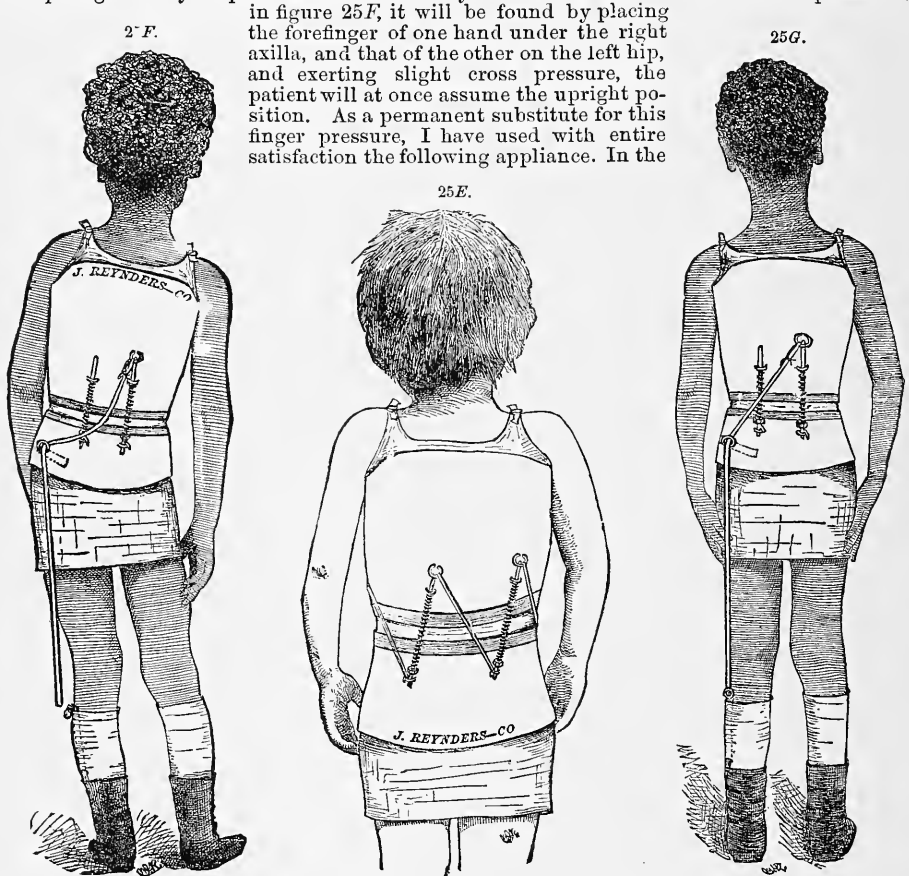

centre of a perforated strip of light tin, about four or five inches long and three-eighths of an inch wide, a short thin piece of steel plate bearing a small ring is soldered (see figure *C*, page 323). During the application of the dressing to the plaster cast one of these is incorporated between the layers of bandage over the left gluteal region, as shown by dotted lines in figure 25*F* and 25*G*. As is also shown in the same figures, a nut of the form already described is screwed to the top of the extension rod on the right side of the spine. To this is attached one end of a long solid rubber cord, six or seven millimetres in diameter. The other end is passed through the ring, which projects from the surface of the jacket below, and attached to the shoe. A strip of non-elastic webbing, long enough to reach from the ankle to the knee, is sewed to the top of the shoe on the outer side. This is passed to the inside of the stocking through the button-hole in it just above the upper margin of the shoe. The free end of the strip of webbing is provided with a ring. Through this ring the lower

end of the elastic cord is passed and drawn sufficiently tight to overcome the distortion, when it is fastened by a simple half hitch, or knot. This elastic cord does not oppose the lifting action of the spiral springs as it would were it attached directly to the upper segment of the jacket.

MEASUREMENTS REQUIRED.

1. Age and height of patient.
2. General appearance of patient.
3. State length of bars desired, also if wanted plain or with ball and socket joints and armed nuts as represented in figure 25F.

PRICES.

- 1 Set plain Spring Extension Bars with Wrench and eight Brackets, from \$6 00\* to \$10 00\*
- 1 Set of the same with ball and socket joints and Armed Nuts for the attachment of Rubber Cord, as represented in figure 25E, ..... from \$17 00\* to \$21 00\*
- Perforated Tin Plates with Rings, ..... each, \$0 30
- Solid Rubber Cord, ..... per foot, \$0 10
- Supplying and attaching three buckskin covered, hinged metal plates and elastic webbing bands with buckles; according to size of jacket, ..... from \$6 00\* to \$9 00\*

## 26. DR. M. JOSIAH ROBERTS' ELASTIC TENSION APPLIANCE FOR PLASTER-OF-PARIS JACKETS.

(Extracts from *The Illustrated Quarterly of Medicine and Surgery*, Vol. 1, No. 3.)



Fig. C.

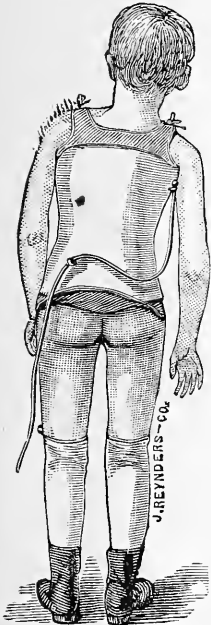

Fig. A.

All who have treated many cases of angular curvature must have met with some, in which, after the application of the plaster jacket or other spinal support, there was still present an undue protrusion of the belly forward or a lateral tilt, as in fig. A. Such distortions are for the most part due to debility of the muscles of the lumbar and the lower half of the dorsal regions. The improved position gained by suspension or extension of the spine in the horizontal decubitus is not maintained, no matter with how much skill the spinal support is applied. And for this reason, the power of the spinal lever is not applied below the level of the weakened muscles. Were it practicable to carry a rigid spinal prop below the hip joints down upon the thighs, the improved position of the spine would be readily maintained. This, however, would necessitate the immobilization of the hip-joints and the crippling of the patient to such an extent as to absolutely prevent locomotion. In a case of projecting abdomen it will be found, by placing the fore-finger of one hand upon the projecting abdomen and that of the other upon the back on a level with the scapulae, and exerting a very slight cross-pressure, that the patient will assume the erect posture.

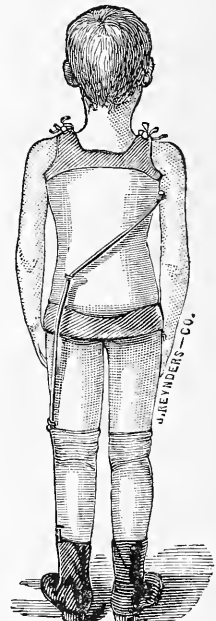

Fig. B.

The same result can in like manner be obtained in the case of a lateral tilt, as in figure A, by placing one finger under the right axilla and the other upon the left hip and exerting slight cross-pressure.

As a substitute for this finger pressure I have used with entire satisfaction the following appliance made for me by John Reynders & Co., of this city. In the centre of a perforated strip of light tin, about six inches long and half an inch wide (see figure C), a short thin piece

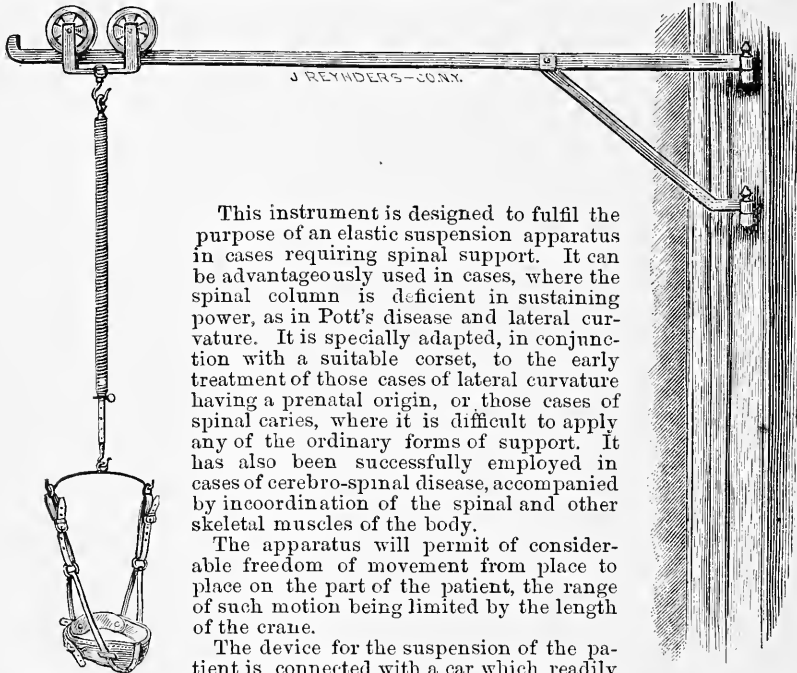

Fig. D.

of steel-plate, bearing a small ring, is soldered. During the application of the jacket one of these pieces is incorporated between the layers of bandage at the points indicated above for the application of finger pressure; the ring only remains uncovered by bandage. After sufficient time has been allowed for the "setting" of the gypsum, one end of a solid rubber cord, about a quarter of an inch in diameter, is passed through the lower ring and fastened to the upper ring. (See figure A.) Figure D illustrates the manner of fastening the lower end of the elastic cord. A non-elastic strip of strong webbing, long enough to pass up to the knee is sewed to the top of the shoe on the outer side. This is passed through a button-hole to the inside of the stocking, as shown in fig. D. The free end of the strap is provided with a ring. Through this, the lower end of the elastic cord is passed and drawn sufficiently tense to overcome the distortion, when it is fastened by a simple half-hitch, or a knot. In overcoming the protrusion of the belly, two elastic cords, one on each side, are necessary. If, in addition, there is present a slight lateral tilt, it can be corrected by making greater tension with one or other of the elastic cords. These elastic cords can be applied to any spinal support. I have made use of the same principle to correct drooping of the head, due to the weakness of the neck-muscles.

Solid rubber cord.....per foot, \$0 10  
 Perforated tin-plates with rings,.....each, 0 30

**27. Dr. M. Josiah Roberts' Swinging Crane for Elastic Suspension.**



This instrument is designed to fulfil the purpose of an elastic suspension apparatus in cases requiring spinal support. It can be advantageously used in cases, where the spinal column is deficient in sustaining power, as in Pott's disease and lateral curvature. It is specially adapted, in conjunction with a suitable corset, to the early treatment of those cases of lateral curvature having a prenatal origin, or those cases of spinal caries, where it is difficult to apply any of the ordinary forms of support. It has also been successfully employed in cases of cerebro-spinal disease, accompanied by incoordination of the spinal and other skeletal muscles of the body.

The apparatus will permit of considerable freedom of movement from place to place on the part of the patient, the range of such motion being limited by the length of the crane.

The device for the suspension of the patient is connected with a car which readily moves back and forth upon the metallic arm. A long spiral spring constitutes the elastic medium; within the coil of the spiral is placed a flat bar, perforated through its entire extent with holes, for the purpose of adjustment to the height of the patient, the bar being secured at any desired height by means of a pin passing through holes in the opposite side of a short section of tubing, brazed to the lower end of the spring. To the lower end of this sliding bar is attached a cross piece. From each extremity of this pass leathern straps, connecting with a well padded occipito-mental encasement of such dimensions, as to accurately fit the patient's head.

By means of butts the crane can be readily secured to a principal in the wall or to the casing of a convenient door or window.

MEASUREMENTS REQUIRED.

1. Weight of patient.
  2. Circumference of head around the chin and back of the neck. In taking this measure care should be exercised that the tape measure encircles these parts in a horizontal line.
- FOR THE SUSPENSION CORSET.
3. Circumference of body under axillae.
  4. Circumference of body at waist.
  5. Circumference of body between the crest of ilium and trochanter major.
  6. Length from crest of ilium to axilla.

Prices of Swinging Crane, as represented by the figure, .....from \$20.50\* upwards  
 Prices of Suspension Corsets, extra, .....from \$10.00



**27B. DR. MEIGS CASE'S SPINAL APPARATUS.**

Means afforded: 1, appropriate exercise under elastic extension with no restrictive appliance. 2, continued extension made endurable by change in position, sitting, standing, or walking. 3, perfect support, balance and guidance in locomotion.

Results obtained: 1, the absolute and speedy cure, without deformity, of recent cases of Pott's disease and lateral curvature. 2, immediate relief followed by permanent cure in acute Pott's disease, either before or after supervention of abscess or paraplegia. 3, deformity lessened, and attending complications alleviated in all chronic curvatures in adults or youths. 4, normal growth stimulated in children dwarfed by disease. 5, spinal irritation relieved, and ultimately, with its causes, removed. 6, remarkable improvement in the condition of children suffering from defective innervation, lack of muscular power, or nervous inco-ordination, with inability to articulate distinctly and to control the use of the limbs. These claims are not merely theoretical; they have been abundantly established by actual use of the apparatus. Prices on application.

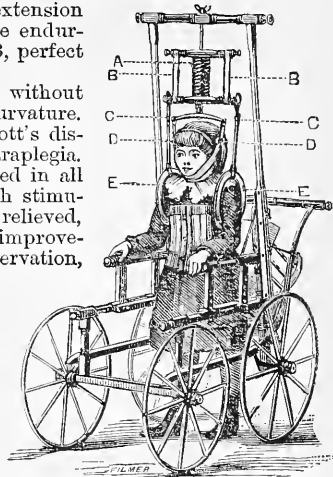

**MEASUREMENTS REQUIRED.**

1, height of patient standing erect, weight, and also sex of patient. (Belts are furnished for males and corsets for females.) 2, height of patient sitting erect; that is to say, from the seat to the top of the head. 3, around the waist, snug measure over the clothing usually worn, not including any spinal brace, corset or jacket that may be in use. 4, from top of ear, where it joins the head, around point of chin to top of the other ear. 5, from top of ear around lower part of back of head, to top of the other ear. The first measurement is to determine the size of the apparatus; the second for the adjustment of the seat; the third for the corset or belt; and the fourth and fifth for the head-rest. The physician should take note of the respiration, circulation, appetite, and other physical conditions, before beginning the use of the apparatus, as improvement in all particulars may be confidently expected.

**27C. DR. SAMUEL W. SMITH'S ARM SPLINT, FOR FRACTURES OF THE UPPER EXTREMITIES EXCLUDING THE HAND.**

(Extracts from the *New York Medical Record*, Dec. 19, 1885.)

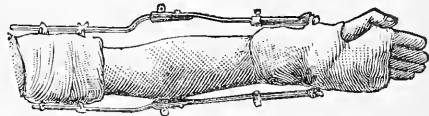

A varied experience, full of disappointments, in the use of the known splints for the more severe fractures of the condyles, set me to work to make a splint with the following requisites: 1st, to hold the fragments in apposition. 2d, to allow the forearm to be flexed or extended, pronated or supinated, with fixation at any point. 3d, to lengthen or lessen the external lateral angle of the arm with fixation. 4th, to leave the entire elbow-joint exposed for local treatment, during the whole time of wearing the splint, without disturbing it.

The result of this work was a splint that my practice has proved to most happily meet every requisite mentioned.

My splint is made with two rods of untempered steel, extending from the upper part of the arm to the wrist, with a ball and socket joint at the elbow, and screws for fixation; the lower ends pass into a sheath-screw on either side of the wrist; the upper ends pass through two iron posts set in tin and made fast to the arm by plaster-of-paris bandages, the rods being made firm in the posts by thumb-screws. On each side of the wrist is a post through which the sheath-screw passes, and made fast to the wrist in the same manner as the upper parts, and fastened with fixation screws. By moving the sheath-screws the lateral angle of the arm may be contracted or widened as needed, thus overcoming any tendency to loss of the carrying point (or gunstock deformity). A turn of the fixation screws at the elbow and wrist will

allow the forearm to be flexed, extended, pronated, supinated, and fixed at any desired point without other interference with the splint.

**MEASUREMENTS REQUIRED.**

1, state age and sex of patient. 2, right or left arm? 3, length from top of shoulder to middle of elbow outside. 4, length from axilla to middle of elbow inside. 5, length from middle of elbow to wrist outside. 6, length from middle of elbow to wrist inside. 7, circumference of arm, close to axilla. 8, circumference of elbow-joint. 9, circumference of arm, close to wrist.

**THE SUSPENSION APPARATUS FOR LOCOMOTOR ATAXIA.**

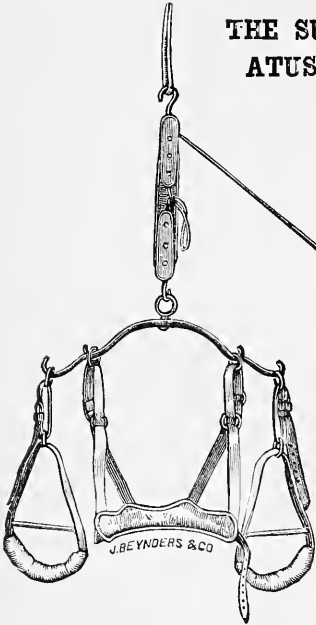
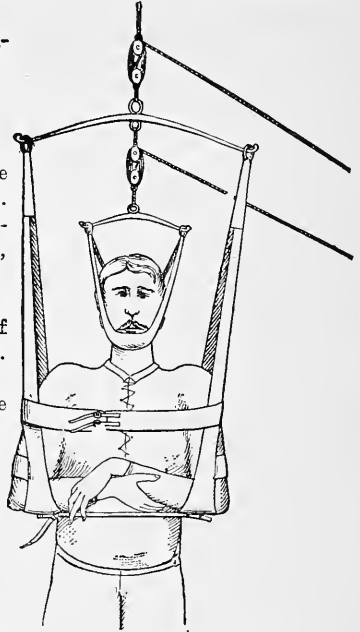

Illustration to the right shows Dr. S. Weir Mitchell's Improvement. Price, \$20.00.

With one set of pulleys only \$14.00.

Apparatus to the left, see page 312.



**DR. SAMUEL W. SMITH'S CLAVICLE APPARATUS.**

(Extracts from the *New York Medical Record*, Dec. 19th, 1885.)

This splint is very simple, easily made, and not expensive. It is a padded gauntlet-shaped piece of leather, laced to fit the forearm, running on either side back of the bend of the elbow. To this part is attached a strap and buckle. A padded collar with strap, buckle and ring is fitted to the uninjured shoulder. Through this ring the strap from the elbow piece passes, and by tightly drawing this strap the arm of the injured shoulder is under sufficient control to bring the fragments into perfect apposition. A sling is made to pass from the ring of the collar on the uninjured side of the neck for the hand of the injured side.

**MEASUREMENTS REQUIRED.**

1, state age and sex of patient. 2, right or left clavicle? 3, length from middle of elbow to wrist. 4, circumference of arm, close to elbow. 5, circumference of arm, midway between elbow and



BACK VIEW.



FRONT VIEW.

wrist. 6, circumference of shoulder, pass the tape measure under the axilla and over the top of the shoulder. 7, length from elbow-joint outside across the back, over the uninjured shoulder, and across the chest back to the elbow-joint inside.

Price, according to size, from \$4.50 to \$6.00.

## 28. Dr. M. Josiah Roberts' Radio-Carpal Elastic Tension Splint.

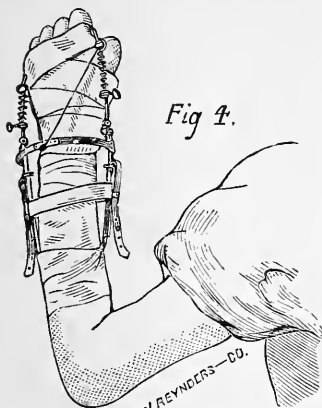

Fig 4.

By means of spiral springs and sidebars with elastic attachments all these various movements are rendered elastic. Furthermore, as the attachments are adjustable, the amount of traction exerted upon the joint of the wrist and the extent of the motion permitted, are placed under the control of the surgeon, and will be determined by his therapeutic instinct, judgment, skill and clinical experience.

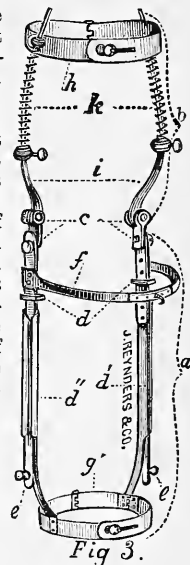

Fig 3.

This splint consists essentially of a proximal (a), and a distal (b) segment, made continuous through two pairs of hinges c, opposite the radio-carpal articulation. This double hinge permits of the movements of flexion, extension, adduction, abduction and circumduction.

The metallic band g is fastened to the forearm in the usual manner of securing extension splints to limbs, strips of strong non-elastic adhesive plaster and a roller bandage. At the distal end of the instrument a counter fixed point for extension is obtained in like manner by securing the metallic ovoid clasp h to the hand, just proximal to the metacarpo-phalangeal articulations of the fingers.

Elastic linear traction is provided for in this instrument by two different mechanisms: viz.: In the proximal segment the side-bars are double and one slides within the other, Fig. 3 d', e; d', e. Now, any force, which brings the point d nearer to e necessarily increases the length of the instrument, and makes linear traction upon the radio-carpal articulation, when the splint is applied. If the force which approximates these two points, d, e, be elastic, the traction will be elastic. Hence by attaching a strip of elastic web to the quadrangular hoop (d) and passing it through a buckle (e) made fast, any desired amount of traction force can be continuously exerted. By a non-elastic strap attached in like manner, rigid traction could be made.

In the distal segment the side bars, i, are single, and are provided with coil-springs, k, made adjustable by movable rings which can be secured at any point on the side bars, see Figs. 3 and 4.

In order to prevent the hand from dropping, an elastic cord is fastened to the distal end of the side bars i, and passed over the hook on the semicircular band j. This arrangement can be best seen in Fig. 4.

When properly applied and adjusted, the instrument affords complete relief from intra-articular pressure and reflex muscular spasm. All movements are made elastic.

Finally, the joint of the wrist is enveloped in elastic medicated adhesive plaster, vid. description page 228.

## MEASUREMENTS REQUIRED.

- 1) Circumference of the arm at a point midway and between the wrist and elbow joints.
- 2) Circumference of the hand just proximal to the metacarpo-phalangeal articulations of the fingers.
- 3) Length from a point midway and between the elbow and wrist joints, to the latter.
- 4) Length from the wrist joint to the metacarpo-phalangeal articulations of the fingers.
- 5) Place the hand, palmar surface downwards, upon a piece of paper and with a pencil trace its outline on the same; send us this tracing.

**29. STROHMAYERS' APPARATUS FOR REAL AND FALSE ANCHYLOSIS OF THE ELBOW-JOINT.**

29.

This apparatus acts on the same principle as a similar apparatus for the knee-joint, to the description of which we refer. Extension in this apparatus is made by a screw; if desired, it can also be made by means of a key and ratchet, as in Sayre's Hipsplints.

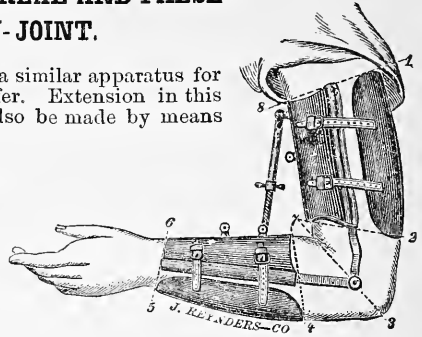

MEASUREMENTS REQUIRED.

1. Sex of patient.
2. General appearance of patient.
3. Length from top of shoulder to elbow outside.
4. " " axilla to elbow inside.
5. " " elbow outside to wrist.
6. " " elbow inside to wrist.
7. Circumference of arm above elbow.
8. " " below elbow.
9. " " at wrist.

Price, with Screw, .....	\$16 00 to \$20 00
" " Key and Ratchet, .....	25 00 to 35 00

**30. DR. L. A. SAYRE'S SHORT SPLINT FOR THE TREATMENT OF HIP DISEASE.**

30.

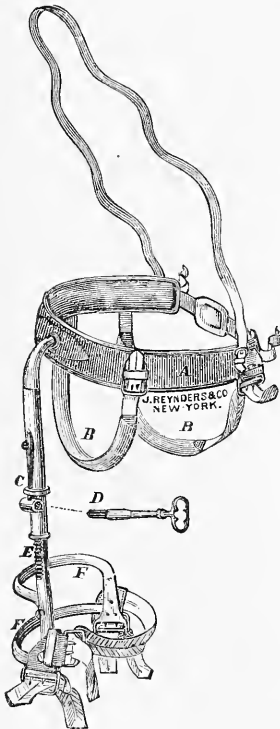

This instrument consists of a pelvic band "A," passing partly around the body under the crest of the ilium, well padded on its inner surface, to which usually two perineal straps, "B," "B," are fastened for counter extension; the outer surface of the pelvic band holds a ball and socket joint terminating into a tubular steel rod, passing down the outer side of the thigh to within about two inches of the lower end of the femur. This rod is divided into two sections, "E" and "C," the lower solid part "E" moving within the upper tubular part, "C," and gauged or controlled by a ratchet and key, "D," by which the length can be in- or decreased. A spring, at "C," armed at its lower extremity, with a tooth passing inwards through the wall of the tubular part into the serrations cut unto the rod, "E," serves to hold the instrument in an elongated position when the split ring grasping the spring and tubular steel rod is pushed downwards (into the position shown on the figure), before withdrawing the key. After insertion of the key the split ring must be pushed upwards, before elongation or shortening of the instrument is made.

At the lower extremity of the bar, "E," is a projecting branch, "E, F," going over to the inner surface of the thigh to receive the attachments of the plaster, hereafter to be described.

Both of the lower extremities terminate, in a cylindrical roller, over which the tabs of the plasters are attached to the two buckles placed at the lower ends of the instrument.

MEASUREMENTS REQUIRED.

1. Sex of patient.
2. General appearance of patient.
3. Circumference of body, between crest of ilium and trochanter major
4. Distance from same point to the centre of kneejoint.
5. Circumference of thigh, two inches above kneejoint.
6. Circumference of middle of thigh.
7. Mention if for right or left hip.

Price, child's sizes .....	\$17.00
" adult's " .....	20.00

(Extracts from Dr. L. A. Sayre's Lectures on Orthopedic Surgery and Diseases of the Joints. Second Edition.)

When the short splint is used some means must be employed

**FOR MAKING EXTENSION DURING THE NIGHT,**

and also at other times, when it is expedient for the patient to lie in bed. This is best effected by means of weight and pulley. To apply it, cut two strips of strong adhesive plas-

ter, two or three inches wide, according to the size of the patient's leg, and long enough to reach from the malleoli to six or seven inches above the condyles of the femur. To the lower end of each strip sew a piece of strong webbing, three or four inches long; see figure A.

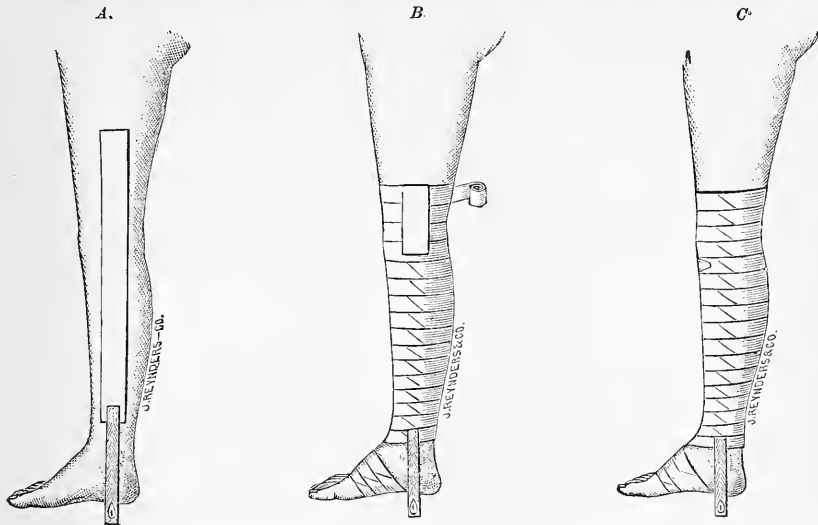

After smoothly bandaging the foot and ankle, apply the ends to which the tabs are attached, one just above either malleolus, and carry the strips of plaster up the inner and outer sides of the leg and thigh, and secure them with a roller, nicking the edges of the plasters to make them fit smoothly, and prevent any folding or creasing.

The proper method of fastening the plasters to the limb is to allow them to hang loose along the sides, and bring them in contact with it by the successive turns of the roller, for in this way you will be much less liable to wrinkle them, and that is an important item. This may appear like an insignificant matter, and hardly worthy of special mention; but it is not, for a single wrinkle in the adhesive plaster may, by the irritation it will produce, defeat the whole plan of treatment.

The tabs should receive a few extra turns of the roller, over one and under the other, weaving them in, for the purpose of making them additionally secure.

When the knee is reached by the roller, *always* cover it in with the figure-of-8 turn, for the edge of a reverse in the bandage at this place may give rise to serious inconvenience, and necessitate its entire removal. When the bandage has been carried two or three inches above the condyles, the remaining portions of the plasters are to be reversed (see figure B), and then a few more turns of the roller will, by the bandage adhering to the plaster, fix the dressing so that it will not easily slip (see figure C).

The plaster should be applied cold, but when the bandage has been applied, the plaster should be moulded to the limb, by firmly squeezing it with the hands. It is also very important to secure the plaster above the condyles of the femur, in order that extension may be made upon the thigh, and *not upon the lateral ligaments of the knee-joint.*

The bandage should then be fastened, and with stitches, for it is to remain a long time.

If the limb is held in the proper position, namely, in the line of the deformity, and gentle extension maintained by an assistant, it can be prepared for the bed extension and the splint without giving the patient the slightest pain whatever.

Next take a round piece of wood, three or four inches long (figure 31C), having a hole drilled through its centre for the attachment of the cord, and a groove cut on each extremity to hold it in place, where it is buttoned into button-holes (figure 31A), made in the lower part of the taps, attached to the strips of adhesive plaster, already fastened to the sides of the limb. To the middle of this round stick is attached a stout cord. The object of the stick is simply to prevent the bands from making uncomfortable pressure upon the malleoli. At the foot of the bed a pulley (fig. 31B), is to be arranged in such a manner, as the ingenuity of the surgeon dictates, the cord from the stick placed upon it and a weight attached, just sufficient to make such extension, as will render the patient comfortable. For a weight a bag of shot or sand is most convenient, because the amount can then be easily regulated.

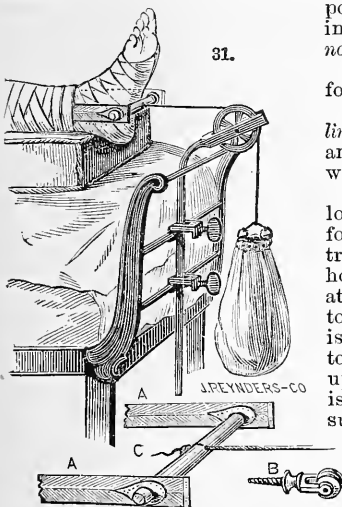

To prevent the patient from slipping down in the bed, its foot end should be raised ten or twelve inches by means of bricks or blocks.

DR. SAYRE'S EXTENSION SUNDRIES, consisting of two tabs, round stick, stout cord, pulley and bag for shot or sand.....\$1 00

ADHESIVE PLASTER, spread on heavy moleskin, specially prepared for extension purposes, .....per yard, 1 00

IRON FULCRA WITH PULLEYS. See descriptions and prices page 57.

The foregoing is for night extension.

### TO APPLY THE SHORT HIP SPLINT

for extension, while the patient is exercising, the limb should be prepared in the following manner :

First, cut two triangular or fan-shaped pieces of adhesive plaster, the broad extremities of which should be wide enough to cover about half the surface of the upper part of the thigh, and are to be slit into strips, an inch or more in width, for the purpose of permitting a more perfect adjustment, and, also, to be reversed in detail over the bandage. They should be of sufficient length to reach from the knee to the groin. To the narrow ends of these fan-shaped pieces sew the pieces of webbing accompanying the instrument. See figures *D* and *E*.

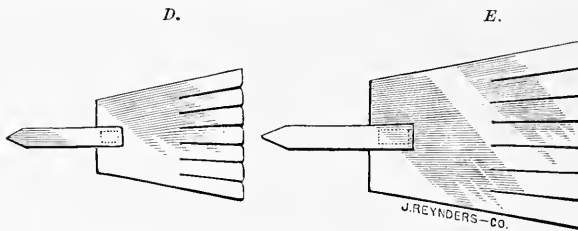

Next, place the instrument upon the thigh with its jaws about three inches above the condyles, and with the thumb and finger grasp the limb at the point upon either side where the instrument comes in contact with it. These two points indicate exactly where the tabbed ends of the fan-shaped pieces of adhesive plaster are to be applied (see figure *F*). Now, having placed the tabbed extremities over these points, secure them in position with the roller bandage by first making a few extra turns near the tabs, and then carry the bandage simply and smoothly over the plaster upon the thigh, until the perinæum is reached, when the strips of plaster, which are now floating loose, are every other one to be reversed, as the bandage goes around the thigh (see figure *G*), continuing the bandage at the perinæum until all of the

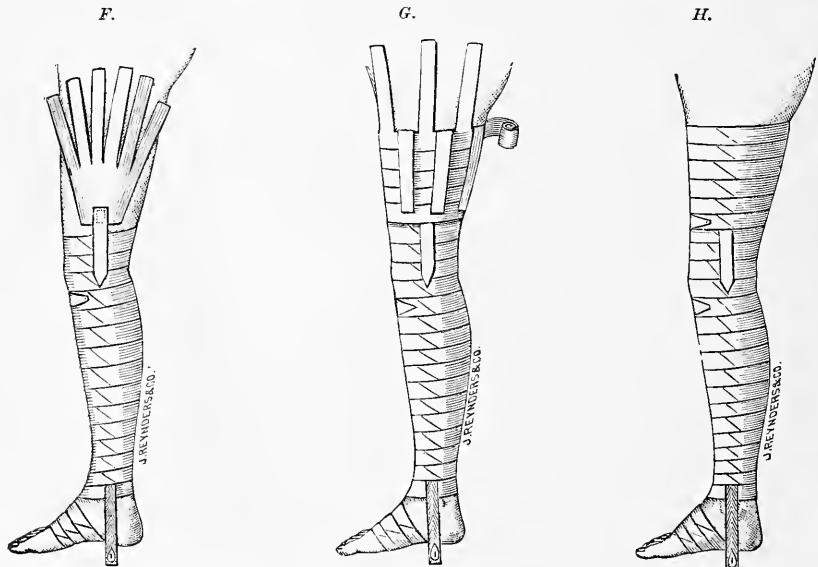

strips of plasters are reversed, and then the bandage is carried down the thigh until the plasters are entirely covered (see figure *H*).

The effect of all this is to hold the dressing firmly in place.

The thigh is now ready for the splint, and, after the shaft has been shortened as much as it can be, we place it in position with the pelvic belt, at the upper end, just under the crest of the ilium. Now, fasten the lower extremity of the splint first, and this is done by passing the tabs over the little cylinders in the jaws upon either side, buckling them as high as possible, and then buckling the strap that passes behind the thigh. Next buckle the perineal bands, drawing them snugly, but not too tightly, and see that the smooth side is next to the skin. It is well, also, to lay a piece of old linen in the groin under the bands to protect the parts from pressure, and, also, to absorb the moisture commonly present in the region.

The neglect of these little points often gives the patient and the surgeon a good deal of annoyance. The instrument now being in position, the nice adjustment, which is to regulate the amount of extension, is made by means of the key.

In this way the amount of extension necessary can be applied, and is to be regulated by the following rule: Apply sufficient extension so that when a sharp, sudden concussion is made from the knee, or the heel when the limb is straight, it will cause no pain whatever; that is all the extension required, and your patient's face is to be your guide in deciding when a sufficient amount has been obtained. More extension than this may give rise to an obstruction to the circulation, and do an infinite amount of harm.

At night, and at such other times as deemed necessary, the patient is placed in bed, and the bed-extension adjusted before the splint is removed or shortened. So, also, whenever the patient wishes to get up you are to apply the instrument and lengthen the shaft, that is make extension, before the bed-extension is removed.

If the patient is a small child, it may be permitted to wear the splint without crutches. If the patient be of much size, crutches will be necessary, for the plaster is only intended to retain the instrument in position and maintain sufficient extension to relieve the joint from all pressure, but not to support the weight of the body, if the child is heavy. If, after the application of the splint, the patient suffers pain, it is evidence that the splint has not been properly adjusted, and it should be carefully examined, for it may be that the plasters have yielded somewhat, so as to permit pressure upon the joint. If so, it can be easily remedied by giving a little more extension with the key. The apparently trivial points which I wish you especially to remember for they are really important, and neglect to observe them has many times brought the instrument into disrepute), are the following:

1. Always shorten the shaft before applying or removing the instrument.
2. See that the jaws are tightly buckled, so that they will not be crowded down, and press upon the condyles.
3. Do not, as I have seen done, tuck the tab between the roller and the buckle.
4. Do not buckle the perineal bands too tightly, for in that manner you may obstruct the femoral vessels, but make the extension with the key, which tightens the band by crowding it upward rather than by girdling the limb.

Finally, it will be noticed that the knee is left to move as freely as it may. I can see no propriety whatever in restraining the movements of this joint in cases of hip-joint disease in its earlier stages, when the thigh is long enough to permit the application of the short splint. There may be other circumstances when it becomes necessary to give the knee support, etc.; where the long splint should be employed and the movements of the knee-joint restrained. But, all such considerations being set aside, there is no reason why unrestricted motion at the knee may not be permitted. It was designed that the motions of the joints should be free, and no harm will attend this freedom of motion, unless the joint itself becomes the seat of disease; but, on the contrary, restraint will give rise to more or less ankylosis and deformity.

I resort to the use of this short splint as early as possible, in order that the patient may have the benefit of exercise in open air. It sometimes happens that it cannot be applied, by reason of abscesses, or some other cause. In such cases the bed with extension may be arranged upon some light wagon or wheel-chair, so that the patient can be carried out-of-doors and placed as far as possible under the influence of good hygienic conditions. In such cases, however, I more commonly employ the long splint, which is a modification of that devised by Dr. C. F. Taylor, of this city.

## 32. DR. L. A. SAYRE'S LONG SPLINTS FOR THE TREATMENT OF HIP DISEASE.

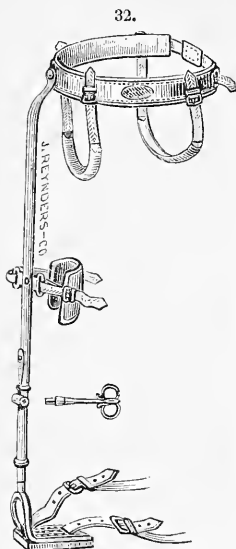

This splint differs from the short one before described in the following particulars: In the first place it extends the entire length of the limb, receives the weight of the body upon a cross bar under the foot and a steel girdle encircling the pelvis, having two perineal straps. The long hollow steel tube reaching from the pelvis to the sole of the foot, has a solid steel rod running inside of it, furnished with a ratchet, moveable up and down for lengthening or shortening, by a key which works in the ratchet through an opening on the outer side of the tube. The contrivance for locking is the same, as that described on the short splint. The upper part of the long hollow steel tube is solid and strong, fastened to the steel girdle by a simple bolt making a flat joint (fig. 32), permitting for- and backward movements of the hip-joint only, or a ball and socket joint (figure 33), permitting all movements that the hip-joint performs in its natural state.

The steel girdle is about two-thirds of the circumference of the pelvis, well-padded on its inner surface and terminates in two buckles, in which are buckled a partly padded strap of webbing for counter extension pass along the perineum and under the ischii. These are made of rolls of blanket, covered with velvet or some other non-irritating material and terminate in pieces of webbing, strong enough to hold in the buckles. The latter are near together in front and far apart behind. A stout leather sole is fastened to the cross bar at the bottom of the instrument, and a strong leather strap, *J* (figure 34), passes through apertures just above the cross bar, turns up an end on each side of the ankle and fastens into the buckles attached to the tabs from the adhesive

plaster of the leg. This completes the attachments at the lower portion of the instrument, for making extension. There is also attached to the bar running along the outer side of the limb a cross piece which can be moved up and down to a position conforming to that of the knee-joint, unto this is buckled by webbing straps a buckskin knee-cap for the steady support of the knee.

An additional means for the applying elastic force is attached to the posterior part of the instrument which is to be used in cases when the thigh is strongly flexed. It consists of an elastic band which is attached above the knee, runs along the back of the thigh, and is secured to the posterior portion of the pelvis belt. This band can be made tighter, as occasion may require, for the purpose of extending the limb, and should be elastic, for the purpose of keeping up a constant tractile force, and at the same time allowing flexion when the patient wishes to sit down.

This instrument has been essentially improved by Mr. Reynders, by the following additions:

The improved parts of this apparatus are where the long rod is attached to the pelvic band. The long rod (see figure 34) is attached at *A* to a round revolving plate or platform, *B*, which is fastened to the pelvic band. When the plate *B* is moved upon its axis, the long rod moves forward and backward. From the point, *A*, the long rod moves from and towards the leg, as shown by the dotted lines towards *L*. *C* is a screw terminating at *D* into a small square stem of steel, fitting to a key. This screw turns in and out of the revolving plate, *B*, and has at the end of its thread a little knob, which is a little larger than the perforation at the upper end of the long rod, so that when the key, is applied, at *D*, and turned, the screw, *C*, will force the

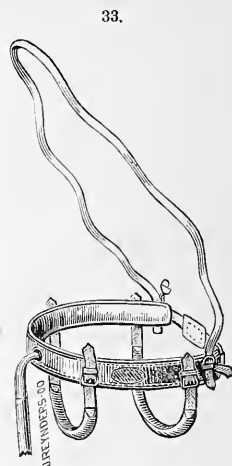

34.

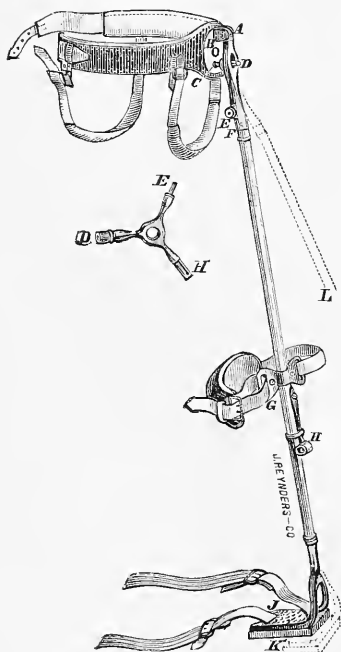



long rod in the direction towards *L*. In this manner abduction is made. At *F* the long rod is divided into two parts, the lower part holds an endless screw transversely, which is worked by a key, and rotation thus produced.

As a matter of comfort to patients, these long splints are used, also, with automatic lock-joints at the knee, as on apparatus, fig. 38, page 333, in slight cases of disease, or when convalescence has definite set in. These joints

are sometimes supplied with elastic springs, as on apparatus, figure 51, page 344, by which when the leg is bent backward, and the power relaxed, it will spring forward involuntarily. For such cases, and where the application of plaster can not be borne, we also manufacture cylindrical spring-boxes, as shown on the annexed cuts, *A* and *B*, fastened to the sole of the shoe, into which the foot-piece of the splint is sprung and firmly held in place by a spring. These cylindrical spring-boxes permit free motion of the ankle-joint.

When using for the lower portion of a hip splint the last described form of attachment, Dr. Sayre employs for night extension a firmly made satin jean anklet, as per annexed figure, this laces over the instep and a heavy buckskin tongue. Secured to this anklet on each side are buckles into which are fastened the tabs holding in button holes the wooden cross-piece.

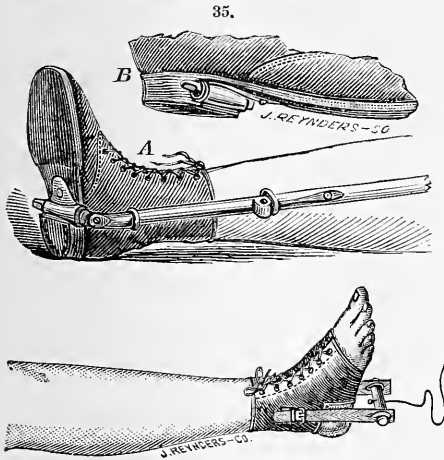

MEASUREMENTS REQUIRED FOR ANY OF THE LONG SPLINTS.

1. Sex of Patient.
2. General appearance of Patient.
3. Circumference of body between crest of ilium and trochanter major.
4. Length from crest of ilium to the sole.
5. Length from crest of ilium to centre of knee-joint.
6. Right or left?

Send a strong and well-fitting lace shoe when a splint with spring box is desired.

MEASUREMENTS REQUIRED FOR EXTENSION ANKLETS.

Circumferences at L, AE, K and J.

Length from K to J, and from sole of foot to L. See figure of leg, page 293.

PRICES.

Long Hip Splint with plain joint, . . . . .	\$25 00
“ “ “ ball and socket joint, . . . . .	25 00
“ “ “ platform joint and abducting screw, . . . . .	35 00
“ “ “ platform joint, abducting and rotating screws, . . . . .	45 00
Any of the above named splints with spring box, extra, . . . . .	5 00
“ “ “ “ automatic lock knee joint, extra, . . . . .	10 00
Extension Anklelet, . . . . .	3 50

TO APPLY THE LONG HIP SPLINTS.

The limb is prepared for the long splint in the following manner:

Cut two strips of strong moleskin adhesive plaster, from two to four inches wide, according to the size of the limb, and long enough to reach its entire length, and divide the upper extremity of the plaster into narrower strips for a distance of two or three inches. Pieces of strong webbing, one or two inches in length, with buckles attached, are sewed to the lower extremities of the plasters. These plasters are then placed on either side of the leg in such a manner, as to leave the buckles a little above the ankle joint, and then so secured by a snugly-adjusted roller as to leave the tabs, with the buckles attached, hanging loose. The

roller is then carried up over the knee, and as far up the thigh as can be done with convenience, when the upper split ends of the strips of plaster are reversed and braided in with the roller as it returns down the thigh, securing it smoothly. The stocking is then pulled up on the foot, holes having been cut on either side for the buckles to pass through, and the shoe applied with holes cut through it in the same way.

The limb now being prepared, the instrument is placed on its outer side, and the cross bar at the bottom brought in front of the heel of the shoe, and securely buckled to the tabs above described.

The pelvis-belt is next brought around the hips and secured by the buckles upon the opposite side, and the perineal bands are next attached as firmly as may be. The cross piece holding knee cap is then slipped up or down until it is made to rest opposite the knee, where the knee cap is passed around the knee and buckled. Extension is now made with the key upon the ratchet until free compression is borne without pain, and the patient can walk without cane or crutch. There is a point with reference to the sound limb that must be mentioned, when the long splint is worn, have the sole of the shoe worn upon that side made extra thick, for the purpose of equalizing the length of the two limbs.

The instrument should always be applied with the patient lying on his back, and great care ought to be taken that the pelvis is not inclined forward by contractions of the flexor muscles. If such should be the case, the leg should be elevated till the lumbar vertebrae come near the couch; or, in other words, the spinal column should be made to take its normal shape by elevating the leg till it can do so. The instrument is then applied, as first described. But the pelvic band ought not to embrace the pelvis tightly, but there should be room enough for the latter to move freely in it. The anterior superior spine of the ilium ought to be above the pelvic band. When all is adjusted, while the patient still lies on his back, the key should be turned to the right and the instrument elongated, when the whole leg will be gently but strongly drawn downward and the pelvic lifted up with a direct, yet easy force from which there is no escape. In any variation of position or muscular action, the direction and amount of force employed are entirely under the surgeon's control. Nor is this all. The instrument should be so adjusted that there is a little space between the foot and the foot-piece, so that in standing or walking the weight does not rest on the leg, but the whole weight of the body should rest directly on the instrument. The patient sits firmly upon the padded straps which, passing under the ischii and perineum, are attached to the pelvic band in front and behind.

If the limb is adducted, the abducting-screw can be used daily, increasing the tension for the purpose of abducting the limb.

If the limb be strongly inverted, the eversion-screw can be used, the force being gradually applied for the purpose of rotating the foot outward; and, if the thigh is strongly flexed, the force exerted by the elastic band upon the posterior part of the splint can be applied for the purpose of extension.

### 37. DR. L. A. SAYRE'S BATHING SPLINT.

(From the *New York Medical Journal*, September 1877.)

We have been shown an admirable arrangement for enabling persons afflicted with hip-disease to enjoy the pleasure and advantage of sea-bathing. It is a splint made in all respects like those used by Dr. Sayre, and covered with India-rubber. The steel rods are thoroughly covered with rubber, as well as the band for the waist; in fact, the whole instrument is so covered as to protect it entirely from the sea-water. It is applied when the ordinary one is removed, and with its use a most important object is gained, as it allows the patient the benefit of bathing without danger to the limb. It is manufactured by John Reynders & Co. of this city. . . . . Price, \$16 00 to \$25 00

Bathing shoes, extra.

#### MEASUREMENTS REQUIRED.

The same as on page 331.

New York, April 17th 1875.

Mr. REYNDERS, No. 303 Fourth Avenue, makes all my instruments better than any other manufacturer here, and I, therefore, refer you to him for any and all my latest improvements.

I use the short or long splint, according to circumstances in each different case, which ever will fulfil the indications the best. If the child is so small to use crutches, and the thigh is not large enough to get sufficient hold of plaster to bear the weight of the child, then I use the long one, and in all cases of great abduction I use the long one with abducting screw, and if the foot is inverted it also requires the rotating screw to turn it outward.

L. A. SAYRE.

**37B. PHELPS' HIP CRUTCH AND FIXATION SPLINT.**

(Extracts from an article by Dr. A. M. Phelps of New York, in *Medical Record* of May 4th, 1889.)

I fully agree with Sayre, Taylor, Barwell, Marsh, and others, that spasm of the muscle should be overcome by extension. I also fully agree with Thomas, of Liverpool, that every joint should be fixed and absolutely

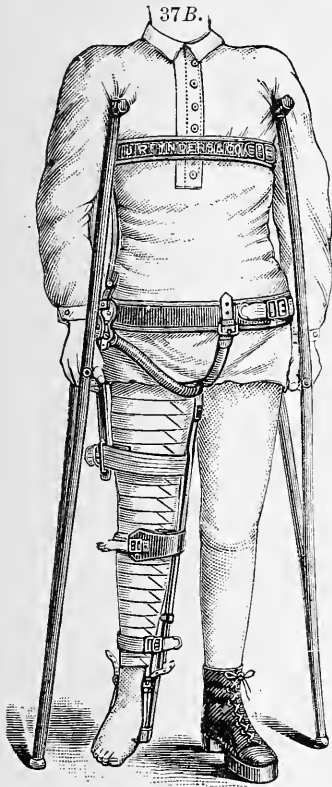

a cure effected. But I do not believe that immobilization of the joint can be accomplished without extension; neither do I agree with the first-named gentleman that extension immobilizes a joint sufficient to get the best results possible, but that a combination of the principles of fixation and extension should be the law. Hence the long traction splint which admits of motion does not immobilize, and the patient produces injury of the joint every time he steps upon it, as is evidenced, in the vast majority of cases, by the almost constant increase of the deformity after the splint is adjusted. Neither does a Thomas splint produce extension; hence there must be abnormal intra-articular pressure when spasm or contraction of muscles is present which must produce congestion of the head of the bone. And, then, if extension is to be applied it should be in the direction opposite to the line of traction made by the muscles. In other words, to apply extension to a hip-joint we should not only make traction in the line of deformity, but also in a line at right angles to that deformity. In other words, to relieve perfectly intra-articular pressure extension must be made in a line corresponding to the axis of the neck, and not with the axis of the shaft, for the following reasons: The adductors and abductors pass from the femur diagonally across the body to the pelvis. These, with other muscles, are the ones affected by spasm. When they contract the head of the bone is drawn firmly into the acetabulum, the force operating on a line corresponding to the axis of the neck. The flexors act on a line corresponding to the axis of the shaft. No apparatus has heretofore been devised which will so perfectly fix a hip-joint as double extension in bed—the body and well leg fixed to a long splint—first recommended, I believe, by Dr. Sayre. The slipping of the bandages proved to be a nuisance. This led me to substitute the plaster-of-paris, which meets every requirement. The splint should extend to the axilla. The diseased limb should be held in the deformed position during its application, that the body and healthy limb may be in a normal position.

My observations lead me to believe that the most serious element of destruction in hip-joint disease is the trauma and pressure produced by the spasm of the muscle; that tubercular will recover as surely as non-tubercular joints, if the spasm of the muscle is overcome; that fixation of the joint without extension is an impossibility; that the successful treatment of the joint must depend upon its absolute immobilization, which can only be produced by proper extension and fixation; that the constitutional treatment of hip-joint disease amounts to but little, independent of mechanical treatment; that the mechanical treatment is everything; that extension in a line with the axis of the shaft and deformity alone in hip-joint disease is entirely wrong; that extension should be made in a line corresponding to the axis of the neck—in other words, two lines of extension—otherwise the idea of extension is not perfectly carried out; that ankylosis of the joint is not produced by its immobilization, but by the severity of the inflammation; that the long traction hip splints in general use neither properly extend neither do they immobilize the joint; that the intra-articular pressure results in the destruction of the joint or ankylosis in the majority of cases; that the results of hip-joint disease should be as good as those of knee-joint disease, and will be, provided perfect immobilization can be carried out; that the surgical law in regard to abscesses should not be violated in the treatment of abscesses of the hip-joint; that nearly all cases should be treated for a time in bed; that when the limbs are parallel and the active symptoms have subsided the hip-crutch can be given adults with crutches, and children the portable bed, and, finally, after convalescence, the hip-crutch, either with or without the high shoe and crutches.

This hip-splint has been devised for the purpose of perfectly immobilizing the hip-joint by preventing all normal motions and applying extension in the line of the neck of the femur. It should only be applied after all deformity has been overcome, either by prolonged extension in bed or operative procedures. The patient is not allowed to walk upon the hip-crutch until the active stage of the disease has passed.

The splint combines all of the qualities of the Thomas splint as regards fixation, together with all that is good in the long traction splints of Sayre, Taylor, and others; and, in addition to it, has the abduction bar for making lateral extension, and a firm perineal ring instead of the

strap as used in the ordinary long traction splint, which is found more comfortable to the patient to wear.

In annexed figure of the Hip-Crutch and Fixation Splint, the abduction bar 1 is adjustable by means of the key 6, for the purpose of making lateral extension. The steel bar 2 is adjusted to the steel ring 3, which makes a firm crutch, the pressure coming on the tuberosity of the ischium. Adhesive straps extending to near the body from the ankle (for manner of application see pages 331 and 332) furnish means of extension by tightly buckling them to the straps 7, 7, the ring 3 furnishing the counter-extension. The rod 5, connecting the pelvis and chest belts, prevents flexion and extension of the legs. The whole splint is intended to prevent every motion at the hip-joint, and at the same time apply extension in a line with the neck of the bone. Fig. 37B shows the crutch and splint adjusted, the patient using crutches and standing on a high shoe upon the well leg.

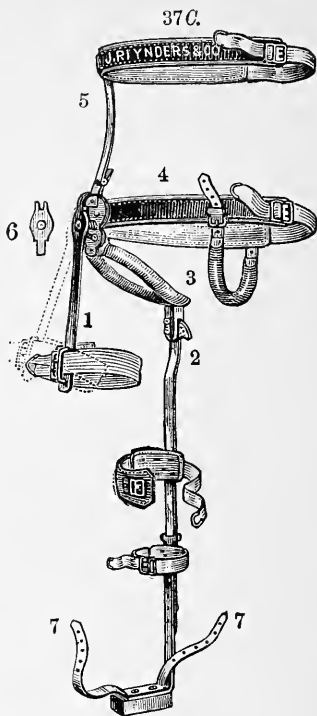

MEASUREMENTS REQUIRED.

1. Sex of patient.
2. Age of patient.
3. Weight of patient (estimated).
4. Mention if for the right or the left hip.
5. State circumference of the chest under the axillæ.
6. State circumference of the waist.
7. State circumference of the pelvis, between the crests of the ilium and trochanters major.
8. State circumference of the thigh, close to the perineum.
9. State circumference of the leg at the middle of the thigh.
10. State circumference of the leg at the middle of the knee-joint.
11. State circumference of the leg midway between the ankle and knee-joints.
12. State distance between axilla and crest of ilium.
13. State distance between crest of ilium and trochanter major.
14. State distance between trochanter major and middle of thigh.
15. State distance between perineum and middle of the knee-joint.
16. State distance between perineum and the sole of foot.
17. Send us a well fitting lace shoe for the well leg.

The measurements needed for crutches find at top of page 376.

Prices, according to size of apparatus . . . . .	from \$40.00 to \$50.00
The same, plain finished (not polished nor plated), for dispensary patients, according to size of apparatus . . . . .	from \$30.00 to 40.00
Steel elevations for the well leg, according to finish . . . . .	“ 6.00 “ 10.00
Cork sole elevations for the well leg . . . . .	“ 8.00* “ 10.00*

For prices of crutches, see pages 374, 375 and 376.

37D. HOSPITAL LONG HIP SPLINTS.

These have been designed for the use of hospital and dispensary patients who cannot afford to pay the cost of better apparatus for the same purpose. They are of the simplest construction, black finished, with plain leather covering and lining. Extension is obtained by employing a splint of two or three inches greater length than the length of the patient's limb.

Price, according to size . . . . . from \$5.00\* to \$10.00\*

In fig. 37E is shown a simple device for extension. The rod has been cut, supplied with a series of equidistant holes, lapped to the extent of three or four inches, and held together by two screws. After application of the splint, the two screws are removed, the proper amount of extension obtained, *i. e.*, the bar lengthened by sliding apart its lapped section and the two screws replaced.

Price, with simple extension device, according to size . . . . . from \$8.00\* to \$13.00\*

Directions for application, see pages 331 and 332.  
Measurements required, see page 331.

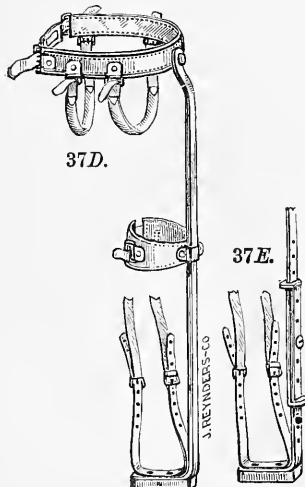

**37F. POLYCLINIC LONG HIP SPLINT.**

This is a modification of Dr. A. B. Judson's long hip splint, simplified, and thereby greatly reduced in cost, by Dr. V. S. Gibney, for the use of hospital and dispensary patients for whom he prescribes it at the New York Polyclinic. It differs from the hospital hip splints described above by having a stronger or less flexible shaft and pelvic band than is commonly found in the long splint, also a bolt and nut connecting these two parts, by the use of which they can be fastened at any angle desired by the surgeon. It is provided with suspending straps buckled to the pelvic belt in front and behind, and passing over the shoulders, by which the plasters and the affected limb are relieved of the weight of the splint in walking. It also has a U-shaped attachment, made of steel, at the level of the lower part of the thigh, by which motion is more fully arrested than by a flexible knee cap, as it serves to retain the limb more closely in a line parallel with the shaft of the splint. Extension is obtained by employing a splint of two or three inches greater length than that of the patient's limb.

Directions for application, see pages 331 and 332.

Measurements required, see page 331.

Price, according to size ..... from \$5.00\* to \$10.00\*

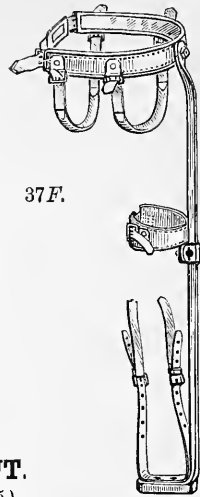

**37G. DR. GEO. R. ELLIOTT'S HIP SPLINT.**

(Extracts from the *Medical and Surgical Reporter*, Oct. 24, 1885)

The accompanying cut illustrates a form of splint for treating hip-joint disease, which I have devised with the object in view of permitting a certain amount of motion in the chronically inflamed joint, thus hastening the reparative process, at the same time rendering thorough support and protection to the disabled part, as evidenced in the complete relief of the patient's suffering.

To Dr. Milton Josiah Roberts is due the credit of clearly bringing before the profession this method of treatment, suggested some years ago by the veteran orthopedic surgeon Dr. Davis.

This instrument is intended to meet the same indications for treatment as Dr. Roberts' long elastic tension splint, which has inside thigh and leg segments, and the mechanism he employs I have largely utilized in its construction. My aim has been to reduce the mechanism necessary to accomplish the object sought after to the minimum, and to make an apparatus so simple that any one, without any special mechanical knowledge, can use it. Once applied, it will retain its place as perfectly as any fixed appliance.

An abdominal band (1) is firmly fixed to the pelvis by means of perineal straps (2 and 3). To this band is attached the main shaft of the splint (at e) by a joint permitting flexion and extension within certain limits. The opposing end of the splint is attached to the shoe, and the latter firmly secured to the leg by means of adhesive plaster. Now, any mechanism which will push the attached shoe from the abdominal band will exert traction upon the limb. This is accomplished by thigh and leg segments, each segment being made up of two bars, one of which slides upon the other, the traction agent being adjustable elastic straps acting upon the bars as shown in the cut. Free motion is permitted at the ankle-joint, so constructed that the shoe or splint respectively can be removed without disturbing the other. At the knee, also, free motion is permitted, controlled by elastic straps. Motion at the hip-joint is under absolute control by means of elastic straps passing from the thigh segment to the abdominal band. The joint (d) is a stop-joint preventing the instrument from being hyper-extended, and the bands (f and g) are firmly buckled about the thigh and leg just above and below the knee-joint. The posterior one-half of these bands is com-

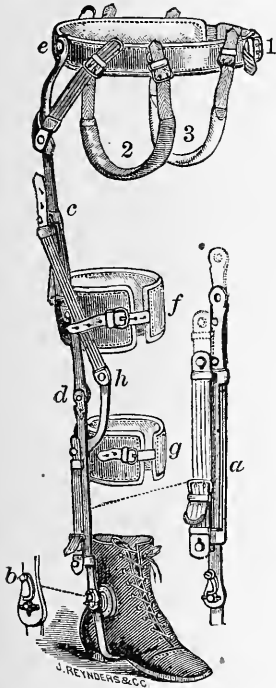

posed of steel. By means, then, of the stop-joint (d) and the half collars (f and g) the elastic straps utilized in exerting traction are prevented from throwing the instrument out of the mid-plane of the thigh and leg.

The merits claimed for this splint are: 1, the satisfactory manner in which it meets the therapeutical indications for treatment. 2, the simplicity of its mechanism. 3, its easy method of application. 4, ready manageability. 5, the comparative inexpensiveness.

The excellent results obtained by the use of this form of apparatus in the treatment of a large number of cases at the clinic, and the satisfaction reported by several physicians who have used it, I offer as my reasons for bringing it before the notice of the profession.

**MEASUREMENTS REQUIRED.**

1, sex of patient. 2, general appearance of patient. 3, circumference of body between crest of ilium and trochanter major. 4, circumference of thigh, one-quarter above the knee-joint. 5, circumference at garter (below the knee-joint). 6, length from crest of ilium to the center of the knee-joint. 7, length from the center of the knee-joint to the center of the ankle-joint. 8, length from the center of the ankle-joint to the sole of the foot. 9, mention if for right or left hip. 10, send us a well-fitting lace shoe.

Prices, according to size of splints, from \$25 net upwards.

### 37H. DR. SAYRE'S WIRE CUIRASS COMBINED WITH JURY MAST, FOR SPONDYLITIS IN VERY YOUNG CHILDREN.

(Extracts from Dr. Lewis A. Sayre's article on "Spondylitis and Rotary Lateral Curvature of Spine—Their Proper Treatment Practically Demonstrated with Exhibition of Cases." Proceedings of the New York State Medical Association, 1885.)

This treatment—the application of the plaster jacket—of course only applies to those cases where the pelvis is sufficiently developed to afford a support to the jacket upon the iliac crests. There are cases of course where the jacket cannot be applied, owing to the lack of development of the pelvis in very young children. In such cases the child should be placed

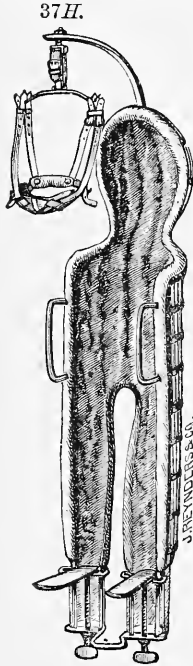

in the wire cuirass with head extension (see fig. 37H), as I show you in these children now before us, the one patient being undressed, and the other dressed for the street. In each case the head, as you observe, is supported and extended by the chin-collar and jury-mast, the same as in the plaster jacket (see fig. 37J), the traction being made by a heavy piece of elastic webbing above the head, attaching the cross-bar to the jury-mast. The principle involved in the two methods of treatment is exactly the same. The child must remain in this cuirass until the disease is cured or the pelvis sufficiently developed to apply the plaster jacket.

In the cuirass, however, the mother can carry the child out in the open air, and allow it to remain there any length of time without any inconvenience, as, being fastened into the cuirass under its clothing by an ordinary roller bandage, it is well wrapped up to guard against the weather. The child may also be placed in the upright position as though it were standing, and, if necessary, may be fastened in this position by the window, or, when playing, at a bench or table. The principle is precisely the same as in the plaster jacket, traction being made in the long axis of the body at all times by the elastic strap, to prevent pressure upon the inflamed vertebrae. The opening in the instrument underneath, and opposite the anus, avoids the necessity of removing the child from the cuirass to relieve the bowels, since defecation is possible in the horizontal



position, over the usual vessel, or napkins may be used in the case of the very young.

Of course as soon as the pelvis has become sufficiently developed to sustain the jacket and jury-mast, if the disease has not been arrested before that time, you may resort to the jacket, as it is preferable to the cuirass, permitting as it does free and voluntary exercise.

#### MEASUREMENTS REQUIRED.

1. State sex of patient.
  2. State age of patient.
  3. Place the patient undressed upon a sheet of wrapping paper of the proper size and with a pencil carefully trace her or his entire outline on the same; also,
  4. Place a flexible strip of lead along the spine, moulding it exactly to the spine and all its sinuosities from the top of the head to the middle of the sacrum. With this pattern trace carefully the shape of the spine and head on the same sheet of paper, marking the points opposite the upper and lower borders of the scapulae and the crest of ilium, also the affected parts of the spine. Send us these tracings.
  5. Circumference of the head, around the chin and back of the neck. In taking this measure care should be exercised that the tape encircles these parts in an even horizontal line.
- Price, \$35.00.

### 37R. DR. A. M. PHELPS' MODIFICATION OF THE ABOVE APPARATUS.

This apparatus possesses no qualities superior to Dr. Sayre's Wire Cuirass with Jury-Mast, it is equally efficient, and the simplicity of its construction brings it within the reach of the dispensary patient. The foot plates, instead of being propelled down or up by tourniquet screws, are held in any position, high or low, on the cuirass frame by thumb screws. Instead of wire netting, strips of tin form the body of the cuirass. The upholstery and the chin piece are made of cheap materials. The Jury-Mast, instead of being polished and nickel-plated, is finished black.

#### MEASUREMENTS REQUIRED.

The same as for Dr. Sayre's Wire Cuirass with Jury-Mast.

Price, \$25.00.

**38. DR. L. A. SAYRE'S APPARATUS FOR THE CONGENITAL MISPLACEMENT OF THE HIP-JOINTS.**

38.

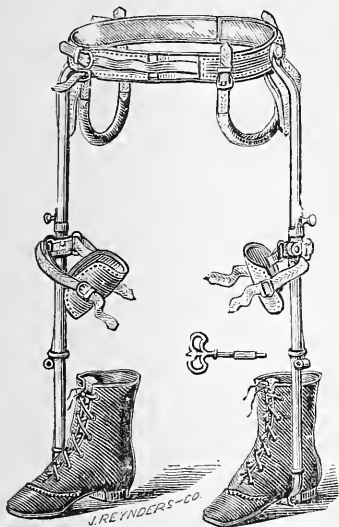

This consists of two of Dr. Sayre's long hip splints fastened to one pelvic belt by simple bolts, making plain joints, as represented in the annexed figure, permitting for- and backward movements of the hip-joints only; or by ball and socket joints, permitting all movements performed by the natural hip-joints. The pelvic belt is divided into two sections which interlock at front and back and are closed by elastic straps and buckles. The shafts of both splints are supplied with joints at the knees, which are fixed by heavy steel rings that drop automatically whilst the patient arises from a sitting position. Small prominent handles attached to these rings, facilitate the pulling upwards of the latter, (without disarranging the clothing), to release the joints and permit the patient to sit down.

Both shafts terminate at the bottom in small hollow axles which stand at right angles with the same and contain springs. These axles are fitted and pass into steel cylinders or hubs fastened to the shoes just in front of of the heels and under the insteps. The axles are held in the hubs by the springs contained in the former, see figures *A* and *B*, page 331. The shoes and splints can be separated in an instant by depressing the springs.

The perineal straps, knee caps and contrivances for extension of this apparatus correspond with the analogous parts of Dr. Sayre's long hip splints, described on page 330.

**MEASUREMENTS REQUIRED.**

1. Sex of patient.
2. General appearance of patient.
3. Circumference of body between crest of ilium and trochanter major.
4. Length from crest of ilium to the sole of foot.
5. Length from crest of ilium to the centre of the knee joint.
6. Send us a pair of strong and well-fitting lace shoes.

Price, with plain joints at hip, .....\$70.00  
 Price, with ball and socket joints at hip, .....\$70.00

39.

**39. DR. L. A. SAYRE'S WIRE CUIRASS**

is used in cases of hip-joint disease of the third stage and excision of the neck of the femur. It consists of strong wire netting, well-padded inside.

The cuirass being properly prepared and well padded; the patient is laid in it so that the anus is opposite the opening and free from any possibility of obstruction, when the well leg is the first to be dressed. By making it perfectly straight and screwing up the footrest until it is brought firmly against the heel of the patient; having a pad between the foot and the rest to absorb the perspiration, the instep is then well-padded with cotton or a blanket; and a roller is carried firmly round it and the foot-rest, running up over the limb; but before going over the knee a piece of paste-board, or leather, or several pieces of folded paper, are placed over the leg, knee and thigh, and the roller carried firmly over this extemporized splint for the purpose of preventing the slightest bending of the knee, when the roller is carried up the entire length of the thigh, around the perineum over the outer arm of the instrument, and several times back through the perineum, and then across the pelvis, by which means the well limb is made a firm counter-extending force.

Two strips of adhesive plaster, from two to four inches in width, according to the size of the patient, are then placed upon either side of the operated limb, and secured with a nicely adjusted roller over the foot and up the limb and thigh, as far as the abscesses on it or the wounds will permit, being careful to leave a sufficient length of the plasters at the lower extremity, free for the purpose of applying them to the foot-rest when extension is made, and firmly secured by a well-adjusted roller. The foot-rest is then screwed up to meet the heel of the shortened limb, and these strips of adhesive plaster are brought down around the foot-rest and securely fastened. The foot-rest is then extended by the screw, slowly and gradually, at times waiting a few moments for the muscles to yield, which have been so long contracted, until the limb is brought down to its full extent. It sometimes happens that, from long contraction of the abductors and the tensor vaginae femoris, subcutaneous section of those tendons and fascia will be requisite

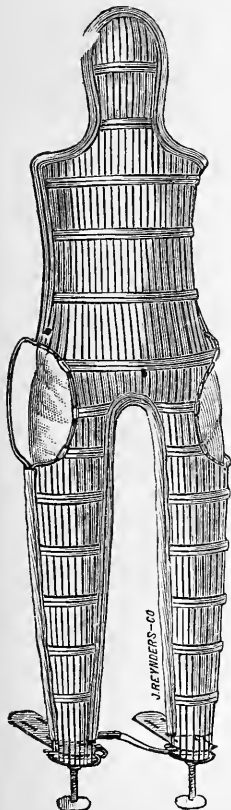

before the limb can be brought to its proper position, even after the head of the femur has been removed. After the limb is brought into this position a roller is carried from the foot over its entire surface; a large wad of oakum is plaited around the wound to absorb the discharge, and the roller is carried firmly over the wound, inner surface of the thigh, and around the pelvis. I place great importance upon this latter part of the dressing, as we thereby compress the tissues, and prevent the burrowing of pus, the oakum, which has already been placed in the wound, allowing of free drainage, no matter how tight the roller may have been applied.

Immediately after the patient is dressed in this way, and has recovered from the anæsthetic, he is capable of being stood up against the wall, or riding out in a carriage or boat, and can take his daily exercise, in this way. I have, in several instances, had them removed a long distance, some miles, in fact, within an hour of the operation and without the slightest inconvenience or pain. This dressing will probably not require to be changed for from 48 to 60 hours, or until secretion has been formed to moisten the dressings, when the oakum plug can be removed without hemorrhage. If this dressing does not come away easily, warm water injections will readily float it out. The wound, made clean, is again filled with Peruvian balsam and dressed as before. After this it may require dressing once or twice a day, according to the amount of discharge, and the child should be removed from the entire instruments as often as is requisite. The well leg should be removed from the instrument at least once a week, and free movements given to all the joints, ankle, knee and hip, otherwise we may anchylose them, although they are not diseased. The wire cuirass should be used from a month to two months, according to necessity, after which the patient can be put upon the long splint and allowed to exercise, thereby increasing his prospects of perfect motion of the new joint.

## MEASUREMENTS REQUIRED.

- |   |   |
|---|---|
| Sex of patient.   | 10. Circumference of body at nates.             |
| 2. General appearance of patient.   | 11. Length from axillae to perineum (back).     |
| 3. Distance between base of neck, from one side to the other, passing over the ears and head. | 12. " " vertebra prominens to perineum.         |
| 4. Circumference of head at the eyes.   | 13. " " perineum to sole of foot inside.        |
| 5. " " neck.  | 14. " " crest of ilium to sole.                 |
| 6. Length from top of skull to the vertebra prominens.  | 15. Circumference of thigh at perineum.         |
| 7. Circumference of body under axillae.   | 16. " " midway between perineum and knee-joint. |
| 8. " " at the waist.  | 17. Circumference of calf.                      |
| 9. " " between crest of ilium and trochanter major.   | 18. " " ankle.                                  |

PRICE, according to size, .....\$25 00 to \$45 00

## 40. DR. NEWTON M. SHAFFER'S IMPROVED HIP SPLINT.

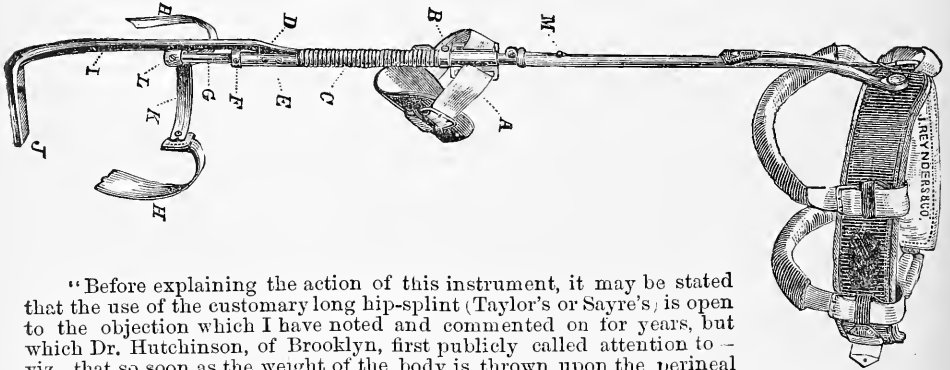

"Before explaining the action of this instrument, it may be stated that the use of the customary long hip-splint (Taylor's or Sayre's) is open to the objection which I have noted and commented on for years, but which Dr. Hutchinson, of Brooklyn, first publicly called attention to—viz., that so soon as the weight of the body is thrown upon the perineal pads, extension, as such, ceases, and the so-called extension splint becomes in reality nothing but a perineal support. This is shown by the "bagging" of the leather straps which pass from the foot piece of the instrument to the adhesive plaster buckles at the ankle, whenever, in walking, the weight of the body overcomes the traction force. In the Taylor-Sayre long splint there is a cylinder attached to a pelvic band. By means of perineal pads attached to the pelvic band, a means of counter-extension is provided. An extension rod slides back and forth in the cylinder by means of a ratchet and key movement. This extension rod terminates in the foot piece, above alluded to, and the foot piece forms the point of attachment for the straps which pass to the adhesive plaster. When the extension rod is pushed out by the ratchet and key movement direct extension of the limb occurs. But when, in walking, the foot piece presents to the ground, the instrument being practically one continuous steel rod, cannot shorten. The entire weight of the body, bearing downward upon the perineal pads, overcomes any extension force, which does not exceed, in pounds, the weight of the patient.



With the Taylor-Sayre splint it is easy to produce and maintain extension when the patient sits or lies down—but the moment he commences to walk, the foot approximates the foot piece—the lower extension straps becomes loose, and the patient is able to swing the limb backward and forward to a very considerable extent. But when the weight is again thrown upon the sound limb, extension again occurs.

In the instrument, pictured above, the usual cylinder and pelvic band are employed. But, instead of continuing the extension rod to and below the foot, as in the Taylor-Sayre instrument, it is made to terminate at a point, about  $1\frac{1}{2}$  inches above the malleoli (*G*) and a band is attached which passes half way around the limb, posteriorly (*K*). To this band are riveted two straps (*HH*) which are attached to the adhesive plaster buckles. The foot piece (*J*) has an independent rod (*I*) which passes upward to the piston arrangement at *D*, and above the point of exit of the extension rod. When this instrument is applied, and the weight of the body is thrown upon the perineal pads the instrument shortens, by a compression of the spiral spring, at *C*. In other words, the entire part, *D, I, J*, moves upward and the weight of the body is expended in shortening the spring—the straps, at *HH*, remaining taut all the while. The same degree of extension is exerted upon the diseased hip-joint, whether the patient lies down or walks. Traction is constantly maintained, and the joint surfaces are not alternately protected and then exposed at every step, as in the instrument, previously described. The spring, of course, acts automatically, and, so soon as the foot piece is removed from the ground the instrument lengthens, and is again ready to receive the weight of the patient.

#### MEASUREMENTS REQUIRED.

1. Length from just below the anterior, superior spine of ilium to a point  $1\frac{1}{2}$  inches above the external malleolus.
2. Length from the same point to  $1\frac{1}{4}$  inches below sole of foot,
3. Circumference of body between crest of ilium and trochanter major.
4. Right or left leg?

PRICE, ..... \$30 00 to \$35 00

## 41. DR. M. JOSIAH ROBERTS' SHORT ELASTIC TENSION SPLINT FOR THE TREATMENT OF HIP DISEASE.

(Extracts from "The Hip and Its Diseases," by V. P. Gibney, A. M., M. D.)

The instrument consist of a pelvic and a femoral segment. The former is made of very thin sheet steel covered with leather on the outside and thoroughly upholstered on the inside, it is broad, and to secure a good fit he moulds it over a plaster cast of the patient's pelvis.

the latter the femoral segment is composed of two compound side bars which extend down along the thigh upon the inner and outer aspects, and are constructed with special reference to exerting continuous elastic linear traction upon the thigh.

The mechanism by means of which this is accomplished can be understood by reference to figure 42, page 337, two side bars are here represented, one is provided with expanded margins which have been turned over so as to perform a shell through which the other slides, the upper or proximal end of the shell is converted into a rectangular loop which completely closes over the sliding bar, and upon this a brass pin is soldered. The lower or distal end of the sliding bar is, likewise, provided with a brass pin, *B*. Any force which brings these two pins nearer together must of necessity lengthen the instrument, as shown by the dotted line in the figure. It must also, as a consequence, exert a tractile force upon the limb to which it is attached. In order to make this tractile force elastic, or, in other words, like manual traction, a narrow elastic strip of strong elastic webbing provided at one end with a button hole is slipped over the brass pin, at *A*. To the pin, *B*, which is screwed into

the opposing end of the other bar, a buckle is attached. The instrument having been applied and secured into position with the brass pins at the greatest possible distance apart,

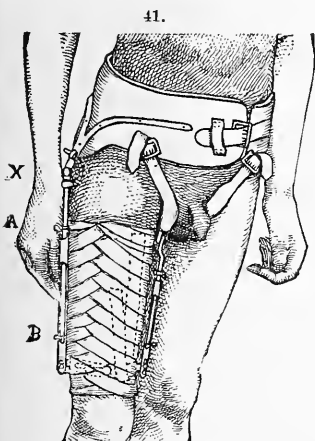

we can, by means of a strip of elastic webbing and a buckle, exert any desired amount of elastic force. By doing this the opposing ends of the two bars are approximated and the instrument is thus lengthened. It is in this way that the tractile force is graduated. By substituting a non-elastic strip for the elastic one, fixed or rigid traction could be maintained by the same mechanism. The distal end of the side bars are fixed to a metallic band which encircles the limb just above the knee. This band is secured in position by means of strips of strong adhesive plaster placed longitudinally around the thigh, with their lower ends turned up over it (the band), and retained in position with a roller bandage, the lower ring is thus prevented from being pushed down over the knee when traction is made, as above described. At X (figure 41) a simple hinge joint connects the outer side bar with pelvic segment. A like joint is found at the proximal end of the inner side bar at its junction with the perineal strap. These two joints permit, it is claimed, articular action at the hip during locomotion, and in changing from the sitting to the standing posture, or the reverse. By continuously exerting elastic traction, it is further claimed, articular motion becomes possible without intra-articular pressure or friction, and without giving rise to the slightest discomfort to the patient.

Under these circumstances, Dr. Roberts thinks it is evident that the condition of the joint more nearly approximates that which we find in health than it would were it fixed. The Doctor argues, that in this way we avoid the depreciating influences, which prolonged immobilization of an articulation necessarily has on the local nutrition, that the circulation through the limb is facilitated, that we get the maximum amount of nutrition in the joint through the agency of which a favorable temperature is sustained for the growth and development of adjacent parts, and that repair in decayed tissues can the more readily be promoted.

Passing over the joint anteriorly, at X, is a semi-circular rod upon which a coiled steel spring is placed, the action of which is to oppose flexion of the thigh on the abdomen. An adjustable nut on the curved rod furnishes the surgeon with the means of exercising his discretion, as to how much motion at the joint shall be permitted. The splint, as applied, is represented in figure 41, and it will be seen that no other joints, save the one diseased, are restricted in their normal movements. The sustaining power of this apparatus lies in its elastic attachments, and not in the steel bars which compose the frame work. The office of these bars is only to give direction to the force exerted by the elastic side straps. This principle enables the Doctor to construct the splint of such light material that it is easily portable, and equally durable with the heavier iron and steel appliances.

Another advantage, he claims, is that it does not interfere with the impact of the foot upon the ground during locomotion, thus preserving the foot sense, which is of the greatest possible advantage to the patient in averting sudden jars and traumatisms. To still further reduce the effect of jar incident to locomotion, he has his patients wear soft rubber heels on their shoes. To recapitulate the advantages, claimed by its author, for this splint:

1. It protects the diseased areas from disastrous traumatism.
2. It furnishes sufficient artificial support to counterbalance the loss of power on the part of the affected member, in mild cases, or during convalescence in severe cases.
3. It places the movements of the diseased articulation absolutely under the control of the surgeon at all times.
4. It prevents intra-articular pressure and friction.
5. By its use we can maintain the general and local nutrition at the highest possible standard for the purposes of carrying on the repair of the diseased tissues.
6. The nullification of reflex muscular spasm is secured by it.
7. It is easily portable.
8. It does not interfere with the performance of the functions of healthy joints.

#### MEASUREMENTS REQUIRED.

1. Send us of your patient's pelvis a plaster-of-Paris, sole leather or gutta-percha mould, shaped as the belt in the figure
2. Sex and age of patient.
3. General appearance of patient.
4. Circumference of body between crest of ilium and trochanter major.
5. Distance between crest of ilium and trochanter major.
6. Distance between crest of ilium and a point two inches above knee-joint.
7. Distance between perineum and a point two inches above knee-joint.
8. Circumference of thigh at a point two inches above knee-joint.
9. Mention if for right or left hip.

Price, \$22.00.

**42. DR. M. JOSIAH ROBERTS' LONG ELASTIC TENSION SPLINT.**  
**FOR THE TREATMENT OF HIP DISEASE.**

42.

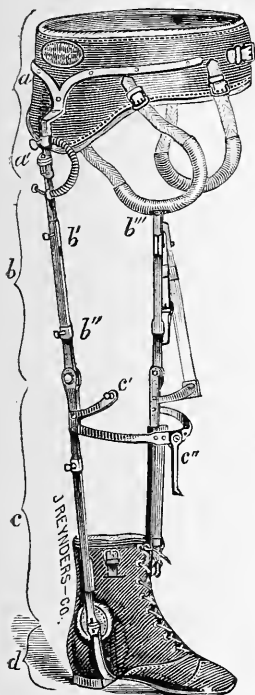

Dr. Roberts says:

In the light of my present experience I should advise the short splint only in those cases where convalescence is in progress; the patient having a long thigh to which the instrument can readily be attached.

The same principles of treatment can be enforced and greater supporting power afforded by the long splint, shown in figures 42 and 42A.

It consists, as will be seen by reference to figure 42, of four segments which respectively correspond to the pelvis, *a*, thigh, *b*, leg, *c*, and foot, *d*. The pelvic and femoral segments are identical in construction with the corresponding parts in the short splint, *vide* figure, excepting at *a'*, where a ratchet clamp joint, as introduced by Dr. Stillman, permits of rotation.

Like the short splint, this instrument is constructed to exert *elastic linear traction*. The mechanism for the accomplishment of this is the same as that in the short splint.

In the long splint, however, the segments corresponding to the thigh and leg are both provided with compound or sliding side bars. At *b'* *b''* are shown the pins secured to the free ends of the sliding bars, to which is attached an elastic side strap. The four side bars comprising the thigh and leg portions of the instrument are similarly provided with pins and elastic straps. At *b'''* is an universal joint, connecting the inner lateral shaft with the upholstered per-

42A.

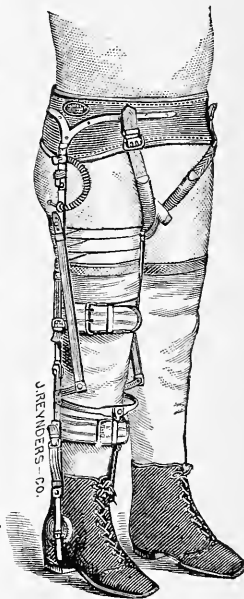

lateral stirrup. From the anteriorly a semicircular piece.

Attached to the middle of this is an adjustable metallic arm projecting downward in a line with the spine of the tibia. From this arm, as a fixed point, there extends a broad elastic band around the leg behind the head of the tibia (figure 42 A), which serves to keep the instrument constantly in the same relative position to the limb. From the semicircular piece on either side at the points of its attachment to the lateral shaft of the splint, there projects directly forward a metallic arm, *c'*, curved upward. To the end of this lever is attached a strong strip of elastic webbing, which passes up through a buckle attached to a pin, *b'*. These elastic straps, one on either side, are designed to supplement the function of the quadriceps extensor muscle.

At the junction of the leg with the foot segment, a French joint permits of their easy disarticulation, a matter of great convenience in the application of the splint. In the application of the instrument, long and broad strips of adhesive plaster are used in precisely the same manner, as in the application of a Sayre splint, the lower ends tipped with non-elastic webbing passing through buckles attached to the shoe on either side.

**MEASUREMENTS REQUIRED.**

1. Send us of your patient's pelvis a plaster-of-Paris, sole leather or gutta-percha mould, shaped as the belt in the figure.
2. Sex and age of patient.
3. General appearance of patient.
4. Circumference of body between crest of ilium and trochanter major.
5. Distance between crest of ilium and trochanter major.
6. Distance between crest of ilium and centre of knee-joint.
7. Distance between perineum and centre of knee-joint.
8. Distance between centre of knee-joint and ankle-joint.
9. Distance between centre of knee-joint and sole of foot.
10. Circumference at garter (below knee).
11. Mention if for right or left hip.
12. Send us a well fitting lace shoe.

**PRICES.** .....from \$40.00 upwards.

## 43. DR. CHAS. F. STILLMAN'S SECTOR JOINT BRACKETS AND SPLINTS.

When properly applied are capable of the following combination without removal from the limb:

1. Extension at any angle with motion.
2. Extension at any angle with fixation.
3. Fixation at any angle.
4. Motion, complete or limited, constant or occasional.
5. Exposure of surface about the joint, admitting compression, elastic or otherwise, hot and cold applications, blisters, dressings, and easy inspection.

6. Motion, extension, and elastic tension by the addition of appropriate rubber cords.

This splint may be inserted into any form of brace attachment known. But when it is desired that the splint should remain upon the limb for any length of time, or, as in acute inflammation of joints where it is used to reduce the contractile antagonism of the muscles, I prefer to use it in the form of a bracket, which is to be attached to the affected part by some immovable dressing, which will be sufficiently inflexible to prevent unequal pressure upon the soft parts.

The sector bracket consist of two terminal plates of thin copper, perforated upon the upper side, connected with each other by a sector bridge raised to any desired distance from the surface. This bridge consists of two overriding slotted steel strips, connected by three clamps which may be either thumb-screws or key-clamps.

### FOR THE HIP-JOINT.

(Extracts from "The Hip and Its Diseases", by V. P. Gibney, A. M., M. D.)

"The aim of the apparatus is extension, *with or without* motion, and at any desired angle. It furthermore, seeks to overcome the compensatory lordosis." A sector splint figure 43, is placed on

the outer side of the thigh over the hip, and is employed either as a "bracket" or a "brace,"—the difference being that the bracket is to be secured by plaster-of-Paris, or some inflexible bandage, which does not admit of removal, while the brace can be removed at pleasure.

The sector splint, it will be seen from the figure, is composed of two plates of perforated tin that partially encircle body and thigh, of two slotted arms connected at one end by means of a clamp and each attached at the other end to one of the perforated plates—near which a sharp curve is seen to prevent undue pressure over prominent parts, and of a slotted sector attached to the slotted arms by three clamps.

To apply this bracket, *first*, several strips of moleskin adhesive plaster are wound tightly around the thigh just below the hip, and around the pelvis above the hip.

*Second*, thigh, pelvis and waist are encircled by plaster-of-Paris bandage which is allowed to partially set.

*Third*, the bracket is applied over this plaster, the angle being fixed as desired, the clamps having been previously loosened, and the slotted strips shortened as much as possible.

*Fourth*, the bracket is now fastened by a few turns of the plaster bandage, and this is covered by a dry muslin roller to ensure cleanliness. When the plaster is set the whole constitutes the splint, and is represented in figure 43 A. Enough precautions have been taken to secure the desired amount of firmness, and the apparatus extends from axilla to knee—the underlying adhesive plaster preventing any slipping or sliding on thigh or trunk. To make the extension, the slotted strips are pushed away from the centre, thus increasing the distance be-

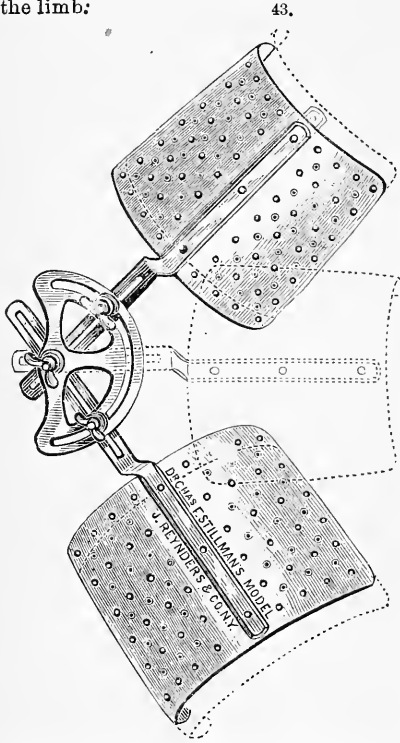

43A.

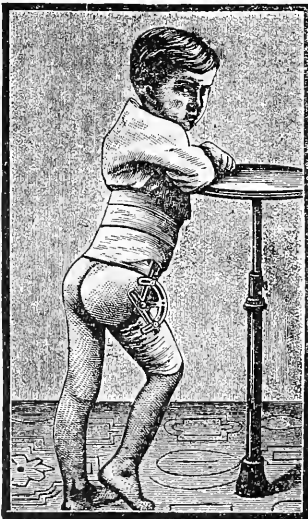

tween body and thigh attachments. The degree of extension gained is secured by the clamps on the slot.

(A perineal band should be improvised with a handkerchief in the centre of which a small roll of cotton or wool is placed, and the whole rolled into cylindrical form, and after being placed in position, is tied firmly around the upper angle of the bracket. This is not shown in the illustration.)

By means of the clamps on the sector fixation may be secured, or motion may be allowed, and extension be maintained at the same time. Dr. Stillman combines this plan with the crutches and high shoe. The advantages, he claims, for this splint are:

1. Local extension of the joint diseased.
2. Fixation at any angle, with or without extension.
3. Motion, with or without extension.
4. Gradual reduction of the flexion.
5. Opportunity for local inspection and topical applications.

When a brace can be afforded and, because of the uncleanness

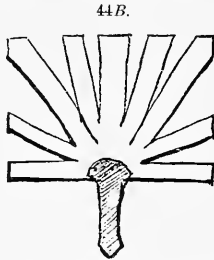
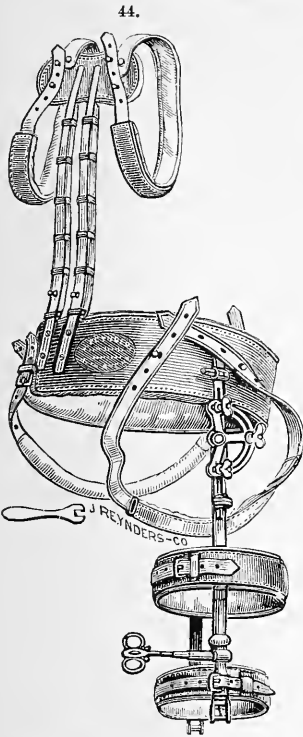

of the plaster, it is desirable to use a brace instead of a bracket, a removable apparatus may be used. This may be of several forms depending upon the fancy of the surgeon. In each, a back frame is provided—and fastened to the body with suitable straps and bands—to prevent the compensatory lordosis which ensues as a feature of the hip disease. This is a feature not

found in any other American hip brace, although the English surgeons consider it a necessary feature.

Figure 44 shows one form of hip brace provided, *first*, with the back frame; *second*, with sector at the hip; *third*, with a clamp above the sector fixing the angles of abduction and adduction, and one below, for fixing the angle of rotation. These are changed by the wrench, shown in the illustration. The sector is operated by thumb screws, and is provided with a removable clamp by which motion in the hip may be limited to any given arc. With extension ratchets, operated by a key, the brace terminating just above the knee in rollers and buckles, to which the attachment to the thigh is made.

**APPLICATION.** Two square pieces of moleskin adhesive plaster should be cut, as shown in figure 44 B, and two tabs of strong webbing sewed to the centre of each. These are placed, one on either side of the thigh, the ends interlacing, as shown in fig. 44 C. A roller bandage is now to be placed



on the thigh from the knee to the hip, allowing the webbing tabs to protrude, as shown in figure 44D.

To apply the brace, the clamps and straps are all loosened and the extension ratchets shortened as much as possible. The pelvic band is then fastened around the pelvis and the two perineal bands buckled tightly in place. The shoulder straps and abdominal band are then buckled, so as to secure the back frame tightly against the back. The thigh is next to be attached, the webbing tabs are to be passed over the rollers at the end of the brace and buckled tightly, the girths around the thigh having been previously buckled.

Traction may now be exerted either under chloroform, which is the better or gradually by the hand until the limb is in the position desired, when the clamps are tightened, thus fastening the thigh on the pelvis. Extension is now to be exerted by the key. The addition of the high heeled shoe on the sound limb, and a pair of crutches (Hutchinson's physiological method) completes the outfit.

Another form of brace, which is somewhat less complicated, is sometimes employed by Dr. Stillman. It differs from the preceding in:

1st. It has no clamp for rotation, or abduction and adduction.

2d. The sector is larger and holds the hip still more immovably.

3d. It extends below the knee and is provided with the two compound side bars and elastic extension straps.

This brace is simpler and more easily managed than the preceding, and is applied in the same manner except that the webbing tabs extend below the knee and are, therefore, necessarily much longer.

#### MEASUREMENTS REQUIRED.

##### *For the Sector Joint Hip Brackets.*

1. Age of patient.
2. Distance between the last vertebræ rib and the great trochanter.
3. Distance between the great trochanter and the centre of the knee-joint.
4. Mention, if for the right or left hip.

##### *For the Sector Joint Hip Splints.*

1. Age of patient.
2. General appearance of patient.
3. Distance between the seventh cervical vertebra and the middle of sacrum.
4. " " the upper borders of the scapulae.
5. " " the lower " "
6. " " crest of ilium and trochanter major.
7. " " trochanter major and a point about two inches above the centre of the knee-joint.
8. Circumference of body under axilla.
9. " " " " at waist.
10. " " " " between crest of ilium and trochanter major.
11. " " " leg at a point about two inches above the centre of the knee-joint.
12. " " " leg at the middle of thigh.
13. Mention, if for the right or left leg.

#### PRICES.

Sector Joint Hip Brackets, .....	each, \$10.00
Sector Joint Hip Splints, as per figures 44 and 44 A, .....	" \$45.00
Sector Joint Hip Splints of simpler form, .....	" \$30.00

45.

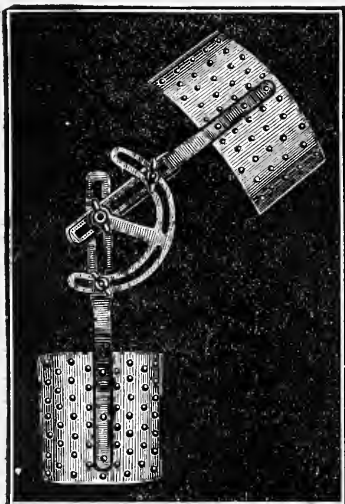

#### FOR THE KNEE-JOINT.

For the knee, two sector joint brackets are usually required, one upon either side of the joint. The brackets are intended for use with the plaster-of-Paris or some other immobile dressing. They are secured to the limb, either with plaster-of-Paris or starch bandage, or a combination of either with adhesive plaster. If plaster-of-Paris be used alone, a long stocking is divided in two parts, one of which extends from the toes to the knee and the other from the knee to the hip, and over these the plaster-of-Paris bandage is placed in two layers.

The brackets are then laid upon the limb, one upon each side, the pivotal centre of the sectors to be in the pivotal axis of the knee, and are secured in this position by more plaster-of-Paris bandage. The plaster-of-Paris surface is then to be covered by an ordinary roller bandage to insure cleanliness. When this dries, the brackets become incorporated with the plaster-of-Paris, and form a continuous splint. Another form of application, in some respects preferable to that just detailed, consists of a combination of adhesive plaster and plaster-of-Paris. Strips of adhesive plaster, moleskin being preferred, about eighteen inches in length and one inch in width, are cut and

wound around the limb above and below the joint, care being taken that there is no wrinkling or creasing. The plaster-of-Paris bandage is now wound over it and the splint completed, as already described.

46.

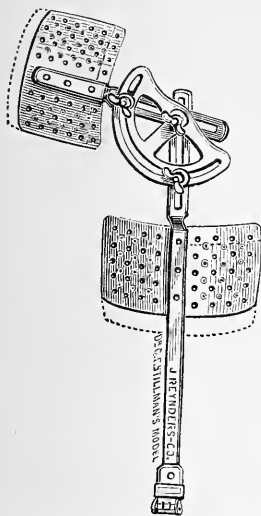

This combination of adhesive plaster and plaster-of-Paris seems a better attachment of the bracket to the limb than if plaster-of-Paris alone is used. Extension is effected after the plaster becomes firm, by pushing the upper portion away from the knee and clamping the upper clamp of the sector.

Another form of the sector joint bracket, is that shown in figure 46, which differs from the preceding only in the lower bar being extended and terminating in a roller and buckle. It is applied by means of adhesive plaster and plaster-of-Paris.

Two pieces of moleskin plaster, as fresh as possible, are cut in the shape of a fan and have sewed to each of them a tab of strong webbing, and are then placed one upon each side of the limb below the knee, as shown in figure A, their extremities being interlaced.

Strips of plaster are now cut of sufficient length to more than encircle the thigh. These are wound around it snugly, as also shown in figure A.

Over the leg and thigh a plaster-of-Paris bandage is now rolled, as shown in figure B, the webbing tab being allowed to protrude. The brackets are now placed in position, one on either side of the limb, taking care to have them in the axis of the thigh and leg, and to have pivotal centre of the splint in the pivotal axis of the knee, see figure C. A few turns of the plaster bandage secures the splint in place, and the plaster surface is now to be neatly covered with a bleached muslin roller bandage. The webbing tab should next be passed over the roller and buckled to

the end of the splint, of course, waiting until the plaster has become firm, figure D. Extension may now be exerted against the muscular bulk of the thigh, and secured by the upper clamp of the sector. If fixation be desired, the other clamp should now also be secured, and we have the surface over the joint exposed and the joint held free from the least possible

A.

B.

C.

D.

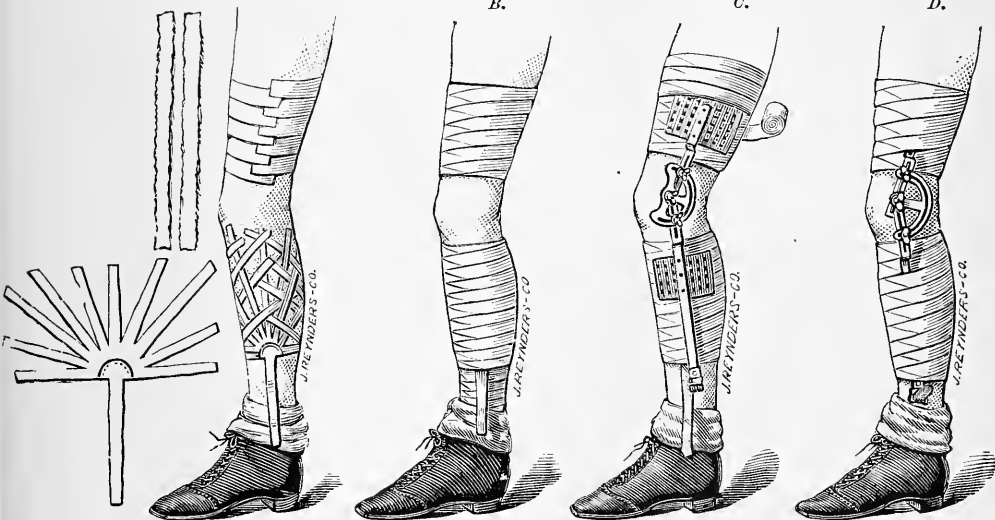

motion, and yet extended, or the two lower clamps may remain loosened and motion may be allowed in the joint without interfering with the extension.

A rubber bandage can now be placed around the knee or it may be strapped or bandaged with an ordinary roller bandage in the usual manner, to increase the circumferential pressure.

47.

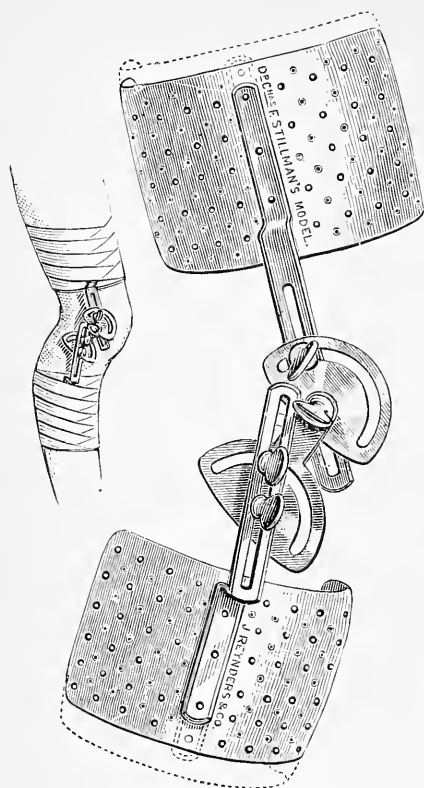

If much subluxation of the knee has taken place, a double sector of the form, shown in figure 47, may be employed. It is applied like the bracket already shown, and admits of considerable force being employed in the direction to diminish the deformity, and yet subdue the inflammatory condition of the joints.

For prolonged wear, or if it can be afforded by the patient, the copper plates of these brackets may be removed and padded girths substituted which will permit the removal of the splint from the limb and ensure greater cleanliness. But, for this purpose, the roller and buckle must be attached, both superiorly and inferiorly, and the fan-shaped moleskin dressing be applied to the limb, both above and below the joint, and securely fastened there by a roller bandage, the tabs to pass over the rollers and buckled to the splint.

This makes a light, firm and exceedingly efficient knee-brace.

#### MEASUREMENTS REQUIRED.

*For the Sector Joint Knee Brackets.*

1. Age of patient.
2. Distance between trochanter major and the centre of the knee-joint.
3. Distance between the centre of the knee-joint and the ankle-joint.
4. Circumference of thigh at P and Q. See figure of leg, page 293.
5. Circumferences of leg at O, N and M. See figure of leg, page 293.

#### PRICES.

Sector Joint Knee Brackets, as per figure 45, each, .....	\$10.00
Sector Joint Knee Brackets, as per figure 46, each, .....	\$12.00
Sector Joint Knee Brackets, as per figure 47, each, .....	\$20.00

### 48. FOR THE ANKLE-JOINT.

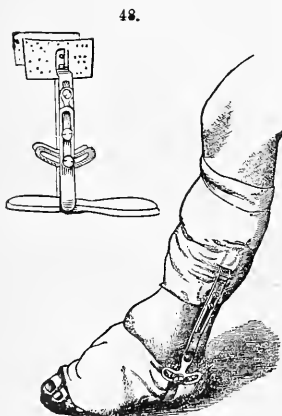

Sector Joint Bracket applied to the ankle-joint.  
Side view.

For the ankle, the splint is constructed, as shown in figure 48, and is very serviceable. It is attached inferiorly to a sole of leather or felt moulded to the plantar surface of the foot, and bound down with some firm dressing. It allows motion and yet removes all undue pressure from the articular surfaces, and will be found of use in all varieties of injury or inflammation in or about this joint.

For the elbow, the sectors are somewhat smaller than for the knee, and in general the same form, made small in proportion, is used for the smaller articulations.

#### MEASUREMENTS REQUIRED.

1. Trace the outlines of the sole on a piece of paper and mail to us.
2. Length from sole to ankle.
3. Length from sole to garter (below knee).
4. Circumference at garter (below knee).

See page 377.

48A.



Sector Joint Bracket applied to the ankle-joint.  
Front view.



## Dr. L. A. Sayre's Rubber Compressor for the Knee and Ankle Joints.

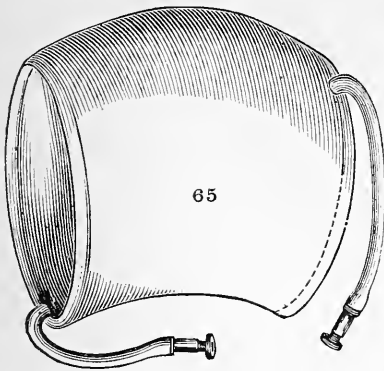

It is simply an India Rubber sac with double walls of suitable form enclosing the knee or ankle joints. A tube connects with this hollow bag through which warm water may be poured, or the bag may be blown up either by the mouth or a pair of bellows, a stop cock attached to the end of this tube retains the liquid or air.

In this manner even pressure with the advantage of a hot poultice can be made which will be exceedingly powerful, and yet so soft and elastic as to be easily borne.

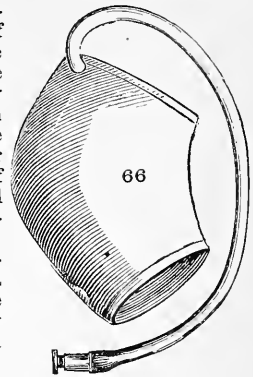

## MEASUREMENTS REQUIRED FOR KNEE COMPRESSOR, FIG. 65.

1. Circumference at letters O. F. P. (See Fig. of Leg, page 293).
2. Length from centre of knee upward.
3. Length from centre of knee downward.

## FOR ANKLE COMPRESSOR, FIG. 66.

1. Circumference at J. K. A. L. (See Fig. of Leg, page 293).
2. Length from centre of ankle along foot.
3. Length from centre of ankle upward.

Price each \$6.00 to \$10.00

## 64. Dr. L. A. Sayre's Apparatus for chronic inflammation of the Ankle-joint.

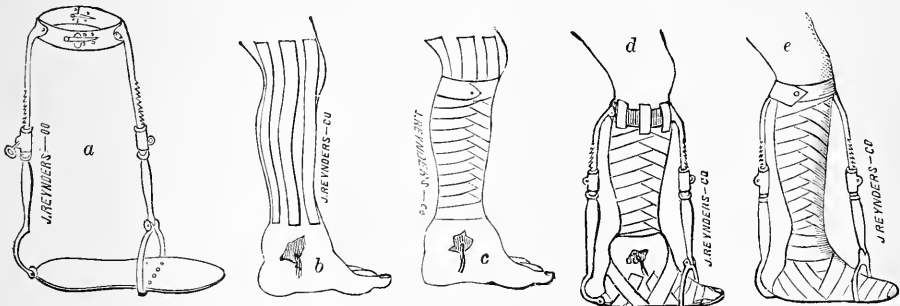

This instrument, fig. *a*, consists of a firm steel plate, made to fit the sole of the foot; at the heel is a hinge-joint, and attached to it a rod, slightly curved at the bottom, and extending up the back of the leg to near the knee. Over the instep is an arch, like the top of a stirrup with a hinge joint at its summit from which springs another rod, which runs in front of the leg, up to an equal height, with the one behind. These rods are made with a ratchet and cog for extension, and connected at the top by a firm band of sheet steel, on the side of which is a hinge, and a lock on the other like a dog-collar.

The instrument is applied with firm adhesive plaster, cut in strips about one inch in width, and long enough to reach from the ankle to near the tubercle of the tibia, and placed all round the limb, as in Fig. *B*.

The plaster is secured in its position, to within an inch of its upper extremity, by a well adjusted roller, as seen in Fig. *C*.

The instrument is fixed, and the foot firmly secured by a number of strips of adhesive plaster, as seen in Fig. *D*. A roller should be carefully applied over this plaster to prevent its slipping, and the ends of the plaster at top of the instrument turned over the collar, which has been previously locked, just tight enough to be comfortable, and secured by a turn or two of the bandage, as seen in Fig. *E*.

## MEASUREMENTS REQUIRED:

- 1) Trace the outlines of the sole on a piece of paper.
- 2) Length from sole to garter.
- 3) Circumference at garter.

Price, \$20.00 to \$25.00

See page 377.

## 64B. DR. CHAS. F. STILLMAN'S KNEE EXTENSION APPARATUS.

(Extracts from Dr. C. F. Stillman's article: "The Mechanical Treatment of Knee-Joint Disease," from the *New York Medical Journal* of January 8th, 1887.)

The sector splint which the writer devised thus fulfilled a mechanical condition, or a series of mechanical conditions, necessary to the proper treatment of joint disease, which were not fulfilled by either of the others just described, for, when applied firmly to the limb by plaster of Paris and adhesive plaster, the joint could be locked firmly in any position, with or without extension being produced at the same time, and the surface over the joint was left exposed for whatever dressings or applications were considered necessary.

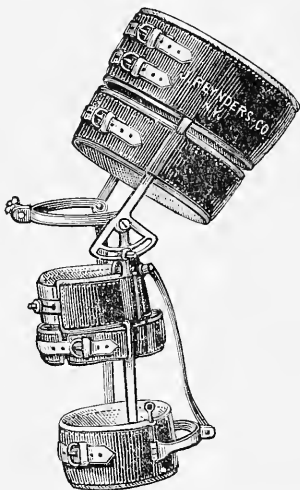

Fig. 64B.

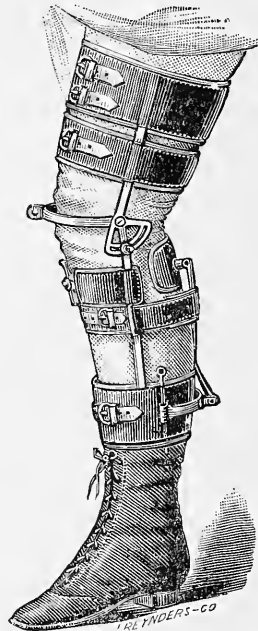

Fig. 64C.

In chronic conditions of the knee joint, however, the plaster of Paris attachment is always uncomfortable, and cannot be removed without disturbance of the joint. Since the atrophic changes in the soft parts about the joint render frequent removal of the dressing desirable, it becomes almost a necessity to provide special forms of apparatus which can be removed whenever necessary. These should retain in their formation the principles governing the construction of the sector joint splint itself; in fact, the treatment of diseases of the knee joint, as a class, has, from a surgical standpoint, been impeded by a difficulty in procuring apparatus which could be used advantageously through all stages of the treatment, and through all possible conditions which might arise during such treatment.

One of the most important of these indications is to incorporate in the brace, and to place on either side of the joint (in its transverse pivotal axis), a movement which will allow of either fixation or motion.

In fig. 43, page 338, such an one is shown, and if the pivotal center is placed in the transverse pivotal axis of the joint, its arc of motion will correspond closely to the arc of motion in the normal joint, and by means of the clamp in the slotted arc the joint may be fixed in any desired position, or, by releasing the clamp slightly, motion may be allowed.

Another important indication is the occasional employment of traction, and a new feature in this splint consists in the method of obtaining it by having adhesive plaster grasp the knee just below and above the joint over a *very limited* area; and to effect this the plaster is cut in the fan-shape shown in fig. 44B, page 339, and long strips of webbing are attached to each. It requires four of these fan-shaped pieces for each knee, and four long pieces of webbing; and these are to be placed as shown in fig. 44C, page 339, but with the long pieces of webbing extending up and downwards on the leg and thigh, interlaced for greater security from displacement, and then covered with roller bandage, as in fig. 44D, page 339. Upon the superior and inferior extremities of the splint are provided rollers and buckles, to which the webbing is to be attached, and then, by means of an elastic ratchet, force may be applied upon the thigh portion of the instrument to effect the extension.

This arrangement differs from any attachment in ordinary use at the present time in being limited to a small zone just above and below the joint, and consequently does not inter-

fere with the muscular structure of the thigh or leg, as is the case when the splints are applied by adhesive plaster over the whole extent, as in other splints for this purpose, or in the plaster of Paris attachment formerly used by the writer.

To exert the traction and produce extension of the joint, the ends of the webbing strips are to be passed over the rollers at each extremity of the splint, and, after being pulled upon as firmly as possible, are secured in the buckles provided for that purpose.

The upper thigh girth is then pushed away from the remainder of the apparatus by either elastic or rigid ratchets, as the surgeon prefers. The ratchet shown in fig. 37*G*, page 332*C*, consists of two overriding slotted strips, which can be fastened together by a screw-clamp when sufficient traction has been exerted by the elastic strap provided for that purpose.

This form of ratchet is a modification of the original Davis elastic ratchet, and in the hands of the writer is more effective than any other traction ratchet he has used, because, by simply loosening or tightening the clamp (the elastic strap being on the stretch at the same time), the traction may be varied from the elastic to the fixed at the will of the surgeon; but the writer has found that, if the elastic tension is kept up unvaryingly, the adhesive plasters are apt to cut into the skin in very much the same manner as and on the principle of an elastic ligature.

This is obviated, without impairment of the efficacy of the traction, by simply tightening the clamp holding the slotted strips together when the desired amount of extension of the joint is secured.

Another indication, also, of the utmost importance in the treatment of knee joint disease is the prevention of posterior luxation.

Most of the diseases of the knee joint are accompanied by a tendency, even in the milder cases, to luxation of the tibia backward, and this is a feature which the mechanicians of orthopædic surgery have tried to overcome with more or less success.

To meet this indication, the author has devised a new and effective arrangement (see figs. 64*B* and 64*C*), which brings to bear a spring lever power which is distinct from anything heretofore used, and operates without interfering with the action of the remainder of the brace. It will be noticed that it is a long, flat steel bar, bent to conform to the back of the leg, and placed posteriorly. At its upper end is attached a semi-girth which presses on the back of the upper part of the leg, and below it is attached to a stirrup which is itself fastened to the lower girth of the instrument.

This stirrup is provided with a hinge and a socket, so that it may be opened and shut when the rest of the brace is in position, and the forward pressure, which is dependent upon the angle which the posterior lever makes with the rest of the brace, can thus be adjusted by means of a ratchet at the intersection of the lever with the stirrup without the necessity of removing the brace from the limb. One of the features of this arrangement consists in its availability for all classes of cases in which the least tendency to this subluxation exists, for it can be adjusted to any desired angle, thereby giving any degree of forward power, and this power is brought to bear precisely where it is wanted, and without causing impingement of the brace upon the limb at any point.

There are very few cases of joint disease, even of the simplest form and of the most recent date, in which the comfort of the patient is not increased by having a certain amount of forward pressure just below the popliteal space.

How many of these patients say to the surgeon that they feel they could walk if they "had something that would press the leg forward just below the knee, as it seems weak at that point"! And by the arrangement shown this power can be supplied without interfering with the main portion of the brace or with the motion of the joint.

There is no form of knee joint disease in which this forward pressure, in either a lesser or greater degree, is not of advantage; and there is an anatomical reason for this, since in these diseases relaxation of the quadriceps extensor femoris is accompanied by a contraction of the antagonist flexor muscles, the biceps, semi-membranosus, and semi-tendinosus, thus interfering with the possibility, in many cases, of producing linear traction in the proper axes of the thigh and leg; while, if the tibia is held forward in the position it would have if the anterior muscles were exerting their normal power, the extension of the joint is effected without pain to the patient, and the traction is exerted in the proper direction.

By means of a ratchet at the intersection of the inferior extremity of the posterior lever and the stirrup to which it is attached, this power, as has been stated, can be adjusted so that the lever can be varied from a mere upright support to a spring lever of tremendous force, and in every case in which it is applied (provided, of course, that the power exerted is not beyond the proper amount necessary for the particular case) the patient's usual comment is that the comfort of the apparatus is thereby much increased; and from a surgical standpoint the joint is placed in much better condition for curative treatment, because this tendency to backward luxation is greatly overcome.

After traction has accomplished its purpose and extension of the joint is no longer necessary, the splint is so arranged as to permit the removal of the rollers and buckles at each extremity and of the traction ratchets, thus converting it into an effective simple fixation splint or knee support during the stage of convalescence, when by the use of restorative measures the anterior muscles of the thigh have been strengthened so as to hold the tibia forward in its proper axis with the femur.

There is also frequent occasion to force the sides of the brace as closely against the joint as possible in order to afford protection from lateral displacement, and to effect this the knee.

is spanned anteriorly by a metallic band sufficiently raised not to touch the surface. This band is divided in the center anteriorly and the two ends are connected by a screw which draws them nearer together or forces them farther apart, as desired.

This brace is shown in fig. 64B, and perhaps will be still better understood by reference to fig. 64C, which illustrates it as applied upon the limb. So far, the braces shown are used in connection with crutches and a raised shoe, but in convalescence, when the weight of the body can be borne without pain, and yet protection of the joint is desired, the side strips of the brace are frequently extended below the foot, being attached to the shoe underneath the arch by a pivot to allow of the natural movements of the foot, and jointed opposite the ankle on either side.

MEASUREMENTS REQUIRED.

1. Sex of patient.
2. Age of patient.
3. Weight of patient.
4. Right or left knee.
5. Length from sole of shoe to middle of ankle joint.
6. Length from sole of shoe to a point midway and between *M* and *L*. (See diagram of leg on page 293.)
7. Length from sole of shoe to *N*. (See diagram of leg on page 293.)
8. Length from sole of shoe to *O*. (See diagram of leg on page 293.)
9. Length from sole of shoe to middle of knee joint.
10. Length from middle of knee joint to *P*. (See diagram of leg on page 293.)
11. Length from middle of knee joint to *R*. (See diagram of leg on page 293.)
12. Circumferences of leg at *L, M, N, O, P, Q* and *R*. (See diagram of leg on page 293.)
13. When a convalescence apparatus with footpiece is ordered send us a well-fitting lace shoe.

Extension Splint to apply with Adhesive Plaster.....	\$35.00 to	\$40.00
Convalescence Apparatus without Footpiece.....		30.00
Convalescence Apparatus with Footpiece.....		35.00

64D. DR. A. M. PHELPS' KNEE EXTENSION SPLINT.

This splint possesses no qualities superior to Sayre's knee extension splint, or any other splint that extends and fixes the knee joint, only the simplicity of its construction brings it within the reach of the dispensary patient, and it is equally as efficient with the patients of the wealthy.

This splint consists of two circular collars of spring steel, made to close by one end lapping over the other. The lower ends of these collars contain a stout pin, the upper a series of equidistant openings. The adjustment of the collars to the proper size is accomplished by springing the upper end over the lower, on which it secures itself over the pin by the latter snapping into one of the openings. For additional security a strip of adhesive plaster can be passed over the ends of the collars where they lap. These collars are jointed to two side bars divided into two sections, the inner one containing a number of equidistant circular depressions, the outer one a heavy screw with milled head. After application of the splint as directed on pages 347 to 350 of this catalogue, the splint and knee are extended by hand traction upon the thigh and leg and the splint fixed in its extended position by an assistant turning the screws into one of the numerous depressions in the inner bar.

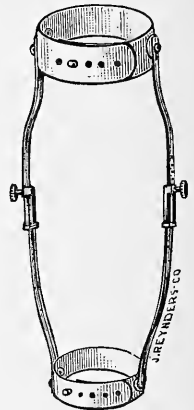

MEASUREMENTS REQUIRED.

1. Sex of patient.
2. Age of patient.
3. Weight of patient (estimated).
4. Mention if for the right or the left knee.
5. State circumference of the thigh at *A*.
6. State circumference of the knee at *F*.
7. State circumference of the leg at a point midway and between *M* and *L*.
8. State length from a point midway and between *M* and *L* to the center of the knee-joint.
9. State length from the center of the knee-joint to *A*. See figure of leg on page 293.

Prices, according to the size of the splint.....	from	\$15.00 to	\$18.00
The same, plain finished (not polished nor plated), for dispensary patients, according to the size of the splint.....		from	\$10.00 to 15.00

**57. DR. M. JOSIAH ROBERTS' ELASTIC EXTENSION APPARATUS, FOR ANCHYLOSIS OF THE KNEE-JOINT.**

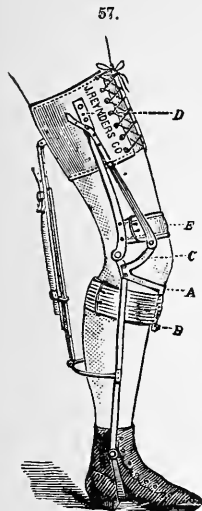

This apparatus is exceedingly light. Owing to its elastic attachments, there is during locomotion a slight yielding of the instrument permitted, which renders it less irksome to the wearer than an absolutely rigid apparatus. The side bars are simple light strips of steel fastened above to a well padded encasement for the thigh, and below to the sole of the shoe. At the knee and ankle are simple hinge joints. A is a semi-circular steel band made fast to the side bars below the knee. Attached to it is an adjustable metallic arm, B, extending downward in a line with a spine of the tibia. A broad elastic band, E, passes behind the head of the tibia, and over the metallic arm, B, which serves as a fixed point for making elastic traction upon the posterior part of the head of the tibia. E is an elastic band passing from one side bar to the other in front of the thigh, thus keeping the instrument in the same relative position to that part of the limb. C is a short lever projecting forward and curved upward. To this is attached a strong strip of elastic webbing, C, D, which supplements the action of the quadriceps extensor muscle, and by means of which any desired amount of elastic tension can be affected.

**MEASUREMENTS REQUIRED.**

The same as for apparatus No. 56, page 346.

**58. DR. L. A. SAYRE'S APPARATUS FOR ANCHYLOSIS OF THE KNEE-JOINT.**

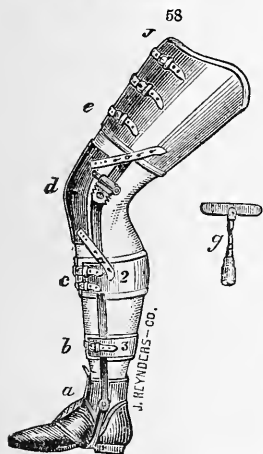

This apparatus is constructed upon similar principles as No. 56, page 346. Extension is made by a key and archmedian screw.

Directions for measuring same as for the before-named apparatus. Price, \$35 00 to \$40 00

Apparatus No. 56 is generally made not riveted to the shoes.

**59. DR. L. A. SAYRE'S EXTENSION APPARATUS FOR DISEASES OF THE KNEE-JOINT.**

(Extracts from Dr. L. A. Sayre's Lectures on "Orthopedic Surgery and Diseases of the Joints"; second edition; and from *The Medical News*, February 23d, 1884.)

In the first place, if the limb is much distorted, the leg flexed upon the thigh, and perhaps the tibia partially luxated backward, extension must be made, while the patient is in bed, until the limb is brought to nearly a straight position, before the instrument is applied. Such extension, previous to the application of the instrument, must be made in two directions: 1. From the foot and lower portion of the tibia by means of

59.

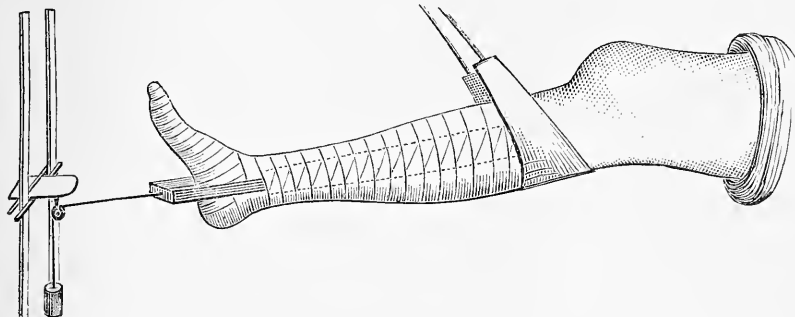

weight and pulley, with the limb placed in such a position that the patient can endure the extension without suffering pain; and, 2. from behind the tibia upward and forward (see figure 59).

It is all-important that such double extension be applied, for more than likely the direct extension from the foot will give pain until the second line of extension is brought to bear. This double extension can be applied to a limb, and continued when the limb is placed in the proper position, so that the extending force is brought to bear at a proper angle without giving pain. This proper angle must be found, which can be easily done by moving the limb about; and the extension should not be made until such position has been obtained. When this has been done, and the extension is properly applied, the pain is immediately relieved. The apparatus for making the direct extension is the ordinary extension apparatus, consisting of adhesive plaster, roller bandage, cord, pulley and weight (see figure 31, page 327).

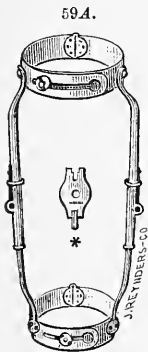

The second line of extension can be made by means of a cord fastened to the ceiling, or other apparatus, such as the ingenuity of the surgeon may devise. When the double extension, the two lines being made to gradually approach each other, has brought the limb into nearly the straight position, it is ready for the instrument.

The instrument consists essentially, as you see (figure 59A), of two sheet-steel bands or collars, connected by two bars, so constructed that they can be made longer or shorter, as required. The bands are about an inch in width, have a joint behind, and slots with a pin and screw for fastening in front.

The hinge-joint at the posterior portion of the band, that is, to surround the leg, is made by cutting straight across the band, and then fastening the pieces in the proper manner for forming a joint. The hinge-joint at the posterior position of the band that is to surround the thigh, is made by cutting out a V-shaped piece, and then fastening the pieces in the proper manner for forming a joint. This V-shaped piece is removed for the purpose of securing a smaller circle at the lower edge of the band than at the upper, which will better adapt it to the natural tapering shape of the

thigh. The band which surrounds the leg should be immovably attached to the side-bars. The band which surrounds the thigh should be attached to the side-bars in such a manner by a single rivet that it can be tilted about at pleasure, which permits the use of the instrument when the leg is flexed upon the thigh at a slight angle. The bars which connect these bands or collars are divided into two pieces, one of which carries the cog and the other the ratchet, by means of which extension is to be made. The ratchet is moved by means of a key, and in this manner any amount of extension desired can be readily obtained.

After you have, by means of your traction, brought the leg almost straight, you can then apply the knee-splint, which I here show you (see figure 59A). In preparing the limb for the application of this instrument, cleanse it thoroughly in order to remove all particles of exudate which would prevent the adhesion of the plaster, which I now intend to show you how to apply. In the application of any kind of splint in which adhesive plaster is used, I prefer to use moleskin plaster, which I here show you. In applying this knee-extension splint, I cut inch-strips of plaster, as you now see, which are long enough to pass from just above the knee to the upper third of the thigh, and allow sufficient to reverse over the collar of the splint. I now pass more strips from just below the knee to a little above the ankle, and in like manner allow of reversing over the bottom collar of the instrument. We now have the plasters adjusted, leaving the knee exposed (see figure B, page 349). My assistant now holding the limb and plasters in position, I take a roller-bandage and bind very firmly around the limb, and then, with my hand, by rubbing, I firmly secure the plaster to the skin; and now, as I remove this tight bandage, you see they remain in their place without my assistant holding them, and he is at liberty to assist me in other ways.

I now take a roller-bandage, and place permanently around the leg, to retain the plasters in position; then I secure those upon the thigh in the same manner, still leaving the knee exposed, you will observe. See figure C, page 349. I am now ready to apply the splint. First, I secure the lower collar by means of the key I regulate the size, as may be required, to prevent strangulation of the circulation; then, reversing the ends of the adhesive plaster over the collar of the instrument, you notice I secure them in that position by passing a strip of adhesive plaster around the leg directly over the collar of the instrument. Having thus secured them, I now continue with my roller-bandage over the collar over the instrument and under the extension-rods around the leg, and over the reversed ends of the adhesive plaster. In this manner we have secured the lower part of the splint, and will now turn our attention to the upper part of the same. I desire specially to call your attention to this collar, inasmuch as it allows of motion upon the rods of the splint; whereas, in the lower collar of the instrument, you noticed that it was perfectly immovable and could not possibly be moved upon the rods, as in this upper collar. If, now, both of these collars were movable, you could not retain the leg in any one position, for the simple reason that the collars would tilt upon themselves,

and thus, while the upper edge of the lower collar and the lower edge of the upper collar would press in upon the leg and cause excoriations, your extension would be lost and the joint surfaces brought together, and the disease within the joint, instead of diminishing, would increase. Now, I wish to be distinctly understood upon this point, and cannot impress upon you too strongly the necessity of one collar being firmly fixed and immovable upon the extension-rods, for it is only those that I use; the other, in which the two collars are movable, is perfectly useless, and is not my splint. The splint which I here show you is made for me by Reynders & Co., 303 Fourth avenue.

Having now secured both upper and lower collars in a similar manner, still leaving the knee exposed (see figures *D* & *E*), I now take my key and make the requisite extension, which will be when my patient tells me he is free from pain. You will notice that, while doing this, my hand is under the upper third of the leg, pressing upward. This is to prevent the anterior

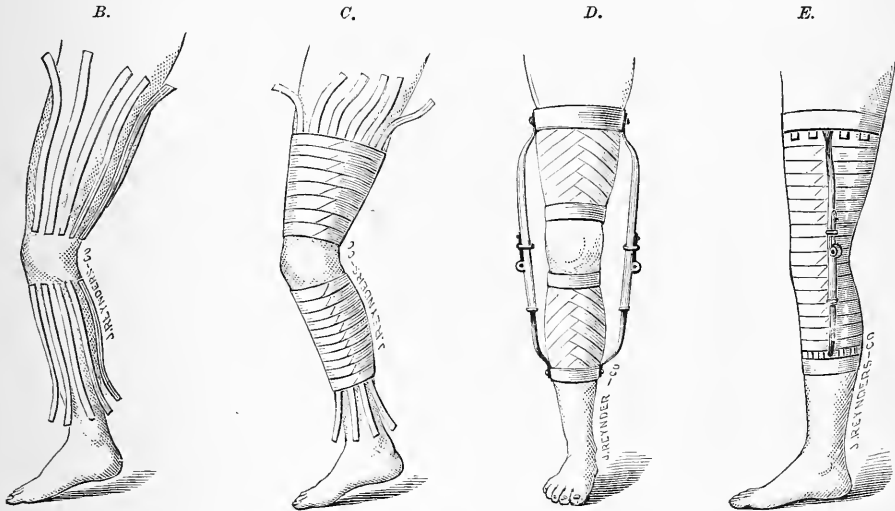

surfaces of the joint from being brought together while I am making extension. Having now secured the requisite extension, and the patient being free from all pain, we shall endeavor to secure the absorption of the effusion around the joint, and for this purpose I now take some strips of adhesive plaster, about an inch wide, and bind them firmly around the joint,

*F.*



leaving no place uncovered; by this means I secure an equal pressure all over the joint surface. Having accomplished this, I now pass a roller bandage around the joint over the plaster, and thus retain them in position (see figure *E*). Any one looking at that leg now, would perhaps suppose that was the end of the dressing; and I regret to say that I have seen some students who manifested so little interest in the pursuit of their studies, and although, perhaps, wishing to see the instrument applied, would rush from the lecture-room because it was almost the close of the hour, and think they had seen enough to warrant them to apply the instrument if they should ever be called upon to do so; whereas, by this very thoughtlessness and carelessness, they lost one of the most important points in the application of this knee-extending splint; and, perhaps, by this very carelessness, when an opportunity offered, would ruin both their own reputation and the leg of the patient. I, therefore, desire you specially to observe this last and final application of the bandage, and make careful notes of the manner in which I apply it. You will notice that, having now bandaged the knee, I carry my roller up the thigh, passing it over the thigh in front and under the rods of the instrument, bringing it in front of the thigh only—not behind at all. By this means I press the femur back and assist in straightening the limb. Having done this, I now pass my roller down below the knee, but instead of passing it in front of the leg, as I did with the thigh, I pass it behind the leg and over the front of the rods of the splint, thus forming a cradle for the leg and still further straightening the limb. This last bandage, you will notice, takes the place of my hand, which I just now drew your

attention to, as pushing the tibia forward to prevent any pressure upon the the anterior surface of the joint (see figure *F*).

You have now seen the complete application of the extension splint in disease of the knee-joint. But, supposing that your patient is very heavy, I should advise the use of a pair of crutches in addition, as the weight of the patient may cause the adhesive plaster to slip, and thus necessitate constant reapplication of the splint. If, however, it is a child, there will in all probability be no need for the use of the crutches, and it can run about with the splint as you have just seen it applied.

#### MEASUREMENTS REQUIRED.

1. Circumferences of thigh at Q.
2. " of knee at F.
3. " of leg at a point midway and between M and L.
4. Length from a point midway and between M and L to the centre of the knee-joint.
5. Length from the centre of knee-joint to Q. See figure of leg on page 293.

PRICES, .....\$20 00 to \$25 00

### 60. SHAFFER'S KNEE-SPLINT.

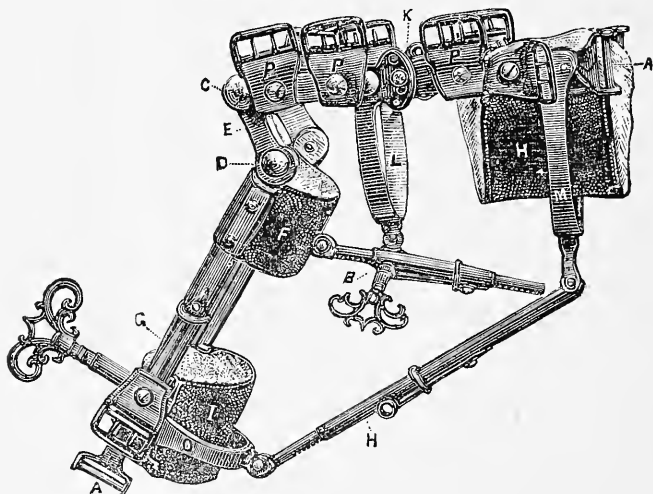

In the *Archives of the Clinical Surgery*, for June, 1877, Dr. Shaffer remarks :

I have attempted to meet the pathological indications presented in knee-joint lesions with an apparatus which I devised sometime ago, and which has answered so excellent a purpose in many cases that I feel warranted in calling the attention of the profession thereto. Its design is to apply the desired force directly to the head of the tibia, throwing the same forward and downward by a simple movement. While we thus overcome the muscular contraction *in a direct line*, we relieve the joint pressure and overcome the deformity simultaneously. The apparatus is represented in figure 60. It consists of three principal parts; the thigh, leg and intermediate. The first two are secured to the limb by adhesive plasters which are attached at the points *A, A*. Extension is made with a key at the extension rod proper at *B*. The joints at *C* and *D* move upon pivots, and as the extremities of the apparatus are secured by their adhesive straps at *A, A*, the joint *D* moves forward and downward, describing the arc of a circle, the radius of which is the bar *E*. Pressure is thus made directly upon the head of the tibia by the band *F*, and this can be very greatly augmented by using the extension rod at *G*, which further relieves the joint of pressure by additional extension in the position already acquired by the preliminary extension of the rod *B*. *H* is an accommodation not properly an extension rod—which glides forwards as



the extension is applied at *B*. As soon as the leg is thrown sufficiently forward, the accommodation rod is secured by a slide, and an extra turn of the key at *B* and *G* leaves the joint free from pressure, and with adequate extension applied directly to the contracted flexors. The thigh and leg bands at *H* and *I* move upon pivots so that they adjust themselves readily to any position, and at *K* there is an arrangement by which the curved bar *L* may be adjusted to suit the requirements of the extension rod *B*. The bars *M* and *O* are secured to the thigh and leg parts by double rivets. Through the buckles at *P, P, P*, webbing straps (padded) are passed, producing counter-extension in addition to that secured by means of the adhesive straps.

## MEASUREMENTS REQUIRED:

- |  |   |
|--|---|
| 1) Length from perineum to the centre of knee-joint. | 4) Circumference of leg at garter (below knee). |
| 2) " " the centre of knee-joint to the ankle.        | 5) " " " calf.                                  |
| 3) Circumference of thigh below perineum.            | 6) Mention angle of flexion.                    |

Prices, according to size, from \$50 00 upwards.

## 61 Dr. M. Josiah Roberts' Elastic Tension Knee Splint.

(Vide Paper read before the Medical Society of the County of New York, Jan. 23, 1882, entitled "Elastic Tension and Articular Motion as Therapeutic Agents in the Mechanical Treatment of Chronic Inflammations of Joints.")

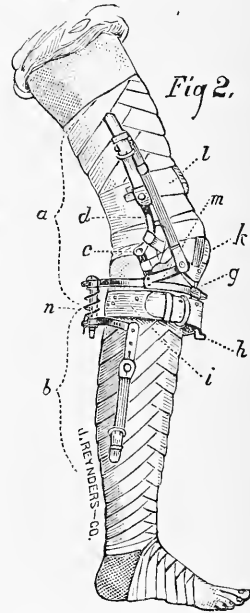
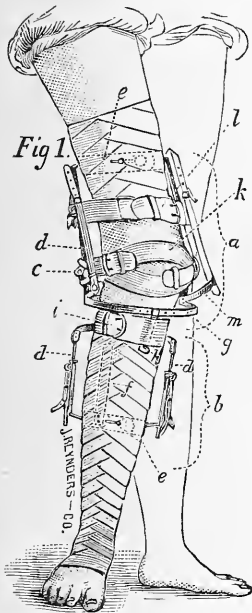

The object of this splint is to accomplish all that can be effected for the comfort of the patient by the most skillful manipulation of the inflamed knee-joint and to continue the same uninterrupted until a cure is executed. It is well known that by gentle manual traction of the limb in the line of the deformity and pressure on the posterior part of the head of the tibia in a direction forward and inward, entire relief from pain and reflex muscular spasm is obtained. In addition, limited articular motion is possible, without, in the least degree, causing discomfort to patient, or aggravating the inflammatory processes in or about the joint. The instrument is so designed that, when applied, *elastic traction* is constantly exerted upon the joint in the line of the deformity, no matter what that may be. Besides this, and for the purpose of reducing the deformity, there is effected by means of the splint and its elastic attachments, a reversal of all the movements which have taken place in the production of the deformity. The force which keeps up traction, subdues reflex muscular spasm, and overcomes the deformity, is *elastic tension* and in this instrument

is developed by means of a spiral spring and rubber straps. As rapidly as the deformity gives way, the instrument automatically follows up the limb and continues to exert nearly as much elastic force upon it as previous to its yielding. In this way, by the *continuous exercise of gentle elastic force*, there is rapid reduction of the deformity without the least discomfort to the patient. Moreover, the instrument, when applied and adjusted, permits of the wearer walking and riding without inconvenience or discomfort, and hence deriving therefrom all the benefits of fresh air, sunshine, and a sufficiency of exercise. This instrument not only renders articular motion possible without intraarticular friction or pressure, but during locomotion, limited movement of the joint obviously takes place and hence very closely approaches the condition obtained in the healthy knee. The circulation of blood through the limb is thus facilitated and the maximum amount of nutrition is furnished the joint for the purpose of carrying on the repair of the diseased tissues.

The splint, being made of the best steel, is very light, not exceeding a pound in weight for a child six years old. It consists essentially of two segments, see *a* and *b*, figs. 1 and 2. The upper segment *a*, when applied, corresponds to the plane of the thigh, and the lower segment to the plane of the leg. The greater the deformity, the greater will be the angle formed by the junction of these two planes. Hence, it must be borne in mind, that in order to effectually overcome the deformity this angle must be practically reduced to naught, and the planes of the leg and thigh made to very nearly coincide as in health. At *c*, opposite, and on a level with the articular surface of the femur, there is a joint. *D, d, d, d*, are the extension bars of the upper and lower segments, with elastic straps attached. An idea of the mechanism by which *continuous elastic extension* is developed with this splint, can be gained by an examination of the side bars in Fig. 28 (3) page 325, which illustrates an instrument for making elastic extension of the wrist joint. The extension is effected by means of two steel bars.

The inside one, *d, d*, figure 3, is provided with expanded margins, which have been turned over so as to form a groove, *d*, in which the other bar, *e*, slides. It will be seen that the inside bar, *d*, is attached by one extremity to the metallic band which encircles the limb, and that the opposite extremity of the bar which slides within the groove, enters into the formation of the joint at *c*. One end of the inside bar, *d*, and the opposing end of the other bar, *e*, are free or unattached. Now any force which brings these two ends nearer together, must necessarily lengthen the instrument, and, consequently, extend the limb to which it is attached. In order to make this extending force elastic, or, in other words, like manual extension, a narrow strip of strong elastic webbing is made fast to the rectangular loop, *d*, of the inside bar. A buckle is attached to the button, *e*, at the opposing end of the other bar. By means of this buckle and strap any desired amount of elastic force can be exerted to approximate the opposing free ends of the two bars, and thus lengthen the instrument. It is in this way that the extending force is graduated. By substituting a non-elastic strap for the elastic one, *fixed traction* could be maintained by the same mechanism.

The side extension bars, *d, d, d, d*, figures 1 and 2, are all constructed and provided with elastic straps, as above described.

In applying the instrument, the upper and lower metallic bands, *e, e*, figure 1, which encircle the limb, are secured in position, in the usual way, by strips of strong non-elastic adhesive plaster and roller bandages. A flat strip of steel is attached to the lower metallic band and projects upward so as to rest upon the belly of the tibialis anticus muscle. In the application of the splint this strip is encased with adhesive plaster, with the adhesive side out. A roller bandage is carried over it, and thus additional leverage and fixation of the instrument to the limb is secured, a very necessary detail as will be seen when we come to speak of the mechanism for rotation of the tibia inward. From the lateral bars of the splint, there projects a semi-circular piece, *g*, figures 1 and 2, directly in front of the head of the tibia. An adjustable metallic arm, *h, h*, figures 1 and 2, attached to the middle of this semi-circular piece projects downward in a line with the spine of the tibia. As will be seen in figure 2, this arm is at a little distance from the front of the leg and serves as a fixed point to which the broad elastic web band (*i, i*, figures 1 and 2) that passes around the leg behind the head of the tibia, is attached. By means of the buckle *i*, figure 1) any desired tension upon the posterior part of the head of the tibia can be exerted. As above stated the metallic arm, *h*, figure 1, is adjustable upon the semi-circular piece, *g*, and hence the direction of the *elastic tension force* applied by means of the webbing to the posterior aspect of the head of the tibia, can be forward or forward and inward, as the necessities of the particular case require. An elastic knee-cap, *k*, and broad strip of webbing, *l*, serve to keep the upper segment of the instrument in the same relative position to the thigh. From the lateral shaft of the brace on each side and below the joint, *o*, there projects directly forward a metallic arm, *m*, curved upward. To the end of this lever is attached a strong strip of elastic webbing which passes up through a buckle fixed to the upper or unattached end of the bar, *d*, figure 2. These elastic straps, one upon either side, are designed to supplement the functions of the quadriceps extensor muscle. Finally, by means of a spiral spring, *n*, fig. 2, you can, with a key applied to the lower or projecting end of pivot, secure the continuance of any desired amount of *elastic force* tending to rotate the tibia inward on its long axis and thus, in conjunction with elastic band, *i*, figures 1 and 2, which passes behind the head of the tibia, overcome the subluxation and rotation outward of the head of the tibia. It is in the accomplishment of this latter result, that the additional leverage upon the leg, secured to the instrument by the flat strip of steel, *f*, attached to the band which encircles the leg, plays the very important part.

62.

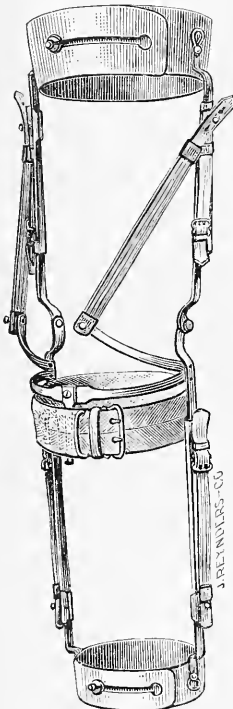

**62. DR. M. JOSIAH ROBERTS' ELASTIC TENSION KNEE-SPLINT WITHOUT TIBIAL ROTATING MECHANISM.**

Whenever a case of chronic disease of the knee-joint comes under treatment before subluxation and rotation outward of the head of the tibia has occurred, the tibial rotating mechanism is dispensed with, and a much simpler instrument fulfils all the therapeutic indications.

The simpler instrument is represented by the annexed figure; the lower and upper ends terminate in bands about the leg, and the side bars are constructed, as previously described, for making *continuous elastic traction*. It is applied to the limb in the same manner as Dr. Sayre's rigid fixed extension knee-splint, (*vide* No. 59, page 350), by means of strips of strong non-elastic adhesive plaster and roller bandages.

MEASUREMENTS REQUIRED.

The same as for apparatus No. 59, page 350.

PRICE, ..... \$25 00

### 63. Hooper's Knee Extension Apparatus. Permitting Flexion of Knee without Loss of Extension.

(Extracts from the Transactions of the Medical Society of Virginia, 1878.)

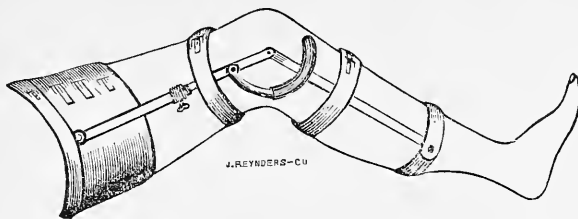

To treat successfully inflammation of the knee or hip-joint, the articulating surfaces must be prevented from coming in contact, not only for weeks, but for months, and during the night when the patient is at rest, as well as in the day. Nor must he be deprived of free use of the joint, or false ankylosis will result, unless the surgeon resorts to passive motion every few days. To accomplish this desired effect, I have had constructed the instrument I present before you. After a thorough test, I have found it to prove as efficient in treating injuries of the knee-joint as is Sayre's hip-joint apparatus for treating that joint. The principle of the instruments is the same, with the exception of the modification adopted when used for treating chronic inflammation of the knee-joint.

The great difficulty met with heretofore in treating diseases of the knee-joint by the extension method, has been the loss of extension during flexion. This is completely overcome by placing a helix spring in curved tubes fastened on each side of the instrument, now offered, three inches below the joint. At the same distance above the joint are fixed rods, curved to the same arc as the tubes. The free end of the rods fit into the tubes and rest upon the upper end of the springs. By this simple arrangement, extension is increased by flexion, instead of being lost, as in other appliances; and, in reality, extension is greater during flexion than when the limb is straight. The play of the joint allows the limb to be flexed at right angles, which is sufficient for all practical purposes. The action of the spring ceases when the limb is extended to its utmost, thereby preventing any undue pressure upon the joint in a direction contrary to the one in which it should be applied. Instead of the padded strap used for counter-extension in the hip-joint apparatus of Professor Sayre, I employ a piece of sheet metal shaped to fit the inner surface of the thigh, the upper edge being curved to correspond to the buttocks, the perineum and the groin. It is also flanged about three quarters of an inch, and well padded, so that great force may be used during extension without injury to the soft parts. This is attached to the inner side bar of the splints by means of a ball and socket joint, which allows every motion of which the hip-joint itself is capable.

To apply the instrument, first remove the hair from the limb; then sponge it well with soap and water, to prevent the itching caused by the application of the adhesive plaster; now cut eight or ten strips of the best English mole-skin adhesive plaster (no other will answer the purpose) an inch wide and long enough to extend from a point two inches above the knee to three inches lower than the point where the end of the instrument will rest. Be careful in their application, allowing no creases or wrinkle to form, else they will have to be removed on account of the pain they produce. Secure them firmly by means of a bandage, commencing its application three inches above the lower end of the strips, and ending five inches above the knee; now adjust the splint, letting the hinged band at the end fit as near the surface of the skin as possible without touching. Turn the free ends of the adhesive strips upward and over the band, securing them likewise with a bandage, extending to a point just below the knee. Twelve hours should elapse before extension is applied, for fear the adhesive strips might slip from their position. The extension should be increased gradually, from day to day, by means of the rack and pinion on the inside bar. If full extension is used in the beginning of the treatment, the crutch will be apt to chafe the groin, especially in warm weather.

The adhesive straps are objectionable in hot weather, if you are treating a grown person, on account of slipping from their position, caused by the softening of the adhesive material. To obviate this, I would suggest the use of a plaster of Paris stocking, with anterior, posterior and lateral straps, incorporated by the same means as Sayre's jury mast is secured in his plaster jacket for treating spinal curvature when the disease is above the shoulders. The stocking should extend from the head of the tibia to a point where the lower band of the splint will rest. The straps can be secured to the band by means of buckles. This will cause no strain upon the muscles, as the extending force is counteracted by the weight of the body.

After Dr. Hooper had exhibited and explained his modification of Sayre's splint for treatment of knee-joint diseases, Dr. Lewis A. Sayre said:

"If nothing else has repaid me for my visit to Richmond, the examination of the great improvements made by Dr. Hooper to my instrument, for making extension of the knee-

joint in cases of chronic inflammation of that articulation, amply compensates me for my time and trouble. It is a modification I have long desired, but as yet have failed to suggest any mechanism that would accomplish the same results as this instrument will—viz., keeping up extension, while, at the same time, it allows of *flexion* of the joint. It is the first instrument that admits of angular flexion, and, at the same time, keeps up continued extension, that I have ever seen.

“The great trouble with my original instrument is, that it prevents the patient from bending the knee when sitting down; and this improvement of Dr. Hooper’s remedies that defect, and, in fact, makes it nearly perfect, and I am much obliged to him for the improvement.

“Dr. Hooper has the correct idea here in this instrument; but with permission, I would suggest, that the motion can be increased even to a right angle.

“In the summer, adhesive plaster is very objectionable, and to get rid of it, I would suggest that a strong shoe be accurately fitted to the foot, with a good thick buckskin tongue, and smoothly laced to the sides of the shoe. Let thimbles or sockets be attached, in such a manner that the splint can be firmly joined to the shoe, and thus make extension, while the counter-extension can be obtained from the perineum, and you have an apparatus with which the patient can move about without the annoyance of the adhesive plaster. Dr. Hooper’s improvements render this instrument well nigh perfect.”

MEASUREMENTS REQUIRED FOR THE HOOPER’S KNEE APPARATUS.

- |   |  |
|---|--|
| 1) Circumference of Thigh at <i>S, R</i> and <i>P</i> . | } See figure of<br>Leg on page<br>283. |
| 2) “ “ “ “ Leg at <i>O</i> and <i>M</i> .               |  |
| 3) Length from <i>M</i> to the centre of Kneejoint.     |  |
| 4) “ “ “ “ “ centre of Kneejoint to <i>S</i> .          |  |
| 5) Mention if for the right or left Leg.                |  |

Price \$35.00

FOR THE HOOPER’S KNEE EXTENSION APPARATUS MODIFIED AS SUGGESTED BY DR. SAYRE.

Send in addition to the above measurements the following:

- 6) Length from Sole of Foot to Anklejoint.
- 7) “ “ “ “ “ centre of Kneejoint.
- 8) Send a strong and well fitting shoe to lace.

Price \$40 00

50 Apparatus for Partial Paralysis of the lower Extremities, Hemiplegia and Paraplegia.

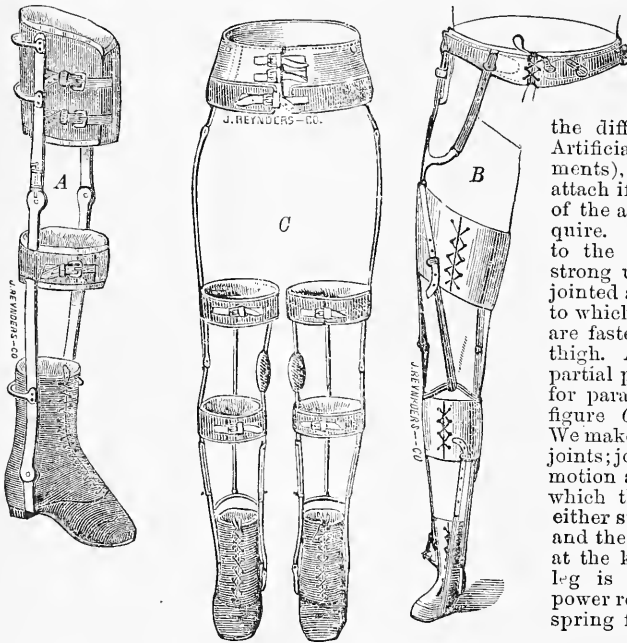

The apparatus illustrated by figures *A, B* & *C*, we have experienced to answer best for restoring the functions of the lower extremities as much as possible in the different stages of paralysis. Artificial muscles, for enabling movements, as shown on figure *B*, we attach if desired, to different parts of the apparatus as special cases require. The apparatus is riveted to the shoes and consist of two strong upright bars for each leg, jointed at the ankle, knee and hip; to which steel bands, well padded, are fastened, encircling the leg and thigh. Apparatus, figure *A* is for partial paralysis of one leg; figure *B* for paralysis of the entire leg, and figure *C* the same for both legs. We make these apparatus with plain joints; joints allowing *only* backward motion at the knee; lock joints, by which the apparatus can be made either stiff or flexible at the joint and the joints with coiled springs at the knee by which, when the leg is bent backwards and the power relaxed, it will involuntarily spring forward.

MEASUREMENTS REQUIRED.

- |   |  |   |
|---|--|---|
| 1) Patient’s Sex.   |  | 4) Circumference of body between crest of ilium and trochanter major. |
| 2) “ general appearance.  |  | 5) Circumference of thigh one quarter below perineum.                 |
| 3) Send invariably a strong shoe or pair of shoes, well fitting and to lace completely down to the toes and with low heels. |  |   |
|   |  |   |
|   |  |   |

- 6) Circumference of thigh one quarter above knee-joint.
- 7) Circumference of leg at knee-joint.
- 8) " " " " garter.
- 9) " " " " ankle.

- 10) Distance from sole to ankle.
- 11) " " " " to knee-joint.
- 12) " " " " to trochanter major.
- 13) " " " " to crest of ilium.
- 14) Which leg? entirely or partly?

Apparatus, figure A, with plain joints, \$18.00 to \$25.00; fig. B, with plain joints, \$30.00 to \$40.00; fig. C, with plain joints, \$35.00 to \$75.00.

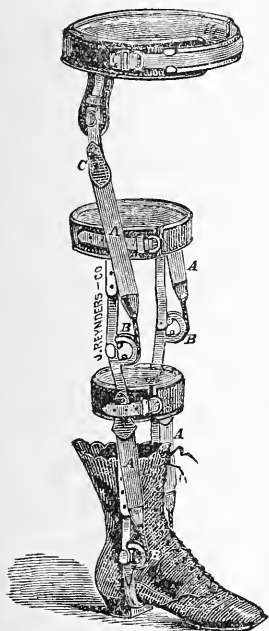

### 51 Apparatus for Partial Paralysis of the Lower Extremities. Hemiplegia and Paraplegia.

WITH IMPROVED ARTIFICIAL MUSCLES.

The Apparatus shown in annexed figure is for paralysis of one leg; the same is made also for both extremities.

Its construction is essentially the same as No. 50B on page 343 and is also made with plain joints; joints allowing backward motion only at the knee; and lock-joints by which the apparatus can be made either stiff or flexible at the knee-joint.

The improvement consists in having the muscles attached at the joints of the apparatus and on each side of the limb, (instead of in front) in which position they work more effectively. These muscles are constructed of very strong elastic webbing "A" "A" "A" "A," secured to their lower ends are pieces of catgut, by which they are permanently secured to the grooved bridges "B" "B" "B" "B," over which the catgut passes

Secured to the upper ends of the webbing are stripes of perforated leather by which the muscles are secured to the brace at "C" "C" "C" "C" to metallic buttons placed there for the purpose. The strength of each muscle can be regulated by buttoning the perforated strap higher or lower.

MEASUREMENTS REQUIRED.

Same as for Apparatus 50.

Price, for one leg, \$35.00 to \$50.00.  
 " " both legs, 70.00 to 100.00.  
 With lock-joints, \$10.00 extra

### 52 Apparatus for Bow Legs.

Bow legs are a consequence of softening of the bone due to a want of mineral matter. They cannot under this circumstance bear the weight of the body and become curved. An apparatus, to counteract this deformity, should therefore give the legs support and act against their curved part. These requirements are filled by the apparatus illustrated by figure 52. The two upright lateral bars give support to the leg and the bands passing around one of the upright bars and leg, where mostly curved, bring the leg in a straight position.

MEASUREMENTS REQUIRED.

- 1) Patient's sex.
- 2) Patient's general appearance.
- 3) Circumference of thigh, midway between perineum and knee-joint.
- 4) " " " " leg, below knee-joint.
- 5) Length from sole to ankle-joint.
- 6) " " " " knee-joint.
- 7) " " " " convexity of leg.
- 8) " " " " middle of thigh.
- 9) Send strong well fitting shoe or pair of shoes to lace.

Price, per pair, plain, according to size, from \$16.00 to \$25.00  
 " " made to lengthen between ankle and knee-joints, according to size, from \$18.00 to \$27.00



This apparatus with the bands A and E, arranged slightly different, will answer for knock knee.

## 54. APPARATUS FOR KNOCK KNEE. (Genu-Valgum.)

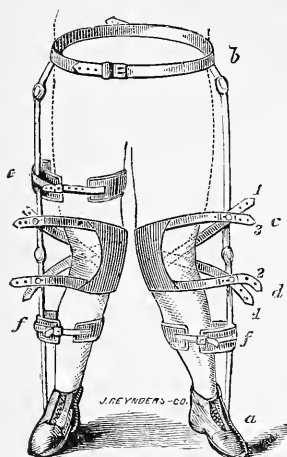

This apparatus consists of two lateral bars with ankle, knee and hip-joints, extending from the heel of the pelvis, each being secured at its upper extremity to a padded pelvic band, which encircles the body, and at the lower are rivetted to the sole. Two leather caps, secured to the knee-joint and to the lateral bars, act against the deformity. The caps are placed on the inside of the knee-joint, which is drawn outward more or less by the straps. If desired this apparatus can also be made with two straps on each knee, one above and the other below, crossing each other behind. \$30.00 to \$40.00

## MEASUREMENTS REQUIRED:

- 1) Patient's Sex.
- 2) Patient's general appearance.
- 3) Circumference of body between crest of ilium and trochanter major.
- 4) Circumference of middle of thigh.
- 5) " " " calf.
- 6) Length from sole to ankle-joint.
- 7) " " " " knee "
- 8) " " " " middle of thigh.
- 9) " " " " hip-joint.
- 10) Send a pair of well fitting strong shoes to lace.

## 55. DR. CHAS. F. STILLMAN'S APPARATUS FOR KNOCK-KNEE.

A brace to overcome this deformity should be provided with facilities for twisting the foot into a normal angle with the leg, and for twisting the leg into better relations with the thigh, at the same time acting laterally at the knee-joint to overcome the angular obliquity which constitutes the most prominent feature of the deformity. The brace, shown in fig. 55, possesses these advantages, and also permits the normal degree of motion in the knee- and ankle-joints during treatment. It can be worn under the clothing with very little discomfort and is not especially noticeable. The figure explains its action, but should show another girth just above the ankle, and also another on the thigh, since it is necessary to have firm fixation on the leg and thigh, if one is to be rotated upon the other.

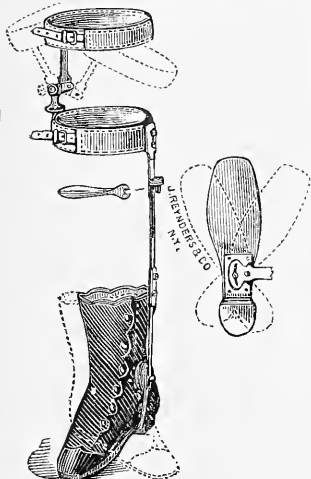

In severe cases, this fixation may be assisted by nooses of strong moleskin plaster encircling the limb opposite the girths, and fastened to the girths by tongues, which protrude through slits in the stockings.

## MEASUREMENTS REQUIRED.

1. Length from sole to ankle-joint.
2. " " " to garter (below knee).
3. " " " to centre of knee-joint.
4. " " " to perineum.
5. Circumference above ankle joint.
6. " " at garter (below knee).
7. " " at middle of thigh.
8. " " of thigh at perineum.
9. Send us a pair of well-fitting lace shoes.

## PRICES.

According to size, per pair, . . . from \$30.00 to \$40.00

## 56. Apparatus for Anchylosis of the Knee-joint.

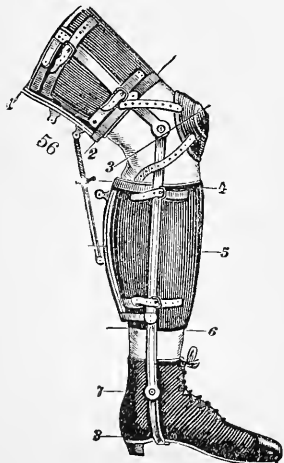

This apparatus consists of strong leather claspings around the leg and thigh, held in position by two lateral upright bars, rivetted to the sole of the shoe and having joints at the ankle and knee. Extension is made by turning the screw *f*; a knee cap serves to keep the apparatus well in position and to protect the joint and patella.

## MEASUREMENTS REQUIRED:

- Circumferences of leg at 1 (below perineum) and at 1, 2, 3, 4, 5, 6 and 7.

Length from 1 to 3, 3 to 7 and 7 to 8.

Price \$22.00 to \$30.00

Send a well-fitting shoe to lace, (see note under 58).

### 53. Plain Apparatus for Bow Legs.

This apparatus has only one upright bar having a joint at ankle, with pads at the knee and ankle joints. This steel bar is fastened to the shoe and placed on the inner side of the leg, where it is secured by a well padded band passing around the garter. A wide bifurcated band passes around the curved part of the leg and is fastened from two sides on buttons placed on the steel bar for this purpose.

#### MEASUREMENTS REQUIRED :

The same as for apparatus No. 52.

Made to lengthen, Price, per pair, according to size, from \$12.00 to \$20.00

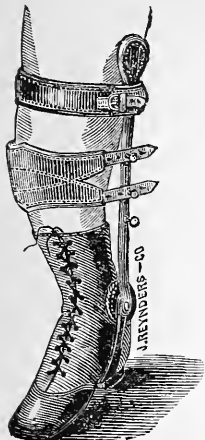

### 533. DR. CHAS. F. STILLMAN'S SHORT BOW-LEG BRACES.

These braces exert a constant spring force, which tends to overcome the deformity gradually. It is adjustable by means of ratchets and key, and is very effective, for not only does it support the limb while the deformity is being reduced, but the ratchets at the lower extremity

of the brace permit the surgeon to control the position of the foot at the same time. They consist of a single bar placed on the outer side of the leg, jointed at the ankle and immediately below the heel and buckled to the leg by two girths, one just below the knee and the other above the ankle-joint. This bar is supplied below the ankle-joint with two ratchets. The one immediately below the ankle-joint for rotation, allowing that part of the brace below it to be rotated outwards and fixed at any angle with the part above; for when so fixed, and the brace secured to the foot and leg, any inversion tendency is combated by the entire brace, which thus acts as a powerful spring to keep the foot rotated outwardly. The second or pronation ratchet is placed where the footpiece of the brace passes under the heel of the shoe and enables the surgeon to entirely prevent any tendency of the foot to turn under, for if the footpiece be clamped by it at an angle of about  $40^{\circ}$  outward

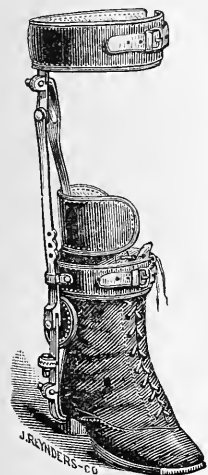

FRONT VIEW.

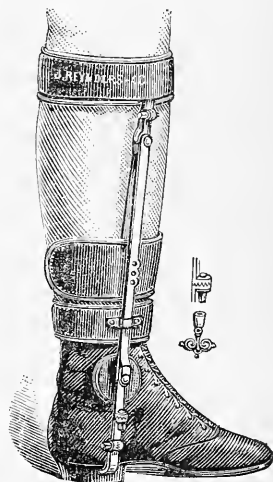

SIDE VIEW.

from the foot, and then brought up against the leg and secured by the girths, the foot will be turned on its long axis so that the patient will walk on the inner instead of the outer side. This effect may be varied by the ratchet in the footpiece, so that the brace may be anything from a simple vertical support to an agent for the production of valgus, so completely does this ratchet place the foot under the control of the surgeon. To overcome the bowed condition of the leg between the ankle and knee-joints, the author has devised a new and effective arrangement, which brings to bear a spring lever power which is distinct from anything heretofore used, and operates without interfering with the action of the remainder of the brace. It will be noticed that it is a flat steel spring to which is attached at its free end a semi-girth, which presses against the leg at its greatest convexity and at its upper end is secured by a ratchet to the bar immediately below the garter band. Inward pressure against the leg, dependent upon the angle which the steel spring makes with the rest of the brace, can be adjusted by means of the ratchet at its upper end. It can be thus adjusted to any pressure desired, giving any degree of power, and this power or pressure is brought to bear against the deformity precisely where it is wanted.

#### MEASUREMENTS REQUIRED.

1, age and sex of patient. 2, length from the sole of the foot to the ankle-joint. 3, length from the sole of the foot to the garter below knee. 4, length from the sole of the foot to the center of convexity of the leg. 5, circumference of the leg, above the ankle. 6, circumference of the leg, at center of convexity. 7, circumference of the leg, at garter (below knee).

Price, per pair, from \$25.00 to \$35.00.

53A. DR. CHAS. F. STILLMAN'S APPARATUS FOR BOW-LEGS.

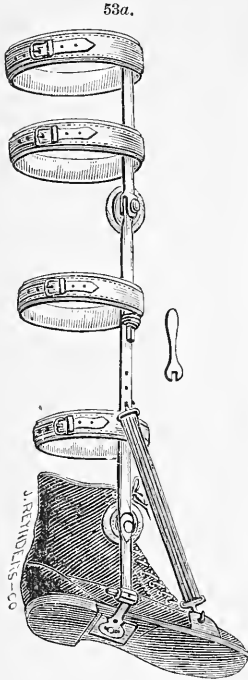

This is accomplished by means of a side bar of steel, passing from the shoe to the upper part of thigh, articulated at the ankle and knee and provided with four girths, two above and two below the knee-joint. Ratchet clamps are placed horizontally at the centres of the curves by which the side bar may be sprung into the form of a double bow, corresponding in shape to the bow which is formed by the base of the leg; but, when applied, these girths are placed reversed to the curves of the limbs, centre against centre, thus, while not interfering with the motions of the limb, exerting a constant spring force directly against the curvature, the power varying with the angle at which the ratchet clamps are fastened. These ratchet clamps are not shown in the accompanying illustration except one, placed at the point where the side strip passes under the shoe. By figure 53B an enlarged representation of the horizontal ratchet clamp is shown.

To correct the malposition of the foot the rotary ratchet clamp, figure 53C, may be placed in the side bar, or a sector pivot may be placed under the shoe, as shown in figure 55, and the foot may be rotated thereby to any desired degree upon the leg and the leg upon the thigh.

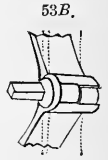

53B.

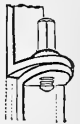

53C.

MEASUREMENTS REQUIRED.

1. Length from sole to ankle-joint.
2. " " sole to centre of knee-joint.
3. " " centre of knee-joint to perineum
4. Circumference of leg above ankle-joint.
5. " " at garter (below knee-joint).
6. " " thigh at perineum.
7. " " thigh, midway between perineum and knee-joint.
8. Send us a pair of strong lace shoes.

PRICES, per pair, according to size, ..... from \$25.00 upwards.

Elevations for Shortened Lower Extremities.

Figs. 67 and 68 illustrate two contrivances for shortened legs; Fig. 67 consists of a piece of sheet steel corresponding to the sole of the shoe and connected with the same by two upright bars. Fig. 68, shows a cork soled lace shoe.

MEASUREMENTS REQUIRED FOR ELEVATION No. 67.

- 1) Send a strong well fitting shoe to lace.
- 2) Determine the difference between the length of the patient's legs by having him stand upright in stockings on a smooth surface and placing different articles like books, boards, etc., under the short leg while the patient without inconvenience can rest firmly on both legs. Then measure the height of these articles.
- 3) Right or left?



67



68

For the shoe containing Elevation of cork, as per Fig. 68, the following additional measurements are required:

- 4) Length of foot.
- 5) Circumference of foot at I, K, A, A E, and L, (see figure of leg and foot on page 293.

Price for elevation No. 67, made of steel japanned, the leather sole riveted to the under side of the steel sole, \$6.00.

The same, made of steel, finely polished and nickel plated, the leather sole neatly stitched to the under side of the steel sole, \$10.00.

Price for Elevation No. 68, according to size of shoe and height of Cork required, \$10.00 to \$15.00.



69. Bigg's Apparatus for Short Legs.

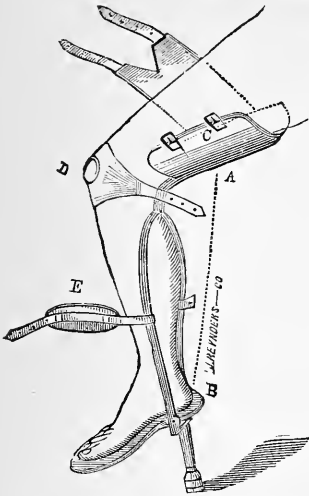

This apparatus is very useful in cases of permanent shortening of the leg resulting from ankylosis of the knee-joint. It consists of a strong leather, well padded thigh-band A and a strong steel bar fastened to its back, which divides into two lateral bars from the knee going downward. A piece of rubber is put in its end for preventing jarring when walking on hard surfaces. At B a foot piece is attached to the apparatus and at E and D caps for keeping it firmly in position.

This apparatus we have also made without the bar dividing into two, but with a single bar fastened to the back of the thigh-band and descending as indicated by the dotted lines A B. In this form the apparatus can not be hidden under the pantaloons so well, but it is more secure and comfortable to the patient.

MEASUREMENTS REQUIRED:

- 1) Circumference of thigh 3 inches below perineum.
- 2) " " 3 " above knee-joint.
- 3) Length of thigh from perineum to knee-joint.
- 4) " leg " knee-joint to the sole.
- 5) Angle of flexion between leg and thigh.
- 6) Distance from patient's heel to the floor when standing erect.

- 7) Distance from patient's toe to the floor when standing erect.
- 8) Right or left?

Price of the apparatus as figured \$30.00 to \$35.00; modified \$20.00 to \$25.00

70. Apparatus for the Support of Weak Ankles.



This apparatus is used with success in cases of weakness of the ankle or as an instrument for after-treatment of talipes and inflammation of the ankle-joint.

According to the necessity this apparatus consists of one or two strong steel bars, jointed at the ankle, riveted to the sole of the shoe and connected with a collar band passing around the calf.

MEASUREMENTS REQUIRED:

- 1) Send a well fitting shoe to lace.
- 2) Age of patient.
- 3) Length from sole to ankle.
- 4) Length of sole to garter.
- 5) Circumference below knee.

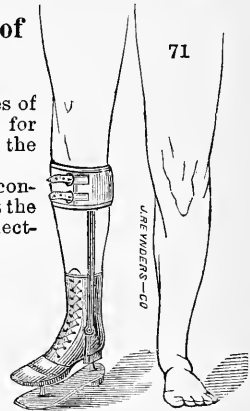

The prices for the above named apparatus vary according to the size of the same.

With uprights or bars measuring in length from the sole of the shoe to the garter:

6 inches, each \$4.50; per pair \$ 8.00	12 inches, each \$6.00; per pair \$11.00
8 " " " 5.00; " 9.00	14 " " " 6.50; " 12.00
10 " " " 5.50; " 10.00	16 " " " 7.00; " 13.00

In some cases where shortened legs and weakened ankles are combined, the apparatus illustrated by Fig. 71 is very efficient.

Measurements required same as 67 and 70.

To the scale of prices given above, add price of the style of Elevation desired as per description etc. at foot of previous page.

72. Improved Apparatus for the Support of Weak Ankles.

For such and cases of slight talipes it is the best made. Passing up one each on inner and outer sides of the leg, are light or heavy (as the patient may require) steel bars, jointed at the ankle to a foot piece that is securely riveted to the sole of a shoe. On top these two steel bars are fastened to a well padded steel collar that encircles the leg at the garter.

A T shaped strap of strong calf skin is stitched between the shoe upper and sole and between the shoe and foot piece of the brace of that side to which the ankle inclines. The two long ends of the T shaped strap pass one each over the instep and heel and fasten on

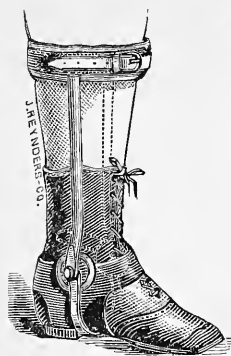

the other side upon a steel button placed there for the purpose, upon the ankle-joint of the brace.

By means of this T shaped strap the amount of pressure necessary for the support of the ankle can be adjusted to the entire comfort of the patient, such pressure being constant, and to some extent yielding, is more easily borne than that of a pad, which in time becomes hard, causing callousness of the skin where pressing against the pad.

#### MEASUREMENTS REQUIRED.

- 1) Send us a well fitting shoe or shoes to lace.
- 2) Length from sole to ankle-joint.
- 3) " " " to garter (below the knee).
- 4) Circumference at garter.
- 5) Mention if for right or left ankle.
- 6) State whether the inclination of the ankle-joint is in- or outward.

The price for the above named apparatus varies according to the size of same:

With uprights or bars measuring in length from the sole of the shoe to the garter:

6 inches, each \$5.50;	per pair \$10.00	12 inches, each \$7.00;	per pair \$13.00
8 " " " 6.00;	" " " 11.00	14 " " " 7.50;	" " " 14.00
10 " " " 6.50;	" " " 12.00	16 " " " 8.00;	" " " 15.00

### 73. Single Ankle Spring with Joint for the Support of Weak Ankles.



This consists of a foot piece secured to the sole of the shoe, having fastened to the former by a joint an upright spring with a well padded band for encircling the limb at the garter and securing it there by strap and buckle. A well upholstered pad of circular form attached to the joint of the brace, serves as support to the ankle and prevents undue pressure there.

On the annexed engraving is represented an ankle-spring applied to the outside of the left leg. The dotted lines show that the tendency of the spring is outward or off from the leg. When brought to the latter by securing the band on its top, around garter the foot is everted and thus the inclination to walk on the outer edge of the foot overcome.

Frequently this form of ankle support is placed on the inner side of the leg, being made nearly straight for such application and when a tendency to walk on the outer edge of the foot is to be overcome; it acts as a bar that guides the sole of the foot flat to the floor.

#### MEASUREMENTS REQUIRED.

The same as for apparatus No. 72; mention whether the spring or springs are to be applied on the inner or outer side of the leg.

Prices vary according to the size of spring required.

With spring measuring in length from sole of the shoe to the garter:

6 inches, each \$3.00;	per pair \$6.00	12 inches, each \$4.50;	per pair \$ 9.00
8 " " " 3.50;	" " " 7.00	14 " " " 5.00;	" " " 10.00
10 " " " 4.00;	" " " 8.00	16 " " " 5.50;	" " " 11.00

### 74. Dr. Charles F. Stillman's Pivoted Elastic Apparatuses for Inverted Feet, Talipes Equinus and Varus.

("Extracts from *Transactions of American Medical Association*, 1880," and from "*The Medical Record*," Sept. 17th, 1881.)

The foot is made up of twelve bones, which in the normal condition are held closely and harmoniously together and may be considered, as far as the ankle is concerned, as one piece, since only one of its bones—the astragalus—comes in contact with the bones of the leg, this articulation constituting the ankle-joint. This joint permits of two free and two limited movements of the foot, "extension and flexion, and inward and outward rotation." The foot is retained at its proper angle by a series of muscles, so exquisitely adjusted that a perfect balance of power exists between them; but let this balance be destroyed, and the harmony of the arrangement is lost and deformity occurs.

This loss of power in the muscles may be limited to one, or several, or may embrace them all. The greater number of cases, however, are those in which the anterior muscles of the leg are impaired, the predominant symptom being a dropping of the foot—the anterior half more than the posterior—with diminution of power to keep the foot at a right angle, or

Fig. P.



to lift the toes while walking. When this is not complicated with changes in the structure of the foot, the latter may either invert or evert as chance may direct, but the tendency is to invert in the majority of cases.

The external and internal supports are also weakened, and the ankle gives way laterally, especially externally, on the smallest provocation.

The treatment of the uncomplicated condition is mechanical and physiological. The mechanical treatment consists in supplying, as far as possible, the muscular power of the anterior of the leg, treating the foot as a whole, giving, at the same time, lateral support.

It is then necessary to use a brace, which will allow all the motions of the ankle-joint, and yet be provided with constant elastic power of sufficient force to keep the foot at a right angle when at rest, and afford the extended muscles a chance to contract and revive under the influence of the physiological treatment.

I have devised for this purpose a brace which fulfills these conditions, and supplies a want long felt in orthopædic surgery, for an apparatus which can be worn with the patient's ordinary shoes, and yet be detachable at pleasure. (Fig. P.)

It consists of a steel strip parallel with the leg and worn externally, so as to interfere less with locomotion, and be opposed to the side towards which flexion takes place; connected above with a leg girth and extended below at an angle to the back of the heel, where it is hinge-jointed with a horizontal strip whose anterior extremity is connected with the vertical strip above the point of divergence by an elastic cord, which may be lengthened or shortened at will.

The horizontal strip is riveted to a strong strip passing under the instep, perforated in the centre to allow the insertion of an oblong pin attached to a plate fastened into the arch of the shoe. This pin may be turned around after such insertion, and then forms both a firm attachment and a pivot, and is situated in the centre of motion of the foot.

The points for which I assume originality and excellence in this arrangement, are: 1st. Placing the hinge-joint at the back of the heel, instead of over the ankle-joint as in every other form of apparatus, thus greatly increasing the leverage, and in connection with elastic power anteriorly, which may be augmented as desired, preventing the toes from dropping beyond a desired line, producing a constant elastic power vertically, which causes the foot to assume any desired angle with the leg. 2d. Making the brace and shoe distinct and connecting the brace with the shoe, only by a detachable pivot in the centre of motion of the foot, and to the leg by a girth allowing them to be removed at pleasure.

The pivot insertion below allows the foot to be everted or inverted at will, without in the least impairing the support of the ankle.

Fig. Q.

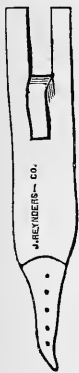

INVERTED FEET.

This affection is an exceedingly common one among children, who are usually designated as pigeon-toed, and causes an extremely awkward gait. It is due to a weakened condition of the peronei muscles, which possess the power of everting the foot, and may be either congenital or non-congenital, the former being much the more common and difficult to treat. In its more advanced stages it constitutes the various types of talipes varus. In simple uncomplicated inverted feet the deformity is slight, the patient being able to wear an ordinary shoe, the weight of the body keeping it in shape, but the toes point inward and downward, both at rest and in motion.

Fig. R.



While the impaired muscles are being treated by electricity, friction, etc., to restore their tone, it becomes necessary for us to use a mechanical appliance to restore the balance of power, to diminish the extra contractility of the antagonistic muscles, to keep the foot at its natural angle with the legs, and to evert it. This is done by adding to the brace just described under the head of weak ankle, an adjustable elastic cord extending from the outside of the shoe, opposite the little toe, to the instep strip of the brace. It thus everts the foot to any desired degree, depending upon the length and strength of the elastic, provided that the pivot is situated in the centre of motion of the foot, and that the girth about the leg be so fixed that it cannot rotate.

It is accomplished in one of three methods: 1st. The girth may be broad, and furnished with elastic straps, which grasp the limb firmly. This is sufficient in a great majority of cases. Or, 2d. The side strip is provided with an oblong pelvic band, with joints at the knee and hip. Or, 3d. By making a fixed point on the leg by means of strong moleskin adhesive plasters. (See Fig. R.)

The object of the leg attachment is to prevent the girth from slipping around, as when this occurs, the action of the everting cord is destroyed.

A piece of adhesive plaster is cut in the shape shown in Fig. Q, and a leather tongue attached to the pointed extremity, after being fastened to the leg. When the brace is applied, this tongue passes into the buckle of the girth, effectually preventing rotation, as the one buckle holds two tongues, one fastened to the leg, and the other to the girth, and each pulling in a contrary direction. These two immovable adhesive attachments afford us the fixed points we require in obstinate cases, and allow us to use a constant elastic power to relieve the super-contraction of the opposing muscles, while relieving the over-distended ones to which the deformity is mainly due, giving us the opportunity to restore these by physiological treatment.

Fig. S shows the brace as it appears when applied, and its effects on the inversion.

Fig. S.



The brace is simple, unique, and efficient in all cases of weak ankles and inverted feet, and out of an experience with over fifty cases since the invention of the brace, I have yet to find one not permanently improved. The steel strip supplies rigid support, imitating the bone; the rubber cord and webbing supplies the elastic support, and the joints of the brace are so placed as to permit the utmost freedom of motion. The length, strength, and position of the elastic cords, to effect a cure in the least time—are of course left to the experience and discretion of the surgeon in charge. In

If inversion alone be present, the elastic cord is adjusted, as shown in Fig. P, after the fixation of the girth, as shown in Figs. Q and R.

If both conditions be present, both cords must be employed.

#### TALIPES EQUINUS.

When the insufficiency of the anterior muscles is associated with contraction of their antagonists, we have induced the condition known as talipes equinus.

When not complicated by structural changes among the bones of the foot itself, this may be reduced by the brace just described, with the addition of two elastic cords passing from a point in the side strip near the girth to points on the sole opposite the bases of the great and little toes, of sufficient strength. (Fig. U.)

#### TALIPES VARUS.

This is an exaggeration of the condition already described under the head of inverted feet, and in it the medio-tarsal joint referred to under the head of Talipes Equinus, plays a very important part, since the tendons of all the muscles of the leg not connected with the tendo Achillis are inserted anterior to it.

In well-marked cases, especially when of the equino-varus—which is much the more common form—the foot is bent sharply in the middle, and the limb is “twisted” (Barwell) laterally, the sole looking backwards, the patient almost walking upon the outer malleolus.

The mechanical treatment is founded upon the idea of aiding and restoring the normal relations of the foot in its different parts, and the balance of power in the muscles of the leg.

Any foot that is not so distorted but that it can be brought into its normal shape and relations by the hand of the surgeon by bandaging, whether flexible, adhesive, or immovable, by the use of my bracket and fixed dressing, by any extension shoe, or by tenotomy, or so nearly so that it can be inserted into an ordinary shoe, can be cured by the attachment of my club-foot brace to such a shoe, for it combines in itself the essential principles of the most effective methods of treatment.

Let us look for a moment at the construction of an ordinary shoe, such as we buy at any shoe shop. It is built on a wooden model of the normal foot, and is of great strength and flexibility. Let us look for a moment at the sole of such a shoe. Grasp the toe with one hand and the heel with the other, and twist it. It will be seen that the twisting takes place anterior to the situation of the medio-tarsal joint, and that this part of the shoe is very flexible and yet very elastic; that when you let it go, it will resume its previous shape. If you now put a club foot into such a shoe, although the shoe is correct in shape, it immediately becomes distorted, because the power of the contraction which the foot has undergone is greater than the inherent power of the shoe to retain its shape.

But if you supply the place of the weakened muscles by elastic cords of sufficient strength to overcome the extra contraction of the antagonistic muscles and attach these appropriately to the shoe, the sole is converted into a powerful elastic spring, which is at the same time a firm support.

The great advantage of the leather continuous sole in my appliance is, that if it be properly controlled by elastic cords, corresponding to the weakened muscles, and fastened firmly and evenly on the foot, as it must be if encased in a well-fitting shoe, as this is not elastic, it

Fig. U.



will exert a constant spring action, which is both a support and an agent of reduction exactly in proportion to the amount of contractive deformity of the foot, and yet as it is continuous with all the twists and sinuosities of the foot, does not impinge or cause discomfort or produce undue pressure on any particular part.

In a previous description of the rigid part of the brace, we have seen that it has but one *fixed* attachment to the leg below the knee, and that by a girth about the upper part of the calf of the leg, corresponding to the origin of the muscles, and one *movable* attachment by a pivot in the centre of motion of the foot; so that beyond protecting the ankle-joint and stiffening the shoe from the heel to the medio-tarsal joint, by the arch-plate to which is attached the pivot, these fastenings possess no regulating power over the foot in the least, except when the shoe is attached to the brace by rubber cords.

Now let us look at the uses of the three elastic cords attached to the club-foot brace.

1. The cord passing from the extremity of the horizontal strip to the angle of divergence in the vertical strip, controls the extension of the foot at the ankle-joint, and acts against extra contraction of the tendo Achillis.

2. The everting cord passing from the instep strip to the toe of the shoe, opposite the base of the little toe, acts in place of the peroneus brevis, having practically its origin in the immovable girth about the calf and its insertion in the sole considerably anterior to the medio-tarsal joint, giving it a tremendous everting power, if the girth be fixed immovably as already detailed.

3. The abducting and rotating cord passes from the base of the little toe to a point in the brace near the girth, supplying the place of the peroneus longus, and acting against the anterior and posterior tibial muscles, whose contraction causes the deformity, and as it is inserted at a point in the sole which is really the apex of the deformity, a power is exerted in exact proportion to the length and strength of the elastic tubing, twisting the anterior half of the foot directly contrary to the tendencies of the contraction.

My elastic brace is really a combination of the essential principles of the various club-foot shoes with the essential principles of Barwell's system of elastic muscles. It possesses the very great advantage over Barwell's system of instant removability, being taken off and put on at pleasure, and furnishing at the same time, which Barwell's does not, an articulated firm support on the outside of the leg, preventing the ankle from turning. It allows the patient to wear a close-fitting, easy shoe, as in a normal foot, and has no constriction or encirclement of the limb or foot, other than the shoe, below the girth about the calf, allowing all the natural movements of the foot full play, simply assisting nature's efforts to guide these in their proper direction. It is light, inexpensive and lasting, and may be readily attached to any shoe.

*For Apparatus Figures P., and U.* 1, send us a well-fitting shoe or shoes to lace. 2, length from sole to ankle-joint. 3, length from sole to garter (below the knee). 4, circumference at garter. 5, mention if for right or left foot.

*For Apparatus Figure S.* 1, send us a well-fitting shoe or shoes to lace. 2, length from sole to ankle-joint. 3, length from sole to center of knee-joint. 4, length from centre of knee-joint to middle of thigh. 5, circumference at middle of thigh. 6, circumference at garter (below the knee). 7, mention if for right or left foot.

Price of apparatus, fig. *U*, \$17.00 upwards.

“ “ “ *S*, 21.00 “

## 74A. SPLINT FOR THE IMMEDIATE DRESSING OF CLUB-FOOT AFTER TENOTOMY, ALSO FRACTURE ABOUT THE ANKLE-JOINT AND LOWER THIRD OF THE LEG.

(Read before the New York Orthopedic Society by Edward Develin, M.D., of New York. From the *Medical News*, August 22, 1885.)

For some time past the desirability has occurred to me of having a simply constructed splint, which can be used for the dressing of club-foot immediately after tenotomy. It has seemed to me that one made of tin, carefully padded, which is both firm and light, as well as simple in its construction, would fulfill the purpose.

I have, therefore, devised a splint which I here present (fig. 74A), and also show the facility with which it can be made by any one. It is, as you see, made out of one piece of stout tin (fig. 74B), and reinforced, if necessary, with another small piece underneath, in order to stiffen it.

The advantage of this splint over those made of rubber, felt, plaster of Paris, feather, or foot-board and adhesive straps as sometimes used, is its simplicity of construction, readiness of application by one person, immobility, and the ease with which the foot can be examined at any time without removing it from the splint. It can be made in ten minutes, and in such a manner as to secure eversion or inversion of the foot at the metatarso-junction, as I here

show you—the former of course being sometimes necessary after division of the plantar fascia, or short flexors, in talipes varus. In simple equinus this eversion is of course not necessary. Again, in other cases, where the tibialis posticus is somewhat shortened, but not sufficient to warrant an operation, the heel assumes a tendency to turn upward and inward, causing the external malleolus apparently to project. In those cases I make a bend in the splint, as you see, just above the ankle; so that when the adhesive straps, which fasten the foot in position in the splint, are properly applied, they draw the external malleolus inward, pressing the heel downward, and bring the foot into its normal position.

In order also to draw the anterior part of the foot out and secure a strong eversion after the plantar fascia has been cut, a band of adhesive plaster is passed over the dorsum of the foot to the inner side, and then underneath outward, so that while the heel is held firmly in position, I can evert the anterior part of the foot to a very marked degree, and secure it in this position by passing the adhesive strap under the splint, and then, again, over the top of the foot, in which position it cannot possibly slip.

In applying the splint after the operation, the foot is at once brought into the normal position, viz.: at a right angle with the leg, and then placed carefully in this position in the splint, which is previously well padded. Then draw a band of adhesive plaster over the heel of the splint and across the instep, padding the instep; then take the adhesive plaster at the foot, and, in order to correct any inversion, make traction outward, and secure it as I have just mentioned. I next turn my attention to the leg and upper part of the splint, securing it in like manner with adhesive straps, and the fixation is almost complete. This is extremely simple, for the foot is exposed clearly to view; hence can be seen in almost a moment what will cause, or may be causing, the patient pain, and it can be as quickly relieved without disturbing the condition of the foot, in which it has been secured.

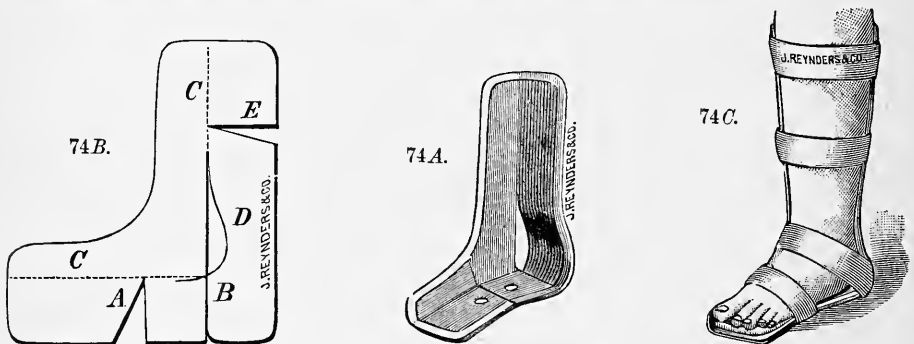

This dressing (fig. 74C) is now supplemented with an ordinary roller bandage, keeping the parts warm and giving more firmness and security to the application of the splint.

This is not theoretical, but practical, as I have tested; and further than this, where the child is so small as to render it difficult to secure a small shoe which will retain its shape, I have allowed the splint to be worn as a shoe, being secured with only a roller bandage, and removed twice daily for the feet to be manipulated and massaged.

Although this splint was designed especially for the treatment of club-foot, it can be used to great advantage in fractures about the ankle-joint or lower third of the leg, either in simple or compound fractures; its cheapness and cleanliness rendering it especially adapted to hospital use.

Fig. 74B shows the piece of tin cut ready to be shaped; C C is the extent of surface placed on the inner side of the leg and foot; A shows V-shaped piece of tin removed to allow of its being bent at the metatarso-junction; E shows V-shaped piece also removed to allow of bending of the splint when the tibialis posticus is contracted as I mentioned. The black line B is simply a direct cut through the tin to allow of its being bent so as to accommodate and form the heel of the splint D. In the majority of cases the V-shaped piece E will not be required to be cut out. If it should require it, then reinforce the back and underpart of the splint after it is formed as in fig. 2.

Fig. 74A shows the splint complete; the curved piece forming the heel being riveted underneath with two rivets, retains the splint in the desired form, the sharp edges of the tin being simply covered with a strip of ordinary rubber adhesive plaster.

Fig. 74C shows padding and dressing of the foot complete, previous to applying the roller bandage.

This splint can be secured of any size from Messrs. Reynders & Co., 303 Fourth Avenue, New York.

#### MEASUREMENTS REQUIRED.

1. Trace the outlines of the affected foot on a piece of paper and send it.
2. State length of foot.
3. State length from sole of foot to garter (below the knee).
4. Circumference at garter.
5. Mention if for right, left or both feet.

Prices vary, according to the sizes of the splints, from \$1.13 net each upwards.

75. **Detmold's Clubfoot Shoe.**



It consists of a shoe, with a steel sole and attachments similar to the apparatus for supporting weak ankles, but without joint at ankle. A steel spring in the direction from heel to toes is fastened to the upright bar, having a slight curvature in opposition to that of the foot, and is placed on the outer side of the foot, but inside the shoe. The upright bar, by a peculiar construction is made to have a tendency to evert the foot, so as to bring the sole to the floor.

IN ADDITION TO MEASUREMENTS REQUIRED FOR APPARATUS No. 77, state: 1) Whether for valgus or varus? 2) If complicated with equinus or calcaneus?

Prices vary according to the sizes of the shoes.

Length of shoe sole	4 inches,	each	\$5.00;	per pair	\$10.00
"	"	"	5	"	12.00
"	"	"	6	"	14.00
"	"	"	7	"	16.00

76. **Scarpa's Clubfoot Shoe.**

This apparatus is similar to Detmold's, with the exception of having a joint at the ankle, and an endless screw between heel and front part of sole. The front part of the foot is moved by a key.

Measures same as for Sayre's Clubfoot shoe.

Prices vary according to the sizes of the shoes.

Length of shoe sole	4 inches,	each	\$10.00;	per pair	\$19.00
"	"	"	5	"	21.00
"	"	"	6	"	23.00
"	"	"	7	"	25.00

77. **Dr. L. A. Sayre's Clubfoot Shoe.**

with ball and socket joint and artificial muscles, for talipes varus and valgus, simple or complicated with equinus.

This club foot shoe consists of two parts, united at the heel by a ball and socket joint, or a joint allowing motion in every direction. This sole and part embracing the heel, consists of strong sheet steel; covered with leather on both sides. Two lateral upright bars *B*, jointed at the ankle, are fastened near the heel and to the collar band, *G*, *H* and *I* are points for the attachment of artificial muscles, made of rubber tubing, with hooks and chains at their ends. To the inside walls of the shoe near *A*, two flaps of chamois leather are attached to lace together, which, passing over the front of the ankle-joint, keep the heel firmly in the back part of the shoe. The accompanying figure shows the result of the last effort to make this shoe resemble an ordinary one as much as possible.

MEASUREMENTS REQUIRED:

- 1) Trace the outlines of the affected foot on a piece of paper and send it.
- 2) Circumference at *L*, *K*, *A*, *AE*, *L*, (see figure, page 293).
- 3) Length of foot.
- 4) Length from sole to below knee.
- 5) Circumference at below knee.
- 6) Mention if for right or left foot.

Length of shoe sole	4 inches,	each	\$10.00;	per pair	\$19.00
"	"	"	6	"	23.00
"	"	"	8	"	27.00
"	"	"	10	"	31.00

78. **Dr. Gross' Clubfoot Shoes.**

The upper portion of this apparatus consists of two upright lateral bars having joints at the knee and ankle, well padded bands passing around the lower part of thigh and garter, secure the same on the leg. This portion of the apparatus is fastened to a steel shoe that is well padded inside and covered with leather outside. Fastened to the sides of the

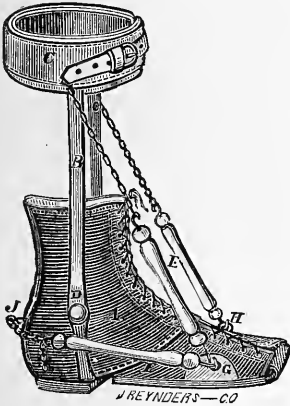

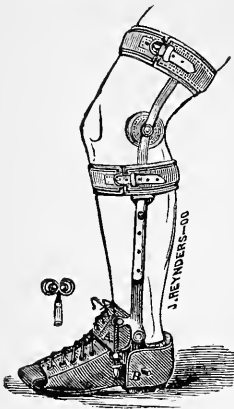

shoe and across its centre are strong leather flaps, which, when laced together, retain the foot firmly in the shoe. The screw "A" forces the foot up or downward, and the screw "B" turns the front part of the foot to the right or left.

- Price, with braces to reach above the knee,  
each..... \$17.00 to \$25.00
- Price, with braces to reach below the knee,  
each..... \$13.00 to \$22.00

MEASUREMENTS REQUIRED :

Same as for apparatus No. 77.

When ordering with braces to reach above the knee send in addition to the above:

7. Length from centre of knee upward.
8. Circumference of thigh.

79. Dr. Charles F. Stillman's Clubfoot Twister.

(Extracts from *The Medical and Surgical Reporter*, Nov. 19th, 1881.)

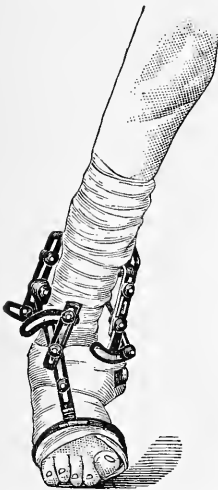

Dr. James S. Green, of New York, contributes to the November number of the *New York Medical Journal and Obstetrical Review*, an article in which he argues that a great majority of the most intractable forms of club foot may be treated successfully without the use of the knife. To effect the purpose of safe, comfortable, and certain reduction of chronic club-foot, by mechanical means, he remarks, the instrument must perform the following functions:—

1st. It must effect by extension the separation of the articular surfaces of the bones involved, exactly in the position in which they are presented by the deformity. The extension should be so complete that the synovial surfaces of the tarsal bones will slide over and not upon each other when the foot is twisted into its normal position. (This condition being obtained of itself, reduces to a minimum the amount of force necessary to be exerted in moving the bones, which are thereby not jammed against each other, the synovial membrane and the cartilages injured, and ulceration of the soft parts made imminent.) 2d. It should produce the gradual reduction of the foot to a normal position by continuous stretching, acting exactly in an opposite direction to the lines of the deformity.

In talipes equino varus (the most common form) it should flex the foot, thereby overcoming the contraction of the gastrocnemius and soleus muscles, while at the same time it should abduct the foot, reducing the rigidity of the tibialis anticus and tibialis posticus muscles. It should stretch the plantar fascia, after overcoming the tendo Achillis, and during the reduction of the tibial muscles. Withal, the

instrument should be light in weight, portable, and easily worn, so that the patient may assist the cure by walking upon the foot, which is being gradually extended and drawn toward its normal position. It should be so constructed that, as the opposing tissues yield to the applied forces, the advantage gained, be it ever so little, can be easily seized and retained. The 'compound club-foot twister,' an instrument employed by the author and his associate, Dr. C. F. Stillman, is described as being so constructed as to twist the anterior portion of the foot on the posterior at the medio-tarsal joint, and also to gradually and painlessly alter the angle of the foot with the leg at the ankle joint. It consists of a local extender, provided with a slotted arch for graduated movement, placed each side of the ankle-joint, and another placed in front of the arch of the foot. Below, these are attached to a flexible felt or leather sole, on which the foot is firmly fastened by bandages; and above they are connected to metal terminal plates, which are bound down to the leg by some immobile dressing. This splint allows the foot to be twisted back into shape without pain, as it provides a local extension which relieves the parts from strain and attrition during the twisting, and also allows the patient to walk without interfering with the action of the instrument, the foot being completely under the control of the surgeon. The instrument and dressing used in a case related, weighed thirteen ounces.

MEASUREMENTS REQUIRED:

1. Trace the outline of the sole of the foot on a piece of paper. Send us this tracing.
2. Length from sole to ankle.
3. Length from sole to M.
4. Length from top of foot at I to the ankle joint.
5. Circumferences at I, K, A, L & M.

} See figure of leg on page 293.



**80. REYNDER'S CLUBFOOT SHOE.**

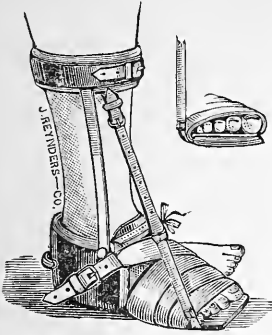

A simple and efficient apparatus for cases of Talipes in very young children.

Of this contrivance the sole and part embracing the heel are made of light sheet steel covered in and outside with leather; the heel portion is well padded. For retaining and securely fastening the heel in the shoe a pad of soft chamois skin with tapes attached to its ends is provided. This pad is placed across the instep and its tapes passed through openings in the heel portion of the shoe; after crossing each other these tapes are repassed through openings in the heel portion of the shoe; brought forward and tied across the pad over the instep. A bandage of strong and soft webbing is fastened to the leather work of the shoe sole and to its outer edge. This bandage serves to overcome the adduction of foot by retaining the latter in a straight position on the sole of the shoe. The proper mode of applying the bandage is as follows: Pass it between the foot and the sole of the shoe in such a manner

that the front part of the foot will be engaged and embraced only, draw the foot as straight as possible, holding it in that position with the left hand until the second, third and possibly fourth turns of the bandage are made to envelop the foot and sole of the shoe; after the last turn of the bandage has been made, secure it in the buckle placed on the side of the heel for the purpose. Flat leather loops on the under side of the shoe sole, and through which the bandage must be drawn before the succeeding turn is made, prevent the bandage from gliding off. A steel spring curved outward or off from the leg secured on the heel of the shoe by a joint, and having on its top a well padded band, serves when brought to the leg and fastened by band at garter to evert the foot.

An india rubber cord fastened to the outer edge and front of the shoe sole, and also attached to top band by strap and buckle, serves to make gradational traction upon the tendon Achilles.

**MEASUREMENTS REQUIRED.**

The same as for Clubfoot shoe No. 77. See page 361.

Prices, according to size, from \$8.00 upwards.

**81. DR. CHARLES F. STILLMAN'S NIGHT BRACE FOR CLUBFOOT.**

(TALIPES EQUINUS.)

Cases of clubfoot in all stages are benefited by elastic traction exerted during sleep as the muscles are then more thoroughly relaxed than during consciousness. An effective night brace for this purpose is made by using a soft lace shoe and attaching to it a pair of vertical side bars articulated opposite the ankle, and passing under the sole, in the centre of which they are pivoted to allow the foot horizontal motion. A thin plate of metal is attached lengthwise to the sole of the shoe and a stirrup of metal passes from this over the foot opposite the base of the great toe. The side bars are held firmly to the leg by girths, and just below the upper girth a detachable hoop of metal is placed. This is connected to the stirrup by elastic webbing, provided with a buckle. The strength of the webbing, and its traction may be varied by sliding the upper end of the webbing to any desired point on the metal hoop and fastening it. This makes a very light and very effective brace for the purpose.

81.



**APPLICATION.**

The hoop is lifted out of its sockets and the foot inserted into the shoe and the girths buckled upon the leg. The hoop is then again placed in position and elastic power varied, as already described.

**MEASUREMENTS REQUIRED.**

1. Send us a well-fitting and very light shoe or shoes to lace.
2. Length from sole to ankle-joint.
3. Length from sole to garter (below knee).
4. Circumference above ankle-joint.
5. Circumference at garter (below knee).
6. Mention, if for right, left or both feet.

**PRICES.**

According to size, each, ..... from \$13.00 upwards.

## 82. DR. CHAS. F. STILLMAN'S SINGLE ANKLE SPRINGS WITH CLAMPS.

For Weak Ankles when associated with Inverted Feet, for the less severe forms of Talipes Varus, especially when due to Infantile Paralysis, and for the After-treatment of such cases as have been subjected to operation.

(Extracts from Dr. C. F. Stillman's article, "A Contribution to the Treatment of Clubfoot," in *N. Y. Medical Journal*, of October 20, 1883.

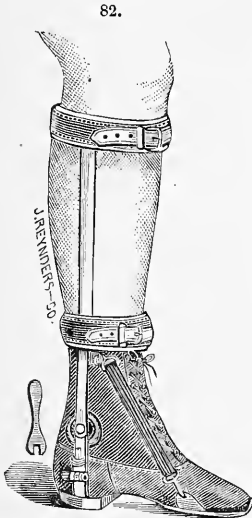

These consist of a single side bar placed on the outer side of the leg; it is jointed at the ankle, riveted to the shoe under the heel and buckled to the leg by two girths, one just below the knee and the other above the ankle.

In order to antagonize the three tendencies in the deformity, namely:

1. Adduction or local inversion at the ankle.
2. Supination or turning under of the foot, the ankle giving way externally; and
3. Contraction of the posterior muscles by which the os calcis is drawn upward, thus forcing the astragalus forward and causing prominence of the metatarsal bones on the sternum of the foot, the single side bar, above described, is fitted with two ratchets and an elastic webbing strap.

These ratchets are clamps, as shown in figures 82, A and B, they admit either fixation at any angle or free motion.

One ratchet is placed just below the ankle for rotation (see figure 82), and allows that part of the brace below it to be thrown out and fixed at any angle with the part above; for when so fixed, and the brace secured to foot and leg, any inversion tendency is combated by the entire brace, which thus acts as a powerful spring to keep the foot rotated

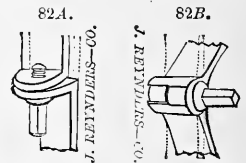

outwardly. The second or pronation ratchet is to be placed where the side-strip passes under the shoe or insole (figure 82), and enables the surgeon to entirely prevent any tendency of the foot to turn under, for if the side-strip be clamped by it at an angle of about 45° outward from the foot, and then brought up against the leg and secured by the girths, the foot will be turned in its long axis so that the patient will walk on the inner instead of the outer side. This effect may be varied by the ratchet in the side-strip, so that the brace may be anything from a simple vertical support to an agent for the production of valgus, so completely does this ratchet place the limb under the control of the surgeon.

The third and last indication is combated by the use of elastic webbing, provided with hooks, passing from an eyelet in the sole opposite the base of the little toe to a point on the side-strip at about the lower girth.

We thus, by means of this brace, place the foot in a position to properly receive the weight of the body, and, if it is so received, the weight becomes an agent for the permanent cure of the deformity, tending to press the foot into normal shape; but if, instead of being rotated outward, the foot received this weight while inverted, or in the median line, the deformity would be increased.

In many cases it may seem preferable to allow a limited range of lateral movement of the foot, instead of having the eversion fixed by the clamp.

This may be secured by having a loose rotary joint, and attaching a coiled spring to the side-strip, whose power can be regulated by a cog and catch, so that it may be "wound up" to any desired degree of rotary power, thus combating the inversion by a constant elastic force, without impairing support (see figure 83).

By either of these forms of apparatus we can mechanically combat any of the simpler forms of deformity presenting the symptoms detailed, and for the after-treatment of the club-foot which has been subjected to operation they fulfill every indication.

The physiological point to which I wish to draw attention is the necessity of rotating the foot outward (extreme eversion) before applying elastic force, if complete reduction of an equino-varus or an equinus be desired. Whenever, in these conditions, the os calcis is drawn upward and the astragalus projects, it is impossible to apply the upward elastic force advantageously in the median line until the foot is rotated outward, as the partial dislocation of itself prevents the normal degree of movement upward in the ankle joint. The foot should be taken in the hands of the surgeon and forcibly everted, and, after passing the median line, pronated;

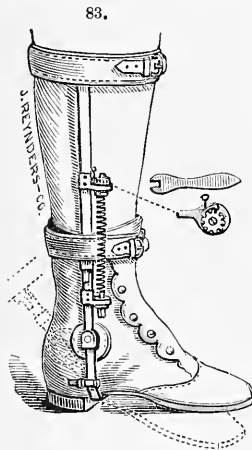

and it will then be found that the deformity can be relieved with much greater ease. It, therefore, follows that a brace, to be effective, should contain provision for these movements and afterward afford fixation in the corrected position while not interfering with the normal motion of the ankle and that braces have not done so in the past may, perhaps, be argued as one of the reasons why so many cases have been relegated to tenotomy, only to have the relief thus obtained often followed by relapse and an unsuccessful termination.

MEASUREMENTS REQUIRED.

1. Send us a well-fitting shoe or shoes to lace.
2. Length from sole to ankle-joint.
3. Length from sole to garter (below knee).
4. Circumference at garter (below knee).
5. Circumference above ankle-joint.
6. Mention, if for right, left or both ankles.

The prices of Ankle Springs, figure 82, vary, according to the size of same,  
 each, ..... from \$13.00 to \$16.00  
 Those of Ankle Springs, figure 83, each, .... from \$25.00 upwards.

**84. DR. CHAS. F. STILLMAN'S SINGLE ANKLE SPRINGS WITH CLAMPS, COMBINED WITH DR. G. DOYLE'S SPIRAL SPRING ROTATORS.**

FOR ROTATION OF THE LOWER EXTREMITIES.

Rotation of the lower extremities is very often met with, either alone or combined with bow-legs, knock-knee, muscular insufficiency and various deformities and conditions of joints. The thigh is usually rotated, either inward or outward, at the hip, the leg upon the thigh at the knee, and the foot upon the leg; the latter also often exhibiting a tendency to turn under at the ankle. A rotator which beautifully overcomes this condition consists of an articulated steel bar, passing from under the shoe to a point half-way between knee and thigh. This is provided with clamps, first, for abduction. This is inserted in the bar at the point where it is bent beneath the shoe, and allows the bar to be adjusted at an outward inclination, which converts it into a spring when the brace is buckled to the limb, effectually preventing the foot from turning under at the ankle.

The local rotation, inward of the foot, on the leg is overcome by a horizontal clamp placed just below the ankle-joint, and which regulates the angle of the foot to any required degree. The inward rotation of the knee on the thigh is overcome by a horizontal ratchet or clamp, inserted in this steel bar just below the knee. The inward rotation of the thigh on the pelvis can be overcome by extending this bar properly articulated opposite the joints to the pelvic band, and inserting just below the joint another horizontal clamp.

But, it is more satisfactorily accomplished, unless support for the limb is also desired by the insertion of a piece of spirally coiled spring into the instrument, from the pelvic band to the knee.

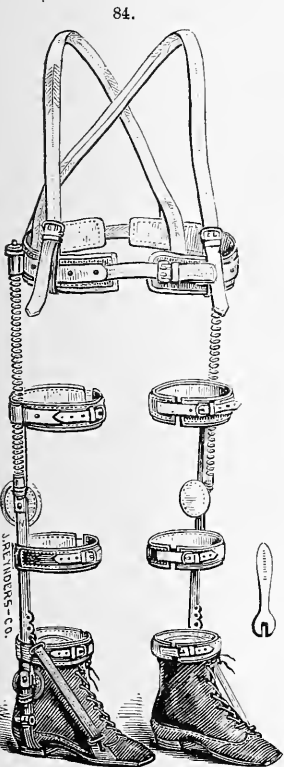

The use of the spirally coiled spring is the devise of Dr. Doyle, of Syracuse, but as used by him, extends from the pelvis to the ankle. The combination brace, shown in figure 84, devised by Dr. Stillman, allows each indication to be met, and provides support as well as rotation force, it is, therefore, thoroughly effective.

MEASUREMENTS REQUIRED.

1. Send us a well-fitting shoe or shoes to lace.
2. Length from sole to ankle-joint.
3. " " " garter (below knee).
4. " " " centre of knee-joint.
5. " " " " " to crest of ilium.
6. Circumference above ankle-joint.
7. " " at garter (below knee).
8. " " at middle of thigh.
9. " " of pelvis between the crest of ilium and trochanter major.
10. Mention, if for right, left or both extremities.

PRICES.

For one extremity, ..... from \$25.00 upwards.  
 For both extremities, ..... from \$42.00 upwards.

## 85. Dr. L. A. Sayre's Apparatus for Aftertreatment of Clubfoot.

Extracted from the Philadelphia Medical and Surgical Reporter, 942, March 20th, 1875.

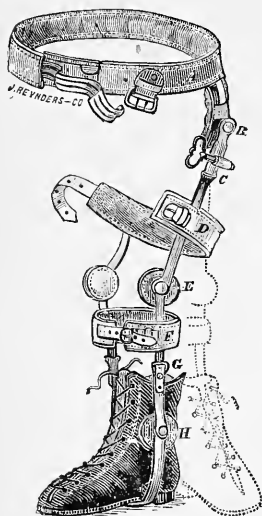

"While he is being anesthetized, I will describe to you the last improvement which I have made in my club-foot shoe. It embodies a principle upon which I have been thinking for several years, and which at last has been admirably carried out by Mr. Reynders, of 303 4th Avenue. In many cases of club-foot there is a tendency to rotation of the entire limb inward, and that tendency, heretofore, we have been unable to combat, from the want of a rotary force which would take its points of motion from the acetabulum. This instrument supplies that deficiency, and consists as you see, of an iron rod, jointed of course, at the ankle, knee and hip, which extends from the shoe to a belt surrounding the pelvis. Just below the joint at the hip, the shaft is divided into two parts, and at which point there is placed an endless screw transversely to the shaft, which is worked by this key, and which rotates, as you see, the foot completely outward. It is the application of the same principle which you have seen me use in my hip-splint, in those cases which have been permitted to get well with the deformity of abduction and inversion of the foot."

## MEASUREMENTS REQUIRED:

- 1) Send a well fitting strong lace shoe.
- 2) Circumference of body between crest of ilium and trochanter major.
- 3) Circumference of middle of thigh.
- 4) " " at garter below knee.
- 5) Length from sole to ankle joint.
- 6) Length from sole to knee joint.
- 7) " " " " hip " "
- 8) Right or left? Price, \$30.00 and upwards.

## 86. Dr. G. Doyle's Spiral Spring Rotator, for Aftertreatment of Clubfoot and Correction of Abnormally Inverted or Everted Feet.

(From Philadelphia Medical Times, December 18th, 1880.)

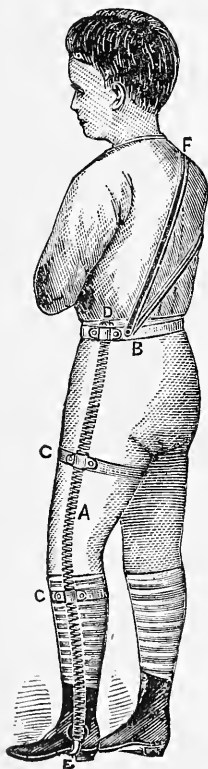

Single Instrument applied.

It consists of a pelvic band buckled about the body and prevented from turning by shoulder-straps. From this extends a steel spiral or "flexible shaft," as it is called by machinists, along the outside of the leg, to be fastened into the shoe. This is three-eighths of an inch in diameter, and is held in position by straps encircling the thigh and leg. From the calf to the foot additional strength is secured by a steel upright riveted to the sole of the shoe and jointed at the ankle.

In applying the apparatus the pelvic and thigh-bands are secured, when, if the case be one of varus, the shoe is rotated *once inward*; the foot is then placed in it and fastened by lacing. It will at once be seen that the constant tendency of this spring will be to uncoil itself into its original position, and in doing this it must carry outward the toes. In valgus the action would be reversed. It is a force exerted gently, constantly, and "coaxingly," awake and asleep, and if increased power be required the shoe can be rotated twice or three times before it is applied to the foot.

A great advantage obtained by its use is the fact that it in no wise interferes with either the motion of the leg or the action of any muscle, save of the ones which it is intended to antagonize. Its tendency to straighten itself as a whole would, in a slight degree, raise the anterior part of the foot, and to that extent benefit even an equinus.

As I have said, it does not act with much force upon the medio-tarsal joints; yet its applicability to very young children is greatly in its favor, as it can thus be used as a continual assistant to manipulations. As is well known, the majority of cases of congenital varus can be cured by manipulation and stretching, but as the hands of the surgeon cannot be always in service, and as the mother will not do this more than fifteen minutes during the day, it will be seen that a force acting steadily through the remaining twenty-three and three-quarter hours will prove no mean accessory, even though it be not equal to the hand of the surgeon or nurse. Such a splint applied even during the first week of the child's life could do no harm, and

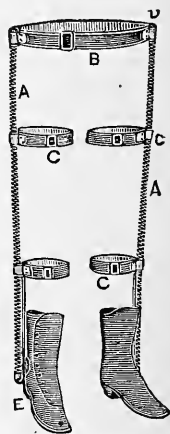

Double Instrument.

if nickel-plated the urin would have but little effect upon it. By the time that three months have passed, and the child is ready for tenotomy, it will frequently be found that no operation is necessary save section of the tendo Achillis.

For pigeon-toed cases this spiral rotator would be most perfect in its action, and the principle could be employed with advantage on any limb which is deformed by rotation upon its long axis. The inventor has used it for torticollis, and also employs it after division of tendons in varus and equinus. I like the mode of action of the spiral, and shall certainly give it a full trial.

EXPLANATORY.

A.—Spiral Steel Spring. B.—Belt around the hips. C. C.—Loops to hold Spring in place. D.—Set screw by which tension may be regulated. E.—Plate by which the Spring is fastened to the shoe. F.—Shoulder strap to prevent belt from shifting.

Where the double instrument is worn, the shoulder-strap is unnecessary.

The Rotator is to be worn under the outer clothing. It is very light and affords no inconvenience to the wearer.

In applying it for cases of club-foot, the pelvic belt, B, is first to be fastened in place, and when necessary to *evert* the foot, the shoe, to which the Spiral Spring is attached, is to be rotated *inwards* one, two, or as many times as the case may require. The foot is then to be placed in the shoe and secured there, and the straps at C, C, are to be buckled. It will be seen at once that the spring's tendency to resume its former position, will rotate the foot *outwards*.

In cases of *everted* or splay-foot, it is evident that to *invert* the foot the shoe should be rotated *outwards* so that the Spring, in resuming its former position, will rotate the foot *inwards*.

Prices: For Double Instrument ..... \$28.00  
 For Single Instrument ..... 20.00

MEASUREMENTS REQUIRED:

1. Sex of patient.
  2. Circumference of body one inch below the crest of the ilium.
  3. Circumference at garter. (Below the knee.)
  4. Circumference at middle of thigh.
  5. Length from the sole of the foot to the garter. (Below the knee.)
  6. Length from the sole of the foot to the crest of the ilium.
  7. State whether for the right or the left foot or for both.
- Send a strong and well fitting lace shoe or a pair of shoes.

87. Detmold's Single Ankle Spring for Aftertreatment of Clubfoot.

This form of brace consists of a well tempered steel spring, forged at one end into a wide flange, by which it is riveted to the sole of the shoe. A well padded band secured to its top fastens it with the aid of a strap and buckle to the leg below the knee.

The lace shoe, if an ordinary one as usually found ready made, is narrowed across the instep by the removal of a wedge shaped piece from its upper. After replacing the eyelets, this enables the tighter lacing of the shoe at the instep, crowding and firmly securing the heel of foot to its place in the shoe. The tendency of the spring is forward and outward, it will, when brought to the leg by securing its padded band at the garter, lift the toes and evert the foot so as to bring the sole of the latter flat to the floor.



MEASUREMENTS REQUIRED.

- 1) Send well fitting shoe or shoes to lace and of a size larger than usually worn so as to admit a steel insole that we secure into the same.
- 2) Length from sole to garter. (Below the knee.)
- 3) Circumference at garter.

Prices vary according to the length of the spring.

Length	6 inches	.....	each	\$3.00;	per pair	\$ 6.00
"	8 "	.....	"	3.50;	"	7.00
"	10 "	.....	"	4.00;	"	8.00
"	12 "	.....	"	4.50;	"	9.00
"	14 "	.....	"	5.00;	"	10.00
"	16 "	.....	"	6.00;	"	12.00

**88. DR. CHARLES F. STILLMAN'S SINGLE ANKLE SPRINGS FOR THE AFTER-TREATMENT OF INFANTILE CLUB-FOOT.**

(Extracts from Dr. C. F. Stillman's article, "Orthopedic Deformities of Early Childhood," in *The American Journal of Obstetrics and Diseases of Women and Children*, July 1882)

Among other methods of retaining the infantile foot in a corrected position, may be mentioned the use of perforated felt. This is to be obtained either in sheet form or, what is more convenient, in pieces already moulded to the normal infantile foot (see figure 88, and the latter can be used in one of two ways.

88.



It may be dipped in hot water, and then applied while soft, hardening in a few moments, the foot meanwhile being held in as nearly normal a position as possible. The splint is secured by a few turns of adhesive bandage. Or the foot may be placed directly in the splint, and fastened in it as firmly as possible. But the latter plan is apt to cause discomfort, and is not so effective.

The principle which governs the use of the plaster-of-Paris or felt splints in infantile club foot is the resistance which the inherent stiffness of the material opposes to the tendency of the foot to resume its original position. At first, the foot is placed in as good a position as possible, and held there rigidly until it has become adapted to its changed relations, when it is put in a little better position, and again held securely, and so on until with the forces applied, the deformity has been obliterated.

By some the use of strips of adhesive plaster alone is advocated, but it is not a sufficiently firm dressing to prevent the foot twisting on itself, nor does it allow the stretch to be secured, which is important for the comfort of

the patient.

When the foot has become so far reduced that it can readily be placed in nearly the normal position, one of the little shoes that children wear may have a spring attached to its side (see figure 88A) so as to oppose the tendency to twist inward, which, of course, the foot still retains if the plaster or felt be left off.

88A.

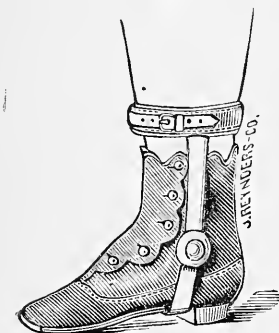

This spring is articulated opposite the ankle, and may be placed internally or externally, as the surgeon desires. In either case, however, the inclination at which it is attached to the shoe should be such, when the girth is buckled, as to turn the outside edge of the foot upward. See figures 88B and 88C.

This simple device will be found very effective for the twisting inward of the foot, and if in addition a rubber strap be added, running from the side of the little shoe to the spring, inversion will be still more opposed; for the effect is to twist the anterior portion of the foot outward as well as upward. And as the little flexible soles follow the surface of the foot

very closely, it acts as a very nice, light and manageable club foot shoe for infants. Fig. 88D.

Another elastic cord may also be added from the girth to the shoe (figure 88D), which will act against the contracted posterior muscles and tend to depress the heel as well as twist and hold the anterior portion of the foot upward.

88C.



Pulling Spring.

But when these rubber cords are used, it becomes necessary to carry the side strip of the brace up to a point just below the knee, terminating there in another girth which is to be fixed immovably on the limb by a strip of adhesive plaster, the extremities of which button on the girth, as shown in figure 88E. If this girth be not so fixed, the rubber cords will pull the side strip and girths around toward the toes, and thus neutralize the effect. And besides, by turning the side strip, they convert the joint opposite the ankle into a lateral instead of an antero-posterior joint, and thus take away even the lateral support of the spring strip. So that it must always be borne in mind, when elastic cords are used, to fix the girths on the leg immovably, just below the knee.

88B.

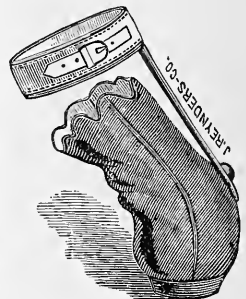

Pushing Spring.

88D.

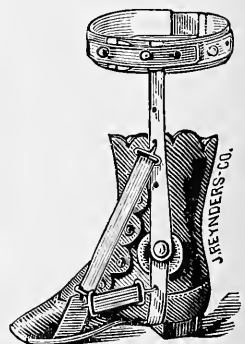

It is important in every young children to have nothing upon the foot which will annoy or give pain, and it is also important to avoid weight.

A shoe prepared in the manner I have described possesses these qualifications, and is in a marked degree applicable to these cases. And, as the mother is usually only too glad to provide a pair of the baby's shoes for such a purpose, any good instrument maker can easily add the attachments. Without the spring at the side, however, in these cases, I do not consider the addition of rubber cords of much advantage.\* Even though by these procedures we have apparently produced a relief of the condition, yet it cannot be considered cured until the child has begun to walk, or at least to stand; and this introduces a new factor into the case which is of the utmost importance, *i. e.*, weight.

The weight of the child is the most important agent in effecting a cure of the condition under consideration that we have, if rightly employed.

It needs but a moment's reflection to understand how the constant reception of twenty-five or thirty pounds upon a mal-placed foot would increase the deformity, and, on the same principle, if the foot can be so placed as to receive this weight in nearly its normal position, the constant application of the force would tend to press out the deformities. To utilize the weight of the body as a curative factor in the treatment of infantile club foot it is necessary for us to use spring power; and this spring power may be either pulling or pushing in character, and formed of thin metal, or rubber, or allied elastic material.

It must be plainly understood, however, in the treatment of these cases, that the weight of the body should not be borne upon the foot until its axis be at its normal angle with the leg when the patient stands.

In the majority of cases the combination of elastic straps and the metallic spring, already described, will be sufficient to keep the *infantile* foot in position to receive the weight of the body, and will assist such weight to complete the cure.

Almost all cases of congenital club foot should receive the benefit of spring power at the time that walking commences; and if they do not receive this, no matter how well the foot may have been manipulated up to this time, relapse is almost sure to occur. This is, indeed, the critical time for treatment of club foot, and I cannot impress it too strongly upon my readers; for if the foot be now so placed and held that the weight is received normally, every step and every jump of the child tends to cure the malposition permanently; while if such be not the case, if the foot be turned inward in the least beyond the normal angle, every step and jump will serve to increase the deformity, and render it more difficult ever to overcome.

\*For older children, the side spring strip, instead of being rigidly attached to the shoe, should be connected to it by means of a pivot below the foot in the centre of motion. See figure 88F. This allows the elastic power to be used to greater advantage without impeding the normal motions of the foot. It also avoids the necessity for a transverse division of the sole opposite the mediatarsal articulation, with its obvious disadvantages to comfort and cleanliness.

MEASUREMENTS REQUIRED.

1. Designate form of spring or springs desired, by number of figure.
2. Send us a well-fitting shoe or shoes to lace.
3. Length from sole to ankle-joint.
4. Length from sole to garter (below knee).
5. Circumference of leg at garter (below knee).
6. Circumference of leg above the ankle-joint.
7. Mention, if for the right or left foot.

PRICES.

Adaptable Porous Felt Clubfoot Splints, as per figure 83, .....each, \$1 00\*  
 Ankle Springs, as per figures 88A, 88B and 88C, .....each, \$3.00 upwards.  
 Ankle Springs, with elastic cords, as per figures 88D and 88E, .....each, 4.50 "  
 Ankle Springs, with elastic cords and pivot, as per figure 88F, .....each, 7.00 "

89. BARWELL'S APPLIANCES FOR THE TREATMENT OF CLUBFOOT.

Used in the treatment of club feet.

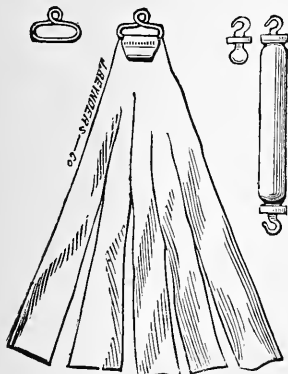

- Plaster on swans-down, p. yard \$0.75
- Plaster, on moleskin per yard, . . . . 1.00
- Wire Loops, each .10
- Hooks for artificial muscles, . . . . .10
- Artificial muscles, each . . . . .50
- Tin Plates with links of chain attached (see right hand engraving.) each . . . . .15

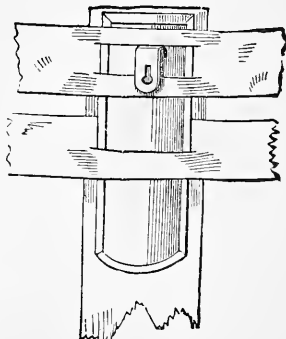

**90. TALIPES CALCANEUS APPARATUS.**

90.



This apparatus consists of two lateral upright bars, fastened to the sole of a shoe, jointed at the ankle-joint and connected to a band around the calf. A stirrup projecting backwards is fastened to the back of the shoe, the end of which is connected to the band around the calf, by two pieces of strong elastic webbing, buckling together. The deformity is counteracted by the tension of these pieces of webbing, which can be regulated by the buckle.

91.

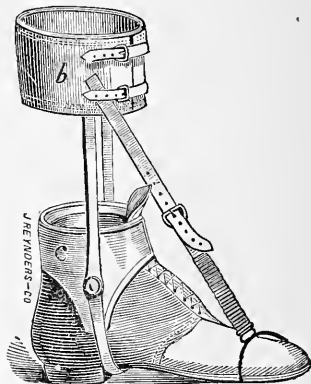

MEASUREMENTS REQUIRED.

The same as for apparatus No. 92.

PRICES, ..... from \$8.00 to \$12.00 each.

**91. TALIPES EQUINUS APPARATUS.**

This apparatus is made upon similar principles as the before-named one. To cure this deformity, the tension should act from the toes to the upper front part of the leg, which is accomplished by a strap of stout elastic webbing, connected by a stirrup over the toes to the calf band.

MEASUREMENTS REQUIRED.

The same as for apparatus No. 92.

PRICE, ..... each, \$10 00 to \$12 00

**92. IMPROVED TALIPES EQUINUS APPARATUS.**

This apparatus, same as the preceding one, has on the inner and outer sides of the leg light or heavy (as the patient may require) steel bars, jointed at the ankle to a foot piece which is securely riveted to the shoe sole. On top these two steel bars are fastened to a well padded collar, encircling the leg in the region of the garter.

92.

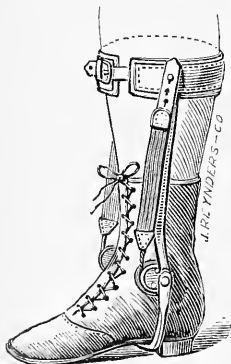

The improvement by Dr. Hudson consists in attaching the artificial muscles at the joints of the apparatus, in which position they work more effectively and are not so liable to catch anywhere or trip the patient. The muscles are constructed of strong elastic webbing, secured to their lower ends are pieces of catgut which in turn are securely fastened to the lower ends of the semi-circular grooved guides attached to the foot-piece, the catgut plays in the grooves of the semi-circular guides.

Sewed to the upper ends of these elastic webbings are strips of perforated leather which fasten on metal buttons placed for this purpose on each side of the garter band. The tension of the artificial muscles can be regulated by buttoning the perforated straps high or low, and by their aid the foot retained in its normal position.

MEASUREMENTS REQUIRED.

1. Send us a well-fitting shoe or shoes to lace.
2. Length from sole to ankle-joint.
3. Length from sole to garter (below the knee).
4. Circumference at garter.
5. Mention, if for the right or the left foot.

The prices of the above described apparatus vary, according to the size of the same, ..... from \$12.00 to \$18.00 each.



**93. APPARATUS FOR INVERTED FEET.**

93.

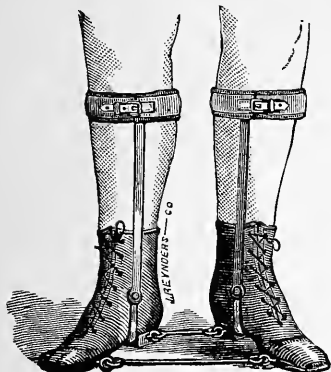

This apparatus is used for everting the feet when they are inverted, resulting from recent club-foot. Heels and toes are connected by steel bars, the former being longer than the latter. For obvious reasons the apparatuses Nos. 85 and 86 are preferable to this one.

PRICE, ..... plain \$4 00 and \$6 00;  
with ankle support \$8 00 and \$10 50.

**MEASUREMENTS REQUIRED.**

Same as for apparatus No. 70, page 356, and state length of bars desired.

**94. DR. L. A. SAYRE'S APPARATUS FOR FLAT FEET.**

94.

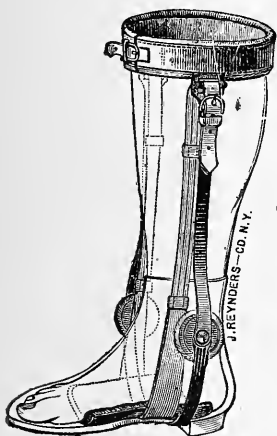

The same consists of an upright steel bar on either side of the leg, with joints at the ankle, and secured to the sole of the shoe. These uprights extend nearly to the head of the tibia secured by a well padded steel band behind and buckle in front. From the top of these bars and passing over rollers a webbing passes down inside the shoe under the arch of the foot, the inner webbing having a few inches of elastic insertion. This webbing can be made taunt or loose at the top of the bars by a buckle, so that the arch of the foot is sustained when stepping by the extra support given it by the piece of webbing.

**MEASUREMENTS REQUIRED.**

Same as for apparatus No. 70, page 356.

PRICE, ..... each, \$12 00

**95. ECLIPTING SPRING FOR FLAT FEET.**

95.

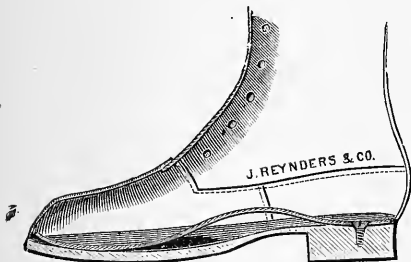

Consist of a spring tempered steel sole, constructed of the exact shape of the arch of the foot in its normal position. This sole is placed in the shoe and fastened at the heel by a screw, leaving the anterior portion free to move as the weight of the body is thrown upon it.

**MEASUREMENTS REQUIRED.**

1. Send a well-fitting strong lace shoe.
2. Send a plaster cast of the foot with its arch elevated to the normal position.

PRICE, ..... \$4 50 to \$6 00

96.

## 96. BIGG'S APPARATUS FOR BUNIONS.

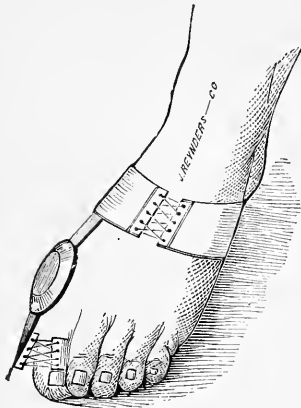

This apparatus consists of a delicate lever of spring steel, with an oval ring in the centre, which is provided with hinges at its anterior and posterior margin. The apparatus is attached to the instep by a laced band, and the toe to the extremity of the spring by a piece of webbing. It affords the articulation freedom of motion in the natural whilst the malposition of the toe is gradually rectified by constant lateral traction. It can be worn in a shoe (Bigg).

## MEASUREMENTS REQUIRED.

1. Place the foot on paper and with a pencil trace its outlines.
2. Circumference of ball of foot.
3. Circumference of instep.

PRICE, .....\$8 00 to \$10 00

### 97. DR. THOMAS H. HOLGATE'S INSTRUMENT FOR MEASURING THE LOWER EXTREMITIES CORRECTLY.

(Extracts from *The Medical Record*, of August 6th, 1881.)

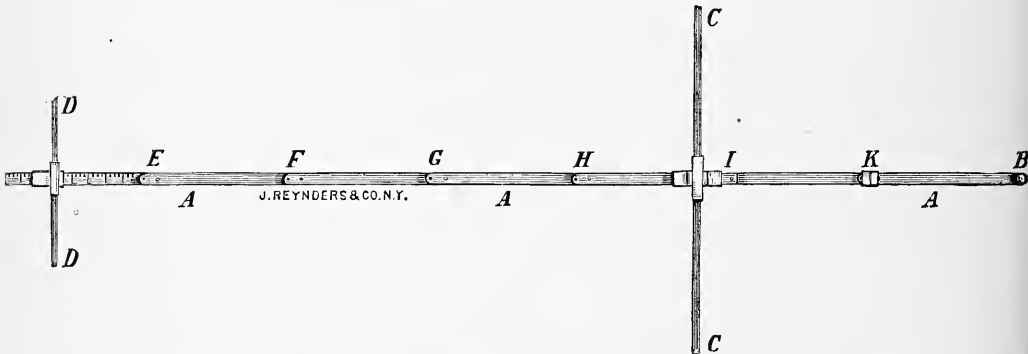

This instrument was constructed in the early part of 1875, but a description of it has not heretofore been published; being called for by the profession, it is described as follows:

A, A, A is a bar of spring steel, nine-sixteenth of an inch wide, one-twelfth of an inch in thickness and five feet six inches in length, at the end and under surface of which, B, is fixed an olive-shaped ivory point. C, C is a piece of spring steel, one foot and ten inches in length, three-eighths of an inch wide and one-twelfth of an inch in thickness; this, by means of a slide, which it is fixed, is made to move upon the bar, A, A, A, at right angles to it. D, D is another piece of spring steel, eleven and one-half inches in length, one-fourth of an inch wide and one-twelfth of an inch in thickness; this also is fixed in a slide, and moves upon the bar at right angles to it.

The subject whose extremities are to be measured with this device, is placed in the horizontal position on the back, the ivory olive-shaped point is placed in the intraclavicular notch, or angle formed by the ascent of each sterno-cleido mastoideus muscle from its sternal origin, and allowing the bar to pass downward over the symphysis pubis, between the lower extremities to beyond the feet; the pelvis is then set at right angles by setting the superior spinous process of each ilium to the edge of the sliding cross-bar, C, C; then move the cross-bar, D, D, up to the soles of the feet, and if there is any difference in the length of either extremity, it will be manifest.

The instrument has lock-joints at *E, F, G, H, I*, and the lengths slide upon each other at *K*, so that it can be folded into a space of eleven inches. The cross-bar, *D, D*, can be withdrawn and placed in its slide so as to be parallel with the long bar, and the cross-bar, *C, C*, being in two sections, can be changed as in the case of *D, D*, making it take up so little space that it can, without inconvenience, be put into a breast-pocket.

For measuring the extremities of persons of diminutive stature, it can be shortened by folding one or more joints, and using the clamps, which are a part of the instrument, to retain the folded part in line. Its weight, when closed, is less than eleven ounces, and it can be obtained from John Reynders & Co., surgical instrument makers, No.303 Fourth Avenue, New York.

PRICE, .....\$18 00

**98. J. REYNDERS & CO'S APPARATUS FOR CHICKEN BREAST.**

This Apparatus consists of two well padded pads; one for the back, the other for the protrusive part of chest in front. These two pads are connected by springs passing under the arms, and fastened by catches on the pads. Pressure on the protuberance is made by the springs which, as it is steady and elastic, is easily borne by the patient. Straps passing over the shoulders retain the apparatus in the proper position.

PRICE, .....\$12 00 to \$25 00

MEASUREMENTS REQUIRED.

1. Sex of patient.
2. General appearance of patient.
3. Circumference of body at highest point of protuberance.

In the foregoing pages we have illustrated and described some of the principal apparatus in use and manufactured by us. Such changes will be made as the nature of the case requires, or according to the ideas of the Physician attending the same.

We can manufacture any apparatus, if described, or by reference to any Orthopædic work.

**99. Darrach's Patent Wheel-Crutch. †**



This is an admirable contrivance for patients, who have lost control of their lower extremities, and for enabling them as much as possible to move freely about. The iron bars below the hand pieces are hollow to receive the upper bars, to which the breast and axilla pad is attached; the latter can be adjusted higher and lower, within the range of 8 to 12 inches, according to size, and made firm by screws. The apparatus is constructed in such a peculiar manner to enable the patient to move at the least exertion, and to change the direction of movement at the slightest attempt. The wheels are bound with sole leather, to prevent sound and jarring on the floor. For very helpless patients a body support is attached which can be adjusted to relieve the arms, and allows the patient to rest, while using the crutch. This crutch is especially adapted for cases of hip-joint disease, diseases of the spine, paralysis and deformities of the legs and feet.

An adjustable sunshade which can be quickly attached, promotes comfort of patient while using the crutch on the street or park. Also an ornamental toy tray placed in front adds to the pleasure of children.

MEASUREMENTS REQUIRED :

Width of the body in *direct* line from arm-pit to arm-pit; distance from arm-pit to floor; circumference of waist over underclothing when supporter is needed. To measure width of body correctly, place a ruler under each arm close to the body, projecting in front *parallel* and take

distance between, (not following curve of breast).

Sizes from	Price.	Diameter of Wheel.	Price of Supporters, range from .
16 to 25 inches. ....	\$50.00.....	4 inches.	\$.50 to \$15.00
25 " 35 " .....	60.00.....	6 " .....	Sunshades and Fixtures, from ...
35 " 45 " .....	70.00.....	8 " .....	6 to 12.00
45 " 55 " .....	85.00.....	10 " .....	Toy Trays .....
			2.50

CRUTCHES.

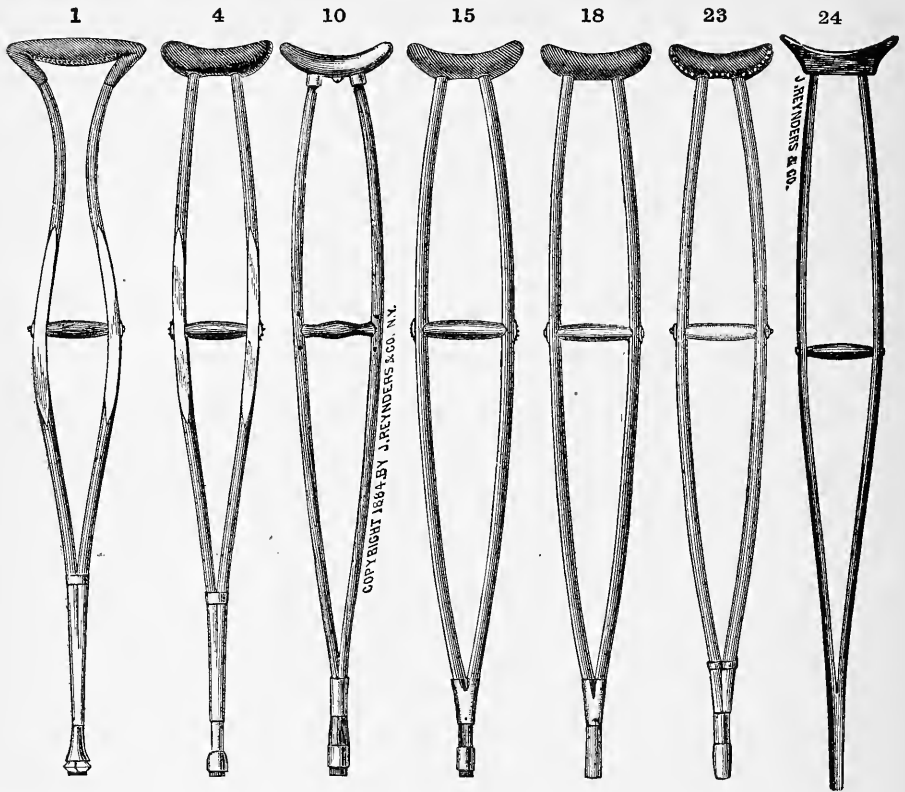

Whittemore's Spring Top Crutches with Whittemore's Sockets and Screw Clamp Jaws for holding the rubber bottoms, see figure 29; possess the following advantages: The spring top dispenses with the tiresome jar that is unavoidably connected with all other styles of crutches. By simply unscrewing from the sockets the screw clamp jaws, worn off rubber bottoms can be readily removed and replaced by new ones. To prevent slipping on wet ice, creepers or brats are provided which can be easily inserted or removed from the central perforations contained in the rubber bottoms. These crutches are not excelled by any manufactured here or abroad. Of the same we furnish the following three styles:

1.*Of selected Rock-maple,.....	per pair	\$9.00
2. Of " Lancewood,.....	"	10.00
3. Of " Rosewood,.....	"	10.00
4.*Rock-maple with velvet covered tops and rubber bottoms as per figure 32, .....	"	7.00
5. The same with Whittemore's Sockets, etc., as per figure 29, .....	"	10.00
6. Malacca with velved covered tops, full German Silver mountings and rubber bottoms as per figure 32, .....	per pair	15.50
7. The same with Whittemore's Sockets, etc., as per figure 29, .....	"	18.00
8. Rosewood with velvet covered tops, full German Silver mountings and rubber bottoms, as per figure 32, .....	per pair	18.00
9. The same with Whittemore's Sockets, etc., as per figure 29, .....	"	20.00

All articles illustrated are designated by a \*.



**Crandall's Crutches**, surpass others in the following particulars: The velvet covered tops can be recushioned or recovered readily. The hand-pieces can be adjusted to suit the length of the arm. The length of the crutches can be easily varied by means of wooden tips as per figure 36, of different lengths, an excellent device for those who use crutches during the period of growth.

Made ordinarily of Hickory or Iron-wood, all the following styles are supplied with rubber bottoms:

- 10.\*With brass mountings and bronzed tops,.....per pair 8.00\*
- 11. With nickle-plated mountings and bronzed tops..... " 10.00\*
- 12. With " " " " plated " ..... " 15.00\*
- 13. With full nickel-plated mountings and bronzed tops..... " 15.00\*
- 14. With " " " " plated tops..... " 20.00\*

Juvenile sizes of these (Nos. 10 to 14 inclusive) and not exceeding 40" in length, are supplied at 10 per cent. less than regular rates.

- 15.\*Plain maple, stained brown, with velvet covered tops and rubber bottoms as per figure 34,....per pair 5.50
- 16. The same with full brass mountings..... " 8.25
- 17. The same " " German silver mountings..... " 10.00
- 18.\*Plain-maple, stained brown, with velvet covered tops, *without* rubber bottoms, per pair..... 4.50
- 19. The same with full brass mountings,.....per pair 7.25
- 20. The same " " German silver mountings..... " 9.00
- 21. Plain maple, stained brown, with twilled enameled cloth tops and rubber bottoms as per figure 34,....per pair 4.25
- 22. The same, not stained, with rubber bottoms as per figure 34..... " 3.50
- 23.\*The same, *without* rubber bottoms,..... " 2.50
- 24.\*Plain-split-maple, tops not covered and *without* rubber bottoms ..... " 1.25

 Crutches enumerated above "with full brass or German silver mountings" have in addition to the usual mountings, the latter attached to the hand-pieces also, where they add greatly to the strength and appearance of the crutches. 

The following with cow-horn shaped tops of smoothly polished black-cherry, wearing smooth and consequently saving the wearers clothes.

25.





26, 27, and 28.



- 25.\*Rock-maple, with nickel-plated ferrules, *without* rubber bottoms (u),...per pair 2.50
- 26.\*Rosewood, with rosewood tops, nickel-plated mountings and Whittemore's sockets, etc., as per figure 29 (B),.....per pair 12.00
- 27.\*Lancewood, with rosewood tops, nickel-plated mountings and Whittemore's sockets, etc., as per figure 29 (B),.....per pair 12.00

All articles illustrated are designated by a \*.

28.\*Rock-maple, with rosewood tops, nickel-plated mountings and Whittemore's sockets, etc., as per figure 29 (B), ..... per pair \$10.00

 The hand-pieces of all the crutches enumerated above (excepting Crandall's) are secured by wire rivets running through both sides of the crutch and handle. 

MEASUREMENTS REQUIRED.

1. Give precise length from under the axilla to the floor when the patient is standing erect; or if the patient is in a horizontal position, length from under the axilla to the sole of foot.
2. When the wearer is uncommonly heavy or light, state weight so that the crutches can be made of proportionate strength.
3. Order by numbers and avoid mistakes.

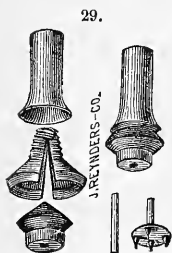

CRUTCH SOCKETS AND RUBBER BOTTOMS.

29.\*Whittemore's sockets with hinged screw clamp jaws for holding the rubber bottoms. The hinged screw clamp jaws holding the rubber bottom, can be readily unscrewed from the socket, opened and a worn-off rubber replaced by a new one.

Including one pair rubber bottoms, ..... per pair \$2.50



- |   |                 |         |
|---|-----------------|---------|
| 30.*Extra rubber bottoms, .....   | per pair        | 0.40    |
| 31.*Creeper or brads, .....   | per set of four | 0.25    |
| 32.*Fine sockets with rubber bottoms, .....   | per pair        | 1.50    |
| 33. Extra rubber bottoms, .....   | "               | 0.40    |
| 34.*Plain sockets with rubber bottoms, .....  | "               | 1.00    |
| 35. Extra rubber bottoms, .....   | "               | 0.40    |
| 36.*Crandall's wooden extension tips with sockets and rubber bottoms, according to the length of the wooden extension tips. Per pair from |                 | 2.50    |
|   |                 | to 3.00 |



- |  |          |         |
|--|----------|---------|
| 37. Crandall's sockets with rubber bottoms, .....                        | per pair | 1.00    |
| 38. Extra rubber bottoms, .....  | "        | 0.50    |
| 39. Crandall's wooden extension tips, according to length. Per pair from |          | 0.50    |
|  |          | to 1.00 |





People who are obliged to wear crutches receive actual benefit from the use of rubber bottoms on the lower ends of the crutches to prevent scarring floors, slipping, and to break the tiresome jar unavoidably connected with a plain wood or metallic end. No one who wears crutches even temporarily can afford to use them without a rubber bottom attached. In consideration of this we offer for Nos. 18, 19, 20, 23, and 24; rubber bottoms as represented below:



- |   |          |      |
|---|----------|------|
| 40.*Rubber bottoms No. 1 for $\frac{3}{4}$ " stick, ..... | per pair | 0.25 |
| " " No. 2 " 1" " .....                                    | "        | 0.25 |
| " " No. 3 " $1\frac{1}{4}$ " " .....                      | "        | 0.30 |
| " " No. 4 " $1\frac{3}{8}$ " " .....                      | "        | 0.35 |

41.\*Heavy rubber bottoms, for sticks measuring from  $\frac{3}{4}$ " to  $1\frac{1}{8}$ " diameter. According to size, per pair from \$0.30 to 0.50.

 Rubber bottoms for sockets Nos. 32, 34, and 36 are made of  $\frac{7}{8}$ ", 1", and  $1\frac{1}{8}$ " diameters. When ordering these state inside diameter of sockets.

When ordering rubber bottoms No. 40 and 41, state diameter of the crutch end. 

All articles illustrated are designated by a \*.

**74D. DR. A. M. PHELPS' MODIFICATION OF VON WIDERHOFER'S SHOE FOR FLATFOOT AND TALIPES VALGUS.**

The object of the inventor was to devise a shoe so constructed as to rotate the foot inwards and support the arch, thereby throwing the weight of the body upon the outside of the foot. In the normal foot the weight of the body is transmitted through the arch on the inner side through the scaphoid bone. With the shoe properly adjusted with the thickened sole on the inside, the foot being rotated inwards, the weight of the body is transmitted through the cupoid bone or the outer side of the arch. The strap, *D*, passed under the inner side of the arch can be adjusted by the patient, and it will be found only a few pounds will be required to support the arch when the foot is properly rotated by the beveled sole and steel rod on the inner side of the ankle.

**DESCRIPTION.** — *A*, lace shoe with sole and heel raised along their inner edges from one-eighth to one-quarter of an inch; secured to the sole of this shoe is a strong foot-piece united by a joint (opposite the ankle joint) to an upright bar with a well padded band, *E*, for encircling the limb. The elevator strap, *D*, is secured inside of the shoe, close to its outer edge, passes under the arch of the foot,



over the padded band, downwards on the outside of the bar, through a ring with roller and into a buckle, where it is secured and by which its tension can be regulated.

**MEASUREMENTS REQUIRED.**

1, sex of patient. 2, age of patient. 3, weight of patient. 4, length from the sole of the shoe to the middle of the ankle-joint. 5, length from the sole of the shoe to *M*, see diagram of leg on page 293. 6, circumference of leg at *M*; (see diagram of leg on page 293). 7, mention if for the right, left foot or for both feet. 8, send us a well-fitting shoe or pair of shoes to lace. Prices, from \$6.00 to \$10.00 each.

**74E. DR. A. M. PHELPS' ANKLE EXTENSION AND FIXATION SPLINT.**

The objects in devising the ankle splint are: 1st, to make it combine extension with fixation, thereby placing the joint absolutely at rest; 2d, a cheap splint, thereby bringing it within the reach of dispensary patients.

The splint combines everything that is found in other fixation and extension splints. It possesses the elements of cheapness, durability, ease of application and comfort.

It consists of a strong flat wooden sole, in its outline shaped to conform with the shape of the sole of the foot. Firmly secured across this and countersunk into the same are two steel bars with a perforation at each end, through which the bifurcated extension bars *A* pass and are secured below by thumb nuts *B*. These extension bars are made of wire flattened at their upper extremities *D*, and perforated with numerous equidistant openings through which looped spring pins *E* are secured. The leg collar *C*, made of heavy tin with beveled edges, is supplied with a looped spring pin for locking also on two opposite sides with three strong loops on each side through which the flattened upper extremities of the extension bars pass.

The manner of application is the same as for Sayre's Ankle Extension Splint (see page 343). After the sole and collar of this splint have been properly secured to the foot and leg of the patient, the flattened extremities of the extension bars are passed upwards through two (one on each side) of the loops on the collar and then pushed downwards through the openings in the cross bars on the wooden sole, where they are secured on the lower side by the thumb nuts. Traction is then made upon the foot and leg until the proper extension has been obtained and an assistant secures, *i. e.*, retains, the extension by pushing looped spring pins into the proper openings in the flattened extremities of the extension bars and under the loops through which they have been previously passed, and as shown by above figures.

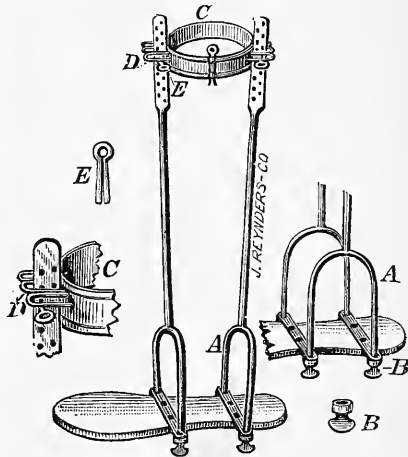

**MEASUREMENTS REQUIRED.**

1, state age and sex of patient. 2, weight of patient (estimated). 3, trace the outlines of the sole of the foot upon a piece of paper and send it. 4, state whether for the right or the left ankle. 5, state length from sole of foot to garter. 6, state circumference at garter. 7, state circumference around ankle-joint.

Price, from \$8.00 to \$15.00.

LECLANCHE DESK OR TABLE APPARATUS.

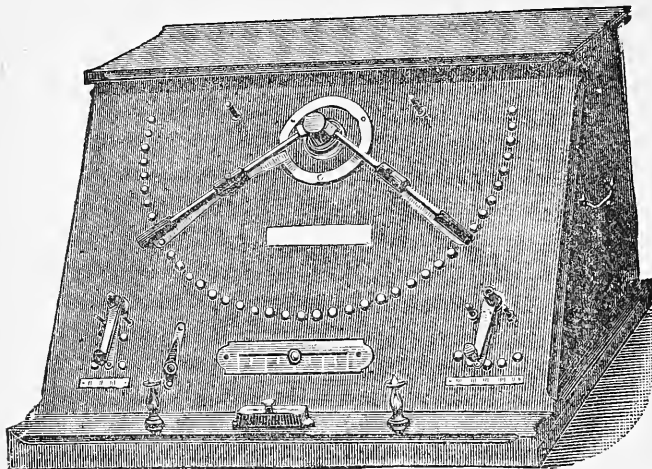

Leclanche Galvanic Cell.

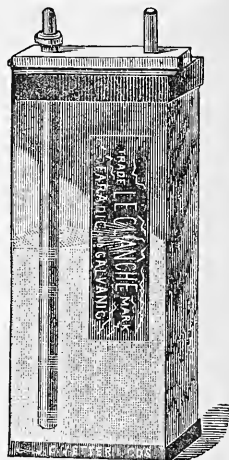

18 in. wide; 18 in. deep; 11 in. high; 40 Cells Galvanic; 2 Cells Faradic.

Fig. A Cell. Height, 4 1/4 in.; depth, 1 1/2 in.; width, 2 in.

- Style No. 1 represents our Desk or Table Combination Galvanic and Faradic Apparatus. Suitable for office work. Contains 40 fig. A Cells for Galvanic, 2 Cells Faradic Currents. Has our Current Selector, Pole Changer, 3 Handles, 4 Sponge Discs, pair of Connecting Cords. Ready for use. . . . . \$90.00††
- Style No. 2. Same as above, without Faradic. . . . . 75.00††
- “ 3. “ “ Galvanic and Faradic, without Cells. . . . . 50.00††
- “ 4. “ “ Galvanic, without Faradic and without Cells. . . . . 35.00††

Nos. 3 and 4 are arranged so that physicians having their own cells can connect them to above apparatus themselves.

THE VETTER MILLIAMPEREMETER.

Fig. A. Ours is an absolutely correct instrument, reading to 50 and 500 milli-amperes, in the construction of which we endeavored to overcome the faults we found in other makes, and thus have succeeded:

1st. To obviate the oscillations of index.

2d. To dispose of the magnetic attraction at the bearings.

3d. To furnish a suspension that will not get blunted, as is the case with the knife edge about the bearings of other makes.

Our improvements consist in so balancing the magnet that it will come to a dead rest at once, enabling instant reading. A nicely pivoted shaft suspended in ruby jeweled bearings and jeweled end pieces affords an apparatus which practically will remain in perfect condition forever.

Price. . . . . \$35.00††

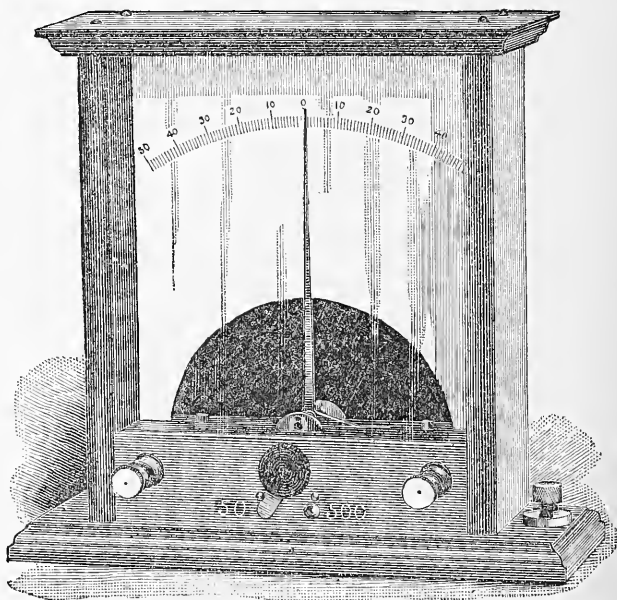
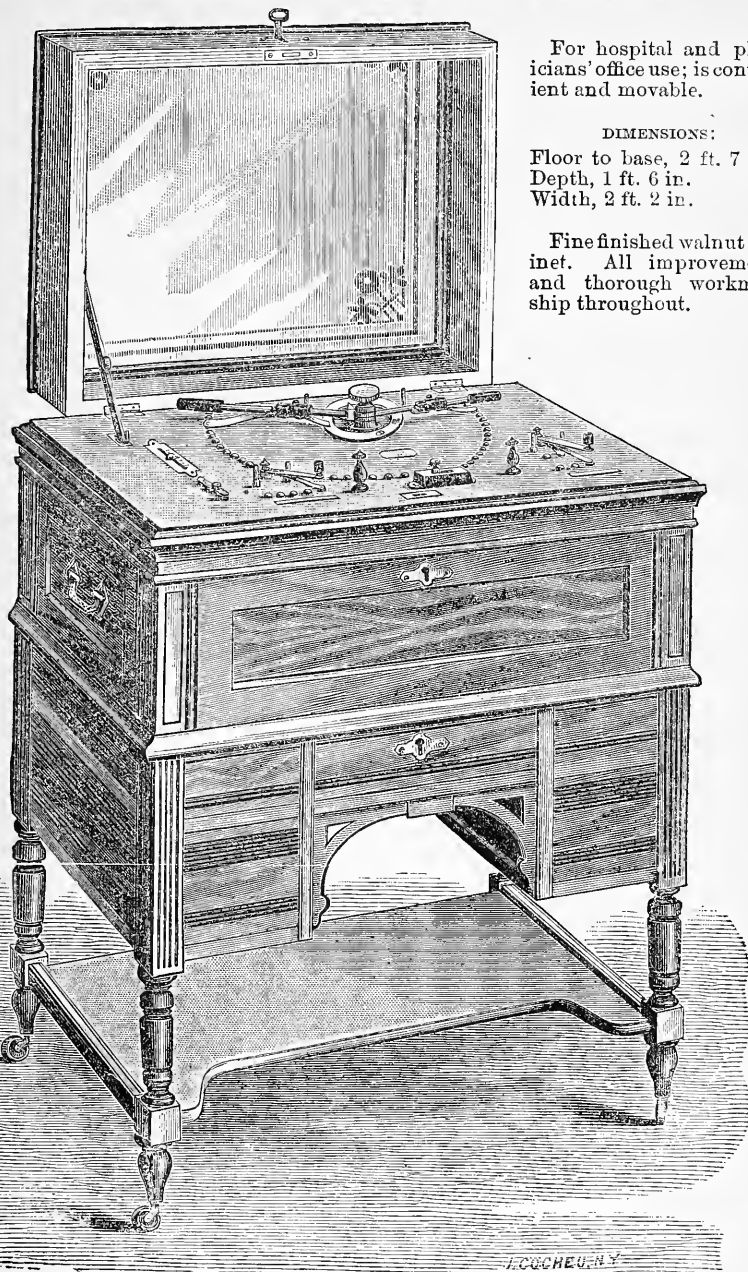

Fig. A.

It is now conceded that the Milliamperemeter is one of the most important factors in the treatment of disease by electricity, as with it the exact amount, or “dosage,” of the current that passes through the patient can be determined.



THE VETTER CABINET COMBINATION APPARATUS.



For hospital and physicians' office use; is convenient and movable.

DIMENSIONS:

Floor to base, 2 ft. 7 in.  
Depth, 1 ft. 6 in.  
Width, 2 ft. 2 in.

Fine finished walnut cabinet. All improvements and thorough workmanship throughout.

- 23. Cabinet Combination Galvanic and Faradic Apparatus, supplied with 40 fig. A glass cells as per cut No. 7 (see page 378)..... \$150.00†
- 24. Cabinet Combination Galvanic and Faradic Apparatus, supplied with 65 fig. A glass cells as per cut No. 7 (see page 378)..... 175.00†
- 25. Cabinet Combination Galvanic and Faradic Apparatus, supplied with 126 fig. A glass cells as per cut No. 7 (see page 378)..... 225.00†

OUTFIT FOR APOSTOLI TREATMENT.

Law Prism Cell.....	\$1.50*	Bi-Polar Vaginal Electrode for Faradic Current.....	\$4.00††
Eclipse "Duplex" (double) Cell.....	2.00*	Same, Intra-Uterine.....	4.00††
Eclipse "Bell" Cell.....	1.25*	Platinum Electrode for Galvano-Puncture and Intra-Uterine use, with a long and a short hard rubber Insulating Shield for same.....	20.00††
Eclipse "Hussey" Cell.....	2.50*	Large Abdominal Electrode.....	5.00††
The above in larger quantities at reduced prices—full particulars on application.			
Bailey Rheostat.....	10.00*		
Milliamperemeter, see page 378.			

## J. R. &amp; CO.'S IMPROVED STORAGE BATTERY. §

FOR GALVANO-CAUTERY, ELECTRIC LIGHT AND MOTOR PURPOSES.

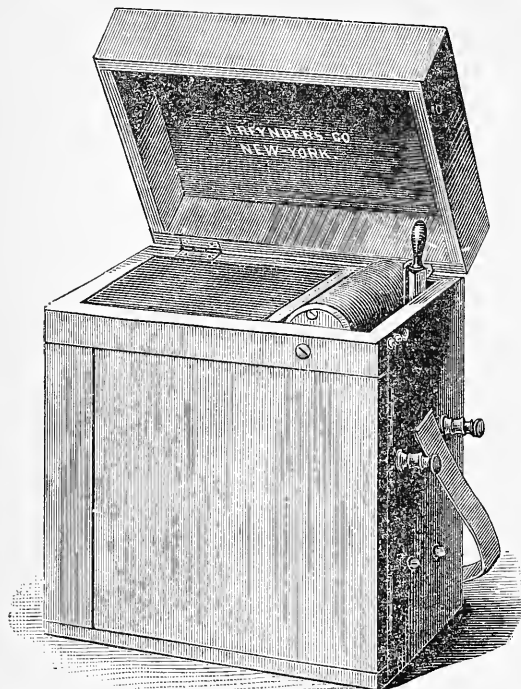

A Storage Battery is, as its name implies, a receptacle or reservoir into which electricity from some primary source is accumulated. This primary source may consist of the requisite number of cells, such as the Crow-foot, or the Watson, or of a Dynamo Machine of proper construction. While the electricity as generated at any given time from the primary cells would not be sufficient for any desired effect, it may be accumulated in a Storage Battery until it has attained such sufficiency in quantity and quality. With a Storage Battery the electricity can be secured so as to be on hand when wanted, doing away, as in Caution Batteries, with the objectionable task of having to generate electricity while operating. The storage current is even and strong for several hours, not deteriorating until the supply of electricity is exhausted. The Rheostat is for controlling the amount of electricity in the current while in use. Our connections are such as to have two pairs of cords in use if desired.

Full directions for charging and manipulating accompany each Battery.

A sufficient number of Primary Cells for charging are furnished with each Battery.

The ONE-CELL STORAGE BATTERY is intended for light galvano-cautery

work, such as the heating of small cautery knives and points to be used for operations on the eye, ear and throat, as well as a one-inch loop of No. 5 platinum wire.

Storage Battery, containing 1 Cell and Rheostat, with 4 Gravity Cells for charging. . . . \$25.00  
Capacity 2 volts, 5 Ampère Hours—Size, 7x8x12 inches.

Storage Battery Outfit A . . . . . \$30.00  
*Consists of:* One-Cell Storage Battery with 4 Gravity Cells. 1 plain Interrupting Handle.  
1 pair of heavy Cables. 2 Nasal Electrodes.

The TWO-CELL BATTERY will heat a three-inch loop, has sufficient power to run our small motors for nasal and dental drills, burrs, etc., and will light our small illuminators.

Storage Battery, containing 2 Cells and Rheostat, with 8 Gravity Cells for charging. . . . \$35.00  
Capacity 4 volts, 5 and 10 Ampère Hours—Size, 7½x8½x12 inches.

Storage Battery Outfit AA . . . . . \$50.00  
*Consists of:* Two-Cell Storage Battery with 8 Gravity Cells. 1 Electrode Outfit No. 2.  
1 pair of heavy Cables. 1 One-Candle Power Illuminator.

The THREE-CELL BATTERY can be used for any kind of galvano-cautery work, will light a two-candle power lamp for ten hours, and run an electric motor of one-eight horse-power about three hours.

Storage Battery, containing 3 Cells and Rheostat, with 12 Gravity Cells for charging. . . \$45.00  
Capacity 6 volts, 5 and 15 Ampère Hours—Size, 7½x10½x12 inches.

Storage Battery Outfit AAA . . . . . \$70.00  
*Consists of:* Three-Cell Storage Battery with 12 Gravity Cells. 1 Electrode Outfit No. 3.  
1 pair of heavy Cables. 1 Two-Candle Power Illuminator.

For description of Electrode Outfits see pages 17 and 20.

**GIBSON STORAGE BATTERY.†**

**SURGEONS' AND PHYSICIANS' PORTABLE BATTERIES.**

Enclosed in polished hard wood case:

- Type C. 1 Cell, capacity 2 volts, 5 Ampère Hours, gross weight 6 lbs., size 3½x4x8 inches. Will heat small cautery knife for ordinary nasal or laryngeal operations. . . . . \$23.00
- Type C-2. 2 Cells, capacity 4 volts, 5 Ampère Hours, gross weight 11 lbs., size 4x6½x8½ inches. Will quickly heat medium size cautery knife for ordinary operations, or it will light a 1 candle lamp for three hours. . . . . \$40.00
- Type C-3. 4 Cells, capacity 6 volts, 5 Ampère Hours, gross weight 16 lbs., size 4x9x10 inches. Will heat cautery knife or platinum loop for removing tumors, etc., or it will light a 3 candle lamp for three hours. . . . . \$56.00
- Type C-4. 4 Cells, capacity 8 volts, 5 Ampère Hours, gross weight 22 lbs., size 7½x6x8 inches. Will heat long platinum loop, or it will light a 4 candle lamp for three hours. . . . . \$73.00
- Type D. 1 Cell, capacity 2 volts, 10 Ampère Hours, gross weight 11 lbs., size 5x5x8 inches. Will heat larger cautery knife than type C, for nasal, laryngeal, uterine or rectal operations. . . . . \$34.00
- Type D-2. 2 Cells, capacity 4 volts, 10 Ampère Hours, gross weight 21 lbs., size 5x10x9 inches. Will heat largest size knife or loop, or it will light a 1 candle lamp for six hours. . . . . \$61.00

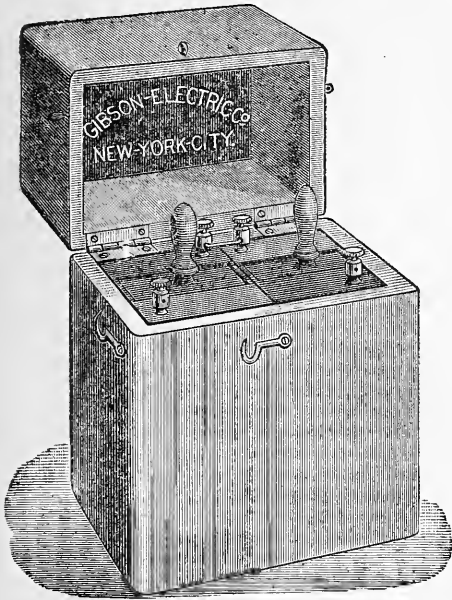

**RIVER AND RAIL STORAGE BATTERY.\***



Price of Three Batteries in case; size, small \$50.00; large \$60.00.

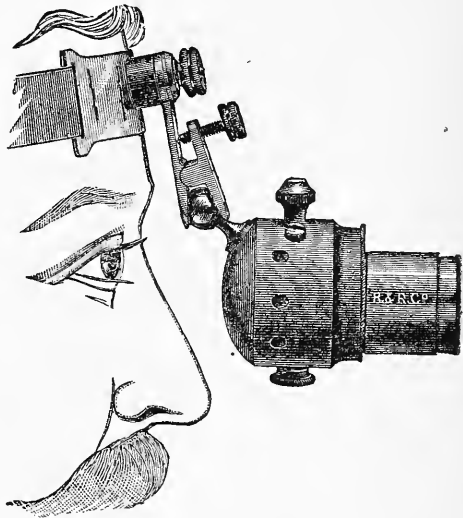

Four Candle Power Electric Lantern, with Head Band, Lenses, Cord, etc., complete \$25.00.

ELECTRO-STORAGE.

CABINET SET.

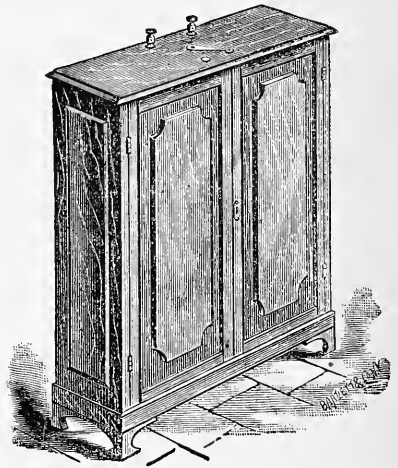
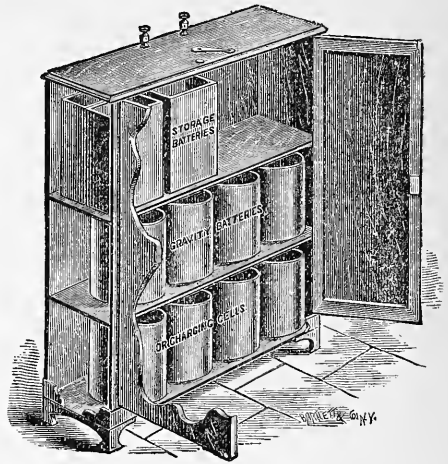
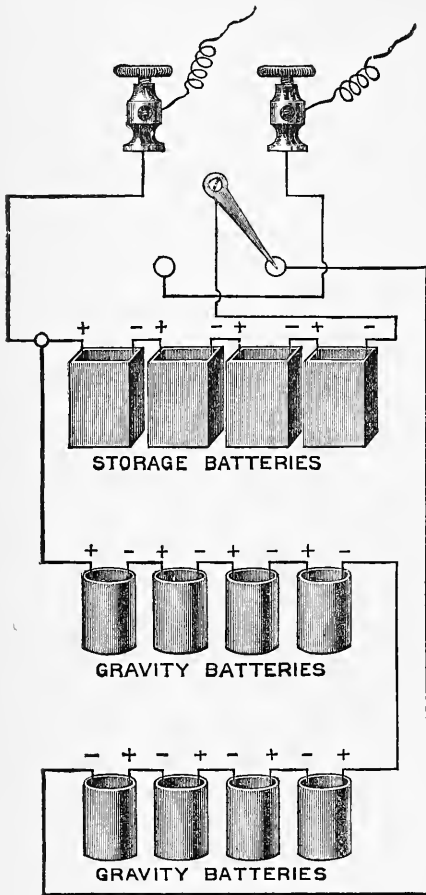

Our Special Cabinet Set for office work, with Sliding Rheostat, four Cells Storage Battery and eight Cells Charging Battery, handsomely mounted in a walnut cabinet, especially manufactured for heavy work.

The Storage Battery is charged from the Gravity Battery, which is so arranged that the charging current can be switched to and from the Storage Battery by a small switch lever, thus keeping the Storage Battery constantly charged.

The portable sets can be charged from the Gravity Battery in the Cabinet Set.

Price of Cabinet Set complete as described.....\$90.00

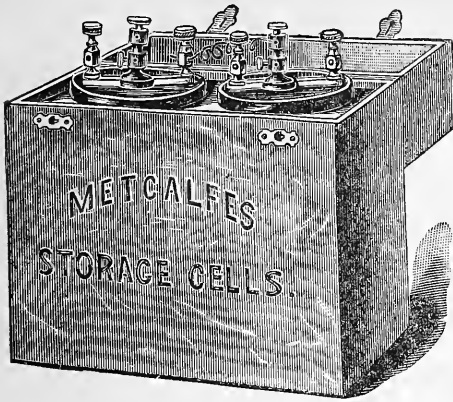

**"BLACK GIANT" STORAGE BATTERY.**

With Latest Improved and Perfect Rheostat.

A new and reliable Storage Battery for Galvano-Cautery, Electric Light and Motor Purposes.

Guarantee: Each "Black Giant" Storage Battery is tested before delivery and a written guarantee that, if handled with proper care, it will keep in good working order for two years accompanies each battery. None genuine without our trade-mark.

	SIZE.	WEIGHT. (WITH FLUID.)	ELECTRO-MOTIVE FORCE.	CURRENT AMPÈRES.	PRICE.
One Cell Battery,	6½x7x11½	15½ lbs.	2½ volts.	1 to 20	\$25.00
4 Primary Cells, for charging, and 25 ft. of Insulated Copper Wire, \$3.00 extra.					
Two Cell Battery,	11 x7x11½	28 'lbs.	4½ volts.	1 to 20	40.00
8 Primary Cells, for charging, and 25 ft. of Insulated Copper Wire, \$6.00 extra.					

**"Black Giant" Storage Battery for Galvano-Cautery.**

**SERIES D.**

Outfit D.....	\$30.00.	Same, with four primary cells,	\$3.00 extra.
<i>Consists of:</i> 1 one-cell "Black Giant" Storage Battery.			
1 pair of heavy Conducting Cables.			
Outfit DD.....	\$40.00.	Same, with four primary cells,	\$3.00 extra.
<i>Consists of:</i> 1 one-cell "Black Giant" Storage Battery.			
1 pair of heavy Conducting Cables.			
1 Universal Handle.			
Outfit DDD.....	\$50.00.	Same, with four primary cells,	\$3.00 extra.
<i>Consists of:</i> 1 one-cell "Black Giant" Storage Battery.			
1 pair of heavy Conducting Cables.			
1 plain Interrupting Handle.			
1 Universal Handle.			
Outfit DDDD.....	\$60.00.	Same, with four primary cells,	\$3.00 extra.
<i>Consists of:</i> 1 one-cell "Black Giant" Storage Battery.			
1 pair of heavy Conducting Cables.			
1 plain Interrupting Handle.			
1 Schech Universal Handle.			

**"Black Giant" Storage Battery Outfits for Electric Motors.**

**SERIES E.**

Outfit E.....	\$80.00.	Same, with eight primary cells,	\$5.00 extra.
<i>Consists of:</i> 1 two-cell "Black Giant" Storage Battery.			
1 ½ h. p. Electric Motor.			
1 Flexible Shaft and Cable.			
Outfit EE.....	\$85.00.	Same, with eight primary cells,	\$5.00 extra.
<i>Consists of:</i> 1 two-cell "Black Giant" Storage Battery.			
1 ½ h. p. Electric Motor.			
1 Flexible Shaft and Cable.			
Outfit EEE.....	\$90.00.	Same, with eight primary cells,	\$5.00 extra.
<i>Consists of:</i> 1 two-cell "Black Giant" Storage Battery.			
1 ½ h. p. Electric Motor.			
1 Flexible Shaft and Cable.			
Single "Black Giant" storage cells, complete.....	\$15 00		
Single primary cell, complete.....	75c.	Watson's	1.50
Copper.....		each	0.12
Jars.....		"	0.30
Insulated Copper Wire.....		per foot	0.02
Zinc, with connector.....		each	0.35
Blue Vitriol.....		per lb.	0.08

**GALVANO-CAUTERY HANDLES, SNARES AND ELECTRODES.**

**NASAL ELECTRODES.\***

(STRAIGHT.)

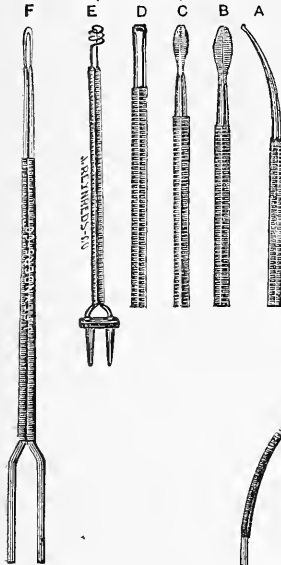

- A. Bulb-pointed, straight or slightly curved.....\$1.50
  - B. Knife..... 1.50
  - C. Curette..... 1.50
  - D. Curette..... 1.50
  - E. Spiral..... 1.50
  - F. Point..... 1.50
- Nasal and Laryngeal Electrodes, heavy and with cross pieces of hard rubber like E, additional 0.50  
The latter are by far more recommendable.
- G. Point.....\$2.00
  - H. Post nares Curette..... 2.00
  - I. Knife..... 2.00
  - J. Laryngeal Curette..... 2.00
  - K. Pointed Bulb..... 2.00
  - L. Tonsil (spiral)..... 2.50

**LARYNGEAL ELECTRODES.\***

(CURVED.)

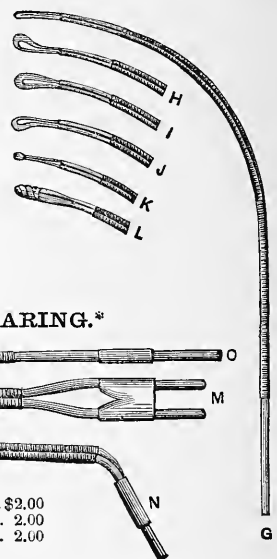

**CANULAE FOR SNARING.\***

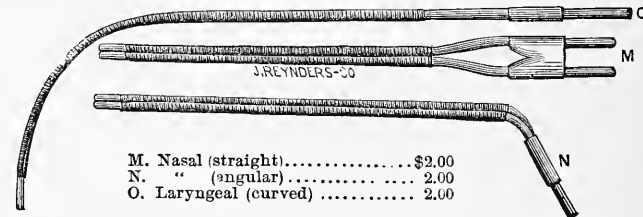

- M. Nasal (straight).....\$2.00
- N. " (angular)..... 2.00
- O. Laryngeal (curved)..... 2.00

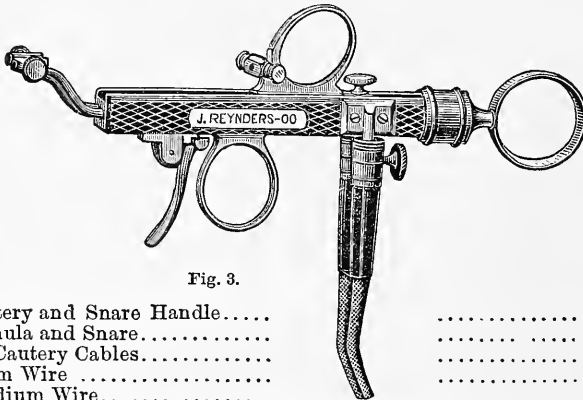

Fig. 3.

- Schech's Cautery and Snare Handle..... \$12.00
- With one Canula and Snare..... 14.00
- Extra heavy Cautery Cables..... \*per pair 3.00
- Pure Platinum Wire..... \*per foot 0.35
- Platinum Iridium Wire..... \* " 0.50
- " " " Gleitsmann's Special Spring Temper..... .21 in. 1.00



Fig. 1.

- Plain Interrupting Handle, with or without Set Screw for Electrodes..... 3.50

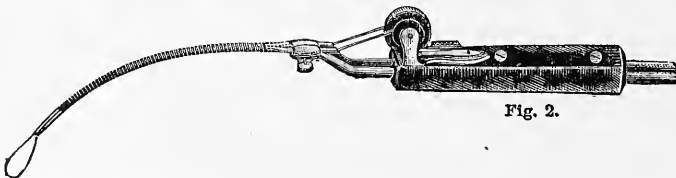

Fig. 2.

- Universal Cautery and Snare Handle..... 10.00
  - With one Canula and Platinum Wire..... 12.00
- N. B.—The handle can be used either straight or angular, and is so constructed that it can be instantly converted into a plain handle, by removing the snare.

**ELECTRODE OUTFITS.**

(See page 384.)

Sattler-Nieden's complete set of Eye-Electrodes and Interrupting Handle, in case . . . . .	\$12.00
Electrode Outfit No. 1 . . . . .	5.00
<i>Consists of:</i> 1 plain Interrupting Handle (Fig. 1). . . . . 2 Nasal Electrodes, B and F.	
Electrode Outfit No. 2 . . . . . in morocco case,	15.00
<i>Consists of:</i> 1 Universal Handle (Fig. 2). . . . . 2 Nasal Electrodes, B and F.	
2 Laryngeal Electrodes, G and I. . . . . 1 Canula, M.	
1 Coil of Platinum Wire.	
Electrode Outfit No. 3 . . . . . in morocco case,	25.00
<i>Consists of:</i> 1 plain Interrupting Handle (Fig. 1). . . . . 1 Universal Handle (Fig. 2).	
3 Nasal Electrodes, B, C and F. . . . . 3 Laryngeal Electrodes, G, H and I.	
1 Tonsil Electrode, L. . . . . 2 Canulae, O and M.	
1 Coil of Platinum Wire.	
Electrode Outfit No. 4 . . . . .	35.00
<i>Consists of:</i> 1 plain Interrupting Handle (Fig. 1). . . . . 1 Schech's Handle (Fig. 3).	
4 Nasal Electrodes, A, B, C and F. . . . . 5 Laryngeal Electrodes, G, H, I, J and K.	
1 Tonsil Electrode, L. . . . . 3 Canulae, O, M and N.	
1 Coil of Platinum Wire.	
The same, with Extra Electrode A, and D and E . . . . .	40.00

OTHER OUTFITS CAN BE MADE TO ORDER.

Should Outfits 2 and 3 be preferred with Schech's Handle (Fig. 3), same will be substituted for \$2.00 additional.

*Notice.* Each Battery, Cables, Handles and Electrodes are carefully tested before they leave our hands.

**ELECTRIC MOTOR OUTFITS.\***

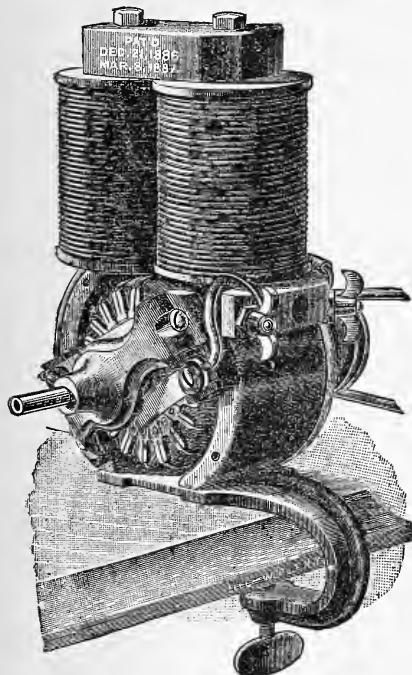

Fig. 4.

For the running of Dental Engines, Static Machines, Nasal Drills and Burrs, and wherever a small motor equal to man-power can be advantageously used.

The motor is so arranged that the flexible shaft and hand piece can be attached directly to the axle-shaft of the armature. Dr. Jarvis describes the mechanism of this motor as follows:—"The axle-shaft can be discerned projecting from the center of the motor-box. By simply unscrewing the face-plate the component parts of the motor can be readily reached and examined. The armature, of the ring type, is wound continuously, wire of trapezoidal section being used. The commutator brushes are so arranged that no injury can arise from reversing the motion of the armature. The commutator segments, seventeen in number, are placed in a circular manner, being separated by an interval of only one-sixteenth of an inch. This close arrangement of the segments secures uninterrupted and great power without sacrificing speed. Hence there is absolutely no dead-point, a prevalent objection with electric motors, and the common annoyance of laboriously adjusting the armature at intervals during an operation is, by this device, relegated to the inconveniences of the past. The counter-electro-motive force generated by the motor running at 1,800 turns a minute, with an 18-ampere current in the field, is 5 volts. The revolutions can be carried as high as 2,000 to the minute. Its extreme capacity equals 1/2-horse power. The dimensions of the instrument are 7 1/2 x 5 x 3 inches, and weight 12 pounds."

Price of Motor . . . . .	\$20.00
Flexible Shaft and Hand Piece . . . . .	15.00
Connecting Cords, with Interrupting Push Buttons . . . . .	5.00
A Complete Outfit, consisting of Motor (Fig. 4), flexible shaft, hand piece and 2 burrs (Fig. 5, T and W), connecting cords and push button . . . . .	40.00
Additional burrs, etc., at list-prices.	

This Motor can be run satisfactorily by our Two and Three Cell Storage Batteries, or Two and Four Cell Galvano-Cautery Batteries.

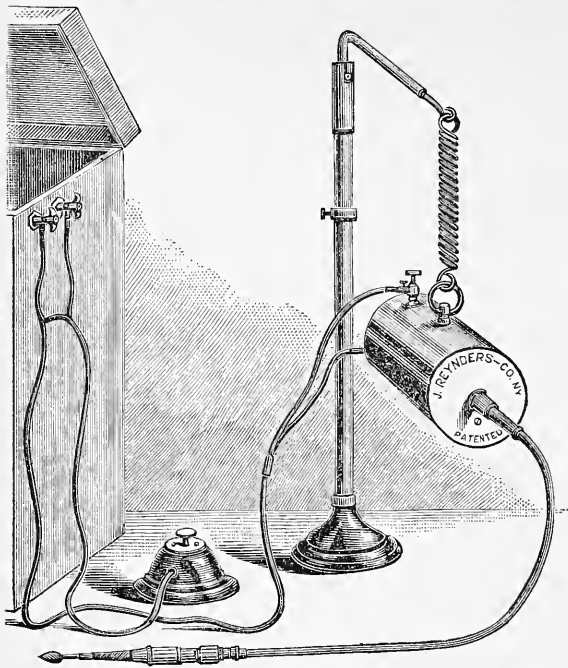

**THE CHALLENGE MOTORS**

Is especially designed for the use of surgeons and dentists to run drills, burrs and trephines for operations on the nasal septum, etc.

It can be hung either on a stand or side bracket, or suspended from the ceiling, and follows freely every movement of the hand.

- Price of Motor with balance spring ..... \$25.00
- Flexible Shaft and Hand Piece ..... 15.00
- Nickel-plated Stand ..... 8.00
- Nickel-plated Side Bracket. 6.00
- Connecting Cords with interrupting Push-Button.. 5.00
- The complete Challenge Motor Outfit, consisting of Motor, with Flexible Shaft, Hand Piece and 2 Burrs, A 4 and 5, Connecting Cords and Push-Button.. 45.00
- Additional Burrs, etc., at list-prices.

**INSTRUMENTS TO BE WORKED BY ELECTRIC MOTORS.**

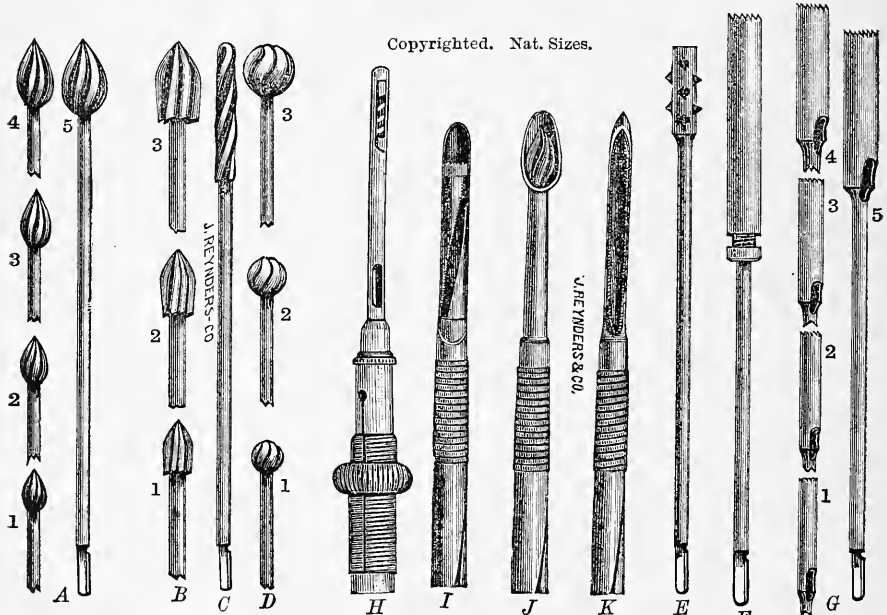

Copyrighted. Nat. Sizes.

Nasal Burrs, A (1 to 5), Olive shape; B (1 to 3), Conic; C, Spiral; D (1 to 3), Globular .....	each	\$2.00
Nasal Rasp E.....		2.00
Nasal Trephines, G (1 to 5), with holes .....	each	2.00
Nasal Trephines, F, unscrewing same sizes as G .....	"	2.00
Dr. Jarvis' antiseptic guarded tubular Scissors Drill .....		7.00
"    "    "    interrupted tubular Spiral Drill .....		6.00
"    "    "    guarded Nasal Plane.....		5.50
"    "    "    Rasp Drill .....		3.00
Dr. Goodwillie's guarded Nasal Scissors Drill, I.....		10.00
"    "    "    Knife Drill, J.....		8.00
"    "    "    Burr Drill, K.....		6.00
Jarvis' Saw, E.....		*12.00



ILLUMINATORS AND UTERINE CAUTERIES.

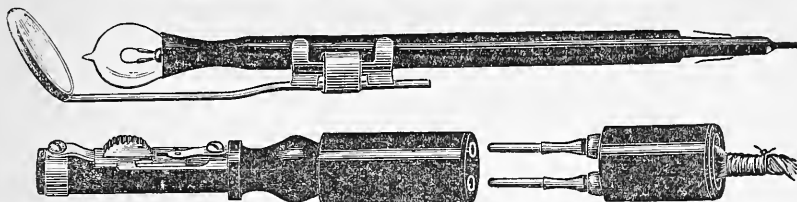

Electric Illuminator, 1 candle power Edison lamp, mounted on a hard rubber handle with interrupting switch and conducting cords, in case..... \$5.00\*  
 Same with laryngeal mirror attachment ..... 6.00\*  
 Extra Lamps ..... each 1.25\*

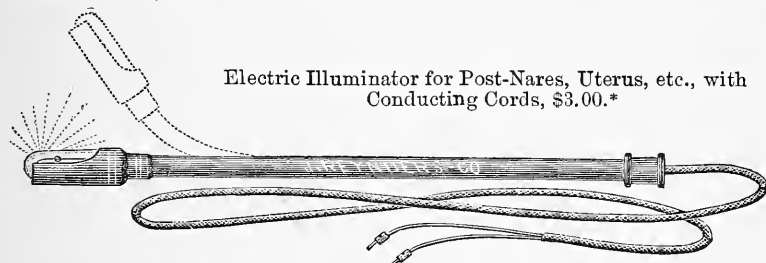

Electric Illuminator for Post-Nares, Uterus, etc., with Conducting Cords, \$3.00.\*

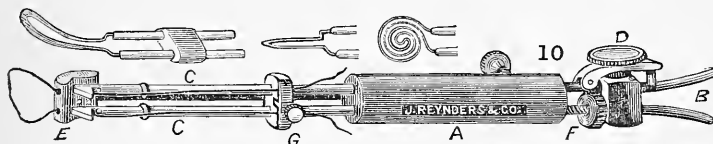

10. Shows Dawson's Electro-Cautery Sling and Knifeholder. *A* is a solid hard rubber handle, through which the connecting rods *CC* pass, connected with the conducting wires at *B*. The rods *CC* being hollow half their length, admit of the rods running from the ivory tip *E* to slide in and out like a telescope, which they are made to do by turning the small wheel *E*. This telescoping of the rods keeps up perfect current connection, and at the same time causes slow contraction of the wire loop at *E*, the ends of the wire being secured in the ivory clamps *G* on the rods *CC*. The current is regulated or cut off and on from the battery by the screw *D*. Price of Dawson's Electrodes and Handle ..... †\$35.00; Handle only †\$25.00
20. Uterine Handle for Cautery Knives ..... \$4.00\*  
 Wire..... per foot, Platinum \*35 cts.; Platinum and Iridium, 0.50\*

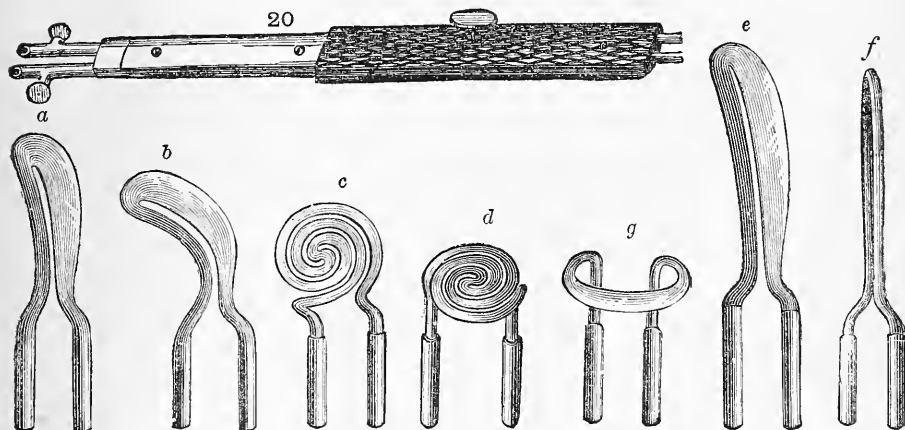

Platinum Knives, *a*, *b*, *f* and *g*..... each \$2.50\*  
 Same, *c*, *d* or *e*..... " 3.00\*

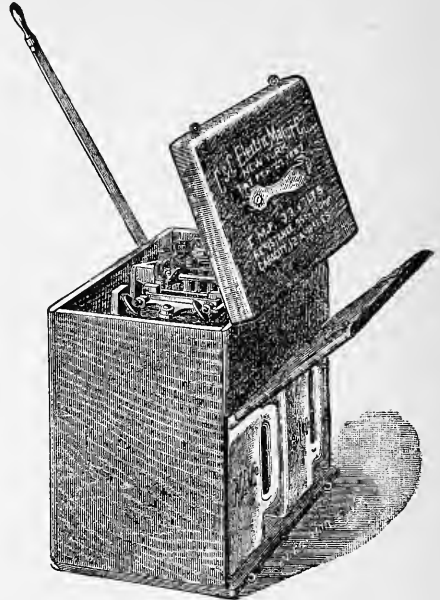
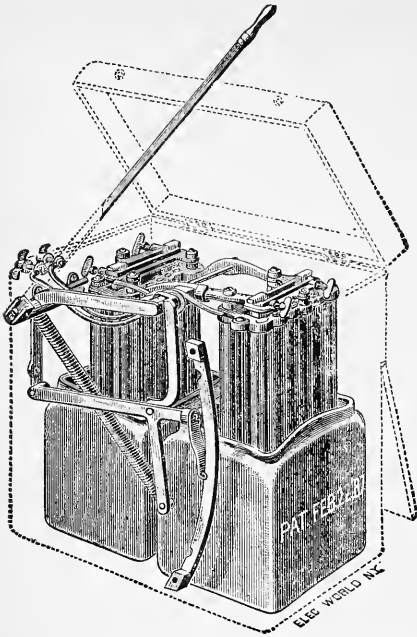

**TWO-CELL GALVANO-CAUTERY BATTERY.\***

**FOR THE EYE, EAR, NOSE AND THROAT.**

In presenting this battery we offer one so complete in its construction as to be under the perfect control of the operator; its mechanism so simple as to prevent any possible chance of its getting out of order, and reducing its cost to such a figure as to place it within the reach of every one.

THE BATTERY consists of two cells in series, the elements of which are zinc and carbon, mounted on an iron frame and balanced by a spring, so that they may be conveniently raised and lowered to any position by a lever which is attached on the outside of the box.

By changing the depth of immersion of the elements, the current can be increased or decreased as desired. It is sufficiently powerful to heat to perfect incandescence a loop of 2 inches of No. 5 platinum wire and all the nasal and laryngeal electrodes made by us.

THE MECHANISM is very simple, and cannot get out of order. To replace the zincs there need be no disconnecting of a single wire; simply loosen the thumb-screws, remove the old plate, drop a new one in its place, and tighten up thumb-screws once more. Care should be taken that the zincs do not touch the carbons and that the points of contact are kept free from oxidation.

THE CELLS are of porcelain, made in the form of a pitcher, with a handle and spout, and hold  $1\frac{3}{4}$  quarts of solution each.

Size, 8x12 Inches. Weight, 20 Pounds. Electro-Motive Force, 3.9 Volts. Current—Ampères, 25 to 35.

PRICE, \$15.00.

**COMPLETE OUTFITS, SERIES B.**

Battery Outfit B.....		\$22.00
<i>Consists of:</i>		
Two-Cell Battery.	1 pair heavy Cautery Cables.	
Electrode Outfit No. 1.	1 package Battery Compound.	
Battery Outfit BB.....		30.00
<i>Consists of:</i>		
Two-Cell Battery.	1 pair heavy Cautery Cables.	
Electrode Outfit No. 2.	1 package Battery Compound.	
Battery Outfit BBB.....		40.00
<i>Consists of:</i>		
Two-Cell Battery.	1 pair heavy Cautery Cables.	
Electrode Outfit No. 3.	1 package Battery Compound.	

 For description of Electrode Outfits see page 9.

**FOUR-CELL GALVANO-CAUTERY BATTERY.\***

For General Galvano-Cautery and the running of Electric Motors.

This Battery consists practically of 2 Two-Cell Batteries set one above the other, mounted in one cabinet, and gives accordingly twice as powerful a current. The lever regulates it the same as the Two-Cell Battery and the Current is similarly under control. The elements are so connected with binding posts on the outside of box that the cells may be used in parallel or in series. The battery cases are made of antique oak, highly polished, and represent a handsome piece of office furniture.

**TO CHARGE THE BATTERIES.**—Raise the lever so that elements clear the cells. Fill the cells to the mark indicated with an aqueous Solution of our NEW BATTERY COMPOUND (see page 6), or a strong Solution of Bichromate of Potassium and Sulphuric Acid. Lower the lever gradually, as the battery generates an intense heat and if immersed suddenly will melt the electrodes.

Electro-Motive Force, 6 to 7 Volts. Current—Ampères, 25 to 35. Size, 8x11x27 inches. Weight, 45 Pounds. Price, \$28.00.

**COMPLETE OUTFITS, SERIES C.**

Battery Outfit C .....		\$35.00
<i>Consists of:</i>		
Four-Cell Battery.....	1 pair of heavy Cables.....	
1 Electrode Outfit No. 1.....	1 package of Battery Compound.....	
Battery Outfit CC .....		42.00
<i>Consists of:</i>		
Four-Cell Battery.....	1 pair of heavy Cables.....	
1 Electrode Outfit No. 2.....	1 package of Battery Compound.....	
Battery Outfit CCC .....		52.00
<i>Consists of:</i>		
Four-Cell Battery.....	1 pair of heavy Cables.....	
1 Electrode Outfit No. 3.....	1 package of Battery Compound.....	

**SEPARATE PARTS OF BATTERIES.**

Extra Zincs for Batteries.....	each	.50
“ Cells “ “ .....	“	2.00
“ Carbon Pencils .....	“	.25
“ heavy Cautery Cables, double.....	per foot	.35

**CAUTERY BATTERIES.\*\***

**No. 1.**

Small, portable Cautery Battery, single-cell; elements consisting of 5 pairs zinc-carbon plates with hydrostat board and conducting cords..... \$15.00

**PORTABLE DOUBLE-CELL CAUTERY BATTERY, No. 2.**

Consisting of 10 pairs zinc-carbon plates, with hydrostat board and wire rheostat for modifying the incandescence on burners..... \$30.00

**SINGLE-CELL CAUTERY BATTERY, No. 3.**

For office use, consisting of one system of 10 pairs zinc-carbon plates, and a treadle arrangement, by means of which the rubber cell (containing three quarts of bi-chromate solution), is raised or lowered. Price of single-cell Cautery Battery including conducting cords..... \$30.00

The same, provided with a Commutator for converting the Cautery into a 10 cell continuous Galvanic Current Battery..... \$50.00

**DOUBLE-CELL CAUTERY BATTERY, No. 4.**

For office use, consisting of two systems of 10 pairs zinc-carbon plates each, with treadle, two rubber cells and conducting cords..... \$50.00

The same, provided with 2 Commutators for converting the Cautery into a 20 cell continuous Galvanic Current Battery..... \$95.00

**A NEW BATTERY COMPOUND.**

PUT UP DRY IN TIN CANS.

One can contains one charge and will give FOUR HOURS OF CONTINUOUS USE, or its equivalent.

Price..... \*per can 50 cts.; per dozen \$4.80

The compound is easily prepared by dividing the contents of one can between the two jars, and dissolving with water. Warm water and stirring with a glass rod will hasten the operation. Particular care should be taken not to expose the compound to the air any length of time before using, as it absorbs moisture rapidly and would soon become softened and unpleasant to handle. Do not spill the compound or fluid over the clothing or carpet; it is destructive. Its advantages are:

- |   |  |
|---|--|
| 1. It is stronger than any Battery Fluid. | 4. It Does Not Polarize.                             |
| 2. It is Easily Carried.                  | 5. It is Free from the Smell of Acids.               |
| 3. It is the Cheapest.                    | 6. It Does Not Exhaust itself, unless actually used. |

N.B.—To obtain the best possible results with this compound, the zincs should be thoroughly cleansed and amalgamated, before recharging the battery.

MINIATURE INCANDESCENT ELECTRIC LAMPS.\*

(Full Size.)

Where not mentioned the price of these is \$1.50 each.

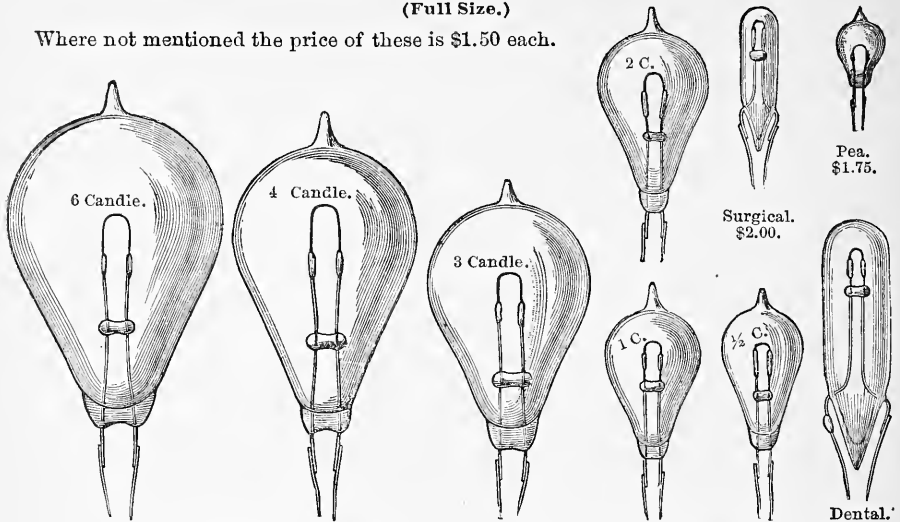

Any of the above can be mounted in a holder with cord at an additional cost of \$1.00.

MICROSCOPIC ILLUMINATOR.\*

We take pleasure in placing before the profession the Electric Light Carrying Stand represented by the cut below. It is especially adapted to be used in connection with the Microscope, but will be found of universal usefulness wherever a steady and powerfully concentrated light is to be brought in close proximity to an object of scientific investigation. Mounted on a stand like a Bull's eye condenser, the Electric Light is borne on a swivel joint, which allows of its being turned in any direction and placed on any angle. The tube is double and thus admits of being lengthened or shortened. Any Microscopist is aware of the difficulty inherent to the use of a source of light which radiates a considerable amount of heat. It is impossible to use it without interposing reflectors, lenses or illuminators. All such trouble is done away with by the introduction of incandescent Electric Lamp, the light rays emanating from such being almost free of heat rays, thus allowing the lamp to be brought in any direct position to the object. Transparent objects can be illuminated from beneath the substage without the use of a mirror, and opaque objects from above in a manner protecting the eyes of the observer from any diffused light without the use of glasses. The Electric Light is also used to an advantage for Polarized objects and all objects in general requiring Microscopical Manipulation. It is very simple and takes but little room.

Price, \$10.00.\*

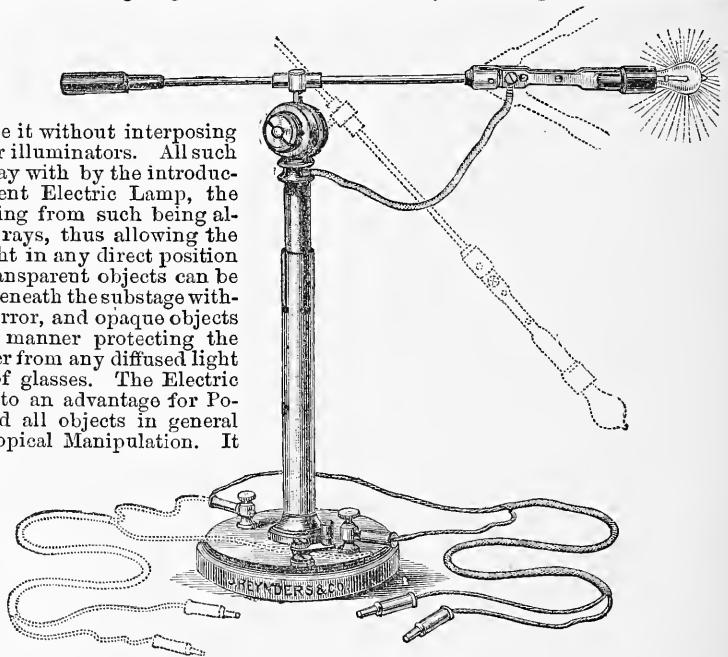

APPENDIX.

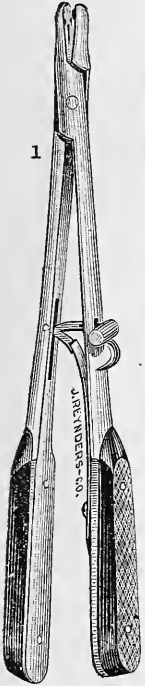

1. Needle Holder, Russian, Automatic, plain \$3.50; aseptic \$4.50.



2. Hahn's Artery Forceps, \$2.50.

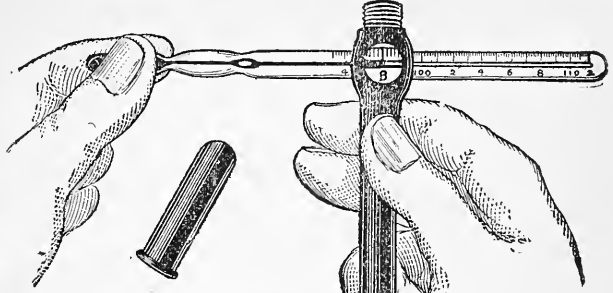

The figures above and below show a new thermometer case. The flat widening in the case, which prevents rolling, at the same time contains a magnifying lens and the case behind it a groove by which the focus is at once

found. Any one having difficulty about seeing the mercury will at once have one of these. Figure above shows its application, figure below illustrates the magnification.

Price, \$1.00.



J. REYNDERS-CO.

Dr. N. A. Powell's Suture Button, figure below shows it applied, per doz. \$1.50.

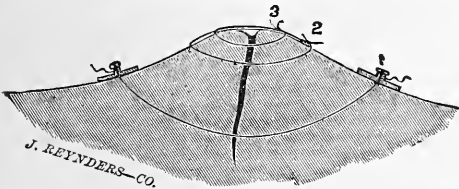

J. REYNDERS-CO.

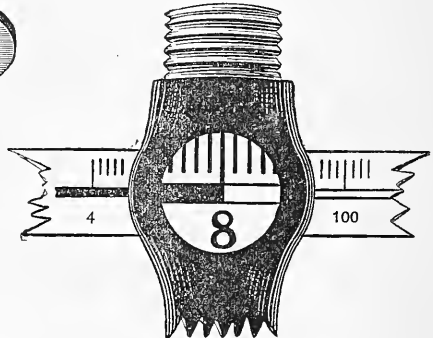

3. Boldt's all steel Tenaculum, \$1.33.

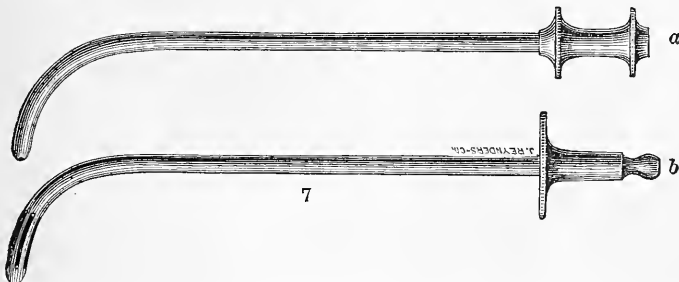

7. The above illustrations show two styles of Uitzmann's Urethral Syringe Tubes. "a" has a terminal opening, measures 14 French outside, and channel is 1/4 inch in diameter throughout, allowing escape of liquid by drops only. Price, with Syringe, \$4.00. "b" is a thick walled tube with four lateral openings. Price, with Syringe, \$3.00

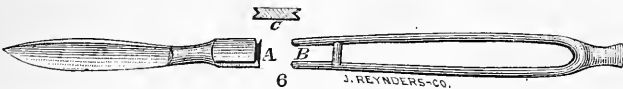

6. Above figure shows new style of aseptic Handle. The end of blades is grooved, as shown by C, and is slid into B. Adapted to pocket cases or operating sets. Price of each Handle and Blade..... \$1.33



5. Boldt's Double Curette..... \$2.00



4. Boldt's Spear-pointed Knife, \$1.50.

J. REYNDERS-CO.

J. REYNDERS-CO.

J. REYNDERS-CO.

NEW LEVIS' SPLINTS.

See pages 58 to 60.

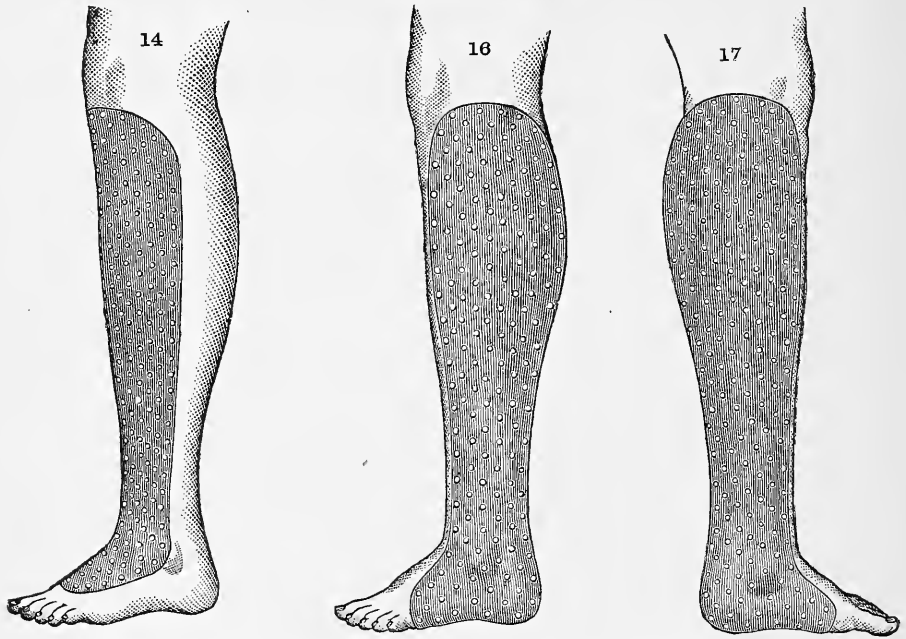

- 14.\* Anterior Tibia Splint, two sizes, adults' and children's. Can be used separately or in combination with No. 9 Levis' Splint..... each \$1.00\*
- 15.\* Anterior Patella Splint, two sizes, adults' and children's. May be used alone or with No. 8 Levis' Splint..... each 1.00\*
- 16.\* External Ankle Splint, two sizes, each right and left (4 in all), adults' and children's " 1.00\*

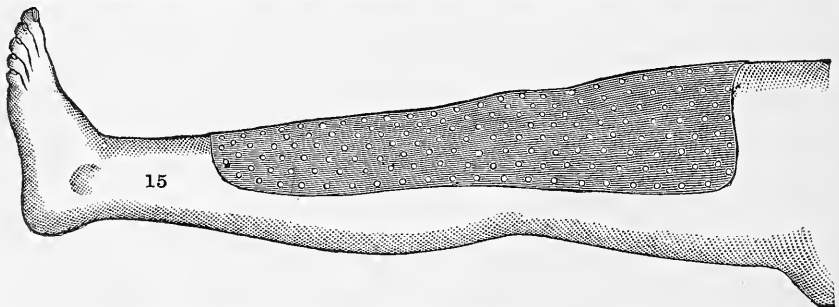

- 17.\* Internal Ankle Splint, two sizes, each right and left (4 in all), adults' and children's .....each 1.00\*

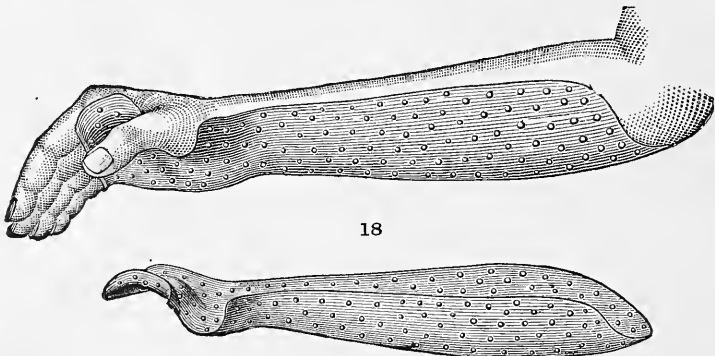

- 18.\* Ulna or Forearm Splint, two sizes, each right and left (4 in all), adult's and children's. For fractures and sprains of the forearm and dislocations of the wrist joint.. 1.00\*

APPENDIX.

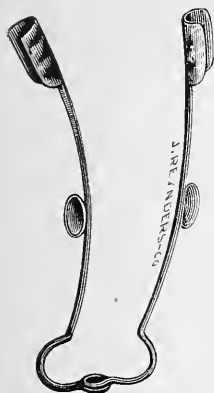

1. Stevens' Eye Speculum.....\$2.00



2. Stevens' Needle Holder ..... \$6.00



3. Stevens' Eyelid Retractor ..... 1.75



4. Stevens' Tenotomy Hook..... 1.50



5. Stevens' Traction Hook..... 2.00



6. Steven's Traction Hook (anterior view)..... 2.00

Set of Stevens' Instruments as here illustrated, \$31.00.\*



7. Stevens' Tendon Scissors..... 3.00



8. Stevens' Fixation Forceps..... \$2.50



9. Stevens' Tendon Forceps, straight..... 2.00



10. Stevens' Tendon Forceps, curved..... 2.00

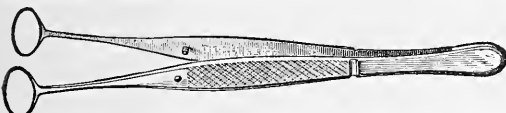

11. Prince's Trachoma Forceps ..... 2.50

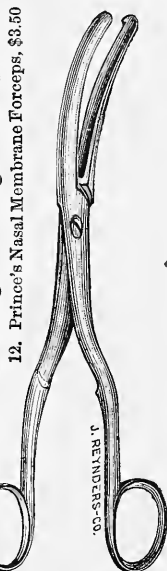

12. Prince's Nasal Membrane Forceps, \$3.50

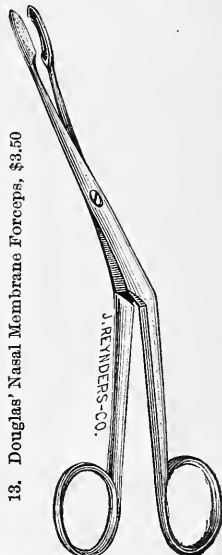

13. Douglas's Nasal Membrane Forceps, \$3.50

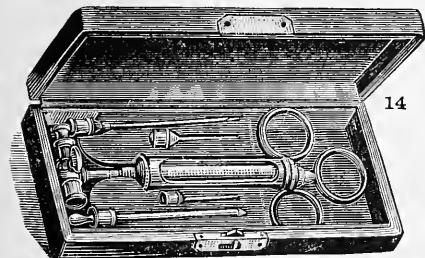

14

14. Aspirator Exploring Syringe and Hypodermic combined, in handsome leather case, containing Syringe (capacity 1/2 oz.), Aspirator Attachment, Trocar, Canula, and two Hypodermic Needles, forming a very portable and complete instrument..... \$4.00

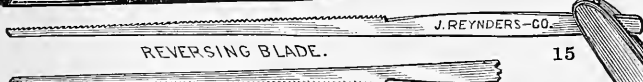

REVERSING BLADE.

15

15. Bucklin's Reversible Nasal Saw..... \$4.00

16. Holbrook-Curtis' Nasal Saw..... 1.75

Bosworth's Nasal Set, in case, consisting of Bosworth's Snare with two Canulas, straight and curved, and a handle with two assorted Nasal Saws and a Scalpel... 10.00



18

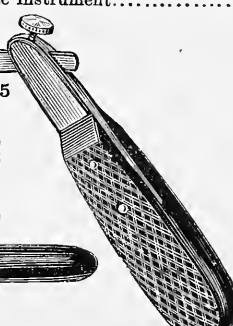

## XXXVI. APPENDIX.

## BOCK—STEGER'S MODELS,\*

COLORED IN IMITATION OF NATURE AND SEPARABLE INTO DIFFERENT PARTS. SIZE LARGE, SUITABLE FOR CLASS DEMONSTRATION. MADE OF A HARD COMPOSITION OF PLASTER OF PARIS. WITH DESCRIPTIONS (KEY) IN ENGLISH.

## A. MAGNIFIED MODELS.

1. *Human Heart*,—front part to be taken off, showing the four chambers of the heart, together with their respective openings and valves. . . . . \$8.00
2. *Human Eye*,—the upper part of the pupil (with a microscopic illustration of the retina) to be taken off, so as to show the cornea, iris, the vitreous body and crystalline lens. . . . . 6.50
3. *Human Ear*,—showing the drum and membrana tympani, the ossicles, labyrinth, and the cochlea, half open. . . . . 8.00
4. *Human Skin*,—vertical section, showing the sudoriparous glands, the organism of the hair, the pigment granules, and the organs of touch. . . . . 4.00
5. *Human Teeth*,—showing a section of the left lower jaw, development and structure of the teeth . . . . . 4.00

## B. MODELS, NATURAL SIZE.

3. *Human Brain*—
  - a. Upper view. . . . . 3.50
  - b. Under view. . . . . 3.50
  - c. Vertical section from front to back. . . . . 3.50
  - d. Horizontal section, showing the cavities. . . . . 3.50
  - e. Skull, the brain to be taken into sections. . . . . 12.00
7. *Human Head*,—with part of the neck, various sections:
  - a. Outer view, showing the muscles, bloodvessels and nerves. . . . . 6.00
  - b. Inner view, showing the cavity partially opened, position of the eye, the upper and lower jaw . . . . . 6.00
  - c. Sections, showing the brain and cavity of the nose, mouth, larynx and pharynx. . . . . 6.00
8. *Human Lungs, Heart and Larynx* (heart can be opened and both lungs can be removed). . . . . 12.00
9. *Human Larynx*,—
  - a. Larynx, front view, with the hyoid bone and thyroid gland. . . . . 2.50
  - b. Back view, showing the glottis and its ligaments. . . . . 2.50
  - c. Larynx, in connection with the tongue and pharynx opened behind. . . . . 3.50
  - d. Mask with mouth open, showing the vocal cords, etc. (Very useful for experimenting with the laryngoscope). . . . . 10.00
10. *Human Joints*,—laid open, with their bones and ligaments:
  - a. Shoulder. . . . . 2.50
  - b. Elbow, front view. . . . . 2.50
  - c. Elbow, side view. . . . . 2.50
  - d. Wrist and hand. . . . . 3.00
  - e. Hip, open. . . . . 2.50
  - f. Knee, open. . . . . 2.50
  - g. Foot. . . . . 4.00
11. *Human Trunk*,—(Torso) with the viscera of the thorax and abdomen (lungs, liver, and stomach to be removed). Extraordinary fine combination model. . . . . 30.00

Price of the whole Collection \$120, without the Torso.

Anatomical Catalogue sent on application.



GENERAL NEEDS.  
SUPERIOR RAZORS.

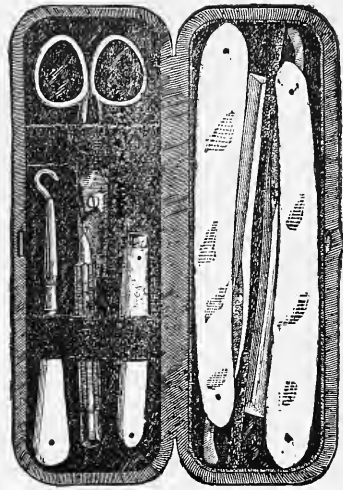
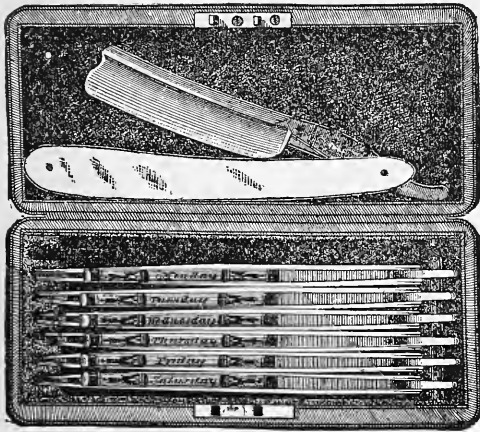

Our friends amongst gentlemen, professional and otherwise, ambitious or particular to practice upon themselves exclusively the razorial art, having often for a long time been perplexed or annoyed as to the achievement of procuring a good or excellent razor, have found us, from our thorough and intimate acquaintance with the trade and manufacturers, able to a most gratifying degree to satisfy them fully in this respect. The success we have met with leads us to make this announcement. For our sets we have a large lot pass muster before us, and select only such as stand our tests. We have only to do with one brand.

Single Razor . . . . . black handle \*\$2.00; ivory handle \*\$3.00  
 Seven Day Case, plain \*\$10.00; best black handles \$14.00; ivory 18.00  
 Toilet Case, shown on right side . . . plain \*\$7.00; calf \*8.00

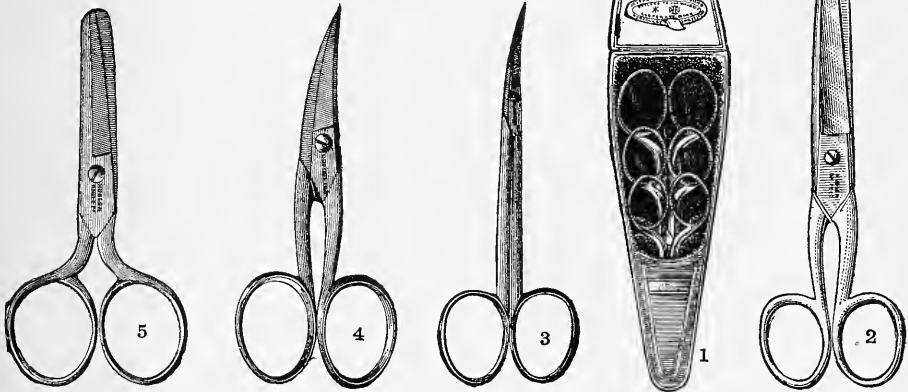

STANDARD SCISSORS.

Warranted superior material.



1. Ladies' Case . . . . . of 3 \*\$6.00; of 4 \*\$7.00
2. " Household . . . . . \*1.25
3. Light Manicure . . . . . \*1.25
4. Nail, straight or curved . . . . . \*0.75
5. Pocket, blunt point . . . . . \*0.75
6. " folding..small \*75 cts; large \*1.00



Quaint Barometer. In good weather the woman, in bad weather the man will come out. . . . \$1.25\*

APPENDIX.

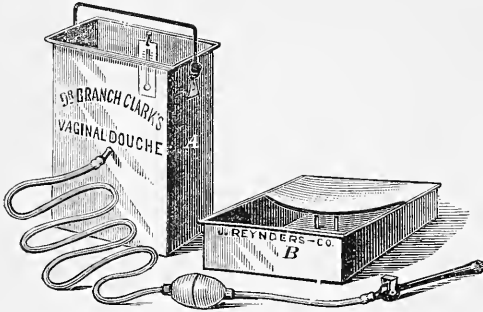

1. Dr. Branch Clark's Douche No. 2 (see also page 197C). The bedpan "B," sliding into the basin "A," affords portability. The outflow is placed several inches above the bottom, so as to insure the water used not cooling down too much. Prices..... Physicians \$5.00;\* Patients \$6.00\*

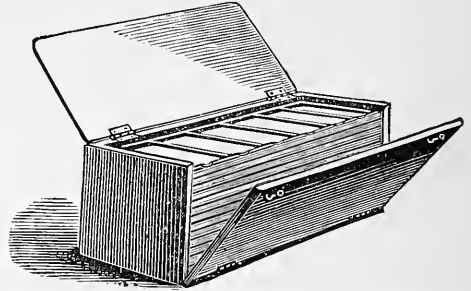

3. Microscopic Object Case. Plain white wood with catch lock.  
 No. 1 contains 4 single trays for 24 objects \$1.25  
 No. 2 " 6 " " " " 36 " 1.50  
 No. 3 " 8 " " " " 48 " 1.75  
 No. 4 " 10 " " " " 60 " 2.00  
 No. 5 " 12 " " " " 72 " 2.50  
 No. 6 " 12 double " " " 144 " 3.50  
 See page 228.

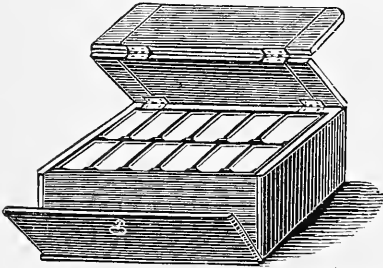

4. Microscopic Object Case. Polished mahogany with lock.  
 No. 7.—12 single trays for 72 objects...each \$3.75  
 No. 8.—12 double " " 144 " ... " 7.00  
 See page 228.

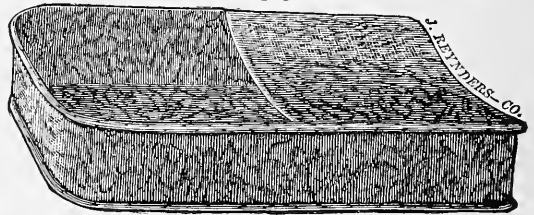

2. Dr. H. T. Hanks' Bedpan. Plain zinc \$1.50;\* "Agate" finish \$6.00\*

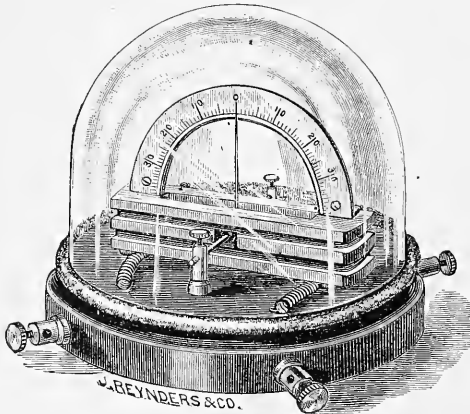

Plain Galvanometer, \$5.00.



"The Hospital Bedpan" is made with a special view to all the requisites of a Hot Water Vaginal Douche, adapting itself to the patient in bed with a minimum of discomfort. It holds about a gallon and is furnished with and without the outflow shown in cut, the former when it is to be used for a longer time continually. Without outflow \$2.50;\* with outflow \$3.50.\*

ARTIFICIAL NOSES AND EARS.

After much experimenting, either of above, made of thin silver, shaped to conform to the rules of beauty and, at the same time, to resemble the lost member as nearly as possible, have been found the most satisfactory. Either is accurately fitted to the skin, covering the remaining parts as well as the opening. It is held in place by a spectacle frame superiorly, while a pair of springs, attached to its base, enter the fossæ and secure its position below. It can be worn with ease, is very light, and, if nicely fitted, will hardly show points of attachment, being painted to correspond to the tint of the face. Ears \$100.00;\* Noses \$50.00\* to \$125.00.\*

PROF. B. S. SCHULTZE'S (JENA) OBSTETRIC MANIKIN.

The best of its kind. On adjustable stand rotating to right or left. Soft rubber Vulva. Soft leather adjustable Abdomen representing Palpitation. Four Parts adjustable for imitating different deformed Pelves. Two clamps for fastening. Prices, Manikin \$50.00;\* Foetus with Placenta \$15.00.\*

**Recipes Recommended with Apparatus mentioned on pages 84A, 84E, 115 and 115B.**

With regard to remedies adapted to use with the Atomizers Nos. 4, 5, 6 and 7, page 5, it is evident that the quality which causes spray to float in the air and to resist absorption into it may be given to any article of the *Materia Medica* which may be combined with glycerine and water, or when the employment of essential oils or gum resins is intended, by combination with one of the lighter vegetable oils, as olive oil or oil of sweet almonds.

The following recipes have been obtained from physicians who have tested them in their practice, and whose reputation for skill in the treatment of pulmonary diseases should cause their opinions to be received everywhere with confidence.

No. 1 is used in cases where there is profuse purulent expectoration. No. 2, in cases suggesting a strumous or scrofulous condition. No. 3, in catarrhal pneumonia and those cases where cough is a prominent feature but the expectoration scanty. Nos. 4, 5 and 6, chiefly in phthisical cases. No. 7, in bronchitis. Nos. 8 and 10, in putrid bronchitis. No. 9, in nasal catarrh. Nos. 11 and 12, in chronic bronchitis. Any requiring it are to be reduced in strength according to sensibility of patient.

No. 1.		No. 2.	
R Cryst. Carbolic Acid . . . . .	3 1/2 to 3 iii	R Com. Tinct. Iodine . . . . .	m7
Borax . . . . .	3 ii	Tinct. Conium . . . . .	m15
Glycerine . . . . .	3 iv	Glycerine . . . . .	3 iv
With distilled water q.s. to make 3 iv. Filter.		With water to make f 3 iv.	

No. 3.		No. 5.	
R Saturated solution Boracic Acid . . . . .	3 iv	} Mix.	
Glycerine . . . . .	3 vi		
No. 4.		No. 6.	
R Sol. Lugol . . . . .		R Same as No. 4, with the addition of Muriate of Ammonium grs. x-xx to every 3 i of water.	
Glycerinæ aa . . . . .	3 i		
Acid. Carbol . . . . .	3 iii		

S. 3 i of this mixture added to 3 i of water.	M.	R Ditto, with the addition of mx-xx of Gardner's Pine-needle Extract after adding the 3 i of water.	M.
---	----	---	----

No. 6.		No. 7.	
R Same as No. 4, with the addition of Muriate of Ammonium grs. x-xx to every 3 i of water.		R Aquæ Camphoræ . . . . .	3 iv
		Glycerinæ . . . . .	3 i
		Acid. Carbolic Crystal . . . . .	3 ss
		M.	

No. 8.		No. 9.	
R Phenyle, or "Royal Disinfectant," Water . . . . .	3 ss 3 iv	R Dobell's Solution.	
To be dashed on to the phenyle and glycerine 3 i added.		Acid Carbolic . . . . .	gr xx
		Sodii Bicarb. . . . .	} aa 3 ss
		Sodii Biborat. . . . .	
		Glycerinæ . . . . .	3 i
		Aquæ . . . . .	ad 3 iv
		M.	

No. 10.		No. 11.	
R Co. Tr. Bensoin . . . . .	3 ss to 3 i	R Terebene . . . . .	3 i
Glycerinæ . . . . .	3 ss	Alcohol . . . . .	3 i
Alcohol . . . . .	3 iss	M.	
M.		No. 12.	

R Lig. Iodi Comp. . . . .	mxxx.	R Infusum picis liquidæ . . . . .	q. S.
Glycerinæ . . . . .	f 3 i	(Tar Water.)	
Aquæ . . . . .	ad to f 3 iv		
M.			

Duration of inhalations varies in the practice of different physicians and with the nature of the remedy from about ten to thirty minutes at a time, and from one to three or more times a day.

**Recipes Recommended with Evans' Inhaler (see Nos. 1 to 4, page 115).**

The following solutions have so far been used for the inhalation treatment of Bronchial and Pulmonary Affections: Acid Carbolic (cryst.), 5 to 20 per cent. sol. Iodine (Lugol's sol.), 1 to 7 per cent. sol. of sol. Listerine, 12 1/2 to 25 per cent. sol. Ferri chlor. Tr., 5 per cent. sol. Acid Tannic, 5 per cent. sol. Sodæ Bi-boras, 6 1/2 to 12 1/2 per cent. sol. Sodæ Salicylat, 12 1/2 to 20 per cent. sol. Potassæ Nitras, 12 1/2 per cent. sol. Glycerine, 20 to 50 per cent. sol. Benzoin Tr. co., 20 to 50 per cent. sol. Cubeb Ext. fl., 20 to 50 per cent. sol. Cocaine Hydrochlorate, 2 to 5 per cent. sol. Terebene, 5 to 50 per cent. sol. Digitalis Tr., 5 to 10 per cent. sol. Sodæ Bromide, 10 to 50 per cent. sol. Conium Tr., 2 to 10 per cent. sol. Hydrarg. Bi-chlor., 1 to 1000.

Good results have been obtained in sub-acute and chronic Pharyngitis, sub-acute and chronic Laryngitis, sub-acute and chronic Bronchitis, acute chronic Pulmonary Phthisis, Pertussis, Diphtheria, and with Iodine in Tertiary Syphilis, Iodine in Struma, Iodine as a general tonic, etc., etc.

Crystallized Carbolic Acid (Squibb's), 10 to 20 per cent. Borax, 6 1/2 per cent. Compound Tincture of Iodine, 1 to 5 per cent. Compound Tincture of Iodine, 1 1/2 to 7 per cent.

The iodine solutions must be freshly made for each inhalation, otherwise the full effect will not be secured.

## CORRECTIONS AND MODIFICATIONS.

(WHICH PLEASE NOTE.)

- Page 5.** Fig. to 25a is shown on page 391.
- Page 7.** 43a should be \$4.00.
- Page 27.** Little's Case, No. 9, is now very much taken with the following additions to the \$100.00 set. Tenotome, Trocar, Thumb Forceps, Mousetooth Forceps, Finger Saw, Hey's Saw, Esmarch instead of Screw Tourniquet, Improved Russian Needle Holder, 4 Haemostatic Forceps, Bone Curette, Vulsellum Forceps and 3 Sponge Holders @ \$128.
- Page 31.** Otis' Evacuator now furnished in latest style "The Perfect," see N. Y. *Medical Journal*, Aug. 24, 1889, No. 560.
- Page 39.** Prices of 32 are net.
- Page 41.** Price of Trocar at bottom of page 41, set of 3 \$4.50; set of 4 \$5.00.
- Page 51.** 24b is identical with Combination Aspirator and Hypodermic Syringe shown on page 393.
- Page 58.** See page 392.
- Page 73.** Price of No. 42 on application. See also pages 91Q, R and S.
- Page 75.** Test Types and Trial Frames, see page 91T.
- Page 109.** Electric Illuminator, page 387.
- Page 115.** See page 397 for Recipes.
- Page 139.** We have a "Student's" Elliot Forceps, long, at \$6.00.
- Page 131D.** The matter referred to in lower left hand corner is now at pages 380 to 390.
- Page 191.** Pessaries, 546, 549, 553, in lots of not less than one dozen, per dozen \$1.75;\* 556 per dozen \$3.50.\* Pessaries, 615 to 620, of material good, but not the best, 50% off.
- Page 197.** 631 should be "best" \$6.00; "good" \$4.00.
- Page 197C.** No. 22 \$5.00\* to physicians; \$6.00\* to patients.
- Page 270.** All above "Family Cases" should be \*\* instead of \*
- Page 289.** Scales of best quality (warranted), similar to figures 19 and 23, with weights: 2 drachms to  $\frac{1}{2}$  grain:
- |                                     |        |
|-------------------------------------|--------|
| No. 9. 0—8 in. beam, net.....       | \$6.00 |
| No. 9—1—7 " " " .....               | 5.00   |
| No. 9—2—5 $\frac{1}{2}$ " " " ..... | 3.50   |
- Improved pattern, quickly balancing, extra fine, with weights:
- |  |      |
|--|------|
| No. 10—2 $\frac{3}{4}$ in. beam, net ..... | 8.00 |
|--|------|
- P. 44, with weights down to  $\frac{1}{30}$  grain.
- |  |       |
|--|-------|
| No. 1, N. P.—pans, 2 $\frac{3}{4}$ in., net..... | 10.50 |
| No. 2, N. P.— " 2 $\frac{3}{4}$ in., " .....     | 12.00 |
| No. 3, N. P.— " 3 in., " .....                   | 14.00 |
- Hand Scales like fig. 21, page 289.
- |  |         |
|--|---------|
| German, 6 in. beam, 2 $\frac{1}{4}$ in. pan, leather box with weights..... | \$0.75* |
| English, 6 in. beam, 2 $\frac{1}{2}$ in. pan, oak box with weights .....   | 1.25*   |
| Berlin, 5 in. beam, 2 in. pan .....  | 1.00*   |
| " 6 in. beam, 2 $\frac{1}{2}$ in. pan .....                                | 1.25*   |
- Weights, aluminium wire,  $\frac{1}{2}$  to 5 grains..... \$0.25\*
- |   |  |
|---|--|
| " " square, $\frac{1}{2}$ to 10 grains.....       | 0.40*  |
| " 6 grains to $\frac{1}{2}$ grain.....            | 0.10*  |
| " 2 drachms to $\frac{1}{2}$ grain.....           | 0.25*  |
| " 300 grains to $\frac{1}{10}$ grain, in box..... | 1.75*  |
| " cup style tray.....                             | 4 oz. down \$1.50;* 8 oz. down \$3.00;* 16 oz. down \$4.00;* 32 oz. down 5.50* |

## ABBREVIATIONS.

h. r.....	Hard Rubber.	riv .....	riveted.
G. S.....	German Silver.	fer .....	ferruled.
pl .....	Plated.	hdle.....	handle.
med .....	Medium.	J. R. & Co.....	John Reynders & Co.
iv.....	ivory.	in.....	inches.
eb .....	ebony.		







