

EX LIBRIS

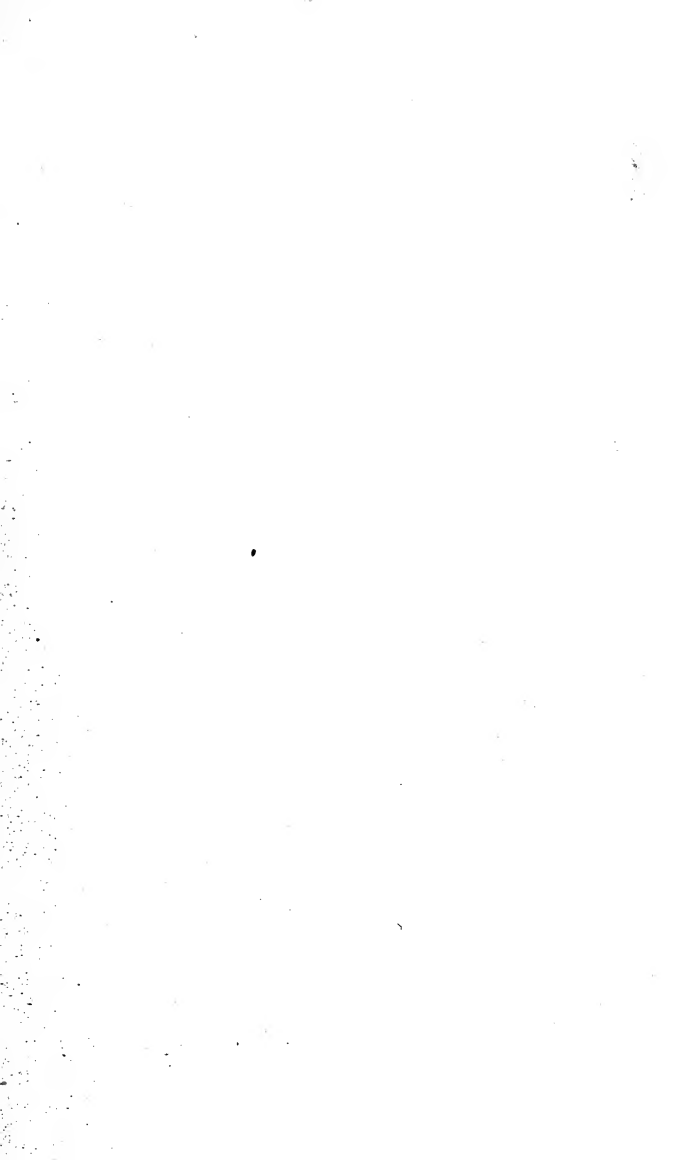

Digitized by the Internet Archive
in 2007 with funding from
Microsoft Corporation



BOHN'S ARTISTS' LIBRARY.



ARMS AND ARMOUR.

G. BELL AND SONS, LTD.

LONDON : PORTUGAL ST., KINGSWAY

CAMBRIDGE : DEIGHTON, BELL AND CO.

NEW YORK : THE MACMILLAN CO.

BOMBAY : A. H. WHEELER AND CO.

AN ILLUSTRATED HISTORY OF ARMS AND ARMOUR

FROM THE EARLIEST PERIOD TO THE
PRESENT TIME.

BY
AUGUSTE DEMMIN

TRANSLATED BY C. C. BLACK, M.A.,
ASSISTANT KEEPER, SOUTH KENSINGTON MUSEUM.

“Quum prorepserunt primis animalia terris,
Mutum et turpe pecus, glandem atque cubilia propter
Unguibus et pugnīs, dein fastibus atque ita porro
Pugnabant armis quae post fabricaverat usus.”

Horace, Sat. I. ii.

LONDON
G. BELL & SONS, LTD.

1911

(have orig. picture)

[Reprinted from Stereotype plates.]

TO THE
ALBANY

CONTENTS.



	PAGE
INTRODUCTION	1
I. ABRIDGED HISTORY OF ANCIENT ARMS	17
II. ARMS OF PRE-HISTORIC TIMES, AND OF THE STONE AGE.	
Arms in chipped flint	75
Arms of polished flint	80
III. ANCIENT ARMS OF THE BRONZE AND IRON AGES.	
Indian arms in bronze and iron	85
American arms	88
Assyrian arms, etc.	92
Egyptian arms	101
Greek and Etruscan arms	106
Roman, Samnite, and Dacian arms	117
IV. ARMS OF THE BRONZE AGE OF THE SO-CALLED BARBARIC WESTERN NATIONS.	
Germanic arms in bronze	129
Kelto-Gallic, Gallic, and Lower-Britannic arms	133
British arms in bronze	136
Scandinavian arms in bronze	139
Bronze arms of various countries	144
V. ARMS OF THE IRON AGE BELONGING TO NORTHERN NATIONS.	
Germanic arms of the iron age	149
Scandinavian arms of the iron age	158
Arms of the iron age of various nations	159

	PAGE
VI. ARMS OF THE CHRISTIAN MIDDLE AGES, OF THE RENAISSANCE, AND OF THE SEVENTEENTH AND EIGHTEENTH CENTURIES.	
Complete equipments of the Middle Ages	161
Complete equipments of the Renaissance	197
Complete equipments of the seventeenth and eighteenth centuries	218
Description of suits of armour, excepting the helmet	222
The helmet	239
The shield	287
Coats and cuirasses	309
The arm-guard	328
The gauntlet	331
Greaves and hose	337
The spur	342
Horse armour	349
The saddle	355
The stirrup	361
The bridle	366
The sword	369
The dagger, poniard, etc.	400
The lance, pike, and stake	414
The mace	420
The morgenstern or morning-star	422
The flail	424
The war-scythe	427
The scythe-knife	428
The gisarme	430
The voulge	433
The war-hammer	435
The war-hatchet	438
The halbard	443
The ranseur	445
The partizan.	446
The bayonet	448
The spontoon	451
The military fork	452
Arms and utensils of war and chase	454
Machines of war and siege weapons	455
The sling and the staff sling	466

Contents.

vii
PAGE

VI. ARMS OF THE CHRISTIAN MIDDLE AGES, ETC.—continued.		
The blow-pipe		468
Bows and arrows		468
The cross-bow		473
VII. FIRE-ARMS.		
Heavy artillery		485
The mortar		488
The cannon		490
Portable fire-arms		511
The hand cannon, hackbuss, arquebus, muskets, etc.		520
The pistol		529
Accessories for fire-arms		534
VIII. THE AIR-GUN		537
IX. THE ART OF THE ARMOURER AND ARQUEBUSIER.—MONOGRAMS, INITIALS, AND NAMES OF ARMOURERS.		
Monograms and names of German armourers		540
German armourers of later years of the eighteenth and beginning of the nineteenth centuries, celebrated for their fire- and air-guns		560
Monograms and names of Italian armourers		563
Monograms and names of Spanish and Portuguese armourers		565
Monograms and names of French armourers		573
Monograms, initials, and names of English armourers.		574
Monograms and names of Swiss armourers		575
Monograms and names of Flemish and Dutch armourers		576
Monograms, initials, marks, and names of armourers and towns found on Oriental arms		576
Monograms and signatures the origin of which is unknown		577
X. ARMS, CROSSES, AND SIGNS OF THE FREE JUDGES		578
XI. ADVICE AND RECEIPTS FOR COLLECTORS OF ARMS		583

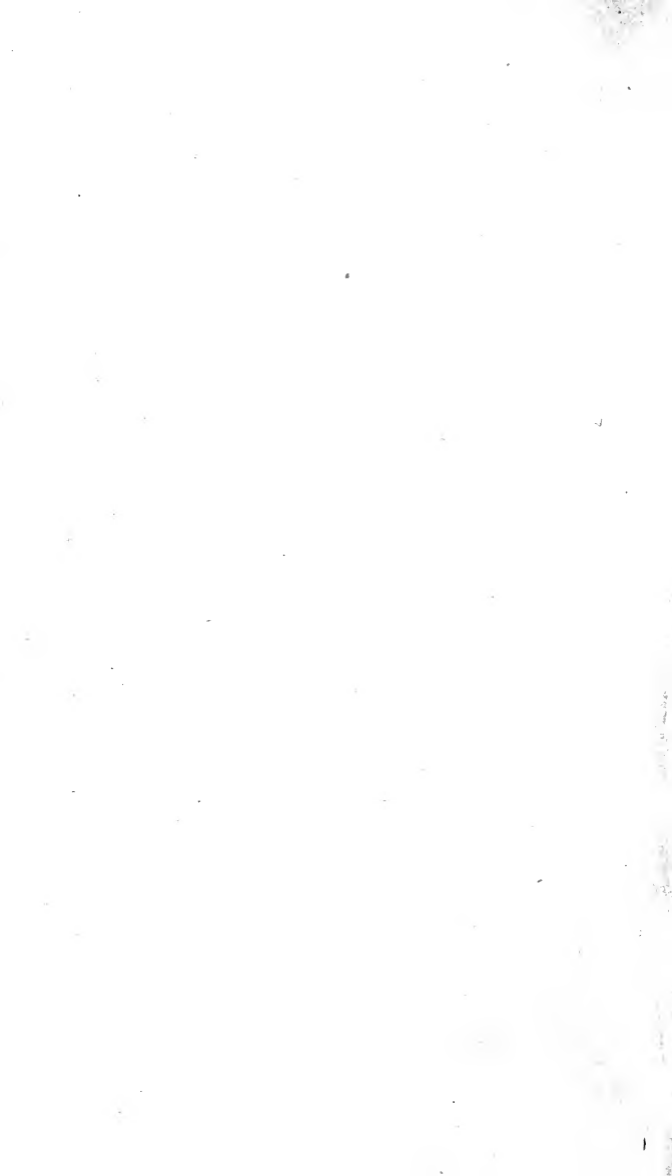

A HISTORY

OF

ARMS AND ARMOUR.



INTRODUCTION.

ALL that can interest the archæologist, the historian, the artist, the soldier, and even the ordinary observer, on the progressive march and the successive development of the arms of various nations in the past centuries, has been condensed in the first chapter of this book in the "Abridged History of Ancient Arms," of which several extracts, more or less modified, are to be seen as headings to the subdivisions, so as to spare the reader the trouble of looking through the whole history every time that he is desirous of information on only one point.

It would have been useless to describe the historical development of each kind of arm, as these will be found in the different special chapters where these arms are described in chronologic order.

This chronological system is found to be the best for a book which is destined to be at the same time a guide to the people at large, and a scientific encyclopædia to collectors, for such repetitions as must inevitably result will contribute to facilitate study.

In addition to this a special chapter describes the progressive march of the armourer's art, and gives all the armourers' signs and marks which it has been possible to collect; another chapter treats of the arms and alphabets which have been used in the tribunals of the free-judges (francs-juges). The whole work is divided into six principal parts, among which the most important treat of the arms of

the middle ages, of the Renaissance, of the seventeenth and eighteenth centuries. The author, who has visited for years all the museums and arsenals of Europe, and the most important collections of amateurs, has thus been enabled to gather enough authentic materials to dispense with referring to any books of compilation. As to the kinds of arms which no longer exist, these have been studied in manuscripts, in miniatures, on coins of the period, and on ancient monuments, where sculpture has preserved forms, the exactitude of which can rarely be disputed.

Notwithstanding the present decided taste for retrospective knowledge, which has given birth to a perfect torrent of local and special treatises, as also to more important works, no complete work has as yet existed, either in France or elsewhere, on the subject of ancient armour. Nevertheless there are few things more indispensable to an artist than the knowledge which enables him, at first sight of a sword, a helmet, a shield, or any other piece of armour, to fix the nation and period to which its wearer belonged.

The uncertainty on this head has given rise to many mistakes, which having rapidly become traditional have thus perpetuated lamentable historical errors. The faulty classification of a large number of museums and arsenals has particularly contributed to the diffusion of these popular errors, which have by degrees crept into historical treatises; the majority of guide-books, sculptures, and mural paintings have actually transformed our galleries of painting and sculpture into public schools for instruction in anachronisms.

Several of these collections of armour exhibit specimens, the alleged dates of which are centuries earlier than the true ones. It is more particularly in the Swiss museums and arsenals that these errors abound. There we find a large number of swords ascribed to the time of Charles the Bold, the shape of which declares immediately the end of the sixteenth and even the beginning of the seventeenth century, as also some armour of the same date, said to have been worn at the battle of Sempach. The gymnasium of Morat exhibits war-harness of the seventeenth century, as "taken from the Burgundians killed in the battle," where under the walls of the city the terrible duke lost, in 1476, his military

honour, after having lost at Granson all his treasures. Another suit of armour, whose burgonet, with its shade and ear-pieces, the lobster-tailed cuishes, and the breastplate, all equally announce the seventeenth century, has been attributed to Adrian of Bubenberg, the valiant chief of the fifteen hundred Bernese who defended Morat for ten days against the artillery of the archduke.

In the arsenal of Soleure the blunders are still greater. All the personages of the celebrated group, which is composed after a design of Disteli, and is meant to represent the reconciliation of the confederates at the Diet of Stanz, in 1487, by the intercession of the venerable Nicolaus Von der Vlue, are clad in armour of the sixteenth and seventeenth centuries.

The famous iron shield of modern fabrication, attributed to Philip the Good (1419), in spite of the round targets with which the knights in relief are armed, has been engraved in a Swiss publication, and accompanied by a learned dissertation. This object, and also a French cuirassier's breastplate of the First Empire, in which an unskilful armourer has awkwardly hammered out two receptacles for a female bust, still figure there as precious relics of the middle ages, a fact at which the merchant who sold them to the arsenal, and who is still living at Soleure, no doubt enjoys many a hearty laugh in his sleeve.

In the arsenal of Zurich all the bossed breastplates of fluted armour are rated as cuirasses for women, as though the female bosom occupied the lower portion of the chest!

In England even, a country famed for its archæological researches, the armoury of the Tower of London had preserved a large quantity of fantastic attributions until Mr. John Hewett had showed their faultiness in a descriptive catalogue. In the classification of this museum, and likewise in the drawing-up the catalogue of his own celebrated collection, Dr. Meyrick, who has long been considered profoundly learned on the subject of ancient armour, has sometimes erroneously attributed dates whose errors have to be measured by centuries. At the armoury of Madrid will be found such gross errors as the assigned dates differing by more than four and even five hundred years from the real ones, and these monstrous blunders are reprinted in

the texts which accompany published representations of the arms. Even in learned Germany these errors are not less frequent. The collection of Ambras at Vienna, for which Schrenk, of Notzing, had published, in 1601, a description in Latin, afterwards translated into German by Engelbertus Moyses van Campenhouten, and illustrated by numerous engravings, each one more fantastic than another, exhibits at this moment a suit of armour of the end of the sixteenth century, which is attributed in the museum to the Roman King Robert, who died in 1410. In the armoury of the same city the observer may have the satisfaction of seeing a fight between lay figures attired in armour of the beginning of the seventeenth century, which are shown to him as "Germans fighting against Romans;" and similarly he may admire at the Dresden Museum a suit of armour and a helmet of the seventeenth century attributed to Edward IV. of England, who had nevertheless ceased to reign in 1483. There was also to be seen at the national museum of Bavaria at Munich, before M. de Hefner Alteneck had been named director of it, a collar of a buff coat, of the time of the Thirty Years' War, attached as a shoulder-piece to the much-valued doublet with cuishes and hose of the fourteenth century.

The museum of Cassel also shows among ancient armour a morion and a small helmet, which are certainly much rusted, but which belonged to ancient troopers of the seventeenth century. In the national museum of Brunswick there is a similar morion, which, as being exceedingly rusty, has been labelled "twelfth century." A great number of these mistakes made by French and Italian museums might be quoted, but we may as well refrain. All these anachronisms have been carried on into books. There may be seen in a small illustrated treatise, published recently at Paris (headed, *Armes et Armures*, par Lacombe, Hachette, 1868), a suit of armour of the end of the reign of Henri IV., who died in 1610, labelled as armour of Charles the Bold, who died in 1477, where the small helmet figures under the name of morion, the large bassineted helmet of the fourteenth century is called a "mezail," a word which signifies the defensive armour worn only over the eye and forehead, the "francisque" is called a defensive weapon, the long pistol of the seventeenth century a *petronel*, the halbard a *partisan*,

the gisarme a *fauchard*, the spontoon and partisan *halbarde*, &c.

The desire of exhibiting "historical" curiosities has tempted many museums to accept and even to construct for their objects, genealogies and titles, which, being affirmed by tradition, have at last become gospel truths to the keepers, and to the crowd among whom these gigantic errors are circulated and preserved. When will the world begin to see that a beautiful specimen of sculpture, painting, chasing, or of any other artistic work, needs no other title than that which the critic finds in its execution, and in the style of its epoch, shown by the archæological imprint, now faded away with Gothic art, and whose stamp is not to be found in the works either of the ancients or of their imitators? Titles so often conjecturally, and falsely, ascribed serve but to throw discredit as much on the collector as on the keeper.

The errors which are so frequent in the chronological classification, and in the histories ascribed to armour, are even more numerous as regards their nationality and manufacture. Many armourers without merit, and whose existence must have equalled that of Methuselah in order to produce only the half of what is attributed to them, are extolled to the detriment of really great artists, whose masterpieces figure under the name of some favourite workman, too often extolled with an idolatrous faith, discreditable to men whose real duty is to plant landmarks to histories based upon substantial evidences which happily are beyond the reach of mutilation.

It is a sad thing to say, that though archæological investigators in vain turn over the dust of centuries and pass their lives in pointing out, with evidence in their hands, all these involuntary errors, these childish jugglings, the band of compilers continue to manufacture books out of old books, copying afresh that which has already been copied without examination, and so going on from father to son, writing about subjects with which they are acquainted only through books.

As in museums of keramic ware and mosaics, the productions of Italian art are generally most numerous, and those of France in collections of enamelling on metals and of sumptuous pieces of furniture, so the museums of ancient

armour are everywhere filled, for the most part, with German work. There is no country where the art of armoury was so widely spread as in Germany, nor brought to such a pitch of excellence, in the manufacture of plate armour, the laminated joints of which covered even the legs of the war-horse. Her numerous towns and princely residences, as well as the greater part of the free cities, have furnished during the middle ages and Renaissance a wide field for the artist to display great beauty in the gorgeous armour and arms of that period; the precious work of which was often paid to him at its weight in gold, by simple patricians, who, like Fugger and others, were rich merchants, and at that time handled the sword as well as the clothyard, or the money bag.

Notwithstanding the monograms with which the handsome arquebuses, swords, helmets, and breastplates are marked, and notwithstanding the design of the figures and ornaments which indicate a German school of art, the greater part of these arms continues to figure in catalogues and treatises as productions of Italian art. As if Italy, the country of such men as Antonio Picinino, Andrea di Ferrara, Ventura Cani, Lazarino Caminazzi, Colombo, Badile, Francino, Mutto, Berselli, Benisolo, Giocatane, and many other celebrated armourers, needed a fictitious reputation, and required to be decorated with borrowed plumes.

It will be seen in the chapter which treats "of the armourer's art," that the Editors of these treatises are but slightly acquainted with art criticisms and recent archæological discoveries; for to them, armours made for the kings of France, at Munich and Augsburg, still remain Italian, and similarly the armour made by such men as Peter Pah, Wulff, Kolmann, and Peter (Pedro), of these same cities, is still counted as Spanish. They persist in ignoring the fact that Seusenhofer of Innsbruck was charged with the forging of the armour of the sons of Francis the First, a magnificent undertaking, which nevertheless retains an Italian label. Even in Germany the depreciation of national art has insinuated itself into public collections, for when the author of this book, not ten years ago, had recognised at the Dresden Museum, in several fine pieces of armour, ascribed to Italian artists, incontestable proofs of German workmanship, he met

with no reply but shrugs and incredulous smiles. At present his statement is no longer contradicted, and it is well known that many of these pieces of armour are the work of the celebrated Kellermann of Augsburg, who for one single suit of armour was paid fourteen thousand dollars. The celebrated piece of armour ornamented with embossed (repoussé) figures representing the labours of Hercules, in the museum of Dresden, is likewise German.

When the armour of Henri II., at the Louvre, is compared with the designs composed for the studios of Munich, by the painters Schwarz, Van Achen, Brockbergen and Jean Milich, which are preserved in the Cabinet of Engravings, in this city, it will be seen (as also on the buckler of the Ambras collection, the counterfeit of which is in France) that its execution has been scrupulously based upon these models, which have been photographed and published by M. de Hefner Alteneck, who discovered them in the cabinet of engravings at Munich. It is particularly PL. XVII. which gives us the most striking proof. To have an idea of what the German armourers were able to do in the fifteenth and sixteenth centuries, the reader should visit the Imperial Arsenal, and the Ambras collection at Vienna. The niello-work and incrustation in gold and silver (Taucher-arbeiten, in German) are of a massiveness that leaves far behind similar works of Spain; and the hammered work is equal to that of Italy. As to the forms of the armour, they are always graceful and noble.

Fire arms even more than side arms and plate armour owe their perfection to the German armourers, who invented the air-gun in 1560; the rifled barrel (called in German Büchsenlauf) in 1440, or according to others, in 1500; the wheel-lock in 1515; the arquebuse in 1551; the double trigger (Stecher in German) in 1543; the iron ramrod (the use of which contributed to the Prussian victory at Mollwitz) in 1730, and lastly, in 1827, the famed needle-gun.

As the archæological and special character of the matter treated of in this book might easily lead to useless digressions and to the use of technicalities which are too often employed to hide the absence of real knowledge and well-digested study, notes of reference have been entirely dispensed with in the Historical Chapter, and names which every one can

understand, printed in French, German and English, are employed for the designation of the objects spoken of in the work. The author nevertheless could not refrain from exactly quoting the sources, whether monuments, manuscripts, or armour, from which he has derived his knowledge, so as to afford means of criticism, as well as of information for this special study.

As soon as the French edition leaves the press, translations in English and in German will be published in London and Leipsic by Messrs. Bell and Daldy, and Mons. E. A. Semann respectively.

Before beginning the work itself, it will be useful to pass in review the more important collections of armour, so as to enable the reader to judge by their formation in what chronological order the taste for ancient armour has developed itself in Europe since the Renaissance.

The first gathering together of arms and armour as a collection, and not for ordinary use, does not appear to date earlier than the sixteenth or end of the fifteenth century. It will be seen by the catalogue published by M. Leroux de Lancy in 1848, in the Library of Charts, that Louis XII. had formed, in 1502, a cabinet of arms at Amboise. The celebrated museum of historical armour at Dresden, one of the finest in Europe, owes its origin to Henry the Pious. Augustus I., who was a collector of armour during thirty-three years (from 1553 to 1586), is nevertheless the real founder of the present museum, which contains upwards of sixty thousand pieces, and is especially rich in swords, but few of the pieces of armour and arms date farther back than the end of the fifteenth century.

The Marshal Strozzi, who died in 1558, left a cabinet of armour of which Brantôme speaks very fully :

“ If the Marshal Strozzi was tasteful in fine books he was equally so in armour, and in arms, for he had a large hall and two rooms, which I had seen in past days in Rome, in his palace in the Borgo; and his arms were of all sorts, as much for horse as for foot-soldiers, and of all countries, French, Spanish, Italian, German, Hungarian and Bohemian, and briefly, of several other Christian nations, and also armour belonging to Turks, Moors, Arabs and savage nations. But what was most beautiful to behold were the

arms in antique fashion, of the old Roman soldiers and legionaries. All this was so beautiful that one knew not which to admire most, the armour itself, or the curiosity of the person who had placed it there. And to complete the whole, there was a separate chamber filled with all sorts of engines of war, of machines, ladders, bridges, fortifications, and ingenious artifices and instruments; in short, of all inventions for offensive and defensive warfare, the whole formed and imitated in wood so cleverly and truly, that any one had only to take the pattern in full size, and use it at need. I have since seen all these cabinets at Lyons, whither the last M. Strozzi, his son, had transferred them, and also saw that they were not kept so carefully as they had been at Rome. I noticed that they were confused and spoiled, at which I mourned in my heart; it is a very great pity, for they were very valuable, and a king could not have done better than buy them, but M. Strozzi disordered and sold everything; this I therefore represented to him one day, for he would take a hundred crowns for a thing which was worth more than a thousand. Among the other rare things which I noticed was a shield made from the entire shell of a turtle, so large that it would have covered the tallest man from head to foot, and so hard that an arquebuse would have pierced it with difficulty from a distance, and yet withal, it was but slightly heavy. There were also the tails of two marine horses, the handsomest, longest, thickest and whitest that I have ever seen. I may possibly have been too long and tedious in speaking of this cabinet of arms, but certainly had I wished to amuse myself in telling over its curiosities, all would have taken pleasure in reading them."

The fine Ambras collection, now in Vienna at the Belvedere, composed only of choice pieces, was commenced in 1570, by the Archduke Ferdinand, Count of Tyrol (son of the Emperor Ferdinand I., and husband of the beautiful Philippine Welser of Augsburg), in his castle of Ambras, near the town of Innsbruck, where the prince had collected a hundred and fifty complete suits of armour, and a large number of offensive and defensive arms, and war harness. A cabinet of curiosities and art-objects, of which the greater number are now in the Armoury at Vienna, and only a small part still remains at Ambras; more than nine hundred historical portraits, of

small artistic merit, it is true; a collection of two thousand five hundred medals and coins, and several thousand engravings; a library of four thousand printed volumes and five hundred manuscripts, among which may still be seen the three celebrated volumes of water-colour drawings, executed by Glockenthon, containing the exact fac-similes of the arms and armour of the three arsenals of the Emperor Maximilian—all these at that time formed a whole, which few cities could equal. The main body of this collection, which had lost only ten handsome suits of armour, carried off by the French army, was transferred to Vienna in 1806. The first work containing representations and descriptions of these treasures was published in the seventeenth century in Latin, by Jacob Schrenk of Notzing, a slight work, which has nevertheless been translated into German by Engelbertus Moyse de Compenhouten.

M. le Baron de Sacken has published another work, in 1862, in which the best pieces of the collection have been reproduced by means of photography. Vienna also possesses the celebrated collection of the emperor at the Arsenal of Artillery, and that of the "Arsenal of the City." The Arsenal of Imperial Artillery at Vienna is an immense pile of buildings close to the terminus of the Southern railway, and contains one of the richest collections of armour in Europe, derived from the private cabinets belonging to the emperors of Austria. Placed in a building which is one of the most successful and beautiful of our time (the work of the Counsellor Hansen), this collection contains more than seven hundred specimens; it is at present under the superintendence of Captain Querin Leitner, who has classified it perfectly, and who is engaged on a publication (*Waffensammlung des österreichischen Kaiserhauses im Artillerie Arsenal; Vienna, 1868*) intended to furnish reproductions of the most remarkable pieces of armour in the museum, which will contribute to diffuse a taste for ancient armour.

The arsenal of the city of Vienna, which dates from the end of the fifteenth century, and whose construction, though worse than insignificant, was erected about 1732, contains but little good armour, yet has forty large shields or "Setzschilde" of the end of the fifteenth century, and a large quantity of cut-and-thrust weapons.

There may also be seen the head of the Grand Vizir **Mustafa**, the cruel monster to whom the sultan sent the bow-string, in 1684, after his defeat beneath the walls of Vienna. The best suits of armour of this museum, where there is a complete absence of classification, and a large number of objects ridiculously misnamed, are shockingly bedaubed with black paint.

The first mention of a collection of armour in the Tower of London is to be found in an inventory of 1547, and in an order of 1578. Paul Hentzner, a German traveller, also speaks, in 1598, of the fine armours of the Tower of London, though at that time they were rather an arsenal than a gallery. In 1630, the real nucleus of the collection was commenced at Greenwich, and with what remained from the pillages of the civil wars, towards the end of the seventeenth century, the actual gallery, whose classification Dr. Meyrick afterwards directed, was formed. Since 1820, the collection has been augmented by different purchases. The fire of 1841 deprived them only of a few cannons, which were completely destroyed. There is no keeper; nevertheless Mr. John Hewett, an archæologist, has been able to publish an official catalogue of the arsenal, divided into twenty classes, in which thirteen objects represent ancient armour, forty stand for the stone age, a hundred and twenty for the age of bronze, and twenty-five for that of iron. The arms, beginning from the commencement of the middle ages down to our own times, number about five thousand seven hundred. The whole collection, therefore, comprises more than five thousand eight hundred objects, the oriental division of which is remarkably well represented. In addition to the collection of the Tower of London we must also mention the celebrated Llewellyn Meyrick collection at Goodrich Court, in Herefordshire, one of the most perfect in Europe.

The arsenal of Berlin, which contains a small quantity of armour belonging to the Electors, is not rich in either ancient armour or arms, and is principally composed of guns, both with flint-locks and with pistons, and of trophies taken in the wars which Prussia has sustained; it is placed in the building to which the masks of Schluter have given an European celebrity. There is also at Berlin, in the Monbijou Palace, a certain amount of historical armour and arms, as

well as the handsome collection of Prince Charles of Prussia, a thing of worth which unfortunately lacks space enough to be properly exhibited and classed chronologically.

The commencement of the Museum of Artillery at Paris dates from 1788. A collection of armour and machinery had been commenced, which was pillaged on the 14th of July, 1789. In 1795, this museum was rearranged in the convent of the Dominican Jacobins of St. Thomas Aquinas; in 1799 it was enriched by the celebrated collection of the arsenal of Strasbourg, and in 1804, by the gallery which the Dukes of Bouillon had already formed at Sedan. The museum was again pillaged in 1830, but lost only a few of its treasures, the greater part of which were brought back after the days of July. In 1852, twenty of the richest and most curious objects were transferred from the Museum of Artillery to be placed in that of the Sovereigns at the Louvre, a loss which was in part repaired by an imperial decree, which presented to the Museum of Artillery the valuable arms belonging to the library of the Rue de Richelieu. Since then many gifts have been made to this beautiful collection, conspicuous among which are those made by Napoleon III. and the Baron des Mazis. At present it is the richest and one of the best organised of collections; for its excellent classification, which is due to the knowledge of the keeper, M. Penguilly l'Haridon, leaves but little to be desired. There are fifty objects for the weapons of the flint age, a hundred and fifty for those of the bronze age and for ancient armour, thirty for the iron age, nineteen hundred and seventy for the armour and weapons of the middle ages, the Renaissance, and the seventeenth and eighteenth centuries, three thousand for oriental and modern weapons, cannon, machines, and divers other objects, comprising in all five thousand and two hundred numbers catalogued with much care.

Another old and important collection of weapons and armour belongs to the Counts of Erbach, at Erbach Castle, in Hesse-Darmstadt, near Oppenheim. It was begun at the end of the eighteenth and beginning of the nineteenth century, by the Count Francis, an enthusiastic collector. The museum contains four hundred and sixty offensive and defensive weapons, six hundred and twenty fire-arms, and a few hundred weapons of the flint, bronze, and iron ages, classic,

Keltic, German, &c. The Count Eberhard, grandson of the founder, has himself drawn up the catalogue.

The Armeria at Turin was founded by the King Charles Albert, in 1833. The Count Vittorio Seyssel of Aix published in 1840 the catalogue, which contains fifteen hundred and fifty-four specimens of ancient and modern weapons, among which are a great number of defensive arms, both rare and artistic.

The museum of Sigmaringen is, like those of Munich and Turin, a modern creation, for the first gathering together of art objects dates no farther back than the year 1842. In the "Artistic Guide for Germany," by the present writer, will be found an especial chapter, which gives summarily a description of the numerous collections which H.R.H. the Prince of Hohenzollern has brought together in his residence, and which have also been largely augmented by the recent purchase of the collection of the Baron of Mayenfisch, superintendent of fine arts to the prince. The Counsellor Dr. Lehner is keeper and librarian, and has been entrusted with the chronological arrangement of the catalogue, in different series, and with publishing fac-similes of the most remarkable objects by means of photography. The collection of weapons and armour numbers more than three thousand pieces, among which are some exceedingly valuable in an historic and artistic point of view. The building, which the prince has had erected in the Anglo-Gothic style, is designed by Krüger of Düsseldorf, and is graceful in form and worthy of its contents. The fresco paintings, by Professor Müller of Düsseldorf, are a work of art, which will in themselves repay a journey to Sigmaringen, a place where the traveller may find museums of every kind, with two exceptions, natural history and natural philosophy.

M. Hefner-Alteneck has also published a work on these museums, in which we recognise the habitual exactness of this careful describer.

The national museum of Bavaria, at this time one of the richest in art-objects of the Gothic and Renaissance styles, originated in 1853, in the reign of King Maximilian II. It occupies fifty-nine halls of a vast building, three stories high. It is to the energetic activity of the late Baron Aretin, and to the solid knowledge of the director, M. de Hefner-Alteneck,

that Germany owes the rapid collection of so many treasures, among which may be counted more than a thousand weapons and pieces of ancient armour. The construction of the building is defective in all respects, and the classification of the contents faulty. Happily the new director is engaged in rendering the classification more available for study by a chronologic and generic catalogue. The large number and, for the most part, the historic and artistic value of the objects exhibited, place the National Museum of Bavaria among the first of these instructive establishments.

We also find at Munich a collection of ancient arms, in the arsenal of the city; these are objects which have belonged to the different corporations, dating as far back as the fourteenth century. But the organisation of this collection dates only from 1866. All is arranged there in chronological order so as to show the armour worn by the lower orders, grouped together in their different epochs, the last of which comes down to the end of the Thirty Years' War. The arsenal of the city of Munich, of which the keeper, M. Kaspar Braun, has published, in 1866, a descriptive catalogue, contains in all about fourteen hundred ancient weapons and pieces of armour, both for the horse and rider.

The King of Sweden, Charles XV., has also commenced a cabinet of ancient armour, composed for the most part of the Soldinska collection from Nuremberg, brought thence about 1856. It comprises more than a thousand specimens, among which will be found a great many oriental weapons, and a large number of western arms of the sixteenth and seventeenth centuries. A series of fac-similes of this beautiful collection has been published by Lahure, at Paris.

The cabinet of armour of the Emperor Napoleon III., commenced only a few years back, and which is placed in the castle of Pierrefonds, is already one of the richest in the empire, especially so in fine German tilting armour of the best periods. According to the catalogue published by M. O. Penguilly l'Haridon, it contains five hundred and twenty-five ancient weapons and suits of armour, and four machines for ancient warfare, of which the two balistæ, erroneously called catapults, and intended to shoot arrows, are constructed after the designs of Hiero and Philo, two Greek authors, contemporaneous with the successors of

Alexander and Vitruvius, which last are supposed to have lived in the reign of Augustus. The other two are catapults of the kind called *palintones*, also constructed after the designs of Hiero. These four machines of warfare have been taken, some years since, to the Museum of St. Germain. Some photographic representations, by Chevalier, have been published by Claye, in 1867, but are not sold to the public.

Another fine collection of armour and weapons but recently begun, is that of the Senator Count of Nieuwerkerke, placed in the apartments which he occupies at the Louvre. This cabinet, entirely formed of choicè pieces, contains more than three hundred and thirty specimens, of which M. de Beaumont is forming a catalogue, to be illustrated with copperplate engravings.

We may also point out in France the museum of Chartres, which possesses a good collection of ancient weapons; among other things the war-harness attributed to Philip IV., le Bel (1285 to 1314), where the bassinet alone indicates the date, for the coat of mail, of which a portion is modern, belongs to many different periods.

For the study of weapons in flint and bronze, of primitive and ancient times, the museums of Mayence, Copenhagen, Schwerin, Sigmaringen, Saint Germain, and Christy's Ethnographic collection at London, are those which offer the greatest amount of resources.

All travellers know the museums of armour at Madrid, and of Tzarskoe-Selo at St. Petersburg; reproductions of the most remarkable objects have been published in photographs and lithographs, but no one has given any information regarding these museums, nor of those of Venice and Malta.

As for the arsenals of the Swiss Cantons, which, though they date back as far as the earliest wars, contain few things anterior to the end of the fifteenth century, there are but those of Geneva, Soleure, Lucerne, and Berne, which possess what can be called a collection of ancient weapons; Morat, Zurich, Basle, and Liesthal are less richly gifted, and the other chief towns of the Cantons have hardly anything remaining of their armour or weapons of offence.

Holland does not possess a museum of ancient arms, nor has she any in her arsenals; private collections are rare; we know of none but that of the Baron de Bogaert van

Heeswyk, in his country-house near Bois-le-Duc, and that of the late M. Kruseman, a painter, which now belongs to the Archæological Society of Amsterdam.

The collection of ancient arms at Brussels is somewhat extensive, and is placed in the museum of the "Porte de Hall."

Besides the first-class museums which we have here cited, there are still a large number of important collections, most of which are mentioned along with the engravings from them in the body of this work, and if we count the galleries in process of formation, we must admit that the taste for armour nearly equals that which has been so universally shown for keramic ware.

I.

ABRIDGED HISTORY OF ANCIENT ARMS.

IN all countries, and as much among primitive tribes as among civilised nations, the question of weapons has been one of great importance. From the beginning, man, exposed on the earth without means of defence, must have been forced to invent methods of repelling the attacks of those creatures who were with him joint proprietors of the soil, and to whom Nature, in depriving them of reason, had given as compensation natural weapons. Hence, weapons, originally invented for destructive purposes, have become the most powerful means of civilisation; the improvement of these deadly instruments has constantly supplied deficiency of numbers, and finally secured the triumph of reason; for, in modern times, the most ambitious of conquerors contributes to civilisation, since he is always followed by the pioneers of intellectual and mechanical culture. Gunpowder has, in all probability, opened the road to printing, has lessened the stoppages and smoothed the road of progress by supplying strength to disciplined minorities arrayed against barbarous masses. Mind has found means of resisting and subduing brute force. If we deplore warfare, we must not regret the ever increasing perfection of weapons, which, though making warfare more deadly at a given time, yet by shortening renders it eventually less fatal to mankind.

Even among the most backward in civilisation, the improvement of weapons can have nothing injurious to the progressive march of society, since all progress is mutually advantageous; and as soon as intellectual culture gains ground, no matter in what branch, the chances of unjust war, and dread of the reign of brute force, diminish.

Of the earliest known civilisations—those of India and America—the latter, though lost and almost ignored, has left the most ancient trace of a defensive weapon, perfected

in its form. This is the helmet worn by a figure on a bas-relief, in Palanqué, in the ruins of the city Culhuacan, whose date may possibly reach back three thousand five hundred years, and the circumference of which measures over eighteen miles.

To obtain an exact account of the progressive march in the construction of weapons among different nations, and of the transitions and combinations which are to be seen in the forms of these products, they should be divided into four distinct heads: weapons of pre-historic times, of the age of stone, rough, chipped, and polished; weapons of the age of bronze—a category in which are comprehended the manufactures of the ancients as well as those of the Scandinavians, Germans, Britons, Kelts, Gauls, and others; the early weapons of the age of iron, which includes the Merovingian times and the reigns of a few of the Carolingian kings, that is to say, the end of ancient times and the beginning of the middle ages; and, lastly, the weapons of the middle ages, the Renaissance, and the seventeenth and eighteenth centuries.

The use of the words, “an age of bronze,” does not infer that iron was unknown at this period; it indicates only that the use of this metal was not widely spread, and that nearly all tools, and all weapons, even edged ones, were among most nations made of bronze. Ingots of iron, wedge or pick-shaped, and a few other objects in forged iron preserved in the Assyrian museum at the Louvre, and also a fragment of an Assyrian coat of mail in steel, in the British Museum, are proofs that in the tenth century before Christ the Assyrians were as well acquainted with this metal as the Egyptians. Thirty passages in the Iliad and the Odyssey, where iron is often spoken of, under the epithet of “difficult to work in,” show that the Greeks were likewise acquainted with it. Bronze, on the contrary, which is a mixture of metals (called erroneously in Grimm’s dictionary “messing,” brass), has nothing in Nature exactly corresponding to it; it is a composition formed by man, and which varies according to the country and the time; sometimes, for instance, it is copper and tin, sometimes copper, tin, lead, *spis-glas*, &c., and requires the knowledge of a mixed fusion of metals; for while pure copper can be worked with the hammer only,

bronze must be submitted to the action of melting. The preparation of iron only needs a high degree of oxygenal heat and its separation from carbon to become malleable—a fact known even to the Kaffirs, who employ bellows to send oxygen through their furnaces. The use of bronze, instead of preceding, must necessarily have followed the use of iron, as the latter metal might be worked without being completely fused.

Earth, wood, stone, and the skins of animals, which can be found over all the earth, must of necessity have been the first materials which man employed in the manufacture of his utensils and weapons. The use of stones for the manufacture of the latter dates back everywhere to the infancy of all nations, and it is these rude creations alone which still compose the arms of the savage. There are even some countries where, notwithstanding that the preparation and employment of metals for other uses was known, the inhabitants still continued to make use of stone only for the manufacture of offensive weapons. Such was the case in America anterior to its final discovery by Columbus. Flint, chalcedony, serpentine, and particularly the fragile black obsidian, in which the ancient mirrors of the Incas were cut, were all in request for the heads of lances, and arrows, and blades of swords, for war-hatchets and knives: copper and bronze were used only for the making of tools.

In Europe stone weapons are found of very great antiquity, and they serve to show that man must have existed during the third geological period; a fact of which the picture of the mastodon or mammoth engraved on a deer's antler found in Périgord, as also the numerous bones of the cave-deer, scattered among flint hatchets, which have been gathered in plutonic strata, have furnished additional proof. When these rough sketches shall have been examined under the microscope, so as to obviate the possibility of deception, it will then be time enough to discuss the hypothesis. It is not enough, though, that these bones and weapons should have been found in alluvial-diluvial districts, for these might have been subjected to disturbance—a fact which is indeed demonstrated by the "movable deposits," so called because composed of objects belonging to different epochs. The *diluvium* (Alpin) contains no organic matter in the state of

ossine, a substance which characterizes bone not fossilized: hence it results that any alluvial deposit containing even the smallest bone with *ossine* must be posterior to that great terrestrial perturbation designated as the deluge.

A great many tools and weapons in worked stone are also a sure sign that they do not date further back than the deluge, as they are made out of pebbles, and everything tends to show that these must have been rolled together before being shaped by man's art.

It is impossible to assert the priority of one people over another respecting the first manufacture of these weapons, as they are to be found everywhere. Some weapons have been found in France of flint, chipped by splintering, mixed with bones of reindeer, and fossil bones, both occasionally carved by the hand of man, and used as handles for the flint, which is always the cutting instrument, and whose manufacture, without the aid of metals or corrosive acids, can be explained only by the comparative ease with which flint, freshly quarried, and before undergoing the influence of the outward air, can be chipped and splintered.

Lines of demarcation between the so-called ages of rough stone, worked stone, and even of bronze, can be drawn only with that small amount of certainty which belongs to epochs partly or wholly pre-historic. Objects of two, and even of all three epochs, have been found intermingled—a fact which indicates a transition state. The researches made in the ancient German cemetery of Hallstatt, near Ischl in Austria, have brought to light instruments in stone, bronze, and iron, and even some half bronze and half iron, the whole at times mingled in a single tomb, of which more than a thousand have been visited. The kitchen refuse heaps (*Kiokkenmoeding—Kitchen midden*) of Denmark, as well as the objects found in the lacustrine habitations of Switzerland, Savoy, and the Duchy of Badeu, though all found in alluvial soil, may nevertheless be attributed with certainty to the pure flint age, when no weapons or utensils showed any trace of metal, while the lake dwellings found near Ncceto, Castiana, and Peschiera belong to the epoch known as the age of bronze.

Of all these primitive weapons those found in Denmark (at present counterfeited in Germany) show the greatest

amount of finish; curiously enough, they appear to indicate that at these epochs civilisation was more advanced in the north than in the central parts of Europe. We must, nevertheless, remember that these arms have been found in alluvial deposits, and must necessarily be more modern than those found in the caverns or in diluvial and quaternary strata.

As for the weapons in polished stone, these are most frequently of granitic serpentine, not a hard stone, though more so than ordinary serpentine. They have also been found in flint, in chalcedony, basalt, jade and jadaic stone of different colours. The jade-like stone, so common in Auvergne, is of the same kind as that which was formerly employed to make amulets against spinal complaints, whence it took the name of nephritic stone. The talismans or stones of victory of the Scandinavian Sagas were probably nothing more than serpentine. Some wedges have been found too small for any other use, which must have been worn round the neck as a talisman, as is shown by the hole through which the string was passed. In the north these stones are always green, a colour which appears to be much liked and considered symbolical by the Teutonic races, for it predominated largely at a later period in their enamels and miniatures, while blue takes the principal place in works of Gaulish and Frankish origin. The nations in remote antiquity appear to have used stone weapons simultaneously with iron and bronze ones, as the museums of London and Berlin possess several very ancient examples of Assyrian and Egyptian origin in these materials.

Bronze weapons have been discovered in the north as frequently as on classic soil. They may have been introduced in the west by victorious oriental races, as the weapons of the so-called age of bronze of the different countries resemble each other more than those of other periods; and in the Scandinavian Sagas we find the conquerors treating disdainfully the people still content with flint weapons, and calling them "little demons of the earth." The use of bronze weapons had not yet ceased completely among the Gauls after the conquest of Cæsar, and it may be admitted that the superiority of iron weapons contributed to the success of the Franks, as it had done to that of the Romans.

If one wishes to become apt in the knowledge of classifying

chronologically the weapons of these periods, which so much resemble one another, and in which transition states are so frequent, the construction of the different tombs should be studied. The high hillocks surrounded or surmounted by stones, more or less colossal (and called dolmens), and whose interiors, closed with slabs of stone, contain bones unburnt, and flint weapons, may be considered as very ancient tombs. The second category of tombs is most commonly recognisable by a smaller hillock, and by the absence of large blocks of stone, by a vault or tomb formed of unhewn stones of small size, and heaped together without much skill, and by the urn, which indicates a burnt corpse. These tombs generally contain objects in bronze. Tombs still less elevated, and constructed almost wholly of earth, belong to the third stage, in which the burning of bodies had again given way to their burial, and where the tombs often form cemeteries, ranging from south to north.

While engaged on the subject of ancient weapons, we must especially seek for the first traces which have reached us on Hindoo, Assyrian, and Egyptian monuments. From the foundation of the cities of Nineveh and Babylon by Assur and Nimrod, in the twenty-fifth century B.C., until the third century B.C., in the reign of Sardanapalus V., there are no monuments from which the slightest notion can be gathered of the arms of a soldier under the five great Asiatic monarchies. We are equally ignorant of the equipment of the armies with which Belus conquered the Arabs in B.C. 1992, and Ninus, his son, subdued Armenia, Media and nearly the whole of Northern Asia; nor does anything indicate to us in what manner were constructed the brilliant weapons in use under the gorgeous Semiramis, the widow of Ninus, who, from B.C. 1968 to 1916, extended her empire as far as the Indus, and accumulated fabulous treasures at Babylon. From the reign of Ninyas, her son, history furnishes absolutely nothing respecting the long line of his successors, save a few tales about the well-known Sardanapalus, who was dethroned in 759.

The Chaldæan, Babylonian, Assyrian, Median, and Persian bas-reliefs and casts in the British Museum, and in those of Berlin, Munich, and Zurich, are useful supplements to written documents, and furnish ample materials for the history of

the armament of these military monarchies, from the thirteenth to the seventh century B.C., for, in contradistinction to all Hindoo and Egyptian monuments, the subjects of these sculptures, which are nearly all provided with cuneiform inscriptions, offer for the most part warlike episodes, and show us the entire armament of the soldier during seven centuries. In this interval military equipment appears to have changed but little, and the valuable evidence of Sennacherib (B.C. 712—707) informs us that the Chaldean soldier was armed like his Assyrian contemporary.

The infantry soldier of the regular troops wore for defensive armour the helmet with chin-strap, sometimes ornamented with a crest of horsehair; a round buckler, and for sieges, a long pavois, a cuirass, or, more properly, corselet, made with plates of metal sewed on to woven stuffs or skins, and also real coats of mail in steel, such as the fragment in the British Museum shows, or sometimes a long tunic, probably of buff leather. Leggings, or greaves, covered the front of the leg as high as the knee-joint. The offensive arms were the lance, sword, sling, and bow. The auxiliary soldier, like the militia, wore either a helmet, without a crest or chin-strap, or a frontlet with chin-strap of leather or metal, resembling that worn by the Frankish-Merovingian warriors. The buckler, generally breast-high when round, and two-thirds of the height of a man when it was long, was usually squared at the base and rounded at the top; it covered nearly the whole body of the man, who wore a long tunic, and had, like the regular soldier, for offensive arms, a sword, which hung at the left side, a lance, sling, and bow. The Persian archer on the bas-reliefs of Persepolis, the ancient capital of the ancient monarchy of Persia (560), is often covered with a casque or bonnet, which resembles in shape the cap of the French magistracy. Two mouldings of these bas-reliefs, exhibited in the British Museum, also show casques in scales, and with chin-pieces, which greatly resemble those of the second part of the Christian middle ages.

The Assyrian horseman rode without either saddle or spurs, wore a casque with cheek-straps, but without a crest, and whose semi-conical shape, something like the Gaulish helmets, differed from those worn by the foot soldiers; he

rarely carried a buckler, but wore a cuirass, or rather, coat of mail, with a sort of miner's apron hanging from the back, which resembled the *garde-reins* in plate-armour of the middle ages, and was, like it, intended to protect the lower part of the back. He also wore leggings of scales made in the same manner as the corselet, and always carried the lance and sword.

The archer, who is sometimes represented mounted, wore the corselet, but seldom the casque. Like the auxiliary soldier, his head was protected only by the frontlet. Often the lower part of the archer's leg is encased in greaves. When on foot he wears the long tunic. In addition to the bow, arrows, and quiver, he carries a sword, but not a lance. The Assyrians were acquainted with war-chariots, which are to be seen on several of their bas-reliefs, carved in the thirteenth century B.C., which invalidates the opinion of Virgil, attributing their invention to Erichthonius, King of Athens, and also those of other authors, who give the credit to Triptolemus and Trochilus. We see, too, on these valuable granite sculptures, the catapult and the balista, whose invention is due to the Assyrians, as classic authors affirm. The shape of these war-engines—intended to hurl projectiles of all kinds against the enemy, to batter in the walls of the besieged cities, and to strike from far off their defenders—differ but slightly from the Greek and Roman ones. As to the ancient Persian arms, the only guides we have are a few casts from the bas-reliefs of Persepolis, exhibited in the Louvre and the British Museum, among those of Chaldæa, Babylonia, Assyria, and Media. The defensive armour, as we have already mentioned, resembles more closely that of Europe during the middle ages than Asiatic armour. They had the helmet with scales, one laid over the other, and with the chin-guard, and perhaps also the vizor turning on a pivot. Mithras sacrificing the bull, on a monument (an engraving of which is to be seen in De la Chaussée, Rom. MS.), wears the helmet with rounded head-piece in the Etruscan style. This piece of sculpture, which is believed to date back to the birth of him who reformed Magianism, a time which wavers between the twelfth and sixteenth centuries B.C., is not much to depend on. It is doubtful whether the shape of the helmet, and still more of the knife, with which the god sacrifices, and which resembles

the modern Indian dagger, can really be attributed to the ancient Persians, whose language, the Zend, has been dead for a long time, though the Ghebir priests use it still, in repeating prayers of which they have ceased to understand the meaning. The bronze Persian helmet with rounded top of the dynasty of the Sassanides (B.C. 220—552), preserved in the British Museum, recalls the shape of the German round-topped casque of the tenth century.

After the fourth dynasty, that of the Caliphs (652), until the end of the twelfth, that of the Mongols, and other Mahomedan rulers, Persian weapons take an entirely Musulman character. During the dynasty of the Sophis (1499—1736), Persian weapons have hardly changed form, and greatly resemble one another. The miniatures in a copy of the Schah-Nameh, or Royal Book, composed by the poet Ferdusi, in the reign of Mahmoud (999), and copied at the beginning of the seventeenth century, now in the library at Munich, show nearly the same shape of helmets, and the same weapons that are still used in Persian warfare, from whence comes the scimitar, a name derived from the Persian *chimichir*, or *chimchir*, a weapon called *seymitar* by the Germans, and *acinace* by the Romans, the forefather of the sabre, the German *Sable*, or *Säbel*, which was already known by the Dacians, and on the farther shore of the Rhine, about the fourth century, and introduced into the rest of Central Europe at the beginning of the first Crusade.

The Chaldean and Median weapons are often confounded with those of Assyria. The soldier of ancient Babylon—which was peopled by Chaldæans from the sea, whose capital was Tereidos—nevertheless appears to have worn, instead of the conical casque, a metal head-dress, similar to that represented on a Persian bas-relief, already mentioned, and which has the shape of a French judge's cap. Media, the most powerful kingdom among those which were formed from the ruins of the first Assyrian empire, can with difficulty be separated in treating of the armament of its troops, from Persia, and particularly inasmuch as its first king, Arbaces, did not live more than 759 years B.C., and that the kingdom of the Medes was, in 536, already absorbed in that of Persians under Cyrus. From this time forward the terms Medes and Persians are always spoken of to-

gether, and employed indistinctly for the inhabitants of these two different countries, so that even the Persian wars against the Greeks have been called Median wars.

Without taking into account the fabulous history in which the Hindoos place their origin at a date of exaggerated antiquity, we may fix the first known dynasty of kings, that of the Chandras, at B.C. 3200, a dynasty which had probably been preceded by many periods of civilisation, now lost to us. It is much to be regretted that the English officials who have successively governed India should not have gathered more of the numerous and splendid architectural ruins, which even now cover the soil. The few sculptures in the British and South Kensington Museums are insufficient, nor do the Louvre or the Berlin Museum possess any of the peculiar carvings, figures twisted and contorted in the style of the European religious sculptures of the end of the seventeenth and beginning of the eighteenth century. And none of the museums possess any monuments for the study of Hindoo armour. The photographs exhibited at the Kensington Museum, which represent a large number of ruined palaces, temples, and a few commemorative stones in sculptured granite, show that the Hindoos, like the Egyptians, cared little to perpetuate their feats of arms on buildings, for among all the sculptures there are only a few stones of Beejanuggur, the Hunguls, which represent warlike subjects, nor do these date farther back than the first half of the Christian middle ages. The figures represented betoken that Hindoo war-harness has changed but little as regards offensive armour; and it is only in the casques that a radical change has manifested itself, since the fourteenth and fifteenth centuries of our era, when the Arab taste began to react against that which had nearly effaced it, in its own productions. As to the Javanese armour, there is only a fine statue of the Goddess of War in the Museum of Berlin, which gives a few indications, though not very ancient, by reason of the sword which she carries.

The funereal and civil monuments of Egypt—a country where the genius of the nation turned more towards agriculture and the sciences than towards war—also exhibit far fewer military subjects than do those of Assyria. Denon, in his “*Voyages dans la Basse et Haute Egypte*,” has, it is true,

given a few drawings of weapons, as also has M. Prisso d'Avesnes, in his "Monuments Egyptiens;" but these are too few, even when combined with the bas-reliefs of Thebes, and the few actual weapons preserved in the museums of London, the Louvre, and Berlin, to convey an exact idea of the arming of the whole of the Egyptian forces. In the drawings we find a helmet, which recalls the fool's cap and bells of the Christian middle ages, and the casque of the Hindoo Hungul; a coat of bronze scale armour, drawn by M. Prisse d'Avesnes from a monument of the age of the Pharaohs (eighteenth dynasty, B. C. 1000), judging from a Biblical inscription engraved on one of the scales, which measures an inch and a half in length, by three-fourths of an inch in breadth. The buckler, square at the base and rounded at the top, has a hole pierced in it, through which the soldier can see the enemy without imperilling his safety; this buckler was nearly the height of a man. The bow, the arrows with their quiver, a *blow-warder*—a peculiar instrument, which brings to mind the small round shield with hooks, and the *sword-breaker* of the middle ages, and intended like the latter to catch and break the adversary's sword; a few swords, or rather knives, with a single edge, in the style of the Merovingian "scrama saxe," and rarely the lance with a metal head; these are all that we know of the armour of this country, for the kind of hood on the wounded warrior, from a bas-relief of Thebes, does not enable one to distinguish whether it be a piece of defensive armour or a simple covering. The few daggers in bronze exhibited in the Egyptian museum at the Louvre seem by their shape to indicate a Greek origin, though the weapons were found in Egypt. The coat in crocodile's skin in the Egyptian museum of the Belvedere at Vienna, and the bronze dagger in the museum of Berlin, appear, nevertheless, to be of very great Egyptian antiquity.

Etruria, Greece, and Rome, have fortunately left us weapons in which art manifests itself as well in the harmony of form as in the detailed execution; and it is only by starting from the epoch when these countries were flourishing that a history of weapons can be based on a firm footing, by studying the pieces exhibited in a large number of museums.

The offensive and defensive Greek weapons in the time of

Homer (B. C. 1000) were all composed of bronze, though iron, as we are aware, was not unknown. The defensive armour was composed of the cuirass, breast- and back-plate, each plate cast or hammered in one piece, and also the corselet of imbricated scales, the casque, the large round convex shield, and the greaves, or leggings. The offensive weapons were the cut-and-thrust sword, straight-bladed, at first short and broad, afterwards longer and double-edged, sharp-pointed, with a rectangular sheath, always worn on the right side; the "parazonium," a short, broad dagger (resembling the "langued de bœuf" of the middle ages), worn on the left, the lance, from eleven to fifteen feet in length, the blade broad, long, and sharp, rounded towards the socket, and with a cross-piece in the centre, and which was used either to thrust or to throw, and the javelin, with its *amentum* or thong, which was a kind of long arrow. The Greeks had at that period no cavalry; they had even no phrase to signify mounting on horseback, similar circumstances being probably the reason why the French language lacks a substantive to render the German word "Reiten." Later on, in the year B. C. 400, the Greeks made an addition to their armies by enrolling slingers and horsemen.

The Etruscan armour, a portion of which ought to precede in this work Greek armour, shows in its first period the influence of the Phœnicians, and in its second that of the Greeks, with whom the Etruscans, after the emigration of Æneas, were so closely allied. The third period is purely Roman, and is involved in obscurity. Polybius, born in the year 552, after the foundation of Rome, or 202 before Christ, is the first author who has described the arms of a Roman soldier, and speaks only of those of his own time. The information left by this tutor and friend of the second Scipio Africanus, taken with the small indications furnished by monumental sculptures on the borders of the Rhine in Germany, by the columns of Trajan and Antoninus, and by the Arch of Orange (in France), comprise almost all that is known on the subject. Thanks to the poems ascribed to Homer, we have much better information about the Greek arms in use in the tenth, or possibly in the thirteenth, century before Christ, at the time of the siege of Troy, than on those with which this sovereign people subdued the

world. It is very probable that the Romans, as well as the Greeks and Etruscans, at first used only bronze in the fabrication of their offensive weapons, but in the time of Polybius this metal was no longer employed except for casques, breast-plates, greaves, and other arms of defence. Whilst bronze was still the only metal in use among the Gauls, the Roman weapons were already made wholly of iron and steel.

The Roman army was composed of three kinds of troops, the *velites*, or foot soldiers lightly-armed, the *hastarii*, spearmen, or legionaries, and the cavalry. The first were armed with small javelins, about four feet in length, the iron of which measured nine inches, with swords, and with a light shield, round or oval, three feet in diameter, and called *parma*, on account of its round shape. This was the same kind of shield which the gladiators used. The casque had generally cheek-pieces, but no crest, though sometimes it was ornamented with wolf-skin. The spearman was protected by a helmet of iron or leather, ornamented with a plume of three black and red feathers, by greaves (*ocreae*), by a breast-plate (or cuirass with two shoulder-pieces), all of bronze. He also carried a large convex shield of wood, leather, and iron, four feet in length and two and a half feet wide. His weapons of attack were the *Iberian* (or Spanish) sword, worn on the right side, similar to the Greek soldier, two javelins, one of which was the celebrated *pilum* of the legionary, which we shall meet at a later period in the Frank equipment. The slinger was armed with the sling, copied from that carried by the Achæans.

The cavalry soldier in the time of Polybius was equipped like the Greek. As before that time the cavalry soldier's only weapon of defence had been a round, oval, or hexagonal shield of bull's hide, it was now found necessary to equip him in a more complete style, so as to resist the formidable attacks of barbarians. Later on, in the time of Trajan and of Septimius Severus, a flexible cuirass was added, being either a *squamata*, composed of small iron or bronze scales sewed on linen or leather, or a *hamata*, made of metal chains—the same kind of coat of mail as those that have been found at Avenches, in Switzerland, and which are at present exhibited in the museum of that town. On examining the Trajan Column it will be seen that a great many of the soldiers represented

on it have breast-plates that are made neither of mail nor scales, but of long plates of metal, something like the armour of the middle ages; and from the bas-reliefs on this monument it will be seen that the Roman army was composed of a great number of troops whose different equipments varied as much as they do now in our modern armies.

The ancient Romans as well as the Greeks made use of machines in war. Besides the scythe chariots originally imported, like many other instruments of warfare, from Assyria, they were acquainted also with battering-rams, which had been already in use at Palæ-Tyros (the ancient Tyre, founded about 1900 B.C.), and are mentioned in the old Testament. Ezekiel (599 B.C.) says that the king of Babylon used battering-rams against the walls of Jerusalem. (Ezekiel, ch. xxi. v. 22.)

Of these instruments of war, already referred to, the *balista* was used to shoot enormous arrows, and the catapult, or *tormentum*, even larger projectiles, some of which were ingot-shaped, sharpened at both ends; these in Greece were often inscribed with the word ΔΕΑΞΙ (receive this), as we may see by several leaden specimens, which have been found in making excavations. Among the Greeks those catapults which fired point-blank were called εἰθύτονα, while those which carried missiles as our mortars throw shells were called παλίντονα.

Another engine used in warfare was the *tolleno*, a kind of weighing machine with two baskets attached to it which was used to deposit the attacking party in the besieged place. M. Rhodios makes mention in his treatise ΠΕΡΙ ΠΟΛΕΜΙΚΗΣ ΤΕΧΝΗΣ (Athens, 1868) of a catapult, or more properly portable balista, something like the crossbow of the middle ages, which he describes and illustrates from the Byzantine MSS.; but we doubt if the kind of crossbow that M. Rhodius calls *gastrafetes*, because the crossbow-man used to rest it on his stomach, can be traced back to the Greeks and Romans, for the ancient writings do not mention it.

We have already seen from the introduction that several of these machines of war, described by Heron, Philon, and Vitruvius, and which were called respectively, *euthytones*, *xybeles*, *palintones*, and *scorpion catapults*, have been made at the present day for Napoleon III.'s collection of arms. With regard to the *polypaste* or crane of Archimedes (an engine

which was used to raise and shatter to pieces whole vessels) a good deal of uncertainty exists, but there is good reason to believe that it may be identified with those enormous hooks that were used to pull off the heads of the battering-rams. The shell-like covering or shed under which the battering-ram was worked was called *testudo*, or tortoise, from its resemblance to the shell of that animal.

M. Rhodios has also told us in his very interesting work that his ancestors, the Greeks, made use also of *explosive machines*, somewhat like an air-cannon or air-gun of the present day on a gigantic scale.

Bronze arms, showing more or less in their make the influence of their ancient models, have been found in the tombs of almost all those European nations which the Romans used to call barbarians; but those of Scandinavia (Northern Germany and Denmark) are like the Danish arms of the stone age, far superior to those of other northern countries, and falling very little short of the arms of the Greeks and Romans themselves. The specimens contained in the museums of Copenhagen and of London, placed, as they are, side by side with the arms of the Britons and Anglo-Saxons, show what progress the art of working in metal had already made. The defensive armour of the Scandinavian soldier seems to have consisted only in the round or oblong shield, the cuirass, and the casque, although not a single specimen of the latter is to be found in the museum at Copenhagen; and the large twists of hair worn seem to prove that the casque was used only by the chiefs, a custom prevailing also among the Franks and Germans. The casque with horns found in the Thames, and preserved in the British Museum among the national arms, may very likely have been of Danish origin, as well as the shield exhibited side by side with it.

In treating of the arms of Keltic Gaul and of Lower Brittany, our researches are attended with still greater complications. It is very difficult, in fact almost impossible, to draw up a distinct category of those that have been found in France. On this point all is uncertain. Even that famous weapon, the *celt*, an axe, or, more properly speaking, axe-head, easily recognisable from its straight socket and ring, has been found in Russia, in France, in Italy, in Germany, and in

England—a fact which shows the extreme difficulty of an accurate classification. The kelts seem to have been spread in every direction, and to have belonged to no country in particular. As late as the time of Julius Cæsar the defensive arms of the Gauls were, like their offensive arms, of bronze, and consisted of a conical casque, very pointed, like those exhibited in the museum at Rouen, and worn most probably only by the chiefs. We cannot even attribute this casque entirely to Gaul, for some have been found at Posen, and at Inn, in Bavaria, where this helmet is exhibited in the national museum of Munich, under the title of *Hungarian* or *Avar* helmet. The cuirass was the same as the one worn by the Roman soldier, some specimens of which are to be seen in the Museum of Artillery in Paris in the Louvre, and at Saint-Germain. The shield completed the defensive arms. From the carvings on the sarcophagus of the Vigna-Ammendola, and from those on the Arch of Orange, we see that the shield was sometimes round and sometimes oblong, but rather wider in the middle than at the ends. The weapons consisted of an axe, which varied considerably in shape; with this is often classed the *celt*, which we incline to believe to have been a javelin-head; a sword, which also varied in its form, being sometimes the short Greek sword, sometimes the three-edged sword, without a guard to it, such as may be seen in the Roman bas-relief of the Melpomene in the Louvre. The lance, the javelin, and the bow, were among their weapons. The Gallic standard with the device of the boar, represented on one of the bas-reliefs of the Arch of Orange, is a proof of the influence of Roman taste in armour. One of these, made of bronze, was discovered in Bohemia, and is now exhibited in the museum at Prague. The arms of the Germanic nations during the so-called bronze age were as varied as those of Gaul.

The numerous excavations that have been made in the cemetery of Hallstatt in Austria, where more than a thousand Germanic tombs have been opened, have only served to increase our uncertainty on this subject, for the bronze casques found in these sepulchres, together with other weapons made of iron, bronze, and stone, are exactly like the double-crested casques preserved in the museum of Saint-Germain, that are generally supposed to be Etruscan, or Umbrian, though by some considered Keltic. We find among the ancient

British weapons exhibited in the museums in England, some that were in shape like the Danish, and among the arms found at Hallstatt the celt frequently occurs; the short swords remind us strongly of those of Greece, while the Scandinavian and Germanic ones bear the same characteristics, without taking into account the so-called *Keltic* sword—an epithet, by-the-bye, unpleasantly vague.

The bronze weapons belonging to this age that have been discovered in Russia and in Hungary consist almost entirely of battle-axes and spear-heads. Several of the Russian axes are ornamented with the device of a ram's head.

The period which by common consent is usually though improperly called the Iron Age, ought, logically speaking, to end at the close of the fifth century, that is, after the downfall of the Western Empire, but many carry it as far as the end of the Carlovingian dynasty, A.D. 987—a very easy but not very correct limit to assign.

Its proper termination is undoubtedly that period immediately preceding the age of chivalry, that is, the seventh and eighth centuries.

We have already seen that iron was known in all times, but that when *universally* adopted for the purpose of making arms of defence and offence, bronze was still in use. The Romans very soon learnt the superiority of the iron over the bronze weapon for offensive purposes; they accordingly used bronze only for arms of defence. In the year 202 B.C. the Roman soldier was furnished with weapons of iron only, and there is no doubt that, in the second Punic war, this fact contributed in no small degree to the Roman victories. Several of the iron weapons discovered in the cemetery of the Catalauni (in the department of Marne), and which are at present preserved in the museum of Saint-Germain, would seem to be of Germanic origin, because the swords are very like those found at Tiefenau and at Neufchatel in Switzerland—weapons probably made by the Burgundians, who were so celebrated for working in iron. Helvetia, which in the year 450 had been rendered almost desert by those systematic massacres perpetrated by the Romans, was repopulated about 550 A.D. by the Burgundians, numbers of which people had already settled in the west, by the Allemanni, who took possession of that portion where German (*Allemand*) is spoken to

this day, and by the Ostrogoths, who settled in the south, where Italian and French is now spoken. The Burgundians were a tall, strong race, and from the length of their sword-hilts we see that they must have had very large hands. A battle-axe and two iron spear-heads, found near the village of Onswala (*Bara-Schonen*) in Switzerland, prove conclusively, from the difference of their shape, that they must have belonged to a people who were neither Gauls nor Franks, but most probably Burgundians.

The arms of the Germanic races generally are very little known; we only know that their favourite weapons were the lance, the battle-axe, and the sword; and that their shields were painted in bright colours—usually white and red; that they were made of plaited osier covered with leather, and generally about eight feet by two in size. Their shields were subsequently made of lime-wood bound with iron; but the iron framework of several round shields, with very prominent bosses (a shape which seems to have been particularly in favour with the Franks), has been discovered at Sigmaringen, in Bavaria, in Hesse, in Silesia, in Denmark, and in England—these shields being everywhere adopted. The battle-axe of the Northern Germanic races is easily distinguishable from that of their brethren of the south by its different shape. The *francisque*, the characteristic weapon of the Franks, is not to be found anywhere; those discovered being always of the *Saxon* shape. The only remains of a Germanic cuirass belonging to these ages that have been discovered, are those at present exhibited in the museum at Zurich, and which were found in the territory originally occupied by the *Allemanni*. The workmanship of this cuirass is very curious: it is made of small metal scales joined together. The *Quadi* were most probably the only people who had armour made of horn.

Concerning the Franks and their mode of equipment, our information is fuller than with regard to any other nation of those times. This we gather from several authors, Sidonius Apollinaris, Procopius, Agathias, and Gregory of Tours, &c., and also from the numerous excavations that have been made in the Merovingian cemeteries, by means of which we can make out a nearly complete classification of armour, such as was originally worn by these rude warriors. This armour, which was, on the whole, not unlike that of the Germans

consisted of a small circular shield of convex shape, about fifty centimetres in diameter, and made of wood or leather. No helmets or cuirasses have yet been found, but we know from history that their chiefs wore them. The common soldier used to have part of his head shaved, and had a pig-tail like a Chinaman; only that it was twisted round his head to form a protection for it, somewhat in the style of a helmet, and dyed red. But with weapons of offence he was well provided: these consisted of a double-edged, smooth, narrow sword, two feet eight inches in length, and pointed at the end, and the long dagger or cutlass about twenty inches in length, called a *scrama saxe*: the latter part of the word means a knife, the first part being derived either from the word *scamata*, a line drawn on the arena between two contending gladiators, or from *scrarsan* (to clip), from which word is derived the German *Scheere*. Hence *scrama saxe* would mean either a cutting-knife, or otherwise a duellist's knife.

Many of these knives have been found with very long *tangs*. A specimen is to be seen in the museum of Zurich more than nine inches in length; another at Sigmaringen, ten inches in length. Some archæologists try to persuade themselves that these swords were intended merely for hewing wood, because the length of the haft seems to prove that both hands were used; but the *scrama saxe* is undoubtedly a weapon, and not an implement of husbandry, as we invariably find it in the tombs of warriors laid side by side with the long *spatha*.

This weapon appears to have been generally in use by all the Teutonic nations, inasmuch as the museum of Copenhagen as well as most of the German and Swiss museums contain specimens of it. The blade is single-edged, sharpened to a point, and scooped out in several places to make it lighter and more serviceable. These weapons, which M. Penguilly l'Haridon has restored in such perfection for the "Musée Impériale d'Artillerie" at Paris, were attached to a leathern belt, furnished with clasps. The javelin, or 'pilum,' with a barbed point, the lance with a long iron head, and the battle-axe, completed the list, bows and arrows being more frequently used for the chase than for war. The javelin being hurled at the enemy's shield, could, if fixed therein, drag it down by its weight.

The Frank used then to follow up his attack with the sword or with the francisque, a single-edged weapon—not double-edged, as many have asserted—often making use of this likewise to hurl at the foeman's shield when the javelin had not taken effect.

The sword said to have belonged to Childeric I. (457-481), and still preserved in the Louvre, has been so imperfectly restored that it is impossible to form a correct idea of its original appearance. The pommel has been placed on the lower part of the hilt instead of the upper, so that it looks a second guard, and gives the weapon an utterly absurd shape. We unfortunately have neither documents nor arms which would enable us to give a detailed account of the manner in which the Franks were armed between the end of the Merovingian and the beginning of the Carolingian dynasty. The sword and spurs that are said to have belonged to Charlemagne are almost all that remains, for the ivory cover belonging to the Antiphonarium of St. Gregory, made in the end of the eighth century, has Roman characters traced upon it, and was no doubt copied from a diptych. We must look in the Bible of Charles II., surnamed "le Chauve," and even on that we must not place much reliance, for the artist has evidently allowed his fancy to guide him in some of the illustrations. In one of these the king is represented sitting on a throne, surrounded by guards clad like Roman warriors, in mantles like those worn by the Pretorian guard; whilst in a bas-relief now in the church of Saint-Julien at Brioude (Haute Loire), made in the seventh or eighth century, a warrior is represented in a coat of mail, and a conical helmet; and in a German MS. of Wessobrunn, at Munich, written in 810, the soldiers have helmets that come low down on the neck, and round shields. It is impossible to reconcile either of these pictures with the evidence of the monk of Saint-Gall, who wrote as an eye-witness about the end of the ninth century, and says that Charlemagne and his soldiers were literally encased in iron; that the emperor wore an iron helmet; his arms were protected by plates of iron, his thighs by scales of the same; the lower part of his legs was protected by greaves, and his horse was clad in armour from head to foot. This testimony is confirmed by the laws of that sovereign, who ordered that all warriors

should wear armlets, helmets, leg-pieces, and also carry a shield. Although the *Codex aureus evangelia* of the monastery of Saint-Emeran at Ratisbon, a work undoubtedly written about 870 A.D., shows in the equipment of the soldiers many Roman characteristics similar to those in the Bible of Charles le Chauve before mentioned, and of the *Codex aureus* of Saint-Gall, it is hardly likely that such a retrogression should have taken place in the days of Charles II. from the formidable and complete equipment in the reign of Charlemagne. The *Leges Longobardorum* of the ninth century, which are preserved in the library of Stuttgart, confirm these doubts, for in them the king of Lombardy is represented bearing a long shield like those worn in the fourteenth century, and the bas-relief on a shrine of the ninth century in the treasury of the church of Saint-Maurice in Switzerland, shows a warrior in a complete suit of mail armour.

After these we find a singular dearth of historical and archæological traces, with the exception of the *Martyrologium*, a manuscript preserved in the same library, and the *Biblia Sacra*, another MS. in the Imperial library at Paris; both these MSS. are of the tenth century. In these the German knights are already armed in the same manner as the Norman knights that are represented in the Bayeux tapestry about the end of the eleventh or the beginning of the twelfth centuries.

As we remarked above, there is a great scarcity of documents on this subject during the Carolingian period, from the year 687 to 987; but for the period of the Crusades (1096 to 1270) our information is much fuller.

An Anglo-Saxon MS. of the British Museum library, the *Psychomachia et Prudentius*, written in the tenth century, represents a soldier without any coat of mail, but wearing a helmet with a rounded crown, like the soldiers in the *Biblia Sacra* mentioned above; whilst another Anglo-Saxon MS., called *Aelfric*, written in the eleventh century, represents a knight in mail armour, with a helmet of a very singular shape, having no nose-piece to it, though in the *Martyrologium*, a MS. written in the tenth century, now in the library at Stuttgart, the soldiers are represented wearing helmets with the nose-guard. The *Aelfric* MS. is particularly interesting to the archæologist for the various shapes of swords it gives, for by the length and shape of the blades one can fix the date with tolerable accuracy.

In the illustrations of this MS. may be seen swords with *tri-lobated* hilts, like those borne by the warriors in the *Biblia Sacra*. The German knight, however, is armed in a very different manner in the *Jeremias Apocalypsis*, a MS. of the eleventh century, in the library at Düsseldorf. He is there represented as wearing a hauberk with long sleeves of mail, and the upper and lower part of his hose are of the same material; while he also carries the little bassinet and the long-pointed shield of a convex shape, square at the top and pointed at the end. The same armour may be seen on one of the statues of the founders of the cathedral at Naumburg, of the same date; the only difference being that the shield on that statue is of the shape that is generally called in France, *Norman*. We also see the same armour in the sculptures of twelfth-century date on the gate of Heimburg in Austria, a town close to the Hungarian frontier. The warriors on the mitre of Seligenthal in Bavaria, on which the artist has represented the martyrdom of St. Stephen and of St. Thomas Becket, have very tall, rounded helmets, like sugar-loaves in shape. A bas-relief of the eleventh century, in the basilica at Zurich, represents the Duke of Bourekhard with helmet and sword, the shape of which reminds one of the weapons of the *Martyrologium* of Stuttgart. A statuette in yellow copper of the tenth century, in the collection of Count Nieuwerkerke, is very interesting, because the nose-piece of the helmet is much broader at the bottom than others of the same time. The Bayeux tapestry, which was made soon after the conquest of England by William the Conqueror, in the year 1066, is our best authority on the subject of Norman armour, as it shows us the manner in which soldiers were armed about the end of the eleventh and first part of the twelfth centuries. The conical helmet on the bas-relief of Brioude is also to be seen in the tapestry, but it has generally a fixed nose-piece, similar to the casques in the *Martyrologium* of the tenth century. Henry I. of England (1100) and Alexander I. of Scotland (1107-1128) are represented on their seals wearing the conical helmets, called in France *Norman*; it is only toward the end of the twelfth century that we find helmets with round crowns worn in England, similar to that on the seal of Richard I., Cœur de Lion (1189-1199), though this same kind of casque was worn in Germany as early as the ninth century. (See MS. of Wes-

sobrunn, and the reliquary of the church of Saint-Maurice.) On the other hand, the frescoes on the dome of the cathedral at Brunswick, painted in the reign of Henry the Lion, who died in the year 1195, represent knights wearing conical casques, and others already provided with rounded *helms*.

About the end of the tenth and beginning of the eleventh century, a knight wore usually a long tunic or hauberk (called in German *Halsberg*; in old German, *brunne* or *brunica*), that extended to just above the knee, and with sleeves which at first reached to the elbow, but were subsequently brought lower down on the arm. He also wore a sort of hood called a *camail*, which covered the greater part of the head and neck, so that only a little of the face remained exposed. This *hauberk* or smock frock was made of leather or linen, and had either strong wrought iron rings, sewed on it side by side, or chains placed either lengthways or crossways, or metal plates in the shape of scales. In the Bayeux tapestry William the Conqueror is represented with the lower part of his stockings covered with rings, while the knights, like the Anglo-Saxon warriors, have their feet bound round with thongs. The statue of one of the founders of the cathedral at Naumburg, a building of the eleventh century, mentioned above, wears leggings covered with mail, and the figures represented on coins of the reign of Henry the Lion, Duke of Brunswick, have the same kind of armour.

The Norman hauberk, therefore, was a sort of close-fitting upper garment, with stockings attached to it. It was made in one piece from the neck to the knees, and reached down to the elbows. The *camail* was a separate garment, and protected the back of the neck, the head, and a portion of the face; but amongst the Normans additional safety was afforded by the conical helmet, fitted sometimes with a long nose-piece, and sometimes with a guard for the back of the neck.

The hauberk is generally represented having a lattice-work, and in each of the squares large iron rings sewed on, or the heads of nails riveted. In the designs on the MSS. it is almost impossible to distinguish the one kind from the other. Coats are also to be seen, made entirely of iron scales, and hauberks latticed all over, but not having either nails or rings fastened to them. The Veleslav manuscript, in the library of the Prince Lobkowitz at Raudnitz, seems

to prove that the knowledge of body-armour in Bohemia had not made very much progress in the thirteenth century; but, nevertheless, we already find pointed mailed shoes in use (*à la poulaine*), hats, large iron helmets, and small shields. The latter may also be seen in the valuable MS. of that time called the German *Æneid* of Henry I. of Waldeck, in the library at Berlin. In this last-mentioned MS. the horses are covered with housings in lattice work and studded with nail-heads, and the knights have high helmets with crests, two things that were very rare at that time. The German MS. *Tiistan and Isolde*, written in the thirteenth century, now in the library at Munich, is also very interesting, for in it we see the knights armed with leg-pieces of plate and solerets, or small shoes, *à la poulaine*.

The defensive armour of the Norman was completed by a shield, generally pear-shaped, being rounded at the top and pointed at the bottom, and of a sufficient size to cover the body, reaching as it did a little above the shoulder and just below the hip. The Anglo-Saxon shield was round and convex, something like those of the Franks, and also like the circular buckler of the fifteenth century. His weapons consisted in a long cross-hilted sword, which was never very sharp, a mace, a battle-axe with either a long or short handle, and a lance with a little pennon hanging to it, about two feet in length. The sling and the bow were their missile weapons. The helmets worn by the archers were mostly without a nose-piece. The best kind of latticed, or chequered, hauberk was made of several layers of stuff with wadding between each, quilted and kept together by pieces of leather placed so as to form diamond-shaped spaces, a ring or nail-head being sewed in each space, and also on every intersecting angle. The coats of scale armour, usually called *jazerans* (*korazims*), are very rare at this period; in fact, we may venture to say there were probably none. The earliest one that I can trace in the manuscripts of the middle ages is a kind of shirt of mail worn by a knight in the *Codex Aureus* of Saint-Gall, written in the ninth century. Nevertheless we must not fail to make a distinction between these *jazerans* and those of a later date, for in the museum at Dresden there is a genuine specimen of the latter kind that King Sobieski wore before Vienna, in the year 1629. It

seems that hauberks made of scale armour were not at all uncommon in the north, for they are to be seen on many of the coins of Magdeburg from 1150 to 1160, as well as several other German coins of the same date.

All these coats of mail above mentioned may be divided into four sorts of ringed coats, made of flat rings sewed on side by side; coats made of oval rings, each one placed so as to overlap half the next, coats made of lozenge-shaped pieces of metal, and coats with scales.

The real coat of mail, which is erroneously thought to have been brought from the East after the crusades, was already in use in the centre and in the north of Europe some time before the eleventh century. Some pieces in the shape of rings, about a quarter of an inch in diameter, have been found at Tiefenau; they are of perfect workmanship and date, certainly some hundreds of years before the crusades. The epic poem of Gudrun relates how Herwig took off his hauberk and placed it upon his shield; and a little farther on, how his clothes were covered with the rust of his hauberk. The "Enigma of Aldhelm," a work written in the eleventh century, mentions this "lorica as being made entirely of metal, having no tissue," a passage which certainly describes the original coat of mail. It is also spoken of in the *Roman de Rou*, written after the Norman conquest. It must be about this species of coat that the Byzantine Princesse Anna Comnena (1083-1148) speaks of in her memoirs, when she says "that it was made entirely of steel rings riveted together, that it was unknown at Byzantium, and was only worn by the inhabitants of the north of Europe." The coat of mail is also mentioned by a monk of Mairemontiers, who lived in the time of Louis VII. (1137-1180), who has given a detailed description of the armour of Geoffrey of Normandy.

The lattice-worked coat, as well the hauberk covered with chains or rings, although proof against arrows, were of no avail against heavier weapons, such as lances; in addition to this, they were found to be too heavy and cumbersome, and so were given up by degrees, so that we find, at the beginning of the thirteenth century, coats of mail very generally worn by the richer knights—a defence which, like the former, was of no avail against rude shocks, but which the art of wire-drawing, invented in 1306 by Rodolf of Nuremberg,

brought within the reach of the poorest knights. The wrought-iron rings had been previously made one by one, and then riveted together, so that on this account coats of mail were far too expensive to be used by the poorer knights or by the simple man-at-arms. At the battle of Bouvines in 1214, the armour of the men was in a very perfect condition. They had ankle and knee-pieces, coats, a kind of shirt called *camail*, arm-guards, all made of mail, and so closely worked that they were proof at every point against the dagger, the detestable *misericorde* and the *Panzerbrecher*, so that in order to kill an unhorsed antagonist one was forced to beat him to death.

During the whole of the reign of St. Louis (1226-1270) the whole suit of mail was in general use amongst people of means in France and Italy. It was alike on both sides, without any seam, and was slipped on like a shirt; over it was worn a garment of quilted stuff or leather, called a *gamboison* or *gambeson*; for a long time this latter garment was the only species of defensive armour worn by the foot soldiers in France. In that country the armour of the common horsemen during the middle ages was very imperfect, for the French towns, not being nearly as rich or as influential as the large German, Flemish, and Italian cities, were unable to organise regular bodies of townsmen properly armed. The *gamboison* of the sixteenth century was made of linen embroidered with eyelet-holes. Plate armour, made at first of leather, and later on of steel, was in use at a much earlier period in Germany than in Italy, for some German MSS. of the thirteenth century represent knights in this new sort of armour with the *heaume* complete, whilst in Italy we do not find any trace of it till the fourteenth century.

Over the coat of mail the knights commonly wore a sort of loose frock made without sleeves; it was of a light material, and was called in German *Waffenrock*. It reached as far as the knee, and on it were embroidered the armorial bearings of its owner. This coat was generally the work of the Castellan's lady. The large hauberk, sometimes called the white hauberk (*die ganze Brünne*), was made entirely of mail, and in France the knights alone had the right of wearing it. It weighed from twenty-five to thirty pounds (French), and was composed of a long tunic, with the hood, sleeves, and stockings. Subsequently the hands were covered with mittens of mail,

the thumb alone having a separate division. Under this coat was worn a large plate of iron, which covered the whole of the chest. At this time such was the usual armour of the French cavalry. The small winglets that were attached to the shoulder-pieces of the earlier coats of leather and of horn, were sorts of escutcheons, which varied in shape; the oval form being usually preferred, like those on the statue of Rudolph of Hierstein in the cathedral at Basle. These winglets, as well as the shield, had the arms of the owner blazoned on them. They were, however, in use for about fifty years only.

The small bassinet (called in Celtic *bac*) must not be confounded with the larger bassinet or casque that was in use from the thirteenth to the beginning of the fifteenth century. It was worn as often under as over the camail, and between it and the head was a cap of quilted stuff, sometimes fastened by strings to the bassinet. Over this was worn, during tournaments or in battle, the *heaume* (derived from the German *helm*), an enormous helmet, which, at first, had no crest, usually carried at the saddle of the knight when riding. The long shield, rounded at the top and pointed at the bottom, completed the equipment. Subsequently the large bassinet was worn underneath the *heaume*, which became in consequence even larger than before. The *habergeon*, a species of small hauberk, was worn only by the shield-bearers, archers, men-at-arms, and such like. It was afterwards called a *jaque*, and came again into fashion in the sixteenth century. It is very difficult to fix the exact date of each separate kind of coat, for all the coats of mail were made in the same way; that is, in small links, called *à grains d'orge*, from their resemblance to barleycorns. Still we may generally take it for granted that the thicker and heavier the link the more ancient is the coat. Chambly on the Oise was celebrated for the manufacture of a double tissue of links, which, according to the authors of the period, was made with four rings joined on to one; still I very much doubt if such a coat were ever really made. Many of the coats of mail that one sees now-a-days are counterfeit, and can easily be detected by an amateur from the fact of their not being riveted.

The Persian coats of mail, however, are still as often made with riveted as unriveted rings. *Brigantines*, which were so often confounded with the *korazins*, and even with the hauberks,

are not to be found earlier than the fifteenth century, at which time they began to be in general use, particularly in Italy. They were worn by the archers on horseback, and by knights of moderate means. Some of these were made of thin plates covered with silk velvet, and were worn by nobles in Italy instead of the quilted doublet, as a protection against bandits. Charles le Temeraire used to wear one. The *brigantine* was generally made of thin rectangular plates of metal, each one being riveted on to the lining, and overlapping half the other. In several museums these *brigantines* have been exhibited on the wrong side, with the scales on the outer side; this is evidently an error, for we can see by the curved scales that they were meant to line the brigantine, which was worn over the ordinary doublet.

Their principal weapons were the lance and the sword, the hilt of which during all this time had remained unaltered as to the straight guard for the hand.

Towards the end of the thirteenth century the hauberk began to be shortened, and, arm-guards and leg-pieces made of prepared leather or steel being added, a radical change soon began.

In the fourteenth century we see German armour, made of plates of steel, and called plate armour (*Schienenrüstung*), gradually gaining ground. This armour, particularly when of good workmanship and well jointed may, when found in the north of Europe, be assigned to a much earlier period than in Italy and France: in these countries the transition period lasted till the reign of Philip VI. (1340), at which time even complete suits of plate armour did not yet exist.

In the German MS. of *Tristan and Isolde*, written in the thirteenth century, knights are represented clad in plate armour, wearing helms, and their horses completely clad in armour, though the illuminations of a Burgundian MS. in the "Bibliothèque de l' Arsenal" at Paris, a work supposed to have been written by the Duke of Burgundy, Jean Sans-Peur (1404 to 1419), but apparently of the fifteenth century, show Burgundian armour in a far less advanced state.

These illuminations satisfy me on a point which I had already noticed in the Swiss arsenals; that is, that black armour was more extensively used among the Burgundian and Sardinian nations, and bright steel armour among the Austrians.

While this new kind of armour had been substituted for the hauberk of mail, the under-garments had also undergone a change. Doublets without sleeves, but with hose attached to them, were worn, very like in appearance to the common dress of little boys at the present day.

This doublet was made entirely of linen, slightly quilted, and having rings of mail under the breast-plate and under the knees and arms, so as to protect the body wherever the armour was weakest, and wherever an opening might occur for the sword or small three-sided poniard (called in German *Panzerbrecher*).

The only specimen of this dress that has been handed down to us at the present day is to be seen complete and in capital preservation in the museum at Munich.

It will not be amiss here to correct an erroneous idea which has sprung up that the men of the days of chivalry were taller and broader than the men of the present day; the fact being that, with very few exceptions, they must have been of smaller make, for the armour from the fourteenth to the sixteenth century is too narrow for any one of average proportions now-a-days to wear. I made several experiments in the arsenals of Germany which strengthened the opinion I had already formed by inspecting other collections. It is in the shape of the leg and calf that the superiority of the present race may be seen; for it is almost impossible for any one of the present day to make a leg-piece of the middle ages or of the Renaissance period meet round the calf.

During the fifteenth and sixteenth centuries the form of plate armour underwent a great many changes, which varied according to the country and the period.

The influence of the changes in ordinary costumes, and the alteration in the manner of fighting through the invention of firearms, may be traced in the altered form of the armour. During the greater part of the fifteenth century the armour was usually Gothic in style. The shapes of the swords and breast-plates of that time are very tasteful, some of them being among the most beautiful ever made.

Towards the end of the fifteenth and beginning of the sixteenth century the breast-plate was often rounded in shape, the *passe-gardes* had increased to an extravagant size, the tassettes of jointed work were made even more curved than

before, and the whole armour began to lose its beauty and simplicity as well as its severe and formidable character.

The fluted armour, which was invented in Germany, and was indifferently called Milanese or Maximilian, marks the period of the decay of chivalry; for the cuirass of the time of Henri II., which is very like a close-fitting coat in shape, as well as the breast-plate, which resembles the deformed figure of Punch, have lost all manly character.

Very shortly armour assumed a most grotesque appearance. The breast-plate was made smaller and flattened, whilst the long *cuissarts*, that had taken the places of *tassets* as thigh coverings, were brought round behind so as to cover the loins—all these alterations making the wearer look like a lobster. We soon find top-boots taking the place of greaves, so that as early as the time of Henry IV., and still more so in the reign of Louis XIV., armour had almost disappeared; in losing its massive character it had become of very little use, and in a very short time tanned leather took its place. In Germany as well as in France during the Thirty Years' War, the *buffletin* with its high stock took the place of the cuirass; the latter was worn only on special occasions.

We are able to distinguish and classify armour through observing the characteristics of its period, which are as easily recognisable as in the civil costumes of the same dates. For instance, the conical casque, called in France Norman, so often represented on monuments of the tenth century; the *heaume*, made according to the English pattern with nose-piece, or according to the German pattern with vizor, belonging to the twelfth and thirteenth centuries; the crested helm, from the thirteenth to the fifteenth century; the small bassinet or *cervelière*, which used to be worn under the *heaume*; the larger bassinet belonging to the thirteenth and fourteenth centuries; the *salade* of the fifteenth century; the metal head-coverings and saucepan helmets, the earliest specimens of which are to be seen in the manuscripts of the tenth and eleventh centuries; the different sorts of burgonets in the sixteenth; the *armet* or helmet of the sixteenth and seventeenth centuries (the last technical name applied in the trade to a headgear); the *morion* and the *cabasset*, both of which, being lighter sorts of helmets, were worn only by the infantry—all these different pieces of armour help us, by their

shape and general characteristics, to fix the date of their make with tolerable accuracy.

The importance of the buckler among the northern nations, and particularly among the German race, gave rise to an art which was quite original in its way. We shall see shortly that the shield was a much more important portion of the armour in mediæval than in ancient times. It is on the Germanic shield that the feudal spirit is first to be traced, as on its surface may be seen the origin of armorial bearings. When Tacitus, writing in the first century of our era, stated in his "De Germaniâ" that the Germans were in the habit of painting their shields with all sorts of gay colours and devices, he was ignorant that these devices were a sort of hieroglyphic denoting the most famous deeds achieved by the owner of the shield. This custom was so general among the Germans that the words for painter (*Schilder*) and the verb to paint (*Schildern*) in old German are derived from *Schild*, a buckler.

These records of deeds achieved, whether they were representations of the weapon by the aid of which they had been accomplished, or of the enemy or monster overcome, remained during the warrior's life as his distinctive badge—a custom which proves that, at the outset, armorial bearings were not hereditary; for as the son could gain no credit in any way from the deeds of his father, he was obliged to conquer in his turn so as to be able to have his shield painted—a fact to which Virgil refers when he says "*Parma inglorius alba.*"

From the beginning of the tenth century tournaments became so frequent in Germany that in a short time armorial bearings were considered common to the whole family, then to their descendants, and in a short time strictly hereditary.

It was about the beginning of this century, and some time before the crusades, that, in order to facilitate the recognition of the new nobility, a knight, when he arrived at the barrier of the tournament, used to deposit there his shield and his helmet, which was a sign to the heralds (derived from the German *Herold*, noble crier) that the bearer of these arms had the right to engage in the tourney.

In the eleventh century, at the time of the first crusades, almost all Europe had adopted these distinctive marks, and from that time armorial bearings and the art of heraldry have

existed amongst Christian nations, and even amongst the Moors in Spain.

It was not long after this that the nobles took to adding to their names the name of their castles or of their lands—a custom which gave rise to the fashion of *differences* in family arms.

The Normans as well as the Franks introduced into France at a very early period the custom of wearing armorial bearings. The shields of the Norman knights were all painted with representations of fantastic animals, which were clearly their personal arms.

The shield has varied in shape more than any other part of defensive armour. The Keltic, the German, the Scandinavian, and British shields—all furnished with a boss—the square Germanic shield of the anti-Merovingian period; the buckler of the Merovingians, Carlovingians, and the Anglo-Saxons; the long painted shield of the tenth and eleventh centuries, generally called the Norman shield; the triangular shield of the same epoch; the small shield of the thirteenth and fourteenth centuries; the German shield called *pavois*; the *manteau d'armes*; the round shield of the fifteenth and sixteenth centuries; the buckler and the target—had all their distinctive features and names, and open a large field for study.

The shape and make of the gauntlet also helps us in most cases to fix the date of the armour with tolerable accuracy.

The first kind, which was used in the twelfth and thirteenth centuries, was only a sort of bag made of mail, formed from the end of the sleeve of the hauberk. In the fourteenth century the regular gauntlet, with separate fingers to it, came into fashion, which again in the fifteenth century was superseded by the mitten. The mitten was made of thin plates of steel, with joints, to enable the hand to move freely, and it is to be found in the armour of the Pucelle d'Orleans. It is also of this mitten that Bayard speaks when he says, "Ce que gantelet gagne, gorgerin le mange." Towards the middle of the sixteenth century gauntlets were again made with divisions for the fingers, the invention of pistols and firearms having rendered this necessary.

About the fourteenth century coverings for the feet, made of thin plates of steel or iron, called *solerets* or *pedieux*,

were universally adopted; and in the north, as early as the twelfth and thirteenth centuries, when also the lower part of the mailed hose was superseded by *tumelières*, or plates of armour. The form of the soleret is a safe indicator of its date; it originally terminated in an *ogival* point; which gradually began to grow longer, till at last it assumed a very extravagant length, like the *chaussures à la poulaine*. From 1420 to 1470 these shoes were worn in a fashion called *l'ogive tiers point*; from 1470 to 1550, *sabot et le pied d'ours*; after 1570, *bec de canne*; but it is difficult to fix the precise date when the changes took place. At the end of the seventeenth century top-boots had taken the place of solerets and greaves. The shape of the shoes called *à la poulaine* is only useful in helping to fix the date of a suit of armour when one is certain of the country to which they belong, for they were adopted at different times in different countries. This kind of shoe called *à la poulaine* was in fashion in France from 1360 to 1420, while, on the other hand, as early as at the battle of Morgarten (1315) the Austrian knights are said to have cut off the long points of their shoes on dismounting from horseback; and still earlier (1154-1189), Henry II., of England, wore shoes *à la poulaine* for the purpose of hiding a deformity on one of his feet. The fashion, however, first originated in Hungary.

✧ The defensive armour worn by horses has undergone changes of fashion as well as that worn by men, for the fluted armour was used as a protection for the breast, the nose, the sides, and the hind-quarters of the horse; the oldest representation of this kind of armour that I have been able to find is on a coin of the time of Henry the Lion of Germany (1195), where the horse belonging to the duke is covered with a trellis-work, with heads of nails riveted into the squares, the same as those represented in the German *Æneid* of the thirteenth century of Henry of Waldeck, now in the library of Berlin.

The spur in use till the eleventh century had a straight point, but no rowel. After that time the point was made so as to slope upwards slightly, while in the thirteenth century it was made with a bend or crook in the shank, but the rowel does not appear to have been used till the fourteenth century, when it generally had eight points. During the

fifteenth and sixteenth centuries the shank became longer and longer, till at last it was transformed, through the fancy of the artist, into a mere toy. The saddle varied much in shape, particularly those used in tournaments. The celebrated wooden saddle made in Germany, and constructed so as to prevent the tilter remaining seated, is the rarest.

The list of swords is very long, and comprises the rapier; a duelling and fencing sword—a weapon which cannot be traced earlier than the first half of the sixteenth century, about which time, in the reign of Charles V., the art of fencing was first introduced—the ancient claymore, which had not a basket hilt, as is generally supposed; the scimitar; the sabre already employed among the Dacians in the time of Trajan; the yatagan, the cangiar, the flissat, the koukris, have as many varieties as the dagger, the poignard, the stiletto, the khouttar, and the *cris*. The lance, the pike, the mace, the *morgenstern*, the scythe and the sickle, the boar-spear, the hammer, the flail, the hatchet, the halberd, the *corsesca*—a kind of spear—the *roncone*, the partisan, the spontoon, the war-fork, and the bayonet, furnish as many subjects for study and research as do the sling, the *fustibale*, the bow, the cross-bow, and the sarbacane, or blow-pipe.

All those machines formerly used in war, such as the balista, the catapult, the *trébuchet*, the battering-ram, and many others, had been adopted by the Christians of the middle ages, who added a large number of their own invention—a fact which we gather from the manuscripts of that period, and of the Renaissance.

Nevertheless, we must not put implicit faith in the supposed existence of all the machines described and represented in these MSS.; very few really existed, the greater number being merely designed by the inventors. But it is quite as certain that fire-barrels and incendiary arrows were hurled by means of these engines, as that pots of unslaked lime were shot into a besieged town to blind the eyes of the defenders. Leonard Fronsperg has described the way in which they were used in his work, *Kriegsbuch*, published in 1573; and in the museum at Zurich are exhibited some specimens which were found under the ruins of an old castle.

It is worth while observing, that from the fourteenth

century until the end of the fifteenth, knights, particularly in France, had adopted a habit common likewise in England, Germany, and Italy, of dismounting and fighting on foot—a practice adopted, as our readers will remember, at the battle of Crécy (1346). It is to this sacrifice of old traditional dignity that may probably be ascribed the change in construction of armour which took place in the reign of Charles VII. (1445).

The Musée Impériale d'Artillerie possesses two of the finest suits of this new kind of armour, which were originally in the Ambras collection; but it appears to me that they must have been useless for all practical purposes. I do not believe it to be possible for a man to move in this double-jointed armour. It would be very interesting if the directors of this museum were to cause some experiments to be made for the purpose of deciding this question.

At the end of the twelfth century, when tournaments became a regular practice, the want was felt of some better protection for the head against the formidable thrusts of the heavy lance, not unlike the trunk of a tree in size and cumbersomeness, and which later on was fixed to the cuirass as in a vice, by means of a hook called *faucre*, or rest. The *heaume*, that enormous helmet that covered the *camail* and the *bassinet*, the earliest existing specimens of which are of English origin, was soon added, and was fastened to the rest of the armour by means of screws and chains.

The introduction into tournaments of the laws of chivalry is thought to date from about the twelfth century, although tournaments, conducted on a certain method, but not regulated by any fixed laws, date much earlier. Some tournaments are known to have taken place in Germany as far back as the ninth century, which accounts for the great perfection to which the manufacture of armour had been carried in that country. According to the registers existing in different towns, no fewer than a hundred and eighty regular tournaments must have taken place at different times, not including a large number of smaller "passages of arms." The most important, starting from the ninth century to the end of the twelfth, were almost all of them held in Germany, and are, at Barcelona in 811, on the occasion of the coronation of Count Linofre; at Strasburg in 842, in the reign of Charles the

Bald; at Ratisbon in 925, under Henry the Fowler; at Magdeburg in 932, under the same; at Spire, under Otho I., in 938; at Rothenburg in 942, under Conrade of Franconia; at Constance in 948, under Lewis the Swabian; at Mersburg, on the Saale, in 968; at Brunswick in 996; at Trèves in 1019, under Conrad I., and another also at Trèves in 1029; at Halle in 1042, under Henry III.; at Augsburg in 1080, under Hermann of Swabia; at Göttingen in 1118, and again in 1119; at Liege in 1148, under Theodore of Holland, in which took part fourteen princes and dukes, ninety-one counts, eighty-four barons, one hundred and thirty-three knights, and three hundred nobles; at Zurich in 1165, under Duke Guelph of Bavaria; at Beaucaire in 1174, under Henry II. of England; at Corbie in Picardy in 1234, where Floris IV. count of Holland was slain.

These tournaments often occasioned much bloodshedding, at one time as many as sixty people being killed in one passage at arms. Notwithstanding the anathema launched by Pope Eugenius, in the ninth century, against these barbarous sports, they increased more and more, so that after the return of the first Crusaders, when hereditary arms were universally adopted, it was found necessary to institute a regular heraldic code, which, though very complicated, still, by its strict regulations, gave to this military exercise a chivalrous bearing, which in Provence assumed almost the character of romance. It is a fact that in these tournaments, which took place of course in time of peace, as many, if not more, titles of knighthood were conferred than in battle; and it was on these grand occasions that noble alliances were generally formed. As the young country squire passed most of his time in hunting in the vicinity of his castle, placed on the top of high rocks, or in the midst of thick forests, he had no other opportunity of meeting the daughters of nobles but at tournaments, at which places they displayed their charms, being dressed out in finery and stuffs of such brilliant colours, that the rude enclosures and galleries seemed to contain nothing but perfect baskets of flowers. Whilst the most beautiful lady, who was usually the queen of the day, was distributing the prizes to the winners, all the ladies remained standing, and the knights

used to look round and select their partners for dancing, and not unfrequently also for life. It was for these very fêtes that many nobles ruined themselves in the desire to eclipse their rivals in the richness of their armour and accoutrements, a step which often reduced them to a state of dependence on the Hebrew usurer.

These tournaments are generally divided into three sorts, the German *Rennen* or tilt, the German *Stechen* or passage at arms, and the German *Fausstournier*; three sorts, which in Germany became subdivided into eighteen. These divisions and limitations were too strict and precise for the middle ages, for in the fêtes of that time these arrangements and restrictions were set at naught far more than is supposed by the authors of the sixteenth century, whose imagination is as fertile on this subject as on that of war machines.

The armour usually worn for tilting is supposed by some authors to have been lighter than that used in war, but this is an error, as it was really a great deal heavier. It is clearly impossible for a man to have borne the weight of one of those polished steel suits of armour so well known by the beauty of their design, their massive character and enormous weight, for more than an hour at a time. The passage at arms was, however, often mixed up with the 'joust' (the latter being always practised on horseback), for the combat was very often continued on foot with the same armour after one of the combatants had been unhorsed. Suits of armour made specially for foot combats are very rare, and in the designs of fifteenth-century date, preserved in the Maximilian Museum at Augsburg, we see that in tournaments the wooden mace (*kolbenturnier*) was not the only weapon employed, for in the *mêlée* knights are represented as wearing the *heaume*, and carrying swords attached to their breastplates by means of small chains, whilst others are using that less dangerous weapon the wooden mace mentioned above.

The Gothic armour which originated first in Germany spread rapidly wherever the spirit of chivalry had shown itself. It is to be found in England, France, Spain, and even on the classic soil of Italy, but in all these places it has undergone certain modifications, according to the customs and tastes of the nation. In Italy armour has always been marked by an incompleteness of style, though the designs and execution

of the ornaments are usually very artistic. The artists of that country were too much influenced by a natural prejudice in favour of classic traditions to be able to abandon the Pagan for the new style, which was characterized by great simplicity of treatment and by a complete change from that of the past age. They also seemed to forget that the changes introduced into the manner of fighting required a corresponding change in the armour.

The Arab invasion in Spain acted rather as an impulse for improvement in the making of armour than for its decadence, as some authors would have us believe, for the decline in the manufacture of armour did not take place till after the expulsion of the Moors from Granada in 1492; and although after this the Spanish artists had recourse again to the Gothic style it was only for a short time, for the decay of this art was complete in the reign of Charles V., on account of the influence of the Italian school. The art of painting alone freed itself at length from this unhealthy foreign influence, and some of the finest master-pieces conspicuous by their originality and beauty date from this era. As to the oriental arms of the present day, they are almost identical in make to those that the eastern nations manufactured hundreds of years ago. We see particularly in the illustrated copy of the *Schah-Nameh*, or Royal Book, that is in the library at Munich, a poem written by the poet Ferdusi in the reign of Mahmoud, the founder of the Ghaznavides, 999 years after Christ, that Persian equipment was in the sixteenth century exactly the same as it is at the present day.

We find very little change in Chinese and Japanese armour, for although a slight alteration can be traced in costume throughout these various epochs, separated by hundreds of years, the form of arms has remained stationary. The sabres, iron-forks, pikes, swords, and even cuirasses and helmets exhibited in the Musée d'Artillerie at Paris, used in the last war, are identical with those dating centuries back, that may seen in the Tower of London and elsewhere.

War machines, the artillery of ancient times, were adopted by the middle ages with very slight modifications from those used by the Romans, for we see from the illustrations of the period that their construction was almost identical. We can have no doubt of these machines having really existed, new

proof having been afforded to us by the remains of balistas found under the ruins of the castle of Russikon in Switzerland, which was destroyed by fire in the thirteenth century. These remains, together with a large number of broad arrow heads, are preserved in the cabinet of antiquities at Zurich. In some illustrations by Zeitblom in a manuscript of the fifteenth century belonging to the library of Prince Waldburg Wolfegg, we have a representation of the catapult or tormentum of the ancient Romans, known in French under a slightly different form by the name of 'onagre,' and very like one in the "Recueil d'anciens poètes français" in the Imperial library at Paris. The records of Mons also make mention of these catapults, but we can nowhere find any traces of the *polyspaste*. Besides these machines for hurling missiles used in the middle ages, many others were invented for the defence of camps and of besieged towns, such as are seen in the water-colour drawings, executed by Nicolaus Glockenthon in 1505, of the arms and armour collected together in the three arsenals of the Emperor Maximilian. Two collections of drawings dating about the beginning of the fifteenth century, which are as well as the above in the "Ambras collection," represent a species of diving-dress not at all unlike the modern ones. Still, as we have already said, too much faith must not be put in the real existence of all the machines which are represented in the MSS. of the middle ages and of the Renaissance, for in those times the minds of men were as fertile in constructing machines for the destruction of human life as they are now, and these drawings may at times represent projected ideas rather than accomplished facts. Passing on to hand weapons, we find at this time, as at all periods, the sling, the *fustibal*, and the bow everywhere prevalent.

The crossbow which M. Rodios supposes to have been identical with the *gastrafetes* of the Greeks, seems to me to have been an invention of central Europe, and to date no farther back than the tenth century at earliest; for if it had been known elsewhere, the Princess Anna Comnena (1083-1148) could scarcely have been ignorant of it, inasmuch as M. Rodios gathers his information from Byzantine MSS. The princess states, however, "the *tzagara* is a bow unknown among us."

The sling and the fustibale (which was only a sling with a handle fastened to it) were used as late as the sixteenth century for hurling fireballs and grenades, as may be seen in the paintings by Glockenthon, mentioned above.

The bow was used by the Germanic races for hunting only; for the Franks, Saxons, Allemanni, Burgundians, Angli, Catti, Cherusci, Marcomanni, and many others, scorned it for warlike purposes, considering it too childish and treacherous a weapon, and preferring to it even the battle-axe or the *anjon* for missile purposes.

In the Bayeux tapestry Normans and Anglo-Saxons are alike armed with bows, and it must be admitted that at the battle of Hastings both sides made good use of them. But the Germans continued to make very little use of missile weapons until the invention of the crossbow. The Norman bow was small, being only about a metre in length, while the bow used by the English archers, who were so celebrated for their skill in archery about the thirteenth century, measured two yards in length, and varied according to the height of the person who used it. The rule was that the bow should measure the exact width between the two middle fingers when the arms were outstretched. The English archers were so expert, that they were able to discharge as many as twelve arrows in a minute, which rarely, if ever, missed their mark.

The Italian bow, generally made of steel, was about a yard and a half in length, like the German bow. The English arrow was a yard in length.

In the twelfth century, an archer usually carried two cases, one of which was the quiver (called *couin*, in old French; in German, *Flitz*); this held the arrows, which, according to the records of Saint Denis, were then called *pilles* and *sayettes*; the other case held the bow. The points of the arrows were of various shapes, some of them being square, like the crossbow bolts, with two, three, or four points, whilst others were barbed like ancient arrows. There were also some of cork-screw shape, others petal-pointed, and even crescent-shaped, for hamstringing men and horses.

The crossbow mentioned by the name of *tzagara* by Anna Comnena is also spoken of by William of Tyre in the year 1098, about the time of the first Crusade. In the reign

of Louis VI., surnamed le Gros (1108-1137), this crossbow was in general use in France, and a law was passed at the Lateran council held in 1139 forbidding its employment amongst Christian nations, though, strange to say, it authorised the use for the purpose of slaying infidels and miscreants. In England, however, Richard Cœur de Lion (1189-1199) allowed crossbowmen to form part of his army, notwithstanding the pastoral letter of Pope Innocent III. Philip Augustus (1180-1233) organised in France some bodies of crossbowmen on foot and on horseback; soon these regiments became so important that their commander took the title of grand master of crossbowmen, a high post in the army, and next in rank to that of marshal of France, and it was not till 1515 that this office was united with that of grand master of artillery.

In the charter of Theobald, Count of Champagne, about the year 1220, it is said, "Chacun de la commune de Vitre aura xx livres, aura *aubeleste* en son ostel et *quarriaux*, etc." Crossbowmen are also mentioned in the chronicle of Saint Denis. The first paintings representing crossbowmen are in an Anglo-Saxon MS. of the eleventh century, now in the British Museum, also in some frescoes in the cathedral at Brunswick, painted in the reign of Henry the Lion, who died in 1195, and in the chapel of Saint John at Ghent, in paintings done in the thirteenth century. It is well known that Boleslaus, Duke of Schweidnitz, introduced amongst his subjects the practice of shooting with the crossbow in the year 1286, and a little later it was introduced at Nuremberg and Augsburg. Charles VII. had caused to be planted in all the cemeteries in Normandy yew-trees for the manufacture of crossbows; in point of fact, throughout France this weapon had entirely superseded the long bow, which however continued to be used in England till the end of the reign of Queen Elizabeth (1558-1603), at which time all archers were armed with open casques and brigantine coats. The bow used by the English was much superior to the French crossbow, for the crossbowman could with difficulty shoot three bolts to the bowman's twelve arrows. Moreover, the rain often slackened the string of the crossbow, while the bow-string could easily be protected. The loss of the battle of Crécy (1346) was in great part owing

to this circumstance, which rendered it almost impossible for the French to return the unerring shots of the English archers. In 1356, after the defeat at Poitiers, the inferiority of the crossbow became so evident, that in France corps of archers were organised, who soon became so expert that the nobility grew fearful of their power, and had them disbanded. In the year 1627, at the siege of La Rochelle, there were some English archers in the pay of Richelieu who distinguished themselves at the attack on the Island of Ré. ☐

The crossbow had also become a favourite weapon amongst the Germans, who had improved it in various ways. In France it fell out of use in the seventeenth century, when the corps of crossbowmen was finally given up. The crossbows of the cavalry were lighter than those of the infantry, and the string was stretched by means of a simple lever, called a *goat's foot*. This species of windlass was called *cranequin*, and the foot-soldiers who used it were surnamed *Cranequeniens*; Monstrelet, however (1390-1543), calls them *Petaudiers* and *Bibaudiers*.

There are seven different sorts of this weapon.

The *Goat's foot crossbow*, used by the cavalry.

The *Windlass crossbow*, generally called *cranequin* crossbow, which, as mentioned above, caused the infantry to be called *cranequeniens*.

The *Latch crossbow*, also called *à tour* and *de passot*, specially adapted for sieges and for shooting at a mark. This was the weapon used by the Genoese at Agincourt (1420).

The *German crossbow*, having the wheel attached to the stock.

The *crossbow à galet*, or pebble crossbow of the sixteenth century, so called from the round pebbles, leaden bullets, and earthenware balls that were shot from it instead of bolts. The Germans called it *Balestre*, from its being somewhat large in size.

The *ramrod-crossbow*, a heavy and comparatively useless weapon of the time of Louis XIV.

The *Chinese crossbow*, fitted with a case which turned on the stock by means of a lever moved by the wrist, and which furnished twenty arrows in succession, just like our modern revolvers. ☐

The projectiles carried by these crossbows, with the exception of the bullets mentioned above, were called *carrels* or *carreaux*, from the square shape of the head. The *vireton* was a bolt furnished with feathers, or thin pieces of wood or iron, which were arranged in a curved direction round the shaft, so as to impart a rotary motion to the bolt. Another bolt called *matras* had a round disk or head, which killed without piercing whatever object it struck; it was, however, oftener used for the chase than in war. It was especially useful in bringing down such beasts as the hunter might wish to preserve with the skin uninjured.

We now come to fire-arms, the use of which in Europe cannot be traced back earlier than the fourteenth century, and on this subject our researches are attended with many complications.

The Chinese knew of gunpowder for several centuries before its use was general among us. It was believed for a long time to have been the invention of two monks, Constantine Amalzen or Schwarz (1280-1320), belonging to the convent of Friburg in Breisgau, but it is now supposed to have been known to the Kelts and to all the ancients. In the Palafittes, or lake-dwellings of Switzerland, which, thanks to Dr. Keller, have been, so to speak, restored, have sometimes been found fire-bullets, which were filled with a composition which might very likely have been gunpowder. The words *Shet à gene* (centueur) and *agenaster* (fire-arms?) found in the sacred Indian books, as well as the machines with which, according to Dion Cassius, Caligula used to imitate thunder and lightning, seem to strengthen our belief in the existence of an explosive powder for the purposes of war. Vossius, in his *Liber observationum*, inclines to the same opinion, from a description by Julius Africanus, who lived in the year 215 A. D.

The Falarica of the Romans, which was also used in the middle ages, and probably identical with the incendiary arrow, assigned by Gregory of Tours to a Keltic origin, was most likely covered with a preparation of similar materials to those used now in the manufacture of gunpowder.

Callinicus, a Greek, had learnt from the Arabs how to make three different kinds of Greek fire, and this secret he communicated to Constantine Pogonatus during the siege of

Constantinople. One of these compositions bore a strong resemblance to gunpowder. The fire-arms which were used by Hagiacus and the Arabs in 690, at the siege of Mecca, would lead one to conclude that Mohamedanism was propagated not only by means of the sword, but also by gunpowder. The secret of gunpowder most likely came over from India, for the Arabs call saltpetre *Thely Sini*, which means Indian or Chinese snow, and the Persians call it *Nemek-Tschini*, that is, Indian or Chinese salt. The embrasures for cannon constructed in the great wall of China, built about 200 B.C., furnish additional proof that the Chinese used artillery at this epoch.

The MS. (*Liber ignium ad comburendos hostes*) written by Marcus Græcus, 846 A.D., contains a receipt for making gunpowder, and also proves that the author was acquainted with a composition called *raquette*. This receipt includes, besides other things, six parts of saltpetre, two of sulphur, and two of charcoal. We have proof that in 1232 the Chinese and the Tartars employed gunpowder regularly in war, and it was also used at the siege of Seville (1247), and the receipt for this powder and for that called *raquette*, given in the *De Mirabilibus Mundi*, a work written by the Bishop Albertus Magnus of Ratisbon in 1280, enables one to assign distinct dates on this question.

Till the commencement of the fourteenth century in Europe, what were called fire-arms were only engines which threw fire into besieged places for the purpose of destroying the buildings and machines of the enemy; and it is not until the end of the fourteenth century that weapons which carried leaden or stone bullets were invented, and that the history of artillery and fire-arms really begins. Before gunpowder was used, victory in battle resulted as much from the muscular strength of the soldiers as from the strategic skill of their leaders or fury of the combatants, for notwithstanding the manœuvres of their captains, it always resolved itself at the last into a hand-to-hand struggle of the most exciting and deadly kind, which has no parallel in our modern warfare, though our appliances for the destruction of life are much more formidable.

As soon as artillery began to be used battles changed entirely in character. The combatants did not rush on each

other after shooting off a few arrows or bolts, but used to station themselves at a distance, and ply destruction among each other's ranks with their pieces of artillery, and it was not till the end of the action that a hand-to-hand struggle for some important locality was needed to decide the day. Gunpowder, the process of *corning* which was known in 1452, has helped, as well as the art of printing, to protect modern civilisation against the chance of again vanishing.

In order to proceed systematically in this matter, we must divide fire-arms into two categories, one comprising all large and heavy pieces of ordnance—such as cannons, etc.—the other, all portable arms.

We are quite justified in believing the traditional story that the idea of making use of gunpowder to shoot balls through an iron tube accidentally occurred to the inventor. While pounding a mixture of sulphur, charcoal, and saltpetre together in a mortar, the composition suddenly exploded, and the man was knocked down; this proves that it must have been from a common domestic mortar that the first idea of a cannon was conceived; a touch-hole was added for the purpose of firing it without danger. The mortar ought, therefore, to be considered as the first European fire-arm. Not long after the invention of this weapon several guns or mortars were made of pieces or bars of wrought-iron, like the staves of a barrel joined one to the other by hoops. The largest one is in the arsenal at Vienna, and is three feet seven inches in diameter, and eight feet two inches in length. The first cannon (a name derived from the German *Kanne*, a drinking-vessel), generally called *bombarde*, was made of wrought-iron, and this was a mortar, though open at both ends. The charge was inserted at the lower extremity, which was then stopped up with wedges of metal or wood, sometimes one whole piece, sometimes several hammered in with a mallet.

This, the most ancient form of cannon, is found in Germany as early as the sixteenth century, but of an improved shape. It was followed by the *charge à la boîte mobile*, called *veuglaire*, from the German *Vogler*, fowler, in which the chamber and tube were formed of separate pieces, and finally, by the muzzle-loading gun.

In examining the MSS. and the designs, more or less

fantastic, of the fifteenth and sixteenth centuries, it appears as if the cannon called *bombarde*, that was open at both ends, were more modern than the *veuglaire*; but from the pieces that still exist, whose origin and date of manufacture is known, the *veuglaire* is proved to be the more modern weapon.

Cast-iron cannons succeeded those of wrought-iron.

The first mention of the use of fire-arms—perhaps powder-arms would have been a better title—which for a very long time did not entirely supplant the old-fashioned machines, as these, particularly for siege operations, are to be found in use throughout the whole of the middle ages, dates as far back as the year 1301, when the town of Amberg in Germany had constructed a large cannon, and Brescia succumbed under a volley of arquebusses (?). In 1313 the town of Ghent had stone-throwing guns; and it was probably from Flanders that Edward III. brought over these new weapons for use against the Scots in 1227.

In the year 1325, the Republic of Florence granted to the priors, the gonfaloniers, and to the twelve municipal magistrates, the right of nominating two officers, charged with the construction of iron bullets and metal cannons, for the defence of the castles and villages belonging to the republic.

A few years later, in 1328, the Teutonic nations throughout the north of Europe made use of large cannons in their wars in Prussia and Lithuania. It was also about this time that all the free towns of Germany began to provide themselves with artillery.

It is stated in authentic history, that at the sieges of Puy-Guillern and of Cambrai by Edward III., cannons were already in use (1339), and there exist representations of the cannons used by the English at the battle of Crécy in 1346.

On referring to a passage in *De remediis utriusque fortunæ*, by Petrarch (1382), it is clear that wooden cannons existed at that date in Italy. But I doubt if the small wooden cannons made of thick staves covered with leather that are to be found in the arsenal at Genoa are of as early a date, and may not rather be contemporary with the leather cannons used by the Swedes in the Thirty Years' War.

In 1428 the English made use of fifteen mortars that were loaded from the breech, at the siege of Orleans.

When the manner of loading was changed from loading at the breech to insertion at the muzzle, the charge was at first enclosed in a small copper case, such as is represented in the work of Fronsberg, written in the sixteenth century, and similar to one exhibited in the arsenal at Soleure. Between the ball (which was at first made of stone, and called *stone*, simply) and the charge of powder was placed a wooden wad. The charge was at first fired by means of a live coal or a red-hot iron, and it was not till some time later that a slow match fastened to the end of a stick was used. The mantlets or wooden blinds which used to be drawn down during the time of loading the cannons, were for the purpose of sheltering the gunner and his man. It was in 1346, at Tournay, that a man named Piers made the first experiment with the long-pointed projectiles, which may be regarded as the precursors of the conical bullets actually used at the present day. According to the Thuringian chronicles of Rothe, it was the artillery of the Duke of Brunswick in 1346 who were the first to use a new kind of projectiles, viz., leaden bullets. Not long after this some German manufacturers sent over to the Venetians a great many iron cannons and balls, that were used with great success in the siege of Claudia-Fossa.

About the year 1400, iron balls superseded those of lead. A MS. of the fifteenth century, in the Ambras collection at Vienna, contains designs where the gunners are represented loading their guns from the breech with red-hot iron cannon-balls. This same MS., as well as another in the Hauslaub collection, Vienna, shows us also how they used the small incendiary barrels in sieges about this time.

In Switzerland fire-arms were not introduced till a later date; at Basle the first cannons were cast in 1371, at Berne in 1413.

In 1372, at the battle of Rhodes, some of the French ships fired carronades.

With regard to the use of bronze in casting of cannons, and of hollow iron and leaden shot, these are mentioned for the first time in the casting of thirty guns at Augsburg in 1378, by a founder called Aarau.

In Italy bronze cannon were not cast earlier than 1470.

The trunnions that support the cannon, keep it evenly

balanced, and prevent its recoil off the carriage, appear in Germany as early as the fifteenth century, but it is not known who was the first person to introduce this improvement, the discovery of which was of great importance, as it enabled the cannon to move easily in a vertical direction.

The artillery of Charles the Bold had no trunnions, as is generally supposed; the idea being taken from MSS. that cannot be relied on. The cannons taken at Morat in 1476, now in the Museum of Artillery at Paris, and in the Gymnasium at Morat, as well as those taken at Grandson and at Nancy, at present in the Museums of Lausanne and Neuville, have no trunnions.

Cannons were introduced into Russia in 1389; and the *Taborites*, the avengers of Huss, used bowitzers in 1434.

At first mortars were usually placed on blocks of wood or in sorts of sockets (*affûts fixés*): later on (1492) they were placed on movable carriages that enabled the shot to be directed on any side. The *scala librorum*, or measure for the bore, was invented by Hartmann of Nuremberg in 1440, and it was brought into use throughout Germany by the celebrated smelter of Charles V., George Lofler of Augsburg, who also instituted a standard of the four sizes (which were 6, 12, 24, and 40). It was at this period that cast shot was invented, which was destined to effect a great change in artillery.

As to the *powder mines*, which were preceded in the middle ages by *firebrand mines*, it is generally admitted that they were first used, in 1503, at Naples, when it was besieged by the Spanish general Gonzalvo of Cordova, though Vannoccio Biringuccio attributes the invention to the Italian Francisco di Giorgio.

The cannons that at first were fixed on wooden blocks and cases were soon placed on gun carriages with wheels, and shortly after fore-carriages and gear were also used. Towards the fourteenth century, chariots bristling with spears, formerly used by the ancient nations, were adopted for the defence of camps, having small cannons fixed on the framework of the car. These were called *Ribaudequins*, from *Ribaud*, an assistant gunner, and were also used as a check against a cavalry charge. These cannons were usually placed on two-wheeled carriages, and are still to be seen in the designs

of Nicolaus Glockenthon, executed about the year 1505, after the cannons then existing in the arsenals of the Emperor Maximilian.

It is very difficult, in fact, almost impossible, to classify exactly, according to the names then in use, all the different species of cannons, for very often the same piece was named differently in each large city. There were *serpentes* (in German *Rothschlangen*), culverins (*Feldschlangen*), demiculverins, falcons, and falconettes. There were also mortars (*Moerser*, or *Boeller*, or *Roller*) that were moved from place to place on chariots. In France the names *passeevolants*, *basilics*, *spirales*, *bombardes*, *veuglaires* and *pierriers*, were used to designate various pieces of ordnance. *L'orgue à serpents*, which was a machine composed of a great number of guns of small bore, loaded either from the muzzle or at the breech, had each separate chamber encased as far as the muzzle in wood or metal: these chambers were fired in succession or all at once.

In Germany they were called *Todtenorgel* (death-organ). Weigel, writing in 1698, says that in the arsenal at Nuremberg there were organs with thirty-three pipes to them; and that death might be said to play dance music on them. One of the earliest of these machines is in the Museum at Sigmaringen; it was made at the beginning of the fifteenth century. It is loaded from the muzzle, and is composed of small wrought-iron cannons rudely mounted on what looks like the trunk of a tree, and moves on two round disks of wood for wheels. Another of these machines, termed *orgue de danse Macabre*, copied in 1505 by Nicolaus Glockenthon from one in the arsenals of the Emperor Maximilian, is composed of forty square-shaped tubes firmly joined together and mounted on a stand with large wheels somewhat similar to the carriage of a field-piece. A third one, of the seventeenth century, consisting of forty-two barrels, mounted so as to form a triangular block, and to fire six successive volleys, is now in the Museum at Soleure. From the "*Études sur l'Artillerie*," by Napoleon III., published in 1846, it will be seen that there were some of these machines which could fire a hundred and forty shots at once. With regard to hand *grenades*, they appear for the first time in 1536, while *petards*, which are supposed to

have been invented by the Hungarians, do not appear till 1579.

The Swedes had in the Thirty Years' War cannons of leather lined with a tubing of brass or yellow copper. These cannons, specimens of which may be seen in the Arsenals of Berlin and Hamburg, in the Museum of Artillery in Paris, and the collection of the king of Sweden, were about three feet seven inches in length. The centre barrel was of thin copper, and wound round it was a stout cord that separated the leathern casing from the metal tube. These guns were not very strong, and the charge was only about a quarter of what would be used at the present day. They were given up after the battle of Leipsig, for on that occasion they became so hot that they discharged themselves spontaneously. They were superseded by a species of ordnance called Swedish guns, which differed very much from those used by the Imperial Austrian army, and which had been proposed by the Count of Hamilton. In the arsenal at Zurich there is another kind of cannon very like the leather cannons of the Swedes. Like those mentioned above, these cannons were made of a tube of yellow copper, but between it and the exterior leather tube there was a thick layer of lime, and round them were also several rings of wrought iron. This gun was very useful because of its light weight in a mountainous country like Switzerland, for a man could carry it on his shoulders; it also had trunnions like the *Suedoise*, and a covering plate on hinges for the touch-hole. The length was about seven feet.

The rifling of hand fire-arms was invented in Germany towards the end of the fifteenth century, and a little later it was applied to large cannons, as may be seen from the rifled cannon of the sixteenth century in the Museum at the Hague. The iron cannon in the arsenal at Berlin has thirteen grooves to it, and is dated A.D. 1661; and at Nuremberg there is a wrought-iron cannon of the year 1694 which has eight grooves. Not much attention had been paid to the rifling of large guns till after Benjamin Robins, a member of the Royal Society of London, born in 1707, had treated the subject mathematically. Modern artillery has been greatly altered through the improvements made by Paixhans, published in 1822; by those of Armstrong, and by the wonderful

progress that M. Krupp has made in the manufacture of cast-steel cannons; one of which, a breech-loader, exhibited by him in 1867, weighed 49 tons 2 cwt.; the shot was also of cast steel, and was 10 cwt. 3 qrs. in weight.

Portable fire-arms were often confounded with heavy artillery in Europe in the days when gunpowder was first employed. The first trace of hand fire-arms is towards the middle of the fourteenth century; and it appears that the Flemings used them some time before other nations. The town of Liege had made several experiments in the manufacture of *small hand cannons*, portable firearms, called by the Germans *Knallbüschen*; they were adopted at Perugia in 1364, at Padua in 1386, and in Switzerland in 1392. These cannons were used also at the battle of Rosebecque in 1382, at the siege of Trosky in Lithuania in 1383; and in the records of Bologna of 1399 they are called *sclopo*, from which word is derived *sclopetto* and *escopette*.

At Arras in 1414 this small hand cannon was used for projecting leaden bullets; at the siege of Bonifacio in Corsica in 1420 these bullets even penetrated the armour. In 1429 and 1430 this new kind of weapon was used for firing at a mark both at Augsburg and Nuremberg. At the close of the fifteenth century its use had extended to the cavalry, as may be concluded from the expression *Equus scoppetarius*, used by Paulus Sanctinus.

The continual alterations that have been made in the different sorts of portable arms that have been invented since the adoption of hand cannon have given birth to more numerous names than even those of large firearms. By classifying them carefully according to their mechanism, we may divide them into thirteen distinct kinds, viz., the *hand cannon* of the middle of the fourteenth century, a rudely-made weapon in wrought iron, fastened to a piece of rough wood, so that it could not be brought to the shoulder; the touch-hole was at first made on the top of the cannon, and had a covering plate on a pivot or on hinges, to preserve it from damp. A little later the touch-hole was placed to the right of the cannon. This primitive weapon is represented in the water-colour drawings of Glockenthon, executed in 1505, and mentioned above as having been copied from some cannons in the arsenal of the Emperor Maximilian. Four small cannons are represented

fixed to the four corners of a board, and a gunner is firing them with a match. This hand cannon was often served by two men. When of a small size, and intended for the use of cavalry, this hand cannon was called in France *petronel*, from the old Spanish word *pedernal*, a fire-arm; or perhaps (*poitrinal*) from the fact of its being rested against the cuirass.

The hand cannon, which could be fired from the shoulder, termed in French *Le canon à main à epauler*, belonging to the end of the fourteenth century, is distinguished from the former by having a rudely-fashioned stock. The touch-hole is generally on the right side. All these weapons were fired with a separate match.

Two other sorts of hand cannons, *à serpent*, or *à dragon*, without trigger or tumbler, were invented about the year 1424. The match was fastened to the weapon itself, and was held by the *serpentin*, a sort of small linstock. When this weapon was better made it was called a hand *culverin*, *pétrinal*, or *poitrinal*, from the shape of the stock, which was often rested on the cuirass.

The hand cannon, with match-holder, without spring, but with a trigger, that could be fired with a surer aim when rested on the shoulder.

The *Harquebus* (from the German word *Hack-Buss*, or cannon with catch), with match-holder, trigger, and tumbler, made about the latter half of the fifteenth century. It is a weapon very perfect in make, and the prototype of our guns of the present day; the barrel was about three feet three inches in length.

The double *Harquebus* (from the German *Doppelhacker*), a firearm with a double catch or match-holder. It was mostly used for defending ramparts; the length being from three to seven feet. The lock is distinguished from that of the simple *Harquebus*, in having two match-holders working in opposite directions. It was often supported by a stand resting on iron spikes or wheels that was called *fourquine*.

The wheeled or German *Harquebus* (*Radschloßbüchse* in German) was invented in 1515 at Nuremberg. Its difference consists in having a wheel-lock, usually made of ten separate pieces. It is not, like all earlier arms, fired with a match, this being superseded by the sulphurous pyrites, called also *marcassite*, which is found in cubes of a brilliant golden

yellow. This is that combination of sulphur and metal that the Roman patrols took care never to be without, so as to procure a light as quickly as possible. The pyrites, when struck by this cogged wheel, ignited and fired the charge.

This new weapon, however, was never able to replace entirely the harquebus with the match, whose mechanism was more simple, solid, and much more sure, for when used the sulphurous pyrites, which was extremely brittle, broke very easily.

The Museum of Dresden possesses a small hand cannon eleven inches long and four inches and three quarters in diameter, of the beginning of the sixteenth century, which appears to have preceded the invention of the wheel-lock and given the first idea of it. A rasp by grating against the sulphurous pyrites showers sparks upon it as soon as it is removed from the screw-plate. This piece has been for a long time ignorantly considered as the first fire-arm invented by Berthold Schwarz (A.D. 1290-1320), a German monk, to whom also was attributed the invention of gunpowder. The flock of compilers still continue to call this little hand-cannon "Moenchsbüchse," or monk's arquebus, and to point it out as the first fire-arm.

The musket, whose construction and mechanism is the same as that of the arquebus, is used either with a wheel lock or match; it differs from the arquebus only in diameter, the charge and bullet being double in size. Being much heavier, it necessitated the use of a rest or carriage like that of the double arquebus. The French musket in 1694 was generally, according to Saint-Remy, of the calibre of twenty leaden bullets to the pound; it was three feet eight inches long in the barrel, and including the stock was five feet long.

The arquebus or musket with rifle barrel, with balls driven home by a mallet.

The rifled barrel invented in Germany, according to some authorities at Leipsig in 1498, according to others at Vienna by Gaspar Zollner, was not adopted by the French army until 1793; it was the carbine of Versailles.

The arquebus or musket with the "chenappan," a name

corrupted from the German "Schnapphahn," a cock pecking, indicates the time of its invention, which was the latter half of the sixteenth century, for mention is made of moneys paid in 1588 by the chamberlain of Norwich to a gunsmith, Henry Radoc, who changed the wheel-lock of a pistol to a "snaphaunce." The name "Chenappan" was soon given in France to robbers who used this new weapon, and the Spanish bandits of the Pyrenees who were enrolled under Louis XIII. were also called "chenappan;" as were also the Barbets of the Alps, the last remnants of the unhappy Vaudois, who were forced by religious intolerance to become marauders and bandits. The "snaphaunce" method, which was worked by means of the sulphurous pyrites, may be looked upon as the forerunner of the French flint-lock, which is derived from it. Nearly all the Oriental arms, and particularly the Turkish guns, subsequent to this date were snaphaunces.

The flint-lock gun was in all probability invented in France about 1640. This gun was also named *fusil-mousquet*, as it had a bayonet with a socket, an invention wrongly attributed to the Scottish General Mackay, in 1691, but really introduced into the French army by Vauban. The socket allowed the marksman to shoot, and still keep his bayonet on the gun-barrel. The handled or "plug" bayonet was obliged to be fixed into the gun-barrel at the moment of charging, which was very inconvenient.

Some few Italian authors have wished to attribute to their country the invention of the musket, because its name "focile" is derived from the Latin "focus," fire, but as the name "fusil" already appears in France in the orders of hunting in the year 1515, that is to say, a hundred and fifty years before the replacing of the wheel-lock by the flint process, it must be admitted that the name of "fusil" was then applied to arquebuses of the old fashion. It has been already mentioned that the invention of the socketed bayonet is wrongly attributed to the Scottish General Mackay, in 1691. M. Culemann at Hanover possesses an arquebus with a wheeled lock of the end of the sixteenth century, where a long bayonet, whose blade at the same time serves as a barrel cleaner, is fastened by a socket.

The change which the lock of the fire-arm underwent

by the invention of the flint battery was important, but neither immediate nor radical, because it was preceded by the snaphaunce lock, in which we already meet with the dog-head or hammer. In the French guns, the pyrites was replaced by flint, which was strongly held in the grip of the dog-head and sharply struck against the steel hammer, as soon as the finger pressing on the trigger loosed the spring, and the shower of sparks set light to the powder in a pan communicating with the touch-hole.

Vauban also invented a gun with a double firelock, after the manner of the arquebus with wheel and screw, so that, supposing the gun were to flash in the pan, a screw-match would set fire to the priming. The old match-lock was not entirely replaced by the new gun with the hammer until 1700.

Prince Leopold I., of Anhalt Dessau, the organiser of Prussian infantry, introduced in 1698 the iron ramrod among his soldiers, and this amelioration of the gun contributed to their victory at the battle of Mollwitz in 1730.

The cartridge, that is to say, the complete charge of the fire-arm wrapped in one packet, appears to have been used for the first time in Spain about 1569; it was not adopted in France until 1644, along with the cartridge-box invented by Gustavus Adolphus in 1630.

The carbine is a fire-arm with a rifled barrel, generally short and used by cavalry; but war and hunting fire-arms with rifled barrels are also called carbines.

The blunderbuss (*mousquet tonnerre*, French; *donderbus*, Dutch; "*Streubüchse*," German) had a wide trumpet-shaped barrel, and discharged ten or twelve balls at once.

The pistol, the diminutive of the arquebus and fusil, whose name was probably derived from "*pistallo*," a pommel, rather than from "*Pistoia*," the city of that name, appears to have come originally from Perugia, where as early as 1364 they constructed "*hand-cannons*" only the length of a "*palma*," about nine inches.

The German "*Tercerole*" was a small pocket pistol, probably of Italian origin.

The percussion-capped gun, whose invention is wrongly attributed to the English Captain Fergusson, commanding a Hessian regiment in the American war (1775-1783), dates

back no further than 1807, when the real inventor, a Scottish armourer of the name of Forsyth, took out a patent for the percussion gun. The first chemical researches concerning the composition of detonating materials,* appear due to Pierre Bouldure, in 1699. Nicholas Lemery continued these researches in 1712. Bayon, army surgeon under Louis XV., appears to have made known in 1764 the fulminate of mercury—a salt composed of carbon, azote, oxygen and mercury—an invention erroneously attributed to Howard, who in 1800 composed the first explosive powder of fulminate of mercury and saltpetre, a preparation fitted to replace the priming powder in fire-arms. Liebig and Gay-Lussac in 1824 analysed these fulminates; and it is to Fourcroy, Vauquelin, and Berthollet, that the discoveries (between 1785 and 1787) of the fulminating salts of gold, silver, and platinum, as well as the muriated oxygen of chlorate of potash, are due.

In 1808 the armourer Pauly, who had modified Forsyth's gun, introduced it into France. The percussion gun of Joseph Egg may also be cited as having led this gunsmith to the invention of the priming capsule, a small copper cylinder open at one side and filled with fulminate.

In 1826 M. Delvigne found out a method of forcing the bullet into the rifled barrel of the carbine without the use of the hammer, and in a manner to avoid the inconveniences of the systems hitherto tried.

The "Stecher," or hair-trigger, erroneously called in French "double détente," an ingenious piece of mechanism to render almost insensible the concussion produced by the loosing of the ordinary trigger, invented by a gunsmith of Munich in 1543, is not a new system, but merely an amelioration which may be adapted to most carbines, and with which all the ancient German fire-arms of the sixteenth and seventeenth centuries are provided.

We have seen that the wheel-lock has been in all ages very little used in warfare, but it was universally adopted for hunting and parade weapons, and has given way only to percussion.

The arquebus and the musket, whether match or wheel-

* *Ammoniures fulminantes*, which must not be confounded with *fulminates*.

lock, were not two different systems, but only two kinds of the same system; they differed neither in form nor mechanism, but only in calibre; they were the usual arms of the regular troops. The arquebusiers were provided with large powder-flasks, a horn for the priming, several yards of match, and a bag of bullets. The musketeers had in addition to the sword and cushion a baldrick with wooden powder-tubes, called *Pulvermassen* in German, a priming horn, a bag of bullets, some matches and a match-case, a copper utensil invented by the Dutch, and nearly identical with the match-case of the grenadiers of the eighteenth century.

The origin of portable breech-loading fire-arms, of guns with more than one barrel, and even of revolvers, dates from the beginning of the sixteenth, or even the end of the fifteenth century; these appear to be all of German invention. The Musée d'Artillerie at Paris possesses a German wheel-lock arquebus of the sixteenth century, which was loaded at the breech, and another, also of the sixteenth century, with an opening in the barrel, receiving the charge either in a metallic envelope, or in a movable chamber, a system which has been brought forward again in modern times.

The "amussette" or plaything of Marshal Saxe, at the Musée d'Artillerie at Paris, is also a breech-loader. There are specimens of these weapons at the Tower of London, at the Museums of Sigmaringen, Dresden, and the Imperial Arsenal of Vienna. The Museum of Sigmaringen possesses a German arquebus of the sixteenth century, which is a revolver with seven barrels, and a German gun of the eighteenth century, with four barrels. The Musée d'Artillerie at Paris also exhibits one of these weapons still retaining the old match-lock. In modern times in France, Pauly in 1808, Leroy in 1813, and more recently Lepage, Gastine-Renette, and Lefauchaux, have invented different systems of percussion breech-loading guns; but that of M. Lefauchaux alone has remained in favour for sporting weapons, after Grévelot had introduced a great amelioration in the manufacture of percussion caps.

The repeating but not revolving fusil, that is to say, a weapon the barrel of which receives various charges in a groove which can be discharged successively, is likewise not a modern invention; the Museum of Sigmaringen possesses

an ancient gun of this character; it is grooved, and fires successively six shots.

Since America has begun to manufacture metallic cartridges the revolving fusil has reappeared in that country, where Spencer and Winchester have invented different processes.

The revolving pistol, revived at Paris by the gunsmith Lenormand in 1815, who constructed one with five barrels, was soon followed by the Devisme revolver with seven barrels, and by the Hermann revolver at Liege, by the Mariette pistol with twenty-four shots, and lastly by the Colt revolver in 1835, the best of all, and which is most generally in use.

After the mention of these different descriptions of fire-arms we have only to speak of the celebrated breech-loading needle-gun. The inventor, Jean Nicolas Dreyse, was born in 1798, at Soemmerda, near Erfurth; he constructed the first needle-gun in 1827, after seventeen years of study, and took out a patent in 1828, for eight years, for his spring needle and fulminating cartridge. This gun, the first perfect model of which was adopted in Prussia about 1841, has since undergone many changes, for it was only in 1836 that breech-loading was applied to the manufacture of this gun. Since that time every nation has produced its needle-gun, and attempted to manufacture a weapon superior to that which produced such terrible results in the late war. It is difficult to ascertain which of the new modifications deserves the palm.

The results of the experiments made on September 5th, at the shooting-gallery of Spandau, with the models of the needle-gun used by different nations, are, according to official report, as follow:—The Prussian needle-gun discharges 12 shots per minute, the Chassepot 11, the Snider (England) 10, the Peabody (Switzerland) 13, the Woenzl (Austria) 10, the Romington (Denmark) 14, the Werndl (Austria) 12, and the revolver of Henry Winchester (North America) 19. In respect of accuracy, however, the last-mentioned weapon takes the lowest rank, only eleven of the nineteen shots being on the target.

II.

WEAPONS OF PRE-HISTORIC TIMES. THE AGE OF STONE.
CHIPPED FLINT WEAPONS, AND WEAPONS IN POLISHED STONE.

CHIPPED FLINT WEAPONS.

IT is certain, as we have already observed, that earth, wood, the skins of wild beasts, and, above all, stone scattered over the earth, must of necessity have been the first materials which man employed for the manufacture of his tools and weapons; and it is with these primitive products that a universal history of the weapons of all people should begin. It would be superfluous to reiterate here what has been said on this subject in the first pages of the preceding chapter; it has been shown that weapons of chipped stone have everywhere preceded those of polished stone, the manufacture of which required less primitive processes. There exist also some of these weapons which are neither in the first rough state, nor in the fine polished state of the second; smoothed but not polished, they belong to epochs of transition, the dates of which naturally vary according to their different countries. In France it has been attempted to divide these productions into three distinct classes; that of their first appearance, that of the existence of the reindeer in France, and that of the *dolmens*; but as epochs in the progressive march of civilisation sometimes differ greatly even among people of the same origin and race, this classification is not altogether satisfactory.

The stone weapons found in the Perigord along with bones in a cavern, some of which are engraved with the image of the mastodon, might indeed add a few proofs of the existence of man during the third geological epoch, but it would be necessary to submit these engravings to a microscopic obser-

vation, so as to assure ourselves of the absence of any deception. It is not enough that these bones and weapons should be gathered up in alluvial-diluvial deposits, which may have undergone disturbances, as is shown by the different "movable deposits," so called because they are composed of objects belonging to different epochs. The Alpine diluvium, when undisturbed, contains no organic matter in the state of *ossine*, a substance which is peculiar to unfossilised bone, so that all alluvial soil containing the least bone, with *ossine*, is later than the great terrestrial disturbance which we call the Deluge.

Many weapons and tools of manufactured flints betoken surely that they are not antediluvian; they are formed out of pebbles which, although found in the interior soils of our continent, have clearly been rolled together before being worked by hand. The manufacture of flint without metallic tools or corrosive acids can be explained only by the facility with which the flint, when freshly quarried, and before it has undergone the influence of the atmosphere, can be divided by splintering.

1. Babylonian flint arrow-head; reign of Nimrod, the founder of Babylon ($2\frac{1}{2}$ inches).

Museum of Berlin.



2

2. Egyptian flint knife (4 inches).

Museum of Berlin.



3

3. Egyptian flint knife (6 inches).

Museum of Berlin.



4

4. Egyptian flint lance-head (6 inches).
A quantity of chips in flint, intended to be made into tools and weapons, has also been found at Sarabut El Khaden.



5

5. German hatchet in basalt (7 inches), found near Lintz (Austria).

Museum of Sigmaringen.



6

6. Wedge of serpentine ($6\frac{1}{2}$ inches), found near Lintz, in Austria.

Museum of Sigmaringen.

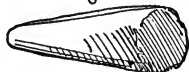

7

7. German flint lance-head (or chisel) ($7\frac{1}{2}$ inches), found at Balingen.

Museum of Sigmaringen.

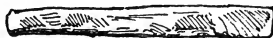

8

8. German flint hatchet (5 inches), found at Rügen, an island in the Baltic.

Museum of Berlin.



9

9. German flint knife (5 inches).

Museum of Berlin.



10

10. Point of German lance.

11. Doubled-headed hatchet of smooth stone; a transitory link between the chipped and polished stones. It is $5\frac{1}{2}$ inches long, and was found at Luneburg.

Museum of the City of Hanover.

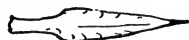

12



13



14



15



16



17



18



19

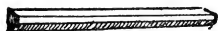

20



21

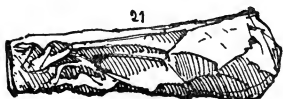

12. Kelto-Gallic yellow flint hatchet called "Pain de beurre." It is 10 inches long, and found at Pressigny-le-Grand (Indre et Loire). See the "Moniteur" of France, 18 May, 1865.

Author's Collection.

13. Kelto-Gallic yellow flint knife of 5 inches: found as above.

Author's Collection.

14. Kelto-Gallic yellow flint knife (3 inches): found as above.

Author's Collection.

15. Helvetian flint dagger of 5 inches length: found near Stavyé, in the lake of Neuchatel.

Museum of Fribourg.

16. British flint arrow-head of $2\frac{1}{2}$ inches length. It may date from a time preceding the arrival of the Phœnicians.

Llewellyn Meyrick Collection.

17. Irish barbed arrow-head, whitish flint, of $5\frac{1}{2}$ inches.

Christy Collection. London.

18. British wedge or hatchet in whitish flint, of $5\frac{1}{2}$ inches: found at Cisburg Camp (*sic*) in Sussex.

Christy Collection. London.

19. Iberian or Spanish flint dagger of $5\frac{1}{2}$ inches; found at Gibraltar.

Christy Collection. London.

20. Bohemian flint knife ($5\frac{1}{2}$ inches).

Museum of Prague.

21. Danish flint hatchet (11 inches) (called in Danish, Kiler of Flint).

Museum of Copenhagen.

22. Danish flint hatchet of superior shape ($5\frac{1}{2}$ inches), (in Danish Kiler of Flint).

Museum of Copenhagen.



23. Danish flint lance-head ($7\frac{1}{2}$ inches). This weapon (Lanse-spits of Flint) is as sharp as any steel weapon.

Museum of Copenhagen.

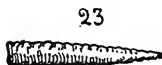

24. Danish flint lance-head (9 inches), less sharp, but showing equally skilful work with the preceding one.

Museum of Copenhagen.



25. Danish flint dagger (8 inches), worked in an admirable manner. (Dolk of Flint).

Museum of Copenhagen.



26. Danish flint dagger with rounded handle ($13\frac{1}{2}$ inches). A marvel of workmanship.

Museum of Copenhagen.



27. Danish flint hatchet-sabre ($15\frac{1}{2}$ inches). Very fine work.

Museum of Copenhagen.



28. Two Danish barbed flint arrow-heads ($1\frac{1}{4}$ inch) (Pilespidser of Flint in Danish).

Museum of Copenhagen.

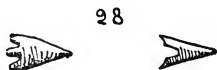

29. Long arrow-head, unbarbed. Danish flint ($3\frac{1}{2}$ inches).

Museum of Copenhagen.



WEAPONS IN POLISHED FLINT.

When we see that Denmark produced these beautiful weapons in chipped flint, the fineness of whose workmanship generally surpasses that of the polished flints of the second epoch of other countries, it must necessarily be admitted that the phases of Danish civilisation do not tally with those of the Germanic and Gallic nations, and that the Danes continued to work in flints at a time when many of their neighbours were already acquainted with bronze weapons. The alluvial soils in which great quantities of these beautiful weapons have been found (in the so-called Kiokkenmoedinge or kitchen-refuse heaps), appear to show that their manufacture is later than that of the weapons from the lake dwellings in Switzerland, Savoy, and Baden, which have yielded us no bronze weapons, and that the Danish flints are probably not of earlier origin than the lake dwellings of Noveto, Castiana, and Peschiera, which date from the bronze age.

Even when taking note of the more or less rapid march of civilisation in each country, it is difficult to fix the priority of one people over another in the construction of these primitive weapons; where everything is plunged in obscurity, and when new excavations from time to time overthrow what preceding ones have established, we can only argue from hypothesis. In England, likewise, these weapons have always been found in alluvial soils; but the hatchets in chipped or rough flint of the Christy collection of London, mentioned in the preceding chapter, may possibly date farther back than the fourth geological epoch. As the modern weapons of savage nations do not enter into the scheme of this work, the flint ones likewise must of necessity be passed over, even when ancient, for the modern construction of savage nations is just what it was in the bygone centuries. The author has nevertheless made an exception in favour of Mexico, because the Mexican arms which have been here represented are no longer made.

It is very difficult to establish exact demarcations between the times when nations made use of rough flint weapons, and the times when these weapons were in polished flint or bronze, for two of these products, and even all three, have been found mingled together.

The excavations made in the cemetery of Hallstatt have in fact furnished proof that iron was not unknown in Germany, even when flint and bronze were still the usual materials for cutting weapons. In the chapter which treats of the products of the so-called iron age will be seen some representations of dagger-points in iron, found in the tombs of Hallstatt along with weapons in bronze and flint.

30



31



32



33



34



35



36



37



38



39



30. German wedge, amulet, or talisman in serpentine (1 inch).
Author's Collection.
31. German hatchet in serpentine (9 inches), found at Gensenheim, near Mayence.
Christy Collection. London.
32. German double hatchet, of greenish touchstone (6 inches), found at Hildesheim.
Christy Collection. London.
33. German hammer-hatchet, in granite (6 inches), found at Mecklenburg.
Christy Collection. London.
34. German hammer-hatchet, in serpentine (6 inches), found at Kaufbeuren.
National Museum of Bavaria at Munich.
35. German hatchet, serpentine (6 inches), found at Enns, near Lintz, with bronze and iron weapons.
Museum Francisco-Carolinum at Lintz.
36. Fragment of German hatchet, serpentine (8 inches), found with bronze and iron weapons in the tombs of Hallstatt.
Museum of Antiquities at Vienna.
37. British double-headed hatchet, basalt (4½ inches).
Christy Collection. London.
38. Large Kelto-Gallic hatchet, jade (16 inches).
Museum of Vannes.
39. Small Kelto-Gallic hatchet, in serpentine granite (3½ inches), found in the Nivernais.
Author's Collection.

40. Kelto-Swiss hatchet, serpentine, fixed into a stag's horn, and with a wooden handle, found in a Swiss lacustrine dwelling.

Museum of Zurich.



41. Kelto-Swiss hatchet, serpentine, with long wooden handle, found at Rotenhausen.

Museum of Zurich.



42. Danish hatchet, basalt (5½ inches).

Museum of Copenhagen.



43. War hammer, Danish basalt (5 inches).

Museum of Copenhagen.



44. Danish double-edged hatchet, basalt (8½ inches).

Museum of Copenhagen.

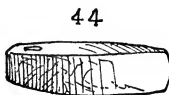

45. Double-edged Danish hatchet, basalt (5 inches).

Museum of Copenhagen.



46. Double-edged Danish hatchet, basalt (8½ inches).

Museum of Copenhagen.

46

47. Danish single hatchet, called *Niolner*, in basalt (9 inches), found in a tomb on the coast of Scotland. The *Niolner* is an attribute of the Scandinavian god Thor, and is often mentioned in the Sagas.

Meyrick Collection.



47

48. Iberian or Spanish hatchet in basalt (7½ inches).

Christy Collection. London.



48

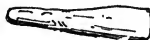

49



49. Fragment of a Hungarian hatchet, in basalt ($7\frac{1}{2}$ inches).

Christy Collection. London.

50

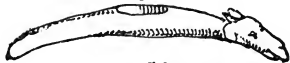

50. Russian war-hammer in black stone ($11\frac{1}{2}$ inches). Museum of St. Petersburg. There is a cast of it at the Museum of St. Germain.

52



51. Mexican sword of the 15th century, of iron wood, with ten blades, fixed into the wood, of black obsidian.* This weapon is 25 inches long.

53



51



52. Mexican sword of 1 metre, 8 inches long, in iron wood and black obsidian.

Museum of Berlin.

53. Mexican spear-head of the 15th century, black obsidian, fixed in a wooden handle.

* Obsidian is a volcanic production, of a greenish black, with an enamelled-looking surface, and capable of taking a high polish. The Peruvian Incas employed it for mirrors, and the priests of Huitzilopochtli for ornaments. It is not the only stone made use of by the ancient inhabitants of America for their weapons; they used also flint, chalcodony, and serpentine.

III.

ANCIENT WEAPONS OF THE AGES OF BRONZE
AND IRON.

WEAPONS FROM INDIA, AMERICA, CHALDÆA, BABYLON, ASSYRIA,
MEDIA AND PERSIA, EGYPT, GREECE, ETRURIA, ROME,
SAMNIUM, ETC.

THE changes in the weapons of the ancients, including in this term the five great Assyrian monarchies, who appear rather to have given the model of their arms to the Egyptians and Greeks than to have borrowed from them, have been explained in the historical chapter, pages 17 to 74. We have seen that even in times of the greatest antiquity iron and bronze were employed indistinctively for the manufacture of offensive and defensive weapons, so that the establishment of a veritable Age of Bronze and Age of Iron is inadmissible. If these terms have been preserved in the chapter which speaks of the weapons of northern nations, it is from fear of creating confusion of ideas by a new, though more correct, method of classification; but the author has only acted thus after having entered his protest, and explained in what manner the conventional denominations were to be understood.

Few arms and weapons and few documents of the Hindoo, American, Assyrian, Persian, and Egyptian nations have reached us, and it has been found necessary to study the military equipment of these countries almost entirely from their monuments. Our museums are much richer in Greek and Roman arms, which enable us to follow the changes of armour on classic soil during a number of centuries.

The American weapons have been placed after those of India, for everything tends to show that the lost civilisations of America have even preceded those of a great part of India,

and probably those of the countries we have been in the habit of calling classic.

The Ceramic wares of the heroic age of America, among which may be counted some products of Palenque and Mitla, show, even in their state of artistic decline, to what height the worship of pure outline and ornament, so visible in Egyptian, Assyrian, and Greek art, had been carried by a people whose very shadow has disappeared from the field of history.

The Louvre possesses one of these ancient pieces of Transatlantic pottery, the design of which recalls the decoration of ancient Etruscan vases, and classic mythology ; it is a Hercules defeating his antagonist ; and many specimens of American ceramic ware are known, the classic ornaments of which show an equally incontestable priority. The more remote the date of these antique products, the more their workmanship resembles Greek art, insomuch that the least ancient are always the least artistic ; a fact which authorises us to draw the conclusion of an ancient American civilisation since declined, but whose most flourishing epoch was two and even three thousand years before Jesus Christ.

See the historical chapter.

Nothing has been found to throw any light on the arms of the ancient civilisation of this country, whose history goes back to B.C. 3000. The figures here represented indicate that Hindoo armour has varied but little in the matter of offensive weapons, and that the helmet alone betokens a decided change, which appears to have manifested itself from the fourteenth and fifteenth centuries of this present era, as will be seen in the chapter which treats of Western weapons of the Christian Middle Ages.

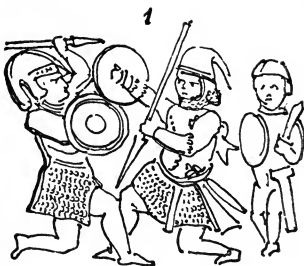

1. Hindoo warriors, from granite memorial stones of Beenjanugar, of which the Kensington Museum possesses photographs. The date of these monuments corresponds with our Middle Ages.

It will be seen that the sword is placed on the right side of the warrior. The Assyrians and all modern nations wore it on the left, while the Greeks and Romans wore it on the right. The engraving of this bas-relief is reversed, so that the combatants appear to hold their spears in their left hands, and their shields in their right.

2. Hindoo hatchet, from an Indian piece of sculpture in the city of Saitron in Rajpootana. (A.D. 1100.)

Kensington Museum.

3. Hindoo sabre from a bas-relief of Beenjanugar and the Hussian monument.
4. Javanese sword, from the statue of the Goddess of War at the Museum of Berlin.

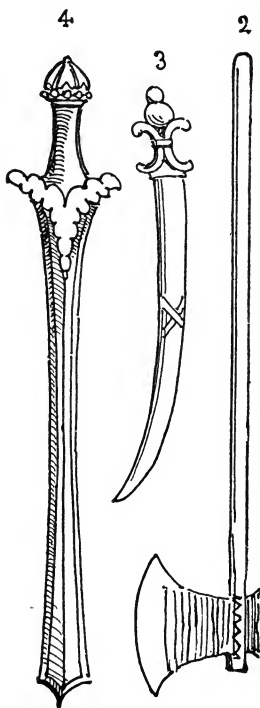

AMERICAN WEAPONS.

It has been observed in the historical chapter that the people of America never employed either bronze or iron in the construction of their offensive weapons, and that the European conquerors found only pure stone in request for all cutting weapons. In regard to those of defence, they were manufactured in bronze, gold, mother-of-pearl, horn, wood, and leather; and traces have been found of different arms, the origin of which is lost in antiquity. Such is the helmet engraved further on, from a stucco bas-relief in the ruins of Palanqué, or city of Culhuacan,* the circumference of which was about eighteen miles. This city was situated in the state of Chiapa, in the northern part of Central America, where the cradle of the most ancient American civilisation, now extinct, was placed—a civilisation which may easily have been contemporaneous with, if not anterior to, that of India. The helmet of the bas-relief of Hochicalco, though less ancient, still belongs to a remote period, when the horse, introduced by European navigators, was as yet unknown. As the American weapons of the period corresponding to the Christian Middle Ages are few and insignificant, they have been placed at the end of the chapter which treats of polished stone weapons, and not in the place where the weapons of a time prior to the Merovingian epoch are mentioned. These American arms, as we have seen, are generally of wood edged with obsidian.

* Palanqui, or Culhuacan, or Huehuetlapatl'an, was discovered only in 1787, by Antonio del Rio, and José Alonzo Calderon.

1. American helmet, drawn from a bas-relief of Palanqué. The figure in this bas-relief, which is mentioned in M. de Waldeck's work, is represented sitting with the left leg folded under the body, similar to the statues of the god Boodha, or the Chinese god Fo.



2. Mexican helmet drawn from a bas-relief of great antiquity at Hochicalco, in the province of Quemaraca, Mexico.

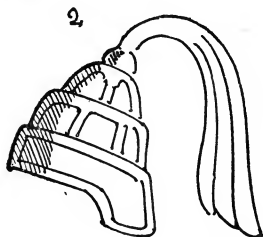

3. Two Mexican helmets drawn from a Mexican manuscript of the beginning of the fifteenth century, the property of M. de Waldeck, in which is described the conquest of Ascapusala.

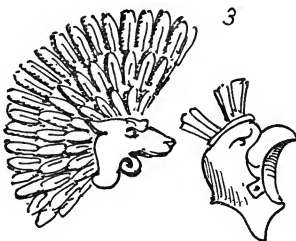

4. Mexican helmet in solid gold, ornamented with feathers, of the fifteenth century. It was part of a royal suit, destroyed in Mexico by fire.



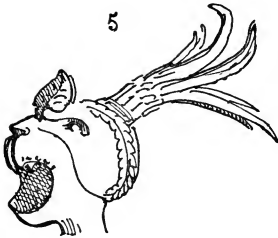

5. Mexican helmet in leather, wood, leopard skin, and feathers, of the fifteenth century.

From a Manuscript.

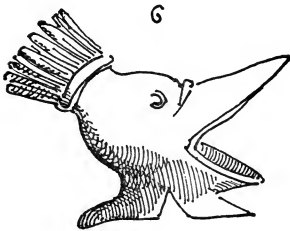

6. Mexican helmet in wood, leather and feathers, fifteenth century.

From a Manuscript.

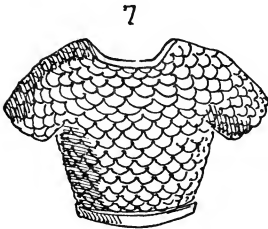

7. Mexican corset of scales of mother of pearl (Jazeran or Korazin) of the fifteenth century. This fine piece of defensive armour was part of a royal suit, mentioned on the preceding page at fig. 4, as having been destroyed in Mexico by fire.

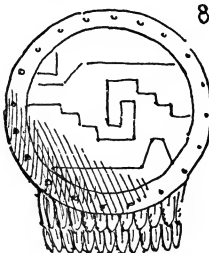

8. Buckler or small round Mexican shield, 25 inches in diameter, of gold and silver, and ornamented with feathers. It was part of the same suit of the fifteenth century, which was burnt. The hieroglyphic ornaments have not hitherto been explained.

9

9. Buckler or round Mexican shield, 25 inches in diameter, composed entirely of leather, and ornamented by the hieroglyphic sign which among the Mexicans stood for a hundred, and which here indicates that the shield belonged to a centurion or captain over a hundred men.

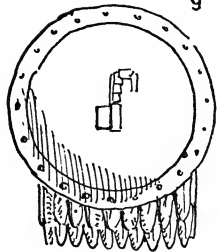

10

10. Ensign or Mexican standard in gold, surmounted by a grasshopper, or locust, 12½ inches long, fifteenth century.



11

11. Mexican ensign in gold, surmounted by an eagle's head, life size, fifteenth century.



For American offensive weapons in wood and obsidian, see the end of the chapter on polished stone weapons.

ASSYRIAN ARMS, WEAPONS, ETC.

The history of the weapons of the five great monarchies, to the whole of which the name Assyrian has been commonly allotted, has been given at pages 22 to 26. It has been seen that iron as well as bronze was already used in these countries in the eleventh century, B.C. as is proved by the ingots of this metal, and the few iron utensils in the Louvre, as also by the fragment of a steel coat of mail in the British Museum.

1. Assyrio-Babylonian archer with war coat, leggings, and fillet instead of a helmet. Bas-relief. B.C. 700.

Museum of the Louvre.



2. Foot soldier of the Assyrian army, armed with the coat, helmet and crest, target and lance. We also notice the greaves or leggings. Bas-reliefs of Nineveh of Sardanapalus V. B.C. 700.

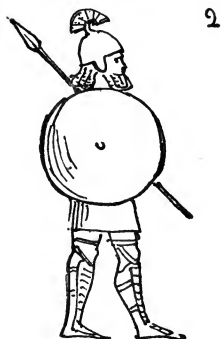

3. Assyrian soldier without leggings, hunting game. Bas-relief of Khorsabad, of the reign of Sargon.

British Museum.





4. Foot soldier of the army of Sennacherib (B.C. 712—707), from a bas-relief in the British Museum. The shape of the conical helmet approaches that of the Samnite one (see the chapter on Roman and Samnite armour); the coat and leggings appear to be of mail; the shield is round, large, and very convex.

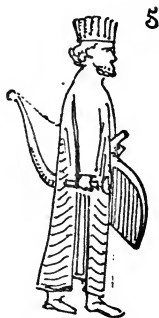

5. Persian archer, from a bas-relief of Persepolis, the ancient capital of Persia and of all the Persian monarchy (B.C. 560). The long coat, probably of leather, descends to the ankle. The headdress has nothing of the helmet, but nevertheless indicates workmanship in metal. The archer carries the sword on the left side, while the Greeks and Romans wore it on the right.

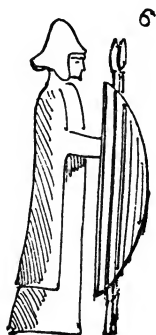

6. Persian warrior from a bas-relief of Persepolis, a cast of which is found in the British Museum. The shield, high enough to rest on, is exceedingly convex, almost hemispherical; the helmet, with ear and neck coverings in one single piece, differs entirely from the other Assyrian helmets known to us from different bas-reliefs.

7. Assyrian hatchet in bronze (8 inches), found at Babylon.

British Museum.

8. Assyrian double hatchet, probably in iron, from a bas-relief.

Kouyunjik.

9. Assyrian single hatchet, probably in iron, from a bas-relief.

Kouyunjik.

10. Assyrian single hatchet, to which the quivers of the warriors fighting on chariots were often fastened. From the cast of a bas-relief in the Louvre.

11. Babylonian dagger in bronze.

British Museum.

12. Assyrian dagger in bronze.

Museums of the Louvre and of Berlin.

13. Assyrian poignard with head of hippopotamus, probably in bronze, from the bas-relief of Nimrod. B.C. 1000.

Museum of the Louvre.

14. Assyrian dagger in bronze.

Museum of Berlin.

15. Assyrian sword in bronze, from the bas-reliefs of Khorsabad, of the reign of king Sargon. B.C. 1300.

16. Assyrian sword, bas-relief from a palace in Nineveh, of the reign of Sardanapalus. B.C. 1000.

Museums of Berlin and of the Louvre.

- 17 and 18. Persian sword and sheath from an antique group, Mithras sacrificing a bull* (M. Rom. by De la Chaussée). It is very like the ancient "Akinake."

* Mithras, the son of the mountain Ulbordi, a Persian mythologic hero, of whom the "Zend-Avesta" fragments of the Works of Zoroaster give details. The time of the birth of Zoroaster, the founder of Magianism, or more correctly the reformer of Parseism, floats between B.C. 1300 and 1100. The Mithras, from whom these arms have been copied, belongs to the period when the ancient Parsees still spoke the Zend language, which is now extinct, but in which the Parsee or Gueber priests still repeat prayers, the sense of which they do not understand.

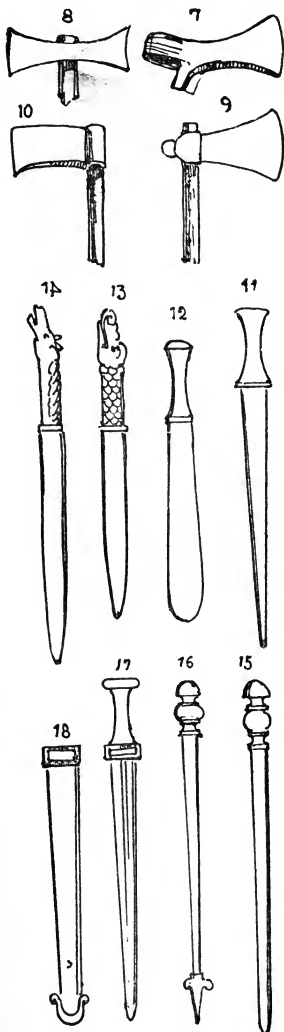

Assyrian Weapons.

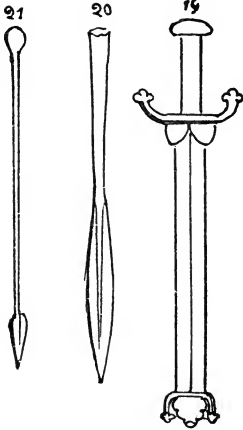

19. Persian sword. Cast from a bas-relief of Persepolis.

British Museum and Louvre.

20. Assyrian spear-head. Bas-relief from a Palace of Nineveh, of the reign of Sardanapalus V. B.C. 700.

British Museum and Louvre.

21. Assyrian lance. The shaft is the height of a man, and has a counter-weight at the end. From a bas-relief.

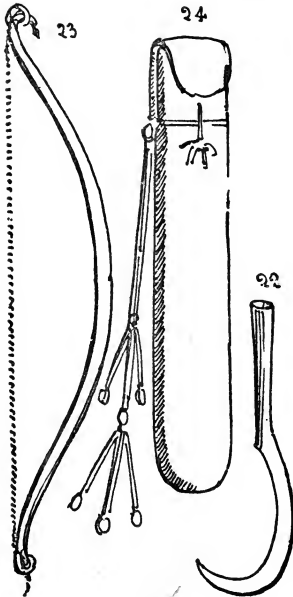

22. Assyrian sickle-shaped weapon from a bas-relief. A similar weapon in iron has been found at Pæstum in Lucania. It is preserved in the Musée d'Artillerie at Paris. See *Roman Arms*.

23. Median bow, bas-relief.

24. Median quiver, bas-relief.

25. Assyrian bronze helmet, the authenticity of which is established. The conical shape of this helmet is to be found in the Christian Middle Ages, especially among the Normans. See also the chapter on Roman arms, and the Samnite helmet.

British Museum.

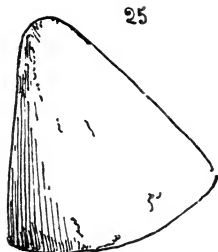

26. Assyrian helmet in iron, said to be from Kouyunjik. This piece of armour, valuable for history, indicates the use of iron in the time which is called the Age of Bronze of the ancients. A similar helmet, but in bronze and attributed to Germany, forms part of the Klemm collection at Dresden.

British Museum.

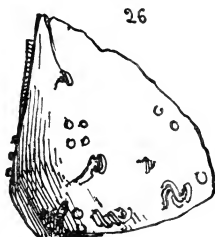

27. Helmet, probably in bronze, of Assyrian horseman, drawn from a bas-relief of Nineveh of the time of Sardanapalus V. This helmet is interesting on account of its cheek-plates. B.C. 700.

Museum of the Louvre.

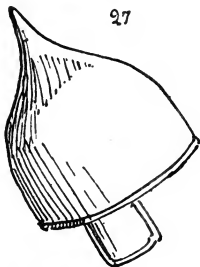

28. Helmet, probably in bronze, of an Assyrian foot-soldier, from a bas-relief of Nineveh, of the time of Sardanapalus V. B.C. 700.

Museum of the Louvre.

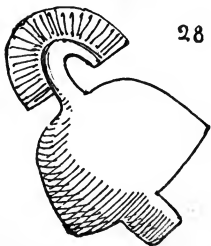

29

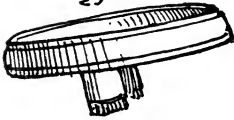

29. Fillet, with chin-strap, or cheek-plates, probably in metal, or leather mounted with metal. Headdress of Assyrian archer, which protected the top of the head, and recalls the headdress of the Frank warriors. From bas-reliefs in the British, Louvre, and Berlin Museums.

30



30. Helmet without chin-strap, probably in bronze, worn by the Assyrian archers and auxiliaries. From a bas-relief, B.C. 1000.

Museum of the Louvre.

31

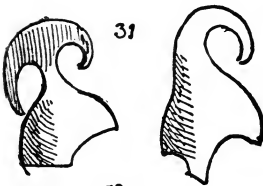

31. Two Assyrian helmets, probably in bronze, from bas-reliefs. The one with a double-pointed crest has been imitated by the Greeks, and appears to come from the ancient civilisation of America.

32



32. Bronze crest of Assyrian helmet. *British Museum.*

33

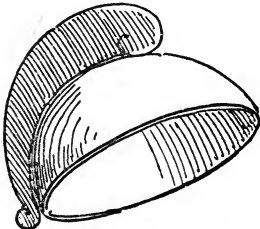

33. Persian helmet from a group representing Mithras sacrificing a bull. (See note to page 95.)

34. Helmet or war headdress of Persian chief, from a bas-relief now in the British Museum. This headdress, which appears to be of metal, has probably been used in war.



34

35. Helmet or headdress of Persian archer, from a bas-relief of Persepolis, a cast of which is in the British Museum. Same observations as for the preceding one. (B.C. 560.)

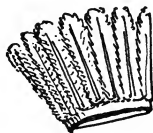

35

36. Persian helmet with movable plates, probably in bronze, from a Persian bas-relief, a cast of which is in the British Museum. This piece of armour is interesting, inasmuch as it prefigures the European Renaissance helmet of the sixteenth century. (B.C. 560.)

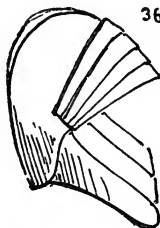

36

37. Persian helmet with cheek-plates and neck-covering, from a bas-relief, casts of which are at the Louvre and British Museum. Same observations as the preceding one.



37

38. Persian helmet of the reign of the dynasty of the Sassanides (A.D. 226-652). This bronze helmet is in the *British Museum*.



38



39

39. Babylonian buckler of the height of a man's shoulder, probably in bronze.

British Museum.

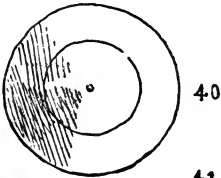

40

40. Assyrian buckler, from a bas-relief. It appears to be of a convex form, like the preceding one.



42



41

41. Persian buckler with vizzor or sight-holes. Bas-relief.

42. Persian buckler from the mosaic of Pompeii, which represents the battle between Alexander and Darius.

Museum of Naples.



43

43. Assyrian shield, or Pavois, of the height of a man's shoulder. Bas-relief of the second Assyrian Empire, reign of Sardanapalus V. B.C. 700.

Museum of the Louvre.

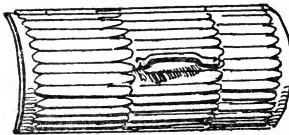

44:

44. Assyrian Pavois, breast-high. From a bas-relief representing the siege of a city by Asshur-Izir-Pal.

British Museum.



45

45. Coat of arms of Assyrian horseman, probably of plates of metal sewed on leather. It covers the loins, and is copied from bas-reliefs in the British Museum, in which is also to be found a fragment of a veritable Assyrian coat of mail, in tempered steel, said to come from Babylon.

EGYPTIAN WEAPONS.

Notwithstanding the knowledge that we have of the history of Egypt, which goes back to the commencement of twenty-six dynasties, that is to say, to the reign of Menes, the first king (B.C. 2450), a time when this country formed, as under the eighteenth dynasty, several distinct states, each under an independent prince, documentary evidence as to the arms of the soldiery fails us almost entirely. The first seventeen dynasties, beginning from Menes to Mœris (2450—1990), which comprised in all three hundred and thirty kings, who reigned simultaneously in Thebes, This, Elephantine, Heraclea, Diospolis, Xoïs, and Tanis, as well as those of the eighteenth dynasty, known as the reign of the Pharaohs (Mœris, Uchoreus the founder of Memphis, Osymandias, Ramses, Amenophis, &c.), have left us no other evidence than a few bas-reliefs.

It has already been observed in the historical chapter, that the civil and funereal monuments of Egypt, on account of its being a country where the genius of the nation was bent more towards science and agriculture than to war, offer fewer military subjects than Assyrian monuments. We have seen that Denon, in his "*Voyages dans la haute et basse Egypte*," has left a few drawings of offensive and defensive weapons; but they are too slight, even when added to the Theban bas-reliefs, to be able to give an exact idea of the complete equipment of Egyptian soldiery.

The few Egyptian tools and weapons in iron, exhibited in the museums of London, the Louvre, and Berlin, which assuredly belong to most ancient times, can leave no doubts as to this metal being used in Egypt as well as in Assyria contemporaneously with bronze. All that has been found of offensive weapons dating from the age of stone consists, as may be seen in the chapter in which these weapons are mentioned, of a few arrow-heads, knives, and lance-heads in flint chipped by splintering, preserved in the museums of London and Berlin. The arrow-blades were found in Babylon itself, and cannot date farther back than the foundation of this city. In addition to this there are in the British Museum a

few flint chips, destined to the manufacture of sharp-bladed weapons, found at Sarabut-el-Khadon.

The most valuable piece, for the reconstituting Egyptian armour, is the imbricated coat of mail which M. Prisse d'Avennes has represented in his work, for the Biblical inscription engraved on one of the bronze scales enables us to fix its date. Several of the offensive weapons drawn by this same archæologist are of such peculiar shape that it is impossible to explain their use.

1. Egyptians fighting, from mural paintings of Thebes. The head-dresses are of a strange form, and the offensive weapons consist of only lances and arrows.



2. Egyptian soldiers, from Theban bas-reliefs. In addition to the shield with sight-holes these men appear to be all armed with the "shop" or "khop" (see farther on, No. 19).



3. Egyptian coat of mail, from Denon's work. Among the designs of M. Prisse d'Avennes may be remarked an Egyptian coat of mail, in scales of bronze, each scale being an inch and a half in length by three-fourths of an inch in breadth. Among the scales the one which bears the Biblical inscription fixes the date of the manufacture to the Pharaonic dynasty.



4. Egyptian coat in crocodile's skin. *Egyptian Museum of the Belvedere, Vienna.*

5. Egyptian buckler with sight-hole, from Denon's work. The bas-relief of Thebes, already mentioned, shows a similar buckler, but of oval shape.

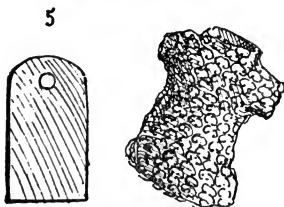

6. Sword-breaker, from Denon's work.
7. Egyptian quivers, *id.*
8. Egyptian hatchet, *id.*
9. " sword, *id.*
10. " scimitar, *id.*
11. " dart, *id.*
12. " sling, *id.*
13. Unknown weapon, *id.*
14. Unknown weapon, *id.*
15. Hatchet, from bas-reliefs of Thebes.
16. Scorpion or whip-goad, *id.*

The size of these weapons could not be given, but they appear to be from 25 to 27 inches long. They were probably in bronze and iron.

17. Egyptian wedge or hatchet, bronze (4 inches).

Museum of Berlin.

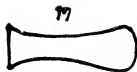

18. Egyptian knife or lance-head, iron (6 inches).

Museum of Berlin.

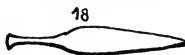

19. Shop or khop, an Egyptian iron weapon (6 inches). Museum of Berlin. It may be seen, a little enlarged, on the group of Seti-Menephthah vanquishing Tahen-nub, of the 18th dynasty (B.C. 1990), at the British Museum.

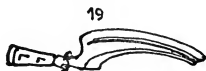

20. Egyptian lance-head, bronze (10½ inches).

Louvre.

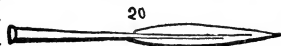

21. Egyptian poignard, bronze. The handle is fixed upon a wooden core.

22. Egyptian hatchet, bronze, of 5 inches, bound with thongs to a wooden handle of 15½ inches.

British Museum.

23. Egyptian hatchet, bronze (4½ inches), fixed into a wooden handle of 16½ inches.

Louvre.

24. Bronze dagger (14 inches). This weapon has, however, a Greek character.

Louvre.

25. Egyptian poignard, bronze (11½ inches), found at Thebes, and drawn in M. Prisse d'Avennes' work. The handle is in horn.

26. Egyptian poignard and sheath, bronze, 1 foot in length. The handle is of ivory, ornamented with studs in gilded bronze.

Museum of Berlin.

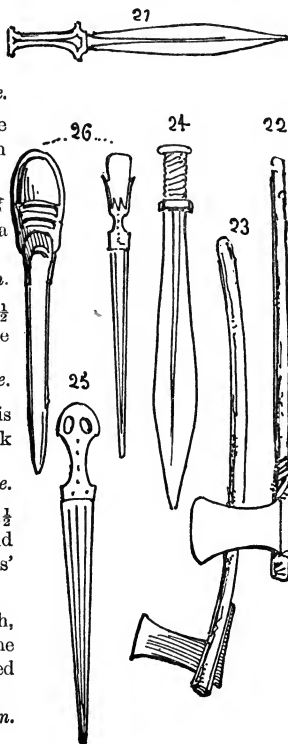

To facilitate research, this chapter will contain a summary of what has already been said in the historical chapter on Greek and Etruscan armour.

The offensive and defensive weapons of Greece in the time of Homer (B.C. 1000) were for the most part in bronze, a few for purposes of defence being in leather, though iron was as well known in Greece as in Egypt and Assyria. Defensive armour was composed of a cuirass or corslet (with breast and back plates, each made of a single piece or shell), of the helmet, of the large round convex shield, and the *κνημίδες*, greaves or defensive leggings.*

The offensive weapons were the cut-and-thrust sword, straight-bladed, more or less long, double-edged, with a slender point and square sheath, which was worn on the right side. The lance was from eleven to fifteen feet long, with a broad, long, and pointed head, rounded towards the socket, and with a cross-piece bevelled, and strongest towards the centre. This weapon served either for thrusting or throwing. The javelin with its *amentum* (a strap fixed to the centre of gravity of the javelin) was a kind of long arrow or dart, which the warrior threw from his hand, and which we find amongst the Germans and Romans; and lastly, the bow and arrows.

The Greeks had at first no cavalry, nor had they even a term to indicate the action of mounting on horseback, for which, even in French, a proper verb does not exist, for the expression "chevaucher" means rather to stroll (*flâner*) on horseback.†

* The different coverings for the feet among the Greeks were, the *sandal*, worn by the men; the *persica*, worn by the women, particularly by the *hetairæ*; the *crepida*, the iron-shod shoe of the philosophers and soldiers, which did not cover the whole of the foot; and the *garbatine*, belonging to the peasant. There were also the *cothurnus*, and the *buskin*. The first was the foot covering of the tragic actors, to appear taller when they acted heroes. Ligatures, fastened to the sole, which was generally of cork, became narrower, as in the modern skate, and passed between the first and second toe. It was also worn by kings and people of the higher classes. The buskin was particularly suited to comic actors; it was a kind of boot laced up the front, and generally coming up higher than the ankle. An antique statue of Diana in the Museo Pio-Clementino, and many other statues, wear the buskin.

† This assertion seems hardly admissible, in the face of the words *ἐπιβεβηκώς*, mounted (*sc.* on horseback), and *ἵππεύειν*, to ride.—
TRANSLATOR'S NOTE.

Later, about B.C. 400, bodies of slingers and horsemen were added to their armies.

As to the Etruscan arms, they may be divided into three categories: those constructed when Phœnician influences prevailed (Asiatic weapons), and which appear anterior even to Greek civilisation; those of the epoch of the end of the Trojan war, and which are perfectly identical with Greek weapons; and lastly those of the Latin time, a little while before the conquest of Etruria by the Romans.

Greek weapons have necessarily been classed with Etruscan ones, of which few or none of the first period exist; to class them separately would have been impracticable.



1. Greek combatants, from a painted vase in the Louvre. The warriors are armed with casques, breastplates, and bucklers, but wear no leggings. The lance and sword constitute the offensive weapons.



2. Greek casque called "kataityx," probably in leather, of the 8th century B.C., copied from a bronze statuette of Diomed. This casque has no crest, but has a chin strap, and appears to indicate well the primitive form of casques.

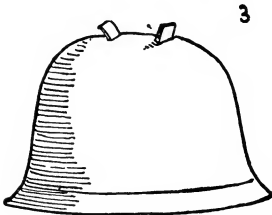

3. Etruscan casque in bronze, said to belong to the first period, C. 1, "Musée d'Artillerie de Paris." A similar casque has, however, been found in the German cemetery of Hallstatt, whose tombs do not date farther than the Christian era.

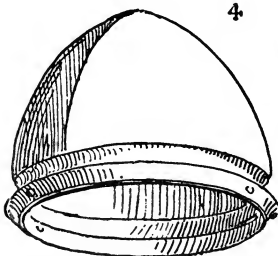

4. Etruscan casque in bronze, preserved in the Louvre. This one is also attributed to archaic times. Similar examples are to be found in the "Musée d'Artillerie de Paris" (C. 2), in the Museums of Berlin, Turin (No. 310), of Mayence (No. 380), and in the Tower of London (4).

5. Bronze casque from the Museum of St. Germain, attributed to the Umbrians.* One similar has been found in the German tombs of Hallstatt, and exhibited in the Cabinet of Antiquities at Vienna, and another found at Steingaden, in Bavaria, is in the museum at Augsburg.

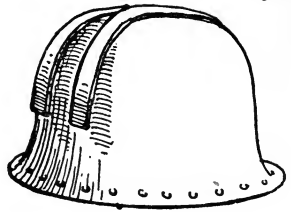

6. Etruscan casque in bronze with long antennæ. Fac-similes to be seen in the Artillery Museum, Paris (C. 12.), in the Museum at Mayence, and in the Cabinet of Medals at Paris. The Louvre possesses a similar specimen, but in gold. The antennæ (from the Latin "ante," before, and "fixus," fixed) are so called from their shape, which resembles the yards of ships.

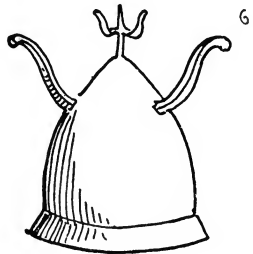

7. Archaic Etruscan bronze casque. A figured vizor may be remarked, which calls to mind the movable vizors of the Christian Middle Ages.

British Museum.

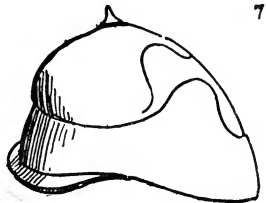

8. Greek casques in bronze, with inscriptions.

British Museum.

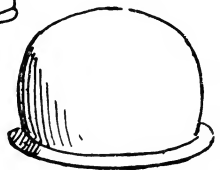

* The Umbrians or Umbri were of the Gallic race, and were allies of the Etruscans, B.C. 311—307. Contrary to the opinion of some modern historians, I believe that this people was a less ancient one than the Etruscan race.

9

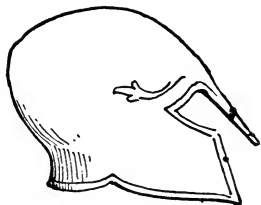

9. Greek casque of a "hoplites," or heavy-armed foot-soldier, in bronze, copied from a statue of that time. Similar examples are to be seen in the armouries of Turin (341), Berlin, Mayence, Goodrich Court, and the Artillery Museum, Paris. A similar object, in the British Museum, is engraved with a Greek inscription. The Venetian *salades* of the fifteenth century resemble in style this helmet. One like it in every respect has been found at Steingaden, near Hohenschwanga, in Bavaria: it is now in the Augsburg Museum.

10

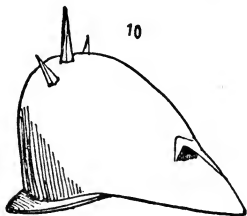

10. Greek casque in bronze. No. 342, Arsenal of Turin.

11

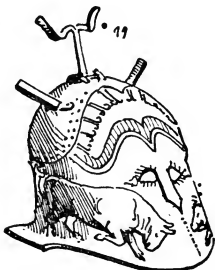

11. Greek casque in bronze. No. 3176, Museum of Mayence. It is an admirable piece of workmanship, the reliefs representing a combat of two bulls; it has antennæ, and is surmounted with a crest-holder.

12

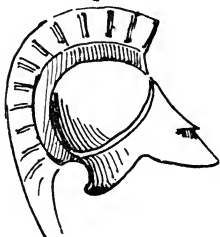

12. Greek casque from a painted vase, said to be Etruscan, in the Louvre. This is the perfect Greek classic casque, which we see in so many sculptures: not a single specimen, however, has descended to us.*

* Singularly enough, two New Zealand casques of twisted vegetable fibre, in the Meyrick Collection, now exhibiting at South Kensington, are of this pure Greek type.—TRANSLATOR'S NOTE.

13. Greek casque from the paintings on a vase said to be Etruscan, in the Louvre Museum; it is of a rare and artistic shape. The crest holder, which represents a kind of eagle, appears to be ornamented with horsehair.



14. Greek casque from an antique statue; the crest is ornamented with horsehair cut short, and the head-piece shows fine embossed workmanship.



15. Crest of a Greek casque in bronze, found in a tomb. C. 13, Museum of Artillery, Paris. Observe the likeness to Assyrian crest, No. 32, page 98.

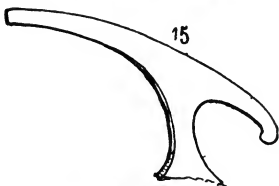

16. Greek casque with neck covering, in bronze. C. 6, Museum of Artillery, Paris. This helmet appears to have belonged to a horseman of the decadence period.



17. Greek casque with chin-strap in bronze. C. 8, Mussum of Artillery, Paris.

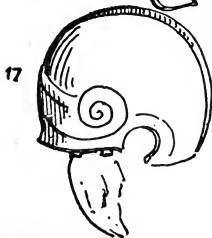



18. Greek helmet with neck-covering and plume-holder, belonging to a horseman. C. 1, Museum of Artillery, Paris; this helmet belongs to the period of decadence.

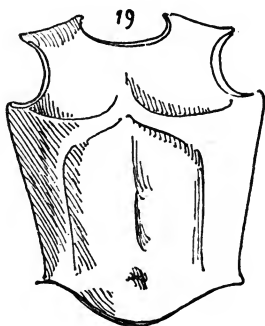

19. Etruscan breastplate in bronze, made in one shell, and showing in relief the human shape. It comes from an Etruscan tomb, and is now in the Museum of Carlsruhe. The Museum of Artillery at Paris possesses a cast of it. C. 17.

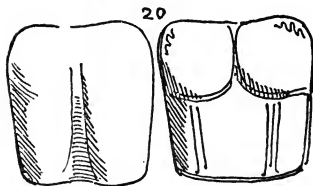

20. Greek corslet composed of two pieces, back and breast plate, in bronze, found in the environs of Naples. C. 13, Museum of Artillery, Paris.

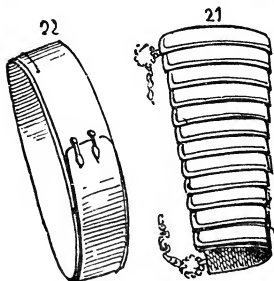

21. Greek arm-guard in bronze. Collection of M. Bonstellen, near Berne, Switzerland.

22. Greek belt in bronze, belonging to a soldier or gladiator (1 foot in length), furnished with hooks. C. 15, Museum of Artillery, Paris, and No. 372, Museum of Mayence.

23. Etruscan buckler, 3 feet in diameter; found in a tomb. The hammered and chased work which fills the circles is of a remarkable character; the style is Asiatic-Phœnician, and indicates that the article belonged to the first Etruscan period. This shield belongs to the British Museum, and a cast is to be seen in the Museum of Artillery, Paris. No. C. 9.

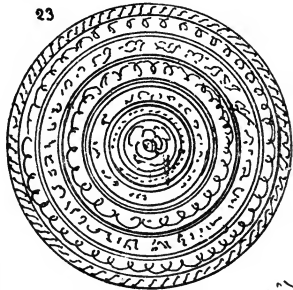

24. Etruscan buckler, in bronze, 17 inches in diameter. The engraving is of the interior of the shield. It was discovered in a tomb, and is now in the Museum of Mayence. The Museum of Artillery at Paris possesses a cast of it. No. C. 10.

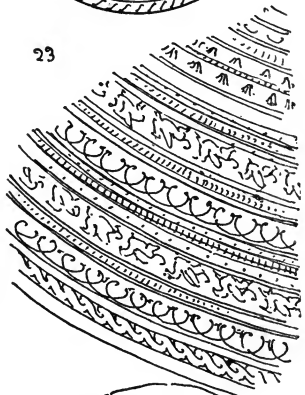

25. Boss of Greek shield.* It measures 10½ inches, and was found in the environs of Mayence, in which city it is exhibited. The Museum of Artillery at Paris possesses a cast of it. No. C. 22.

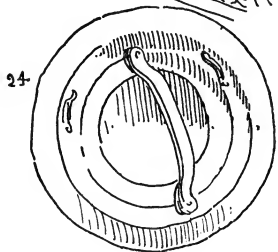

* The Greek buckler had two handles, one in the centre, through which the arm passed, and one at the edge for the hand. In addition to this there was a leathern strap to hang the shield round the neck.



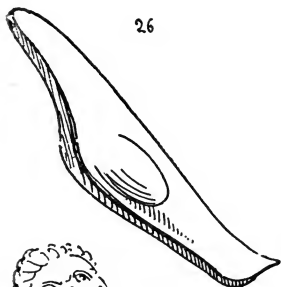

26. Greave of Greek horseman, bronze (18½ inches). Museum of Artillery at Paris, C. 22. The back of the leg is not protected.

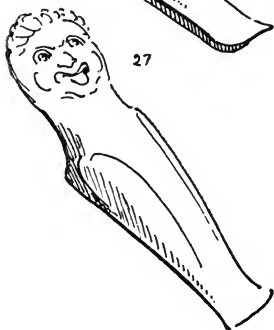

27. Greave of Etruscan horseman, bronze (21 inches). It was found in a tomb. Museum of Carlsruhe. The Museum of Mayence possesses a similar one, and the Museum of Artillery at Paris a cast. No. C. 16. The knee-cap represents the head of a lion. The back of the leg is not protected.



28. Etruscan poitrinal "barde," in bronze, to protect the horse's breast. Museums of Carlsruhe, Mayence, and a cast, No. C. 15, Museum of Artillery, Paris.



29. Etruscan chamfron, or frontal plate for a horse's head, in bronze. The numbers 27, 28, and 29, appear to have belonged to the same suit of horseman's armour. Museums of Carlsruhe, Mayence, and a cast, No. C. 18, Museum of Artillery, Paris.

30. Greek sword, in bronze (19½ inches).

No. 348, *Museum of Mayence.*

31. Greek sword, in bronze (32 inches).

C. 18, *Museum of Artillery, Paris.*

32. Greek sword, called Gallo-Greek (25 inches), with its sheath, both in bronze, found in the department of Uzés.

B. 19, *Museum of Artillery, Paris.*

33. Bronze lance-head, probably Greek, found in a peat moss near Abbeville (Somme). B. 23, *Museum of Artillery, Paris.* The *Museum of Mayence* possesses a similar lance-head. No. 349.

34. Antique dagger, in bronze, called "parazonium," common to the Greeks and Romans. 16½ inches long. *Museum of Artillery, Paris.*

35. Greek (?) hatchet, in bronze. *Museum of Berlin.*

36. Greek or Etruscan mace-head, covered with points, found in the ancient kingdom of Naples.

Museums of Berlin, Saint Germain, and Artillery, Paris.

37. Greek spur, in bronze, found in the ancient kingdom of Naples.

Museum of Artillery, Paris.

38. Antique spur, in bronze, probably Greek.

Museum of Artillery, Paris.

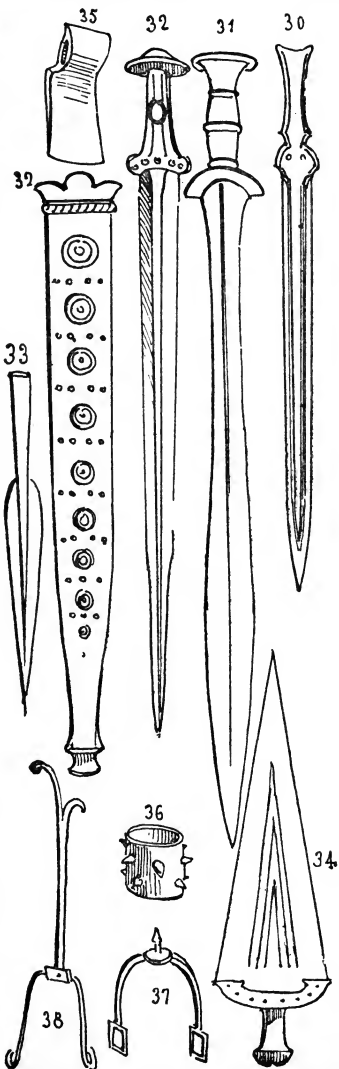



1. "Hoplites," regular soldier, armed with the trefoil-shaped buckler, from the treatise of M. Rodios.

ΕΠΙ ΠΟΛΕΜΙΚΗΣ ΤΕΧΝΗΣ,
Athens, 1868.

This soldier is interesting on account of the helmet of Etruscan shape, and the shield like a three-lobed leaf.

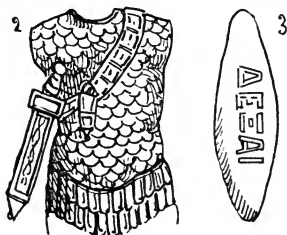

2. Coat of mail. It will be seen that the sword is worn on the right side.

3. Leaden bolt of Greek catapult, engraved with the word ΔΕΞΑΙ, receive.

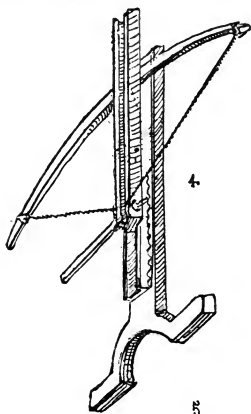

4. Hand arbalist, or *balista*, a weapon much like the cross-bow of the Middle Ages, copied from the work of M. Rodios, who constructed it after a Byzantine text. It is doubtful, however, whether such a portable balista, or arbalist, was really used in ancient Greece.



5. Battering ram with protecting cover, on wheels, called a "tortoise," from M. Rodios' work.

ROMAN, SAMNITE, AND DACIAN ARMS IN BRONZE AND IN IRON.

As in the preceding chapter we have treated of the Greek equipment, in the present we have given a summary of Roman equipment, which in the earliest epochs was most probably the same as that of Etruria, a country where it had been established by the combined influence of the Phœnicians and Greeks.

Polybius, who was born in the year 552 after the foundation of Rome, or 202 B.C. (nearly three hundred years after the conquest of Etruria by the Romans), and who is the earliest author who has described the offensive and defensive arms of the Romans, speaks only of those of his own time. The description given by this contemporary of Scipio Africanus, added to some slight information afforded us by sculptures on or in tombs on the borders of the Rhine in Germany, and by the columns of Trajan and Antoninus, is nearly all that is known on this subject.

But from the works ascribed to Homer we have much fuller information concerning the arms used by the Greeks in the tenth and even in the thirteenth century, B.C., the epoch of the siege of Troy, than concerning those by the aid of which the mighty Roman people conquered the world.

It is very probable that the Romans, in common with the Greeks and Etruscans, at first used only bronze for their weapons, but in the time of Polybius this metal was restricted to helmets, breastplates, and other portions of their armour; all offensive weapons, such as bows, swords, and lances, were always either made entirely of or tipped with iron, while the Gauls at that time still employed bronze.

The Roman army was composed of three divisions of soldiers: the *velites*, or foot-soldiers, who were lightly armed; *hastarii*, or legionary foot soldiers, and cavalry.

The first were armed with seven light javelins, the shaft of which was about three feet in length, and the iron head about nine inches, with a sword, and a small round or oval shield, called *parma*,* about three feet in circumference.

* This was the class of shield worn by gladiators.

The helmet, which was usually made with cheek-pieces, had neither crest nor horsehair, though it was sometimes ornamented with wolf's skin.

The hastarius, or legionary soldier, was protected by an iron or leathern helmet, ornamented with three scarlet and black feathers, by greaves or leggings (*ocreae*),* and by a breastplate or cuirass, composed of a corslet and shoulder-pieces, the whole made of bronze. He also had a large shield called a *scutum*, of a rectangular and convex shape, made of wood, skin, and iron, about four feet long by two and a half feet broad, and covered with plates of iron. For offensive weapons he carried an iron Iberian sword, which was always worn on the right side, as in Greece; though the Assyrians, the Hindoos, the ancient Americans, the Persians, and the Egyptians always wore it on the left side, as at the present day. The hastarius, besides the above weapon, had two javelins, one of which was the famous legionary *pilum*, which we find later in use among the Franks. The Roman slinger was armed with a sling similar to the one used by the Achæans.

The Roman cavalry in the time of Polybius were equipped like the Greek. Before that time they had no defence except a round, oval, or hexagonal shield made of ox-hide; but subsequently the armour was changed and made stronger and better fitted to resist the attacks of barbarians. In the time of Trajan and of Septimius Severus, the horseman wore a flexible cuirass or *squamata*, made of scales of iron or bronze sewed on linen or leather; or a *hamata*, made of metal chains, being in fact a sort of mail-coat. On the column of Trajan are represented many soldiers wearing cuirasses made neither of scales nor of chain mail, but of long pieces of metal similar to the armour of the Middle Ages; and the bas-reliefs on this monument show that there was as much variety in the equipment of their different bodies of troops at that time as there is now-a-days.

The armour of the centurion was more elaborate than that

* The foot-coverings of the Romans, like those of the Greeks, were various. The *solea*, or sandal, a sole of wood or leather attached by straps; the *calceus*, or shoe of civil life; the *ocreae* mentioned in the text, and the *solea lignea*, the wooden shoe of the poor. The boot, derived from the Keltic *bot* (foot), was unknown to all ancient peoples.

of the simple hastarius: his corslet had shoulder-pieces fixed to it, and was long enough to cover his thighs. It was very often ornamented with silver phaleræ, which served as marks of distinction and military rewards at that time. Some of these are represented on page 120.

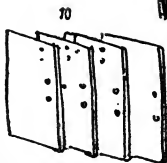
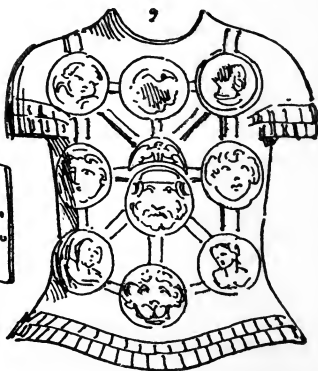

1. A Roman soldier, a *veles*, or auxiliary soldier, from a tombstone found in the Rhine, and now in the Museum at Mayence; a cast of it is in the Museum of Artillery at Paris. This soldier is armed with two long javelins about the same height as himself, with a sword worn on the right side, and with a *parazonium* or dagger on the left. The only defensive armour he has is a small apron made of straps of leather studded with pieces of metal.
2. A Roman legionary soldier (*hastarius*), back view. This figure is taken from the bas-reliefs on the Trajan column, erected by Trajan three years before his death, 114 A.D. On it are represented in particular his exploits in the wars against the Dacians (103-104), wars which were ended by the conquest of Dacia Trajana (now Moldavia, Wallachia, Transylvania, and the north-east of Hungary). The cuirass is made of thin plates of metal.
3. The same, front view.
4. Roman horseman, from the Trajan column. He wears the *squamata*, or shirt, made of metal chain armour, a species of coat of mail; an oval shield, a helmet with a ring and chin strap, and a sword on the right side.
5. Bust of a Roman legionary soldier, from the Trajan column. He wears a crested helmet.
6. Head of a *hastarius* belonging to another legion, from the Trajan column.
7. Head of a *hastarius* of another legion, from the Trajan column.
8. Head of a *hastarius* belonging to another legion, from the Trajan column.
9. Cuirass of a Roman centurion, about 22 inches in length. It is ornamented with nine silver phaleræ, or military distinctions, and is in the possession of King William I. of Prussia. There is a cast of it in the Museum of Artillery in Paris. A centurion belonging to the legion of Varus (who was defeated by the Germans, A.D. 9), represented on a tombstone that is now in the Museum at Mayence, has the same kind of cuirass.
10. Bronze scales of a *squamata*, or Roman cuirass. They are copied from those found at Avenche, the ancient *Aventicum*, capital of Roman Switzerland, which was known of in the time of Julius Cæsar, and was subsequently very much improved by Vespasian. Some of its remains are in the Museum at Avenche. The author has in his own collection several other fragments of Roman arms in bronze, from the ruins of *Aventicum*.
11. Roman helmet, in bronze. It was dug up in the field where the battle of Cannæ took place, B.C. 216, and given by the Superior of an Augustine Convent to Pope Ganganelli. This helmet is now in the Castle d'Erbach in Hesse-Darmstadt, but it is not known how it came there. No. 379, in the Museum at Mayence, and No. D. 1, in the Museum of Artillery at Paris, are helmets similar to the above.

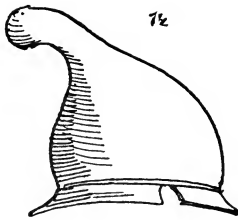

12. Samnite helmet, in bronze, found at Isernia, in ancient Samnium. This helmet is in the Erbach collection, and dates as early as the second Samnite war (B.C. 327-324). A gilded Japanese helmet of similar shape is in the Museum of Artillery at Paris.

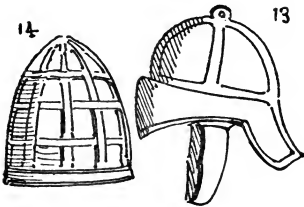

13 and 14. Two Roman helmets, from the Trajan column. No. 14 resembles a helmet copied from the Theodosian column, spoken of later, in the chapter on the iron age.



15. Roman helmet, in iron, about 1 foot in height. It is ornamented with bronze, and dates from the time of the decline of the empire. It is one of the most curious of that age. The face is almost entirely covered by a sort of mask. It is in the Museum of Artillery in Paris. D. 29.

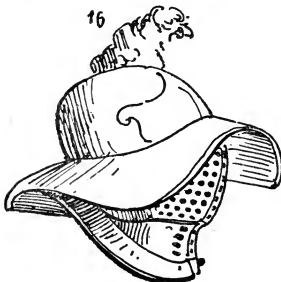

16. Roman gladiator's helmet, from the Pourtales collection. The face is entirely protected by a fixed vizar, pierced all over with round holes. This sort of helmet came into use in the 16th century of our era. Now in the Museum of St. Germain.

17. Roman helmet, found at Pompeii. Museum of Artillery in Paris.

18. Dacian sword, from the Trajan column, erected by Trajan three years before his death, in the year 114. The Dacians were the people who inhabited Moldavia, Wallachia, and Transylvania, and the north-east of Hungary. They fought bareheaded, and had only a shield for defensive armour.

19. Roman war-hatchet, in iron. From the *Collegio Romano* at Rome.

20, 21. Roman sword of iron worn with belt, called *parazonium*, 10 inches in length; and its sheath made of bronze. A cast of this weapon (which was found in Germany) is now in the Museum of Artillery in Paris. D. 20.

22. Iron head of Roman javelin, 6 inches long. From the Museum at Mayence.

23. Iron head of Roman (?) javelin, 11 inches long. From the Museum at Mayence.

23 bis. Iron head of Roman *pilum*.

24. Roman (?) bill, in bronze, found in Ireland.

¹⁶⁷ Tower of London.

25. Roman bill, in iron, from the ruins of Pæstum, on the coast of Lucania. C. 2, Museum of Artillery in Paris. This weapon, which is also found on Assyrian sculpture, is not the harpè (*ἄρπη*) or scimeter of the Greeks, which was a sort of sword, with a sharp hook projecting from the cutting edge of the weapon—a weapon with which Mercury is represented killing Argus, Perseus, when cutting off Medusa's head, and which the gladiators often used.

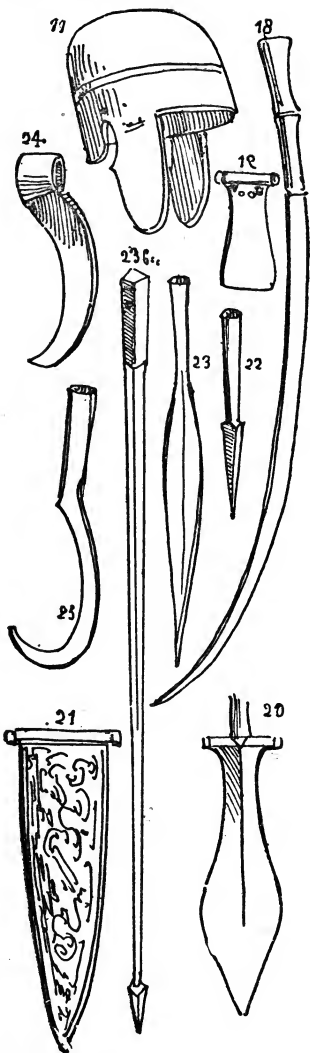

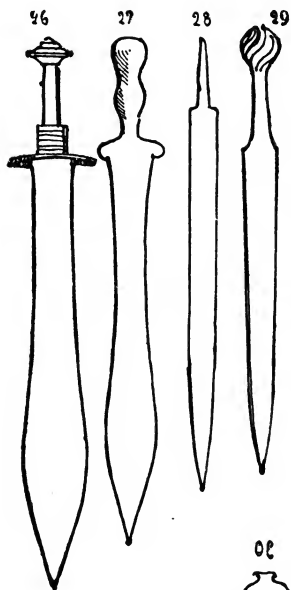

26. Roman sword, in iron, 26 inches in length. The hilt is ornamented with bronze.* It was found at Bingen.

Collection of the Burgomaster Sollen.

27. Roman sword, in iron, 23 inches in length.

Sollen Collection.

28. Roman sword, in iron, 25 inches in length. The armourer's mark is *Sabini*. A cast of it is in the Museum of Artillery, Paris. D. 13.

29. Roman sword, in iron, 22 inches in length, found at Bingen.

Sollen Collection.

30. Roman sword-blade, in iron, 19 inches in length, found at Mayence.

D. 14, *Museum of Artillery, Paris.*

31. Roman spur, in bronze, found at Salburg, near Homburg, by the Keeper of the Archives, Habel.

32. Roman spur, in iron.
D. 43, *Museum of Artillery, Paris.*

33. Roman caltrop of iron (*hameus ferreus*): it is pointed at both ends.

Museum of Artillery, Paris.

34. Roman horse-shoe, that was fastened to the hock of the horse by means of a strap passed through the ring of the shoe. D. 12, *Museum of Artillery, Paris*; *Museums at Avenche (Aventicum)*. These horse-shoes have been found in Switzerland, and at Lintz, in Austria.

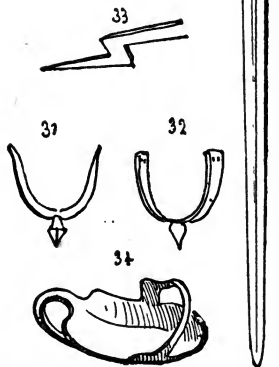

* A scabbard dug up at Mayence, now in the British Museum, bears a portrait of Augustus, and a group of Thibenius offering to the emperor a statue of Victory.

35. Signum, or badge, of Roman cohort, in bronze, found in Asia Minor. This is a most beautiful piece of work, and must have been designed by a Greek artist.

D. 3, *Museum of Artillery, Paris.*

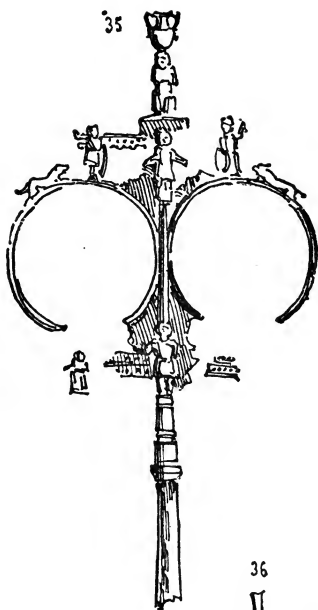

36. Poniard, or short sword, in bronze, found in a lake dwelling at Peschiera.

Cabinet of Antiquities at Vienna.

37. Plain war-hatchet, in bronze, found in the old kingdom of Naples. Its shape shows that it was a weapon, and not an implement of husbandry or carpentry.

B. 36, *Museum of Artillery in Paris.*

38. Plain war-hatchet, in bronze, found at Naples. These two last weapons may very likely have been of an earlier date.

B. 37, *Museum of Artillery, Paris.*

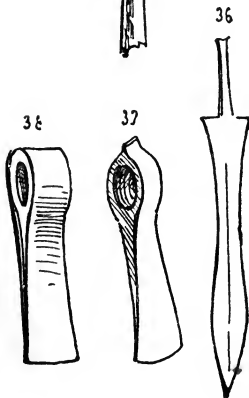

With regard to the machines of war that have been already mentioned in a former chapter, there is not one existing in its original shape ; and the balistas and catapults which have been restored from drawings ought not to figure in a work which is devoted exclusively to the history of such arms as are based upon authentic documentary evidence.

IV.

WEAPONS OF THE BRONZE AGE.

THE Keltic tribes, who occupied most probably a large portion of Central Europe, and also some of the northern districts, have left weapons that are not easily distinguished from those of contemporary and later races.

The names of Galatian and Gaul are often confounded with that of Kelt, and even of German. Where everything is involved in obscurity it is hazardous to attempt to establish exact limits and periods for the weapons of the bronze age; it is safer to treat of them under one category, as we are often obliged to do when dealing with matters belonging to pre-historic times.

We should never be able to classify satisfactorily the so-called Keltic productions; the Scandinavian, Germanic, and Gallic elements are manifest everywhere, and those who have wished to assign the tombs discovered in these different countries to races of well-distinguished origin have constantly had their arguments disproved by fresh discoveries.

The author has been careful to separate only the weapons coming from different places, and to classify them into countries according to the languages there spoken, so that weapons of bronze, possibly Keltico-Gallic, Keltico-Germanic, Keltico-Britannic, Scandinavian, &c., which are so often confounded with the bronze weapons of our era down to what is called the age of iron, have been included under one head and described *seriatim*. The iron *celt* in the national Museum at Munich, the stone hatchets and the long iron lance-heads similar to the celts found, together with a quantity of weapons and of bronze and gold ornaments, in the cemetery at Hallstatt, show that it is not possible to discriminate exactly between the bronze, stone, and iron ages. The excavations that have been made in this cemetery not only show that stone was used at the same time as bronze

and iron, but even that iron was used for the sword-blades and bronze for hilts, just as at the present day. Hallstatt is situated near Ischl, in Austria. The cabinet of antiquities in Vienna possesses a large quantity of utensils, weapons, and ornaments that have been found amongst the ruins of the said cemetery; and M. Az, at Linz, has some very remarkable objects from the same place. As these ruins have been perfectly described by M. de Sacken in his *Grabfeld von Hallstatt*, written in 1868, it would be useless to describe them again.

There does not exist a single piece of sculpture that represents a Germanic warrior thoroughly equipped, but it is well known that his equipment varied in different countries. The shield used by the Germans of the north was very large, covered with thin plates of copper, and without a boss, though in the Frankish tombs belonging to the end of the iron age (Merovingian) small round shields with projecting bosses were discovered. And what is even more remarkable is that these same kind of shields were used by the Danes during the bronze age, and perhaps also by other Scandinavian nations, and by the Britons. Bronze was used in the manufacture of weapons by the Scandinavians and the Britons at the same time as by the Germans and the Gauls. It will be seen in the following chapter, which treats of the weapons of the iron age, that the shape of the battle-axes of the Franks differed from that adopted by the Saxons.

1. German helmet in bronze, found in one of the tombs at Hallstatt, in Austria. This double-crested helmet is very like one in the Museum at St. Germain, which is said to be either Etruscan or Umbrian.

Cabinet of Antiquities in Vienna.

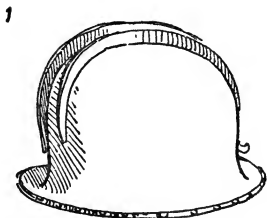

2. German helmet in bronze, which was also found in Hallstatt cemetery. Cabinet of Antiquities in Vienna. These two helmets may very likely have been made in Italy, though found in Germany, for their shape is Etruscan.

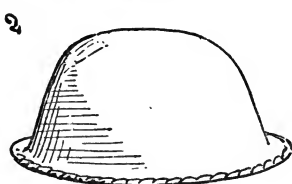

3. German helmet in bronze, about three and a half inches in height; found at Britsch, near Pforten, Saxony, and now in the Klemm collection at Dresden. It is an unique specimen, and the shape is similar to that of the Assyrian helmets in the British Museum.

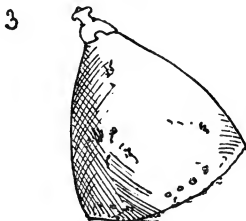

4. German arm-guard in bronze, found at Winnsbach, near Lintz, in Austria; now in the Museum at Lintz. Similar arm-guards have been found in Denmark. (See No. 261, Museum of Copenhagen.)



5. German arm-guard in bronze, found in the principality of Hohenzollern, and preserved in the Museum at Sigmaringen. A similar specimen in the Maximilian Museum at Augsburg.

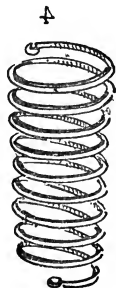

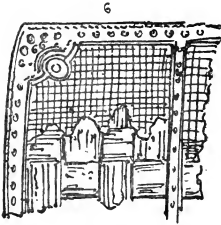

7

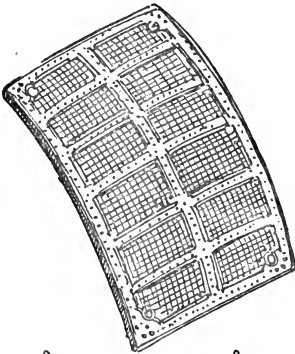

8



9

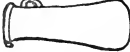

17



10



12



13

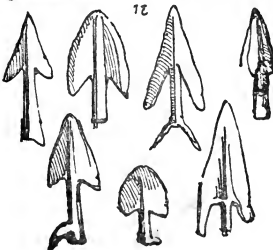

6. Fragment of a large square German shield in wood covered with bronze. Found in a tomb at Waldhausen, and published by M. C. Rath at Tubingen. In the Museum at Munich there are fragments of a German cuirass, ornamented in the same way, with copper, as this shield.

7. German shield. *Same as above.**

8. Celt, German, 5½ inches long; found in the cemetery, Hallstatt.

M. Az' Collection at Linz.

9. Celt, German (said to be Keltic) found at Stade.

Museum at Hanover.

10. Celt, German, 4 inches long. Found in the principality of Hohenzollern, and preserved in the Museum of Sigmaringen.

11. Celt, German, 6 inches long. *Museum of Sigmaringen.*

12. Celt, German, 6½ inches long. *Museum of Sigmaringen.*

13. Seven German arrow-heads. *Museum of Sigmaringen.*

* The size and shape of these shields indicate a period anterior to the Roman influence, which makes itself felt in the circular Frankish bucklers of the Merovingian epoch.

14. German hatchet in bronze, $10\frac{1}{2}$ inches long. Found in the Palatinate, and preserved in National Museum of Munich.

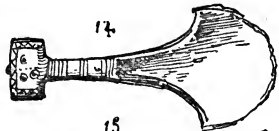

15. Celt, German, in bronze, $8\frac{1}{2}$ inches long. The Abyssinian lances at the present day are ornamented with these chisel-edged blades (see chapter on lances).

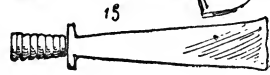

Museum of Cassel.

16. Celt, German.

Museums of Cassel and Erbach.

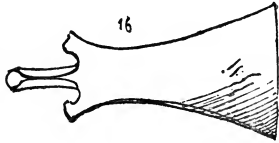

17. German hatchet in bronze, 12 inches long. Found in the Hallstatt cemetery. This weapon resembles in its ornament those of Denmark.

Cabinet of Antiquities at Vienna.

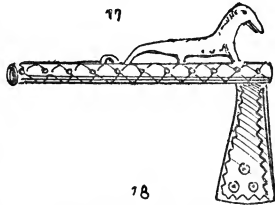

18. German war-hammer in bronze (about 18 inches), found at Thuringen. The handle is ornamented with 9 rings, formed of 6 lines each. The ornament of this weapon is also like Danish work.

Klemm Collection at Dresden.

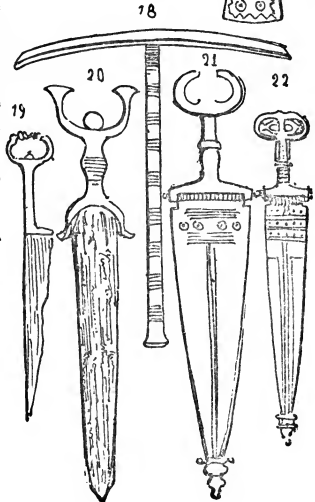

19 to 22. Four German daggers or poniards.

Museum at Sigmaringen.

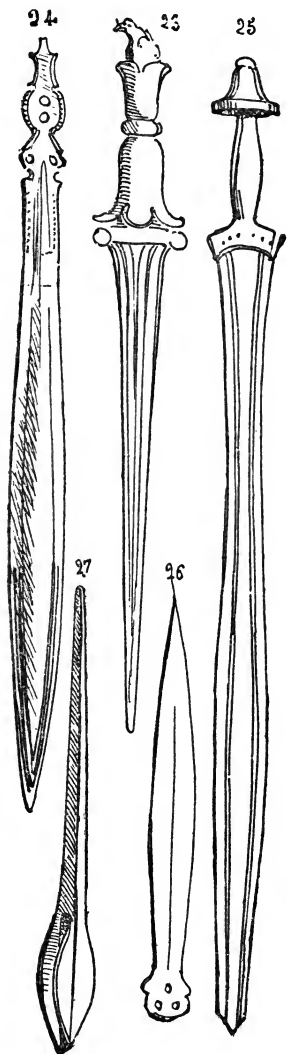

23. German sword in bronze, 22 inches long. The pommel is ornamented with an eagle's head. This sword is made entirely of metal.

Museum of Cassel.

24. German sword, 27 inches long, found near Augsburg. The flat part of the hilt is pierced with holes, which shows that the handle must have been mounted in either wood, bone, horn, or metal.

Museum of Sigmaringen.

25. German swords in bronze, 31 inches long. The pommels and hilts are of bone and bronze, some entirely of bone. Found in the tombs at Hallstatt. The points are not sharp.

Cabinet of Antiquities at Vienna.

26. Short German sword in bronze. The shape of these swords differs essentially from that of the Greek *parazonium*.

Museum of Hanover.

27. Head of German lance in bronze. Found at Hallstatt.

Cabinet of Antiquities at Vienna.

WEAPONS, KELTO-GALLIC, GALLIC, AND OF LOWER BRITTANY,
ETC., IN BRONZE.

It has already been observed that it is not possible to classify distinctly the bronze weapons that have been found in France. Even the *celt*, that point of a lance so well known by the rings fastened to it, has been found everywhere, even in Russia. As to the Gallic weapons of the time of Cæsar, they were almost all in bronze.

It has already been said elsewhere that if one wishes to be accurate, and to classify chronologically the western weapons of pre-historic times, when the productions of different nations were more nearly alike than at any other epoch, and where periods of transition, although frequent, are less distinctly indicated, it is necessary to study the construction and contents of the various tombs. The high hillocks surrounded and surmounted by stones of a more or less colossal size (dolmens), and the caves generally closed with flag-stones, containing unburnt bones, and stone weapons, may be considered as very ancient tombs. The second category is usually signalised by smaller hillocks, by the absence of large blocks of stone, by a cave or tomb formed of small rough stones built up with little art, and by the urn, which indicates the burning of the corpse. These latter sepulchres generally contain bronze weapons, which will be described in this chapter.

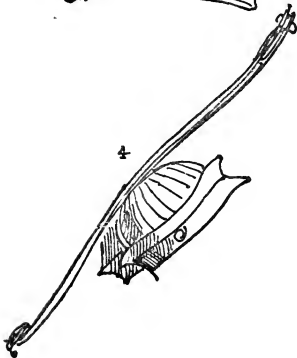
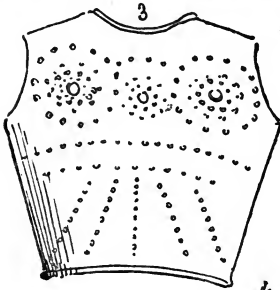
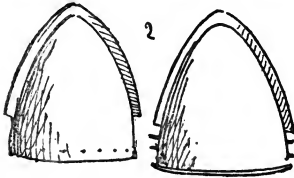
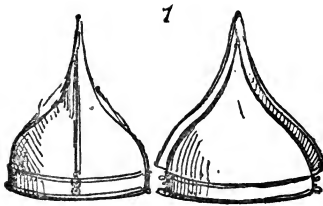

1. Bronze helmet, 11 inches in height, ascribed in France to the Gauls. Museum of Rouen. A similar one has been found at Posen, and another in Bavaria, in the river Inn. This last figures in the National Museum of Munich, under the title of a Hungarian or Avaric helmet.

2. Two bronze helmets, attributed by the Museum of Saint Germain to the Gauls. The shape is the same as that of the Assyrian helmets, and of a German helmet found at Britsch, and preserved in the Klemm collection, at Dresden.

3. Gallic cuirass in bronze, found in a field near Grenoble. B. 16, Museum of Artillery, Paris. The Museums of the Louvre, and of Saint Germain, possess similar specimens.

4. Framework of boss in bronze : the shape is not unlike the iron bosses of the Frankish shields, but it is difficult to explain why the iron bar passes under, instead of over, the boss.*

Museum of Saint Germain.

* The bar, if fixed at both extremities to the circumference of the buckler, might act as a sword-breaker.—TRANSLATOR'S NOTE.

5. Gallic shield, from a sculpture on the sarcophagus found in the Vigna Ammendola.

6. Gallic shield, from a bas-relief on the Arch of Orange.

7. *Signum* or Gallic standard, from a bas-relief on the Arch of Orange. A similar standard, 5½ inches high, has been found in Bohemia, and is preserved in the National Museum of Prague.

8. Gallic sword, from a bas-relief fitted into the pedestal of the Melpomene of the Louvre.

9. Gallic sword in bronze. 18½ inches long, found in the Seine at Paris.

B. 7. *Museum of Artillery, Paris.*

10. Kelto-Gallic lance, found in the Seine.

Museum of Artillery, Paris.

11. Lance head, found in the Seine.
Museum of Artillery, Paris.

12. Hatchet.

Louvre.

13. Arrow head.

Louvre.

14. Lance head, called *celt*, 3½ inches long.

Author's Collection.

15. Lance head, called *celt*, 6 inches long.

B. 20. *Museum of Artillery, Paris.*

16. Hatchet, 5½ inches long.

B. 34. *Museum of Artillery, Paris.*

17. Lance blade.

Louvre Museum.

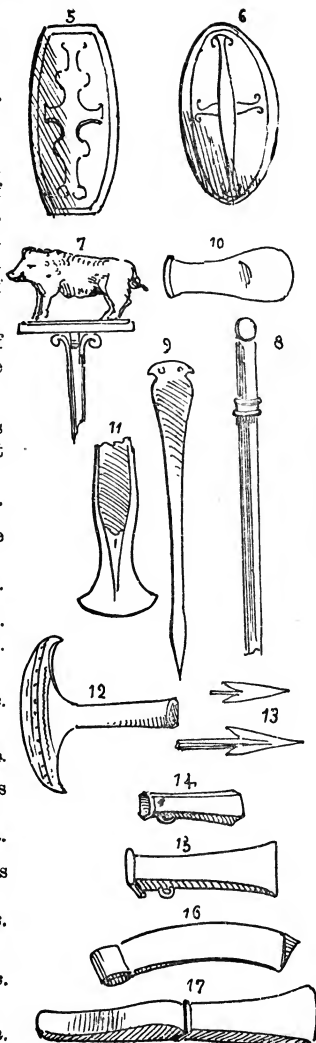

BRITISH WEAPONS IN BRONZE.

These weapons are rare, and it is difficult to fix accurately their age and origin. Several specimens, preserved in museums in England and described as British, are doubtful. The horned helmet, for example, and the buckler by the side of it, in the British Museum, and the long shield in the Meyrick collection, may very likely have been Danish.*

The epoch of the bronze age in England, which the British Commission on the history of labour for the Universal Exhibition in Paris in 1867 has described as "second epoch, anterior to the Roman invasion," cannot be limited in this manner, because the use of bronze weapons, at first general, did not cease under the Roman dominion, and even continued partially till the time of the Saxon invasion in the fifth, and the Danish in the sixth centuries.

If we compare the Danish shields, the horns, and even the swords, the heads of lances, and of hatchets in bronze which are in the Museum at Copenhagen with the antiquities of the same sort exhibited in England amongst British productions, we shall find amongst most of them a similarity in taste and manufacture which cannot have been produced by chance or imitation alone. It is very probable that the greater part of these weapons were made in Scandinavia itself, or in the northern part of North Germany, and that they were brought into the British Isles by the Norman corsairs (*Nordmannen, or Nordmaenner, or Men of the North*), who did not cease to ravage that country till it had been quite conquered by their descendants in A.D. 1066.

* It will be observed in the introduction to the chapter which treats of Germanic arms that the author considers the use of bronze for weapons in Scandinavia to correspond with that of iron in Germany.

1. Bronze helmet, found in the Thames, and preserved in the British Museum. It is in beaten work, and is ornamented with incrustations in coloured cement, which resembles enamel.

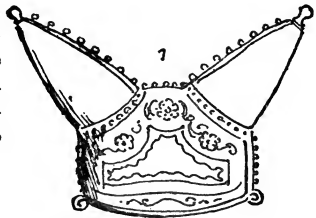

2. Framework of helmet found at Leckhampton Hill.
British Museum.

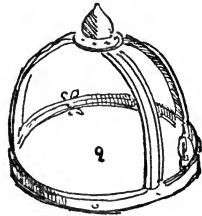

3. Bronze shield.
Meyrick Collection.

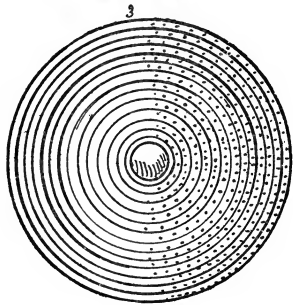

4. Plating in gilt bronze and beaten work, belonging to a British shield called *Ysgwyd*, similar in shape to the Roman *Scutum*. It was found in the river Witham.
Meyrick Collection.

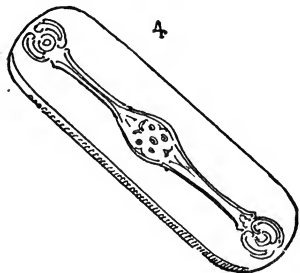

See in the preceding page the observations respecting the great similarity in these weapons to those found in Denmark, and exhibited in the Copenhagen Museum. In that part of the Introduction which refers to German bronze weapons, mention was made of the fact that the use of metal in the manufacture of weapons began at a later date in Scandinavia than in either Gaul or Germany.

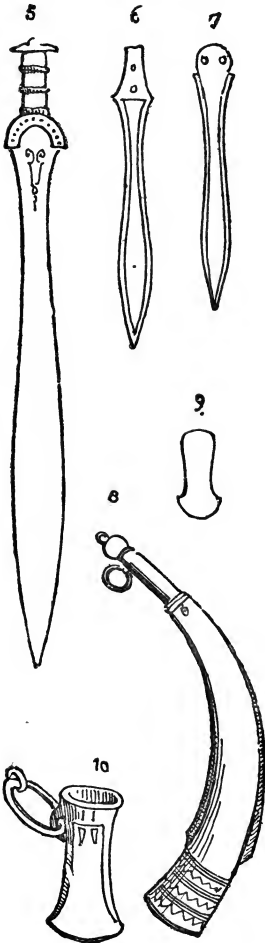

5. Bronze sword. It is very like German and Scandinavian weapons, and may easily have been Danish. *Tower of London*, $\frac{1}{63}$. Several similar ones are in the British Museum.

6. Sword blade in bronze; called Gwaew-fon.

Meyrick Collection.

7. Sword blade in bronze, found in Ireland.

Meyrick Collection.

8. War horn, Irish, called *Stuic*.

Meyrick Collection.

9. Bronze hatchet.

British Museum.

10. Blade of "framée" called a *celt*, in bronze, with a double ring to it.

British Museum.

In the London Museums there are a large quantity of celts, hatchets, swords, daggers, and lance and arrow-heads, whose shape does not vary in the least from that of Continental weapons of the same epoch. This fact has made me hesitate to class them amongst British weapons. (See observations on this question in the introduction to this chapter.)

SCANDINAVIAN WEAPONS.

The bronze arms of Continental Scandinavia (Denmark) are, as well as the stone weapons of this country, superior to those of other so-called barbaric nations, and very little inferior to those of the Greeks and Romans; a fact explicable to those who adopt the author's suggestion that the use of bronze in Denmark was later than in other countries, and coincided with the iron age in Germany and Gaul. (See observations on German bronze weapons, in the introduction to this chapter.) The specimens exhibited in the Museum at Copenhagen, which will be found represented farther on, show with what a degree of art they worked in this metal. The defensive armour of a Scandinavian warrior seems to have consisted in the round or long shield, in the cuirass, and in the helmet, though not one single complete or perfect helmet exists in the Copenhagen Museum,* and their circles of hair may lead us to suppose that the helmet was only worn by the chiefs, as amongst the Franks. In the preceding article, which treats of British arms, a horned helmet is mentioned that may very probably have been Danish.

The use of stone and bronze weapons seems to have been continued much longer in Scandinavia than in the rest of Europe; since M. Worsaae has been obliged in his illustrated catalogue of the Copenhagen Museum to class amongst the products of the iron age objects belonging to the middle ages, and even to a late period of the middle ages, for he introduces even swords of the thirteenth and fourteenth centuries.

* See following page, the crest that is supposed to have belonged to a helmet.



1. Crest of helmet (?) Danish, in bronze, 9 inches high (*Hjelmprydelse* in Danish), preserved in the Copenhagen Museum. This singular crest is in the shape of a candlestick.



2. Head band, a sort of helmet, 5 inches high, engraved and hammered.

Copenhagen Museum.

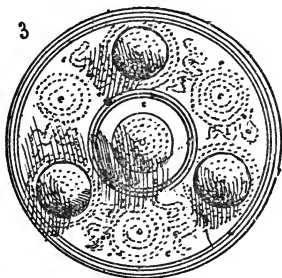

3. Round Danish shield in bronze (*Bronces-Kjold* in Danish); 23 inches in length, with central boss, and three surrounding ones.

Copenhagen Museum.

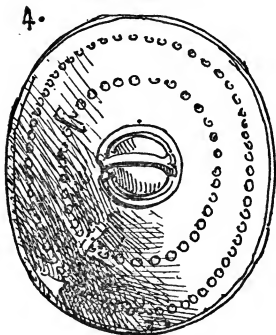

4. Oval Danish shield in bronze, 26 inches long, inside view, the boss serves to receive the handle.

Copenhagen Museum.

5. Covering of round Danish shield in bronze, 18 inches in diameter; it is richly ornamented, and has a pointed boss.

Copenhagen Museum.



6. Round Danish shield in bronze, 22 inches in diameter, ornamented with nail heads, and with round boss.

Copenhagen Museum.

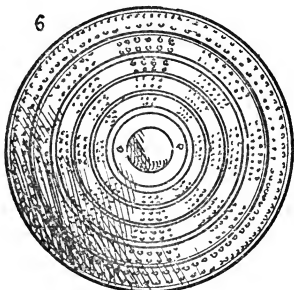

7. Danish spring arm guard in bronze, 12½ inches long. Copenhagen Museum. (See this same sort of arm-guard in the chapter on German arms in bronze.)

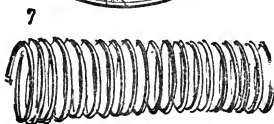

8. Danish arm-guard in bronze, 6 inches long.

Copenhagen Museum.



9. Danish arm-guard in bronze, 7½ inches long. It is ornamented with medals.

Copenhagen Museum.

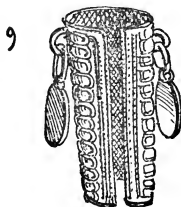

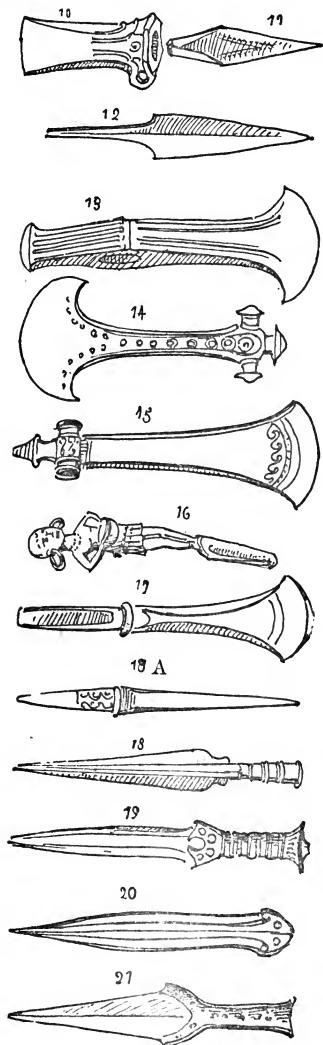

10. Danish celt, $3\frac{1}{2}$ inches long.
Copenhagen Museum.

11. Danish arrow-head in bronze,
 $2\frac{1}{2}$ inches long.
Copenhagen Museum.

12. Danish arrow-head in bronze,
6 inches long.
Copenhagen Museum.

13. Danish hatchet in bronze,
 $6\frac{1}{2}$ inches long.
Copenhagen Museum.

14. Danish hatchet in bronze,
10 inches long.

15. Danish hatchet in bronze,
18 inches long.
Copenhagen Museum.

16. Danish knife in bronze, $6\frac{1}{2}$
inches long.

17. Celt, 11 inches in length,
and a part of the staff re-
maining.
Copenhagen Museum.

18. Head of lance, Danish, in
bronze, $12\frac{1}{2}$ inches long.
Copenhagen Museum.

18A. Same as above.

19. Danish dagger in bronze, $14\frac{1}{2}$
inches in length.
Copenhagen Museum.

20. Danish dagger in bronze, $8\frac{1}{2}$
inches in length.
Copenhagen Museum.

21. Danish poniard in bronze,
4 inches long.
Copenhagen Museum.

22. Danish sword in bronze, 37 inches in length. The workmanship is very remarkable, and similar to that found in German tombs.

Copenhagen Museum.

23. Danish sword in bronze, 35 inches in length.

Copenhagen Museum.

24. War horn in bronze, Danish, 4 feet 4 inches in length.

Copenhagen Museum.

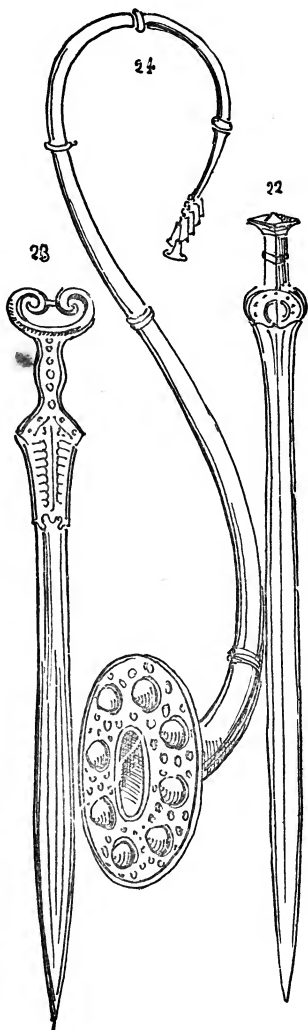

The Museum at Copenhagen possesses more than two hundred remarkable objects belonging to the age of bronze, amongst which, besides those here represented, should be mentioned a sword with its leathern sheath, poniards and knives of unusual shapes, rings of hair worn as head-dresses, and some ceramic ware, amongst which are *domestic urns* of great value in fixing their respective epochs, according to the methods of interment or of burning.

BRONZE ARMS OF VARIOUS COUNTRIES.

1. Bronze *celt*, found in Switzerland, and preserved in the Museum of Geneva.



2. Bronze *celt*, found in Switzerland, and preserved in the Museum of Geneva.

3. Swiss hatchet in bronze.
Museum of Geneva.

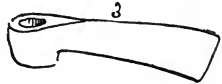

4. Hatchet or lance head in bronze, 7 inches long.
Museum of Lausanne.

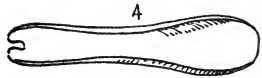

5. Bronze hatchet found at Lieli near Oberwyl, not far from Bremgarten in Switzerland. Preserved in the Zurich Museum.



6. Bronze hatchet, found in Russia. A cast of it is in the Museum of Saint Germain.



7. Knife with ram's head, in bronze, 10 inches long, found in Siberia.
Klemm Collection, Dresden.

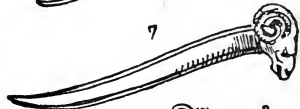

8 and 9. Two hatchets in bronze, called *celts*, found in Russia. Casts of them in the Saint Germain Museum.



Oziersky Collection.

Excavations made in the provinces of Minsk and Vladimir, and also in Siberia, have brought to light a large quantity of arms and tools of the stone age, some rough, and some polished, or rather smoothed. Many of the specimens are preserved in the Oziersky collection at St. Petersburg.

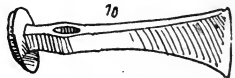

10. Bronze axe, found in Hungary. A cast of the same is in the Museum of Saint Germain.

11. Head of lance, in bronze, 6½ inches long, found in Bohemia.
National Museum of Prague.



V.

ARMS OF THE IRON AGE BELONGING TO THE NORTHERN NATIONS.

THE epoch in England called the iron age, which the British commission for the history of labour at the Universal Exhibition of 1867, in Paris, has designated as the "third epoch—that of the Roman reign,"—does not begin till a hundred years before the Saxon invasion; for the knowledge of iron weapons does not imply their prevalence. The use of bronze for offensive weapons was continued much longer in the British Isles than on the Continent, to which fact was mainly due the easy subjugation of the country at that epoch. The iron weapons of the Romans, the Saxons, the Franks, the Burgundians, and also of other German tribes, had contributed greatly to their victories over people whose cutting weapons were still formed of copper. The badly armed Gauls were entirely conquered by the Romans, though the latter were never able to subdue Germany, where their legions constantly met with reverses.

The periods that it has been decided to include under the title of the iron age ought logically to terminate at the end of the fifth century, that is, after the decline of the Eastern Empire; they have, however, been brought down to a much later date, even to the end of the Carolingian race (987), a system which though not correct had better be accepted in part, for fear of bringing disorder among chronologic classification, and thus aggravating the difficulty of researches, as so many museums have classed a large quantity of arms belonging to the middle ages amongst the products of the iron age.

We have seen in the introduction that iron was known everywhere and in all ages, but that its *universal* employment for the fabrication of offensive and defensive weapons was preceded by that of bronze. The Romans very soon found out the superiority of iron for offensive weapons to bronze, which metal was thenceforth restricted by them to defensive armour. In the year 202 B.C. the Roman soldier had no longer any offensive weapon of bronze, and it may be admitted that in the second Punic war the iron arms contributed greatly

to the Roman victories over the Carthaginians. The few iron weapons that have been found in the Gallic tombs, where they were mingled with those of bronze, such as the specimens that are preserved in the Museum of Saint Germain, and those found in the Gallic cemetery of Catalaunum (in the department of Marne), seem to be of German origin, because they resemble greatly the swords found at Tiefenau and at Neufchatel in Switzerland, which will be found represented farther on, and which I attribute to the Burgundians, who were so celebrated for working in iron. Helvetia, which in the year 450 was almost depopulated by the systematic massacres of the Romans, was repopled about 550 by the Burgundians, bands of which people had possessed themselves of the west; by the Almans, who occupied all the districts where German is now spoken; and by the Ostrogoths, who established themselves in the south, where the French, Italian, and Romansch tongues now prevail.

The Burgundians were a strong and tall race, and from the large hilts of their swords must have had very large hands. The axe and two lance-heads in iron that were found near the village of Onswala in Switzerland (see illustration farther on) show by their different shape that they must have belonged to a nation which was not Frank, and was probably Burgundian.

The swords of the Britons at a later period were of a very great length, longer even than those of the Kimbri and Marcomanni.

The form and character of the greater part of the Danish or Scandinavian arms classed in the Copenhagen Museum amongst those of the so-called age of iron show that they belonged to the middle ages, and there is nothing to authorise their being carried back to the iron age, which ought to terminate at the end of the fifth century, after the fall of the Eastern Empire. As in England, so in Denmark, the use of iron began but a little while before the middle ages, the eminently Germanic character of which was stamped on their arms and monuments.

The equipment of the warriors varied but slightly amongst the numerous branches of the great German race. Everywhere the Saxe (Sacks) or Scramasax,* a sort of Roman *Gladius* with a grooved blade, sharp only on one side, and the long sword, *spata*, or *ensis*, that was so formidable, according to Guglielmus Apuliensis and Nicetas Choniates, in the Teutonic hand,† were their favourite offensive

* See the etymology of this word, p. 35.

† The swords found in Germany measure generally 36 to 38 inches in

weapons. The long sword, renowned for its temper, and bearing often the name of its owner engraved in Runic letters, played an important part in the lives of these people, and was frequently known by a proper name. Such were the *Mimung* of Wieland, the *Balmung* of Sigfried, the *Durndart* or *Durnadal* of Roland, the poisoned *Hrunting* of Beowulf, the *Dainleif* of Hagen the father of Gudrun, the *Tryfing*, the weapon of Svafrlamis, the *Mistelstein*, that exterminated two thousand four hundred men, the *Skeop Liusingi* and *Hwittingi* of Danish history, written by Saxo Grammaticus, the *Jciuse* of Charlemagne, the *Almace* of Turpin, the *Atteclre* of Olivier, the *Chlaritel* of Engliir, the *Preciosa* of King Poligan, the *Schoyeuse* of Orange, the *Mal* of Rother, the *Calibarn* of King Artus, and the English *Quersteinbeis* of Hakon, which, as its name shows, by a single stroke split in two an enormous mill-stone.

It is curious to remark that among Northern races the sword is everywhere recognized as male; in the South, as female.

It is with this weapon (much shorter among the Merovingians than in the days of knighthood) that Clotaire II. according to history committed the dreadful crime of massacring all the Saxons that he had vanquished, men, women, and children, that were taller than his sword. The *scramasax*, though bearing a Saxon name, is rarely met with in Saxon tombs, nor in those of Northern Germany. It is by the Burgundian, the Almain, and the Frank branches that the weapon was familiarly used.

The axes, which varied in form according to the races to which they belonged, and amongst which the *francisque* of the latest conquerors of Gaul was one of the most celebrated, were, however, the most characteristic weapon of the German nation; these battle-axes are found in Scandinavia as well as in Great Britain, into which country they had been brought by the Saxons and the Danes. For the study of the equipment of these so-called barbarian peoples, there exist very few documents, and these few relating only to the Franks. All that remain in the way of arms belonging to the end of the Merovingian reigns, are the sword and the *francisque* of Childeric I., preserved in the Louvre. The sword and spurs attributed to Charlemagne constitute probably the sole re-

length, with a rounded blade, whilst the Frank swords found in Gaul are 28 to 30 inches long, and have the blade more pointed.

maining arms of the commencement of the Carolingian epoch. For written and painted documents in this matter we must have recourse to the Bible of Charles le Chauve (840—877), though the miniatures seem not very exact, and are certainly influenced by the imagination of the artist, for in them the king is represented seated on his throne surrounded by guards, whose costumes may be considered Roman, the leathern fringes and other portions of the dress seeming almost prætorian. The *Codex Aureus* of St. Gall, the cover of the *Antiphonarium* of St. Gregory, the *Leges Longobardorum* of the Stuttgart Library, the *Wessobrunn* of A.D. 810, in the Munich Library, the bas-relief of the Church of St. Julien at Brioude (?) and other documents all contradict the illustration of this Bible of Charles le Chauve.

After this there is no other historical nor archæological trace for a hundred years, when, in the Martyrologium of the tenth century, a manuscript preserved in the Library of Stuttgart, are represented, as likewise in the bas-relief of the reliquary of the treasury of St. Moritz of the ninth century, warriors already armed in the same manner as in the Bayeux tapestry of the end of the eleventh century.

Thanks to the descriptions given by several authors (Sidonius Apollinarius, writing in A.D. 450; Procopius Agathios, Gregory of Tours, and others), and to the excavations made in the Merovingian cemeteries, we are able to reconstruct nearly the whole of the equipment of the last conquerors of Gaul. As with most other Germanic races, the defensive armour of the Frank consisted only in the small round convex shield, 20 inches in diameter, made of wood covered with skin. As yet no casques nor cuirasses have been found, but we have written evidence that the chiefs wore them. The common soldier had part of his head shaved like a Chinese, the remainder of the hair was dyed a bright red, plaited and matted together on the front part of the head, which was a kind of protection, to serve as a casque, and was usually confined by a leathern band. His offensive armour consisted in the *angon* or *pilum*, barbed at the point, the lance (*framée*), with a long blade of iron, the battle axe, single-edged and called *francisque*, the sword and the scramasax, a long dagger or rather cutlass with a single edge. The bow and arrow he used only in hunting, for the *angon*, and even the *francisque*, served him occasionally as missiles. See pp. 35 to 39.

1. Blade of Germanic lance in iron, called *celt*, $7\frac{1}{2}$ inches long.

National Museum of Munich.

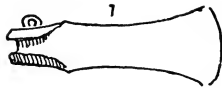

2. Blade of Germanic lance in iron, with a socket, $11\frac{1}{2}$ inches long; and a portion of the staff remaining, about 6 inches in length. Found in one of the tombs of the Hallstatt cemetery, in Austria.

Collection of M. Az, at Lintz.

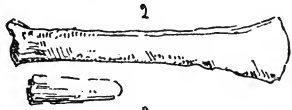

3. Germanic lance-blade in iron, $11\frac{1}{2}$ inches long.

Collection of M. Az, at Lintz.

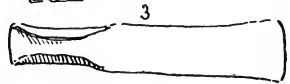

4. Germanic lance-blade in iron, $11\frac{1}{2}$ inches long, *idem*. A similar specimen is in the Cabinet of Antiquities in Vienna, and a third, found at Lüneburg, in the Museum at Hanover.

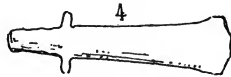

5. Germanic lance-blade, with socket in iron. Length $11\frac{1}{2}$ inches. Found in the Hallstatt cemetery.

Collection of M. Az, Lintz.



6. Germanic lance-blade in iron, with socket, and a ring similar to the rings on the lances called *celts*. It measures 15 inches, and was found in the Hallstatt cemetery.

Cabinet of Antiquities in Vienna.

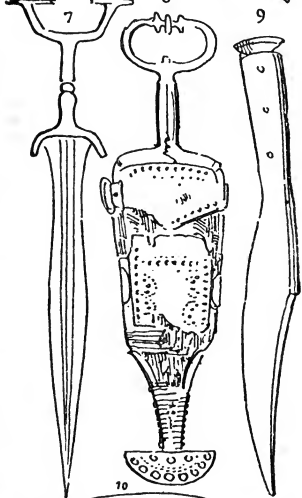

7. Small Germanic sword, length $16\frac{1}{2}$ inches. The blade is iron, the hilt bronze. Found in the cemetery at Hallstatt.

Cabinet of Antiquities, Vienna.

8. Germanic poniard in iron, length 15 inches. Found in a tomb in Bavaria.

Museum of Sigmaringen.

9. Germanic war-knife in iron, length 14 inches. Found at Ringenbach.

Museum of Sigmaringen.

10. Germanic war-knife in iron, length $11\frac{1}{2}$ inches.

National Museum of Munich.

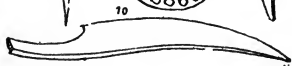

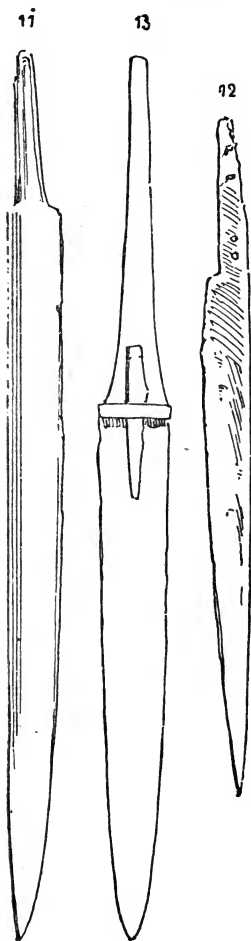

mounted with a wooden casing, which is covered with linen and leather thongs. The blade is about 16 inches in length, the whole weapon therefore measuring about 26 inches.

13. Scramasax in iron, length of blade, 15 inches, and of haft, 8 inches;

11. Dagger or *semispata* in iron (Frankish), called a scramasax. It has a single edge, and several grooves on the back of the blade. Its length, including the haft, is about 24 inches; it was found near Chalons. N. E. 19, Museum of Artillery, Paris.

The great length of the hafts of the scramasaxes found in Switzerland (they vary between 6 and 10 inches) has led Dr. Keller of Zurich to suppose that they were not weapons, but hatchets intended to be used with both hands for cleaving wood. I believe them, however, to be the scramasax of the Franks, and of other Germanic nations, for they are often found in the tombs of warriors side by side with their long sword.

12. Scramasax in iron, length 18 inches, found in Switzerland. Author's Collection. One of these scramasaxes found at Mannheim is in the Tower of London ($\frac{1}{181}$). The Museum at Geneva also has one of these weapons that was found in a tomb at Bellecan (Canton of Vaud). The Museum at Lausanne possesses others, whose hilts are about 6 inches in length, and which seem to have belonged to the Burgundians. A scramasax in the Avenches Museum, found in that town, may date as far back as the third century, for it was in 264 that the Allemanni penetrated that country, and destroyed Aventicum entirely. One of these weapons has also been found at Gruningen, Windisch. It is preserved in the Zurich Museum; the haft measures about $8\frac{1}{2}$ inches. There is also one in the Signaringen Museum, which was found at Hohenzollern. The handle, which is about 10 inches in length, is of copper,

found at Wulfingen and preserved in the Museum of Sigmaringen. This weapon is distinct from others of its kind by having a small knife attached on the outside of the sheath.

14. Germanic sword in iron, length 37 inches. The point of the blade is rounded; found at Langeneslingen. Sigmaringen Museum. Similar swords have been found of more than a metre in length, at the cemetery of Selzen, near Nierstein, where by excavating 28 tombs have been discovered, all containing skeletons, several of which have these long swords and battle-axes of the Saxon and Frankish shape by their side.

We recognise the same sort of sword in the illuminations of the *Codex Aureus* of Saint Gall, written in the eighth century, as well as in those of many other Anglo-Saxon MSS. of the ninth and eleventh centuries.

15. Frankish sword of the Merovingian epoch, about 30 inches in length, with a sharp point. Found at Moselle. E. 14, Museum of Artillery, Paris. Similar swords have been found in tombs at Fronstetten.

16. Sword with sheath, found in the tomb of Childeric I. (457-481), preserved in the Museum of the Louvre, Paris. There is an error in the mounting of this sword. The armourer who was intrusted to restore it has placed the pommel close to the blade, and not at the end of the hilt, as represented in the illustration (No. 17) and in the MSS. The same mistake has been made with regard to a Frankish spata.

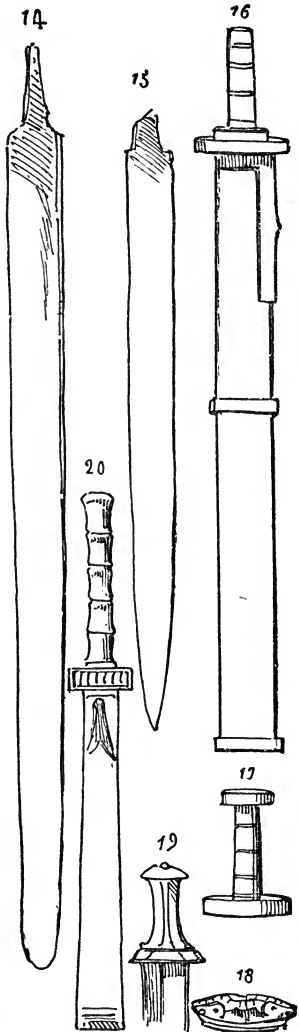

In the Cabinet de Medailles, in Paris, there is the cast of a similar sword to the above, most probably of the same date; it is about 36 inches in length, and was found on the battle-field of Pouan, department of Aube. The guard of this sword scarcely projects beyond the blade, which is wide and pointed.

17. Haft of Merovingian sword, after MSS.
 18. Pommel of sword, attributed to Childeric.
 19. Haft of Germanic sword, found at Peiting in Bavaria.
 20. Germanic or Slavonic sword, square at the point, belonging to the sixth century. Copied from the bas-relief of a diptych that is in the treasury of the Cathedral of Halberstadt. The great length of the handle resembles the Burgundian swords found in Switzerland (see No. 21, later on).
-

I must repeat here what I have already observed in the historical chapter about the etymology of the word *Scramasax*. *Sax* means knife, and *Scrama* may be derived from the word *scamata*, a line traced on the sand between two Greek combatants; or from *scaran* to shear, from which the German *Schere*, scissors, is derived. The *scramasax* is thus a weapon used in duels or a cutting knife.

21. Burgundian sword in iron, about 3 feet 3 inches in length, including the haft, which is very long, and proves that it must have been used by a robust and large-handed race. The Museum of Artillery in Paris possesses casts of the 11 swords found at Tiefenau in Switzerland, on a field of battle. They have been alluded to in a work of Troyon, but in it they should not have been placed amongst lacustrine arms. The Museum of St. Germain possesses similar swords that were found in the lake of Neuchatel.

22. Germanic dagger of the Merovingian epoch, length 17 inches. Found in a tomb at Hettingen, and preserved in the Sigmaringen Museum.

23. Germanic dagger of the Merovingian epoch, found at Rothenlachen, and preserved in the Museum of Sigmaringen. Length 8½ inches. This shape was used for more than 800 years, for it is to be found in the fifteenth century.

24. Germanic sword in iron, 34 inches in length. Found in a tomb in the Hallstatt cemetery. Cabinet of Antiquities, Vienna (for shape of blade, see bronze arms).

25. Germanic dagger-knife (length 13½ inches) of the Merovingian epoch, found in a tomb near Sigmaringen, in the museum of which city it is preserved. It is a rare specimen, on account of its shape; there is a similar one in the National Museum of Munich.

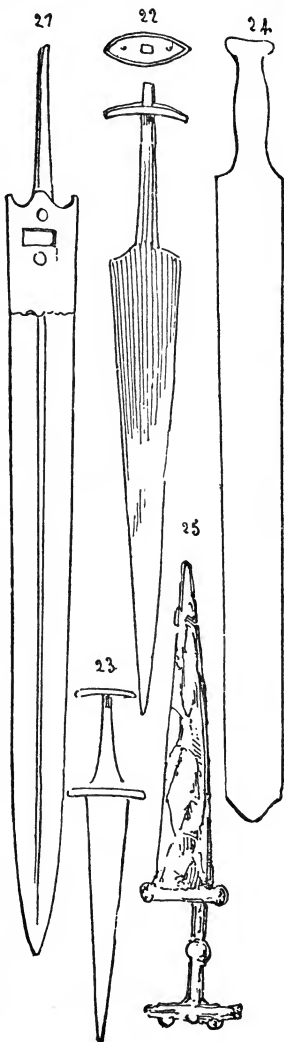

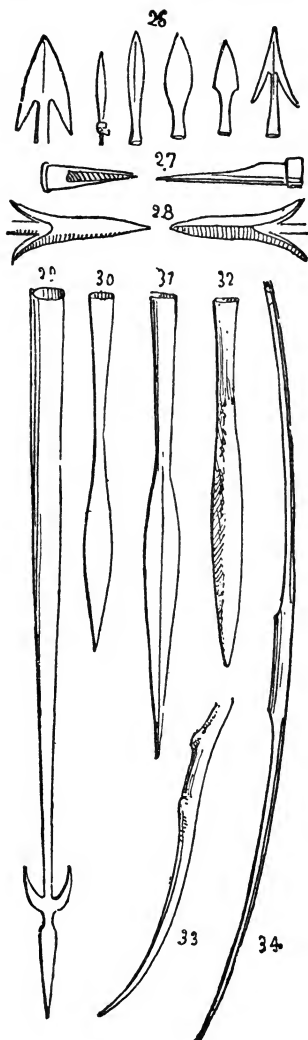

26. Six Germanic arrow-heads of different shapes, belonging to the Merovingian epoch.

Museum of Sigmaringen.

27. Two poisoned arrow-heads, actual size.

Museum of Sigmaringen.

28. Two heads of darts, Germanic origin, found in the principality of Hohenzollern, and preserved in the Museum of Sigmaringen.

29. Blade of Frankish anjon or dart (Merovingian epoch). E. 23, Museum of Artillery, Paris.

30. Head of framée (a kind of lance, in German *Pfriem*), length 15 inches. Found in the Merovingian cemetery of Londenières. E. 7, Museum of Artillery, Paris.

31. Head of framée, 16 inches in length, found at Selzen (Hesse) in a tomb.

32. Head of Burgundian spear, length 14 inches, found in the village of Onswala (Bara Schonen) in Switzerland, and preserved in the Museum of Lund in Sweden. A similar one, but somewhat shorter, has been found in the tomb of Childeric I. (457—487), and is in the Louvre.

33. Fragment of Germanic bow (Almain?) of wood, found in a lake dwelling in Switzerland. This piece measures 3 feet 5 inches, which would make the bow 7 feet 6 inches.

34. Germanic bow of Merovingian reign, found in a tomb near Lupfen. It is of oak, and 6 feet in length.

33*. Germanic battle-axe of the Saxon shape, found in the Frankish cemetery of Selzen (Hesse). M. Lindenschmidt in 1848 visited 28 tombs, and has published the result of his excavations.

Museum of Mayence.

34*. Germanic battle-axe of the Saxon shape (6½ inches), found in the department of the Moselle. E. 5, Museum of Artillery, Paris.

35. Germanic battle-axe, Saxon shape, 9½ inches.

Museums of St. Germain and Sigmaringen.

36. Almain battle-axe, Saxon shape; found in Switzerland. *Cabinet of Antiquities, Zurich.*

37. Anglo-Saxon battle-axe, found in the Thames.

187 Tower of London.

38 and 39. Germanic battle-axes, belonging to the end of the Merovingian epoch.

Museum of Sigmaringen.

40. Germanic battle-axe (6½ inches).

Museum of Munich.

41. Germanic battle-axe found at Schlieben, in Saxony.

Klemm Collection, Dresden.

42. Battle-axe, probably British (pole-axe). Found in the Thames.

187 Tower of London.

43. Burgundian axe (9 inches), found at Onswala (Bara Schonen) in Switzerland.

Museum at Lund, Sweden.

44. Frank hatchet (called *francisque*), found at Enversmen, near Augsburg. Museum of Artillery in Paris; Museum of Augsburg. Another, found at Selzen, in Hesse, is in the Museum of Mayence; another, at Hohenzollern, in the Museum of Sigmaringen. One of

these axes is in the Tower of London, and is there called *Taper axe*. The Louvre Museum possesses the *francisque* of Childeric I.

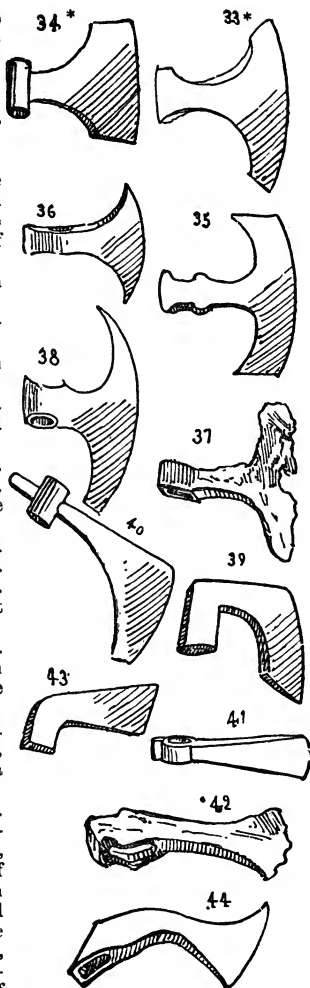

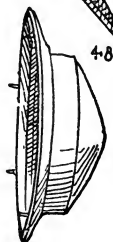
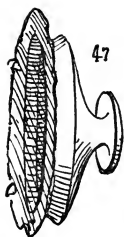
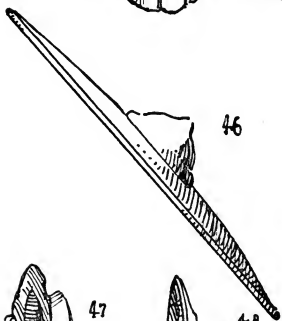
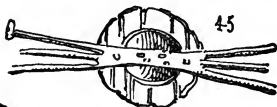

45. Frame-work of the iron boss of a Frank shield, found at Tondinières, and described by the Abbé Cochet. Similar frame-works, which have been excavated in the principality of Hohenzollern, are preserved in the Museum of Sigmaringen.

46. Frankish shield, convex and round, 21 inches in diameter, of wood covered with leather, with iron boss, 7 inches in diameter. Designed from the shield reconstructed for the Museum of Artillery in Paris.

47. Boss of Anglo-Saxon shield, found in Lincolnshire, and preserved in the Meyrick Collection subsequently. The shape of these bosses was changed to a spherical form ending in a point.

48. Germanic boss (Frankish) in iron, found at Selzen (Hesse).

49 and 50. Germanic bosses in iron found in Bavaria, and preserved in the Maximilian Museum at Augsburg. Several bosses similar to the above have been found in tombs of as early a date as the sixth century, and are now in the Bavarian Museum at Munich.

50*. Boss in iron, belonging to an Anglo-Saxon shield.

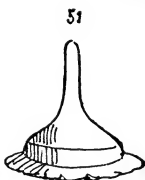

51. Boss in iron, belonging to a Germanic shield, found at Groschnowitz (Oppeln), and preserved in the Museum of Berlin. A similar boss, found at Lüneburg, is in the Hanover Museum. No. 492 in the Museum of Copenhagen is also a similar boss.

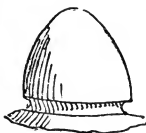

52. Germanic bosses in iron, preserved in the Museum of Sigmaringen.

53. Fragment of cuirass, found in Switzerland, probably made by the Allemanni who invaded Switzerland in the fourth century. Cabinet of Antiquities, Zurich. This valuable specimen is made of long plates of iron riveted to each other.

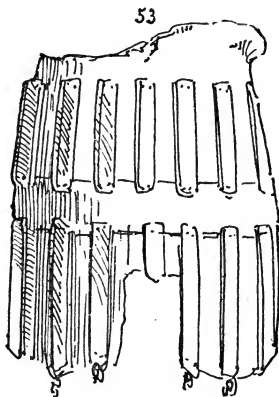

54. Germanic spur of the Merovingian epoch.

Museum of Sigmaringen.



55. Germanic bit (*Trense* in German) in iron, of Merovingian epoch.

Museum of Sigmaringen.

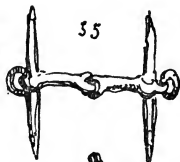

56. Germanic bit in iron, of the Merovingian epoch.

Museum of Sigmaringen.



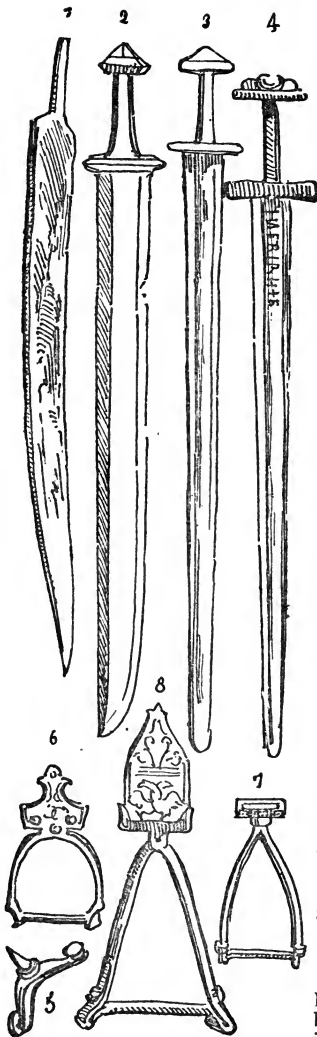

1. Danish sword in iron, one-edged, length 3 feet. The shape is very like that of the scramasax. 496, Museum of Copenhagen.
2. Danish sword, iron, one-edged, length 44 inches. The handle in the shape of the hilt and pommel resembles the Frankish swords of the Merovingian epoch. No. 493, Museum of Copenhagen.
3. Danish two-edged sword, length 43½ inches. The blade is deeply grooved, and is not pointed, in fact, almost as rounded as the Germanic swords. 494, Museum of Copenhagen.
4. Danish sword in iron, length 43½ inches. The handle is three-lobed, like the swords in the Anglo-Saxon MSS. of *Aelfric*, written in the eleventh century, now in the British Museum. In the collection of M. Nieuwerkerke there is a similar one. When the handle is five-lobed and not three-lobed, and when the two extremities of the guard are slightly bent towards the blade, it belongs to the thirteenth century. (See the one in the Munich Museum in the chapter on swords of the Middle Ages.) The sword in the Nieuwerkerke Collection is five-lobed, but the ends of the guard are not bent.
5. Danish spur in bronze.
Museum of Copenhagen.
6. Danish stirrup in bronze (8½ inches).
Museum of Copenhagen.
7. Danish stirrup in bronze, inlaid with silver (12 inches).
Museum of Copenhagen.
8. Danish stirrup in bronze (15½ inches).
Museum of Copenhagen.

P.S. Almost all these objects belong to the Christian Middle Ages, but have been classed erroneously, in the museum and in M. Worsaae's catalogue, as belonging to the iron age.

9 Casque and coat of arms, probably in leather and iron, copied from the column of Theodosius at Constantinople.* As these arms display no Roman characteristics, we may suppose that they belonged to allies or to barbarian mercenaries.

This coat has nothing of the ancient classic character, and its singular shape makes one hesitate about its origin.

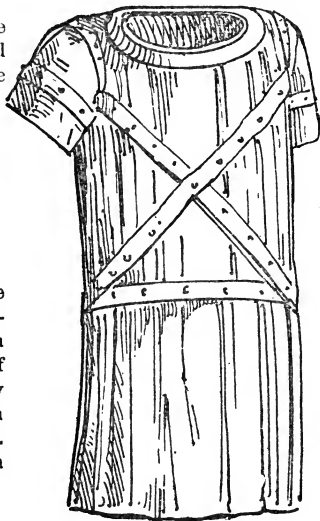
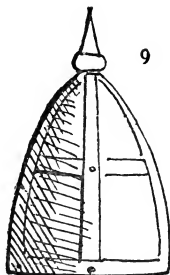

* Constantinople, already the residence of the Emperor Constantine, became in 330, on the partition of the Roman Empire, the capital of the East. In the year 557 the city suffered from an earthquake, and in 1207 it was taken by the Turks. The Emperor Theodosius was born in 346, and died in 398.

VI.

ARMS OF THE CHRISTIAN MIDDLE AGES, OF THE
RENAISSANCE, AND OF THE SEVENTEENTH AND
EIGHTEENTH CENTURIES.

THE historical introduction has shown the gradual progress that was made in the improvement of arms from the earliest ages; and though the description of the equipment of the ancients and even of pre-historic nations has been sometimes based on supposition, the history of the two later stages of the Christian middle ages may be established from existing specimens. Starting from the tenth century, we are already able to follow step by step the gradual change in defensive armour, the alterations in which are always more apparent than those of offensive weapons, whether missile or for close combat. The mail-shirt remained in use for more than five hundred years, and was replaced by complete plate armour only after a transition period in which coats of mail, partly composed of plates of iron or of leather, were used. This chapter, after having passed in review the complete equipment of the different epochs, will give a separate history of each weapon, accompanied by illustrations of the objects, however small, which, it is hoped, will greatly facilitate the comprehension of the text. As to the more general historical development, the reader is referred to the chapter on the abridged history of ancient arms, pages 37 to 59.



Combatants from the ivory cover of the Antiphonary of Saint Gregory, a manuscript of the eighth century, preserved in the library of Saint Gall, in Switzerland. This sculpture has much of the Roman and even Byzantine character about it; it may very likely have come from a diptych. The shape of the shields, however, is not Roman, and the sort of Moses-like horns on the heads of the warriors remind one of the defensive head-gear of the northern nations. The two combatants do not wear beards, and their only weapon of defence is the shield, which shows a single loop for the arm.



Merovingian knight, from a bas-relief in the church of Saint Julien at Brioude (Haute Loire), attributed to the eighth century. This warrior is equipped in the short hauberk or jacket of scales called *Jazerans* or *Korazins* (see explanation in the chapter on mail coats and cuirasses), without hose or leggings, but with sleeves that reached to the wrist. The conical casque resembles those of the eleventh century, called in France *Norman*, though without nose-guard. The chin-piece seems to be made by a portion of the hood that appears from under the casque. The general character of this equipment indicates rather the tenth or eleventh century, on which account the author hesitates about giving it this place.

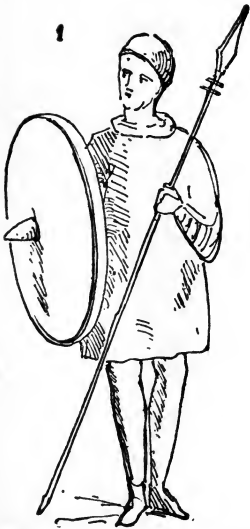

1. German man-at-arms, of the beginning of the ninth century, from a miniature in Wessobrunn MSS. (810), preserved in the Munich library. It is worthy of notice that this warrior wears no beard, and that he carries a round shield with boss, and has a rounded helmet.
2. Lombard king from *Leges Longobardorum*, of the ninth century, in the Stuttgart library. This miniature is interesting on account of the elongated square and convex shape of the shield; which is also seen in the long targe of Germany, of the fourteenth century. The king wears his beard, but with the chin bare.

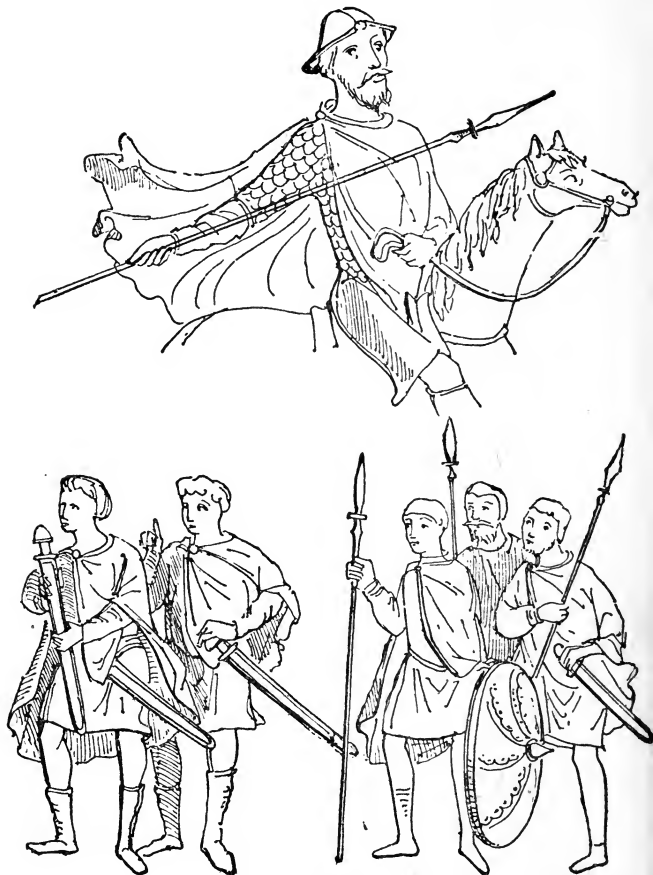

3. Horseman and foot-soldiers from the miniatures of the Codex Aureus, of the eighth or ninth century, now at St. Gall. The horseman and one of the foot-soldiers wears the beard and moustache.



1. German warrior of the tenth century, with conical-shaped helmet and nose-piece, and hauberk of mail, remarkable by its long sleeves. From the "Martyrologie," a manuscript of the tenth century, in the library of Stuttgard.
2. Warrior in large hauberk of mail, with short sleeves and hood, but without casque; from the bas-reliefs of a reliquary in beaten silver, of the end of the ninth century. Treasury of the Convent of Saint Maurice, in the Canton of the Valais, Switzerland. The warriors have no beards.
3. Man-at-arms of the tenth century, from a statuette on a cover of yellow leather, of that time; in the collection of M. the Count of Nieuwerkerke. This valuable example is 3 inches high. The conical helmet is remarkable by the shape of the nose-piece, which is very broad at the base. The sword is pointed. The coat of mail is long, but has not



the close-fitting leggings of the Norman armour of the eleventh century. The shield is long, pointed, and with a boss.

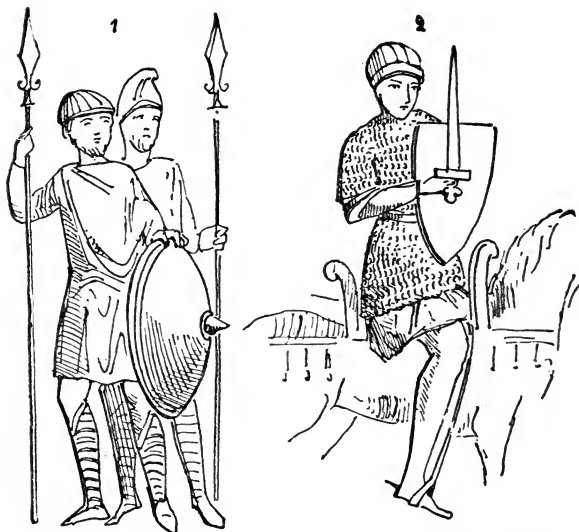

1. Anglo-Saxon men-at-arms; from the Prudentius *Psychomachia*, etc., Anglo-Saxon manuscript of the tenth century, in the library of the British Museum. The whole of the defensive armour consists of the round shield with boss, and the casque with rounded shell, which may be seen on the seal of Richard Cœur-de-Lion (1157—1173).
2. Warrior of the tenth (?) century; from a manuscript of that time, the *Biblia Sacra*, in the Imperial Library of Paris. This miniature is remarkable on account of the shape of the sword-handle, which is trilobed, as in the *Aelfric*, an Anglo-Saxon manuscript, in the library of the British Museum, and by the small buckler, which was used likewise in the reign of Saint Louis (1226—1270). The same kind of saddle is found on the Bayeux tapestries of the end of the eleventh century.

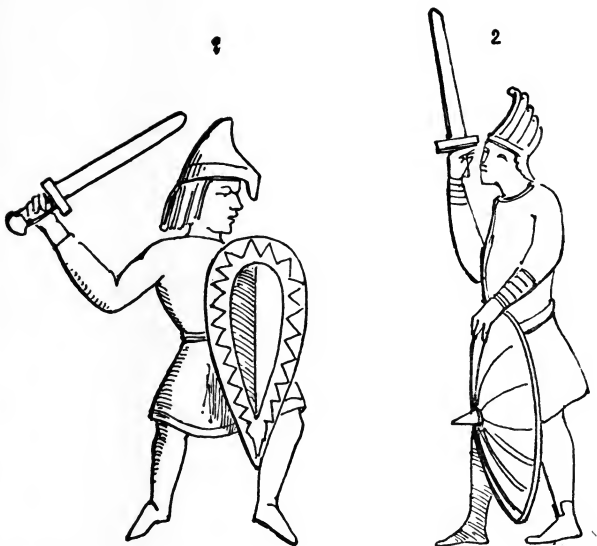

1. The Duke Bourckhard of Swabia (965); bas-relief in the Basilica of Zurich, Switzerland, which was built towards the end of the eleventh century, in place of the church burnt in 1078. Helmet and sword recalling those of the tenth century, in the Martyrology (already mentioned), in the Library of Stuttgard.
2. Anglo-Saxon man-at-arms, from the miniatures of an Anglo-Saxon manuscript, the *Aelfric*, of the end of the eleventh century, in the library of the British Museum. The shield has no resemblance to the Norman shield, which was long and very pointed at the base; the helmet, also, differs entirely from those we are acquainted with. The sword-handle is trilobed, or trefoil-shaped, and the hauberk with long sleeves does not resemble the Norman hauberks. These men-at-arms are both represented without beards.

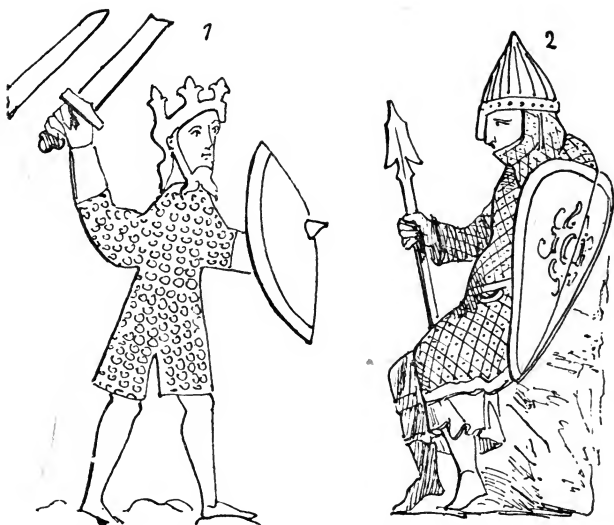

1. Anglo-Saxon warrior from the *Aelfric* manuscript, of the beginning of the eleventh century, mentioned on preceding page. Same kind of trilobed sword-handle, same round shield, but the hauberk here is ringed, without leggings, but with close-fitting breeches. It may be noticed that the Anglo-Saxon is represented with a beard.
2. French warrior, from a bas-relief in the cloister of Saint Aubin at Angers. He wears the conical helmet with nose-piece, the heart-shaped buckler, the Germanic "framée" (lance), and the large hauberk of trellised mail, with long sleeves and hood. The shield is adorned with paintings, which probably represent personal armorial bearings.

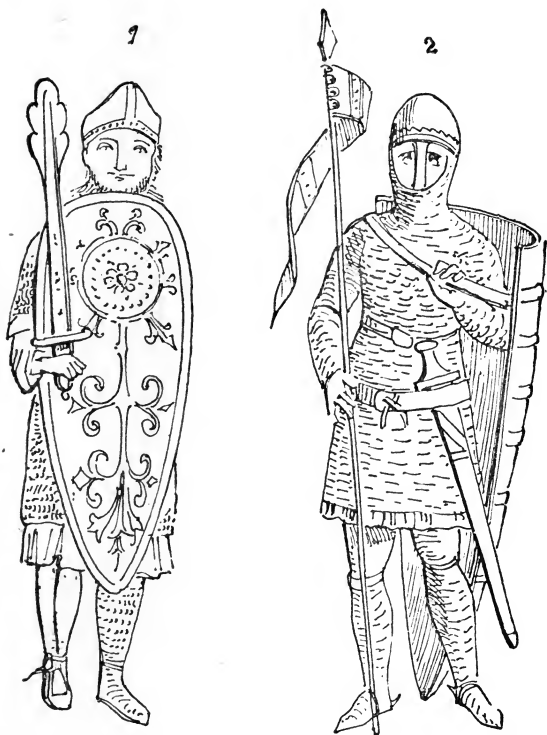

1. German equipment of the eleventh century, from the statue of one of the founders of the Cathedral of Naumburg. The casque is similar to that in the Codex Aureus of Saint Gall. Strangely enough, the right leg is without armour. A beard is seen on the chin.
2. German warrior of the eleventh century, in a hauberk with long sleeves, hood, and breeches and leggings in mail. From the *Jeremias Apocalypsis*, in the library at Darmstadt.

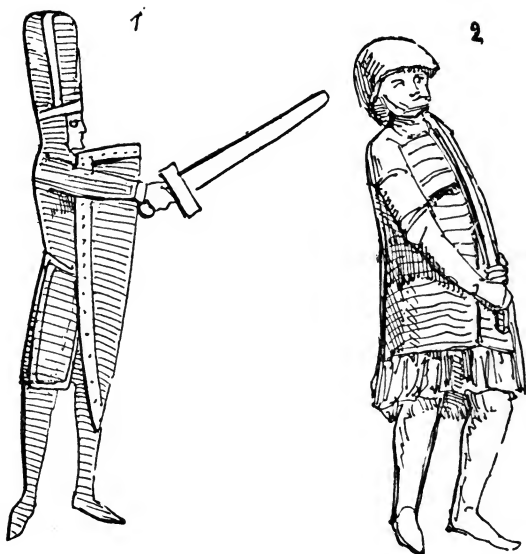

1. German man-at-arms of the end of the twelfth century, from the embroideries on the mitre in the Convent of Seligenthal at Lands-lut, in Bavaria, on which are represented the martyrdoms of Saint Etienne (997), and of the Archbishop Thomas Becket of Canterbury (Saint Thomas died A.D. 1170).

National Museum of Munich.

2. German warrior; from a stone sculpture of the twelfth century, at the gate of Heimburg, in Austria. The hauberk, with long tight sleeves and hood, appears to be of thongs covered with iron, and of a kind unknown. The rounded shell of the helmet shows the radical difference which existed between this piece of German defensive armour and that of the Normans. The arm-guards, with shoulder-pieces and elbows, to protect the back of the arms, are also very characteristic of the time. The sword-blade appears to be broken in the hands of the statue, so that the shape of it cannot be rightly conjectured, but it resembles that of the Dacian sabre.

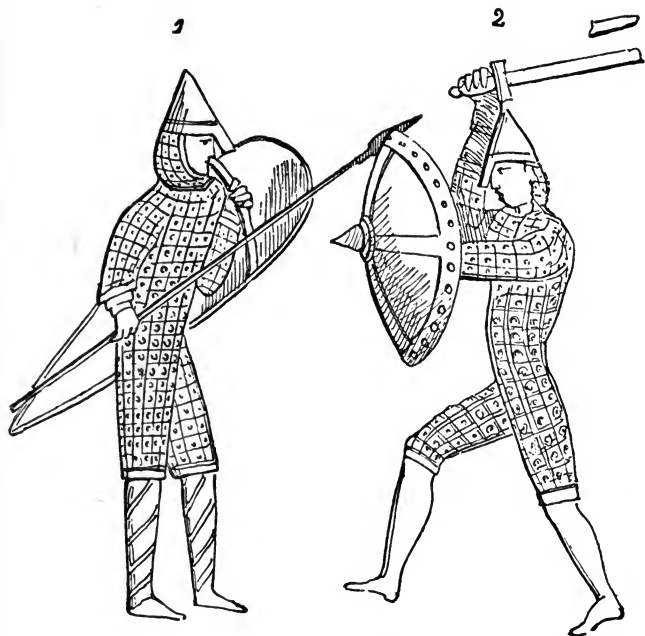

1. Norman warrior of the eleventh century, in large ringed or trellised hauberk, with sleeves, close-fitting breeches, and hood. The legs are bound round with thongs. The conical helmet has a nose-piece, and the shield reaches to the height of a man's shoulder.

Bayeux Tapestry.

2. Anglo-Saxon warrior, recognisable by his round shield with boss, and whose defensive armour does not differ in other things from the Norman. The sword is very long in the blade, and has a simple pommel.

Bayeux Tapestry.

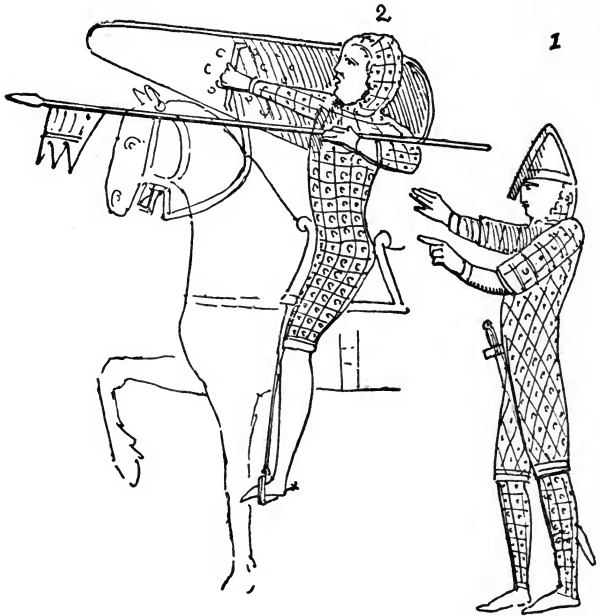

1. Norman warrior of the eleventh century in large ringed or trellised hauberk, with sleeves, breeches, and leggings, and hood in one piece. This figure is probably meant for William the Conqueror, because it alone has the legs armed like the rest of the body. The conical casque with nose-piece does not differ from that of the other warriors.

Bayeux Tapestry.

2. Norman warrior fighting without helmet, and wearing the hood alone. The defensive armour is the same, but this warrior is interesting on account of the form of his saddle, bridle, and the pennant on his lance.

Bayeux Tapestry.

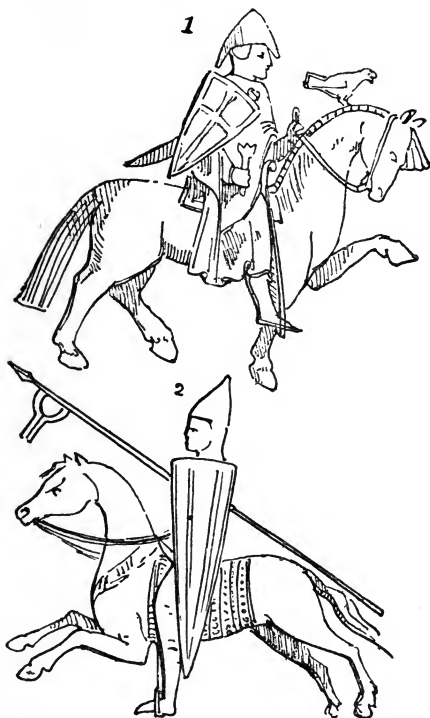

1. Scandinavian warrior; end of the eleventh or beginning of the twelfth century, from a sculpture in wood on the door of a church in Iceland, preserved in the Museum of Copenhagen. The equipment is remarkable by the conical casque with nose-piece and neck-covering, and by the curved sword or *glaiue* which the warrior bears along with the buckler on his right shoulder.
2. Count of Barcelona, Don Ramon Berenger IV. (1140); from an engraved seal. The conical helmet has a nose-piece, and the rest of the armour seems to consist of a hauberk with hood, and breeches and leggings of mail, all in one piece. The long shield has a coat of arms on one of his seals, and stripes on the other. The lance has a pennant.

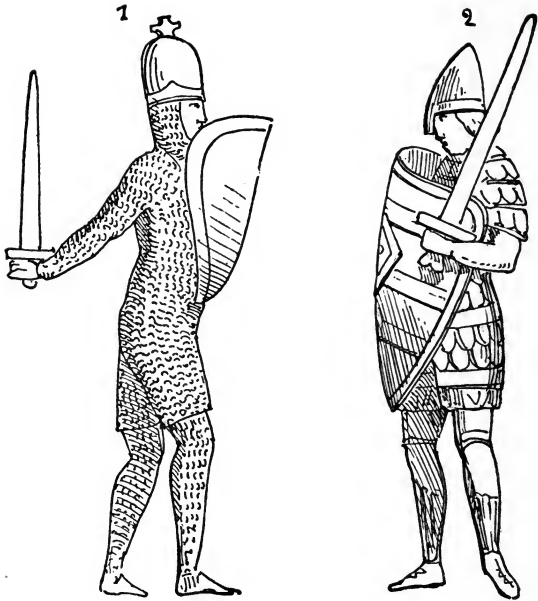

1. Louis VII. the young (1137—1180), from his seal. The coat of mail has a hood, close-fitting sleeves, breeches, and leggings. The helmet has a rounded shell without a nose-piece, a cross as a crest, and the buckler differs greatly from the Norman one.

2. German warrior from the mural paintings on the cathedral of Brunswick, executed in the reign of Henry the Lion, who died in 1195. The equipment is interesting on account of the coat of scale-armour, which resembles the Roman *squamata*, the large shield, the pommel of the sword, which is double-lobed, and the metal rings which encircle the knees.

(See at page 180 the equipment of Richard Cœur-de-Lion (1189—1199), which, according to chronological order, should follow here.)

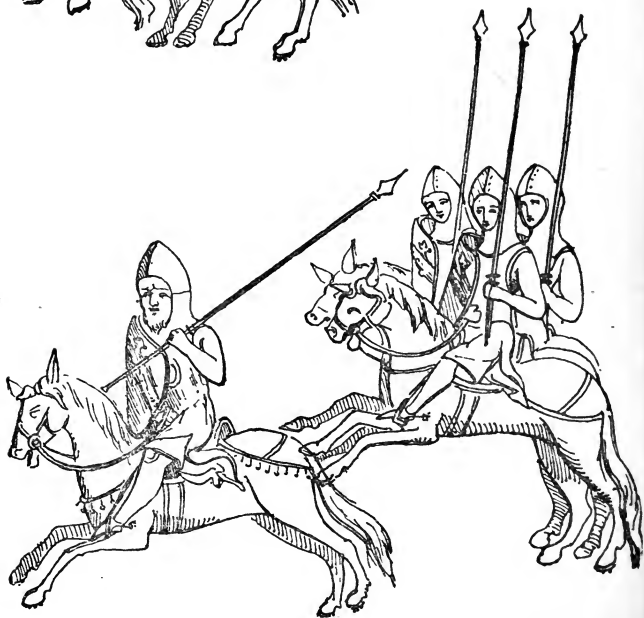
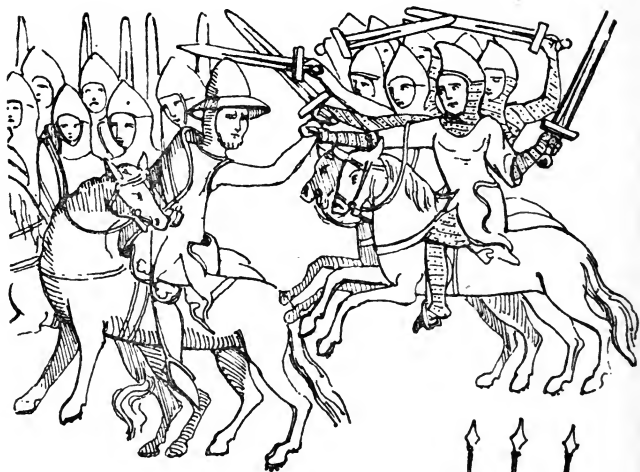

The engraving on the preceding page represents Bohemian or German warriors, from the manuscript of *Voleslav* of Bohemia, in the thirteenth century; preserved in the library of Prince Lobkowitz, at Raudnitz, in Bohemia.

The second group on the page is headed by a chieftain whose equipment differs in no respect from that of the other warriors, many of whom already wear the large bassinet, generally supposed to belong to the fourteenth century, and which, worn with the hood, reaches to the shoulders.

The hauberks with long, close-fitting sleeves, and breeches with leggings, are evidently of the kind called "ringed" (see the explanation in the chapter on corslets and coats).

The bassinets do not appear to be made of a single shell, judging from the line riveted with nail-heads, which divides the pointed shell of the helmet into two halves.

The swords are not yet pointed, but the saddles have raised cantles, while the chiefs wear beards and have sharp-pointed shoes *à la poulaine*. The most remarkable feature in this elaborate illumination, as far as the history of defensive armour is concerned, is the broad-brimmed iron hat with pointed crown like that of the bassinet. There is no existing specimen of this kind of hat, for the iron hats of the fourteenth and fifteenth centuries, which are sometimes to be met with in collections of armour, have not the crown thus pointed.

It may be remarked that only the two chiefs wear beards, and that the shields with armorial devices resemble in shape the shield of Louis VII. (1137—1180), represented on page 174.



1. German armourer forging a helm, copied from a miniature of the German *Æneid* of Henry of Waldeck, thirteenth century, preserved in the library of Berlin. The coat of mail at the foot of the anvil, inaccurately copied, appears, in the original design, to be trellised and studded with nail-heads, if it be not ringed. The helm (*Topfhelm* in German, and *heaume* in French) which the armourer is forging has a fixed vizor and is flat-crowned.
2. German warrior, from the same manuscript. The helm has a crest; the buckler is heart-shaped, like the small shield which was universally worn in the time of Saint Louis. The armour already appears to be in plates, probably of leather, judging from the arm-guards, the cuisses, leggings, and pointed shoes, which are all evidently laminated. The armour of the horse, which is completely trellised, and studded with heads of nails, or ringed like the coat lying at the foot of the anvil in the first engraving, shows a great progress in equipment. The "Waffenrock" or frock which the warrior wears above his armour is grotesque enough with its long skirts like the overcoats of the present day; it is also to be seen on the Dutch statue of the same period, represented at page 181.



Richard I. Cœur-de-Lion (1189—1199),* from a seal. The coat of mail has tight-fitting sleeves, and hood, but without hose. The “jams” or leggings are also of mail, reaching to the knee, while the buckler seems to be the forerunner of the small shield of the thirteenth century. The helmet with rounded top of Northern Germanic origin has replaced the Franco-Norman conical helmet; its shape is much higher, and recalls the helmets of the embroideries of Seligenthal, which also belong to the second half of the twelfth century.

* This woodcut, which, according to the chronologic order followed in this book, should have been placed to follow p. 174, has been obliged to be inserted on this page for typographical reasons.

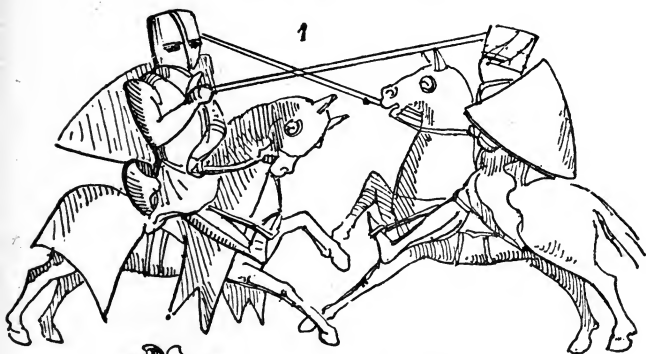

1. German warriors, wearing plate-armor, arm-guards, "jams" or leggings of plate armour, and plated shoes *à la poulaine*. They wear tilting helmets (*Stechhelm* in German, *heumes de joute* in French), and the *Waffenrock* or surcoat above their armour. From a German manuscript, *Tristan and Isolde*, written in the thirteenth century by Godfrey of Strasburg, and preserved in the library of Berlin.
2. Equestrian statue in bronze, of the end of the thirteenth century, front and back view; in the collection of M. Six at Amsterdam. The Dutch warrior in coat of mail with tight-fitting sleeves, the hose jams in plates, probably of leather, has a grotesque appearance, on account of the long-skirted coat worn over the armour, and the singularly disproportionate size of the crest of his helm.



1. French warrior of the thirteenth century, from a *champlevé* enamel on copper, in high relief, 4 inches in height, in the collection of M. le Comte de Nieuwerkerke. It is alternately enamelled in blue and gilt, in shades of citron and orange, and dates from the thirteenth century. The sword-guard has the two ends turned towards the point of the sword, the helm is crested, the armour covered with the *Waffenrock*, or frock with long skirts, and the horse is caparisoned.



2. French warrior of the thirteenth century, from a *champlevé* enamel candlestick of that period, in the collection of M. le Comte de Nieuwerkerke.



3. French warrior of the fourteenth century, from the ornaments on a stamped and engraved leathern coffer of that period in the collection of M. le Comte de Nieuwerkerke. The French inscriptions in Gothic letters indicate a time posterior to 1360. Above the figure are the words, CHARLES LE GRAND. The armour is all plate, the shoes are à *la poulaine*, and the gauntlets have separate fingers.



Italian warriors of the fourteenth century, from a canvas printed by hand by means of engraved wood blocks in oil colours.* red and black, belonging to M. Odet, at Sitten. The chiefs wear helmets, while the other warriors have the fluted bassinet of which no specimen is now known. All wear the fluted "jambes," but their body armour is still the hauberk, which had fallen into disuse in Germany.

* Dr. Keller, who has published the fac-simile, confounds this manner of hand-printing, already known among the Mexicans, with the real wood-engraving, which necessitates the use of the printing-press.

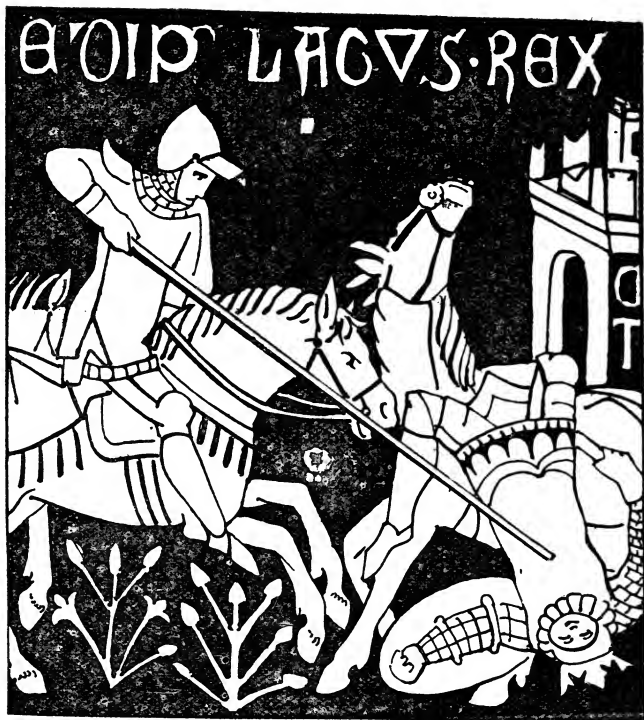

Italian warriors of the fourteenth century, from the same canvas as the preceding engraving. The plain bassinet is noticeable, on account of the frontlet, a kind of vizor which resembles the shade or peak on modern caps, and which seems to be the precursor of the peak on the burgonet of the fifteenth century. The Gothic capitals in use from 1200 to 1360 show that the canvas cannot date later than the fourteenth century.



Danish warrior of the fourteenth century, whose armour is curious because of the *braconnière* or apron and loinquards in trellised work which partly cover the mailed hauberk. The helm is still of the shape of the "Topfhelm" of the Germans, thirteenth century. From an ecclesiastical bowl in the Museum of Copenhagen.



German warrior ; beginning of the fourteenth century ; he is already armed with plated *jambes* and mailed shoes *à la poulaine*. The helm has a plume, and the shield is larger than the buckler of the thirteenth century. Manuscript 2576 of the Imperial Library at Vienna : *Historia sacra et profana*, etc.



1. Knight of Neufchatel of the year 1372. This is the date of the completion of the funereal monument in the Upper Church of Neufchatel. It represents Rodolph II., who died in 1196.
2. Armour of a Neufchatel knight. This armour is drawn from an exact fac-simile of the monument to the Count of Berthold, who died in 1258, at the time when this sculpture was carved. We notice the greaves or *jambes* of plate-armour, but the buckler is still small.

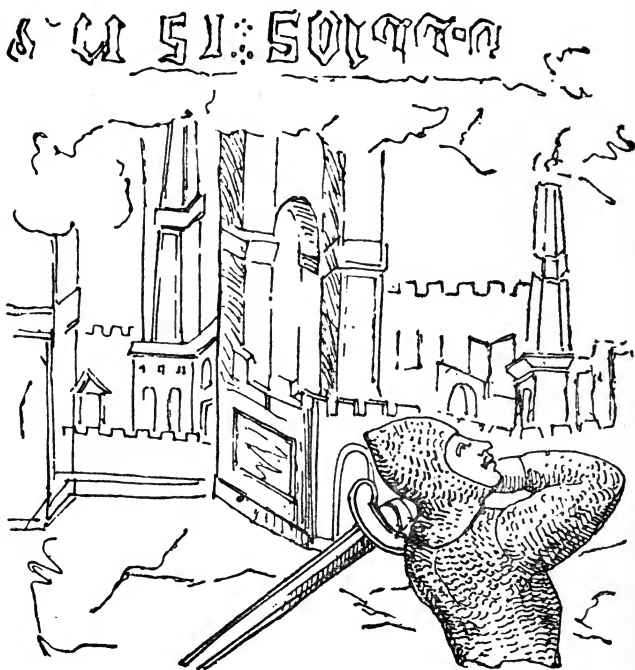

Spanish warrior; end of the fourteenth or beginning of the fifteenth century, but still armed with the hooded hauberk, without helmet; from a fragment of sculpture in the Alhambra. This bas-relief is surrounded with an inscription in small Gothic letters, which were not used earlier than 1360.

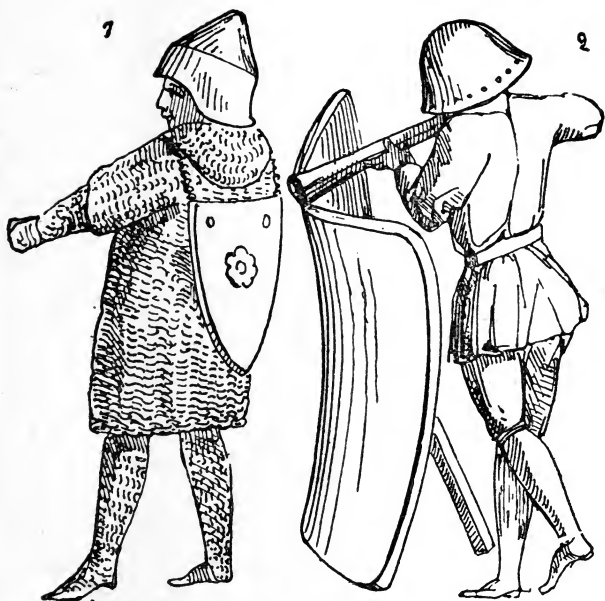

1. Burgundian warrior, from the illuminations of a manuscript in the Library of the Arsenal at Paris, a Roman history, which appears to have been written for the Duke of Burgundy, "Jean sans peur" (1404—1419). It will be seen that the armour still consists of the mailed hauberk, and the *salade* kind of helmet. The small buckler, also of the thirteenth century, is seen on the back of the warrior.
2. Man-at-arms firing a small hand-cannon, from a manuscript of the fifteenth century.

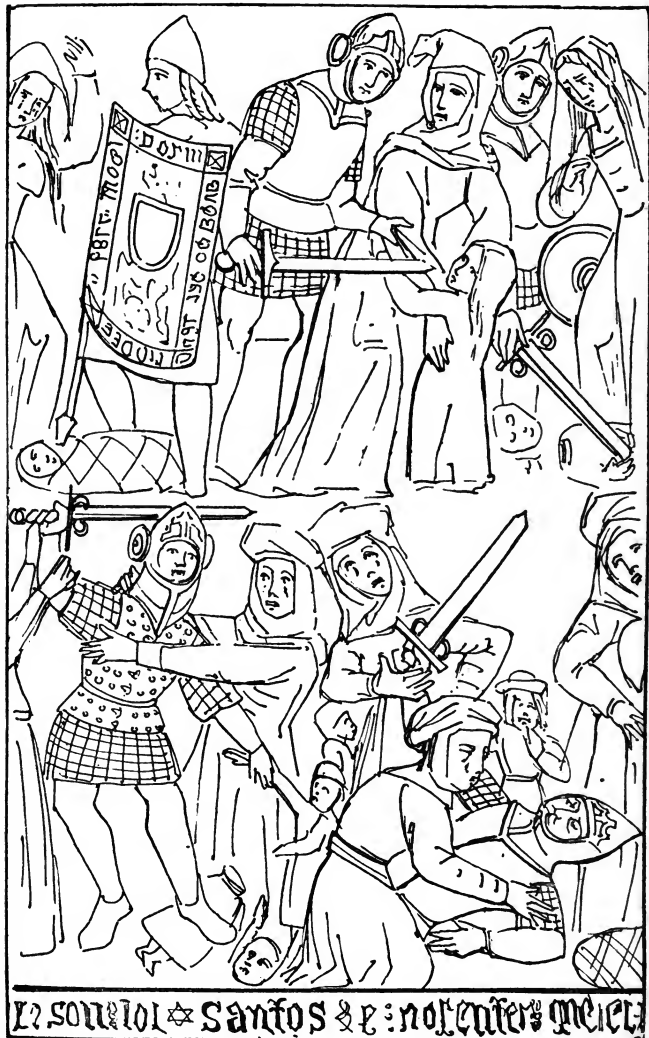

Et souletoi ★ Santos & e: no: entes: me: et:

Spanish men-at-arms; from a mural painting dating about the end of the fourteenth century, in the Cathedral of Mondoneda, representing the massacre of the Innocents.

The soldiers carry swords with the "pas d'âne"* guard, and wear trellised coats, partly covered by a breastplate.

The inscription on the large *pavois* of one of the soldiers is in Gothic capitals, while that underneath the engraving is in small letters, which were not in use anterior to 1360.

The legs of the soldiers, as well as the lower part of their arms, are without protection. The coats are very short, and do not even reach to the knee; the feet also are without *solerets* or armed shoes.

All the armour of these warriors is on the whole very defective, considering the time (second half or end of the fourteenth century), and inferior to English, French, and German equipments of the same period.

* "Pas d'âne" is the name of the ring-shaped sword-guard below the cross-piece, on each side of the blade; it is not generally met with until the second half of the sixteenth century.

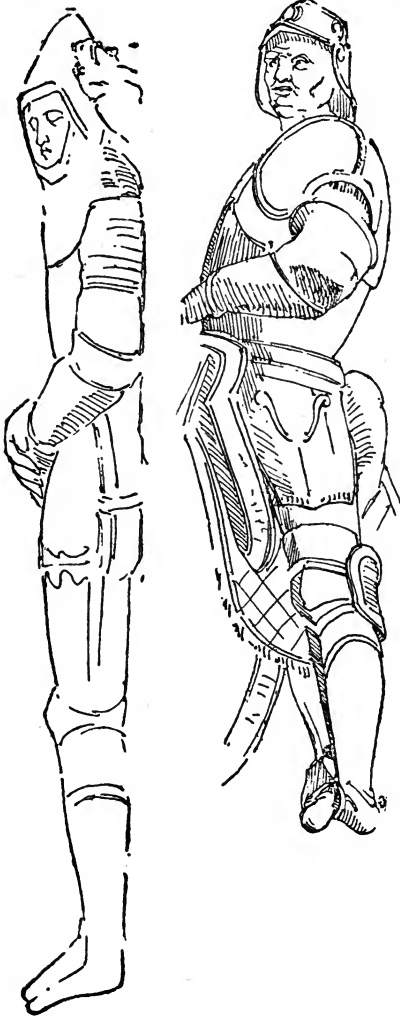

1. Italian armour of the end of the fourteenth century, from the tomb of Jacopo Cavalli at Venice, who died in 1384, the sculpture of whose tomb was executed by Paolo di Jacomello of Masegna.

2. Italian armour of the end of the fifteenth century, from the equestrian statue of Bartolommeo Colleoni, at Venice, executed in 1496 by Andrea Verrocchio and Alessandro Leopardi. This war harness is interesting on account of its enormous shoulder-pieces, which are not fastened either to the arm-guards, to the back, or to the breastplate, for between them may be seen a large surface of coat of mail. The body armour, as well as the *salade* without a vizor, forms a very insufficient protection, and is much inferior to the English, French, and German equipments of that period.

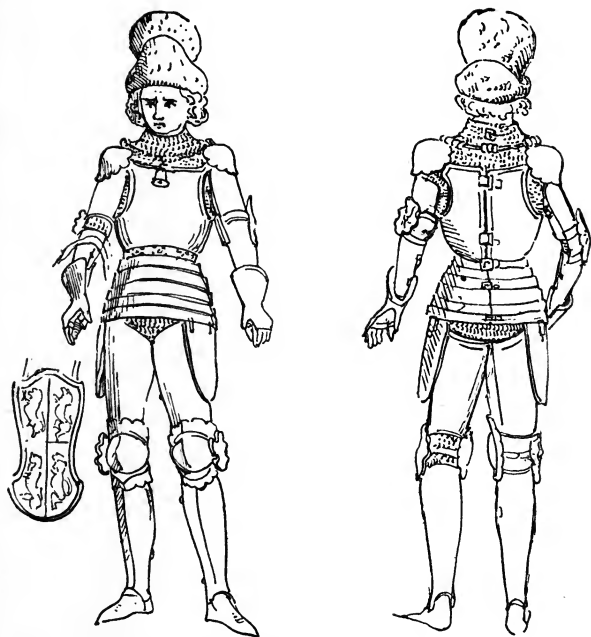

Dutch armour, front and back view, of the fifteenth century, from a bronze statuette of William VI. (1404—1417), formerly on the balustrade of the old Townhall of Amsterdam, where the tribunal sat, and now preserved in the collection of antiquities of this city. The armour is worthy of notice on account of its enormous knee-pieces, "genouillères," and of the back-plate, composed of two pieces.

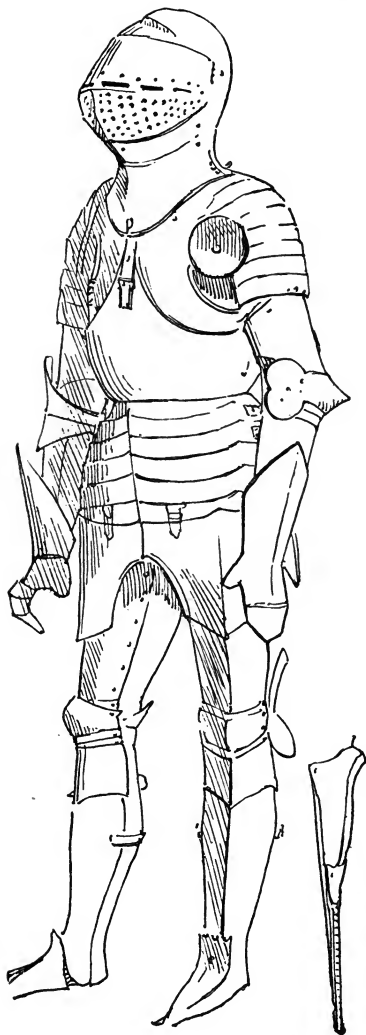

Gothic armour of polished steel, of the fifteenth century, the casque, a kind of *heaume*, has a rounded crown, and hinged vizor; it is attributed to Frederick I., Count Palatine of the Rhine, who died in 1476.

Ambras Collection, Vienna.

A similar suit, in the same collection, is attributed to Frederick the Catholic.

This war harness, as is obvious at first sight, belongs to the middle of the fifteenth century, from the singular form of the tassets, the gauntlets, and the ends of the solerets, one of which is represented in full, by the side of the left leg. The casque already partakes of the character of the armet, and seems to be more modern than the rest of the armour.

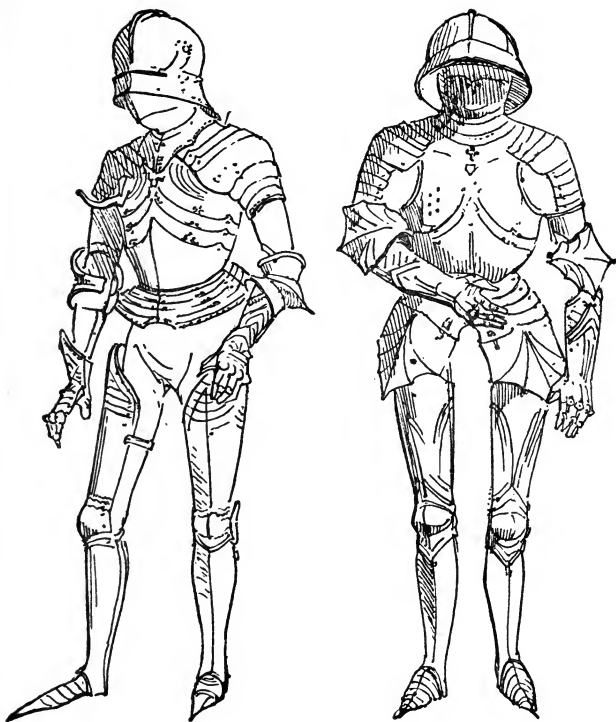

1. German Gothic armour of the fifteenth century, attributed to Sigismund of Tyrol.

Ambras Collection at Vienna.

This suit of armour with its salade is incomplete, as the tassets are wanting.

2. Fine Gothic armour of the first half of the fifteenth century, in polished steel. It forms a part of the collection in the Museum of Sigmaringen, and is erroneously attributed to the Count of Hohenzollern-Eitel, Frederick I., of the thirteenth century. The suit of armour of the Ambras collection (drawn above), attributed to Sigismund of Tyrol, is almost the same as this one of the Sigmaringen Museum.

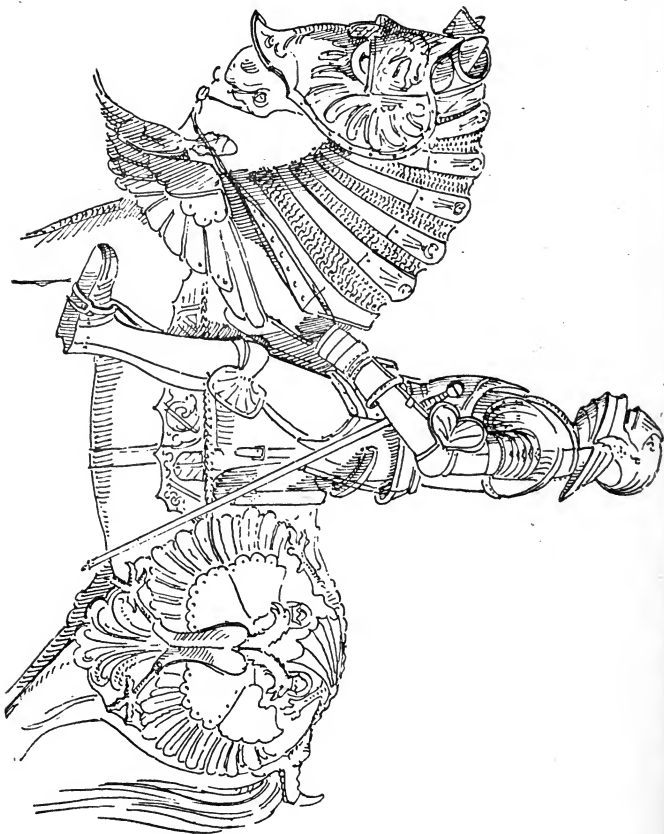

Armour of man and horse, attributed to Maximilian I., born in 1459, died in 1519. The cuisses, greaves, *solerets*, and arm-guards, do not properly belong to the suit, but are of the sixteenth century. The *salade* has a movable vizor, and a laminated chin piece. Ambras Collection. M. the Count of Nieuwerkerke possesses a similar suit of armour for a warrior and horse, purchased in Nuremberg.



German Gothic tilting armour of the second half of the fifteenth century, in polished steel. It is remarkable on account of the large size of the palettes, the tilting targe, and the heaume. Ambras Collection at Vienna. The Emperor Napoleon III. possesses three similar suits of armour, and M. le Comte de Nieuwerkerke has one. No. G. 115 in the Musée d'Artillerie is another suit of armour of the same kind, of the first years of the sixteenth century.

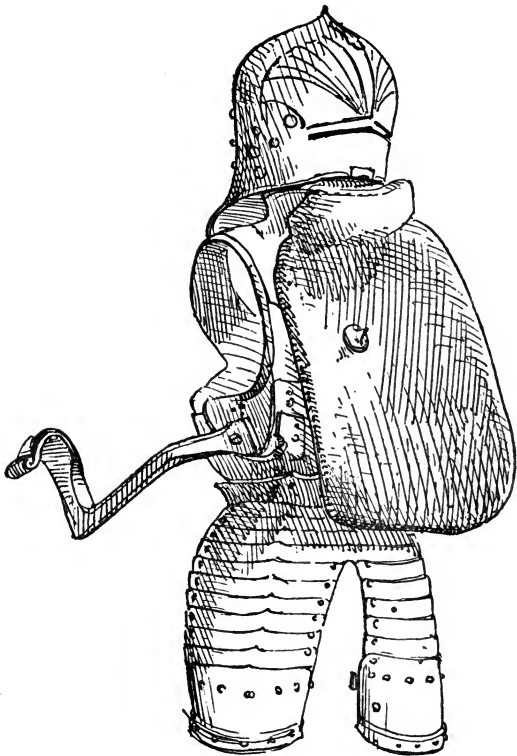

German tilting armour of the end of the fifteenth, or beginning of the sixteenth century, in polished steel, and weighing 82 lbs. (French). It is worthy of note on account of the beautiful *salade*, the flutings of which indicate the end of the fifteenth century, its large placcate or tilting guard, with chin piece, and the huge lance rest. Ambras Collection. The laminated tassets are long, and joined to the breastplate. N. G. 116, Musée d'Artillerie, Paris, is a similar suit of armour.

German Gothic tilting armour of the second half of the fifteenth century, in polished steel. The most noticeable features are the heaume, the gauntleted arm-guard of the left hand, and the leg-guard; this last was to prevent the left foot from being crushed against the barrier.

The suit, which is attributed to Maximilian I., who died in 1493, was made at Augsburg, and is to be found in the Imperial Arsenal of Vienna.

The elbow pieces have a distinct Gothic character about them, and the large tassets are surmounted by a plated breastplate, partly fluted.

This is a fine and elegant suit of armour, belonging to the best period.



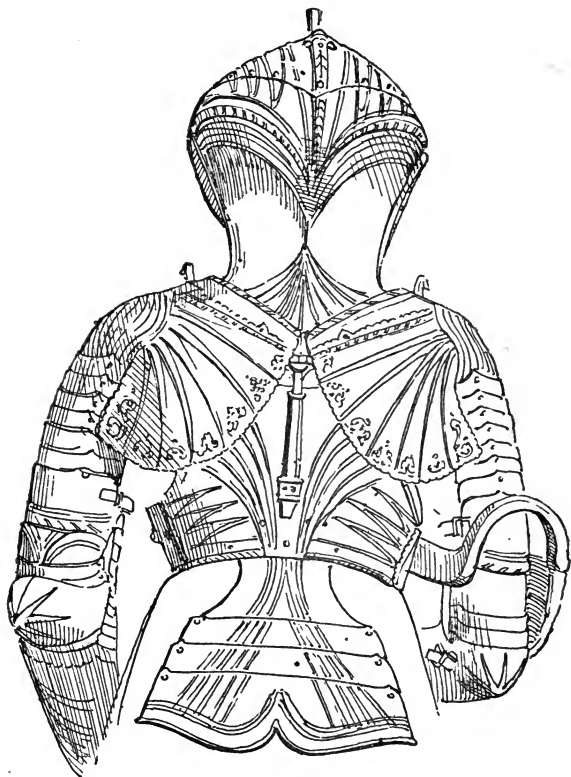

Fine Gothic armour of the second half of the fifteenth century, back view; the front view is engraved on the following page; here the tilting heaume is seen fixed to the back-plate by a strong hinge. The lance rest and shoulder pieces are very large, but the loin guard is defective, and rendered a coat of mail an indispensable addition.

German armour, end of the fifteenth, or beginning of the sixteenth century, with "volant" piece, two large tassets, and the breastplate of the cuirass with a *tapul*, or ridge.

The sword is of the middle of the sixteenth century. The crested helmet with movable vizor, lowered by means of a pivot on the top of the crown, is not yet the proper "armet," but a transition helmet between it and the *salade*.

The armed shoes, "bec de cane" shaped, the elbow and knee-pieces being of a small size, the shape of the shoulder pieces and gauntlets, indicate exactly the time of the construction of this suit of armour.

Imperial Arsenal of Vienna.

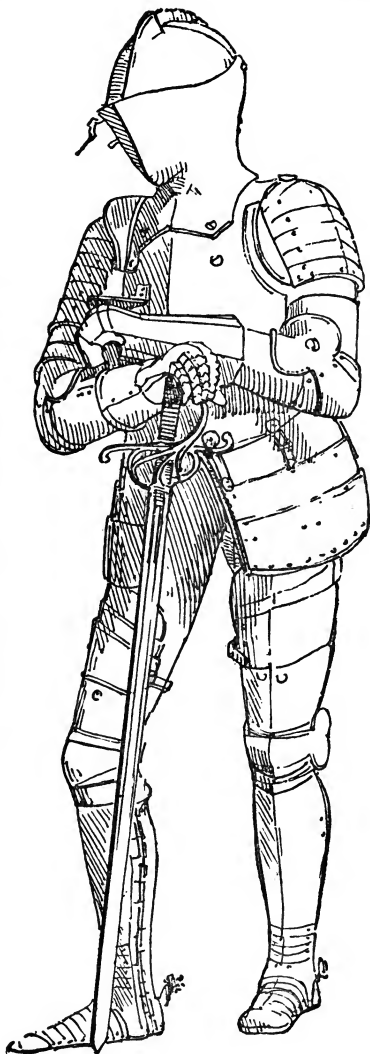

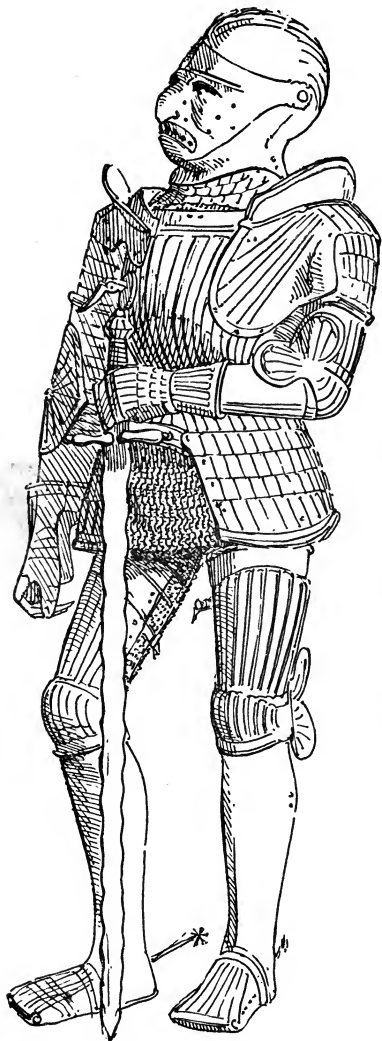

German fluted armour, called "Maximilienne" and "Milanaise," of the beginning of the sixteenth century (*Geripte Rüstung* in German). The cuirass is rounded, the breastplate does not possess the central ridge or "tapul," and the shoulder-pieces large, and with passe-gardes (*Ränder* in German). The cuishes and upper arm pieces are fluted like the rest of the armour, but the lower arm pieces and the greaves are plain. The sole-rets, or armed shoes, paw-shaped, indicate the time to which this armour belongs, the sixteenth century.

A similar suit in the author's collection, the shape of whose soleret indicates the second half of the fifteenth century, has a helmet, where the vizor, not following the lines of the human face, allows the wearer to see and breathe through eleven small holes. The gauntlet is articulated only for the first division of the hand.

Imperial Arsenal of Vienna.

German armour in polished steel, cut in facets, for fighting on foot, of 1515, the date of the coronation of Francis I., which is engraved on the right wrist.

The catalogue (G. 117), mentions it as coming from the gallery of Sedan, while at Vienna it is supposed to have belonged to the Ambras Collection. Musée d'Artillerie de Paris. The "bouillonée," or puffed suit of armour (see next page), of the Ambras Collection, ornamented with the same facet cutting, was probably wrought by the same artist.

This harness covers the whole body, leaving no part unprotected; it is everywhere laminated, and thus does not need the coat of mail to protect weaknesses which do not exist. It is also worthy of note on account of the shape of the "brayette," which resembles the one engraved at No. 16, p. 229.

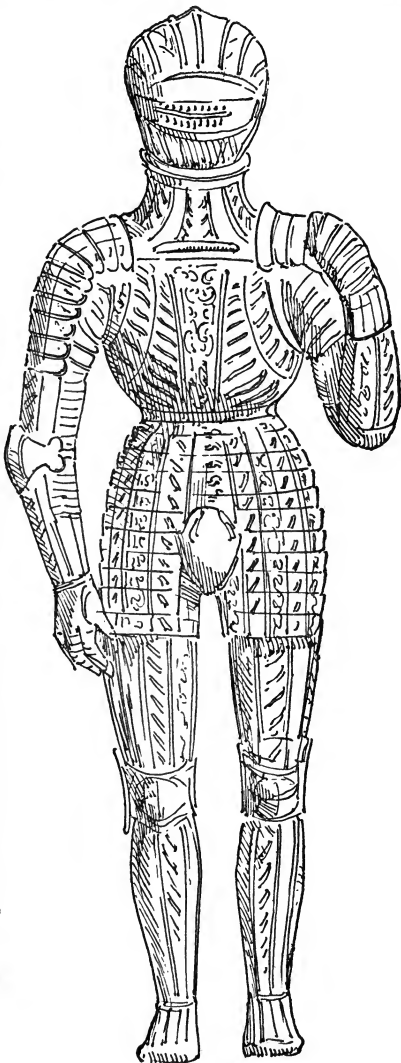



German puffed armour, in steel cut in facets, of the first half of the sixteenth century. It belonged to William of Rogendorf, one of the captains who defended Vienna against the Turks in 1529, and who died in 1541. This fine war harness, with the exception of the cuishes and greaves, indicates a suit to be worn for fighting on foot; it also shows that it proceeds from the same hand which constructed the suit in the Museum of Artillery in Paris, the engraving of which is found on the preceding page. Ambras Collection. There is a similar suit in the Tower of London.



Back view of the suit of armour described on the preceding page. It will be seen that the plated loin guard is exactly similar to the one belonging to the suit of armour erroneously called Italian, the engraving of which is given at page 203.

Ambras Collection.



German armour in steel, polished and faceted, of 1526. The cuirass is rather rounded in shape, and bears in the centre of it the initials S. L. as a monogram. The tassets and waist-piece are joined, and the shoulder pieces have *passe-gardes*. The *armet* is very peculiar, having a double movable vizor. The sole-lets are club or paw-shaped, and the greaves not being ornamented, may possibly have belonged to another suit. The deficiency between the waist-piece and the tassets is here supplied by a piece of mail which reaches to the loin-guard.

Imperial Arsenal of Vienna.

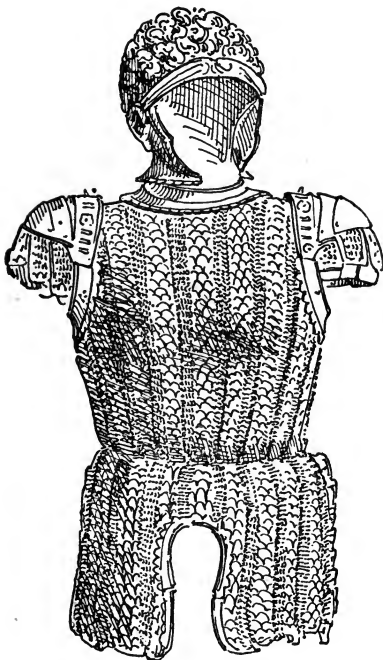

Italian armour of the first half of the sixteenth century, in the style of the brigantine jacket, which was worn in Italy during the fifteenth century. It is attributed to the Duke of Urbino (1538).

Ambras Collection at Vienna.



Richly damascened or inlaid armour (*tanchirt* in German), of the second half of the sixteenth century ; it is of Nuremberg workmanship, and is now in the Imperial Arsenal of Vienna. The armet being joined to the cuirass by the gorget and collar, formed one solid piece, which, closing hermetically, left no hold for the enemy's sword.



Richly inlaid armour, manufactured at Nuremberg in the second half of the sixteenth century. Imperial Arsenal of Vienna. The left arm is provided with an arm-guard called large tilting guard; the armet closing everywhere hermetically, and being joined to the cuirass by the gorget and collar, offered no place of vantage for the point of the enemy's sword.



German suit of steel armour, richly ornamented with engraving and inlaying, of the second half of the sixteenth century. The cuirass is already lengthening, and the tassets are, on that account, becoming smaller. The volant-piece (*Vorhelm* in German) has "passe-gardes," and is screwed on to the breastplate, which is tabulated, or gradually rising towards the centre until it terminates in a ridge. The gauntlets are entirely articulated, and the elbow-pieces small.

The tassets and cuishes are very short, and the absence of a waist in plate armour necessitates the use of one in mail, to protect the waist and thighs.

Imperial Arsenal of Vienna.

German skirted armour, of the second half of the sixteenth century, attributed to the Archduke Ferdinand, Count of Tyrol. The small engraved ornaments represent eagles. This armour was intended to be worn when fighting on foot, but the skirt was divisible so as to allow it to be worn on horseback. The armet, the ridge on the cuirass, its great length, the large palettes, and the bear's foot so-lerets, indicate exactly the period of manufacture.

Ambras Collection.

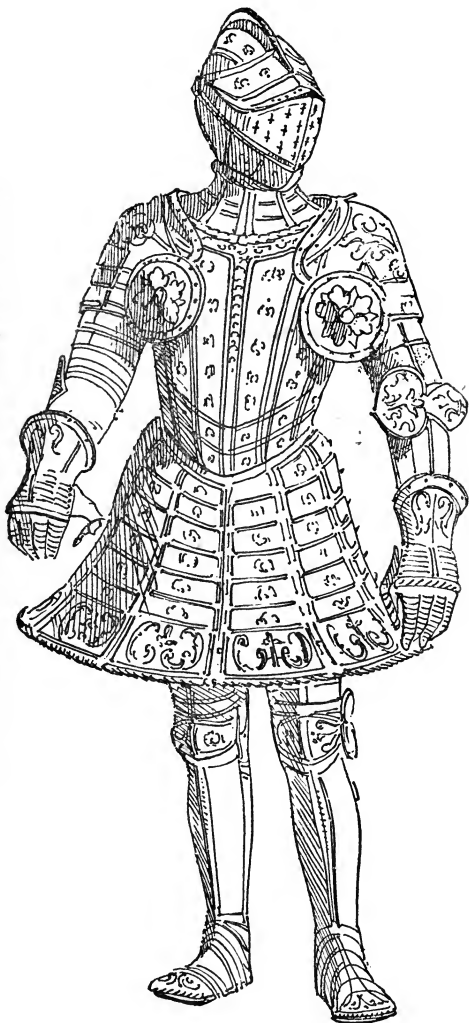



Suit of armour, Augsburg manufacture, of the second half of the sixteenth century. It is entirely covered with rich "repoussé," or embossed ornament, which recalls the designs by the painters Schwarz, Van Achen, Brockberger, and Milich, in the Cabinet of Engravings at Munich.

Museum of Imperial Artillery at Vienna.

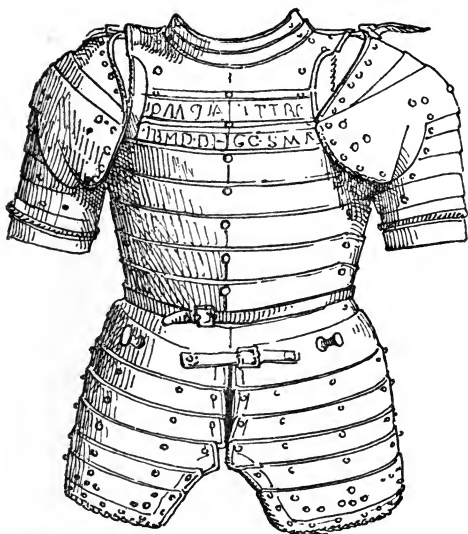

German plate armour in polished steel; second half of the sixteenth century. On the breastplate is the name of the knight to whom it belonged, Adam Gall, who died in 1574.

Imperial Arsenal of Vienna.

This kind of armour was worn in Spain more generally than in Germany. The profusion of buttons, and the absence of the lance-rest, cause it to resemble the war harness of the seventeenth century, when the tassets were joined with the cuishes, forming what was called the lobster-tail.

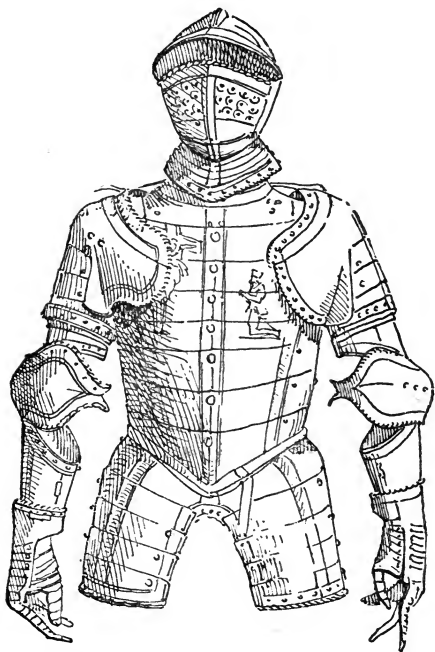

Spanish plate armour, attributed to the Duke of Alva, the stern ruler of the Low Countries (1508–1582). The armet, a kind of burgonet, is deficient, as it leaves too large a space between the chin-piece and eye-shade of the helmet. On the breastplate is engraved a knight in prayer before a crucifix. Ambras Collection. Same observation as for the armour on the preceding page.



Italian armour in steel, inlaid with silver, end of the sixteenth century, and which is believed to have belonged to Alessandro Farnese. This suit is of splendid workmanship, as well as of great fineness. The breastplate rises into a ridge, and has a lance-rest. The space between the tassets, and the absence of the large brayette, necessitate the use of mail.

Imperial Arsenal of Vienna.



German armour of the end of the sixteenth century, richly embossed (*Getrieben* in German), and whose work indicates the school of Munich or Augsburg. It is considered to have belonged to the Emperor Rodolph II. (1572—1612). The sword indicates by the shape of the hilt and the “*pas d'âne*” the beginning of the seventeenth century. The large shoulder and elbow pieces, the shape of the armet, the “*bec de cane*” solerets, and the absence of the large brayette, as well as the shape of the breastplate without lance-rest, point out the time of the manufacture of this fine armour.

*Ambras Collection at
Vienna.*



Complete equipment of Persian horseman. The man wears a coat of mail, and the horse is covered with an armour composed of plates of iron joined together with small chain links. From a manuscript in the library of Munich, illustrated with 215 beautiful miniatures, illuminated about the year 1580 to 1600. It is a copy of the *Schah Nameh* or Royal Book, a poem composed by Ferdusi, in the reign of Mahmoud the Gaznevide (999).



Dutch warrior; time of the "War of Independence," during the Stadtholdership of Henry Frederick (1625—1647), from a picture of that time, painted on earthenware, by Ter Himpelen of Delft, and which represents the celebrated battle before Bois le Duc, on the heath of Lekkerbeetze, between the Dutch, under the Norman captain, Breauté, and the Spaniards, under the command of Lieutenant Abrahami. The armour is still an entire covering, and the loin-guard is worn, and, what is somewhat remarkable, we find already flint-lock guns and pistols. Author's Collection. For fuller detail, see p. 631, 3rd edition, of the "*Encyclopédie céramique monogrammique*," of the author.

German armour of the seventeenth century, attributed to the Archduke Leopold, who became Emperor in 1658, and died in 1705. Ambras Collection at Vienna. A similar suit in the Louvre is attributed to Louis XIII. (1610—1643), and several other suits in the Artillery Museum at Paris are said to be of the reign of Louis XIV. (1643—1715). The date of the construction of these inferior suits of harness may be seen by the huge shoulder-pieces, the diminution of the breast-plate, and the long “lobster-tails,” which replaced the waist-piece and the tassets.

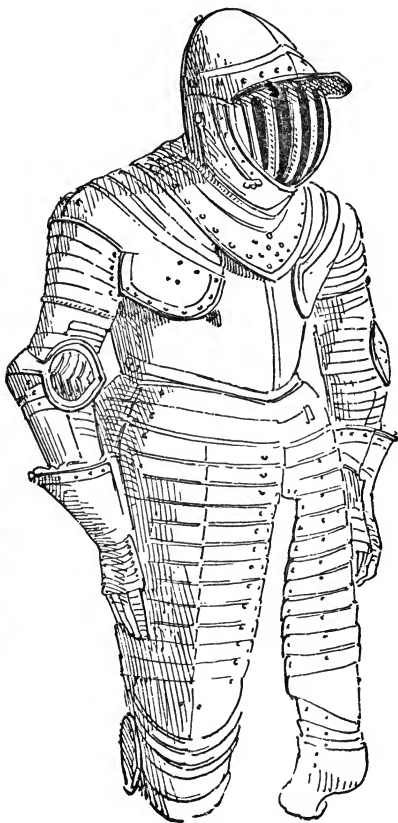

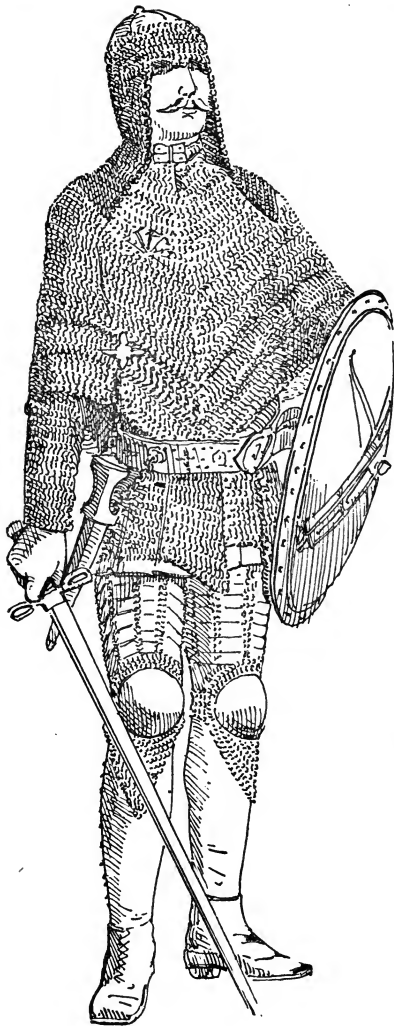

Hungarian armour, of the end of the sixteenth or beginning of the seventeenth century, composed of chain and plate. The round shield is ornamented with a painting representing a cross-bow. The whole equipment has an oriental character about it, especially the cuishes and knee-pieces, composed of plates joined by rings, such as are used in Persia. The casque is made with a low crown, and covered with a mail hood, the front part of which protects the forehead and cheeks.

The whole appears graceful, and very picturesque.

Imperial Arsenal of Vienna.

Hungarian war-harness, in steel, richly damascened, of German manufacture of the seventeenth century. It is characterised by the peculiar form of the casque and shield. The mace in the right hand of the man is a weapon of the sixteenth century, and was not in use at the time to which this armour belongs. It appears that this half-suit was worn over the buff coat, similar to those of the Swedes in the Thirty Years' War. The sabre is of Eastern shape.

*Imperial Arsenal of
Vienna.*





Cuirass with ridged breastplate, and helmet with nose-piece, cheek and neck guards, a kind of burgonet. Arms of the end of the seventeenth or beginning of the eighteenth century, richly damascened and engraved.

Imperial Arsenal of Vienna.

ARMOUR IN ALL ITS DETAIL, WITH THE EXCEPTION OF
THE CASQUE.

We have seen in the historical chapter, and in the introduction to the present one, in what way a soldier's equipment underwent continual changes from the commencement of the Middle Ages. The perfected plate armour, which will here be described in detail, belongs to the end of the fifteenth or beginning of the sixteenth century. It comprises, besides the casque (which at this time was always considered a thing apart), the following pieces :

The neck collar (*Halsberge* in German), which supported the whole of the rest of the harness, must not be confounded with the gorget (*Kehlstück*, Ger.), underneath which it was placed, and which, like it, was formed of several plates.

The cuirass (*Kürass* in German) was composed of the breastplate (*Brustplatte*), which protected the chest and was often made with a salient ridge called *tapul* down the centre (*Graete*), and of the back plate (*Rückenplatte*).

The lance rest (*Rüsthacken*), which was placed on the right of the breastplate, and was used to fix the lance.

The small plates (*Kleine Schienen*), to protect the armpits.

The shoulder-plates (*Achselstücke*), with or without passe-gardes (*Ränder*).

The palettes (*Achselhölscheiben*), which protected the armpits, and whose use does not date farther back than the middle of the fifteenth century, and disappears at the end of the sixteenth.

The large brayette (*Vorderschürz*), that part of the armour which covered the abdomen. It was composed of steel plates, and ended in the tassets.

The small brayette, which English taste has eliminated from the armour preserved in the Tower of London.

The tassets, or tuiles (*Krebse*), destined to protect the upper part of the thighs, and strapped with thongs on to the large brayette or waist-piece. Some German authors, however, give the name "Krebs" to a complete suit of armour composed of imbricated plates, and "halber Krebs" to the lower part of the armour in plates and the long cuishes of the end of the sixteenth and beginning of the seventeenth centuries. Fouchet also, who wrote about the end of the sixteenth century, says that armour entirely composed of imbricated plates was called "écrevisses" in France, and "a suit of splints" in England.

The loin guard (*Hinterschürz*) was composed of imbricated plates, like the waist-piece.

The arm guards (*Armzeug* and *Armschienen*), composed of front and back pieces (*vor* and *hinter Armzeug*), joined together by the elbow-pieces (*Meuseln* or *Ellenbogen Kacheln*).

The cuishes (*Dielinge*, *Dichlinge*, or *Schenkelschienen*), which before 1500 protected only the front of the thigh.

The knee-plates (*Kniestücke*).

The greaves, or double leggings with hinges (*Beinschienen*), which before 1500 generally covered only the front of the leg.

The armed shoes, or solerets (*Rüst- or Eisenschuhe*). The many varieties of foot-armour being designated by French titles to which no recognised English synonyms exist, it has been thought better to give in this instance the terms

employed by M. Demmin rather than attempt to translate them. First, *Solerets* *à* *crochet*, in the eleventh century; *à la poulaine*, from early twelfth to middle fourteenth century; *ogivale lancette*, or *demi-poulaine*, from 1350 to 1470, and return to *à la poulaine* in the fifteenth century; *arcs tiers-points* from 1440 to 1470; *à demi-sabots*, or *demi-pieds d'ours*, about 1485; *à sabots*, or *pieds d'ours*, from 1490 to 1560; and *à bec de cane* about 1585.

The gauntlets (*Kampfhandschuhe*) had in the fourteenth century articulated fingers (*Fingerhandschuhe*, or *Gefingerte Tatze*); in the fifteenth century they were without joints; and in the sixteenth century they were again made with separate fingers. The gauntlets of the seventeenth century, in doeskin and armed with plated scales, were called in German *Schapphandschuhe*.

The large shoulder-guard (*Kleines Brustschild*) was used from the end of the fifteenth century.

The shoulder-plate with *pas-se-garde* (*Schulterschild mit Rand*).

The large tilting breast-shield (*Grosses Brustschild* and *Scharfrenntartsche*) was sometimes simple; sometimes with the chin-piece, with or without sight-holes; with volant-piece, or with the arm-guard, but all these were used only for tilting.

The large tilting cuishes (*Turnier Lendenplatte*).

The vam-plate (*Schweber Scheibe*).

The different pieces belonging to the helmet, which will all be found in the following chapter, were:

The volant-piece (*Vorhelm*).

The movable chin-piece, or half mentonnière (*Kinnhelm*).

The great mentonnière (*Kinnhelm*).

The armour of the sixteenth century is remarkable by its beautiful flutings; such was the armour called "Maximilian" or "Milanaise:" that of the second half of this same century is adorned with artistic engravings, done with the tool and with aquafortis.

When, towards the end of the sixteenth century, armour had attained its highest degree of perfection, but notwithstanding could no longer offer a sufficient protection against fire arms, it declined, and ended by disappearing entirely in the second half of the seventeenth century. After the

tassets had been replaced by the ungraceful cuishes, armour was reduced to its latest change, in which there were neither greaves nor cuishes, and very soon no more arm-guards; the cuirass alone being worn to the end, and even this only as a special arm by the cuirassiers. The buff coat or jerkin (*Koller*), on which was worn a light collar, then took the place of armour, while greaves and solerets were discarded for the heavy riding boots of Louis XIV. and William III.

Before the introduction of half armour ungraceful breastplates, imitating the fashion of doublets, had already been the precursors of decadence in armour; these breastplates, which resembled the Punch's hump of the reign of Henry III., and afterwards the flat forms of costume under Louis XIII., were followed, lastly, by the long lobster-tails of Louis XIV.'s reign.

Respecting armours ornamented with aquafortis engraving, a style of art probably invented by Wohlgemuth (1434--1519), if not by his pupil Dürer (1471--1528), these are very rare in the fifteenth century: as for the supposition that engraving by aquafortis was in use among the Arabs from the eleventh century, it has not been confirmed by any existing object. Engraving by the tool was used for the ornamenting of swords from the second half of the Christian Middle Ages, but everything which dates farther back than the fifteenth century is very unartistic.



7

1. Neck collar (*Halsberge*). This piece supported the whole of the harness.



1A ✓

- 1A. Ditto, ditto.



2 ✓

2. Breastplate (*Brustplatte*), or front part of the cuirass. The salient ridge in the centre is sometimes called *tapul* (*Graete*). The lance-rest is seen on the right of the breastplate (*Rüsthacken*).

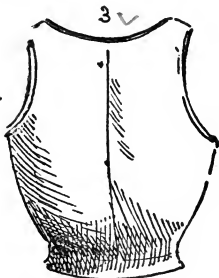

3 ✓

3. Back-plate of the cuirass (*Rückenplatte*).

Ambras Collection.

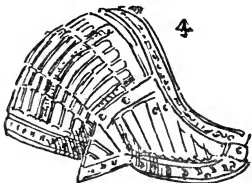

4

4. Shoulder-plate, or pauldron (*Achselstück*), of a fluted suit of armour; second half of the fifteenth century.

Author's Collection.

5. Palette (*Achselhölscheibe*) of a fluted suit; end of the fifteenth century.

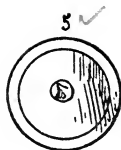

6. Palette of a Gothic suit; fifteenth century.

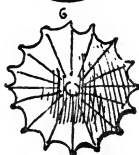

7. Palette, larger than the preceding ones, of a suit belonging to the middle of the sixteenth century.

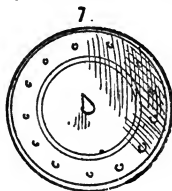

8. Palette, 10 inches in diameter, studded with copper nail-heads; belonging to a suit of the end of the sixteenth century, in the Ambras Collection. A few suits of tilting armour of the end of the fifteenth and beginning of the sixteenth century have, nevertheless, similarly large palettes.

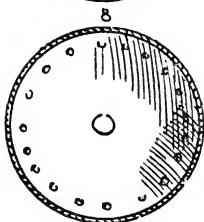

9. Gorget with pauldrons attached; end of the sixteenth century. In England a piece of armour so composed was called "allecret." A similar gorget and shoulder-piece may be seen in No. G. 256, Museum of Artillery, Paris.

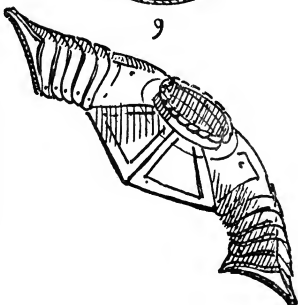

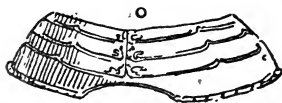

10. Waist-piece, or great brayette (*Vorderschurz*), belonging to a Gothic suit of the fifteenth century, in the Imperial Arsenal of Vienna. This waist-piece was always completed by the two large tassets, or *tuiles*, which protected the cuishes.

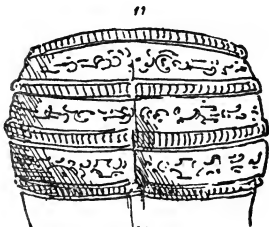

11. Waist-piece of an engraved and embossed suit, end of the fifteenth or beginning of the sixteenth century, for fighting on foot. Its shape renders the tassets unnecessary.

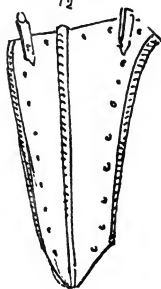

12. Tasset* (*Krebs*), tuile-shaped, of a fifteenth-century suit.

Museum of Artillery, Paris.

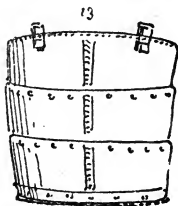

13. Small tasset, in plates, end of the fifteenth century; used also in the sixteenth century.

* During the fifteenth century the tassets were generally composed of one piece, like No. 12. After that they assumed a rounded shape, and were for the most part smaller, during the sixteenth century, and with movable plates.

14. Tasset and waist-piece in one, of an unusual size, and almost entirely covering the cuishes, like a Freemason's apron; it is part of a suit attributed to Francis I. (died in 1547).

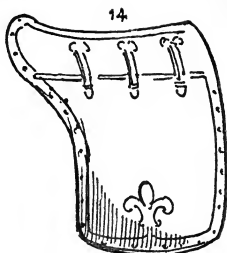

15. Small brayette (*Gliedschirm*) of a sixteenth-century suit.



16. Small brayette, sixteenth century.

No. G. 119, *Museum of Artillery, Paris.*



17. Loin-guard, or garde-reins (*Hinterschurz*), of a suit belonging to the end of the fifteenth century.

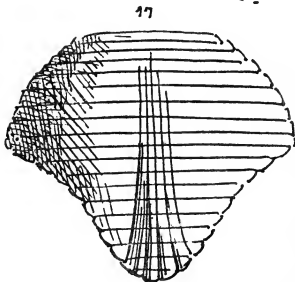

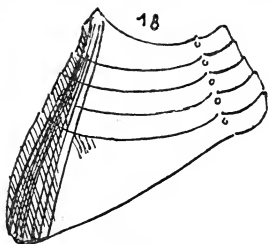

18. Garde-reins, or loin-guard, of a Gothic suit of armour, one of the most graceful pieces of fifteenth-century work known.

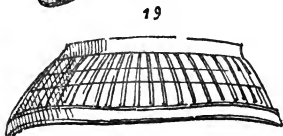

19. Garde-reins of a fluted suit called "Maximilienne;" end of the fifteenth or beginning of the sixteenth century.

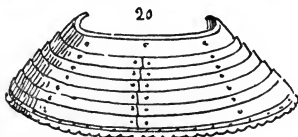

20. Two garde-reins of the seventeenth century. The smaller one belongs to a suit of the reign of Louis XIV., preserved in the Museum of Artillery, Paris.

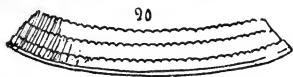

21. Complete arm-guard (*Ganzes Armzeug*). It is composed of an upper and lower arm-plate, called vambrace and rear-brace (*Vor- and Hinterarm*), and these two pieces are joined together by the elbow-piece (*Meusel, or Ellenbogenkachel*). The shape of the elbow-piece varies greatly. Sometimes it is more rounded, as at the end of the fifteenth century; sometimes with jointed plates; and during the sixteenth century it was of small dimensions.



22. Cuish (*Dieling* or *Schenkel-schiene*), or thigh-plate, with knee-cap (*Kniestück*), and greave (*Beinschiene*). It is double or hinged, which shows its manufacture to be later than 1500.

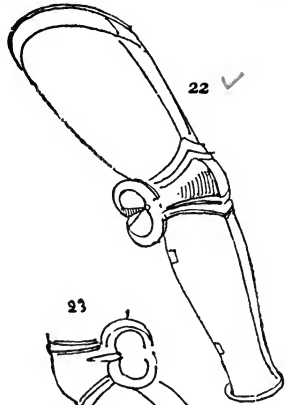

23. Greave with soleret (*Eisen-schuhe*). The soleret is of the shape called "bec de cane;" end of the sixteenth century.

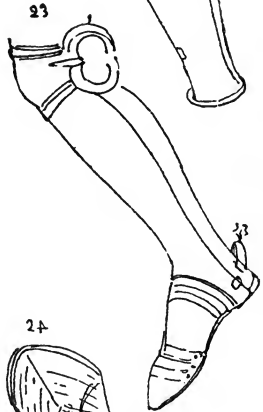

24. Gauntlet (*Kampfhandschuhe* or *gefingerte Handtätze*), with separately articulated fingers, belonging to a Gothic suit; middle of the fifteenth century.



25. Shoulder-plate, or grand guard (*kleines Schulterschild*), used in tilting towards the end of the fifteenth century.



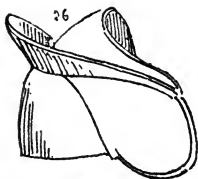

26. Pauldron with passe-garde (*Schulter-schild mit Rand*).

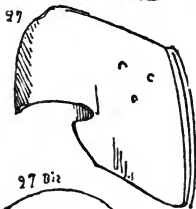

27. Great tilting shoulder-guard (*Turner schulterschild*).

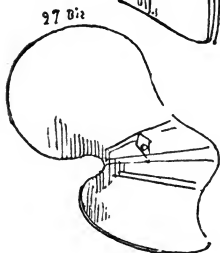

27 bis. Elbow-piece belonging to a left arm-guard; German, beginning of the sixteenth century.

G. 10, *Museum of Artillery, Paris*.

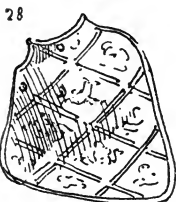

28. Tilting breastplate, in iron, richly engraved; German work on a tilting suit, beginning of the sixteenth century. This piece of armour is called in German *Grosses Brustschild*, and also *Scharfrenntartsche*.

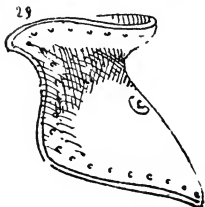

29. Tilting breastplate with mentonnière (*Brustschild mit Schönbart*), from the "Book of Tournays" of Duke William IV. of Bavaria (1510—1545).

30. Tilting breastplate with mentonnière and helmet, same description as No. 29.



31. Ditto, ditto.

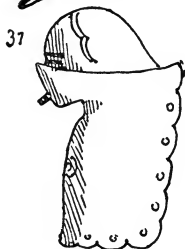

32. Tilting breastplate with mentonnière, belonging to a suit of the beginning of the sixteenth century. It is composed of thick wood, and covered with canvas, painted black.



Ambras Collection.

33. Tilting breastplate with mentonnière and sight-holes. This protection to tilting armour, which covers nearly the whole of the helmet, and forms a sort of vizor, is older than the preceding tilting shields, and has been copied from the engraving of the "Triumph of Maximilian," executed about 1517.



34

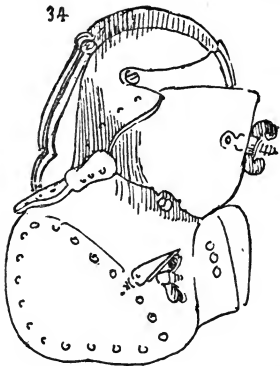

34. Large German tilting guard, with volant-piece and a screw lance-rest. The helmet, already protected by the chin-guard, to which it is screwed, is also fastened to the back-plate of the cuirass by the crest or comb, called in German *Rennhutschraube*. The screw lance-rest was used to keep in its place and support the tilting shield, to hold the prizes won at tournaments, and to rest the lance. It is also believed that the knight sometimes placed a ball there to serve as a target for his adversary.

Museum of Dresden. G. 124, fac-simile, Museum of Artillery, Paris.

35

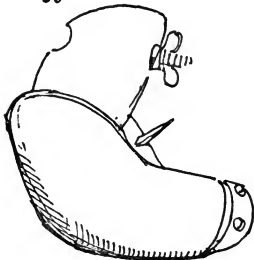

35. Ditto, ditto, but without the helmet and crest fastened to the back-plate.

36

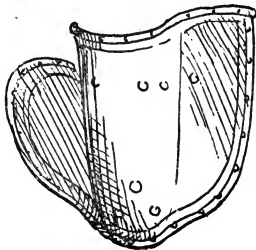

36. Large tilting cuisse (*Turnier-Lendenplatte*), belonging to a suit of armour called *Maximilienne*; beginning of the sixteenth century.

G. 114, *Museum of Artillery, Paris.*

37. Large *cuisse*, or thigh-piece, for tilting, of Maximilian armour, of the beginning of the sixteenth century.

G. 115, *Museum of Artillery, Paris.*

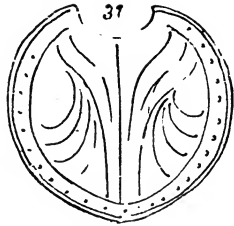

38. German leg-piece, for tournaments. End of the fifteenth century. This was worn over the greaves of the armour, so as to shield the leg from collision with the barrier.

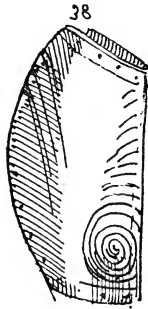

39. Large *cuisse* for tilting; beginning of the sixteenth century.

Collection of M. le Comte de Nieuwerkerke.

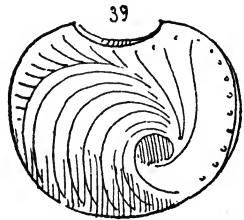

40. Vamplate of lance (*Schwebescheibe* in German),

Museum of Artillery, Paris.

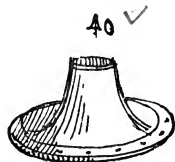

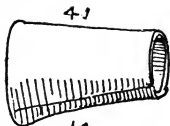

4.1

41. Vamplate of lance of the sixteenth century.

Museum of Dresden.

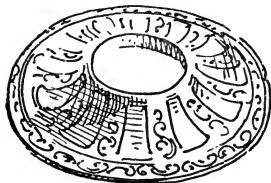

4.2

42. Vamplate of lance of the sixteenth century.

Meyrick Collection.

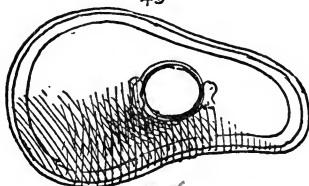

4.3

43. Vamplate of lance of the sixteenth century.

Meyrick Collection.



4.4 ✓

44. Lance-rest (*Rüsthacken* in German) of the middle of the sixteenth century.

Museum of Dresden.

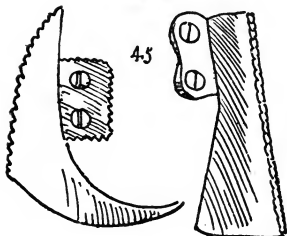

4.5

45. Two sorts of lance-rests of the end of the sixteenth century.

Museum of Dresden.

46. Crète-échelle (*Rennhutschraube* in German).

Museum of Dresden, see No. 34.

47. Screwed lance-rest.

Museum of Dresden, see No. 34.

48. High placcate, or volant - piece (*Vorhelm* in German).

Museum of Dresden.

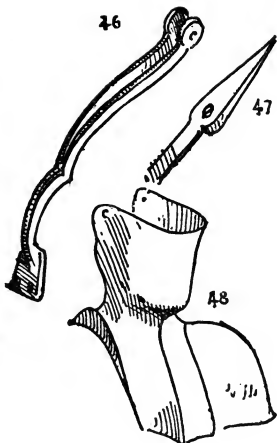

49. Volant-piece with placcate, pauldrons, and elbow-pieces, from a set of tilting armour belonging to the end of the fifteenth century.

Renné Collection at Constance.

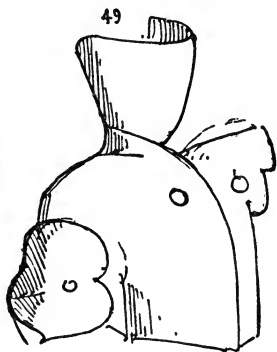

50. Great chin-guard (*Grosse Barthaube* in German).

Nieuwerkerke Collection.

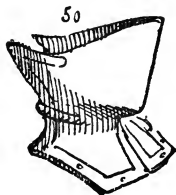

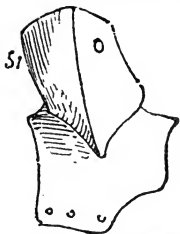

51. Volant-piece.

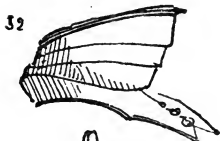
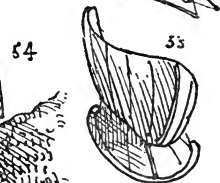
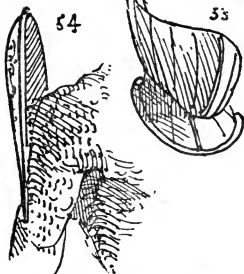
Meyrick Collection.52. Plated chin-guard and gorget (*Geschobene Barthaube* in German) of German workmanship. Used in the end of the fifteenth century, when it was worn with the *salade*.*Nieuwerkerke Collection.*53. Halfchin-guard (*Halbe Barthaube* in German) of the end of the fifteenth century.

54. Ailette, or plate, used during the transition period, and worn between the coat and the leathern armour. It was in use for about 30 years. One is to be seen on the statue of Rodolph de Hierstein (who died in 1318) at Bahl.

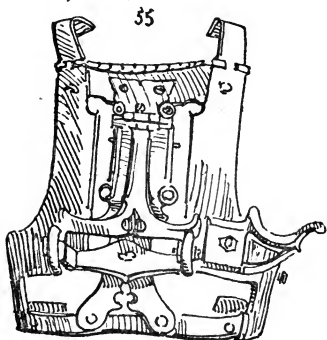

55. Breastplate of tilting armour, German, of the first part of the sixteenth century. This is of very peculiar make, and there exist only two specimens (one in the Ambras Collection, and one in the Museum of Artillery in Paris). When the centre part of the breastplate was touched by the lance, the whole opened with a spring. The place to be touched was marked by a pierced heart.

THE CASQUE.

The word *casque* (German, *Helm*) is derived from the Keltic words *cas*, box or sheath, and *ked*, from *cead*, head.

We have seen what were the shapes of the ancient casques, and of those worn by such people as were called barbarians during the iron and bronze ages. Only two sorts exist: the horned casque, attributed by the British Museum to the Britons, but which appears to have been more probably Scandinavian, and the conical casques, similar to the Assyrian ones of the earliest times: in the Museums of Rouen and Saint Germain they are attributed to the Gauls, and in the Munich Museum to the Avars. The casques of the chiefs of the Germanic races, though not a single specimen has been found as yet, were most probably of the same conical shape amongst the people of Southern Germany, inasmuch as the Franco-Norman casque of the eleventh century still preserved that shape unchanged.

This last has a fixed nose-piece (*Nasenberge* or *Schönbart* in German), several inches in width, which was fixed to the helmet and came just beyond the nose, so as to protect it. This casque was worn over the hood (*Ringhaube* in German), which was usually of small chains or mail, and was often a continuation of the hauberk, or mail-shirt.

The casque of the people of Northern Germany had also a fixed nose-piece, and, according to MSS. of the time, a round crown, and later on, movable earplates and neck-guard, as represented in page 248, No. 20, from the specimen in the Museum of Artillery in Paris; this casque sometimes was of a disproportionate height, as may be seen in the Seligenthal embroidery, represented in page 170.

The first helmets appear towards the end of the twelfth century. (In German they are called *Topfformhelm*.) The Museum of Artillery in Paris possesses a specimen marked No. H. 1, which is represented in page 250. This is really a casque of the transition period which has preserved its nose-piece.

The real helmet (*Topfhelm*) dates no earlier than the end of the thirteenth or the beginning of the fourteenth century, and the crested helmet is of about the same period, for in the

German Æneid of Henry of Waldeck several knights are represented with crested helms of fantastic shapes. This helm (word derived from the German *Helm*, helmet) was the large flat-crowned helmet usually fastened to the saddle, and seldom worn except at tilting matches, and during battle.

A canvas, printed by hand and not by wood blocks, of the middle of the fourteenth century, belonging to M. Odet at Sitten, shows that in Italy the helm was used in battle as well as at tournaments. It was worn over the mail hood, which in its turn was worn over the quilted cap. Sometimes also the small bassinet (from the Keltic word *bac*, boat, and the Latin *bacinalum*) was worn over the cap above mentioned.

Sometimes the mail capuchin or the bassinet alone was used, but generally the two were both worn under the huge helm. The small bassinet, which was a pointed helmet of an oriental shape, close-fitting like a skull cap, must not be confounded with the large bassinet of the fourteenth century, which was of a similar shape, but which covered the cheeks and neck as well, and often had a movable vizor, that was hinged at the left side and fastened at the point of the helmet. In a MS. of the thirteenth century knights are represented as wearing the large bassinet. In the fourteenth century the great tilting helmet (*Stechtopfhelm* in German) was more used in tournaments than in battle; it weighed between twenty and twenty-three pounds, while the one used in battle weighed from six and a half to nine pounds, and the great bassinet, under which the mail capuchin was often worn, was also adopted. This headgear (*Grosse Kesselhaube*), as we have already mentioned, was ovoid and pointed. At the beginning of the fifteenth century the great bassinet went out of fashion, and the *salade* came into use; the latter was of German origin, as its name implies; the ancient German authors called it *Schallern*, from the word *schale*, a bowl. This *salade*, which some authors think is derived from the Spanish *celada*, hidden, had a neck-guard to it, and was at first made with fixed vizor, but subsequently movable vizors were adopted. These, however, were so short that they came no lower than the end of the nose, and necessitated the employment of the *beaver*, to protect the chin, neck, and mouth.

The iron hat (*Eisenhut* in German), a helmet without vizor or neck-guard, but with a rim to it, and the skull-cap (*Eisenkappe* in German), are first seen in the twelfth, and remained in use until the seventeenth century.

The Oriental and Russian helmets of these times, like those of modern times, varied very little, and preserved the oval form, with movable nose-pieces.

The burgonet (*Burgunder Helm*) is a helmet that dates from the end of the fifteenth century. It has a rounded crown with a crest, and is distinguished by a shade over the eyes, cheek-pieces, and a neck-guard. The president Faucher, who wrote about the end of the sixteenth century, confounds the burgonet with the armet when he says, "Ces heaumes ont mieux représenté la teste d'un homme, ils furent nommés bourguinotes, possible à cause des Bourguignons inventeurs." (*Glock*, in German, is crown; *Kamm*, crest; *Augenschirm*, helmet-shade; *Wangenklappen*, check-pieces; *Nackenschutz*, neck-guard.)

The armet, helmet (*Visierhelm* in German), which the president Faucher mistakes for the burgonet, is the most perfect helmet; it dates only from the second half of the fifteenth century, and was still in use in the middle of the seventeenth. All the front part of this helmet was called *mezail*. The crown (*timbre*) was rounded; the vizor (*Visier* in German), the nose-piece, and the *ventail* (fan), were all movable, and could be raised up to the crest by means of a pivot.

The *mentonnière*, chin-piece, or beaver (*Kinnstück* in German), and the gorget (*Halsberge* in German), both of which protected the lower part of the face, were made of thin plates of metal and were fastened to the helmet.

Besides the above helmets, that were in use almost everywhere, and may be said to be types of the different epochs of chivalry, there existed many others used by archers and foot-soldiers, some of which are here described.

The *morion* (*Morian* in German) was originally a Spanish helmet, and the word is derived from the Spanish word *morro*, round. It had neither vizor, nose-piece, gorget, nor neck-guard, but was surmounted by a high crest sometimes half the height of the helmet; and its edge turned up in a point in front and behind, so as to form a crescent when seen in profile

The *cabasset*, or pear helmet (*Birnhelm* in German), derived its name from the gourd-like or calabash form, was without vizor, gorget, neck guard, or crest, but was pointed like a pear, of which the stalk made a little crest. This helmet, like the morion, was worn by both horse and foot soldiers, particularly in France and Italy, till about the middle of the seventeenth century. The morion, ornamented with an enormous embossed fleur-de-lys, is to be seen in many arsenals of Germany, especially those of Austria and Bavaria, where it was part of the municipal equipment in the middle ages. This fleur-de-lys has nothing to do with the arms of the kings of France, being simply the emblem of the Virgin, whose image many bodies of crossbowmen and halberdiers had adopted for the sign of their civic banners.

The ordinary burgonet (*Pickelhaube* in German) was widely spread throughout Germany, and was the usual helmet of *Knappen*, or men-at-arms of the feudal castellans, and sometimes of the lansquenets, or lightly armed cavalry.

The iron hat (*Eisenhuth* in German), which dates as far back as the thirteenth century, as may be seen from the Bohemian manuscript *Voleslav* in the library of Prince Lobkowitz at Raudnitz, had neither vizor nor crest. There were some in the seventeenth century resembling in form a cap with a vizor, and sometimes with a movable nose-piece: the iron hat, twenty pounds in weight (No. 101), worn in battle by Augustus the Strong (1670—1733), which is to be seen in the Museum at Dresden, is of this kind; but the iron hat, weighing twenty-five pounds (No. 100), worn by the Elector at the battle of Fehrbellin in 1677, has a rounded crown and wide brim, like a shepherd's hat. The helmet worn by the foot-soldiers of the household of King Louis XIV. (1643—1743) was flat-crowned, and with a movable nose-piece (No. 114).

The real pot-helmet (*Eisenkappe* in German), a sort of skull-cap of thick iron, and very heavy, was used, particularly in sieges, in the sixteenth and seventeenth centuries (see No. 97). The word pot-helmet is also used for iron hats much lighter in weight, that were worn by Cromwell's foot-soldiers.

The *calottes*, or caps, and iron frameworks of the seven-

teenth and eighteenth centuries were only used inside other hats. In the Historical Museum of the Monbijou Palace at Berlin there is a triangular framework that must have served as lining to a three-cornered hat (No. 111.)

As to the casques of ancient shapes of the sixteenth century, mostly of Italian, German, and Spanish workmanship, which enrich the collections of amateurs, they are principally helmets for pride and pomp rather than for war or tournaments. They are of no archæological value, as they are all of the Renaissance period, and are only reminiscences of ancient days, which do not reflect the habits and customs of their time.

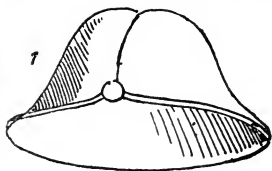

1. Germanic casque, either of iron or bronze, belonging to the eighth and ninth centuries, from the *Codex Aureus*, a MS. of that time preserved in the Saint Gall Library.



2. Carlovingian casque, either in bronze or iron, of the ninth century, from the *Ademari-Cronicon* in the Imperial Library of Paris.



3. Carlovingian casque of the ninth century, either in bronze or iron, from the Bible of Charles the Bald in the Louvre.



4. German casque in iron, of the tenth century, from the *Psalterium*, a MS. in the Stuttgart library. (See this shape among the Greek and Japanese casques.)

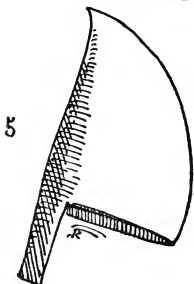

5. German casque, half conical, and with nasal, called in France Norman casque, from the *Martyrologium*, a MS. of the tenth century, in the library at Stuttgart.

6. Conical casque, with nose-piece broader at the bottom, from a statuette of the tenth century.

Collection of the Count of Nieuwerkerke.

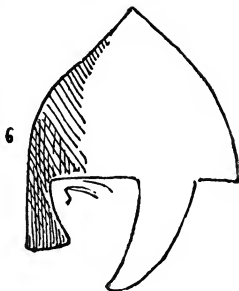

7. Casque of ancient form, with crest and cheek-pieces, from a bust in silver, life size, in embossed work of the tenth century.

Convent of Saint Maurice, Canton Valais, Switzerland.

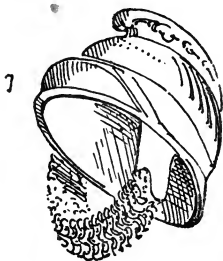

8. Casque in iron, inlaid with silver, with fixed nose-piece, belonging to Saint Wenceslaus, who died in 935.

Cathedral of Prague.

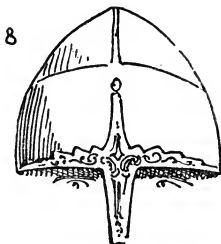

9. German casque with rounded crown in iron, from an illumination in the *Biblia Sacra* of the tenth century, in the Imperial Library of Paris, and also copied from the *Prudentius* of the same date in the British Museum.

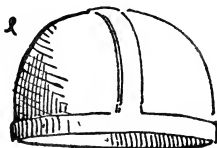

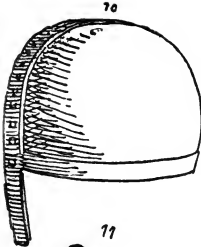

10. German casque in iron, with fixed nose-piece, from a MS. of the eleventh century, belonging to M. de Hefner-Alteneck. This same kind of casque is represented in some illuminations in the *Jeremias* MS. of the same century, in the library at Darmstadt.



11. Anglo-Saxon casque with neck-guard, from the *Aelfric* MS. of the eleventh century in the library of the British Museum.

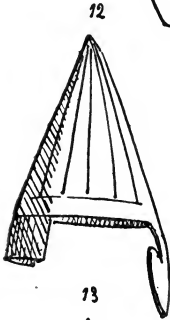

12. Conic Norman casque with nose-piece and neck-guard. William the Conqueror is represented in the Bayeux tapestry wearing one. This shape is also to be seen in the *Aelfric* MS. already mentioned.



13. German conic casque with nose-piece, from a bronze bas-relief in the baptistery of the Cathedral at Hildesheim; the work of Saint Bernard in the eleventh century. This same sort of casque is also to be seen in the mural paintings in the Cathedral of Brunswick, executed in the reign of Henry the Lion, who died in 1195.

14. Anglo-Saxon casque with nose-piece, of the end of the twelfth century. From an illumination in the *Harleian MS.* in the library of the British Museum



15. Russian casque with small nose-piece and long neck-guard, made of iron imbricated or curved scales. Attributed in Saint Petersburg to the eleventh century.

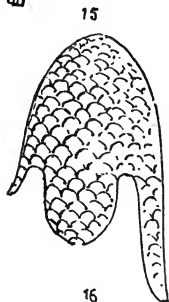

16. Small conic casque in iron, with fixed nose-piece, of the eleventh century, found in Moravia.

Ambras Collection.

17. German casque with neck guard, of the eleventh century, from the embroidery on the mitre belonging to the convent of Seligenthal. National Museum of Munich. Louis VII. (1137-1180), and Richard Cœur de Lion (1157-1183), are represented on their seals with this sort of casque.

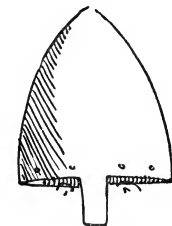

17 bis. Casque in iron of the twelfth century, attributed to Henry the Lion, Duke of Brunswick, who died in 1195. The crown is of iron, ornamented with a crest and six bands in gilt and engraved copper, and with an embossed band in front of the same material, the principal ornament of which is a lion, such as is represented in the duke's arms. Collection of the Baron de Zu-Rhein at Wurzburg, and previously in that of the Duchesse de Berry.

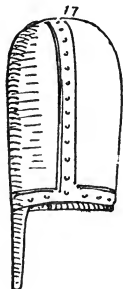



18. Casque in red copper of the eleventh century, with Greek cross and three pierced holes. It was found in the Saône, and is now in the Museum of Artillery in Paris.

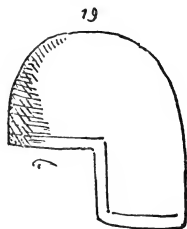

19. German casque with neck-guard, of the twelfth century. From a mural painting in the Cathedral of Brunswick, executed in the reign of Henry the Lion, who died in 1195.

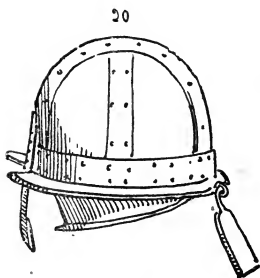

20. German casque with movable neck-guard and cheek-plates, but with the nose-piece fixed. It is of the twelfth century, and was found in the Somme. *Museum of Artillery, Paris.*

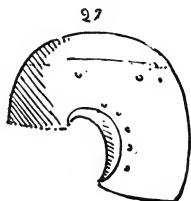

21. Bronze casque with neck-guard, of either the tenth or twelfth century; more probably the latter; for it was discovered in the river Lech, near the field of battle where Saint Ulrich, at the head of his flock, contributed to the defeat of Attila.

Maximilian Museum at Augsburg.

22. German casque with chin-piece and gorget affixed, and with open mezail, of the thirteenth century, from the German MS. of *Tristan and Isolde*, by Gottfried of Strasburg.

Library of Munich.

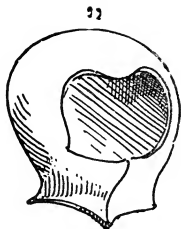

23. Small cap of mail riveted à grains d'orge, of the thirteenth century, found in a tomb at Epernelle (Côte d'Or).

H. 7, *Museum of Artillery, Paris.*

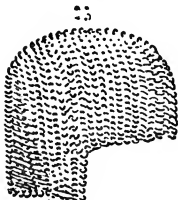

24. Small German bassinet, or skull-cap, of the thirteenth century. It was worn over the *camail* and under the *heaume*.

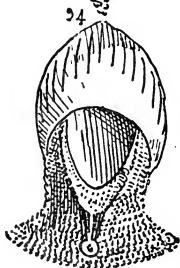

25. Small bassinet, probably French, of the thirteenth century. It has a neck-guard of mail, and a fixed nose-piece, which has been broken, and which appears to be the last trace of the *nasal* of the tenth and eleventh centuries.

H. 18, *Museum of Artillery, Paris.*

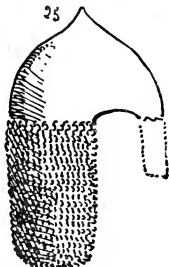

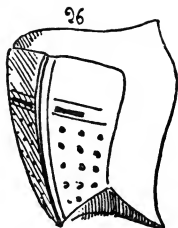

26. German heaume (*Topfhelm* in German) of the twelfth century. From the mural paintings in the Cathedral at Brunswick, executed in the reign of Henri le Lion, who died in 1195.

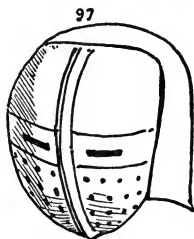

27. *Id.* as above. These are, so far as the author knows, the earliest specimens of *heaumes*, casques of German origin, intended to be worn above the *basinet*.

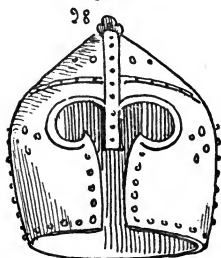

28. Primitive English heaume, with nose-piece, of the end of the twelfth century. It is of blackened iron, about seventeen inches in height.

H. 1, *Museum of Artillery, Paris.*

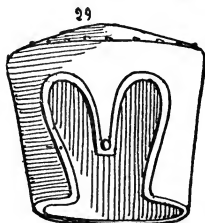

29. Early English heaume, also with nose-piece, of the end of the twelfth century
 † *Tower of London.*

30. Heaume worn by archers on foot and on horseback, of the thirteenth century, from the *Cronicon Colmariense*, of 1298.

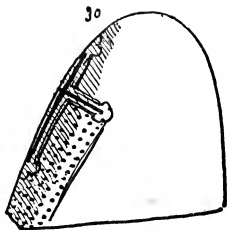

31. English heaume of the thirteenth century. This is probably the new sort of helmet spoken of by the writers contemporary with the battle of Bouvines (1214). The German heaume, however, of the same date, represented on the frescoes in the Cathedral of Brunswick, is a much more perfect piece of armour.

Museum of Artillery, Paris.

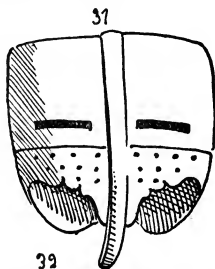

32. English heaume, or high helmet, marked in the Parham Collection as belonging to the twelfth century. But the author believes it to be a counterfeit, as not a single one of the same shape is to be found in any manuscript



33. German heaume of the beginning of the thirteenth century, from the *Tristan and Isolde* MS. in the library of Munich.

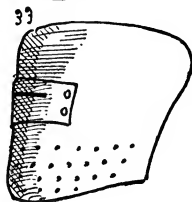

34



34. Heaume of the thirteenth century, in iron, decorated with polychrome designs.

Nieuwerkerke Collection.

35

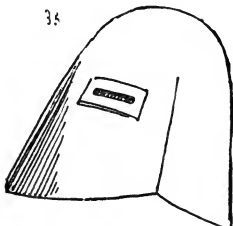

35. German heaume of the end of the thirteenth century, from an illumination in the *Manessis* manuscript, preserved in the Imperial Library of Paris, which represents the death of Albert of Heigerloch, the Minnesinger of the lineage of Hohenzollern, in 1298.

36

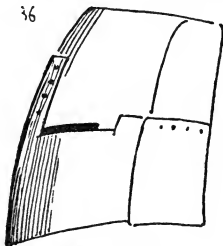

36. Heaume, preserved in the Museum of Prague, said to be of the thirteenth century. But the helmet is altogether so light that it looks like a counterfeit.

37

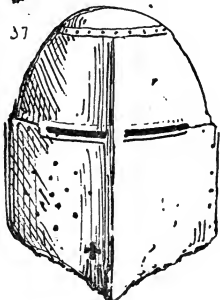

37. German heaume of the fourteenth century. It was found, together with some bassinets, represented farther on, under the ruins of the Castle of Tannenburg, which was destroyed in the fourteenth century. The helmet marked No. 570 in the Museum of Copenhagen is very like this one, and another in the Museum Franciscocarinum at Lintz also closely resembles it.

- 38 English heaume with hinged flap, beginning of the fourteenth century.

‡ *Tower of London.*

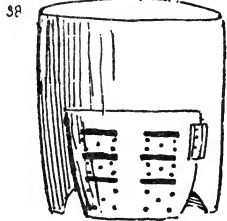

39. German heaume; end of the fourteenth century.

H. 5, *Museum of Artillery, Paris.*

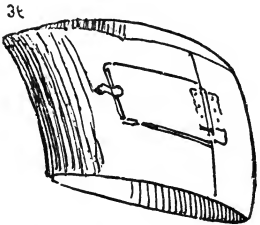

40. German heaume with crest, of the thirteenth century. From the German *Æneid* of Henry of Waldeck.

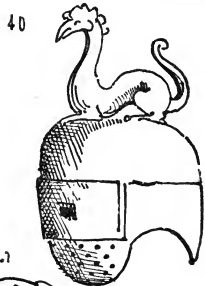

41. Same as above. These two are the earliest crested helmets which the author has been able to find. Till lately it was believed that the crest had been added to the *heaumes* about the middle of the fourteenth century, and that the earliest defences of this character could not date sooner than the end of the thirteenth century. But the Nos. 26 and 27, copied from the frescoes in the Cathedral of Brunswick, and the ones here represented, appear to militate against this opinion.

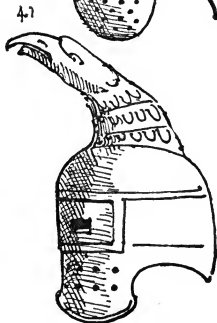

42.

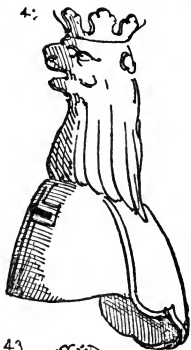

42. Large heaume with crest, from the cenotaph of the King of the Romans, Gunther of Schwarzburg, who was poisoned at Frankfort in 1349. The monument is of red stone, and was erected in the Cathedral of Frankfort in 1352.

43.

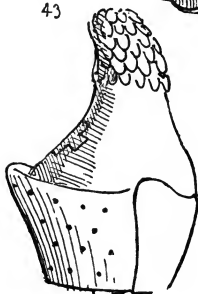

43. Large heaume for tilting, in polished iron, and with the remains of a crest, of the fourteenth century. The lower part of the crest is of plates of metal *imbricated* or curved, and the *mezail* is fixed. It is probable that the crest is not complete, and that there was a heraldic badge or some other emblem on the top.

H. 3, *Museum of Artillery, Paris.*

44.

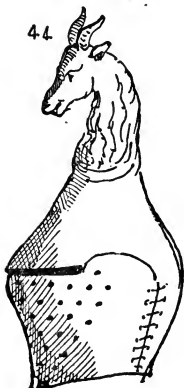

44. Large tilting heaume, English, in black iron, with crest, of the beginning of the fifteenth century. The crest is of wood, and seems to be modern.

H. 4, *Museum of Artillery, Paris.*

45. Large tilting heaume of the fifteenth century, either English or German. It has a hinged flap or ventilator, and a small collar, that was meant to be riveted on to the cuissas.

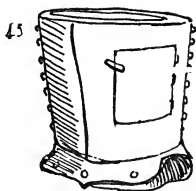

46. Large tilting helmet, English, of the end of the fifteenth century. It is of polished iron, and has a small collar.

Tower of London.

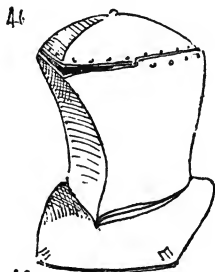

47. Large German tilting heaume; end of the fifteenth century. It is in polished iron, and with a small collar, similar to the one in the Munich Museum.

H. 6, Museum of Artillery, Paris.

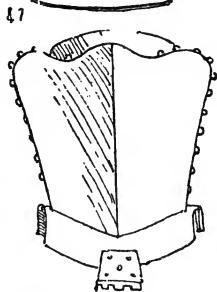

48. Large tilting heaume, supposed to have belonged to Maximilian I., who died in 1519. Imperial Arsenal of Vienna. A similar helm, found at Klingenberg in Bohemia, is in the Prague Museum, and another in the Arsenal at Berlin. This shape continued in fashion, though somewhat modified, till the middle of the sixteenth century.

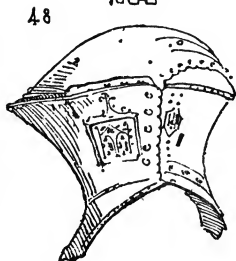

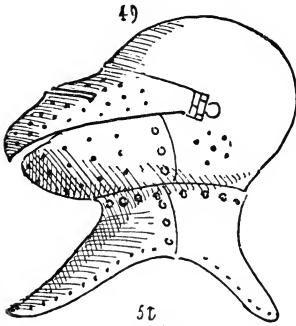

- 49 Heaume for war in polished iron. It has a round crown and hinged vizor; the gorget and collar are fixed. It is part of a complete suit of armour in the Arsenal of Berlin.

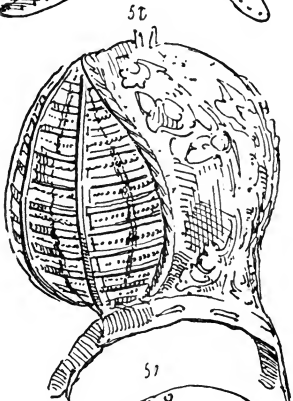

50. German heaume used in tournaments with *massettes** (*Kolbentournier* in German), of the fifteenth century. It is twenty inches in height, and the framework is of wrought iron, while the back part is covered over with linen, on which can be distinguished the painted arms of the barons of Spaeth; part of the gilding still remains.

Museum at Sigmaringen.

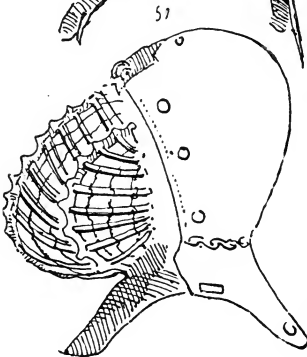

51. German heaume, used in tournaments with maces, of the fifteenth century. It belonged to the Count of Esendorf, who was killed at Biberach.

Sæter Collection in the Maximilian Museum at Augsburg.

* The mace, *massette*, and sword were equally used in military exercises and in tournaments.

52. Bohemian bassinet, from the *Voleslav* MS. of the thirteenth century, in the library of Prince Lobkowitz at Raudnitz, in Bohemia.

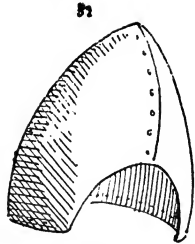

53. German bassinet of the thirteenth century. It is eleven by eight and a half inches, and is in the Museum at Berlin.

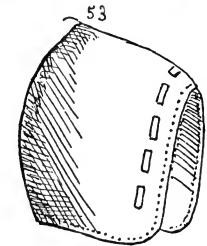

54. German bassinet, of the end of the thirteenth century, found amongst the ruins of the Castle of Tannenburg, which was burnt in the fourteenth century. It has been copied and described by M. de Hefner-Alteneck.

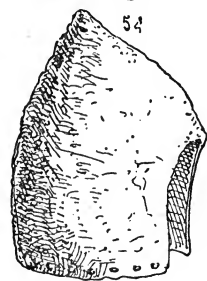

55. Bassinet, either French or Italian,* of the fourteenth century, ornamented with twelve large screw-rings, with square holes for holding the rod on which the piece of mail was strung. This helmet was in the collection of the Count of Thun, at Val di Non; M. Spengel, of Munich, has since disposed of it to the Count de Nieuwerkerke.

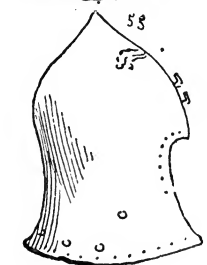

The great bassinet appears in the second half of the thirteenth century. It was of an oval-pointed shape, at first without either nose-piece or vizor, but with buttons, to which the mail shirt, used for a neck-guard, was fastened.

* More likely Italian, for the neck-guard like that of the Venetian *celata* of the fifteenth century.

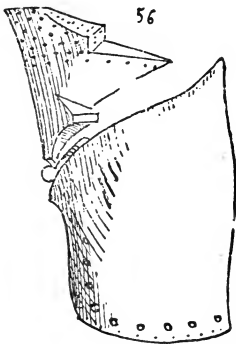
Large Bassinets with hinged Vizors.

56. Large German bassinet of the fourteenth century, in black iron, with movable *mezail*; the upper part of the vizor lifts up by means of a hinge. The 20 large screw-rings, which fitted into the square holes shown in the engraving, held the rod on which the piece of mail used as a neck-guard was strung.

Collection of M. de Hefner-Alteneck.

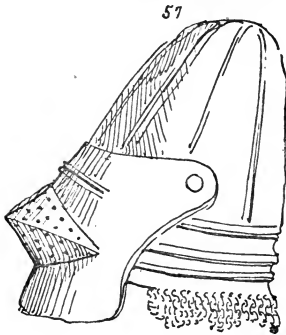

57. Large English bassinet of the middle of the fourteenth century. The vizor lifts up by means of a pivot, like those of the *armets* of the sixteenth century. There is still a piece of the mail gorget left, which is fastened to the collar.

Warwick Castle.

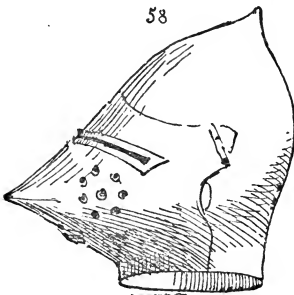

58. Large bassinet with hinged vizor. Tower of London, Museum of Artillery, Paris, and in the collection of M. le Comte de Nieuwerkerke. These helmets are of polished steel, the crown is of pointed oval shape, and in one piece. The vizor comes very forward, so as to leave a large space for the wearer to breathe freely.

59. Large English bassinet of the middle of the fourteenth century, with hinged vizor and fixed collar. Tower of London, and collection of M. de Renné at Constance. This helmet is in some respects very like the preceding one.

The salades (in German *Schale*, *Schallern*, and *Schellern*), which took the place of the bassinets in the fifteenth century, were distinguished particularly by their neck-guards, and by other characteristics in which they are not unlike the iron hats. The salade was generally worn with the chin-piece, that was usually part of the high collar. It was worn sideways, so that the slit for the sight came before the eyes.

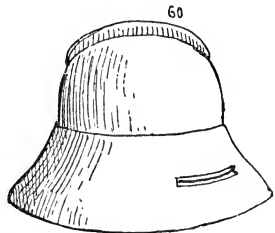
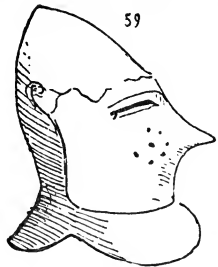

60. German salade-heaume of the fourteenth century, used in tournaments. It had a fixed vizor, and was worn straight.

Museum of Artillery, Paris.

61. German salade of the fifteenth century in a single piece, and with a chin-piece.

Collection of the King of Sweden, Charles XV.

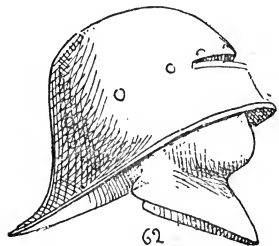

62. German salade with nose-piece, of the fifteenth century.

Collection of M. de Renné at Constance.

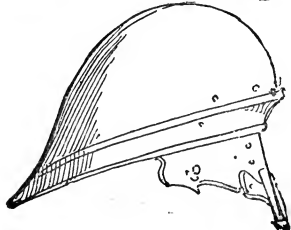

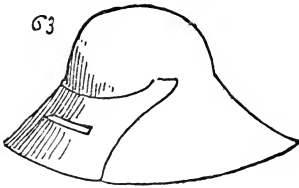

63. German salade in blackened iron, with movable vizor on a pivot, of the end of the fifteenth century. It comes from the Chateaux d'Ort in Bavaria, and must have been worn sideways and with a chin-piece. Tower of London. A similar one in the Spengel Collection at Munich, that was originally in the collection of the Comte de Thun at Val di Non.

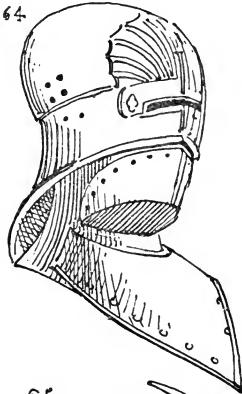

64. Salade with sight-piece in shape of a shell, with chin-piece of a peculiar form, and with a high collar. Of the fifteenth century.

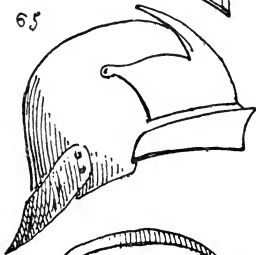

65. Salade of the fifteenth century, with vizor and neck-guard; it must have been worn sideways like the preceding one. The neck-guard is of the same piece, and is small.

Museum at Prague.



66. Salade with crest, of the fifteenth century, from the Isle of Rhodes. This helmet has an ornamented vizor, and the neck-guard is of the same piece as the helmet. It did not protect the face, and formed but an imperfect defence. The workmanship looks like early Italian.

67. German salade to be used in battle, copied from the statue of Duke William the younger, of Brunswick, a work completed in 1494. It has a fixed vizor, but movable chin-plate and gorget.

Munten-Hanoverien, near Cassel.

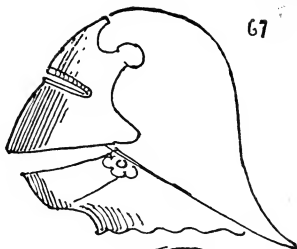

68. German salade to be used in battle, of the fifteenth century. The crown is pointed, a very uncommon and perhaps unique shape. The vizor is hinged, and the neck-guard in plates of metal. The small print gives a front view.

Musée historique of the Monbijou Palace at Berlin.

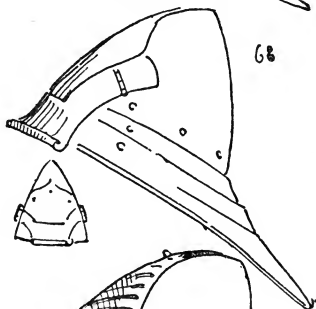

69. Same as above, but with elongated *mentonnière* or chin-piece, which forms a sort of gorget or high collar.

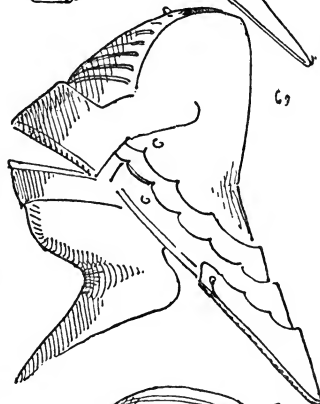

70. Fluted salade with front brim, which, according to the author, is of the sixteenth century, and comes from the Isle of Rhodes. Museum of Artillery in Paris, where it is said to be of the fifteenth century. The shape of the brim and the fluting would fix it in the first half of the sixteenth century, when these sorts of vizor were very generally in use. (See No. 125, Burgonet.)

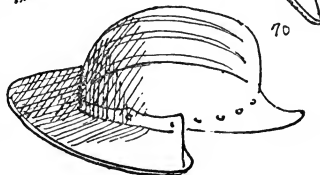



71. English salade, from the Tower of London, where it is marked as being of fifteenth-century date; but from the singular shape I believe it to be counterfeit.



72. Venetian salade (*celata Veneziana*) and nose-piece, of the first half of the fifteenth century.

Meyrick Collection, Renne' Collection at Constance, Nieuwerkerke Collection in Paris, and in the Tower of London.



73. Venetian salade with crest, but without nose-piece, of the second half of the fifteenth century.* The neck-guard of this helmet is larger than that of the preceding one.

Meyrick Collection.

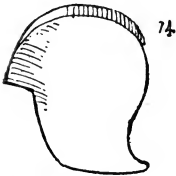

74. Venetian salade for archers, with crest, but without nose-piece. The neck-guard is smaller than that of the preceding one. *H. 22, Museum of Artillery in Paris, and also in the Tower of London.*

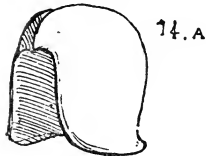

- 74 A. Italian salade of the second half of the fifteenth century, from the bas-reliefs in white marble on the triumphal arch of Alphonso V., King of Arragon, at Naples, which represent his triumphal entry into that city in 1443.

- 74 B. Italian salade with vizzor, same as above.

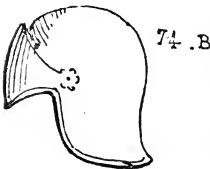

* This helmet is not unlike the Greek *hoplite* casque (see No. 9, page 110), but it has a neck-guard, which the other had not. The point in the front forms a nose-piece, which is also to be seen in the *celata Veneziana* of the second half of the fifteenth century.

75. War-hat in iron (*Eisenhut* in German) of the twelfth century, from the frescoes in the Cathedral of Brunswick, done in the reign of Henry the Lion, who died in 1195.



76. War-hat in iron, from the Bohemian MS. *Voleslav*, of the thirteenth century.

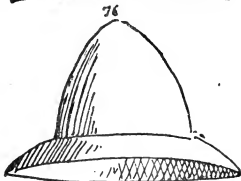

77. Skull-cap (*Eisenkappe* in German), from the German *Aeneid* of Henry of Waldeck, a MS. of the thirteenth century, in the library of Berlin.

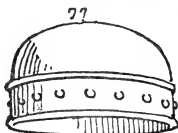

78. War-hat, from an illumination in the *Manassis manuscript*, of the end of the thirteenth century, which represents the death of Albrecht of Heigerloch, the Minnesinger of the race of Hohenzollern.

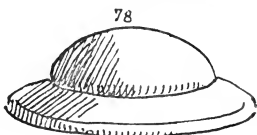

Imperial Library, Paris.

79. War-hat in iron of the end of the fourteenth century, from a painting at Saint-Michel in Schwabisch Hall, copied by M. de Hefner-Alteneck.

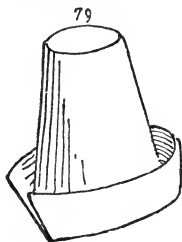

80. Same as above.

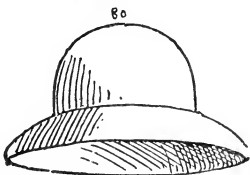

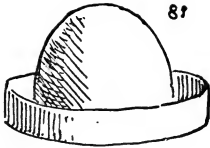

81

81. War-hat of the end of the fourteenth century, from a painting at Saint-Michel, at Schwaebisch Hall.

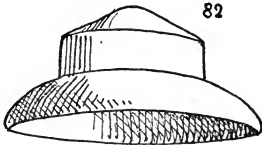

82

82. War-hat in iron, from a MS. at Constance, date 1435, preserved in the Library of Prague.

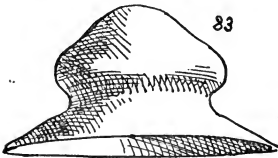

83

83. War-hat in iron, of the fifteenth century. *Museum of Copenhagen and Collection of M. de Hefner-Alteneck at Munich.*

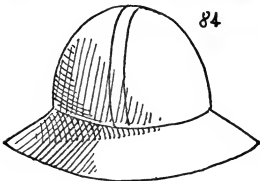

84

84. War-hat in iron, of the fifteenth century. From a MS. in the collection of M. le Chevalier von Hauslaub at Vienna.

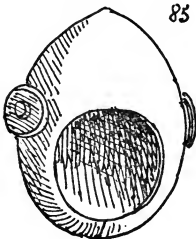

85

85. Skull-cap of the fourteenth and fifteenth centuries; slightly oval shape, with chin-piece. From a MS. in the collection of M. le Chevalier von Hauslaub at Vienna, and from frescoes in the Cathedral of Mondoñeda, in Spain. The under view of these helmets, as seen in the pictures, leads one to suppose that the back part was rendered movable by means of a hinge or pivot, so as to allow the head to be inserted.

86. Skull-cap (*Eisenkappe* in German) with ear-plates, from a manuscript of the fifteenth century in the collection of M. le Chevalier von Hauslaub at Vienna.

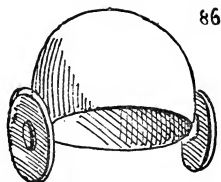

87. War-hat with vizor, from the water-colour paintings of Glockenthon of the year 1505, which represent the arms in the Arsenal of Maximilian I. *Ambras Collection.*

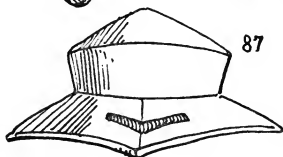

88. Same as above.



89. Frame-work of pot-helmet. This helmet was used most probably in sieges, and was worn, like the heaume, over the ordinary helmet.

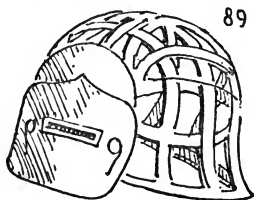

90. War-hat, German, of the end of the fifteenth century, from a cast in the Germanic Museum at Nuremberg. Its shape is almost identical with that of the iron hat, No. 83, copied from one in the collection of M. de Hefner - Alteneck at Munich. Like it, the crown is made in a single piece.

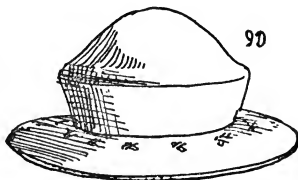



92. War-hat belonging to the Reformer Zwinglius, who was killed at the battle of Capel in 1531.

Arsenal of Zurich.

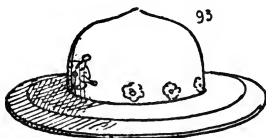

93. War-hat of the end of the fifteenth century. The principal ornament is in the shape of the Burgundy cross, and made of pierced copper. Renné Collection at Constance. A similar one, with the exception of the cross, is in the Spengel Collection, Munich.



94. War-hat from the *Theuerdanck*, published at Augsburg at the commencement of the sixteenth century.



95. German war-hat of the sixteenth century, surmounted by three large twisted ridges, and with movable ear-plates. This helmet is covered with red velvet, and was used principally for hunting. From the Spengel and Hefner-Alteneck Collections at Munich. In the Arsenal of that city there is a similar casque, covered with black and yellow cloth, which are the colours of Munich. There are others in the Ambras Collection, and in the castle of Laxemburg. One in the Mazis Collection, in the Museum of Artillery at Paris, is attributed to Henri IV. (1559 — 1610), whose initials it bears. The twists are richly ornamented with trophies and other subjects, engraved and embossed.

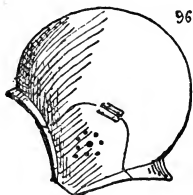

96. Pot-helmet with ear-plates, of the sixteenth century.

Arsenal of Munich.

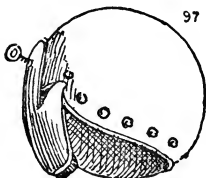

97. Pot-helmet used in sieges, of the seventeenth century.

H. 154, *Museum of Artillery, Paris.*

98. War-hat in iron, belonging to Charles I. of England (1625—1649). It bears the mark of the armourer

A. B. O.

Warwick Castle.

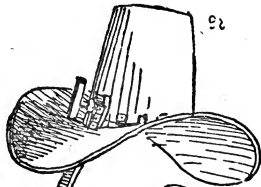

99. War-hat in iron, of the seventeenth century.

Az Collection at Lintz.

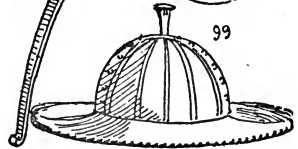

100. War-hat in iron, with a socket for plume. It weighs about 27 lbs., and measures 12 inches by 16, and belonged to the Great Elector of Brandenburg, who wore it at the battle of Fehrbellin in 1677.

Berlin Museum.

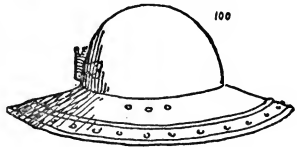

101. Iron skull-cap with vizor. The outer part is perforated, and weighs 20 lbs. It belonged to Augustus the Strong (1670—1733).

Museum of Dresden.

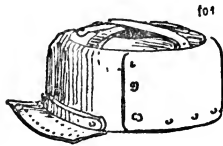

102. German skull-cap in iron, with vizor and nose-piece, of the seventeenth century. The neck-guard is of mail, and is covered on the outside with grey linen.

Dres'en Museum

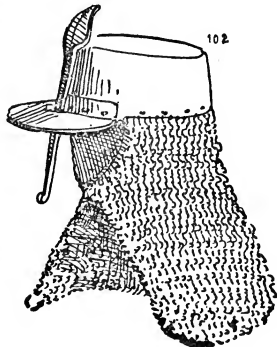

Iron Skull-caps.



103

103. Skull-cap of the seventeenth century in thick iron, and the upper part open-work.

Berlin Arsenal.



104

104. Skull-cap of imbricated scales, from a drawing by Holbein of the sixteenth century.

Industrial Museum of Vienna.

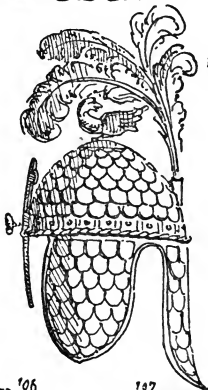

105

105. Skull-cap of imbricated scales, in polished steel, with movable nose-piece, cheek-plates, and neck-guard. The socket for the feather and several other parts are in gilt copper. It was worn by John Sobieski, King of Poland, before Vienna, in 1683.

Museum of Dresden.

106. Frame-work of skull-cap in iron, of the seventeenth century.

Museum of Prague.



106



107

107. Same as above.
108. Frame-work of skull-cap in iron, worn by French carabineers inside their war-hats in 1680.

Museum of Artillery, Paris.



108

109. Frame-work of skull-cap in iron, for lining the interior of the war-hats.

Museum of Sigmaringen.

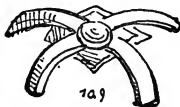

109

All these perforated or open-work skull-caps belong to the time when the helmet had been superseded by the war-hat, the latter forming an outer covering.

110. German skull-cap in iron, intended to be worn inside the iron hats, of the seventeenth century.

Imperial Arsenal of Vienna.

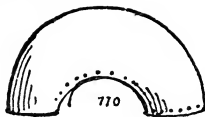

111. Frame-work for lining the three-cornered hat of the eighteenth century.

Historical Museum of the Monbijou Palace at Berlin.

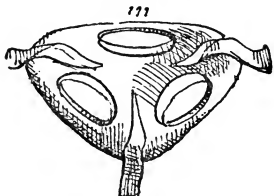

112. War-hat, probably Italian, of the seventeenth century. It is in iron, has a chin-strap, and is studded with nail-heads in copper.

Imperial Arsenal of Vienna.

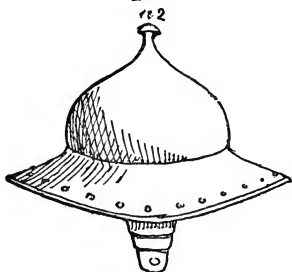

113. German war-hat, which, according to the description given in Arsenal of Vienna, where it is preserved, was used in besieging castles and towns. The large brim protected the face from the boiling liquids that the besieged used in defence. The author, however, thinks that this sort of hat was only used at ceremonies, entries of princes, etc.

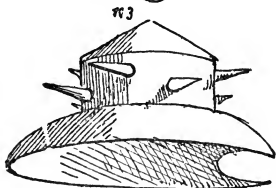

114. Iron hat with nose-piece, worn by the household foot-soldiers of King Louis XIV. (1643—1715).

H. 152, Museum of Artillery, Paris.

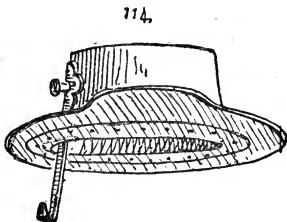

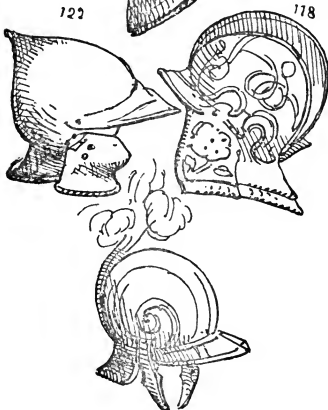
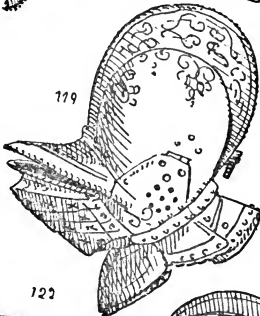
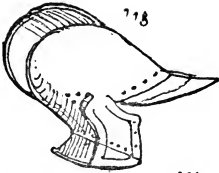

115. Burgonet (*Burgunder helm* in German) of the sixteenth century. This sort of helmet is known by the crest, shade, cheek-pieces, and neck-guard.

116. Burgonet of the sixteenth century, with gorget and *mentonnière*, or chin-piece, which make it very like the "armet." (See later.) H. 53, *Museum of Artillery, Paris.*

117. Burgonet of the end of the sixteenth century. (Same remarks as for the preceding one.) *Arsenal of Soleure.*

118. Burgonet of the sixteenth century, formerly in the collection of the Castle of Luxemburg. *Imperial Arsenal, Vienna.*

119. Burgonet of the sixteenth century, with gorget, *mentonnière*, and movable vizor, which make it resemble the armet. The workmanship is German, in engraved iron, and very beautiful. *Ambras Collection.*

121. German burgonet, from the "*Descriptions des Nocces Princières*," etc., of Wirzig, a work printed in Vienna in 1571. *Industrial Museum of Vienna.*

122. German burgonet-bassinet of the sixteenth century. It is chiefly noticeable on account of its pointed shape, and being without a crest.

Az Collection at Lints.



120. Burgonet, splendid Italian work, in beaten iron, of the sixteenth century. In the Imperial Arsenal of Vienna, formerly in the Castle of Laxenburg. It is the finest specimen that exists of this sort, and has been satisfactorily photographed at the Industrial Museum of Vienna.



123. Burgonet of the seventeenth century.

Tower of London.

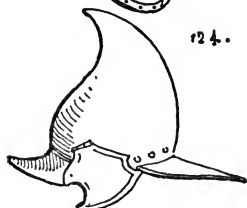

124. Burgonet-cabasset of the beginning of the seventeenth century, in blackened iron. It has a peak, cheek-pieces, neck-guard, but no crest. The crown is pointed, like that of the *cabasset*.

Arsenal of Geneva.

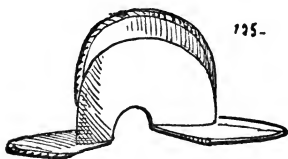

125. Burgonet used at sieges, of the end of the seventeenth century. It is of very thick iron, and has a flat neck-guard and peak.

H. 76, *Museum of Artillery, Paris.*

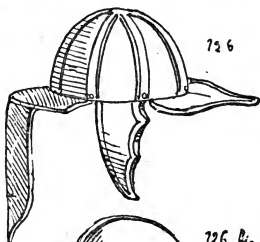

126. Burgonet-skull-cap, German, of the beginning of the seventeenth century. It is covered with red velvet.

Guelf Museum at Hanover.

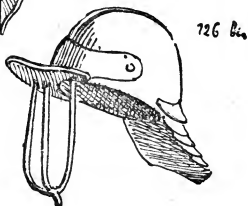

- 126 *bis*. Burgonet-skull-cap of the seventeenth century. A sort of vizard, in the shape of a trident, is fastened on to the peak, and the neck-guard is of metal plates.

Tower of London.

127. Burgonet skull-cap of the seventeenth century, with nose-piece, Polish. These casques, on account of the kind of fan on each side of the crown, resemble those of the winged cavalry (*Jazala Skrzydlata*) of Sobieski.

Museum of Dresden.

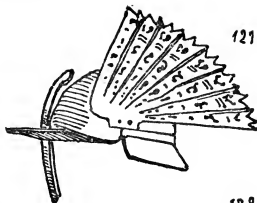

127

128. Burgonet skull-cap in iron, with movable nose-piece and plated neck-guard, called *zucchetto*. It is of Hungarian origin, and was called *dschycksc*.

No. 366, *Royal Arsenal of Turin.*

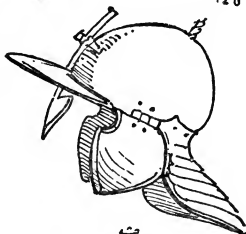

128

129. Burgonet skull-cap, with cheek-pieces, nasal-vizor, and plated neck-guard, of the middle of the seventeenth century. This helmet, which is in the Arsenal of Soleure, is wrongly said to have belonged to Vengi (1540). It is in engraved iron, and studded with copper nail-heads.

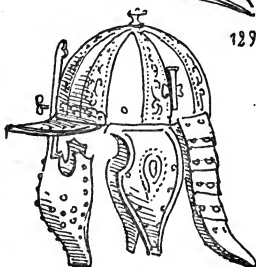

129

130. Burgonet skull-cap, with cheek-pieces, and long plated neck-guard. It is said to have belonged to Charles de Tyrol, who died in 1662.

Ambras Collection.

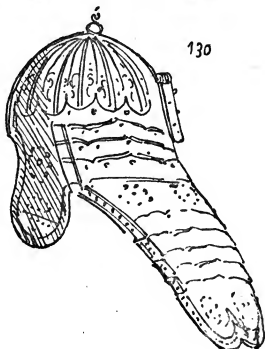

130

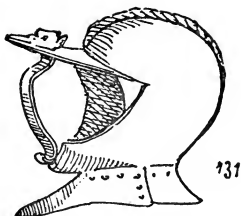

131

131. German burgonet of the seventeenth century. It has a fixed nose-piece, and the front part is like that of the armets. H. 56, *Museum of Artillery, Paris.*



132

132. Burgonet of the seventeenth century, with plated neck-guard, in the Meyrick Collection, where it is said to be of the fifteenth century. The front and back of this specimen have been engraved, in order to show the double line of ornaments on the back, resembling flutings.

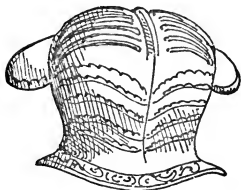

133

133. English burgonet of the seventeenth century, in the Dresden Museum, where it is erroneously attributed to Edward IV. (1461-1483). According to common tradition it was originally in the collection of the Tower of London, and was given by William III. to John George I. The peak, the plated neck-guard riveted with gilt nail-heads, as well as the tinsel ornaments of the crest and the plume-clasp, show at first sight that we must assign this piece of workmanship to the latter half of the seventeenth century.

134. Morion (*Morian* in German).

This is an Italian casque for a foot-soldier of the sixteenth century, from the Arsenal of Geneva, and formerly belonged to the Savoyard captain Chaffardin Branaulien, who was killed before the walls of Geneva, during a night attack. It is richly engraved in a very artistic style.

Author's Collection.

135. French morion of foot-soldier, of the end of the sixteenth century. It is also engraved.

Tower of London.

136. German morion of the end of the sixteenth century. The fleur-de-lys in embossed work on the front of the helmet was the badge of the civic regiment of the city of Munich, and is the symbol of the Virgin, having nothing to do with the arms of the kings of France.

Arsenal of the town of Munich, and Imperial Arsenal of Vienna.

137. German morion, from the "Descriptions des Noces Princières" of Wirzig, published at Vienna in 1571.

Industrial Museum of Vienna.

The morion of the suit attributed in the Louvre to King Henry IV. of France (1559-1610). It is rather higher, and the rims narrower and vandycked. (See p. 266, No. 95).

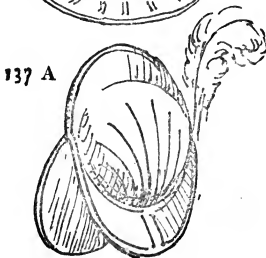
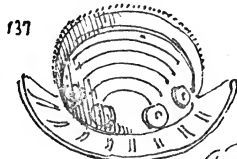
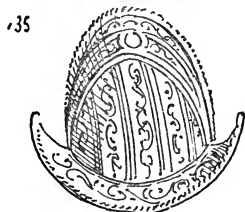
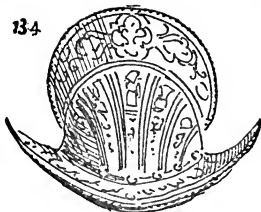
137 A. Same as above.

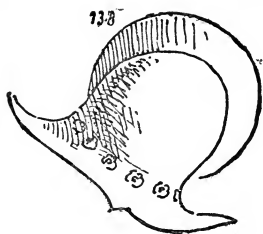

138. German morion of the sixteenth century. This shape is rare.
Arsenal of Munich.

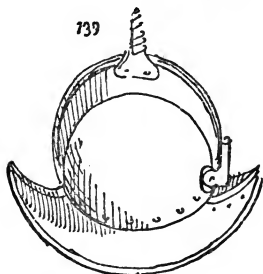

139. German morion of the end of the sixteenth century. In the National Museum of Brunswick, where it is described as being of the twelfth century. The large screw on the top distinguishes it from the usual morions.

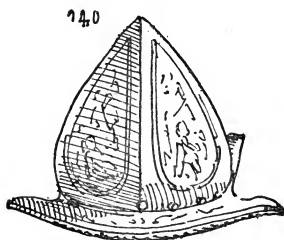

140. Cabasset, or pear-shaped casque (*Birnen-helm* in German), of the sixteenth century; richly engraved iron, with socket for plume.

Collection of M. le Comte de Nieuwerkerke.



141. German cabasset with cheek-pieces, in engraved iron, of the sixteenth century. This same shape, but with a slightly different rim, was very much in use in France and Italy.

Arsenal of Munich.

142. Italian cabasset for foot-soldier, of the sixteenth century, in iron, beaten, chased, and damascened in gold. The subject represents Perseus and Andromeda. It is a very fine specimen.

H. 100, *Museum of Artillery, Paris.*



143. Italian cabasset for foot-soldier, of the sixteenth century. It is richly engraved, and pointed.

Tower of London.



144. German cabasset in blackened iron, with socket for plume, of the sixteenth century. The only ornaments on this helmet are copper nail-heads.

Collection of M. le Comte de Nieuwerkerke.

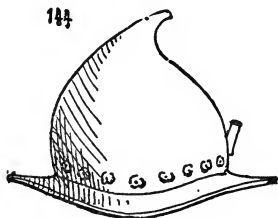

145. Italian cabasset in embossed iron, of the sixteenth century. It is a very beautiful specimen of workmanship.



246

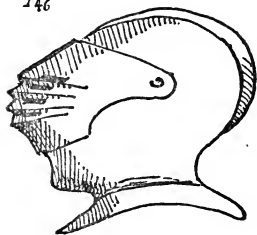

146. Armet (*Visier-helm** in German) of the second half of the fifteenth century. The armet is the most perfect form of helmet. It is composed of the crown with crest, the vizor, nose-piece and ventoyle (these latter three forming altogether the *mezail*), and the gorget.

H. 28, *Museum of Artillery, Paris.*

147

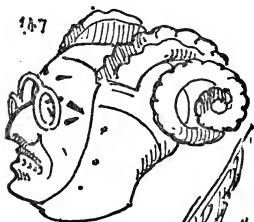

147. Armet of the sixteenth century, in iron, with real ram's horns. It formed part of the armour of the jester of Henry VIII. (1509-1547).

Tower of London.

148.

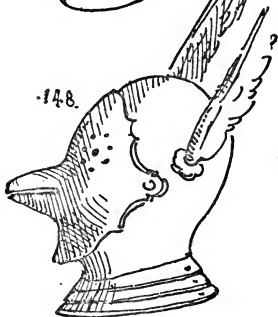

148. Armet with small plumes, of the sixteenth century, from the *Weisskunig*.



149

149. Armet of the sixteenth century, in tooled leather. The lower part of the *mezail* is wanting, as also the vizor. Arsenal of Geneva. It is the only helmet of this kind known to the author.

* From this word the English *helmet* is presumably derived.

150. Armet with fluted crown, and with vizor moving on a pivot, part of a suit of Maximilian's time, of German workmanship, of the first half of the sixteenth century. Imperial Arsenal of Vienna. A similar one is in the author's collection.

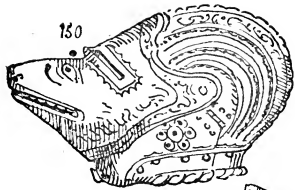

151. German armet of the sixteenth century, from the *Triomphe de Maximilien*, by Burckmayer, in 1517. The vizor turns on a pivot, and the lower part is in the shape of an eagle's beak.

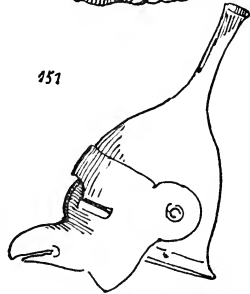

152. Armet with vizor on pivot, and high *mentonnière* (*Barthaube*). German work of the second half of the sixteenth century. It is richly engraved and damascened.

Imperial Arsenal of Vienna.



153. Armet with vizor on pivot, and high *mentonnière*. German work of the second half of the sixteenth century. This helmet is richly engraved.

Imperial Arsenal of Vienna.

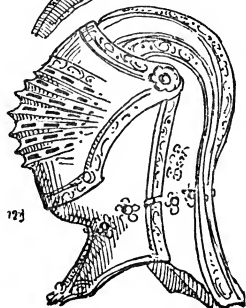

154



154. Armet of the end of the sixteenth century. The dome is in embossed work, and represents a maritime subject, and the vizor is latticed.

Royal Armoury at Madrid.

155

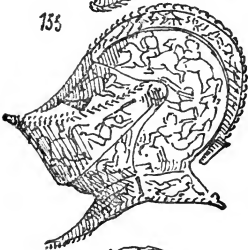

155. Italian armet of the end of the sixteenth century. It is richly chased in all parts.

Museum of Artillery, Paris.

156

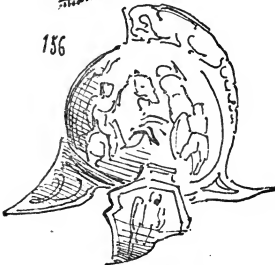

156. Italian casque, copied from the antique, called *caschetto*, of the sixteenth century, in iron beaten work, chased and damascened. It is a splendid specimen.

H. 131, *Museum of Artillery, Paris.*

157



157. Italian casque, of a shape called antique, but much resembling the burgonets of the middle of the sixteenth century. Formerly in the Imperial Library, now in the Museum of Artillery, Paris, marked H. 129.

158. Casque, called antique Russian, but whose workmanship appears thoroughly Italian.

Museum of Tsarskoe-Selo at St. Petersburg.

158



159. Swiss armet, of the beginning of the seventeenth century, in polished iron, belonging to the cavalry regiment of the city of Geneva.

Arsenal of Geneva.

159

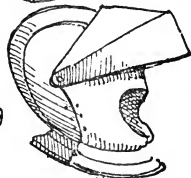

160. German armet of the first half of the sixteenth century. The vizor represents a man's face with moustaches.

Meyrick Collection.

160



161. Turkish casque with movable nose-piece, in iron damascened with gold, of the fifteenth century. It belonged to Bajazet II.

H. 173, *Museum of Artillery, Paris.*

161



162. Turkish casque of the fifteenth century, found at Rhodes.

H. 180, *Museum of Artillery, Paris.*

162

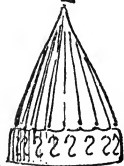

163. Albanian casque, attributed to Prince George Castriota (Scanderbeg), who died in 1467. The goat's head and the other ornaments are in copper.

163

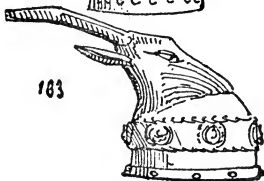

Different Casques.

164



164. Turkish casque of the sixteenth century, formerly belonging to the Seraskier Soliman. This helmet has a nose-piece, cheek-pieces, and neck-guard.

Meyrick Collection.

165



165. Iron casque with copper studs, worn by Jean Ziska * (1420), in a picture now in the library of Geneva. It is uncertain whether the painter copied this helmet from one of the time, or drew it from fancy.

166

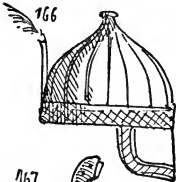

166. Persian casque, from a MS. of about 1600, a copy of the *Schah Nameh*, or Royal Book, a poem composed by Ferdusi, in the reign of Mahmoud (999-1030).

167

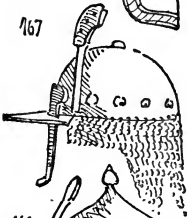

167. Mongolian casque, probably of the fifteenth century.

G. 138, *Museum of Artillery, Paris.*

168

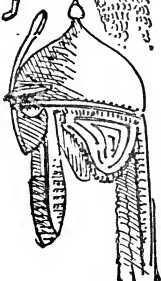

168. Indian casque from Delhi. The nose-piece is movable, and the neck-guard is composed of small metal plates.

* Ziska (one-eyed), the chief of the Hussites, or Taborites, was born in 1360, died in 1424; he lost his remaining eye in 1421. The hinged plate on the side concealed the cavity of the left eye, which he had already lost before the death of Huss.

169. Mongolian casque in iron, damascened with gold, with movable nose-piece and neck-guard. Found in the battle-field of Koulikowo (1380).

Tsarskoe-Selo Museum at St. Petersburg.

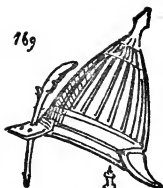

170. Russian casque with movable nose-piece and neck-guard, of the fifteenth century, richly ornamented in gilt copper.

H. 176, *Museum of Artillery, Paris.*



171. Russian casque with cheek-pieces and movable nose-piece, and large neck-guard.

Tsarskoe-Selo Museum at St. Petersburg.



172. Hungarian casque of the sixteenth century, with cheek-pieces, neck-guard, and nose-piece. This helmet belonged to the hero Nicolao Zrinyi, who was buried under the ruins of Sigeth, in 1566.

Ambras Collection.



173. Italian casque, or burgonet, belonging formerly to Ascanier Sforza Pallavicino, who took an important part in the naval battle of Lepanto, in 1571.*

Tsarskoe-Selo Museum at St. Petersburg.



174. Pot-helmet with cheek-pieces, neck-guard, and movable nose-piece, in thick iron, engraved, gilt, and ornamented with shell-like mountings and gilt studs. It belongs to the seventeenth century, and the screw of the nose-piece is in the shape of a fleur-de-lis.

Arsenal of Soleure.

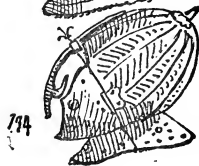

* There is a celebrated tragedy on this subject by the German, Körner.

175

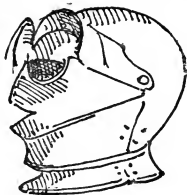

175. Savoyard armet in blackened iron, of the beginning of the seventeenth century. It was taken from the troop of Branaulien Chaffardin, who was killed in 1602 before the walls of Geneva, which city he attempted to surprise.

Arsenal of Soleure, and Author's Collection.

176



176. Polish casque, with winglets, of the seventeenth century, worn by the troops under Sobieski, who were called *winged cavalry* (*Jazala Skrzydlata*). (See No. 127 in preceding pages.)

Tsarskoe-Selo Museum at St. Petersburg.

177

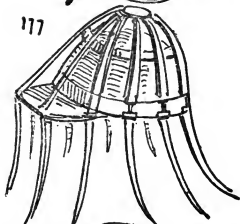

177. Casque of French soldier under Henri IV., known as a Spider helmet. It has a peak or flat vizor, with iron strips or ribbons all round.

Tower of London.

178



178. German tilting casque of the beginning of the seventeenth century. This helmet has a crest and neck-guard, and is provided with a screw for fastening to the *placcate* in front. It is rather like the *salade* of the fifteenth century.

H. 135, Museum of Artillery, Paris.

179



179. Armet of the beginning of the seventeenth century. This helmet is very like the Savoyard helmet, No. 175.

Tower of London.

180. Indian casque with neck-guard, cheek-pieces, and movable nose-piece. It is ornamented with precious stones, and the work is very beautiful.

Tsarskoe-Selo Museum at St. Petersburg.

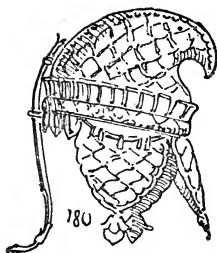

181. Polygar casque of Central India, with fixed nose-piece, cheek-pieces, and very long neck-guard, or mail hood.

Meyrick Collection.



182. Mahratta casque (Indian). This helmet has a long movable nose-piece of a singular shape, a large mail hood, which protects all the head, and a neck-guard like a tail, which descends to the loins.

Meyrick Collection.



183. Mongolian casque, with peak crest and socket for plume. It is very beautiful, and richly ornamented with damascened work.

Tsarskoe-Selo Museum at St. Petersburg.

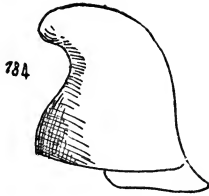

Different Casques.

184. Japanese casque with neck-guard; from the Imperial Library, now in Museum of Artillery, Paris, No. 183. A bronze Samnite helmet in the Museum of Erbach is very like it in shape. (See p. 122.)



185. Japanese helmet in lacquered iron, of a shape actually in use at the present day. It has a fixed nose-piece and neck-guard; the mask protects the entire face. G. 140, *Museum of Artillery, Paris*.*

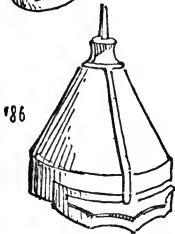

186. Conical Chinese helmet with peak. *Tower of London.*

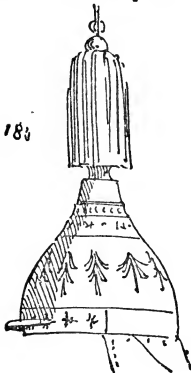

187. Casque in gold and precious stones. It belonged to the Emperor of China, and was taken at Peking in 1860. G. 142, *Museum of Artillery, Paris*.

* A similar object of modern date is in the South Kensington Museum.

It should be remarked that the Chinese and Japanese helmets have remained unchanged during several centuries, so that these arms have not the same interest as attaches to European arms of different historical periods.

THE SHIELD OR BUCKLER.

This portion of the armour, which derives its name from the old German word *Buckel*, boss, and *leder*, leather, and not from the Celtic word *bwa*, to cover, an etymology often assigned to it, was originally called *scilt* in German, but at the present day *schild*.

We have already noticed what were the shapes of the ancient bucklers, and we have seen that they underwent very little variation.

The most ancient shields of the nations of the Germanic race (Franks, Saxons, Alemanni, and Burgundians) were large, square-shaped, and made sometimes of wood, but more often of osier branches covered with bronze plates. During the iron age the bucklers were circular, and usually with a boss in the centre, called in French *ombilic d'umbo*, in German *schildnahel* or *schildbuckel*.

The cover of the Antiphonary of Saint Gregory, which was made in the eighth century and is preserved at Saint Gall, represents combatants armed with small square shields with pointed bosses; but the character of this piece of carving is certainly of earlier date; it is probably taken from a diptych.

The *Leges Longobardorum*, a MS. of the ninth century, represents the king carrying a long German targe, which we meet with again in the fourteenth century; whilst the *Codex Aureus Evangelicus* of the ninth century, as also the *Wessobrunn* MS. of the same date, show us the *rondache* with a boss to it, a shield that is also to be seen in the *Prudentius* and *Psalterium* MSS. of the tenth century, in the Libraries of London and Stuttgart, as likewise in the Bayeux tapestry of the eleventh century, where the pear-shaped buckler, slightly tapering towards the base, and sometimes as high as a man, seems to have been the shield of the Norman, and the *rondache*, or round buckler, that of the Anglo-Saxon warrior.

One may also see in the *Prudentius Psychomachia*, a MS. of

the tenth century, in the Library of the British Museum, Anglo-Saxon warriors armed with circular bossed targets; but a knight in the *Biblia Sacra*, of the tenth century, carries already a small targe, a shield that was not in general use till the reign of St. Louis (1226–1270).

The Duke of Bourchard of Swabia (965) is represented in the basilica of Zurich with a shield not unlike the Norman ones in the Bayeux tapestry mentioned above; and this same sort of shield is borne by a horseman in a bas-relief in the cloister of Saint Aubin at Angers, and by one of the founders of the Cathedral of Naumbourg of the eleventh century. The Count of Barcelona, Don Ramon Berenger IV. (1140), is represented on his seal bearing the same sort of shield that is to be seen in the frescoes in the Cathedral of Brunswick, painted in the reign of Henry the Lion, who died in 1195. These large shields always had two armlets (*Handgriffe* in German), whilst the ancient shields, and more especially the Greek, had only one. The long shields had besides a *guige*, or strap (*Hangband* in German), by which to suspend them from the left shoulder, the point of the shield towards the rear.

The earliest Germanic shields were large and square, but not a single uninjured specimen has reached us. They appear to have been padded inside; the framework was usually made of wood covered with leather, and painted with grotesque figures, while the whole shield was bound round with iron. These shields gave rise to the use of the first armorial bearings, as we have seen in pages 47 and 48 of the historical chapter. Several remains of these shields are represented in the chapter on arms of the iron age, and also the little round buckler of the Franks. The small targe or triangular buckler seldom appears before the thirteenth century in France; that is to say, before the reign of Saint Louis: this shield was as wide as it was long. The buckler used in Germany at this period was larger, as may be seen on the statue of Henri II. on his funereal monument in the Church of Saint Vincent at Breslau. The English buckler of the fourteenth century was very like the small targe, and was only two feet in length. After this the small *rondelle*, or round shield, appears; it was only a foot and a quarter in length, and remained in use till the sixteenth century.

The Burgundian shields of the beginning of the fifteenth century (see p. 291, No. 13) were usually triangular, and reached to the shoulder. The *pavois*, of German origin, in which may be recognised the primitive form of the most ancient Germanic shields, was slightly rounded at the top and square at the bottom, and appears about the fourteenth century.

The long targe,* in wood and skin, of the same epoch, is easily distinguished from the little targe of the fifteenth century, which was hollowed out at the edge.

In the sixteenth century, when in Germany, as well as elsewhere, the shield was almost out of use, may be seen some heart-shaped, but with three points at the top. It was also about this same time, that is, about the end of the fifteenth century, that the *placcates*, the *rondaches*, the *rondelles*, and *targettes* with a hook, were used. Many of these were finished with great care, and bear evidence of master hands having been employed on them. The greater part of the Italian *rondaches* that were chased and ornamented in embossed work were not meant to be used in combat, but were rather part of the pride, pomp, and circumstance of war.

* Targe is derived from the Arab word *dardy* and *tarcha*. At the present day, at Toulon and Marseilles, the shield that the sailors use in naval sports is called a *targe*.

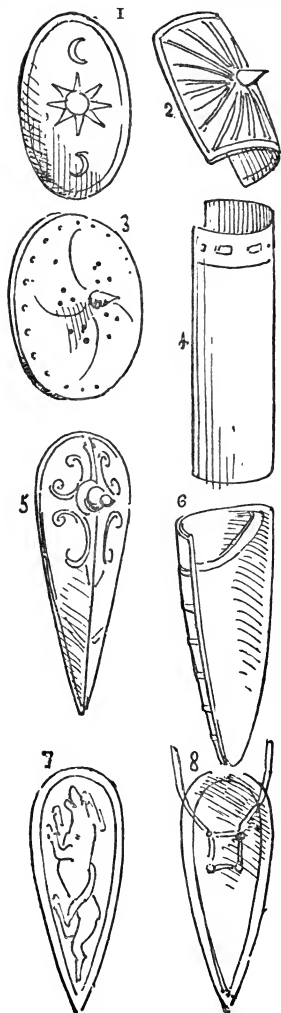

1. Shield, Oriental, (?)^{*} from the Theodosian column erected to the Emperor Theodosius, surnamed the Great, born in 346, died in 396, the year of the commencement of the Eastern Empire.
2. Square and convex shield with boss, from the *Antiphonarium* of Saint-Gall of the eighth century.
3. Shield or *rondache* with boss, in use from the eighth to the eleventh centuries, represented in the MSS. of *Wessobrunn*, A.D. 810; the *Aureus Evangelicus* of St. Emeran, 870; the *Codex Aureus*, ninth century; the *Prudentius Psychomachia* of the tenth century; the *Aelfric* and the *Bayeux* tapestry, etc.
4. Lombard-German targe of the ninth century, from the *Leges Longobardorum*.
5. Buckler of the tenth century, called in France "Norman" buckler, from a statuette in the collection of M. le Comte de Nieuwerkerke.
6. German shield of the eleventh century, from the *Jeremias Apocalypsis*.
7. Norman shield, from the Bayeux tapestry.
8. Norman shield, back view, showing the armlets and the strap, used for suspending it from the left shoulder.

* The crescents do not prove that this shield is of Mussulman origin, for Mahomet was not born till A.D. 570.

9. Small German targe of the twelfth century, 18 inches long, from a coin of the time of Henry the Lion, who died in 1195.



10. German convex shield, about 32 inches in length, from the frescoes in the Cathedral of Brunswick, painted in the reign of Henry the Lion, who died in 1195.

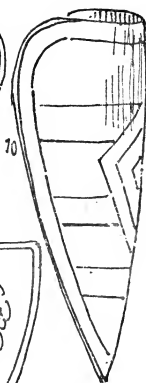

11. German shield, about 2 feet in length, from the frescoes in the Cathedral of Brunswick.



12. Shield of the twelfth century, about 21 inches by 30, from a tombstone found in the convent of Steinbach, now in the chapel of the Castle of Erbach.

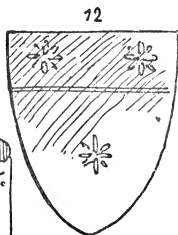

13. Triangular shield, from the MS. of Tristan and Isolde of the thirteenth century. It was also used in the Burgundian equipment of the fifteenth century, as will be seen on reference to the MS. in the library of the Arsenal of Paris.

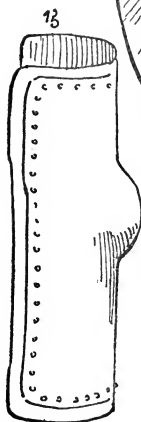

14. Small targe used in the reign of Saint Louis (1226-1270).

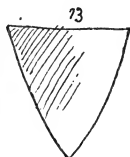

15. Semi-cylindrical targe with round boss, of the thirteenth century, from an illumination of the period in the British Museum. A similar targe, but without the boss, existed in the equipment of the fifteenth century, as a specimen in the same museum proves. (See also No. 4, Lombard targe of the ninth century, preceding page.)

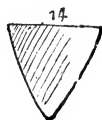

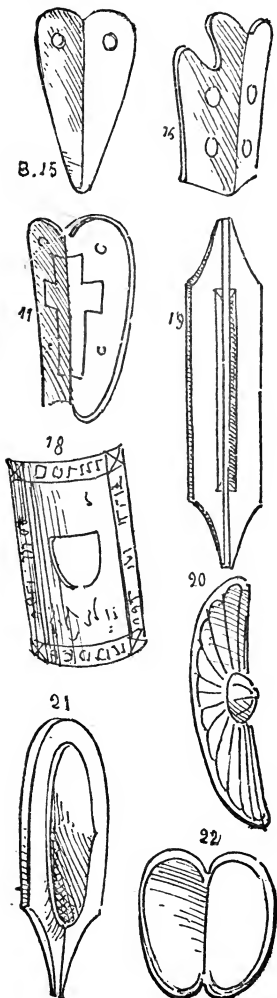

15 B. German targe with sight-holes, of the end of the fourteenth century, from a picture in the church of Saint-Michel at Schwaebisch-Hall.

16. German targe with sight-holes, of the end of the fourteenth century.

Cathedral of Bamberg.

17. Same as above.

18. Spanish targe of the end of the fourteenth century, from a mural painting in the Cathedral of Mondoneda, representing the massacre of the Innocents.

19. German shield, about the height of a man, from the picture of a single combat called the Judgment of God in the *Codex* of the *maître d'armes* of Tolhofer, of the fifteenth century.

20. Spanish shield, from an illumination of 1480.

21. Shield from a woodcut of the fifteenth century.

Cabinet of Engravings at Munich.

22. Hispano-Mussulman shield of the fifteenth century. The Museum of Artillery in Paris possesses a similar targe in leather. (See p. 296, No. 45.)

23. German shield, from the *Theur-danck* published at the commencement of the sixteenth century at Augsburg.

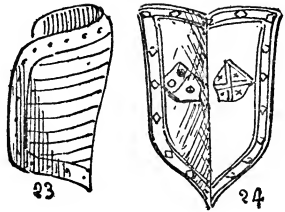

24. Shield in steel of the sixteenth century, about 2 feet high, ornamented with two coats of arms engraved, and studded all round with large screw-heads. *Historical Museum of the Palace of Monbijou at Berlin.*

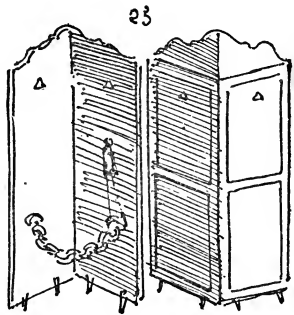

25. German shield, termed *pavois d'assaut* (*Setzschild* or *Sturmwand* in German), 51 inches by 76, of the fifteenth century. It is of wood covered over with leather, painted red and yellow. The points and the inside mountings are of iron. *Museum of Sigmaringen.*



26. German *pavois d'assaut* of the fifteenth century, 44 inches by 72, of wood covered over with leather. The painting, which is in black and white, represents the arms of the city of Ravensburg. *Arsenal of Berlin.*

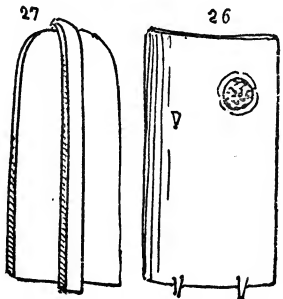

27. German *pavois d'assaut* of the fifteenth century. *Museum of Artillery, Paris.*

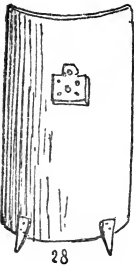
Shields and Targes.

28

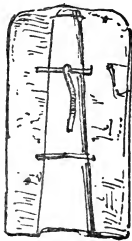

29

28. Swiss *pavois d'assaut*, 72 inches in height, of the end of the fifteenth century.

Arsenal of Berne.



30

- 29 and 30. German *pavois d'assaut*, 26 inches by 45 inches, of the fifteenth century, from the ancient arsenal of Ens, in Austria. The painting is a representation of St. George. Az Collection at Lintz. It is a valuable specimen on account of the beauty of the painting, and its capital preservation.

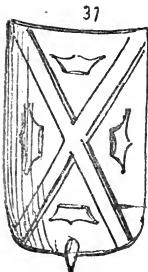

31

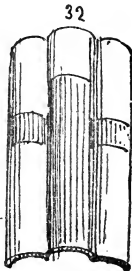

32

31. Swiss or German *targe* (*Tartsche* in German), 19 inches by 40, of wood covered over with leather. It is smaller than the *pavois d'assaut*, is rounded at the bottom, and has only one iron point. It was probably the buckler of an archer.

Arsenal of Berlin.

32. German *targe*, with three longitudinal bosses of wood, covered with hide.

Museum of Sigmaringen.

33. German tilting targe of the end of the fifteenth century; side, rear, and front views. It is of wood and skin, and ornamented with painted decorations, and belonged to the Landgrave of Thuringia.

Cathedral of Marburg.

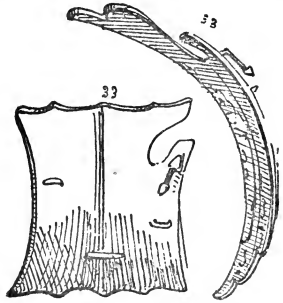

34. German targe of the fifteenth century, in wood and iron, ornamented with painted devices.

Tower of London.

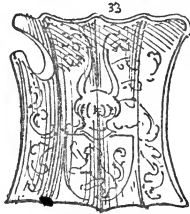

35. German fluted targe of the fifteenth century, 26 inches in length, in wood and leather.

Museum of Artillery, Paris.



36. German tilting targe of the fifteenth century, wood and leather, 14 inches by 16.

Museum of Artillery, Paris.



37. German tilting targe of the fifteenth century, in wood and leather, with an inscription, and painted in polychrome, with the representation of a tournament, which is very remarkable in an archæological point of view, on account of the helmets worn by the knights.

Museum of Artillery, Paris.

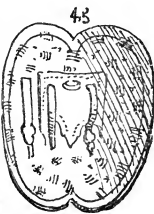
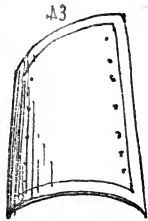
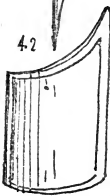
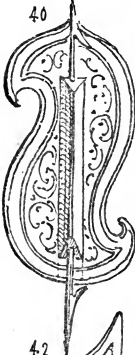
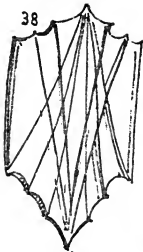

38. German targe in wood and leather, painted and silvered, copied from the water-colour drawings painted by Glockenthon in the first part of the sixteenth century, illustrative of the arms and suits of armour in the Arsenals of Maximilian I.

Ambras Collection, Vienna.

39. Targe, silvered.

Ambras Collection, Vienna.

40. Targe, painted and silvered.

Ambras Collection, Vienna.

41. Targe, painted and gilt.

Ambras Collection, Vienna.

42. Small targe, convex, of the sixteenth century; probably Spanish.

Armerial of Madrid.

43. German targe of the sixteenth century, 32 inches by 36. It is of wood and cloth, decorated with painted designs.

Museum of Cluny.

44. Moorish targe.

Armerial of Madrid.

45. Spanish-Moorish targe (*adarga*), of the end of the sixteenth century, entirely of supple leather, 30 inches by 38. (See No. 22, preceding pp.)

Museum of Artillery, Paris.

46. German target, termed *Rondache*, with gauntlet and lantern, of the fifteenth century. It was used for night combats. I. 35, Museum of Artillery, Paris. In the Arsenal at Hamburg there is a similar target, with a lantern but no gauntlet. (See also at page 301, No. 61.)

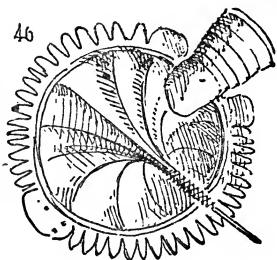

47. Italian target of the fifteenth century, in wood and leather, ornamented with polychrome paintings. The Arsenal of Lucerne possesses twenty-one of these shields, taken by Frischhaus Thelig of Lucerne, in the battle of Jornico (Gornis), in 1478. On it are painted the arms of the first Duke of Milan, Giovanni Galeazzo Visconti, whose initials, surmounted by a crown, are visible.



48. German target of the end of the fifteenth century, from the water-colour drawings of Glockenthon, mentioned above.

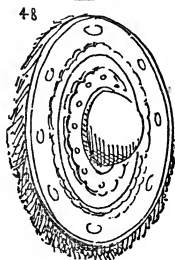

Ambras Collection.

49. English target of the beginning of the sixteenth century. In the centre of this shield there is a small hand-cannon, with sliding chamber and match, something like a *veuglaire*. The Tower of London possesses twenty-five of these targets, mention of which is made in the inventory made in the reign of Edward VI. (1547).

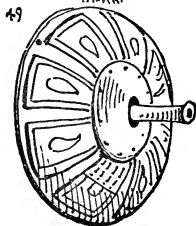

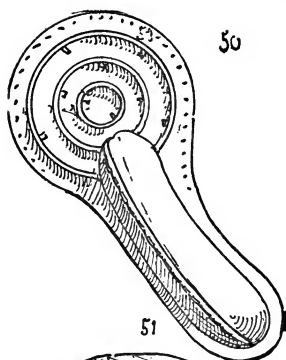

50. Small target with sword-breaker and arm-guard, in one piece of iron.

Museum of Artillery, Paris, and Imperial Arsenal of Vienna.



51. Italian target of the sixteenth century; it seems only for show. It is in high-relief embossed work, and in one single piece.

Museum of Turin

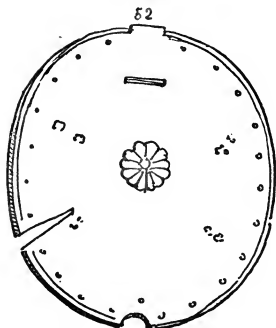

52. Target of foot-soldier in blackened steel, size 2 feet by 1½, of the seventeenth century. This shield, which weighs 12 lbs., has a sight-hole and a slit for the sword.

Meyrick Collection,

[Engraved in reverse.]

53. Italian shield of the sixteenth century, 28 inches in length, with a sword, 20 inches in length. The engraving represents the back view.

Museum of Dresden.

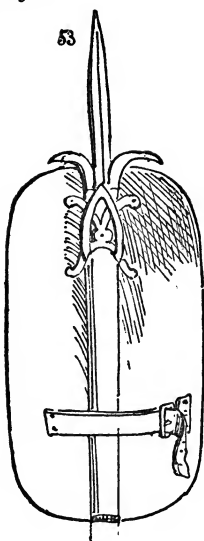

54. German shield of the sixteenth century in blackened iron, about 20 by 24 inches. It is in the shape of a heart, the centre part curving inwards.

Collection of the Castle of Löwenberg or Wilhelmshöhe, near Cassel.

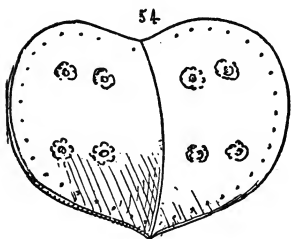

55. Small round German hand shield of the fifteenth century, from engravings of the time.

Cabinet of Engravings at Munich.

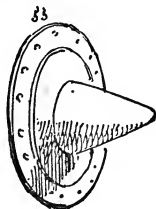

56

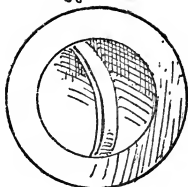

56. Small hand shield of the middle of the fourteenth century, called *pavoisienne*, from a carving on a comb made at that time. 1 foot $\frac{1}{2}$ inch in diameter.

57



57. Small German hand shield, about a foot in diameter, of the end of the fifteenth century.

Arsenal of Munich.

58

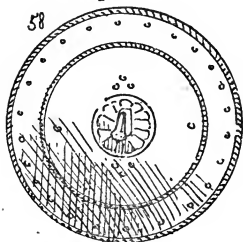

58. Small hand shield with hook for sword - breaking; it measures about 11 inches diameter, and is of the end of the fifteenth century.

Meyrick Collection.

59

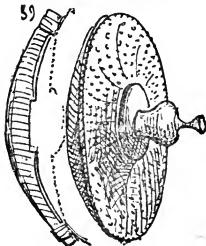

59. Small hand target in steel of the fifteenth century, about 10 inches in diameter. It is said to have belonged to the Earl of Richmond (Henry VII. of England, 1485).

I. 5, Museum of Artillery, Paris.

60. Turkish small hand shield of iron, of the sixteenth century. The word *Allah* (God) is engraved on it. Many arms coming from the Arsenal of Mahmoud II. are similarly marked. Historical Museum of the Palace of Monbijou at Berlin. A similar object exists in the Erbach Museum.

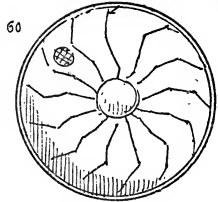

61. Iron hand shield, German, about 14 inches in diameter. It has a dart and a lantern, which shows that it was used at night. Museum of the Guelphs at Hanover. See page 297, No. 46, for *targets with lanterns*.

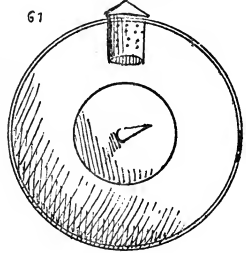

62. Small German hand shield of the sixteenth century, from the *Triumph of Maximilian*, by Bureckmayer (1517).

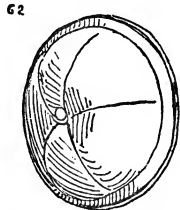

63. Small hand target made of the elk's horn, with an iron escutcheon; belonging to the second half of the fifteenth century.

I. 4, *Museum of Artillery, Paris*.

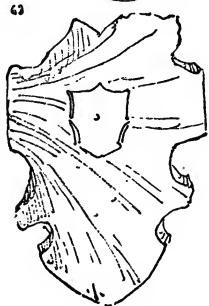

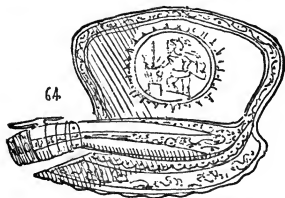

64. Small German target with gauntlet, of the first half of the sixteenth century. It belonged to the Count of Henneberg, and is now at Meiningen in Germany.

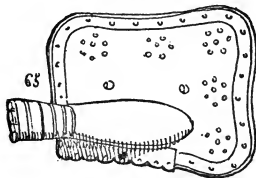

65. German target with gauntlet, of the sixteenth century.

Museum of Turin.

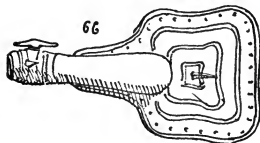

66. German target with gauntlet and hook for breaking the adversary's sword; of the sixteenth century.

Historical Museum in the Palace of Monbijou at Berlin.

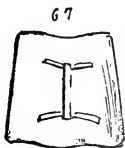

67. Small German hand target with a hook for breaking a sword, about $8\frac{1}{2}$ inches in size. Meyrick Collection. The engraving represents both sides. A similar one exists in the Collection of M. le Comte de Nieuwerkerke.

68. Small German hand target of the end of the fifteenth century. (Exterior view.)

Historical Museum of the Palace of Monbijou at Berlin.

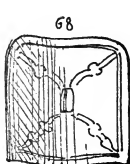
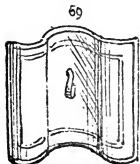

69. Small German hand shield with hook for breaking the adversary's sword, of the end of the fifteenth century.

Museum at Erbach.

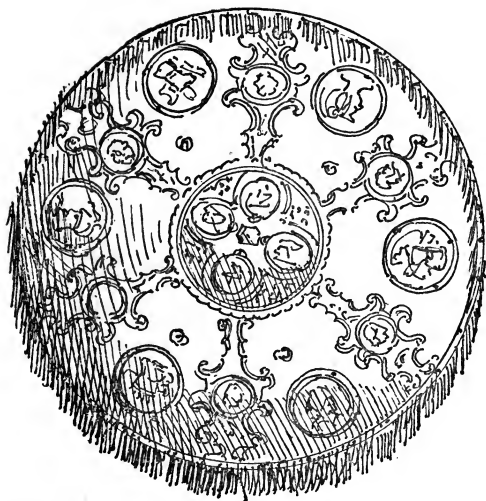

70. German pageant shield of the sixteenth century, made at Augsburg. It is ornamented with medallions and trophies in embossed work, very beautifully executed. The fringe all round is fastened with screws and is quilted at the back.

Ambras Collection, Vienna.



71. German pageant shield of the sixteenth century, probably made at Augsburg. The ornaments on this shield, which are very beautiful, indicate by their workmanship that the shield was made at the end of the sixteenth century or beginning of the seventeenth. The trophies are like the work of the French artists of the reign of Henri IV.

Ambras Collection, Vienna



German pageant shield in embossed iron, of the sixteenth century; it belonged to Charles V. This piece of defensive armour, which is one of the most perfect specimens of this style of German art, has been several times counterfeited and sold at a high price to purchasers who have not seen the original. One of these imitations was brought into France and purchased by the late Baron of Mazis, to whom it had been represented as a first-rate Italian work of art. The real shield, which is in the Ambras Collection, is, however, characterized by a beauty of design and a delicacy of workmanship which disheartens even the cleverest imitators. The subjoined sketch gives but a very imperfect idea of the beauty of this artistic work.

It has been already stated that these sorts of arms were not intended as instruments of warfare, but only to be worn on gala days, when the nobles rivalled one another in the magnificence and artistic richness of their equipments.

Italy was especially famous for this kind of work during the whole period of the Renaissance, and her most favoured and celebrated artists furnished designs, and often themselves manufactured these splendid arms, which now embellish collections by their beauty of design and exquisite finish, but which hardly answer the purpose for which weapons are generally made.



German pageant shield in embossed iron, of the sixteenth century. Its execution is of the most finished nature, and the design may be taken as a characteristic type of a master engraver's composition in Germany at that period.

Ambras Collection at Vienna.

COATS AND CUIRASSES.—HAUBERKS OR COATS OF MAIL, RINGED, RUSTRED, MACLED, AND TRELLISED.—COATS OF MAIL AND SCALE ARMOUR. — BRIGANTINE JACKETS. — GAMBOISONS. — BISHOPS' MANTLES OR MAIL TIPPETS.—CUIRASSES, BUFF COATS, ETC.

The history of the changes in armour during the Middle Ages, the Renaissance, and the seventeenth and eighteenth centuries has been already treated of in the second chapter of this work, but the different kinds of armour have yet to be described.

The coat of mail (from the German *Kutte*), which preceded the armour composed of plates, either of leather or steel, was called hauberk (from the the German *Halsberge*), neck-protector; it was also called *Brünne*, *Brunica*, and *Panzerhemd*. The small hauberk, which afterwards became the dress of the squire or of the poorer class of gentlemen, was in the eighth century worn by all knights, as the *Codex Aureus* of Saint Gall bears evidence. This hauberk was a kind of jacket in scales, which did not descend much lower than the hips, the sleeves of which were rather loose, and ended before reaching the elbow. The large hauberk, in the shape of a frock, and with the "camail" or hood, at first reached just to the knee, and the sleeves or loose arm-guards a little below the elbow, like the hauberk represented in the Martyrology, a manuscript of the tenth century in the Library of Stuttgart, and also in the Aelfric, an Anglo-Saxon manuscript of the eleventh century in the Library of the British Museum. As for the equipment of the German knight in the "Jeremias Apocalypsis" of the eleventh century, in the Library of Darmstadt, it is a hundred and fifty years in advance of what we know to have been worn at that time; for according to the embroidery on the mitre of Seligenthal and the Bayeux tapestry, which are both of the eleventh century, the large hauberk, which the "Jeremias" represents as having already long sleeves, with hose and leggings in separate pieces, was still worn in all other countries perfectly close-fitting, the leggings in one piece with the hauberk, and the sleeves short. The defensive armour of this German knight in the "Jeremias" of the eleventh century does not appear either in England, France, or Spain, until the twelfth, when similar

costumes may be seen on the seals of Richard I., Cœur de Lion (1157–1173), of Louis VII. the younger (1137–1180), and of the Count of Barcelona, Don Ramon Berenger IV. (1140).

The hauberk, before the use of mail became universal, was made in many different ways. The most ancient was probably the ringed hauberk (*Beringt*), in which the defence consisted of rings of metal sewed flatly, side by side, on coarse leather, or padded stuff. The "rustred" hauberk (*Bekettet*) was protected by oval flattened rings, overlapping each other half way.

The "maeled" coat (*Beschildet*) was composed of small lozenge-shaped plates of metal.

The trellised coat (*Benagelt*) was made of leathern thongs trellised in and out over the stuff or skin of which the coat was composed; each interstice was strengthened with a riveted nail-head.

The "jazeran," or "korazin,"* was the large *imbricated* hauberk, that is to say, covered with overlapping (*Geschuppt*) plates, like the small hauberk of the eighth century, of which we have already spoken.

The coat of mail, or chain mail hauberk (*Ketten*, or *Maschenpanzerhemd*), was composed entirely of mail, generally in iron, without a lining of leather or stuff, and without either a right or wrong side; it thus formed a complete tissue of iron which might be put on like a shirt, the rings of which were riveted piece by piece, and were called *grains d'orge*.

There are two kinds of this work, the single and double mail; Chambly (Oise) was celebrated for the manufacture of the latter. The double mail, like the single, always shows us each ring joined to four others.

The coat of mail in France dates much farther back than the time of the Crusades. to which date most compilers consider it incumbent on them to assign it. It was not the Crusaders who, on their return from Jerusalem, were the first to introduce it into their country; the coat of mail was well known before the eleventh century. The Byzantine princess Anna Comnena was acquainted with it only from seeing it worn by northern warriors. (See her *Memoirs*.)

* The name is probably derived from Khorassan, a country in the Empire of Persia.

The coat of mail is still worn by the Indians, Persians, Chinese, Japanese, Mongols, Mahrattas, Polygars, Circassians, and other people whose civilisation is still rather backward. These coats are often without rivets, like the counterfeit Parisian coats, but there are also riveted coats of Persian and Circassian manufacture; all this, however, has no interest in an archæological point of view.

The "jacket" was a kind of small hauberk, not descending further than the hips, and made in various ways, like the large hauberk.

The "brigantine" was a jacket composed of small plates of metal, somewhat in the style of the *maeled* coats, and imbricated; these plates were riveted underneath the stuff, so that the outside, generally made of velvet, lined with linen, shows a quantity of small rivets, like copper-headed nails; thus the armour is next the body. The brigantine jacket (*Italiänische Panzerjacke*) was most generally worn in Italy during the fifteenth century. It was the favourite coat of Charles the Bold.

By the *gamboison*, or *gambeson*, was meant the doublet of leather or linen cloth without sleeves, and quilted so that it was entirely covered with stitches. The high *gamboison*, with cuishes and leggings, which in the fourteenth century was worn under the earliest suits of plate armour, and the only specimen of which is at present in the Museum of Munich, was also in leather or linen lightly quilted, and was worn with the breastplate, waist-piece, and the sides of the knee-plates armed with mail, so as to compensate for the defects of the armour. The bishop's mantle, or mailed cape, was often worn over the cuirass, particularly in Italy during the fifteenth century.

The cuirass (*Kürass*), from the Italian word *corazza*, derived from the Latin *corium*, probably on account of the first Roman cuirasses having been made of leather, was composed of two pieces: the breastplate (*Brustplatte*), to protect the chest; and the back-plate (*Rückenplatte*), to protect the back. The line down the centre of the breastplate is called *tapul* (*Graete*), centre-ridge, or salient ridge.

The breast- and back-plate are generally fastened together by leather straps passing over the shoulder and gorget. The shape of the cuirass, as also of the other pieces

of a suit, always enable us to fix its date and place of manufacture with tolerable certainty. The Gothic breast-plates, as well as those of the beginning of the sixteenth century, are sometimes pointed, and sometimes more or less rounded, but generally imitate the peaceful costume of their respective times.

The reader will find fuller information respecting the various changes undergone by the cuirass in the historical chapter, as well as in that one which treats of armour in general, while the engravings in the present chapter represent in their order of date all the different sorts of cuirasses in use up to the time of their being superseded (from about 1620—1660) by buff coats or jerkins (German, *Koller*; French, *buffletin*), an article of costume made generally of deer-skin, and furnished with a metal gorget.

1. Specimen of the ringed coat (*Beringt*), composed of flat rings sewed side by side on quilted linen or leather.

This kind of coat is very difficult, if not impossible, to distinguish from the maced coat, in the illuminations of different manuscripts. (See plate No. 4.)

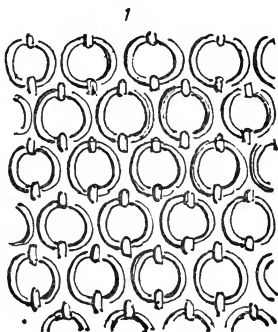

2. Specimen of rustred coat (*Bekettet*). Here the flat rings are oval, and overlap each other half way.

This sort of coat, in which the rings do not really interlace, is represented in illuminations as actual chain armour.



3. Specimen of maced coat (*Beschildet*). This is composed of small lozenge-shaped plates of metal, sewed on a foundation of cloth or leather, and sometimes overlapping each other half way.

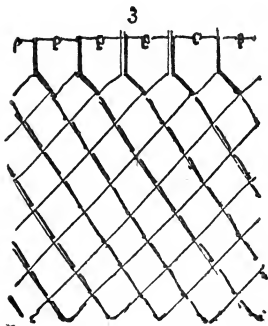

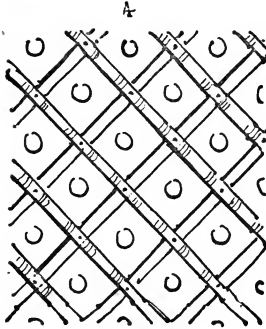

4. Specimen of trellised coat (*Gegittert* and also *Benagelt*). This coat is made both of quilted linen and skin, strengthened with straps of thick leather, placed trellis-wise; each square is armed with a riveted nail-head. It is difficult, in the illuminations on manuscripts, to distinguish the trellised from the ringed coat.

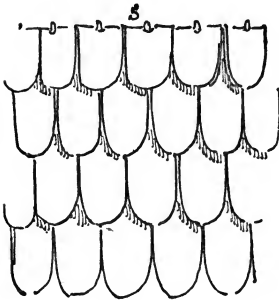

5. Specimen of scaled or imbricated coat (*Geschuppt*). It is also called *jazeran* and *korazin*. The armour consists of scales of metal sewed by rows, so as to overlap each other, on quilted linen or on leather.

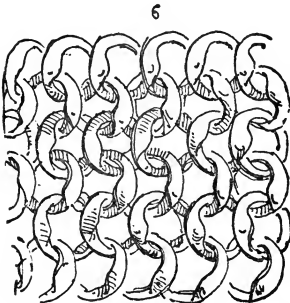

6. Specimen of coat of mail in riveted rings, called *grains d'orge* (*Genietetes Ketten* or *Maschengevebe*). Being entirely formed of metal rings, the coat of mail has neither wrong side nor lining.

7. Small hauberk or jacket* of the eighth century (*Kleines Panzerhemd*) in overlapping scales of metal, a kind of armour which is known under the name of *jazeran* or *korazin*, a name probably derived from Khorassan, a country in the Persian Empire. Codex Aureus of Saint Gall, eighth century.

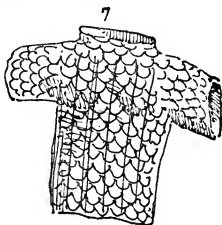

8. Great hauberk (*Brünne* or *Ganzes Panzerhemd*), ringed. From the Martyrologium, a manuscript of the tenth century, in the library at Stuttgart. It has the camail and close-fitting short sleeves.



9. Great Norman trellised hauberk of the eleventh century. It has a movable camail and short sleeves.

Bayeux Tapestry.

* Some coins of Magdeburg, dating about 1150—1160, as well as some older coins of Germany, have representations of coats engraved on them, on which we can easily recognize the *imbricated* or curved scales of far larger dimensions which formed the material of the hauberks of the knights painted on the walls of the Cathedral of Brunswick in the eleventh century. The earliest instance of an *imbricated* hauberk is one in the Codex Aureus of Saint Gall, about the eighth or ninth century, represented above.





17

11. German hauberk of the eleventh century, with fixed hood, cuisses, and leggings, from the *Jeremias Apocalypsis*, preserved in the library at Darmstadt.

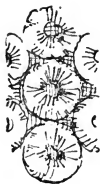

72

12. Gamboison, or gambeson (*Gehörter leinener Unterpanser*). A sort of coat or jacket of the sixteenth century, made of linen quilted and embroidered. The gamboison was generally worn under the cuirass.

Cluny Museum, and Renné Collection at Constance.

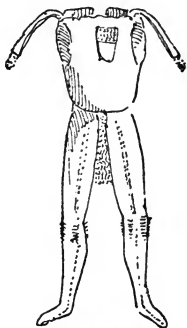

13

13. Gamboison of the fourteenth century, with fixed cuisses and legging. It is of quilted linen, fitted with mail at the breast, waist and knees.

The only known specimen, from which this drawing has been taken, is in the Museum of Munich.

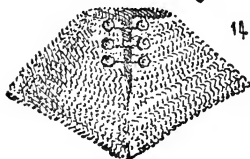

14

14. Venetian mail cape, called bishop's mantle (*Bischof's Mantel*), with which the Doges were armed; it was also worn in Germany during the fifteenth and sixteenth centuries. Renné Collection at Constance, but supposed to have come from the Dresden Museum.

15. Gorget with sleeves in chain mail, of the fifteenth century.

Dresden Museum.



16. Brigantine jacket (*Italiünische Panzerjacke*) of the fifteenth century. The trilobed scales, No. 17, are stamped with the fleur-de-lys, and riveted, overlapping each other on the velvet doublet of which they form a metal lining.

Museum of Darmstadt.

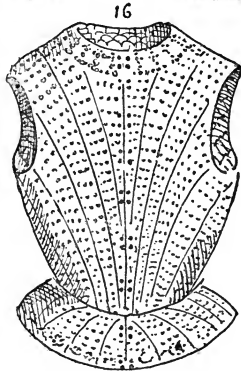

17. Trilobed scale of armour belonging to the above described brigantine, nearly the actual size.

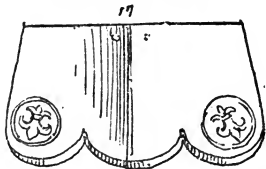

18. Scales of a brigantine, stamped with lions (probably the armourer's mark), in the author's collection. Many museums and collections have exhibited this piece of defensive armour on the wrong side. The error arises from presuming that the stuff, whether velvet or linen, should be worn next the body. The curve of the scales, however, shows on which side the brigantine was worn. This mistake is found in the Museums of Dresden, Cluny, the Ambras Collection, etc.

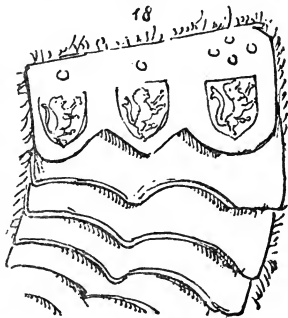

19

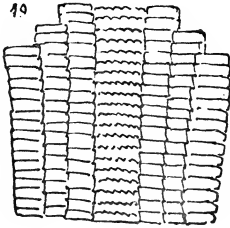

19. Breastplate of brigantine, fifteenth century, composed of small plates of steel. It is exhibited in the Cluny Museum on the reverse side, as it is here drawn.

20

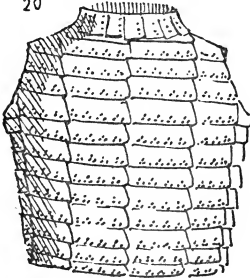

20. Brigantine of the fifteenth century, composed of small steel plates, exhibited on the reverse side at the Musée d'Artillerie, Paris. No. 127. Similar specimens may be seen in the Museums of Sigmaringen and Munich.

21

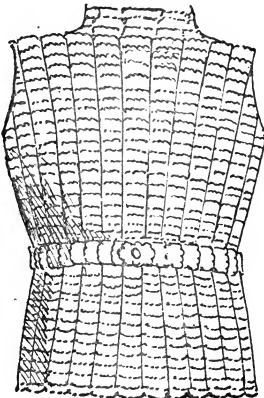

21. Brigantine of the fifteenth century, composed of trefoil-shaped imbricated scales. This specimen is remarkable on account of its waist-piece, which protects the thighs below the hips. Dresden Museum. The Ambras Collection also possesses a similar brigantine, and both museums have exhibited it on the reverse side.

22. Jacket in imbricated plates of steel, with collar and arm-guards in chain mail, fifteenth century. The scales of this armour are not riveted on to any material, like the brigantine, but riveted to one another, with lining of stuff or skin, so that it resembles a coat of mail.

Erbach Collection.

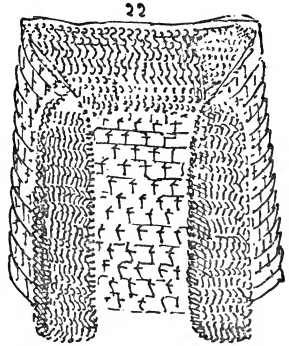

23. Scales of the preceding jacket, drawn half their actual size.

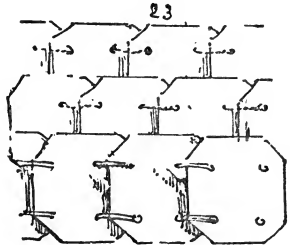

24. Coat of mail of Jean Ziska (died 1424), from an old picture, probably painted from a drawing of that time and preserved in the library at Geneva. The coat and breastplate are in iron, but the mail of the gorget and the surrounding rims are of copper.

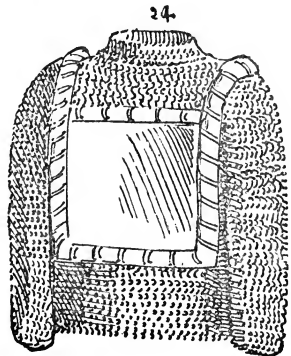



25. Coat in steel plates, from a Persian manuscript of about 1600. This copy of the *Schah Nameh*, or Royal Book, a poem composed by Ferdusi in the reign of Mahommed the Gaznevide (999), is ornamented with 215 beautiful illuminations, and is exhibited in the library at Munich.

26. Persian hauberk in chain mail, with sleeves, cuisses, and leggings, from the same manuscript.

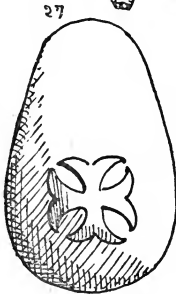

27. Polished steel plate or scale, rather smaller than the actual size, from the *jazeran* or imbricated jacket of Sobieski (1648 to 1696), exhibited in the Dresden Museum. Many of these scales are ornamented with crosses in gilded copper, which are riveted on. See in the chapter on helmets the pot-helm belonging to this same suit.

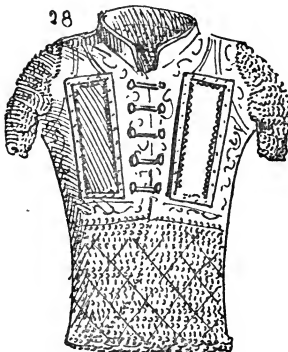

28. Mongolian coat of steel plate armour. Early part of the eighteenth century. The links are without rivets.

G. 138, *Museum of Artillery, Paris.*

29. Polygar coat of mail. Meyrick Collection. This armour is remarkable on account of the points round the collar descending on to the shoulders.

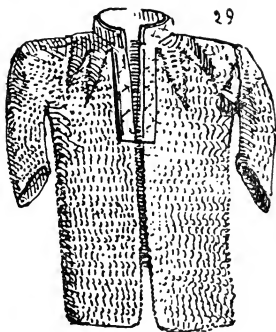

30. Indian coat. Meyrick Collection. The straight collar appears to indicate a comparatively modern origin.

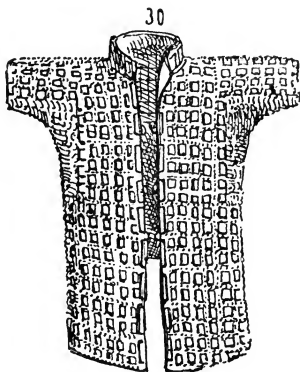

31. Indian coat in rhinoceros hide.* This armour, which is ornamented with inlaid plates, has a very modern, and far from graceful character about it. The Musée d'Artillerie at Paris possesses a few similar Eastern coats.

Meyrick Collection.

* According to the Meyrick Catalogue, this kind of armour is manufactured at Mundavien, in the Gulf of Cutch, in Western India. The coats, like the round bucklers, are made with rhinoceros and buffalo hides, boiled in oil.

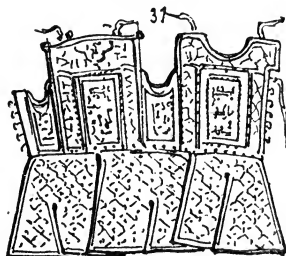

32



32. Saracenic coat of mail; sixteenth century; back view. It is doubled at the back with a plain and pointed hood, which serves both as a protection to the shoulders and also as a "camail," or hood. This coat, exhibited in the Musée d'Artillerie, Paris, is short, reaching only a little below the hips.

33

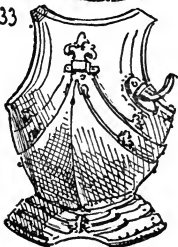

33. Gothic cuirass with salient ridge (*Graete*) and lance rest; fifteenth century. Ambras Collection. This is the most elegant form of cuirass.

34

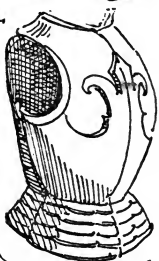

34. Gothic cuirass, fifteenth century, without lance rest, with scaled back plate and waist-piece.

Arsenal of Zurich.

35

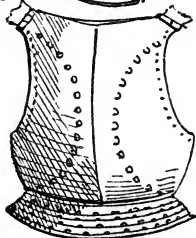

35. Cuirass with salient ridge, fifteenth century, in iron, and very heavy, covered with red velvet, and studded with iron-headed nails.

National Museum of Bavaria, at Munich.

36. Gothic cuirass without salient ridge, very rounded, and believed to belong to a German suit, end of the fifteenth century. Arsenal of Maximilian I., from drawings by Glockenthon in 1505.

Ambras Collection.



37. Semi-rounded cuirass without *tapul*, or salient ridge, of a German suit, in embossed iron; end of the fifteenth century.

Meyrick Collection.

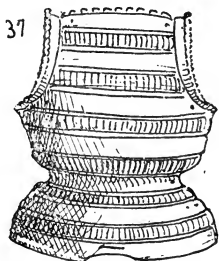

38. Semi-rounded cuirass without *tapul*, but with lance rest, of a German fluted suit; end of the fifteenth century. It is called "Maximilienne" and Milanese; the shape is very beautiful, the waist-piece large, and does not end with the tassets, as is usually the case, the tassets in this instance being joined to the rest of the suit.

Arsenal of Vienna.

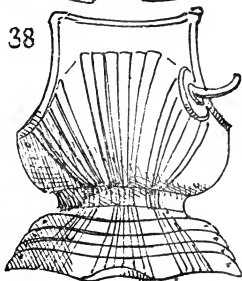

39. Semi-rounded cuirass without *tapul*, part of a German suit; end of the fifteenth and beginning of the sixteenth century.

G. 5, *Musée d'Artillerie, Paris, and also in the Collection of the Count of Nieuwerkerke.*

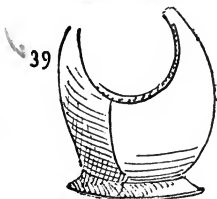

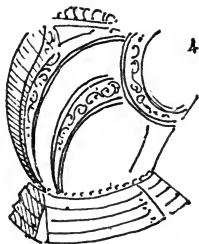

40

- ✓ 40. Semi-rounded cuirass with *tapul* and waist-piece; first half of the sixteenth century; part of a German suit of armour belonging to the Landgrave Philip the Magnanimous (died 1567).

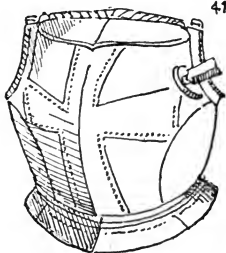

41

41. Semi-rounded cuirass with *tapul* and lance rest; first half of the sixteenth century; part of a suit belonging to a knight of the order of St. George.

Meyrick Collection.

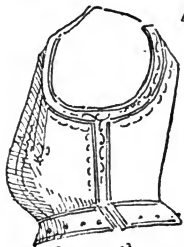

41

42. Cuirass with lance rest, but without *tapul*; part of a German suit; middle of the sixteenth century. Count of Nieuwerkerke's Collection. In the arsenal of the city, Vienna, there are many similar suits, which formerly belonged to the civic troops of this town, and all bear the date 1546.

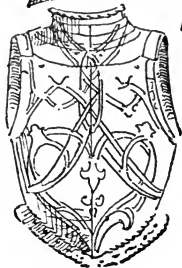

43

43. Cuirass with *tapul*; part of a Nuremberg suit, of the year 1570.
Imperial Arsenal of Vienna.

44

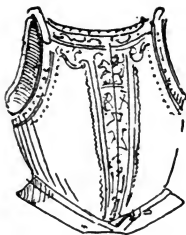

44. Italian engraved cuirass with *tapul*; end of the sixteenth century.

*Ambras Collection.**

45

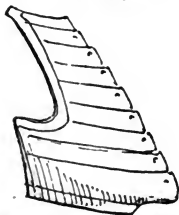

45. Cuirass in plates, and with *tapul*, peascod-shaped, or like a Punch's hump (*Gänsebauch*); end of the reign of Henry III. (1589).

46

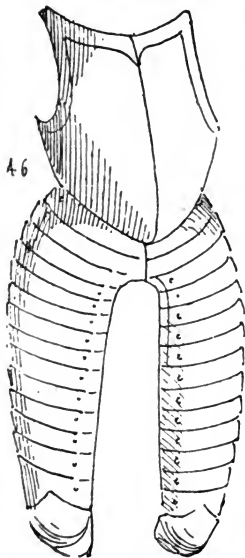

46. Italian cuirass with buttons and peascod-shaped *tapul*.

Count of Nieuwerkerke's Collection, and M. Süter's Collection at Augsburg.

47

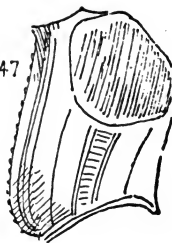

* The cuirass of the suit of armour in the Louvre, attributed to Henry IV. of France, is of a similar shape; the waist-piece is composed of three large metal plates.

48

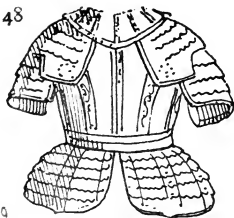

48. Half armour in engraved iron, ornamented with gilt nails; latter half of the seventeenth century; preserved at the Arsenal of Soleure, where it is wrongly attributed to Vengli (1550).

49

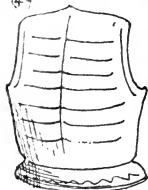

51



49. Cuirass in plates belonging to a German *Reiter*; middle of the seventeenth century. Some German authors have called these suits of plate or scaled armour *Krebse*, or crabs.

50

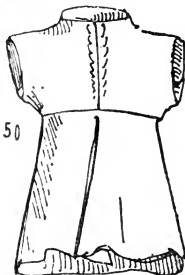

50. Buff coat (*Koller*, German; *buffletin*, French), of deer-skin; time of the Thirty Years' War, and reign of Louis XIII. of France (1618 — 1640). G. 162, Musée d'Artillerie, Paris. The Imperial Arsenal of Vienna possesses the buff coat which Gustavus Adolphus wore when killed at the battle of Lutzen.

52

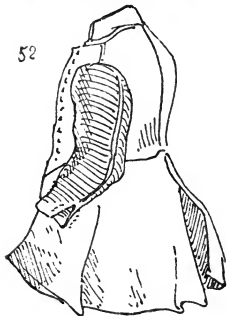

51. Collar in russet steel belonging to the buff coat No. 50.

52. Cuirassier's buff coat with sleeves, of 1650.

53. Persian leather cuirass, probably of the sixteenth or seventeenth century. This piece of armour, which is inlaid and quilted, resembles very much the cuirasses of the janissaries, mentioned below.

Meyrick Collection.

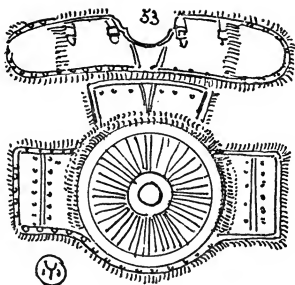

54. Janissary's* cuirass; sixteenth century. G. 134, Musée d'Artillerie, Paris. This piece of armour is stamped with a mark, which is drawn near plate 53. This is the monogram or device by which the Turks represent the name of Allah (God). See the observation concerning this mark in the chapter on shields.

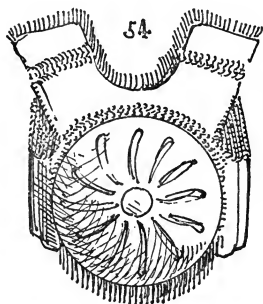

55. Janissary's cuirass; seventeenth century. G. 133, Musée d'Artillerie, Paris. Same observations as the preceding number.

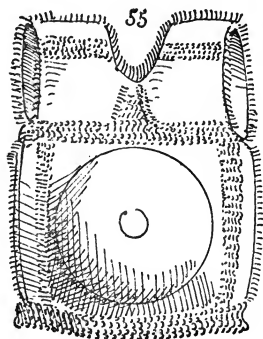

* The janissaries (a name derived from the two Turkish words, *ieni tcheri*, signifying new soldiers) composed the infantry of the Turkish militia. They were organised in 1362 by Amurath I, and almost all massacred in 1826.

THE ARM-GUARD.

The arm-guard, properly so called (German, *Armschiene*; French, *brassard*), did not form any essential part of ancient armour; but it has been ascertained to have been in some instances used by the ancient nations as well as by barbarians during the brazen age; it was then in the form of a screw, as already shown above.

During that part of the Middle Ages when plate armour was not yet invented, the coat of mail often had sleeves which formed a protection for the arm. These terminated in the chain mail mitten, or gauntlet without fingers, and were superseded at first by boiled leather plates, and later by steel ones. There were both single and double arm-guards, and also the arm-guard complete, which protected the upper and lower portion of the arm, and was joined together by the elbow-piece. The large tilting arm-guards of the fifteenth and sixteenth centuries were used only for the left arm, and had often a fixed gauntlet without joints; they were generally worn instead of the *manteau d'armes*. The shape and size of the elbow and shoulder pieces are always a help towards recognising the date of a complete arm-guard, which was generally hinged, and protected the arm entirely.

1. Arm-guard with mitten (*Arm-schutz mit Maschen-Fausthandschuh*) of a coat of mail.



2. Complete Gothic arm-guard with elbow, upper arm-piece, and gauntlet, from a monument of 1460 in Oxfordshire. The elbow-pieces are very large.



3. Gothic arm-guard with elbow and upper arm-piece, to protect the upper and lower part of the arm; middle of the fifteenth century.



4. *Id.*, *id.*

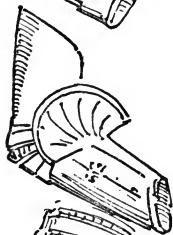

5. Complete arm-guard, protecting, like the preceding ones, the upper and lower part of the arm. It is ornamented with bands of embossed work, which, as well as the shape of the elbow-piece, indicate the end of the fifteenth century or the beginning of the sixteenth, for these kinds of armour were contemporaneous with the fluted suits called Maximilian and Milanese armour.

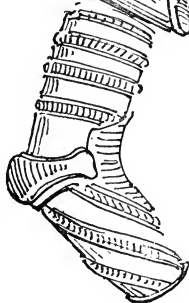

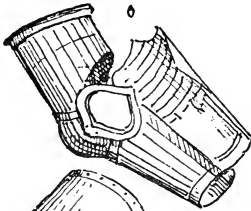

6. Arm-guard, with elbow and upper arm-piece; part of a fluted or Maximilian, suit of armour end of the fifteenth, or beginning of the sixteenth century.

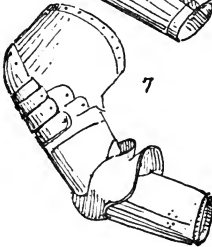

7. Arm-guard, with elbow and upper arm-piece; end of the sixteenth century.

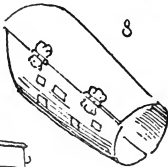

8. Lower-arm guard: the inner arm-plate is pierced with eight square holes.

Spengel Collection at Munich

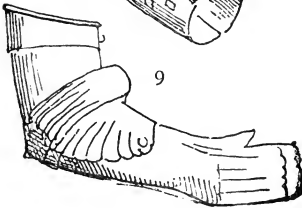

9. German tilting arm-guard, with mitten, for the left hand; end of the fifteenth century.

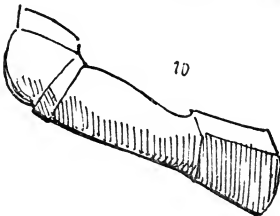

10. German tilting arm-guard, with mitten, for the left hand; beginning of the sixteenth century. All these guards protected the upper and lower arm.

THE GAUNTLET.

The shape of the gauntlet or armed glove (*Kampfhandschuh* or *Gefingerte Handtätze* in German), which covered not only the hand, but part of the arm, is, as well as the soleret or shoe, a great help towards the classification of a suit of armour, for both one and the other have undergone great changes. It appears to be tolerably certain that the use of the gauntlet proper does not date farther back than the end of the thirteenth century. The Martyrologium, the Prudentius Psychomachia, the Biblia Sacra, the Aelfric, the Jeremias Apocalypsis, the embroidery on the mitre of Seligenthal, and the Bayeux tapestry, authorities which have already been cited, and which date from the ninth to the end of the eleventh century, always represent the warrior with bare hands, but the seal of Richard Cœur de Lion (1157-1173) shows the hand of the king already protected by a sort of continuation of the chain mail sleeve, forming a bag or mitten, in which the thumb alone has a separate place. A warrior in the illustrations of the German *Æneid* of Henry of Waldeck, thirteenth century, with a crested heaume, and riding a horse covered with ringed or trellised armour, has the hand covered with a mail mitten, or with a continuation of the sleeve of the coat, which seems to be trellised if not already plated.

The first real gauntlet had separate fingers, and was covered with scales, plates, or some other overlapping plates of iron; the back of the hand was protected by a plate of metal or leather, such as is represented on the tombstone of the King of the Romans, Günther of Schwarzburg, carved in 1352, in the Cathedral of Frankfort, where this prince was poisoned in 1349. We recognise this kind of gauntlet in an Italian painting of the fourteenth century, in the possession of M. Odet at Sitten. The illuminations in a manuscript of Roman history preserved in the Library of the Arsenal at Paris, probably executed at the beginning of the fifteenth century for the Duke of Burgundy, still represent all the men-at-arms with their hands protected only by the mitten, made by a continuation of the mail sleeve, which

shows how far the Burgundian equipment was behind that of other nations.

The mitten (*Fausthandschuh*), a kind of gauntlet in which the fingers were not separated, and with plates of steel placed so as to move with the principal movements of the hand, makes its appearance in the fifteenth century. The armour of Joan of Arc, in the catalogue of Dezest, the bronze statuette of William VI. (1404-1417) at Amsterdam, and the armour of Frederick I., Palatine of the Rhine, preserved in the Ambras Collection at Vienna, show that the mitten was everywhere used during the first half of the fifteenth century, but it is to the articulated gauntlet that Bayard's favourite proverb applies, "Ce que gantelet gagne, gorgerin le mange," also the terms of "throwing the gauntlet" and "raising the gauntlet," which in the fifteenth century occur in the French language.

There are, however, some German suits of armour where the gauntlets have already separate spaces for the fingers, like those in the Museum of Sigmaringen, and a large number of suits of the second half of the fifteenth and beginning of the sixteenth century, more especially tilting suits, are provided with mittens. See the harness of Maximilian I. (1459-1519) in the Ambras Collection and in the Imperial Arsenal of Vienna.

The articulated gauntlet came into general use towards the end of the fifteenth, and not in the middle of the sixteenth century, at the time when the pistol made its appearance, as compilers insist; nevertheless almost all the fluted suits of armour have the inarticulated gauntlet. The gauntlet with separate fingers—in which the fore-finger has fifteen, the ring finger sixteen, and the middle finger has twenty-two small plates or scales, while the reverse or outside of the glove is composed only of three or four plates—was in use contemporaneously with the mitten, but after a little while this latter fell into disuse and disappeared. Several of these gauntlets were provided with a screw ring on a pivot, by which means the closed hand might be fixed on to the sword or handle of the hammer, like the curious specimen which the Imperial Arsenal of Vienna possesses, and which forms part of a suit of armour attributed to Charles V.

Several of these iron gauntlets are studded with nail-heads

placed on the outside of the glove, and in inverted positions, but the reason of these excrescences is not known to us.*

The tilting gauntlet arm-guard, for the left arm, was a piece of defensive armour which belonged to the latter half of the fifteenth century. About a hundred years later were worn the "gauntlet tilting shield," the "sword gauntlet," and the "gauntlet for bear-hunting." The last articulated gauntlet was soon afterwards replaced by the glove with deerskin gauntlet, such as was worn during the Thirty Years' War.

In England, however, during part of the seventeenth century, gloves armed with scales were worn; a specimen of which is to be found in the Meyrick Collection.

* They served probably to increase the power of a blow from the fist, being analogous to the *cestus* of classic, or "knuckle-duster" of modern times.—TRANSLATOR.

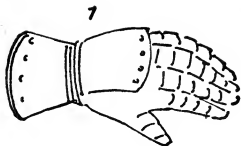

1. Gauntlet with separately articulated fingers (*Gefingertes Kampfhandschuh*, or *Gefingerte Tutze*), from the monument of the Roman king, Günther of Schwarzburg, erected in 1352, in the Cathedral of Frankfort-on-the-Main.

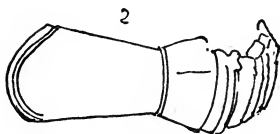

2. Mitten (*Fausthandschuh*), fifteenth century; the thumbalone is separate.

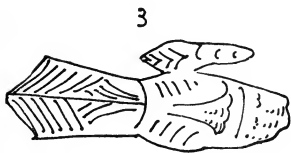

3. Mitten gauntlet, in which the fingers are indicated; latter half of the fifteenth century.

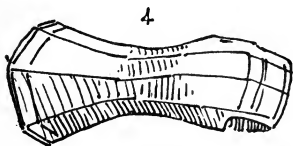

4. Mitten gauntlet.

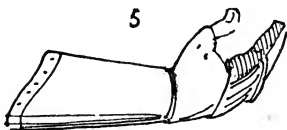

5. Id., id.
Collection of Baron des Mazis, Museum of Artillery, Paris.

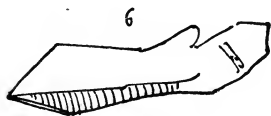

6. German gauntlet; first half of the fifteenth century.

- 7 Articulated gauntlet, sixteenth century, which closes by means of a screw-ring and pivot. It belongs to a suit of armour in the Imperial Arsenal at Vienna.

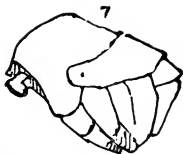

8. German articulated gauntlet; middle of the fifteenth century.

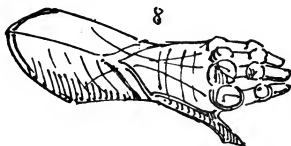

9. Mitten gauntlet of a fluted "Maximilian" armour; latter half of the fifteenth century.*

Author's Collection.

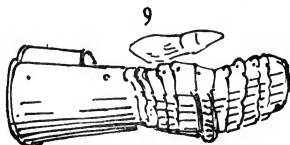

10. Articulated gauntlet of a fluted "Maximilian" armour; beginning of the sixteenth century.

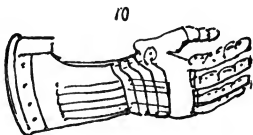

11. Gauntlet of a German *Reiter*; beginning of the seventeenth century.

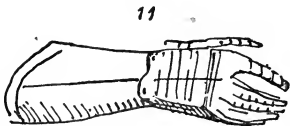

12. English gauntlet in deerskin covered with scales; seventeenth century.

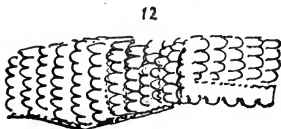

* The fluted armour of the beginning of the sixteenth century has generally articulated gauntlets, and the bear's paw-shaped soleret. (See Nos. 11 and 13 in the chapter on Solerets.)



13. Gauntlet of the sixteenth century, in iron, for the left hand, used in bear-hunting. It is armed with darts, and two daggers sharpened like a saw. The weapon is more fanciful than useful, and most probably extremely local, as it is very seldom met with.

Ambras Collection.

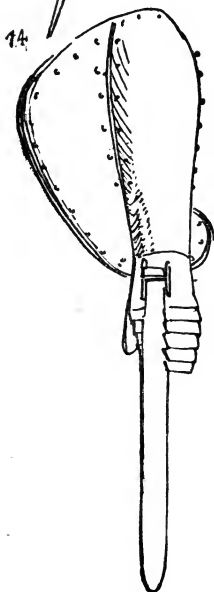

14. German gauntlet, in iron, for the left hand, with a large arm-guard, or small buckler, and a sword fastened to it. This gauntlet, of the sixteenth century, appears also to have been intended for bear-hunting. These pieces of armour are very rare; they must have been very little known, and probably only in the North.

GREAVES, OR LEGGINGS.—HOSE, MAIL AND STRAPPED.—FOOT COVERINGS CALLED SOLERETS, AND SHOES.—WAR BOOTS AND HOSE.

All the manuscripts of the eighth to the tenth century show the warrior without either leggings or greaves (*Beinschienen* and *Kettenstrümpfe*), and if he be not represented without any protection whatever on the legs, he has them bound only with thongs of leather. Even in the Bayeux tapestries, which nevertheless do not date farther back than the end of the eleventh century, William the Conqueror alone has the lower part of the legs protected, while none of his warriors wear leggings, either of mail or other materials. Dating from the eleventh century, cuishes and leggings with foot-soles of one piece are almost invariably made of iron chain-mail.

Towards the end of the thirteenth century the first plated greaves appeared in France (*Beinschienen* in German, and *tumelières* or *grève* in French), the buckled knee-caps (*Kniestücke*), and the cuishes (*Dieling* or *Schenkelschienen*): they were at first made in boiled leather, and afterwards in iron or steel. In Germany, greaves and solerets had already appeared at the close of the eleventh century, as the monument at Merseburg shows.

At first only the front of the leg was protected by the plate, which was fastened by thongs on the chain-mail legging. The tombstone of Sir Hugh Hastings, erected in 1347, seems to prove that the English knight of that period still wore the leggings and greaves in mail, while the monument of Merseburg, of the eleventh century; the miniatures on a manuscript in the Library of Berlin, of the thirteenth century; and the "Lancelot of the Lake," 1360, already depict the plate armour which Germany and Switzerland appear to have been the first to adopt; for after the Merseburg monument and the thirteenth-century manuscript at Berlin, the tomb of Berthold, who died in 1258, offers the most ancient evidence, on which this novel kind of armour is represented.

The solerets (*Eisenschuh*) were articulated plates or coverings for the feet in iron; they do not appear to date farther

than the beginning of the fourteenth century. The shoes which Rodolph the Swabian wears on a monument of 1080 in the Cathedral of Merseburg do not show any plates. The first known soleret is pointed, like the soleret "à la poulaine" (so called from *poulaine*, the prow of a galley), and which is wrongly considered to belong only to the fifteenth century.

An incontrovertible proof that this fashion already existed in the twelfth century is found in the memoirs of the Byzantine princess Anna Comnena (1080-1148), where the authoress says, "the Frank is terrible when on horseback, but should he fall, the knight scarcely appears the same person, so weighted is he by his shield, and the long-pointed shoes, which prevent his walking, and render him an easy prisoner." The German manuscript of the thirteenth century, "Tristan and Isolde," also depicts the knights with shoes *à la poulaine*, a fashion which came originally from Hungary, where it universally prevailed during the twelfth century. It is, however, also attributed to Falco IV., Count of Anjou (1087), and to Henry II. (1154-1189) of England, who adopted it to hide a deformity, which gave him the name of Cornadu or Cornatus. At the battle of Sempach (1386) the knights after dismounting from horseback cut off the long ends of their solerets. The shoe "à la poulaine," which had disappeared towards the middle of the fourteenth century, to make way for the "demi-poulaine" or "ogivale de lancette," reappears towards the end of this century, and reigns anew during the fourteenth, in which century, however, from 1440 to 1470, was worn also the shape "arc tiers point," and towards 1485 the "demi-sabot" or the "demi pied d'ours." The "sabot" or "pied d'ours," a style belonging to the fluted armour, was worn from 1490 to 1560, and was followed by the "bec de cane." This last soleret was replaced by the boot and top-boot. The knowledge of the differently shaped foot-coverings adopted by the Christians in Europe during the different periods of the Middle Ages and Renaissance are highly important for the classification of sculptures, miniatures, and arms, for military equipment has always been subject to the influences of fashion which governs civil costumes.

1. Legging bound with thongs, in use before the eleventh century.

2. Iron mail legging, which belongs to the beginning of the eleventh century, and disappears partly at the beginning of the thirteenth, when it is replaced by the greaved soleret.

3. First greaved soleret known, from the tomb of Rodolph the Swabian, 1080, in the Cathedral of Merseburg.

4. Soleret "à la poulaine," of the twelfth, thirteenth, and first half of the fourteenth century.

5. Soleret "demi-poulaine" or ogivale lancette; end of the fourteenth century.

6 and 7. Solerets "à la poulaine;" fifteenth century.

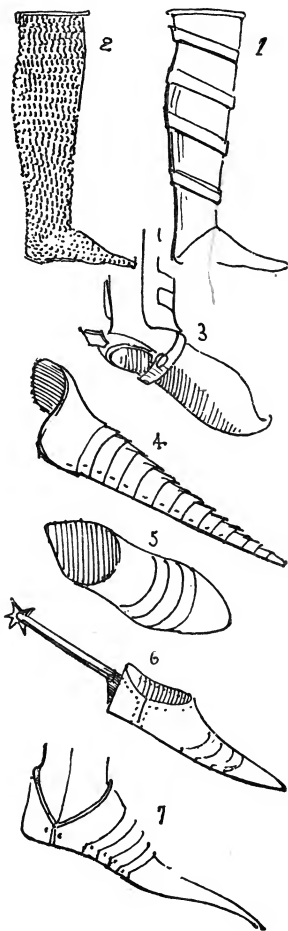

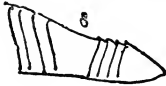

8. Soleret "arc tiers point," worn from 1450 to 1485.

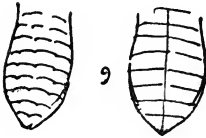

9. Soleret, middle of the fifteenth century, from bas-reliefs in marble on the triumphal arch of Alphonso V., King of Arragon, at Naples, erected on his entry there, in 1443. This same shape of iron shoe may be seen also on a piece of earthenware of Nuremberg which forms part of the author's collection, and the subject of which represents Charlemagne.

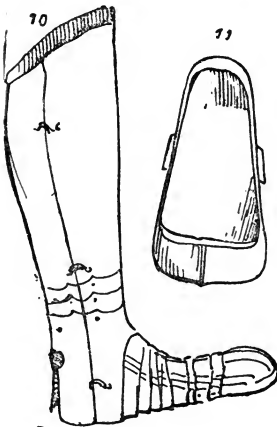

- ✓ 10. Greave with soleret "demi-sabot," in use about 1480 and 1485: it forms part of a German fluted suit, called "Maximilian," in the author's collection. The mitten gauntlets of this suit, as well as the shape of the soleret, indicate the end of the fifteenth, and slightly the beginning of the sixteenth century.

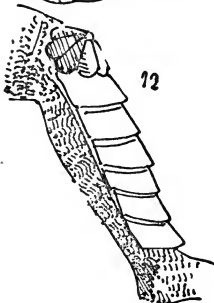

11. "Sabot," or bear's paw-shaped soleret, sixteenth century (1490-1560).

Museum of Artillery, Paris.

12. Persian greave, from a manuscript of the sixteenth century; a copy of the Schah Nameh.

Library of Munich.

13. Greave with soleret shaped like a bear's paw, from a suit of Maximilian or Milanese armour, in use from 1490 to 1560.

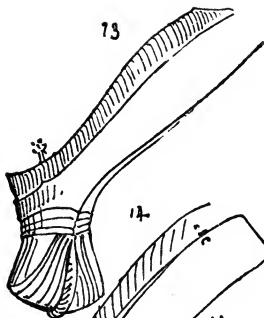

14. Greave with soleret *bec de cane*, from a suit of armour in use about 1560. This kind of soleret must not be confounded with those called *ogivale tiers point* of the fifteenth century.

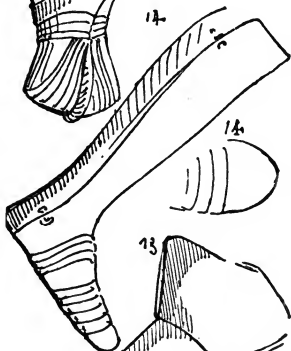

15. Top-boot of carabineer of 1680.

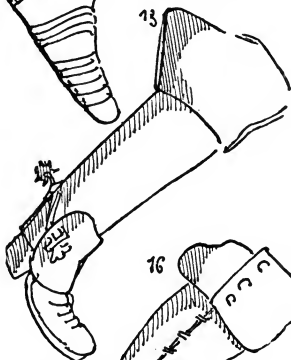

16. French top-boot in leather of the reign of Louis XV. (1715—1774). They are in the shape of gaiters laced up one side, the tops being furnished with three buttons. They are square-toed and high-heeled; the spurs belong to the end of the reign of Louis XIV., and are very like those of Mexico.

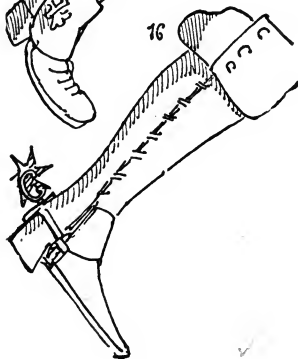

A. 325, *Museum of Artillery, Paris.*

THE SPUR.

The spur, from the Italian *sperone*, which in the Middle Ages was called *carcaire*, from the the Latin *calcar* (German, *Sporn*), is composed of the shank (German, *Bügel*), the spur-neck (*Hals* in German), and the prick or rowel (*Stachel* or *Rad* in German).

The spur seems to have been first used by the Romans, who introduced it most probably among the Gauls. Neither the horsemen on Assyrian bas-reliefs, nor those on Persian or Egyptian monuments, have spurs, while the Greeks of the Heroic Ages, who had neither cavalry nor even a verb in their language to express mounting on horseback, were also ignorant of this appliance.

The most ancient spurs were those made with a single point of a conical shape, which was very thick and riveted on at right angles to the shank. About the tenth century the spur began to show a slighter and sharper point, towards the eleventh century it became longer, and in the twelfth century was curved upwards. The rowel we find in the thirteenth century. This wheel, by the number and length of its points, indicates quite as well as the shank and point, the epoch to which the spur belongs. English heraldry considers the *mullet* or heraldic star to be derived from the five-pointed rowel of the spur, though most of these rowels belong to the seventeenth century, and in England the six-pointed rowel was unknown before the reign of Henry VI. (1422); but some are to be seen in the illuminations of the *Histoire Romaine*, a Burgundian MS. of the fifteenth century, at present in the Library of the Arsenal of Paris.

In Germany as early as the fourteenth century the eight-pointed rowel was used, a fact proved by the spurs of that time that are in the National Museum of Munich, which belonged to the knights of Heideck and the Duke Albrecht II. of Bavaria.

These spurs all show a wonderful degree of finish in their make, considering the early period at which they were manufactured, and are also noticeable on account of the shape of their shank, which indicates that they were worn over an iron greave, of which the part covering the tendon

formed an acute angle. Before the time of greaves or plates, as also later, in the seventeenth century, when top-boots had displaced greaves, the branches of the spur were rounded.

The spur-neck, which in the time when tournaments were most in fashion, about the fifteenth century, was extravagantly long, became shorter again in the sixteenth century, at which time spurs had often rowels of twelve, fifteen, and even eighteen points.

The spur of the time of Louis XIII. was small and sometimes embellished with perforations, whilst in the reign of Louis XIV. it was in the Mexican shape, with a large spur-neck cut in open-work and with very large rowels, generally of nine points. After the fifteenth century the number of the points cannot be taken always as a guide, as they varied according to the time and the country. Of all accoutrements the spur is the most difficult to classify in correct chronologic order.

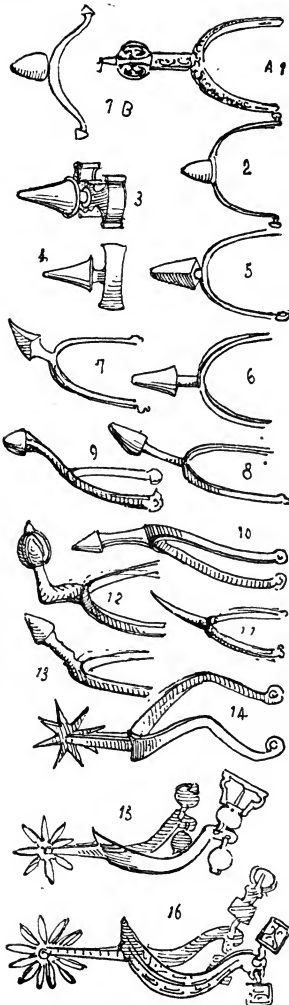

1 B and 2. German spurs in iron, of the eighth century, found at Groschnowitz, near Oppeln.
Museum of Berlin.

1 A. Gold spur belonging to Charlemagne.
Museum of the Louvre, Paris.

3. Danish spur in bronze, of the eighth century, with an iron point.
Museum of Copenhagen.

4. German spur in iron, of the eighth century, found at Gnevikon in Ruppin.
Museum of Berlin.

5. German spur in iron, of the tenth century, found at Brandenburg.
Author's Collection.

6. Anglo-Saxon or Norman spur of the eleventh century.
Tower of London.

7. German spur of the tenth century, found at Constance.
Museum of Sigmaringen.

8. German spur in iron, of the eleventh century.
Museum of Sigmaringen.

9. German spur in iron, of the twelfth century, copied from the frescoes in the Cathedral at Brunswick, painted in the reign of Henry the Lion, who died in 1195.

10. English spur, found at Chesterford; twelfth century.
Neville Museum at Audley End.

11. Spur copied from a reliquary of the twelfth century, in the collection of the late King of Hanover.

12. Spur in iron, of the thirteenth century.
Hanover Museum.

13. Swiss spur in iron, of the thirteenth century, found in the lake of Morat.

Gymnasium Collection at Morat.

14. German spur in iron, of the commencement of the fourteenth century, found at Brandenburg.
Author's Collection.
15. German spur of the end of the fourteenth century, with eight-pointed rowel, found in the tomb of a knight of Heideck.
Museum of Munich.
16. German spur of the end of the fourteenth century, with a twelve-pointed rowel. It belonged to Duke Albrecht II. of Bavaria.
Museum of Munich.



17. Italian spur in iron, of the fourteenth century.

Museum of Sigmaringen.



18. German spur in iron, of the fourteenth century, found at Constance.

Museum of Sigmaringen.



19. Spur in copper, of the fourteenth century.

Meyrick Collection.



20. Spur in iron with a double neck, of the fourteenth century, found at Mayence.

Museum of Sigmaringen.



21. Spur in iron, of the fifteenth century, with six-pointed rowel.

Widter Collection at Vienna.



22. German spur in iron, of the fifteenth century, with eight-pointed rowel, found in the isle of Rügen.

Museum of Berlin.

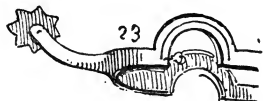

23. Spur in iron, of the end of the fifteenth century.

Museum of Sigmaringen.

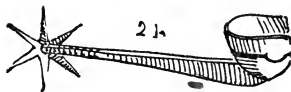

24. Moorish spur of the fifteenth century. Museum of Artillery, Paris. Similar ones in the Ambras Collection are said to be of Polish origin, and of the sixteenth century.

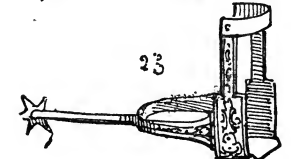

25. Spur with stirrup attached, in gilt copper, of the fifteenth century. It belonged to Duke Christopher of Bavaria, and is now in the Museum of Munich.

26. German spur in copper, about 10 inches long, of the end of the fifteenth century.

Söter and Ambras Collections.

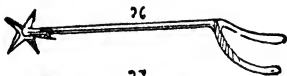

27. English spur in copper, about 5 inches long, of the end of the fifteenth century.

Meyrick Collection.

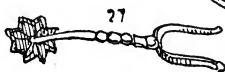

28. Spur in gilt iron, of the sixteenth century.

Museum of Artillery, Paris.

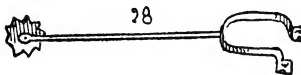

29. Spur in iron, of the seventeenth century, with rounded branches.

Museum of Sigmaringen.



30. English spur in steel of the sixteenth century.

Meyrick Collection.



31. German spur in iron, of the sixteenth century.

Museum of Sigmaringen.



- 32 A. English spur in gilt iron. It belonged to Ralph Sadler in the reign of Edward VI. (1547—1553).

Meyrick Collection.



- 32 B. German spur, copied from one on a suit of armour for a man on horseback.



33. German spur, said to be of sixteenth-century date. It has three rowels, and is of a very rare shape. The author believes it to be of the seventeenth century on account of the rounded branches.



34. Large spur in blackened iron, the branches of which are hollow, and served as a receptacle for concealed despatches. The heel of the shank, which unscrewed, formed the mouth.

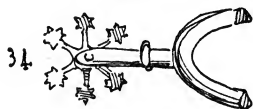

35. German spur of the sixteenth century.

Museum of Dresden.

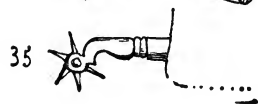

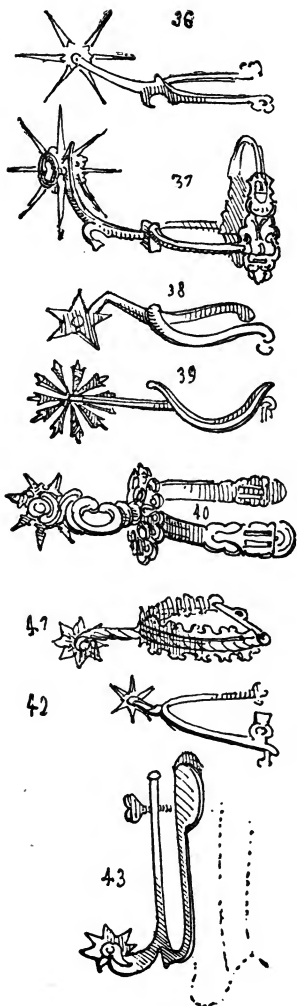

36. English spur of the sixteenth or seventeenth century. In the Meyrick Collection it is said to be of the fifteenth; but the shape of the bent branch renders this unlikely.

37. Spanish spur of the middle of the seventeenth century, copied from a work by a Spaniard, in which it is said to have belonged to Alphonso Perez de Guzman, who was born in 1278, died in 1320; but at that time the rowel was much smaller, and had, in fact, barely come into use. The branches are rounded.

38. English spur of the sixteenth century.

Meyrick Collection.

39. Spur in gilt copper, of the sixteenth century, wrongly attributed to Louis XIV. (1643—1715).

Museum of the Louvre.

40. Spur in iron of the reign of Louis XIV. (1643—1715). It resembles the Mexican spurs.

Author's Collection.

41. German spur in iron of the seventeenth century.

Museum of Sigmaringen.

42. English spur of the end of the seventeenth century, called *gaiter spur*.

Meyrick Collection.

43. Polish spur of the seventeenth century.

Museums of Prague and Sigmaringen.

44. German spur of the sixteenth century.

Museum of Berlin.

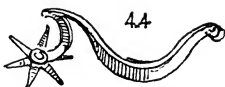

- 45 A. Persian spur of the fifteenth century.

Author's Collection.

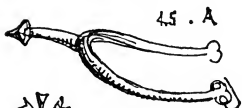

- 46 B. German spur of the seventeenth century. The width and shape of the branches show that this spur belongs to a time when greaves were no longer worn. For the branches of the spurs which were worn over greaves formed an acute angle, and could not possibly be arched or curved.



46. Ancient African spur in iron. This same kind is in use at the present day.

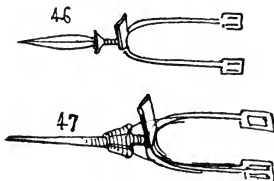

47. Arab spur, in use at the present day.



48. Brazilian spur, in use at the present day.

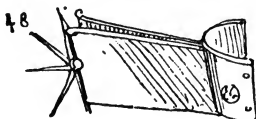

HORSE-ARMOUR.

The horse-armour for battle and tournaments (*Panzerdecke* in German) is often wrongly termed caparisons (derived from the Spanish word *cape*), a word which properly means only the rich coverings or housings spread over the back of the spare horse (*destrier*, from the Latin *dextra*), which was led along on the right hand by the squire. Horse-armour during the Middle Ages had not attained the same degree of perfection as armour for men; it was not until the middle of the fifteenth century that it assumed the form of a complete equipment, which consisted of the *chanfrein* (German, *Rosstirne*), the part which covers the forehead of the horse (and which was either open or shut, *i.e.*, with or without "blinkers," to prevent the horse from shying); the *testière*,

or head-piece (German, *Kopfstück*), a name which was given to the plate which covered the juncture of the chanfrein, neck-armour, and jaw-plates, and was also sometimes applied to the whole head-armour of the steed; the mane-armour (*Mähnenpanzer* or *Kammkappe* in German; French, *barde de crinière*); the *poitrail* (*Brustpanzer* or *Vordergebüge* in German), or breastplate, fitted either with hinges or like a flounce; the crupper and thigh-pieces (German, *Krupp und Lendenpanzer* or *Hintergebüge*), which were either formed in one piece, which came all round like a flounce, or else in two pieces, that is to say, separated under the tail; the rear-protector (German *Schwanzriempanzer*); the side pieces or flanchards (*Flankenpanzer* or *Seitenblätter* in German), which joined the front plate or breast-piece to the thigh-pieces and croupière; the saddle with stirrups; the bridle and bit; the snaffle bridle and *bossettes*,* and the nose-band or horse-muzzle, which latter article was very much in vogue in Germany during the sixteenth century, and, according to the *Diversarum gentium armatura equestris*, a MS. of about 1617, was used by all the German cavalry.

This assertion appears to be supported by doubtful authority; for the muzzle, which was placed over the nostrils, was only an ornament, and could be of no use in war; most probably it was only used at festivals to heighten the beauty of the caparison, as proved by the drawings of Jobst Ammon in his *Traité d'équitation civile*. The German armourers had brought horse-armour to such a degree of perfection, that a picture of the year 1480, preserved in the Arsenal of Vienna, represents Master Albrecht, armourer to the Archduke Maximilian, mounted on a horse furnished with articulated greaves.

At the commencement of the fourteenth century horse-armour was of mail, as in many countries that of man still was; but it was covered over with a caparison of cloth. The *chanfrein* was known to the Greeks, but was not used in Europe till the end of the fourteenth or beginning of the fifteenth century, for before this date the head-stall of the horse is always represented as being made of mail, or of plates of boiled leather.

* *Bossettes*: these are ornaments on the side of the bit. The name is also applied to the piece of leather, or blinker, which covers the eyes of the mule.

1. Head-stall (*Kopfstück*) from a MS. of the fourteenth century.



2. Head-stall of the fifteenth century.

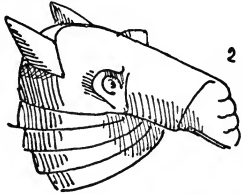

3. Open chamfron (*Ross-stirne*) of the middle of the fifteenth century.



4. Complete head-piece with open chamfron.

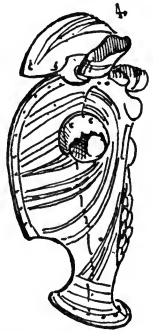

5. Closed chamfron, sixteenth century.

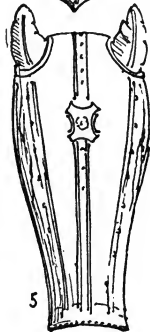

6. Open chamfron, sixteenth century, richly embossed. It is part of a set of horse-armour of the Imperial Arsenal of Vienna. The Meyrick and the Ambras Collections, the Imperial Arsenal of Vienna, the Armoury of Madrid, the Tower of London, the Museum of Artillery, the Collection of M. le Comte de Nieuwerkerke, etc., all possess good specimens of this piece of the horse-armour, on which the makers of that day so delighted to exercise their inventive and decorative taste.

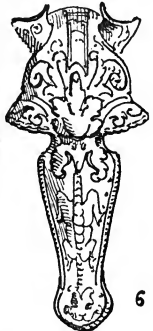

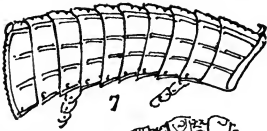

7. Crinet or mane-guard (*Müshnenpanzer* or *Kammkappe*) of the end of the fifteenth or beginning of the sixteenth century.

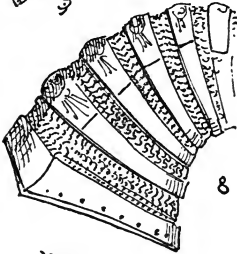

8. Crinet and gorget of the end of the fifteenth century, said to have belonged to Maximilian I. It is alternately in mail and plate armour. Ambras Collection. A similar one in the Nieuwerkerke Collection.



9. Poitrel (*Brustpanzer* or *Vorgebüge*) of the middle of the fifteenth century.

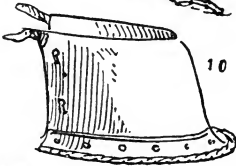

10. Poitrel à jupe, or in the shape of a frounce, of the sixteenth century.

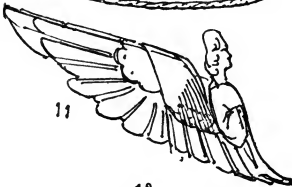

11. Poitrel of the end of the fifteenth century. It is part of a set of horse-armor said to have belonged to Maximilian I.

Ambras Collection.

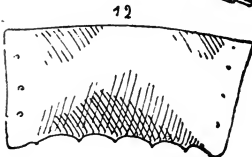

12. Flanchard (*Flankenpanzer*) of the middle of the fifteenth century.

13. Flanchard from a suit of armour called *à jupe*, in the shape of a founce.

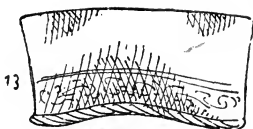

14. *Croupière* or hind-piece with cuissards (*Krupp und Lendenpanzer* or *Hintergebüge*), from a suit of horse-armour of the end of the fifteenth century, said to have belonged to Maximilian I.

Ambras Collection.

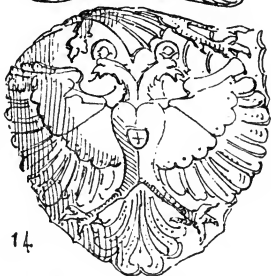

15. *Croupière* or hind-piece *à jupe*, of the sixteenth century.

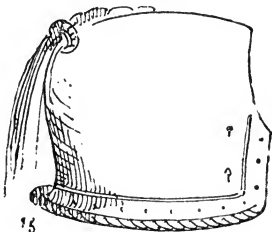

16. *Croupière* or hind-piece *à jupe* and trellised, of the second half of the fifteenth or beginning of the sixteenth century.

Ambras Collection.

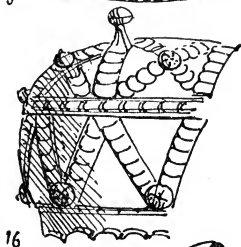

17. Tail-guard (*Schwanzriempfer*).

Meyrick Collection.





18. Leg-guard of German horse-armour; copied from a painting of 1480 in the Arsenal of Vienna, representing the horse of Master Albrecht, the armourer of the Archduke Maximilian.

19. Horse-muzzle (*Maulkorb* or *Nasenband*). The Museum of Sigmaringen, Tower of London, Arsenal of Turin, Museum of Artillery, at Paris, Ambras and Meyrick Collections, all have similar ones.

20. Front piece of horse-armour, comprising head-stall, *poitrel*, neck-guard, with a saddle used at tournaments that protected the legs and chest of the rider; from an engraving in the *Tournierbuch* (book on tournaments) of the commencement of the sixteenth century.

THE SADDLE.

The saddle (from the Latin *sella*) seems to have been unknown in ancient times before the Christian era. The Assyrian bas-reliefs show neither saddles nor stirrups, and on the Egyptian monuments the horse is invariably harnessed to the chariot. The Greeks, who had no cavalry, nor even a word in their language to express the action of riding, could not have known much about an article which even the Romans did not possess till the fourth century after Christ. Zonaras, an author of that time, is the first to describe a saddle, properly so called, in giving the account of a combat fought in the year 340 between Constans and his brother Constantine.

The use of the saddle in Scandinavia dates as far back as the iron age, that is, to a time perhaps anterior to the sixth century, judging from the bronze pommels and stirrups that are preserved in the Copenhagen Museum; and the *Codex Aureus* of the eighth or ninth century represents the German courser with a saddle and stirrups. In France there is a bas-relief of this date (?) at Saint-Julien de Brioude (Haute Loire), on which, as also in the Bayeux tapestry, saddles and stirrups are represented.

The saddle used in battle was almost exactly the same shape at first as it was at the end of the Middle Ages, with the exception of the cantle, which was much lower. The saddle used at tournaments in the thirteenth and fourteenth centuries had two sorts of sheaths or guards, which covered entirely the legs, the thighs, the hips, and even came as high as the chest: these were originally made of wood, but subsequently of iron.

The five specimens of these curious saddles that have come down to us are to be found at Regensburg, at Constance, at Schaffhausen, at the Tower of London, and at the Germanic Museum at Nuremberg.

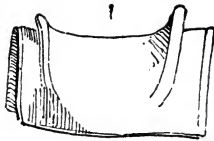

1. German war-saddle of the eighth or ninth century.

Codex Aureus of Saint Gall.

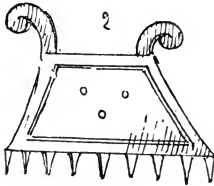

2. Norman war-saddle of the eleventh century.

Bayeux Tapestry.

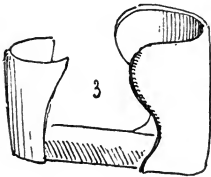

3. Bohemian war-saddle of the thirteenth century.

MS. of Boleslav in the Library of Raudnitz.

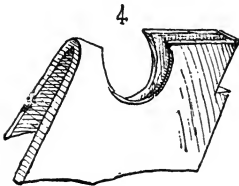

4. German war-saddle of the thirteenth century.

MS. of Tristan and Isolde in the Munich Library.

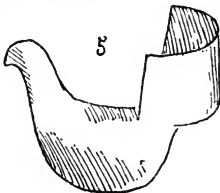

5. German war-saddle of the thirteenth century.

MS. of the German Æneid in the Library at Berlin.

6. War-saddle from an ivory of the fourteenth century.

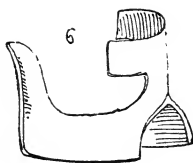

7. Italian war-saddle, copied from a piece of printed cloth of the fourteenth century.

Odet Collection at Sitten.

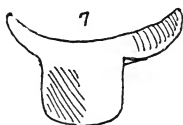

8. Italian war-saddle of the second half of the fifteenth century. Copied from an equestrian statue of Bartolomeo Colleoni at Venice.

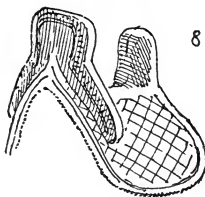

9. German war-saddle of the fifteenth century.

Museum of Artillery, Paris.

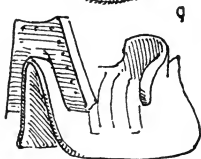

10. German war-saddle of the commencement of the sixteenth century, found at Strasburg.

Museum of Artillery, Paris

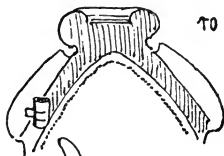

11. Persian war-saddle, from a copy of the Schah Nameh, written about 1600.

Museum of Munich.



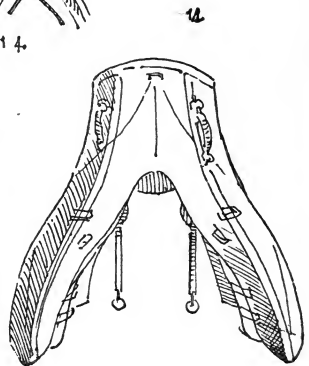
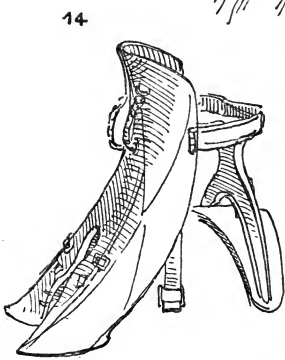
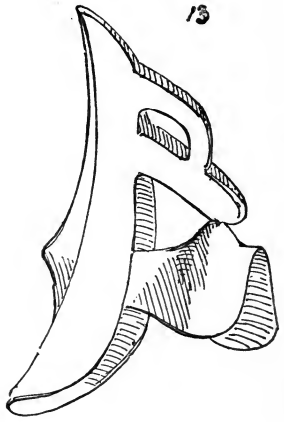
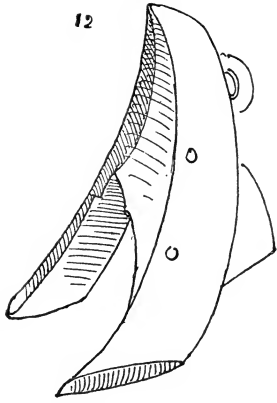

12. Tilting-saddle, either German or Swiss, of the fourteenth century. It is from the Arsenal of Schaffhausen, and it is said to have been used in the tournament held in that town in 1392. It is of wood covered over with pig-skin, and is not very unlike the saddles that are in the Tower of London and in the Museum of Ratisbon, excepting that the horseman is meant to sit down instead of standing, as he must have done in those mentioned. It measures about 3 feet 8 inches in height, but the part meant to protect the stomach and chest is only 22 inches, whilst in the other saddles it is about 26 inches high.

Museum of the Historical Society of Schaffhausen, and also in the Renne Collection at Constance.

13. German tilting-saddle of the end of the fourteenth, or beginning of the fifteenth century, originally in the Penker Collection at Berlin. It is about 5 feet 6 inches in height, 4 feet in length, and protected entirely the legs and chest of the rider, who stood up in the stirrups.

Tower of London.

14. Saddle, similar to the preceding one; it belonged to the *Paulstorfer* family, which became extinct in 1622. It bears the colours of that family. The height is only 3 feet 4 inches, and it appears to have belonged to the second half of the fifteenth century. It was hung up in the Chapel of the Minorités at Ratisbon, where the vaults of the *Paulstorfer* s.c., but is now in the Museum of Ratisbon. M. Hans Weiningen has kindly copied it for me. In the Germanic Museum there is a similar one, which belonged to the same family.

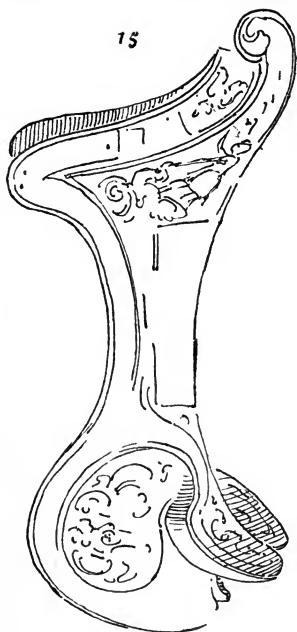

15. German saddle in ivory, of the end of the fifteenth century. Meyrick, Ambras, and Nieuwerkerke Collections, and also those in the Museums of Monbijou at Berlin, and Brunswick. This last belonged to Duke Magnus, who was killed at the battle of Liefenhausen. The saddle in the Tower of London has the following inscription :

" Ich hoff des pesten

Hilf Got wal auf Sand Jorger Nam."

I hope for the best, if God help me in the name of Saint George.

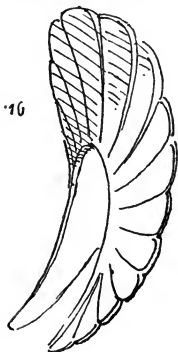

16. German tilting-saddle of the sixteenth century, from the *Tournierbuch*. It is like Nos. 12, 13, and 14, but it differs from these saddles of the fourteenth, in being much lower, and that it does not entirely cover the legs and chest.

These five specimens, which may be found at Schaffhausen, Constance, Nuremberg, and London, are the only ones that the author has been able to find in European collections.

THE STIRRUP.

The stirrup, a word derived from the Latin *strivarium* or *straperium* (*Steigbügel* in German), is composed of the flat piece where the foot rests, and the ring through which the strap that fastens it to the saddle passes.

As the saddle was unknown to the ancients before the Christian era, the stirrup was not used before the fourteenth century; at which time the author Zonaras lived, who is the first who mentions a saddle, in his description of the combat in 340 A.D. between Constans and his brother Constantine.

The shape of the stirrup has varied very much, according to the time and people. At first it was only a strap, * to which was subsequently added a flat piece of wood or metal, and afterwards it was of a triangular shape, as may be seen in the frescoes of the Cathedral of Brunswick.

The *pyrophore* stirrup had a lantern to it, which gave light and warmed the feet of the rider, but not a single specimen is to be found in any museum. The stirrups used by women, as well as those used in battle of the fifteenth century, which took the place of the *soleret*, are closed at one end, so as to prevent the passage of the foot.

* See the knight on the bas-relief of Brioude.

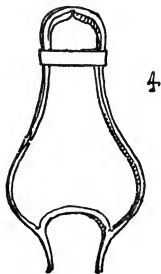
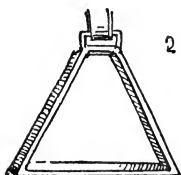
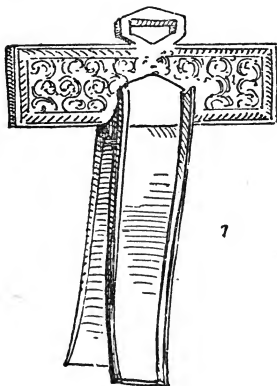

1. Mussulman-Spanish stirrup of the twelfth century. This specimen is about 18 inches high, and 13 inches wide. It belonged to the Emperor Maximilian I., who sent it, not long before his death, to Austria, where it is now in the Ambras Collection. This valuable stirrup in iron, judging from the work, belongs to the Romanic period, and was most likely taken over to America by the Spaniards, who had captured it from the Moors. Similar stirrups are in the collection of M. Culemann at Hanover, in the Museum of Lyons, and in the possession of an antiquary at Geneva.

2. German stirrup of the twelfth century, from the frescoes in the Cathedral of Brunswick.

3. German stirrup in iron, of the thirteenth century.

Museum of Sigmaringen.

4. Spanish stirrup in iron, of the end of the fourteenth century, but attributed in the Armoury of Madrid, where it is preserved, to King James the Conqueror, who died in 1276.

5. Arab stirrup in iron, of the commencement of the fifteenth century. It is richly engraved with gold and silver.

Author's Collection.

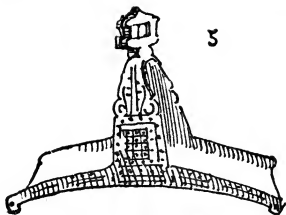

6. English *soleret* stirrup in iron, of the fifteenth century.

Warwick Castle.

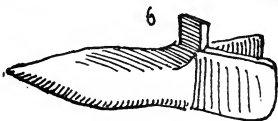

7. English *soleret* stirrup in iron; it is meant for the right foot. (Query: meant for female use?)

Meyrick Collection.

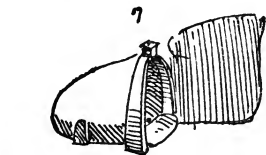

8. Iron stirrup of the end of the fifteenth century. It belongs to a carved ivory saddle in the Historical Museum of Monbijou at Berlin.



9. Iron stirrup of the end of the fifteenth century.

Museum of Sigmaringen.



10. Tilting (or, query, ladies') stirrup of the sixteenth century. It is ornamented with armorial bearings, and the work is perforated.

G. 361, *Museum of Artillery, Paris.*

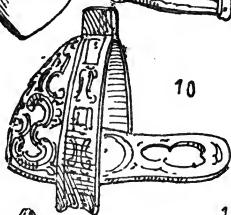

11. Large iron stirrup, 8 inches wide, 6½ inches high, belonging to the sixteenth century.

National Museum of Prague.

71

12. Stirrup from a set of armour for man and horse, of the sixteenth century.

Arsenal of Berlin.

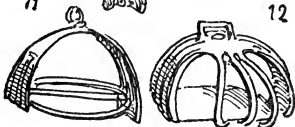

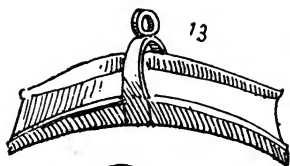

13

13. Large Saracen stirrup in iron, of the beginning of the sixteenth century.

G. 130, *Museum of Artillery, Paris.*

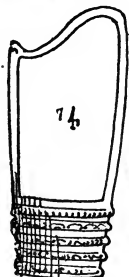

14

14. Polish stirrup in iron, perforated work, of the commencement of the sixteenth century.

Ambras Collection.



15

15. Small stirrup to be used with a *soleret* of the *bec de cane* shape (1585).

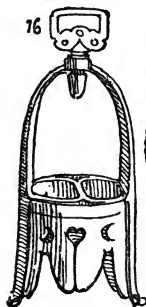

16

16. Stirrup in chased iron, probably for a mule. It belonged to the sixteenth century.

Author's Collection.



17

17. *Id.* *id.*



19

19. Stirrup in embossed and perforated iron.

Tower of London.



18

18. *Id.* *id.*



19 bis

- 19 bis. *Id.* *id.*

20. Hungarian stirrup of the sixteenth century. It is covered over with silver filigree work, and ornamented with gilt rosettes and precious stones.

Ambras Collection.



21. Persian stirrup from a MS. of the sixteenth century.

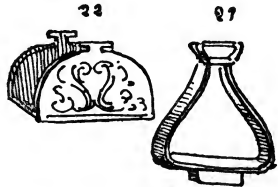

22. Arab stirrup in perforated iron.
Museum of Artillery, Paris.



23. Stirrup in yellow copper of the end of the seventeenth century.

24. German stirrup in iron of the seventeenth century, found at Dielfort.

Museum of Sigmaringen.

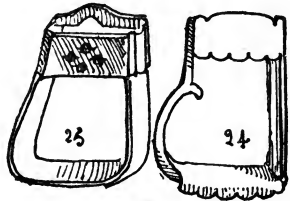

25. German stirrup in iron of the seventeenth century.

Museum at Cassel.

26. Iron stirrup used in the north of Africa.



THE BRIDLE.

The bridle, a word derived from the Celtic *brid* (*Zaum* in German), consists of the head-stall with frontal, of the bit, and of the reins.

The bit is usually either solid or with branches.

The name snaffle (French, *bridon* ; German, *Trense*) is sometimes applied to a jointed bit with branches, and sometimes to a light bridle with reins and bit. There are also bridles with double reins.

The bridle is to be found in the earliest times ; in fact, it is not possible to determine the exact date when it came first into use ; but bits with branches do not appear to have been used before the beginning of the Middle Ages, for the MSS. of the ninth and tenth centuries only represent bits without branches or cross-pieces. The snaffles or jointed bits with branches in the Copenhagen Museum, and attributed there to the iron age, seem to belong to the Middle Ages, for the Roman solid bit in the Meyrick Collection has neither branches nor cross-pieces.

1. Danish bridle, copied from the door of a church, carved in the tenth or eleventh century, now in the Museum of Copenhagen.

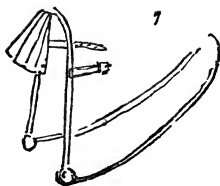

2. Danish bridle, copied from an *aquamane* of the twelfth century, now in the Copenhagen Museum. The headstalls of these two specimens have no front-piece, and the second one seems to be held on by the band that goes round the ears. The first has no nose-piece.

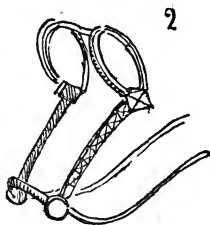

3. Bridle from a bas-relief in the church of Brioude, carved in the ninth century (?).

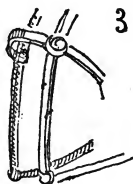

4. Norman bridle of the eleventh or twelfth century, copied from the Bayeux tapestry.

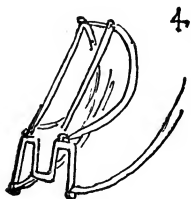

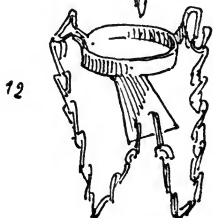
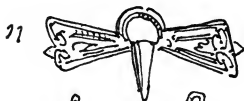
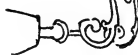
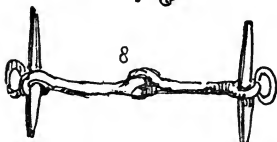
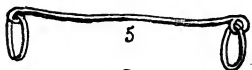

5. Roman solid bit.

Meyrick Collection.

6. Jointed bit, also called snaffle, without cross-piece, copied from MSS. of ninth and tenth centuries.

7. Bit without joint, Norman, end of the eleventh century.

Bayeux Tapestry.

8. Bridon, snaffle, or jointed bit, with branches, belonging to the Iron Age or commencement of the Middle Ages.

Museum of Copenhagen.

9. German bit without joint or branches, from a set of harness in the Dresden Museum.

10. German bit without joint, and with long branches and cross-piece, of the first part of the sixteenth century.

G. 62, *Museum of Artillery, Paris.*

11. Branch or cross-piece of a bit in perforated iron, of the sixteenth century.

Museum of Artillery, Paris.

12. Bit with chains belonging to an Arab bridle.

Museum of Artillery, Paris.

THE SWORD.*

The sword (*spatha* in Latin, *spada* in Italian, *espada* in Spanish, *Schwert* or *Degen* in German) is one of the most ancient of weapons, and it is found amongst all nations. By the Greeks and Romans it was used in battle only, but the Persians, the Germans, the Scandinavians, and the Gauls wore it at all times. The Germans still retain the name *Glaive* (*Schwert*) for the sword, when applied to the weapon used in the days of knighthood, or to that used for executions.

The sword is composed of two principal parts: the blade (*Klinge* in German), the extremity of which is called the point (*Spitze* or *Ort* in German); the "tang," which fits into the handle; the edge; and the hilt, which includes the pommel (*Knauf* in German); the handle (*Hilse* in German), generally of wood or horn, wound round with iron or copper wire, which is an outer case to the tang; the guard (*Parirstangen* or *Stichblätter* in German); the counter-guard, which is opposite the guard, and which protects the back of the hand and the wrist; the *pas d'âne*, a species of guard only used in the sixteenth century, which came partly over the edge of the blade; † the *quillons*, which crossed horizontally between the tang and blade—all these are comprised in the one word hilt. The flat piece of metal which is sometimes affixed to the bottom of the hilt is called a shield (*Korb* in German); and the term *shell* is applied to the semicircular hilts, such as the Spanish rapiers have, which protected one side of the hand; the grooved blades, introduced so as to lighten the weight, must likewise be mentioned.

The *espadon*, from the Italian word *spadone*, implied at first a long sword, used with both hands, but later the word was applied to all double-edged weapons.

The *estoc*, from the German word *Stock*, or the Celtic *stoc*, was the long narrow sword intended for thrusting rather than cutting. Therefore the expression *frapper d'estoc et de taille* can only apply to the long broad-bladed sword, inas-

* For swords famed in history, see the introductory chapter, which treats of the arms of the iron age.

† See the illustration, page 190, of the end of the fourteenth, or beginning of the fifteenth century, where the men on horseback are holding this sort of sword.

much as the blade of the rapier and pointed sword, which was straight, thin, and either three or four sided, was suitable only for thrusts.

The rapiers of the *estoc* shape were not in use before the reign of Charles V., in whose time the modern art of fencing seems to have originated. The blades of the *estoc* rapiers were made at Toledo, Seville, and Solingen, and they are very celebrated. The rapier has a basket hilt, either solid or of perforated work, and a long straight handle. The *colichemarde* rapier, or Königsmark sword, is known by its large hilt, and by the blade being cut or engraved into little squares. It was used only in the reign of Louis XIV., and then only in duels. The word *colichemarde* is only a corruption of Königsmark.

The scimitar (in Persian *chimchir* or *chimichir*, in German *Scymitar*) was the *acinace* of the Romans, and most probably gave rise to the sabre. It was used only by Oriental nations in ancient times, and afterwards by the Moors in Spain, by Saracens, and by the Turks. The handle of this sword has no guard, the blade is single-edged, short, and curved; it is slightly wider towards the end.

The *sabre* (from the German *Sabel* or *Säbel*, or from the Slavonic *sabla*) is the weapon that is most like the scimitar. It was unknown to the Greeks and also for some time to the Romans, but most probably it was known to the Persians and the inhabitants of Iberia before the conquest of this country by the Visigoths and Arabs. The sabre was also the principal weapon of the Dacians in the time of Trajan (A.D. 101 to 106), as may be seen by the bas-reliefs on the Trajan column, which represent the campaigns of that emperor. Dacia was bordered on the south by the Danube, on the north-east by the Carpathian mountains, and on the north by the Dniester, and corresponds to Moldavia, Wallachia, Transylvania, and also a portion of Hungary. The sabre first appears in Germany about the fourteenth century, and was universally employed in Europe at the time of the first crusade.

This weapon, which Meyer, in his book on fencing, published in 1570, wrongly calls a *düsack*,* and which is often

* The *düsack* was a Bohemian sabre of a peculiar shape, without a handle or hilt. It was wielded with a gauntlet protecting the hand.

represented in the engravings of Hans Burgmeier, was the favourite weapon of the Mussulmans, who used to give special names to their sabres. Mohammed, the founder of Islamism, had nine, which were named respectively, *Mabur*, *Al-Adhb*, *Daulfakar*, *Ali-Kola* (after the city of Kola, where there were at that time many manufactories of arms), *Al-Ballar*, *Al-Hatif*, *Al-Medham*, *Al-Rosul*, and *Al-Kadhib*.

The real Scotch claymore had a plain cross-guard, without the basket hilt which protected the whole of the hand: swords and sabres with these hilts are often wrongly called claymores, but they were used only by the Venetians, and were called *schiarone*, being the weapon used by the Doge's guards in the sixteenth and seventeenth centuries, as may be seen in pictures of that time; in Scotland they were not known till the eighteenth century.

The *yatagan*, the *khandjar*, the *flissa*, the *konkri*, the *kampak*, etc., etc., are all different sorts of *hatchet sabres*, generally without hilts or cross-guards. These Oriental weapons are all so like each other, and they have varied so little during many centuries, that they do not afford a subject for study, nor can they be classed chronologically, on which account the sword of the Christian Middle Ages is more valuable to the antiquary. This weapon in the eighth, ninth, tenth, and eleventh centuries was large, long, two-edged, with a rounded point, and only useful for cutting or slashing. The handle was straight, and formed with the blade a Latin cross. The pommel was usually rounded or flattened, and had sometimes two or three lobes in the eleventh and twelfth centuries. The guards are always straight, but in the thirteenth century their points were curved slightly towards the blade, which at that time was sharp-pointed, and about three feet in length.

In Germany the sword was a very formidable weapon as early as the thirteenth century. The one of the knight Konrad Schenck de Winterstetten (1209—1240), that is preserved in the Museum of Dresden, has a straight guard, free from any curve. The pommel is about four inches in diameter, the handle six, and the hilt about ten inches in length; but these dimensions are unusually great.

The sword of the fourteenth century is even longer than that of the preceding ages; it was generally about forty-five

or fifty inches in length. The handles are always in the shape of a cross.

—The sword of the fifteenth century had a longer haft than those of earlier times; those of the sixteenth century are more complicated in the arrangements of the hilt, from which the simple cross-guard now disappears. After this time the *pas-d'âne* form began to be used.

Braquemart, malchus, coustil à croc, épée de passot, are all names that were used to describe the short sword of Italian origin, which had a blade very broad at the top, but gradually tapering towards the end till it came into a point like a tongue, which form seems to have been copied from the ancient parazonium. This kind of sword belongs to the fifteenth century, and in England was commonly known as an *aneluce*.

The *flamberg*, or Swiss flame-sword, must not be mistaken for the flame-sword intended to be used with both hands, which was a weapon in use in the sixteenth century.

The *two-handed sword* (*Zweihänder*), or real *espadon*, is no earlier than the fifteenth century. It was the ordinary weapon of the foot-soldier in Switzerland; in Germany its use was confined mainly to the defence of besieged towns.

The *lansquenette* of the sixteenth century was short, wide, two-edged, and pointed. The handle was like a truncated cone, and flattened at the end, which formed the pommel.

The *verdun* was a long narrow weapon, which took its name from the town where it was made.

[The handle of the seventeenth-century sword was even more complicated than that of the sixteenth. Many of the handles have quite a profusion of guards, counter-guards, *pas-d'âne* guards, etc. Their shape indicates a decline in taste, from the want of simplicity and severity of design. Several swords of the sixteenth and seventeenth centuries have rings intended to be slipped over the thumb so as to protect it. The Germans call them *Degen mit Daumringe*.]

For swords of the epoch called the *iron age*, see the chapter in which the arms of this period are described. In it will be found the names of the celebrated swords of the heroic times, described in "sagas" and in poems.

1. Sword belonging to Charlemagne (771-814), 3 feet in length. The handle is in embossed work, the blade is very wide, and with a blunted end.

In the Louvre.

2. Sword in sheath, of the ninth century, from the illustrations in the Bible of Charles II. le Chauve (840-877). It will be noticed that the pommel is in the shape of a cross.

In the Louvre.

3. Sword in sheath, of the eighth or ninth century, copied from the *Codex Aureus* of Saint Gall. It measures about 4 feet 3 inches in length, and has a rounded end.

4. Anglo-Saxon sword of the tenth century, about 2 feet in length, found in Hertfordshire.

British Museum.

5. Anglo-Saxon sword of the eleventh century, from a MS. in the British Museum. It measures about 35 inches in length. It will be observed that Anglo-Saxon swords are shorter than those of Germany.

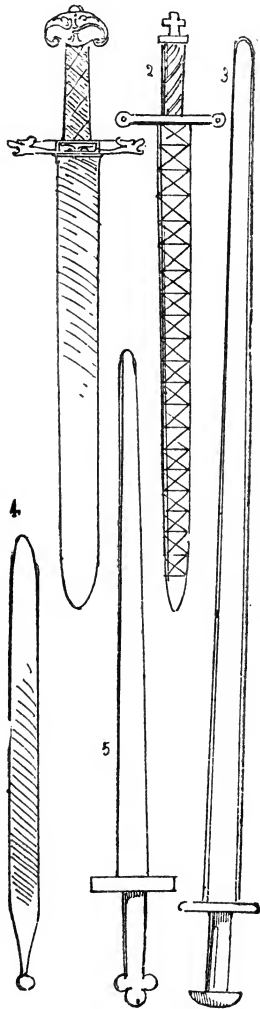

or fifty inches in length. The handles are always in the shape of a cross.

—The sword of the fifteenth century had a longer haft than those of earlier times; those of the sixteenth century are more complicated in the arrangements of the hilt, from which the simple cross-guard now disappears. After this time the *pas-d'âne* form began to be used.

Braquemart, malchus, coustil à croc, épée de passot, are all names that were used to describe the short sword of Italian origin, which had a blade very broad at the top, but gradually tapering towards the end till it came into a point like a tongue, which form seems to have been copied from the ancient parazonium. This kind of sword belongs to the fifteenth century, and in England was commonly known as an *aneluce*.

The *flamberg*, or Swiss flame-sword, must not be mistaken for the flame-sword intended to be used with both hands, which was a weapon in use in the sixteenth century.

The *two-handed sword* (*Zweihänder*), or real espadon, is no earlier than the fifteenth century. It was the ordinary weapon of the foot-soldier in Switzerland; in Germany its use was confined mainly to the defence of besieged towns.

The *lansquenette* of the sixteenth century was short, wide, two-edged, and pointed. The handle was like a truncated cone, and flattened at the end, which formed the pommel.

The *verdun* was a long narrow weapon, which took its name from the town where it was made.

[The handle of the seventeenth-century sword was even more complicated than that of the sixteenth. Many of the handles have quite a profusion of guards, counter-guards, *pas-d'âne* guards, etc. Their shape indicates a decline in taste, from the want of simplicity and severity of design. Several swords of the sixteenth and seventeenth centuries have rings intended to be slipped over the thumb so as to protect it. The Germans call them *Degen mit Daumringe*.]

For swords of the epoch called the *iron age*, see the chapter in which the arms of this period are described. In it will be found the names of the celebrated swords of the heroic times, described in "sagas" and in poems.

1. Sword belonging to Charlemagne (771-814), 3 feet in length. The handle is in embossed work, the blade is very wide, and with a blunted end.

In the Louvre.

2. Sword in sheath, of the ninth century, from the illustrations in the Bible of Charles II. le Chauve (840-877). It will be noticed that the pommel is in the shape of a cross.

In the Louvre.

3. Sword in sheath, of the eighth or ninth century, copied from the *Codex Aureus* of Saint Gall. It measures about 4 feet 3 inches in length, and has a rounded end.

4. Anglo-Saxon sword of the tenth century, about 2 feet in length, found in Hertfordshire.

British Museum.

5. Anglo-Saxon sword of the eleventh century, from a MS. in the British Museum. It measures about 35 inches in length. It will be observed that Anglo-Saxon swords are shorter than those of Germany.

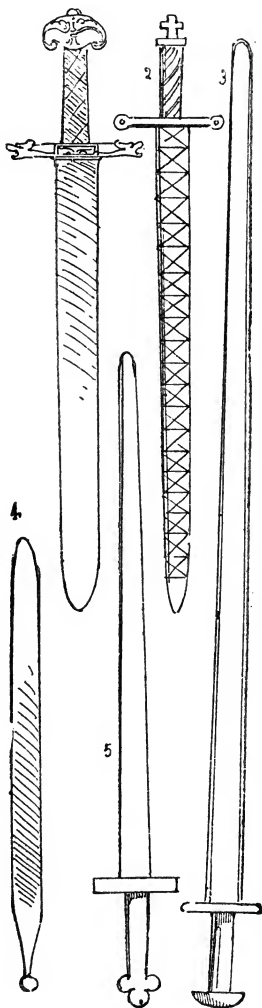

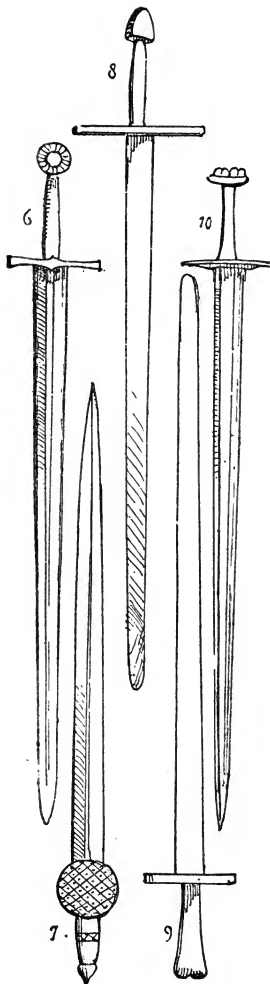

6. Sword of the end of the eleventh century, about 38 inches in length, of tempered iron, with the exception of the pommel, which is of copper. I. 1, Museum of Artillery, Paris. This sword has a sharp point, and is the same as those carried by the knights in the Bayeux tapestry.

7. Mussulman sword of the eleventh century. Its length is about 34 inches.

8. German or French sword, either of the eleventh or twelfth century, found at Saint Agata dei Goti, in the kingdom of Naples. 3 feet in length.

Museum of Erbach.

9. German sword of the twelfth century, copied from the frescoes on the dome of the cathedral at Brunswick, which were painted in the reign of Henry the Lion, who died in 1195. This sword is not very sharp, and it has a pommel with six lobes.

10. German sword, either of the eleventh or twelfth century, about 38 inches in length, with a five-lobed pommel. Museum of Munich. M. le Comte de Nieuwerkerke has a similar sword, but with straight hilt. There is also another in the Copenhagen Museum with a three-lobed pommel.

11. Indian sabre, probably of the twelfth century. The handle of the weapon is richly inlaid with silver; it was excavated at Neumark, in Bavaria, and most likely brought over by the crusaders.

National Bavarian Museum at Munich.

12. German sword of the thirteenth century; formerly belonged to the knight Konrad Schenck de Winsterstetten (1209—1240). It is very large, the length being about 8 feet 2 inches, and the width 4 inches. The pommel is 4 inches in diameter, the haft $6\frac{1}{2}$ inches, and the hilt 10 inches in length. On the blade the following inscription is engraved:—

“Konrad viel werther Schenck,
Hierbei du mein gedencck:
Von Winsterstetten hochgemuth,
Lass ganz keinen Eisenhut.”

(Conrad, be mindful of me. May brave Winsterstetten leave no helmet unscathed.)

13. Fragment of a sword of the thirteenth century.
M. le Comte de Nieuwerkerke's Collection.

14. Sword of the thirteenth century, found in a tomb in Livonia. British Museum. It dates from the time when the knighthood of the Glaive (*Schwert-Ritter*), which was eventually conquered by the Lithuanians, was founded in the Teutonic order. The two ends of the guard are curved towards the blade, a fact which indicates it to be of thirteenth-century date.

15. British sword in iron, about 30 inches in length, of the thirteenth century, as is indicated by the ends of the hilt, which are curved towards the point. This weapon is called Anglo-Saxon.

Tower of London 170.

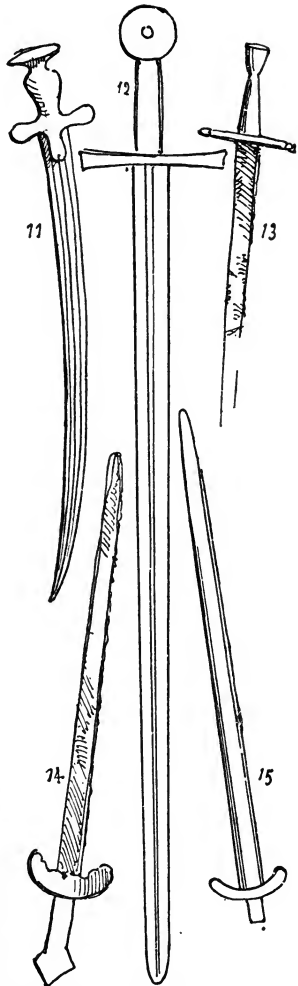

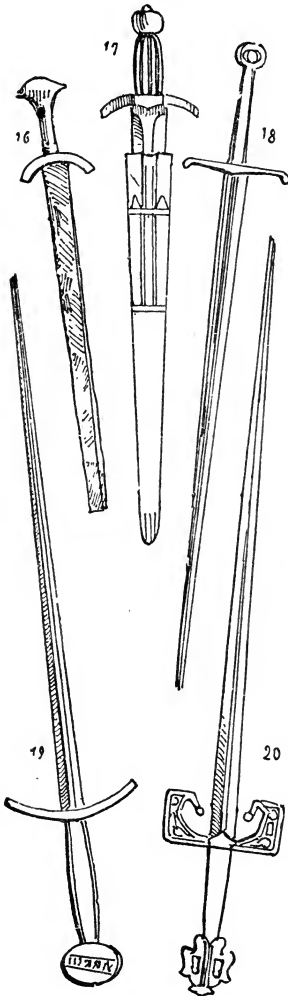

16. English sword, thirteenth century; the handle is only $2\frac{3}{4}$ inches long. This weapon, like the preceding one, has been wrongly attributed to the Anglo-Saxon period.

No. 174, *Tower of London.*

17. Sword in its sheath, probably of the thirteenth century, but if not, of a still earlier date. This weapon, preserved at Jerusalem, is said to have belonged to Godfrey of Bouillon (eleventh century).

18. Sword of the thirteenth century, 39 inches long. The blade is ridged, and not grooved in the centre. The slight inclination of the *quillons* towards the point of the sword denotes the time of its manufacture.

J. 2, *Musée d'Artillerie, Paris.*

19. Sword, end of the thirteenth or beginning of the fourteenth century. It is 41 inches in length. The inscription which the flattened pommel of the sword bears, MARIA, in Gothic capitals, leads us to conclude that it must be prior to 1350, and not of the fifteenth century, as the catalogue of the *Musée d'Artillerie* affirms, where it is exhibited under No. J. 10. This handsome sword was found in the Bois de Satory.

20. German sword in iron, with copper pommel, 38 inches long, end of the fourteenth century. Found near Brunnen, in the lake of Lucerne.

Collection of M. Buchhölzer, curator of the Arsenal of Berlin.

21. German sword of the fourteenth century, 33 inches long, and with a thumb ring. If the ornaments and the armorial bearings did not point out its origin, it might be reasonably supposed that this weapon was of Eastern manufacture.

National Museum of Munich.

- 22 and 25. Engravings on the blade of the preceding object.

23. Arab sword, fourteenth century; the handle silver-gilt and richly engraved. The *quillons* are double and curved towards the point. This weapon bears the date 1323 engraved in Arabic numerals, and resembles in shape the Moorish swords. Spengel Collection, Munich, but now in the Nieuwerkerke Collection.

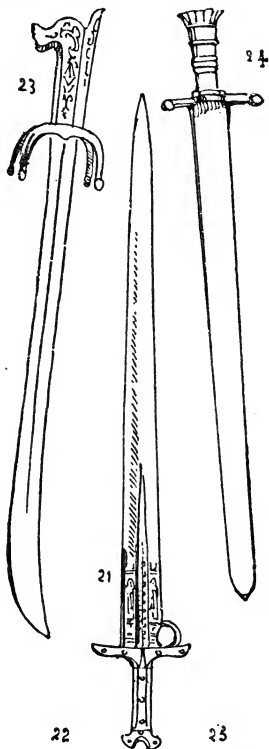

24. Executioner's sword of the fifteenth century, 27 inches in length; the hilt and handle resemble the *lansquenets* swords of the sixteenth century. The blade has a gallows engraved on it, and the date 1407.

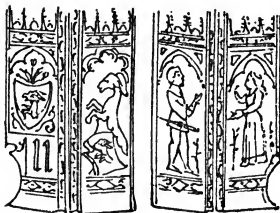

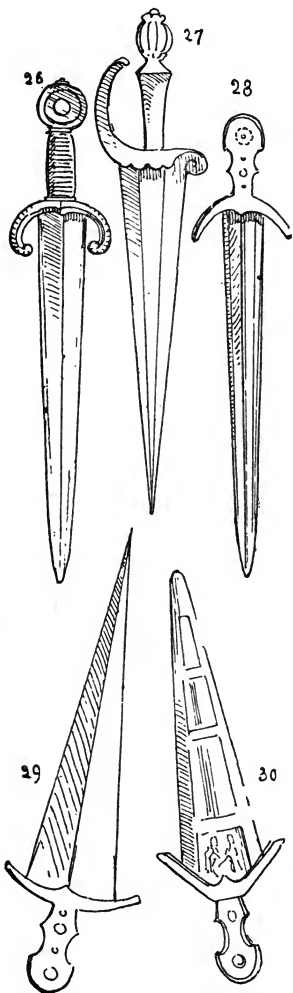

26. Sword of the fifteenth century, *anelace*, with broad, short, double-edged blade,* 26 inches long; without a groove, but with a ridge in the centre. The *quillons* are very much curved towards the point of the blade.

J. 13, *Musee d'Artillerie*.

27. Italian sword, *anelace*, fifteenth century; blade broad, short, and double-edged, 26 inches in length.

28. Italian sword, *anelace*, fifteenth century; the blade about 4 inches broad by 26 inches long, double-edged, and fluted long, handle. The guard bears the word "Solla." Ambras Collection. Similar specimens may be seen in the collections of the Count of Nieuwerkerke, of M. Söter, at Augsburg, and in the Museum of Munich.

29. Sword, like the preceding one, 25 inches long, but broader in the blade, sometimes called "langue de boeuf."†

Arsenal of Prince Lobkowitz at Raudnitz.

30. Sword, like the preceding one, about 22 inches long.

J. 476, *Musée d'Artillerie de Paris*.

* These kinds of swords, called "pistos" and "anelaces," represent the weapon known in France under the names of "braquemart, malchus, coustil à croc" and "épée de passol."

† This is the parazonium or small sword of the ancient Greeks and Romans, which they carried on the left side.

31. Bohemian sword, fifteenth century, called *Düsack* or *Tesack*, 89 inches long, composed entirely of iron. The wearer had his sword hand protected by an iron or deer-skin gauntlet, which reached to the elbow.

32. Iron sword in one piece, fifteenth century. This weapon, 38 or 39 inches long, and used in Germany, resembles the Bohemian *Düsack*.

Dresden Museum.

33. Scimitar, 32 or 33 inches long, from a painting on a table of the fifteenth century, at Augsburg.

Industrial Museum, Vienna.

34. Claymore* or Scottish sword of the fifteenth century, 3 feet long.

Warwick Castle.

35. German sword, fifteenth century, 3 feet 2 inches long.

Museum of Munich.

* The name claymore has been incorrectly applied to those sixteenth-century swords which have iron basket-work hilts. These are in reality Venetian swords, and were originally called *schiacona*. (*Vide* No. 69.) The long-bladed swords with similar handles belong to the end of the seventeenth and beginning of the eighteenth centuries. They were used among all nations as cavalry swords.

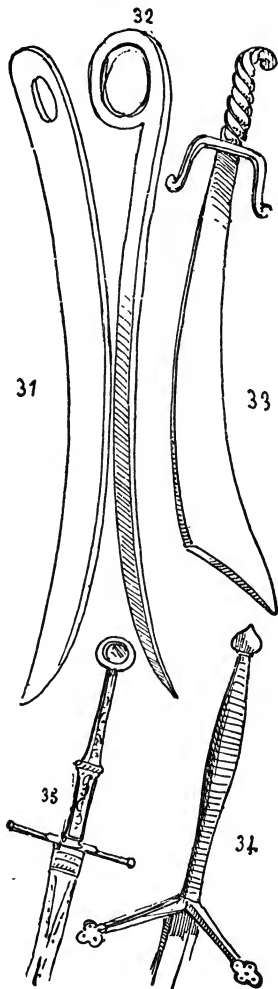

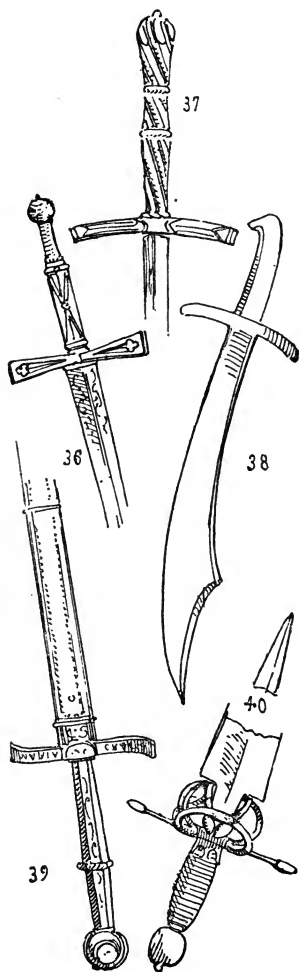

36. German sword, fifteenth century
38 inches long; the pommel
in crystal.

Museum of Munich.

37. German sword, fifteenth century,
4 feet in length; the pommel
and handle are of copper.

Museum of Munich.

38. Cutlass sabre, fifteenth century,
extremely large, about 3 feet
10 inches in length; from
an engraving.

Cabinet of Engravings, Munich.

39. German sword, fifteenth century,
3 feet 10 inches long, belong-
ing to a knight of St. George.

Imperial Arsenal of Vienna.

40. Sword, Swiss, end of the fif-
teenth century, with broad
blade and *quillon* hilt, *pas*
d'âne,* and counter guard.
The whole length is 3 feet.

Author's Collection.

* This is the most ancient sword
with a *pas d'âne* which the author
has ever met with. Some frescoes
of the end of the fourteenth or be-
ginning of the fifteenth century, on
the walls of the church of Mon-
doneda, represent warriors armed
with swords with *pas d'âne* hilts.

40 A. Sword, end of the fifteenth or beginning of the sixteenth century, restored according to a description in the manuscripts, "The Arsenals of the Emperor Maximilian," three volumes of polychrome water-colour drawings, executed in 1505, on an order of the Emperor, by Nicholas Glockenthon, and containing all the remarkable arms which were then preserved in the three Imperial Arsenals.

Ambras Collection.

41. Same period and same source.

42. Ditto, ditto.

43. Ditto, ditto.

44. Ditto, ditto.

45. Ditto, ditto.

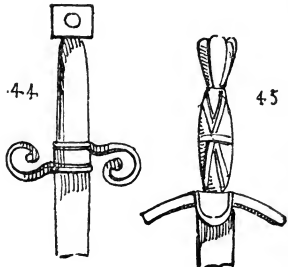
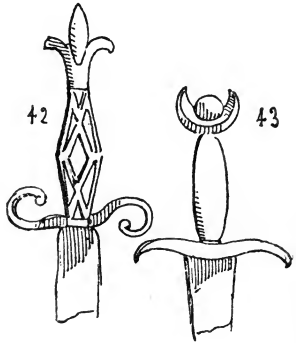
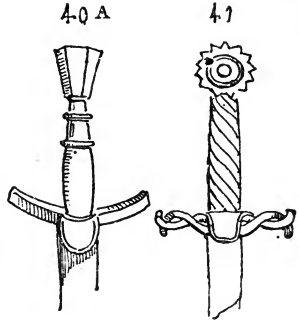

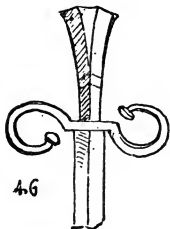

46. Same period and same source.

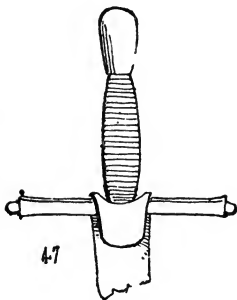

47. Ditto, ditto.

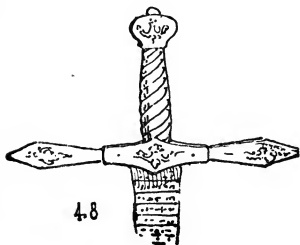

48. Sword, with handle and guard in gilded copper. A calendar for the year 1506 is very elaborately engraved on the blade, thus rendering it a curious piece of workmanship.

Arsenal of Berlin.

50. Sword, German, sixteenth century, with *quillons*, *pas d'âne*, and counter-guard with five branches. 3 feet 10 inches long.

J. 52, *Musée d'Artillerie, Paris.*

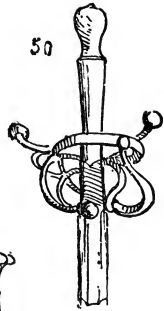

51. Sword, Swiss, all of iron; the blade is 2 feet 7 inches long, and the handle about 9 inches long. It belonged to the reformer Zwinglius, who died in the battle of Cappel (1531).

Arsenal of Zurich.

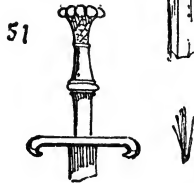

52. Sword, German, beginning of the sixteenth century, 3 feet 8 inches long. The blade is ornamented with a crucifix in high relief, which renders it unsuited for being sheathed.

Museum of Sigmaringen.

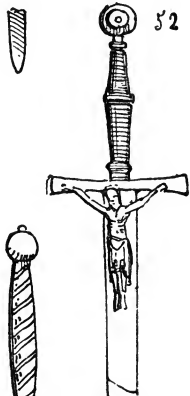

53. Sword, Dutch, with long and broad blade. It belonged to William the Silent, who was murdered in 1584.

Arsenal of Berlin.

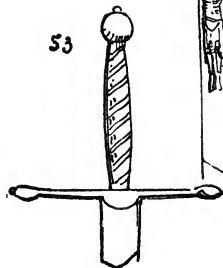

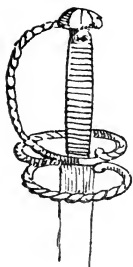

54

54. Sword, German, belonging to a *lansquenet*, of the sixteenth century. Plain pattern, with counter-guard. The total length is 2 feet 11 inches; the blade measuring 29 inches in length and 2 in breadth.

Museum of Sigmaringen.



55

55. Sword, Spanish, with Moorish ornaments, sixteenth century, belonging to the collection of the Marquis of Villaseca, and attributed by him to Boabdil, the last Moorish king of Granada, who was dethroned in 1492. This sword is very like one preserved in the *Armeria Real*, at Madrid, and attributed to Don John of Austria, who died in 1578. Two similar swords are to be seen, one in the Cabinet de Médailles, at Paris, and one in the possession of Don Fernando Nuñez. The sword in the Cabinet de Médailles, No. 876, bears the inscription, "Il n'y a de vainqueur que Dieu."



56

56. Sword, German, sixteenth century, manufactured at Augsburg. It is 4 feet 3 inches in length, and the pommel and *quillons* are engraved.

Museum of Sigmaringen.

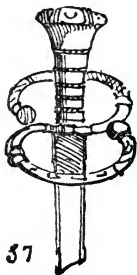

57

57. Sword, German, belonging to a *lansquenet*, sixteenth century, 2½ feet long. The double guard, hilt, and pommel are of iron, with copper mountings.

Museum of Carlsruhe.

58. Sword, cut and thrust, French, 3 feet 9 inches long, with a slender blade, in the style of the Spanish rapier blades. The *quillons* are curved: it has a *pas d'âne* and an openwork pommel, and bears on the guard the initial letter H. This sword either belonged to Henri II. of France himself or to one of his courtiers. The ornaments on the pommel consist of H's interlaced, and the ornament on the scutcheon is formed by an H interlaced with a heart.

Author's Collection.

59. Sword, German, sixteenth century. The blade has a double edge, narrow, and with a ridge; the handle is of black iron. The *quillons* are curved towards the point. Guard and *pas d'âne*.

J. 27, *Musée d'Artillerie, Paris.*

60. Sword, cut and thrust, German, beginning of the sixteenth century. The blade has three ridges. Two guards and a counter-guard. The *quillons* are straight. The handle of shagreen. *Pas d'âne*.

J. 47, *Musée d'Artillerie, Paris.*

61. Sword, beginning of the sixteenth century, with Spanish blade, bearing the mark of the armourer, Alonzo de Sahagon of Toledo.

J. 50, *Musée d'Artillerie, Paris.*

62. Tilting sword, sixteenth century, from a picture of that period in the collection of the Count of Engenberg.

63. Sword, German, sixteenth century. It is 3 feet 6 inches in length; the *pas d'âne*

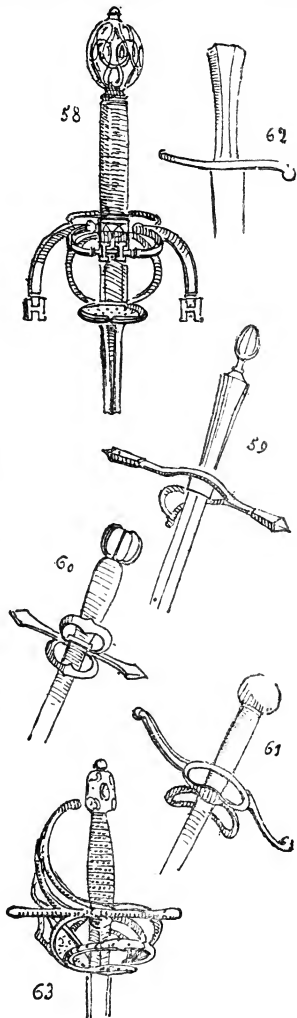

hilt* is richly inlaid with silver allegoric figures representing the Danube, Rhine, etc. The blade bears the inscription, PETER. MUNSTER. ME. FECIT. SOLINGEN.

Museum of Sigmaringen.

* We may again remark it was by this name that the small guard on the blade was called. It was not until the latter half of the sixteenth century that the *pas d'âne* was generally adopted, but it may be seen at page 380, both in the text (No. 40) and in the foot-note, that the *pas d'âne* dates back even to the fifteenth century. See also the explanation of the word *pas d'âne* in the introduction to this chapter, and also at No. 63.

64. Sword, German, sixteenth century, from the descriptions of the "Noces princières," by Wirtzig.
Industrial Museum of Vienna.

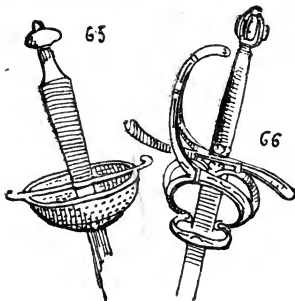

65. Sword or Spanish rapier, end of the sixteenth century. Basket hilt and straight quillons.
J. 85, *Musée d'Artillerie, Paris.*

66. Sword, German, inlaid with gold and enamelled, beginning of the seventeenth century; with quillons and pas d'âne.
Museum of Sigmaringen.

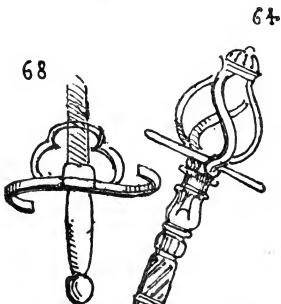

67. Sword, or rapier.
J. 102, *Museum of Paris.*

38. Outline of a sword, German, beginning of the seventeenth century, with pas d'âne and a German inscription, "Ich halte Jesus und Maria." It is preserved in the *Armeria* of Madrid, where it is attributed to St. Ferdinand (1200—1252). There is thus a difference of 400 years between the date of the manufacture and the date assigned to the sword.

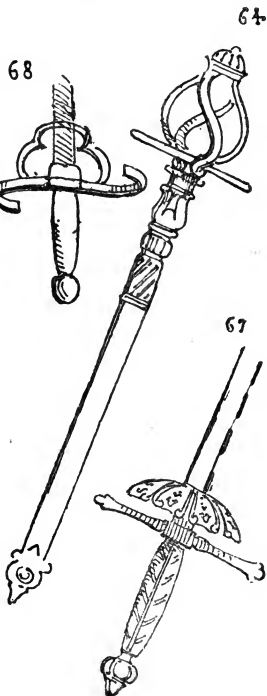

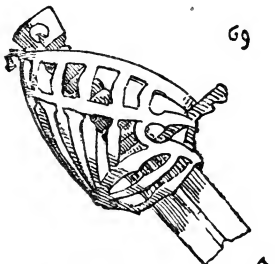

69. Sword, Venetian, 2 feet 9 inches long, beginning of the seventeenth century, called "schia-vcna."* This sword and the scythed sword were the offensive weapons of the *Schiavoni* or Doge's guards. In almost all collections it is described as a claymore, which is the Scottish sword with a plain cross hilt. Museum of Sigmaringen and Faily Collection. In this last-named collection there is a *schivona* stamped with the winged lion of Venice.

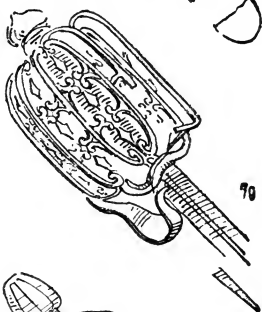

70. Same as above. J. 119, Musée d'Artillerie de Paris, where it is erroneously described as a claymore.

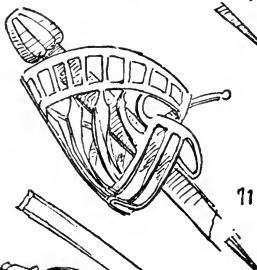

71. Cavalry sword, end of the seventeenth century. J. 96, Musée d'Artillerie, Paris.

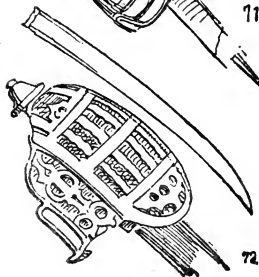

72. Scottish cavalry sword, eighteenth century, erroneously called claymore. J. 118, Musée d'Artillerie, Paris.

* The pictures of Pietro della Vecchia often represent people armed with this kind of sword.

73. Savoyard sword, beginning of the seventeenth century. It belonged to Captain Branau-lieu-Chaffardin, who was killed under the walls of Geneva in 1602.

Arsenal of Geneva.

74. German sword, beginning of the seventeenth century. It is grooved and measures 7 feet 2 inches in length. With *quillons* and *pas d'âne*.

Museum of Munich.

75. Sword of the latter years of the seventeenth or beginning of the eighteenth century. It is 5 feet 4 inches in length.

J. 135, *Musée d'Artillerie, Paris, and the Imperial Arsenal of Vienna.*

76. Cutlass or mariner's sword, seventeenth century; *quillons* and counter-guard.

Museum of Erbach.

77. Sword of the seventeenth century, with guard covering the back of the hand, and *quillons*, the ends of which are curved in opposite directions.

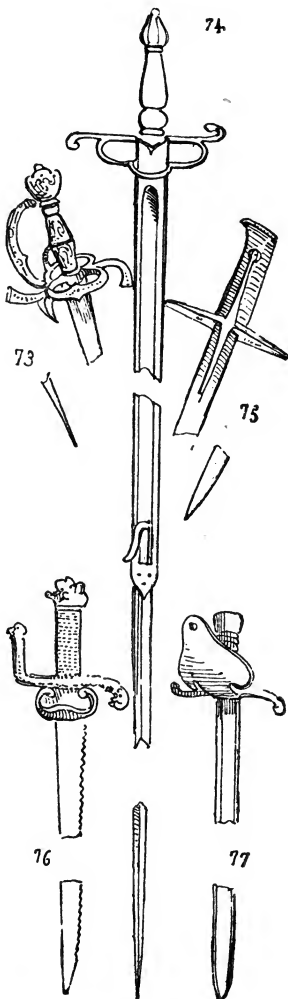

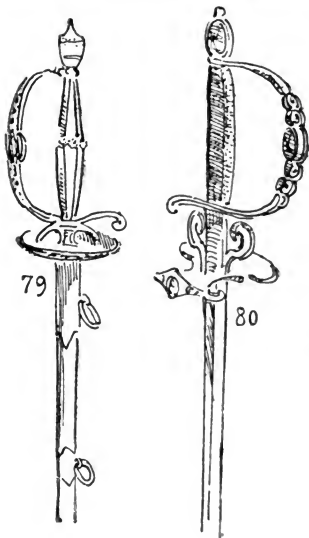

78. Court sword of the time of Louis XV. (1715—1774), in polished iron or steel cut in facets.

Merville Collection.

79. Court sword of the time of Louis XV. (1715—1774), in steel, with gilt ornament, and with a *pas d'âne* of a peculiar shape.

Merville Collection.

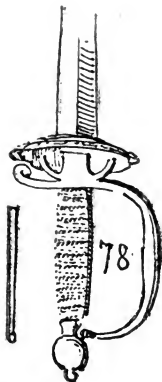

80. Court sword of the time of Louis XVI. (1778—1793), in steel. *Merville Collection.* A large quantity of these kinds of swords have been made whose shapes vary but little. Some of them have in the eyes of the amateur a great artistic value, especially when the date of their manufacture is shown by the stamp.

- 78*. Indian sword called "*Kunda de Rajah*,"* sixteenth century, 3 feet 3 inches long, and entirely made of iron. The blade is damascened, the handle, guard, and hilt are beautifully ornamented with embossed and engraved work.

Author's Collection.

- 79*. Indian sword called "*Johur de Rajah*," beginning of the seventeenth century.

Museum of Tsarskoe-Selo.

- 80*. Nepal sword, called "*Konkri Kora*."

J. 453, *Musée d'Artillerie, Paris.*

81. Hindoo-Mussulman sword in Khorassan damascened work. The difference between the Indian and purely Turkish taste may be seen in the handle of this sword. The damascening of the blade is of a yellowish tint, which is the most esteemed.

J. 407, *Musée d'Artillerie, Paris.*

* At the Museum of Tsarskoe-Selo, and at the Musée d'Artillerie, Paris, there are similar swords.

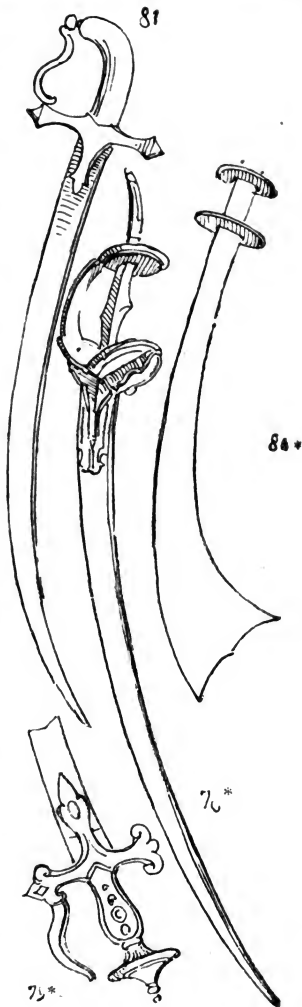

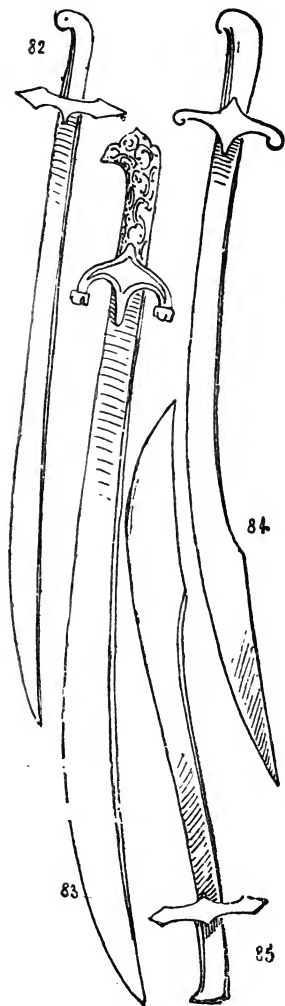

82. Persian sword from a manuscript of 1600, an illustrated copy of the "*Schah Nameh*," a poem by Ferdusi, composed in the reign of Mahmoud, A.D. 999.

Library of Munich.

83. Albanian or *Arnaut** sword, recognisable by the peculiar shape of the handle, which in other specimens is often ornamented with small chains. The handle and sheath of this weapon is inlaid with bright embossed silver, and the damascened blade is almost straight in shape.

Musée d'Artillerie, Paris.

84. Turkish sabre with black damascened blade, of ancient manufacture of Constantinople.

J. 390, *Musée d'Artillerie Paris.*

85. Turkish sabre, seventeenth century.

Dresden Museum.

* The Turks call the Albanians *Arnauts*.

85 B. Scimitar, from a German manuscript, beginning of the fifteenth century.

86. Turkish scimitar, which differs greatly from the scimitars of the West in the shape of its guards, the ends of which curve towards the point of the sabre. This guard is in the shape of a heart, like almost all Eastern sabres.

87. Chinese scimitar, a weapon easily known, like almost all Chinese sabres, by the absence of *quillons*, counter-guard, *pas d'âne*, and basket hilt, by the handle being corded, and by the pommel, which resembles the Chinese head-dress.

87 A. Large cutlass or mariner's sword. Blade 1 foot 4 inches long.

Museum of Sigmaringen.

87 B. Matador's sword with which the toreador on foot fights and kills the bull. The handle of this weapon is bound with a piece of red woollen braid.

G. Arosa Collection at Paris.

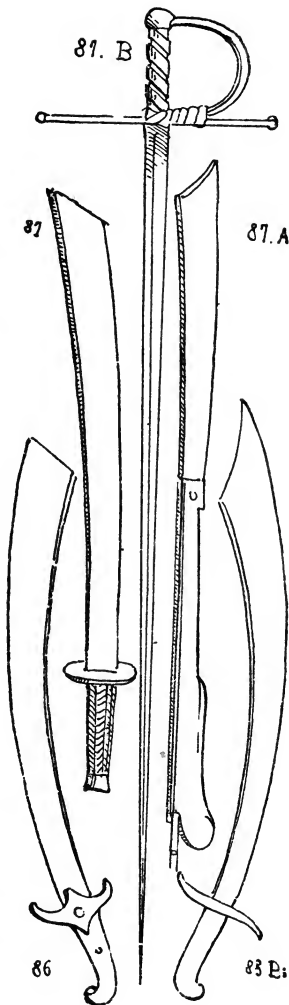

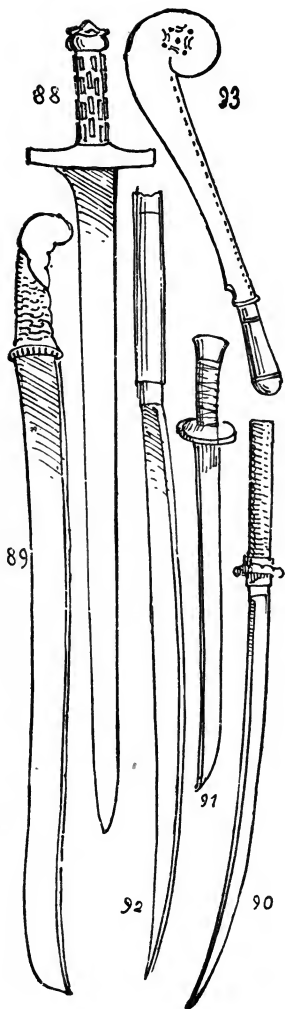

88. Japanese yataghan with damascened blade, and rhinoceros horn handle, studded with dice-shaped ornaments.

J. 439, *Musée d'Artillerie, Paris.*

89. Japanese sabre with curved point; the handle is of carved wood, mounted with silver.

J. 414, *Musée d'Artillerie, Paris.*

90. Japanese sabre called "Sio-bookatana."

91. Chinese sabre.

Tower of London.

92. Modern Chinese sabre; the handle is of white wood. It was part of the spoil taken from Peking, and is exhibited in the *Musée d'Artillerie, Paris.*

93. Chinese sabre-knife, given to condemned criminals to kill themselves with.

Museum of Berlin.

94. Turkish yataghan with blade damascened in gold. Taken from the Turks before Vienna in 1683.

95. Albanian yataghan. The handle, like the sheath, is plated with bright silver, embossed and engraved. The blade is damascened.

Musée d'Artillerie, Paris.

96. Kabyle flissa, with handle ornamented in copper. It will be noticed that the flissa and yataghan resemble one another.

97. Turkish kandgiar. Horn handle, studded with copper; damascened blade. J. 427, Musée d'Artillerie, Paris. It may be noticed that yataghans, flissas, and kandgiars are very like each other, which renders their classification difficult. The yataghan, as well as the flissa and kandgiar, are generally single-edged and without guards; they are more like sabres than swords.

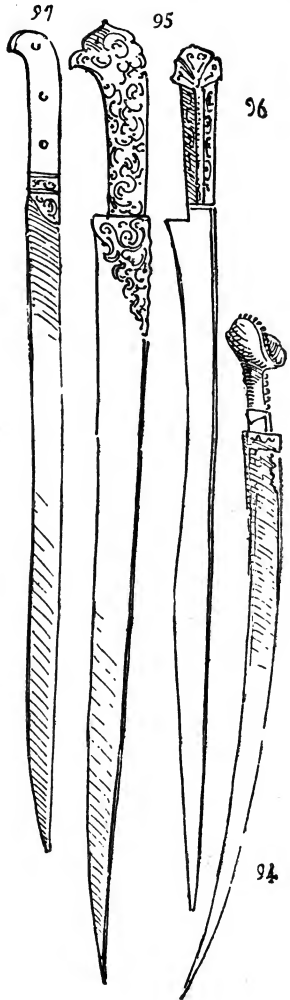

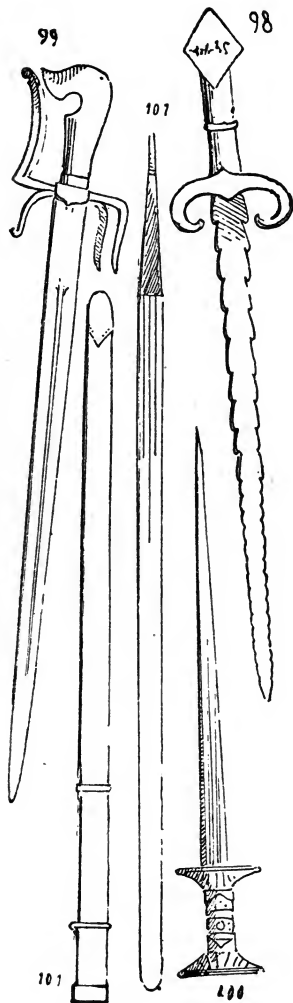

98. Arab sword, exhibited under No. G. 413, Musée d'Artillerie, Paris, where it is described as an Indian weapon. The quillons are curved towards the blade, which is indented.

99. Sword from Morocco with rhinoceros horn handle. The guard is composed of three quillons, all curved towards the blade; there is also a counter-guard.

100. Zanguebar sword (Eastern Africa), 1 foot 10 inches long. The blade is single-edged, but has three grooves. The sheath and handle are in embossed or engraved copper, ornamented with precious stones.

Christy Collection, London.

101. Large Zanguebar sword with crimped leather sheath. The haft, tapering towards the end and twisted, forms a handle, which is without either guard or quillons. As the sword is very long, it is difficult to understand how this singular weapon could be wielded.

Musée d'Artillerie, Paris.

102. Zanguebar sword.*
Musée d' Artillerie, Paris.

103. Scythed yataghan of Tonarik†
 manufacture.
Musée d' Artillerie, Paris.

104. Hatchet yataghan of Tonarik
 manufacture.
Musée d' Artillerie, Paris.

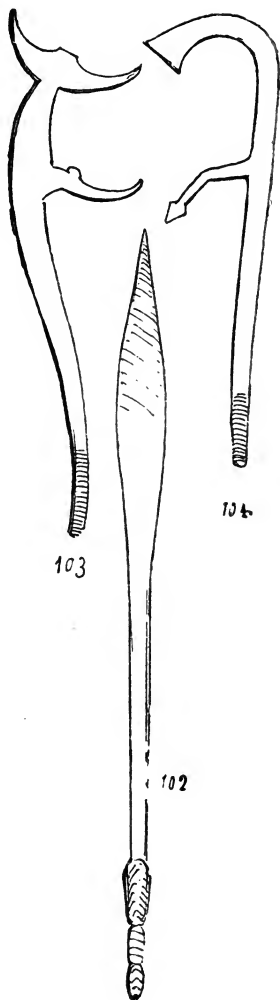

* The coast of Zanguebar is a large district of Eastern Africa, which borders on the Indian Ocean; it comprises many states, among which may be named those of Magodexo, Melinda, Zanzibar, and Quiloo. The inhabitants speak the Caffre tongue, and many of them are Arabs.

† The Tonarik tribes inhabit part of the Sahara.

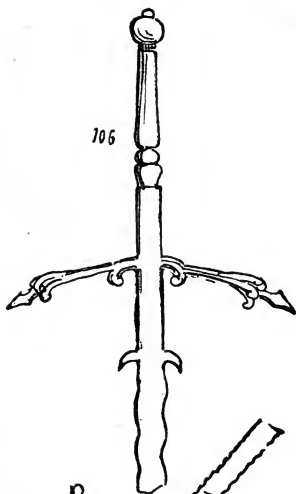

106

105. Two-handed German sword (*Zweihänder* in German), fifteenth century. J. 148, Museum of Paris. The British Museum possesses a similar weapon, 5 feet 8 inches in length. It was the state sword of Edward V. (1475—1483). The sheath and handle are enriched with polychrome enamels.

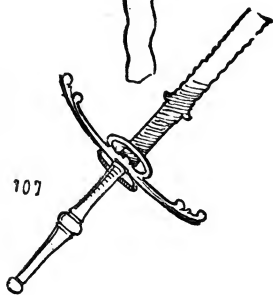

107

106. Swiss or German two-handed sword of the sixteenth century, with wavy blade and hooks. J. 151, Musée d'Artillerie, Paris. A similar sword is in the Az Collection at Lintz, and bears the date 1590, and the German inscription: "*Weich nit von mir, o treuer Gott!*" "Forsake me not, oh true God!"

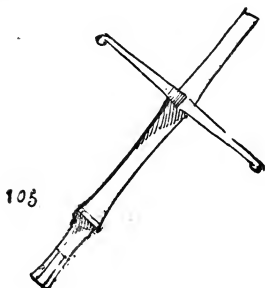

105

107. Swiss two-handed sword, beginning of the seventeenth century.

108. Two-handed sword, end of the sixteenth or beginning of the seventeenth century, as the curvature of the quillons towards the handle and the ring for the thumb seem to indicate.

J. 169, *Musée d'Artillerie, Paris.*

109. Swiss two-handed sword, with curved and saw-edged blade, fifteenth century, about 4 feet in length, the handle being 18 inches in length; the quillons are curved towards the blade.

Arsenal of Berne.

110. Two-handed German sword (*Zweihändiges Hiebmesser*), end of the fifteenth century. This singular weapon, which is cutlass-shaped, is not straight; the blade and handle incline in opposite directions.

Arsenal of Vienna.

111. Two-handed German sword with cushions (*Faustkappen*), sixteenth century.

Dresden Museum.

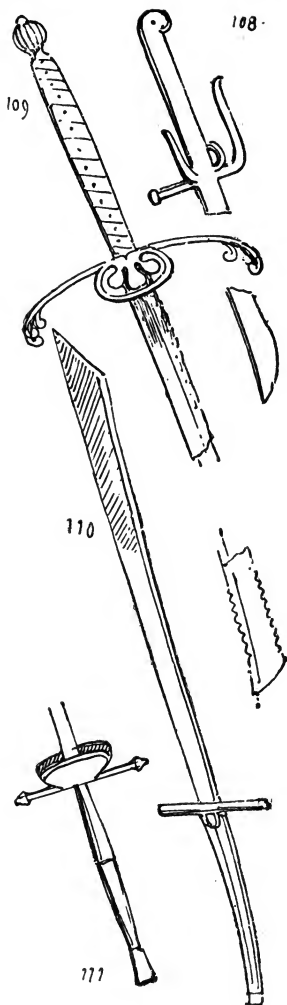

THE DAGGER, PONIARD, STILETTO, KUTTAR, GREASE. ETC.

This kind of weapon, the diminutive of the sword—the war-knife, in fact—has been in use among all people and during all epochs. The shades of difference between the poniard (from the Latin *pungere*, to prick, or *pugnus*, a fist, and called in German *Dolch*) and the dagger* (from the Celtic *dag*, point; in German, *Grosser Dolch* or *Dolchmesser*) are often so slight that the two weapons are continually confounded one with the other. The poniard, properly so called, is smaller and shorter in the blade than the dagger, which was identical with the ancient broad and short sword of the early nations.

It has been seen that the poniard was in use during the ages of flint, whether chipped or polished, a time at which the Danish weapons were the most finished and most artistic.

During the bronze period the poniard equally maintained its sway, it was the *parazonium* of the ancients, and was worn on the left side, while amongst the Greeks and Romans the sword always hung from the right side; among the Assyrians and Egyptians, on the contrary, it hung on the left.

The dagger of the Germans was the *scramasax* (see under this name), a species of single-edged cutlass with a very long haft. The guards of the poniard and dagger, as well as those of the sword, are a great help towards fixing the date of their manufacture, and it has been remarked that during the thirteenth century the ends of the quillons were slightly curved towards the point of the blade.

The *misericorde* was a poniard which received its name from being used to give the last or finishing stroke (*coup de grâce*) to an adversary; its triangular blade rendered it serviceable for thrusting through the points of the armour, on which account it was called in German *Panzerbrecher* (cuirass-breaker). The French *misericorde* of the fourteenth and fifteenth centuries was nevertheless larger than the German *Panzerbrecher*, and it was also used in England for planting in the ground and tethering the horse to during the reign of James I. (1603).

* In venery or hunting terms, "dague" is the name given to the first horn which grows on the head of the young stag in his second year; hence the name "daguët" given in France to the young stag before he is three years old.

The dagger with thumb-ring (*Dolch mit Daumring*), the use of which dates from 1410, is the long Spanish poniard, the guard of which, placed above the *quillons*, has a large ring fastened to it in which the thumb was placed. Towards the end of the fifteenth century it was worn on the right side, and also on the loins. During the sixteenth century it had a double thumb-ring, and was placed on the end of the pike to resist cavalry.

The *anelace*, so called because it was worn fastened to a ring (*annulus*), is distinguished by the size of the blade, the shape of which, broad above and pointed below, resembles an ox-tongue. Hence its French name "langue de bœuf." The small knife often seen on the sheath of this weapon, and which was generally made at Verona, is called "batardeau."

The *lansquenet* dagger, end of the fifteenth and beginning of the sixteenth century, was somewhat long, and worn below the girdle, as the pictures of that time show. The Swiss lansquenet dagger was shorter, and more like a poniard with a steel sheath.

The Frankish archers, the foot archers, and almost all the foot-soldiers of the Middle Ages, were armed with daggers.

The *main gauche*, end of the fifteenth and beginning of the sixteenth century, believed to be of Spanish origin, and from thence brought into Italy and France, was more properly a duelling weapon. It was held in the left hand to ward off blows, while the right was armed with the long rapier. The Italian *main gauche* preserved in the Musée d'Artillerie at Paris, No. J. 485, and engraved further on (see No. 28), represents one of these weapons called "pennated," with three blades expanding by means of a spring when a button was pressed in the handle, and forming a guard of great length and breadth, in which the adversary's sword might be caught and snapped.

This dagger, however, is neither of Spanish nor of Italian origin, as compilers have always repeated; it was already known in Germany during the fifteenth century, when it was used in the secret sittings of the Free Judges, at the taking of the oath vowed in the name of the Holy Trinity, which was represented by the three divisions of the weapon, with which all the Schoeffen were provided.

The stiletto (*Spitzdolch*) was a small point which came

into use during the Middle Ages, and which is well known even at this day.

The "creese," sometimes written *krees*, which the Dictionnaire de l'Académie Française erroneously spells "crid," is a Javanese dagger, generally with a wavy or "flaming" blade, which the Malay tribes render still more fatal by dipping into poison.

The "khouttar," a Hindoo weapon, has a large blade like the Italian *anelace*, fixed on to a square handle, into which the hand is slipped, and thus protected as far as the wrist by this kind of guard or gauntlet. There are *khouttars* in which the blade is divided into two points, but they are not common, and are called serpent-tongued.

The "wag-nuk" is not a poniard, properly so called, but a weapon meant for striking with as a tiger strikes with his claws. It was invented in 1659 by Sevaja, the chief of a secret society, and was used by bandits in assassinations. The wounds inflicted by this weapon resembled those made by a tiger, and thus diverted suspicion from the real authors of the crime.

The Italian daggers are celebrated for their fine workmanship in wrought iron, being often incrustated and damascened with silver; the blades are frequently of pierced work.

Ancient Italian and German daggers and poniards have been known to fetch at the public sales in Paris the high price of a thousand francs.

In more modern times the names of knife-swords and bayonet-poniards were given to the knives, swords, and bayonets in the shape of poniards, that is, with a pointed blade sharpened on both sides.



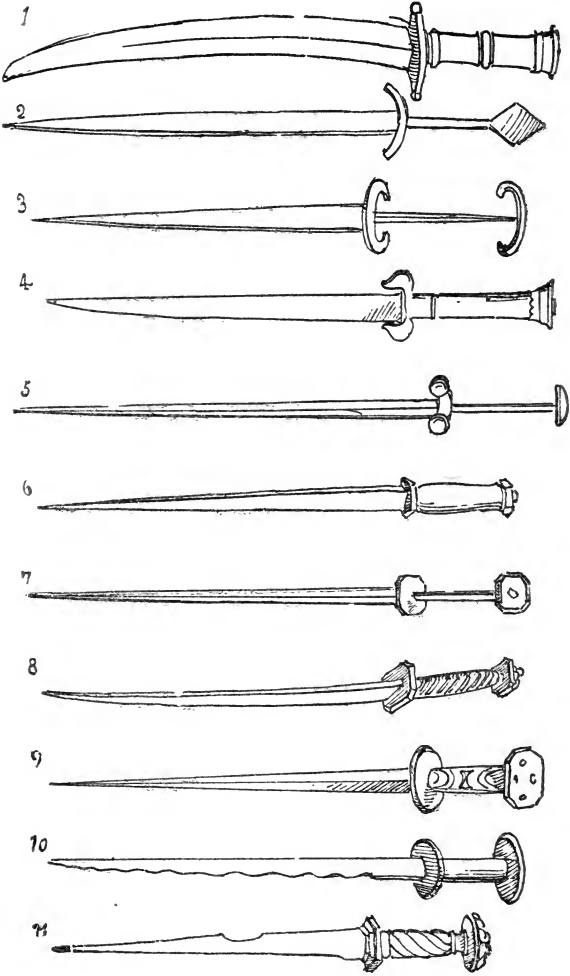

1. British cutlass, tenth century. It bears on the blade the names "Edwardus," and "prins agile." It is attributed to Edward II.
Machel Manuscript.
2. Iron dagger, about a foot long, thirteenth century.
Museum of the Canton, Lausanne
3. Iron dagger, thirteenth century, the blade of which measures about 12, and the haft about 5 inches.
Museum of the Canton, Lausanne.
4. Iron poniard, probably Scottish, fourteenth century.
Collection of Prince Charles of Prussia (see No. 13, next page).
5. Same as above.
6. Poniard, beginning of the fourteenth century.
7. Iron dagger, about 14 inches in length, beginning of the fourteenth century. The haft is very long.
Museum of the Canton, Lausanne.
8. Iron dagger, about 19½ inches long, end of the fourteenth century.
Tower of London.
9. Iron dagger, 14½ inches in length, end of the fourteenth century. It was found in the lake of Morat, and the handle is of carved bone. Arsenal of Geneva. Poniards of this shape were manufactured until the sixteenth century, for the 'Feldbuch,' published at that time by Egge at Frankfort-on-the-Main, and preserved in the cabinet of engravings at Munich, contains similar illustrations.
10. Iron dagger, end of the fourteenth, or beginning of the fifteenth century. Collection of the Count of Nieuwerkerke. Similar weapons (found in the Thames) may be seen in the British Museum, and in the Museum of Sigmaringen, found in Hohenzollern. A manuscript of the fifteenth century, illuminated by Zeitblom for the Prince of Waldburg, also shows this same kind of poniard.
11. Poniard, end of the fourteenth century.

Daggers and Poniards.

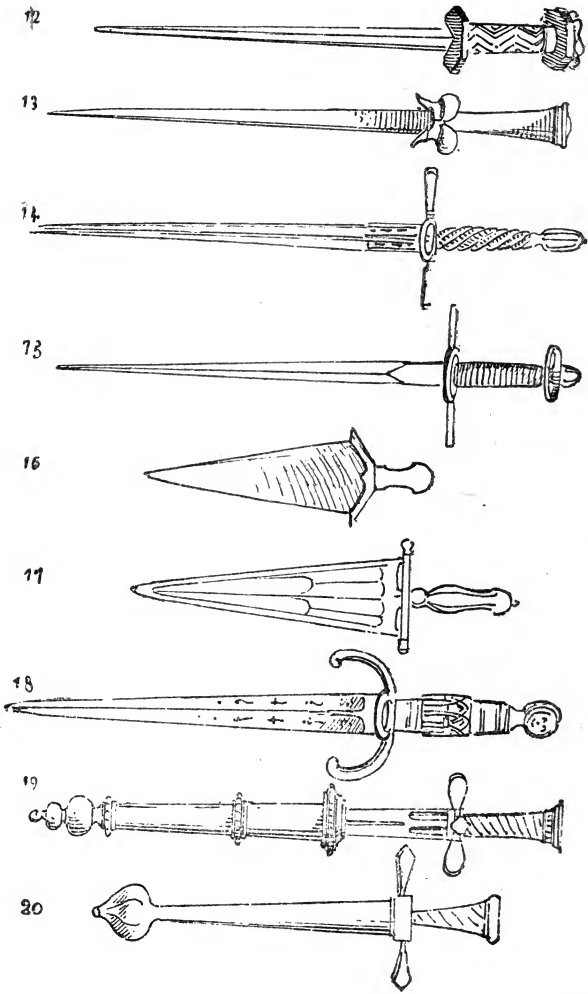

12. Dagger, fifteenth century, of a shape belonging also to the fourteenth century.
Arsenal of Vienna.
13. Scottish dagger, about $14\frac{1}{2}$ inches long, the handle is of wood; fifteenth century. See the observations on the claymores, and the dagger, No. 4.
Count of Nieuwerkerke's Collection.
14. Dagger with single thumb ring, about 16 inches long, fifteenth century.
Author's Collection.
15. Dagger with double thumb ring, sixteenth century. The two rings were placed there to fix the dagger on a shaft, or at the end of a lance, to resist cavalry.
16. Dagger, *anelace*, or Verona dagger, fifteenth century.
Musée d'Artillerie, Paris.
17. Dagger, *anelace*, fifteenth century.
18. Dagger, fifteenth century.
Musée d'Artillerie, Paris.
19. Dagger of a German lansquenet, sixteenth century, about 14 inches long. Sheath in polished steel.
Musée d'Artillerie, Paris.
20. Dagger of German lansquenet, sixteenth century.
Söter Collection, Maximilian Museum, Augsburg.

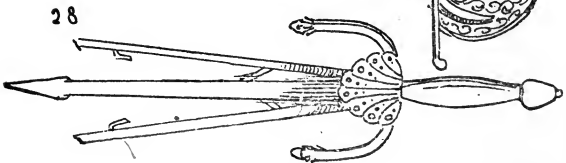
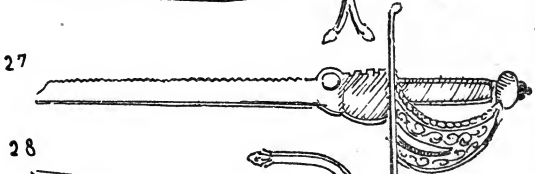
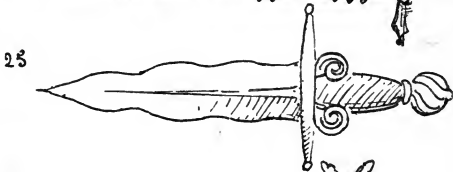
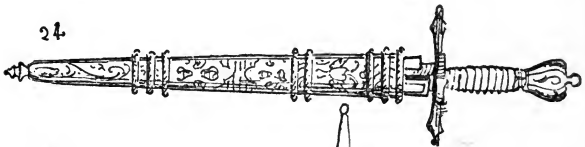
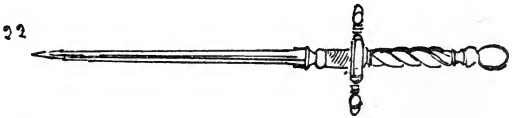
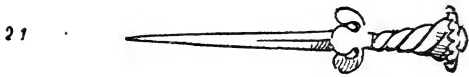

21. Poniard, German, sixteenth century.
22. Stiletto (*Spitzdolch*), about 12 inches long, end of the sixteenth century. In Germany these weapons were also called Panzerbrecher, or cuirass-breaker.
23. Dagger, Swiss, sixteenth century, from the Soltikoff Collection. Similar weapons, belonging to M. Buchholzer of Lucerne, and the Count of Nieuwerkerke at Paris, have in embossed work on the sheaths, instead of the usual hunting subjects, representations of the Dance of Death. These daggers are often provided with small knives, which served to cut the thongs of the armour, to pierce holes, and for various purposes during the campaign.
24. Dagger, German, sixteenth century.
Ancient Soltikoff Collection.
25. Poniard, German, with wavy blade, very short and broad.
Arsenal of the City of Vienna.
26. Poniard, German, sixteenth century. The guard has four quillons.
Collection of Charles XV., King of Sweden.
27. *Main gauche*, sixteenth century.
Musée d'Artillerie, Paris.
28. *Main gauche*, German, sixteenth century. Musée d'Artillerie, Paris, and also in the museums of Prague and Sigmaringen. See the arms of the Free Judges.

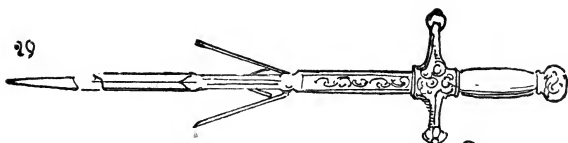

30

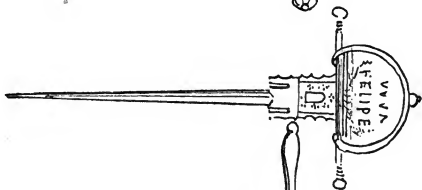

31

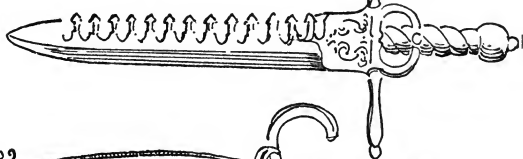

32

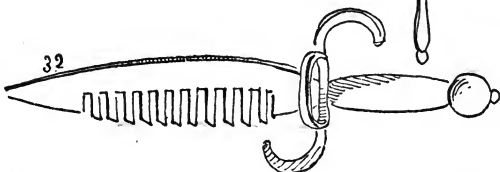

33

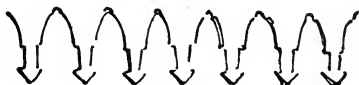

34

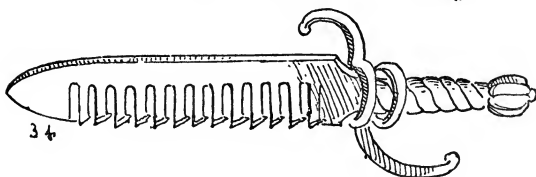

35



29. *Main gauche*, German, about 20 inches long, sixteenth century.
The handle is richly engraved.
Museum of Sigmaringen.
30. *Main gauche*, Spanish, with the inscription "Viva Felipe V.," which
shows that this weapon was in use in the year 1701.
Meyrick Collection.
31. *Main gauche*, German, with indented blade for breaking swords,
sixteenth century.
Count of Nieuwerkerke's Collection.
32. *Main gauche*, German, with indented blade for breaking the enemy's
sword; thumb ring, and quillons curved in inverse directions;
sixteenth century.
Museum of Dresden Collection.
33. Indented blade of No. 31.
34. Large German *brise-épée*, sixteenth century.
Meyrick Collection.
35. Indented blade of the preceding object.

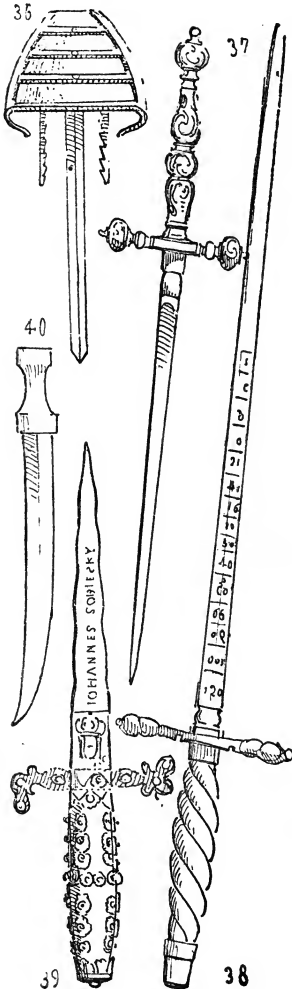

36. Large *main gauche*, German, with indented quillons, and grated guard as sword-breaker, seventeenth century. It measures about 25 by 10 inches.
National Museum of Munich.

37. Stiletto, German, called *Panzerbrecher*, or cuirass-breaker, about 12 inches long, sixteenth century.
Museum of Sigmaringen.

38. Poniard, German, called *Panzerbrecher*. The numbers on the blade serving probably for measuring the bore of cannons.
Museum of Sigmaringen.

39. Poniard, about 10 inches long, richly studded with precious stones. This weapon belonged to Sobieski.
Museum of Sigmaringen.

40. Poniard, Persian.
J. 533, *Musée d'Artillerie, Paris.*

41. Wag-nuk, or tiger's claw, two and a half feet in length; this was an Indian weapon belonging to a secret society, and was invented about 1659 by Sewaja, a Hindoo. It was used for purposes of murder, and as it counterfeited the wounds of a tiger's claw, diverted suspicion from the offender.

Meyrick Collection.

42. Persian poniard, with damascened blade and ivory handle.

43. Hindoo khouttar with blade, called "langue de boeuf."

Musée d'Artillerie, Paris.

44. Hindoo khouttar with forked blade.

Museum of Tsarskoe-Selo.

45. Turkish kandjar dagger.

46. Javanese krees.

47. Javanese dagger, but of Indian or Persian workmanship, 17 inches long. The blade is grooved, and the handle of a massive piece of ivory, ornamented with nail-heads in damascened iron. The sheath of shagreen is partly covered by plaques of niello-work.

Author's Collection.

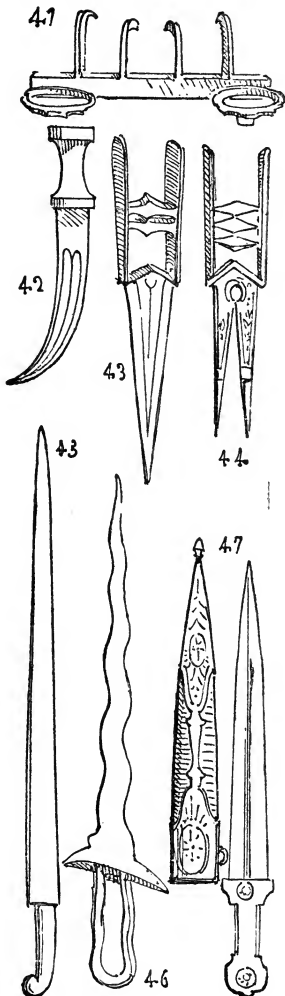

THE LANCE, PIKE, AND SPEAR.

The lance (from the barbarous Latin *lancea*, in German *Speer*, and also *Spiess*) was in use at a very remote period of antiquity, and was common among the Assyrians as well as among the Egyptians. From the eighth to the thirteenth century after Christ the lance remained much the same in shape, a simple cylindrical shaft of smooth wood, about twelve feet long, with the lance-head fixed by a socket on to the staff.*

The tilting lance, which did not appear until the thirteenth century, and was soon utilised in warfare, had a handle; it was thicker at that place, and gradually tapered towards the head and base. In France the use of the lance was forbidden during the reign of Henry IV. in 1605. The lances of the tenth and eleventh centuries are conspicuous by the pennons fastened below the socket of the lance-head. The lances of the mercenaries known under the name of *lansquenets* had generally small blades, whose sockets were strengthened by long stems branching down the shaft, to which they were fixed by means of screws; these lances were sometimes twenty-four or even twenty-seven feet in length. The lances of the Swiss foot-soldiers were not often more than sixteen feet long, for the Swiss method consisted in forming their soldiers into four close rows.

The spear was a weapon used in hunting the wild boar.

* In the Bayeux tapestry, and in miniatures of the same period, pennons are attached to the lances.

1. German lance, from the *Codex aureus* of Saint Gall, of the eighth or ninth century.



2. German lance, beginning of the ninth century, and afterwards called *Knebelspiess*, copied from the Wessobrun manuscript in the Munich Library.

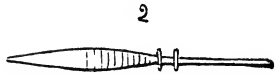

3. Norman * lance, eleventh century, from the Bayeux tapestries.

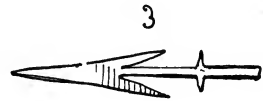

4. The same, with pennon.

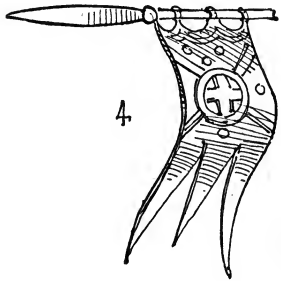

5. The same.

* The lance, as also the sword, were among the Normans the weapons of *free men*, for in the laws of William the Conqueror on the subject of freeing a serf, it is said, *Tradidit illi arma libera, scilicet lanceam et gladium.*

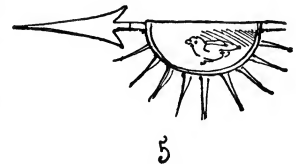

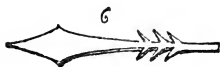

6. Anglo-Saxon lance from a miniature in the *Aelfric* manuscript, of the eleventh century, in the British Museum.



7. Large spear-head, damascened with gold, of the fifteenth century, fifteen inches in length, the blade measuring ten and a half, and the haft, four and a half inches.

Renné Collection at Constance.

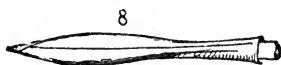

8. Large spear-head, fifteenth century, with a long shaft.

Arsenal of Zurich.



9. Lance of a lansquenet (*Lang-spiess* in German), end of the fifteenth century. The shaft is about twenty-four feet long, and is one inch and a half in diameter. The Museum of Salzburg, possessing several similar lances, presented some of them to the Emperor Napoleon III., who gave them to the Musée d'Artillerie at Paris. Monsieur Az at Lintz has also a few lances of this kind in his collection.



- 10 A and 10 B. Lances of Austrian foot-soldiers, end of the fifteenth century. Weapons like these are to be seen in the drawings made by Nicholas Glockenthon in 1505, from the *Arsenals of the Emperor Maximilian*.

Ambras Collection.

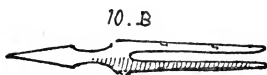

- 11 A. Lance of Swiss foot-soldiers, of the fifteenth and sixteenth centuries.

Arsenals of Soleure and Lucerne.

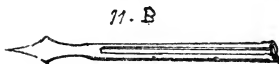

- 11 B. The same.

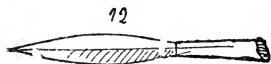

12. Slender lance, called *Assagai*, from the Arsenal of Rhodes, and belonging formerly to the knights of St. John of Jerusalem (1522).

F. 43, *Musée d'Artillerie, Paris.*

13 A. Long slender lance, beginning of the sixteenth century. The lance-head is nearly a foot and a half in length. From drawings already mentioned, executed in 1505 by Glockenthon, and which are to be found in the Ambras Collection.

13 B. The same.

14. War lance of the fifteenth century, from a piece of tapestry, said to have been found in the tent of Charles the Bold.

15. Tilting lance, with vamplate, sixteenth century.

Meyrick Collection.

16. War lance of the sixteenth century, profusely ornamented with red eagles on a white ground, the arms of the city of Innsbruck.

Meyrick Collection.

17. Tilting and war lance, from the above-mentioned illustrated manuscript of Glockenthon, 1505.

18. The same.

All these lances have an indented place in the shaft for the hand to obtain a firm grip. This fashion does not date farther back than the end of the thirteenth century, at which time the tournaments were frequent, and well regulated.

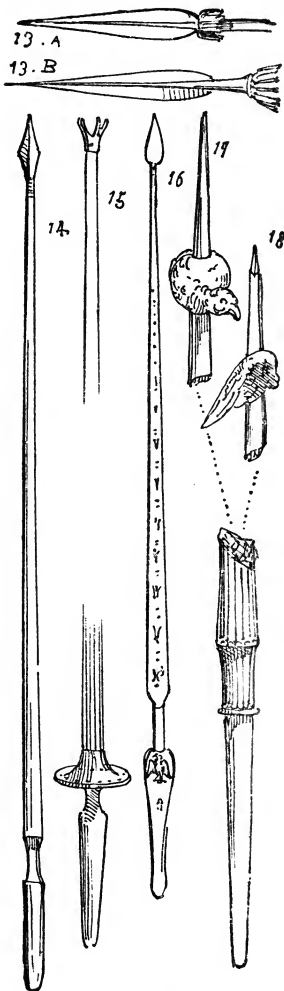

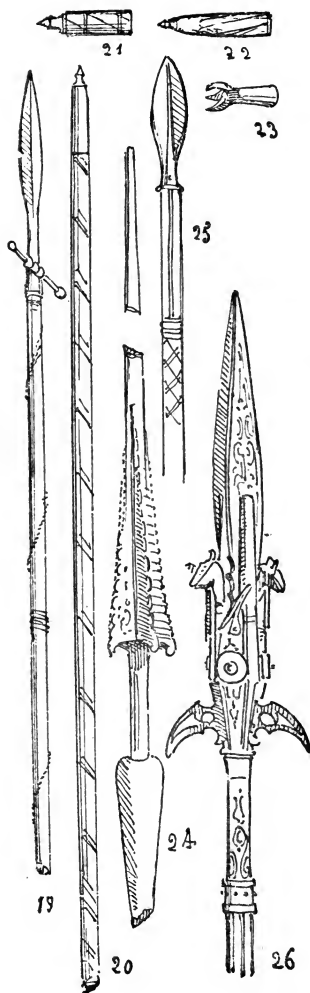

19. German lance, called *Knebelspiess*, from Glockenthon's manuscript, 1505, in the Ambras Collection.

20. German hunting javelin, sixteenth century.

Dresden Museum.

21. Point of a German war and tilting lance, of the sixteenth century; it is 7 inches in length.

Dresden Museum.

22. The same. 8 inches in length.

Arsenal of Berlin.

23. The same. $5\frac{1}{2}$ inches in length.

Arsenal of Berlin.

24. Lance for tilting at the ring. A lance on this model will be found in the "Traité d'Equitation," by Pluvinel, of the reign of Louis XIII. (1610—1643).

K. 262, *Musée d'Artillerie, Paris.*

25. German hunting spear, sixteenth century (*Sau* or *Bärenfanger*, and also *Schweinsfeder* in German). It was used more especially for boar-hunting.

26. Hunting spear of the sixteenth century, with three wheel-lock pistols, and two "hallebarde" hooks: this weapon was part of the Soltikoff Collection.

27. Lance of the seventeenth century.

28. Double-headed Persian lances, from a very late sixteenth-century manuscript copy of Ferdusi's *Schah-Nameh* of the year 999.

29. Arrow-shaped javelin for throwing (*Wurfpfeil* in German), used for boar-hunting.
Arsenal of Berlin.

30. Abyssinian lance, conspicuous on account of its broad, iron, shovel-shaped base. The broad point recalls exactly the bronze and iron heads of the "framées," belonging to the bronze and iron ages. One lance of this kind has a ring fastened to it, and is known under the name of "celt."

Musée d'Artillerie, Paris.

31. The same.

32. Chinese lance.

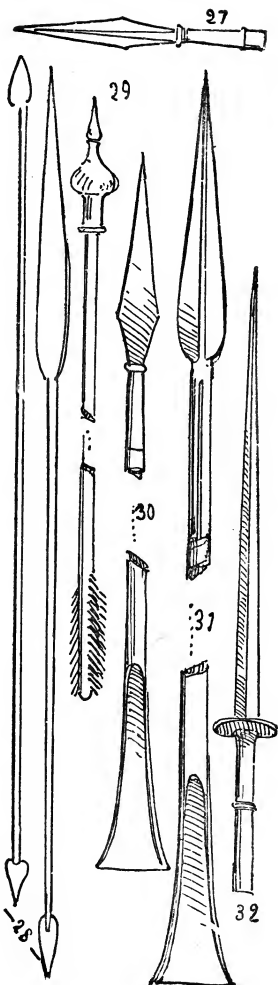

THE MACE.

The mace (from the Latin *massa*, *Streitkolben* in German) is a weapon heavy at one end, not made either for piercing or cutting, but only for stunning an enemy; it was much used by the cavalry, and there are several representations of it in the Bayeux tapestries, end of the eleventh century.

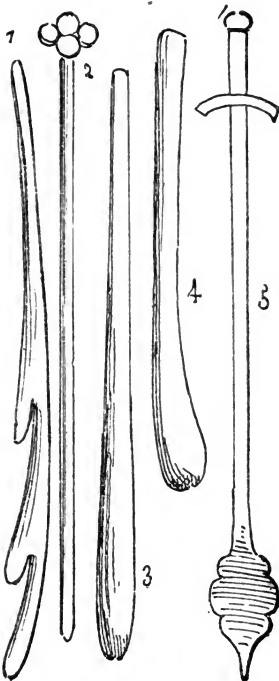

1. Iron mace, end of the eleventh century.

Bayeux Tapestries.

2. The same.

3. The same.

4. Mace, from the "German Æneid" of Henry of Waldeck, thirteenth century.

Library of Berlin.

5. Burgundian mace, beginning of the fifteenth century, from a manuscript believed to have belonged to the Duke of Burgundy.

Library of the Arsenal, Paris.

6. English mace, in wood and iron, reign of Henry V. (1413—1422).

Meyrick Collection.

7. English mace, in iron, middle of the fifteenth century.

8. German mace, fifteenth century, engraved iron; it is about 22 inches in length, and has the handle wired.

Arsenal of Lucerne.

9. Turkish mace, iron, fifteenth century; an architectural rose is damascened in the top.

Musée d'Artillerie, Paris.

- 10 A. Mace, from a manuscript of the end of the fifteenth century, being a copy, illustrated with numerous miniatures, of the *Schah-Nameh* or royal book, composed by the poet Ferdusi in the reign of Mahmoud (999).

Library of Munich.

- 10 B. The same.

11. French mace, sixteenth century.

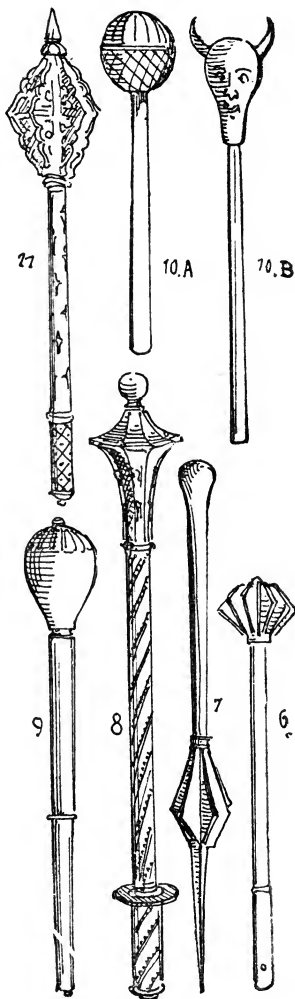

+

THE MORGENSTERN, OR MORNING-STAR.

This mace had generally a long handle, and its head bristled with wooden or iron points ; it was common among the ancients, for many museums possess several fragments of these weapons belonging to the age of bronze.

The morning-star was well known and much used in Germany and in Switzerland ; it received its name from the ominous jest of wishing the enemy good-morning with the morning-star when they had been surprised in camp or city.

This weapon became very popular on account of the facility and quickness with which it could be manufactured. The peasant made it easily with the trunk of a small shrub and a handful of large nails ; it was also in great request during the wars of the peasantry which have devastated Germany at different times, and the Swiss arsenals possess great numbers of them.

Morning-stars were also made for horsemen ; they were short in the handle like hammers, and generally better manufactured than the long-shafted ones used by the foot-soldiers. A few of these little maces, studded with iron points, have even been supplemented with hand cannons. When so provided they are called in German *Schiessprügel*. See No. 8.

1 and 2. Maces, which should be classed among the weapons of the iron age, for they are copied from the column of Theodosius at Constantinople, which dates from the fourth century.

3. Swiss morning-star of the fifteenth century on a long shaft. The length of the iron, which is armed with four blades and a spike, is 18 inches.

Gymnasium of Morat.

4. Swiss morning-star of the fifteenth century, with a wooden ball studded with iron spikes and a long shaft.

Museum of Berne.

5. Hand morning-star, probably a horseman's. It is of engraved iron, 26 inches in length, and has a dart or spike which starts from the handle by means of a spring.

Museum of Sigmaringen.

6. Morning-star and partisan on a long shaft with iron bands.

Az Collection, Lintz.

7. Morning-star of 11 feet 4 inches in length, studded with spear-heads; end of the fifteenth century.

Arsenal of the City of Vienna.

8. Morning-star with hand cannon, called in German *Schiessprügel*; end of the fourteenth or beginning of the fifteenth century.

Collection of Prince Charles, at Berlin; Ambras and Meyrick Collections; and Museum of Sigmaringen.

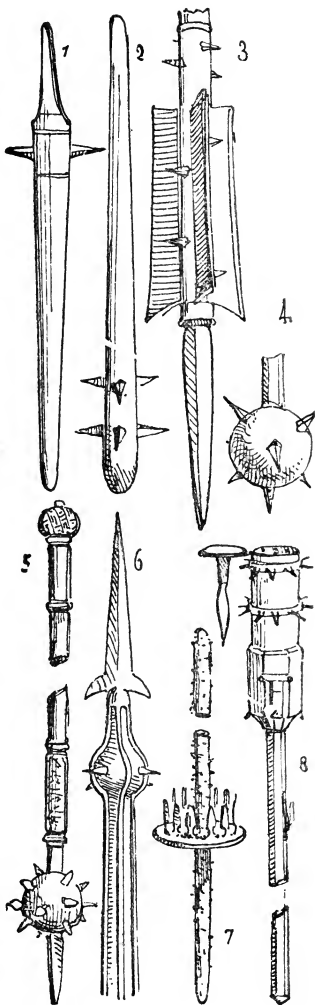

MILITARY FLAILS.

The *flail*, or *holy-water sprinkler** (from the Latin *flagellum* and the German *Flegel*), is a weapon whose name indicates its shape; it was also called holy-water sprinkler from the shape, and from the drops of blood which started from those upon whom it was used. It was composed of the shaft and the whips, the latter either with or without iron points; or else of the shaft, to which was fastened a chain ending in an iron ball, or a wooden one studded with iron.

The invention of this weapon does not appear to be of ancient date, for the first mention of it is found in the manuscripts of the beginning of the eleventh century.

A statue of this epoch in the Cathedral of Naumburg in Germany, representing one of the founders, is armed with a flail, and so is the statue of the Palatine Oliver, in the Cathedral of Verona.

The flail, which was very well known in Switzerland and Germany during the fifteenth century, was also used in England since the period of the Norman conquest (eleventh century), and existed during the reign of Henry VIII. (1509—1547), though then but little used, and only in the trenches and on board ships. The military flail with a short handle belonged more particularly to Russia and Japan.

The *armed whip*, or *scorpion* (also called *Scorpion* in German), was a kind of hand flail or knout, with three, four, or six chains.

* Some authors erroneously give this name to the *morsing-star*.

1. German holy - water sprinkler (*Flegel* in German) of the eleventh century, with chain and ball without spikes, from the statue of one of the founders of Naumburg Cathedral.

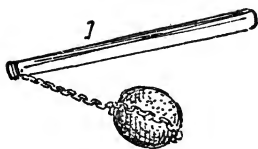

2. Iron hammer of flail, without points, on a long shaft, probably of the fourteenth century.
K. 83, *Musée d'Artillerie, Paris.*

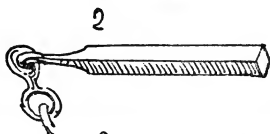

3. Flail with chain and spiked ball on long shaft, probably of the fourteenth century.
K. 81, *Musée d'Artillerie, Paris.*

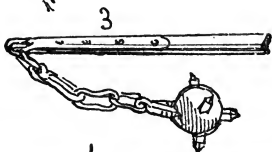

4. Scorpion, or flail, with four chains without balls (called *Scorpion* in German), a Hussite weapon of the fifteenth century.
National Museum of Prague.

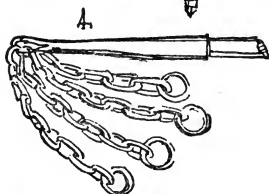

5. English flail with chain and spiked ball on long shaft; reign of Henry VII. (1485—1509).
Meyrick Collection.

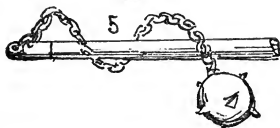

6. Swiss flail with iron hammer on long shaft.
Arsenal of Geneva

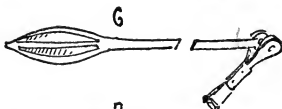

7. Short - handled flail, 2 feet 7 inches in length.
National Museum Munich.

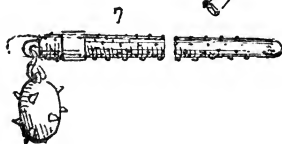

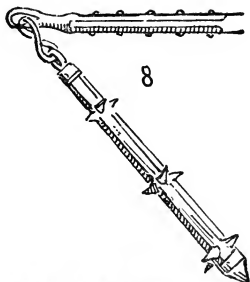

8. German flail of the fifteenth century on a very long shaft. It has an iron hammer with twelve spikes.

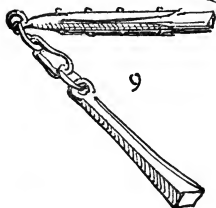

9. Swiss flail of the fifteenth century with a squared iron hammer without spikes, on a long shaft.

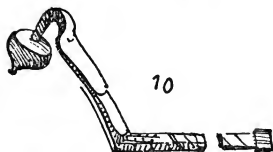

10. Ancient Russian knout,* with a short handle.

Dresden Museum.



11. Japanese flail. The handle is only 26 inches in length, and the ball at the end of the chain is studded with very sharp spikes.

* The knout actually employed in Russia for punishments differs but slightly from the ancient instrument, painful as it is to us to believe in the existence of such a thing in the present state of civilisation.

THE BILL, OR WAR-SCYTHE.

The *war-scythe* (from the Latin *falx*, *Kriegssense* in German) is nothing but the agricultural scythe slightly straightened; the blade is in a line with the haft;* it is single-edged, the point slightly curved towards the sharp edge, while the scythe-knife, also single-edged, has the point curving from the edge to the back; the blade of the *gisarme*, or *glaiive-gisarme*, is, as the name *glaiive* indicates, double-edged, like the cut and thrust sword.

1. Unstraightened war-scythe, beginning of the ninth century. From the manuscript of Wessobrunn, year 810, in the library of Munich.
2. Bohemian crescent-shaped war-scythe, thirteenth century. From the manuscript of Voelav in Prince Lobkowitz's library, at Raudnitz.
3. War-scythe, fourteenth century. K. 145, *Musée d'Artillerie, Paris*.
4. Swiss war-scythes of the fourteenth and fifteenth centuries. *Arsenals of Zurich and Soleure*.

War-scythes of colossal dimensions (4 feet to 4 feet 6 inches in the length of the blade) were used by the *Tschaikeists* of Austria to mow down the crews of their enemies' boats. The Austrian troops so-called derived their name from the river *Tschaike*.

Imperial Arsenal of Vienna.

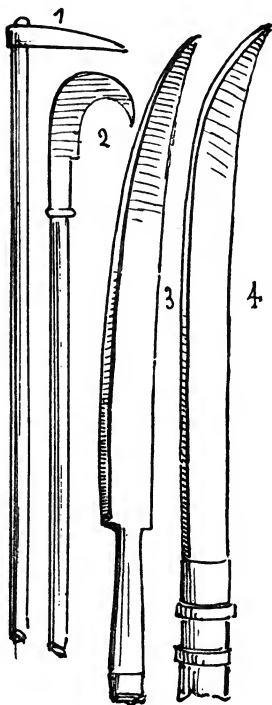

* In Austria, during the *Jacquerie* or peasants' war, all smiths detected in turning agricultural implements into weapons were punished with death.

THE SCYTHE-KNIFE, OR GLAIVE.

The scythe-knife, and another very like it, often confounded with the gisarme, but in reality a *breach knife*, is, like the war-scythe, single-edged, being in fact a modified form of the war-scythe, but, as has been before stated, the blade of the glaive curves from the edge, and the blade of the scythe towards it. The point is double-edged, and at the base of the blade there is a hook or spur. The glaive was greatly used in France during the fourteenth century, which is proved by the especial mention of it in the poem of the "Trente."

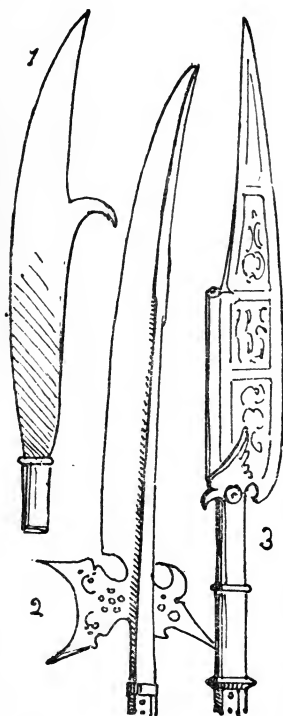

1. Burgundian glaive, fifteenth century. From a manuscript in the library of the Arsenal at Paris.

2. Swiss glaive: at the base are hallebarde blades.

Museum of Sigmaringen.

3. German glaive, sixteenth century, with wheel-lock pistol. It is richly inlaid.

National Museum of Munich.

4. Glaive called *Cracouse*, seven-teenth century.

Klemm Collection, Dresden.

5. German glaive,* ornamented with the armorial bearings of King Ferdinand, the Order of the Golden Fleece, and the letter F.

Meyrick Collection.

6. German glaive, very large size, sixteenth century. It bears the date 1580, and the Bavarian arms.

K. 156, *Musée d'Artillerie, Paris.*

7. Scythe trident, or "Ranseur," for charging (*Sturmsense* in German), of the seventeenth century. A German weapon of enormous dimensions, being 5 feet by 4.

Imperial Arsenal of Venice.

* This kind of weapon is also called breach-knife (*Brechmesser* in German). It was especially common in Austria and in other parts of Germany, and was used as late as the eighteenth century, but in reality it was nothing but a scythe-knife.

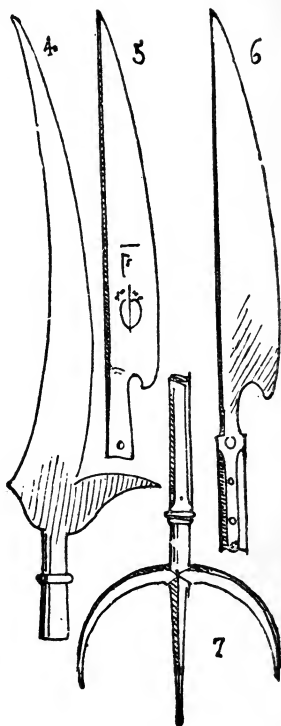

THE GISARME.

The *gisarme*, or glaive-gisarme (*Gleefe*, and also *Ross-schinder* * in German), which almost all British authors confound with the halberd, is simply a glaive fixed on a shaft. The gisarme is quite different from the war-scythe and breach-knife, as it is double-edged and armed with hooks. The origin of the glaive-gisarme dates from the age of bronze among the Keltic and Germanic nations, at which time many tribes were in the habit of fastening glaives or scramasax swords to long shafts. The Welsh called them *llawmawr*, a name derived from *cleddy* or *gleddy*. In some parts of Germany the name of *Gleefe* has given place to the more modern one of *Sensen mit Spitzen*. The French name of *guisarme* is apparently derived from the *guisards* or followers of the house of Guise, who were armed with them. Olivier de la Marche, a chronicler, born in 1426, maintains that the name of gisarme is of great antiquity, and believes this weapon to originate in the habit of fastening a dagger to the blade of a battle-axe.

* *Ross-schinder*: this name was given to the foot-soldiers who were in the habit of using this weapon to hamstring the knights' horses.

1. English gisarme (*Gleeffe* and *Ross-schinder* in German), of which mention is made in the twelfth-century manuscripts of Westminster. The Chinese use this weapon at the present day, as may be seen from the specimens in the Musée d'Artillerie, at Paris.

2. Swiss gisarme, thirteenth century.

Troyon Collection in the Museum of the Canton, at Lausanne.

3. Swiss gisarme "bill," fifteenth century.

Arsenal of Soleure.

4. Swiss gisarme "bill," end of the fifteenth century.

Museum of Sigmaringen.

5. English gisarme "bill," end of the fifteenth century.

6. Swiss gisarme, end of the fifteenth century.

Arsenal of Zurich and Wittmann Collection at Geisenheim.

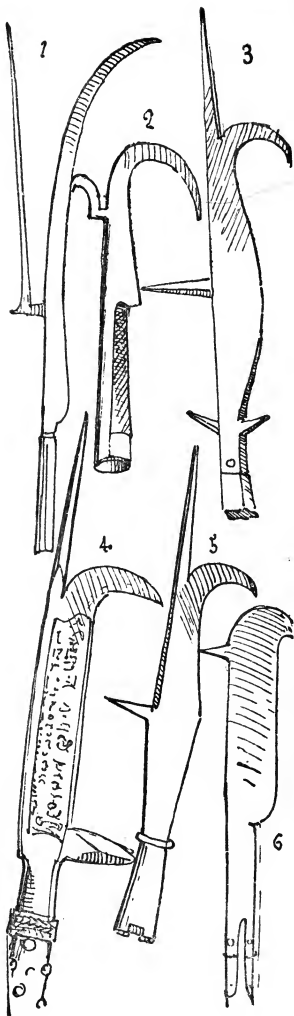

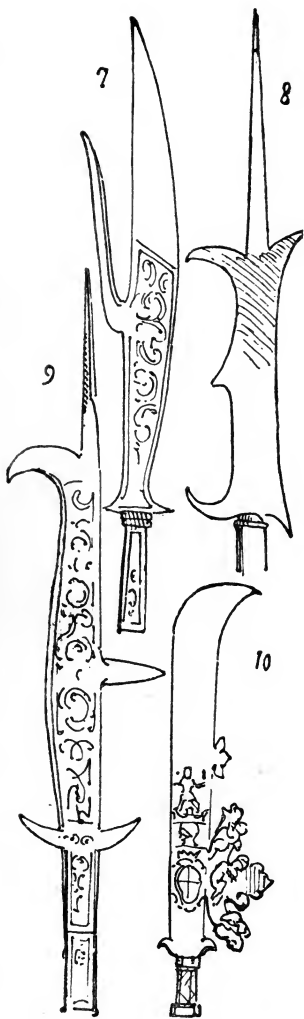

7. Italian gisarme "glaive," richly engraved, end of the fifteenth century.

Meyrick Collection.

8. Gisarme on long shaft, bound with iron. The blade is about $2\frac{1}{2}$ feet in length, and bears the inscription X. IVANI. X.

Az Collection, Lintz.

9. Swiss gisarme "bill," inlaid, sixteenth century.

Museum of Sigmaringen.

10. Italian gisarme "glaive," belonging to the Doge's guards: they were armed with this weapon, and with the basket-hilted sword, called *Schiavona*, which in almost all collections has been erroneously catalogued as a *claymore*, but the Scottish sword has a simple guard without either a *pas d'âne* or basket hilt.

THE VOULGE.

Though very rarely met with now, this weapon was one of the most ancient among the Swiss, and also much sought after in France during the fifteenth century, at which time there existed a regiment of infantry called *voulgiers*, who were armed with this broad-bladed and long-hafted weapon. A large number of archers also carried them. Some few authors wrongly give the name of voulge to the boar-spear, the shape of which bears not the least resemblance to the voulge of ancient warfare.

1. Swiss voulge, about 16 inches in length, found on the battle-field of Morgarten (1319).

Arsenal of Lucerne.

2. Swiss voulge with hook, fourteenth century.

3. Swiss voulge, fourteenth century.

Arsenal of Zurich.

A representation of this voulge may be seen in a fifteenth-century manuscript of the Hauslaub Collection.

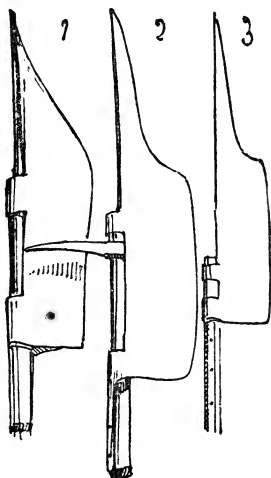

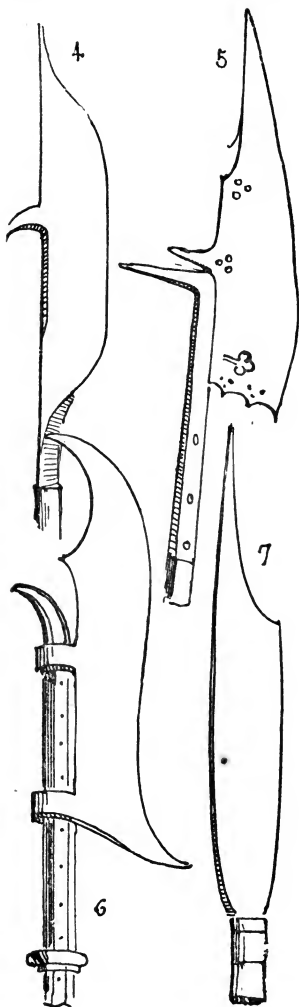

4. Swiss voulge, end of the fourteenth century.

*Meyer Biermann Collection
at Lucerne.*

5. German voulge, end of the fifteenth century.

Az Collection, Lintz.

6. Saxon voulge, taken at the battle of Mühlberg (1547).

Imperial Arsenal of Venice.

7. Austrian voulge, about 2 feet in length. It is of the time of the Jacquerie or peasants' war, (1620-1625), when it was forged out of a ploughshare.

Az Collection, Lintz.

THE POLE- OR WAR-HAMMER.

Fixed on a long shaft, the pole-hammer has been known in Germany and Switzerland under the name of *Luzerner Hammer*, as it was a favourite arm of the people of Lucerne. It is called pole-hammer in English from the fact of having the spiked hammer placed at the end of a long shaft or pole. The foot-soldiers' war-hammer is of great antiquity, as we may see in the hammers of the so-called stone and bronze ages; and Charles Martel (715--741) owes his name to this formidable weapon, which became general during the fourteenth century. The French poem of the *Combats des Trente* mentions the war-hammer and its weight:

"Cil combattait d'un mail qui pesoit bien le quart
De cent livres d'acier, si Dieu en moi part."

This war-hammer, of *twenty five pounds' weight*, belonged to Tommelin Belefort. They were also used in the passages of arms, as Olivier de la Marche, born in 1426, remarks in his "Memoirs," where he also makes mention of the passage of arms of the "sire Hautbourdin et de Delalain."

The short-handled horseman's hammer (*Reiterhammer* in German) which the knights carried, like the mace, at their saddle-bow, is almost as ancient as the pole-hammer. Some antique bas-reliefs at the Louvre represent Amazons attacking their enemies with short-handled double-edged pole-axes (?), one of which is, in armourer's phraseology, falcon or parrot-beak shaped, a term used however when the hammer was long-handled.

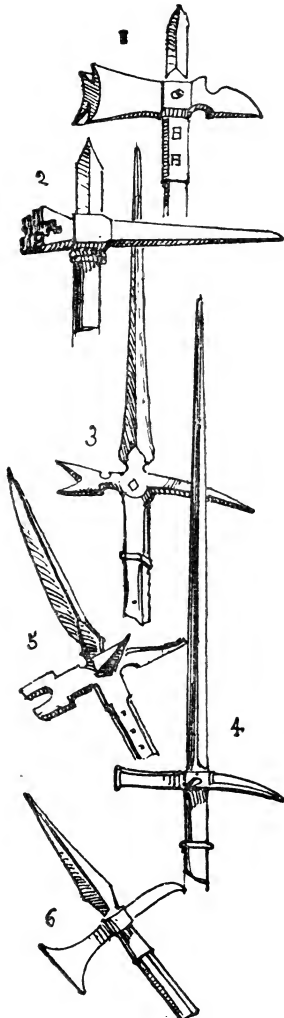

1. Steel war-hammer on long shaft, fourteenth century (*Luzerner Hammer* in German).

K. 84, *Musée d'Artillerie, Paris*.

2. Steel war-hammer on long shaft, fifteenth century.

3. Swiss steel war-hammer on long shaft, fifteenth century. This weapon, of which there are a great number in the Arsenal of Lucerne, is a fair type of the *Luzerner Hammer*, or hammer of Lucerne.

Meyer Biermann Collection and Museum of Sigmaringen.

4. Steel war-hammer on long shaft, end of the fifteenth, or beginning of the sixteenth century. The sword which forms the apex of the whole is more than 3 feet in length.

K. 88, *Musée d'Artillerie, Paris*

5. Swiss steel war-hammer on long shaft, from a drawing of Hans Holbein (1445-1554), representing the combat of Theibaut d'Arx.

Industrial Museum of Vienna.

6. Hammer-pike. This long-shafted weapon was carried by the subalterns in charge of the flag under the First Empire (1804-1814).

K. 275, *Musée d'Artillerie, Paris.*

7. Horseman's war-hammer (*Reiterhammer* in German), 2 feet in length; iron handle studded with copper ornaments of Gothic character, denoting the end of the fifteenth century.

8. War-hammer, 3 feet 4 inches in length, belonging to a Hussite chief of the fifteenth century, serving at once the purposes of a weapon and a rod of office. The handle, about 16 inches in length, is covered with red velvet. A dart 2½ feet long springs from the hammer on pressing a button near the socket.

Museum of Sigmaringen.

9. Horseman's parrot-beaked war-hammer, end of the fifteenth century.

Meyrick Collection.

10. Horseman's parrot-beaked war-hammer in chiselled iron, ornamented with fleurs-de-lys; 22½ inches in length, sixteenth century.

Arsenal of Berne.

11. Horseman's parrot-beaked war-hammer, sixteenth century.

K. 69, *Musée d'Artillerie, Paris.*

12. Scaling war-hammer, taken from the Savoyards under the command of Branaulieu Chaffardin in 1602, under the walls of Geneva, in an unsuccessful night attack.

Arsenal of Geneva.

13. Horseman's war hammer with very long spike of iron and copper. The shaft is wood, the handle ivory; sixteenth century.

Dresden Museum.

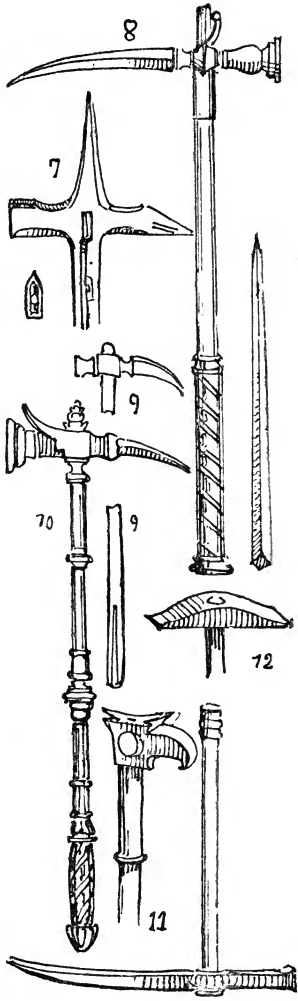

THE BATTLE-AXE.

The battle-axe (from the German *Hacken*, and not from the Latin *ascia*) was generally called *Streitaxt* in German, but when the handle was greatly lengthened and used by foot-soldiers it became a pole-axe, and was called *Fuss-Streitaxt*. This cuneiform weapon, like the common hatchet, from which it is modified, is one of the most ancient and best known during the so-called ages of stone and bronze, and was the favourite weapon of all Germanic nations.

The Frank hatchet, the well-known *francisque*, was short-handled, while that of the Saxons was fixed on so long a shaft that among the Anglo-Saxons it was named pole-axe.

At the battle of Hastings (1066), where Harold was defeated by William the Conqueror, the Saxons at first repelled with success the repeated attacks of their Norman foes, whom they overthrew in large numbers with their long battle-axes, etc., a weapon which among them was generally about five feet in length. In the Bayeux tapestries are many representations of battle-axes without either point or hook, in this resembling the domestic hatchet and the *francisque*.

The foot-soldier's battle-axe of the fourteenth century differs considerably from the weapon of an earlier date. Though on one side an axe, it becomes on the other a war-hammer, either with a saw edge or a sharp point, but generally large and curved, called *falcon-beaked*; whilst the term *parrot-beaked* was applied when the weapon was short in the handle and belonged to a horseman.

The battle-axe sometimes was provided with a long dart or sword fixed at the top.

The short-handled horseman's axe (*Reiteraxt* and *Barthe* in German) is found to have sometimes a gun-barrel encased in the handle, either the primitive hand-cannon or the wheel-lock pistol.

The short-handled battle-axe as well as the war-hammer appears to have been known to the ancients. It is sometimes seen in engravings of Assyrian war-chariots and in sculpture which represents Amazons.

- 1 and 2. Foot-soldier's long-shafted pole-axes (*Fuss-Streitaxt* in German), end of the eleventh century.

Bayeux Tapestry.

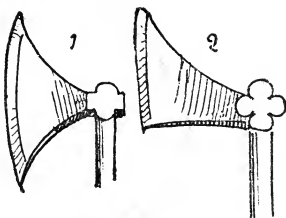

3. German foot-soldier's pole-axe, end of the fourteenth century. K. 93, *Musée d'Artillerie, Paris.*

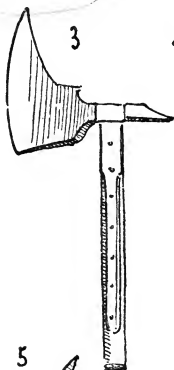

4. German foot-soldier's pole-axe, fifteenth century. From a wood engraving. *Cabinet of Engravings, Munich.*



5. German foot-soldier's pole-axe, fifteenth century. *Museum of Munich, Collection of Charles XV. of Sweden, and Meyrick Collection.*



6. Swiss foot-soldier's pole-axe, fifteenth century.

Arsenal of Lucerne.

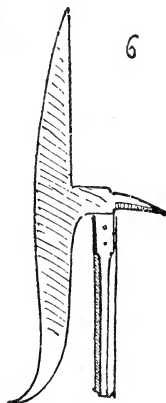

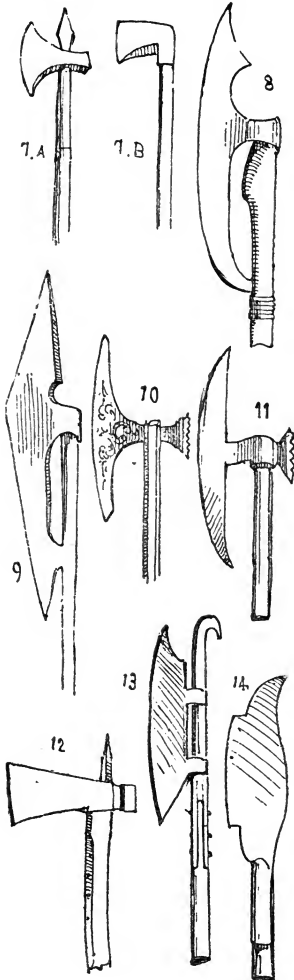

7 A. German foot-soldier's pole-axe, fifteenth century.
Cabinet of Engravings, Munich.

7 B. The same.

8. Russian foot-soldier's pole-axe, called Bardiche.
K. 95, *Musée d'Artillerie, Paris.*

9. Russian * foot-soldier's pole-axe, with which the *Strelites* or *Stre-
litzen* were armed.
Museum of Tsarskoe-Selo.

10. Venetian pole-axe with saw-
edged hammer, sixteenth
century.
Meyrick Collection.

11. Swiss pole-axe with saw-edged
hammer, sixteenth century.
Arsenal of Berne.

12. Swiss pole-axe, with hammer
and dart.
Arsenal of Berne.

13. Long-shafted Scottish Lochaber
axe, the national weapon of
Scotland.
*Collection of Prince Charles at
Berlin.*

14. German pole-axe, fifteenth cen-
tury.†
*Historical Museum of Monbijou at
Berlin.*

* The modern battle-axes of the inhabitants of the Caucasus are of this same shape: this may be seen from the weapon of Schamyl, also in the Museum of Tsarskoe-Selo, and in German fifteenth-century engravings in the Cabinet of Engravings at Munich.

† Nos. 9 and 14 might be classed among the voulges.

- 15 English foot-soldier's Jedburgh axe, sixteenth century.

Meyrick Collection.

16. Scottish or English foot-soldier's pole-axe.

K. 96, *Musée d'Artillerie, Paris.*

17. German horseman's short-handled battle-axe (*Reiteraxt* and *Barthe* in German), end of the fifteenth century.

Dresden Museum.

18. Turkish horseman's battle-axe, end of the fifteenth century; it belonged to the Sultan Mahomed Ben Kaitbai, who reigned from 1495 to 1499. An inscription in open-work letters says, "The Sultan, the victorious king, the father of fortune, Mahomed Ben Kaitbai, may the servant of God be glorified in him." There is also in Cufic characters the name of God five times repeated.

Ambras Collection.

19. Slavonic horseman's battle-axe. From a drawing by Albert Dürer.

20. Horseman's iron battle-axe, beginning of the sixteenth century.

21. English horseman's battle-axe, beginning of Queen Elizabeth's reign (1558).

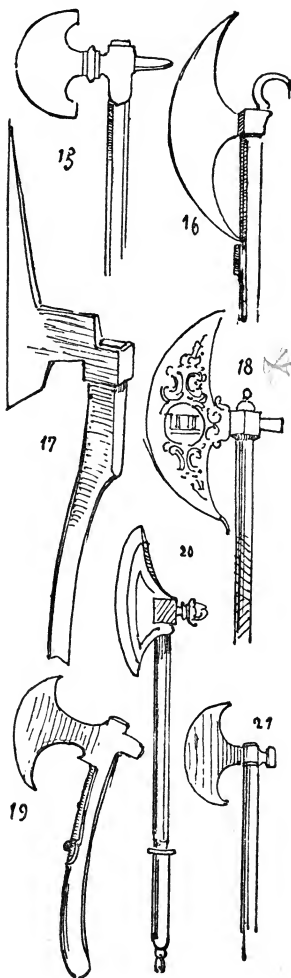

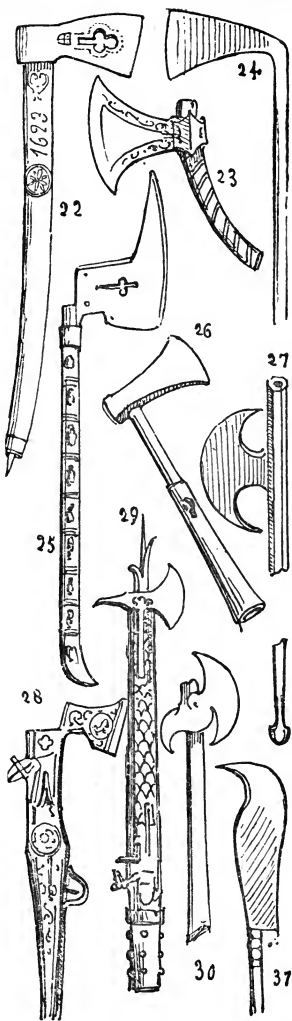

22. Austrian battle-axe: the handle is about a yard in length, and bears the date 1623 and a wheel, a sign for gathering themselves together adopted by the peasants in the Jacquerie rebellion, to conquer which the aid of the Bavarian horsemen were called in.

Az Collection, Lintz.

23. Short-handed Polish battle-axe, bound with strips of leather, beginning of the seventeenth century.

Meyrick Collection.

24. English executioner's axe, end of the sixteenth century, with which the Earl of Essex was beheaded in the reign of Elizabeth (1558-1603).

Tower of London.

25. Saxony miner's axe, for show, called *Bergbarthe*, with the date 1685; the handle is inlaid with ivory, and the blade pierced in open work. These arms are only intended for the festival day processions of miners' corporations, and not for actual use.

26. Horseman's battle-axe, with small hand cannon, fifteenth century.

27. Battle-axe with small hand cannon, 34 inches in length: it belonged to the reformer Zwingli, who died in the battle of Cappel in 1531.

Arsenal of Zurich.

28. German battle-axe with wheel lock pistol, inlaid with ivory and silver, end of the fifteenth century.

Szokau Museum (Hungary), and Museum of Sigmaringen.

29. Battle-axe with flint-lock pistol, end of the seventeenth century.

30 and 31. Chinese battle-axes.

Musée d'Artillerie, Paris.

THE HALBARD.

The halbard may be derived from the German *Halbe-Barthe*, half battle-axe; or from *Helm*, casque, and *Barthe*, battle-axe; or from *Alte Barthe*, old battle-axe: in Germany and Scandinavia it dates from the earliest centuries of the present era, though it was not known in France until the Swiss introduced it in 1420. The president Fouchet, whose writings are about the end of the sixteenth century, attributes the introduction of the halbard to Louis XI. (1461—1483). "This prince," he writes, "ordered at Angiers and other good cities some new war-blades called halberds." This assertion is confirmed by miniatures of the fifteenth century in which the halbard is represented, though the shape varied greatly according to the time and country.

1, 2, and 3. Three kinds of halbards, somewhat like the *ranseurs*, eleventh century. From the *Psalterium*, a manuscript in the Stuttgart Library.

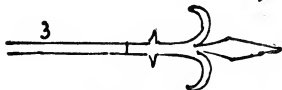

4. Swiss halbard, fourteenth century.

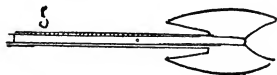
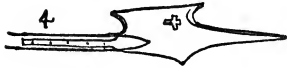

5, 6, 7, and 8. Four German halbards of the fourteenth century. *National Museum of Munich.*





9. Swiss halbard, beginning of the fifteenth century.

Author's Collection.

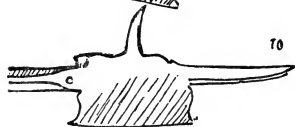

10. Swiss halbard, end of the fifteenth century.

Arsenal of Berne.



11. Swiss halbard with three-pronged hammer, end of the fifteenth century.

Arsenal of Berne.

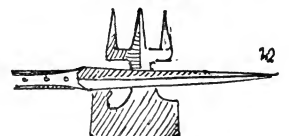

12. German halbard with three-pronged hammer, beginning of the sixteenth century.

Imperial Arsenal of Vienna.

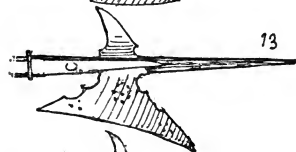

13. Swiss halbard, middle of the sixteenth century.

Author's Collection.



14. German halbard, sixteenth century, engraved and gilt, a very handsome weapon.

Museum of Sigmaringen.



15. German halbard, sixteenth century.

Söter Collection in the Maximilian Museum at Augsburg.

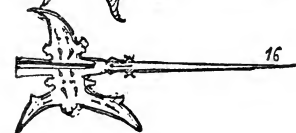

16. Venetian halbard, end of the sixteenth century.

Meyrick Collection.

RANSEURS.

The ranseur is a kind of partizan, but coming originally from Corsica it has been called in France *corsèque*, and also by some authors *roncone*; the weapon was well known in Germany during the fifteenth century. The ancient *Cérémonial Français* says that it was a long and broad javelin with two barbs.

1. Burgundian ranseur, or roucone, from miniatures in a fifteenth-century manuscript.

Library of the Arsenal, Paris.

2. Ranseur, end of the fifteenth century.

K. 98, *Musée d'Artillerie, Paris.*

3. German ranseur, beginning of the sixteenth century. From the Glockenthon manuscript.

Ambras Collection.

4. German ranseur, sixteenth century.

Nieuwerkerke Collection.

5. Italian ranseur, sixteenth century.

6. Ranseur, seventeenth century.

Arsenal of Berlin.

7. Four-sided ranseur. The point is above a yard in length. Arsenal of the city of Vienna. This same ranseur is found in drawings made in 1505 by Glockenthon, who made facsimiles of the arms in the arsenals of Maximilian I.

8. Ranseur, beginning of the seventeenth century.

Museum of Sigmaringen.

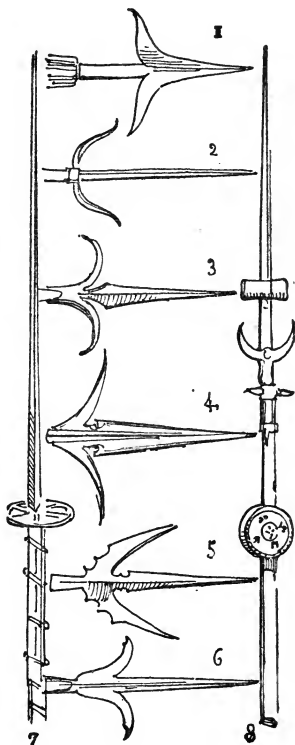

THE PARTIZAN.

The partizan is derived from the Spanish *partesana*, or from *pertuis*, opening, on account of the large wounds made by it, or perhaps simply from the French *partisan*; in German called *Partisane*, and also *Böhmischer Ohrlöffel*; and is a species of halbard. The iron is long, broad, and double edged; there is no axe, but barbs in the style of the ranseur. The partizan was known in France since the time of Louis XI. (1461) until the end of the seventeenth century, but its invention is not earlier than 1400. Pietro Monti, in his *Exercitiorum atque Artis Militaris Collectanea*, Milan, 1509, who has particularly wished to describe this weapon, with which the guards of Francis I. and his successors were armed, has confounded the partizan with ranseurs and halbards, an error which has been committed in our days in the catalogue of the celebrated Meyrick Collection at Goodrich Court, where even spontoons and *langue-de-bœuf* bayonets have been placed in the category of partizans.

1. German partizan (*Partisane* or *Böhmischer Ohrlöffel* in German), whose iron measures $14\frac{1}{2}$ inches. It dates probably from the early years of the fifteenth century.

National Museum of Munich.

2. Swiss partizan with armourer's mark, fifteenth century.

Meyer Biermann Collection at Lucerne.

3. Swiss partizan with armourer's mark, fifteenth century.

Meyer Biermann Collection at Zurich.

4. French engraved partizan, reign of Francis I., sixteenth century.
K. 166, *Musée d'Artillerie, Paris.*

5. German partizan, richly engraved, and bearing the date 1615 and the order of the Golden Fleece. It belonged to the guards of the Palatine of the Rhine.

Meyrick Collection.

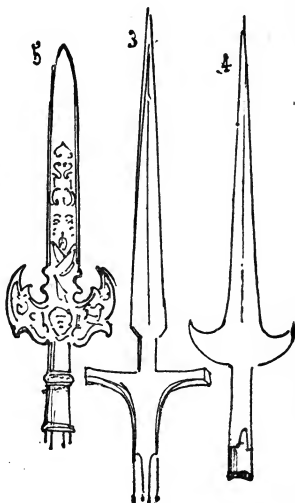
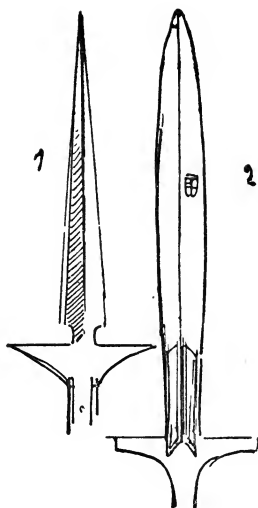

THE BAYONET.

Nearly all authors of encyclopædias and dictionaries, from the habit of copying one another, have repeated that the bayonet (*Bajonnet* in German) was invented and manufactured at Bayonne by Puységur, who died in 1682. Nevertheless this sort of dagger or sword has not been carried at the end of a fusil only, it had been already adapted to the arquebus, and even perhaps to the earliest portable firearms. The bayonet was already known in France about 1570, but was not universally adopted until about 1640, when it replaced the pike in certain regiments. At the present day the bayonet is composed of the blade and socket with collar, which latter invention has been wrongly attributed in England to Mackay, in 1691, and in France to Vauban; but it was at first a simple handle in wood, iron, or horn, intended to fix into the barrel. Subsequently the bayonet was fixed at the end of the gun by means of the socket, which was sloped so as to turn on the collar. This was the side-arm joined to the firearm, called *musket-gun* or *fusil-musket*, and attributed to Vauban, which Couhorn, his rival, introduced among the Dutch infantry about 1680.

A wheel-lock musket, made towards the end of the sixteenth century, and preserved in the Culman Collection at Hanover, weakens, however, the supposition that Vauban was the inventor of the socketed bayonet, for this firearm possesses a long bayonet with socket and collar, whose blade serves at the same time for a screw to draw the charge.

There are *langue-de-bœuf* bayonets, Spanish *knife bayonets*, *triangular* bayonets, Bohemian *scythe-bayonets*, *bayonet-sabres*, etc., etc.

1. German bayonet with socketed collar, sixteenth century.

Culmann Collection, Hanover.

2. Bayonet-poniard with handle and sword-breaker, end of the sixteenth century; about 15 inches in length.

Söter Collection at Augsburg.

3. Wooden - handled triangular - bladed bayonet-poniard; total length 14 inches; seventeenth century.

Söter Collection at Augsburg, and in Swiss Arsenals.

4. English langue-de-bœuf plug-bayonet (*Pflug Bajonnet* in German), end of the seventeenth century. Tower of London. A similar one in the same museum bears the inscription: "God save King James the 2d." 1686.

5. Spanish wooden-handled knife-bayonet, seventeenth century. It bears the inscription:

"No me saches sin rason
Ne me embainez sin honor."
(Unsheath me not without reason, nor sheath me without honour.)

Meyrick Collection.

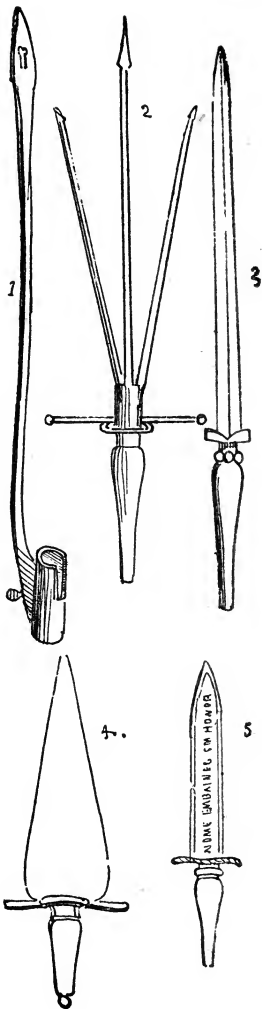

THE MILITARY FORK.

This weapon (*Sturm-gabel* in German) began to appear towards the end of the fifteenth century. The Arsenal of Geneva possesses several Italian scaling-ladder forks taken from the Savoyards in 1602. The military fork is also mentioned in the accounts of the siege of Mons, in 1691, where the grenadiers of the elder Dauphin's regiment, under the command of Vauban, assaulted a breastwork and carried away the Austrian forks. To recompense their bravery Louis XIV. gave the sergeants of that regiment the right of carrying a fork in place of the halbard.

1. Military fork, fifteenth century.
From the original collection in
the Cabinet of Engravings,
Munich.

2. German military fork, beginning
of the sixteenth century. From
a water-colour drawing of
Glockenthon's, made in 1505
from the arsenals of Maxi-
milian I.

3. Italian scaling-ladder fork taken
from the Savoyard troops under
the walls of Geneva in 1602.
Arsenal of Geneva.

4. Scaling-ladder fork from the
second siege of Vienna in 1683.

5. Double military fork, seven-
teenth century.

6. Simple military fork, seven-
teenth century.
Arsenal of Geneva.

7. Three-pronged military fork,
seventeenth century.
Az Collection, Lintz.

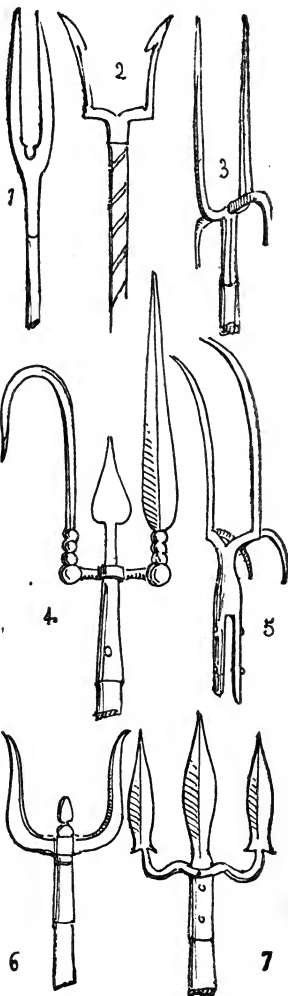

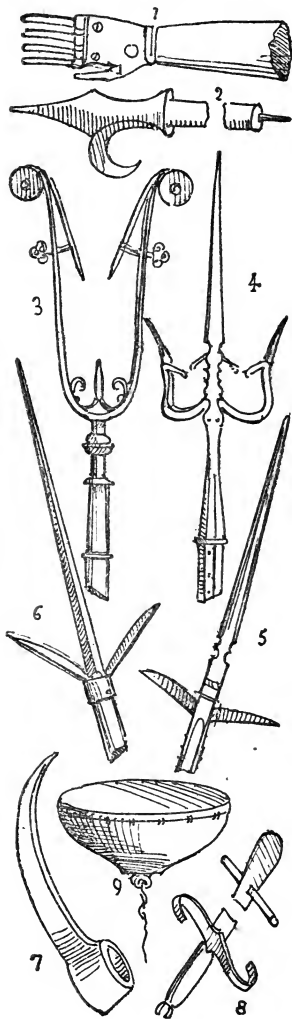

1. Articulated iron hand, sixteenth century; attributed to Götz of Berlichingen. Museum of Sigmaringen. In the National Museum of Munich there is a similar hand.

2. Long-shafted hook used by the besieged in a town to tear away burning arrows, from the *Walturius* of 1472 and a manuscript of the beginning of the fifteenth century in the Hauslaub Collection at Vienna. (See the chapter on war-engines.)

3. German catchpole (*Fangeisen* in German), fifteenth and sixteenth centuries; it is 14 inches in length, and fixed on to a long shaft. This terrible weapon was intended to catch the knight by the throat and unhorse him.

Museum of Sigmaringen, Tower of London, and Imperial Arsenal of Venice.

4. German double catchpole, sixteenth century.
Dresden Museum.

5. Hunting spear with a spring-blade on either side, inlaid, sixteenth century. It is about 2 feet in height.
Dresden Museum.

6. Hunting spear with spring and double knife, sixteenth century, bearing the name Bartolam Biella.
Dresden Museum.

7. Battle-hook, sixteenth century, found among the ruins of the fortified castle of Erperath, near Neus and Düsseldorf, which was destroyed by the Swedes.
Museum of Sigmaringen.

8. Hunting sword with cross-piece near the point of the blade, sixteenth century.

J. 171, *Musée d'Artillerie, Paris.*

9. Small Turkish drums covered with human skin, taken by General Rauchhaupt, who commanded, during the grand elector's reign, a Brandenburg brigade at the battle of St. Gotthard in Hungary. (1664).

Arsenal of Berlin and Author's Collection.

WAR ENGINES AND BESIEGING WEAPONS.

The war engines (*Antwerp* in German) which were employed during the Middle Ages, and before the time of large-calibred firearms, have been copied from those of the ancients. (See Introduction, pp. 29, 30, 31, 54 and 55.) We recognise the *balista*, intended to shoot large arrows; the *catapult* or *tormentum* of the Latins, and the *onagre* in old French, which shot forth stones and pieces of rock; the battering ram, and a modification of it called in French *trebuchet*, and the ancient *tolleno* or see-saw with two baskets, which deposited the combatants within besieged places. In Germany were also used different sorts of engines with the names of *Manges*, *Blindes*, *Tribocs*, *Patrarias*, *Tanten*, *Igel* (hedgehog), *Katzen* (cat), and a variety of other names, to designate different kinds of machines whose names and shapes were modified according to their respective provinces. The miniatures in the Codex Aureus of Saint-Gall, ninth century, represent inflammatory machines in the shape of fish carried on the points of lances. The Musée d'Artillerie at Paris possesses two bows of balistas from the castle of Damascus, probably made in the time of the Crusaders, and the Cabinet of Antiquities at Zurich several iron rods of balista arrows, found with many broken bits of these machines in the ruins of the Castle of Russikon, which was destroyed towards the end of the thirteenth century.

The archives of Mons, in the year 1406, make mention of war engines, drawings of which are met with in all the manuscripts of that time, particularly in the fifteenth-century drawings of Zeitblom, in Prince Waldburg Wolfegg's library.

The inventors of war engines were at that time particularly occupied in discovering new methods of setting fire to besieged places, and even went so far as to devise portable fire machines indented to be fastened to dogs, cats, and even birds. The cock himself, the beloved and living time-piece of the lansquenets, who never quitted them in their campaigns, was transformed into an incendiary torch by these terrible inventors.

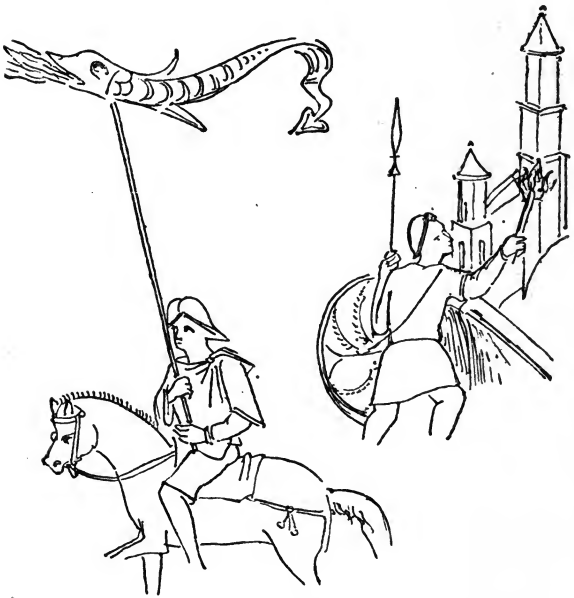

Two hand torches. *Codex Aureus* of Saint-Gall, ninth century. The engine which the horseman carries at his lance's point is shaped like a fish. As the manuscript represents it as vomiting fire before the besiegers have arrived at the place, the fiery torches are probably not made with gunpowder or other explosive material, but simply of resin.

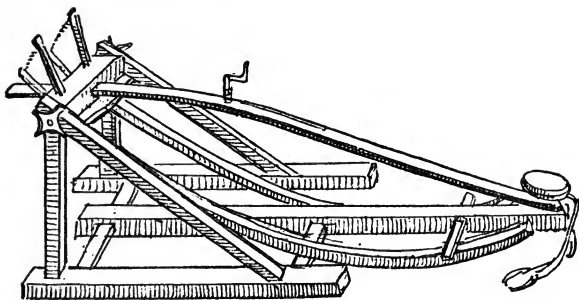

War engine to shoot large stones, balls, or pieces of rock (this was the *catapult* or *tormentum* of the ancients, the French *onagre*, and the German *Bleydenn*), from the drawings of Zeitblom, fifteenth century, in the library of Prince Waldburg Wolfegg. Authors of the fifteenth and sixteenth centuries have drawn a large number of these machines, but so varied in their construction as to appear productions of fancy rather than copies from actual objects.

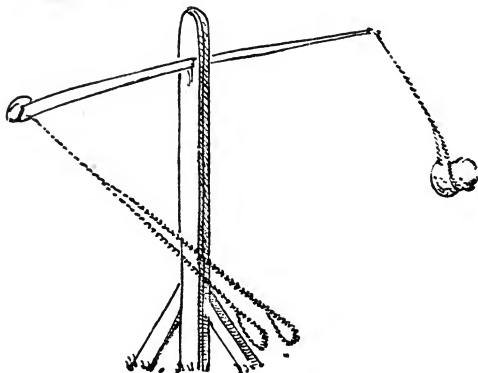

Machine for shooting stones and making a breach, called *trebuchet*, from Zeitblom's drawings, fifteenth century. Library of Prince Waldburg Wolfegg. At that time there were double *trebuchets*, which shot stones by the backward and forward motion of the beam called rod (*verge*), or arrow (*flèche*), one end of which was always loaded while the other returned. The simple *trebuchet* was put in motion by means of a rope pulled by four men. The trebuchet with a sling was constructed in much the same manner as the simple trebuchet, with this difference, that, at a given moment, a hook fastened to the long end of the beam let fly one of the ropes, and the stone was shot forth from the tangent of the circle described.

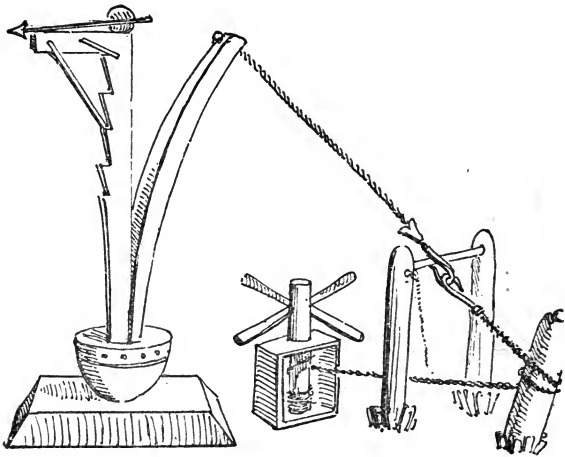

War engine for shooting arrows (the *balista* of the ancients, and the *Belagerungsbalester* of the Germans), copied from the *Walturius* printed at Verona in 1472. Hauslaub Library at Vienna. This machine shoots off the arrow by means of a very strong piece of wood, which, being drawn down by ropes wound round posts, springs back against the beam as soon as the ropes are loosed, and thus propels the arrow.

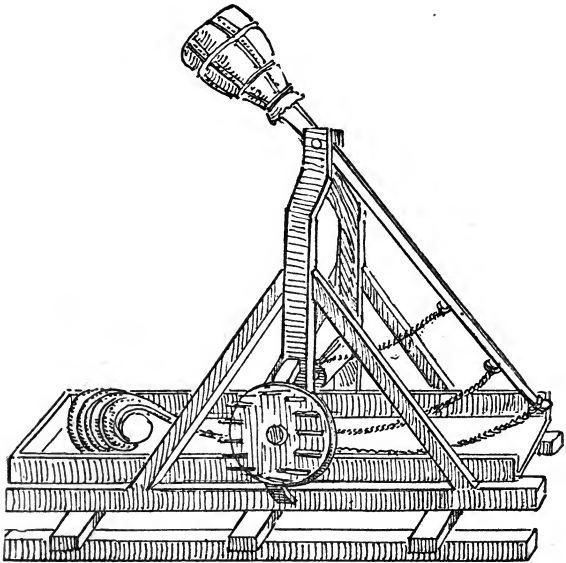

Engine with gear, for battering in breach (from the German *Brechen*, break, or from the Keltic *brech*, *breca*, opening), which must have been far more efficacious than the battering ram, whose blows could only have made a hole in the wall, while the impetus of this machine must have often broken down the entire side. This drawing is copied from those in the *Pyrotechnie de l'Anselot Lorrain*; the same engine is also drawn in the *Walturius* of the Hauslaub Library at Vienna.

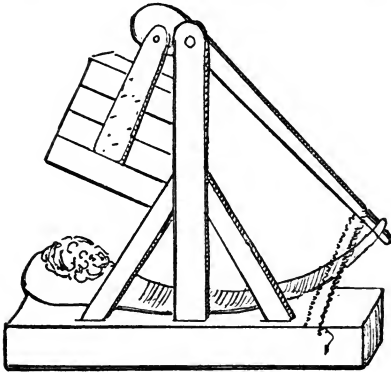

Slinging engine with backward and forward motion, from a manuscript, *Recueil d'Anciens Poëtes*, in the Imperial Library at Paris. This is one of the simplest engines; the end of the beam, freed from the holder, rises with rapidity as the other end is weighed down, and giving impetus to the sling, discharges the projectile.

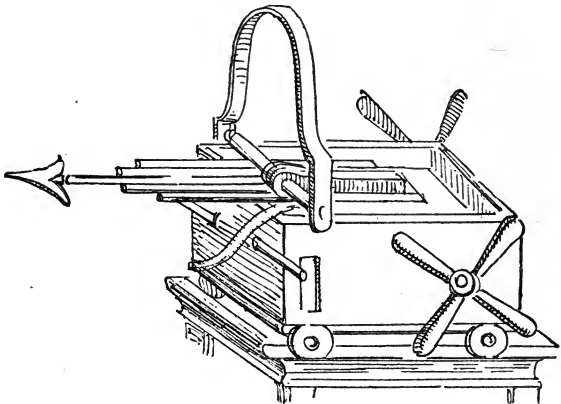

Four-wheeled balista (*Balista quadrirota*), from the *Notitia Utraque eum Orientis tum Occidentis*, etc. Bâle, 1552. The author of this *Notitia*, who has copied notes of the administration of the Roman armies in the East and West, has added drawings of balistas which he copied from machines or pictures of his time.

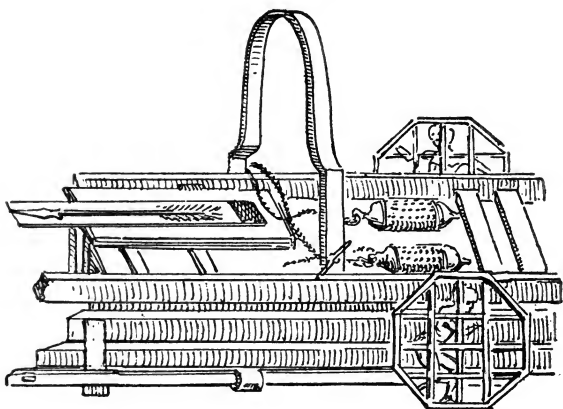

War engine from the *Notitia Utraque cum Orientis tum Occidentis*, etc. Bâle, 1552, where it is called *balista fulminatrix*. This engine is interesting on account of the men inside wheels who form its motive power. In the same work may be seen a wheeled boat called by the author *Libourna*, in which the wheels are moved by oxen.

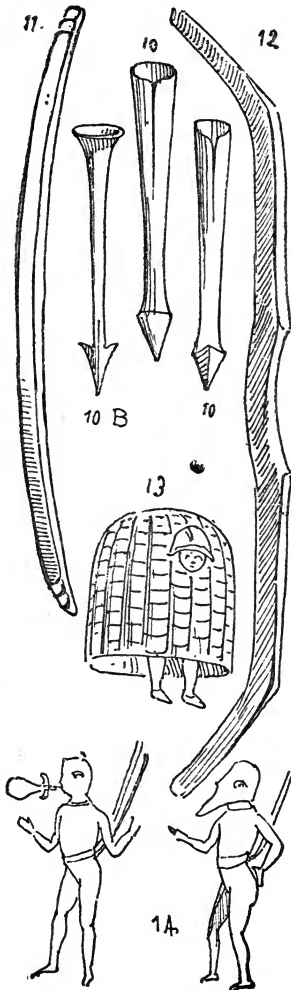

10. Iron of a balista arrow, $5\frac{1}{2}$ inches long, found under the ruins of the castle of Russikon, in the Zurich Canton, which was destroyed towards the end of the thirteenth century.

10 B. Iron of a balista arrow, from the *Kriegsbuch* of Fronsperger, 1573.

11. Bow of a balista, from the castle of Damascus. It is of palm-wood, covered with small pieces of horn.

Musée d'Artillerie, Paris.

12. The same.

13. Besieging or miner's basket, wicker, from a fifteenth-century manuscript in the Hauslaub Collection, Vienna.

14. Diver's dress from a fifteenth-century manuscript in the Ambras Collection. In the illustration the figures are quite black, probably intended to imitate leather.

15. Armed dog carrying a torch to set fire to a camp.

Hauslaub Collection, Vienna.

16. Cat with torch to set fire to a besieged place.

17. Bird. The same.

18. Jug in baked earth without a cover, and filled with quicklime, which the besieged used against the besiegers. It was found in the Ketzerturm. Cabinet of Antiquities at Zurich. Leonard Fronsperger explains the use of this seemingly childish projectile in his *Kriegsbuch* (War book), published at Frankfort in 1573: "Soll man füllen ein Theil mit Aschen unt ungeloeschten Kalk der Klein ist wie Mehl, derven unter die Feind geworfen mit Krafftten dass die Hafen zerbrechen und unter sie streun gleich wie man das Weihwasser giebt kommt dann in deun Mundt, etc., etc." (These jugs should be filled with ashes and powdered quicklime, and thrown with strength against the enemy; when broken they scatter their contents and sprinkle the enemy as with holy water, and enter into his mouth, &c.)

- 18 bis. Incendiary barrel used by the besiegers in the Middle Ages. From a manuscript, beginning of the fifteenth century.

Hauslaub Library, Vienna.

19. Chariot of intrenchment, used in the seventeenth century in the war against the Turks.

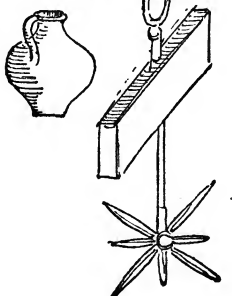
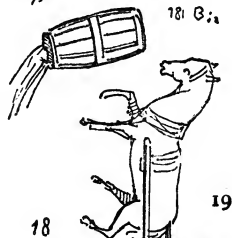
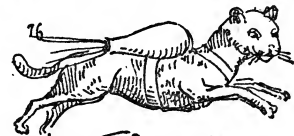
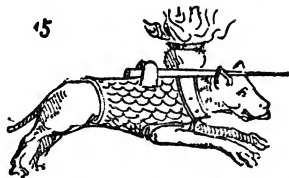

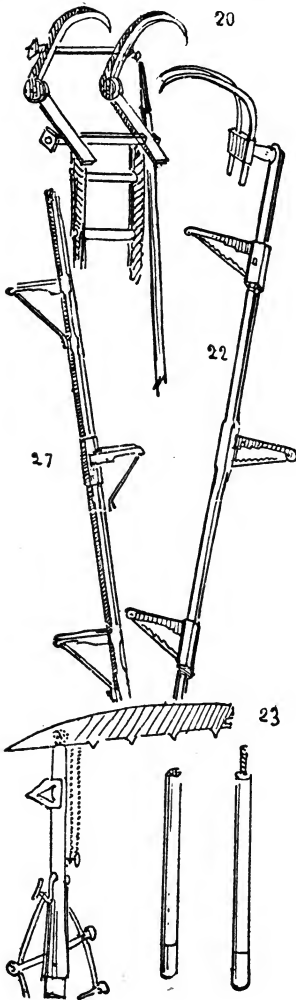

20. Iron scaling-ladder (*Sturmleiter* in German), from a German manuscript, beginning of the fifteenth century.

Hauslaub Library, Vienna.

21. Danish iron scaling-ladder, with joints and articulations (*Stormstige* in Danish).

Museum of Copenhagen.

22. German iron scaling-ladder with joints and articulations. Dating from the war against the Turks, seventeenth century.

Dresden Museum.

23. German scaling-ladder, with scythe-knife, beginning of the seventeenth century. This ingenious instrument, preserved in the Museum of Munich, is fixed on a long shaft having at the lower end a furrow or channel which screws on to other shafts, and may be lengthened at pleasure, so as to touch the top of the walls of besieged places, to which it hooks by means of the teeth in the moveable knife. The length of the moveable knife is about 2 feet.

24. Calthrop (*Fussangel* in German), found at Rosna.

Museum of Sigmaringen.

25. Calthrop from the water-colour drawings made by Glockenthon in 1505 of the arms in the three arsenals of Maximilian I.

Ambras Collection.

26. Calthrop from a manuscript of the sixteenth century in the Hauslaub Library, Vienna.

27. Calthrop knife (*Fussangel-Messer* in German), about 9 inches long, used in Saxony during the Seven Years' War (eighteenth century). These knives were screwed on to beams of wood and placed under water in moats. The hole in the blade was intended to put a piece of stick through, so as to form a handle to screw the knife.

Klemm Collection, Dresden.

28. Cheval de frise (*Spanischer Reiter* in German), from the Prague arsenal. This engine was used as protection against a charge of cavalry.

Arsenal of Berlin.

29. Cheval de frise, from the wars of the French republic, eighteenth century.

Arsenal of Berlin.

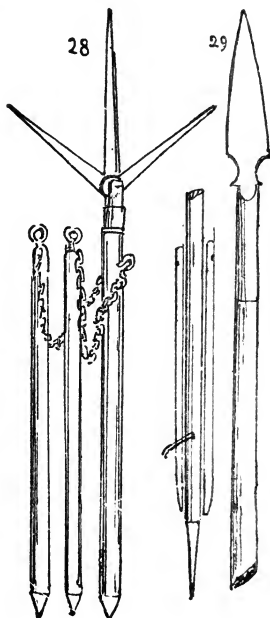
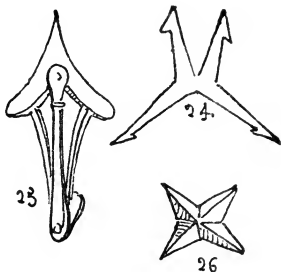

THE SLING AND THE STAFF SLING.

The sling, whose French name of *fronde* was derived from the Latin *funda* (*Schleuder* in German), which was anciently written *fonde*, gave its name to the party who took up arms against the court during the minority of Louis XIV., 1648—1652. The sling is a weapon whose origin, like that of the bow and arrow, is of remote antiquity. Made of rope or of a leathern thong, the sling is used to hurl stones, and even fire-balls. After placing the missile in the socket, the slinger whirled his weapon round and round, gradually augmenting the speed until the greatest possible amount of swiftness had been attained, when he loosed one of the cords, retaining the other.

The sling, the range of which was generally above five hundred paces, was much used by the ancients and during the Middle Ages, at which time it constituted, with the bow, the equipment of by far the greater number of foot-soldiers. The inhabitants of the Balearic Islands were celebrated for their skill with this weapon.

The Greeks, Romans, and Carthaginians, as well as the Germans, had each their regiments of slingers.

The use of the sling has continued even among European armies until the sixteenth century, at which time they were employed to hurl grenades. Savage nations, however, have always adhered to the sling, and there are those among them who have succeeded so far as sometimes with it to resist successfully the fire of a carbine.

The staff sling (in French, *fustibale* or *fustibalus*, from the Latin *fustis*, stick, and the Greek $\beta\acute{\alpha}\lambda\lambda\omega$, to throw; *Stock Schleuder*, in German) was composed of the shaft, about a yard in length, and a leathern sling fixed on to one end. The slinger held it with both hands, and could hurl stones with great violence. This weapon was subsequently employed to throw grenades.

The name *fustibale* was also given to large engines which were a species of catapult intended to hurl heavy missiles.

1 Two illustrations of slings, one with the thong loosened, the other with both thongs held in the slinger's hand; from a tenth-century manuscript.

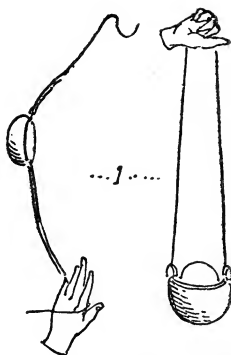

2. Slinger with his staff sling, from a manuscript of Mathieu Paris, an English chronicler, born at the end of the twelfth century, died in 1259, who was the author of a *Historia Major Angliæ* from 1066 to 1259.

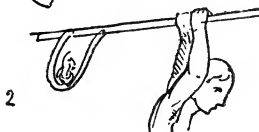

3. Staff sling from a manuscript of the beginning of the fifteenth century.

Ambras Collection.

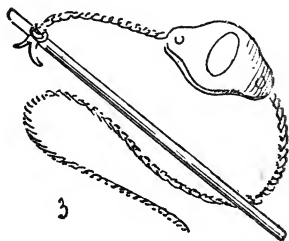

4. Long-shafted staff sling, intended to hurl grenades. From a manuscript of the sixteenth century.

Library of the Chevalier von Hauslaub at Vienna.

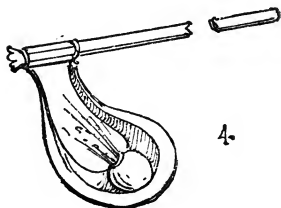

THE BLOWPIPE.

The blowpipe, or shooting tube, is called in French *sarbacane*, in Italian *cerbotana*, which latter word is derived from *Carpi*, the place of manufacture, and from the Latin *canna*, reed; in German it is called *Blasrohr*. At the present day the blowpipe is only used to hunt small birds. This weapon is a simple tube or pipe, through which small earthen balls are blown. As a war weapon the blowpipe was used to shoot poisoned arrows, Greek fire which scattered sparks, and small shot. As the blowpipe is nothing but a tube, varying only in length and thickness, it is needless to give an illustration. The modern ones now employed to kill the little feathered songsters are divided into several pieces, joining together like a fishing rod.

BOWS AND ARROWS.

The bow, called in Latin *arcus*, in German *Bogen*, is a weapon of offence formed of an elastic piece of metal or wood slightly depressed in the centre, and which, bent by the drawing of the string fixed at each end, shoots off the arrow in the endeavour to straighten itself, as soon as the archer looses the string he has drawn towards him. The arrow in German is called *Pfeil*.)

The Scythians, Cretans, Parthians, and Thracians were as much celebrated in ancient times for their skill in the handling of this weapon as the English archers were during the Christian Middle Ages. The Bayeux tapestries, besides several miniatures, prove that the bow was among the Normans and Britons, as well as among the Kelts and Gauls, an instrument of war, while the Germanic races used it only for the chase; with the Huns, however, the bow, which was wholly composed of horn, served both purposes.

During the twelfth century the archer generally carried two cases, one was the *quiver*, from the old French word *courir*, containing the arrows (*flèches* in French, from the old German *Flitz*, but called at that time, according to the

chronicles of Saint Denis, *pilles* and *sayettes*); the other was the bow case.

Arrow-heads of the long bow were generally like the *quarrells* of the cross-bow, which in after years superseded the bow. They were square (*carrels* and *carreaux* in French), with two, three, and even four points, but seldom barbed like the arrows of ancient days. The length of the bow and arrow varied according to the country and the height of the archer. In England, where the archer shot at least twelve arrows in a minute, and seldom missed his aim at two hundred and forty yards, the length of a bow was the breadth of the archer's span between his outstretched arms, which in a well-proportioned man would equal his height. When bent the English bow measured about half that size, and the arrow was a yard in length. The wood most sought after in France for the making of bows was the yew, which was also employed for cross-bows.

In Charles VII.'s time (1422—1463) a law was passed for the planting of yew-trees in all the Norman churchyards, so that wood might never fail for the new weapon, which was then in great favour among the French. The bodies of horse and foot archers were maintained for a long period, the royal regiments under Louis XII. (1514) being the last body of archers in France.

The bow was used until the introduction of fire-arms and guns; even later it was still popular, and preferred to the cross-bow, on account of the greater simplicity and sureness of the weapon. The cross-bow, more difficult to bend, necessarily took more time. The cross-bowman could only shoot three bolts during the time in which a skilful archer might discharge from ten to twelve arrows. Besides this, the rain slackened the string of the cross-bow, thereby taking away all strength, but the long bow-string was easily protected from damp. The loss of the battle of Crécy was partly the result of this accident (1346), for the French cross-bowmen could hardly make any return to the arrows of the English archers, and in 1356, when, after the defeat of Poitiers, the inferiority of the cross-bow in this respect was again shown, bodies of French archers were formed, who soon acquired so great skill as to excite the envy of the nobles, by whom they were dissolved. In England the bow

was used much later than on the continent, the English archers being so skilful that they long looked with contempt upon the rude and heavy hand-gun, at that time in its infancy. In the reign of Elizabeth (1558—1603) the organisation of bodies of archers had attained the greatest degree of perfection; they were all provided with brigantines and casques.

In 1627, at the siege of La Rochelle, we hear of English archers, mercenaries in the pay of Richelieu. They are mentioned in the attack on the island of Ré.) (See, for ancient bows, the Chapters on Arms of the Stone, Iron, and Bronze Ages.)

1. German bow, early part of the Middle Ages. It was about 4 feet 8 inches in length, and made generally of elm or oak.

2. German bow, end of the Middle Ages, from Glockenthon's drawings in the Ambras Collection.

3. Italian bow, of the Middle Ages; they were often of steel, and about 4 feet 8 inches in length.

4. Italian bow, fifteenth century, from an illustration in the *Walturius*, printed at Verona in 1472.

Hauslaub Library, Vienna.

5. Eastern bow, steel, probably of the time of the Christian Middle Ages.

L. 89, *Musée d'Artillerie, Paris.*

6. German quiver, from the German *Aeneid* of Henry of Waldeck, manuscript of the thirteenth century.

Library of Berlin.

7. Persian quiver, from a sixteenth-century manuscript, a copy of the *Schah Nameh*.

Munich Library.

8. Persian bow case. The same.

9. Ivory arm-brace (*Spannarmband* in German) to protect the left arm from being struck with the bow-string.

10. Arm-brace. The same.

L. 97, *Musée d'Artillerie, Paris.*

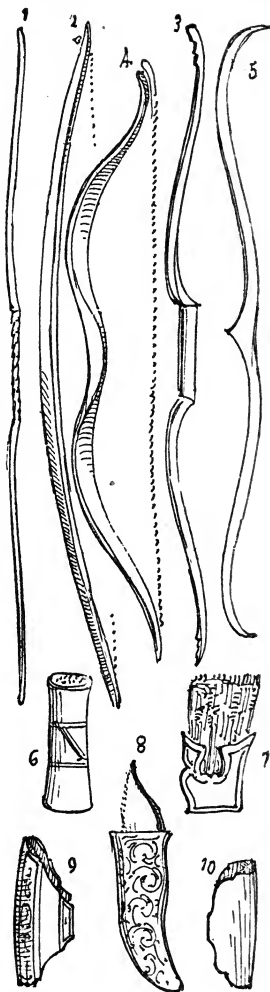

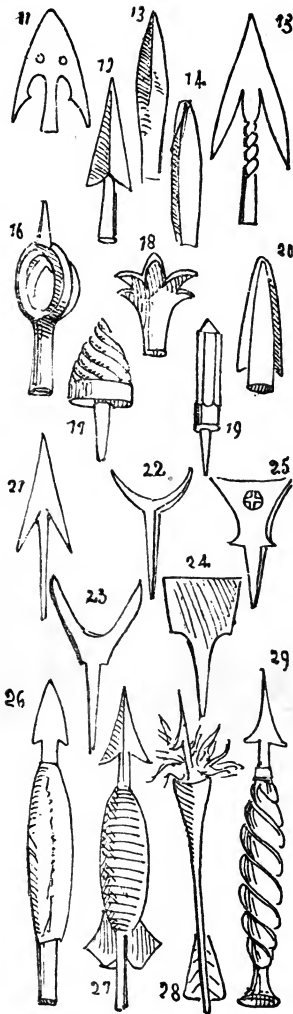

11. German barbed arrow-head, 3 inches long; fourteenth century.
Klemm Collection, Dresden.
12. German barbed arrow-head, fourteenth century.
Söter Collection, Augsburg.
13. Hussite arrow-head, fifteenth century.
Author's Collection.
14. Ditto.
15. Italian arrow-head, fifteenth century.
Museum of Sigmaringen.
16. Shell-framed arrow-head. The same.
17. Iron and copper screw arrow-head. The same.
18. Flower-shaped arrow-head, fifteenth century. The same.
19. Iron and copper octagonal arrow-head. The same.
20. Ditto, with short barb. The same.
21. Ditto.
22. Ditto, crescent-shaped.
23. Ditto, *larger moon-shaped*. It was used to hamstring both men and horses.
24. Hatchet-shaped arrow-head, fifteenth century.
Museum of Sigmaringen.
25. Ditto. This head bears the German eagle, gilt and engraved.
26. German incendiary arrow, found at Vrach.
Museum of Sigmaringen.
27. Ditto, fifteenth century. Manuscript in the Hauslaub Collection, Vienna.
28. Ditto. Manuscript of Glockenthon.
Ambras Collection.
29. Ditto, sixteenth century. Fronsperger's *Kriegsbuch*, 1573.

THE CROSS-BOW.

The cross-bow, called in French *arbalète*, a word which is derived from the two Latin words *arcus* and *bulista*,* is believed by M. Rodios (wrongly, as I consider) to have existed among the Greeks, and that they called the weapon *gastrafetes*, because the cross-bowman rested it on the pit of the stomach. (See the Greek arms, and see also p. 30, and pp. 55 to 59). The Princess Anna Comnena (1083—1148), however, only knew the cross-bow from seeing the weapon used by the Northern men-at-arms of the first crusade. There can be no doubt on this point, for she says in her memoirs, "This *tzagra*, a bow we are not acquainted with," etc. The cross-bow—composed of the bow; the stock (*Rüstung* in German), with nut; the sight, for aiming; the winding key, or spring; and, lastly, of the cross-bow string—is in all probability an invention of the nations stigmatised as barbarians.

An Anglo-Saxon manuscript of the eleventh century, in the British Museum, and a mural painting in the Cathedral of Brunswick, executed in the time of Henry the Lion, who died in 1195, represent cross-bowmen; but the Bayeux tapestries, on the other hand, of the end of the eleventh and beginning of the twelfth century, portray only archers. Anna Comnena is not the only author of her time who speaks of the cross-bow; it is mentioned also by William of Tyre.

This weapon, which does not appear to have been used in China until the reign of the emperor Kien-Long (1736), was already well known in France during the life of Louis le Gros (1108—1137). A decree of the second council of the Lateran, held in 1139, prohibits the use of the cross-bow against Christians, but allows it for the purpose of killing miscreants and infidels.

In England Richard Cœur de Lion (1157—1173) furnished a large number of his foot-soldiers with cross-bows, heedless of the bull of Innocent III., in which the prohibition of the second council of the Lateran was renewed. A short time after, Philip Augustus (1180—1223) organised in

* When the cross-bow was above the ordinary size, the Germans called it *ballestre*. The German *ballestre* was generally used to shoot pebbles, from which it derived its French name *galet*.

France the first regular bodies of cross-bowmen, both horse and foot, who became of great importance. (See pp. 468 to 470.)

As it is needless to repeat here what has already been spoken of in the historical chapter, it is sufficient to describe the different kinds of cross-bows.

A. The *cross-bow with goat's-foot lever*, which machine is intended to string the bow, is sometimes detached, sometimes fastened to the stock, the difference being easily seen by the position of the two rests close to the nut (for the purpose of fulcrum to the lever). This weapon was constructed either with or without a stirrup.

B. The cross bow with windlass, in which the windlass (called in French *cranequin*) is not fixed to the stock. This cross-bow is distinct from the one with goat's-foot lever, by reason of the two rests being placed about six inches below the nut, as the windlass has a much longer catch than the goat's-foot.

C. The cross-bow with windlass is called in French *arbalète à tours*, *arbalète de passe*, and *de passot*.

The windlass was called *à tours*, because that part of it intended to be fixed to the stock to draw the string was often battlemented like a tower. The stock of the windlass cross-bow, when the detached mechanism to draw the bow-string is provided with two cranks and two pulleys, has no fixed rests, but is always worked by a stirrup. The Genoese archers were armed with this kind of cross-bow at the battle of Agincourt (1420); which was also extremely in request among the Belgians, and was particularly used for shooting at a mark, and for the defence of ramparts. In Germany these cross-bows were sometimes from twenty to thirty feet in size.

D. The crossbow with wheeled gear is an exceedingly rare kind, the author never having met specimens in any collection, and consequently collecting his knowledge of them from fifteenth-century manuscripts. The wheeled gear, which replaces the windlass and goat's-foot lever, was fixed to the stock of the cross-bow in a groove, and was wound up by means of an equally stationary key. A catch, such as exists in a capstan, prevented the wheel from unwinding when the pressure on the key was relaxed. The illustrations represent the cross-bow with the stirrup.

E. The cross bow (*à galet* in French, because the missiles used were stones) of the sixteenth century is the next in order. Instead of quarrells or cross-bow bolts this weapon shot leaden balls, and even stones. The stock, which between the nut and the bow was generally curved, was often made of iron. This weapon of medium strength is bent by means of a lever fixed to the stock, or with the hand alone.

F. The barrelled cross-bow, so called because the groove through which the quarrell slips is covered by a half tube, leaving a passage for the string. This tunnel gives the stock the appearance of a gun. The barrelled cross-bow was used during the seventeenth century, and is not of much strength; it is bent by means of a stick, or simply with the hand, and has served as a model for the manufacture of modern cross-bows.

G. The Chinese cross-bow with sliding chamber, which supplied twenty arrows in succession; this might be termed a repeating or revolving cross-bow.

There are some German cross-bows which, when the weapon is not bent, curve outwards from the stock, instead of towards it, as the steel arm does. This contrary curve was employed to increase the strength of the bow when bent. The bows of the cross-bow, manufactured in layers of wood and horn, were for a long time considered to be *phalli* of elephants.

The missiles used for all cross-bows, with the exception of the pebble shooting cross-bow, were called quarrells or bolts (*Bolzen* in German).

One kind of quarrell was feathered (*vireton* in French), so as to regulate the flight by giving a rotatory movement. Another kind (*matras*, or *carreau assommeur* in French; *Fogelbolzen* in German) ended in a round knob, which killed without shedding blood. It was used in hunting, especially against feathered game, when the hunters desired to preserve their spoils uninjured.



German cross-bowmen, from a manuscript, beginning of the fifteenth century. The cross-bow with windlass may be noticed, as well as fiery arrows. One of the soldiers already carries a hand-cannon.

Hauslaub Library, Vienna.

A. Cross-bow with goat's-foot lever
(*Armbrust mit Geisfuss*, or
Hebelarmbrust in German).

1. Cross-bow with goat's-foot lever,
from an Anglo-Saxon miniature
of the eleventh century.
Library of the British Museum.

2. Cross-bow with goat's-foot lever,
from a mural painting in the
Cathedral of Brueswick, exe-
cuted in the reign of Henry
the Lion, who died in 1195.

3. Cross-bow with goat's-foot lever.
It may be noticed that the
rests *x* are placed close to the
sides of the nut. The cata-
logue of the Museum of Copen-
hagen, where this weapon is
exhibited, has engraved it along
with a windlass, which cannot
possibly belong to it, for the
cross-bow with windlass has
the rests *x* placed at least six
inches below the nut, the lever
of the windlass being much
longer than that of the goat's-
foot.

4. Goat's-foot lever (*Geisfuss* in
German) intended to bend the
preceding cross-bow.

4 *bis*. Cross-bow with goat's-foot
lever fixed to the stock.*

* A similar weapon in iron wood,
sixteenth century, belonging to
Ferdinand I., proved by the inscrip-
tion on the bow: *Don Fernando rei*
de Romano, followed by four Golden
Fleeces. It bears the name of the
Spanish armourer, *Juan Deneinas*.
This valuable cross-bow once be-
longed to M. Spengel, at Munich,
but is at present in the collection of
the Count of Nieuwerkerke.

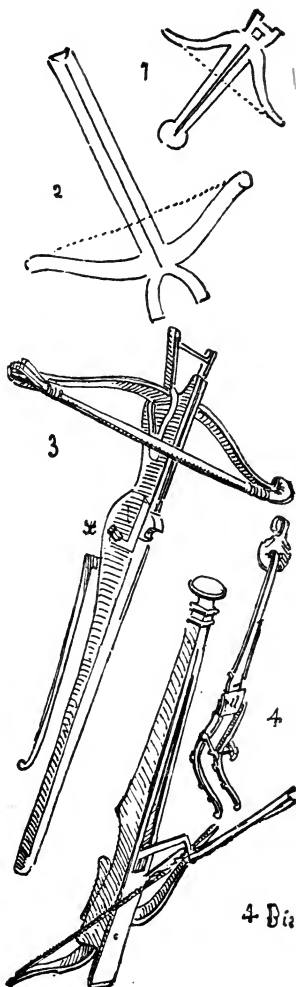

B. Cross-bow with windlass (*Windarmbrust* in German).

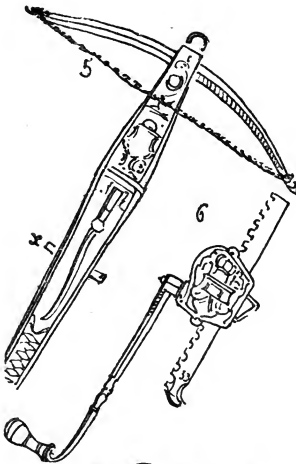

5. German cross-bow with windlass, fifteenth century. The rests x are placed about 6 inches below the nut.

Imperial Gewehr-kammer, Vienna.

6. Windlass for the preceding cross-bow.

Imperial Gewehr-kammer, Vienna.

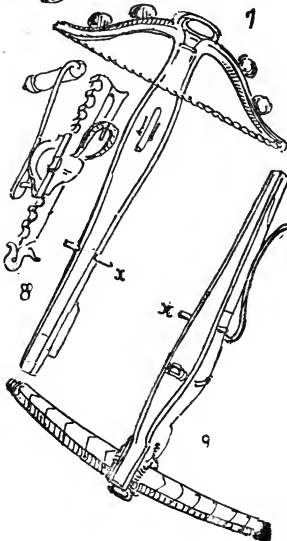

7. Swiss cross-bow with windlass, fifteenth century. Same description as No. 5.

8. Windlass for the preceding cross-bow.

9. Tyrolese cross-bow with windlass, end of the fifteenth century. Same description as for Nos. 5 and 7.

10. Cross-bow with the windlass applied to the stock. It will be remarked that the rests *x* are placed from 4 to about 6 inches below the nut, as the grip of the windlass requires more space than the goat's-foot lever.

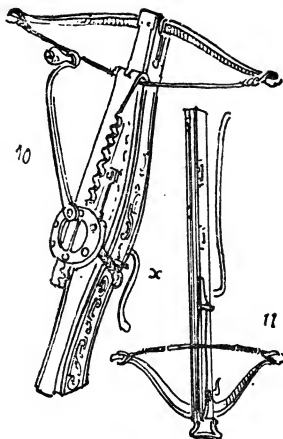

- C. Cross-bow with latch, sometimes styled simply *Latch* (*Flaschenzug Armbrust* in German).

11. Cross-bow with windlass. There are no rests, for the windlass is fitted to the foot of the stock.

12. Windlass (*Flaschenzug* in German) for the preceding cross-bow.

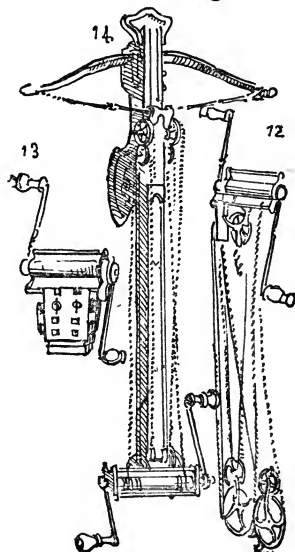

13. Part of a windlass, in the shape of a battlemented tower.
Musée d'Artillerie, Paris.

14. Cross-bow with windlass fastened on.



15

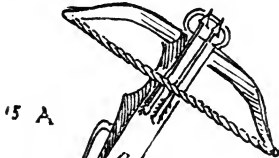

15 A

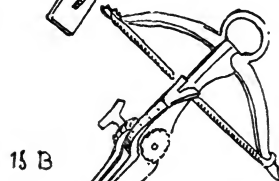

15 B



16

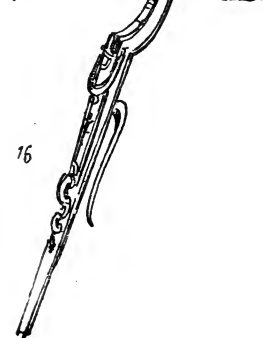

15. Bow of a German cross-bow with windlass, about 4 feet 8 inches, beginning of the fifteenth century. This huge weapon, whose stock measures somewhat over 4 feet 6 inches, is exhibited in the Arsenal of the city of Munich.

15 A. Cross-bow to shoot two arrows at a time, from the *Wallurius*, 1472.

Hauslaub Library, Vienna.

D. Wheel cross-bow with gear and catch (*Zahnradarmbrust*, in German).

15 B. Wheel cross-bow with gear, from a manuscript, beginning of the fifteenth century.

Ambras Collection.

E. Prodd, a light cross-bow, used chiefly in field sports; sixteenth century (*Stein- or Kugelarmbrust*, also *Ballestre* in German).

16. Prodd, to shoot pebbles.

17. Steel chain of a prodd; a very rare kind.

Az Collection, Lintz.



18. Iron prodd, end of the seventeenth century.

18



- F. Barrelled cross-bow (*Lant- or Rinmen-Armbrust* in German).



19. Grooved or barrelled cross-bow, seventeenth century.

L. 72, *Musée d'Artillerie, Paris.*

19

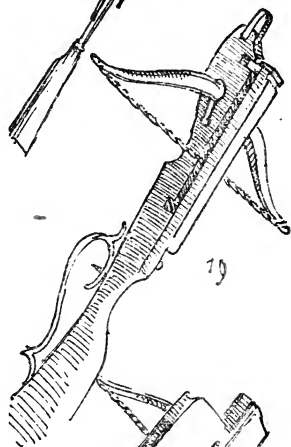

- G. Chinese cross-bow with sliding chamber (*Chinesische Repetitions Armbrust* in German).

20. Chinese cross-bow with sliding chamber, for shooting twenty arrows successively.

Musée d'Artillerie, Paris.

20

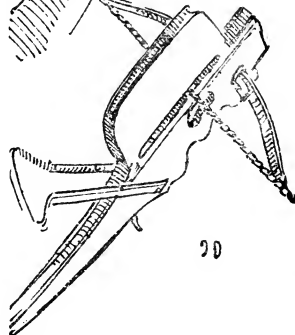

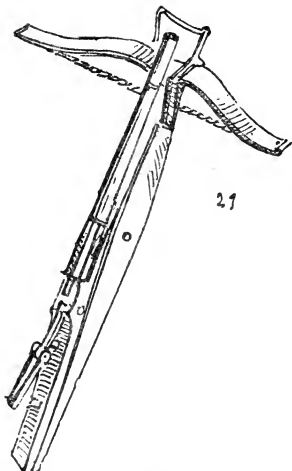

21. Gun cross-bow (*Pistolen-Armbrust* in German), sixteenth century, once belonging to Ferdinand I. (1503—1564), shown by the name *Ferdinandus* and his coat of arms engraved on the barrel and on the steel bow. This cross-bow, serving a twofold purpose, measures 30 inches by 22½.
National Museum of Munich.

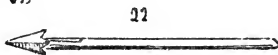

22. Quarrell, or cross-bow bolt (*Bolzen* in German), used at the battle of Sempach (1386).
Arsenal of Geneva.

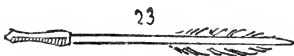

23. Single-pointed and feathered cross-bow bolt, for battle.



24. Treble-pointed and feathered cross-bow bolt, for battle.

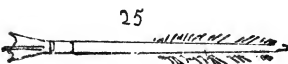

25. Four-pointed and feathered cross-bow bolt, for battle.

- 26 Barbed (*Gewiderhakt* in German) and feathered cross-bow bolt, for war and chase.

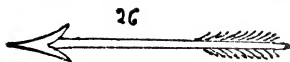

- 27 Tyrolese feathered cross-bow bolt, for hunting chamois.

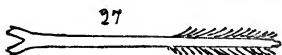

28. Tyrolese feathered cross-bow bolt, for hunting chamois.



29. War cross-bow bolt. The steel head is three-sided and the feather is made of leather and slightly curved, so as to strengthen the arrow's flight by a rifled or rotatory movement.

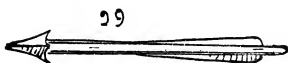

30. The same, with a single point.

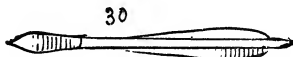

31. Bird bolt (*Vogelbolzen* in German). The circular head is flattened at the top, with a small steel square rising in the centre.

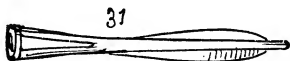

32. Fiery cross-bow bolt.

Arsenal of Zurich.

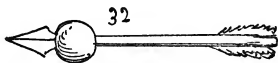

33. German barbed and feathered bolt (*Gewiderhakt* in German), 2 feet 7 inches long. The cross-bow to which this bolt belongs is about 5 feet 2 inches by 4 feet 11 inches.

Arsenal of the City of Munich.

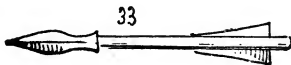

34



34. Quiver for bolts (*Bolzen-Köcher* in German), twelfth century, from a mural painting in the Cathedral of Brunswick, reign of Henry the Lion, who died in 1195.

35



35. Quiver for bolts, leather and wood.
Collection of Prince Charles, Berlin.

36



36. Quiver for bolts, leather and wood.
Historical Museum in the Palace of Monbijou, at Berlin.

37



37. Steel quiver for bird-bolts, end of the sixteenth or beginning of the seventeenth century.

Meyrick Collection.

VII.

FIRE-ARMS — FIRE-ARMS OF LARGE BORE, PORTABLE
OR HAND FIRE-ARMS.

THE history of the fire-arm, dating from its first appearance in Europe at the commencement of the fourteenth century, has been given at pages 59 to 74, and each illustration has been explained in a detailed manner, which could not figure at so great length in the historical chapter. Two things we know: that it is impossible to fix the date of the invention of gunpowder, and that the first fire-arm was a large bored weapon; in fact, the common kitchen mortar. In crushing a mixture of saltpetre, sulphur, and charcoal, the tyro found himself blown backwards by the explosion which resulted from the pounding. Turning the lesson to good account, he made a small hole at the further end of this kitchen mortar, so as to fire the compound without personal danger, and thus invented the first fire-arm. We may then fairly consider the mortar to be the shape of the first invented fire-arm of heavy calibre; it was followed in succession by the *cannon* (from *quennon*, a name derived from the German *Kanne* or *Canne*, pot, or can), which was loaded at the breech; the cannon, which received its charge by means of a movable chamber;* and, finally, by the muzzle-loading cannon.

Originally made of forged iron, from the beginning of the fifteenth century fire-arms were cast in bronze, at which period also appear the trunnions, supporting the weight of the cannon, besides preventing the recoil against the gun-carriage, doing away with the use of the butt, and rendering more easy the vertical pointing. Movable gun-carriages also replaced stationary ones, and fore-carriages were soon afterwards added.

The first portable fire-arm, or small hand cannon, is of the

* Cannons loaded by means of a movable chamber are used at the present day in China, for the cannons from the ramparts taken in the campaign of 1860, and preserved in the Musée d'Artillerie at Paris, are almost all of this description.

same date as the breech-loading cannon, both being invented in the beginning of the fourteenth century.

We have seen that the fire-arms of large bore may be reduced into four distinct classes, notwithstanding the diversified descriptions of those authors of the sixteenth century who have often described the same weapon in a dozen different ways. The classification of the portable fire-arm may also be simplified by considering only the varieties in the mechanism required for discharging the piece, the improvements of the lock, in short (*Gewehrschloss* in German); and paying no heed either to varied forms or fanciful names. These different kinds may be reduced to twelve, without including either the air-gun, which should be quite put aside, as the propelling power is pneumatic force, and not explosion of gunpowder, or the hair trigger (*Stecher*), erroneously called in France *la double détente*, which may be adapted to all fire-arms constructed with a view to accuracy of aim.

The species differing by the mechanism of their locks are :

The first hand cannon; middle of the fourteenth century. This weapon was of forged iron, roughly made, and fastened to a heavy block of wood; it could not be raised to the shoulder, and the touch-hole (*Zündloch* in German), placed above the charge, had sometimes a small hinged plate cover, to preserve the priming from damp. When made shorter it was called *petronel*, and used by cavalry.

The portable hand cannon; end of the fourteenth century. This one differs from its predecessor by the wood being more shaped and provided with a stock (*Kolbe* in German), intended to be shouldered; the touch-hole also is on the right of the barrel.

These weapons were fired by means of a detached match.

The serpentine gun, but without trigger or spring (*Mit Schlangenhahn-Luntenträger, ohne Feder noch Drücker*, in German), invented about 1424. From henceforth the match was always held by the serpentine or *linstock*.

The springless matchlock (*Mit Schlangenhahn-Luntenträger und Drücker, ohne Feder*, in German), with which better aim could be taken.*

* This arm is still used among the Mahrattas of India, among whom it was introduced by the Europeans of the east coast towards the end of the sixteenth century. The serpentine generally represents a dragon's head.

The matchlock, or arquebus, from the old German.

The harquebus (*Schlangenhahn-Luntenträger, mit Drücker und Feder*), invented in the second half of the fifteenth century. This is the first invented weapon capable of taking a steady aim. The barrel was generally about a yard in length.

The double matchlock (*Doppelhaken* in German). It differs from the matchlock on account of the two serpentines striking downwards on opposite sides by means of two triggers and springs. The barrels of these weapons measured from a yard and a half to two yards in length. They were sometimes fixed to a stand with iron points, or with wheels, and sometimes placed on the rampart wall. For this end the cannons were provided with hooks (*Haken*), from which may have been derived the old German term of Hackbusse.

The matchlock arquebus, which differs in hardly any respect from the matchlock gun.

The wheel-lock gun (*Radschlossbüchse* in German), invented in Nuremberg, 1515. It is remarkable by the wheel-lock, composed of ten pieces, and has nothing in common with the matchlock, the match being replaced by the sulphurous pyrites (*Schwefelkies* in German).

The hair trigger (*Stecher*), invented at Munich in 1543, and erroneously called in France the double trigger, is an ingenious construction, intended to render the motion produced by the snapping of the ordinary trigger hardly perceptible, but cannot be considered a new category of arms; as it may be adapted to all gun-locks.

The rifle-barrelled arquebus (*Büchse* in German). The rifled barrel was invented in Germany; according to some, at Leipsic, in 1498; according to others, at Vienna or Nuremberg, by Gaspard Zollner or Kullner.

As for the wheel-lock musket (*Muskete* in German), it differs from the arquebus only in the greater size of the calibre.

The snaphaunce gun (*Schnapphahn* in German) derives its name from a pecking fowl, and dates from the sixteenth century. (See pages 69 and 70.)

The snaphaunce lock, which worked by means of the sulphurous pyrites, was the forerunner of the flint lock.

The French * flint-lock gun (*Flinte* in German), probably invented in France between 1630—1640. See page 70.

The carbine (from the Arab *Karab*, weapon), which has a rifled barrel, and whose name is given in Germany both to the small cavalry weapon and to the hunting weapon, does not form a different category. It is simply a rifled-barrelled arquebus.

The percussion-capped gun, invented by the Scottish gunsmith Forsyth in 1807. (See pages 71 and 72.)

The needle gun, invented in 1827 by the German Nicholas Dreysc. (See page 74.)

THE MORTAR.

The *mortar*, from the Latin *mortarium* (*Mörser* or *Böhler* in German), is the most ancient European fire-arm, and derives both name and existence from the same source, namely, the common mortar used to pound solids. When first invented, about the middle of the fourteenth century, the mortar was forged of iron and without trunnions (*Zapfen* in German), that is to say, without the pivots placed under the barrel of the cannon, to prevent the recoil on the gun-carriage, and to facilitate the pointing.

This important benefit dates from the fourteenth century, at which period the armourers began to cast cannons instead of manufacturing them with iron bars bound together by hoops, as the casks of the present day are made. See pages 59 to 66.

* This fire-arm, which had been gradually brought to a high degree of perfection, was composed of the *barrel* (*Lauf* in German), the farther end of which was called *chamber*, the nearer, *mouth*, and the diameter of the barrel, *calibre*; of the *lock* (*Schloss* in German), and the *stock* (*Schaft* in German). The extreme end of the barrel, joining it to the stock (termed by English gunsmiths the *lump*), is called *queue* in French; *touch-hole* is the opening through which the powder is fired (*Zündloch* in German); *trigger* (*Drücker* in German), the piece of iron which moves the *spring* (*Feder* in German) to snap the cock (*Hahn* in German).

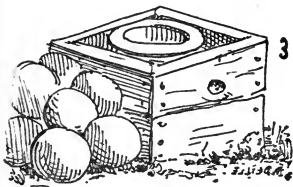
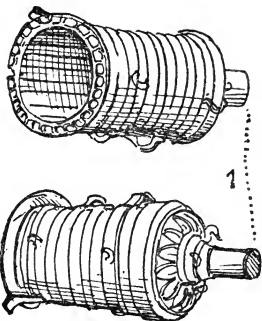

1. German monster cannon or mortar, manufactured of iron bars, which being placed lengthwise from end to end are fastened by circles of iron. This cannon, 7 feet 10 inches in length, and 3 feet 6 inches in diameter, has a shield placed between the handles, the shape of which indicates the beginning of the fourteenth century. The cannon was forged at Stier in Austria, and was taken by the Turks, from whom the Austrians recovered it in 1529.

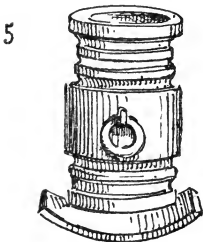
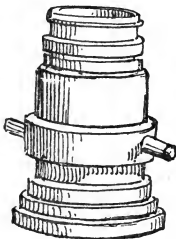

- Imperial Arsenal of Vienna.*
2. Mortar, forged iron, with rings, but without trunnions; middle of the fourteenth century.
 3. Stone mortar (*Stein-Böhler* or *Stein-Mörser* in German), from the siege of Waldshut (1468).
 4. Mortar, forged iron, 2 feet 8 inches in length, and about 1 foot in diameter. This cannon has trunnions (*Zapfen* in German), and cannot be earlier than the beginning of the fifteenth century.

Arsenal of Berlin.

5. Bronze mortar with ring, but without trunnions; end of the fifteenth century. It was found in the drawings made by Glockenthon of the armour contained in the arsenals of the Emperor Maximilian I. (1505).

Ambras Collection.

THE CANNON.

The barrel of this fire-arm is generally of a conical shape; the name is derived from the German *Kanne* and *Kanone*, and not from the Greek *Kávva*, *reed*: the cannon is the follower of the mortar. The name *trunnions* is given to the large pivots placed under the gun to prevent the recoil against the gun-carriage, and also to facilitate the pointing. The half rings, often in the shape of dolphins, surmounting the cannon, are called *handles*; the diameter of the bore is the *calibre*; the opposite end to the mouth is the *breech*, finished by the button, now termed *cascabel*.

The first breech-loading cannons were called *bombardes* and *pierriers*; these were shortly followed by the movable chamber system, and then by the muzzle-loading cannon. (See pages 59 to 67).

Serpentines, *coulevrines*, *demi-coulevrines*, *faucons*, *faucon-neaux*, *passé volants*, *basilics*, *spiraies*, *bombardes*, are the vague names by which the same kind of cannons are often described in different localities.



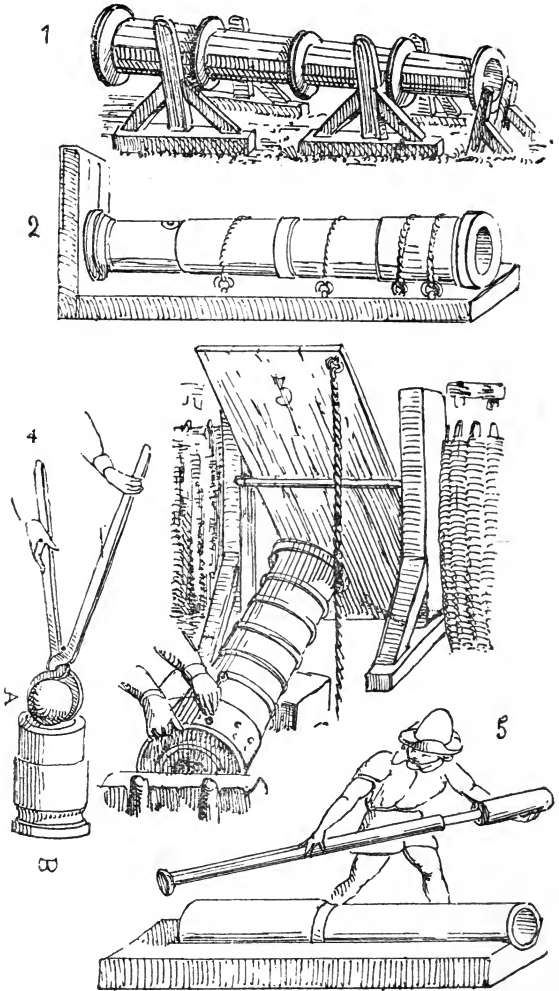

1. Breech-loading cannon, forged iron, open at both ends; English, from the battle of Crécy (1346).
2. Breech-loading cannon, open at both ends. The butt, or recoil piece, was lowered during the loading. From a manuscript, fourteenth century.
3. Blind, or mantlet to a breech-loading cannon (*Schirmdach* in German), second half of the fourteenth century.
4. Breech-loading cannon, which the artilleryman is about to load with red-hot shot.* Manuscript, beginning of the fifteenth century.
5. Breech-loading cannon, fifteenth-century manuscript.

Ambras Collection.

Ambras Collection.

* The illustration in this manuscript shows that neither Franz von Sickingen, 1525, nor Etienne Bathory, King of Poland, were the first to use red-hot shot. It is well known that during the fifteenth century red-hot shot, or pieces of iron wrapped in wet linen, were shot into besieged towns to burn them, though they did not become general until the seventeenth century. A represents the breech, B the muzzle.

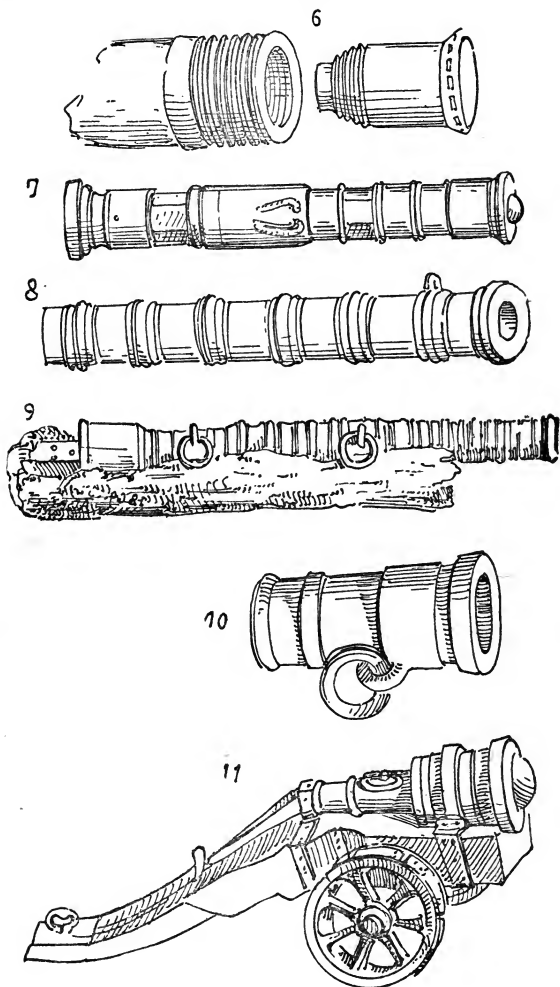

6. Flemish breech-loading cannon. This curious engine, whose fire-chamber screws into the barrel, is of forged iron, made at Ghent between 1404 and 1419.
7. German cannon cast in bronze, beginning of the fifteenth century. The length is 12 feet, the diameter 2. The cannon bears the following inscription in German: *My name is Catherine, beware of my contents. I punish injustice. George Endorfer cast me.* Also: *Sigismund, Archduke of Austria, anno 1404.* This cannon, already with handles and showing traces of a cover to the lock, comes from Rhodes, and is now in the Musée d'Artillerie at Paris.
8. Wrought-iron cannon, taken at the battle of Grandson (1476). The length is 4 feet 8 inches, the diameter is 2 inches, and there are no trunnions.

Museum of Lausanne.

9. Breech-loading cannon, wrought iron, fifteenth century, taken from the Mary Rose, a ship sunk at the beginning of the sixteenth century.

Tower of London.

10. Wrought-iron cannon, taken at the battle of Grandson (1476). Length 4 feet 6 inches, diameter 1 foot 8 inches.

Museum of Lausanne.

11. Wrought-iron cannon or mortar, with wheeled gun-carriage, from the battle-field of Morat (1476). The length of the cannon is 2 feet 6 inches, the diameter 8 inches; the gun-carriage is 2 yards long, and the granite ball or shot 10 inches in diameter. This Burgundian cannon has no trunnions.

Gymnasium of Morat.

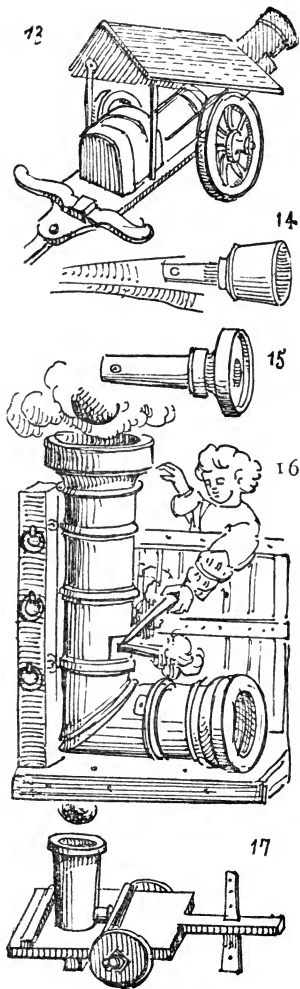

12. Breech-loading cannon with wheeled and roofed gun-carriage, end of the fifteenth century. This piece is still without trunnions.

14. Breech-loading wrought-iron cannon without trunnions, from the Château de Sainte Ursane, Switzerland, where it was placed after the battle of Morat (1476). Martinus Jacobus (*De machinis libri decem*, 1449)* gives the drawing of a similar cannon.

15. The same.

16. Mortar or cannon, elbow-shaped, German, fifteenth century, with movable chamber and breech-loading; from the engravings of the *Institutionum reipublicæ militaris*, &c., by Nicolai Marescalchi, printed at Rostock, 1515.
Hauslaub Library at Vienna.

17. Mortar or cannon, elbow-shaped, Italian, fifteenth century, breech-loader, with movable chamber; from Martinus Jacobus, *De machinis libri decem*, 1449.

* Manuscripts in the library of St. Mark at Venice.

18. Breech-loading cannon, fifteenth century. Manuscript in the Hauslaub Library, Vienna.

19. Wrought-iron cannon, loaded by means of a movable chamber. Called in French *veuglaire*, from the German *Vogler* and *Vogelfänger*, and from the Flemish *Vogheleer*. The muzzle is raised to the wished-for height.

Museum of Brussels and Manuscript in the Hauslaub Library at Vienna.

20. Wrought-iron cannon with movable chamber, fifteenth century.

Tower of London.

21. Cannon with movable chamber, fifteenth century, from a manuscript in the Ambras Collection, Vienna.

22. English cannon with movable chamber, fifteenth century.
A, The movable chamber.

23. Wrought-iron cannon with movable chamber and trunnions.* The movable chamber is missing.

No. 1, *Musée d'Artillerie, Paris.*

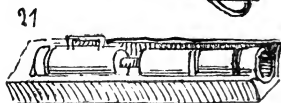
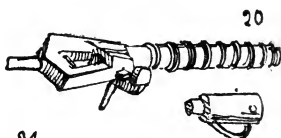

* See the explanation of this name at the beginning of the chapter. See also, for the *veuglaire*, No. 34.

24.

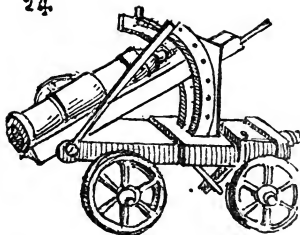

24. German cannon or culverin (in German, *Feldschlange*), muzzle-loader, without trunnions, but on a movable gun-carriage with toothed rack; from a manuscript by Zeitblom, fifteenth century.

Library of Prince Waldburg Wolfegg.

25

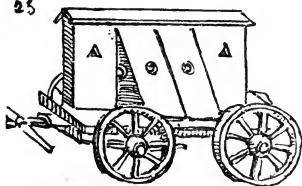

25. German gun-carriage, fitted with small cannons.

26

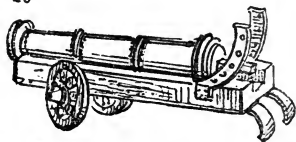

26. German muzzle-loading cannon. Still without trunnions, but has the toothed rack for raising and depressing the cannon.

27

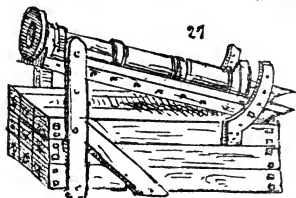

27. *Id., id.*

28

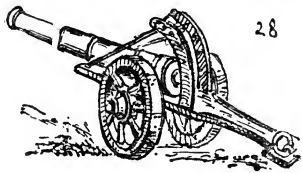

28. German muzzle-loading culverin (in German, *Feldschlange*). Still without trunnions, but on a movable gun-carriage with toothed rack.

29. Burgundian muzzle-loading cannon, without trunnions, but on a movable gun-carriage with toothed rack; this weapon was brought from the field of Nancy (1477), and is at present at Neuveville.

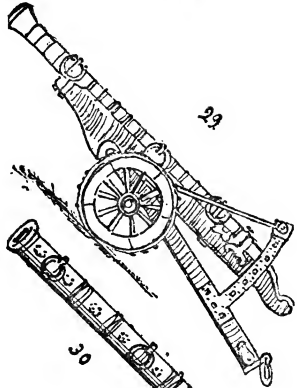

30. English muzzle-loading cannon, end of the fifteenth century.
Tower of London.

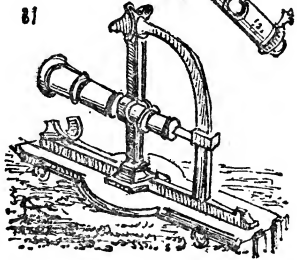

31. English muzzle-loading cannon, without trunnions, and on grooved rack.

32. German muzzle-loading cannon, without trunnions, fifteenth century.
Hauslaub Library at Vienna.

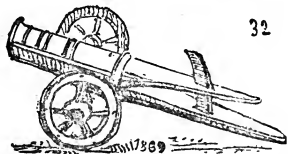

33. Swiss cannon rammer, called *lanterne*, fifteenth century, copper, on a long shaft, the end of which contains a wadding screw. Arsenal of Soleure. See also, farther on, the same kind of loading rod from Fronsperger's book, sixteenth century.



34. A.

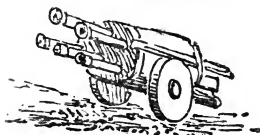

34. B.

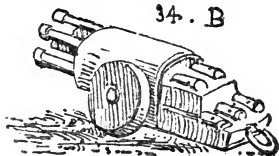

- 34 A and B. German serpentine cannons (called *Orgelgeschütz* in German: see also, at p. 65, the *Todtenorgel*, or death organ), wrought iron, each with five muzzle-loading barrels, middle of the fifteenth century.

Museum of Sigmaringen.

35.

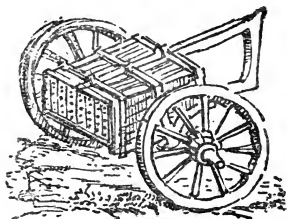

35. German serpentine organ with forty cannons, from the *reproductions des armes de l'Empereur Maximilien I.*, drawn in 1505, by Nicolas Glockenthon. Ambras Collection. See, farther on, the "organs" of the seventeenth century.



36



36. Cannons with trunnions, which make their first appearance in the middle of the fifteenth century.



37



37. German cannon with separate chamber and trunnions, from the drawings by Glockenthon. See also No. 23.

Ambras Collection.



38. German war chariot, called in French *Ribaudequin*, fortified with arrows and four bronze *falconets*. From Glockenthon's drawings. *Ambras Collection.*

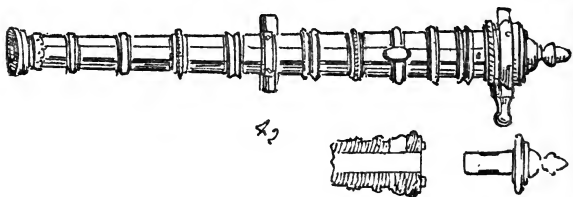
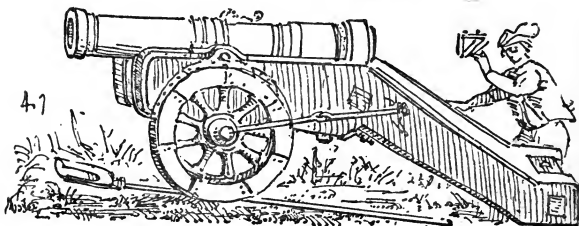
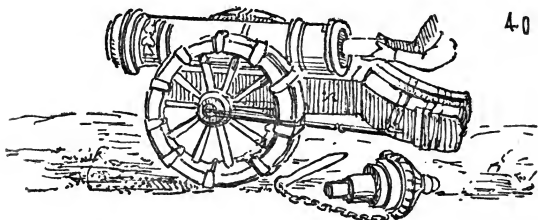
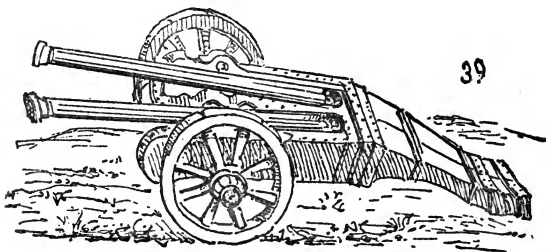

39. Two small falconets or cannons, iron, with trunnions, from Glockenthon's drawings.

Ambras Collection.

40. Breech-loading cannon with trunnions, from a manuscript of Senftenberg, a commander of artillery at Dantzic; sixteenth century.

41. Muzzle-loading cannon with trunnions, called by Fronsperger, in his *Kriegsbuch*, published at Frankfort in 1573, *Basilium*; weighing 75 hundredweight, carrying 70 lbs. of iron, and drawn by 25 horses. By the side is the loading rod of copper, sometimes called *lanterne*, already mentioned under No. 33. The artilleryman takes his level by means of a square. The Austrian army still used the loader at the battle of Mollwitz in 1741, while the Prussians had for some time used a prepared charge or cartridge. The rammer and sponge are still used.

42. Breech-loading and rifled cannon with trunnions, end of the sixteenth century. Length, 6 feet 4 inches; diameter, 7 inches; calibre, 3 inches. The breech is grooved, which closes the end of the cannon. By the side is a section of the chamber.

Arsenal of Zurich.

43

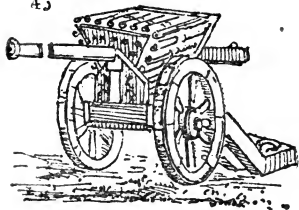

43. Serpentine organ, with forty-two cannons, to be fired six at once, seventeenth century.

Arsenal of Soleure.

44



44. Small Swedish muzzle-loading cannon, with trunnions, seventeenth century. Length, 3 feet 8 inches; diameter, 4 inches. The barrel is formed of a thin copper tube, wired outside, and the whole covered with leather. Arsenals of Berlin and Hamburg, Musée d'Artillerie, Paris, and collection of the King of Sweden. In the Imperial Arsenal at Vienna is a leathern gun lined with a bronze tube, which the city of Augsburg offered to the Emperor Joseph I. (1705-1711).

43



45. Muzzle-loading cannon, with trunnions, made of a tube of copper encased in a thick coating of lime, and the whole covered with leather: this was a light weapon, and easy to carry in mountainous districts; the length is 7 feet; it belongs to the seventeenth century.

Arsenal of Zurich.

46

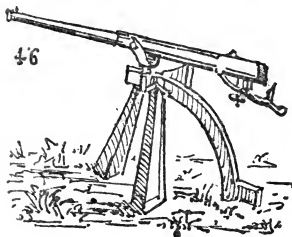

46. Swiss breech-loading serpentine cannon, seventeenth century.

Arsenal of Soleure.

47

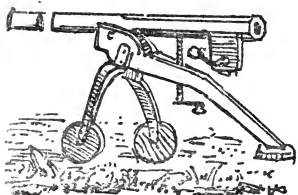

47. Swiss breech-loading serpentine cannon, with the maker's name, Zell Blasi, 1614:

Arsenal of Bâle.

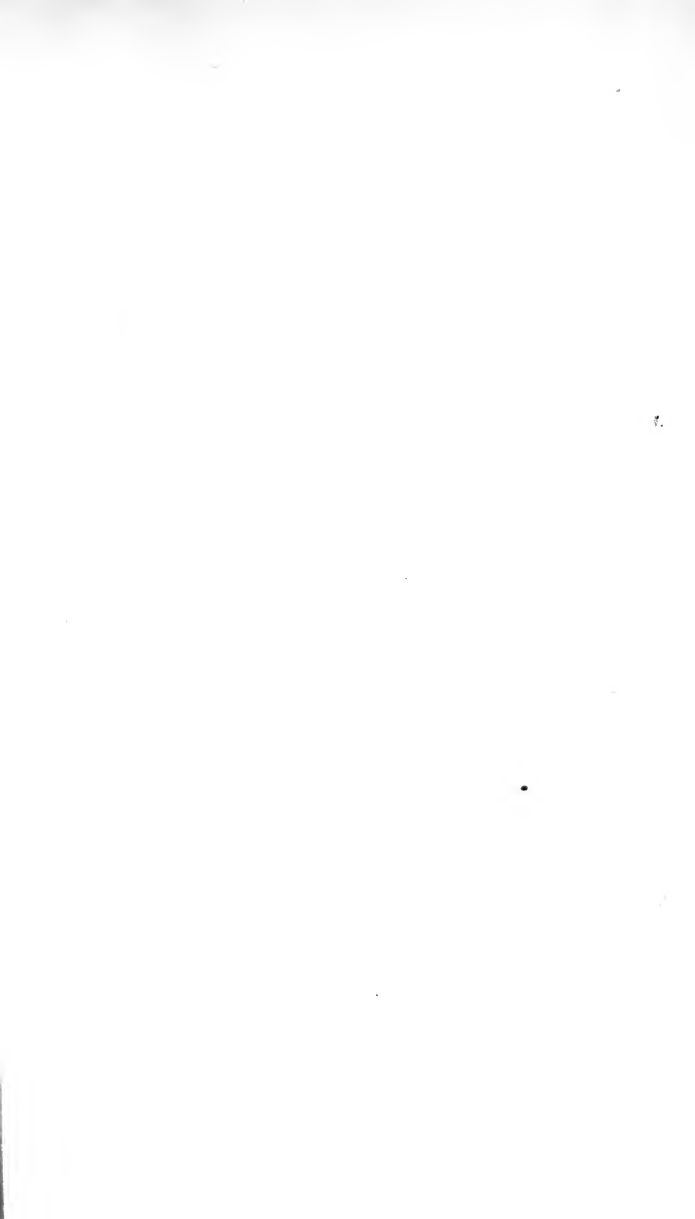

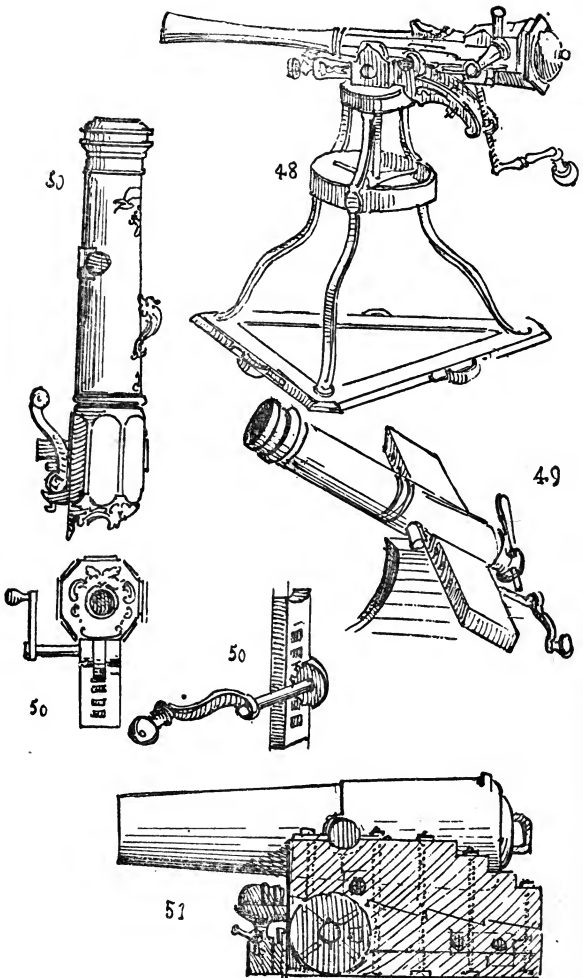

48. Small iron breech-loading cannon, on revolving gun-carriage (German, *Drehbasse*). This piece was left at Munich in 1632 by Gustavus Adolphus.
49. Small copper cannon (Swiss), adapted for firing ten successive charges. The length is 27 inches, and it bears the signature of *Welten, Inventor, 1742.*
- Arsenal of Zurich.*
50. Breech loading cannon of the eighteenth century, from the memoirs of Colonel Wurstemberger.
51. Paixhans howitzer cannon, invented by H. C. Paixhans.

52

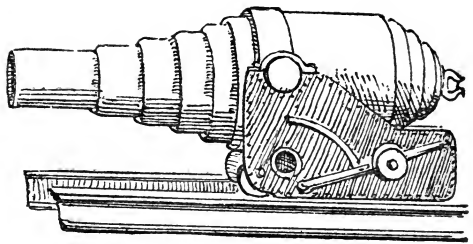

33

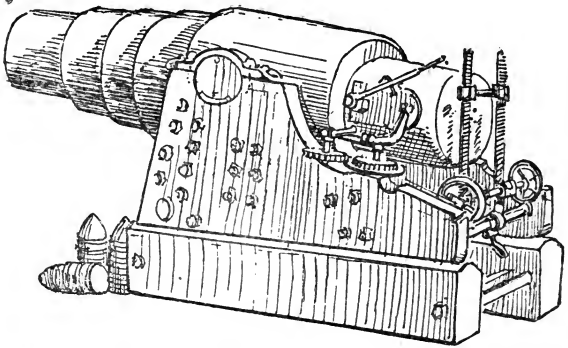

34

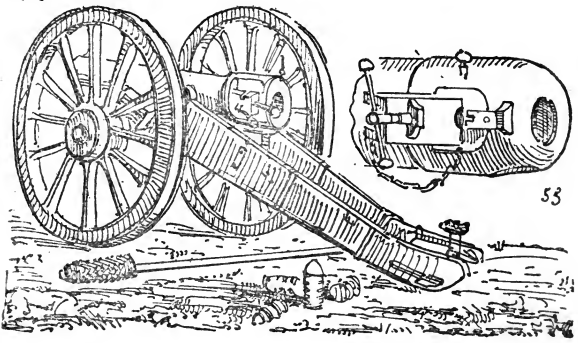

53

52. Armstrong gun, 600 lb. projectile, invented by Sir William Armstrong & Co.
53. Large breech-loading Prussian cannon, of steel, cast in the foundry of M. Krupp, exhibited in Paris in 1867. It weighs rather under 50 tons, and the shot 1192 pounds.
54. Prussian rifled field-piece, loaded at the breech. It is of cast steel, and was invented by M. Krupp. This cannon, which is of the same power as the French "*pièce de douze*," is loaded with solid shot, covered with a leaden casing, so as to fit closely into the rifling.
55. Breech of preceding guns, on M. Krupp's principle. The closing is effected by means of a lateral shield, which is pressed by a turn of the key, and the breech closed at the moment of firing.

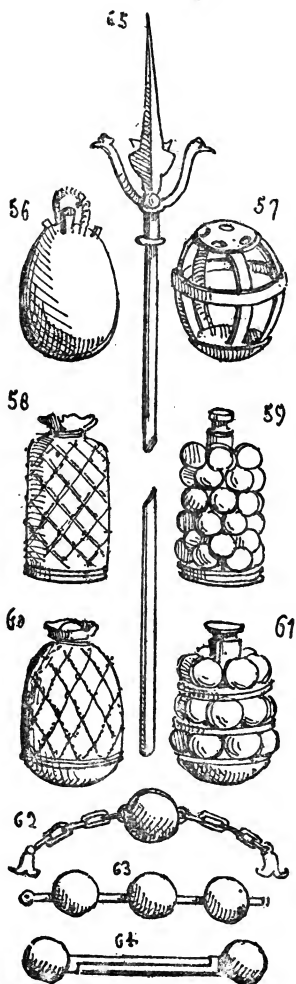

56. A grenade enclosed in a canvas bag, sixteenth century: this was discharged from a mortar.

57. Inner casing of the preceding grenade.

58. Grape-shot (German, *Traubenlagel*), sixteenth century. It consisted of sixteen balls placed around a wooden stem, and enclosed in a bag.

59. Interior view of preceding shot.

60. Grape-shot composed of eighteen balls.

61. Interior view of the preceding shot.

62. Chain-shot (French, *chaîne ramée*).

63. Shot united together.

64. Double shot with connecting rod.

65. Linstock (German, *Luntenstock*; French, *Porte-mèche*).

Woolwich Arsenal.

The history of hand fire-arms has been already given at pages 67 to 74, and continued at the beginning of this chapter.

1. Hand cannon for foot soldier in cast iron, belonging to the first half of the fourteenth century. The touch-hole (German, *Zündloch*) is on the upper part of the cannon.



Arsenal of Berne, and National Museum of Prague.

2. Hand cannon for foot soldier, from a MS. of the end of the fourteenth century. The touch-hole is on the top of the cannon.

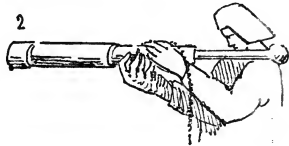

3. Hand cannon for foot soldier, from a manuscript of the year 1472, in the library of Hauslaub at Vienna.

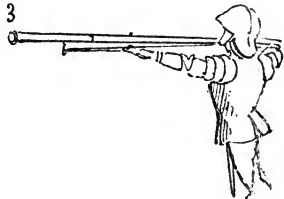

4. Hand cannon for a knight, called a petronel (see historical chapter), from a manuscript in the ancient library of Burgundy. The articulated plate armour is characteristic of the latter half of the fifteenth century, though the bassinet has a movable vizor. These hand cannons were in use at the same time as the serpentine arquebuse, and even as the flint and steel arquebuses and muskets, *i.e.* till the beginning of the sixteenth century, as may be seen from the drawings, by Glockenthon, of the arms of the Emperor Maximilian I. (1505).

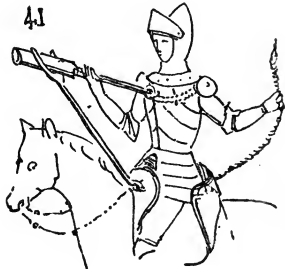

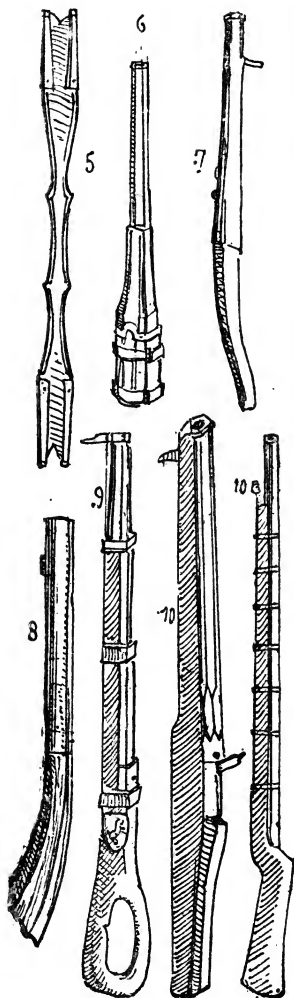

5. German hand cannon, fixed on wooden boards or stands, belonging to the beginning of the sixteenth century. The touch-hole is still on the upper part of the cannon. From the drawings of Glockenthon, done in 1505.

Ambras Collection.

6. German hand cannon in fluted iron, of the beginning of the sixteenth century, or end of the fifteenth century. It is only $9\frac{1}{2}$ inches in length, 2 inches in diameter, and is fixed on to a piece of oak about 5 feet in length. In the Germanic Museum, where it is wrongly ascribed to the fourteenth century.
7. Hand cannon in wrought iron, called a petronel, to be used by a knight. It is of the end of the fifteenth century.

Museum of Artillery, Paris.

8. Hand cannon with stock, of the end of the fourteenth century. The touch-hole is on the top of the cannon.
9. Angular hand cannon on stock; to be used in defending ramparts. It is a little over 6 feet in length, and the touch-hole is on the top of the cannon. This piece was used in the defence of Morat against Charles le Téméraire (1479).

Gymnasium of Morat.

10. Eight-sided hand cannon with stock. The touch-hole, which is on the top of the cannon, has a cover moving on a pivot. This cannon is $5\frac{1}{4}$ inches in length, and the balls or bullets about $1\frac{1}{2}$ inch in diameter. It belongs to the first part of the fifteenth century.

Museum of Dresden.

- 10 B. Persian matchlock cannon, copied from the *Schah-Namen*, in the Library of Munich.

11. Hand cannon on stock, end of the fourteenth, or beginning of the fifteenth century. In this piece the touch-hole is on the right side.
12. Hand cannon with serpentine, a match-holder, without trigger or spring, invented about the year 1424.
13. Serpentine or guncock for match, without trigger or spring.
14. Serpentine without trigger, but with spring.
15. Serpentine with spring, but without trigger.
16. Serpentine lock, without trigger or spring.
17. Hackbuss lock with spring and trigger.
18. Hackbuss (in German, *Hakenbüchse*) or hand cannon, with butt end and serpentine lock. It belongs to the second half of the fifteenth century. The match is no longer loose, but fixed to the serpentine, which springs back by means of the trigger. This sort of cannon is generally about 40 inches in length, and it is usually provided with a hook, so that when it is placed on a wall it cannot slip back. The hackbuss without a hook is, as a rule, better made, and was subsequently called *arquebuse with matchlock*. It had also front and back sights (in German, *Visir und Kern*).

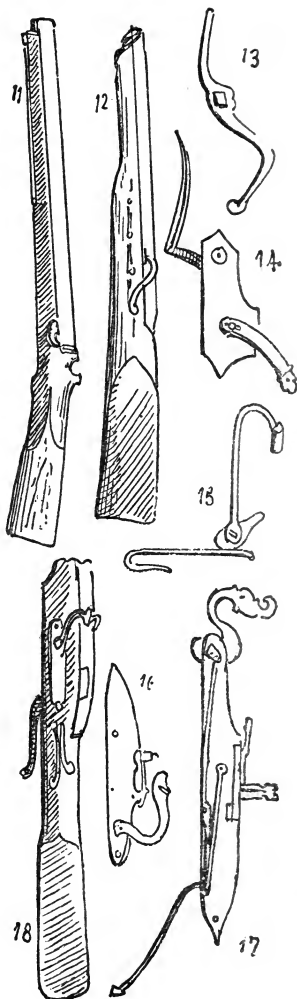

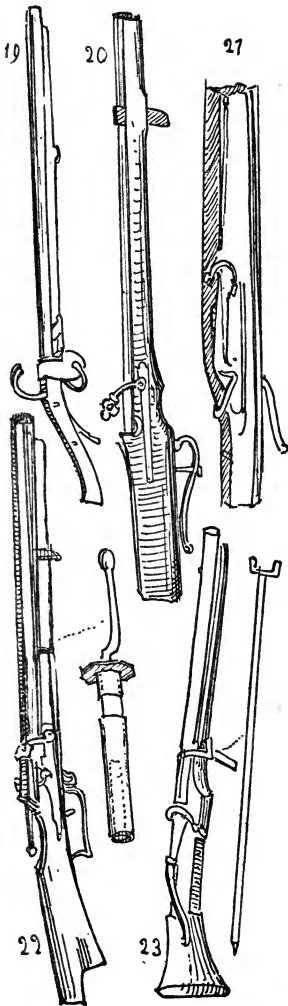

19. Chinese arquebuse.
Tower of London.
20. Swiss arquebuse of the second half of the fifteenth century.
Arsenal of Schaffhausen.
21. Double arquebuse (in German, *Doppelhaken*). This weapon had two *serpentine*s, or dog-heads, falling from opposite points, and was generally used in defending ramparts; the barrel was usually from 5 to 6½ feet in length.
22. Hackbuss, loaded from the breech by means of a revolving chamber, a weapon belonging to the beginning of the sixteenth century.
Arsenal of Berne.

In the Museum of Zurich there is a double arquebuse, for using on ramparts, loaded from the breech, and 10 feet in length. It is of the end of the sixteenth century, and has a wheel-lock and *serpentine*.

23. Hackbuss and gun fork (German, *Gabel*), from the drawings of Glockenthon; it may also be seen in the engraving of the "Triumph of the Emperor Maximilian I." From this we see that the hackbuss, or match arquebuse, was used for a long time together with the wheel-lock arquebuse.

24. *Serpentine* hackbuss with match, also called musket. It is also furnished with a fork, called *fourquine* in French.

25. Hackbuss or musket, with link.*
Tower of London.

26. *Serpentine* hackbuss with link, also called arquebuse, loaded from the breech by means of a revolving chamber. It dates from the year 1537, and bears the initials W. H. by the side of a fleur-de-lys.

$\frac{12}{1}$, *Tower of London.*

26 *bis*. Eye protector, belonging to a musket in the Arsenal of Geneva.

27. Hand cannon with rasp, early part of the sixteenth century. It is entirely of iron, and is called *Mönchsbüchse* (monk's arquebuse). For a very long time it was wrongly thought to be the first fire-arm ever made, and to have belonged to a monk named Berthold Schwartz (1290-1320), who was also said to have invented gunpowder. This little weapon is about $11\frac{1}{2}$ inches in length, and the barrel 5 inches in diameter. It preceded the wheel-lock, and appears to have suggested the idea of it. A rasp scatters sparks from the sulphurous pyrites by friction.

Museum of Dresden.

* It may be noticed that the author has classed all the *serpentine* and *link* or *match* fire-arms as *hackbusses*, though they were sometimes called arquebuses and link muskets. The musket is distinguished from the arquebuse by its larger dimensions.

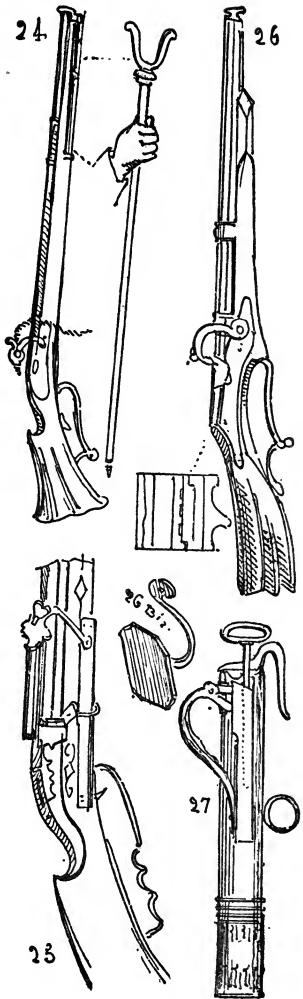

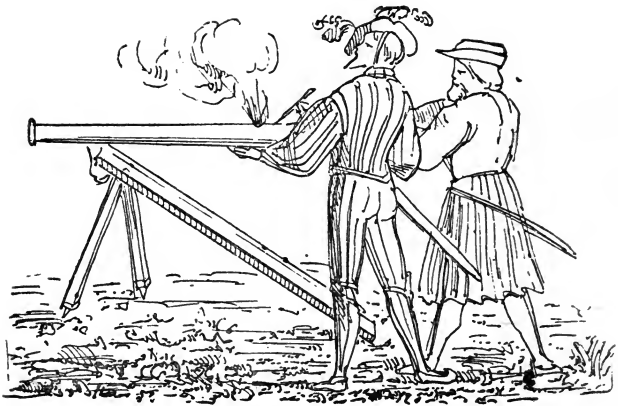

28. Hand cannon on rest, and German arquebusier. From the designs of Glockenthon of the three Arsenals of the Emperor Maximilian I.
Ambras Collection.

This engraving is very interesting on account of the study of the costumes, while it proves that the simple hand cannon of a large size was still used along with flint and wheel lock arquebuses.

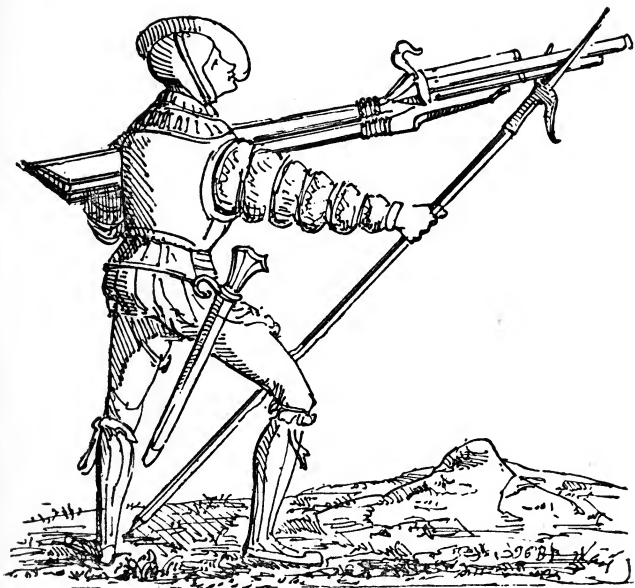

29. *Serpentine* hand cannon and German soldier, from the designs of Glockenthon, spoken of in the preceding page.

This weapon appears to have three barrels, but as only one *serpentine* is visible, most likely the two other barrels were discharged by means of a detached link.



30. German soldier with hackbuss, from the designs of Glockenthon, mentioned in the preceding pages.

The ammunition pouch is worn on the right side, above the lansquennette. The hackbuss has a *serpentine* or dog-head.

31. Wheel-lock (in German, *Rad-schloss*), invented at Nuremberg in 1515.* It is in ten pieces, and is not at all like the *serpentine* locks, for the match is superseded by the sulphurous pyrites (in German, *Schwefelkies*).

32. Same as above (inside view).

33. Same as above (outside view).

34. *Serpentine* and wheel-lock.

35. Very elaborate *serpentine* and wheel-lock.

36. Key for wheel-lock.

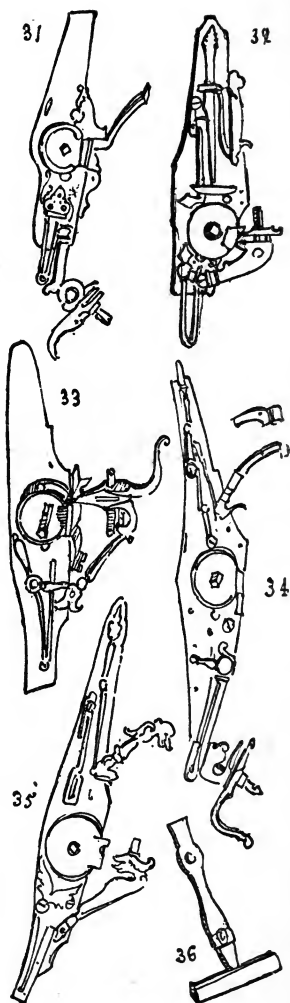

* Mr. Pritchett, an English collector, has a wheel-lock, which he believes to date from the year 1509.

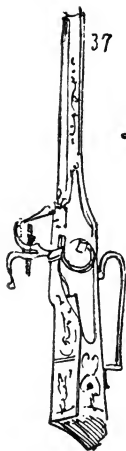

37. Wheel-lock arquebuse of the sixteenth century.

Museum of Artillery, Paris.

38. Wheel-lock musket of the sixteenth century.

Museum of Artillery, Paris.

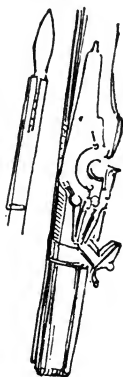
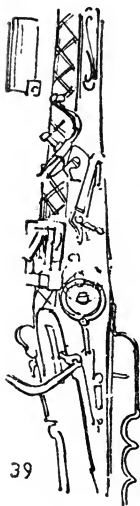

39. Wheel-lock musket of the sixteenth century. It is loaded from the breech by means of a revolving chamber.

Museum of Sigmaringen.

The Museum of Dresden has a similar one.

39



40. Rest of wheel-lock musket (in German, *Musketen Gabel*), of the beginning of the seventeenth century. It is about 5 feet 10 inches in length.

Museum of Sigmaringen.

40

41. Rest for musket, about 5 feet 2 inches in length. It is a three-sided dart of steel damascened with gold, and fastened to it is a wheel-lock pistol. This weapon belongs to the sixteenth century, and resembles the preceding one.

Historical Museum of the Monbijou Palace at Berlin.

42. Rest for musket (*Musketen Gabeldegen*), of the beginning of the seventeenth century. *Collection of Prince Charles at Berlin.*

13. Blunderbuss with wheel-lock and copper barrel, covered over with a thick leathern casing in the same way as the Swedish cannons. The blunderbuss is 27 inches in length, and barrel nearly 2 inches in diameter.

Museum of Sigmaringen.

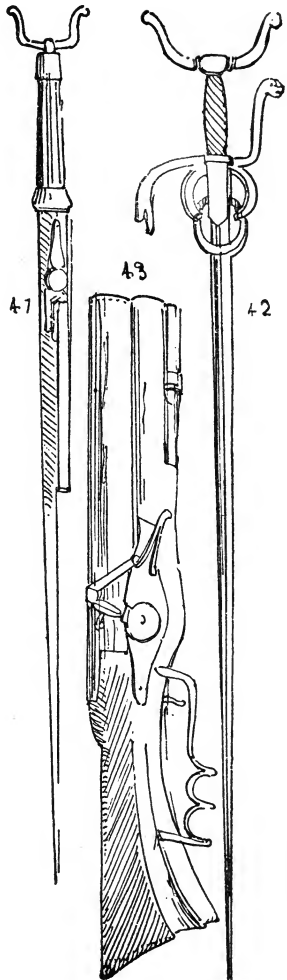

44.

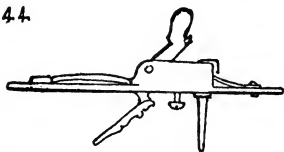

44. Supplementary trigger, or trigger of precision (*Stecker* in German), invented in the year 1543 at Munich. It could be fixed to all kinds of wheel-locks.

45.

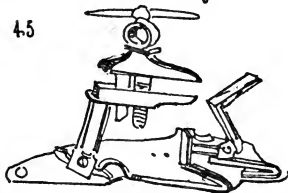

45. Snaphaunce lock to be used with the sulphurous pyrites.

46.



46. Flint-lock, probably invented in France between 1630 and 1640. Ancient model (outside view).

47.

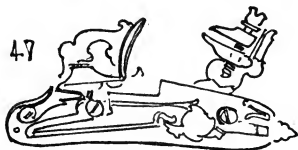

47. Same as above (inside view).

48.

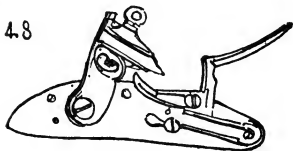

48. Flint-lock of French gun of the year 1670 (outside view).

49.

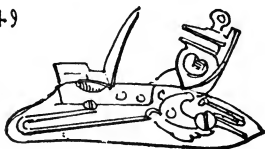

49. Same as above (inside view).

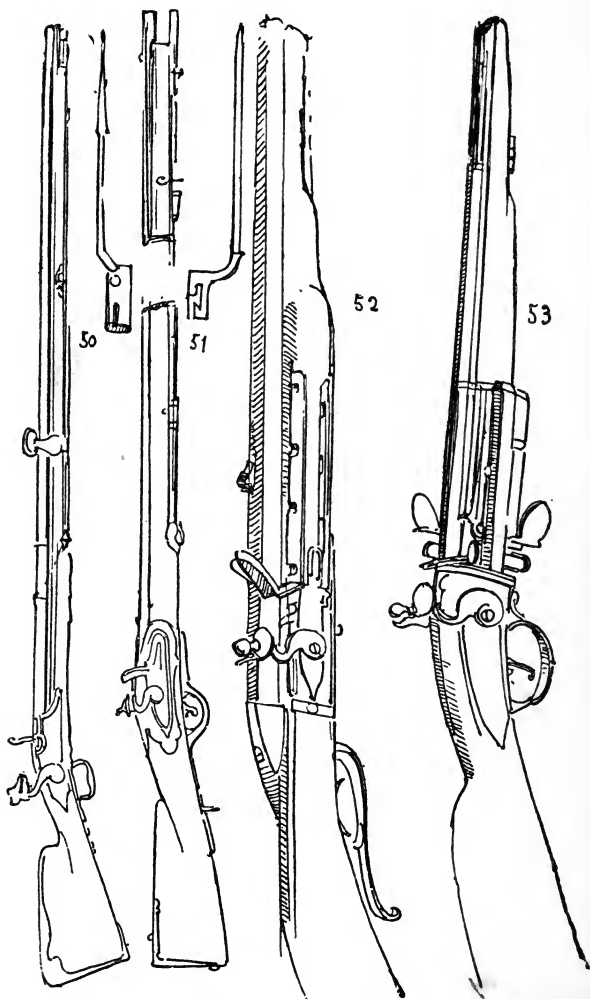

50. Flint-lock and bayonet gun, French, of the seventeenth century.
51. Prussian flint-lock and bayonet gun, time of Frederick the Great.
In 1730 an iron ramrod was added to this weapon, an addition which contributed greatly to the victory of the battle of Mollwitz. Prince Leopold I. of Anhalt-Dessau, the organizer of the Prussian infantry, had already introduced the iron ramrod in his own regiment in 1698.
52. German repetition gun, grooved and adapted for firing six shots successively, of the seventeenth century.
Museum of Sigmaringen.
53. German revolver, with turning cylinder, firing four shots, end of the eighteenth century.
Museum of Sigmaringen.

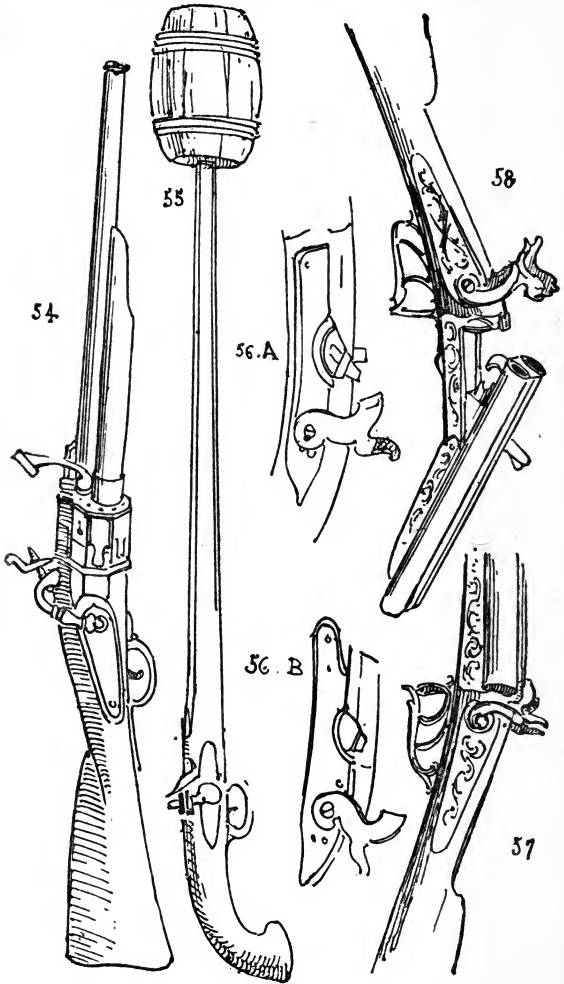

54. Carbine revolver. with turning cylinder, firing eight shots, for cavalry use.
55. *Raquette* gun of the eighteenth century. *Arsenal of Berlin.*
- 56 A and B. Piston and percussion locks, invented in 1807 by the Scottish gunsmith, Forsyth.
57. Breech-loading percussion gun, made on the Lefancheux system.
58. Same as above. This engraving represents the gun open and ready to receive the charge.

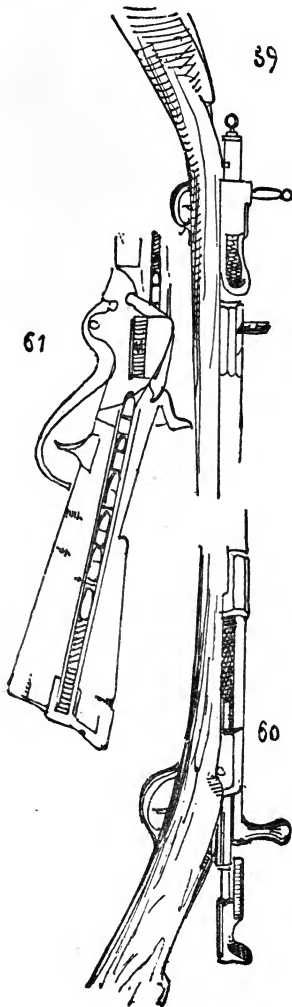

59. Prussian needle-gun, invented by a German named Nicolas Dreyse, born in 1827, died in 1868. The weapon is represented open and ready to receive the charge.

60. French needle-gun, invented by M. Chassepot in 1866, upon the Dreyse model. The gun is represented open and ready to receive the charge.

61. Spencer repetition gun of the middle of the nineteenth century. It was invented by Messrs. Spencer of Winchester. This sort of gun was a German invention originally, as may be seen from the weapon preserved (see page 524, No. 52). M. Dreyse had already made several experiments, in 1828, with a gun adapted for repeated discharges, of his own invention; but finding it inferior to his needle-gun he gave it up. Nevertheless, his son has taken up the invention, and continues his experiments.

THE PISTOL.

This weapon probably derives its name from the word *pistallo*, which means pommel, and not from *Pistoja*, for it appears not to have been first made at Pistoja, but at Perugia, where they made some small hand cannons a hand's span in length.*

I do not know of a single Museum which possesses a match-lock pistol. The *Mönchsbüchse* in the Dresden Museum, that is, the small hand cannon with a rasp, spoken of in the historical chapter, and in the introduction to this one, appears to have preceded the wheel-lock pistol, which is the most ancient weapon of this kind at present in existence.

The *coup de poing*, a small pistol, which the Germans call *Terzerol*, is not a modern invention, for the author has one of the same kind, with a wheel-lock, of the sixteenth century. It is made entirely of iron, and the barrel is only $6\frac{1}{2}$ inches in length. The revolver pistol, as well as revolver guns, existed in the seventeenth and eighteenth centuries, and those made at the present day, amongst which the *Colt* revolver is the most celebrated, cannot be called inventions, but only improvements on an old invention.

* The Roman span is about $7\frac{1}{2}$ inches.

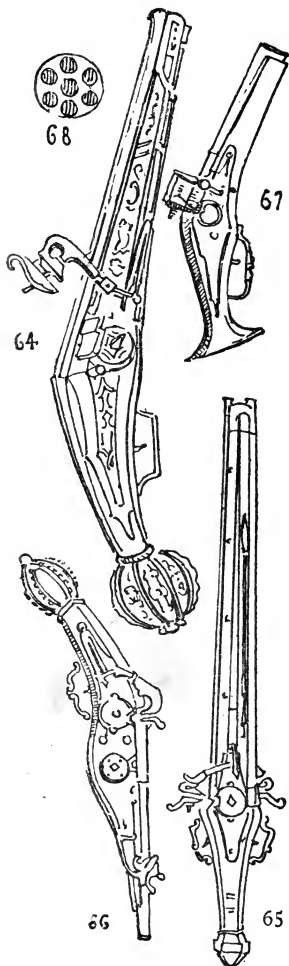

64. Wheel-lock pistol of the sixteenth century. This was the sort of pistol used by the German cavalry, and also by the *Ritter*, or knights.

65. Double wheel-lock, end of the sixteenth century. Arsenal of Zurich. The Dresden Museum has some similar ones with double wheel-locks and three barrels.

66. Wheel-lock pistol with double barrel, beginning of the seventeenth century.

Tower of London.

67. Wheel-lock pistol, firing seven shots.

Museum of Sigmaringen.

68. Barrel of the preceding pistol.

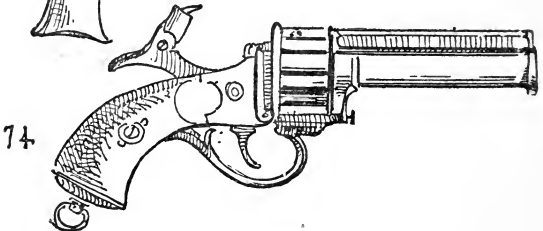
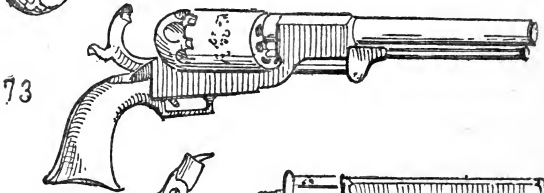
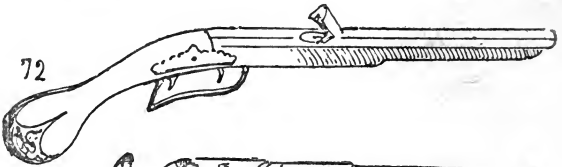
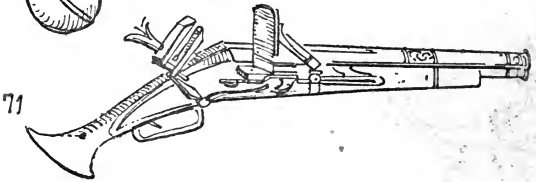
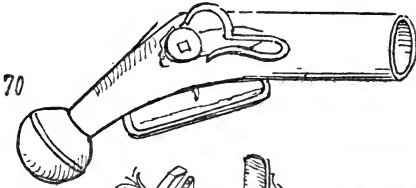

69. Wheel-lock and mortar pistol, called in German *Katzenkopf*, of the seventeenth century.
Arsenals of Woolwich and Berlin.
70. Wheel-lock and mortar pistol of the seventeenth century. It is entirely of iron.
Castle of Löwenberg, on the Wilhelmshöhe near Cassel.
71. Flint-lock pistol, end of the seventeenth century.
Tower of London.
72. Pistol with flint-lock, of the beginning of the eighteenth century.
Museum of Prague and Gewelrkammer (Museum) at Dresden.
73. Colt's revolver, invented by Samuel Colt, of the United States, in 1835.
74. **Mat** revolver, invented a short time back by M. Le Mat.

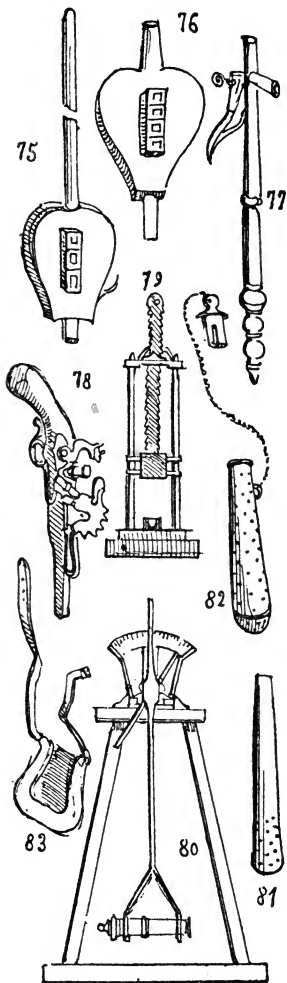

75. Priming turncrew for wheel-lock pistols.

Arsenal of Berlin.

76. Same as above.

Ternow Collection at Berlin.

77. Priming turncrew for wheel-lock pistol.

Museum of Prague and Spengel Collection at Munich.

78. Powder *eprouvette*, or appliance for trying the strength of powder with flint and wheel-lock.

79. Powder *eprouvette* with screw and rack.

80. Powder *eprouvette* with pendulum action.

81. Matchlock case for musketeer.

82. Matchlock case for Bohemian grenadier. Author's Collection. Similar ones are to be seen in the historical museum of the Palace of Monbijou at Berlin, and in the collection of arms of the Prince of Lobkowitz at Raudnitz in Bohemia.

83. Arquebusier's ammunition bag, end of the fifteenth century, from the designs of Glockenthon.

Ambras Collection.

84. Baldrick, or cross-belt, belonging to a musketeer,* fitted with wooden capsules (*Patronen-Gürtel* in German).

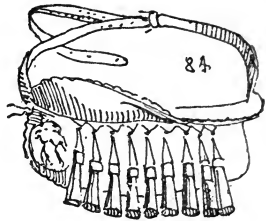

85. Same as above. This baldrick is also fitted with a priming-horn, and a bag for bullets and links.

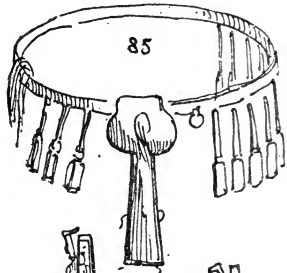

86. German primer, end of the sixteenth century, made of oak inlaid with ivory and gilt copper.

Meyrick Collection.

87. Italian primer, or touch-box (*Zündpulverflasche*), end of the sixteenth century. It is made of gold.

Meyrick Collection.



88. German powder-flask for arquebusier, second half of the sixteenth century.

* In loading the arquebuse the powder-flask was used. We see therefore conclusively that this belt must have belonged to a musketeer, as it is fitted with wooden capsules (German, *Pulvermassen*).

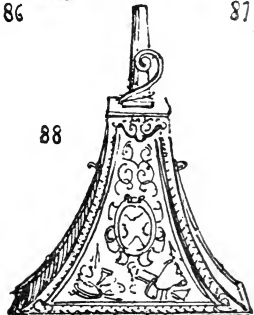



89. German powder-horn (German, *Pulverhorn*), called *Saxon*, about $12\frac{1}{2}$ inches in length, end of the sixteenth century. The light part of the horn is ornamented with some excellent carved work. The mountings are in iron.

Author's Collection.



90. Powder-flask (*Pulverflasche*) in boiled leather, ornamented with iron.

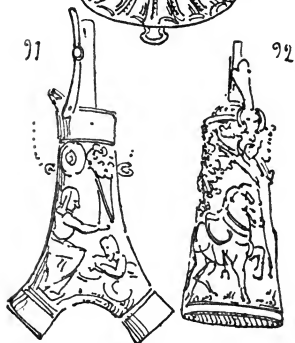

91. German powder-flask of the sixteenth century. It is made of buck-horn, and is 9 inches in length.

Museum of Sigmaringen.

92. German powder-flask in ivory, of the seventeenth century; it is 7 inches in length.

Museum of Sigmaringen.

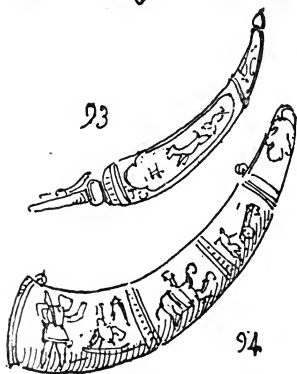

93. German powder-horn in ivory, $11\frac{1}{2}$ inches in length.

Museum of Sigmaringen.

94. German powder-horn of the beginning of the seventeenth century. It is 17 inches in length.

Museum of Sigmaringen.

VIII.

THE AIR-GUN.

THE air-gun (German, *Windbüchse*), invented by Guter of Nuremberg in 1560, and improved on successively by Gerlach and by Sars of Berlin, by Contriner of Vienna, Facher of Liége, Martin Fischer of Suhl, Futter of Dresden, Schreiber of Halle (1760—1769), C. G. Werner of Leipsic (1750—1780), Gottsche of Merseburg, Müller of Warsaw, Valentin Siegling of Frankfort-on-the-Main, Vrel of Coblantz, John and Nicholas Bouillet of Saint-Etienne, Bate of England, Facka Speyer of Holland, and others, is an explosive weapon, fired by the air, which, being compressed by an air-pump, is allowed to escape rapidly. Two sorts of air-guns are known of: one in which the air is compressed in the butt-end, the other in which it is contained in a copper ball, placed above or below the barrel. This gun, the use of which is forbidden in France, ought to be classed amongst the weapons adapted for successive discharges, because some of the barrels of these guns are able to contain as many as twenty bullets, to be fired in succession without reloading. It was used in the Austrian war at the end of the eighteenth century, and became the special weapon of some regiments.

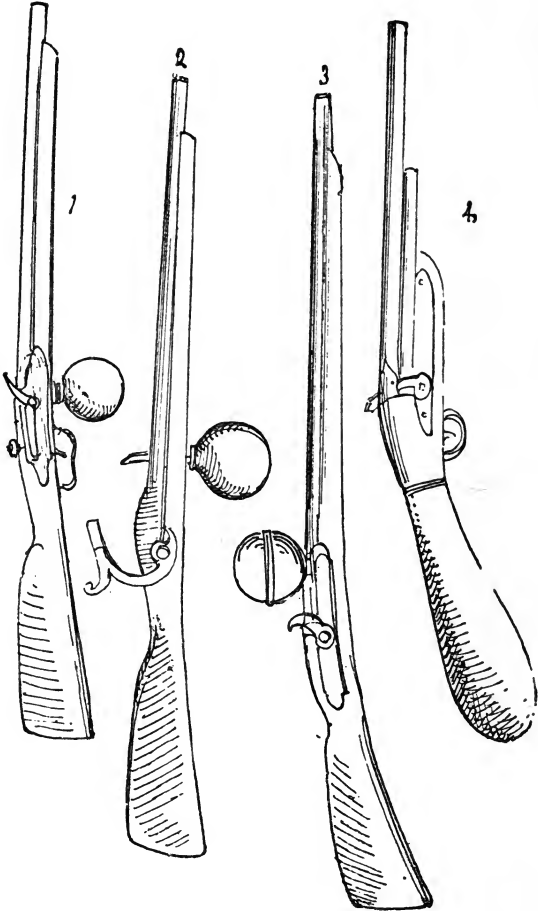

1. Air-gun, with copper barrel and ball; the latter is placed below the barrel.
Arsenal of Prince Lobkowitz at Raudnitz in Bohemia.
2. Same as above. An air-gun of the same make, but bearing the signature, *T. C. Sars, Berlin*, is in the Museum of Artillery in Paris, No. 1348.
3. Air-gun, in which the receptacle for air is placed on the upper part of the barrel. Arsenal of Berlin. No. 1349, in the Museum of Artillery, Paris, is on exactly the same principle.
4. Air-gun, with the receptacle for air placed in the butt-end, made by Contriner of Vienna. Arsenal of Berlin. In the Museum of Artillery at Paris there are several air-guns with the receptacle for air placed in the butt-end.

IX.

THE ART OF THE ARMOURER AND ARQUEBUSIER.*—
MONOGRAMS, INITIALS, AND NAMES OF ARMOURERS.

THE East has always been famed for the beauty of her pageantry weapons, and at a time when the greater part of Europe made use of rudely-forged arms, Hindustan, Persia, Khorassan, and even Java had attained to a great perfection in the arts of enamelling,† inlaying (*Tauchierarbeit* in German), and damascening.

On the other hand, the knowledge of embossing iron, and of making complete suits of articulated armour, belongs much more to the Christian Middle Ages, and northern nations of recent civilization, than to the ancients, and to eastern people.

At the end of the fifteenth century the embossers of Central Europe had already excelled the Persian and Greek armourers in respect of their art, and had also arrived at the highest degree of art combined with great practical strength and durability of work.

The Renaissance of art, the influence of which showed itself in an elaborate method of working up details and in beautiful chasings (*Ausgestochene Arbeiten*), can only be said to have brought about a decadence, for it adopted designs

* At the present day the word *armourer* means a maker of *defensive and offensive* arms. Formerly only a maker of *armour* was called *armourer*, while an *arquebusier* was a maker of portable and large fire-arms.

† Enamel-work (*Email*, or *Schmelz* or *Tauchierarbeit*) is in laying small pieces and ornaments of black enamel (*galena*) in precious metals and in other materials. Galena is a mineral composition of lead, sulphur, and earthy substances. There is an antimonial galena called *silver galena*, *iron galena*, *bismuth galena*, and *mock galena*.

Damascening on steel is the inlaying of small threads of gold or silver into iron or steel.

Damasked steel, also called *Indian* or *Wootz steel*, must not be confounded with embossed steel, for it is steel waved or watered in different shades. The words *enamelling*, *inlaying*, and *damascening*, are very

of a past age, which were not at all in harmony with the new inventions and improvements.

The armourer of that time, who was able to make the bell of a helmet in one entire piece without the aid of machinery, had also in many cases designed suits of armour, which, for beauty of workmanship and for ingenuity of design, will always make an imitator despair.

often confounded one with another, for, the fact is, they all mean inlaying on metal, just as inlaying on wood and other *vegetable matter* is called *marqueterie*.

Damascus steel is melted steel on which many waved patterns are formed by the presence of carburet of iron, which is brought out by means of acids. Other waved or watered patterns are made by means of small quantities of metals, such as platina, silver, or palladium. There are grey, black, and brown damasks, which water the steel when mixed with it.

Clouet, in 1804, was the first man in France to imitate damascus steel, the production of which has been very greatly improved on by *De-grand, Gurgey, Conleause*, and particularly by *Stodart* and *Faraday* in 1822. The factories of the *Bouches du Rhone* sent their damascened blades to the East. The town of *Liège* used the ribbon damask for a very long time in the manufacture of their cannons, guns, and carbines used in hunting, even for the common ones, and they sold them at an almost incredibly cheap rate.

Damascening is an entirely different work from the *damas*, being only inlaying, which is done in the following manner: As soon as the workman has fired the steel blade or plate, he engraves with a tool the subject he wishes to represent; in the crevice he inlays a narrow thread of metal, which he works in with a blunt chisel: as soon as the design is filled in, he goes over the whole with a very fine file. Damascening was known and practised in Italy, Spain, and Germany in the Middle Ages and during the Renaissance period. It was not introduced into France until the reign of *Henri IV.*

Embossing (*Treiben* in German), chasing (*Ausstechen*), and engraving (*Stechen*), are words often mistaken one for the other, though the difference is great and very important.

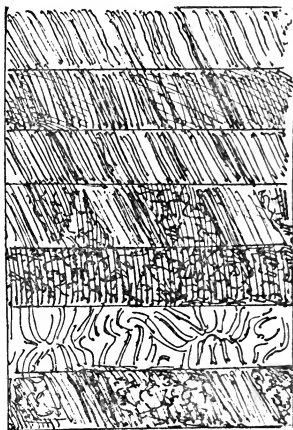

Very few documents relating to the armour of the Middle Ages have come down to us. In the chapter which treats of complete suits of armour of this time, there is a representation of an illumination of the thirteenth century (p. 178), which shows us an armourer making a helm; besides this the *Weisse König*, a work written entirely by the Emperor Maximilian I. about the end of the fifteenth century, represents the complete workshop of one of these armourers.

Italy and Germany have been especially celebrated for the manufacture of defensive arms, whilst Spain has been renowned for the manufacture of blades, amongst which Toledo ones were the best.

In Italy this manufacture was conducted on so large a scale, that the armourers of the single town of Milan were able, after the battle of Macalo (1427), to supply in a few days arms and armour for 4000 cavalry and 2000 infantry soldiers. > Filippo Nigroli and his brothers, who worked for Charles V. and for Francis I., John Ambrogio the elder, Bernardo Civo, and Hieronimo Spacini, a Milanese, the maker of the famous shield of Charles V., are the most celebrated Italian armourers, to which names may be added Figino, Ghinello, Pellizoni, and Piatti. It was more particularly at the period of the Renaissance that Italian armour attained its highest perfection; during the Middle Ages it could not bear comparison with German, Hispano-Moorish, French, and English workmanship.

As far as regards portable fire-arms, Italy (where pistols were probably first invented) holds the highest place. Antonio Picinino, Andrea di Ferrara, of the seventeenth century, for sword blades; Ventura Cani, Lazarino Cominazzi, Colombo and Badile, Francino, Mutto, Berselli, Bonisolo, Giocatane and Cotel, of the eighteenth century, for fire-arms—are names that cannot be forgotten, because their signatures are stamped on arms which have been collected from every quarter on account of their superior workmanship.

In Spain, Madrid, Cordova, Cuença, Catugel, Saint-Clement, Cuella, Badajoz, Valencia, Seville, Valladolid, Saragossa, Orgoz, Bilbao, and particularly Toledo, are the cities most celebrated for their manufactories of blades, and farther on will be found more than two hundred monograms, copied from those on arms, which, however, are none of them of an

earlier date than the second half of the sixteenth century; but it must be mentioned that in several of these places there were some made as early as the thirteenth century, which was due, as nearly all the industry of the Spaniards was, in great measure to the Moors. The steel, or rather iron, used in these manufactories, was brought from the mines of Biscaye and Guipuscoa.)

Germany (where the monk Schwartz of Freiburg, in Breisgau, in the fourteenth century, had made the first step in European artillery) was famous already during the second part of the Middle Ages, and no less so during the Renaissance period.

After Rudolf of Nuremberg had in 1306 discovered the art of wire-drawing (*Drahtziehn*, German), by which riveted mail, or suits à *points d'orges*, were brought within the reach of almost every man-at-arms, jointed plate armour, of which all the defensive improvements, and probably the very invention, are fairly due to armourers from beyond the Rhine, attained, towards the end of the Middle Ages, or in the Renaissance, a high degree of perfection. In the hands of Desiderius Kollmann of Augsburg, of Lorenz Plattner, Wilhelm Seussenhofer, and others, the magnificent armours of Maximilian I., Charles V., and Francis I., rose to the dignity of objects of fine art, the taste of which was, however, even then unfavourably influenced by foreign admixture. Seussenhofer died in 1547, Kollmann flourished about 1532, at which date he furnished, among others, to Philip of Spain, armour of great beauty, which is still preserved.

The admirable suit for horse and rider in the Dresden Museum, on which the artist has represented the Labours of Hercules, in all probability issued from the workshop of Kollmann, who held at that time perhaps the highest rank among armourers, and received for this suit fourteen thousand crowns, a sum which, bearing in mind the relative value of money at that age, appears truly gigantic for a single suit of armour. He held one of the highest ranks amongst German armourers of that time.

M. de Hefner-Alteneck has published, by Bruckmann of Munich,* 86 of the 170 Indian-ink sketches, representing

* "Dessins originaux de maîtres Allemands pour Armures de luxe destinées à des rois de France," published by J. H. de Hefner-Alteneck,

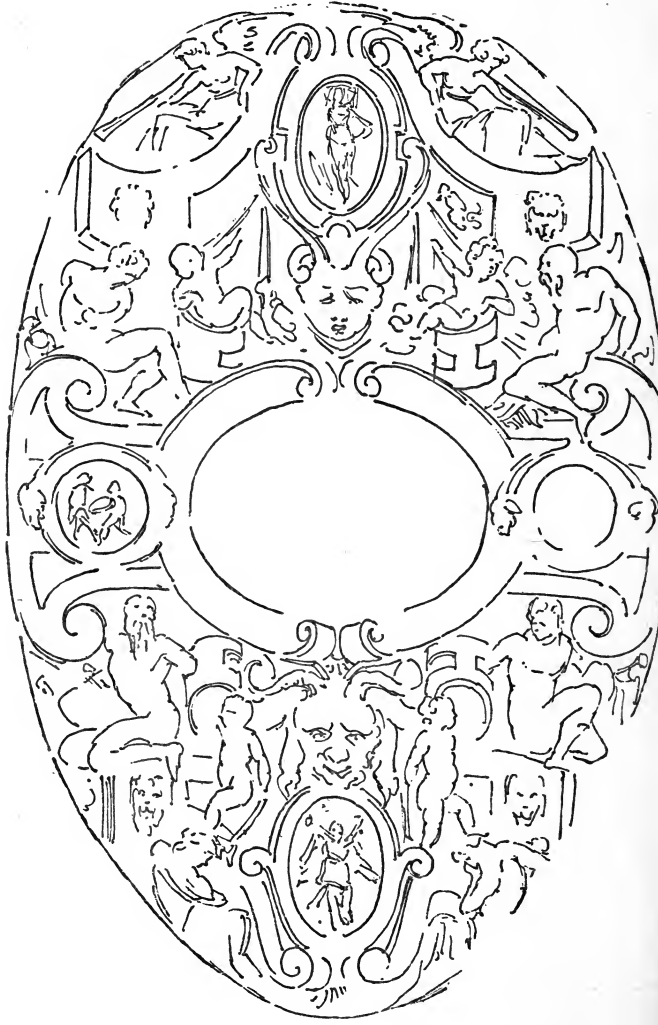



more than 25 proposed complete suits of armour for man and horse, which were designed by the painters *Schwarz* (who died in 1597), *Van Achen*, *Brockberger*, and *John Milich* (born at Munich in 1517, died in 1572), for the armourers of Munich and Augsburg.*

Spain also obtained from Munich some of the most costly of the suits of armour now in the *Armeria real de Madrid*, there marked as Italian and Spanish arms. Thanks, however, to the researches of M. le Baron G. de Werthern, the Prussian

photographed at the photographic institute of Frederick Bruckmann at Munich. Folio.

Several other of these designs belong to General von Hauslaub at Vienna, and to M. Destailleur, government architect at Paris: they were all bought in 1840 at the sale of the collection of State Councillor Kirschbaum.

* These drawings, which bear evident traces of having been used, and in which all indicates the work of the artists above named, as known to us through German engravings (*vide* the last two illustrations, selected indiscriminately), are the designs for each separate piece in the armours of Francis I., Henri II., and the Emperor Rodolph II., hitherto falsely ascribed to Italian or Spanish armourers.

ambassador, among the archives, no farther doubt can exist on the matter.

This is the copy of the letter written by M. le Baron de Werthern :

“ We had here last winter two of our countrymen, M. Bergenroth and M. Friedmann, who had been sent by the English government to examine the records of Madrid and Simancas.

“ A casual observation of M. Bergenroth concerning the influence of German art in Spain, gave me the idea of engaging M. Friedmann to examine the accounts of the reigns of Charles V. and Philip II., to see if there were not the names of German armourers who must undoubtedly have been the makers of some of the beautiful suits of armour preserved in the Arsenal of Madrid, the style and workmanship of which seemed to indicate the hand of a German artist.

“ I send you the result of these researches, which have fully confirmed my suppositions.” And farther on : “ M. Bergenroth recollects perfectly having seen in the records of the reign of Charles V. several accounts which show also some other names of celebrated German armourers.

“ He has promised me that on his return next winter I shall have a copy.

“(Signed)

BARON G. DE WERTHERN,
“ *Prussian Ambassador.*

“ Madrid, 13th April, 1866.”

TEXTUAL AND AUTHORIZED EXTRACT FROM THE ARCHIVES.

Simancas Estado. Leg. 1565, Fol. 33.

Anuentas de la capa de don Philipe de Austria principe de Espana.

Augsburg.—755¼ escudos de oro por diez copas de plata donado warpradoc aqui a razon de 17½ y 16 Flonucel marco.—Aug. 25 Hebr. 1549.

Augsburg.—Por pagas compradas an Aqueta, 1720 due.—*Brus.*, 30 May, 1549.

Munich.—Por 8 arcabuzes à *Pater Pah von Minichen*, 100 escudos de oro.—*Antwerp*, 19 Sept., 1549.

Augsburg.—Por ciertas armur que ha de hacer *Maestre Bulff*, veino de Lanuete (wheel-lock musket) 100 escudos de 22 baçor.—*Aug.*, 18 Julio, 1550.

Augsburg.—A Camargo por 5 sacabuches (Passauer Schwerte) por il 80 escudos.—*Augusta*, 20 Ag., 1550.

Augsburg.—A Colman (Kollmann) armero de *Augusta* 2,000 escudos de oro en cuenta de 3,000 que ha de aver por unas armur que haze pasa mi sevoais.—*Augusta*, 22 Oct., 1550.

Munich.—A Peter Pah de *Munich*, 52 escudos por ciertos Ascabuzer.—*Aug.*, 10 Oct., 1550.

Augsburg.—A Desiderio Colman armero de *Augusta*, 400 duc en cuenta de loque a de aver por unas armas negras que haze para mi.—*Augusta*, 27 Febr., 1551.

Munich.—A Peter Pah por quatro carabuzes 41 escudo, 19 Marco, 1551.

Munich.—A Maestro Bolfe (*Bulff*) 250 escudos por unas armas que hace por mi persona 24 mace y 150 mas por ciertas armas que hace por don Antonio de Toledo.

Augsburg.—A Maestro Haur (*Staur*?) de *Augusta* 50 ducados por ciertas armas que muado hacer y quedavou con il *Augusta*, 10 de Abril, 1551.

Munich.—A M. Pedro arquebuzes de *Minich*, 40 escudos por ciertos arquebuzes.—28 Abr. 1551.

Munich.—A M. Pedro Mallero de *Munich* 114 escudos por ciertos pieças de Malla.—*Aug.*, 7 Abril, 1551.

Munich.—A Maestro Vulff (*Bolfe*? *Bulf*?), 225 escudos, 200 por unas armas doradas que ha de hacer y 25 por unas pillar que hin por un harneo blanco que havia hecho para mi personio.—*Aug.*, 2 Mayo, 1551.

Augsburg.—A Colman, 650 escudos por una armas.—12 Mayo, 1551.

Munich.—A Pedro de *Minich*, 30 escudos por un arcabuz y 20 escudos por los moços de Colman de Merced.

Another important discovery in the history of original works of art, bearing on the fame of German armourers of this epoch, is that made by the Archivist of Innspruck.

M. Schönherr found amongst the records of the capital of the Tyrol proof that: "Joerg Seussenhofer, of Innspruck, master armourer and heraldic engraver of Ferdinand I., had orders to make a magnificent set of harness, which his master intended for Francis I., King of France. Nevertheless, when the present was finished it was not sent, and it was this identical harness which Napoleon I. caused to be removed from the Ambras Collection at Vienna, and sent to Paris, in which city it was received with great state, as belonging to Francis I.*

* This suit of armour is at present in the Louvre, where it is thought to be Italian.

Two other sets of harness were, however, actually made by this artist, and sent to the sons of Francis I. The groundwork of these harnesses was intended to have been in gold, but not being finished in time, the ornaments were placed on a black ground.

Seussenhofer also made six sets of harness for the court of France, and many suits of armour for the kings of England and of Portugal.

Passau and Solingen were celebrated at a very early time for making blades of weapons, the quality of which was as highly esteemed as those of Toledo.

Georg Springenkee, a celebrated armourer of the town of Passau, a place famous for its arms as early as the thirteenth century, obtained at the beginning of the fourteenth century, from the Emperor Charles IV., armorial bearings to be used by his township. These arms were two crossed swords. Another very usual mark is a wolf,* which is believed to have been granted by the Archduke Albert in 1349 to the armourers' guild of Passau; it is also to be seen on some of the earlier arms made at Solingen, in which city the armourers Clement Horn and Johann Hopp flourished at the commencement of the sixteenth century. Arms were also made in the last-named city as early as the latter half of the twelfth century, when the art was first introduced by Styrian armourers. For a long time Solingen had its stamp-office in the large market-place of the town, where each armourer was obliged to bring his manufactures to be proved and stamped. This custom was, however, suppressed by the French.

Damascening and inlaying, which have already been spoken of in the first part of this chapter, were carried on in Germany at the end of the Middle Ages, and their process was a much more solid one than that adopted by the Spanish armourers, a fact which can be proved by examining the magnificent suits of armour in the Imperial Arsenal of Vienna.

In portable fire-arms, Germany may be said to have no rival.

The beautifully-finished "precision" arms of the sixteenth and seventeenth centuries, which are preserved in various museums and collections, are all of them German, with the

* The swords with this mark are very much sought after by the inhabitants of the Caucasus.

exception of a few Italian and French productions, remarkable for the beautiful chiselling and carving on them. These latter, however, were intended only for pageants and shows.

As early as the sixteenth century the manufacture of fire-arms had spread to such an extent over Germany, that there was not a single town, however small, in which there was not an armourer able to make an arquebuse without the aid of machinery. Valentin, Stephan Klett, and Clauss Reitz, at Suhl, in the province of Henneberg, had, as early as 1586, established two such large manufactories, that they were able to supply Switzerland with 2000 fire-arms of different sorts, and 500 precision muskets. We have seen that the rifling of the barrel had been invented in Germany at the end of the fifteenth century, the wheel-lock and snaphaunce in the sixteenth century, as well as the air and the needle-gun in later times.

France, which most certainly must have had skilful armourers, has allowed their names to fall into obscurity, for, notwithstanding long researches, I have not been able to trace either the names or monograms of any French armourer of an earlier date than the commencement of the seventeenth century.

Nevertheless, Chamblay (Oise) was famous in the Middle Ages for the manufacture of certain coats of mail, which ancient authors wrongly describe as having a *double mesh*, the fact being that there does not exist but one kind of mesh, which is more or less close, according to the fancy of the maker. We may mention that the flint-lock, which took the place of the snaphaunce with the sulphurous pyrites, was invented in France at the beginning of the seventeenth century, but it is not known where or by whom.

Amongst the modern French armourers must be mentioned the names of Delvigne, Minié, Lepage, Gastine-Renette, Lefauchaux, and Chassepot.

Amongst the ancient English armour there are some beautiful tilting and war helmets called *heaumes*, which are noticeable on account of their solid make and great thickness of steel. Unfortunately, not a single name of any of the able makers of these helmets has been found, and the monograms are also extremely rare.

The same remarks apply to Switzerland and Flanders, though this latter country has held an important place in the manufacture of heavy fire arms ever since the invention of cannons, and at the present day is renowned for hunting appliances and arms, which are manufactured at Liège. The city of Toula in Russia distinguished itself by its factories for casting arms in the year 1712.

The Hindoos had at a very remote period attained a high reputation, particularly for shields. These were manufactured at Delhi, being wrought when cold, in two separate pieces for the centre and the rim, and preserve their traditional reputation down to our own days.

It is a remarkable fact that the more elaborately the Indian shield was ornamented the less was its value, for the inlaid and damascened flowers served but to hide the defects of workmanship.

Gwalior and *Lushkur* were celebrated for the blades of weapons, *Nurwur* and *Lahore* for fire-arms, *Nurwur* and *Shahjehanabad* for damascened arms and coats of mail, as well as for the superiority of their offensive weapons.

In Persia and Hindostan the manufacture of damascened weapons is still continued, and casques, arm-guards, round bucklers, breastplates, and mail shirts (many of the latter being of the class termed *grains d'orge*), are still produced, the shapes of which rival in beauty those of the fifteenth and sixteenth centuries.

The principal manufactories of portable fire-arms at the end of the eighteenth century were—

In Germany, those of Saint Blaisien in the Black Forest, Dantzic (established in 1720), Chemnitz, Essen, Harzberg in Hanover, Klosterdorf, Linz, Olbernhau, Prague, Remscheid, Solingen, Spandau (established in 1720), Suhl, Teschen, and Wiener-Neustadt.

In Italy, those of Brescia, Florence, Milan, and Turin.

In Spain, those of Esqualada, Oviedo, Plascencia, Sililos, and Toledo.

In France, those of Abbéville, Charleville, Saint-Etienne, Maubeuge, and Versailles.

In England, those of Birmingham, Sheffield, and London.

In Belgium, that of Liège.

In Russia, that of Toula.

MONOGRAMS, INITIALS, AND NAMES OF ARMOURERS.

MONOGRAMS, INITIALS, AND NAMES OF GERMAN ARMOURERS.

TREBUCHET is the name of an armourer in the epic poem of *Percival*.

SCHÖYT, son of the above (Willehalm, 356-16).

KINN DE MUNLEUN, another armourer, mentioned in Willehalm (429-28).



Monogram found on the blades of two swords belonging to the fourteenth century, preserved in the Arsenal of Zurich. It is probably the *wolf* badge, that was used by the armourers of Passau and Solingen toward the end of the thirteenth century.



Monogram of a German armourer, on a suit of armour in the Ambras Collection, No. 37, said to be of the year 1476.



Badge or mark of the embossers (*Tauchiere*) of Augsburg.

M. Mark of the beginning of the sixteenth century.

CLEMENT HORN, of Solingen; this signature occurs on some swords of the sixteenth century in the Museums of Artillery of Paris and Dresden.

CLEMENS HORUM is the Latin form (or meant as such) of the same name, and it has been found on a two-handed sword in the Museum of Artillery at Paris.

H. K. Raised letters on a wheel-lock arquebuse with rifled barrel, of the beginning of the sixteenth century.

Museum of Artillery, Paris.

I AND W. Raised letters on a wheel-lock arquebuse with rifled barrel, of the middle of the sixteenth century, in the Museum of Artillery, Paris.

M. W. Same as above.

F. L. F. H. V. Z. Z. Same as above.

BOEST DER JUNGE. Name found on a wheel-lock pistol, dated 1569, in the Tower of London.

P. O. V. G. Raised letters on a wheel-lock with rifled barrel, dated 1590.

Museum of Artillery, Paris.

PETER MUNSTER. Name on a sword blade, which has likewise the *wolf* mark. The name of this armourer, who lived in the sixteenth century, as well as that of his brother, **ANDREAS MUNSTER**, is also found on some swords in the Dresden Museum. The name of **PETER MUNSTER** exists also on a magnificent sword in the Museum of Sigmaringen.

H with a crown above it is the mark of the renowned armourer, **PLATTNER**, who constructed the armour of Maximilian I., as also the sword of that monarch, both of which are now in the Ambras Collection.



This monogram is not an armourer's. It forms the initials of Maximilian II., and was found on a halbard dated 1566.

Museum of Artillery, Paris.



Monogram found on a halbard of German manufacture, of the end of the sixteenth century, bearing the arms of Austria.

Museum of Artillery, Paris.

SCHÖNBERG (J. A. V.) is the name of a celebrated armourer of Munich, who lived in the sixteenth century. Many of his works are in the arsenal of that city.

AMBROSIUS GEMLICH and **WILHELM SEUSSENHOFER**, both of Munich, were armourers of Charles V. (1516—1558), and of Ferdinand I.

JÖRG SEUSSENHOFER and **KOLLMANN (Helmschmidt*)**, **PLATTNER** (makers of armour) of Augsburg, lived in the sixteenth century, and exported a great quantity of arms to Spain.

FRANZ GROSSCHEDL, of Landshut, lived about the year 1568; to whom the Duke of Bavaria paid 1325 florins for a single cuirass.

MARTIN HOFER, of Munich, lived about the year 1578.

ANTON PFEFFENHAUSER, of Augsburg, about 1580.

PAUL SCHALLER, about 1606.

ANTONIN MILLER, of Augsburg, about 1592.

PAUL VISCHER, of Landshut, about 1600.

JOHANN ALLICH.

MEVES BERNS, of Solingen.

* Maker of helmets.

PETER BROCK.

CLEMENS KOLLER.

JOHANN KIRSCHBAUM.

CLEMENS MEIZEN.

JOHANN MOUM.

HEINRICH AND PETER PATHER.

HANS PRUM, of Mesene.

C. POLS.

PETER WERSBERG.

The above fifteen armourers' names are to be found on arms which are mostly of the sixteenth century, in the Dresden Museum.

BARTHOLOMES HACHNER is the name of an armourer which has been found on a wheel-lock arquebuse with rifled barrel, the woodwork of which is inlaid with engraved *plaques*.

T. Mark found on a hunting German arquebuse with wheel-lock, of the end of the sixteenth century.

Museum of Artillery, Paris.

JOHANN BROCH. Signature found on a sword of the sixteenth century.

Museum of Artillery, Paris.

RG AS

Monogram and initials found on a small German arquebuse of the end of the sixteenth century.

Museum of Artillery, Paris.



Monogram of German armourer of the end of the sixteenth century, found on the rack of a cross-bow.



Same as above.

JOHANNES HOPP. Signature found on a *glaiive*, or sword of justice, of the sixteenth century.

Museum of Artillery, Paris.

J. P. 1595. On a magnificent German fire-arm in the Erbach Collection.

H. C. R. Raised letters on a wheel-lock arquebuse, with rifled barrel, dated 1600.

Museum of Artillery, Paris.



Monogram on wheel-lock arquebuse with rifled barrel.
German (?)



Same as above.

These two arms, in the Museum of Artillery, Paris, may very probably not have been German.

JOHANN GEORG HOFFMANN. Signature found on a wheel-lock arquebuse with rifled barrel, in the Museum of Artillery, Paris.

ANDREAS M. SIGL. Same as above.

GEORG AND ANDRÉ SEIDEL. Same as above.

H AND S. Same as above.

JOHANN HAUER, 1612. Signature of an armourer of Nuremberg with date, found on an engraved suit of nobleman's armour, easily known in the Imperial Arsenal of Vienna by the peculiar back-piece, which has been hammered into bosses to suit the unlucky proportions of its patrician wearer.

M. H. I. B. Initials found on a German halbard, dated 1613.*
Museum of Artillery, Paris.

J. K. 1629. Initials and date found on a flint-lock gun, in the Erbach Collection.



Monogram from a German halbard, which also has the arms of the Prince Palatine, Duke of the Deux-Ponts, and the date 1613.

Museum of Artillery, Paris.

ANGUSTINUS KOLTER. Signature found on a wheel-lock arquebuse with rifled barrel, dated 1616. There is a similar signature on another arquebuse of the same sort, dated 1621.

Museum of Artillery, Paris.

H.F. 1638. Found on some fire-arms.

JOHANN KEINDT, of Solingen. Signature found on a soldier's sword, belonging to the first half of the seventeenth century.

Museum of Artillery, Paris.

MIEROVINUS † LÉGER. Signature found on a wheel-lock arquebuse with rifled barrel, dated 1632.

Museum of Artillery, Paris.

* The date appears to me doubtful, for the flint-lock was not introduced into France till about 1640.

† *Sic in orig.*: but quære if not a printer's error for Hieronimus?—
TRANSLATOR'S NOTE.

- T. A. M.** 1650. On a fire-arm in the Erbach Collection.
- H. V.** Initials on a German arquebuse with wheel-lock, used for hunting. It is dated 1656.
Museum of Artillery, Paris.
- JOTTAN GSEL ARTZBERG.** Signature of a German* armourer on a wheel-lock arquebuse.
Museum of Artillery, Paris.
- MATHEUS MATL.** Signature on an arquebuse with rifled barrel, dated 1661.
Museum of Artillery, Paris.
- HANS HENRICH DEILER.** of Frankfort, 1663. On a fire-arm with rifled barrel, in the Erbach Collection.
- GEORG HOCH,** 1654. On a fire-arm in the Erbach Collection.
- L** An initial, probably, of the Emperor Leopold (1660—1705), on a breach-knife (German).
Museum of Artillery, Paris.
- KILLIAN ZOLLNER,** of Salzburg. On a wheel-lock arquebuse, used for hunting, in the Arsenal of Berlin.
- ICH. SOMMER,** of Bamberg, 1685, famous for his arquebuses.
- HANS BREITEN.** Signature on the rifled barrel of an arquebuse dated 1666.
Museum of Artillery, Paris.
- BREITENFELDER.** On a fire-arm in the Erbach Collection.
- GEORG ALT. F. A.** Signature on an arquebuse with rifled barrel, dated 1666.
Museum of Artillery, Paris.
- DIETRICH VEBAN.** Signature on an arquebuse with rifled barrel, dated 1668.
Museum of Artillery, Paris.
- ICH ULRICH TILEMANN,** of Marburg, 1676. Signature found on a flint-lock gun in the Erbach Collection.
- MARIUS LINCK,** at Prague, second half of the seventeenth century.
Tower of London.
- H. NIC. MARKLOFF,** of Hanau, 1680. On a flint-lock gun in the Erbach Collection.
- WILHELM EICH,** seventeenth century; the signature is in the Museum of Artillery, Paris.
- JAN SANDER,** of Hanover. Signature found on a cross-bow, dated 1669.
Museum of Artillery, Paris.

* This man was probably Swiss.

JOHANN GUTZINGER, 1677. The signature occurs on both a small and a large rampart gun, dated 1677.

CLEMENT POËTER, of Solingen. The signature occurs on a sword of the seventeenth century.

Museum of Artillery, Paris.

HANS JACOB STUMPF, of Mossbrunn, armourer, engraver, and etcher of 1682.

JOHANN MARTIN. The signature occurs on an arquebuse with rifled barrel, date 1684.

Museum of Artillery, Paris.

LEONHARDIES BIESLINGER, of Vienna. Signature on an arquebuse with rifled barrel, and serpentine match; it is dated 1687.

Museum of Artillery, Paris.

DANIEL ECK, of Nordlingen. Signature on a wheel-lock arquebuse with rifled barrel, dated 1668.

Museum of Artillery, Paris.

H. MARTIN MÜLER. Signature on a musket with rifled barrel, of the end of the seventeenth century.

ANDREAS PRANTNER. Signature on a carbine dated 1675.

Tower of London.

P. V. 1678. On a harquebuse in the Tower of London.

SIMON RUEF, or RVEF in Filwang(?). Signature on a wheel-lock arquebuse with rifled barrel, dated 1689.

H. P. United in a monogram is another mark on the same arquebuse.

A. WASUNGEN, 1690. On a flint-lock gun in the Erbach Collection.

HEINRICH KEIMER. Signature of an armourer on a wheel-lock arquebuse with rifled barrel, dated 1691.

Museum of Artillery, Paris.

LEON GEORG DAX. Signature on a wheel-lock arquebuse with rifled barrel, dated end of the seventeenth century.

Museum of Artillery, Paris.

BAISELLMANS SCHACHNER, of Innsbruck. On a wheel-lock arquebuse with rifled barrel.

Museum of Artillery, Paris.

JOHANN ADAM ALTER. Signature of armourer on a wheel-lock arquebuse with rifled barrel.

ANDREAS ZARUBA, of Salzburg. Signature of armourer on a wheel-lock arquebuse with rifled barrel.

JOHANN SEITEL, 1704. On a wheel-lock arquebuse with rifled barrel.

Museum of Artillery, Paris.

GEORG DINCKL, of the Upper Tyrol. Signature on a wheel-lock arquebuse with rifled barrel.

Museum of Artillery, Paris.

JOSEPH HAMERL, of Vienna. Signature on a wheel-lock arquebuse with rifled barrel.

Museum of Artillery, Paris.

T. P. C. D. G. E. B. 1702. Initials found on a flint-lock gun in the Erbach Collection.

WILHELM BRABENDER. Signature on a suit of German armour.

No. 19³³, *Tower of London.*

STANISLAUS PACZELT. Armourer's name on a flint-lock gun for the chase, dated 1738.

Tower of London.

W. Initial on a German spontoon of the reign of Charles VI. (1711—1740).

Museum of Artillery, Paris.



Monogram of Charles VI. (1711—1740).



These two monograms occur on a German spontoon; they are the initials of Marie Thérèse and François of Lorraine, who married the Empress in 1738. The last is very similar to that of the Palatine Charles Theodore.

Museum of Artillery, Paris.



Escutcheon on a German boar-spear used for hunting in the seventeenth century.

Museum of Artillery, Paris.

WILFING. Signature on a wheel-lock arquebuse of the eighteenth century.

Museum of Artillery, Paris.

DANIEL ANTHOINE, of Berlin. Signature on a small German sword belonging to a Prussian officer of the reign of Frederick II. (1740—1786).

UTTER, of Warsaw. Signature on a wheel-lock arquebuse with rifled barrel, dated 1759.

Museum of Artillery, Paris.

I. A. JOSEPH GRAF. The initials and the signature of a German armourer, found on a carbine.

TURSCHEM-REITH. Inscription on a carbine.

ULRICH WAGNER, of Eychstett. Same as above.

HARTMANN. The name of a German armourer who worked in Amsterdam. In the Museum of Artillery there is a flint-lock musket by the same maker.

- REWER, of Dresden. Signature on a wheel-lock carbine, dated 1797.
Tower of London.
- DANIEL HEISCHAUPE, of Ulm, an armourer of the middle of the eighteenth century. He made the flint-lock carbine preserved in the Museum of Artillery in Paris, marked M. 343.
- ZWALTER. Signature on a flint-lock carbine.
- ECKART, of Prague. Signature on a flint-lock carbine.
- PGERTTEL, of Dresden. Signature on a flint-lock carbine.
- JOHANN HEREITER, of Salzburg. Signature on a carbine with rifled barrel in the Museum of Artillery in Paris.
- RIEGEL, of Zweibrücken, an armourer of the eighteenth century, whose signature is on a flint-lock gun in the Museum of Artillery, Paris.
- ANDREAS GANS, of Augsburg. Signature on a German hunting-gun.
M. 1288, *Museum of Artillery, Paris.*
- SPAZIERER, of Prague.
M. 1289, *Museum of Artillery, Paris.*
- PICART OHRINGEN.
M. 1291, *Museum of Artillery, Paris.*
- T. W. PETER, of Ottingen.
M. 1292, *Museum of Artillery, Paris.*
- ERTEL, of Dresden.
M. 1294, *Museum of Artillery, Paris, and also Erbach Collection.*
- CHRISTIAN, of Vienna.
M. 1297, *Museum of Artillery, Paris*
- F. L. L. I. G. The initials of an armourer of Bayreuth on a German hunting-gun.
Museum of Artillery, Paris.
- GEORG KEISER, of Vienna. Signature in the Museum of Artillery, Paris.
- CHRISTOPH JOSEPH FREY, of Munich.
Museum of Artillery, Paris.
- ADAM KULNIC, of Munich.
Museum of Artillery, Paris.
- HEINRICH KAPEL, of Munich.
Museum of Artillery, Paris.
- VALENTIN SIEGLING, of Frankfort-on-the-Main, maker of an air-gun in the eighteenth century.
Museum of Artillery, Paris.
- FL. BOSIER, of Darmstadt.
Museum of Artillery, Paris.
- VREL, of Coblenz.
Museum of Artillery, Paris.
- S. GERLACH, of Berlin.
Museum of Artillery, Paris.

S. GERLACH, of Meerholz. Maker of an air-gun.

Erbach Collection.

MÜLLER, of Warsaw.

Museum of Artillery, Paris.

CONTRINER, of Vienna.

Museum of Artillery, Paris.

STEPHAN STOCKMAR, of Potsdam, died in 1782; he was celebrated for his guns.

J. C. SARS, of Berlin, celebrated for his air-guns.

C. Z. with half a carriage wheel, is the badge of the manufactory of ZIEGLER at Dresden, in the eighteenth century, famous for sword blades.

VALENTIN MAKL, a German armourer, who lived at Copenhagen; his signature occurs on a flint-lock pistol.

Museum of Artillery, Paris.

J. A. KUCHENREITER, of Regensburg. Signature on a flint-lock pistol. This armourer is held in very high repute in Germany.

Museum of Artillery, Paris.

JOH. ANDREAS KUCHENREITER. On a flint-lock gun, early present century.

Museum of Sigmaringen.

I. I. BEHR. Signature on a rampart gun of the eighteenth century. (See page 560).

MAY, of Manheim. Same as above.

GEORG KOINT. Same as above.

NOCK. Signature on a rampart gun, dated 1793.

STIRLETS. Signature on a rampart gun.

C. NUTERISCH, of Vienna, is an armourer of the second half of the eighteenth century, whose signature is on a carbine.

Tower of London.

C. E. F. Initials of an armourer on a flint-lock gun in the Erbach Collection.

H. T. of Heubach.

Erbach Collection.

J. BELEN, AUGUSTE HORTEZ, F. G. GURZ, ISIDORE SOLER, N. O. and F. R. BIS, are all German armourers, whose names and monograms, as they occur on the arms preserved in the *Almeria Real* of Madrid, have been given by Don José Maria Marchesi in the table of monograms of armourers who lived at Madrid from 1684 to 1849.

MANUEL SOLER, MARTIN MANUEL, SAMUEL TILL, and FERDINAND DEZ—names of German armourers collected from the list of armourers who visited Madrid, collected by the same author as above.

GERMAN ARMOURERS OF THE LAST YEARS OF THE EIGHTEENTH
AND BEGINNING OF THE NINETEENTH CENTURY, CELEBRATED
FOR FIRE AND AIR-ARMS.

HEINRICH ALBRECHT, of Darmstadt.

Erbach Collection.

ANSCHÜTZ, of Suhl.

ARGENS, of Stuttgart.

DAVID ARNTH, of Mergentheim.

V. BARTHOLOMAE, of Potsdam.

BAUMANN, of Villingen.

BEHR, of Wallenstein.

Erbach Collection.

BRENNECK.

Erbach Collection.

BERGSTRÄSSER.

Erbach Collection.

BERGH.

Erbach Collection.

CALVIS, of Spandau.

Erbach Collection.

CLAUS, of Halberstadt.

Erbach Collection.

CORNELIUS COSTER.

Erbach Collection.

DINKEL, of Hall.

Erbach Collection.

S. DISON.

Erbach Collection.

EBERT, of Sondershausen.

Erbach Collection.

ECHL the elder, younger, and third, of Berlin.

ECHL (von der), of Berlin.

LEOPOLD ECKHARD, of Prague.

J. M. FELBER, of Ravensberg.

MARTIN FISCHER, of Suhl.

CHRISTOPH WILHELM FREUND, of Fürstenau.

Erbach Collection.

CARL FREUND, of Fürstenau.

Erbach Collection.

FREMMERY, of Berlin.

Erbach Collection.

FRIEDLER, of Ulm.

- J. GEORG, of Stuttgart.
 JEAN GRENET, of Perleberg.
Erbach Collection.
- GOTTSCHALCK, of Ballenstadt.
 J. C. GORGAS, of Ballenstadt.
 STACK.
Erbach Collection.
- STARK, of Vienna.
Erbach Collection.
- TANNER, of Cöthen.
Erbach Collection and Dresden Museum.
- TÖLL, of Sahl.
 ULRICH, of Eberndorf.
Erbach Collection.
- CHRISTIAN VOIGT, of Altburg.
 J. JOS. VETT.
Erbach Collection.
- WAAS, of Bamberg.
 WALSTER, of Saarbruck.
Erbach Collection.
- M. WERTSCHGEN, of Willingen.
 JUAN ZERGH.
Erbach Collection.
- ZURICH, of Vienna.
 PFAFF, of Cassel.
 PFAFF, of Posen.
 PISTOR, of Schmalkalden.
Erbach Collection.
- A. PÖTZI, of Carlsbad.
 POLZ, of Carlsbad.
 PRESSELMAYER, of Vienna.
 QUADE, of Vienna.
 RASCH, of Brunswick.
 DAVID REME.
Erbach Collection.
- JOH. RISCHER, of Spandau.
 C. RENER.
Erbach Collection.
- J. ROSCHER, of Carlsbad.
 MANFRIED REICHERT.
Erbach Collection.
- J. AND. RECHOLD, of Dolp.
Erbach Collection.
- PETRE SAETER, of Lemgo, in Lippe-Detmold.
Erbach Collection

GEORG RECK (1769—1782).

Erbach Collection.

SCHACKAU, of Bamberg.

SCHEDL, of Stuttgart.

SCHIRRMANN, of Basewalk.

SCHRAMM, of Zelle.

FR. SCHULZE, of Breslau.

SPALDECK, of Vienna.

HARZ, of Cranach.

HAUSER, of Würzburg.

HEBER, of Carlsbad.

CHRIST. HIRSCH.

Erbach Collection.

JACH, of Speier, maker of a double gun with damasked barrel.

Erbach Collection.

F. JAIEDTEL, of Vienna.

Erbach Collection.

JUNKER, of Grambach.

Erbach Collection.

JUNG, a German armourer established at Warsaw.

KAUFMANN.

Erbach Collection.

GEORGE KAYSER, of Vienna.

Museum of Artillery, Paris.

KEMMERER, of Thorn.

G. KALB.

Erbach Collection.

H. H. KAPPE.

J. C. KLETT, of Potsdam.

KNOPF, of Salztal.

KRAWINSKY, of Posen.

KRUGER, of Ratibor.

KLEINSCHMIDT, of Wisterberg.

Erbach Collection.

J. LAMMERER, of Cranach.

LICHTENFELS, of Karlsruhe.

LIPPE (Van der), of Stettin.

LIPPERT, of Cöthen.

MARTER, of Cologne.

DAMIEN MARTER, of Bonn.

MATHE, of Mannheim.

Erbach Collection.

MÜLLER, of Bernberg.

MÜLLER, of Steinau.

NAUMANN, of Cassel.

JOH. NEUREUTER, of Salzburg (a very famous maker).

NORDMANN, of Berlin.

ORTEL, of Dresden, established at Amsterdam.

M. OIT, of Wiesbaden.

OTTO, of Brandenburg.

MONOGRAMS, INITIALS, AND NAMES OF ITALIAN ARMOURERS.

DANIELO DE CASTELO MILANO, of 1475. Name of an armourer in the Dresden Museum, which, in the author's opinion, is wrongly said to be that of a Spaniard.

A. B. in a monogram of about 1480.

B. A. B. ditto.

S. ditto.

ANTONIO ROMERO, a celebrated armourer of the sixteenth century.

PHILIPPI NIGROLI, of Milan, of about 1522.

S. P. Q. R. Initials found on a round Italian shield, belonging to the middle of the sixteenth century, in the Museum of Artillery, Paris. They are the first letters of the words *Senatus Populus que Romanus*.

BARTOLAM BIELLA. Signature on a damascened hunting weapon in the Dresden Museum.

JOHANNES DE LA ORTA. Signature on a sword of the middle of the sixteenth century, which has also the arms of the Montmorency family.

Museum of Artillery, Paris.

JOHANNES DE L'ORTA. The same signature, though a little varied, found on a weapon in the Dresden Museum, wrongly classed among Spanish arms.



Monogram of an Italian armourer of the beginning of the sixteenth century, found on an Italian gisarme in the Söter Collection at Augsburg. It is called the *Scorpion* mark.

ANTONIO PICCININO. Signature on a rapier marked No. $\frac{9}{65}$, of the beginning of the seventeenth century, preserved in the Tower of London.



Monogram of armourer on a Venetian sword,* of the claymore shape, preserved in the Museum of Sigmaringen.

LAZARO LAZARONI, of Venice, lived about 1640; he was celebrated for his fire-arms.

ANDREA, of Ferrara. Signature on a sword, wrongly called a claymore, of the seventeenth century.

No. J. 118, *Museum of Artillery, Paris.*

VENTURA CANI. Signature on an Italian wheel-lock arquebuse, of the beginning of the seventeenth century.

Museum of Artillery, Paris.

LAZARINO COMINAZZI (sometimes COMMAZZO). Signature of a celebrated armourer on some pistols in the Sigmaringen Museum.

LAZARINO COMINACO. Signature of the same armourer on a wheel-lock arquebuse of the second half of the seventeenth century, and on a gun of the eighteenth century, No. M. 113 and 1285, in the Museum of Artillery, Paris, as well as on a flint-lock gun in the Erbach Collection.

COLOMBO. Name found on an Italian musket of the seventeenth century.

Museum of Artillery, Paris.

MATTEO BADILE. Signature on a pistol, a small musket, and a wheel-lock arquebuse, of the second half of the seventeenth century; in the Museum of Artillery, Paris.

GEO. BAT. FRANCINO. Signature on a wheel-lock arquebuse, and on a pistol, of the second half of the seventeenth century, in the Museum of Artillery, Paris. A pistol with the same signature is in the Tower of London.

GERONIMO MUTTO or MOTTO, of the middle of the eighteenth century.

BORSELLI, of Rome. Signature on a wheel-lock gun.

LARO ZARINO, or LAZARO LAZARINO. Signature on a pistol of the beginning of the eighteenth century.

ANTONIO BONISOLO. Same as above.

GIOCATANE. Signature on a pistol of the eighteenth century.

BARTOLOMEO COTEL, an armourer of about the year 1740, according to the signature on a gun in the Tower of London.

JOHANDY, of Brescia, and POSTINDOL, of Spezzia, both lived about the latter part of the eighteenth century, and were celebrated for their fire-arms.

CARLO CONTINO. Name of an armourer found on a flint-lock gun in the Erbach Collection.

* These sorts of swords were used by the guard of the Doges, and were called *Schiavona*.

MONOGRAMS AND NAMES OF SPANISH AND PORTUGUESE
ARMOURERS.

C. A. MORA, about 1586, found in the Museum of Dresden.

SEBASTIEN HERNANDEZ, about 1599, found in the Museum of Dresden.

JOHANNES RUCOCA, in the Dresden Museum.

MARTINEZ DEIVAN, in the Dresden Museum.

JUAN VENCINAS. The name of an armourer which occurs on the cross-bow of Ferdinand I. in the Spengel Collection at Munich. This weapon was made about the year 1533.

THOMAS DI AJALA. Name of an armourer of the sixteenth century, in raised letters on some arms in the Dresden Museum.

With regard to the armourers of Toledo we know the names of the most celebrated, and their stamps, from the second half of the sixteenth to the eighteenth century, thanks to the work of Don Manuel Rodriguez Palamino, who has made an exact copy of the records of Ayuntamiento. From this we learn that several of these armourers worked also at Madrid, Cordova, Cuença, Catugel, Saint-Clement, Cuella, Badajoz, Seville, Valladolid, Saragossa, Lisbon, Orgoz, and Bilbao, but the principal towns that were celebrated for the manufacture of Spanish arms were Toledo, Saragossa, Seville, and Saint-Clement.

Of the 99 monograms the most sought after are the *scissors* (No. 21), the *wolf* or the *goat* (No. 59), and the No. 76, used by Lupus Aguado. The Spanish armourers used often to have their name, as well as their monogram, engraved either on the blade or on the *tang*.

The following are the monograms :

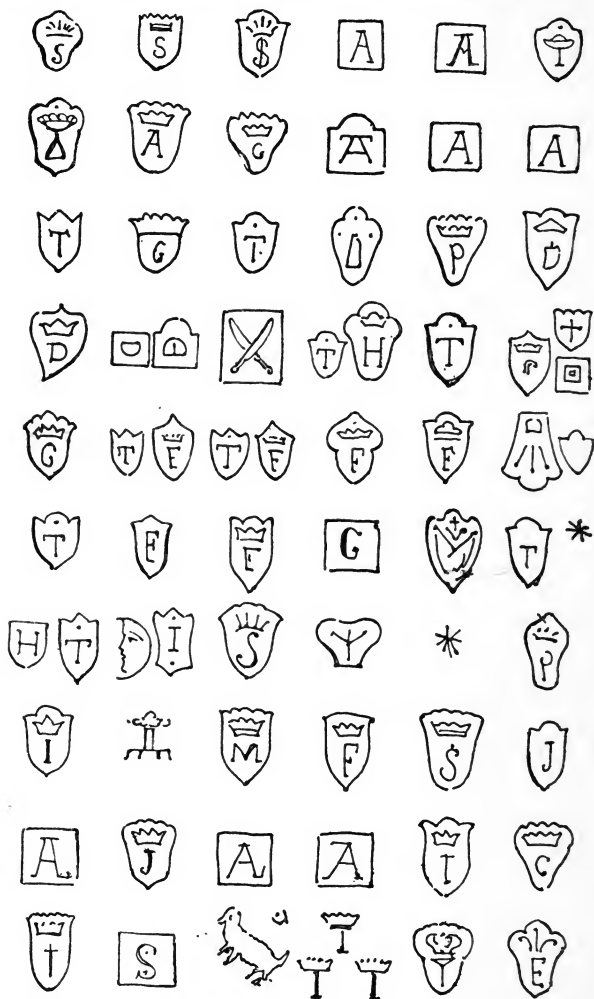

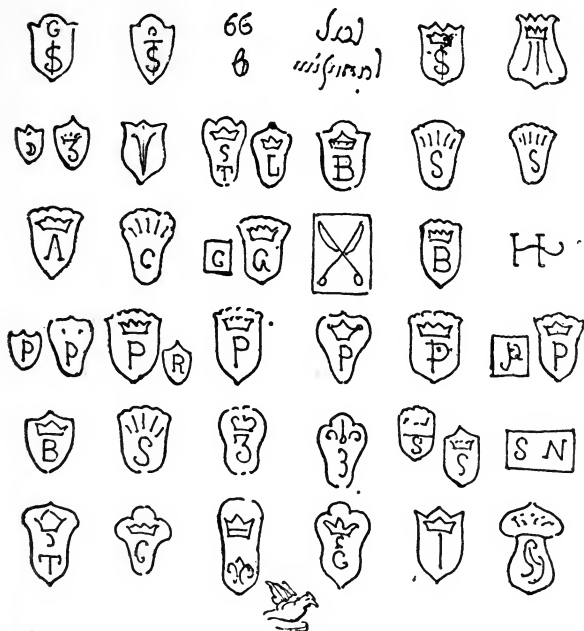

All these monograms belong to the armourers of Toledo, Madrid, Cordova, Cuença, Catugel, Saint-Clement, Cuella, Badajoz, Seville, Valladolid, Saragossa, Orgoz, and Bilbao, and they have been placed in the following order :

1. Alonzo de Sahagun, senior, lived about 1570.
2. Alonzo de Sahagun, junior, lived about 1570.
3. Alonzo Perez.
4. Alonzo de los Rios, who worked at Toledo and Cordova.
5. Alonzo de Caba.
6. Andres Martinez, son of Zabala.
7. Andres Herraез, who worked at Toledo and Cuença.
8. Andres Munesten, who worked at Toledo and Catugel.
9. Andres Garcia.
10. Antonio de Buena.
11. Anton Gutierrez.
12. Anton Gutierrez.

13. Anton. Ruy, who worked at Toledo and Madrid.
14. Adrian de Lafra, who worked at Toledo and Saint-Clement.
15. Bartholome di Nieva.
16. C. Alcado di Nieva, who worked at Cuella and Badajoz.
17. Domingo di Orosco.
18. Domingo Maestre, senior.
19. Domingo Maestre, junior.
20. Domingo Rodriguez.
21. Domingo Sanchez Clamade.
22. Domingo, of Aquirre, son of Hortuno.
23. Domingo de Lama.
24. Domingo Corrientez, who worked at Toledo and Madrid.
25. Favian de Zafia.
26. Francisco Ruiz, senior.
27. Francisco Ruiz, junior, brother of Antonio.
28. Francisco Gomez.
29. Francisco de Zamora, who worked at Toledo and Seville.
30. Francisco de Alcoees, who worked at Toledo and Madrid.
31. Francisco Lourdi.
32. Francisco Cordoi.
33. Francisco Perrez.
34. Giraldo Reliz.
35. Gonzalo Simon.
36. Gil de Alman.
37. Ditto.
38. Hortuno de Aquirre, senior.
39. Juan Martin.
40. Juan de Leizade, who worked at Toledo and Seville.
41. Juan Martinez, senior, ditto.
42. Juan Martinez, junior, ditto.
43. Juan de Alman.
44. Juan de Toro, son of Pedro Toro.
45. Juan Ruiz.
46. Juan Martus de Garata Zabala, senior.
47. Juan Martinez Menchaca, who worked at Toledo and Lisbon.
48. Juan Ros, who worked at Toledo and Lisbon.
49. Juan de Salcedo, who worked at Toledo and Valladolid.
50. Ditto, ditto.
51. Juan de Maladocia.
52. Juan de Vergos.
53. Joannez de la Horta, who lived about 1545.
54. Joannez de Toledo.
55. Joannez de Alquiviva.
56. Joannez Maletto.
57. Joannez, senior.
58. Joannez Uriza.
59. Julian del Rey, who worked at Toledo and Saragossa.
60. Julian Garcia, who worked at Toledo and Cuença.
61. Julian Zamora.
62. Josepe Gomez.

63. Josepe de la Hera, senior.
64. Josepe de la Hera, junior.
65. Josepe de la Hera, grandson.
66. Josepe de la Hera, great-grandson.
67. Josepe de la Hera, son of Sylvester.
68. Ygnacio Fernandez, senior.
69. Ygnacio Fernandez, junior.
70. Louis de Rivez.
71. Louis de Ayala.
72. Louis de Velmonte.
73. Louis de Sahagun the 1st.
74. Louis de Sahagun the 2nd.
75. Louis de Nieva.
76. Lupus Aguado, who worked at Toledo and Saint-Clement.
77. Miguel Cantero.
78. Miguel Suarez, who worked at Toledo and Lisbon.
79. Ditto, ditto.
80. Nicolas Hortuno de Acuirre.
81. Petro de Toro.
82. Petro de Arechiga.
83. Petro de Lopez, who worked at Toledo and Urgos.
84. Petro de Lopez, who worked at Toledo and Seville.
85. Petro de Lazaretta, who worked at Toledo and Bilbao.
86. Petro de Orezco.
87. Petro de Vilmonte.
88. Rogue Hernandez.
89. Sebastian Hernandez, the elder, who lived about 1637.
90. Sebastian Hernandez, the younger, who worked at Toledo and Seville.
91. Silvestre Nieto.
92. Silvestre Nieto, the son.
93. Thomas Ayala, who lived about 1625 (a fine sword by this armourer is in the Munich Arsenal).
94. Zamorano, surnamed El Toledano.
- 95 to 99. Five monograms belonging to some armourers of Toledo whose names are unknown.



Marks and monograms of armourers who lived at Madrid from 1684 to 1849. A list of these was published in 1849 by Don José Maria Marchesi, in his "Catalogo de la Real Armeria;" they belong to the following German and Spanish armourers :

ALBAREZ (DIEG.)

ALGORA.

BAEZA (M. A.)

CANO (I. P.)

DORCENARRO (S. V.)

FERNANDEZ (I. U.)

GOMEZ (A.)

LOPEZ (F. R. C.)

LOPEZ (G. R. E.)

SANTOS (S. E. V.)

SOTO (JUAN DE).

TARGARONA.

ZEGARRA.

ZULOAGA, and some others, as AUGUSTE HORTEZ, ISIDORE SOLER, J. BELEN, N. O. and F. R. N. BIS, German armourers established at Madrid.

MATHEO (on a sword).

DANIEL DE. COM. (on a dagger).

LEON (on a dagger).

JOAN DE OIPE *me fecit* (on a cross-bow).

JOHAN, ditto.

SALADO (on a fire-arm). These six names of armourers are mentioned by the same author, and all of them occur on arms in the same armoury, but with no indication of epoch or nationality.

APORICIO (A.)

BARZINA (J.)

CANTERO (MANUEL).

DEZ (FERDINAND), German.

ESCULANTE (BASILIO).

FERNANDEZ (P.)

LOPEZ (BALENS).

—— (FRANCISCO).

—— (JOSE).

—— (JUAN).

MARTIN, German.

MARTINEZ.

MÂTHEO (HILARIO).

MONTOKEIS (CARLOS).

NAVARRO (ANTONIO).

RAMIREZ (P.)

RODRIGUE (CARL).

SANTOS (Z.)

—— (L.)

SOLER (MANUEL), German.

TIL (M. S.), German. These twenty-one names of armourers are to be found in the list of names and monograms in Marchesi's book, where they are described as having worked for a short time at Madrid; no date is mentioned, but they have all been found on arms which are in the Museum of Madrid.

With regard to the marks and monograms which have been collected at random from swords, daggers, lances, halberds, bucklers, etc., in the "Armeria Real," and published by M. Marchesi, without any notes respecting the time of their manufacture or nationality, I have not thought it necessary to speak of them here, as they could be of no historic use.

BARTOLAM BIELLA is the name of an armourer on a fowling-piece of the sixteenth century in the Museum of Dresden.

BASTIAN ARMANDO.

DE PEDRO DE BELMONTE, armourer of the king.

HISPANGO.

C. A. MORA (1586).

FRANCISCO, ANTONIO, and FREDERICO PICINO are armourers of Toledo of the sixteenth century; their names occur in the Museum of Dresden, but they are neither in the records of Ayuntamiento, published by Manuel Rodriguez Palamino, nor in the catalogue of M. Marchesi.



Armourer's mark found on a suit of Spanish armour richly inlaid with gold, of the sixteenth century, in the Arsenal of Vienna.

ALONZO DE SCHAGON, of the end of the sixteenth century, was also, according to Jäger, one of the most celebrated armourers of Toledo; his name has been omitted in the list of records.

JUAN and CLÉMENT PEDRONSTÉVA.

EUDAL PONS and MARTIN MARCHAL were celebrated at Toledo about the last years of the eighteenth century.

CAMO. Name of armourer on a sword of the seventeenth century, in the Museum of Artillery, Paris.

THOMAS HAÏALA. Id.

SAHAGOM. Id.



and V. Monogram and initial on a Spanish partizan of the beginning of the seventeenth century.

Museum of Artillery, Paris

LASINTO LAUMANDREU, of Manresa; he worked about the year 1739, according to the signature on a revolver in the Tower of London.

G. MORINO, a Spanish armourer who signed and dated (1745) a gun now in the Tower of London.

MONOGRAMS AND NAMES OF FRENCH ARMOURERS.



Monogram found on a suit of French (?) armour of the reign of Louis XIII. (1610—1643), in the Museum of Artillery, Paris. It is marked in three places.



Monogram found on a hatchet with hammer and long handle, a weapon which appears to be Burgundian. *Collection of Colonel Meyer-Biermann at Lucerne.*



Monogram found on a sword of the reign of Louis XIV. (1643—1715). J. 133, in the Museum of Artillery, Paris.

CLAUDE THOMAS, of Epinal, 1623. On pistols in the Erbach Collection.

D. JUMEAU. Signature on a wheel-lock arquebuse of the first half of the seventeenth century.

Museum of Artillery, Paris.

ARBOIS, probably the name of the town of Arbois, found on a cuirass of the sixteenth century.

JEAN SIMONIN, of Luneville. Name found on an arquebuse with wheel-lock, dated 1627.

GABRIEL. Name of an armourer of the seventeenth century, on a pistol in the Museum of Artillery, Paris.

PIERRE BAROY, who died at Paris in 1780, was the inventor of an ingenious four-barrelled flint-lock gun, which is in the Arsenal of Berlin.

PIERRE BEVIER, a watch-movement maker and armourer of the beginning of the seventeenth century, invented a double pistol-lock of peculiar character, in the Museum of Artillery, Paris.

BOUILLET frères, of Saint-Etienne, were armourers in the reign of Louis XV. (1715—1774), celebrated for their air-guns.

DE THURAINÉ, of Paris, made a flint-lock carbine in the time of Louis XV. (1715—1774).

BREZOL-LAINE, of Charleville. Name of armourer found on a blunderbuss in the Museum of Artillery, Paris.

MARCHAN, of Grenoble, armourer of the eighteenth century, maker of a flint-lock gun in the Museum of Artillery, Paris.

PHILIPPE LE SELIER, armourer of the eighteenth century, and maker of two flint-lock guns preserved in the Museum of Artillery, Paris. There is another in the Erbach Collection.

H. RENIER, of Paris, maker of flint-lock pistols of the eighteenth century.

LILOUVILLE, of Paris. Id.

LAME, of Mézières, maker of flint-lock gun in the Erbach Collection.

CHATEAU, of Paris Id.

BOUTET, armourer of Marseilles, end of the eighteenth century.

FRAPPIER, of Paris. On a pistol in the Museum of Artillery, Paris.

ACQUIS-GRAIN.

LAMARRE. Name on a pistol with flint-lock, in the Museum of Artillery, Paris.

JEAN DUBOIS, of Sedan. Name of an armourer on a pistol.

HUBERT, of Bordeaux. Signature of an armourer found on a large rampart gun, brought from the citadel of Blaye.

Museum of Artillery, Paris.

GIVERDE, HILPERT and RUBERSBURG, of Strasburg, were armourers celebrated for their fire-arms in the latter part of the eighteenth century.

VINCENT. On a flint-lock gun in the Erbach Collection.

JEAN GRIOTTIER, maker of a double-barrelled gun in the Erbach Collection.

JEAN RENIER, armourer of the middle of the eighteenth century, whose name is engraved on a pistol in the Museum of Artillery in Paris.

GUSTAVE DELVIGNE, who since 1826 has been continually improving on rifled barrels so that the ball need not be hammered with a mallet.

JULIEN LEROY, GASTINE RENATTE, and LEFAUCHEUX, are other armourers celebrated for their breech-loading guns.

In addition, MM. ROBERT MANCEAUX and VIELLARD, and last of all M. CHASSEPOT, are names well-known in the army for their improvements in fire-arms.

MONOGRAMS, INITIALS, AND NAMES OF ENGLISH ARMOURERS.

RADOC, an armourer of the end of the sixteenth century, whose name is known on account of a payment which was made to him by the chamberlain of the city of Norwich, as compensation for changing the wheel-lock on a pistol for a snaphaunce.

H. MARTIN MULER is the name of an armourer on a musket with rifled barrel, the stock of which is ornamented with the arms of England and other inlaid work. It is probably of the reign of James II. (1685—1689).

Museum of Artillery, Paris.



with a crown, is the mark of the company of armourers of London of the reign of George I. (1714—1727).



These initials are on two rampart guns of the years 1739 and 1740, in the Tower of London.

STEPHEN, of London, an armourer of the end of the eighteenth century, whose name is on a wheel-lock gun, as well as on an air-gun, preserved in the Museum of Artillery, Paris.

N. THOMSON, born in England, and established at Rotterdam, about the end of the eighteenth century, celebrated for his fire-arms.

BATE, an armourer whose name is engraved on the supposed lock of an air-gun in the Museum of Artillery, Paris.

FORSYTH, a Scotch armourer, who invented in 1807 the percussion or piston gun.

JOSEPH EGG, an English armourer, who was inventor of the percussion cap.

MONOGRAMS AND NAMES OF SWISS ARMOURERS.



Mark found on a Swiss halbard of the fifteenth century, in the Author's Collection.



Mark found on a Swiss halbard of the sixteenth century, in the Author's Collection.



Mark found on a partizan, probably of the beginning of the sixteenth century, in the Collection of Colonel Meyer-Biermann at Lucerne.



Same description as for preceding one.

ZELL BLASI, 1614. Signature on a *serpentine* in the Arsenal of Bâle.

WYS, of Zurich, who died in 1788, was celebrated for his fire-arms.

STRANGLÉ and MICHEL, father and son, who lived in the last years of the eighteenth century, were celebrated for their fire-arms.

FRORER, of Winterthur, and HUSBAUM, of Berne, were celebrated at the end of the eighteenth century for their fire-arms.

VITT, of Schaffhausen. On a fire-arm with rifled barrel, in the Erbach Collection.

PAULY, of Geneva, who invented about the year 1808 a percussion-gun which differed from that of Forsyth, and which was a breech-loader.

MONOGRAMS AND NAMES OF FLEMISH AND DUTCH ARMOURERS.

JACOBUS VAN OPPY, of Antwerp. Signature on a rampart gun of the middle of the seventeenth century, in the Tower of London.

JOHANNES WYND. Found on an infantry sword of the seventeenth century, which has the badge of the *hare*.

J. 103, *Museum of Artillery, Paris.*

CLOEDE HIQUET, of Liège. Signature on a flint-lock gun and on a pistol of the end of the seventeenth century, in the Museum of Artillery, Paris.

GATHY, of Liège. Signature found on a pistol with flint-lock, of the eighteenth century, in the Museum of Artillery, Paris.

L. GOSUNI, of Liège. Signature on a musket.

LE CLERK, of Maestricht.

Erbach Collection.

VAN WALSEN, of Maestricht.

Id.

MICHARIUS, of Bréda, on a flint-lock gun.

Id.

TENDERMAN, of Utrecht, on a flint-lock.

Id.

MERCIER, of Liège, on a double-barrelled damasked musket. *Id.*

FACHTER, of Liège, celebrated for his air-guns.

FACKA SPEGER is the name of a Dutch armourer, occurring on an air-gun of the eighteenth century, the air-chamber of which is in the butt.

Museum of Artillery, Paris.

MONOGRAMS, INITIALS, MARKS, AND NAMES OF ARMOURERS AND OF TOWNS WHICH HAVE BEEN FOUND ON ORIENTAL ARMS.

On a large number of Christian and Turkish arms taken from the ancient church of Saint Irene at Constantinople, where the Arsenal of Mahomet II. was. The arms may be of the end of the fifteenth, or beginning of the sixteenth century. The mark is not an armourer's badge, but probably the stamp of the Arsenal, and means, in Cufic character, *Allah*. This monogram is also on a



janissary's cuirass in the Museum of Artillery at Paris.

HUSSEIN, of about the year 1094 of the Hegira (1680).



This mark is supposed to have been on sword blades that the Crusaders had had either made or stamped at Jerusalem. I have found it, however, on a sword in the Arsenal of Berlin, the handle of which indicates the sixteenth century.

NURWUR is the name of a town in Central India where there was a manufactory of fire-arms in the eighteenth century. This name has been found with the initials **A. D.** of the armourer, and the date **1649** of the Hindoo era (1786 of the Christian era), on a gun with match-lock in the Tower of London.

SHAHJEHANABAD. The name of a town of India where a manufactory of arms once flourished. The name occurs on some damascened arm-guards, at present in the Tower of London.

GWALIOR and LUSHKUR are names of towns famous for their manufactory of blades. The names frequently occur on the weapons, and that of

LAHORE occurs on fire-arms.

MONOGRAMS AND SIGNATURES OF UNCERTAIN ORIGIN.

A. F. 1605.

Initials and date engraved on a halbard in the Tower of London.

TAYRAS. Signature found on a cuirass in the Tower; date, about the latter part of the seventeenth century.

H. K.

by the side of a punch mark in the shape of a swan, engraved on a pistol in the Museum of Artillery, Paris.

JEAN-PAUL CLEFT. Signature on a wheel-lock pistol of seventeenth-century date, in the Museum of Artillery, Paris.

RUDOLSTADT (town).

Id.

Id.

A. C.

Monogram on a bayonet of the time of Louis XIII.

X.

ARMS, CROSSES, AND SIGNS PECULIAR TO THE
TRIBUNALS OF FREE JUDGES.

THE institution of Free Tribunals (*Fehmgerichte*) (the origin of which must be ascribed to the disorder and excessive subdivision consequent from a rigid enforcement of the feudal system) does not date as far back as Charlemagne, the period usually assigned to it; but there is little doubt that it practically resulted from the want of harmonious legislation in the wide dominion of that monarch.

Notwithstanding the partial enforcement of the *Jus Romanum*, the remembrance of national rights claimed and exercised in broad daylight by freemen (the origin of trial by jury), as well as that individual character which is so innate in the Germanic races, gave rise, as soon as regular justice had been rendered nugatory by physical force, to this speedy and terrible means of administering justice, a law at once secret and powerful, and which romance has clothed with such terrors and mystery.

If, as has been lately shown, many places where these tribunals used to sit were openly known, historical researches have yet failed to disprove their secret administration of justice, as well as their summary and dread punishments. The "Redland," a name used to designate, in the symbolical language of the members, Westphalia, the place where these secret tribunals were first organized, and where every magistrate or free judge (*Freischöffe*) was enrolled and initiated, was literally a land dyed with human blood.

There is also tolerable proof that a large number of courts organized in addition to the regular courts, used to sit in places known only to the initiated (*die Wissenden*). In such places hatred, envy, and private vengeance, had full scope for action under the mask of justice.

The arms attributed to the tribunals of Free Judges are rarer in collections than the instruments of torture used by

them to extort confessions from their victims, and even these few, as well as the alphabets, ciphers, and marks, are of very dubious authenticity.

The dagger with three forks belonging to the Museum of Sigmaringen, and attributed to these Free Judges (*Fehmrichter*), is in every respect similar to the *mains gauches* with springs, which were in use from the fifteenth to the seventeenth centuries.

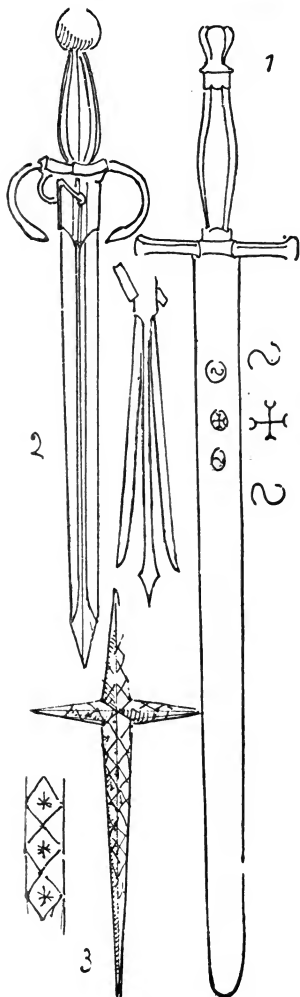

1. Executioner's sword of the Free Judges. On the blade are engraved three circles, the centre one being described around a Greek cross with four crescents, and possessing a symbolical meaning in these secret tribunals; the other two have an S inscribed in each, these being the initial letters of the words *Sacrificium Sanctum*.

Museum of Sigmaringen.

2. Dagger of the Free Judges, with an inscription nearly obliterated. The blade divides into three pieces on the pressure of a small button which communicates with a spring. It is probable that this weapon was used in administering an oath in the name of the Trinity. Its length is about 18 inches.

Museum of Sigmaringen.

3. Iron cross (about $8\frac{1}{2}$ by $15\frac{1}{2}$ inches) of the Free Judges. It was in use among them as a sign of the justice of their tribunal. It was usually inserted in a tree above the victim, and was also employed in summoning the accused to appear before his judges. In the latter case the cross was inserted in the door of the house or castle above the summons (*Ladung*).

Museum of Sigmaringen.

The double S separated by a cross is generally supposed to denote, as mentioned above, *Sacrificium Sanctum*.

The three following alphabets are supposed to have been used by three of these tribunals (*Freistühle*) in Westphalia :

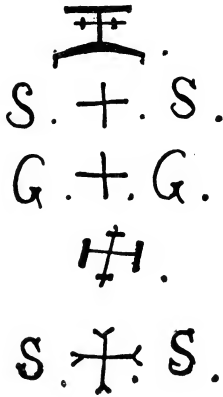

A	B	C	D	E	F
4	7	5	M	H	Q
W	A	H	II	∞	H
U	J	B	III	+	U
G	H	I	K	L	M
Q	X	9	X	X	o
7	2	M	h	T	M
Q	X	P	X	X	o
N	O	P	Q	R	S
B	V	2	X	H	Q
T	U	V	^	U	F
B	V	o	X	X	Q
T	U	W	X	Y	Z
S	E	X	L	^	π
7	A	Y	E	Q	U
S	2	8	Q	T	II

XI.

ADVICE TO AMATEUR COLLECTORS.

WITH a view to avoid the constant cleaning which iron or steel arms have usually to be subjected to, it is advisable to cover them with a light coat of colourless copal varnish, previously diluted in essential oil. Through this all the niceties of workmanship can be clearly seen.

Iron is easily cleansed from rust by rubbing with emery powder or paper which has been dipped in a composition of petroleum or benzine, essential oil, and spirits of wine. All arms elaborately damascened, polished, engraved, or enamelled, which would be damaged by rubbing with emery, should be immersed from eight days to a month in a bath of benzine, and afterwards rubbed briskly with woollen rags. Every piece of armour after being cleaned should be dried before a fire, and lightly moistened with oil.

In order to rust pieces of armour which have been restored, and to produce cavities such as accumulate through age, muriatic acid diluted with water should be used. Iron, after being dipped in this corrosive solution, should be exposed to the air for one or more days, and again moistened, until the required amount of oxydization is obtained; it should then be rinsed in spring water, and greased to stop all further action.

To obtain little inequalities in the surface, it will be necessary to sprinkle the iron with lithographic ink; every portion touched by the ink will be kept free from rust, while the acid eats away the rest of the surface.

Steel can easily be distinguished from iron by dropping on the polished surface a little diluted sulphuric acid; if the liquid produce a black stain, due to charcoal, the metal is steel; if the stain be greenish, and easily removed by water, it is iron.

Cast iron, which in some counterfeit productions is with difficulty distinguishable from wrought iron, and which can even be rendered malleable, has often puzzled amateurs. The file must be used to detect the *grain*, which, when subjected to the microscope, appears at once coarser and brighter.

MUSEUMS AND ARSENALS REFERRED TO IN THIS WORK.

AMSTERDAM.	Lyons.
Antiquities, at Vienna.	Madrid.
Arsenal of Vienna.	Malta.
Artillery, at Paris.	Medals, at Paris.
Augsburg.	Munich.
Avenches.	Naples.
Belvedere, <i>see</i> Vienna.	Neville.
Berlin.	Neuveville.
British.	Nuremberg.
Brunswick.	Prague.
Brussels.	Prince Charles at Berlin.
Carlsruhe.	Raudnitz.
Cassel.	Ratisbon.
City of Vienna.	Rouen.
Cluny.	Saint-Germain.
Copenhagen.	Salzburg.
Dresden.	Schaff hausen.
Epinal.	Schwerin.
Erbach.	Sigmaringen.
Fribourg, Switzerland.	Soleure.
Geneva.	Stockholm, <i>see</i> Sweden.
Hague.	Szokau (Hungary).
Hanover.	Turin.
Industry at Vienna.	Tzarskoe Selo, <i>see</i> Petersburg,
Kensington.	Tower of London.
Lausanne.	Vannes.
Lintz.	Venice.
Louvre.	Woolwich.
Lucerne.	Zurich.
Lund.	

COLLECTIONS REFERRED TO IN THIS WORK.

AMBRAS.	Merville.
Arosa.	Meyer Biermann.
Az.	Meyrick.
Bogaert.	Napoleon III.
Bonstetten.	Nieuwerkerke.
Buchholzer.	Odet.
Charles XV., King of Sweden.	Parham.
Charles, Prince of Prussia.	Pourtalés.
Christy.	Renné.
Culeman.	Romano, Collegio.
Demmin.	Six.
Destailleur.	Söter.
Erbach.	Soltikoff.
Faily.	Spengel.
Hauslaub.	Ternow.
Hefner-Alteneck.	Troyon.
Klemm.	Villaseca.
Löwenberg.	Waldburg Wolfegg.
Mazis.	Warwick Castle.

INDEX.

NAMES of armourers and gunsmiths will be found from page 551 to page 557.

-
- ABBEVILLE**, manufacture of arms at, 550.
Abyssinian arms, 419.
Acinace, 25, 95.
Akinace, *see* Acinace.
Air-guns, 537, 538, 539.
Albanian arms, 392.
Allhambra, sculptures in the, 188.
Alphabets of the Free Judges, 581, 582.
Amalzen (monk), 59.
Ambras Collection, 9, 194, 195, 196, 198, 204, 205, 211, 214, 216, 238, 247, 265, 270, 273, 283, 297, 303, 304, 308, 318, 322, 323, 325, 336, 346, 347, 351, 352, 353, 360, 364, 365, 378, 381, 416, 418, 423, 441, 445, 462, 465, 471, 480, 493, 500, 501, 503, 512, 516, 517, 518, 534, 552.
Amentum, 28, 106.
American arms, 84, 88.
Amsterdam, antiquities in the city of, 193.
 — collection of the Archæological Society in, 16.
Amussette of Marshal Saxe, 73.
Anelace, 372, 378, 401, 407.
Argers, sculptures at, 168.
Anglo-Saxon arms, 167, 168, 416.
Antennæ, 109.
Antwerp, 455.
Arab arms, 349, 365, 368, 377, 396.
Aretin, Baron, 13.
Arm guard, 328, 329, 330.
Armet, 278.
Armet in leather, 278.
Armorial bearings, 47.
Armourers, names of, 551 to 557.
Armour in detail, 222.
 — for horses, 49, 349.
Armstrong, 66, 509.
Arms of the stone age, 75.
 — of bronze and iron, 85.
 — of the bronze age, 127.
 — of the iron age, 145.
 — of the Renaissance, 196.
 — of different nations, *see* their names.
 — of the Christian middle ages, 160.
 — of the seventeenth and eighteenth centuries, 218.
Arnaut, *see* Albanian.
Arosa, Gustave, 393.
Arquebus, 68, 487.
 — with matchlock, 487.
 — with snaphaunce lock, 69 and 70.
 — with wheel lock, 487, 520.
 — with rifled barrel, 68, 487.
Assagai (lance), 416.
Assyrian and Babylonian equipments, 22.
 — and Babylonian weapons, 77, 88.
 — coat of arms, 100.
 — pavois, 100.
Augsburg, Museum of, 109, 110, 129, 156, 248, 414.
Avenches, Museum of, 29, 121, 124, 150.

- Aventizum, *see* Avenches.
 Az Collection, 130, 149, 267, 270,
 294, 398, 416, 423, 432, 434, 442,
 453, 481.
 Badajoz, manufacture of arms at,
 542.
 Baldrick of a musketeer, 535.
 Balista, 14, 455.
 Barbed bolts, 483.
 Barde (horse armour), 49, 114, 352,
 354.
 Bardiche (pole-axe), 440.
 Basilics, 65.
 Basle, Arsenal of, 15, 504.
 Bassinet, large, 257, 258, 259.
 — small, 43, 249.
 Bastardeau, 401, 409.
 Battering rams, 30, 116, 455.
 Bavaria, Museum of, *see* Munich.
 Bayeux tapestry, 37, 56, 171, 172,
 246, 290, 315, 356, 367, 374, 415,
 420, 439.
 Bayon, chymist, 72.
 Bayonet, 70, 448.
 Beejanuggur, 26.
 Belgian arms, 495, 550.
 Belvedere, Museum of the, 103.
 Bergbarthe (miner's hatchet), 442.
 Berlin, Arsenal of, 11, 66, 268, 293,
 363, 383, 418, 419, 445, 454, 465,
 539.
 — Library of, 179, 181, 253, 263,
 420, 471.
 — Museum of, 77, 84, 87, 95, 105,
 108, 110, 115, 157, 257, 267, 344,
 346, 349, 394.
 — Museum of Montbijou at, 261,
 269, 293, 301, 360, 363, 440, 484,
 521, 534.
 Berne, Arsenal of, 15, 294, 399, 423,
 437, 440, 444, 511.
 Berthollet (chymist), 72.
 Besieging basket, 462.
 Bilbao, manufacture of arms at,
 542.
 Bi-lobed sword, 174.
 Birmingham, manufacture of arms
 at, 550.
 Blind, 63, 492.
 Blow-pipe, 468.
 Bogaert Collection, 15.
 Bohemian arms, 78, 177, 379, 450.
 — bassinet, 257.
 Bombardes (cannons), 61.
 Bonstetten Collection, 112.
 Bore (of a cannon), 490.
 Boss of shields, 113, 287.
 Bossettes (of a bridle), 350.
 Bouldure (chymist), 72.
 Braquemart (sword), 272.
 Brayette, 229.
 Brazilian arms, 349.
 Breastplate, 226, 238.
 Bridles and bits, 366, 367, 368.
 Brigantine jackets, 43, 44, 309, 317,
 318.
 Brioude, sculpture at, 162.
 British armour and arms, 78, 136,
 166, 180, 227, 250, 251, 253, 254,
 255, 258, 259, 262, 267, 274, 278,
 300, 335, 344, 347, 348, 363, 375,
 379, 388, 398, 405, 407, 431, 440,
 441, 442, 449, 550.
 British Museum, 22, 23, 24, 93 to
 100, 105, 109, 113, 137, 138, 166,
 167, 168, 245, 246, 247, 373, 375,
 398, 405.
 Brittany, arms in, 31.
 Brockberger, 545.
 Brunswick, Museum of, 276.
 — mural paintings in the Cathed-
 ral of, 174, 361.
 Buchholzer Collection, 376, 409.
 Buff coat, 312, 326.
 Burgundian arms, 153, 154, 155.
 Buskin, 106.
 Cabassets (casques), 276, 277.
 Calibre, 64, 490.
 Calthrop, 124, 465.
 Camail, 39.
 Cannons, 61, 66, 490, 492 to 509.
 — covered with leather, 66,
 504.
 — hand, 485, 511 to 517.
 Cap in mail, 249.
 Caparisons, 349.
 Capsules for muskets, 535.
 — small, 72, 73.

- Carbine, 71, 488.
 — of Versailles, 69.
 — revolver, 527.
 Carlsruhe, Museum of, 114, 384.
 Cartridge, 71.
 Cascabel of the cannon, 490.
 Casques, 239 to 287.
 — from the antique, 280.
 Cassel, Museum of, 4, 131, 132, 365.
 Catapults, 30, 455.
 Catugel, manufacture of arms at, 542.
 Caucasian arms, 440.
 Celt (weapon), 31, 127, 133, 135.
 Centurion, 118.
 Chain shot, 510.
 Chaldean equipment, *see* Assyrian.
 Chambly, manufacture of arms at, 43, 310, 549.
 Chamfron, 351.
 Charlemagne, 36.
 —, arms of, 36.
 Charles XV., King of Sweden, collection of, 14, 66, 259, 409.
 Charles, Prince of Prussia, collection of, 405, 423, 440, 484, 521.
 Charles II., arms of, 36.
 Charleville, manufacture of arms at, 550.
 Chassepot, 74, 528.
 Chemnitz, manufacture of arms at, 550.
 Chevaux de frise, 465.
 Childeric, arms of, 36, 151, 155.
 Chinese arms, 58, 286, 393, 394, 419, 442, 485, 514.
 Christy Collection, 15, 78, 82, 83, 396.
 Claymore, 371, 379.
 Clouet, damascener, 560.
 Cluny Museum, 316, 318.
 Colichemarde (sword), 370.
 Collar, 244, 326.
 Colt, 74, 533.
 Comnena, Anna, 41, 357.
 Compenhouten, 10.
 Copenhagen, Museum of, 15, 78, 79, 83, 139, 140, 141, 142, 143, 157, 158, 173, 185, 344, 367, 368, 374, 464, 477.
 Cordova, manufacture of arms at, 542.
 Creese (dagger), 402, 413.
 Cremation, 133.
 Cross-bow, 55, 56, 473 to 482.
 — barrelled, 58, 475, 481.
 — Chinese, 58, 475, 481.
 — with goat's-foot lever, 58, 474, 477.
 — with latch or windlass, 58, 474, 478, 479.
 — German, 58, 474, 480.
 — or prodd, to shoot pebbles, 58, 475, 480, 481.
 Crupper, or croupière, 353.
 Cuirasses and coats, 309, 324, 325, 326, 327.
 Cuissards, or cuishes, 231, 234, 235.
 Culeman Collection, 262, 449.
 Dacian arms, 121, 123.
 Daggers, 400.
 Damascened work, 540.
 Danish arms, *see* Scandinavian.
 Darmstadt Library, 169, 246, 317.
 Demmin Collection, 78, 82, 135, 202, 218, 226, 275, 335, 340, 344, 345, 348, 349, 363, 364, 380, 385, 391, 407, 413, 444, 455, 472, 534, 536.
 Denon, 101, 103, 104.
 Destailleur Collection, 545.
 Divers objects of war and chase, 454.
 Doghead, 71.
 Dolmens, 22, 133.
 Dresden, Museum of, 8, 69, 73, 236, 237, 268, 274, 299, 316, 317, 318, 320, 347, 368, 379, 392, 399, 411, 418, 426, 437, 441, 454, 464, 512, 515, 533, 551, 553.
 Dress (of a diver), 462.
 Dutch armour, 193, 218.
 Egyptian equipments, 26.
 — arms, 77, 101.
 Elbow-shaped cannon, 496.
 Epinal Museum, 489.
 Erbach Museum, 12, 121, 131, 291, 301, 302, 319, 374, 389, 555, 556, 561.

- Esqualada, manufacture of arms at, 550.
 Essen, manufacture of arms at, 550.
 Etruscan arms, 106.
 — equipment, 28.
 Faily Collection, 388.
 Falcon or parrot-beaked war-hammers, 436, 437, 438.
 Ferguson, 71.
 Fiery cross-bow bolt, 483.
 — fish, 456.
 Fire-chamber, 61.
 Flails, 424.
 Flaming dagger, 402, 409.
 Flanchard, 352, 353.
 Flemish arms, 495, 550.
 — armourers, 576.
 Flint-lock gun, 488, 525.
 Flint weapons, chipped, 75 to 79.
 — polished, 80 to 84.
 Flissa, 395.
 Florence, manufacture of arms at, 550.
 Fluted armour, 46, 202.
 Fore carriages, 64.
 Forks, military, 452.
 Fork of a gun, 514, 517.
 Forsyth, 72.
 Fourcroy, 72.
 Fragment of cuirass, 157.
 Frame work for hats, 269.
 — helmets, 265.
 Francisque, 36.
 Frankish arms, 150, 156.
 Free Judges, 578.
 French arms, 168, 182, 385, 418, 421, 447, 450, 550.
 — armourers, 573, 574.
 Fribourg, Museum of, 78.
 Fulminates, 72.

 Gallic arms, 32, 78, 82, 83, 134.
 Gambeson, or Gamboison, 42, 316.
 Garde reins, 230.
 Gauntlet, 48, 231, 331 to 336.
 — articulated, 335.
 — mitten, 334.
 Geneva, Arsenal of, 15, 272, 278, 281, 389, 405, 425, 437, 453, 482, 515.
 Geneva, Museum of, 144, 150.
 Germanic Museum at Nuremberg, 512.
 Germanic arms, 33, 77, 129, 130, 131, 149, 151, 153, 154, 155, 156, 157, 163, 164, 165, 169, 170, 174.
 German arms, 169, 170, 175, 176, 178, 181, 186, 194, 195, 196, 197, 198, 199, 200, 201, 202, 203, 204, 205, 206, 208, 209, 210, 211, 212, 213, 216, 219, 222, and on almost every succeeding page.
 — armourers, 551 to 563.
 — salade, 259.
 Gisarmes, 430, 431, 432.
 Golden casque, 286.
 — helmet, 89.
 — shield, 90.
 — standard, 91.
 Grape shot, 510.
 Greaves, 114, 231, 337.
 Greek arms, 108.
 — equipment, 27, 28.
 Guard and counter-guard, 369.
 Guard for the arm, 328, 329, 330.
 — for the leg, 354.
 Gun-carriages, fixed, 64.
 — movable, 64.
 — on wheels, 64.
 Gunpowder, 61.
 Guns, with flint locks, 488, 525.
 — snaphaunce locks, 487, 522.
 — percussion locks, 527.
 — wheel lock, 487, 519, 520.
 — match lock, 487, 512.
 Gun, raquette, 527.
 — repetition, 525, 528.
 — revolving, 525.
 — needle, 528.
 Gwalior, manufacture of arms at, 550.

 Hague, Museum of the, 66.
 Hall, Museum of the Porte de 16.
 Halbards, 443.
 Hallstatt cemetery, 32.
 Hamata, 29.
 Hameus ferreus, *see* Calthrop.
 Handles (of the cannon), 490.

- Hanover, Museum of the city of, 77, 132, 149, 157, 344.
 — Guelph Museum at, 272, 301.
 Harquebus, 487, 513.
 — double, 487.
 Harzberg, manufacture of arms at, 550.
 Hastarius, 118.
 Hauberk, great, 309, 315.
 — small, 315.
 — white, 42.
 Hauslaub Collection, 433, 454, 458, 459, 462, 463, 464, 465, 471, 472, 475, 480, 496, 497, 499, 511, 545.
 Heaumes, 240, 250 to 255.
 Hefner-Alteneck, author, 543.
 — Collection, 257, 258, 264.
 Heimburg, sculptures at, 170.
 Helvetian and Swiss arms, 78, 83, 157, 167, 187, 398, 431, 440, 447, 450, 514.
 Hewitt, 11.
 Hildesheim, sculptures in the cathedral of, 246.
 Hindoo arms, 87, 285, 321, 375, 391, 550.
 Hoplites, 110.
 Hungarian armour, 220, 221, 273, 365.
 Hungul stones, 26.
 Hunting spears, 418.
 Iberian arms, 78, 83.
 Imbricated coats, 314, 319.
 Incendiary torches, 456, 463.
 Indian or Hindoo arms, 87, 285, 321, 375, 391, 550.
 — equipment, 26.
 Iron hand, 454.
 Italian arms, 183, 184, 192, 207, 215, 325, 432, 440, 445, 471, 535, 550.
 — armourers, 563, 564.
 Ivory arm brace, 471.
 Jackets, 311, 315, 319.
 Janissaries, 327.
 Japanese arms, 122, 286, 394.
 Javanese, 87, 413.
 Javelins, 106.
 Joust, 53.
 Kabyle flissa, 395.
 Kandgiar, 395.
 Keltic arms, 31, 78, 82, 83, 135.
 Kensington Museum, 87, 286.
 Khorassan, 540.
 Khouttar, 402, 413.
 Kitchen midden, 20, 80.
 Klemm Collection, 129, 131, 144, 155, 429, 465, 472.
 Klosterdorf, manufacture of arms at, 550.
 Knout, 426.
 Koukri, 371.
 Lacustrine dwellings, 20, 83, 154.
 Lahore, 550.
 Lances, 414 to 419.
 Langues de bœuf daggers, 413.
 — swords, 378.
 Latch cross-bow, 479.
 Lausanne, Museum of, 144, 150, 405, 431, 495.
 Leather casque, 108.
 Leggings, 337.
 — for horsemen, 339, 340, 341.
 — for horses, 354.
 Liège, manufacture of arms at, 541, 550.
 Liesthal, Arsenal of, 15.
 Liutz, manufacture of arms at, 550.
 Lobster tails, 219, 325.
 Lochaber axe, 440.
 Locks of firearms, 69 to 72.
 Löwenberg Collection, 299, 533.
 London, manufacture of arms at, 550.
 —, collection in the Tower of, 11, 73, 108, 123, 138, 150, 155, 250, 253, 255, 260, 262, 272, 274, 277, 278, 284, 286, 295, 344, 351, 359, 360, 364, 375, 376, 405, 442, 449, 495, 497, 515, 530, 533, 552.
 Louvre, Museum of the, 24, 93, 96, 97, 98, 99, 100, 105, 108, 109, 110, 111, 134, 135, 151, 154, 155, 244, 344, 348, 373.
 Lucerne, Arsenal of, 15, 297, 421, 433, 439.

- Lund, Museum of, 154, 155.
 Lushkur, manufacture of arms at, 550.
 Lyons, Museum of, 362.
 Maces, 420, 421.
 Mackay, General, 70.
 Macted coat, 313.
 Madrid, manufacture of arms at, 542.
 — Armeria of, 280, 296, 351, 384, 387.
 Mahratta arms, 285.
 Mail, 314, 315, 316, 317, 321.
 — double, 310.
 Mains gauches, 401, 409, 411, 412.
 Malta, Museum of, 15.
 Mantle, Bishop's, 311, 316.
 Massettes, tilting with, 256.
 Matchlock case, 534.
 Matras, bird bolt, 59.
 Maubeuge, manufacture of arms at, 550.
 Maximilian armour, 202.
 Mayence, Museum of, 108, 109, 110, 113, 114, 115, 121, 123, 155.
 Mayenfisch, Baron, 13.
 Mazis Collection, 12.
 Median equipment, *see* Persian.
 Meiningen, Museum of, 302.
 Merville Collection, 390.
 Mexican arms, 88, 89, 90, 91.
 Meyer Biermann Collection, 434, 436.
 Meyrick Collection, 11, 78, 83, 110, 137, 156, 236, 238, 262, 274, 281, 282, 285, 298, 300, 302, 321, 323, 324, 327, 346, 347, 351, 360, 363, 368, 411, 413, 417, 421, 425, 429, 432, 437, 439, 440, 441, 444, 446, 447, 484, 535.
 Milan, manufacture of arms at, 550.
 Misericorde (dagger), 400.
 Mönchsbüchse, 69, 515.
 Mondoneda, painting at, 191.
 Mongolian casque, 285.
 — coat, 320.
 Monograms of armourers, 551 to 577.
 — of the Free Judges, 578 to 581.
 Morat, gymnasium of, 344, 423, 495, 512.
 Morions, 275, 276.
 Morning star, 422.
 Mortars, 488 to 497.
 Mundavien, manufacture of arms at, 321.
 Munich, Arsenal of the city of, 276, 300, 480, 483, 552.
 — Library of, 163, 217, 249, 251, 421, 427, 471, 512.
 — Cabinet of engravings at, 439, 440, 454.
 — National Museum of, 82, 130, 131, 134, 149, 153, 155, 170, 316, 318, 321, 345, 346, 357, 374, 375, 377, 378, 379, 380, 389, 412.
 Musket with wheel lock, 520.
 Muzzles for horses, 354.
 Naples, Museum of, 100
 Napoleon III., collection of the Emperor, 197.
 Naumbourg, sculptures at, 169.
 Needle gun, 74, 488, 528.
 Neuchatel, sculptures at, 187.
 Neuveville Museum, 499.
 Neville Museum, 344.
 Nieuwerkerke Collection, 15, 38, 165, 182, 197, 235, 237, 238, 245, 252, 257, 258, 262, 276, 277, 302, 323, 324, 351, 352, 360, 374, 375, 377, 378, 405, 407, 409, 411, 445, 477.
 Norman arms and equipments, 40, 171, 172, 290.
 Nuremberg, Arsenal of, 65, 67.
 — Germanic Museum at, 355, 359, 360.
 Nurwur, 550.
 Obsidian, 84.
 Ocreæ, 29, 118.
 Odet Collection, 183, 184, 357.
 Oil paintings, 183, 184.
 Olbernhau, manufacture of arms at, 550.
 Olivier de la Marche, 430.
 Onagre, 55, 457.
 Orange, Arch of, 135.
 Organs, death, 65.
 Ossine, 76.

- Oviedo, manufacture of arms at, 550.
- Oziersky Collection, 144.
- Padua, 67.
- Paixhans, 66.
- Palettes, 197, 211, 223, 227.
- Parazonium, 115, 121, 378.
- Parham Collection, 251.
- Paris, Museum of Artillery at, 12, 73, 96, 108, 109, 110, 111, 112, 113, 114, 115, 121, 122, 123, 124, 125, 134, 135, 150, 151, 153, 154, 155, 156, 198, 203, 227, 228, 229, 230, 232, 234, 235, 238, 248, 249, 250, 251, 253, 254, 255, 258, 259, 261, 262, 266, 268, 269, 270, 272, 274, 277, 278, 280, 281, 282, 283, 284, 286, 292, 293, 295, 296, 297, 298, 300, 301, 320, 321, 322, 323, 327, 334, 340, 341, 346, 347, 351, 354, 357, 363, 364, 365, 368, 374, 376, 378, 383, 385, 387, 388, 389, 391, 392, 394, 395, 396, 397, 398, 399, 407, 409, 412, 413, 416, 418, 419, 425, 427, 429, 431, 436, 437, 439, 440, 441, 442, 445, 447, 455, 462, 471, 479, 481, 497, 512, 520, 539, 551, 552, 553, 554, 555, 556, 557, 558, 559, 563, 564, 572, 573, 574, 575, 576, 577.
- Imperial Library at, 166, 244, 252, 263.
- Library of the Arsenal at, 189, 420, 428.
- , Cabinet of Medals at, 109, 152, 384.
- Partisan, 446.
- Pas d'âne (of a sword), 372, 380, 385, 387, 389, 390.
- Passau, manufacture of arms at, 548.
- Passot, épée de, 372.
- Pavois (shield), 293, 294.
- Paw-shaped solerets, 202, 203, 206, 211.
- Peabody, 74.
- Pear-shaped casque, 276.
- Peascod armour, 325.
- Pengilly l'Haridon, 12, 14, 35.
- Pennated dagger, 401, 409, 580.
- Pennons, 415.
- Persian arms, 282, 320, 349, 365, 392, 413, 471, 550.
- equipment, 217.
- ancient arms, *see* Assyrian.
- leather cuirass, 327.
- Perugia, 67, 71.
- Petard, 65.
- Petronel, 68.
- Pikes, 451.
- Pilum, 29, 35, 81.
- Pistol, 529.
- Plascencia, manufacture of arms at, 550.
- Poignards, 400.
- Polish arms, 273, 284, 348, 442.
- Polygar arms, 285, 321.
- casque, 285.
- coat of mail, 321.
- Polyspastes, 30.
- Pot helmets, 242, 266.
- Poulaine, 49.
- Powder horns and flasks, 535, 536.
- Prague, manufacture of arms at, 550.
- Museum of, 78, 135, 144, 260, 268, 348, 363, 409, 425, 511, 533.
- Library of, 264.
- Prisse d'Avesnes, 27, 103, 105.
- Puffed armour, 204.
- Pulvermassen, 73, 535.
- Puységur, 448.
- Pyrites, 68, 69, 71.
- Quadi equipment, 34.
- Quarrels, or bolts, 482, 483.
- Quillons (of a sword), 369.
- Ranseurs, 445.
- Rapier, 370, 387.
- Raquette gun, 527.
- Ratisbon, 359.
- Raudnitz, collection of arms at, 378, 450, 534, 539.
- library at, 177, 427.
- Receipts for amateurs, 582.
- Remschied, manufacture of arms at, 550.

- Renné Collection, 237, 259, 262, 316,
 359, 416, 437.
 Revolvers, 73, 74, 525, 527.
 Ribaudequins, 501.
 Ringed coat, 313.
 Rodios, 55, 116.
 Rodolph of Nuremberg, 41, 543.
 Roman arms, 117, 121.
 Romano, Collegio, 123.
 Rondache, 297.
 Russian arms, 84, 144, 283, 440.
 Russikon, Castle of, 455.
 Rustred coat, 313.

 Sabre, 370.
 Sabres of Mohammed, 371.
 Sacken, Baron, 10, 128.
 Saddles, 50, 355 to 360.
 Saint Blaisien, manufacture of arms
 at, 550.
 — Clement, manufacture of arms
 at, 542.
 — Etienne, manufacture of arms
 at, 550.
 — Gall, Library of, 161, 164, 169,
 244.
 — Germain, Museum of, 15, 84,
 122, 134, 144, 153, 155.
 — Maurice, curiosities found at,
 165, 245.
 Salades (casques), 260, 261, 262.
 Salzburg, Museum of, 416.
 Samnite arms, 122.
 Saracenic arms, 322.
 Saragossa, manufacture of arms at,
 542.
 Savoyan arms, 389.
 Scala librorum, 64.
 Scaled coat, 314.
 Scaling ladder, 464.
 Scandinavian arms, 139, 162, 173,
 185, 367.
 Schaffhausen, Museum of, 359.
 Schiavona (sword), 388.
 Schiesprügel, 423.
 Schwerin, Museum of, 15.
 Scimitars, 25, 370, 393.
 Slavonic arms, 152, 441.
 Scorpion, 424.
 Scottish arms, 379, 388, 441.
 Scramasax, 35, 150, 151, 152, 400.
 Sedan, Museum of, 12.
 Serpentine cannons, 500.
 — hand cannons, 517.
 Seville, manufacture of arms at,
 542.
 Shahjehanabad, 550.
 Sheffield, 550.
 Shot, cannon, 63.
 — united together, 510.
 — chain, 510,
 — with connecting link, 510.
 — conical, 63.
 — iron, 63.
 — leaden, 63.
 — red hot, 63.
 Shoulder plate, 226, 231.
 Sigmaringen, Museum of, 13, 15,
 35, 65, 73, 77, 129, 130, 131, 132,
 150, 153, 155, 156, 157, 195, 256,
 268, 293, 294, 318, 346, 347, 348,
 362, 363, 365, 383, 384, 386, 387,
 388, 393, 405, 409, 411, 412, 423,
 428, 431, 432, 436, 437, 442, 444,
 445, 451, 454, 465, 472, 500, 520,
 521, 525, 530, 536, 580.
 Signum, 125.
 Six Collection, 181.
 Size of men in the Middle Ages,
 45.
 Skirted armour, 211.
 Skull cap, 267, 268, 269.
 Sling and staff sling, 466.
 Small buckler, 166, 179, 182, 189,
 288, 291.
 Snaffle, 366.
 Snaphaunce, 10.
 Söter Collection, 256, 325, 347, 378,
 407, 449, 472.
 Solerets, 48, 49, 231, 337 to 341.
 Soleure, Arsenal of, 15, 270, 273,
 283, 326, 427, 431, 504.
 Sollen Collection, 124.
 Soltikoff Collection, 409, 418.
 Span, 529.
 Spandau, 550, 54,
 Spanish arms, 173, 188, 214, 292,
 348, 384, 393, 449, 542.
 — armourers, 565 to 573.
 Spears, boar, 418, 419.

- Spengel Collection, 260, 266, 377, 531.
- Spontoons, 451.
- Spurs, 342 to 349.
- Squamata, 29, 118.
- Stiletto, 401, 409, 412.
- Stirrups, 361 to 368.
- Strap of buckler, 113.
- Strasburg, Arsenal of, 12.
- Stuttgard, Library of, 163, 165, 167, 443.
- Surcoat, 181.
- Sweden, *see* Collection of King Charles XV.
- Swiss Arsenals, 15.
- armourers, 575, 576.
- glaive, 428.
- Swords, 369 to 399.
- two-handed, 418, 419.
- Sword-breaker, 27, 104, 411.
- Szokau, Museum of, 442.
- Tail guard for horses, 353.
- Tang (of a sword), 369.
- Targes, 294 to 298, 300, 301, 302.
- Tassets, 228, 229.
- Terzerole, 71.
- Ternow Collection, 534.
- Teschen, 550.
- Theodosian Columu, 122, 159, 423.
- Tilting heaumes, 254, 255.
- Toledo, 550.
- Tombs, construction of, 22, 133.
- Tormentum, 455.
- Tortoise, 31, 116.
- Touarique arms, 397.
- Touch-hole, 71.
- Touch-box, 535.
- Troyon Collection, 431.
- Turin, Armeria of, 13, 108, 110, 273, 298, 302.
- Turin, 550.
- Turkish arms, 392, 393, 441.
- drums, 455.
- Tyrolse bolts, 483.
- Tzagra, 473.
- Tzarskoe Selo, Museum of, 15, 283, 284, 285, 391, 413, 440.
- Umbrians, 109.
- Valencia, 542.
- Valladolid, 542.
- Vamplate of lance, 235, 236.
- Vannes, Museum of, 82.
- Vauban, 71, 448.
- Vauquelin, 72.
- Velites, 29, 117.
- Venice, Museum of, 15.
- sculptures at, 192.
- Versailles, carbine of, 69.
- manufacture of arms at, 550.
- Veuglaire, 61.
- Vienna, Imperial arsenal of, 10, 61, 73, 199, 201, 202, 206, 208, 209, 210, 212, 213, 215, 220, 221, 222, 228, 235, 255, 269, 270, 275, 279, 298, 323, 324, 332, 351, 380, 389, 399, 407, 423, 427, 429, 444, 454, 489.
- Arsenal of the city of, 269, 409, 445.
- Cabinet of Antiquities at, 82, 109, 125, 129, 131, 132, 149, 153.
- Imperial Library at, 186.
- Industrial Museum of, 270, 271, 275, 379, 387, 436.
- Gewehrhammer of, 478.
- Museum of the Belvedere at, 103.
- Vigna Ammandola, 32, 135.
- Villaseca Collection, 384.
- Volant piece, 237, 238.
- Voulge, 433.
- Waffenrock, or surcoat, 179, 181.
- Wagnuk, 402, 413.
- Waldburg-Wolfegg, Library of Prince, 457, 498.
- War engines, 50, 54, 55, 126, 455 to 465.
- hammers, 435, 436, 437.
- hats, 263 to 269.
- Weapons in flint, 75 to 84.
- obsidian, 84.
- Wiener Neustadt, 550.
- Winglets, 43, 238.
- Wolf mark, 548.

Wooden swords, 84.

Yataghan, 394, 395.

Zanguebar sword, 396, 397.

Zend language, 25.

Zurich, Arsenal of, 66, 266, 322,
383, 416, 431, 442, 483, 504.

— Museum of Antiquities at, 83.
150, 155, 157, 463.

THE END.



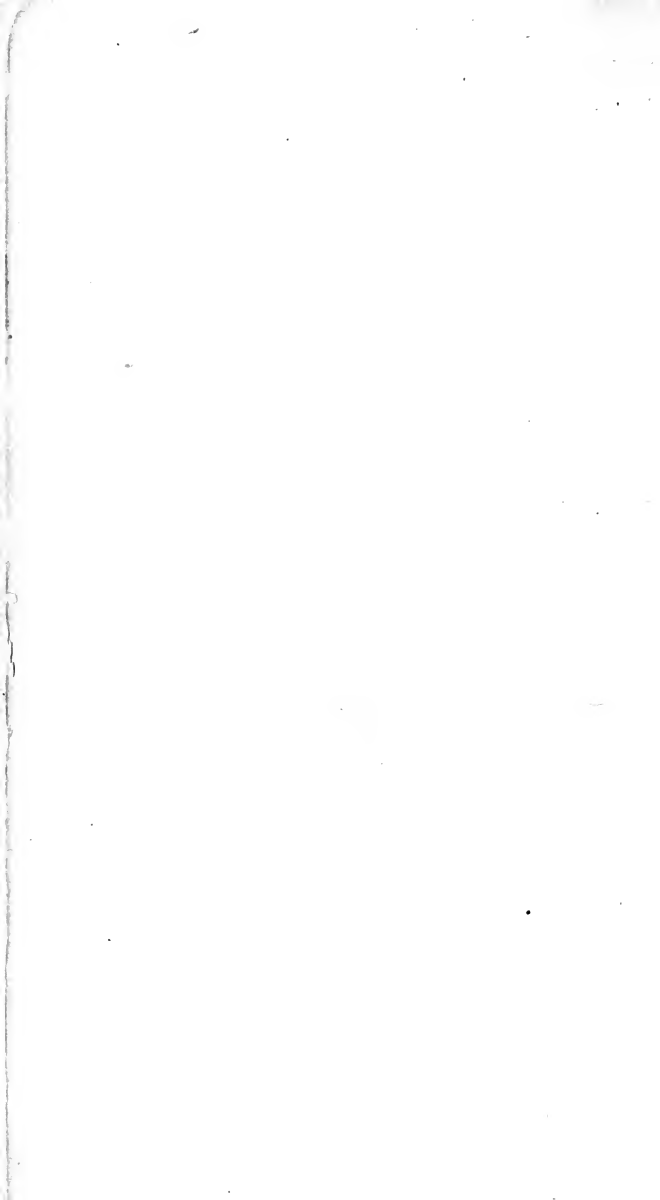



GENERAL LIBRARY - U.C. BERKELEY



8000770776

228-6

THE UNIVERSITY OF CALIFORNIA LIBRARY

ENR 6642

